

Standards-based cylinders DSBG, ISO 15552

FESTO



Characteristics

At a glance



- Standards-based cylinders to ISO 15552 (corresponds to the withdrawn standards ISO 6431, DIN ISO 6431, VDMA24562, NFE49003.1 and UNI 10290)

- Sturdy tie rod design
- Double-acting
- For contactless position sensing
- Optionally with protection against rotation
- EX4: for use in potentially explosive areas
- Extensive range of accessories makes it possible to install the cylinder virtually anywhere

- Three types of cushioning available:
 - Elastic cushioning: elastic cushioning rings/plates at both ends
 - PPS cushioning: pneumatic cushioning, self-adjusting at both ends
 - PPV cushioning: pneumatic cushioning, adjustable at both ends

- The variants can be configured according to individual needs using a modular product system
- Wide range of variants provides high level of flexibility

DSBG-...-P2 – With bellows kit DADB, to ISO 15552

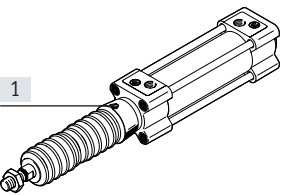

The bellows protects the piston rod, the seal and the bearing from the effects of a wide range of media, which has a positive impact on the service life of these components.

The bellows kit is a leak-free system. To prevent unwanted media from being drawn in, the supply and exhaust air for the kit must be ducted via a pressure compensation hole in the connection part [1].

The kit protects the piston rod, seal and bearing against a wide variety of media, for example:

- Dust
- Chippings
- Oil
- Grease
- Fuel

Ordering the bellows kit

An extended piston rod is absolutely essential if a bellows kit is to be used. The bellows kit can be ordered via the modular product system or as an accessory. The following must be noted in this case:

Ordering via the modular product system:

The bellows kit is supplied mounted on the bearing cap using characteristic P2. The required piston rod extension is automatically taken into consideration. This means that there is no need to specify a value for characteristic ...E.

Ordering as an accessory:

If the bellows kit is ordered as an accessory, the required value → page 39 must be entered for characteristic ...E in the modular product system.

Position sensing/force control

With position transmitter SMAT, SDAT → page 43



Analogue position feedback possible

- Analogue output
 - 0 ... 10 V

With proportional-pressure regulator VPPM















Infinite adjustment of the gripping force possible

- Setpoint value input
 - 0 ... 10 V
 - 4 ... 20 mA

Variants from the modular product system

Symbol	Characteristics	Description
	Q Square piston rod	Protection against rotation. For correctly oriented feeding
	L Low friction	<ul style="list-style-type: none"> Break-away pressure: low Dynamic response: Suitable for very fast movements, especially at low operating pressures Application example: Very dynamic movements with no standstill

Characteristics

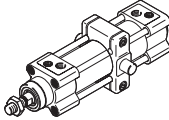
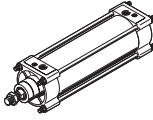
Variants from the modular product system		
Symbol	Characteristics	Description
	U Constant, slow movement	<ul style="list-style-type: none"> Break-away pressure: very low Dynamic response: Suitable for very slow, constant and stick-slip-free movements Application example: Slow, constant feed motion
	L1 Low friction for balancer applications	<ul style="list-style-type: none"> Break-away pressure: low Dynamic response: Suitable for slow movements with constant application of pressure at one end. System friction is independent of operating pressure Application example: Applications for load balancing (balancer, belt tensioner with constant feed motion)
	T Through piston rod	For working at both ends with the same force in the forward and return stroke, for attaching external stops
	F Female piston rod thread	–
	R3 High corrosion protection	All external cylinder surfaces comply with corrosion resistance class 3 to Festo standard 940 070. The piston rod is made from corrosion- and acid-resistant steel
	T1 Heat-resistant seals	Temperature range 0 ... +120°C
	T3 Low temperature	Temperature range –40 ... +80°C
	T4 Heat-resistant seals	Temperature range 0 ... +150°C
	A2 Wiper variant	Hard scraper: The cylinder has a hard-chromium plated piston rod and a hard scraper, which protects against dry, dusty and viscous media
	A3 Wiper variant	Unlubricated operation: Cleaning processes degrease the piston rod. A special piston rod seal designed for unlubricated operation permits a longer service life compared to the standard seal.
	A6 Wiper variant	Metal scraper: The cylinder has a hard-chromium plated piston rod and metal scraper, which scrapes off hard particles (e.g. welding spatter) sticking to the piston rod. For use in welding systems, for example
	...E Extended piston rod	1 ... 500 mm
	...L Extended piston rod thread	1 ... 70 mm
	...S Shortened piston rod thread	1 ... 44 mm
	M... Piston rod thread	Piston rod thread version: M16/M16x1.5/M20/M20x1.5/M24/M27
	...V Swivel mounting position	<ul style="list-style-type: none"> Swivel mounting, position freely selectable Position can be moved at any time
	Thread length of spacer bolts: ...LB2 on the bearing cap ...LB3 on the end cap	<ul style="list-style-type: none"> Variable thread length: 20 ... 140 mm Optionally on the bearing or end cap

Product range overview

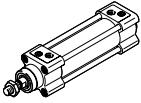
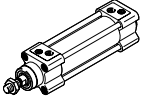
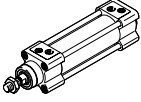
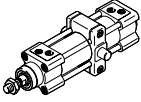
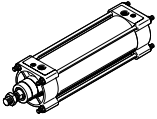
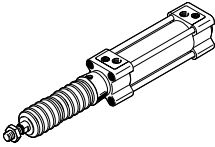
Function	Design	Type	Piston diameter	Stroke	Through piston rod	Female piston rod thread	Cushioning			
			[mm]	[mm]			T	F	P	PPS
Double-acting	DSBG-...									
		DSBG-...	32, 40, 50, 63, 80, 100, 125	1 ... 2800		■	■	■	■	■
	DSBG-...-Q – With protection against rotation									
		DSBG-...-Q	32, 40, 50, 63, 80, 100	1 ... 1500		■	■	■	■	■
	DSBG-...-L/-U/-L1 – With special running characteristics									
		DSBG-...-L	32, 40, 50, 63, 80, 100	1 ... 2800		–	■	■	■	■
		DSBG-...-U	32, 40, 50, 63, 80, 100, 125	1 ... 2800		–	■	■	■	■
		DSBG-...-L1	32, 40, 50, 63, 80, 100, 125	10 ... 1000		–	■	■	■	–
	DSBG-...-V – With swivel mounting position									
		DSBG-...-V	32, 40, 50, 63, 80, 100, 125	10 ... 2800		■	■	■	■	■
DSBG-...-LB2/3 – With spacer bolts on the bearing/end cap										
	DSBG-...-LB2/3	80, 100, 125	10 ... 2800		■	■	■	■	■	
DSBG-...-P2 – With bellows										
	DSBG-...-P2	32, 40, 50, 63, 80, 100	10 ... 500		■	■	■	■	■	

Product range overview

Type	Position sensing	High corrosion protection	Temperature range 0 ... +120°C	Temperature range -40 ... +80°C	Temperature range 0 ... +150°C	Wiper variant Hard scraper	Wiper variant for unlubricated operation	Wiper variant Metal scraper	EU certification	Extended piston rod	Extended piston rod thread	Shortened piston rod thread
	A	R3	T1	T3	T4	A2	A3	A6	EX4	..E	..L	..S
DSBG-...												
DSBG-...	■	■	■	■	■	■	■	■	■	■	■	■
DSBG-...-Q – With protection against rotation												
DSBG-...-Q	■	■	■	-	-	-	-	-	■	■	■	■
DSBG-...-L/-U/-L1 – With special running characteristics												
DSBG-...-L	■	-	-	-	-	-	-	-	-	■	■	■
DSBG-...-U	■	-	-	-	-	-	-	-	-	■	■	■
DSBG-...-L1	■	-	-	-	-	-	-	-	-	■	■	■
DSBG-...-...V – With swivel mounting position												
DSBG-...-...V	■	-	■	■	■	■	■	■	■	■	■	■
DSBG-...-...LB2/3 – With spacer bolts on the bearing/end cap												
DSBG-...-...LB2/3	■	■	■	■	■	■	■	■	■	■	■	■
DSBG-...-P2 – With bellows												
DSBG-...-P2	■	■	-	-	-	-	-	-	-	■	■	■

Peripherals overview

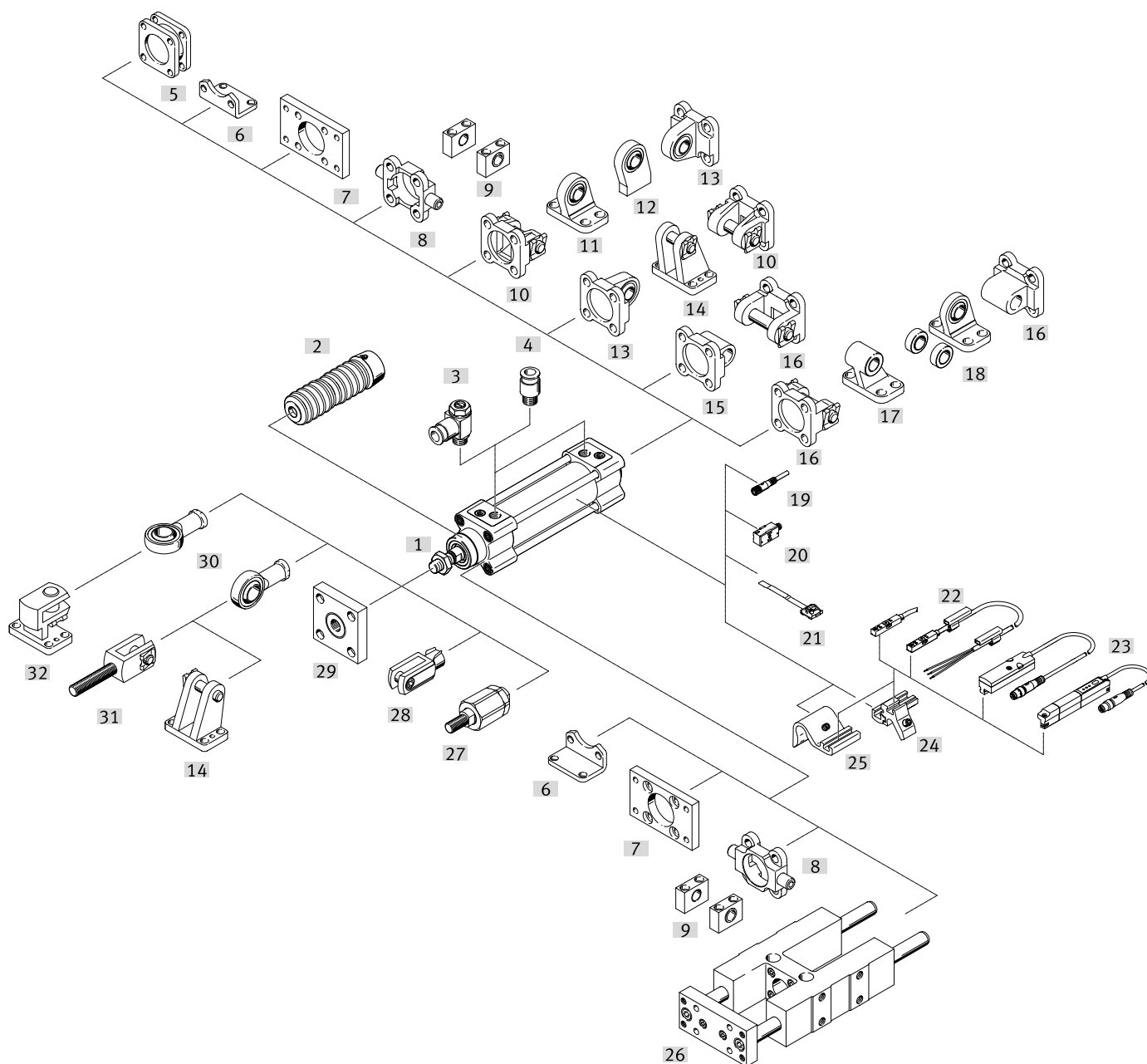

Mounting components and accessories		Description	DSBG-...			→ Page/ Internet
				-L/-U/ -L1	-T	
[1]	Standards-based cylinder DSBG	Standards-based cylinder without accessories, basic version				9
[2]	Bellows kit DADB	<ul style="list-style-type: none"> Protects the cylinder (piston rod, seal and bearing) against a wide range of media and thus prevents premature wear Can only be used in combination with an extended piston rod (E) 	■	-	■	36
[3]	One-way flow control valve GRLA	For speed regulation	■	■	■	44
[4]	Push-in fitting QS	For connecting compressed air tubing with standard O.D.	■	■	■	q5
[5]	Multi-position kit DPNC	For connecting two cylinders with identical piston diameters to form a multi-position cylinder	■	-	■	40

Peripherals overview

Mounting components and accessories		Description	DSBG-...			→ Page/ Internet
				-L/-U/ -L1	-T	
[6]	Foot mounting HNC/CRHNC	For bearing or end caps	■	■	■	26
[7]	Flange mounting FNC/CRFNG	<ul style="list-style-type: none"> For bearing or end caps Cannot be used on the bearing cap in combination with the bellows kit DADB 	■	■	■	27
[8]	Trunnion flange ZNC/CRZNG	<ul style="list-style-type: none"> For bearing or end caps Cannot be used on the bearing cap in combination with the bellows kit DADB 	■	■	■	28
[9]	Trunnion support LNZG/CRLNZG	–	■	■	■	29
[10]	Swivel flange SNC	For end caps	■	■	–	30
[11]	Clevis foot LSNG	With spherical bearing	■	■	–	34
[12]	Clevis foot LSNSG	Weld-on, with spherical bearing	■	■	–	34
[13]	Swivel flange SNCS/CRSNCS/SNCS-...-R3	With spherical bearing for end caps	■	■	–	32
[14]	Clevis foot LBG/LBG-...-R3	–	■	■	–	34
[15]	Swivel flange SNCL	For end caps	■	■	–	33
[16]	Swivel flange SNCB/SNCB-...-R3	For end caps	■	■	–	31
[17]	Clevis foot LNG/CRLNG	–	■	■	–	34
[18]	Clevis foot LSN	With spherical bearing	■	■	–	34
[19]	Connecting cable NEBU	–	■	■	■	43
[20]	Proximity switch SMPO-1-H-B	–	■	■	■	44
[21]	Mounting kit SMBS	For proximity switch SMPO-1-H-B	■	■	■	43
[22]	Proximity switch SME/SMT-8M/SDBT-MS	Can be integrated in the cylinder profile barrel	■	■	■	42
[23]	Position transmitter SMAT, SDAT	<ul style="list-style-type: none"> Continuously senses the position of the piston Has an analogue output 	■	■	■	43
[24]	Mounting kit SMBZ-8- ...	For proximity switch SME/SMT-8M, for piston diameter 32 ... 100	■	■	■	43
[25]	Sensor bracket DASP-M4- ...	For proximity switch SME/SMT-8M, for piston diameter 125	■	■	■	43
[26]	Guide unit FENG	For protecting standards-based cylinders against rotation at high torques	■	■	■	41
[27]	Self-aligning rod coupler FK, CRFK	For compensating radial and angular deviations	■	■	■	35
[28]	Rod clevis SG/CRSG	Permits a swivelling movement of the cylinder in one plane	■	■	■	35
[29]	Coupling piece KSG	For compensating radial deviations	■	■	■	35
	Coupling piece KSZ	For cylinders with a non-rotating piston rod to compensate radial deviations	■	■	■	35
[30]	Rod eye SGS/CRSGS	With spherical bearing	■	■	■	35
[31]	Rod clevis SGA	With male thread	■	■	■	35
[32]	Right-angle clevis foot LQG	–	■	■	■	34

Type codes

001	Series	
DSBG	Standards-based cylinder, double-acting, based on ISO 15552	
002	Protection against rotation	
	None	
Q	With protection against rotation	
003	Running characteristics	
	Standard	
L	Low friction	
U	Uniform, slow movement	
L1	Low friction for balancer applications	
004	Central swivel mounting	
	None	
Y	Central	
V	Central, clamped	
005	Piston diameter	
32	32	
40	40	
50	50	
63	63	
80	80	
100	100	
125	125	
160	160	
200	200	
250	250	
320	320	
006	Stroke	
...	1 ... 2800	
007	Piston rod type	
	At one end	
T	Through piston rod	
008	Piston rod thread type	
	Male thread	
F	Female thread	
009	Piston rod bearing version	
SL	Sintered bearing	
	Polymer bearing	
010	Cushioning	
P	Elastic cushioning rings/plates on both sides	
PPS	Pneumatic cushioning, self-adjusting at both ends	
PPV	Pneumatic cushioning, adjustable at both ends	

011	Position sensing	
	None	
A	For proximity sensor	
012	Standard	
	Not according to standard	
N3	Conforms to ISO 15552	
013	Corrosion protection	
	Standard	
R3	High corrosion protection	
014	Temperature range	
	Standard	
T1	Heat-resistant seals max. 120°C	
T3	-40 ... +80°C	
T4	0 ... +150°C	
015	Protection against particles	
	Standard	
P2	Bellows on bearing cap	
016	Scraper variant	
	None	
A2	Hard scraper	
A3	For unlubricated operation	
A6	Metal scraper	
017	EU certification	
	None	
EX4	II 2GD	
018	Swivel mounting position	
	None	
...V	163 ... 2483 mm	
019	Trunnion flange mounting position, positive locking	
	None	
...Y	With	
020	Piston rod extension	
	None	
...E	1 ... 500 mm	
021	Piston rod thread extension	
	None	
...L	0 ... 70 mm	
022	Piston rod thread shortening	
	None	
...S	0 ... 86 mm	

Data sheet

Function
Elastic cushioning

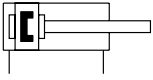

PPV cushioning

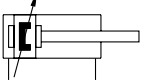

PPS cushioning

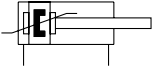

∅ - Diameter
32 ... 125 mm

- | - Stroke length
1 ... 2800 mm



www.festo.com

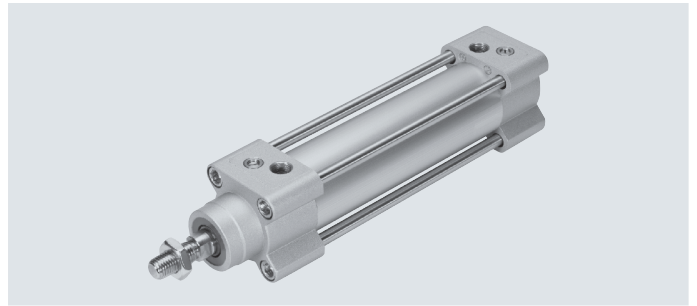

General technical data								
Piston diameter		32	40	50	63	80	100	125
Design	Piston/piston rod/cylinder barrel							
Mode of operation	Double-acting							
Pneumatic connection		G1/8	G1/4	G1/4	G3/8	G3/8	G1/2	G1/2
Stroke								
DSBG-...	[mm]	1 ... 2800						
DSBG-...-Q	[mm]	1 ... 1500						-
DSBG-...-L1	[mm]	10 ... 1000						
DSBG-...-P2	[mm]	10 ... 500						-
DSBG-...-E	[mm]	1 ... 2000						
DSBG-...-L	[mm]	1 ... 2000						
Cushioning								
DSBG-...-P	Elastic cushioning rings/plates at both ends							
DSBG-...-PPV	Pneumatic cushioning, adjustable at both ends							
DSBG-...-PPS	Pneumatic cushioning, self-adjusting at both ends							
Cushioning length								
DSBG-...-PPV	[mm]	17	19	22	22	31	31	45
Position sensing	Via proximity switch							
Type of mounting	With female thread/accessories							
Mounting position	Any							

Data sheet

Operating and environmental conditions								
Piston diameter		32	40	50	63	80	100	125
Operating medium	Compressed air to ISO 8573-1:2010 [7:4:4]							
Note on the operating/pilot medium	Lubricated operation possible (in which case lubricated operation will always be required)							
Operating pressure								
DSBG-...	[MPa]	0.06 ... 1.2		0.04 ... 1.2		0.02 ... 1.0		
	[bar]	0.6 ... 12		0.4 ... 12		0.2 ... 10		
DSBG-...-Q	[MPa]	0.1 ... 1.2						–
	[bar]	1 ... 12						–
DSBG-...-L ¹⁾	[MPa]	0.03 ... 1.2	0.025 ... 1.2		0.02 ... 1.2	0.015 ... 1.2	–	
	[bar]	0.3 ... 12	0.25 ... 12		0.2 ... 12	0.15 ... 12	–	
DSBG-...-U ¹⁾	[MPa]	0.01 ... 1.2			0.005 ... 1.2		0.005 ... 1.0	
	[bar]	0.1 ... 12			0.05 ... 12		0.05 ... 10	
DSBG-...-L1 ¹⁾	[MPa]	0.03 ... 1.2	0.025 ... 1.2		0.02 ... 1.2	0.015 ... 1.2	0.01 ... 1.0	
	[bar]	0.3 ... 12	0.25 ... 12		0.2 ... 12	0.15 ... 12	0.1 ... 10	
DSBG-...-T3/-A2	[MPa]	0.1 ... 1.2						0.1 ... 1.0
	[bar]	1 ... 12						1 ... 10
DSBG-...-A3	[MPa]	0.15 ... 1.2		0.1 ... 1.2	0.06 ... 1.2		0.06 ... 1.0	
	[bar]	1.5 ... 12		1 ... 12	0.6 ... 12		0.6 ... 10	
DSBG-...-A6	[MPa]	0.2 ... 1.2	0.15 ... 1.2				0.15 ... 1.0	
	[bar]	2 ... 12	1.5 ... 12				1.5 ... 10	
Ambient temperature ²⁾								
DSBG-...	[°C]	–20 ... +80						
DSBG-...-L/-U	[°C]	+5 ... +80						
DSBG-...-L1	[°C]	0 ... +60						
DSBG-...-A1	[°C]	0 ... +80						
DSBG-...-A6	[°C]	–20 ... +80						
DSBG-...-T1-A6	[°C]	0 ... +120						
DSBG-...-T3-A6	[°C]	–40 ... +80						
DSBG-...-T4-A6	[°C]	0 ... +150						
DSBG-...-T1	[°C]	0 ... +120						
DSBG-...-T3	[°C]	–40 ... +80						
DSBG-...-T4	[°C]	0 ... +150						
DSBG-...-P2	[°C]	–10 ... +80					–	
DSBG-...-EX4	[°C]	–20 ... +60						
Corrosion resistance CRC								
DSBG-...		2 ³⁾						
DSBG-...-R3		3 ⁴⁾						

1) Values apply only for strokes ≤ 500 mm and after 10 double strokes.

In combination with cushioning PPV/PPS, the specifications only apply outside the cushioning range

2) Note operating range of proximity switches.

3) Corrosion resistance class CRC 2 to Festo standard FN 940070

Moderate corrosion stress. Indoor applications in which condensation can occur. External visible parts with primarily decorative surface requirements which are in direct contact with a normal industrial environment.

4) Corrosion resistance class CRC 3 to Festo standard FN 940070

High corrosion stress. Outdoor exposure under moderate corrosive conditions. Externally visible parts with primarily functional surface requirements which are in direct contact with a normal industrial environment.

Weight [g]								
Piston diameter		32	40	50	63	80	100	125
DSBG-...								
Product weight with 0 mm stroke		465	740	1190	1740	2660	3665	6611
Additional weight per 10 mm stroke		25	35	52	55	85	94	143
Moving mass with 0 mm stroke		110	205	365	430	810	1000	2245
Moving mass per 10 mm stroke		9	16	25	25	39	39	63
DSBG-...-Q								
Product weight with 0 mm stroke		503	755	1241	1821	2717	3827	–
Additional weight per 10 mm stroke		24	30	47	50	78	87	–
Moving mass with 0 mm stroke		103	170	332	391	757	890	–
Moving mass per 10 mm stroke		8	11	20	20	32	32	–

Data sheet

Weight [g]							
Piston diameter	32	40	50	63	80	100	125
DSBG-...-L1							
Product weight with 0 mm stroke	465	741	1200	1759	2651	3693	6651
Additional weight per 10 mm stroke	25	35	52	55	85	94	143
Moving mass with 0 mm stroke	110	206	375	449	801	1028	2285
Moving mass per 10 mm stroke	9	16	25	25	39	39	63
DSBG-...-T							
Product weight with 0 mm stroke	581	924	1523	2103	3243	4353	7450
Additional weight per 10 mm stroke	34	51	77	80	124	133	206
Moving mass with 0 mm stroke	181	339	613	684	1292	1516	3084
Moving mass per 10 mm stroke	18	32	50	50	78	78	126
DSBG-...-F							
Product weight with 0 mm stroke	453	721	1145	1695	2570	3575	6389
Additional weight per 10 mm stroke	25	35	52	55	85	94	143
Moving mass with 0 mm stroke	98	186	320	385	720	910	2023
Moving mass per 10 mm stroke	9	16	25	25	39	39	63
DSBG-...E							
Additional weight per piston rod extension of 10 mm	9	16	25	25	39	39	63
DSBG-...L							
Additional weight per piston rod extension of 10 mm	6	8	14	14	22	22	41

ATEX¹⁾	
ATEX category for gas	II 2G
Type of ignition protection for gas	Ex h IIC T4 Gb
ATEX category for dust	II 2D
Type of ignition protection for dust	Ex h IIIC T120°C Db
Explosion-proof ambient temperature	-20°C ≤ Ta ≤ +60°C
CE marking (see declaration of conformity)	To EU Explosion Protection Directive (ATEX)
UKCA marking (see declaration of conformity)	To UK EX instructions
Explosion protection certification outside the EU	EPL Gb (GB)
	EPL Db (GB)

1) Note the ATEX certification of the accessories.

Forces [N] and impact energy [J]							
Piston diameter	32	40	50	63	80	100	125
Theoretical force at 6 bar, advancing	483	754	1178	1870	3016	4712	7363
Theoretical force at 6 bar, retracting	415	633	990	1682	2721	4418	6881
Max. impact energy in the end positions							
DSBG-...	0.4	0.7	1.0	1.3	1.8	2.5	3.3
DSBG-...-L/-U/-T1/-T3/-T4	0.2	0.35	0.5	0.65	0.9	1.25	1.65
DSBG-...-L1	0.1	0.2	0.3	0.4	0.9	1.25	1.65

Permissible impact velocity:
$$V = \sqrt{\frac{2 \times E}{m_1 + m_2}}$$

Maximum permissible mass:
$$m_2 = \frac{2 \times E}{V^2} - m_1$$

V Perm. impact velocity
E Max. impact energy
m1 Moving mass (drive)
m2 Moving payload

Data sheet

Materials

Sectional view

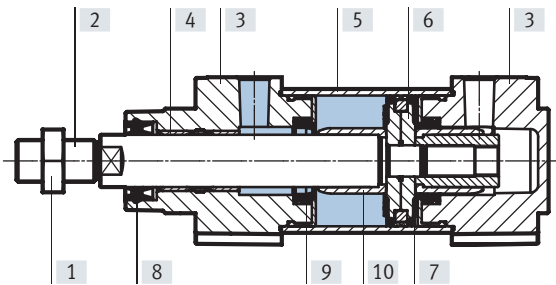

Standards-based cylinder

[1]	Nut	Galvanised steel
[2]	Piston rod	
	DSBG-...	High-alloy steel
	DSBG-...-R3	High-alloy stainless steel
	DSBG-...-A2/-A6	Hard-chrome-plated tempered steel
[3]	Cover	Coated die-cast aluminium
[4]	Bearing	
	DSBG-...	POM
	DSBG-...-A2	Bronze
	DSBG-...-L/-U/-T1/-T4	Metal polymer compound
[5]	Cylinder barrel	Anodised wrought aluminium alloy
[6]	Piston	Anodised wrought aluminium alloy
[7]	Piston seal	
	DSBG-...	TPE-U(PU)
	DSBG-...-L/-U/-T1/-T4	FPM
	DSBG-...-T3	TPE-U(PU) (suitable for low temperatures)
	DSBG-...-L1	HNBR
[8]	Piston rod wiper seal	
	DSBG-...	TPE-U(PU)
	DSBG-...-L/-U	FPM
	DSBG-...-L1	HNBR
	DSBG-...-T1/-T4/-A1	FPM
	DSBG-...-T3	TPE-U(PU) (suitable for low temperatures)
	DSBG-...-A3	UHMW-PE
[9]	Buffer seal	
	DSBG-...	PUR
	DSBG-...-U	FPM
	DSBG-...-T1/-T4	FPM
	DSBG-...-T3	PUR (suitable for low temperatures)
[10]	Cushion piston	
-	Tie rods	
	DSBG-...	Steel, high-alloy
	DSBG-...-R3	High-alloy stainless steel
-	Rod wiper seal	
	DSBG-...-A6	CuZn
	DSBG-...	POM
	DSBG-...-L/-U	Aluminium
	DSBG-...-T1/-T3/-T4	Aluminium
-	Spacer bolt	
	DSBC-...-...LB2/-...LB3	High-alloy stainless steel
-	Swivel mounting	
	DSBC-...-...V	Painted spheroidal graphite cast iron
-	Collar nut	Galvanised steel
-	Note on materials	RoHS-compliant
	PWIS conformity	
	DSBG-...	VDMA 24364-B1/B2-L
	DSBG-...-L/U/-T3/-T4/-A3	VDMA 24364 zone III
	Cleanroom class	
	DSBG-32 ... 50	Class 6 to ISO 14644-1

Data sheet

Max. transverse load F_q as a function of stroke length l

Horizontal installation

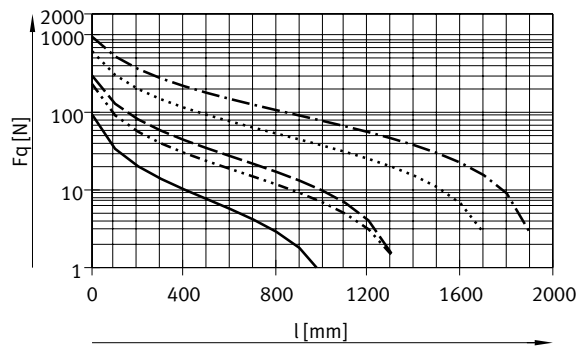

Vertical installation

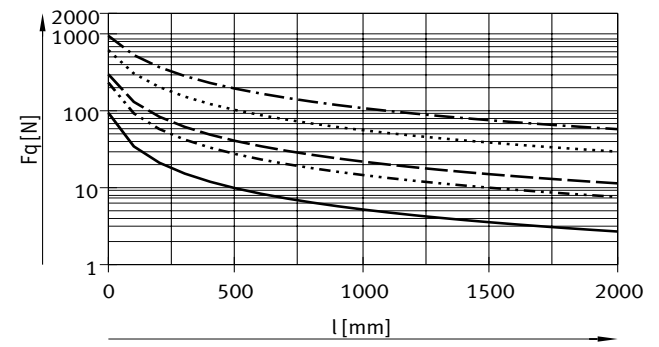

- Diameter 32
- · · · · · Diameter 40
- - - - - Diameter 50/63
- · · · · Diameter 80/100
- · - · - Diameter 125

 **Note**
No transverse loads are permitted in combination with characteristic DSBG-...-L1.

Permissible torsional backlash with variant Q – With protection against rotation							
Piston diameter		32	40	50	63	80	100
Torsional backlash	[°]	±0.65	±0.6	±0.45	±0.45	±0.45	±0.45

Data sheet

Max. transverse load F_q as a function of stroke length l and lever arm s

Q – With protection against rotation

Diameter 32

Max. torque = 800 Nmm/max. stroke = 300 mm

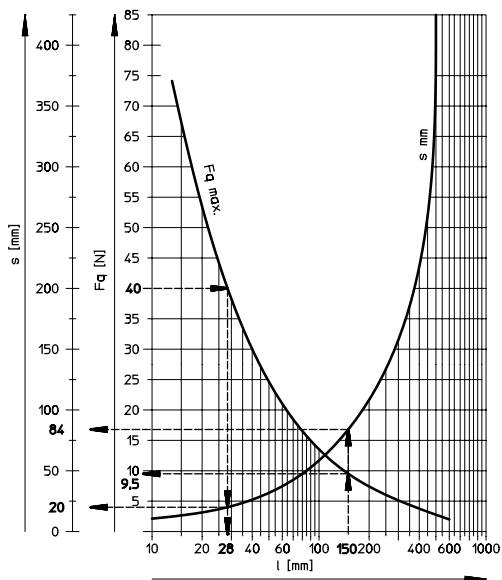

Diameter 40

Max. torque = 1100 Nmm/max. stroke = 400 mm

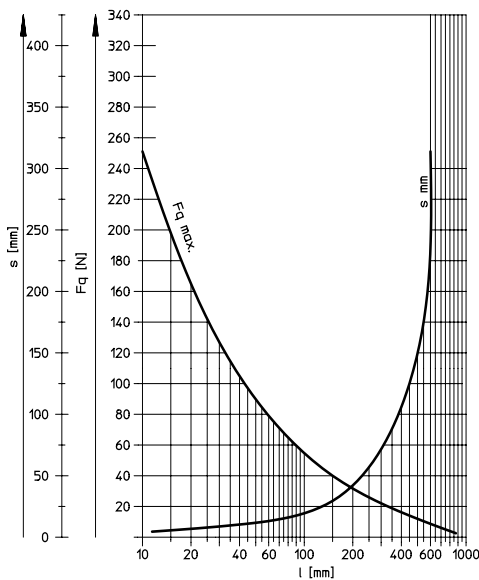

Diameter 50/63

Max. torque = 1500 Nmm/max. stroke = 500 mm

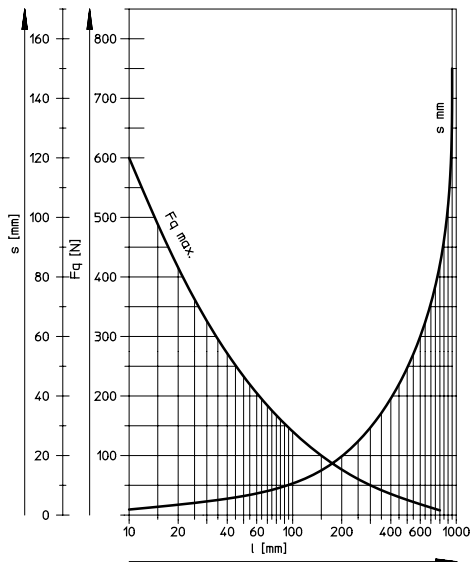

Diameter 80/100

Max. torque = 3000 Nmm/max. stroke = 600 mm

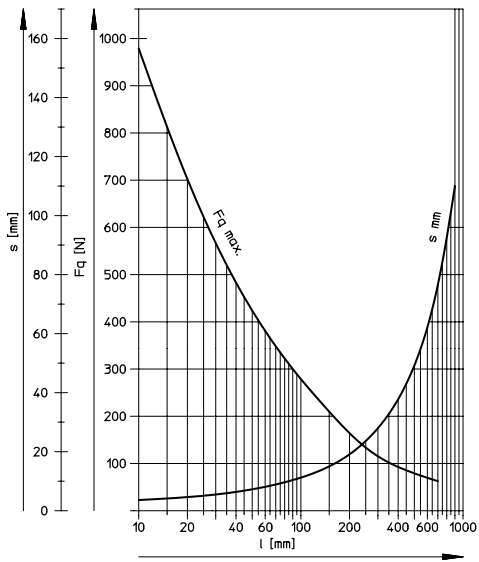

Data sheet

Examples for piston diameter 32 mm

Example 1:

Stroke length l = 150 mm

Result: permissible

Transverse load F_q = 9.5 N

Lever arm s = 84 mm

Example 2:

Transverse load F_q = 40 N

Result: permissible

Stroke length l = 28 mm

Lever arm s = 20 mm

Example 3:

$$F_q = \frac{M}{s} = \frac{800 \text{ Nmm}}{100 \text{ mm}}$$

Result: permissible

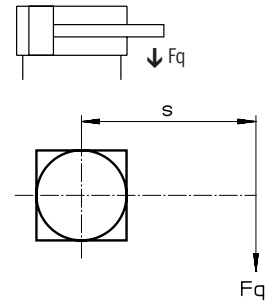
 $F_q = 8 \text{ N} < F_{q_{\max}} = 9.5 \text{ N}$ 1m
1m

Data sheet

Dimensions

Download CAD data → www.festo.com

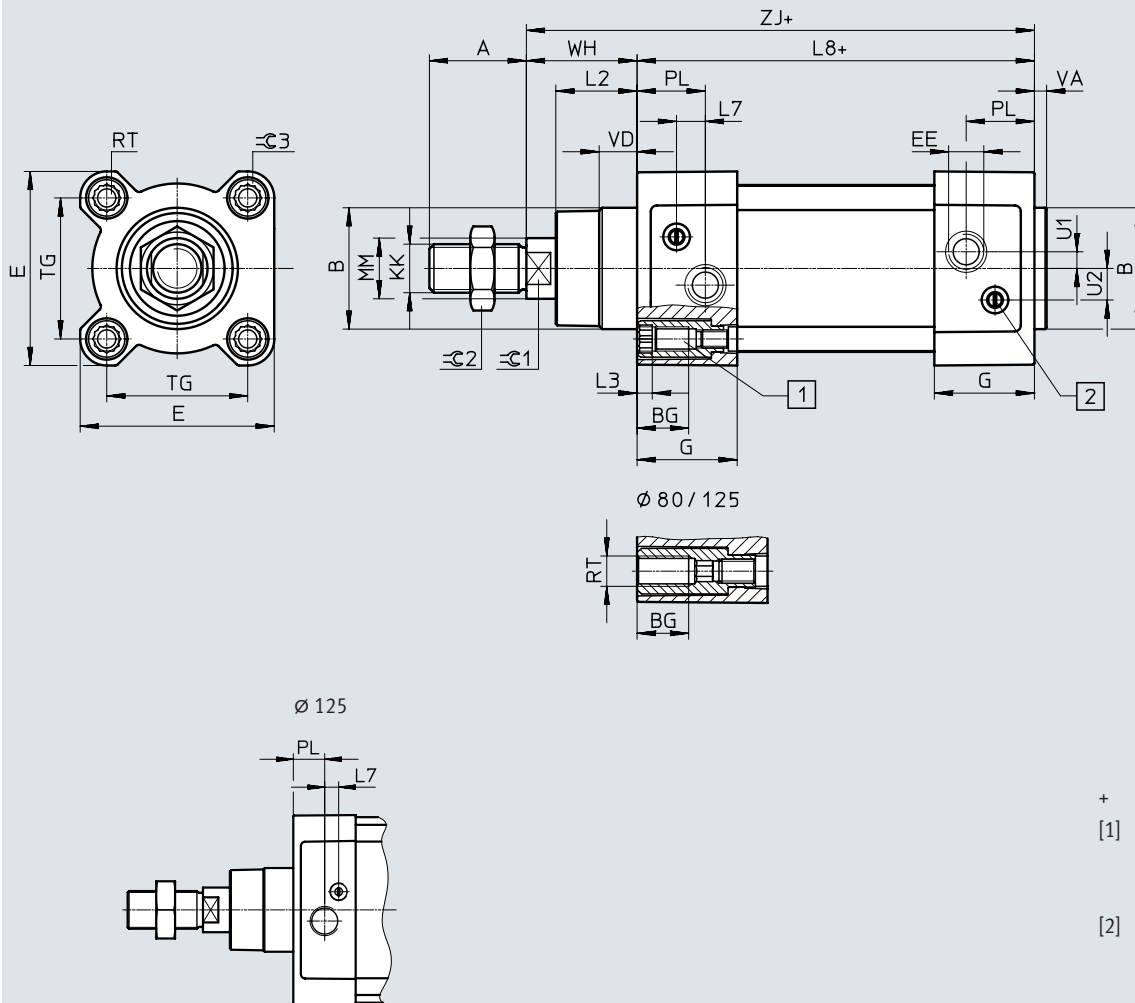

- + = plus stroke length
- [1] Socket head screw with female thread for mounting components
- [2] Adjusting screw for adjustable end-position cushioning (PPV)

Variant
T – Through piston rod

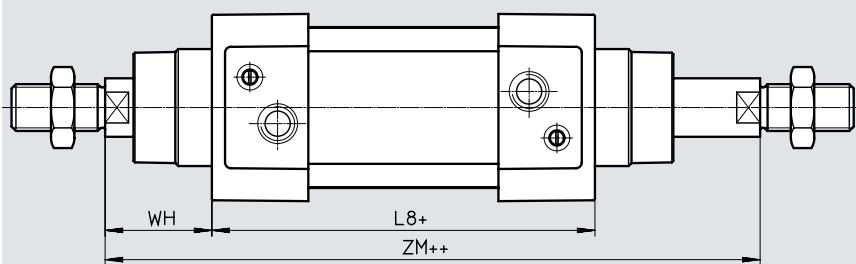

- + = plus stroke length
- ++ = plus 2x stroke length

Data sheet

∅ [mm]	A -0.5	B ∅ d11	BG min.	E +0.5	EE	G -0.2	L2	L3 max.
32	22	30	16	45	G1/8	28	18 _{-0.2}	5
40	24	35	16	54	G1/4	33	21.3 _{-0.2}	5
50	32	40	16	64	G1/4	33	26.8 _{-0.2}	5
63	32	45	16	75	G3/8	40.5	27 _{-0.2}	5
80	40	45	17	93	G3/8	43	34.2 _{-0.2}	–
100	40	55	17	110	G1/2	48	38 _{-0.2}	–
125	54	60	20	136	G1/2	44.7	45 _{-0.3}	–

∅ [mm]	L7	L8 ±0.4	MM ∅	PL ±0.1	RT	TG ±0.3	U1 ±0.1	U2 ±0.1
32	6.5	94	12	19.5	M6	32.5	5.25	5.7
40	7.5	105	16	22.5	M6	38	4	8
50	9.5	106	20	22.5	M8	46.5	5.5	10.4
63	9	121	20	27.5	M8	56.5	6.25	12.75
80	11	128	25	30	M10	72	8	12.5
100	7.5	138	25	31.5	M10	89	10	13.5
125	10	160	32	22.5	M12	110	8	13

∅ [mm]	VA	VD +0.5	WH +2.2	ZJ +1.8	ZM +1	≈G1	≈G2	≈G3
32	4 _{-0.2}	10	25	119.1	146.1	10	17	6
40	4 _{-0.2}	10.5	28.7	133.9	164.8	13	19	6
50	4 _{-0.2}	11.5	35.6	141.8	179.8	17	24	8
63	4 _{-0.2}	15	35.9	157.1	195.4	17	24	8
80	4 _{-0.2}	15.7	45.4	173.6	221	22	30	6
100	4 _{-0.2}	19.2	49.3	187.5	238.8	22	30	6
125	6 _{-0.3}	20.5	64.1	225	290	27	41	8

∅ [mm]	KK	
	DSBG-...	-M... ¹⁾
32	M10x1.25	–
40	M12x1.25	–
50	M16x1.5	–
63	M16x1.5	–
80	M20x1.5	M16/M16x1.5/M20
100	M20x1.5	M16/M16x1.5/M20
125	M27x2	M16/M16x1.5/M20/M20x1.5/M24/M27

1) Threads with smaller nominal diameter than in the basic version can generally not withstand such high loads. If necessary, the screw connection must be engineered.

Data sheet

Dimensions – Variants

Download CAD data → www.festo.com

Q – With protection against rotation

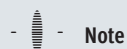
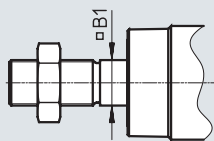

Note
In combination with variant T, the piston rod is protected against rotation at one end.

F – Female thread

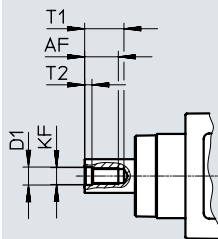

Note
In combination with variant T, the piston rod has female threads at both ends.

...E – Extended piston rod

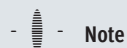
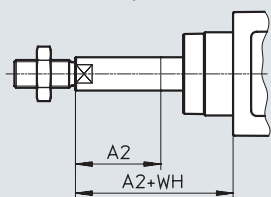

Note
In combination with variant T, the piston rod is extended at one end.
In combination with variants T and Q, the piston rod is extended only at the square piston rod.

...L – Extended piston rod thread

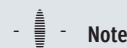
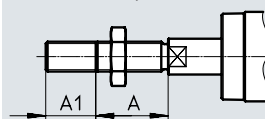

Note
In combination with variant T, the piston rod thread is extended at both ends.

.....S – Shortened piston rod thread

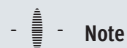
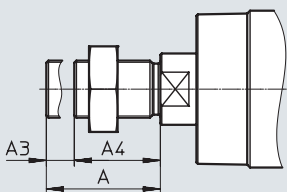

Note
In combination with variant T, the piston rod thread is shortened at both ends.

Effective thread length: $A4 = A - A3$

∅ [mm]	A	A1		A2		A3	
		min.	max.	min.	max.	min.	max.
32	22	1	35	1	500	–	–
40	24	1	35	1	500	–	–
50	32	1	70	1	500	–	–
63	32	1	70	1	500	–	–
80	40	1	70	1	500	1	30
100	40	1	70	1	500	1	30
125	54	1	70	1	500	1	44

∅ [mm]	AF	B1	D1	KF	T1	T2	WH
	min.						
32	12	10	6.4	M6	16	2.6	25
40	12	12	8.4	M8	16	3.3	28.7
50	16	16	10.5	M10	21	4.7	35.6
63	16	16	10.5	M10	21	4.7	35.9
80	20	20	13	M12	26.5	6.1	45.4
100	20	20	13	M12	26.5	6.1	49.3
125	32	–	17	M16	40	8	64.1

Data sheet

Dimensions – Variants

Download CAD data → www.festo.com

...V – Swivel mounting position

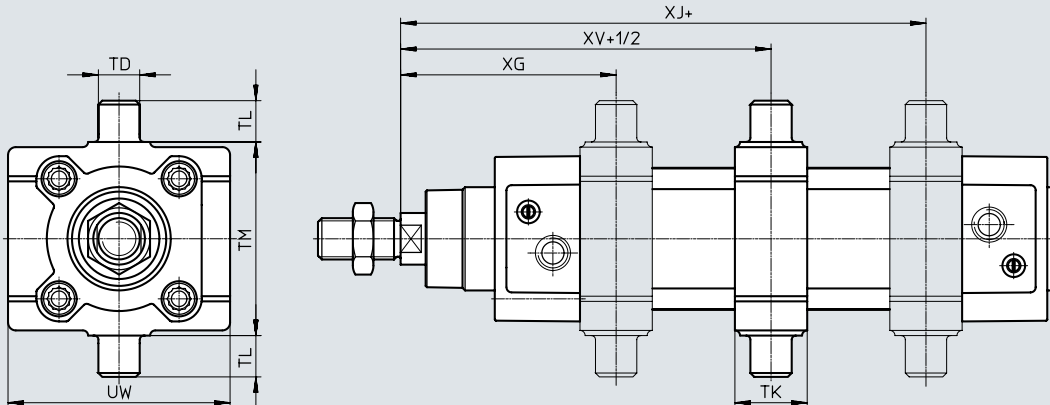

Note

The dimensions for the swivel mounting position (...V) refer to the basic design without piston rod extension.

The swivel mounting can be moved at any time.

+ = plus stroke length
+1/2 = plus half stroke length

∅ [mm]	TD ∅ e9	TK	TL h14	TM h14	UW	XG min.	XJ max.	XV
32	12	20	12	50	65	64±1.4	81±1.4	73±1.4
40	16	25	16	63	72	74.2±1.4	88.4±1.4	81.2±1.4
50	16	28	16	75	86	82.6±1.4	94.8±1.4	88.6±1.4
63	20	30	20	90	98	91.4±1.8	101.6±1.8	96.4±1.8
80	20	32	20	110	110	104.4±1.8	114.6±1.8	109.4±1.8
100	25	38	25	132	136	116.3±1.8	120.5±1.8	118.3±1.8
125	25	44	25	160	160	131.7±1.8	158.3±1.8	145±1.8

...LB2/-LB3 – Thread length of spacer bolts

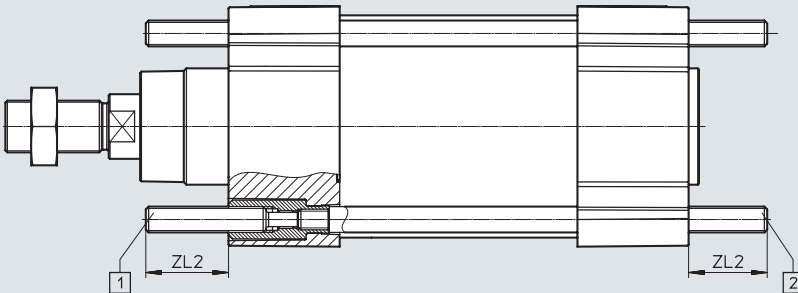

[1] = DSBG-...-LB2
(on the bearing cap)
[2] = DSBG-...-LB3
(on the end cap)

∅ [mm]	ZL2 ±1	
	min.	max.
80	20	140
100	20	140
125	24	140

Data sheet

Dimensions – Variants

Download CAD data → www.festo.com

P2 – Bellows on the bearing cap

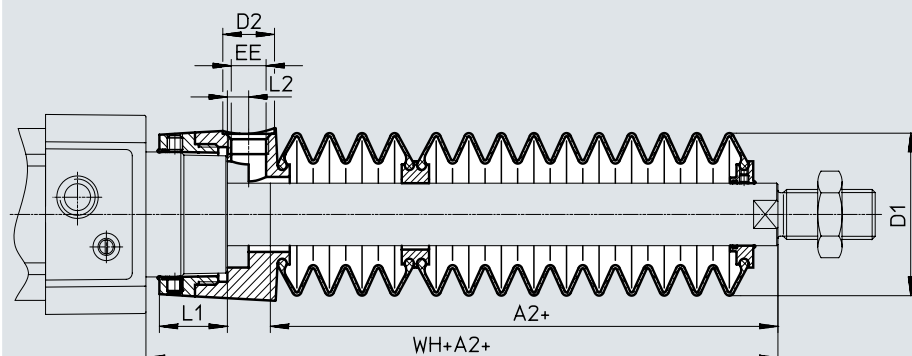

+ = plus stroke length

∅ Stroke [mm]	32							40						
	A2 ¹⁾	D1 max.	D2	EE	L1	L2	WH+A2	A2 ¹⁾	D1 max.	D2	EE	L1	L2	WH+A2
10 ... 50	29	38	14	G1/8	12.9	5.4	55	28	46	14	G1/8	16.3	5.4	56.7
51 ... 125	47						73	43						71.7
126 ... 175	61						87	56						84.7
176 ... 250	80						106	72						100.7
251 ... 300	96						122	86						114.7
301 ... 350	112						138	100						128.7
351 ... 375	114						140	101						129.7
376 ... 425	130						156	115						143.7
426 ... 475	145						171	130						158.7
476 ... 500	147	173	131	159.7										

∅ Stroke [mm]	50							63						
	A2 ¹⁾	D1 max.	D2	EE	L1	L2	WH+A2	A2 ¹⁾	D1 max.	D2	EE	L1	L2	WH+A2
10 ... 50	28	57	17	G1/4	22.35	7	63.6	28	57	17	G1/4	22.4	7	63.9
51 ... 125	46						81.6	46						81.9
126 ... 175	56						91.6	56						91.9
176 ... 250	73						108.6	73						108.9
251 ... 300	86						121.6	86						121.9
301 ... 350	97						132.6	97						132.9
351 ... 375	105						140.6	105						140.9
376 ... 425	116						151.6	116						151.9
426 ... 475	126						161.6	126						161.9
476 ... 500	134	169.6	134	169.9										

∅ Stroke [mm]	80							100						
	A2 ¹⁾	D1 max.	D2	EE	L1	L2	WH+A2	A2 ¹⁾	D1 max.	D2	EE	L1	L2	WH+A2
10 ... 50	25	93	17	G1/4	28	4	70.4	25	93	17	G1/4	28	4	74.3
51 ... 125	37						82.4	37						86.3
126 ... 175	49						94.4	49						98.3
176 ... 250	62						107.4	62						111.3
251 ... 300	74						119.4	74						123.3
301 ... 350	86						131.4	86						135.3
351 ... 375	87						132.4	87						136.3
376 ... 425	98						143.4	98						147.3
426 ... 475	110						155.4	110						159.3
476 ... 500	111	156.4	111	160.3										

1) The dimension corresponds to the E value (piston rod extension) of the drive

Data sheet

Ordering data				With PPS cushioning	
Piston diam. [mm]	Stroke [mm]	Part no.	Type	Part no.	Type
32	25	1638842	DSBG-32-25-PPVA-N3	1645460	DSBG-32-25-PPSA-N3
	40	1638843	DSBG-32-40-PPVA-N3	1645461	DSBG-32-40-PPSA-N3
	50	1638844	DSBG-32-50-PPVA-N3	1645462	DSBG-32-50-PPSA-N3
	80	1638845	DSBG-32-80-PPVA-N3	1645463	DSBG-32-80-PPSA-N3
	100	1638846	DSBG-32-100-PPVA-N3	1645464	DSBG-32-100-PPSA-N3
	125	1638848	DSBG-32-125-PPVA-N3	1645465	DSBG-32-125-PPSA-N3
	160	1638849	DSBG-32-160-PPVA-N3	1645466	DSBG-32-160-PPSA-N3
	200	1638850	DSBG-32-200-PPVA-N3	1645467	DSBG-32-200-PPSA-N3
	250	1638851	DSBG-32-250-PPVA-N3	1645468	DSBG-32-250-PPSA-N3
	320	1638852	DSBG-32-320-PPVA-N3	1645469	DSBG-32-320-PPSA-N3
	400	1638853	DSBG-32-400-PPVA-N3	1645470	DSBG-32-400-PPSA-N3
	500	1638854	DSBG-32-500-PPVA-N3	1645471	DSBG-32-500-PPSA-N3
	1 ... 2800	1634781	DSBG-32-...-PPVA-N3	1634560	DSBG-32-...-PPSA-N3
40	25	1646547	DSBG-40-25-PPVA-N3	1646559	DSBG-40-25-PPSA-N3
	40	1646548	DSBG-40-40-PPVA-N3	1646560	DSBG-40-40-PPSA-N3
	50	1646549	DSBG-40-50-PPVA-N3	1646561	DSBG-40-50-PPSA-N3
	80	1646550	DSBG-40-80-PPVA-N3	1646562	DSBG-40-80-PPSA-N3
	100	1646551	DSBG-40-100-PPVA-N3	1646563	DSBG-40-100-PPSA-N3
	125	1646552	DSBG-40-125-PPVA-N3	1646564	DSBG-40-125-PPSA-N3
	160	1646553	DSBG-40-160-PPVA-N3	1646565	DSBG-40-160-PPSA-N3
	200	1646554	DSBG-40-200-PPVA-N3	1646566	DSBG-40-200-PPSA-N3
	250	1646555	DSBG-40-250-PPVA-N3	1646567	DSBG-40-250-PPSA-N3
	320	1646556	DSBG-40-320-PPVA-N3	1646568	DSBG-40-320-PPSA-N3
	400	1646557	DSBG-40-400-PPVA-N3	1646569	DSBG-40-400-PPSA-N3
	500	1646558	DSBG-40-500-PPVA-N3	1646570	DSBG-40-500-PPSA-N3
	1 ... 2800	1644503	DSBG-40-...-PPVA-N3	1645473	DSBG-40-...-PPSA-N3
50	25	1646709	DSBG-50-25-PPVA-N3	1646723	DSBG-50-25-PPSA-N3
	40	1646710	DSBG-50-40-PPVA-N3	1646724	DSBG-50-40-PPSA-N3
	50	1646711	DSBG-50-50-PPVA-N3	1646725	DSBG-50-50-PPSA-N3
	80	1646712	DSBG-50-80-PPVA-N3	1646726	DSBG-50-80-PPSA-N3
	100	1646713	DSBG-50-100-PPVA-N3	1646727	DSBG-50-100-PPSA-N3
	125	1646714	DSBG-50-125-PPVA-N3	1646728	DSBG-50-125-PPSA-N3
	160	1646715	DSBG-50-160-PPVA-N3	1646729	DSBG-50-160-PPSA-N3
	200	1646716	DSBG-50-200-PPVA-N3	1646730	DSBG-50-200-PPSA-N3
	250	1646717	DSBG-50-250-PPVA-N3	1646731	DSBG-50-250-PPSA-N3
	320	1646718	DSBG-50-320-PPVA-N3	1646732	DSBG-50-320-PPSA-N3
	400	1646719	DSBG-50-400-PPVA-N3	1646733	DSBG-50-400-PPSA-N3
	500	1646720	DSBG-50-500-PPVA-N3	1646734	DSBG-50-500-PPSA-N3
	1 ... 2800	1646708	DSBG-50-...-PPVA-N3	1646722	DSBG-50-...-PPSA-N3

 Note

Other variants in the modular product system → page 24

Data sheet

Ordering data				With PPS cushioning	
Piston diam. [mm]	Stroke [mm]	With PPV cushioning		Part no.	Type
		Part no.	Type		
63	25	1646740	DSBG-63-25-PPVA-N3	1646754	DSBG-63-25-PPSA-N3
	40	1646741	DSBG-63-40-PPVA-N3	1646755	DSBG-63-40-PPSA-N3
	50	1646742	DSBG-63-50-PPVA-N3	1646756	DSBG-63-50-PPSA-N3
	80	1646743	DSBG-63-80-PPVA-N3	1646757	DSBG-63-80-PPSA-N3
	100	1646744	DSBG-63-100-PPVA-N3	1646758	DSBG-63-100-PPSA-N3
	125	1646745	DSBG-63-125-PPVA-N3	1646760	DSBG-63-125-PPSA-N3
	160	1646746	DSBG-63-160-PPVA-N3	1646761	DSBG-63-160-PPSA-N3
	200	1646747	DSBG-63-200-PPVA-N3	1646762	DSBG-63-200-PPSA-N3
	250	1646748	DSBG-63-250-PPVA-N3	1646763	DSBG-63-250-PPSA-N3
	320	1646749	DSBG-63-320-PPVA-N3	1646764	DSBG-63-320-PPSA-N3
	400	1646750	DSBG-63-400-PPVA-N3	1646765	DSBG-63-400-PPSA-N3
	500	1646751	DSBG-63-500-PPVA-N3	1646766	DSBG-63-500-PPSA-N3
	1 ... 2800	1646739	DSBG-63-...-PPVA-N3	1646753	DSBG-63-...-PPSA-N3
	80	25	1646771	DSBG-80-25-PPVA-N3	1646785
40		1646772	DSBG-80-40-PPVA-N3	1646786	DSBG-80-40-PPSA-N3
50		1646773	DSBG-80-50-PPVA-N3	1646787	DSBG-80-50-PPSA-N3
80		1646774	DSBG-80-80-PPVA-N3	1646788	DSBG-80-80-PPSA-N3
100		1646775	DSBG-80-100-PPVA-N3	1646789	DSBG-80-100-PPSA-N3
125		1646776	DSBG-80-125-PPVA-N3	1646790	DSBG-80-125-PPSA-N3
160		1646777	DSBG-80-160-PPVA-N3	1646791	DSBG-80-160-PPSA-N3
200		1646778	DSBG-80-200-PPVA-N3	1646792	DSBG-80-200-PPSA-N3
250		1646779	DSBG-80-250-PPVA-N3	1646793	DSBG-80-250-PPSA-N3
320		1646780	DSBG-80-320-PPVA-N3	1646794	DSBG-80-320-PPSA-N3
400		1646781	DSBG-80-400-PPVA-N3	1646795	DSBG-80-400-PPSA-N3
500		1646782	DSBG-80-500-PPVA-N3	1646796	DSBG-80-500-PPSA-N3
1 ... 2800		1646770	DSBG-80-...-PPVA-N3	1646784	DSBG-80-...-PPSA-N3
100		25	1646801	DSBG-100-25-PPVA-N3	1646815
	40	1646802	DSBG-100-40-PPVA-N3	1646816	DSBG-100-40-PPSA-N3
	50	1646803	DSBG-100-50-PPVA-N3	1646817	DSBG-100-50-PPSA-N3
	80	1646804	DSBG-100-80-PPVA-N3	1646818	DSBG-100-80-PPSA-N3
	100	1646805	DSBG-100-100-PPVA-N3	1646819	DSBG-100-100-PPSA-N3
	125	1646806	DSBG-100-125-PPVA-N3	1646820	DSBG-100-125-PPSA-N3
	160	1646807	DSBG-100-160-PPVA-N3	1646821	DSBG-100-160-PPSA-N3
	200	1646808	DSBG-100-200-PPVA-N3	1646822	DSBG-100-200-PPSA-N3
	250	1646809	DSBG-100-250-PPVA-N3	1646823	DSBG-100-250-PPSA-N3
	320	1646810	DSBG-100-320-PPVA-N3	1646824	DSBG-100-320-PPSA-N3
	400	1646811	DSBG-100-400-PPVA-N3	1646825	DSBG-100-400-PPSA-N3
	500	1646812	DSBG-100-500-PPVA-N3	1646826	DSBG-100-500-PPSA-N3
	1 ... 2800	1646800	DSBG-100-...-PPVA-N3	1646814	DSBG-100-...-PPSA-N3

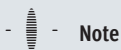

Note

Other variants in the modular product system → page 24

Data sheet

Ordering data					
Piston diam. [mm]	Stroke [mm]	With PPV cushioning		With PPS cushioning	
		Part no.	Type	Part no.	Type
125	25	2159622	DSBG-125-25-PPVA-N3	2159907	DSBG-125-25-PPSA-N3
	40	2159623	DSBG-125-40-PPVA-N3	2159908	DSBG-125-40-PPSA-N3
	50	2159624	DSBG-125-50-PPVA-N3	2159909	DSBG-125-50-PPSA-N3
	80	2159625	DSBG-125-80-PPVA-N3	2159910	DSBG-125-80-PPSA-N3
	100	2159626	DSBG-125-100-PPVA-N3	2159911	DSBG-125-100-PPSA-N3
	125	2159627	DSBG-125-125-PPVA-N3	2159912	DSBG-125-125-PPSA-N3
	160	2159628	DSBG-125-160-PPVA-N3	2159913	DSBG-125-160-PPSA-N3
	200	2159629	DSBG-125-200-PPVA-N3	2159915	DSBG-125-200-PPSA-N3
	250	2159630	DSBG-125-250-PPVA-N3	2159916	DSBG-125-250-PPSA-N3
	320	2159631	DSBG-125-320-PPVA-N3	2159917	DSBG-125-320-PPSA-N3
	400	2159632	DSBG-125-400-PPVA-N3	2159918	DSBG-125-400-PPSA-N3
	500	2159633	DSBG-125-500-PPVA-N3	2159919	DSBG-125-500-PPSA-N3
	1 ... 2800	2158455	DSBG-125-...-PPVA-N3	2158471	DSBG-125-...-PPSA-N3

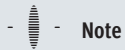
**Note**

Other variants in the modular product system → page 24

Ordering data – Modular product system

Ordering table												
Size	32	40	50	63	80	100	125	Conditions	Code	Enter code		
Module no.	1634484	1645477	1646707	1646738	1646769	1646799	2045493					
Function	Standards-based cylinder, double-acting, based on ISO 15552								DSBG	DSBG		
Protection against rotation	Without											
	With protection against rotation							–	[1]	-Q		
Running characteristics	Standard											
	Low friction							–	[2]	L		
	Constant, slow movement								[2]	U		
	Low friction for balancer applications								[3]	L1		
Piston diameter [mm]	32	40	50	63	80	100	125		-...			
Stroke [mm]	1 ... 2800									-...		
Piston rod type	At one end											
	Through piston rod									-T		
Piston rod thread type	Male thread											
	Female thread								[4]	F		
Cushioning	Elastic cushioning rings/plates at both ends									-P		
	Pneumatic cushioning, self-adjusting at both ends								[5]	-PPS		
	Pneumatic cushioning, adjustable at both ends									-PPV		
Position sensing	Via proximity switch									A	A	
Standard	Based on ISO 15552											
	Complies with ISO 15552									-N3		
Corrosion protection	Standard											
	High corrosion protection								[6]	R3		
Temperature range	Standard											
	[°C]	Heat-resistant seals up to max. 120								[7]	T1	
	[°C]	–40 ... +80								[7]	T3	
	[°C]	0 ... +150								[7]	T4	

- [1] Q Not with L, U, N3, T3, T4, P2, A2, A3, A6
Only up to stroke of 1500 mm
- [2] L, U Not with T, R3, T1, T3, T4, P2, A2, A3, A6, EX4
- [3] L1 Not with T, PPV, R3, T1, T3, T4, P2, A2, A3, A6, EX4
- [4] F Not with N3, ...L, M...
- [5] PPS Not with T1, T3, T4
- [6] R3 Not with A2, A6, ...V
- [7] T1, T3, T4 Not with P2, A2, A3, EX4

 - **Note**

If characteristic L is used in combination with transverse loads or strokes of above 500 mm, suitable measures must be taken to support the piston rod.

The operating pressure (→ page 10) is applicable for strokes up to 500 mm.

 - **Note**

If characteristic L1 is used in combination with strokes of above 500 mm, suitable measures must be taken to support the piston rod.

The operating pressure (→ page 10) is applicable for strokes up to 500 mm.

Ordering data – Modular product system

Ordering table											
Size	32	40	50	63	80	100	125	Conditions	Code	Enter code	
Protection against particles	Standard										
	Bellows on bearing cap							–	[8]	P2	
Wiper variant	None										
	Hard scraper									A2	
	For unlubricated operation									A3	
	Metal scraper									A6	
EU certification	None										
	II 2GD								[9]	EX4	
Swivel mounting position [mm]	Without										
	0 ... 2800									-...V	
Extended piston rod [mm]	Without										
	1 ... 500								[10]	-...E	
Extended piston rod thread [mm]	Without										
	1 ... 35		1 ... 70						[10]	-...L	
Shortened piston rod thread [mm]	Without										
	–				1 ... 30		1 ... 44			-...S	
Piston rod thread	Standard (→ 17)										
	–				M16			[11]	-M16		
	–				M16x1.5			[11]	-M16P		
	–				M20			[11]	-M20		
	–				M20x1.5		[11]	-M20P			
	–				M24		[11]	-M24			
–				M27		[11]	-M27				
Thread length of spacer bolts [mm]	Without										
	–				On the bearing cap			[11]	-...LB2		
	–				20 ... 140		24 ... 140				
	–				On the end cap			[11]	-...LB3		
–				20 ... 140		24 ... 140					

[8] P2 Not with N3, A2, A3, A6, EX4
Only for strokes 10 ... 500 mm

[9] EX4 Not with T1, T3, T4, P2, A3, A6, ...LB2, ...LB3

[10] ...E, ...L Only up to stroke of 2000 mm.
Not with N3

[11] M..., LB... Not with N3

 - **Note**

The piston rod extension for the bellows is automatically taken into consideration when characteristic P2 is selected. This means that there is no need to specify a value for characteristic ...E.

 - **Note**

When characteristic ...E is selected in combination with characteristic P2, the part of the piston rod extension ...E is not covered by the bellows.

 - **Note**

When characteristic P2 is selected in combination with characteristic T (through piston rod), the bellows is mounted at one end only.

 - **Note**

If a thread smaller than the standard thread is selected for characteristic M... (piston rod thread), this may reduce the load capacity.

 - **Note**

When characteristic M... is selected, the piston rod nut is not included.

Accessories

Foot mounting HNC/CRHNC

Material:

HNC: galvanised steel

CRHNC: high-alloy steel

Free of copper and PTFE

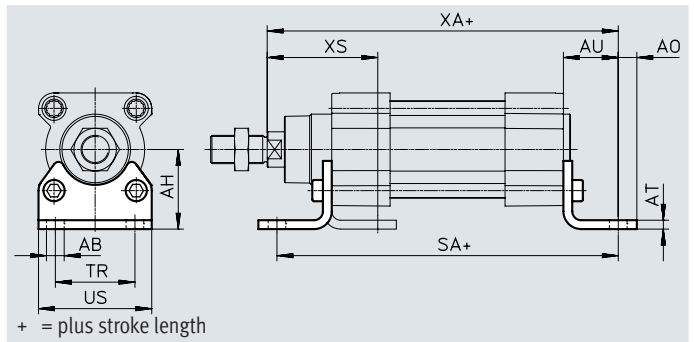

Dimensions and ordering data

For diam. [mm]	AB ∅	AH	AO	AT	AU	SA	TR	US	XA	XS
32	7	32	6.5	4	24	142	32	45	143.1	46
40	10	36	9	4	28	161	36	54	161.9	52.7
50	10	45	9.5	5	32	170	45	64	173.8	62.6
63	10	50	12.5	5	32	185	50	75	189.1	62.9
80	12	63	15	6	41	210	63	93	214.6	80.4
100	14.5	71	17.5	6	41	220	75	110	228.5	84.3
125	16.5	90	22	8	45	250	90	131	270	102

For diam. [mm]	Basic type				Corrosion-resistant			
	CRC ¹⁾	Weight [g]	Part no.	Type ²⁾	CRC ¹⁾	Weight [g]	Part no.	Type ²⁾
32	2	144	174369	HNC-32	4	139	176937	CRHNC-32
40	2	193	174370	HNC-40	4	188	176938	CRHNC-40
50	2	353	174371	HNC-50	4	341	176939	CRHNC-50
63	2	436	174372	HNC-63	4	424	176940	CRHNC-63
80	2	829	174373	HNC-80	4	809	176941	CRHNC-80
100	2	1009	174374	HNC-100	4	990	176942	CRHNC-100
125	2	1902	174375	HNC-125	4	1920	176943	CRHNC-125

1) Corrosion resistance class CRC 2 to Festo standard FN 940070

Moderate corrosion stress. Indoor applications in which condensation can occur. External visible parts with primarily decorative surface requirements which are in direct contact with a normal industrial environment.

Corrosion resistance class CRC 4 to Festo standard FN 940070

Particularly high corrosion stress. Outdoor exposure under extreme corrosive conditions. Parts exposed to aggressive media, e.g. in the chemical or food industries. Such applications may need to be safeguarded by special tests (→ also FN 940082), using appropriate media.

2) Suitable for ATEX

Accessories

Flange mounting FNC/CRFNG

Material:

FNC: galvanised steel

CRFNG: high-alloy steel

Free of copper and PTFE

RoHS-compliant

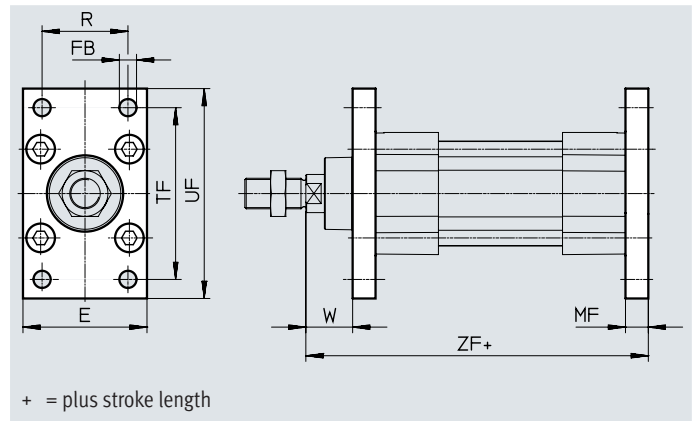
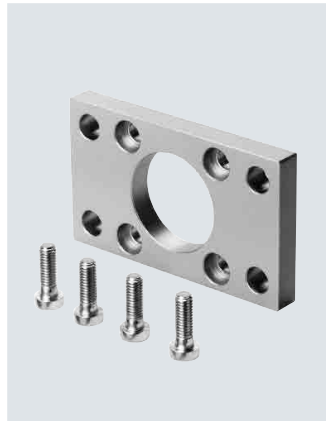

Dimensions and ordering data

For diam.	E	FB ∅	MF	R	TF	UF	W	ZF
[mm]		H13						
32	45	7	10	32	64	80	16	129.1
40	54	9	10	36	72	90	18.7	143.9
50	65	9	12	45	90	110	23.6	153.8
63	75	9	12	50	100	120	23.9	169.1
80	93	12	16	63	126	150	29.4	189.6
100	110	14	16	75	150	175	33.3	203.5
125	132	16	20	90	180	210	45	245

For diam. [mm]	Basic type				Corrosion-resistant			
	CRC ¹⁾	Weight [g]	Part no.	Type ²⁾	CRC ¹⁾	Weight [g]	Part no.	Type ²⁾
32	1	221	174376	FNC-32	4	220	161846	CRFNG-32
40	1	291	174377	FNC-40	4	291	161847	CRFNG-40
50	1	536	174378	FNC-50	4	526	161848	CRFNG-50
63	1	679	174379	FNC-63	4	680	161849	CRFNG-63
80	1	1495	174380	FNC-80	4	1508	161850	CRFNG-80
100	1	2041	174381	FNC-100	4	2054	161851	CRFNG-100
125	1	3775	174382	FNC-125	4	3787	185363	CRFNG-125

1) Corrosion resistance class CRC 1 to Festo standard FN 940070

Low corrosion stress. Dry internal application or transport and storage protection. Also applies to parts behind coverings, in the non-visible interior area, and parts which are covered in the application (e.g. drive trunnions).

Corrosion resistance class CRC 4 to Festo standard FN 940070

Particularly high corrosion stress. Outdoor exposure under extreme corrosive conditions. Parts exposed to aggressive media, e.g. in the chemical or food industries. Such applications may need to be safeguarded by special tests (→ also FN 940082), using appropriate media.

2) Suitable for ATEX

Accessories

Trunnion flange ZNCF/CRZNG

Material:
 ZNCF: stainless steel casting
 CRZNG: electropolished stainless steel casting
 Free of copper and PTFE
 RoHS-compliant

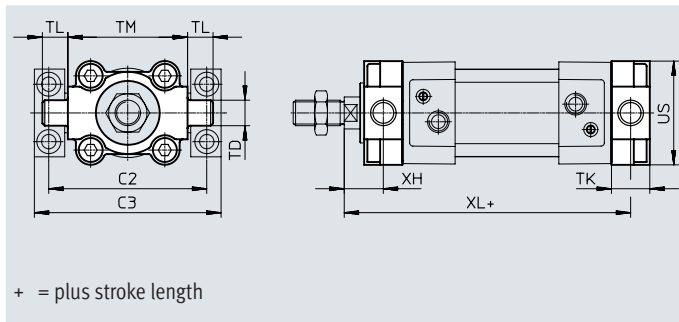

Dimensions and ordering data

For diam. [mm]	C2	C3	TD ∅ e9	TK	TL	TM	US	XH	XL
32	71	86	12	16	12	50	45	18	127.1
40	87	105	16	20	16	63	54	18.7	143.9
50	99	117	16	24	16	75	64	23.6	153.8
63	116	136	20	24	20	90	75	23.9	169.1
80	136	156	20	28	20	110	93	31.4	187.6
100	164	189	25	38	25	132	110	30.3	206.5
125	192	217	25	50	25	160	131	40	250

For diam. [mm]	Basic type				Corrosion-resistant			
	CRC ¹⁾	Weight [g]	Part no.	Type ²⁾	CRC ¹⁾	Weight [g]	Part no.	Type ²⁾
32	2	150	174411	ZNCF-32	4	150	161852	CRZNG-32
40	2	285	174412	ZNCF-40	4	285	161853	CRZNG-40
50	2	473	174413	ZNCF-50	4	473	161854	CRZNG-50
63	2	687	174414	ZNCF-63	4	687	161855	CRZNG-63
80	2	1296	174415	ZNCF-80	4	1296	161856	CRZNG-80
100	2	2254	174416	ZNCF-100	4	2254	161857	CRZNG-100
125	2	3484	174417	ZNCF-125	4	3484	185362	CRZNG-125

- 1) Corrosion resistance class CRC 2 to Festo standard FN 940070
 Moderate corrosion stress. Indoor applications in which condensation can occur. External visible parts with primarily decorative surface requirements which are in direct contact with a normal industrial environment.
 Corrosion resistance class CRC 4 to Festo standard FN 940070
 Particularly high corrosion stress. Outdoor exposure under extreme corrosive conditions. Parts exposed to aggressive media, e.g. in the chemical or food industries. Such applications may need to be safeguarded by special tests
 (→ also FN 940082), using appropriate media.
- 2) Suitable for ATEX

Accessories

Trunnion support LNZG

Material:
Trunnion support: anodised aluminium
Plain bearing: plastic
Free of copper and PTFE
RoHS-compliant

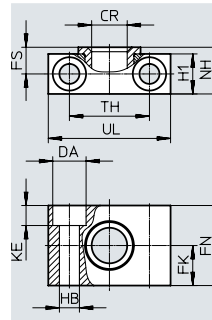
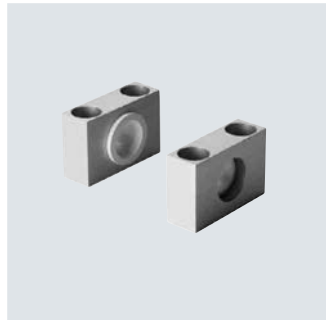

Dimensions and ordering data

For diam. [mm]	CR ∅	DA ∅	FK ∅	FN	FS	H1	HB ∅	KE	NH	TH	UL	CRC ¹⁾	Weight [g]	Part no.	Type
32	D11	H13	±0.1				H13			±0.2					
32	12	11	15	30	10.5	15	6.6	6.8	18	32	46	2	83	32959	LNZG-32
40, 50	16	15	18	36	12	18	9	9	21	36	55	2	129	32960	LNZG-40/50
63, 80	20	18	20	40	13	20	11	11	23	42	65	2	178	32961	LNZG-63/80
100, 125	25	20	25	50	16	24.5	14	13	28.5	50	75	2	306	32962	LNZG-100/125

1) Corrosion resistance class CRC 2 to Festo standard FN 940070

Moderate corrosion stress. Indoor applications in which condensation can occur. External visible parts with primarily decorative surface requirements which are in direct contact with a normal industrial environment.

Trunnion support CRLNZG

Material:
High-alloy steel
Free of copper and PTFE
RoHS-compliant

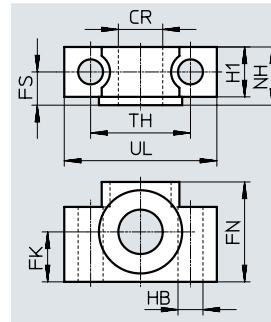
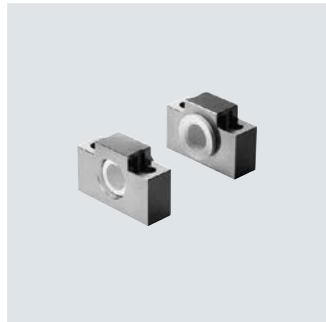

Dimensions and ordering data

For diam. [mm]	CR ∅	FK ∅	FN	FS	H1	HB ∅	NH	TH	UL	CRC ¹⁾	Weight [g]	Part no.	Type
	D11	±0.1				H13		±0.2					
32	12	15	30	10.5	15	6.6	18	32	46	4	205	161874	CRLNZG-32
40, 50	16	18	36	12	18	9	21	36	55	4	323	161875	CRLNZG-40/50
63, 80	20	20	40	13	20	11	23	42	65	4	435	161876	CRLNZG-63/80
100, 125	25	25	50	16	24.5	14	28.5	50	75	4	739	161877	CRLNZG-100/125

1) Corrosion resistance class CRC 4 to Festo standard FN 940070

Particularly high corrosion stress. Outdoor exposure under extreme corrosive conditions. Parts exposed to aggressive media, e.g. in the chemical or food industries. Such applications may need to be safeguarded by special tests (→ also FN 940082), using appropriate media.

Accessories

Swivel flange SNC

Material:
Die-cast aluminium
RoHS-compliant

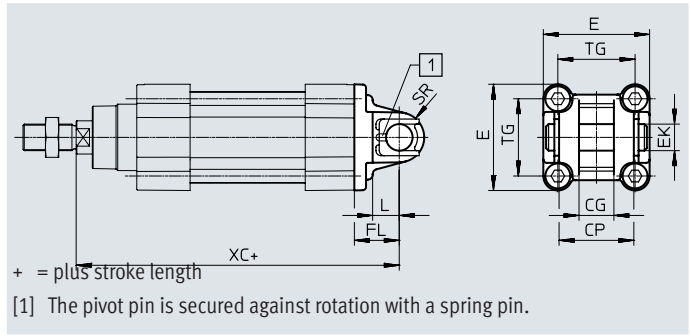

Dimensions and ordering data

For diam.	CG	CP	E	EK ∅ H9	FL ±0.2	L	SR	TG	XC	CRC ¹⁾	Weight [g]	Part no.	Type ²⁾
[mm]	H14	h14											
32	14	34	45 ^{+0.2/-0.5}	10	22	13	10	32.5	141.1	1	93	174383	SNC-32
40	16	40	54 ^{-0.5}	12	25	16	12	38	158.9	1	140	174384	SNC-40
50	21	45	64 ^{-0.6}	16	27	16	12	46.5	168.8	1	234	174385	SNC-50
63	21	51	75 ^{-0.6}	16	32	21	16	56.5	189.1	1	331	174386	SNC-63
80	25	65	93 ^{-0.8}	20	36	22	16	72	209.6	1	618	174387	SNC-80
100	25	75	110 ^{+0.3/-0.8}	20	41	27	20	89	228.5	1	865	174388	SNC-100
125	37	97	131 ^{-0.8}	30	50	30	25	110	275	1	1728	174389	SNC-125

1) Corrosion resistance class CRC 1 to Festo standard FN 940070

Low corrosion stress. Dry internal application or transport and storage protection. Also applies to parts behind coverings, in the non-visible interior area, and parts which are covered in the application (e.g. drive trunnions).

2) Suitable for ATEX

Accessories

Swivel flange SNCB/SNCB-...-R3

Material:
 SNCB: die-cast aluminium
 SNCB-...-R3: die-cast aluminium with protective coating
 Free of copper and PTFE
 RoHS-compliant

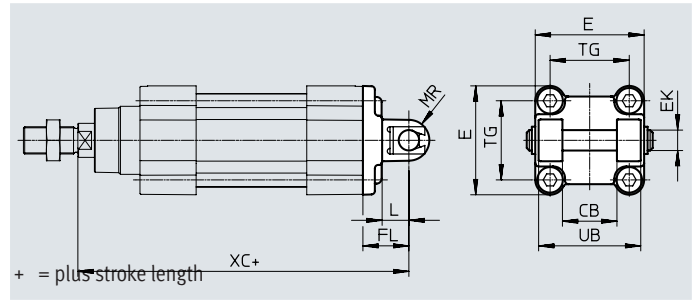
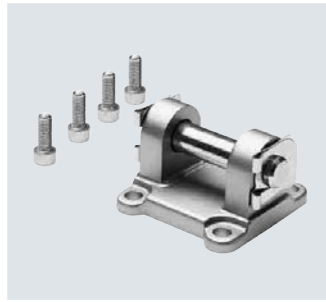

Dimensions and ordering data									
For diam.	CB	E	EK ∅	FL	L	MR	TG	UB	XC
[mm]	H14		H9/e8	±0.2		-0.5		h14	
32	26	45 ^{+0.2/-0.5}	10	22	13	8.5	32.5	45	141.1
40	28	54 _{-0.5}	12	25	16	12	38	52	158.9
50	32	64 _{-0.6}	12	27	16	12	46.5	60	168.8
63	40	75 _{-0.6}	16	32	21	16	56.5	70	189.1
80	50	93 _{-0.8}	16	36	22	16	72	90	209.6
100	60	110 ^{+0.3/-0.8}	20	41	27	20	89	110	228.5
125	70	131 _{-0.8}	25	50	30	25	110	130	275

For diam. [mm]	Basic type				R3 – High corrosion protection			
	CRC ¹⁾	Weight [g]	Part no.	Type	CRC ¹⁾	Weight [g]	Part no.	Type
32	1	103	174390	SNCB-32	3	100	176944	SNCB-32-R3
40	1	155	174391	SNCB-40	3	151	176945	SNCB-40-R3
50	1	232	174392	SNCB-50	3	228	176946	SNCB-50-R3
63	1	375	174393	SNCB-63	3	371	176947	SNCB-63-R3
80	1	636	174394	SNCB-80	3	632	176948	SNCB-80-R3
100	1	1035	174395	SNCB-100	3	986	176949	SNCB-100-R3
125	1	1860	174396	SNCB-125	3	1776	176950	SNCB-125-R3

1) Corrosion resistance class CRC 1 to Festo standard FN 940070
 Low corrosion stress. Dry internal application or transport and storage protection. Also applies to parts behind coverings, in the non-visible interior area, and parts which are covered in the application (e.g. drive trunnions).
 Corrosion resistance class CRC 3 to Festo standard FN 940070
 High corrosion stress. Outdoor exposure under moderate corrosive conditions. Externally visible parts with primarily functional surface requirements which are in direct contact with a normal industrial environment.

Accessories

Swivel flange SNCS/CRSNCS/SNCS-...-R3

Material:
 SNCS 32 ... 50:
 Die-cast aluminium
 SNCS 63 ... 125:
 Wrought aluminium alloy
 CRSNCS 32 ... 80:
 High-alloy stainless steel
 SNCS-...-R3 100 ... 125:
 Wrought aluminium alloy with
 protective coating
 RoHS-compliant

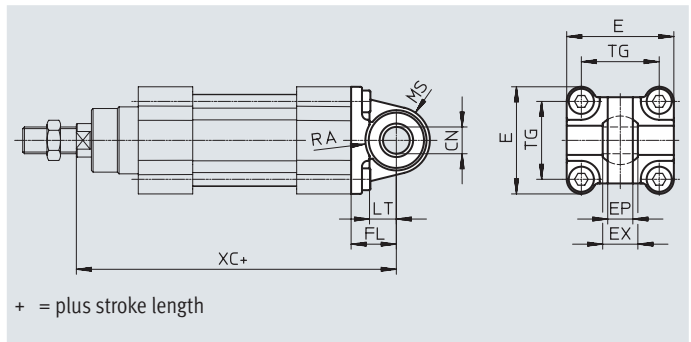

Dimensions and ordering data

For diam. [mm]	CN ∅		E		EP ±0.2	EX	FL ±0.2
	DSBG-...	DSBG-...-R3	DSBG-...	DSBG-...-R3			
32	10 ^{+0.013}	10+0.015/-0.04	45+0.2/-0.5	45-0.5	10.5	14	22
40	12 ^{+0.015}	12+0.018/-0.04	54-0.5	54-0.5	12	16	25
50	16 ^{+0.015}	16+0.018/-0.04	64-0.6	64-0.6	15	21	27
63	16 ^{+0.015}	16+0.018/-0.04	74.5±0.5	75-0.6	15	21	32
80	20 ^{+0.018}	20+0.021/-0.04	92.2±0.8	93-0.8	18	25	36
100	20 ^{+0.018}	20+0.021/-0.04	109+1/-0.7	109+1/-0.7	18	25	41
125	30 ^{+0.018}	30+0.021/-0.04	132+1/-0.7	132+1/-0.7	25	37	50

For diam. [mm]	LT	MS		RA		TG	XC
		DSBG	DSBG-...-R3	DSBG +1	DSBG-...-R3 +1		
32	13	15 ^{+0.5}	15 ^{+0.5}	14.5	14.5	32.5	141.1
40	16	17 ^{+0.5}	17 ^{+0.5}	17.5	17.5	38	158.9
50	16	20 ^{+0.5}	20 ^{+0.5}	18.5	19	46.5	168.8
63	21	23-0.5	22 ^{+0.5}	23	23	56.5	189.1
80	22	28-0.5	27 ^{+0.5}	25	25	72	209.6
100	27	30±0.5	30±0.5	95	100	89	228.5
125	30	39±0.5	39±0.5	100	100	110	275

For diam. [mm]	Basic type				High corrosion protection			
	CRC ¹⁾	Weight [g]	Part no.	Type	CRC ¹⁾	Weight [g]	Part no.	Type
32	1	86	174397	SNCS-32	4	161	2895920	CRSNCS-32
40	1	122	174398	SNCS-40	4	239	2895921	CRSNCS-40
50	1	216	174399	SNCS-50	4	403	2895922	CRSNCS-50
63	2	281	174400	SNCS-63	4	576	2895923	CRSNCS-63
80	2	557	174401	SNCS-80	4	1173	2895924	CRSNCS-80
100	2	683	174402	SNCS-100	3	684	2895925	SNCS-100-R3
125	2	1369	174403	SNCS-125	3	1369	2895926	SNCS-125-R3

1) Corrosion resistance class CRC 1 to Festo standard FN 940070
 Low corrosion stress. Dry internal application or transport and storage protection. Also applies to parts behind coverings, in the non-visible interior area, and parts which are covered in the application (e.g. drive trunnions).
 Corrosion resistance class CRC 2 to Festo standard FN 940070
 Moderate corrosion stress. Indoor applications in which condensation can occur. External visible parts with primarily decorative surface requirements which are in direct contact with a normal industrial environment.

Corrosion resistance class CRC 3 to Festo standard FN 940070
 High corrosion stress. Outdoor exposure under moderate corrosive conditions. Externally visible parts with primarily functional surface requirements which are in direct contact with a normal industrial environment.

Corrosion resistance class CRC 4 to Festo standard FN 940070
 Particularly high corrosion stress. Outdoor exposure under extreme corrosive conditions. Parts exposed to aggressive media, e.g. in the chemical or food industries. Such applications may need to be safeguarded by special tests (→ also FN 940082), using appropriate media.

Accessories

Swivel flange SNCL

Material:
Die-cast aluminium
Free of copper and PTFE
RoHS-compliant

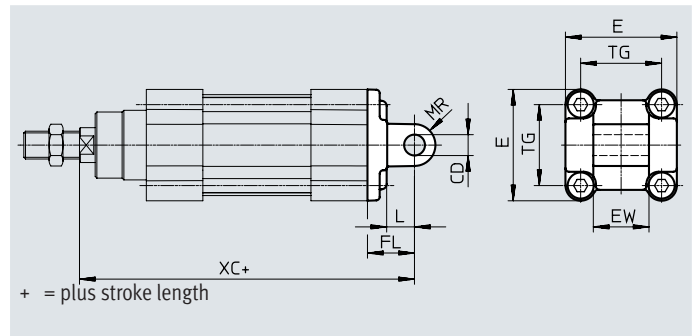

Dimensions and ordering data



For diam. [mm]	CD ∅ H9	E	EW h12	FL ±0.2	L	MR	TG	XC	CRC ¹⁾	Weight [g]	Part no.	Type
32	10	45 ^{+0.2/-0.5}	26	22	13	10	32.5	141.1	1	71	174404	SNCL-32
40	12	54 ^{+0.5}	28	25	16	12	38	158.9	1	95	174405	SNCL-40
50	12	64 ^{+0.6}	32	27	16	12	46.5	168.8	1	158	174406	SNCL-50
63	16	75 ^{+0.6}	40	32	21	16	56.5	189.1	1	225	174407	SNCL-63
80	16	93 ^{+0.8}	50	36	22	16	72	209.6	1	436	174408	SNCL-80
100	20	110 ^{+0.3/-0.8}	60	41	27	20	89	228.5	1	606	174409	SNCL-100
125	25	131 ^{+0.8}	70	50	30	25	110	275	1	1135	174410	SNCL-125

1) Corrosion resistance class CRC 1 to Festo standard FN 940070

Low corrosion stress. Dry internal application or transport and storage protection. Also applies to parts behind coverings, in the non-visible interior area, and parts which are covered in the application (e.g. drive trunnions).



Accessories

Ordering data – Mounting components

Designation	For diameter	Part no.	Type
Clevis foot LNG			
	32	33890	LNG-32
	40	33891	LNG-40
	50	33892	LNG-50
	63	33893	LNG-63
	80	33894	LNG-80
	100	33895	LNG-100
	125	33896	LNG-125
Clevis foot LSNG			
	32	31740	LSNG-32
	40	31741	LSNG-40
	50	31742	LSNG-50
	63	31743	LSNG-63
	80	31744	LSNG-80
	100	31745	LSNG-100
	125	31746	LSNG-125
Clevis foot LBG¹⁾			
	32	31761	LBG-32
	40	31762	LBG-40
	50	31763	LBG-50
	63	31764	LBG-63
	80	31765	LBG-80
	100	31766	LBG-100
	125	31767	LBG-125

1) Suitable for ATEX

Data sheets → Internet: clevis foot

Designation	For diameter	Part no.	Type
Clevis foot LSN			
	32	5561	LSN-32
	40	5562	LSN-40
	50	5563	LSN-50
	63	5564	LSN-63
	80	5565	LSN-80
	100	5566	LSN-100
	125	6987	LSN-125
Clevis foot LSNSG			
	32	31747	LSNSG-32
	40	31748	LSNSG-40
	50	31749	LSNSG-50
	63	31750	LSNSG-63
	80	31751	LSNSG-80
	100	31752	LSNSG-100
	125	31753	LSNSG-125
Right-angle clevis foot LQG¹⁾			
	32	31768	LQG-32
	40	31769	LQG-40
	50	31770	LQG-50
	63	31771	LQG-63
	80	31772	LQG-80
	100	31773	LQG-100
	125	31774	LQG-125

Ordering data – Mounting components, corrosion-resistant

Designation	For diameter	Part no.	Type
Clevis foot CRLNG			
	32	161840	CRLNG-32
	40	161841	CRLNG-40
	50	161842	CRLNG-50
	63	161843	CRLNG-63
	80	161844	CRLNG-80
	100	161845	CRLNG-100
	125	176951	CRLNG-125

Ordering data – Mounting components, high corrosion protection

Designation	For diameter	Part no.	Type
Clevis foot LBG-R3			
	32	2078790	LBG-32-R3
	40	2078792	LBG-40-R3
	50	2078794	LBG-50-R3
	63	2078795	LBG-63-R3
	80	2078797	LBG-80-R3
	100	2078799	LBG-100-R3
	125	2078837	LBG-125-R3

Accessories

Ordering data – Piston rod attachments

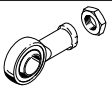
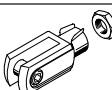
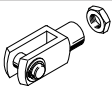
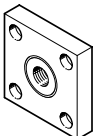
Designation	For diameter	Part no.	Type
Rod eye SGS			
	32	9261	SGS-M10x1.25
	40	9262	SGS-M12x1.25
	50	9263	SGS-M16x1.5
	63		
	80	9264	SGS-M20x1.5
	100		
	125	10774	SGS-M27x2
Rod clevis SG¹⁾			
	32	6144	SG-M10x1.25
	40	6145	SG-M12x1.25
	50	6146	SG-M16x1.5
	63		
	80	6147	SG-M20x1.5
	100		
	125	14987	SG-M27x2-B
Coupling piece KSG¹⁾			
	32	32963	KSG-M10x1.25
	40	32964	KSG-M12x1.25
	50	32965	KSG-M16x1.5
	63		
	80	32966	KSG-M20x1.5
	100		
	125	32967	KSG-M27x2

1) Suitable for ATEX

Data sheets → Internet: piston rod attachment

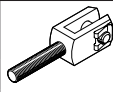
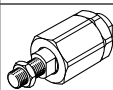
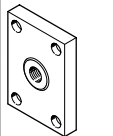
Designation	For diameter	Part no.	Type
Rod clevis SGA¹⁾			
	32	32954	SGA-M10x1.25
	40	10767	SGA-M12x1.25
	50	10768	SGA-M16x1.5
	63		
	80	10769	SGA-M20x1.5
	100		
	125	10770	SGA-M27x2
Self-aligning rod coupler FK¹⁾			
	32	6140	FK-M10x1.25
	40	6141	FK-M12x1.25
	50	6142	FK-M16x1.5
	63		
	80	6143	FK-M20x1.5
	100		
	125	10485	FK-M27x2
Coupling piece KSZ¹⁾			
	32	36125	KSZ-M10x1.25
	40	36126	KSZ-M12x1.25
	50	36127	KSZ-M16x1.5
	63		
	80	36128	KSZ-M20x1.5
	100		
	125	-	-

Ordering data – Piston rod attachments, corrosion-resistant

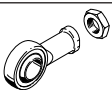
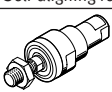
Designation	For diameter	Part no.	Type
Rod eye CRSGS			
	32	195582	CRSGS-M10x1.25
	40	195583	CRSGS-M12x1.25
	50	195584	CRSGS-M16x1.5
	63		
	80	195585	CRSGS-M20x1.5
	100		
	125	195586	CRSGS-M27x2
Self-aligning rod coupler CRFK¹⁾			
	32	2305778	CRFK-M10x1.25
	40	2305779	CRFK-M12x1.25
	50	2490673	CRFK-M16x1.5
	63		
	80	2545677	CRFK-M20x1.5
	100		

1) Suitable for ATEX

Data sheets → Internet: piston rod attachment

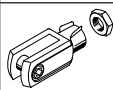
Designation	For diameter	Part no.	Type
Rod clevis CRSG¹⁾			
	32	13569	CRSG-M10x1.25
	40	13570	CRSG-M12x1.25
	50	13571	CRSG-M16x1.5
	63		
	80	13572	CRSG-M20x1.5
	100		
	125	185361	CRSG-M27x2

Accessories

Bellows kit DADB



General technical data

Type DADB-V6-	32	40	50	63	80	100
Max. stroke range of the cylinder ¹⁾ [mm]	10 ... 500	10 ... 500	10 ... 500	10 ... 500	10 ... 500	10 ... 500
Type of mounting	Via threaded pin					
Mounting position	Any					
Media resistance	Dust, chippings, oil, grease, fuel (→ Internet: media resistance)					
Ambient temperature ²⁾ [°C]	-10 ... +80					
Degree of protection	IP54					
Corrosion resistance CRC ³⁾	3					

1) In combination with the bellows kit DADB

2) Note operating range of proximity switches and cylinder

3) Corrosion resistance class CRC 3 to Festo standard FN 940070

High corrosion stress. Outdoor exposure under moderate corrosive conditions. Externally visible parts with primarily functional surface requirements which are in direct contact with a normal industrial environment.

Materials

Sectional view

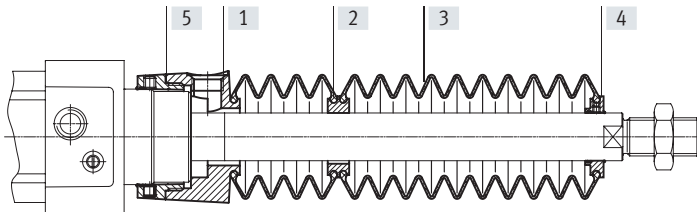

Bellows

[1]	Connection	Polyamide
[2]	Adapter	Polyamide
[3]	Bellows	NBR
[4]	End piece	Polyamide
[5]	Connector	Polyamide
-	O-ring	NBR
	Note on materials	Free of copper and PTFE RoHS-compliant

Weight [g]

Type DADB-V6- Stroke [mm]	32	40	50	63	80	100
10 ... 50	29	42	71	69	99	124
51 ... 125	41	56	91	89	127	152
126 ... 175	52	68	105	103	140	165
176 ... 250	66	85	129	127	193	218
251 ... 300	79	100	147	145	231	255
301 ... 350	92	115	166	164	268	293
351 ... 375	92	115	167	165	259	284
376 ... 425	104	129	185	183	296	321
426 ... 475	117	144	204	202	334	359
476 ... 500	117	144	205	203	324	349

Accessories

Travel speed v as a function of tubing length l

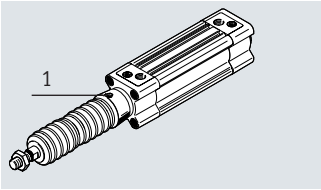

The bellows kit is a leak-free system. To prevent unwanted media from being drawn in, the supply and exhaust air for the kit must be ducted via a pressure

compensation hole in the connection part [1]. The pressure generated in the bellows kit by the positioning motion is primarily defined by the travel speed and the

tubing length. The recommended tubing length based on the travel speed of the drive can be read from the graph.

Advancing

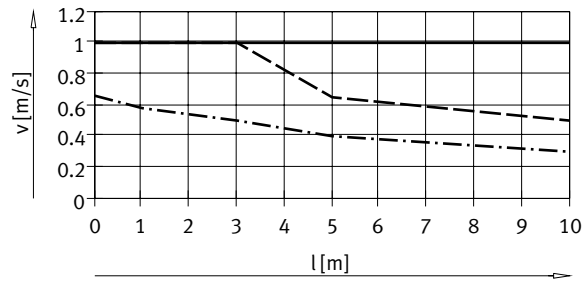

- Diameter 32/50/63
- Diameter 40
- - - Diameter 80/100

Retracting

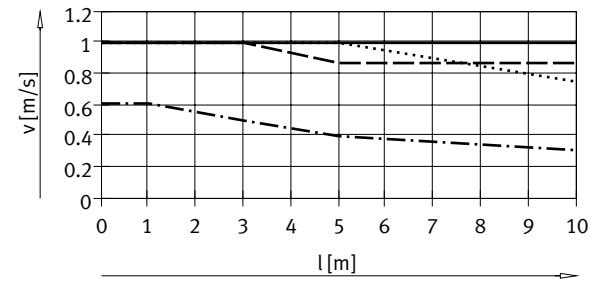

- Diameter 32
- Diameter 40
- - - Diameter 50/63
- · - · Diameter 80/100

Note
The push-in fittings in the adjacent table must be used for the pressure compensation hole. Silencers can be used as an alternative. This reduces the travel speed slightly.

Tube size and push-in fitting for pressure compensation hole			
\varnothing [mm]	Tubing O.D. [mm]	Push-in fitting	
		Part no.	Type
32, 40	8	186109	QS-G1/8-8-I
		578376	NPQH-DK-G18-Q8-P10
		578362	NPQH-D-G18-S8-P10
50, 63, 80, 100	12	186350	QS-G1/4-12
		578344	NPQH-D-G14-Q12-P10
		578366	NPQH-D-G14-S12-P10

Accessories

Dimensions

Download CAD data → www.festo.com

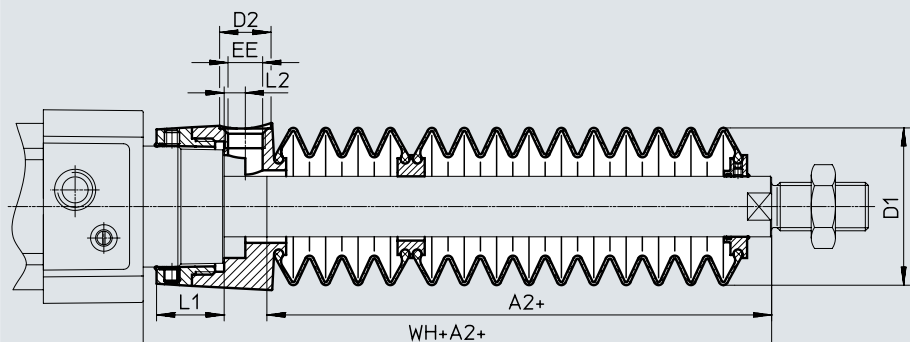

+ = plus stroke length

ø Stroke [mm]	32							40						
	A2 ¹⁾	D1 max.	D2	EE	L1	L2	WH+A2	A2 ¹⁾	D1 max.	D2	EE	L1	L2	WH+A2
10 ... 50	29	38	14	G1/8	12.9	5.4	55	28	46	14	G1/8	16.3	5.4	56.7
51 ... 125	47						73	43						71.7
126 ... 175	61						87	56						84.7
176 ... 250	80						106	72						100.7
251 ... 300	96						122	86						114.7
301 ... 350	112						138	100						128.7
351 ... 375	114						140	101						129.7
376 ... 425	130						156	115						143.7
426 ... 475	145						171	130						158.7
476 ... 500	147	173	131	159.7										

ø Stroke [mm]	50							63						
	A2 ¹⁾	D1 max.	D2	EE	L1	L2	WH+A2	A2 ¹⁾	D1 max.	D2	EE	L1	L2	WH+A2
10 ... 50	28	57	17	G1/4	22.35	7	63.6	28	57	17	G1/4	22.4	7	63.9
51 ... 125	46						81.6	46						81.9
126 ... 175	56						91.6	56						91.9
176 ... 250	73						108.6	73						108.9
251 ... 300	86						121.6	86						121.9
301 ... 350	97						132.6	97						132.9
351 ... 375	105						140.6	105						140.9
376 ... 425	116						151.6	116						151.9
426 ... 475	126						161.6	126						161.9
476 ... 500	134	169.6	134	169.9										

ø Stroke [mm]	80							100						
	A2 ¹⁾	D1 max.	D2	EE	L1	L2	WH+A2	A2 ¹⁾	D1 max.	D2	EE	L1	L2	WH+A2
10 ... 50	25	93	17	G1/4	28	4	70.4	25	93	17	G1/4	28	4	74.3
51 ... 125	37						82.4	37						86.3
126 ... 175	49						94.4	49						98.3
176 ... 250	62						107.4	62						111.3
251 ... 300	74						119.4	74						123.3
301 ... 350	86						131.4	86						135.3
351 ... 375	87						132.4	87						136.3
376 ... 425	98						143.4	98						147.3
426 ... 475	110						155.4	110						159.3
476 ... 500	111	156.4	111	160.3										

1) The dimension corresponds to the E value (piston rod extension) of the drive

Accessories

Ordering data – Bellows kit

An extended piston rod (order code E) is absolutely essential when using a bellows kit → Ordering data – Modular product system.

The necessary dimension for order code E as a function of piston diameter and cylinder stroke as well as the corresponding bellows kit is indicated in the table below:

Order example:

Selected standards-based cylinder:
DSBG-32-320-PPV-A...

The dimension for the corresponding E value (see table):
112 mm

Complete order reference for standards-based cylinder:
DSBG-32-320-PPV-A-...-112E

The corresponding bellows kit:
DADB-V6-32-S301-350

Cylinder data			Bellows kit		Cylinder data			Bellows kit	
∅	Stroke	Dimension for E	Part no.	Type	∅	Stroke	Dimension for E	Part no.	Type
[mm]	[mm]	[mm]			[mm]	[mm]	[mm]		
32	10 ... 50	29	553271	DADB-V6-32-S10-50	40	10 ... 50	28	553291	DADB-V6-40-S10-50
	51 ... 125	47	553273	DADB-V6-32-S51-125		51 ... 125	43	553293	DADB-V6-40-S51-125
	126 ... 175	61	553275	DADB-V6-32-S126-175		126 ... 175	56	553295	DADB-V6-40-S126-175
	176 ... 250	80	553277	DADB-V6-32-S176-250		176 ... 250	72	553297	DADB-V6-40-S176-250
	251 ... 300	96	553279	DADB-V6-32-S251-300		251 ... 300	86	553399	DADB-V6-40-S251-300
	301 ... 350	112	553281	DADB-V6-32-S301-350		301 ... 350	100	553301	DADB-V6-40-S301-350
	351 ... 375	114	553283	DADB-V6-32-S351-375		351 ... 375	101	553303	DADB-V6-40-S351-375
	376 ... 425	130	553285	DADB-V6-32-S376-425		376 ... 425	115	553305	DADB-V6-40-S376-425
	426 ... 475	145	553287	DADB-V6-32-S426-475		426 ... 475	130	553307	DADB-V6-40-S426-475
476 ... 500	147	553289	DADB-V6-32-S476-500	476 ... 500	131	553309	DADB-V6-40-S476-500		
50	10 ... 50	28	553311	DADB-V6-50-S10-50	63	10 ... 50	28	553331	DADB-V6-63-S10-50
	51 ... 125	46	553313	DADB-V6-50-S51-125		51 ... 125	46	553333	DADB-V6-63-S51-125
	126 ... 175	56	553315	DADB-V6-50-S126-175		126 ... 175	56	553335	DADB-V6-63-S126-175
	176 ... 250	73	553317	DADB-V6-50-S176-250		176 ... 250	73	553337	DADB-V6-63-S176-250
	251 ... 300	86	553319	DADB-V6-50-S251-300		251 ... 300	86	553339	DADB-V6-63-S251-300
	301 ... 350	97	553321	DADB-V6-50-S301-350		301 ... 350	97	553341	DADB-V6-63-S301-350
	351 ... 375	105	553323	DADB-V6-50-S351-375		351 ... 375	105	553343	DADB-V6-63-S351-375
	376 ... 425	116	553325	DADB-V6-50-S376-425		376 ... 425	116	553345	DADB-V6-63-S376-425
	426 ... 475	126	553327	DADB-V6-50-S426-475		426 ... 475	126	553347	DADB-V6-63-S426-475
476 ... 500	134	553329	DADB-V6-50-S476-500	476 ... 500	134	553349	DADB-V6-63-S476-500		
80	10 ... 50	25	553351	DADB-V6-80-S10-50	100	10 ... 50	25	553371	DADB-V6-100-S10-50
	51 ... 125	37	553353	DADB-V6-80-S51-125		51 ... 125	37	553373	DADB-V6-100-S51-125
	126 ... 175	49	553355	DADB-V6-80-S126-175		126 ... 175	49	553375	DADB-V6-100-S126-175
	176 ... 250	62	553357	DADB-V6-80-S176-250		176 ... 250	62	553377	DADB-V6-100-S176-250
	251 ... 300	74	553359	DADB-V6-80-S251-300		251 ... 300	74	553379	DADB-V6-100-S251-300
	301 ... 350	86	553361	DADB-V6-80-S301-350		301 ... 350	86	553381	DADB-V6-100-S301-350
	351 ... 375	87	553363	DADB-V6-80-S351-375		351 ... 375	87	553383	DADB-V6-100-S351-375
	376 ... 425	98	553365	DADB-V6-80-S376-425		376 ... 425	98	553385	DADB-V6-100-S376-425
	426 ... 475	110	553367	DADB-V6-80-S426-475		426 ... 475	110	553387	DADB-V6-100-S426-475
476 ... 500	111	553369	DADB-V6-80-S476-500	476 ... 500	111	553389	DADB-V6-100-S476-500		

Accessories

Multi-position kit DPNC

Material:
 Flange: wrought aluminium alloy
 Threaded pins, hex nuts: galvanised steel

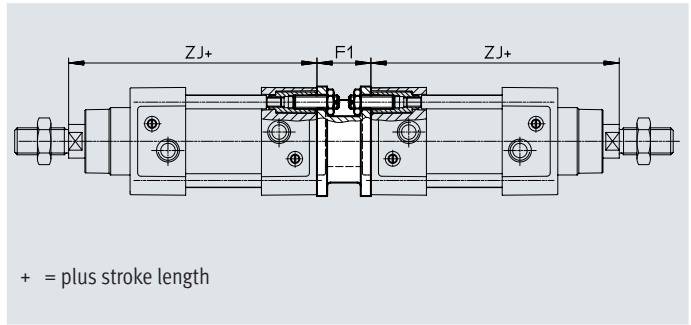

Dimensions and ordering data						
For diam.	F1	ZJ	Max. complete stroke	Weight	Part no.	Type ¹⁾
[mm]		+1.8	[mm]	[g]		
32	27	119.1	500	292	174418	DPNC-32
40	27	133.9	800	410	174419	DPNC-40
50	32	141.8	800	335	174420	DPNC-50
63	28	157.1	700	390	174421	DPNC-63
80	38	173.6	1000	847	174422	DPNC-80
100	38	187.5	900	1200	174423	DPNC-100
125	48	225	1000	2102	174424	DPNC-125

1) Suitable for ATEX

Note

The maximum overall stroke length must not be exceeded when combining cylinders and multi-position kits.

Connecting two cylinders with identical piston diameters to form a three or four-position cylinder

A three or four-position cylinder consists of two separate cylinders whose piston rods advance in opposing directions.

This means that depending on the actuation and stroke pattern, this type of cylinder can assume up to four positions. In each case the cylinder is moved precisely

against a stop. Note that when one end of the piston rod is fixed, the cylinder barrel

executes the movement. The line connections to the cylinder must be flexible.

To achieve 3 positions

Two cylinders with identical stroke length must be connected together.

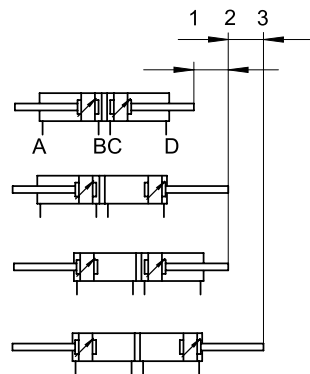

To achieve 4 positions

Two cylinders with different stroke lengths must be connected together.

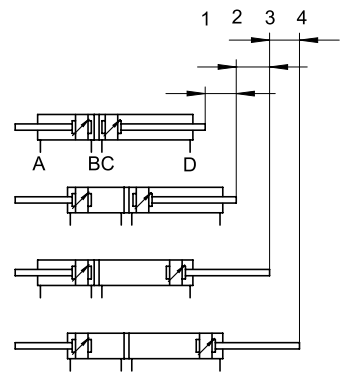

Accessories

Ordering data – Guide units for fixed strokes (recirculating ball bearing guide only)

Data sheets → Internet: feng

Stroke [mm]	Part no.	Type ¹⁾	Stroke [mm]	Part no.	Type ¹⁾
For diam. 32 mm			For diam. 40 mm		
10 ... 50	34493	FENG-32-50-KF	10 ... 50	34499	FENG-40-50-KF
10 ... 100	34494	FENG-32-100-KF	10 ... 100	34500	FENG-40-100-KF
10 ... 160	34495	FENG-32-160-KF	10 ... 160	34501	FENG-40-160-KF
10 ... 200	34496	FENG-32-200-KF	10 ... 200	34502	FENG-40-200-KF
10 ... 250	150289	FENG-32-250-KF	10 ... 250	34503	FENG-40-250-KF
10 ... 320	34497	FENG-32-320-KF	10 ... 320	34504	FENG-40-320-KF
10 ... 400	150290	FENG-32-400-KF	10 ... 400	150291	FENG-40-400-KF
10 ... 500	34498	FENG-32-500-KF	10 ... 500	34505	FENG-40-500-KF
For diam. 50 mm			For diam. 63 mm		
10 ... 50	34506	FENG-50-50-KF	10 ... 50	34513	FENG-63-50-KF
10 ... 100	34507	FENG-50-100-KF	10 ... 100	34514	FENG-63-100-KF
10 ... 160	34508	FENG-50-160-KF	10 ... 160	34515	FENG-63-160-KF
10 ... 200	34509	FENG-50-200-KF	10 ... 200	34516	FENG-63-200-KF
10 ... 250	34510	FENG-50-250-KF	10 ... 250	34517	FENG-63-250-KF
10 ... 320	34511	FENG-50-320-KF	10 ... 320	34518	FENG-63-320-KF
10 ... 400	150292	FENG-50-400-KF	10 ... 400	34519	FENG-63-400-KF
10 ... 500	34512	FENG-50-500-KF	10 ... 500	34520	FENG-63-500-KF
For diam. 80 mm			For diam. 100 mm		
10 ... 50	34521	FENG-80-50-KF	10 ... 50	34529	FENG-100-50-KF
10 ... 100	34522	FENG-80-100-KF	10 ... 100	34530	FENG-100-100-KF
10 ... 160	34523	FENG-80-160-KF	10 ... 160	34531	FENG-100-160-KF
10 ... 200	34524	FENG-80-200-KF	10 ... 200	34532	FENG-100-200-KF
10 ... 250	34525	FENG-80-250-KF	10 ... 250	34533	FENG-100-250-KF
10 ... 320	34526	FENG-80-320-KF	10 ... 320	34534	FENG-100-320-KF
10 ... 400	34527	FENG-80-400-KF	10 ... 400	34535	FENG-100-400-KF
10 ... 500	34528	FENG-80-500-KF	10 ... 500	34536	FENG-100-500-KF





Ordering data – Guide units for variable strokes

Data sheets → Internet: feng

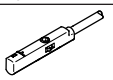
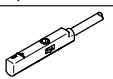
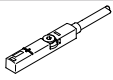
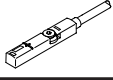
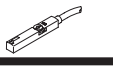

For diameter [mm]	Stroke [mm]	With recirculating ball bearing guide		With plain-bearing guide	
		Part no.	Type ¹⁾	Part no.	Type ¹⁾
32	10 ... 500	34487	FENG-32-...-KF	34481	FENG-32-...-GF
40	10 ... 500	34488	FENG-40-...-KF	34482	FENG-40-...-GF
50	10 ... 500	34489	FENG-50-...-KF	34483	FENG-50-...-GF
63	10 ... 500	34490	FENG-63-...-KF	34484	FENG-63-...-GF
80	10 ... 500	34491	FENG-80-...-KF	34485	FENG-80-...-GF
100	10 ... 500	34492	FENG-100-...-KF	34486	FENG-100-...-GF

1) Suitable for ATEX

Accessories

Ordering data – Proximity switches for T-slot, magneto-resistive						Data sheets → Internet: smt
	Type of mounting	Switching output	Electrical connection	Cable length [m]	Part no.	Type
N/O contact						
	Insertable in the slot from above, flush with the cylinder profile, short design	PNP	Cable, 3-wire	2.5	574335	SMT-8M-A-PS-24V-E-2.5-OE
			Plug M8x1, 3-pin	0.3	574334	SMT-8M-A-PS-24V-E-0.3-M8D
			Plug M12x1, 3-pin	0.3	574337	SMT-8M-A-PS-24V-E-0.3-M12
		NPN	Cable, 3-wire	2.5	574338	SMT-8M-A-NS-24V-E-2.5-OE
Plug M8x1, 3-pin	0.3		574339	SMT-8M-A-NS-24V-E-0.3-M8D		
N/C contact						
	Insertable in the slot from above, flush with the cylinder profile, short design	PNP	Cable, 3-wire	7.5	574340	SMT-8M-A-PO-24V-E-7.5-OE
Ordering data – Proximity switches for T-slot, magnetic reed						Data sheets → Internet: sme
	Type of mounting	Switching output	Electrical connection	Cable length [m]	Part no.	Type
N/O contact						
	Insertable in the slot from above, flush with the cylinder profile	Contacting	Cable, 3-wire	2.5	543862	SME-8M-DS-24V-K-2.5-OE
				5.0	543863	SME-8M-DS-24V-K-5.0-OE
			Plug M8x1, 3-pin	Cable, 2-wire	2.5	543872
		0.3		543861	SME-8M-DS-24V-K-0.3-M8D	
N/C contact						
	Insertable in the slot from above, flush with the cylinder profile	Contacting	Cable, 3-wire	7.5	546799	SME-8M-DO-24V-K-7.5-OE
Ordering data – Proximity sensor for T-slot, NAMUR						Data sheets → Internet: sdbt
	Type of mounting	Switching output	Electrical connection	Cable length [m]	Part no.	Type
N/O contact						
	Insertable in the slot from above, flush with the cylinder profile	NAMUR	Cable, 2-wire	5	579071	SDBT-MS-20NL-ZN-E-5-LE-EX6
				10	579072	SDBT-MS-20NL-ZN-E-10-LE-EX6
Ordering data – Safety clip for ATEX zone						
	Description	For size	Part no.	Type		
	<ul style="list-style-type: none"> Protects "equipment that is not intrinsically safe" against simple disconnection, here the plug of the proximity switch SMT and connecting cable NEBU ATEX category: gas: II 3G / dust: II 3D 	Plug M8x1	548067	NEAU-M8-GD		
Ordering data – Connecting cables						Data sheets → Internet: nebu
	Electrical connection, left	Electrical connection, right	Cable length [m]	Part no.	Type	
	Straight socket, M8x1, 3-pin	Cable, open end, 3-wire	2.5	541333	NEBU-M8G3-K-2.5-LE3	
			5	541334	NEBU-M8G3-K-5-LE3	
	Straight socket, M12x1, 5-pin	Cable, open end, 3-wire	2.5	541363	NEBU-M12G5-K-2.5-LE3	
			5	541364	NEBU-M12G5-K-5-LE3	
	Angled socket, M8x1, 3-pin	Cable, open end, 3-wire	2.5	541338	NEBU-M8W3-K-2.5-LE3	
			5	541341	NEBU-M8W3-K-5-LE3	
	Angled socket, M12x1, 5-pin	Cable, open end, 3-wire	2.5	541367	NEBU-M12W5-K-2.5-LE3	
			5	541370	NEBU-M12W5-K-5-LE3	

Accessories

Ordering data – Mounting kits for proximity switches SME/SMT-8				
	For diameter	Materials	Part no.	Type
	32 ... 100	Rail: anodised wrought aluminium alloy Screws: high-alloy stainless steel Free of copper and PTFE	537806	SMBZ-8-32/100
	125		1451483	DASP-M4-125-A

Ordering data – Mounting kit for proximity switches SME/SMT-8					Data sheets → Internet: smbr
	For diameter	Mounting	CRC ¹⁾	Part no.	Type
	32 ... 100	On the cylinder barrel using clamping strap	4	538937	SMBR-8-8/100-S6

1) Corrosion resistance class CRC 4 to Festo standard FN 940070

Particularly high corrosion stress. Outdoor exposure under extreme corrosive conditions. Parts exposed to aggressive media, e.g. in the chemical or food industries. Such applications may need to be safeguarded by special tests (→ also FN 940082), using appropriate media.

Position transmitter

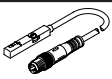
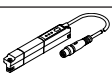

The position transmitter continuously senses the position of the piston.

It has an analogue output with an output signal in proportion to the piston position.

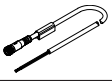
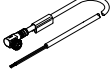
Ordering data – Position transmitters for T-slot								Data sheets → Internet: position transmitter	
	For diam.	Position measuring range	Analogue output		Type of mounting	Electrical connection	Cable length [m]	Part no.	Type
			[V]	[mA]					
	32 ... 125	0 ... 40	0 ... 10	–	Insertable in the slot from above	Plug M8x1, 4-pin, in-line	0.3	553744	SMAT-8M-U-E-0.3-M8D
	32 ... 125	0 ... 50	–	4 ... 20	Insertable in the slot from above	Plug M8x1, 4-pin, in-line	0.3	1531265	SDAT-MHS-M50-1L-SA-E-0.3-M8
		0 ... 80						1531266	SDAT-MHS-M80-1L-SA-E-0.3-M8
		0 ... 100						1531267	SDAT-MHS-M100-1L-SA-E-0.3-M8
		0 ... 125						1531268	SDAT-MHS-M125-1L-SA-E-0.3-M8
		0 ... 160						1531269	SDAT-MHS-M160-1L-SA-E-0.3-M8
		0 ... 50						8115394	SDAT-MHS-M50-1L-SV-E-0.3-M8

Ordering data – Connecting cables					Data sheets → Internet: nebu
	Electrical connection, left	Electrical connection, right	Cable length [m]	Part no.	Type
	Straight socket, M8x1, 4-pin	Cable, open end, 4-wire	2.5	541342	NEBU-M8G4-K-2.5-LE4
			5	541343	NEBU-M8G4-K-5-LE4
	Angled socket, M8x1, 4-pin	Cable, open end, 4-wire	2.5	541344	NEBU-M8W4-K-2.5-LE4
			5	541345	NEBU-M8W4-K-5-LE4

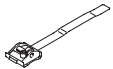
Accessories

Ordering data – Proximity switch in block design, pneumatic				Data sheets → Internet: smpo	
	Mounting	Pneumatic connection	Part no.	Type	
3/2-way valve, normally closed					
	Via accessories	Barbed fitting for tubing I.D. 3 mm	31008	SMPO-1-H-B	
Ordering data – Mounting kit for proximity switch SMPO-1				Data sheets → Internet: smbs	
	For diameter	Mounting	Part no.	Type	
	32 ... 100 mm	On the cylinder barrel using clamping strap	151226	SMBS-2	
Ordering data – One-way flow control valves				Data sheets → Internet: grla	
		Connection	Material	Part no.	Type
		Thread			
For exhaust air					
	G1/8	4	Metal design	193143	GRLA-1/8-QS-4-D
		6		193144	GRLA-1/8-QS-6-D
		8		193145	GRLA-1/8-QS-8-D
	G1/4	6		193146	GRLA-1/4-QS-6-D
		8		193147	GRLA-1/4-QS-8-D
		10		193148	GRLA-1/4QS-10-D
	G3/8	6		193149	GRLA-3/8-QS-6-D
		8		193150	GRLA-3/8-QS-8-D
		10		193151	GRLA-3/8-QS-10-D
	G1/2	12		193152	GRLA-1/2-QS-12-D

Festo - Your Partner in Automation



1 Festo Inc.
5300 Explorer Drive
Mississauga, ON L4W 5G4
Canada

Festo Customer Interaction Center
Tel: 1 877 463 3786
Fax: 1 877 393 3786
Email: customer.service.ca@festo.com



2 Festo Pneumatic
Av. Ceylán 3,
Col. Tequesquináhuac
54020 Tlalnepantla,
Estado de México

Multinational Contact Center
01 800 337 8669
ventas.mexico@festo.com



3 Festo Corporation
1377 Motor Parkway
Suite 310
Islandia, NY 11749

Festo Customer Interaction Center
1 800 993 3786
1 800 963 3786
customer.service.us@festo.com



4 Regional Service Center
7777 Columbia Road
Mason, OH 45040

Connect with us



www.festo.com/socialmedia



www.festo.com

Subject to change