

Proximity switches SIEN..., inductive

FESTO

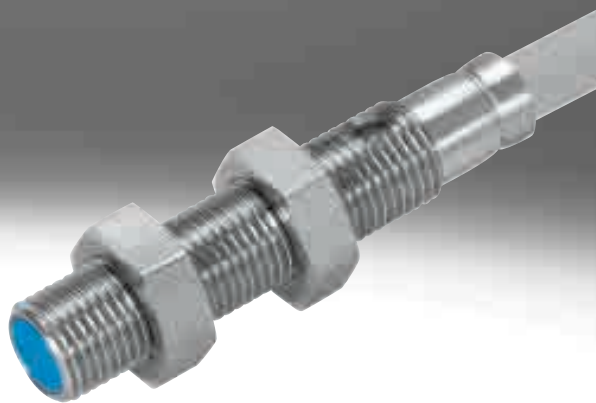

Festo Core Range
Solves the majority of your automation tasks

Worldwide: Quickest delivery – wherever, whenever
Simply good: Expected high Festo quality
Fast: Easy and fast to select

With the Festo Core Range, we have selected the most important products and functions from our broad product catalogue, and added the quickest delivery.

The Core Range offers you the best value for your automation tasks.

Just look
for the
star!

Product range overview

Design	Type	Operating voltage	Switching output/ analogue output	Type of installation	Size	→ Page
Reduction factor, material-specific						
Standard switching distance	SIEN Basic version	10 ... 30 V DC 15 ... 34 V DC	PNP NPN	Flush Not flush	∅ 4 mm, M5, ∅ 6.5 mm, M8, M12, M18, M30	5
	SIEN-...-PA Polyamide housing	10 ... 30 V DC	PNP NPN	Flush Not flush	M12, M18, M30	13
	SIED Basic version	20 ... 265 V AC 20 ... 320 V DC	Non-contacting, 2-wire	Flush Not flush	M12, M18, M30	–
	SIED-...-PA Polyamide housing	20 ... 250 V AC 10 ... 300 V DC	Non-contacting, 2-wire	Flush Not flush	M12, M18, M30	–
	SIES Special design	10 ... 30 V DC	PNP NPN	Flush	5x5x25 mm ... 40x40x120 mm	–
Increased switching distance	SIEH Basic version	10 ... 30 V DC 15 ... 34 V DC	PNP NPN	Flush	∅ 3 mm, M12, M18	–
	SIEH-...-CR Stainless steel housing	10 ... 30 V DC	PNP NPN	Flush	M12, M18	–
	Reduction factor 1 for all metals, welding-field-resistant					
Increased switching distance	SIEF Basic version	10 ... 65 V DC	PNP NPN	Flush Partially flush	M8, M12, M18, M30 40x40x65 mm	–
	SIEF-...-WA Housing resistant to welding spatter	10 ... 30 V DC	PNP NPN	Flush Partially flush	M12, M18, M30	–

Peripherals overview

SIE...

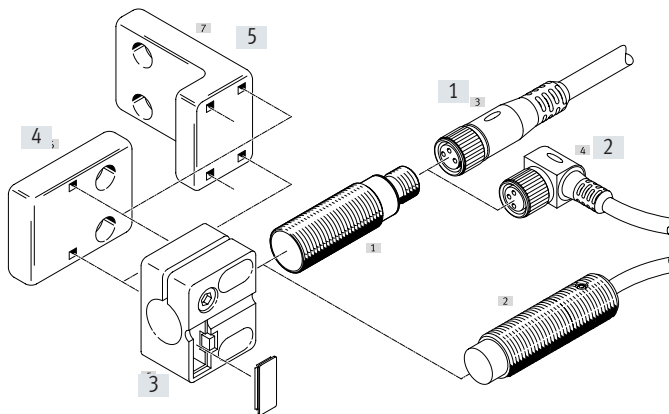

Mounting components and accessories		→ Page
[1]	Connecting cable, straight socket NEBU-M...G...	17
[2]	Connecting cable, angled socket NEBU-M...W...	17
[3]	Sensor bracket SIEZ-B...	17
[4]	Sensor bracket SIEZ-NB...	17
[5]	Sensor bracket SIEZ-UH	17
-	Mounting bracket HV-M5	17
Mounting components and accessories		→ Page
-	Foot mounting HBN	17
-	Flange mounting FBN	17
-	Stop SDA	17

Type codes

001	Series	
SIEN	Proximity sensor, inductive, with standard switching distance	

002	Design	
4	Round, diameter 4 mm	
6,5	Round, diameter 6.5 mm	
M5	M5	
M8	M8	
M12	M12	
M18	M18	
M30	M30	

003	Mounting type	
B	Flush	
NB	Not flush	

004	Switching input/output	
P	PNP	
N	NPN	

005	Switching element function	
O	N/C contact	
S	N/O contact	

006	Electrical connection	
S	Plug	
K	Open end	

007	Display	
L	Switching status	

008	Housing material	
	Standard	
PA	Polyamide housing	

Data sheet – Standard switching distance, basic version

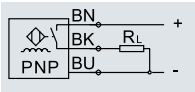
Function¹⁾

1) e.g. N/O contact with PNP output and cable

- Standard switching distance
- For DC voltage
- Round design

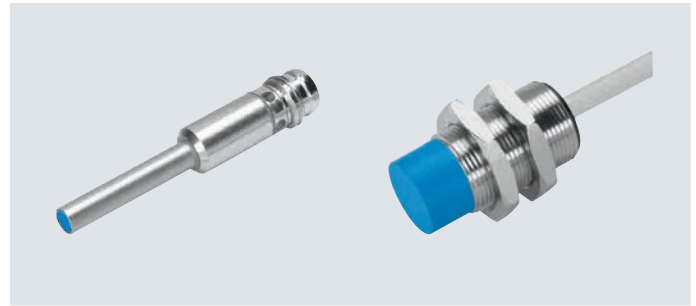

General technical data		4 mm	M5	6.5 mm	M8	M12	M18	M30			
Conforms to standard		EN 60947-5-2									
Certification		c UL us listed (OL) RCM trademark									
CE marking (see declaration of conformity)		To EU EMC Directive ¹⁾									
Note on materials		Free of copper and PTFE RoHS-compliant – Contains paint-wetting impairment substances									

1) For information about the area of use, see the EC declaration of conformity at: www.festo.com/sp → Certificates.
If the devices are subject to usage restrictions in residential, commercial or light-industrial environments, further measures for the reduction of the emitted interference may be necessary.

Input signal/measuring element	
Ambient temperature	[°C] –25 ... +70

Output, general		Flush							Not flush			
Type of installation												
Size		4 mm	M5	6.5 mm	M8	M12	M18	M30	M8	M12	M18	M30
Repetition accuracy	[mm]	0.04	0.04	0.07	0.07	0.1	0.25	0.5	0.12	0.2	0.4	0.75

Switching output		Flush							Not flush			
Type of installation												
Size		4 mm	M5	6.5 mm	M8	M12	M18	M30	M8	M12	M18	M30
Switching output		PNP							PNP			
		NPN							NPN			
Switching element function		N/O contact							N/O contact			
		N/C contact							N/C contact			
Rated operating distance	[mm]	0.8	0.8	1.5	1.5	2	5	10	2.5	4	8	15
Assured operating distance	[mm]	0.64	0.64	1.21	1.21	1.62	4.05	8.1	2.03	3.24	6.48	12.15

Reduction factors													
Aluminium		0.4	0.4	0.25	0.25	0.4	0.4	0.45	0.25	0.5	0.5	0.5	0.5
Stainless steel St18/8		0.7	0.7	0.7	0.7	0.6	0.8	0.8	0.7	0.9	0.8	0.85	0.85
Copper		0.3	0.3	0.2	0.2	0.3	0.4	0.4	0.2	0.5	0.4	0.43	0.43
Brass		0.4	0.4	0.35	0.35	0.5	0.5	0.55	0.35	0.6	0.5	0.53	0.53
Steel St 37		1.0	1.0	1.0	1.0	1.0	1.0	1.0	1.0	1.0	1.0	1.0	1.0
Hysteresis	[mm]	–	–	≤ 0.07	≤ 0.07	≤ 0.18	≤ 0.55	≤ 1.1	≤ 0.12	≤ 0.36	≤ 0.88	≤ 1.65	≤ 1.65
Max. switching frequency	[Hz]	3 000	3 000	5 000	5 000	3 000	2 000	1 200	3 000	2 000	2 000	700	700
Max. output current	[mA]	200											
Voltage drop	[V]	0 ... 2											

Data sheet – Standard switching distance, basic version

Output, additional data												
Size	4 mm	M5	6.5 mm	M8	M12	M18	M30					
Short circuit current rating	Pulsed											
Inductive protective circuit	Integrated											
Induced voltage protection	Integrated			-								
Electronics												
Size	4 mm	M5	6.5 mm	M8	M12	M18	M30					
Operating voltage range [V DC]	10 ... 30											
Residual ripple [%]	10			±10			±20					
Idle current [mA]	0 ... 10											
Reverse polarity protection	For all electrical connections											
Electromechanics												
Size	4 mm	M5	6.5 mm	M8	M12	M18	M30					
Cable												
Electrical connection	Cable, 3-wire											
Cable length [m]	2.5											
Information on materials: Cable sheath	TPE-U (PUR)											
Plug												
Electrical connection	Plug, M8x1, 3-pin	Plug, M8x1, 3-pin	Plug, M8x1, 3-pin	Plug, M8x1, 3-pin	Plug, M12x1, 3-pin	Plug, M12x1, 3-pin	Plug, M12x1, 3-pin					
Mechanics												
Size	4 mm	M5	6.5 mm	M8	M12	M18	M30					
Type of mounting	Clamped	With lock nut	Clamped	With lock nut								
Type of installation	Flush		Flush		Not flush	Flush	Not flush	Flush	Not flush	Flush	Not flush	
Tightening torque [Nm]	-	2	-	-	-	-	20	40				
Cable												
Product weight [g]	48	48	45	53	53	110	90	108	105	155	150	
Information on materials: Housing	High-alloy stainless steel					Nickel-plated brass				Chrome-plated brass		
	-	PA	-			-						
Information on materials: Housing	High-alloy stainless steel					-						
	-	-	Chrome-plated brass			Nickel-plated brass			Chrome-plated brass			
Information on materials: Housing	-					PBTP						
	-					PBTP						
Plug												
Product weight [g]	9	9	4	18	18	30	25	43	40	100	100	
Information on materials: Housing	High-alloy stainless steel					-						
	-	-	Chrome-plated brass			Nickel-plated brass			Chrome-plated brass			
Information on materials: Housing	-					PBTP						
	-					PBTP						
Display/operation												
Switching status indication	Yellow LED											

Data sheet – Standard switching distance, basic version

Immission/emission		4 mm	M5	6.5 mm	M8	M12	M18	M30
Ambient temperature with flexible cable installation	[°C]	-	-5 ... +70	-5 ... +70			-5 ... +70	
Degree of protection		-			IP65		-	
		IP67			IP67		IP67	
Surge resistance	[kV]	-	1	-			0.8	
Corrosion resistance class CRC ¹⁾		-	4	2			-	
Pollution degree		-	3	-			3	

- 1) Corrosion resistance class CRC 2 to Festo standard FN 940070
 Moderate corrosion stress. Indoor applications in which condensation can occur. External visible parts with primarily decorative surface requirements which are in direct contact with a normal industrial environment.
 Corrosion resistance class CRC 4 to Festo standard FN 940070
 Particularly high corrosion stress. Outdoor exposure under extreme corrosive conditions. Parts exposed to aggressive media, e.g. in the chemical or food industries.
 Such applications may need to be safeguarded by means of special testing (→ also FN 940082), using appropriate media.

Pin allocation to EN 60947-5-2				M8x1, 3-pin				M12x1, 3-pin			
N/O contact / N/C contact				N/O contact				N/C contact			
	Pin	Wire colour	Allocation		Pin	Wire colour	Allocation		Pin	Wire colour	Allocation
	1	Brown	+		1	Brown	+		1	Brown	+
	3	Blue	-		3	Blue	-		3	Blue	-
	4	Black	Output		4	Black	Output		2	White	Output

Dimensions – 4 mm

Download CAD data → www.festo.com

Flush installation

Cable SIEN-...-K-L

Plug SIEN-...-S-L

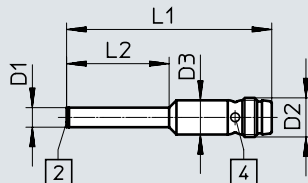
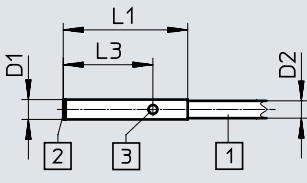

- [1] 3-wire cable, 2.5 m long
- [2] Active surface

- [3] 1 switching status indication, yellow
- [4] 4 switching status indications, yellow

Type	D1 ∅	D2 ∅	D2	D3 ∅	L1	L2	L3
SIEN-4B-...-K-L	4	3.5	-	-	25	-	18
SIEN-4B-...-S-L	4	-	M8x1	6.5	38	21	-

Data sheet – Standard switching distance, basic version

Dimensions – M5

Download CAD data → www.festo.com

Flush installation
Cable SIEN-...-K-L

Plug SIEN-...-S-L

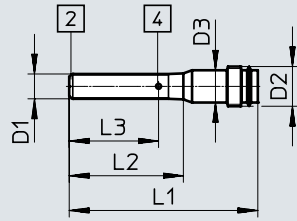
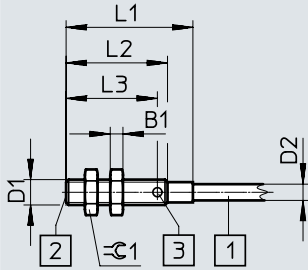

- [1] 3-wire cable, 2.5 m long
- [2] Active surface

- [3] 1 switching status indication, yellow
- [4] 1 switching status indication, yellow

Type	B1	D1	D2 ∅	D2	D3 ∅	L1	L2	L3	⊘ 1
SIEN-M5B-...-K-L	2.5	M5x0.5	3.5	-	-	25	20	18	7
SIEN-M5B-...-S-L	-	M5x0.5	-	M8x1	6.5	38	23	-	6.5

Dimensions – 6.5 mm

Download CAD data → www.festo.com

Flush installation
Cable SIEN-...-K-L

Plug SIEN-...-S-L

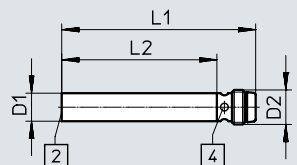
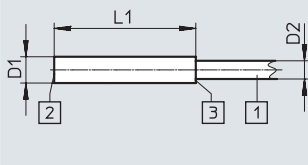

- [1] 3-wire cable, 2.5 m long
- [2] Active surface

- [3] 1 switching status indication, yellow
- [4] 4 switching status indication, yellow

Type	D1 ∅	D2 ∅	D2	L1	L2
SIEN-M6.5B-...-K-L	6.5	3.5	-	35	-
SIEN-M6.5B-...-S-L	6.5	-	M8x1	45	36

Dimensions – M8

Download CAD data → www.festo.com

Flush installation
Cable SIEN-...-K-L

Plug SIEN-...-S-L

Non-flush installation
Cable SIEN-M8NB-...-K-L

Plug SIEN-M8NB-...-S-L

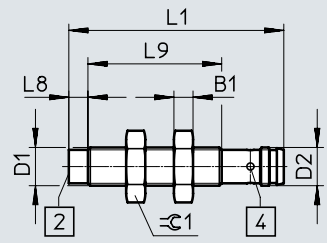
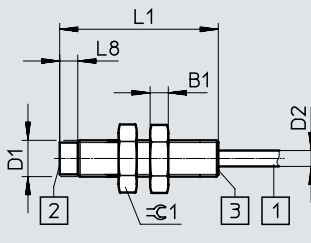
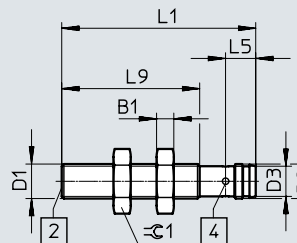
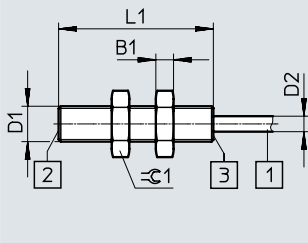

- [1] 3-wire cable, 2.5 m long
- [2] Active surface

- [3] 1 switching status indication, yellow
- [4] 4 switching status indications, yellow

- [1] 3-wire cable, 2.5 m long
- [2] Active surface

- [3] 1 switching status indication, yellow
- [4] 4 switching status indications, yellow

Type	B1	D1	D2 ∅	D2	L1	L5	L8	L9	⊘ 1
SIEN-M8B-...-K-L	4	M8x1	3.5	-	35	-	-	-	13
SIEN-M8B-...-S-L	4	M8x1	-	M8x1	45	7	-	32	13
SIEN-M8NB-...-K-L	4	M8x1	3.5	-	35	-	4	-	13
SIEN-M8NB-...-S-L	4	M8x1	-	M8x1	45	-	4	27.5	13

Data sheet – Standard switching distance, basic version

Dimensions – M12

Flush installation
Cable SIEN-...-K-L

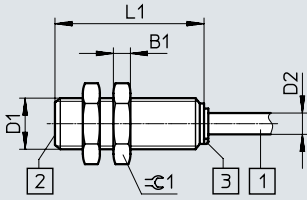

- [1] 3-wire cable, 2.5 m long
- [2] Active surface
- [3] 1 switching status indication, yellow

Plug SIEN-...-S-L

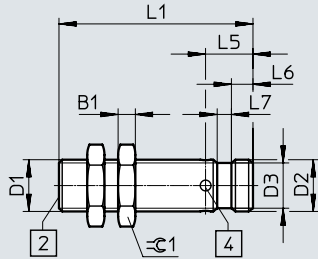

- [4] 4 switching status indications, yellow

Non-flush installation
Cable SIEN-M12NB-...-K-L

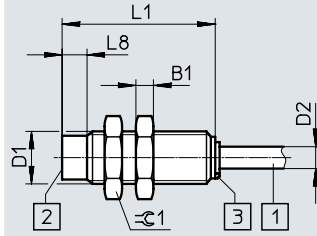

- [1] 3-wire cable, 2.5 m long
- [2] Active surface
- [3] 1 switching status indication, yellow

Download CAD data → www.festo.com

Plug SIEN-M12NB-...-S-L

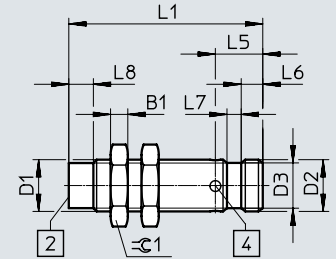

- [4] 4 switching status indications, yellow

Type	B1	D1	D2 ∅	D2	D3 ∅	L1	L5	L6	L7	L8	⊕ 1
SIEN-M12B-...-K-L	4	M12x1	5	-	-	35	-	-	-	-	17
SIEN-M12B-...-S-L	4	M12x1	-	M12x1	-	45	11	5	3.3	-	17
SIEN-M12NB-...-K-L	4	M12x1	5	-	-	35	-	-	-	5.7	17
SIEN-M12NB-...-S-L	4	M12x1	-	M12x1	10.5	45	11	5	3.3	5.7	17

Dimensions – M18

Flush installation
Cable SIEN-...-K-L

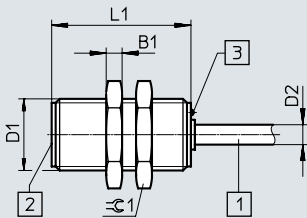

- [1] 3-wire cable, 2.5 m long
- [2] Active surface
- [3] 1 switching status indication, yellow

Plug SIEN-...-S-L

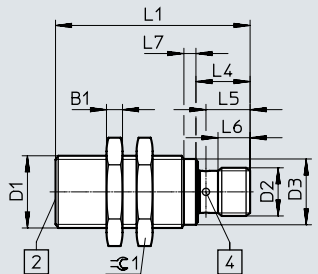

- [4] 4 switching status indications, yellow

Non-flush installation
Cable SIEN-M18NB-...-K-L

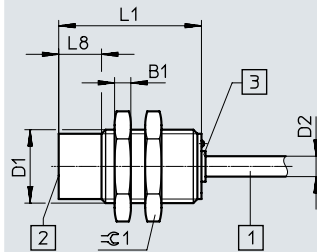

- [1] 3-wire cable, 2.5 m long
- [2] Active surface
- [3] 1 switching status indication, yellow

Download CAD data → www.festo.com

Plug SIEN-M18NB-...-S-L

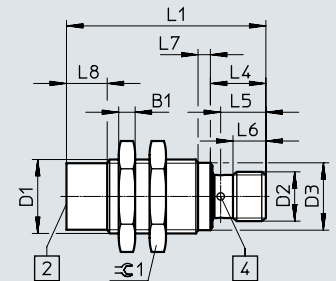

- [4] 4 switching status indications, yellow

Type	B1	D1	D2 ∅	D2	D3 ∅	L1	L4	L5	L6	L7	L8	⊕ 1
SIEN-M18B-...-K-L	4	M18x1	5	-	-	35	-	-	-	-	-	24
SIEN-M18B-...-S-L	4	M18x1	-	M12x1	16.4	48.5	13.5	11	8	3	-	24
SIEN-M18NB-...-K-L	4	M18x1	5	-	-	35	-	-	-	-	10	24
SIEN-M18NB-...-S-L	4	M18x1	-	M12x1	16.4	48.5	13.5	11	8	3	10	24

Data sheet – Standard switching distance, basic version

Dimensions – M30

Download CAD data → www.festo.com

Flush installation
Cable SIEN-...-K-L

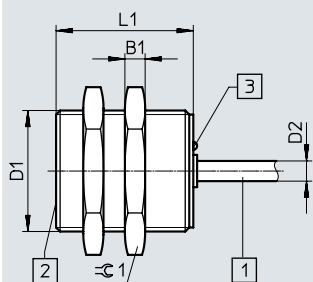

- [1] 3-wire cable, 2.5 m long
- [2] Active surface
- [3] 1 switching status indication, yellow

Plug SIEN-...-S-L

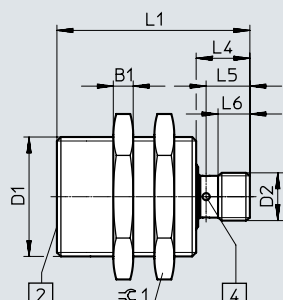

- [4] 4 switching status indications, yellow

Non-flush installation
Cable SIEN-M30NB-...-K-L

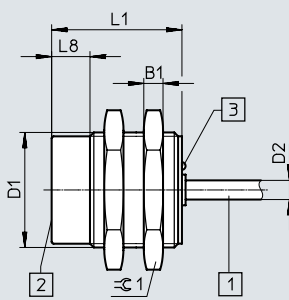

- [1] 3-wire cable, 2.5 m long
- [2] Active surface
- [3] 1 switching status indication, yellow

Plug SIEN-M30NB-...-S-L

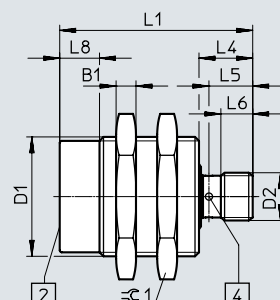

- [4] 4 switching status indications, yellow

Type	B1	D1	D2	D2	L1	L4	L5	L6	L8	∅ 1
SIEN-M30B-...-K-L	5	M30x1.5	5	-	35	-	-	-	-	36
SIEN-M30B-...-S-L	5	M30x1.5	-	M12x1	48.5	13.5	11	8	-	36
SIEN-M30NB-...-K-L	5	M30x1.5	5	-	35	-	-	-	10	36
SIEN-M30NB-...-S-L	5	M30x1.5	-	M12x1	48.5	13.5	11	8	10	36

Fitting instructions

Flush installation

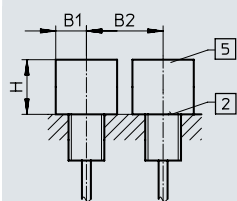

- [2] Active surface
- [5] Metal-free zone

Non-flush installation

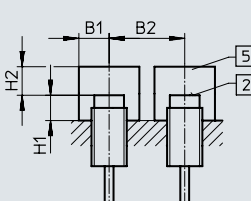



- [2] Active surface
- [5] Metal-free zone

Size	B1	B2	H
4 mm	2.5	5	2
M5	3.3	5	2.4
6.5 mm	5	9.5	4.5
M8	5.5	10	4.5
M12	8	18	6
M18	14	32	15
M30	25	60	30



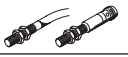

Size	B1	B2	H1	H2
M8	9	16	8	7.5
M12	12	28	6	12
M18	20	50	10	24
M30	30	75	15	45

Data sheet – Standard switching distance, basic version

★ Core product range



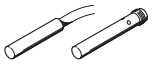



Ordering data								
Size	$S_n^{1)}$ [mm]	Type of installation	Switching output	Switching element function	Electrical connection			
					Cable		Plug	
					Part no.	Type	Part no.	Type
M5								
	0.8	Flush	PNP	N/O contact	★ 150370	SIEN-M5B-PS-K-L	★ 150371	SIEN-M5B-PS-S-L
			NPN	N/O contact	★ 150368	SIEN-M5B-NS-K-L	★ 150369	SIEN-M5B-NS-S-L
M8								
	1.5	Flush	PNP	N/O contact	★ 150386	SIEN-M8B-PS-K-L	★ 150387	SIEN-M8B-PS-S-L
			NPN	N/O contact	★ 150384	SIEN-M8B-NS-K-L	★ 150385	SIEN-M8B-NS-S-L

1) S_n Rated operating distance [mm]

Ordering data								
Size	$S_n^{1)}$ [mm]	Type of installation	Switching output	Switching element function	Electrical connection			
					Cable		Plug	
					Part no.	Type	Part no.	Type
4 mm								
	0.8	Flush	PNP	N/O contact	150362	SIEN-4B-PS-K-L	150363	SIEN-4B-PS-S-L
				N/C contact	150366	SIEN-4B-PO-K-L	150367	SIEN-4B-PO-S-L
			NPN	N/O contact	150360	SIEN-4B-NS-K-L	150361	SIEN-4B-NS-S-L
				N/C contact	150364	SIEN-4B-NO-K-L	150365	SIEN-4B-NO-S-L
M5								
	0.8	Flush	PNP	N/C contact	150374	SIEN-M5B-PO-K-L	150375	SIEN-M5B-PO-S-L
			NPN	N/C contact	150372	SIEN-M5B-NO-K-L	150373	SIEN-M5B-NO-S-L
6.5 mm								
	1.5	Flush	PNP	N/O contact	150378	SIEN-6.5B-PS-K-L	150379	SIEN-6.5B-PS-S-L
				N/C contact	150382	SIEN-6.5B-PO-K-L	150383	SIEN-6.5B-PO-S-L
			NPN	N/O contact	150376	SIEN-6.5B-NS-K-L	150377	SIEN-6.5B-NS-S-L
				N/C contact	150380	SIEN-6.5B-NO-K-L	150381	SIEN-6.5B-NO-S-L
M8								
	1.5	Flush	PNP	N/C contact	150390	SIEN-M8B-PO-K-L	150391	SIEN-M8B-PO-S-L
			NPN	N/C contact	150388	SIEN-M8B-NO-K-L	150389	SIEN-M8B-NO-S-L
	2.5	Not flush	PNP	N/O contact	150394	SIEN-M8NB-PS-K-L	150395	SIEN-M8NB-PS-S-L
				N/C contact	150398	SIEN-M8NB-PO-K-L	150399	SIEN-M8NB-PO-S-L
			NPN	N/O contact	150392	SIEN-M8NB-NS-K-L	150393	SIEN-M8NB-NS-S-L
				N/C contact	150396	SIEN-M8NB-NO-K-L	150397	SIEN-M8NB-NO-S-L

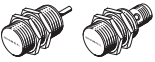
1) S_n Rated operating distance [mm]

Data sheet – Standard switching distance, basic version

Ordering data								
Size	S _n ¹⁾ [mm]	Type of installation	Switching output	Switching element function	Electrical connection			
					Cable		Plug	
					Part no.	Type	Part no.	Type
M12								
	2.0	Flush	PNP	N/O contact	150402	SIEN-M12B-PS-K-L	150403	SIEN-M12B-PS-S-L
				N/C contact	150406	SIEN-M12B-PO-K-L	150407	SIEN-M12B-PO-S-L
			NPN	N/O contact	150400	SIEN-M12B-NS-K-L	150401	SIEN-M12B-NS-S-L
				N/C contact	150404	SIEN-M12B-NO-K-L	150405	SIEN-M12B-NO-S-L
	4.0	Not flush	PNP	N/O contact	150410	SIEN-M12NB-PS-K-L	150411	SIEN-M12NB-PS-S-L
				N/C contact	150414	SIEN-M12NB-PO-K-L	150415	SIEN-M12NB-PO-S-L
			NPN	N/O contact	150408	SIEN-M12NB-NS-K-L	150409	SIEN-M12NB-NS-S-L
				N/C contact	150412	SIEN-M12NB-NO-K-L	150413	SIEN-M12NB-NO-S-L
M18								
	5.0	Flush	PNP	N/O contact	150418	SIEN-M18B-PS-K-L	150419	SIEN-M18B-PS-S-L
				N/C contact	150422	SIEN-M18B-PO-K-L	150423	SIEN-M18B-PO-S-L
			NPN	N/O contact	150416	SIEN-M18B-NS-K-L	150417	SIEN-M18B-NS-S-L
				N/C contact	150420	SIEN-M18B-NO-K-L	150421	SIEN-M18B-NO-S-L
	8.0	Not flush	PNP	N/O contact	150426	SIEN-M18NB-PS-K-L	150427	SIEN-M18NB-PS-S-L
				N/C contact	150430	SIEN-M18NB-PO-K-L	150431	SIEN-M18NB-PO-S-L
			NPN	N/O contact	150424	SIEN-M18NB-NS-K-L	150425	SIEN-M18NB-NS-S-L
				N/C contact	150428	SIEN-M18NB-NO-K-L	150429	SIEN-M18NB-NO-S-L
M30								
	10.0	Flush	PNP	N/O contact	150434	SIEN-M30B-PS-K-L	150435	SIEN-M30B-PS-S-L
				N/C contact	150438	SIEN-M30B-PO-K-L	150439	SIEN-M30B-PO-S-L
			NPN	N/O contact	150432	SIEN-M30B-NS-K-L	150433	SIEN-M30B-NS-S-L
				N/C contact	150436	SIEN-M30B-NO-K-L	150437	SIEN-M30B-NO-S-L
	15.0	Not flush	PNP	N/O contact	150442	SIEN-M30NB-PS-K-L	150443	SIEN-M30NB-PS-S-L
				N/C contact	150446	SIEN-M30NB-PO-K-L	150447	SIEN-M30NB-PO-S-L
			NPN	N/O contact	150440	SIEN-M30NB-NS-K-L	150441	SIEN-M30NB-NS-S-L
				N/C contact	150444	SIEN-M30NB-NO-K-L	150445	SIEN-M30NB-NO-S-L

1) S_n Rated operating distance [mm]

Data sheet – Standard switching distance, polyamide housing

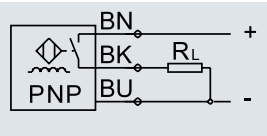
Function¹⁾

1) e.g. N/O contact with PNP output and cable

- Standard switching distance
- Corrosion-resistant
- Polyamide housing
- For DC voltage
- Round design

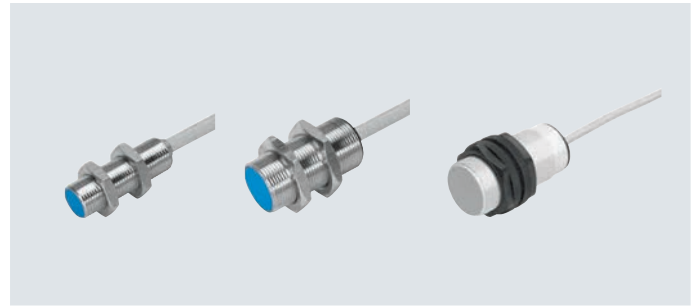

General technical data

Design	Round
Conforms to standard	EN 60947-5-2
Certification	c UL us listed (OL) RCM trademark
CE marking (see declaration of conformity)	To EU EMC Directive ¹⁾
Note on materials	Free of copper and PTFE

1) For information about the area of use, see the EC declaration of conformity at: www.festo.com/sp → Certificates.

If the devices are subject to usage restrictions in residential, commercial or light-industrial environments, further measures for the reduction of the emitted interference may be necessary.

Input signal/measuring element

Ambient temperature	[°C]	-25 ... +70
---------------------	------	-------------

Output, general

Type of installation	Flush			Not flush			
	Size	M12	M18	M30	M12	M18	M30
Repetition accuracy	[mm]	0.04	0.1	0.2	0.08	0.16	0.3

Switching output

Type of installation	Flush			Not flush			
	Size	M12	M18	M30	M12	M18	M30
Switching output	PNP			PNP			
	NPN			NPN			
Switching element function	N/O contact			N/O contact			
Rated operating distance	[mm]	2	5	10	4	8	15
Assured operating distance	[mm]	1.62	4.05	8.1	3.24	6.48	12.15

Reduction factors

Aluminium		0.35 ... 0.5			0.35 ... 0.5		
Stainless steel St18/8		0.6 ... 1.0			0.6 ... 1.0		
Copper		0.25 ... 0.45			0.25 ... 0.45		
Brass		0.35 ... 0.5			0.35 ... 0.5		
Steel St 37		1.0			1.0		
Hysteresis	[mm]	0.06 ... 0.3	0.15 ... 0.75	0.3 ... 1.5	0.12 ... 0.6	0.24 ... 1.2	0.45 ... 2.25
Max. switching frequency DC	[Hz]	2 000	1 000	500	2 000	1 000	500
Max. output current	[mA]	200			200		
Voltage drop	[V]	≤ 1.8			≤ 1.8		

Output, additional data

Short circuit current rating		Pulsed
------------------------------	--	--------

Data sheet – Standard switching distance, polyamide housing

Electronics						
Operating voltage range	[V DC]	10 ... 30				
Residual ripple	[%]	10				
Idle current	[mA]	≤ 15				
Reverse polarity protection		For all electrical connections				
Electromechanics						
Electrical connection		Cable, 3-wire				
Cable length	[m]	2.5				
Information on materials: Cable sheath		PVC				
Information on materials: Insulating sheath		PVC				
Mechanics						
Size		M12	M18		M30	
Type of mounting		With lock nut				
Type of installation		Flush	Not flush	Flush	Not flush	Flush
Tightening torque	[Nm]	–	25	–	25	15
Product weight	[g]	41	38	124	141	48
Information on materials: Housing		Reinforced PA				
Display/operation						
Switching status indication		Yellow LED				
Immission/emission						
Type of installation		Flush		Not flush		
Size		M12	M18	M30	M12	M18
Ambient temperature with flexible cable installation	[°C]	0 ... +70			0 ... +70	
Degree of protection		IP65			IP67	
		IP67				
Corrosion resistance class CRC ¹⁾		4			4	

1) Corrosion resistance class CRC 4 to Festo standard FN 940070

Particularly high corrosion stress. Outdoor exposure under extreme corrosive conditions. Parts exposed to aggressive media, e.g. in the chemical or food industries. Such applications may need to be safeguarded by means of special testing (→ also FN 940082), using appropriate media.

Data sheet – Standard switching distance, polyamide housing

Dimensions

Download CAD data → www.festo.com

M12

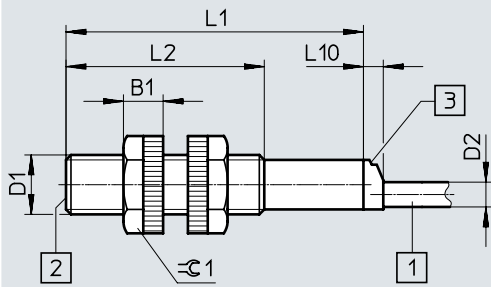

- [1] 3-wire cable, 2.5 m long
- [2] Active surface
- [3] 1 switching status indication, yellow

M18

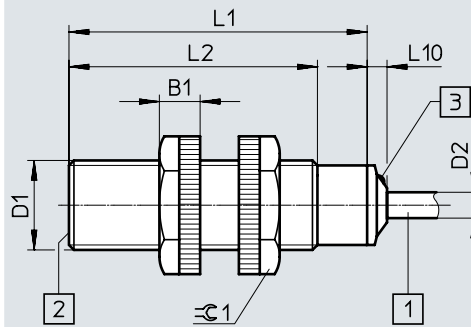

- [1] 3-wire cable, 2.5 m long
- [2] Active surface
- [3] 1 switching status indication, yellow

Type	B1	D1	D2 ∅	L1	L2	L10	∠ 1
SIEN-M12-...-B-...-K-L-PA	8	M12x1	5	60	40	4	17
SIEN-M18-...-B-...-K-L-PA	8.2	M18x1	5.2	60	50	4	24

Dimensions

Download CAD data → www.festo.com

M30

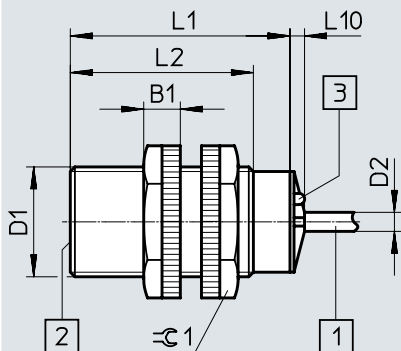

- [1] 3-wire cable, 2.5 m long
- [2] Active surface
- [3] 1 switching status indication, yellow

Type	B1	D1	D2 ∅	L1	L2	L10	∠ 1
SIEN-M30-...-B-...-K-L-PA	10	M30x1.5	5	60	50	4	36

Data sheet – Standard switching distance, polyamide housing

Fitting instructions

Flush installation

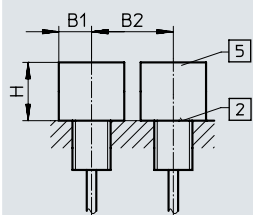

[2] Active surface
[5] Metal-free zone

Non-flush installation

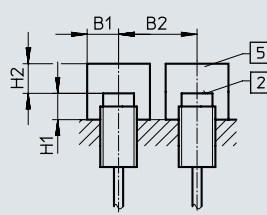



[2] Active surface
[5] Metal-free zone

Size	B1	B2	H
M12	18	24	6
M18	27	36	15
M30	45	60	30



Size	B1	B2	H1	H2
M12	18	36	8	12
M18	27	54	16	24
M30	45	90	30	45



Ordering data

Size	S _n ¹⁾ [mm]	Type of installation	Switching output	Switching element function	Electrical connection	
					Cable Part no.	Type
M12						
	2.0	Flush	PNP	N/O contact	538323	SIEN-M12B-PS-K-L-PA
			NPN		538324	SIEN-M12B-NS-K-L-PA
	4.0	Not flush	PNP		538329	SIEN-M12NB-PS-K-L-PA
			NPN		538330	SIEN-M12NB-NS-K-L-PA
M18						
	5.0	Flush	PNP	N/O contact	538325	SIEN-M18B-PS-K-L-PA
			NPN		538326	SIEN-M18B-NS-K-L-PA
	8.0	Not flush	PNP		538331	SIEN-M18NB-PS-K-L-PA
			NPN		538332	SIEN-M18NB-NS-K-L-PA
M30						
	10.0	Flush	PNP	N/O contact	538327	SIEN-M30B-PS-K-L-PA
			NPN		538328	SIEN-M30B-NS-K-L-PA
	15.0	Not flush	PNP		538333	SIEN-M30NB-PS-K-L-PA
			NPN		538334	SIEN-M30NB-NS-K-L-PA





1) S_n Rated operating distance [mm]

Accessories





Ordering data – Connecting cables M8x1				Data sheets → Internet: nebu
	Number of wires	Cable length [m]	Part no.	Type
Straight socket				
	3	2.5	★ 541333	NEBU-M8G3-K-2.5-LE3
		5	★ 541334	NEBU-M8G3-K-5-LE3
Angled socket				
	3	2.5	★ 541338	NEBU-M8W3-K-2.5-LE3
		5	★ 541341	NEBU-M8W3-K-5-LE3

Ordering data – Connecting cables M12x1				Data sheets → Internet: nebu
	Number of wires	Cable length [m]	Part no.	Type
Straight socket				
	3	2.5	★ 541363	NEBU-M12G5-K-2.5-LE3
		5	★ 541364	NEBU-M12G5-K-5-LE3
	4	2.5	★ 550326	NEBU-M12G5-K-2.5-LE4 ¹⁾
		5	★ 541328	NEBU-M12G5-K-5-LE4 ¹⁾
Angled socket				
	3	2.5	541367	NEBU-M12W5-K-2.5-LE3
		5	541370	NEBU-M12W5-K-5-LE3
	4	2.5	550325	NEBU-M12W5-K-2.5-LE4 ¹⁾
		5	541329	NEBU-M12W5-K-5-LE4 ¹⁾

1) For connecting proximity switches SIE...-M12/M18/M30 in N/C contact version with plug.

Ordering data – Mounting components			
	For size	Part no.	Type
Sensor bracket with stop for flush mounting			
	M8	538346	SIEZ-B-8
	M12	538348	SIEZ-B-12
	M18	538350	SIEZ-B-18
	M30	538352	SIEZ-B-30
Sensor bracket without stop			
	4	538343	SIEZ-NB-4
	6.5	538344	SIEZ-NB-6.5
	M8	538345	SIEZ-NB-8
	M12	538347	SIEZ-NB-12
	M18	538349	SIEZ-NB-18
	M30	538351	SIEZ-NB-30
	M12, M18	538354	SIEZ-UH

Accessories

Ordering data – Mounting components		Part no.	Type
	For size		
Foot mounting			
	M12	5123	HBN-8/10X1
Flange mounting			
	M30	195855	FBN-32
Mounting bracket			
	SIES-V3B	9634	HV-M5
Stop			
	M8	11542	SDA-8x1-B
	M12	11541	SDA-12x1-B

Festo - Your Partner in Automation



1 Festo Inc.
5300 Explorer Drive
Mississauga, ON L4W 5G4
Canada

Festo Customer Interaction Center
Tel: 1 877 463 3786
Fax: 1 877 393 3786
Email: customer.service.ca@festo.com



2 Festo Pneumatic
Av. Ceylán 3,
Col. Tequesquináhuac
54020 Tlalnepantla,
Estado de México

Multinational Contact Center
01 800 337 8669
ventas.mexico@festo.com



3 Festo Corporation
1377 Motor Parkway
Suite 310
Islandia, NY 11749

Festo Customer Interaction Center
1 800 993 3786
1 800 963 3786
customer.service.us@festo.com



4 Regional Service Center
7777 Columbia Road
Mason, OH 45040

Connect with us



www.festo.com/socialmedia



www.festo.com

Subject to change