

Butterfly valve units KVZA



Butterfly valve units KVZA

Key features

At a glance

The new configurator supports you with requests for customised process valve units, and supports the engineering department with

processing these requests. It is now possible to find, select, size and order process valve units without waiting times. Access to

prices and delivery times is provided immediately after configuration. Configuration-compatible data sheets are also available, as

well as 2D -CAD data and 3D -CAD models in many native and neutral formats. The complete units of course also come with certificates.

Innovative

- The new configurator provides support throughout the entire process, from searching for products to ordering
- Configuration, sizing, documentation, RFQ, ordering and delivery of the process valve unit are combined in a single tool

Function

- Direct link to the Festo Online Shop
- User-friendly user interface
- Advice on solutions
- Specific 2D/3D CAD files available for download after configuration
- Configuration-compatible bill of materials available for download
- Delivery date query possible

Possible variants

Butterfly valve type, wafer



Hand lever



Butterfly valve type, lug



Quarter turn actuator



Butterfly valve units KVZA

Key features

Possible variants

Quarter turn actuator, pilot valve



Quarter turn actuator, sensor box



Quarter turn actuator, opto-electronic sensor box



Quarter turn actuator, optical position indicator



Quarter turn actuator, pilot valve, sensor box



Quarter turn actuator, pilot valve, opto-electronic sensor box



Quarter turn actuator, pilot valve, optical position indicator



Quarter turn actuator, positioner



Ordering data – Product options

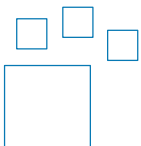

Configurable product
This product and all its product options can be ordered using the configurator.

The configurator can be found under Products on the DVD or
→ www.festo.com/catalogue/...

Part No. Type code
8073655 **KVZA**

Butterfly valve units KVZA

Peripherals overview using a sample configuration

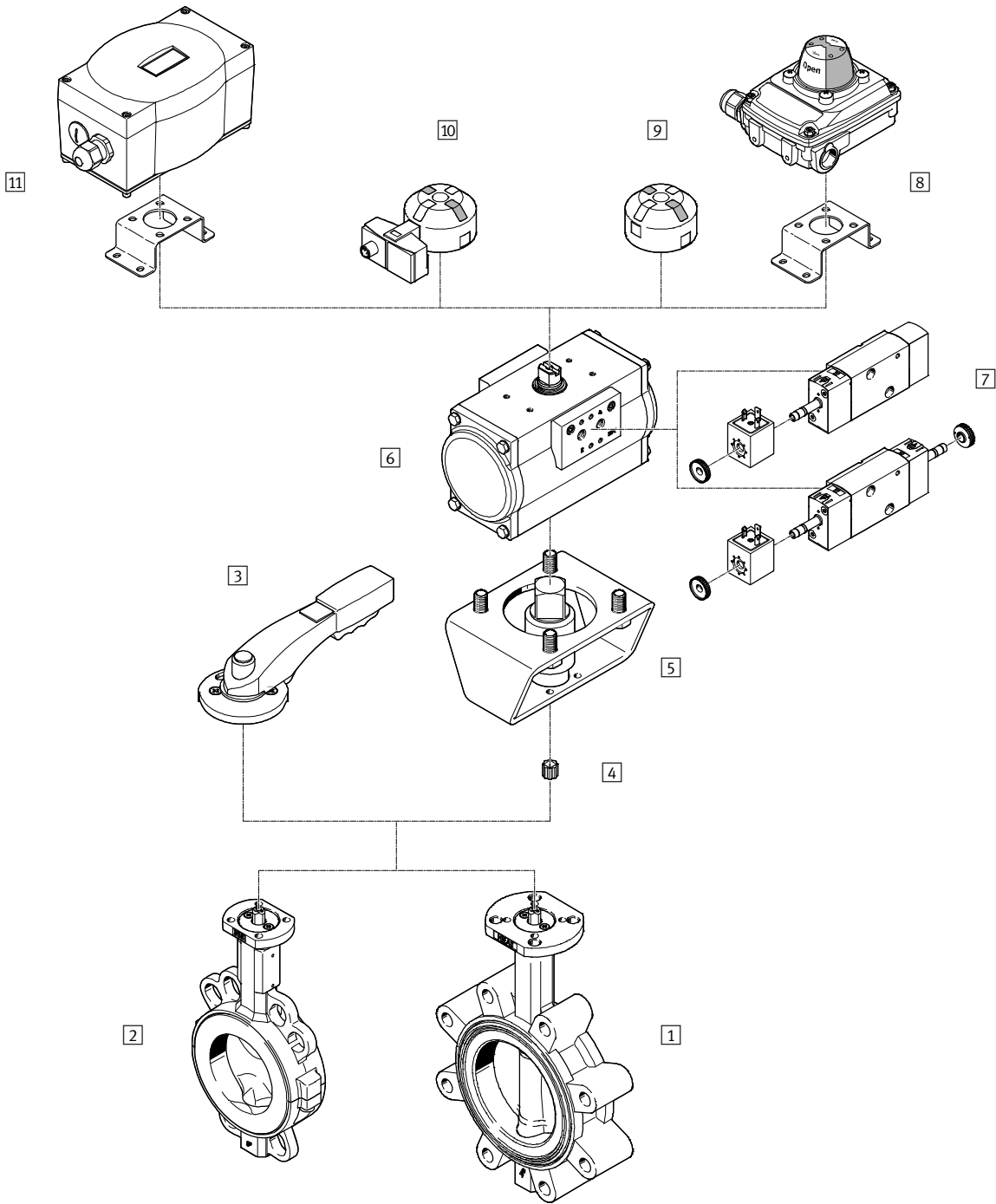

Butterfly valve units KVZA

Peripherals overview using a sample configuration

System components			
	Brief description	→ Page/ Internet	
1	Butterfly valves VZAV	In wafer or lug versions, in nominal widths DN25 ... DN300, with connection standards DIN EN 1092-1 or ASME B 16.5 Class 150	vzav
2	Butterfly valves VZAF	In wafer or lug versions, in nominal widths DN25 ... DN300, with connection standards DIN EN 1092-1 or ASME B 16.5 Class 150	vzaf
3	Hand lever VAOH	For manual actuation of butterfly valves, with lock, detenting in 10 positions	vaoh
4	Reducing sleeve squares DARQ-R	For adjustment of butterfly valves	darq
5	Mounting kits DARQ-K	For connecting quarter turn actuators and butterfly valves	darq
6	Quarter turn actuators DFPD	In single-acting or double-acting version, features a rack and pinion combination with a constant torque characteristic across the entire swivel range, connection pattern to VDI/VDE 3845	dfpd
7	Solenoid valves VSNV	Pilot valves with solenoid coils VACF for single-acting and double-acting quarter turn actuators with a connection pattern to VDI/VDE 3845, conversion from 3/2-way to 5/2-way valve simply by turning the seal	vsnc
8	Sensor boxes SRBC	For electrical position feedback and monitoring the position of process valves, with mounting adapter, sturdy, corrosion-resistant design, clearly visible 3D position indicator allows rapid detection of the current position of the quarter turn actuator	srbc
9	Position indicators SASF	The compact solution, direct mounting means that they require minimal space, with four fixed actuating lugs at intervals of 90°	sasf
10	Sensor boxes SRBG	For electrical position feedback and monitoring the position of process valves, mounted directly without other accessories on quarter turn actuators with connection pattern to VDI/VDE 3845, with M12 plug or terminal rail connection	srbg
11	Positioners CMSX	Based on the PID control algorithm, for controlling the position of single-acting and double-acting pneumatic quarter turn actuators, with mechanical interface to VDI/VDE 3845	cmsx

Butterfly valve units KVZA

System components

Ordering using the configurator

The configurator for butterfly valve units comprises a number of tried and tested components from Festo. The scope and specifications can be selected on the "System", "Valve & medium", "Application" and "Additional electrical specifications" pages.

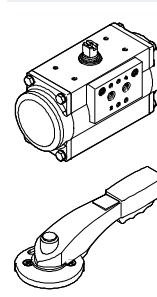

System components	Description	Technical data
-------------------	-------------	----------------

<p>Actuation</p> 	<ul style="list-style-type: none"> • Automatic actuation via a pneumatic quarter turn actuator • Manual actuation possible using a hand lever 	
--	---	--

Application	<p>Controlled</p> <ul style="list-style-type: none"> • The desired position of the process valve is specified via an analogue positioning signal, e.g. 4 ... 20 mA <p>Open/Closed</p> <ul style="list-style-type: none"> • The process valve is moved into both end positions 	
-------------	---	--

Position indicator	<p>Shows the current end position of the process valve unit</p> <ul style="list-style-type: none"> • Optically via a mechanical, inductive or magnetic sensor box, mounted using a mounting adapter • Optically via a position indicator, directly mounted on the quarter turn actuator • Optically/electrically via an inductive dual sensor with M12 connection or terminal rail connection, directly mounted on the quarter turn actuator 	
--------------------	---	--

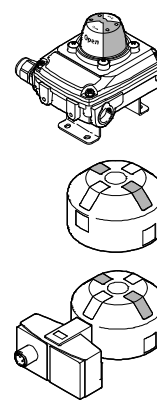
		
---	--	--

Pilot valve	<p>The pneumatic pilot valve is mounted using the NAMUR interface, either on a valve terminal, which can be housed in a control cabinet, for example, or directly on the actuator.</p>	
-------------	--	--

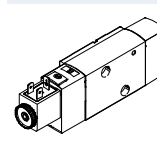
		
---	--	--

Butterfly valve units KVZA

System components

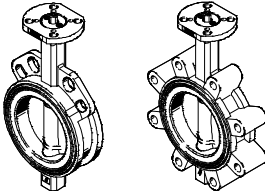
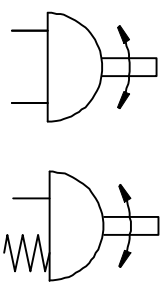
System components	Description	Technical data
<p>Butterfly valve type</p> 	<p>Wafer</p> <ul style="list-style-type: none"> • With centring holes for installation between two pipe flanges, extremely lightweight housing <p>Lug</p> <ul style="list-style-type: none"> • With threaded flange holes for installation between two pipe flanges or at the end of a pipeline, one-sided disconnection possible 	<ul style="list-style-type: none"> • Nominal diameter DN25 ... DN300 • Nominal diameter 1" ... 12"
Shut-off element material	<p>Ductile cast iron, PA coated</p> <ul style="list-style-type: none"> • Ductile cast iron with polyamide coating is used to refine and protect metallic surfaces, is highly resistant to wear and exhibits excellent insulation properties <p>Stainless steel, PFA coated</p> <ul style="list-style-type: none"> • The perfluoroalkoxy alkane coating is resistant to aggressive organic and inorganic chemicals as well as solvents across a wide temperature range <p>Stainless steel</p> <ul style="list-style-type: none"> • Suitable for extracting almost all organic fluids, 50% caustic soda up to 90 °C, cathodic dip coating, pure phosphoric acid, dry chlorine, liquid sulphur, PSA and many other media 	<ul style="list-style-type: none"> • Ductile cast iron EN-GJS-400-15, PA coated 250 μ • Stainless steel 1.4408, PFA coated • Stainless steel 1.4408
Sealing element material	<p>EPDM</p> <ul style="list-style-type: none"> • Resistant to acids and alkalis, water, hot water and vapour, not resistant to oil and grease <p>NBR</p> <ul style="list-style-type: none"> • Can be used for oils, greases, fuel, oil gas, CO₂, CO and H₂ <p>PTFE/silicone</p> <ul style="list-style-type: none"> • Excellent chemical resistance, electrical properties, great resistance to high and low temperatures, and exceptional adhesion and flame resistance, with silicone base layer for standard applications 	
Mode of operation	 <p>Double-acting</p> <ul style="list-style-type: none"> • The double-acting quarter turn actuator requires compressed air for every direction of movement. In this operating mode, the torque for opening or closing the process valve is generated purely via the compressed air <p>Single-acting</p> <ul style="list-style-type: none"> • In the single-acting quarter turn actuator, the incoming compressed air moves the piston in one direction. This generates the torque of the actuator. At the same time, the springs installed in the actuator are pretensioned. This spring force generates torque in the opposite direction of rotation when the pressure chambers of the actuator are exhausted. This causes the process valve to move to the required initial position 	

Butterfly valve units KVZA

System components

System components	Description	Technical data														
Safety function	<p>Closing</p> <ul style="list-style-type: none"> In the event of a system crash (failure of the operating voltage supply or compressed air), the process valve is closed. <p>Opening</p> <ul style="list-style-type: none"> In the event of a system crash (failure of the operating voltage supply or compressed air), the process valve is opened. <p>Maintain position</p> <ul style="list-style-type: none"> In the event of a system crash (failure of the operating voltage supply or compressed air), the process valve is held in the current position. This means the quarter turn actuator must be pressurised on both sides. 															
Operating pressure	The operating pressure available for actuating the quarter turn actuator.	<ul style="list-style-type: none"> 2 ... 8 bar 														
Safety factor	<p>The specification of a safety factor is recommended when configuring a quarter turn actuator because this increases the torque reserve available.</p> <table border="1"> <thead> <tr> <th rowspan="2">Pipeline medium</th> <th colspan="2">Safety factor</th> </tr> <tr> <th>Ball valves</th> <th>Butterfly valves</th> </tr> </thead> <tbody> <tr> <td>Liquid</td> <td>1.2</td> <td>1.35</td> </tr> <tr> <td>Sticky/viscous</td> <td>1.6</td> <td>1.75</td> </tr> <tr> <td>Gaseous</td> <td>1.5</td> <td>1.5</td> </tr> </tbody> </table>	Pipeline medium	Safety factor		Ball valves	Butterfly valves	Liquid	1.2	1.35	Sticky/viscous	1.6	1.75	Gaseous	1.5	1.5	
Pipeline medium	Safety factor															
	Ball valves	Butterfly valves														
Liquid	1.2	1.35														
Sticky/viscous	1.6	1.75														
Gaseous	1.5	1.5														
Closing torque factor	<p>Specification is optional</p> <ul style="list-style-type: none"> The torque required for actuating the process valve is at its greatest at the start of the movement (breakaway torque). The closing torque of the process valve may be smaller than the breakaway torque under certain conditions. If this difference is known, it can be taken into account by specifying a closing torque factor. 															
High corrosion resistance	Higher corrosion resistance through epoxy coating of the pneumatic quarter turn actuator, the drive shaft is stainless steel.															
Nominal operating voltage	Configuration-dependent specification required, e.g. when selecting a position indicator or a pilot valve.	<ul style="list-style-type: none"> 24 V DC 250 V AC 110 V AC/50 ... 60 Hz 														

Butterfly valve units KVZA

Technical data

- Butterfly valves nominal diameter DN25 ... DN300 or 1" ... 12"
- Swivel angle 0 ... 90°
- Medium pressure 10 ... 16 bar
- Operating pressure 2 ... 8 bar
- Safety factor 0 ... 2



General technical data	
Product weight	[kg] 1 ... 140
Operating and environmental conditions	
Note on materials	Contains paint-wetting impairment substances
	RoHS-compliant

Festo - Your Partner in Automation



1 Festo Inc.
5300 Explorer Drive
Mississauga, ON L4W 5G4
Canada

Festo Customer Interaction Center
Tel: 1 877 463 3786
Fax: 1 877 393 3786
Email: customer.service.ca@festo.com

2 Festo Pneumatic
Av. Ceylán 3,
Col. Tequesquináhuac
54020 Tlalneantla,
Estado de México

Multinational Contact Center
01 800 337 8669
ventas.mexico@festo.com

3 Festo Corporation
1377 Motor Parkway
Suite 310
Islandia, NY 11749

Festo Customer Interaction Center
1 800 993 3786
1 800 963 3786
customer.service.us@festo.com

4 Regional Service Center
7777 Columbia Road
Mason, OH 45040

Connect with us



www.festo.com/socialmedia



www.festo.com

Subject to change