

## Motor controllers CMMP-AS, for servo motors

**FESTO**

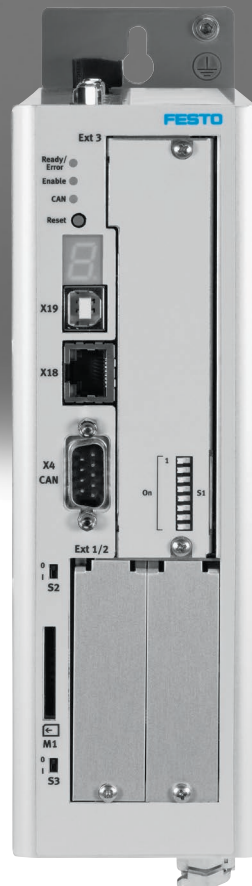

Festo core product range  
Covers 80% of your automation tasks

Worldwide:  
Superb:  
Easy:

Always in stock  
Festo quality at an attractive price  
Simplified procurement and warehousing

- ★ Generally ready for dispatch from the factory within 24 hours  
In stock at 13 Service Centres worldwide  
More than 2200 products
- ★ Generally ready for dispatch from the factory within 5 days  
Assembled for you in 4 Service Centres worldwide  
Up to  $6 \times 10^{12}$  variants per product family

Just look  
for the  
star!

## Key features

### Features

#### Compact

- Extremely small dimensions
- Full integration of all components for the controller and power unit, including USB interface, Ethernet and CANopen interface
- Integrated brake chopper
- Integrated EMC filters
- Automatic actuation for a holding brake
- Compliance with the current CE and EN standards without additional external measures (→ page 6)

#### Motion control

- Evaluation of digital absolute encoders (EnDat/HIPERFACE) in single-turn or multi-turn versions
- Can be operated as a torque, rotational speed or position controller
- Integrated positioning control
- Time-optimised (trapezoidal) or jerk-free (S-shaped) positioning
- Absolute and relative movements
- Point-to-point positioning with and without motion path smoothing
- Position synchronisation
- Electronic gear unit
- 255 position sets
- Wide range of homing methods

#### Bus protocols

**CANopen**

**EtherCAT**

**PROFI  
BUS**

**EtherNet/IP**

**DeviceNet**  
CONFORMANCE TESTED

**PROFI  
NET**

**Modbus**

#### Input/output

- Freely programmable I/Os
- High-resolution 16-bit analogue input
- Jog/teach mode
- Easy connection to a higher-order controller via I/O or fieldbus
- Synchronous operation
- Master/slave mode
- Additional I/Os with the plug-in card CAMC-D-8E8A → page 18

#### Integrated sequence control

- Automatic sequence of position sets without a higher-level controller
- Linear and cyclical position sequences
- Adjustable delay times
- Branches and wait positions
- Overlapping restart possible during the movement

#### Integrated safety functions

- Depending on the variant or plug-in card, the motor controller supports the following safety functions:
  - Safe torque off (STO)
  - Safe stop 1 (SS1)
  - Safe brake control (SBC)
  - Safe operating stop (SOS)
  - Safe stop 2 (SS2)
  - Safely limited speed (SLS)
  - Safe speed range (SSR)
  - Safe speed monitor (SSM)

#### Interpolating multi-axis movement

- With a suitable controller, the CMMP-AS can perform path movements with interpolation via CANopen or EtherCAT. To do this, the controller specifies set-point position values in a fixed time pattern. In between, the servo position controller independently interpolates the data values between two interpolation points.

## Key features

### Motion program

- Linking of any number of position sets into a motion program
- Step enabling conditions for the motion program possible via digital inputs, for example
  - MC – motion complete
  - I/O – digital inputs

### Library for EPLAN

→ [www.festo.com/eplan](http://www.festo.com/eplan)



EPLAN macros for fast and reliable planning of electrical projects in combination with motor controllers, motors and cables. This enables a high level of planning reliability and standardisation of documentation without the need to create symbols, graphics and master data.

### Cam disc functionality

The "electronic cam disc" application type creates optimised motion profiles that generate less vibration and lower acceleration forces at the machine. In addition, the movement of the motor is always synchronised with the position of a master axis so that overlapping, time-optimised motion sequences can be easily defined. To be able to use the cam disc function, you will need the Festo Configuration Tool (FCT) and also the cam editor → Page 4.

Key features:

- High flexibility of the system. The mechanical system does not need to be modified if the requirements for the cam shapes change.
- User-friendly motion plan editor. All limits for position, speed and acceleration are immediately displayed in the editor. Up to 16 cam discs with a total of up to 2048 interpolation points can be managed. The interpolation points can be randomly distributed along the cam discs.
- There are four digital trip cams coupled with each cam disc.
- Each cam disc can be offset by a certain amount from the master axis.

## Key features

### FCT software – Festo Configuration Tool

Software platform for electric drives from Festo

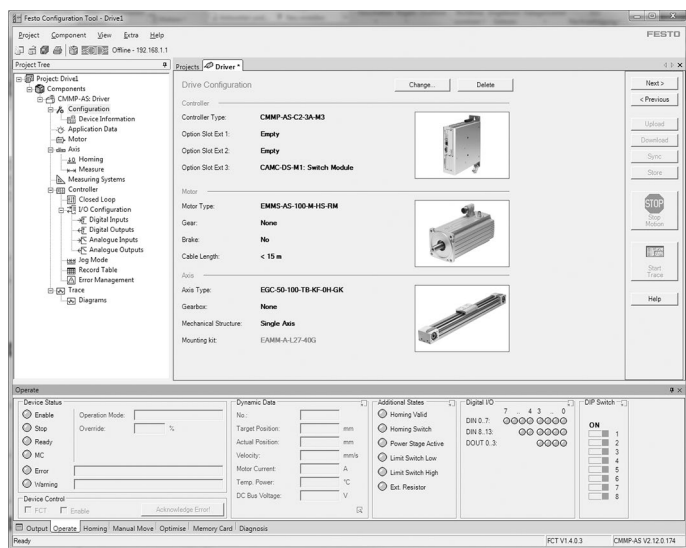

- All drives in a system can be managed and saved in a common project
- Project and data management for all supported types of equipment
- Easy to use thanks to graphically supported parameter entry
- Universal mode of operation for all drives
- Work offline at your desk or online at the machine

### FHPP – Festo Handling and Positioning Profile

Optimised data profile

Festo has developed an optimised data profile, the "Festo Handling and Positioning Profile (FHPP)", which is specifically tailored to handling and positioning applications.

With the FHPP data profile, Festo motor controllers can be controlled using a fieldbus interface via standardised control and status bytes.

The following are defined, among others:

- Operating modes
- I/O data structure
- Parameter objects
- Sequence control

Product range overview and type codes

Type	CMMP-AS-...-M0	CMMP-AS-...-M3
<b>Bus protocols</b>		
<b>Integrated in the controller</b>		
CANopen	■	■
Modbus TCP	■	■
<b>Optional via plug-in card</b>		
PROFIBUS DP	-	■
DeviceNet	-	■
EtherCAT	-	■
EtherNet/IP	-	■
PROFINET RT	-	■
<b>Safety functions</b>		
Integrated in the controller	■	-
Optional via plug-in card	-	■

**Type codes**

001	Series
CMMP	Motor controller, premium

002	Motor type
AS	AC synchronous

003	Nominal current
C2	2 A
C5	5 A
C10	10 A
C15	15 A

004	Nominal input voltage
3A	230 V AC/50-60Hz
11A	400 V AC

005	Number of phases
	Single-phase
P3	Three-phase

006	Number of slots
M0	Without slots
M3	With 3 slots

## Data sheet

Bus protocols

CANopen®

PROFIBUS

DeviceNet  
CONFORMANCE TESTED

Modbus

EtherCAT®

EtherNet/IP™

PROFINET

UL US LISTED



General technical data		C2-3A...	C5-3A...	C5-11A-P3...	C10-11A-P3...	C15-11A-P3...
CMMP-AS-						
Type of mounting		Screwed onto connection plate				
Display		Seven-segment display				
Parameterisation interface		USB, Ethernet				
Active PFC		Yes		-		
DIP switch		Firmware download/fieldbus settings <sup>1)</sup> /CAN terminating resistor				
SD card slot		Memory card → page 18				
Encoder interface input		Resolver				
		Incremental encoder with analogue or digital tracking signals				
		Absolute encoder with EnDat V2.1 serial/V2.2				
		Absolute encoder with HIPERFACE				
Encoder interface output		Additional input for synchronous/cam disc operation				
		Actual value feedback via encoder signals in rotational speed control mode				
		Setpoint specification for downstream slave drive				
Braking resistor, integrated	[Ω]	60		68		
Pulse power of braking resistor	[kVA]	2.8		8.5		
Braking resistor, external	[Ω]	≥ 50		≥ 40		
Impedance of setpoint input	[kΩ]	20				
Number of analogue outputs		2				
Operating range of analogue outputs	[V]	±10				
Resolution of analogue outputs		9 bit				
Characteristics of analogue outputs		Short-circuit-proof				
Number of analogue inputs		3				
Operating range of analogue inputs	[V]	±10				
Characteristics of analogue inputs		1x differential, resolution 16 bit				
		2x single-ended, resolution 10 bit				
		Configurable for rotational speed setpoint value/torque setpoint value/position setpoint value				
Mains filter		Integrated				External <sup>2)</sup>
Max. motor cable length <sup>3)</sup>	[m]	25				-
Product weight	[g]	2100	2200	3800		3450

- 1) Not in combination with CMMP-AS-...-M0
- 2) The mains filter is mandatory for compliance with the CE and EN standards → page 20
- 3) Without external mains filter

Function blocks for PLC programming							
Programming software	Controller manufacturer	Interfaces					
		CANopen	PROFIBUS DP	DeviceNet	EtherCAT	EtherNet/IP	PROFINET RT
CODESYS TwinCAT	Festo	■	■	■	■	■	■
	Beckhoff						
	Other manufacturers						
RSLogix5000	Rockwell Automation	-	-	■	-	■	-
Step 7/TIA Portal	Siemens	-	■	-	-	-	■

## Data sheet

Technical data – Bus protocols/control										
Interfaces	I/O	Additional I/O <sup>1)</sup>	CANopen	Modbus TCP	PROFIBUS DP	DeviceNet	EtherCAT	EtherNet/IP	PROFINET RT	
Number of digital logic outputs	5	8	5							
Characteristics of digital logic outputs	Freely configurable									
Number of digital logic inputs	10	8	10							
Characteristics of logic inputs	Freely configurable									
Process interfacing	16 (127) position sets <sup>2)</sup>	255 position sets	250 position sets							
Communication profile	–	–	DS301; FHPP+ DS301; DSP402	FHPP+	DP-V0/ FHPP+	FHPP+	DS301; FHPP+ CoE: DS301; DSP402	FHPP+	FHPP+	FHPP+
Max. fieldbus transmission rate [Mbps]	–	–	1	100	12	0.5	100	100	100	
Interface										
CMMP-AS-...-M0	Integrated	■	–	■	■	–	–	–	–	–
CMMP-AS-...-M3	Integrated	■	–	■	■	–	–	–	–	–
	Optional <sup>3)</sup>	–	■	–	–	■	■	■	■	■

1) With the plug-in card CAMC-D8E8A → page 18

2) Can be extended with configurable logic inputs up to max. 127 position sets

3) Plug-in cards can be ordered separately → page 18

Electrical data		C2-3A...	C5-3A...	C5-11A-P3...	C10-11A-P3...	C15-11A-P3...
<b>Output connection data</b>						
Output voltage range	[V AC]	3x 0 ... 270		3x 0 ... 360		
Nominal current	[A <sub>eff</sub> ]	2.5	5	5	10	15
Peak current	[A <sub>eff</sub> ]	5	10	10	20	30
at max. peak current duration	[s]	5				
	[A <sub>eff</sub> ]	10	20	20	40	45
	[s]	0.5				
Max. DC link voltage	[V DC]	320/380 <sup>1)</sup>		560		
Output frequency	[Hz]	0 ... 1000				
<b>Load supply</b>						
Nominal voltage phases		1		3		
Input voltage range	[V AC]	100 ... 230 ±10%		3x 230 ... 480 ±10%		
Max. nominal input current	[A]	3	6	5.5	11	13
Nominal power	[VA]	500	1000	3000	6000	9000
Peak power	[VA]	1000	2000	6000	12000	18000
Mains frequency	[Hz]	50 ... 60				
<b>Logic supply</b>						
Nominal voltage	[V DC]	24 ±20%				
Nominal current	[A]	0.55/2.05 <sup>2)</sup>	0.65/2.15 <sup>2)</sup>	1/3.5 <sup>2)</sup>		
Max. current of digital logic outputs	[mA]	100				

1) Without PFC/with PFC

2) Max. current with brake and I/Os

## Data sheet

Safety functions to EN 61800-5-2			
Motor controller	CMMP-AS- C2/C5/C10-...-M0	C2/C5/C10/C15-...-M3	
With plug-in card	-	CAMC-G-S1 → Page 14	CAMC-G-S3 → Page 15
Safe torque off (STO)	■	■	■
Safe stop 1 (SS1)	-	-	■
Safe brake control (SBC)	■	■	■
Safe operating stop (SOS)	-	-	■
Safe stop 2 (SS2)	-	-	■
Safely limited speed (SLS)	-	-	■
Safe speed range (SSR)	-	-	■
Safe speed monitor (SSM)	-	-	■

Safety data	
CMMP-AS-	C2/C5/C10-...-M0
Safety function to EN 61800-5-2	Safe torque off (STO)
Performance Level (PL) to EN ISO 13849-1	Category 4, Performance Level e
Safety Integrity Level (SIL) to EN 61800-5-2, EN 62061, EN 61508	SIL 3
Certificate issuing authority	German Technical Control Board (TÜV) 01/205/5162.02/19
Proof test interval	20a
Diagnostic coverage [%]	97
Safe failure fraction (SFF) [%]	99.2
Hardware fault tolerance	1
CE marking (see declaration of conformity)	To EU EMC Directive <sup>1)</sup> To EU Machinery Directive

1) For information about the area of use, see the EC declaration of conformity at: [www.festo.com/sp](http://www.festo.com/sp) → Certificates.

If the devices are subject to usage restrictions in residential, commercial or light-industrial environments, further measures for the reduction of the emitted interference may be necessary.

Technical data – Connection to the integrated safety module with CMMP-AS-...-M0		
<b>Control input STO-A/STO-B</b>		
Nominal voltage	[V DC]	24 (related to 0V-A/B)
Operating range	[V]	19.2 ... 28.8
Nominal current	[mA]	20 (typical; max. 30)
Starting current	[mA]	450 (typical, duration approx. 2 ms; max. 600 at 28.8 V)
Max. positive test pulse length with logic 0	[ms]	0.3 (related to nominal voltage 24 V and intervals > 2 s between pulses)
Max. allowable time for test pulses at 24 V signal	[ms]	< 2 ... 6
Key features		Galvanically isolated
<b>Monitoring contact C1, C2</b>		
Nominal voltage	[V DC]	24
Max. voltage	[V DC]	< 30 (overvoltage-resistant up to 60 V)
Nominal current	[mA]	< 200 (not short-circuit-proof)
Design		Potential-free signal contact
Switching logic		Contact closes at STO



## Data sheet

Operating and environmental conditions		C2-3A-...	C5-3A-...	C5-11A-P3-...	C10-11A-P3-...	C15-11A-P3-...
Digital logic outputs		Galvanically isolated				
Logic inputs		Galvanically isolated				
Degree of protection						
With plug at X6 and X9		IP20				
Without plug at X6 and X9		IP10				
Protective function						
		I <sup>2</sup> t monitoring				
		Intermediate circuit over/undervoltage				
		Output stage short circuit				
		Standstill monitoring				
		Temperature monitoring				
Ambient temperature	[°C]	0 ... +40				
Storage temperature	[°C]	-25 ... +70				
Relative humidity	[%]	0 ... 90 (non-condensing)				
CE marking (see declaration of conformity)						
		To EU Low Voltage Directive				
		To EU EMC Directive <sup>1)</sup>				
		To EU Machinery Directive				
UKCA marking (see declaration of conformity)						
		To UK instructions for EMC				
		To UK instructions for machines				
		To UK regulations for electrical equipment				
Certification						
		cUL us listed (OL)				
		RCM compliance mark				
PWIS conformity						
		VDMA24364 zone III				
Note on materials						
		RoHS-compliant				

1) For information about the area of use, see the EC declaration of conformity at: [www.festo.com/sp](http://www.festo.com/sp) → Certificates.

If the devices are subject to usage restrictions in residential, commercial or light-industrial environments, further measures for the reduction of the emitted interference may be necessary.

### Installation clearance for motor controller

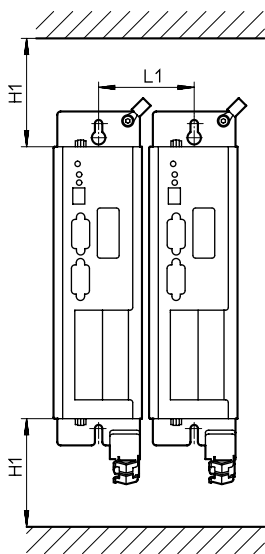

Type	H1 <sup>1)</sup>	L1
CMMP-AS-C2-3A-...	100	71
CMMP-AS-C5-3A-...		
CMMP-AS-C5-11A-P3-...	100	85
CMMP-AS-C10-11A-P3-...		
CMMP-AS-C15-11A-P3-...		

1) An installation clearance of 150 mm is recommended for optimum wiring of the motor or encoder cable on the underside of the motor controller

## Data sheet

### View of motor controller

CMMP-AS-...-M0

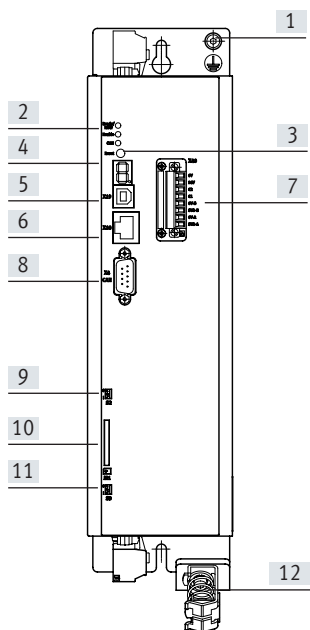

- [1] PE connection
- [2] LEDs
- [3] Reset button
- [4] Seven-segment display
- [5] X19 USB interface
- [6] X18 Ethernet interface
- [7] X40 digital I/O interface for controlling the STO function
- [8] X4 CANopen interface
- [9] Activation of CANopen terminating resistor
- [10] SD/MMC card slot
- [11] Activation of firmware download
- [12] Shield connection

### From above

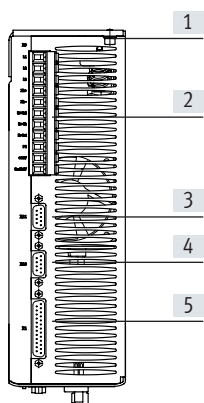

- [1] PE connection
- [2] X9 power supply
- [3] X11 incremental encoder interface (output)
- [4] X10 incremental encoder interface (input)
- [5] X1 I/O interface

### From underneath

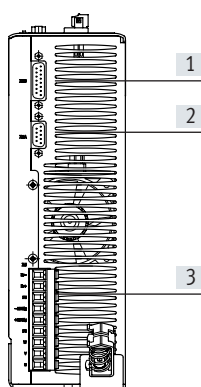

- [1] X2B encoder connection
- [2] X2A resolver connection
- [3] X6 motor connection

Data sheet

**View of motor controller**  
CMMP-AS-...-M3

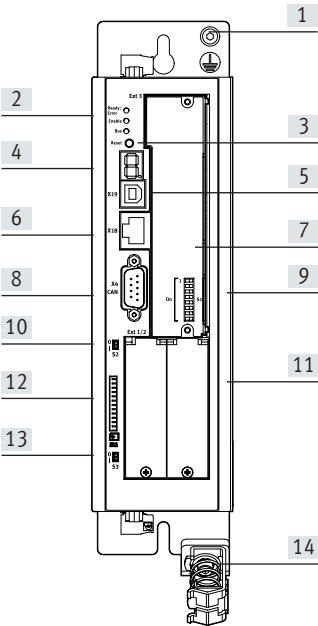

- [1] PE connection
- [2] LEDs
- [3] Reset button
- [4] Seven-segment display
- [5] X19 USB interface
- [6] X18 Ethernet interface
- [7] Slot for switch or safety module
- [8] X4 CANopen interface
- [9] Fieldbus settings
- [10] Activation of CANopen terminating resistor
- [11] Slots for extension modules
- [12] SD/MMC card slot
- [13] Activation of firmware download
- [14] Shield connection

**Note**  
One of the plug-in cards must be inserted in slot [7] in order to operate the motor controller.

Possible plug-in cards:  
CAMC-DS-M1 → page 18  
CAMC-G-S1 → page 14  
CAMC-G-S3 → page 15

From above

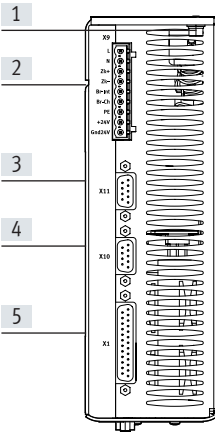

- [1] PE connection
- [2] X9 power supply
- [3] X11 incremental encoder interface (output)
- [4] X10 incremental encoder interface (input)
- [5] X1 I/O interface

From underneath

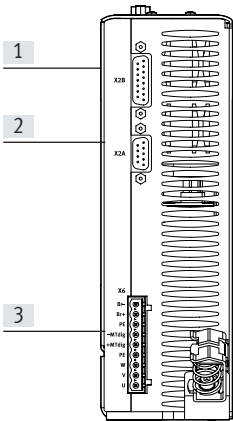

- [1] X2B encoder connection
- [2] X2A resolver connection
- [3] X6 motor connection

Data sheet

Dimensions

Download CAD data → [www.festo.com](http://www.festo.com)

CMMP-AS-C2/C5-3A-M0, CMMP-AS-C5/C10-11A-P3-M0

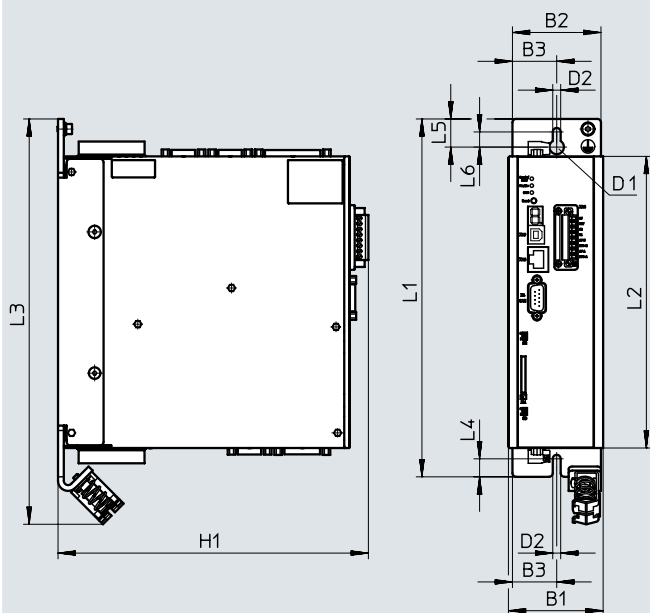

Type	B1	B2	B3	D1 ∅	D2 ∅	H1	L1	L2	L3	L4	L5	L6
CMMP-AS-C2-3A-M0	66	61	30.7	10	5.5	215	248	202	281	12.5	19.5	10.5
CMMP-AS-C5-3A-M0												
CMMP-AS-C5-11A-P3-M0	79	75	37.5	10	5.5	255	297	252	330	12.5	19.8	10.5
CMMP-AS-C10-11A-P3-M0												

CMMP-AS-C2/C5-3A-M3, CMMP-AS-C5/C10/-C15-11A-P3-M3

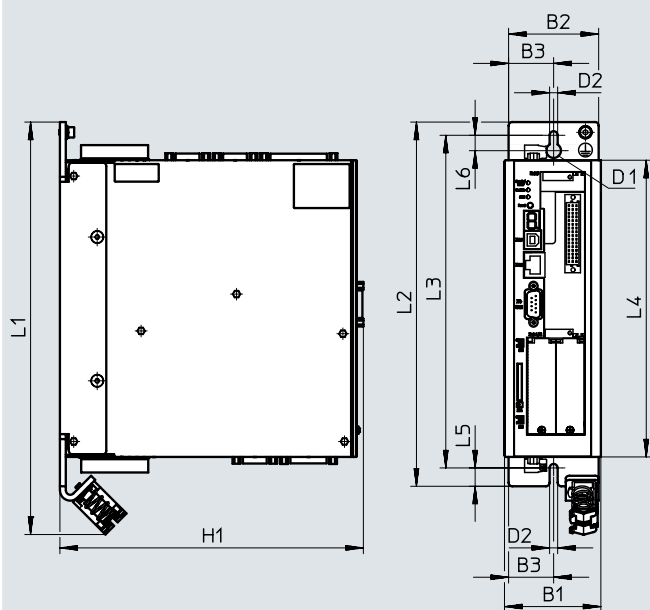

Type	B1	B2	B3	D1 ∅	D2 ∅	H1	L1	L2	L3	L4	L5	L6
CMMP-AS-C2-3A-M3	66	61	30.7	10	5.5	207	281	248	227	202	12.5	10.5
CMMP-AS-C5-3A-M3												
CMMP-AS-C5-11A-P3-M3	79	75	37.5	10	5.5	247	330	297	276	252	12.5	10.5
CMMP-AS-C10-11A-P3-M3												
CMMP-AS-C15-11A-P3-M3												

Data sheet

★ Core product range

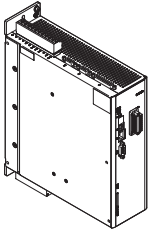
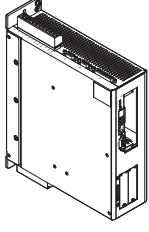
Ordering data	Description	Part no.	Type
<b>CMMP-AS-...-M0 – Without slot</b>			
	The plug assortment NEKM (→ page 19) is included in the scope of delivery of the motor controller.	1622901 1622902 1622903 1622904	CMMP-AS-C2-3A-M0 CMMP-AS-C5-3A-M0 CMMP-AS-C5-11A-P3-M0 CMMP-AS-C10-11A-P3-M0
<b>CMMP-AS-...-M3 – With 3 slots</b>			
	<ul style="list-style-type: none"> <li>• One of the plug-in cards must be inserted in slot [7] (→ page 11) in order to operate the motor controller.</li> <li>Possible plug-in cards:                             <ul style="list-style-type: none"> <li>– CAMC-DS-M1 → page 18</li> <li>– CAMC-G-S1 → page 14</li> <li>– CAMC-G-S3 → page 15</li> </ul> </li> <li>• The mains filter is mandatory with CMMP-AS-C15... for compliance with the CE and EN standards (→ page 20).</li> <li>• The plug assortment NEKM (→ page 19) is included in the scope of delivery of the motor controller.</li> </ul>	★ 1501325 ★ 1501326 ★ 1501327 ★ 1501328 3215473	CMMP-AS-C2-3A-M3 CMMP-AS-C5-3A-M3 CMMP-AS-C5-11A-P3-M3 CMMP-AS-C10-11A-P3-M3 CMMP-AS-C15-11A-P3-M3

Festo core product range      ★ Generally ready for dispatch from the factory within 24 hours  
 ★ Generally ready for dispatch from the factory within 5 days

## Accessories

### Safety module CAMC-G-S1

Only for motor controller:  
CMMP-AS-...-M3

The safety module serves as an extension to achieve the safety function:

- Safe torque off (STO)

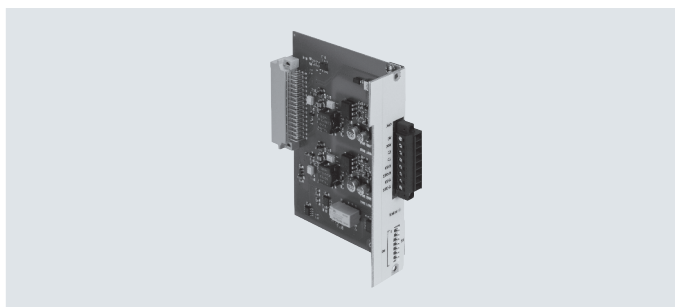

Safety data	
Safety function to EN 61800-5-2	Safe torque off (STO)
Performance Level (PL) to EN ISO 13849-1	Category 4, Performance Level e
Safety Integrity Level (SIL) to EN 61800-5-2, EN 62061, EN 61508	SIL 3
Certificate issuing authority	German Technical Control Board (TÜV) 01/205/5165.02/19
Proof test interval	20a
PFH	$1.27 \times 10^{-10}$
Diagnostic coverage [%]	97
Safe failure fraction (SFF) [%]	99.2
Hardware fault tolerance	1
CE marking (see declaration of conformity) <sup>1)</sup>	To EU EMC Directive
	To EU Machinery Directive
UKCA marking (see declaration of conformity) <sup>1)</sup>	To UK instructions for EMC
	To UK instructions for machines

1) More information [www.festo.com/catalogue/camc](http://www.festo.com/catalogue/camc) → Support/Downloads

Technical data	
<b>Control input STO-A/STO-B</b>	
Nominal voltage [V DC]	24 (related to 0V-A/B)
Operating range [V]	19.2 ... 28.8
Nominal current [mA]	20 (typical; max. 30)
Max. positive test pulse length with logic 0 [ms]	0.3 (related to nominal voltage 24 V and intervals > 2 s between pulses)
Max. allowable time for test pulses at 24 V signal [ms]	< 2 ... 6
Key features	Galvanically isolated
<b>Monitoring contact C1, C2</b>	
Nominal voltage [V DC]	24
Max. voltage [V DC]	< 30 (overvoltage-resistant up to 60 V)
Nominal current [mA]	< 200 (not short-circuit-proof)
Design	Potential-free signal contact
Switching logic	Contact closes at STO

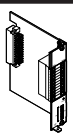
Ordering data – Plug-in card			
	Description	Part no.	Type
	Safety module: <ul style="list-style-type: none"> <li>• One of the plug-in cards CAMC-G-S1, CAMC-G-S3 or CAMC-DS-M1 must be inserted in slot [7] (→ page 11) in order to operate the motor controller.</li> <li>• The plugs are included in the scope of delivery. To reorder plug NEKM → page 19</li> </ul>	★ 1501330	CAMC-G-S1



## Accessories

### Safety module CAMC-G-S3

Only for motor controller:  
CMMP-AS-...-M3

The safety module serves as an extension to achieve the safety functions:

- Safe torque off (STO)
- Safe stop 1 (SS1)
- Safe brake control (SBC)
- Safe operating stop (SOS)
- Safe stop 2 (SS2)
- Safely limited speed (SLS)
- Safe speed range (SSR)
- Safe speed monitor (SSM)

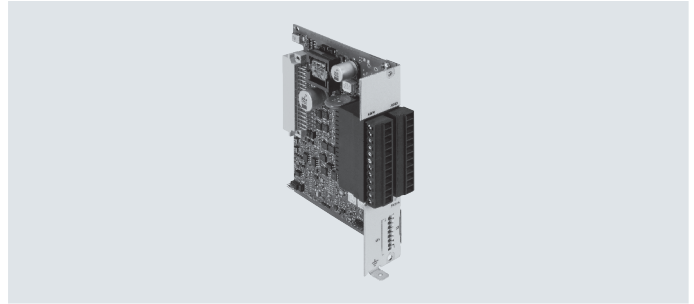

Safety data	
Safety function to EN 61800-5-2	Safe torque off (STO)
	Safe stop 1 (SS1)
	Safe brake control (SBC)
	Safe operating stop (SOS)
	Safe stop 2 (SS2)
	Safely limited speed (SLS)
	Safe speed range (SSR)
	Safe speed monitor (SSM)
Performance Level (PL) to EN ISO 13849-1	Up to category 4, Performance Level e
Safety Integrity Level (SIL) to EN 61800-5-2, EN 62061, EN 61508	SIL 3
Certificate issuing authority	German Technical Control Board (TÜV) 01/205/5165.02/19
Proof test interval	20a
PFH	$9.5 \times 10^{-9}$
Diagnostic coverage [%]	97.5
Safe failure fraction (SFF) [%]	99.5
Hardware fault tolerance	1
CE marking (see declaration of conformity) <sup>1)</sup>	To EU EMC Directive
	To EU Machinery Directive
UKCA marking (see declaration of conformity) <sup>1)</sup>	To UK instructions for EMC
	To UK instructions for machines

1) More information [www.festo.com/catalogue/camc](http://www.festo.com/catalogue/camc) → Support/Downloads

## Accessories

Technical data		
<b>General</b>		
Parameterisation	Using SafetyTool, integrated into the FCT plug-in for CMMP-AS-...	
<b>Digital safe inputs DIN 40A/B to DIN 43A/B</b>		
Specification	IEC 61131-2, type 3	
Number of 2-channel inputs	4	
Nominal voltage	[V DC]	24
Operating range	[V]	-3 ... 30
Nominal current	[mA]	15
Max. nominal current	[mA]	200
Key features	Suitable for emergency-stop switchgear, protective door circuit, light curtain, enabling button, two-hand operator unit; Inputs switching equivalently/antivalently; Test pulses can be configured; Function can be configured	
<b>Digital safe inputs DIN 44 to DIN 49</b>		
Specification	IEC 61131-2, type 3	
Number of 1-channel inputs	6	
Nominal voltage	[V DC]	24
Operating range	[V DC]	-3 ... 30
Nominal current	[mA]	15
Max. nominal current	[mA]	200
Key features	Suitable for start button, brake feedback, mode selector, error acknowledgement, restart blocking; Test pulses can be configured; Function can be configured	
<b>Digital safe outputs DOUT 40A/B to 42A/B</b>		
Number of 2-channel outputs	3	
Output	High-side switch with pull-down	
Nominal voltage	[V DC]	24
Operating range	[V DC]	18 ... 30
Permissible output current	[mA]	< 50
Key features	Semiconductor outputs: parameterisable PNP (positive switching) Outputs switching equivalently/antivalently Test pulses can be configured Function can be configured	
<b>Monitoring contact C1, C2</b>		
Nominal voltage	[V DC]	24
Max. voltage	[V DC]	< 30 (overvoltage-resistant up to 60 V)
Nominal current	[mA]	< 200 (not short-circuit-proof)
Design	Potential-free signal contact	
Key features	Suitable for the diagnostics of safety functions Function can be configured	



## Accessories

### Supported position encoders

- Resolver via X2A
- SIN/COS incremental encoder
- SICK Hiperface shaft encoder (only process data channel)

- Heidenhain EnDat encoder
- Incremental encoder with digital A/B signals

- BISS position sensors for linear motors
- Incremental encoder with digital A/B signals

The manufacturers of SIL-certified shaft encoders publish guidelines for their use in safety applications.

The safety module CAMC-G-S3 takes the following manufacturer specifications into account when evaluating the encoder signals:

- Implementation Manual HIPERFACE® Safety dated 21.12.2010 (801412 0/2010-12-21) → [www.sick.com](http://www.sick.com)

- Specification of the E/E/PES safety requirements for EnDat Master dated 19.10.2009 (D533095-04-G-01) → [www.heidenhain.de](http://www.heidenhain.de) (in preparation)

### Permissible combinations of position encoders

First encoder	Second encoder	Achievable safety level		Note
Resolver	Other encoder	SIL 3	Cat. 3/PL d; Cat. 3/PL e	–
Resolver	Incremental encoder	SIL 3	Cat. 4/PL e	–
Resolver	None	SIL 2	Cat. 3/PL d	Please see the note below
SIN/COS incremental encoder	None	SIL 3	Cat. 3/PL d	Requires SIL classification of the encoder
SIN/COS incremental encoder	Incremental encoder	SIL 3	Cat. 4/PL e	Please see the note below
Hiperface incremental encoder	Incremental encoder	SIL 3	Cat. 3/PL e	Please see the note below
Hiperface incremental encoder	None	SIL 2 or 3	Cat. 3/PL d; Cat. 4/PL e	Requires SIL classification of the encoder
EnDat encoder	Incremental encoder	SIL 3	Cat. 4/PL e	Encoder setting: "Other encoder" Please see the note below
EnDat encoder	None	SIL 2	Cat. 3/PL d	In preparation. Requires SIL classification of the encoder
Other encoder	Incremental encoder	SIL 2	Cat. 3/PL d	–



### Note

- Please check whether your selected position encoder is sufficiently accurate to fulfil the monitoring task, in particular the SOS safety function.
- In applications with only one shaft encoder/position encoder, it must have the SIL classification required in accordance with the risk assessment. In most cases, the classification requires additional requirements or fault exclusions in the mechanical system. Please check carefully that these requirements are fulfilled in your application and that the appropriate fault exclusions can be performed.
- In applications with only one shaft encoder/position encoder with analogue signal interface (resolver, SIN/COS, Hiperface, etc.), the restrictions on diagnostic coverage as well as the restrictions on the achievable accuracy of standstill and speed monitoring must be taken into account.
- When using two functional encoders without SIL classification, the suitability of the encoder combination for use in safe systems up to SIL3 must be proven separately (for example, the following are required: diversity of the encoder systems with regard to CCF, MTTfd, etc., suitability of the encoders for the operating and ambient conditions, EMC, etc.).

### Ordering data – Plug-in card

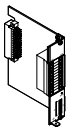

	Description	Part no.	Type
	Safety module: <ul style="list-style-type: none"> <li>• One of the plug-in cards CAMC-G-S1, CAMC-G-S3 or CAMC-DS-M1 must be inserted in slot [7] (→ page 11) in order to operate the motor controller.</li> <li>• The plugs are included in the scope of delivery. To reorder plug NEKM → page 19</li> </ul>	★ 1501331	CAMC-G-S3

Festo core product range





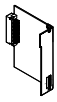
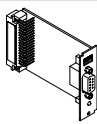
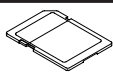
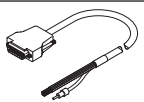
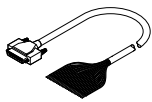
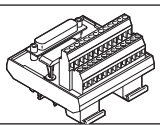
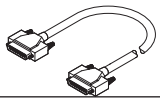

Generally ready for dispatch from the factory within 24 hours  
 Generally ready for dispatch from the factory within 5 days

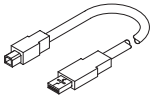

## Accessories

Ordering data – Plug-in card				
	Description	Part no.	Type	
	Switch module: • One of the plug-in cards CAMC-G-S1, CAMC-G-S3 or CAMC-DS-M1 must be inserted in slot [7] (→ page 11) in order to operate the motor controller CMMP-AS-...-M3.	★ 1501329	CAMC-DS-M1	
Ordering data – Plug-in cards for bus protocols				
	Description	Part no.	Type	
	For PROFIBUS DP	★ 547450	CAMC-PB	
	For PROFINET RT	★ 1911916	CAMC-F-PN	
	For DeviceNet	547451	CAMC-DN	
	For EtherCAT	★ 567856	CAMC-EC	
	For EtherNet/IP	★ 1911917	CAMC-F-EP	
Ordering data – Memory card				
	Description	Part no.	Type	
	Memory card, for data backup and firmware download	★ 1436343	CAMC-M-S-F10-V1	
Ordering data – Connection options from I/O interface to the controller				
	Description	Cable length [m]	Part no.	Type
Control cable				
	<ul style="list-style-type: none"> <li>For I/O interface to any controller</li> <li>Recommended for analogue signals since the cable is shielded</li> </ul>	2.5	552254	NEBC-S1G25-K-2.5-N-LE26
	<ul style="list-style-type: none"> <li>For I/O interface to any controller</li> <li>Cannot be used if the incremental encoder interface (plug X10) is in use</li> </ul>	3.2	★ 8001373	NEBC-S1G25-K-3.2-N-LE25
Connection block				
	Ensures simple and clear wiring. The connection to the motor controller is established via the connecting cable NEBC-S1G25-K-...	–	8001371	NEFC-S1G25-C2W25-S7
Connecting cable				
	<ul style="list-style-type: none"> <li>Connects the motor controller to the manifold block.</li> <li>Cannot be used if the incremental encoder interface (input) is in use</li> </ul>	1.0	8001374	NEBC-S1G25-K-1.0-N-S1G25
		2.0	8001375	NEBC-S1G25-K-2.0-N-S1G25
		5.0	8001376	NEBC-S1G25-K-5.0-N-S1G25
Plug				
	<ul style="list-style-type: none"> <li>25-pin Sub-D plug. Each single core can be individually assembled using screw terminals.</li> <li>Cannot be used if the incremental encoder interface (input) is in use</li> </ul>	–	★ 8001372	NEFC-S1G25-C2W25-S6

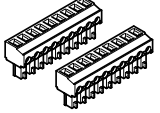

## Accessories

Ordering data – Cables and plugs				
	Description	Cable length [m]	Part no.	Type
<b>Programming cable</b>				
	For CMMP-AS-...-M0, CMMP-AS-...-M3	1.8	1501332	NEBC-U1G4-K-1.8-N-U2G4
<b>Encoder plug</b>				
	For incremental encoder interface	–	564264	NECC-A-S-S1G9-C2M
<b>Plugs</b>				
	For PROFIBUS interface	–	533780	FBS-SUB-9-WS-PB-K
	For CANopen interface	–	533783	FBS-SUB-9-WS-CO-K
	For DeviceNet interface	–	525635	FBSD-KL-2X5POL

Ordering data – Assortment of plugs				
	Description	Part no.	Type	
	Assortment of plugs for:			
	• Motor controller CMMP-AS-C5/-C10-11A-P3-M0	★ 552256	NEKM-C-3 <sup>1)</sup>	
	• Motor controller CMMP-AS-C5/-C10/-C15-11A-P3-M3			
	• Interface CAMC-D-8E8A	569959	NEKM-C-5 <sup>2)</sup>	
	• Motor controller CMMP-AS-C2/-C5-3A-M0	★ 1659228	NEKM-C-7 <sup>1)</sup>	
	• Motor controller CMMP-AS-C2/-C5-3A-M3			
	• Safety module CAMC-G-S1	★ 1660640	NEKM-C-8 <sup>3)</sup>	
	• Motor controller CMMP-AS-...-M0			
	• Safety module CAMC-G-S3	★ 1660937	NEKM-C-9 <sup>4)</sup>	

- 1) Plugs are included in the scope of delivery of the motor controller CMMP-AS-...-M0, CMMP-AS-...-M3
- 2) Plugs are included in the scope of delivery of the plug-in card CAMC-D-8E8A
- 3) Plug is included in the scope of delivery of the plug-in card CAMC-G-S1  
Plug is included in the scope of delivery of the motor controller CMMP-AS-...-M0
- 4) Plug is included in the scope of delivery of the plug-in card CAMC-G-S3

### Ordering data – EMC filter for servo motors EMME-AS

Data sheets → Internet: emme-as

For cable lengths  $\geq 10$  m, the use of the EMC filter is recommended to reduce EMC interference.

For encoder cables  $\geq 10$  m, the filter is included in the scope of delivery of the cable.

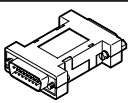
	Degree of protection	Ambient temperature	Part no.	Type
	IP30 (in mounted state)	–40 ... +80°C	4825847	CAMF-C5-FC

Festo core product range

- ★ Generally ready for dispatch from the factory within 24 hours
- ★ Generally ready for dispatch from the factory within 5 days

## Accessories

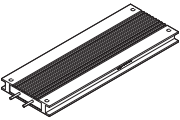
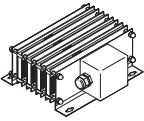
Ordering data – Braking resistors				Data sheets → Internet: cacr	
	For type	Resistance value [Ω]	Nominal power [W]	Part no.	Type
<b>CACR-LE2-...</b>					
	CMMP-AS-C2-3A-...	50	200	2882342	CACR-LE2-50-W500 <sup>1)</sup>
	CMMP-AS-C5-3A-...	72	200	1336611	CACR-LE2-72-W500
<b>CACR-KL2-...</b>					
	CMMP-AS-C5-11A-P3-...	67	720	1336617	CACR-KL2-67-W1800
	CMMP-AS-C10-11A-P3-...	40	800	2882343	CACR-KL2-40-W2000 <sup>1)</sup>
	CMMP-AS-C15-11A-P3-...				

1) Recommended braking resistor

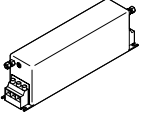
Ordering data – Mains filter						
	For type	Operating voltage [V]	Input current [A]	Dimensions [mm]	Part no.	Type
	CMMP-AS-C15-11A-P3-...	520/300	16	Length: 230 Width: 50 Height: 70	3947275	CADF-C15-11A-P3

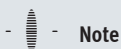

### Note

Regardless of the length of the motor cable, the mains filter is mandatory for compliance with the CE and EN standards.

Ordering data – Software and documentation		
	Description	→ Internet
	<p>The following descriptions are available on the Festo website:</p> <ul style="list-style-type: none"> <li>• Hardware: mounting and installation of all variants</li> <li>• Functions: instructions on commissioning with FCT + functional description</li> <li>• FHPP: control and parameterisation of the motor controller via the FHPP profile</li> <li>• DS402: control and parameterisation of the motor controller via the device profile CiA 402 (DS402)</li> <li>• Safety module: functional safety engineering for the motor controller with the safety function STO</li> </ul>	<a href="http://www.festo.com/net/SupportPortal">www.festo.com/net/SupportPortal</a>

Ordering data – Software and documentation for the cam editor			
	Description	Part no.	Type
	<p>Software package contains:</p> <ul style="list-style-type: none"> <li>• CD-ROM                             <ul style="list-style-type: none"> <li>– With user documentation in de, en, es, fr, it, ru, zh</li> </ul> </li> </ul> <p>The software package is not included in the scope of delivery</p>	570903	GSPF-CAM-MC-ML