

ZW Series Confocal Fiber Displacement Sensor

The 24x24x64-mm Sensor Head
redefines the meaning of ultra-compact



SYSTMAC
always in control

EtherCAT

» Robust Sensor Head Structure

» Ultra-compact and Ultra-lightweight

» Stable Measurements for Any Material

Omron's Confocal Fiber Displacement Sensor that Goes Beyond Triangulation Concepts with a New Principle

In machine control, displacement sensors are indispensable for non-contact measurements of heights, thickness and other dimensions. However, integrating them into the system poses challenges such as the size of the sensor, its weight and noise immunity.

The ZW Series confocal displacement sensor solves these problems in ways not possible using traditional triangulation sensors. They provide the compact size, light weight, immunity to electrical/magnetic noise, and other features to make them ideal for solving installation problems.

OMRON's new confocal principle provides the measurement resolution that is needed for precise control. The ZW Series solves the problems that are inevitable with laser triangulation, such as deviations between different materials and inclination tolerance.

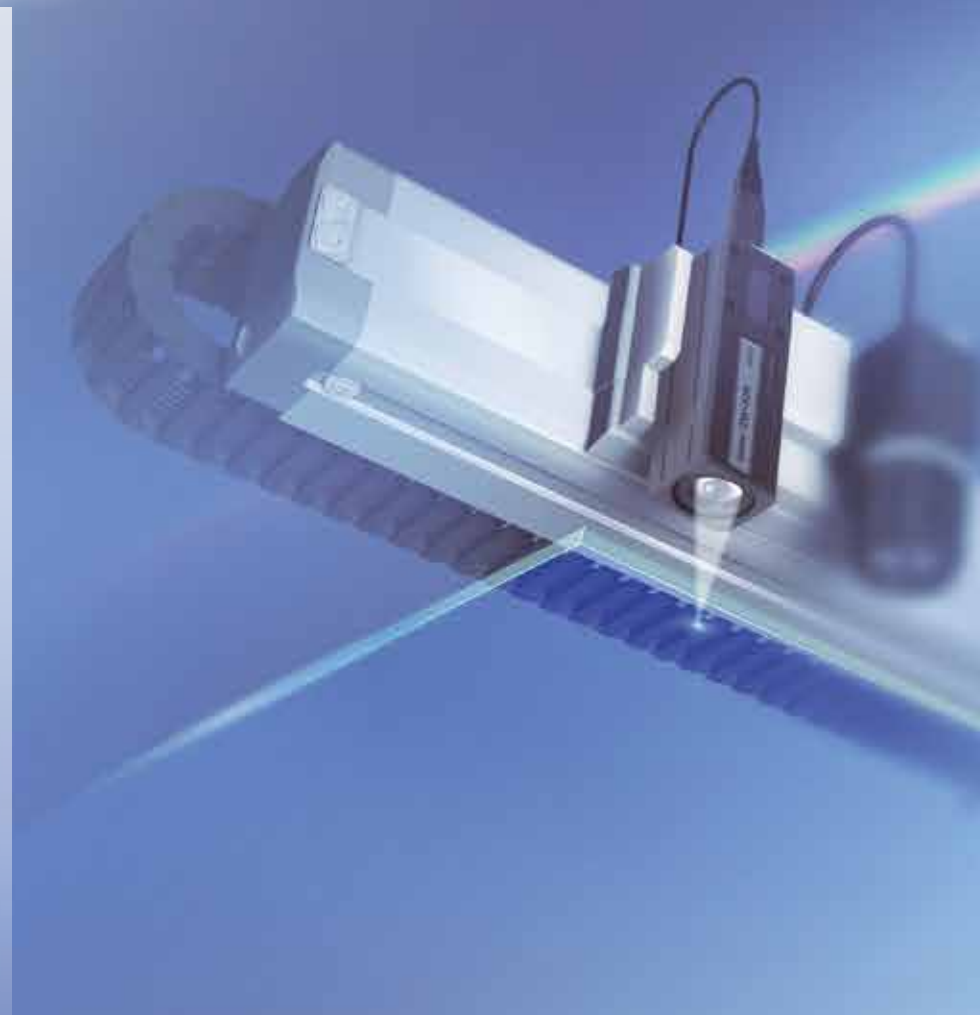

A Wider Selection of Models with the Same Head Size

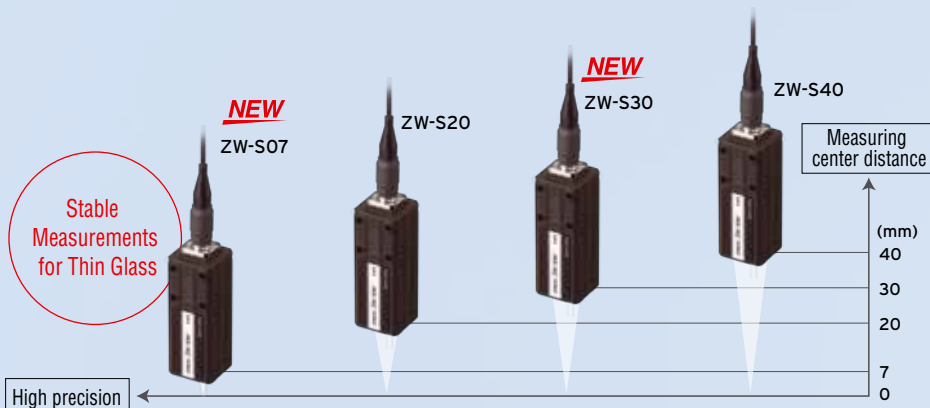

Expanded Communications

Standard-feature EtherCAT

> p.10

Standard-feature EtherNet/IP™

NEW



Omron's White Light Confocal Principal Offers Three Unique Benefits



Save Machine Space and Reduce Settling Time

The slim design measures only 24 X 24 mm. It weighs only 105 g. This incredibly compact size could not be achieved with traditional triangulation sensors. Any object can be measured with the Sensor mounted perpendicularly to them to save even more space.

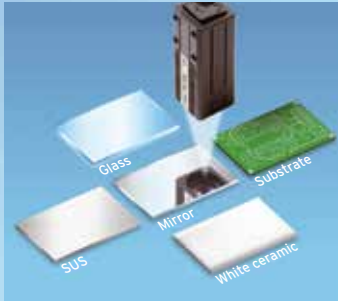

Stable Measurements for Any Material

Measure different materials or color, there is no need to reposition the sensor. A wide angle characteristic of $\pm 8^\circ$ enables high-resolution measurement of the position even for large objects with mirror-like surfaces without being affected by warping.

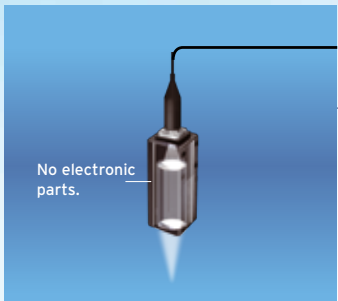

Electrical Noise and Heat are Not a Problem

The sensor head design maintains reliable operation in installations where electrical noise exists. Devices in close proximity to the sensor head or cable, will not be affected by noise or heat due to the sensor head's advanced design.



Ultra-Compact and Ultra-Lightweight

Utilize Narrow Spaces in Machines

The 24 x 24-mm Sensor Head fits easily into essentially any machine.

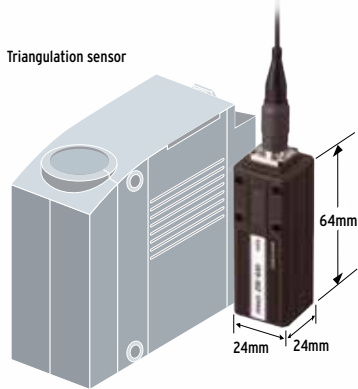

**87% less
Volume & Weight**
compared to previous
models*

*In-house comparisons.

Mounting area Reduced to 1/7*

*In-house comparison.

With traditional triangulation sensors, it was necessary to use either diffuse reflection or regular reflection depending on the material. However, the confocal principle used for the ZW Series eliminates the need to change the Sensor installation even if the material changes.

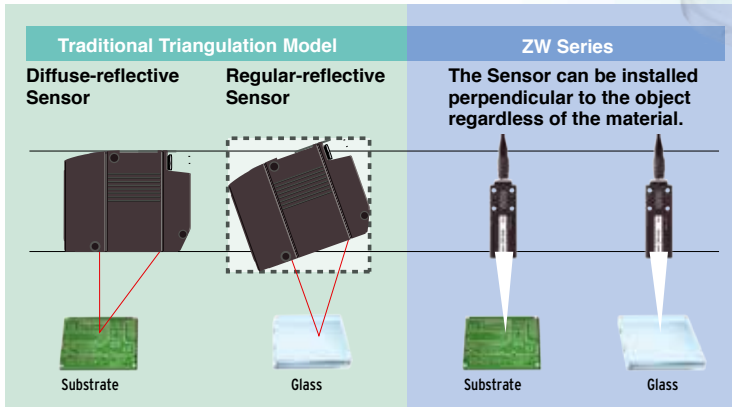

Sensor Installation in a Row with No Interference

Mutual interference or space restrictions often prevent the installation of traditional triangulation sensors. The compact ZW Series sensor heads allow you to install more sensors, in a row or pattern.

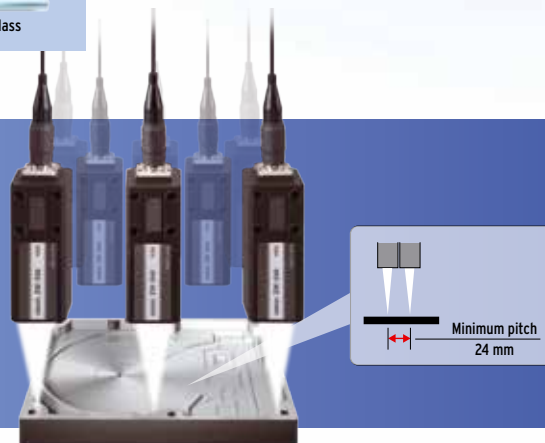

Non-contact Flatness Inspection of HDD Cases

Low Inertia Delivers Smooth and Fast Response

When mounting the measurement sensor to an actuator, the sensor head has a significant influence. The heavier the sensor, the longer the settling time, which results in slower production. With the ZW Series sensors, the settling time is significantly reduced because it weighs 0.23 lbs allowing measurements to start sooner creating greater time savings for faster production speeds.

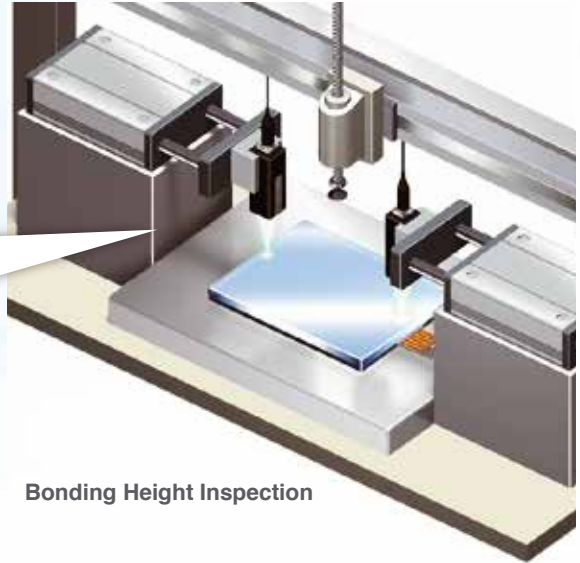
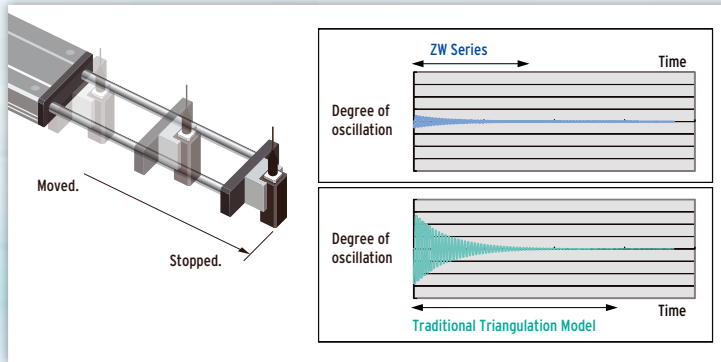

Bonding Height Inspection

Easy and Flexible Cable Installation

The Controller connects to the Sensor Head with a 2-mm-diameter Flexible Fiber Cable. The cable has cleared a bending test consisting of 2,000,000* repetitions for reliable application on moving parts.



Installation in a Cable Carrier

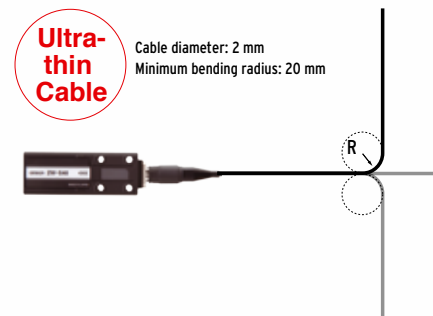

*Cable was tested with OMRON's bending test consisting of 2,000,000 bends to a 70-mm bending radius and 1,000,000 bends to a 20-mm bending radius.

Cable Extendable to 32 meters

An Extension Fiber Cable can be used between the Sensor Head and Controller to extend the distance to up to 32 m. Attach the Sensor Head to a moving part and place the Controller in the control panel or other convenient location to achieve a flexible system design.

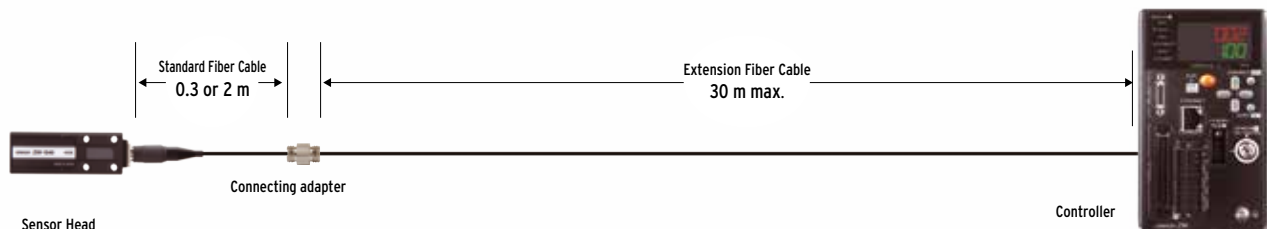

Non-Stop Production Even When Material Being Measured Changes

Stable Measurements from the Same Mounting Position Even for Different Materials

No need to adjust parameters or tune sensor for each individual material to be measured. Achieve stable measurements without adjusting parameters or changing the mounting positions even as the material changes.

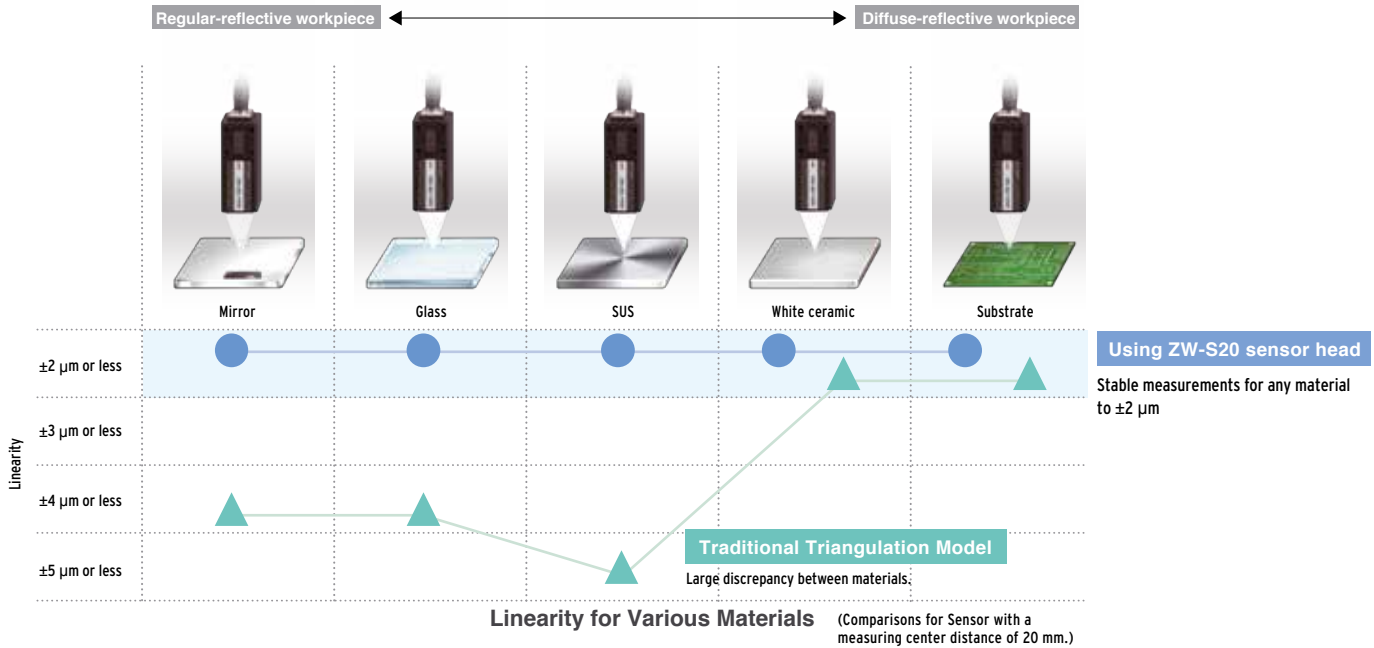

Stable Measurements across Boundaries between Materials

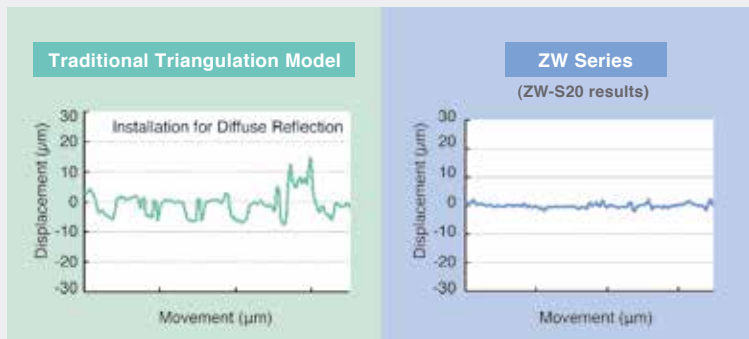

Thin Transparent glass - Thickness measurement is not a problem using the ZW compact sensor heads

To make stable measurements on glass, the light waveform received from the front and back surfaces of the glass must be separated. When using compact sensor heads, the influence of lens aberration makes it difficult to achieve such separations when measuring these surfaces. Even with its compact size that saves space, the ZW-S07 stably measures transparent surface displacement on glass as thin as 75 μm, a feat not easily achieved by previous compact sensor heads.

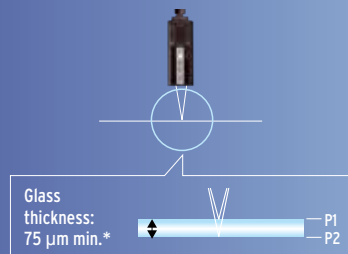

*ZW-S07: 75 μm min.
ZW-S20: 200 μm min.

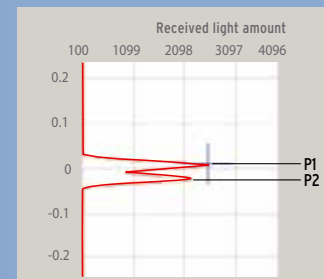

Received Waveform for ZW Series Sensor

(All measurement graphs represent typical examples.)

Reduce Machine Setup Costs with Superior Angle Characteristics

Using traditional triangulation sensors, the angle of the sensor head has to be adjusted when measuring mirror-like surfaces. This angle adjustment compromises not only the sensor performance, but also causes downtime for setup.

If several sensors are used in an application such as height control during glass conveyance, the angle of every sensor must be adjusted with high precision. This again contributes to downtime for setup.

The confocal ZW Series offers a superior angle characteristic, which enables high resolution measurements without strict angle adjustment. This results in cost reduction for setup and downtime, not to mention the reduction of space or costs in the design of an adjustable jig.

* This is not a guaranteed value.
Refer to Characteristic Data (P17)
for typical examples.

**Angle
characteristic
 $\pm 8^\circ$ ***

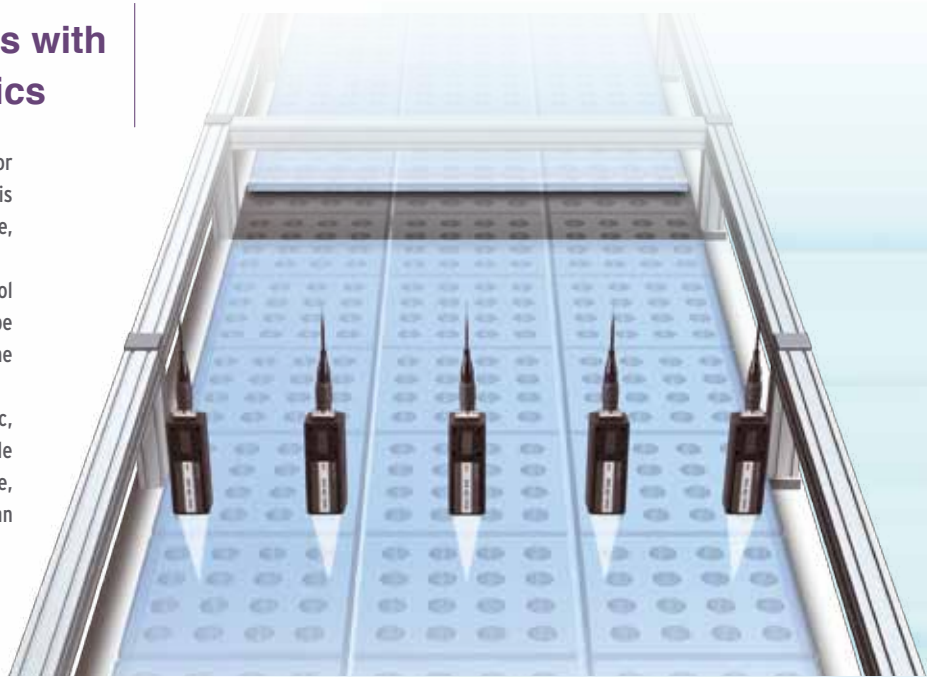

Height Control during Glass Conveyance

Traditional Triangulation Model

With triangulation, even if the angle is adjusted with high precision during the setup of the Sensor, stable measurement results are difficult to obtain when the measurement object is warped or inclined.

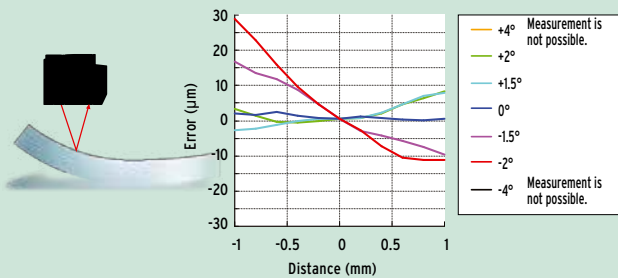

ZW Series

ZW Series Sensors operate on the confocal principle, so high-resolution measurements are possible regardless of inclination and warping of the measurement object.

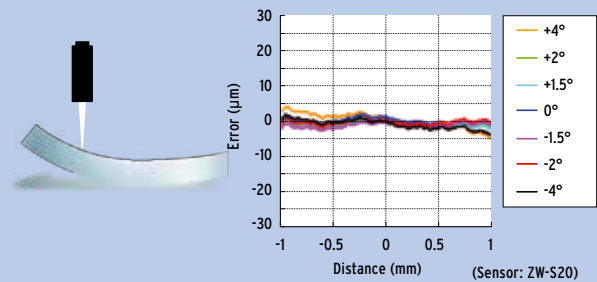

No Discrepancy in the Measurement Point

Superior angle characteristics are not the only advantage of a confocal principle. With a traditional triangulation, the measurement position and spot size vary with the height. This means there are times when the position cannot be measured with high resolution due to warping and inclination. With the confocal principle used in the ZW Series, the measurement point remains the same at any position in the measuring range so that precise measurements can always be made.

Traditional Triangulation Model

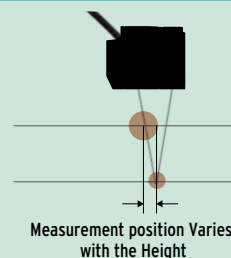

ZW Series



Advanced Sensor Head Structure

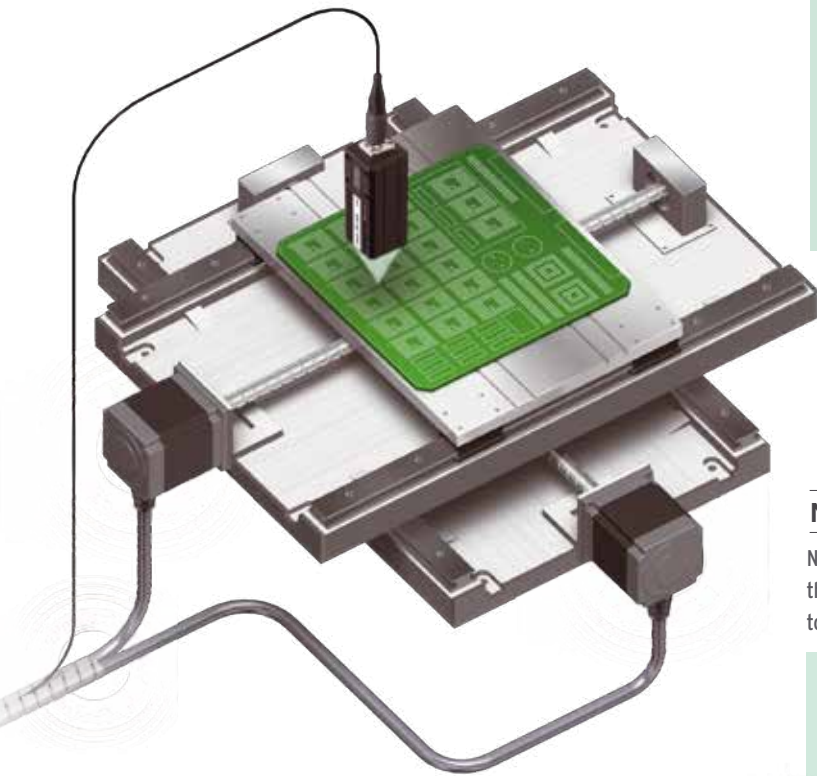

Substrate Height Inspection

No Noise

Reduced Work for
EMC Countermeasures

Not Affected by Noise

To ensure high-resolution measurements with Standard sensors, countermeasures must be implemented to protect the sensor from the electromagnetic noise that is emitted by any nearby electrical devices. The ZW Series Sensor Heads, however, contain no electronic parts to enable stable measurements even if they are near power lines or electrical equipment. Also, the Fiber Cable that connects the Sensor Head to the Controller can be placed near power lines and other cables that emit noise without affecting operation.

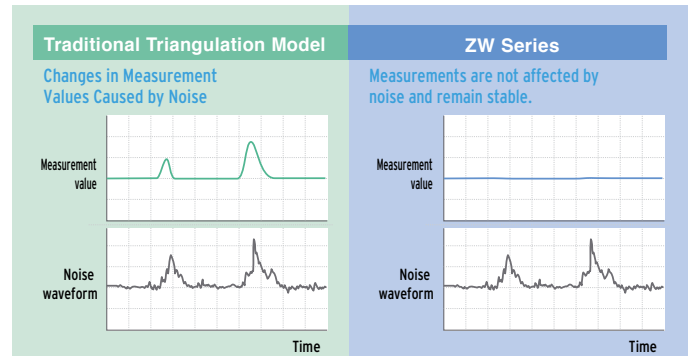

No Noise Emission

No electronic parts are used in the ZW Series Sensor Heads or Fiber Cables, so they give off no electromagnetic noise. You can therefore use them reliably together with other devices sensitive to electrical noise.

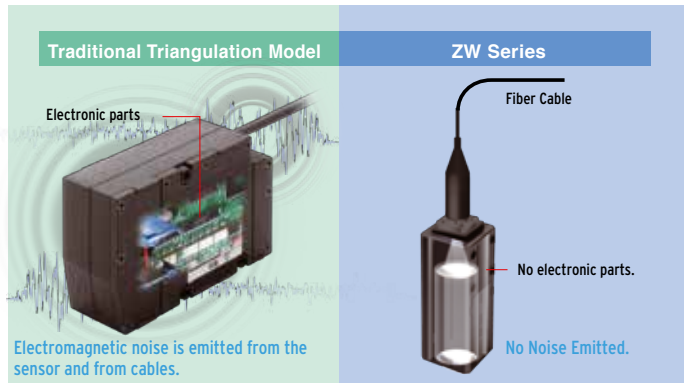

No Heat Generation

Reduced Work in Thermal Design

In high-resolution machine control, the heat generated by a sensor head can adversely affect nearby equipment and cause the error to increase. The ZW Series Sensor Heads, however, generate no heat and therefore do not affect nearby equipment. You can also install many Sensor Heads side by side and still be sure of reliable operation.

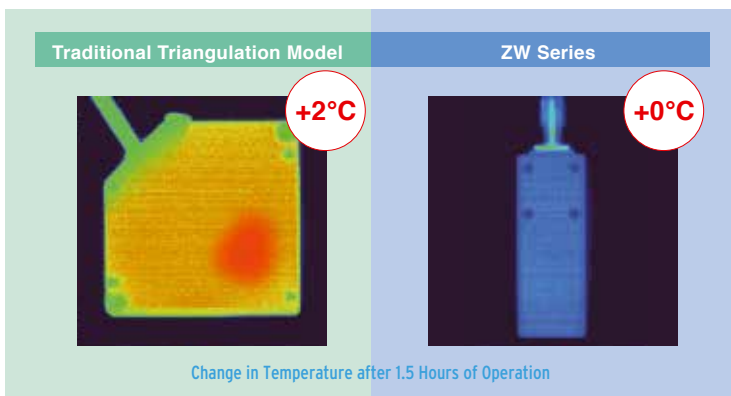

No Electronic Parts

Reduced Maintenance Costs

Displacement sensors are often installed in moving applications and other installations that are subject to vibration. It is important that they can withstand this type of requirement. The ZW Series Sensor Heads are designed for this type of environment, they have no electronic parts or PCB's that a standard triangulation sensor contains. The reduction of parts to lenses and Fiber Cables reduces the maintenance requirements, and the LED light source also eliminates the standard safety measures required for lasers.

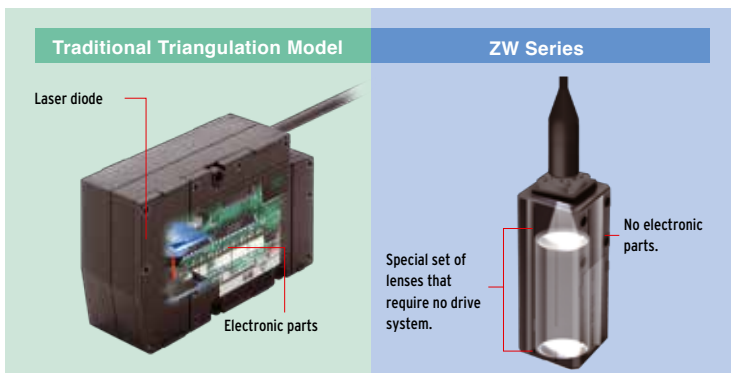

No electronic parts in the Sensor Head.

An LED is used in place of a laser for the light source to eliminate the need for safety measures.

Electric circuits and the light source are contained in the Controller.



Throughput is Increased with High Speed Data Transmission



The EtherCAT high-speed open network was optimized for machine control. The ZW Series Sensors are the first OMRON Displacement Sensors with EtherCAT to provide a highly efficient design for high-precision machine control applications that use measurement results to control machine operation.

Increase Processing Precision in Machine Control Applications

EtherCAT can be used to network to servo drives or encoder input slaves to quickly transfer the position coordinates and ZW displacement to the machine controller. The accuracy of height measurements with XY position data provides the added maintenance benefit to use the inspection application to help isolate errors and perform trend analysis.

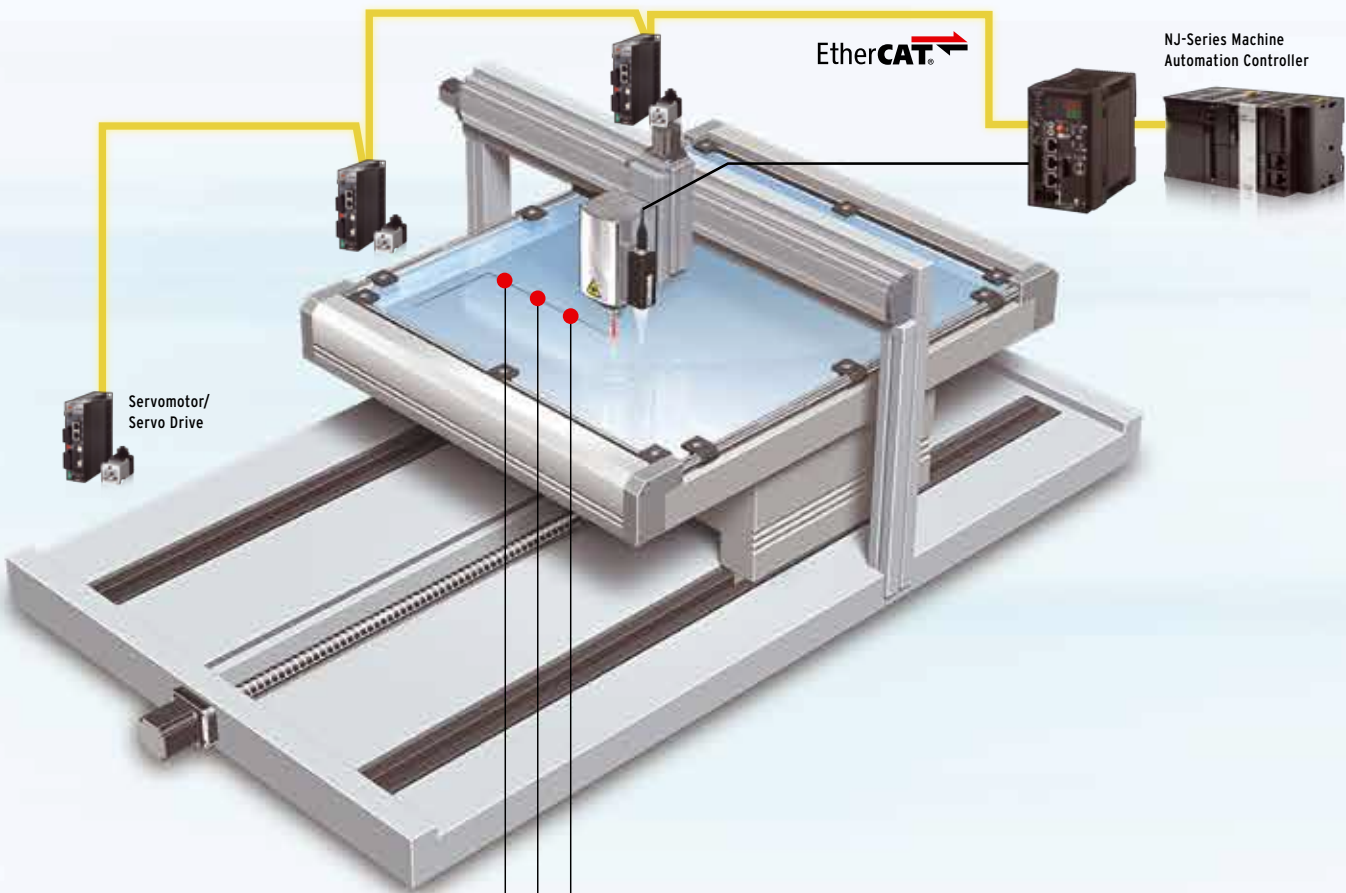

Measurement point	Measurement result Z	Servo/encoder X	Servo/encoder Y
Point 1	Z1	X1	Y1
Point 2	Z2	X2	Y2
Point 3	Z3	X3	Y3
⋮	⋮	⋮	⋮

Results of Linking with the Position Coordinates

Machine Controls

- Increased processing precision
- No need for constant-speed control

Inspection Applications

- Isolation of errors
- Trend management for specific positions

High-speed Digital Output

Shorter Machine Cycle Times

When comparing EtherCAT over previous communications outputs through Ethernet or RS-232C, the response period for measurement commands was both inconsistent and slow, making them unsuitable for realtime control. With EtherCAT, a constant period as short as 500 μ s enables continuous digital (serial) outputs allowing measurement values to be mapped at high speed.

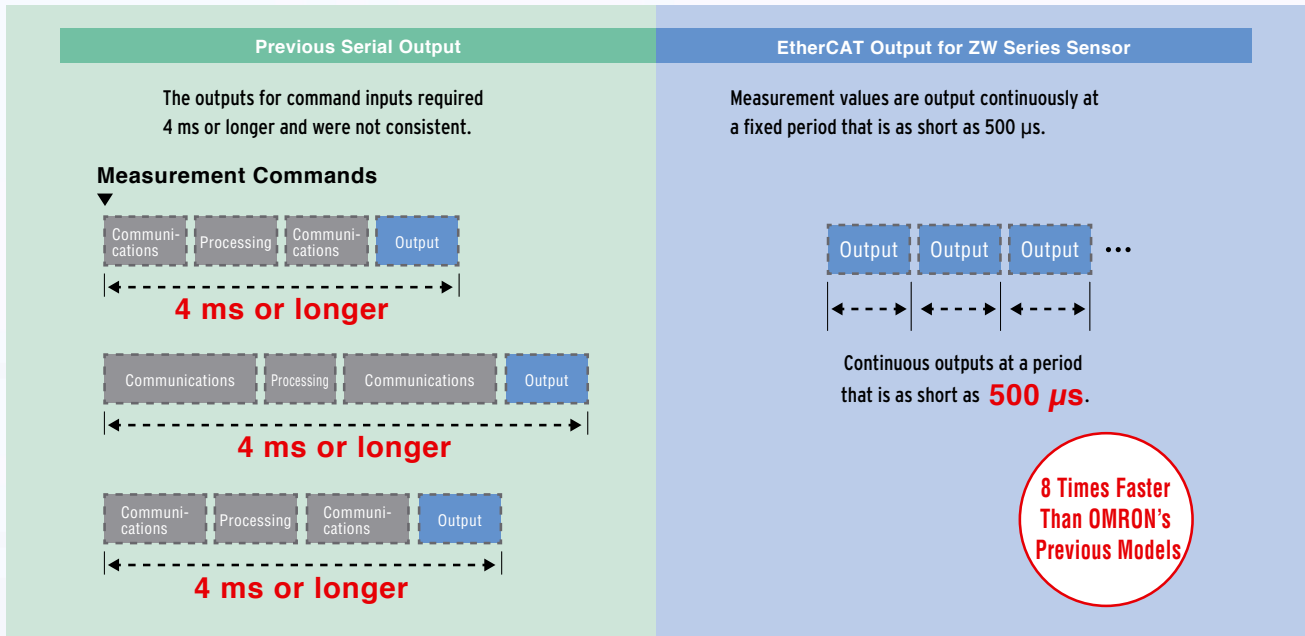

Tracing Machine Movement

Fewer Steps in System Commissioning

You can develop, test, and adjust devices that are connected via EtherCAT with just one Support Software package. Omron's Sysmac Studio software allows you to creatively design your controls. You can see the entire range from sensing to motion control to reduce the number of steps required to commission the system or to aid in troubleshooting. There are also plenty of offline features to debug signal control programming. You can also simulate machine operation before actual application onsite.

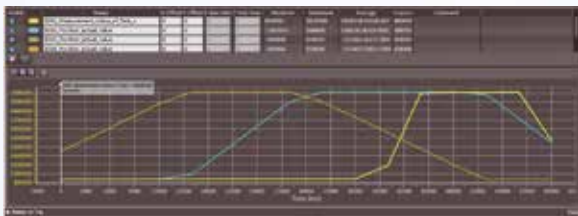

Data Trace



Debugging Control Programming

Note: Sysmac Studio version 1.05 or higher is required for these software interface features described.

Long-distance Wiring: 100 m

Flexible Wiring for Machines

You can use EtherCAT to connect slaves that are up to 100 m apart. With digital communications, the influence of ambient noise does not cause errors. This solves the previous problems with analog output methods, such as the inability to support long-distance transmissions and noise countermeasures, and enables reliable installation in previously difficult large-scale machines.

- Sysmac is a trademark or registered trademark of OMRON Corporation in Japan and other countries for OMRON factory automation products.
- Windows is registered trademarks of Microsoft Corporation in the USA and other countries.
- Other company names and product names in this document are the trademarks or registered trademarks of their respective companies.
- Microsoft product screen shot(s) reprinted with permission from Microsoft Corporation.

Simultaneous Calculations and Instant Multi-Point Measurements

EtherCAT communications provide both high speed and time-consistent performance so that integrated controls for Sensors and other slaves can be achieved in realtime. Even for multipoint measurements for Displacement Sensor applications, the following advantages are provided.

Reduced Wiring: Only Two Cables Plug and Play

With previous parallel I/O, manual wiring was required for dozens of points, and it was necessary to take sufficient caution to avoid sources of noise. This required extensive time to use many Displacement Sensors in a row. With EtherCAT, all you have to do is connect two lines for each Controller.

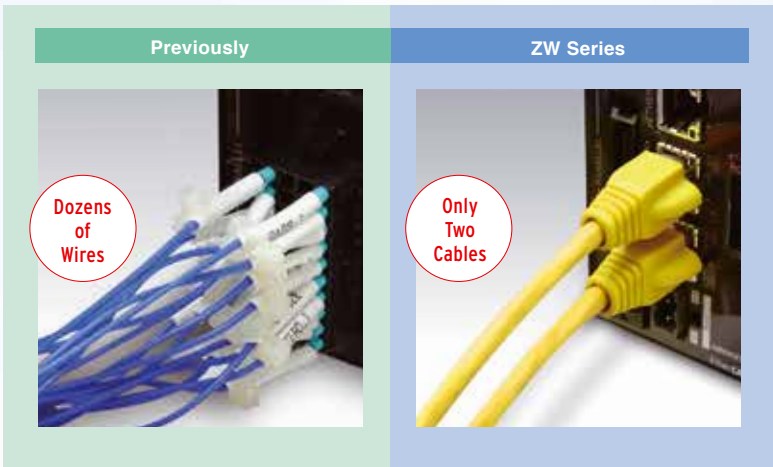

NJ-Series Machine Automation Controller



EtherCAT

One Software Fewer Steps in System Design

You can set up all of the slaves that are connected via EtherCAT with Measurement Utility of the Automation Software Sysmac Studio. Even when you combine multiple Sensors, you can copy setup data to effectively integrate setup work or you can easily program calculations between the Sensors.

Sysmac Studio



Efficient Setup of Measurement Conditions for Many Sensors



Easy Programming of Thickness Calculations

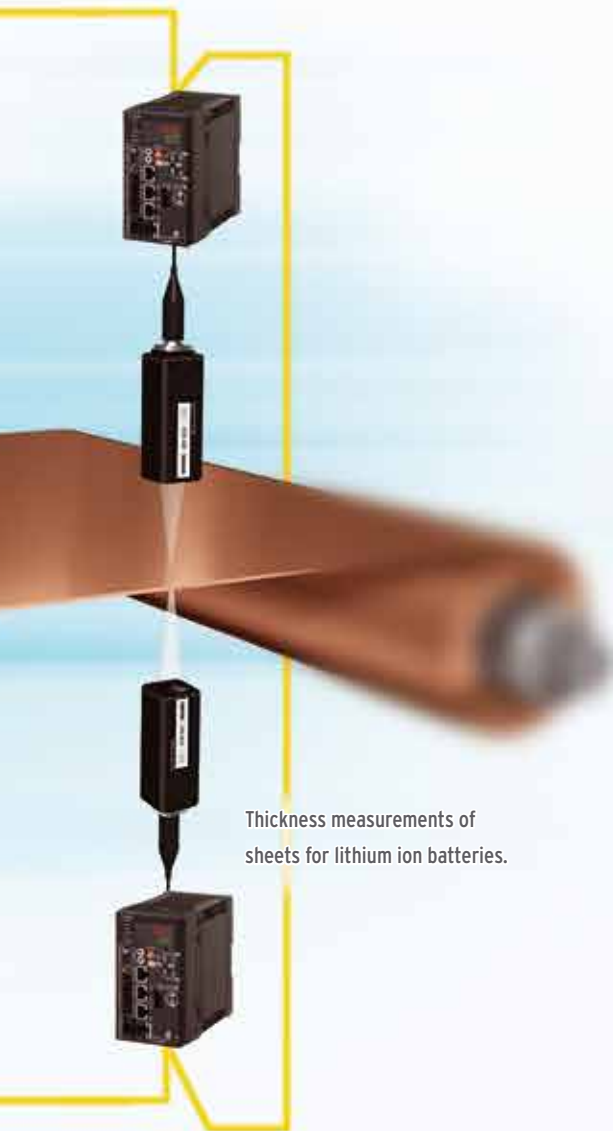

Thickness measurements of sheets for lithium ion batteries.

Synchronous Measurements

Fewer Thickness Errors due to Vibration

The highly precise synchronization performance of EtherCAT reduces the time error in measurements between different Sensors to 1 μ s or less. Synchronous measurement is useful when measurements must be made with more than one Sensor at the same time, such as measurements from both sides of a sheet or inclination control of a substrate.

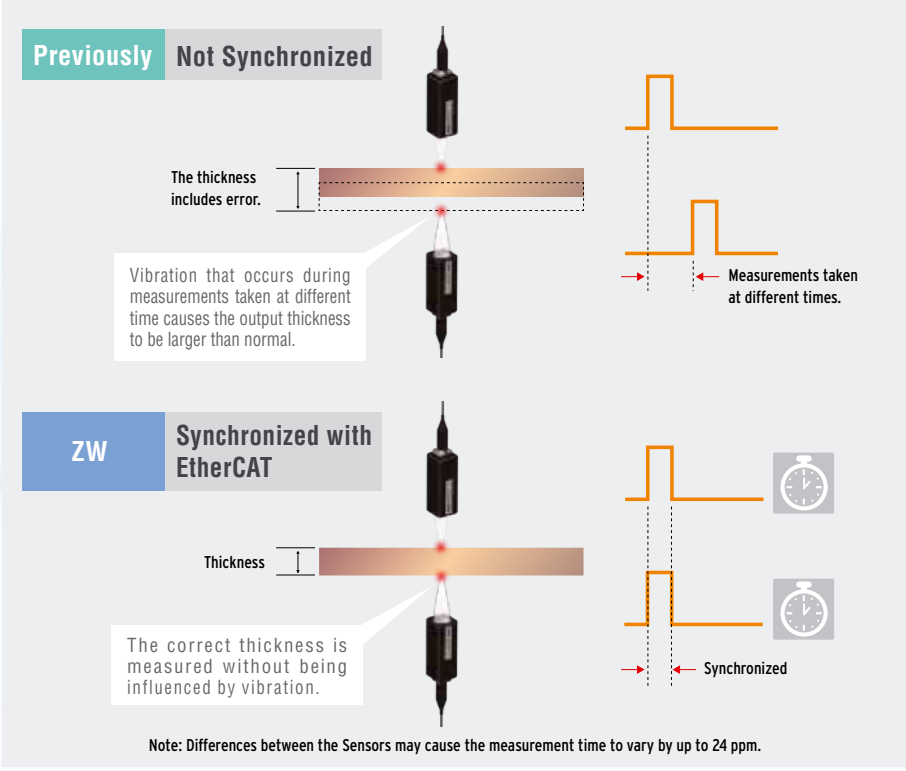

Continuous Measurements of Sheets without Position Offset

When Sensors are installed in a row to continuously log sheet height, nonsynchronous measurements can cause offsets in the lateral measurement positions. With synchronous measurements using EtherCAT, you can continuously log sheet height with all of the Sensors at the same lateral position.

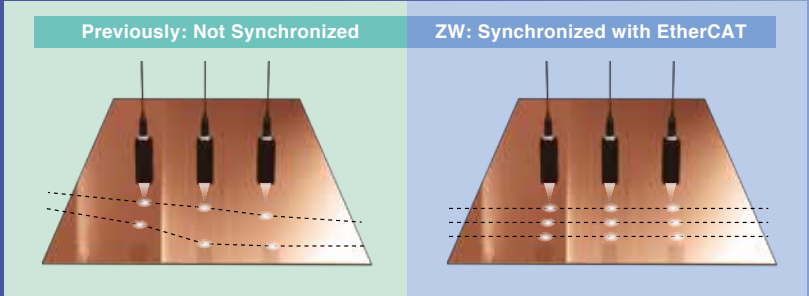

Robust Sensor Head Structure

To achieve a compact Sensor Head and high-resolution measurements, the ZW Series uses a white light confocal principle to detect objects. This principle is described below.

Confocal principle Confocal Light Emission and Reception

Based on the confocal principle, the emitted light and received light are positioned along the same axis. Light is received only when it is focused on the measurement object, allowing the height to be calculated. Unlike triangulation, the received light waveform is not disrupted by the material type or inclination of the measurement object. The received light waveform is always stable, which enables high-resolution measurements.

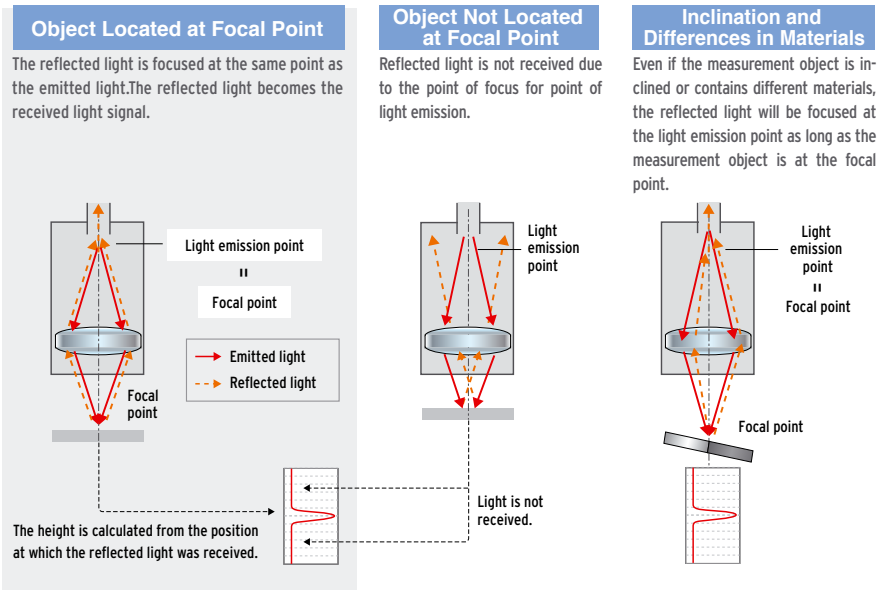

White Light Separation into Colors with Different Wavelengths at Emission

Patent Pending

The white light from the LED is focused at different points for each color (i.e., wavelength) due to a special set of lenses in the OCFL module in the Sensor Head. As a result, only the color of light that is focused on the measurement object is returned, allowing the distance from the Sensor Head to the measurement object to be calculated based on the color of the reflected light. The Sensor Head contains the special set of lenses that separates white light into different colors and the Controller contains the white LED light source, and the spectroscope and processor that convert the color of the reflected light to a distance. There is no need for a lens drive mechanism or electronic parts in the Sensor Head, even though they were considered to be standard for other manufacturer's confocal models. This achieves a compact design with greater immunity to noise than triangulation models and or competitor models. The ZW controller contains a white LED light source, the spectroscope and processor that analyzes the color of the reflected light.

OCFL Module

The OCFL module contains a special lens set developed by OMRON that changes the focal point for each color (i.e., wavelength) of white light. The spot diameter is the same at any position within the measuring range. It does not change the way it does for a triangulation. High-precision lens manufacturing technology has allowed us to achieve a lens structure that is extremely small and that also does not require a drive mechanism.



*OCFL: Omron Chromatic Focus Lens

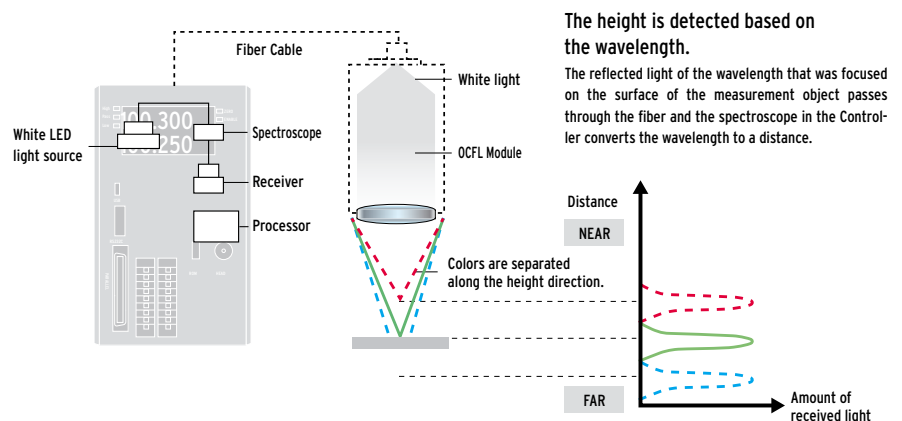

Problems with Previous Models

Triangulation

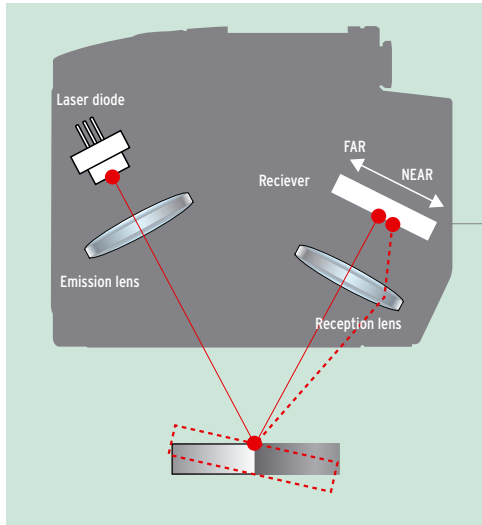

Triangulation measures the height of an object based on the position of the spot on a receiver (CCD or CMOS). The peak, center of gravity, and other features are calculated from the received light waveform to reduce error, but in principle, the received waveform is offset or disrupted due to differences in materials or inclination. This results in measurement error.

Light Reception for Different Materials

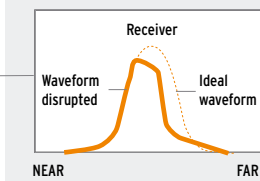

Different materials have different reflection factors. This disrupts the waveform that is received on the receiver. The peak in the waveform or the center of gravity are used to calculate the height, but error will remain in the measurement results.

Light Reception for Inclination

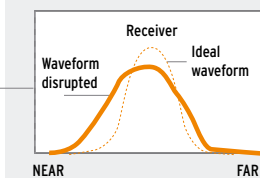

If the measurement object is inclined, the received waveform is offset or disrupted due to the effects of aberration. This results in measurement error.

Normal Confocal Principle

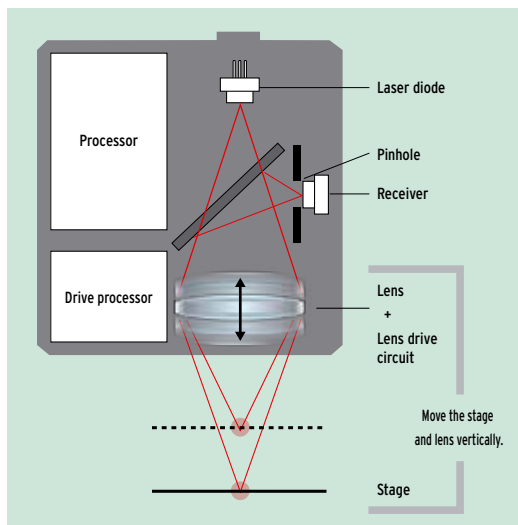

In a normal confocal model, a stage and lens are driven vertically to change the focal point. This requires a more complex structure, and the large number of parts interferes with downsizing. The use of a laser beam increases the chances of interference, and the received light waveform can be disrupted by the surface conditions within the small spot on the measurement object.

System Configuration

EtherCAT connections

Basic Configuration

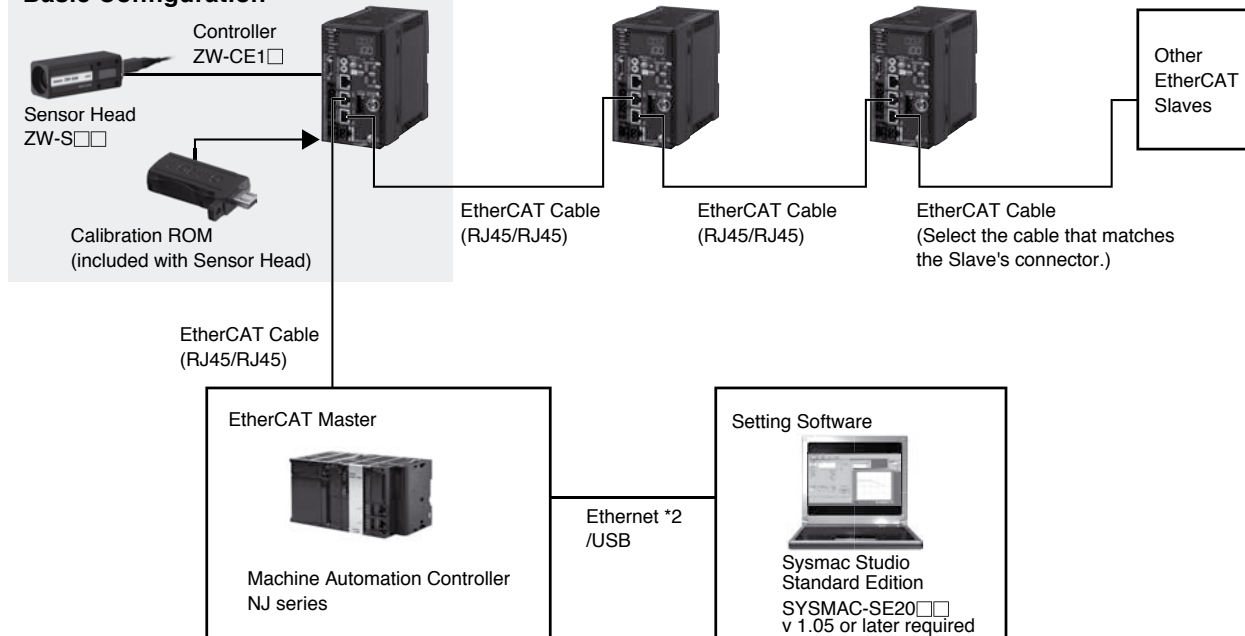

Analog, EtherNet/IP, Ethernet, RS-232C and Parallel connections

Communications capabilities depends on model type

Basic Configuration

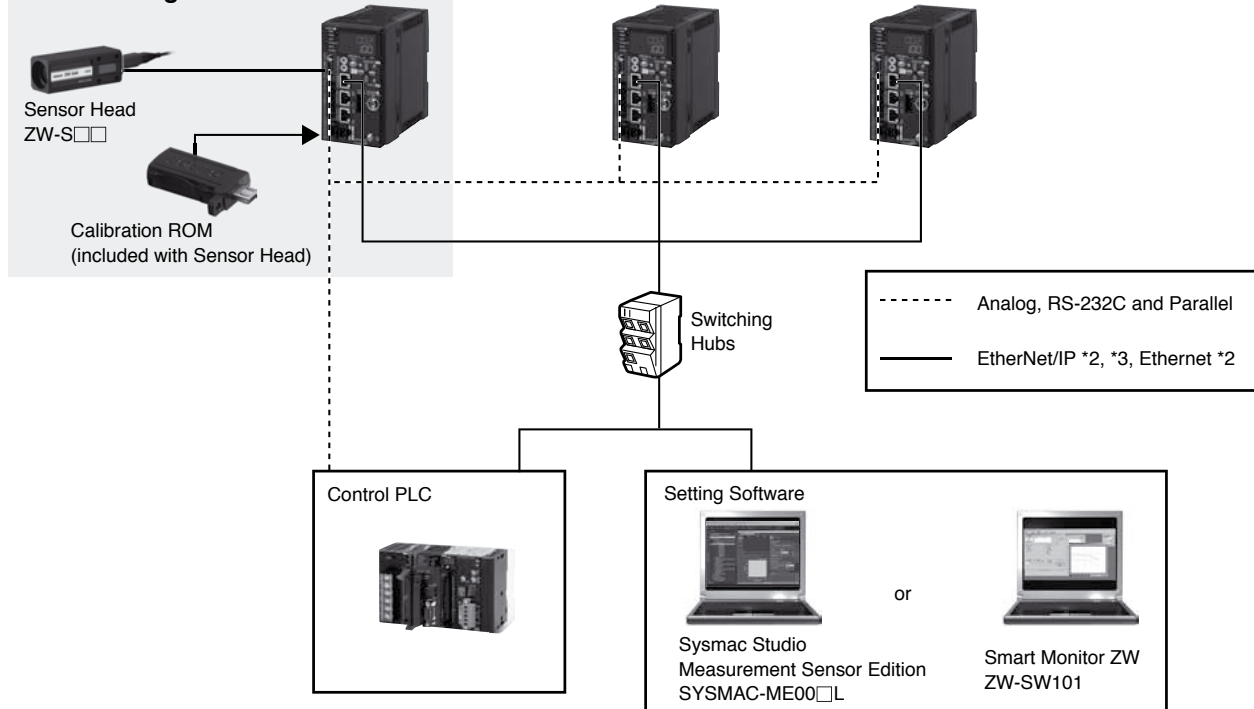

*1 Controllers with binary outputs are also available (ZW-C10T/-C15T).

Please contact your OMRON sales representative for details.

*2 Prepare commercially available Ethernet cable satisfying the following requirements:

- Category 5e or higher, 30 m or less
- RJ45 connector (8-pin modular jack)
- For direct connection: Select cross cable.
- For connection through an industrial switching hub: Select straight cable.

*3 Ethernet/IP is only on ZW-CE10T/CE15T Controllers.

Order Information

Sensor Head

Measuring range	7±0.3mm	20±1mm	30±3mm	40±6mm
Spot diameter	18 μm dia.	40 μm dia.	60 μm dia.	80 μm dia.
Static resolution	0.25μm	0.25μm	0.25μm	0.25μm
Model	ZW-S07□m	ZW-S20□m	ZW-S30□m	ZW-S40□m

Note: When ordering, specify the cable length (0.3 m, 2 m).

Controller

Appearance	Power supply	Output type	EtherCAT Model	Ethernet Model
	DC24V	NPN	ZW-CE10T	ZW-C10T
		PNP	ZW-CE15T	ZW-C15T

Cable

Appearance	Item	Cable length	Model
	Sensor Head - Controller Extension Fiber Cable (flexible cable) (Fiber Adapter ZW-XFC provided)	2m	ZW-XF02R
		5m	ZW-XF05R
		10m	ZW-XF10R
		20m	ZW-XF20R
	Fiber Adapter (between Sensor Head pre-wired cable and Extension Fiber Cable)	—	ZW-XFC
	Parallel cable for ZW-CE1□T 32-pole* (included with Controller ZW-CE1□T)	2m	ZW-XCP2E

Appearance	Item	Cable length	Model
	Parallel cable for ZW-C1□T 52-pole required (NOT included with Controller ZW-C1□T)	2m	ZW-XCP2
	RS-232C Cable for personal computer	2m	ZW-XRS2
	RS-232C Cable for PLC/programmable terminal	2m	ZW-XPT2

Right Angle & Vacuum Heads *NEW Coming Soon*

Appearance	Specification	ZW-SR20□m
	WD	20mm
	Measuring range	20mm
	Static resolution	0.25μm (average 4096)
	Linearity	± 1.2μm (mirror)
	Spot size	40μm
	Sensor size	24 x 24 x 64mm

Micro Heads *NEW Coming Soon*

Model	ZW-SP12□m	ZW-SP20□m	ZW-SP40□m
Measuring range	12±0.3mm	20±0.7mm	40±2mm
Static resolution	0.25μm	0.25μm	0.25μm
Linearity	±0.5μm	±1.0μm	±2.5μm
GAP separation ability	60μm~	100μm~	300μm~
Temperature characteristic	1.1μm/°C	1.6μm/°C	2.6μm/°C
Spot size	Near	25μm	35μm
	Center	20μm	30μm
	Far	25μm	35μm

Sysmac Studio Software

Please purchase a DVD and required number of licenses the first time you purchase the Sysmac Studio. DVDs and licenses are available individually. Software License does not include DVD.

Product name	Specifications	Number of licenses		Media	Model	Standards
		— (Media only)	1 license*1			
Sysmac Studio Standard Edition Ver.1.□□*2	The Sysmac Studio provides an integrated development environment to set up, program, debug, and maintain NJ-series Controllers and other Machine Automation Controllers, as well as EtherCAT slaves.	— (Media only)	—	DVD	SYSMAC-SE200D	—
	Sysmac Studio runs on the following OS. Windows XP (Service Pack 3 or higher, 32-bit version)/Vista(32-bit version)/7(32-bit/64-bit version)	1 license*1	—	—	SYSMAC-SE201L	—
Sysmac Studio Measurement Sensor Edition Ver.1.□□	This software provides functions of the Measurement Sensor Edition. Refer to Sysmac Catalog (P072) for details such as supported models and functions.	1 license	—	—	SYSMAC-ME001L	—
	Sysmac Studio Measurement Sensor Edition is a limited license that provides selected functions required for ZW-series Displacement Sensor settings. Because this product is a license only, you need the Sysmac Standard Edition DVD media to install it.	3 license	—	—	SYSMAC-ME003L	—

*1 Multi licenses are available for the Sysmac Studio (3, 10, 30, or 50 licenses).
*2 ZW-series is supported by Sysmac Studio version 1.05 or higher.

Setting Software

Item	Model
Smart Monitor ZW	ZW-SW101

Accessories



Item	Model
Fiber Connector Cleaner	ZW-XCL

Recommended EtherCAT Communications Cables

Use Straight STP (shielded twisted-pair) cable of category 5 or higher with double shielding (braiding and aluminum foil tape) for EtherCAT.

Cable with Connectors

Wire Gauge and Number of Pairs: AWG22, 2-pair Cable

Item	Appearance	Recommended manufacturer	Cable length(m)	Model
Cable with Connectors on Both Ends (RJ45/RJ45)		OMRON	0.3	XS5W-T421-AMD-K
			0.5	XS5W-T421-BMD-K
			1	XS5W-T421-CMD-K
			2	XS5W-T421-DMD-K
			5	XS5W-T421-GMD-K
			10	XS5W-T421-JMD-K
Cable with Connectors on Both Ends (M12/RJ45)		OMRON	0.3	XS5W-T421-AMC-K
			0.5	XS5W-T421-BMC-K
			1	XS5W-T421-CMC-K
			2	XS5W-T421-DMC-K
			5	XS5W-T421-GMC-K
			10	XS5W-T421-JMC-K
Cable with Connectors on Both Ends (M12 L/RJ45)		OMRON	0.3	XS5W-T422-AMC-K
			0.5	XS5W-T422-BMC-K
			1	XS5W-T422-CMC-K
			2	XS5W-T422-DMC-K
			5	XS5W-T422-GMC-K
			10	XS5W-T422-JMC-K

Note: The cable length 0.3, 0.5, 1, 2, 3, 5, 10 and 15m are available. For details, refer to Cat.No.G019.

Cables / Connectors

Wire Gauge and Number of Pairs: AWG24, 4-pair Cable

Item	Appearance	Recommended manufacturer	Model
Cables	—	Hitachi Cable, Ltd.	NETSTAR-C5E SAB 0.5 × 4P *
	—	Kuramo Electric Co.	KETH-SB *
	—	SWCC Showa Cable Systems Co.	FAE-5004 *
RJ45 Connectors	—	Panduit Corporation	MPS588-C *

* We recommend you to use above cable and connector together.



Wire Gauge and Number of Pairs: AWG22, 2-pair Cable

Item	Appearance	Recommended manufacturer	Model
Cables	—	Kuramo Electric Co.	KETH-PSB-OMR *
	—	Nihon Electric Wire&Cable Co.,Ltd.	PNET/B *
RJ45 Assembly Connector		OMRON	XS6G-T421-1 *

* We recommend you to use above cable and connector together.



Note: Connect both ends of cable shielded wires to the connector hoods.

Industrial Switching Hubs for Ethernet

Appearance	Number of ports	Failure detection	Current consumption	Model
	3	None	0.22A	W4S1-03B
	5	None	0.22A	W4S1-05B
		Supported		W4S1-05C

Note: Industrial switching hubs cannot be used for EtherCAT.

EtherCAT Junction Slaves

Appearance	Number of ports	Power supply voltage	Current consumption	Model
	3	20.4 to 28.8 VDC (24 VDC -15 to 20%)	0.08A	GX-JC03
	6		0.17A	GX-JC06

Note: 1. Do not connect EtherCAT junction slave with OMRON position control unit, Model CJ1W-NC□81/□82
2. EtherCAT junction slaves cannot be used for EtherNet/IP™ and Ethernet connectivity.

Specifications

Sensor Head

Item	ZW-S07	ZW-S20	ZW-S30	ZW-S40
Measuring center distance	7mm	20 mm	30mm	40 mm
Measuring range	±0.3mm	±1 mm	±3mm	±6 mm
Static resolution *1	0.25 μm	0.25 μm	0.25 μm	0.25 μm
Linearity *2	±0.8 μm	±1.2 μm	±4.5 μm	±7.0 μm
Spot diameter *3	Near	20 μm dia.	45 μm dia.	70 μm dia.
	Center	18 μm dia.	40 μm dia.	60 μm dia.
	Far	20 μm dia.	45 μm dia.	70 μm dia.
Measuring cycle	500 μs to 10 ms			
Operating ambient illumination	Illumination on object surface 10,000 lx or less: incandescent light			
Ambient temperature range	Operating: 0 to 50°C, Storage: -15 to 60°C (with no icing or condensation)			
Ambient humidity range	Operating and storage: 35% to 85% (with no condensation)			
Degree of protection	IP40 (IEC60529)			
Vibration resistance (destructive)	10 to 150 Hz, 0.35 mm single amplitude, 80 min each in X, Y, and Z directions			
Shock resistance (destructive)	150 m/s ² 3 times each in six directions (up/down, left/right, forward/backward)			
Temperature characteristic *4	0.6 μm/°C	1.5 μm/°C	2.8 μm/°C	4.8 μm/°C
Materials	Case: aluminum die-cast Fiber cable sheath: PVC Calibration ROM: PC			
Fiber cable length	0.3 m, 2 m (Flex-resistant cable)			
Fiber cable minimum bending radius	20 mm			
Insulation resistance (Calibration ROM)	Between case and all terminals: 20 MΩ (by 250 V megger)			
Dielectric strength (Calibration ROM)	Between case and all terminals: 1,000 VAC, 50/60 Hz, 1 min			
Weight	Approx. 105 g (Chassis, fiber cable total)			
Accessories included with sensor head	Instruction sheet, Fixing screw (M2) for Calibration ROM, Precautions for correct use			

*1. Capacity value when Omron standard mirror surface target is measured at the measurement center distance as the average of 4,096 times.

*2. Material setting for the Omron standard mirror surface target: Error from an ideal straight line when measuring on mirror surface.
The reference values for linearity when targets to measure other than the above are as in the table below.

Item	ZW-S07	ZW-S20	ZW-S30	ZW-S40
Glass	±1.0 μm	±1.2 μm	±4.5 μm	±7.0 μm
SUS BA	±1.2 μm	±1.4 μm	±5.5 μm	±8.5 μm
White ceramic	±1.6 μm	±1.7 μm	±6.4 μm	±9.5 μm

*3. Capacity value defined by $1/e^2$ (13.5%) of the center optical intensity in the measured area.

*4. Temperature characteristic at the measurement center distance when fastened with an aluminum jig between the Sensor Head and the target and the Sensor Head and the controller are set in the same temperature environment.

Sysmac Studio Software (For ZW-CE1□T type only)

System Requirements

Item	Requirement
Operating system (OS) *1 *2	Windows XP (Service Pack 3 or higher, 32-bit version)/Vista(32-bit version)/7(32-bit/64-bit version)
CPU	Windows computers with Celeron 540 (1.8 GHz) or faster CPU. Core i5 M520 (2.4 GHz) or equivalent or faster recommended
Main memory	2 GB min.
Recommended video memory / video card for using 3D motion trace	Video memory: 512 MB min. Video card: Either of the following video cards: • NVIDIA GeForceR 200 Series or higher • ATI RadeonHD5000 Series or higher
Hard disk	At least 1.6 GB of available space
Display	XGA 1024 × 768, 16 million colors. WXGA 1280 × 800 min. recommended
Disk drive	DVD-ROM drive
Communications ports	USB port corresponded to USB 2.0, or Ethernet port *3
Supported languages	Japanese, English, German, French, Italian, Spanish, simplified Chinese, traditional Chinese, Korean

*1. Sysmac Studio Operating System Precaution: System requirements and hard disk space may vary with the system environment.

*2. The following restrictions apply when Sysmac Studio is used with Microsoft Windows Vista or Windows 7.

Some Help files cannot be accessed.

The Help files can be accessed if the Help program distributed by Microsoft for Windows (WinHlp32.exe) is installed. Refer to the Microsoft homepage listed below or contact Microsoft for details on installing the file. (The download page is automatically displayed if the Help files are opened while the user is connected to the Internet.)

<http://support.microsoft.com/kb/917607/en-us>

*3. Refer to the hardware manual for your Controller for hardware connection methods and cables to connect the computer and Controller.

Setting Software Smart Monitor ZW-SW101

System Requirements

Item	Condition
Operating System(OS)	Windows 7 (32 or 64-bit version) Windows XP (Service Pack3 or more, 32-bit version)
CPU	Intel Pentium III, 850 MHz or more (2 GHz or more is recommended.)
Main memory	1 GB or more
Hard disk	50 MB or more
Display	1024 × 768 dots or more, 16 million colors or more
Supported languages	Japanese/English
Communication port	Ethernet port

Controller

Item	ZW-CE1□T		ZW-C1□T		
	ZW-CE10T	ZW-CE15T	ZW-C10T	ZW-C15T	
Input/Output type	NPN	PNP	NPN	PNP	
Number of connected Sensor Heads	1 per Controller				
Sensor Head compatibility	Available				
Light source for measurement	White LED				
Segment display	Main display	11-segment red display, 6 digits			
	Sub-display	11-segment green display, 6 digits			
LED display	Status indicators	HIGH (orange), PASS (green), LOW (orange), STABILITY (green), ZERO (green), ENABLE (green), THRESHOLD-H (orange), THRESHOLD-L (orange), RUN (green)			
	EtherCAT indicators	L/A IN(Link Activity IN)(green), L/O OUT(Link Activity OUT)(green), ECAT RUN(green), ECAT ERR(red)	N/A		
External interface	Ethernet	100BASE-TX, 10BASE-T, No-protocol Communications (TCP/UDP)			
	Ethernet I/P	Yes	N/A		
	EtherCAT	EtherCAT-specific protocol 100BASE-TX		N/A	
	RS-232C	115,200 bps max.			
	Analog voltage output (OUT1V)	Analog output terminal block	-10 V to +10 V, output impedance: 100 Ω	20-pole extension connector	
	Analog current output (OUT1A)		4 mA to 20 mA, maximum load resistance: 300 Ω		
	Judgment output (HIGH1/PASS1/LOW1)	32-pole extension connector	Transistor output system Output voltage: 21.6 to 30 VDC Load current: 50 mA or less Residual voltage when turning ON: 1.2 V or less Leakage voltage when turning OFF: 0.1 mA or less		(Specifications are the same as 32-pole connectors for ZW-CE1□T models)
	ALARM output (ALARM1)		DC input system. Input voltage: 24 VDC 10% (21.6 to 26.4 VDC) Input current: 7 mA Typ. (24 VDC) Voltage/Current when turning ON: 19 V/3 mA or more Voltage/Current when turning OFF: 5 V/1 mA or less		
	ENABLE output (ENABLE)				
	LED OFF input (LED OFF1)				
ZERO RESET input (ZERO)					
TIMING output (TIMING1)					
RESET output (RESET1)					
Bank	Selected bank output (BANK_OUT 1 to 3)	Transistor output system Output voltage: 21.6 to 30 VDC Load current: 50 mA or less Residual voltage when turning ON: 1.2 V or less Leakage voltage when turning OFF: 0.1 mA or less		52-pole extension connector	
	Selected bank input (BANK_SEL 1 to 3)	DC input system. Input voltage: 21.6 to 24VDC Input current: 7 mA Typ. (24 VDC) Voltage/Current when turning ON: 19 V/3 mA or more Voltage/Current when turning OFF: 5 V/1 mA or less			
Main functions	Exposure time	Auto/Manual			
	Measuring cycle	500 μs to 10 ms			
	Material setting	Standard/Mirror/Diffusion surfaces			
	Measurement Item	Height/Thickness/Calculation			
	Filtering	Median/Average/Differentiation/High pass/Low pass/Band pass			
	Outputs	Scaling/Different holds/Zero reset/Logging for a measured value			
	Display	Measured value/Threshold value/Analog output voltage or current value/Judgment result/ Resolution/Exposure time			
	Number of configurable banks	Max. 8 banks			
	Task process	Multi-task (up to 4 tasks per bank)			
	System	Save/Initialization/Display measurement information/Communication settings/Sensor Head calibration/Key-lock/Trigger-key input			
Ratings	Power supply voltage	21.6 to 26.4 VDC (including ripple)			
	Current consumption	600 mA max.	500 mA max.		
	Insulation resistance	Across all lead wires and controller case: 20 MΩ(by 250 V megger)			
	Dialectic strength	Across all lead wires and controller case: 1,000 VAC, 50/60 Hz, 1 min.			
Environmental	Degree of protection	IP20(IEC60529)			
	Vibration resistance (destructive)	10 to 55 Hz, 0.35-mm single amplitude, 50 min each in X, Y, and Z directions			
	Shock resistance (destructive)	150 m/s ² , 3 times each in six directions (up/down, left/right, forward/backward)			
	Ambient temperature	Operating: 0 to 40°C, Storage: -15 to 60°C (with no icing or condensation)			
	Ambient humidity	Operating and storage: 35° to 85° (with no condensation)			
Grounding	D-type grounding (Grounding resistance of 100 Ω or less) Note: For conventional Class D grounding				
Materials	Case: PC				
Weight	Approx. 750 g (main unit only), Approx. 150 g (Parallel Cable)				
Accessories included with controller	Instruction sheet, Member registration sheet, Parallel cable ZW-XCP2E included with ZW-CE1_T controller only				

ZW Series EtherCAT Communications Specifications

Item	Specification
Communications standard	IEC61158 Type12
Physical layer	100BASE-TX(IEEE802.3)
Connectors	RJ45 × 2 ECAT IN: EtherCAT input ECAT OUT: EtherCAT output
Communications media	Category 5 or higher (cable with double, aluminum tape and braided shielding) is recommended.
Communications distance	Distance between nodes: 100 m max.
Process data	Variable PDO mapping
Mailbox (CoE)	Emergency messages, SDO requests, SDO responses, and SDO information
Distributed clock	Synchronization in DC mode.
LED display	L/A IN (Link/Activity IN) × 1, AL/A OUT (Link/Activity OUT) × 1, AECAT RUN × 1, AECAT ERR × 1

Characteristic data (typical examples)

Linearity Characteristic by Materials

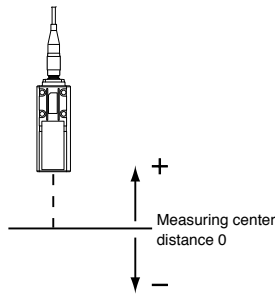

ZW-S07

Material setting: Normal

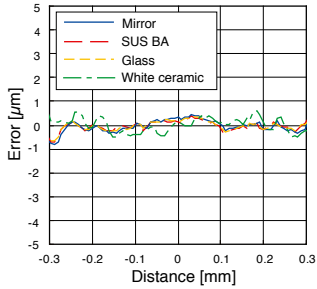

Material setting: Mirror surface

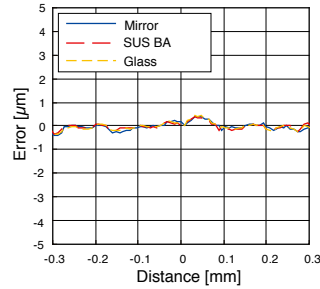

Material setting: Diffusion surface

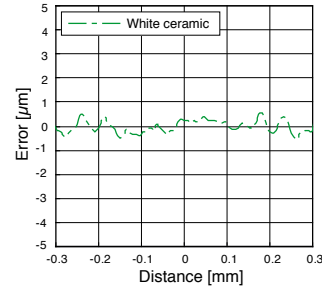

ZW-S20

Material setting: Normal

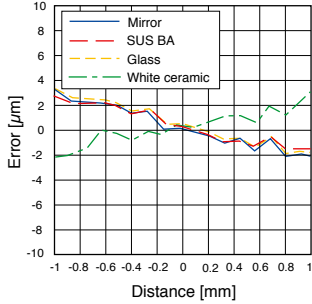

Material setting: Mirror surface

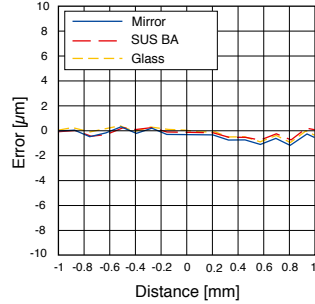

Material setting: Diffusion surface

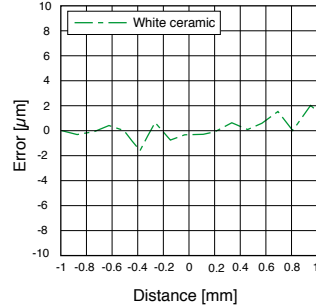

ZW-S30

Material setting: Normal

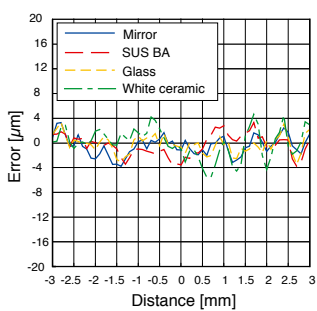

Material setting: Mirror surface

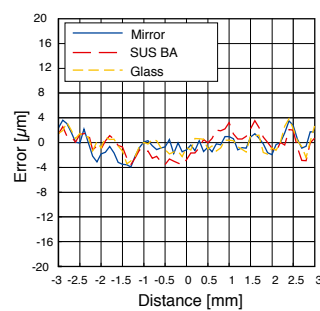

Material setting: Diffusion surface

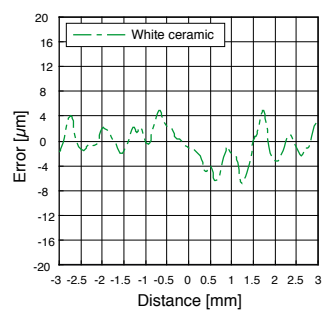

ZW-S40

Material setting: Normal

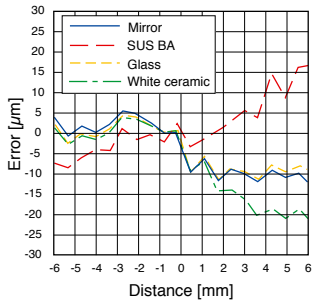

Material setting: Mirror surface

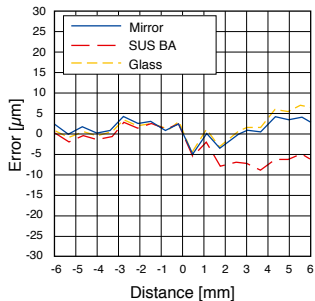

Material setting: Diffusion surface

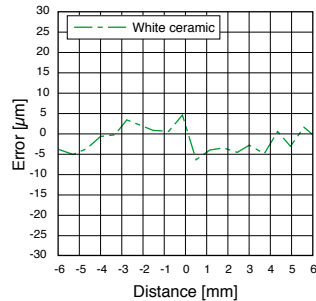

Angle Characteristic *

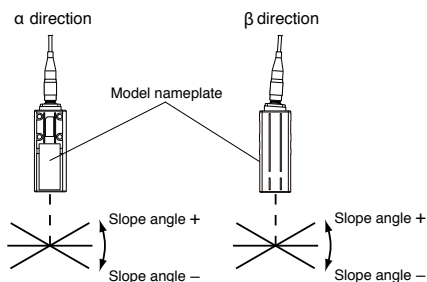

*The above show the results after executing scaling.

ZW-S07

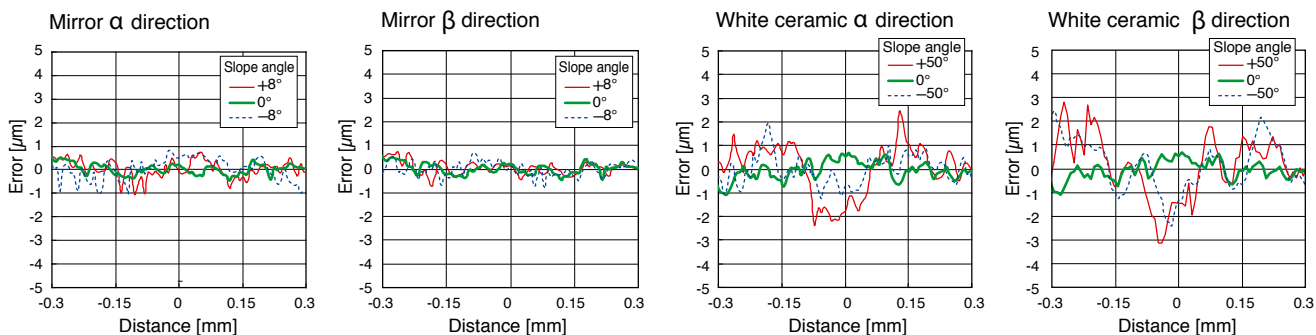

ZW-S20

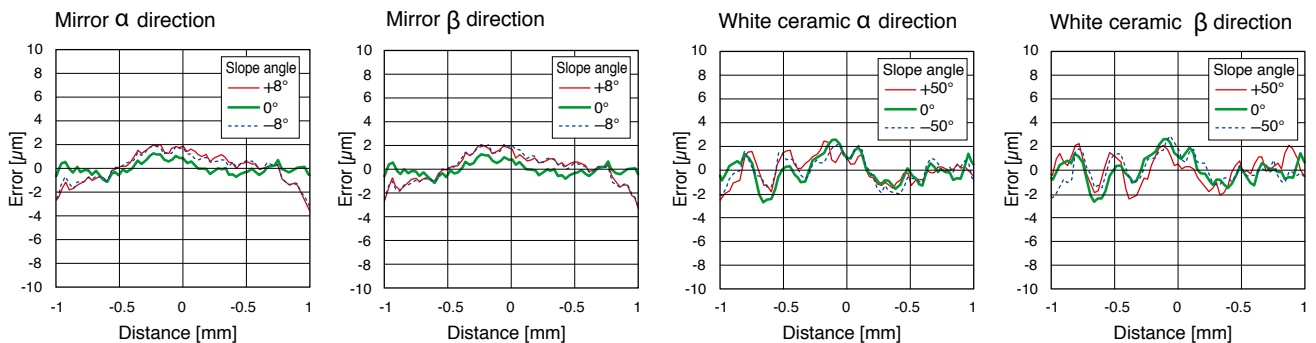

ZW-S30

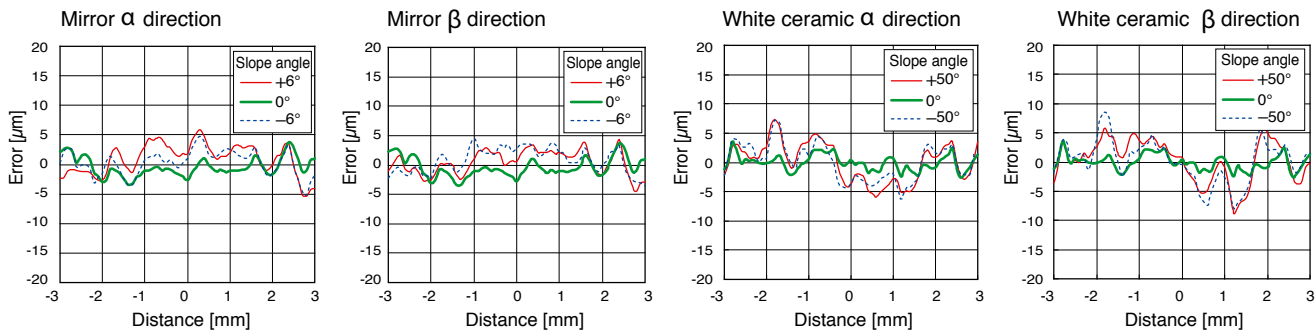

ZW-S40

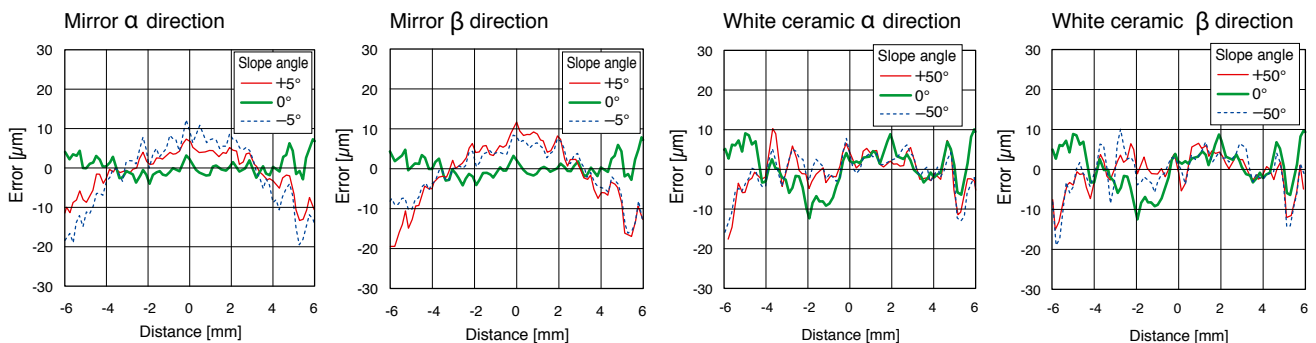

External Dimensions

(Unit: mm)

Sensor Head ZW-S07/-S20/-S30/-S40

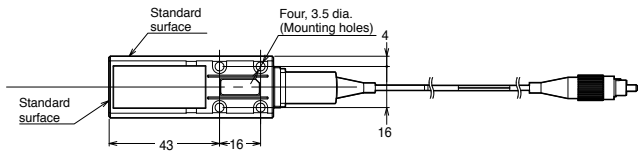
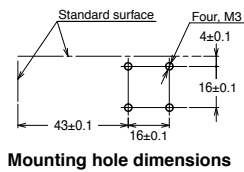

Note:

Model	L	M	X
ZW-S07	7	0.3	12
ZW-S20	20	1	11.8
ZW-S30	30	3	11.7
ZW-S40	40	6	11.7

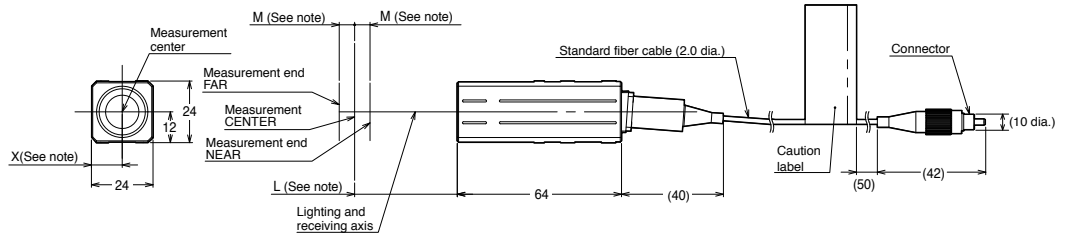

Controller

ZW-CE10T/-CE15T

ZW-C10T/-15T
External Reference
dimensions only.
Connector connection differs

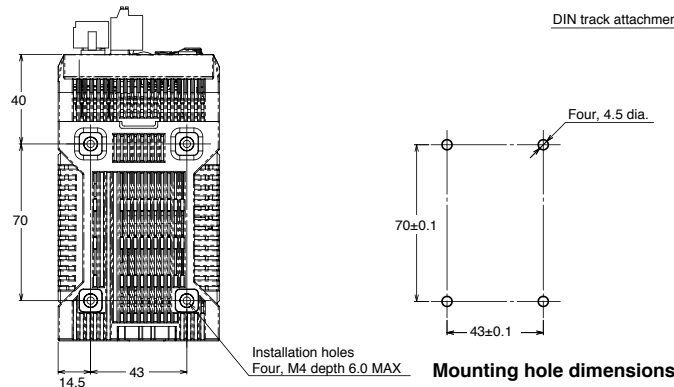
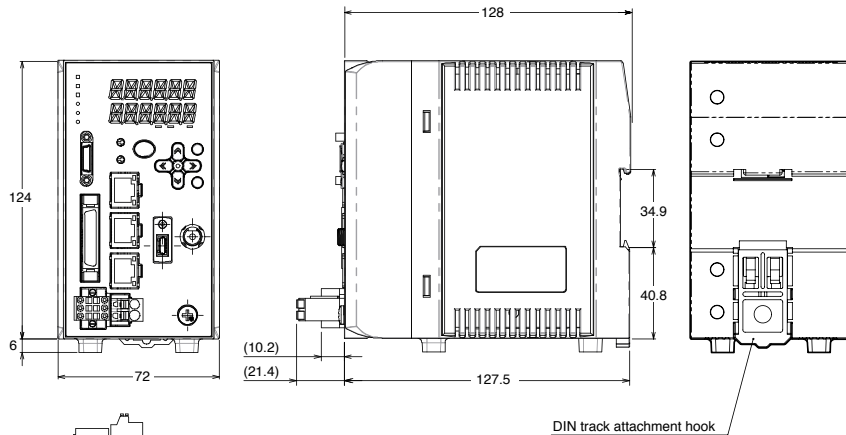

Extension Fiber Cable

ZW-XF02R/-XF05R/-XF10R/-XF20R/-XF30R

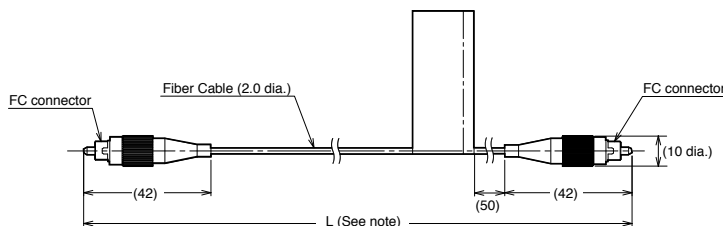

Note: The following table lists cable lengths per models.

Model	Cable length	L
ZW-XF02R	2 m	2,000±20
ZW-XF05R	5 m	5,000±50
ZW-XF10R	10 m	10,000±100
ZW-XF20R	20 m	20,000±200
ZW-XF30R	30 m	30,000±300

Related Manuals

Man.No.	Model number	Manual
Z332	ZW-CE1□T	Displacement Measurement Sensor ZW EtherCAT Model User's Manual
Z332	ZW-C1□T	Displacement Measurement Sensor ZW Ethernet Model User's Manual

OMRON AUTOMATION AND SAFETY • THE AMERICAS HEADQUARTERS • Schaumburg, IL USA • 847.843.7900 • 800.556.6766 • www.omron247.com

OMRON CANADA, INC. • HEAD OFFICE

Toronto, ON, Canada • 416.286.6465 • 866.986.6766 • www.omron247.com

OMRON ELECTRONICS DE MEXICO • HEAD OFFICE

México DF • 52.55.59.01.43.00 • 001.800.556.6766 • mela@omron.com

OMRON ELECTRONICS DE MEXICO • SALES OFFICE

Apodaca, N.L. • 52.81.11.56.99.20 • 001.800.556.6766 • mela@omron.com

OMRON ELETRÔNICA DO BRASIL LTDA • HEAD OFFICE

São Paulo, SP, Brasil • 55.11.2101.6300 • www.omron.com.br

OMRON ARGENTINA • SALES OFFICE

Cono Sur • 54.11.4783.5300

OMRON CHILE • SALES OFFICE

Santiago • 56.9.9917.3920

OTHER OMRON LATIN AMERICA SALES

54.11.4783.5300

OMRON EUROPE B.V. • Wegalaan 67-69, NL-2132 JD, Hoofddorp, The Netherlands. • Tel: +31 (0) 23 568 13 00 • Fax: +31 (0) 23 568 13 88 • www.industrial.omron.eu

Authorized Distributor:

Automation Control Systems

- Machine Automation Controllers (MAC) • Programmable Controllers (PLC)
- Operator interfaces (HMI) • Distributed I/O • Software

Drives & Motion Controls

- Servo & AC Drives • Motion Controllers & Encoders

Temperature & Process Controllers

- Single and Multi-loop Controllers

Sensors & Vision

- Proximity Sensors • Photoelectric Sensors • Fiber-Optic Sensors
- Amplified Photomicrosensors • Measurement Sensors
- Ultrasonic Sensors • Vision Sensors • RFID/Code Readers

Industrial Components

- Relays • Pushbuttons & Indicators • Limit and Basic Switches • Timers
- Counters • Metering Devices • Power Supplies

Safety

- Laser Scanners • Safety Mats • Edges and Bumpers
- Programmable Safety Controllers • Light Curtains • Safety Relays
- Safety Interlock Switches