

Fast Switching SCR T507_40

40A Avg.
(63 RMS)
Up to 1400 Volts
10-50 μ s



Conforms to TO-94 Outline

Symbol	Inches		Millimeters	
	Min.	Max.	Min.	Max.
A	5.775	6.265	146.69	159.13
A ₁	6.850	7.500	173.99	190.50
B	.055	.075	1.40	1.91
ϕ D	.860	1.000	21.84	25.40
E	1.031	1.063	26.19	27.00
F	.255	.400	6.48	10.16
J	2.50		63.50	
M	.437	.650	11.10	16.51
N	.796	.827	20.24	21.01
Q		1.675		42.55
ϕ T	.260	.291	6.60	7.39
Z	.250		6.35	
ϕ W	$\frac{1}{2}$ -20 UNF-2A			

Creep & Strike Distance.

T500—.50 in. min. (12.85 mm).
(In accordance with NEMA standards.)

Finish—Nickel Plate.

Approx. Weight—5 oz. (142 g).

- Complete threads to extend to within 2½ threads of seating plane.
- Angular orientation of terminals is undefined.
- Pitch diameter of $\frac{1}{2}$ -20 UNF-2A (coated) threads (ASA B1.1-1960).
- Dimension "J" denotes seated height with leads bent at right angles.

*For 10 μ sec turn-off, consult factory.

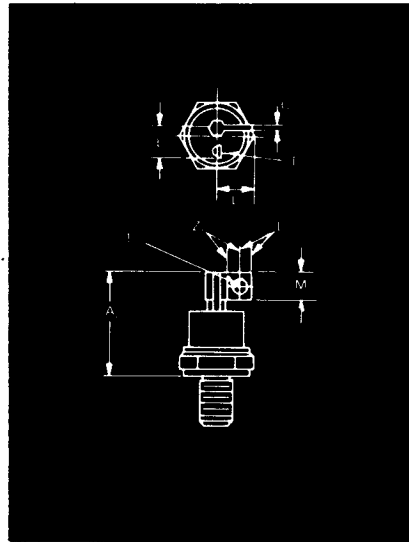

Conforms to TO-83 Outline

Symbol	Inches		Millimeters	
	Min.	Max.	Min.	Max.
A ₂		1.810		45.97
C	.070	.110	1.78	2.79
L		.650		16.51
L ₁	.420	.520	10.67	13.21
L ₂	.180		4.57	
M ₁	.360	.470	9.14	11.94
ϕ T ₁	.190	.235	4.83	5.97
ϕ T ₂	.060	.080	1.52	2.03
Z ₁	.180		4.57	
ϕ W	$\frac{1}{2}$ -20 UNF-2A			

Approx. Weight—4 oz. (114 g).

- Basic dimensions of TO-94 and TO-83 are same except as noted.

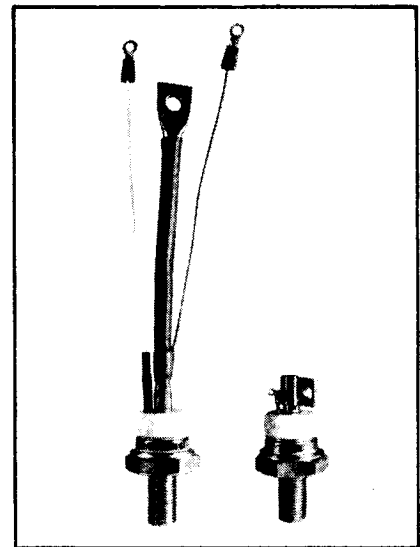

Features:

- Center fired di/damic
- High di/dt with soft gate control
- High frequency operation
- Sinusoidal waveform operation to 20 KHz
- Rectangular waveform operation to 20 KH.
- Low dynamic forward voltage drop
- Low switching losses at high frequency
- Lifetime Guarantee

Applications:

- Inverters for UPS
- Induction Heating
- AC Motor Control
- Switching power supplies
- Cycloconverters
- Choppers
- Crowbars

Ordering Information

Type	Voltage		Current		Turn off		Gate current		Leads	
	V _{DRM} and V _{RRM} (V)	Code	I _{T(av)} (A)	Code	t _q (μ sec)	Code	I _{GT} (ma)	Code	Case	Code
T507	100	01	40	04	10	5	150	4	TO-94	AQ
	200	02			15					AB
	300	03			20					
	400	04			25					
	500	05			30					
	600	06			40					
	700	07			50					
	800	08								
	900	09								
	1000	10								
	1100	11								
	1200	12								
1400	14									

Type	Voltage	Current	Turn Off	Gate Current	Leads
T 5 0 7	1 0	8 0	5	4	A Q

FAST SWITCHING THYRISTORS

Example

Obtain optimum device performance for your application by selecting proper Order Code.

Type T 507 rated at 40 A average with V_{DRM} = 1000V, I_{GT} = 150 ma, t_q = 30 μ sec max. and flex leads—order as:

**40A Avg.
(63 RMS)
Up to 1400 Volts
10-50 μ s**

**Fast Switching
SCR
T507_40**

Voltage

Blocking State Maximums $\textcircled{2}$ ($T_J = 125^\circ\text{C}$)

Symbol	100	200	300	400	500	600	700	800	900	1000	1100	1200	1400
Repetitive peak forward blocking voltage, V $\textcircled{1}$ V_{DRM}	100	200	300	400	500	600	700	800	900	1000	1100	1200	1400
Repetitive peak reverse voltage, V V_{RRM}	100	200	300	400	500	600	700	800	900	1000	1100	1200	1400
Non-repetitive transient peak reverse voltage, $t \leq 5.0$ msec, V V_{RSM}	200	300	400	500	600	700	800	900	1000	1100	1200	1300	1500
Forward leakage current, mA peak I_{DRM}	←----- 15 -----→												
Reverse leakage current, mA peak I_{RRM}	←----- 15 -----→												

Current

Conducting State Maximums
($T_J = 125^\circ\text{C}$)

Symbol	T507_40
RMS forward current, A $I_{T(rms)}$	63
Ave. forward current, A $I_{T(av)}$	40
One-half cycle surge current $\textcircled{3}$, A I_{TSM}	1000
I^2t for fusing (for times ≥ 8.3 ms) $A^2 \text{ sec.}$ I^2t	4000
Forward voltage drop at $I_{TM} = 500A$ and $T_J = 25^\circ\text{C}$, V V_{TM}	4.2
Min. repetitive di/dt $\textcircled{1}$ $\textcircled{2}$ $\textcircled{3}$, A/ μ sec di/dt	100

Switching

($T_J = 25^\circ\text{C}$)

Symbol	
Max. turn-off time, $I_T = 50A$, $T_J = 125^\circ\text{C}$, $di_T/dt = 5 A/\mu$ sec, reapplied $dv/dt = 20V/\mu$ sec linear to $0.8 V_{DRM}$, μ sec $\textcircled{1}$ $\textcircled{2}$ t_q	10 to 50
Typ. turn-on-time, $I_T = 100A$, $V_D = 100V$, μ sec t_{on}	3.5
Min. critical dv/dt , exponential to V_{DRM} , $T_J = 125^\circ\text{C}$, V/ μ sec $\textcircled{1}$ $\textcircled{2}$ dv/dt	200
Min. di/dt non-repetitive, A/ μ sec $\textcircled{1}$ $\textcircled{2}$ $\textcircled{3}$ di/dt	800

Gate

Maximum Parameters
($T_J = 25^\circ\text{C}$)

Symbol	
Gate current to trigger at $V_D = 12V$, mA I_{GT}	150
Gate voltage to trigger at $V_D = 12V$, V V_{GT}	3
Non-triggering gate voltage, $T_J = 125^\circ\text{C}$, and rated V_{DRM} , V V_{GDM}	0.15
Peak forward gate current, A I_{GTM}	4
Peak reverse gate voltage, V V_{GRM}	5
Peak gate power, Watts P_{GM}	16
Average gate power, Watts $P_{G(av)}$	3

Thermal and Mechanical

Symbol	
Min., Max. oper. junction temp., $^\circ\text{C}$ T_J	-40 to +125
Min., Max. storage temp., $^\circ\text{C}$ T_{stg}	-40 to +150
Max. mounting torque, in lb. $\textcircled{1}$	130
Max. Thermal resistance $\textcircled{1}$	
Junction to case, $^\circ\text{C}/\text{Watt}$ $R_{\theta JC}$.28
Case to sink, lubricated, $^\circ\text{C}/\text{Watt}$ $R_{\theta CS}$.12

- $\textcircled{1}$ Consult recommended mounting procedures.
- $\textcircled{2}$ Applies for zero or negative gate bias.
- $\textcircled{3}$ Per JEDEC RS-397, 5.2.2.1.
- $\textcircled{4}$ With recommended gate drive.
- $\textcircled{5}$ Higher dv/dt ratings available, consult factory.
- $\textcircled{6}$ Per JEDEC standard RS-397, 5.2.2.6.
- $\textcircled{7}$ For operation with antiparallel diode, consult factory.

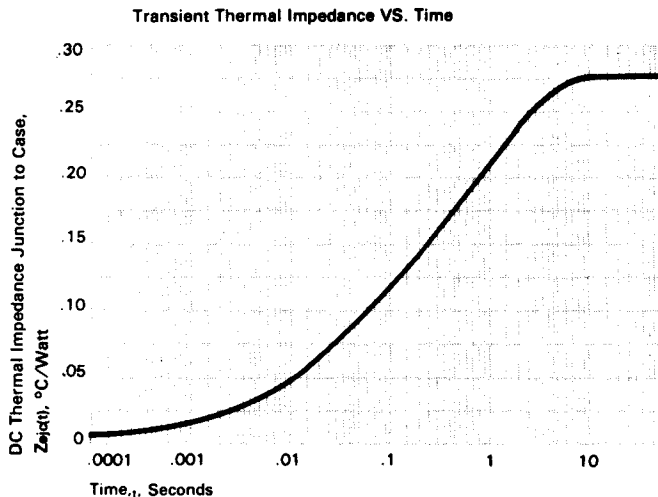
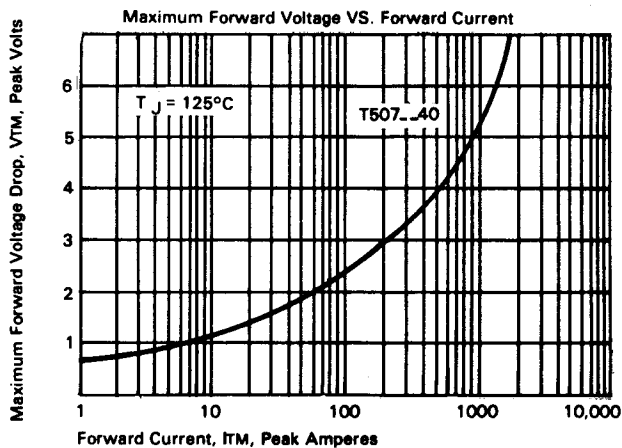

FAST SWITCHING THYRISTORS

Fast Switching SCR T507_40

40A Avg.
(63 RMS)
Up to 1400 Volts
10-50 μ s

Sinusoidal Current Data



ENERGY PER PULSE FOR SINUSOIDAL PULSES

Trapezoidal Wave Current Data

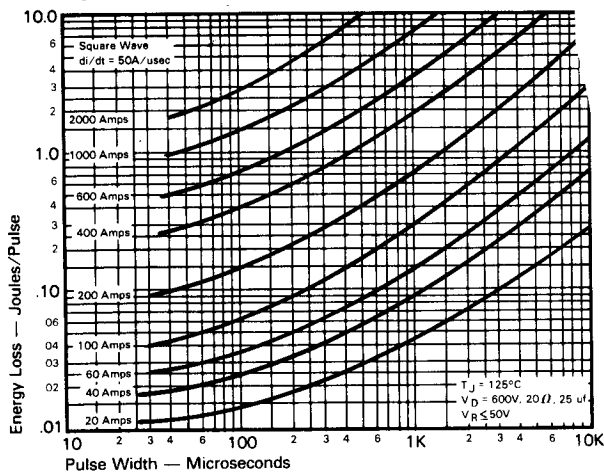

ENERGY PER PULSE FOR TRAPEZOIDAL PULSES
($di/dt = 50\text{A/usec}$)

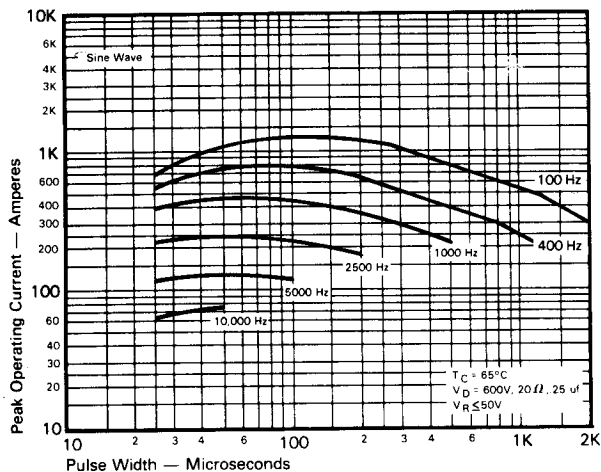

MAXIMUM ALLOWABLE PEAK ON-STATE CURRENT
vs. PULSE WIDTH ($T_C = 65^\circ\text{C}$)

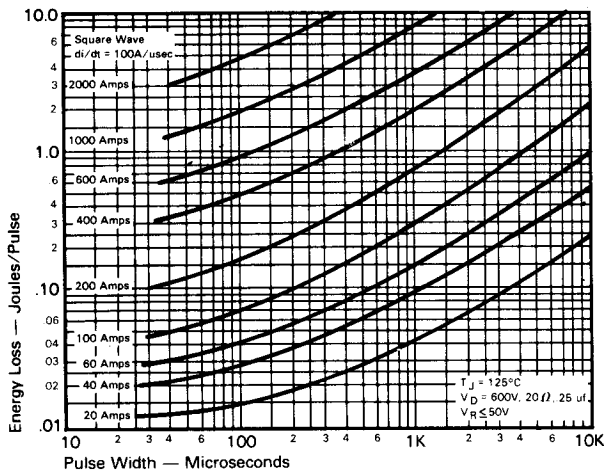

ENERGY PER PULSE FOR TRAPEZOIDAL PULSES
($di/dt = 100\text{A/usec}$)

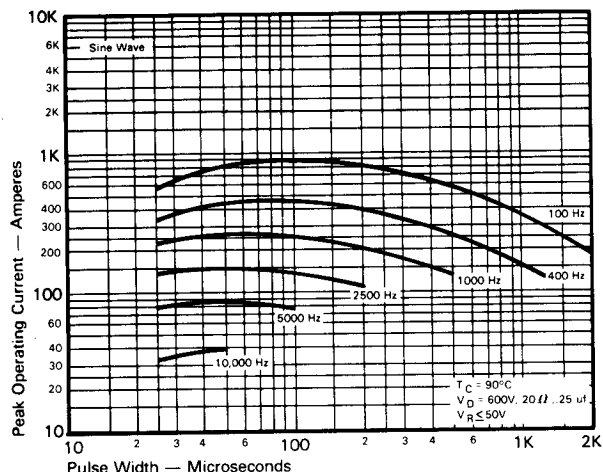

MAXIMUM ALLOWABLE PEAK ON-STATE CURRENT
vs. PULSE WIDTH ($T_C = 90^\circ\text{C}$)

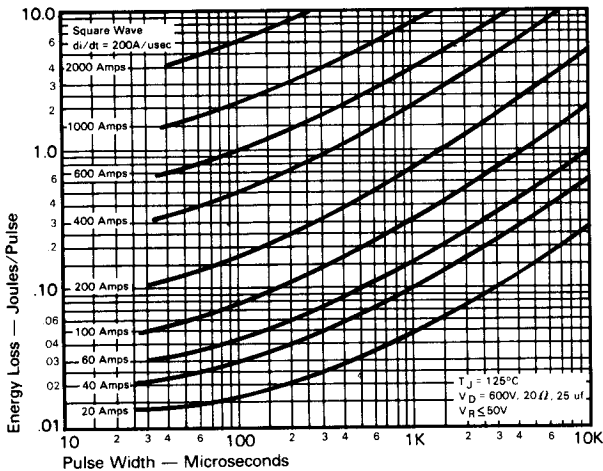

ENERGY PER PULSE FOR TRAPEZOIDAL PULSES
($di/dt = 200\text{A/usec}$)

**40A Avg.
(63 RMS)
Up to 1400 Volts
10-50 μ s**

**Fast Switching
SCR
T507_40**

**Trapezoidal Wave Current Data
($T_C = 65^\circ\text{C}$)**

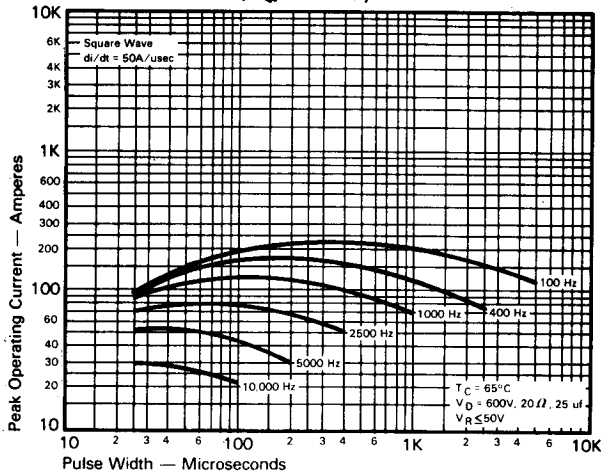

MAXIMUM ALLOWABLE PEAK ON-STATE CURRENT vs. PULSE WIDTH ($di/dt = 50\text{A/usec}$)

**Trapezoidal Wave Current Data
($T_C = 90^\circ\text{C}$)**

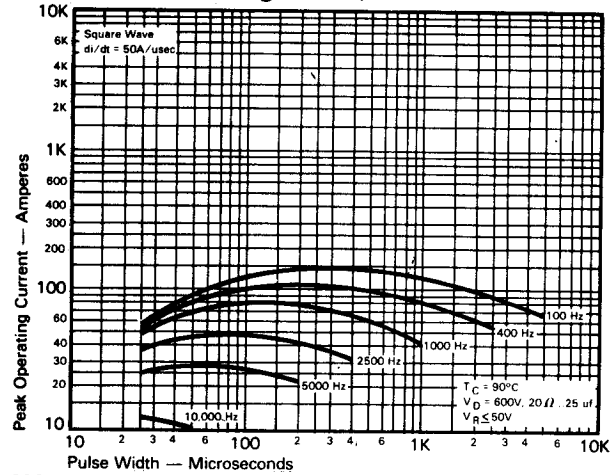

MAXIMUM ALLOWABLE PEAK ON-STATE CURRENT vs. PULSE WIDTH ($di/dt = 50\text{A/usec}$)

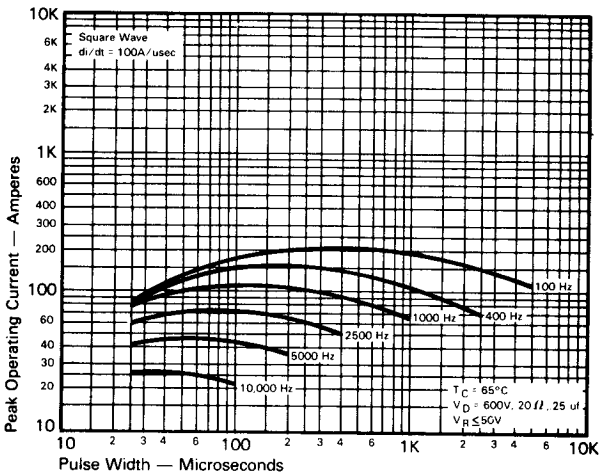

MAXIMUM ALLOWABLE PEAK ON-STATE CURRENT vs. PULSE WIDTH ($di/dt = 100\text{A/usec}$)

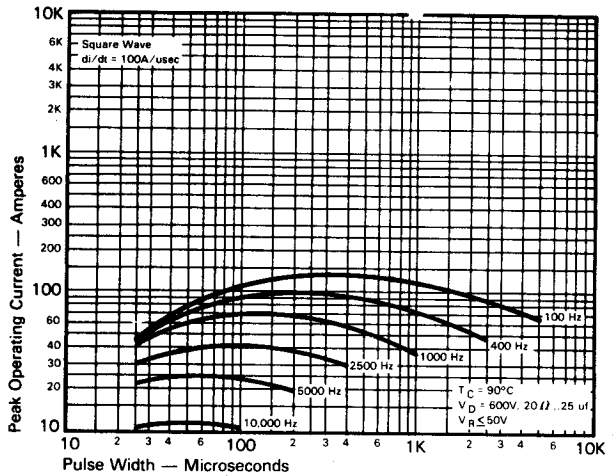

MAXIMUM ALLOWABLE PEAK ON-STATE CURRENT vs. PULSE WIDTH ($di/dt = 100\text{A/usec}$)

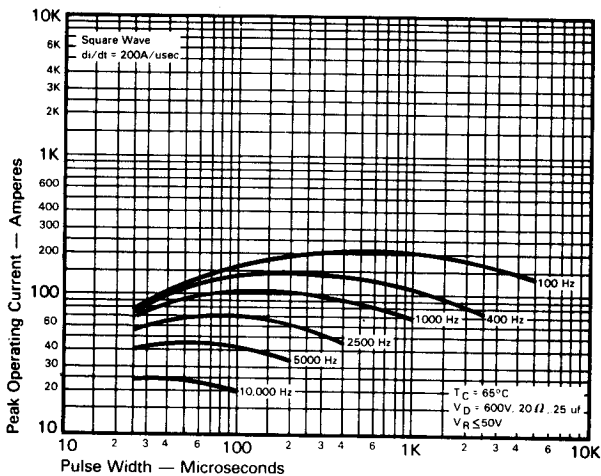

MAXIMUM ALLOWABLE PEAK ON-STATE CURRENT vs. PULSE WIDTH ($di/dt = 200\text{A/usec}$)

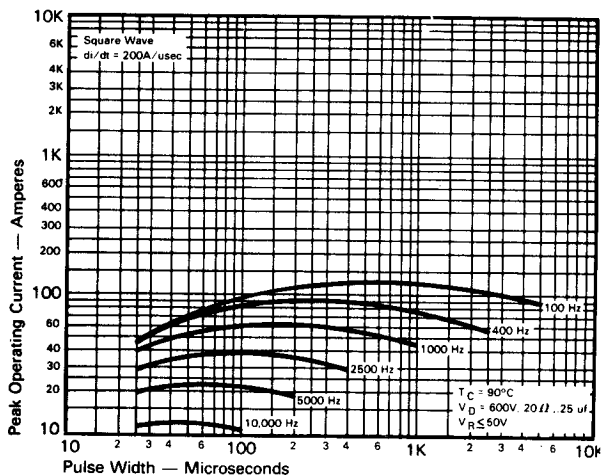

MAXIMUM ALLOWABLE PEAK ON-STATE CURRENT vs. PULSE WIDTH ($di/dt = 200\text{A/usec}$)

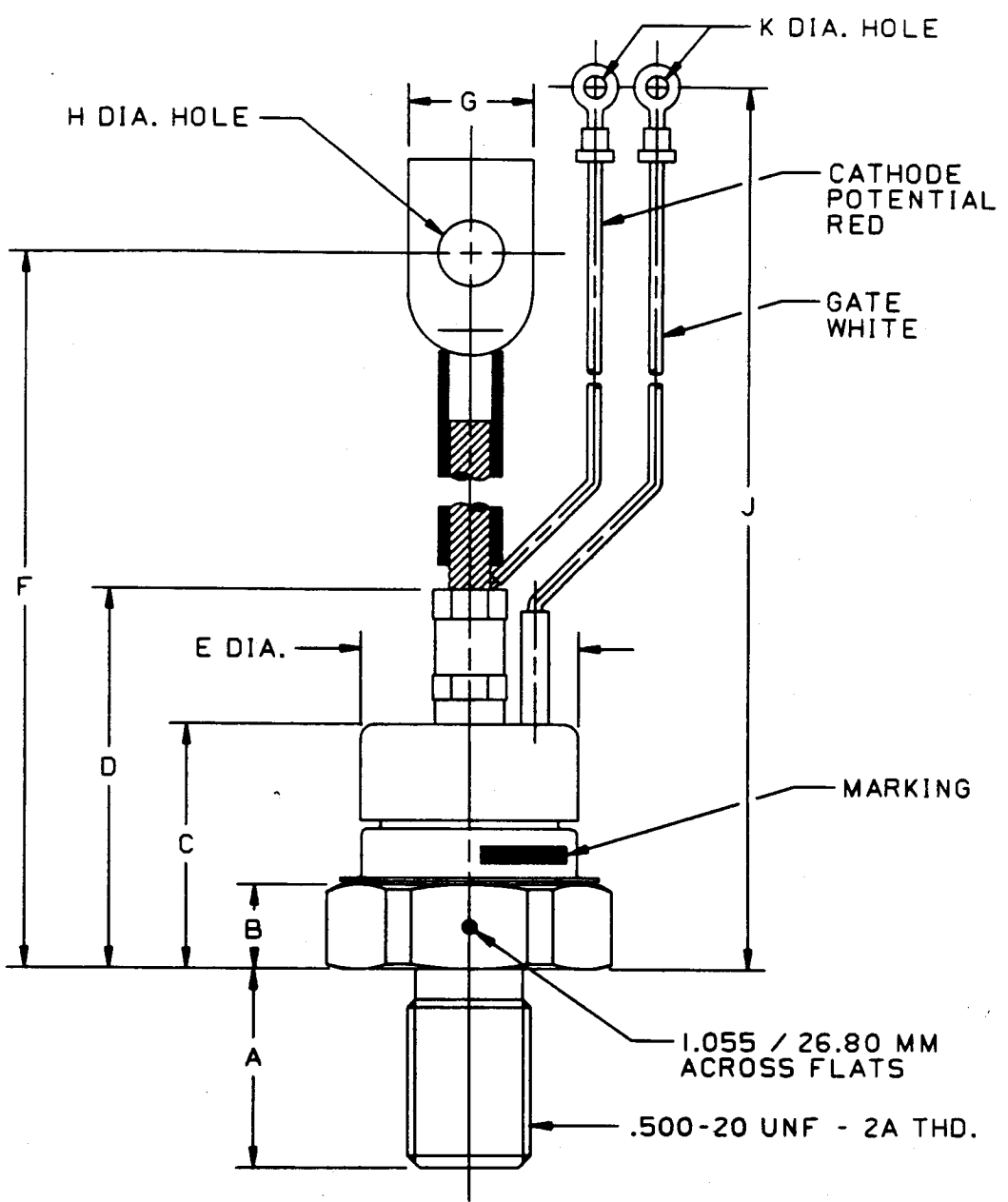

CASE NUMBER T50
NOMINAL DIMENSIONS

STRIKE DISTANCE = .44 INCH / 11.2 MM MIN.
CREEPAGE DISTANCE = .44 INCH / 11.2 MM MIN.

SYM.	A	B	C	D	E	F	G	H	J	K
INCHES	.81	.34	.98	1.58	.89	6.12	.48	.266	7.44	.146
MM	20.6	8.6	24.9	40.1	22.6	155.4	12.2	6.76	189.0	3.71

ALL DIMENSIONS ARE REFERENCE