

# M63824GP/KP

7-UNIT 500mA DARLINGTON TRANSISTOR-ARRAY WITH CLAMP DIODE

## DESCRIPTION

The M63824GP/KP 7-channel sinkdriver, consists of 14 NPN transistors connected to form seven high current gain driver pairs.

## FEATURES

- High breakdown voltage ( $BV_{CEO} \geq 50V$ )
- High-current driving ( $I_{C(max)} = 500mA$ )
- With clamping diodes
- 3V micro computer series compatible input
- Wide operating temperature range ( $T_a = -40$  to  $+85^\circ C$ )

## APPLICATION

Output for 3 voltage microcomputer series and interface with high voltage system. Relay and small printer driver, LED, or incandescent display digit driver.

## FUNCTION

The M63824GP/KP is transistor-array of high active level seven units type which can do direct drive of 3 voltage micro-computer series. A resistor of  $1.05k\Omega$  is connected between the input pin. A clamp diode for inductive load transient suppression is connected for the output pin (collector) and COM pin (pin9). All emitters of the output transistor are connected to GND (pin8). The outputs are capable of driving 500mA and are rated for operation with output voltage up to 50V.

## PIN CONFIGURATION

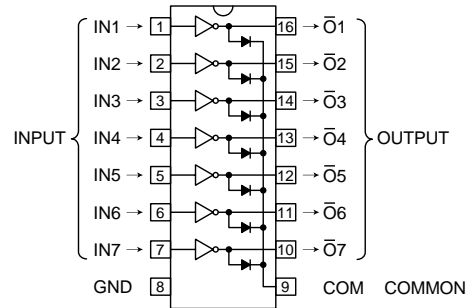

16P2S-A(GP)

Package type 16P2Z-A(KP)

## CIRCUIT DIAGRAM

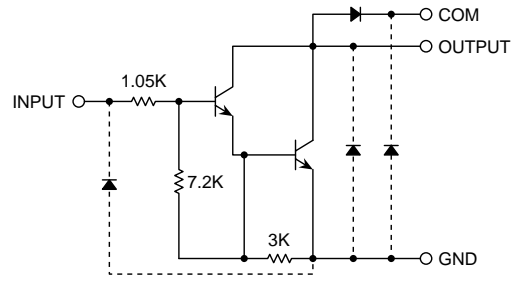

The seven circuits share the COM and GND

The diode, indicated with the dotted line, is parasitic, and cannot be used.

Unit :  $\Omega$

## ABSOLUTE MAXIMUM RATINGS (Unless otherwise noted, $T_a = -40 \sim +85^\circ C$ )

| Symbol    | Parameter                      | Conditions                                 | Ratings          | Unit       |
|-----------|--------------------------------|--|------------------|------------|
| $V_{CEO}$ | Collector-emitter voltage      | Output, H                                  | $-0.5 \sim +50$  | V          |
| $I_C$     | Collector current              | Current per circuit output, L              | 500              | mA         |
| $V_i$     | Input voltage                  |  | $-0.5 \sim +10$  | V          |
| $I_F$     | Clamping diode forward current |  | 500              | mA         |
| $V_R$     | Clamping diode reverse voltage |  | 50               | V          |
| $P_d$     | Power dissipation              | $T_a = 25^\circ C$ , when mounted on board | 0.80(GP)/0.6(KP) | W          |
| $T_{opr}$ | Operating temperature          |  | $-40 \sim +85$   | $^\circ C$ |
| $T_{stg}$ | Storage temperature            |  | $-55 \sim +125$  | $^\circ C$ |

# M63824GP/KP

## 7-UNIT 500mA DARLINGTON TRANSISTOR-ARRAY WITH CLAMP DIODE

### RECOMMENDED OPERATING CONDITIONS (Unless otherwise noted, Ta = -40 ~ +85°C)

| Symbol | Parameter  | Conditions   | Limits |     |     | Unit |
|--------|--|--|--------|-----|-----|------|
|        |  |  | min    | typ | max |      |
| Vo     | Output voltage   |  | 0      | —   | 50  | V    |
| Ic     | Collector current (Current per 1 circuit when 7 circuits are coming on simultaneously) | Duty Cycle<br>GP : no more than 4%<br>KP : no more than 3%   | 0      | —   | 400 | mA   |
|        |  | Duty Cycle<br>GP : no more than 15%<br>KP : no more than 12% | 0      | —   | 200 |      |
| VIH    | "H" input voltage  | Ic ≤ 400mA   | 2.4    | —   | 10  | V    |
| VIL    | "L" input voltage  |  | 0      | —   | 0.4 | V    |

### ELECTRICAL CHARACTERISTICS (Unless otherwise noted, Ta = 25°C)

| Symbol     | Parameter                            | Test conditions        | Limits |      |     | Unit |
|------------|--------------------------------------|------------------------|--------|------|-----|------|
|            |                                      |                        | min    | typ  | max |      |
| V (BR) CEO | Collector-emitter breakdown voltage  | ICEO = 100μA           | 50     | —    | —   | V    |
| VCE(sat)   | Collector-emitter saturation voltage | II = 500μA, IC = 350mA | —      | 1.2  | 1.6 | V    |
|            |                                      | II = 350μA, IC = 200mA | —      | 1.0  | 1.3 |      |
|            |                                      | II = 250μA, IC = 100mA | —      | 0.9  | 1.1 |      |
| II         | Input current                        | VI = 3V                | —      | 1.5  | 2.4 | mA   |
| VF         | Clamping diode forward voltage       | IF = 350mA             | —      | 1.4  | 2.0 | V    |
| IR         | Clamping diode reverse current       | VR = 50V               | —      | —    | 100 | μA   |
| hFE        | DC amplification factor              | VCE = 2V, IC = 350mA   | 1000   | 2500 | —   | —    |

### SWITCHING CHARACTERISTICS (Unless otherwise noted, Ta = 25°C)

| Symbol | Parameter     | Test conditions    | Limits |     |     | Unit |
|--------|---------------|--------------------|--------|-----|-----|------|
|        |               |                    | min    | typ | max |      |
| ton    | Turn-on time  | CL = 15pF (note 1) | —      | 15  | —   | ns   |
| toff   | Turn-off time |                    | —      | 350 | —   | ns   |

### NOTE 1 TEST CIRCUIT

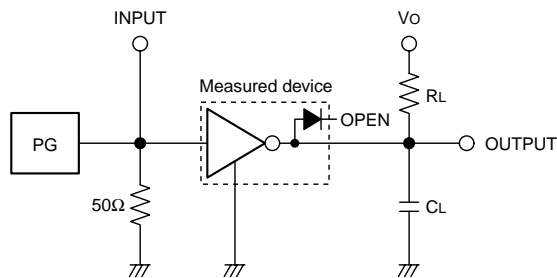

- (1) Pulse generator (PG) characteristics : PRR=1kHz,  
tw = 10μs, tr = 6ns, tf = 6ns, Zo = 50Ω  
VI = 0 ~ 3V
- (2) Input-output conditions : RL = 25Ω, Vo = 10V
- (3) Electrostatic capacity CL includes floating capacitance  
at connections and input capacitance at probes

### TIMING DIAGRAM

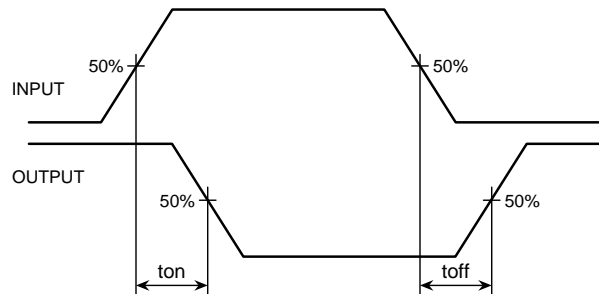

# M63824GP/KP

## 7-UNIT 500mA DARLINGTON TRANSISTOR-ARRAY WITH CLAMP DIODE

### TYPICAL CHARACTERISTICS

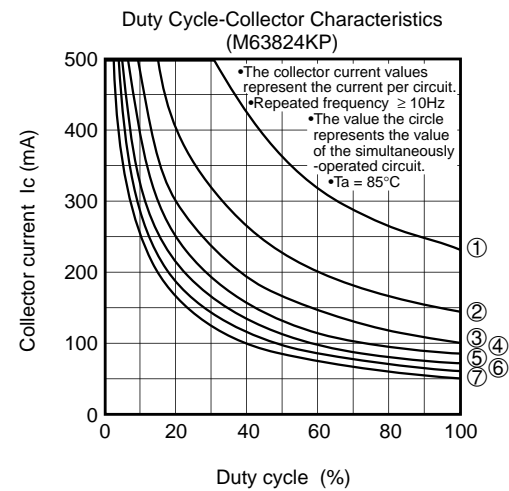
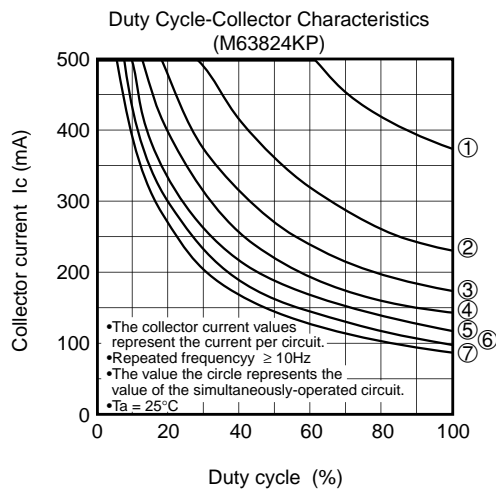
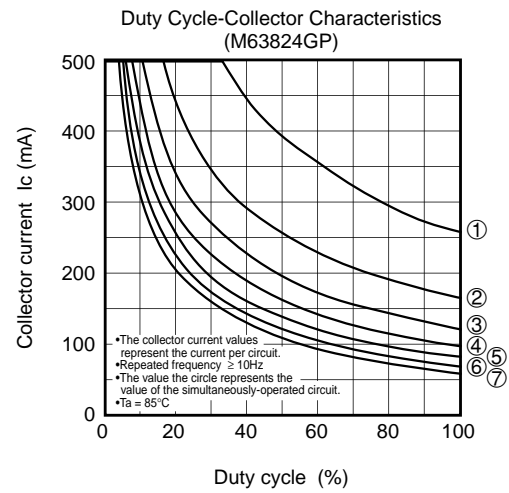
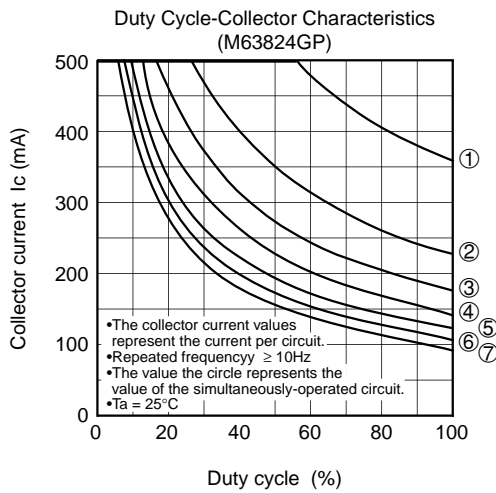
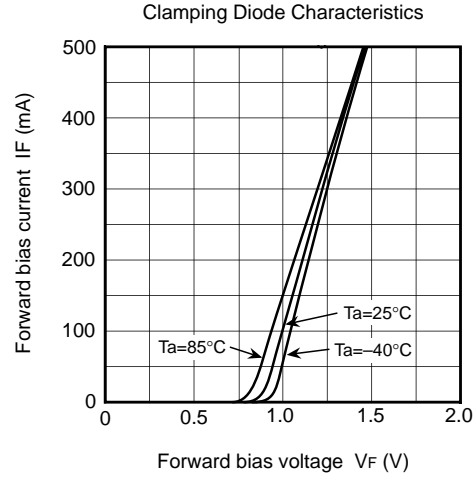
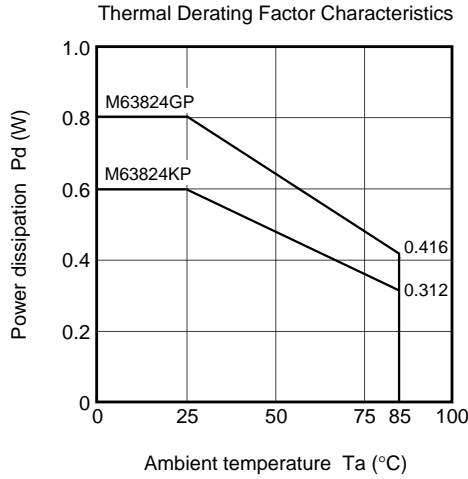

**M63824GP/KP**

7-UNIT 500mA DARLINGTON TRANSISTOR-ARRAY WITH CLAMP DIODE

