



Programmable Controller

MELSEC iQ-R
series

MELSEC iQ-R MELSECNET/H Network Module User's Manual (Application)

-RJ71LP21-25
-RJ71BR11

SAFETY PRECAUTIONS



(Read these precautions before using this product.)

Before using this product, please read this manual and the relevant manuals carefully and pay full attention to safety to handle the product correctly.

If the equipment is used in a manner not specified by the manufacturer, the protection provided by the equipment may be impaired.

The precautions given in this manual are concerned with this product only. For the safety precautions of the programmable controller system, refer to the MELSEC iQ-R Module Configuration Manual.

In this manual, the safety precautions are classified into two levels: "⚠ WARNING" and "⚠ CAUTION".

 WARNING	Indicates that incorrect handling may cause hazardous conditions, resulting in death or severe injury.
 CAUTION	Indicates that incorrect handling may cause hazardous conditions, resulting in minor or moderate injury or property damage.

Under some circumstances, failure to observe the precautions given under "⚠ CAUTION" may lead to serious consequences.

Observe the precautions of both levels because they are important for personal and system safety.

Make sure that the end users read this manual and then keep the manual in a safe place for future reference.

[Design Precautions]

WARNING

- Configure safety circuits external to the programmable controller to ensure that the entire system operates safely even when a fault occurs in the external power supply or the programmable controller. Failure to do so may result in an accident due to an incorrect output or malfunction.
 - (1) Emergency stop circuits, protection circuits, and protective interlock circuits for conflicting operations (such as forward/reverse rotations or upper/lower limit positioning) must be configured external to the programmable controller.
 - (2) When the programmable controller detects an abnormal condition, it stops the operation and all outputs are:
 - Turned off if the overcurrent or overvoltage protection of the power supply module is activated.
 - Held or turned off according to the parameter setting if the self-diagnostic function of the CPU module detects an error such as a watchdog timer error.
 - (3) All outputs may be turned on if an error occurs in a part, such as an I/O control part, where the CPU module cannot detect any error. To ensure safety operation in such a case, provide a safety mechanism or a fail-safe circuit external to the programmable controller. For a fail-safe circuit example, refer to "General Safety Requirements" in the MELSEC iQ-R Module Configuration Manual.
 - (4) Outputs may remain on or off due to a failure of a component such as a relay and transistor in an output circuit. Configure an external circuit for monitoring output signals that could cause a serious accident.
 - In an output circuit, when a load current exceeding the rated current or an overcurrent caused by a load short-circuit flows for a long time, it may cause smoke and fire. To prevent this, configure an external safety circuit, such as a fuse.
 - Configure a circuit so that the programmable controller is turned on first and then the external power supply. If the external power supply is turned on first, an accident may occur due to an incorrect output or malfunction.
 - For the operating status of each station after a communication failure, refer to the troubleshooting in this manual. Incorrect output or malfunction due to a communication failure may result in an accident.
 - When connecting an external device with a CPU module or intelligent function module to modify data of a running programmable controller, configure an interlock circuit in the program to ensure that the entire system will always operate safely. For other forms of control (such as program modification, parameter change, forced output, or operating status change) of a running programmable controller, read the relevant manuals carefully and ensure that the operation is safe before proceeding. Improper operation may damage machines or cause accidents.
-

[Design Precautions]

WARNING

- Especially, when a remote programmable controller is controlled by an external device, immediate action cannot be taken if a problem occurs in the programmable controller due to a communication failure. To prevent this, configure an interlock circuit in the program, and determine corrective actions to be taken between the external device and CPU module in case of a communication failure.
 - Do not write any data to the "system area" and "write-protect area" of the buffer memory in the module. Also, do not use any "use prohibited" signals as an output signal from the CPU module to each module. Doing so may cause malfunction of the programmable controller system. For the "system area", "write-protect area", and the "use prohibited" signals, refer to the user's manual for the module used.
 - If a communication cable is disconnected, the network may be unstable, resulting in a communication failure of multiple stations. Configure an interlock circuit in the program to ensure that the entire system will always operate safely even if communications fail. Incorrect output or malfunction due to a communication failure may result in an accident.
 - To maintain the safety of the programmable controller system against unauthorized access from external devices via the network, take appropriate measures. To maintain the safety against unauthorized access via the Internet, take measures such as installing a firewall.
-

[Design Precautions]

CAUTION

- Do not install the control lines or communication cables together with the main circuit lines or power cables. Doing so may result in malfunction due to electromagnetic interference. Keep a distance of 100mm or more between those cables.
 - During control of an inductive load such as a lamp, heater, or solenoid valve, a large current (approximately ten times greater than normal) may flow when the output is turned from off to on. Therefore, use a module that has a sufficient current rating.
 - After the CPU module is powered on or is reset, the time taken to enter the RUN status varies depending on the system configuration, parameter settings, and/or program size. Design circuits so that the entire system will always operate safely, regardless of the time.
 - Do not power off the programmable controller or reset the CPU module while the settings are being written. Doing so will make the data in the flash ROM and SD memory card undefined. The values need to be set in the buffer memory and written to the flash ROM and SD memory card again. Doing so also may cause malfunction or failure of the module.
-

[Security Precautions]

WARNING

- To maintain the security (confidentiality, integrity, and availability) of the programmable controller and the system against unauthorized access, denial-of-service (DoS) attacks, computer viruses, and other cyberattacks from external devices via the network, take appropriate measures such as firewalls, virtual private networks (VPNs), and antivirus solutions.
-

[Installation Precautions]

WARNING

- Shut off the external power supply (all phases) used in the system before mounting or removing the module. Failure to do so may result in electric shock or cause the module to fail or malfunction.
-

[Installation Precautions]

CAUTION

- Use the programmable controller in an environment that meets the general specifications in the Safety Guidelines included with the base unit. Failure to do so may result in electric shock, fire, malfunction, or damage to or deterioration of the product.
 - To mount a module, place the concave part(s) located at the bottom onto the guide(s) of the base unit, and push in the module until the hook(s) located at the top snaps into place. Incorrect interconnection may cause malfunction, failure, or drop of the module.
 - To mount a module with no module fixing hook, place the concave part(s) located at the bottom onto the guide(s) of the base unit, push in the module, and fix it with screw(s). Incorrect interconnection may cause malfunction, failure, or drop of the module.
 - When using the programmable controller in an environment of frequent vibrations, fix the module with a screw.
 - Tighten the screws within the specified torque range. Undertightening can cause drop of the screw, short circuit, or malfunction. Overtightening can damage the screw and/or module, resulting in drop, short circuit, or malfunction.
 - When using an extension cable, connect it to the extension cable connector of the base unit securely. Check the connection for looseness. Poor contact may cause malfunction.
 - When using an SD memory card, fully insert it into the SD memory card slot. Check that it is inserted completely. Poor contact may cause malfunction.
 - Securely insert an extended SRAM cassette or a battery-less option cassette into the cassette connector of the CPU module. After insertion, close the cassette cover and check that the cassette is inserted completely. Poor contact may cause malfunction.
 - Do not directly touch any conductive parts and electronic components of the module, SD memory card, extended SRAM cassette, battery-less option cassette, or connector. Doing so can cause malfunction or failure of the module.
-

[Wiring Precautions]

WARNING

- Shut off the external power supply (all phases) used in the system before installation and wiring. Failure to do so may result in electric shock or cause the module to fail or malfunction.
- After installation and wiring, attach a blank cover module (RG60) to each empty slot before powering on the system for operation. Also, attach an extension connector protective cover^{*1} to each unused extension cable connector as necessary. Directly touching any conductive parts of the connectors while power is on may result in electric shock.

*1 For details, please consult your local Mitsubishi Electric representative.

[Wiring Precautions]

CAUTION

- Individually ground the FG and LG terminals of the programmable controller with a ground resistance of 100 ohms or less. Failure to do so may result in electric shock or malfunction.
 - Use applicable solderless terminals and tighten them within the specified torque range. If any spade solderless terminal is used, it may be disconnected when the terminal screw comes loose, resulting in failure.
 - Check the rated voltage and signal layout before wiring to the module, and connect the cables correctly. Connecting a power supply with a different voltage rating or incorrect wiring may cause fire or failure.
 - Connectors for external devices and connectors for coaxial cables must be crimped or pressed with the tool specified by the manufacturer, or must be correctly soldered. Incomplete connections may cause short circuit, fire, or malfunction.
 - Securely connect the connector to the module. Poor contact may cause malfunction.
 - Do not install the control lines or communication cables together with the main circuit lines or power cables. Keep a distance of 100mm or more between them. Failure to do so may result in malfunction due to noise.
 - Place the cables in a duct or clamp them. If not, dangling cables may swing or inadvertently be pulled, resulting in malfunction or damage to modules or cables.
In addition, the weight of the cables may put stress on modules in an environment of strong vibrations and shocks.
Do not clamp the extension cables with the jacket stripped. Doing so may change the characteristics of the cables, resulting in malfunction.
 - Check the interface type and correctly connect the cable. Incorrect wiring (connecting the cable to an incorrect interface) may cause failure of the module and external device.
 - Tighten the terminal screws or connector screws within the specified torque range. Undertightening can cause drop of the screw, short circuit, fire, or malfunction. Overtightening can damage the screw and/or module, resulting in drop, short circuit, fire, or malfunction.
 - Properly solder the parts of a soldering-type coaxial cable connector. Incomplete soldering may result in malfunction.
 - Crimp the parts of a crimping-type coaxial cable connector with proper force at a proper position. Failure to do so may cause drop of the cable or malfunction.
 - When disconnecting the cable from the module, do not pull the cable by the cable part. For the cable with connector, hold the connector part of the cable. For the cable connected to the terminal block, loosen the terminal screw. Pulling the cable connected to the module may result in malfunction or damage to the module or cable.
 - Prevent foreign matter such as dust or wire chips from entering the module. Such foreign matter can cause a fire, failure, or malfunction.
 - When a protective film is attached to the top of the module, remove it before system operation. If not, inadequate heat dissipation of the module may cause a fire, failure, or malfunction.
-

[Wiring Precautions]

CAUTION

- Programmable controllers must be installed in control panels. Connect the main power supply to the power supply module in the control panel through a relay terminal block. Wiring and replacement of a power supply module must be performed by qualified maintenance personnel with knowledge of protection against electric shock. For wiring, refer to the MELSEC iQ-R Module Configuration Manual.
 - For Ethernet cables to be used in the system, select the ones that meet the specifications in the user's manual for the module used. If not, normal data transmission is not guaranteed.
 - For optical fiber cables and coaxial cables to be used in the system, select the ones that meet the specifications in the MELSEC iQ-R MELSECNET/H Network Module User's Manual (Startup). If not, normal data transmission is not guaranteed.
-

[Startup and Maintenance Precautions]

WARNING

- Do not touch any terminal while power is on. Doing so will cause electric shock or malfunction.
 - Shut off the external power supply (all phases) used in the system before cleaning the module or retightening the terminal screws, connector screws, or module fixing screws. Failure to do so may result in electric shock.
-

[Startup and Maintenance Precautions]

CAUTION

- When connecting an external device with a CPU module or intelligent function module to modify data of a running programmable controller, configure an interlock circuit in the program to ensure that the entire system will always operate safely. For other forms of control (such as program modification, parameter change, forced output, or operating status change) of a running programmable controller, read the relevant manuals carefully and ensure that the operation is safe before proceeding. Improper operation may damage machines or cause accidents.
 - Especially, when a remote programmable controller is controlled by an external device, immediate action cannot be taken if a problem occurs in the programmable controller due to a communication failure. To prevent this, configure an interlock circuit in the program, and determine corrective actions to be taken between the external device and CPU module in case of a communication failure.
 - Do not disassemble or modify the modules. Doing so may cause failure, malfunction, injury, or a fire.
 - Use any radio communication device such as a cellular phone or PHS (Personal Handy-phone System) 25cm or more away in all directions from the programmable controller. Failure to do so may cause malfunction.
 - Shut off the external power supply (all phases) used in the system before mounting or removing the module. Failure to do so may cause the module to fail or malfunction.
 - Tighten the screws within the specified torque range. Undertightening can cause drop of the component or wire, short circuit, or malfunction. Overtightening can damage the screw and/or module, resulting in drop, short circuit, or malfunction.
 - After the first use of the product, do not perform each of the following operations more than 50 times (IEC 61131-2/JIS B 3502 compliant).
Exceeding the limit may cause malfunction.
 - Mounting/removing the module to/from the base unit
 - Inserting/removing the extended SRAM cassette or battery-less option cassette to/from the CPU module
 - Mounting/removing the terminal block to/from the module
 - After the first use of the product, do not insert/remove the SD memory card to/from the CPU module more than 500 times. Exceeding the limit may cause malfunction.
 - Do not touch the metal terminals on the back side of the SD memory card. Doing so may cause malfunction or failure of the module.
 - Do not touch the integrated circuits on the circuit board of an extended SRAM cassette or a battery-less option cassette. Doing so may cause malfunction or failure of the module.
 - Startup and maintenance of a control panel must be performed by qualified maintenance personnel with knowledge of protection against electric shock. Lock the control panel so that only qualified maintenance personnel can operate it.
 - Before handling the module, touch a conducting object such as a grounded metal to discharge the static electricity from the human body. Wearing a grounded antistatic wrist strap is recommended. Failure to discharge the static electricity may cause the module to fail or malfunction.
 - After unpacking, eliminate static electricity from the module to prevent electrostatic discharge from affecting the module. If an electrostatically charged module comes in contact with a grounded metal object, a sudden electrostatic discharge of the module may cause failure. For details on how to eliminate static electricity from the module, refer to the following.
Antistatic Precautions Before Using MELSEC iQ-R Series Products (FA-A-0368)
-

[Operating Precautions]

CAUTION

- When changing data and operating status, and modifying program of the running programmable controller from an external device such as a personal computer connected to an intelligent function module, read relevant manuals carefully and ensure the safety before operation. Incorrect change or modification may cause system malfunction, damage to the machines, or accidents.
-

[Disposal Precautions]

CAUTION

- When disposing of this product, treat it as industrial waste.
-

[Transportation Precautions]

CAUTION

- The halogens (such as fluorine, chlorine, bromine, and iodine), which are contained in a fumigant used for disinfection and pest control of wood packaging materials, may cause failure of the product. Prevent the entry of fumigant residues into the product or consider other methods (such as heat treatment) instead of fumigation. The disinfection and pest control measures must be applied to unprocessed raw wood.
-

CONDITIONS OF USE FOR THE PRODUCT

- (1) MELSEC programmable controller ("the PRODUCT") shall be used in conditions;
- i) where any problem, fault or failure occurring in the PRODUCT, if any, shall not lead to any major or serious accident; and
 - ii) where the backup and fail-safe function are systematically or automatically provided outside of the PRODUCT for the case of any problem, fault or failure occurring in the PRODUCT.
- (2) The PRODUCT has been designed and manufactured for the purpose of being used in general industries. MITSUBISHI ELECTRIC SHALL HAVE NO RESPONSIBILITY OR LIABILITY (INCLUDING, BUT NOT LIMITED TO ANY AND ALL RESPONSIBILITY OR LIABILITY BASED ON CONTRACT, WARRANTY, TORT, PRODUCT LIABILITY) FOR ANY INJURY OR DEATH TO PERSONS OR LOSS OR DAMAGE TO PROPERTY CAUSED BY the PRODUCT THAT ARE OPERATED OR USED IN APPLICATION NOT INTENDED OR EXCLUDED BY INSTRUCTIONS, PRECAUTIONS, OR WARNING CONTAINED IN MITSUBISHI ELECTRIC USER'S, INSTRUCTION AND/OR SAFETY MANUALS, TECHNICAL BULLETINS AND GUIDELINES FOR the PRODUCT.
- ("Prohibited Application")
- Prohibited Applications include, but not limited to, the use of the PRODUCT in;
- Nuclear Power Plants and any other power plants operated by Power companies, and/or any other cases in which the public could be affected if any problem or fault occurs in the PRODUCT.
 - Railway companies or Public service purposes, and/or any other cases in which establishment of a special quality assurance system is required by the Purchaser or End User.
 - Aircraft or Aerospace, Medical applications, Train equipment, transport equipment such as Elevator and Escalator, Incineration and Fuel devices, Vehicles, Manned transportation, Equipment for Recreation and Amusement, and Safety devices, handling of Nuclear or Hazardous Materials or Chemicals, Mining and Drilling, and/or other applications where there is a significant risk of injury to the public or property.
- Notwithstanding the above restrictions, Mitsubishi Electric may in its sole discretion, authorize use of the PRODUCT in one or more of the Prohibited Applications, provided that the usage of the PRODUCT is limited only for the specific applications agreed to by Mitsubishi Electric and provided further that no special quality assurance or fail-safe, redundant or other safety features which exceed the general specifications of the PRODUCTS are required. For details, please contact the Mitsubishi Electric representative in your region.
- (3) Mitsubishi Electric shall have no responsibility or liability for any problems involving programmable controller trouble and system trouble caused by DoS attacks, unauthorized access, computer viruses, and other cyberattacks.

INTRODUCTION

Thank you for purchasing the Mitsubishi Electric MELSEC iQ-R series programmable controllers.

This manual describes the functions, programming, and troubleshooting of the relevant product listed below.

Before using this product, please read this manual and the relevant manuals carefully and develop familiarity with the functions and performance of the MELSEC iQ-R series programmable controller to handle the product correctly.

Note that the menu names and operating procedures may differ depending on an operating system in use and its version.

When reading this manual, replace the names and procedures with the applicable ones as necessary.

When applying the program examples provided in this manual to an actual system, ensure the applicability and confirm that it will not cause system control problems.

Please make sure that the end users read this manual.

Relevant product

RJ71LP21-25

RJ71BR11

CONTENTS

SAFETY PRECAUTIONS	1
CONDITIONS OF USE FOR THE PRODUCT	9
INTRODUCTION	10
RELEVANT MANUALS	14
TERMS	15
GENERIC TERMS AND ABBREVIATIONS	16

CHAPTER 1 FUNCTIONS 17

1.1 Cyclic Transmission Function	17
Cyclic transmission	17
Low speed cyclic transmission	20
Link refresh	24
Direct access to link devices	26
Constant link scan	30
Data assurance	30
Interlink transmission	32
Cyclic transmission stop and restart	33
1.2 Transient Transmission Function	34
Transient transmission	34
Group transient transmission	37
Sending messages by using logical channel numbers	38
1.3 RAS	40
Automatic return	40
Control station switching	41
Control station return control	42
Loopback function (RJ71LP21-25 only)	43
Station detach function (RJ71BR11 only)	45
1.4 Application Function	46
Interrupt program activation	46
Multiplex transmission function (RJ71LP21-25 only)	46
Number of send points extension	47
1.5 Redundant System Function (RJ71LP21-25 Only)	48
System configuration	48
System switching operation	49
System switching request to the control system CPU module	52
Functions restricted in a redundant system	52

CHAPTER 2 PARAMETER SETTINGS 53

2.1 Setting Parameters	53
2.2 Required Settings	54
Station Type	55
Network No.	55
Station No.	55
Network Range Assignment	56
Operation after Reconnection	60
Transmission Speed	60
2.3 Basic Settings	61
Link Refresh Settings	62

2.4	Application Settings	65
	Supplementary Cyclic Settings	66
	Interrupt Settings	67
	Transient Transmission Group No.	73
	Dynamic Routing	73
	Parameter Name	73
	Event Reception from Other Stations	73
	Module Operation Mode	74
	Interlink Transmission Settings	75
	Redundant System Settings (RJ71LP21-25 only)	79

CHAPTER 3 PROGRAMMING **80**

3.1	Precautions for Programming	80
3.2	Program Examples of the Redundant System (RJ71LP21-25 Only)	82
	System configuration	82
	Setting parameters	83
	Checking the network status	88
	Program examples	88

CHAPTER 4 TROUBLESHOOTING **91**

4.1	Checking with LED	91
4.2	Checking the Module Status	93
	Self-diagnostics test	96
	Station-to-station test	101
	Forward loop test/reverse loop test (RJ71LP21-25 only)	106
4.3	Checking the Network Status	109
	Host Station Information	109
	Other Station Information	112
	Circuit Monitor Details	114
	Error History Monitor	116
	Loop Test (RJ71LP21-25 only)	119
	Setting Check Test	120
	Station Order Check Test (RJ71LP21-25 only)	121
	Communication Test	122
	Network Test	123
4.4	Troubleshooting by Symptom	124
4.5	List of Error Codes	132
4.6	List of Parameter Numbers	147
4.7	Event List	148

APPENDICES **149**

Appendix 1	Module Label	149
Appendix 2	Buffer Memory	150
	List of buffer memory addresses	150
	Details of buffer memory addresses	150
Appendix 3	List of Link Special Relay (SB) Areas	151
Appendix 4	List of Link Special Register (SW) Areas	163
Appendix 5	Dedicated Instruction	182
	Precautions for dedicated instructions	183
Appendix 6	Processing Time	184

Link scan time	185
Cyclic transmission delay time	186
Interlink transmission time	189
Cyclic data holding time when system switching occurs	190
Appendix 7 Differences Between MELSEC-Q Series and MELSEC iQ-R Series	196
Appendix 8 Added and Enhanced Functions	198

INDEX **200**

REVISIONS	202
WARRANTY	203
TRADEMARKS	204

RELEVANT MANUALS

Manualname [manual number]	Description	Available form
MELSEC iQ-R MELSECNET/H Network Module User's Manual (Application) [SH-082204ENG] (this manual)	Functions, parameter settings, programming, troubleshooting, and buffer memory of the MELSECNET/H network module	Print book e-Manual PDF
MELSEC iQ-R MELSECNET/H Network Module User's Manual (Startup) [SH-082202ENG]	System configuration, performance specifications, procedures before operation, wiring, and communication examples of the MELSECNET/H network module	Print book e-Manual PDF
MELSEC iQ-R Module Configuration Manual [SH-081262ENG]	The combination of the MELSEC iQ-R series modules, common information on the installation/wiring in the system, and specifications of the power supply module, base unit, SD memory card, and battery	Print book e-Manual PDF
MELSEC iQ-R Ethernet, CC-Link IE, and MELSECNET/H Function Block Reference [BCN-P5999-0381]	Specifications of the following MELSEC iQ-R module function blocks: MELSEC iQ-R Ethernet equipped module function blocks, CC-Link IE TSN module function blocks, CC-Link IE Controller Network module function blocks, CC-Link IE Field Network module function blocks, and MELSECNET/H network module function blocks	e-Manual PDF
MELSEC iQ-R Programming Manual (Module Dedicated Instructions) [SH-081976ENG]	Dedicated instructions for the intelligent function modules	e-Manual PDF
GX Works3 Operating Manual [SH-081215ENG]	System configuration, parameter settings, and online operations of GX Works3	e-Manual PDF

Point

e-Manual refers to the Mitsubishi Electric FA electronic book manuals that can be browsed using a dedicated tool.

e-Manual has the following features:

- Required information can be cross-searched in multiple manuals.
- Other manuals can be accessed from the links in the manual.
- The hardware specifications of each part can be found from the product figures.
- Pages that users often browse can be bookmarked.
- Sample programs can be copied to an engineering tool.

TERMS

Unless otherwise specified, this manual uses the following terms.

Term	Description
Baton pass	A data transmission method by which transmission right (token) is passed around the network.
Buffer memory	Memory in an intelligent function module to store data such as setting values and monitor values. For CPU modules, it refers to memory to store data such as setting values and monitor values of the Ethernet function, or data used for data communication of the multiple CPU system function.
Coaxial bus system	A network system used for the RJ71BR11
Control CPU	A CPU module that controls connected I/O modules and intelligent function modules. In a multiple CPU system, a control CPU module can be set for each module.
Control station shift time	Time taken from when the control station went down due to a reason such as power-off until data link is started by the sub-control station.
Control system	A system that controls a redundant system and performs network communications in a redundant system
Cyclic transmission	A function by which data are periodically exchanged among stations on the same network using link devices
Dedicated instruction	An instruction that simplifies programming for using functions of intelligent function modules
Device	A memory of a CPU module to store data. Devices such as X, Y, M, D, and others are provided depending on the intended use.
Engineering tool	A tool used for setting up programmable controllers, programming, debugging, and maintenance
Global label	A label that is valid for all the program data when multiple program data are created in the project. There are two types of global label: a module specific label (module label), which is generated automatically by GX Works3, and an optional label, which can be created for any specified device.
Group number	Number that is assigned for transient transmission to any given stations. By specifying a group of stations as transient transmission target, data can be sent to the stations of the same group No.
Intelligent function module	A module that has functions other than an input or output, such as an A/D converter module and D/A converter module
Link device	A device (LB, LW, LX, LY, SB, or SW) in a MELSECNET/H network module
Link refresh	Processing of data transfer between link devices of the network module and CPU module devices. Link refresh is performed in "END processing" of the sequence scan of the CPU module.
Link scan (link scan time)	Time required for all the stations on the network to transmit data. The link scan time depends on data volume and the number of transient transmission requests.
Logical channel	Eight input channels that can be changed by using a program. The channel number can be specified from 1 to 64 by changing the values in the link special register. This channel number is used to receive only the messages selected on the receiving station when they have a lot of information types. The sending station is equivalent to a broadcasting station, which sends messages to logical channels. The receiving station is equivalent to a TV receiver in household, which receives the messages in the required logical channels by switching channels.
MELSECNET/10 mode	Mode that the MELSECNET/H network module operates on the MELSECNET/10 network
MELSECNET/H extended mode	A mode in which the maximum number of link points per station in MELSECNET/H mode is extended. Values exceeding 2000 bytes to maximum 35840 bytes can be set. Set this mode for a system that uses a large number of link points per station.
MELSECNET/H mode	Mode that the MELSECNET/H network module operates on the MELSECNET/H network
Module label	A label that represents one of memory areas (I/O signals and buffer memory areas) specific to each module in a given character string. For the module used, GX Works3 automatically generates this label, which can be used as a global label.
Multiple CPU system	A system where two to four CPU modules separately control I/O modules and intelligent function modules
Normal station	A station that performs cyclic transmission and transient transmission with the control station and other normal stations
Optical loop system	A network system used for the RJ71LP21-25
Process CPU (redundant mode)	A Process CPU operating in redundant mode. A redundant system is configured with this CPU module. Process control function blocks and the online module change function can be used even in this mode.
Redundant system	A system consisting of two systems that have same configuration (CPU module, power supply module, network module, and other modules). Even after an error occurs in one of the two system, the other system takes over the control of the entire system.
Relay station	A station in which multiple network modules are mounted on one programmable controller to relay data link to other stations
Reserved station	A station reserved for future use. This station is not actually connected, but counted as a connected station.
Standby system	A backup system in a redundant system
System A	A system that is set as system A to distinguish two systems in a redundant system. It is used to distinguish connected two systems (system A and system B).

Term	Description
System B	A system that is set as system B to distinguish two systems in a redundant system. It is used to distinguish connected two systems (system A and system B).
System switching	A function which switches the systems between the control system and the standby system to continue operation of the redundant system when a failure or an error occurs in the control system
Tracking cable	An optical fiber cable used to connect two redundant function modules in a redundant system
Transient transmission	A function of communication with another station, which is used when requested by a dedicated instruction or the engineering tool.

GENERIC TERMS AND ABBREVIATIONS

Unless otherwise specified, this manual uses the following generic terms and abbreviations.

Generic term/abbreviation	Description
Common parameter	A generic term for module parameters for the following settings <ul style="list-style-type: none"> • Network range assignment setting • Supplementary cyclic setting
MELSECNET/H network module	A generic term for the following modules: <ul style="list-style-type: none"> • RJ71LP21-25 • RJ71BR11
Network module	A generic term for the following modules: <ul style="list-style-type: none"> • Ethernet interface module • A module on CC-Link IE TSN (the RJ71GN11-T2 and a module on a remote station) • CC-Link IE Controller Network module • A module on CC-Link IE Field Network (a master/local module, and a module on a remote I/O station, a remote device station, and an intelligent device station) • MELSECNET/H network module • MELSECNET/10 network module • RnENCPU (network part)
Network parameter	Another name for module parameters
Unique parameter	A generic term for module parameters other than common parameters

1 FUNCTIONS

1.1 Cyclic Transmission Function

Cyclic transmission

This function allows data to be periodically exchanged among stations on the same network using link devices.

Communications using LB and LW

This function writes data on the link device (LB, LW) of the MELSECNET/H network module and sends the data to all stations connected in the same network.

The status data of the link devices (LB, LW) of the control station are stored in the link devices (LB, LW) of each normal station. The status data of the link devices (LB, LW) of normal stations are stored in the link devices (LB, LW) of the control station and the link devices (LB, LW) of other normal stations.

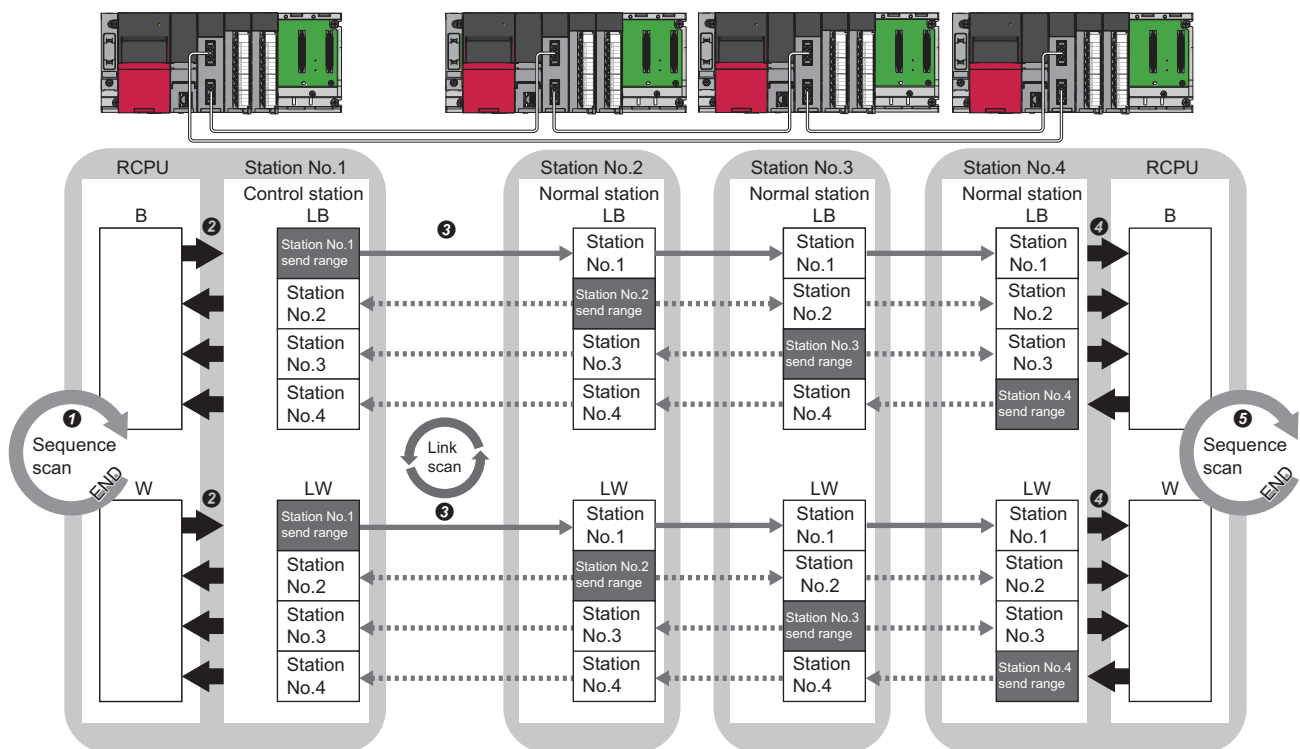

- 1 The device is turned on by the sequence scan of the CPU module on sending side.
- 2 The status data of the device of the CPU module on sending side are stored in the link devices (LB, LW) of the MELSECNET/H network module by link refresh.
- 3 The status data of the link devices (LB, LW) are stored in the link devices (LB, LW) of the MELSECNET/H network module on receiving side by link scan.
- 4 The status data of the link devices (LB, LW) are stored in the devices of the CPU module on receiving side.

Setting method

Assign the link devices under "Network Range Assignment" in "Required Settings". (Page 56 Network Range Assignment)

Link refresh can be set under "Link Refresh Settings" in "Basic Settings". (Page 62 Link Refresh Settings)

Communications using LX and LY

This function is used to exchange data between the I/O master station that controls LX and LY and another station on a one-to-one (1:1) basis.

Up to two I/O master stations can be set for one network (block 1 and block 2), regardless of the status of control or normal station. The link input (LX) is used to receive the information input from each station in a block, and the link output (LY) is used to send the output information of the I/O master station.

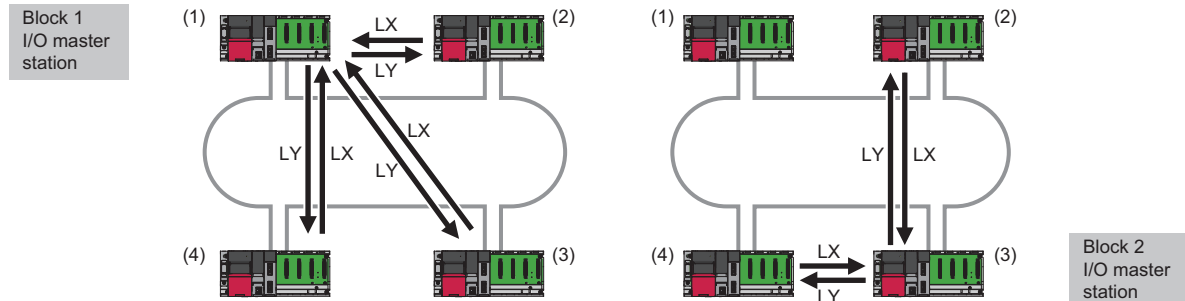

- (1) Control station (station No.1)
- (2) Normal station (station No.2)
- (3) Normal station (station No.3)
- (4) Normal station (station No.4)

The status data of the link output (LY) of the I/O master station is output to the link input (LX) of another station, and the status data of the link output (LY) of another station is stored in the link input (LX) of the I/O master station.

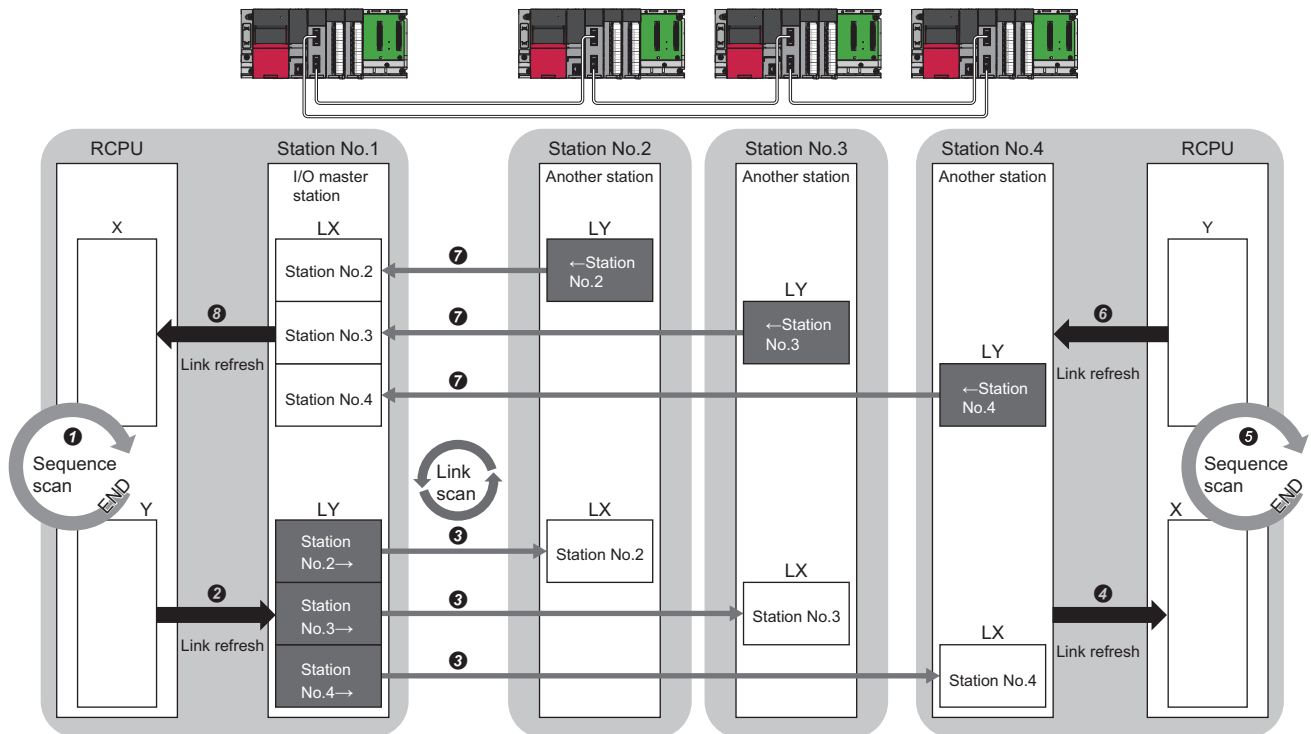

Station No.2 →, Station No.3 →, Station No.4 →: Send range to stations No.2, No.3, and No.4
 ← Station No.2, ← Station No.3, ← Station No.4: Send range from stations No.2, No.3, and No.4

• Output from the I/O master station

- ① The device is turned on by the sequence scan of the CPU module.
- ② The status data of the device of the CPU module are stored in the link output (LY) of the I/O master station by link refresh.
- ③ The status data of the link output (LY) of the I/O master station are stored in the link input (LX) of another station by link scan.
- ④ The status data of the link input (LX) of another station are stored in the device of the CPU module by link refresh.

• Input from another station

- ⑤ The device is turned on by the sequence scan of the CPU module.
- ⑥ The status data of the device of the CPU module are stored in the link output (LY) of another station by link refresh.
- ⑦ The status data of the link output (LY) of another station are stored in the link input (LX) of the I/O master station by link scan.
- ⑧ The status data of the link input (LX) of the I/O master station are stored in the device of the CPU module by link refresh.

Setting method

Assign the link devices under "Network Range Assignment" in "Required Settings". (☞ Page 56 Network Range Assignment)

The link refresh is assigned under "Link Refresh Settings" in "Basic Settings". (☞ Page 62 Link Refresh Settings)

Point

- Any station can be set as the I/O master station regardless of the station type of the control station or normal station.
- The setting range of X and Y for LX and LY communication is the device range after the actual I/O of the own station (1000 or greater is recommended for X/Y). When using multiple network modules (CC-Link IE TSN, CC-Link IE Controller Network, CC-Link IE Field Network, MELSECNET/H, and CC-Link) or when using two I/O master stations, assign the device ranges so that they do not overlap.

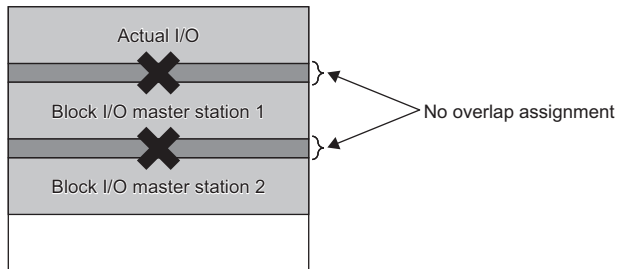

Low speed cyclic transmission

The low speed cyclic transmission function collectively sends the data that does not require high-speed performance to another station by link devices (LB, LW) to share the data between modules.

It has the same performance as the transient transmission function. (☞ Page 34 Transient Transmission Function)

The number of transmissions per station during one link scan is one.

When data is simultaneously sent from multiple stations, a link scan time of at least the number of sending stations is required.

Setting the send range

Assign the send range of link devices (low speed LB, low speed LW) at each station to the extended function area (2000H to 3FFFH) in units of 16 points for LB and in units of 1 point for LW. The send range that is not in station number order can be also assigned for each station. There are no device numbers that can be assigned to the device (B, W) of the CPU module corresponding to the extended function area.

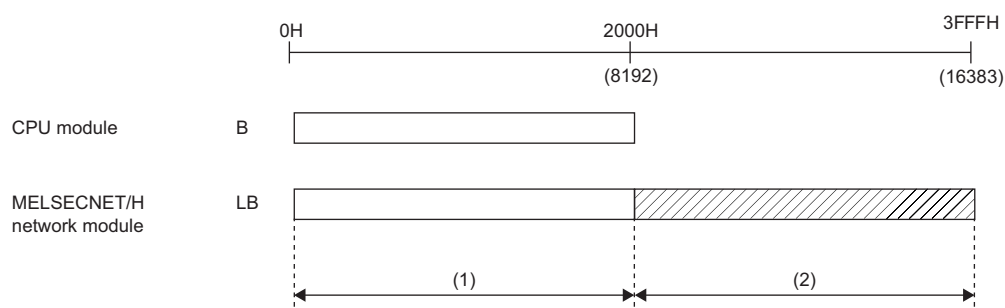

(1) Normal cyclic transmission area
(2) Extended function area

Point

- When using 32-bit data, set the number of send points and send range so that the execution condition of 32-bit data assurance is satisfied. (☞ Page 30 32-bit data assurance)
- The number of device points (B, W) for the CPU module can be changed by the CPU parameter. (☞ MELSEC iQ-R CPU Module User's Manual (Application))
- The link device for the extended function area (2000H to 3FFFH) is also used for normal cyclic transmission. (When using 8193 or more link devices for normal cyclic transmission) For link devices for low speed cyclic transmission, use link devices in the extended function area that is not used for normal cyclic transmission.
- The total send range per station for low speed cyclic transmission should be 2000 bytes or less. (The send range of normal cyclic transmission is not included.)
- The link devices for low speed cyclic transmission are only LB and LW.

Sending timing

Low speed cyclic transmission is performed separately from normal cyclic transmission.

This section describes the sending method setting, send processing interval, and link cycle for low speed cyclic transmission.

The following indicates the sending method.

Sending method	Description
Transmit Data of One Station in 1 Scan.	Sends low speed cyclic data for one station maximum during one link scan of normal cyclic transmission.
Fixed Interval Cycle Setting	Sends low speed cyclic data in the link cycle of the specified time period.*1
System Timer Setting	Sends low speed cyclic data in the link cycle of the specified time.*1

*1 The maximum number of stations that can be sent during one link scan of normal cyclic transmission varies depending on the "Maximum No. of Transient Transmissions" setting.

Send processing interval

The following system configuration examples are used for explanation.

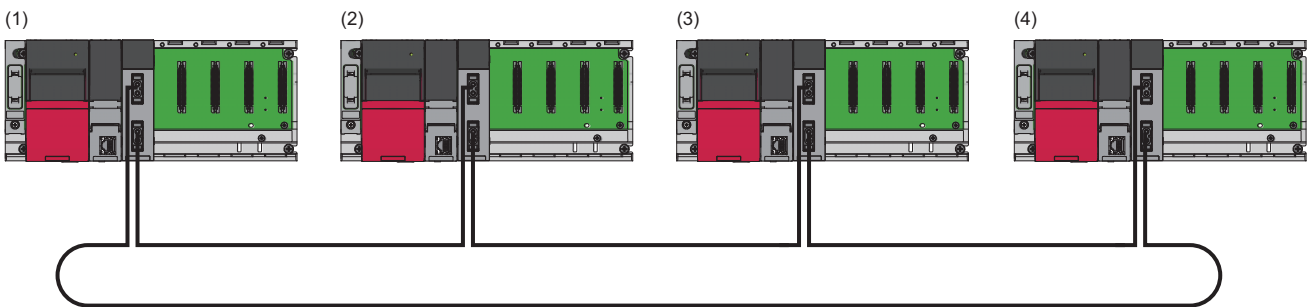

- (1) Control station (station No.1)
- (2) Normal station (station No.2)
- (3) Normal station (station No.3)
- (4) Normal station (station No.4)

Ex.

For "Transmit Data of One Station in 1 Scan.", "Fixed Interval Cycle Setting (Maximum No. of Transient Transmissions: 1)", and "System Timer Setting (Maximum No. of Transient Transmissions: 1)"

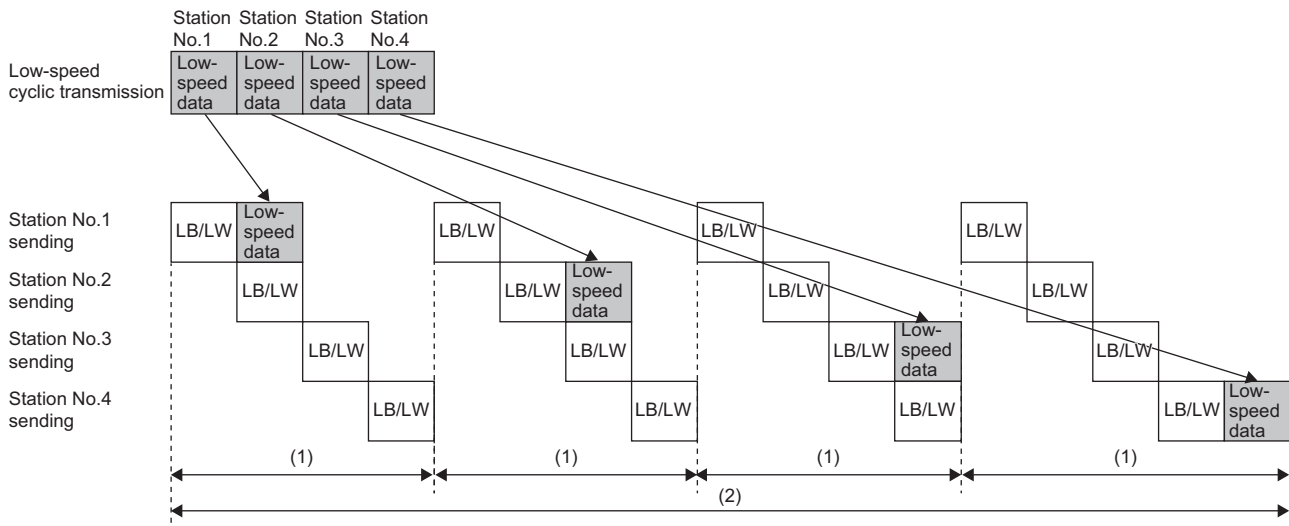

- (1) Normal link scan
- (2) Send processing interval

Ex.

For "Fixed Interval Cycle Setting (Maximum No. of Transient Transmissions: 2)" and "System Timer Setting (Maximum No. of Transient Transmissions: 2)"

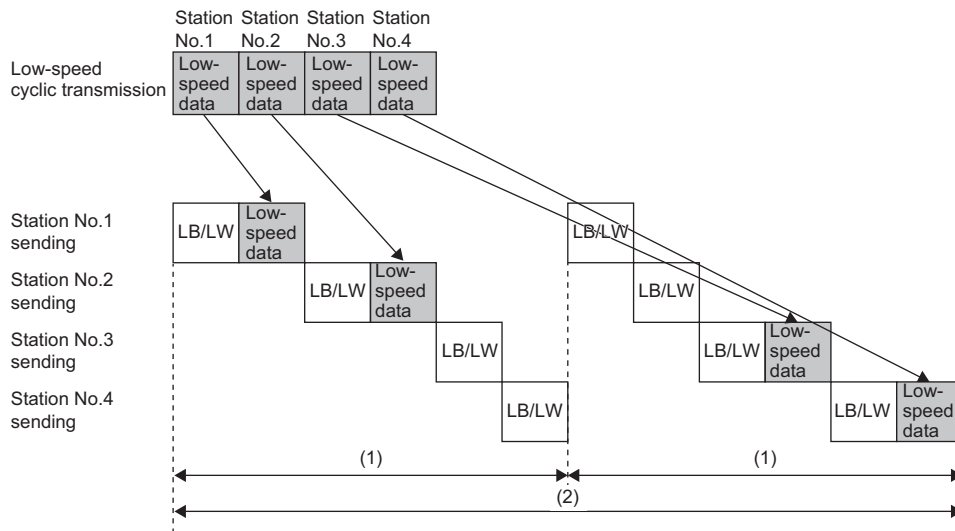

- (1) Normal link scan
- (2) Send processing interval

■ Link cycle

The following shows the link cycle of low speed cyclic transmission.

- For "Transmit Data of One Station in 1 Scan."

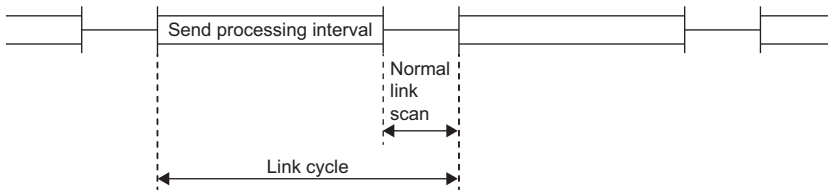

- For "Fixed Interval Cycle Setting"

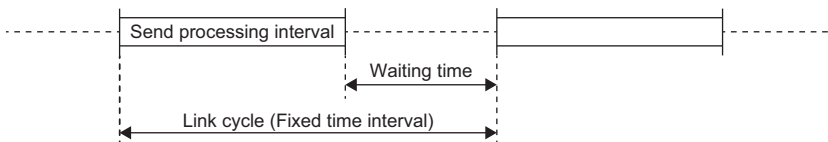

- For "System Timer Setting"

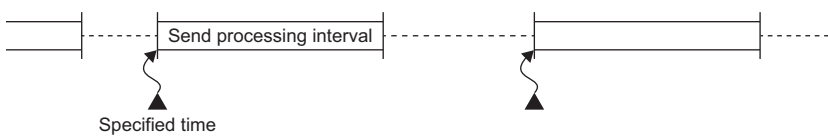

Setting method

■For "Transmit Data of One Station in 1 Scan."

1. Select "Transmit Data of One Station in 1 Scan." in "Low Speed Cycle Setting" under "Supplementary Cyclic Settings" in "Application Settings".

Item	Setting
Low Speed Cyclic Setting	
<i>Low Speed Cyclic Setting</i>	Transmit Data of One Station in 1 Scan.

2. Click the [Apply] button to finish the settings.

Point

The fastest link scan time of low speed cyclic transmission is calculated as follows:

$$LSL = LS \times \text{the number of stations} + LS = LS \times (\text{the number of stations} + 1)$$

LSL: The fastest link scan time of low speed cyclic transmission

LS: Normal link scan time

■For "Fixed Interval Cycle Setting"

1. Select "Fixed Interval Cycle Setting" in "Low Speed Cycle Setting" under "Supplementary Cyclic Settings" in "Application Settings".
2. Set the setting value for "Fixed Interval Cycle Setting".

Item	Setting
Low Speed Cyclic Setting	
<i>Low Speed Cyclic Setting</i>	Fixed Interval Cycle Setting
Fixed Interval Cycle Setting	600 Second

3. Click the [Apply] button to finish the settings.

■For "System Timer Setting"

1. Select "System Timer Setting" in "Low Speed Cycle Setting" under "Supplementary Cyclic Settings" in "Application Settings".
2. Set the specified time.

Item	Setting
Low Speed Cyclic Setting	
Low Speed Cyclic Setting	System Timer Setting
Fixed Interval Cycle Setting	
System Timer Setting 1	
Year	2019
Month	8
Day	29
Hour	11
Minute	7
Second	0

3. Click the [Apply] button to finish the settings.

Point

- The system timer operates based on the clock of the own station. If the time is not synchronized between the sending station and receiving station, the time may lag between stations.
- When handling multiple data without station-based block data assurance, new data and old data may be mixed. Therefore, configure an interlock. (☞ Page 80 Precautions for Programming)

Link refresh

Link refresh is a process of transferring data between a link device used for cyclic transmission and a device in a CPU module. Link refresh is automatically performed at program END processing.

Concept of the link refresh range (number of points)

The area range set under "Link Refresh Settings" in "Basic Settings" and also specified under "Network Range Assignment" in "Required Settings" is executed by link refresh.

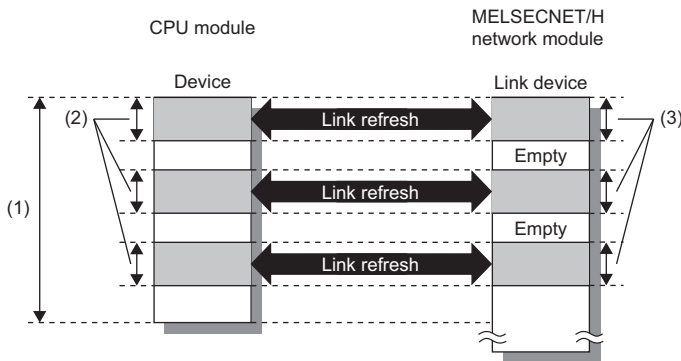

- (1) Range set in "Link Refresh Settings" under "Basic Settings"
- (2) Actual link refresh range
- (3) Range set under "Network Range Assignment" in "Required Settings"

Shortening the link refresh time

This function reduces the number of the link refresh points to the CPU module, resulting in a shorter link refresh time. The following methods can be used to reduce the number of the link refresh points.

- Set only the link devices used in the CPU module as the link refresh range in "Link Refresh Setting" under "Basic Settings". (☞ Page 62 Link Refresh Settings)
- Directly access infrequently used link devices from the program, and remove the corresponding settings from the link refresh range. (☞ Page 26 Direct access to link devices)

Setting method

The link refresh is assigned under "Link Refresh Settings" in "Basic Settings". (☞ Page 62 Link Refresh Settings)

Precautions

■ Latched devices of the CPU module

If data in latched devices of the CPU module are cleared to zero on a program when the CPU module is turned off and on or reset, the data may be output without being cleared to zero, depending on the timing of the link scan and link refresh. Execute the actions listed in the table below to disable the data in the latched devices of the CPU module.

CPU module device	How to disable the setting
Latch relay (L), file register (R, ZR)	Use the initial device value of the CPU module to clear the device to zero.*1
CPU module device within the latch range	Delete all the latch range settings specified in "Latch Interval Operation Setting" under "Device Latch Interval Setting" in "Memory/Device Setting" of "CPU Parameter".

*1 For the initial device value setting of the CPU module, refer to the following.

☞ GX Works3 Operating Manual

Link refresh by COM instruction

Link refresh can be executed at the timing of the COM instruction execution instead of at the timing of the END processing. For details, refer to the following.

 MELSEC iQ-R Programming Manual (CPU Module Instructions, Standard Functions/Function Blocks)

Direct access to link devices

This function allows direct access to the link devices of the MELSECNET/H network module from the program. Specify a link device (LB, LW, LX, LY, SB, SW) as the link direct device (J□\□) for direct access.

Specification method

Specify the network number and the link device of the MELSECNET/H network module for reading or writing.

J□\□
 ↑ ↑
 (1) (2)

(1) Network number: 1 to 239

(2) Link device

Link relay (LB): B0 to B3FFF

Link register (LW): W0 to W3FFF

Link input (LX): X0 to X1FFF

Link output (LY): Y0 to Y1FFF

Link special relay (SB): SB0 to SB1FF

Link special register (SW): SW0 to SW1FF

Ex.

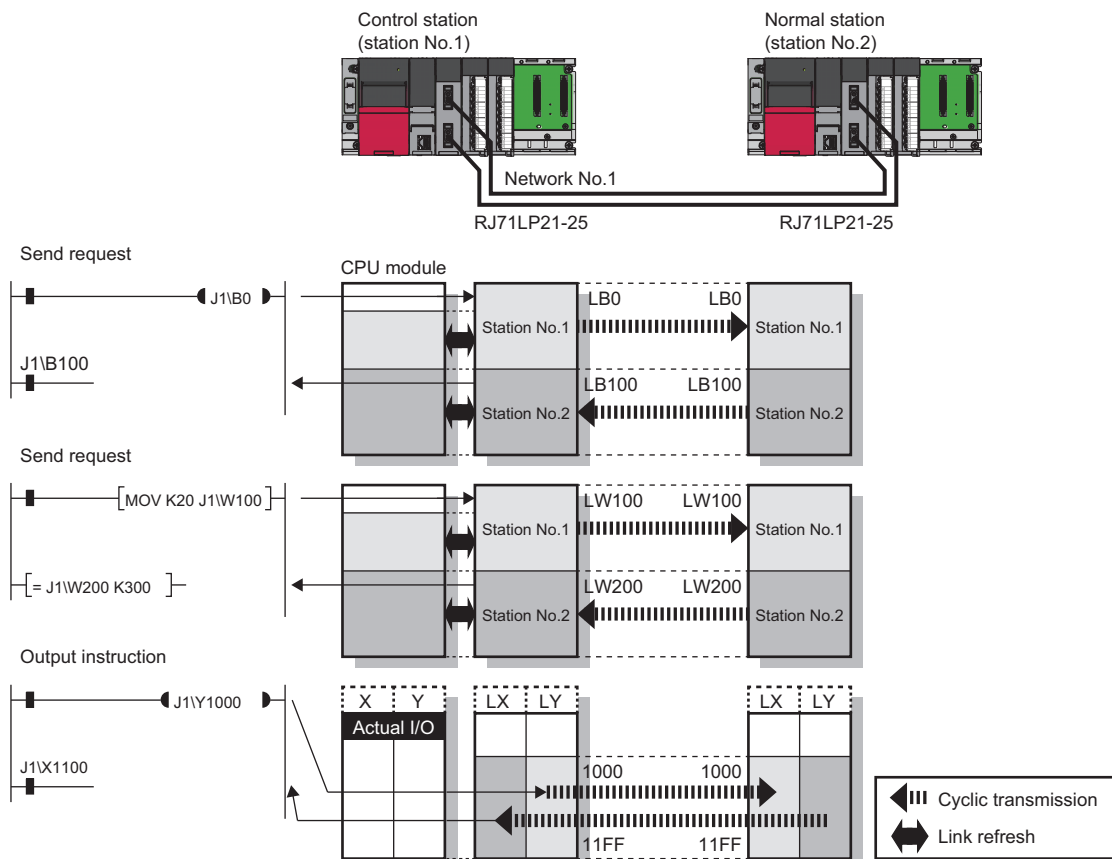

Readable and writable range

Data can be read or written between the MELSECNET/H network module and CPU module mounted on the same base unit.

■Read

All link devices of the MELSECNET/H network module can be specified. (☞ Page 26 Specification method)

■Write

The range that satisfies all of the following conditions can be specified.

- Area where data is sent to other stations and outside the link refresh range (☞ Page 17 Cyclic Transmission Function)
- Within the link device range of the MELSECNET/H network module (☞ Page 26 Specification method)

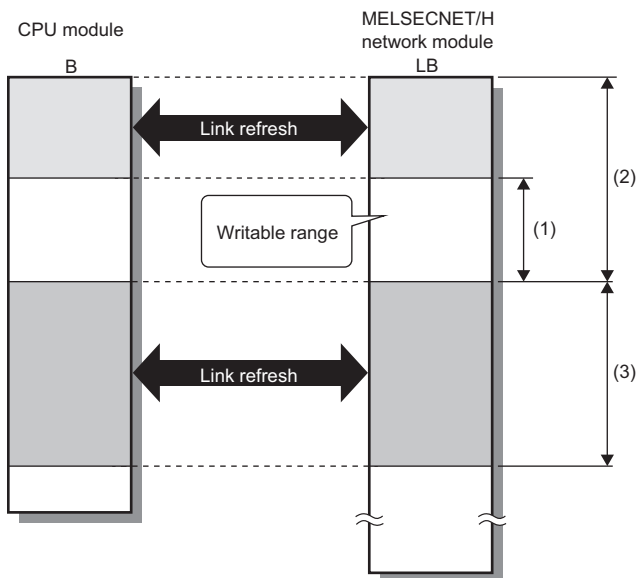

- (1) Out of the link refresh range
(2) Area where data is sent to other stations
(3) Area for receiving the data from other stations

When writing data to the area in the link refresh range, directly access the link device and write the same data in the device of the CPU module.

- Bad example (Only direct access to the link refresh target)

Link refresh overwrites the value.

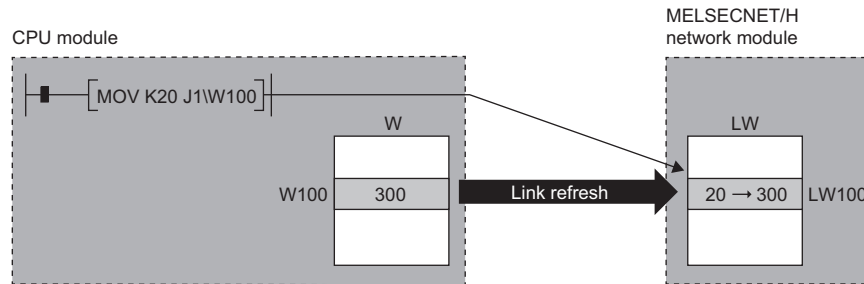

- Good example (In addition to direct access, writing the same data to the device of the CPU module)

The value written by direct access is reflected.

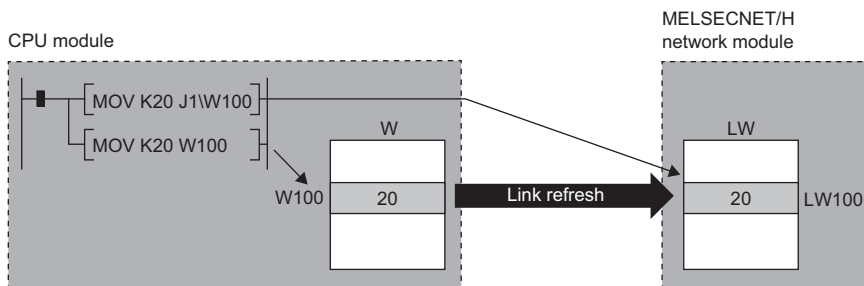

Differences from link refresh

Item	Access method	
	Link refresh	Direct access
Number of steps	1 step	2 steps
Processing speed*1	High speed	Low speed
Cyclic data assurance	Available	Not available

*1 For actual values, refer to the following.

 MELSEC iQ-R Programming Manual (Module Dedicated Instructions)

Shortening the link refresh time and transmission delay time

■Shortening the link refresh time

Remove infrequently used link devices from the link refresh range, and directly read or write the corresponding data using link direct devices. This function reduces the number of the link refresh points to the CPU module, resulting in a shorter link refresh time. ( Page 24 Link refresh)

■Shortening the transmission delay time

Because the link direct device allows direct reading or writing of data to the link devices of the MELSECNET/H network module at the time of the instruction execution, the transmission delay time can be shortened.

Point

Link refresh is executed in END processing of the sequence scan of the CPU module.

Precautions

■Cyclic data assurance

Direct access to link devices does not provide station-based block data assurance. Use 32-bit data assurance, or if cyclic data of more than 32 bits needs to be assured, use interlock programs. ( Page 80 Precautions for Programming)

■Mounting multiple modules of the same network number

When multiple MELSECNET/H network modules of the same network number are mounted, the target of direct access is the module which has the smallest slot number in the base unit.

Constant link scan

If the network status is unstable, the link scan time can be kept constant by specifying the link scan time at the control station to allow for possible fluctuations in the link scan time.

For the setting method, refer to the following.

 Page 66 Supplementary Cyclic Settings

Data assurance

This function assures the cyclic data in units of 32 bits or station-based units.

The following three methods are available for cyclic data assurance.

Method		Description
32-bit data assurance		Assures data in 32-bit units. Data is automatically assured by satisfying assignment conditions of link devices.
Assurance of data of more than 32 bits	Station-based block data assurance	Assures data in station-based units. Data is assured by enabling the send/receive data station-based block data assurance in the parameter setting.
	Interlock program	Assures data of more than 32 bits. Data is assured by configuring interlocks on programs.

Point

Link scans are performed asynchronously with link refresh.

Therefore, when the following cyclic data of 32 bits or more are handled, new and old data may be mixed in units of 16 bits depending on the link refresh timing.

- Floating-point data
- Present value or command speed value of a positioning module

32-bit data assurance

The link relay (LB) and link register (LW) data can be assured in units of 32 bits.

When LB and LW are set with the following four conditions met, 32-bit data assurance is automatically assured.

- The start device number of LB is a multiple of 20H.
- The number of points assigned per station in LB is a multiple of 20H.
- The start device number of LW is a multiple of 2.
- The number of points assigned per station in LW is a multiple of 2.

Set LB and LW under "Network Range Assignment" in "Required Settings" of the control station. ( Page 56 Network Range Assignment)

Point

If the network is configured with the MELSECNET/10 mode, 32-bit data assurance is disabled for the ACPU/QnACPU installed stations. Configure an interlock by the program for the ACPU/QnACPU installed stations.

( Page 80 Precautions for Programming)

Station-based block data assurance

Integrity of the cyclic data is assured for each station by handshake between the CPU module and MELSECNET/H network module for a link refresh.

■Setting method

To enable station-based block data assurance, set "Enable" under "Supplementary Cyclic Settings" in "Application Settings" of the control station. (☞ Page 66 Supplementary Cyclic Settings)

Once this setting is enabled on the control station, the data for all stations is assured for each station.

■Access to link devices

During a link refresh, data are assured for each station as shown below.

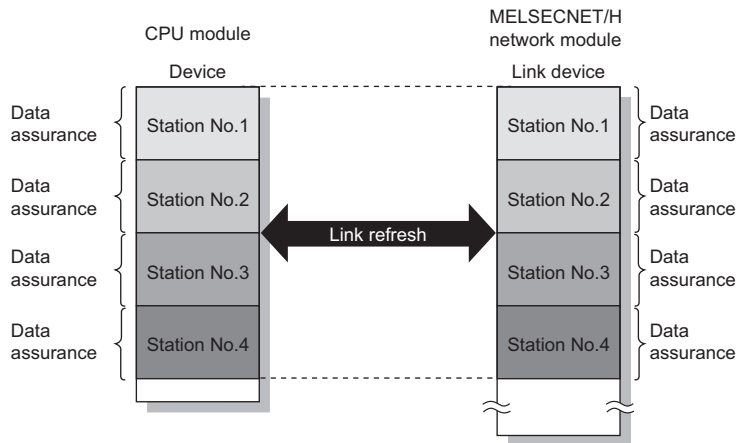

Point

- Since station-based block data assurance is only applied for link refresh processing, configure an interlock when using the direct access to link devices (J□□ specification).
- When the send/receive data station-based block data assurance is set to "Enable", refer to the following description for the formula to calculate transmission delay time. (☞ Page 184 Processing Time)
- If the network is configured with the MELSECNET/10 mode, station-based block data assurance is disabled for the ACPU/QnACPU installed stations. Configure an interlock by the program for the ACPU/QnACPU installed stations. (☞ Page 80 Precautions for Programming)

Interlink transmission

This function transfers data in the link devices (LB, LW) of the MELSECNET/H network module to another network module on a relay station.

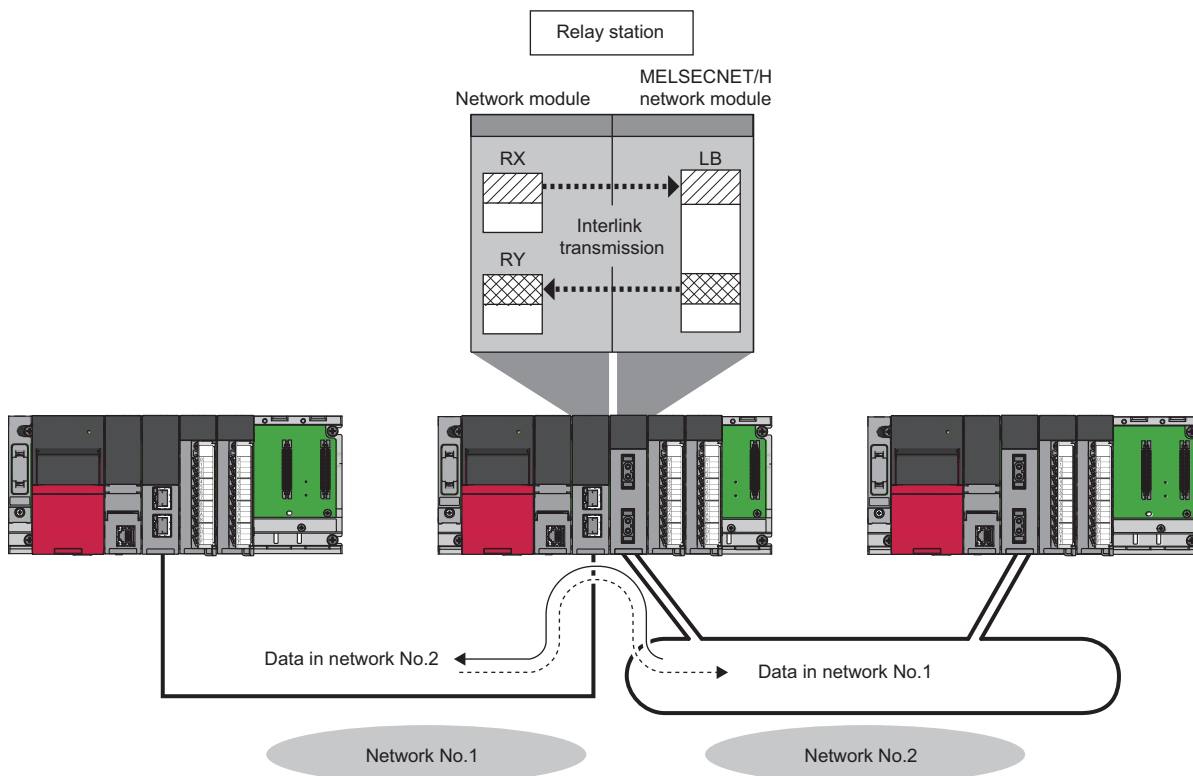

Setting method

Set interlink transmission in "Interlink Transmission Settings" in "Application Settings". ([Page 75 Interlink Transmission Settings](#))

Precautions

For the precautions, refer to the following.

[Page 75 Interlink Transmission Settings](#)

Cyclic transmission stop and restart

This function is used to stop the cyclic transmission during debugging and other operations. (Data reception from other stations and data sending from the own station are stopped.) Also, the stopped cyclic transmission is restarted. Transient transmission does not stop.

Cyclic transmission is stopped and restarted using the link start/stop or the program of the MELSECNET diagnostics.

( Page 123 Network Test)

Point

- Whether to stop/restart cyclic transmission by the stop/restart instruction of cyclic transmission is determined for each station that received the instruction.
 - When giving an instruction to restart cyclic transmission by specifying a station or target station that is different from the station instructed to stop in such a case where the station instructed to stop cyclic transmission goes down, perform forced link start.
 - When link stop (all stations) is enabled, the link stop instruction (all stations) is always performed for all stations. Therefore, cyclic transmission stops at the station connected to the network after the instruction is given. Also, even if the instruction to restart cyclic transmission is given to an individual station (for forced link start or other purposes), the station will remain stopped. When restarting cyclic transmission, perform link startup (all stations) or forced link start (all stations).
-

1.2 Transient Transmission Function

Transient transmission

This function allows communications with other stations when a request is made by a method such as a dedicated instruction and engineering tool. Communications with different networks is also possible.

Communications within the same network

This function performs the transient transmission to other stations using dedicated instructions and the engineering tool.

For details on dedicated instructions, refer to the following.

📖 MELSEC iQ-R Programming Manual (Module Dedicated Instructions)

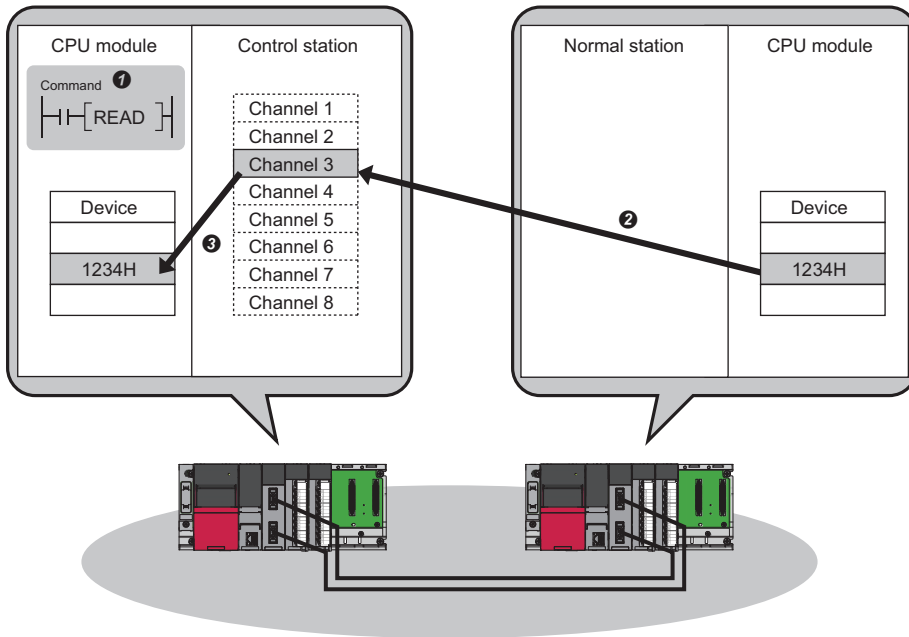

Communications with different networks

This function performs the transient transmission seamlessly to stations on different networks using dedicated instructions and the engineering tool.

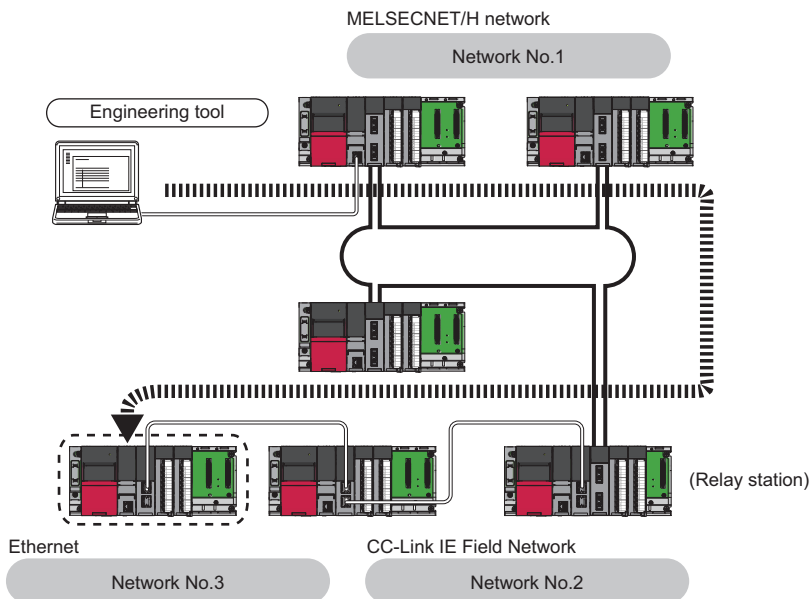

Point

Including the station directly connected to the engineering tool, communications can be made with stations up to eight networks apart (number of relay stations: 7).

When the networks consist of only MELSEC iQ-R series

Communication paths are automatically set for communication with the following networks of MELSEC iQ-R series.

- Ethernet
- CC-Link IE TSN
- CC-Link IE Controller Network
- CC-Link IE Field Network
- MELSECNET/H

Setting method

Check that "Dynamic Routing" in "Application Settings" is set to "Enable".

Point

- Communication paths are automatically set, but they can also be manually set. (☞ Page 36 When the networks consist of MELSEC iQ-R series and other series)
- Communication paths cannot be automatically set to Ethernet-equipped modules connected via a router. Set communication paths manually for such modules. (☞ Page 36 When the networks consist of MELSEC iQ-R series and other series)

When the networks consist of MELSEC iQ-R series and other series

Setting communication paths allows communication with the following networks configured with modules other than MELSEC iQ-R series.

- Ethernet
- CC-Link IE Controller Network
- CC-Link IE Field Network
- MELSECNET/H
- MELSECNET/10

■Setting method

Set communication paths in "Routing Setting" of "CPU Parameter". ( MELSEC iQ-R CPU Module User's Manual (Application))

When the networks contain a redundant system (RJ71LP21-25 only)

- When the communication paths are automatically set, the paths are updated if system switching occurs in a redundant system on the paths. During update of the communication paths, communications may be interrupted or data may be lost because the paths are temporarily undetermined. If an error occurs in communications, resend data from the request source.
- When the request source is a redundant system and the communication paths are automatically set, perform the transient transmission from the control system. When performing the transient transmission from the standby system, set "Routing Setting" of "CPU Parameter"
- When the request destination is a redundant system and the communication paths are automatically set, specify the control system station as the destination. When specifying the standby system as the request destination, set "Routing Setting" of "CPU Parameter".
- When relaying a redundant system and setting the communication paths manually, set the control system station as a relay station in "Routing Setting" of "CPU Parameter". If system switching occurs, the relay station needs to be changed to a station in the new control system using the RTWRITE instruction.

Execution condition setting

Set the transient transmission execution condition.

Adjust the setting of "Maximum No. of Transient Transmission" and "Maximum No. of Transients in One Station" as necessary.

■Setting method

1. Set the settings under "Transient Setting". ( Page 66 Supplementary Cyclic Settings)
2. Click the [Apply] button to finish the settings.

Point

- Increasing the number of transient transmissions allows simultaneous execution of multiple transient transmission instructions (in one link scan).
- When the number of transient transmissions is increased and the transient request in one network occurs simultaneously at each station, the link scan time is extended temporarily. As this affects the cyclic transmission, avoid setting an unnecessarily large number for the setting.
- When transient transmission is simultaneously used with low speed cyclic transmission, this parameter limits the number of transmission times including both transmissions.

Group transient transmission

This function sends data to all stations of the same transient transmission group number by dividing the transient transmission target stations into groups.

One network can be divided into a maximum of 32 groups.

Setting the group specification for the target station number of the control data of the link dedicated instruction allows capturing of transient data at the station where the group number matches.

Executing instructions by setting No.1 for group specification from station No.2 allows capturing of transient data at three stations: station No.3, station No.4, and station No.5.

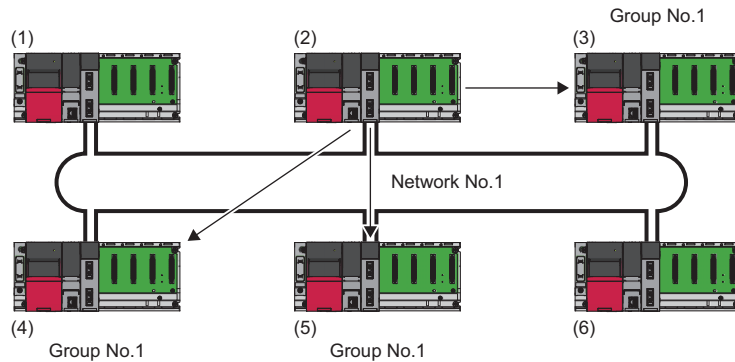

- (1) Control station (station No.1)
- (2) Normal station (station No.2)
- (3) Normal station (station No.3)
- (4) Normal station (station No.4)
- (5) Normal station (station No.5)
- (6) Normal station (station No.6)

Setting method

For the setting method, refer to the following.

📖 Page 73 Transient Transmission Group No.

Dedicated Instruction

The following describes the dedicated instructions for which group numbers can be specified.

📖 MELSEC iQ-R Programming Manual (Module Dedicated Instructions)

Instruction	Description
WRITE	Writes data in the word device of another station.
SWRITE	Writes data in the word device of another station. (With completion device)
SEND	Sends data to another station.
REQ	Requests the remote RUN/STOP to the CPU module on another station. Reads/writes clock data from/to another station.
ZNWR	Writes data in the word device of another station. (For MELSEC-A series)
RRUN	Sends the request of remote RUN to another station.
RSTOP	Sends the request of remote STOP to another station.
RTMWR	Writes the clock data to another station.

Precautions

- The execution cannot be checked with the transient transmission by group specification.
- If executed transient transmission continuously, transient transmission cannot be performed because of too much processing of transient transmission (link dedicated instruction). Continuous execution may cause an error (Error code: 1845H). Therefore, perform debugging after ensuring that the execution interval is set in the system and check that continuous execution can be performed.

Sending messages by using logical channel numbers

This function is used to receive only the messages selected on the receiving station when they have a lot of information types. The sending station performs transient transmission by using the destination logical channel without specifying a specific station number (the number can be specified). After the sent message is received at all other stations in one network, only the messages whose logical channel number matches the one specified for the receiving side are left, and other messages are deleted at the receiving station.

Ex.

When messages are sent from system D to logical channel 9, only systems A and C whose logical channel is set to 9 can receive messages.

System B does not receive messages because logical channel 9 is not set.

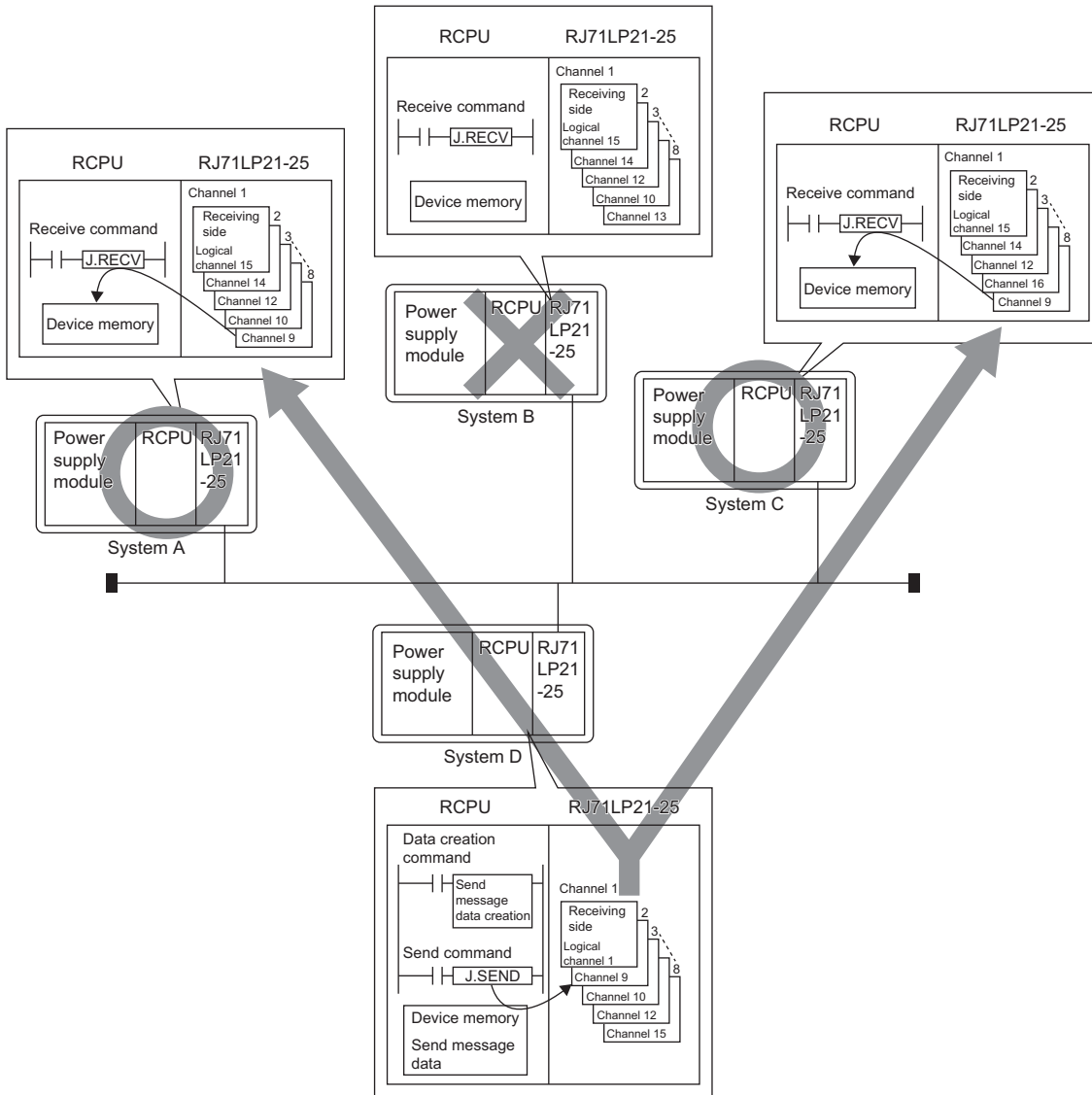

Transient transmission instruction where logical channel number can be specified

Instruction	Description
SEND	Sends data to another station.

For details on dedicated instructions, refer to the following.

 MELSEC iQ-R Programming Manual (Module Dedicated Instructions)

Precautions

- The execution cannot be checked with the transient transmission by channel number specification.
- If executed transient transmission continuously, transient transmission cannot be performed because of too much processing of transient transmission (link dedicated instruction). Continuous execution may cause an error (Error code: 1845H). Therefore, perform debugging after ensuring that the execution interval is set in the system and check that continuous execution can be performed.

Setting method

For the logical channel number, set numbers from 'Logical channel setting (Channel 1)' (SW0008) to 'Logical channel setting (Channel 8)' (SW000F) by the program.

For link special register, refer to the following.

 Page 163 List of Link Special Register (SW) Areas

1.3 RAS

This function improves reliability, availability, and serviceability, allowing for comprehensively easier use of automation facilities.

Automatic return

This function automatically returns the station disconnected from the network due to a data link error to the network when it recovers and restarts data link.

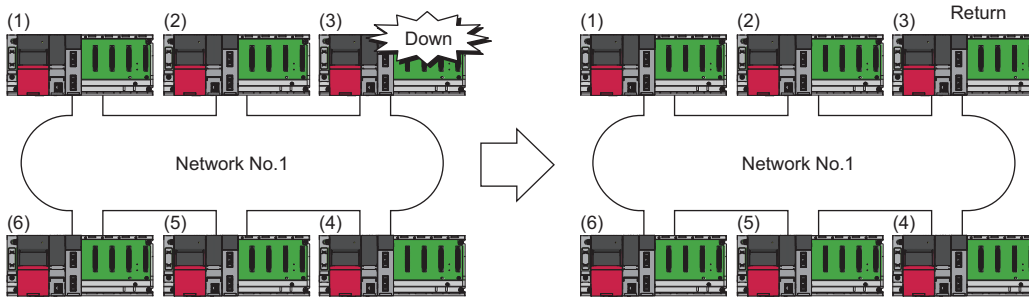

- (1) Control station (station No.1)
- (2) Sub-control station (station No.2)
- (3) Normal station (station No.3)
- (4) Normal station (station No.4)
- (5) Normal station (station No.5)
- (6) Normal station (station No.6)

Restriction

There is a limit on the number of stations that can be returned during one link scan. For the maximum number of stations that can be returned, refer to the following. (☞ Page 66 Supplementary Cyclic Settings)

Control station switching

This function continues data link with another normal station that serve as a sub-control station even if the control station goes down.

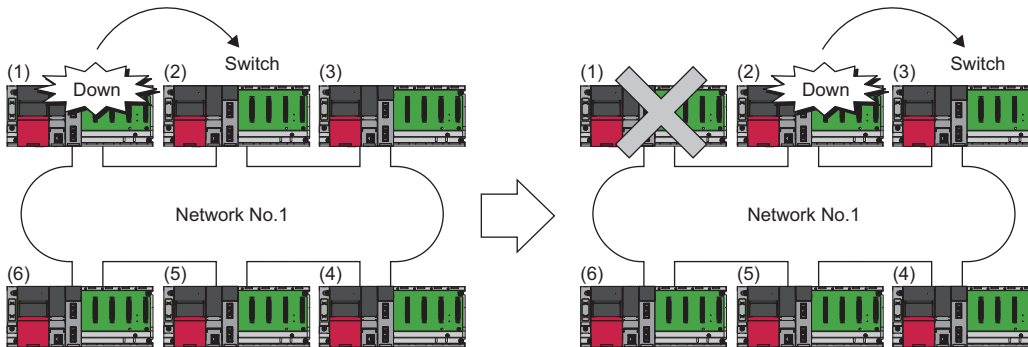

No	When the control station (station No.1) is down	When the sub-control station (station No.2) is down
(1)	The control station (station No.1) is down.	The control station (station No.1) is down.
(2)	Sub-control station (station No.2)	The sub-control station (station No.2) is down.
(3)	Normal station (station No.3)	Sub-control station (station No.3)
(4)	Normal station (station No.4)	Normal station (station No.4)
(5)	Normal station (station No.5)	Normal station (station No.5)
(6)	Normal station (station No.6)	Normal station (station No.6)

Setting method

Set control station switching in "Control Station Shift Setting" under "Supplementary Cyclic Settings" in "Application Settings".
 (📖 Page 66 Supplementary Cyclic Settings)

Point

- Data link temporarily stops when the control station is switched. While data link is stopped, data prior to the stop is held.
- While data link is stopped, all stations become communication faulty stations other than the own station.
- The control station is not switched even if cyclic transmission at the control station is stopped by the engineering tool.
- The control station is also switched to the normal station where cyclic transmission is stopped by the engineering tool.

Control station return control

This function shortens network downtime by resolving the cause of an error in the control station and making that station join the network as a normal station.

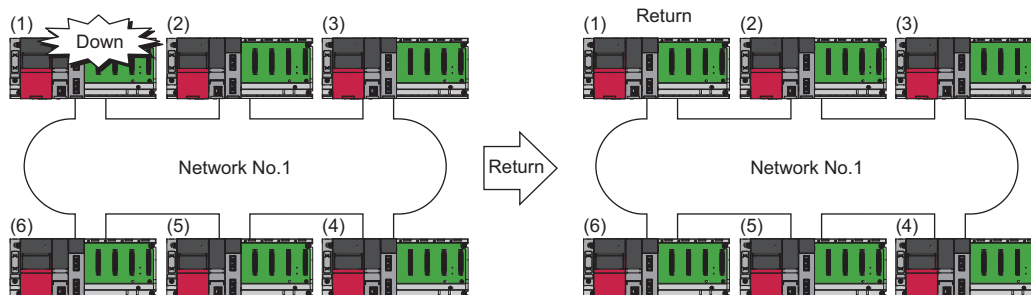

- (1) Control station (station No.1)
- (2) Sub-control station (station No.2)
- (3) Normal station (station No.3)
- (4) Normal station (station No.4)
- (5) Normal station (station No.5)
- (6) Normal station (station No.6)

Setting method

Set the control station return control under "Operation after Reconnection" in "Required Settings". (☞ Page 60 Operation after Reconnection)

Precautions

- Baton pass stops when "Return as Control Station" is set. The common parameters can be changed only by the CPU reset operation of the control station although the network stop time is prolonged. Transient transmission that is executed when baton pass stops may be completed with an error. In this case, execute the transmission again.
- Baton pass is returned without stopping if "Return as Normal Station" is set. Since the network connection does not stop, perform CPU reset operation for all stations after changing the common parameters of the control station during network connection. When CPU reset operation is performed only for the control station, an error occurs and the control station is disconnected with an error. (Error code: F826H)

Loopback function (RJ71LP21-25 only)

This function continues data link with normal stations even if a cable disconnection or faulty station occurs. The loopback function is only for RJ71LP21-25.

At the time of cable disconnection

Even if a cable disconnection occurs, the system automatically performs loopback to continue the data link.

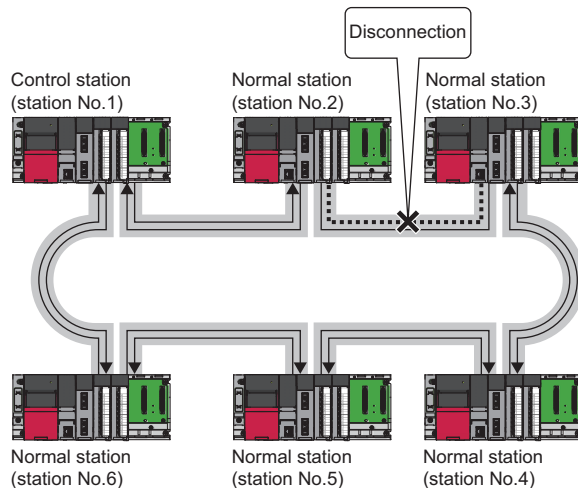

Point

- When loopback is being performed due to cable disconnection, both the forward loop and reverse loop may be considered normal depending on the cable disconnection condition. Whether the forward loop or reverse loop is normal or abnormal is determined by the reception status of the loopback station.
- If the cable is connected after being disconnected, the line to be used (forward loop/reverse loop) may be switched, but the data link is performed normally.

Occurrence of faulty stations

The system disconnects faulty stations and automatically performs loopback to continue the data link.

If two or more faulty stations occur, a station located between the faulty stations cannot perform data link. However, when more than one station exists between the faulty stations, a normal station with a smaller station number is changed to a sub-control station and continues data link.

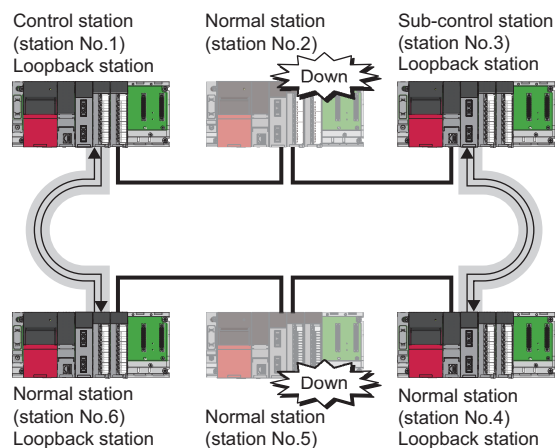

Precautions

When the RJ71LP21-25 fails, loopback may not be performed depending on what kind of failure occurs.

In such a case, data link may be stopped. To identify the RJ71LP21-25 with a failure, perform either of the following.

- Check the LED indication of all network modules for abnormal stations. (☞ Page 91 Checking with LED)
- Turn off the power of all stations, then turn on the power of stations in order, starting from the control station. While doing this, check up to which station on the network loopback is normally performed. Check whether the control station and a returned normal station are displayed on a loopback station in the link information of the MELSECNET diagnostics (own station information).

Replace the RJ71LP21-25 where a failure was detected with a new one and check that data link has returned to normal status.

Station detach function (RJ71BR11 only)

Even if the power to a connected station is turned off, the data link continues between other stations which are still able to perform data communication.

The station detach function is only for the RJ71BR11.

When completed normally

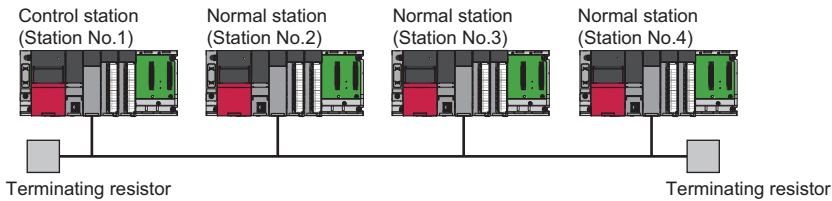

Occurrence of faulty stations

The data link continues excluding the station that is down.

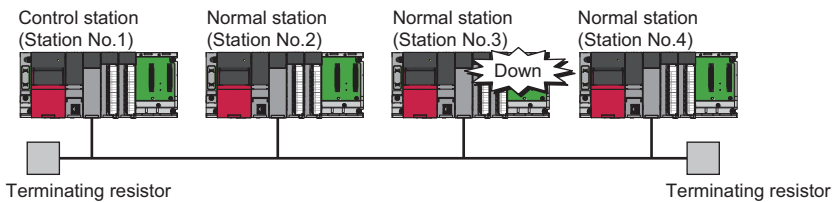

Point

When a cable disconnection occurs, the data link cannot be performed because there will be no terminating resistors.

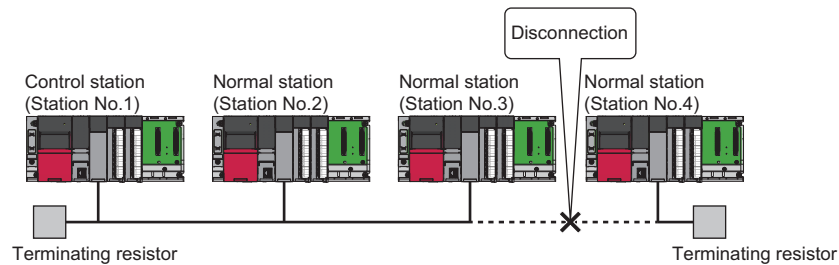

In addition, even if the cable is normal, the data link cannot be performed if a terminating resistor is detached.

1.4 Application Function

Interrupt program activation

Check the interrupt condition when receiving data from another station using the interrupt settings parameters of the own station. When the interrupt condition is established, an interrupt request is sent from the MELSECNET/H network module to the CPU module, and the interrupt program of the CPU module on the own station is activated.

Setting method

Set the interrupt request to the CPU module in "Interrupt Settings" under "Application Settings". (📖 Page 67 Interrupt Settings)

Multiplex transmission function (RJ71LP21-25 only)

This function is used to perform high speed communication using duplex transmission path (forward loop and reverse loop). The multiplex transmission function is only for the RJ71LP21-25.

Restriction

The RJ71LP21-25 cannot operate as a control station with multiplex transmission.

However, in the environment where the QJ71LP21-25 with multiplex transmission operates as a control station, the RJ71LP21-25 is allowed to participate in the network as a sub-control station or normal station. For details on multiplex transmission, refer to the following.

📖 Q Corresponding MELSECNET/H Network System Reference Manual (PLC to PLC network)

Number of send points extension

This function is used to increase the number of send points (a maximum of 2000 bytes per station) to a maximum of 8000 bytes by mounting multiple MELSECNET/H network modules with the same network number to one CPU module.

Ex.

A maximum of 4000 bytes can be sent by installing the control station (station No.1) and normal station (station No.2) at network No.1 in one CPU module.

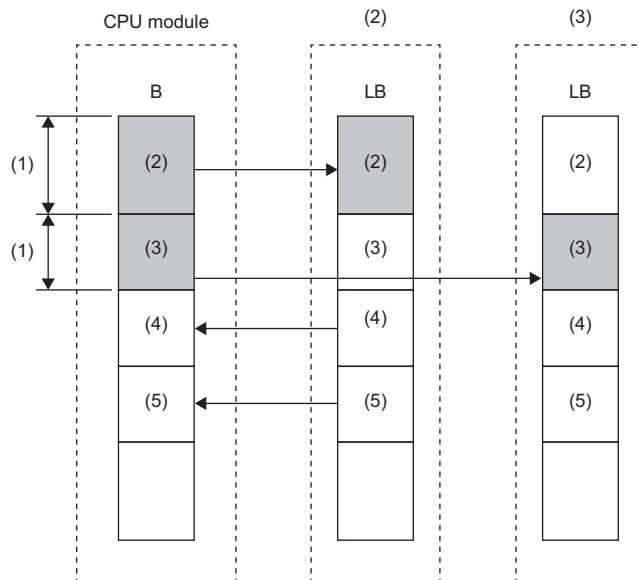

- (1) 2000 bytes maximum
- (2) Network No.1, control station (station No.1)
- (3) Network No.1, normal station (station No.2)
- (4) Network No.1, normal station (station No.3)
- (5) Network No.1, normal station (station No.4)

Precautions

Pay attention to the following points when installing multiple MELSECNET/H network modules with the same network number on one CPU module.

- Multiple network modules cannot be set on the same station number.
- Multiple stations cannot be set as a control station.
- Changing the setting of "Link Refresh Setting" under "Basic Settings" is required.
- For the function of specifying the target MELSECNET/H network module by a network number, such as the link direct device or the dedicated instruction, the smallest slot number on the base unit will be the target.

1.5 Redundant System Function (RJ71LP21-25 Only)

The redundant system function improves system reliability by mounting RJ71LP21-25 modules on the base units of both systems of a redundant system so that the new control system can continue data link even if an error occurs in the control system.

Restriction

The following modules are required to use the redundant system function.

- Process CPU
- Redundant function module

When using a redundant system, check the versions of the Process CPU and the engineering tool. (📖 MELSEC iQ-R CPU Module User's Manual (Application))

System configuration

This section describes the RJ71LP21-25 redundant system configuration.

The RJ71LP21-25s are mounted on the base units of both systems of a redundant system.

A redundant system is configured by connecting the RJ71LP21-25s in both systems together using optical fiber cables.

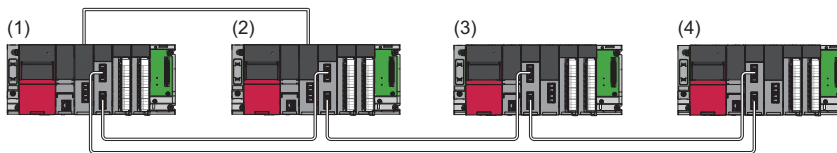

- (1) Control station (station No.1) as the control system (system A)
- (2) Normal station (station No.2) as the standby system (system B)
- (3) Normal station (station No.3)
- (4) Normal station (station No.4)

System switching operation

In a redundant system, if the control system fails, the control system and the standby system are switched. In the RJ71LP21-25, send data is transferred to the new control system after system switching to continue data link. The following shows system switching operation when a communication error occurs in the control system.

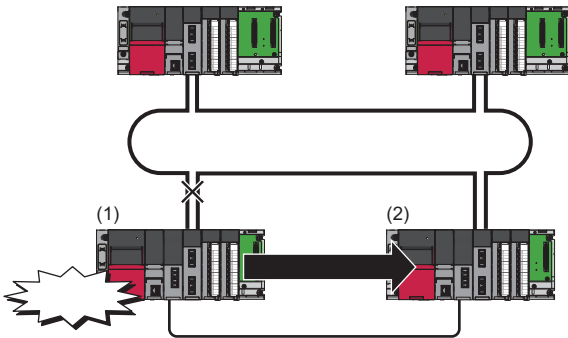

1. A communication error occurs in control system (1).
2. The RJ71LP21-25 of control system (1) issues a system switching request to the CPU module.
3. System switching occurs in the redundant system.
4. Standby system (2) starts operating as the new control system to continue network control.

Point

In the RJ71LP21-25, settings can be made from "System Switching Monitoring Time" under "Supplementary Cyclic Settings" in "Application Settings", or by directly rewriting 'System switching monitoring time setting' (SW0018).

Setting method

When using the module in a redundant system, select "RJ71LP21-25(R)" for the module model name in the "Add New Module" window.

In addition, pairing setting is required for the RJ71LP21-25 of both systems.

Pairing is set under "Network Range Assignment" in "Required Settings" of the control station. (☞ Page 56 Network Range Assignment)

Precautions

- If system switching is performed by any reason other than a communication error, control station switching is not performed.
- While the control is switched to a station of the new control system, the cyclic data output is held. For cyclic data holding time (output holding time) when system switching occurs, refer to the following.

☞ Page 190 Cyclic data holding time when system switching occurs

Cyclic transmission send/receive processing

When pairing is set for the RJ71LP21-25 of both systems, send data is transferred to the new control system at the time of system switching to continue cyclic transmission.

The following is the send range of cyclic transmission when pairing is set.

- The own station send ranges of the link devices (LB, LW) of both systems become the same when pairing is set.
- The station operating as the control system sends and receives cyclic data.
- The station operating as the standby system only receives cyclic data.

Each number in the figure, from No.1 to No.4, represents a station number.

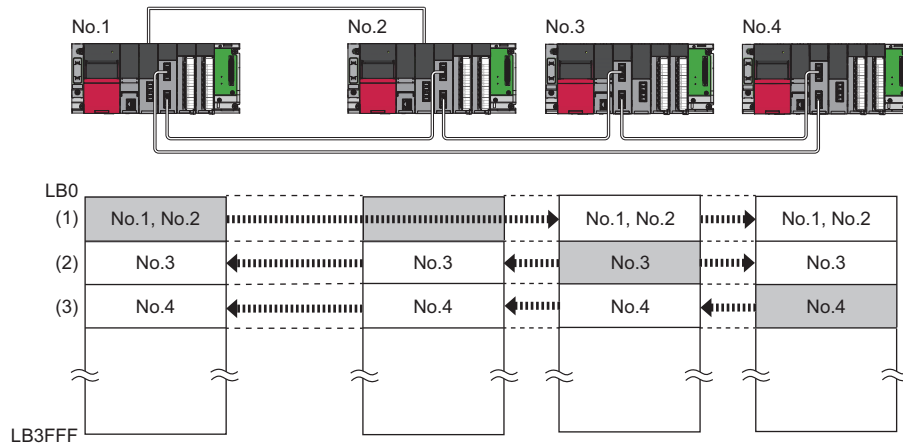

Send range of each station number

- (1) From station No.1 as the control system, data in the send ranges of station No.1 and station No.2 are sent to station No.3 and station No.4. If system switching occurs due to an error in station No.1, data in the send ranges of stations No.1 and No.2 are sent from station No.2, which starts operating as the new control system.
- (2) Data in the send range of station No.3 is sent to all stations including station No.2 operating as the standby system.
- (3) Data in the send range of station No.4 is sent to all stations including station No.2 operating as the standby system.

Precautions

■Tracking

- Of all link refresh target devices (B, W) of link devices (LB, LW), tracking needs to be set for the devices in the own station send range.
- Tracking cannot be set for link direct devices.
- Do not set tracking for the link special relay areas (SB0020 to SB01FF), which are turned on/off by the system, or the link special register areas (SW0020 to SW01FF), where data is stored by the system.
- When setting link devices (LX, LY), do not set the refresh target device for the link input (LX) from tracking setting (redundant settings on the CPU parameter side). When the link input (LX) changes after system switching occurs, a data conflict occurs in the tracking transfer and the send data from the I/O master station.

Point

For details on tracking transfer, refer to the following.

 MELSEC iQ-R CPU Module User's Manual (Application)

■Programming

In the RJ71LP21-25, the network detects a temporary communication error based on the condition of power-on/off, cables, noise, and others. Create a program using the RJ71LP21-25 in such a way that control operation is not stopped even if such a temporary communication error is detected. ( Page 80 Precautions for Programming)

■Detection of an error when another station is powered on/off

When either of the following operations is performed, a temporary data link error may be detected and a system switching request may be issued.

- Another station (including the standby system) is powered on/off.
- A personal computer equipped with a MELSECNET/H interface board boots or shuts down.

If the above system switching request is issued before the standby system starts up, the control system CPU module may detect a continuation error (system switching error). Even in this case, the control system continues to control the system normally. Create a program where control operation is not stopped due to error detection.

Before clearing the continuation error (system switching error) detected by the control system CPU module, check that the standby system and the RJ71LP21-25s operate correctly with the special register. ( MELSEC iQ-R CPU Module User's Manual (Application))

System switching request to the control system CPU module

When the RJ71LP21-25 mounted on the control system detects a data link error, it issues a system switching request to the control system CPU module.

However, depending on the operating status of the standby system, system switching is not executed.

For details on the operating status of the standby system and whether system switching is executable, refer to the following.

 MELSEC iQ-R CPU Module User's Manual (Application)

System switching cause

This section describes causes that make the RJ71LP21-25 issue a system switching request.

Point

For details on causes other than a system switching request from the RJ71LP21-25, refer to the following.

 MELSEC iQ-R CPU Module User's Manual (Application)

■Moderate/major error and hardware failure

When detecting an error where the RJ71LP21-25 cannot continue the processing, the RJ71LP21-25 notifies the control system CPU module about the error and issues a system switching request.

■Data link error





If the data link error status (D LINK LED off) continues for the system switching monitoring time set in "Supplementary Cyclic Settings" under "Application Settings" or longer, the RJ71LP21-25 issues a system switching request to the control system CPU module.

Point

When cyclic transmission is stopped using the link start/stop of the MELSECNET diagnostics, a system switching request is not issued to the control system CPU module. (This also applies to cyclic transmission is stopped by the link special relay (SB) or link special register (SW).)

Functions restricted in a redundant system



The following table lists the functions restricted when the RJ71LP21-25 is used in a redundant system.

Function	Restrictions
Transient transmission	<ul style="list-style-type: none">• To perform the transient transmission specifying the control system or standby system, acquire the current target station address (address of the control system or standby system) by using the module FB RedundantSystem_GetAddress and access the acquired address. ( MELSEC iQ-R Ethernet, CC-Link IE, and MELSECNET/H Function Block Reference)• Precautions exist for communications with different networks when the networks contain a redundant system. ( Page 36 When the networks contain a redundant system (RJ71LP21-25 only))• Precautions exist for when the dedicated instructions are used to a redundant system. ( Page 183 Precautions for dedicated instructions (when used in a redundant system))
Control station return control	<ul style="list-style-type: none">• In the redundant system, precautions exist for when the redundant CPU with a network module at returning the control station is the standby system. ( Page 60 Operation after Reconnection)

2 PARAMETER SETTINGS

This chapter describes the parameter settings required for communications between the MELSECNET/H network module and other stations.

2.1 Setting Parameters

1. Add the MELSECNET/H network module to the engineering tool.
 [Navigation window] ⇒ [Parameter] ⇒ [Module Information] ⇒ Right click ⇒ [Add New Module]
2. The required settings, basic settings, and application settings are included in the parameter settings. Select one of the settings from the tree on the window shown below.
 [Navigation window] ⇒ [Parameter] ⇒ [Module Information] ⇒ Target Module
3. After setting parameters, click the [Apply] button.
4. Write the settings to the CPU module using the engineering tool.
 [Online] ⇒ [Write to PLC]
5. The settings are reflected by resetting the CPU module or powering off and on the system.

2.2 Required Settings

Set the station type, network number, and other parameters for the MELSECNET/H network module.

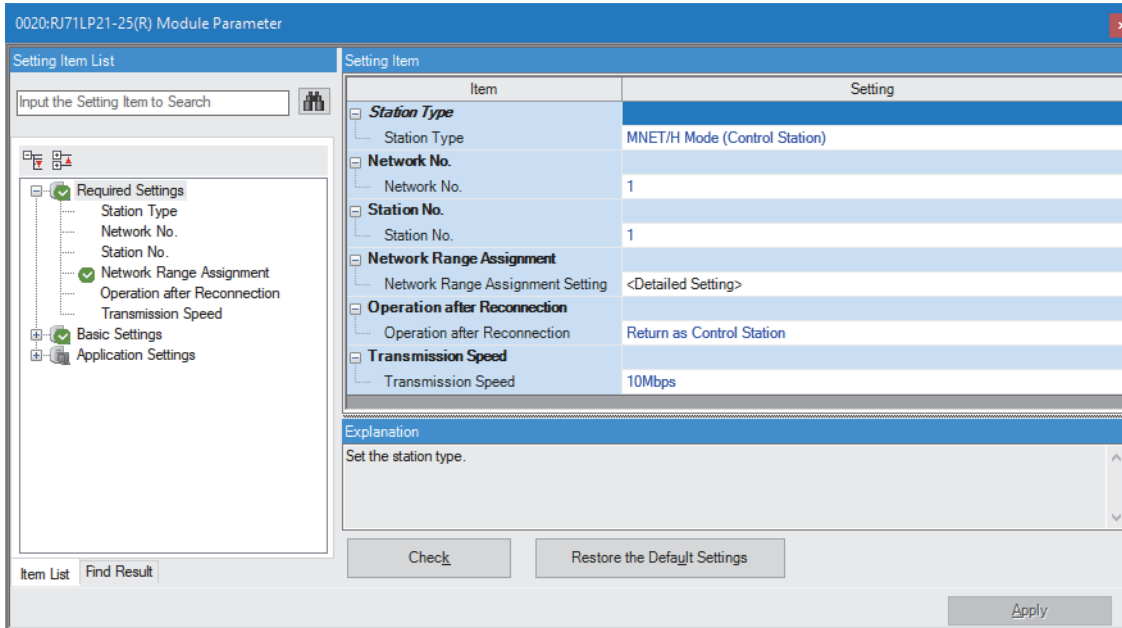

○: Can be set, ×: Cannot be set

Item	Description	Availability		Reference
		Control station	Normal station	
Station Type	Set the network type and station type for the MELSECNET/H network module.	○	○	Page 55 Station Type
Network No.	Set the network number for the MELSECNET/H network module.	○	○	Page 55 Network No.
Station No.	Set the station number for the MELSECNET/H network module.	○	○	Page 55 Station No.
Network Range Assignment	Set parameters of each station (the number of points and assignment of link devices) in the control station.	○	×	Page 56 Network Range Assignment
Operation after Reconnection	Set the station type of when the control station returns.	○	×	Page 60 Operation after Reconnection
Transmission Speed	Set the transmission speed for the RJ71LP21-25.	○	○	Page 60 Transmission Speed

Station Type

Set the network type and station type for the MELSECNET/H network module.

Item	Description	Setting range
Station Type	Set the network type and station type for the MELSECNET/H network module. One control station can be set per network. ■Network type <ul style="list-style-type: none"> MELSECNET/H mode MELSECNET/H extended mode MELSECNET/10 mode ■Station type <ul style="list-style-type: none"> Control station Normal station 	<ul style="list-style-type: none"> MNET/H Mode (Control Station) MNET/H Mode (Normal Station) MNET/H Extended Mode (Control Station) MNET/H Extended Mode (Normal Station) MNET/10 Mode (Control Station) MNET/10 Mode (Normal Station) (Default: MNET/H Mode (Normal Station))

Precautions

After setting the parameter, perform the setting check test using the MELSECNET diagnostics. (☞ Page 120 Setting Check Test)

Even when no error occurs as described below, errors can be detected by the MELSECNET diagnostics.

- Even when control stations and station numbers are duplicated in the network, the station number duplication detection error (Error code: 3001H) does not occur.
- Even when a different network number is set for the normal station and control station, no error occurs. (Although cyclic transmission continues, transient transmission cannot be performed.)

Network No.

Set the network number for the MELSECNET/H network module.

Item	Description	Setting range
Network No.	Set the network number for the MELSECNET/H network module.	1 to 239 (Default: 1)

Station No.

Set the station number for the MELSECNET/H network module.

Item	Description	Setting range
Station No.	Set the station number for the MELSECNET/H network module. If this item is not set when "Station Type" is selected, a default value is automatically set. <ul style="list-style-type: none"> Station number is set within the range set in "Total No. of Stations" in the "Network Range Assignment" window in "Required Settings" of the control station. To set the larger value, change the value in "Total No. of Stations" in the "Network Range Assignment" window in "Required Settings" of the control station beforehand. Set a station number different from those used in the same network. 	<ul style="list-style-type: none"> RJ71LP21-25: 1 to 64^{*1} RJ71BR11: 1 to 64^{*2} (Default: 1 for control station, 2 for normal station)

*1 The setting range is 1 to 63 when the "RJ71LP21-25" is used in a redundant system.

*2 When the MELSEC-Q series module is replaced with the MELSEC iQ-R series one, set a value within the range of 33 to 64 only when replacing the MELSECNET/H network module with the station number 33 or greater.

Precautions

- Set control stations and station numbers so that they are not duplicated in the network. Incorrect setting may cause failure to detect the station number duplication error (Error code: 3001H) depending on the parameter setting details or the network join timing. After setting the parameter, perform the setting check test using the MELSECNET diagnostics. (☞ Page 120 Setting Check Test)
- Even when the duplication of control stations and station numbers could not be detected as the station number duplication error (Error code: 3001H), it can be detected by the MELSECNET diagnostics.

Network Range Assignment

Set parameters of each station (the number of points and assignment of link devices) in the control station.

Setting method

The procedure for the network range assignment settings is shown below.

1. Set the required items.

Total No. of Stations <input type="text" value="2"/>		Switch Windows <input type="text" value="LB/LW Setting"/>		Batch Setting(G)											
Station No.	Station Type	LB/LW Setting												Reserved Station	Pairing
		LB			LW			Low Speed LB			Low Speed LW				
		Points	Start	End	Points	Start	End	Points	Start	End	Points	Start	End		
7	Control Station													No Setting	Enable
2	Normal Station													No Setting	Enable

2. Click the [Apply] button to finish the network range assignment.

Setting items

Item	Description	Setting range
Total No. of Stations	Set the total number of stations for one network. <ul style="list-style-type: none"> • When any reserved station is required, include the number of reserved stations. • When skipping a station number, specify the number to be skipped as a reserved station. 	<ul style="list-style-type: none"> • RJ71LP21-25: 2 to 64 • RJ71BR11: 2 to 64^{*1} (Default: 2)
Switch Windows	Select the "LB/LW Setting" window or "LX/LY Setting" window.	<ul style="list-style-type: none"> • LB/LW Setting • LX/LY Setting (1) • LX/LY Setting (2) (Default: LB/LW Setting)
Device Assignment Method	Right-click in the setting window and select a link device assignment method from the "Device Assignment Method" menu. Start/End: Enter the start and end numbers of link devices. Points/Start: Enter the points and start numbers of link devices.	Start/End Points/Start (Default: Start/End)

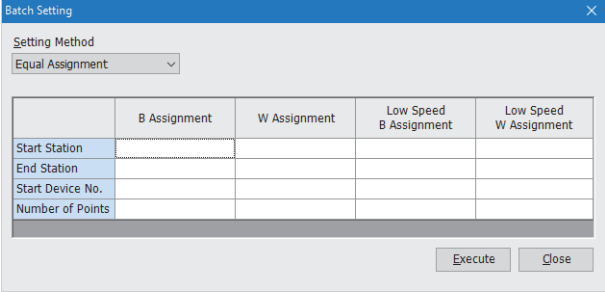
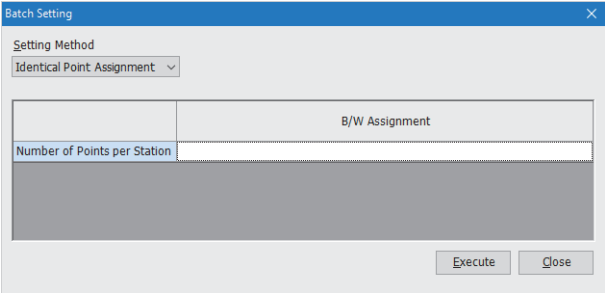
Item	Description	Setting range
Batch Setting	<p>[Batch Setting] button</p> <p>Clicking the [Batch Setting] buttons opens the "Batch Setting" window. The number of points for LB/LW and LX/LY is set in a batch. (The "Batch Setting" window for LB/LW and LX/LY are switched in conjunction with "Switch Windows".)</p>	<ul style="list-style-type: none"> • Equal Assignment • Identical Point Assignment <p>(Default: Equal Assignment)</p>
	<p>Equal Assignment</p> <p>Equally assign the range of the specified link device to the send range of the target station. LB/LX/LY points can be assigned in increments of 16, and LW points can be assigned in increments of 1.</p>  <ul style="list-style-type: none"> • Start Station: Enter the start station number of stations for which link devices are equally assigned. • End Station: Enter the end station number of stations for which link devices are equally assigned. • Start Device No.: Enter the start number of link devices to be equally assigned. • Number of Points: Enter the total points of link devices to be equally assigned. 	<p>(Default: Blank)</p>
	<p>Identical Point Assignment</p> <p>Assign the same specified points to LB/LW range to be sent by each station. LB points can be assigned in increments of 16, and LW points can be assigned in increments of 1.</p> 	<p>(Default: Blank)</p>

Item		Description	Setting range	
LB/LW Setting	LB	Points	Set the number of points (decimal) of LB sent by each station. Set in increments of 16 point.	<ul style="list-style-type: none"> MELSECNET/H mode: 16 to 16000 MELSECNET/H extended mode: 16 to 16384 MELSECNET/10 mode: 16 to 8192 (Default: Blank)
		Start	Set the start number of the LB range to be sent by each station. Set in multiples of 16 including 0.	<ul style="list-style-type: none"> MELSECNET/H mode, MELSECNET/H extended mode: 0000H to 3FF0H MELSECNET/10 mode: 0000H to 1FF0H (Default: Blank)
		End	Set the end number of the LB range to be sent by each station. Set in multiples of 16-1.	<ul style="list-style-type: none"> MELSECNET/H mode, MELSECNET/H extended mode: 000FH to 3FFFH MELSECNET/10 mode: 000FH to 1FFFH (Default: Blank)
	LW	Points	Set the number of points (decimal) of LW sent by each station.	<ul style="list-style-type: none"> MELSECNET/H mode: 1 to 1000 MELSECNET/H extended mode: 1 to 16384 MELSECNET/10 mode: 1 to 1000 (Default: Blank)
		Start	Set the start number of the LW range to be sent by each station.	<ul style="list-style-type: none"> MELSECNET/H mode, MELSECNET/H extended mode: 0000H to 3FFFH MELSECNET/10 mode: 0000H to 1FFFH (Default: Blank)
		End	Set the end number of the LW range to be sent by each station.	<ul style="list-style-type: none"> MELSECNET/H mode, MELSECNET/H extended mode: 0000H to 3FFFH MELSECNET/10 mode: 0000H to 1FFFH (Default: Blank)
	Low Speed LB	Points	Set the number of points (decimal) of low speed LB sent by each station. Set in increments of 16 point.	16 to 8192 (Default: Blank)
		Start	Set the start number of the low speed LB range to be sent by each station. Set in multiples of 16 including 0.	2000H to 3FF0H (Default: Blank)
		End	Set the end number of the low speed LB range to be sent by each station. Set in multiples of 16-1.	200FH to 3FFFH (Default: Blank)
Low Speed LW	Points	Set the number of points (decimal) of low speed LW sent by each station.	1 to 1000 (Default: Blank)	
	Start	Set the start number of the low speed LW range to be sent by each station.	2000H to 3FFFH (Default: Blank)	
	End	Set the end number of the low speed LW range to be sent by each station.	2000H to 3FFFH (Default: Blank)	

Item			Description		Setting range
LX/LY Setting (1) LX/LY Setting (2)	M Station →L Station	LY	Points	Set the number of points (decimal) of the output range (LY) sent from the M station (I/O master station) to the other station. Set in increments of 16 point.	16 to 8192 (Default: Blank)
			Start	Set the start number of the output range (LY) of the M station (I/O master station). Set in multiples of 16 including 0.	0000H to 1FF0H (Default: Blank)
			End	Set the end number of the output range (LY) of the M station (I/O master station). Set in multiples of 16-1.	000FH to 1FFFH (Default: Blank)
		LX	Points	The number of points (decimal) of the input range (LX) received by the L station (the station other than the I/O master station) from the M station is displayed.	—
			Start	Set the start number of the input range (LX) of the L station (the station other than the I/O master station). Set in multiples of 16 including 0.	0000H to 1FF0H (Default: Blank)
			End	The end number of the input range (LX) of the L station (the station other than the I/O master station) is displayed.	—
	M Station ←L Station	LY	Points	The number of points (decimal) of the output range (LY) sent from the L station (the station other than the I/O master station) to the I/O master station is displayed.	—
			Start	Set the start number of the output range (LY) of the L station (the station other than the I/O master station). Set in multiples of 16 including 0.	0000H to 1FF0H (Default: Blank)
			End	The end number of the output range (LY) of the L station (the station other than the I/O master station) is displayed.	—
		LX	Points	Set the number of points (decimal) of the input range (LX) received by the M station (I/O master station) from the other station. Set in increments of 16 point.	16 to 8192 (Default: Blank)
			Start	Set the start number of the input range (LX) of the M station (I/O master station). Set in multiples of 16 including 0.	0000H to 1FF0H (Default: Blank)
			End	Set the end number of the input range (LX) of the M station (I/O master station). Set in multiples of 16-1.	000FH to 1FFFH (Default: Blank)
I/O Master Station		Set the station to be set as the I/O master station. Set each I/O master station with LX/LY Setting (1) and LX/LY Setting (2).		<ul style="list-style-type: none"> • No Setting • I/O Master Station (Default: No Setting) 	
Reserved Station			Set to specify the normal station as a reserved station. No Setting: The normal station is connected to the network. Reserved Station: The normal station is reserved for future expansion. By reserving a normal station, link device assignment will not change even if the normal station is added or the reservation is canceled. Therefore, the program needs not to be modified. Physical connection of the normal station is not required.	<ul style="list-style-type: none"> • No Setting • Reserved Station (Default: No Setting) 	
Pairing			When the network contains a redundant system, set a combination of stations of system A and system B.	<ul style="list-style-type: none"> • Disable • Enable (Default: Disable) 	

*1 Normally, set a value for the total number of stations up to 32. However, only when a MELSECNET/H network module with the station number 33 or greater exists on the existing network, set the greatest station number on the network to "Total No. of Stations". Since the maximum number of connected stations is 32, set unused station numbers for reserved stations to satisfy the following conditions.
 Total number of stations - number of reserved stations ≤ 32 (maximum number of connected stations)

Pairing

When the network contains a redundant system, set a combination of stations of system A and system B.

■Setting method

To pair station No.3 with station No.4, set as follows:

Total No. of Stations		Switch Windows		Batch Setting(G)											
4		LB/LW Setting													
Station No.	Station Type	LB/LW Setting												Reserved Station	Pairing
		LB			LW			Low Speed LB			Low Speed LW				
		Points	Start	End	Points	Start	End	Points	Start	End	Points	Start	End		
7	Control Station	256	0000	00FF	256	00000	000FF	256	2000	20FF	256	02000	020FF	No Setting	Disable
2	Normal Station	256	0100	01FF	256	00100	001FF	256	2100	21FF	256	02100	021FF	No Setting	Disable
3	Normal Station	256	0200	02FF	256	00200	002FF	256	2200	22FF	256	02200	022FF	No Setting	Enable
4	Normal Station	256	0200	02FF	256	00200	002FF	256	2200	22FF	256	02200	022FF	No Setting	Enable

■Precautions

- Only stations with adjacent station numbers can be paired in the pairing setting.
- Pairing cannot be set in "LX/LY Setting (1)" or "LX/LY Setting (2)".

■List of CPU modules available for pairing setting as a control station

MELSEC series	Type
MELSEC-QnA series	Q4ARCPU*1
MELSEC-Q series	<ul style="list-style-type: none"> • Redundant CPU • High Performance model QCPU • Process CPU • Basic model QCPU • Universal model QCPU
MELSEC iQ-R series	<ul style="list-style-type: none"> • RnCPU • RnENCPU • Process CPU • Safety CPU

*1 For the Q4ARCPU, set pairing with the J.PAIRSET instruction.

Operation after Reconnection

Item	Description	Setting range
Operation after Reconnection	<p>Set the station type of when the control station returns. For details on the functions, refer to the following. ☞ Page 42 Control station return control</p> <p>Return as Control Station: The control station returns as the control station of the network again.</p> <p>Return as Normal Station: While the operating sub-control station works as the control station of the network, the control station returns as the normal station of the network again. The station works as the control station again only when all stations go down and recover. In the RJ71LP21-25 redundant system, when the redundant CPU with a network module at returning the control station is the standby system, the station is returned as the normal station even if "Operation after Reconnection" is set to "Return as Control Station".</p>	<ul style="list-style-type: none"> • Return as Control Station • Return as Normal Station (Default: Return as Control Station)

Transmission Speed

Item	Description	Setting range
Transmission Speed	<p>Set the transmission speed for the RJ71LP21-25. Set 10Mbps or 25Mbps when the station type is set to the "MNET/H mode" or "MNET/H extended mode", and set 10Mbps when it is set to the "MNET/10 mode".</p>	<ul style="list-style-type: none"> • RJ71LP21-25: 10Mbps, 25Mbps (Default: 10Mbps) • RJ71BR11: 10Mbps

2.3 Basic Settings

Set the link refresh settings for the MELSECNET/H network module.

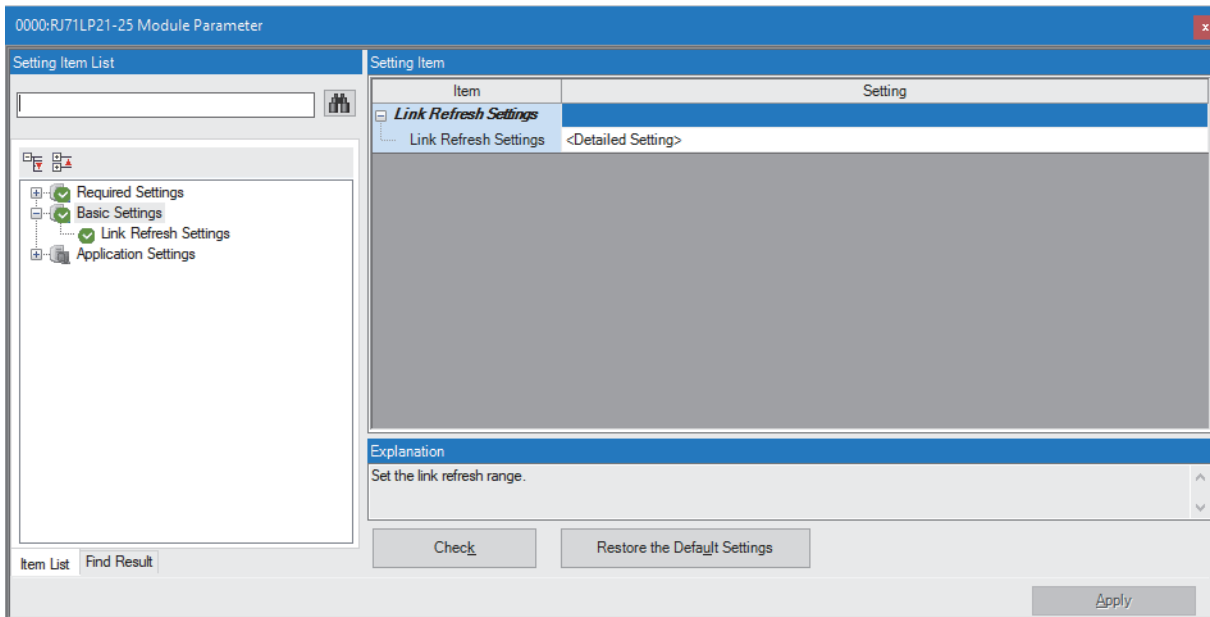

○: Can be set, ×: Cannot be set

Item	Description	Availability		Reference
		Control station	Normal station	
Link Refresh Settings	Set the link refresh ranges for the following. <ul style="list-style-type: none"> Between the MELSECNET/H network module link device (LB, LW, LX, LY) and the CPU module device Between the MELSECNET/H network module link device (SB, SW) and the CPU module device or module label 	○	○	Page 62 Link Refresh Settings

Link Refresh Settings

Set the link refresh range between the MELSECNET/H network module link device and the CPU module device or module label.

Setting method

The procedure for the link refresh settings is shown below.

1. Set the required items.

No.	Link Side					CPU Side				
	Device Name	Points	Start	End		Target	Device Name	Points	Start	End
-	SB	512	00000	001FF	↔	Module Label				
-	SW	512	00000	001FF	↔	Module Label				
1	LB	256	00000	000FF	↔	Specify Device	B	256	00000	000FF
2	LW	256	00000	000FF	↔	Specify Device	W	256	00000	000FF
3					↔					
4					↔					
5					↔					
6					↔					
7					↔					
8					↔					

2. Click the [Apply] button to finish the link refresh settings.

Setting items

Item	Description	Setting range		
Device Assignment Method	Right-click in the setting window and select a link device assignment method from the "Device Assignment Method" menu. <ul style="list-style-type: none"> Start/End: Enter the start and end numbers of link devices. Points/Start: Enter the points and start numbers of link devices. 	<ul style="list-style-type: none"> Start/End Points/Start (Default: Start/End)		
—	Link Side	Device Name	Set the link refresh ranges of SB and SW. One range can be set for each SB and SW.	<ul style="list-style-type: none"> SB (fixed) SW (fixed)
		Points	Set the number of points (decimal) to perform link refresh for the link special relay (SB) and link special register (SW). When "Start/End" is set for "Device Assignment Method", the number of link refresh points (decimal) is displayed.	<ul style="list-style-type: none"> SB: 16 to 512 SW: 1 to 512 (Default: 512)
		Start	Set the device number for the link special relay (SB) and link special register (SW) that are to be at the start of the link refresh range.	<ul style="list-style-type: none"> SB: 00000H to 001F0H SW: 00000H to 001FFH (Default: 00000H)
		End	Set the device number for the link special relay (SB) and link special register (SW) that are to be at the end of the link refresh range. When "Points/Start" is set for "Device Assignment Method", the end of the link refresh range is displayed.	<ul style="list-style-type: none"> SB: 0000FH to 001FFH SW: 00000H to 001FFH (Default: 001FFH)
	CPU Side	Target	Set the device/label memory of the CPU module that is to perform link refresh.	<ul style="list-style-type: none"> Module Label Specify Device (Default: Module Label)
		Device Name	Set the CPU module device for which link refresh is to be performed.	<ul style="list-style-type: none"> Module Label: — Specify Device (when link side is SB): SB, M, L, B, D, R, ZR, RD Specify Device (when link side is SW): SW, M, L, B, D, R, ZR, RD (Default: No setting)
		Points	The number of points (decimal) in the link refresh range of the CPU module device is displayed.	—
		Start	Set the device number of the CPU module device that is to be at the start of the link refresh range.	Follow the device setting of the CPU parameter.
		End	The device number of the final CPU module in the link refresh range is displayed.	—

Item		Description	Setting range	
1 to 64	Link Side	Device Name	Set the link refresh ranges of LB, LW, LX, and LY. Up to 64 ranges can be set.	<ul style="list-style-type: none"> • LB • LW • LX • LY (Default: Blank)
		Points	Set the number of link refresh points for LB, LW, LX, and LY. When "Start/End" is set for "Device Assignment Method", the number of link refresh points (decimal) is displayed.	LB: MELSECNET/H mode, MELSECNET/H extended mode: 16 to 16384 MELSECNET/10 mode: 16 to 8192 LW: MELSECNET/H mode, MELSECNET/H extended mode: 1 to 16384 MELSECNET/10 mode: 1 to 8192 <ul style="list-style-type: none"> • LX, LY: 16 to 8192 (Default: Blank)
		Start	Set the device number of LB, LW, LX, and LY that are to be at the start of the link refresh range.	LB: MELSECNET/H mode, MELSECNET/H extended mode: 00000H to 03FF0H MELSECNET/10 mode: 00000H to 01FF0H <ul style="list-style-type: none"> • LW: MELSECNET/H mode, MELSECNET/H extended mode: 00000H to 03FFFH MELSECNET/10 mode: 00000H to 01FFFH <ul style="list-style-type: none"> • LX, LY: 00000H to 01FF0H (Default: Blank)
		End	Set the device number of LB, LW, LX, and LY that are to be at the end of the link refresh range. When "Points/Start" is set for "Device Assignment Method", the end of the link refresh range is displayed.	<ul style="list-style-type: none"> • LB: MELSECNET/H mode, MELSECNET/H extended mode: 0000FH to 03FFFH MELSECNET/10 mode: 0000FH to 01FFFH <ul style="list-style-type: none"> • LW: MELSECNET/H mode, MELSECNET/H extended mode: 00000H to 03FFFH MELSECNET/10 mode: 00000H to 01FFFH <ul style="list-style-type: none"> • LX, LY: 0000FH to 01FFFH (Default: Blank)
	CPU Side	Target	Set the memory of the CPU module that is to perform link refresh.	Specify Device (fixed)
		Device Name	Set the CPU module device for which link refresh is to be performed.	<ul style="list-style-type: none"> • Specify Device: X, Y, M, L, B, D, W, R, ZR, RD (Default: Blank)
		Points	The number of points (decimal) in the link refresh range of the CPU module device is displayed.	—
		Start	Set the device number of the CPU module that is to be at the start of the link refresh range.	Follow the device setting of the CPU parameter.
	End	The device number of the final CPU module in the link refresh range is displayed.	—	

Precautions

■Device set to "CPU Side"

Set a device range that differs from the one used for the following:

- "Link Refresh Settings" in "Basic Settings" of other modules
- "Refresh Setting between Multiple CPUs" of "CPU Parameter" for a multiple CPU system
- I/O numbers used for I/O modules and intelligent function modules

■Link refresh range

Set only link devices used in the CPU module for link refresh range. Doing so will reduce link refresh points, resulting in a shorter link refresh time.

■Changing link device assignment in the "Network Range Assignment" window of "Required Settings"

Correct the setting range in "Link Refresh Settings" of "Basic Settings".

2.4 Application Settings

Set the supplementary cyclic settings, interrupt settings, or other parameters for the MELSECNET/H network module.

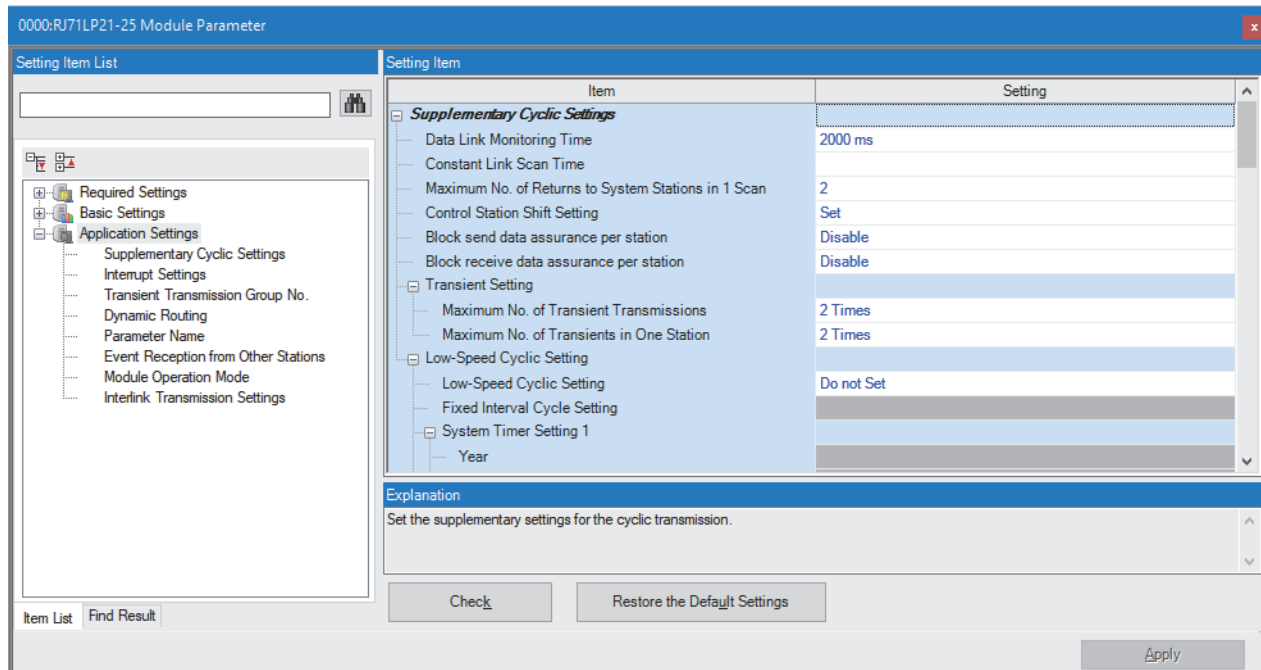



○: Can be set, ×: Cannot be set

Item	Description	Availability		Reference
		Control station	Normal station	
Supplementary Cyclic Settings	Set the data link monitoring time and system switching monitoring time.	○	×	Page 66 Supplementary Cyclic Settings
Interrupt Settings	Set conditions for sending an interrupt request to the CPU module.	○	○	Page 67 Interrupt Settings
Transient Transmission Group No.	Set a group number for transient transmission with group specification.	○	○	Page 73 Transient Transmission Group No.
Dynamic Routing	Select whether to enable the dynamic routing function.	○	○	Page 73 Dynamic Routing
Parameter Name	Set a name for the module parameter arbitrarily.	○	×	Page 73 Parameter Name
Event Reception from Other Stations	Select whether to obtain the events occurring in the other stations.	○	○	Page 73 Event Reception from Other Stations
Module Operation Mode	Set the operation mode for the MELSECNET/H network module.	○	○	Page 74 Module Operation Mode
Interlink Transmission Settings	Set link device ranges when cyclic data are transferred from a station in the own network to a station in another network.	○	○	Page 75 Interlink Transmission Settings
Redundant System Settings	Set the operation mode for the RJ71LP21-25 mounted on system B in a redundant system. This item can be set only when "RJ71LP21-25(R)" is selected for the module model name.	○	○	Page 79 Redundant System Settings (RJ71LP21-25 only)

Supplementary Cyclic Settings

Set the data link monitoring time and system switching monitoring time.

Item	Description	Setting range
Data Link Monitoring Time	Set the time for monitoring the link scan time in units of 10ms. Normally, it is recommended to use the default value. If the link scan time exceeds the value set in "Data Link Monitoring Time", data linking is disabled.	10ms to 2000ms (Default: 2000ms)
System Switching Monitoring Time ^{*1*2*3}	Set the time (in increments of 10ms) from data link stop ('Data link error status of own station' (SB0049) is turned on) to issuance of a system switching request.	10ms to 5000ms (Default: 2000ms)
Constant Link Scan Time	Set the constant link scan time. This will keep the link scan time at the set time.	1ms to 500ms (Default: Blank)
Maximum No. of Returns to System Stations in 1 Scan	Set the number of communication faulty stations that can be returned during one link scan. (Unit: Station)	1 to 64 (Default: 2)
Control Station Shift Setting	Set this item when another normal station in the network continues cyclic transmission as an alternate station (sub-control station) when the specified control station is disconnected due to an error.	• Set • Not Set (Default: Set)
Block send data assurance per station	Set this item to prevent data inconsistency of the link data per station during cyclic transmission. This setting enables data operation of multiple words without interlocking. However, data inconsistency prevention function is enabled only during the link refresh processing between the CPU module and MELSECNET/H network module. ( Page 30 Data assurance) The default settings are shown below: • MELSECNET/H mode, MELSECNET/10 mode: Disable • MELSECNET/H extended mode: Enable	• Disable • Enable (Default: As shown on the left)
Block receive data assurance per station		
Transient Setting	Maximum No. of Transient Transmissions	Set the number of transient transmissions that can be performed in one link scan. 1 to 255 times ^{*4} (Default: 2 times)
	Maximum No. of Transient in One Station	Set the number of transient transmissions that one station can perform in a link scan. 1 to 10 times ^{*4} (Default: 2 times)
Low-Speed Cyclic Setting	Low-Speed Cyclic Setting	Set the sending method of low speed cyclic transmission. For details, refer to the following.  Page 21 Sending timing
	Fixed Interval Cycle Setting	Performs low speed cyclic transmission at the set period. 1 to 65535 seconds (Default: Blank)
	System Timer Setting 1 to 8	Performs low speed cyclic transmission at the set date and time. Time/minute/second cannot be omitted in the system timer. Number of set points: 1 to 8 points (Year/Month/day/Time/Minute/Second) (Default: Blank)

- *1 When 'System switching monitoring time setting valid flag' (SB0018) is enabled, the setting value of 'System switching monitoring time setting' (SW0018) is prioritized.
- *2 Only a project of the Process CPU (redundant mode) can be set.
- *3 When the RJ71BR11 is used, the setting will be disabled.
- *4 Always set "Maximum No. of Transient Transmissions" and "Maximum No. of Transient in One Station". Also, set the value of "Maximum No. of Transient Transmissions" to be equal to or greater than the set value of "Maximum No. of Transient in One Station".

Interrupt Settings

Set conditions for sending an interrupt request to the CPU module.

Setting method

1. Set the interrupt conditions.

Up to 16 interrupt conditions can be set.

No.	Device/ Reception Channel	Device No./ Channel No.	Detection Method	Condition Type	Condition Value	Interrupt Pointer	Comment
SI 00	LB	00000	Edge	ON		I0	
SI 01	LW	00000	Edge	Values Match	0	I1	
SI 02							
SI 03							
SI 04							
SI 05							
SI 06							
SI 07							
SI 08							
SI 09							

2. Click the [Apply] button to finish the interrupt settings.

Setting items

Item	Description	Setting range
Word Device Setting Value Input Format	Right click in the setting window and select a format from the "Word Device Setting Value Input Format" menu.	<ul style="list-style-type: none"> • Decimal • Hexadecimal (Default: Decimal)
Device/Reception Channel	Set an interrupt condition device. When "RECVS instruction" is selected, an interrupt program is executed when the channel specified in "Device No./Channel No." receives data.	<ul style="list-style-type: none"> • LB • LX • SB • LW • SW • RECVS instruction • Scan Completed (Default: Blank)
Device No./Channel No.	Set the device number and channel number in the interrupt condition.	<ul style="list-style-type: none"> • SB, SW: 00000H to 001FFFH • LB: MELSECNET/H mode, MELSECNET/H extended mode: 00000H to 03FFFFH MELSECNET/10 mode: 00000H to 01FFFFH • LW: MELSECNET/H mode, MELSECNET/H extended mode: 00000H to 03FFFFH MELSECNET/10 mode: 00000H to 01FFFFH • LW: 00000H to 03FFFFH • LX: 00000H to 01FFFFH • RECVS instruction: 1 to 8 (Default: Blank)
Detection Method	Set the method of detecting the conditions set in "Condition Type".	<ul style="list-style-type: none"> • Edge • Level (Default: Blank)
Condition Type	Set the detection condition of an interrupt generated by the device set in "Device/Reception Channel" and "Device No./Channel No.".	<ul style="list-style-type: none"> • ON (When LB, LX, or SB is selected) • OFF (When LB, LX, or SB is selected) • Values Match (When LW or SW is selected) • Values Mismatch (When LW or SW is selected) • Reception Completed (When RECVS instruction is selected) (Default: Blank)
Condition Value	When "LW" or "SW" is selected in "Device/Reception Channel", enter a word device value that triggers an interrupt.	0000H to FFFFH (Default: Blank)
Interrupt Pointer	Set an interrupt pointer to be used for a program. For the priority of the interrupt pointer, refer to the following.  MELSEC iQ-R CPU Module User's Manual (Application)	<ul style="list-style-type: none"> • I0 to I15 • I50 to I1023 (Default: Blank)
Comment	Set a comment for the interrupt pointer used.	(Default: Blank)

The following shows the combination with other setting items for "Device/Reception Channel".

Device/Reception Channel	Device No./Channel No.	Detection Method*1	Condition Type	Condition Value	Interrupt Pointer
LB	0000H to 3FFFH	<ul style="list-style-type: none"> Level + ON: Interrupt occurs by turning on the device. Level + OFF: Interrupt occurs by turning off the device. Edge + ON: Interrupt occurs at the rising edge of the device. Edge + OFF: Interrupt occurs at the falling edge of the device. 		—	Device: I0 to I15, I50 to I1023
LX	0000H to 1FFFH				
SB	000H to 1FFH				
LW	00000H to 3FFFFH	<ul style="list-style-type: none"> Level + Values Match: Interrupt occurs when values match. Level + Values Mismatch: Interrupt occurs when values do not match. Edge + Values Match: Interrupt occurs when values match (first time only). Edge + Values Mismatch: Interrupt occurs when values do not match (first time only). 		0 to 65535 (0000H to FFFFH)	
SW	000H to 1FFH				
RECVS instruction	1 to 8	Edge (fixed)	Reception Completed (fixed)	—	
Scan Completed*2	—	—	—	—	

*1 When "Level" is selected for "Detection Method", the level condition of the specified device is checked for each link scan of the set MELSECNET/H network module and an interrupt occurs. Therefore, if the sequence scan takes much longer than the link scan, sequence scan time may greatly increase, resulting in the WDT time being exceeded in the CPU module.
When "Detection Method" is set to "Level" and the interrupt condition is always met, do not use interrupt settings and check the condition in the program.

*2 When "Scan Completed" is selected, an interrupt occurs for each link scan of the set MELSECNET/H network module.

Point

Using an interrupt program will eliminate the need for describing a start condition in a program. This leads to reduction in the number of steps and sequence scan time.

Restriction

A changed value in the device cannot be detected if the changed value is shorter than the transmission delay time.

When an interrupt program is executed, link refresh is not performed between the CPU module device and link device. Use the direct access function to access the link device when an interrupt program is being executed.

Precautions

■When "Detection Method" is set to "Level" and the interrupt condition is always met

If the sequence scan takes much longer than the link scan, since interrupt processing is activated in each link scan, sequence scan time may greatly increase, resulting in a watchdog timer error of the CPU module.

When "Detection Method" is set to "Level" and the interrupt condition is always met, do not use interrupt settings and correct the interrupt condition in the program.

■Before executing an interrupt program

Execute the EI instruction in a main routine program and enable an interrupt. (MELSEC iQ-R CPU Module User's Manual (Application))

■When multiple interrupts have simultaneously occurred

The operation may delay.

■When the MELSECNET/H network module mode is set to "Offline"

The module cannot send an interrupt request to the CPU module when the mode is set to "Offline".

■Starting an interrupt program by the rising/falling edge of the specified device

Do not use the rising/falling edge of a specified device (such as the PLS and PLF instructions) as a trigger of an interrupt program because a change in the device may fail to be read.

■An interrupt cannot be generated

A changed value in the interrupt condition device cannot be detected if the changed value is shorter than the transmission delay time.

■Using cyclic data in an interrupt program

When an interrupt program is executed, the link device data is not link-refreshed to CPU module devices. Directly access the link devices of the MELSECNET/H network module by direct access.

Setting examples

■ For an interrupt by the RECVS instruction

When a channel whose parameter is specified in the RECVS instruction receives a SEND instruction, the interrupt program can be started. When "RECVS instruction" is selected for "Device/Reception Channel", the "Device No./Channel No." and "Interrupt Pointer" are enabled.

Ex.

The following is a setting example to execute the interrupt program corresponding to the interrupt pointer I50 when the channel specified in the RECVS instruction (channel 5 of the control station (station No.15)) receives data sent from the normal station (station No.3) using the SEND instruction.

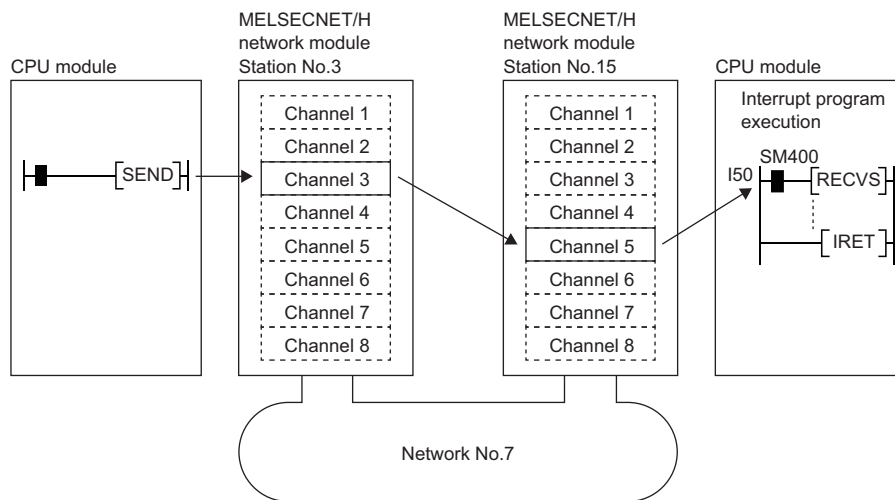

1. Set the interrupt setting parameters for the control station (station No.15) of the MELSECNET/H network module as shown below.

No.	Device/ Reception Channel	Device No./ Channel No.	Detection Method	Condition Type	Condition Value	Interrupt Pointer	Comment
SI 00	RECVS instruction	5	Edge	Reception Corr		I50	

■ For an interrupt by a link device (LB, LW, LX)

The specified interrupt program can be executed from another station in the condition of "ON/OFF" for the link device (LB, LX) or "Values Match/Values Mismatch" for the link register (LW).

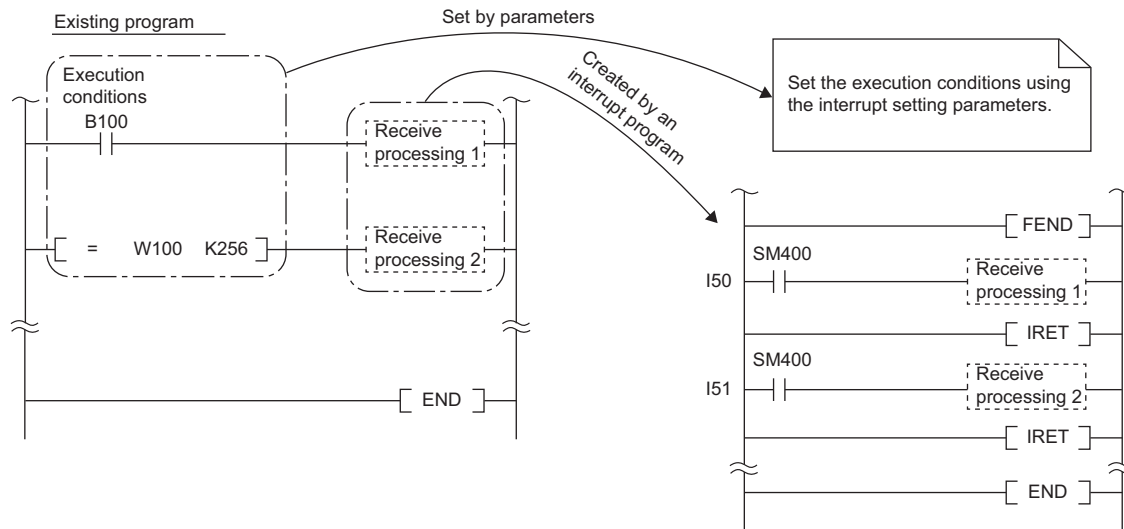

An interrupt by the link device (LB, LW, LX) can be used for the normal cyclic transmission and direct access destination.

Ex.

The following is a setting example to execute the interrupt program corresponding to the interrupt pointer I50 of the control station (station No.15) when LB100 turns on in the normal station (station No.3).

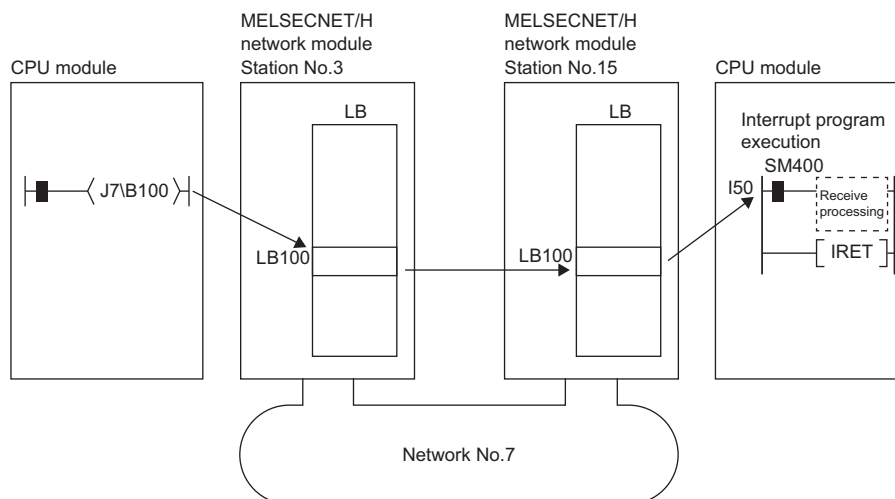

1. Set the interrupt setting parameters for the control station (station No.15) of the MELSECNET/H network module as shown below.

No.	Device/ Reception Channel	Device No./ Channel No.	Detection Method	Condition Type	Condition Value	Interrupt Pointer	Comment
SI 00	LB	00100	Edge	ON		I50	

Point

- If the program is fast, the execution time of the interrupt program may be affected, thereby leading to the effect of the interrupt program not being fully exerted and resulting in the scan time being extended.
- When multiple interrupts occur simultaneously, an operation delay may occur.
- This function cannot be used during offline or online test operation.
- Do not use the rising/falling edge of a specified device (such as the PLS and PLF instructions) as a trigger of an interrupt program because a change in the device may fail to be read.

■For an interrupt by a special device (SB, SW)

The specified interrupt program can be executed in the condition of the control information (SB, SW) for data link.

Ex.

The following shows an example of executing an interrupt program with the interrupt pointer I51 when 'Data link error status of own station' (SB0049) of the control station (station No.15) is turned on (error).

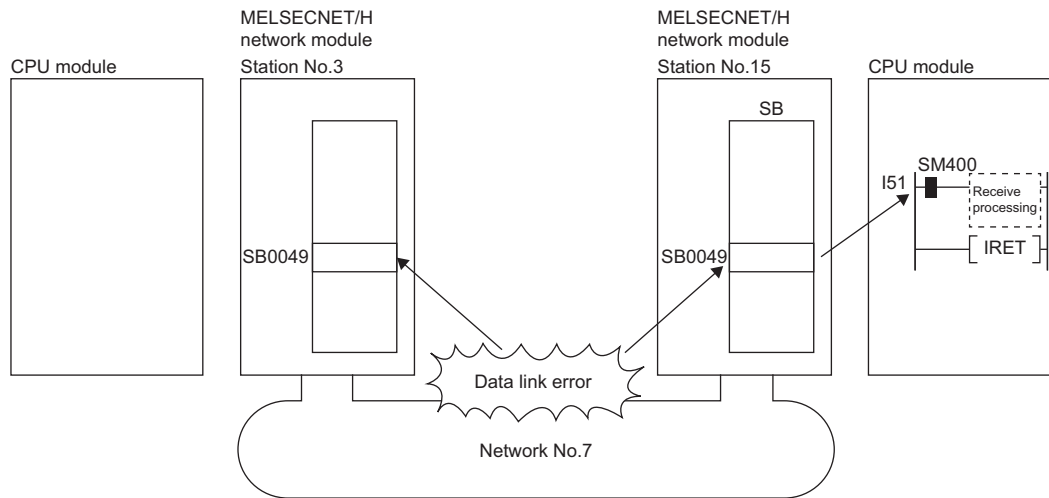

1. Set the interrupt setting parameters for the control station (station No.15) of the MELSECNET/H network module as shown below.

No.	Device/ Reception Channel	Device No./ Channel No.	Detection Method	Condition Type	Condition Value	Interrupt Pointer	Comment
SI 00	SB	00049	Edge	ON		I51	

Point

- If the program is fast, the execution time of the interrupt program may be affected, thereby leading to the effect of the interrupt program not being fully exerted and resulting in the scan time being extended.
- When multiple interrupts occur simultaneously, an operation delay may occur.
- This function cannot be used during offline or online test operation.

Transient Transmission Group No.

Set the transient transmission group number.

Item	Description	Setting range
Transient Transmission Group No.	Set a group number for transient transmission with group specification.	0 to 32 (0: No group specification) (Default: 0)

Dynamic Routing

Select whether to enable the dynamic routing function.

Item	Description	Setting range
Dynamic Routing	Set whether to enable the routing function when communicating with a station connected to a different network via a relay station connecting multiple networks. If a static routing has already been set, the set static routing is prioritized.	<ul style="list-style-type: none"> • Enable • Disable (Default: Enable)

Parameter Name

Set a name for the module parameter arbitrarily.

Item	Description	Setting range
Parameter Name	Set a name for the module parameter arbitrarily.	Up to 8 one-byte or two-byte characters (Default: Blank)

Event Reception from Other Stations

Select whether to obtain the events occurring in the other stations.

Item	Description	Setting range
Event Reception from Other Stations	Set whether to obtain the events occurring in the other stations in the same network. When "Enable" is selected, events that occurred in other stations are registered in the event history.	<ul style="list-style-type: none"> • Enable • Disable (Default: Enable)

Module Operation Mode

Select the operation mode of the MELSECNET/H network module.

For a redundant system, select the module operation mode of system A.

Item	Description	Setting range
Module Operation Mode	Set the operation mode for the MELSECNET/H network module.	<ul style="list-style-type: none"> ■RJ71LP21-25 • Online • Debug Mode • Offline • Forward Loop Test (RJ71LP21-25) • Reverse Loop Test (RJ71LP21-25) • Test between Master Station • Test between Slave Station • Self-loopback Test • Internal Self-loopback Test • Hardware test (Default: Online)
	Online	This mode is used to operate the MELSECNET/H network module normally.
	Debug Mode	This mode is used to place the MELSECNET/H network module in the send stop status. The station is recognized as a normal station by other stations.
	Offline	This mode is used to stop operation of the MELSECNET/H network module (station disconnected).
	Forward Loop Test (RJ71LP21-25)	This mode is used to check the connection status with the optical fiber cable on the forward loop side.
	Reverse Loop Test (RJ71LP21-25)	This mode is used to check the connection status with the optical fiber cable on the reverse loop side.
	Test between Master Station	This mode is used to set the station that executes the hardware operation for checking the line between two stations.
	Test between Slave Station	This mode is used to set the station for which the hardware operation for checking the line between two stations was executed.
	Self-loopback Test	In this mode, the MELSECNET/H network module alone checks the hardware including the send/receive circuits and cables of the transmission system.
	Internal Self-loopback Test	In this mode, the MELSECNET/H network module alone checks the hardware including the send/receive circuits and cables of the transmission system.
Hardware test	This mode is used to check the hardware in the MELSECNET/H network module.	<ul style="list-style-type: none"> ■RJ71BR11 • Online • Debug Mode • Offline • Test between Master Station • Test between Slave Station • Self-loopback Test • Internal Self-loopback Test • Hardware test (Default: Online)

Restriction

The following functions are disabled when "Module Operation Mode" is set to "Offline", "Forward Loop Test" (RJ71LP21-25), "Reverse Loop Test" (RJ71LP21-25), "Test between Master Station", "Test between Slave Station", "Self-loopback Test", "Internal Self-loopback Test", or "Hardware test".

- Cyclic transmission
- Transient transmission
- RAS (automatic return, loopback function (RJ71LP21-25), control station switching)
- Interrupt request to CPU module
- Multiplex transmission (RJ71LP21-25)
- Number of send points extension

Interlink Transmission Settings

Set link device ranges when cyclic data are transferred from a station in the own network to a station in another network.

Setting method

The procedure for the interlink transmission settings is shown below.

1. Select combination of modules in the "Transfer Source Module" and "Transfer Destination Module" boxes and enter setting values.

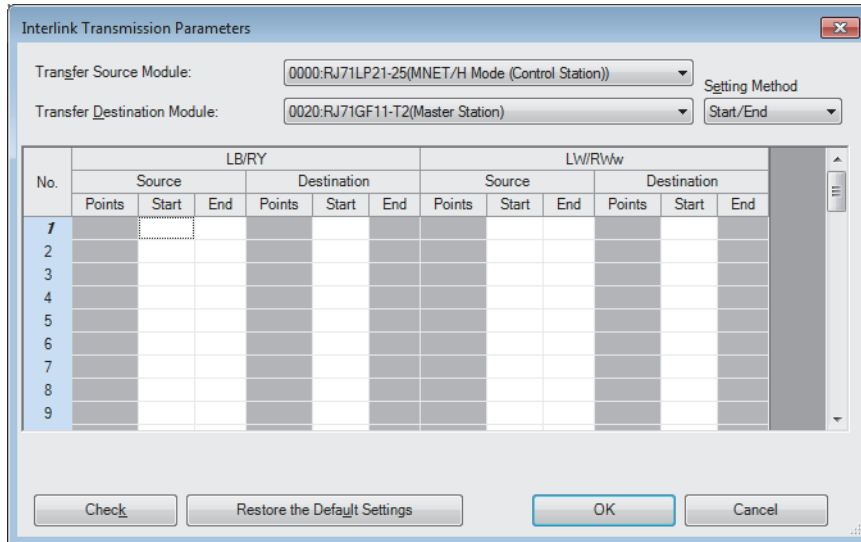

2. Click the [OK] button to finish the interlink transmission settings.

Setting items

Item	Description	Setting range
Setting Method	Select a link device assignment method. <ul style="list-style-type: none"> Start/End: Enter the start and end numbers of link devices. Points/Start: Enter the points and start numbers of link devices. 	<ul style="list-style-type: none"> Start/End Points/Start (Default: Start/End)
Transfer Source Module	Select the transfer source and destination modules.	The setting varies depending on the set module.
Transfer Destination Module		
LB/Ry RX/LB	<p>Enter the link device range of the transfer source and destination modules. Up to 64 ranges can be set. LB points can be assigned in increments of 16 (Start: □□□□H, End: □□□□FH).</p> <p>When the transfer source is the MELSECNET/H network module</p> <p>When the transfer destination is the MELSECNET/H network module</p> <p>MELSECNET/H network module Network module Network module MELSECNET/H network module</p>	<p>LB Points: 16 to 16384 Range: 0H to 3FFFH (Default: Blank)</p>

Item		Description	Setting range
LW/RWw RWr/LW	Source	Enter the link device range of the transfer source and destination modules. Up to 64 ranges can be set. LW points can be assigned in increments of 1. <div style="display: flex; justify-content: space-around;"> <div style="text-align: center;"> <p>When the transfer source is the MELSECNET/H network module</p> </div> <div style="text-align: center;"> <p>When the transfer destination is the MELSECNET/H network module</p> </div> </div>	LW Points: 1 to 16384 Range: 0H to 3FFFFH (Default: Blank)
	Destination		



Link devices set for "Source" can be overlapped. Doing so will allow transfer of the same link devices to multiple network modules.

Precautions

■ Modules supporting interlink transmission

Relevant modules are as follows.

- RJ71GN11-T2 (master station)
- CC-Link IE Controller Network-equipped module (control station, normal station)
- CC-Link IE Field Network-equipped module (master station, submaster station).
- MELSECNET/H network module (control station, normal station)

■ Transfer destination link device setting

Do not use link devices set for link refresh range as a transfer destination. If doing so, transfer destination link devices will be overwritten by link refresh. To use transfer destination link device data in the CPU module, set the transfer source link device as the link refresh range.

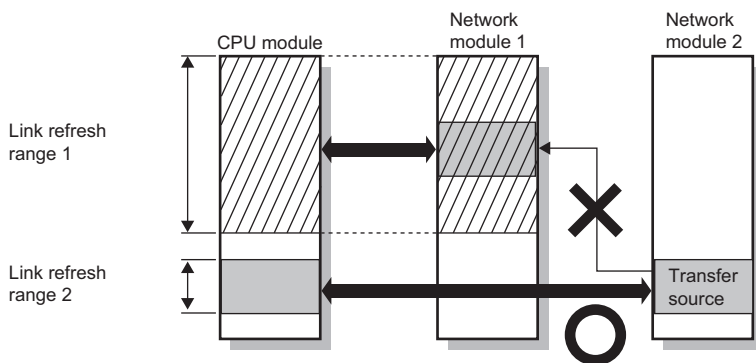

■ Setting 65 or more interlink transmission ranges

Use link direct devices in a program to perform interlink transmission.

Ex.

The following shows an example of performing interlink transmission between the master station on Network No.1 (CC-Link IE Field Network) and the normal station on Network No.2 (MELSECNET/H network).

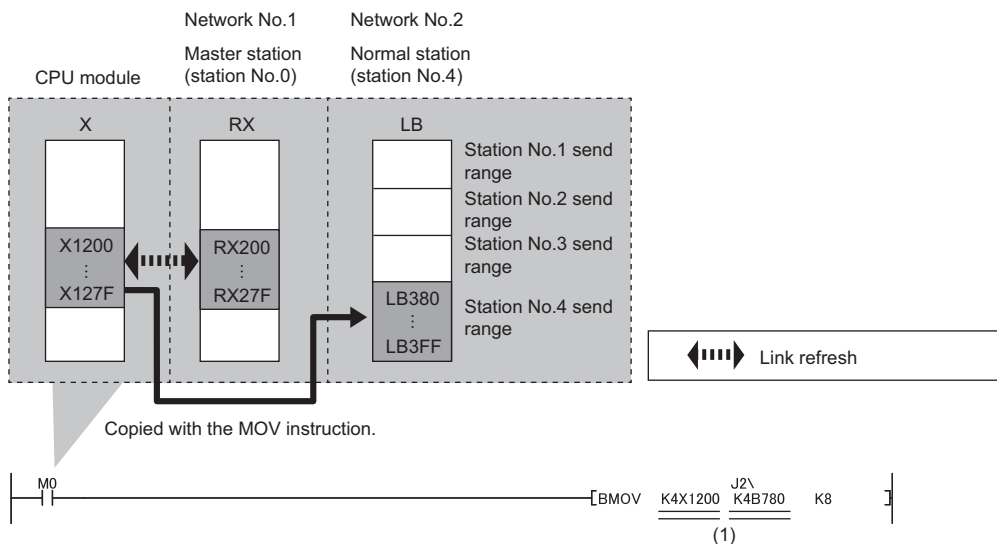

(1) The link direct device cannot be specified for both the first and second arguments. Use link refresh for either of the argument to specify the CPU device.

■ Performing interlink transmission in a multiple CPU system

When different control CPUs are set for the network modules, interlink transmission cannot be performed using interlink transmission parameters or a program. Perform interlink transmission using data communication by the CPU buffer memory.

(MELSEC iQ-R CPU Module User's Manual (Application))

Setting example

The following is a setting example to perform interlink transmission from the master station on CC-Link IE Field Network to stations on MELSECNET/H network. In this example, 128-point data input from the device station (station No.1) on CC-Link IE Field Network is transferred.

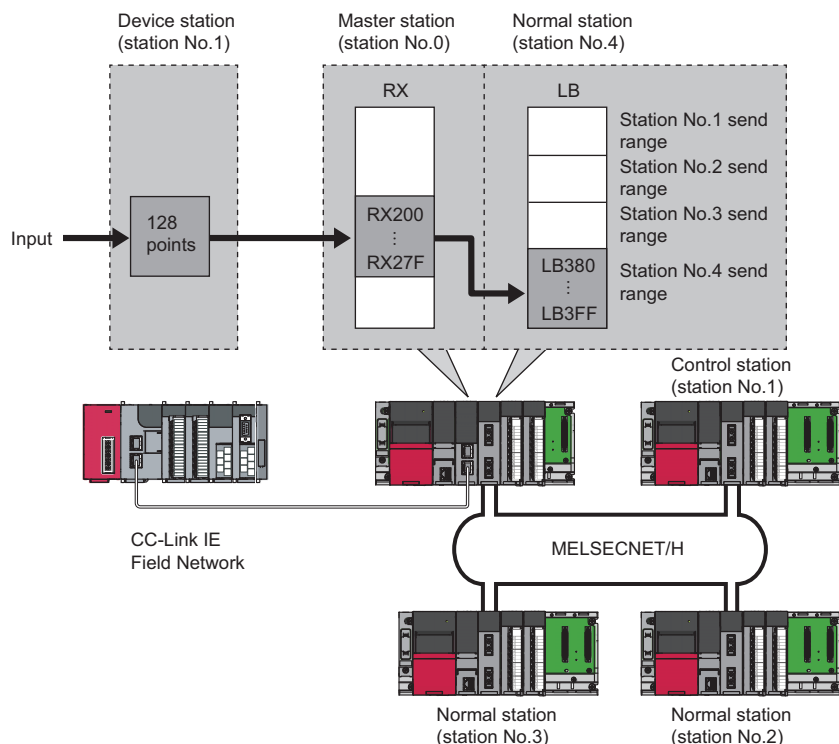

1. Select "0000: RJ71GF11-T2 (Master Station)" for "Transfer Source Module" and "0020: RJ71LP21-25 (MNET/H Mode (Normal Station))" for "Transfer Destination Module", and enter the transfer ranges of link devices.

The screenshot shows the 'Interlink Transmission Parameters' dialog box. The 'Transfer Source Module' is set to '0000:RJ71GF11-T2(Master Station)' and the 'Transfer Destination Module' is set to '0020:RJ71LP21-25(MNET/H Mode (Normal Station))'. The 'Setting Method' is 'Start/End'. The table below shows the transfer ranges for link devices.

No.	RX/LB						RW/LW					
	Source			Destination			Source			Destination		
	Points	Start	End	Points	Start	End	Points	Start	End	Points	Start	End
1	128	0200	027F	128	0380	03FF						
2												
3												
4												
5												
6												
7												
8												

2. Click the [OK] button.

Point 

If the transfer target network module is on a network other than MELSECNET/H network, set the transfer destination link devices within the own station send range of the network module. If the link devices are set within the send range of another station, the transferred data are overwritten with the send data of another station.

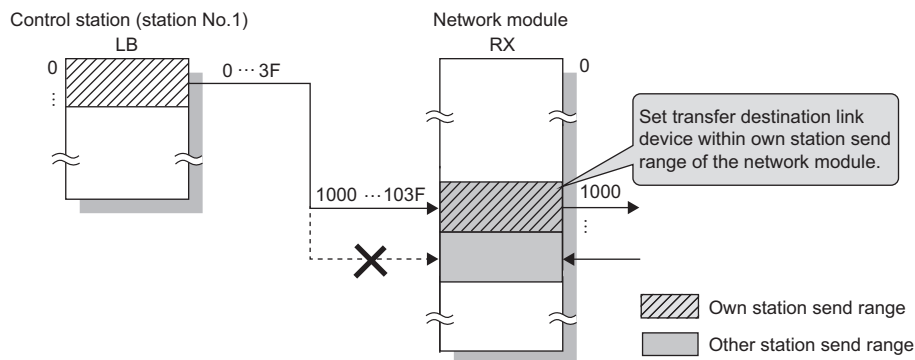

Redundant System Settings (RJ71LP21-25 only)

Set the operation mode for the RJ71LP21-25 mounted on system B in a redundant system.

Item	Description	Setting range
Station No. (System A)	Displays the station number set in "Station No." under "Required Settings".	—
Module Operation Mode (System A)	Displays the module operation mode set for "Module Operation Mode" under "Application Settings".	—
Station No. (System B)	Displays the station number of system B.	—
Module Operation Mode (System B)	Set the module operation mode of system B. For details on the module operation mode, refer to the following.  Page 74 Module Operation Mode	<ul style="list-style-type: none"> • Online • Debug Mode • Offline • Forward Loop Test • Reverse Loop Test • Test between Master Station • Test between Slave Station • Self-loopback Test • Internal Self-loopback Test • Hardware test (Default: Online)

Point 

For the parameter errors that occur in the redundant CPU, refer to the following.

 MELSEC iQ-R CPU Module User's Manual (Application)

3 PROGRAMMING

3.1 Precautions for Programming

This section describes the precautions for creating MELSECNET/H network module programs.

For MELSECNET/H network module programs, use the link special relay (SB) and link special register (SW) to configure an interlock according to the link status of the own station and other stations.

The following shows the link special relay (SB) and link special register (SW) for the interlock used in programs.

- Communication status with CPU module (SB0020)
- Baton pass error status of own station (SB0047)
- Data link error status of own station (SB0049)
- Baton pass status (SB0070)
- Data link error status of each station (SB0074)
- Baton pass status (SW0070 to SW0073)
- Data link status (SW0074 to SW0077)
- Standby system CPU status in redundant system (SW01FC to SW01FF)

For details, refer to the following.

 Page 151 List of Link Special Relay (SB) Areas, Page 163 List of Link Special Register (SW) Areas

Ex.

Interlock of the communication program using the link status of the own station and station No.2

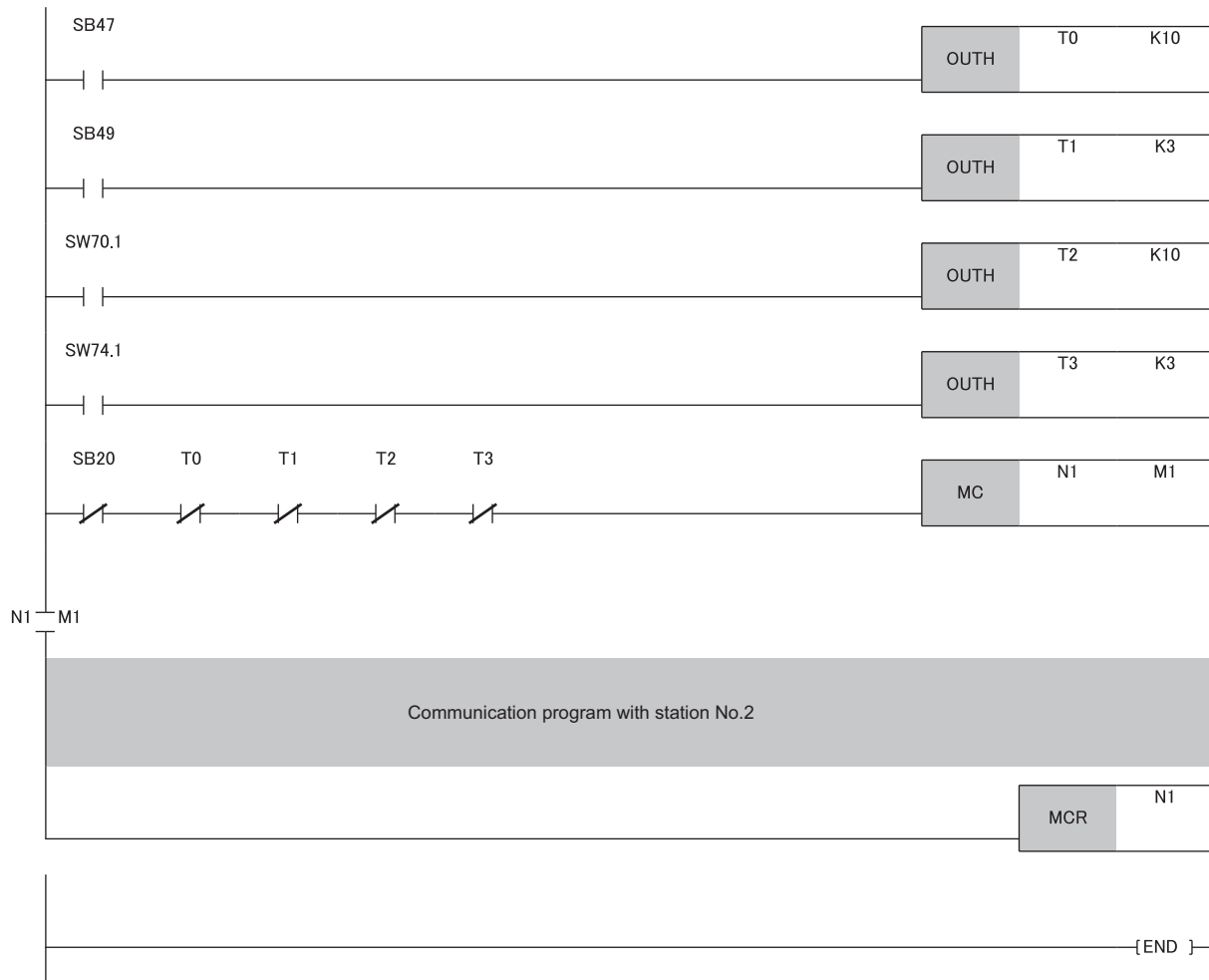

3

Point

Set the following values for the timer constant K□ so that the control does not stop even if the network detects a momentary error due to cable or noise conditions. (Six times, two times, and three times are provided just as a guide.)

- Baton pass status (T0, T2): (Link scan time × 6) + (Scan time of the CPU module of the target station × 2) or more
- Data link status (T1, T3): (Link scan time × 3) or more

For the communication examples of using the interlock, refer to the following.

📖 MELSEC iQ-R MELSECNET/H Network Module User's Manual (Startup)

3.2 Program Examples of the Redundant System (RJ71LP21-25 Only)

This section describes program examples of when using the RJ71LP21-25 in a redundant system.

System configuration

This section describes a program example of when accessing the control system of the control station (station No.1) or sub-control station (station No.2) in the redundant system from the normal station (station No.3).

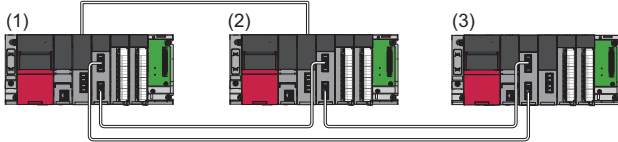

(1) Control station: Station No.1

(2) Sub-control station: Station No.2

(3) Normal station: Station No.3

■Common to the control station (station No.1) and sub-control station (station No.2)

- Power supply module: R61P
- CPU module: R08PCPU
- Redundant function module: R6RFM (Start I/O number: 0000H to 001FH)
- MELSECNET/H network module: RJ71LP21-25 (Start I/O number: 0020H to 003FH)

■Normal station (station No.3)

- Power supply module: R61P
- CPU module: R04CPU
- MELSECNET/H network module: RJ71LP21-25 (Start I/O number: 0000H to 001FH)

Setting parameters

Setting parameters in the control station

Connect the engineering tool to the CPU module to be set as the control system and set the parameters.

In a redundant system, the same program and parameter are written to both systems. A new project does not need to be created.

1. Set the CPU module as follows.

 [Project] ⇨ [New]

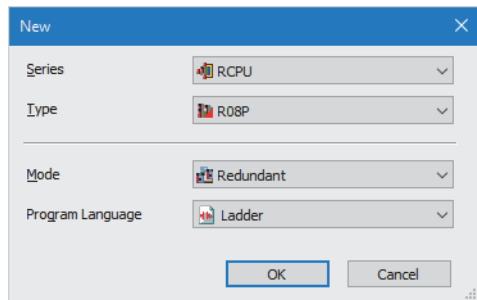

2. Click the [Setting Change] button to set the module label to be used.

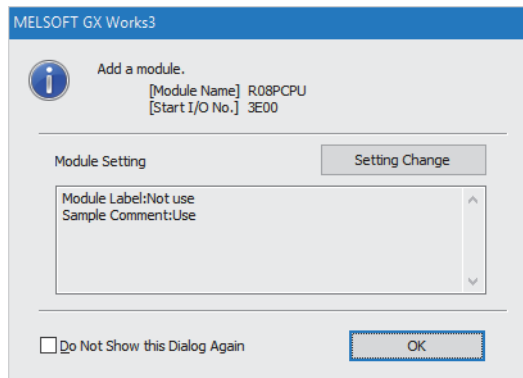

3. In the I/O assignment setting, set the redundant function module for slot No.0.

[Navigation window] ⇒ [Parameter] ⇒ [System Parameter] ⇒ [I/O Assignment] tab ⇒ [I/O Assignment Setting]

4. Set the RJ71LP21-25 (R) for slot No.1.

5. Click the [OK] button to add a module label of the RJ71LP21-25 (R).

6. Set the items in "Required Settings" as follows.

[Navigation window] ⇒ [Parameter] ⇒ [Module Information] ⇒ [RJ71LP21-25 (R)] ⇒ [Required Settings]

Item	Setting
Station Type	
Station Type	MNET/H Mode (Control Station)
Network No.	
Network No.	1
Station No.	
Station No.	1
Network Range Assignment	
Network Range Assignment Setting	<Detailed Setting>
Operation after Reconnection	
Operation after Reconnection	Return as Control Station
Transmission Speed	
Transmission Speed	10Mbps

7. Set the network range assignment as follows and click the [Apply] button.

[Navigation window] ⇒ [Parameter] ⇒ [Module Information] ⇒ [RJ71LP21-25 (R)] ⇒ [Required Settings] ⇒ [Network Range Assignment] ⇒ [Detailed Setting]

Station No.		Station Type		LB/LW Setting												Reserved Station	Pairing
		LB			LW			Low Speed LB			Low Speed LW						
		Points	Start	End	Points	Start	End	Points	Start	End	Points	Start	End				
7	Control Station	512	0000	01FF	512	00000	001FF							No Setting	Enable		
2	Normal Station	512	0000	01FF	512	00000	001FF							No Setting	Enable		
3	Normal Station	512	0200	03FF	512	00200	003FF							No Setting	Disable		

8. Set the link refresh settings as follows and click the [Apply] button.

[Navigation window] ⇒ [Parameter] ⇒ [Module Information] ⇒ [RJ71LP21-25 (R)] ⇒ [Basic Settings] ⇒ [Link Refresh Settings] ⇒ [Detailed Setting]

No.	Link Side						CPU Side				
	Device Name	Points	Start	End	Target		Device Name	Points	Start	End	
-	SB	512	00000	001FF	Module Label						
-	SW	512	00000	001FF	Module Label						
1	LB	1024	00000	003FF	Specify Device	B	1024	00000	003FF		
2	LW	1024	00000	003FF	Specify Device	W	1024	00000	003FF		

9. Write the set parameters to the system A CPU module.

[Online] ⇒ [Write to PLC]

10. Click the [Yes] button to write the parameters to the CPU modules of both systems.

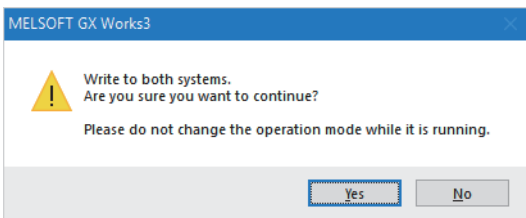

11. Either reset the CPU modules of both systems or power off and on both systems.

Setting parameters in the normal station

Connect the engineering tool to the CPU module on the normal station and set parameters.

1. Set the CPU module as follows.

 [Project] ⇒ [New]

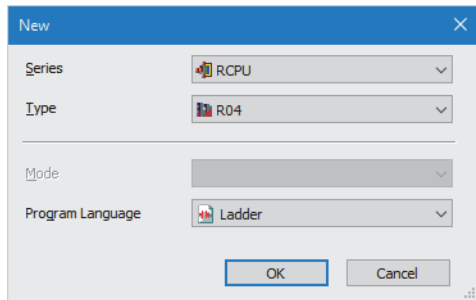

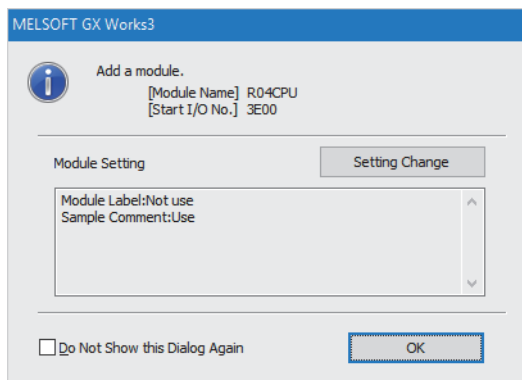

2. Click the [Setting Change] button to set the module label to be used.

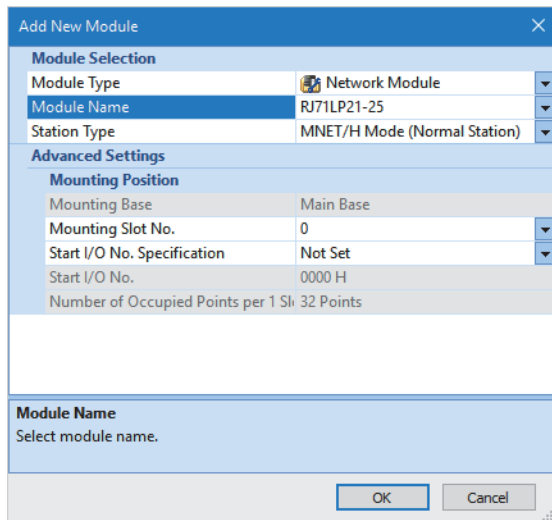

3. Set the RJ71LP21-25 as follows.

 [Navigation window] ⇒ [Parameter] ⇒ [Module Information] ⇒ Right click ⇒ [Add New Module]



4. Add the module label of the RJ71LP21-25. The addition method of the module label is the same as that of the control station. ( Page 83 Setting parameters in the control station)

5. Set the items in "Required Settings" as follows.

[Navigation window] ⇒ [Parameter] ⇒ [Module Information] ⇒ [RJ71LP21-25] ⇒ [Required Settings]

Setting Item	
Item	Setting
Station Type	
Station Type	MNET/H Mode (Normal Station)
Network No.	
Network No.	1
Station No.	
Station No.	3
Transmission Speed	
Transmission Speed	10Mbps

6. Set the link refresh settings as follows and click the [Apply] button.

[Navigation window] ⇒ [Parameter] ⇒ [Module Information] ⇒ [RJ71LP21-25] ⇒ [Basic Settings] ⇒ [Link Refresh Settings] ⇒ [Detailed Setting]

No.	Link Side					CPU Side				
	Device Name	Points	Start	End		Target	Device Name	Points	Start	End
-	SB	512	00000	001FF	↔	Module Label				
-	SW	512	00000	001FF	↔	Module Label				
1	LB	1024	00000	003FF	↔	Specify Device	B	1024	00000	003FF
2	LW	1024	00000	003FF	↔	Specify Device	W	1024	00000	003FF

7. Write the set parameters to the CPU module of the normal station. Then reset the CPU module or power off and on the system.

[Online] ⇒ [Write to PLC]

Checking the network status

Once parameters are set for the control station and normal station, the MELSECNET diagnostics of the engineering tool can be used to check whether data link is normally operating.

1. Connect the engineering tool to the CPU module on the control station.
2. Start MELSECNET diagnostics.

 [Diagnostics] ⇒ [MELSECNET Diagnostics]

If the following display appears, data link is normal.

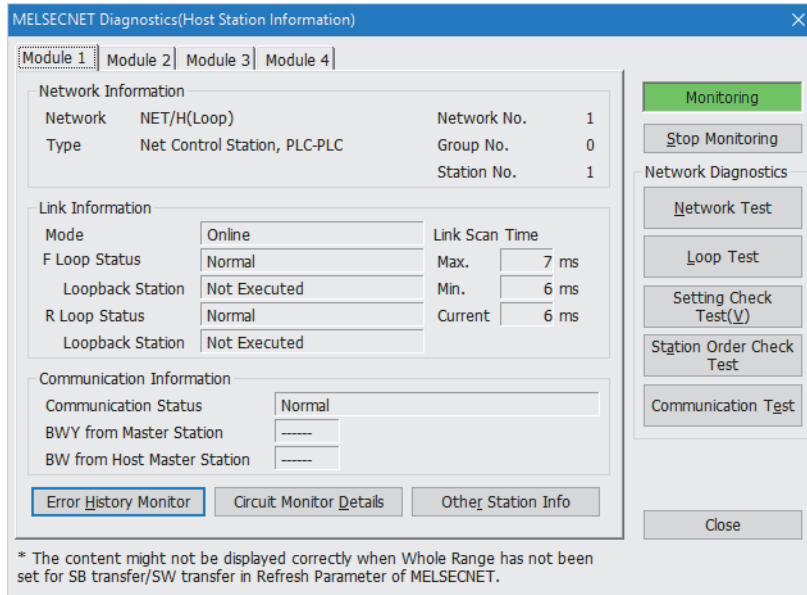

For details on the "MELSECNET Diagnostics (Host Station Information)" window, refer to the following.

 Page 109 Checking the Network Status

Program examples

Write the following program to the CPU module in the normal station.

Classification	Label name	Description	Device
Module Label	LP21_1	Module label	—
Labels to be used for the module FB	M_RJ71LP21_RedundantSystem_GetAddress_01B_1.pbi_uTargetSystem_Type	Target system type	—

Label to be defined Define global labels as shown below:

Label Name	Data Type	Class	Assign (Device/Label)	Constant
bStartDeviceRead	Bit	...	VAR_GLOBAL M0	
uSystemA_Address	Word [Unsigned]/Bit String [16-bit](0.1)	...	VAR_GLOBAL D0	
uSystemB_Address	Word [Unsigned]/Bit String [16-bit](0.1)	...	VAR_GLOBAL D2	
bENO_1	Bit	...	VAR_GLOBAL M1 0	
bDK_1	Bit	...	VAR_GLOBAL M1 1	
bErr_1	Bit	...	VAR_GLOBAL M1 2	
uErrId_1	Word [Unsigned]/Bit String [16-bit]	...	VAR_GLOBAL D1 00	
c_Address_A	Word [Unsigned]/Bit String [16-bit]	...	VAR_GLOBAL_CONSTANT	K1
c_Address_B	Word [Unsigned]/Bit String [16-bit]	...	VAR_GLOBAL_CONSTANT	K2
u2TargetAddress	Word [Unsigned]/Bit String [16-bit](0.1)	...	VAR_GLOBAL D20	
c_NetworkNo	Word [Unsigned]/Bit String [16-bit]	...	VAR_GLOBAL_CONSTANT	K1
c_DataLength	Word [Unsigned]/Bit String [16-bit]	...	VAR_GLOBAL_CONSTANT	K4
c_Channel	Word [Unsigned]/Bit String [16-bit]	...	VAR_GLOBAL_CONSTANT	K1
bENO_2	Bit	...	VAR_GLOBAL M2 0	
bDK_2	Bit	...	VAR_GLOBAL M2 1	
bErr_2	Bit	...	VAR_GLOBAL M2 2	
uErrId_2	Word [Unsigned]/Bit String [16-bit]	...	VAR_GLOBAL D1 01	
uReadData	Word [Unsigned]/Bit String [16-bit](0.3)	...	VAR_GLOBAL D200	
s32_TargetDevice	String(32)	...	VAR_GLOBAL_CONSTANT	'D0'
bTargetSystem	Bit	...	VAR_GLOBAL M1	
c_TargetSystemTypeA	Word [Unsigned]/Bit String [16-bit]	...	VAR_GLOBAL_CONSTANT	K0
c_TargetSystemTypeB	Word [Unsigned]/Bit String [16-bit]	...	VAR_GLOBAL_CONSTANT	K1
uDKCount	Word [Signed]	...	VAR_GLOBAL D1 02	
uNGCount	Word [Signed]	...	VAR_GLOBAL D1 03	

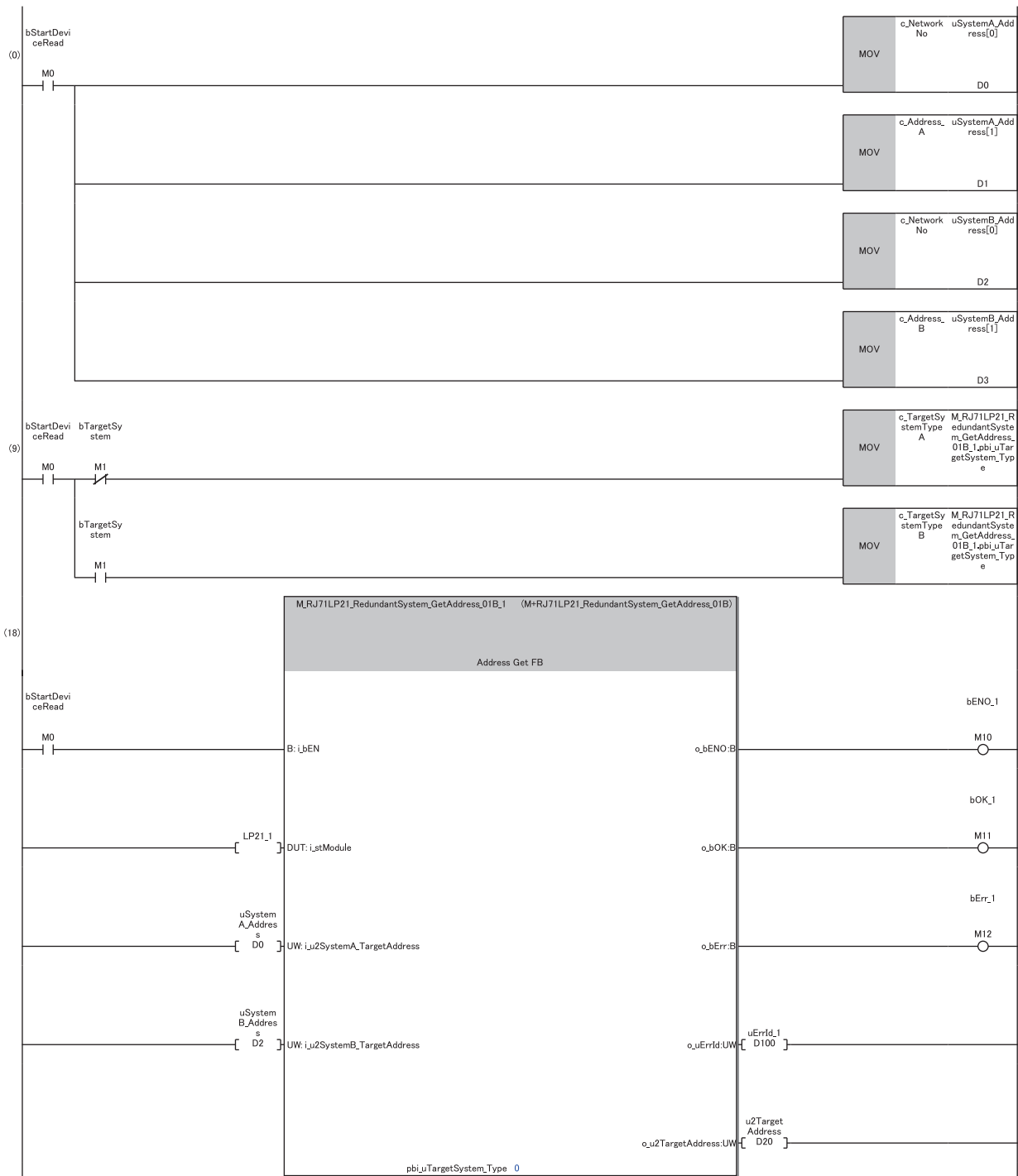

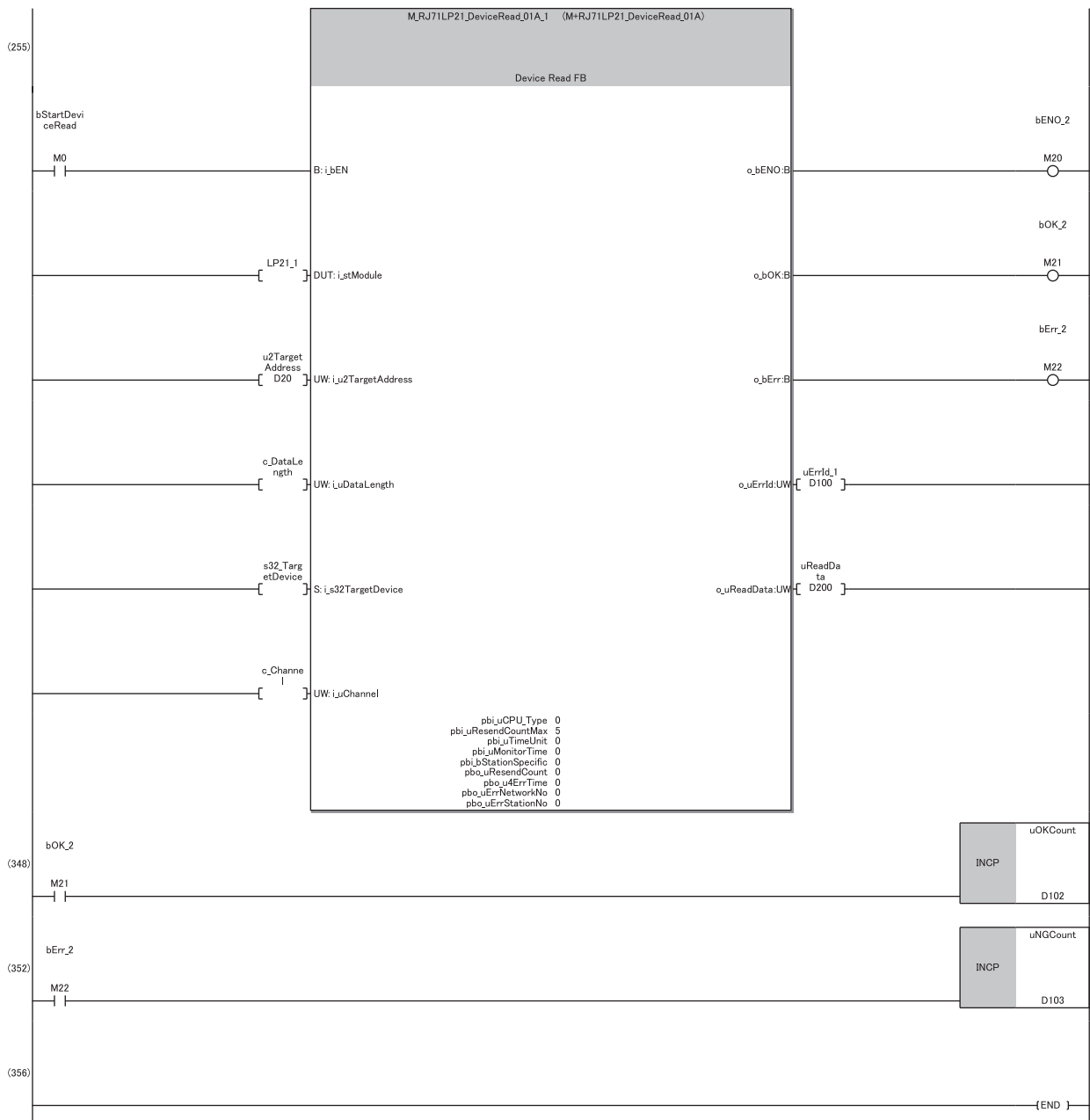

(9) Specify the target system used in the module FB RedundantSystem_GetAddress.

(18) Acquire the current target station address of the control system or standby system by executing the module FB RedundantSystem_GetAddress.

(255) Read the data for the target station acquired with RedundantSystem_GetAddress by executing the module FB DeviceRead.

4 TROUBLESHOOTING

This chapter describes troubleshooting for the MELSECNET/H network module.

4.1 Checking with LED

This section describes troubleshooting using LED.

Error status can be determined by status of the RUN LED and the ERR LED.

RUN LED	ERR LED	Error status* ¹	Description
Off	On, flashing	Major error	An error such as hardware failure or memory failure. The module stops operating.
On	Flashing	Moderate error	Although an error, such as a parameter error, which affects module operation has occurred, the module continues operation.
On	On	Minor error	An error such as communication failure. The module continues operating.

*1 When multiple errors occur, the error status is displayed in the order of major, moderate, and minor.

When the RUN LED turns off

When the RUN LED turns off after powering on the MELSECNET/H network module, check the following.

Check item	Action
Has any error occurred in the result of the hardware test?	The possible cause is a hardware failure. Replace the module.
Check if the MELSECNET/H network module has been properly mounted.	If not, properly mount the module on the base unit.

When the ERR LED turns on or is flashing

When the ERR LED turns on or is flashing, check the following.

Check item	Action
Does any error occur in the module diagnostics?	Follow the instruction displayed on the window.
Does any error occur in the MELSECNET diagnostics?	<ul style="list-style-type: none">• Correct "Network Range Assignment" in "Required Settings" in accordance with the station actually connected.• When there is a disconnected station, perform troubleshooting for when the D LINK LED turns off. (Page 92 When the D LINK LED turns off)

If the above action does not solve the problem, perform the self-diagnostics test to check for hardware failure. (Page 96 Self-diagnostics test)

When the T PASS LED turns on and off in an unstable condition

When the T PASS LED turns on and off in an unstable condition, check the following.

Check item	Action
Does the communication cable used conform to the standard?	Replace the communication cable with one conforming to the standard.
Does the station-to-station distance meet the specifications?	Set the station-to-station distance within range.
Is any communication cable disconnected?	Replace the communication cable.
Is the connector about to come loose?	Firmly insert the connector.
For the RJ71LP21-25, is the transmission speed setting of the RJ71LP21-25 of all stations the same?	Match the transmission speed setting of all stations.
For the RJ71BR11, is the terminating resistor about to come loose?	Firmly insert the terminating resistor.
Is the reserved station set for the control station?	Remove the reserved station specified in the control station setting.
Is the set station number greater than the number of connected modules?	Correct the station number so that it is within the number of connected modules.

When the D LINK LED turns off

When the D LINK LED turns off, check the following.

Check item	Action
Is the control station operating normally?	Check if the control station (sub-control station) is performing data link using the MELSECNET diagnostics.
Is the control station connected to the network?	Check if the control station (sub-control station) is performing data link using the MELSECNET diagnostics.
Does the communication cable used conform to the standard?	Replace the communication cable with one conforming to the standard.
Does the station-to-station distance meet the specifications?	Set the station-to-station distance within range.
Does the cabling condition (bending radius) meet the specifications?	Refer to the manual for the communication cable, and correct the bending radius.
Is any communication cable disconnected?	Replace the communication cable.
Are the modules of other stations connected normal?	<ul style="list-style-type: none"> • Check if the modules on the other stations are performing data link using the MELSECNET diagnostics. • Check the operating status of the modules on the other stations. (📖 User's manual for the module used)
Are station numbers unique?	Change the duplicated station number.
For an optical loop system, are 65 or more stations connected, including the control station and the normal stations?	Keep the total number of connected control stations and normal stations to 64 stations or less.
For a coaxial bus system, are 33 or more stations connected, including the control station and the normal stations?	Keep the total number of connected control stations and normal stations to 32 stations or less.
Is the reserved station set for the control station?	Remove the reserved station specified in the control station setting.
Is the set station number greater than the number of connected modules?	Correct the station number so that it is within the number of connected modules.
Does a stop error occur in the CPU module?	Follow the instruction displayed on the window.

If the above action does not solve the problem, perform the self-diagnostics test to check for hardware failure. (📖 Page 96 Self-diagnostics test)

When the L ERR LED turns on or turns on and off in an unstable condition

When the L ERR LED turns on or turns on and off in an unstable condition, check the following.

Check item	Action
Are the communication cables used normally?	<ul style="list-style-type: none"> • Check if the communication cable which conforms the standard is used. • Check if the station-to-station distance is set within range. • Check if the communication cables are not disconnected. • Check if a connector is about to come loose.
Are other stations connected to the MELSECNET/H network module normal?	Check if the other stations are performing data link using the MELSECNET diagnostics.
For the RJ71LP21-25, is the transmission speed setting of the RJ71LP21-25 of all stations the same?	Match the transmission speed setting of all stations.

If the above actions do not solve the problem, perform the following tests to check for an error.

- Troubleshooting for when communication is unstable (📖 Page 127 When communication is unstable)

4.2 Checking the Module Status

The following items can be checked in the "Module Diagnostics" window for the MELSECNET/H network module.

Item	Description	
[Error Information] tab	Displays the details of the errors currently occurring.	
[Module Information List] tab	Displays LED information, logical LED information, and individual information of the MELSECNET/H network module.	
Supplementary Function	MELSECNET Diagnostics	Enables checking the cause to resolve the problem when an error occurs in the MELSECNET/H network module. (Page 109 Checking the Network Status)

Error information

Displays the details of the errors currently occurring and actions to be taken in the [Error Information] tab.

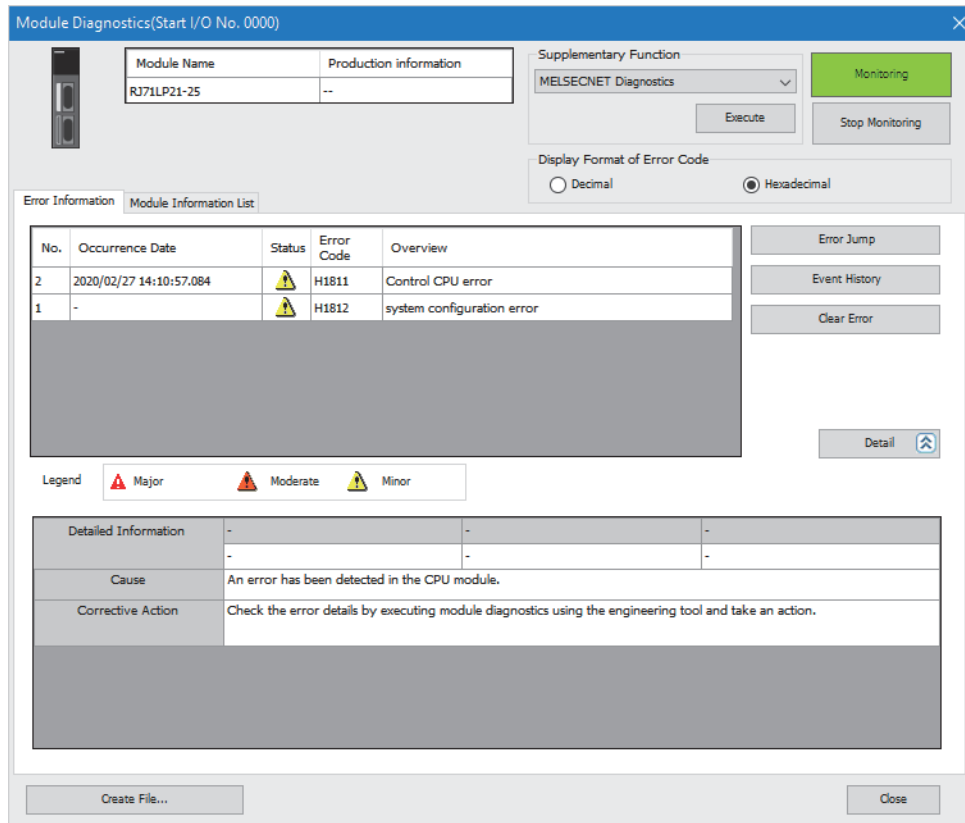

Item	Description
Status	Major: An error such as hardware failure or memory failure. The module stops operating. Moderate: An error such as system bus failure. The module stops operating. Minor: The module continues operating.
Error code	Page 132 List of Error Codes
[Event History] button	Click the [Event History] button to check the history of errors that have occurred on the network, errors detected for each module, and operations that have been executed. (Page 148 Event List)
Detailed Information	Displays up to three items, such as the parameter information, operation source information, and system configuration information of each error. (Page 147 List of Parameter Numbers)
Cause	Displays the detailed error causes.
Corrective Action	Displays the actions to eliminate the error causes.

Module information list

LED information, logical LED information, and individual information of the MELSECNET/H network module are displayed in the [Module Information List] tab.

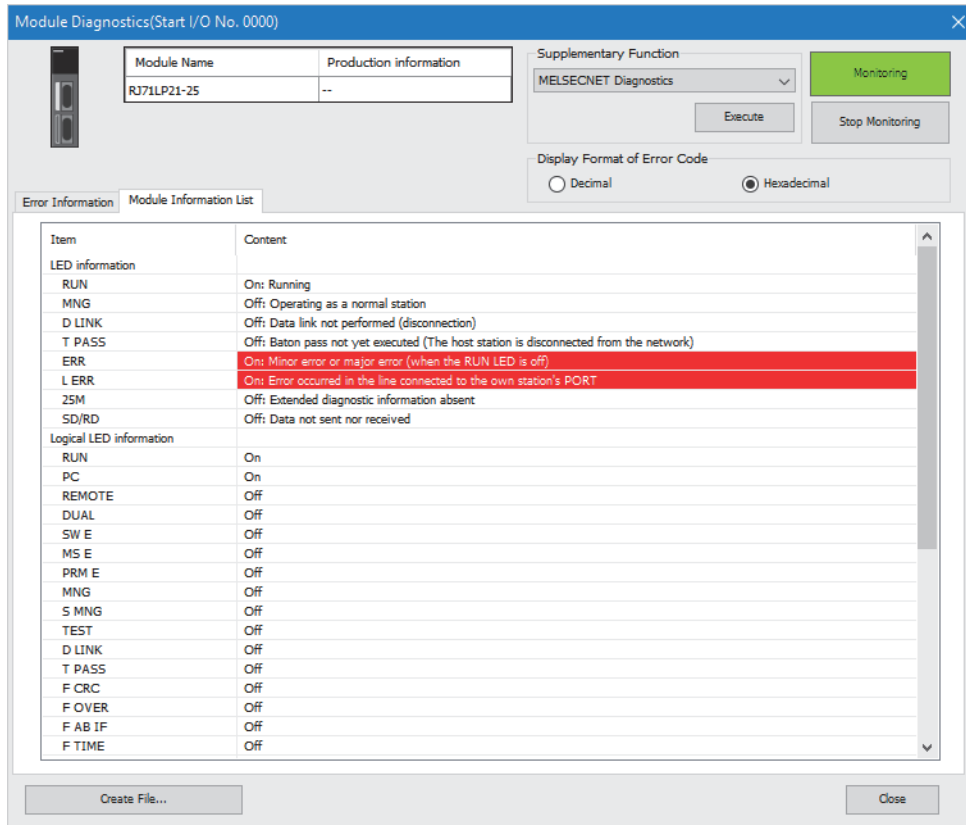

Item	Description	
LED information	Displays the LED status on the MELSECNET/H network module.	
Logical LED information	Displays the on/off status of the LED on the MELSECNET/H network module.	
Individual information	Station Type	Displays the station type set for the MELSECNET/H network module.
	Network No.	Displays the network number set for the MELSECNET/H network module.
	Station Number	Displays the station number set for the MELSECNET/H network module.
	Transient transmission group No.	Displays the transient transmission group number set for the MELSECNET/H network module.
	Module Operation Mode	Displays the module operation mode set for the MELSECNET/H network module.

The following shows the on/off status of the logical LED information.

Item	Description
RUN	On: Normal operation
PC	On: PLC to PLC network ^{*1}
REMOTE	On: Remote I/O network ^{*2}
DUAL	On: Multiplex transmission in progress ^{*3}
SW E	On: Switch setting error ^{*2}
MS E	On: Duplicated station number or control station on the same network
PRM E	On: Parameter error
MNG	On: Control station is set. Off: Normal station is set.
S MNG	On: Sub-control station is set.
TEST	On: Testing
D LINK	On: Data link in progress (cyclic transmission being performed)
T PASS	On: Baton pass in progress (joined in the network) Flashing: Testing
F CRC	For the RJ71LP21-25, On: A CRC error has occurred on the forward loop side. For the RJ71BR11, On: A CRC error has occurred. (An error was detected in checking code for receive data)
F OVER	For the RJ71LP21-25, On: An overrun error has occurred on the forward loop side. For the RJ71BR11, On: An overrun error has occurred. (An error has occurred due to a delayed processing of receive data.)
F AB IF	For the RJ71LP21-25, On: An abort error has occurred on the forward loop side. For the RJ71BR11, On: An abort error has occurred. (An error has occurred when the value "1" is continuously received over the specified number of times or the receive data length is short.)
F TIME	For the RJ71LP21-25, On: A timeout error has occurred on the forward loop side. For the RJ71BR11, On: A timeout error has occurred. (An error has occurred when the data link monitoring timer operated.)
F DATA	For the RJ71LP21-25, On: An error of reception of 2K bytes or more has occurred on the forward loop side. For the RJ71BR11, On: An error of reception of 2K bytes or more has occurred. (An error has occurred due to receiving abnormal data whose size is 2K bytes or more.)
F UNDER	For the RJ71LP21-25, On: An under-error has occurred on the forward loop side. For the RJ71BR11, On: An under-error has occurred. (An error has occurred due to the internal processing of send data not being performed at the specified intervals.)
F LOOP	On: A faulty station exists on the forward loop side. ^{*3} (An error has occurred due to the loop being faulty.)
R CRC	On: A CRC error has occurred on the reverse loop side. ^{*3} (An error was detected in checking code for receive data)
R OVER	On: An overrun error has occurred on the reverse loop side. ^{*3} (An error has occurred due to a delayed processing of receive data.)
R AB IF	On: An abort error has occurred on the reverse loop side. ^{*3} (An error has occurred when the value "1" is continuously received over the specified number of times or the receive data length is short.)
R TIME	On: A timeout error has occurred on the reverse loop side. ^{*3} (An error has occurred when the data link monitoring timer operated.)
R DATA	On: An error of reception of 2K bytes or more has occurred on the reverse loop side. ^{*3} (An error has occurred due to receiving abnormal data whose size is 2K bytes or more.)
R UNDER	On: An under-error has occurred on the reverse loop side. ^{*3} (An error has occurred due to the internal processing of send data not being performed at the specified intervals.)
R LOOP	On: A faulty station exists on the reverse loop side. ^{*3} (An error has occurred due to the loop being faulty.)

*1 Always on

*2 Always off

*3 Always off for the RJ71BR11

Self-diagnostics test

Self-diagnostics test can check the hardware status of the MELSECNET/H network module.

The MELSECNET/H network module alone can perform the following three types of tests.

Test item	Description
Self-loopback Test	For this test, the MELSECNET/H network module alone checks the hardware including the send/receive circuits and cables of the transmission system.
Internal Self-loopback Test	For this test, the MELSECNET/H network module alone checks the hardware including the send/receive circuits of the transmission system.
Hardware test	Checks the hardware in the MELSECNET/H network module.

Self-loopback test

■For the RJ71LP21-25

Operating procedure

1. Connect the IN connector and OUT connector of the RJ71LP21-25 with optical fiber cables.
2. Set the module operation mode to "Self-loopback Test".

 [Navigation window] ⇒ [Parameter] ⇒ [Module Information] ⇒ RJ71LP21-25 ⇒ [Application Settings] ⇒ [Module Operation Mode]

3. Click the [Apply] button.

4. Write the module parameters and reset the CPU module.

Do not connect/disconnect the optical fiber cable during the test. Connecting/disconnecting the cable causes completion with an error.

■For the RJ71BR11

Operating procedure

1. Connect the terminating resistor to both connectors of the RJ71BR11 F-type connector.
2. Set the module operation mode to "Self-loopback Test".

 [Navigation window] ⇒ [Parameter] ⇒ [Module Information] ⇒ RJ71BR11 ⇒ [Application Settings] ⇒ [Module Operation Mode]

3. Click the [Apply] button.

4. Write the module parameters and reset the CPU module.

Do not connect/disconnect the terminating resistor during the test. Connecting/disconnecting the cable causes completion with an error.

■Checking the status and result of self-loopback test.

The status and result of self-loopback test can be checked with the LED indicator of the module.

Test status	LED indication
Test in progress	The RUN LED is turned on, the ERR LED is turned off, and the T PASS LED flashes. The SD/RD LED is turned on. The dot matrix LED indicates "MD7".
Completed successfully	Since the test is repeated during normal operation, the test is judged to have been completed successfully when the T PASS LED flashes 20 times (for about 10 seconds) or more.
Completed with an error	The ERR LED flashes and the dot matrix LED indicates "ER7" and error number alternately at intervals of one second.

■Checking the status when the operation is completed with an error

When an error is detected, the test is immediately completed (with an error).

When the test is completed with an error, the dot matrix at the front side of the MELSECNET/H network module indicates an error number. Take actions according to the error number displayed. " _ " in the error number is displayed as a space on the dot matrix display.

- List of errors displayed on the RJ71LP21-25

Error No.	Loop direction	Description	Action
0_1	—	Data error in loop test 1	Check that the optical fiber cable is connected correctly. Replace the optical fiber cable and perform the test again. If the test fails again, please consult your local Mitsubishi representative.
0_2	—	Data error in loop test 2	Check that the optical fiber cable is connected correctly. Replace the optical fiber cable and perform the test again. If the test fails again, please consult your local Mitsubishi representative.
0_3	—	Data error in repeat test	Check that the optical fiber cable is connected correctly. Replace the optical fiber cable and perform the test again. If the test fails again, please consult your local Mitsubishi representative.
0_4	—	Data error in loopback test	Check that the optical fiber cable is connected correctly. Replace the optical fiber cable and perform the test again. If the test fails again, please consult your local Mitsubishi representative.
1_1	Forward loop side	Loop test 1 completed with an error	Check that the optical fiber cable is connected correctly. Replace the optical fiber cable and perform the test again. If the test fails again, please consult your local Mitsubishi representative.
2_1	Reverse loop side		
3_1	Forward loop side and reverse loop side		
1_2	Forward loop side	Loop test 2 completed with an error	Check that the optical fiber cable is connected correctly. Replace the optical fiber cable and perform the test again. If the test fails again, please consult your local Mitsubishi representative.
2_2	Reverse loop side		
3_2	Forward loop side and reverse loop side		
1_3	Forward loop side	Repeat test completed with an error	Check that the optical fiber cable is connected correctly. Replace the optical fiber cable and perform the test again. If the test fails again, please consult your local Mitsubishi representative.
2_3	Reverse loop side		
3_3	Forward loop side and reverse loop side		
1_4	Forward loop side	Loopback test completed with an error	Check that the optical fiber cable is connected correctly. Replace the optical fiber cable and perform the test again. If the test fails again, please consult your local Mitsubishi representative.
2_4	Reverse loop side		
3_4	Forward loop side and reverse loop side		

- List of errors displayed on the RJ71BR11

Error No.	Description	Action
0_1	Data error	Check that the terminating resistor is connected correctly. Replace the terminating resistor and perform the test again. If the test fails again, please consult your local Mitsubishi representative.
1_1	Completed with an error	Check that the terminating resistor is connected correctly. Replace the terminating resistor and perform the test again. If the test fails again, please consult your local Mitsubishi representative.

Internal Self-loopback Test

■For the RJ71LP21-25

Operating procedure

1. An optical fiber cable does not need to be connected to the RJ71LP21-25 connector. Do not allow light to enter from the connector.
2. Set the module operation mode to "Internal Self-loopback Test".
 [Navigation window] ⇒ [Parameter] ⇒ [Module Information] ⇒ RJ71LP21-25 ⇒ [Application Settings] ⇒ [Module Operation Mode]
3. Click the [Apply] button.
4. Write the module parameters to the CPU module and reset the CPU module.

■For the RJ71BR11

Operating procedure

1. A cable or terminating resistor does not need to be connected to the RJ71BR11 connector.
2. Set the module operation mode to "Internal Self-loopback Test".
 [Navigation window] ⇒ [Parameter] ⇒ [Module Information] ⇒ RJ71BR11 ⇒ [Application Settings] ⇒ [Module Operation Mode]
3. Click the [Apply] button.
4. Write the module parameters to the CPU module and reset the CPU module.

■Checking the status and result of internal selfloopback test

Check the status and result of internal selfloopback test with the LED indicator of the module.

Test status	LED indication
Test in progress	The RUN LED is turned on, the ERR LED is turned off, and the T PASS LED flashes. The SD/RD LED is turned on. The dot matrix LED indicates "MD8".
Completed successfully	Since the test is repeated during normal operation, the test is judged to have been completed successfully when the T PASS LED flashes 20 times (for about 10 seconds) or more.
Completed with an error	The ERR LED flashes and the dot matrix LED indicates "ER8" and error number alternately at intervals of one second.

■Checking the status when the operation is completed with an error

When an error is detected, the test is immediately completed (with an error).

When the test is completed with an error, the dot matrix at the front side of the MELSECNET/H network module indicates an error number. Take actions according to the error number displayed. " _ " in the error number is displayed as a space on the dot matrix display.

- List of errors displayed on the RJ71LP21-25

Error No.	Loop direction	Description	Action
0_1	—	Data error in loop test	Please consult your local Mitsubishi representative.
0_2	—	Data error in CRC test	Please consult your local Mitsubishi representative.
1_1	Forward loop side	Loop test completed with an error	Please consult your local Mitsubishi representative.
2_1	Reverse loop side		
3_1	Forward loop side and reverse loop side		
1_2	Forward loop side	CRC test completed with an error	Please consult your local Mitsubishi representative.
2_2	Reverse loop side		
3_2	Forward loop side and reverse loop side		

- List of errors displayed on the RJ71BR11

Error No.	Description	Action
0_1	Data error	Please consult your local Mitsubishi representative.
1_1	Encoder/decoder test completed with an error	Please consult your local Mitsubishi representative.

Hardware test

■For the RJ71LP21-25

Operating procedure

1. Connect the IN connector and OUT connector of the RJ71LP21-25 with one optical fiber cable.

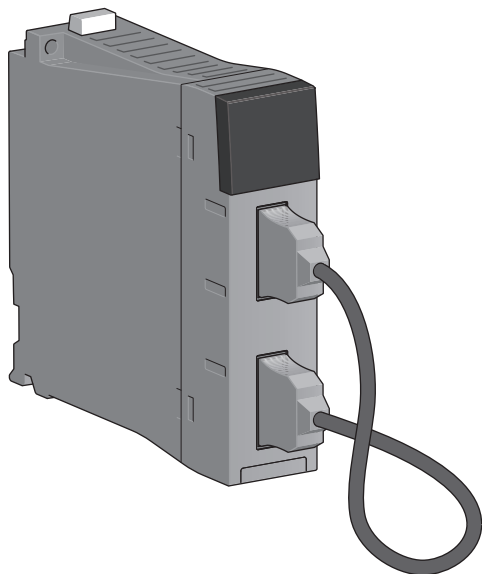

2. Set the module operation mode to "Hardware test".

 [Navigation window] ⇒ [Parameter] ⇒ [Module Information] ⇒ RJ71LP21-25 ⇒ [Application Settings] ⇒ [Module Operation Mode]

3. Click the [Apply] button.

4. Write the module parameters to the CPU module and reset the CPU module.

■For the RJ71BR11

Operating procedure

1. A cable or terminating resistor does not need to be connected to the RJ71BR11 connector.

2. Set the module operation mode to "Hardware test".

 [Navigation window] ⇒ [Parameter] ⇒ [Module Information] ⇒ RJ71BR11 ⇒ [Application Settings] ⇒ [Module Operation Mode]

3. Click the [Apply] button.

4. Write the module parameters to the CPU module and reset the CPU module.

■Checking the status and result of hardware test.

Check the status and result of hardware test with the LED indicator of the module.

Test status	LED indication
Test in progress	The RUN LED is turned on, the ERR LED is turned off, and the T PASS LED flashes. The SD/RD LED is turned on. The dot matrix LED indicates "MD9".
Completed successfully	Since the test is repeated during normal operation, the test is judged to have been completed successfully when the T PASS LED flashes 120 times (for about 60 seconds) or more.
Completed with an error	The ERR LED flashes and the dot matrix LED indicates "ER9" and error number alternately at intervals of one second.

■Checking the status when the operation is completed with an error

When an error is detected, the test is immediately completed (with an error).

When the test is completed with an error, the dot matrix at the front side of the MELSECNET/H network module indicates an error number. Take actions according to the error number displayed. "_" in the error number is displayed as a space on the dot matrix display.

- List of errors displayed on the RJ71LP21-25

Error No.	Description	Action
0_1	ROM test completed with an error	Please consult your local Mitsubishi representative.
0_2	RAM test completed with an error	Please consult your local Mitsubishi representative.
1_3	Light quantity test on the forward side completed with an error	Please consult your local Mitsubishi representative.
2_4	Light quantity test on the reverse side completed with an error	Please consult your local Mitsubishi representative.

- List of errors displayed on the RJ71BR11

Error No.	Description	Action
0_1	ROM test completed with an error	Please consult your local Mitsubishi representative.
0_2	RAM test completed with an error	Please consult your local Mitsubishi representative.

Station-to-station test

This test checks the MELSECNET/H network module and cable status between the two adjacent stations.

For a system other than a redundant system

Operating procedure

1. For the RJ71LP21-25, connect the OUT connector of the executing station and the IN connector of the executed station with optical fiber cables.

For the RJ71BR11, connect the network modules with a coaxial cable.

- For the RJ71LP21-25



- (1) Control station (station No.1): Executing station
- (2) Normal station (station No.2): Executed station

- For the RJ71BR11

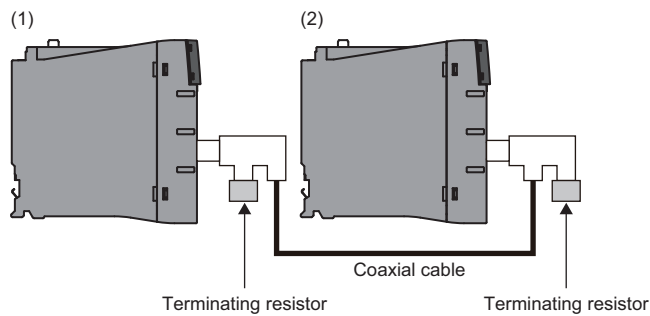

- (1) Control station (station No.1): Executing station
- (2) Normal station (station No.2): Executed station

Before conducting the station-to-station test when three or more stations are connected in a coaxial bus system, any stations that are not tested must be switched to offline or powered off.

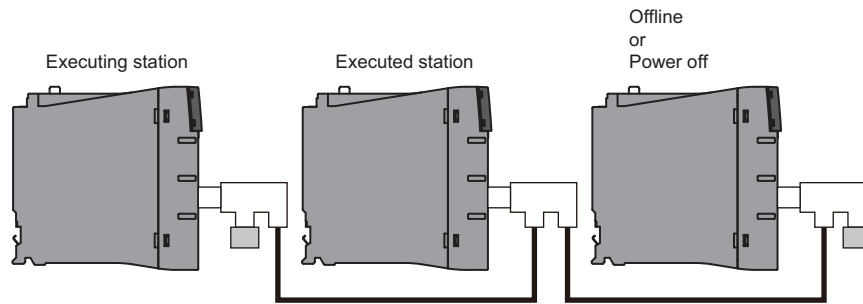

2. Set the module operation mode of the executing station to "Test between Master Station".

[Navigation window] ⇒ [Parameter] ⇒ [Module Information] ⇒ RJ71LP21-25 or RJ71BR11 ⇒ [Application Settings] ⇒ [Module Operation Mode]

3. Set the module operation mode of the executed station to "Test between Slave Station".

[Navigation window] ⇒ [Parameter] ⇒ [Module Information] ⇒ RJ71LP21-25 or RJ71BR11 ⇒ [Application Settings] ⇒ [Module Operation Mode]

4. Click the [Apply] button for the executing station and executed station.

5. Write the module parameters to the CPU module of the executing station and executed station.

6. Reset the CPU module of the executed station.

7. Reset the CPU module of the executing station.

8. If the test is completed with an error, check the following.

■Checking the status and result

Check the status and result of station-to-station test with the LED indicator of the module.*1

*1 After resetting the CPU module of the executing station, an error may be temporarily displayed on the executed station until the station-to-station test is started. When the test of the executing station starts, the status of the executed station also returns to "Test in progress".

Test status	LED indication
Test in progress	The RUN LED is turned on, the ERR LED is turned off, and the T PASS LED flashes. The SD/RD LED is turned on, and the L ERR LED is turned on or off. Executing station: The dot matrix LED indicates "MD5". Executed station: The dot matrix LED indicates "MD6".
Completed successfully	Since the test is repeated during normal operation, the test is judged to have been completed successfully when the T PASS LED on the executing station flashes 20 times (for about 10 seconds) or more.
Completed with an error	The ERR LED flashes. Executing station: The dot matrix LED indicates "ER5" and error number alternately at intervals of one second. Executed station: The dot matrix LED indicates "ER6" and error number alternately at intervals of one second.

■Checking the status when the operation is completed with an error

When an error is detected, the test is immediately completed (with an error).

The following describes the causes of the failure in the optical loop system.

- The cable on the forward loop or reverse loop is disconnected.
- The sending side and receiving side on the forward loop is not connected with a cable.
- The sending side of the forward loop is connected to the sending side of the reverse loop, and the receiving side of the forward loop is connected to the receiving side of the reverse loop.
- The sending side and receiving side on the reverse loop is not connected with a cable.
- Cable failure has occurred.
- The cable being tested is mismatched or disconnected.
- Hardware failure has occurred.

The following describes the causes of the failure in the coaxial bus system.

- The cable is broken or defective.
- The cable being tested is mismatched or disconnected.
- The terminating resistor was detached.
- Hardware failure has occurred.

When the test is completed with an error, the dot matrix at the front side of the MELSECNET/H network module indicates an error number. Take actions according to the error number displayed. " _ " in the error number is displayed as a space on the dot matrix display.

- List of errors displayed on the RJ71LP21-25

Error No.	Description	Action
0_1	Data error in station-to-station test	After resetting the CPU module of the station-to-station test (executed station), reset the CPU module of the station-to-station test (executing station). If the test fails again, please consult your local Mitsubishi representative.
1_1, 3_1	Station-to-station test completed with an error	Check that the optical fiber cable is connected correctly. Replace the optical fiber cable and perform the test again. If the test fails again, please consult your local Mitsubishi representative.
2_1	Station-to-station test completed with an error	Check that the system configuration and module operation mode are correctly set. If the test fails again, please consult your local Mitsubishi representative.

- List of errors displayed on the RJ71BR11

Error No.	Description	Action
0_1	Station-to-station test completed with an error	Check that the terminating resistor is connected correctly. Replace the terminating resistor and perform the test again. If the test fails again, please consult your local Mitsubishi representative.
1_1	Station-to-station test completed with an error	Check that the coaxial cable is connected correctly. Replace the coaxial cable and perform the test again. If the test fails again, please consult your local Mitsubishi representative.
2_1	Station-to-station test completed with an error	Check that the system configuration and module operation mode are correctly set. If the test fails again, please consult your local Mitsubishi representative.

Precautions

The RJ71LP21-25 station-to-station test detects errors such as cable disconnection, and cable failure in the configuration where only the OUT connector of the executing station and the IN connector of the executed station are connected with optical fiber cables. Since the IN connector of the executing station and the OUT connector of the executed station are ignored by the station-to-station test, errors, such as cable disconnection, are not detected.

For a redundant system (RJ71LP21-25 only)

Operating procedure

1. Connect the OUT connector of the executing station and the IN connector of the executed station with optical fiber cables.

- When a redundant system is configured in both the executing station and the executed station

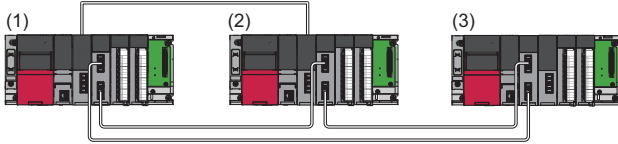

(1) Control station (station No.1): Executing station (A station where station-to-station test is performed)

(2) Normal station (station No.2): Executed station (A station where station-to-station test is performed)

(3) Normal station (station No.3): Offline (A station where station-to-station test is not performed)

- When a redundant system is not configured in the executing station but is configured in the executed station

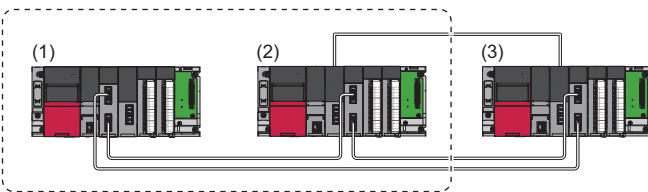

(1) Control station (station No.1): Executing station (A station where station-to-station test is performed)

(2) Normal station (station No.2): Executed station (A station where station-to-station test is performed)

(3) Normal station (station No.3): Offline (A station where station-to-station test is not performed)

2. Set the operation mode for the redundant CPU to "Backup Mode".

When the power of both systems cannot be turned on or off, set the operation mode for the redundant CPU to "Separate Mode".

The following shows the mode setting when station-to-station test is performed for the redundant system.

Set station	Operation mode of the redundant CPU	Module operation mode of the RJ21LP-25
A station where station-to-station test is performed	Backup Mode	Set the mode to "Test between Master Station" or "Test between Slave Station".
	Separate Mode	
A station where station-to-station test is not performed	Backup Mode	"Offline"
	Separate Mode	"Online"

3. Click the [Apply] button for the executing station and executed station.

4. Write the module parameters to the CPU module of the executing station and executed station.

5. Reset the CPU module of the executed station.

6. Reset the CPU module of the executing station.

7. If the test is completed with an error, check the following.

■Checking the status and result

Check the status and result of station-to-station test with the LED indicator of the module.

Test status	LED indication
Test in progress	The RUN LED is turned on, the ERR LED is turned off, and the T PASS LED flashes. The SD/RD LED is turned on, and the L ERR LED is turned on or off. Executing station: The dot matrix LED indicates "MD5". Executed station: The dot matrix LED indicates "MD6".
Completed successfully	Since the test is repeated during normal operation, the test is judged to have been completed successfully when the T PASS LED flashes 20 times (for about 10 seconds) or more.
Completed with an error	The ERR LED flashes. Executing station: The dot matrix LED indicates "ER5" and error number alternately at intervals of one second. Executed station: The dot matrix LED indicates "ER6" and error number alternately at intervals of one second.

■Checking the status when the operation is completed with an error

When an error is detected, the test is immediately completed (with an error).

The following describes the causes of the failure in the optical loop system.

- The cable on the forward loop or reverse loop is disconnected.
- The sending side and receiving side on the forward loop is not connected with a cable.
- The sending side of the forward loop is connected to the sending side of the reverse loop, and the receiving side of the forward loop is connected to the receiving side of the reverse loop.
- The sending side and receiving side on the reverse loop is not connected with a cable.
- Cable failure has occurred.
- The cable being tested is mismatched or disconnected.
- Hardware failure has occurred.

When the test is completed with an error, the dot matrix at the front side of the RJ71LP21-25 indicates an error number. Take actions according to the error number displayed. "_" in the error number is displayed as a space on the dot matrix display.

Error No.	Description	Action
0_1	Data error in station-to-station test	After resetting the CPU module of the station-to-station test (executed station), reset the CPU module of the station-to-station test (executing station). If the test fails again, please consult your local Mitsubishi representative.
1_1, 3_1	Station-to-station test completed with an error	Check that the optical fiber cable is connected correctly. Replace the optical fiber cable and perform the test again. If the test fails again, please consult your local Mitsubishi representative.
2_1	Station-to-station test completed with an error	Check that the system configuration and module operation mode are correctly set. If the test fails again, please consult your local Mitsubishi representative.

Precautions

The RJ71LP21-25 station-to-station test detects errors such as cable disconnection, and cable failure in the configuration where only the OUT connector of the executing station and the IN connector of the executed station are connected with optical fiber cables. Since the IN connector of the executing station and the OUT connector of the executed station are ignored by the station-to-station test, errors, such as cable disconnection, are not detected.

Forward loop test/reverse loop test (RJ71LP21-25 only)

Check the following.

- Checking the RJ71LP21-25 and optical fiber cable hardware
- Checking that the optical fiber cables are connected correctly at the OUT and IN connectors

Forward loop test/reverse loop test can be used only with RJ71LP21-25.

For a system other than a redundant system

Operating procedure

1. Connect all stations with optical fiber cables.
2. Connect the OUT connector and IN connector of the RJ71LP21-25 for the executing station and executed station with optical fiber cables.
3. Set the module operation mode as follows.

 [Navigation window] ⇒ [Parameter] ⇒ [Module Information] ⇒ RJ71LP21-25 ⇒ [Application Settings] ⇒ [Module Operation Mode]

Test target	Module operation mode setting	
	Executing station	Executed station
Forward loop	"Forward Loop Test"	"Online"
Reverse loop	"Reverse Loop Test"	"Online"

4. Click the [Apply] button for the executing station and executed station.
5. Write the module parameters to the CPU module of the executing station and executed station.
6. Reset the CPU module of the executed station.
7. Reset the CPU module of the executing station.
8. If the test is completed with an error, check the following.

■Checking the status and result

Check the status and result of forward/reverse loop test with the LED indicator of the module.

Test status	LED indication
Test in progress	The RUN LED is turned on, the ERR LED is turned off, and the T PASS LED flashes. The SD/RD LED is turned on, and the L ERR LED is turned on or off. Forward loop test: The dot matrix LED of the executing station indicates "MD3". A station number is displayed for the executed station. Reverse loop test: The dot matrix LED of the executing station indicates "MD4". A station number is displayed for the executed station.
Completed successfully	Since the test is repeated during normal operation, the test is judged to have been completed successfully when the T PASS LED flashes 20 times (for about 10 seconds) or more.
Completed with an error	The ERR LED flashes. Forward loop test: The dot matrix LED indicates "ER3" and error number alternately at intervals of one second. Reverse loop test: The dot matrix LED indicates "ER4" and error number alternately at intervals of one second.

■Checking the status when the operation is completed with an error

When an error is detected, the test is immediately completed (with an error).

Loopback is performed due to wiring mistake, optical fiber cable failure, or other station failure.

- If wiring is incorrect, check the connections of the IN and OUT connectors.
- If the optical fiber cable or another station is faulty, replace the defective optical fiber cable or module with the new one.

When the test is completed with an error, the dot matrix at the front side of the RJ71LP21-25 indicates an error number. Take actions according to the error number displayed. "_" in the error number is displayed as a space on the dot matrix display.

Error No.	Description	Action
1_1	Forward loop test completed with an error	Check that the optical fiber cable is connected correctly. Replace the optical fiber cable and perform the test again. If the test fails again, please consult your local Mitsubishi representative.
2_1	Reverse loop test completed with an error	Check that the optical fiber cable is connected correctly. Replace the optical fiber cable and perform the test again. If the test fails again, please consult your local Mitsubishi representative.

For a redundant system

Operating procedure

1. Connect all stations with optical fiber cables.
2. Connect the IN connector and OUT connector of the RJ71LP21-25 for the executing station and executed station with optical fiber cables.
3. Set the operation mode and the module operation mode for the redundant system as follows.

When the power of the both systems cannot be turned on or off, execute the forward/reverse loop test in the separate mode.

Set station		Operation mode	Module operation mode setting
Executing station	Redundant system	Backup mode	"Forward Loop Test" or "Reverse Loop Test"
		Separate mode	
Executed station	Redundant system	Backup mode	"Online"
		Separate mode	
	Stations other than the redundant system	—	

4. Click the [Apply] button for the executing station and executed station.
5. Reset the CPU module of the executed station.
6. Reset the CPU module of the executing station.
7. If the test is completed with an error, check the following.

■Checking the status and result

Check the status and result of forward/reverse loop test with the LED indicator of the module.

Test status	LED indication
Test in progress	The RUN LED is turned on, the ERR LED is turned off, and the T PASS LED flashes. The SD/RD LED is turned on, and the L ERR LED is turned on or off. Forward loop test: The dot matrix LED of the executing station indicates "MD3". Reverse loop test: The dot matrix LED of the executing station indicates "MD4".
Completed successfully	Since the test is repeated during normal operation, the test is judged to have been completed successfully when the T PASS LED flashes 20 times (for about 10 seconds) or more.
Completed with an error	The ERR LED flashes. Forward loop test: The dot matrix LED indicates "ER3" and error number alternately at intervals of one second. Reverse loop test: The dot matrix LED indicates "ER4" and error number alternately at intervals of one second.

■Checking the status when the operation is completed with an error

When an error is detected, the test is immediately completed (with an error).

Loopback is performed due to wiring mistake, optical fiber cable failure, or other station failure.

- If wiring is incorrect, check the connections of the IN and OUT connectors.
- If the optical fiber cable or another station is faulty, replace the defective optical fiber cable or module with the new one.

When the test is completed with an error, the dot matrix at the front side of the RJ71LP21-25 indicates an error number. Take actions according to the error number displayed. "_" in the error number is displayed as a space on the dot matrix display.

Error No.	Description	Action
1_1	Forward loop test completed with an error	Check that the optical fiber cable is connected correctly. Replace the optical fiber cable and perform the test again. If the test fails again, please consult your local Mitsubishi representative.
2_1	Reverse loop test completed with an error	Check that the optical fiber cable is connected correctly. Replace the optical fiber cable and perform the test again. If the test fails again, please consult your local Mitsubishi representative.

4.3 Checking the Network Status

Perform the MELSECNET diagnostics to check the network status and error details or to perform an operation test for troubleshooting.

Host Station Information

This diagnostics checks the overall network information of the connection destination and the status of the own station.

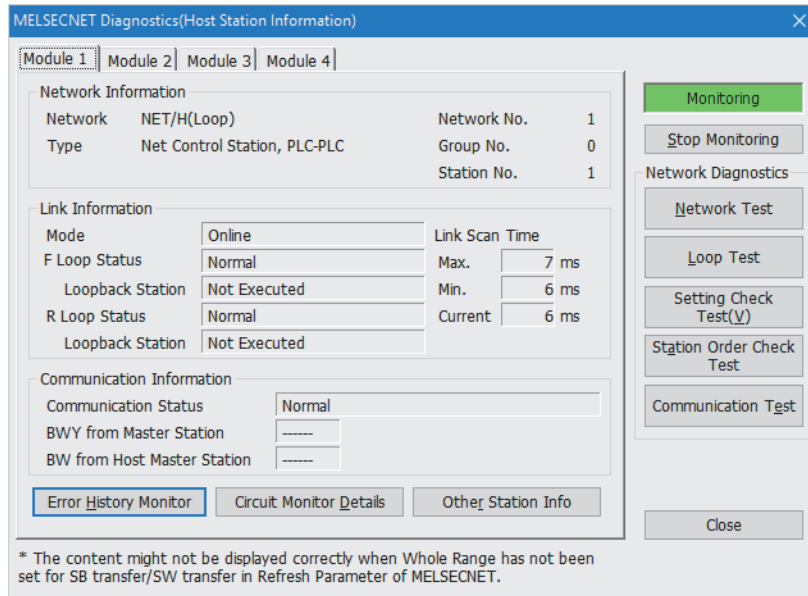

Item	Description	Displayed information
[Module 1] to [Module 4] tab	Switches the window displaying the MELSECNET diagnostics result for each 1st to 4th RJ71LP21-25 module.	—
Network Information	Network Type	<ul style="list-style-type: none"> ■RJ71LP21-25 • NET/H(Loop) Net Control Station, PLC-PLC • NET/H(Loop) Normal Net Station, PLC-PLC • NET/H Extended Mode(Loop) Net Control Station, PLC-PLC • NET/H Extended Mode(Loop) Normal Net Station PLC-PLC • NET/10(Loop) Net Control Station, PLC-PLC • NET/10(Loop) Normal Net Station, PLC-PLC ■RJ71BR11 • MELSECNET/H(Bus) Net Control Station, PLC-PLC • MELSECNET/H(Bus) Normal Net Station, PLC-PLC • MELSECNET/H Extended Mode(Bus) Net Control Station, PLC-PLC • MELSECNET/H Extended Mode(Bus) Normal Net Station PLC-PLC • MELSECNET/10(Bus) Net Control Station, PLC-PLC • MELSECNET/10(Bus) Normal Net Station, PLC-PLC
	Network No.	Indicates the own station network number. 1 to 239
	Group No.	Indicates the own station group number. • 0: No group specification • 1 to 32: Transient transmission group number
	Station No.	Indicates the station number of the own station. 1 to 64

Item		Description	Displayed information
Link Information	Mode	Indicates the own station operation mode.	<ul style="list-style-type: none"> • Online^{*1} • Offline • Forward Loop Test • Reverse Loop Test • Test between Master Station • Test between Slave Station • Self-loopback Test • Internal Self-loopback Test • Hardware test
	F Loop Status Loopback Station	<p>■RJ71LP21-25 Indicates the loopback status and the station number of the loopback station on the forward loop side.</p> <p>■RJ71BR11 "———" is displayed.</p>	<p>■Loopback status</p> <ul style="list-style-type: none"> • Normal • Loopback Transmission • Data Link not Possible <p>■Loopback station number 1 to 64</p>
	R Loopback Status Loopback Station	<p>■RJ71LP21-25 Indicates the loopback status and the station number of the loopback station on the reverse loop side.</p> <p>■RJ71BR11 "———" is displayed.</p>	
	Link Scan Time	Indicates the maximum/minimum/current value of the own station link scan time.	<ul style="list-style-type: none"> • Max.^{*3} • Min. • Current
Communication Information	Communication Status	Indicates the own station communication status.	<ul style="list-style-type: none"> • Normal • There is a stop instruction (Station Own) • There is a stop instruction (Station All) • Stop Instruction Present (1) to Stop Instruction Present (64)^{*2} • No Parameter • Error Parameter • Error Host PLC • Suspend Communication
Monitor status		Indicates the monitor status.	—
[Stop Monitoring] button [Start Monitoring] button		Stops/starts monitoring.	—
[Error History Monitor] button		Opens the "Error History Monitor" window.	📖 Page 116 Error History Monitor
[Circuit Monitor Details] button		Opens the "Circuit Monitor Details" window.	📖 Page 114 Circuit Monitor Details
[Other Station Info] button		Opens the "Other Station Information" window.	📖 Page 112 Other Station Information
Network Diagnostics	[Network Test] button	Opens the "Network Test" window.	📖 Page 123 Network Test
	[Loop Test] button	<p>■RJ71LP21-25 Opens the "Loop Test" window.</p> <p>■RJ71BR11 This function is excluded.</p>	📖 Page 119 Loop Test (RJ71LP21-25 only)
	[Setting Check Test] button	Opens the "Setting Check Test" window.	📖 Page 120 Setting Check Test
	[Station Order Check Test] button	<p>■RJ71LP21-25 Opens the "Station Order Check Test" window.</p> <p>■RJ71BR11 This function is excluded.</p>	📖 Page 121 Station Order Check Test (RJ71LP21-25 only)
	[Communication Test] button	Opens the "Communication Test" window.	📖 Page 122 Communication Test

*1 "Online" is displayed when operating in debug mode.

*2 The station number of the other station that issued the stop instruction is displayed.

*3 If a normal station starts up first, and then the control station starts up, the maximum link scan may be delayed.

Precautions for using network diagnostics

- The network diagnostics (test function such as the network test) of the own station cannot be performed when an item other than "Not Specified" is set in "Specify Redundant CPU" on the "Specify Connection Destination Connection" window of the engineering tool in a redundant system. Perform diagnostics by directly connecting the engineering tool to the target system (control system/standby system/system A/system B) and setting "Specify Redundant CPU" to "Not Specified".
- The network diagnostics (test function such as the network test) of the own station cannot be performed when an item other than "No Specification" is set in "Other Station Setting" on the "Specify Connection Destination Connection" window of the engineering tool. Even if "Other Station Setting" is set to "No Specification", the network diagnostics (test function such as the network test) cannot be performed when "PC side I/F" is set to "Ethernet board".
- The network diagnostics cannot be displayed correctly while the network module is executing the offline test.

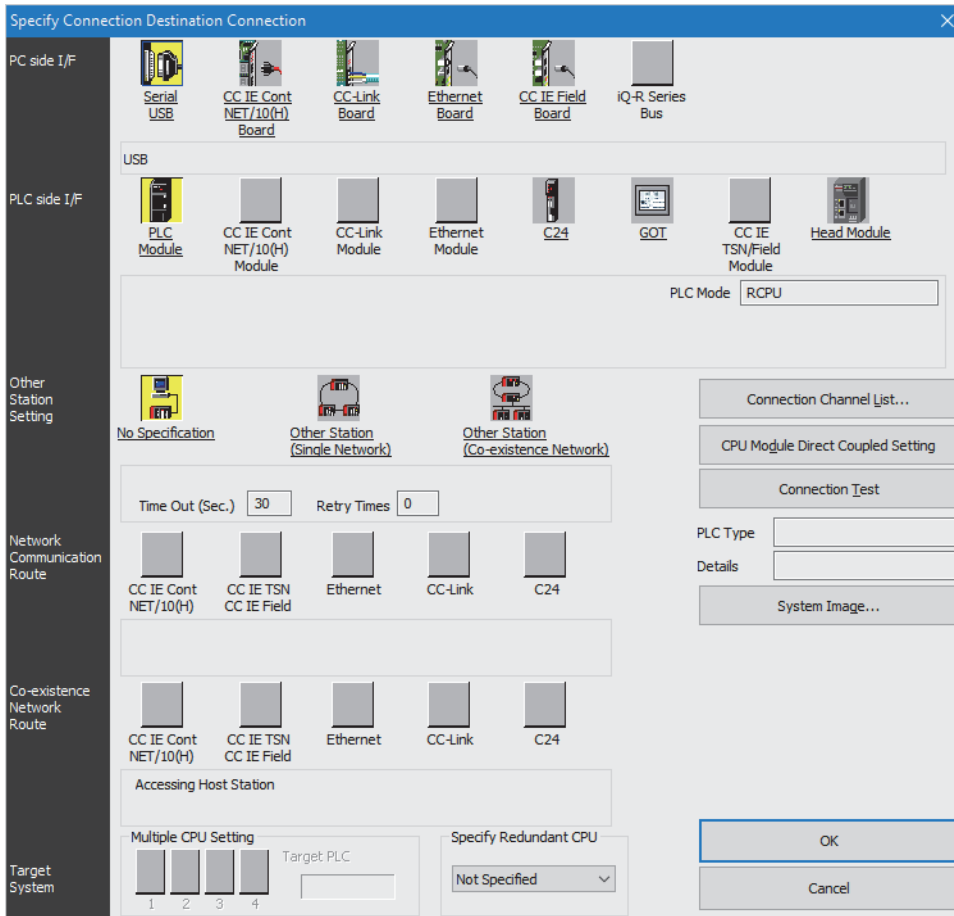

Other Station Information

From this window, the status of communication, data link, parameters, CPU module, loop, and reserved stations at each station can be checked.

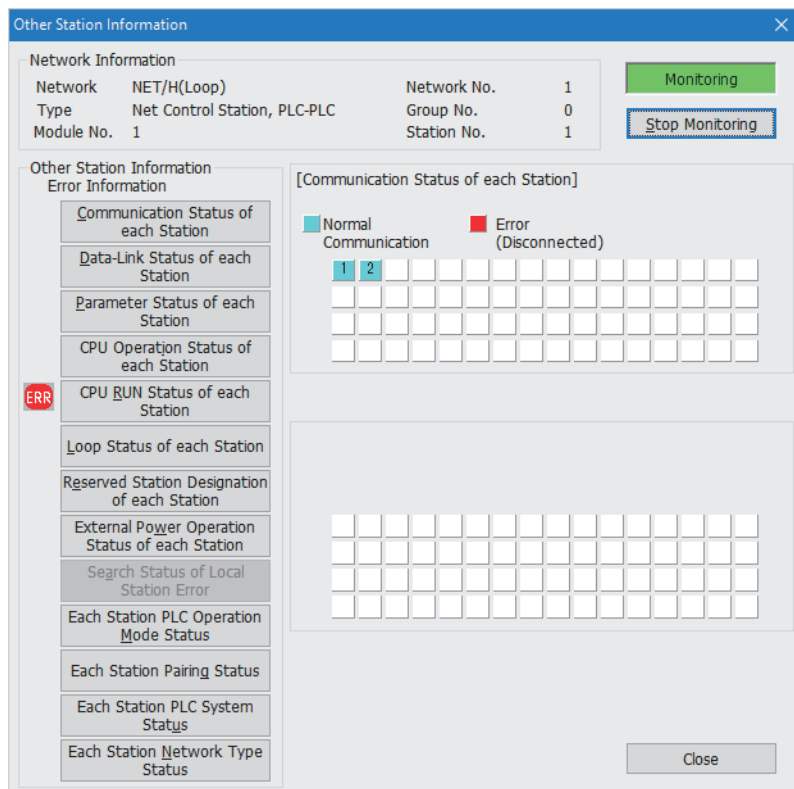

Item	Description	Displayed information
Network Information	Indicates the same information as own station information.	☞ Page 109 Host Station Information
Other Station Information	Communication Status of each Station	Indicates the baton pass status (transient transmission availability). • Normal display: Baton pass normal station, reserved station • Reverse display: Baton pass faulty station (Disconnection status)
	Data-Link Status of each Station	Indicates the cyclic transmission status. • Normal display: Normal station, reserved station • Reverse display: Faulty station (Data link not in operation)
	Parameter Status of each Station	Indicates the parameter status of each station. When each station is in the parameter communication status • Normal display: Parameter communication not in progress, reserved station, unconnected station • Reverse display: Parameter communication in progress When each station is in the parameter error status • Normal display: Parameters normal, reserved station, unconnected station • Reverse display: Parameter error
	CPU Operation Status of each Station	Indicates the operating status of the CPU module. Enabled when the communication status of each station is "Baton pass normal station". • Normal display: Normal CPU, reserved station, unconnected station • Reverse display: CPU error (Minor: Minor error, Severe: Moderate error, Severe error)
	CPU RUN Status of each Station	Indicates the RUN/STOP status of the CPU module. Enabled when the communication status of each station is "Baton pass normal station". • RUN: RUN, STEP-RUN • STOP: STOP, PAUSE, ERROR • DOWN: Unconnected station • Reserved station: Reserved station
	Loop Status of each Station	■RJ71LP21-25 Indicates the forward/reverse loop status. Enabled only for normally operating stations in 'Baton pass status of each station'. ■RJ71BR11 This function is excluded. • Normal display: Normal, reserved station, unconnected station • Reverse display: Error
	Reversed Station Designation of each Station	Indicates the reserved station setting status. • Normal display: Non-reserved station • Reverse display: Reserved station
	External Power Operation Status of each Station	■RJ71LP21-25 Indicates the external 24VDC power supply status of the network module. Enabled when the communication status of each station is "Baton pass normal station". ■RJ71BR11 This function is excluded. • Normal display: 24VDC not input, MELSECNET/H network module without a supply terminal • Reverse display: 24VDC input
	Each Station PLC Operation Mode Status	Indicates the operation mode of the redundant CPU. For the items other than the redundant CPU, "———" is displayed. The following is indicated for the CPU status. • Backup Mode • Separate Mode
	Each Station Pairing Status	Indicates the status of the pairing setting. The following is indicated for the CPU status. • No Pair • Pair
Each Station PLC System Status	Indicates the redundant CPU system status. For the items other than the redundant CPU, "———" is displayed. The following is indicated for the CPU status. • Control System • Standby System	
Each Station Network Type Status	Displays the consistency between the network type set for the control station and the network type set for the normal station. Normal display: Reserved station, communication faulty station Reverse display: Shown below • Normal station set to MELSECNET/H mode or MELSECNET/10 mode when the control station is in MELSECNET/H extended mode • Normal station set to MELSECNET/H extended mode when the control station is in MELSECNET/H mode or MELSECNET/10 mode	

Circuit Monitor Details

From this window, the control station information, data link information, and the own station parameter status can be checked.

Item	Description	Displayed information
Network Information	Indicates the same information as own station information.	Page 109 Host Station Information
Control Station Information	Specified Control Station	<ul style="list-style-type: none"> • 0: Control station does not exist. • 1 to 64: Station number of the control station
	Present Control Station	<ul style="list-style-type: none"> • 0: Control station or sub-control station does not exist. • 1 to 64: Station number of the station actually controlling the network
	Communication Information	<ul style="list-style-type: none"> • Control Station • Sub-Control Station
	Sub Control Station Transmission	<ul style="list-style-type: none"> • Yes • None
	I/O Master Station	<ul style="list-style-type: none"> • 1 to 64: Station number (Indicates "None" for the block that is not specified.)
	Block 1	Indicates the station number of the I/O master station of X/Y communication block 1.
	Block 2	Indicates the station number of the I/O master station of X/Y communication block 2.

Item		Description	Displayed information
Data Link Information	Total Number of Linked Stations	Indicates the total number of the link stations specified by the parameter.	1 to 64: Total number of link stations
	Station of Maximum Normal Communication	Indicates the maximum station number with a successful baton pass (in a state in which transient transmission is possible). The T PASS LED of the network module is turned on in a station with a successful baton pass.	1 to 64: Station number 0: Own station disconnected
	Station of Maximum Data Link	Indicates the maximum station number with a successful data link (cyclic transmission and transient transmission). The D LINK LED of the network module is turned on in a station with a successful data link.	1 to 64: Station number 0: Own station disconnected
	Communication Status	Indicates the own station communication status.	<ul style="list-style-type: none"> • Data Linking • Suspend Data Link(Other) • Suspend Data Link(Host) • Baton Pass(No Area) • Baton Pass(Parameter Halt) • Baton Pass(No Receive) • Disconnecting(No Baton) • Disconnecting(Line Error) • In Test • Resetting
Data Link Information	Communication Interruption Factors	Indicates the cause behind communication (transient transmission) not being performed at the own station.	<ul style="list-style-type: none"> • Normal • Offline • Offline Test • Initial state • Shift Control Station • Online testing • Baton disappearance • Baton repetition • Same Station Present • Control station repetition • Reception retry error • Transmission retry error • Timeout error • Network Disorder • Disconnecting • No baton to local station <p>Indicates an error code if communication is interrupted for any reason other than the above. ( Page 132 List of Error Codes)</p>
	Communication Stop Factors	Indicates the cause behind data link (cyclic transmission) not being performed at the own station.	<ul style="list-style-type: none"> • Normal • There is a stop instruction (Station Own) • There is a stop instruction (Station All) • Stop Instruction Present (1) to Stop Instruction Present (64)^{*1} • No Parameter • Illegal Parameter • Host PLC Error • Suspend Communication
Host Status	Parameter Setting	Indicates the own station parameter setting status.	• Common Parameter
	Reserved Station Specification	Indicates the reserved station specification status.	<ul style="list-style-type: none"> • Exists • Does Not Exist
	Communication Mode	Indicates the link scan status.	<ul style="list-style-type: none"> • Normal • Constant Scan
	Duplex Transmission Setting	Indicates the multiplex transmission specification status. "———" is displayed for the RJ71BR11.	<ul style="list-style-type: none"> • None • Multiple Transmission
	Duplex Transmission Sett	Indicates the multiplex transmission status. "———" is displayed for the RJ71BR11.	<ul style="list-style-type: none"> • Normal • Multiple Transmitting

*1 The station number of the other station that issued the stop instruction is displayed.

Error History Monitor

From this window, the occurrence condition of the forward/reverse loop error, communication error, and transient transmission error can be checked.

Error history details and error histories can also be cleared from here.

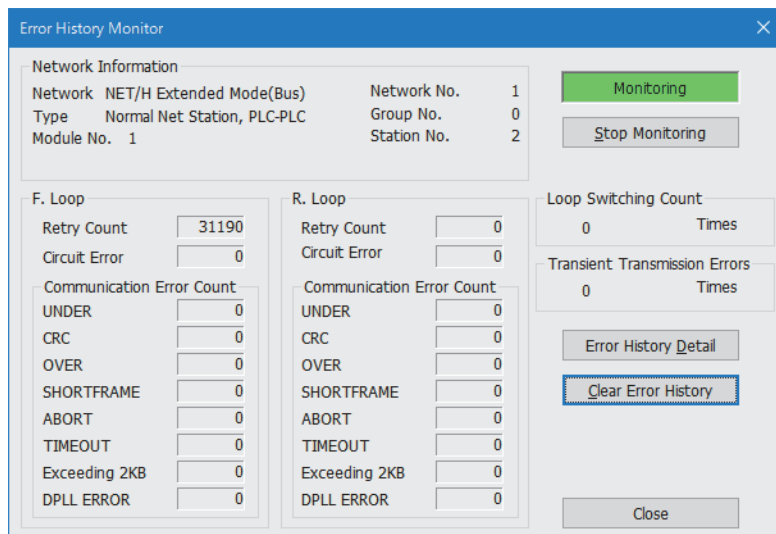

Item	Description	Displayed information
Network Information	Indicates the same information as own station information.	☞ Page 109 Host Station Information
F. Loop	Retry Count	<ul style="list-style-type: none"> • 0: No count • 1 or greater: Cumulative count
R. Loop	Circuit Error	
	UNDER	
	CRC	
	OVER	
	SHORTFRAME	
	ABORT	
	TIMEOUT	
	Exceeding 2KB	
	DPLL ERROR	
Loop Switching Count	Indicates the number of occurrence times of switching.	
Transient Transmission Errors	Indicates the number of transient transmission errors.	
[Error History Detail] button	Opens the "Error History Monitor Details" window.	☞ Page 117 Error History Monitor Details
[Clear Error History] button	Opens the "Clear Error History Monitor" window.	☞ Page 118 Clear Error History Monitor

Point

The number of occurrences of each error does not cause any problem unless the count value rises frequently during operation.

Take the following actions if the count value rises frequently:

- Check the power on/off status of the own station and other station.
- Check the cable and connector status (removal and loosening of connectors, cable disconnection, and cable length).
- Perform self-loopback test, internal self-loopback test, and hardware test.
- Perform station-to-station test and forward loop test (RJ71LP21-25)/reverse loop test (RJ71LP21-25).
- Rewire the cable by referring to the wiring described in MELSEC iQ-R MELSECNET/H Network Module User's Manual (Startup). Also, perform installation again by referring to the user's manual for the CPU module used.

Error History Monitor Details

This window displays the loop switching cause and transient transmission error history.

Network Information

Network	NET/H(Bus)	Network No.	1
Type	Net. Control Station, PLC-PLC	Group No.	0
Module No.	1	Station No.	1

Monitoring **Stop Monitoring**

Loop Switching

	Station No.	Cause	Status after Switching
1			
2			
3			
4			
5			
6			
7			
8			
9			
10			
11			
12			
13			
14			
15			
16			

Transient Transmission Errors

	Error Code	Error Type
1		
2		
3		
4		
5		
6		
7		
8		
9		
10		
11		
12		
13		
14		
15		
16		

Close

Item	Description	Displayed information
Network Information	Indicates the same information as own station information.	Page 109 Host Station Information
Loop Switching	Station No.	1 to 64
	Cause	<ul style="list-style-type: none"> H/W Error(F) H/W Error(R) Forced Error(F) Forced Error(R) Communication(F) Error Communication(R) Error Seq-Line Error(F) Seq-Line Error(R) Return Instruction
	Status after Switching	<ul style="list-style-type: none"> Multiple Transmission F.Loop R.Loop Loopback
Transient Transmission Errors	Error Code	Page 132 List of Error Codes
	Error Type	

Clear Error History Monitor

Select the checkbox of the item whose error history is to be cleared and click the [Execute] button.

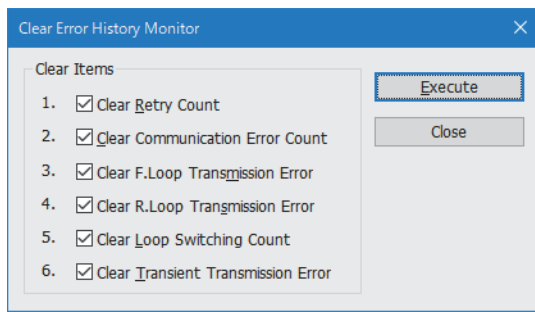

Item	Description
Clear Retry Count	Clears the retry count.
Clear Communication Error Count	Clears the communication error count
Clear F.Loop Transmission Error	Clears the forward loop transmission error.
Clear R.Loop Transmission Error	Clears the reverse loop transmission error.
Clear Loop Switching Count	Clears the switching count.
Clear Transient Transmission Error	Clears the transient transmission error count.

Loop Test (RJ71LP21-25 only)

This function performs the loop test of the forward/reverse loop status in the status where the wiring of the optical loop system is completed. The loopback station can also be checked during loopback.

Loop test can be used only with RJ71LP21-25.

Select "Test Method" and "Target Module" and click the [Execute] button.

Item	Description
Network Information	Indicates the same information as own station information. (Page 109 Host Station Information)
Loop Test	<p>Test Method</p> <ul style="list-style-type: none"> ■Parameter Specified Select this item to test the total number of stations set in the network parameters (excluding reserved stations). If no network parameter exists, test is performed for all stations. ■All Stations Specified Select this item to test all stations. <p>Target Module</p> <p>Select a module that is to perform loop test.</p>
Execution Result	Indicates the number of stations and results (normal/error, reserved station: R).

Setting Check Test

Select "Test Method" and "Target Module" and click the [Execute] button.

The following three checks are performed:

- Checking for the presence of any duplicated control station
- Checking for the presence of any duplicated station number
- Checking for consistency between the network number set for the station connected with the engineering tool and the network number set in the network parameter of the own station

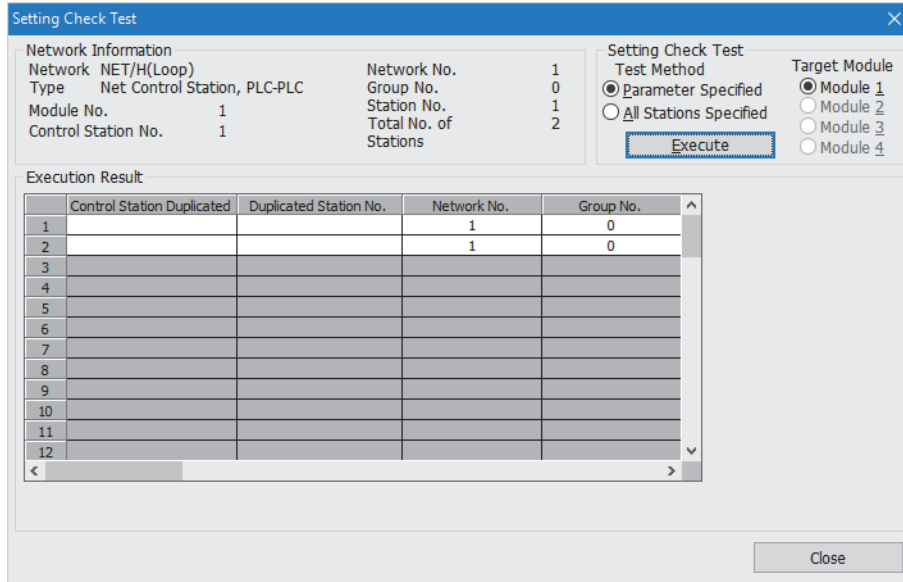

Item	Description
Network Information	Indicates the same information as own station information. (Page 109 Host Station Information)
Setting Check Test	Test Method <input checked="" type="checkbox"/> Parameter Specified Select this item to test the total number of stations set in the network parameters (excluding reserved stations). If no network parameter exists, test is performed for all stations. <input type="checkbox"/> All Stations Specified Select this item to test all stations.
	Target Module Select a module to perform setting check test.
Execution Result	1 to 64 Indicates the station number of the station for which the setting check test was executed. (Up to 64 stations)*1
	Control Station Duplicated Places the ○ sign for the control stations whose station number is duplicated.
	Duplicated Station No. Places the ○ sign for the target stations whose station number is duplicated.
	Network No. Indicates the network number of the station for which the setting check test was executed. The station whose network number is different from that of the own station is indicated in red.
	Group No. Indicates the group number of the station for which the setting check test was executed. (When the test execution method is set to "Parameter Specified")
	Reserved station Places the ○ sign for stations that are specified as a reserved station by the parameter setting. (When the test execution method is set to "Parameter Specified")
	Error Station Places the ○ sign for any stations that are specified as a reserved station by the parameter setting or whose module is faulty in all stations specification.
	Network Type Error Station Places the ○ sign for any stations whose parameter setting and the actual connection type are inconsistent.
	Multiplexed R Sub M Station (Multiplexed remote sub-master station duplication) Parallel R Sub M Station (Parallel remote sub-master station duplication)

*1 Only for the RJ71BR11, when "Test Method" is set to "All Stations Specified", up to 32 stations are displayed.

Station Order Check Test (RJ71LP21-25 only)

Station order check test can be used only with RJ71LP21-25.

Select "Test Method" and "Target Module" and click the [Execute] button.

The following connection order can be checked using the loop status:

- Forward/reverse loop: The station number of the stations connected in the forward loop direction from the own station, and the station number of the stations connected in the reverse loop direction from the own station
- Forward loop: Only the station number of the stations connected in the forward loop direction from the own station
- Reverse loop: Only the station number of the stations connected in the reverse loop direction from the own station
- Loopback: Only the station number of the stations connected in the forward loop direction from the own station

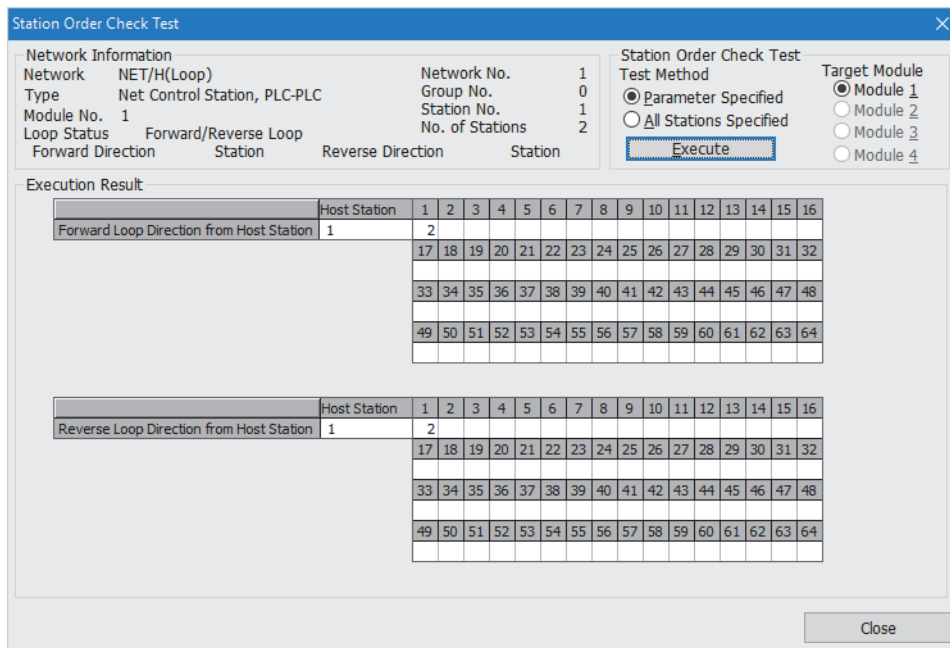

Item	Description	
Network Information	Indicates the same information as own station information. (Page 109 Host Station Information)	
Station Order Check Test	Test Method	<ul style="list-style-type: none"> ■Parameter Specified Select this item to test the total number of stations set in the network parameters (excluding reserved stations). If no network parameter exists, test is performed for all stations. ■All Stations Specified Select this item to test all stations.
	Target Module	Select a module to perform station order check test.
Execution Result	Indicates the station number of the station in the forward or reverse loop direction from the own station. In loopback, it is executed only for the station in the forward loop direction from the own station. The station number of the reserved station is not displayed.	

Communication Test

This test checks whether the own station and the communication destination (specified by the network number and station number) can communicate normally.

Since this window displays the network number and station number that are being relayed, it can be used to check whether the routing parameter is correctly set.

Set "Destination" and "Communication Data" and click the [Execute Test] button.

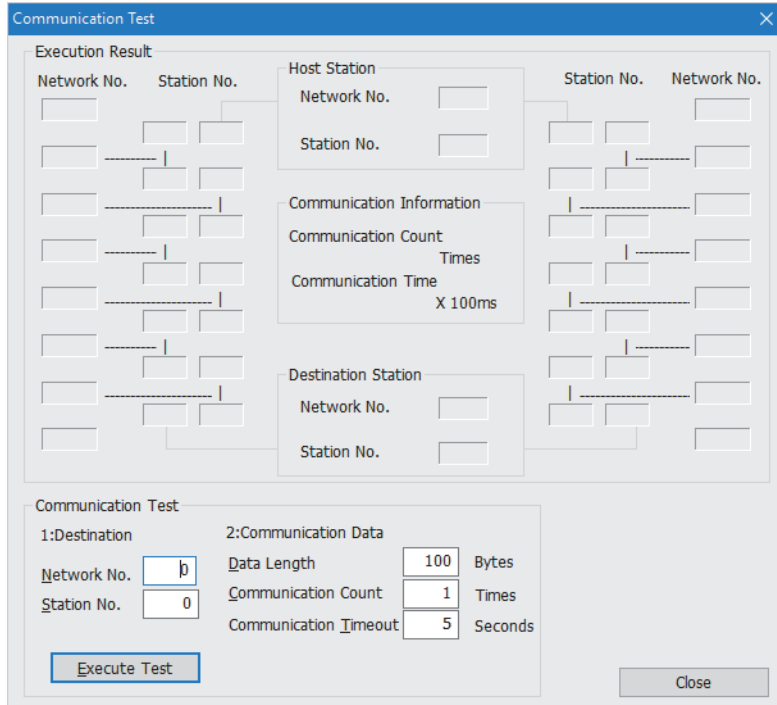

Item	Description	
Communication Test	Destination	Set the network number and station number.
	Communication Data	Set the parameters required for the execution of the communication test. <ul style="list-style-type: none"> • Data length (1 to 900 bytes) • Communication count (1 to 100 times) • Communication monitoring time (1 to 100 seconds)
Execution Result	Indicates the result of the communication test between networks.	

Precautions

When a relay sending station is set to "Destination", only an error code appears without an error message. Set a relay receiving station to "Destination".

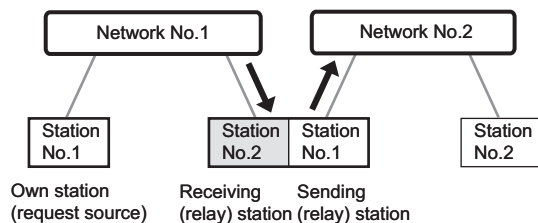

Network Test

This test stops/restarts cyclic transmission. This function is used when it is not desirable to receive data from another station or to send own station data when starting up the system.



For stopping/restarting cyclic transmission, data communication (link refresh) between the CPU module and the MELSECNET/H network module is not stopped or restarted. Use the program to stop/restart data communication (link refresh).

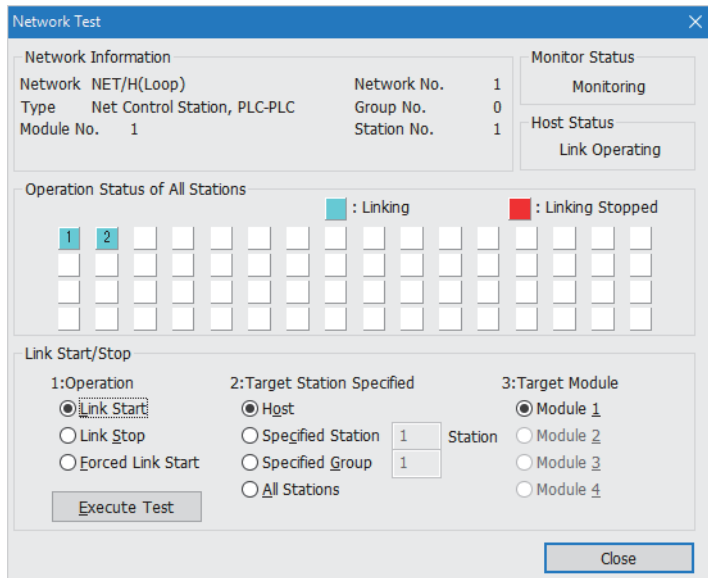

Item	Description	
Network Information	Indicates the same information as own station information. (Page 109 Host Station Information)	
Operation Status of All Stations	Indicates the link status of each station on the network for which the test was executed.	
Link Start/Stop	Operation <input checked="" type="radio"/> Link Start <input type="radio"/> Link Stop <input type="radio"/> Forced Link Start 2:Target Station Specified <input checked="" type="radio"/> Hgst <input type="radio"/> Specified Station 1 Station <input type="radio"/> Specified Group 1 <input type="radio"/> All Stations 3:Target Module <input checked="" type="radio"/> Module 1 <input type="radio"/> Module 2 <input type="radio"/> Module 3 <input type="radio"/> Module 4	
	Target Station Specified	Specify the target station of network test.
	Target Module	Selects a module that is to perform network test.
Monitor Status	Indicates the monitor status.	
Host Status	Indicates the operating status of the own station of the selected module.	



Link start cannot be done even if the link start operation is performed to an offline-mode station (disconnected from the network). No error will be detected, in this case, because no response is returned from the target station.











4.4 Troubleshooting by Symptom

Perform these troubleshooting if data link cannot be performed even though no error is detected in the MELSECNET/H network module.

If an error has occurred in the MELSECNET/H network module, identify the error cause using the engineering tool. ( Page 93 Checking the Module Status)

When cyclic transmission cannot be performed



The following lists the actions to be taken if cyclic transmission cannot be performed.

Check item	Action
Is the D LINK LED of the control or normal station turned off?	Perform troubleshooting for when the D LINK LED turns off. ( Page 92 When the D LINK LED turns off)
Is the setting value of data link monitoring time shorter than that of actual link scan time?	Increase the setting value of "Data Link Monitoring Time" in "Application Settings". ( Page 66 Supplementary Cyclic Settings)
Is a target station set as a reserved station in "Network Range Assignment" of "Required Settings" of the control station?	Cancel the reserved station setting. ( Page 56 Network Range Assignment)
Has "Network Range Assignment" of "Required Settings" of the control station been set?	Set "Network Range Assignment" of "Required Settings" of the control station. ( Page 56 Network Range Assignment)
Is there any station which exceed total number of stations set in "Network Range Assignment" of "Required Settings" of the control station?	Correct station numbers. ( Page 55 Station No.)
Are station numbers unique?	Change the duplicated station number. ( Page 55 Station No.)
Is the data link set by the sub-control station when the control station is down?	Change the data link setting by the sub-control station when the control station is down to "Yes".
Is the program correct?	<ul style="list-style-type: none"> • Check that data can be sent to the receiving station normally by switching the CPU modules to STOP on the sending station and receiving station and by the link devices on the sending station is turned on and off with the test operation of the engineering tool to communicate data. • If the data communications have no problem, check whether the program is correct.
Is the setting range in "Link Refresh Settings" of "Basic Settings" correct?	Correct the setting range in "Link Refresh Settings" of "Basic Settings". ( Page 62 Link Refresh Settings)
Is any link refresh target device in "Link Refresh Settings" of "Basic Settings" overlapped with that of another network module?	Correct the range setting in "Link Refresh Settings" of "Basic Settings". ( Page 62 Link Refresh Settings)
Are the transfer ranges set in "Interlink Transmission Settings" of "Application Settings" correct?	Correct the transfer ranges set in "Interlink Transmission Settings" of "Application Settings". ( Page 75 Interlink Transmission Settings)
Are the source and destination modules set in "Interlink Transmission Settings" of "Application Settings" correct?	Correct the source and destination modules set in "Interlink Transmission Settings" of "Application Settings". ( Page 75 Interlink Transmission Settings)
Are MELSECNET/10 mode, MELSECNET/H mode, and MELSECNET/H extended mode mixed?	Correct the mode setting. ( Page 55 Station Type)

If the above action does not solve the problem, perform the self-diagnostics test to check for hardware failure. ( Page 96 Self-diagnostics test)

Transient transmission cannot be performed

The following lists the actions to be taken if transient transmission cannot be performed.

Check item	Action
Does any error occur during execution of transient transmission?	Follow the instruction displayed on the window.
Is the setting of the station number in the connected station correct?	Correct station numbers.
Are the following control data of the dedicated instruction correct? · Is the CPU type of the target module correct? · Is the network number of the target station correct? · Is the target station number correct?	Correct the control data of the dedicated instruction.
Is the routing parameter for the sending source of transient transmission correct?	Correct the "Routing Setting" of "CPU Parameters".  MELSEC iQ-R CPU Module User's Manual (Application)
Have the routing parameters of the relay station correctly been set?	Correct the "Routing Setting" of "CPU Parameters".  MELSEC iQ-R CPU Module User's Manual (Application)
Is the network number duplicated on the network?	Change the duplicated network number.
Is a value out of the range set for the CPU type in the target station?	Correct the setting according to the manual of the CPU in the target station.
Is the communication path to the target network number decided?	<ul style="list-style-type: none"> • Power on the system and start transient transmission after a while. • When "Dynamic Routing" under "Application Settings" of the station on the communication path is set to "Disable", change it to "Enable". Correct the setting if the setting in "Link Refresh Settings" of "Basic Settings" is incorrect.
Does the relay station to be passed support the dynamic routing function?	If the relay station to be passed does not support the dynamic routing function, set all the stations on the communication path in "Routing Setting" of "CPU Parameter".
Are multiple link dedicated instructions with same channel setting executed simultaneously?	<ul style="list-style-type: none"> • Set different channel to each instructions. • Shift the execution timing of the link dedicated instructions.
Is the access range of transient transmission satisfied?	Correct the system configuration.
Does the communication pass through the network module in the standby system when passing through the redundant system?	Change the routing parameter using the RTWRITE instruction so that the communication passes through the network module in the control system.
Is the version of the QCPU and network module in the target station the one shown below? · QCPU: Serial number (first five digits) of "06092" or later · Network module: Serial number (first five digits) of "06092" or later	Use the QCPU and network modules with the following version. <ul style="list-style-type: none"> • QCPU: Serial number (first five digits) of "06092" or later • Network module: Serial number (first five digits) of "06092" or later
Is the number of resends set every time an instruction is executed?	Correct the program so that the number of resends is set every time an instruction is executed.
Is the station issuing the link dedicated instruction set to offline?	<ul style="list-style-type: none"> • Set the station issuing the link dedicated instruction to online and execute the link dedicated instruction. • To check the online status with the program, use 'Mode setting of own station' (SB0043) as an interlock.

If the above action does not solve the problem, perform the communication test and self-diagnostics test to check for failure in the network configuration or module. ( Page 122 Communication Test, Page 96 Self-diagnostics test)

Modules cannot join a network

If the modules cannot join a network, check the following.

Check item	Action
Is the RUN LED of the own station turned off?	Perform troubleshooting for when the RUN LED turns off. (☞ Page 91 When the RUN LED turns off)
Is the ERR LED of the own station turned on or flashing?	Perform troubleshooting for when the ERR LED turns on or is flashing. (☞ Page 91 When the ERR LED turns on or is flashing)
Is the set station number greater than the number of connected modules?	Correct the station number so that it is within the number of connected modules.
For the RJ71LP21-25, check 'Loop usage status of each station' (SW009C to SW009F).	Correct the cable connection status of the faulty part.
For the RJ71LP21-25, is wiring performed correctly?	Check the wiring status using the loop test of the MELSECNET diagnostics.
Is any cable disconnected? Or is any cable missing?	Check and correct the overall cable connection status and system configuration. Check the status of each station and check the faulty area.
Is the link monitoring time correctly set?	Set the link monitoring time to the maximum and check if the modules can join the network.
For the RJ71LP21-25, is the transmission speed setting of the MELSECNET/H network module of all stations the same?	Match the transmission speed setting of all stations.
For the RJ71BR11, is the terminating resistor about to come loose?	Correct the terminating resistor connection status.

Point

In the optical loop system, do not reset the CPU modules of adjacent stations on the wiring at the same time. Otherwise, the modules may not join the network. When simultaneous initialization is required for adjacent stations, turn the power off and on.

When a station is disconnected from the network

The following is the action to be taken when a station in data link is disconnected.

Check item	Action
Is the ambient temperature for the module within the specified range?	Keep the ambient temperature within the specified range by taking action such as removing heat source.

If the above action does not solve the problem, perform the self-diagnostics test to check for hardware failure. (☞ Page 96 Self-diagnostics test)

When a station is repeatedly disconnected and reconnected

The following lists the actions to be taken when a station in data link is repeatedly disconnected and reconnected.

Check item	Action
Does the communication cable used conform to the standard?	Replace the communication cable with one conforming to the standard. ☞ MELSEC IQ-R MELSECNET/H Network Module User's Manual (Startup)
Does the length of the communication cable meet the specifications?	Set the length of the communication cable within range. ☞ MELSEC IQ-R MELSECNET/H Network Module User's Manual (Startup)
Does the cabling condition (bending radius) meet the specifications?	Refer to the manual for the communication cable, and correct the bending radius.
Is any cable disconnected?	Replace the cable.

If the above action does not solve the problem, perform the self-diagnostics test to check for hardware failure. (☞ Page 96 Self-diagnostics test)

Cyclic data becomes 0 when each station is reset and powered on

If the cyclic data becomes 0 when each station is reset and the power is turned on, check the following items.

Check item	Action
Is the send range latched?	Check whether the B/W device in the send range is latched by the latch setting of the CPU parameter. For the CPU parameter latch setting, refer to the following. MELSEC iQ-R Programmable Controller CPU Module User's Manual
Is the block data assurance per station of the cyclic data set?	Check whether "Block send data assurance per station" is set to "Enable". (Page 66 Supplementary Cyclic Settings)

Point

A network module may send the initial value 0 in LB/LW data, even if the B/W device in the send range of CPU parameter is latched.

Setting the send data assurance per station prevents cyclic data from being 0, since LB/LW data is sent after link refresh.

4

When communication is unstable

The following lists the actions to be taken when link scan time or transmission delay time is long or when a transient transmission timeout occurred.

Check item	Action
Is the ambient temperature for the module within the specified range?	Keep the ambient temperature within the specified range by taking action such as removing heat source.
Is the module being affected by noise?	For the RJ71BR11, consider cable laying by using double shield coaxial cables. MELSEC iQ-R MELSECNET/H Network Module User's Manual (Startup)

If the above action does not solve the problem, perform the self-diagnostics test to check for hardware failure. (Page 96 Self-diagnostics test)

When redundant system function is used

■An error occurs in a CPU module

When a redundant system is configured, if an error occurs in a CPU module, check the following items.

Check item	Action
Is pairing setting made when the redundant function module is used?	Set pairing in "Network Range Assignment" of "Required Settings". (Page 56 Network Range Assignment) When the CPU module of the control station is the Q4ARCPU, set pairing with the J.PAIRSET instruction.
Does the CPU module of the control station support the pairing setting?	Replace the CPU module with a CPU module that supports the pairing setting, and configure the setting. (Page 60 List of CPU modules available for pairing setting as a control station)

■System switching cannot be performed

When system switching cannot be performed by a system switching cause of the RJ71LP21-25, check the following.

Check item	Action
Is the power supply module, CPU module, or redundant function module of the standby system operating normally?	Perform troubleshooting on the power supply module, CPU module, or redundant function module of the standby system. MELSEC iQ-R CPU Module User's Manual (Application)
Is the cable disconnected in the standby system network module?	Check the wiring condition and put the network of the standby system in normal condition.

■Cyclic data communications are disconnected or are unstable

If cyclic data communications are disconnected or are unstable when the RJ71LP21-25 system switching occurs, check the following items.

Check item	Action
Is the station number of the network module set to "No. n" and "No. n+1" for system A and system B in the redundant system?	Correct the setting so that the station number of the network module is set to "No. n" and "No. n+1" for system A and system B in the redundant system.
Is the cyclic data communication range included in the tracking target? ( MELSEC iQ-R CPU Module User's Manual (Application))	Correct the tracking setting.

When a communication error such as a CRC error occurs frequently

The following lists the actions to be taken when a communication error such as a CRC error occurs frequently.

Check item	Action
Is the optical fiber cable or the RJ71LP21-25 faulty?	Power off all stations, then power on stations in order, starting from the control station. At this time, check which station causes an increase in the number of communication errors (such as CRC errors) in the error history monitor of MELSECNET diagnostics when the station is powered on, and identify the error location. Replace the optical fiber cable or the RJ71LP21-25 where the error occurs with new one. The examples of identifying the error locations are shown below.

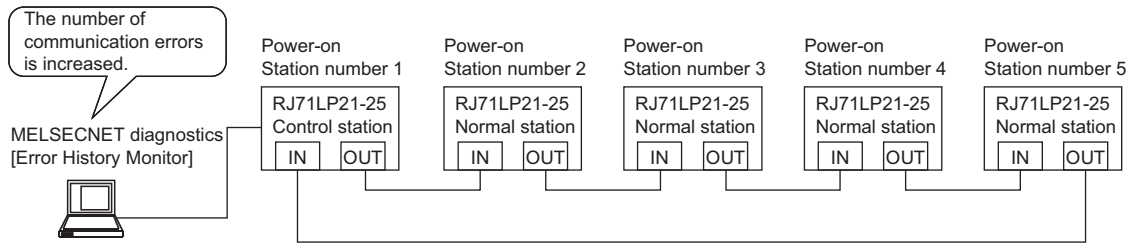

(1) Power off all stations.

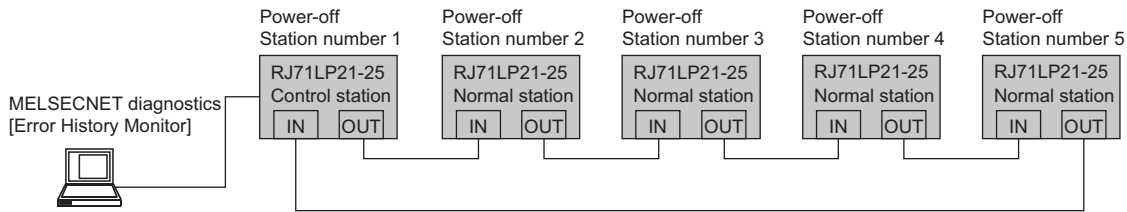

(2) Power on the control station (station No.1) and normal station (station No.2).

Check if the number of communication errors is increased during a certain time in the error history monitor of MELSECNET diagnostics.

If the number of communication errors is increased, the RJ71LP21-25 at the station number 1 or 2 is faulty or the optical fiber cable between station number 1 and 2 is faulty.

When the number of communication errors is not increased, go to step (3).

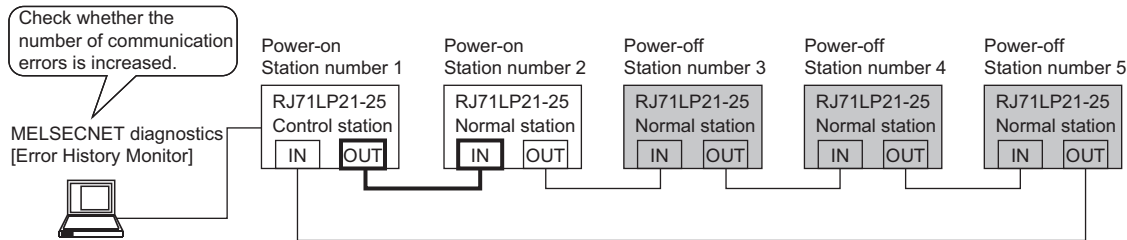

(3) Power on the normal station (station number 3).

Check if the number of communication errors is increased during a certain time in the error history monitor of MELSECNET diagnostics.

If the number of communication errors is increased, the RJ71LP21-25 at the station number 2 or 3 is faulty or the optical fiber cable between station number 2 and 3 is faulty.

When the number of communication errors is not increased, go to step (4).

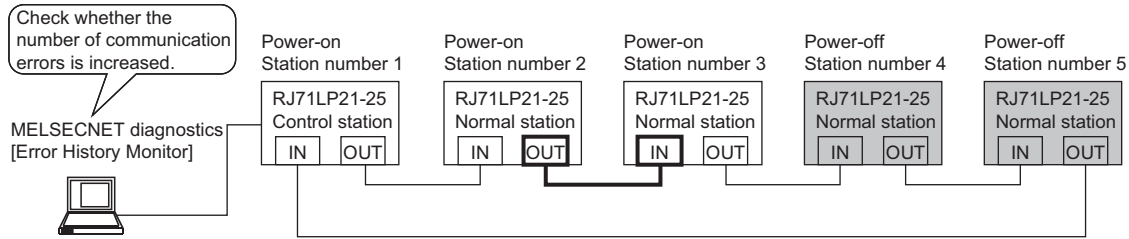

(4) Power on the normal station (station number 4).

Check if the number of communication errors is increased during a certain time in the error history monitor of MELSECNET diagnostics.

If the number of communication errors is increased, the RJ71LP21-25 at the station number 3 or 4 is faulty or the optical fiber cable between station number 3 and 4 is faulty.

When the number of communication errors is not increased, go to step (5).

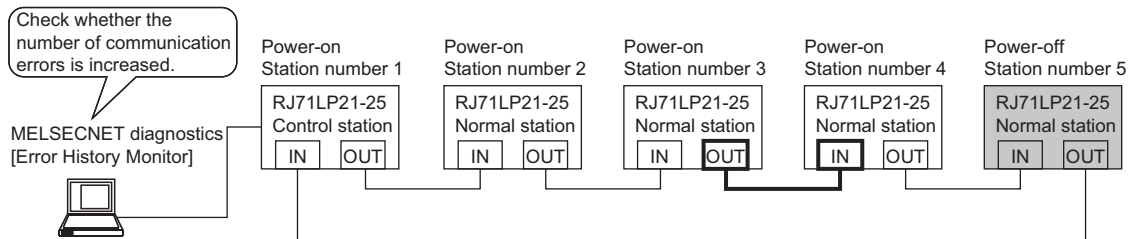

(5) Disconnect the optical fiber cable from OUT side of the end of the normal station (station number 5), then power on the station.

Check if the number of communication errors is increased during a certain time in the error history monitor of MELSECNET diagnostics.

If the number of communication errors is increased, the RJ71LP21-25 at the station number 4 or 5 is faulty or the optical fiber cable between station number 4 and 5 is faulty.

When the number of communication errors is not increased, go to step (6).

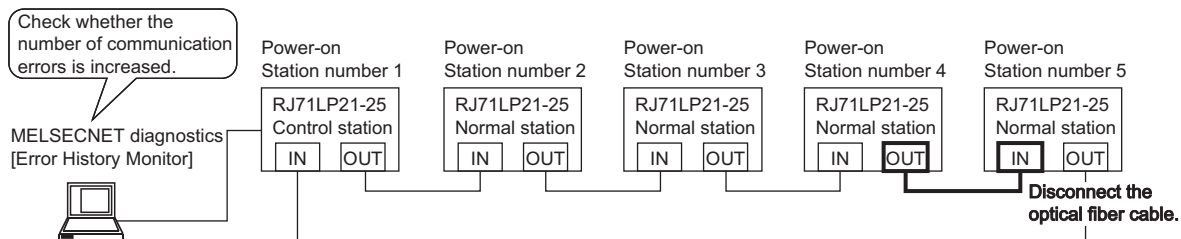

(6) Connect the optical fiber cable to OUT side of the end of the normal station (station number 5).

Check if the number of communication errors is increased during a certain time in the error history monitor of MELSECNET diagnostics.

If the number of communication errors is increased, the RJ71LP21-25 at the station number 5 or 1 is faulty or the optical fiber cable between station number 5 and 1 is faulty.

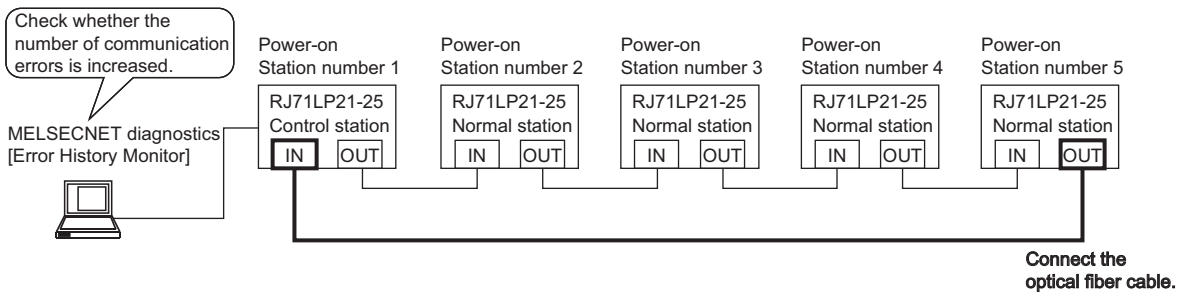

4.5 List of Error Codes

This section lists the error codes, error details and causes, and action for the errors occur in the processing for data communication between the MELSECNET/H network module and external devices or caused by processing requests from the CPU module on the own station.

Error codes are classified into major error, moderate error, and minor error, and can be checked in the [Error Information] tab of the "Module Diagnostics" window of the MELSECNET/H network module. ( Page 93 Checking the Module Status)

Error code	Error details and causes	Action	Detailed Information
1811H	An error was detected in the CPU module.	Check the error of the CPU module and take action using the module diagnostics of the engineering tool.	—
1812H	The module is installed in a CPU module that does not support the MELSEC iQ-R MELSECNET/H network module.	Check the version of the CPU module and use a product supporting the MELSEC iQ-R MELSECNET/H network module.	—
1830H	Number of reception requests of transient transmission (link dedicated instruction) exceeded upper limit of simultaneously processable requests.	Lower the transient transmission usage frequency, and then retry the operation.	—
1845H	Too many processings of transient transmission (link dedicated instruction) and cannot perform transient transmission.	Correct the transient transmission execution count.	—
1860H	Baton pass stops with an error of communication line or MELSECNET/H network module.	<ul style="list-style-type: none"> Check the network status using the MELSECNET diagnostics of the engineering tool. If the error occurs again even after taking the above, please consult your local Mitsubishi representative. 	—
20E0H	The module cannot communicate with the CPU module.	The hardware failure of the CPU module may have been occurred. Please consult your local Mitsubishi representative.	—
2220H	The parameter setting is corrupted.	Check the detailed information of the error by executing module diagnostics using the engineering tool, and write the displayed parameter. If the error occurs again even after taking the above, the possible cause is a hardware failure of the module. Please consult your local Mitsubishi representative.	Parameter information <ul style="list-style-type: none"> Parameter type
2221H	<ul style="list-style-type: none"> The set value is out of the range. The network type of the own station is inconsistent with that of the control station. 	<ul style="list-style-type: none"> Check the detailed information of the error by executing module diagnostics using the engineering tool, and correct the parameter setting corresponding to the displayed number. Change the network type of the normal station to the one set for the control station. 	Parameter information <ul style="list-style-type: none"> Parameter type I/O No. Parameter No. Network No. Station No.
24C0H to 24C3H	An error was detected on the system bus.	<ul style="list-style-type: none"> Take measures to reduce noise. After the CPU module is reset, switch to RUN. If the error occurs again even after taking the above, the possible cause is a hardware failure of the module, base unit, or extension cable. Please consult your local Mitsubishi representative. 	System configuration information <ul style="list-style-type: none"> I/O No. Base No. Slot No. CPU No.
24C6H	An error was detected on the system bus.	<ul style="list-style-type: none"> Take measures to reduce noise. After the CPU module is reset, switch to RUN. If the error occurs again even after taking the above, the possible cause is a hardware failure of the module, base unit, or extension cable. Please consult your local Mitsubishi representative. 	—
3001H	<ul style="list-style-type: none"> A station with the same station number was found in the same network. Multiple control stations were detected in the same network. 	Correct the station number or station type of the station where the error was detected. After taking the above actions, power off and on or reset all stations where the error was detected.	■Parameter information <ul style="list-style-type: none"> Parameter type I/O No. Parameter No. ■Duplication type information <ul style="list-style-type: none"> 0: Station duplication 1: Master station duplication

Error code	Error details and causes	Action	Detailed Information
3006H	Pairing is not set to the stations in a redundant system.	Check the pairing setting in "Network Range Assignment" of "Required Settings" of the control station.	Parameter information • Parameter type • I/O No. • Parameter No. • Network No. • Station No.
3007H	Pairing is set to the stations not included in a redundant system.	Check the pairing setting in "Network Range Assignment" of "Required Settings" of the control station.	Parameter information • Parameter type • I/O No. • Parameter No. • Network No. • Station No.
3008H	"RJ71LP21-25" is selected for the module name in a redundant system.	When using the module in a redundant system, select "RJ71LP21-25(R)" for the module model name in the "Add New Module" window.	Parameter information • Parameter type • I/O No. • Parameter No. • Network No. • Station No.
	"RJ71LP21-25(R)" is selected for the module name in a system other than a redundant system.	When using the module in a system other than a redundant system, select "RJ71LP21-25" for the module model name in the "Add New Module" window.	
3040H	Response data of the dedicated instruction cannot be created.	<ul style="list-style-type: none"> • Increase the request interval. • Decrease the number of request stations. • Wait for a response to the previous request before sending the next request. • Correct the timeout value. 	—
3C00H to 3C02H	A hardware failure has been detected.	<ul style="list-style-type: none"> • Take measures to reduce noise. • After the CPU module is reset, switch to RUN. If the error occurs again even after taking the above, the possible cause is a hardware failure of the module, base unit, or extension cable. Please consult your local Mitsubishi representative. 	—
3C0FH	A hardware failure has been detected.	<ul style="list-style-type: none"> • Take measures to reduce noise. • After the CPU module is reset, switch to RUN. If the error occurs again even after taking the above, the possible cause is a hardware failure of the module, base unit, or extension cable. Please consult your local Mitsubishi representative. 	—
3C10H	A hardware failure has been detected.	<ul style="list-style-type: none"> • Take measures to reduce noise. • After the CPU module is reset, switch to RUN. If the error occurs again even after taking the above, the possible cause is a hardware failure of the module, base unit, or extension cable. Please consult your local Mitsubishi representative. 	—
3C14H	A hardware failure has been detected.	After the CPU module is reset, switch to RUN. If the error occurs again even after taking the above, the possible cause is a hardware failure of the error module or CPU module. Please consult your local Mitsubishi representative.	—
3C2FH	An error was detected in the memory.	After the CPU module is reset, switch to RUN. If the error occurs again even after taking the above, the possible cause is a hardware failure of the error module. Please consult your local Mitsubishi representative.	—
3E00H	An error was detected in the network module.	After the CPU module is reset, switch to RUN. If the error occurs again even after taking the above, the possible cause is a hardware failure of the error module. Please consult your local Mitsubishi representative.	—
3E01H	Network type of the own station is unexpected setting.	Rewrite the module parameter using the engineering tool. If the error occurs again even after taking the above, the possible cause is a hardware failure of the error module. Please consult your local Mitsubishi representative.	—
F007H to F008H	An error was detected in the network module.	Please consult your local Mitsubishi representative.	—
F013H	The network parameter setting is incorrect.	<ul style="list-style-type: none"> • Correct the network parameter setting and write data to the programmable controller. • If the error occurs again even after taking the above, please consult your local Mitsubishi representative. 	—
F101H to F102H	The network is booting.	Wait until 'Baton pass error status of own station' (SB0047) and 'Data link error status of own station' (SB0049) go back to normal.	—
F103H	Online test is being executed.	Wait until 'Baton pass error status of own station' (SB0047) and 'Data link error status of own station' (SB0049) go back to normal.	—

Error code	Error details and causes	Action	Detailed Information
F104H	The control station and sub-control station are under transition.	Wait until 'Baton pass error status of own station' (SB0047) and 'Data link error status of own station' (SB0049) go back to normal.	—
F105H ¹	Parameter processing is being performed.	Wait until 'Baton pass error status of own station' (SB0047) and 'Data link error status of own station' (SB0049) go back to normal.	—
F106H	The control station went down.	Check the power supply status, cable failure, disconnection, connector connection failure, wiring error, and control station CPU status of the control station.	—
F107H	A baton has disappeared in baton pass.	<ul style="list-style-type: none"> • Check the line status for cable failure and check for the presence of a power-off station. • If transient transmission is performed frequently and the link scan time sometimes exceeds 200ms, adjust "Supplementary Cyclic Settings" in "Application Settings" to reduce the link scan time. 	—
F108H	A baton has been duplicated in baton pass.	<ul style="list-style-type: none"> • Check the station number duplication and control station duplication by the setting check test using the MELSECNET diagnostics of the engineering tool. • If the setting check test cannot be performed, check the data link faulty station in "Data-Link Status of each Station" under "Other Station Information" of the MELSECNET diagnostics and check the station number setting and parameters of the faulty station. • Check for cable failure, disconnection, connector connection failure, and wiring error. 	—
F109H	Online test is being executed.	Wait until 'Baton pass error status of own station' (SB0047) and 'Data link error status of own station' (SB0049) go back to normal.	—
F10AH	Online test or offline loop test is being executed.	<ul style="list-style-type: none"> • When online test is being executed, wait until 'Baton pass error status of own station' (SB0047) and 'Data link error status of own station' (SB0049) go back to normal. • When offline test is being executed, change "Module Operation Mode" under "Application Settings" to "Online" after the test is completed. 	—
F10BH	The station number of the own station is already used for another station.	Correct the station number setting. Check the duplicated station number by the setting check test using the MELSECNET diagnostics of the engineering tool.	—
F10CH	There is a control station other than the own station in the network.	Correct the control station setting. Check the duplicated control station by the setting check test using the MELSECNET diagnostics of the engineering tool.	—
F10DH	The mode setting is set to offline.	Correct the setting of "Module Operation Mode" under "Application Settings" to "Online".	—
F10EH	Reception has failed consecutively.	<ul style="list-style-type: none"> • Check for cable failure, hardware failure, wiring error, station number duplication, control station duplication, and mismatched transmission speed in the same network. • Check for an error by the setting check test and loop test performed from the MELSECNET diagnostics of the engineering tool. 	—
F10FH	Send operation has failed consecutively.	<ul style="list-style-type: none"> • Check for cable failure, hardware failure, wiring error, station number duplication, control station duplication, and mismatched transmission speed in the same network. • Check for an error by the setting check test and loop test performed from the MELSECNET diagnostics of the engineering tool. 	—
F110H	Timeout error has occurred consecutively.	<ul style="list-style-type: none"> • Check for cable failure, hardware failure, wiring error, station number duplication, control station duplication, and mismatched transmission speed in the same network. • Check for an error by the setting check test and loop test performed from the MELSECNET diagnostics of the engineering tool. 	—
F111H	No baton pass is performed by the target station.	<ul style="list-style-type: none"> • Correct the target station status. • Correct the relay station status if the instruction is sent to another network. • Correct the module parameter. (Check if a parameter error has occurred or if the target station is correctly set in the control station.) • Check the power supply status of the target station. (Check if the power-on and off is repeated.) • Check for cable failure, hardware failure, wiring error, station number duplication, control station duplication, and mismatched transmission speed in the same network. • Check for an error by the setting check test and loop test performed from the MELSECNET diagnostics of the engineering tool. 	—

Error code	Error details and causes	Action	Detailed Information
F112H	The loop status is faulty.	<ul style="list-style-type: none"> • Check for cable failure, hardware failure, wiring error, station number duplication, control station duplication, and mismatched transmission speed in the same network. • Check the power supply status of each module. (Check if the power-on and off is repeated.) • Check whether the network module of the MELSECNET/H mode is mixed with that of the MELSECNET/10 mode. (Check the control station type.) 	—
F113H	No baton pass is performed by the own station or relay station.	<ul style="list-style-type: none"> • Retry the operation later. If the error cannot be eliminated after a retry, check for cable failure, hardware failure, wiring error, station number duplication, control station duplication, and mismatched transmission speed in the same network. • Check if a parameter error has occurred or if the target station is correctly set in the control station. • Wait until 'Baton pass error status of own station' (SB0047) and 'Data link error status of own station' (SB0049) of own station or relay station go back to normal. 	—
F114H	Send operation has failed.	<ul style="list-style-type: none"> • Retry the operation later. If the error cannot be eliminated after a retry, check for cable failure, hardware failure, wiring error, station number duplication, control station duplication, and mismatched transmission speed in the same network. • Check if a parameter error has occurred or if the target station is correctly set in the control station. • Wait until 'Baton pass error status of own station' (SB0047) and 'Data link error status of own station' (SB0049) go back to normal. 	—
F115H	The send packet data specification is incorrect.	<ul style="list-style-type: none"> • Check for cable failure, hardware failure, wiring error, station number duplication, control station duplication, and mismatched transmission speed in the same network. • If this error occurs during online test, check if offline test or online test is also executed in another station. 	—
F116H	Online test is not performed normally.	Check for cable failure, hardware failure, wiring error, station number duplication, control station duplication, and mismatched transmission speed in the same network.	—
F117H	Send operation has failed in online test.	Check for cable failure, hardware failure, noise, and wiring error.	—
F118H	Send operation has been interrupted.	Wait until 'Baton pass error status of own station' (SB0047) and 'Data link error status of own station' (SB0049) go back to normal.	—
F11AH	Send operation has failed because a loop error has occurred during send operation.	Retry the operation later.	—
F11BH	There is no normal station other than the own station in the network.	<ul style="list-style-type: none"> • Correct the module parameter of the control station. (Check if a parameter error has occurred or if the target station is correctly set in the control station.) • Check for cable failure, hardware failure, noise, wiring error, station number duplication, control station duplication, and mismatched transmission speed in the same network. 	—
F11CH	The hardware of the network module has failed.	Please consult your local Mitsubishi representative.	—
F11FH	No baton to the own station is detected.	<ul style="list-style-type: none"> • Check for the operating status of the control station/sub-control station, cable failure, wiring error, station number duplication, control station duplication, and mismatched transmission speed in the same network. • Check whether the network module of the MELSECNET/H mode is mixed with that of the MELSECNET/10 mode. (Check the control station type.) 	—
F120H	The sending station is incorrectly specified.	Check for cable failure, hardware failure, wiring error, station number duplication, control station duplication, and mismatched transmission speed in the same network.	—
F122H	The coaxial cable is not connected.	Check for coaxial cable connection, connector connection failure, terminating resistor connection, and cable failure.	—
F172H	An error was detected in the network module.	Please consult your local Mitsubishi representative.	—
F179H	Cable failure or network module error is detected.	<ul style="list-style-type: none"> • If a communication error occurs, correct the communication cable. • If no communication error has occurred, the error is caused by hardware failure. Please consult your local Mitsubishi representative. 	—

Error code	Error details and causes	Action	Detailed Information
F17BH	An error was detected in the network module.	Please consult your local Mitsubishi representative.	—
F200H	An error was detected in the network module.	Please consult your local Mitsubishi representative.	—
F201H	The same transient data have been received two times or more.	Check the network status using the MELSECNET diagnostics of the engineering tool, and retry the operation. Although the error occurs, the second or later received transient data is discarded in the module.	—
F202H	Cable failure or network module error is detected.	<ul style="list-style-type: none"> • If a communication error occurs, correct the communication cable. • If no communication error has occurred, the error is caused by hardware failure. Please consult your local Mitsubishi representative. 	—
F203H	The send buffer is full.	<ul style="list-style-type: none"> • Pause the transient transmission temporarily, and retry the operation. • Lower the transient transmission usage frequency, and then retry the operation. • Use the COM instruction or "Device/Label Access Service Processing Setting" in "Service Processing Setting" using the CPU parameter to increase the frequency of transient transmission. If the error occurs again even after taking the above, please consult your local Mitsubishi representative.	—
F204H	The specified number of resends has been reached.	Check the network status using the MELSECNET diagnostics of the engineering tool.	—
F207H	Although the target station of transient transmission is connected in the same network, different network number is set.	Correct "Network No." in "Required Settings". When the parameter is not set, network number is set to 1 (default). Correct the network number of the other station.	—
F209H	The transient transmission data is incorrect.	Correct the transient transmission data.	—
F20CH	The transient transmission data is incorrect.	Correct the transient transmission data.	—
F210H	The transient transmission data is incorrect.	Correct the transient transmission data.	—
F211H	There is no control station when "Specified Control Station" is specified for the target station of transient transmission.	<ul style="list-style-type: none"> • Correct the target station number at the own station, and retry the operation. • If the error occurs again even after taking the above, please consult your local Mitsubishi representative. 	—
F212H	There is no control station when "Present Control Station" is specified for the target station of transient transmission.	<ul style="list-style-type: none"> • Correct the target station number at the own station, and retry the operation. • If the error occurs again even after taking the above, please consult your local Mitsubishi representative. 	—
F213H	Timeout has occurred in the state of waiting for the completion of send operation.	<ul style="list-style-type: none"> • Wait until 'Baton pass error status of own station' (SB0047) and 'Data link error status of own station' (SB0049) go back to normal. • Check for cable failure, hardware failure, wiring error, station number duplication, control station duplication, and mismatched transmission speed in the same network. • Check the network status using the MELSECNET diagnostics of the engineering tool. • If the error occurs again even after taking the above, please consult your local Mitsubishi representative. 	—
F216H	A command indicating that group/global specification cannot be performed is received.	<ul style="list-style-type: none"> • Correct the SLMP command. • If the error occurs again even after taking the above, please consult your local Mitsubishi representative. 	—
F217H	A command indicating that specification to another station cannot be performed is received.	<ul style="list-style-type: none"> • Correct the SLMP command. • If the error occurs again even after taking the above, please consult your local Mitsubishi representative. 	—
F218H	A command indicating that specification to the own station cannot be performed is received.	<ul style="list-style-type: none"> • Correct the SLMP command. • If the error occurs again even after taking the above, please consult your local Mitsubishi representative. 	—
F219H to F21AH	An error was detected in the network module.	Please consult your local Mitsubishi representative.	—
F21CH	The number of reception requests of transient transmission (link dedicated instruction) exceeds the upper limit of simultaneously processable requests.	<ul style="list-style-type: none"> • Lower the transient transmission usage frequency, and then retry the operation. • If the error occurs again even after taking the above, please consult your local Mitsubishi representative. 	—

Error code	Error details and causes	Action	Detailed Information
F21DH	An invalid value is received for the clear type.	<ul style="list-style-type: none"> Correct the SLMP command. If the error occurs again even after taking the above, please consult your local Mitsubishi representative. 	—
F21EH	A command that is not supported is received.	<ul style="list-style-type: none"> Correct the SLMP command. If the error occurs again even after taking the above, please consult your local Mitsubishi representative. 	—
F220H to F221H	The hardware of the network module has failed.	Please consult your local Mitsubishi representative.	—
F222H	The maximum number of the receive buffer is used.	<ul style="list-style-type: none"> Retry the operation later. If the error cannot be eliminated after a retry, correct the number of transient transmission and the communication interval of the entire system. Turn off and on the power of the entire system. 	—
F223H	Invalid data is received.	<ul style="list-style-type: none"> Correct the SLMP command. Check if C24 connection or CC-Link connection is specified for access to other stations. If the error occurs again even after taking the above, please consult your local Mitsubishi representative. 	—
F224H	A receive data size error has detected. The hardware of the module from which the transient transmission was started may have failed. Please consult your local Mitsubishi representative.	Please consult your local Mitsubishi representative.	—
F225H	The logical channel number error has detected. The hardware of the module from which the transient transmission was started may have failed.	Please consult your local Mitsubishi representative.	—
F226H	The logical channel number of the SEND instruction is incorrectly set.	<ul style="list-style-type: none"> Check whether the logical channel number of the target network module is set to the target station storage channel (logical channel number) of the control data at the start of the SEND instruction. Specify the logical channel number that is set for the target network module. 	—
F228H	The control data of the SEND instruction is incorrectly set.	Correct the target network number and target station number of the control data at the start of the SEND instruction.	—
F258H	The network number specified for the dedicated instruction is out of range.	<ul style="list-style-type: none"> Execute the instruction again after correcting the target network number in the control data. If the error occurs again even after taking the above, please consult your local Mitsubishi representative. 	—
F268H	In the execution/abnormal completion type specification which was set at the execution of the dedicated instruction, the bit in the area fixed to 0 is turned on.	<ul style="list-style-type: none"> Execute the instruction again after correcting the execution/abnormal completion type in the control data. If the error occurs again even after taking the above, please consult your local Mitsubishi representative. 	—
F301H ¹	The hardware of the network module has failed.	Please consult your local Mitsubishi representative.	—
F701H to F702H	When the dedicated instruction is executed, the target station number setting is not correct.	<ul style="list-style-type: none"> Execute the instruction again after correcting the target station number in the control data. If the error occurs again even after taking the above, please consult your local Mitsubishi representative. 	—
F703H	The send destination group number is incorrectly set.	<ul style="list-style-type: none"> Correct the send destination group number. If the error occurs again even after taking the above, please consult your local Mitsubishi representative. 	—
F704H	Invalid data is received.	<ul style="list-style-type: none"> Correct the SEND instruction. If the error occurs again even after taking the above, please consult your local Mitsubishi representative. 	—
F705H	The send destination CPU is incorrectly set.	<ul style="list-style-type: none"> Correct the send destination CPU. If the error occurs again even after taking the above, please consult your local Mitsubishi representative. 	—
F706H	A receive data size error has detected. Cable failure or network module error may have occurred.	<ul style="list-style-type: none"> If a communication error occurs, correct the communication cable. If no communication error has occurred, the error is caused by hardware failure. Please consult your local Mitsubishi representative. 	—
F707H ¹	In transient transmission, the number of relay to other networks exceeded seven.	<ul style="list-style-type: none"> Change the system configuration so that the number of relay stations may be seven or less. Check if "Routing Setting" in "CPU Parameter" is correctly set. 	—

Error code	Error details and causes	Action	Detailed Information
F708H	When the dedicated instruction is executed, the target group number setting is out of range.	<ul style="list-style-type: none"> Execute the instruction again after correcting the target group number in the control data. If the error occurs again even after taking the above, please consult your local Mitsubishi representative. 	—
F709H	The network number specified for the dedicated instruction is out of range.	<ul style="list-style-type: none"> Execute the instruction again after correcting the target network number in the control data. If the error occurs again even after taking the above, please consult your local Mitsubishi representative. 	—
F70AH	Cable failure or network module error is detected.	<ul style="list-style-type: none"> If a communication error occurs, correct the communication cable. If no communication error has occurred, the error is caused by hardware failure. Please consult your local Mitsubishi representative. 	—
F70BH ^{*1}	No response has been returned after send operation.	Wait until 'Baton pass error status of own station' (SB0047) and 'Data link error status of own station' (SB0049) go back to normal.	—
F70CH ^{*1}	Cable failure or network module hardware failure has occurred.	<ul style="list-style-type: none"> If a communication error occurs, correct the communication cable. If no communication error has occurred, the error is caused by hardware failure. Please consult your local Mitsubishi representative. 	—
F70EH ^{*1}	Cable failure or network module hardware failure has occurred.	<ul style="list-style-type: none"> If a communication error occurs, correct the communication cable. If no communication error has occurred, the error is caused by hardware failure. Please consult your local Mitsubishi representative. 	—
F710H to F712H	An error was detected in the network module.	Please consult your local Mitsubishi representative.	—
F781H	The target network number specified for transient transmission is out of range.	<ul style="list-style-type: none"> Correct the target network number at the own station, and retry the operation. If the error occurs again even after taking the above, please consult your local Mitsubishi representative. 	—
F782H	The target station number specified for transient transmission is out of range.	<ul style="list-style-type: none"> Correct the target station number at the own station, and retry the operation. If the error occurs again even after taking the above, please consult your local Mitsubishi representative. 	—
F783H	The request data size of transient transmission is out of range.	<ul style="list-style-type: none"> Correct the request command at the request source, and retry the operation. If the error occurs again even after taking the above, please consult your local Mitsubishi representative. 	—
F7C1H	The channel used at the own station is used by another instruction.	<ul style="list-style-type: none"> Change the channel number or retry the instruction after a while. Check the channel interlock. Change the channels used by own station or the target station storage channel in the control data. 	—
F7C2H	The target station storage channel is used by another instruction.	<ul style="list-style-type: none"> Retry the SEND instruction after a while. Check whether the target station has executed the instruction by using the target channel or the RECV processing has been executed. Check whether a station other than the own station has executed the SEND instruction for the target channel of the target station. 	—
F7C3H	The instruction was not completed within the arrival monitoring time.	<ul style="list-style-type: none"> If this error occurs at the ZNRD/ZNWR instruction execution, check whether the version of the CPU module of another station being accessed is AY (manufactured in July 1995) or later when the module is A2UCPU(S1), A3UCPU, or A4UCPU, or is CP (manufactured in July 1995) or later when the module is A2ASCPU(S1). If this error occurs at the RECV instruction execution and another station is executing the SEND instruction, specify a large value for the arrival monitoring time. Or, activate the RECV instruction by turning on the RECV execution request flag. If this error occurs at an instruction execution other than the RECV instruction, specify a large value for the arrival monitoring time, or check the target station operating status, network status, and relay station status (if the instruction is sent to another network). If this error occurs at the RRUN/RSTOP/RTMRD/RTMWR instruction execution and the CPU module of another station being accessed is QnACPU, change the instruction to the REQ instruction supporting QnACPU. When the dynamic routing function is used, check if communication to the target network number is possible using the MELSECNET diagnostics communication test. Check that the data length is within the range of the size that can be used for the CPU module of another station being accessed. <p>If the error occurs again even after taking the above, please consult your local Mitsubishi representative.</p>	—

Error code	Error details and causes	Action	Detailed Information
F7C4H	The instruction is not completed although the number of resends is reached.	<ul style="list-style-type: none"> • Increase the value of the arrival monitoring time. • Check the target station operating status, network status, and relay station status (if the instruction is sent to another network). • If this error occurs at the ZNRD/ZNWR instruction execution, check whether the CPU module of another station being accessed is the A2UCPU(S1), A3UCPU, A2ASCPU(S1), or A4UCPU. In that case, check that the version of the A2UCPU(S1), A3UCPU, or A4UCPU is AY (manufactured in July 1995) or later, or the version of the A2ASCPU(S1) is CP (manufactured in July 1995) or later. • If this error occurs at the RRUN/RSTOP/RTMRD/RTMWR instruction execution and the CPU module of another station being accessed is QnACPU, change the instruction to the REQ instruction supporting QnACPU. • Check that the data length is within the range of the size that can be used for the CPU module of another station being accessed. • If the request destination is another network, check if the CPU module of the relay station supports the routing setting, and take an action. <p>If the error occurs again even after taking the above, please consult your local Mitsubishi representative.</p>	—
F7C5H ¹	The target network number or target station number for the control data of the send/receive instruction is incorrectly set.	Correct the target network number or target station number for the control data of the send/receive instruction.	—
F7C6H	The channel number for the own station or target station is incorrectly set.	<ul style="list-style-type: none"> • Correct the channel number of the own station and target station in the control data. • If the error occurs again even after taking the above, please consult your local Mitsubishi representative. 	—
F7C7H	The target station number is incorrectly set.	<ul style="list-style-type: none"> • Specify a station number other than that of the own station for the target station number in the control data. • If the error occurs again even after taking the above, please consult your local Mitsubishi representative. 	—
F7C8H	The execution type is incorrectly set.	<ul style="list-style-type: none"> • If the execution/abnormal completion type in the control data is set to all stations specification or group specification, set the execution type to "No arrival acknowledgment". • If the error occurs again even after taking the above, please consult your local Mitsubishi representative. 	—
F7C9H	The number of resends is incorrectly set.	<ul style="list-style-type: none"> • Correct the number of resends in the control data. • If the error occurs again even after taking the above, please consult your local Mitsubishi representative. 	—
F7CAH	The arrival monitoring time is incorrectly set.	<ul style="list-style-type: none"> • Correct the arrival monitoring time in the control data. • If the error occurs again even after taking the above, please consult your local Mitsubishi representative. 	—
F7CBH	The send data length is incorrectly set.	<ul style="list-style-type: none"> • Correct the send data length in the control data. • If the error occurs again even after taking the above, please consult your local Mitsubishi representative. 	—
F7CDH	An error was detected in the network module.	Please consult your local Mitsubishi representative.	—
F7CEH	The same instruction is being executed.	<ul style="list-style-type: none"> • Retry the instruction after a while. • Check the instruction interlock. 	—
F7E1H	The control data is incorrectly set.	<ul style="list-style-type: none"> • Correct the setting value in the control data. • If the error occurs again even after taking the above, please consult your local Mitsubishi representative. 	—
F7E2H ¹	The hardware of the network module has failed.	Please consult your local Mitsubishi representative.	—
F7E3H	<ul style="list-style-type: none"> • An error was detected in the network module. • The device specified for the ZNRD/ZNWR instruction is incorrect. 	<ul style="list-style-type: none"> • Execute the instruction again after checking the setting data. • If the error occurs again even after taking the above, please consult your local Mitsubishi representative. 	—
F7E4H	The target CPU does not support the instruction.	<ul style="list-style-type: none"> • Check if the target station CPU type specified by the control data is out of range. • If the error occurs again even after taking the above, please consult your local Mitsubishi representative. 	—
F7E5H ¹	Send operation has failed.	<ul style="list-style-type: none"> • Retry the REMFR/REMTO instruction after a while. • Check the target station operating status and network status. If the instruction is sent to another network, check the relay station status. 	—

Error code	Error details and causes	Action	Detailed Information
F7E7H ¹	The buffer memory address is incorrectly set.	Check if the buffer memory address specified by the REMFR/REMTO instruction exceeds 8000H.	—
F7E8H ¹	The target network does not support the instruction.	Check if the PLC to PLC network is set by the network number specified by the REMFR/REMTO instruction.	—
F7E9H ¹	The REMFR/REMTO instruction was executed during disconnection.	Check if the own station is performing data link when the REMFR/REMTO instruction is executed.	—
F7EAH	The SEND instruction was received from other network.	<ul style="list-style-type: none"> Change the target station at the station that executed the SEND instruction. If the error occurs again even after taking the above, please consult your local Mitsubishi representative. 	—
F7EBH	When there was no control station on the network, the dedicated instruction was executed specifying the specified control station or current control station.	<ul style="list-style-type: none"> Execute the instruction again after correcting the target station number in the control data. If the error occurs again even after taking the above, please consult your local Mitsubishi representative. 	—
F7ECH	The channel specified is being used for event parameters.	<ul style="list-style-type: none"> Execute the instruction again after correcting the channel used by own station in the control data. Execute the instruction again after correcting the channel used in "Interrupt Settings" of "Application Setting". If the error occurs again even after taking the above, please consult your local Mitsubishi representative. 	—
F800H ¹	The mode switch is incorrectly set.	<ul style="list-style-type: none"> Check the mode switch setting. If the error still occurs after re-setting, the hardware has failed. Please consult your local Mitsubishi representative. 	—
F801H ¹	The network number in the parameter is incorrectly set.	<ul style="list-style-type: none"> Correct the network parameter setting and write data to the programmable controller. If the error occurs again, the error is the hardware failure of the CPU module or network module. Please consult your local Mitsubishi representative. 	—
F802H ¹	The group number in the parameter is incorrectly set.	<ul style="list-style-type: none"> Correct the network parameter setting and write data to the programmable controller. If the error occurs again, the error is the hardware failure of the CPU module or network module. Please consult your local Mitsubishi representative. 	—
F803H ¹	The station number is incorrectly set.	<ul style="list-style-type: none"> Check if the station number is set within 1 to 64. If the error still occurs after re-setting, the hardware has failed. Please consult your local Mitsubishi representative. 	—
F804H ¹	The DIP switch in the parameter is incorrectly set.	<ul style="list-style-type: none"> Correct the network parameter setting and write data to the programmable controller. If the error occurs again, the error is the hardware failure of the CPU module or network module. Please consult your local Mitsubishi representative. 	—
F805H ¹	The hardware of the network module has failed.	Please consult your local Mitsubishi representative.	—
F806H ¹	The hardware of the CPU module or network module has failed.	Please consult your local Mitsubishi representative.	—
F808H ¹	The hardware of the network module has failed.	Please consult your local Mitsubishi representative.	—
F80AH to F80FH ¹	The hardware of the network module has failed.	Please consult your local Mitsubishi representative.	—
F811H to F812H ¹	The hardware of the network module has failed.	Please consult your local Mitsubishi representative.	—
F813H ¹	The common parameter and unique parameter are faulty.	<ul style="list-style-type: none"> Replace the network module of the control station or normal station to the one supporting the MELSECNET/H extended mode. Change the network type of the normal station to the one set for the control station. Correct the network parameter setting and write data to the programmable controller. If the error occurs again, the error is the hardware failure of the CPU module or network module. Please consult your local Mitsubishi representative. 	—

Error code	Error details and causes	Action	Detailed Information
F814H ¹	The common parameter and unique parameter are faulty.	<ul style="list-style-type: none"> Correct the network parameter setting and write data to the programmable controller. If the error occurs again, the error is the hardware failure of the CPU module or network module. Please consult your local Mitsubishi representative. 	—
F820H	The network parameter is faulty.	<ul style="list-style-type: none"> Replace the network module of the normal station to the one supporting the MELSECNET/H extended mode. Change the network type of the normal station to the one set for the control station. Correct the network parameter setting and write data to the programmable controller. If the error occurs again, the error is the hardware failure of the CPU module or network module. Please consult your local Mitsubishi representative. 	—
F821H	The unique parameter is faulty.	<ul style="list-style-type: none"> Correct the unique parameter for each station. If the error occurs again, the error is the hardware failure of the CPU module or network module. Please consult your local Mitsubishi representative. 	—
F822H ¹	The hardware of the CPU module or network module has failed.	Please consult your local Mitsubishi representative.	—
F823H ¹	The common parameter is inconsistent with the unique parameter.	<ul style="list-style-type: none"> Set the own station send range so that the common parameter \geq unique parameter of each station. If there is no parameter unique to the station, the error is the hardware failure of the CPU module or network module. Please consult your local Mitsubishi representative. 	—
F825H	The hardware of the CPU module or network module has failed.	Please consult your local Mitsubishi representative.	—
F826H	The parameter of the own station is inconsistent with that of the control station.	<ul style="list-style-type: none"> Change the module parameter setting to the one set for the sub-control station. Or, activate the own station as a control station. If the error occurs again, the error is the hardware failure of the CPU module or network module. Please consult your local Mitsubishi representative. 	—
F828H	"Control Station Shift Setting" under "Supplementary Cyclic Settings" in "Application Settings" is not set to "Set".	Set "Control Station Shift Setting" under "Supplementary Cyclic Settings" in "Application Settings" to "Set".	—
F829H	Pairing is not set to the stations equipped with a redundant CPU. Or, pairing is set to the stations without a redundant CPU.	For the station equipped with a redundant system, set "Network Range Assignment" of "Required Settings" to "Enable".	—
F82AH F82BH ¹	The network type of the own station is inconsistent with that of the control station.	Change the network type of the normal station to the one set for the control station.	—
F830H ¹ F831H	The hardware of the CPU module or network module has failed.	Please consult your local Mitsubishi representative.	—
F832H	Data link could not be activated because there are multiple data link stop instructions.	<ul style="list-style-type: none"> If the data link stop is performed for the station by all stations specification, activate the data link by setting all stations specification. If the data link stop is performed for the station by station specification, activate the data link by setting station specification from the data link stop station or forcibly activate the station. 	—
F833H	Link startup is executed from the station that is different from the one that stopped cyclic transmission.	Activate the data link from the station that stopped the data link. Or, forcibly start the data link.	—
F834H to F835H ¹	Cable failure or network module hardware failure has occurred.	<ul style="list-style-type: none"> If a communication error occurs, correct the communication cable. If no communication error has occurred, the error is caused by hardware failure. Please consult your local Mitsubishi representative. 	—
F836H	Cable failure or network module hardware failure has occurred.	<ul style="list-style-type: none"> If a communication error occurs, correct the communication cable. If no communication error has occurred, the error is caused by hardware failure. Please consult your local Mitsubishi representative. 	—
F837H to F838H	Although start or stop of cyclic transmission was requested, no response is received.	Check the control station status to see if reset or error has occurred during transmission.	—

Error code	Error details and causes	Action	Detailed Information
F839H	The network parameter is not registered.	Check if the control station exists. If the control station exists, correct the network parameter setting and write data to the programmable controller. If the control station does not exist, add a control station.	—
F83AH	'Link start/stop instruction details' (SW0000) or 'Link start/stop station' (SW0001 to SW0004) is incorrectly set.	Check the setting and stop or restart cyclic transmission.	—
F83BH ¹	The conditions for switching the multiplexed remote master station are not satisfied.	Check if the following conditions are satisfied. <ul style="list-style-type: none"> • The system is a multiplexed remote I/O network system. • The parameter of the master station is set to "Returns as Control Station". • The own station is operating as the master station. • The submaster operating station is performing data link. 	—
F83CH to F83DH	An error was detected in the CPU module or network module.	Please consult your local Mitsubishi representative.	—
F840H ¹	The low speed common parameter is faulty.	<ul style="list-style-type: none"> • Correct the network parameter setting and write data to the programmable controller. • If the error occurs again, the error is the hardware failure of the CPU module or network module. Please consult your local Mitsubishi representative. 	—
F841H to F842H ¹ F843H	The network parameter is faulty or the hardware of the network module has failed.	<ul style="list-style-type: none"> • Correct the network parameter setting and write data to the programmable controller. • If the error occurs again, the error is the hardware failure of the CPU module or network module. Please consult your local Mitsubishi representative. 	—
F881H to F888H	An error was detected in the network module.	Please consult your local Mitsubishi representative.	—
F890H	Number of transient request exceeded the upper limit of simultaneously processable requests.	<ul style="list-style-type: none"> • Pause the transient transmission temporarily, and retry the operation. • Lower the transient transmission usage frequency, and then retry the operation. 	—
F891H	The request data size of memory read/write command is out of range.	Correct the read or write size specification at the transient request source, and retry the operation.	—
F892H	<ul style="list-style-type: none"> • Routing information to the destination network number is not registered. • In transient transmission, the number of relay to other networks exceeded seven. 	<ul style="list-style-type: none"> • Correct the target network number at the request source, and retry the operation. • Correct the communication path from the transient request source to the destination, and retry the operation. • When the dynamic routing is not used, or the module of the series other than MELSEC iQ-R is included, retry the operation after correcting the routing setting. • Change the system configuration so that the number of relay stations may be seven or less. 	—
F893H	The module operation mode is set to a mode in which transient transmission cannot be executed.	After completion of the offline test, retry the transient transmission.	—
F894H	Incorrect frame is received. <ul style="list-style-type: none"> • Unsupported pre-conversion protocol • Unsupported frame type • Application header variable part • Application header HDS • Application header RTP • Read command not requiring response 	Correct the request data at the transient request source, and retry the operation.	—
F901H	Cable failure or network module error is detected.	<ul style="list-style-type: none"> • If a communication error occurs, correct the communication cable. • If no communication error has occurred, the error is caused by hardware failure. Please consult your local Mitsubishi representative. 	—
F902H	In transient transmission, the number of relay to other networks exceeded seven.	<ul style="list-style-type: none"> • Change the system configuration so that the number of relay stations may be seven or less. • Check if "Routing Setting" in "CPU Parameter" is correctly set. 	—
F903H	The target network number specified for transient transmission is out of range.	<ul style="list-style-type: none"> • Correct the target network number at the own station, and retry the operation. • If the error occurs again even after taking the above, please consult your local Mitsubishi representative. 	—

Error code	Error details and causes	Action	Detailed Information
F904H	The target station number specified for transient transmission is out of range.	<ul style="list-style-type: none"> Correct the target station number at the own station, and retry the operation. If the error occurs again even after taking the above, please consult your local Mitsubishi representative. 	—
F905H	Cable failure or network module error is detected.	<ul style="list-style-type: none"> If a communication error occurs, correct the communication cable. If no communication error has occurred, the error is caused by hardware failure. Please consult your local Mitsubishi representative. 	—
FA00H to FA04H, FA10H to FA18H	An error was detected in the network module.	Please consult your local Mitsubishi representative.	—
F AE0H to F AE1H	An error was detected in the CPU module or network module.	Please consult your local Mitsubishi representative.	—
F AE2H	An error was detected in the network module.	Please consult your local Mitsubishi representative.	—
F AE4H	An error was detected in the network module.	Please consult your local Mitsubishi representative.	—
F AE5H	An error was detected in the CPU module or network module.	Please consult your local Mitsubishi representative.	—
F AF0H to F AF7H	An error was detected in the network module.	Please consult your local Mitsubishi representative.	—
FD01H ^{*1}	A CRC error has occurred during the execution of the station-to-station test and self-loopback test.	No action is required because the system performs a retry. However, if the error occurs frequently, check for cable failure, hardware failure, noise, and wiring error.	—
FD02H ^{*1}	An overrun error has occurred during the execution of the station-to-station test and self-loopback test.	No action is required because the system performs a retry. However, if the error occurs frequently, check for cable failure, hardware failure, noise, and wiring error.	—
FD03H ^{*1}	An abort error has occurred during the execution of the station-to-station test and self-loopback test.	No action is required because the system performs a retry. However, if the error occurs frequently, check for cable failure, hardware failure, noise, and wiring error.	—
FD04H ^{*1}	A timeout error has occurred during the execution of the station-to-station test and self-loopback test.	No action is required because the system performs a retry. However, if the error occurs frequently, check for cable failure, hardware failure, noise, and wiring error.	—
FD05H ^{*1}	A data error has occurred during the execution of the station-to-station test and self-loopback test.	No action is required because the system performs a retry. However, if the error occurs frequently, check for cable failure, hardware failure, noise, and wiring error.	—
FD06H ^{*1}	An under-error has occurred during the execution of the station-to-station test and self-loopback test.	No action is required because the system performs a retry. However, if the error occurs frequently, check for cable failure, hardware failure, noise, and wiring error.	—
FD07H ^{*1}	The sending data has failed during the execution of the station-to-station test and self-loopback test.	No action is required because the system performs a retry. However, if the error occurs frequently, check for cable failure, hardware failure, noise, and wiring error.	—
FD08H	The sending data has failed during the execution of the station-to-station test and self-loopback test.	Check for coaxial cable connection and looseness, terminating resistor connection, and cable failure.	—
FD09H	The loop status is changed during the execution of the loop test.	No action is required because the system performs a retry. (Do not switch the loop in the middle.) However, if the error occurs frequently, check the line and wiring status.	—
FD0AH	The loop status is unstable during the execution of the loop test.	No action is required because the system performs a retry. (Do not switch the loop in the middle.) However, if the error occurs frequently, check the line and wiring status.	—
FD0BH	Wiring error is detected during the execution of the loop test.	Check the wiring.	—
FD0CH	An error was detected in the network module.	Please consult your local Mitsubishi representative.	—
FD11H	The setting check test, station order check test, loop test, and communication test are executed in duplicate.	Perform the test after the completion of the test from another station.	—
FD12H	The setting check test, station order check test, and loop test are executed during disconnection.	Eliminate the cause of disconnection and take actions.	—

Error code	Error details and causes	Action	Detailed Information
FD13H	An error was detected in the test data.	<ul style="list-style-type: none"> Check for cable failure, hardware failure, wiring error, station number duplication, control station duplication, and mismatched transmission speed in the module in the same network. If the error occurs again, please consult your local Mitsubishi representative. 	—
FD14H	An error was detected in the network module.	Please consult your local Mitsubishi representative.	—
FD15H	Send operation has failed in online test.	Check for cable failure, hardware failure, noise, and wiring error.	—
FD16H to FD17H	An error was detected in the test data.	<ul style="list-style-type: none"> Check for cable failure, hardware failure, wiring error, station number duplication, control station duplication, and mismatched transmission speed in the module in the same network. If the error occurs again, please consult your local Mitsubishi representative. 	—
FD18H to FD19H	An error was detected in the network module.	Please consult your local Mitsubishi representative.	—
FD1AH	The station whose station number is duplicated is detected by the station order check test.	Correct the station whose station number is duplicated.	—
FD1BH	The test is interrupted.	<ul style="list-style-type: none"> Retry the test. If the error occurs again, the error is the hardware failure of the network module. Please consult your local Mitsubishi representative. 	—
FD1CH	The setting check test, station order check test, and loop test are executed during line control.	<ul style="list-style-type: none"> Do not switch the loop in the middle. If the error occurs again, check the line and wiring status. 	—
FD1DH	An error was detected in the test data.	<ul style="list-style-type: none"> Check for cable failure, hardware failure, wiring error, station number duplication, control station duplication, and mismatched transmission speed in the module in the same network. If the error occurs again, please consult your local Mitsubishi representative. 	—
FD1EH ^{*1}	The test cannot be executed by the bus type.	Perform the test that can be executed by the bus type.	—
FD20H ^{*1}	The mode is incorrectly set.	<ul style="list-style-type: none"> Correct the network parameter setting and write data to the programmable controller. If the error occurs again, the error is the hardware failure of the CPU module or network module. Please consult your local Mitsubishi representative. 	—
FD21H to FD22H ^{*1}	The cable was disconnected during the execution of the online test.	Restore the cable and execute the online test.	—
FD23H ^{*1}	An error caused by data comparison has occurred during the execution of the station-to-station test.	Check for cable failure, hardware failure, wiring error, station number duplication, control station duplication, and mismatched transmission speed in the same network.	—
FD24H	A communication error has occurred during the station-to-station test and self-loopback test.	Check for cable failure, hardware failure, wiring error, station number duplication, control station duplication, and mismatched transmission speed in the same network.	—
FD25H ^{*1}	The hardware of the network module has failed.	Please consult your local Mitsubishi representative.	—
FD26H to FD27H ^{*1}	The cable is faulty.	Connect a correct cable and execute the online test.	—
FD28H to FD2BH ^{*1}	An error was detected in the network module.	Please consult your local Mitsubishi representative.	—
FD31H ^{*1}	Offline diagnostics is executed during the execution of online diagnostics.	Retry the operation after the completion of one online diagnostics.	—
FD32H to FD33H ^{*1}	An error was detected in the network module.	Please consult your local Mitsubishi representative.	—
FD35H ^{*1}	Response wait timeout has occurred during the communication test.	<ul style="list-style-type: none"> Retry the operation later. Check the target station and line status. 	—
FD36H	Response wait timeout has occurred during the communication test.	<ul style="list-style-type: none"> Retry the operation later. Check the target station and line status. If the dynamic routing setting is not enabled, check if "Routing Setting" in "CPU Parameter" is correctly set. 	—

Error code	Error details and causes	Action	Detailed Information
FD37H ¹	Communication test is executed for the station in which online test is being executed.	<ul style="list-style-type: none"> • Retry the operation later. • Check the target station and line status. 	—
FD38H	The duplicated request packet is received during the communication test.	<ul style="list-style-type: none"> • Retry the operation later. • Check the target station and line status. 	—
FD39H	Communication test is executed for the own station.	Change the request destination.	—
FD3AH	Communication test is executed for the relay sending station and the station which is mounted on the same base unit (main base unit and extension base unit).	Change the request destination.	—
FD40H	A send size error has occurred during the execution of the station-to-station test and self-loopback test.	No action is required because the system performs a retry. However, if the error occurs frequently, check for cable failure, hardware failure, noise, and wiring error.	—
FD41H	An under-error has occurred during the execution of the station-to-station test and self-loopback test.	No action is required because the system performs a retry. However, if the error occurs frequently, check for cable failure, hardware failure, noise, and wiring error.	—
FD42H	A line error has occurred during the execution of the station-to-station test and self-loopback test.	No action is required because the system performs a retry. However, if the error occurs frequently, check for cable failure, hardware failure, noise, and wiring error.	—
FD43H	A timeout error (send) has occurred during the execution of the station-to-station test and self-loopback test.	No action is required because the system performs a retry. However, if the error occurs frequently, check for cable failure, hardware failure, noise, and wiring error.	—
FD44H	Error reception has occurred during the execution of the station-to-station test and self-loopback test.	No action is required because the system performs a retry. However, if the error occurs frequently, check for cable failure, hardware failure, noise, and wiring error.	—
FD45H	A parity error has occurred during the execution of the station-to-station test and self-loopback test.	No action is required because the system performs a retry. However, if the error occurs frequently, check for cable failure, hardware failure, noise, and wiring error.	—
FD46H	A timeout error (receive) has occurred during the execution of the station-to-station test and self-loopback test.	No action is required because the system performs a retry. However, if the error occurs frequently, check for cable failure, hardware failure, noise, and wiring error.	—
FD47H	A reception error other than an overrun error has occurred during the execution of the station-to-station test and self-loopback test.	No action is required because the system performs a retry. However, if the error occurs frequently, check for cable failure, hardware failure, noise, and wiring error.	—
FD48H	An overrun error (normal frame) has occurred during the execution of the station-to-station test and self-loopback test.	No action is required because the system performs a retry. However, if the error occurs frequently, check for cable failure, hardware failure, noise, and wiring error.	—
FD49H	An overrun error has occurred during the execution of the station-to-station test and self-loopback test.	No action is required because the system performs a retry. However, if the error occurs frequently, check for cable failure, hardware failure, noise, and wiring error.	—
FD4AH	A short frame error or a reception error of 2K bytes or more has occurred during the execution of the station-to-station test and self-loopback test.	No action is required because the system performs a retry. However, if the error occurs frequently, check for cable failure, hardware failure, noise, and wiring error.	—
FD4BH	A data error has occurred during the execution of the station-to-station test and self-loopback test.	No action is required because the system performs a retry. However, if the error occurs frequently, check for cable failure, hardware failure, noise, and wiring error.	—
FE20H ¹	The transient data received from the MELSECNET/10 is faulty.	Correct the routing parameter or change the relay CPU module to the one supporting the MELSECNET/10, such as AnUCPU or QnACPU.	—
FE21H ¹	The start number and the number of access points for the access target device specified by the ZNRD/ZNWR instructions are incorrectly set.	Correct the range of the access target device of the ZNRD/ZNWR instructions to be sent to ACPU.	—
FE22H ¹	An access to another station was executed with the project type different from the actual CPU module.	With the engineering tool, check if an access to another station was executed in the CPU module with a different project type.	—

Error code	Error details and causes	Action	Detailed Information
FE23H ^{*1}	Hardware failure has occurred at the start of the dedicated instruction and MC protocol.	Please consult your local Mitsubishi representative.	—
FE24H	An error has occurred in the CPU module of the target station and relay station.	Check the status of the CPU module of the target station and relay station. Or, change the corresponding CPU module.	—
FE25H ^{*1}	Power supply error has occurred in the target station and relay station.	Check the power supply status of the transient transmission target station and relay station. (Check for voltage shortage, momentary power failure, and overvoltage.) Or, change the corresponding CPU module.	—
FE26H ^{*1}	An error has occurred in the CPU module of the target station and relay station.	Check the operating status (such as a watchdog timer error) of the CPU module of the target station and relay station. Or, change the corresponding CPU module.	—
FE27H ^{*1}	The hardware of the CPU module or network module has failed.	Please consult your local Mitsubishi representative.	—
FE28H ^{*1}	The hardware of the target station for the transient transmission or the network module of the own station has failed.	Please consult your local Mitsubishi representative.	—
FE30H to FE32H ^{*1}	The hardware of the network module has failed.	Please consult your local Mitsubishi representative.	—
FE34H ^{*1}	The hardware of the network module has failed.	Please consult your local Mitsubishi representative.	—
FE36H to FE38H ^{*1}	The hardware of the network module has failed.	Please consult your local Mitsubishi representative.	—
FE39H ^{*1}	The hardware of the CPU module or network module has failed.	Please consult your local Mitsubishi representative.	—
FE3BH to FE3FH ^{*1}	The hardware of the network module has failed.	Please consult your local Mitsubishi representative.	—
FFF9H	An error was detected in the network module.	Please consult your local Mitsubishi representative.	—

*1 This error code occurs in another station such as the QJ71LP21-25. It does not occur in RJ71LP21-25 and the RJ71BR11.

4.6 List of Parameter Numbers

This section lists the parameter numbers displayed in the module diagnostics.

If a parameter number is displayed when an incorrect parameter is set, the target parameter can be identified.

Parameter numbers are displayed in "Detailed Information" in the [Error Information] tab under the "Module Diagnostics" window of the MELSECNET/H network module. ( Page 93 Error information)

Item		Parameter No.	
Required Settings	Station Type	Station Type	
	Network No.	Network No.	
	Station No.	Station No.	
	Network Range Assignment	Total No. of Stations	A06EH
		LB/LW Setting	A06EH
		LX/LY(1) Setting	A06EH
		LX/LY(2) Setting	A06EH
		I/O Master Station	A06EH
		Reserved Station	A06EH
	Pairing	A06EH	
Operation after Reconnection	Operation after Reconnection	7100H/7110H	
Transmission Speed	Transmission Speed	7100H/7110H	
Basic Settings	Link Refresh Settings	SB	7401H
		SW	7401H
		LB/LW/LX/LY setting (1 to 64)	7401H
Application Settings	Supplementary Cyclic Settings	Data Link Monitoring Time	A06EH
		System Switching Monitoring Time	A06EH
		Constant Link Scan Time	A06EH
		Maximum No. of Returns to System Stations in 1 Scan	A06EH
		Control Station Shift Setting	A06EH
		Block send data assurance per station	A06EH
		Block receive data assurance per station	A06EH
		Maximum No. of Transient Transmissions	A06EH
		Maximum No. of Transient in One Station	A06EH
		Low Speed Cyclic Setting	Low Speed Cyclic Setting
	Fixed Interval Cycle Setting		A06FH
	System Timer Setting (1 to 8)		A06FH
	Interrupt Settings		A07FH/A015H/7800H
	Transient Transmission Group No.		7100H/7110H
	Dynamic Routing		A07FH
	Parameter Name		7310H/7311H
	Event Reception from Other Stations		A07FH
	Module Operation Mode		7100H/7110H
	Redundant System Settings	Module Operation Mode (System B)	7110H
	Others	Interlink Transmission Parameters	7500H

4.7 Event List

The following lists the events that occur in the MELSECNET/H network module.

System		
Event code	Overview	Cause
00500	Own station: Baton pass return (network entry)	Baton pass of the own station was returned from interruption status to normal status.
00501	Another station: Baton pass return (network entry)	Baton pass of another station was returned from interruption status to normal status.
00502	All stations baton pass normalization (network entry in all stations)	Baton pass was returned to normal status at all stations.
00510	Own station: Data link restart (cyclic transmission started)	Data link of the own station was restarted.
00511	Another station: Data link restart (cyclic transmission started)	Data link of another station was restarted.
00512	All stations data link normalization (cyclic transmission in all stations started)	Data link was returned to normal status at all stations.
00513	Own station: Data link start instruction acceptance	Data link startup of the own station instruction was received.
00514	Own station: Data link stop instruction acceptance	Data link stop instruction of the own station was received.
00540	Loopback resolution	Loopback execution status was resolved when using a ring topology (using the loopback function).
00541	Receive parameter error resolution	A parameter error received from the control station was resolved. (Normal parameter was received.)
00A00	System switching request issued	A system switching request occurred.
00C00	Own station: Baton pass interruption (departure from network)	Baton pass of the own station was interrupted.
00C01	Another station: Baton pass interruption (departure from network)	Baton pass of another station was interrupted.
00C02	Response error from/to another station	<ul style="list-style-type: none"> Abnormal response was returned from another station when accessing another station. Abnormal response was returned to another station when accessed from another station.
00C10	Own station: Data link stop (cyclic transmission stopped)	Data link of the own station was stopped.
00C11	Another station: Data link stop (cyclic transmission stopped)	Data link of another station was stopped.
00C20	Another station: Parameter error occurrence	A parameter error has occurred in another station.
00C21	Another station: CPU error occurrence	An error has occurred in the CPU module on another station.
00C23	Loopback occurrence	Path switching has occurred when using a ring topology (using the loopback function).
00C25	Receive parameter error occurrence	A parameter error received from the control station has been detected.

Operation		
Event code	Overview	Cause
24000	Data link startup instruction	Data link startup to the own station or another station was instructed.
24001	Data link stop instruction	Data link stop to the own station or another station was instructed.
24100	Own station: Parameter change/new parameter acceptance	Parameter was changed. Or new parameter was received at power-on.
24F00	Another station: CPU operating status change detection	Operating status of the programmable controller CPU on another station was changed.

APPENDICES

Appendix 1 Module Label

The link special relay (SB) and link special register (SW) of the MELSECNET/H network module can be set using module label.

Structure of the module label

The module label name is defined with the following structure.

"Instance name"_"Module number"."Label name"

"Instance name"_"Module number"."Label name"_D

Ex.

LP21_1.bDetect_DataLinkError

■Instance name

The following are the instance names of the RJ71LP21-25 and the RJ71BR11.

Module model name	Instance name
RJ71LP21-25	LP21
RJ71BR11	BR11

■Module number

A sequential number starting with "1" for identifying a module from the one with the same instance name.

■Label name

A label name unique to the module.

■_D

This symbol indicates that the module label is for direct access. The label without "_D" is for link refresh. The following are the differences between link refresh and direct access.

Type	Description	Access timing
Link refresh	The values read/written from/to the module labels are reflected to the module at link refresh. The execution time of the program can be shortened.	At link refresh
Direct access	The values read/written from/to the module labels are reflected to the module immediately. Although the execution time of the program is longer than the one at the link refresh, the responsiveness is improved. For the instruction processing time, refer to the following.  MELSEC iQ-R Programming Manual (CPU Module Instructions, Standard Functions/Function Blocks)	At writing to or reading from the module label

Point

When multiple MELSECNET/H network modules of the same network number are mounted and the module labels of link special relay (SB) and link special register (SW) are used for direct access, the access target is the module which has the smallest slot number in the base unit.

Appendix 2 Buffer Memory

The buffer memory is used to exchange data between the MELSECNET/H network module and the CPU module. Buffer memory values are defaulted when the CPU module is reset or the system is powered off.

List of buffer memory addresses

Address (decimal)	Address (hexadecimal)	Name	Initial value	Read, write
0 to 12079	0H to 2F2FH	System area		
12080	2F30H	Communication path determination status	Communication path determination information (network No.1 to 16)	0
12081 to 12095	2F31H to 2F3FH		Communication path determination information (network No.17 to 239)	
12096 to 65535	2F40H to FFFFH	System area		

Point

- Do not write data to the system area. Doing so may cause malfunction of the programmable controller system.
- If the value in an area of one word in size becomes equal to or higher than 65536, the count stops at 65535 (FFFFH).

Details of buffer memory addresses

Communication path determination status

■ Communication path determination status (Un\G12080 to Un\G12095)

The determination information on the communication path for each network number of the destination station is stored.

- 0: Path undetermined
- 1: Path determined

Address	b15	b14	b13	b12	b11	b10	b9	b8	b7	b6	b5	b4	b3	b2	b1	b0
Un\G12080	16	15	14	13	12	11	10	9	8	7	6	5	4	3	2	1
Un\G12081	32	31	30	29	28	27	26	25	24	23	22	21	20	19	18	17
Un\G12082	48	47	46	45	44	43	42	41	40	39	38	37	36	35	34	33
Un\G12083	64	63	62	61	60	59	58	57	56	55	54	53	52	51	50	49
Un\G12084	80	79	78	77	76	75	74	73	72	71	70	69	68	67	66	65
Un\G12085	96	95	94	93	92	91	90	89	88	87	86	85	84	83	82	81
Un\G12086	112	111	110	109	108	107	106	105	104	103	102	101	100	99	98	97
Un\G12087	128	127	126	125	124	123	122	121	120	119	118	117	116	115	114	113
Un\G12088	144	143	142	141	140	139	138	137	136	135	134	133	132	131	130	129
Un\G12089	160	159	158	157	156	155	154	153	152	151	150	149	148	147	146	145
Un\G12090	176	175	174	173	172	171	170	169	168	167	166	165	164	163	162	161
Un\G12091	192	191	190	189	188	187	186	185	184	183	182	181	180	179	178	177
Un\G12092	208	207	206	205	204	203	202	201	200	199	198	197	196	195	194	193
Un\G12093	224	223	222	221	220	219	218	217	216	215	214	213	212	211	210	209
Un\G12094	Empty	239	238	237	236	235	234	233	232	231	230	229	228	227	226	225
Un\G12095	Empty															

The numbers in the table indicate network numbers.

Appendix 3 List of Link Special Relay (SB) Areas

The link special relay (SB) is turned on/off depending on various factors during data link. Any error status of the data link can be checked by using or monitoring it in the program.

Application of the link special relay (SB)

By using link special relay (SB), the status of MELSECNET/H network can be checked from HMI (Human Machine Interfaces) as well as the engineering tool.

Link refresh of the link special relay (SB)

To use the link special relay (SB), set them in "Link Refresh Settings" in "Basic Settings" so that they are link-refreshed to the devices or labels of the CPU module. (📖 Page 62 Link Refresh Settings)

Ranges turned on/off by users and by the system

The following ranges correspond to when the link special relay (SB) areas are assigned from SB0000 to SB01FF.

- Turned on/off by users: SB0000 to SB001F
- Turned on/off by the system: SB0020 to SB01FF

List of link special relay (SB) areas

The following table lists the link special relay (SB) areas when they are assigned from SB0000 to SB01FF.

Each abbreviation and symbol in the table indicates the following.

Loop: RJ71LP21-25, Bus: RJ71BR11

○: Available, ×: Not available



Do not turn on or off areas whose numbers are not on the following list or ranges turned on/off by the system. Doing so may cause malfunction of the programmable controller system.

No.	Name	Description	Availability			
			Control station		Normal Station	
			Loop	Bus	Loop	Bus
SB0000	Link startup of own station	Starts cyclic transmission of the own station. Off: Startup not requested On: Startup requested (valid at rising edge) (Conditions) • This register is enabled when 'Baton pass error status of own station' (SB0047) is off. • For SB0000 to SB0003, only one of the areas can be turned on.	○	○	○	○
SB0001	Link stop of own station	Stops cyclic transmission of the own station. Off: Stop not requested On: Stop requested (valid at rising edge) (Conditions) • This register is enabled when 'Baton pass error status of own station' (SB0047) is off. • For SB0000 to SB0003, only one of the areas can be turned on.	○	○	○	○
SB0002	System link start	Starts cyclic transmission of the entire system. The station where cyclic transmission is started is specified in 'Link start/stop instruction details' (SW0000) and 'Link start/stop station' (SW0001 to SW0004). Off: Startup not requested On: Startup requested (valid at rising edge) (Conditions) • This register is enabled when 'Baton pass error status of own station' (SB0047) is off. • For SB0000 to SB0003, only one of the areas can be turned on.	○	○	○	○
SB0003	System link stop	Stops cyclic transmission of the entire system. The station where cyclic transmission is stopped is specified in 'Link start/stop instruction details' (SW0000) and 'Link start/stop station' (SW0001 to SW0004). Off: Stop not requested On: Stop requested (valid at rising edge) (Conditions) • This register is enabled when 'Baton pass error status of own station' (SB0047) is off. • For SB0000 to SB0003, only one of the areas can be turned on.	○	○	○	○
SB0005	Clear retry count	Clears 'Number of retries on the forward loop side' (SW00C8) and 'Number of retries on the reverse loop side' (SW00C9) to 0. Off: Clear not requested On: Clear requested (valid while on)	○	○	○	○
SB0006	Clear communication error count	Clears the link special register areas related to communication errors (SW00B8 to SW00C7) to 0. Off: Clear not requested On: Clear requested (valid while on)	○	○	○	○
SB0007	Clear forward loop transmission error count	Clears 'Line error on the forward loop side' (SW00CC) to 0. Off: Clear not requested On: Clear requested (valid while on)	○	×	○	×
SB0008	Clear reverse loop transmission error count	Clears 'Line error on the reverse loop side' (SW00CD) to 0. Off: Clear not requested On: Clear requested (valid while on)	○	×	○	×

No.	Name	Description	Availability			
			Control station		Normal Station	
			Loop	Bus	Loop	Bus
SB0009	Clear loop switching count	Clears the path switching detection area of the own station (SW00CE to SW00E7) to 0. Off: Clear not requested On: Clear requested (valid while on) SB0009 is turned on until SW00CE reaches 0.	○	×	○	×
SB000A	Clear transient transmission error count	Clears the transient transmission error area of the own station (SW00EE, SW00EF) to 0. Off: Clear not requested On: Clear requested (valid while on)	○	○	○	○
SB000B	Transient transmission error area setting	Prohibits 'Transient transmission error history' (SW00F0 to SW00FF) from being overwritten. Off: Overwriting permitted On: Overwriting prohibited	○	○	○	○
SB0011	Data link operation designation	Requests data link operation. Off: Switch not requested On: Switch requested (valid at rising edge) When ON is detected, the operation switches from online (normal data link) operation to online (debug) operation, or from online (debug) operation to online (normal data link) operation.	○	○	○	○
SB0018	System switching monitoring time setting valid flag	Enables or disables 'System switching monitoring time setting' (SW0018). Off: Disabled On: Enabled (valid at rising edge)	○	×	○	×
SB0020	Communication status with CPU module	Stores the communication status between the MELSECNET/H network module and CPU module. Off: Normal On: Error	○	○	○	○
SB0040	Network type of own station	Stores the network type of the own station. Off: PLC to PLC network (fixed)	○	○	○	○
SB0041	Redundant function information of own station	Stores the redundant system support information of the own station. Off: Redundant function not supported On: Redundant function supported (Conditions) Enabled only when the own station is online.	○	○	○	○
SB0043	Mode of own station	Stores the module operation mode of the own station. Off: Online On: Other than online	○	○	○	○
SB0044	Station setting of own station	Stores the station type of the own station. Off: Normal station On: Control station	○	○	○	○
SB0046	Data link operation designation result of own station	Stores the data link operation specification status of the network module of the own station. Off: Normal data link in operation On: Operating in debug mode	○	○	○	○
SB0047	Baton pass error status of own station	Stores the baton pass status (transient transmission availability) of the own station. Off: Normal On: Error When this relay is turned on, the cause of the error can be checked with 'Baton pass status of own station' (SW0047) and 'Cause of baton pass interruption' (SW0048). Depending on the link refresh timing, the update of 'Baton pass status of own station' (SW0047) and 'Cause of baton pass interruption' (SW0048) may be offset by one sequence scan.	○	○	○	○
SB0048	Station status of own station	Stores the current station type status of the own station. Off: Normal station On: Control station (when SB0044 is turned on)/sub-control station (when SB0044 is turned off) (Conditions) • This register is enabled when 'Baton pass error status of own station' (SB0047) is off.	○	○	○	○



No.	Name	Description	Availability			
			Control station		Normal Station	
			Loop	Bus	Loop	Bus
SB0049	Data link error status of own station	Stores the data link status of the own station. Off: Normal On: Error When this relay is turned on, the cause of the error can be checked with 'Cause of data link stop' (SW0049). Depending on the link refresh timing, the update of 'Cause of data link stop' (SW0049) may be offset by one sequence scan.	○	○	○	○
SB004A	CPU minor error status of own station	Stores the minor error occurrence status of the CPU module on the own station. Off: No minor error On: Minor error	○	○	○	○
SB004B	CPU moderate to major error status of own station	Stores the moderate/major error occurrence status of the CPU module on own station. Off: No moderate/major error On: Moderate/major error	○	○	○	○
SB004C	Link start request accept status of own station	Stores the acceptance status of 'Link startup of own station' (SB0000). Off: Not accepted (SB0000 is off.) On: Accepted (SB0000 is on.) (Conditions) • This register is enabled when 'Baton pass error status of own station' (SB0047) is off. When 'Baton pass error status of own station' (SB0047) is turned on (error), data prior to error is held.	○	○	○	○
SB004D	Link start completion status of own station	Stores the status of link startup processing requested with 'Link startup of own station' (SB0000). Off: Link startup not completed (SB0000 is off.) On: Link startup completed (SB0000 is on.) (Conditions) • This register is enabled when 'Baton pass error status of own station' (SB0047) is off. When 'Baton pass error status of own station' (SB0047) is turned on (error), data prior to error is held.	○	○	○	○
SB004E	Link stop request accept status of own station	Stores the acceptance status of 'Link stop of own station' (SB0001). Off: Not accepted (SB0001 is off.) On: Accepted (SB0001 is on.) (Conditions) • This register is enabled when 'Baton pass error status of own station' (SB0047) is off. When 'Baton pass error status of own station' (SB0047) is turned on (error), data prior to error is held.	○	○	○	○
SB004F	Link stop completion status of own station	Stores the link stop processing status requested with 'Link stop of own station' (SB0001). Off: Not completed (SB0001 is off.) On: Completed (SB0001 is on.) (Conditions) • This register is enabled when 'Baton pass error status of own station' (SB0047) is off. When 'Baton pass error status of own station' (SB0047) is turned on (error), data prior to error is held.	○	○	○	○
SB0050	System link start request accept status	Stores the acceptance status of 'System link startup' (SB0002). Off: Not accepted (SB0002 is off.) On: Accepted (SB0002 is on.) (Conditions) • This register is enabled when 'Baton pass error status of own station' (SB0047) is off. When 'Baton pass error status of own station' (SB0047) is turned on (error), data prior to error is held.	○	○	○	○
SB0051	System link start completion status	Stores the status of link startup processing requested with 'System link startup' (SB0002). Off: Not completed (SB0002 is off.) On: Completed (SB0002 is on.) (Conditions) • This register is enabled when 'Baton pass error status of own station' (SB0047) is off. When 'Baton pass error status of own station' (SB0047) is turned on (error), data prior to error is held.	○	○	○	○

No.	Name	Description	Availability			
			Control station		Normal Station	
			Loop	Bus	Loop	Bus
SB0052	System link stop request accept status	Stores the acceptance status of 'System link stop' (SB0003). Off: Not accepted (SB0003 is off.) On: Accepted (SB0003 is on.) (Conditions) • This register is enabled when 'Baton pass error status of own station' (SB0047) is off. When 'Baton pass error status of own station' (SB0047) is turned on (error), data prior to error is held.	○	○	○	○
SB0053	System link stop completion status	Stores the status of link stop processing requested with 'System link stop' (SB0003). Off: Not completed (SB0003 is off.) On: Completed (SB0003 is on.) (Conditions) • This register is enabled when 'Baton pass error status of own station' (SB0047) is off. When 'Baton pass error status of own station' (SB0047) is turned on (error), data prior to error is held.	○	○	○	○
SB0054	Parameter reception incomplete status	Stores the status of parameter reception. (For the control station, this relay stores the status of parameter reception from the CPU module.) Off: Reception completed On: Reception not completed	○	○	○	○
SB0055	Receive parameter error	Stores the status of received parameter. (For the control station, this relay stores the own parameter status.) Off: Parameters normal On: Parameter error	○	○	○	○
SB0056	Communication status	Stores the transient transmission status. Off: Transient transmission by the control station On: Transient transmission by the sub-control station (Conditions) • This register is enabled when 'Baton pass error status of own station' (SB0047) is off. When 'Baton pass error status of own station' (SB0047) is turned on (error), data prior to error is held.	○	○	○	○
SB0057	Parameter type	Stores the parameter type that has been set. Off: MELSECNET/10 parameter On: MELSECNET/H parameter	○	○	○	○
SB0058	Operation designation at fault of control or remote master station	Stores the operation specification when the control station fails. Off: Cyclic transmission performed by the sub-control station On: Cyclic transmission not performed by the sub-control station	○	○	○	○
SB0059	Low-speed cyclic designation	Stores low speed cyclic parameter setting information. Off: No setting On: Set	○	○	○	○
SB005A	Control station type	Stores the station type (mode) of the control station. Off: MELSECNET/10 mode, MELSECNET/H mode On: MELSECNET/H extended mode	○	○	○	○
SB005 C	Block 1 I/O master station	Stores the I/O master station settings status of block 1 (LX/LY setting (1)). Off: No setting On: Set When this relay is turned on, the station number is stored in 'Block 1 I/O master station' (SW005C). (Conditions) • This register is enabled when 'Data link error status of own station' (SB0049) is off.	○	○	○	○
SB005 D	Block 2 I/O master station	Stores the I/O master station settings status of block 2 (LX/LY setting (2)). Off: No setting On: Set When this relay is turned on, the station number is stored in 'Block 2 I/O master station' (SW005D). (Conditions) • This register is enabled when 'Data link error status of own station' (SB0049) is off.	○	○	○	○

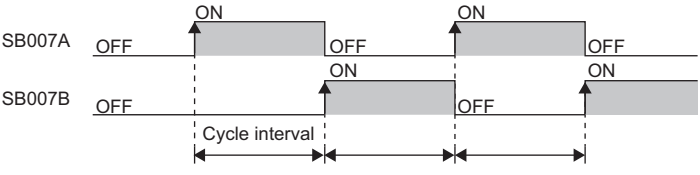

No.	Name	Description	Availability			
			Control station		Normal Station	
			Loop	Bus	Loop	Bus
SB0064	Reserved station setting status	Stores the reserved station setting status. Off: No setting On: Set When this relay is turned on, the status of each station can be checked with 'Reserved station setting' (SW0064 to SW0067). Depending on the link refresh timing, the update of 'Reserved station setting' (SW0064 to SW0067) may be offset by one sequence scan. (Conditions) • This register is enabled when 'Data link error status of own station' (SB0049) is off.	○	○	○	○
SB0068	Constant link scan status	Stores the constant link scan setting status. Off: No setting On: Set (Conditions) • This register is enabled when 'Data link error status of own station' (SB0049) is off.	○	○	○	○
SB0069	Multiplex transmission designation	Stores the transmission specification status (the status of supplementary setting of common parameters). Off: Normal transmission specified On: Multiplex transmission specified (Conditions) • This register is enabled when 'Data link error status of own station' (SB0049) is off.	○	×	○	×
SB006A	Multiplex transmission status	Displays the transmission status. Off: Normal transmission performed On: Multiplex transmission performed • When multiplex transmission is performed, each station status can be checked with 'Multiplex transmission status of forward loop side' (SW00B0 to SW00B3) and 'Multiplex transmission status of reverse loop side' (SW00B4 to SW00B7). (Conditions) This register is enabled when 'Baton pass error status of own station' (SB0047) is off. When 'Baton pass error status of own station' (SB0047) is turned on (error), data prior to error is held.	○	×	○	×
SB0070	Baton pass status of each station	Stores the baton pass status of each station. Off: All stations normal On: Faulty station exists When this relay is turned on, the status of each station can be checked with 'Baton pass status' (SW0070 to SW0073). Depending on the link refresh timing, the update of 'Baton pass status' (SW0070 to SW0073) may be offset by one sequence scan. (Conditions) • This register is enabled when 'Baton pass error status of own station' (SB0047) is off. • Reserved stations and stations exceeding the maximum station number are ignored.	○	○	○	○
SB0074	Data link error status of each station	Stores the data link status for each station. Off: Data link in progress for all stations On: Data link not in progress for some stations When this relay is turned on, the status of each station can be checked with 'Data link status' (SW0074 to SW0077). Depending on the link refresh timing, the update of 'Data link status' (SW0074 to SW0077) may be offset by one sequence scan. (Conditions) • This register is enabled when 'Baton pass error status of own station' (SB0047) is off. • Reserved stations and stations exceeding the maximum station number are ignored.	○	○	○	○

No.	Name	Description	Availability			
			Control station		Normal Station	
			Loop	Bus	Loop	Bus
SB0078	Parameter communication status of each station	Stores the parameter communication status of each station. Off: Parameter communication not in progress On: Parameter communication in progress When this relay is turned on, the status of each station can be checked with 'Parameter communication status' (SW0078 to SW007B). Depending on the link refresh timing, the update of 'Parameter communication status' (SW0078 to SW007B) may be offset by one sequence scan. (Conditions) • This register is enabled when 'Baton pass error status of own station' (SB0047) is off. When 'Baton pass error status of own station' (SB0047) is turned on (error), data prior to error is held. • Reserved stations and stations exceeding the maximum station number are ignored.	○	○	×	×
SB007A to SB007B	Low-speed cyclic communication status  (Conditions) • This register is enabled when 'Baton pass error status of own station' (SB0047) is off. When 'Baton pass error status of own station' (SB0047) is turned on (error), data prior to error is held.	○	○	○	○	
SB007C	Parameter status of each station	Stores the parameter status of each station. Off: There is no station where a parameter error is detected. On: There is a station where a parameter error is detected. When this relay is turned on, the status of each station can be checked with 'Parameter error status' (SW007C to SW007F). Depending on the link refresh timing, the update of 'Parameter error status' (SW007C to SW007F) may be offset by one sequence scan. (Conditions) • This register is enabled when 'Baton pass error status of own station' (SB0047) is off. When 'Baton pass error status of own station' (SB0047) is turned on (error), data prior to error is held. • Reserved stations and stations exceeding the maximum station number are ignored.	○	○	×	×
SB0080	CPU moderate to major error occurrence status	Stores the moderate/major error occurrence status of the CPU module on each station. (Including own station) Off: No moderate/major error On: Station with a moderate/major error exists When this relay is turned on, the status of each station can be checked with 'CPU moderate to major error occurrence status' (SW0080 to SW0083). Depending on the link refresh timing, the update of 'CPU moderate to major error occurrence status' (SW0080 to SW0083) may be offset by one sequence scan. (Conditions) • This register is enabled when 'Baton pass error status of own station' (SB0047) is off. When 'Baton pass error status of own station' (SB0047) is turned on (error), data prior to error is held.	○	○	○	○
SB0084	CPU operating status of each station	Stores the operating status of the CPU module on each station. (Including own station) Off: All stations are at RUN or STEP-RUN state On: Station at STOP or PAUSE state, or station with a moderate/major error exists. When this relay is turned on, the status of each station can be checked with 'CPU operating status' (SW0084 to SW0087). Depending on the link refresh timing, the update of 'CPU operating status' (SW0084 to SW0087) may be offset by one sequence scan. (Conditions) • This register is enabled when 'Baton pass error status of own station' (SB0047) is off. When 'Baton pass error status of own station' (SB0047) is turned on (error), data prior to error is held.	○	○	○	○



No.	Name	Description	Availability			
			Control station		Normal Station	
			Loop	Bus	Loop	Bus
SB0088	CPU minor error occurrence status	Stores the minor error occurrence status of the CPU module on each station. (Including own station) Off: All stations normal or station with a moderate/major error exists. On: Station with a minor error exists. When this relay is turned on, the status of each station can be checked with 'CPU minor error occurrence status' (SW0088 to SW008B). Depending on the link refresh timing, the update of 'CPU minor error occurrence status' (SW0088 to SW008B) may be offset by one sequence scan. (Conditions) • This register is enabled when 'Baton pass error status of own station' (SB0047) is off. When 'Baton pass error status of own station' (SB0047) is turned on (error), data prior to error is held.	○	○	○	○
SB008C	External power supply information of each station	Stores the power supply status for external power supply by the MELSECNET/H network module with external power supply function of each station. (Including own station) Off: No external power supplied to any station On: External power supplied to station(s) When this relay is turned on, the status of each station can be checked with 'External power supply status' (SW008C to SW008F). Depending on the link refresh timing, the update of 'External power supply status' (SW008C to SW008F) may be offset by one sequence scan. (Conditions) • This register is enabled when 'Baton pass error status of own station' (SB0047) is off. When 'Baton pass error status of own station' (SB0047) is turned on (error), data prior to error is held.	○	×	○	×
SB008D	Module type of each station	Stores the module type of each station. Off: Stations with MELSECNET/10 type module included On: All stations with MELSECNET/H type module (Conditions) • This register is enabled when 'Baton pass error status of own station' (SB0047) is off. When 'Baton pass error status of own station' (SB0047) is turned on (error), data prior to error is held. • This register is enabled when 'Baton pass status of each station' (SB0070) is off.	○	○	○	○
SB008E	Path switching detection flag	Stores the path switching detection status. Off: Path switching not detected On: Path switching detected When 'Clear loop switching count' (SB0009) is turned on, the stored value is cleared.	○	×	○	×
SB0090	Loop status of own station	Stores the transmission path status of the own station. When this relay is turned on, the error definition can be checked with 'Loopback information' (SW0090). Off: Normal On: Error (Conditions) • This relay is turned on when a value other than 00H is set for 'Loopback information' (SW0090).	○	×	○	×
SB0091	Forward loop (IN-side) status	Stores the status of the station connected to the forward loop (IN-side). Off: All stations normal On: Faulty station exists When this relay is turned on, the status of each station can be checked with 'Forward loop status of each station' (SW0091 to SW0094). Depending on the link refresh timing, the update of 'Forward loop status of each station' (SW0091 to SW0094) may be offset by one sequence scan. (Conditions) • This register is enabled when 'Baton pass error status of own station' (SB0047) is off. When 'Baton pass error status of own station' (SB0047) is turned on (error), data prior to error is held.	○	×	○	×

No.	Name	Description	Availability			
			Control station		Normal Station	
			Loop	Bus	Loop	Bus
SB0095	Reverse loop (OUT-side) status	Stores the status of the station connected to the reverse loop (OUT-side). Off: All stations normal On: Faulty station exists When this relay is turned on, the status of each station can be checked with 'Reverse loop status of each station' (SW0095 to SW0098). Depending on the link refresh timing, the update of 'Reverse loop status of each station' (SW0095 to SW0098) may be offset by one sequence scan. (Conditions) • This register is enabled when 'Baton pass error status of own station' (SB0047) is off. When 'Baton pass error status of own station' (SB0047) is turned on (error), data prior to error is held.	○	×	○	×
SB0099	Forward (IN-side) Loopback status	Stores the loopback status for the loopback function. The station number of the forward loop (IN-side) loopback station can be checked with 'Loopback station of forward loop side' (SW0099). Off: Normal (no loopback stations) On: Error (loopback being performed) (Conditions) • This register is enabled when 'Baton pass error status of own station' (SB0047) is off. When 'Baton pass error status of own station' (SB0047) is turned on (error), data prior to error is held.	○	×	○	×
SB009A	Reverse (OUT-side) Loopback status	Stores the loopback status for the loopback function. The station number of the reverse loop (OUT-side) loopback station can be checked with 'Loopback station of reverse loop side' (SW009A). Off: Normal (no loopback stations) On: Error (loopback being performed) (Conditions) • This register is enabled when 'Baton pass error status of own station' (SB0047) is off. When 'Baton pass error status of own station' (SB0047) is turned on (error), data prior to error is held.	○	×	○	×
SB009C	Send transmission path mismatch status	Stores the status of the transmission path used for transmission at another station. Off: All matched On: Inconsistent station exists Depending on the link refresh timing, the update of 'Loop usage status of each station' (SW009C to SW009F) may be offset by one sequence scan. (Conditions) • This register is enabled when 'Baton pass error status of own station' (SB0047) is off. When 'Baton pass error status of own station' (SB0047) is turned on (error), data prior to error is held.	○	×	○	×
SB00A0	RECV execution request flag CH1	Stores the data reception status of own station channel 1. Off: No data received On: Data received (Conditions) • This register is enabled when 'Baton pass error status of own station' (SB0047) is off. When 'Baton pass error status of own station' (SB0047) is turned on (error), data prior to error is held.	○	○	○	○
SB00A1	RECV execution request flag CH2	Stores the data reception status of own station channel 2. Off: No data received On: Data received (Conditions) • This register is enabled when 'Baton pass error status of own station' (SB0047) is off. When 'Baton pass error status of own station' (SB0047) is turned on (error), data prior to error is held.	○	○	○	○
SB00A2	RECV execution request flag CH3	Stores the data reception status of own station channel 3. Off: No data received On: Data received (Conditions) • This register is enabled when 'Baton pass error status of own station' (SB0047) is off. When 'Baton pass error status of own station' (SB0047) is turned on (error), data prior to error is held.	○	○	○	○



No.	Name	Description	Availability			
			Control station		Normal Station	
			Loop	Bus	Loop	Bus
SB00A3	RECV execution request flag CH4	Stores the data reception status of own station channel 4. Off: No data received On: Data received (Conditions) • This register is enabled when 'Baton pass error status of own station' (SB0047) is off. When 'Baton pass error status of own station' (SB0047) is turned on (error), data prior to error is held.	○	○	○	○
SB00A4	RECV execution request flag CH5	Stores the data reception status of own station channel 5. Off: No data received On: Data received (Conditions) • This register is enabled when 'Baton pass error status of own station' (SB0047) is off. When 'Baton pass error status of own station' (SB0047) is turned on (error), data prior to error is held.	○	○	○	○
SB00A5	RECV execution request flag CH6	Stores the data reception status of own station channel 6. Off: No data received On: Data received (Conditions) • This register is enabled when 'Baton pass error status of own station' (SB0047) is off. When 'Baton pass error status of own station' (SB0047) is turned on (error), data prior to error is held.	○	○	○	○
SB00A6	RECV execution request flag CH7	Stores the data reception status of own station channel 7. Off: No data received On: Data received (Conditions) • This register is enabled when 'Baton pass error status of own station' (SB0047) is off. When 'Baton pass error status of own station' (SB0047) is turned on (error), data prior to error is held.	○	○	○	○
SB00A7	RECV execution request flag CH8	Stores the data reception status of own station channel 8. Off: No data received On: Data received (Conditions) • This register is enabled when 'Baton pass error status of own station' (SB0047) is off. When 'Baton pass error status of own station' (SB0047) is turned on (error), data prior to error is held.	○	○	○	○
SB00A8	Online test instruction (acceptance at the own station)	Stores the online test request status (the status of request acceptance at the own station). Off: Not requested On: Requested	○	○	○	○
SB00A9	Online test completion (issuance at the own station)	Stores the online test completion status (the status of request issuance from the own station). Off: Not completed On: Completed When the relay is turned on, the online test information can be checked with 'Online test execution item/faulty station of requesting side' (SW00A8) and 'Online test result of requesting side' (SW00A9).	○	○	○	○
SB00A A	Online test response instruction (acceptance at another station)	Stores the online test response status (the status of response acceptance from another station). Off: Response not received On: Response received	○	○	○	○
SB00A B	Online test response completion (issuance at another station)	Stores the online test response completion status (the status of response completion from another station). Off: Response not completed On: Response completed When the relay is turned on, the online test information can be checked with 'Online test execution item of responding side' (SW00AA) and 'Online test execution item of responding side' (SW00AB).	○	○	○	○
SB00A C	Offline test instruction (acceptance at the own station)	Stores the offline test request status (the status of request acceptance from the own station). Off: Not requested On: Requested	○	○	○	○

No.	Name	Description	Availability			
			Control station		Normal Station	
			Loop	Bus	Loop	Bus
SB00A D	Offline test completion (issuance at the own station)	Stores the offline test completion status (the status of request issuance from the own station). Off: Not completed On: Completed When the relay is turned on, the offline test information can be checked with 'Offline test execution item/faulty station of requesting side' (SW00AC) and 'Offline test result of requesting side' (SW00AD).	○	○	○	○
SB00A E	Offline test response instruction (acceptance at another station)	Stores the offline test instruction status (the status of response acceptance from another station). Off: Response not received On: Response received	○	×	○	×
SB00A F	Offline test response completion (issuance at another station)	Stores the offline test response completion status (the status of response completion from another station). Off: Response not completed On: Response completed When the relay is turned on, the offline test information can be checked with 'Offline test execution item of responding side' (SW00AE) and 'Offline test result of responding side' (SW00AF).	○	×	○	×
SB00E E	Transient error	Stores the transient transmission error detection status. Off: Error not detected On: Error detected When this relay is turned on, the number of errors can be checked with 'Transient transmission error cumulative count' (SW00EE).	○	○	○	○
SB01E0	Network type consistency check	Indicates the status of the occurrence of inconsistency between the network type of the control station and the network type of the normal station. ■ If the control station is set to the MELSECNET/H extended mode Off: Consistent (All normal stations are set to the MELSECNET/H extended mode.) On: Inconsistent (There are normal stations set to the MELSECNET/H mode or MELSECNET/10 mode.) ■ If the control station is set to the MELSECNET/H mode or MELSECNET/10 mode Off: Consistent (All normal stations are set to the MELSECNET/H mode or MELSECNET/10 mode.) On: Inconsistent (There are normal stations set to the MELSECNET/H extended mode.) When this relay is turned on, the status of each station can be checked with 'Network type consistency status' (SW01E0 to SW01E3). Depending on the link refresh timing, the update of 'Network type consistency status' (SW01E0 to SW01E3) may be offset by one sequence scan. (Conditions) • This register is enabled when 'Baton pass error status of own station' (SB0047) is off. When 'Baton pass error status of own station' (SB0047) is turned on (error), data prior to error is held.	○	○	○	○
SB01F4	Separate mode status in redundant system	Stores the CPU operation mode status of each station. Off: CPU backup mode set for all stations On: Separate mode This relay is turned off when 0 is set for all the settings of 'Separate mode status in redundant system' (SW01F4 to SW01F7). When this relay is turned on, the status of each station can be checked with 'Separate mode status in redundant system' (SW01F4 to SW01F7). Depending on the link refresh timing, the update of 'Separate mode status in redundant system' (SW01F4 to SW01F7) may be offset by one sequence scan. (Conditions) • This register is enabled when 'Baton pass error status of own station' (SB0047) is off. When 'Baton pass error status of own station' (SB0047) is turned on (error), data prior to error is held. • Reserved stations and stations exceeding the maximum station number are ignored.	○	○	○	○



No.	Name	Description	Availability			
			Control station		Normal Station	
			Loop	Bus	Loop	Bus
SB01F8	Pairing setting status in redundant system	<p>Stores the pairing setting status for each station.</p> <p>Off: No pairing-set station On: Pairing-set station exists</p> <p>When this relay is turned on, the status of each station can be checked with 'Pairing setting status in redundant system' (SW01F8 to SW01FB).</p> <p>Depending on the link refresh timing, the update of 'Pairing setting status in redundant system' (SW01F8 to SW01FB) may be offset by one sequence scan.</p> <p>(Conditions)</p> <ul style="list-style-type: none"> • This register is enabled when 'Baton pass error status of own station' (SB0047) is off. When 'Baton pass error status of own station' (SB0047) is turned on (error), data prior to error is held. • Reserved stations and stations exceeding the maximum station number are ignored. 	<input type="radio"/>	<input type="radio"/>	<input type="radio"/>	<input type="radio"/>
SB01FC	Standby system CPU status in redundant system	<p>Stores the CPU operation status (control/standby system) of each station.</p> <p>Off: Control system CPU at all stations On: Standby system CPU exists.</p> <p>When this relay is turned on, the status of each station can be checked with 'Standby system CPU status in redundant system' (SW01FC to SW01FF).</p> <p>Depending on the link refresh timing, the update of 'Standby system CPU status in redundant system' (SW01FC to SW01FF) may be offset by one sequence scan.</p> <p>(Conditions)</p> <ul style="list-style-type: none"> • This register is enabled when 'Baton pass error status of own station' (SB0047) is off. When 'Baton pass error status of own station' (SB0047) is turned on (error), data prior to error is held. • Reserved stations and stations exceeding the maximum station number are ignored. 	<input type="radio"/>	<input type="radio"/>	<input type="radio"/>	<input type="radio"/>

Appendix 4 List of Link Special Register (SW) Areas

The link special register (SW) stores the information during data link as a numerical value. Error locations and causes can be checked by using or monitoring the link special register (SW) in programs.

Application of the link special register (SW)

By using link special register (SW), the status of MELSECNET/H network can be checked from HMI (Human Machine Interfaces) as well as the engineering tool.

Link refresh of the link special register (SW)

To use the link special register (SW), set them in "Link Refresh Settings" in "Basic Settings" so that link refresh is performed for the devices or labels of the CPU module. ( Page 62 Link Refresh Settings)

Range where data are stored by users and range where data are stored by the system

The following ranges correspond to when the link special register (SW) areas are assigned from SW0000 to SW01FF.

- Stored by users: SW0000 to SW001F
- Stored by the system: SW0020 to SW01FF

List of link special register (SW) areas

The following table lists the link special register (SW) areas when they are assigned from SW0000 to SW01FF.

Each abbreviation and symbol in the table indicates the following.

Loop: RJ71LP21-25, Bus: RJ71BR11

○: Available, ×: Not available



Do not write any data to an area whose number is not on the following list or ranges where data are stored by the system. Doing so may cause malfunction of the programmable controller system.

No.	Name	Description	Availability																																																																																								
			Control station		Normal Station																																																																																						
			Loop	Bus	Loop	Bus																																																																																					
SW0000	Link start/stop instruction details	Set the content of link startup/stop directions. 00H: Own station 01H: All stations 02H: Specified stations 80H: Own station enforced (enabled only for link startup) 81H: All stations enforced (enabled only for link startup) 82H: Specified stations enforced (enabled only for link startup) • Link startup is performed by 'System link start' (SB0002), and link stop is performed 'System link stop' (SB0003).	○	○	○	○																																																																																					
SW0001 to SW0004	Link start/stop station to SW0004	Set the station number to start or stop data link when 02H or 82H is set in 'Link start/stop instruction details' (SW0000). Off: Startup or stop not requested On: Startup or stop requested <table border="1" style="margin-left: 40px;"> <tr> <td></td> <td>b15</td><td>b14</td><td>b13</td><td>b12</td><td>b11</td><td>b10</td><td>b9</td><td>b8</td><td>b7</td><td>b6</td><td>b5</td><td>b4</td><td>b3</td><td>b2</td><td>b1</td><td>b0</td> </tr> <tr> <td>SW0001</td> <td>16</td><td>15</td><td>14</td><td>13</td><td>12</td><td>11</td><td>10</td><td>9</td><td>8</td><td>7</td><td>6</td><td>5</td><td>4</td><td>3</td><td>2</td><td>1</td> </tr> <tr> <td>SW0002</td> <td>32</td><td>31</td><td>30</td><td>29</td><td>28</td><td>27</td><td>26</td><td>25</td><td>24</td><td>23</td><td>22</td><td>21</td><td>20</td><td>19</td><td>18</td><td>17</td> </tr> <tr> <td>SW0003</td> <td>48</td><td>47</td><td>46</td><td>45</td><td>44</td><td>43</td><td>42</td><td>41</td><td>40</td><td>39</td><td>38</td><td>37</td><td>36</td><td>35</td><td>34</td><td>33</td> </tr> <tr> <td>SW0004</td> <td>64</td><td>63</td><td>62</td><td>61</td><td>60</td><td>59</td><td>58</td><td>57</td><td>56</td><td>55</td><td>54</td><td>53</td><td>52</td><td>51</td><td>50</td><td>49</td> </tr> </table> Each number in the table represents a station number.		b15	b14	b13	b12	b11	b10	b9	b8	b7	b6	b5	b4	b3	b2	b1	b0	SW0001	16	15	14	13	12	11	10	9	8	7	6	5	4	3	2	1	SW0002	32	31	30	29	28	27	26	25	24	23	22	21	20	19	18	17	SW0003	48	47	46	45	44	43	42	41	40	39	38	37	36	35	34	33	SW0004	64	63	62	61	60	59	58	57	56	55	54	53	52	51	50	49	○	○	○	○
	b15	b14	b13	b12	b11	b10	b9	b8	b7	b6	b5	b4	b3	b2	b1	b0																																																																											
SW0001	16	15	14	13	12	11	10	9	8	7	6	5	4	3	2	1																																																																											
SW0002	32	31	30	29	28	27	26	25	24	23	22	21	20	19	18	17																																																																											
SW0003	48	47	46	45	44	43	42	41	40	39	38	37	36	35	34	33																																																																											
SW0004	64	63	62	61	60	59	58	57	56	55	54	53	52	51	50	49																																																																											
SW0008	Logical channel setting (Channel 1)	Set the channel number for Physical Channel 1. (Only enabled for the receiving side channel) 0: Logical Channel No.1 (Default) 1 to 64: Set	○	○	○	○																																																																																					
SW0009	Logical channel setting (Channel 2)	Set the channel number for Physical Channel 2. (Only enabled for the receiving side channel) 0: Logical Channel No.2 (Default) 1 to 64: Set	○	○	○	○																																																																																					
SW000A	Logical channel setting (Channel 3)	Set the channel number for Physical Channel 3. (Only enabled for the receiving side channel) 0: Logical Channel No.3 (Default) 1 to 64: Set	○	○	○	○																																																																																					
SW000B	Logical channel setting (Channel 4)	Set the channel number for Physical Channel 4. (Only enabled for the receiving side channel) 0: Logical Channel No.4 (Default) 1 to 64: Set	○	○	○	○																																																																																					
SW000C	Logical channel setting (Channel 5)	Set the channel number for Physical Channel 5. (Only enabled for the receiving side channel) 0: Logical Channel No.5 (Default) 1 to 64: Set	○	○	○	○																																																																																					
SW000D	Logical channel setting (Channel 6)	Set the channel number for Physical Channel 6. (Only enabled for the receiving side channel) 0: Logical Channel No.6 (Default) 1 to 64: Set	○	○	○	○																																																																																					
SW000E	Logical channel setting (Channel 7)	Set the channel number for Physical Channel 7. (Only enabled for the receiving side channel) 0: Logical Channel No.7 (Default) 1 to 64: Set	○	○	○	○																																																																																					

No.	Name	Description	Availability			
			Control station		Normal Station	
			Loop	Bus	Loop	Bus
SW000F	Logical channel setting (Channel 8)	Set the channel number for Physical Channel 8. (Only enabled for the receiving side channel) 0: Logical Channel No.8 (Default) 1 to 64: Set	○	○	○	○
SW0018	System switching monitoring time setting	Sets the time from when a data link error occurs to when the data link stop is recognized in a redundant system. 0: 2s (default) 1 to 500: Can be set in increments of 10ms (10ms to 5s)	○	×	○	×
SW0020	Communication status with CPU module	Stores the communication status between the MELSECNET/H network module and CPU module. 0: Normal 1 or greater: Error (An error code is stored.)	○	○	○	○
SW0031	Link dedicated instructions processing result CH1	Stores the processing results of the link dedicated instruction that used channel 1 of the own station. 0: Completed normally 1 or greater: Completed with an error (An error code is stored.)	○	○	○	○
SW0033	Link dedicated instructions processing result CH2	Stores the processing results of the link dedicated instruction that used channel 2 of the own station. 0: Completed normally 1 or greater: Completed with an error (An error code is stored.)	○	○	○	○
SW0035	Link dedicated instructions processing result CH3	Stores the processing results of the link dedicated instruction that used channel 3 of the own station. 0: Completed normally 1 or greater: Completed with an error (An error code is stored.)	○	○	○	○
SW0037	Link dedicated instructions processing result CH4	Stores the processing results of the link dedicated instruction that used channel 4 of the own station. 0: Completed normally 1 or greater: Completed with an error (An error code is stored.)	○	○	○	○
SW0039	Link dedicated instructions processing result CH5	Stores the processing results of the link dedicated instruction that used channel 5 of the own station. 0: Completed normally 1 or greater: Completed with an error (An error code is stored.)	○	○	○	○
SW003B	Link dedicated instructions processing result CH6	Stores the processing results of the link dedicated instruction that used channel 6 of the own station. 0: Completed normally 1 or greater: Completed with an error (An error code is stored.)	○	○	○	○
SW003D	Link dedicated instructions processing result CH7	Stores the processing results of the link dedicated instruction that used channel 7 of the own station. 0: Completed normally 1 or greater: Completed with an error (An error code is stored.)	○	○	○	○
SW003F	Link dedicated instructions processing result CH8	Stores the processing results of the link dedicated instruction that used channel 8 of the own station. 0: Completed normally 1 or greater: Completed with an error (An error code is stored.)	○	○	○	○
SW0040	Network No.	Stores the network number of the own station. Range: 1 to 239	○	○	○	○
SW0041	Transient transmission group No.	Stores the transient transmission group number of the own station. 0: No group specification 1 to 32: Transient transmission group number	○	○	○	○
SW0042	Station No.	Stores the station number of the own station. 1 to 64: Own station's station number	○	○	○	○
SW0043	Mode status of own station	Stores the module operation mode setting of the own station.*1 0: Online mode 2: Offline mode 3: Forward loop test (RJ71LP21-25) 4: Reverse loop test (RJ71LP21-25) 5: Station-to-station test (Executing station) 6: Station-to-station test (Executed station) 7: Self-loopback test 8: Internal selfloopback test 9: Hardware test	○	○	○	○

No.	Name	Description	Availability			
			Control station		Normal Station	
			Loop	Bus	Loop	Bus
SW0044	Station setting	<p>Stores the settings status of the own station.</p> <p> </p> <p> b0: Network type • 0: PLC to PLC network (Fixed to 0) b1: Station type • 0: Normal station • 1: Control station b7: Control station operation • 0: Specified control station switching • 1: Current control station maintained b8: Operation mode • 0: Online mode • 1: Debug mode b12: Own station network type • 0: MELSECNET/H mode, MELSECNET/10 mode • 1: MELSECNET/H extended mode </p>	<input type="radio"/>	<input type="radio"/>	<input type="radio"/>	<input type="radio"/>
SW0046	Module type	<p>Stores the hardware status of the own station.</p> <p> </p> <p> ■RJ71LP21-25 b1 to b0: Hardware status • 01: Light (fixed at 01) b14: Hardware status • 0: Duplex (fixed at 0) b15: Hardware status • 0: Loop (fixed at 0) </p> <p> ■RJ71BR11 b1 to b0: Hardware status • 10: Coaxial (fixed at 10) b14: Hardware status • 1: Simplex (fixed at 1) b15: Hardware status • 1: Bus (fixed at 1) </p>	<input type="radio"/>	<input type="radio"/>	<input type="radio"/>	<input type="radio"/>
SW0047	Baton pass status of own station	<p>Stores the baton pass status (transient transmission availability) of the own station.</p> <p> 00H: Data link in progress 01H: Data link stop (Instructed by another station) 02H: Data link stop (Instructed by the own station) 03H: Baton pass in progress (Parameter received (No own station send area)) 04H: Baton pass in progress (Parameter error) 05H: Baton pass in progress (Parameter not received) 06H: Disconnecting (No baton pass) 07H: Disconnecting (Line error) 11H: Loop test 12H: Setup check test 13H: Station order check test 14H: Communication test 1FH: Offline test </p>	<input type="radio"/>	<input type="radio"/>	<input type="radio"/>	<input type="radio"/>
SW0048	Cause of baton pass interruption	<p>Stores the cause of interruption in the communication (baton pass) of the own station.</p> <p> 00H: Normal communication 01H: Offline 02H: Offline test 03H or greater: Cause of interruption (Error code) </p>	<input type="radio"/>	<input type="radio"/>	<input type="radio"/>	<input type="radio"/>
SW0049	Cause of data link stop	<p>Stores the cause which stopped the data link of the own station.</p> <p> 00H: Normal 01H: Stop direction 02H: No common parameter exists 03H: Common parameter error 04H: Own station CPU error 06H: Communication interruption </p>	<input type="radio"/>	<input type="radio"/>	<input type="radio"/>	<input type="radio"/>

No.	Name	Description	Availability																	
			Control station		Normal Station															
			Loop	Bus	Loop	Bus														
SW004A	Data link stop request station	<p>Stores the station number of the station that performed the data link stop request for the own station.</p> <p>The data link stop request is performed by 'System link stop' (SB0003).</p> <div style="text-align: center;"> <table border="1"> <tr> <td>b15</td><td>b14</td><td>...</td><td>b7</td><td>b6</td><td>...</td><td>b0</td> </tr> <tr> <td>SW004A</td><td>0</td><td>...</td><td>0</td><td>...</td><td></td><td></td> </tr> </table> </div> <p>b6 to b0: Station number</p> <ul style="list-style-type: none"> • 0: Own station • 1 to 64: Another station <p>b15: Specified station</p> <ul style="list-style-type: none"> • 0: Station number specified • 1: All stations specified <p>(Conditions)</p> <ul style="list-style-type: none"> • This register is enabled when 'Cause of data link stop' (SW0049) is 01H. • This register is enabled when 'Baton pass error status of own station' (SB0047) is off. <p>When 'Baton pass error status of own station' (SB0047) is turned on (error), data prior to error is held.</p>	b15	b14	...	b7	b6	...	b0	SW004A	0	...	0	...			○	○	○	○
b15	b14	...	b7	b6	...	b0														
SW004A	0	...	0	...																
SW004B	CPU status of own station	<p>Stores the status of the CPU module of the own station.</p> <p>0: Normal</p> <p>1 or greater: Error (An error code is stored.)</p>	○	○	○	○														
SW004D	Link start result of own station	<p>Stores the results when link is started by 'Link startup of own station' (SB0000).</p> <p>0: Completed normally</p> <p>1 or greater: Completed with an error (An error code is stored.)</p> <p>(Conditions)</p> <ul style="list-style-type: none"> • This register is enabled when 'Baton pass error status of own station' (SB0047) is off. <p>When 'Baton pass error status of own station' (SB0047) is turned on (error), data prior to error is held.</p>	○	○	○	○														
SW004F	Link stop result of own station	<p>Stores the results when link is stopped by 'Link stop of own station' (SB0001).</p> <p>0: Completed normally</p> <p>1 or greater: Completed with an error (An error code is stored.)</p> <p>(Conditions)</p> <ul style="list-style-type: none"> • This register is enabled when 'Baton pass error status of own station' (SB0047) is off. <p>When 'Baton pass error status of own station' (SB0047) is turned on (error), data prior to error is held.</p>	○	○	○	○														
SW0051	System link start results	<p>Stores the results when link is started by 'System link start' (SB0002).</p> <p>0: Completed normally</p> <p>1 or greater: Completed with an error (An error code is stored.)</p> <p>(Conditions)</p> <ul style="list-style-type: none"> • This register is enabled when 'Baton pass error status of own station' (SB0047) is off. <p>When 'Baton pass error status of own station' (SB0047) is turned on (error), data prior to error is held.</p>	○	○	○	○														
SW0053	System link stop results	<p>Stores the results when link is stopped by 'System link stop' (SB0003).</p> <p>0: Normal</p> <p>1 or greater: Completed with an error (An error code is stored.)</p> <p>(Conditions)</p> <ul style="list-style-type: none"> • This register is enabled when 'Baton pass error status of own station' (SB0047) is off. <p>When 'Baton pass error status of own station' (SB0047) is turned on (error), data prior to error is held.</p>	○	○	○	○														
SW0054	Parameter information	<p>Stores parameter information.</p> <div style="text-align: center;"> <table border="1"> <tr> <td>b15</td><td>b14</td><td>b13</td><td>...</td><td>b2</td><td>b1</td><td>b0</td> </tr> <tr> <td>SW0054</td><td>0</td><td>0</td><td>...</td><td>0</td><td></td><td></td> </tr> </table> </div> <p>b1 to b0: Type</p> <ul style="list-style-type: none"> • 00: Only common parameter is used (fixed at 00) <p>b15: MELSECNET/H</p> <ul style="list-style-type: none"> • 0: Not specified • 1: Specified <p>When 'Receive parameter error' (SB0055) is on, the value is "000FH".</p> <p>(Conditions)</p> <ul style="list-style-type: none"> • This register is enabled when 'Receive parameter error' (SB0055) is off. 	b15	b14	b13	...	b2	b1	b0	SW0054	0	0	...	0			○	○	○	○
b15	b14	b13	...	b2	b1	b0														
SW0054	0	0	...	0																



No.	Name	Description	Availability																																																																																								
			Control station		Normal Station																																																																																						
			Loop	Bus	Loop	Bus																																																																																					
SW0055	Parameter setting status	Stores the parameter status. 0: Normal 1 or greater: Error (An error code is stored.) (Conditions) • This register is enabled when 'Receive parameter error' (SB0055) is on.	○	○	○	○																																																																																					
SW0056	Current control station	Stores the station number of the station which is actually operating as a control station. (Including sub-control station) 0: Control station or sub-control station does not exist. 1 to 64: Station number of the control station or sub-control station (Conditions) • This register is enabled when 'Baton pass error status of own station' (SB0047) is off. When 'Baton pass error status of own station' (SB0047) is turned on (error), data prior to error is held.	○	○	○	○																																																																																					
SW0057	Designated control station	Stores the control station number that has been set using a parameter. 0: Control station does not exist in a network. 1 to 64: Station number of the control station	○	○	○	○																																																																																					
SW0059	Total number of link stations	Stores the total number of stations which is set by a parameter. Range: 1 to 64	○	○	○	○																																																																																					
SW005A	Maximum baton pass station	Stores the maximum station number of the stations where the baton pass is normally performed. 0: Own station disconnected 1 to 64: Station number (Conditions) • This register is enabled when 'Baton pass error status of own station' (SB0047) is off.	○	○	○	○																																																																																					
SW005B	Maximum data link station	Stores the maximum station number of the station where the data link is normally performed. 0: Own station disconnected 1 to 64: Station number (Conditions) • This register is enabled when 'Data link error status of own station' (SB0049) is off.	○	○	○	○																																																																																					
SW005C	I/O master station of block 1	Stores the I/O master station number of block 1 (LX/LY setting (1)). 0: No I/O master station 1 to 64: Station number (Conditions) • This register is enabled when 'Data link error status of own station' (SB0049) is off.	○	○	○	○																																																																																					
SW005D	I/O master station of block 2	Stores the I/O master station number of block 2 (LX/LY setting (2)). 0: No I/O master station 1 to 64: Station number (Conditions) • This register is enabled when 'Data link error status of own station' (SB0049) is off.	○	○	○	○																																																																																					
SW0064 to SW0067	Reserved station setting status	Stores a station that is set as a reserved station. Off: A station other than a reserved station On: Reserved station <table border="1" style="margin-left: 40px;"> <thead> <tr> <th></th> <th>b15</th> <th>b14</th> <th>b13</th> <th>b12</th> <th>b11</th> <th>b10</th> <th>b9</th> <th>b8</th> <th>b7</th> <th>b6</th> <th>b5</th> <th>b4</th> <th>b3</th> <th>b2</th> <th>b1</th> <th>b0</th> </tr> </thead> <tbody> <tr> <td>SW0064</td> <td>16</td> <td>15</td> <td>14</td> <td>13</td> <td>12</td> <td>11</td> <td>10</td> <td>9</td> <td>8</td> <td>7</td> <td>6</td> <td>5</td> <td>4</td> <td>3</td> <td>2</td> <td>1</td> </tr> <tr> <td>SW0065</td> <td>32</td> <td>31</td> <td>30</td> <td>29</td> <td>28</td> <td>27</td> <td>26</td> <td>25</td> <td>24</td> <td>23</td> <td>22</td> <td>21</td> <td>20</td> <td>19</td> <td>18</td> <td>17</td> </tr> <tr> <td>SW0066</td> <td>48</td> <td>47</td> <td>46</td> <td>45</td> <td>44</td> <td>43</td> <td>42</td> <td>41</td> <td>40</td> <td>39</td> <td>38</td> <td>37</td> <td>36</td> <td>35</td> <td>34</td> <td>33</td> </tr> <tr> <td>SW0067</td> <td>64</td> <td>63</td> <td>62</td> <td>61</td> <td>60</td> <td>59</td> <td>58</td> <td>57</td> <td>56</td> <td>55</td> <td>54</td> <td>53</td> <td>52</td> <td>51</td> <td>50</td> <td>49</td> </tr> </tbody> </table> Each number in the table represents a station number. (Conditions) • This register is enabled when 'Data link error status of own station' (SB0049) is off.		b15	b14	b13	b12	b11	b10	b9	b8	b7	b6	b5	b4	b3	b2	b1	b0	SW0064	16	15	14	13	12	11	10	9	8	7	6	5	4	3	2	1	SW0065	32	31	30	29	28	27	26	25	24	23	22	21	20	19	18	17	SW0066	48	47	46	45	44	43	42	41	40	39	38	37	36	35	34	33	SW0067	64	63	62	61	60	59	58	57	56	55	54	53	52	51	50	49	○	○	○	○
	b15	b14	b13	b12	b11	b10	b9	b8	b7	b6	b5	b4	b3	b2	b1	b0																																																																											
SW0064	16	15	14	13	12	11	10	9	8	7	6	5	4	3	2	1																																																																											
SW0065	32	31	30	29	28	27	26	25	24	23	22	21	20	19	18	17																																																																											
SW0066	48	47	46	45	44	43	42	41	40	39	38	37	36	35	34	33																																																																											
SW0067	64	63	62	61	60	59	58	57	56	55	54	53	52	51	50	49																																																																											
SW0068	Constant link scan set value	Stores the setting value of the constant link scan which is set by a parameter. 0: No setting 1 to 500: Setting value of constant link scan (Unit: ms) (Conditions) • This register is enabled when 'Data link error status of own station' (SB0049) is off.	○	○	○	○																																																																																					

No.	Name	Description	Availability																																																																																								
			Control station		Normal Station																																																																																						
			Loop	Bus	Loop	Bus																																																																																					
SW006B	Maximum link scan time	<p>Stores the maximum value of the link scan time during cyclic transmission. (Unit: ms) When the constant link scan is specified, the register is set as follows:</p> <p>■For the control station</p> <ul style="list-style-type: none"> When the setting value is smaller than "Link scan actual measurement value + KB in the link scan time calculation formula", the value of "Link scan actual measurement value + KB in the link scan time calculation formula" is stored. When the setting value is larger than "Link scan actual measurement value + KB in the link scan time calculation formula", the link scan actual measurement value is stored. <p>(Conditions)</p> <ul style="list-style-type: none"> This register is enabled when 'Baton pass error status of own station' (SB0047) is off. When 'Baton pass error status of own station' (SB0047) is turned on (error), data prior to error is held. 	<input type="radio"/>	<input type="radio"/>	<input type="radio"/>	<input type="radio"/>																																																																																					
SW006C	Minimum link scan time	<p>Stores the minimum value of the link scan time during cyclic transmission. (Unit: ms) When the constant link scan is specified, the register is set as follows:</p> <p>■For the control station</p> <ul style="list-style-type: none"> When the setting value is smaller than "Link scan actual measurement value + KB in the link scan time calculation formula", the value of "Link scan actual measurement value + KB in the link scan time calculation formula" is stored. When the setting value is larger than "Link scan actual measurement value + KB in the link scan time calculation formula", the link scan actual measurement value is stored. <p>(Conditions)</p> <ul style="list-style-type: none"> This register is enabled when 'Baton pass error status of own station' (SB0047) is off. When 'Baton pass error status of own station' (SB0047) is turned on (error), data prior to error is held. 	<input type="radio"/>	<input type="radio"/>	<input type="radio"/>	<input type="radio"/>																																																																																					
SW006D	Current link scan time	<p>Stores the present value of the link scan time during cyclic transmission. (Unit: ms) When the constant link scan is specified, the register is set as follows:</p> <p>■For the control station</p> <ul style="list-style-type: none"> When the setting value is smaller than "Link scan actual measurement value + KB in the link scan time calculation formula", the value of "Link scan actual measurement value + KB in the link scan time calculation formula" is stored. When the setting value is larger than "Link scan actual measurement value + KB in the link scan time calculation formula", the link scan actual measurement value is stored. <p>(Conditions)</p> <ul style="list-style-type: none"> This register is enabled when 'Baton pass error status of own station' (SB0047) is off. When 'Baton pass error status of own station' (SB0047) is turned on (error), data prior to error is held. 	<input type="radio"/>	<input type="radio"/>	<input type="radio"/>	<input type="radio"/>																																																																																					
SW006E	Low-speed cyclic scan time	<p>Stores the link scan count for the implementation of low speed cyclic transmission (send interval).</p> <p>(Conditions)</p> <ul style="list-style-type: none"> This register is enabled when 'Baton pass error status of own station' (SB0047) is off. When 'Baton pass error status of own station' (SB0047) is turned on (error), data prior to error is held. 	<input type="radio"/>	<input type="radio"/>	<input type="radio"/>	<input type="radio"/>																																																																																					
SW0070 to SW0073	Baton pass status	<p>Stores the baton pass status of each station.</p> <p>Off: Baton pass normal station On: Baton pass faulty station</p> <table border="1"> <thead> <tr> <th></th> <th>b15</th> <th>b14</th> <th>b13</th> <th>b12</th> <th>b11</th> <th>b10</th> <th>b9</th> <th>b8</th> <th>b7</th> <th>b6</th> <th>b5</th> <th>b4</th> <th>b3</th> <th>b2</th> <th>b1</th> <th>b0</th> </tr> </thead> <tbody> <tr> <td>SW0070</td> <td>16</td> <td>15</td> <td>14</td> <td>13</td> <td>12</td> <td>11</td> <td>10</td> <td>9</td> <td>8</td> <td>7</td> <td>6</td> <td>5</td> <td>4</td> <td>3</td> <td>2</td> <td>1</td> </tr> <tr> <td>SW0071</td> <td>32</td> <td>31</td> <td>30</td> <td>29</td> <td>28</td> <td>27</td> <td>26</td> <td>25</td> <td>24</td> <td>23</td> <td>22</td> <td>21</td> <td>20</td> <td>19</td> <td>18</td> <td>17</td> </tr> <tr> <td>SW0072</td> <td>48</td> <td>47</td> <td>46</td> <td>45</td> <td>44</td> <td>43</td> <td>42</td> <td>41</td> <td>40</td> <td>39</td> <td>38</td> <td>37</td> <td>36</td> <td>35</td> <td>34</td> <td>33</td> </tr> <tr> <td>SW0073</td> <td>64</td> <td>63</td> <td>62</td> <td>61</td> <td>60</td> <td>59</td> <td>58</td> <td>57</td> <td>56</td> <td>55</td> <td>54</td> <td>53</td> <td>52</td> <td>51</td> <td>50</td> <td>49</td> </tr> </tbody> </table> <p>Each number in the table represents a station number.</p> <p>(Conditions)</p> <ul style="list-style-type: none"> This register is enabled when 'Baton pass error status of own station' (SB0047) is off. When 'Baton pass error status of own station' (SB0047) is turned on (error), data prior to error is held. Reserved stations and stations exceeding the maximum station number are ignored. 		b15	b14	b13	b12	b11	b10	b9	b8	b7	b6	b5	b4	b3	b2	b1	b0	SW0070	16	15	14	13	12	11	10	9	8	7	6	5	4	3	2	1	SW0071	32	31	30	29	28	27	26	25	24	23	22	21	20	19	18	17	SW0072	48	47	46	45	44	43	42	41	40	39	38	37	36	35	34	33	SW0073	64	63	62	61	60	59	58	57	56	55	54	53	52	51	50	49	<input type="radio"/>	<input type="radio"/>	<input type="radio"/>	<input type="radio"/>
	b15	b14	b13	b12	b11	b10	b9	b8	b7	b6	b5	b4	b3	b2	b1	b0																																																																											
SW0070	16	15	14	13	12	11	10	9	8	7	6	5	4	3	2	1																																																																											
SW0071	32	31	30	29	28	27	26	25	24	23	22	21	20	19	18	17																																																																											
SW0072	48	47	46	45	44	43	42	41	40	39	38	37	36	35	34	33																																																																											
SW0073	64	63	62	61	60	59	58	57	56	55	54	53	52	51	50	49																																																																											

No.	Name	Description	Availability																																																																																								
			Control station		Normal Station																																																																																						
			Loop	Bus	Loop	Bus																																																																																					
SW0074 to SW0077	Data link status	<p>Stores the data link status for each station. Off: Data link normal station On: Data link faulty station</p> <table border="1"> <thead> <tr> <th></th> <th>b15</th> <th>b14</th> <th>b13</th> <th>b12</th> <th>b11</th> <th>b10</th> <th>b9</th> <th>b8</th> <th>b7</th> <th>b6</th> <th>b5</th> <th>b4</th> <th>b3</th> <th>b2</th> <th>b1</th> <th>b0</th> </tr> </thead> <tbody> <tr> <td>SW0074</td> <td>16</td> <td>15</td> <td>14</td> <td>13</td> <td>12</td> <td>11</td> <td>10</td> <td>9</td> <td>8</td> <td>7</td> <td>6</td> <td>5</td> <td>4</td> <td>3</td> <td>2</td> <td>1</td> </tr> <tr> <td>SW0075</td> <td>32</td> <td>31</td> <td>30</td> <td>29</td> <td>28</td> <td>27</td> <td>26</td> <td>25</td> <td>24</td> <td>23</td> <td>22</td> <td>21</td> <td>20</td> <td>19</td> <td>18</td> <td>17</td> </tr> <tr> <td>SW0076</td> <td>48</td> <td>47</td> <td>46</td> <td>45</td> <td>44</td> <td>43</td> <td>42</td> <td>41</td> <td>40</td> <td>39</td> <td>38</td> <td>37</td> <td>36</td> <td>35</td> <td>34</td> <td>33</td> </tr> <tr> <td>SW0077</td> <td>64</td> <td>63</td> <td>62</td> <td>61</td> <td>60</td> <td>59</td> <td>58</td> <td>57</td> <td>56</td> <td>55</td> <td>54</td> <td>53</td> <td>52</td> <td>51</td> <td>50</td> <td>49</td> </tr> </tbody> </table> <p>Each number in the table represents a station number.</p> <ul style="list-style-type: none"> When the CPU unit equipped with the MELSECNET/H network module with external power supply function is turned off, the data link error detection timing may be delayed. To detect the data link error immediately in this case, create a program by configuring an interlock with the link relay (LB) in each station's send range. <p>(Conditions)</p> <ul style="list-style-type: none"> This register is enabled when 'Baton pass error status of own station' (SB0047) is off. When 'Baton pass error status of own station' (SB0047) is turned on (error), data prior to error is held. Stations exceeding the maximum station number are ignored. 		b15	b14	b13	b12	b11	b10	b9	b8	b7	b6	b5	b4	b3	b2	b1	b0	SW0074	16	15	14	13	12	11	10	9	8	7	6	5	4	3	2	1	SW0075	32	31	30	29	28	27	26	25	24	23	22	21	20	19	18	17	SW0076	48	47	46	45	44	43	42	41	40	39	38	37	36	35	34	33	SW0077	64	63	62	61	60	59	58	57	56	55	54	53	52	51	50	49	○	○	○	○
	b15	b14	b13	b12	b11	b10	b9	b8	b7	b6	b5	b4	b3	b2	b1	b0																																																																											
SW0074	16	15	14	13	12	11	10	9	8	7	6	5	4	3	2	1																																																																											
SW0075	32	31	30	29	28	27	26	25	24	23	22	21	20	19	18	17																																																																											
SW0076	48	47	46	45	44	43	42	41	40	39	38	37	36	35	34	33																																																																											
SW0077	64	63	62	61	60	59	58	57	56	55	54	53	52	51	50	49																																																																											
SW0078 to SW007B	Parameter communication status	<p>Stores the parameter communication status of each station. Off: Parameter communication completed or not executed On: Parameter communication in progress</p> <table border="1"> <thead> <tr> <th></th> <th>b15</th> <th>b14</th> <th>b13</th> <th>b12</th> <th>b11</th> <th>b10</th> <th>b9</th> <th>b8</th> <th>b7</th> <th>b6</th> <th>b5</th> <th>b4</th> <th>b3</th> <th>b2</th> <th>b1</th> <th>b0</th> </tr> </thead> <tbody> <tr> <td>SW0078</td> <td>16</td> <td>15</td> <td>14</td> <td>13</td> <td>12</td> <td>11</td> <td>10</td> <td>9</td> <td>8</td> <td>7</td> <td>6</td> <td>5</td> <td>4</td> <td>3</td> <td>2</td> <td>1</td> </tr> <tr> <td>SW0079</td> <td>32</td> <td>31</td> <td>30</td> <td>29</td> <td>28</td> <td>27</td> <td>26</td> <td>25</td> <td>24</td> <td>23</td> <td>22</td> <td>21</td> <td>20</td> <td>19</td> <td>18</td> <td>17</td> </tr> <tr> <td>SW007A</td> <td>48</td> <td>47</td> <td>46</td> <td>45</td> <td>44</td> <td>43</td> <td>42</td> <td>41</td> <td>40</td> <td>39</td> <td>38</td> <td>37</td> <td>36</td> <td>35</td> <td>34</td> <td>33</td> </tr> <tr> <td>SW007B</td> <td>64</td> <td>63</td> <td>62</td> <td>61</td> <td>60</td> <td>59</td> <td>58</td> <td>57</td> <td>56</td> <td>55</td> <td>54</td> <td>53</td> <td>52</td> <td>51</td> <td>50</td> <td>49</td> </tr> </tbody> </table> <p>Each number in the table represents a station number.</p> <p>(Conditions)</p> <ul style="list-style-type: none"> This register is enabled when 'Baton pass error status of own station' (SB0047) is off. When 'Baton pass error status of own station' (SB0047) is turned on (error), data prior to error is held. This register is enabled only for normally operating stations in 'Baton pass status' (SW0070 to SW0073). Reserved stations and stations exceeding the maximum station number are ignored. 		b15	b14	b13	b12	b11	b10	b9	b8	b7	b6	b5	b4	b3	b2	b1	b0	SW0078	16	15	14	13	12	11	10	9	8	7	6	5	4	3	2	1	SW0079	32	31	30	29	28	27	26	25	24	23	22	21	20	19	18	17	SW007A	48	47	46	45	44	43	42	41	40	39	38	37	36	35	34	33	SW007B	64	63	62	61	60	59	58	57	56	55	54	53	52	51	50	49	○	○	×	×
	b15	b14	b13	b12	b11	b10	b9	b8	b7	b6	b5	b4	b3	b2	b1	b0																																																																											
SW0078	16	15	14	13	12	11	10	9	8	7	6	5	4	3	2	1																																																																											
SW0079	32	31	30	29	28	27	26	25	24	23	22	21	20	19	18	17																																																																											
SW007A	48	47	46	45	44	43	42	41	40	39	38	37	36	35	34	33																																																																											
SW007B	64	63	62	61	60	59	58	57	56	55	54	53	52	51	50	49																																																																											
SW007C to SW007F	Parameter error status	<p>Stores the parameter error status of each station. Off: Normal On: Error</p> <table border="1"> <thead> <tr> <th></th> <th>b15</th> <th>b14</th> <th>b13</th> <th>b12</th> <th>b11</th> <th>b10</th> <th>b9</th> <th>b8</th> <th>b7</th> <th>b6</th> <th>b5</th> <th>b4</th> <th>b3</th> <th>b2</th> <th>b1</th> <th>b0</th> </tr> </thead> <tbody> <tr> <td>SW007C</td> <td>16</td> <td>15</td> <td>14</td> <td>13</td> <td>12</td> <td>11</td> <td>10</td> <td>9</td> <td>8</td> <td>7</td> <td>6</td> <td>5</td> <td>4</td> <td>3</td> <td>2</td> <td>1</td> </tr> <tr> <td>SW007D</td> <td>32</td> <td>31</td> <td>30</td> <td>29</td> <td>28</td> <td>27</td> <td>26</td> <td>25</td> <td>24</td> <td>23</td> <td>22</td> <td>21</td> <td>20</td> <td>19</td> <td>18</td> <td>17</td> </tr> <tr> <td>SW007E</td> <td>48</td> <td>47</td> <td>46</td> <td>45</td> <td>44</td> <td>43</td> <td>42</td> <td>41</td> <td>40</td> <td>39</td> <td>38</td> <td>37</td> <td>36</td> <td>35</td> <td>34</td> <td>33</td> </tr> <tr> <td>SW007F</td> <td>64</td> <td>63</td> <td>62</td> <td>61</td> <td>60</td> <td>59</td> <td>58</td> <td>57</td> <td>56</td> <td>55</td> <td>54</td> <td>53</td> <td>52</td> <td>51</td> <td>50</td> <td>49</td> </tr> </tbody> </table> <p>Each number in the table represents a station number.</p> <p>(Conditions)</p> <ul style="list-style-type: none"> This register is enabled when 'Baton pass error status of own station' (SB0047) is off. When 'Baton pass error status of own station' (SB0047) is turned on (error), data prior to error is held. Reserved stations and stations exceeding the maximum station number are ignored. 		b15	b14	b13	b12	b11	b10	b9	b8	b7	b6	b5	b4	b3	b2	b1	b0	SW007C	16	15	14	13	12	11	10	9	8	7	6	5	4	3	2	1	SW007D	32	31	30	29	28	27	26	25	24	23	22	21	20	19	18	17	SW007E	48	47	46	45	44	43	42	41	40	39	38	37	36	35	34	33	SW007F	64	63	62	61	60	59	58	57	56	55	54	53	52	51	50	49	○	○	×	×
	b15	b14	b13	b12	b11	b10	b9	b8	b7	b6	b5	b4	b3	b2	b1	b0																																																																											
SW007C	16	15	14	13	12	11	10	9	8	7	6	5	4	3	2	1																																																																											
SW007D	32	31	30	29	28	27	26	25	24	23	22	21	20	19	18	17																																																																											
SW007E	48	47	46	45	44	43	42	41	40	39	38	37	36	35	34	33																																																																											
SW007F	64	63	62	61	60	59	58	57	56	55	54	53	52	51	50	49																																																																											

No.	Name	Description	Availability																																																																																								
			Control station		Normal Station																																																																																						
			Loop	Bus	Loop	Bus																																																																																					
SW0080 to SW0083	CPU moderate to major error occurrence status	<p>Stores the moderate/major error occurrence status of the CPU module on each station. (Including own station)</p> <p>Off: No moderate/major error On: Moderate/major error</p> <table border="1"> <thead> <tr> <th></th> <th>b15</th> <th>b14</th> <th>b13</th> <th>b12</th> <th>b11</th> <th>b10</th> <th>b9</th> <th>b8</th> <th>b7</th> <th>b6</th> <th>b5</th> <th>b4</th> <th>b3</th> <th>b2</th> <th>b1</th> <th>b0</th> </tr> </thead> <tbody> <tr> <td>SW0080</td> <td>16</td> <td>15</td> <td>14</td> <td>13</td> <td>12</td> <td>11</td> <td>10</td> <td>9</td> <td>8</td> <td>7</td> <td>6</td> <td>5</td> <td>4</td> <td>3</td> <td>2</td> <td>1</td> </tr> <tr> <td>SW0081</td> <td>32</td> <td>31</td> <td>30</td> <td>29</td> <td>28</td> <td>27</td> <td>26</td> <td>25</td> <td>24</td> <td>23</td> <td>22</td> <td>21</td> <td>20</td> <td>19</td> <td>18</td> <td>17</td> </tr> <tr> <td>SW0082</td> <td>48</td> <td>47</td> <td>46</td> <td>45</td> <td>44</td> <td>43</td> <td>42</td> <td>41</td> <td>40</td> <td>39</td> <td>38</td> <td>37</td> <td>36</td> <td>35</td> <td>34</td> <td>33</td> </tr> <tr> <td>SW0083</td> <td>64</td> <td>63</td> <td>62</td> <td>61</td> <td>60</td> <td>59</td> <td>58</td> <td>57</td> <td>56</td> <td>55</td> <td>54</td> <td>53</td> <td>52</td> <td>51</td> <td>50</td> <td>49</td> </tr> </tbody> </table> <p>Each number in the table represents a station number.</p> <p>(Conditions)</p> <ul style="list-style-type: none"> This register is enabled when 'Baton pass error status of own station' (SB0047) is off. When 'Baton pass error status of own station' (SB0047) is turned on (error), data prior to error is held. This register is enabled only for normally operating stations in 'Baton pass status' (SW0070 to SW0073). Reserved stations and stations exceeding the maximum station number are ignored. 		b15	b14	b13	b12	b11	b10	b9	b8	b7	b6	b5	b4	b3	b2	b1	b0	SW0080	16	15	14	13	12	11	10	9	8	7	6	5	4	3	2	1	SW0081	32	31	30	29	28	27	26	25	24	23	22	21	20	19	18	17	SW0082	48	47	46	45	44	43	42	41	40	39	38	37	36	35	34	33	SW0083	64	63	62	61	60	59	58	57	56	55	54	53	52	51	50	49	<input type="radio"/>	<input type="radio"/>	<input type="radio"/>	<input type="radio"/>
	b15	b14	b13	b12	b11	b10	b9	b8	b7	b6	b5	b4	b3	b2	b1	b0																																																																											
SW0080	16	15	14	13	12	11	10	9	8	7	6	5	4	3	2	1																																																																											
SW0081	32	31	30	29	28	27	26	25	24	23	22	21	20	19	18	17																																																																											
SW0082	48	47	46	45	44	43	42	41	40	39	38	37	36	35	34	33																																																																											
SW0083	64	63	62	61	60	59	58	57	56	55	54	53	52	51	50	49																																																																											
SW0084 to SW0087	CPU operating status	<p>Stores the CPU RUN state of each station. (Including own station)</p> <p>Off: RUN, STEP-RUN On: STOP, PAUSE, or a moderate or serious error occurring</p> <table border="1"> <thead> <tr> <th></th> <th>b15</th> <th>b14</th> <th>b13</th> <th>b12</th> <th>b11</th> <th>b10</th> <th>b9</th> <th>b8</th> <th>b7</th> <th>b6</th> <th>b5</th> <th>b4</th> <th>b3</th> <th>b2</th> <th>b1</th> <th>b0</th> </tr> </thead> <tbody> <tr> <td>SW0084</td> <td>16</td> <td>15</td> <td>14</td> <td>13</td> <td>12</td> <td>11</td> <td>10</td> <td>9</td> <td>8</td> <td>7</td> <td>6</td> <td>5</td> <td>4</td> <td>3</td> <td>2</td> <td>1</td> </tr> <tr> <td>SW0085</td> <td>32</td> <td>31</td> <td>30</td> <td>29</td> <td>28</td> <td>27</td> <td>26</td> <td>25</td> <td>24</td> <td>23</td> <td>22</td> <td>21</td> <td>20</td> <td>19</td> <td>18</td> <td>17</td> </tr> <tr> <td>SW0086</td> <td>48</td> <td>47</td> <td>46</td> <td>45</td> <td>44</td> <td>43</td> <td>42</td> <td>41</td> <td>40</td> <td>39</td> <td>38</td> <td>37</td> <td>36</td> <td>35</td> <td>34</td> <td>33</td> </tr> <tr> <td>SW0087</td> <td>64</td> <td>63</td> <td>62</td> <td>61</td> <td>60</td> <td>59</td> <td>58</td> <td>57</td> <td>56</td> <td>55</td> <td>54</td> <td>53</td> <td>52</td> <td>51</td> <td>50</td> <td>49</td> </tr> </tbody> </table> <p>Each number in the table represents a station number.</p> <p>(Conditions)</p> <ul style="list-style-type: none"> This register is enabled when 'Baton pass error status of own station' (SB0047) is off. When 'Baton pass error status of own station' (SB0047) is turned on (error), data prior to error is held. This register is enabled only for normally operating stations in 'Baton pass status' (SW0070 to SW0073). Reserved stations and stations exceeding the maximum station number are ignored. 		b15	b14	b13	b12	b11	b10	b9	b8	b7	b6	b5	b4	b3	b2	b1	b0	SW0084	16	15	14	13	12	11	10	9	8	7	6	5	4	3	2	1	SW0085	32	31	30	29	28	27	26	25	24	23	22	21	20	19	18	17	SW0086	48	47	46	45	44	43	42	41	40	39	38	37	36	35	34	33	SW0087	64	63	62	61	60	59	58	57	56	55	54	53	52	51	50	49	<input type="radio"/>	<input type="radio"/>	<input type="radio"/>	<input type="radio"/>
	b15	b14	b13	b12	b11	b10	b9	b8	b7	b6	b5	b4	b3	b2	b1	b0																																																																											
SW0084	16	15	14	13	12	11	10	9	8	7	6	5	4	3	2	1																																																																											
SW0085	32	31	30	29	28	27	26	25	24	23	22	21	20	19	18	17																																																																											
SW0086	48	47	46	45	44	43	42	41	40	39	38	37	36	35	34	33																																																																											
SW0087	64	63	62	61	60	59	58	57	56	55	54	53	52	51	50	49																																																																											
SW0088 to SW008B	CPU minor error occurrence status	<p>Stores the minor error occurrence status of the CPU module on each station. (Including own station)</p> <p>Off: Normal operation, or a moderate or serious error occurring On: Minor error</p> <table border="1"> <thead> <tr> <th></th> <th>b15</th> <th>b14</th> <th>b13</th> <th>b12</th> <th>b11</th> <th>b10</th> <th>b9</th> <th>b8</th> <th>b7</th> <th>b6</th> <th>b5</th> <th>b4</th> <th>b3</th> <th>b2</th> <th>b1</th> <th>b0</th> </tr> </thead> <tbody> <tr> <td>SW0088</td> <td>16</td> <td>15</td> <td>14</td> <td>13</td> <td>12</td> <td>11</td> <td>10</td> <td>9</td> <td>8</td> <td>7</td> <td>6</td> <td>5</td> <td>4</td> <td>3</td> <td>2</td> <td>1</td> </tr> <tr> <td>SW0089</td> <td>32</td> <td>31</td> <td>30</td> <td>29</td> <td>28</td> <td>27</td> <td>26</td> <td>25</td> <td>24</td> <td>23</td> <td>22</td> <td>21</td> <td>20</td> <td>19</td> <td>18</td> <td>17</td> </tr> <tr> <td>SW008A</td> <td>48</td> <td>47</td> <td>46</td> <td>45</td> <td>44</td> <td>43</td> <td>42</td> <td>41</td> <td>40</td> <td>39</td> <td>38</td> <td>37</td> <td>36</td> <td>35</td> <td>34</td> <td>33</td> </tr> <tr> <td>SW008B</td> <td>64</td> <td>63</td> <td>62</td> <td>61</td> <td>60</td> <td>59</td> <td>58</td> <td>57</td> <td>56</td> <td>55</td> <td>54</td> <td>53</td> <td>52</td> <td>51</td> <td>50</td> <td>49</td> </tr> </tbody> </table> <p>Each number in the table represents a station number.</p> <p>(Conditions)</p> <ul style="list-style-type: none"> This register is enabled when 'Baton pass error status of own station' (SB0047) is off. When 'Baton pass error status of own station' (SB0047) is turned on (error), data prior to error is held. This register is enabled only for normally operating stations in 'Baton pass status' (SW0070 to SW0073). Reserved stations and stations exceeding the maximum station number are ignored. 		b15	b14	b13	b12	b11	b10	b9	b8	b7	b6	b5	b4	b3	b2	b1	b0	SW0088	16	15	14	13	12	11	10	9	8	7	6	5	4	3	2	1	SW0089	32	31	30	29	28	27	26	25	24	23	22	21	20	19	18	17	SW008A	48	47	46	45	44	43	42	41	40	39	38	37	36	35	34	33	SW008B	64	63	62	61	60	59	58	57	56	55	54	53	52	51	50	49	<input type="radio"/>	<input type="radio"/>	<input type="radio"/>	<input type="radio"/>
	b15	b14	b13	b12	b11	b10	b9	b8	b7	b6	b5	b4	b3	b2	b1	b0																																																																											
SW0088	16	15	14	13	12	11	10	9	8	7	6	5	4	3	2	1																																																																											
SW0089	32	31	30	29	28	27	26	25	24	23	22	21	20	19	18	17																																																																											
SW008A	48	47	46	45	44	43	42	41	40	39	38	37	36	35	34	33																																																																											
SW008B	64	63	62	61	60	59	58	57	56	55	54	53	52	51	50	49																																																																											



No.	Name	Description	Availability																																																																																								
			Control station		Normal Station																																																																																						
			Loop	Bus	Loop	Bus																																																																																					
SW008C to SW008F	External power supply status	<p>Stores the power supply status for external power supply by the MELSECNET/H network module with external power supply function of each station. (Including own station)</p> <p>Off: Not supplied On: Supplied</p> <p>This register is always off when the MELSECNET/H network module does not have the external power supply function.</p> <table border="1"> <thead> <tr> <th></th> <th>b15</th><th>b14</th><th>b13</th><th>b12</th><th>b11</th><th>b10</th><th>b9</th><th>b8</th><th>b7</th><th>b6</th><th>b5</th><th>b4</th><th>b3</th><th>b2</th><th>b1</th><th>b0</th> </tr> </thead> <tbody> <tr> <td>SW008C</td> <td>16</td><td>15</td><td>14</td><td>13</td><td>12</td><td>11</td><td>10</td><td>9</td><td>8</td><td>7</td><td>6</td><td>5</td><td>4</td><td>3</td><td>2</td><td>1</td> </tr> <tr> <td>SW008D</td> <td>32</td><td>31</td><td>30</td><td>29</td><td>28</td><td>27</td><td>26</td><td>25</td><td>24</td><td>23</td><td>22</td><td>21</td><td>20</td><td>19</td><td>18</td><td>17</td> </tr> <tr> <td>SW008E</td> <td>48</td><td>47</td><td>46</td><td>45</td><td>44</td><td>43</td><td>42</td><td>41</td><td>40</td><td>39</td><td>38</td><td>37</td><td>36</td><td>35</td><td>34</td><td>33</td> </tr> <tr> <td>SW008F</td> <td>64</td><td>63</td><td>62</td><td>61</td><td>60</td><td>59</td><td>58</td><td>57</td><td>56</td><td>55</td><td>54</td><td>53</td><td>52</td><td>51</td><td>50</td><td>49</td> </tr> </tbody> </table> <p>Each number in the table represents a station number. (Conditions)</p> <ul style="list-style-type: none"> This register is enabled when 'Baton pass error status of own station' (SB0047) is off. When 'Baton pass error status of own station' (SB0047) is turned on (error), data prior to error is held. This register is enabled only for normally operating stations in 'Baton pass status' (SW0070 to SW0073). Reserved stations and stations exceeding the maximum station number are ignored. 		b15	b14	b13	b12	b11	b10	b9	b8	b7	b6	b5	b4	b3	b2	b1	b0	SW008C	16	15	14	13	12	11	10	9	8	7	6	5	4	3	2	1	SW008D	32	31	30	29	28	27	26	25	24	23	22	21	20	19	18	17	SW008E	48	47	46	45	44	43	42	41	40	39	38	37	36	35	34	33	SW008F	64	63	62	61	60	59	58	57	56	55	54	53	52	51	50	49	○	×	○	×
	b15	b14	b13	b12	b11	b10	b9	b8	b7	b6	b5	b4	b3	b2	b1	b0																																																																											
SW008C	16	15	14	13	12	11	10	9	8	7	6	5	4	3	2	1																																																																											
SW008D	32	31	30	29	28	27	26	25	24	23	22	21	20	19	18	17																																																																											
SW008E	48	47	46	45	44	43	42	41	40	39	38	37	36	35	34	33																																																																											
SW008F	64	63	62	61	60	59	58	57	56	55	54	53	52	51	50	49																																																																											
SW0090	Loopback information	<p>Stores the loop status of the own station.</p> <p>0: Normal loop 1: Forward loop error 2: Reverse loop error 3: Loopback 4: Data link disabled</p>	○	×	○	×																																																																																					
SW0091 to SW0094	Forward loop (IN-side) status of each station	<p>Stores the forward loop (IN-side) status of each station. (Including own station)</p> <p>Off: Normal On: Error</p> <table border="1"> <thead> <tr> <th></th> <th>b15</th><th>b14</th><th>b13</th><th>b12</th><th>b11</th><th>b10</th><th>b9</th><th>b8</th><th>b7</th><th>b6</th><th>b5</th><th>b4</th><th>b3</th><th>b2</th><th>b1</th><th>b0</th> </tr> </thead> <tbody> <tr> <td>SW0091</td> <td>16</td><td>15</td><td>14</td><td>13</td><td>12</td><td>11</td><td>10</td><td>9</td><td>8</td><td>7</td><td>6</td><td>5</td><td>4</td><td>3</td><td>2</td><td>1</td> </tr> <tr> <td>SW0092</td> <td>32</td><td>31</td><td>30</td><td>29</td><td>28</td><td>27</td><td>26</td><td>25</td><td>24</td><td>23</td><td>22</td><td>21</td><td>20</td><td>19</td><td>18</td><td>17</td> </tr> <tr> <td>SW0093</td> <td>48</td><td>47</td><td>46</td><td>45</td><td>44</td><td>43</td><td>42</td><td>41</td><td>40</td><td>39</td><td>38</td><td>37</td><td>36</td><td>35</td><td>34</td><td>33</td> </tr> <tr> <td>SW0094</td> <td>64</td><td>63</td><td>62</td><td>61</td><td>60</td><td>59</td><td>58</td><td>57</td><td>56</td><td>55</td><td>54</td><td>53</td><td>52</td><td>51</td><td>50</td><td>49</td> </tr> </tbody> </table> <p>Each number in the table represents a station number. (Conditions)</p> <ul style="list-style-type: none"> This register is enabled when 'Baton pass error status of own station' (SB0047) is off. When 'Baton pass error status of own station' (SB0047) is turned on (error), data prior to error is held. This register is enabled only for normally operating stations in 'Baton pass status' (SW0070 to SW0073). Reserved stations and stations exceeding the maximum station number are ignored. The disconnected station is held in the state of disconnection. 		b15	b14	b13	b12	b11	b10	b9	b8	b7	b6	b5	b4	b3	b2	b1	b0	SW0091	16	15	14	13	12	11	10	9	8	7	6	5	4	3	2	1	SW0092	32	31	30	29	28	27	26	25	24	23	22	21	20	19	18	17	SW0093	48	47	46	45	44	43	42	41	40	39	38	37	36	35	34	33	SW0094	64	63	62	61	60	59	58	57	56	55	54	53	52	51	50	49	○	×	○	×
	b15	b14	b13	b12	b11	b10	b9	b8	b7	b6	b5	b4	b3	b2	b1	b0																																																																											
SW0091	16	15	14	13	12	11	10	9	8	7	6	5	4	3	2	1																																																																											
SW0092	32	31	30	29	28	27	26	25	24	23	22	21	20	19	18	17																																																																											
SW0093	48	47	46	45	44	43	42	41	40	39	38	37	36	35	34	33																																																																											
SW0094	64	63	62	61	60	59	58	57	56	55	54	53	52	51	50	49																																																																											

No.	Name	Description	Availability																																																																																								
			Control station		Normal Station																																																																																						
			Loop	Bus	Loop	Bus																																																																																					
SW0095 to SW0098	Reverse loop status of each station	<p>Stores the reverse loop (OUT-side) status of each station. (Including own station) Off: Normal On: Error</p> <table border="1"> <thead> <tr> <th></th> <th>b15</th> <th>b14</th> <th>b13</th> <th>b12</th> <th>b11</th> <th>b10</th> <th>b9</th> <th>b8</th> <th>b7</th> <th>b6</th> <th>b5</th> <th>b4</th> <th>b3</th> <th>b2</th> <th>b1</th> <th>b0</th> </tr> </thead> <tbody> <tr> <td>SW0095</td> <td>16</td> <td>15</td> <td>14</td> <td>13</td> <td>12</td> <td>11</td> <td>10</td> <td>9</td> <td>8</td> <td>7</td> <td>6</td> <td>5</td> <td>4</td> <td>3</td> <td>2</td> <td>1</td> </tr> <tr> <td>SW0096</td> <td>32</td> <td>31</td> <td>30</td> <td>29</td> <td>28</td> <td>27</td> <td>26</td> <td>25</td> <td>24</td> <td>23</td> <td>22</td> <td>21</td> <td>20</td> <td>19</td> <td>18</td> <td>17</td> </tr> <tr> <td>SW0097</td> <td>48</td> <td>47</td> <td>46</td> <td>45</td> <td>44</td> <td>43</td> <td>42</td> <td>41</td> <td>40</td> <td>39</td> <td>38</td> <td>37</td> <td>36</td> <td>35</td> <td>34</td> <td>33</td> </tr> <tr> <td>SW0098</td> <td>64</td> <td>63</td> <td>62</td> <td>61</td> <td>60</td> <td>59</td> <td>58</td> <td>57</td> <td>56</td> <td>55</td> <td>54</td> <td>53</td> <td>52</td> <td>51</td> <td>50</td> <td>49</td> </tr> </tbody> </table> <p>Each number in the table represents a station number. (Conditions)</p> <ul style="list-style-type: none"> This register is enabled when 'Baton pass error status of own station' (SB0047) is off. When 'Baton pass error status of own station' (SB0047) is turned on (error), data prior to error is held. This register is enabled only for normally operating stations in 'Baton pass status' (SW0070 to SW0073). Reserved stations and stations exceeding the maximum station number are ignored. The disconnected station is held in the state of disconnection. 		b15	b14	b13	b12	b11	b10	b9	b8	b7	b6	b5	b4	b3	b2	b1	b0	SW0095	16	15	14	13	12	11	10	9	8	7	6	5	4	3	2	1	SW0096	32	31	30	29	28	27	26	25	24	23	22	21	20	19	18	17	SW0097	48	47	46	45	44	43	42	41	40	39	38	37	36	35	34	33	SW0098	64	63	62	61	60	59	58	57	56	55	54	53	52	51	50	49	○	×	○	×
	b15	b14	b13	b12	b11	b10	b9	b8	b7	b6	b5	b4	b3	b2	b1	b0																																																																											
SW0095	16	15	14	13	12	11	10	9	8	7	6	5	4	3	2	1																																																																											
SW0096	32	31	30	29	28	27	26	25	24	23	22	21	20	19	18	17																																																																											
SW0097	48	47	46	45	44	43	42	41	40	39	38	37	36	35	34	33																																																																											
SW0098	64	63	62	61	60	59	58	57	56	55	54	53	52	51	50	49																																																																											
SW0099	Loopback station of forward loop side	<p>Stores the number of the station where loopback is being performed on the forward loop (IN-side). 1 to 64: Station number (Conditions)</p> <ul style="list-style-type: none"> This register is enabled when 'Baton pass error status of own station' (SB0047) is off. When 'Baton pass error status of own station' (SB0047) is turned on (error), data prior to error is held. 	○	×	○	×																																																																																					
SW009A	Loopback station of reverse loop side	<p>Stores the number of the station where loopback is being performed on the reverse loop (OUT-side). 1 to 64: Station number (Conditions)</p> <ul style="list-style-type: none"> This register is enabled when 'Baton pass error status of own station' (SB0047) is off. When 'Baton pass error status of own station' (SB0047) is turned on (error), data prior to error is held. 	○	×	○	×																																																																																					
SW009C to SW009F	Loop usage status of each station	<p>Stores the status of reverse insertion (IN-IN, OUT-OUT) of the optical fiber cable. All 0 or all 1: Optical fiber cable normally connected Other than above: A station with an optical fiber cable inserted in reverse exists.</p> <table border="1"> <thead> <tr> <th></th> <th>b15</th> <th>b14</th> <th>b13</th> <th>b12</th> <th>b11</th> <th>b10</th> <th>b9</th> <th>b8</th> <th>b7</th> <th>b6</th> <th>b5</th> <th>b4</th> <th>b3</th> <th>b2</th> <th>b1</th> <th>b0</th> </tr> </thead> <tbody> <tr> <td>SW009C</td> <td>16</td> <td>15</td> <td>14</td> <td>13</td> <td>12</td> <td>11</td> <td>10</td> <td>9</td> <td>8</td> <td>7</td> <td>6</td> <td>5</td> <td>4</td> <td>3</td> <td>2</td> <td>1</td> </tr> <tr> <td>SW009D</td> <td>32</td> <td>31</td> <td>30</td> <td>29</td> <td>28</td> <td>27</td> <td>26</td> <td>25</td> <td>24</td> <td>23</td> <td>22</td> <td>21</td> <td>20</td> <td>19</td> <td>18</td> <td>17</td> </tr> <tr> <td>SW009E</td> <td>48</td> <td>47</td> <td>46</td> <td>45</td> <td>44</td> <td>43</td> <td>42</td> <td>41</td> <td>40</td> <td>39</td> <td>38</td> <td>37</td> <td>36</td> <td>35</td> <td>34</td> <td>33</td> </tr> <tr> <td>SW009F</td> <td>64</td> <td>63</td> <td>62</td> <td>61</td> <td>60</td> <td>59</td> <td>58</td> <td>57</td> <td>56</td> <td>55</td> <td>54</td> <td>53</td> <td>52</td> <td>51</td> <td>50</td> <td>49</td> </tr> </tbody> </table> <p>Each number in the table represents a station number. (Conditions)</p> <ul style="list-style-type: none"> This register is enabled when 'Baton pass error status of own station' (SB0047) is off. When 'Baton pass error status of own station' (SB0047) is turned on (error), data prior to error is held. This register is enabled only for normally operating stations in 'Baton pass status' (SW0070 to SW0073). Reserved stations and stations exceeding the maximum station number are ignored. 		b15	b14	b13	b12	b11	b10	b9	b8	b7	b6	b5	b4	b3	b2	b1	b0	SW009C	16	15	14	13	12	11	10	9	8	7	6	5	4	3	2	1	SW009D	32	31	30	29	28	27	26	25	24	23	22	21	20	19	18	17	SW009E	48	47	46	45	44	43	42	41	40	39	38	37	36	35	34	33	SW009F	64	63	62	61	60	59	58	57	56	55	54	53	52	51	50	49	○	×	○	×
	b15	b14	b13	b12	b11	b10	b9	b8	b7	b6	b5	b4	b3	b2	b1	b0																																																																											
SW009C	16	15	14	13	12	11	10	9	8	7	6	5	4	3	2	1																																																																											
SW009D	32	31	30	29	28	27	26	25	24	23	22	21	20	19	18	17																																																																											
SW009E	48	47	46	45	44	43	42	41	40	39	38	37	36	35	34	33																																																																											
SW009F	64	63	62	61	60	59	58	57	56	55	54	53	52	51	50	49																																																																											



No.	Name	Description	Availability									
			Control station		Normal Station							
			Loop	Bus	Loop	Bus						
SW00A8	Online test execution item/faulty station of requesting side	<p>Stores the items/faulty stations of the online test at the request side. The station disconnected from the network is not included in faulty stations because no response is made.</p> <p style="text-align: center;"> b15 ... b8 b7 ... b0 SW00A8 <table border="1" style="display: inline-table; vertical-align: middle;"><tr><td style="width: 15px; height: 15px;"></td><td style="width: 15px; height: 15px;"></td><td style="width: 15px; height: 15px;"></td><td style="width: 15px; height: 15px;"></td><td style="width: 15px; height: 15px;"></td><td style="width: 15px; height: 15px;"></td></tr></table> </p> <p>b7 to b0: Item number</p> <ul style="list-style-type: none"> • 10H: Loop test • 20H: Setup check test • 30H: Station order check test • 40H: Communication test <p>b15 to b8: Faulty station number</p> <ul style="list-style-type: none"> • When there are multiple stations, the station detected first is stored. <p>(Conditions)</p> <ul style="list-style-type: none"> • This register is enabled when 'Online test completion (issuance at the own station)' (SB00A9) is on. 							○	○	○	○
SW00A9	Online test result of requesting side	<p>Stores the results of the online test at the request side. 0: Completed normally 1 or greater: Completed with an error (An error code is stored.)</p> <p>(Conditions)</p> <ul style="list-style-type: none"> • This register is enabled when 'Online test completion (issuance at the own station)' (SB00A9) is on. 	○	○	○	○						
SW00AA	Online test execution item of responding side	<p>Shows the items of the online test at the response side. 10H: Loop test 20H: Setup check test 30H: Station order check test 40H: Communication test</p> <p>(Conditions)</p> <ul style="list-style-type: none"> • This register is enabled when 'Online test response completion (issuance at another station)' (SB00AB) is on. 	○	○	○	○						
SW00AB	Online test result of responding side	<p>Stores the online test result at the response side. 0: Completed normally 1 or greater: Completed with an error (An error code is stored.)</p> <p>(Conditions)</p> <ul style="list-style-type: none"> • This register is enabled when 'Online test response completion (issuance at another station)' (SB00AB) is on. 	○	○	○	○						
SW00AC	Offline test execution item/faulty station of requesting side	<p>Stores the items/faulty stations of the offline test at the request side. The station disconnected from the network is not included in faulty stations because no response is made.</p> <p style="text-align: center;"> b15 ... b8 b7 ... b0 SW00AC <table border="1" style="display: inline-table; vertical-align: middle;"><tr><td style="width: 15px; height: 15px;"></td><td style="width: 15px; height: 15px;"></td><td style="width: 15px; height: 15px;"></td><td style="width: 15px; height: 15px;"></td><td style="width: 15px; height: 15px;"></td><td style="width: 15px; height: 15px;"></td></tr></table> </p> <p>b7 to b0: Item number</p> <ul style="list-style-type: none"> • 3: Loop test (Forward loop) • 4: Loop test (Reverse loop) • 5: Station-to-station test (Executing station) • 6: Station-to-station test (Executed station) • 7: Self-loopback test • 8: Internal selfloopback test • 9: Hardware test <p>b15 to b8: Maximum faulty station number</p> <p>(Conditions)</p> <p>The maximum faulty station number (b15 to b8) is enabled when 'Offline test completion (issuance at the own station)' (SB00AD) is on.</p>							○	○	○	○
SW00AD	Offline test result of requesting side	<p>Stores the results of the offline test at the request side. 0: Completed normally 1 or greater: Completed with an error (An error code is stored.)</p> <p>(Conditions)</p> <ul style="list-style-type: none"> • This register is enabled when 'Offline test completion (issuance at the own station)' (SB00AD) is on. 	○	○	○	○						

No.	Name	Description	Availability																																																																																								
			Control station		Normal Station																																																																																						
			Loop	Bus	Loop	Bus																																																																																					
SW00AE	Offline test execution item of responding side	Shows the items of the offline test at the response side. 3: Loop test (Forward loop) 4: Loop test (Reverse loop) (Conditions) • This register is enabled when 'Offline test response completion (issuance at another station)' (SB00AF) is on.	○	×	○	×																																																																																					
SW00AF	Offline test result of responding side	Stores the results of the offline test at the response side. 0: Completed normally 1 or greater: Completed with an error (An error code is stored.) (Conditions) • This register is enabled when 'Offline test response completion (issuance at another station)' (SB00AF) is on.	○	×	○	×																																																																																					
SW00B0 to SW00B3	Multiplex transmission status of forward loop side	Stores the forward loop (IN-side) use status of each station during multiplex transmission. Off: Other than forward loop (IN-side) On: Forward loop (IN-side) used <table border="1" style="margin-left: auto; margin-right: auto;"> <thead> <tr> <th></th> <th>b15</th><th>b14</th><th>b13</th><th>b12</th><th>b11</th><th>b10</th><th>b9</th><th>b8</th><th>b7</th><th>b6</th><th>b5</th><th>b4</th><th>b3</th><th>b2</th><th>b1</th><th>b0</th> </tr> </thead> <tbody> <tr> <td>SW00B0</td> <td>16</td><td>15</td><td>14</td><td>13</td><td>12</td><td>11</td><td>10</td><td>9</td><td>8</td><td>7</td><td>6</td><td>5</td><td>4</td><td>3</td><td>2</td><td>1</td> </tr> <tr> <td>SW00B1</td> <td>32</td><td>31</td><td>30</td><td>29</td><td>28</td><td>27</td><td>26</td><td>25</td><td>24</td><td>23</td><td>22</td><td>21</td><td>20</td><td>19</td><td>18</td><td>17</td> </tr> <tr> <td>SW00B2</td> <td>48</td><td>47</td><td>46</td><td>45</td><td>44</td><td>43</td><td>42</td><td>41</td><td>40</td><td>39</td><td>38</td><td>37</td><td>36</td><td>35</td><td>34</td><td>33</td> </tr> <tr> <td>SW00B3</td> <td>64</td><td>63</td><td>62</td><td>61</td><td>60</td><td>59</td><td>58</td><td>57</td><td>56</td><td>55</td><td>54</td><td>53</td><td>52</td><td>51</td><td>50</td><td>49</td> </tr> </tbody> </table> Each number in the table represents a station number. (Conditions) • This register is enabled when 'Baton pass error status of own station' (SB0047) is off. When 'Baton pass error status of own station' (SB0047) is turned on (error), data prior to error is held. • Reserved stations and stations with a number equal to or greater than the maximum station number are ignored.		b15	b14	b13	b12	b11	b10	b9	b8	b7	b6	b5	b4	b3	b2	b1	b0	SW00B0	16	15	14	13	12	11	10	9	8	7	6	5	4	3	2	1	SW00B1	32	31	30	29	28	27	26	25	24	23	22	21	20	19	18	17	SW00B2	48	47	46	45	44	43	42	41	40	39	38	37	36	35	34	33	SW00B3	64	63	62	61	60	59	58	57	56	55	54	53	52	51	50	49	○	×	○	×
	b15	b14	b13	b12	b11	b10	b9	b8	b7	b6	b5	b4	b3	b2	b1	b0																																																																											
SW00B0	16	15	14	13	12	11	10	9	8	7	6	5	4	3	2	1																																																																											
SW00B1	32	31	30	29	28	27	26	25	24	23	22	21	20	19	18	17																																																																											
SW00B2	48	47	46	45	44	43	42	41	40	39	38	37	36	35	34	33																																																																											
SW00B3	64	63	62	61	60	59	58	57	56	55	54	53	52	51	50	49																																																																											
SW00B4 to SW00B7	Multiplex transmission status of reverse loop side	Stores the reverse loop (OUT-side) use status of each station during multiplex transmission. Off: Other than reverse loop (OUT-side) On: Reverse loop (OUT-side) used <table border="1" style="margin-left: auto; margin-right: auto;"> <thead> <tr> <th></th> <th>b15</th><th>b14</th><th>b13</th><th>b12</th><th>b11</th><th>b10</th><th>b9</th><th>b8</th><th>b7</th><th>b6</th><th>b5</th><th>b4</th><th>b3</th><th>b2</th><th>b1</th><th>b0</th> </tr> </thead> <tbody> <tr> <td>SW00B4</td> <td>16</td><td>15</td><td>14</td><td>13</td><td>12</td><td>11</td><td>10</td><td>9</td><td>8</td><td>7</td><td>6</td><td>5</td><td>4</td><td>3</td><td>2</td><td>1</td> </tr> <tr> <td>SW00B5</td> <td>32</td><td>31</td><td>30</td><td>29</td><td>28</td><td>27</td><td>26</td><td>25</td><td>24</td><td>23</td><td>22</td><td>21</td><td>20</td><td>19</td><td>18</td><td>17</td> </tr> <tr> <td>SW00B6</td> <td>48</td><td>47</td><td>46</td><td>45</td><td>44</td><td>43</td><td>42</td><td>41</td><td>40</td><td>39</td><td>38</td><td>37</td><td>36</td><td>35</td><td>34</td><td>33</td> </tr> <tr> <td>SW00B7</td> <td>64</td><td>63</td><td>62</td><td>61</td><td>60</td><td>59</td><td>58</td><td>57</td><td>56</td><td>55</td><td>54</td><td>53</td><td>52</td><td>51</td><td>50</td><td>49</td> </tr> </tbody> </table> Each number in the table represents a station number. (Conditions) • This register is enabled when 'Baton pass error status of own station' (SB0047) is off. When 'Baton pass error status of own station' (SB0047) is turned on (error), data prior to error is held. • Reserved stations and stations with a number equal to or greater than the maximum station number are ignored.		b15	b14	b13	b12	b11	b10	b9	b8	b7	b6	b5	b4	b3	b2	b1	b0	SW00B4	16	15	14	13	12	11	10	9	8	7	6	5	4	3	2	1	SW00B5	32	31	30	29	28	27	26	25	24	23	22	21	20	19	18	17	SW00B6	48	47	46	45	44	43	42	41	40	39	38	37	36	35	34	33	SW00B7	64	63	62	61	60	59	58	57	56	55	54	53	52	51	50	49	○	×	○	×
	b15	b14	b13	b12	b11	b10	b9	b8	b7	b6	b5	b4	b3	b2	b1	b0																																																																											
SW00B4	16	15	14	13	12	11	10	9	8	7	6	5	4	3	2	1																																																																											
SW00B5	32	31	30	29	28	27	26	25	24	23	22	21	20	19	18	17																																																																											
SW00B6	48	47	46	45	44	43	42	41	40	39	38	37	36	35	34	33																																																																											
SW00B7	64	63	62	61	60	59	58	57	56	55	54	53	52	51	50	49																																																																											
SW00B8	UNDER on the forward loop side	<p>■RJ71LP21-25</p> <ul style="list-style-type: none"> Stores the cumulative error occurrence count of the forward loop (IN-side) communication under-error. <p>■RJ71BR11</p> <ul style="list-style-type: none"> Stores the cumulative error occurrence count of communication under-error. <p>0: No error 1 or greater: Cumulative count</p> <p>There is no problem if values are counted up little by little over a long period of time. If values are rapidly counted up in a short period of time, check if the cables are faulty.</p>	○	○	○	○																																																																																					



No.	Name	Description	Availability			
			Control station		Normal Station	
			Loop	Bus	Loop	Bus
SW00B9	CRC on the forward loop side	<p>■RJ71LP21-25</p> <ul style="list-style-type: none"> Stores the cumulative error occurrence count of the forward loop (IN-side) communication CRC error. <p>■RJ71BR11</p> <ul style="list-style-type: none"> Stores the cumulative error occurrence count of communication CRC error. <p>0: No error 1 or greater: Cumulative count</p> <p>There is no problem if values are counted up little by little over a long period of time. If values are rapidly counted up in a short period of time, check if the cables are faulty.</p>	<input type="radio"/>	<input type="radio"/>	<input type="radio"/>	<input type="radio"/>
SW00BA	OVER on the forward loop side	<p>■RJ71LP21-25</p> <ul style="list-style-type: none"> Stores the cumulative error occurrence count of the forward loop (IN-side) communication overrun error. <p>■RJ71BR11</p> <ul style="list-style-type: none"> Stores the cumulative error occurrence count of communication overrun error. <p>0: No error 1 or greater: Cumulative count</p> <p>There is no problem if values are counted up little by little over a long period of time. If values are rapidly counted up in a short period of time, check if the cables are faulty.</p>	<input type="radio"/>	<input type="radio"/>	<input type="radio"/>	<input type="radio"/>
SW00BB	Short frame on the forward loop side	<p>■RJ71LP21-25</p> <ul style="list-style-type: none"> Stores the cumulative error occurrence count of the forward loop (IN-side) communication short frame error. <p>■RJ71BR11</p> <ul style="list-style-type: none"> Stores the cumulative error occurrence count of communication short frame error. <p>0: No error 1 or greater: Cumulative count</p> <p>There is no problem if values are counted up little by little over a long period of time. If values are rapidly counted up in a short period of time, check if the cables are faulty.</p>	<input type="radio"/>	<input type="radio"/>	<input type="radio"/>	<input type="radio"/>
SW00BC	Abort on the forward loop side (AB, IF)	<p>■RJ71LP21-25</p> <ul style="list-style-type: none"> Stores the cumulative error occurrence count of the forward loop (IN-side) communication abort error. <p>■RJ71BR11</p> <ul style="list-style-type: none"> Stores the cumulative error occurrence count of communication abort error. <p>0: No error 1 or greater: Cumulative count</p> <p>There is no problem if values are counted up little by little over a long period of time. If values are rapidly counted up in a short period of time, check if the cables are faulty.</p>	<input type="radio"/>	<input type="radio"/>	<input type="radio"/>	<input type="radio"/>
SW00BD	Timeout on the forward loop side (TIME)	<p>■RJ71LP21-25</p> <ul style="list-style-type: none"> Stores the cumulative error occurrence count of the forward loop (IN-side) communication timeout. <p>■RJ71BR11</p> <ul style="list-style-type: none"> Stores the cumulative error occurrence count of communication timeout. <p>0: No error 1 or greater: Cumulative count</p> <p>There is no problem if values are counted up little by little over a long period of time. If values are rapidly counted up in a short period of time, check if the cables are faulty.</p>	<input type="radio"/>	<input type="radio"/>	<input type="radio"/>	<input type="radio"/>
SW00BE	Receiving 2k bytes or more on forward loop side (DATA)	<p>■RJ71LP21-25</p> <ul style="list-style-type: none"> Stores the cumulative error occurrence count of the reception of 2K bytes or more at the forward loop (IN-side). <p>■RJ71BR11</p> <ul style="list-style-type: none"> Stores the cumulative error occurrence count of the reception of 2K bytes or more. <p>0: No error 1 or greater: Cumulative count</p> <p>There is no problem if values are counted up little by little over a long period of time. If values are rapidly counted up in a short period of time, check if the cables are faulty.</p>	<input type="radio"/>	<input type="radio"/>	<input type="radio"/>	<input type="radio"/>
SW00BF	DPLL error on the forward loop side	<p>■RJ71LP21-25</p> <ul style="list-style-type: none"> Stores the cumulative error occurrence count of the forward loop (IN-side) communication DPLL error. <p>■RJ71BR11</p> <ul style="list-style-type: none"> Stores the cumulative error occurrence count of communication DPLL error. <p>0: No error 1 or greater: Cumulative count</p> <p>There is no problem if values are counted up little by little over a long period of time. If values are rapidly counted up in a short period of time, check if the cables are faulty.</p>	<input type="radio"/>	<input type="radio"/>	<input type="radio"/>	<input type="radio"/>

No.	Name	Description	Availability			
			Control station		Normal Station	
			Loop	Bus	Loop	Bus
SW00C0	UNDER on the reverse loop side	Stores the cumulative error occurrence count of the reverse loop (OUT-side) communication under-error. 0: No error 1 or greater: Cumulative count There is no problem if values are counted up little by little over a long period of time. If values are rapidly counted up in a short period of time, check if the cables are faulty.	○	×	○	×
SW00C1	CRC on the reverse loop side	Stores the cumulative error occurrence count of the reverse loop (OUT-side) communication CRC error. 0: No error 1 or greater: Cumulative count There is no problem if values are counted up little by little over a long period of time. If values are rapidly counted up in a short period of time, check if the cables are faulty.	○	×	○	×
SW00C2	OVER on the reverse loop side	Stores the cumulative error occurrence count of the reverse loop (OUT-side) communication overrun error. 0: No error 1 or greater: Cumulative count There is no problem if values are counted up little by little over a long period of time. If values are rapidly counted up in a short period of time, check if the cables are faulty.	○	×	○	×
SW00C3	Short frame on the reverse loop side	Stores the cumulative error occurrence count of the reverse loop (OUT-side) communication short frame error. 0: No error 1 or greater: Cumulative count There is no problem if values are counted up little by little over a long period of time. If values are rapidly counted up in a short period of time, check if the cables are faulty.	○	×	○	×
SW00C4	Abort on the reverse loop side (AB, IF)	Stores the cumulative error occurrence count of the reverse loop (OUT-side) communication abort error. 0: No error 1 or greater: Cumulative count There is no problem if values are counted up little by little over a long period of time. If values are rapidly counted up in a short period of time, check if the cables are faulty.	○	×	○	×
SW00C5	Timeout on the reverse loop side (TIME)	Stores the cumulative error occurrence count of the reverse loop (OUT-side) communication timeout. 0: No error 1 or greater: Cumulative count There is no problem if values are counted up little by little over a long period of time. If values are rapidly counted up in a short period of time, check if the cables are faulty.	○	×	○	×
SW00C6	Receiving 2k bytes or more on reverse loop side (DATA)	Stores the cumulative error occurrence count of the reception of 2K bytes or more at the reverse loop (OUT-side). 0: No error 1 or greater: Cumulative count There is no problem if values are counted up little by little over a long period of time. If values are rapidly counted up in a short period of time, check if the cables are faulty.	○	×	○	×
SW00C7	DPLL error on the reverse loop side	Stores the cumulative error occurrence count of the reverse loop (OUT-side) communication DPLL error. 0: No error 1 or greater: Cumulative count There is no problem if values are counted up little by little over a long period of time. If values are rapidly counted up in a short period of time, check if the cables are faulty.	○	×	○	×
SW00C8	Number of retries on the forward loop side	<ul style="list-style-type: none"> ■RJ71LP21-25 • Stores the cumulative occurrence count of the forward loop (IN-side) communication retry. ■RJ71BR11 • Stores the cumulative occurrence count of communication retry. 0: No error 1 or greater: Cumulative count Values may be counted up at power-on or reset, but it is not an error. If the retry count is unnecessary before data link starts, clear the value using 'Clear retry count' (SB0005).	○	○	○	○
SW00C9	Number of retries on the reverse loop side	Stores the cumulative occurrence count of the reverse loop (OUT-side) communication retry. 0: No error 1 or greater: Cumulative count Values may be counted up at power-on or reset, but it is not an error. If the retry count is unnecessary before data link starts, clear the value using 'Clear retry count' (SB0005).	○	×	○	×



No.	Name	Description	Availability																									
			Control station		Normal Station																							
			Loop	Bus	Loop	Bus																						
SW00C C	Line error on the forward loop side	Stores the cumulative occurrence count of the forward loop (IN-side) line error detection (hardware error detection). 0: No error 1 or greater: Cumulative count	○	×	○	×																						
SW00C D	Line error on the reverse loop side	Stores the cumulative occurrence count of the reverse loop (OUT-side) line error detection (hardware error detection). 0: No error 1 or greater: Cumulative count	○	×	○	×																						
SW00CE	Loop switch cumulative occurrence count	Stores the cumulative occurrence count of loop switching. 0: No count 1 or greater: When 'Clear reverse loop transmission error count' (SB0009) is turned on, the cumulative count is cleared.	○	×	○	×																						
SW00CF	Loop switching history pointer	Stores a pointer storing the latest loop switching status in loop switching history (1) (SW00D0 to SW00DF). 0: The latest loop switching status is stored in SW00DF. 1: The latest loop switching status is stored in SW00D0. 2: The latest loop switching status is stored in SW00D1. 3: The latest loop switching status is stored in SW00D2. 4: The latest loop switching status is stored in SW00D3. 5: The latest loop switching status is stored in SW00D4. 6: The latest loop switching status is stored in SW00D5. 7: The latest loop switching status is stored in SW00D6. 8: The latest loop switching status is stored in SW00D7. 9: The latest loop switching status is stored in SW00D8. 10: The latest loop switching status is stored in SW00D9. 11: The latest loop switching status is stored in SW00DA. 12: The latest loop switching status is stored in SW00DB. 13: The latest loop switching status is stored in SW00DC. 14: The latest loop switching status is stored in SW00DD. 15: The latest loop switching status is stored in SW00DE.	○	×	○	×																						
SW00D0 to SW00DF	Loop switching history (1)	Stores the error status when loop switching occurs. Paired with 'Loop switching history (2)' (SW00E0 to SW00E7). <div style="display: flex; align-items: center;"> <div style="margin-right: 5px;">SW00D0</div> <div style="margin-right: 5px;">⋮</div> <div style="margin-right: 5px;">SW00DF</div> <table border="1" style="border-collapse: collapse; text-align: center;"> <tr> <td style="width: 15px;">b15</td><td style="width: 15px;">⋮</td><td style="width: 15px;">b8</td><td style="width: 15px;">b7</td><td style="width: 15px;">b6</td><td style="width: 15px;">b5</td><td style="width: 15px;">b4</td><td style="width: 15px;">b3</td><td style="width: 15px;">b2</td><td style="width: 15px;">b1</td><td style="width: 15px;">b0</td> </tr> <tr> <td style="width: 15px;">□</td><td style="width: 15px;">⋮</td><td style="width: 15px;">□</td><td style="width: 15px;">□</td><td style="width: 15px;">□</td><td style="width: 15px;">□</td><td style="width: 15px;">□</td><td style="width: 15px;">□</td><td style="width: 15px;">□</td><td style="width: 15px;">□</td><td style="width: 15px;">□</td> </tr> </table> </div> b7 to b0: Cause Stores a bit corresponding to each error. (0: Off, 1: On) 0 for b7 to b0: Return instruction <ul style="list-style-type: none"> • b0: Forward loop (IN-side) hardware error • b1: Reverse loop (OUT-side) hardware error • b2: Forward loop (IN-side) enforced error • b3: Reverse loop (OUT-side) enforced error • b4: Forward loop (IN-side) continuous communication error • b5: Reverse loop (OUT-side) continuous communication error • b6: Forward loop (IN-side) continuous line error • b7: Reverse loop (OUT-side) continuous line error b15 to b8: Post-switching status <ul style="list-style-type: none"> • 0: Multiplex transmission • 1: Forward loop (IN-side) transmission • 2: Reverse loop (OUT-side) transmission • 3: Loopback transmission 	b15	⋮	b8	b7	b6	b5	b4	b3	b2	b1	b0	□	⋮	□	□	□	□	□	□	□	□	□	○	×	○	×
b15	⋮	b8	b7	b6	b5	b4	b3	b2	b1	b0																		
□	⋮	□	□	□	□	□	□	□	□	□																		
SW00E0 to SW00E7	Loop switching history (2)	Stores the switching request station when loop switching occurs. Paired with 'Loop switching history (1)' (SW00D0 to SW00DF). <div style="display: flex; align-items: center;"> <div style="margin-right: 5px;">SW00E0</div> <div style="margin-right: 5px;">⋮</div> <div style="margin-right: 5px;">SW00E7</div> <table border="1" style="border-collapse: collapse; text-align: center;"> <tr> <td style="width: 15px;">b15</td><td style="width: 15px;">⋮</td><td style="width: 15px;">b8</td><td style="width: 15px;">b7</td><td style="width: 15px;">⋮</td><td style="width: 15px;">b0</td> </tr> <tr> <td style="width: 15px;">□</td><td style="width: 15px;">⋮</td><td style="width: 15px;">□</td><td style="width: 15px;">□</td><td style="width: 15px;">⋮</td><td style="width: 15px;">□</td> </tr> </table> </div> b7 to b0: Odd number count switching station b15 to b8: Even number count switching station Since the station that first detected the loop error functions as a loop switching request station, stations other than the both end stations having loop errors are stored.	b15	⋮	b8	b7	⋮	b0	□	⋮	□	□	⋮	□	○	×	○	×										
b15	⋮	b8	b7	⋮	b0																							
□	⋮	□	□	⋮	□																							

No.	Name	Description	Availability																																																																																								
			Control station		Normal Station																																																																																						
			Loop	Bus	Loop	Bus																																																																																					
SW00E8 to SW00EB	Module type of each station	<p>Stores the module type of each station. Off: MELSECNET/10 type On: MELSECNET/H type</p> <table border="1"> <thead> <tr> <th></th> <th>b15</th> <th>b14</th> <th>b13</th> <th>b12</th> <th>b11</th> <th>b10</th> <th>b9</th> <th>b8</th> <th>b7</th> <th>b6</th> <th>b5</th> <th>b4</th> <th>b3</th> <th>b2</th> <th>b1</th> <th>b0</th> </tr> </thead> <tbody> <tr> <td>SW00E8</td> <td>16</td> <td>15</td> <td>14</td> <td>13</td> <td>12</td> <td>11</td> <td>10</td> <td>9</td> <td>8</td> <td>7</td> <td>6</td> <td>5</td> <td>4</td> <td>3</td> <td>2</td> <td>1</td> </tr> <tr> <td>SW00E9</td> <td>32</td> <td>31</td> <td>30</td> <td>29</td> <td>28</td> <td>27</td> <td>26</td> <td>25</td> <td>24</td> <td>23</td> <td>22</td> <td>21</td> <td>20</td> <td>19</td> <td>18</td> <td>17</td> </tr> <tr> <td>SW00EA</td> <td>48</td> <td>47</td> <td>46</td> <td>45</td> <td>44</td> <td>43</td> <td>42</td> <td>41</td> <td>40</td> <td>39</td> <td>38</td> <td>37</td> <td>36</td> <td>35</td> <td>34</td> <td>33</td> </tr> <tr> <td>SW00EB</td> <td>64</td> <td>63</td> <td>62</td> <td>61</td> <td>60</td> <td>59</td> <td>58</td> <td>57</td> <td>56</td> <td>55</td> <td>54</td> <td>53</td> <td>52</td> <td>51</td> <td>50</td> <td>49</td> </tr> </tbody> </table> <p>Each number in the table represents a station number. (Conditions) This register is enabled when 'Baton pass error status of own station' (SB0047) is off. When 'Baton pass error status of own station' (SB0047) is turned on (error), data prior to error is held.</p>		b15	b14	b13	b12	b11	b10	b9	b8	b7	b6	b5	b4	b3	b2	b1	b0	SW00E8	16	15	14	13	12	11	10	9	8	7	6	5	4	3	2	1	SW00E9	32	31	30	29	28	27	26	25	24	23	22	21	20	19	18	17	SW00EA	48	47	46	45	44	43	42	41	40	39	38	37	36	35	34	33	SW00EB	64	63	62	61	60	59	58	57	56	55	54	53	52	51	50	49	○	○	○	○
	b15	b14	b13	b12	b11	b10	b9	b8	b7	b6	b5	b4	b3	b2	b1	b0																																																																											
SW00E8	16	15	14	13	12	11	10	9	8	7	6	5	4	3	2	1																																																																											
SW00E9	32	31	30	29	28	27	26	25	24	23	22	21	20	19	18	17																																																																											
SW00EA	48	47	46	45	44	43	42	41	40	39	38	37	36	35	34	33																																																																											
SW00EB	64	63	62	61	60	59	58	57	56	55	54	53	52	51	50	49																																																																											
SW00EC	Low-speed cyclic transmission start execution results	<p>Stores the execution result of the low speed cyclic startup request. 0: Completed normally 1 or greater: Completed with an error (An error code is stored.)</p>	○	○	○	○																																																																																					
SW00EE	Transient transmission error	<p>Stores the cumulative error occurrence count of transient transmission. 0: No error 1 or greater: Cumulative count</p>	○	○	○	○																																																																																					
SW00EF	Transient transmission error pointer	<p>Stores a pointer of 'Transient transmission error history' (SW00F0 to SW00FF). 0: The latest transient transmission error is stored in SW00FF. 1: The latest transient transmission error is stored in SW00F0. 2: The latest transient transmission error is stored in SW00F1. 3: The latest transient transmission error is stored in SW00F2. 4: The latest transient transmission error is stored in SW00F3. 5: The latest transient transmission error is stored in SW00F4. 6: The latest transient transmission error is stored in SW00F5. 7: The latest transient transmission error is stored in SW00F6. 8: The latest transient transmission error is stored in SW00F7. 9: The latest transient transmission error is stored in SW00F8. 10: The latest transient transmission error is stored in SW00F9. 11: The latest transient transmission error is stored in SW00FA. 12: The latest transient transmission error is stored in SW00FB. 13: The latest transient transmission error is stored in SW00FC. 14: The latest transient transmission error is stored in SW00FD. 15: The latest transient transmission error is stored in SW00FE.</p>	○	○	○	○																																																																																					
SW00F0 to SW00FF	Transient transmission error history	<p>Stores the history of the transient transmission error occurrence status. 1 or greater: Error code</p>	○	○	○	○																																																																																					



No.	Name	Description	Availability																																																																																								
			Control station		Normal Station																																																																																						
			Loop	Bus	Loop	Bus																																																																																					
SW01E0 to SW01E3	Network type consistency check	<p>Indicates the status of the occurrence of inconsistency between the network type of the control station and the network type of the normal station.</p> <ul style="list-style-type: none"> If the control station is set to the MELSECNET/H extended mode <p>Off: Consistent (set to the MELSECNET/H extended mode (including stations higher than the maximum station number, reserved stations, and communication faulty stations))</p> <p>On: Inconsistent (set to the MELSECNET/H mode or MELSECNET/10 mode)</p> <ul style="list-style-type: none"> If the control station is set to the MELSECNET/H mode or MELSECNET/10 mode <p>Off: Consistent (set to the MELSECNET/H mode or MELSECNET/10 mode (including stations exceeding the maximum station number, reserved stations, and communication faulty stations))</p> <p>On: Inconsistent (set to the MELSECNET/H extended mode)</p> <table border="1"> <thead> <tr> <th></th> <th>b15</th> <th>b14</th> <th>b13</th> <th>b12</th> <th>b11</th> <th>b10</th> <th>b9</th> <th>b8</th> <th>b7</th> <th>b6</th> <th>b5</th> <th>b4</th> <th>b3</th> <th>b2</th> <th>b1</th> <th>b0</th> </tr> </thead> <tbody> <tr> <td>SW01E0</td> <td>16</td> <td>15</td> <td>14</td> <td>13</td> <td>12</td> <td>11</td> <td>10</td> <td>9</td> <td>8</td> <td>7</td> <td>6</td> <td>5</td> <td>4</td> <td>3</td> <td>2</td> <td>1</td> </tr> <tr> <td>SW01E1</td> <td>32</td> <td>31</td> <td>30</td> <td>29</td> <td>28</td> <td>27</td> <td>26</td> <td>25</td> <td>24</td> <td>23</td> <td>22</td> <td>21</td> <td>20</td> <td>19</td> <td>18</td> <td>17</td> </tr> <tr> <td>SW01E2</td> <td>48</td> <td>47</td> <td>46</td> <td>45</td> <td>44</td> <td>43</td> <td>42</td> <td>41</td> <td>40</td> <td>39</td> <td>38</td> <td>37</td> <td>36</td> <td>35</td> <td>34</td> <td>33</td> </tr> <tr> <td>SW01E3</td> <td>64</td> <td>63</td> <td>62</td> <td>61</td> <td>60</td> <td>59</td> <td>58</td> <td>57</td> <td>56</td> <td>55</td> <td>54</td> <td>53</td> <td>52</td> <td>51</td> <td>50</td> <td>49</td> </tr> </tbody> </table> <p>Each number in the table represents a station number.</p> <p>(Conditions)</p> <ul style="list-style-type: none"> This register is enabled when 'Baton pass error status of own station' (SB0047) is off. When 'Baton pass error status of own station' (SB0047) is turned on (error), data prior to error is held. 		b15	b14	b13	b12	b11	b10	b9	b8	b7	b6	b5	b4	b3	b2	b1	b0	SW01E0	16	15	14	13	12	11	10	9	8	7	6	5	4	3	2	1	SW01E1	32	31	30	29	28	27	26	25	24	23	22	21	20	19	18	17	SW01E2	48	47	46	45	44	43	42	41	40	39	38	37	36	35	34	33	SW01E3	64	63	62	61	60	59	58	57	56	55	54	53	52	51	50	49	○	○	○	○
	b15	b14	b13	b12	b11	b10	b9	b8	b7	b6	b5	b4	b3	b2	b1	b0																																																																											
SW01E0	16	15	14	13	12	11	10	9	8	7	6	5	4	3	2	1																																																																											
SW01E1	32	31	30	29	28	27	26	25	24	23	22	21	20	19	18	17																																																																											
SW01E2	48	47	46	45	44	43	42	41	40	39	38	37	36	35	34	33																																																																											
SW01E3	64	63	62	61	60	59	58	57	56	55	54	53	52	51	50	49																																																																											
SW01F4 to SW01F7	Separate mode status in redundant system	<p>Stores the redundant system CPU operating mode of each station.</p> <p>Off: Backup mode (including a stand-alone system)</p> <p>On: Separate mode</p> <table border="1"> <thead> <tr> <th></th> <th>b15</th> <th>b14</th> <th>b13</th> <th>b12</th> <th>b11</th> <th>b10</th> <th>b9</th> <th>b8</th> <th>b7</th> <th>b6</th> <th>b5</th> <th>b4</th> <th>b3</th> <th>b2</th> <th>b1</th> <th>b0</th> </tr> </thead> <tbody> <tr> <td>SW01F4</td> <td>16</td> <td>15</td> <td>14</td> <td>13</td> <td>12</td> <td>11</td> <td>10</td> <td>9</td> <td>8</td> <td>7</td> <td>6</td> <td>5</td> <td>4</td> <td>3</td> <td>2</td> <td>1</td> </tr> <tr> <td>SW01F5</td> <td>32</td> <td>31</td> <td>30</td> <td>29</td> <td>28</td> <td>27</td> <td>26</td> <td>25</td> <td>24</td> <td>23</td> <td>22</td> <td>21</td> <td>20</td> <td>19</td> <td>18</td> <td>17</td> </tr> <tr> <td>SW01F6</td> <td>48</td> <td>47</td> <td>46</td> <td>45</td> <td>44</td> <td>43</td> <td>42</td> <td>41</td> <td>40</td> <td>39</td> <td>38</td> <td>37</td> <td>36</td> <td>35</td> <td>34</td> <td>33</td> </tr> <tr> <td>SW01F7</td> <td>64</td> <td>63</td> <td>62</td> <td>61</td> <td>60</td> <td>59</td> <td>58</td> <td>57</td> <td>56</td> <td>55</td> <td>54</td> <td>53</td> <td>52</td> <td>51</td> <td>50</td> <td>49</td> </tr> </tbody> </table> <p>Each number in the table represents a station number.</p> <p>(Conditions)</p> <ul style="list-style-type: none"> This register is enabled when 'Baton pass error status of own station' (SB0047) is off. When 'Baton pass error status of own station' (SB0047) is turned on (error), data prior to error is held. This register is enabled only for normally operating stations in 'Baton pass status' (SW0070 to SW0073). Reserved stations and stations exceeding the maximum station number are ignored. 		b15	b14	b13	b12	b11	b10	b9	b8	b7	b6	b5	b4	b3	b2	b1	b0	SW01F4	16	15	14	13	12	11	10	9	8	7	6	5	4	3	2	1	SW01F5	32	31	30	29	28	27	26	25	24	23	22	21	20	19	18	17	SW01F6	48	47	46	45	44	43	42	41	40	39	38	37	36	35	34	33	SW01F7	64	63	62	61	60	59	58	57	56	55	54	53	52	51	50	49	○	○	○	○
	b15	b14	b13	b12	b11	b10	b9	b8	b7	b6	b5	b4	b3	b2	b1	b0																																																																											
SW01F4	16	15	14	13	12	11	10	9	8	7	6	5	4	3	2	1																																																																											
SW01F5	32	31	30	29	28	27	26	25	24	23	22	21	20	19	18	17																																																																											
SW01F6	48	47	46	45	44	43	42	41	40	39	38	37	36	35	34	33																																																																											
SW01F7	64	63	62	61	60	59	58	57	56	55	54	53	52	51	50	49																																																																											
SW01F8 to SW01FB	Pairing setting status in redundant system	<p>Stores the pairing setting status for each station.</p> <p>Off: No pairing setting (including a stand-alone system)</p> <p>On: Pairing set</p> <p>If pairing is set, the bit corresponding to the system B station is turned on.</p> <table border="1"> <thead> <tr> <th></th> <th>b15</th> <th>b14</th> <th>b13</th> <th>b12</th> <th>b11</th> <th>b10</th> <th>b9</th> <th>b8</th> <th>b7</th> <th>b6</th> <th>b5</th> <th>b4</th> <th>b3</th> <th>b2</th> <th>b1</th> <th>b0</th> </tr> </thead> <tbody> <tr> <td>SW01F8</td> <td>16</td> <td>15</td> <td>14</td> <td>13</td> <td>12</td> <td>11</td> <td>10</td> <td>9</td> <td>8</td> <td>7</td> <td>6</td> <td>5</td> <td>4</td> <td>3</td> <td>2</td> <td>1</td> </tr> <tr> <td>SW01F9</td> <td>32</td> <td>31</td> <td>30</td> <td>29</td> <td>28</td> <td>27</td> <td>26</td> <td>25</td> <td>24</td> <td>23</td> <td>22</td> <td>21</td> <td>20</td> <td>19</td> <td>18</td> <td>17</td> </tr> <tr> <td>SW01FA</td> <td>48</td> <td>47</td> <td>46</td> <td>45</td> <td>44</td> <td>43</td> <td>42</td> <td>41</td> <td>40</td> <td>39</td> <td>38</td> <td>37</td> <td>36</td> <td>35</td> <td>34</td> <td>33</td> </tr> <tr> <td>SW01FB</td> <td>64</td> <td>63</td> <td>62</td> <td>61</td> <td>60</td> <td>59</td> <td>58</td> <td>57</td> <td>56</td> <td>55</td> <td>54</td> <td>53</td> <td>52</td> <td>51</td> <td>50</td> <td>49</td> </tr> </tbody> </table> <p>Each number in the table represents a station number.</p> <p>(Conditions)</p> <ul style="list-style-type: none"> This register is enabled when 'Baton pass error status of own station' (SB0047) is off. When 'Baton pass error status of own station' (SB0047) is turned on (error), data prior to error is held. This register is enabled only for normally operating stations in 'Baton pass status' (SW0070 to SW0073). Reserved stations and stations exceeding the maximum station number are ignored. 		b15	b14	b13	b12	b11	b10	b9	b8	b7	b6	b5	b4	b3	b2	b1	b0	SW01F8	16	15	14	13	12	11	10	9	8	7	6	5	4	3	2	1	SW01F9	32	31	30	29	28	27	26	25	24	23	22	21	20	19	18	17	SW01FA	48	47	46	45	44	43	42	41	40	39	38	37	36	35	34	33	SW01FB	64	63	62	61	60	59	58	57	56	55	54	53	52	51	50	49	○	○	○	○
	b15	b14	b13	b12	b11	b10	b9	b8	b7	b6	b5	b4	b3	b2	b1	b0																																																																											
SW01F8	16	15	14	13	12	11	10	9	8	7	6	5	4	3	2	1																																																																											
SW01F9	32	31	30	29	28	27	26	25	24	23	22	21	20	19	18	17																																																																											
SW01FA	48	47	46	45	44	43	42	41	40	39	38	37	36	35	34	33																																																																											
SW01FB	64	63	62	61	60	59	58	57	56	55	54	53	52	51	50	49																																																																											

No.	Name	Description	Availability																																																																																								
			Control station		Normal Station																																																																																						
			Loop	Bus	Loop	Bus																																																																																					
SW01FC to SW01FF	Standby system CPU status in redundant system	Stores the redundant CPU system status (control/standby system) of each station. Off: Control system (including a stand-alone system) On: Standby system <table border="1"> <thead> <tr> <th></th> <th>b15</th> <th>b14</th> <th>b13</th> <th>b12</th> <th>b11</th> <th>b10</th> <th>b9</th> <th>b8</th> <th>b7</th> <th>b6</th> <th>b5</th> <th>b4</th> <th>b3</th> <th>b2</th> <th>b1</th> <th>b0</th> </tr> </thead> <tbody> <tr> <td>SW01FC</td> <td>16</td> <td>15</td> <td>14</td> <td>13</td> <td>12</td> <td>11</td> <td>10</td> <td>9</td> <td>8</td> <td>7</td> <td>6</td> <td>5</td> <td>4</td> <td>3</td> <td>2</td> <td>1</td> </tr> <tr> <td>SW01FD</td> <td>32</td> <td>31</td> <td>30</td> <td>29</td> <td>28</td> <td>27</td> <td>26</td> <td>25</td> <td>24</td> <td>23</td> <td>22</td> <td>21</td> <td>20</td> <td>19</td> <td>18</td> <td>17</td> </tr> <tr> <td>SW01FE</td> <td>48</td> <td>47</td> <td>46</td> <td>45</td> <td>44</td> <td>43</td> <td>42</td> <td>41</td> <td>40</td> <td>39</td> <td>38</td> <td>37</td> <td>36</td> <td>35</td> <td>34</td> <td>33</td> </tr> <tr> <td>SW01FF</td> <td>64</td> <td>63</td> <td>62</td> <td>61</td> <td>60</td> <td>59</td> <td>58</td> <td>57</td> <td>56</td> <td>55</td> <td>54</td> <td>53</td> <td>52</td> <td>51</td> <td>50</td> <td>49</td> </tr> </tbody> </table> Each number in the table represents a station number. (Conditions) <ul style="list-style-type: none"> • This register is enabled when 'Baton pass error status of own station' (SB0047) is off. When 'Baton pass error status of own station' (SB0047) is turned on (error), data prior to error is held. • This register is enabled only for normally operating stations in 'Baton pass status' (SW0070 to SW0073). • Reserved stations and stations exceeding the maximum station number are ignored. 		b15	b14	b13	b12	b11	b10	b9	b8	b7	b6	b5	b4	b3	b2	b1	b0	SW01FC	16	15	14	13	12	11	10	9	8	7	6	5	4	3	2	1	SW01FD	32	31	30	29	28	27	26	25	24	23	22	21	20	19	18	17	SW01FE	48	47	46	45	44	43	42	41	40	39	38	37	36	35	34	33	SW01FF	64	63	62	61	60	59	58	57	56	55	54	53	52	51	50	49	○	○	○	○
	b15	b14	b13	b12	b11	b10	b9	b8	b7	b6	b5	b4	b3	b2	b1	b0																																																																											
SW01FC	16	15	14	13	12	11	10	9	8	7	6	5	4	3	2	1																																																																											
SW01FD	32	31	30	29	28	27	26	25	24	23	22	21	20	19	18	17																																																																											
SW01FE	48	47	46	45	44	43	42	41	40	39	38	37	36	35	34	33																																																																											
SW01FF	64	63	62	61	60	59	58	57	56	55	54	53	52	51	50	49																																																																											

*1 "0: Online" is stored when operating in debug mode.



Appendix 5 Dedicated Instruction

This section describes the dedicated instructions and transmission ranges that can be used in the MELSECNET/H network module.

Point

For details on dedicated instructions, refer to the following.

 MELSEC iQ-R Programming Manual (Module Dedicated Instructions)

Link dedicated instructions

The following table lists the instructions used for transient transmission to or from programmable controllers on other stations. Each link dedicated instruction allows access to a station on a network other than MELSECNET/H network.

Instruction	Description
READ	Reads data from the word device of another station.
SREAD	Reads data from the word device of another station. (With completion device)
WRITE	Writes data in the word device of another station.
SWRITE	Writes data in the word device of another station. (With completion device)
SEND	Sends data to another station.
RECV	Reads the receive data from another station. (For main program)
RECVS	Reads the receive data from another station. (For interrupt program)
REQ	Requests the remote RUN/STOP to the CPU module on another station. Reads/writes clock data from/to another station.
ZNRD	Reads data from the word device of another station. (For MELSEC-A series)
ZNWR	Writes data in the word device of another station. (For MELSEC-A series)
RRUN	Sends the request of remote RUN to another station.
RSTOP	Sends the request of remote STOP to another station.
RTMRD	Reads the clock data from another station.
RTMWR	Writes the clock data to another station.

Precautions for dedicated instructions

This section describes precautions when using dedicated instructions.

Precautions for dedicated instructions (common)

■When changing data specified by dedicated instructions

Do not change any data (such as control data) until execution of the dedicated instruction is completed.

■When the dedicated instruction is not completed

Check whether the module operation mode setting of the MELSECNET/H network module is online mode.

The instruction cannot be executed when the module operation mode setting is set to a mode other than online mode.

■When executing multiple link dedicated instructions simultaneously

When executing multiple link dedicated instructions simultaneously, check that the channels for the instructions are not duplicated.

■ZNRD and ZNWR instructions

The ZNRD and ZNWR instructions cannot be executed for the RCP. If they are executed, an error occurs. If the target station is specified as the RCP, replace the instruction with the READ/WRITE instruction.

Precautions for dedicated instructions (when used in a redundant system)

■System switching during execution of a dedicated instruction

When systems are switched during execution of a dedicated instruction, the dedicated instruction may not be completed.

Execute the dedicated instruction again from the control system CPU module after system switching.

■Processing at abnormal end of a dedicated instruction

When the dedicated instruction is executed by specifying the access destination CPU module, it may be completed with an error if systems are switched in the target station. If the dedicated instruction was completed with an error, execute it again.

■SEND instruction

- When the target station is in a redundant system, the communication request source station must identify that the target station is the control system to execute the SEND instruction. When the target station is the standby system, the RECV instruction is not executed at the target station after data is sent by the SEND instruction, and the target station storage channel becomes occupied and unable to be used.
- When a redundant system exists in a network where broadcast communications are performed, the RECV instruction is not executed at the standby system, and the storage channel becomes occupied and unable to be used.

■RECV and RECVS instructions

- When the SEND instruction is executed for the control system, if the systems are switched before execution of the RECV instruction and interrupt program, the control system retains RECV execution request flag (SB00A0 to SB00A7) and the interrupt program interrupt factor (interrupt pointer). If system switching occurs again, and the standby system is switched to the control system, the RECV instruction and interrupt program will be executed by the RECV execution request flag (SB00A0 to SB00A7) and the retained interrupt program interrupt factor.
- When the SEND instruction is executed for the standby system, and the standby system receives data from the sending station, the standby system retains RECV execution request flag (SB00A0 to SB00A7) and the interrupt program interrupt factor (interrupt pointer). Therefore, when the standby system is switched to the control system due to system switching, the RECV instruction and interrupt program will be executed by the RECV execution request flag (SB00A0 to SB00A7) and the retained interrupt program interrupt factor.

■REQ, RRUN, and RSTOP instructions

When performing remote STOP or remote RUN on a redundant system, do as follows: Perform STOP on the standby system → STOP on the control system → RUN on the control system → RUN on the standby system.

Appendix 6 Processing Time

The cyclic transmission delay time of the MELSECNET/H network module consists of the following.

(1) Sending-side sequence scan time + (2) Link scan time + (3) Receiving-side sequence scan time = Transmission delay time

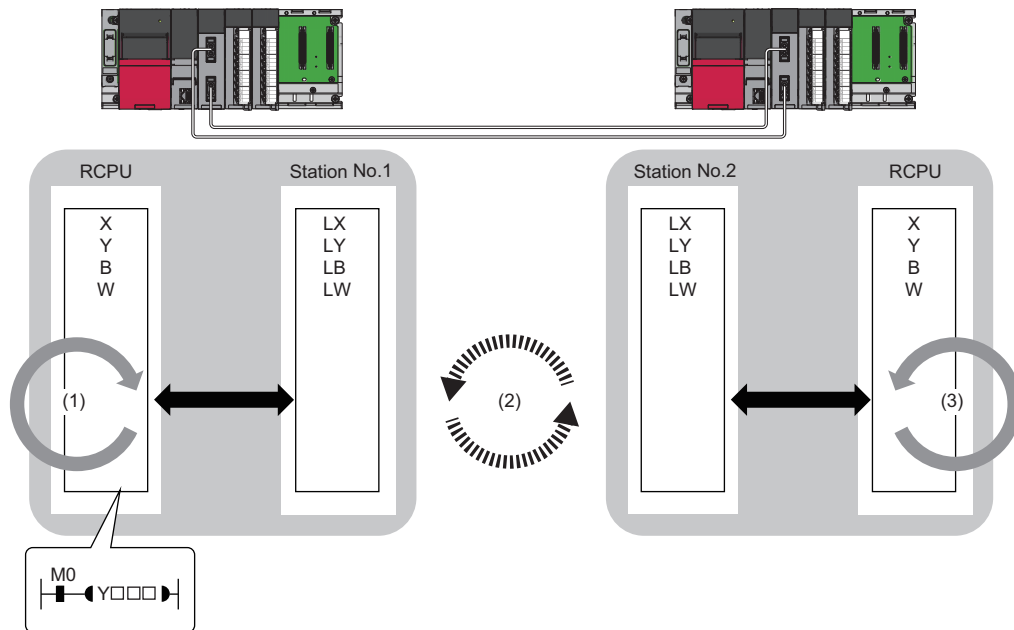

- Sequence scan time: MELSEC iQ-R CPU Module User's Manual (Application)
- Link scan time: Page 185 Link scan time
- Transmission delay time: Page 186 Cyclic transmission delay time

Link scan time

The following is the formula to calculate the link scan time (LS).

Precautions

The calculation formula is a guideline and does not guarantee that the actual measurement value of the link scan time will be less than the calculation formula for each scan.

Calculation formula

■ For the MELSECNET/H mode

• At a communication speed of 10Mbps

$$LS [ms]^*1 = KB + (n \times 0.45) + \{LB + LY + (LW \times 16)\} \div 8 \times 0.001 + (T \times 0.001) + (F \times 4)$$

• At a communication speed of 25Mbps (RJ71LP21-25 only)

$$LS [ms]^*1 = KB + (n \times 0.40) + \{LB + LY + (LW \times 16)\} \div 8 \times 0.0004 + (T \times 0.0004) + (F \times 4)$$

■ For the MELSECNET/H extended mode

• At a communication speed of 10Mbps

$$LS [ms]^*1 = KB + (SP \times 0.45) + \{LB + LY + (LW \times 16)\} \div 8 \times 0.001 + (T \times 0.001) + (F \times 4)$$

• At a communication speed of 25Mbps (RJ71LP21-25 only)

$$LS [ms]^*1 = KB + (SP \times 0.40) + \{LB + LY + (LW \times 16)\} \div 8 \times 0.0004 + (T \times 0.0004) + (F \times 4)$$

*1 The decimal part is rounded up.

The meanings of the variables and constants in the equation are as follows.

Variable	Meaning
n	Total number of stations (stations actually connected, not including reserved stations)
SP	$\sum_{i=1}^n \left[\frac{\text{Number of send bytes in station No. (i)}}{2000} \right]$ <p>n: Total number of stations The formula to calculate the number of bytes sent is $\{(LY + LB) \div 8 + (2 \times LW)\}$. The decimal part is rounded up. (If the value is 0, set 1.)</p>
LB	Total number of LB points set using LB/LW setting (excluding reserved stations) ^{*2}
LW	Total number of LW points set using LB/LW setting (excluding reserved stations) ^{*2}
LY	Total number of LY points set using LX/LY setting (1) and LX/LY setting (2) (excluding reserved stations) ^{*2}
T	The maximum number of bytes for transient transmissions within one link scan. ^{*3}
F	Number of return stations (only when there is a faulty station: Maximum number of return stations for scan (set value))

*2 Total number of link devices set under "Network Range Assignment" ( Page 56 Network Range Assignment)

*3 This variable means the total number of bytes at each station when the instruction is simultaneously executed from multiple stations.

Constant	Total number of stations set under "Network Range Assignment"							
	N = 1 to 8	N = 9 to 16	N = 17 to 24	N = 25 to 32	N = 33 to 40	N = 41 to 48	N = 49 to 56	N = 57 to 64
KB	4.0	4.5	4.9	5.3	5.7	6.2	6.6	7.0

Point

For the link scan time in the MELSECNET/10 mode, refer to the following.

 For QnA/Q4AR MELSECNET/10 Network System Reference Manual

Cyclic transmission delay time

The following are the formulas to calculate cyclic transmission delay time.

For a single network system

■When a redundant system is not used

Condition				Calculation formula [ms]
For $S_T > LS$	Station-based block data assured	Other than the MELSECNET/H extended mode	Normal value	$TD1 = (ST + \alpha T) + (LS \times 0.5) + (SR + \alpha R) \times 1.5 + 0.5 \times (ST + \alpha T)$
			Maximum value	$TD1_{max} = (ST + \alpha T) + (LS \times 1) + (SR + \alpha R) \times 2 + 1.0 \times (ST + \alpha T)$
		MELSECNET/H extended mode	Normal value	$TD1 = (ST + \alpha T) + (LS \times 0.5) + (SR + \alpha R) \times 1.5 + 0.5 \times (ST + \alpha T)$
			Maximum value	$TD1_{max} = (ST + \alpha T) + (LS \times 1) + (SR + \alpha R) \times 2 + 1.0 \times (ST + \alpha T)$
	Station-based block data not assured	Other than the MELSECNET/H extended mode	Normal value	$TD1 = (ST + \alpha T) + (LS \times 0.5) + (SR + \alpha R) \times 1.5$
			Maximum value	$TD1_{max} = (ST + \alpha T) + (LS \times 1) + (SR + \alpha R) \times 2$
		MELSECNET/H extended mode	Normal value	$TD1 = (ST + \alpha T) + (LS \times 0.5) + (SR + \alpha R) \times 1.5 + 0.5 \times (ST + \alpha T)$
			Maximum value	$TD1_{max} = (ST + \alpha T) + (LS \times 1) + (SR + \alpha R) \times 2 + 1.0 \times (ST + \alpha T)$
For $S_T < LS$	Station-based block data assured	Other than the MELSECNET/H extended mode	Normal value	$TD1 = (ST + \alpha T) + (LS \times 0.5) + (SR + \alpha R) \times 1.5 + 0.5 \times LS$
			Maximum value	$TD1_{max} = (ST + \alpha T) + (LS \times 1) + (SR + \alpha R) \times 2 + 1.0 \times LS$
		MELSECNET/H extended mode	Normal value	$TD1 = (ST + \alpha T) + (LS \times 0.5) + (SR + \alpha R) \times 1.5 + 0.5 \times LS$
			Maximum value	$TD1_{max} = (ST + \alpha T) + (LS \times 1) + (SR + \alpha R) \times 2 + 1.0 \times LS$
	Station-based block data not assured	Other than the MELSECNET/H extended mode	Normal value	$TD1 = (ST + \alpha T) + (LS \times 0.5) + (SR + \alpha R) \times 1.5$
			Maximum value	$TD1_{max} = (ST + \alpha T) + (LS \times 1) + (SR + \alpha R) \times 2$
		MELSECNET/H extended mode	Normal value	$TD1 = (ST + \alpha T) + (LS \times 0.5) + (SR + \alpha R) \times 1.5 + 0.5 \times LS$
			Maximum value	$TD1_{max} = (ST + \alpha T) + (LS \times 1) + (SR + \alpha R) \times 2 + 1.0 \times LS$

■When a redundant system is used

Condition				Calculation formula [ms]
For $S_T > LS$	Station-based block data assured	Other than the MELSECNET/H extended mode	Normal value	$TD1 = (ST + \alpha T) + (LS \times 0.5) + (SR + \alpha R + TS) \times 1.5 + 0.5 \times (ST + \alpha T)$
			Maximum value	$TD1_{max} = (ST + \alpha T) + (LS \times 1) + (SR + \alpha R + TS) \times 2 + 1.0 \times (ST + \alpha T)$
		MELSECNET/H extended mode	Normal value	$TD1 = (ST + \alpha T) + (LS \times 0.5) + (SR + \alpha R + TS) \times 1.5 + 0.5 \times (ST + \alpha T)$
			Maximum value	$TD1_{max} = (ST + \alpha T) + (LS \times 1) + (SR + \alpha R + TS) \times 2 + 1.0 \times (ST + \alpha T)$
	Station-based block data not assured	Other than the MELSECNET/H extended mode	Normal value	$TD1 = (ST + \alpha T) + (LS \times 0.5) + (SR + \alpha R + TS) \times 1.5$
			Maximum value	$TD1_{max} = (ST + \alpha T) + (LS \times 1) + (SR + \alpha R + TS) \times 2$
		MELSECNET/H extended mode	Normal value	$TD1 = (ST + \alpha T) + (LS \times 0.5) + (SR + \alpha R + TS) \times 1.5 + 0.5 \times (ST + \alpha T)$
			Maximum value	$TD1_{max} = (ST + \alpha T) + (LS \times 1) + (SR + \alpha R + TS) \times 2 + 0.1 \times (ST + \alpha T)$

Condition				Calculation formula [ms]
For $S_T < LS$	Station-based block data assured	Other than the MELSECNET/H extended mode	Normal value	$TD1 = (ST + \tau T) + (LS \times 0.5) + (SR + \tau R + TS) \times 1.5 + 0.5 \times LS$
			Maximum value	$TD1_{max} = (ST + \tau T) + (LS \times 1) + (SR + \tau R + TS) \times 2 + 1.0 \times LS$
		MELSECNET/H extended mode	Normal value	$TD1 = (ST + \tau T) + (LS \times 0.5) + (SR + \tau R + TS) \times 1.5 + 0.5 \times LS$
			Maximum value	$TD1_{max} = (ST + \tau T) + (LS \times 1) + (SR + \tau R + TS) \times 2 + 1.0 \times LS$
	Station-based block data not assured	Other than the MELSECNET/H extended mode	Normal value	$TD1 = (ST + \tau T) + (LS \times 0.5) + (SR + \tau R + TS) \times 1.5$
			Maximum value	$TD1_{max} = (ST + \tau T) + (LS \times 1) + (SR + \tau R + TS) \times 2$
		MELSECNET/H extended mode	Normal value	$TD1 = (ST + \tau T) + (LS \times 0.5) + (SR + \tau R + TS) \times 1.5 + 0.5 \times LS$
			Maximum value	$TD1_{max} = (ST + \tau T) + (LS \times 1) + (SR + \tau R + TS) \times 2 + 1.0 \times LS$

The transmission delay time (TD1) for B/W/Y periodic communication is asynchronous between scan and link scan. Therefore, if the condition differs, use the formula to calculate the transmission delay time (maximum value) (TD1max). The meaning of the variables in the equation are as follows.

Variable	Meaning
TD1	Transmission delay time (normal value)
TD1max	Transmission delay time (maximum value)
ST	Sequence scan time on sending side (excluding link refresh time)
SR	Sequence scan time on receiving side (excluding link refresh time)
αT	Sending side link refresh time ^{*1}
αR	Receiving side link refresh time ^{*1}
TS	Extended scan time due to tracking For details, refer to the following.  MELSEC iQ-R CPU Module User's Manual (Application)
LS	Link scan time

*1 Total number of mountable network modules

For a multi-network system

The following shows the cyclic transmission delay time for the case where link device data are transferred to another network with the interlink transmission function.

$$TD [\text{ms}] = KM4 \times (LB \div 16 + LW)$$

The meaning of the variables in the equation are as follows.

Variable	Meaning
TD	Transmission delay time
LB	Total number of LB points set using "Interlink Transmission Settings" in "Application Settings"
LW	Total number of LW points set using "Interlink Transmission Settings" in "Application Settings"

The meanings of the constants (KM4) in the equation are as follows.

Base unit to which the network module is mounted		KM4($\times 10^{-3}$)
Transfer source	Transfer destination	
Main base unit	Main base unit	0.470
Main base unit	Extension base unit	0.478
Extension base unit	Main base unit	0.483
Extension base unit	Extension base unit	0.489

Point

For the calculation formula used for the relay station that is configured with other module than that of the MELSEC iQ-R series, refer to the manual of the relay target module.

Precautions

The interlink transmission time may become longer due to the following causes.

- Communication with the engineering tool (such as MELSECNET diagnostics or module diagnostics)
- Execution of a link dedicated instruction
- Link refresh
- Interlink transmission between other units

Interlink transmission time

The following is the formula to calculate the time required for interlink transmission. Interlink transmission does not affect the sequence scan time.

Calculation formula

■ Interlink transmission time required for one END processing

The time required for one END processing is 0 [ms] for interlink transmission with the MELSEC iQ-R series network module.

■ Interlink transmission time to completely transmit all set points

$$\alpha DL [\text{ms}] = KM4 \times (LB \div 16 + LW)$$

The meanings of the variables and constants in the equation are as follows.

Variable	Meaning
αDL	Interlink transmission time
LB	The total number of LB points actually transferred is within the range set in the interlink transmission setting. (Page 75 Interlink Transmission Settings)
LW	The total number of LW points actually transferred is within the range set in the interlink transmission setting. (Page 75 Interlink Transmission Settings)

The meanings of the constants (KM4) in the equation are as follows.

Base unit to which the network module is mounted		KM4($\times 10^{-3}$)
Transfer source	Transfer destination	
Main base unit	Main base unit	0.470
Main base unit	Extension base unit	0.478
Extension base unit	Main base unit	0.483
Extension base unit	Extension base unit	0.489

Precautions

The interlink transmission time may become longer due to the following causes.

- Communication with the engineering tool (such as MELSECNET diagnostics or module diagnostics)
- Execution of a link dedicated instruction
- Link refresh
- Interlink transmission between other units

A

Cyclic data holding time when system switching occurs

This section describes cyclic data holding time when system switching occurs.

Calculation formula

The following are the formulas to calculate cyclic data holding time when system switching occurs.

Pattern number	System switching cause	Condition	Cyclic data holding time (T_H) [ms]	Timing chart
1	<ul style="list-style-type: none"> Power-off of the control system Failure of the control system CPU module Failure of the control system base unit 	<ul style="list-style-type: none"> The control station is in a redundant system. $T_{jo} < C_{sw}$ 	Delay time until detection of the system switching cause ^{*1} + T_{sw} + C_{sw} + SS	Page 191 Pattern 1
2		<ul style="list-style-type: none"> The control station is in a redundant system. $T_{jo} > C_{sw}$ 	Delay time until detection of the system switching cause ^{*1} + T_{sw} + T_{jo} + SS	Page 192 Pattern 2
3		A normal station is in a redundant system.		Page 193 Pattern 3
4	<ul style="list-style-type: none"> Stop error of the control system CPU module Execution of the system switching instruction System switching operation from the engineering tool System switching request from another network module 	—	Delay time until detection of the system switching cause ^{*1} + T_{sw} + T_{jo} + SS	Page 194 Pattern 4
5	System switching request from the RJ71LP21-25 (own station)	—	Delay time until detection of the α + T_d + T_c system switching cause ^{*1} + T_{sw} + T_{jo} + SS	Page 195 Pattern 5

*1 For delay time until detection of the system switching cause, refer to the following.

📖 MELSEC iQ-R CPU Module User's Manual (Application)

The meaning of the variables in the equation are as follows.

Variable	Meaning
T_H	Cyclic data holding time [ms]
T_{sw}	CPU module system switching time [ms] (📖 MELSEC iQ-R CPU Module User's Manual (Application))
T_{jo}	Delay time until initial output after system switching [ms] (📖 MELSEC iQ-R CPU Module User's Manual (Application))
T_c	System switching monitoring time [ms] (Setting value of "System Switching Monitoring Time" of the network parameter) (📖 Page 66 Supplementary Cyclic Settings)
T_d	Data link monitoring time [ms] (Setting value of "Data Link Monitoring Time" of the network parameter) (📖 Page 66 Supplementary Cyclic Settings)
C_{sw}	Control station switching time $C_{sw} [ms] = (a \times 12) + (b \times 11) + (c \times 3) + 450$ a: Number of the normally operating stations after disconnection of the control station b: Number of the faulty stations after disconnection of the control station c: Constant link scan setting value (📖 Page 66 Supplementary Cyclic Settings)
SS	CPU module sequence scan time [ms] (📖 MELSEC iQ-R CPU Module User's Manual (Application))
α	Module internal processing time $\alpha [ms] = 150ms$ (Constant)

Timing chart

This section describes a timing chart for each system switching cause.

■ Pattern 1

The following figure shows a timing chart for normal value.

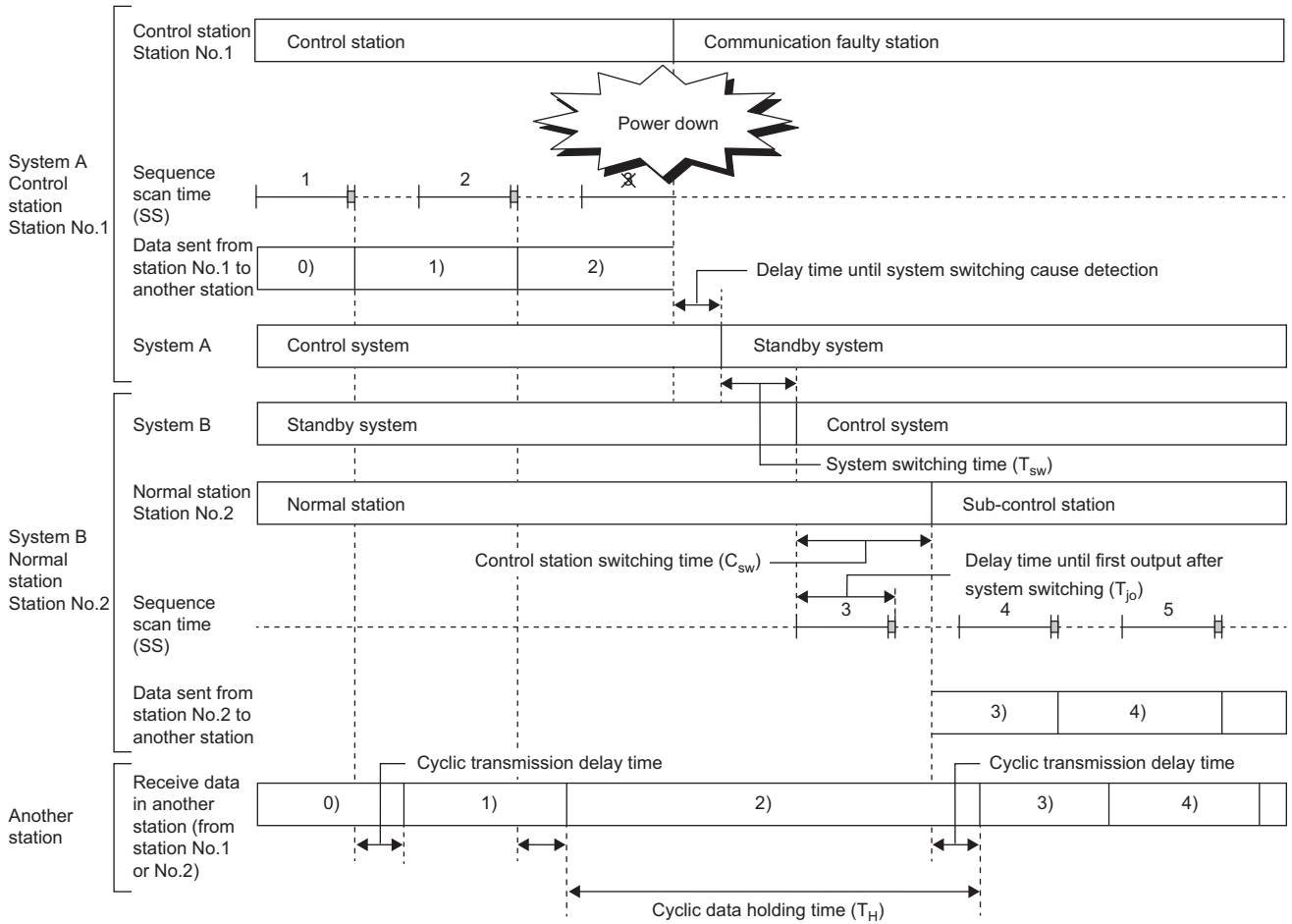

■ Pattern 2

The following figure shows a timing chart for normal value.

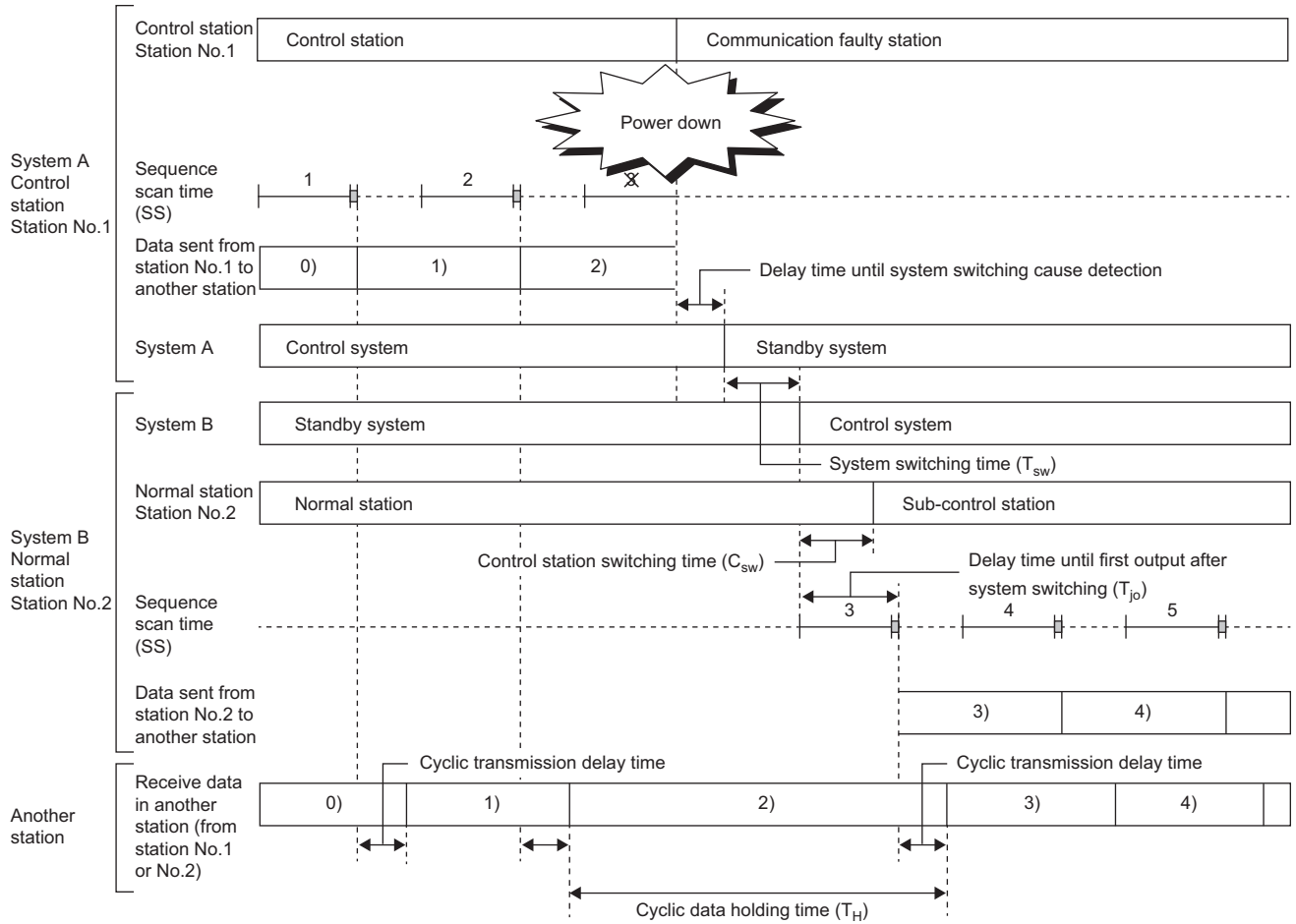

■ Pattern 3

The following figure shows a timing chart for normal value.

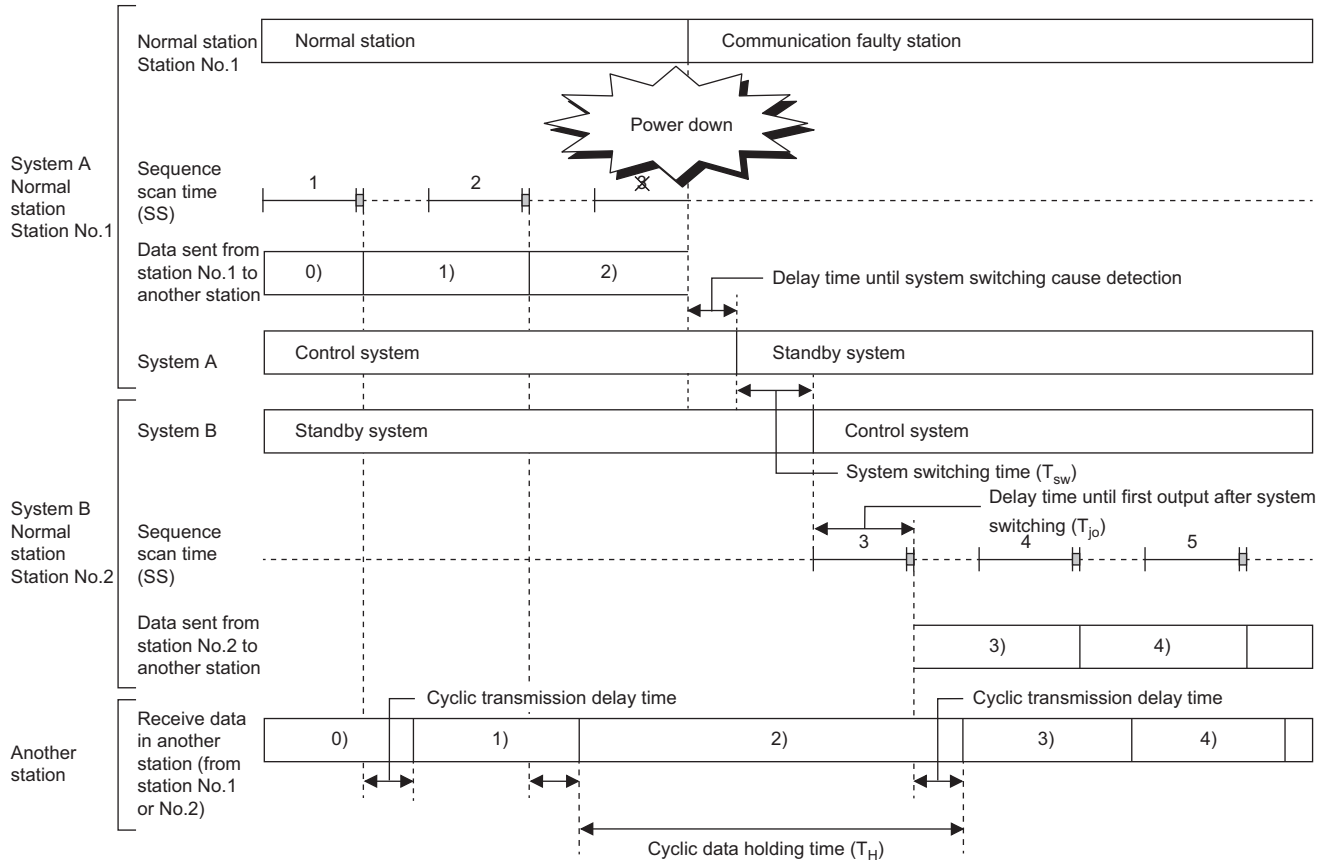

■Pattern 4

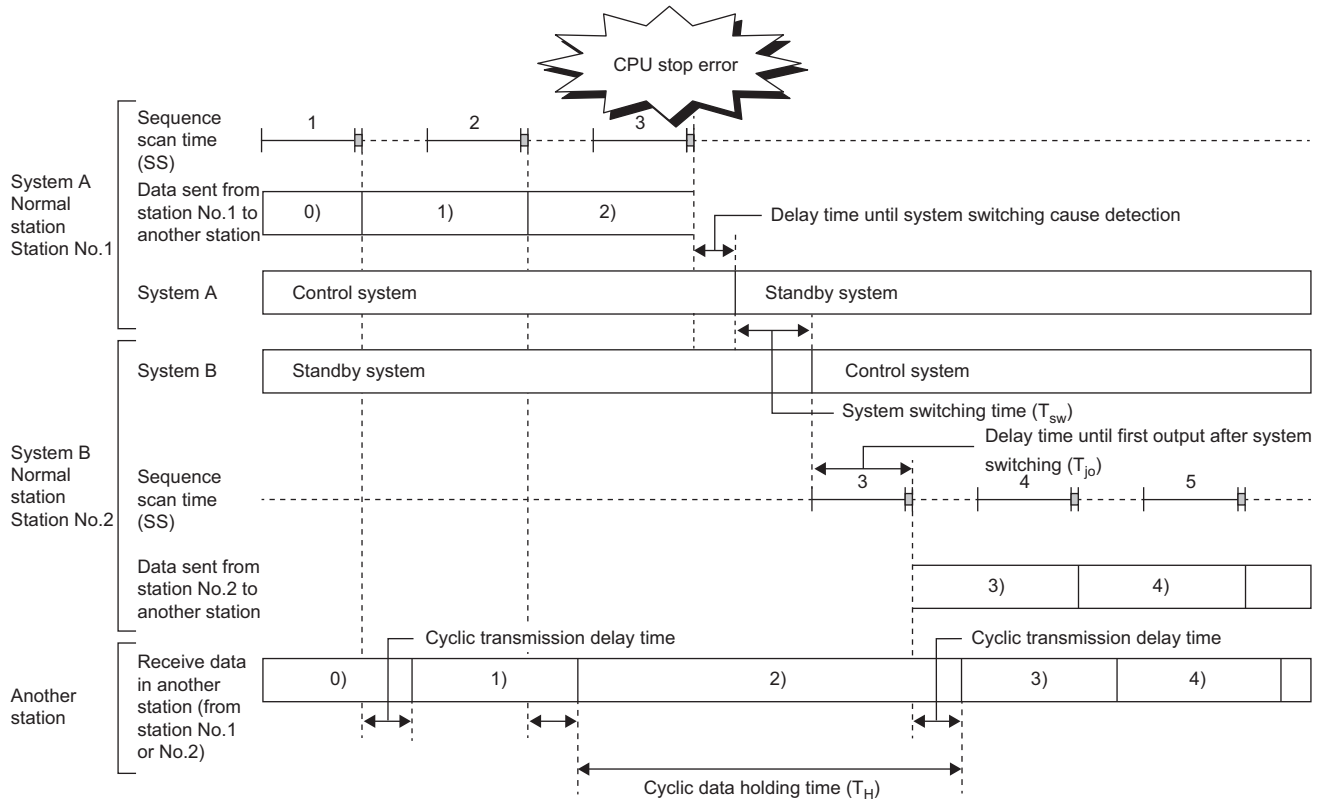

■ Pattern 5

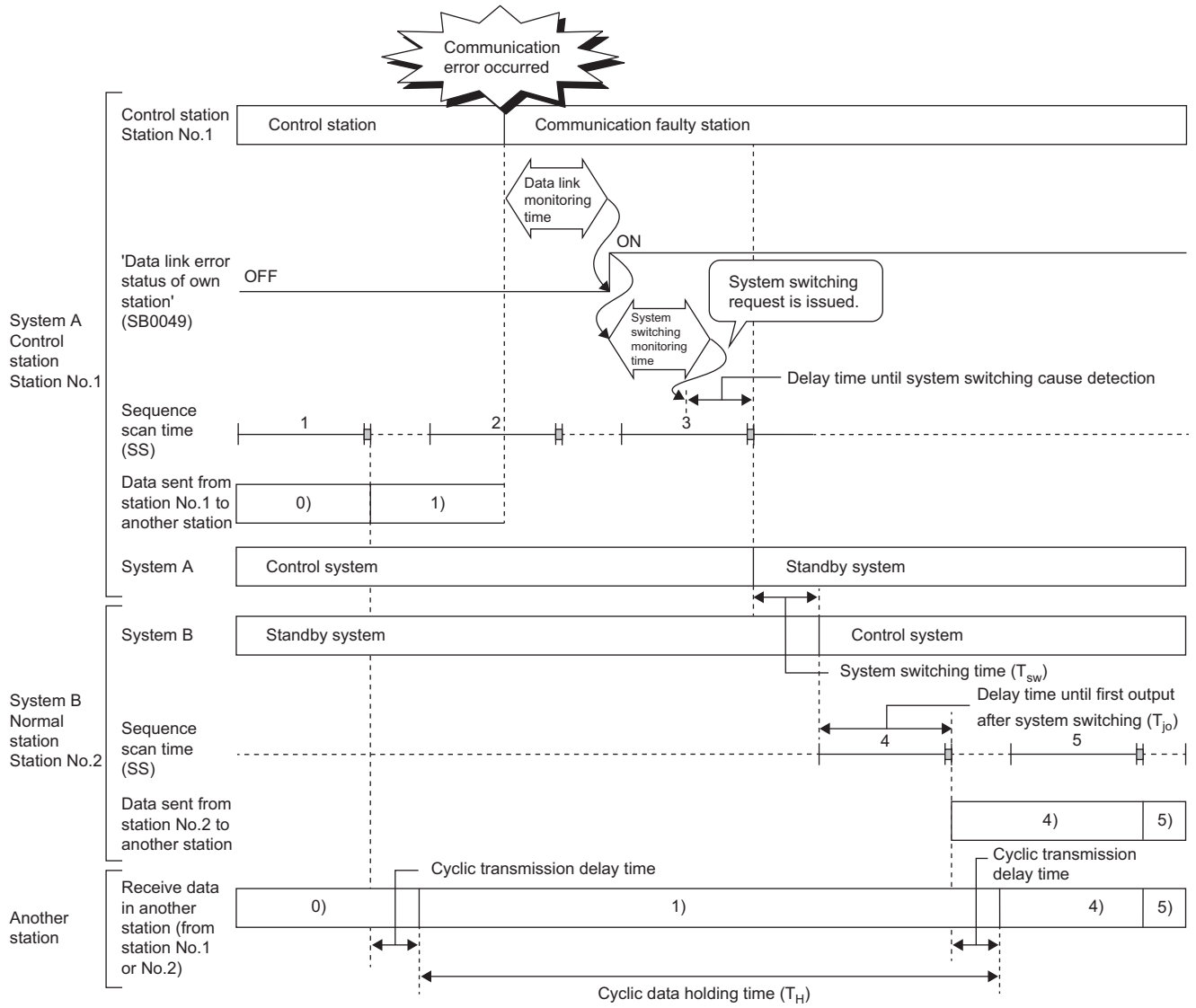

Appendix 7 Differences Between MELSEC-Q Series and MELSEC iQ-R Series



The following differences must be addressed when replacing the MELSEC-Q series with the MELSEC iQ-R series (RJ71LP21-25, RJ71BR11). For the replacement procedure, refer to the following.

 MELSECNET/H Transition Handbook (MELSEC-Q Series)

Specifications

Item	MELSEC-Q series	MELSEC iQ-R series	Action
System supported	<ul style="list-style-type: none"> Optical loop system Coaxial bus system Twist bus system 	<ul style="list-style-type: none"> Optical loop system Coaxial bus system 	Replacement is not possible when the system is configured using a twist bus system. All modules and wiring need to be replaced.
Optical loop system	<ul style="list-style-type: none"> SI optical fiber cable H-PCF optical fiber cable Broadband H-PCF optical fiber cable QSI optical fiber cable, 1000m GI optical fiber cable (QJ71LP21G only) 	<ul style="list-style-type: none"> SI optical fiber cable H-PCF optical fiber cable Broadband H-PCF optical fiber cable QSI optical fiber cable 	Replacement is not possible when the system is configured using a GI optical fiber cable. All modules and wiring need to be replaced.
Coaxial bus system	<ul style="list-style-type: none"> 3C-2V coaxial cable 5C-2V coaxial cable 5C-FB, S-5C-FB coaxial cable 	<ul style="list-style-type: none"> 3C-2V coaxial cable 5C-2V coaxial cable 5C-FB, S-5C-FB coaxial cable 	System was used in the Q series and can be replaced as is.
External power supply	Available (QJ71LP21S-25 only)	Not available	Cannot be replaced from the QJ71LP21S-25.
Network supported	<ul style="list-style-type: none"> PLC to PLC network Remote I/O network 	PLC to PLC network	Cannot be replaced from the remote I/O network.

Functions

Item	MELSEC-Q series	MELSEC iQ-R series	Action
Parameter unique to the station	Enabled	Disabled	Replace assignments of parameters unique to the station with refresh parameters. ( Page 197 Replacing a parameter unique to the station)
Multiplex transmission function	Enabled	<ul style="list-style-type: none"> RJ71LP21-25 Enabled: Sub-control station, Normal station Disabled: Control station RJ71BR11 Disabled 	Multiplex transmission cannot be specified when replacing the control station.
Simple redundancy	Enabled (High Performance model QCPU, Process CPU only)	Disabled	Perform replacement so as to execute refresh with the program without making refresh settings. ( Page 197 Method of replacement for simple redundancy)
ZNRD/ZNWR instruction	No restriction	An error occurs when the RCPUR is set as the target station.	Replace with the READ/WRITE instruction.
Redundant system	<ul style="list-style-type: none"> QJ71LP21-25 QJ71BR11 	RJ71LP21-25	Cannot be replaced from a QJ71BR11 redundant system.

■Replacing a parameter unique to the station

The following describes the method of replacing a parameter unique to the station.

Ex.

To use the same program for stations No.2 and No.3, replace the assignment of the stations No.2 and No.3.

- For MELSEC-Q series

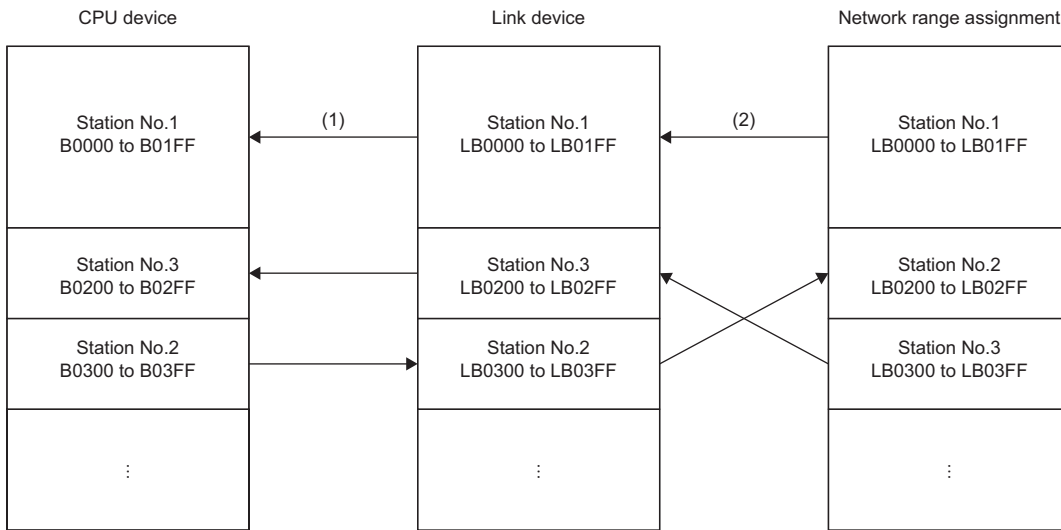

- (1) Refresh parameter
(2) Parameter unique to the station

- For MELSEC iQ-R series (RJ71LP21-25, RJ71BR11)

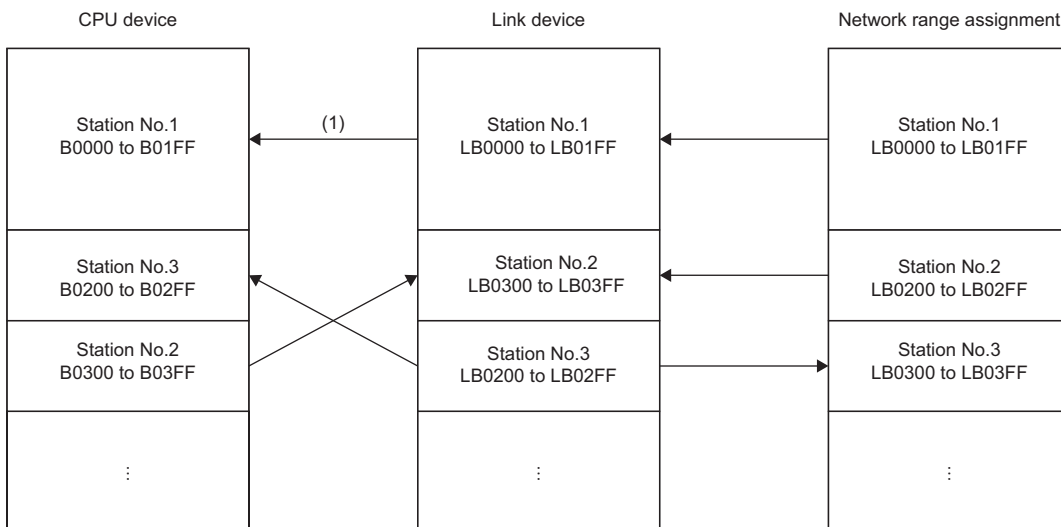

- (1) Refresh parameter

Precautions

The number of refresh parameters that can be set is 64. When more than 65 parameters unique to the station are set, it is required to review the refresh range or perform refresh with the program.

■Method of replacement for simple redundancy

The refresh parameter in the network can be replaced with the refresh by instructions using the link direct device (J□ \ B□, J□ \ W□).

For details on the method of replacement for multiplex transmission, refer to the following.

Method of replacing High Performance model QCPU with Universal model QCPU (FA-A-0001)

A

Appendix 8 Added and Enhanced Functions

The following table lists the added and enhanced functions in the RJ71LP21-25.

Added and enhanced functions	Firmware version
SLMP relay	"03" or later

MEMO

A

INDEX

B

Baton pass	15
Buffer memory	15

C

Common parameter	16
Control CPU	15
Control station shift time	15
Control system	15
Cyclic transmission	15

D

Dedicated instruction	15
Device	15

E

Engineering tool	15
----------------------------	----

G

Global label	15
Group number	15

I

Intelligent function module	15
---------------------------------------	----

L

Link dedicated instructions	182
Link device	15
Link refresh	15
Link scan (link scan time).	15
Logical channel.	15

M

MELSECNET/10 mode	15
MELSECNET/H extended mode	15
MELSECNET/H mode	15
Module label	15
Multiple CPU system	15

N

Network module	16
Network parameter	16
Normal station	15

P

Process CPU (redundant mode)	15
--	----

R

Redundant system	15
Relay station	15

Reserved station	15
----------------------------	----

S

Standby system	15
System A	15
System B	16
System switching	16

T

Tracking cable	16
Transient transmission	16

U

Unique parameter	16
----------------------------	----

MEMO

REVISIONS

*The manual number is given on the bottom left of the back cover.

Revision date	*Manual number	Description
February 2020	SH(NA)-082204ENG-A	First edition
April 2022	SH(NA)-082204ENG-B	■ Added or modified parts SAFETY PRECAUTIONS, CONDITIONS OF USE FOR THE PRODUCT, RELEVANT MANUALS, Section 2.2, 2.4, 4.5, Appendix 1
February 2023	SH(NA)-082204ENG-C	■ Added or modified parts SAFETY PRECAUTIONS, INTRODUCTION, Section 1.5, 2.2, 4.3, 4.4
May 2023	SH(NA)-082204ENG-D	■ Added model RJ71BR11 ■ Added or modified parts SAFETY PRECAUTIONS, INTRODUCTION, TERMS, GENERIC TERMS AND ABBREVIATIONS, Section 1.1, 1.2, 1.3, 1.4, 1.5, Chapter 2, Section 2.1, 2.2, 2.3, 2.4, 3.1, 3.2, Chapter 4, Section 4.1, 4.2, 4.3, 4.4, 4.5, 4.6, 4.7, Appendix 1, 2, 3, 4, 5, 6, 7
April 2024	SH(NA)-082204ENG-E	■ Added or modified parts Section 2.2, 4.3, 4.4, 4.5, Appendix 8

Japanese manual number: SH-082203-E

This manual confers no industrial property rights or any rights of any other kind, nor does it confer any patent licenses. Mitsubishi Electric Corporation cannot be held responsible for any problems involving industrial property rights which may occur as a result of using the contents noted in this manual.

© 2020 MITSUBISHI ELECTRIC CORPORATION

WARRANTY

Please confirm the following product warranty details before using this product.

1. Gratis Warranty Term and Gratis Warranty Range

If any faults or defects (hereinafter "Failure") found to be the responsibility of Mitsubishi occurs during use of the product within the gratis warranty term, the product shall be repaired at no cost via the sales representative or Mitsubishi Service Company.

However, if repairs are required onsite at domestic or overseas location, expenses to send an engineer will be solely at the customer's discretion. Mitsubishi shall not be held responsible for any re-commissioning, maintenance, or testing on-site that involves replacement of the failed module.

[Gratis Warranty Term]

The gratis warranty term of the product shall be for one year after the date of purchase or delivery to a designated place. Note that after manufacture and shipment from Mitsubishi, the maximum distribution period shall be six (6) months, and the longest gratis warranty term after manufacturing shall be eighteen (18) months. The gratis warranty term of repair parts shall not exceed the gratis warranty term before repairs.

[Gratis Warranty Range]

- (1) The range shall be limited to normal use within the usage state, usage methods and usage environment, etc., which follow the conditions and precautions, etc., given in the instruction manual, user's manual and caution labels on the product.
- (2) Even within the gratis warranty term, repairs shall be charged for in the following cases.
 1. Failure occurring from inappropriate storage or handling, carelessness or negligence by the user. Failure caused by the user's hardware or software design.
 2. Failure caused by unapproved modifications, etc., to the product by the user.
 3. When the Mitsubishi product is assembled into a user's device, Failure that could have been avoided if functions or structures, judged as necessary in the legal safety measures the user's device is subject to or as necessary by industry standards, had been provided.
 4. Failure that could have been avoided if consumable parts (battery, backlight, fuse, etc.) designated in the instruction manual had been correctly serviced or replaced.
 5. Failure caused by external irresistible forces such as fires or abnormal voltages, and Failure caused by force majeure such as earthquakes, lightning, wind and water damage.
 6. Failure caused by reasons unpredictable by scientific technology standards at time of shipment from Mitsubishi.
 7. Any other failure found not to be the responsibility of Mitsubishi or that admitted not to be so by the user.

2. Onerous repair term after discontinuation of production

- (1) Mitsubishi shall accept onerous product repairs for seven (7) years after production of the product is discontinued. Discontinuation of production shall be notified with Mitsubishi Technical Bulletins, etc.
- (2) Product supply (including repair parts) is not available after production is discontinued.

3. Overseas service

Overseas, repairs shall be accepted by Mitsubishi's local overseas FA Center. Note that the repair conditions at each FA Center may differ.

4. Exclusion of loss in opportunity and secondary loss from warranty liability

Regardless of the gratis warranty term, Mitsubishi shall not be liable for compensation to:

- (1) Damages caused by any cause found not to be the responsibility of Mitsubishi.
- (2) Loss in opportunity, lost profits incurred to the user by Failures of Mitsubishi products.
- (3) Special damages and secondary damages whether foreseeable or not, compensation for accidents, and compensation for damages to products other than Mitsubishi products.
- (4) Replacement by the user, maintenance of on-site equipment, start-up test run and other tasks.

5. Changes in product specifications

The specifications given in the catalogs, manuals or technical documents are subject to change without prior notice.

TRADEMARKS

The company names, system names and product names mentioned in this manual are either registered trademarks or trademarks of their respective companies.

In some cases, trademark symbols such as '™' or '®' are not specified in this manual.

SH(NA)-082204ENG-E(2404)MEE

MODEL: R-NET/H-U-OU-E

MODEL CODE: 13JX1F

MITSUBISHI ELECTRIC CORPORATION

HEAD OFFICE: TOKYO BLDG., 2-7-3, MARUNOUCHI, CHIYODA-KU, TOKYO 100-8310, JAPAN
NAGOYA WORKS: 1-14, YADA-MINAMI 5-CHOME, HIGASHI-KU, NAGOYA 461-8670, JAPAN

When exported from Japan, this manual does not require application to the
Ministry of Economy, Trade and Industry for service transaction permission.

Specifications subject to change without notice.