



Programmable Controller

MELSEC **Q** series

Digital-Analog Converter Module User's Manual

- Q62DAN
- Q62DA
- Q64DAN
- Q64DA
- Q68DAVN
- Q68DAV
- Q68DAIN
- Q68DAI
- GX Configurator-DA (SW2D5C-QDAU-E)

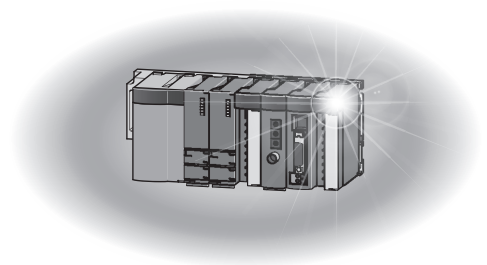



• SAFETY PRECAUTIONS •

(Always read these precautions before using this equipment.)

Before using this product, please read this manual and the relevant manuals introduced in this manual carefully and pay full attention to safety to handle the product correctly.

The precautions given in this manual are concerned with this product only. For the safety precautions of the programmable controller system, refer to the user's manual for the CPU module used.

In this manual, the safety precautions are classified into two levels: "⚠ WARNING" and "⚠ CAUTION".

 WARNING	Indicates that incorrect handling may cause hazardous conditions, resulting in death or severe injury.
 CAUTION	Indicates that incorrect handling may cause hazardous conditions, resulting in minor or moderate injury or property damage.

Under some circumstances, failure to observe the precautions given under "⚠ CAUTION" may lead to serious consequences.

Observe the precautions of both levels because they are important for personal and system safety.

Make sure that the end users read this manual and then keep the manual in a safe place for future reference.

[Design Precautions]

 WARNING
<ul style="list-style-type: none">• Do not write data into the "System area" of the buffer memory of intelligent function modules. Also, do not use any "Use prohibited" signals as an output signal to an intelligent function module from the programmable controller CPU. Writing data into the "System area" or outputting a signal for "Use prohibited" may cause a malfunction of the programmable controller system.

 CAUTION
<ul style="list-style-type: none">• Do not bunch the control wires or communication cables with the main circuit or power wires, or install them close to each other. They should be installed 100mm or more from each other. Not doing so could result in noise that may cause malfunction.• At power on/off, voltage or current may instantaneously be output from the output terminal of this module. In such case, wait until the analog output becomes stable to start controlling the external device.

[Installation Precautions]

CAUTION

- Use the programmable controller in an environment that meets the general specifications contained in the user's manual of the CPU module to use.
Using this programmable controller in an environment outside the range of the general specifications may cause electric shock, fire, malfunction, and damage to or deterioration of the product.
- While pressing the installation lever located at the bottom of module, insert the module fixing tab into the fixing hole in the base unit until it stops. Then, securely mount the module with the fixing hole as a supporting point.
Improper installation may result in malfunction, breakdown or the module coming loose and dropping. Securely fix the module with screws if it is subject to vibration during use.
- Tighten the screws within the range of specified torque.
If the screws are loose, it may cause the module to fallout, short circuits, or malfunction.
If the screws are tightened too much, it may cause damage to the screw and/or the module, resulting in fallout, short circuits or malfunction.
- Be sure to shut off all phases of the external power supply used by the system before mounting or removing the module.
Not doing so may cause damage to the module.
In the system where a CPU module supporting Online module change is used and on the MELSECNET/H remote I/O stations, modules can be replaced online (during energizing). However, there are some restrictions on replaceable modules and the replacement procedures are predetermined for each module.
For details, refer to the chapter of Online module change in this manual.
- Do not directly touch the conductive area or electronic components of the module.
Doing so may cause malfunction or failure in the module.

[Wiring Precautions]

CAUTION

- Always ground the FG terminal for the programmable controller.
There is a risk of electric shock or malfunction.
- Use applicable solderless terminals and tighten with the specified torque. If any solderless spade terminal is used, it may be disconnected when the terminal screw comes loose, resulting in failure.
- When turning on the power and operating the module after wiring is completed, always attach the terminal cover that comes with the product.
There is a risk of electric shock if the terminal cover is not attached.
- Tighten the terminal screws within the range of specified torque.
If the terminal screws are loose, it may result in short circuits or malfunction.
If the terminal screws are tightened too much, it may cause damage to the screw and/or the module, resulting in short circuits or malfunction.
- Be careful not to let foreign matter such as sawdust or wire chips get inside the module.
They may cause fires, failure or malfunction.
- The top surface of the module is covered with protective film to prevent foreign objects such as cable offcuts from entering the module when wiring.
Do not remove this film until the wiring is complete.
Before operating the system, be sure to remove the film to provide adequate ventilation.

[Startup and Maintenance Precautions]

CAUTION

- Do not disassemble or modify the modules.
Doing so could cause failure, malfunction injury or fire.
- Be sure to shut off all phases of the external power supply used by the system before mounting or removing the module.
Not doing so may cause failure or malfunction of the module.
In the system where a CPU module supporting Online module change is used and on the MELSECNET/H remote I/O stations, modules can be replaced online (during energizing). However, there are some restrictions on replaceable modules and the replacement procedures are predetermined for each module.
For details, refer to the chapter of Online module change in this manual.
- Do not install/remove the module to/from the base unit, or the terminal block to/from the module more than 50 times after the first use of the product. (IEC 61131-2 compliant)
Failure to do so may cause malfunction.
- Do not touch the connector while the power is on.
Doing so may cause malfunction.
- Switch off all phases of the externally supplied power used in the system when cleaning the module or retightening the terminal or module fixing screws.
Not doing so may cause failure or malfunction of the module.
If the screws are loose, it may cause the module to fallout, short circuits, or malfunction.
If the screws are tightened too much, it may cause damages to the screws and/or the module, resulting in the module falling out, short circuits or malfunction.
- Always make sure to touch the grounded metal to discharge the electricity charged in the body, etc., before touching the module.
Failure to do so may cause a failure or malfunctions of the module.

[Disposal Precautions]

CAUTION

- When disposing of this product, treat it as industrial waste.

• CONDITIONS OF USE FOR THE PRODUCT •

- (1) Mitsubishi programmable controller ("the PRODUCT") shall be used in conditions;
 - i) where any problem, fault or failure occurring in the PRODUCT, if any, shall not lead to any major or serious accident; and
 - ii) where the backup and fail-safe function are systematically or automatically provided outside of the PRODUCT for the case of any problem, fault or failure occurring in the PRODUCT.

- (2) The PRODUCT has been designed and manufactured for the purpose of being used in general industries.

MITSUBISHI SHALL HAVE NO RESPONSIBILITY OR LIABILITY (INCLUDING, BUT NOT LIMITED TO ANY AND ALL RESPONSIBILITY OR LIABILITY BASED ON CONTRACT, WARRANTY, TORT, PRODUCT LIABILITY) FOR ANY INJURY OR DEATH TO PERSONS OR LOSS OR DAMAGE TO PROPERTY CAUSED BY the PRODUCT THAT ARE OPERATED OR USED IN APPLICATION NOT INTENDED OR EXCLUDED BY INSTRUCTIONS, PRECAUTIONS, OR WARNING CONTAINED IN MITSUBISHI'S USER, INSTRUCTION AND/OR SAFETY MANUALS, TECHNICAL BULLETINS AND GUIDELINES FOR the PRODUCT.

("Prohibited Application")

Prohibited Applications include, but not limited to, the use of the PRODUCT in;

- Nuclear Power Plants and any other power plants operated by Power companies, and/or any other cases in which the public could be affected if any problem or fault occurs in the PRODUCT.
- Railway companies or Public service purposes, and/or any other cases in which establishment of a special quality assurance system is required by the Purchaser or End User.
- Aircraft or Aerospace, Medical applications, Train equipment, transport equipment such as Elevator and Escalator, Incineration and Fuel devices, Vehicles, Manned transportation, Equipment for Recreation and Amusement, and Safety devices, handling of Nuclear or Hazardous Materials or Chemicals, Mining and Drilling, and/or other applications where there is a significant risk of injury to the public or property.

Notwithstanding the above, restrictions Mitsubishi may in its sole discretion, authorize use of the PRODUCT in one or more of the Prohibited Applications, provided that the usage of the PRODUCT is limited only for the specific applications agreed to by Mitsubishi and provided further that no special quality assurance or fail-safe, redundant or other safety features which exceed the general specifications of the PRODUCTS are required. For details, please contact the Mitsubishi representative in your region.

REVISIONS

* The manual number is given on the bottom left of the back cover.

Print Date	* Manual Number	Revision
Dec., 1999	SH (NA)-080054-A	First printing
Oct., 2000	SH (NA)-080054-B	<p>Add the contents of the function version B.</p> <p>Correction</p> <p>About the Generic Terms and Abbreviations, Section 2.1, Section 3.1.3, 3.3.1, 3.4, Section 4.3, Section 5.2.1, 5.2.2, 5.3.3, 6.5.1</p> <p>Partial addition</p> <p>Section 1.1, Section 3.1.1, 3.1.2, 3.2.1, 3.2.2, 3.3.1, 3.3.2, 3.4.3, Section 4.5, Section 5.6.1, Section 7.2.3, 7.2.4</p> <p>Addition</p> <p>Section 1.2, Section 2.2, Section 3.2.3, Appendix 1</p>
Dec., 2000	SH (NA)-080054-C	<p>Addition of Models</p> <p>Q68DAV, Q68DAI</p> <p>Correction</p> <p>Section 3.2, 3.2.1, 3.2.2, 3.2.3, 3.3.1, 3.3.2, 3.4.1, 3.4.2, 3.4.3, 3.4.4, 3.4.6, 3.4.7, Section 4.5, Section 7.2.3, App-1.3</p> <p>Partial addition</p> <p>About the Generic Terms and Abbreviations, Product Structure, Chapter 1, Section 1.1, Section 2.1, Section 3.1.1, 3.1.4, Section 4.1, 4.3, Section 7.1, Appendix 2</p>
Jun., 2001	SH (NA)-080054-D	<p>Standardize the name from software package (GPP function) to Product name (GX Developer).</p> <p>Standardize the name from utility package (QDAU) to Product name (GX Configurator-DA).</p> <p>Correction</p> <p>Conformation to the EMC Directive and Low Voltage Instruction, About the Generic Terms and Abbreviations, Product Structure, Section 2.1, 2.2, Section 4.6, Section 5.2, 5.2.1, 5.2.2, 5.3.3, Appendix 1.2</p>
Feb., 2002	SH (NA)-080054-E	<p>Add the contents of the function version B.</p> <p>Correction</p> <p>Product Structure, Section 1.2, Section 2.2, Section 3.2.2, 3.2.3, 3.4.1, Section 4.2, 4.4.1, Section 5.3.3</p> <p>Partial addition</p> <p>SAFETY PRECAUTIONS, About the Generic Terms and Abbreviations, Section 1.2, Section 2.1, Section 3.1.1, 3.2, 3.2.2, 3.2.3, Section 4.3, 4.6, Section 5.2.1, 5.2.2, Section 8.1, 8.2.1, Appendix 1</p> <p>Addition</p> <p>Section 3.4.2, 3.4.3, 3.4.4, 3.4.12, 3.4.13, 3.4.14, Chapter 7, App-2, 2.1, 2.2, 2.3</p> <p>Renumbering</p> <p>Section 3.4.2 to Section 3.4.8 → Section 3.4.5 to Section 3.4.11, Chapter 7 → Chapter 8, Appendix 2 → Appendix 3</p>

* The manual number is given on the bottom left of the back cover.

Print Date	* Manual Number	Revision
May, 2002	SH(NA)-080054-F	<p>Correction</p> <p>Section 3.4.1, 3.4.2, 3.4.3, 3.4.4, 3.4.6, 3.4.13, 3.4.14, Section 4.5, 4.6, Section 7.3.1, 7.3.2, 7.3.3, 7.3.4, 7.3.5, 7.3.6, 7.4, 7.5, Appendix 1.1, 2.2, 2.3</p> <p>Partial addition</p> <p>Section 3.3.2, Section 8.2.3</p>
Feb., 2003	SH(NA)-080054-G	<p>Correction</p> <p>SAFETY PRECAUTIONS, Section 1.2, Section 3.2, 3.4.1 to 3.4.4, 3.4.14, Section 4.5, Section 5.1, 5.2.1, 5.2.2, 5.3.2, 5.6.1 to 5.6.3, Section 7.3.3 to 7.3.6, 7.4, Appendix 1.1 to Appendix 1.3, Appendix 2.2, Appendix 2.3</p> <p>Addition</p> <p>Section 5.6.4, 5.6.5</p>
May, 2003	SH(NA)-080054-H	<p>Correction</p> <p>Section 2.2, Section 3.1.1, 3.4.1, 3.4.2, 3.4.3, 3.4.4, 3.4.13, 3.4.14, Section 4.5, 4.6, Section 5.3.1</p>
May, 2004	SH(NA)-080054-I	<p>Addition of program example for use on the remote I/O network</p> <p>Correction</p> <p>Section 2.2, Section 3.1.4, 3.2.1, 3.2.2, 3.4.7, Chapter 6, Section 7.1, 7.3.1 to 7.3.6</p>
Aug., 2004	SH(NA)-080054-J	<p>Correction</p> <p>Section 1.1, Section 5.1, 5.2.1, 5.2.2, 5.3.1, 5.3.2, 5.3.3, 5.6.1, 5.6.2, 5.6.3, Appendix 2.3</p> <p>Partial addition</p> <p>Section 5.6.4, Section 5.7, 5.8</p>
Oct., 2004	SH(NA)-080054-K	<p>Correction</p> <p>SAFETY PRECAUTIONS, Section 2.1, Section 3.1.1, Section 4.1, Section 6.2, 6.2.1</p>
Nov., 2005	SH (NA)-080054-L	<p>Addition of Models</p> <p>Q62DAN, Q64DAN, Q68DAVN, Q68DAIN</p> <p>Correction</p> <p>SAFETY PRECAUTIONS, Conformation to the EMC Directive and Low Voltage Instruction, Product Structure, Section 2.1, Section 5.2.2, Section 6.2.2</p> <p>Addition</p> <p>Appendix 1.4</p>

* The manual number is given on the bottom left of the back cover.

Print Date	* Manual Number	Revision
Mar., 2006	SH (NA)-080054-M	<p>Correction</p> <p>SAFETY PRECAUTIONS, Conformation to the EMC Directive and Low Voltage Instruction, Section 2.1, 4.6, Appendix 2</p>
Jan., 2007	SH (NA)-080054-N	<p>Correction</p> <p>Section 3.2.1, Section 3.4.2, Section 4.6</p>
Jun., 2007	SH (NA)-080054-O	<p>Correction</p> <p>Section 4.3, Appendix 3</p>
Jan., 2008	SH (NA)-080054-P	<p>Correction</p> <p>SAFETY PRECAUTIONS, About the Generic Terms and Abbreviations Section 1.1, Section 2.1, Section 2.3, Section 3.4.1 to Section 3.4.4, Section 4.1, Section 4.6, Section 5.2.1, Section 5.2.2, Section 7.3.3, Section 7.3.5, Section 8.1, Appendix 1.1, Appendix 2, Appendix 2.1, Appendix 2.2, Appendix 2.3</p> <p>Addition</p> <p>Section 2.2</p>
May, 2008	SH (NA)-080054-Q	<p>Correction</p> <p>SAFETY PRECAUTIONS, Compliance with the EMC and Low Voltage Directives, About the Generic Terms and Abbreviations, Section 2.1, Section 4.1, Section 5.2.1, Section 5.2.2, Section 5.3.1, Section 5.3.3, Section 7.1</p>
Dec., 2010	SH (NA)-080054-R	<p>Correction</p> <p>About the Generic Terms and Abbreviations, Product Structure, Section 1.1, Sections 2.1 to 2.3, Section 3.1.1, Section 3.1.2, Section 3.2.1, Section 3.2.2, Sections 3.4.1 to 3.4.4, Section 3.4.9, Section 4.1, Section 4.3, Section 4.5, Section 5.2.1, Section 5.3.1, Section 5.3.3, Section 5.4, Section 5.5, Section 5.6.1, Section 5.7, Section 6.2, Section 6.2.2, Section 7.1, Sections 7.3.1 to 7.3.6, Section 8.1, Section 8.2.3, Section 8.2.5, Appendix 2, Appendices 2.1 to 2.3, Appendix 3</p> <p>Addition</p> <p>CONDITIONS OF USE FOR THE PRODUCT</p>
May, 2015	SH (NA)-080054-S	<p>Correction</p> <p>SAFETY PRECAUTIONS, RELEVANT MANUALS, Compliance with the EMC and Low Voltage Directives, About the Generic Terms and Abbreviations, Section 2.1, Section 2.2, Section 3.2.3, Section 4.3, Section 4.6, Section 5.2.1, Section 5.2.2, Section 5.6.2, Section 5.6.3, Section 6.1.2, Section 7.1, Section 7.3.6, Section 7.5, Appendix 3</p>

* The manual number is given on the bottom left of the back cover.

Print Date	* Manual Number	Revision
Jun., 2016	SH (NA)-080054-T	<div style="border: 1px solid black; display: inline-block; padding: 2px;">Correction</div> Sections 4.3, Section 4.4.2, Section 4.5, Appendix 3 <div style="border: 1px solid black; display: inline-block; padding: 2px;">Addition</div> DISCONTINUED MODELS
Jun., 2017	SH (NA)-080054-U	<div style="border: 1px solid black; display: inline-block; padding: 2px;">Correction</div> INTRODUCTION, COMPLIANCE WITH THE EMC AND LOW VOLTAGE DIRECTIVES, ABOUT THE GENERIC TERMS AND ABBREVIATIONS, Section 3.1.1
Jan., 2020	SH (NA)-080054-V	<div style="border: 1px solid black; display: inline-block; padding: 2px;">Correction</div> Section 8.2.3

Japanese Manual Version SH-080027-Y

This manual confers no industrial property rights or any rights of any other kind, nor does it confer any patent licenses. Mitsubishi Electric Corporation cannot be held responsible for any problems involving industrial property rights which may occur as a result of using the contents noted in this manual.

© 1999 MITSUBISHI ELECTRIC CORPORATION

INTRODUCTION

Thank you for purchasing the Mitsubishi Electric MELSEC-Q series programmable controllers. Before using the product, please read this manual carefully to develop full familiarity with the functions and performance of the Q series programmable controllers to ensure correct use.

CONTENTS

SAFETY PRECAUTIONS.....	A- 1
CONDITIONS OF USE FOR THE PRODUCT	A- 4
REVISIONS	A- 5
INTRODUCTION.....	A- 9
CONTENTS.....	A- 9
ABOUT MANUALS	A-12
COMPLIANCE WITH THE EMC AND LOW VOLTAGE DIRECTIVES.....	A-12
ABOUT THE GENERIC TERMS AND ABBREVIATIONS	A-13
PRODUCT STRUCTURE.....	A-14
DISCONTINUED MODELS	A-14
1 OVERVIEW 1- 1 to 1- 3	
1.1 Features.....	1- 1
1.2 Functions Added to Function Version B and Later.....	1- 3
2 SYSTEM CONFIGURATION 2- 1 to 2- 7	
2.1 Applicable Systems	2- 1
2.2 Precautions on System Configuration	2- 4
2.3 Checking Function Version, Serial Number, and Software Version.....	2- 5
3 SPECIFICATIONS 3- 1 to 3-33	
3.1 Performance Specifications	3- 1
3.1.1 Performance specifications list.....	3- 1
3.1.2 I/O conversion characteristics	3- 3
3.1.3 Accuracy.....	3-10
3.1.4 Conversion speed	3-10
3.2 D/A Converter Module Function.....	3-11
3.2.1 Synchronous output function	3-11
3.2.2 Analog output HOLD/CLEAR function	3-12
3.2.3 Analog output test during programmable controller CPU STOP	3-14
3.3 I/O Signals for the Programmable Controller CPU.....	3-15
3.3.1 List of I/O signals.....	3-15
3.3.2 Details of I/O signals	3-16
3.4 Buffer Memory	3-20
3.4.1 Buffer memory assignment (Q62DAN/Q62DA).....	3-20
3.4.2 Buffer memory assignment (Q64DAN/Q64DA).....	3-22
3.4.3 Buffer memory assignment (Q68DAVN/Q68DAV).....	3-24
3.4.4 Buffer memory assignment (Q68DAIN/Q68DAI).....	3-26
3.4.5 D/A conversion enable/disable (buffer memory address 0: Un\G0)	3-28
3.4.6 Digital value (buffer memory address 1 to 8: Un\G1 to Un\G8)	3-28
3.4.7 Set value check code (buffer memory address 11 to 18: Un\G11 to Un\G18).....	3-29
3.4.8 Error code (buffer memory address 19: Un\G19).....	3-29

3.4.9	Setting range (buffer memory address 20, 21: Un\G20, Un\G21)	3-30
3.4.10	Offset/gain setting mode and Offset/gain specification (buffer memory address 22, 23: Un\G22, Un\G23)	3-30
3.4.11	Offset/gain adjustment value specification (buffer memory address 24: Un\G24)	3-31
3.4.12	Mode switching setting (buffer memory address 158, 159: Un\G158, Un\G159)	3-31
3.4.13	Pass data classification setting (buffer memory address 200: Un\G200) (Q62DAN, Q64DAN, Q62DA, and Q64DA only)	3-32
3.4.14	Industrial shipment settings and User range settings Offset/gain value (buffer memory address 202 to 233: Un\G202 to Un\G233)	3-33

4	SETUP AND PROCEDURES BEFORE OPERATION	4- 1 to 4-17
----------	--	---------------------

4.1	Handling Precautions	4- 1
4.2	Setup and Procedures before Operation	4- 2
4.3	Part Identification Nomenclature	4- 3
4.4	Wiring	4- 6
4.4.1	Wiring precautions	4- 6
4.4.2	External wiring	4- 7
4.5	Switch Setting for Intelligent Function Module	4- 9
4.6	Offset/Gain Settings	4-13

5	UTILITY PACKAGE (GX Configurator-DA)	5- 1 to 5-36
----------	---	---------------------

5.1	Utility Package Functions	5- 1
5.2	Installing and Uninstalling the Utility Package	5- 2
5.2.1	Handling precautions	5- 2
5.2.2	Operating environment	5- 5
5.3	Utility Package Operation	5- 7
5.3.1	Common utility package operations	5- 7
5.3.2	Operation overview	5-10
5.3.3	Starting the intelligent function module utility	5-12
5.4	Initial Setting	5-15
5.5	Auto Refresh Setting	5-17
5.6	Monitor/Test	5-19
5.6.1	Monitor/test screen	5-19
5.6.2	Offset/gain setting operation (Function version C or later)	5-23
5.6.3	Offset/gain setting operation (Function version B or earlier)	5-25
5.6.4	Confirmation of Conversion Characteristic	5-27
5.6.5	Pass data (Q62DAN/Q64DAN/Q62DA/Q64DA)	5-29
5.6.6	Pass data (Q68DAVN/Q68DAIN/Q68DAV/Q68DAI)	5-31
5.7	FB Conversion of Initial Setting/Auto Refresh Setting	5-32
5.8	Usage of FB	5-33
5.8.1	Outline	5-33
5.8.2	Paste an FB to a Sequence Program	5-35
5.8.3	Convert (Compile) a Sequence Program	5-36

6	PROGRAMMING	6- 1 to 6-11
----------	--------------------	---------------------

6.1	For Use in Normal System Configuration	6- 1
6.1.1	Programming example using the utility package	6- 2
6.1.2	Programming example without using the utility package	6- 4

6.2 For Use on Remote I/O Network	6- 6
6.2.1 Programming example using the utility package	6- 7
6.2.2 Programming example without using the utility package	6-10

7 ONLINE MODULE CHANGE	7- 1 to 7-36
-------------------------------	---------------------

7.1 Online Module Change Conditions	7- 2
7.2 Online Module Change Operations	7- 3
7.3 Online Module Change Procedure	7- 4
7.3.1 When industrial shipment setting is used and initial setting was made with GX Configurator-DA	7- 4
7.3.2 When industrial shipment setting is used and initial setting was made with sequence program	7- 9
7.3.3 When user range setting is used and initial setting was made with GX Configurator-DA (other system is available).....	7-14
7.3.4 When user range setting is used and initial setting was made with GX Configurator-DA (other system is unavailable)	7-19
7.3.5 When user range setting is used and initial setting was made with sequence program (other system is available).....	7-25
7.3.6 When user range setting is used and initial setting was made with sequence program (other system is unavailable)	7-30
7.4 Range Reference Table	7-35
7.5 Precautions for Online Module Change.....	7-36

8 TROUBLESHOOTING	8- 1 to 8- 5
--------------------------	---------------------

8.1 Error Code List.....	8- 1
8.2 Troubleshooting.....	8- 2
8.2.1 When the "RUN" LED is flashing or turned off.....	8- 2
8.2.2 When the "ERROR" LED is on or flashing.....	8- 2
8.2.3 When an analog output value is not output	8- 3
8.2.4 When analog output value is not held	8- 4
8.2.5 Checking the D/A converter module status using GX Developer system monitor	8- 4

APPENDICES	App- 1 to App-21
-------------------	-------------------------

Appendix 1 Function upgrade for the D/A converter module.....	App- 1
Appendix 1.1 A comparison of functions of the D/A converter module.....	App- 1
Appendix 1.2 Combinations of D/A converter module functions and GX Configurator-DA software versions.....	App- 2
Appendix 1.3 Precautions for replacing the module of function version A with the one of function version B or later.....	App- 3
Appendix 1.4 Precautions for replacing the Q62DA/Q64DA/Q68DAV/Q68DAI with Q62DAN/Q64DAN/Q68DAVN/Q68DAIN.....	App- 4
Appendix 2 Dedicated Instruction List and Available Devices	App- 5
Appendix 2.1 G(P).OFFGAN	App- 6
Appendix 2.2 G(P).OGLOAD.....	App- 8
Appendix 2.3 G(P).OGSTOR	App-13
Appendix 3 External Dimensions	App-19

INDEX	Index- 1 to Index- 2
--------------	-----------------------------

ABOUT MANUALS

The following manuals are also related to this product.
If necessary, order them by quoting the details in the tables below.

Related Manuals

Manual Name	Manual Number (Model Code)
GX Developer Version 8 Operating Manual Describes the methods of using GX Developer to create a program and print out, monitor, and debug the program. (Sold separately)	SH-080373E (13JU41)
GX Developer Version 8 Operating Manual (Function Block) Describes the methods of using GX Developer to create a function block and print out the function block. (Sold separately)	SH-080376E (13JU44)
GX Works2 Version 1 Operating Manual (Common) Describes the system configuration, parameter settings, and online operations (common to Simple project and Structured project) of GX Works2 (Sold separately)	SH-080779E (13JU63)
GX Works2 Version 1 Operating Manual (Intelligent Function Module) Describes how to operate the parameter settings, monitor, predefined protocol support function, and others of the intelligent function modules on GX Works2 (Sold separately)	SH-080921E (13JU69)

REMARK

If you would like to obtain a manual individually, printed matters are available separately. Order the manual by quoting the manual number on the table above (model code).

COMPLIANCE WITH THE EMC AND LOW VOLTAGE DIRECTIVES

(1) For programmable controller system

To ensure that Mitsubishi Electric programmable controllers maintain EMC and Low Voltage Directives when incorporated into other machinery or equipment, certain measures may be necessary. Please refer to one of the following manuals.

- QCPU User's Manual (Hardware Design, Maintenance and Inspection)
- Safety Guidelines

(This manual is included with the CPU module or the base unit.)

The CE mark on the side of the programmable controller indicates compliance with EMC and Low Voltage Directives.

(2) For the product

No additional measures are necessary for the compliance of this product with the EMC and Low Voltage Directives.

ABOUT THE GENERIC TERMS AND ABBREVIATIONS

Unless otherwise specified, this manual uses the following generic terms and abbreviations.

Abbreviation/general terms	Description of the abbreviation/general terms
D/A converter module	Generic term for Q62DAN, Q64DAN, Q68DAVN, Q68DAIN, Q62DA, Q64DA, Q68DAV, Q68DAI.
DOS/V personal computer	IBM PC/AT® or compatible computer with DOS/V.
GX Developer	Product name of the software package for the MELSEC programmable controllers.
GX Works2	
GX Configurator-DA	Generic term for digital-analog converter module setting and monitor tool GX Configurator-DA (SW2D5C-QDAU-E).
QCPU (Q mode)	Generic term for Basic model QCPU, High Performance model QCPU, Process CPU, Redundant CPU, and Universal model QCPU.
Basic model QCPU	Generic term for Q00JCPU, Q00CPU, and Q01CPU.
High Performance model QCPU	Generic term for Q02CPU, Q02HCPU, Q06HCPU, Q12HCPU, and Q25HCPU.
Process CPU	Generic term for Q02PHCPU, Q06PHCPU, Q12PHCPU, and Q25PHCPU.
Redundant CPU	Generic term for the Q12PRHCPU and Q25PRHCPU.
Universal model QCPU	Generic term for Q00UJCPU, Q00UCPU, Q01UCPU, Q02UCPU, Q03UDCPU, Q03UDVCPU, Q03UDECPU, Q04UDHCPU, Q04UDVCPU, Q04UDEHCPU, Q06UDHCPU, Q06UDVCPU, Q06UDEHCPU, Q10UDHCPU, Q10UDEHCPU, Q13UDHCPU, Q13UDVCPU, Q13UDEHCPU, Q20UDHCPU, Q20UDEHCPU, Q26UDHCPU, Q26UDVCPU, Q26UDEHCPU, Q50UDEHCPU, and Q100UDEHCPU.
Personal computer	Generic term for DOS/V personal computer.
Industrial shipment setting	Generic term for analog input ranges 1 to 5V, 0 to 5V, -10 to 10V, 4 to 20mA and 0 to 20mA.
FB	Abbreviation of function block.

PRODUCT STRUCTURE

The product structure of this product is given in the table below.

Model code	Product name	Quantity
Q62DAN	Q62DAN Model Digital-Analog Converter module	1
Q64DAN	Q64DAN Model Digital-Analog Converter module	1
Q68DAVN	Q68DAVN Model Digital-Analog Converter module	1
	FG terminal L-Shaped metal fitting	1
Q68DAIN	Q68DAIN Model Digital-Analog Converter module	1
	FG terminal L-Shaped metal fitting	1
Q62DA	Q62DA Model Digital-Analog Converter module	1
Q64DA	Q64DA Model Digital-Analog Converter module	1
Q68DAV	Q68DAV Model Digital-Analog Converter module	1
	FG terminal L-Shaped metal fitting	1
Q68DAI	Q68DAI Model Digital-Analog Converter module	1
	FG terminal L-Shaped metal fitting	1
SW2D5C-QDAU-E	GX Configurator-DA Version 2 (1-license product) (CD-ROM)	1
SW2D5C-QDAU-EA	GX Configurator-DA Version 2 (Multiple-license product) (CD-ROM)	1

DISCONTINUED MODELS

The models in the table below are described in this manual, but are no longer produced.
 For the onerous repair term after discontinuation of production, refer to "WARRANTY".

Model	Production discontinuation
Q62DA	December 2007
Q64DA	December 2007
Q68DAV	December 2007
Q68DAI	December 2007

MEMO

1 OVERVIEW

1

This User's Manual provides the specifications, handling instructions and programming methods for the following digital-analog converter modules that are used in combination with MELSEC-Q series CPU modules (hereinafter referred to as programmable controller CPU).

- Q62DAN type digital-analog converter module (hereinafter referred to as the Q62DAN)
- Q64DAN type digital-analog converter module (hereinafter referred to as the Q64DAN)
- Q68DAVN type digital-analog converter module (hereinafter referred to as the Q68DAVN)
- Q68DAIN type digital-analog converter module (hereinafter referred to as the Q68DAIN)
- Q62DA type digital-analog converter module (hereinafter referred to as the Q62DA)
- Q64DA type digital-analog converter module (hereinafter referred to as the Q64DA)
- Q68DAV type digital-analog converter module (hereinafter referred to as the Q68DAV)
- Q68DAI type digital-analog converter module (hereinafter referred to as the Q68DAI)

In this manual, the Q62DAN, Q64DAN, Q68DAVN, Q68DAIN, Q62DA, Q64DA, Q68DAV and Q68DAI are collectively referred to as the D/A (Digital-Analog) converter modules.

1.1 Features

(1) Available models

- Q62DAN, Q62DA 2 channels: Voltage or current output can be selected for each channel.
- Q64DAN, Q64DA 4 channels: Voltage or current output can be selected for each channel.
- Q68DAVN, Q68DAV 8 channels: All of which are voltage output.
- Q68DAIN, Q68DAI 8 channels: All of which are current output.

(2) Improved security and noise immunity (Q62DAN, Q64DAN, Q68DAVN, Q68DAIN only)

Since isolation is provided between the external power supply and analog output channels, the security and noise immunity have been increased.

(3) High-speed conversion processing

Conversion processing is performed at a speed of 80 μ s/channel.

(4) High degree of accuracy

The conversion accuracy is $\pm 0.1\%$ (When the ambient temperature is 25 ± 5 °C).

(5) Changing the resolution mode

The resolution mode can be changed according to the application, and digital-value resolution settings of 1/4000, 1/12000 or 1/16000 can be selected.

(6) Changing the output range

The output range*¹ can easily be changed using GX Developer.

*¹ The output range refers to the type of offset/gain settings. The most frequently used range is set as the default but the user can also specify their own offset/gain settings.

(7) Synchronous output function

This function sets a constant time (120 μ s) until the analog value is output after the digital value is written from the programmable controller CPU. Highly accurate analog control can be achieved by combining this function with a constant cycle execution type program for the programmable controller CPU or the constant scan function*¹.

*¹ The constant scan function executes the sequence program within a fixed time interval.

(8) Analog output HOLD/CLEAR function

This function is set to either retain or clear the analog output value when the CPU module is in the STOP status or when a stop error occurs.

(9) Easy settings with GX Configurator-DA

The number of sequence programs can be reduced since GX Configurator-DA (sold separately) allows the D/A converter module settings on the screen. Also, GX Configurator-DA simplifies checking of the module settings and operation status.

FB^{*1} can be automatically created from intelligent function module parameters set in advance to use them in a sequence program.

*1 FB is the function for making a circuit block used in a sequence program repeatedly a part (FB) to use it in the sequence program.

This function can improve the efficiency of program development and minimize program bugs to improve program qualities.

For the details of FB, refer to "GX Developer Version 8 Operating Manual (Function Block)."

1.2 Functions Added to Function Version B and Later

(1) Functions added to function version B D/A converter module

The functions added by the function version B D/A converter module are listed below.

Item	Function overview	Reference section
Multiple CPU system compatibility	Compatible with a Multiple CPU system. A programmable controller CPU of function version B or later are required.	Section 2.1
Analog output test during programmable controller CPU STOP	When the CH□ output enable/disable flag is forced on during programmable controller CPU STOP, the D/A converted value is output.	Section 3.2.3
Resolution mode	The resolution mode can be changed according to the application, and a resolution setting can be selected from 1/4000, 1/12000 and 1/16000.	Section 3.2
High resolution mode status flag (X8)	This turns on when in high resolution mode.	Section 3.3

POINT

- (1) Refer to Appendix 1.1 for a comparison of functions of the function version.
- (2) Refer to Section 2.3 on how to check the function version.

(2) Functions added to function version C D/A converter module

The functions added by the function version C D/A converter module are listed below.

Item	Function overview	Reference section
Online module change	You can change the module without stopping the system. A programmable controller CPU of function version C or later is required.	Chapter 7
Mode switching that does not require programmable controller CPU to be reset	Mode switching setting (buffer memory address 158, 159: Un\G158, Un\G159) and Operating condition setting request (Y9), the module is switched between the normal mode and offset/gain setting mode without the programmable controller CPU being reset.	Section 3.4.12
	Using the dedicated instruction (G(P).OFFGAN), the module is switched between the normal mode and offset/gain setting mode without the programmable controller CPU being reset.	Appendix 3.1
	Using GX Configurator-DA, the module is switched between the normal mode and offset/gain setting mode without the programmable controller CPU being reset.	Section 5.6.2

2 SYSTEM CONFIGURATION

This chapter explains the system configuration of the D/A converter module.

2.1 Applicable Systems

This section describes the applicable systems.

(1) Applicable modules and base units, and No. of modules

(a) When mounted with a CPU module

For the applicable modules, the number of modules, and base units applicable to the D/A converter module, refer to the user's manual for the CPU module used.

Note the following when the D/A converter module is mounted with a CPU module.

- Depending on the combination with other modules or the number of mounted modules, power supply capacity may be insufficient. Pay attention to the power supply capacity before mounting modules, and if the power supply capacity is insufficient, change the combination of modules.
- Mount a module within the number of I/O points for the CPU module. If the number of slots is within the available range, the module can be mounted on any slot.

REMARK

When the module is used with a C Controller module, refer to the user's manual for the C Controller module.

(b) Mounting to a MELSECNET/H remote I/O station

For the applicable MELSECNET/H remote I/O station, the number of mountable modules, and the applicable base units, refer to the Q Corresponding MELSECNET/H Network System Reference Manual (Remote I/O Network).

(2) Support of the multiple CPU system

When using the D/A converter module in a multiple CPU system, refer to the following manual first.

- QCPU User's Manual (Multiple CPU System)

(3) Compatibility with Online module change

To make an Online module change, use the module of function version C or later.

(4) Supported software packages

The relationship between the system including the D/A converter module and the software package is shown in the following table.

GX Developer or GX Works2 is necessary when using the D/A converter module.

		Software Version		
		GX Developer	GX Configurator-DA * 1, * 2	GX Works2
Q00J/Q00/Q01CPU	Single CPU system	Version 7 or later	Version 1.10L or later (cannot be used with the SW0D5C-QDAU-E 60G or earlier versions).	Refer to the GX Works2 Version 1 Operating Manual (Common).
	Multiple CPU system	Version 8 or later		
Q02/Q02H/Q06H/ Q12H/Q25HCPU	Single CPU system	Version 4 or later	SW0D5C-QDAU-E 00A or later	
	Multiple CPU system	Version 6 or later	SW0D5C-QDAU-E 20C or later	
Q02PH/Q06PHCPU	Single CPU system	Version 8.68W or later	Version 1.13P or later (cannot be used with the SW0D5C-QDAU-E 60G or earlier versions).	
	Multiple CPU system			
Q12PH/Q25PHCPU	Single CPU system	Version 7.10L or later		
	Multiple CPU system			
Q12PRH/ Q25PRHCPU	Redundant CPU system	Version 8.45X or later	Version 1.15R or later	
Q00UJ/Q00U Q01UCPU	Single CPU system	Version 8.78G or later	Version 2.06G or later	
	Multiple CPU system			
Q02U/Q03UD/ Q04UDH/ Q06UDHCPU	Single CPU system	Version 8.48A or later		
	Multiple CPU system			
Q10UDH/ Q20UDHCPU	Single CPU system	Version 8.78G or later		
	Multiple CPU system			
Q13UDH/ Q26UDHCPU	Single CPU system	Version 8.62Q or later		
	Multiple CPU system			
Q03UDE/Q04UDEH/ Q06UDEH/Q13UDEH/ Q26UDEHCPU	Single CPU system	Version 8.68W or later		
	Multiple CPU system			
Q10UDH/ Q20UDHCPU	Single CPU system	Version 8.78G or later		
	Multiple CPU system			
CPU modules other than the above	Single CPU system	Not supported		Not supported
	Multiple CPU system			
If installed in a MELSECNET/H remote I/O station		Version 6 or later		SW0D5C-QDAU-E 50F or later

*1: Refer to Appendix 1.2 for the combinations of the D/A converter module functions and GX Configurator-DA software versions.

When using the Q68DAVN, Q68DAIN, Q68DAV or Q68DAI, use SW0D5C-QDAU-E 60G or later.

*2: The Q62DAN, Q64DAN, Q68DAVN and Q68DAIN can be selected for GX Configurator-DA Version 2.03D or later.

To use the software package of an earlier version, select a model name from which suffix "N" is removed.

POINT
(1) The products of function version C include the functions of the products of function versions A and B.
(2) Depending on the version of GX Configurator-DA, CPU modules and functions of the D/A converter module differ.
(3) When using GX Works2, refer to the following: <ul style="list-style-type: none">• GX Works2 Version 1 Operating Manual (Common)• GX Works2 Version 1 Operating Manual (Intelligent Function Module)

2.2 Precautions on System Configuration

(1) Using D/A converter module with Redundant CPU

(a) Dedicated instruction

The dedicated instruction cannot be used.

(b) GX Configurator-DA

GX Configurator-DA cannot be used when accessing the Redundant CPU via an intelligent function module on an extension base unit from GX Developer.

Connect a personal computer to the Redundant CPU with a communication path indicated below.

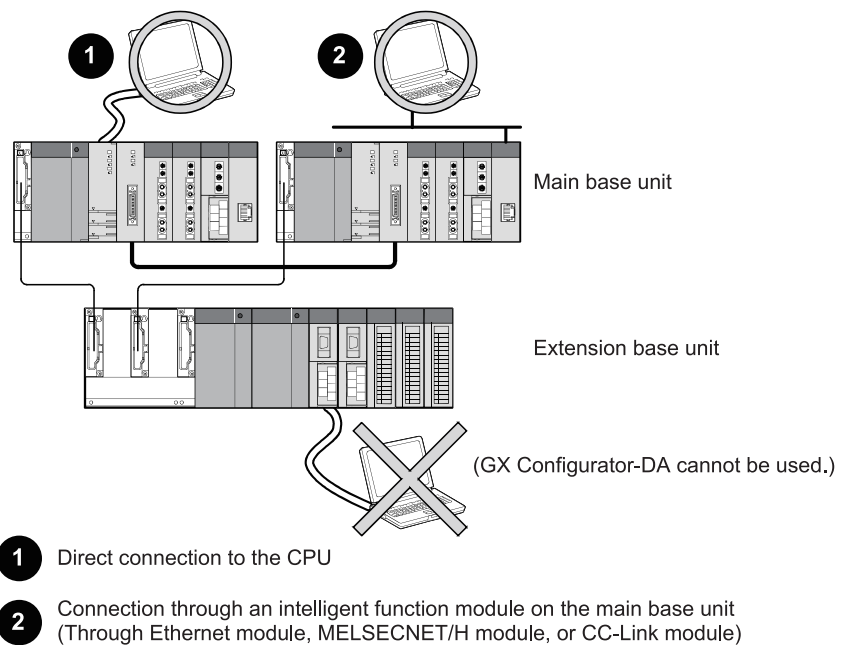

2.3 Checking Function Version, Serial Number, and Software Version

This section describes how to check the function version of the D/A converter module and the GX Configuration-DA software version.

(1) Checking the function version and serial number of the D/A converter module

The serial number and function version of the D/A converter module are described in the rating plate, on the front part of the module, or displayed in the System monitor dialog box developer.

(a) Checking on the rating plate on the side of the D/A converter module

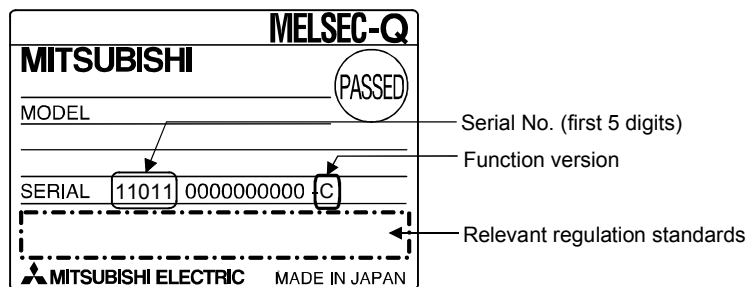

(b) Checking on the front of the module

The serial number and function version on the rating plate is shown on the front (at the bottom) of the module.

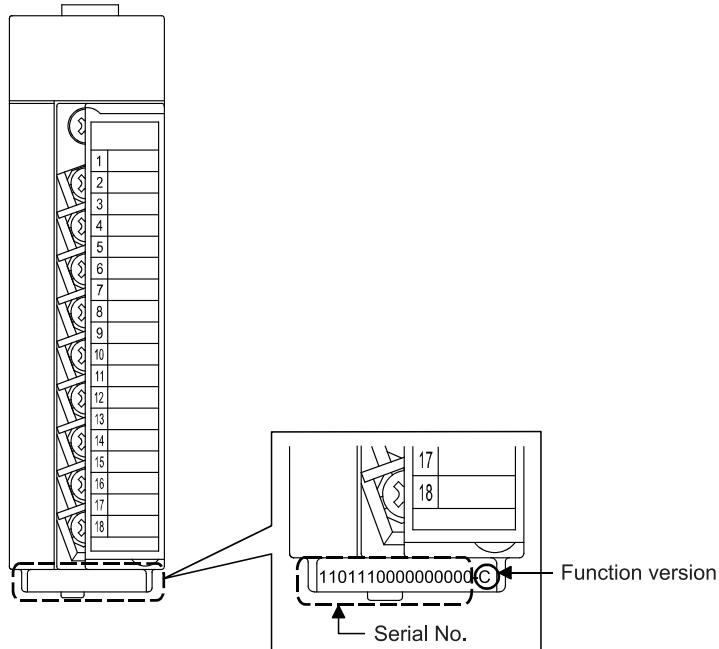

(c) Checking on the System monitor dialog box (Product Information List)

To display the system monitor, select [Diagnostics] → [System monitor] and click the **Product Information List** button of GX Developer.

Function version
Serial No. Product No.

Slot	Type	Series	Model name	Points	I/O No.	Master PLC	Serial No.	Ver.	Product No.
PLC	PLC	Q	Q06UDHCPU	-	-	-	1101300000000000	B	091013092955015-B
0-0	Intelli.	Q	Q64DAN	16pt	0000	-	0708100000000000	C	-
0-1	-	-	None	-	-	-	-	-	-
0-2	-	-	None	-	-	-	-	-	-
0-3	-	-	None	-	-	-	-	-	-
0-4	-	-	None	-	-	-	-	-	-

1) Displaying the product No.

Since the D/A converter modules do not support the display function, "-" is displayed in the "Product No." field.

POINT
<p>The serial number displayed on the Product information list dialog box of GX Developer may differ from that on the rating plate and on the front of the module.</p> <ul style="list-style-type: none"> • The serial number on the rating plate and front part of the module indicates the management information of the product. • The serial number displayed on the Product information list dialog box of GX Developer indicates the function information of the product. <p>The function information of the product is updated when a new function is added.</p>

(2) Checking the software version of GX Configurator-DA

The software version of GX Configurator-DA can be checked by selecting [Help] → [Product information] of GX Developer.

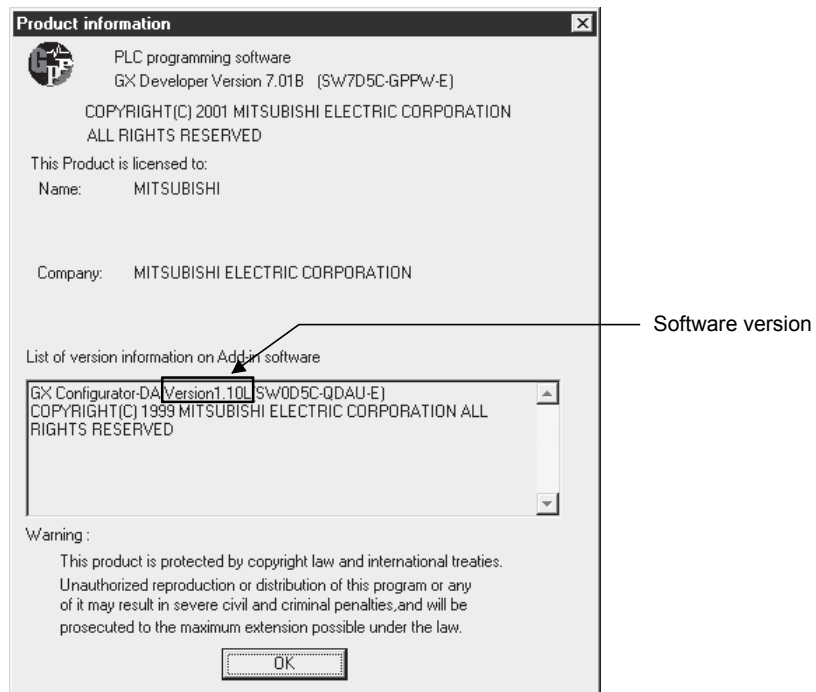

(In the case of GX Developer Version 7)

REMARK

The version indication for the GX Configurator-DA has been changed as shown below from the SW0D5C-QDAU-E 60G upgrade product.

Previous product	Upgrade and subsequent versions
SW0D5C-QDAU-E 60G	→ GX Configurator-DA Version 1.10L

3 SPECIFICATIONS

3.1 Performance Specifications

3.1.1 Performance specifications list

(1) Q62DAN, Q64DAN, Q68DAVN, Q68DAIN

Table 3.1 Performance specifications list

Model name		Q62DAN	Q64DAN	Q68DAVN	Q68DAIN	
Item		2 channels	4 channels	8 channels		
Digital input		16-bit signed binary (normal resolution mode: -4096 to 4095, high resolution mode: -12288 to 12287, -16384 to 16383)				
Analog output	Voltage	-10 to 10 V DC (External load resistance value: 1 k Ω to 1M Ω)			—	
	Current	0 to 20 mA DC (External load resistance value: 0 Ω to 600 Ω)		—	0 to 20 mA DC (External load resistance value: 0 Ω to 600 Ω)	
I/O characteristics, Maximum resolution	Analog output range	Normal resolution mode		High resolution mode		
		Digital input value	Maximum resolution	Digital input value	Maximum resolution	
	Voltage	0 to 5V	0 to 4000	1.25 mV	0 to 12000	0.416 mV
		1 to 5V		1.0 mV		0.333 mV
		-10 to 10V	-4000 to 4000	2.5 mV	-16000 to 16000	0.625 mV
	User range setting	0.75 mV		-12000 to 12000		0.333 mV
	Current	0 to 20 mA	0 to 4000	5 μ A	0 to 12000	1.66 μ A
		4 to 20 mA		4 μ A		1.33 μ A
User range setting		-4000 to 4000	1.5 μ A	-12000 to 12000	0.83 μ A	
Accuracy (Accuracy in respect to maximum analog output value) *1	Ambient temperature 25 \pm 5 $^{\circ}$ C	Within \pm 0.1 % (Voltage: \pm 10 mV, Current: \pm 20 μ A)				
	Ambient temperature 0 to 55 $^{\circ}$ C	Within \pm 0.3 % (Voltage: \pm 30 mV, Current: \pm 60 μ A)				
Conversion speed		80 μ s/channel				
Absolute maximum output	Voltage	\pm 12 V			—	
	Current	21 mA	—	—	21 mA	
E ² PROM write count		Max. 100 thousand times				
Output short circuit protection		Available				
Insulation method		Between the I/O terminal and programmable controller power supply : Photo coupler insulation Between output channels : No insulation Between external supply power and analog output : Transformer insulation				
Dielectric withstand voltage		Between the I/O terminal and programmable controller power supply: 500VAC for 1 minute Between external supply power and analog output: 500VAC for 1 minute				
Insulation resistance		Between the I/O terminal and programmable controller power supply: 500VDC 20M Ω or more Between external supply power and analog output: 500VDC 20M Ω or more				
I/O occupied points		16 points (I/O assignment: Intelligent 16 points)				
External interface		18-points terminal block				
Applicable wire size		0.3 to 0.75 mm ²				
Applicable solderless terminal		R 1.25-3 (A solderless terminal with sleeve cannot be used)		FG terminal: R1.25-3, 1.25-YS3, RAV1.25-3, V1.25-YS3A Other terminals than FG: R1.25-3 (A solderless terminal with sleeve cannot be used)		
		24 V DC + 20 %, - 15 % Ripple, spike 500 mV P-P or less				
External supply power		Inrush current: 4.7 A, within 280 μ s	Inrush current: 4.7 A, within 280 μ s	Inrush current: 4.7 A, within 280 μ s	Inrush current: 4.7 A, within 280 μ s	
		0.15 A	0.24 A	0.20 A	0.27 A	
Internal current consumption (5 V DC)		0.33 A	0.34 A	0.38 A	0.38 A	
Weight		0.19 kg	0.20 kg	0.20 kg	0.20 kg	

*1: D/A converter modules need to be powered on 30 minutes prior to operation for compliance to the specification (accuracy).

REMARK

Refer to the user's manual for the CPU module being used for the general specifications for the D/A converter module.

(2) Q62DA, Q64DA, Q68DAV, and Q68DAI

Table 3.2 Performance specifications list

Model name		Q62DA	Q64DA	Q68DAV	Q68DAI		
Item		2 channels	4 channels	8 channels			
Number of analog input channels		16-bit signed binary (normal resolution mode: -4096 to 4095, high resolution mode: -12288 to 12287, -16384 to 16383)					
Analog output	Voltage	-10 to 10 V DC (External load resistance value: 1 kΩ to 1MΩ)			—		
	Current	0 to 20 mA DC (External load resistance value: * 1)		—	0 to 20 mA DC (External load resistance value: * 1)		
I/O characteristics, Maximum resolution		Analog output range		Normal resolution mode		High resolution mode	
				Digital input value	Maximum resolution	Digital input value	Maximum resolution
		Voltage	0 to 5V	0 to 4000	1.25 mV	0 to 12000	0.416 mV
			1 to 5V		1.0 mV		0.333 mV
			-10 to 10V	-4000 to 4000	2.5 mV	-16000 to 16000	0.625 mV
			User range setting		0.75 mV	-12000 to 12000	0.333 mV
		Current	0 to 20 mA	0 to 4000	5 μA	0 to 12000	1.66 μA
			4 to 20 mA		4 μA		1.33 μA
			User range setting	-4000 to 4000	1.5 μA	-12000 to 12000	0.83 μA
		Accuracy (Accuracy in respect to maximum analog output value)	Ambient temperature 25 ± 5 °C	Within ± 0.1 % (Voltage: ±10 mV, Current: ± 20 μA)			
Ambient temperature 0 to 55 °C	Within ± 0.3 % (Voltage: ± 30 mV, Current: ± 60 μA)						
Conversion speed		80 μs/channel					
Absolute maximum output	Voltage	± 12 V			—		
	Current	21 mA	—	—	21 mA		
E ² PROM write count		Max. 100 thousand times					
Output short circuit protection		Available					
Insulation method		Between the I/O terminal and programmable controller power supply : Photo coupler insulation Between output channels : No insulation Between external supply power and analog output : No insulation					
Dielectric withstand voltage		Between the I/O terminal and programmable controller power supply: 500VAC for 1 minute					
Insulation resistance		Between the I/O terminal and programmable controller power supply: 500VDC 20MΩ or more					
I/O occupied points		16 points (I/O assignment: Intelligent 16 points)					
External interface		18-points terminal block					
Applicable wire size		0.3 to 0.75 mm ²					
Applicable solderless terminal		R 1.25-3 (A solderless terminal with sleeve cannot be used)		FG terminal: R1.25-3, 1.25-YS3, RAV1.25-3, V1.25-YS3A Other terminals than FG: R1.25-3 (A solderless terminal with sleeve cannot be used)			
External supply power		24 V DC + 20 %, - 15 %					
		Ripple, spike 500 mV P-P or less					
		Inrush current: 1.9 A, within 300 μs	Inrush current: 3.1 A, within 300 μs	Inrush current: 3.3 A, within 70 μs	Inrush current: 3.1 A, within 75 μs		
Internal current consumption (5 V DC)		0.33 A	0.34 A	0.39 A	0.38 A		
Weight		0.19 kg		0.18 kg			

3

*1 When the voltage of the external power supply is less than 22.85V DC, the analog output current and the external load resistance value are as follows.

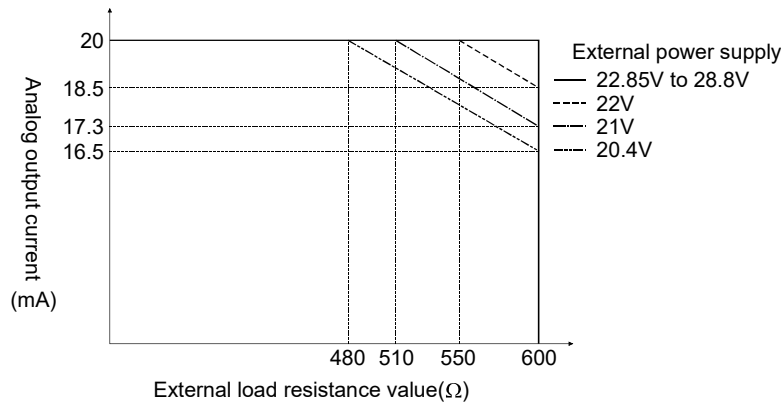

REMARK

Refer to the user's manual for the CPU module being used for the general specifications for the D/A converter module.

3.1.2 I/O conversion characteristics

I/O conversion characteristics are used for converting the digital value written from the programmable controller CPU to an analog output value (voltage or current output), and represented by inclined straight lines when offset and gain values are included.

Offset value

The offset value is the analog output value (voltage or current) when the digital input value set from the programmable controller CPU is 0.

Gain value

The gain value denotes the analog output value (voltage or current) when the digital input value set from the programmable controller CPU is

4000 (in normal resolution mode),

12000 (when 1 to 5V, 0 to 5V, 4 to 20 mA, 0 to 20 mA or the user range setting is selected in high resolution mode),

16000 (when -10 to 10V is selected in high resolution mode).

(1) Voltage output characteristic

(a) Voltage output characteristic in normal resolution mode

Figure 3.1 shows a graph of the voltage output characteristic in normal resolution mode.

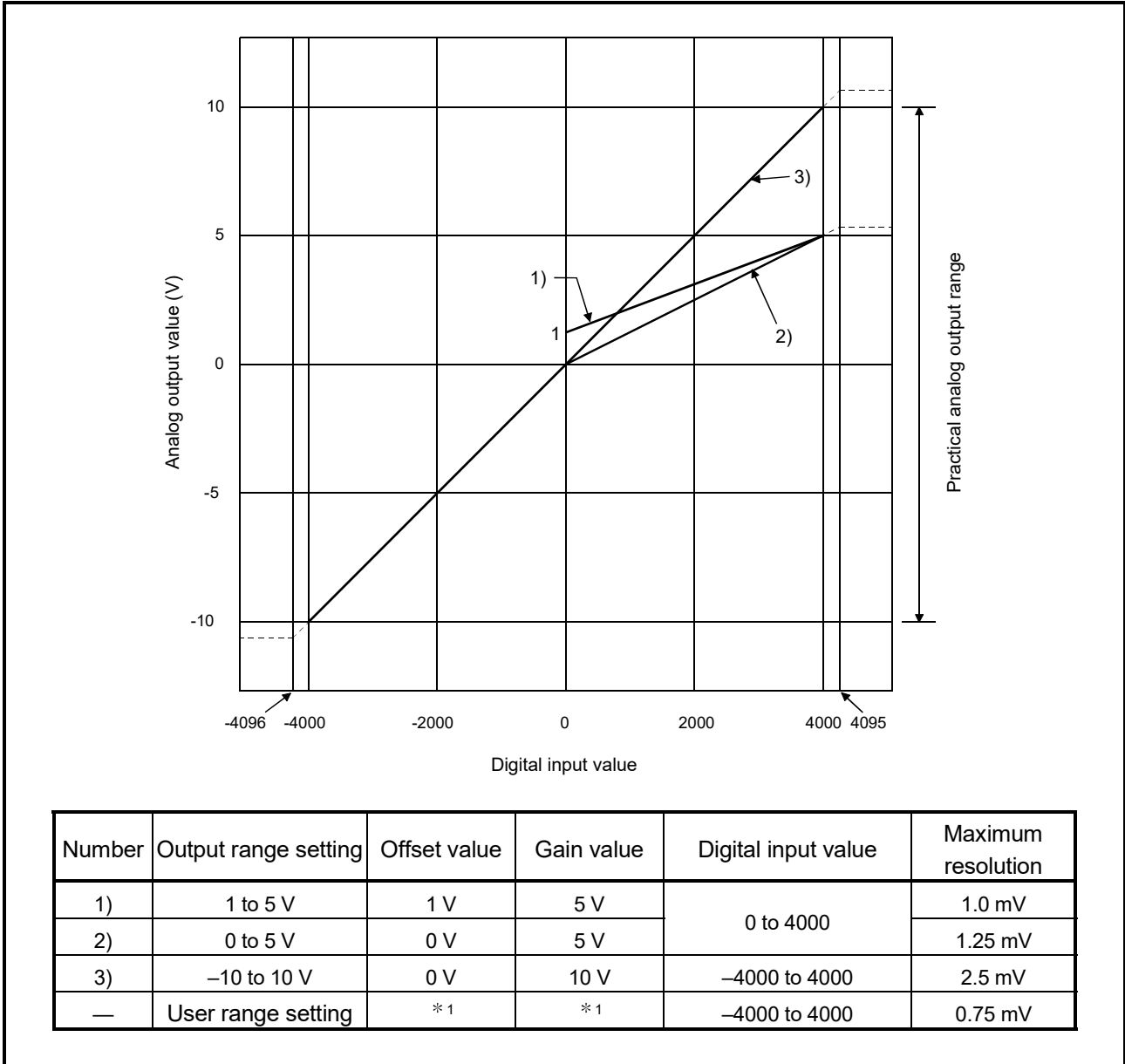

Figure 3.1 Voltage output characteristic in normal resolution mode

(b) Voltage output characteristic in high resolution mode
 Figure 3.2 shows a graph of the voltage output characteristic in high resolution mode.

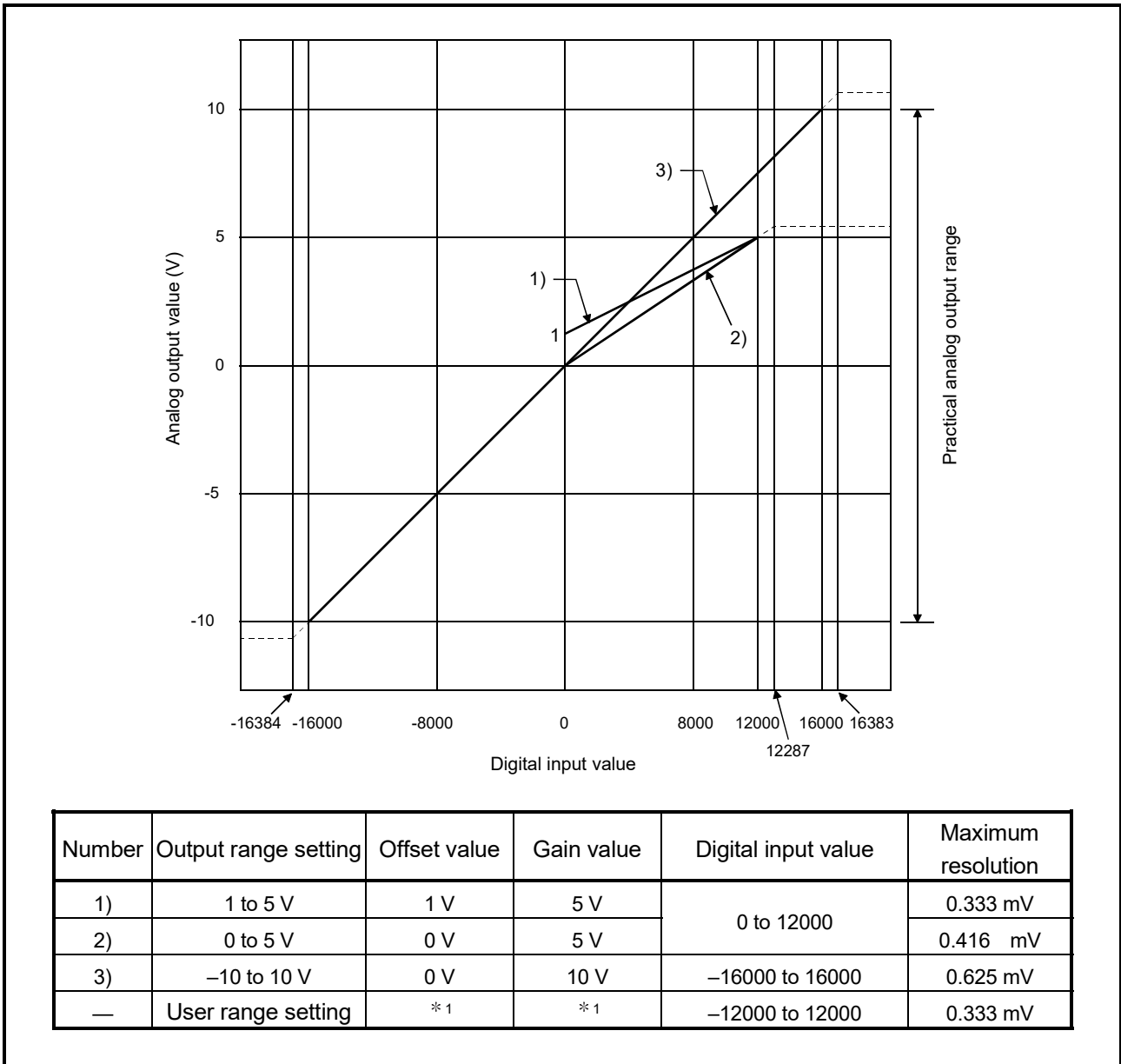

Figure 3.2 Voltage output characteristic in high resolution mode

POINT
<p>(1) Set within the digital input range and analog output range for each output range. If these ranges are exceeded, the maximum resolution and accuracy may not fall within the performance specifications. (Avoid using the dotted line area shown in Figures 3.1 and 3.2.)</p> <p>(2) Set the offset/gain values for the user setting range *1 within a range in which the following conditions are satisfied.</p> <p>(a) Setting range is from -10 to 10 V.</p> <p>(b) Without using the utility package Normal resolution mode setting: $\{ (\text{Gain value}) - (\text{Offset value}) \} > 3.0\text{V}$ High resolution mode setting: $\{ (\text{Gain value}) - (\text{Offset value}) \} \geq 4.0\text{V}$</p> <p>(c) Using the utility package Normal resolution mode setting: $\{ (\text{Gain value}) - (\text{Offset value}) \} > 3.0\text{V}$ High resolution mode setting: $\{ (\text{Gain value}) - (\text{Offset value}) \} > 4.0\text{V}$</p>

(2) Current output characteristic

(a) Current output characteristic in normal resolution mode

Figure 3.3 shows a graph of the current output characteristic in normal resolution mode.

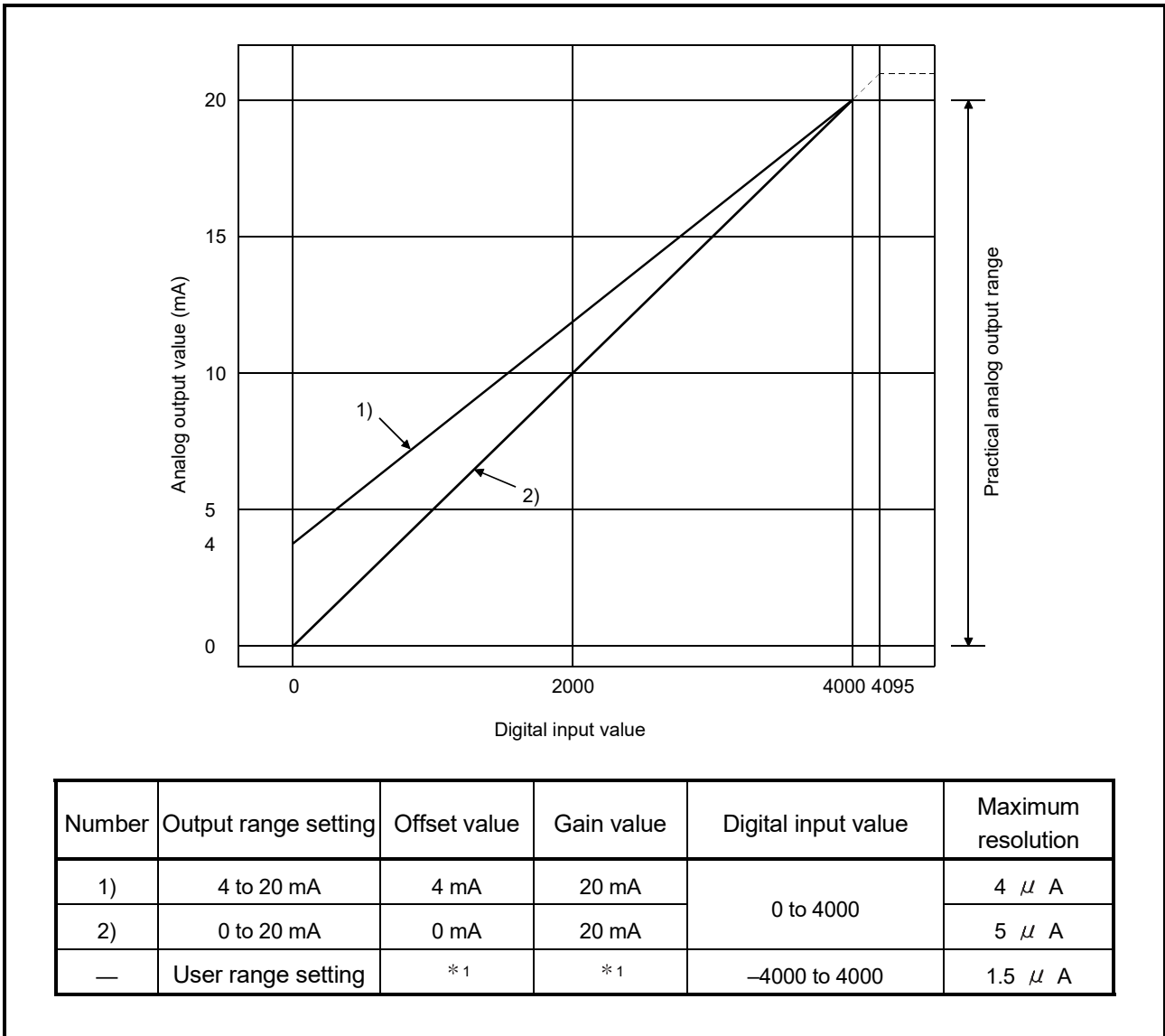

Figure 3.3 Current output characteristic in normal resolution mode

(b) Current output characteristic in high resolution mode
 Figure 3.4 shows a graph of the current output characteristic in high resolution mode.

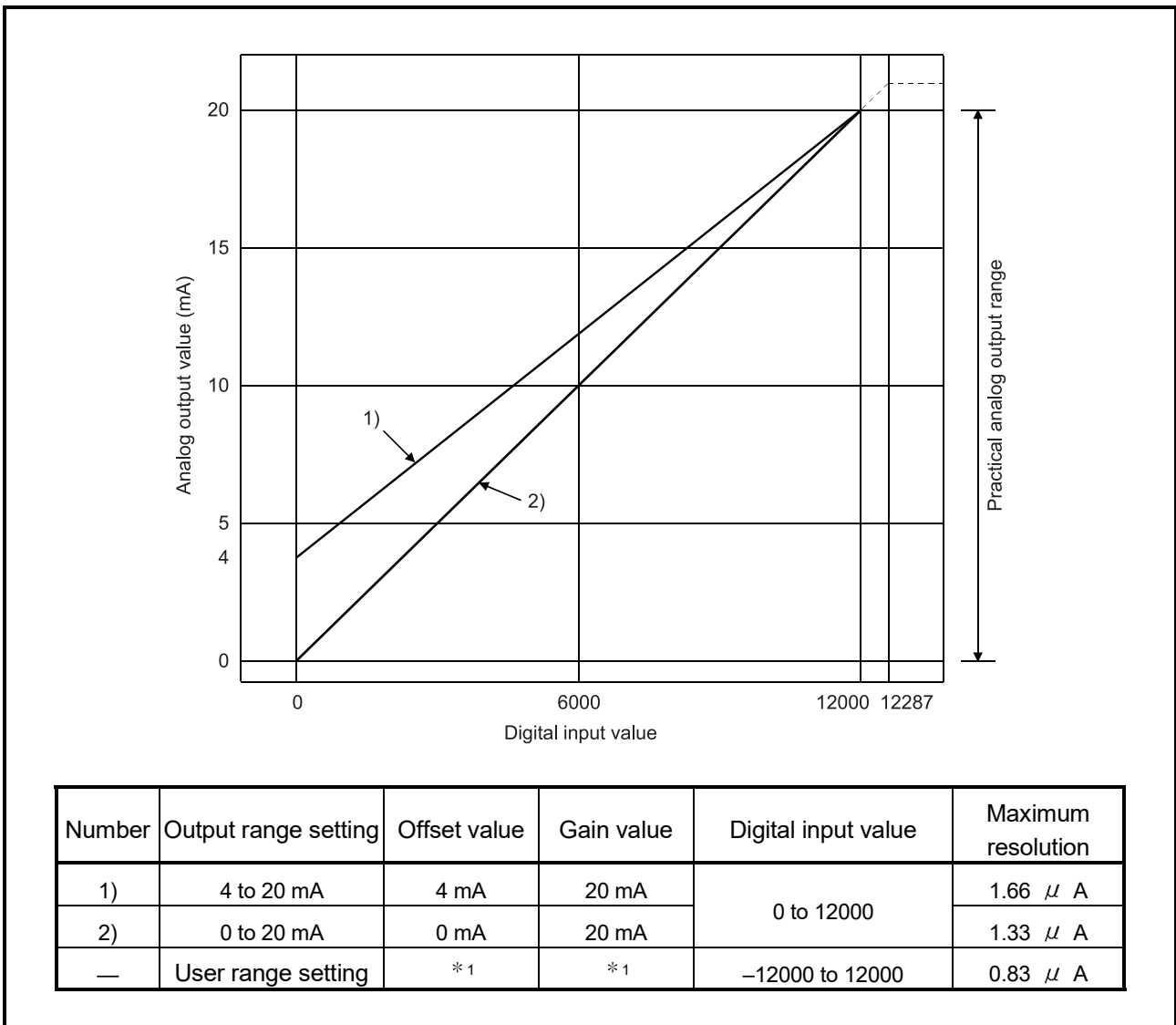

Figure 3.4 Current output characteristic in high resolution mode

POINT
<p>(1) Set within the digital input range and analog output range for each output range. If these ranges are exceeded, the maximum resolution and accuracy may not fall within the performance specifications. (Avoid using the dotted line area shown in Figures 3.3 and 3.4.)</p> <p>(2) Set the offset/gain values for the user setting range *1 within a range in which the following conditions are satisfied.</p> <p>(a) Setting range is from 0 to 20 mA</p> <p>(b) Normal resolution mode setting: { (Gain value) - (Offset value) } > 6.0mA High resolution mode setting: { (Gain value) - (Offset value) } > 10.0mA</p>

3.1.3 Accuracy

Accuracy is represented with respect to the maximum analog output value. Accuracy does not change and remains within the range listed in the performance specification even if the output characteristic is changed by changing offset/gain settings, output range and resolution mode.

Figure 3.5 shows the range of fluctuation in accuracy when a -10 to 10V range is selected and in normal resolution mode.

Accuracy for the analog output is within $\pm 0.1\%$ (± 10 mV) when the ambient temperature is 25 ± 5 °C and within $\pm 0.3\%$ (± 30 mV) when the ambient temperature is 0 to 55°C.

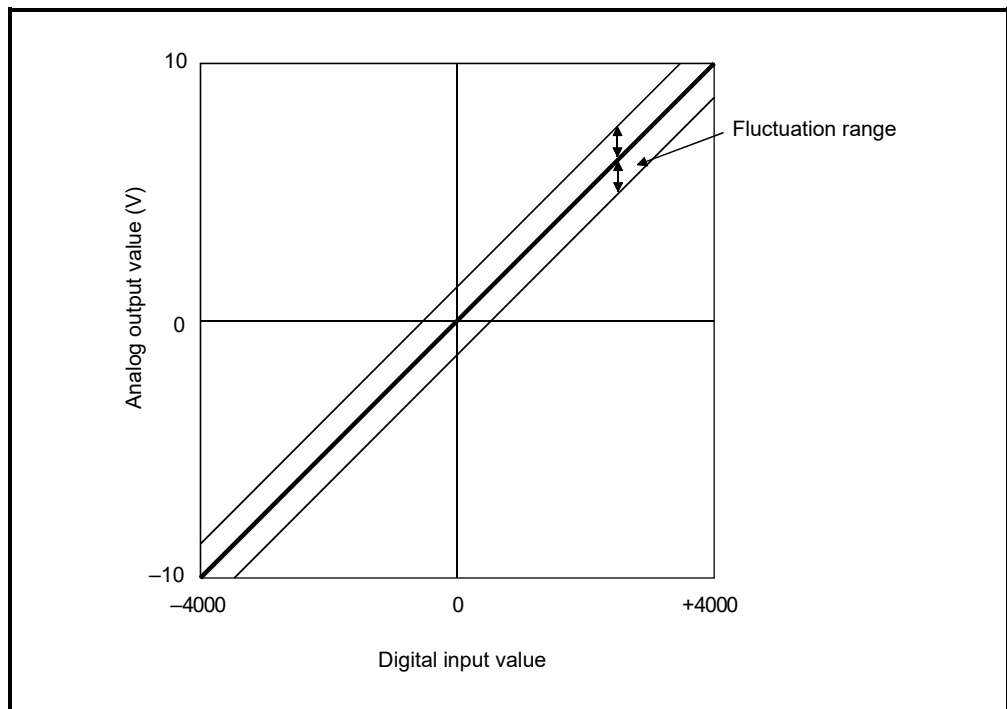

Figure 3.5 Accuracy

3.1.4 Conversion speed

The conversion speed for the D/A converter module is " $80 \mu\text{s} \times$ the number of conversion enabled channels".

By setting the unused channels to D/A conversion disabled in buffer memory address 0 (Un\G0), the conversion speed can be increased.

3.2 D/A Converter Module Function

Table 3.3 shows the function of the D/A converter modules.

Table 3.3 Function list

Item	Function	Reference section
D/A conversion enable/disable	(1) Specifies whether to enable or disable the D/A conversion for each channel. (2) By disabling the D/A conversion for the channels that are not used, the conversion speed can be shortened.	Section 3.4.4
D/A output enable/disable function	(1) Specifies whether to output the D/A converted value or output the offset value for each channel. (2) The conversion speed stays constant regardless of whether D/A output is enabled or disabled.	Section 3.3.1
Synchronous output function	(1) An analog output synchronized with the programmable controller CPU can be obtained.	Section 3.2.1
Analog output HOLD/CLEAR function	(1) The output analog value can be retained when the programmable controller CPU module is placed in the STOP status or when an error occurs.	Section 3.2.2
Analog output test during programmable controller CPU STOP	(1) When CH□ Output enable/disable flag is forced on during programmable controller CPU STOP, the D/A converted analog value is output.	Section 3.2.3
Resolution mode	(1) The resolution mode can be changed according to the application, and a resolution setting can be selected from 1/4000, 1/12000 and 1/16000. (2) The resolution mode setting is applicable to all channels in block. (3) Refer to Section 3.1.1 for the digital input values and maximum resolution in normal resolution mode and high resolution mode.	Section 3.1.1 Section 4.5
Online module change	(1) A module change is made without the system being stopped.	Chapter 7

3.2.1 Synchronous output function

An analog output that is synchronized with the programmable controller CPU can be obtained.

The analog output will be updated after Synchronous output request (YD) is set to on and the time specified as "Programmable controller CPU processing time + 120 μs" has elapsed.

However, the analog output will be fixed to CH1, and other channels (CH2 to CH8) cannot be used.

When the module is mounted on a remote I/O station, the analog output will not be synchronized because of a link scan delay if the synchronous output function is specified.

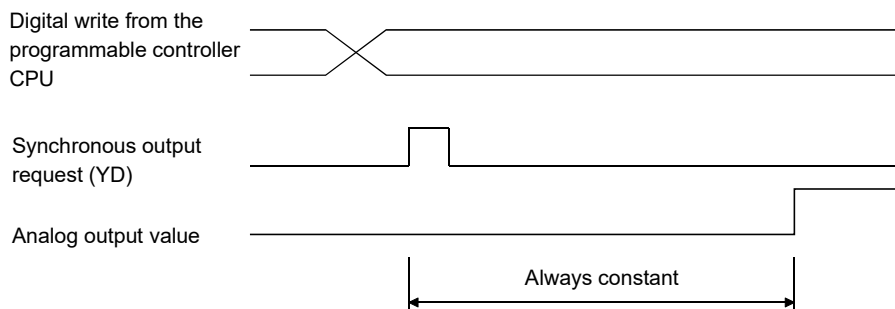

<Program example>

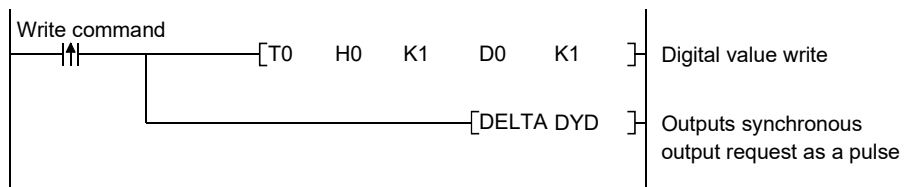

3.2.2 Analog output HOLD/CLEAR function

- (1) For the case where the programmable controller CPU is placed in STOP or in a stop error status, whether to hold (HOLD) or clear (CLEAR) the analog output value can be set.
- (2) Set the HOLD/CLEAR in "Switch 3" (HOLD/CLEAR function setting) cell of Switch setting for I/O and intelligent function module dialog box. (Refer to Section 4.5 (1))
- (3) Depending on combinations of the HOLD/CLEAR setting, D/A conversion enable/disable setting, and CH□ Output enable/disable flag (Y1 to Y8), the analog out-put status varies as shown in Table 3.4.

Table 3.4 Analog output status combination list

Setting combination execution status	D/A conversion enable/disable (buffer memory address 0: Un\G0)	Enable		Disable	
	CH□ Output enable/disable flags (Y1 to Y8)	Enable		Disable	
	HOLD/CLEAR setting	HOLD	CLEAR	HOLD or CLEAR	
Analog output status when programmable controller CPU is RUN		Outputs the analog value of the D/A converted digital value.		Offset	0 V/0 mA
Analog output status when programmable controller CPU is STOP		Hold	Offset	Offset	0 V/0 mA
Analog output status when a programmable controller CPU stop error occurs		Hold	Offset	Offset	0 V/0 mA
Analog output status when a watchdog timer error *1 occurs in D/A converter module		0 V/0 mA	0 V/0 mA	0 V/0 mA	0 V/0 mA

*1 This occurs when program operations are not completed within the scheduled time due to a hardware problem of the D/A converter module. When a watchdog timer error occurs, Module ready (X0) turns off and the D/A converter module RUN LED turns off.

POINT

The following conditions should be satisfied when the analog output HOLD/CLEAR function is used on a MELSECNET/H remote I/O station.

- The master module of function version D or later and the remote I/O module of function version D or later are required.
- Validate the station unit block guarantee of the send side cyclic data.
- The setting for holding the D/A converter module output in the case of a link error must be made in the "Error time output mode in the I/O assignment setting". (Refer to Section 4.5 (2).) The HOLD/CLEAR setting by the intelligent function module switch is invalid.

This setting is validated on a per-module basis, and is not made on a per-channel basis. Therefore, to make the output status at a stop error or STOP of the programmable controller CPU matched with the output status at a link error, set the same HOLD/CLEAR setting to all channels. (Refer to the table below.)

	Error time output mode	HOLD/CLEAR setting (Same setting to all channels)
Hold analog output	Hold	HOLD
Clear analog output (Output offset value)	Clear	CLEAR

For the station unit block guarantee of the cyclic data, refer to the Q Corresponding MELSECNET/H Network System Reference Manual (Remote I/O Network).

3.2.3 Analog output test during programmable controller CPU STOP

- (1) During the programmable controller CPU STOP, an analog output test as shown in Table 3.5 can be performed.
- (2) The analog output test performs the following operations in GX Developer device testing or GX configurator-DA selection testing described in Section 5.6.1.
 - (a) Set D/A conversion enable/disable (buffer memory address 0: Un\G0) of the channel to be tested to enable.
 - (b) Turn Operating condition setting request (Y9) from off to on. (Refer to Section 3.3.2)
 - (c) Check that Operating condition setting completed flag (X9) turns off, and turn Operating condition setting request (Y9) from on to off.
 - (d) Enable (off → on) Output enable/disable flag (Y1 to Y8) of the channel where the test is to be conducted.
 - (e) Write a digital value corresponding to the desired analog output value in CH□ Digital value (refer to Table 3.7 in Section 3.4.1) in the buffer memory.

This function is performed with the D/A converter module of function version B or later.

Table 3.5 List of analog output test

Setting combination	D/A conversion enable/disable (Un\G0)	Enable		Disable	
	CH□ Output enable/disable flag (Y1 to Y8)	Enable	Disable	Enable	disable
Analog output test		Allowed	Not allowed	Not allowed * 1	

*1 Perform the analog output test after changing D/A conversion enable/disable (buffer memory address 0: Un\G0) to enable.

POINT
<p>When the digital value storage device has been set in the automatic refresh setting of GX Configurator-DA, the buffer memory is overwritten since automatic refresh is performed if the programmable controller CPU is during STOP.</p> <p>In this case, write a digital value to the digital value storage device instead of the buffer memory.</p>

3.3 I/O Signals for the Programmable Controller CPU

3.3.1 List of I/O signals

Table 3.6 shows a list of the I/O signals for the D/A converter modules.

The following explanation is mentioned based on the Q68DAVN, Q68DAIN, Q68DAV and Q68DAI with 8-channel analog output (CH1 to CH8).

Note that I/O numbers (X/Y) shown in this chapter and thereafter are the values when the start I/O number for the D/A converter module is set to 0.

Table 3.6 List of I/O signal

Signal direction	D/A converter module → CPU module	Signal direction	CPU module ← D/A converter module
Device No	Signal name	Device No.	Signal name
X0	Module ready	Y0	Use prohibited *1
X1	Use prohibited *1	Y1	CH1 Output enable/disable flag
X2		Y2	CH2 Output enable/disable flag
X3		Y3 *2	CH3 Output enable/disable flag
X4		Y4 *2	CH4 Output enable/disable flag
X5		Y5 *2	CH5 Output enable/disable flag
X6		Y6 *2	CH6 Output enable/disable flag
X7		Y7 *2	CH7 Output enable/disable flag
X8		High resolution mode status flag	Y8 *2
X9	Operating condition setting completed flag	Y9	Operating condition setting request
XA	Offset/gain setting mode flag	YA	User range writing request
XB	Channel change completed flag	YB	Channel change request
XC	Set value change completed flag	YC	Set value change request
XD	Synchronous output mode flag	YD	Synchronous output request
XE	Use prohibited *1	YE	Use prohibited *1
XF	Error flag	YF	Error clear request

POINT

*1 The Use prohibited signal cannot be used by the user since they are used by the system. If these are turned on/off by the sequence program, the functioning of the D/A converter module cannot be guaranteed.

*2 For the Q62DAN and Q62DA, Y3 to Y8 Use prohibited.
For the Q64DAN and Q64DA, Y5 to Y8 Use prohibited.

3.3.2 Details of I/O signals

I/O signals for the D/A converter module are explained in detail below.

(1) Input signals

Device No.	Signal name	Description
X0	Module ready	(1) When the programmable controller CPU is powered on or reset, this signal turns on once the preparation for D/A conversion has been completed, and D/A conversion processing is then performed. (2) When Module ready (X0) signal is off, D/A conversion processing is not performed. Module ready (X0) turns off in the following situations: <ul style="list-style-type: none"> • During offset/gain setting mode • When the D/A converter module has a watchdog timer error
X8	High resolution mode status flag	(1) This turns on when in high resolution mode.
X9	Operating condition setting completed flag	(1) This is used as an interlock condition for turning Operating condition setting request (Y9) on/off when the setting for D/A conversion enable/disable (buffer memory address 0: Un\G0) is changed. (2) Under the following conditions, Operating condition setting completed flag (X9) turns off. <ul style="list-style-type: none"> • Module ready (X0) is off. • Operating condition setting request (Y9) is on <div style="text-align: right; margin-right: 50px;"> - - - - -> Performed by the D/A converter module ———> Performed by the sequence program </div>

Device No.	Signal name	Description
XA	Offset/gain setting mode flag	<p>[In offset/gain setting mode]</p> <p>(1) This is used as an interlock condition for setting User range writing request (YA) to on/off when registering the value after adjustment of the offset/gain settings have been completed.</p> <p>(2) Refer to Section 4.6 regarding the offset/gain settings.</p> <p style="text-align: right;"> -----> Performed by the D/A converter module —————> Performed by the sequence program </p> <p>Module ready (X0) OFF</p> <p>Offset/gain setting mode flag (XA)</p> <p>User range writing request (YA)</p>
		<p>[In normal mode]</p> <p>(1) This signal is used as an interlock condition to turn on/off User range writing request (YA) when the user range is restored.</p> <p>(2) Refer to Chapter 7 regarding the user range restoration.</p> <p style="text-align: right;"> -----> Performed by the D/A converter module —————> Performed by the sequence program </p> <p>Module ready (X0) ON</p> <p>Offset/gain setting mode flag (XA)</p> <p>User range writing request (YA)</p>
XB	Channel change completed flag	<p>(1) This is used as an interlock condition for setting Channel change request (YB) to on/off when changing the channel for which the offset/gain settings are to be performed.</p> <p>(2) Refer to Section 4.6 regarding the offset/gain settings.</p> <p style="text-align: right;"> -----> Performed by the D/A converter module —————> Performed by the sequence program </p> <p>Offset/gain setting mode Offset/gain specifications (buffer memory addresses 22 and 23: Un\G22 and Un\G23)</p> <p>Channel change completed flag (XB)</p> <p>Channel change request (YB)</p>

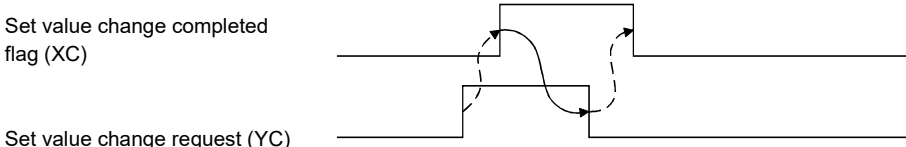
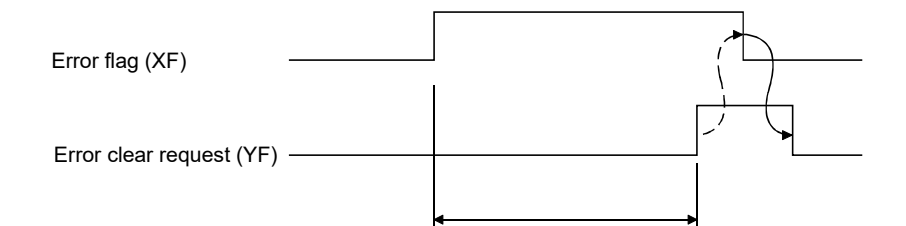
Device No.	Signal name	Description
XC	Set value change completed flag	<p>(1) This is used as an interlock condition for setting Set value change request (YC) to on/off when adjusting the offset/gain settings.</p> <p>(2) Refer to Section 4.6 regarding the offset and gain settings.</p> <p style="text-align: right;"> -----> Performed by the D/A converter module —————> Performed by the sequence program </p>  <p>Set value change completed flag (XC)</p> <p>Set value change request (YC)</p>
XD	Synchronous output mode flag	<p>This flag turns on when the system is set to the synchronous output mode.</p>
XF	Error flag	<p>(1) Error flag (XF) turns on when a write error occurs.</p> <p>(2) To turn Error flag (XF) off, remove the cause of the error and set Error clear request (YF) to on.</p> <p style="text-align: right;"> -----> Performed by the D/A converter module —————> Performed by the sequence program </p>  <p>Error flag (XF)</p> <p>Error clear request (YF)</p> <p style="text-align: center;">Error code is read during this interval.</p>

(2) Output signals

Device No.	Signal name	Description
Y1 to Y8	CH□ Output enable/disable flag	(1) Specifies whether to output the D/A converted value or offset value for each channel. on: D/A converted value off: Offset value (2) The D/A conversion speed is constant regardless of whether the output enable/disable flag is on or off.
Y9	Operating condition setting request	(1) This turns on when the contents of D/A conversion enable/disable are validated. (2) Refer to the X9 column for the on/off timing.
YA	User range writing request	[In offset/gain setting mode] (1) This turns on when the values for the adjusted offset/gain settings are registered in the D/A converter module. (2) Refer to the XA column for on/off timing. Refer to Section 4.6 for offset/gain settings.
		[In normal mode] (1) Turn on this signal when restoring the user range. (2) Refer to the XA column for the on/off timing. Refer to Chapter 7 for the user range restoration.
YB	Channel change request	(1) This turns on when changing the channel for which offset/gain settings are to be performed. (2) Refer to the XB column for the on/off timing.
YC	Set value change request	(1) This turns on/off when increasing or decreasing the analog output value during adjustment of the offset/gain settings. (2) The analog output is either increased or decreased based on the value that was set in buffer memory address 24 (Un\G24).
YD	Synchronous output request	(1) While in the synchronous output mode, D/A conversion is performed and the analog value is output at the timing when Synchronous output request (YD) is on.
YF	Error clear request	(1) This turns on when a write error is cleared. (2) Refer to the XF column for on/off timing.

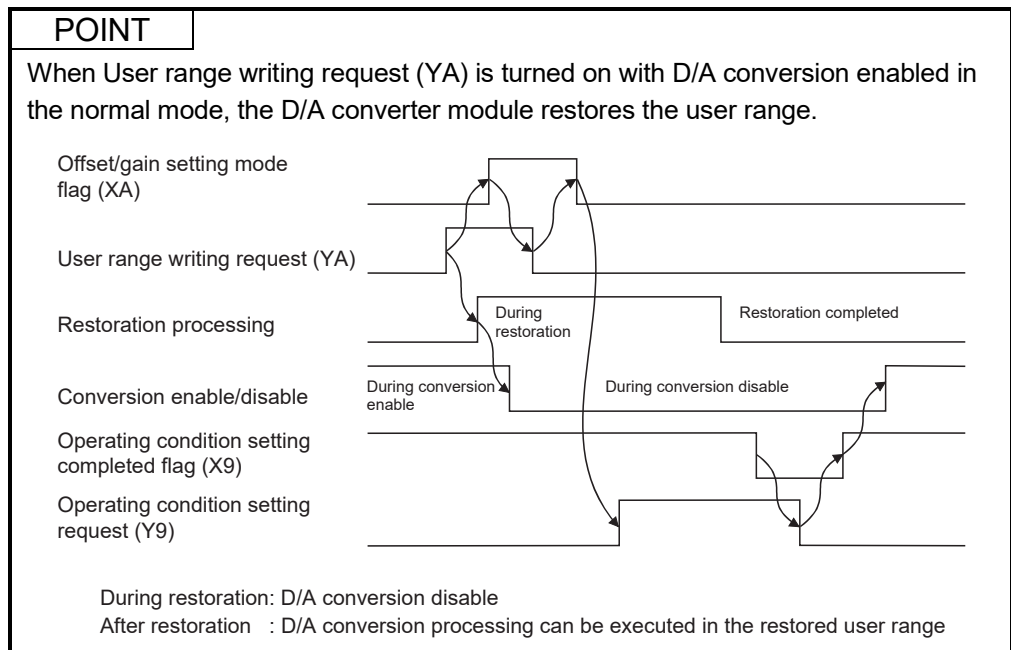

3.4 Buffer Memory

The explanation in Section 3.4.5 and later is based on the Q68DAVN/Q68DAIN/Q68DAV/Q68DAI in 8-channel analog output (CH1 to CH8).

3.4.1 Buffer memory assignment (Q62DAN/Q62DA)

This section describes the assignment of the Q62DAN/Q62DA buffer memory.

POINT

Do not write data from System area or sequence program to the buffer memory area where writing is disabled. Doing so may cause malfunction.

Table 3.7 Buffer memory assignment (Q62DAN/Q62DA) (1/2)

Address		Description	Default *1	Read/write *2	Reference section
Hexadecimal	Decimal				
0H	0	D/A conversion enable/disable	3H	R/W	Section 3.4.5
1H	1	CH1 Digital value	0	R/W	Section 3.4.6
2H	2	CH2 Digital value	0	R/W	
3H	3	System area	—	—	—
to	to				
AH	10				
BH	11	CH1 Set value check code	0	R	Section 3.4.7
CH	12	CH2 Set value check code	0	R	
DH	13	System area	—	—	—
to	to				
12H	18				
13H	19	Error code	0	R/W	Section 3.4.8
14H	20	Setting range (CH1 and CH2)	0H	R	Section 3.4.9
15H	21	System area	—	—	—
16H	22	Offset/gain setting mode Offset specification	0	R/W	Section 3.4.10
17H	23	Offset/gain setting mode Gain specification	0	R/W	
18H	24	Offset/gain adjustment value specification	0	R/W	Section 3.4.11
19H	25	System area	—	—	—
to	to				
9DH	157				
9EH	158	Mode switching setting	0	R/W	Section 3.4.12
9FH	159		0	R/W	
A0H	160	System area	—	—	—
to	to				
C7H	199				

*1 This is the initial value set after the power is turned on or the programmable controller CPU is reset.

*2 Indicates whether reading from and writing to a sequence program are enabled.

R : Reading enabled W : Writing enabled

Table 3.7 Buffer memory assignment (Q62DAN/Q62DA) (2/2)

Address		Description	Default *1	Read/write *2	Reference section
Hexadecimal	Decimal				
C8 _H	200	Pass data classification setting *3	0	R/W	Section 3.4.13
C9 _H	201	System area	—	—	—
CA _H	202	CH1 Industrial shipment settings offset value *3	0	R/W	Section 3.4.14
CB _H	203	CH1 Industrial shipment settings gain value *3	0	R/W	
CC _H	204	CH2 Industrial shipment settings offset value *3	0	R/W	
CD _H	205	CH2 Industrial shipment settings gain value *3	0	R/W	
CE _H	206	CH1 User range settings offset value *3	0	R/W	
CF _H	207	CH1 User range settings gain value *3	0	R/W	
D0 _H	208	CH2 User range settings offset value *3	0	R/W	
D1 _H	209	CH2 User range settings gain value *3	0	R/W	

*1 This is the initial value set after the power is turned on or the programmable controller CPU is reset.

*2 Indicates whether reading from and writing to a sequence program are enabled.

R : Reading enabled W : Writing enabled

*3 Areas used to restore the user range settings offset/gain values when online module change is made. Refer to chapter 7 for details of Online module change.

3.4.2 Buffer memory assignment (Q64DAN/Q64DA)

This section describes the assignment of the Q64DAN/Q64DA buffer memory.

POINT

Do not write data from System area or sequence program to the buffer memory area where writing is disabled. Doing so may cause malfunction.

Table 3.8 Buffer memory assignment (Q64DAN/Q64DA) (1/2)

Address		Description	Default *1	Read/write *2	Reference section
Hexadecimal	Decimal				
0H	0	D/A conversion enable/disable	F _H	R/W	Section 3.4.5
1H	1	CH1 Digital value	0	R/W	Section 3.4.6
2H	2	CH2 Digital value	0	R/W	
3H	3	CH3 Digital value	0	R/W	
4H	4	CH4 Digital value	0	R/W	
5H	5	System area	—	—	—
to	to				
AH	10				
BH	11	CH1 Set value check code	0	R	Section 3.4.7
CH	12	CH2 Set value check code	0	R	
DH	13	CH3 Set value check code	0	R	
EH	14	CH4 Set value check code	0	R	
FH	15	System area	—	—	—
to	to				
12H	18				
13H	19	Error code	0	R/W	Section 3.4.8
14H	20	Setting range (CH1 to CH4)	0 _H	R	Section 3.4.9
15H	21	System area	—	—	—
16H	22	Offset/gain setting mode Offset specification	0	R/W	Section 3.4.10
17H	23	Offset/gain setting mode Gain specification	0	R/W	
18H	24	Offset/gain adjustment value specification	0	R/W	Section 3.4.11
19H	25	System area	—	—	—
to	to				
9DH	157				
9EH	158	Mode switching setting	0	R/W	Section 3.4.12
9FH	159		0	R/W	
A0H	160	System area	—	—	—
to	to				
C7H	199				

*1 This is the initial value set after the power is turned on or the programmable controller CPU is reset.

*2 Indicates whether reading from and writing to a sequence program are enabled.

R : Reading enabled W : Writing enabled

Table 3.8 Buffer memory assignment (Q64DAN/Q64DA) (2/2)

Address		Description	Default *1	Read/write *2	Reference section
Hexadecimal	Decimal				
C8 _H	200	Pass data classification setting *3	0	R/W	Section 3.4.13
C9 _H	201	System area	—	—	—
CA _H	202	CH1 Industrial shipment settings offset value *3	0	R/W	Section 3.4.14
CB _H	203	CH1 Industrial shipment settings gain value *3	0	R/W	
CC _H	204	CH2 Industrial shipment settings offset value *3	0	R/W	
CD _H	205	CH2 Industrial shipment settings gain value *3	0	R/W	
CE _H	206	CH3 Industrial shipment settings offset value *3	0	R/W	
CF _H	207	CH3 Industrial shipment settings gain value *3	0	R/W	
D0 _H	208	CH4 Industrial shipment settings offset value *3	0	R/W	
D1 _H	209	CH4 Industrial shipment settings gain value *3	0	R/W	
D2 _H	210	CH1 User range settings offset value *3	0	R/W	
D3 _H	211	CH1 User range settings gain value *3	0	R/W	
D4 _H	212	CH2 User range settings offset value *3	0	R/W	
D5 _H	213	CH2 User range settings gain value *3	0	R/W	
D6 _H	214	CH3 User range settings offset value *3	0	R/W	
D7 _H	215	CH3 User range settings gain value *3	0	R/W	
D8 _H	216	CH4 User range settings offset value *3	0	R/W	
D9 _H	217	CH4 User range settings gain value *3	0	R/W	

*1 This is the initial value set after the power is turned on or the programmable controller CPU is reset.

*2 Indicates whether reading from and writing to a sequence program are enabled.

R : Reading enabled W : Writing enabled

*3 Areas used to restore the user range settings offset/gain values when Online module change is made. Refer to chapter 7 for details of Online module change.

3.4.3 Buffer memory assignment (Q68DAVN/Q68DAV)

This section describes the assignment of the Q68DAVN/Q68DAV buffer memory.

POINT

Do not write data from System area or sequence program to the buffer memory area where writing is disabled. Doing so may cause malfunction.

Table 3.9 Buffer memory assignment (Q68DAVN/Q68DAV) (1/2)

Address		Description	Default *1	Read/write *2	Reference section
Hexadecimal	Decimal				
0H	0	D/A conversion enable/disable	FFH	R/W	Section 3.4.5
1H	1	CH1 Digital value	0	R/W	Section 3.4.6
2H	2	CH2 Digital value	0	R/W	
3H	3	CH3 Digital value	0	R/W	
4H	4	CH4 Digital value	0	R/W	
5H	5	CH5 Digital value	0	R/W	
6H	6	CH6 Digital value	0	R/W	
7H	7	CH7 Digital value	0	R/W	
8H	8	CH8 Digital value	0	R/W	
9H	9	System area	—	—	—
AH	10				
BH	11	CH1 Set value check code	0	R	Section 3.4.7
CH	12	CH2 Set value check code	0	R	
DH	13	CH3 Set value check code	0	R	
EH	14	CH4 Set value check code	0	R	
FH	15	CH5 Set value check code	0	R	
10H	16	CH6 Set value check code	0	R	
11H	17	CH7 Set value check code	0	R	
12H	18	CH8 Set value check code	0	R	
13H	19	Error code	0	R/W	Section 3.4.8
14H	20	Setting range (CH1 to CH4)	2222H	R	Section 3.4.9
15H	21	Setting range (CH5 to CH8)	2222H	R	
16H	22	Offset/gain setting mode Offset specification	0	R/W	Section 3.4.10
17H	23	Offset/gain setting mode Gain specification	0	R/W	
18H	24	Offset/gain adjustment value specification	0	R/W	Section 3.4.11

*1 This is the initial value set after the power is turned on or the programmable controller CPU is reset.

*2 Indicates whether reading from and writing to a sequence program are enabled.

R : Reading enabled W : Writing enabled

Table 3.9 Buffer memory assignment (Q68DAVN/Q68DAV) (2/2)

Address		Description	Default *1	Read/write *2	Reference section
Hexadecimal	Decimal				
19 _H	25	System area	—	—	—
to	to				
9D _H	157				
9E _H	158	Mode switching setting	0	R/W	Section 3.4.12
9F _H	159		0	R/W	
A0 _H	160	System area	—	—	—
to	to				
C9 _H	201				
CA _H	202	CH1 Industrial shipment settings offset value *3	0	R/W	Section 3.4.14
CB _H	203	CH1 Industrial shipment settings gain value *3	0	R/W	
CC _H	204	CH2 Industrial shipment settings offset value *3	0	R/W	
CD _H	205	CH2 Industrial shipment settings gain value *3	0	R/W	
CE _H	206	CH3 Industrial shipment settings offset value *3	0	R/W	
CF _H	207	CH3 Industrial shipment settings gain value *3	0	R/W	
D0 _H	208	CH4 Industrial shipment settings offset value *3	0	R/W	
D1 _H	209	CH4 Industrial shipment settings gain value *3	0	R/W	
D2 _H	210	CH5 Industrial shipment settings offset value *3	0	R/W	
D3 _H	211	CH5 Industrial shipment settings gain value *3	0	R/W	
D4 _H	212	CH6 Industrial shipment settings offset value *3	0	R/W	
D5 _H	213	CH6 Industrial shipment settings gain value *3	0	R/W	
D6 _H	214	CH7 Industrial shipment settings offset value *3	0	R/W	
D7 _H	215	CH7 Industrial shipment settings gain value *3	0	R/W	
D8 _H	216	CH8 Industrial shipment settings offset value *3	0	R/W	
D9 _H	217	CH8 Industrial shipment settings gain value *3	0	R/W	
DA _H	218	CH1 User range settings offset value *3	0	R/W	
DB _H	219	CH1 User range settings gain value *3	0	R/W	
DC _H	220	CH2 User range settings offset value *3	0	R/W	
DD _H	221	CH2 User range settings gain value *3	0	R/W	
DE _H	222	CH3 User range settings offset value *3	0	R/W	
DF _H	223	CH3 User range settings gain value *3	0	R/W	
E0 _H	224	CH4 User range settings offset value *3	0	R/W	
E1 _H	225	CH4 User range settings gain value *3	0	R/W	
E2 _H	226	CH5 User range settings offset value *3	0	R/W	
E3 _H	227	CH5 User range settings gain value *3	0	R/W	
E4 _H	228	CH6 User range settings offset value *3	0	R/W	
E5 _H	229	CH6 User range settings gain value *3	0	R/W	
E6 _H	230	CH7 User range settings offset value *3	0	R/W	
E7 _H	231	CH7 User range settings gain value *3	0	R/W	
E8 _H	232	CH8 User range settings offset value *3	0	R/W	
E9 _H	233	CH8 User range settings gain value *3	0	R/W	

*1 This is the initial value set after the power is turned on or the programmable controller CPU is reset.

*2 Indicates whether reading from and writing to a sequence program are enabled.

R : Reading enabled W : Writing enabled

*3 Areas used to restore the user range settings offset/gain values when Online module change is made. Refer to chapter 7 for details of Online module change.

3.4.4 Buffer memory assignment (Q68DAIN/Q68DAI)

The following explains based on the Q68DAIN/Q68DAI with 8-channel analog output (CH1 to CH8).

POINT

Do not write data from System area or sequence program to the buffer memory area where writing is disabled. Doing so may cause malfunction.

Table 3.10 Buffer memory assignment (Q68DAIN/Q68DAI) (1/2)

Address		Description	Default *1	Read/write *2	Reference section
Hexadecimal	Decimal				
0H	0	D/A conversion enable/disable	FFH	R/W	Section 3.4.5
1H	1	CH1 Digital value	0	R/W	Section 3.4.6
2H	2	CH2 Digital value	0	R/W	
3H	3	CH3 Digital value	0	R/W	
4H	4	CH4 Digital value	0	R/W	
5H	5	CH5 Digital value	0	R/W	
6H	6	CH6 Digital value	0	R/W	
7H	7	CH7 Digital value	0	R/W	
8H	8	CH8 Digital value	0	R/W	
9H	9	System area	—	—	—
AH	10				
BH	11	CH1 Set value check code	0	R	Section 3.4.7
CH	12	CH2 Set value check code	0	R	
DH	13	CH3 Set value check code	0	R	
EH	14	CH4 Set value check code	0	R	
FH	15	CH5 Set value check code	0	R	
10H	16	CH6 Set value check code	0	R	
11H	17	CH7 Set value check code	0	R	
12H	18	CH8 Set value check code	0	R	
13H	19	Error code	0	R/W	Section 3.4.8
14H	20	Setting range (CH1 to CH4)	0000H	R	Section 3.4.9
15H	21	Setting range (CH5 to CH8)	0000H	R	
16H	22	Offset/gain setting mode Offset specification	0	R/W	Section 3.4.10
17H	23	Offset/gain setting mode Gain specification	0	R/W	
18H	24	Offset/gain adjustment value specification	0	R/W	Section 3.4.11

*1 This is the initial value set after the power is turned on or the programmable controller CPU is reset.

*2 Indicates whether reading from and writing to a sequence program are enabled.

R : Reading enabled W : Writing enabled

Table 3.10 Buffer memory assignment (Q68DAIN/Q68DAI) (2/2)

Address		Description	Default *1	Read/write *2	Reference section
Hexadecimal	Decimal				
19 _H	25	System area	—	—	—
to	to				
9D _H	157				
9E _H	158	Mode switching setting	0	R/W	Section 3.4.12
9F _H	159		0	R/W	
A0 _H	160	System area	—	—	—
to	to				
C9 _H	201				
CA _H	202	CH1 Industrial shipment settings offset value *3	0	R/W	Section 3.4.14
CB _H	203	CH1 Industrial shipment settings gain value *3	0	R/W	
CC _H	204	CH2 Industrial shipment settings offset value *3	0	R/W	
CD _H	205	CH2 Industrial shipment settings gain value *3	0	R/W	
CE _H	206	CH3 Industrial shipment settings offset value *3	0	R/W	
CF _H	207	CH3 Industrial shipment settings gain value *3	0	R/W	
D0 _H	208	CH4 Industrial shipment settings offset value *3	0	R/W	
D1 _H	209	CH4 Industrial shipment settings gain value *3	0	R/W	
D2 _H	210	CH5 Industrial shipment settings offset value *3	0	R/W	
D3 _H	211	CH5 Industrial shipment settings gain value *3	0	R/W	
D4 _H	212	CH6 Industrial shipment settings offset value *3	0	R/W	
D5 _H	213	CH6 Industrial shipment settings gain value *3	0	R/W	
D6 _H	214	CH7 Industrial shipment settings offset value *3	0	R/W	
D7 _H	215	CH7 Industrial shipment settings gain value *3	0	R/W	
D8 _H	216	CH8 Industrial shipment settings offset value *3	0	R/W	
D9 _H	217	CH8 Industrial shipment settings gain value *3	0	R/W	
DA _H	218	CH1 User range settings offset value *3	0	R/W	
DB _H	219	CH1 User range settings gain value *3	0	R/W	
DC _H	220	CH2 User range settings offset value *3	0	R/W	
DD _H	221	CH2 User range settings gain value *3	0	R/W	
DE _H	222	CH3 User range settings offset value *3	0	R/W	
DF _H	223	CH3 User range settings gain value *3	0	R/W	
E0 _H	224	CH4 User range settings offset value *3	0	R/W	
E1 _H	225	CH4 User range settings gain value *3	0	R/W	
E2 _H	226	CH5 User range settings offset value *3	0	R/W	
E3 _H	227	CH5 User range settings gain value *3	0	R/W	
E4 _H	228	CH6 User range settings offset value *3	0	R/W	
E5 _H	229	CH6 User range settings gain value *3	0	R/W	
E6 _H	230	CH7 User range settings offset value *3	0	R/W	
E7 _H	231	CH7 User range settings gain value *3	0	R/W	
E8 _H	232	CH8 User range settings offset value *3	0	R/W	
E9 _H	233	CH8 User range settings gain value *3	0	R/W	

*1 This is the initial value set after the power is turned on or the programmable controller CPU is reset.

*2 Indicates whether reading from and writing to a sequence program are enabled.

R : Reading enabled W : Writing enabled

*3 Areas used to restore the user range settings offset/gain values when Online module change is made. Refer to chapter 7 for details of Online module change.

3.4.5 D/A conversion enable/disable (buffer memory address 0: Un\G0)

- (1) Set whether D/A conversion is enabled or disabled for each channel.
- (2) To validate a value set in D/A conversion enable/disable, turn on and off Operating condition setting request (Y9). (Refer to Section 3.3.2.)
- (3) By default, all channels are set to D/A conversion disabled.
- (4) When the Q62DAN and Q62DA are used, b2 to b7 (CH3 to CH8) become invalid. When the Q64DAN and Q64DA are used, b4 to b7 (CH5 to CH8) become invalid.

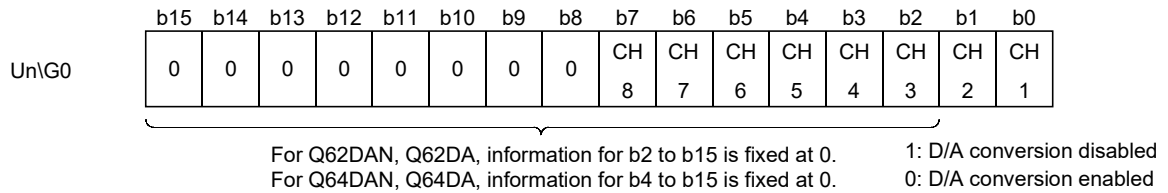

POINT

Design the system so that D/A conversion enable/disable (buffer memory address 0: Un\G0) changes to "Enable" after the external power (refer to Section 4.3) is supplied.

Analog output may not properly be performed if the external power is not at the specified voltage.

3.4.6 Digital value (buffer memory address 1 to 8: Un\G1 to Un\G8)

- (1) This area is used to write digital values for performing D/A conversion from the programmable controller CPU as 16-bit signed binary code.
- (2) If a value outside the settable range is written, the upper or lower limit value of the range is used for D/A conversion. (Refer to Table 3.11.) Also, if this happens, a check code and an error code will be stored in CH□ Set value check code (buffer memory address 11 to 18 : Un\G11 to 18) and Error code (buffer memory address 19 : Un\G19) respectively.
- (3) For the Q62DAN and Q62DA, Un\G3 to Un\G8 (CH3 to CH8) become invalid. For the Q64DAN and Q64DA, Un\G5 to Un\G8 (CH5 to CH8) become invalid.

Table 3.11 Output range settings and valid range

Output range setting	Normal resolution mode		High resolution mode	
	Valid range (practical range)	Digital value that is set when a value outside the valid range is written	Valid range (practical range)	Digital value that is set when a value outside the valid range is written
0: 4 to 20 mA	0 to 4095 (Practical range: 0 to 4000)	4096 or larger: 4095 -1 or smaller: 0	0 to 12287 (Practical range: 0 to 12000)	12288 or larger: 12287 -1 or smaller: 0
1: 0 to 20 mA				
2: 1 to 5 V				
3: 0 to 5 V				
4: -10 to 10 V	-4096 to 4095 (Practical range: -4000 to 4000)	4096 or larger: 4095 -4097 or smaller: -4096	-16384 to 16383 (Practical range: -16000 to 16000)	16384 or larger: 16383 -16385 or smaller: 16384
F: User range setting			-12288 to 12287 (Practical range: -12000 to 12000)	12288 or larger: 12287 -12289 or smaller: -12288

3.4.7 Set value check code (buffer memory address 11 to 18: Un\G11 to Un\G18)

- (1) This area stores the result of checking whether a digital value that was set is within or outside the valid range.
- (2) When a digital value outside the valid range (refer to Table 3.11) is written, one of the check codes listed in Table 3.12 is stored.

Table 3.12 Check code list

Check code	Description
000FH	A digital value exceeding the valid range was written.
00F0H	A digital value that falls short of the valid range was written.
00FFH	A digital value that either falls short or exceeds the valid range was written. For example, the 00FFH check code is stored if a digital value exceeding the valid range is written, and then, without the check code being reset, a digital value that falls short of the valid range is written.

- (3) Once a check code is stored, it will not be reset even if the digital value is within the valid range.
- (4) To reset CH□ Set value check code (buffer memory address 11 to 18 : Un\G11 to 18), set Error clear request (YF) to on after rewriting the digital value so that it is within the valid range.
- (5) For the Q62DAN and Q62DA, Un\G13 to Un\G18 (CH3 to CH8) become invalid.
For the Q64DAN and Q64DA, Un\G15 to Un\G18 (CH5 to CH8) become invalid.

3.4.8 Error code (buffer memory address 19: Un\G19)

- (1) Error code detected by the D/A converter module are stored.
- (2) For details on Error code, refer to Section 8.1.

3.4.9 Setting range (buffer memory address 20, 21: Un\G20, Un\G21)

- (1) This area is used to confirm the setting range of the D/A converter module.
Settings for channels 1 to 4 are stored in Un\G20.
Settings for channels 5 to 8 are stored in Un\G21.
- (2) For the Q62DAN and Q62DA, b8 to b15 (CH3 and 4 information) for Un\G20 and Un\G21 (information of CH5 to CH8) are invalid.
For the Q64DAN and Q64DA, Un\G21 (CH5 to CH8 information) is invalid.

	b15	to	b12	b11	to	b8	b7	to	b4	b3	to	b0
Un\G20 (setting range CH1 to CH4)	CH4			CH3			CH2			CH1		
Un\G21 (setting range CH5 to CH8)	CH8			CH7			CH6			CH5		

Output range	Setting value
4 to 20 (mA)	0 _H
0 to 20 (mA)	1 _H
1 to 5 (V)	2 _H
0 to 5 (V)	3 _H
-10 to 10 (V)	4 _H
User range setting	F _H

- (3) The default is 0_H. The Q68DAVN and Q68DAV are operated in 2_H (1 to 5 V) setting even when 0_H (default) is set for the output range setting so that 2_H will be stored.

POINT

Setting ranges cannot be changed by using Setting range (buffer memory addresses 20, 21: Un\G20, Un\G21).
Change the setting range in the Switch setting for I/O and intelligent function module dialog box. (Refer to Section 4.5.)

3.4.10 Offset/gain setting mode Offset/gain specification (buffer memory address 22, 23: Un\G22, Un\G23)

- (1) Specifies the channel to be adjusted for the offset/gain settings.
- (2) Specification can be made for 1 channel only.
An offset/gain setting mode error (Error code 500) will occur if more than one channel is specified at the same time.
- (3) For the Q62DAN and Q62DA, b2 to b7 (CH3 to CH8) are invalid.
For the Q64DAN and Q64DA, b4 to b7 (CH5 to CH8) are invalid.
- (4) Refer to Section 4.6 for the details of the offset/gain settings.

	b15	b14	b13	b12	b11	b10	b9	b8	b7	b6	b5	b4	b3	b2	b1	b0
Un\G22 (Offset specification)	0	0	0	0	0	0	0	0	CH8	CH7	CH6	CH5	CH4	CH3	CH2	CH1
Un\G23 (Gain specification)	0	0	0	0	0	0	0	0	CH8	CH7	CH6	CH5	CH4	CH3	CH2	CH1

For Q62DAN, Q62DA, b2 to b15 information is fixed at 0. 1: Channel to be set
 For Q64DAN, Q64DA, b4 to b15 information is fixed at 0. 0: Invalid

3.4.11 Offset/gain adjustment value specification (buffer memory address 24: Un\G24)

- (1) This area is used to set the amount of adjustment for analog output values in the offset/gain setting mode.
- (2) The valid input range is from –3000 to 3000.
When the input value is 1000, the analog output values can be adjusted by about 0.33 V for voltage output and about 0.65 mA for current output.
- (3) Refer to Section 4.6 for the details of the offset/gain settings.

3.4.12 Mode switching setting (buffer memory address 158, 159: Un\G158, Un\G159)

- (1) Set the values of the mode to which you want to switch.
- (2) After setting the values, turning Operating condition setting request (Y9) from off to on switches to that mode.
- (3) When mode switching is performed, this area is cleared to zero and Operating condition setting completed flag (X9) turns off.
After confirming that Operating condition setting completed flag (X9) has turned off, turn off Operating condition setting request (Y9).

Mode to be switched to	Set values	
	Buffer memory address 158	Buffer memory address 159
Normal mode	0964H	4144H
Offset/gain setting mode	4144H	0964H

POINT

If the values written are other than the above, mode switching is not performed and only the operating condition is changed.

3.4.13 Pass data classification setting (buffer memory address 200: Un\G200)
(Q62DAN, Q64DAN, Q62DA, and Q64DA only)

- (1) Areas used to restore the user range settings offset/gain values when online module change is made.
Refer to Chapter 7 for details of online module change.
- (2) Specify whether the offset/gain values to be saved/restored are voltages or currents when saving/restoring the offset/gain values of the user range setting.

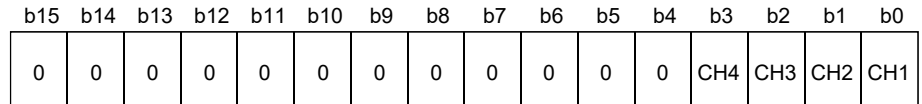

Q62DAN, Q62DA: Data in b2 to b15 are fixed to 0.
Q64DAN, Q64DA: Data in b4 to b15 are fixed to 0.

1: Current specified
0: Voltage specified

POINT
Refer to Section 4.6 for the offset/gain value setting method.

3.4.14 Industrial shipment settings and User range settings Offset/gain value (buffer memory address 202 to 233: Un\G202 to Un\G233)

- (1) Areas used to restore the user range settings offset/gain values when online module change is made.
Refer to chapter 7 for details of online module change.
- (2) When the offset/gain values of the user range setting are restored, the used data are stored.
The data are stored (saved) when:
 - Initial setting write is performed by the utility;
 - Operating condition setting request is set (Y9 turns from off to on * 1); or
 - The offset/gain values are written in the offset/gain setting mode (YA turns from off to on).
 *1: The data are not saved when values have been written to Mode switching setting area (buffer memory addresses 158, 159: Un\G158, Un\G159).
- (3) When restoring the offset/gain values of the user range setting, set the data saved here similarly into the corresponding area of the module where the data will be restored.
- (4) Buffer memory saving recording procedure for online module change
 - 1) Set Pass data classification setting *1 (buffer memory address 200: Un\G200).
 - 2) Turn on and off Operating condition setting request (Y9).
 - 3) Compare the offset/gain values of CH□ Industrial shipment settings and User range settings offset/gain value (buffer memory addresses 202 to 233: Un\G202 to Un\G233) with the range reference values. Refer to Section 7.4 for the range reference values.
 - 4) If the values are proper, record Offset/gain values of the Pass data classification setting *1, Industrial shipment settings and User range settings.
*1: The Q68DAVN/Q68DAIN/Q68DAV/Q68DAI do not require the setting and recording of the Pass data classification setting.

POINT	Refer to Section 4.6 for the offset/gain value setting method.
--------------	--

4 SETUP AND PROCEDURES BEFORE OPERATION

4.1 Handling Precautions

- (1) Do not drop the module case or subject it to heavy impact.
- (2) Do not remove the PCB of the module from its case. Doing so may cause the module to fail.
- (3) Be careful not to let foreign particles such as swarf or wire chips enter the module. They may cause a fire, mechanical failure or malfunction.
- (4) The top surface of the module is covered with a protective film to prevent foreign objects such as wire burrs from entering the module during wiring. Do not remove this film until the wiring is complete. Before operating the system, be sure to remove the film to provide adequate heat ventilation.
- (5) Tighten the screws such as module fixing screws within the following ranges. Loose screws may cause short circuits, failures, or malfunctions.

Screw location	Tightening torque range
Module fixing screw (M3 screw) * 1	0.36 to 0.48 N·m
Terminal block terminal screw (M3 screw)	0.42 to 0.58 N·m
Terminal block mounting screw (M3.5 screw)	0.66 to 0.89 N·m
FG terminals screw (M3 screw) * 2	0.42 to 0.58 N·m

*1: The module can be easily fixed onto the base unit using the hook at the top of the module.

However, it is recommended to secure the module with the module fixing screw if the module is subject to significant vibration.

*2 Q68DAVN, Q68DAIN, Q68DAV, Q68DAI only.

- (6) While pressing the installation lever located at the bottom of module, insert the module fixing tab into the fixing hole in the base unit until it stops. Improper installation may result in malfunction, breakdown or the module coming loose and dropping.

4.2 Setup and Procedures before Operation

4

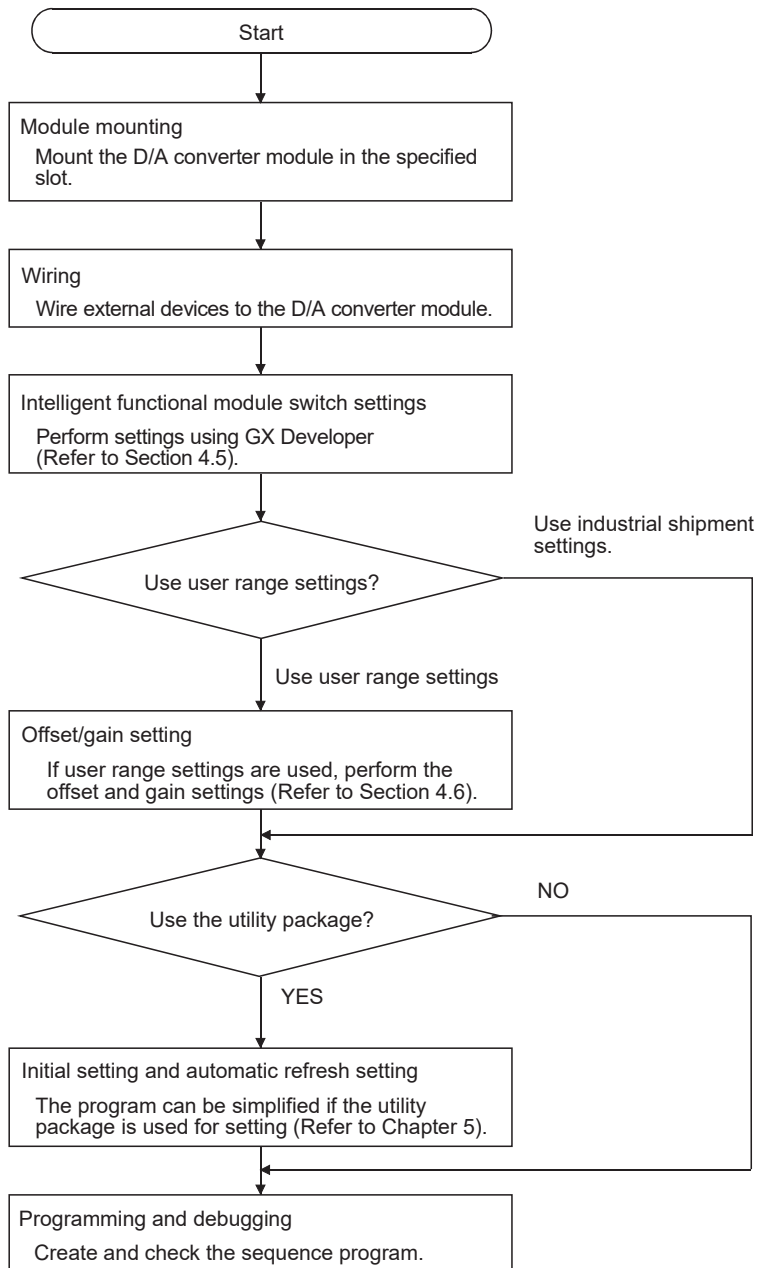

4.3 Part Identification Nomenclature

This section explains each part name of the D/A converter module, providing examples of the Q62DAN, Q64DAN, Q68DAVN, and Q68DAIN.

The differences between the Q62DAN, Q64DAN, Q68DAVN, and Q68DAIN, also, Q62DA, Q64DA, Q68DAV, and Q68DAI are model names, external dimensions, and serial number plates.

For details, refer to Appendix 3 External Dimension Diagram.

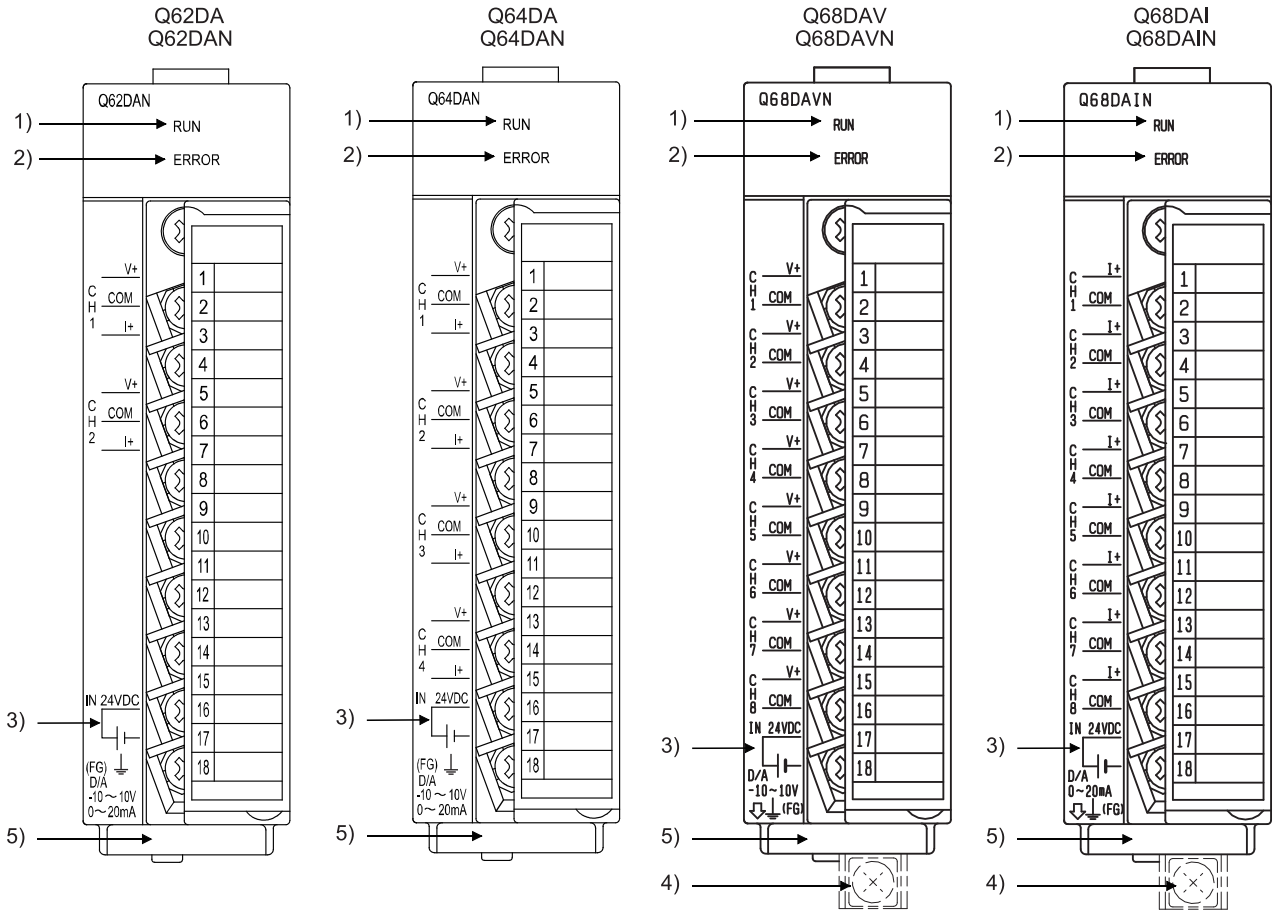

Number	Name and appearance	Description
1)	RUN LED	Displays the operating status of the D/A converter module. On : Normal operation Flashing : During offset/gain setting mode Off : 5V power switched off, watchdog timer error occurred, or online module change enabled
2)	ERROR LED	Displays the error status of the D/A converter module. On : Error * 1 Off : Normal operation Flashing : Error in switch settings Switch No. 5 of the intelligent function module has been set to a value other than "0".
3)	External power supply terminal	This is the terminal for connecting the 24 V DC external power supply.
4)	FG terminal	Frame ground terminal
5)	Serial number plate	Indicates the serial No. of the D/A converter module.

* 1: Check Error code for details.

Terminal number	Signal name							
	Q62DAN, Q62DA		Q64DAN, Q64DA		Q68DAVN, Q68DAV		Q68DAIN, Q68DAI	
1	CH1	V +	CH1	V +	CH1	V +	CH1	I +
2		COM		COM		COM		COM
3		I +		I +		I +		I +
4	Vacant		Vacant		CH2	V +	CH2	I +
						COM		COM
5	CH2	V +	CH2	V +	CH3	V +	CH3	I +
6		COM		COM		COM		COM
7		I +		I +		I +		I +
8	Vacant		Vacant		CH4	V +	CH4	I +
						COM		COM
9	Vacant		CH3	V +	CH5	V +	CH5	I +
10	Vacant			COM		COM		COM
11	Vacant			I +		I +		I +
12	Vacant		Vacant		CH6	V +	CH6	I +
						COM		COM
13	Vacant		CH4	V +	CH7	V +	CH7	I +
14	Vacant			COM		COM		COM
15	Vacant			I +		I +		I +
16	24V				CH8	V +	CH8	I +
						COM		COM
17	24G				24V			
18	FG				24G			

4.4 Wiring

The wiring precautions and examples of module connection are provided below.

4.4.1 Wiring precautions

In order to optimize the functions of the D/A converter module and ensure system reliability, external wiring that is protected from noise is required.

Please observe the following precautions for external wiring:

- (1) Use separate cables for the AC control circuit and the external input signals of the D/A converter module to avoid the influence of the AC side surges and inductions.
- (2) Do not mount the cables close to or bundle them with the main circuit line, a high-voltage cable or a load cable from other than the programmable controller. This may increase the effects of noise, surges and induction.
- (3) Perform a one-point grounding for shielded lines and the shields of sealed cables.
- (4) A solderless terminal with insulating sleeve cannot be used for the terminal block. Covering the cable-connection portion of the solderless terminal with a marked tube or an insulation tube is recommended.

POINT
For using the Q68DAVN, Q68DAIN, Q68DAV or Q68DAI, when it is difficult to wire FG terminals due to the limited installation space, use FG terminal L-shaped metal fitting.

4.4.2 External wiring

(1) For voltage output of the Q62DAN, Q64DAN, or Q68DAVN

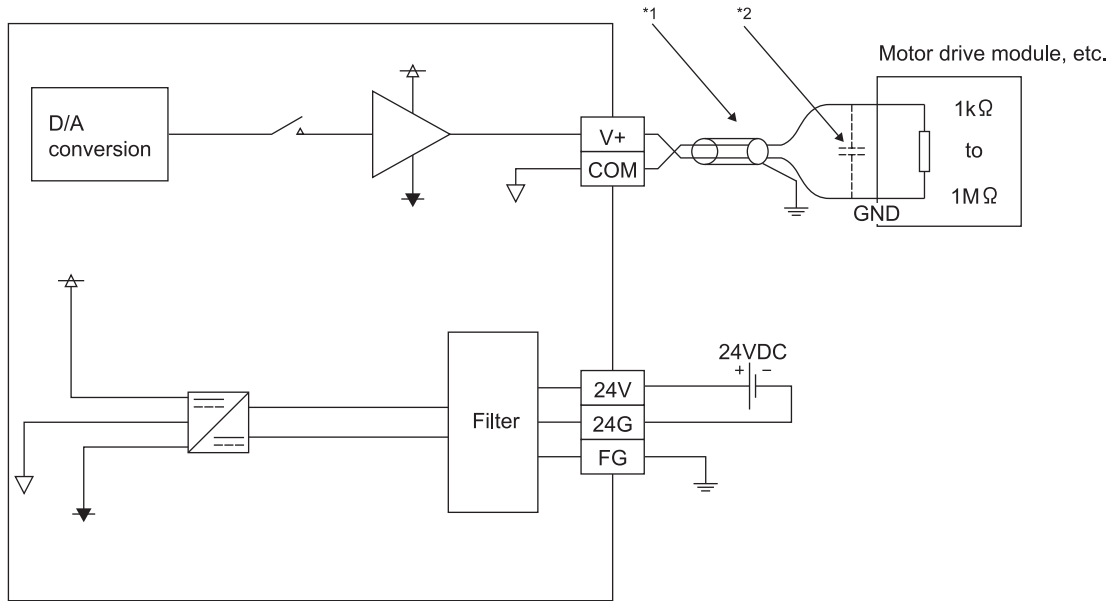

- *1 Use a twisted two core shielded wire for the power wire.
- *2 If there is noise or ripples in the external wiring, connect a 0.1 to 0.47 μ F 25V capacitor between the V+ terminal and COM.

(2) For current output of the Q62DAN, Q64DAN, or Q68DAIN

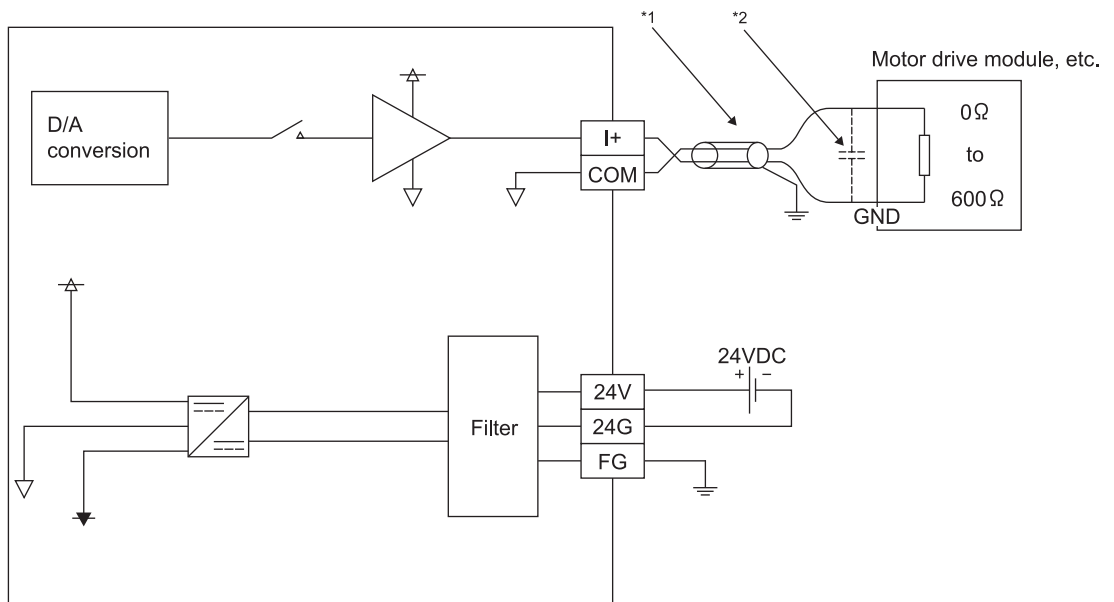

- *1 Use a twisted two core shielded wire for the power wire.
- *2 If there is noise or ripples in the external wiring, connect a 0.1 to 0.47 μ F 25V capacitor between the I+ terminal and COM.

(3) For voltage output of the Q62DAN, Q64DAN, or Q68DAVN

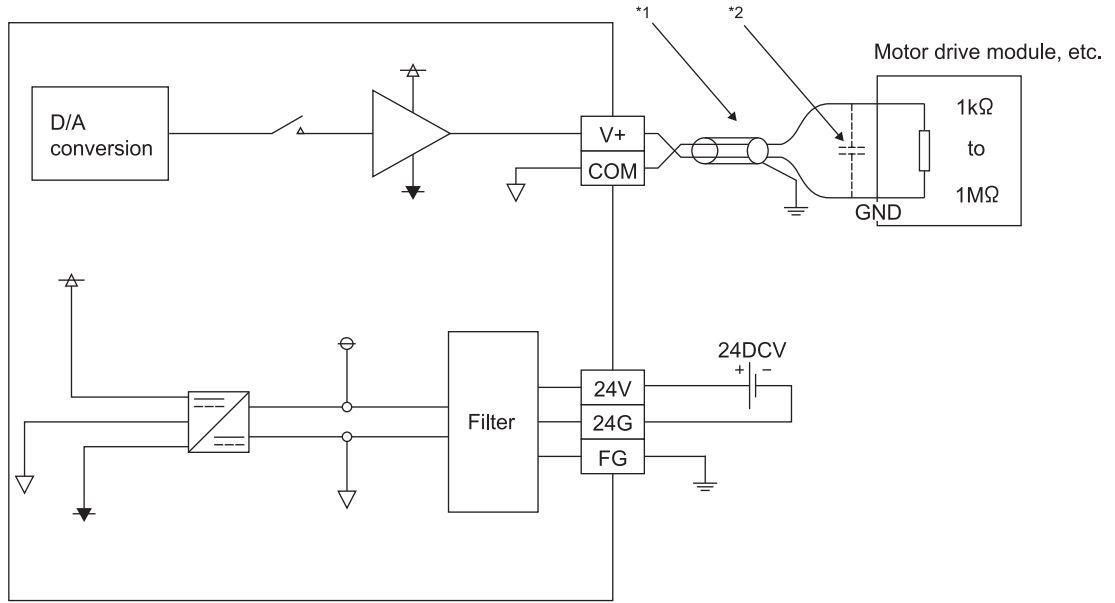

- *1 Use a twisted two core shielded wire for the power wire.
- *2 If there is noise or ripples in the external wiring, connect a 0.1 to 0.47 μ F 25V capacitor between the V+ terminal and COM.

(4) For current output of the Q62DAN, Q64DAN, or Q68DAIN

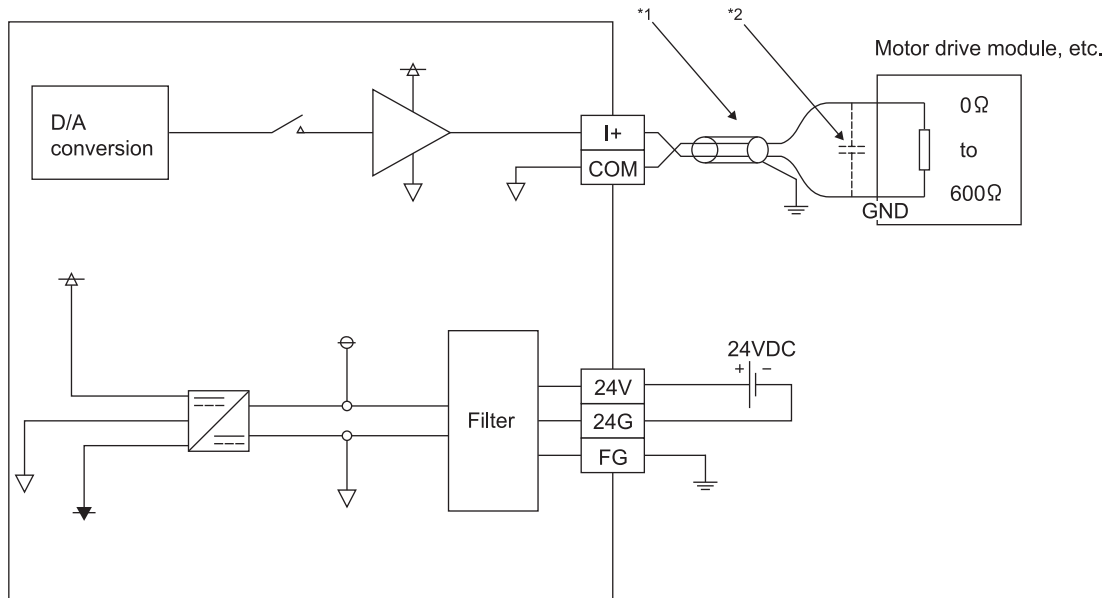

- *1 Use a twisted two core shielded wire for the power wire.
- *2 If there is noise or ripples in the external wiring, connect a 0.1 to 0.47 μ F 25V capacitor between the I+ terminal and COM.



4.5 Switch Setting for Intelligent Function Module

The settings for the intelligent function module are performed using the I/O assignment settings of GX Developer.

(1) Setting item

The intelligent function module switches consist of switches 1 to 5 and are set using 16 bit data. When the intelligent function module switches are not set, the default value for switches 1 to 5 is 0.

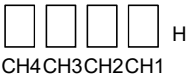
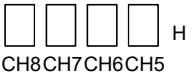
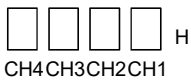
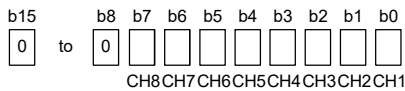
Table 4.1 Switch setting item for intelligent function module

		Setting item															
Switch 1	Output range setting (CH1 to CH4)  H CH4CH3CH2CH1	<table border="1"> <thead> <tr> <th>Analog output range</th> <th>Output range setting value</th> </tr> </thead> <tbody> <tr> <td>4 to 20 mA</td> <td>0H *1</td> </tr> <tr> <td>0 to 20 mA</td> <td>1H</td> </tr> <tr> <td>1 to 5 V</td> <td>2H</td> </tr> <tr> <td>0 to 5 V</td> <td>3H</td> </tr> <tr> <td>- 10 to 10 V</td> <td>4H</td> </tr> <tr> <td>User range setting</td> <td>FH</td> </tr> </tbody> </table>	Analog output range	Output range setting value	4 to 20 mA	0H *1	0 to 20 mA	1H	1 to 5 V	2H	0 to 5 V	3H	- 10 to 10 V	4H	User range setting	FH	
	Analog output range		Output range setting value														
4 to 20 mA	0H *1																
0 to 20 mA	1H																
1 to 5 V	2H																
0 to 5 V	3H																
- 10 to 10 V	4H																
User range setting	FH																
Switch 2	Output range setting (CH5 to CH8)  H CH8CH7CH6CH5																
Switch 3	For the Q62DAN, Q64DAN, Q62DA and Q64DA  H CH4CH3CH2CH1	HOLD/CLEAR function setting 0H : CLEAR 1H to FH (numeric value other than 0H) *2: HOLD															
	For the Q68DAVN, Q68DAIN, Q68DAV and Q68DAI b15 to b0  CH8CH7CH6CH5CH4CH3CH2CH1	HOLD/CLEAR function setting 0 : CLEAR 1 : HOLD															
Switch 4	 H 00H : Normal mode (non-synchronized) 01H to FFH (numeric value other than 00H)*2: Synchronized output mode 0H : Normal resolution mode 1H to FH (numeric value other than 0H)*2 : High resolution mode 0H : Normal mode (D/A conversion processing) 1H to FH (numeric value other than 0H)*2 : Offset/gain setting mode																
Switch 5	0H: Fixed																

*1 For details, refer to the POINT(1) in the following page.

*2 Setting any value within the setting range will provide the same operation. When the setting range is 1H to FH, set 1H for example.

POINT							
(1)	<p>Depending on the type of module used, the settings for D/A module output range are shown below.</p> <ul style="list-style-type: none"> • Q62DAN, Q64DAN, Q62DA, Q64DA 0H to 4H, FH • Q68DAVN, Q68DAV..... 0H, 2H to 4H, FH <li style="padding-left: 20px;">*1 When the setting is 0H, the output operating ranges will be 1 to 5 V. • Q68DAIN, Q68DAI..... 0H, 1H, FH 						
(2)	For the Q62DAN, Q64DAN, Q62DA and Q64DA, leave the switch 2 vacant.						
(3)	<p>For the Q68DAVN, Q68DAIN, Q68DAV and Q68DAI, the switch 3 will set in binary.</p> <p>Setting will be easy if the input format is changed to binary number.</p> <p>Example) For setting CH3, CH5 and CH8 to HOLD.</p> <table border="1" style="margin-left: auto; margin-right: auto; border-collapse: collapse;"> <thead> <tr> <th style="width: 30%;">Input format</th> <th style="width: 30%;">Binary</th> <th style="width: 30%;">Hexadecimal</th> </tr> </thead> <tbody> <tr> <td style="text-align: center;">Setting value</td> <td style="text-align: center;">10010100</td> <td style="text-align: center;">94H</td> </tr> </tbody> </table>	Input format	Binary	Hexadecimal	Setting value	10010100	94H
Input format	Binary	Hexadecimal					
Setting value	10010100	94H					
(4)	<p>If the offset/gain setting mode is set using intelligent function module switch 4, other settings by switch 4 (settings for resolution mode and synchronous output mode) will be ignored.</p>						
(5)	<p>Setting of the offset/gain setting mode differs from function version A to function version B.</p> <p>Perform the offset/gain settings after checking the RUN LED flashes in offset/gain setting mode. If the RUN LED does not flash, check to see if the switch 4 setting is correct. (Refer to Appendix 1.3)</p>						
(6)	<p>Since the analog output value will differ considerably, depending on the resolution mode setting, thoroughly check the settings for the intelligent function module switches before performing the analog output processing.</p> <p>Example) Analog output value when the setting range is -10 to 10V and the digital input value is set to 4000.</p> <table border="1" style="margin-left: auto; margin-right: auto; border-collapse: collapse;"> <thead> <tr> <th style="width: 30%;"></th> <th style="width: 30%;">High resolution mode</th> <th style="width: 30%;">Normal resolution mode</th> </tr> </thead> <tbody> <tr> <td style="text-align: center;">Analog output value</td> <td style="text-align: center;">About 2.5 V</td> <td style="text-align: center;">About 10.0 V</td> </tr> </tbody> </table>		High resolution mode	Normal resolution mode	Analog output value	About 2.5 V	About 10.0 V
	High resolution mode	Normal resolution mode					
Analog output value	About 2.5 V	About 10.0 V					

(2) Operating procedure

Start the settings with GX Developer I/O assignment setting dialog box.

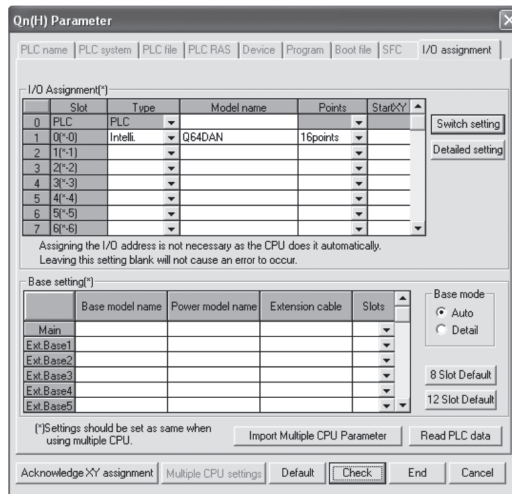

(a) I/O assignment setting dialog box

Set the following for the slot in which the D/A converter module is mounted. The type setting is required; set other items as needed.

- Type : Select "intelli."
- Model name : Enter the module model name.
- Points : Select 16 points.
- Start XY : Enter the start I/O signal for the D/A converter module.

Detailed setting :

- 1) When using in the standard system configuration (on the main or extension base), specify the control CPU of the D/A converter module. The analog output status of when an error has occurred in the D/A converter module is determined according to the setting of "HOLD/CLEAR function setting" of the switch setting for intelligent function module. Therefore, the setting of "Error time output mode" is invalid.
- 2) When using on a remote I/O station, if the analog output is to be held in the case of a link error, "Error time output mode" must be set to "Hold".

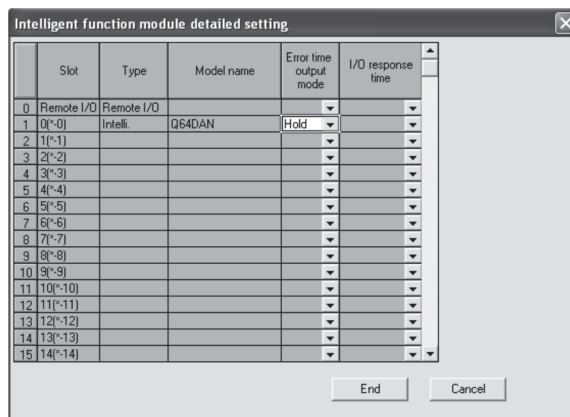

(b) Switch setting for intelligent function module screen

Click on [Switch setting] on the I/O assignment setting to display the dialog box shown at the left, then set switches 1 to 5.

The switches can easily be set if values are entered in hexadecimal. Change the entry format to hexadecimal and then enter the values.

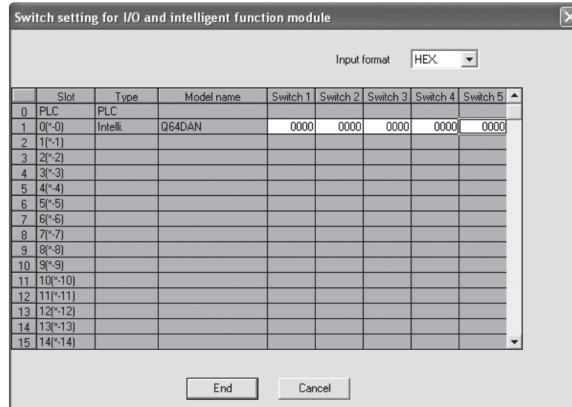

4.6 Offset/Gain Settings

When the user range setting is used, perform the offset and gain settings according to the following procedure.

When the industrial shipment setting is used, offset/gain setting is not necessary.

If the utility package is installed, perform the offset/gain settings according to the procedure described in Section 5.6.2.

(1) Offset/gain setting procedure

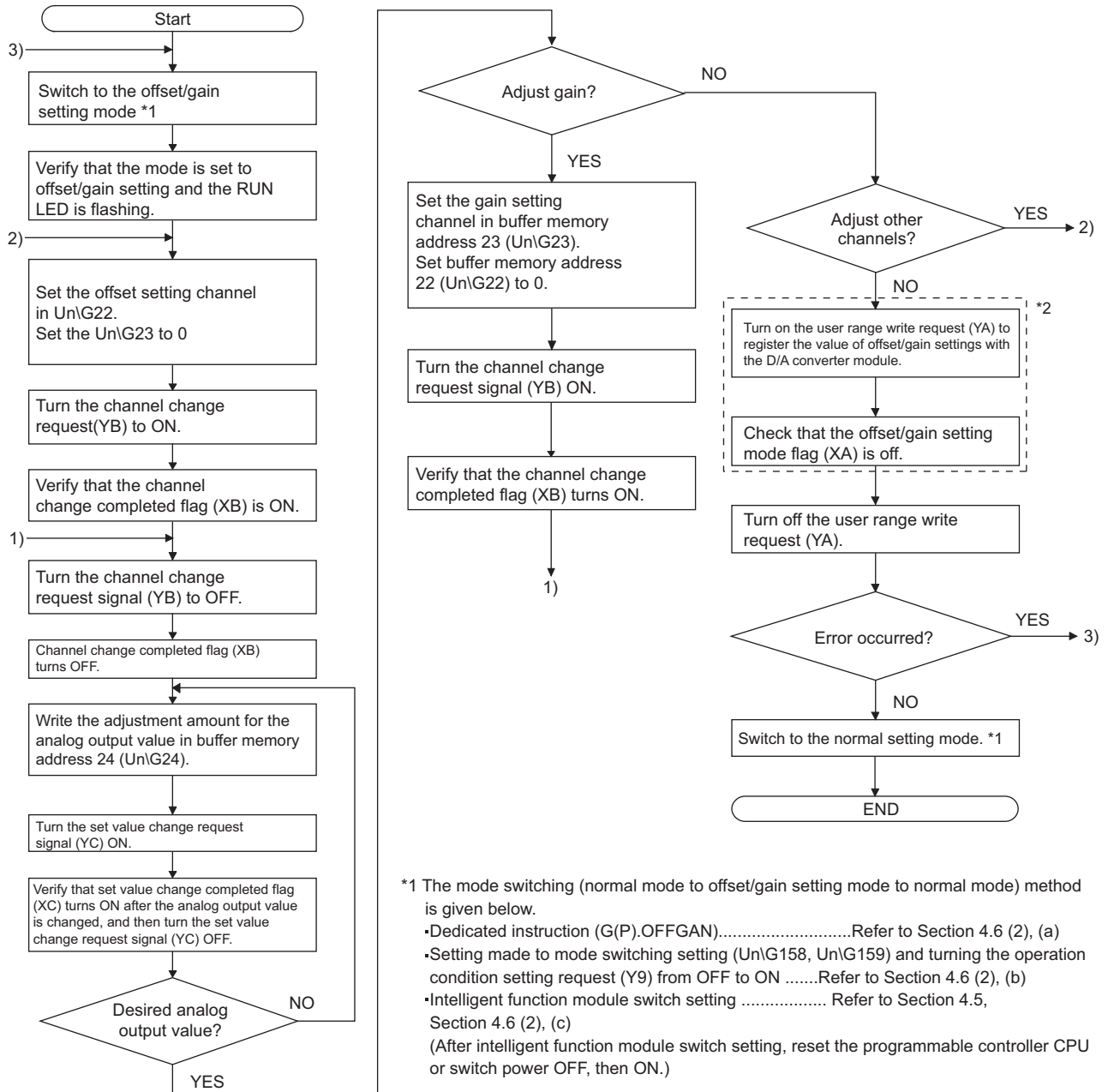

*1 The mode switching (normal mode to offset/gain setting mode to normal mode) method is given below.
 •Dedicated instruction (G(P).OFFGAN).....Refer to Section 4.6 (2), (a)
 •Setting made to mode switching setting (UnG158, UnG159) and turning the operation condition setting request (Y9) from OFF to ONRefer to Section 4.6 (2), (b)
 •Intelligent function module switch setting Refer to Section 4.5, Section 4.6 (2), (c)
 (After intelligent function module switch setting, reset the programmable controller CPU or switch power OFF, then ON.)

*2 Do not perform the following during operation of "*2". Doing so may cause a flash memory data error, resulting in malfunction of the D/A converter module.
 •Power-off of the programmable controller CPU
 •Reset of the programmable controller CPU

- *1 The mode switching (normal mode to offset/gain setting mode to normal mode) method is given below.
 - Dedicated instruction (G(P).OFFGAN) Refer to Section 4.6 (2), (a)
 - Setting made to mode switching setting (buffer memory address 158, 159: Un\G158, Un\G159) and turning Operating condition setting request (Y9) from off to on Refer to Section 4.6 (2), (b)
 - Intelligent function module switch setting Refer to Section 4.5, Section 4.6 (2), (c)

(After intelligent function module switch setting, reset the programmable controller CPU or switch power off, then on.)

POINT
(1) Perform the offset/gain settings in the range that satisfies the conditions specified in Section 3.1.2, (1) and (2). When the setting exceeds this range, the maximum resolution or total accuracy may not be within the range indicated in the performance specification.
(2) Perform the offset/gain settings separately for each channel. If channels are set in Offset/gain setting mode Offset specification (buffer memory address 22: Un\G22) and Offset/gain setting mode Gain specification (buffer memory address 23: UN\G23), at the same time, an error will occur and the ERROR LED will be lit.
(3) After the offset and gain settings are completed, verify that the offset and gain values have been set correctly under actual usage conditions.
(4) The offset and gain values are stored into the E ² PROM and are not erased at power-off.
(5) At the time of offset/gain setting, turn on User range writing request (YA) to write the values to the E ² PROM. Data can be written to the E ² PROM up to 100 thousand times. To prevent accidental write to the E ² PROM, an error will occur and Error code (buffer memory address 19: Un\G19) will be stored if write is performed 26 consecutive times.
(6) If an error (Error code: 40 □ *1) occurs during offset/gain setting, re-set the correct offset/gain value. The offset/gain value of the channel where the error has occurred is not written to the D/A converter module. (*1: □ indicates the corresponding channel number.)
(7) Module ready (X0) turns from off to on when the offset/gain setting mode switches to the normal mode by the dedicated instruction (G(P).OFFGAN) or the setting of Mode switching setting (buffer memory addresses 158, 159: Un\G158, Un\G159). Note that initial setting processing will be executed if there is a sequence program that makes initial setting when Module ready (X0) turns on.
(8) D/A conversion is discontinued if the mode is switched (from the normal mode to the offset/gain setting mode or from the offset/gain setting mode to the normal mode) by the dedicated instruction (G(P).OFFGAN) or the setting of Mode switching setting (buffer memory addresses 158, 159: Un\G158, Un\G159). To resume D/A conversion, switch the mode to the normal mode if it is set to the offset/gain setting mode, and then turn on and off Operating condition setting request (Y9).
(9) Pass data classification setting (buffer memory address 200: Un\G200) 202 to 233 (Un\G202 to Un\G233) are the areas used to restore the user range

settings offset/gain values when online module change is made.
Refer to chapter 7 for details of online module change.

(2) Program examples

The program in the dotted area of (a) is common to (a), (b) and (c).

In this example, the I/O signals for the D/A converter module are X/Y0 to X/YF.

- Channel selection M0
- Offset setting M1
- Gain setting M2
- Channel change command M3
- Writing the adjustment amount M4
- Analog output value adjust command M5
- Offset/gain setting value write command to the module M6
- Mode switching M7
- Normal mode checking signal M50
- Channel designation storage device D0
- Dedicated instruction (G(P).OFFGAN) setting storage device D2
- Offset/gain adjustment storage device D1

- (a) When switching the mode using the dedicated instruction (G(P).OFFGAN)
 The following sample program switches to the offset/gain setting mode with the dedicated instruction (G(P).OFFGAN), changes the channel where offset/gain setting will be made, adjusts the offset/gain values, and writes the offset/gain values to the D/A converter module.

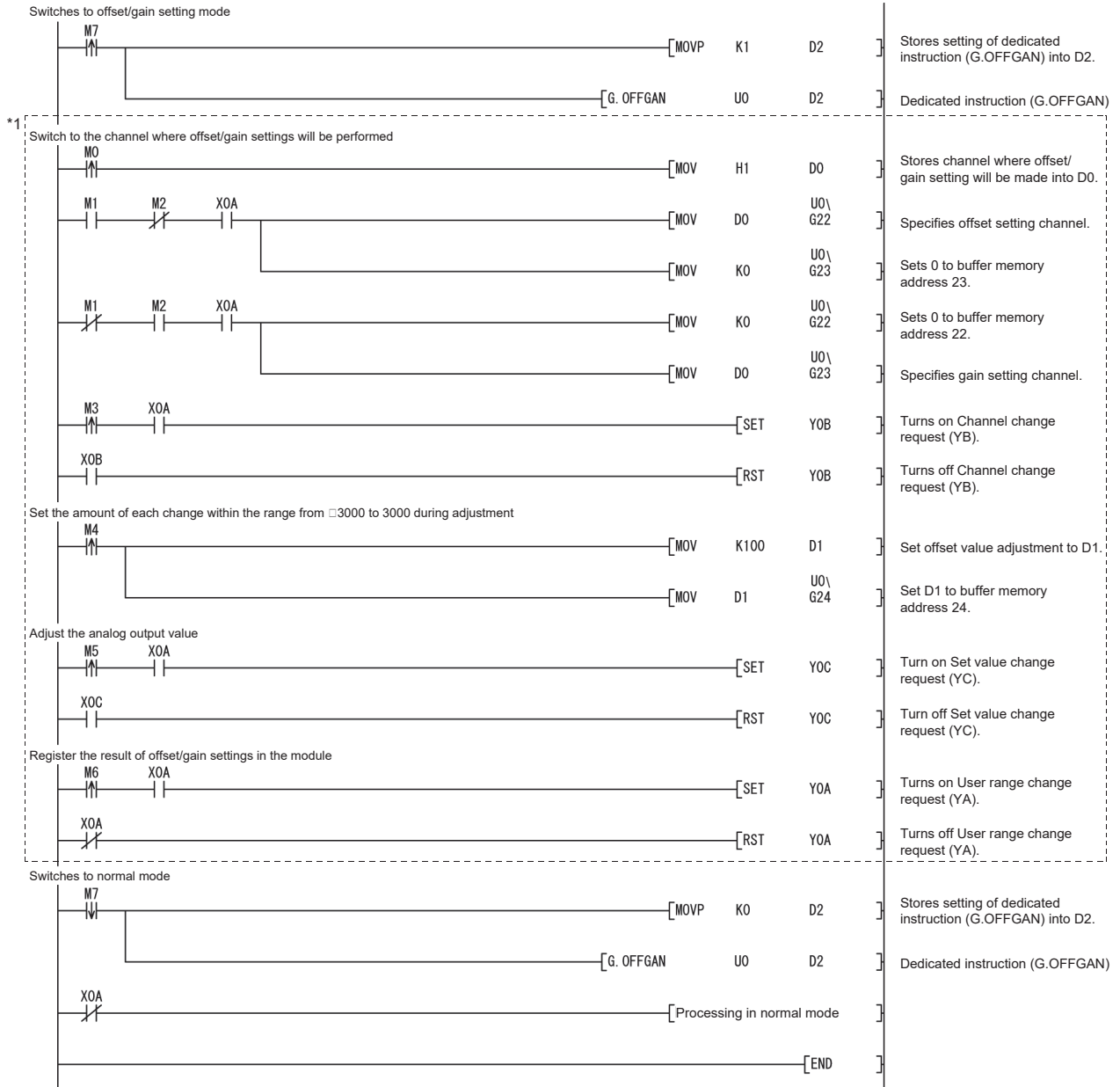

*1: The program in the dotted area is a common program.

- (b) When switching the mode to the setting of Mode switching setting (buffer memory address 158, 159: Un\G158, Un\G159) and Operating condition setting request (Y9).

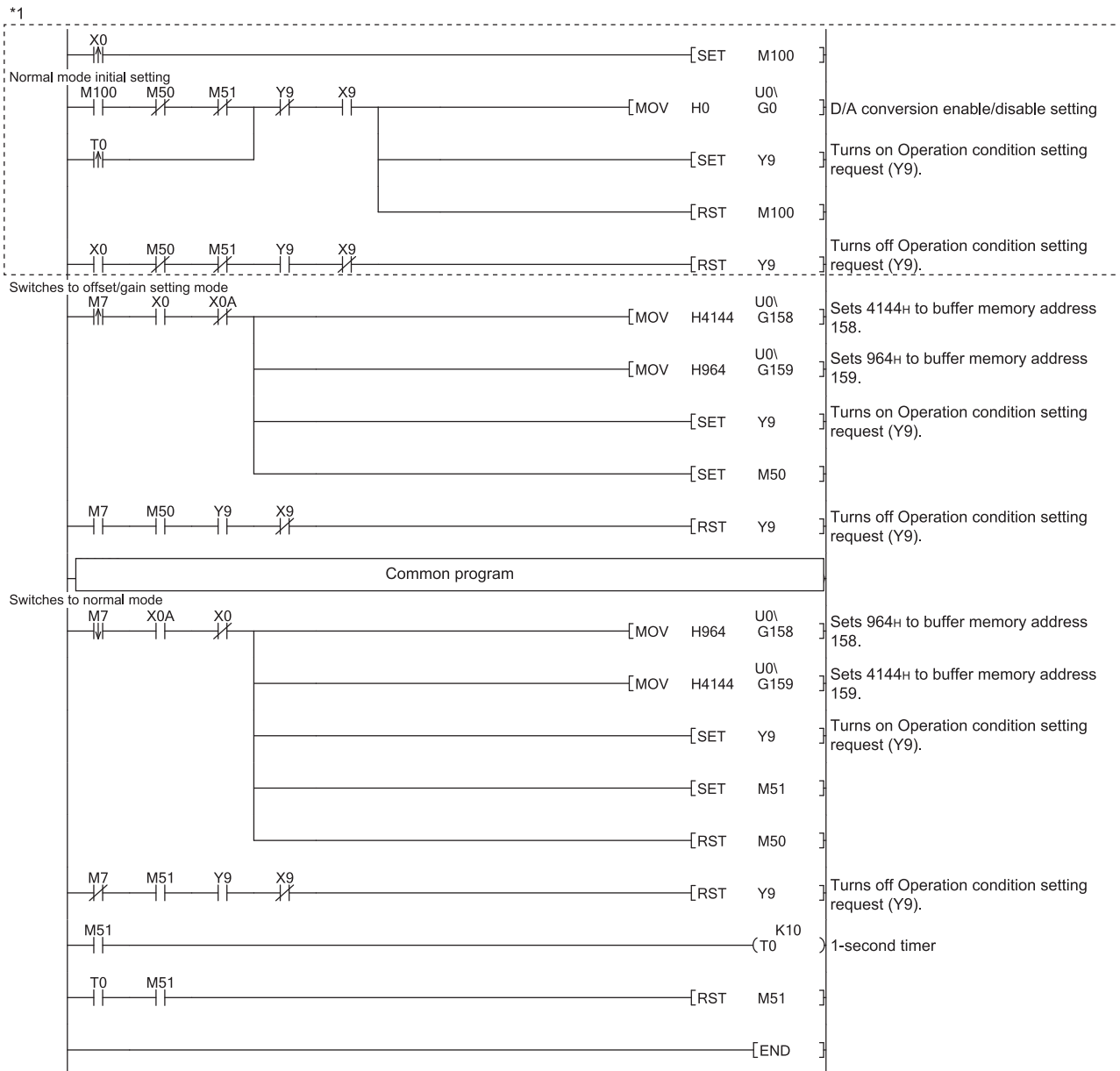

POINT

When running this program together with the normal-mode A/D conversion program (shown in Section 6.4.2), use *1 of this program as the initial setting program.

Note) When adding this program to the normal-mode D/A conversion program (shown in Section 6.4.2), replace the existing initial setting items with the program marked *1.

- (c) When switching the mode by making intelligent function module switch setting
Only the common program is necessary.

5 UTILITY PACKAGE (GX Configurator-DA)

5.1 Utility Package Functions

Table 5.1 shows an overview of the utility package functions.

Table 5.1 Utility package (GX Configurator-DA) function list

Item	Description	Reference section
Initial Setting *1	(1) Sets D/A conversion enable/disable. (2) The data for which initial setting has been completed is registered in the parameters for the programmable controller CPU, and automatically written to the D/A converter module when the programmable controller CPU changes to RUN status.	Section 5.4
Auto Refresh Setting *1	(1) Sets automatic refresh for the D/A converter module buffer memory. (2) The buffer memory that was set for automatic refresh is automatically read and written to the specified device when the END command for the programmable controller CPU is executed.	Section 5.5
Monitor/test	(1) Monitor/test The buffer memory and I/O signals for the D/A converter modules are monitored and tested. (2) Operating condition setting Changes D/A conversion enable/disable during the operation. (3) Offset/gain setting When setting the offset/gain to a value selected by the user (when the analog output range setting is user range setting), the offset and gain can be easily set while viewing the dialog box. (4) Pass data The pass data (Pass data classification setting, industrial shipment settings offset/gain values, user range settings offset/gain values) can be monitored and set.	Section 5.6
FB conversion	Generates FB automatically from the intelligent function module parameter (initial setting/auto refresh setting).	Section 5.7

POINT

*1 If initial setting and auto refresh setting are performed, the intelligent function module parameters require a maximum of 24 bytes per module.

5.2 Installing and Uninstalling the Utility Package

For how to install or uninstall the utility package, refer to "Method of installing the MELSOFT Series" included in the utility package.

5.2.1 Handling precautions

The following explains the precautions on using the GX Configurator-DA.

(1) For safety

Since GX Configurator-DA is add-in software for GX Developer, read "Safety Precautions" and the basic operating procedures in the GX Developer Operating Manual.

(2) About installation

GX Configurator-DA is add-in software for GX Developer Version 4 or later. Therefore, GX Configurator-DA must be installed on the personal computer that has already GX Developer Version 4 or later installed.

(3) Error of Intelligent function module utility

Insufficient system resource may cause the dialog box to be displayed inappropriately while using the Intelligent function module utility. If this occurs, close the Intelligent function module utility, GX Developer (program, comments, etc.), and other applications, and then start GX Developer and Intelligent function module utility again.

(4) To start the Intelligent function module utility

(a) In GX Developer, select "QCPU (Q mode)" for PLC series and specify a project.

If any PLC series other than "QCPU (Q mode)" is selected, or if no project is specified, the Intelligent function module utility will not start.

(b) Multiple Intelligent function module utilities can be started.

However, [Open parameters] and [Save parameters] operations under [Intelligent function module parameter] are allowed for one Intelligent function module utility only. Only the [Monitor/test] operation is allowed for the other utilities.

(5) Switching between two or more Intelligent function module utilities

When two or more Intelligent function module utility windows cannot be displayed side by side, select the window to be displayed on the top of others using the task bar.

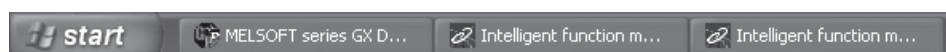

(6) Number of parameters that can be set in GX Configurator-DA

When multiple intelligent function modules are mounted, the number of parameter setting must not exceed the following limit.

When intelligent function modules are installed to:	Maximum number of parameter settings	
	Initial setting	Auto refresh setting
Q00J/Q00/Q01CPU	512	256
Q02/Q02H/Q06H/Q12H/Q25HCPU	512	256
Q02PH/Q06PH/Q12PH/Q25PHCPU	512	256
Q12PRH/Q25PRHCPU	512	256
Q00UJ/Q00U/Q01UCPU	512	256
Q02UCPU	2048	1024
Q03UD/Q04UDH/Q06UDH/Q10UDH/ Q13UDH/Q20UDH/Q26UDH/Q03UDE/ Q04UDEH/Q06UDEH/Q10UDEH/Q13UDEH/ Q20UDEH/Q26UDEH/Q50UDEH/Q100UDEHCPU	4096	2048
CPU modules other than the above	Not supported	Not supported
MELSECNET/H remote I/O station	512	256

For example, if multiple intelligent function modules are installed to the MELSECNET/H remote I/O station, configure the settings in GX Configurator-DA so that the number of parameter settings for all the intelligent function modules does not exceed the limit of the MELSECNET/H remote I/O station.

Calculate the total number of parameter settings separately for the initial setting and for the auto refresh setting.

The number of parameters that can be set for one module in GX Configurator-DA is as shown below.

Target module	Initial setting	Auto refresh setting
Q62DAN/Q62DA	1 (Fixed)	5 (Max.)
Q64DAN/Q64DA	1 (Fixed)	9 (Max.)
Q68DAVN/Q68DAIN/Q68DAV/Q68DAI	1 (Fixed)	17 (Max.)

Example) Counting the number of parameter settings in Auto refresh setting

Auto refresh setting

Module information
 Module type: D/A Conversion Module Start I/O No.: 0000
 Module model name: Q64DA(N)

Setting item	Module side Buffer size	Module side Transfer word count	Transfer direction	PLC side Device
CH1 Digital value	1	1	<-	D1
CH2 Digital value	1	1	<-	D2
CH3 Digital value	1	1	<-	D3
CH4 Digital value	1	1	<-	D4
CH1 Set value check code	1	1	->	D5
CH2 Set value check code	1	1	->	D6
CH3 Set value check code	1	1	->	D7
CH4 Set value check code	1	1	->	D8
Error code	1	1	->	D9

Make text file End setup Cancel

← This one row is counted as one setting. Blank rows are not counted. Count up all the setting items on this screen, and add the total to the number of settings for other intelligent function modules to get a grand total.

5.2.2 Operating environment

This section explains the operating environment of the personal computer that runs GX Configurator-DA.

Item	Description
Installation (Add-in) target *1	Add-in to GX Developer Version 4 (English version) or later *2
Computer	Personal computer running the operating systems listed below
	CPU
	Required memory
	Refer to "Operating system and performance required for personal computer" in the next page.
Hard disk space	For installation
	For operation
	65 MB or more
	20 MB or more
Display	800×600 dots or more resolution *3
Operating system	Microsoft® Windows® 95 Operating System (English version) Microsoft® Windows® 98 Operating System (English version) Microsoft® Windows® Millennium Edition Operating System (English version) Microsoft® Windows NT® Workstation Operating System Version 4.0 (English version) Microsoft® Windows® 2000 Professional Operating System (English version) Microsoft® Windows® XP Professional Operating System (English version) Microsoft® Windows® XP Home Edition Operating System (English version) Microsoft® Windows Vista® Home Basic Operating System (English version) Microsoft® Windows Vista® Home Premium Operating System (English version) Microsoft® Windows Vista® Business Operating System (English version) Microsoft® Windows Vista® Ultimate Operating System (English version) Microsoft® Windows Vista® Enterprise Operating System (English version) Microsoft® Windows® 7 Starter Operating System (English version) *4 Microsoft® Windows® 7 Home Premium Operating System (English version) *4 Microsoft® Windows® 7 Professional Operating System (English version) *4 Microsoft® Windows® 7 Ultimate Operating System (English version) *4 Microsoft® Windows® 7 Enterprise Operating System (English version) *4

*1 Install GX Configurator-DA in GX Developer Version 4 or higher in the same language.

GX Developer (English version) and GX Configurator-DA (Japanese version) cannot be used in combination, and GX Developer (Japanese version) and GX Configurator-DA (English version) cannot be used in combination.

*2 GX Configurator-DA is not applicable to GX Developer Version 3 or earlier.

In addition, GX Developer Version 8 or later is necessary to use the FB conversion function.

*3 Resolution of 1024 X 768 pixels or higher is recommended for Windows Vista® and Windows® 7.

*4 For Windows® 7 (32-bit version), install GX Configurator-DA Version 2.11M or later as an add-in to GX Developer Version 8.91V or later.

For Windows® 7 (64-bit version), install GX Configurator-DA Version 2.11M or later as an add-in to GX Developer Version 8.98C or later.

Operating system and performance required for personal computer

Operating system	Performance required for personal computer	
	CPU	Memory
Windows® 95	Pentium® 133MHz or more	32MB or more
Windows® 98	Pentium® 133MHz or more	32MB or more
Windows® Me	Pentium® 150MHz or more	32MB or more
Windows NT® Workstation 4.0	Pentium® 133MHz or more	32MB or more
Windows® 2000 Professional	Pentium® 133MHz or more	64MB or more
Windows® XP	Pentium® 300MHz or more	128MB or more
Windows Vista®	Pentium® 1GHz or more	1GB or more
Windows 7®	Pentium® 1GHz or more	1GB or more (for 32-bit version) 2GB or more (for 64-bit version)

POINT

- (1) The functions shown below are not available for Windows® XP, Windows Vista® and Windows® 7.

If any of the following functions is attempted, this product may not operate normally.

Start of application in Windows® compatible mode

Fast user switching

Remote desktop

Large fonts (Details setting of Display Properties)

DPI settings other than 100%

In addition, Windows® XP (64-bit version) and Windows Vista® (64-bit version) are not supported.

- (2) On Windows Vista® and Windows® 7, the user should have USER authority or higher.
- (3) The functions shown below are not available for Windows® 7.
- Windows XP Mode
- Windows Touch

5.3 Utility Package Operation

5.3.1 Common utility package operations

(1) Control keys

Special keys that can be used for operation of the utility package and their applications are shown in the table below.

Key	Application
Esc	Cancels the current entry in a cell. Closes the window.
Tab	Moves between controls in the window.
Ctrl	Used in combination with the mouse operation to select multiple cells for test execution.
Delete	Deletes the character where the cursor is positioned. When a cell is selected, clears all of the setting contents in the cell.
Back Space	Deletes the character where the cursor is positioned.
↑ ↓ ← →	Moves the cursor.
Page Up	Moves the cursor one page up.
Page Down	Moves the cursor one page down.
Enter	Completes the entry in the cell.

(2) Data created with the utility package

The following data or files that are created with the utility package can be also handled in GX Developer. Figure 5.1 shows respective data or files are handled in which operation.

(a) Intelligent function module parameter

This represents the data created in Auto refresh setting, and they are stored in an intelligent function module parameter file in a project created by GX Developer.

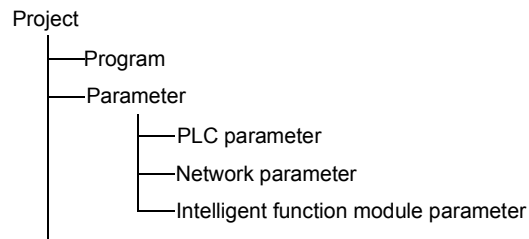

(b) Text files

A text file can be created by clicking the **Make text file** button on the Initial setting, Auto refresh setting, or Monitor/Test window.

The text files can be utilized to create user documents.

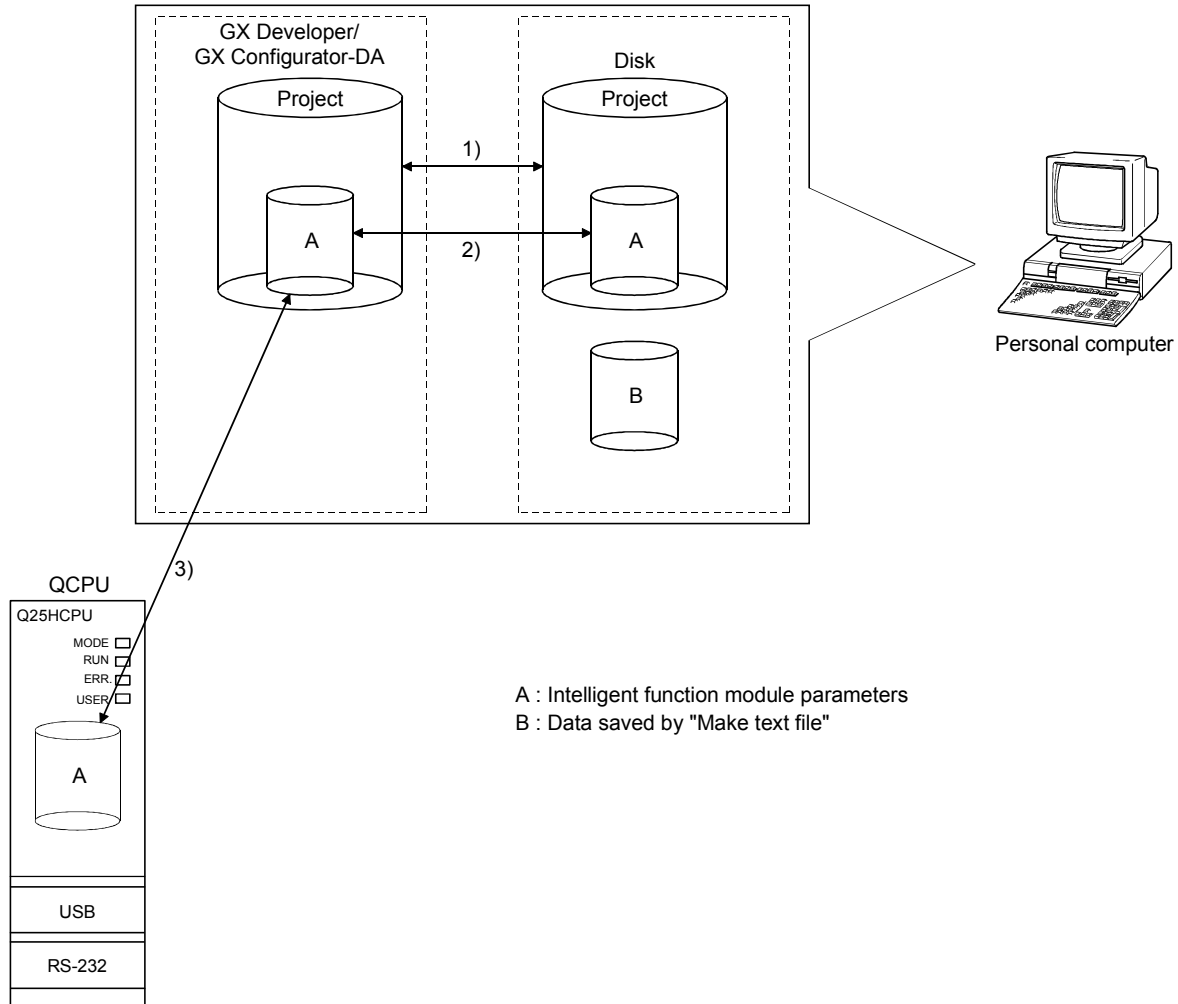

Figure 5.1 Correlation chart for data created with the utility package

Steps 1) to 3) shown in Figure 5.1 are performed as follows:

- 1) From GX Developer, select:
[Project] → [Open project] / [Save] / [Save as]
- 2) On the intelligent function module selection screen of the utility, select:
[Intelligent function module parameter] → [Open parameters] / [Save parameters]
- 3) From GX Developer, select:
[Online] → [Read from PLC] / [Write to PLC] → "Intelligent function module parameters"
Alternatively, from the intelligent function module selection screen of the utility, select:
[Online] → [Read from PLC] / [Write to PLC]

5.3.2 Operation overview

GX Developer screen

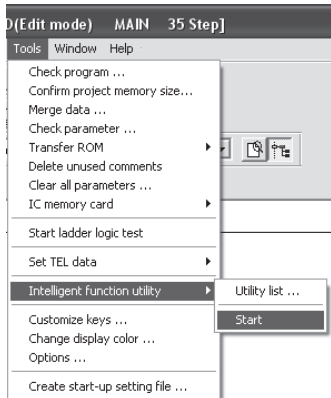

[Tools]- [Intelligent function utility]- [Start]

Screen for selecting a target intelligent function module

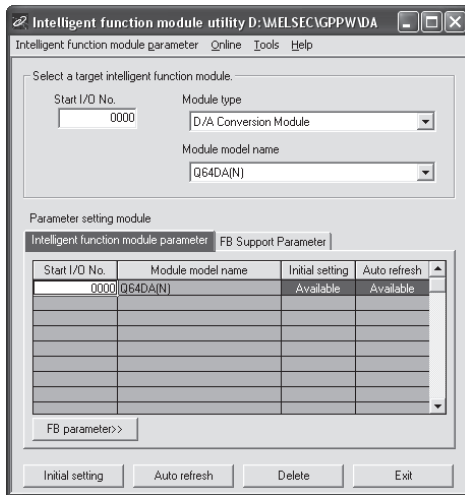

1)

Refer to Section 5.3.3.

Enter "Start I/O No.", and select "Module type" and "Module model name".

Initial setting

Auto refresh

Initial setting screen

Auto refresh setting screen

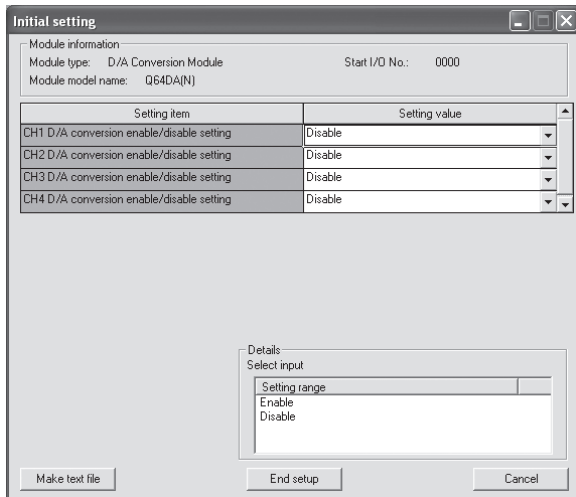

Refer to Section 5.4.

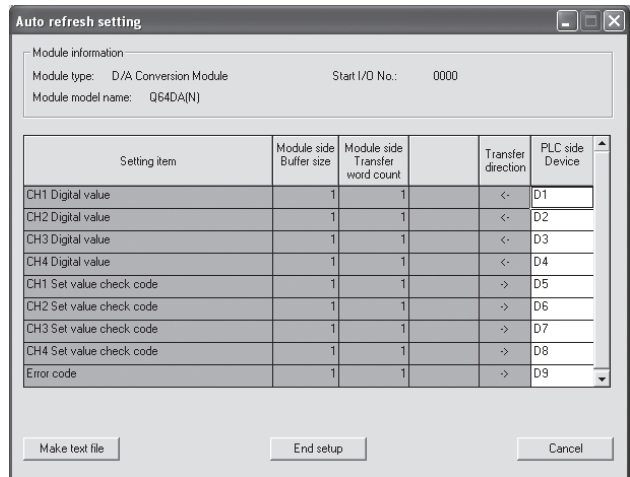

Refer to Section 5.5.

1) [Online] - [Monitor/Test] <<FB support parameter>> tab - [FB conversion]

Selecting monitor/test module screen

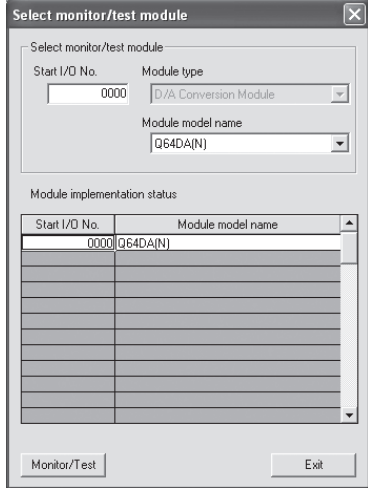

FB conversion screen

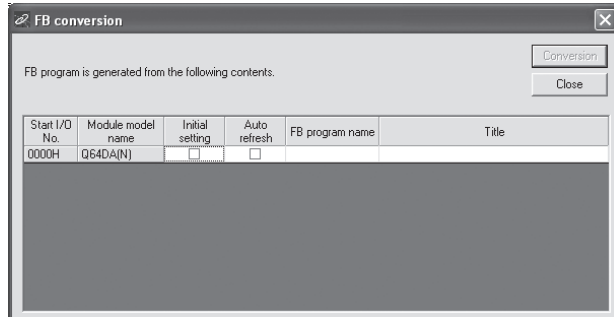

Refer to Section 5.7.

Select a module to be monitored/tested.

Monitor/Test

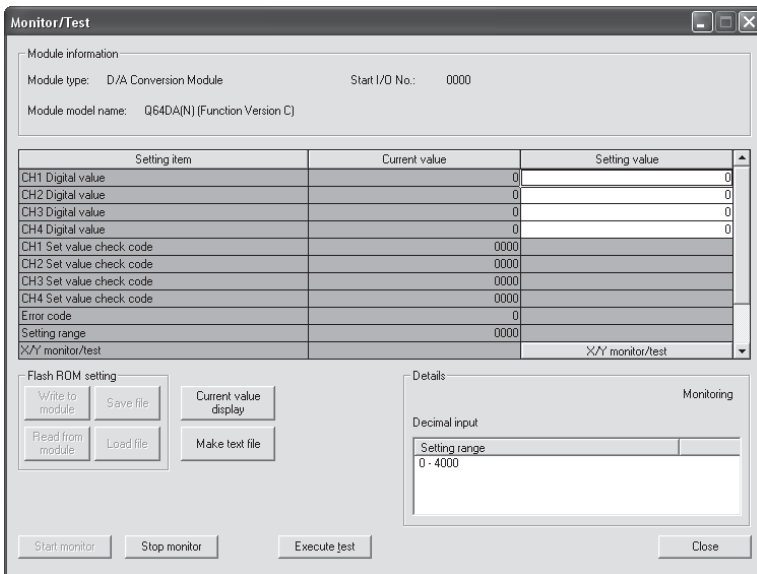

Refer to Section 5.6.

5.3.3 Starting the Intelligent function module utility

[Operating procedure]

Intelligent function module utility is started from GX Developer.

[Tools] → [Intelligent function utility] → [Start]

[Setting window]

Display when the <<FB support parameter>> tab is selected.

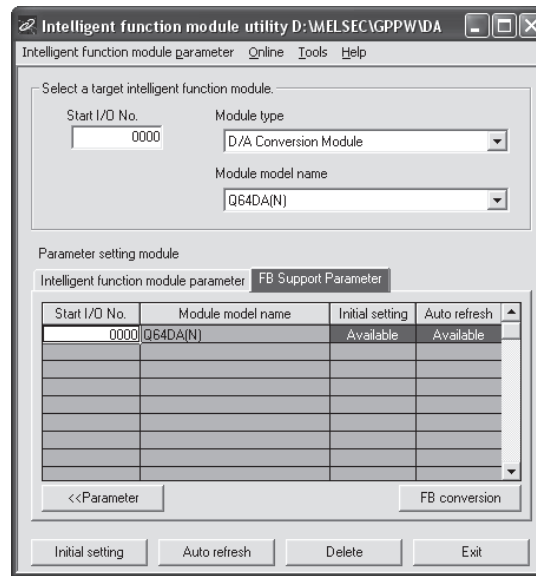

[Explanation of items]

(1) Activation of other windows

Following windows can be displayed from the intelligent function module utility.

Common operations to the <<Intelligent function module parameter>> tab and

<<FB support parameter>> tab

(a) Initial setting

"Start I/O No.*1" → "Module type" → "Module model name" →

Initial setting

(b) Auto refresh setting

"Start I/O No.*1" → "Module type" → "Module model name" →

Auto refresh

(c) Select monitor/test module

[Online] → [Monitor/Test]

*1: Enter the start I/O No. in hexadecimal.

On the <<FB support parameter>> tab

(a) FB conversion

<<FB support parameter>> tab → **FB conversion**

For details, refer to section 5.7.

POINT

The <<FB support parameter>> tab is displayed when the project which is being edited is a label project.

(2) Command buttons

Common operations to the <<Intelligent function module parameter>> tab and <<FB support parameter>> tab

Delete

Deletes the initial setting and auto refresh setting of the selected module.

However, if initial setting and auto refresh setting have been prepared and the cell of "Initial setting" or "Auto refresh" is selected and executed, only the setting of the selected cell is deleted.

Exit

Closes this window.

When the <<FB support parameter>> tab is selected

<<Parameter

Moves the setting of the selected line to the <<Intelligent function module parameter>> tab.

When the <<Intelligent function module parameter>> tab is selected

FB parameter>>

Moves the setting of the selected line to the <<FB support parameter>> tab.

(3) Menu bar

(a) File menu

Intelligent function module parameters of the project opened by GX Developer are handled.

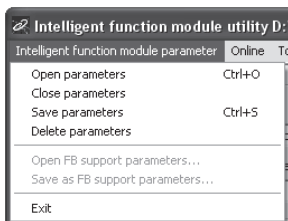

[Open parameters]:

Reads a parameter file.

[Close parameters]:

Closes the parameter file. If any data are modified, a dialog asking for file saving will appear.

[Save parameters]:

Saves the parameter file.

[Delete parameters]:

Deletes the parameter file.

[Open FB support parameters]:

Opens the FB support parameter file.

[Save as FB support parameters]:

Saves the FB support parameter file.

[Exit]:

Closes this window.

(b) Online menu

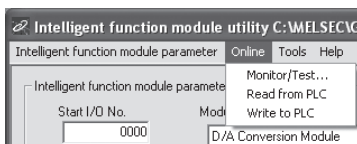

[Monitor/Test]:

Activates the Select monitor/test module window.

[Read from PLC]:

Reads intelligent function module parameters from the CPU module.

[Write to PLC]:

Writes intelligent function module parameters to the CPU module.

POINT	
(1)	<p>Saving intelligent function module parameters in a file Since intelligent function module parameters cannot be saved in a file by the project saving operation of GX Developer, save them on the shown module selection dialog box for intelligent function module parameter setting.</p>
(2)	<p>Reading/writing intelligent function module parameters from/to a programmable controller CPU using GX Developer</p> <ul style="list-style-type: none"><li data-bbox="507 562 1423 633">(a) Intelligent function module parameters can be read from and written into a programmable controller after having been saved in a file.<li data-bbox="507 645 1423 716">(b) Set a target programmable controller CPU in GX Developer: [Online] → [Transfer setup].<li data-bbox="507 728 1423 799">(c) When the D/A converter module is installed to the remote I/O station, use "Read from PLC" and "Write to PLC".
(3)	<p>Checking the required utility While the start I/O is displayed on the Intelligent function module utility setting dialog box, "*" may be displayed for the model name. This means that the required utility has not been installed or the utility cannot be started from GX Developer. Check the required utility, selecting [Tools] - [Intelligent function utility] - [Utility list...] in GX Developer.</p>

5.4 Initial Setting

[Purpose]

Set D/A conversion enable/disable with an initial setting parameter. Setting parameters in the Initial setting window can omit parameter settings with sequence program.

[Operating procedure]

"Start I/O No.*1" → "Module type" → "Module model name" → **Initial setting**

*1: Enter the start I/O No. in hexadecimal.

[Setting window]

Setting item	Setting value
CH1 D/A conversion enable/disable setting	Disable
CH2 D/A conversion enable/disable setting	Disable
CH3 D/A conversion enable/disable setting	Disable
CH4 D/A conversion enable/disable setting	Disable

[Explanation of items]**(1) Setting contents**

Set whether D/A conversion is "Enable" or "Disable" for each channel.

(2) Command button

Make text file

Creates a file containing the data in text file format window.

End setup

Saves the set data and ends the operation.

Cancel

Cancels the setting and ends the operation.

POINT

Initial settings are stored in an intelligent function module parameter file.

After being written to the CPU module, the initial setting is made effective by either (1) or (2).

(1) Cycle the RUN/STOP switch of the CPU module: STOP → RUN → STOP → RUN.

(2) With the RUN/STOP switch set to RUN, turn off and then on the power or reset the CPU module.

When using a sequencer program to write the initial settings, when the CPU is switched from STOP to RUN the initial settings will be written, So ensures that programming is carried out to re-execute the initial settings.

5.5 Auto Refresh Setting

[Purpose]

Configure the D/A converter module's buffer memory for automatic refresh.

[Operating procedure]

"Start I/O No. *1" → "Module type" → "Module model name" → Auto refresh

*1 Enter the start I/O No. in hexadecimal.

[Setting window]

Setting item	Module side Buffer size	Module side Transfer word count	Transfer direction	PLC side Device
CH1 Digital value	1	1	<-	D1
CH2 Digital value	1	1	<-	D2
CH3 Digital value	1	1	<-	D3
CH4 Digital value	1	1	<-	D4
CH1 Set value check code	1	1	->	D5
CH2 Set value check code	1	1	->	D6
CH3 Set value check code	1	1	->	D7
CH4 Set value check code	1	1	->	D8
Error code	1	1	->	D9

[Items]

(1) Contents of the window display

- Module side Buffer size** : Displays the buffer memory size of the setting item. (fixed at one word).
- Module side Transfer word count** : Displays the number of words to be transferred to the CPU devices from the designated address (fixed at one word).
- Transfer direction** : "**<-**" indicates that data are written from the device to the buffer memory.
"**->**" indicates that data are loaded from the buffer memory to the device.
- PLC side Device** : Enter a CPU module side device that is to be automatically refreshed.
Applicable devices are X, Y, M, L, B, T, C, ST, D, W, R and ZR.
When using bit devices X, Y, M, L or B, set a number that can be divided by 16 points (examples: X10, Y120, M16, etc.)
Also, buffer memory data are stored in a 16-point area, starting from the specified device number.
For example, if X10 is entered, data are stored in X10 to X1F.

(2) Command button

Creates a file containing the data in text file format window.

Saves the set data and ends the operation.

Cancels the setting and ends the operation.

POINT

The auto refresh settings are stored in an intelligent function module parameter file. After being written to the CPU module, the auto refresh setting takes effect by either (1) or (2).

(1) Cycle the RUN/STOP switch of the CPU module: STOP → RUN → STOP → RUN.

(2) With the RUN/STOP switch set to RUN, turn off and then on the power or reset the CPU module.

The auto refresh settings cannot be changed from sequence programs.

However, processing equivalent to auto refresh can be added using the FROM/TO instruction in the sequence program.

5.6 Monitor/Test

5.6.1 Monitor/test screen

[Purpose]

Start buffer memory monitoring/testing and I/O signal monitoring/testing, operating condition setting, offset/gain settings (refer to Section 5.6.2, 5.6.3), pass data (refer to Section 5.6.5, 5.6.6) from this window.

[Operating procedure]

Select monitor/test module window → "Start I/O No.*1" → "Module type" → "Module model name" → **Monitor/test**

*1 Enter the start I/O No. in hexadecimal.

The window can also be started from System monitor of GX Developer Version 6 or later.

Refer to the GX Developer Operating Manual for details

[Setting screen]

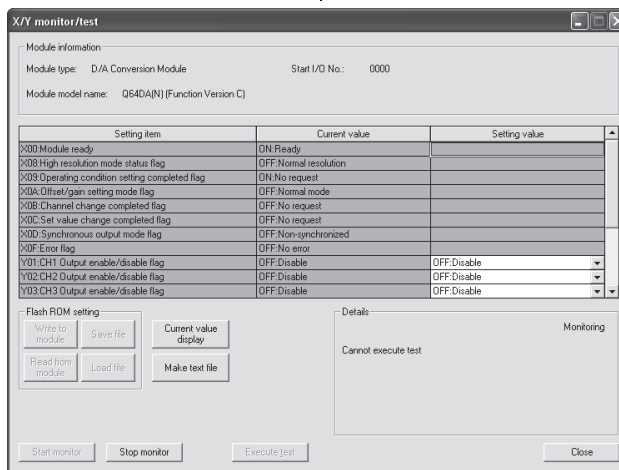
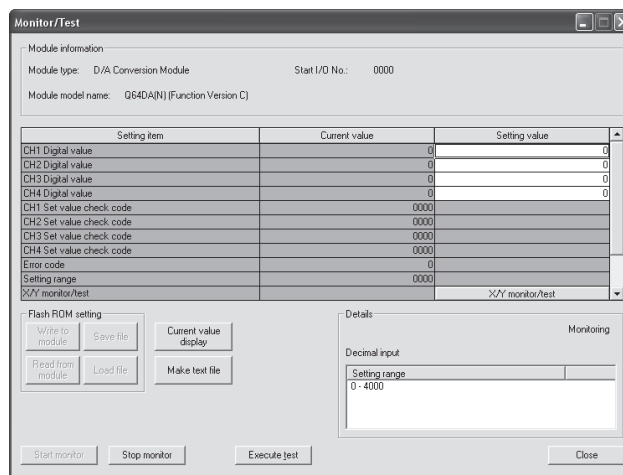

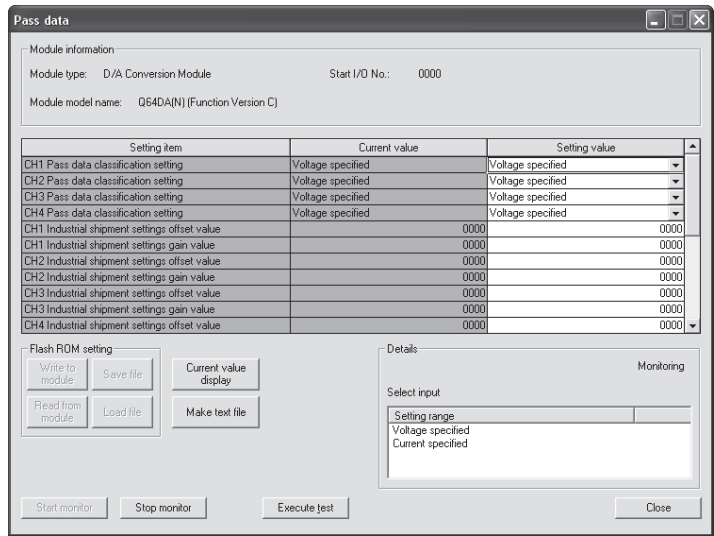

1)

Operating setting

Pass data
Offset/gain setting

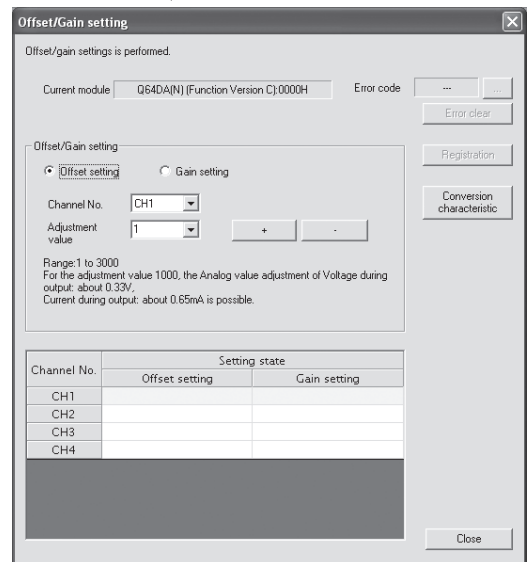
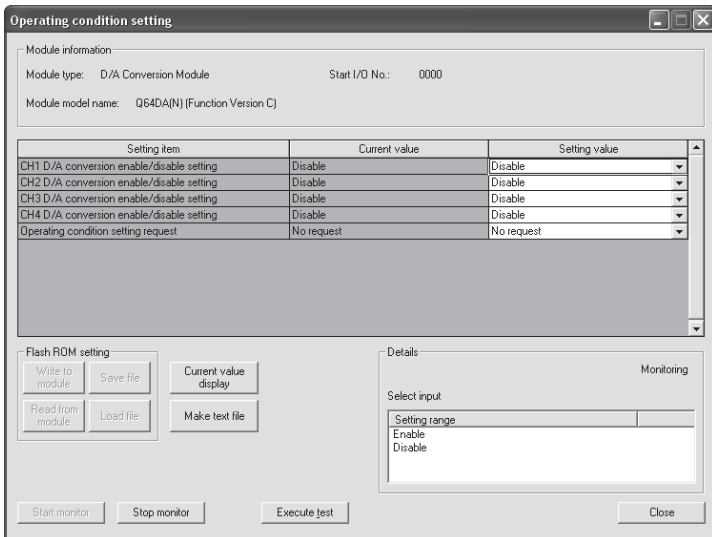

Conversion characteristic

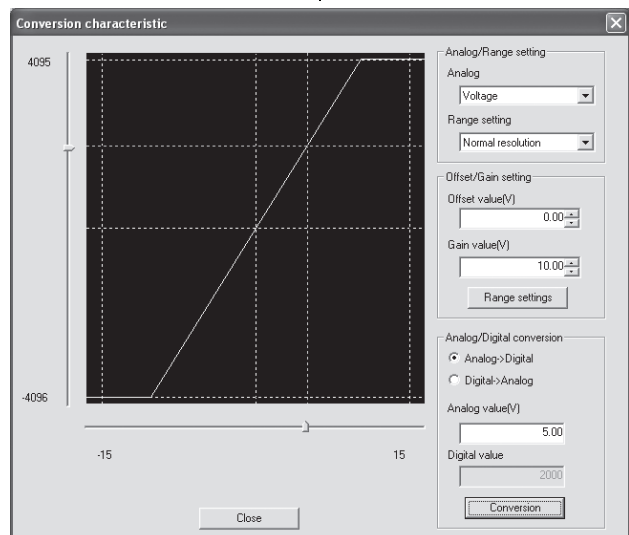

[Explanation of items]

(1) Items

Setting item : Displays buffer memory names.

Current value : Monitors the present buffer memory values.

Setting value : Enter or select values to be written into the buffer memory for test operation.

(2) Command button

Displays the current value of the item selected. (This is used to check the text that cannot be displayed in the current value field. However, in this utility package, all items can be displayed in the display fields).

Creates a file containing the data in text file format window.

/ Selects whether or not to monitor current values.

Performs a test on the selected items. To select more than one item, select them while holding down the key.

Closes the currently opened window and returns to the previous window.

POINT

- (1) Turning the output enable/disable flag on/off or writing CH□ Digital value during test operation changes the analog output, so perform these after taking ample safety precautions.

(3) Examples of "Selection test"

The following explains the case of forcing on CH1 Output enable/disable flag (Y1).

- (a) Click the button in the Monitor/Test window.
- (b) Change the setting value field for "Y01: CH1 Output enable/disable flag" to "ON: enable".
At this point, the setting data have not been written to the D/A converter module.
- (c) Click on the field, of which setting value has been changed in step (b).
(When multiple items have been changed in operation (b), select the setting value fields where setting values were changed, while holding down the key. Multiple fields can be selected by dragging the mouse over them.)
- (d) Click the Execute test button to write the data.
After the writing is completed, the written values are displayed in the "Current value" field.

5.6.2 Offset/gain setting operation (Function version C or later)

Perform the offset/gain setting operation in the following sequence.

(1) Switch to the offset/gain setting dialog box

Perform the operation in Section 5.6.1 to display the offset/gain setting dialog box.

At this point, a dialog box to confirm the transition of module's operation mode (normal mode -> offset/gain setting mode) is displayed. Click the **Yes** button to transit to the offset/gain setting mode.

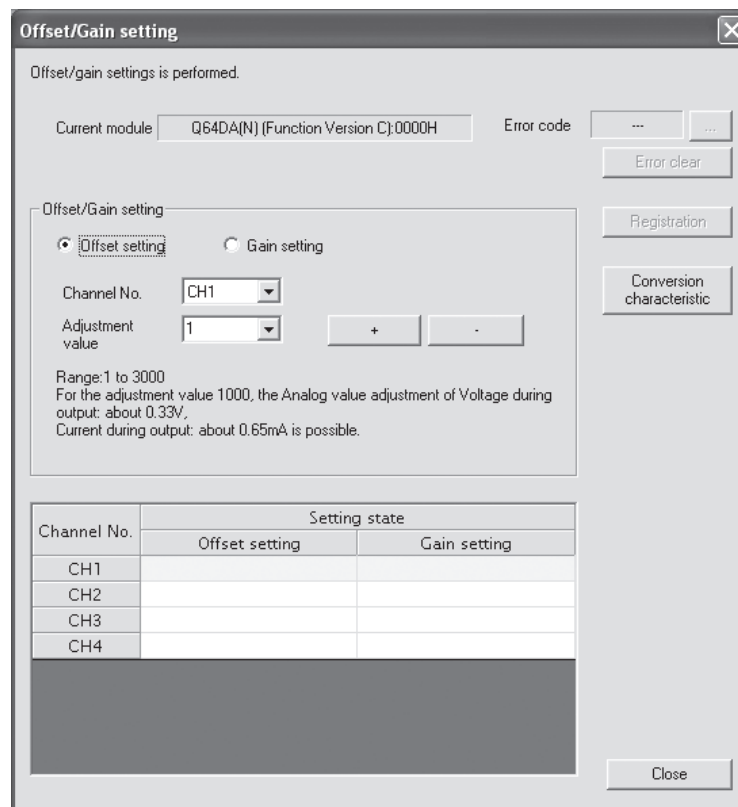

(2) Specify a channel

Specify the target channel of offset setting or gain setting on the channel No. combo box.

(3) Specify offset/gain setting

Specify either offset setting or gain setting on the channel specified on the channel No. combo box using the radio button.

(4) Set up adjustment values

Set up an adjustment value of the offset value or gain value. Select "1", "10," "100", or "1000" on the combo box, however, you can also set up adjustment values by entering a number (1 to 3000).

(5) Fine adjustment of voltage output or current output

By clicking the button or button, the value of voltage output or current output for the prepared adjustment value is finely adjusted.

(6) Write settings into module

Write the content set up by operations (2) to (5) into module by clicking the button.

(a) Precautions

Avoid the following operations during the writing of the data, which has been set up by operations (2) to (5), into the module after the click of the button. Doing so causes an error in the E²PROM data and the D/A converter module may not operate properly.

- 1) Power off the programmable controller CPU.
- 2) Reset the programmable controller CPU.

(7) Switch to the normal mode

When the offset/gain setting dialog box is closed by clicking the button after the setting operation has finished, module's operation mode transits to the normal mode.

POINT

If Error code is displayed while performing the setting operation, the details and measure of the error can be confirmed by clicking the button to the right of the error code display area. In addition, Error code can be cleared by clicking the button.

5.6.3 Offset/gain setting operation (Function version B or earlier)

Perform the offset/gain setting operation in the following sequence.

- (1) **Switch to the offset/gain setting mode**
 Change switch 4 for intelligent function module switch setting to the offset/gain setting mode (Refer to Section 4.5).
- (2) **Switch to the offset/gain setting dialog box**
 Display the offset/gain setting dialog box using the operation described in Section 5.6.1.

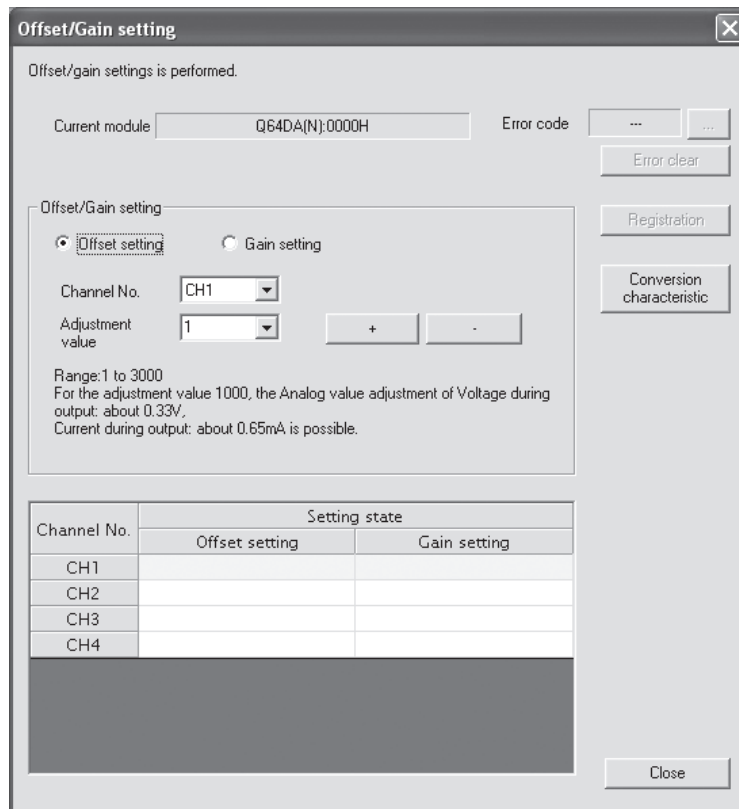

- (3) Specify a channel
Specify the target channel of offset setting or gain setting on the channel No. combo box.
- (4) Specify offset/gain setting
Specify either offset setting or gain setting on the channel specified on the channel No. combo box using the radio button.
- (5) Set up adjustment values
Set up an adjustment value of the offset value or gain value. Select "1", "10," "100", or "1000" on the combo box, however, you can also set up adjustment values by entering a number (1 to 3000).
- (6) Fine adjustment of voltage output or current output
By clicking the button or button, the value of voltage output or current output for the prepared adjustment value is finely adjusted.
- (7) Write settings into module
Write the content set up by operations (3) to (6) into module by clicking the button.
- (a) Precautions
Avoid the following operations during the writing of the data, which has been set up by operations (3) to (6), into the module after the click of the button. Doing so causes an error in the E²PROM data and the D/A converter module may not operate properly.
- 1) Power off the programmable controller CPU.
 - 2) Reset the programmable controller CPU.
- (8) Switch to the normal mode
After the setting is finished, click the button to close the offset/gain setting dialog box, and set Switch 4 of the intelligent function module switch settings to the normal mode. (Refer to Section 4.5.)

POINT

If Error code is displayed while performing the setting operation, the details and measure of the error can be confirmed by clicking the button to the right of the error code display area. In addition, Error code can be cleared by clicking the button.

5.6.4 Confirmation of Conversion Characteristic

[Purpose]

The converted value of digital-analog conversion can be confirmed according to the tilt of the graph, based on the offset/gain setting.

[Operating procedure]

Monitor/Test window → **Offset/gain setting** → **Conversion characteristic**

[Setting screen]

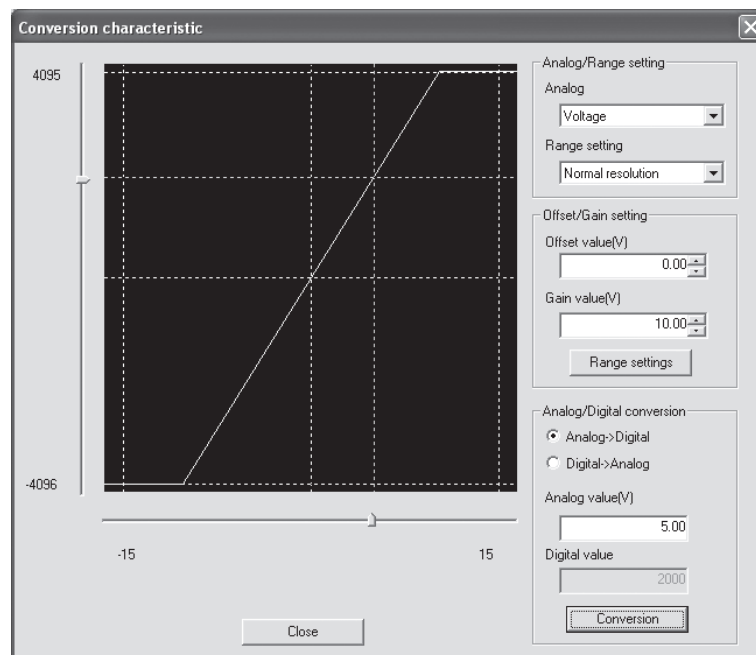

[Explanation of items]

(1) Items

I/O characteristic diagram: Displays the I/O conversion characteristic to the prepared offset/gain setting.

(2) Setting details

Analog/Range setting

Analog: Select the output (voltage/current) when a digital value is converted to an analog value.

Range setting: Make selection from "Normal resolution" or "High resolution".

Refer to Section 3.1.1 for the digital input values and maximum resolutions of the normal resolution mode and high resolution mode.

Offset/Gain setting

Offset value: Enter an offset value to display the I/O characteristic diagram.

Gain value: Enter a gain value to display the I/O characteristic diagram.

Analog/Digital conversion: Select a conversion type shown below for confirming the correspondence between an analog value and a digital value caused by the conversion characteristic.

- Digital → Analog

- Analog → Digital

Analog value: <When converted to a digital value>

Enter an analog value to be converted to a digital value

<When converted to an analog value>

The analog value converted from a digital value is displayed.

Digital value: <When converted to a digital value>

The digital value corresponding to an entered analog value is displayed.

<When converted to an analog value>

Enter a digital value to be converted to an analog value.

POINT

- The offset value is the analog output value (voltage or current) when a digital entry value of 0 is set from the programmable controller CPU.
- The gain value is the analog value (voltage or current) output when the digital input value set from the programmable controller CPU is as follows:

4000 (When Normal resolution is selected)

12000 (When High resolution is selected)

(3) Command button

Range setting

The entered offset/gain value is determined, and the I/O characteristic diagram is updated.

Conversion

Conversion for the entered value is performed.

5.6.5 Pass data (Q62DAN/Q64DAN/Q62DA/Q64DA)

Perform operation in the following sequence to save/restore the user range.

(1) Switch to the pass data window

Perform the operation in Section 5.6.1 to display the Pass data window.

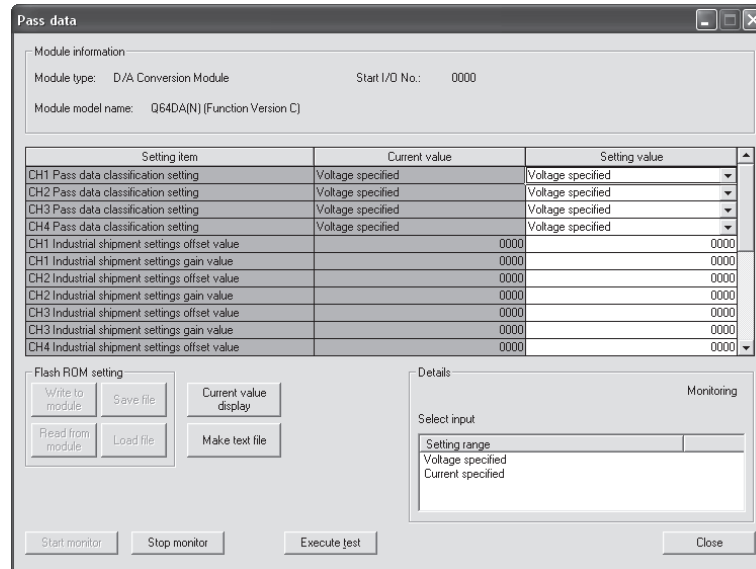

(2) User range saving

- (a) Set "Voltage specified" or "Current specified" in the Setting value field of CH□ Pass data classification setting, and click the **Execute test** button.

When the setting is completed, the set data is displayed in the Current value field of CH□ Pass data classification setting.

- (b) Change the Setting value field of Pass data read request to "Request", and click the **Execute test** button.

When read is completed, the values are displayed in the Current value fields of CH□ Industrial shipment settings offset/gain values/CH□ User range settings offset/gain values.

- (c) Compare the values with those in the range reference table, and record them if they are correct.

Refer to Section 7.4 for the range reference table.

(3) User range restoration

- (a) Set "Voltage specified" or "Current specified" in the Setting value field of CH□ Pass data classification setting, and click the button.

When the setting is completed, the set data is displayed in the Current value field of CH□ Pass data classification setting.

- (b) Set the values recorded in the setting value fields of CH□ Industrial shipment settings offset/gain values/user range settings offset/gain values.

- (c) Select all the setting value fields of CH□ Industrial shipment settings offset/gain values and User range settings offset/gain values, and click the button.

When write is completed, the set values are displayed in the Current value fields of CH□ Industrial shipment settings offset/gain values and CH□ User range settings offset/gain values.

- (d) Change the Setting value field of Pass data write request to "Request", and click the button.

Make sure that the indication in the Current value field of Pass data write request changes from "Request" to "OFF" on completion of write.

5.6.6 Pass data (Q68DAVN/Q68DAIN/Q68DAV/Q68DAI)

Perform operation in the following sequence to save/restore the user range.

(1) Switch to the Pass data window

Perform the operation in Section 5.6.1 to display the pass data window.

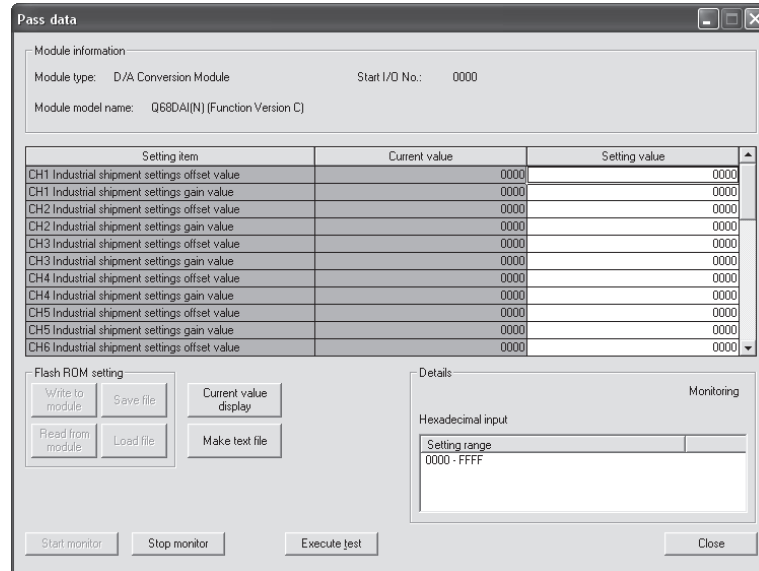

(2) User range saving

- (a) Change the Setting value field of Pass data read request to "Request", and click the **Execute test** button.

When read is completed, the values are displayed in the current value fields of CH□ Industrial shipment settings offset/gain values and CH□ User range settings offset/gain values.

- (b) Compare the values with those in the range reference table, and record them if they are correct.

Refer to Section 7.4 for the range reference table.

(3) User range restoration

- (a) Set the values recorded in the Setting value fields of CH□ Industrial shipment settings offset/gain values and User range settings offset/gain values.

- (b) Select all the Setting value fields of CH□ Industrial shipment settings offset/gain values/user range settings offset/gain values, and click the **Execute test** button.

When write is completed, the set values are displayed in the current value fields of CH□ Industrial shipment settings offset/gain values and CH□ User range settings offset/gain values.

- (c) Change the Setting value field of Pass data write request to "Request", and click the **Execute test** button.

Make sure that the indication in the Current value field of Pass data write request changes from "Request" to "OFF" on completion of write.

5.7 FB Conversion of Initial Setting/Auto Refresh Setting

[Purpose]

FB is generated automatically from the intelligent function module parameter (initial setting/auto refresh setting).

[Operating procedure]

Intelligent Function Module Parameter Setting Module Selection dialog box → <<FB Support Parameter>> tab → **FB conversion**

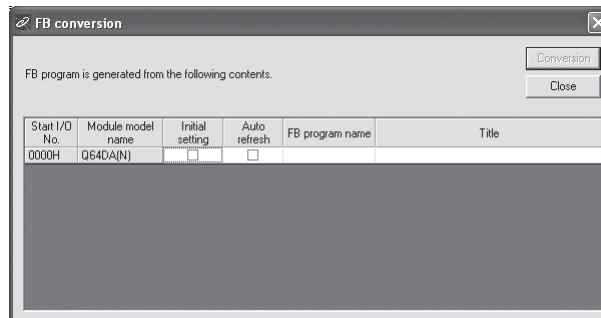
[Setting dialog box]**[Explanation of items]****(1) Items**

Start I/O No.:

The start I/O No. of the information which is set up on the currently open intelligent function module parameter is displayed.

Module model name:

The module model name of the information which is set up on the currently open intelligent function module parameter is displayed.

Initial setting:

Set up whether to apply FB conversion to the parameter or not.

Check if you apply FB conversion to the parameter.

Auto refresh:

Set up whether to apply FB conversion to the parameter or not.

Check if you apply FB conversion to the parameter.

FB program name:

Set up the name of the converted FB program.

Up to six single-byte characters can be set up as an FB program name.

However, the characters and terms shown below cannot be set up as FB program name.

Character: \, /, :, ;, *, ?, ", <, >, |, ,

Term: COM1 to COM9, LPT1 to LPT9, AUX, PRN, CON, NUL, CLOCK\$

In addition, I- is added for initial setting and A- is added for auto refresh setting respectively to the top of the FB name setting to be registered in GX Developer after FB conversion is performed.

Ex.: If the FB program name is "ABCDE", the initial setting is "I-ABCDE" and the auto refresh setting is "A-ABCDE".

Title: Set up a title on a converted FB program. Up to 32 single-byte characters can be set up as a title.

(2) Command buttons

Conversion

FB conversion is performed for the checked columns of initial setting and auto refresh setting.

5.8 Usage of FB

This section describes the procedure for using FB with GX Developer.
 Refer to the "GX Developer Version 8 Operating Manual (Function Block)" for details.

5.8.1 Outline

The procedure for creating FB is shown below.

- (1) Set up the intelligent function module parameter (initial setting/auto refresh setting).
- (2) Convert the intelligent function module parameter into FB.
- (3) Paste the FB to a sequence program.
- (4) Convert (compile) the sequence program.

Next, a flowchart of procedures (1) to (4) is shown below.

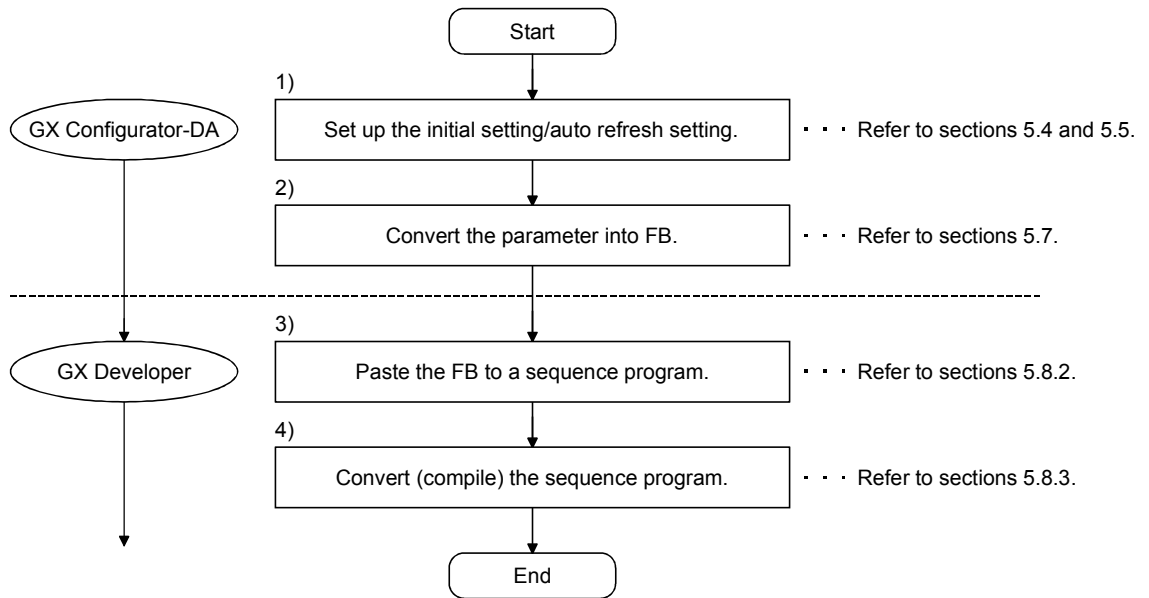

POINT

The initial setting/auto refresh setting of the intelligent function module can be performed by each of the following methods.

- (1) Set intelligent function parameters (Initial setting/Auto refresh setting) and write them to the programmable controller CPU.
- (2) Create an FB of the intelligent function module parameter (initial setting/auto refresh setting) and paste it to the sequence program.

In accordance with the specification of the system, perform the initial setting/auto refresh setting of the intelligent function module by one of the methods above. *¹

*1: The following explains the case in which both of (1) and (2) are performed.

(a) Initial setting

FB setting given in (2) is valid.

(b) Auto refresh setting

- Both (1) and (2) are valid.
- At the time of FB execution and in the END processing of the sequence program, automatic refresh is performed.

Therefore, an analog value corresponding to the specified digital value is output at each auto refresh time.

5.8.2 Paste an FB to a Sequence Program

[Purpose of operation]

Paste an FB in order to use it with a sequence program.

[Operation procedure]

Switch the <<Project>> tab into the <<FB>> tab on GX Developer, and drag & drop the FB to be used onto the sequence program.

Before pasting

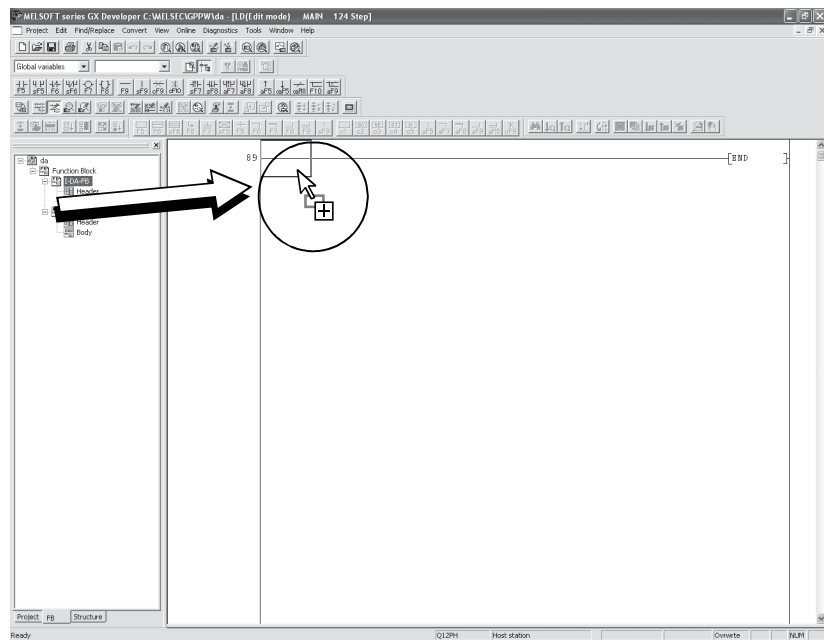

After pasting

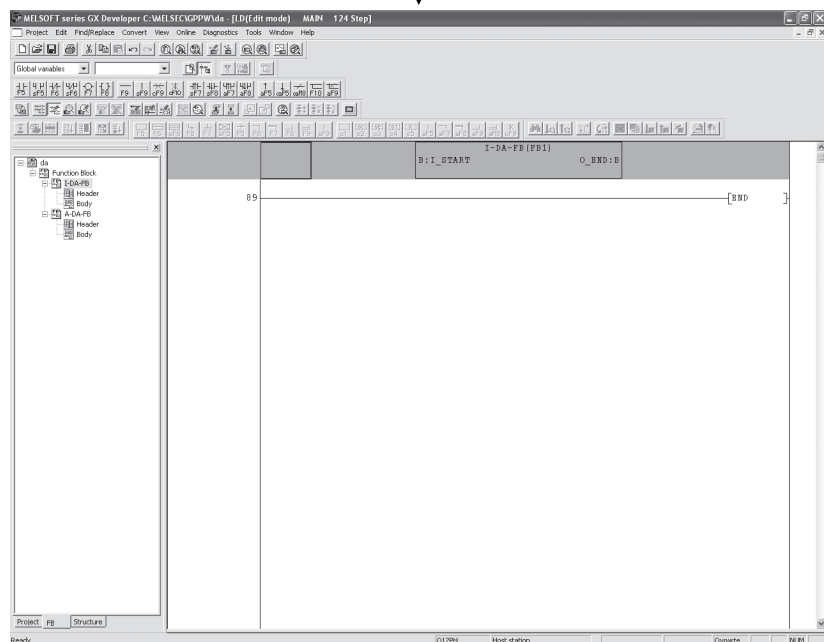

5.8.3 Convert (Compile) a Sequence Program

[Purpose of operation]

Convert (compile) the sequence program to which an FB was pasted so that it can be executed.

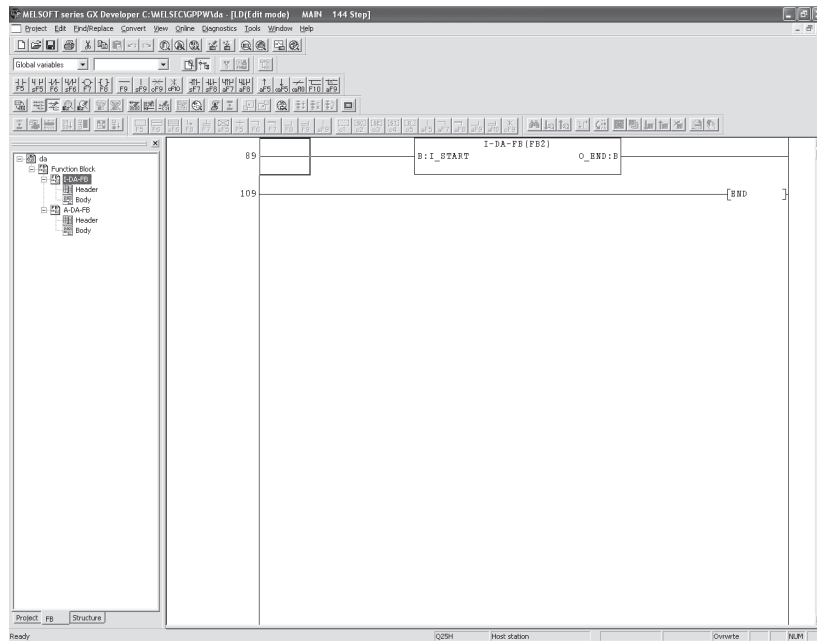

[Operation procedure]

Click the [Convert] menu → [Convert/Compile] menu of GX Developer.

6 PROGRAMMING

This chapter describes the programs of the D/A converter module.

When applying any of the program examples introduced in this chapter to the actual system, verify the applicability and confirm that no problems will occur in the system control.

6.1 For Use in Normal System Configuration

System configuration used in the program explanation

(1) System configuration

Power supply module	QnCPU	Q62DA	QX10	QY10		
		X/Y0 to X/YF	X/Y10 to X/Y1F	X/Y20 to X/Y2F		

Perform the following intelligent function module switch settings in advance.

- Switch 1 0030H (CH1: 4 to 20mA, CH2: 0 to 5V)
- Switch 2 Empty
- Switch 3 0000H (CH1, CH2: Clear)
- Switch 4 0000H (Normal mode (D/A conversion processing))
- Switch 5 0000H (0: Fixed)

(2) Program conditions

If a digital value writing error occurs while a digital value is being written into CH1 or CH2 Digital value area for the Q62DA, read Error code.

(a) Contents of initial setting

- Analog output enabled channel CH1 and CH2

(b) Devices used by the user

- Output enable X10
- Digital value write signal X11
- Error code reset signal X12
- Error code display (3-digit BCD) Y20 to Y2B
- CH1 Digital value D11
- CH2 Digital value D12
- Error code D13

6.1.1 Programming example using the utility package

- (1) Operating the utility package
 - (a) Initial setting (Refer to Section 5.4.)
 CH1, CH2 D/A conversion enable/disable setting "Enable"

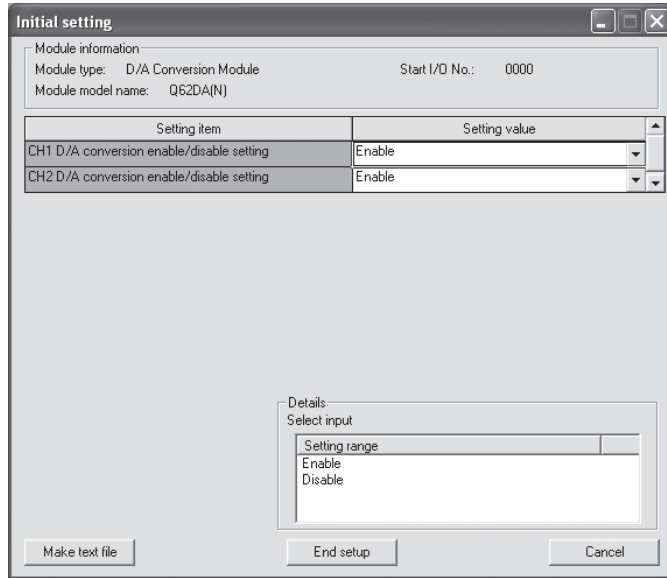

- (b) Automatic refresh setting (Refer to Section 5.5.)
 CH1, CH2 Digital value "D11, D12"
 Error code "D13"

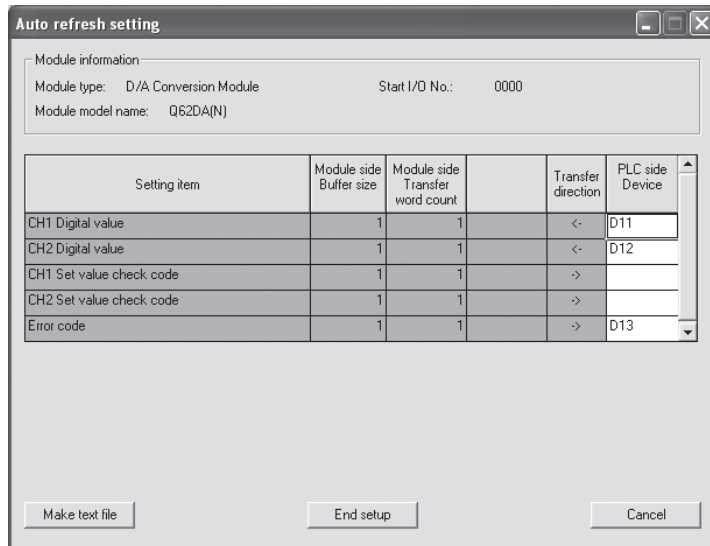

- (c) Writing the intelligent function module parameters (Refer to Section 5.3.3.)
 Write the intelligent function module parameters to the CPU module.
 This operation is performed using the parameter setting module selection screen.

(2) Programming example

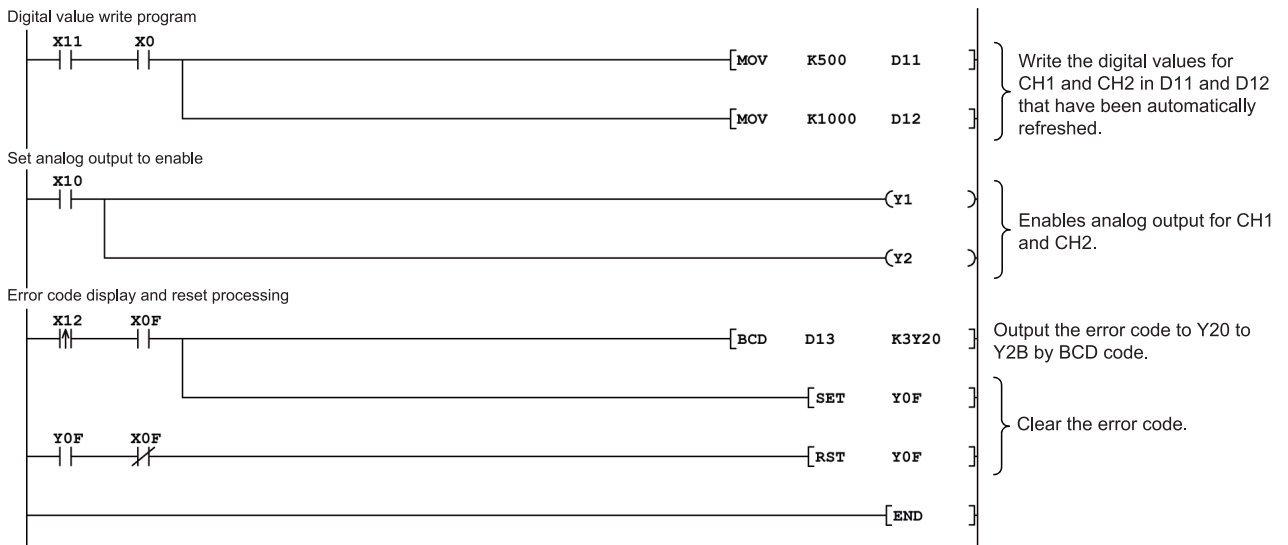

6.1.2 Programming example without using the utility package

(1) Programming example using the FROM/TO commands

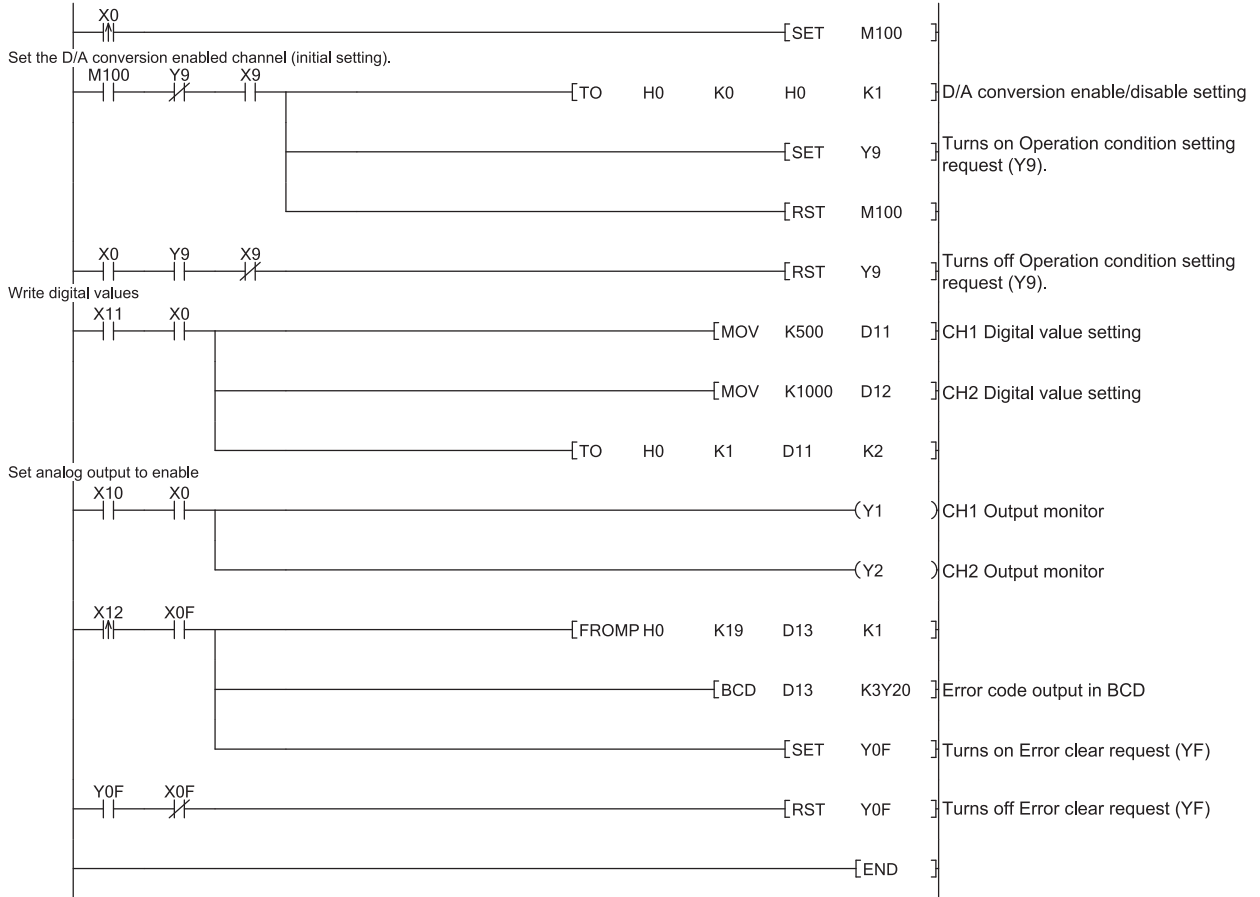

(2) Programming example using the intelligent function module device (U□\G□)

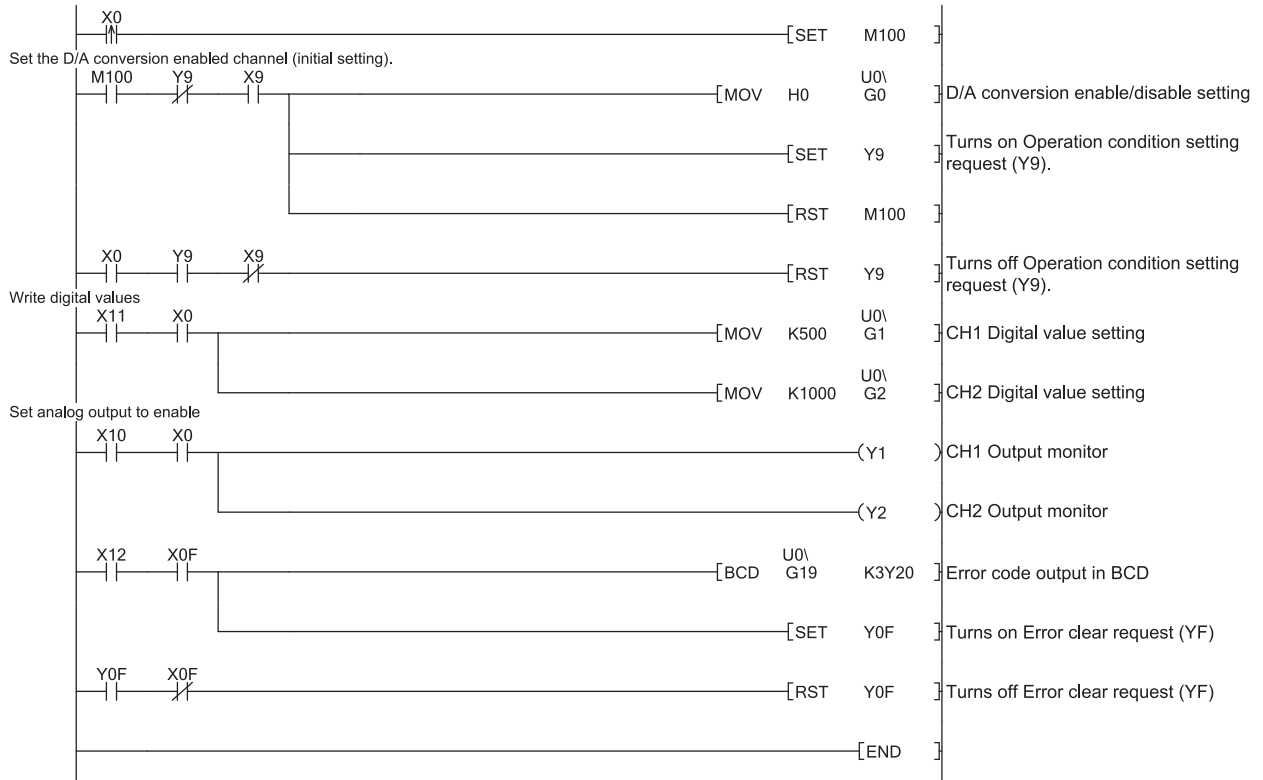

6.2 For Use on Remote I/O Network

System configuration used in the program explanation

(1) System configuration

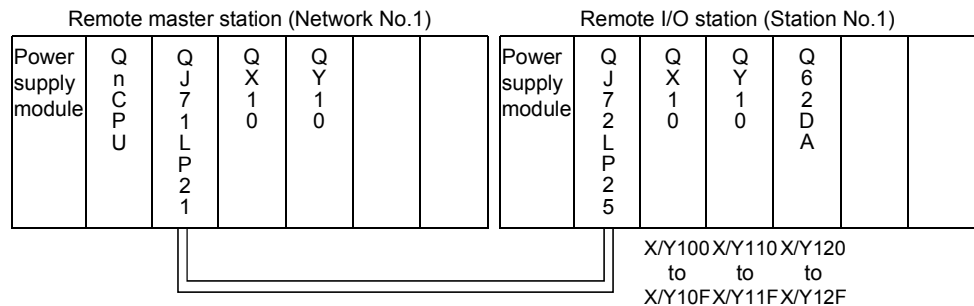

Perform the following intelligent function module switch settings in advance.

- Switch 1 0030H (CH1: 4 to 20mA, CH2: 0 to 5V)
- Switch 2 Empty
- Switch 3 0000H (CH1, CH2: Clear)
- Switch 4 0000H (Normal mode (D/A conversion processing))
- Switch 5 0000H (0: Fixed)

(2) Program conditions

The digital values of CH1 and CH2 of the Q62DA are written, and if a digital value write error occurs, Error code is displayed in BCD.

- (a) Initial settings
- Analog output enabled channel..... CH1, CH2
- (b) Devices used by user
- Initial setting request signalX20
 - Output enable.....X21
 - Digital value write signalX22
 - Error code reset signal.....X23
 - Error code display (BCD 3 digits) Y30 to Y3B
 - CH1 digital valueD11 (W11)
 - CH2 digital valueD12 (W12)
 - Error code.....D13 (W113)

POINT

For details on the MELSECNET/H remote I/O network, refer to the Q Corresponding MELSECNET/H Network System Reference Manual (Remote I/O Network).

6.2.1 Programming example using the utility package

(1) Operating GX Developer

(a) Network parameter setting

- Network type : MNET/H (remote master)
- Head I/O No. : 0000H
- Network No. : 1
- Total number of (slave) stations : 1
- Mode : Online
- Network range assignment :

StationNo.	M station -> R station						M station <- R station					
	Y			Y			X			X		
	Points	Start	End	Points	Start	End	Points	Start	End	Points	Start	End
1	256	0100	01FF	256	0000	00FF	256	0100	01FF	256	0000	00FF

StationNo.	M station -> R station			M station <- R station			M station -> R station			M station <- R station		
	B			B			W			W		
	Points	Start	End	Points	Start	End	Points	Start	End	Points	Start	End
1							256	0000	00FF	256	0100	01FF

- Refresh parameters :

	Link side					PLC side			
	Dev. name	Points	Start	End		Dev. name	Points	Start	End
Transfer SB	SB	512	0000	01FF	↔	SB	512	0000	01FF
Transfer SW	SW	512	0000	01FF	↔	SW	512	0000	01FF
Random cyclic	LB				↔				
Random cyclic	LW				↔				
Transfer1	LB	8192	0000	1FFF	↔	B	8192	0000	1FFF
Transfer2	LW	8192	0000	1FFF	↔	w	8192	0000	1FFF
Transfer3	LX	512	0000	01FF	↔	X	512	0000	01FF
Transfer4	LY	512	0000	01FF	↔	Y	512	0000	01FF
Transfer5					↔				
Transfer6					↔				

(2) Operating the utility package

(a) Initial setting (Refer to Section 5.4)

CH1, CH2 D/A conversion enable/disable setting "Enable"

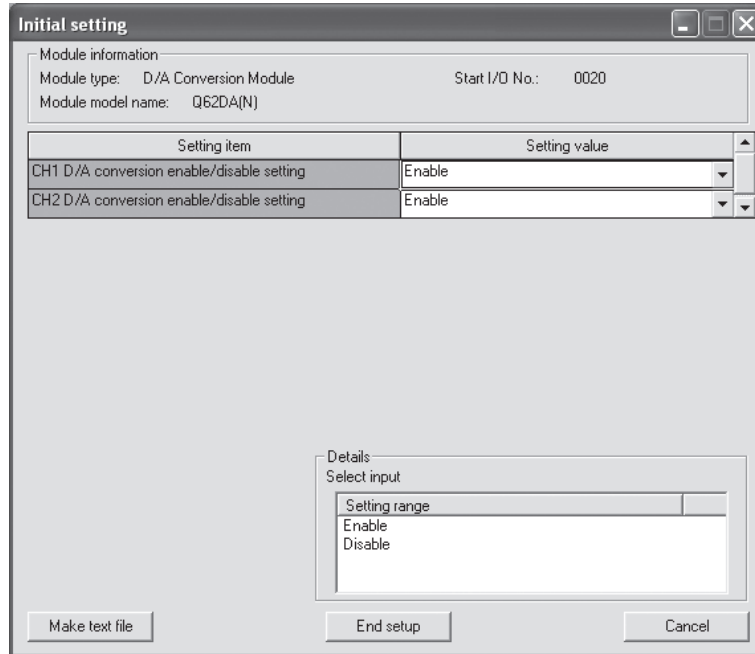

(b) Auto refresh setting (Refer to Section 5.5)

CH1, CH2 digital value W11, W12

Error code W113

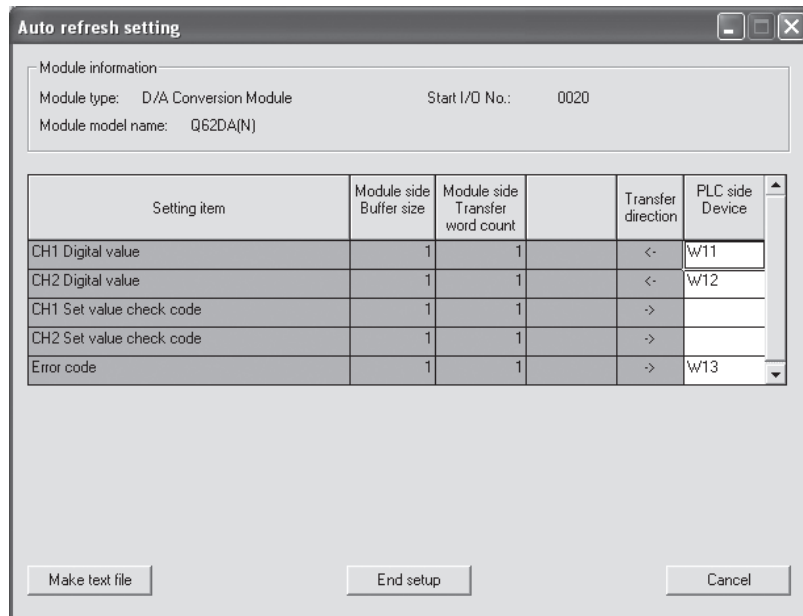

(c) Write of intelligent function module parameters (Refer to Section 5.3.3)

The intelligent function module parameters are written to the remote I/O station.

Perform this operation on the parameter setting module selection screen.

(3) Programming example

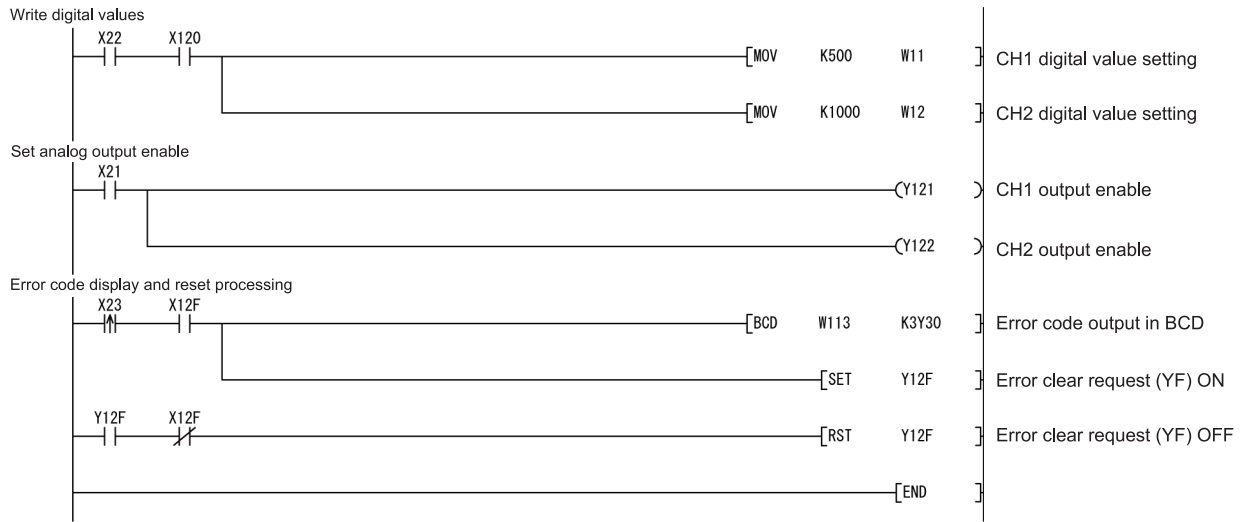

POINT

To write the intelligent function module parameters, set the target remote I/O station from [Online] - [Transfer setup] on GX Developer.

They can be written by:

- Directly connecting GX Developer to the remote I/O station.
- Connecting GX Developer to another device such as a CPU module and passing through the network.

6.2.2 Programming example without using the utility package

(1) Operation of GX Developer (Network parameter setting)

- Network type : MNET/H (remote master)
- Head I/O No. : 0000H
- Network No. : 1
- Total number of (slave) stations : 1
- Mode : Online
- Network range assignment :

StationNo.	M station -> R station						M station <- R station					
	Y			Y			X			X		
	Points	Start	End	Points	Start	End	Points	Start	End	Points	Start	End
1	256	0100	01FF	256	0000	00FF	256	0100	01FF	256	0000	00FF

- Refresh parameters :

	Link side						PLC side				
	Dev. name	Points	Start	End	Dev. name		Points	Start	End		
Transfer SB	SB	512	0000	01FF	↔	SB	512	0000	01FF		
Transfer SW	SW	512	0000	01FF	↔	SW	512	0000	01FF		
Random cyclic	LB				↔						
Random cyclic	LW				↔						
Transfer1	LB	8192	0000	1FFF	↔	B	8192	0000	1FFF		
Transfer2	LW	8192	0000	1FFF	↔	w	8192	0000	1FFF		
Transfer3	LX	512	0000	01FF	↔	X	512	0000	01FF		
Transfer4	LY	512	0000	01FF	↔	Y	512	0000	01FF		
Transfer5					↔						
Transfer6					↔						

(2) Programming example

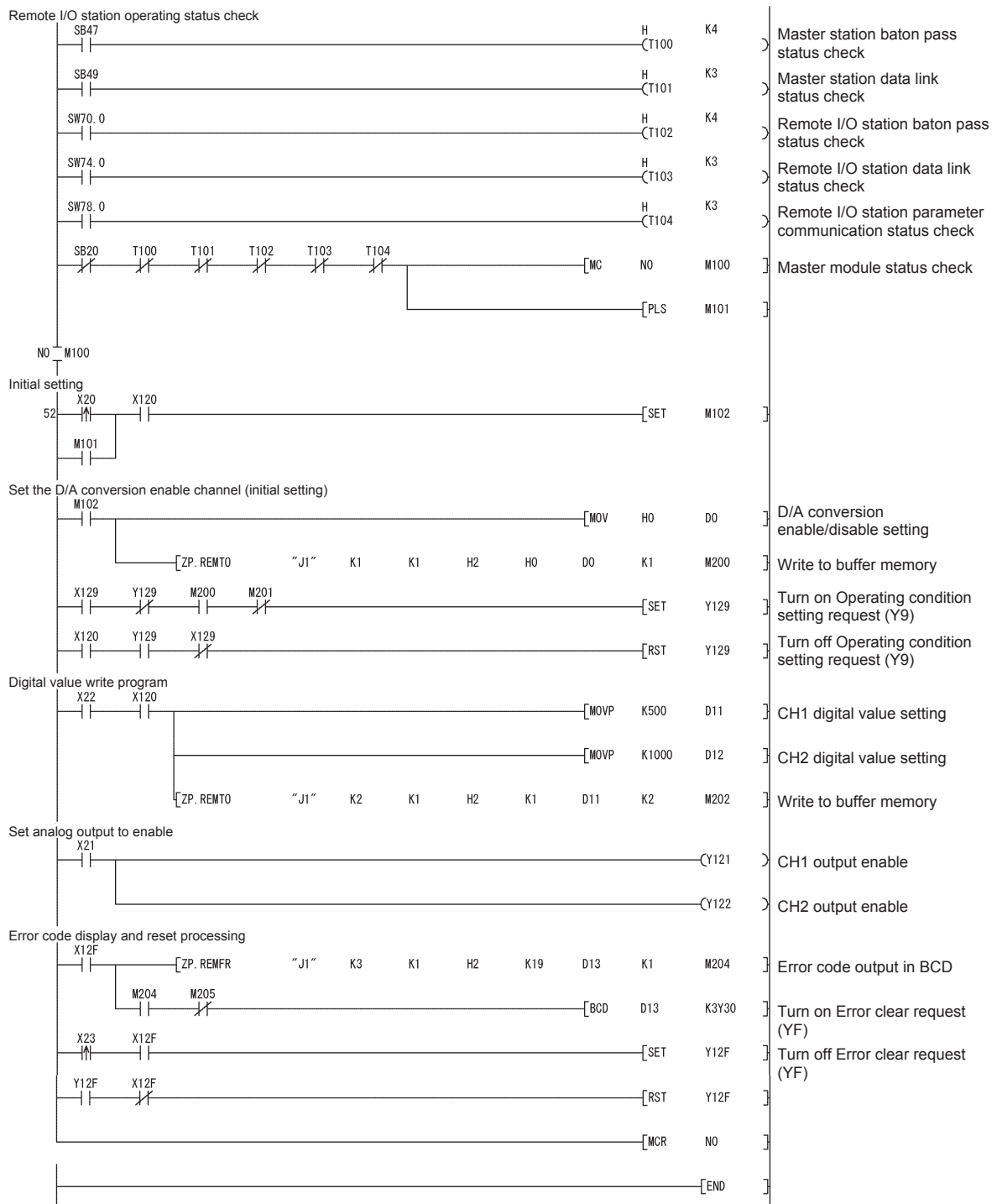

7 ONLINE MODULE CHANGE

When changing a module online, carefully read the QCPU User's Manual (Hardware Design, Maintenance and Inspection), Section 12.4.1 "Online module change".

This chapter describes the specifications of an online module change.

- (1) Perform an online module change by operating GX Developer.
- (2) To ensure ease of offset/gain re-setting, there is a user range save/restoration function that is performed by executing the dedicated instruction or read/write from/to buffer memory.

POINT
<p>(1) Perform an online module change after making sure that the system outside the programmable controller will not malfunction.</p> <p>(2) To prevent an electric shock and malfunction of operating modules, provide means such as switches for powering off each of the external power supply and external devices connected to the module to be replaced online.</p> <p>(3) After the module has failed, data may not be saved properly. Referring to Section 3.4.15, therefore, prerecord the data to be saved (offset/gain values of the industrial shipment settings and user range settings in the buffer memory).</p> <p>(4) It is recommended to perform an online module change in the actual system in advance to ensure that it would not affect the other modules by checking the following:</p> <ul style="list-style-type: none"> • Means of cutting off the connection to external devices and its configuration are correct. • Switching on/off does not bring any undesirable effect. <p>(5) Do not install/remove the module to/from the base unit, or the terminal block to/from the module more than 50 times after the first use of the product. (IEC 61131-2 compliant) Failure to do so may cause malfunction.</p>

(Note)

The dedicated instruction cannot be executed during an online module change. When using the dedicated instruction to execute save/restoration, therefore, execute save/restoration in the other system. *1

If the other system is unavailable, execute restoration by performing write to the buffer memory.

- *1 If the module is mounted on the remote I/O station, execute save/restoration in the other system mounted on the main base unit. (Save/restoration cannot be executed in the other system mounted on the remote I/O station.)

7.1 Online Module Change Conditions

The CPU, MELSECNET/H remote I/O module, D/A converter module, GX Developer and base unit given below are needed to perform an online module change.

(1) CPU

The Process CPU and Redundant CPU are required.

For precautions for multiple CPU system configuration, refer to the QCPU User's Manual (Multiple CPU System).

For precautions for redundant system configuration, refer to the QnPRHCPU User's Manual (Redundant system).

(2) MELSECNET/H remote I/O module

The module of function version D or later is necessary.

(3) D/A converter module

The module of function version C or later is necessary.

(4) GX Developer

GX Developer of Version 7.10L or later is necessary.

GX Developer of Version 8.18U or later is required to perform an online module change on the remote I/O station.

(5) Base unit

1) When the slim type main base unit (Q3□SB) is used, an online module change cannot be performed.

2) When the power supply module unnecessary type extension base unit (Q5□B) is used, online module change cannot be performed for the modules on all the base units connected.

7.2 Online Module Change Operations

The following gives the operations performed for an online module change.

CPU operation ○: Executed ×: Not executed						(User operation)	(Intelligent function module operation)
X/Y refresh	FROM/TO instruction * 1	Dedicated instruction	Device test	GX Configurator			
				Initial setting parameter	Monitor/test		
○	○	○	○	×	○	(1) Conversion disable Turn off all Y signals that were turned on by a sequence program.*2 ↓ (2) Dismounting of module Operate GX Developer to start an online module change. ↓ Click the [Execution] button of GX Developer to make the module dismountable. ↓ Dismount the corresponding module. ↓ (3) Mounting of new module Mount a new module. ↓ After mounting the module, click the [Execution] button of GX Developer. ↓ Operation check before control start (4) Operation check Click the [Cancel] button of GX Developer to leave the online mode. ↓ Conduct an operation test on the new module using "Device test" of GX Developer or "Monitor/test" of GX Configurator. (Perform user range restoration processing by write to buffer memory at this point.) ↓ Operation check completed (5) Resumption of control Operate GX Developer to resume the online module change mode, and click the [Execution] button to resume control.	Module is operating as usual. ↓ Module stops operating. • RUN LED turns off. • Conversion disabled. • Analog output is 0V/0mA. ↓ *3 X/Y refresh resumes and the module starts. • RUN LED turns on. • Default operation (X0 remains off.) (When there are initial setting parameters, operation is performed according to the initial setting parameters at this point.) ↓ Module operates according to test operation.*4 ↓ X0 (Module READY) turns on. ↓ Start is made when X0 turns from off to on. Operation is performed according to the initial setting sequence.*4
×	×	×	×	×	×		
○	×	×	×	○	×		
○	×	×	○	×	○		
○	○	○	○	×	○		

* 1: Access to the intelligent function module device (U□G□) is included.

* 2: Operating the intelligent function module switches (* 3) starts the module and resumes X/Y refresh. When there are initial setting parameters, operation is performed according to the initial setting parameters.

Hence, if the Y signals are not turned off, analog outputs will be provided at this point. Therefore, always turn off the Y signals that were turned on by the sequence program.

* 4: In the absence of the operation marked * 4, the operation of the intelligent function module is the operation performed prior to that.

7.3 Online Module Change Procedure

There are the following online module change procedures depending on whether the user range setting has been made or not, whether the initial setting of GX Configurator-DA has been made or not, and whether the other system exists or not.

Range setting	Initial setting	Other system	Reference section
Industrial shipment setting	GX Configurator-DA	—	Section 7.3.1
Industrial shipment setting	Sequence program	—	Section 7.3.2
User range setting	GX Configurator-DA	Present	Section 7.3.3
User range setting	GX Configurator-DA	Absent	Section 7.3.4
User range setting	Sequence program	Present	Section 7.3.5
User range setting	Sequence program	Absent	Section 7.3.6

7.3.1 When industrial shipment setting is used and initial setting was made with GX Configurator-DA

- (1) Conversion disable
 - (a) Take the following steps to disable the conversion:
 - 1) Set D/A conversion enable/disable (buffer memory address 0: Un\G0) to All channel conversion disable (FH).
 - 2) Turn Operating condition setting request (Y9) from off to on to stop the conversion.
 - 3) Operating condition setting completed flag (X9) turns off from on.
 - 4) Check that the conversion is stopped by seeing the actual analog output value.
 - 5) Turn Operating condition setting request (Y9) from on to off.

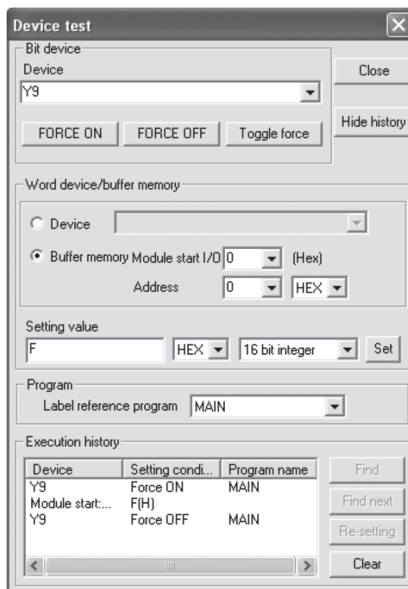

(2) Dismounting of module

- (a) After choosing [Diagnosis] - [Online module change] on GX Developer to enter the "Online module change" mode, double-click the module to be changed online to display the "Online module change" dialog box.

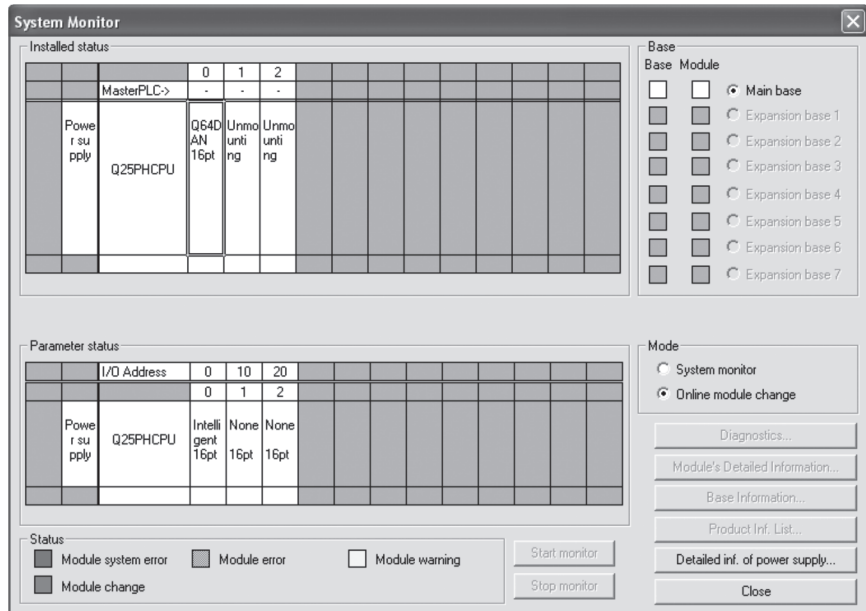

- (b) Click the "Execution" button to enable a module change.

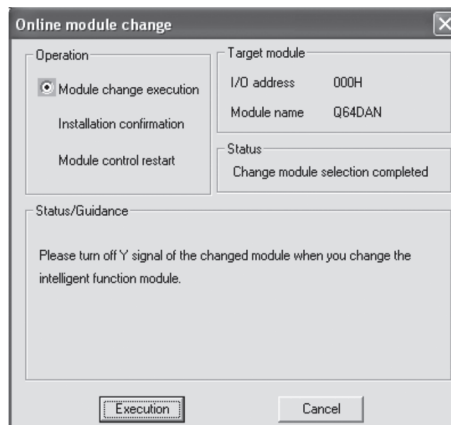

If the following error dialog box appears, click the [OK] button, dismount the module as-is, and mount a new module.

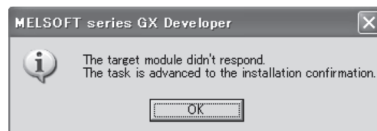

- (c) After confirming that the "RUN" LED of the module has turned off, remove the terminal block and dismount the module.

POINT

Always dismount the module. If mounting confirmation is made without the module being dismounted, the module will not start properly and the "RUN" LED will not be lit.

(3) Mounting of new module

- (a) Mount a new module to the same slot and install the terminal block.
- (b) After mounting the module, click the [Execution] button and make sure that the "RUN" LED is lit. Module ready (X0) remains off.

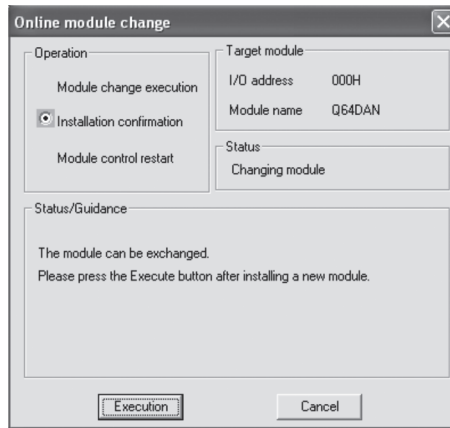

(4) Operation check

- (a) To make an operation check, click the [Cancel] button to cancel control resumption.

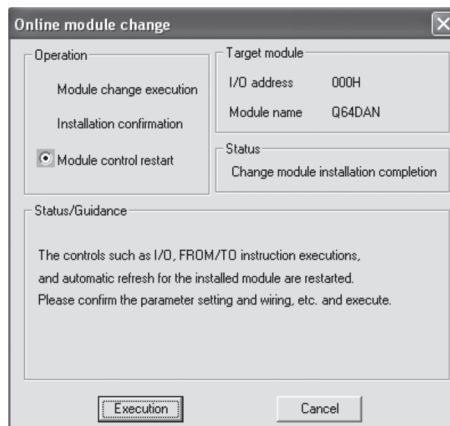

- (b) Click the [OK] button to leave the "Online module change" mode.

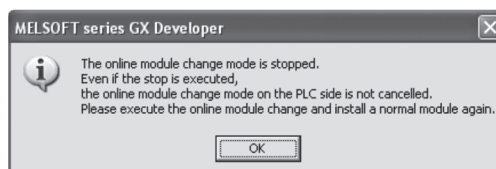

- (c) Click the [Close] button to close the System monitor dialog box.

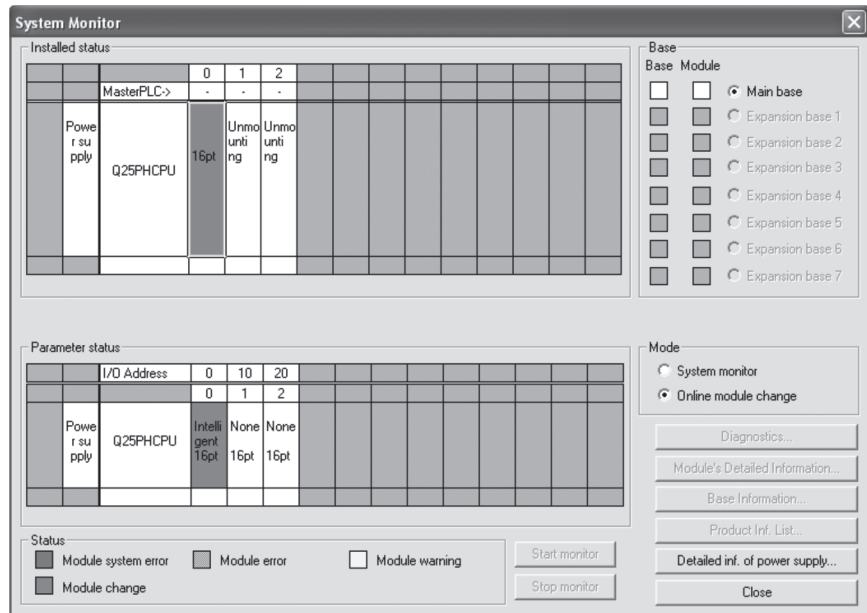

- (d) Set a digital value to CH Digital value (buffer memory address 1 to 8: Un\G1 to 8) and turn on and off Operating condition setting request (Y9). Turn on CH Output enable/disable flag (Y1, Y2) of a channel to be used, and check whether proper conversion has been made or not. (Be careful since analog outputs are provided actually.)

(5) Resumption of control

- (a) After choosing [Diagnosis] - [Online module change] on GX Developer to display the "Online module change" dialog box again, click the [Execution] button to resume control. Module ready (X0) turns on.

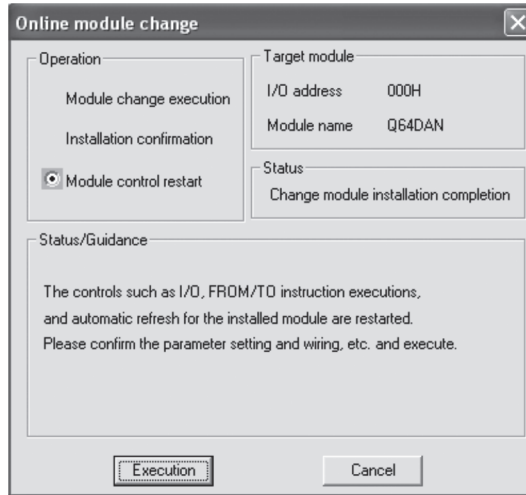

- (b) The "Online module change completed" dialog box appears.



7.3.2 When industrial shipment setting is used and initial setting was made with sequence program

(1) Conversion disable

(a) Take the following steps to disable the conversion:

- 1) Set D/A conversion enable/disable (buffer memory address 0: Un\G0) to All channel conversion disable (F_H).
- 2) Turn Operating condition setting request (Y9) from off to on to stop the conversion.
- 3) Operating condition setting completed flag (X9) turns off from on.
- 4) Check that the conversion is stopped by seeing the actual analog output value.
- 5) Turn Operating condition setting request (Y9) from on to off.

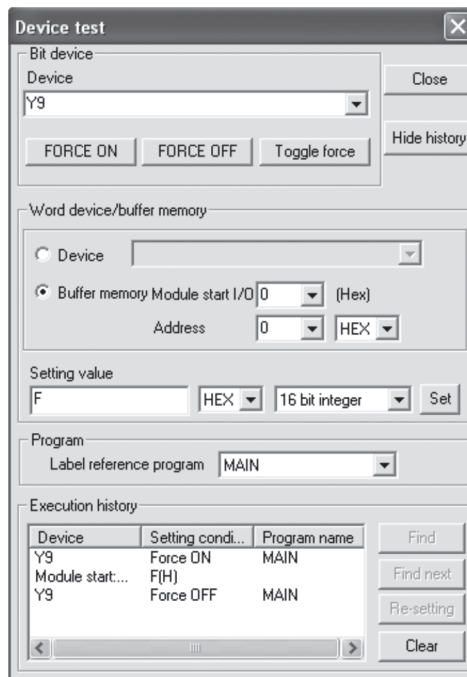

(2) Dismounting of module

- (a) After choosing [Diagnosis] - [Online module change] on GX Developer to enter the "Online module change" mode, double-click the module to be changed online to display the "Online module change" dialog box.

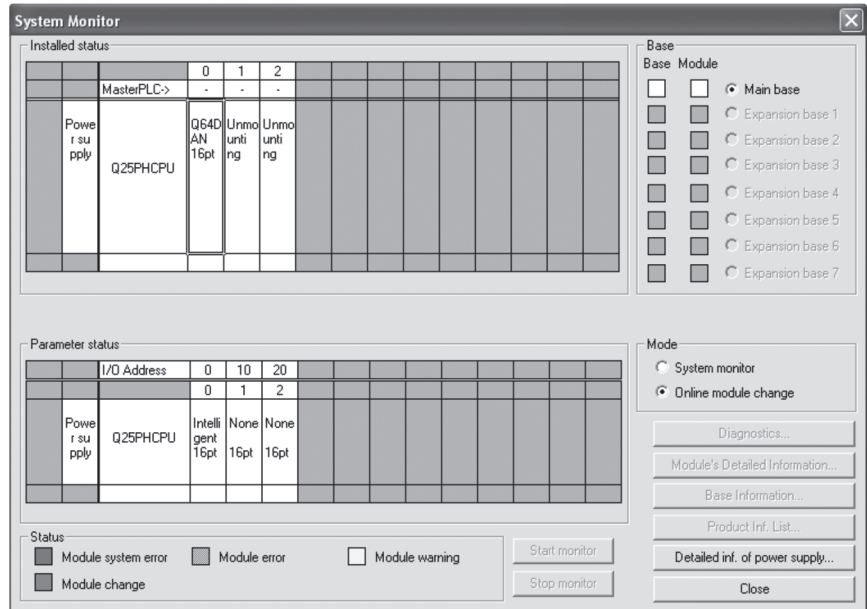

- (b) Click the "Execution" button to enable a module change.

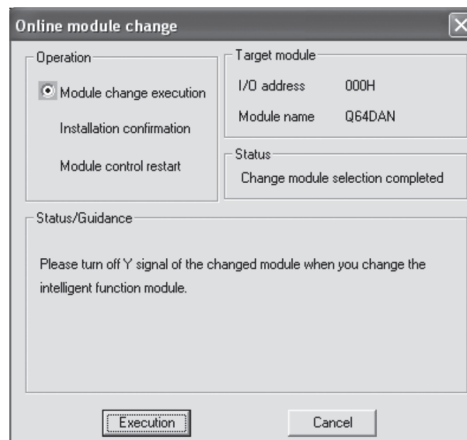

If the following error dialog box appears, click the [OK] button, dismount the module as-is, and mount a new module.

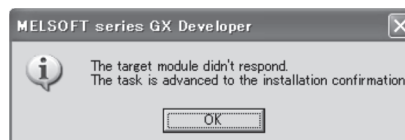

- (c) After confirming that the "RUN" LED of the module has turned off, remove the terminal block and dismount the module.

POINT

Always dismount the module. If mounting confirmation is made without the module being dismounted, the module will not start properly and the "RUN" LED will not be lit.

(3) Mounting of new module

- (a) Mount a new module to the same slot and install the terminal block.
- (b) After mounting the module, click the [Execution] button and make sure that the "RUN" LED is lit. Module ready (X0) remains off.

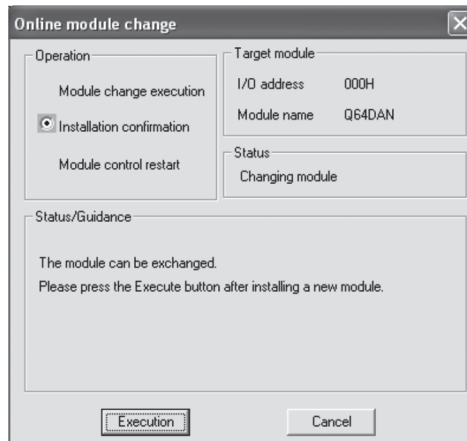

(4) Operation check

- (a) To make an operation check, click the [Cancel] button to cancel control resumption.

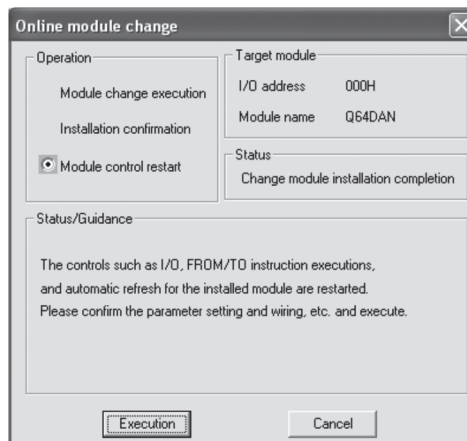

- (b) Click the [OK] button to leave the "Online module change" mode.

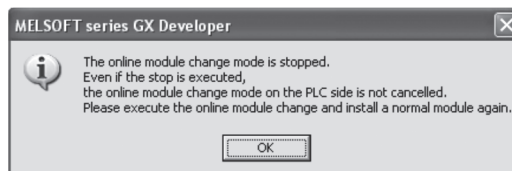

- (c) Click the [Close] button to close the System monitor dialog box.

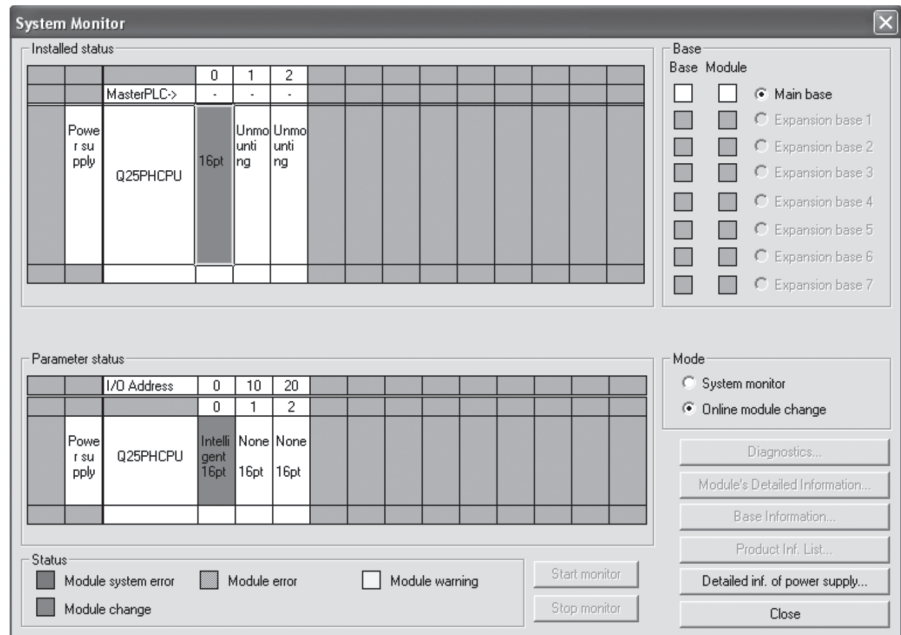

- (d) Enable conversion for a channel to be used by setting D/A conversion enable/disable (buffer memory address 0: Un\G0). Set a digital value to CH Digital value (buffer memory address 1 to 8: Un\G1 to 8) and turn on and off Operating condition setting request (Y9). Turn on CH Output enable/disable flag (Y1, Y2) of a channel to be used, and check whether proper conversion has been made or not. (Be careful since analog outputs are provided actually.)
- (e) Since the new module is in a default status, it must be initialized by a sequence program after control resumption. Before performing initialization, check whether the contents of the initialization program are correct or not.
- 1) Normal system configuration

The sequence program should perform initialization on the leading edge of Module ready (X0) of the D/A converter module. When control resumption is executed, Module ready (X0) turns on and initialization is performed. (If the sequence program performs initialization only one scan after RUN, initialization is not performed.)
 - 2) When used on remote I/O network

Insert a user device that will execute initialization at any timing (initialization request signal) into the sequence program. After control resumption, turn on the initialization request signal to perform initialization. (If the sequence program performs initialization only one scan after a data link start of the remote I/O network, initialization is not performed.)

(5) Resumption of control

- (a) After choosing [Diagnosis] - [Online module change] on GX Developer to display the "Online module change" dialog box again, click the [Execution] button to resume control. Module ready (X0) turns on.

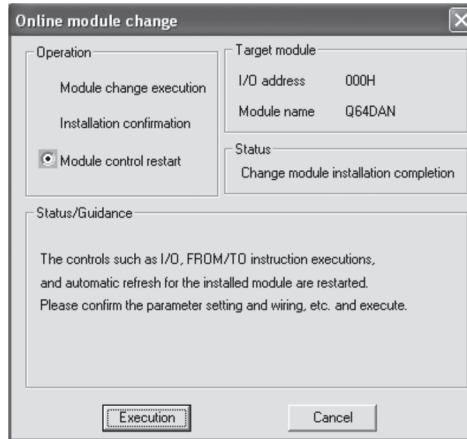

- (b) The "Online module change completed" dialog box appears.



7.3.3 When user range setting is used and initial setting was made with GX Configurator-DA (other system is available)

(1) Conversion disable

(a) Take the following steps to disable the conversion:

- 1) Set D/A conversion enable/disable (buffer memory address 0: Un\G0) to All channel conversion disable (FH).
- 2) Turn Operating condition setting request (Y9) from off to on to stop the conversion.
- 3) Operating condition setting completed flag (X9) turns off from on.
- 4) Check that the conversion is stopped by seeing the actual analog output value.
- 5) Turn Operating condition setting request (Y9) from on to off.

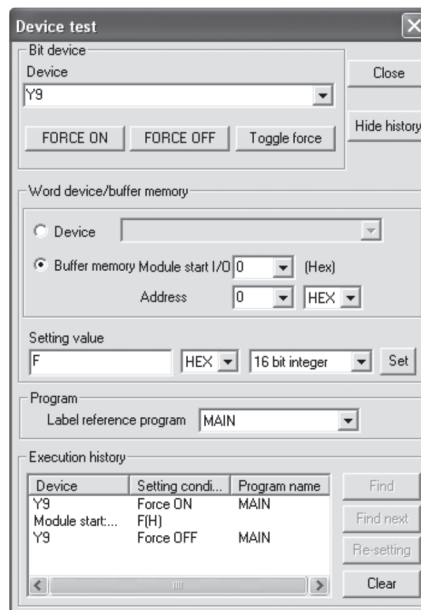

(2) Dismounting of module

- (a) After choosing [Diagnosis] - [Online module change] on GX Developer to enter the "Online module change" mode, double-click the module to be changed online to display the "Online module change" dialog box.

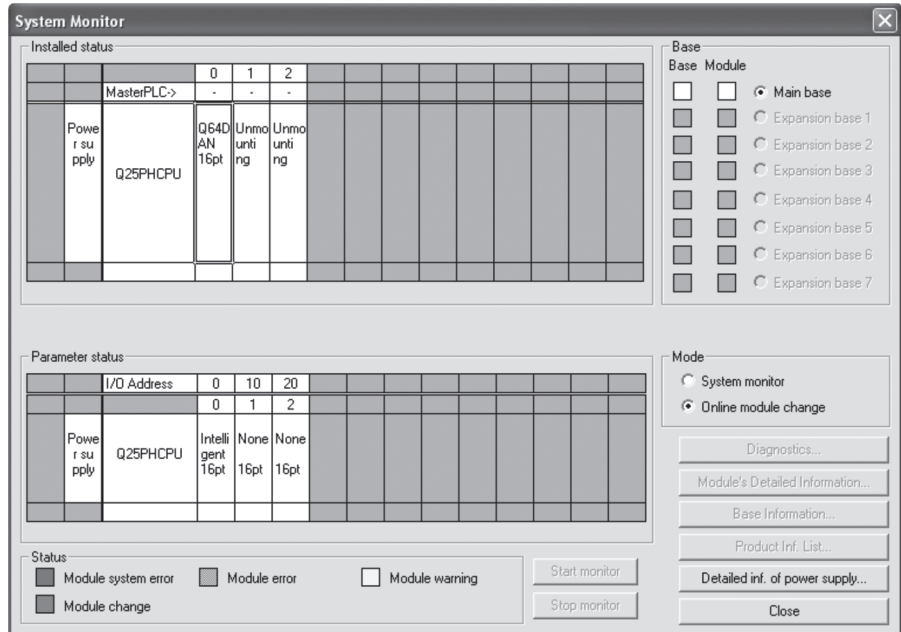

- (b) Click the "Execution" button to enable a module change.

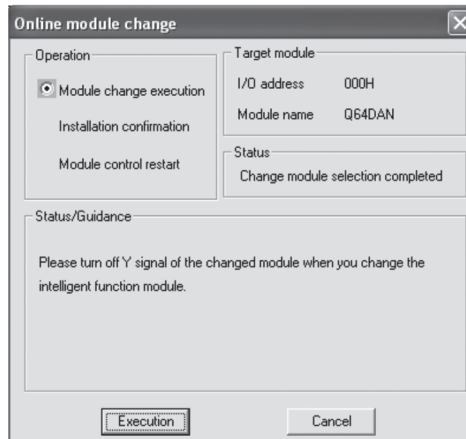

If the following error dialog box appears, the user range cannot be saved. Click the [OK] button, and perform the operation in Section 7.3.4 (2)(c) and later.

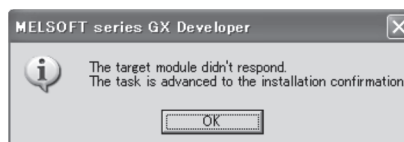

- (c) After confirming that the "RUN" LED of the module has turned off, remove the terminal block and dismount the module.

POINT

Always dismount the module. If mounting confirmation is made without the module being dismounted, the module will not start properly and the "RUN" LED will not be lit.

- (3) Mounting of new module
- (a) Mount the dismounted module and new module to the other system.
 - (b) Using the G(P).OGLOAD instruction, save the user set values to the CPU device. Refer to Appendix 2.2 for the G(P).OGLOAD instruction.
 - (c) Using the G(P).OGSTOR instruction, restore the user set values to the module. Refer to Appendix 2.3 for the G(P).OGSTOR instruction.
 - (d) Dismount the new module from the other system, mount it to the slot from where the old module was dismounted in the original system, and install the terminal block.
 - (e) After mounting the module, click the [Execution] button and make sure that the "RUN" LED is lit. Module ready (X0) remains off.

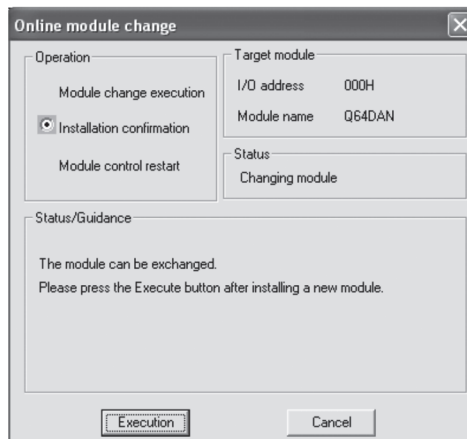

(4) Operation check

- (a) To make an operation check, click the [Cancel] button to cancel control resumption.

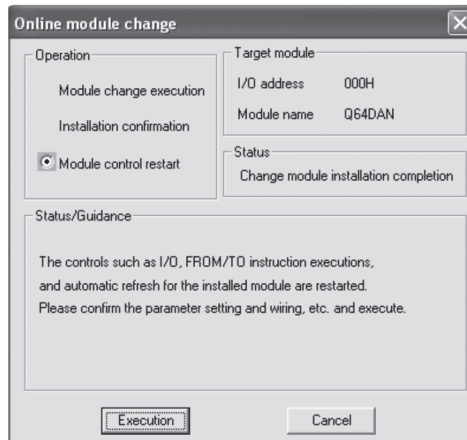

- (b) Click the [OK] button to leave the "Online module change" mode.

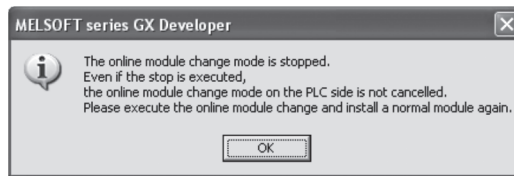

- (c) Click the [Close] button to close the System monitor dialog box.

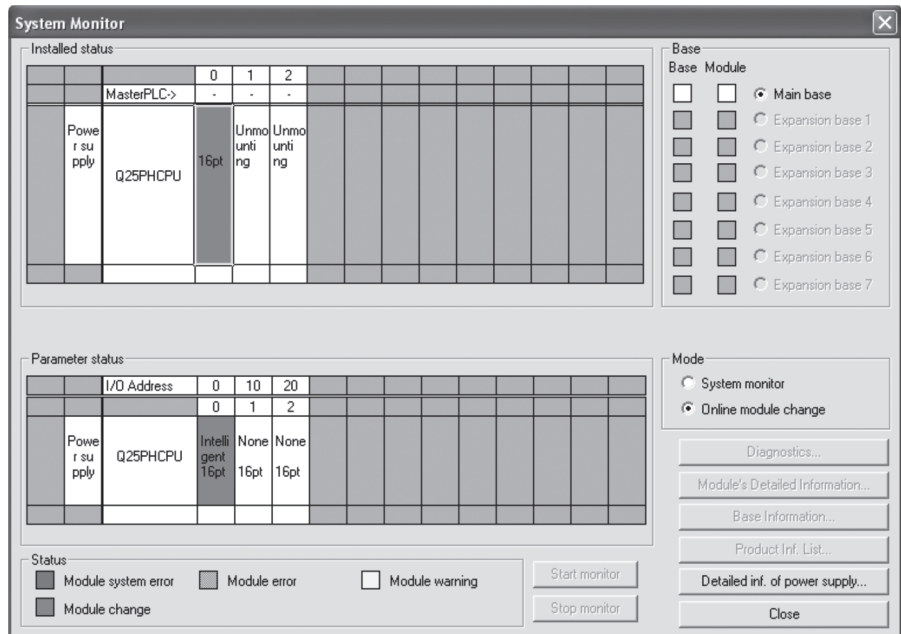

- (d) Set a digital value to CH□ Digital value (buffer memory address 1 to 8: Un\G1 to 8) and turn on and off Operating condition setting request (Y9). Turn on CH□ Output enable/disable flag (Y1, Y2) of a channel to be used, and check whether proper conversion has been made or not. (Be careful since analog outputs are provided actually.)

(5) Resumption of control

- (a) After choosing [Diagnosis] - [Online module change] on GX Developer to display the "Online module change" dialog box again, click the [Execution] button to resume control. Module ready (X0) turns on.

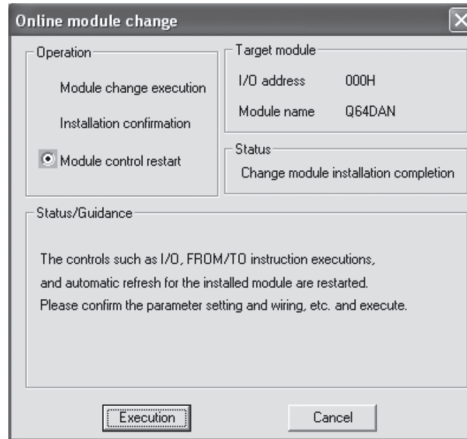

- (b) The "Online module change completed" dialog box appears.



7.3.4 When user range setting is used and initial setting was made with GX Configurator-DA (other system is unavailable)

(1) Conversion disable

- (a) On the Operating condition setting window of GX Configurator-DA, set "Disable" in the Setting value field of CH□ D/A conversion enable/disable setting, and click the [Execute test] button.

Confirm that conversion has stopped with the actual analog output value.

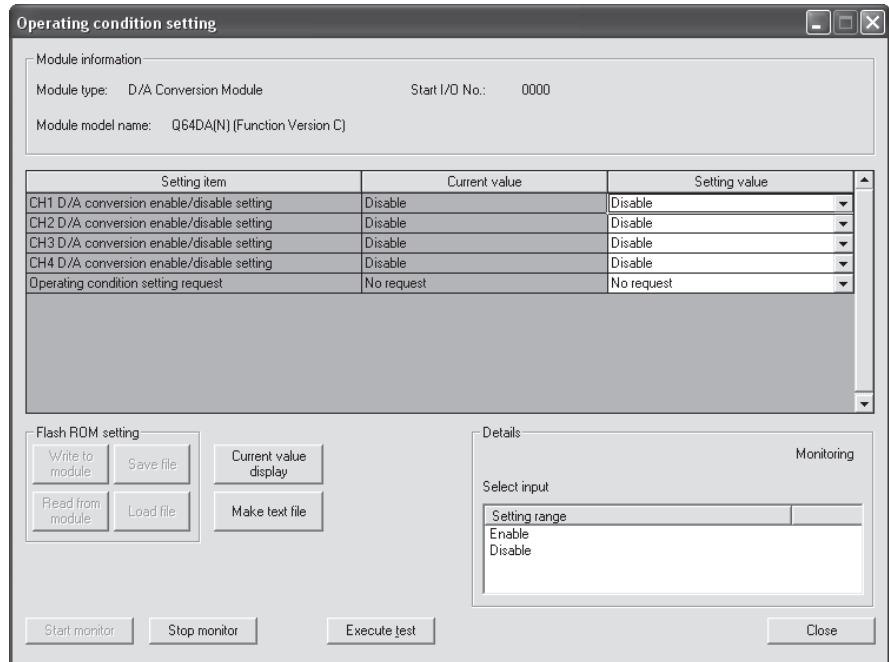

- (b) After checking the indication in the current value field of CH□ D/A conversion enable/disable setting is "Disable", change the setting value field of Operating condition setting request to "Setting request", and click the [Execute test] button to stop conversion.

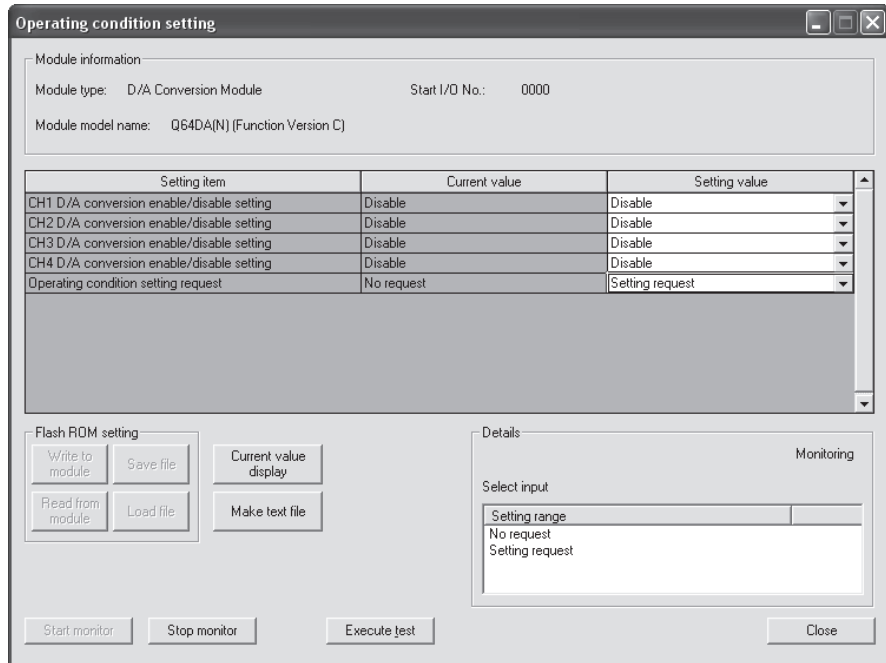

- (c) If the saved buffer memory contents are not yet prerecorded, record them in the following procedure.
- 1) Display the pass data window of GX Configurator-DA.
 - 2) Set Pass data classification setting * 1 and make a pass data read request. (Refer to Section 5.6.5, 5.6.6.)
 - 3) Compare the current values of the industrial shipment settings and user range settings offset/gain values with those of the range reference table. Refer to Section 7.4 for the range reference table.
 - 4) If the values are proper, record the offset/gain values of Pass data classification setting, industrial shipment settings and user range settings.
- *1 The Q68DAVN/Q68DAIN/Q68DAV/Q68DAI does not require the setting and recording of Pass data classification setting.

POINT

If the buffer memory values compared with the reference table are not proper, save and restoration of the user range cannot be executed.

Before executing module control resumption, make offset/gain setting in the GX Configurator-DA. (Refer to Section 5.6.2)

Note that if module control is resumed without offset/gain setting being made, operation will be performed with the default values.

(2) Dismounting of module

- (a) After choosing [Diagnosis] - [Online module change] on GX Developer to enter the "Online module change" mode, double-click the module to be changed online to display the "Online module change" dialog box.

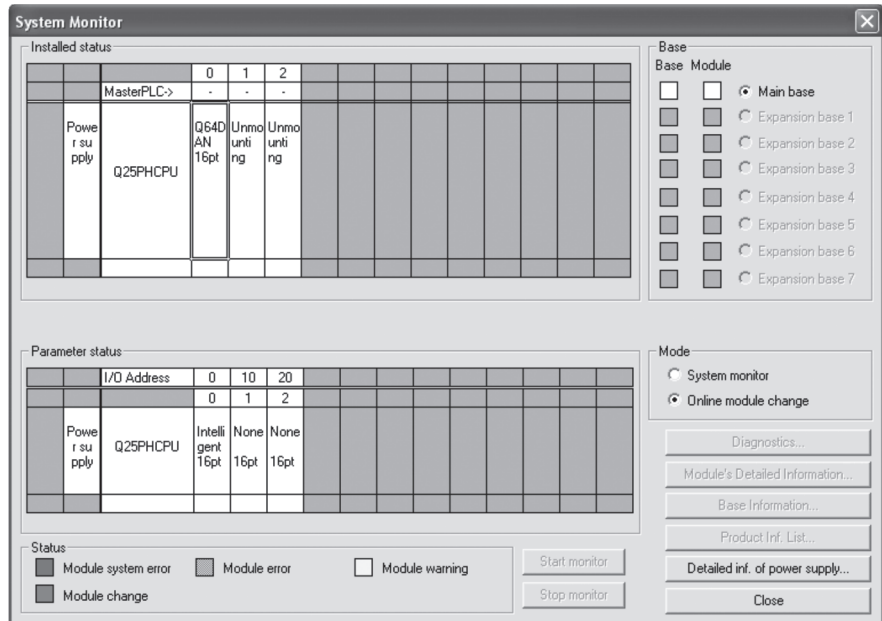

- (b) Click the "Execution" button to enable a module change.

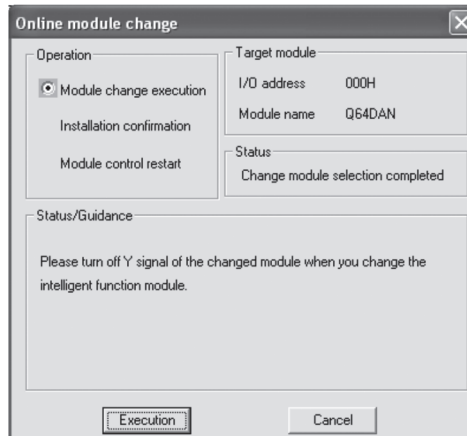

If the following error dialog box appears, the user range cannot be saved. Click the "OK" button, and perform the operations described in (2)(c) in this section and later.

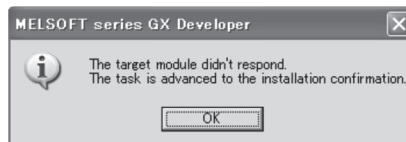

- (c) After confirming that the "RUN" LED of the module has turned off, remove the terminal block and dismount the module.

POINT

Always dismount the module. If mounting confirmation is made without the module being dismounted, the module will not start properly and the "RUN" LED will not be lit.

(3) Mounting of new module

- (a) Mount a new module to the same slot and install the terminal block.
- (b) After mounting the module, click the [Execution] button and make sure that the "RUN" LED is lit. Module ready (X0) remains off.

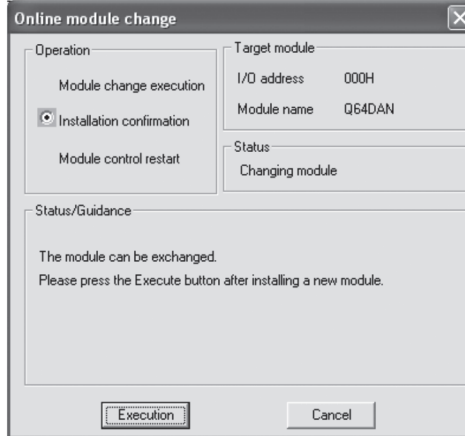

(4) Operation check

- (a) To make an operation check, click the [Cancel] button to cancel control resumption.

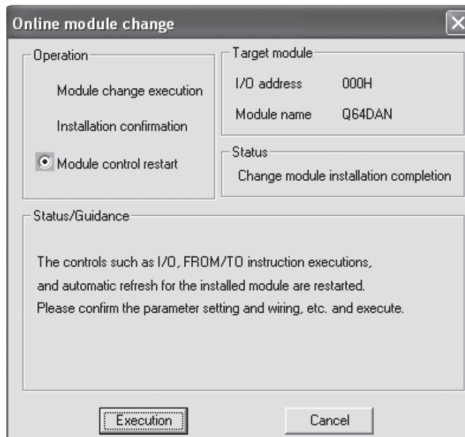

- (b) Click the [OK] button to leave the "Online module change" mode.

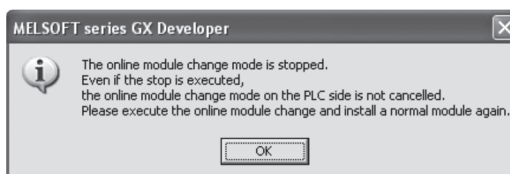

- (c) Click the [Close] button to close the System Monitor dialog box.

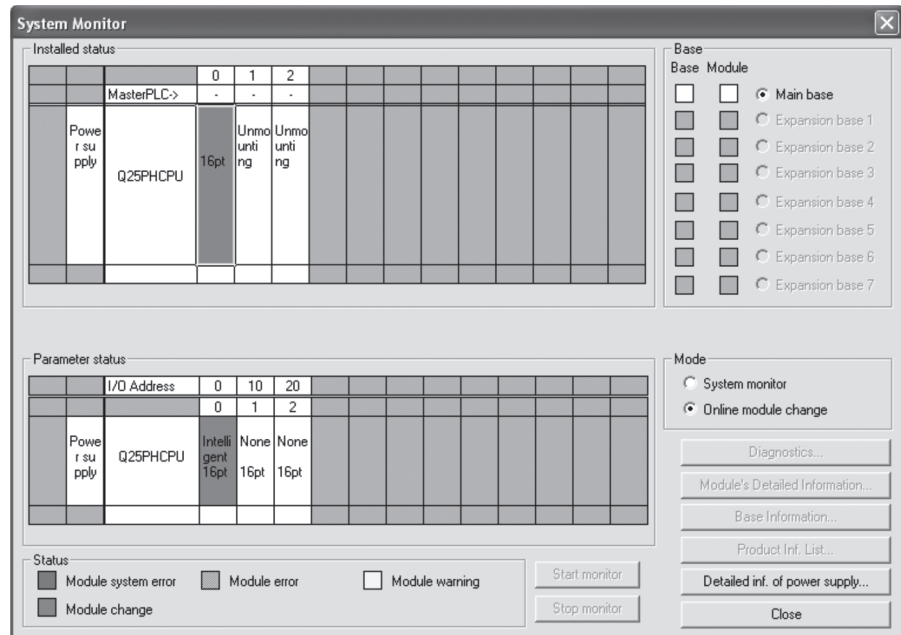

- (d) On the pass data dialog box of GX Configurator-DA, set the prerecorded values and perform User range writing request. (Refer to Section 5.6.5 and 5.6.6.)
- (e) Set a digital value to CH□ Digital value (buffer memory address 1 to 8: Un\G1 to 8) and turn on and off Operating condition setting request (Y9). Turn on CH□ Output enable/disable flag (Y1, Y2) of a channel to be used, and check whether proper conversion has been made or not. (Be careful since analog outputs are provided actually.)

(5) Resumption of control

- (a) After choosing [Diagnosis] - [Online module change] on GX Developer to display the "Online module change" dialog box again, click the [Execution] button to resume control. Module ready (X0) turns on.

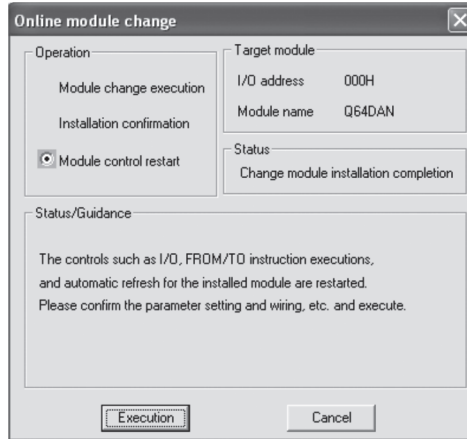

- (b) The "Online module change completed" dialog box appears.



7.3.5 When user range setting is used and initial setting was made with sequence program (other system is available)

(1) Conversion disable

(a) Take the following steps to disable the conversion:

- 1) Set D/A conversion enable/disable (buffer memory address 0: Un\G0) to All channel conversion disable (F_H).
- 2) Turn Operating condition setting request (Y9) from off to on to stop the conversion.
- 3) Operating condition setting completed flag (X9) turns off from on.
- 4) Check that the conversion is stopped by seeing the actual analog output value.
- 5) Turn Operating condition setting request (Y9) from on to off.

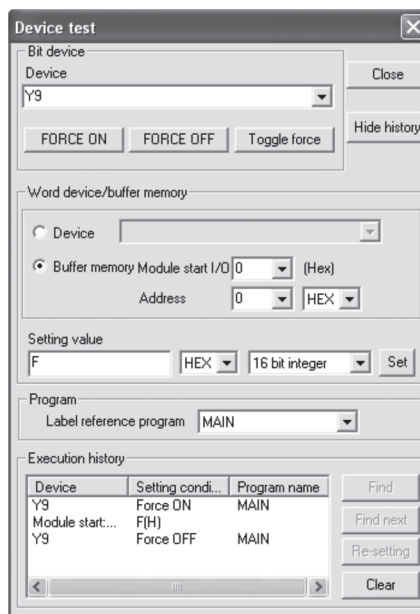

(2) Dismounting of module

- (a) After choosing [Diagnosis] - [Online module change] on GX Developer to enter the "Online module change" mode, double-click the module to be changed online to display the "Online module change" dialog box.

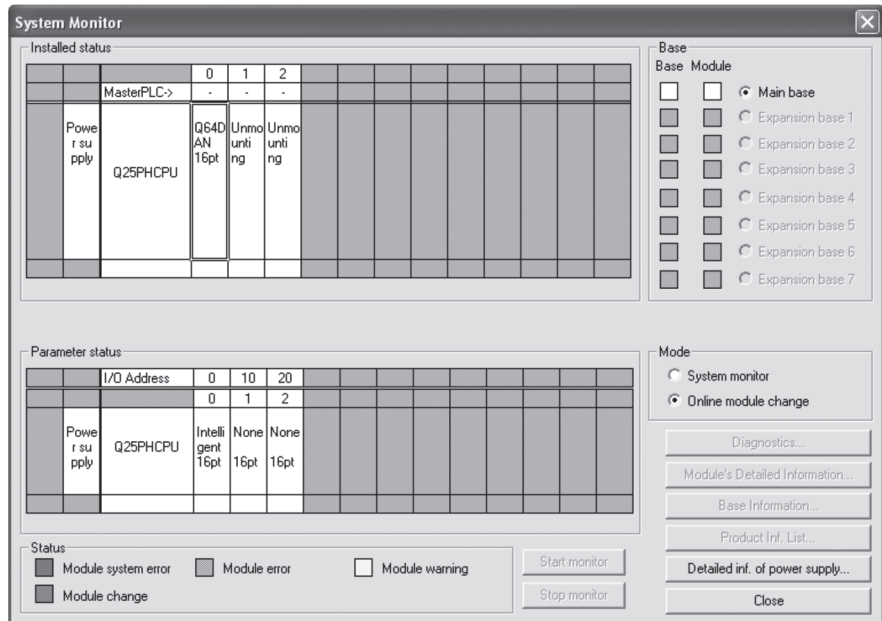

- (b) Click the "Execution" button to enable a module change.

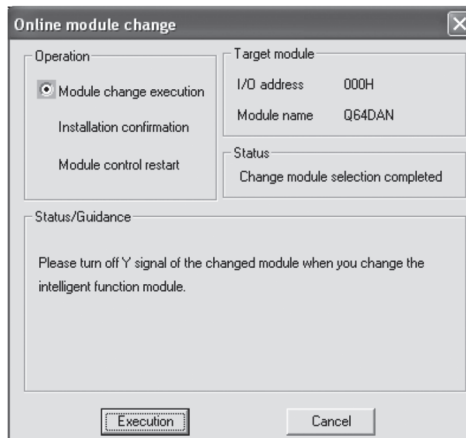

If the following error dialog box appears, the user range cannot be saved. Click the [OK] button, and perform the operation in Section 7.3.6 (2)(c) and later.

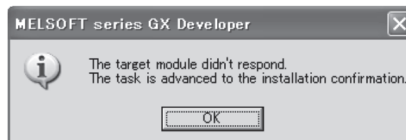

- (c) After confirming that the "RUN" LED of the module has turned off, remove the terminal block and dismount the module.

POINT

Always dismount the module. If mounting confirmation is made without the module being dismounted, the module will not start properly and the "RUN" LED will not be lit.

- (3) Mounting of new module
- (a) Mount the dismantled module and new module to the other system.
 - (b) Using the G(P).OGLOAD instruction, save the user set values to the CPU device. Refer to Appendix 2.2 for the G(P).OGLOAD instruction.
 - (c) Using the G(P).OGSTOR instruction, restore the user set values to the module. Refer to Appendix 2.3 for the G(P).OGSTOR instruction.
 - (d) Dismount the new module from the other system, mount it to the slot from where the old module was dismantled in the original system, and install the terminal block.
 - (e) After mounting the module, click the [Execution] button and make sure that the "RUN" LED is lit. Module ready (X0) remains off.

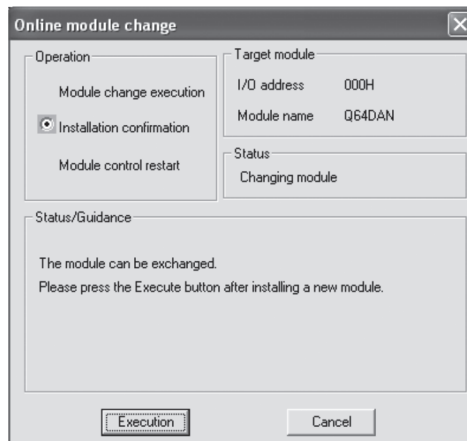

- (4) Operation check
- (a) To make an operation check, click the [Cancel] button to cancel control resumption.

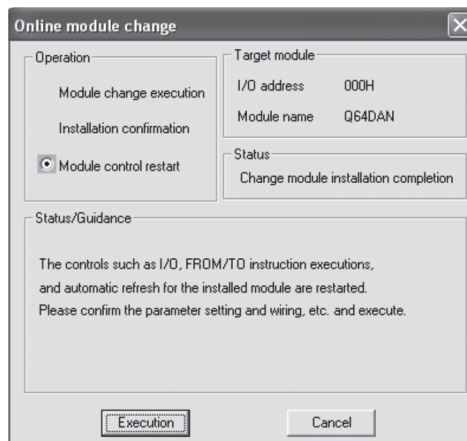

- (b) Click the [OK] button to leave the "Online module change" mode.

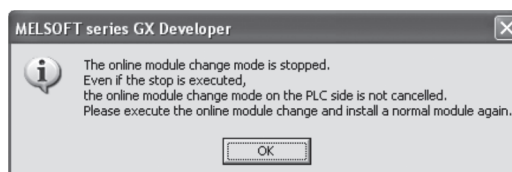

- (c) Click the [Close] button to close the System Monitor dialog box.

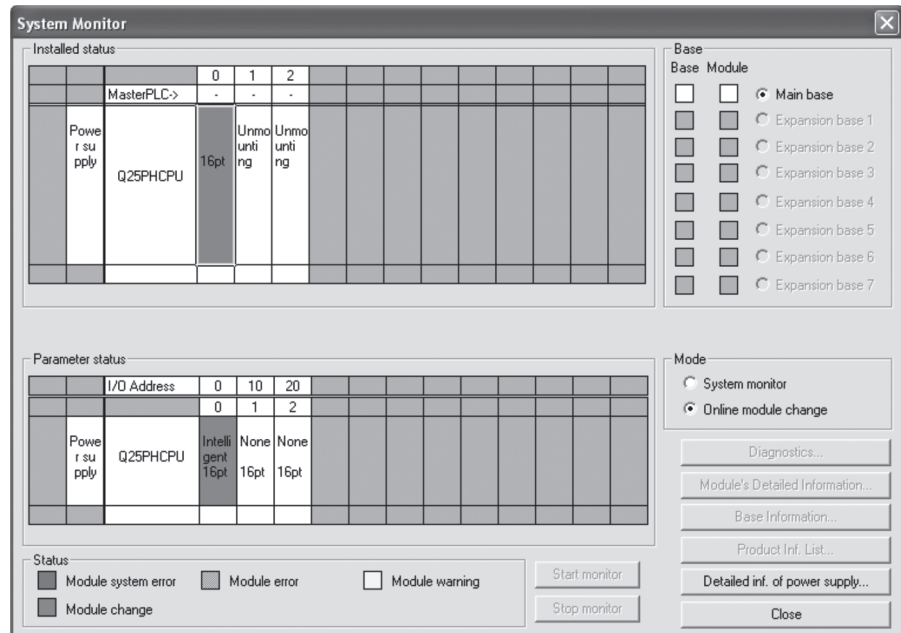

- (d) Enable conversion for a channel to be used by setting D/A conversion enable/disable (buffer memory address 0: Un\G0). Set a digital value to CH Digital value (buffer memory address 1 to 8: Un\G1 to 8) and turn on and off Operating condition setting request (Y9). Turn on CH Output enable/disable flag (Y1, Y2) of a channel to be used, and check whether proper conversion has been made or not. (Be careful since analog outputs are provided actually.)
- (e) Since the new module is in a default status, it must be initialized by a sequence program after control resumption. Before performing initialization, check whether the contents of the initialization program are correct or not.
- 1) Normal system configuration
The sequence program should perform initialization on the leading edge of Module ready (X0) of the D/A converter module. When control resumption is executed, Module ready (X0) turns on and initialization is performed. (If the sequence program performs initialization only one scan after RUN, initialization is not performed.)
 - 2) When used on remote I/O network
Insert a user device that will execute initialization at any timing (initialization request signal) into the sequence program. After control resumption, turn on the initialization request signal to perform initialization. (If the sequence program performs initialization only one scan after a data link start of the remote I/O network, initialization is not performed.)

(5) Resumption of control

- (a) After choosing [Diagnosis] - [Online module change] on GX Developer to display the "Online module change" dialog box again, click the [Execution] button to resume control. Module ready (X0) turns on.

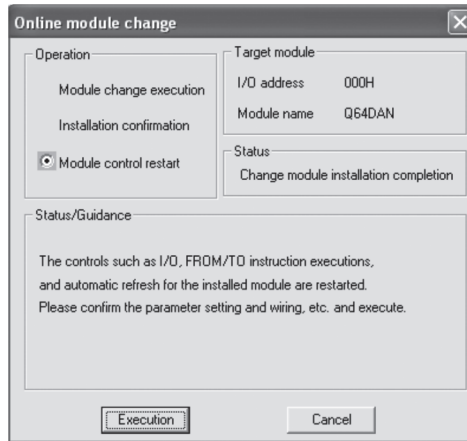

- (b) The "Online module change completed" dialog box appears.



7.3.6 When user range setting is used and initial setting was made with sequence program (other system is unavailable)

(1) Conversion disable

(a) Take the following steps to disable the conversion:

- 1) Set D/A conversion enable/disable (buffer memory address 0: Un\G0) to All channel conversion disable (FH).
- 2) Turn Operating condition setting request (Y9) from off to on to stop the conversion.
- 3) Operating condition setting completed flag (X9) turns off from on.
- 4) Check that the conversion is stopped by seeing the actual analog output value.
- 5) Turn Operating condition setting request (Y9) from on to off.

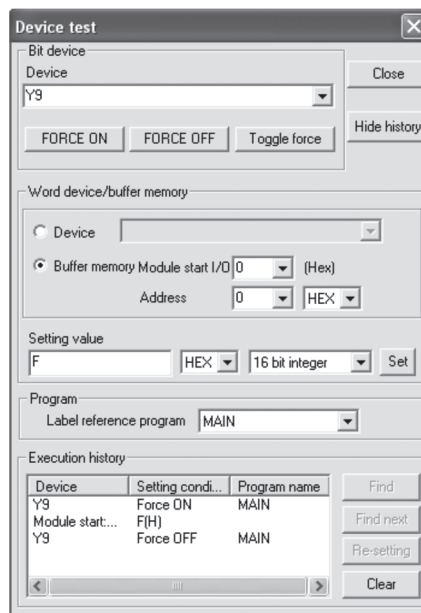

- (b) When the contents of buffer memory to be saved has not saved yet, record them in the following procedure.
- 1) Perform Pass data classification setting * 1 (buffer memory address 200: Un\G200).
 - 2) Turn on and off Operating condition setting request (Y9).
 - 3) Compare the offset/gain values of CH□ Industrial shipment settings offset/gain value and User range settings offset/gain value (buffer memory address 202 to 233: Un\G202 to Un\G233) with the range reference table. Refer to Section 7.4 for the range reference table.
 - 4) If the values are proper, record the offset/gain values of Pass data classification setting * 1, industrial shipment settings, and user range settings.
- *1: The Q68DAVN/Q68DAIN/Q68DAV/Q68DAI do not require the setting and recording of Pass data classification setting.

POINT

If the buffer memory values compared with the reference table are not proper, save and restoration of the user range cannot be executed.
 Before executing module control resumption, follow the flowchart in Section 4.6 and make offset/gain setting in the device test of GX Developer.
 To switch modes, set a value to Mode switching setting (buffer memory address 158, 159: Un\G158, Un\G159) and turn on and off Operating condition setting request (Y9).
 Note that if module control is resumed without offset/gain setting being made, operation will be performed with the default values.

- (2) Dismounting of module
- (a) After choosing [Diagnosis] - [Online module change] on GX Developer to enter the "Online module change" mode, double-click the module to be changed online to display the "Online module change" dialog box.

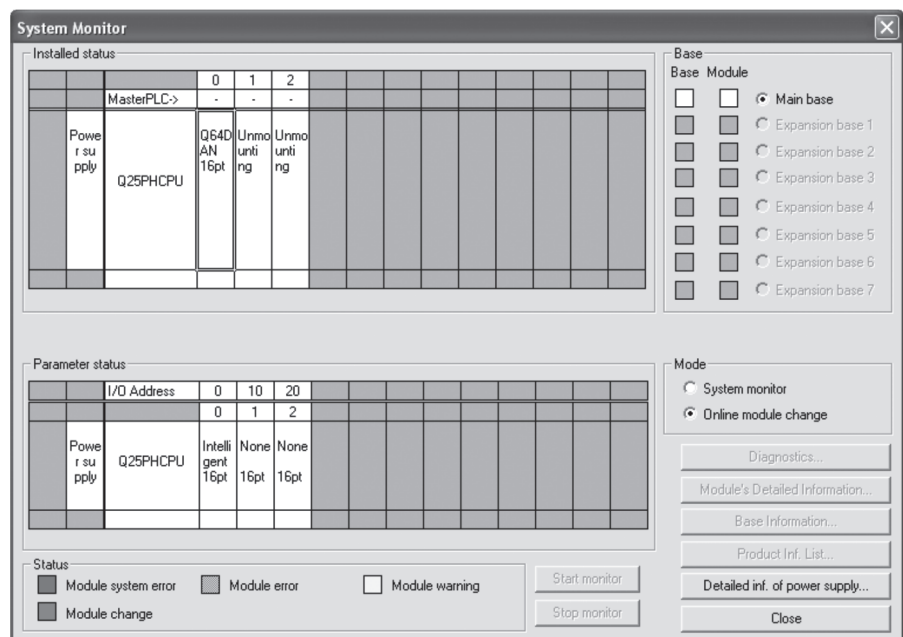

- (b) Click the "Execution" button to enable a module change.

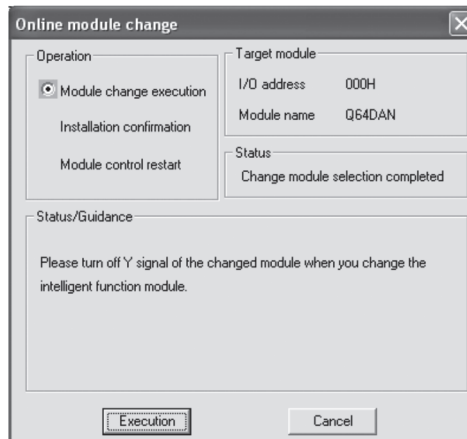

If the following error dialog box appears, the user range cannot be saved. Click the "OK" button, and perform the operations described (2)(c) in this section and later.

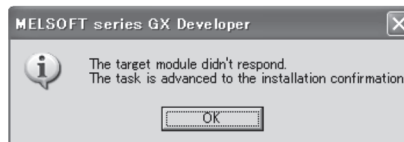

- (c) After confirming that the "RUN" LED of the module has turned off, remove the terminal block and dismount the module.

POINT

Always dismount the module. If mounting confirmation is made without the module being dismounted, the module will not start properly and the "RUN" LED will not be lit.

(3) Mounting of new module

- (a) Mount a new module to the same slot and install the terminal block.
- (b) After mounting the module, click the [Execution] button and make sure that the "RUN" LED is lit. Module ready (X0) remains off.

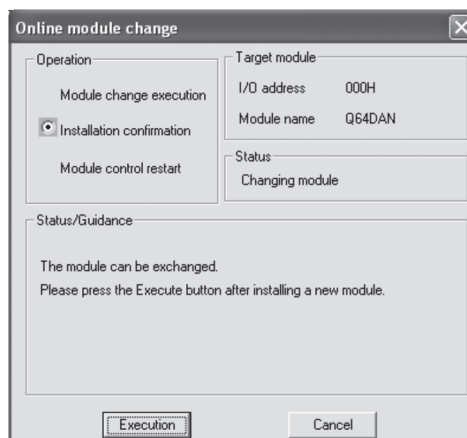

(4) Operation check

(a) To make an operation check, click the [Cancel] button to cancel control resumption.

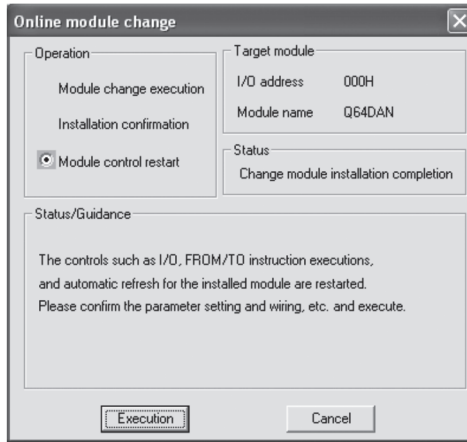

(b) Click the [OK] button to leave the "Online module change" mode.

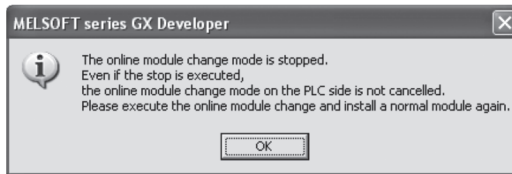

(c) Click the [Close] button to close the System monitor dialog box.

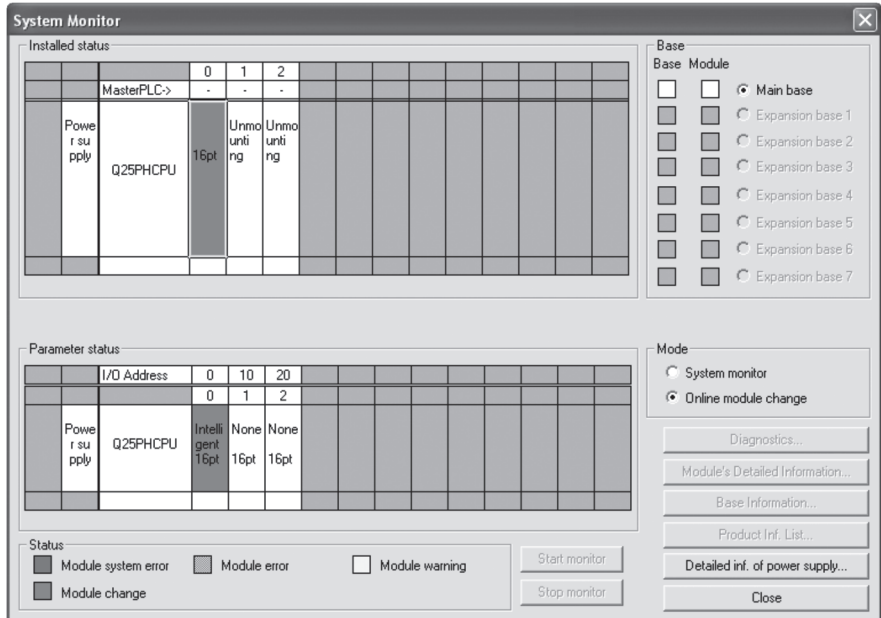

(d) Choose [Online] - [Debug] - [Device test] on GX Developer and set the prerecorded values to the buffer memory.

(e) Turn User range writing request (YA) from off to on to restore the user set values to the module.

After confirming that Offset/gain setting mode flag (XA) is on, turn off User range writing request (YA).

- (f) Enable conversion for a channel to be used by setting D/A conversion enable/disable (buffer memory address 0: Un\G0). Set a digital value to CH Digital value (buffer memory address 1 to 8: Un\G1 to 8) and turn on and off Operating condition setting request (Y9).
Turn on Output enable/disable flag (Y1, Y2) of a channel to be used, and check whether proper conversion has been made or not.
(Be careful since analog outputs are provided actually.)
- (g) Since the new module is in a default status, it must be initialized by a sequence program after control resumption.
Before performing initialization, check whether the contents of the initialization program are correct or not.
- 1) Normal system configuration
The sequence program should perform initialization on the leading edge of Module ready (X0) of the D/A converter module.
When control resumption is executed, Module ready (X0) turns on and initialization is performed. (If the sequence program performs initialization only one scan after RUN, initialization is not performed.)
 - 2) When used on remote I/O network
Insert a user device that will execute initialization at any timing (initialization request signal) into the sequence program. After control resumption, turn on the initialization request signal to perform initialization. (If the sequence program performs initialization only one scan after a data link start of the remote I/O network, initialization is not performed.)
- (5) Resumption of control
- (a) After choosing [Diagnosis] - [Online module change] on GX Developer to display the "Online module change" dialog box again, click the [Execution] button to resume control. Module ready (X0) turns on.

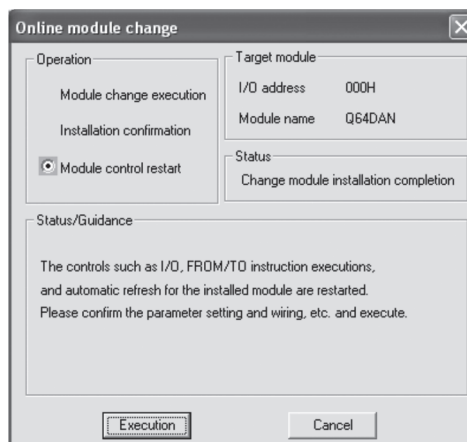

- (b) The "Online module change completed" dialog box appears.



7.4 Range Reference Table

The range reference tables are given below.

- (1) Reference table for CH□ Industrial shipment settings offset/gain value (buffer memory address 202 to 233: Un\G202 to 233)

(a) For the Q62DAN and Q62DA

The reference values change depending on the setting of Pass data classification setting (buffer memory address 200: Un\G200).

Address (Decimal)		Description	Pass data classification setting	Reference value (Hexadecimal)
CH1	CH2			
202	204	Industrial shipment settings offset value	Voltage specified	Approx. 7FF8H
			Current specified	Approx. 7FF8H
203	205	Industrial shipment settings gain value	Voltage specified	Approx. FF5AH
			Current specified	Approx. F92EH

(b) For the Q64DAN and Q64DA

The reference values change depending on the setting of Pass data classification setting (buffer memory address 200: Un\G200).

Address (Decimal)				Description	Pass data classification setting	Reference value (Hexadecimal)
CH1	CH2	CH3	CH4			
202	204	206	208	Industrial shipment settings offset value	Voltage specified	Approx. 7FF8H
					Current specified	Approx. 7FF8H
203	205	207	209	Industrial shipment settings gain value	Voltage specified	Approx. FF5AH
					Current specified	Approx. F92EH

(c) For the Q68DAVN and Q68DAV

Address (Decimal)								Description	Reference value (Hexadecimal)
CH1	CH2	CH3	CH4	CH5	CH6	CH7	CH8		
202	204	206	208	210	212	214	216	Industrial shipment settings offset value	Approx. 7FF8H
203	205	207	209	211	213	215	217	Industrial shipment settings gain value	Approx. FF5AH

(d) For the Q68DAIN and Q68DAI

Address (Decimal)								Description	Reference value (Hexadecimal)
CH1	CH2	CH3	CH4	CH5	CH6	CH7	CH8		
202	204	206	208	210	212	214	216	Industrial shipment settings offset value	Approx. 7FF8H
203	205	207	209	211	213	215	217	Industrial shipment settings gain value	Approx. F92EH

- (2) Reference table for User range settings offset/gain values (buffer memory address 218 to 233: Un\G218 to 233)

Example: When the offset value and gain value of channel 1 are 1V and 5V respectively, in the Q68DAV, the reference value of CH1 User range settings offset value (buffer memory address 218: Un\G218) is approx. 8CB4H and that of CH1 User range settings gain value (buffer memory address 220: Un\G220) is approx. BFAEH.

Offset/gain value		Reference value (Hexadecimal)
Voltage	0V	Approx. 7FF8H
	1V	Approx. 8CB4H
	5V	Approx. BFAEH
	10V	Approx. FF5AH
Current	0mA	Approx. 7FF8H
	4mA	Approx. 983AH
	20mA	Approx. F92EH

7.5 Precautions for Online Module Change

The following are the precautions for online module change.

- (1) Always perform an online module change in the correct procedure. A failure to do so can cause a malfunction or failure.
- (2) If an online module change is made with the user range setting, the accuracy after that will fall to about less than three times of the accuracy before that.
Re-set the offset/gain values as necessary.
- (3) Do not perform online module change in the offset/gain setting mode. (If performed, the D/A converter module may not operate properly.)
- (4) Never perform the following operations (a) and (b) during online module change. (If performed, the D/A converter module may not operate properly.)
 - (a) Turn off the programmable controller CPU.
 - (b) Reset the programmable controller CPU.

8 TROUBLESHOOTING

This chapter explains the types of errors that may occur when the D/A converter module is used, and how to troubleshoot such errors.

8.1 Error Code List

If an error occurs in D/A converter module while writing to or reading data from the PLC CPU, the applicable error code is written to buffer memory address 19 (Un\G19).

Table 8.1 Error code list

Error code (decimal)	Error description	Processing
10□	The setting is outside the output range setting that can be made by the intelligent function module switch of the GX Developer. □ indicates the incorrectly specified channel number.	Reset to the correct parameter with GX Developer parameter setting. (Refer to Section 4.5.)
111	Module error at startup.	Turn the power on and off again. If the error occurs again, the module may be malfunctioning. Contact the nearest distributor or branch office with a description of the problem.
161 *1	The G.OGSTOR instruction was executed in the offset/gain setting mode.	Do not execute the G.OGSTOR instruction in the offset/gain setting mode.
162 *2	<ul style="list-style-type: none"> The G.OGSTOR instruction was executed consecutively. At the time of offset/gain setting, a set value was written to the E²PROM 26 or more times. 	<ul style="list-style-type: none"> Execute the G.OGSTOR instruction only once for one module. At the time of offset/gain setting, write a set value only once at one time.
163 *2	The G.OGSTOR instruction was executed for the model that differs from the model for which the G.OGLOAD instruction had been executed.	Execute the G.OGLOAD and G.OGSTOR instructions for the same model.
40□ *2	The offset value is equal to or greater than the gain value at the time of user range setting or user range restoration. □ indicates the channel number causing the error.	Reset so that the offset value becomes smaller than the gain value.
500 *2	More than one channel was set at the same time during offset/gain settings.	Set the correct value in Offset/gain setting mode and offset/gain specification (buffer memory addresses 22, 23: Un\G22 and Un\G23).
60□ *2	The specified digital value is outside the valid range. □ indicates the channel number where the error occurred.	Set a value that is within the valid range.
700 *2	The analog adjustment output in the offset/gain setting mode is outside the specified value range.	Change the contents of Offset/gain adjustment value specification (buffer memory address 24 (Un\G24) so that it is within the range from -3000 to 3000.

POINT

- (1) If more than one error occurs, the error code first detected by the D/A converter module is stored. No other error codes will be stored.
- (2) Error code 161 marked with *1 is not stored in Error code (buffer memory address 19 (Un\G19)). It is written to the Completion status area, (S) + 1, of the G(P).OGSTOR instruction.
- (3) Error code marked with *2 can be cleared by turning on Error clear request (YF).
- (4) The error is cleared at the time of mode switching.

8.2 Troubleshooting

8.2.1 When the "RUN" LED is flashing or turned off

(1) When flashing

Check item	Corrective action
Is the mode set to the offset/gain setting mode?	Reset switch 4 of the intelligent function module setting for GX Developer to the normal mode (Refer to Section 4.5).

(2) When off

Check item	Corrective action
Is power being supplied?	Confirm that the supply voltage for the power supply module is within the rated range.
Is the capacity of the power supply module adequate?	Calculate the current consumption of the CPU module, I/O module and intelligent function module mounted on the base unit to see if the power supply capacity is adequate.
Has a watchdog timer error occurred?	Reset the PLC CPU and verify that it is lit. If the RUN LED does not light even after doing this, the module may be malfunctioning. Contact the nearest distributor or branch office with a description of the problem.
Is the module correctly mounted on the base unit?	Check the mounting condition of the module.
Is a module change enabled during an online module change?	Refer to Chapter 7 and take corrective action.

8.2.2 When the "ERROR" LED is on or flashing

(1) When on

Check item	Corrective action
Is an error being generated?	Confirm the error code and take corrective action described in Section 8.1.

(2) When flashing

Check item	Corrective action
Is intelligent function module setting switch 5 set to "other than 0"?	Using GX Developer parameter setting, set intelligent function module setting switch 5 to "0" (Refer to Section 4.5).

8.2.3 When an analog output value is not output

Check item	Action to be taken
Is 24VDC external power supply being supplied?	Verify that 24VDC voltage is being supplied to the external power supply terminals (Q62DAN, Q64DAN, Q62DA, Q64DA: terminal numbers 16, 17 Q68DAVN, Q68DAIN, Q68DAV, Q68DAI: terminal numbers 17, 18).
Is there any fault with the analog signal lines such as broken or disconnected line?	Check for any abnormality on the signal lines by doing a visual check and performing a continuity check.
Is the CPU module in the STOP status?	Set the CPU module to the RUN status.
Are the offset/gain settings correct?	Verify that the offset/gain settings are correct (Refer to sections 4.6, 5.6.2 and 5.6.3). If the user range setting is being used, switch to a different default output range and check if D/A conversion is correctly performed. If it is correctly performed, redo the offset/gain settings.
Is the output setting range correct?	Verify setting range (buffer memory addresses 20, 21 (Un\G20, Un\G21) in GX Developer monitor. If the output range setting is incorrect, redo GX Developer intelligent function module switch settings (Refer to Section 4.5).
Is the resolution mode setting correct?	Check the on/off status of High resolution mode status flag (X8) in GX Developer system monitor. If the resolution mode setting is incorrect, redo the GX Developer intelligent function module switch setting. (Refer to Section 4.5.)
Is D/A conversion enable/disable setting for the channel to be output set to Disable?	Check the setting of D/A conversion enable/disable (buffer memory address 0: Un\G0) in GX Developer monitor and set it to Enable using the sequence program or utility package (Refer to Section 3.4).
Is the D/A output enable/disable setting for the channel to be output set to Disable?	Check the on/off status of CH□ Output enable/disable flag (Y1 to Y8) in GX Developer monitor. If CH□ Output enable/disable flag (Y1 to Y8) is off, check the sequence program (Refer to Section 3.3), or check that the CPU module is not in STOP state.
Is the digital value being written to the channel to be output?	Verify CH□ Digital value (buffer memory address 1 to 8 (Un\G1 to 8) in GX Developer monitor (Refer to Section 3.4).
Has Operating condition setting request (Y9) been executed?	Turn on and off Operating condition setting request (Y9) using GX Developer, and check whether an analog value that is output is normal. If the analog value is normal, check whether descriptions related to Operating condition setting request (Y9) are correct on the sequence program (Refer to Section 3.3).

POINT

If the analog output value is not output after the proper corrective action is taken in accordance with the above check item, the possible cause is a module failure.
Consult the nearest sales representative or branch.

8.2.4 When analog output value is not held

Check item	Action to be taken
Is the HOLD/CLEAR setting correct?	Check the Switch 3 setting of the intelligent function module switch setting on GX Developer.
Is the D/A converter module used on a MELSECNET/H remote I/O station?	Take corrective actions, referring to POINT (2) in Section 3.2.2.

8.2.5 Checking the D/A converter module status using GX Developer system monitor

When the D/A converter module detail information is selected in GX Developer system monitor, the function version, Error code, LED on status and status of the intelligent function module switch setting can be checked.

(1) Operating the GX Developer

[Diagnostics] → [System monitor] → Select the D/A conversion module checking the status. → Module's Detailed Information

(2) Module Detailed Information

(a) Checking the function version

The function version of the D/A converter module is displayed in the product information field.

(b) Checking the Error code

The error code stored in buffer memory address 19 (Un\G19) of the D/A converter module is displayed in the latest Error code field.

(When the Error History button is pressed, the contents displayed in the latest Error code field are displayed in the No.1 field.)

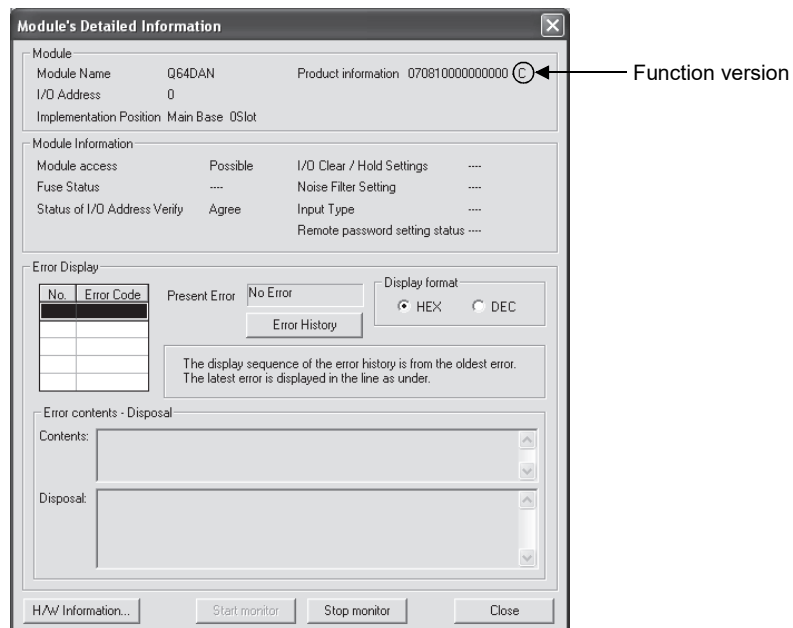

(3) H/W information

(a) H/W LED information

The LED status is displayed.

No.	LED name	Status
1	RUN LED	0000H : Indicates that LED is unlit.
2	ERROR LED	0001H : Indicates that LED is lit

(b) H/W SW information

The status of the intelligent function module switch setting is displayed.

No.	Switch setting for intelligent function module
1	Switch 1
2	Switch 2
3	Switch 3
4	Switch 4
5	Switch 5

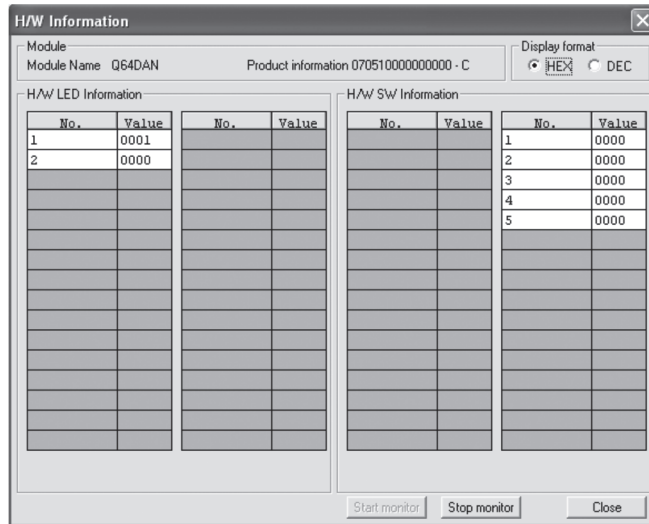

APPENDICES

Appendix 1 Function upgrade for the D/A converter module

The D/A converter modules of function versions B and C have more functions than the conventional model (function version A).

This section describes a comparison of functions of the D/A converter module based on the function additions, combinations with GX Configurator-DA software version and precautions when replacing the module.

Appendix 1.1 A comparison of functions of the D/A converter module

The following table indicates the functions supported by the corresponding function versions.

Function	Function version A	Function version B	Function version C
D/A conversion enable/disable function	○	○	○
D/A output enable/disable function	○	○	○
Synchronous output function	○	○	○
Multiple CPU system compatibility	×	○	○
Analog output test during programmable controller CPU STOP	×	○	○
Resolution mode	—	—	—
Normal resolution mode	○	○	○
High resolution mode	×	○	○
High resolution mode status flag (X8)	×	○	○
Online module change	×	×	○
Switching between normal mode and offset/gain setting mode	—	—	—
Dedicated instruction (G(P).OFFGAN)	×	×	○
Buffer memory (Mode switching setting) and Operating condition setting request (Y9)	×	×	○
GX Configurator-DA	×	×	○
Intelligent function module switch setting	○	○	○

○ : Compatible × : Not compatible

Appendix 1.2 Combinations of D/A converter module functions and GX Configurator-DA software versions

The following table indicates the D/A converter module functions and corresponding GX Configurator-DA software versions.

Function	Software version			
	SW0D5C-QDAU-E 00A	SW0D5C-QDAU-E 10B	GX Configurator-DA Version 1.10L to 1.15R	GX Configurator-DA Version 1.16S or later
Normal resolution mode	○	○	○	○
High resolution mode *1	×	×	○	○
High resolution mode status flag (X8) *1 *2	×	×	○	○
Multiple CPU system compatibility *1	×	×	○	○
Analog output test during programmable controller CPU STOP *1	○	○	○	○
Normal mode - offset/gain setting mode switching *3	×	×	×	○

○ : Compatible × : Not compatible

*1 Functions added by function version B.

*2 When the D/A converter module is function version A and the GX Configurator-DA software version is SW0D5C-QDAU-E 20C or later or GX Configurator-DA Version 1.10L or later, off is always displayed.

*3 Functions added by function version C.

Appendix 1.3 Precautions for replacing the module of function version A with the one of function version B or later

(1) Incorporation into an existing system

You can use the wiring designed for function version A as-is to mount the D/A converter module of function version B or later.

(2) Program utilization

You can use the program created for function version A as-is with the D/A converter module of function version B or later.

(3) Switch setting for Intelligent function module

The setting of the offset/gain setting mode differs between function versions A and B or later.

Perform the offset/gain settings after checking the RUN LED flashes in offset/gain setting mode. If the RUN LED does not flash, check to see if the switch 4 setting is correct.

(Refer to Section 4.5 for the intelligent function module switch setting of function version B or later.)

<Contents of switch 4 setting for function version A>

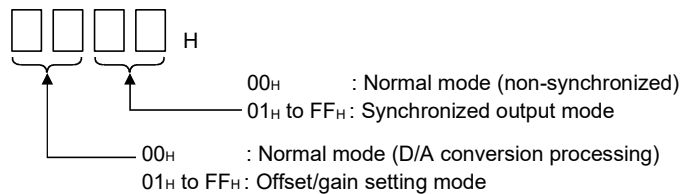

(4) Analog output during programmable controller CPU STOP

If CH□ Output enable/disable flag (Y1 to Y8) is forced on (enabled) in the function version B D/A converter module, the D/A converted value may be output in some cases.

Refer to Section 3.2.3 for details.

Appendix 1.4 Precautions for replacing the Q62DA/Q64DA/Q68DAV/Q68DAI with Q62DAN/Q64DAN/Q68DAVN/Q68DAIN

(1) Wiring precautions

To use existing wires of the Q62DA/Q64DA/Q68DAV/Q68DAI, an extra length of 30mm is required for the wiring of an alternative module.

When replacing the module, verify this in the actual system configuration.

(2) Differences between the Q62DA/Q64DA/Q68DAV/Q68DAI and Q62DAN/Q64DAN/Q68DAVN/Q68DAIN

The following shows the differences between the Q62DA/Q64DA/Q68DAV/Q68DAI and Q62DAN/Q64DAN/Q68DAVN/Q68DAIN.

These modules can be replaced without taking any specific attention except for the wiring precautions.

Item \ Model		Q62DA	Q64DA	Q68DAI	Q68DAV	Q62DAN	Q64DAN	Q68DAIN	Q68DAVN
		No differences							
Analog output	Voltage	No differences							
	Current	0 to 20 mA DC (External load resistance value: refer to Section 3.1.1)			—	0 to 20 mA DC (External load resistance value: 0 Ω to 600 Ω)			—
Insulation method		Between the I/O terminal and programmable controller power supply: Photo coupler insulation Between output channels: No insulation Between external supply power and analog output: No insulation				Between the I/O terminal and programmable controller power supply: Photo coupler insulation Between output channels: No insulation Between external supply power and analog output: Transformer insulation			
Dielectric withstand voltage		Between the I/O terminal and programmable controller power supply: 500VAC for 1 minute				Between the I/O terminal and programmable controller power supply: 500VAC for 1 minute Between external supply power and analog output: 500VAC for 1 minute			
Insulation resistance		Between the I/O terminal and programmable controller power supply: 500VDC 20M Ω or more				Between the I/O terminal and programmable controller power supply: 500VDC 20M Ω or more Between external supply power and analog output: 500VDC 20M Ω or more			
External Dimension		98(H) × 27.4(W) × 90(D) [mm]				98(H) × 27.4(W) × 112(D) [mm]			

Appendix 2 Dedicated Instruction List and Available Devices

(1) Dedicated instruction list

The following table lists the dedicated instructions that can be used with the D/A converter modules.

Instruction	Description	Reference section
G(P).OFFGAN	Switches to the offset/gain setting mode. Switches to the normal mode.	Appendix 2.1
G(P).OGLOAD	Reads the offset/gain values of the user range setting to the CPU.	Appendix 2.2
G(P).OGSTOR	Restores the offset/gain values of the user range setting stored in the CPU to the D/A converter module.	Appendix 2.3

POINT

When the module is mounted to a MELSECNET/H remote station, the dedicated instructions cannot be used.

(2) Available devices

The following devices are available for the dedicated instructions:

Internal devices		File register	Constant * ²
Bit * ¹	Word		
X, Y, M, L, F, V, B	T, ST, C, D, W	R, ZR	K, H

*1: Word device bit designation can be used as bit data.

Word device bit designation is done by designating Word device . Bit No..

(Designation of bit numbers is done in hexadecimal.)

For example, bit 10 of D0 is designated as D0.A.

However, there can be no bit designation for timers (T), retentive timers (ST) and counters (C).

*2: Available devices are given in each of the Constant field.

Appendix 2.1 G(P).OFFGAN

Switches the mode of the D/A converter module. (Normal mode to offset/gain setting mode, offset/gain setting mode to normal mode)

Setting data	Usable devices									
	Internal device (System, user)		File register	Link direct device J□\□		Intelligent function module device U□\G□	Index register Z□	Constant		Other
	Bit	Word		Bit	Word			K, H	\$	
(S)	—	○	—		—		—	—	—	

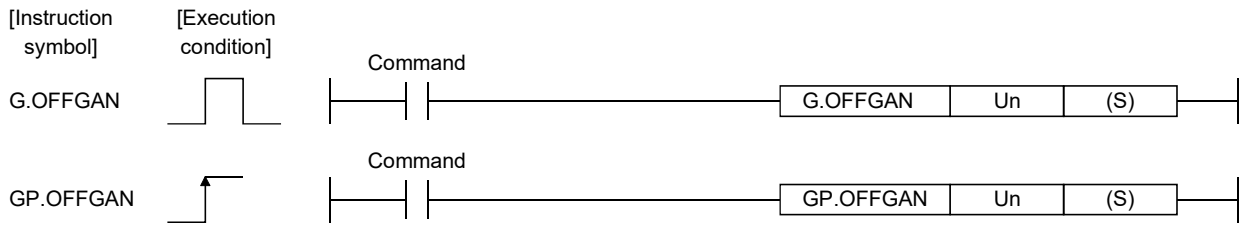

Setting data

Setting data	Description	Setting range	Data type
Un	Start I/O number of the module	0 to FEH	Binary 16 bits
(S)	Mode switching 0: Switching to normal mode 1: Switching to offset/gain setting mode The setting of any other value results in "switching to offset/gain setting mode".	0, 1	Binary 16 bits

(1) Function

Switches the mode of the D/A converter module.

- Normal mode to offset/gain setting mode (Offset/gain setting mode flag (XA) turns on.)
- Offset/gain setting mode to normal mode (Offset/gain setting mode flag (XA) turns off.)

POINT
<p>(1) When the offset/gain setting mode is switched to the normal mode, Module ready (X0) turns from off to on. Note that initial setting processing will be executed if there is a sequence program that makes initial setting when Module ready (X0) turns on.</p> <p>(2) D/A conversion is discontinued if the mode is switched (from the normal mode to the offset/gain setting mode or from the offset/gain setting mode to the normal mode). To resume D/A conversion, switch the mode to the normal mode if it is set to the offset/gain setting mode, and then turn on and off Operating condition setting request (Y9).</p>

(2) Operation error

No errors.

(3) Program example

The following program is designed to switch the D/A converter module mounted in the position of I/O number X/Y0 to X/YF to the offset/gain setting mode when M10 is turned on, and to return it to the normal mode when M10 is turned off.

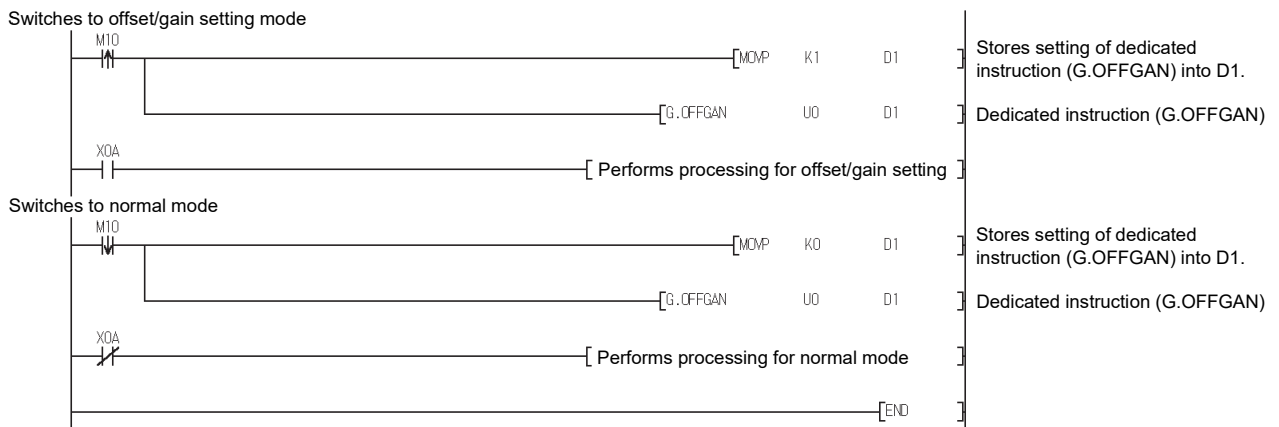

Appendix 2.2 G(P).OGLOAD

Reads the offset/gain values of the user range setting of the D/A converter module to the CPU.

Setting data	Usable devices									
	Internal device (System, user)		File register	Link direct device J□\□		Intelligent function module device U□\G□	Index register Z□	Constant		Others
	Bit	Word		Bit	Word			K, H	\$	
(S)	—	○						—	—	—
(D)		○						—	—	—

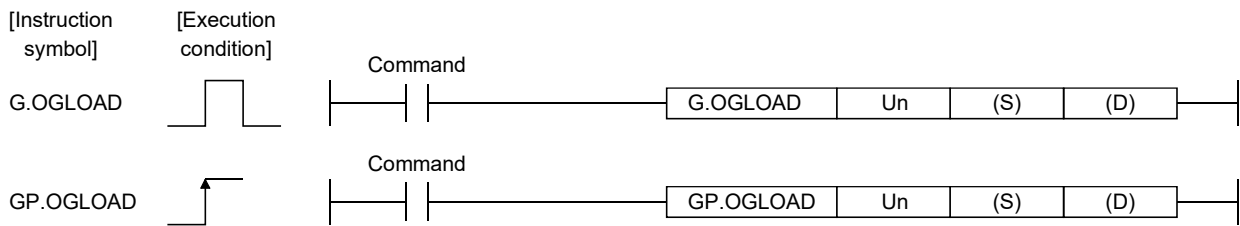

Setting data

Setting data	Description	Setting range	Data type
Un	Start I/O number of the module	0 to FEH	Binary 16 bits
(S)	Start number of the device in which control data is stored.	Within the range of the specified device	Device name
(D)	Device that is turned on 1 scan on completion of dedicated instruction processing. (D) + 1 also turns on at an abnormal completion.	Within the range of the specified device	Bit

Control data*1 of the Q62DAN and Q62DA

Device	Item	Setting data	Setting range	Set by										
(S)	System area	—	—	—										
(S) + 1	Completion status	Stores the status when the instruction is complete. 0 : Normal completion Other than 0: Abnormal completion	—	System										
(S) + 2	Pass data classification setting	Specify the voltage/current of the offset/gain values to be read. 0: Voltage specified 1: Current specified <table border="1" style="margin-left: auto; margin-right: auto;"> <tr> <td>b15</td> <td>~</td> <td>b2</td> <td>b1</td> <td>b0</td> </tr> <tr> <td>0</td> <td></td> <td>0</td> <td>CH.2</td> <td>CH.1</td> </tr> </table>	b15	~	b2	b1	b0	0		0	CH.2	CH.1	0000H to 0003H	User
b15	~	b2	b1	b0										
0		0	CH.2	CH.1										
(S) + 3	System area	—	—	—										
(S) + 4	CH1 Industrial shipment settings offset value	—	—	System										
(S) + 5	CH1 Industrial shipment settings gain value	—	—	System										
(S) + 6	CH2 Industrial shipment settings offset value	—	—	System										
(S) + 7	CH2 Industrial shipment settings gain value	—	—	System										
(S) + 8	CH1 User range settings offset value	—	—	System										
(S) + 9	CH1 User range settings gain value	—	—	System										
(S) + 10	CH2 User range settings offset value	—	—	System										
(S) + 11	CH2 User range settings gain value	—	—	System										

*1 Set only Pass data classification setting (S)+2. If data is written to the area set by the system, the offset/gain values will not be read properly.

Control data *2 of the Q64DAN and Q64DAA

Device	Item	Setting data	Setting range	Set by													
(S)	System area	—	—	—													
(S) + 1	Completion status	Stores the status when the instruction is complete. 0 : Normal completion Other than 0: Abnormal completion	—	System													
(S) + 2	Pass data classification setting	Specify the voltage/current of the offset/gain values to be read. 0: Voltage specified 1: Current specified <table border="1" style="margin-left: auto; margin-right: auto;"> <tr> <td>b15</td> <td>b4</td> <td>b3</td> <td>b2</td> <td>b1</td> <td>b0</td> </tr> <tr> <td>0</td> <td>~</td> <td>0</td> <td>CH.4</td> <td>CH.3</td> <td>CH.2</td> <td>CH.1</td> </tr> </table>	b15	b4	b3	b2	b1	b0	0	~	0	CH.4	CH.3	CH.2	CH.1	0000 _H to 000F _H	User
b15	b4	b3	b2	b1	b0												
0	~	0	CH.4	CH.3	CH.2	CH.1											
(S) + 3	System area	—	—	—													
(S) + 4	CH1 Industrial shipment settings offset value	—	—	System													
(S) + 5	CH1 Industrial shipment settings gain value	—	—	System													
(S) + 6	CH2 Industrial shipment settings offset value	—	—	System													
(S) + 7	CH2 Industrial shipment settings gain value	—	—	System													
(S) + 8	CH3 Industrial shipment settings offset value	—	—	System													
(S) + 9	CH3 Industrial shipment settings gain value	—	—	System													
(S) + 10	CH4 Industrial shipment settings offset value	—	—	System													
(S) + 11	CH4 Industrial shipment settings gain value	—	—	System													
(S) + 12	CH1 User range settings offset value	—	—	System													
(S) + 13	CH1 User range settings gain value	—	—	System													
(S) + 14	CH2 User range settings offset value	—	—	System													
(S) + 15	CH2 User range settings gain value	—	—	System													
(S) + 16	CH3 User range settings offset value	—	—	System													
(S) + 17	CH3 User range settings gain value	—	—	System													
(S) + 18	CH4 User range settings offset value	—	—	System													
(S) + 19	CH4 User range settings gain value	—	—	System													

*2 Set only Pass data classification setting (S)+2. If data is written to the area set by the system, the offset/gain values will not be read properly.

Control data *3 of the Q68DAVN and Q68DAV

Device	Item	Setting data	Setting range	Set by
(S)	System area	—	—	—
(S) + 1	Completion status	Stores the status when the instruction is complete. 0 : Normal completion Other than 0: Abnormal completion	—	System
(S) + 2	System area	—	—	—
(S) + 3				
(S) + 4	CH1 Industrial shipment settings offset value	—	—	System
(S) + 5	CH1 Industrial shipment settings gain value	—	—	System
(S) + 6	CH2 Industrial shipment settings offset value	—	—	System
(S) + 7	CH2 Industrial shipment settings gain value	—	—	System
(S) + 8	CH3 Industrial shipment settings offset value	—	—	System
(S) + 9	CH3 Industrial shipment settings gain value	—	—	System
(S) + 10	CH4 Industrial shipment settings offset value	—	—	System
(S) + 11	CH4 Industrial shipment settings gain value	—	—	System
(S) + 12	CH5 Industrial shipment settings offset value	—	—	System
(S) + 13	CH5 Industrial shipment settings gain value	—	—	System
(S) + 14	CH6 Industrial shipment settings offset value	—	—	System
(S) + 15	CH6 Industrial shipment settings gain value	—	—	System
(S) + 16	CH7 Industrial shipment settings offset value	—	—	System
(S) + 17	CH7 Industrial shipment settings gain value	—	—	System
(S) + 18	CH8 Industrial shipment settings offset value	—	—	System
(S) + 19	CH8 Industrial shipment settings gain value	—	—	System
(S) + 20	CH1 User range settings offset value	—	—	System
(S) + 21	CH1 User range settings gain value	—	—	System
(S) + 22	CH2 User range settings offset value	—	—	System
(S) + 23	CH2 User range settings gain value	—	—	System
(S) + 24	CH3 User range settings offset value	—	—	System
(S) + 25	CH3 User range settings gain value	—	—	System
(S) + 26	CH4 User range settings offset value	—	—	System
(S) + 27	CH4 User range settings gain value	—	—	System
(S) + 28	CH5 User range settings offset value	—	—	System
(S) + 29	CH5 User range settings gain value	—	—	System
(S) + 30	CH6 User range settings offset value	—	—	System
(S) + 31	CH6 User range settings gain value	—	—	System
(S) + 32	CH7 User range settings offset value	—	—	System
(S) + 33	CH7 User range settings gain value	—	—	System
(S) + 34	CH8 User range settings offset value	—	—	System
(S) + 35	CH8 User range settings gain value	—	—	System

*3 Setting is not necessary. If setting is made, the offset/gain values will not be read properly.

Control data *4 of the Q68DAIN and Q68DAI

Device	Item	Setting data	Setting range	Set by
(S)	System area	—	—	—
(S) + 1	Completion status	Stores the status when the instruction is complete. 0 : Normal completion Other than 0: Abnormal completion	—	System
(S) + 2	System area	—	—	—
(S) + 3				
(S) + 4	CH1 Industrial shipment settings offset value	—	—	System
(S) + 5	CH1 Industrial shipment settings gain value	—	—	System
(S) + 6	CH2 Industrial shipment settings offset value	—	—	System
(S) + 7	CH2 Industrial shipment settings gain value	—	—	System
(S) + 8	CH3 Industrial shipment settings offset value	—	—	System
(S) + 9	CH3 Industrial shipment settings gain value	—	—	System
(S) + 10	CH4 Industrial shipment settings offset value	—	—	System
(S) + 11	CH4 Industrial shipment settings gain value	—	—	System
(S) + 12	CH5 Industrial shipment settings offset value	—	—	System
(S) + 13	CH5 Industrial shipment settings gain value	—	—	System
(S) + 14	CH6 Industrial shipment settings offset value	—	—	System
(S) + 15	CH6 Industrial shipment settings gain value	—	—	System
(S) + 16	CH7 Industrial shipment settings offset value	—	—	System
(S) + 17	CH7 Industrial shipment settings gain value	—	—	System
(S) + 18	CH8 Industrial shipment settings offset value	—	—	System
(S) + 19	CH8 Industrial shipment settings gain value	—	—	System
(S) + 20	CH1 User range settings offset value	—	—	System
(S) + 21	CH1 User range settings gain value	—	—	System
(S) + 22	CH2 User range settings offset value	—	—	System
(S) + 23	CH2 User range settings gain value	—	—	System
(S) + 24	CH3 User range settings offset value	—	—	System
(S) + 25	CH3 User range settings gain value	—	—	System
(S) + 26	CH4 User range settings offset value	—	—	System
(S) + 27	CH4 User range settings gain value	—	—	System
(S) + 28	CH5 User range settings offset value	—	—	System
(S) + 29	CH5 User range settings gain value	—	—	System
(S) + 30	CH6 User range settings offset value	—	—	System
(S) + 31	CH6 User range settings gain value	—	—	System
(S) + 32	CH7 User range settings offset value	—	—	System
(S) + 33	CH7 User range settings gain value	—	—	System
(S) + 34	CH8 User range settings offset value	—	—	System
(S) + 35	CH8 User range settings gain value	—	—	System

*4 Setting is not necessary. If setting is made, the offset/gain values will not be read properly.

(1) Functions

- (a) Reads the offset/gain values of the user range setting of the D/A converter module to the CPU.
- (b) There are two types of interlock signals for the G(P).OGLOAD instruction: the completion device (D) and the status display device at completion (D) + 1.
 - 1) Completion device
Turns on in the END processing of the scan where the G(P).OGLOAD instruction is completed, and turns off in the next END processing.
 - 2) Status display device at completion
Turns on and off depending on the completion status of the G(P).OGLOAD instruction.
Normal completion : Stays off and does not change.
Abnormal completion : Turns on in the END processing of the scan where the G(P).OGLOAD instruction is completed, and turns off in the next END processing.

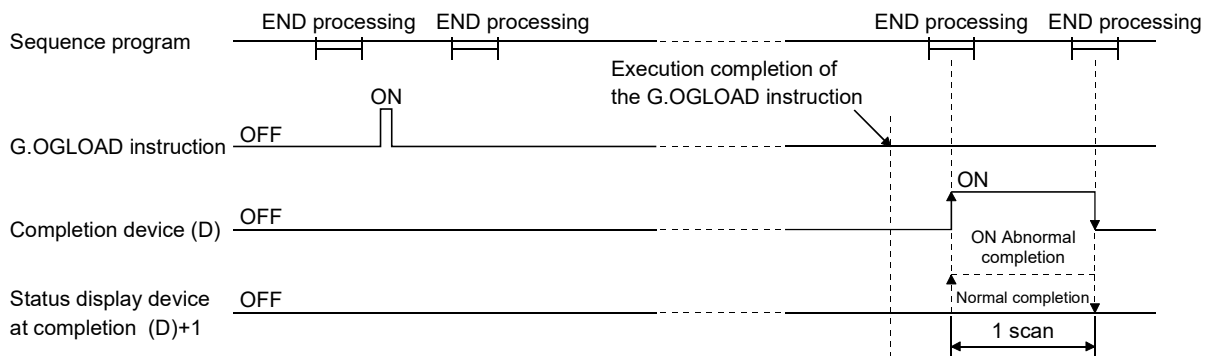

(2) Operation error

No errors.

(3) Program example

The following program is designed to read the offset/gain values of the D/A converter module mounted in the position of I/O number X/Y0 to X/YF when M11 is turned on.

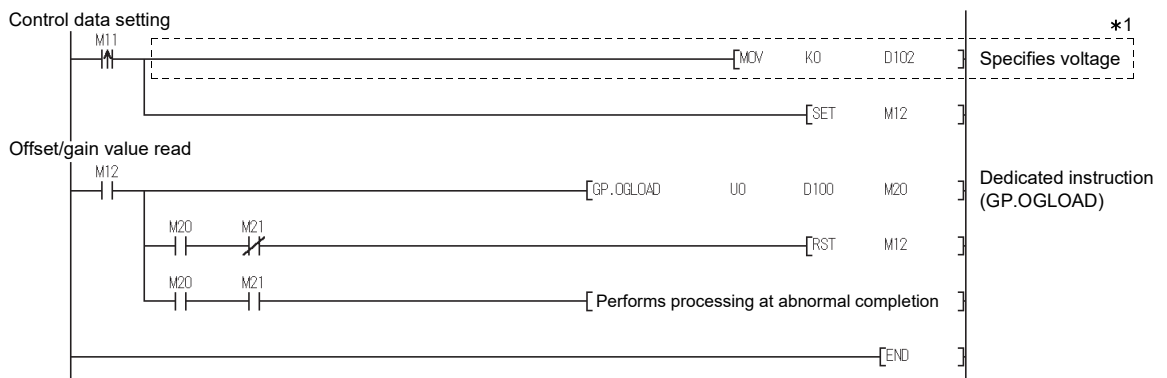

* For the Q68DAVN/Q68DAIN/Q68DAV/Q68DAI, the program in the dotted area is not necessary.

Appendix 2.3 G(P).OGSTOR

Restores the offset/gain values of the user range setting stored in the CPU to the D/A converter module.

Setting data	Usable devices									
	Internal device (System, user)		File register	Link direct device J□\□		Intelligent function device U□\G□	Index register Z□	Constant		Other
	Bit	Word		Bit	Word			K, H	\$	
(S)	—	○						—	—	—
(D)		○						—	—	—

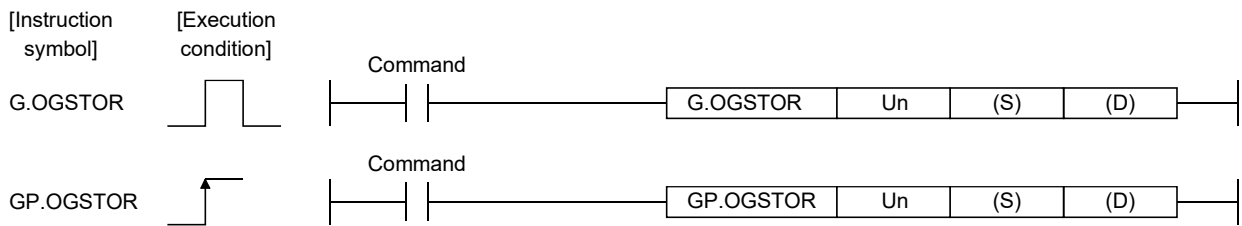

Setting data

Setting data	Description	Setting range	Data type
Un	Start I/O number of the module	0 to FEH	Binary 16 bits
(S) *1	Start number of the device in which control data is stored.	Within the range of the specified device	Device name
(D)	Device that is turned on 1 scan on completion of dedicated instruction processing. (D) + 1 also turns on at an abnormal completion.	Within the range of the specified device	Bit

*1 When executing the G(P).OGLOAD instruction, specify the device designated in (S). Do not change the data read with the G(P).OGLOAD instruction. If it is changed, normal operation cannot be guaranteed.

Control data of the Q62DAN and Q62DA

Device	Item	Setting data	Setting range	Set by										
(S)	System area	—	—	—										
(S) + 1	Completion status	Stores the status when the instruction is complete. 0 : Normal completion Other than 0: Abnormal completion (Error code)	—	System										
(S) + 2	Pass data classification setting	The value set to Pass data classification setting (S)+2 using the G(P).OGLOAD instruction is stored. 0: Voltage specified 1: Current specified <table border="1" style="margin-left: auto; margin-right: auto;"> <tr> <td>b15</td> <td></td> <td>b2</td> <td>b1</td> <td>b0</td> </tr> <tr> <td>0</td> <td>~</td> <td>0</td> <td>CH.2</td> <td>CH.1</td> </tr> </table>	b15		b2	b1	b0	0	~	0	CH.2	CH.1	0000H to 0003H	User
b15		b2	b1	b0										
0	~	0	CH.2	CH.1										
(S) + 3	System area	—	—	—										
(S) + 4	CH1 Industrial shipment settings offset value	—	—	System										
(S) + 5	CH1 Industrial shipment settings gain value	—	—	System										
(S) + 6	CH2 Industrial shipment settings offset value	—	—	System										
(S) + 7	CH2 Industrial shipment settings gain value	—	—	System										
(S) + 8	CH1 User range settings offset value	—	—	System										
(S) + 9	CH1 User range settings gain value	—	—	System										
(S) + 10	CH2 User range settings offset value	—	—	System										
(S) + 11	CH2 User range settings gain value	—	—	System										

Control data of the Q64DAN and Q64DA

Device	Item	Setting data	Setting range	Set by												
(S)	System area	—	—	—												
(S) + 1	Completion status	Stores the status when the instruction is complete. 0 : Normal completion Other than 0: Abnormal completion (Error code)	—	System												
(S) + 2	Pass data classification setting	The value set to Pass data classification setting (S)+2 using the G(P).OGLOAD instruction is stored. 0: Voltage specified 1: Current specified <table border="1" style="margin-left: auto; margin-right: auto;"> <tr> <td style="text-align: center;">b15</td> <td style="text-align: center;">b4</td> <td style="text-align: center;">b3</td> <td style="text-align: center;">b2</td> <td style="text-align: center;">b1</td> <td style="text-align: center;">b0</td> </tr> <tr> <td style="text-align: center;">0</td> <td style="text-align: center;">~</td> <td style="text-align: center;">0</td> <td style="text-align: center;">CH.4</td> <td style="text-align: center;">CH.3</td> <td style="text-align: center;">CH.2 CH.1</td> </tr> </table>	b15	b4	b3	b2	b1	b0	0	~	0	CH.4	CH.3	CH.2 CH.1	0000 _H to 000F _H	User
b15	b4	b3	b2	b1	b0											
0	~	0	CH.4	CH.3	CH.2 CH.1											
(S) + 3	System area	—	—	—												
(S) + 4	CH1 Industrial shipment settings offset value	—	—	System												
(S) + 5	CH1 Industrial shipment settings gain value	—	—	System												
(S) + 6	CH2 Industrial shipment settings offset value	—	—	System												
(S) + 7	CH2 Industrial shipment settings gain value	—	—	System												
(S) + 8	CH3 Industrial shipment settings offset value	—	—	System												
(S) + 9	CH3 Industrial shipment settings gain value	—	—	System												
(S) + 10	CH4 Industrial shipment settings offset value	—	—	System												
(S) + 11	CH4 Industrial shipment settings gain value	—	—	System												
(S) + 12	CH1 User range settings offset value	—	—	System												
(S) + 13	CH1 User range settings gain value	—	—	System												
(S) + 14	CH2 User range settings offset value	—	—	System												
(S) + 15	CH2 User range settings gain value	—	—	System												
(S) + 16	CH3 User range settings offset value	—	—	System												
(S) + 17	CH3 User range settings gain value	—	—	System												
(S) + 18	CH4 User range settings offset value	—	—	System												
(S) + 19	CH4 User range settings gain value	—	—	System												

Control data of the Q68DAVN and Q68DAV

Device	Item	Setting data	Setting range	Set by
(S)	System area	—	—	—
(S) + 1	Completion status	Stores the status when the instruction is complete. 0 : Normal completion Other than 0: Abnormal completion (Error code)	—	System
(S) + 2	System area	—	—	—
(S) + 3				
(S) + 4	CH1 Industrial shipment settings offset value	—	—	System
(S) + 5	CH1 Industrial shipment settings gain value	—	—	System
(S) + 6	CH2 Industrial shipment settings offset value	—	—	System
(S) + 7	CH2 Industrial shipment settings gain value	—	—	System
(S) + 8	CH3 Industrial shipment settings offset value	—	—	System
(S) + 9	CH3 Industrial shipment settings gain value	—	—	System
(S) + 10	CH4 Industrial shipment settings offset value	—	—	System
(S) + 11	CH4 Industrial shipment settings gain value	—	—	System
(S) + 12	CH5 Industrial shipment settings offset value	—	—	System
(S) + 13	CH5 Industrial shipment settings gain value	—	—	System
(S) + 14	CH6 Industrial shipment settings offset value	—	—	System
(S) + 15	CH6 Industrial shipment settings gain value	—	—	System
(S) + 16	CH7 Industrial shipment settings offset value	—	—	System
(S) + 17	CH7 Industrial shipment settings gain value	—	—	System
(S) + 18	CH8 Industrial shipment settings offset value	—	—	System
(S) + 19	CH8 Industrial shipment settings gain value	—	—	System
(S) + 20	CH1 User range settings offset value	—	—	System
(S) + 21	CH1 User range settings gain value	—	—	System
(S) + 22	CH2 User range settings offset value	—	—	System
(S) + 23	CH2 User range settings gain value	—	—	System
(S) + 24	CH3 User range settings offset value	—	—	System
(S) + 25	CH3 User range settings gain value	—	—	System
(S) + 26	CH4 User range settings offset value	—	—	System
(S) + 27	CH4 User range settings gain value	—	—	System
(S) + 28	CH5 User range settings offset value	—	—	System
(S) + 29	CH5 User range settings gain value	—	—	System
(S) + 30	CH6 User range settings offset value	—	—	System
(S) + 31	CH6 User range settings gain value	—	—	System
(S) + 32	CH7 User range settings offset value	—	—	System
(S) + 33	CH7 User range settings gain value	—	—	System
(S) + 34	CH8 User range settings offset value	—	—	System
(S) + 35	CH8 User range settings gain value	—	—	System

Control data of the Q68DAIN and Q68DAI

Device	Item	Setting data	Setting range	Set by
(S)	System area	—	—	—
(S) + 1	Completion status	Stores the status when the instruction is complete. 0 : Normal completion Other than 0: Abnormal completion	—	System
(S) + 2	System area	—	—	—
(S) + 3				
(S) + 4	CH1 Industrial shipment settings offset value	—	—	System
(S) + 5	CH1 Industrial shipment settings gain value	—	—	System
(S) + 6	CH2 Industrial shipment settings offset value	—	—	System
(S) + 7	CH2 Industrial shipment settings gain value	—	—	System
(S) + 8	CH3 Industrial shipment settings offset value	—	—	System
(S) + 9	CH3 Industrial shipment settings gain value	—	—	System
(S) + 10	CH4 Industrial shipment settings offset value	—	—	System
(S) + 11	CH4 Industrial shipment settings gain value	—	—	System
(S) + 12	CH5 Industrial shipment settings offset value	—	—	System
(S) + 13	CH5 Industrial shipment settings gain value	—	—	System
(S) + 14	CH6 Industrial shipment settings offset value	—	—	System
(S) + 15	CH6 Industrial shipment settings gain value	—	—	System
(S) + 16	CH7 Industrial shipment settings offset value	—	—	System
(S) + 17	CH7 Industrial shipment settings gain value	—	—	System
(S) + 18	CH8 Industrial shipment settings offset value	—	—	System
(S) + 19	CH8 Industrial shipment settings gain value	—	—	System
(S) + 20	CH1 User range settings offset value	—	—	System
(S) + 21	CH1 User range settings gain value	—	—	System
(S) + 22	CH2 User range settings offset value	—	—	System
(S) + 23	CH2 User range settings gain value	—	—	System
(S) + 24	CH3 User range settings offset value	—	—	System
(S) + 25	CH3 User range settings gain value	—	—	System
(S) + 26	CH4 User range settings offset value	—	—	System
(S) + 27	CH4 User range settings gain value	—	—	System
(S) + 28	CH5 User range settings offset value	—	—	System
(S) + 29	CH5 User range settings gain value	—	—	System
(S) + 30	CH6 User range settings offset value	—	—	System
(S) + 31	CH6 User range settings gain value	—	—	System
(S) + 32	CH7 User range settings offset value	—	—	System
(S) + 33	CH7 User range settings gain value	—	—	System
(S) + 34	CH8 User range settings offset value	—	—	System
(S) + 35	CH8 User range settings gain value	—	—	System

(1) Functions

- (a) Restores the offset/gain values of the user range setting stored in the CPU to the D/A converter module.
- (b) There are two types of interlock signals for the G(P).OGSTOR instruction: the completion device (D) and the status display device at completion (D) + 1.
 - 1) Completion device
Turns on in the END processing of the scan where the G(P).OGSTOR instruction is completed, and turns off in the next END processing.
 - 2) Status display device at completion
Turns on and off depending on the completion status of the G(P).OGSTOR instruction.
Normal completion : Stays off and does not change.
Abnormal completion : Turns on in the END processing of the scan where the G(P).OGSTOR instruction is completed, and turns off in the next END processing.

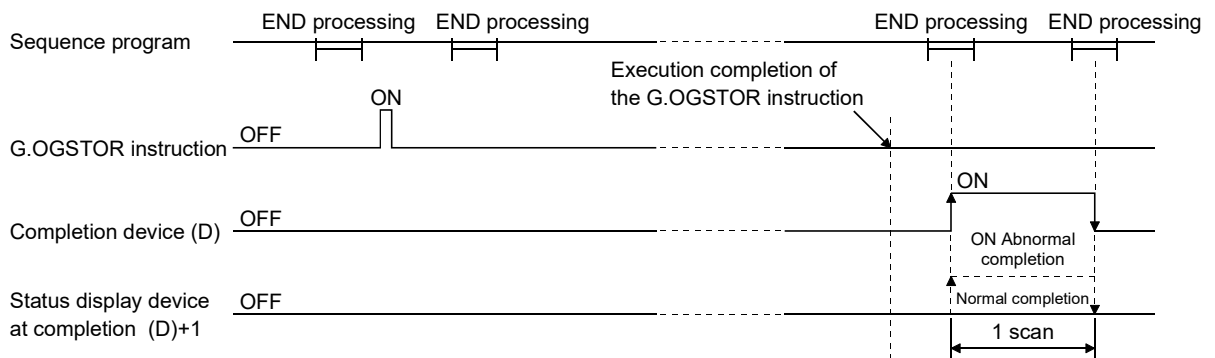

- (c) When the offset/gain values are restored, the reference accuracy falls to about less than three times of the accuracy before that.

(2) Operation error

In any of the following cases, an error occurs and the corresponding error codes are stored into the completion status area (S)+1.

Error code	Case resulting in operation error
161	The G(P).OGSTOR instruction was executed in the offset/gain setting mode.
162	The G(P).OGSTOR instruction was executed consecutively.
163	The G(P).OGSTOR instruction was executed for the model that differs from the model for which the G(P).OGLOAD instruction had been executed.

(3) Program example

The following program is designed to read the offset/gain values of the D/A converter module mounted in the position of I/O number X/Y0 to X/YF when M11 is turned on.

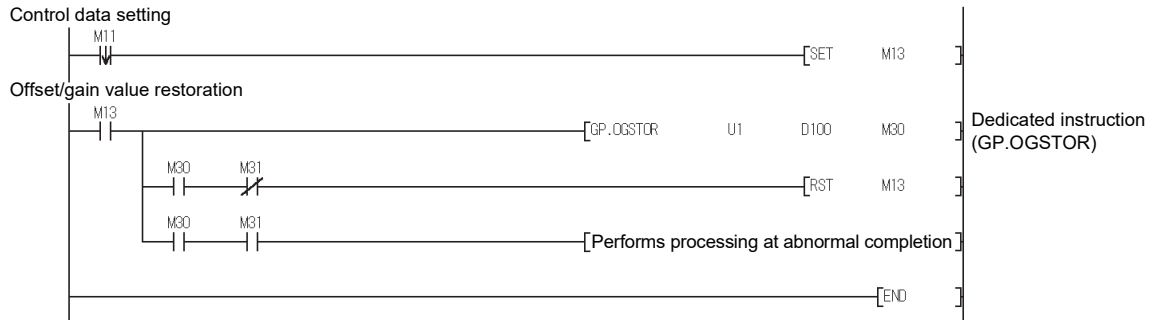

Appendix 3 External Dimensions

(1) Q62DAN, Q64DAN

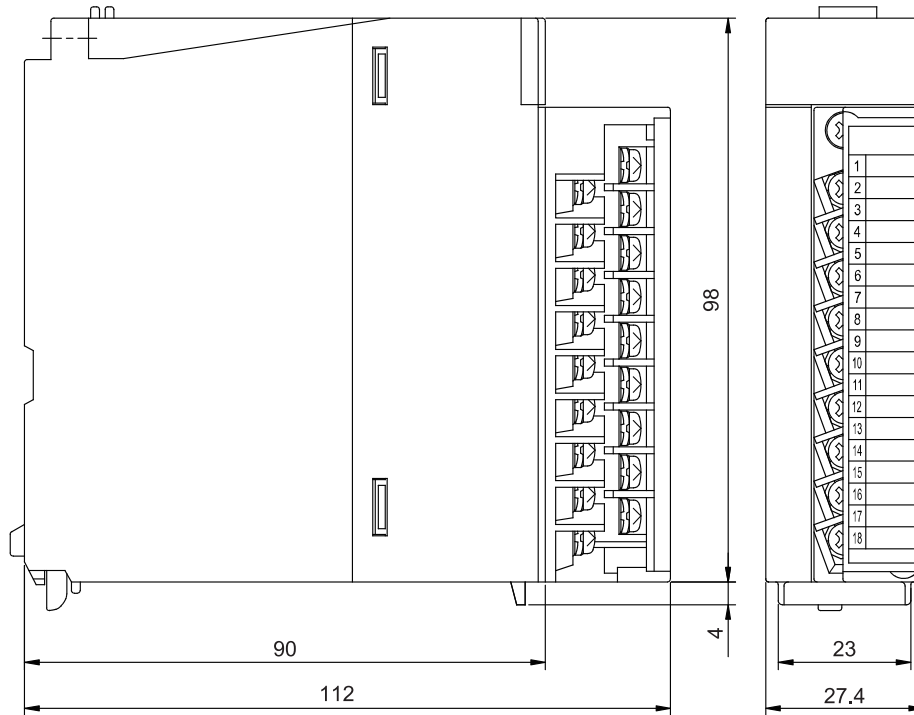

Unit: mm

(2) Q68DAVN, Q68DAIN

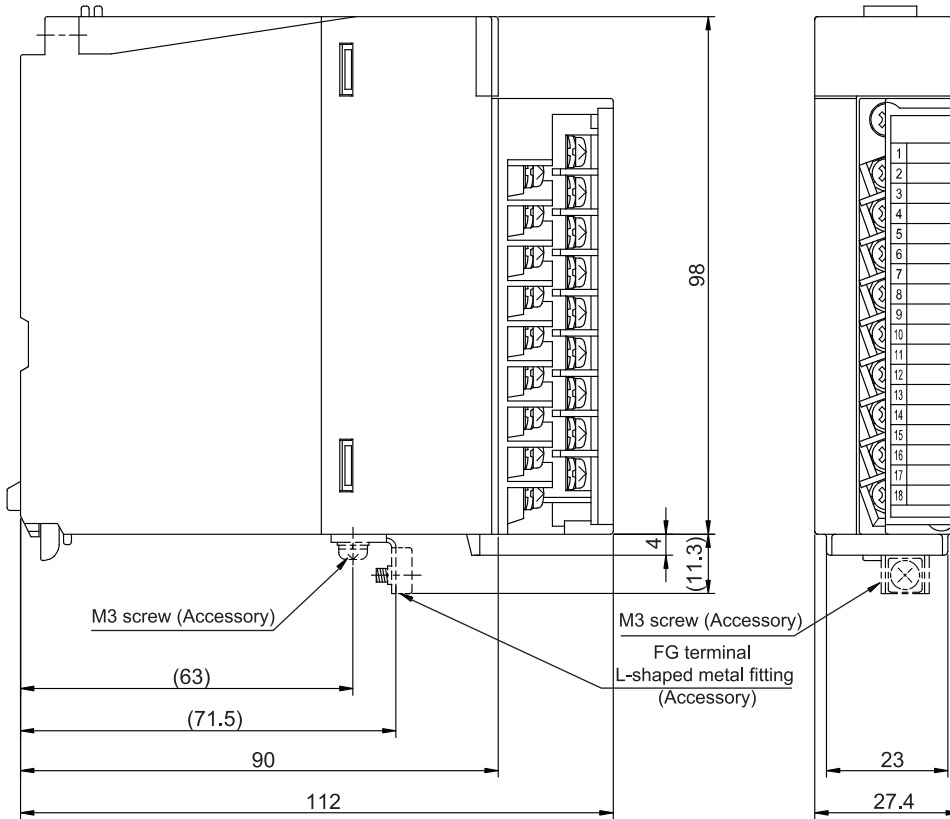

Unit: mm

(3) Q62DA, Q64DA

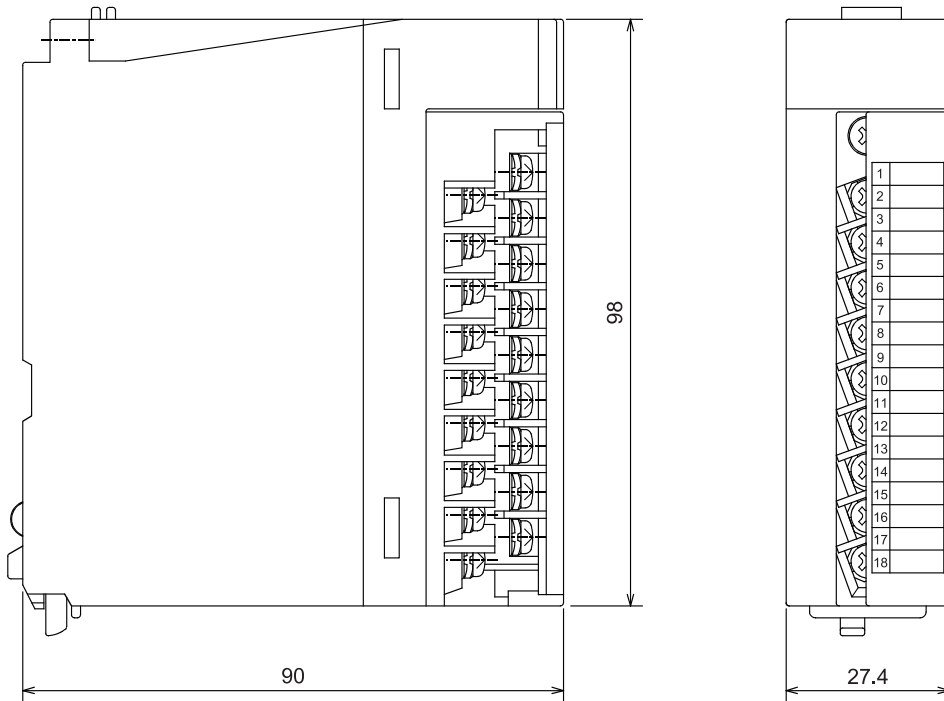

Unit: mm

(4) Q68DAV, Q68DAI

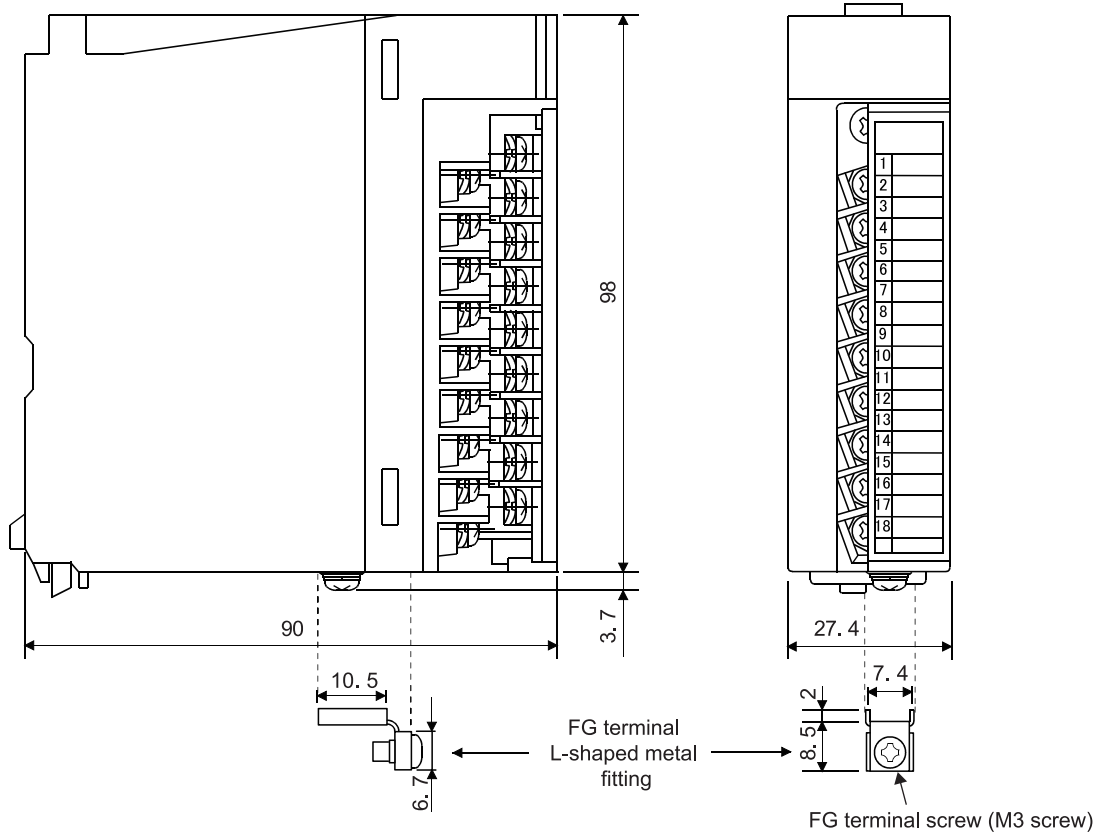

Unit: mm

INDEX

- [A]
 Absolute maximum output 3-1, 3-2
 Accuracy 3-1, 3-2, 3-10
 Analog output 3-1, 3-2
 Analog output HOLD/CLEAR function 3-12
 Analog output test during programmable controller
 CPU STOP 3-14
- [B]
 Buffer memory 3-20
- [C]
 Channel change completed flag 3-17
 Channel change request 3-19
 CH□ Digital value 3-28
 CH□ Output enable/disable flag 3-19
 CH□ Set value check code 3-29
 Close parameters 5-13
 Confirmation of conversion characteristic 5-27
 Conversion speed 3-1, 3-2, 3-10
 Current output characteristic 3-7
- [D]
 D/A conversion enable/disable function 3-11
 D/A conversion enable/disable 3-28
 D/A converter module A-13
 D/A output enable/disable function 3-11
 Dedicated instruction App-5
 Delete parameters 5-13
 Digital input 3-1, 3-2
- [E]
 EMC directive A-12
 Error clear request 3-19
 Error code list 8-1
 Error code 3-29
 ERROR LED 4-4
 Error flag 3-18
 External Dimensions App-19
 External supply power 3-1, 3-2
- [F]
 FB conversion 5-32
 FG terminal L-shaped metal fitting
 4-6, App-19, App-20
- Function version 2-5
- [G]
 Gain value 3-3
 G(P).OFFGAN App-6
 G(P).OGLOAD App-8
 G(P).OGSTOR App-13
 GX Configurator-DA 2-2
 GX Configurator-DA software Version App-2
 GX Developer A-13
- [H]
 Handling precautions 4-1, 5-2
 High resolution mode 3-1, 3-2
 High resolution mode status flag 3-16
- [I]
 I/O assignment setting 4-11
 I/O characteristics 3-1, 3-2
 Industrial shipment settings offset/gain value
 3-33
 Initial setting 5-15
 Installing 5-2
 Insulation method 3-1, 3-2
 Intelligent function module parameter 5-8
 Intelligent function module switch setting 4-9
 Internal current consumption 3-1, 3-2
- [L]
 List of I/O signals 3-15
- [M]
 Multiple CPU system 2-1
 Maximum resolution 3-1, 3-2
 Mode switching setting 3-31
 Module ready 3-16
 Monitor/test 5-19
- [N]
 Normal resolution mode 3-1, 3-2

- [O]
- Offset value 3-3
 - Offset/gain adjustment value specification ... 3-31
 - Offset/gain setting mode flag 3-17
 - Offset/gain setting mode 3-30
 - Offset/gain settings..... 4-13
 - Online module change 7-1
 - Open parameters 5-13
 - Operating condition setting completed flag .. 3-16
 - Operating condition setting request..... 3-19
 - Operating environment 5-5
 - Output range..... 3-30
 - Output short circuit protection..... 3-1, 3-2
- [P]
- Part identification nomenclature 4-3
 - Pass data..... 5-29
 - Pass data classification setting 3-32
 - Programming 6-1
- [Q]
- QCPU (Q mode).....A-13
- [R]
- Read from PLC..... 5-13
 - Resolution mode 3-11
 - RUN LED 4-4
- [S]
- Save parameters 5-13
 - Screen for selecting a target intelligent function module 5-10
 - Set value change completed flag 3-18
 - Set value change request 3-19
 - Setting range 3-30
 - Setup and procedures before operation..... 4-1
 - Synchronous output function 3-11
 - Synchronous output mode flag 3-18
 - Synchronous output request..... 3-19
- [T]
- Text files 5-9
 - Transfer setup 5-14
 - Troubleshooting..... 8-1
- [U]
- Uninstalling 5-2
 - User range settings offset/gain value 3-33
- User range writing request3-19
- Utility package 5-1
- [V]
- Voltage output characteristic 3-4
- [W]
- Weight 3-1, 3-2
 - Write to PLC.....5-13
- [X]
- X/Y monitor/test5-19

WARRANTY

Please confirm the following product warranty details before using this product.

1. Gratis Warranty Term and Gratis Warranty Range

If any faults or defects (hereinafter "Failure") found to be the responsibility of Mitsubishi occurs during use of the product within the gratis warranty term, the product shall be repaired at no cost via the sales representative or Mitsubishi Service Company.

However, if repairs are required onsite at domestic or overseas location, expenses to send an engineer will be solely at the customer's discretion. Mitsubishi shall not be held responsible for any re-commissioning, maintenance, or testing on-site that involves replacement of the failed module.

[Gratis Warranty Term]

The gratis warranty term of the product shall be for one year after the date of purchase or delivery to a designated place. Note that after manufacture and shipment from Mitsubishi, the maximum distribution period shall be six (6) months, and the longest gratis warranty term after manufacturing shall be eighteen (18) months. The gratis warranty term of repair parts shall not exceed the gratis warranty term before repairs.

[Gratis Warranty Range]

- (1) The range shall be limited to normal use within the usage state, usage methods and usage environment, etc., which follow the conditions and precautions, etc., given in the instruction manual, user's manual and caution labels on the product.
- (2) Even within the gratis warranty term, repairs shall be charged for in the following cases.
 1. Failure occurring from inappropriate storage or handling, carelessness or negligence by the user. Failure caused by the user's hardware or software design.
 2. Failure caused by unapproved modifications, etc., to the product by the user.
 3. When the Mitsubishi product is assembled into a user's device, Failure that could have been avoided if functions or structures, judged as necessary in the legal safety measures the user's device is subject to or as necessary by industry standards, had been provided.
 4. Failure that could have been avoided if consumable parts (battery, backlight, fuse, etc.) designated in the instruction manual had been correctly serviced or replaced.
 5. Failure caused by external irresistible forces such as fires or abnormal voltages, and Failure caused by force majeure such as earthquakes, lightning, wind and water damage.
 6. Failure caused by reasons unpredictable by scientific technology standards at time of shipment from Mitsubishi.
 7. Any other failure found not to be the responsibility of Mitsubishi or that admitted not to be so by the user.

2. Onerous repair term after discontinuation of production

- (1) Mitsubishi shall accept onerous product repairs for seven (7) years after production of the product is discontinued. Discontinuation of production shall be notified with Mitsubishi Technical Bulletins, etc.
- (2) Product supply (including repair parts) is not available after production is discontinued.

3. Overseas service

Overseas, repairs shall be accepted by Mitsubishi's local overseas FA Center. Note that the repair conditions at each FA Center may differ.

4. Exclusion of loss in opportunity and secondary loss from warranty liability

Regardless of the gratis warranty term, Mitsubishi shall not be liable for compensation to:

- (1) Damages caused by any cause found not to be the responsibility of Mitsubishi.
- (2) Loss in opportunity, lost profits incurred to the user by Failures of Mitsubishi products.
- (3) Special damages and secondary damages whether foreseeable or not, compensation for accidents, and compensation for damages to products other than Mitsubishi products.
- (4) Replacement by the user, maintenance of on-site equipment, start-up test run and other tasks.

5. Changes in product specifications

The specifications given in the catalogs, manuals or technical documents are subject to change without prior notice.

TRADEMARKS

Celeron, Intel, and Pentium are either registered trademarks or trademarks of Intel Corporation in the United States and/or other countries.

Microsoft, Microsoft Access, ActiveX, Excel, SQL Server, Visual Basic, Visual C++, Visual Studio, Windows, Windows NT, Windows Server, Windows Vista, and Windows XP are either registered trademarks or trademarks of Microsoft Corporation in the United States and/or other countries.

The company names, system names and product names mentioned in this manual are either registered trademarks or trademarks of their respective companies.

In some cases, trademark symbols such as [™] or [®] are not specified in this manual.

SH(NA)-080054-V(2001)MEE

MODEL: Q-D/A-U-S-E

MODEL CODE: 13JR02

MITSUBISHI ELECTRIC CORPORATION

HEAD OFFICE : TOKYO BUILDING, 2-7-3 MARUNOUCHI, CHIYODA-KU, TOKYO 100-8310, JAPAN
NAGOYA WORKS : 1-14, YADA-MINAMI 5-CHOME, HIGASHI-KU, NAGOYA, JAPAN

When exported from Japan, this manual does not require application to the
Ministry of Economy, Trade and Industry for service transaction permission.

Specifications subject to change without notice.