



Programmable Controller

CC-Link IE TSN Remote I/O Module (With Safety Functions) User's Manual

-NZ2GNSS2-8D
-NZ2GNSS2-8TE
-NZ2GNSS2-16DTE

SAFETY PRECAUTIONS



(Read these precautions before using this product.)

Before using this product, please read this manual and the relevant manuals carefully and pay full attention to safety to handle the product correctly.

If products are used in a different way from that specified by manufacturers, the protection function of the products may not work properly.

The precautions given in this manual are concerned with this product only. For the safety precautions of the programmable controller system, refer to the user's manual for the CPU module used.

In this manual, the safety precautions are classified into two levels: "⚠️ WARNING" and "⚠️ CAUTION".

 WARNING	Indicates that incorrect handling may cause hazardous conditions, resulting in death or severe injury.
 CAUTION	Indicates that incorrect handling may cause hazardous conditions, resulting in minor or moderate injury or property damage.

Under some circumstances, failure to observe the precautions given under "⚠️ CAUTION" may lead to serious consequences.

Observe the precautions of both levels because they are important for personal and system safety.

Make sure that the end users read this manual and then keep the manual in a safe place for future reference.

[Design Precautions]

WARNING

- When the safety remote I/O module detects an error in an external power supply or a failure in the module, it turns off the outputs. Configure an external circuit to ensure that the power source of a hazard is shut off by turning off the outputs. Failure to do so may result in an accident due to an incorrect output or malfunction.
 - When a load current exceeding the rated current or an overcurrent caused by a load short-circuit flows, the safety remote I/O module defines it as a fault and turns off the outputs. Note that if the overcurrent state continues for a long time, it may cause smoke and fire. To prevent this, configure an external safety circuit, such as a fuse.
 - At the start-up of the system, if the external power supply is short-circuited by the output wiring of the safety remote I/O module, or if the external power supply is connected with a wrong polarity, a load may turn on just after the power-on. Configure an interlock circuit to ensure that the entire system will always operate safely.
 - When a communication failure occurs in the network, the failed station becomes the following status. Check the communication status information and configure an interlock circuit in the program to ensure that the entire system will operate safely. Failure to do so may result in an accident due to an incorrect output or malfunction.
 - (1) Remote stations turn off all output from terminals.
 - (2) Remote stations suspend safety communications.
 - Do not use any "use prohibited" signals as a remote input or output signal. These signals are reserved for system use. Do not write any data to the "use prohibited" areas in the remote register. If any of the "use prohibited" signals are used (turned on or off), or any data is written to the "use prohibited" areas, the correct operation of the module cannot be guaranteed. For system areas, "use prohibited" areas, and "use prohibited" signals, refer to "APPENDICES" in the CC-Link IE TSN Remote I/O Module (With Safety Functions) User's Manual. For areas used for safety communications, they are protected from being written by users, and thus safety communications failure caused by data writing does not occur.
 - When the fast logic interlock is disabled, it is customer's responsibility to build the interlock circuit externally so that the entire system always operates safely. Be sure to connect an interlock mechanism to the output of this I/O module.
 - If the measure to prevent the restart cannot be taken, take other measures and ensure that operators are safe and machine parts are not damaged even if a device has restarted with the fast logic interlock disabled.
 - To satisfy SIL3, Category 4 PLe, use input devices with normally closed contacts. Inputs using the devices with normally open contacts do not satisfy SIL3, Category 4 PLe.
 - Use a SELV power supply for the devices to be connected to the input part of the safety remote I/O module. If not, SIL3, Category 4 PLe is not satisfied.
-

[Design Precautions]

CAUTION

- Do not install the cables connected to external devices or the communication cables together with the main circuit lines or power cables. Keep a distance of 100mm or more between them. Failure to do so may result in malfunction due to noise.
 - Select the external devices to be connected to the module by referring to the performance specifications in this manual and considering the maximum inrush current. Connecting a device exceeding the maximum inrush current may cause malfunction or failure of the module.
-

[Security Precautions]

WARNING

- To maintain the security (confidentiality, integrity, and availability) of the programmable controller and the system against unauthorized access, denial-of-service (DoS) attacks, computer viruses, and other cyberattacks from external devices via the network, take appropriate measures such as firewalls, virtual private networks (VPNs), and antivirus solutions.
-

[Installation Precautions]

WARNING

- Shut off the external power supply (all phases) used in the system before mounting or removing a module. Failure to do so may result in electric shock or cause the module to fail or malfunction.
-

[Installation Precautions]

CAUTION

- Use the module in an environment that meets the general specifications in this manual. Failure to do so may result in electric shock, fire, malfunction, or damage to or deterioration of the product.
 - Do not directly touch any conductive parts and electronic components of the module. Doing so can cause malfunction or failure of the module.
 - After the first use of the product, do not connect/remove the connectors more than 50 times (IEC 61131-2/JIS B 3502 compliant). Exceeding the limit may cause malfunction.
 - Connect each connection cable to the connector securely. Poor contact may cause malfunction.
-

[Wiring Precautions]

WARNING

- Shut off the external power supply (all phases) used in the system before wiring. Failure to do so may result in electric shock or cause the module to fail or malfunction.
-

[Wiring Precautions]

CAUTION

- Individually ground the FG terminal of the programmable controller with a ground resistance of 100 ohms or less. Failure to do so may result in electric shock or malfunction.
 - Check the rated voltage and terminal layout before wiring to the module, and connect the cables correctly. Connecting a power supply with a different voltage rating or incorrect wiring may cause fire or failure.
 - Tighten the terminal block mounting screws within the specified torque range. Undertightening can cause short circuit, fire, or malfunction. Overtightening can damage the screw and/or module, resulting in drop, short circuit, or malfunction.
 - Prevent foreign matter such as dust or wire chips from entering the module. Such foreign matter can cause a fire, failure, or malfunction.
 - Place the cables in a duct or clamp them. If not, dangling cables may swing or inadvertently be pulled, resulting in malfunction or damage to modules or cables. In addition, the weight of the cables may put stress on modules in an environment of strong vibrations and shocks.
 - When disconnecting the cable from the module, do not pull the cable by the cable part. For the cable with connector, hold the connector part of the cable. For the cable connected to the terminal block, loosen the terminal block screw. Pulling the cable connected to the module may result in malfunction or damage to the module or cable.
 - Do not install the control lines or communication cables together with the main circuit lines or power cables. Keep a distance of 100mm or more between them. Failure to do so may result in malfunction due to noise.
 - When an overcurrent caused by an error of an external device or a failure of the module flows for a long time, it may cause smoke and fire. To prevent this, configure an external safety circuit, such as a fuse.
 - Mitsubishi programmable controllers must be installed in control panels. Wiring and replacement of a module must be performed by qualified maintenance personnel with knowledge of protection against electric shock. For wiring methods, refer to "INSTALLATION AND WIRING" in this manual.
-

[Startup and Maintenance Precautions]

WARNING

- Do not touch any terminal while power is on. Doing so will cause electric shock or malfunction.
 - Shut off the external power supply (all phases) used in the system before cleaning the module or retightening the terminal block mounting screw. Failure to do so may result in electric shock. Tighten the terminal block mounting screws within the specified torque range. Undertightening can cause short circuit, fire, or malfunction. Overtightening can damage the screw and/or module, resulting in drop, short circuit, or malfunction.
-

[Startup and Maintenance Precautions]

CAUTION

- Do not disassemble or modify the modules. Doing so may cause failure, malfunction, injury, or a fire.
 - Use any radio communication device such as a cellular phone or PHS (Personal Handy-phone System) 25cm or more away from wiring as well as away in all directions from the module. Failure to do so may cause malfunction.
 - Shut off the external power supply (all phases) used in the system before mounting or removing a module. Failure to do so may cause the module to fail or malfunction.
 - Before handling the module, touch a conducting object such as a grounded metal to discharge the static electricity from the human body. Wearing an anti-static wrist strap (grounded) is also recommended. Not discharging the static electricity may cause the module to fail or malfunction.
 - Do not drop or apply strong shock to the module. Doing so may damage the module.
 - Shut off the external power supply (all phases) used in the system before installing or removing a module in/from the control panel. Failure to do so may cause the module to fail or malfunction.
 - Check the module once a day, by turning on output signals and confirming that no error occurs.
 - Startup and maintenance of a control panel must be performed by qualified maintenance personnel with knowledge of protection against electric shock. Lock the control panel so that only qualified maintenance personnel can operate it.
-

[Disposal Precautions]

CAUTION

- When disposing of this product, treat it as industrial waste.
-

[Precautions for Using Products]

WARNING

- Although MELCO has obtained the certification for Product's compliance to the international safety standards IEC 61508 and ISO 13849-1 from TUV Rheinland, this fact does not guarantee that Product will be free from any malfunction or failure.
 - With very small probability shown in PFDavg / PFH, the safety remote I/O module has residual risk that input and output may remain on or off. When using this product, perform risk assessment on target equipment, and select appropriate SIL and PL, as well as reduce the risk.
-

[Transportation Precautions]

CAUTION

- For shipping, always use the original packaging.
-

CONDITIONS OF USE FOR THE PRODUCT

- (1) Although MELCO has obtained the certification for Product's compliance to the international safety standards IEC61508, ISO13849-1 from TUV Rheinland, this fact does not guarantee that Product will be free from any malfunction or failure. The user of this Product shall comply with any and all applicable safety standard, regulation or law and take appropriate safety measures for the system in which the Product is installed or used and shall take the second or third safety measures other than the Product. MELCO is not liable for damages that could have been prevented by compliance with any applicable safety standard, regulation or law.
- (2) MELCO prohibits the use of Products with or in any application involving, and MELCO shall not be liable for a default, a liability for defect warranty, a quality assurance, negligence or other tort and a product liability in these applications.
 - (a) power plants,
 - (b) trains, railway systems, airplanes, airline operations, other transportation systems,
 - (c) hospitals, medical care, dialysis and life support facilities or equipment,
 - (d) amusement equipments,
 - (e) incineration and fuel devices,
 - (f) handling of nuclear or hazardous materials or chemicals,
 - (g) mining and drilling,
 - (h) and other applications where the level of risk to human life, health or property are elevated.
- (3) Mitsubishi shall have no responsibility or liability for any problems involving programmable controller trouble and system trouble caused by DoS attacks, unauthorized access, computer viruses, and other cyberattacks.

INTRODUCTION

Thank you for purchasing the CC-Link IE TSN remote I/O module (with safety functions) (hereinafter referred to as safety remote I/O module).

This manual describes the procedures, system configuration, parameter settings, functions, and troubleshooting of the relevant products listed below.

Before using this product, please read this manual and the relevant manuals carefully and develop familiarity with the functions and performance of the safety remote I/O module to handle the product correctly.

Note that the menu names and operating procedures may differ depending on an operating system in use and its version.

When reading this manual, replace the names and procedures with the applicable ones as necessary.

When applying the program examples introduced in this manual to an actual system, ensure the applicability and confirm that it will not cause system control problems.

Relevant products

NZ2GNSS2-8D, NZ2GNSS2-8TE, NZ2GNSS2-16DTE

Point

Unless otherwise specified, this manual describes the examples in which the safety remote I/O signals, remote control/monitor signals, and remote registers are assigned for a safety remote I/O module as follows.

- Safety remote inputs: SA\X0 to SA\X1F
- Safety remote outputs: SA\Y0 to SA\Y1F
- Remote control/monitor signals: RX0 to RXF, RY0 to RYF
- Remote registers: RWr0 to RWr3, RWw0 to RWw3

For how to assign safety remote I/O signals, refer to the following.

 Page 69 Safety Communication Setting

For how to assign remote control/monitor signals and remote registers, refer to the following.

 Page 60 Parameter Setting

CONTENTS

SAFETY PRECAUTIONS	1
CONDITIONS OF USE FOR THE PRODUCT	7
INTRODUCTION	8
RELEVANT MANUALS	12
TERMS	13
GENERIC TERMS AND ABBREVIATIONS	14
CHAPTER 1 PRODUCT LINEUP	15
1.1 List of Products	15
Input modules	15
Output modules	15
I/O combined module	15
CHAPTER 2 PART NAMES	17
CHAPTER 3 SPECIFICATIONS	19
3.1 General Specifications	19
3.2 Performance Specifications	20
Input module	20
Output module	24
I/O combined module	27
Safety remote I/O module safety response time	31
3.3 Function List	32
CHAPTER 4 PROCEDURES BEFORE OPERATION	35
CHAPTER 5 SYSTEM CONFIGURATION	37
5.1 Applicable Systems	37
5.2 Safety Standards	39
CHAPTER 6 INSTALLATION AND WIRING	40
6.1 IP Address Setting Switch Setting	40
6.2 Installation Environment and Installation Position	42
Installation environment	42
Installation position	42
Installation direction	43
6.3 Installation	44
Mounting the modules on a DIN rail	44
6.4 Wiring of Terminal Block for Module Power Supply and FG	47
6.5 Wiring of Ethernet Cable	50
6.6 Wiring of External Device and I/O Terminal Block	52
Precautions for wiring the safety remote I/O module to safety devices	56
CHAPTER 7 SETTINGS	57
7.1 Network Configuration Settings	57
7.2 Parameter Setting	60
Device station parameter automatic setting	63
Parameter processing for device station	66

7.3	Safety Communication Setting	69
CHAPTER 8 FUNCTIONS		74
8.1	Safety Input	74
	Safety input wiring selection function	74
8.2	Standard Input	77
	Standard input wiring selection function	77
8.3	Input Response Time Setting Function	78
8.4	Safety Output	79
	Safety output wiring selection function	79
	Fast logic function	82
8.5	Input Diagnostic	93
	Double input discrepancy detection function	93
	Input dark test function	97
	Internal input dark test function	99
8.6	Output Diagnostic	100
	Output dark test function	100
	Output read-back function	102
8.7	Protection Functions	103
8.8	User Authentication Function	104
8.9	CC-Link IE TSN Class Setting Function	105
8.10	Communication Speed Setting Function	117
	Setting by CC-Link IE TSN Configurator	117
	Setting with the engineering tool	129
8.11	SLMP Communication Function	130
8.12	Operation Setting Function at Detection of External Power Supply Voltage Error	131
CHAPTER 9 MAINTENANCE AND INSPECTION		139
9.1	Daily Inspection	139
9.2	Periodic Inspection	140
CHAPTER 10 TROUBLESHOOTING		141
10.1	CC-Link IE TSN/CC-Link IE Field Diagnostics	141
10.2	Checking the LEDs	143
10.3	Unit Test	149
10.4	Troubleshooting by Symptom	150
10.5	Fault Examples with the Safety Remote I/O Module	152
	Troubleshooting for input circuit	152
	Troubleshooting for output circuit	154
10.6	Method for Checking Error Codes	155
10.7	List of Error Codes	157
	Error classification by error number	157
	Error codes related to the safety remote I/O module	157
	Error codes related to CC-Link IE TSN	164
	Error codes related to CC-Link IE TSN safety communications	167
APPENDICES		168
Appendix 1 Safety Remote I/O Signals		168
	List of safety remote I/O signals	169
	Details of safety remote input signals	172

Details of safety remote output signals	174
Details of safety remote I/O signals	175
Appendix 2 Remote Control/Monitor Signals	177
List of remote control/monitor signals	177
Details of remote control/monitor signals	178
Appendix 3 Remote Register	179
List of remote registers	179
Details of remote registers.	179
Appendix 4 Remote Buffer Memory	183
Remote buffer memory list	183
Details of remote buffer memory areas	189
Appendix 5 EMC and Low Voltage Directives	195
Measures to comply with the EMC Directive	195
Requirements for Low Voltage Directive compliance	200
Measures to comply with the Machinery Directive	201
Appendix 6 How to Check Production Information and Firmware Version	203
Checking the production information.	203
Checking the firmware version	204
Appendix 7 Software Licenses and Copyright	205
Appendix 8 Added and Changed Functions	206
Appendix 9 External Dimensions	207
INDEX	209
<hr/>	
REVISIONS	211
WARRANTY	212
TRADEMARKS	214

RELEVANT MANUALS

Manual name [manual number]	Description	Available form
CC-Link IE TSN Remote I/O Module (With Safety Functions) User's Manual [SH-082227ENG] (this manual)	Part names, specifications, procedures before operation, system configuration, installation, wiring, parameter settings, functions, and troubleshooting of the safety remote I/O module	Print book e-Manual PDF
MELSEC iQ-R CC-Link IE TSN User's Manual (Startup) [SH-082127ENG]	Specifications, procedures before operation, system configuration, wiring, and communication examples of CC-Link IE TSN	Print book e-Manual PDF
MELSEC iQ-R CC-Link IE TSN User's Manual (Application) [SH-082129ENG]	Functions, parameter settings, troubleshooting, I/O signals, and buffer memory of CC-Link IE TSN	Print book e-Manual PDF
GX Works3 Operating Manual [SH-081215ENG]	System configuration, parameter settings, and online operations of GX Works3	e-Manual PDF
SLMP Reference Manual [SH-080956ENG]	A protocol used to access an SLMP-compatible device from an external device (such as a personal computer or HMI (Human Machine Interface)) or an SLMP-compatible module (such as the Ethernet-equipped module or modules on CC-Link IE TSN)	Print book e-Manual PDF

Point

e-Manual refers to the Mitsubishi Electric FA electronic book manuals that can be browsed using a dedicated tool.

e-Manual has the following features:

- Required information can be cross-searched in multiple manuals.
- Other manuals can be accessed from the links in the manual.
- The hardware specifications of each part can be found from the product figures.
- Pages that users often browse can be bookmarked.
- Sample programs can be copied to an engineering tool.

TERMS

Unless otherwise specified, this manual uses the following terms.

Term	Description
CC-Link IE TSN Class ^{*1}	A group of devices and switching hubs compatible with CC-Link IE TSN, ranked according to the functions and performance by the CC-Link Partner Association. For CC-Link IE TSN Class, refer to the CC-Link IE TSN Installation Manual (BAP-C3007ENG-001) published by the CC-Link Partner Association.
CC-Link IE TSN Protocol version 1.0	This protocol is used to perform communications by using the time sharing method defined by IEEE 802.1AS or IEEE 1588 for time synchronization.
CC-Link IE TSN Protocol version 2.0	This protocol is used to perform communications by using the time sharing method defined by IEEE 802.1AS and time-managed polling method for time synchronization.
Cyclic transmission	A function by which data are periodically exchanged among stations on the same network using link devices
Data link	Communications performed by cyclic transmission and transient transmission
Device station	A station other than a master station: a local station, a remote station
Engineering tool	A tool used for setting up programmable controllers, programming, debugging, and maintenance
Link device	A device (RX, RY, RWr, RWw, LB, and LW) in a module on CC-Link IE TSN
Local station	This station serves as a safety station or a standard station. This station can perform cyclic transmission and transient transmission with the master station and other local stations. When set as a safety station, the station can perform safety communication with another safety station on the same network. The station is controlled by programs in the CPU module or other equivalent modules on the station.
Master station	A station that controls the entire network. Only one master station can be used in a network. This station serves as a safety station or a standard station. The station can perform cyclic transmission and transient transmission with all stations. When set as a safety station, the station can perform safety communication with another safety station on the same network.
Multicast filter	A filter function that selects whether or not the own station sends cyclic data of multicast to the subsequent stations after receiving them. Since the master station sets the multicast filter according to the system configuration, parameter settings for this filter function are not required.
Multicast mode	Cyclic data are sent to multiple stations in this communication mode.
Remote station	A station that exchanges I/O signals (bit data) and I/O data (word data) with another station by cyclic transmission. This station can perform transient transmission.
Reserved station	A station reserved for future use. This station is not actually connected, but counted as a connected station.
Safety communications	A function for exchanging safety data between safety stations on the same network
Safety remote input (SAIX)	A safety device (safety input) that can be used in safety programs
Safety remote output (SAIY)	A safety device (safety output) that can be used in safety programs
Safety remote station	A remote station to perform safety communications
Transient transmission	A function of communication with another station, which is used when requested by a dedicated instruction or an engineering tool

*1 The term has been changed for standardization among manuals and software applications related to CC-Link IE TSN. However, the term used in some CC-Link IE TSN related software windows may remain unchanged and may be different from the term used in this manual.

In case of inconsistency, refer to the following.

Term used in software window	Term after change
Authentication Class	CC-Link IE TSN Class

GENERIC TERMS AND ABBREVIATIONS

Unless otherwise specified, this manual uses the following generic terms and abbreviations.

Generic term and abbreviation	Description
I/O combined module	A generic term for modules that can input and output a digital signal
Input module	A generic term for modules that can input a digital signal
Output module	A generic term for modules that can output a digital signal
RWr	An abbreviation for the remote register of link device. Word data input from a device station to the master station. (For some areas in a local station, data are input in the opposite direction.)
RWw	An abbreviation for the remote register of link device. Word data output from the master station to a device station. (For some areas in a local station, data are output in the opposite direction.)
RX	An abbreviation for remote input of link device. Bit data input from a device station to the master station. (For some areas in a local station, data are input in the opposite direction.)
RY	An abbreviation for remote output of link device. Bit data output from the master station to a device station. (For some areas in a local station, data are output in the opposite direction.)
Safety remote I/O module	An abbreviation for the CC-Link IE TSN remote I/O module with safety functions
SLMPSND	A generic term for the J.SLMPSND, JP.SLMPSND, G.SLMPSND, and GP.SLMPSND

1 PRODUCT LINEUP

1.1 List of Products

Input modules

Module name		Input specifications	Module power supply current	Weight	Model	Reference
DC input module	Negative common type	Spring clamp terminal block 24VDC, 8 points	160mA	0.25kg	NZ2GNSS2-8D	Page 20 NZ2GNSS2-8D DC input module

Output modules

Module name		Output specifications	Module power supply current	Weight	Model	Reference
Transistor output module	Source type	Spring clamp terminal block 24VDC, 0.5A/point, 8 points	170mA	0.25kg	NZ2GNSS2-8TE	Page 24 NZ2GNSS2-8TE transistor output module

I/O combined module

Module name		Input specifications	Output specifications	Module power supply current	Weight	Model	Reference
DC input/transistor output module	<ul style="list-style-type: none">Input part: Negative common typeOutput part: Source type	Spring clamp terminal block 24VDC, 8 points	Spring clamp terminal block 24VDC, 0.5A/point, 8 points	170mA	0.25kg	NZ2GNSS2-16DTE	Page 27 NZ2GNSS2-16DTE DC input/transistor output module

MEMO

2 PART NAMES

The part names of the safety remote I/O module are listed below.

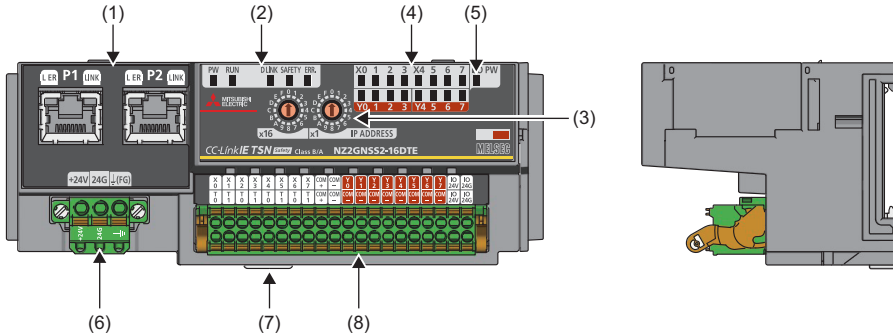

No.	Name	Description
(1)	P1	A port for the connection to CC-Link IE TSN (RJ45 connector) Connect an Ethernet cable. (☞ Page 50 Wiring of Ethernet Cable) There are no restrictions on the connection order of the cables for P1 and P2.
	L ER LED	Indicates the port status. On: Abnormal data received or loopback being performed Off: Normal data received and loopback not performed
	LINK LED	Indicates the link status. On: Link-up in progress Flashing: Communicating (100Mbps) Off: Link-down in progress
	P2	Same as P1
	LINK LED	
(2)	PW LED	Indicates the power supply status of the safety remote I/O module. On: Power supply ON Off: Power supply OFF
	RUN LED	Indicates the operating status of the safety remote I/O module. On: Operating normally, in initial processing Flashing: Operating in unit test mode Off: A major error has occurred.
	D LINK LED	Indicates the data link status of the safety remote I/O module. On: Cyclic transmission being performed, in initial processing Flashing: Cyclic transmission stopped*1 Off: Disconnected
	SAFETY LED	Indicates the safety communications status of the safety remote I/O module. On: In safety communication connection, in initial processing Flashing: Checking the position of the setting target module Off: Safety communication being disconnected
	ERR. LED	Indicates the error status of the safety remote I/O module. On: A moderate error or major error has occurred, in initial processing Flashing: A minor error has occurred.*2 Off: Operating normally
(3)	IP address setting switch	Sets the fourth octet of the IP address. (☞ Page 40 IP Address Setting Switch Setting)
(4)	I/O LED	When error points are not indicated Indicates the ON/OFF status of I/O. On: ON status of input or output*3 Off: OFF status of input or output
		When error points are indicated Flashes the error points. On: ON status of input or output*3 Flashing: An error has occurred.*4 Off: OFF status of input or output
(5)	I/O PW LED	Indicates the status of the power supply from the external power supply. On: External power supply ON Off: External power supply OFF
(6)	Terminal block for module power supply and FG	A terminal block to connect the module power supply (24VDC) and FG.

No.	Name	Description
(7)	DIN rail hook	A hook to mount a safety remote I/O module on a DIN rail.
(8)	I/O terminal block	A terminal block for I/O power supply and I/O signals

- *1 When cyclic transmission is stopped only for the master station, the safety remote I/O module maintains the cyclic transmission. Thus, the D LINK LED turns on.
- *2 After a minor error has been eliminated, the LED flashes for 5 seconds or longer and turns off.
- *3 In the safety drive mode, the status of actual input signals that are externally input is indicated on the LEDs regardless of the setting of the input response time setting function.
For details on the safety drive mode, refer to the following.
☞ Page 34 Operation mode and state transition
- *4 When the LED is flashing, the minor error state is applied to the safety remote I/O module.
For I/O LED indication setting at error occurrence, refer to the following.
☞ Page 189 I/O LED indication setting at error occurrence

Safety remote I/O module status and LED status

The correspondence between the safety remote I/O module status and the LED status is described below.

For the status of the safety remote I/O module, refer to the following.

☞ Page 34 Operation mode and state transition

For details on each error, refer to the following.

☞ Page 157 Error codes related to the safety remote I/O module

Safety remote I/O module status		Data link status	LED status				
			PW LED	RUN LED	D LINK LED	SAFETY LED	ERR. LED
Initial processing state ^{*1}		Disconnection	On	On	On	On	On
Initial processing state (wait for supply of module power supply voltage) ^{*2}		Disconnection	On	Off	Off	Off	Flashing
Standby mode	Disconnected	Disconnection	On	On	Off	Off	Off
	Data link in operation	Data link in operation	On	On	On	Off	Off
	Reserved station setting in progress	Cyclic stop	On	On	Flashing	Off	Off
	Link stop	Cyclic stop	On	On	Flashing	Off	Off
	Checking the position of the setting target module	Data link in operation/cyclic stop	On	On	^{*3}	Flashing	Off
Safety drive mode		Data link in operation	On	On	On	On	Off
Unit test mode	In progress	—	On	Flashing	Off	Off	Off
	Completed successfully	—	On	On	Off	Off	Off
	Completed with an error	—	On	On	Off	Off	On
Communication error		Cyclic stop	On	On	Flashing	Off	Off
Error	Major error	—	On	Off	^{*5}	^{*6}	On ^{*4}
	Moderate error	—	On	On	^{*5}	^{*6}	On
	Minor error	—	On	On	^{*5}	^{*5}	Flashing

- *1 At the initial processing, the LEDs (RUN LED, ERR. LED, D LINK LED, SAFETY LED, I/O LED) turn on for a moment to check if the LEDs turn on.
- *2 When the module power supply voltage does not reach the allowable voltage range at the initial processing, the initial processing is suspended and the module enters the standby state until the module power supply voltage reaches the allowable voltage range. If this state continues for two minutes or longer, a module power supply voltage error (error code: 0109H) occurs and the safety remote I/O module stops the operation. To recover the module, power off and on the module power supply. When the module power supply voltage reaches the allowable voltage range within two minutes after this state occurs, the initial processing is continued.
- *3 Either of On or Flashing.
- *4 When the safety remote I/O module fails, the LED may not turn on.
- *5 Any of On, Flashing, or Off.
- *6 Either of Flashing or Off.

3 SPECIFICATIONS

This chapter describes the specifications of the safety remote I/O module.

3.1 General Specifications

Item	Specifications					
Operating ambient temperature	0 to 55°C					
Storage ambient temperature	-40 to 75°C					
Operating ambient humidity	5 to 95%RH, non-condensing					
Storage ambient humidity						
Vibration resistance	Compliant with JIS B 3502 and IEC 61131-2	—	Frequency	Constant acceleration	Half amplitude	Number of sweeps
		Under intermittent vibration	5 to 8.4Hz	—	3.5mm	X, Y, Z 10 times each in X, Y, and Z directions
			8.4 to 150Hz	9.8m/s ²	—	
		Under continuous vibration	5 to 8.4Hz	—	1.75mm	—
8.4 to 150Hz	4.9m/s ²		—			
Shock resistance	Compliant with JIS B 3502 and IEC 61131-2 (147m/s ² , Operation time: 11ms, 3 times each in X, Y, and Z directions with sine half-wave pulses)					
Operating atmosphere	No corrosive gases, flammable gases, less conductive dust					
Operating altitude* ¹	0 to 2000m					
Installation location	Inside a control panel* ²					
Overvoltage category	II or less					
Pollution degree* ³	2 or less					
Equipment class	ClassIII					

- *1 Do not use or store the safety remote I/O module under pressure higher than the atmospheric pressure of altitude 0m. Doing so may cause malfunction.
- *2 If the environment satisfies the operating ambient temperature, operating ambient humidity, and other conditions, the module can be used even outside the control panel.
- *3 This index indicates the degree to which conductive material is generated in terms of the environment in which the equipment is used. Pollution degree 2 is when only non-conductive pollution occurs. A temporary conductivity caused by incidental condensation must be expected occasionally.

3.2 Performance Specifications

Input module

NZ2GNSS2-8D DC input module

Item		NZ2GNSS2-8D
Station type		Remote station
CC-Link IE TSN Class		CC-Link IE TSN Class B CC-Link IE TSN Class A ⁵
CC-Link IE TSN Protocol version	CC-Link IE TSN Class B	CC-Link IE TSN Protocol version 1.0 CC-Link IE TSN Protocol version 2.0 ⁵
	CC-Link IE TSN Class A	CC-Link IE TSN Protocol version 2.0 ⁵
Maximum response time for time-managed polling (for CC-Link IE TSN Class A) ⁷		512μs
Network topology		Line topology, star topology, mixture of star topology and line topology, ring topology ¹¹⁶
Number of input points		Single wiring: 8 points, double wiring: 4 points
Rated input voltage		24VDC (ripple ratio: 5% or less) (allowable voltage range: 20.4 to 28.8VDC)
Rated input current		7.3mA TYP. (for 24VDC)
Maximum number of simultaneous input points		100%
ON voltage/ON current		12VDC or higher/3mA or higher
OFF voltage/OFF current		5VDC or lower/1.3mA or lower
Input resistance		2.6kΩ
Input circuit response time	OFF→ON	0.4ms or less (24VDC)
	ON→OFF	
Safety remote station safety cycle time		2.0ms
Communication path response time		0.3ms
Safety remote station refresh response processing time		Safety remote station safety cycle time + Communication path response time
Safety remote station input response time		Input circuit response time + Input response time (1ms, 1.5ms, 5ms, 10ms, 20ms, 50ms, 70ms)
External power supply for input part ²	Voltage	24VDC (ripple ratio: 5% or less) (allowable voltage range: 20.4 to 28.8VDC)
	Current	100mA
	Protection function	External power supply overvoltage protection function
Power supply current for input device (COM+)		0.4A/1 terminal
Input type		Negative common type
Withstand voltage		510VAC for 1 minute between all DC external terminals and ground
Insulation resistance		10MΩ or higher between all DC external terminals and ground (500VDC insulation resistance tester)
Noise immunity		Noise voltage 500Vp-p, noise width 1μs, noise frequency 25 to 60Hz (DC type noise simulator condition)
Protection degree		IP2X
Wiring method for common		Input 8 points/common (spring clamp terminal block)
External interface	Communication part	RJ45 connector
	Module power supply part	Terminal block for module power supply and FG (2-piece spring clamp terminal block (push-in))
	I/O part, external power supply part	40 points, 2-piece spring clamp terminal block (push-in)
Applicable wire size	Terminal block for module power supply and FG	Stranded wire: 0.3 to 1.5mm ² (22 to 16 AWG), terminal slot size: 2.8mm × 2.0mm
	I/O terminal block	Stranded wire: 0.5 to 1.5mm ² (20 to 16 AWG)
Applicable solderless terminal ³	Terminal block for module power supply and FG	☞ Page 47 Applicable solderless terminal
	I/O terminal block	☞ Page 52 Applicable solderless terminal
Multicast filter		Available ¹
Cyclic transmission	RX/R _Y points	16 points
	R _W r/R _W w points	4 points
	SA _X / SA _Y points	32 points

Item		NZ2GNSS2-8D
Module power supply ^{*2,4}	Voltage	24VDC (ripple ratio: 5% or less) (allowable voltage range: 20.4 to 28.8VDC)
	Current	160mA
	Protection function	Module power supply overvoltage protection function, module power supply overcurrent protection function
	Fuse	1.6A (user-unchangeable)
Safety element		Type B, HFT = 1, SC 3
Weight		0.25kg

*1 The performance specifications vary depending on firmware versions of modules used. (📄 Page 206 Added and Changed Functions)

*2 To connect to the safety remote I/O module, use the power supply that meets the following conditions:

- SELV (Safety Extra Low Voltage): Product with reinforced insulation from the hazardous potential part (60V or higher)
- LVD-compliant product
- Output voltage specifications: 20.4 to 28.8VDC (ripple ratio: 5% or less)

*3 Only one wire can be inserted into a wire insertion opening. Multiple wires cannot be connected to a terminal. Connecting two or more wires may cause a poor contact.

*4 To connect to the safety remote I/O module, use a power supply whose output hold time is 10ms or longer.

*5 This can be used for the safety remote I/O modules with the firmware version "03" or later.

*6 Ring topology can be used only when CC-Link IE TSN Class B is selected for the CC-Link IE TSN Class setting. If a safety remote I/O module with CC-Link IE TSN Class A is connected in ring topology, data link cannot be performed.

*7 For details on the time-managed polling, refer to the following.

- 📖 User's manual for the master station used

External wiring

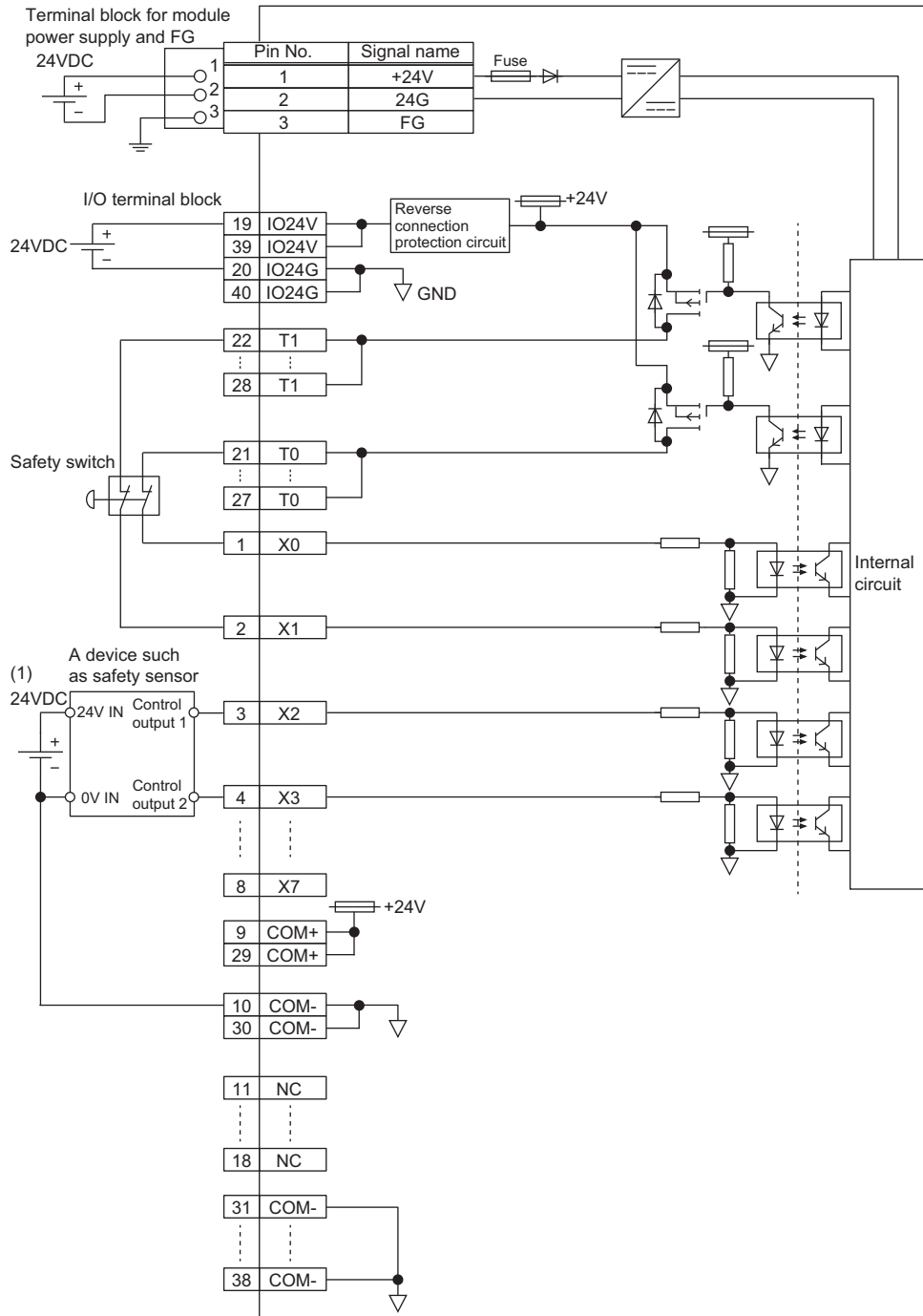

(1) The COM+ terminals can supply 24VDC as well.

I/O terminal block

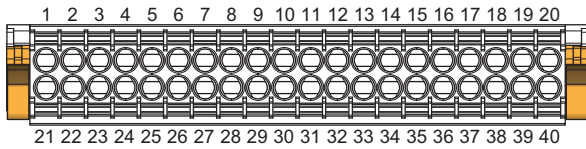



Terminal number	Signal name	Terminal number	Signal name
1	X0	21	T0
2	X1	22	T1
3	X2	23	T0
4	X3	24	T1
5	X4	25	T0
6	X5	26	T1
7	X6	27	T0
8	X7	28	T1
9	COM+	29	COM+
10	COM-	30	COM-
11	NC	31	COM-
12	NC	32	COM-
13	NC	33	COM-
14	NC	34	COM-
15	NC	35	COM-
16	NC	36	COM-
17	NC	37	COM-
18	NC	38	COM-
19	IO24V	39	IO24V
20	IO24G	40	IO24G

Among the terminals with the same signal name, you can choose any terminals since they are internally connected. In addition, NC is reserved. Do not use this terminal.

Output module

NZ2GNSS2-8TE transistor output module

Item		NZ2GNSS2-8TE
Station type		Remote station
CC-Link IE TSN Class		CC-Link IE TSN Class B CC-Link IE TSN Class A ⁵
CC-Link IE TSN Protocol version	CC-Link IE TSN Class B	CC-Link IE TSN Protocol version 1.0 CC-Link IE TSN Protocol version 2.0 ⁵
	CC-Link IE TSN Class A	CC-Link IE TSN Protocol version 2.0 ⁵
Maximum response time for time-managed polling (for CC-Link IE TSN Class A) ⁷		512 μ s
Network topology		Line topology, star topology, mixture of star topology and line topology, ring topology ¹⁶
Number of output points		Single wiring: 8 points, double wiring: 4 points
Rated load voltage		24VDC (ripple ratio: 5% or less) (allowable voltage range: 20.4 to 28.8VDC)
Maximum load current		0.5A/point, 4A/common
Maximum inrush current		1.0A, 10ms or less
Leakage current at OFF		0.1mA or less
Max. voltage drop at ON		0.5VDC (TYP.) 0.5A, 0.8VDC (MAX.) 0.5A
Output circuit response time	OFF \rightarrow ON	0.4ms or less (24VDC)
	ON \rightarrow OFF	
Safety remote station safety cycle time		2.0ms
Communication path response time		0.3ms
Safety remote station refresh response processing time		Safety remote station safety cycle time + Communication path response time
Safety remote station output response time		Output circuit response time
Surge suppressor		Zener diode
External power supply for output part ²	Voltage	24VDC (ripple ratio: 5% or less) (allowable voltage range: 20.4 to 28.8VDC)
	Current	70mA
	Protection function	External power supply overvoltage protection function
Double output type		Source + Source type
Withstand voltage		510VAC for 1 minute between all DC external terminals and ground
Insulation resistance		10M Ω or higher between all DC external terminals and ground (500VDC insulation resistance tester)
Noise immunity		Noise voltage 500Vp-p, noise width 1 μ s, noise frequency 25 to 60Hz (DC type noise simulator condition)
Protection degree		IP2X
Wiring method for common		Output 8 points/common (spring clamp terminal block)
Protection function		Output overload protection function
External interface	Communication part	RJ45 connector
	Module power supply part	Terminal block for module power supply and FG (2-piece spring clamp terminal block (push-in))
	I/O part, external power supply part	40 points, 2-piece spring clamp terminal block (push-in)
Applicable wire size	Terminal block for module power supply and FG	Stranded wire: 0.3 to 1.5mm ² (22 to 16 AWG), terminal slot size: 2.8mm \times 2.0mm
	I/O terminal block	Stranded wire: 0.5 to 1.5mm ² (20 to 16 AWG)
Applicable solderless terminal ³	Terminal block for module power supply and FG	 Page 47 Applicable solderless terminal
	I/O terminal block	 Page 52 Applicable solderless terminal
Multicast filter		Available ¹
Cyclic transmission	RX/R Y points	16 points
	RW r/RW w points	4 points
	SAIX / SA IY points	32 points

Item		NZ2GNSS2-8TE
Module power supply ^{*2,4}	Voltage	24VDC (ripple ratio: 5% or less) (allowable voltage range: 20.4 to 28.8VDC)
	Current	170mA
	Protection function	Module power supply overvoltage protection function, module power supply overcurrent protection function
	Fuse	1.6A (user-unchangeable)
Safety element	Type B, HFT = 1, SC 3	
Weight	0.25kg	

- *1 The performance specifications vary depending on firmware versions of modules used. (☞ Page 206 Added and Changed Functions)
- *2 To connect to the safety remote I/O module, use the power supply that meets the following conditions:
 - SELV (Safety Extra Low Voltage): Product with reinforced insulation from the hazardous potential part (60V or higher)
 - LVD-compliant product
 - Output voltage specifications: 20.4 to 28.8VDC (ripple ratio: 5% or less)
- *3 Only one wire can be inserted into a wire insertion opening. Multiple wires cannot be connected to a terminal. Connecting two or more wires may cause a poor contact.
- *4 To connect to the safety remote I/O module, use a power supply whose output hold time is 10ms or longer.
- *5 This can be used for the safety remote I/O modules with the firmware version "03" or later.
- *6 Ring topology can be used only when CC-Link IE TSN Class B is selected for the CC-Link IE TSN Class setting. If a safety remote I/O module with CC-Link IE TSN Class A is connected in ring topology, data link cannot be performed.
- *7 For details on the time-managed polling, refer to the following.
 - ☞ User's manual for the master station used

External wiring

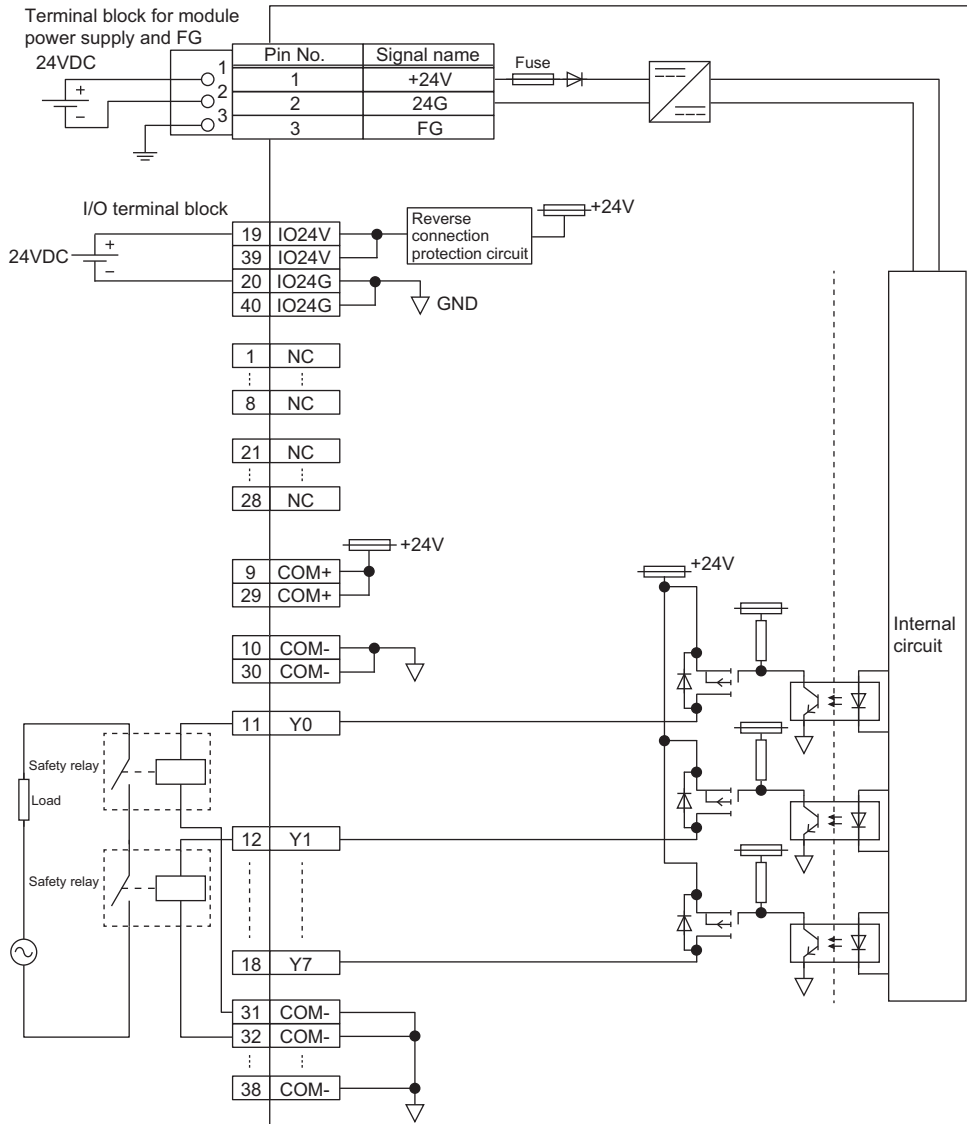

I/O terminal block

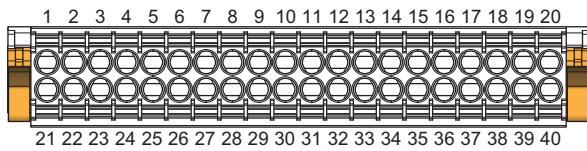

Terminal number	Signal name	Terminal number	Signal name
1	NC	21	NC
2	NC	22	NC
3	NC	23	NC
4	NC	24	NC
5	NC	25	NC
6	NC	26	NC
7	NC	27	NC
8	NC	28	NC
9	COM+	29	COM+
10	COM-	30	COM-
11	Y0	31	COM-
12	Y1	32	COM-
13	Y2	33	COM-
14	Y3	34	COM-
15	Y4	35	COM-
16	Y5	36	COM-
17	Y6	37	COM-
18	Y7	38	COM-
19	IO24V	39	IO24V
20	IO24G	40	IO24G

Among the terminals with the same signal name, you can choose any terminals since they are internally connected. In addition, NC is reserved. Do not use this terminal.

I/O combined module

NZ2GNSS2-16DTE DC input/transistor output module

Item		NZ2GNSS2-16DTE
Station type		Remote station
CC-Link IE TSN Class		CC-Link IE TSN Class B CC-Link IE TSN Class A ^{*5}
CC-Link IE TSN Protocol version	CC-Link IE TSN Class B	Protocol version 1.0 Protocol version 2.0 ^{*5}
	CC-Link IE TSN Class A	Protocol version 2.0 ^{*5}
Maximum response time for time-managed polling (for CC-Link IE TSN Class A) ^{*7}		512 μ s
Network topology		Line topology, star topology, mixture of star topology and line topology, ring topology ^{**6}
Number of input points		Single wiring: 8 points, double wiring: 4 points
Rated input voltage		24VDC (ripple ratio: 5% or less) (allowable voltage range: 20.4 to 28.8VDC)
Rated input current		7.3mA TYP. (for 24VDC)
Maximum number of simultaneous input points		100%
ON voltage/ON current		12VDC or higher/3mA or higher
OFF voltage/OFF current		5VDC or lower/1.3mA or lower
Input resistance		2.6k Ω
Input circuit response time	OFF→ON	0.4ms or less (24VDC)
	ON→OFF	
Safety remote station safety cycle time		2.0ms
Communication path response time		0.3ms
Safety remote station refresh response processing time		Safety remote station safety cycle time + Communication path response time
Safety remote station input response time		Input circuit response time + Input response time (1ms, 1.5ms, 5ms, 10ms, 20ms, 50ms, 70ms)
External power supply for I/O part ^{*2}	Voltage	24VDC (ripple ratio: 5% or less) (allowable voltage range: 20.4 to 28.8VDC)
	Current	160mA
	Protection function	External power supply overvoltage protection function
Power supply current for input device (COM+)		0.4A/1 terminal
Input type		Negative common type
Withstand voltage		510VAC for 1 minute between all DC external terminals and ground
Insulation resistance		10M Ω or higher between all DC external terminals and ground (500VDC insulation resistance tester)
Noise immunity		Noise voltage 500Vp-p, noise width 1 μ s, noise frequency 25 to 60Hz (DC type noise simulator condition)
Protection degree		IP2X
Wiring method for common		Input 8 points/common (spring clamp terminal block)
Number of output points		Single wiring: 8 points, double wiring: 4 points
Rated load voltage		24VDC (ripple ratio: 5% or less) (allowable voltage range: 20.4 to 28.8VDC)
Maximum load current		0.5A/point, 4A/common
Maximum inrush current		1.0A, 10ms or less
Leakage current at OFF		0.1mA or less
Max. voltage drop at ON		0.5VDC (TYP.) 0.5A, 0.8VDC (MAX.) 0.5A
Output circuit response time	OFF→ON	0.4ms or less (24VDC)
	ON→OFF	
Safety remote station output response time		Output circuit response time
Surge suppressor		Zener diode
Double output type		Source + Source type
Wiring method for common		Output 8 points/common (spring clamp terminal block)
Protection function		Output overload protection function

Item		NZ2GNSS2-16DTE
External interface	Communication part	RJ45 connector
	Module power supply part	Terminal block for module power supply and FG (2-piece spring clamp terminal block (push-in))
	I/O part, external power supply part	40 points, 2-piece spring clamp terminal block (push-in)
Applicable wire size	Terminal block for module power supply and FG	Stranded wire: 0.3 to 1.5mm ² (22 to 16 AWG), terminal slot size: 2.8mm × 2.0mm
	I/O terminal block	Stranded wire: 0.5 to 1.5mm ² (20 to 16 AWG)
Applicable solderless terminal ^{*3}	Terminal block for module power supply and FG	☞ Page 47 Applicable solderless terminal
	I/O terminal block	☞ Page 52 Applicable solderless terminal
Multicast filter		Available ^{*1}
Cyclic transmission	RX/R _Y points	16 points
	R _W r/R _W w points	4 points
	SA _X / SA _Y points	32 points
Module power supply ^{*2*4}	Voltage	24VDC (ripple ratio: 5% or less) (allowable voltage range: 20.4 to 28.8VDC)
	Current	170mA
	Protection function	Module power supply overvoltage protection function, module power supply overcurrent protection function
	Fuse	1.6A (user-unchangeable)
Safety element		Type B, HFT = 1, SC 3
Weight		0.25kg

*1 The performance specifications vary depending on firmware versions of modules used. (☞ Page 206 Added and Changed Functions)

*2 To connect to the safety remote I/O module, use the power supply that meets the following conditions:

- SELV (Safety Extra Low Voltage): Product with reinforced insulation from the hazardous potential part (60V or higher)
- LVD-compliant product
- Output voltage specifications: 20.4 to 28.8VDC (ripple ratio: 5% or less)

*3 Only one wire can be inserted into a wire insertion opening. Multiple wires cannot be connected to a terminal. Connecting two or more wires may cause a poor contact.

*4 To connect to the safety remote I/O module, use a power supply whose output hold time is 10ms or longer.

*5 This can be used for the safety remote I/O modules with the firmware version "03" or later.

*6 Ring topology can be used only when CC-Link IE TSN Class B is selected for the CC-Link IE TSN Class setting. If a safety remote I/O module with CC-Link IE TSN Class A is connected in ring topology, data link cannot be performed.

*7 For details on the time-managed polling, refer to the following.

- ☞ User's manual for the master station used

External wiring

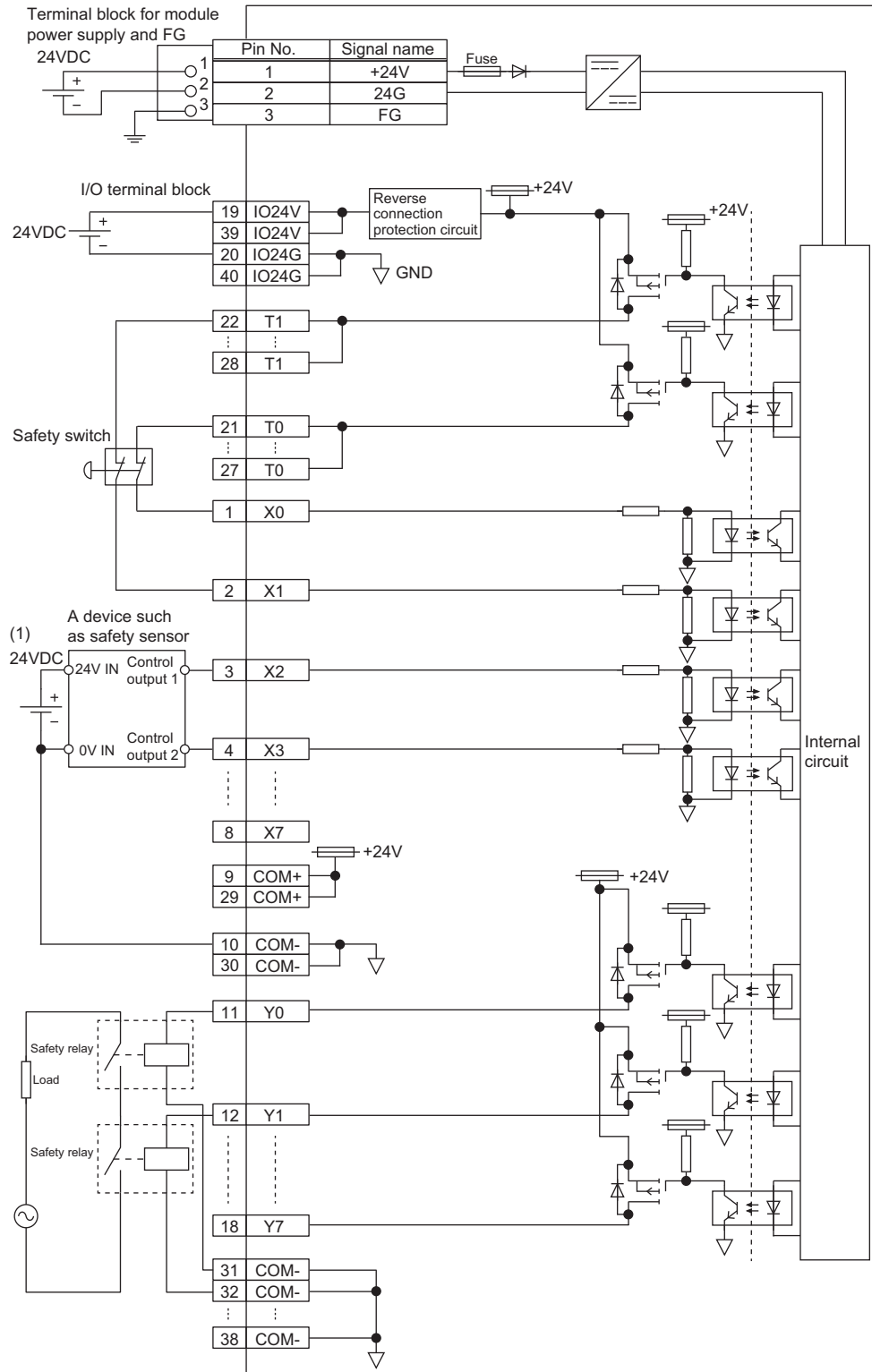

(1) The COM+ terminals can supply 24VDC as well.

I/O terminal block

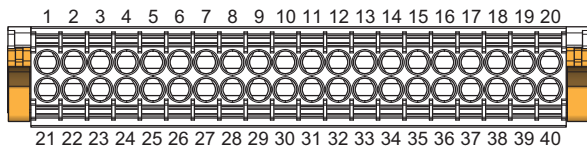

Terminal number	Signal name	Terminal number	Signal name
1	X0	21	T0
2	X1	22	T1
3	X2	23	T0
4	X3	24	T1
5	X4	25	T0
6	X5	26	T1
7	X6	27	T0
8	X7	28	T1
9	COM+	29	COM+
10	COM-	30	COM-
11	Y0	31	COM-
12	Y1	32	COM-
13	Y2	33	COM-
14	Y3	34	COM-
15	Y4	35	COM-
16	Y5	36	COM-
17	Y6	37	COM-
18	Y7	38	COM-
19	IO24V	39	IO24V
20	IO24G	40	IO24G

Among the terminals with the same signal name, you can choose any terminals since they are internally connected. In addition, NC is reserved. Do not use this terminal.

Safety remote I/O module safety response time

The safety response time of the safety remote I/O module is shown below.

For the response time including the transmission delay time, refer to the following.

 Mitsubishi Electric Safety Programmable Controller MELSEC iQ-R Series Machinery Directive (2006/42/EC) Compliance

Input

Transmission interval monitoring time \times 2 + Safety remote station input response time

Output

Transmission interval monitoring time \times 2 + Safety remote station output response time

Point

For the transmission interval monitoring time, refer to the "Processing Time" of the following manual.

 User's manual for the master station used

3.3 Function List

The following table lists the functions of the safety remote I/O module.

○: Available, —: Not available

Item		Description	Function availability			Reference
			Input module	Output module	I/O combined module	
Safety input	Safety input wiring selection function	The safety double wiring function or safety single wiring function can be selected for input wiring.	○	—	○	Page 74 Safety input wiring selection function
Standard input	Standard input wiring selection function	Sets the standard single wiring function for input wiring.	○	—	○	Page 77 Standard input wiring selection function
Input response time setting function		This function is used to set the filter time to reduce incorrect inputs caused by noise in input signals.	○	—	○	Page 78 Input Response Time Setting Function
Safety output	Safety output wiring selection function	The safety double wiring function or safety single wiring function can be selected for output wiring.	—	○	○	Page 79 Safety output wiring selection function
	Fast logic function	Output control according to the input status is performed inside the safety remote I/O module without going through the master station.	—	—	○	Page 82 Fast logic function
Input diagnostic* ¹	Double input discrepancy detection function	Discriminates failures by monitoring the discrepancy state of doubled safety remote inputs (SA\X).	○	—	○	Page 93 Double input discrepancy detection function
	Input dark test function	Outputs test pulses to turn off the external input signals (X0 to X7) that are on and diagnoses contacts including external devices for failure.	○	—	○	Page 97 Input dark test function
	Internal input dark test function	Outputs test pulses to the input circuit of the safety remote I/O module to detect a circuit-fixing failure. The test pulses turn off the external input signals (X0 to X7) that are on to detect the failure.	○	—	○	Page 99 Internal input dark test function
Output diagnostic* ²	Output dark test function	Outputs test pulses to turn off the external output signals (Y0 to Y7) that are on and diagnoses the internal circuit for failure.	—	○	○	Page 100 Output dark test function
	Output read-back function	Reads back output results and diagnoses whether the external output signals (Y0 to Y7) are correctly output.	—	○	○	Page 102 Output read-back function
Protection function		Prevents effects due to overvoltage and overcurrent from spreading to other modules of the safety system.	○	○	○	Page 103 Protection Functions
User authentication function		Limits the users (persons and personal computers) that can access the CPU module or safety remote I/O module.	○	○	○	Page 104 User Authentication Function
CC-Link IE TSN Class setting function		Sets the CC-Link IE TSN Class (CC-Link IE TSN Class B or CC-Link IE TSN Class A) of the safety remote I/O module and saves it in the non-volatile memory.	○	○	○	Page 105 CC-Link IE TSN Class Setting Function
Communication speed setting function		Sets the communication speed.	○	○	○	Page 117 Communication Speed Setting Function
SLMP communication function		Allows communications with the safety remote I/O modules using SLMP.	○	○	○	Page 130 SLMP Communication Function

Item	Description	Function availability			Reference
		Input module	Output module	I/O combined module	
Operation setting function at detection of external power supply voltage error	Allows users to select whether to continue safety communication or stop it when an external power supply voltage error occurs.	○	○	○	Page 131 Operation Setting Function at Detection of External Power Supply Voltage Error

- *1 This function is used only for safety input.
 *2 This function is used only for safety output.

Operation mode and state transition

The following describes the state transition and transition conditions of the safety remote I/O module.

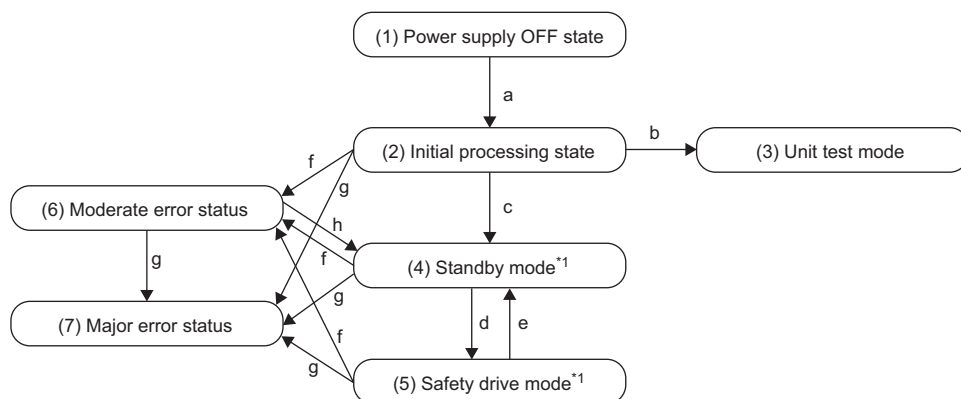

*1 When a moderate error or major error has occurred, the state is changed into an error state.

■ Operation mode/state

No.	Mode/state	Description
(1)	Power supply OFF state	The power supply is not turned on. Change the IP address using the IP address setting switch or wire the module in this state. (☞ Page 40 INSTALLATION AND WIRING)
(2)	Initial processing state	The initial processing is performed at this state. When the mode is changed to this mode, PW LED turns on, and RUN LED, D LINK LED, SAFETY LED, ERR. LED, and I/O LED turn on for a moment.
(3)	Unit test mode	The unit test is performed in this mode. (☞ Page 149 Unit Test)
(4)	Standby mode	The safety functions of the safety remote I/O module do not operate in this mode. Set parameters in this mode. (☞ Page 60 Parameter Setting)
(5)	Safety drive mode	The safety functions of the safety remote I/O module operate in this mode.
(6)	Moderate error state	A moderate error has occurred.
(7)	Major error state	A major error has occurred.

■ Transition condition

Symbol	Transition condition
a	When the module is powered on
b	When both IP address setting switches x16 and x1 are set to F in the power supply OFF state
c	When the initial processing is completed successfully
d	When Safety module enabled flag (RWr0.b0) is on and the safety communication with the master station is established. For Safety module enabled flag (RWr0.b0), refer to the following. (☞ Page 179 Safety module enabled flag (RWr0.b0))
e	When the safety communication is disconnected
f	When a moderate error has occurred
g	When a major error has occurred
h	When a parameter data error is eliminated. For parameter data errors, refer to the following. (☞ Page 157 List of Error Codes)

Point

To switch the operation mode/state from the unit test mode, moderate error state, or major error state, power off and on the module.

4 PROCEDURES BEFORE OPERATION

This chapter describes the procedures before operation.

Consideration of system configuration

1. Determine a safety category required for configuring the safety system.
2. Determine function wiring required for configuring the safety system.

Safety remote I/O module installation, wiring, and parameter setting

1. IP address setting switch setting

Set the fourth octet of IP address of the safety remote I/O module.

☞ Page 40 IP Address Setting Switch Setting

2. Attaching

Mount the safety remote I/O module on a DIN rail.

☞ Page 44 Mounting the modules on a DIN rail

3. CC-Link IE TSN Class setting*1

Set the CC-Link IE TSN Class for the safety remote I/O module.

☞ Page 105 CC-Link IE TSN Class Setting Function

4. Communication speed setting

Set the communication speed for the safety remote I/O module.

☞ Page 117 Communication Speed Setting Function

5. Wiring

Connect the power supply, Ethernet cables, and external devices to the safety remote I/O module.

☞ Page 47 Wiring of Terminal Block for Module Power Supply and FG

☞ Page 50 Wiring of Ethernet Cable

☞ Page 52 Wiring of External Device and I/O Terminal Block

6. Network parameter setting

Set the network parameters.

📖 User's manual for the master station used

7. Parameter setting

Set the module parameters of the safety remote I/O module.

☞ Page 60 Parameter Setting

8. Safety module validation

Enable the module parameters of the safety remote I/O module.

☞ Page 69 Safety Communication Setting

*1 This setting is available only for the module with the firmware version "03" or later.

Point

To replace the safety remote I/O module, follow the procedure described below:

- Export the parameter settings. Exporting is not necessary when device station parameter automatic setting is enabled.
- Power off the safety remote I/O module and remove it.
- Prepare a new safety remote I/O module and perform the procedure of all steps from step 1. At that time, import the parameter settings. The IP address setting switch setting of the new module must be the same as the setting of the module before replacement. Step 7 (Parameter setting) is not necessary when device station parameter automatic setting is enabled.

MEMO

5 SYSTEM CONFIGURATION

This chapter describes the safety system configuration using a safety remote I/O module.
For details on the CC-Link IE TSN configuration, refer to the following.

 User's manual for the master station used

5.1 Applicable Systems

Applicable products

When using a safety remote I/O module, use the following products.

For model names of the Safety CPU and the safety function module, refer to the following.

 MELSEC iQ-R Module Configuration Manual

Model	Firmware version
Safety CPU (R08SF CPU, R16SF CPU, R32SF CPU, R120SF CPU)	"20" or later
Safety function module (R6SFM)	"20" or later
Master station (RJ71GN11-T2)	"10" or later
Master station (RD78GHV, RD78GHW, RD78G64, RD78G32, RD78G16, RD78G8, RD78G4)	"08" or later

The above information on "master station" is the one at the time of this manual's issuance.

For the latest information, refer to the CC-Link Partner Association's website.

www.cc-link.org

Point

CPU modules other than Safety CPUs cannot be used with the safety remote I/O module.

Compatible software version

For the compatible software version, always keep the engineering tool of the master station up to date.

Only GX Works3 is a compatible engineering tool.

When the latest software is necessary, please consult your local Mitsubishi representative.

Compatible software package

Settings or diagnostics of the safety remote I/O module require the following engineering tool.

Product name	Software version
GX Works3	Version 1.080J or later*1

*1 For the safety remote I/O module with the firmware version "02" or earlier, GX Works3 with the version 1.065T or later can be used.
For the communication speed setting or the CC-Link IE TSN Class setting of the safety remote I/O module, the tool listed below is required.

Product name	Software version
CC-Link IE TSN Configurator	Version 1.108L or later

Applicable profile

A profile is required to use the safety remote I/O module in the CC-Link IE TSN configuration setting.

The following table shows the applicable profile versions.

Model	Firmware version	Profile version
NZ2GNSS2-8D, NZ2GNSS2-8TE, NZ2GNSS2-16DTE	"01" or later	"00" or later
	"02" or later	"01" or later
	"03" or later	"02" or later
	"04" or later	"03" or later

When the latest profile of the safety remote I/O module is necessary, please consult your local Mitsubishi representative.

The profile is a setting file that stores information required for the start-up, operation, and maintenance of devices supporting the CC-Link family.

A module is added to the "Module List" of the "CC-Link IE TSN Configuration" window by profile registration to the engineering tool of the master station.

For the profile registration, refer to the following.

 GX Works3 Operating Manual

Ethernet cable

For the specifications of the Ethernet cable, refer to the following.

 User's manual for the master station used

Switching hub

For compatible switching hubs, refer to the following.

 User's manual for the master station used

5.2 Safety Standards

Observe the following safety standards.

Region	Standard
Global	IEC 61508 (SIL3), IEC 62061 (SIL3), ISO 13849-1 (Category 4 PLe) IEC 61131-2 IEC 61000-6-2, IEC 61000-6-4 IEC 61784-3 IEC 60204-1
Europe	EN ISO 13849-1 (Category 4 PLe) EN 61131-2 EN 61000-6-2, EN 61000-6-4
North America	UL 61010-1, UL 61010-2-201

For records which safety standards the safety remote I/O module complies with, check EC-Type-Examination Certificate of the product.

6 INSTALLATION AND WIRING

This chapter describes the installation and wiring of the safety remote I/O module.

6.1 IP Address Setting Switch Setting

Set the fourth octet of IP address using the IP address setting switch on the front of the safety remote I/O module. The setting of the IP address setting switch is enabled when the safety remote I/O module is powered on. Thus, set this function when the power of the module is off.

Setting method

Set the fourth octet (decimal) of IP address using the IP address setting switch x1 and x16 (hexadecimal). Combinations of x1 and x16 are as follows.

		x1															
		0	1	2	3	4	5	6	7	8	9	A	B	C	D	E	F
x16	0	0	1	2	3	4	5	6	7	8	9	10	11	12	13	14	15
	1	16	17	18	19	20	21	22	23	24	25	26	27	28	29	30	31
	2	32	33	34	35	36	37	38	39	40	41	42	43	44	45	46	47
	3	48	49	50	51	52	53	54	55	56	57	58	59	60	61	62	63
	4	64	65	66	67	68	69	70	71	72	73	74	75	76	77	78	79
	5	80	81	82	83	84	85	86	87	88	89	90	91	92	93	94	95
	6	96	97	98	99	100	101	102	103	104	105	106	107	108	109	110	111
	7	112	113	114	115	116	117	118	119	120	121	122	123	124	125	126	127
	8	128	129	130	131	132	133	134	135	136	137	138	139	140	141	142	143
	9	144	145	146	147	148	149	150	151	152	153	154	155	156	157	158	159
	A	160	161	162	163	164	165	166	167	168	169	170	171	172	173	174	175
	B	176	177	178	179	180	181	182	183	184	185	186	187	188	189	190	191
	C	192	193	194	195	196	197	198	199	200	201	202	203	204	205	206	207
	D	208	209	210	211	212	213	214	215	216	217	218	219	220	221	222	223
	E	224	225	226	227	228	229	230	231	232	233	234	235	236	237	238	239
	F	240	241	242	243	244	245	246	247	248	249	250	251	252	253	254	255

Ex.

To set to 30:

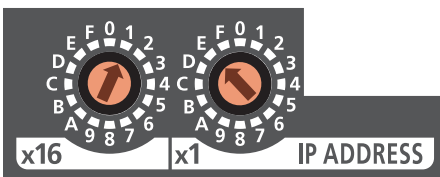

Setting range

The setting value must be in the range between 1 and 254.

When a value in the range between 1 and 254 is set, the IP address and subnet mask are as follows.

- The first three octets of the IP address: Octets one, two, and three from the IP address of the master station are used for operation.
- Subnet mask: The subnet mask of the master station is used for operation.

Do not set 0.

When 255 is set, operation is done in unit test mode.

Point

- Do not change the IP address setting switch while the power of the safety remote I/O module is on. Changing the IP address setting switch while the safety remote I/O module is on causes an IP address setting switch changed error (error code: 0202H) and flashing of the ERR. LED. After the IP address setting switch is returned to the original settings, the error is automatically recovered 5 seconds later and the ERR. LED turns off.
- When the power is turned on with the IP address setting switch set to a value in the range 1 to 254, the safety remote I/O module automatically sets the IP address. Moreover, the IP address and subnet mask are saved in the non-volatile memory at the time a data link with the master station is established.
- Do not set an IP address with duplicated fourth octet in the access range of CC-Link IE TSN. Duplicated fourth octet causes the duplicated IP address due to the automatic setting of the first to third octet, resulting in failure of data link establishment.

Restriction

The following IP addresses cannot be used for the safety remote I/O module.

- IP addresses whose host addresses are all 0 or 255
- IP addresses whose third and fourth octets are all 255
- IP addresses outside the range 0.0.0.1 to 223.255.255.254

6.2 Installation Environment and Installation Position

Installation environment

Installation location

Do not install the safety remote I/O module in a location where:

- Ambient temperature is outside the range of 0 to 55°C;
- Ambient humidity is outside the range from 5 to 95% RH;
- Condensation occurs due to rapid temperature change;
- Corrosive gas or combustible gas is present;
- There is a lot of conductive powder such as dust and iron powder, oil mist, salinity, or organic solvent;
- The safety remote I/O module is exposed to direct sunlight;
- A strong electric field or strong magnetic field is generated (☞ Page 196 Immunity requirements); and
- The safety remote I/O module is subject to vibration and shocks (☞ Page 19 General Specifications).

Installation surface

Install the safety remote I/O module on the flat surface. When the installation surface is uneven, excessive force is applied to the printed-circuit board and may cause a defect.

Handling of screws

Be sure that oil does not adhere to the screws used for wiring or installing the module. Adhered oil may damage the screws. In addition, tighten the screws with an applicable screwdriver. Tightening with an inapplicable screwdriver may damage the screws.

Installation position

When installing the safety remote I/O module on a control panel, provide clearance of 60mm or more (1) between the module and the sides of any neighboring structures or parts to ensure good ventilation and allow easy safety remote I/O module replacement.

When installing two or more safety remote I/O modules next to each other, they can be installed in contact with each other.

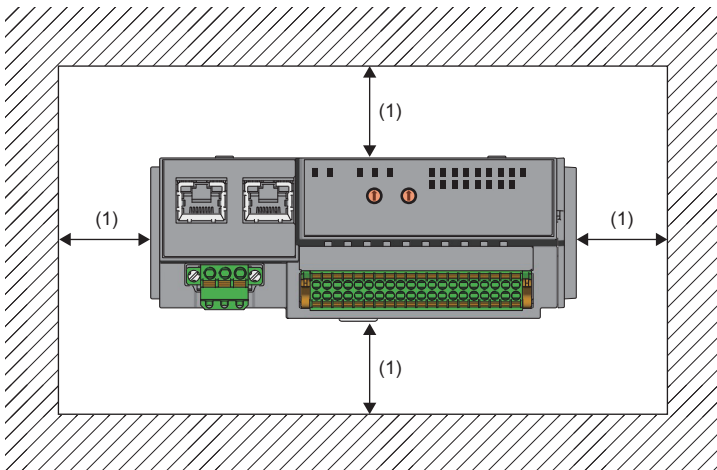

Installation direction

The safety remote I/O module can be installed in six directions.
Use the DIN rail (1) to install the safety remote I/O module.

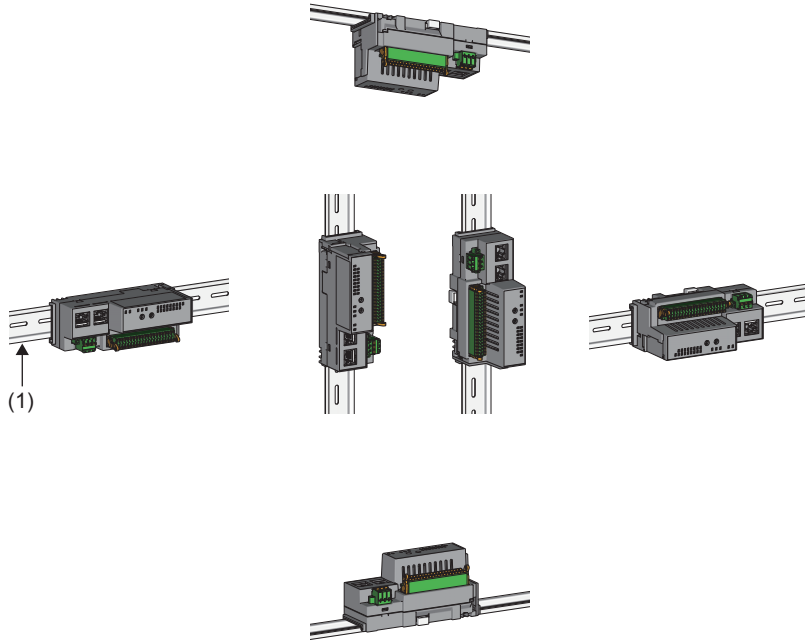

6.3 Installation

Mounting the modules on a DIN rail

Point

The following procedure is just an example of fixing the module with a DIN rail stopper. When fixing the safety remote I/O module, refer to the manual of the DIN rail stopper used.

Installation procedure

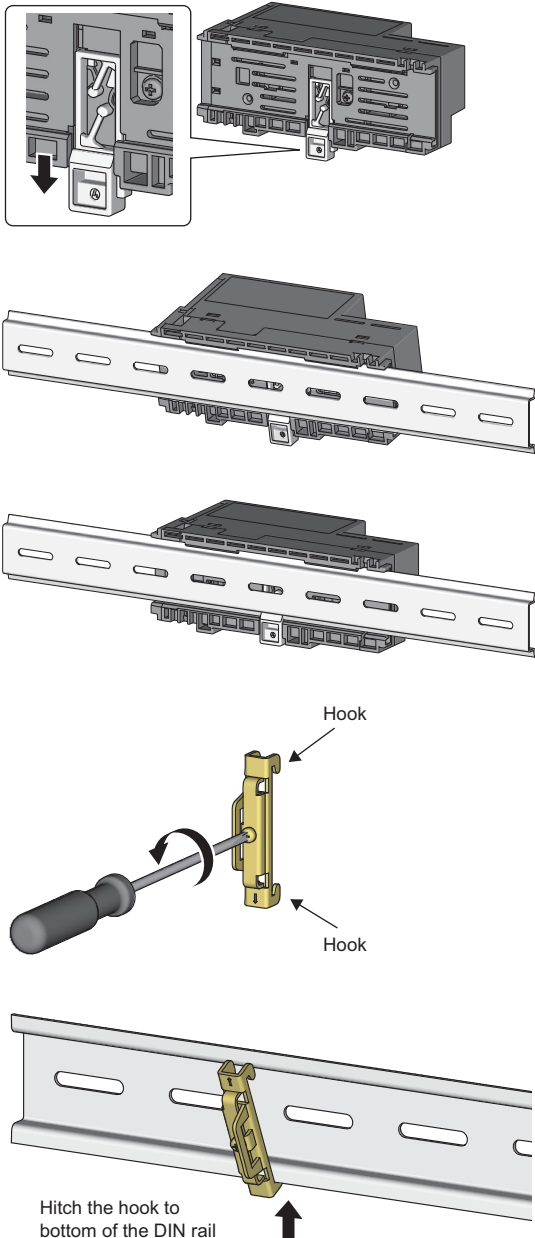

1. Pull down the DIN rail hooks on the back of the safety remote I/O module. The hooks should be pulled down until they click.
2. Hang the upper tabs of the module on the upper side of a DIN rail, and push the safety remote I/O module in position.
3. Lock the DIN rail hooks to the DIN rail to secure the safety remote I/O module in position. Push each hook up until it clicks. If the hooks are beyond the reach, use a tool such as a screwdriver.
4. Loosen the screw on the DIN rail stopper.
5. Hitch the bottom hook of the DIN rail stopper to the bottom of the DIN rail. Hitch the hook according to the orientation of the arrow on the front of the stopper.

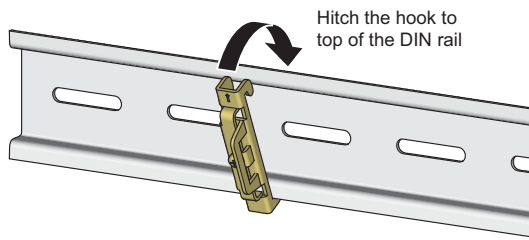

Hitch the hook to top of the DIN rail

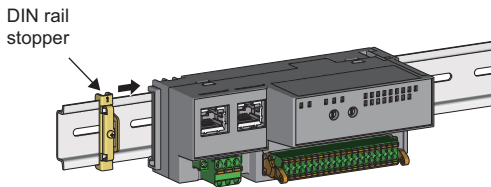

DIN rail stopper

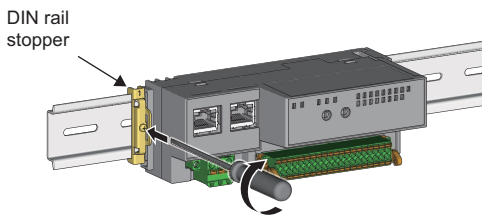

DIN rail stopper

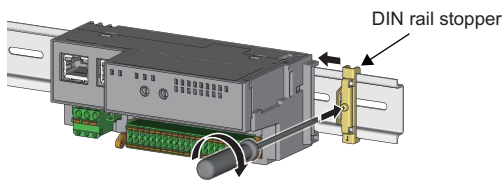

DIN rail stopper

6. Hitch the upper hook of the DIN rail stopper to the top of the DIN rail.
7. Slide the DIN rail stopper up to the left side of the safety remote I/O module.
8. Hold the DIN rail stopper in the direction opposite to the arrow on the stopper and tighten the screw with a screwdriver.
9. Install the DIN rail stopper on the right side of the safety remote I/O module in the same procedure. Install the stopper upside down for the right side.

Point 

Do not slide the module from the edge of the DIN rail when mounting it. Doing so may damage the safety remote I/O module.

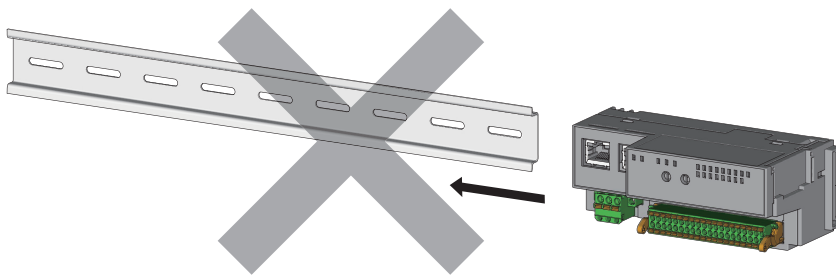

Removal procedure

Remove the safety remote I/O module from the DIN rail by reversing the installation procedure.

Applicable DIN rail models

Use the following DIN rails that are compliant with JIS C 2812 and IEC 60715.

- TH35-7.5Fe
- TH35-7.5Al

Interval between DIN rail mounting screws

Tighten the screws at intervals of 200mm or less.

DIN rail stopper

Use a stopper that is attachable to the DIN rail.

6.4 Wiring of Terminal Block for Module Power Supply and FG

Tightening torque

Tighten the terminal block mounting screws within the following specified torque range.
Tightening the screws too much may damage the safety remote I/O module case.

Screw type	Tightening torque range
Terminal block mounting screw (M2.5 screw)	0.2 to 0.3N·m

Wire to be used

The following table describes the wire to be connected to the terminal block for module power supply and FG.

Diameter	Type	Material	Temperature rating
22 to 16 AWG	Stranded wire	Copper wire	75°C or higher

Applicable solderless terminal

The following table lists the applicable solderless terminal.

Product name	Model	Applicable wire size	Contact
Bar solderless terminal	AI0.34-8TQ	0.34mm ²	PHOENIX CONTACT GmbH & Co. KG
	AI0.5-8WH	0.5mm ²	
	AI0.5-10WH		
	AI0.75-8GY	0.75mm ²	
	AI0.75-10GY		
	AI1-8RD	1.0mm ²	
	AI1-10RD		
	AI1.5-8BK	1.5mm ²	
	AI1.5-10BK		
Bar solderless terminal tool	CRIMPFOX6	—	

Installing and removing the terminal block

To remove the terminal block, loosen the terminal block mounting screws with a flathead screwdriver.
To install the terminal block, tighten the terminal block mounting screws with a flathead screwdriver.
Failure to secure the terminal block may cause drop, short circuit, or malfunction.

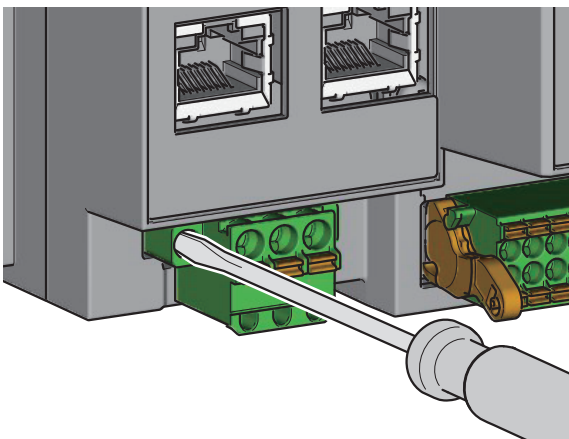

Connecting and disconnecting the cable

To connect the cable, fully insert a wire with a bar solderless terminal into a wire insertion opening. After inserting the wire, pull it lightly to check that it is securely clamped.

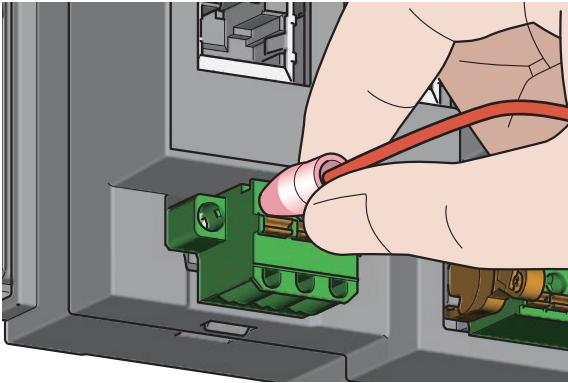

To disconnect the cable, push in the open/close button with a flathead screwdriver. With the button pushed in, pull out the wire having a bar solderless terminal.

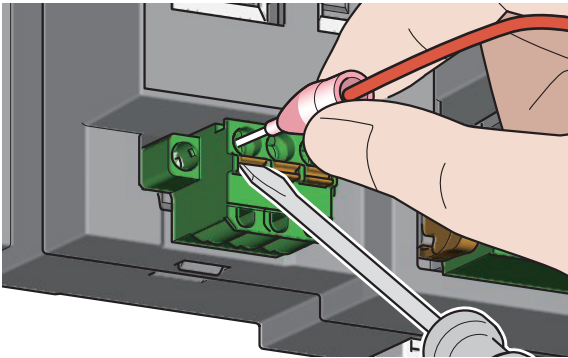

Precautions

- Use a bar solderless terminal for the wiring to the push-in type spring clamp terminal block. If a stripped wire is inserted into a wire insertion opening, the wire cannot be securely clamped.
- For how long the wire should be stripped, follow the specifications of the bar solderless terminal used. To attach a bar solderless terminal to a wire, use a crimping tool.
- Before inserting a bar solderless terminal into a wire insertion opening (1), check the shape of the opening and the shape of the terminal. Insert the terminal paying attention to the orientation. If a bar solderless terminal larger than wire insertion opening (1) is inserted, the terminal block may be damaged.

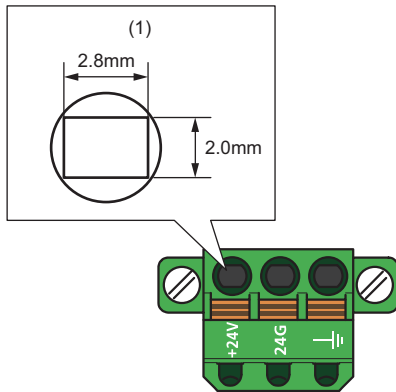

6

Point

Do not install the FG lines and communication cables together or closely each other. Doing so may result in malfunction due to noise.

Processing method of the cable terminal

Strip the cable about 10mm from the tip to connect a bar solderless terminal at the stripped area. Stripping the cable too long may cause electric shock or short circuit between adjacent terminals because the conductive part sticks out of the terminal block. Stripping the cable too short may cause a poor contact to the spring clamp terminal part.

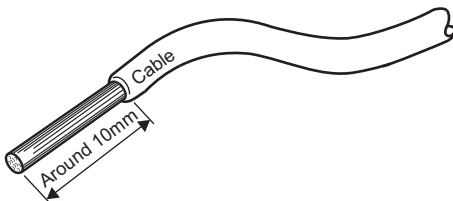

6.5 Wiring of Ethernet Cable

Wiring method

■Installation method

1. Power off the module power supply of the safety remote I/O module and the power supply of the external device.
2. Push the Ethernet cable connector into the safety remote I/O module until it clicks. Pay attention to the connector's direction.
3. Power on the module power supply of the safety remote I/O module.
4. Power on the power supply of the external device.
5. Check if the LINK LED on the port into which the Ethernet cable is connected is on. ^{*1*2}

*1 The time taken for the LINK LED to turn on after connection of the Ethernet cable may vary. The LINK LED normally turns on in a few second. However, if link-up processing is repeated due to a condition of a device on the line, the longer time may be required. If the LINK LED does not turn on, refer to the following and take a corrective action.

☞ Page 148 When the LINK LED turns off

*2 When the communication speed of both the safety remote I/O module and a device to be connected to P1 or P2 of safety remote I/O module is 100Mbps, enable the auto-negotiation of the device.



Both P1 and P2 connectors can be used.

- When using only one of them in star topology, either P1 or P2 can be connected.
- When using both connectors in line topology or ring topology, P1-P1, P2-P2, and P1-P2 connections are possible.

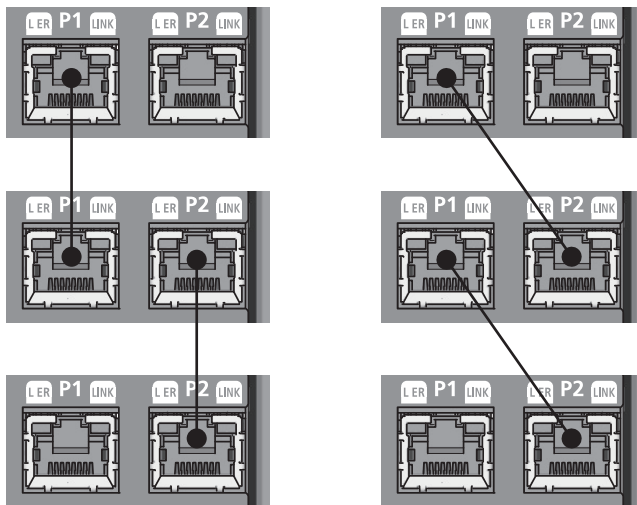

■How to disconnect

1. Power off the module power supply of the safety remote I/O module.
2. Press the latch down and unplug the Ethernet cable.

Precautions

■Laying Ethernet cables

- Place the Ethernet cable in a duct or clamp it. If not, dangling cable may swing or inadvertently be pulled, resulting in damage to the safety remote I/O modules or cables or malfunction due to poor contact.
- Do not touch the core of the connector of the cable or the module, and protect it from dirt and dust. If any skin oil, or any dirt or dust sticks to the core, it can increase transmission loss, causing data link to fail.
- Check that the Ethernet cables are not disconnected or short and the connector is properly connected.

■Broken cable latch

Do not use Ethernet cables with broken latches. Doing so may cause the cable to unplug or malfunction.

■Connecting and disconnecting the Ethernet cable

Hold the connector part when connecting and disconnecting the Ethernet cable. Pulling the cable connected to the safety remote I/O module may result in damage to the safety remote I/O module or cable, or malfunction due to poor contact of the cable.

■Connectors without Ethernet cable

To prevent dust and dirt from getting inside or to prevent module failure and malfunction caused by static electricity, attach the provided connector cover.

The function and application of the connector cover provided with the safety remote I/O module are the same as those of other models' covers, although its shape is different from the others.

■Maximum station-to-station distance for the Ethernet cable (Maximum cable length)

The maximum station-to-station distance is 100m. However, the distance may be shorter depending on the operating environment of the cable. For details, contact the manufacturer of the cables used.

■Bending radius of the Ethernet cable

There are restrictions on the bending radius of the Ethernet cable. Check the bending radius in the specifications of the Ethernet cables used.

6.6 Wiring of External Device and I/O Terminal Block

Wire to be used

The following table shows the type of wire to be used for connection to the I/O terminal block and the external devices.

Diameter	Type	Material	Temperature rating
20 to 16 AWG	Stranded wire	Copper wire	75°C or higher

Applicable solderless terminal

The following table lists the applicable solderless terminal.

Product name	Model	Applicable wire size	Contact
Bar solderless terminal	A10.5-10WH	0.5mm ²	PHOENIX CONTACT GmbH & Co. KG
	A10.75-10GY	0.75mm ²	
	A1.0-10	1.0mm ²	
	A1.5-10	1.5mm ²	
Bar solderless terminal tool	CRIMPFOX6	—	

Installing or removing the terminal block

The following procedures show how to install and remove the terminal block.

■ Lock and release lever positions

To make it easy to install and remove the terminal block, a three-stage positioning stopper is attached so that the lever does not freely turn around.

When installing or removing the terminal block, turn the lever to the lock or release lever position.

View from the right side of the safety remote I/O module: When pulling the terminal block

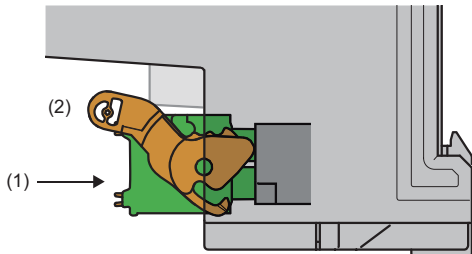

1. Release lever position

This lever position shows the state in which the terminal block (1) has been completely pulled out from the safety remote I/O module. Turn the lever from the lock lever position to the release lever position (2), and lift the terminal block from the safety remote I/O module.

View from the right side of the safety remote I/O module: When the terminal block has been inserted

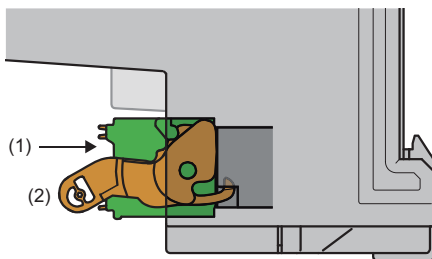

2. Lock lever position

This lever position shows the state in which the terminal block (1) is completely fitted to the safety remote I/O module. Check the lock lever position (2) and pull the terminal block lightly to check that the terminal block is completely fitted to the safety remote I/O module.

■ Removal procedure

Turn the lever to the release lever position and remove the terminal block from the safety remote I/O module.

■ Installation procedure

Move the lever to the locking lever position and push in the terminal block. When the terminal block is fully pushed in, the hook of the lever hangs on the safety remote I/O module and fits the terminal block.

Point

The terminal block can be inserted with the lever locations other than the lock lever position. After insertion, check that the lever is in the lock lever position.

Connecting and disconnecting the cable

■Connecting the cable

Insert a wire with a bar solderless terminal into the wire insertion opening (2) and push it all the way in.

If the wire cannot be inserted by this method, insert the wire all the way in while pressing the open/close button (1) using a flathead screwdriver with a tip width of 2.0 to 2.5mm. Once the wire is inserted all the way in to the back, remove the flathead screwdriver.

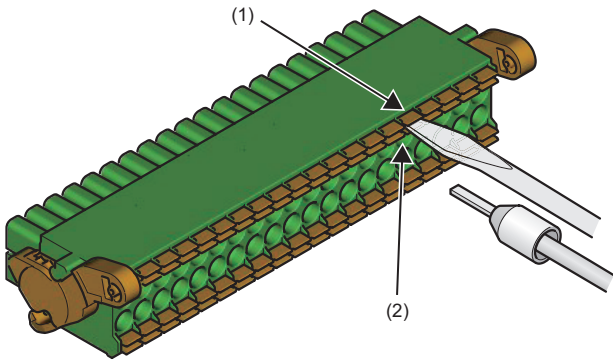

Point

Pull the wire or bar solderless terminal lightly to check that it is securely clamped.

■Disconnecting the cable

Pull the wire while pressing the open/close button using a flathead screwdriver with a tip width of 2.0 to 2.5mm.

Precautions

- When wiring to the terminal block, use a bar solderless terminal. If a stripped wire is inserted into a wire insertion opening without using a bar solderless terminal, the wire cannot be securely clamped.
- Use a crimping tool to connect a bar solderless terminal to a wire. (☞ Page 52 Applicable solderless terminal)
- When inserting a bar solderless terminal, check that the size of the terminal and its insertion direction are correct to prevent the terminal from getting stuck in or the terminal block damage. When using a bar solderless terminal other than the applicable solderless terminals, check that for its size, the cross-sectional shape of the terminal after processing (1) is smaller than the size mentioned below, even including an error in processing. For the correct terminal insertion direction, refer to the figure below.

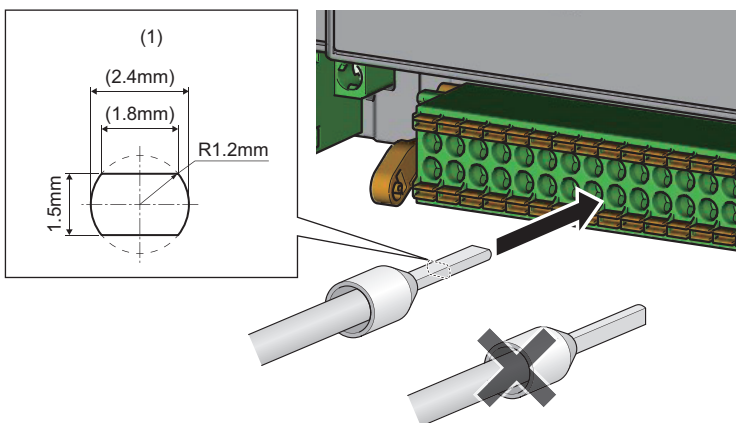

Processing method of the cable terminal

Strip the cable about 10mm from the tip to connect a bar solderless terminal at the stripped area. Stripping the cable too long may cause electric shock or short circuit between adjacent terminals because the conductive part sticks out of the terminal block. Stripping the cable too short may cause a poor contact to the spring clamp terminal part.

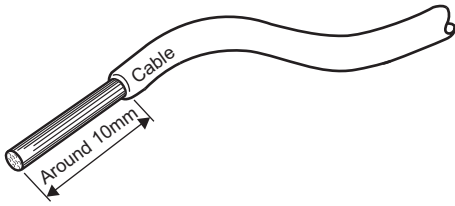

Wiring of the external power supply

If the external power supply is off while the module power supply is turned on, an external power supply voltage error (error code: 0102H or 020CH) will occur. Power on the external power supply at the same timing of power-on of the module power supply.

Precautions for wiring the safety remote I/O module to safety devices

When wiring the input part

■Combination of input terminals for double input

For double input, the input terminals can be used only in the combinations shown below.

Combination of input terminals for double input			
X0, X1	X2, X3	X4, X5	X6, X7

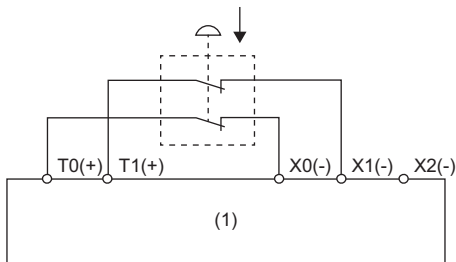

(1) Safety remote I/O module

■Combination of input terminals and test pulse output terminals

The test pulse output terminals and input terminals can be used only in the combinations shown below.

Combination of input terminals and test pulse output terminals	
Test pulse output terminal	Input terminal
T0	X0, X2, X4, X6
T1	X1, X3, X5, X7

When wiring the output part

■Combination of output terminals for double output

For double output, the output terminals can be used only in the combinations shown below.

Combination of output terminals for double output			
Y0, Y1	Y2, Y3	Y4, Y5	Y6, Y7

7 SETTINGS

7.1 Network Configuration Settings

Set the parameters of the safety remote I/O module with the network parameters written to the CPU module of the master station.

For the setting procedure for the master station, refer to the following.

 User's manual for the master station used

Communication cycle interval setting

When using the safety remote I/O module, set values listed in the tables below for "Communication Period Interval Setting" of "Basic Period Setting" of "Communication Period Setting" of "Basic Settings" of the network parameters.

■When the CC-Link IE TSN Class setting of the safety remote I/O module is CC-Link IE TSN Class B

Firmware version	Communication speed		Value that can be set
	Master station	Safety remote I/O module	
"02" or later	1Gbps	1Gbps	126.00μs or more and 10000.00μs or less
		100Mbps ^{*1}	126.00μs or more and 625.00μs or less
	100Mbps	1Gbps	126.00μs or more and 10000.00μs or less
		100Mbps ^{*2}	500.00μs or more, 10000.00μs or less, and divisible by 2μs
"01"	1Gbps	1Gbps	126.00μs or more and 8000.00μs or less
		100Mbps ^{*1}	126.00μs or more and 500.00μs or less
	100Mbps	1Gbps	126.00μs or more and 8000.00μs or less
		100Mbps ^{*2}	500.00μs or more, 8000.00μs or less, and divisible by 2μs

*1 To use the safety remote I/O module in this combination, set "Communication Period Setting" to "Low-Speed" for the safety remote I/O module.

*2 To use the safety remote I/O module in this combination, do not set "Communication Period Setting" to "Low-Speed" for the safety remote I/O module.

■When the CC-Link IE TSN Class setting of the safety remote I/O module is CC-Link IE TSN Class A

Set a value so that "Basic period × Magnification" becomes 1ms or longer.

Item	Description
Basic period	Setting value of "Communication Period Interval Setting" of master station parameters. For the setting range of "Communication Period Interval Setting", refer to the manual for the master station used.
Magnification	<ul style="list-style-type: none"> Setting value of "Communication Period Setting"^{*1} of network configuration settings Setting value of "Multiple Period Setting" of master station parameters

*1 When "Communication Period Setting" is set to "Low-Speed", refer to the following.

 Page 58 Communication cycle setting value

When the communication speed of the master station is 1Gbps and the communication speed of the safety remote I/O module is 100Mbps, set "Communication Period Setting" of the safety remote I/O module to "Low-Speed".

■Communication cycle setting value

Set the communication cycle values that satisfy all of the following conditions. (Unit: ms)

- $LS \leq 500 - SCmst$
- $LS \leq 500 - SRref$
- $LS \leq 250 + a / 2$
- $LS \leq 250 + c / 2$

SRref: Safety remote station refresh response processing time

SCmst: Safety cycle time of the master station (MELSEC iQ-R CPU Module User's Manual (Application))

LS: Communication cycle interval (MELSEC iQ-R CC-Link IE TSN User's Manual (Application))

a: This value is valid only when the station set to Active is the RJ71GN11-T2. In the other cases, the value is 0.

- $a = 1000ms - b$

b: A value obtained by rounding up 500ms to a multiple of safety cycle time

c: This value is valid only when the station set to Passive is the RJ71GN11-T2, NZ2GNSS2-8D, NZ2GNSS2-8TE, or NZ2GNSS2-16DTE. In the other cases, the value is 0.

- $c = 1000ms - d$

d: A value obtained by rounding up 500ms to a multiple of safety cycle time (safety remote station refresh response processing time)

If "Communication Period Setting" of the communication destination is set to other than "Basic Period" in "Network Configuration Settings" in "Basic Settings" of the master station, depending on the setting, multiply LS: Communication cycle interval by the multiple specified in "Multiple Period Setting" in "Communication Period Setting" in "Basic Settings". (MELSEC iQ-R CC-Link IE TSN User's Manual (Application))

Window

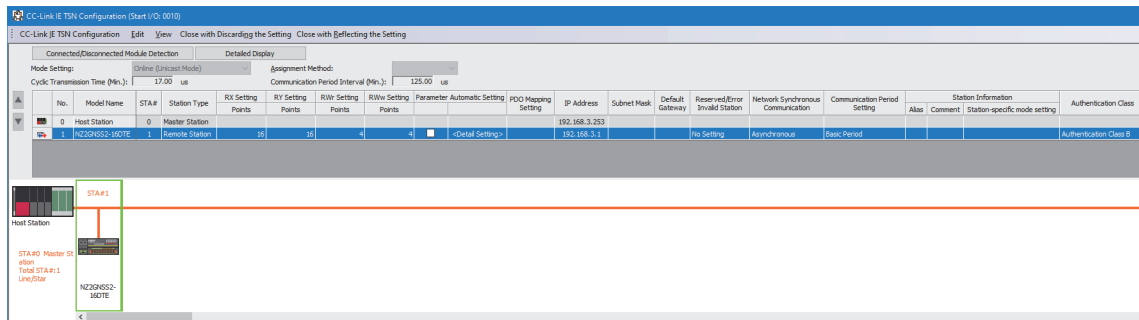

In this manual, "Authentication Class" is described as "CC-Link IE TSN Class".

Network topology setting

When using the safety remote I/O module, set the network topology setting as follows.

Firmware version of safety remote I/O module	CC-Link IE TSN Class for the safety remote I/O module	Setting item
"03" or later	CC-Link IE TSN Class B	<ul style="list-style-type: none"> • Line topology, star topology, or mixture of star topology and line topology • Ring topology*¹
	CC-Link IE TSN Class A	Line topology, star topology, or mixture of star topology and line topology
"02"	CC-Link IE TSN Class B	<ul style="list-style-type: none"> • Line topology, star topology, or mixture of star topology and line topology • Ring topology*¹
"01"	CC-Link IE TSN Class B	Line topology, star topology, or mixture of star topology and line topology

*¹ Check that the firmware versions of all safety remote I/O modules on the network are "02" or later before setting the ring topology. If a safety remote I/O module with the firmware version of "01" is connected to the network, data link cannot be performed.

Point

Ring topology can be used only when CC-Link IE TSN Class B is selected for the CC-Link IE TSN Class setting. If a safety remote I/O module with CC-Link IE TSN Class A is connected in ring topology, data link cannot be performed.

Communication mode

Although the unicast mode and multicast mode are available for communication mode, safety remote I/O module operation varies depending on the firmware version if an Ethernet device (or a remote station of CC-Link IE TSN Class A) is connected to the safety remote I/O module in multicast mode.

Firmware version of safety remote I/O module	Description
"02" or later	Cyclic frames of multicast are not relayed to an Ethernet device (or a remote station of CC-Link IE TSN Class A) connected to a safety remote I/O module.
"01"	Cyclic frames of multicast are relayed to an Ethernet device (or a remote station of CC-Link IE TSN Class A) connected to a safety remote I/O module. Because of this, the Ethernet device (or the remote station of CC-Link IE TSN Class A) receives unnecessary cyclic frames, and thus the safety remote I/O module may not operate properly.

Setting item list



Item	Setting details	Setting range
RX Setting, RY Setting	Points	Set the assignment of RX/Ry points. 0 to 16 (Default value: 16)
	Start	The RX/Ry start number is displayed. —
	End	The RX/Ry end number is displayed. —
RWr Setting, RWw Setting	Points	Set the assignment of RWr/RWw points. 0 to 16 (Default value: 4)
	Start	The RWr/RWw start number is displayed. —
	End	The RWr/RWw end number is displayed. —
Network Synchronous Communication	Set "Asynchronous" for the safety remote I/O module.	<ul style="list-style-type: none"> Asynchronous (Default value) Synchronous
Communication Period Setting	Set the cycle of the safety remote I/O module when setting multiple communication cycles. When the communication speed differs between the master station and the safety remote I/O module, the setting range is limited. (☞ Page 57 Communication cycle interval setting)	<ul style="list-style-type: none"> Basic Period Normal-Speed Low-Speed
CC-Link IE TSN Class	Set the CC-Link IE TSN Class for the safety remote I/O module. Set the same Class as the Class set on the safety remote I/O module. (☞ Page 105 CC-Link IE TSN Class Setting Function)	<ul style="list-style-type: none"> CC-Link IE TSN Class B CC-Link IE TSN Class A

Point

- When using the safety remote I/O module, always enable "Station-based Block Data Assurance" of the master station. When it is disabled, correct operation of the safety remote I/O module cannot be guaranteed. For "Station-based Block Data Assurance", refer to the following.
 -  User's manual for the master station used
- Set the number of points of the RX/Ry setting and the number of points of the RWr/RWw setting within their setting ranges. If a value out of range is set, Number of RX/Ry points error (error code: D021H) or Number of RWr/RWw points error (error code: D022H) occurs.

7.2 Parameter Setting

Parameter setting of the safety remote I/O module can be done with the following methods.

- Device station parameter automatic setting ( Page 63 Device station parameter automatic setting)
- Parameter processing for a device station ( Page 66 Parameter processing for device station)

Even if the safety remote I/O module is replaced due to a failure of the safety remote I/O module when parameters are set with the device station parameter automatic setting, the parameters of the safety remote I/O module are automatically set via the master station.

This saves one the trouble of having to newly set parameters.

Window

Parameter of Device Station

Target Module Information: NZ2GNSS2-16DTE
Start I/O No.:0010 - Station No.:1

Method selection: Parameter auto-setting Set the parameters that support parameter auto-setting.

Parameter Information

Select All Cancel All Selections Clear All "Read Value" Clear All "Write Value/Setting Value"
Copy "Initial Value" to "Write Value/Setting Value" Copy "Read Value" to "Write Value/Setting Value"

Name	Initial Value	Unit	Read Value	Unit	Write Value/Setting Value	Unit	Setting Range	Description
Station parameter								
<input checked="" type="checkbox"/> Safety setting								
Transmission interval monit...	35	ms		ms			4 to 1000	Set the transmission interva
I/O LED indication setting o...	0: Hide abn...							Set the LED indication meth
Safety authentication code	0xFFFFFFFF						0x00000000 to ...	Set the safety authenticati
<input checked="" type="checkbox"/> Communication speed setting	0: 1Gbps							Sets the communication spe
Module parameter								
<input checked="" type="checkbox"/> Double input discrepancy auto...	0: Not used							The operation of error poin
<input checked="" type="checkbox"/> Input dark test pulse OFF time...	0: 400us							Set the width of the OFF pu
<input checked="" type="checkbox"/> Number of pulse output for in...	0: 1 time							Set the number of OFF puls

Process Option

There is no option in the selected process.

The value set in write value/setting value is set to device station automatically by Device Station Parameter Automatic Setting function.
- For information on items not displayed on the screen, please refer to the Operating Manual.

Enable safety module when succeed to write parameter

Execute Parameter Processing

Import... Export... Close with Discarding the Setting Close with Reflecting the Setting

Setting item list

Item			Setting details	Setting range	Reference
Station parameter	Safety setting	Transmission interval monitoring time	Set the transmission interval monitoring time for safety data.	4 to 1000(ms)	Page 189 Transmission interval monitoring time
		I/O LED indication setting at error occurrence	Set whether the input and output points where an error is detected is indicated with an LED.	0: No indication of error point 1: Indication of error point	Page 189 I/O LED indication setting at error occurrence
		Safety approval code	Set a safety approval code that identifies the individual safety remote I/O module.	0x00000000 to 0xFFFFFFFF	Page 190 Safety approval code
	Operation setting of external power supply voltage error detection		Set the operation to be performed at the detection of external power supply voltage error.	0: Stop safety communication 1: Continue safety communication (Without output interlock) 2: Continue safety communication (With output interlock)	Page 190 Operation setting of external power supply voltage error detection
	Link speed setting		Set a communication speed with which the safety remote I/O module links up.	0: 1Gbps 1: 100Mbps 2: automatic	Page 190 Communication speed setting
Basic module parameter	Double input discrepancy auto recovery setting		When double input discrepancy occurs, set whether to keep the abnormal point in the stop state, or to automatically return when the error is resolved.	0: Not used 1: Used	Page 191 Double input discrepancy auto recovery setting
	Input dark test pulse OFF time setting		Set the width of the OFF pulses that the terminals T0 and T1 output, on a module-by-module basis.	0: 400μs 1: 1ms 2: 2ms	Page 192 Input dark test pulse OFF time setting
	Number of pulse output for input dark test		Set the number of OFF pulses for input dark test diagnostic on a module-by-module basis.	0: 1 time 1: 2 times 2: 3 times	Page 192 Number of pulse output for input dark test
	Fast logic pattern setting		Set the logic patterns for the fast logic function.	0: Not used 1: Pattern 1 2: Pattern 2 3: Pattern 3 4: Pattern 4	Page 194 Fast logic pattern setting
	Fast logic interlock mode setting		When the fast logic function is enabled, set whether to perform output point interlock when the output is turned off.	0: Enable 1: Disable	Page 194 Fast logic interlock mode setting
	Basic module parameter (X0 to X7)	Wiring selection of inputs X0 to X7		Set the input wiring method.	0: Not used 1: Safety double wiring (NC/NC) 2: Safety single 3: General single
Input response time X0 to X7		To prevent malfunction of the input signal, set the sensitivity to react to the input signal in units of 1 point.	0: 1.0ms 1: 1.5ms 2: 5ms 3: 10ms 4: 20ms 5: 50ms 6: 70ms	Page 191 Input response time	
Double input discrepancy detection setting (X0, X1) to (X6, X7)		Set whether to detect double input discrepancy in units of 2 points.	0: Detect 1: Do not detect	Page 191 Double input discrepancy detection setting	
Double input discrepancy detection time (X0, X1) to (X6, X7)		Set the double input discrepancy allowed time in units of 2 points.	1 to 6000(×10ms)	Page 192 Double input discrepancy detection time	
Input dark test execution setting X0 to X7		Set whether to perform the input dark test function of the diagnostic function in the safety remote I/O module in units of 1 point.	0: Perform 1: Do not perform	Page 192 Input dark test execution setting	

Item	Setting details	Setting range	Reference	
Basic module parameter (Y0 to Y7)	Wiring selection of output Y0 to Y7	Set the wiring selection of output in units of 1 point.	0: Not used 1: Safety double wiring (Source/Source) 2: Safety single	Page 193 Wiring selection of output
	Output dark test execution setting Y0 to Y7	Set whether to perform the output dark test function of the diagnostic function in the safety remote I/O module in units of 1 point.	0: Perform 1: Do not perform	Page 193 Output dark test execution setting
	Output dark test pulse OFF time setting Y0 to Y7	Set the width of OFF pulses used for an output dark test in units of 1 point.	0: 400 μ s 1: 1ms 2: 2ms	Page 194 Output dark test pulse OFF time setting
	Number of pulse output for output dark test Y0 to Y7	Set the number of OFF pulses for output dark test diagnostic in units of 1 point.	0: 1 time 1: 2 times 2: 3 times	Page 194 Number of pulse output for output dark test

Device station parameter automatic setting

The device station parameter automatic setting writes the parameters of the safety remote I/O module to the CPU module. The parameters of the safety remote I/O module are saved in the CPU internal memory.

When the safety remote I/O module enters or returns to the network, the parameters of the safety remote I/O module are automatically set via the master station. The parameters are written to the non-volatile memory of the safety remote I/O module.

The safety remote I/O module starts data link with the master station after parameter automatic setting.

The status of parameter automatic setting can be checked with the remote register. (☞ Page 182 Parameter automatic setting status monitor area)

Point

- When the user authentication function of the CPU module is enabled, perform the logon of the user authentication function in advance. (☞ Page 104 User Authentication Function)
- The parameters of the safety remote I/O module are not saved on the SD memory card.

Parameter setting

Operating procedure

1. Open the "CC-Link IE TSN Configuration" window.
 [Navigation window] ⇒ [Parameter] ⇒ [Module Information] ⇒ Model ⇒ [Basic Settings] ⇒ [Network Configuration Settings]
2. Select the safety remote I/O module in "Module List" and drag and drop it to the list of stations (1) or the network map (2).
 "Station Type", "RX/Ry Setting", and "RWw/RWr Setting" are automatically input. Change a value as necessary.

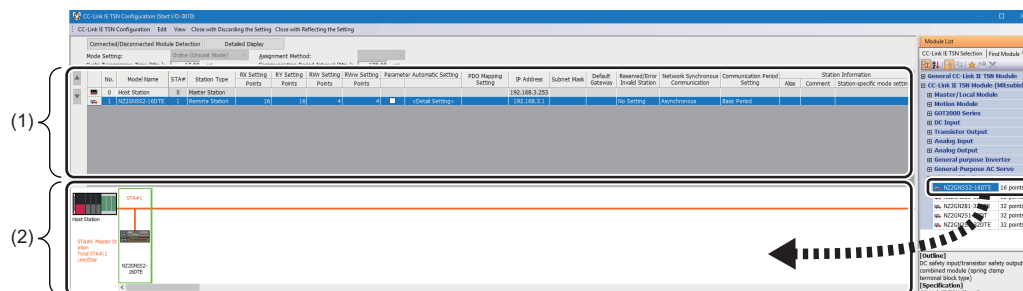

3. Select the "Parameter Automatic Setting" check box.

No.	Model Name	STA#	Station Type	RX Setting	RY Setting	RWr Setting	RWw Setting	Parameter Automatic Setting	
				Points	Points	Points	Points	<input type="checkbox"/>	<input type="checkbox"/>
0	Host Station	0	Master Station					<input type="checkbox"/>	<input type="checkbox"/>
1	NZ2GNSS2-16DTE	1	Remote Station	16	16	4	4	<input checked="" type="checkbox"/>	<Detail Setting>

- Right-click the safety remote I/O module and select "Parameter of Device Station" to display the "Parameter of Device Station" window.

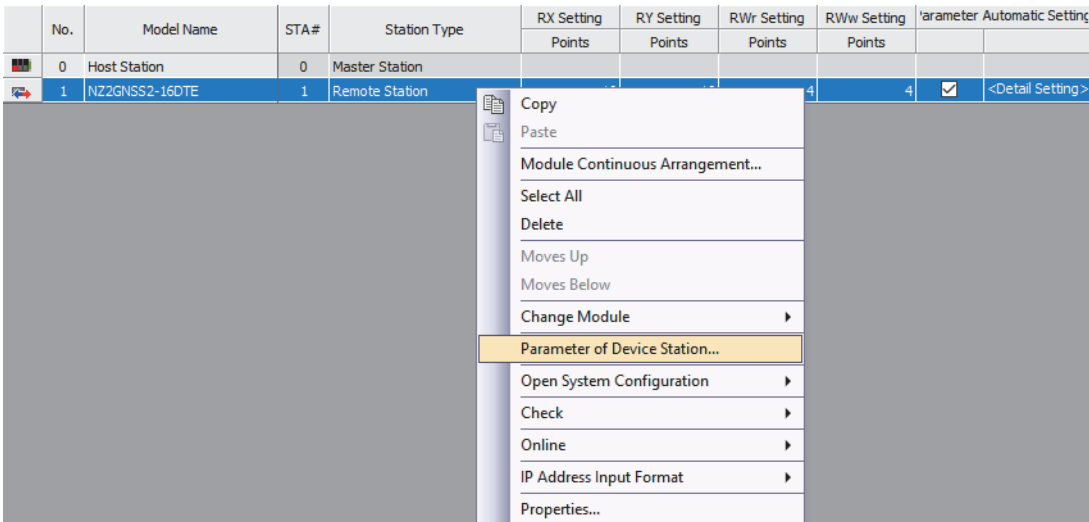



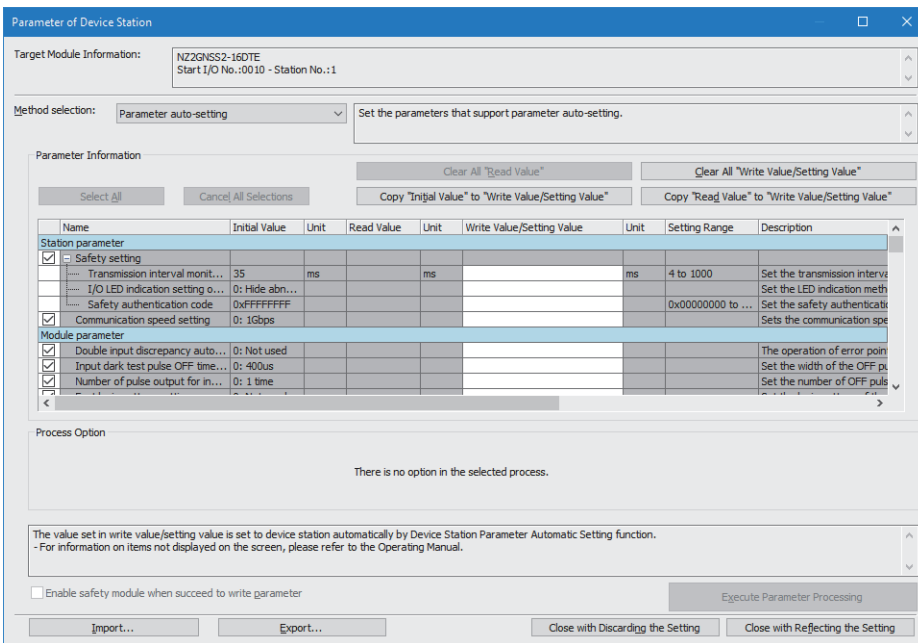



- Set each parameter in the "Parameter of Device Station" window.



For "Safety authentication code", set a value that does not overlap with those of other safety remote I/O modules, such as a MAC address. When setting a MAC address, set the lower eight digits of the MAC address.

6. Select [Close with Reflecting the Setting] and close the "Parameter of Device Station" window.
7. Select [Close with Reflecting the Setting] and close the "CC-Link IE TSN Configuration" window.
8. Display the refresh parameter setting window and configure the setting as follows.

 [Navigation window] ⇒ [Parameter] ⇒ [Module Information] ⇒ Model ⇒ [Basic Settings] ⇒ [Refresh Settings]

No.	Link Side					CPU Side				
	Device Name	Points	Start	End		Target	Device Name	Points	Start	End
-	SB	512	00000	001FF		Specify Device	SB	512	00000	001FF
-	SW	512	00000	001FF		Specify Device	SW	512	00000	001FF
1	RX	16	00000	0000F		Specify Device	X	16	01000	0100F
2	RY	16	00000	0000F		Specify Device	Y	16	01000	0100F
3	RWr	4	00000	00003		Specify Device	W	4	00100	00103
4	RWw	4	00000	00003		Specify Device	W	4	00200	00203

9. Click the [Apply] button.
10. Write the set parameters to the CPU module of the master station and reset the CPU module of the master station, or turn off and on the power supply of the programmable controller.

 [Online] ⇒ [Write to PLC]

11. Set the CPU module of the master station to RUN, and check that the D LINK LED of the safety remote I/O module is turned on.

Parameter processing for device station

The following describes the procedure for setting module parameters of the safety remote I/O module from the "Network Configuration Settings" window.

Parameter setting

Operating procedure

1. Open the "CC-Link IE TSN Configuration" window.
 - [Navigation window] ⇒ [Parameter] ⇒ [Module Information] ⇒ Model ⇒ [Basic Settings] ⇒ [Network Configuration Settings]
2. Select the safety remote I/O module in "Module List" and drag and drop it to the list of stations (1) or the network map (2). "Station Type", "RX/Ry Setting", and "RWw/RWr Setting" are automatically input. Change a value as necessary.

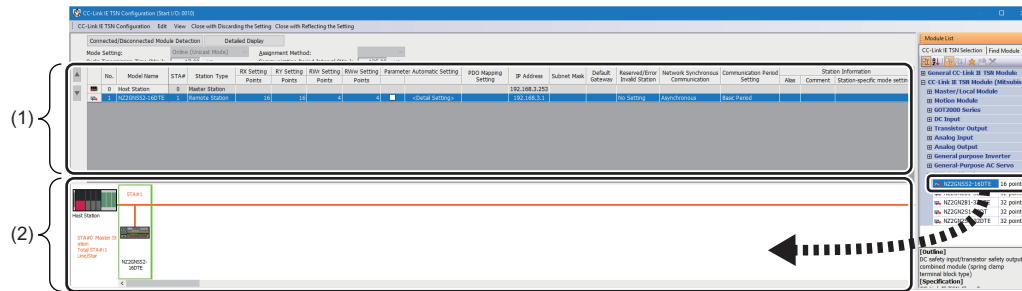

3. Right-click the safety remote I/O module and select "Parameter of Device Station" to display the "Parameter of Device Station" window.

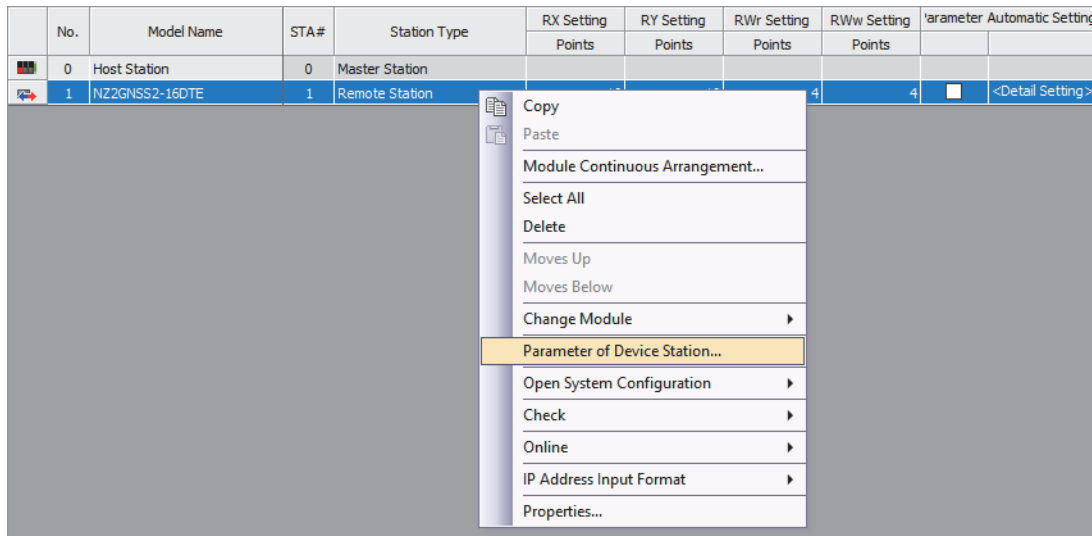

4. Set "Method selection" to "Parameter write" so that setting values can be set in the items of "Write Value/Setting Value". Set values in all the items of "Write Value/Setting Value". If an item where a value is not set exists, "Parameter write" cannot be executed.

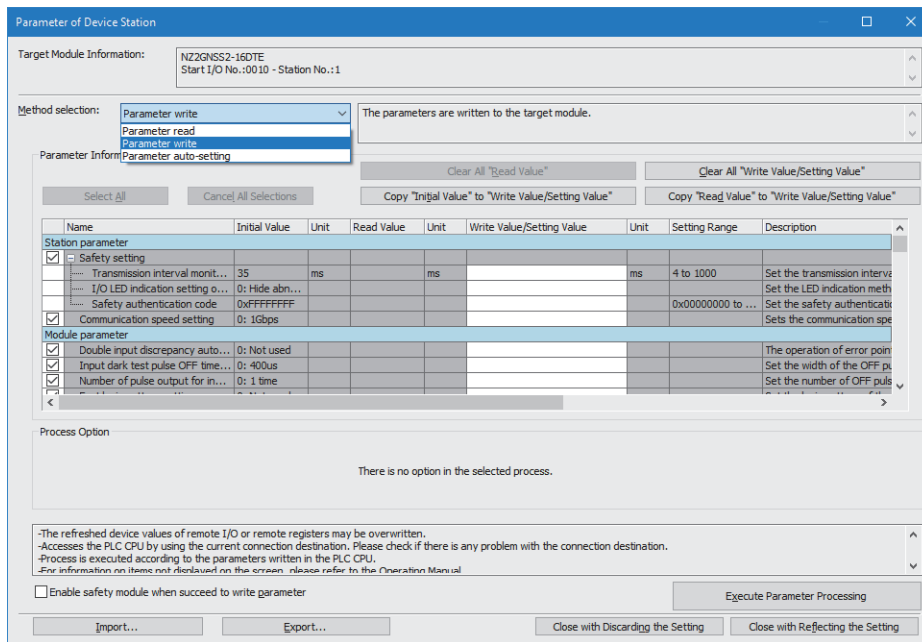

Point

- For "Safety authentication code", set a value that does not overlap with those of other safety remote I/O modules, such as a MAC address. When setting a MAC address, set the lower eight digits of the MAC address.
- When "Parameter write" has failed, the following window is displayed.

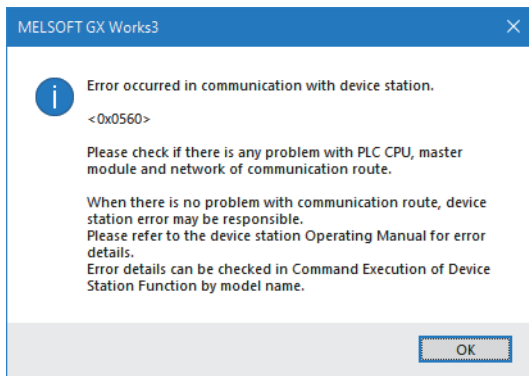

For error codes, refer to the following and take corrective actions.

Page 157 List of Error Codes

5. Clicking the [Execute Parameter Processing] button displays a confirmation window. Check the contents and click the [Yes] button to execute "Parameter write".

6. After "Parameter write" is complete, the following window is displayed.

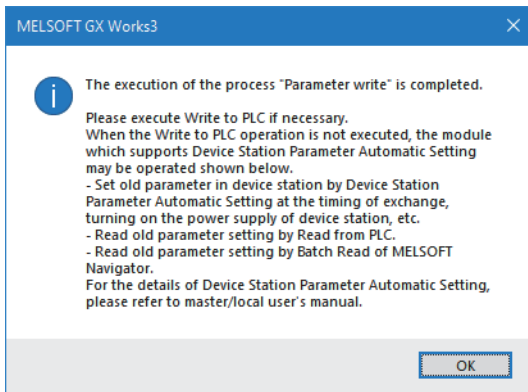

7. Select [Close with Reflecting the Setting] and close the "Parameter of Device Station" window.

8. Select [Close with Reflecting the Setting] and close the "CC-Link IE TSN Configuration" window.

9. Display the refresh parameter setting window and configure the setting as follows.

[Navigation window] ⇒ [Parameter] ⇒ [Module Information] ⇒ Model ⇒ [Basic Settings] ⇒ [Refresh Settings]

No.	Link Side					CPU Side				
	Device Name	Points	Start	End		Target	Device Name	Points	Start	End
-	SB	512	00000	001FF		Specify Device	SB	512	00000	001FF
-	SW	512	00000	001FF		Specify Device	SW	512	00000	001FF
1	RX	16	00000	0000F		Specify Device	X	16	01000	0100F
2	RY	16	00000	0000F		Specify Device	Y	16	01000	0100F
3	RWr	4	00000	00003		Specify Device	W	4	00100	00103
4	RWw	4	00000	00003		Specify Device	W	4	00200	00203

10. Click the [Apply] button.

11. Write the set parameters to the CPU module of the master station and reset the CPU module of the master station, or turn off and on the power supply of the programmable controller.

[Online] ⇒ [Write to PLC]

12. Set the CPU module of the master station to RUN, and check that the D LINK LED of the safety remote I/O module is turned on.

7.3 Safety Communication Setting

Write the safety communication setting of the master station to the CPU module.

Make the following settings before configuring the safety communication setting. Check that the safety remote I/O module and master/local module can perform cyclic transmission (the D LINK LED is lit).

☞ Page 57 Network Configuration Settings

☞ Page 60 Parameter Setting

Operating procedure

1. Set the module parameter of the master station "To Use or Not to Use the Safety Communication Setting" to "Use".

☞ [Module Parameter] ⇒ [Basic Settings] ⇒ [Safety Communication Setting] ⇒ [To Use or Not to Use the Safety Communication Setting]

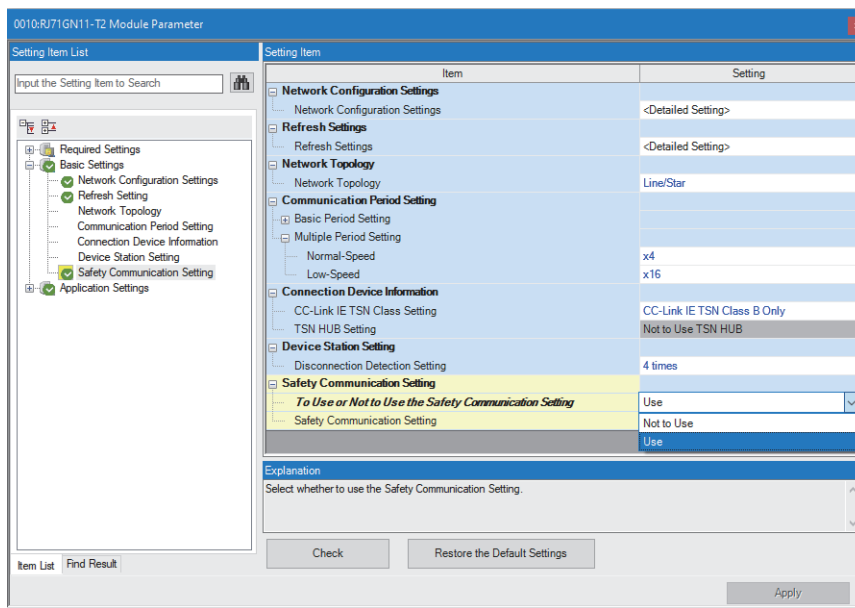

2. Select "Detailed Setting" of the module parameter of the master station "Safety Communication Setting", and the "Safety Communication Setting" window is displayed.

☞ [Module Parameter] ⇒ [Basic Settings] ⇒ [Safety Communication Setting] ⇒ [Safety Communication Setting]

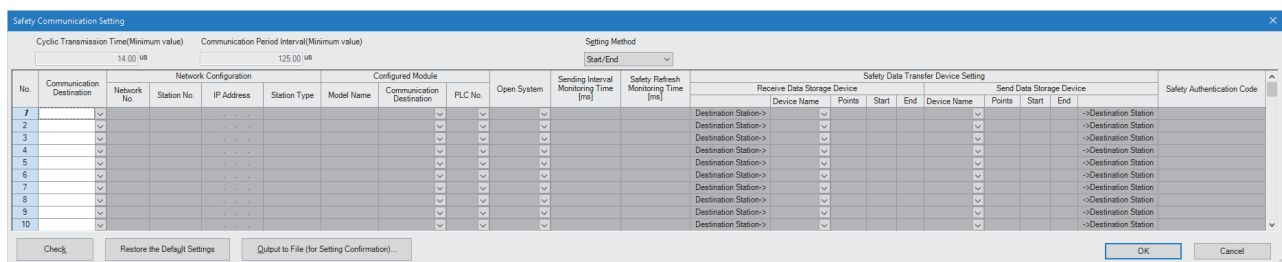

3. Select "Local Network" in "Communication Destination", and the "Select the target module for the Safety Communication Setting" window is displayed. Select the target safety remote I/O module and click the [Add] button.

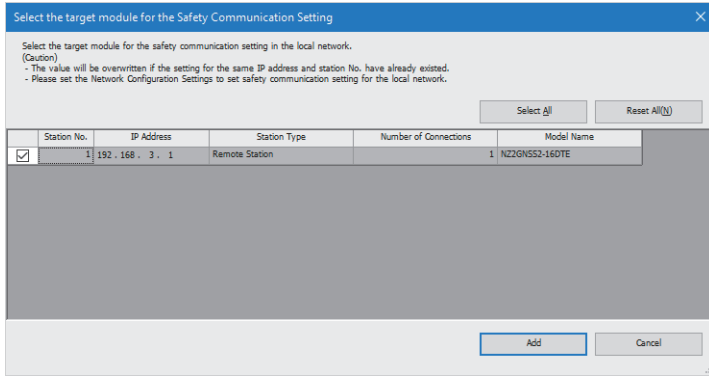

4. The parameters of the safety remote I/O module selected on the "Select the target module for the Safety Communication Setting" window are imported into the safety communication setting. Set "Sending Interval Monitoring Time", "Safety Refresh Monitoring Time", and "Safety Data Transfer Device Setting" and click the [OK] button.

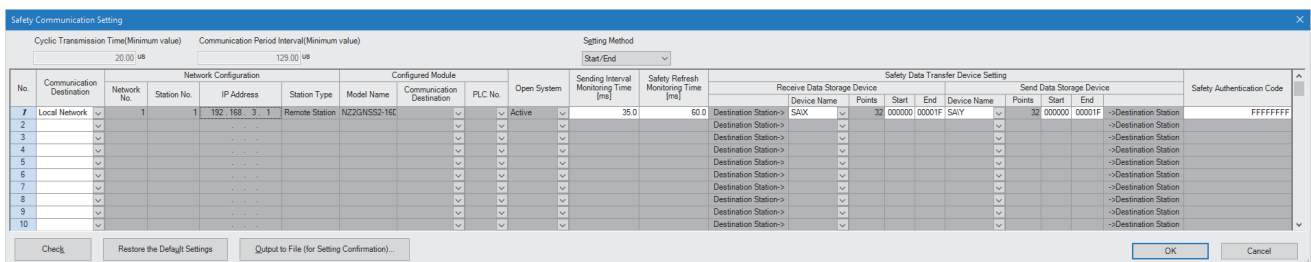

- For the setting values of "Transmission Interval Monitoring Time" and "Safety Refresh Monitoring Time", refer to the following.
 - Page 189 Parameter data per station
 - User's manual for the master station used
- For "Safety authentication code", set the same value as the "Safety authentication code" set in the parameters of the safety remote I/O module.
- No restrictions are provided on the access level for writing parameters to the safety remote I/O module. However, when the access level is "Users", even if parameters have been set to the safety remote I/O module, safety communications are disabled because the safety communication setting cannot be set in the CPU module. To perform the safety communications, set "Developers" or a higher access level. For details on the access levels, refer to the following.
 - GX Works3 Operating Manual

5. After applying the module parameter setting of the master station, perform "Write to PLC".

For the module parameter setting of the master station, refer to the following.

User's manual for the master station used

6. When "Write to PLC" is completed, right-click the target safety remote I/O module in the "Network Configuration Settings" and display the "Command Execution of Device Station" window.

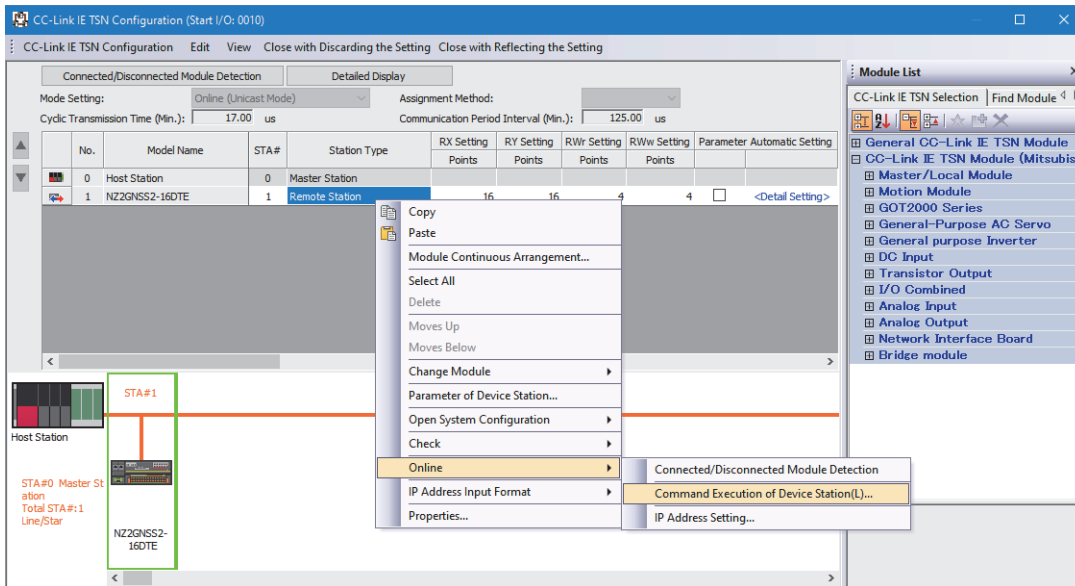

7. Select "Start of checking the module position" in "Method selection" and click the [Execute] button.

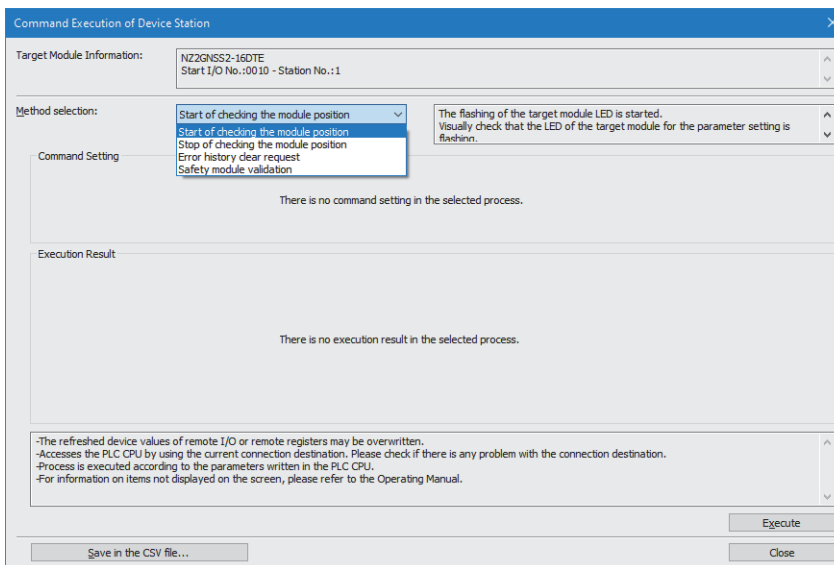

8. Clicking the [Execute] button displays a confirmation window. Check the contents and click the [Yes] button. The SAFETY LED of the selected safety remote I/O module starts flashing. Visually check that the safety remote I/O module on which the SAFETY LED is flashing is installed on the desired position. At the same time, visually check that the SAFETY LEDs of other safety remote I/O modules not targeted for the position checking are not flashing.

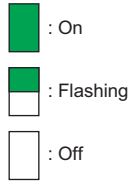

9. After checking the safety remote I/O module position is completed, select "Stop of checking the module position" in "Method selection" on the "Command Execution of Device Station" window and click the [Execute] button.

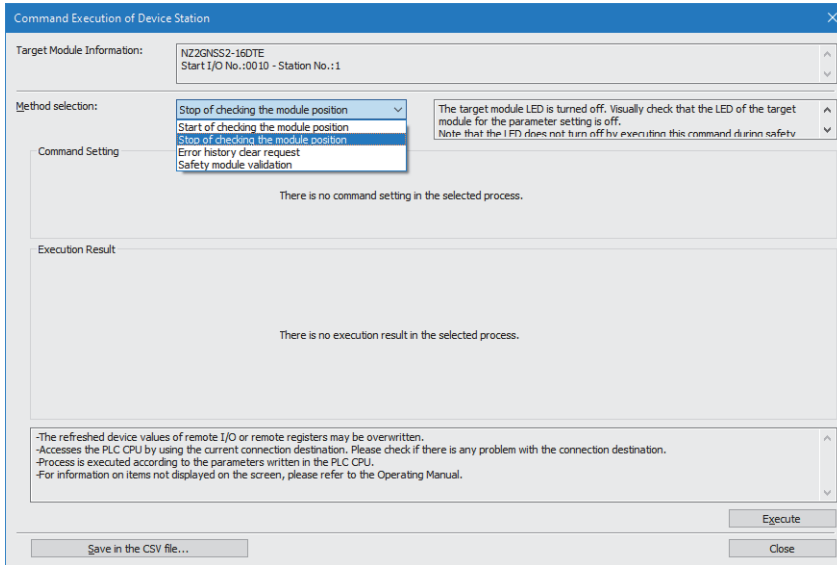

10. Clicking the [Execute] button displays a confirmation window. Check the contents and click the [Yes] button. The SAFETY LED of the safety remote I/O module turns off.



11. Perform the operations from "Start of checking the module position" to "Stop of checking the module position" for all safety remote I/O modules connected.

12. Select "Safety module validation" in "Method selection" and click the [Execute] button.

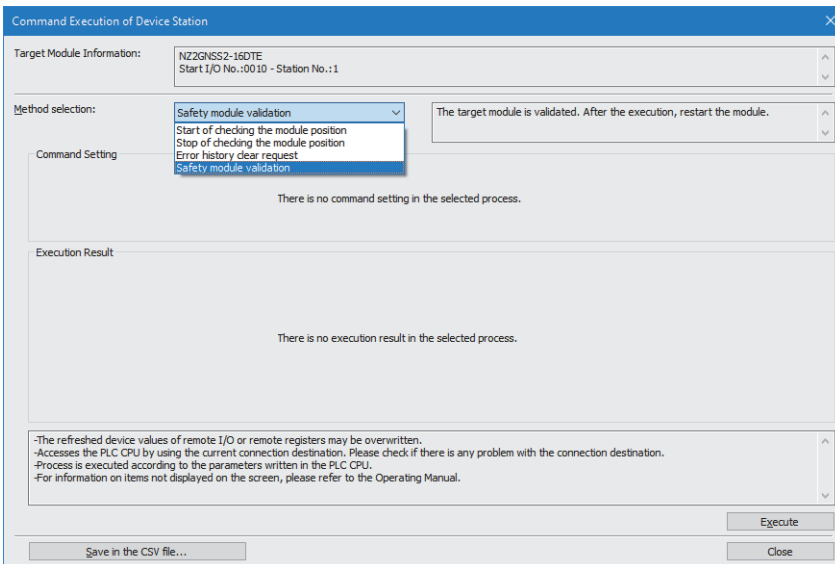

13. Clicking the [Execute] button displays the following confirmation window. Check the contents, and if the operations mentioned on the window are completed, click the [Yes] button. When the operations are not completed, click the [No] button. After performing the operations of "Confirm 1" and "Confirm 2", perform "Safety module validation" again.

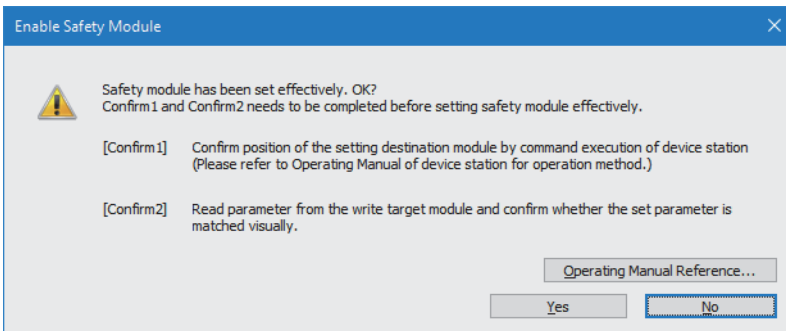

14. Clicking the [Yes] button displays a confirmation window. Check the contents and click the [Yes] button to validate the parameters set to the safety remote I/O module.

Point

- If "Safety module validation" has not been implemented, execute "Safety module validation" within 10 minutes after the safety remote I/O module is powered on. If it cannot be implemented, Safety module validation not performed (error code: 0206H) occurs.
- If "Parameter write" is performed after "Safety module validation" is performed, the safety module enabled flag (RWr0.b0) turns off. If the safety module enabled flag (RWr0.b0) remains off for 10 minutes, Safety module validation not performed (error code: 0206H) occurs, so perform "Safety module validation" within 10 minutes.
- "Safety module validation" cannot be performed while a moderate error caused by parameter settings persists. If "Safety module validation" is performed, a safety module validation failure (error code: 0205H) occurs.

15. Restart the safety remote I/O module. The SAFETY LED turns on and the mode shifts to the safety drive mode.

16. Perform the operations from "Safety module validation" to the restart of the safety remote I/O module for all safety remote I/O modules connected.

8 FUNCTIONS

This chapter describes the functions available in the safety remote I/O module, and the setting procedures for those functions. For details on safety remote I/O signals, remote control/monitor signals, and remote buffer memory, refer to the following.

☞ Page 168 Safety Remote I/O Signals

☞ Page 177 Remote Control/Monitor Signals

☞ Page 183 Remote Buffer Memory

8.1 Safety Input

This function safely inputs external signals. This function cannot be used in any modes other than the safety drive mode. All the safety remote inputs (SAX) are off in any modes other than the safety drive mode.

Safety input wiring selection function

The safety double wiring function or safety single wiring function can be selected for input wiring.

Safety double wiring function

The safety double wiring function supports double input wiring.

By verifying input signals of double wiring, safety inputs can be turned off even if one of the signals has an error.

In the safety drive mode, the power supply current terminal for input device (COM+) and 24V output of the T0/T1 terminals are enabled.

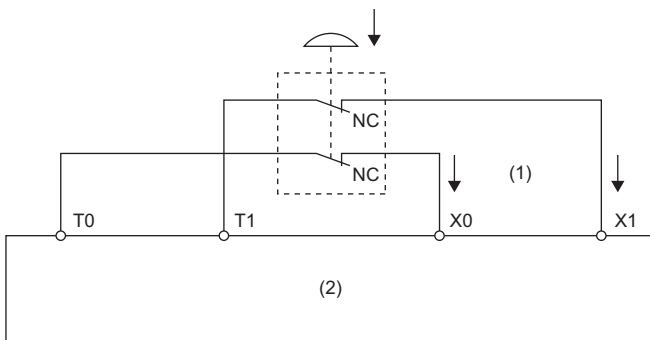

(1) 2 inputs

(2) Safety remote I/O module

■Combination for double wiring

Use the following combinations of input terminals for safety double wiring to the safety remote I/O module.

Combination of input terminals			
X0, X1	X2, X3	X4, X5	X6, X7

Safety single wiring function

This function can connect input devices with single wiring.

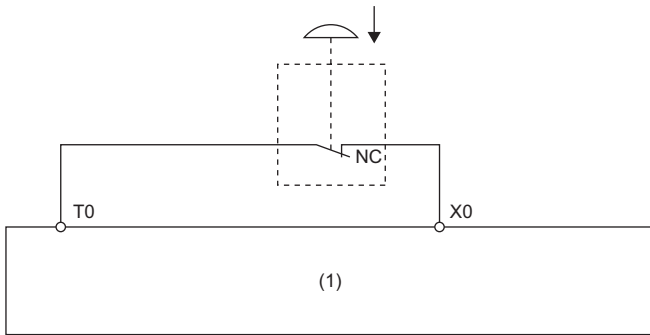

(1) Safety remote I/O module

Point

Use the safety double wiring function to comply with SIL3 or Category 4 PLe.

Systems using safety single wiring do not comply with SIL3 or Category 4 PLe, although the wiring is used for input using safety devices.

Diagnostic functions to detect input errors

Input errors can be detected by using the following diagnostic functions.

Diagnostic function	Description	Reference
Double input discrepancy detection function	Detects the discrepancy of double input signals.	Page 93 Double input discrepancy detection function
Input dark test function	Outputs test pulses to turn off the inputs that are on and diagnoses contacts including external devices for failure.	Page 97 Input dark test function

Combination of safety double inputs

The safety remote I/O module evaluates the logic of input signals and reflects the results to safety remote inputs (SA\X). When the double input signals differ, the double input discrepancy detection state is applied. The following table lists the correspondence between each double input signal state and safety remote input (SA\X).

Input terminal state		Safety remote input (SA\X)		Evaluation result of double inputs
X_n^{*1}	X_{n+1}^{*1}	$SA\X_m^{*2}$	$SA\X_{m+1}^{*2}$	
OFF	OFF	OFF	OFF	OFF (Normal)
OFF	ON	OFF	OFF	OFF (Discrepancy)
ON	OFF	OFF	OFF	OFF (Discrepancy)
ON	ON	ON	ON	ON (Normal)

*1 n: Even number of 0 to 6

*2 m: Safety device address (even number of 0 to 6) assigned to the master station

States of safety remote inputs (SA\X0, SA\X1) for X0 and X1 (double wiring)

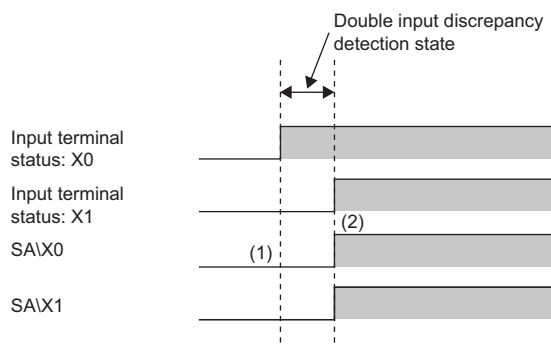

(1) Even when the input terminal X0 turns on, SA\X0 does not turn on because X1 is off.

(2) When the double inputs are on (X0 and X1 are on), safety remote inputs (SA\X0 and SA\X1) turn on.

External input signal monitor function

The state of input terminals can be monitored. This function facilitates the investigation for the cause of a double input discrepancy error. For details, refer to the following.

 Page 181 External input monitor area

Point

The signals of the external input signal monitor are used to investigate the cause of a double input discrepancy error. Do not use these signals in a safety program.

Setting method

Set the input wiring selection in "Wiring selection of input" from the "Parameter of Device Station" window of the engineering tool.

Set safety input to either "1: Safety double wiring (NC/NC)" or "2: Safety single".

Item	Setting range
Wiring selection of input Xn	0: Not used 1: Safety double wiring (NC/NC) 2: Safety single 3: General single

Point

- When "Wiring selection of input" Xn is set to "0: Not used", input data is always off.
- When "Wiring selection of input" Xn (n: even number) is set to "1: Safety double wiring (NC/NC)", Xn+1, the partner of Xn, is automatically set to "1: Safety double wiring (NC/NC)", and no other settings are possible.
- When "Wiring selection of input" Xn (n: even number) is set to anything other than "1: Safety double wiring (NC/NC)", do not set "1: Safety double wiring (NC/NC)" for Xn+1, the partner of Xn. When "1: Safety double wiring (NC/NC)" is set, a parameter data error (wiring selection of input) (error code: 0560H) occurs when "Write to PLC" is executed.

8.2 Standard Input

This function inputs external signals. This function cannot be used in any modes other than the safety drive mode. All the safety remote inputs (SA\X) are off in any modes other than the safety drive mode.

Unlike the safety input function, this function cannot use the input diagnostic function.

Standard input wiring selection function

Sets the standard single wiring function for input wiring.

Standard single wiring function

This function can connect input devices with single wiring.

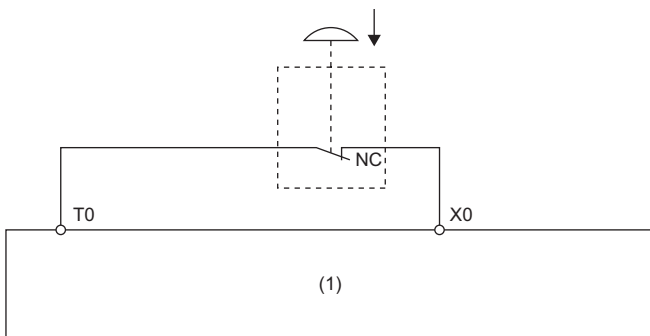

(1) Safety remote I/O module

Setting method

Set the input wiring selection in "Wiring selection of input" from the "Parameter of Device Station" window of the engineering tool.

For standard input, set "3: General single".

Item	Setting range
Wiring selection of input Xn	0: Not used 1: Safety double wiring (NC/NC) 2: Safety single 3: General single

Point

When "Wiring selection of input" Xn (n: even number) is set to "3: General single", do not set "1: Safety double wiring (NC/NC)" for Xn+1. Likewise, when "3: General single" is set for Xn+1, do not set "1: Safety double wiring (NC/NC)" for Xn.

8.3 Input Response Time Setting Function

This function is used to set the filter time to reduce incorrect inputs caused by noise in input signals.

The longer the input response time is, the higher tolerance for chattering and noise the module has. But the response to input signals becomes slower.

The shorter the input response time is, the quicker the response to input signals is. But the tolerance for chattering and noise is reduced.

To set the input response time, consider fully the operating environment.

Ex.

When Input response time is set to "0: 1ms"

Without any noise effects, the time set in input response time and the time taken from when an external input (1) turns on or off until when the corresponding X input signal (2) in the safety remote I/O module turns on or off are equal.

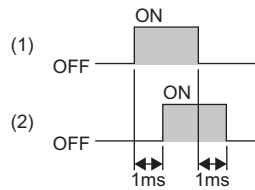

Point

The minimum value of input response time is set to 1ms for the safety remote I/O module, with the internal circuit diagnostic taken into account. When connecting the safety remote I/O module to an external device that generates OFF pulses, set Input response time to the following value: Minimum value of input response time + Pulse OFF time of the external device or longer.

When the set input response time does not include the pulse OFF time of the external device, an OFF pulse of the external device may be detected as an OFF signal.

Setting method

Set the input response time in "Input response time" from the "Parameter of Device Station" window of the engineering tool.

Item	Setting range
Input response time Xn	0: 1ms 1: 1.5ms 2: 5ms 3: 10ms 4: 20ms 5: 50ms 6: 70ms

Point

When "Wiring selection of input" Xn (n: even number) is set to "1: Safety double wiring (NC/NC)", only the same value as Xn can be set for Xn+1, the partner of "Input response time" Xn. If a different value is set, a parameter data error (input response time) (error code: 0564H) occurs.

Relation of the parameters for the input response time and input dark test

Set the input response time to satisfy the following condition.

Input response time > Input dark test pulse output time^{*1}

*1 Pulse output time for the input dark test = Pulse OFF time for the input dark test × ((Number of pulse outputs for the input dark test × 2) - 1)

For details on the input dark test, refer to the following.

☞ Page 97 Input dark test function

8.4 Safety Output

This function safely outputs signals. This function cannot be used in any modes other than the safety drive mode. All the safety remote outputs (SA\Y) are off in any modes other than the safety drive mode.

Safety output wiring selection function

The safety double wiring function or safety single wiring function can be selected for output wiring.

Safety double wiring function

The safety double wiring function supports double outputs.

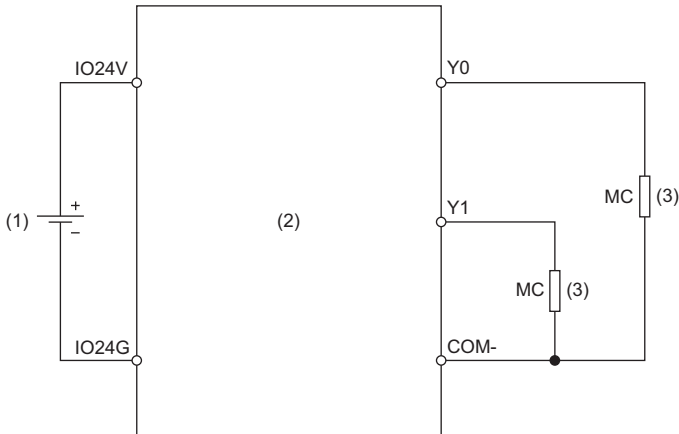

- (1) External power supply
- (2) Safety remote I/O module
- (3) Load

■Combination for double wiring

Use the following combinations of output terminals for double wiring to the safety remote I/O module.

Combination of output terminals			
Y0, Y1	Y2, Y3	Y4, Y5	Y6, Y7

Safety single wiring function

This function can connect output devices with single wiring.

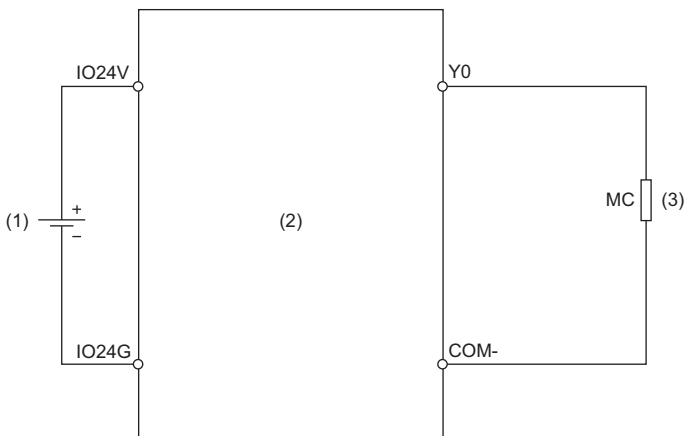

- (1) External power supply
- (2) Safety remote I/O module
- (3) Load

Diagnostic functions to detect output errors

Output errors can be detected by using the following diagnostic functions.

Diagnostic function	Description	Reference
Output dark test function	Outputs test pulses to turn off the outputs that are on and diagnoses contacts for failure.	☞ Page 100 Output dark test function
Output read-back function	Reads back output results and diagnoses whether the external output signals (Y0 to Y7) are correctly on or off.	☞ Page 102 Output read-back function

Combination of safety double outputs

Both terminals of double outputs are turned on only when both safety remote outputs (SA\Y) are on. The safety remote I/O module evaluates the logic of safety remote outputs (SA\Y) and determines the state of the output terminals. The following table lists the correspondence between each state of safety remote output (SA\Y) and output terminal for double outputs.

Safety remote output (SA\Y)		Output terminal state		Evaluation result of double outputs
SA\Y ^m *1	SA\Y ^{m+1} *1	Y ⁿ *2	Y ⁿ⁺¹ *2	
OFF	OFF	OFF	OFF	OFF (Normal)
OFF	ON	OFF	OFF	OFF (Discrepancy)
ON	OFF	OFF	OFF	OFF (Discrepancy)
ON	ON	ON	ON	ON (Normal)

*1 m: Safety device address (even number of 0 to 6) assigned to the master station

*2 n: Even number of 0 to 6



Even if the double outputs do not match, the safety remote I/O module does not detect an error.

States of safety remote outputs (SA\Y0, SA\Y1) for Y0 and Y1 (double wiring)

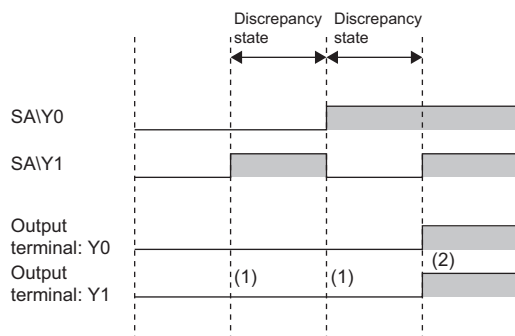

(1) When double outputs (source/source) are in the discrepancy state (safety remote outputs (SA\Y0 and SA\Y1) are different), Y0 and Y1 are off.

(2) When double outputs (source/source) are on (safety remote outputs (SA\Y0 and SA\Y1) are on), Y0 and Y1 are on.

Setting method

Set the safety output wiring selection in "Wiring selection of output" from the "Parameter of Device Station" window of the engineering tool.

Set safety output to either "1: Safety double wiring (Source/Source)" or "2: Safety single".

Item	Setting range
Wiring selection of output Yn	0: Not used 1: Safety double wiring (Source/Source) 2: Safety single

Point

- When "Wiring selection of output" Yn is set to "0: Not used", output data is always off.
- When "Wiring selection of output" Yn (n: even number) is set to "1: Safety double wiring (Source/Source)", set Yn+1, the partner of Yn, to "1: Safety double wiring (Source/Source)".
- When "Wiring selection of output" Yn (n: even number) is set to other than "1: Safety double wiring (Source/Source)", do not set Yn+1, the partner of Yn, to "1: Safety double wiring (Source/Source)".

Fast logic function

Output control according to the input status is performed inside the safety remote I/O module without going through the master station. Because the output status can be changed without CPU module processing such as programs, high-speed output control is possible.

The fast logic function can only be used with an I/O combined module.

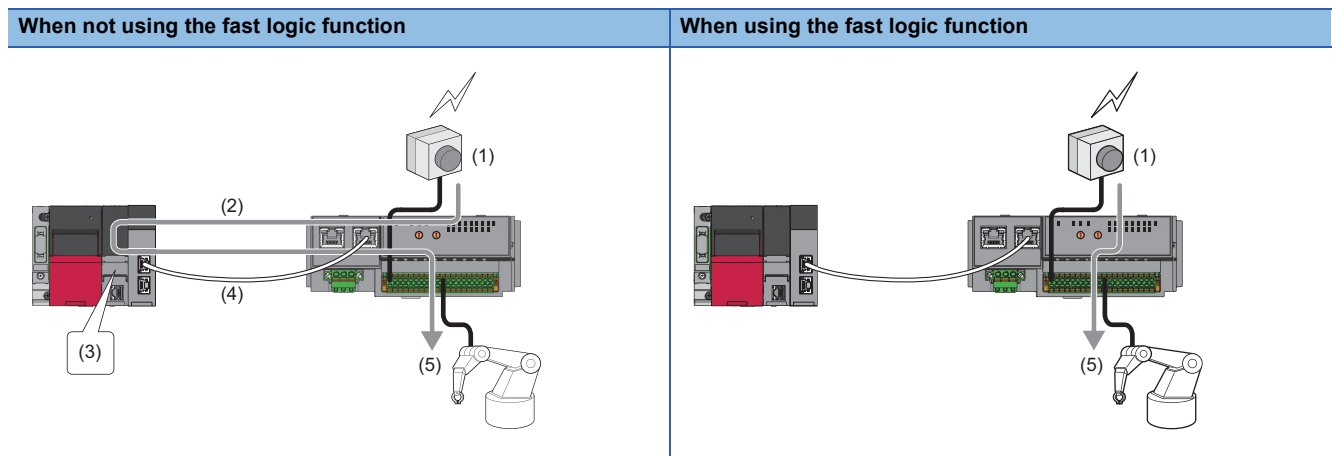

- (1) Emergency stop button push
- (2) Input status transmission
- (3) CPU module processing (program)
- (4) Output instruction reception
- (5) Robot stop

- The fast logic function performs logic operations based on the safety input and reflects the result to the safety output.
- When using the fast logic function, the I/O wiring selection is fixed, and the "Wiring selection of input" and "Wiring selection of output" parameters are ignored. Other parameters are valid.
- I/O points not used by the fast logic function are turned off. The operation is the same as when "0: Not used" is set for "Wiring selection of input" and "Wiring selection of output".

Logic patterns of fast logic function

The logic patterns of the fast logic function can be selected from the following four patterns.

No.	Fast logic pattern setting	Logical operation circuit of fast logic
1	Pattern 1 Four safety double wiring inputs (without reset signal)	
2	Pattern 2 Three safety double wiring inputs (with reset signal)	
3	Pattern 3 Three safety double wiring inputs (with reset signal)	
4	Pattern 4 Safety single wiring (with reset signal)	

(1) Input signals

(2) Logical operation circuit

(3) Output signals (fast logic output)

*1 The logical products of the safety output enable signals (SA\Y0, SA\Y1) and the fast logic output signals (Y0, Y1) are output as the output signals (Y0, Y1).

*2 The logical products of the safety output enable signal (SA\Y0) and the fast logic output signal (Y0) are output as the output signal (Y0).

Point

- In Pattern 2 to Pattern 4, a reset signal from external and a start signal can be input. In this case, the reset signal is input to X7 and the start signal is input to X6.
- When using the fast logic function, the safety output signals (SA\Y0, SA\Y1) are used as the safety output enable signals for the fast logic output. Other safety output signals are ignored even if they are operated from a program or engineering tool.
- Do not use Pattern 4 in a safety system.

Fast logic interlock

When the output is turned off by the fast logic function, the output is interlocked. When the fast logic interlock state is entered, the output signals (Y0/Y1) do not turn ON again unless there is a restart instruction, reset signal, or start signal input from the CPU module. This prevents unintended fast logic restarts. For applications that do not require interlock, fast logic interlock can be disabled.

■Fast logic interlock state conditions

Under the following conditions, the output signals (Y0, Y1) of the fast logic function are turned OFF and the fast logic interlock state is set.

- When the safety remote I/O module is disconnected from safety communications
- When the safety output enable signals (SA\Y0, SA\Y1) are turned off
- When the output conditions of the set logic pattern of the fast logic function are not satisfied

■Resumption of output from fast logic interlock state

The method of restarting output from the fast logic interlock state differs depending on the conditions that caused the output signals (Y0, Y1) of the fast logic function to turn on. For details, refer to the following.

☞ Page 87 Operation when fast logic output is off

☞ Page 89 Operation when safety output enable signal is off

Precautions

- When the fast logic interlock is disabled, it is customer's responsibility to build the interlock circuit externally so that the entire system always operates safely. Be sure to connect an interlock mechanism to the output of this I/O module.
- If the measure to prevent the restart cannot be taken, take other measures and ensure that operators are safe and machine parts are not damaged even if a device has restarted with the fast logic interlock disabled.

Operation at fast logic start

The fast logic function operates in the safe operation mode, and operation is stopped (output OFF) except in the fast logic interlock state and the safe operation mode.

The operation when the fast logic pattern setting is Pattern 2 is shown below.

Operating procedure

1. Turn on the safety output enable signals (SAIY0, SAIY1).
2. Turn on and off the fast logic initial request flag (SAIY8).
3. Check whether the fast logic initial completion flag (SAIXD) is on, and then turn on and off the fast logic start flag (SAIY9).
4. Turn on the input signals that satisfy the conditions of the logic pattern.
5. The output signals (Y0, Y1) turn on.

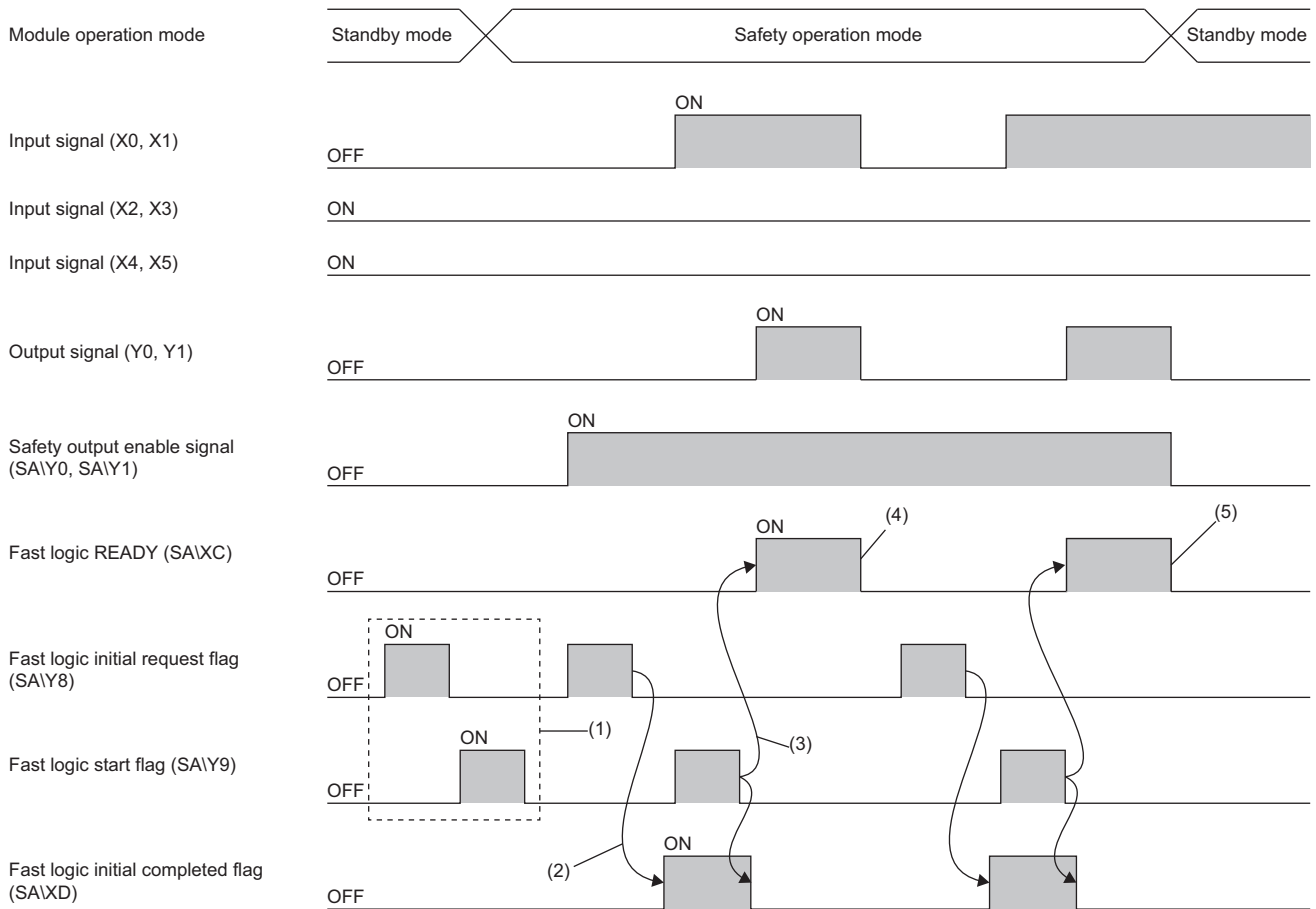

- Executed by the program
- (1) Even when the fast logic initial request flag (SAIY8) and fast logic start flag (SAIY9) are operated in other than the safe operation mode, the fast logic function is not enabled.
 - (2) Turning off the fast logic initial request flag (SAIY8) in the safety drive mode causes fast logic initial processing to be performed. When initial processing is completed, the fast logic initial completion flag (SAIXD) turns ON.
 - (3) When the fast logic start flag (SAIY9) is turned on while the fast logic initial completion flag (SAIXD) is on, fast logic READY (SAIXC) turns on, fast logic initial completion flag (SAIXD) turns off, and the fast logic function is enabled.
 - (4) When the fast logic interlock state is entered, fast logic READY (SAIXC) turns off and the fast logic function stops.
 - (5) When a mode other than safe operation mode is entered, fast logic READY (SAIXC) turns off and the fast logic function stops.

-
- The fast logic function turns off the output signals (Y0, Y1) and stops operation when the safety remote I/O module enters major or moderate error status.
 - If the input point is turned off due to a minor error, remove the cause of the error and then operate the fast logic initial request flag (SA\Y8) and fast logic start flag (SA\Y9) to start operation of the fast logic function.
 - To prevent unintended start of the fast logic function when the safety communications change from disconnected to connected, turn on and off both the fast logic initial request flag (SA\Y8) and the fast logic start flag (SA\Y9). When the fast logic initial completion flag (SA\XD) is turned off and fast logic READY (SA\XC) turns on, the operation starts.
 - Even if the fast logic interlock mode setting is disabled, perform the operation at the start of the fast logic function first.
 - Perform the operation so that the width of the pulse output from on to off for the fast logic initial request flag (SA\Y8) and the fast logic start flag (SA\Y9) is in the range of 200ms to 4s.
 - To restart the fast logic function, operate the fast logic initial request flag (SA\Y8) and fast logic start flag (SA\Y9) with the reset signal (X7) and start signal (X6) turned off.
-

Operation when fast logic output is off

■When fast logic interlock is enabled

When all the corresponding output signal points are turned off by the fast logic function, the fast logic READY (SA\XC) is turned off, the fast logic function stops operating, and the fast logic interlock state is entered.

When restarting the fast logic function, turning on the fast logic initial request flag (SA\Y8) and fast logic start flag (SA\Y9), or operating the reset signal X7 and start signal X6 causes fast logic READY (SA\XC) to turn ON and the operation to resume.

The operation when the fast logic pattern setting is Pattern 2 is shown below.

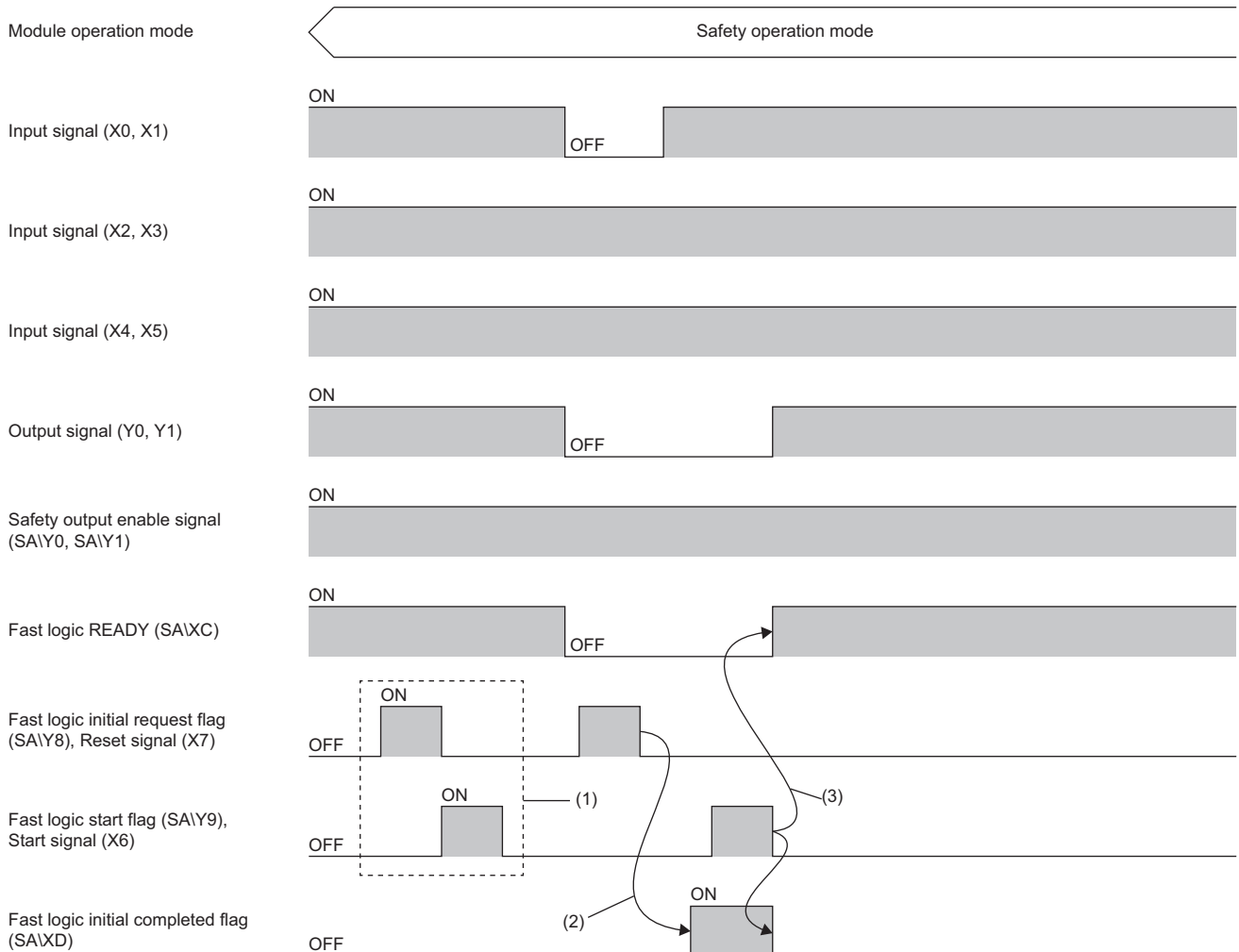

→ Executed by the program

- (1) When the fast logic output is not off, even if the fast logic initial request flag (SA\Y8) and fast logic start flag (SA\Y9) are operated, the fast logic initial completion flag (SA\XD) does not change.
- (2) Turning on the fast logic initial request flag (SA\Y8) when fast logic output is off causes fast logic initial processing to be performed. When initial processing is completed, the fast logic initial completion flag (SA\XD) turns ON.
- (3) When the fast logic start flag (SA\Y9) is turned on while the fast logic initial completion flag (SA\XD) is on, fast logic READY (SA\XC) turns on, fast logic initial completion flag (SA\XD) turns off, and the fast logic function is enabled.

Point

The operation of the fast logic function can be resumed by operating reset signal X7 and start signal X6 only when the fast logic function stops operating during safety communications return (fast logic interlock state). After safety communications changes from disconnected to connected, operate the fast logic initial request flag (SA\Y8) and fast logic start flag (SA\Y9) to restart the fast logic function.

■When fast logic interlock is disabled

Even when the output is turned off by the fast logic function, fast logic READY (SA\XC) remains on and the fast logic function does not stop. Operations of the fast logic initial request flag (SA\Y8) and fast logic start flag (SA\Y9), or operations of the reset signal X7 and start signal X6 will be ignored.

Since fast logic interlock is disabled, output resumes when an input signal that satisfies the logic pattern conditions is turned on again.

The operation when the fast logic pattern setting is Pattern 2 is shown below.

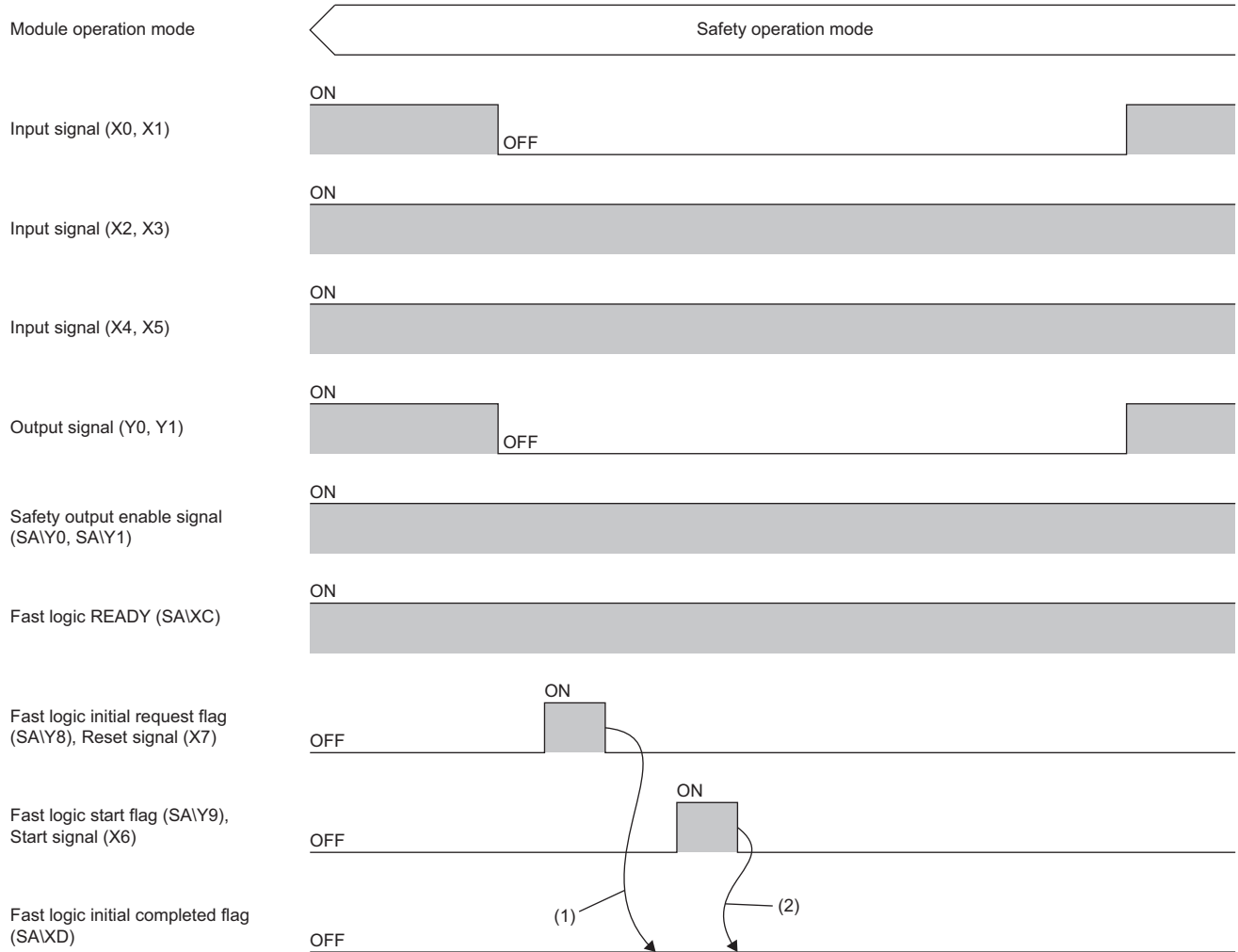

→ Executed by the program

- (1) Even if the fast logic initial request flag (SA\Y8) is turned on, the fast logic initial completion flag (SA\XD) does not change.
- (2) Even if the fast logic start flag (SA\Y9) is turned on, the fast logic initial completion flag (SA\XD) does not change.

Operation when safety output enable signal is off

■When fast logic interlock is enabled

When the safety output enable signals (SAIY0, SAIY1) are turned off while the output signals (Y0, Y1) are on, all output signal points are turned off, fast logic READY (SAIXC) turns off, the fast logic function stops operating, and the fast logic interlock state is entered.*1

The operation when the fast logic pattern setting is Pattern 2 is shown below.

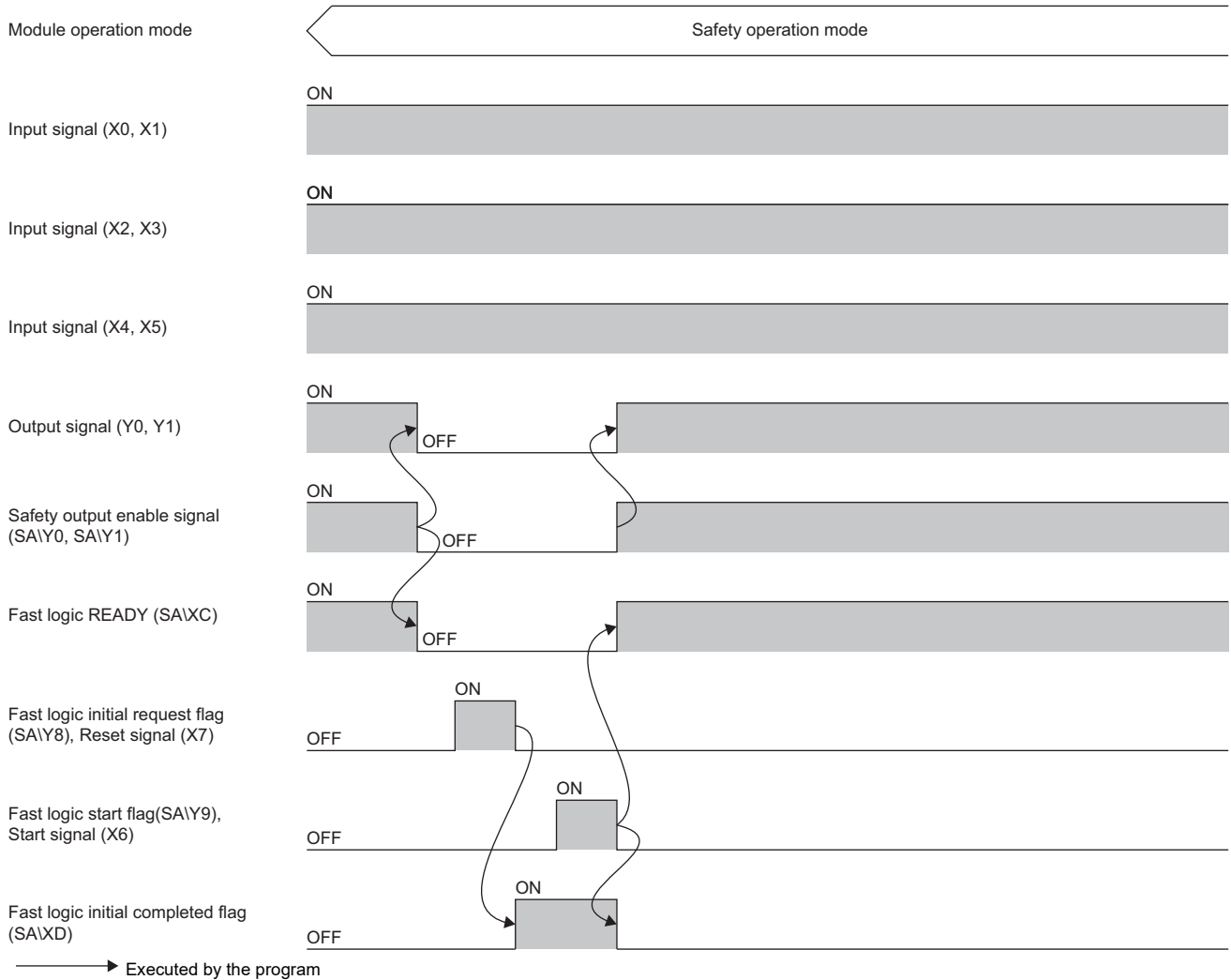

*1 When the safety output enable signals (SAIY0, SAIY1) are turned off while the output signals (Y0, Y1) are off, the fast logic READY (SAIXC) remains on, and the fast logic interlock state is not entered.

■When fast logic interlock is disabled

Turning off the safety output enable signals (SAI\Y0, SAI\Y1) turns off all the output signal points.

Since fast logic interlock is disabled, output resumes when the safety output enable signals (SAI\Y0, SAI\Y1) are turned on.

The operation when the fast logic pattern setting is Pattern 2 is shown below.

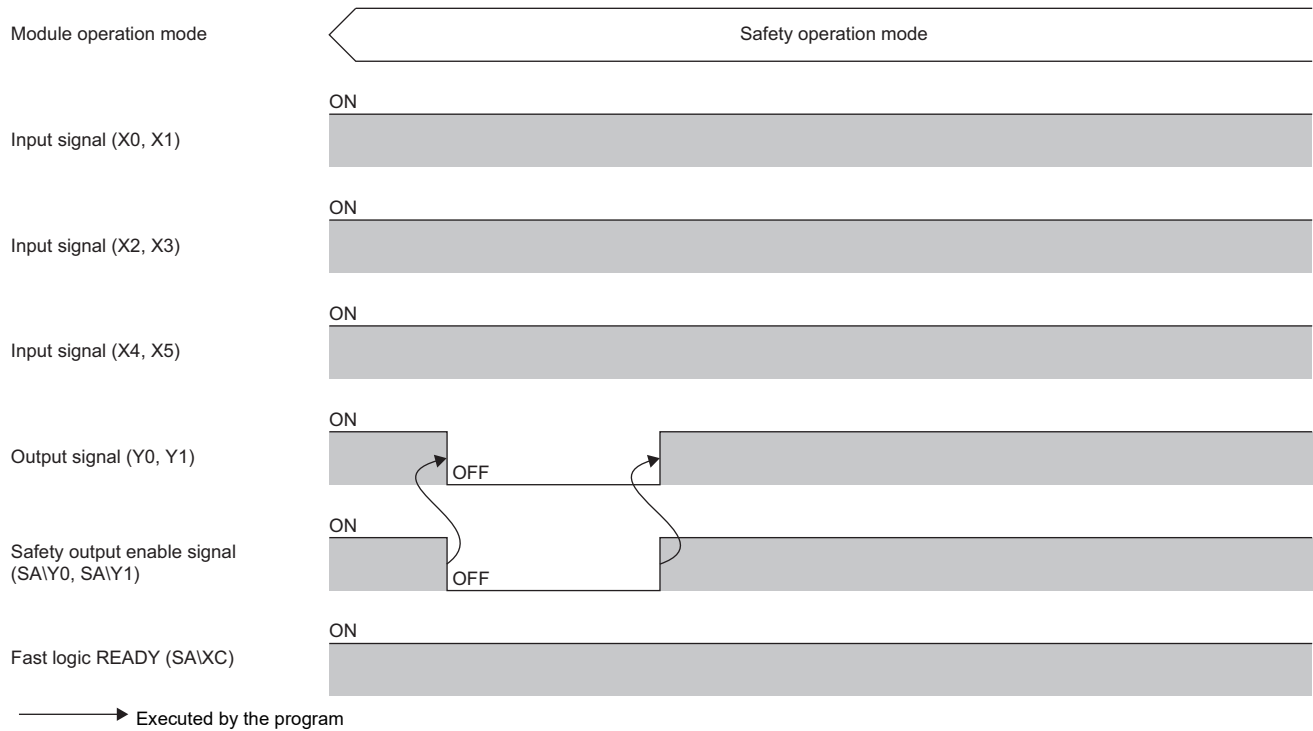

Total response time when using fast logic function

The total response time from input to output when using the fast logic function is shown below.

Safety remote station input response time + Fast logic function response time (4ms) + Safety remote station output response time

For details on the safety remote station input response time and safety remote station output response time, refer to the following.

📖 Page 27 I/O combined module

Fast logic function parameter setting method

■Fast logic pattern setting

Enable/disable the fast logic function and set the logic pattern.

Fast logic pattern setting is done with "Fast logic pattern setting" from the "Parameter of Device Station" window of the engineering tool.

Item	Setting range
Fast logic pattern setting	0: Not used 1: Pattern 1 2: Pattern 2 3: Pattern 3 4: Pattern 4

For details on the logic patterns, refer to the following.

☞ Page 83 Logic patterns of fast logic function

Precautions

When "Fast logic pattern setting" is other than "0: Not used", the parameter settings of "Wiring selection of input" and "Wiring selection of output" in the safety remote I/O module are automatically replaced with the following setting values. The replaced setting values cannot be checked on the "Parameter of Device Station" window.

No.	Fast logic pattern setting	Wiring selection of input/output	Setting value	
1	Pattern 1 Four safety double wiring inputs (without reset signal)	Wiring selection of input	X0	Safety double wiring (NC/NC)
			X1	
			X2	Safety double wiring (NC/NC)
			X3	
			X4	Safety double wiring (NC/NC)
			X5	
			X6	Safety double wiring (NC/NC)
		X7		
		Wiring selection of output	Y0	Safety double wiring (Source/Source)
			Y1	
			Y2	Not used
			Y3	
			Y4	
			Y5	
Y6				
Y7				
2	Pattern 2 Three safety double wiring inputs (with reset signal)	Wiring selection of input	X0	Safety double wiring (NC/NC)
			X1	
			X2	Safety double wiring (NC/NC)
			X3	
			X4	Safety double wiring (NC/NC)
			X5	
			X6	Safety single ^{*1}
		X7	Safety single ^{*2}	
		Wiring selection of output	Y0	Safety double wiring (Source/Source)
			Y1	
			Y2	Not used
			Y3	
			Y4	
			Y5	
Y6				
Y7				

No.	Fast logic pattern setting	Wiring selection of input/output		Setting value
3	Pattern 3 Three safety double wiring inputs (with reset signal)	Wiring selection of input	X0	Safety double wiring (NC/NC)
			X1	
			X2	Safety double wiring (NC/NC)
			X3	
			X4	Safety double wiring (NC/NC)
			X5	
			X6	Safety single ^{*1}
		X7	Safety single ^{*2}	
		Wiring selection of output	Y0	Safety double wiring (Source/Source)
			Y1	
			Y2	Not used
			Y3	
			Y4	
			Y5	
Y6				
Y7				
4	Pattern 4 Safety single wiring (with reset signal)	Wiring selection of input	X0	Safety single
			X1	
			X2	
			X3	
			X4	Not used
			X5	
			X6	Safety single ^{*1}
		X7	Safety single ^{*2}	
		Wiring selection of output	Y0	Safety single
			Y1	Not used
			Y2	
			Y3	
			Y4	
			Y5	
Y6				
Y7				

*1 Start signal

*2 Reset signal

■Fast logic interlock mode setting

Fast logic interlock mode setting is done with "Fast logic Interlock mode setting" on the "Parameter of Device Station" window of the engineering tool.

Item	Setting range
Fast logic interlock mode setting	0: Enable 1: Disable

For details on the fast logic interlock, refer to the following.

 Page 87 Resumption of output from fast logic interlock state

8.5 Input Diagnostic

The input diagnosis function is a safety function for determining failure of input signals using the safety input function.

Double input discrepancy detection function

Discriminates failures by monitoring the discrepancy state of doubled safety remote inputs (SAIX).

Double input discrepancy detection

If "Double input discrepancy detection setting" is set to "0: Detect" from the "Parameter of Device Station" window, a double input discrepancy detection error is generated as an input error when the discrepancy state of double inputs continues for the set time or longer. For the double input discrepancy detection time, refer to the following.

☞ Page 95 Double input discrepancy detection time

The following figure shows the operation overview of the double input discrepancy detection for double wiring inputs X0 and X1.

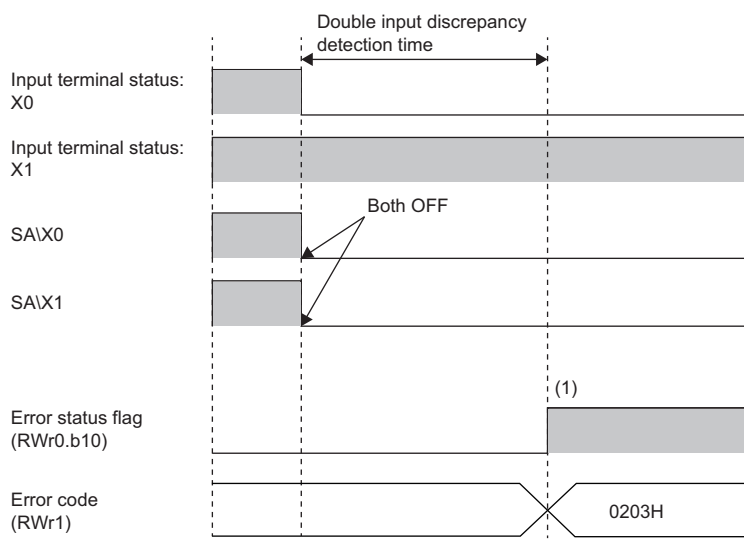

(1) After the double input discrepancy detection time elapses, a double input discrepancy detection error occurs.

■ Operation at error detection

When the discrepancy state of double inputs continues for the set time or longer, the double input discrepancy detection error (error code: 0203H) state is applied to the safety remote I/O module, and the corresponding input point is turned off. For the error state, refer to the following.

 Page 157 Error codes related to the safety remote I/O module

Point

When an error occurs for all the input points due to the input dark test error (error code: 0204H) or double input discrepancy detection error (error code: 0203H) and the input function cannot be performed anymore, an I/O data error (error code: 0108H) results. However, when a double input discrepancy detection error (error code: 0203H) occurs while "1: Used" is set for "Double input discrepancy auto recovery setting", the input function may be recovered. Thus, an I/O data error (error code: 0108H) does not occur even if the error occurs for all the input points.

■ Setting method

Set the double input discrepancy detection setting in "Double input discrepancy detection setting" from the "Parameter of Device Station" window of the engineering tool.

Item	Setting range
Double input discrepancy detection setting Xn, Xn+1*1	0: Detect 1: Do not detect

*1 n: Even number of 0 to 6

Point

- When an item other than "1: Safety double wiring (NC/NC)" is selected in "Wiring selection of input", the "Double input discrepancy detection setting" parameter is ignored.
- When double input discrepancy errors do not need to be detected during equipment maintenance including system start-up and inspection, select "1: Do not detect".

Double input discrepancy detection time

When the double input discrepancy detection time is set, an error does not occur during the set detection time even if double input discrepancy occurs. The following table lists the relation of each double input evaluation result and the double input discrepancy detection time.

Input terminal state		Time passed after the discrepancy state is applied	Safety remote input		Evaluation result of double inputs
Xn*1	Xn+1*1		SAIXm*2	SAIXm+1*2	
OFF	OFF	—	OFF	OFF	OFF (Normal)
OFF	ON	< Double input discrepancy detection time	OFF	OFF	OFF (Discrepancy)
OFF	ON	≥ Double input discrepancy detection time	OFF	OFF	Double input discrepancy detection error
ON	OFF	< Double input discrepancy detection time	OFF	OFF	OFF (Discrepancy)
ON	OFF	≥ Double input discrepancy detection time	OFF	OFF	Double input discrepancy detection error
ON	ON	—	ON	ON	ON (Normal)

*1 n: Even number of 0 to 6

*2 m: Safety device address (even number of 0 to 6) assigned to the master station

Setting method

Set the double input discrepancy detection time in "Double input discrepancy detection time" from the "Parameter of Device Station" window of the engineering tool.

Item	Setting range
Double input discrepancy detection time Xn, Xn+1*1	1 to 6000(×10ms)

*1 n: Even number of 0 to 6

Point

A double input discrepancy error is detected in signals after the input response time has elapsed. Therefore, the time taken from when actual signals are in the discrepancy state until when a double input discrepancy detection error (error code: 0203H) occurs is equal to the input response time + double input discrepancy detection time.

Reference for the double input discrepancy detection time

- For mechanical switches and sensor inputs

Set the time based on the following values: 100ms for mechanical switches and 20ms for sensor inputs.

- When the synchronous time for double inputs can be defined

For the input devices whose synchronous time specifications is open to the public, set the double input discrepancy detection time considering the safety factor for the false detection.

Use the safety factor of 2 times or higher and set the double input discrepancy detection time to prevent false detection depending on the input devices used.

Ex.

When the synchronous time is 1s, 2s shall be set as the double input discrepancy detection time considering the safety factor of 2 times.

- When the synchronous time for double inputs cannot be defined

When the synchronous time cannot be defined for the application, such as usage of a door switches that are opened or closed manually, set the maximum time or set "1: Do not detect" in "Double input discrepancy detection setting". Even when "1: Do not detect" is set, the system stops when one of the input signals turns off. Therefore, safety is ensured by inspecting the safety remote I/O module periodically at a sufficiently short interval.

Double input discrepancy auto recovery function

When a double input discrepancy detection error has occurred, removing the error factor recovers the module into the normal state automatically.

By enabling this function, the reset operation of the safety remote I/O module to reset errors is not required.

When this function is enabled and a double input discrepancy is detected, the minor error state is applied to the safety remote I/O module. For details on the error state, refer to the following.

☞ Page 157 Error codes related to the safety remote I/O module

■Auto recovery timing

To clear a double input discrepancy detection error, turning off both of the actual input signals is required. The following figure shows the timing of when the module is automatically recovered from a double input discrepancy detection error.

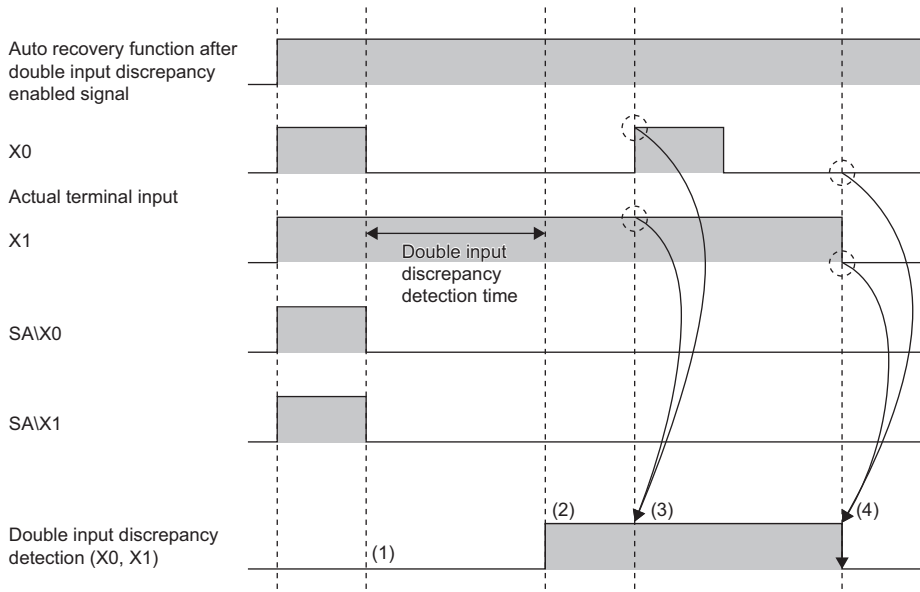

- (1) Both SAIX0 and SAIX1 turn off when discrepancy is detected.
- (2) A double input discrepancy detection error occurs.
- (3) The auto recovery is not performed even though both X0 and X1 turn on.
- (4) The auto recovery is performed when both X0 and X1 turn off.

■Double input discrepancy detection state

The double input discrepancy detection state can be monitored with the safety remote inputs (SAIX8 to SAIXB).

Point

Do not use the double input discrepancy detection state in a safety program.

■Setting method

Set the double input discrepancy auto recovery function in "Double input discrepancy auto recovery setting" from the "Parameter of Device Station" window of the engineering tool.

Item	Setting range
Double input discrepancy auto recovery setting	0: Not used 1: Used

Point

The double input discrepancy auto recovery setting function is valid only for the input signals for which "0: Detect" is set in "Double input discrepancy detection setting".

Input dark test function

Outputs test pulses to turn off the external input signals (X0 to X7) that are on and diagnoses contacts including external devices for failure. Failures including circuit fixing and short-circuit faults can be detected.

The input dark test detects a short-circuit fault that occurs between Xn (n: even number) and Xn+1. The Xn is an input terminal to be connected to T0, and the Xn+1 is an input terminal to be connected to T1. Note that a short-circuit fault between Xn and Xn or between Xn+1 and Xn+1 cannot be detected. Thus, do not use the input dark test for a system where a short-circuit fault may occur between Xn and Xn or between Xn+1 and Xn+1.

The OFF time of test pulses and the number of pulse outputs used in one diagnostic can be set depending on the usage environment.

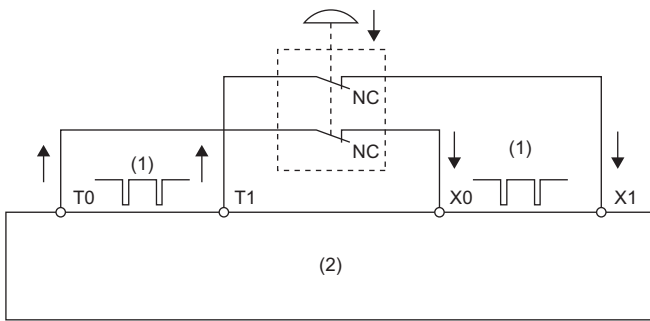

(1) Test pulse

(2) Safety remote I/O module

To use the input dark test function, use the test pulse output terminals (T0, T1) and connect input devices.

Use the input terminals and test pulse output terminals (T0, T1) of the safety remote I/O module in the following combinations.

An incorrect combination results in an error.

Test pulse output terminal	Input terminal
T0	X0, X2, X4, X6
T1	X1, X3, X5, X7

Point

When the input dark test is not executed, input devices can be connected with a combination of input terminals and COM+ terminals.

Operation at error detection

When an error is detected in a diagnostic of the input dark test, the input dark test error (error code: 0204H) state is applied. For details on the error state, refer to the following.

Page 157 Error codes related to the safety remote I/O module

Point

When an error occurs for all the input points due to the input dark test error or double input discrepancy detection error and the input function cannot be performed anymore, an I/O data error (error code: 0108H) results. However, when a double input discrepancy detection error (error code: 0203H) occurs while "1: Used" is set for the parameter "Double input discrepancy auto recovery setting", the input function may be recovered. Thus, an I/O data error (error code: 0108H) does not occur even if the error occurs for all the input points.

Setting method

Set the following parameters for the input dark test function.

Point

There is a mutual relation of the parameter values of the input response time and input dark test. When setting parameters, set values that meet the mutual relation. For details, refer to the following.

 Page 78 Relation of the parameters for the input response time and input dark test

■ Input dark test execution setting

Set whether to perform the input dark test or not in "Input dark test execution setting" from the "Parameter of Device Station" window of the engineering tool.

Item	Setting range
Input dark test execution setting X0 to X7	0: Perform 1: Do not perform

■ Input dark test pulse OFF time setting

Set the input dark test pulse OFF time in "Input dark test pulse OFF time setting" from the "Parameter of Device Station" window of the engineering tool.

Item	Setting range
Input dark test pulse OFF time setting	0: 400 μ s 1: 1ms 2: 2ms

Point

Adjust the input dark test pulse OFF time depending on the installation environment or wiring length.

■ Number of pulse output for input dark test

Set the number of input dark test pulse outputs in "Number of pulse output for input dark test" from the "Parameter of Device Station" window of the engineering tool.

Item	Setting range
Number of pulse output for input dark test	0: 1 time 1: 2 times 2: 3 times

Point

Adjust the number of input dark test pulse outputs depending on the installation environment or wiring length.

Internal input dark test function

This function outputs test pulses to the input circuit of the safety remote I/O module to detect a circuit-fixing failure. The test pulses turn off the external input signals (X0 to X7) that are on to detect the failure.

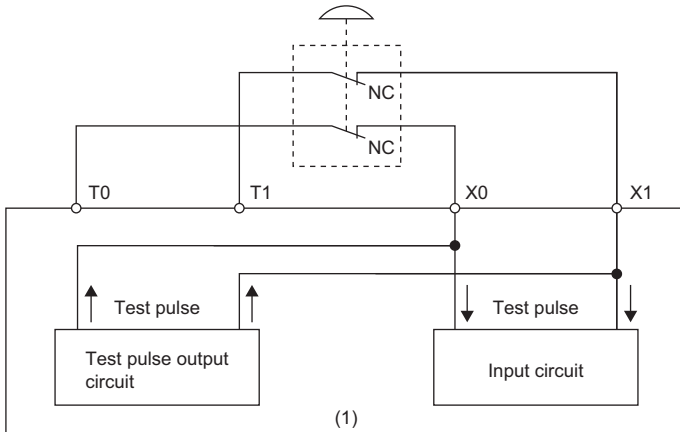

(1) Safety remote I/O module

Point

The test using this function is conducted to all input signals except for the signals where "Wiring selection of input" is set to "0: Not used".

Operation at error detection

If an error is detected by the internal input dark test, the safety remote I/O module is in the I/O data error (error code: 0108H) state and all I/O points are turned off.

For details on the error state, refer to the following.

📖 Page 157 Error codes related to the safety remote I/O module

Setting method

The parameter setting is not required for the internal input dark test function.

8.6 Output Diagnostic

The output diagnosis function is a safety function for determining failure of output signals using the safety output function.

Output dark test function

Outputs test pulses to turn off the external output signals (Y0 to Y7) that are on and diagnoses the internal circuit for failure. The read-back circuit checks the test pulse and output circuit fixing can be detected. The OFF time of test pulses and the number of pulse outputs used in one diagnostic can be set depending on the usage environment.

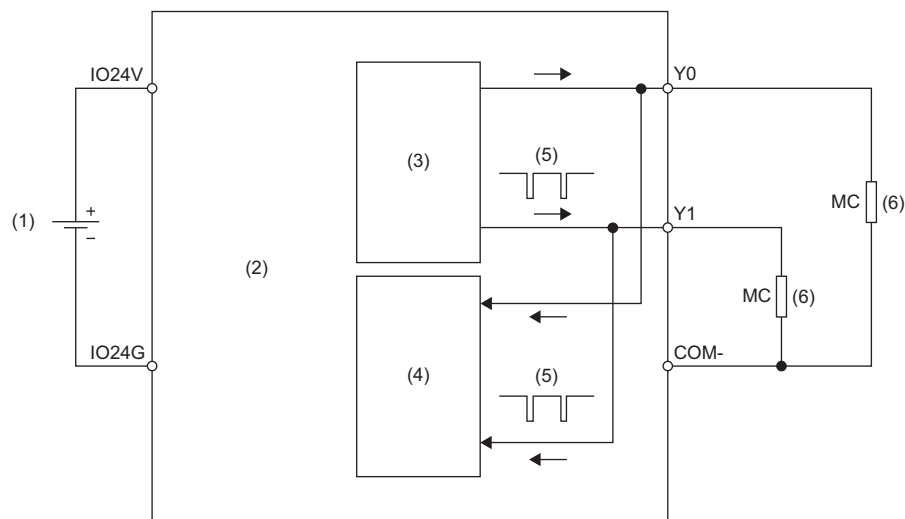

- (1) External power supply
- (2) Safety remote I/O module
- (3) Output circuit
- (4) Read-back circuit
- (5) Test pulse
- (6) Load

Operation at error detection

When the safety remote I/O module detects an error in a diagnostic of the output dark test, the output dark test error (error code: 0107H) state is applied and all output points are turned off. For details on the error state, refer to the following.

📖 Page 157 Error codes related to the safety remote I/O module

Setting method

Set the following parameters for the output dark test function.

■Output dark test execution setting

Set whether to perform the output dark test or not in "Output dark test execution setting" from the "Parameter of Device Station" window of the engineering tool.

Item	Setting range
Output dark test execution setting Y0 to Y7	0: Perform 1: Do not perform

■Output dark test pulse OFF time setting

Set the output dark test pulse OFF time (OFF pulse width) in "Output dark test pulse OFF time" from the "Parameter of Device Station" window of the engineering tool.

Item	Setting range
Output dark test pulse OFF time setting Y0 to Y7	0: 400 μ s 1: 1ms 2: 2ms

Point

Adjust the output dark test pulse OFF time depending on the installation environment or wiring length.

■Number of pulse output for output dark test

Set the number of output dark test pulse outputs in "Number of pulse output for output dark test" from the "Parameter of Device Station" window of the engineering tool.

Item	Setting range
Number of pulse output for output dark test Y0 to Y7	0: 1 time 1: 2 times 2: 3 times

Point

Adjust the number of output dark test pulse outputs depending on the installation environment or wiring length.

Output read-back function

Reads back output results and diagnoses whether the external output signals (Y0 to Y7) are correctly output.

By diagnosing whether the output terminal status matches the output data of the safety device, the output read-back function detects output operation errors of the safety remote I/O module.

To use this function, setting parameters is not required.

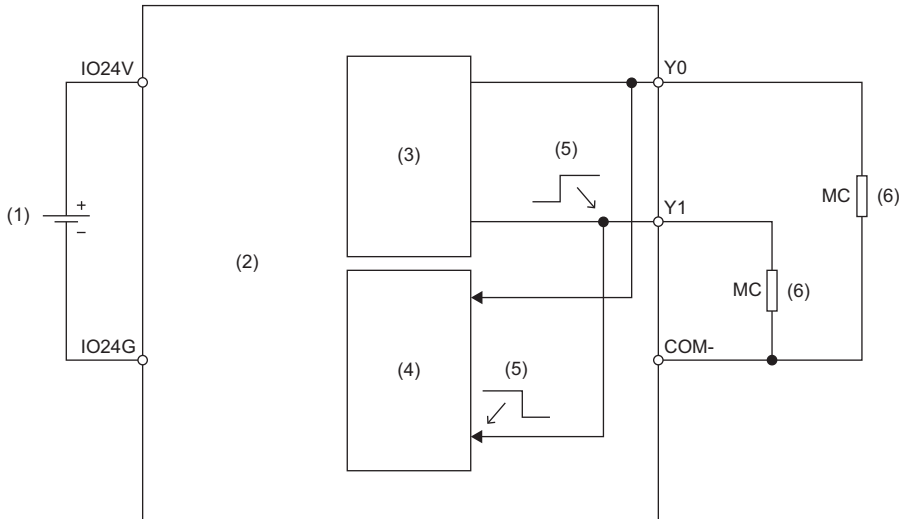

- (1) External power supply
- (2) Safety remote I/O module
- (3) Output circuit
- (4) Read-back circuit
- (5) Output signal
- (6) Load

Operation at error detection

When the safety remote I/O module detects an error with the output read-back function, the output read-back error (error code: 0106H) state is applied and all output points are turned off. For details on the error state, refer to the following.

📖 Page 157 Error codes related to the safety remote I/O module

Point

The maximum output voltage in the output OFF state is 1.2V. However, even if the voltage exceeds 1.2V due to a short circuit or failure of the hardware, no error is detected until the voltage exceeds 7V. Thus, connected devices may turn on even when the output of the safety remote I/O module is in the OFF state.

8.7 Protection Functions

Prevents effects due to overvoltage and overcurrent from spreading to other modules of the safety system.

The following table lists the protection functions.

Function name	Purpose	Description
Module power supply overvoltage protection	Prevents ignition or burnouts from/of the safety remote I/O module due to overvoltage on the primary side.	This function operates when the module power supply is in the primary side overvoltage state.
Module power supply overcurrent protection	Prevents ignition or burnouts from/of the safety remote I/O module due to overcurrent on the primary side.	This function operates when the module power supply is in the primary side overcurrent state.
External power supply overvoltage protection	Prevents ignition or burnouts from/of the safety remote I/O module and load circuits due to overvoltage.	This function operates when the external power supply circuit is in the primary side overvoltage state.
External power supply overcurrent protection	Prevents ignition or burnouts from/of the safety remote I/O module and load circuits due to overcurrent.	This function operates when the external power supply circuit is in the primary side overcurrent state.

Point

The protection functions are intended to protect the internal circuit of a safety remote I/O module, not to protect external devices.

8.8 User Authentication Function

Limits the users (persons and personal computers) that can access the CPU module or safety remote I/O module.

Using this function permits only the specified users to access the CPU module.

This function is implemented in the CPU module used. For details on the user authentication function, refer to the following.

 GX Works3 Operating Manual

Online operations that require user authentication

The following table lists the online operations that require user authentication. No limitation is applied to the access levels of the user authentication function. With any access level of "Administrators", "Developers", "AssistantDevelopers", and "Users", the operations can be performed after the user authentication.

Operation name	Necessity of user authentication	Online operation
"Parameter read"	Required	"Parameter Processing of Device Station"
"Parameter write"	Required	
"Error/Event History"	Not required	"CC-Link IE TSN/CC-Link IE Field Diagnostics"
"Start of checking the module position"	Required	"Command Execution of Device Station"
"Stop of checking the module position"	Required	
"Error history clear request"	Required	
"Delete Error/Event History"	Not required	"CC-Link IE TSN/CC-Link IE Field Diagnostics"
"Safety module validation"	Required	"Command Execution of Device Station"
"CC-Link IE TSN/CC-Link IE Field Diagnostics"	Not required	"CC-Link IE TSN/CC-Link IE Field Diagnostics"
"Remote Operation"	Not required	

8.9 CC-Link IE TSN Class Setting Function

This function sets the CC-Link IE TSN Class (CC-Link IE TSN Class B or CC-Link IE TSN Class A) of the safety remote I/O module and saves it in the non-volatile memory.

The setting of the CC-Link IE TSN Class is stored in the non-volatile memory inside the safety remote I/O module, and CC-Link IE TSN Class B is set by factory default. Change the CC-Link IE TSN Class as necessary.

System configuration

Connect the personal computer with CC-Link IE TSN Configurator installed to the safety remote I/O modules targeted for the CC-Link IE TSN Class setting, using Ethernet cables.

For CC-Link IE TSN Configurator, download it from the CC-Link Partner Association website (www.cc-link.org).

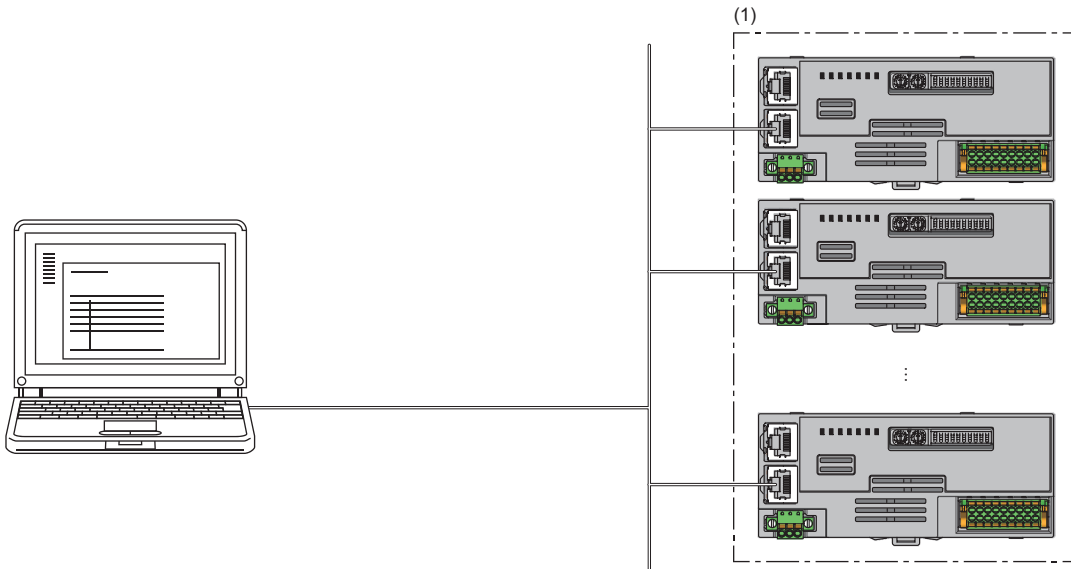

(1) Safety remote I/O module

Point

- It is recommended that settings using CC-Link IE TSN Configurator should be configured before starting up the system (before incorporating the safety remote I/O module into the system). When configuring settings using CC-Link IE TSN Configurator for the safety remote I/O module that operates with CC-Link IE TSN Class A, ensure that the entire system is disconnected beforehand.
- CC-Link IE TSN Configurator cannot detect a safety remote I/O module that has not linked up.

For differences between system configurations where the module with CC-Link IE TSN Class B or CC-Link IE TSN Class A can be incorporated, refer to the following.

User's manual for the master station used

Applicable version

The safety remote I/O modules with firmware version "03" or later support this function.

The safety remote I/O modules not supporting this function operate only with Class B.

Page 206 Added and Changed Functions

Setting method

The setting procedure for CC-Link IE TSN Class is shown below.

- Set at the module start-up
- Set while the module is operating

■Set at the module start-up

The following describes the procedure to set CC-Link IE TSN Class at the module start-up.

Point

Connect safety remote I/O modules to the external power supply if needed.

1. Connect the personal computer with CC-Link IE TSN Configurator installed to the safety remote I/O modules targeted for the CC-Link IE TSN Class setting, using Ethernet cables.
2. Power on the module power supply of the safety remote I/O modules.
3. Display the "Function setting of remote station batch/individual execution function" window.

[Tool] ⇒ [Function setting of Remote station batch/individual execution function...]

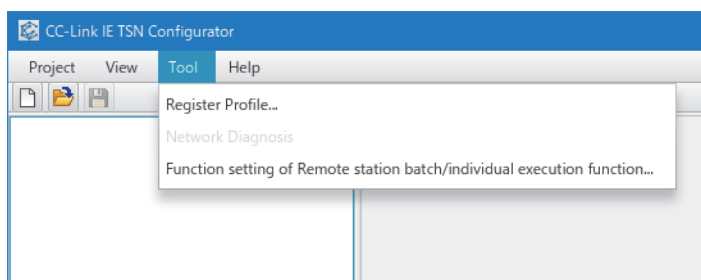

4. A safety remote I/O module is detected.

Function setting of remote station batch/individual execution function

Number of detected stations: Number of detection execution times: times
 Number of stations corresponding to "Process to be executed": Waiting time for per detection: Second Detection of connected/disconnected devices

Process to be executed: Communication speed read Read the communication speed from the remote station.

Copy the specified value to "Write value" 100Mbps (full duplex) Copy "Read value" to "Write value"

Select All Not select all Clear all "Read value" Clear all "Write value"

	Device model	IP address	Communication speed		Result	Error code
			Read value	Write value		
<input type="checkbox"/>	NZ2GNSS2-16DTE	192.168.3.1		<input type="text" value=""/>		
<input type="checkbox"/>						
<input type="checkbox"/>						
<input type="checkbox"/>						
<input type="checkbox"/>						
<input type="checkbox"/>						

- If you press the "Copy specified value to 'Write value'" or "Copy 'Read value' to 'Write value'" button, the value will be copied to the "Write value" of the checked line.
 - The execution result of the process is displayed in the "Result" column. If there is an error, an error code will be displayed. Refer to the following for the details of the error and h
 4 digit error code ... Manual of the target device
 8 digit error code ... Manual of this tool
 - If the device you want to detect is not displayed, adjust the number of detection execution times and waiting time for per detection, and then execute it again.

Execute Close(F)

5. Set "Process to be executed" to "CC-Link IE TSN Class read".

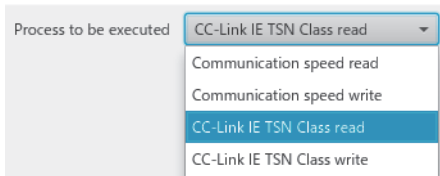

6. Select a checkbox of the safety remote I/O module on which "CC-Link IE TSN Class read" is to be executed.

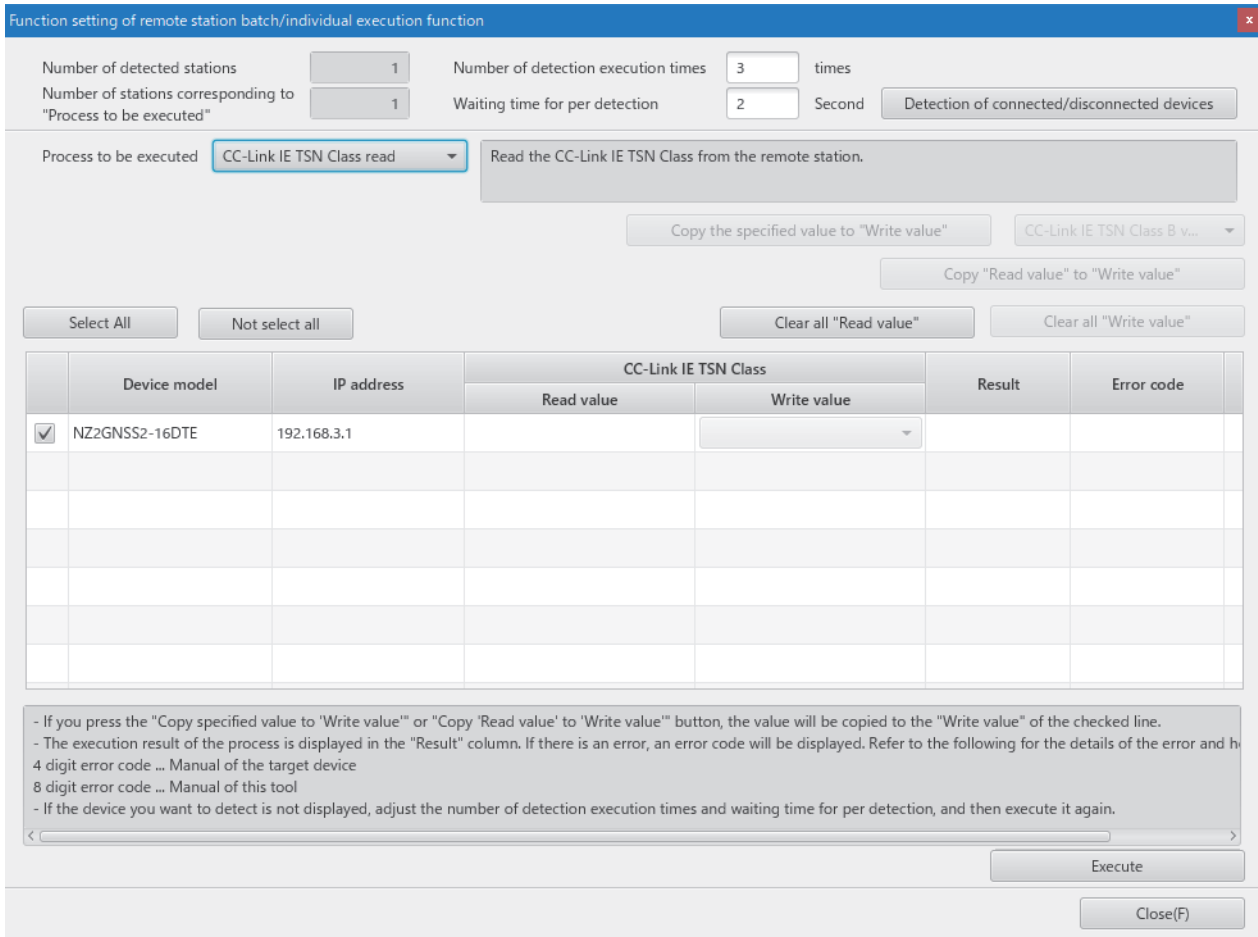

7. When the [Execute] button is clicked, the following window appears.

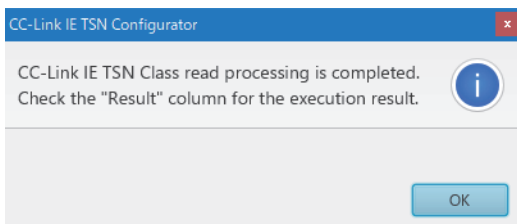

8. Click the [OK] button.

9. Check that "Result" is "Normal completion". The CC-Link IE TSN Class is displayed in "Read value".

Function setting of remote station batch/individual execution function

Number of detected stations: 1 Number of detection execution times: 3 times
 Number of stations corresponding to "Process to be executed": 1 Waiting time for per detection: 2 Second Detection of connected/disconnected devices

Process to be executed: CC-Link IE TSN Class read Read the CC-Link IE TSN Class from the remote station.

Copy the specified value to "Write value" CC-Link IE TSN Class B v...
 Copy "Read value" to "Write value"

Select All Not select all Clear all "Read value" Clear all "Write value"

	Device model	IP address	CC-Link IE TSN Class		Result	Error code
			Read value	Write value		
<input checked="" type="checkbox"/>	NZ2GNSS2-16DTE	192.168.3.1	CC-Link IE TSN Class B ver.2.0	<input type="text"/>	Normal completion	

- If you press the "Copy specified value to 'Write value'" or "Copy 'Read value' to 'Write value'" button, the value will be copied to the "Write value" of the checked line.
 - The execution result of the process is displayed in the "Result" column. If there is an error, an error code will be displayed. Refer to the following for the details of the error and h
 4 digit error code ... Manual of the target device
 8 digit error code ... Manual of this tool
 - If the device you want to detect is not displayed, adjust the number of detection execution times and waiting time for per detection, and then execute it again.

Execute Close(F)

Point A value to be read out by the CC-Link IE TSN Class read is the CC-Link IE TSN Class with which the safety remote I/O module is currently operating.

10. Set "Process to be executed" to "CC-Link IE TSN Class write".

Process to be executed: CC-Link IE TSN Class write

- Communication speed read
- Communication speed write
- CC-Link IE TSN Class read
- CC-Link IE TSN Class write

11. Select a checkbox of the safety remote I/O module on which "CC-Link IE TSN Class write" is to be executed, and set a CC-Link IE TSN Class to "Write value".

Function setting of remote station batch/individual execution function

Number of detected stations: 1
 Number of detection execution times: 3 times
 Number of stations corresponding to "Process to be executed": 1
 Waiting time for per detection: 2 Second
 Detection of connected/disconnected devices

Process to be executed: CC-Link IE TSN Class write
 Write the CC-Link IE TSN Class to the remote station.

Copy the specified value to "Write value"
 Copy "Read value" to "Write value"

Select All | Not select all | Clear all "Read value" | Clear all "Write value"

	Device model	IP address	CC-Link IE TSN Class		Result	Error code
			Read value	Write value		
<input checked="" type="checkbox"/>	NZ2GNSS2-16DTE	192.168.3.1	CC-Link IE TSN Class B ver.2.0	CC-Link IE TSN Class A...		
<input type="checkbox"/>						
<input type="checkbox"/>						
<input type="checkbox"/>						
<input type="checkbox"/>						
<input type="checkbox"/>						
<input type="checkbox"/>						

- If you press the "Copy specified value to 'Write value'" or "Copy 'Read value' to 'Write value'" button, the value will be copied to the "Write value" of the checked line.
 - The execution result of the process is displayed in the "Result" column. If there is an error, an error code will be displayed. Refer to the following for the details of the error and the 4 digit error code ... Manual of the target device
 8 digit error code ... Manual of this tool
 - If the device you want to detect is not displayed, adjust the number of detection execution times and waiting time for per detection, and then execute it again.

Execute
 Close(F)

Point

Values that can be set to "Write value" by using the CC-Link IE TSN Class write of a safety remote I/O module are shown below.

- CC-Link IE TSN Class B ver.1.0
- CC-Link IE TSN Class A ver.2.0 (NW time distribution available)
- CC-Link IE TSN Class B ver.2.0 (factory default)

12. When the [Execute] button is clicked, the following window appears.

CC-Link IE TSN Configurator

CC-Link IE TSN Class write processing is completed.
 Check the "Result" column for the execution result.

OK

13. Click the [OK] button.

14. Check that "Result" is "Normal completion".

Function setting of remote station batch/individual execution function

Number of detected stations: 1 Number of detection execution times: 3 times
 Number of stations corresponding to "Process to be executed": 1 Waiting time for per detection: 2 Second Detection of connected/disconnected devices

Process to be executed: CC-Link IE TSN Class write Write the CC-Link IE TSN Class to the remote station.

Copy the specified value to "Write value" CC-Link IE TSN Class B v...
 Copy "Read value" to "Write value"

Select All Not select all Clear all "Read value" Clear all "Write value"

	Device model	IP address	CC-Link IE TSN Class		Result	Error code
			Read value	Write value		
<input checked="" type="checkbox"/>	NZ2GNSS2-16DTE	192.168.3.1	CC-Link IE TSN Class B ver.2.0	CC-Link IE TSN Class A...	Normal completion	

- If you press the "Copy specified value to 'Write value'" or "Copy 'Read value' to 'Write value'" button, the value will be copied to the "Write value" of the checked line.
 - The execution result of the process is displayed in the "Result" column. If there is an error, an error code will be displayed. Refer to the following for the details of the error and h
 4 digit error code ... Manual of the target device
 8 digit error code ... Manual of this tool
 - If the device you want to detect is not displayed, adjust the number of detection execution times and waiting time for per detection, and then execute it again.

Execute Close(F)

15. Power off the module power supply of the safety remote I/O module for which the CC-Link IE TSN Class has been set.

Point

- To operate the safety remote I/O module with a newly set CC-Link IE TSN Class, power off and on the module power supply after the execution of CC-Link IE TSN Class write.
- When "CC-Link IE TSN Class B ver.1.0" has been set by "CC-Link IE TSN Class write", the module operates at its restart as if "CC-Link IE TSN Class B ver.2.0" was set.

■Set while the module is operating

The following describes the procedure to set CC-Link IE TSN Class while the module is operating.

1. Connect the personal computer with CC-Link IE TSN Configurator installed to the safety remote I/O modules targeted for the CC-Link IE TSN Class setting, using Ethernet cables.
2. Display the "Function setting of remote station batch/individual execution function" window.

[Tool] ⇒ [Function setting of Remote station batch/individual execution function...]

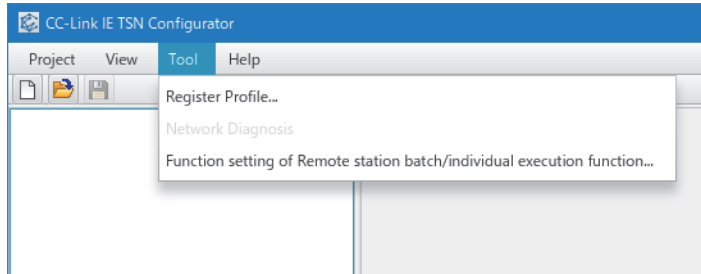

3. A safety remote I/O module supporting the CC-Link IE TSN Class setting is detected.

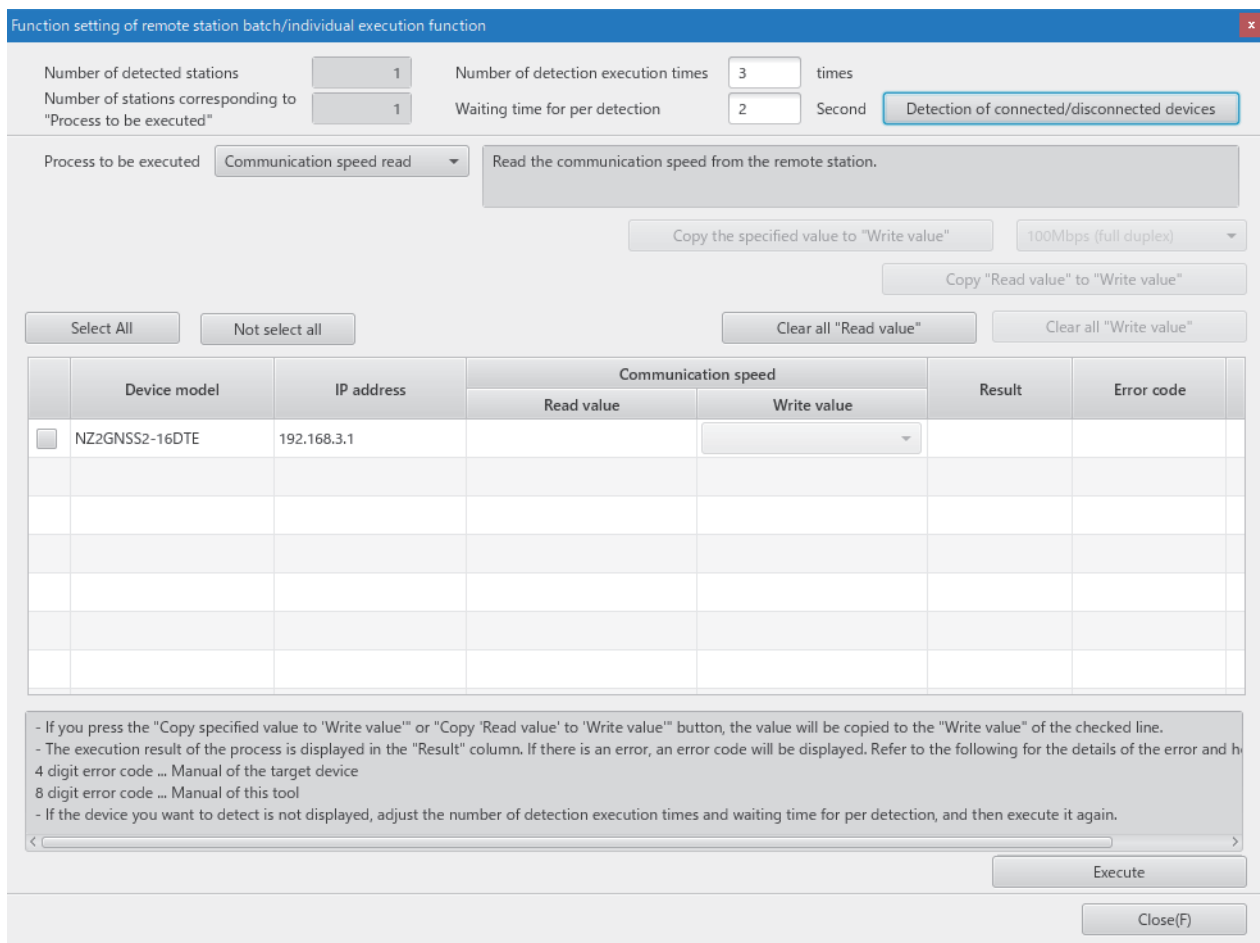

4. Set "Process to be executed" to "CC-Link IE TSN Class read".

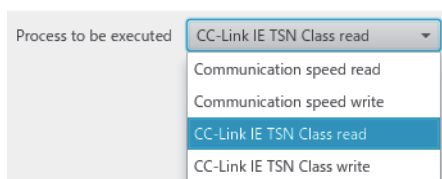

5. Select a checkbox of the safety remote I/O module on which "CC-Link IE TSN Class read" is to be executed.

Function setting of remote station batch/individual execution function

Number of detected stations: 1 Number of detection execution times: 3 times
 Number of stations corresponding to "Process to be executed": 1 Waiting time for per detection: 2 Second Detection of connected/disconnected devices

Process to be executed: CC-Link IE TSN Class read Read the CC-Link IE TSN Class from the remote station.

Copy the specified value to "Write value" CC-Link IE TSN Class B v...
 Copy "Read value" to "Write value"

Select All Not select all Clear all "Read value" Clear all "Write value"

	Device model	IP address	CC-Link IE TSN Class		Result	Error code
			Read value	Write value		
<input checked="" type="checkbox"/>	NZ2GNSS2-16DTE	192.168.3.1				

- If you press the "Copy specified value to 'Write value'" or "Copy 'Read value' to 'Write value'" button, the value will be copied to the "Write value" of the checked line.
 - The execution result of the process is displayed in the "Result" column. If there is an error, an error code will be displayed. Refer to the following for the details of the error and h
 4 digit error code ... Manual of the target device
 8 digit error code ... Manual of this tool
 - If the device you want to detect is not displayed, adjust the number of detection execution times and waiting time for per detection, and then execute it again.

Execute Close(F)

6. When the [Execute] button is clicked, the following window appears.

CC-Link IE TSN Configurator

CC-Link IE TSN Class read processing is completed.
 Check the "Result" column for the execution result.

OK

7. Click the [OK] button.

8. Check that "Result" is "Normal completion". The CC-Link IE TSN Class is displayed in "Read value".

Function setting of remote station batch/individual execution function

Number of detected stations: 1 Number of detection execution times: 3 times
 Number of stations corresponding to "Process to be executed": 1 Waiting time for per detection: 2 Second Detection of connected/disconnected devices

Process to be executed: CC-Link IE TSN Class read Read the CC-Link IE TSN Class from the remote station.

Copy the specified value to "Write value" CC-Link IE TSN Class B v...
 Copy "Read value" to "Write value"

Select All Not select all Clear all "Read value" Clear all "Write value"

	Device model	IP address	CC-Link IE TSN Class		Result	Error code
			Read value	Write value		
<input checked="" type="checkbox"/>	NZ2GNSS2-16DTE	192.168.3.1	CC-Link IE TSN Class B ver.2.0	<input type="text"/>	Normal completion	

- If you press the "Copy specified value to 'Write value'" or "Copy 'Read value' to 'Write value'" button, the value will be copied to the "Write value" of the checked line.
 - The execution result of the process is displayed in the "Result" column. If there is an error, an error code will be displayed. Refer to the following for the details of the error and h
 4 digit error code ... Manual of the target device
 8 digit error code ... Manual of this tool
 - If the device you want to detect is not displayed, adjust the number of detection execution times and waiting time for per detection, and then execute it again.

Execute Close(F)

Point

A value to be read out by the CC-Link IE TSN Class read is the CC-Link IE TSN Class with which the safety remote I/O module is currently operating.

9. Set "Process to be executed" to "CC-Link IE TSN Class write".

Process to be executed: CC-Link IE TSN Class write

- Communication speed read
- Communication speed write
- CC-Link IE TSN Class read
- CC-Link IE TSN Class write

10. Select a checkbox of the safety remote I/O module on which "CC-Link IE TSN Class write" is to be executed, and set a CC-Link IE TSN Class to "Write value".

Function setting of remote station batch/individual execution function

Number of detected stations: 1
 Number of detection execution times: 3 times
 Number of stations corresponding to "Process to be executed": 1
 Waiting time for per detection: 2 Second
 Detection of connected/disconnected devices

Process to be executed: CC-Link IE TSN Class write
 Write the CC-Link IE TSN Class to the remote station.

Buttons: Copy the specified value to "Write value", CC-Link IE TSN Class B v..., Copy "Read value" to "Write value", Select All, Not select all, Clear all "Read value", Clear all "Write value"

	Device model	IP address	CC-Link IE TSN Class		Result	Error code
			Read value	Write value		
<input checked="" type="checkbox"/>	NZ2GNSS2-16DTE	192.168.3.1	CC-Link IE TSN Class B ver.2.0	CC-Link IE TSN Class A...		
<input type="checkbox"/>						
<input type="checkbox"/>						
<input type="checkbox"/>						
<input type="checkbox"/>						
<input type="checkbox"/>						
<input type="checkbox"/>						

Execute
Close(F)

Notes:
 - If you press the "Copy specified value to 'Write value'" or "Copy 'Read value' to 'Write value'" button, the value will be copied to the "Write value" of the checked line.
 - The execution result of the process is displayed in the "Result" column. If there is an error, an error code will be displayed. Refer to the following for the details of the error and the error code:
 4 digit error code ... Manual of the target device
 8 digit error code ... Manual of this tool
 - If the device you want to detect is not displayed, adjust the number of detection execution times and waiting time for per detection, and then execute it again.

11. When the [Execute] button is clicked, the following window appears.

CC-Link IE TSN Configurator

CC-Link IE TSN Class write processing is completed.
 Check the "Result" column for the execution result.

OK

12. Click the [OK] button.

13. Check that "Result" is "Normal completion".

Function setting of remote station batch/individual execution function

Number of detected stations: 1 | Number of detection execution times: 3 times
 Number of stations corresponding to "Process to be executed": 1 | Waiting time for per detection: 2 Second | Detection of connected/disconnected devices

Process to be executed: CC-Link IE TSN Class write | Write the CC-Link IE TSN Class to the remote station.

Buttons: Copy the specified value to "Write value", Copy "Read value" to "Write value", Select All, Not select all, Clear all "Read value", Clear all "Write value"

	Device model	IP address	CC-Link IE TSN Class		Result	Error code
			Read value	Write value		
<input checked="" type="checkbox"/>	NZ2GNSS2-16DTE	192.168.3.1	CC-Link IE TSN Class B ver.2.0	CC-Link IE TSN Class A...	Normal completion	

Execute | Close(F)

14. Power off and on the module power supply of the safety remote I/O module for which the CC-Link IE TSN Class has been set.

CC-Link IE TSN Class setting of the network configuration settings

In the "CC-Link IE TSN Configuration" window of the network configuration settings, set "CC-Link IE TSN Class" for the safety remote I/O module.

1. Display the "CC-Link IE TSN Configuration" window.

[Navigation window] ⇒ [Parameter] ⇒ [Module Information] ⇒ Model ⇒ [Basic Settings] ⇒ [Network Configuration Settings]

2. Set "CC-Link IE TSN Class" to the same class that is already set for the safety remote I/O module.

No.	Model Name	STA#	Station Type	RX Setting	RY Setting	RW Setting	RWiv Setting	Parameter Automatic Setting	POD Mapping Setting	IP Address	Subnet Mask	Default Gateway	Reserved/Error Invalid Station	Network Synchronous Communication	Communication Period Setting	Station Information			Authentication Class
				Points	Points	Points	Points									Alias	Comment	Station-specific mode setting	
0	Host Station	0	Master Station							192.168.3.253									
1	NZ2GNSS2-16DTE	1	Remote Station	16	16	4	4	<input type="checkbox"/>	<Detail Setting>	192.168.3.1			No Setting	Asynchronous	Basic Period				Authentication Class B Authentication Class B Authentication Class A

In this manual, "Authentication Class" is described as "CC-Link IE TSN Class".

Point

- For the safety remote I/O module not supporting the CC-Link IE TSN Class setting function, set "CC-Link IE TSN Class" of the network configuration settings to "CC-Link IE TSN Class B".
- If "CC-Link IE TSN Class" of the network configuration settings is set to a different class from the one already set for the safety remote I/O module, the event code of 00C81 is registered with event history of the master station, and the safety remote I/O module does not perform data link.
- When the profile of the version not supporting the CC-Link IE TSN Class setting function is used, "CC-Link IE TSN Class" of the network configuration settings cannot be set for the corresponding safety remote I/O module.

Monitoring a set class

■Monitoring with the remote register

Which class is set as the CC-Link IE TSN Class can be checked by using CC-Link IE TSN Class setting status (RWr0.b2).

CC-Link IE TSN Class setting status (RWr0.b2)	CC-Link IE TSN Class
ON	CC-Link IE TSN Class A
OFF	CC-Link IE TSN Class B

☞ Page 180 CC-Link IE TSN Class setting status (RWr0.b2)

■Monitoring with the "Selected Station Communication Status Monitor" window

Which class is set as the CC-Link IE TSN Class can be checked with the "Selected Station Communication Status Monitor" window of "CC-Link IE TSN/CC-Link IE Field Diagnostics". For details, refer to the following.

📖 User's manual for the master station used

Precautions

- The module not supporting CC-Link IE TSN Class A operates only with CC-Link IE TSN Class B.
- The range of values that can be set for the communication cycle interval setting of the master station parameter varies depending on CC-Link IE TSN Class. For details, refer to the following.

☞ Page 57 Network Configuration Settings

- Ring topology cannot be used when CC-Link IE TSN Class A is set for the CC-Link IE TSN Class. To use ring topology, set CC-Link IE TSN Class B.
- The following table lists error codes that are displayed in "Error code" of CC-Link IE TSN Configurator if the CC-Link IE TSN Class write of the safety remote I/O module has been completed with an error. When the other error codes are displayed, refer to the manual of CC-Link IE TSN Configurator to take actions.

Error code	Description and cause	Action
0001H	The CC-Link IE TSN Class setting failed to be saved in the non-volatile memory.	<ul style="list-style-type: none">• The CC-Link IE TSN Class setting is not saved in the non-volatile memory.• Take measures to reduce noise, such as using a shielded cable for connection.• If this error persists, the failure of the module is a possible cause. Please consult your local Mitsubishi representative.

8.10 Communication Speed Setting Function

This function sets the communication speed.

- Setting by CC-Link IE TSN Configurator
- Setting by the parameter

Setting by CC-Link IE TSN Configurator

This function sets the communication speed (1Gbps or 100Mbps) of safety remote I/O module, and saves it in the non-volatile memory.

The communication speed 1Gbps is set to the non-volatile memory by factory default.

System configuration

Connect the personal computer with CC-Link IE TSN Configurator installed to the safety remote I/O modules targeted for the communication speed setting, by using Ethernet cables.

For CC-Link IE TSN Configurator, download it from the CC-Link Partner Association website (www.cc-link.org).

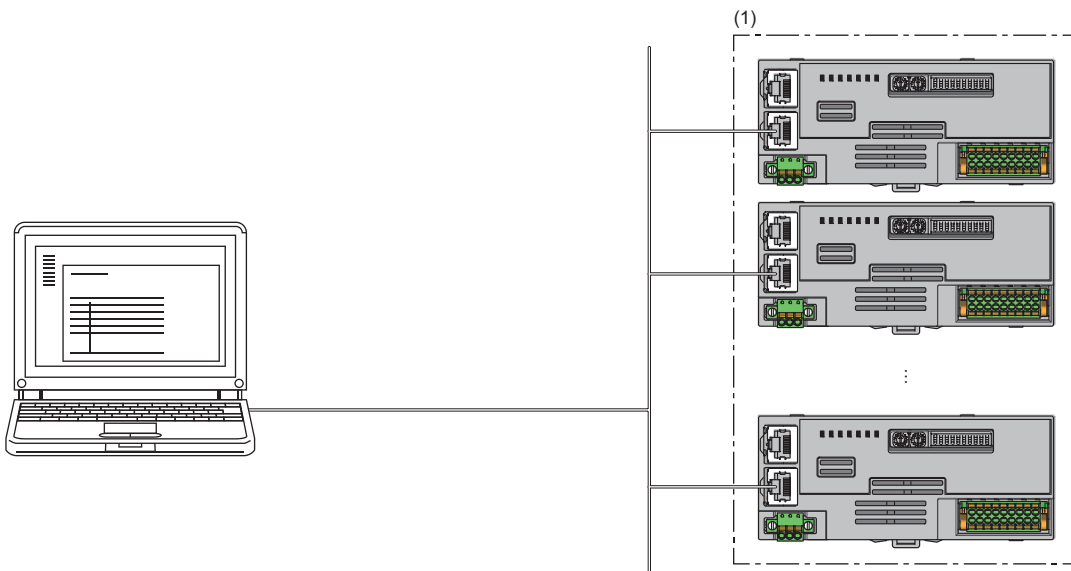

(1) Safety remote I/O module

Point

- It is recommended that settings using CC-Link IE TSN Configurator should be configured before starting up the system (before incorporating the safety remote I/O module into the system). When configuring settings using CC-Link IE TSN Configurator for the safety remote I/O module that operates with CC-Link IE TSN Class A, ensure that the entire system is disconnected beforehand.
- CC-Link IE TSN Configurator cannot detect a safety remote I/O module that has not linked up.

Applicable version

The safety remote I/O modules with firmware version "03" or later support this function.

☞ Page 206 Added and Changed Functions

Setting method

The setting procedure for communication speed is shown below.

- Set at the module start-up
- Set while the module is operating

■Set at the module start-up

The following describes the procedure to set a communication speed at the module start-up.

Point

Connect safety remote I/O modules to the external power supply if needed.

1. Connect the personal computer with CC-Link IE TSN Configurator installed to the safety remote I/O modules targeted for the communication speed setting, by using Ethernet cables.
2. Power on the module power supply of the safety remote I/O modules.
3. Display the "Function setting of remote station batch/individual execution function" window.

[Tool] ⇒ [Function setting of Remote station batch/individual execution function...]

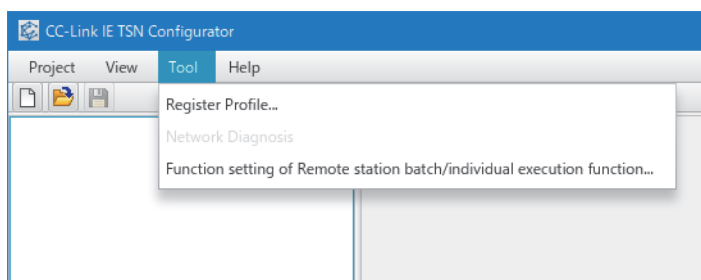

4. A safety remote I/O module is detected.

Function setting of remote station batch/individual execution function

Number of detected stations: Number of detection execution times: times
 Number of stations corresponding to "Process to be executed": Waiting time for per detection: Second Detection of connected/disconnected devices

Process to be executed: Communication speed read Read the communication speed from the remote station.

Copy the specified value to "Write value" 100Mbps (full duplex) Copy "Read value" to "Write value"

Select All Not select all Clear all "Read value" Clear all "Write value"

	Device model	IP address	Communication speed		Result	Error code
			Read value	Write value		
<input type="checkbox"/>	NZ2GNSS2-16DTE	192.168.3.1		<input type="text" value=""/>		

- If you press the "Copy specified value to 'Write value'" or "Copy 'Read value' to 'Write value'" button, the value will be copied to the "Write value" of the checked line.
 - The execution result of the process is displayed in the "Result" column. If there is an error, an error code will be displayed. Refer to the following for the details of the error and h
 4 digit error code ... Manual of the target device
 8 digit error code ... Manual of this tool
 - If the device you want to detect is not displayed, adjust the number of detection execution times and waiting time for per detection, and then execute it again.

Execute Close(F)

5. Set "Process to be executed" to "Communication speed read".

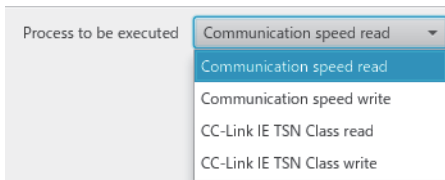

6. Select a checkbox of the safety remote I/O module on which "Communication speed read" is to be executed.

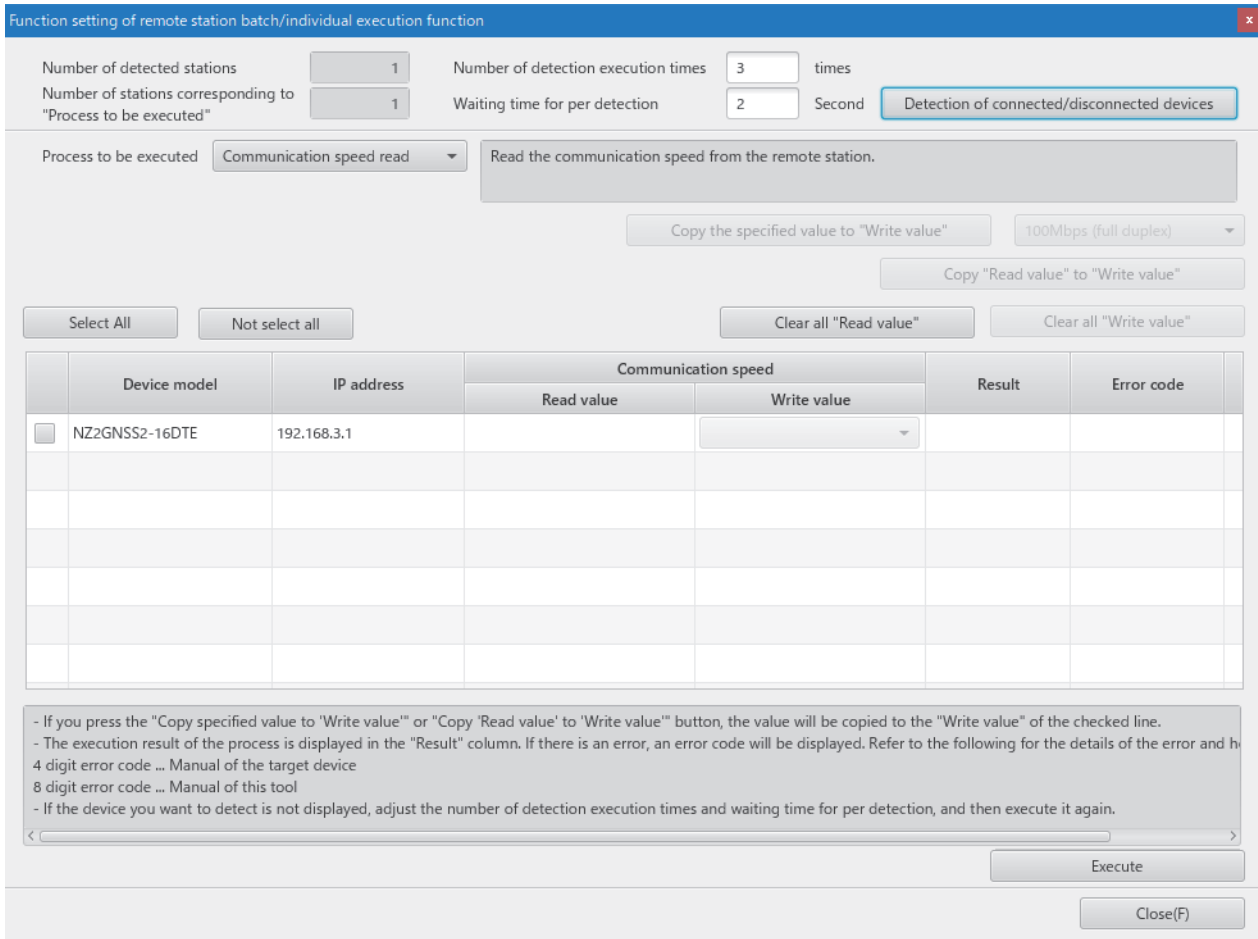

7. When the [Execute] button is clicked, the following window appears.

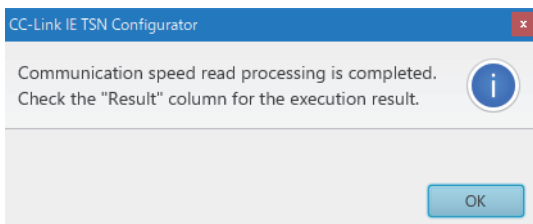

8. Click the [OK] button.

9. Check that "Result" is "Normal completion". The communication speed is displayed in "Read value".

Function setting of remote station batch/individual execution function

Number of detected stations: 1 Number of detection execution times: 3 times
 Number of stations corresponding to "Process to be executed": 1 Waiting time for per detection: 2 Second Detection of connected/disconnected devices

Process to be executed: Communication speed read Read the communication speed from the remote station.

Copy the specified value to "Write value" 100Mbps (full duplex) Copy "Read value" to "Write value"

Select All Not select all Clear all "Read value" Clear all "Write value"

	Device model	IP address	Communication speed		Result	Error code
			Read value	Write value		
<input checked="" type="checkbox"/>	NZ2GNSS2-16DTE	192.168.3.1	1Gbps (full duplex)		Normal completion	

- If you press the "Copy specified value to 'Write value'" or "Copy 'Read value' to 'Write value'" button, the value will be copied to the "Write value" of the checked line.
 - The execution result of the process is displayed in the "Result" column. If there is an error, an error code will be displayed. Refer to the following for the details of the error and h
 4 digit error code ... Manual of the target device
 8 digit error code ... Manual of this tool
 - If the device you want to detect is not displayed, adjust the number of detection execution times and waiting time for per detection, and then execute it again.

Execute Close(F)

Point A value to be read out by the communication speed read is an actual communication speed with which the safety remote I/O module is operating.

10. Set "Process to be executed" to "Communication speed write".

Process to be executed: Communication speed write

- Communication speed read
- Communication speed write
- CC-Link IE TSN Class read
- CC-Link IE TSN Class write

11. Select a checkbox of the safety remote I/O module on which the communication speed write is to be executed, and set the communication speed to "Write value".

Function setting of remote station batch/individual execution function

Number of detected stations: 1
 Number of detection execution times: 3 times
 Number of stations corresponding to "Process to be executed": 1
 Waiting time for per detection: 2 Second
 Detection of connected/disconnected devices

Process to be executed: Communication speed write
 Write the communication speed to the remote station.

Copy the specified value to "Write value" | 100Mbps (full duplex)
 Copy "Read value" to "Write value"

Select All | Not select all | Clear all "Read value" | Clear all "Write value"

	Device model	IP address	Communication speed		Result	Error code
			Read value	Write value		
<input checked="" type="checkbox"/>	NZ2GNSS2-16DTE	192.168.3.1	1Gbps (full duplex)	100Mbps (full duplex)		
<input type="checkbox"/>						
<input type="checkbox"/>						
<input type="checkbox"/>						
<input type="checkbox"/>						
<input type="checkbox"/>						

- If you press the "Copy specified value to 'Write value'" or "Copy 'Read value' to 'Write value'" button, the value will be copied to the "Write value" of the checked line.
 - The execution result of the process is displayed in the "Result" column. If there is an error, an error code will be displayed. Refer to the following for the details of the error and the 4 digit error code ... Manual of the target device
 8 digit error code ... Manual of this tool
 - If the device you want to detect is not displayed, adjust the number of detection execution times and waiting time for per detection, and then execute it again.

Execute | Close(F)

Point

Values that can be set to "Write value" by using the communication speed write of a safety remote I/O module are shown below.

- 100Mbps (full duplex)
- 1Gbps (full duplex) (factory default)

12. When the [Execute] button is clicked, the following window appears.

CC-Link IE TSN Configurator

Communication speed write processing is completed.
 Check the "Result" column for the execution result.

OK

13. Click the [OK] button.

14. Check that "Result" is "Normal completion".

Function setting of remote station batch/individual execution function

Number of detected stations: 1 Number of detection execution times: 3 times
 Number of stations corresponding to "Process to be executed": 1 Waiting time for per detection: 2 Second Detection of connected/disconnected devices

Process to be executed: Communication speed write Write the communication speed to the remote station.

Copy the specified value to "Write value": 100Mbps (full duplex) Copy "Read value" to "Write value"

Select All Not select all Clear all "Read value" Clear all "Write value"

	Device model	IP address	Communication speed		Result	Error code
			Read value	Write value		
<input checked="" type="checkbox"/>	NZ2GNSS2-16DTE	192.168.3.1	1Gbps (full duplex)	100Mbps (full duplex)	Normal completion	

- If you press the "Copy specified value to 'Write value'" or "Copy 'Read value' to 'Write value'" button, the value will be copied to the "Write value" of the checked line.
 - The execution result of the process is displayed in the "Result" column. If there is an error, an error code will be displayed. Refer to the following for the details of the error and h
 4 digit error code ... Manual of the target device
 8 digit error code ... Manual of this tool
 - If the device you want to detect is not displayed, adjust the number of detection execution times and waiting time for per detection, and then execute it again.

Execute Close(F)

15. Power off the module power supply of the safety remote I/O module for which the communication speed has been set.

Point

To operate the safety remote I/O module with a newly set communication speed, power off and on the module power supply after the execution of communication speed write.

■Set while the module is operating

The following describes the procedure to set a communication speed while the module is operating.

1. Connect the personal computer with CC-Link IE TSN Configurator installed to the safety remote I/O modules targeted for the communication speed setting, by using Ethernet cables.
2. Display the "Function setting of remote station batch/individual execution function" window.

[Tool] ⇒ [Function setting of Remote station batch/individual execution function...]

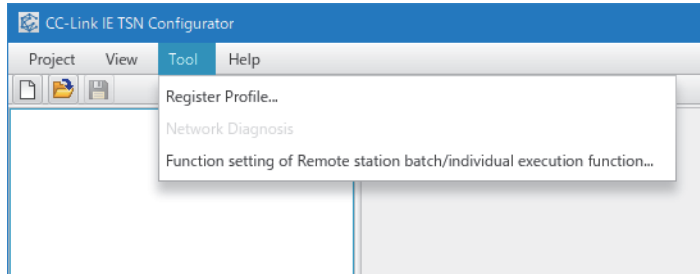

3. A safety remote I/O module supporting the communication speed setting is detected.

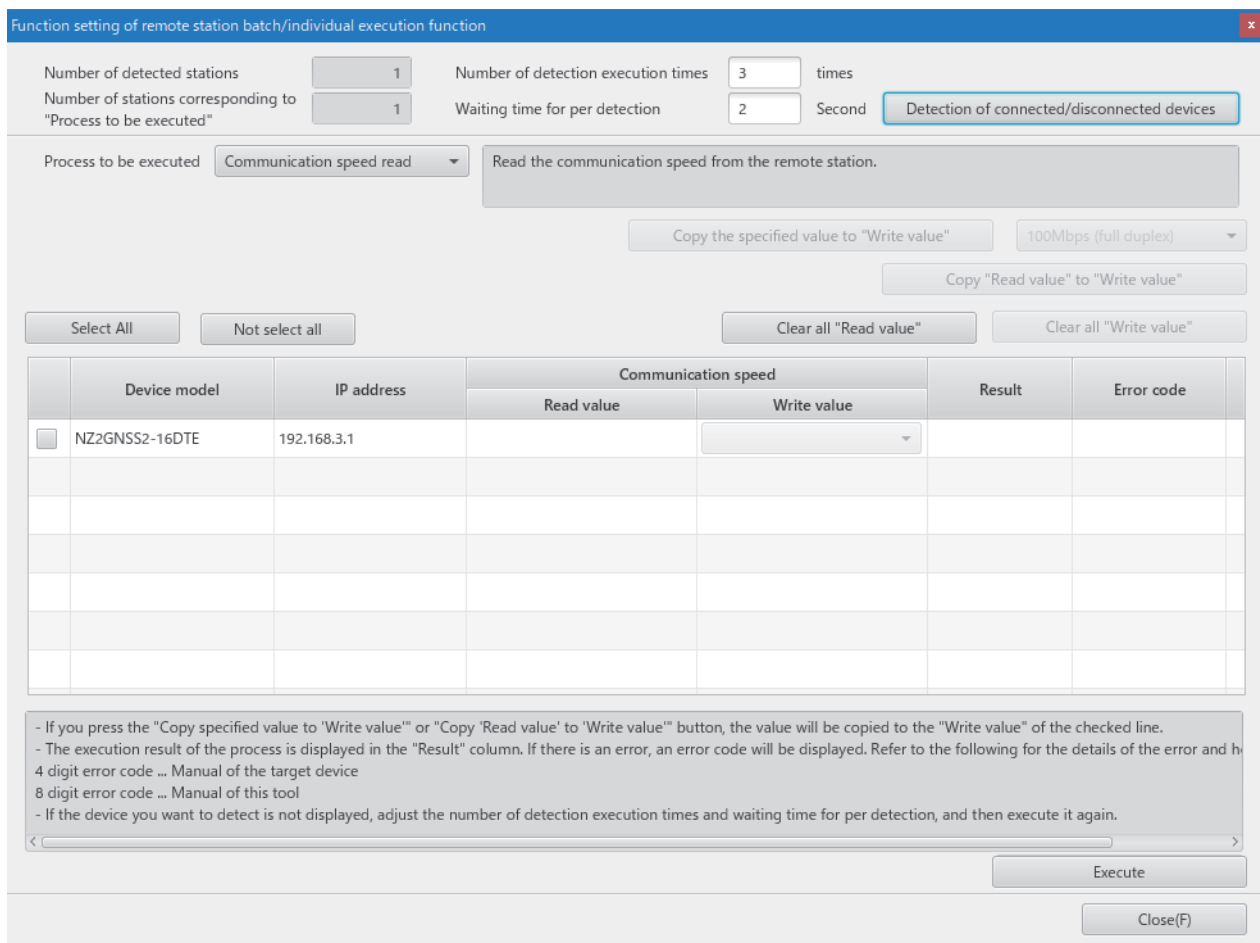

4. Set "Process to be executed" to "Communication speed read".

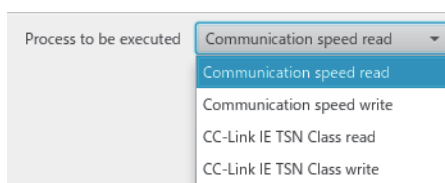

5. Select a checkbox of the safety remote I/O module on which "Communication speed read" is to be executed.

Function setting of remote station batch/individual execution function

Number of detected stations: 1 Number of detection execution times: 3 times
 Number of stations corresponding to "Process to be executed": 1 Waiting time for per detection: 2 Second Detection of connected/disconnected devices

Process to be executed: Communication speed read Read the communication speed from the remote station.

Copy the specified value to "Write value" 100Mbps (full duplex)
 Copy "Read value" to "Write value"

Select All Not select all Clear all "Read value" Clear all "Write value"

	Device model	IP address	Communication speed		Result	Error code
			Read value	Write value		
<input type="checkbox"/>	NZ2GNSS2-16DTE	192.168.3.1				

- If you press the "Copy specified value to 'Write value'" or "Copy 'Read value' to 'Write value'" button, the value will be copied to the "Write value" of the checked line.
 - The execution result of the process is displayed in the "Result" column. If there is an error, an error code will be displayed. Refer to the following for the details of the error and how to solve it.
 4 digit error code ... Manual of the target device
 8 digit error code ... Manual of this tool
 - If the device you want to detect is not displayed, adjust the number of detection execution times and waiting time for per detection, and then execute it again.

Execute Close(F)

6. When the [Execute] button is clicked, the following window appears.

CC-Link IE TSN Configurator

Communication speed read processing is completed.
 Check the "Result" column for the execution result.

OK

7. Click the [OK] button.

8. Check that "Result" is "Normal completion". The communication speed is displayed in "Read value".

Function setting of remote station batch/individual execution function

Number of detected stations: 1 Number of detection execution times: 3 times
 Number of stations corresponding to "Process to be executed": 1 Waiting time for per detection: 2 Second Detection of connected/disconnected devices

Process to be executed: Communication speed read Read the communication speed from the remote station.

Copy the specified value to "Write value" 100Mbps (full duplex) Copy "Read value" to "Write value"

Select All Not select all Clear all "Read value" Clear all "Write value"

	Device model	IP address	Communication speed		Result	Error code
			Read value	Write value		
<input checked="" type="checkbox"/>	NZ2GNSS2-16DTE	192.168.3.1	1Gbps (full duplex)		Normal completion	

- If you press the "Copy specified value to 'Write value'" or "Copy 'Read value' to 'Write value'" button, the value will be copied to the "Write value" of the checked line.
 - The execution result of the process is displayed in the "Result" column. If there is an error, an error code will be displayed. Refer to the following for the details of the error and how to solve it.
 4 digit error code ... Manual of the target device
 8 digit error code ... Manual of this tool
 - If the device you want to detect is not displayed, adjust the number of detection execution times and waiting time for per detection, and then execute it again.

Execute Close(F)

Point

A value to be read out by the communication speed read is an actual communication speed with which the safety remote I/O module is operating.

9. Set "Process to be executed" to "Communication speed write".

Process to be executed: Communication speed write

- Communication speed read
- Communication speed write
- CC-Link IE TSN Class read
- CC-Link IE TSN Class write

10. Select a checkbox of the safety remote I/O module on which the communication speed write is to be executed, and set the communication speed to "Write value".

Function setting of remote station batch/individual execution function

Number of detected stations: 1
 Number of detection execution times: 3 times
 Number of stations corresponding to "Process to be executed": 1
 Waiting time for per detection: 2 Second
 Detection of connected/disconnected devices

Process to be executed: Communication speed write
 Write the communication speed to the remote station.

Copy the specified value to "Write value" | 100Mbps (full duplex)
 Copy "Read value" to "Write value"

Select All | Not select all | Clear all "Read value" | Clear all "Write value"

	Device model	IP address	Communication speed		Result	Error code
			Read value	Write value		
<input checked="" type="checkbox"/>	NZ2GNSS2-16DTE	192.168.3.1	1Gbps (full duplex)	100Mbps (full duplex)		
<input type="checkbox"/>						
<input type="checkbox"/>						
<input type="checkbox"/>						
<input type="checkbox"/>						
<input type="checkbox"/>						
<input type="checkbox"/>						

- If you press the "Copy specified value to 'Write value'" or "Copy 'Read value' to 'Write value'" button, the value will be copied to the "Write value" of the checked line.
 - The execution result of the process is displayed in the "Result" column. If there is an error, an error code will be displayed. Refer to the following for the details of the error and h
 4 digit error code ... Manual of the target device
 8 digit error code ... Manual of this tool
 - If the device you want to detect is not displayed, adjust the number of detection execution times and waiting time for per detection, and then execute it again.

Execute | Close(F)

11. When the [Execute] button is clicked, the following window appears.

CC-Link IE TSN Configurator

Communication speed write processing is completed.
 Check the "Result" column for the execution result.

OK

12. Click the [OK] button.

13. Check that "Result" is "Normal completion".

Function setting of remote station batch/individual execution function

Number of detected stations: Number of detection execution times: times
 Number of stations corresponding to "Process to be executed": Waiting time for per detection: Second Detection of connected/disconnected devices

Process to be executed: Communication speed write Write the communication speed to the remote station.

Copy the specified value to "Write value" 100Mbps (full duplex)
Copy "Read value" to "Write value"

Select All Not select all Clear all "Read value" Clear all "Write value"

	Device model	IP address	Communication speed		Result	Error code
			Read value	Write value		
<input checked="" type="checkbox"/>	NZ2GNSS2-16DTE	192.168.3.1	1Gbps (full duplex)	100Mbps (full duplex)	Normal completion	

- If you press the "Copy specified value to 'Write value'" or "Copy 'Read value' to 'Write value'" button, the value will be copied to the "Write value" of the checked line.
 - The execution result of the process is displayed in the "Result" column. If there is an error, an error code will be displayed. Refer to the following for the details of the error and h
 4 digit error code ... Manual of the target device
 8 digit error code ... Manual of this tool
 - If the device you want to detect is not displayed, adjust the number of detection execution times and waiting time for per detection, and then execute it again.

Execute
Close(F)

14. Power off and on the module power supply of the safety remote I/O module for which the communication speed has been set.

Monitoring a set value

Which value is set as the communication speed can be checked by using Communication speed (RWr0.b1).

Communication speed (RWr0.b1)	A value set as communication speed
ON	100Mbps
OFF	1Gbps

☞ Page 180 Communication speed (RWr0.b1)

Precautions

- When the device station parameter automatic setting is used, change the parameter setting of the device station parameter automatic setting before setting a communication speed using CC-Link IE TSN Configurator.
- The communication cycle interval setting range varies depending on the communication speed. For details, refer to the following.

☞ Page 57 Communication cycle interval setting

- When using a device station that operates with the communication speed of 100Mbps, check which system configuration should be used by referring to the manual for the master station used.
- When the module with the firmware version of "03" or later is used, after the communication speed setting using CC-Link IE TSN Configurator, that parameter must be written again by using the engineering tool. If "Safety module validation" is executed before the parameter writing with the engineering tool, a parameter data error occurs. (This does not include the case where the parameter has not been changed.)
- When the module with the firmware version of "03" or later is used and the parameter is set to a value other than automatic, this module links up only with devices having the communication speed matched with the set parameter.
- The following table lists error codes that are displayed in "Error code" of CC-Link IE TSN Configurator if the communication speed write has been completed with an error. When the other error codes are displayed, refer to the manual of CC-Link IE TSN Configurator to take actions.

Error code	Description and cause	Action
0001H	The communication speed setting failed to be saved in the non-volatile memory.	<ul style="list-style-type: none">• The communication speed setting is not saved in the non-volatile memory.• Take measures to reduce noise, such as using a shielded cable for connection.• If this error persists, the failure of the module is a possible cause. Please consult your local Mitsubishi representative.
0002H	A module parameter error has occurred.	<ul style="list-style-type: none">• The set value is not saved in the non-volatile memory.• Check the module parameter setting and set the parameter again. Or restart the safety remote I/O module to return the module parameter to the setting it had when the module was powered on.
0003H	The communication speed write was not executed because the module parameter was being processed.	<ul style="list-style-type: none">• The set value is not saved in the non-volatile memory.• Execute the communication speed write again.

Setting with the engineering tool

Setting method

The communication speed can be set with the parameter. For details, refer to the following.

☞ Page 60 Parameter Setting

When the module with the firmware version of "03" or later is used and the parameter cannot be set via the master station due to the communication speed setting discrepancy, change the communication speed setting by using CC-Link IE TSN Configurator, and then write the parameter again by using the engineering tool.

Operating status

Which value is set as the communication speed can be checked by using Communication speed (RWr0.b1).

Communication speed (RWr0.b1)	A value set as communication speed
ON	100Mbps
OFF	1Gbps

☞ Page 180 Communication speed (RWr0.b1)

Precautions

- Depending on the communication speed, the communication cycle range that can be set changes. For details, refer to the following.
☞ Page 57 Communication cycle interval setting
- For the system configuration for using a remote station that operates at a communication speed of 100Mbps, refer to the following.
- ☞ User's manual for the master station used
- When a device connected to each PORT of the module has different communication speed from each other (such as 1Gbps device connected to P1 and 100Mbps device connected to P2), only the PORT side where the connected device has the same communication speed as a set parameter links up. When a set value of the parameter is "automatic", only the PORT side where a device starts up faster links up.
- For the module with the firmware version of "02" or earlier, it links up with devices having the communication speed different from the set parameter, but a communication speed not matched (error code: D026H) occurs.
- When the module with the firmware version of "03" or later is used and the parameter is set to "automatic", this module links up with devices having the communication speed of either 1Gbps or 100Mbps. When a device connected to each PORT of the module has different communication speed from each other (such as 1Gbps device connected to P1 and 100Mbps device connected to P2), only the PORT side where the connected device has the same communication speed as a set parameter links up. When a set value of the parameter is "automatic", only the PORT side where a device starts up faster links up.
- When the module with the firmware version of "03" or later is used and the parameter is set to a value other than automatic, this module links up only with devices having the communication speed matched with the set parameter.

8.11 SLMP Communication Function

This function allows communications with the safety remote I/O modules using SLMP.

For details on SLMP, refer to the following.

 SLMP Reference Manual

Available commands

SLMP command*1				Application
Type	Operation	Command	Subcommand	
Remote Control	Remote Reset	1006H	0000H	Remotely resets the safety remote I/O module.
Memory	Read	0613H	0000H	Reads data from the remote buffer memory.
	Write	1613H	0000H	Writes data to the remote buffer memory.

*1 The SLMP commands are compatible with 3E frame, 4E frame, and station number extension frame.

Point

For a single safety remote I/O module, do not execute multiple SLMP commands at the same time. If multiple SLMP commands are executed at the same time, the safety remote I/O module may not be able to receive the SLMP commands, and the SLMP commands may time out.

Communication settings

To communicate with the safety remote I/O modules using SLMP, use the following.

- TCP/UDP: UDP
- Port: 45239
- Code: Binary code

How to communicate

Use the SLMPSEND instruction to send SLMP commands to the safety remote I/O module from the CPU module.

For the SLMPSEND instruction, refer to the following.

 MELSEC iQ-R Programming Manual (Module Dedicated Instructions)

When a safety remote I/O module detects an SLMP command error, it sends back an abnormal response, but the safety remote I/O module itself does not enter an error state.

The error code is stored in the end code of the abnormal response data. Check the error details and take actions by referring to the following.

 Page 130 End codes for SLMP communications

End codes for SLMP communications

If the safety remote I/O module sends back an abnormal response, any of the following codes is stored in the end code of the message.

End code	Description and cause	Action
C059H	The command or subcommand is not specified correctly.	Correct the command or subcommand and send the SLMP command again.
C05CH	The request content is not specified correctly.	Correct the request content and send the SLMP command again.
C061H	The request data length and the number of data do not match.	Correct the request data content or the request data length, and send the SLMP command again.
CF44H	The request destination cannot handle divided data.	The safety remote I/O module cannot handle divided data. Send a request message without dividing it.

8.12 Operation Setting Function at Detection of External Power Supply Voltage Error

Users can select whether to continue safety communication or stop it when an external power supply voltage error occurs.

Operations at detection of external power supply voltage error

The following table shows the operations to be performed at the detection of external power supply voltage error.

Setting item	Restoration	Operation at the error	Error status of the module
Stop safety communication	The safety inputs and safety outputs will restart by turning off and on the module power supply.	<ul style="list-style-type: none"> Safety communications are stopped. Safety inputs and safety outputs are OFF. 	Moderate error
Continue safety communication (Without output interlock)* ¹	Safety communications continue, but safety outputs are turned off. After the error causes are eliminated, a minor error in the module will be cleared and the safety outputs will restart. The control will restart at the canceling of the safety output interlock by the external circuit.	<ul style="list-style-type: none"> Safety communications are continued. Safety outputs are OFF. (interlock by the external circuit) 	Minor error
Continue safety communication (With output interlock)	Safety communications continue, but safety outputs are turned off and the outputs are interlocked. At the cancellation of the interlock by the Safety CPU, a minor error will be cleared and the safety outputs will restart.	<ul style="list-style-type: none"> Safety communications are continued. Safety outputs are OFF. (interlock by the module) 	Minor error

*1 To prevent unintended restart, configure an external interlock circuit for the safety outputs.

Point

- The interlock is applied to the test pulse output terminals (T0/T1) as well.
- If an external power supply voltage error occurs, the output of the power supply current terminal for input device (COM+) is forcedly turned off.
- The output of the power supply current terminal for input device (COM+) momentarily turns on at the following timing: at the occurrence of an external power supply voltage error (minor error); at the checking whether the external power supply voltage has returned to normal after the minor error. If this becomes a problem for the safety system, configure an interlock circuit to ensure that the entire system will always operate safely.

Stop safety communication

■ Output interlock

After an external power supply voltage error is detected, safety communications stop and the outputs are interlocked.

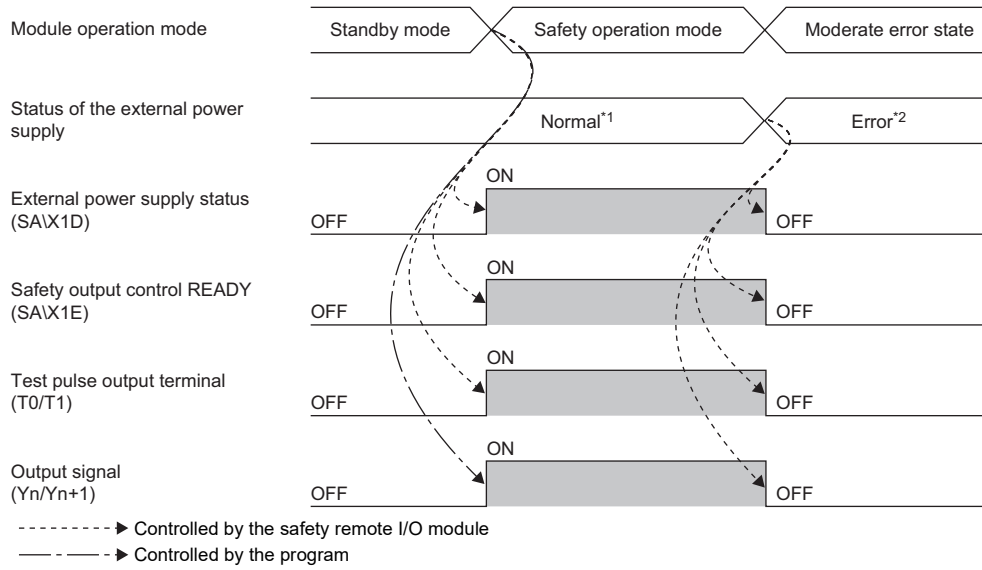

*1 An external power supply voltage error has not occurred.

*2 An external power supply voltage error has occurred.

Continue safety communication (Without output interlock)

■ Output interlock

If safety outputs are turned off due to an external power supply voltage error detection, the outputs are interlocked. If the outputs are interlocked, the safety output control stops and the output signals (Yn/Yn+1) are turned off.

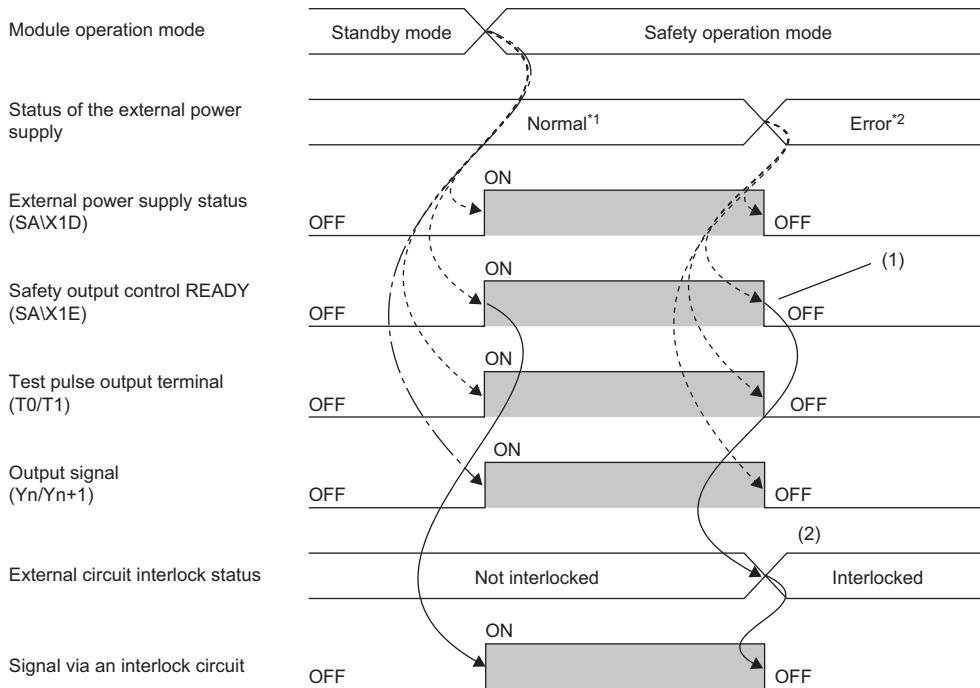

(1) If an external power supply voltage error occurs, Safety output control READY (SAIX1E) turns off and safety outputs and test pulse outputs stop.

(2) The interlock operates.

- ▶ Controlled by the safety remote I/O module
- ▶ Implemented in the external circuit
- ▶ Controlled by the program

*1 An external power supply voltage error has not occurred.

*2 An external power supply voltage error has occurred.

■ Output interlock cancellation

After causes of an external power supply voltage error are eliminated, the safety output control restarts and safety outputs and test pulse outputs restart.

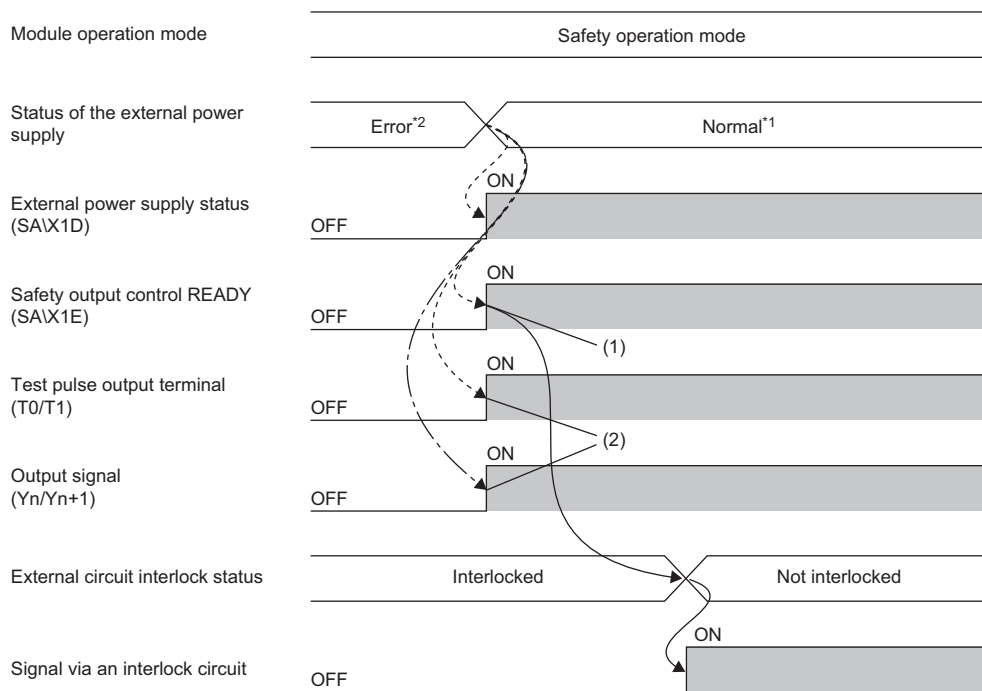

(1) When an external power supply voltage error is cleared, Safety output control READY (SAIX1E) turns on.

(2) After Safety output control READY (SAIX1E) becomes on, safety outputs and test pulse outputs restart.

-----> Controlled by the safety remote I/O module

————> Implemented in the external circuit

- · - · -> Controlled by the program

*1 An external power supply voltage error has not occurred.

*2 An external power supply voltage error has occurred.

Continue safety communication (With output interlock)

■ Output interlock

In the following cases, the outputs are interlocked.

- Module operation mode is switched from standby mode to safety drive mode.
- Safety outputs are turned off due to an external power supply voltage error detection.

If the outputs are interlocked, the safety output control stops and the output signals (Yn/Yn+1) are turned off.

The safety output control does not start until the safety output interlock is canceled by the Safety CPU. This prevents an incorrect output before completion of checking safety in the working area and an incorrect output due to unintended recovery of the external power supply.

- When the module shifts to the safety drive mode

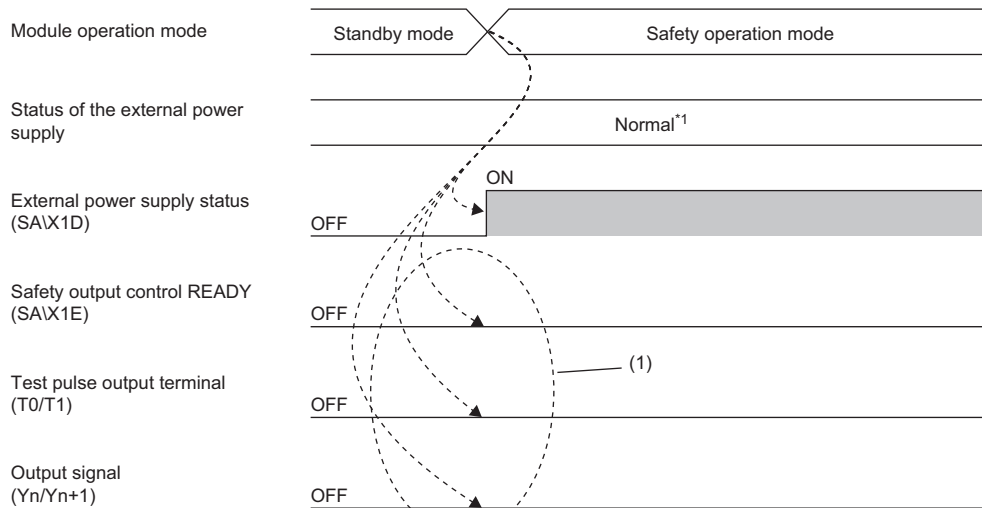

(1) Outputs are interlocked and each signal remains off.

-----> Controlled by the safety remote I/O module

*1 An external power supply voltage error has not occurred.

- When an external power supply voltage error has occurred

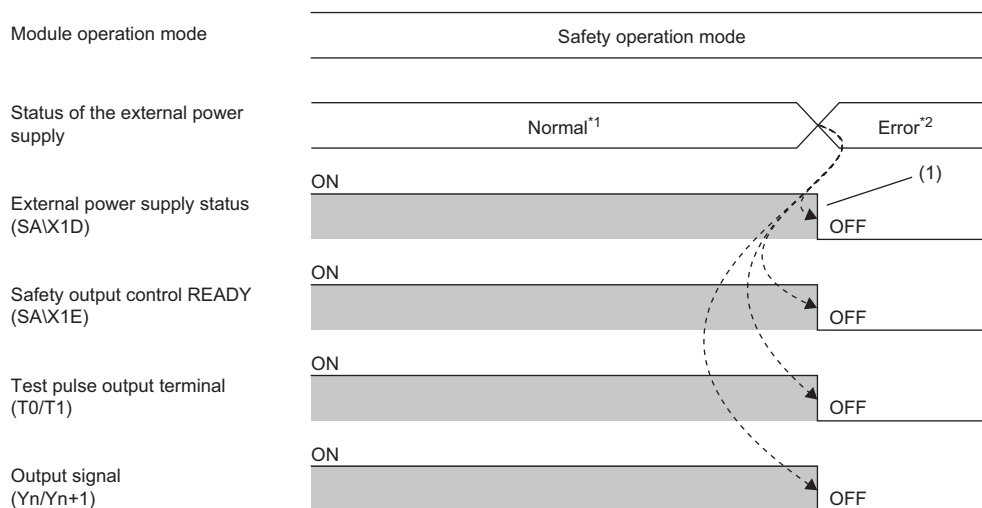

(1) If an external power supply voltage error occurs, Safety output control READY (SAIX1E) turns off and safety outputs and test pulse outputs stop.

-----> Controlled by the safety remote I/O module

*1 An external power supply voltage error has not occurred.

*2 An external power supply voltage error has occurred.

■Output interlock cancellation

After causes of the external power supply voltage error are eliminated, the safety output control will start by canceling the output interlock by the Safety CPU.

Operating procedure

1. After checking that External power supply status (SA\X1D) is on, turn on Safety output control initial processing request flag (SA\Y1E).
2. After checking that Safety output control initial processing completion flag (SA\X1F) is on, turn off Safety output control initial processing request flag (SA\Y1E).
3. After checking that Safety output control initial processing completion flag (SA\X1F) is off, turn on Safety output control start flag (SA\Y1F).
4. After checking that Safety output control READY (SA\X1E) is on, turn off Safety output control start flag (SA\Y1F).
5. After Safety output control READY (SA\X1E) turns on, turn on safety output signals (SA\Yn/Yn+1) so that output signals (Yn/Yn+1) turn on.

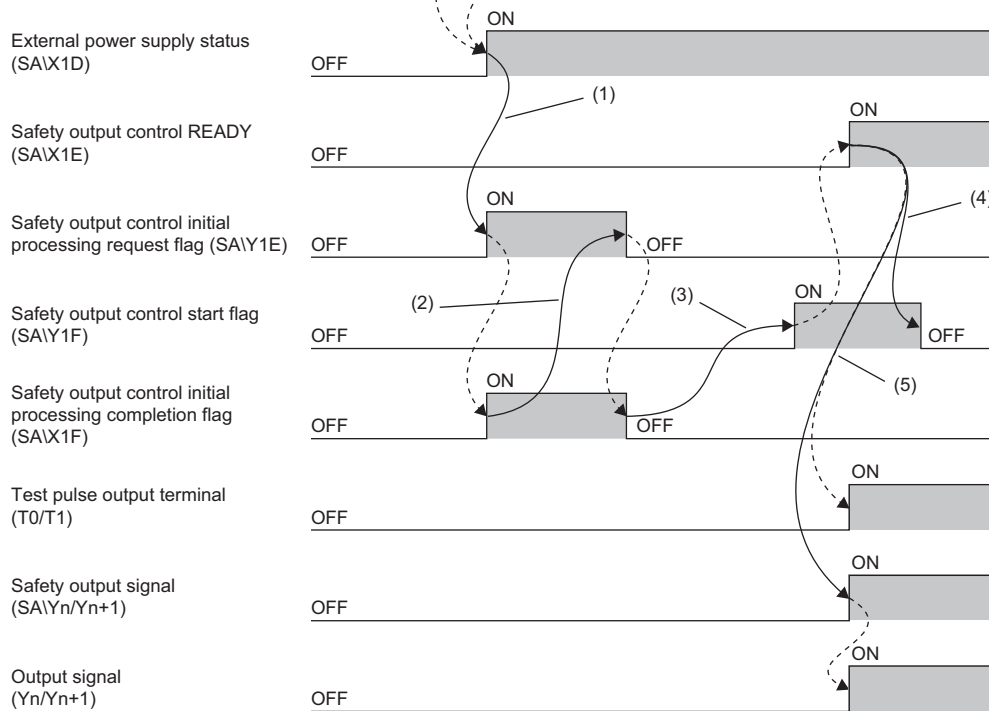
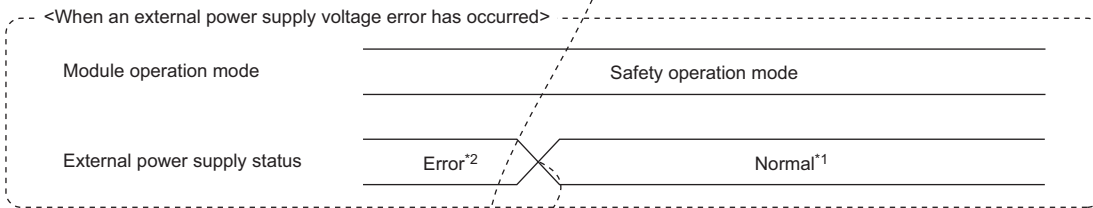
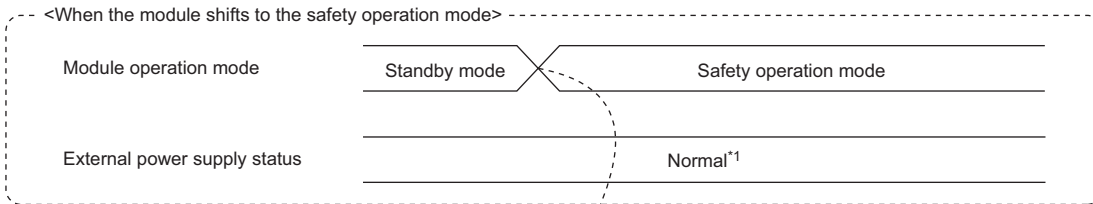

- (1) After checking that External power supply status (SAIX1D) is on, turn on Safety output control initial processing request flag (SAIY1E) so that Safety output control initial processing completion flag (SAIX1F) turns on.
- (2) After checking that Safety output control initial processing completion flag (SAIX1F) is on, turn off Safety output control initial processing request flag (SAIY1E) so that Safety output control initial processing completion flag (SAIX1F) turns off.
- (3) After checking that Safety output control initial processing completion flag (SAIX1F) is off, turn on Safety output control start flag (SAIY1F) so that Safety output control READY (SAIX1E) turns on.
- (4) After checking that Safety output control READY (SAIX1E) is on, turn off Safety output control start flag (SAIY1F).
- (5) Safety output control READY (SAIX1E) turns on, and the test pulse output terminals (T0/T1) turn on. Turn on safety output signals (SAIYn/Yn+1) so that output signals (Yn/Yn+1) turn on.

-----> Controlled by the safety remote I/O module
 —————> Controlled by the program

*1 An external power supply voltage error has not occurred.
 *2 An external power supply voltage error has occurred.

Applicable version

The safety I/O modules with firmware version "04" or later support this function.

☞ Page 206 Added and Changed Functions

Setting method

To select what operation is to be performed at the detection of an external power supply voltage error, set the operation in "Operation setting of external power supply voltage error detection" on the "Parameter Processing of Device Station" window of the engineering tool.

For the procedure to display the "Parameter Processing of Device Station" window, refer to the following.

☞ Page 60 Parameter Setting

Item	Setting range
Operation setting of external power supply voltage error detection	0: Stop safety communication 1: Continue safety communication (Without output interlock) 2: Continue safety communication (With output interlock)

9 MAINTENANCE AND INSPECTION

This chapter describes the maintenance and inspection of the safety remote I/O module.



Read [Startup and Maintenance Precautions] in the safety precautions carefully before performing the inspection, and observe the precautions.

9.1 Daily Inspection

The following table lists the items that must be inspected on a daily basis.

Item	Inspection item	Inspection method	Judgment criterion	Corrective action
1	Mounting status on a DIN rail	Rattling	Check for a rattling noise of the safety remote I/O module.	The safety remote I/O module does not rattle. Remount the safety remote I/O module on the DIN rail securely.
2	Connection status	Terminal block mounting screw	Check for the looseness of terminal block mounting screws.	The terminal block mounting screws must not be loose. Retighten terminal block mounting screws securely.
		Clearance between solderless terminals	Check the clearance between solderless terminals.	The proper clearance must be provided between solderless terminals. Provide the proper clearance.
		Terminal block condition	Check for attachment of dirt and foreign matters.	Dirt and foreign matters must not be attached to terminal blocks. Remove dirt and foreign matters from the terminal block and clean it.
3	LED status at power-on or reset	PW LED	Check that the LED is on.	On Refer to the following and take corrective actions. ☞ Page 143 Checking the LEDs
		RUN LED	Check that the LED is on.	On
		ERR. LED	Check that the LED is on.	On
		D LINK LED	Check that the LED is on.	On
		SAFETY LED	Check that the LED is on.	On
4	LED status in operation	I/O PW LED	Check that the LED is on.	The LED must be on when the external power supply is applied.*1 Replace the safety remote I/O module. (When an LED fails)
		PW LED	Check that the LED is on.	On
		RUN LED	Check that the LED is on.	On
		ERR. LED	Check that the LED is off.	Off
		D LINK LED	Check that the LED is on.	On
		SAFETY LED	Check that the LED is on.	On
		Input status indicator LED	Check that the LED is on, flashing, or off.	The LED must be on when an input is on. The LED must be off when an input is off. Flashing indicates the error point.*2
		Output status indicator LED	Check that the LED is on, flashing, or off.	The LED must be on when an output is on. The LED must be off when an output is off. Flashing indicates the error point.*2

*1 If the LED is off with the power applied from the external power supply, it indicates an error.

*2 For when the I/O LED indication at error occurrence is set to "1: Indication of error point"

9.2 Periodic Inspection

This section describes items that must be inspected one or two times every six months to one year. When the equipment has been relocated or modified, or cable laying has been changed, inspect the module for the items.

Item	Inspection item	Inspection method	Judgment criterion	Corrective action	
1	Environment	Ambient temperature	Measure the temperature by using a thermometer.	0 to 55°C	Create the environment that satisfies the judgment criterion.
		Ambient humidity	Measure the humidity by using a hygrometer.	5 to 95%RH	
		Atmosphere	Measure corrosive gases.	No corrosive gases	
2	Power supply voltage check	Measure the voltage across 24VDC terminals.	20.4 to 28.8VDC	Change the supply power.	
3	Installation	Mounting status on a DIN rail	Check for a rattling noise of the safety remote I/O module.	The safety remote I/O module does not rattle.	Remount the safety remote I/O module on the DIN rail securely.
		Terminal block condition	Check for attachment of dirt and foreign matters.	Dirt and foreign matters must not be attached to terminal blocks.	Remove dirt and foreign matters from the terminal block and clean it.
4	Connection status	Terminal block mounting screw	Check for the looseness of terminal block mounting screws.	The terminal block mounting screws must not be loose.	Retighten terminal block mounting screws securely.
		Clearance between solderless terminals	Check the clearance between solderless terminals.	The proper clearance must be provided between solderless terminals.	Provide the proper clearance.

10 TROUBLESHOOTING

This chapter describes the errors that may occur while the safety remote I/O module is used and their troubleshooting.

10.1 CC-Link IE TSN/CC-Link IE Field Diagnostics

10

For CC-Link IE TSN, monitor the status and conduct an operation test.

For details on CC-Link IE TSN/CC-Link IE Field diagnostics, refer to the following.

 User's manual for the master station used

Remote reset

The safety remote I/O module can be remotely reset.

Operating procedure

1. Select a device station to be reset and click the [Remote Operation] button.

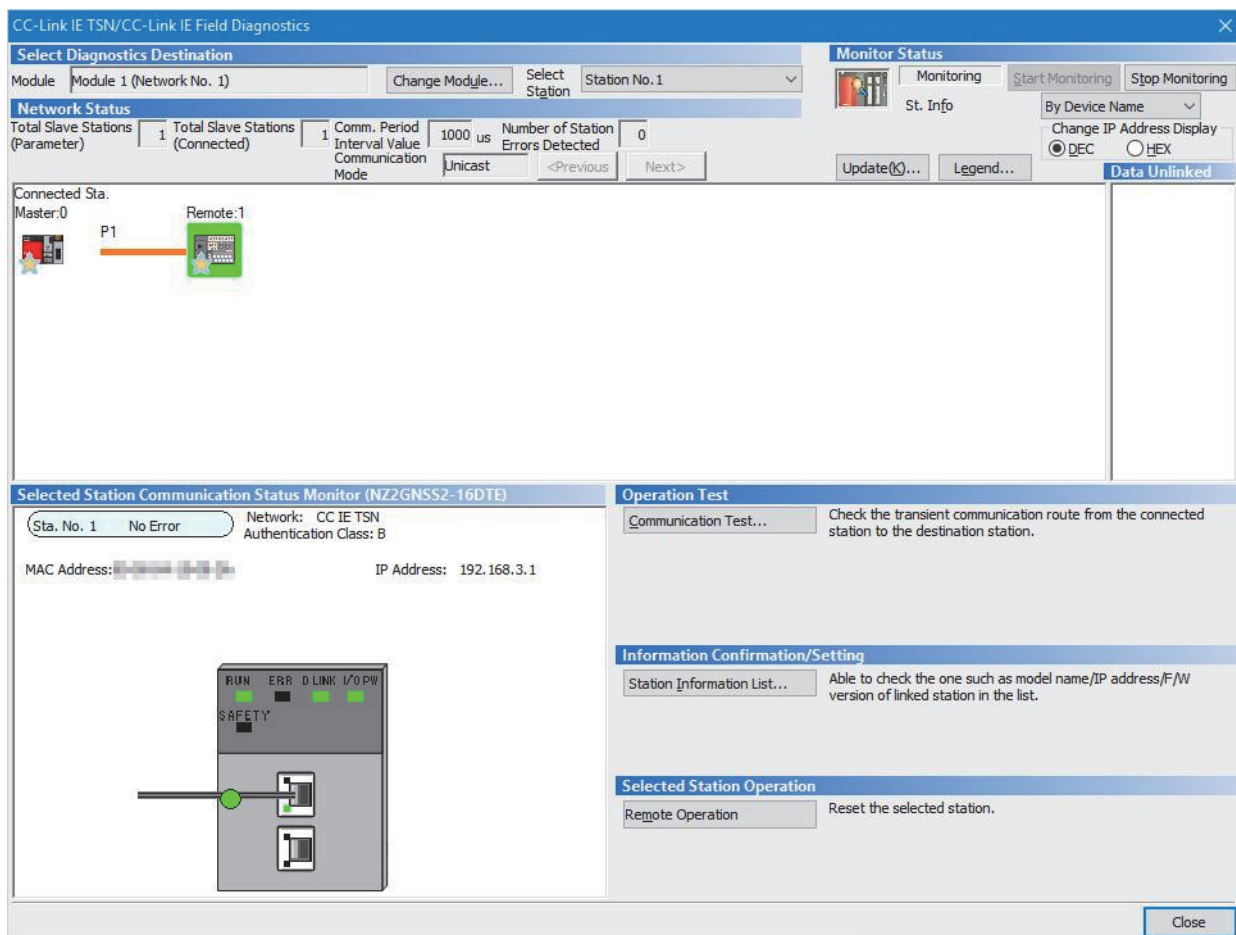

In this manual, "Authentication Class" is described as "CC-Link IE TSN Class".

2. Follow the on-screen instructions and click the [Yes] button.
3. Follow the on-screen instructions and click the [OK] button.

Precautions

Remote reset of a safety remote I/O module may cause the following.

- Another station is disconnected.
- If the communication speed setting of the parameter is different from the setting it had when the module power supply was powered on, a remote reset disable error (error code: 0270H) occurs, and the safety remote I/O module is not reset remotely.

Checking station information

Information on safety remote I/O modules where data link is established are displayed in the "Station Information List" window. Information on each safety remote I/O module, such as the production information and firmware version, can be checked by clicking the [Station Information List] button in the "CC-Link IE TSN/CC-Link IE Field Diagnostics" window.

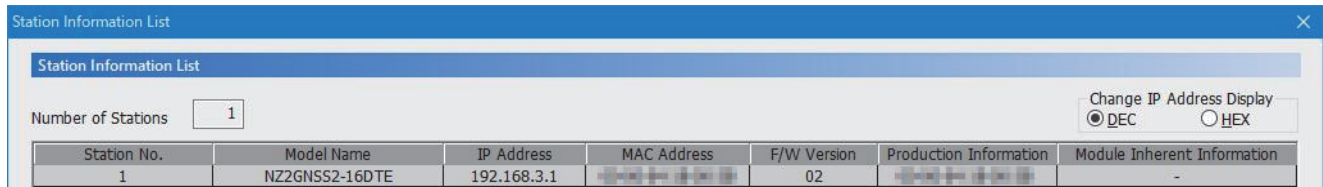

Point

- When checking the station information of each safety remote I/O module in the "Station Information List" window, check the versions of safety remote I/O modules that support the "Station Information List" window display function. (👉 Page 206 Added and Changed Functions)
- For items displayed in the "Station Information List" window, refer to the following.
📖 User's manual for the master station used

10.2 Checking the LEDs

This section describes how to troubleshoot the system by the LEDs.

When the PW LED does not turn on

When the PW LED does not turn on, check the following items.

Check item	Action
Is any LED other than the PW LED on?	When any LED other than the PW LED is on, the possible cause is a hardware failure. Please consult your local Mitsubishi representative.
Is the module power supply (24VDC) wired?	Wire the module power supply (24VDC).
Is the module power supply (24VDC) turned on?	Turn on the module power supply (24VDC).
Is the voltage of the module power supply (24VDC) within the specified range?	<ul style="list-style-type: none">• Set the module power supply voltage (24VDC) within the range of performance specifications. (☞ Page 20 Performance Specifications)• After performing the above action, power off and on the module power supply (24VDC). If the PW LED does not turn on even after the module power supply (24VDC) is powered off and on, the possible cause is a safety remote I/O module failure or the activation of the overvoltage protection function. Please consult your local Mitsubishi representative.

When the RUN LED does not turn on

When the RUN LED does not turn on, check the following items.

Check item	Action
Has the voltage of the module power supplied externally reached the voltage of the specifications?	<ul style="list-style-type: none">• Check that module power supply voltage is within the range of performance specifications. (☞ Page 20 Performance Specifications)• After performing the above action, power off and on the module power supply (24VDC). If the RUN LED does not turn on even after the module power supply (24VDC) is powered off and on, the possible cause is a safety remote I/O module failure. Please consult your local Mitsubishi representative.
Has any hardware failure occurred?	Power off and on the module power supply (24VDC). If the RUN LED does not turn on even after the module power supply (24VDC) is powered off and on, the possible cause is a safety remote I/O module failure. Please consult your local Mitsubishi representative.



When the RUN LED flashes

When the RUN LED flashes, check the following items.

Check item	Action
Is the safety remote I/O module in execution of the unit test?	When the safety remote I/O module is in execution of the unit test, the RUN LED turns on after the unit test is completed. Take corrective action according to the result of the unit test. When a unit test is not conducted, set the IP address setting switch to an appropriate value. (☞ Page 149 Unit Test)

When the D LINK LED turns off

When the D LINK LED turns off, check the following items.

Check item	Action
Is the safety remote I/O module on the network operating normally?	Connect the engineering tool to the master station, and check that the safety remote I/O module is data-linked using the CC-Link IE TSN/CC-Link IE Field diagnostics.  User's manual for the master station used
Are Ethernet cables used compliant with the relevant standard?	Replace the cable with an Ethernet cable compliant with the relevant standard.  User's manual for the master station used
Is the station-to-station distance 100m or less?	Change the station-to-station distance to 100m or less.
Does the cabling condition (bending radius) meet the specifications?	Refer to the manual for the Ethernet cable used, and correct the bending radius.
Is any Ethernet cable disconnected?	Replace the Ethernet cable.
Does the switching hub in use normally operate?	<ul style="list-style-type: none"> • Check that the power supply of the switching hub is turned on. • Check that the switching hub satisfying the specifications of the master module in use is used. ( User's manual for the master station used) • Disconnect the Ethernet cables and then reconnect them. • Power off and on the switching hub.
Are other stations connected to the safety remote I/O module normally operating?	<ul style="list-style-type: none"> • Check that the power supplies of the other stations are turned on. • Disconnect the Ethernet cables and then reconnect them. • Power off and on the switching hub.
Is the IP address of the safety remote I/O module duplicated with any of other stations within the access range of CC-Link IE TSN?	Change the IP address so that no IP address duplication occurs in the access range of CC-Link IE TSN.
Does another station between the master station and the safety remote I/O module link up at the desired communication speed?	Change the communication speed of another station or the switching hub to satisfy the communication speed conditions.

When the D LINK LED flashes

When the D LINK LED flashes, check the following items.

Check item	Action
Does the IP address setting of the safety remote I/O module match the IP address of the safety remote I/O module specified in the network configuration settings of the master station?	Match the IP address of the safety remote I/O module with the IP address specified in the network configuration settings of the master station or the CC-Link IE TSN configuration settings.
Is the station type remote station?	In the network configuration settings of the master station, change "Station type" for the safety remote I/O module to "Remote station".
Is the module set to a reserved station?	Change the setting of "Reserved/Error Invalid Station" to "No Setting" in the network configuration settings of the master station.
Is the IP address of the safety remote I/O module duplicated with other stations?	If two or more duplicate IP addresses exist, change the setting so that they are different from each other.
In the network configuration settings of the master station, are the third or fourth octets of the IP address duplicated with those of other stations?	Set the IP address so that there is no duplication in the third and fourth octets of the IP address for all the stations.
In the network configuration settings of the master station, does each network address (the subnet mask part of IP address) match that of the master station?	Set each IP address and subnet mask so that the network addresses of all the stations are the same.
Is a station in which a communication error has occurred connected between the master station and the safety remote I/O module?	A safety remote I/O module cannot establish data link if there is no path available with which the safety remote I/O module can communicate with the master station without relaying data via a station with a communication error. If a communication error has occurred in two or more stations, clear the error one by one, starting from the station closest to the master station on the communication path.
Has another station been reset or powered off?	Disconnection temporarily occurs due to reset or power-off of another station. Wait until communication restarts.
Does a station on the network link up at the desired communication speed?	Change the communication speed of another station or the switching hub to satisfy the communication speed conditions.
Does the time synchronization source station operate normally?	<ul style="list-style-type: none"> • If an error occurs in the time synchronization source station, clear the error. • When the time synchronization source station is reset or powered off, disconnection temporarily occurs due to switching of time synchronization sources. Wait until communication restarts.
Is a time synchronization source station with a higher priority newly connected to the network?	Disconnection temporarily occurs due to switching of time synchronization sources. Wait until communication restarts.
Does the master station connected to the network operate normally?	If an error occurs in the master station, clear the error in the master station.
Is the system configured with ring topology?	<ul style="list-style-type: none"> • When the firmware version of the safety remote I/O module is "01", configure the system with line topology, star topology, or mixture of star topology and line topology. • When the firmware version of the safety remote I/O module is "03" or later and the CC-Link IE TSN Class setting is CC-Link IE TSN Class A, change the setting to CC-Link IE TSN Class B or configure the system with line topology, star topology, or mixture of star topology and line topology.
Does the model name of the device station set in the network configuration settings of the master station match the model name of the actual device?	Change the network configuration settings so that the model name of the device station set in the network configuration settings of the master station matches the model name of the actual device. Or, in the network configuration settings, set the safety remote I/O module as a general remote station.
Is a value out of the setting range set for the communication cycle interval setting of the master station?	Set a value within the setting range for the communication cycle interval setting of the master station. (Page 57 Communication cycle interval setting)
Is "Network Synchronous Communication" of the safety remote I/O module set to "Synchronous"?	Set "Network Synchronous Communication" of the safety remote I/O module to "Asynchronous".
Are RX/RX with a number of points that cannot be handled by the safety remote I/O module set?	Set 16 for the number of points for RX and RY in the network configuration setting.
Are RWr/RWw with a number of points that cannot be handled by the safety remote I/O module set?	Set 16 or less for the number of points for RWr and RWw in the network configuration setting.
Has any error occurred in the safety remote I/O module?	<ul style="list-style-type: none"> • Change the network configuration settings so that the model name of the device station set in the network configuration settings of the master station matches the model name of the actual device. • Power off and on the module power supply (24VDC).
When the device station parameter automatic setting is enabled, has the device station parameter automatic setting been completed with an error?	Check the device station parameter automatic setting execution result details (SW0194) and the event history of the master/local module, and take appropriate action according to the stored error code.

Check item	Action
Is the CC-Link IE TSN Class setting of the safety remote I/O module set to CC-Link IE TSN Class A?	When CC-Link IE TSN Class A is set, perform the following. <ul style="list-style-type: none"> • Check the version of master station. When the version does not support CC-Link IE TSN Protocol version 2.0, update the master station to the version supporting the Protocol version 2.0.
Is the event code of 00C81 registered with event history of the master station?	<ul style="list-style-type: none"> • For the safety remote I/O module not supporting the CC-Link IE TSN Class setting function, set CC-Link IE TSN Class of the network configuration settings to CC-Link IE TSN Class B. • The profile may not support the CC-Link IE TSN Class setting function. In that case, set the safety remote I/O module to CC-Link IE TSN Class B or change the profile to the one that supports the CC-Link IE TSN Class setting function. • Change "CC-Link IE TSN Class" of the network configuration settings or the CC-Link IE TSN Class setting of the safety remote I/O module so that the CC-Link IE TSN Class set with the network configuration settings matches with the CC-Link IE TSN Class setting of the safety remote I/O module.
Is the network overloaded?	Perform the following and reduce the load on the network. <ul style="list-style-type: none"> • If a broadcast storm has occurred, eliminate the cause. • The I/O module may not be able to send packet because it intermittently relays packet sent from an Ethernet device to other stations. When an Ethernet device is connected to the network, reduce the frequency of packet sending from the Ethernet device.

When the SAFETY LED turns off

When the SAFETY LED turns off, check the following items.

Check item	Action
Have parameters been set to the safety remote I/O module?	Set parameters to the safety remote I/O module. (☞ Page 60 Parameter Setting) If the parameters are changed, configure the safety communication setting and safety module validation again.
Has the safety communication setting been configured?	Configure the safety communication setting. After configuring the setting, perform "Write to PLC". For details on the safety communication setting, refer to the following. ☞ User's manual for the master station used
Has the safety module validation been performed?	Perform the safety module validation using the engineering tool. (☞ Page 69 Safety Communication Setting)
Has the safety station interlock of the CPU module been canceled?	Fully check wiring and connection, and cancel the safety station interlock of the CPU module. For the safety station interlock, refer to the following. ☞ User's manual for the master station used
Has any error occurred?	Identify the error factor of the safety remote I/O module with the engineering tool and take corrective actions. (☞ Page 155 Method for Checking Error Codes)

When the ERR. LED turns on or flashes

When the ERR. LED turns on or flashes, check the following items.

Check item	Action
Has any error occurred?	Identify the error factor of the safety remote I/O module with the engineering tool and take corrective actions. (☞ Page 155 Method for Checking Error Codes)

When the L ER LED turns on

When the L ER LED turns on, check the following items.

Check item	Action
Are Ethernet cables used compliant with the relevant standard?	Replace the cable with an Ethernet cable compliant with the standard of communication specifications used. ☞ User's manual for the master station used
Is the station-to-station distance 100m or less?	Change the station-to-station distance to 100m or less.
Is any Ethernet cable disconnected?	Replace the Ethernet cable.
Does the switching hub in use normally operate?	<ul style="list-style-type: none"> • Check that the power supply of the switching hub is turned on. • Check that the switching hub satisfying the communication specifications in use is used.
Are other stations connected to the safety remote I/O module normally operating?	Check that the power supplies of the other stations are turned on.
Is the mode of a module on the master station set to other than Online?	Change the mode of the module to Online.
Is there any noise affecting the system?	Check the status of wiring.
Is the network topology setting of the master station set to ring topology?	Check for the PORT where the L ER LED is on, and properly re-connect it in ring topology.

When the LINK LED turns off

When the LINK LED turns off, check the following items.

Check item	Action
Are Ethernet cables used compliant with the relevant standard?	Replace the cable with an Ethernet cable compliant with the relevant standard. 📖 User's manual for the master station used
Is the station-to-station distance 100m or less?	Change the station-to-station distance to 100m or less.
Does the cabling condition (bending radius) meet the specifications?	Refer to the manual for the Ethernet cable used, and correct the bending radius.
Is any Ethernet cable disconnected?	Replace the Ethernet cable.
Does the switching hub in use normally operate?	<ul style="list-style-type: none"> • Check that the power supply of the switching hub is turned on. • Check that the switching hub satisfying the specifications of the master module in use is used. (📖 User's manual for the master station used) • Disconnect the Ethernet cables and then reconnect them. • Power off and on the switching hub.
Are other stations connected to the safety remote I/O module normally operating?	<ul style="list-style-type: none"> • Check that the power supplies of the other stations are turned on. • Disconnect the Ethernet cables and then reconnect them. • Power off and on the switching hub.
Is a device connected to the PORT compatible with the communication speed of the safety remote I/O module?	Connect a device that can communicate at the communication speed set in the safety remote I/O module.
When the communication speed of the safety remote I/O module is set to 100Mbps, is auto-negotiation of the connected device enabled?	Enable auto-negotiation of the connected device. Alternatively, connect a device with auto-negotiation enabled.

When the I/O LED flashes

When the I/O LED flashes, check the following items.

Check item	Action
Has any error related to safety I/O occurred when "I/O LED indication at error occurrence" is "1: Indication of error point"?	Identify the error factor of the safety remote I/O module with the engineering tool and take corrective actions. (🔧 Page 141 CC-Link IE TSN/CC-Link IE Field Diagnostics)

When the I/O PW LED does not turn on

When the I/O PW LED does not turn on, check the following items.

Check item	Action
Is the external power supply turned on?	<ul style="list-style-type: none"> • Keep the external power supply voltage within the range of performance specifications. (🔧 Page 20 Performance Specifications) • After performing the above action, power off and on the module power supply (24VDC). If the I/O PW LED does not turn on even after the module power supply (24VDC) is powered off and on, the possible cause is a safety remote I/O module failure. Please consult your local Mitsubishi representative.

10.3 Unit Test

Run a unit test to check if there is any hardware failure in the safety remote I/O module.

1. Power off the power supply of the safety remote I/O module.
2. Connect P1 and P2 of the safety remote I/O module with an Ethernet cable.
3. Set the IP address setting switch as follows.
 - IP address setting switch (x1): F
 - IP address setting switch (x16): F
4. Power on the power supply of the safety remote I/O module.
5. Unit test begins.

The RUN LED flashes during the unit test.

6. The RUN LED turns on when the unit test is completed.
 - If the test is completed normally, the ERR. LED does not turn on, but remains off.
 - If the test is completed with an error, the ERR. LED turns on. If the test is completed with an error, replace the Ethernet cable and run the test again. If the test fails again, it may be due to a hardware failure in the safety remote I/O module. Please consult your local Mitsubishi representative.

Precautions

If the safety remote I/O module is connected to the network while IP address setting switch (x16) and IP address setting switch (x1) are set to F, data link may not be properly performed on safety remote I/O modules of other stations.

Set appropriate values both for IP address setting switch (x16) and IP address setting switch (x1), and connect the safety remote I/O module to the network.

10.4 Troubleshooting by Symptom

Perform the troubleshooting by symptom when the safety remote I/O module does not operate properly with no error. If an error occurs in the safety remote I/O module, identify the cause of the error using the engineering tool.

When the ON/OFF status of a safety input cannot be read

When the ON/OFF status of a safety input cannot be read, check the following items.

Check item	Action
Is the SAFETY LED on?	<p>When the SAFETY LED is not on, "Safety module validation" has not been performed or the CPU module is in the safety station interlock status. Take the following actions.</p> <ul style="list-style-type: none"> • Perform "Safety module validation". For details on "Safety module validation", refer to the following. <ul style="list-style-type: none"> ☞ Page 69 Safety Communication Setting • Fully check wiring and connection, and cancel the safety station interlock of the CPU module. For the safety station interlock, refer to the following. <ul style="list-style-type: none"> 📖 User's manual for the master station used
Is the corresponding LED (X0 LED to X7 LED) of the safety remote I/O module on when a safety input device is on?	<p>If the LED is not on, there is a problem with the input wiring.</p> <p>Check the wiring confirming that the input wiring is not disconnected or short-circuited, or the voltage of the input signal is correct.</p> <p>For the rated input voltage, check the rated input voltage of each module.</p> <ul style="list-style-type: none"> ☞ Page 20 Input module ☞ Page 27 I/O combined module <p>Refer to the following as well.</p> <ul style="list-style-type: none"> ☞ Page 152 Troubleshooting for input circuit
Is the setting of the refresh device (SA\X/SA\Y) correct?	<p>Check and correct the device setting of the safety communication setting so that the setting of the refresh device (SA\X/SA\Y) matches the setting in the program. For details on the device setting of the safety communication setting, refer to the following.</p> <ul style="list-style-type: none"> 📖 User's manual for the master station used
Is there any incorrect setting in the wiring selection of input?	<p>Review the settings in the wiring selection of input. (☞ Page 74 Safety input wiring selection function)</p>

When the ON/OFF status of a standard input cannot be read

When the ON/OFF status of a standard input cannot be read, check the following items.

Check item	Action
Is the SAFETY LED on?	<p>When the SAFETY LED is not on, "Safety module validation" has not been performed or the CPU module is in the safety station interlock status. Take the following actions.</p> <ul style="list-style-type: none"> • Perform "Safety module validation". For details on "Safety module validation", refer to the following. <ul style="list-style-type: none"> ☞ Page 69 Safety Communication Setting • Fully check wiring and connection, and cancel the safety station interlock of the CPU module. For the safety station interlock, refer to the following. <ul style="list-style-type: none"> 📖 User's manual for the master station used
Is the corresponding LED (X0 LED to X7 LED) of the safety remote I/O module on when an input device is on?	<p>If the LED is not on, there is a problem with the input wiring.</p> <p>Check the wiring confirming that the input wiring is not disconnected or short-circuited, or the voltage of the input signal is correct.</p> <p>For the rated input voltage, check the rated input voltage of each module.</p> <ul style="list-style-type: none"> ☞ Page 20 Input module ☞ Page 27 I/O combined module <p>Refer to the following as well.</p> <ul style="list-style-type: none"> ☞ Page 152 Troubleshooting for input circuit
Is the setting of the refresh device (RX0 to RXF) correct?	<p>Check and correct the device settings of the refresh parameter so that the setting of the refresh device (RX0 to RXF) matches the setting in the program. For the settings of the refresh parameter areas, refer to the following.</p> <ul style="list-style-type: none"> 📖 User's manual for the master station used
Is there any incorrect setting in the wiring selection of input?	<p>Review the settings in the wiring selection of input. (☞ Page 77 Standard input wiring selection function)</p>

When safety output cannot be turned on

When a safety output cannot be turned on, check the following items.

Check item	Action
Is the SAFETY LED on?	When the SAFETY LED is not on, "Safety module validation" has not been performed or the CPU module is in the safety station interlock status. Take the following actions. <ul style="list-style-type: none"> • Perform "Safety module validation". For details on "Safety module validation", refer to the following. <ul style="list-style-type: none"> ☞ Page 69 Safety Communication Setting • Fully check wiring and connection, and cancel the safety station interlock of the CPU module. For the safety station interlock, refer to the following. <ul style="list-style-type: none"> ☞ User's manual for the master station used
Is the setting of the refresh device (SAIX/SAIY) correct?	Check and correct the device setting of the safety communication setting so that the setting of the refresh device (SAIX/SAIY) matches the setting in the program. For details on the device setting of the safety communication setting, refer to the following. <ul style="list-style-type: none"> ☞ User's manual for the master station used
Is there any incorrect setting in the wiring selection of output?	Review the settings in the wiring selection of output. (☞ Page 79 Safety output wiring selection function)
Is the fast logic function being used by mistake?	When the fast logic function is enabled, the Y output is turned on/off according to the calculation result inside the safety remote I/O module, not the remote output signal (SAIY) received from the master station. Disable the fast logic function or review the output conditions. For details on the fast logic function, refer to the following. <ul style="list-style-type: none"> ☞ Page 82 Fast logic function
Are the outputs interlocked?	When the safety remote I/O module parameter "Operation setting of external power supply voltage error detection" is set to "2: Continue safety communication (With output interlock)", check that the outputs are not interlocked. For how to check the condition, refer to the following. <ul style="list-style-type: none"> ☞ Page 135 Output interlock If the outputs are interlocked, cancel the interlock. For how to cancel the interlock, refer to the following. <ul style="list-style-type: none"> ☞ Page 136 Output interlock cancellation

When safety output ON signal intermittently turns off

When a safety output ON signal turns off intermittently, check the following items.

Check item	Action
Is an output dark test being executed?	Check the specifications of the safety devices used, and review the setting of the output dark test pulse OFF time. (☞ Page 100 Output dark test function)

When the safety remote I/O module cannot be accessed with the engineering tool

When the safety remote I/O module cannot be accessed with the engineering tool, check the following items.

Check item	Action
Is the D LINK LED on?	Check the D LINK LED. When the LED is not on, refer to the following to perform troubleshooting. <ul style="list-style-type: none"> ☞ Page 144 When the D LINK LED turns off ☞ Page 145 When the D LINK LED flashes Refer to the following to check other LEDs. <ul style="list-style-type: none"> ☞ Page 143 Checking the LEDs
Is the version of the module on the master station correct?	Check the firmware version of the module on the master station, and if the version is not the applicable one, replace the module with a module of the applicable version or later. For the applicable version, refer to the following. <ul style="list-style-type: none"> ☞ Page 37 Applicable products
Is the version of the engineering tool supported?	Check the version of the engineering tool, and if it is prior to the compatible versions, update it. For the applicable version, refer to the following. <ul style="list-style-type: none"> ☞ Page 37 Compatible software version
Do the module parameter settings of the master station and those of the CPU module match?	Perform "Verify With PLC" to check whether the CPU module and module parameters match. If they do not match, execute "Write to PLC".

When the safety remote I/O module is repeatedly disconnected and reconnected

Refer to the following and check the items described there.

☞ Page 145 When the D LINK LED flashes

10.5 Fault Examples with the Safety Remote I/O Module

Troubleshooting for input circuit

This section describes the troubleshooting for input circuit.

An input signal does not turn off.

■Cause

Leakage current that exceeds the OFF current of the safety remote I/O module occurs even though the switch with LED indicator is turned off.

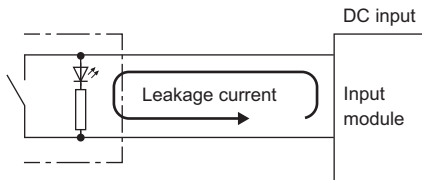

■Action

Connect an appropriate resistor as shown below so that the leakage current flowing into the input module falls below the OFF current.

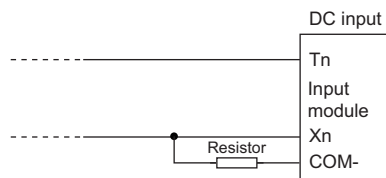

For the calculation example of a resistor to be connected, refer to the following.

■Calculation example

When the 24VDC external power supply of the NZ2GNSS2-8D is on and the switch with LED indicator that has a leakage current of 3mA at a maximum is connected

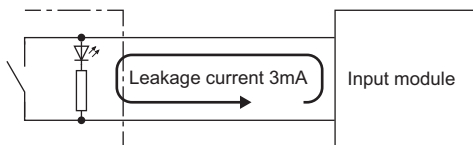

1. Check the following items with the module specifications.

- OFF voltage/OFF current: 5VDC or lower/1.3mA or lower
- Input resistance: Approx. 2.6kΩ

I (Leakage current) = I_Z (Off current of the NZ2GNSS2-8D) + I_R (Current flowing to connected resistor)

$$I_R = I - I_Z = 3.0 - 1.3 = 1.7 \text{ [mA]}$$

2. The leakage current through the NZ2GNSS2-8D does not satisfy the condition of the OFF current of 1.3mA or lower. Therefore, connect a resistor as shown below.

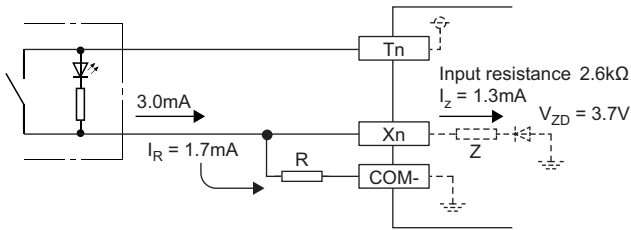

3. To satisfy the condition of the OFF current of the NZ2GNSS2-8D (1.3mA or lower), the current through the connected resistor should be 1.7mA or higher. From the formula below, the connected resistor (R) is lower than or equal to 4.2kΩ.

$$R \times I_R \leq Z (\text{Input resistance}) \times I_Z + V_{ZD}$$

$$R \leq \frac{Z (\text{Input resistance}) \times I_Z + V_{ZD}}{I_R} = \frac{2.6 \times 1.3 + 3.7}{1.7} = 4.2 \text{ [k}\Omega\text{]}$$

4. When the resistor (R) is 3.6kΩ, for example, the power capacity (W) of the resistor (R) becomes 0.23W.

$$W = (\text{Input voltage})^2 \div R = 28.8^2 \div 3600 = 0.23\text{[W]}$$

5. Because the resistor requires a power capacity that is 3 to 5 times larger than the actual current consumption, the resistor connected to the terminal should be 3.6kΩ; and 0.75 to 1.2W.

A signal incorrectly inputs data

■Cause

Noise is taken in the input.

■Action

- To prevent excessive noise, avoid installing power cables together with I/O cables.
- Set a longer input response time. (☞ Page 191 Input response time)
- Take noise reduction measures such as connecting surge absorbers to noise-generating devices such as relays and contactors using the same power supply.
- To prevent noise from being taken in, take measures to reduce noise for the I/O cable by using a part such as a ferrite core.
- To prevent radiation noise to the I/O cable, take measures to reduce noise by using a shielded cable.

Troubleshooting for output circuit

This section describes the troubleshooting for output circuit.

A load momentarily turns on from off when the system is powered off

■Cause

When an inductive load is connected, the load [2] in the off state may turn on due to a sneak current from the back EMF at the shutoff [1].

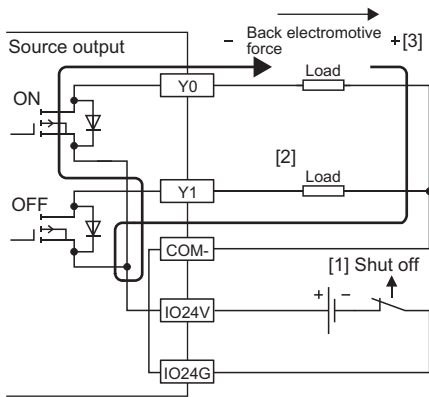

■Action

Take one of the two actions shown below.

- To suppress the back EMF, connect a diode in parallel with the load under the back EMF influence [3].

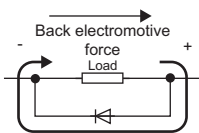

- Configure another current path by connecting a diode across positive and negative of the external power supply.

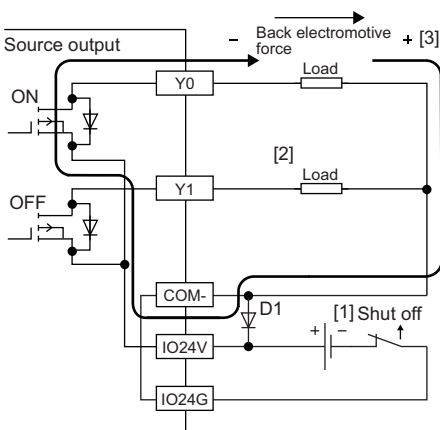

D1 indicates the following.

Reverse voltage VR (VRM)^{*1}

Forward current IF (IFM)^{*2}

*1 Approximately 10 times the rated load voltage in the specifications

Example: 24VDC → Approx. 200VDC

*2 Twice the maximum load current (common) in the performance specifications or more

Example: 4A/1 common → 8A or more

10.6 Method for Checking Error Codes

Error codes can be checked by any of the following methods:

- Checking with the engineering tool
- Checking by Error code (RWr1)

Checking with the engineering tool

The error history held in the safety remote I/O module can be read. Errors that occurred before powering-off can be checked as well.

The error history can be checked by using "CC-Link IE TSN/CC-Link IE Field Diagnostics".

Point

- The error history records a maximum of 16 errors in reverse chronological order of occurrence. If more than 16 errors occur, errors are deleted from the oldest.
- "Occurrence Date" information in the error history is recorded after clock information is distributed from the master station. When an error occurs before clock information is distributed from the master station, "Occurrence Date" information is not recorded.
- If the same error occurs successively, only the latest error is stored to the error history.
- Even after the module power supply is powered off and on, the error history remains.
- To initialize the error history, set "Method selection" to "Error history clear request" on the "Command Execution of Device Station" window and click the [Execute] button.
- For "Error Code", "Error details", and "Solution Methods", refer to the following.

 Page 157 List of Error Codes

- For detailed information, refer to the following.

 Page 161 Detailed information

■Checking by using CC-Link IE TSN/CC-Link IE Field diagnostics

Operating procedure

1. Connect the engineering tool to the CPU module.
2. Start "CC-Link IE TSN/CC-Link IE Field Diagnostics" from the menu.
 [Diagnostics] ⇒ [CC-Link IE TSN/CC-Link IE Field Diagnostics]
3. Right-click the device station whose error history is to be checked, and select "Error/Event History".
4. Follow the on-screen instructions and click the [Yes] button.
5. The error history appears.

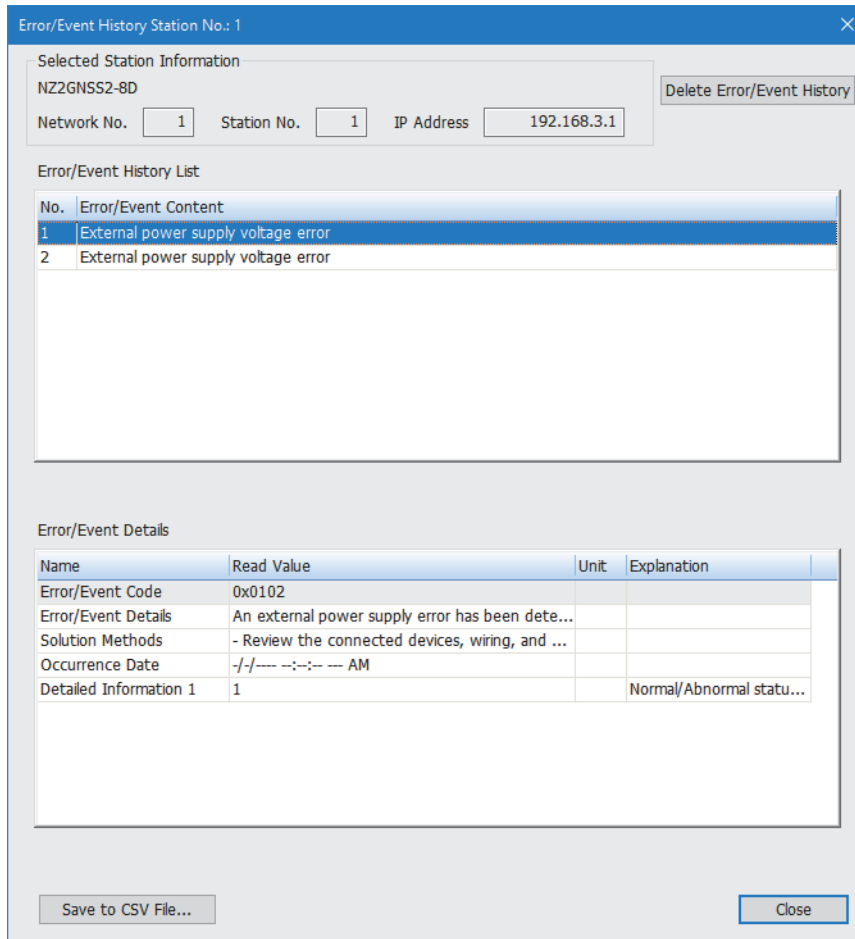

Checking by Error code (RWr1)

Check the latest error code with the remote register of the master/local module.

Operating procedure

 [Online] ⇒ [Monitor] ⇒ [Device/Buffer Memory Batch Monitor]

Ex.

When the refresh target device for Error code (RWr1) is W101

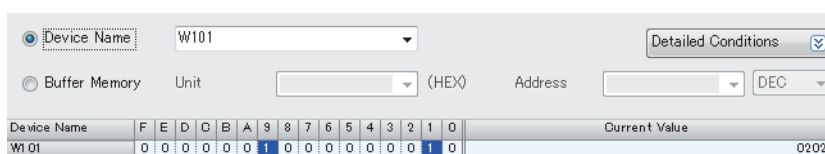

10.7 List of Error Codes

Error classification by error number

Error codes are classified by error number as follows.

Error code	Classification	Reference
0000H to 3FFFH	Safety remote I/O module error	Page 157 Error codes related to the safety remote I/O module
D000H to DFFFH	CC-Link IE TSN error	Page 164 Error codes related to CC-Link IE TSN
8400H to 84FFH	CC-Link IE TSN safety communications error	Page 167 Error codes related to CC-Link IE TSN safety communications

Error codes related to the safety remote I/O module

Errors of the safety remote I/O module are classified into the following four types.

Error status	Description
Major error	Error because of which the module stops, such as hardware failure. The safety functions (safety I/O, safety diagnostics, and safety communications) stop, and the SAFETY LED turns off.
Moderate error	Error because of which the module stops, such as a parameter error related to module operation. The safety functions (safety I/O, safety diagnostics, and safety communications) stop, and the SAFETY LED turns off.
Minor error	Error after which the module continues its operation, such as double input discrepancy detection. The safety functions keep operating.
Communication error	A CC-Link IE TSN safety communications error that causes the module to continue operating. The safety functions (safety I/O, safety diagnostics, and safety communications) stop.

List of Error Codes

Error code (hexadecimal)	Classification	Error name	Description and cause	Action
0001H	Major error	Hardware failure	A hardware error was detected.	<ul style="list-style-type: none"> Review the connected devices, wiring, and voltage. When the connected devices, wiring, and voltage have no errors, there may be an influence from noise or a hardware failure. Take measures to reduce noise. If the same error occurs again even after measures have been taken against noise, the module may be in failure. Please consult your local Mitsubishi representative.*3
0101H	Moderate error	Self-diagnostic error	An error was detected by the self-diagnostics.	
0102H*1	Moderate error	External power supply voltage error	An external power supply error was detected.	<ul style="list-style-type: none"> Review the connected devices, wiring, and voltage. Power on the external power supply at the same timing of power-on of the module power supply. There may be an influence from noise of external wiring (such as power supply part and I/O signal part). Take measures to reduce noise. If the same error occurs again, the module may be in failure. Please consult your local Mitsubishi representative.
0103H	Moderate error	Non-volatile memory data error (IP address information)	The IP address and subnet mask stored in the non-volatile memory are abnormal.	<ul style="list-style-type: none"> The module will be automatically recovered immediately after the error occurs. However, the stored IP address and subnet mask are lost, and operation is performed assuming that the following are stored. IP address: 192.168.3.250 Subnet mask: 255.255.255.0 Take measures against noise with a shielded cable for connection. If the same error occurs again, the module may be in failure. Please consult your local Mitsubishi representative.

Error code (hexadecimal)	Classification	Error name	Description and cause	Action
0104H	Moderate error	Restart not performed after safety module validation	The module has not been restarted after the safety module validation.	<ul style="list-style-type: none"> Restart the safety remote I/O module. After performing safety module validation, safety communications can be performed by restarting the module. If the same error occurs again, the module may be in failure. Please consult your local Mitsubishi representative.
0105H	Moderate error	Non-volatile memory data error (parameter)	An error of the parameter data stored in the non-volatile memory has been detected.	<ul style="list-style-type: none"> Restart the safety remote I/O module. The parameters are initialized and the module is recovered. In such a case, parameters are required to be set again by users. If the same error occurs again, the module may be in failure. Please consult your local Mitsubishi representative.
0106H ¹	Moderate error	Output read-back error	A discrepancy of an output read-back value and an output value was detected.	<ul style="list-style-type: none"> Review the connected devices and wiring. Check that 24VDC is supplied to the external power supply using a tester. Check that the external connection is not overloaded. When the connected devices and wiring have no errors, there may be an influence from noise or a hardware failure. Take measures to reduce noise. Power on the external power supply at the same timing of power-on of the module power supply. If the same error occurs again, the module may be in failure. Please consult your local Mitsubishi representative.
0107H ¹	Moderate error	Output dark test error	During an output dark test, test pulses were not detected.	<ul style="list-style-type: none"> Review the connected devices and wiring. Check that 24VDC is supplied to the external power supply using a tester. Check that the external connection is not overloaded. Correct the parameter settings of "Output dark test pulse OFF time setting" and "Number of pulse output for output dark test". When the connected devices and wiring have no errors, there may be an influence from noise or a hardware failure. Take measures to reduce noise. Power on the external power supply at the same timing of power-on of the module power supply. If the same error occurs again, the module may be in failure. Please consult your local Mitsubishi representative.
0108H ¹	Moderate error	I/O data error	An error was detected by the input diagnostic.	<ul style="list-style-type: none"> Review the connected devices and wiring. When the connected devices and wiring have no errors, there may be an influence from noise or a hardware failure. Take measures to reduce noise. Power on the external power supply at the same timing of power-on of the module power supply. If the same error occurs again, the module may be in failure. Please consult your local Mitsubishi representative.
0109H ¹	Moderate error	Module power supply voltage error	A module power supply error was detected.	<ul style="list-style-type: none"> Review the connected devices, wiring, and voltage. If the same error occurs again, the module may be in failure. Please consult your local Mitsubishi representative.
0201H ¹	Minor error	Remote buffer memory access error	An area outside the range of the remote buffer memory areas has been accessed using a dedicated instruction.	<ul style="list-style-type: none"> The module will automatically recover immediately after the error occurs. Correct the setting data of the dedicated instruction to access within the range of remote buffer memory areas.

Error code (hexadecimal)	Classification	Error name	Description and cause	Action
0202H	Minor error	IP address switch changed error	An IP address setting switch has been changed with the module power supply on.	The module will recover from this error by setting the switches to the previous IP address that was set when the module power supply was powered on.
0203H ¹	Minor error	Double input discrepancy detection error	A double input discrepancy was detected in a pair of inputs (X0 and X1, X2 and X3, ...).	<ul style="list-style-type: none"> Power on the external power supply at the same timing of power-on of the module power supply. Correct the parameter settings of "Double input discrepancy detection time". Review the connected devices and wiring. When the connected devices and wiring have no errors, there may be an influence from noise. Take measures to reduce noise. If the same error occurs again, the module may be in failure. Please consult your local Mitsubishi representative. When "Double input discrepancy auto recovery setting" is set to "1: Used", the module will recover from this error after the double input discrepancy is eliminated.
0204H ¹	Minor error	Input dark test error	During an input dark test, test pulses were not detected.	<ul style="list-style-type: none"> Power on the external power supply at the same timing of power-on of the module power supply. Correct the parameter settings of "Input dark test pulse OFF time" and "Number of pulse output for input dark test". Review the connected devices and wiring. When the connected devices and wiring have no errors, there may be an influence from noise. Take measures to reduce noise. If the same error occurs again, the module may be in failure. Please consult your local Mitsubishi representative.
0205H	Minor error	Safety module validation failure	The safety module validation failed.	<ul style="list-style-type: none"> The module will automatically recover immediately after the error occurs. Check the module's ERR. LED and error history to see if a moderate error due to parameter settings has occurred in the module. If an error has occurred, eliminate the cause. If the same error occurs again even after "Safety module validation" is executed in no error state, the module may be in failure. Please consult your local Mitsubishi representative.
0206H	Minor error	Safety module validation not performed	The safety module validation has not been performed.	<ul style="list-style-type: none"> Perform "Safety module validation". After performing safety module validation, safety communications can be performed by restarting the module. If the same error occurs again, the module may be in failure. Please consult your local Mitsubishi representative.
0208H	Minor error	Non-volatile memory data error (communication speed information)	An error of the communication speed information stored in a non-volatile memory was detected.	<ul style="list-style-type: none"> Take measures against noise with a shielded cable for connection. If the same error occurs again, the module may be in failure. Please consult your local Mitsubishi representative.
020CH	Minor error	External power supply voltage error	An external power supply error was detected.	<ul style="list-style-type: none"> Review the connected devices, wiring, and voltage. Power on the external power supply at the same timing of power-on of the module power supply. There may be an influence from noise of external wiring (such as power supply part and I/O signal part). Take measures to reduce noise. If the same error occurs again, the module may be in failure. Please consult your local Mitsubishi representative.

Error code (hexadecimal)	Classification	Error name	Description and cause	Action
020EH ²	Minor error	Non-volatile memory data error (CC-Link IE TSN Class setting information)	An error of the CC-Link IE TSN Class setting information stored in a non-volatile memory was detected.	<ul style="list-style-type: none"> Take measures against noise with a shielded cable for connection. If the same error occurs again, the module may be in failure. Please consult your local Mitsubishi representative.
0270H	Minor error	Remote reset disable error	Remote reset could not be performed because the communication speed setting of the parameter is different from the setting it had when the module power supply was powered on.	Power off and on the module power supply.
0500H ¹	Moderate error	Parameter data error	An incorrect value or parameter data out of the range is set.	<ul style="list-style-type: none"> Correct the module parameter settings and module configuration. When the parameters are set again and the parameter setting has succeeded, the module will recover from this error.
0560H ¹	Moderate error	Parameter data error (wiring selection of input)	An incorrect value or parameter (wiring selection of input) out of the range is set.	<ul style="list-style-type: none"> Correct the module parameter settings (wiring selection of input) and module configuration. When "0: Not used", "2: Safety single", or "3: General single" is set to Xn (n: even number) in "Wiring selection of input", set a value other than "1: Safety double wiring (NC/NC)" for Xn+1. When the parameters are set again and the parameter setting has succeeded, the module will recover from this error.
0564H ¹	Moderate error	Parameter data error (input response time)	An incorrect value or parameter data out of the range is set.	<ul style="list-style-type: none"> Correct the module parameter settings (input response time) and module configuration. Set the input response time so that it is longer than the input dark test pulse output time. Input dark test pulse output time = Pulse OFF time for the input dark test × ((Number of pulse outputs for the input dark test × 2) - 1) When the parameters are set again and the parameter setting has succeeded, the module will recover from this error.
0580H ¹	Moderate error	Parameter data error (wiring selection of output)	An incorrect value or parameter (wiring selection of output) out of the range is set.	<ul style="list-style-type: none"> Correct the module parameter settings (wiring selection of output) and module configuration. When "0: Not used" or "2: Safety single" is set to Yn (n: even number) in "Wiring selection of output", set a value other than "1: Safety double wiring (Source/Source)" for Yn+1. When the parameters are set again and the parameter setting has succeeded, the module will recover from this error.

*1 Detailed information of the error is stored in Detailed Information 1 to 3 in Error history data. For detailed information, refer to the following.

 Page 161 Detailed information

*2 This error occurs only when the module with the firmware version of "03" or later is used.

*3 If power-off of the module power supply coincides with the safety diagnostics, an error of the hardware failure can be logged in the error history. Restart the module and check that the error has been eliminated before using the module.

Point

When multiple errors have occurred, only the latest error code is stored in Error code (RWr1). The errors that occurred before can be checked by executing "Error/Event History" of the "CC-Link IE TSN/CC-Link IE Field Diagnostics" in the engineering tool. For the error history, refer to the following.

 Page 156 Checking by using CC-Link IE TSN/CC-Link IE Field diagnostics

However, when a moderate error occurs during a major error occurrence, the error code of the major error will remain in Error code.

Moreover, when a minor error occurs during a moderate error occurrence, the error code of the moderate error will remain in Error code.

Detailed information

External power supply voltage error (error code: 0102H)

An external power supply status (normal or error) is stored in Detailed information 1.

- Detailed information 1

b15	b14	b13	b12	b11	b10	b9	b8	b7	b6	b5	b4	b3	b2	b1	b0
0 (fixed)														00: Normal 01: Error	

Output read-back error (error code: 0106H)

Output read-back error detection point information is stored in Detailed information 1.

- Detailed information 1

b15	b14	b13	b12	b11	b10	b9	b8	b7	b6	b5	b4	b3	b2	b1	b0
0 (fixed)								Y7	Y6	Y5	Y4	Y3	Y2	Y1	Y0
								0: Normal 1: Error							

Output dark test error (error code: 0107H)

The diagnostic result of an output dark test (normal or error) is stored in Detailed information 1.

- Detailed information 1

b15	b14	b13	b12	b11	b10	b9	b8	b7	b6	b5	b4	b3	b2	b1	b0
0 (fixed)								Y7	Y6	Y5	Y4	Y3	Y2	Y1	Y0
								0: Normal 1: Error							

■ I/O data error (error code: 0108H)

The cause of an I/O data error is stored in Detailed information 1.

- Detailed information 1

b15	b14	b13	b12	b11	b10	b9	b8	b7	b6	b5	b4	b3	b2	b1	b0
0 (fixed)														01: All input points error 10 or 11: Error detected by internal input dark test	

Error detection point information is stored in Detailed information 2.

- Detailed information 2

Values to be stored in Detailed information 2 depend on a value stored in Detailed information 1.

All points become 0 in Error code details 2 when 01 is stored in Error code details 1.

The diagnostic result of an internal input dark test (normal or error) is stored in Error code details 2 when 10 or 11 is stored in Error code details 1.

b15	b14	b13	b12	b11	b10	b9	b8	b7	b6	b5	b4	b3	b2	b1	b0
0 (fixed)								X7	X6	X5	X4	X3	X2	X1	X0
								0: Normal 1: Error							

Point

An action to be taken when an I/O data error has occurred depends on the error cause stored in Detailed information 1. For details, refer to the following.

- All input points error: If an error occurs for all the input points due to the input dark test error (error code: 0204H) or the double input discrepancy detection error (error code: 0203H) and the input function cannot be performed anymore, a moderate error state of I/O data error (error code: 0108H) is applied. In such a case, take actions to restore from the previous error state (0205H or 0204H: minor error).
- Error detected by internal input dark test: Correct the wiring on the error detection points indicated in Detailed information 2.

■ Module power supply voltage error (error code: 0109H)

A module power supply voltage error status is stored in Detailed information 1.^{*1}

- 0H: Undervoltage
- 1H: Internal circuit error

*1 Only for the module with the firmware version of "01"

Remote buffer memory access error (error code: 0201H)

The start address of a remote buffer memory area that was accessed using the REMFR/REMTO instruction is stored in Detailed information 1 and Detailed information 2. The lower 16 bits are stored in Detailed information 1 and the upper 16 bits are stored in Detailed information 2.

For details on the remote buffer memory addresses, refer to the following.

☞ Page 183 Remote buffer memory list

Double input discrepancy detection error (error code: 0203H)

Occurrence of a double input discrepancy error is stored in Detailed information 1. The input signal status after the input response time has passed is stored in Detailed information 3.

- Detailed information 1

b15	b14	b13	b12	b11	b10	b9	b8	b7	b6	b5	b4	b3	b2	b1	b0
0 (fixed)												X6	X4	X2	X0
												X7	X5	X3	X1
												0: Match 1: Mismatch			

- Detailed information 3

b15	b14	b13	b12	b11	b10	b9	b8	b7	b6	b5	b4	b3	b2	b1	b0
0 (fixed)								X7	X6	X5	X4	X3	X2	X1	X0
								0: OFF 1: ON							

Input dark test error (error code: 0204H)

The diagnostic result of an input dark test (normal or error) is stored in Detailed information 1.

- Detailed information 1

b15	b14	b13	b12	b11	b10	b9	b8	b7	b6	b5	b4	b3	b2	b1	b0
0 (fixed)								X7	X6	X5	X4	X3	X2	X1	X0
								0: Normal 1: Error							

External power supply voltage error (error code: 020CH)

An external power supply status (normal or error) is stored in Detailed information 1.

- Detailed information 1

b15	b14	b13	b12	b11	b10	b9	b8	b7	b6	b5	b4	b3	b2	b1	b0
0 (fixed)														00: Normal 01: Error	

Parameter data error (error code: 05□□H)

The start address (16 bits) of the remote buffer memory of the parameter where the error was detected is stored in Detailed information 1.

The value (16 bits) written in the corresponding address is stored in Detailed information 2.

If the set value is a 32-bit parameter, the lower 16 bits of the value written to the corresponding address are stored in Detailed information 2, and the upper 16 bits are stored in Detailed information 3.

For details on the remote buffer memory addresses, refer to the following.

☞ Page 189 Details of remote buffer memory areas

Error codes related to CC-Link IE TSN

The CC-Link IE TSN error codes are shown below.

List of Error Codes

Error code (hexadecimal)	Classification	Error name	Description and cause	Action
D000H ^{1*2}	Minor error	Communication setting error 1	Invalid network settings are received.	Power off and on the module power supply. If the same error occurs again, the module may be in failure. Please consult your local Mitsubishi representative.
D001H ^{1*2}	Minor error	Communication setting error 2	Network settings that cannot be handled by the safety remote I/O module are received.	Check that the model name of the device station set in the network configuration settings matches the model name of the actual device. If this error occurs even when the model names match, the possible cause is a module failure. Please consult your local Mitsubishi representative.
D010H ¹	Minor error	IP address duplication detection	An IP address duplication is detected.	Change the IP address so that no IP address duplication occurs in the access range of CC-Link IE TSN. After change, power off and on the module power supply.
D011H ^{1*2}	Moderate error	IP address setting error	Values the safety remote I/O module cannot use were set for the IP address and subnet mask settings.	<ul style="list-style-type: none"> Without using the set IP address and subnet mask, the module is operated based on the previous IP address and subnet mask. The set IP address and subnet mask will not be saved in non-volatile memory. Check the IP address and subnet mask again, and change the settings to values the safety remote I/O module can use. After change, power off and on the module power supply.
D020H ^{1*2}	Minor error	Network synchronous communication setting error	The network synchronous communication setting of the safety remote I/O module is set to synchronous.	Set the network synchronous communication setting of the safety remote I/O module to asynchronous.
D021H ^{1*2}	Minor error	Number of RX/Ry points error	RX/Ry with a number of points that cannot be handled by the safety remote I/O module are set.	Set 16 for the number of points for RX and Ry in the network configuration setting.
D022H ^{1*2}	Minor error	Number of RWr/RWw points error	RWr/RWw with a number of points that cannot be handled by the safety remote I/O module are set.	Set 16 or less for the number of points for RWr and RWw in the network configuration setting.
D023H ^{1*2}	Minor error	Safety PDU number of points error	A safety PDU with a number of points that cannot be handled by the safety remote I/O module was received.	Power off and on the module power supply. If the same error occurs again, the module may be in failure. Please consult your local Mitsubishi representative.
D024H ^{1*2}	Minor error	Communication cycle setting error (CC-Link IE TSN Class B/ 1Gbps)	When the safety remote I/O module was operating with CC-Link IE TSN Class B and at a communication speed of 1Gbps, a communication cycle the safety remote I/O module did not support was set.	For the communication cycle setting, set a value supported by the safety remote I/O module.
D025H ^{1*2}	Minor error	Communication cycle setting error (CC-Link IE TSN Class B/ 100Mbps)	When the safety remote I/O module was operating with CC-Link IE TSN Class B and at a communication speed of 100Mbps, a communication cycle the safety remote I/O module did not support was set.	For the communication cycle setting, set a value supported by the safety remote I/O module.
D026H ³	Moderate error	Communication speed not matched	A device linked up with a communication speed different from "Link speed setting" of the parameter.	<ul style="list-style-type: none"> Correct "Link speed setting" of the parameter. Check that the switching hub satisfying the specifications of the master module in use is used. Connect a device that can communicate at the communication speed set in the safety remote I/O module.

Error code (hexadecimal)	Classification	Error name	Description and cause	Action
D027H ^{1*2*4}	Minor error	Communication cycle setting error (CC-Link IE TSN Class A)	When the safety remote I/O module was operating with CC-Link IE TSN Class A, a communication cycle the safety remote I/O module did not support was set.	For the communication cycle setting, set a value supported by the safety remote I/O module.

- *1 This error occurs only once when an abnormality is detected.
- *2 For these types of errors, more than one error may not occur at the same time. If errors occur, eliminate the cause of one error after another until a data link is established.
- *3 This error is registered when an error is detected at link-up and link-down.
- *4 This error occurs only when the module with the firmware version of "03" or later is used.

Point 

When multiple errors have occurred, only the latest error code is stored in Error code (RWr1). The errors that occurred before can be checked by executing "Error/Event History" of the "CC-Link IE TSN/CC-Link IE Field Diagnostics" in the engineering tool. For the error history, refer to the following. However, when a moderate error occurs during a major error occurrence, the error code of the major error will remain in Error code.
( Page 156 Checking by using CC-Link IE TSN/CC-Link IE Field diagnostics)

Error codes related to CC-Link IE TSN safety communications

The CC-Link IE TSN safety communications error codes are shown below.

The ERR. LED does not turn on when an error related to CC-Link IE TSN safety communications occurs, the same as when a CC-Link IE TSN communication error occurs.

When a CC-Link IE TSN safety communications error occurs, the SAFETY LED turns off and the D LINK LED does not change.

List of Error Codes

Error code (hexadecimal)	Classification	Error name	Description and cause	Action
8400H	Communication error	Safety communication error	An error was detected in the safety communication with the master station.	<ul style="list-style-type: none"> Set module parameters and perform the safety module validation according to the parameter setting procedure. (☞ Page 69 Safety Communication Setting) When the parameter setting has no errors, there may be an influence from noise or a hardware failure. If the same error occurs again even after measures have been taken against noise, the module may be in failure. Please consult your local Mitsubishi representative.
8401H	Communication error	Safety communication disabled due to a communication interrupt	A communication interrupt has occurred on CC-Link IE TSN and safety communications stopped.	<ul style="list-style-type: none"> Check the network status using the CC-Link IE TSN/CC-Link IE Field diagnostics of the engineering tool for errors. When no error has occurred on the network, there may be an influence from noise or a hardware failure. If the same error occurs again even after measures have been taken against noise, the module may be in failure. Please consult your local Mitsubishi representative.
8402H	Communication error	Safety communication connection being established, Response monitoring timeout	Response monitoring timeout was detected while the safety connection was being established in the safety communication with the master station.	<ul style="list-style-type: none"> Correct the values of "Transmission Interval Monitoring Time" of the module parameter as well as "Safety Communication Setting" of the master station. After that, refer to the following and set module parameters and perform the safety module validation according to the parameter setting procedure. (☞ Page 60 Parameter Setting) When the parameter setting has no errors, there may be an influence from noise or a hardware failure. If the same error occurs again even after measures have been taken against noise, the module may be in failure. Please consult your local Mitsubishi representative.
8403H	Communication error	Safety communication being refreshed, Response monitoring timeout	Response monitoring timeout was detected while the safety communication was being refreshed in the safety communication with the master station.	<ul style="list-style-type: none"> Correct the values of "Transmission Interval Monitoring Time" of the module parameter as well as "Safety Communication Setting" of the master station. After that, refer to the following and set module parameters and perform the safety module validation according to the parameter setting procedure. (☞ Page 60 Parameter Setting) When the parameter setting has no errors, there may be an influence from noise or a hardware failure. If the same error occurs again even after measures have been taken against noise, the module may be in failure. Please consult your local Mitsubishi representative.
8404H	Communication error	Safety communication error in processing, Response monitoring timeout	Response monitoring timeout was detected while a safety communication error was being processed in the safety communication with the master station.	<ul style="list-style-type: none"> Correct the values of "Transmission Interval Monitoring Time" of the module parameter as well as "Safety Communication Setting" of the master station. After that, refer to the following and set module parameters and perform the safety module validation according to the parameter setting procedure. (☞ Page 60 Parameter Setting) When the parameter setting has no errors, there may be an influence from noise or a hardware failure. If the same error occurs again even after measures have been taken against noise, the module may be in failure. Please consult your local Mitsubishi representative.
8405H	Communication error	Safety communication receiving interval monitoring timeout	Receiving interval monitoring timeout was detected in the safety communication with the master station.	<ul style="list-style-type: none"> Correct the values of "Transmission Interval Monitoring Time" of the module parameter as well as "Safety Communication Setting" of the master station. After that, refer to the following and set module parameters and perform the safety module validation according to the parameter setting procedure. (☞ Page 60 Parameter Setting) When the parameter setting has no errors, there may be an influence from noise or a hardware failure. If the same error occurs again even after measures have been taken against noise, the module may be in failure. Please consult your local Mitsubishi representative.
8406H	Communication error	Safety communication receive data delay detection	Unacceptable delay was detected in the analysis of the data received from the master station.	<ul style="list-style-type: none"> Correct the values of "Transmission Interval Monitoring Time" of the module parameter as well as "Safety Communication Setting" of the master station. After that, refer to the following and set module parameters and perform the safety module validation according to the parameter setting procedure. (☞ Page 60 Parameter Setting) When the parameter setting has no errors, there may be an influence from noise or a hardware failure. If the same error occurs again even after measures have been taken against noise, the module may be in failure. Please consult your local Mitsubishi representative.
8407H	Communication error	Safety communication receive data loss detection	A loss was detected in the analysis of the data received from the master station.	<ul style="list-style-type: none"> Correct the values of "Transmission Interval Monitoring Time" of the module parameter as well as "Safety Communication Setting" of the master station. After that, refer to the following and set module parameters and perform the safety module validation according to the parameter setting procedure. (☞ Page 60 Parameter Setting) When the parameter setting has no errors, there may be an influence from noise or a hardware failure. If the same error occurs again even after measures have been taken against noise, the module may be in failure. Please consult your local Mitsubishi representative.

APPENDICES

Appendix 1 Safety Remote I/O Signals

Safety remote I/O signals are dedicated signals for safety control that are assigned to the safety device of the master station. These signals can be used in the safety remote I/O module. The following table shows the list of safety remote I/O signals for the master station.

Item	Description
Safety remote input (SAIX)	Safety input signals from the safety remote I/O module to the master station
Safety remote output (SAIY)	Safety output signals from the master station to the safety remote I/O module

Point

For details on the safety device, refer to the following.

 MELSEC iQ-R CPU Module User's Manual (Application)

List of safety remote I/O signals

Input modules

Safety remote input (SAIX)		Safety remote output (SAIY)	
Signal direction: Safety remote I/O module → Master station		Signal direction: Master station → Safety remote I/O module	
Device number	Name	Device number	Name
SAIX0	Safety input signal X0	SAIY0	Use prohibited
SAIX1	Safety input signal X1	SAIY1	
SAIX2	Safety input signal X2	SAIY2	
SAIX3	Safety input signal X3	SAIY3	
SAIX4	Safety input signal X4	SAIY4	
SAIX5	Safety input signal X5	SAIY5	
SAIX6	Safety input signal X6	SAIY6	
SAIX7	Safety input signal X7	SAIY7	
SAIX8	Double input discrepancy state X0 X1	SAIY8	
SAIX9	Double input discrepancy state X2 X3	SAIY9	
SAIXA	Double input discrepancy state X4 X5	SAIYA	
SAIXB	Double input discrepancy state X6 X7	SAIYB	
SAIXC	Use prohibited	SAIYC	
SAIXD		SAIYD	
SAIXE		SAIYE	
SAIXF		SAIYF	
SAIX10		SAIY10	
SAIX11		SAIY11	
SAIX12		SAIY12	
SAIX13		SAIY13	
SAIX14		SAIY14	
SAIX15		SAIY15	
SAIX16		SAIY16	
SAIX17		SAIY17	
SAIX18		SAIY18	
SAIX19		SAIY19	
SAIX1A	SAIY1A		
SAIX1B	SAIY1B		
SAIX1C	SAIY1C		
SAIX1D	External power supply status	SAIY1D	
SAIX1E	Safety output control READY	SAIY1E	Safety output control initial processing request flag ^{*1}
SAIX1F	Safety output control initial processing completion flag ^{*1}	SAIY1F	Safety output control start flag ^{*1}

*1 Used only when the operation to be performed at the detection of external power supply voltage error is set as follows.
 2: Continue safety communication (With output interlock)



Output modules

Safety remote input (SA\X)		Safety remote output (SA\Y)		
Signal direction: Safety remote I/O module → Master station		Signal direction: Master station → Safety remote I/O module		
Device number	Name	Device number	Name	
SA\X0	Use prohibited	SA\Y0	Safety output signal Y0	
SA\X1		SA\Y1	Safety output signal Y1	
SA\X2		SA\Y2	Safety output signal Y2	
SA\X3		SA\Y3	Safety output signal Y3	
SA\X4		SA\Y4	Safety output signal Y4	
SA\X5		SA\Y5	Safety output signal Y5	
SA\X6		SA\Y6	Safety output signal Y6	
SA\X7		SA\Y7	Safety output signal Y7	
SA\X8		Use prohibited	SA\Y8	Use prohibited
SA\X9			SA\Y9	
SA\XA			SA\YA	
SA\XB			SA\YB	
SA\XC			SA\YC	
SA\XD			SA\YD	
SA\XE			SA\YE	
SA\XF			SA\YF	
SA\X10			SA\Y10	
SA\X11			SA\Y11	
SA\X12		SA\Y12		
SA\X13		SA\Y13		
SA\X14	SA\Y14			
SA\X15	SA\Y15			
SA\X16	SA\Y16			
SA\X17	SA\Y17			
SA\X18	SA\Y18			
SA\X19	SA\Y19			
SA\X1A	SA\Y1A			
SA\X1B	SA\Y1B			
SA\X1C	SA\Y1C			
SA\X1D	External power supply status	SA\Y1D		
SA\X1E	Safety output control READY	SA\Y1E	Safety output control initial processing request flag ^{*1}	
SA\X1F	Safety output control initial processing completion flag ^{*1}	SA\Y1F	Safety output control start flag ^{*1}	

*1 Used only when the operation to be performed at the detection of external power supply voltage error is set as follows.

2: Continue safety communication (With output interlock)

I/O combined module

Safety remote input (SA\X)		Safety remote output (SA\Y)	
Signal direction: Safety remote I/O module → Master station		Signal direction: Master station → Safety remote I/O module	
Device number	Name	Device number	Name
SA\X0	Safety input signal X0	SA\Y0	Safety output signal Y0
SA\X1	Safety input signal X1	SA\Y1	Safety output signal Y1
SA\X2	Safety input signal X2	SA\Y2	Safety output signal Y2
SA\X3	Safety input signal X3	SA\Y3	Safety output signal Y3
SA\X4	Safety input signal X4	SA\Y4	Safety output signal Y4
SA\X5	Safety input signal X5	SA\Y5	Safety output signal Y5
SA\X6	Safety input signal X6	SA\Y6	Safety output signal Y6
SA\X7	Safety input signal X7	SA\Y7	Safety output signal Y7
SA\X8	Double input discrepancy state X0 X1	SA\Y8	Fast logic initial request flag
SA\X9	Double input discrepancy state X2 X3	SA\Y9	Fast logic start flag
SA\XA	Double input discrepancy state X4 X5	SA\YA	Use prohibited
SA\XB	Double input discrepancy state X6 X7	SA\YB	
SA\XC	Fast logic READY	SA\YC	
SA\XD	Fast logic initial completion flag	SA\YD	
SA\XE	Use prohibited	SA\YE	
SA\XF		SA\YF	
SA\X10	External output monitor Y0	SA\Y10	
SA\X11	External output monitor Y1	SA\Y11	
SA\X12	External output monitor Y2	SA\Y12	
SA\X13	External output monitor Y3	SA\Y13	
SA\X14	External output monitor Y4	SA\Y14	
SA\X15	External output monitor Y5	SA\Y15	
SA\X16	External output monitor Y6	SA\Y16	
SA\X17	External output monitor Y7	SA\Y17	
SA\X18	Use prohibited	SA\Y18	
SA\X19		SA\Y19	
SA\X1A		SA\Y1A	
SA\X1B		SA\Y1B	
SA\X1C		SA\Y1C	
SA\X1D	External power supply status	SA\Y1D	
SA\X1E	Safety output control READY	SA\Y1E	Safety output control initial processing request flag ^{*1}
SA\X1F	Safety output control initial processing completion flag ^{*1}	SA\Y1F	Safety output control start flag ^{*1}

*1 Used only when the operation to be performed at the detection of external power supply voltage error is set as follows.

2: Continue safety communication (With output interlock)

Details of safety remote input signals

Safety input signals

■Device number

Name	Device number
Safety input signal X0 to X7	SAIX0 to SAIX7

■Description

These signals indicate the ON/OFF state of safety remote input (SAIX□) due to the external input signals (X□) of the safety remote I/O module.

However, depending on the settings of the safety double wiring function and input response time, the ON/OFF state of the safety input signals X□ (SAIX□) and that of the actual external input signals (X□) may differ. For details on the safety double wiring function, refer to the following.

☞ Page 74 Safety double wiring function

Point

When "Wiring selection of input" is set to "0: Not used" or "3: General single", the corresponding safety input signal X□ (SAIX□) is fixed to OFF.

When the ON or OFF state of the safety input signal X□ (SAIX□) cannot be read, refer to the following.

☞ Page 150 When the ON/OFF status of a safety input cannot be read

Double input discrepancy state

■Device number

Name	Device number
Double input discrepancy state X0 X1	SAIX8 to SAIXB
Double input discrepancy state X2 X3	
Double input discrepancy state X4 X5	
Double input discrepancy state X6 X7	

■Description

This area stores the double input discrepancy detection state. This area turns on when a double input discrepancy detection error has occurred in a pair of the corresponding input signals.

Fast logic READY

■Device number

Name	Device number
Fast logic READY	SAIXC

■Description

This flag indicates that the fast logic function is in the enabled state. The ON/OFF state of the fast logic function is indicated. This signal turns ON when all the following conditions are met.

- In safety drive mode
- When "Fast logic pattern setting" is set to anything other than "0: Not used"
- When fast logic initial request flag (SAIY8) is operated
- When fast logic initial completion flag (SAIXD) is operated
- When fast logic start flag (SAIY9) is operated

Fast logic initial completion flag

■Device number

Name	Device number
Fast logic initial completion flag	SAIXD

■Description

This operation flag starts the fast logic function.

Turning on and off the fast logic initial request flag (SA\Y8) in the safety drive mode turns on the fast logic initial completion flag (SAIXD). After that, turning on and off the fast logic start flag (SA\Y9) turns off the fast logic initial completion flag (SAIXD), turns on the fast logic READY (SA\XC), and enables the fast logic function of the safety remote I/O module.

External output monitor

■Device number

Name	Device number
External output monitor Y0 to Y7	SAIX10 to SAIX17

■Description

These signals indicate the ON/OFF state of the external output signals (Y□).

The state of the fast logic output can be monitored by monitoring the external output signal (Y□).

Do not use external output monitor Y□ in a program that operates safety functions. If the signal is used, the correct operation of the safety remote I/O module safety functions is not guaranteed.

External power supply status

■Device No.

Name	Device number
External power supply status	SAIX1D

■Description

This signal indicates the external power supply status.

When "Operation setting of external power supply voltage error detection" is set to "1: Continue safety communication (Without output interlock)", the signal is also used as the condition to cancel the interlock by an external circuit.

When "Operation setting of external power supply voltage error detection" is set to "2: Continue safety communication (With output interlock)", the signal is also used as the condition to cancel the interlock and operate relevant flags to restart the safety output control.

Signal status	External power supply status
OFF	External power supply error
ON	External power supply in normal state.

Safety output control READY

■Device No.

Name	Device number
Safety output control READY	SAIX1E

■Description

This signal indicates that the safety output control is enabled.

It is used for the 'operation setting function at detection of external power supply voltage error', and turns on when all of the following conditions are met.

- When the module is in the safety drive mode
- When the external power supply is normal state
- When the operation of flags^{*1} to restart the safety output control is completed

*1 Use this signal when "Operation setting of external power supply voltage error detection" is set to "2: Continue safety communication (With output interlock)".

Details of safety remote output signals

Safety output signal

■Device number

Name	Device number
Safety output signal Y0 to Y7	SAIY0 to SAIY7

■Description

These signals turn on or off the external output signals (Y□) of the safety remote I/O module.

When the safety output wiring selection function setting or the fast logic function is enabled, the ON/OFF state of the safety output signal Y□ (SAIY□) and that of the actual external output signal (Y□) may differ. For details on each function, refer to the following.

☞ Page 79 Safety double wiring function

☞ Page 82 Fast logic function

If the safety output signal Y□ (SAI Y□) cannot be turned on, refer to the following.

☞ Page 151 When safety output cannot be turned on

Fast logic initial request flag

■Device number

Name	Device number
Fast logic initial request flag	SAIY8

■Description

This operation flag starts the fast logic function. For details on the operation, refer to the following.

☞ Page 173 Fast logic initial completion flag

Fast logic start flag

■Device number

Name	Device number
Fast logic start flag	SAIY9

■Description

This operation flag starts the fast logic function. For details on the operation, refer to the following.

☞ Page 173 Fast logic initial completion flag

Details of safety remote I/O signals

Control signals for safety output interlock cancellation

■Device No.

Name	Device number
Safety output control initial processing completion flag	SA\X1F
Safety output control initial processing request flag	SA\Y1E
Safety output control start flag	SA\Y1F

■Description

After causes of the external power supply voltage error are eliminated, the safety program uses these control signals to cancel the safety output interlock.

■Operation

In the safety drive mode, Safety output control READY (SA\X1E) turns on and the safety output control is enabled by performing the following operations.

1. After checking that External power supply status (SA\X1D) is on, turn on Safety output control initial processing request flag (SA\Y1E).
2. After checking that Safety output control initial processing completion flag (SA\X1F) is on, turn off Safety output control initial processing request flag (SA\Y1E).
3. After checking that Safety output control initial processing completion flag (SA\X1F) is off, turn on Safety output control start flag (SA\Y1F).
4. After checking that Safety output control READY (SA\X1E) is on, turn off Safety output control start flag (SA\Y1F).
5. After Safety output control READY (SA\X1E) turns on, turn on safety output signals (SA\Yn/Yn+1) so that output signals (Yn/Yn+1) turn on.

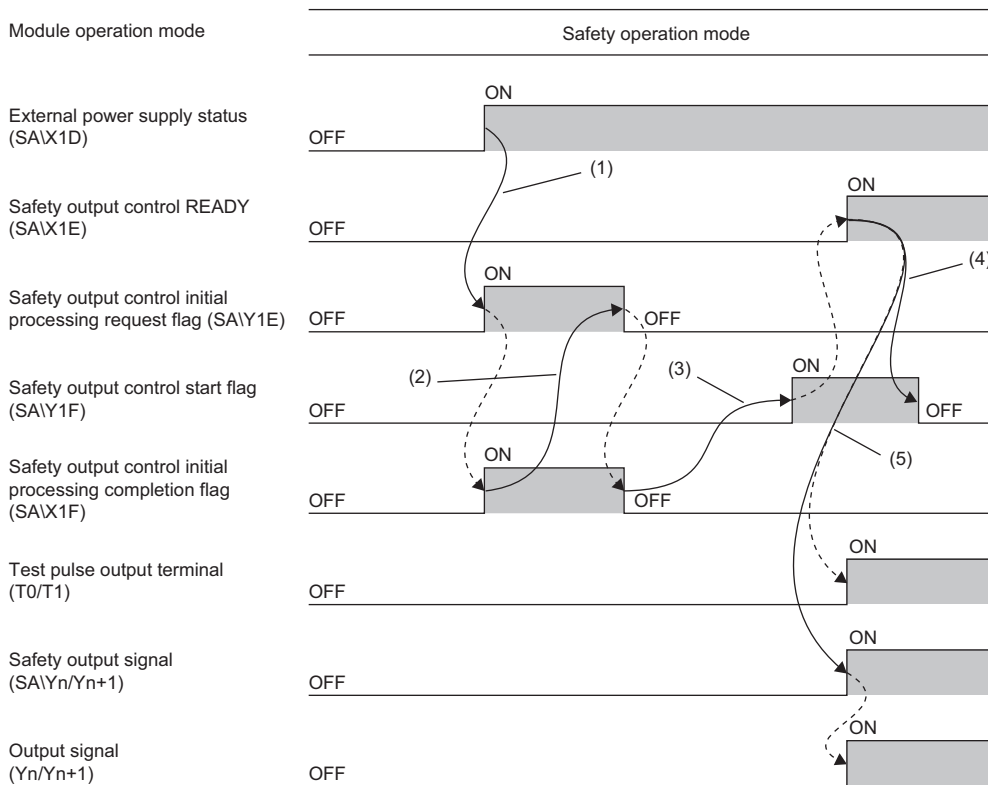

- (1) After checking that External power supply status (SAIX1D) is on, turn on Safety output control initial processing request flag (SAIY1E) so that Safety output control initial processing completion flag (SAIX1F) turns on.
 - (2) After checking that Safety output control initial processing completion flag (SAIX1F) is on, turn off Safety output control initial processing request flag (SAIY1E) so that Safety output control initial processing completion flag (SAIX1F) turns off.
 - (3) After checking that Safety output control initial processing completion flag (SAIX1F) is off, turn on Safety output control start flag (SAIY1F) so that Safety output control READY (SAIX1E) turns on.
 - (4) After checking that Safety output control READY (SAIX1E) is on, turn off Safety output control start flag (SAIY1F).
 - (5) Safety output control READY (SAIX1E) turns on, and the test pulse output terminals (T0/T1) turn on. Turn on safety output signals (SAIYn/Yn+1) so that output signals (Yn/Yn+1) turn on.
- > Controlled by the safety remote I/O module
 -----> Controlled by the program

Appendix 2 Remote Control/Monitor Signals

Remote control/monitor signals are used as external input signals for functions other than the safety functions of the safety remote I/O module. Do not use these signals in a program that operates the safety functions. If used, correct operation as the safety remote I/O module is not guaranteed.

The following table shows the list of the remote control/monitor signals for the master station.

Item	Description
Remote control/monitor input signal (RX)	Control/monitor signals from the safety remote I/O module to the master station
Remote control/monitor output signal (RY)	There are no control/monitor signals from the master station to the safety remote I/O module. Using any of RY signals is not allowed.

Point

- The external I/O signals are communicated to the master station using the safety remote I/O signals (SAIX and SAIX).
- When "Link Stop" is performed using the CC-Link IE TSN/CC-Link IE Field diagnostics or the cyclic transmission is stopped from the link special relay (SB) or link special register (SW), the input status of the remote control/monitor input signal (RX) is retained. Thus, the status may be different from the actual status of the safety remote I/O module.

List of remote control/monitor signals

The following table lists the assignment of the remote control/monitor signals.

Remote control/monitor input signal (RX)		Remote control/monitor output signal (RY)	
Signal direction: Safety remote I/O module → Master station		Signal direction: Master station → Safety remote I/O module	
Device number	Name	Device number	Name
RX0 to RXF	External input signal ^{*1}	RY0 to RYF	Use prohibited

*1 For the input module and I/O combined module

Details of remote control/monitor signals

External input signal

The following table lists the assignment of the external input signals.

Device number	Name
RX0	External input signal X0
RX1	External input signal X1
RX2	External input signal X2
RX3	External input signal X3
RX4	External input signal X4
RX5	External input signal X5
RX6	External input signal X6
RX7	External input signal X7
RX8 to RXF	Use prohibited

Point

Do not read or write data from/to the use-prohibited areas. If data is read or written, the correct operation of the safety remote I/O module cannot be guaranteed.

■ External input signals (RX0 to RX7)

These signals are external input signals from the safety remote I/O module to the master station. These signals can be used only in the safety drive mode.

For details on the safety drive mode, refer to the following.

 Page 34 Operation mode and state transition

Point

When "Wiring selection of input" is set to "3: General single", the corresponding external input signals (RX0 to RX7) are fixed to OFF.

Appendix 3 Remote Register

List of remote registers

This section lists remote registers for a master/local module.

The remote registers shown are example with the remote registers of the safety remote I/O module assigned to the RWr0 to RWr3 and RWw0 to RWw3.

Remote register (RWr)		Remote register (RWw)	
Signal direction: Safety remote I/O module → Master/local module		Signal direction: Master/local module → Safety remote I/O module	
Device number	Name	Device number	Name
RWr0	Module status area	RWw0	Use prohibited
RWr1	Error code area	RWw1	
RWr2	External input monitor area* ¹	RWw2	
RWr3	Parameter automatic setting status monitor area	RWw3	

*1 For the input module and I/O combined module



Do not read or write data from/to the use-prohibited areas. If data is read or written, the correct operation of the safety remote I/O module cannot be guaranteed.

Details of remote registers

Module status area

■ Device number

Name	Device number
Module status area	RWr0

■ Description

The following table indicates the safety remote I/O module status.

b15	b14	b13	b12	b11	b10	b9	b8	b7	b6	b5	b4	b3	b2	b1	b0
Use prohibited					(4)	Use prohibited						(3)	(2)	(1)	

(1) Safety module enabled flag

(2) Communication speed

(3) CC-Link IE TSN Class setting status*¹

(4) Error status flag

*1 (3) is use-prohibited for the module with the firmware version "02" or earlier.

■ Safety module enabled flag (RWr0.b0)

The safety module enabled flag (RWr0.b0) turns on when the set parameters can be used in the safety drive mode. When the safety module enabled flag (RWr0.b0) is off, the mode cannot be switched to the safety drive mode.

For details on the safety drive mode, refer to the following.

Page 34 Operation mode and state transition



The safety module enabled flag (RWr0.b0) turns off when parameters are set or changed with the engineering tool, when the safety remote I/O module detects a parameter error, or when station parameters are changed. When "Safety module validation" is performed after the parameters have been set with the engineering tool, the safety module enabled flag turns on.

■Communication speed (RWr0.b1)

The communication speed (RWr0.b1) indicates a communication speed at which the safety remote I/O module is operating.

- ON: 100Mbps
- OFF: 1Gbps

■CC-Link IE TSN Class setting status (RWr0.b2)

The CC-Link IE TSN Class setting status (RWr0.b2) indicates the setting status of the CC-Link IE TSN Class.

- ON: CC-Link IE TSN Class A
- OFF: CC-Link IE TSN Class B

■Error status flag (RWr0.b10)

The error status flag (RWr0.b10) turns on when an error occurs.

- Moderate errors and major errors

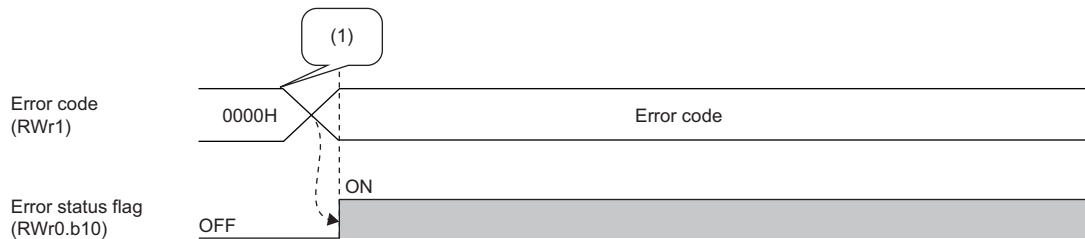

- (1) Moderate error or major error occurred
- > Implemented with the safety remote I/O module

- Minor error

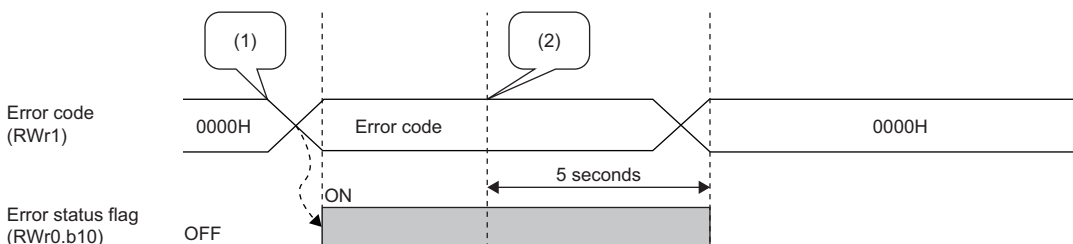

- (1) Minor error occurred
- (2) Minor error was eliminated
- > Implemented with the safety remote I/O module

Point

- When a moderate error or major error occurs, recovery from the error status is not possible unless the error is cleared and the safety remote I/O module is restarted (by powering off and on the module or performing remote reset).
- When a minor error occurs, five seconds after the cause of the error is eliminated, the error code (RWr1) is automatically set to 0H and the error status flag (RWr0.b10) is turned off at the same time.

Error code area

■Device number

Name	Device number
Error code area	RWr1

■Description

The error code is stored in this area when an error occurs. ( Page 157 List of Error Codes)

Errors that occurred in the past can be checked in the error history. ( Page 155 Method for Checking Error Codes)

External input monitor area

■Device number

Name	Device number
External input monitor area	RWr2

■Description

The ON/OFF state of external input signals (X□) is indicated.

By monitoring the external input signals (X□), double discrepancy detection errors can be troubleshooted easily when they occur.

Use of b15 to b8 is prohibited.

External input monitor X7 to external input monitor X0 are assigned to b7 to b0.

Parameter automatic setting status monitor area

■Device number

Name	Device number
Parameter automatic setting status monitor area	RWr3

■Description

This area stores the parameter automatic setting execution status. Details are provided below.

Parameter automatic setting execution status	Monitored value	Description
Not executed	0000H	Parameter automatic setting is not executed.
Completed successfully (non-volatile memory updated)	0002H	Parameter automatic setting was executed and completed successfully. The non-volatile memory is updated with the parameters for the parameter automatic setting.
Completed with an error	0003H	Parameter automatic setting was executed but completed with an error.
Completed successfully (non-volatile memory not updated)	0004H	Parameter automatic setting was executed and completed successfully. The non-volatile memory is not updated when parameter automatic setting is performed under the following conditions where parameter automatic setting is not required or cannot be performed. <ul style="list-style-type: none">• When the parameters stored in the non-volatile memory are the same as the parameters for the parameter automatic setting• When a non-volatile memory data error (parameter) has occurred

Appendix 4 Remote Buffer Memory

Remote buffer memory is divided into a parameter area, monitor area, and module control data area for each address. The initial value is set in remote buffer memory at power-on or hardware reset. Data can be read or written from/to remote buffer memory areas by using SLMP commands or dedicated instructions. For SLMP commands, refer to the following.

☞ Page 130 SLMP Communication Function

Point

Do not read/write data from/to a use prohibited area of remote buffer memory. If data is read or written, the correct operation of the safety remote I/O module cannot be guaranteed.

Remote buffer memory list

The remote buffer memory list of the safety remote I/O module is shown below. The remote buffer memory of the safety remote I/O module is allocated as follows.

Remote buffer memory address		Area	Target
Decimal	Hexadecimal		
0 to 255	0000H to 00FFH	Parameter area	Parameter data per station
256 to 511	0100H to 01FFH		Parameter data per module
512 to 1279	0200H to 04FFH		Use prohibited
1280 to 2559	0500H to 09FFH	Monitoring area	Use prohibited
2560 to 5375	0A00H to 14FFH	Module control data area	Use prohibited

Point

Do not use SLMP commands as well as the REMFR instruction, REMFRIP instruction, REMTO instruction, REMTOIP instruction, and SLMPSND instruction of the dedicated instructions, to access the areas other than the above. Doing so causes a remote buffer memory access error (error code: 0201H), and the response to the SLMP command or dedicated instruction becomes an abnormal response.

- SLMP commands: An abnormal response is returned, with C05CH stored in the end code of that message.
- Dedicated instructions: The dedicated instruction is completed with an error, and 4041H is stored in the REMFR/REMTO instruction execution status of the link special register of the master station.

Parameter area

Parameters can be set in these areas using the parameter setting window of the engineering tool. Parameters cannot be set using the program.

If these parameters are changed, the safety module valid flag (RWr0.b0) turns OFF and the safety remote I/O module enters the standby mode.

For details on the standby mode, refer to the following.

☞ Page 34 Operation mode and state transition

Point

- Always use the engineering tool to set parameters.
- When a use-prohibited area is read from/written to, the dedicated instruction is completed successfully.

Parameter data per station

○: Enabled, ×: Disabled

Address		Name		Default value	Read	Write
Decimal	Hexadecimal					
0	0000H	Safety setting	Transmission interval monitoring time	35	○	○
1	0001H		I/O LED indication setting at error occurrence	0	○	○
2	0002H		Safety approval code	FFFFFFFFH	○	○
3	0003H					
4	0004H	Operation setting of external power supply voltage error detection	0	○	○	
5 to 10	0005H to 000AH	Use prohibited	—	×	×	
11	000BH	Communication speed setting	0	○	○	
12 to 255	000CH to 00FFH	Use prohibited	—	×	×	

Parameter data per module (input module)

○: Enabled, ×: Disabled

Address		Name	Default value*1	Read	Write			
Decimal	Hexadecimal							
256 to 271	0100H to 010FH	Use prohibited	—	×	×			
272	0110H	Wiring selection of input X0	0000H	○	○			
273	0111H	Wiring selection of input X1						
274	0112H	Wiring selection of input X2						
275	0113H	Wiring selection of input X3						
276	0114H	Wiring selection of input X4						
277	0115H	Wiring selection of input X5						
278	0116H	Wiring selection of input X6						
279	0117H	Wiring selection of input X7	—	×	×			
280 to 287	0118H to 011FH	Use prohibited						
288	0120H	Input response time X0				0000H	○	○
289	0121H	Input response time X1						
290	0122H	Input response time X2						
291	0123H	Input response time X3						
292	0124H	Input response time X4						
293	0125H	Input response time X5						
294	0126H	Input response time X6						
295	0127H	Input response time X7	—	×	×			
296 to 303	0128H to 012FH	Use prohibited						
304	0130H	Double input discrepancy detection setting X0, X1				0000H	○	○
305	0131H	Double input discrepancy detection setting X2, X3						
306	0132H	Double input discrepancy detection setting X4, X5						
307	0133H	Double input discrepancy detection setting X6, X7						
308 to 319	0134H to 013FH	Use prohibited	—	×	×			
320	0140H	Double input discrepancy auto recovery setting	0000H	○	○			
321 to 335	0141H to 014FH	Use prohibited	—	×	×			
336	0150H	Double input discrepancy detection time X0, X1	0001H	○	○			
337	0151H	Double input discrepancy detection time X2, X3						
338	0152H	Double input discrepancy detection time X4, X5						
339	0153H	Double input discrepancy detection time X6, X7						
340 to 351	0154H to 015FH	Use prohibited	—	×	×			
352	0160H	Input dark test execution setting X0	0000H	○	○			
353	0161H	Input dark test execution setting X1						
354	0162H	Input dark test execution setting X2						
355	0163H	Input dark test execution setting X3						
356	0164H	Input dark test execution setting X4						
357	0165H	Input dark test execution setting X5						
358	0166H	Input dark test execution setting X6						
359	0167H	Input dark test execution setting X7	—	×	×			
360 to 367	0168H to 016FH	Use prohibited						
368	0170H	Input dark test pulse OFF time setting				0000H	○	○
369	0171H	Number of pulse output for input dark test						
370 to 511	0172H to 01FFH	Use prohibited	—	×	×			

*1 This value is a factory default.

A

Parameter data per module (output module)

○: Enabled, ×: Disabled

Address		Name	Default value*1	Read	Write
Decimal	Hexadecimal				
256 to 383	0100H to 017FH	Use prohibited	—	×	×
384	0180H	Wiring selection of output Y0	0000H	○	○
385	0181H	Wiring selection of output Y1			
386	0182H	Wiring selection of output Y2			
387	0183H	Wiring selection of output Y3			
388	0184H	Wiring selection of output Y4			
389	0185H	Wiring selection of output Y5			
390	0186H	Wiring selection of output Y6			
391	0187H	Wiring selection of output Y7			
392 to 399	0188H to 018FH	Use prohibited	—	×	×
400	0190H	Output dark test execution setting Y0	0000H	○	○
401	0191H	Output dark test execution setting Y1			
402	0192H	Output dark test execution setting Y2			
403	0193H	Output dark test execution setting Y3			
404	0194H	Output dark test execution setting Y4			
405	0195H	Output dark test execution setting Y5			
406	0196H	Output dark test execution setting Y6			
407	0197H	Output dark test execution setting Y7			
408 to 415	0198H to 019FH	Use prohibited	—	×	×
416	01A0H	Output dark test pulse OFF time setting Y0	0000H	○	○
417	01A1H	Output dark test pulse OFF time setting Y1			
418	01A2H	Output dark test pulse OFF time setting Y2			
419	01A3H	Output dark test pulse OFF time setting Y3			
420	01A4H	Output dark test pulse OFF time setting Y4			
421	01A5H	Output dark test pulse OFF time setting Y5			
422	01A6H	Output dark test pulse OFF time setting Y6			
423	01A7H	Output dark test pulse OFF time setting Y7			
424 to 431	01A8H to 01AFH	Use prohibited	—	×	×
432	01B0H	Number of pulse output for output dark test Y0	0000H	○	○
433	01B1H	Number of pulse output for output dark test Y1			
434	01B2H	Number of pulse output for output dark test Y2			
435	01B3H	Number of pulse output for output dark test Y3			
436	01B4H	Number of pulse output for output dark test Y4			
437	01B5H	Number of pulse output for output dark test Y5			
438	01B6H	Number of pulse output for output dark test Y6			
439	01B7H	Number of pulse output for output dark test Y7			
440 to 511	01B8H to 01FFH	Use prohibited	—	×	×

*1 This value is a factory default.

Parameter data per module (I/O combined module)

○: Enabled, ×: Disabled

Address		Name	Default value ^{*1}	Read	Write
Decimal	Hexadecimal				
256 to 271	0100H to 010FH	Use prohibited	—	×	×
272	0110H	Wiring selection of input X0	0000H	○	○
273	0111H	Wiring selection of input X1			
274	0112H	Wiring selection of input X2			
275	0113H	Wiring selection of input X3			
276	0114H	Wiring selection of input X4			
277	0115H	Wiring selection of input X5			
278	0116H	Wiring selection of input X6			
279	0117H	Wiring selection of input X7			
280 to 287	0118H to 011FH	Use prohibited	—	×	×
288 to 295	0120H to 0127H	Input response time	0000H	○	○
288	0120H	Input response time X0	0000H		
289	0121H	Input response time X1			
290	0122H	Input response time X2			
291	0123H	Input response time X3			
292	0124H	Input response time X4			
293	0125H	Input response time X5			
294	0126H	Input response time X6			
295	0127H	Input response time X7			
296 to 303	0128H to 012FH	Use prohibited	—	×	×
304	0130H	Double input discrepancy detection setting X0, X1	0000H	○	○
305	0131H	Double input discrepancy detection setting X2, X3			
306	0132H	Double input discrepancy detection setting X4, X5			
307	0133H	Double input discrepancy detection setting X6, X7			
308 to 319	0134H to 013FH	Use prohibited	—	×	×
320	0140H	Double input discrepancy auto recovery setting	0000H	○	○
321 to 335	0141H to 014FH	Use prohibited	—	×	×
336	0150H	Double input discrepancy detection time X0, X1	0001H	○	○
337	0151H	Double input discrepancy detection time X2, X3			
338	0152H	Double input discrepancy detection time X4, X5			
339	0153H	Double input discrepancy detection time X6, X7			
340 to 351	0154H to 015FH	Use prohibited	—	×	×
352	0160H	Input dark test execution setting X0	0000H	○	○
353	0161H	Input dark test execution setting X1			
354	0162H	Input dark test execution setting X2			
355	0163H	Input dark test execution setting X3			
356	0164H	Input dark test execution setting X4			
357	0165H	Input dark test execution setting X5			
358	0166H	Input dark test execution setting X6			
359	0167H	Input dark test execution setting X7			
360 to 367	0168H to 016FH	Use prohibited	—	×	×
368	0170H	Input dark test pulse OFF time setting	0000H	○	○
369	0171H	Number of pulse output for input dark test	0000H	○	○
370 to 383	0172H to 017FH	Use prohibited	—	×	×

A

Address		Name	Default value ^{*1}	Read	Write
Decimal	Hexadecimal				
384	0180H	Wiring selection of output Y0	0000H	○	○
385	0181H	Wiring selection of output Y1			
386	0182H	Wiring selection of output Y2			
387	0183H	Wiring selection of output Y3			
388	0184H	Wiring selection of output Y4			
389	0185H	Wiring selection of output Y5			
390	0186H	Wiring selection of output Y6			
391	0187H	Wiring selection of output Y7			
392 to 399	0188H to 018FH	Use prohibited	—	×	×
400	0190H	Output dark test execution setting Y0	0000H	○	○
401	0191H	Output dark test execution setting Y1			
402	0192H	Output dark test execution setting Y2			
403	0193H	Output dark test execution setting Y3			
404	0194H	Output dark test execution setting Y4			
405	0195H	Output dark test execution setting Y5			
406	0196H	Output dark test execution setting Y6			
407	0197H	Output dark test execution setting Y7			
408 to 415	0198H to 019FH	Use prohibited	—	×	×
416	01A0H	Output dark test pulse OFF time setting Y0	0000H	○	○
417	01A1H	Output dark test pulse OFF time setting Y1			
418	01A2H	Output dark test pulse OFF time setting Y2			
419	01A3H	Output dark test pulse OFF time setting Y3			
420	01A4H	Output dark test pulse OFF time setting Y4			
421	01A5H	Output dark test pulse OFF time setting Y5			
422	01A6H	Output dark test pulse OFF time setting Y6			
423	01A7H	Output dark test pulse OFF time setting Y7			
424 to 431	01A8H to 01AFH	Use prohibited	—	×	×
432	01B0H	Number of pulse output for output dark test Y0	0000H	○	○
433	01B1H	Number of pulse output for output dark test Y1			
434	01B2H	Number of pulse output for output dark test Y2			
435	01B3H	Number of pulse output for output dark test Y3			
436	01B4H	Number of pulse output for output dark test Y4			
437	01B5H	Number of pulse output for output dark test Y5			
438	01B6H	Number of pulse output for output dark test Y6			
439	01B7H	Number of pulse output for output dark test Y7			
440 to 463	01B8H to 01CFH	Use prohibited	—	×	×
464	01D0H	Fast logic pattern setting	0000H	○	○
465	01D1H	Fast logic interlock mode setting	0000H	○	○
466 to 511	01D2H to 01FFH	Use prohibited	—	×	×

*1 This value is a factory default.

Details of remote buffer memory areas

The remote buffer memory details of the safety remote I/O module are shown below.

Parameter data per station

■Transmission interval monitoring time

Set the safety input data transmission interval time of the safety remote I/O module. This time is to be monitored by the master station.

Address (hexadecimal)	Name	Setting range	Default value
0000H	Safety setting Transmission interval monitoring time	4 to 1000ms	35ms

Point

Set a value that meets all the following calculation formulas for the transmission interval monitoring time.

- $TM \geq SRref \times 2$
- $TM \geq SCmst \times 2 + LS \times 2$

SRref: Safety remote station refresh response processing time

TM: Transmission interval monitoring time

SCmst: Safety cycle time of the master station *1

LS: Communication cycle interval *2

When TM: Transmission interval monitoring time exceeds the upper limit value of the setting range, check and correct SCmst: Safety cycle time of the master station and LS: Communication cycle interval.

If "Communication Period Setting" is set to other than "Basic Period" in "Network Configuration Settings", depending on the setting, multiply LS: Communication cycle interval by the multiple specified in "Multiple Period Setting" in "Communication Period Setting" in "Basic Settings". For the magnification, refer to the following.

 User's manual for the master station used

For the setting values of "Transmission Interval Monitoring Time" and "Safety Refresh Monitoring Time" for the master station, refer to the following.

 User's manual for the master station used

*1 For details on the safety cycle time, refer to the following.

 User's manual for the master station used

*2 For the communication cycle interval, refer to the following.

 User's manual for the master station used

■I/O LED indication setting at error occurrence

Set whether the input and output points where an error is detected is indicated with an I/O LED.

Address (hexadecimal)	Name	Setting range	Default value
0001H	I/O LED indication setting at error occurrence	0: No indication of error point 1: Indication of error point	0: No indication of error point

When "1: Indication of error point" is set, the I/O LED where an error occurs flashes.

The LED flashes with the following errors.

- Double input discrepancy detection error
- Input dark test error
- I/O data error
- Output read-back error
- Output dark test error

For the minor error from which the module can recover, the LED flashing stops when the error is cleared.

The value set in b1 to b15 will be ignored.

■Safety approval code

Set a value that identifies the individual safety remote I/O module. Set a value that does not overlap with those of other safety remote I/O modules, such as a MAC address.*1

*1 When setting a MAC address, set the lower eight digits of the MAC address.

Address (hexadecimal)	Name	Setting range	Default value
0002H	Safety approval code (lower 16 bits)	00000000H to FFFFFFFFH	FFFFFFFH
0003H	Safety approval code (upper 16 bits)		

■Communication speed setting

Set a communication speed with which the safety remote I/O module links up.

Address (hexadecimal)	Name	Setting range	Default value
000BH	Communication speed setting	0: 1Gbps 1: 100Mbps 2: Automatic	0: 1Gbps

■Operation setting of external power supply voltage error detection

Set the operation to be performed at the detection of external power supply voltage error.

Address (hexadecimal)	Name	Setting range	Default value
0004H	Operation setting of external power supply voltage error detection	0: Stop safety communication 1: Continue safety communication (Without output interlock) 2: Continue safety communication (With output interlock)	0: Stop safety communication

Parameter data per module

■Wiring selection of input

Set the input wiring method in units of 1 point.

Module	Address (hexadecimal)	Name	Setting range	Default value
Input module	0110H to 0117H	Wiring selection of inputs X0 to X7	0: Not used 1: Safety double wiring (NC/NC) 2: Safety single 3: General single	0: Not used
Output module	—			
I/O combined module	0110H to 0117H			

Point

- When "Wiring selection of input" X_n (n: even number) is set to "1: Safety double wiring (NC/NC)", X_{n+1}, the partner of X_n, is automatically set to "1: Safety double wiring (NC/NC)", and no other settings are possible.
- When X_n (n: even number) in "Wiring selection of input" is set to "0: Not used", "2: Safety single", or "3: General single", set X_{n+1}, the partner of X_n, to other than "1: Safety double wiring (NC/NC)". When "1: Safety double wiring (NC/NC)" is set, a parameter data error (wiring selection of input) (error code: 0560H) occurs when "Write to PLC" is executed.
- For unused input terminals, set "0: Not used" in "Wiring selection of input".
- When "Fast logic pattern setting" is set to other than "0: Not used", this parameter is ignored.

Input response time

Set the input response time of the input signal in units of 1 point.

Module	Address (hexadecimal)	Name	Setting range	Default value
Input module	0120H to 0127H	Input response time X0 to X7	0: 1.0ms 1: 1.5ms 2: 5ms 3: 10ms 4: 20ms 5: 50ms 6: 70ms	0: 1.0ms
Output module	—			
I/O combined module	0120H to 0127H			

Point

- Select a longer time than the input dark test pulse OFF time for the parameter. When "1: Do not perform" is selected for "Input dark test execution setting", a shorter time than the input dark test pulse OFF time can be set for the parameter.
- When "Wiring selection of input" is set to "0: Not used", this parameter is ignored.

Double input discrepancy detection setting

Set whether to detect double input discrepancy in units of 2 points.

Module	Address (hexadecimal)	Name	Setting range	Default value
Input module	0130H to 0133H	Double input discrepancy detection setting (X0, X1) to (X6, X7)	0: Detect 1: Do not detect	0: Detect
Output module	—			
I/O combined module	0130H to 0133H			

Point

- When "Wiring selection of input" is set to "0: Not used", "2: Safety single", or "3: General single", or when "Fast logic pattern setting" is set to "4: Pattern 4", this parameter is ignored.
- When "Fast logic pattern setting" is set to "2: Pattern 2" or "3: Pattern 3", double input discrepancy detection settings X6 and X7 are ignored.

Double input discrepancy auto recovery setting

Set whether or not to use auto recovery when a double input discrepancy detection error occurs, on a module-by-module basis.

Module	Address (hexadecimal)	Name	Setting range	Default value
Input module	0140H	Double input discrepancy auto recovery setting	0: Not used 1: Used	0: Not used
Output module	—			
I/O combined module	0140H			

Point

When "0: Not used", "2: Safety single", or "3: General single" is selected in "Wiring selection of input" for all points, when "Fast logic pattern setting" is set to "4: Pattern 4", or when "Double input discrepancy detection setting" is set to "1: Do not detect", double input discrepancy detection errors do not occur and thus auto recovery is not performed.

■Double input discrepancy detection time

Set the double input discrepancy detection time in units of 2 points.

Module	Address (hexadecimal)	Name	Setting range	Default value
Input module	0150H to 0153H	Double input discrepancy detection time (X0, X1) to (X6, X7)	1 to 6000 (×10ms)	1 (×10ms)
Output module	—			
I/O combined module	0150H to 0153H			

Point

- When "Wiring selection of input" is set to "0: Not used", "2: Safety single", or "3: General single", when "Fast logic pattern setting" is set to "4: Pattern 4", or when "Double input discrepancy detection setting" is set to "1: Do not detect", this parameter is ignored.
- When "Fast logic pattern setting" is set to "2: Pattern 2" or "3: Pattern 3", double input discrepancy detection times X6 and X7 are ignored.

■Input dark test execution setting

Set whether to perform the input dark test function of the diagnostic function in the safety remote I/O module in units of 1 point.

Module	Address (hexadecimal)	Name	Setting range	Default value
Input module	0160H to 0167H	Input dark test execution setting X0 to X7	0: Perform 1: Do not perform	0: Perform
Output module	—			
I/O combined module	0160H to 0167H			

Point

When "Wiring selection of input" is set to "0: Not used" or "3: General single", this parameter is ignored.

■Input dark test pulse OFF time setting

Set the width of the OFF pulses that the terminals T0 and T1 output, on a module-by-module basis.

Module	Address (hexadecimal)	Name	Setting range	Default value
Input module	0170H	Input dark test pulse OFF time	0: 400 μ s 1: 1ms 2: 2ms	0: 400 μ s
Output module	—			
I/O combined module	0170H			

Point

When "Wiring selection of input" is set to "0: Not used" or "3: General single", or when "Input dark test execution setting" is set to "1: Do not perform", this parameter is ignored.

■Number of pulse output for input dark test

Set the number of pulse output for input dark test on a module-by-module basis.

Module	Address (hexadecimal)	Name	Setting range	Default value
Input module	0171H	Number of pulse output for input dark test	0: 1 time 1: 2 times 2: 3 times	0: 1 time
Output module	—			
I/O combined module	0171H			

Point

When "Wiring selection of input" is set to "0: Not used" or "3: General single", or when "Input dark test execution setting" is set to "1: Do not perform", this parameter is ignored.

■Wiring selection of output

Set the wiring selection of output in units of 1 point.

Module	Address (hexadecimal)	Name	Setting range	Default value
Input module	—	Wiring selection of output Y0 to Y7	0: Not used 1: Safety double wiring (Source/Source) 2: Safety single	0: Not used
Output module	0180H to 0187H			
I/O combined module	0180H to 0187H			

Point

- When Y_n (n: even number) in "Wiring selection of output" is set to "1: Safety double wiring (Source/Source)", only "1: Safety double wiring (Source/Source)" can be set for Y_{n+1}. Outputting ON of a pair of outputs turns on the output signal.
- For unused output terminals, set "0: Not used" in "Wiring selection of output".
- When Y_n (n: even number) in "Wiring selection of output" is set to "0: Not used" or "2: Safety single", set a value other than "1: Safety double wiring (Source/Source)" for Y_{n+1}.
- When "Fast logic pattern setting" is set to other than "0: Not used", this parameter is ignored.

■Output dark test execution setting

Set whether to perform the output dark test function of the diagnostic function in the safety remote I/O module in units of 1 point.

Module	Address (hexadecimal)	Name	Setting range	Default value
Input module	—	Output dark test execution setting Y0 to Y7	0: Perform 1: Do not perform	0: Perform
Output module	0190H to 0197H			
I/O combined module	0190H to 0197H			

Point

- When "Wiring selection of output" is set to "0: Not used", the points that are set to "0: Not used" ignore this setting value.
- When "Wiring selection of output" Y_n (n: even number) is set to "1: Safety double wiring (Source/Source)", set the same value for "Output dark test execution setting" Y_n and Y_{n+1}, the partner of Y_n.

A

■Output dark test pulse OFF time setting

Set the width of OFF pulses used for an output dark test in units of 1 point.

Module	Address (hexadecimal)	Name	Setting range	Default value
Input module	—	Output dark test pulse OFF time setting Y0 to Y7	0: 400 μ s 1: 1ms 2: 2ms	0: 400 μ s
Output module	01A0H to 01A7H			
I/O combined module	01A0H to 01A7H			

Point

- When "Wiring selection of output" is set to "0: Not used" or "Output dark test execution setting" is set to "1: Do not perform", the points with those settings ignore this setting value.
- When "Wiring selection of output" Yn (n: even number) is set to "1: Safety double wiring (Source/Source)", set the same value for "Output dark test pulse OFF time setting" Yn and Yn+1, the partner of Yn.

■Number of pulse output for output dark test

Set the number of pulse output for output dark test in units of 1 point.

Module	Address (hexadecimal)	Name	Setting range	Default value
Input module	—	Number of pulse output for output dark test Y0 to Y7	0: 1 time 1: 2 times 2: 3 times	0: 1 time
Output module	01B0H to 01B7H			
I/O combined module	01B0H to 01B7H			

Point

- When "Wiring selection of output" is set to "0: Not used" or "Output dark test execution setting" is set to "1: Do not perform", the points with those settings ignore this setting value.
- When "Wiring selection of output" Yn (n: even number) is set to "1: Safety double wiring (Source/Source)", set the same value for "Number of pulse output for output dark test" Yn and Yn+1, the partner of Yn.

■Fast logic pattern setting

Set the logic patterns for the fast logic function.

Module	Address (hexadecimal)	Name	Setting range	Default value
Input module	—	Fast logic pattern setting	0: Not used 1: Pattern 1 2: Pattern 2 3: Pattern 3 4: Pattern 4	0: Not used
Output module	—			
I/O combined module	01D0H			

Point

When "Fast logic pattern setting" is set to "0: Not used", the fast logic function is disabled.

■Fast logic interlock mode setting

When the fast logic function is enabled, set whether to perform output point interlock when the output is turned off.

Module	Address (hexadecimal)	Name	Setting range	Default value
Input module	—	Fast logic interlock mode setting	0: Enable 1: Disable	0: Enable
Output module	—			
I/O combined module	01D1H			

Point

When "Fast logic pattern setting" is set to "0: Not used", this parameter is ignored.

Appendix 5 EMC and Low Voltage Directives

In each country, laws and regulations concerning electromagnetic compatibility (EMC) and electrical safety are enacted. For the products sold in the European countries, compliance with the EU's EMC Directive has been a legal obligation as EMC regulation since 1996, as well as the EU's Low Voltage Directive as electrical safety regulation since 1997.

Manufacturers who recognize their products are compliant with the EMC and Low Voltage Directives are required to attach a "CE marking" on their products in European countries.

In some other countries and regions, manufacturers are required to make their products compliant with applicable laws or regulations and attach a certification mark on the products as well (such as UK Conformity Assessed (UKCA) marking in the UK, and Korea Certification (KC) marking in South Korea).

Each country works to make their regulatory requirements consistent across countries based on international standards. When the requirements are consistent, measures to comply with the EMC and electrical safety regulations become common across countries.

The UK and South Korea have enacted EMC regulations whose requirements are consistent with those of the EMC Directive. The UK has also enacted electrical safety regulations whose requirements are consistent with those of the Low Voltage Directive. In this section, the requirements of the EMC and Low Voltage Directives are described as examples of those of the EMC and electrical safety regulations.

Measures to comply with the EMC Directive

The EMC Directive specifies that "products placed on the market must be so constructed that they do not cause excessive electromagnetic interference (emissions) and are not unduly affected by electromagnetic interference (immunity)".

This section summarizes the precautions on compliance with the EMC Directive of the machinery constructed with the module.

These precautions are based on the requirements and the standards of the regulation, however, it does not guarantee that the entire machinery constructed according to the descriptions will comply with abovementioned directives.

The method and judgment for complying with the EMC Directive must be determined by the person who constructs the entire machinery.

A

EMC Directive related standards

■ Emission requirements

Specifications	Test item	Test description	Value of standard
EN 61131-2: 2007	CISPR16-2-3 Radiated emission ^{*2}	The electromagnetic waves emitted by the product are measured.	<ul style="list-style-type: none"> • 30 to 230MHz QP: 40dBμV/m (measured at 10m distance)^{*1} • 230 to 1000MHz QP: 47dBμV/m (measured at 10m distance)
	CISPR16-2-1, CISPR16-1-2 Conducted emission ^{*2}	The level of the noise which the product emits to the power supply line is measured.	<ul style="list-style-type: none"> • 0.15 to 0.5MHz QP: 79dB, Mean: 66dB^{*1} • 0.5 to 30MHz QP: 73dB, Mean: 60dB

*1 QP: Quasi-Peak value, Mean: Average value

*2 The module is an open type device (a device designed to be housed in other equipment) and must be installed inside a conductive control panel. The tests were conducted with the module installed in a control panel.

■ Immunity requirements

Specifications	Test item	Test description	Value of standard
EN 61131-2: 2007	EN 61000-4-2 Electrostatic discharge immunity* ¹	Static electricity is applied to the cabinet of the equipment.	<ul style="list-style-type: none"> • 8kV air discharge • 4kV contact discharge
	EN 61000-4-3 Radiated, radio-frequency electromagnetic field immunity* ¹	Electric fields are radiated to the product.	80% AM modulation@1kHz <ul style="list-style-type: none"> • 80 to 1000MHz: 10V/m • 1.4 to 2.0GHz: 3V/m • 2.0 to 2.7GHz: 1V/m
	EN 61000-4-4 Fast transient burst immunity* ¹	Burst noise is applied to the power lines and signal lines.	<ul style="list-style-type: none"> • AC/DC main power, I/O power, AC I/O (unshielded): 2kV • DC I/O, analog, communication: 1kV
	EN 61000-4-5 Surge immunity* ¹	A lightning surge is applied to the power lines and signal lines.	<ul style="list-style-type: none"> • AC power line, AC I/O power, AC I/O (unshielded): 2kV CM, 1kV DM • DC power line, DC I/O power: 0.5kV CM, DM • DC I/O, AC I/O (shielded), analog*², and communication lines: 1kV CM
	EN 61000-4-6 Conducted RF immunity* ¹	High frequency noise is applied to the power lines and signal lines.	0.15 to 80MHz, 80% AM modulation @1kHz, 10Vrms
	EN 61000-4-8 Power-frequency magnetic field immunity* ¹	The product is installed in an inductive magnetic field.	50Hz/60Hz, 30A/m
	EN 61000-4-11 Voltage dips and interruption immunity* ¹	A momentary power failure is caused to the power supply voltage.	<ul style="list-style-type: none"> • Apply at 0%, 0.5 cycles, and zero-cross point • 0%, 250/300 cycles (50/60Hz) • 40%, 10/12 cycles (50/60Hz) • 70%, 25/30 cycles (50/60Hz)

*1 The module is an open type device (a device designed to be housed in other equipment) and must be installed inside a conductive control panel. The tests were conducted with the module installed in a control panel.

*2 The accuracy of an analog-digital converter module may temporarily vary within $\pm 10\%$.

Installation in a control panel

The module is an open type device and must be installed inside a control panel.

This ensures safety as well as effective shielding of module-generated electromagnetic noise.

■ Control panel

- Use a conductive control panel.
- When securing the top or bottom plate using bolts, cover the grounding part on the control panel so that the part will not be painted.
- To ensure electrical contact between the inner plate and control panel, take measures such as covering the bolts so that conductivity can be ensured in the largest possible area.
- Ground the control panel with a thick ground cable so that low impedance can be ensured even at high frequencies.
- Holes in the control panel must be 10cm diameter or less. If the holes are larger than 10cm in diameter, radio waves may leak. In addition, because radio waves leak through a clearance between the control panel and its door, reduce the clearance as much as possible. The leakage of radio waves can be suppressed by the direct application of an EMI gasket on the paint surface.

Our tests have been carried out on a control panel having the damping characteristics of 37dB (max.) and 30dB (mean) (measured by 3m method, 30 to 300MHz).

■ Wiring of power cables and ground cables

Near the power supply part, provide a ground point to the control panel. Ground the FG terminal with the thickest and shortest possible ground cable (30cm or shorter).

Cables

Use shielded cables for the cables which are connected to the module and run out from the control panel. If a shielded cable is not used or not grounded correctly, the noise immunity will not meet the value of standard.

■Network cable

A shielded cable is used for the network cable. Strip a part of the jacket as shown below and ground the exposed shield in the largest possible area.

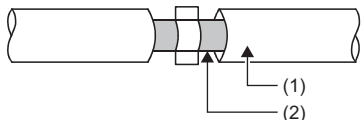

- (1) Network cable
- (2) Shield

■Grounding the cable clamp

Use shielded cables for external wiring and ground the shields of the external wiring cables to the control panel with the AD75CK cable clamp (manufactured by Mitsubishi Electric). (Ground the shield section 20 to 30cm away from the module.)

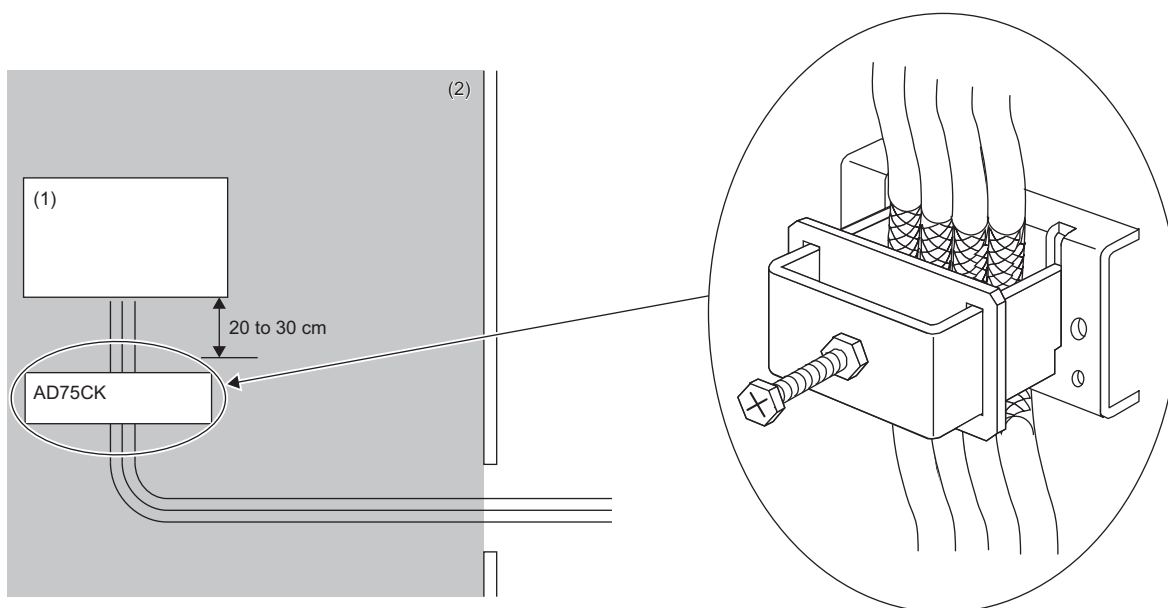

- (1) Module
- (2) Inside the control panel

For detail on AD75CK, refer to the following.

 AD75CK Cable Clamping Instruction Manual

External power supply

- For the external power supply for the module power supply and external power supply, use an AC/DC power supply adapter.
- Use a CE-marked product for an external power supply and always ground the FG terminal. (External power supply used for the tests conducted by Mitsubishi: TDK-Lambda Corporation DRJ240-24-1)
- Use a power cable of 10m or shorter when connecting it to the module power supply terminal.
- Use a power cable of 30m or shorter when connecting it to the external power supply for output part.

Others

■ Ferrite core

A ferrite core is effective for reducing radiated noise in the 30MHz to 100MHz frequency band.

It is recommended to install a ferrite core if a shielded cable extended out of the control panel does not provide sufficient shielding effects.

Note that the ferrite cores must be attached at the position closest to the cable hole inside the control panel. If attached at an improper position, the ferrite core will not produce any effect.

Install a ferrite core to each power cable as shown below.

- Ferrite core used for the tests conducted by Mitsubishi: ESD-SR-250 (manufactured by TOKIN Corporation), ZCAT3035-1330 (manufactured by TDK Corporation)

Ex.

Ferrite core attachment example

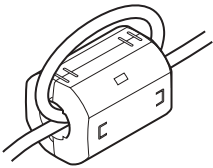

■ Noise filter (power supply line filter)

A noise filter is a component which has an effect on conducted noise. Attaching the filter can suppress more noise. (The noise filter has the effect of reducing conducted noise of 10MHz or less.)

Connect a noise filter to the external power supply of the safety remote I/O module.

The precautions for attaching a noise filter are described below.

- Do not bundle the cables on the input side and output side of the noise filter. If bundled, the output side noise will be induced into the input side cables from which the noise was removed.

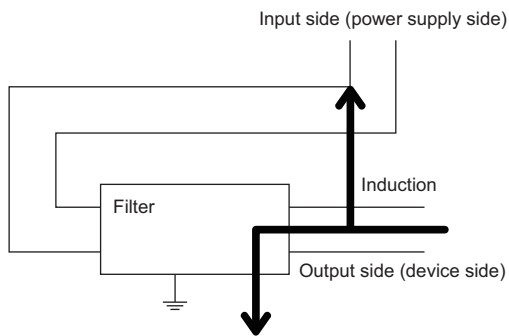

- Example of problem
Noise is induced when the input and output cables are bundled.

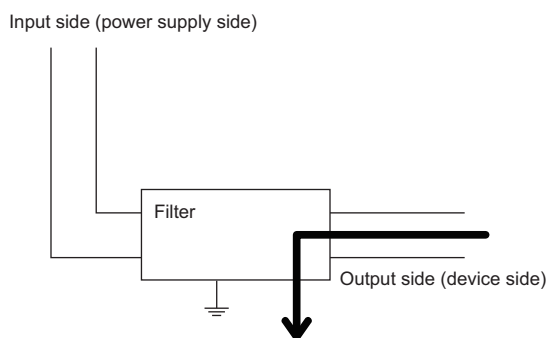

- Example of improvement
Install the input and output cables separately.

- Ground the noise filter grounding terminal to the control panel with the shortest cable possible (approx. 10cm).

■AC surge protective device

An AC surge protective device absorbs a lightning surge on a path for an alternating current to protect electronic devices from being damaged by the surge. When it is probable that a common-mode surge exceeding the voltage of "Value of standard \pm 2kV" will occur in the installation environment, connect the AC surge protective device.

Point

Before using the AC surge protective device, check its specifications and precautions on using it by referring to manuals relevant to the device.

Requirements for Low Voltage Directive compliance

Module

The module operates at the rated voltage of 24VDC. The Low Voltage Directive is not applied to the modules that operate at the rated voltage of less than 50VAC and 75VDC.

External wiring

■24VDC external power supply

To connect to the module, use the power supply that meets the following conditions:

- SELV (Safety Extra Low Voltage): Product with reinforced insulation from the hazardous potential part (60V or higher)
- LVD applicable product
- 24VDC (ripple ratio: 5% or less) (allowable voltage range: 20.4 to 28.8VDC)

■External devices

For external devices connected to a module, use the one of which insulation between the interface circuit section to the module and the dangerous voltage circuit section is reinforced (if the device internally has a dangerous voltage circuit section).

■Reinforced insulation

The reinforced insulation covers the withstand voltages shown in the table below.

Rated voltage of hazardous voltage	Surge voltage withstand (1.2/50 μ s)
150VAC or less	2500V
300VAC or less	4000V

Measures to comply with the Machinery Directive

The Machinery Directive (2006/42/EC) requires that machinery satisfy the three pillars of safety: mechanical safety, electrical safety, and worker safety.

This product complies with the Machinery Directive (2006/42/EC). Before using this product, please read this manual, the relevant manuals, the manuals for standard programmable controller, and the safety standards carefully and pay full attention to safety to handle the product correctly.

The descriptions are based on the requirements of the Machinery Directive and the harmonized standards. However, they do not guarantee that the entire machinery constructed according to the descriptions complies with the Machinery Directive. The manufacturer of the machinery must determine the testing method for compliance and declare conformity to the Machinery Directive.

Specifications	Test item	Test description	Value of standard
IEC 61326-3-1: 2017	IEC 61000-4-2 IEC 61326-3-1 Electrostatic discharge immunity ^{*1}	Static electricity is applied to the cabinet of the equipment.	8kV contact discharge
	IEC 61000-4-3 IEC 61326-3-1 Radiated, radio-frequency electromagnetic field immunity ^{*1}	Electric fields are radiated to the product.	80% AM modulation@1kHz <ul style="list-style-type: none"> • 80 to 1000MHz: 20V/m • 1.4 to 2.0GHz: 10V/m • 2.0 to 6.0GHz: 3V/m • 84.000, 137 to 174, 219.500, 380 to 400, 420 to 470, 698 to 960MHz: 20V/m • 1.24 to 1.30, 1.428 to 2.0GHz: 10V/m • 2.0 to 2.7, 3.3 to 3.6, 5.15 to 5.925GHz: 3Vm
	IEC 61000-4-4 IEC 61326-3-1 Fast transient burst immunity ^{*1}	Burst noise is applied to the power lines and signal lines.	<ul style="list-style-type: none"> • AC main power: 4kV • DC main power, DC I/O, I/O, communication: 2kV
	IEC 61000-4-5 IEC 61326-3-1 Surge immunity ^{*1}	A lightning surge is applied to the power lines and signal lines.	<ul style="list-style-type: none"> • AC main power, AC/DC main power: 4kV • DC I/O, I/O, communication: 2kV
	IEC 61000-4-6 IEC 61326-3-1 Conducted RF immunity ^{*1}	High frequency noise is applied to the power lines and signal lines.	80% AM modulation @1kHz, <ul style="list-style-type: none"> • 0.15 to 80MHz: 20V • 3.39, 6.780, 13.560, 27.120, 40.680MHz: 20V
	IEC 61000-4-11 Voltage dips and interruption immunity ^{*1}	A momentary power failure is caused to the power supply voltage.	<ul style="list-style-type: none"> • Apply at 0%, 1 cycle, and zero-cross point • 0%, 250/300 cycles (50/60Hz) • 40%, 10/12 cycles (50/60Hz) • 70%, 25/30 cycles (50/60Hz)
	IEC 61326-3-1 IEC 61000-4-6-16 Conducted common-mode voltage immunity ^{*1}	Common-mode noise is applied to the power lines and signal lines.	<ul style="list-style-type: none"> • 1.5 to 15kHz: 1 to 10V • 15 to 150kHz: 10V • 16.7, 50, 60, 150, 180Hz: 10V (continuously) • 16.7, 50, 60Hz: For short period of time (1s)

*1 The module is an open type device (a device designed to be housed in other equipment) and must be installed inside a conductive control panel. The tests were conducted with the module installed in a control panel.



Precautions for use of safety programmable controller

Users must prove that their entire safety system complies with the safety standards and the Machinery Directive. The third-party certification organization will validate the safety of product for the entire safety system, including a safety programmable controller and safety components.

■ Target failure measure (PFDavg/PFH) calculation

To establish a safety system, calculate the target failure measure (PFDavg/PFH) for each safety application (safety function) based on the PFDavg/PFH values of the safety programmable controller and connected safety components. The target failure measure (PFDavg/PFH) is the reliability target value for each Safety Integrity Level (SIL) defined in IEC 61508 and can be calculated by the following formula.

$PFD_{avg}/PFH = A + B + C + D \dots$ Calculation formula of PFDavg/PFH

Variable	Definition
A*1	PFDavg/PFH of safety CPU
B	PFDavg/PFH of the CC-Link IE TSN remote I/O module (with safety functions) (1) When safety input device(s) and safety output device(s) are connected to the same CC-Link IE TSN remote I/O module (with safety functions): $B = B1$ (2) When safety input device(s) and safety output device(s) are connected to the different CC-Link IE TSN remote I/O modules (with safety functions): $B = B1 + B2$
B1	PFDavg/PFH of the CC-Link IE TSN remote I/O module (with safety functions) to which safety input device(s) is connected
B2	PFDavg/PFH of the CC-Link IE TSN remote I/O module (with safety functions) to which safety output device(s) is connected
C*1	PFDavg/PFH of safety input device(s)
D*1	PFDavg/PFH of safety output device(s)

*1 For the values of PFDavg/PFH, refer to the manuals for the safety components used.

The following table lists the PFDavg/PFH of safety remote I/O modules.

Module	PFDavg	PFH(/h)*2
NZ2GNSS2-8D	1.38×10^{-5}	6.12×10^{-9}
NZ2GNSS2-8TE	1.37×10^{-5}	5.49×10^{-9}
NZ2GNSS2-16DTE	1.46×10^{-5}	9.25×10^{-9}

*2 Proof test interval is 5 years.

■ PL evaluation described in ISO 13849-1

For the PL evaluation described in ISO 13849-1, use the $MTTF_D$ (mean time to dangerous failure) and the DCavg (average diagnostic coverage) listed in the following table.

Module	$MTTF_D$	DCavg
NZ2GNSS2-8D	243 years	97.0%
NZ2GNSS2-8TE	271 years	96.8%
NZ2GNSS2-16DTE	161 years	97.7%

Appendix 6 How to Check Production Information and Firmware Version

Checking the production information

The production information of a safety remote I/O module can be checked with the following.

- Rating plate
- CC-Link IE TSN/CC-Link IE Field Diagnostics

Checking on the rating plate

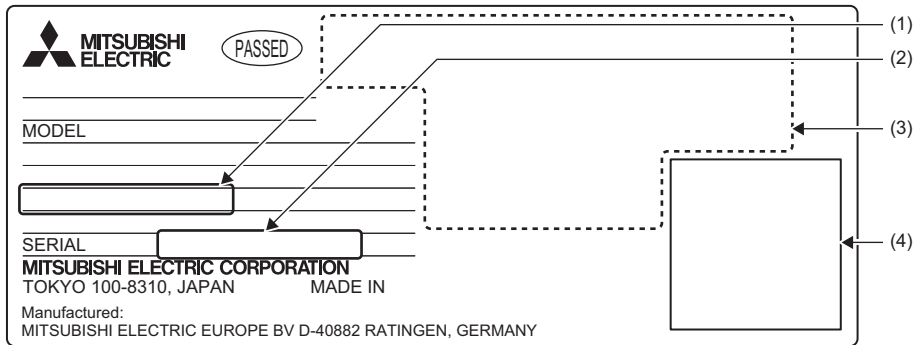

- (1) MAC address
- (2) Production information
- (3) Relevant standard symbol
- (4) QR code

Checking by using CC-Link IE TSN/CC-Link IE Field diagnostics

■Checking by each safety remote I/O module

The production information of each safety remote I/O module can be checked by following the procedure below.

A

Operating procedure

1. Connect the engineering tool to the CPU module.
2. Start CC-Link IE TSN/CC-Link IE Field diagnostics from the menu.
🔗 [Diagnostics] ⇒ [CC-Link IE TSN/CC-Link IE Field Diagnostics]
3. Right-click on the device station of which the production information is displayed, and select "Production Information".
4. The production information appears.

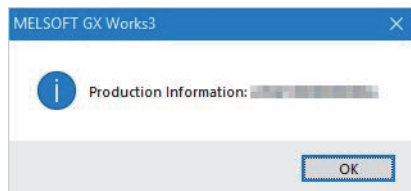

■Checking with the "Station Information List" window

For how to check the production information, refer to the following.

📖 Page 142 Checking station information

Checking the firmware version

The firmware version of a safety remote I/O module can be checked on the "Station Information List" window. For how to check the firmware version, refer to the following.

 Page 142 Checking station information

Point

The firmware version can also be checked with the production information. (The first two digits of production information show the firmware version.) ( Page 203 Checking the production information)

Appendix 7 Software Licenses and Copyright

This section describes the licenses and copyrights to the software used in this product.

MD5 Message-Digest Algorithm

This product includes code that was developed by RSA Data Security, Inc.

Copyright © 1991-2, RSA Data Security, Inc.

License to copy and use this software is granted provided that it is identified as the "RSA Data Security, Inc. MD5 Message-Digest Algorithm" in all material mentioning or referencing this software or this function.

License is also granted to make and use derivative works provided that such works are identified as "derived from the RSA Data Security, Inc. MD5 Message-Digest Algorithm" in all material mentioning or referencing the derived work.

RSA Data Security, Inc. makes no representations concerning either the merchantability of this software or the suitability of this software for any particular purpose. It is provided "as is" without express or implied warranty of any kind.

These notices must be retained in any copies of any part of this documentation and/or software.

Appendix 8 Added and Changed Functions

The functions added to or changed in the safety remote I/O module are shown below.

Added functions

The following table shows the functions that were added to the safety remote I/O module and the versions supporting these functions.

Details of addition	Firmware version	Profile version	Reference
Ring topology	"02" or later	—*1	☞ Page 58 Network topology setting
"Station Information List" window display	"02" or later	—*1	☞ Page 142 Checking station information
CC-Link IE TSN Class setting function	"03" or later	"02" or later	☞ Page 105 CC-Link IE TSN Class Setting Function
SLMP communication function	"03" or later	—*1	☞ Page 130 SLMP Communication Function
Operation setting function at detection of external power supply voltage error	"04" or later	"03" or later	☞ Page 131 Operation Setting Function at Detection of External Power Supply Voltage Error

*1 The function can be used regardless of the version.

Function changes

The following table shows the functions that were changed in the safety remote I/O module and the versions supporting these functions.

Details of change	Firmware version	Reference
Setting values of the communication cycle interval setting	"02" or later	☞ Page 57 Communication cycle interval setting
Operation in multicast mode	"02" or later	☞ Page 59 Communication mode
Communication speed setting function	"03" or later	☞ Page 117 Communication Speed Setting Function

Appendix 9 External Dimensions

The external dimensions of the safety remote I/O module are shown below.

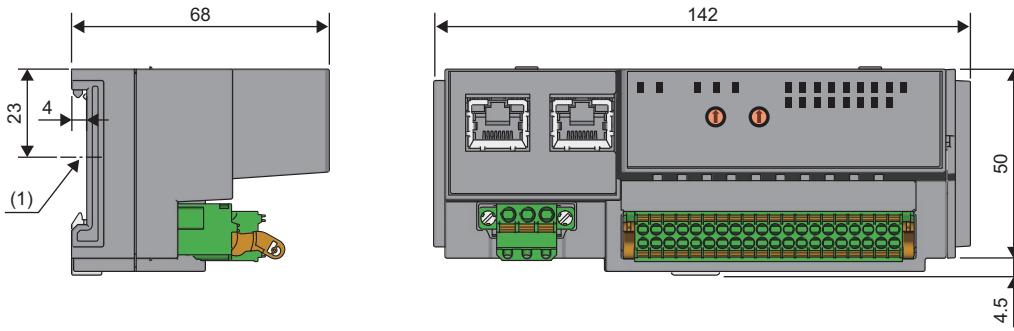

(1) DIN rail center

(Unit: mm)



MEMO

INDEX

A

Applicable master station	37
Applicable profile	38

C

CC-Link IE TSN Class setting status (RWr0.b2)	180
Communication speed (RWr0.b1)	180
Compatible software package	37
Compatible software version	37

D

D LINK LED	17
DIN rail hook	18
Double input discrepancy auto recovery function	96
Double input discrepancy state	172

E

ERR. LED	17
Error code area	181
Error status flag (RWr0.b10)	180
Ethernet cable	38
External input monitor area	181
External input signal monitor function	76
External input signals (RX0 to RX7)	178
External output monitor	173
External power supply overcurrent protection . . .	103
External power supply overvoltage protection . . .	103

F

Fast logic initial completion flag	173
Fast logic initial request flag	174
Fast logic READY	172
Fast logic start flag	174

I

I/O LED	17
I/O PW LED	17
I/O terminal block	18
Installation direction	43
Installation environment	42
Installation position	42
IP address setting switch	17

L

L ER LED	17
LINK LED	17

M

Measures to comply with the EMC Directive	195
Measures to comply with the Machinery Directive	201
Module power supply overcurrent protection . . .	103

Module power supply overvoltage protection	103
Module status area	179
Mounting the modules on a DIN rail	44

O

Operation mode and state transition	34
---	----

P

P1	17
P2	17
Parameter area	183
Parameter automatic setting status monitor area	182
Parameter data per module	190
Parameter data per station	189
Precautions for wiring the safety remote I/O module to safety devices	56
PW LED	17

R

Requirements for Low Voltage Directive compliance	200
RUN LED	17

S

Safety input signals	172
SAFETY LED	17
Safety module enabled flag (RWr0.b0)	179
Safety output signal	174
Switching hub	38

T

Terminal block for module power supply and FG . .	17
---	----

MEMO

REVISIONS

*The manual number is given on the bottom left of the back cover.

Revision date	*Manual number	Description
May 2020	SH(NA)-082227ENG-A	First edition
July 2020	SH(NA)-082227ENG-B	■Added or modified parts TERMS, GENERIC TERMS AND ABBREVIATIONS, Chapter 2, Section 3.2, 5.1, 6.5, 7.1, 10.1, 10.2, 10.7, Appendix 6, 7
June 2022	SH(NA)-082227ENG-C	■Added or modified parts SAFETY PRECAUTIONS, INTRODUCTION, RELEVANT MANUALS, TERMS, Chapter 2, Section 3.2, 3.3, Chapter 4, Section 5.1, 6.2, 7.1, 8.5, 8.8, 8.9, 8.10, 8.11, 10.2, 10.4, 10.7, Appendix 3, 4, 5, 7
January 2024	SH(NA)-082227ENG-D	■Added or modified parts TERMS, GENERIC TERMS AND ABBREVIATIONS, Section 3.2, 3.3, 5.1, 6.6, 7.1, 7.2, 8.5, 8.12, 10.2, 10.4, 10.7, Appendix 1, 4, 7, 8

Japanese manual number: SH-082226-E

This manual confers no industrial property rights or any rights of any other kind, nor does it confer any patent licenses. Mitsubishi Electric Corporation cannot be held responsible for any problems involving industrial property rights which may occur as a result of using the contents noted in this manual.

©2020 MITSUBISHI ELECTRIC CORPORATION

WARRANTY

Please confirm the following product warranty details before using this product.

1. Limited Warranty and Product Support.

- a. Mitsubishi Electric Company ("MELCO") warrants that for a period of eighteen (18) months after date of delivery from the point of manufacture or one year from date of Customer's purchase, whichever is less, Mitsubishi MELSEC Safety programmable logic controllers (the "Products") will be free from defects in material and workmanship.
- b. At MELCO's option, for those Products MELCO determines are not as warranted, MELCO shall either repair or replace them or issue a credit or return the purchase price paid for them.
- c. For this warranty to apply:
 - (1) Customer shall give MELCO (i) notice of a warranty claim to MELCO and the authorized dealer or distributor from whom the Products were purchased, (ii) the notice shall describe in reasonable details the warranty problem, (iii) the notice shall be provided promptly and in no event later than thirty (30) days after the Customer knows or has reason to believe that Products are not as warranted, and (iv) in any event, the notice must be given within the warranty period;
 - (2) Customer shall cooperate with MELCO and MELCO's representatives in MELCO's investigation of the warranty claim, including preserving evidence of the claim and its causes, meaningfully responding to MELCO's questions and investigation of the problem, grant MELCO access to witnesses, personnel, documents, physical evidence and records concerning the warranty problem, and allow MELCO to examine and test the Products in question onsite or at the premises where they are installed or used; and
 - (3) If MELCO requests, Customer shall remove Products it claims are defective and ship them to MELCO or MELCO's authorized representative for examination and, if found defective, for repair or replacement. The costs of removal, shipment to and from MELCO's designated examination point, and reinstallation of repaired or replaced Products shall be at Customer's expense.
 - (4) If Customer requests and MELCO agrees to effect repairs onsite at any domestic or overseas location, the Customer will pay for the costs of sending repair personnel and shipping parts. MELCO is not responsible for any re-commissioning, maintenance, or testing on-site that involves repairs or replacing of the Products.
- d. Repairs of Products located outside of Japan are accepted by MELCO's local authorized service facility centers ("FA Centers"). Terms and conditions on which each FA Center offers repair services for Products that are out of warranty or not covered by MELCO's limited warranty may vary.
- e. Subject to availability of spare parts, MELCO will offer Product repair services for (7) years after each Product model or line is discontinued, at MELCO's or its FA Centers' rates and charges and standard terms in effect at the time of repair. MELCO usually produces and retains sufficient spare parts for repairs of its Products for a period of seven (7) years after production is discontinued.
- f. MELCO generally announces discontinuation of Products through MELCO's Technical Bulletins. Products discontinued and repair parts for them may not be available after their production is discontinued.

2. Limits of Warranties.

- a. MELCO does not warrant or guarantee the design, specify, manufacture, construction or installation of the materials, construction criteria, functionality, use, properties or other characteristics of the equipment, systems, or production lines into which the Products may be incorporated, including any safety, fail-safe and shut down systems using the Products.
- b. MELCO is not responsible for determining the suitability of the Products for their intended purpose and use, including determining if the Products provide appropriate safety margins and redundancies for the applications, equipment or systems into which they are incorporated.
- c. Customer acknowledges that qualified and experienced personnel are required to determine the suitability, application, design, construction and proper installation and integration of the Products. MELCO does not supply such personnel.
- d. MELCO is not responsible for designing and conducting tests to determine that the Product functions appropriately and meets application standards and requirements as installed or incorporated into the end-user's equipment, production lines or systems.
- e. MELCO does not warrant any Product:
 - (1) repaired or altered by persons other than MELCO or its authorized engineers or FA Centers;
 - (2) subjected to negligence, carelessness, accident, misuse, or damage;
 - (3) improperly stored, handled, installed or maintained;
 - (4) integrated or used in connection with improperly designed, incompatible or defective hardware or software;
 - (5) that fails because consumable parts such as batteries, backlights, or fuses were not tested, serviced or replaced;
 - (6) operated or used with equipment, production lines or systems that do not meet applicable and commensurate legal, safety and industry-accepted standards;
 - (7) operated or used in abnormal applications;
 - (8) installed, operated or used in contravention of instructions, precautions or warnings contained in MELCO's user, instruction and/or safety manuals, technical bulletins and guidelines for the Products;
 - (9) used with obsolete technologies or technologies not fully tested and widely accepted and in use at the time of the Product's manufacture;
 - (10) subjected to excessive heat or moisture, abnormal voltages, shock, excessive vibration, physical damage or other improper environment; or
 - (11) damaged or malfunctioning due to Acts of God, fires, acts of vandals, criminals or terrorists, communication or power failures, or any other cause or failure that results from circumstances beyond MELCO's control.
- f. All Product information and specifications contained on MELCO's website and in catalogs, manuals, or technical information materials provided by MELCO are subject to change without prior notice.

- g. The Product information and statements contained on MELCO's website and in catalogs, manuals, technical bulletins or other materials provided by MELCO are provided as a guide for Customer's use. They do not constitute warranties and are not incorporated in the contract of sale for the Products.
- h. These terms and conditions constitute the entire agreement between Customer and MELCO with respect to warranties, remedies and damages and supersede any other understandings, whether written or oral, between the parties. Customer expressly acknowledges that any representations or statements made by MELCO or others concerning the Products outside these terms are not part of the basis of the bargain between the parties and are not factored into the pricing of the Products.
- i. THE WARRANTIES AND REMEDIES SET FORTH IN THESE TERMS ARE THE EXCLUSIVE AND ONLY WARRANTIES AND REMEDIES THAT APPLY TO THE PRODUCTS.
- j. MELCO DISCLAIMS THE IMPLIED WARRANTIES OF MERCHANTABILITY AND FITNESS FOR A PARTICULAR PURPOSE.

3. Limits on Damages.

- a. MELCO'S MAXIMUM CUMULATIVE LIABILITY BASED ON ANY CLAIMS FOR BREACH OF WARRANTY OR CONTRACT, NEGLIGENCE, STRICT TORT LIABILITY OR OTHER THEORIES OF RECOVERY REGARDING THE SALE, REPAIR, REPLACEMENT, DELIVERY, PERFORMANCE, CONDITION, SUITABILITY, COMPLIANCE, OR OTHER ASPECTS OF THE PRODUCTS OR THEIR SALE, INSTALLATION OR USE SHALL BE LIMITED TO THE PRICE PAID FOR PRODUCTS NOT AS WARRANTED.
- b. Although MELCO has obtained the certification for Product's compliance to the international safety standards IEC61508 and ISO13849-1 from TUV Rheinland, this fact does not guarantee that Product will be free from any malfunction or failure. The user of this Product shall comply with any and all applicable safety standard, regulation or law and take appropriate safety measures for the system in which the Product is installed or used and shall take the second or third safety measures other than the Product. MELCO is not liable for damages that could have been prevented by compliance with any applicable safety standard, regulation or law.
- c. MELCO prohibits the use of Products with or in any application involving power plants, trains, railway systems, airplanes, airline operations, other transportation systems, amusement equipments, hospitals, medical care, dialysis and life support facilities or equipment, incineration and fuel devices, handling of nuclear or hazardous materials or chemicals, mining and drilling, and other applications where the level of risk to human life, health or property are elevated.
- d. MELCO SHALL NOT BE LIABLE FOR SPECIAL, INCIDENTAL, CONSEQUENTIAL, INDIRECT OR PUNITIVE DAMAGES, FOR LOSS OF PROFITS, SALES, OR REVENUE, FOR INCREASED LABOR OR OVERHEAD COSTS, FOR DOWNTIME OR LOSS OF PRODUCTION, FOR COST OVERRUNS, OR FOR ENVIRONMENTAL OR POLLUTION DAMAGES OR CLEAN-UP COSTS, WHETHER THE LOSS IS BASED ON CLAIMS FOR BREACH OF CONTRACT OR WARRANTY, VIOLATION OF STATUTE, NEGLIGENCE OR OTHER TORT, STRICT LIABILITY OR OTHERWISE.
- e. In the event that any damages which are asserted against MELCO arising out of or relating to the Products or defects in them, consist of personal injury, wrongful death and/or physical property damages as well as damages of a pecuniary nature, the disclaimers and limitations contained in these terms shall apply to all three types of damages to the fullest extent permitted by law. If, however, the personal injury, wrongful death and/or physical property damages cannot be disclaimed or limited by law or public policy to the extent provided by these terms, then in any such event the disclaimer of and limitations on pecuniary or economic consequential and incidental damages shall nevertheless be enforceable to the fullest extent allowed by law.
- f. In no event shall any cause of action arising out of breach of warranty or otherwise concerning the Products be brought by Customer more than one year after the cause of action accrues.
- g. Each of the limitations on remedies and damages set forth in these terms is separate and independently enforceable, notwithstanding the unenforceability or failure of essential purpose of any warranty, undertaking, damage limitation, other provision of these terms or other terms comprising the contract of sale between Customer and MELCO.

4. Delivery/Force Majeure.

- a. Any delivery date for the Products acknowledged by MELCO is an estimated and not a promised date. MELCO will make all reasonable efforts to meet the delivery schedule set forth in Customer's order or the purchase contract but shall not be liable for failure to do so.
- b. Products stored at the request of Customer or because Customer refuses or delays shipment shall be at the risk and expense of Customer.
- c. MELCO shall not be liable for any damage to or loss of the Products or any delay in or failure to deliver, service, repair or replace the Products arising from shortage of raw materials, failure of suppliers to make timely delivery, labor difficulties of any kind, earthquake, fire, windstorm, flood, theft, criminal or terrorist acts, war, embargoes, governmental acts or rulings, loss or damage or delays in carriage, acts of God, vandals or any other circumstances reasonably beyond MELCO's control.

5. Choice of Law/Jurisdiction.

These terms and any agreement or contract between Customer and MELCO shall be governed by the laws of the State of New York without regard to conflicts of laws. To the extent any action or dispute is not arbitrated, the parties consent to the exclusive jurisdiction and venue of the federal and state courts located in the Southern District of the State of New York. Any judgment there obtained may be enforced in any court of competent jurisdiction.

6. Arbitration.

Any controversy or claim arising out of, or relating to or in connection with the Products, their sale or use or these terms, shall be settled by arbitration conducted in accordance with the Center for Public Resources (CPR) Rules for Non-Administered Arbitration of International Disputes, by a sole arbitrator chosen from the CPR's panels of distinguished neutrals. Judgment upon the award rendered by the Arbitrator shall be final and binding and may be entered by any court having jurisdiction thereof. The place of the arbitration shall be New York City, New York. The language of the arbitration shall be English. The neutral organization designated to perform the functions specified in Rule 6 and Rules 7.7(b), 7.8 and 7.9 shall be the CPR.

TRADEMARKS

QR Code is either a registered trademark or a trademark of DENSO WAVE INCORPORATED in the United States, Japan, and/or other countries.

The company names, system names and product names mentioned in this manual are either registered trademarks or trademarks of their respective companies.

In some cases, trademark symbols such as [™] or [®] are not specified in this manual.

SH(NA)-082227ENG-D(2401)MEE

MODEL: CCIETSN-SFIO-U-E

MODEL CODE: 13JX2C

MITSUBISHI ELECTRIC CORPORATION

HEAD OFFICE: TOKYO BLDG., 2-7-3, MARUNOUCHI, CHIYODA-KU, TOKYO 100-8310, JAPAN
NAGOYA WORKS: 1-14, YADA-MINAMI 5-CHOME, HIGASHI-KU, NAGOYA 461-8670, JAPAN

When exported from Japan, this manual does not require application to the
Ministry of Economy, Trade and Industry for service transaction permission.

Specifications subject to change without notice.