

# mitsubishi

**GPP Function software  
for Windows  
SW5D5C-GPPW-E**

**Operating Manual**



Mitsubishi Programmable Logic Controller

# • SAFETY PRECAUTIONS •

(Always read these instructions before using this equipment.)

Before using this product, please read this manual and the relevant manuals introduced in this manual carefully and pay full attention to safety to handle the product correctly.

The instructions given in this manual are concerned with this product. For the safety instructions of the programmable controller system, please read the CPU module user's manual.

In this manual, the safety instructions are ranked as "DANGER" and "CAUTION".



Indicates that incorrect handling may cause hazardous conditions, resulting in death or severe injury.



Indicates that incorrect handling may cause hazardous conditions, resulting in medium or slight personal injury or physical damage.

Note that the  CAUTION level may lead to a serious consequence according to the circumstances. Always follow the instructions of both levels because they are important to personal safety.

Please save this manual to make it accessible when required and always forward it to the end user.

## [Design Instructions]

### DANGER

- For data change, program change, and status control made to the PLC which is running from a peripheral device, configure the interlock circuit externally so that the system safety is ensured. The action to be taken for the system at the occurrence of communication errors caused by such as loose cable connection must be determined for online operation of PLC from peripheral devices.

### CAUTION

- Before connecting a peripheral device to a CPU module in the RUN status and carrying out online operation (particularly program changes, forced output, and changing the operating status), read the manual carefully and confirm safety. Failure to do this could result in damage to the machine and accidents due to misoperation.

Revisions

\*The manual number is given on the bottom left of the back cover.

Print Date	*Manual Number	Revision
Feb,2000	SH(NA)-080062-A	First edition
Feb,2000	SH(NA)-080062-B	Partial corrections Section 17.1.1
Jun,2000	SH(NA)-080062-C	Additions How the manual describes the explanation is shown below. Section 17.3.1, 18 Corrections Section 5.1, 17.1.1, 17.2.1 (3), 17.2.3 (1), 17.2.3 (2), 17.9, 22.4, Appendix 2.2, 2.3, 2.5, 2.6

This manual confers no industrial property rights or any rights of any other kind, nor does it confer any patent licenses. Mitsubishi Electric Corporation cannot be held responsible for any problems involving industrial property rights which may occur as a result of using the contents noted in this manual.

## INTRODUCTION

Thank you for purchasing the Mitsubishi general-purpose MELSEC series sequencer.

Read this manual and make sure you understand the functions and performance of MELSEC series sequencer thoroughly in advance to ensure correct use.

Please make this manual available to the end user.

SAFETY PRECAUTIONS.....	A - 1
REVISIONS.....	A - 2
CONTENTS.....	A - 3
About Manuals .....	A - 12
How the manual describes the explanation is shown below .....	A - 13
Abbreviations and Terms in This Manual.....	A - 15

### CONTENTS

<b>Chapter 1 GENERAL DESCRIPTION</b>	<b>1- 1 to 1- 12</b>
1.1 Functions Lists .....	1- 3
1.2 FX Series Programming .....	1- 10
1.3 Basic Key Specifications.....	1- 12
<b>Chapter 2 SYSTEM CONFIGURATION</b>	<b>2- 1 to 2- 6</b>
2.1 Connection from the Serial Port .....	2- 1
2.2 Connection from the Interface Boards.....	2- 4
2.3 System Equipment Lists .....	2- 5
2.4 Precautions for Handling Project on the Version of SW4D5C-GPPW or earlier .....	2- 6
<b>Chapter 3 COMMON OPERATIONS</b>	<b>3- 1 to 3- 22</b>
3.1 List of Shortcut Keys and Access Keys.....	3- 1
3.2 Project Designation.....	3- 5
3.2.1 Saving a project.....	3- 6
3.2.2 Opening a project.....	3- 9
3.3 Cut, Copy, and Paste.....	3- 10
3.3.1 Cut and paste .....	3- 10
3.3.2 Copy and paste .....	3- 12
3.3.3 Notes on cutting, copying and pasting network parameters.....	3- 14
3.4 Toolbar .....	3- 16
3.5 Status Bar.....	3- 17
3.6 Zooming in on or out of the Edit Screen.....	3- 18
3.7 Project Data List.....	3- 19
3.8 Comment Display.....	3- 21
3.9 Statement Display.....	3- 21
3.10 Note Display .....	3- 21
3.11 Device Name Display.....	3- 22
3.12 Comment Format .....	3- 22

**Chapter 4 INITIALIZATION**

4- 1 to 4- 2

4.1 Creating a Project .....	4- 1
------------------------------	------

**Chapter 5 HANDLING PROJECT FILES**

5- 1 to 5- 36

5.1 Opening the Existing Project File .....	5- 1
5.2 Closing a Project File .....	5- 2
5.3 Saving a Project.....	5- 2
5.4 Saving a Project with a New Name .....	5- 3
5.5 Deleting a Project.....	5- 3
5.6 Verifying Data in Projects.....	5- 4
5.7 Copying a Project.....	5- 6
5.8 Adding Data to a Project.....	5- 8
5.9 Copying Data within a Project.....	5- 9
5.10 Deleting Data in a Project.....	5- 10
5.11 Renaming Data in a Project.....	5- 11
5.12 Changing the Ladder and SFC with each other.....	5- 12
5.13 Changing the PLC Type of a Project.....	5- 13
5.14 Reading Other Format Files .....	5- 14
5.14.1 Reading GPPQ, GPPA, FXGP(DOS) or FXGP(WIN) files.....	5- 14
5.14.2 Reading a MELSEC MEDOC format file (Printout).....	5- 18
5.14.3 Reading a MELSEC MEDOC format file.....	5- 19
5.15 Exporting GPPQ, GPPA, FXGP(DOS) or FXGP(WIN) Files .....	5- 21
5.16 About Macros .....	5- 25
5.16.1 Registering a macro .....	5- 27
5.16.2 Utilizing a macro.....	5- 29
5.16.3 Deleting a macro .....	5- 31
5.16.4 Displaying macro references .....	5- 32
5.17 Starting Multiple Projects .....	5- 35
5.18 Existing GPPW .....	5- 35

**Chapter 6 CREATING CIRCUIT**

6- 1 to 6- 48

6.1 Restrictions on Circuit Creation .....	6- 5
6.1.1 Restrictions in circuit display window .....	6- 5
6.1.2 Restrictions in circuit edit window.....	6- 6
6.2 Creating and Editing Circuits .....	6- 10
6.2.1 Inputting contacts and application instructions.....	6- 10
6.2.2 Inputting lines (vertical and horizontal) .....	6- 12
6.2.3 Deleting contacts and application instructions .....	6- 14
6.2.4 Deleting connecting lines .....	6- 15
6.2.5 Inserting and deleting in circuit blocks.....	6- 16
6.2.6 Inserting NOPs .....	6- 18
6.2.7 Deleting NOPs.....	6- 18
6.2.8 Cutting, copying and pasting circuits .....	6- 19
6.2.9 Undo the last operation.....	6- 20

6.3 Changing T/C Setting Values .....	6- 21
6.4 Find and Replace .....	6- 23
6.4.1 Finding a device .....	6- 25
6.4.2 Finding an instruction .....	6- 27
6.4.3 Finding a step No. ....	6- 29
6.4.4 Finding a character string.....	6- 30
6.4.5 Finding a contact/coil.....	6- 31
6.4.6 Finding data.....	6- 32
6.4.7 Replacing a device .....	6- 33
6.4.8 Replacing an instruction.....	6- 35
6.4.9 Changing A and B contacts .....	6- 37
6.4.10 Replacing a character string .....	6- 39
6.4.11 Changing the statement or note type .....	6- 41
6.4.12 Replacing data .....	6- 43
6.4.13 Searching for a contact coil.....	6- 44
6.4.14 Searching for a device-use instruction .....	6- 46

Chapter 7 CREATING INSTRUCTION LIST	7- 1 to 7- 12
-------------------------------------	---------------

7.1 Common Notes on Instruction List Creation .....	7- 1
7.2 Creating a Program Instruction list .....	7- 3
7.2.1 Inputting a contact or application instruction .....	7- 3
7.2.2 Changing the existing program in overwrite mode .....	7- 4
7.2.3 Inserting or adding the existing program .....	7- 5
7.2.4 Deleting the existing program list.....	7- 6
7.2.5 Inserting NOPs .....	7- 7
7.2.6 Deleting NOPs .....	7- 7
7.3 Find and Replace .....	7- 8
7.3.1 Finding a device .....	7- 8
7.3.2 Finding an instruction .....	7- 8
7.3.3 Finding a step No. ....	7- 8
7.3.4 Finding a character string.....	7- 8
7.3.5 Finding a contact/coil.....	7- 8
7.3.6 Replacing a device .....	7- 8
7.3.7 Replacing an instruction.....	7- 8
7.3.8 Changing an A or B contact.....	7- 9
7.3.9 Replacing a character string .....	7- 9
7.3.10 Changing the statement or note type .....	7- 9
7.3.11 Searching for a contact coil.....	7- 9
7.3.12 Searching for an instruction using a device .....	7- 9
7.4 Display.....	7- 10
7.4.1 Displaying a device name .....	7- 10
7.5 Switching Read and Write Modes .....	7- 11
7.5.1 Switching to read mode.....	7- 11
7.5.2 Switching to write mode .....	7- 11
7.5.3 Switching to circuit mode .....	7- 11
7.6 Changing T/C Setting Values .....	7- 11

Chapter 8 CONVERSION	8- 1 to 8- 2
----------------------	--------------

8.1 Converting an Edit Program .....	8- 1
8.2 Converting Multiple Edit Programs.....	8- 1

Chapter 9 SETTING DEVICE COMMENTS	9- 1 to 9- 28
-----------------------------------	---------------

9.1 Points to be Noted before Comment Creation with GPPW .....	9- 1
9.1.1 Editing comments only on peripheral devices.....	9- 3
9.1.2 Writing to ACPU/GPPA file .....	9- 5
9.1.3 Reading from ACPU/GPPA file .....	9- 6
9.1.4 Writing to QCPU(Q mode) QnACPU/GPPQ file .....	9- 8
9.1.5 Reading from QCPU(Q mode) QnACPU .....	9- 8
9.1.6 Writing to FXCPU/FXGP(DOS), FXGP(WIN) file.....	9- 9
9.1.7 Reading from FXCPU/FXGP(DOS), FXGP(WIN) file .....	9- 10
9.2 List of Device Comments.....	9- 11
9.3 Common Comments and Comments by Program .....	9- 12
9.4 Creating Device Comments.....	9- 15
9.4.1 Creating device comments on the device comment edit window.....	9- 15
9.4.2 Creating device comments for the created circuit.....	9- 17
9.4.3 Creating device comments after creating a circuit .....	9- 18
9.4.4 Editing comments on the ladder editing screen .....	9- 19
9.5 Deleting Device Comments .....	9- 20
9.5.1 Deleting all device comments and device names .....	9- 20
9.5.2 Deleting display device comments and device names .....	9- 20
9.6 Setting Comment Types .....	9- 21
9.7 Setting Comment Ranges.....	9- 23

Chapter 10 SETTING STATEMENTS AND NOTES	10- 1 to 10- 14
---	-----------------

10.1 Statement.....	10- 1
10.2 Note .....	10- 3
10.3 Creating and Deleting Statements .....	10- 5
10.3.1 When editing the circuit window .....	10- 5
10.3.1(1) Creating statements in the circuit edit window .....	10- 5
10.3.1(2) Deleting statements in the circuit edit window .....	10- 6
10.3.2 When editing the list window .....	10- 7
10.3.2(1) Editing statements on the list edit window .....	10- 7
10.3.2(2) Deleting statements on the list edit window.....	10- 8
10.3.3 Creating statements in the statement edit mode .....	10- 9
10.4 Creating and Deleting Notes .....	10- 10
10.4.1 Creating notes on the circuit edit window.....	10- 10
10.4.1 (1) Creating notes on the circuit edit window .....	10- 10
10.4.1 (2) Deleting notes in the circuit edit window.....	10- 11
10.4.2 Creating notes in the list edit window .....	10- 12
10.4.2 (1) Creating notes in the list edit window.....	10- 12
10.4.2 (2) Deleting notes in the list edit window .....	10- 13
10.4.3 Creating notes in the note edit mode .....	10- 14

Chapter 11 SETTING DEVICE MEMORY (DWR SETTING)	11- 1 to 11- 6
--	----------------

11.1 Device Memory .....	11- 1
11.2 Device Value Input.....	11- 2
11.3 All Clear .....	11- 5
11.3.1 Clearing all devices .....	11- 5
11.3.2 Clearing all display devices.....	11- 5
11.4 Making Fill Settings.....	11- 6

Chapter 12 SETTING DEVICE INITIALIZATION VALUES	12- 1 to 12- 2
---	----------------

Chapter 13 SETTING THE PLC PARAMETERS	13- 1 to 13- 12
---------------------------------------	-----------------

13.1 Common Notes on Parameters.....	13- 2
13.2 Setting the PLC Parameters.....	13- 4
13.3 PLC Parameter Item Lists.....	13- 5
13.4 Explanations for PLC Parameter Setting Screen.....	13- 11

Chapter 14 SETTING THE NETWORK PARAMETERS	14- 1 to 14- 10
---	-----------------

14.1 About Items Common to the Network Parameters .....	14- 2
14.2 Setting the Network Parameters .....	14- 4
14.3 Network Parameter Item Lists .....	14- 5
14.4 Explanations for Network Parameter Setting Screen .....	14- 10

Chapter 15 PRINT	15- 1 to 15- 36
------------------	-----------------

15.1 Setting Up a Printer.....	15- 2
15.2 Setting a Page Layout.....	15- 4
15.3 Previewing a Print Image.....	15- 7
15.4 Printing .....	15- 9
15.5 Setting the Details for Printing .....	15- 12
15.5.1 Creating a title .....	15- 12
15.5.2 Setting a ladder print range.....	15- 13
15.5.3 Setting a Instruction list print range .....	15- 16
15.5.4 Setting a TC setting value print range .....	15- 18
15.5.5 Setting a device comment print range.....	15- 19
15.5.6 Setting a device use list print range.....	15- 21
15.5.7 Setting a device memory print range.....	15- 23
15.5.8 Setting a device initial value print range.....	15- 24
15.5.9 Setting a PLC parameter print item .....	15- 26
15.5.10 Setting a network parameter print item .....	15- 27
15.5.11 Setting a list of contact coil used .....	15- 28
15.5.12 Displaying a project contents list .....	15- 29
15.5.13 Setting the TEL data print area.....	15- 30
15.6 Print Examples .....	15- 31



16.1	Checking Programs .....	16- 1
16.2	Merging Programs .....	16- 3
16.3	Checking Parameters .....	16- 6
16.4	All-clearing the Parameters .....	16- 7
16.5	IC Memory Card (GPPW ↔ IC Memory Card) .....	16- 8
16.5.1	Reading the data of the IC memory card .....	16- 10
16.5.2	Writing data to the IC memory card .....	16- 11
16.6	Intelligent Function Utility .....	16- 12
16.7	Transferring ROM Data .....	16- 14
16.7.1	ROM reading, writing, and verification .....	16- 20
16.7.2	Writing to files in ROM format .....	16- 22
16.8	Batch-Deleting the Unused Device Comments .....	16- 24
16.9	Customizing Keys .....	16- 25
16.10	Setting Options .....	16- 26
16.11	Displaying Multiple Windows .....	16- 33
16.12	Opening a Specific Project Using a Shortcut .....	16- 34
16.13	Starting the Ladder Logic Test Tool .....	16- 35
16.14	Outline of Help Function .....	16- 35

17.1	Specifying the Connection Target .....	17- 1
17.1.1	When accessing the own station .....	17- 1
17.1.2	When accessing the other station .....	17- 3
17.2	Making access via Ethernet, CC-Link, G4 module, C24 or telephone line .....	17- 9
17.2.1	Setting method for communication via the ethernet board .....	17- 9
17.2.1 (1)	For A series .....	17- 9
17.2.1 (2)	For QnA series .....	17- 13
17.2.1 (3)	For Q series .....	17- 16
17.2.2	Setting Method for Communication Via CC-Link (AJ65BT-G4) .....	17- 19
17.2.2 (1)	For A series .....	17- 19
17.2.2 (2)	For QnA series .....	17- 21
17.2.3	Setting Method for Communication Via C24 .....	17- 24
17.2.3 (1)	Connection in the form of one-for-one .....	17- 24
17.2.3 (2)	Connection in the form of multidrop .....	17- 26
17.2.4	Setting method for communication via a modem interface module .....	17- 31
17.3	Using PLC Read/Write .....	17- 39
17.3.1	Executing PLC read/PLC write .....	17- 39
17.3.2	Setting the read/write range for device data .....	17- 45
17.3.3	Setting the program reading/writing range .....	17- 47
17.3.4	Setting the comment read/write range .....	17- 48
17.4	Verifying the Peripheral Side and PLC Side Data .....	17- 51
17.5	Write to PLC (Flash ROM) .....	17- 54
17.5.1	Write the program memory to ROM .....	17- 54

17.5.2 Write to PLC (Flash ROM).....	17- 55
17.6 Deleting Data in the PLC .....	17- 56
17.7 Changing PLC Data Attributes .....	17- 58
17.8 Reading/Writing PLC User Data.....	17- 61
17.8.1 Reading .....	17- 61
17.8.2 Writing PLC user data.....	17- 62
17.9 Executing Online Change.....	17- 63
17.10 Concept of the Routing Parameters.....	17- 68

<b>Chapter 18 MONITORING</b>	<b>18- 1 to 18- 32</b>
------------------------------	------------------------

18.1 Monitoring, and Stopping/Resuming Monitoring.....	18- 2
18.2 Monitoring/Stopping Monitoring in All Windows.....	18- 4
18.3 Editing Programs During Ladder Monitoring.....	18- 5
18.4 Switching Present Values Between Decimal and Hexadecimal .....	18- 7
18.5 Batch Monitoring Devices/Buffer Memories.....	18- 8
18.6 Monitoring after Registering Devices .....	18- 12
18.7 Setting Monitor Conditions/Stop Conditions .....	18- 15
18.8 Program List Monitor.....	18- 17
18.9 Monitoring the Interrupt Program List.....	18- 20
18.10 Measuring Scan Time.....	18- 21
18.11 Executing Sampling Trace.....	18- 22
18.11.1 Setting execution & status display.....	18- 23
18.11.2 Setting trace data .....	18- 26
18.11.3 Setting trace conditions.....	18- 28
18.12 Monitoring the Ladders Registered .....	18- 30
18.13 Deleting All Ladders Registered.....	18- 31

<b>Chapter 19 DEBUGGING PROGRAMS</b>	<b>19- 1 to 19- 16</b>
--------------------------------------	------------------------

19.1 Carrying Out a Device Test .....	19- 2
19.2 Carrying Out Partial Operation .....	19- 4
19.3 Executing Step Run .....	19- 8
19.4 Setting the Scan Range.....	19- 11
19.5 Operating the PLC Remotely.....	19- 13

<b>Chapter 20 REGISTERING KEYWORD/PASSWORDS</b>	<b>20- 1 to 20- 10</b>
---	------------------------

20.1 Registering Keyword .....	20- 1
20.1.1 Registering new keyword/changing keyword .....	20- 1
20.1.2 Canceling a keyword .....	20- 4
20.1.3 Releasing a keyword .....	20- 5
20.2 Registering Passwords.....	20- 6
20.2.1 Register new passwords/changing passwords.....	20- 7
20.2.2 Delete the passwords.....	20- 9
20.2.3 Disable the passwords.....	20- 10

Chapter 21 PLC MEMORY	21- 1 to 21- 10
-----------------------	-----------------

21.1 Clearing the PLC Memory .....	21- 1
21.1.1 All-clearing on ACPU memory .....	21- 1
21.1.2 All-clearing the QCPU, QnACPU device memory .....	21- 3
21.1.3 All-clearing an FXCPU memory.....	21- 4
21.2 Formatting a QCPU (Q mode), QnACPU Memory .....	21- 6
21.3 Sorting the QCPU (Q mode), QnACPU Memory.....	21- 8
21.4 Setting for the PLC's Clock.....	21- 9

Chapter 22 DIAGNOSIS	22- 1 to 22- 28
----------------------	-----------------

22.1 Diagnosing the PLC.....	22- 1
22.1.1 Diagnosing an ACPU .....	22- 1
22.1.2 Diagnosing a QCPU (Q mode), QnACPU.....	22- 3
22.1.3 Diagnosing an FXCPU.....	22- 5
22.2 Diagnosing a Network.....	22- 6
22.2.1 Testing a network .....	22- 8
22.2.2 Performing a loop test .....	22- 9
22.2.3 Performing a setting confirmation test .....	22- 10
22.2.4 Performing a station order confirmation test .....	22- 12
22.2.5 Performing a transmission test .....	22- 14
22.2.6 Monitoring the error history .....	22- 15
22.2.7 Network monitor details .....	22- 17
22.2.8 Monitoring other station information .....	22- 18
22.3 Running CC-Link Diagnostics.....	22- 21
22.3.1 Monitoring the line (own station).....	22- 21
22.3.2 Conducting a line test.....	22- 23
22.3.3 Monitoring the lines (other stations) .....	22- 24
22.4 System Monitor .....	22- 25

Chapter 23 SETTING A6TEL/Q6TEL/FX <sub>2N</sub> DATA	23- 1 to 23- 38
--	-----------------

23.1 Function Setting Item List .....	23- 2
23.2 Preparations for Connecting the Telephone Line .....	23- 3
23.2.1 Making remote access/pager notice (for ACPU) .....	23- 3
23.2.2 Making remote access/pager notice (for QnACPU).....	23- 5
23.2.3 Making remote access to FXCPU .....	23- 7
23.2.4 Making Q6TEL-Q6TEL communication .....	23- 9
23.3 Making Initial Setting of Data .....	23- 12
23.3.1 Creating a phone number book .....	23- 12
23.3.2 Registering the AT command .....	23- 16
23.3.3 Registering A6TEL data.....	23- 19
23.3.4 Registering Q6TEL data .....	23- 23
23.3.5 Setting the FX PLC .....	23- 28
23.4 Connecting/Disconnecting the Line.....	23- 32
23.4.1 Connecting the line automatically.....	23- 32



About Manuals

The following lists the manuals for this software package.  
Refer to the following table when ordering manuals.

**Related Manuals**

Manual Name	Manual No. (Model Code)
GPP Function software for Windows SW5D5C-GPPW SW5D5C-LLT Operating Manual (Startup). Describes the system configuration, installation procedure, and start-up procedure of the SW5D5C-GPPW-E and SW5D5C -LLT-E software packages. (Packed with the product)	IB-0800093 (13J975)
GPP Function software for Windows SW4D5C-GPPW SW4D5F-GPPW SW4D5C-LLT SW4D5F-LLT Starting GPPW. Describes the following using illustrations for persons who use SW4D5C -GPPW and SW4D5C -LLT for the first time: installation procedure, start-up procedure, basic information, ladder creating and editing procedure, printing out procedure, monitoring procedure, and debugging procedure. (Sold separately)	IB-0800057 (13J966)
Ladder Logic Test Function Software for Windows SW5D5C-LLT Operating Manual. This manual gives a product summary, device memory monitoring and setting/operating methods for machine simulation. (Sold separately)	SH-080064 (13J977)
GPP Function Software for Windows SW5D5C-GPPW Operating Manual (SFC). Provides the program creation method, print-out method and so on using SW5D5-GPPW. (Sold separately)	SH-080063 (13J976)
Data Conversion Software Package for Windows SW0D5C-CNVW-E Operating Manual. Explains the data conversion method and other functions using SW0D5C-CNVW-E. (Sold separately)	IB-0800004 (13J949)
GPP Function Software for Windows SW5D5C-GPPW Operating Manual (MELSAP-L). Provides the program creation method, print-out method and so on using SW5D5C-GPPW. (Sold separately)	SH-080075 (13J980)

How the manual describes the explanation is shown below.

### 5.11 Renaming Data in a Project

A	QnA	FX
○	○	○

**[Purpose]**  
 Renames the existing data in a project.

**[Operating Procedure]**  
 Select [Project] → [Edit data] → [Rename].

**[Dialog Box]**

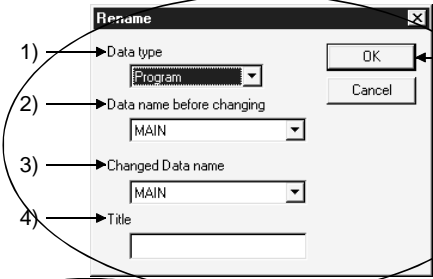

**[Description]**

- 1) Data type  
 Designates the data type (program, common comment, comments by program, device memory).
- 2) Data name before renaming  
 Designates the data name before renaming.
- 3) Renamed data name  
 Designates the new data name after renaming.  
 The data name must be designated in up to 8 characters.
- 4) Title  
 Displays the set title of the data.  
 If necessary, the title can be edited and stored.  
 It must be designated in up to 32 characters.
- 5)  button  
 Click this button after making necessary settings.

**POINT**

This operation cannot change the data name of comments by program to "COMMENT".  
 For changing the comments by program to the common comment (COMMENT), refer to "Setting Comment Types" (Section 9.6).

5 - 11

This table indicates the applicable items for A series, QnA series and FX series.

Items which are set in the section are explained.

The desired window opens by selecting the items in the specified order.

The dialog boxes set in the section are explained.

The contents of the items and buttons are explained. The numbers correspond to those specified in the window shown under the title of [Dialog box].

This gives the information related to the topic discussed and also the helpful information.

Symbols used in this manual, and the contents and examples of them are shown below.

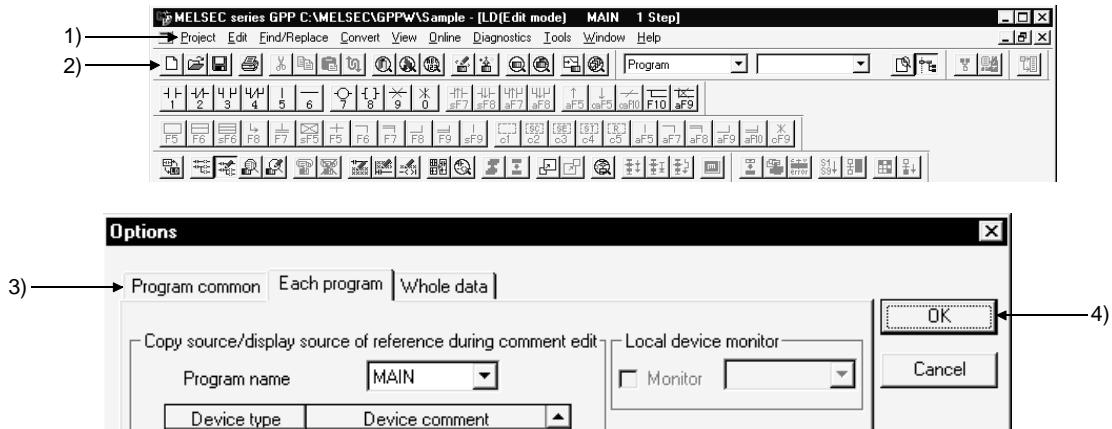

No.	Symbol	Contents	Example
1)	[ ]	Menu name of menu bar	[Project]
2)		Icon in toolbar	
3)	<< >>	Tab name of dialog box	<<Program common>>
4)		Command button in dialog box	button

The functions that cannot be operated on GPPW are grayed (masked) and cannot be selected. There are the following reasons why they are not selectable.

- (1) The PLC CPU used does not have the functions  
 For example, when the A1SCPU is chosen as the PLC type, it does not have the STEP-RUN function and therefore [Online] → [Debug] → [Debug] cannot be selected.  
 To see if your PLC CPU has the operable functions, check the specifications in the PLC CPU user's manual or the like.
- (2) The functions cannot be selected because they cannot be used with the currently operated function  
 For example, when the monitor screen is open, PLC type change, connection setup, PLC data attribute change, data coupling, parameter check and all parameter clear cannot be performed.

## Abbreviations and Terms in This Manual

This manual uses the abbreviations and terms listed in the following table to discuss the GPP Function Software Package and PLC module. In addition, the following table lists the names of modules whose names must be indicated explicitly.

Abbreviation/Generic Term		Description/Target Module
ACPU		Generic term for PLC available with MELSEC-A Including MOTION (SCPU) (However, GPPW does not support A1, A2, A3, A3H, A3M, A52G, A73, A0J2 and A3V.)
QCPU (A mode)		Generic term for Q02(H)-A and Q06H-A
QnACPU		Generic term for PLC available with MELSEC-QnA
QCPU (Q mode)		Generic term for Q02(H), Q06H, Q12H and Q25H
FXCPU		Generic term for PLC available with MELSEC-F (The target PLCs are FX0, FX0S, FX0N, FX1, FX, FX2, FX2C, FX1S, FX1N, FX2N and FX2NC. )
GPPA		SW <input type="checkbox"/> SRXV-GPPA SW <input type="checkbox"/> IVD-GPPA
GPPQ		SW <input type="checkbox"/> IVD-GPPQ
FXGP(DOS)		SW1PC-FXGP/EE/AT
FXGP(WIN)		SW0PC-FXGP/WIN-E
GPPW		SW4D5C-GPPW-E
SW4D5-GPPW-E		Generic term for SW4D5C-GPPW
SW3D5-GPPW-E		SW3D5C-GPPW-E SW3D5F-GPPW-E
SW2D5-GPPW-E		SW2D5C-GPPW-E SW2D5F-GPPW-E
Logic test function (LLT)		SW <input type="checkbox"/> D5C-LLT-E, SW <input type="checkbox"/> D5F-LLT-E
A series		For GPPW PLC type selection by ACPUCPU
QnA series		For GPPW PLC type selection by QnACPU
Q series		For GPPW PLC type selection by QCPU (Q mode)
FX series		For GPPW PLC type selection by FXCPU
Peripheral device		Personal computer compatible with Windows 95/98 and Windows NT Workstation 4.0
E71		AJ71AJ71E71-S3, A1SJ71E71-B2-S3, A1SJ71E71-B5-S3 A1SJ71E71-B2, A1SJ71E71-B5
QE71		AJ71QE71(B5), A1SJ71QE71-B2, A1SJ71QE71-B5
Q series-compatible E71		Generic term for QJ71E71 and QJ71E71-B2
Ethernet board		Ethernet PLC card, Ethernet I/F board
Computer link Unit	For A series	A1SJ71C24-R2, A1SJ71C24-R4, A1SJ71C24-PRF A2CCPUC24(-PRF), A1SCPUC24-R2
	For AnU	AJ71UC24, A1SJ71UC24-R2, A1SJ71UC24-R4, A1SJ71UC24-PRF
Serial communication unit	For QnA series	Generic term for AJ71QC24, AJ71QC24-R2, AJ71QC24-R4, AJ71QC24N, A1SJ71QC24, A1SJ71QC24-R2, AJ71QC24N-R2, AJ71QC24N-R4, A1SJ71QC24N and A1SJ71QC24N-R2
	For Q series	Generic term for QJ71C24 and QJ71C24-R2
MEDOC		MELSEC-MEDOC
CC-Link		Control & Communication Link
PLC		PROGRAMMABLE LOGIC CONTROLLER
SFC		Generic term for MELSAP2/MELSAP3/MELSAP-L
C24		Computer link Unit, Serial Communication Unit





# 1. GENERAL DESCRIPTION

## Product Outline and Features

### Outline

This section explains the type SW5D5C-GPPW-E GPP Function Software Package (called GPPW). GPPW is a software package having the following functions.

1. Program creation

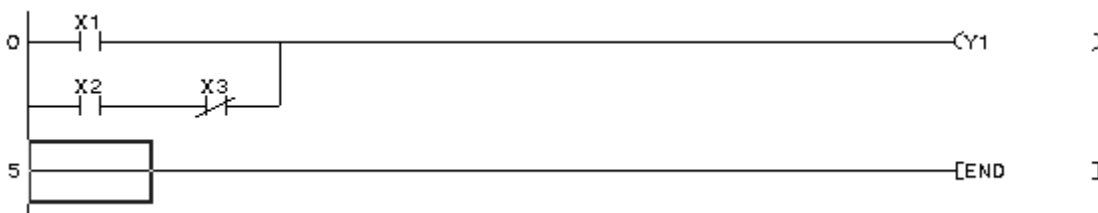

2. Writing and reading to/from PLC

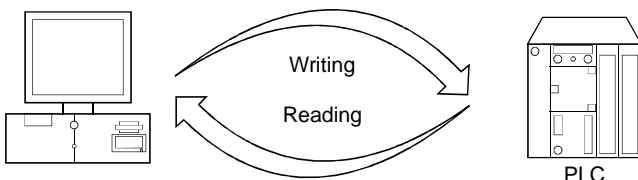

3. Monitoring (example: device batch monitoring)

The circuit monitor, device monitor, and device registration monitor can be used for monitoring.

Device	+F	E	D	C	+B	A	9	8	+7	6	5	4	+3	2	1	0		
D01	0	0	0	0	0	0	0	0	0	0	0	0	0	0	0	0	0	0
D02	0	0	0	0	0	0	0	0	0	0	1	0	0	1	0	1		37
D03	0	0	0	0	0	0	0	0	1	0	0	1	0	0	0	0		144

4. Debugging

The created sequence program is written into PLC to test that the written sequence program operates normally.

In addition, the newly developed SW5D5C -LLT-E ladder logic test tool function software package\*1 (called the logic test function (LLT)) can be used to debug the program with a single personal computer.

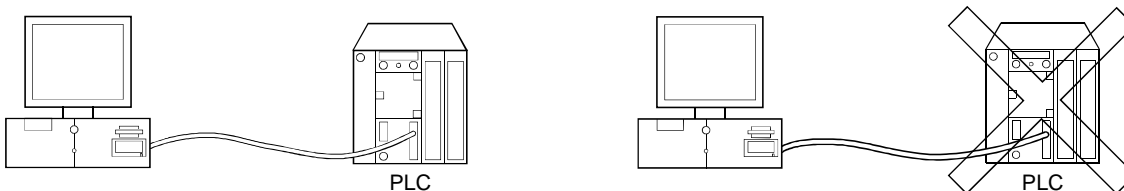

5. Diagnostics PLC

The current error status, error status or error log can be displayed to shorten the time required for error recovery.

\*: The logic test function (LLT) is an independent function and may be purchased separately.

## Features

The following summarizes the GPPW features.

1. GPPW can create Q, A (including MOTION (SCPU)) QnA and FX series data. Setting operations are common.
2. Enhanced programming tools
  - Instruction list                      • Function key
  - Tools button                         • Menu barPrograms can be created using the tools the user wishes to use.
3. Data created by GPPW is converted into files for the SW □-GPPA GPP Function Software Package (simply called GPPA, but exclude the software package for A6GPP/A6PHP) or SW □-GPPQ GPP Function Software Package (simply called GPPQ so that they can be edited by GPPA or GPPQ). In addition, when FX series has been selected, data created by GPPW is converted into files for the DOS Programming Software (called FXGP (DOS) simply) or SW0PC-FXGP/WIN-E Programming Software called FXGP(WIN) so that they can be edited by FXGP(DOS) or FXGP(WIN).
4. GPPW is compatible with SFC program of FX series.
5. Multiple device memory data can be contained in a project.
6. Comment data created by Excel or Word can be copied or pasted for efficient creation.
7. Windows data can be easily used (cut, copied or pasted).
8. When an error occurs during data creation, the error cause is displayed and the time required for data creation can be reduced greatly.
9. The helpfile contains the descriptions of CPU errors, special relays and special registers so that they can be referenced to check the causes at online error occurrence or the contents of the special relays or special registers during program creation.
10. The logic test function (LLT) can be used for ease of debugging.
  - (1) Connection to PLC is not required.
  - (2) Dummy sequence programs (programs for debugging) need not be created.
11. Graphical designation of a connection target ensures ease of setting even when the system configured is complex.

DOS, Windows, Word, Excel are the registered trademarks of Microsoft Corporation.  
The company name and product name in this manual are the trademarks or the registered trademarks of the respective company.

## 1.1 Functions Lists

The GPPW functions are listed below.

The functions are divided into normally common functions (project, online, diagnosis, tool, window, help) and functions for objects to be edited and set (edit, search/replacement, conversion, display).

In addition, there are executable and inexecutable functions depending on the CPU series.

POINTS
<ul style="list-style-type: none"> <li>The QCPU (A mode) and motion controller (SCPU) are described as the ACPU.</li> <li>Refer to the corresponding manuals for details of the motion controller and SFC.</li> </ul>

### (1) List of common functions

Fixed functions independent of the type of the object being edited or set

Project (Common functions)			Refer To
New project	Creates a new project.		4.1
Open project	Opens an existing project.		5.1
Close project	Closes an open project.		5.2
Save	Saves the project.		5.3
Save as	Names and saves the project.		5.4
Delete project	Deletes an existing project.		5.5
Verify	Verifys data between projects.		5.6
Copy	Copies data between projects.		5.7
Edit data			
New	Adds data to a project.		5.8
Copy	Copies data in a project.		5.9
Delete	Deletes data in a project.		5.10
Rename	Renames data in a project.		5.11
Change program type	Change the program type in the project		5.12
Change PLC type	Changes the PLC type.		5.13
Import file			
Import from GPPQ format file	Read a GPPQ file	(QnA only)	5.14.1
Import from GPPA format file	Read a GPPA file	(A only)	5.14.1
Import from FXGP(WIN) format file	Read a FXGP(WIN) file	(FX only)	5.14.1
Import from FXGP(DOS) format file	Read a FXGP(DOS) file	(FX only)	5.14.1
Import from Melsec Medoc format file (Print out)	Import from Melsec Medoc format file	(Print out)	5.14.2
Import from Melsec Medoc format file	Import from Melsec Medoc format file		5.14.3
Export file			
Export to GPPQ format file	Write a GPPQ files	(QnA only)	5.15
Export to GPPA format file	Write a GPPA files	(A only)	5.15
Export to FXGP(WIN) format file	Write a FXGP(WIN) files	(FX only)	5.15
Export to FXGP(DOS) format file	Write a FXGP(DOS) files	(FX only)	5.15
Macro			
Registration macros	Registration macros		5.16.1
Macro utilize	Macro utilize		5.16.2
Delete macros	Delete macro instruction from the file		5.16.3
Macro reference path	Set the macro instruction reference path		5.16.4
Printer setup	Changes the printer settings.		15.1
Print	Prints data.		15
Start new GPPW session	Restarts GPPW.		5.17
End GPPW	Exits GPPW.		5.18

(To the next page)

(Continued from the previous page)

Online (Common functions)		Refer To
Transfer setup	Designates a PLC destination from GPPW.	17.1
Read from PLC	Reads data from PLC.	17.3
Write to PLC	Writes data to PLC.	17.3
Verify with PLC	Verifys data with PLC data.	17.4
Write to PLC (Flash ROM)		
Write the program memory to ROM	Writes program memory data to the standard ROM/IC memory card (ROM). (Q only)	17.5.1
Write to PLC (Flash ROM)	Writes data to the standard ROM/IC memory card (ROM). (Q only)	17.5.2
Delete PLC data	Deletes PLC data. (QnA only)	17.6
Change PLC data attributes	Changes PLC data attributes. (QnA only)	17.7
PLC user data		
Read PLC user data	Reads user data from the PLC. (Q only)	17.8.1
Write PLC user data	Writes user data to the PLC. (Q only)	17.8.2
Delete PLC user data	Deletes user data of the PLC. (Q only)	17.8.1
Monitor		
Monitor mode	Places the circle edit screen in monitor mode.	18.1
Monitor (Write mode)	Sets the circuit (monitor write) mode.	18.3
Start monitor (All windows)	Starts monitoring all open windows.	18.2
Stop monitor (All windows)	Stops monitoring all open windows.	18.2
Start monitor	Restarts the stopped monitor.	18.1
Stop monitor	Stops the monitor.	18.1
Change current value monitor (Decimal)	Displays the current device value of the circuit monitor in decimal form.	18.4
Change current value monitor (Hexadecimal)	Displays the current device value of the circuit monitor in hexadecimal form.	18.4
Device batch	Monitors devices in batch mode.	18.5
Entry data monitor	Entry data mode	18.6
Buffer memory batch	Monitors the buffer memory in batch mode.	18.5
Monitor condition setup	Sets the monitor execution conditions. (QnA only)	18.7
Monitor stop condition setup	Sets the monitor stop conditions. (QnA only)	18.7
Program monitor list	Monitors a program list.	18.8
Interrupt program monitor list	Lists the interrupt programs.	18.9
Scan time measurement	Measures the scan time.	18.10
Entry ladder monitor	Entry the ladder block	18.12
Delete all entry ladder	Delete all entry ladder	18.13
Debug (ladder)		
Device test	Turns on or off the device or changes the value.	19.1
Debug	Executes/disables the debugging function.	19
Skip execution	Makes settings for skip. (QnA, FX)	19.4
Partial execution	Makes settings for partial operation.	19.2
Step execution	Makes settings for step execution.	19.3
Trace		
Sampling trace	Execute sampling trace.	18.11
Remote operation	Operates the PLC remotely.	19.5

















(To the next page)

(Continued from the previous page)

Online (Common functions)			Refer To
Keyword/Password (Q series)			
Register keyword	Registers or changes the keyword.		20
Delete keyword	Cancels the keyword.		20
Disable keyword	Unlocks access by keywords		20
Clear PLC memory	Clears the PLC memory cassette or device memory.		21.1
Format PLC memory	Formats the PLC memory. (QnA only)		21.2
Arrange PLC memory	Arranges the data area within the PLC memory. (QnA only)		21.3
Set clock	Sets the internal timer of the PLC.		21.4
Diagnosis (Common functions)			Refer To
PLC Diagnostics	Diagnoses the PLC.		22.1
Network diagnostics	Diagnoses the network (A, QnA)		22.2
CC-Link diagnostics	CC-Link diagnostics (A, QnA)		22.3
System monitor	Monitors the system status of the PLC. (Q only)		22.4
Tool (Common functions)			Refer To
Check program	Checks the program.		16.1
Merge data	Links data.		16.2
Check parameter	Checks the parameter.		16.3
Transfer ROM			
Read	Reads data from ROM. (A, FX)		16.8.1
Write	Writes data to ROM. (A, FX)		16.8.1
Compare	Compares data with ROM data. (A, FX)		16.8.1
Write to file	Writes ROM data to files. (A, FX)		16.8.2
Delete unused comments	Delete the comments which isn't used at program		16.9
Clear all parameters	Deletes parameters.		16.4
IC memory card			
Read IC memory card	Reads data from the IC memory card. (Q only)		16.5.1
Write IC memory card	Writes data to the IC memory card. (Q only)		16.5.2
Start ladder logic test	Starts the ladder logic test.		16.14
Set TEL data			
Connection	Connect the line for A6TEL/Q6TEL		23.4
Disconnect	Disconnect the line		23.4.3
TEL data	Set the report data of A6TEL or Q6TEL		23.3.3
AT command	Entry the modem		23.3.2
Call book	Set the call book		23.3.1
Intelligent function utility			
Utility list	Shows the utility names required to edit the intelligent function unit parameters. (Q only)		16.7
Session	Starts the intelligent function utility. (Q only)		16.7
Customize keys	Changes key assignments for circuit symbol input.		16.10
Options	Sets the options.		16.11
Create start-up settings file	Creates a file to save initial settings of the project.		16.13
Window (Common functions)			Refer To
Cascade	Cascades windows.		16.12
Tile vertically	Tiles the windows vertically.		16.12
Tile horizontally	Tiles the windows horizontally.		16.12
Arrange icons	Arranges the icons in the lower part of the window.		16.12
Help (Common functions)			Refer To
CPU error	Displays the description of each CPU error code.		16.14
Special relay/register	Displays the description of special relays or registers.		16.14
Key operation list	Displays the description of each key operation.		16.14
Product information	Displays product information (such as version number).		16.14

## (2) Ladder editing function list

The following functions can be performed to edit the ladders and operation outputs/transition conditions.

Edit (Ladder editing functions)		Refer To
Undo	Reverses the last operation.	6.2.9
Cut	Moves the selected data to the Clipboard.	3.3.1
Copy	Copies the selected data to the Clipboard.	3.3.2
Paste	Pastes the contents of the Clipboard at the cursor position.	3.3.1
Insert line	Inserts a row at the cursor position.	6.2.5
Delete line	Deletes a row at the cursor position.	6.2.5
Insert row	Inserts a column at the cursor position.	6.2.5
Delete row	Deletes a column at the cursor position.	6.2.5
Insert NOP batch	Inserts NOP before a circuit block at the cursor position.	6.2.6
Delete NOP batch	Deletes all NOPs in the program at a time.	6.2.7
Draw line	Inserts a line.	6.2.2
Delete line	Deletes a line.	6.2.4
Change TC setting	Changes the setting value of the timer or counter.	6.3
Read mode	Places the circuit screen in the read mode.	6
Write mode	Places the circuit screen in write mode.	6
Ladder symbol		
Open contact	Inserts  at the cursor position.	6.2
Close project contact	Inserts  at the cursor position.	6.2
Open branch	Inserts  at the cursor position.	6.2
Close project branch	Inserts  at the cursor position.	6.2
Coil	Inserts  at the cursor position.	6.2
Application instruction	Inserts  at the cursor position.	6.2
Vertical line	Inserts  at the cursor position.	6.2
Horizontal line	Inserts  at the cursor position.	6.2
Delete vertical line	Inserts  at the cursor position.	6.2
Delete Horizontal line	Inserts  at the cursor position.	6.2
Rising pulse	Inserts  at the cursor position. (QnA, FX)	6.2
Falling pulse	Inserts  at the cursor position. (QnA, FX)	6.2
Rising pulse Open branch	Inserts  at the cursor position. (QnA, FX)	6.2
Falling pulse Close branch	Inserts  at the cursor position. (QnA, FX)	6.2
Invert operation results	Inserts  at the cursor position. (QnA, FX)	6.2
Convert operation results to rising pulse	Inserts  at the cursor position. (QnA, FX)	6.2
Convert operation results to falling pulse	Inserts  at the cursor position. (QnA, FX)	6.2
Documentation		
Comment	Edits the comment at the cursor position.	9.4.4
Statement	Edits the statement in the ladder at the cursor position.	10.3.1(1)
Note	Edits the note in the ladder at the cursor position.	10.4.1(1)

Search/Replacement (Ladder editing functions)		Refer To	
Find device	Searches for a device.	6.4.1	
Find instruction	Searches for an instruction.	6.4.2	
Find step No.	Searches for a step number.	6.4.3	
Find character string	Searches for a character string in comment, note, or statement.	6.4.4	
Find contact or coil	Find contact or coil	6.4.5	
Finding data	Finding data	6.4.6	
Replace device	Searches for and replaces a device.	6.4.7	
Replace instruction	Searches for and replaces an instruction.	6.4.8	
Change open/close contact	Searches for and replaces a contact a with a contact b.	6.4.9	
Replace character string	Searches for and replaces a character string in comment, note, or statement.	6.4.10	
Replace statement/note type	Searches for and replaces the type of a character string between statement and note. (Q, QnA only)	6.4.11	
Replacing data	Replacing data	6.4.12	
Cross referense list	Finds whether the device is being used by a contact or coil.	6.4.13	
List of used devices	Finds where the device is used.	6.4.14	
Conversion (Ladder editing functions)		Refer To	
Convert	Converts the program.	8.1	
Convert (All programs being edited)	Converts the programs (not converted yet) in all windows.	8.2	
Convert block (Online change)	Converts the program and writes it during run.	17.9	
Display (Ladder editing functions)		Refer To	
Comment	Displays or hides comments.	3.8	
Statement	Displays or hides statements.	3.9	
Note	Displays or hides notes.	3.10	
Device Label	Displays or hides device names.	3.11	
Macro instruction format display	Provides display in the user macro instruction format. (Except FX)	5.16	
Comment format			
	4 × 8 characters	Shows comments in 4 × 8 or 2 × 8 characters.	3.12
	3 × 5 characters	Shows comments in 3 × 5 characters.	3.12
Toolbar	Displays of hides the toolbar.	3.4	
Status bar	Displays of hides the status bar.	3.5	
Zoom			
	50%	Displays a circuit reduced to 50%.	3.6
	75%	Displays a circuit reduced to 75%.	3.6
	100%	Displays a full-size circuit.	3.6
	150%	Displays a circuit magnified to 150%.	3.6
	Auto	Displays a circuit according to the screen size.	3.6
Project data list	Displays or hides the project data list.	3.7	
Instruction list	Switches program circuit display and list display.	6	
Elapsed time	Displays the elapsed time.	23.4.1	

## (3) Device comment editing function list

The following functions can be performed to edit device comments.

Edit		Refer To
Clear all (all devices)	Deletes the comments or device names of all devices.	9.5.1
Clear all (displayed devices)	Deletes the displayed comments or device names.	9.5.2
Setup comment	Sets the common comments or comments by program.	9.6
Setup comment range	Sets a comment range.	9.7



## (4) Device memory setting function list









The following functions can be performed to set the device memory.

Edit		Refer To
Clear all (all devices)	Deletes data of all devices.	11.3.1
Clear all (displayed devices)	Deletes the data of displayed devices.	11.3.2
FULL	Sets all data to the specified value.	11.4

## (5) SFC editing function list



The following functions can be performed to edit SFC.

For details, refer to the GPP function software for Windows SW5D5C-GPPW operating manual (SFC manual).

Edit (SFC editing functions)		
Insert line	Inserts a row at the cursor position.	
Delete line	Deletes a row at the cursor position.	
Insert row	Inserts a column at the cursor position.	
Delete row	Deletes a column at the cursor position.	
Edit the line		
	Vertical line	Writes a vertical line.
	Selection divergence	Writes selective branch.
	Simultaneous divergence	Write a parallel branch.
	Selection convergence	Writes a selective coupling.
	Simultaneous convergence	Writes a parallel coupling.
Delete the line	Deletes the selective/parallel branch or selective/parallel coupling.	
Change TC setting	Changes the setting value of the timer or counter.	
Read mode	Places the circuit screen in the read mode.	
Write mode	Places the circuit screen in write mode.	
Step attribute		
	Normal	Set the normal (A/Q/QnA)
	Stored coil	Set the stored coil (SC) type (A/Q/QnA)
	Stored operation (without transition check)	Stored operation (without transition check) [SE] type (Q/QnA)
	Stored operation (with transition check)	Set the stored operation (with transition check) [ST] type (Q/QnA)
	Reset	Set the reset [R] type (Q/QnA)
SFC symbol		
	Step	Inserts  at the cursor position.
	Block START step (with END check)	Inserts  at the cursor position. (A/Q/QnA)
	Block START step (without END check)	Inserts  at the cursor position. (Q/QnA)
	Jump	Inserts  at the cursor position.
	End step	Inserts  at the cursor position. (A/Q/QnA)
	Dummy step	Inserts  at the cursor position. (A/Q/QnA)
	Transition	Inserts  at the cursor position.
	Selection divergence	Inserts  at the cursor position.
	Simultaneous divergence	Inserts  at the cursor position.

(To the next page)

(Continued from the previous page)

Edit (SFC editing functions)		
SFC symbol	Selection convergence	Inserts  at the cursor position.
	Simultaneous convergence	Inserts  at the cursor position.
	Vertical line	Inserts  at the cursor position.
Documentation		
	Comment	Edit comment
Block information		Set the block information
Search/Replacement (SFC editing functions)		
Find device		Finds device.
Find instruction		Finds instruction.
Find step No./block No.		Finds the step number.
Find character string		Finds character string.
Replace device		Replaces a device.
Replace instruction		Replaces an instruction.
Change open/close contact		Replaces open/close contact.
Replace step No.		Replace the step number
Replace character string		Replaces a character string.
Cross reference list		Finds whether the device is being used by a contact or coil.
List of used devices		Finds where the device is used.
Conversion (SFC editing functions)		
Convert (All programs being edited)		Converts the programs (not converted yet) in all windows.
Convert (block)		Convert the block data
Convert block (all block)		Convert the all block
Display convert error		Display the convert error
Display (SFC editing functions)		
Display comment of step and TR		Displays the step and transition comment.
Display label of step and TR		Displays the step and transition label.
Row of SFC		Set the row number of SFC diagram.
Zoom setting		
	Below	Display the zoom ladder of list at below
	Right	Display the zoom ladder of list at right
	Split	Display the zoom ladder of list
Set the contact at right		
	5 contacts	Display 5 contacts at the line of ladder
	11 contacts	Display 11 contacts at the line of ladder
Review SFC		Review SFC
Display block list		Display block list
Online (Common functions)		
Debug (SFC)		
	Device test	Sets the device value.
	Block brake	Block brake (A/Q/QnA)
	Step brake	Step brake
	Block run	Block run
	Step run	Step run
	1 step run	1 step run
	Block forced stopping	Block forced stopping
	Step forced stopping	Step forced stopping
	Reset stored step	Reset stored step
	Run all block	Run All Block

## 1.2 FX Series Programming

---

This section describes the main differences between the GPPW operating environment and FX-dedicated programming software (DOS version, Windows version) operating environment and the points to be noted.

### Target PLC:

FX0, FX0S, FX0N, FX1, FX2, FX2C, FX1S, FX1N, FX2N, and FX2NC series

In the selection of PLC type, select FXU/FX2C for FX,FX2 and FX2C

See Section 2 for details on the system configuration and connection method.

### Operating Environment

- Differences of main terms
  - Program file handling

GPPW programming data is created in units of folders (directories) called the projects.  
FXGP(DOS) and FXGP(WIN) do not have the concept of project, and program files are created in any folders (directories) for management.  
For this reason, the program file names in FXGP(DOS) and FXGP(WIN) are project names in GPPW.  
For details on project specification, see Section 3.2.
  - Comments
    - (1) The number of characters that can be input may be different (see Appendix 11).
    - (2) The circuit comment is called the statement.
    - (3) The coil comment is called the note.
  - Parameter settings

Some setup screens have different names (see Section 13).
- Differences in operations
  - Step ladder instructions (STL, RET) are displayed in different ways (see Section 6.2.2).
  - Monitor display may be partially different (see Appendix 11).
  - Application instructions using the FNC. No. are not available.
  - Although FX PLC operates in the sequence program with no End instructions, END instructions are forceful input in GPPW.

- Common items and others
  - Items that are available for only A series or QnA series are disabled and displayed in gray in the GPPW operation screens.
  - Partial execution, step run, and step run debug functions cannot be used when FXCPU is connected. However, these debug functions can be used for debugging with a single personal computer when the ladder logic test function (LLT) is connected (see Chapter 19 for details).
  - The program conversion function is provided for conversion from A to FX series and vice versa (see Section 5.12 and Appendix 4 for details).
  - The GPPW FX series allows users to create only one program file. Because A series or QnA series allows users to create multiple program files, this manual may use screen examples including multiple program files when describing the function. However, when FX series is selected, only the main program is displayed on the screen.
  - The connection cable and RS-232C/RS-422 converter for FX PLC may be different from those for A or QnA series PLC (see Subsection 2 for details).
  - GPPW is capable of reading from or writing to FXGP(DOS) and FXGP(WIN) files basically. However, note that there are some exceptions (see Sections 5.13 and 5.14 and Chapter 9 for details).
  - SFC program of FX series is displayed as STL and RET instructions on the circuit edit screen of the GPPW since the program is described as the step ladder instructions.  
It is possible to edit on the circuit.

### 1.3 Basic Key Specifications

The following table summarizes the purposes of the keys used with the GPP function.

Key Name	Purpose
<b>Esc</b>	Closes the window, interrupts execution, and selects instructions.
<b>Tab</b>	Enters a tab code and switches the target to which the cursor must be moved quickly.
<b>Ctrl</b> + <b>Tab</b>	Used in a combination with a alphanumeric key or a function key.
<b>Ctrl</b>	
<b>Shift</b>	Selects a character at the Shift position.
<b>Caps Lock</b>	Switches upper-case and lower-case letters.
<b>Alt</b>	Selects the menu.
<b>Back space</b>	Deletes a character to the left of the cursor position.
<b>Enter</b>	Enters a carriage return.
<b>Page Up</b>	Scrolls down the circuit or list by page. (Scrolls a screen in minus direction.)
<b>Page Down</b>	Scrolls up the circuit or list by page. (Scrolls a screen in plus direction.)
<b>Insert</b>	Enters a space character at the cursor position.
<b>Delete</b>	Deletes a character at the cursor position. (Clears all settings.)
<b>Home</b>	Moves the cursor to the home position.
<b>↑</b> <b>↓</b> <b>←</b> <b>→</b>	Moves the cursor or scrolls the circuit or list in unit of lines. ( <b>↑</b> <b>↓</b> )
<b>Ctrl</b> + <b>Home</b>	Moves circuit the cursor to step 0 in the mode.
<b>Ctrl</b> + <b>End</b>	Moves the cursor to the End instruction in the circuit mode.
<b>Scroll Lock</b>	Inhibits scroll-up and scroll-down.
<b>Num Lock</b>	Uses the Ten-key pad for numeric key input only.

## 2. SYSTEM CONFIGURATION

### 2.1 Connection from the Serial Port

The following system configuration is made up by connection from the serial port.

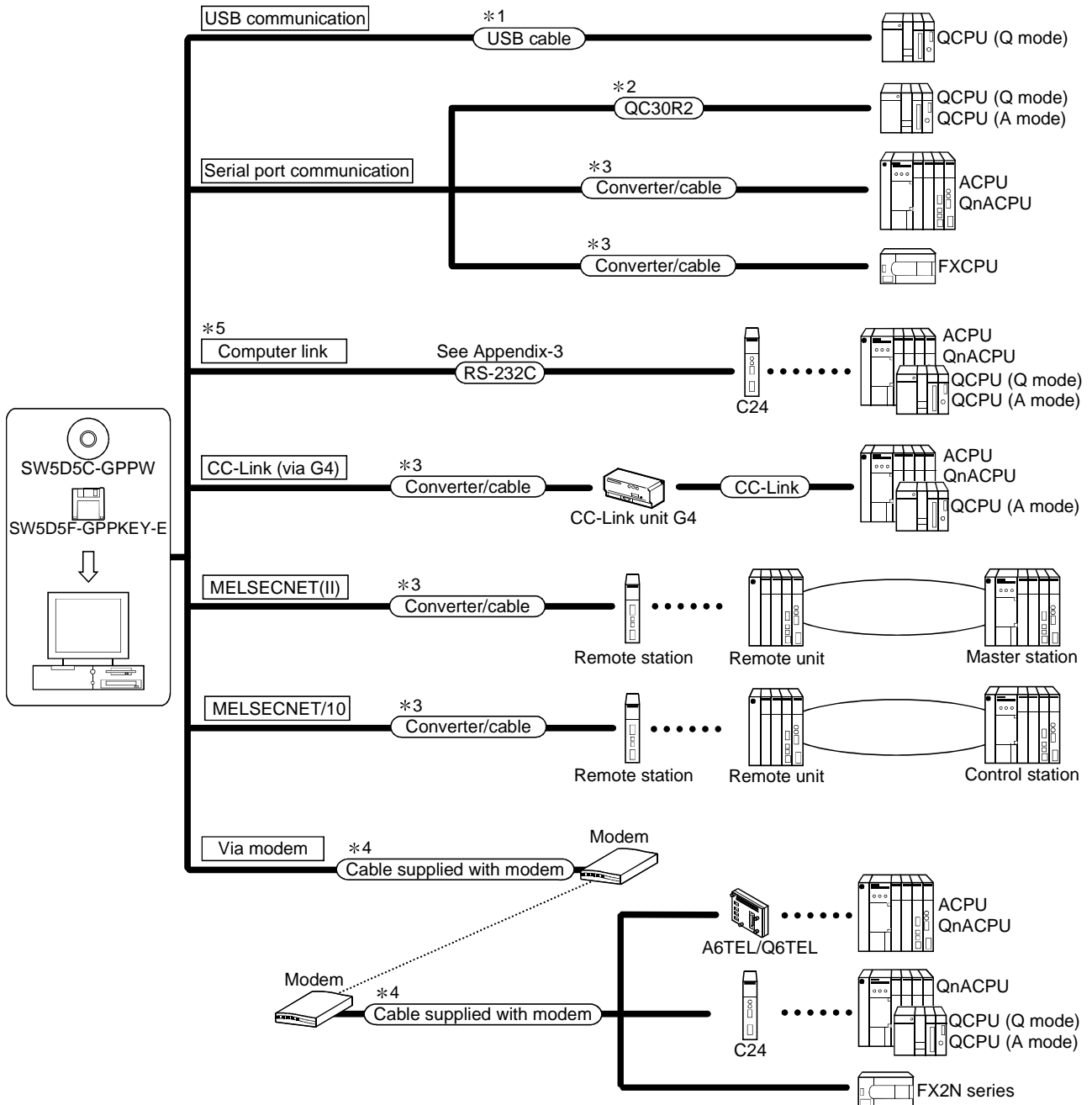

- \*1: About the USB cable (QCPU (Q mode) compatible)
  - (1) Usable when Windows 98 and USB driver have been installed.
  - (2) Unusable for Windows 95, Windows NT Workstation 4.0.
  - (3) Use of the USB cable allows only one PLC CPU to be connected.
  - (4) Use the USB cable which conforms to the USB Standard Rev. 1.1.
  - (5) Refer to POINT in Section 17.1.2 for precautions for and restrictions on using the USB cable to make communications.

- \*2: About the cable (QCPU (Q mode), QCPU (A mode) compatible)
 





For communication in 115.2/57.6kbps  
 Fast communication cannot be made if the peripheral device used is not compatible with the communication speed of 115.2/57.6kbps.  
 If a communication error occurs, reduce the baud rate setting and restart communication.

The following cable has been confirmed by Mitsubishi Electric that it will work properly.

Using the cable of Mitsubishi Electric make

RS-232 cable

QC30R2 (when peripheral device connector is D-sub, 9-pin)

- \*3: About the converter/cable (ACPU, QnACPU, FXCPU compatible)
  - (1) Using the products of Mitsubishi Electric make

Peripheral Device Side (RS-232C cable)	RS-232C/RS-422 Converter	PLC CPU Side (RS-422 cable)
 <p>F2-232CAB-1 (when peripheral device connector is D-sub, 9-pin)</p>	 <p>FX-232AW(C)</p>	<p>For ACPU, QnACPU, FX<sub>1</sub>/FX<sub>2</sub>CPU/FX<sub>2</sub>CPU</p> <div style="text-align: center; padding: 5px;">  </div> <p>FX-422CAB (0.3m)                      FX-422CAB-150 (1.5m)</p> <hr/> <p>For FX<sub>0</sub>/FX<sub>0</sub>S/FX<sub>0</sub>N/FX<sub>1</sub>S/FX<sub>1</sub>N/FX<sub>2</sub>N/FX<sub>2</sub>NCPU</p> <div style="text-align: center; padding: 5px;">  </div> <p>FX-422CABO (1.5m)</p>

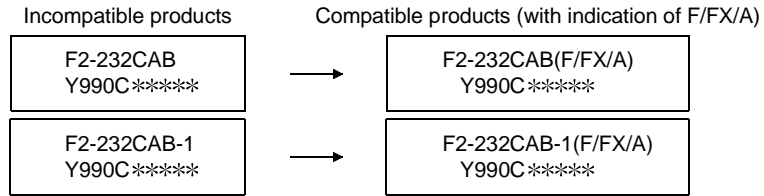
- How to identify compatibility of the F2-232CAB and F2-232CAB-1 cables with the ACPU and QnACPU  
Check the indication of the model label attached to the cable.



- \*4: About the modems relayed  
Use the straight cables supplied with the modems.
- \*5: About computer link  
When the A series is used for communication via the C24/UC24, the program which uses V, Z (index qualification) cannot be monitored.



## 2.2 Connection from the Interface Boards

The following system configuration is made up by connection from the interface boards.

Refer to the corresponding board manuals for the way to connect the boards and install the drivers.

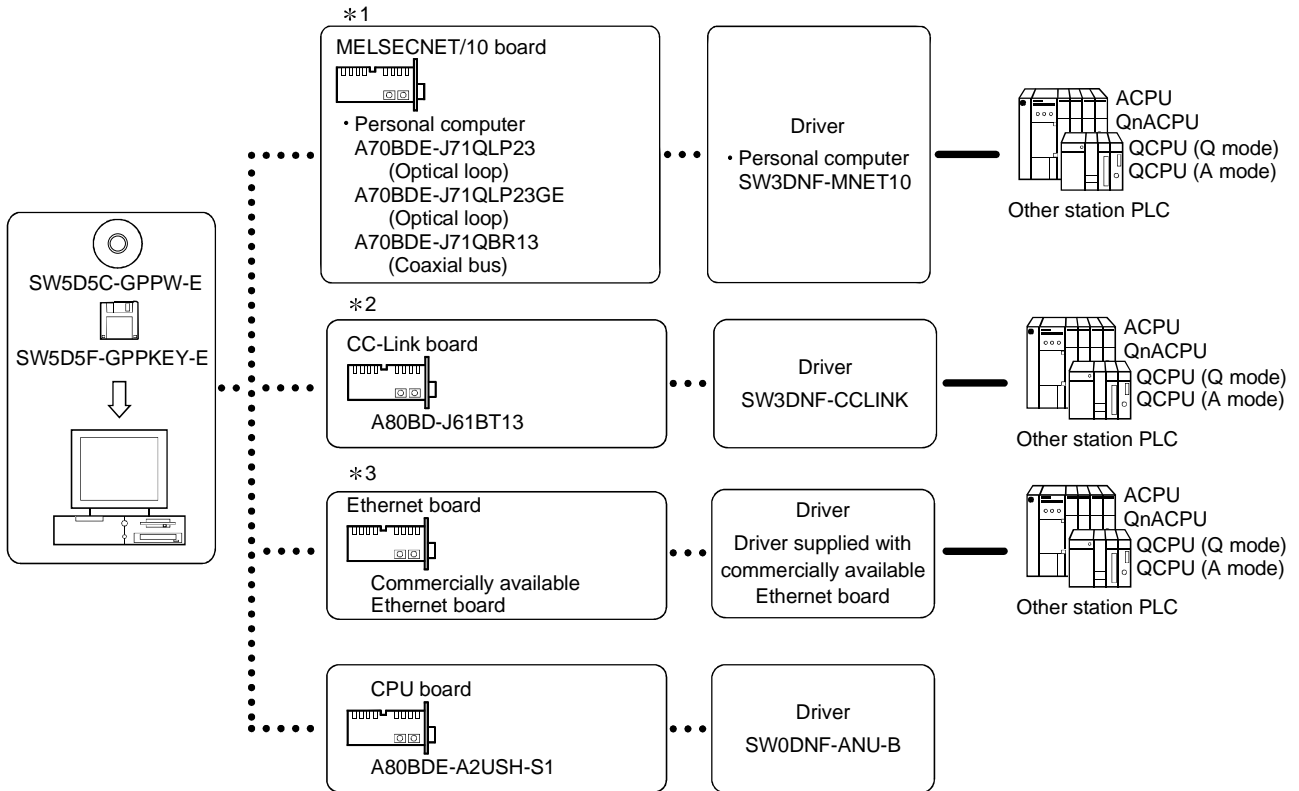

**\*1: MELSECNET/10 board**

If a communications error takes place, an error code is indicated in the least significant 4 digits.

Refer to the error code list of the MELSECNET/10 board manual.

**\*2: CC-Link board**

Accessible only when the CC-Link board is set as the local station.

**\*3: Ethernet board**

(1) The following Ethernet boards/cards have been confirmed by Mitsubishi Electric to operate properly.

	Maker Name	Model
Ethernet board/card	3COM make	Ethernet Link III LAN PC Card
	Allied Telesis make	Center COM LA-PCM Ethernet PC Card LAN Adapter
	TDK make	10BASE-T LAN card (Model: LAN-CD021BX)
Ethernet board	Allied Telesis make	RE2000 (ISA)

## 2.3 System Equipment Lists

(1) The following list indicates units connectable from the serial port.

PLC Series	Unit Name	Unit Model
A series	PLC CPU unit	A0J2H, A1S, A1FX, A1SJ, A1SH, A1SJH, A1N, A2C, A2CJ, A2N(S1)A2S, A2SH, A171SH, A172SH, A3N, A2A(S1), A3A, A2U(S1), A2US(S1), A2USH-S1, A3U, A4U, A173UH(S1), A273UH, Q02(H)-A, Q06H-A
	Computer link unit	AJ71UC24, A1SJ71UC24-R2, A1SJ71UC24-PRF, A1SJ71UC24-R4, A1SJ71C24-R2, A1SJ71C24PRF, A1SJ71C24-R4, A1SCPUC24-R2, A2CCPUC24, A2CCPUC24-PRF
	MELSECNET(II) data link remote I/O unit	AJ72P25, AJ72R25
	MELSECNET/B data link remote I/O unit	AJ72T25B, A1SJ72T25B
	MELSECNET/10 network remote I/O unit	AJ72QLP25, AJ72QLP25G, AJ72QBR15, AJ72LP25
	CC-Link G4 unit	AJ65BT-G4
QnA series	PLC CPU unit	Q2A, Q2AS(H), Q2AS1, Q2AS(H)S1, Q3A, Q4A, Q4AR
	Serial communication unit	AJ71QC24, AJ71QC24-R2, AJ71QC24-R4, AJ71QC24N, A1SJ71QC24, A1SJ71QC24-R2, AJ71QC24N-R2, AJ71QC24N-R4, A1SJ71QC24N, 0A1SJ71QC24N-R2
	MELSECNET/10 network remote I/O unit	AJ72QLP25, AJ72QBR15, A1SJ72QLP25, A1SJ72QBR15
	CC-Link G4 unit	AJ65BT-G4
Q series	PLC CPU unit	Q02(H), Q06H, Q12H, Q25H
	Serial communication unit	QJ71C24, QJ71C24-R2
FX series	PLC CPU unit	FX0(S), FX0N, FX1, FX2(C), FX1S, FX1N, FX2N(C)

(2) The following list indicates units connectable from the MELSEC/10 board.

	Unit Name	
A series	MELSECNET/10 board	AJ71LP21, AJ71BR11, A1SJ71LP21, A1SJ71BR11
QnA series	MELSECNET/10 board	AJ71QLP21, AJ71QBR11, A1SJ71QLP21, A1SJ71QBR11
Q series	MELSECNET/10 board	QJ71LP21, QJ71BR11

(3) The following list indicates units connectable from the CC-Link board.

	Unit Name
A series	AJ61BT11, A1SJ61BT11
QnA series	AJ61QBT11, A1SJ61QBT11
Q series	QJ61BT11

(4) The following list indicates units connectable from the Ethernet board.

	Unit Name
A series	AJ71E71-S3, A1SJ71E71-B2-S3, A1SJ71E71-B5-S3, A1SJ71E71-B2, A1SJ71E71-B5
QnA series	AJ71QE71, AJ71QE71-B5, A1SJ71QE71-B2, A1SJ71QE71-B5
Q series	QJ71E71, QJ71E71-B2

## 2.4 Precautions for Handling Project on the Version of SW4D5C-GPPW or earlier

When handling the SW5D5C-GPPW created project on the version of SW4D5C-GPPW or earlier, observe the precautions below.

Before handling the project, ensure to read them carefully.

About device memory:

1. When editing on SW5D5C-GPPW and the version of SW4D5C-GPPW or earlier, do not create multiple device memories.
2. Do not read the SW5D5C-GPPW created multiple device memories on the version of SW4D5C-GPPW or earlier. The data cannot be read correctly.
3. Do not read the SW5D5C-GPPW created device memory of 32 MB or more on the version of SW4D5C-GPPW or earlier.

### 3. COMMON OPERATIONS











This chapter describes the common key operations and screen operations in GPPW and the common function operations in some modes.

#### 3.1 List of Shortcut Keys and Access Keys

(1) List of shortcut keys  
The following table lists the shortcut keys available with GPPW.

Shortcut Key	Tool Button	Function	Description			
[Alt] + [F4]	—	Close	Closes the active window.			
[Ctrl] + [F6]	—	Next window	Activates the next window.			
[Ctrl] + [N]		Project	Create project	Creates a new project.		
[Ctrl] + [O]			Open project	Opens an existing project.		
[Ctrl] + [S]			Save project	Saves the project.		
[Ctrl] + [P]			Print	Prints the project.		
[Ctrl] + [Z]		Edit	Undo	Reverts the previous operation.		
[Ctrl] + [X]			Cut	Moves the selected data to the Clipboard.		
[Ctrl] + [C]			Copy	Copies the selected data to the Clipboard.		
[Ctrl] + [V]			Paste	Copies the contents of the Clipboard to the cursor position.		
[Ctrl] + [A]	—		Select all	Selects all the edit objects.		
[Shift] + [Ins]	—		Insert row	Inserts a row at the cursor position.		
[Shift] + [Del]	—		Delete row	Deletes a row at the cursor position.		
[Ctrl] + [Ins]	—		Insert column	Inserts a column at the cursor position.		
[Ctrl] + [Del]	—		Delete column	Deletes a column at the cursor position.		
[Shift] + [F2]			Read mode	Sets the read mode.		
[F2]			Write mode	Sets the write mode.		
GPPA GPPQ	[F5]		Circuit symbol	Open contact	Inserts the contact a at the cursor position.	
MEDOC	1					
GPPA GPPQ	[Shift] + [F5]			Close contact	Inserts the contact b at the cursor position.	
MEDOC	2					
GPPA GPPQ	[F6]			Open branch	Inserts the contact a (open branch) at the cursor position.	
MEDOC	3					
GPPA GPPQ	[Shift] + [F6]	Close branch				Inserts the contact b (close branch) at the cursor position.
MEDOC	4					

Shortcut Key		Tool Button	Function	Description	
GPPA GPPQ	<b>F7</b>		Edit Circuit symbol	Coil Inserts the coil (OUT) at the cursor position.	
MEDOC	<b>7</b>				
GPPA GPPQ	<b>F8</b>			Application instruction Inserts an application instruction at the cursor position.	
MEDOC	<b>8</b>				
GPPA	<b>F10</b>			Vertical line Inserts a vertical line at the cursor position.	
GPPQ	<b>Shift + F9</b>				
MEDOC	<b>5</b>				
GPPA GPPQ	<b>F9</b>			Horizontal line Inserts a horizontal line at the cursor position.	
MEDOC	<b>6</b>				
GPPA GPPQ	<b>Ctrl + F10</b>			Delete vertical line Deletes a vertical line at the cursor position.	
MEDOC	<b>0</b>				
GPPA GPPQ	<b>Ctrl + F9</b>			Delete horizontal line Deletes a horizontal line at the cursor position.	
MEDOC	<b>9</b>				
<b>Shift + F7</b>			Leading pulse	Inserts a leading pulse at the cursor position.	
<b>Shift + F8</b>			Trailing pulse	Inserts the trailing pulse at the cursor position.	
<b>Alt + F7</b>			Leading pulse open branch	Inserts the leading pulse (open branch) at the cursor position.	
<b>Alt + F8</b>			Trailing pulse open branch	Inserts the trailing pulse (open branch) at the cursor position.	
<b>Ctrl + Alt + F10</b>			Op result invert	Inserts the inverted Op result at the cursor position.	
<b>Alt + F5</b>			Op result leading pulse	Inserts the inverted Op result at the cursor position.	
<b>Ctrl + Alt + F5</b>			Op result trailing pulse	Inserts the Op result trailing pulse at the cursor position.	
GPPA GPPQ MEDOC	<b>Alt + F10</b> <b>F10</b>		Insert line	Inserts a line.	
<b>Alt + F9</b>					Delete line
<b>F4</b>			Convert	Convert	Converts the program.
<b>Ctrl + Alt + F4</b>				Convert (all edit programs)	Converts all programs being edit at a time.
<b>Shift + F4</b>		—		Convert (online change)	Converts the program and writes it to the CPU during running.

Shortcut Key	Tool Button		Function	Description	
Ctrl + F5	—	View	Comment	Displays or hides comments.	
Ctrl + F7	—		Statement	Displays or hides statements.	
Ctrl + F8	—		Note	Displays or hides notes.	
Ctrl + Alt + F6	—		Device name	Displays or hides device names.	
Alt + O			Project data list	Displays or hides the project data list.	
Alt + F1			Instruction list	Switches circuit screen and list screen.	
F3		Online	Monitor	Monitor	Monitors the screen.
Ctrl + F3	—			Monitor (all windows)	Monitors all circuits of the programs currently open.
Shift + F3				Monitor (write mode)	Sets the write mode during circuit monitoring.
F3				Start monitor	Starts (restarts) circuit monitoring.
Alt + F3				Stop monitor	Stops circuit monitoring.
Ctrl + Alt + F3	—			Stop monitor (all windows)	Stops monitoring of all circuits of the program currently open.
Alt + 1			Debug	Device test	Forcibly turns on or off the device and changes the current value.
Alt + 2				Skip	Performs a skip operation for a sequence program for which a range has been specified.
Alt + 3				Partial operation	Partially executes the sequence program.
Alt + 4				Run step	Performs step operation for the PLC.
Alt + 6	—			Remote operation	Performs remote operation.

(2) Access key

An access key is indicated by an alphabetic character shown at the end of each menu title to enable the user to select the menu with the keyboard.

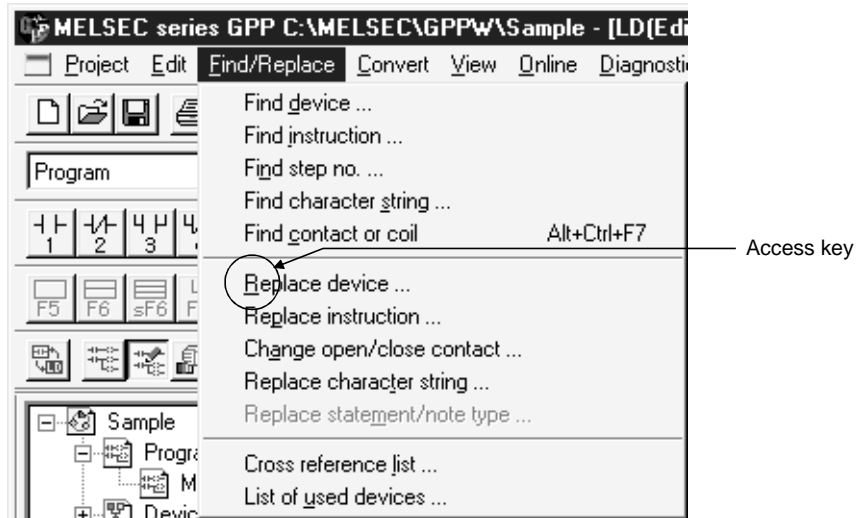

Press **[Alt]** and **[P]** key in order to highlight the [Project] menu.  
 Press **[↓]** key, then the drop-down menu will be displayed.

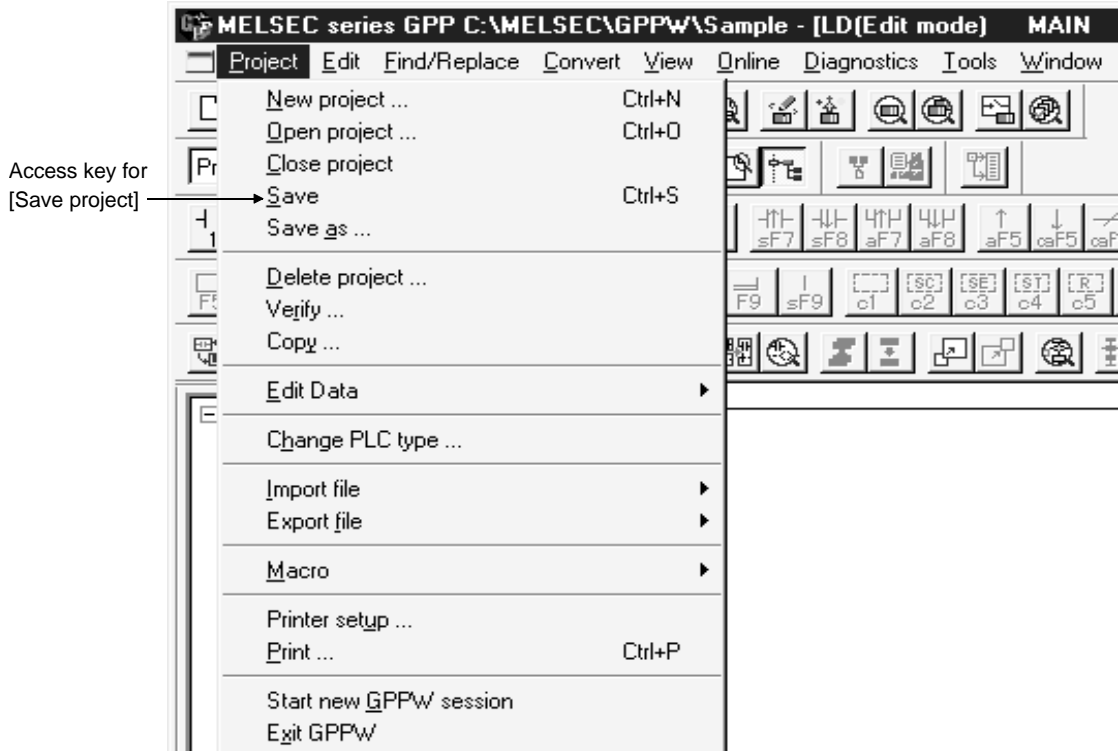

Press **[S]** key to save the project.

### 3.2 Project Designation

GPPW sets a drive/path and a project name, but does not set the system name set like GPPA and GPPQ.

This section compares and describes the differences between GPPW and GPPA/GPPQ.

- Designation in GPPA

..\GPP\USR\system-name\machine-name  
 Path name

- Designation in GPPQ

..\GPPQ\SYS\system-name\machine-name\file-name  
 Path name

- Designation in GPPW

..\project-name  
 Path name

Corresponds to the machine name in GPPA or GPPQ.

- The GPPW project path and project names can be designated as follows:  
 Example

1.C:\GPPW-program\main\data-1  
 Project path      Project name

2.C:\factory-A\line-1  
 Project path      Project name

As shown above, the project can be saved in a desired folder.



### 3.2.1 Saving a project



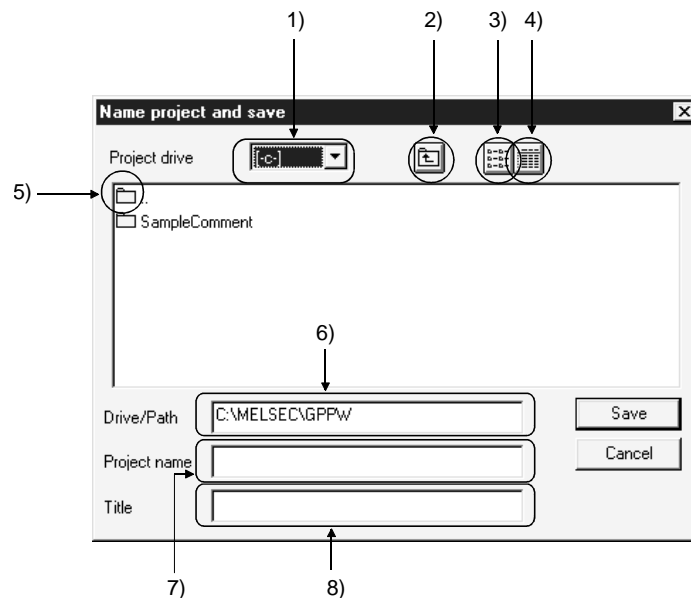

[Purpose]

Designate a project name to read, save or delete a project, or to create a new project.

[Dialog Box]



[Description]

- 1) Project drive  
Designates a drive in which the project has been saved or is to be saved.
- 2)  button  
Click this button to move to the folder one level upper than the current folder.
- 3)  button  
Click this button to list the names of folders and projects contained in the current folder.
- 4)  button  
Click this button to display the details of the folders and projects contained in the current folder such as the PLC types, creation dates, and title.
- 5)  ..  
Double-click the icon to move to the folder one level upper than the current folder.
- 6) Drive/path  
Designates the path of the folder where the project has been saved or is to be saved.

7) Project name

Designates a project name.

The following shows the characters and the number of characters that can be used to designate a drive path, project name, or data name.

- Number of characters

The total number of characters used for designating both the project path and the project name (8 or more characters may be set) is 150.

<Example>

C:\SW3D5GPPW\ABCDEFGHIJKLMNQRSTUWXYZ

- Characters not available in A, QnA and FX series

/, \, >, <, \*, ?, " ", |, :, ; (: and \ can be set for drive designation only)

(: and \ are available only when the drive is specified.)

Any project name cannot be ended by a period (.).

8) Title

Sets the title for the project in up to 32 characters.

POINT
<ul style="list-style-type: none"> <li>• If you set a project name of 8 or more characters on SW3D5-GPPW-E, reading it on the version of SW2D5-GPPW or earlier will not display the eighth and latter characters.</li> <li>• If the project path or project name includes a space, double-clicking the GPPW.gpj, **.gps file on Explorer will not start GPPW properly. If the project path or project name includes a space, start GPPW and then open the project from the [Project] → [Open project] menu.</li> </ul>

[Example]

Project name to be saved : TEST1  
 Title : Test program  
 Project location : A:\GPPW\  
 GPPW installation location : C:\MELSEC\GPPW

[Operating Procedure]

1. Select [Project] → [Save as].
2. Change the project drive from [-c-] to [-a-].

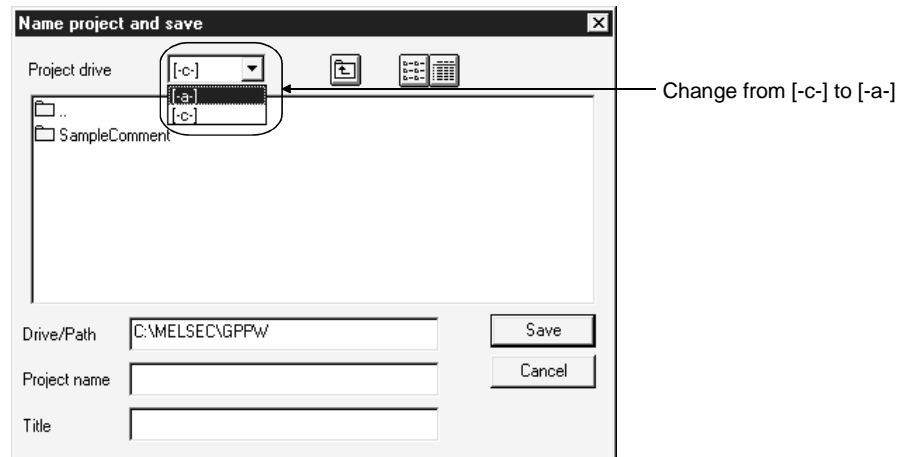

3. Type "GPPW" as the project path.

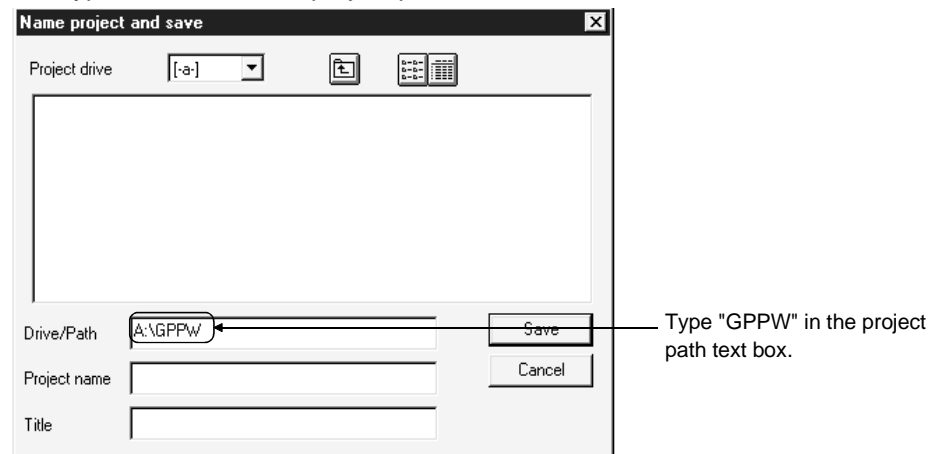

4. Type "TEST1" as a project name. Then, type "Test program" as the project title. Click the [Save] button, and the project will be saved in the designated folder.

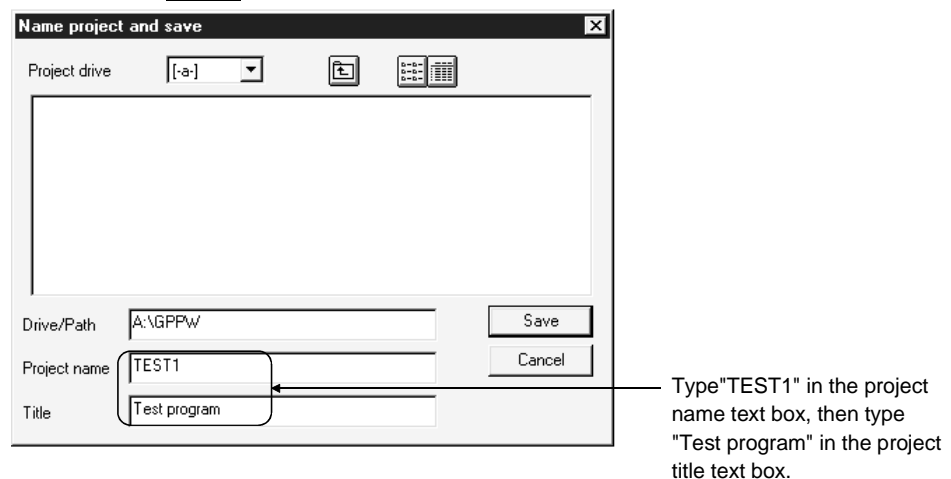

### 3.2.2 Opening a project

[Example]

Name of project to be read : TEST1  
 Project save location : A:\GPPW\  
 GPPW installation location : C:\MELSEC\GPPW

[Operating Procedure]

1. Select [Project] → [Open project].
2. Change the project drive from [-c-] to [-a-].

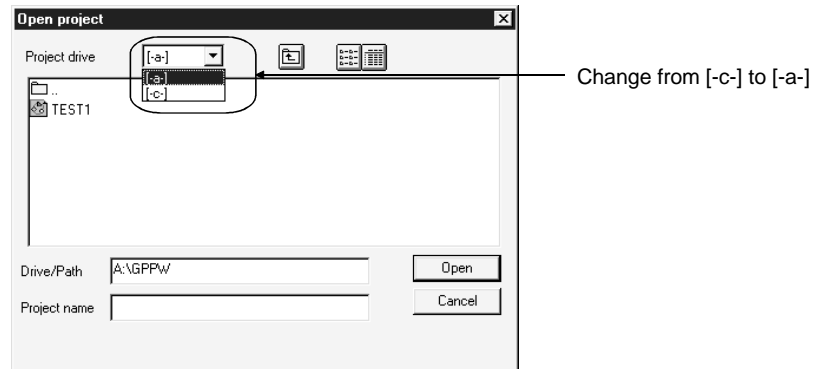

3. Double-click the "GPPW" folder icon in the list box to designate a project path.

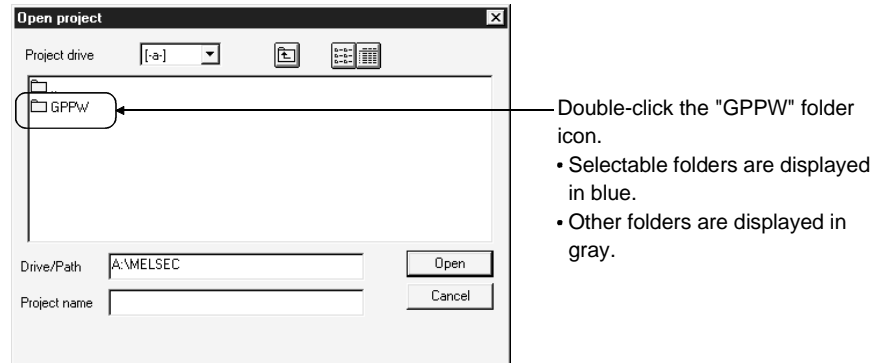

4. Click the "TEST1" project icon in the list box to designate the name of a project to be read.

Click the **Open** button, and the designated project will be opened.

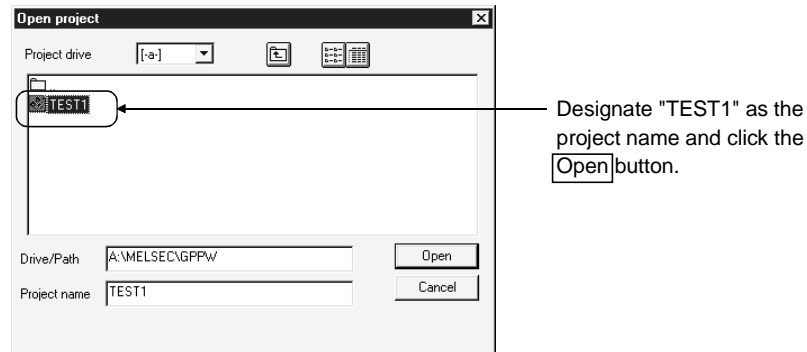

### 3.3 Cut, Copy, and Paste

This section describes the common operations such as cutting, copying and pasting table data such as comments, parameters, etc.

For details on how to cut, copy and paste the circuits, see Section 6.3.9.

#### 3.3.1 Cut and paste

- Cutting and pasting the data  
The following example shows how to cut and paste the comments. Comments, parameters, and device memory can be cut and pasted through the same procedure.

[Operating Procedure]

1. Click the first cell of the comments to be cut, and the cursor will be positioned there.

Device	Comment	Label
X0	Unit abnormal	
X1	Host data link condition	
X2	Parameter setting condition	
X3	Other station condition	
X4	Unit reset receive complete	
X5	Start data link	
X6		
X7		
X8		

2. Confirm that the cursor (  ) is displayed, then drag the mouse over the range of the comments to be cut.  
The dragged comment cells are highlighted (the first cell in the range is not highlighted).  
To change the designated range, click any cell in the comment column.

Device	Comment	Label
X0	Unit abnormal	
X1	Host data link condition	
X2	Parameter setting condition	
X3	Other station condition	
X4	Unit reset receive complete	
X5	Start data link	
X6		
X7		
X8		

3. Select [Edit] → [Cut] or click  ( **[Ctrl] + [X]** ), and the designated range of comments will be cut.

Device	Comment	Label
X0	Unit abnormal	
X1	Host data link condition	
X2	Parameter setting condition	
X3		
X4		
X5	Start data link	
X6		
X7		
X8		

- Click the first cell in the comment column where the comments are to be pasted, and the cursor will be positioned there.

Device	Comment	Label
X0	Unit abnormal	
X1	Host data link condition	
X2		
X3		
X4		
X5	Start data link	
X6		
X7		
X8		
X9		
X0A		

- Confirm that the cursor (  ) is displayed, then select [Edit] → [Paste] or click  ( [Ctrl] + [V] ).  
The cut comments are pasted into the cells in the comment column starting from the designated cell.

Device	Comment	Label
X0	Unit abnormal	
X1	Host data link condition	
X2		
X3		
X4		
X5	Start data link	
X6		
X7	Parameter setting condition	
X8	Other station condition	
X9	Unit reset receive complete	
X0A		

**POINT**

- The cut, copy, and paste menus can also be selected from the popup menu displayed by clicking the right mouse button.

### 3.3.2 Copy and paste

- Copying and pasting the data  
 The following example shows how to copy and paste comments.  
 Comments, parameters, and device memory can be copied and pasted through the same procedure.

[Operating Procedure]

1. Click the first cell of the comments to be copied, and the cursor will be positioned there.

Device	Comment	Label
X0	Unit abnormal	
X1	Host data link condition	
X2	Parameter setting condition	
X3	Other station condition	
X4	Unit reset receive complete	
X5	Start data link	
X6		
X7		
X8		

2. Confirm that the cursor (  ) is displayed, then drag the mouse over the range of the comments to be copied.  
 The dragged comment cells are highlighted (the first cell in the range is not highlighted).  
 To change the designated range, click any cell in the comment column.

Device	Comment	Label
X0	Unit abnormal	
X1	Host data link condition	
X2	Parameter setting condition	
X3	Other station condition	
X4	Unit reset receive complete	
X5	Start data link	
X6		
X7		
X8		

3. Click the first cell in the comment column where the comments are to be pasted, and the cursor will be positioned there.

Device	Comment	Label
X0	Unit abnormal	
X1	Host data link condition	
X2		
X3		
X4		
X5	Start data link	
X6		
X7		
X8		
X9		
X0A		

4. Confirm that the cursor (  ) is displayed, then select [Edit] → [Paste] or click  ( [Ctrl] + [V] ).

The copy comments are pasted into the cells in the comment column starting from the designated cell.

Device	Comment	Label	▲
X0	Unit abnormal		
X1	Host data link condition		
X2			
X3			
X4			
X5	Start data link		
X6			
X7	Parameter setting condition		
X8	Other station condition		
X9	Unit reset receive complete		
X0A			

POINTS
<ul style="list-style-type: none"> <li>• The cut, copy, and paste menus can also be selected from the popup menu displayed by clicking the right mouse button.</li> <li>• Notes on cut, copy and paste operations of parameters                             <ol style="list-style-type: none"> <li>1. Only numeric characters can be pasted. (Alphabetic characters cannot be pasted.)</li> <li>2. The format conversion of the numeric value does not take place at a destination for pasting.</li> </ol> <p>&lt;Example&gt; Even when the network number (decimal) "10" is copied and pasted at the first I/O number (hexadecimal), it is not converted to "A."</p> </li> </ul>



### 3.3.3 Notes on cutting, copying and pasting network parameters

The following shows the areas in which you can cut, copy and paste network parameters and also the areas that prevent these operations.

Valid units during other station access: 1

Network parameter capacity: 2 KB

	Unit No.1	Unit No.2	Unit No.
Network Type	MNET/10(Controlling stati	MNET/10(Controlling stati	None
Start I/O No.	0000	0020	
Network No.	1	2	
Total No.	6	9	
Group No.			
Station No.			
	Network range assignment	Network range assignment	
	Refresh parameters	Refresh parameters	

Prevent cut, copy and paste. (points to dropdown menu)

Allows cut, copy and paste. (points to table cells)

Setting common parameters and station inherent parameters.

Assignment method:  No. of points/Start  Start/End

Supplemental settings: Monitoring time: 200 X 10ms, No. of link slave stations: 6

Parameter name:

Switch screens: LB/LW setting

StationNo.	Send range for each st			Send range for each station.								
	Point	Start	End	Point	Start	End	Point	Start	End	Point	Start	End
1												
2												
3												
4												
5												
6												

Allows cut, copy and paste. (points to table cells)

Allows cut, copy and paste. (points to supplemental settings)

Prevents cut, copy and paste. (points to parameter name)

	Link side				PLC side			
	Point	Start	End		BlockNo.	Point	Start	End
LB<->B transfer(1)	4096	0000	00FF	↔		4096	0000	00FF
LW<->W transfer(1)	4096	0000	00FF	↔		4096	0000	00FF
LX<->X transfer(1)				↔				
LY<->Y transfer(1)				↔				
SB transfer	256	0000	00FF	↔		256	Y1C00	Y1CFF
SW transfer	256	0000	00FF	↔		256	D7168	D7423

Allows cut, copy and paste. (points to table cells)

POINTS
--------

- When used together with MELSECNET(II), the L/R type is not changed even if lines in a local station are copied and pasted to a remote station (or vice versa).
- When some destination items allow paste but some prevent paste, parameter paste takes place only in the items allowing paste.
- When the data types of copy source and destination are not the same, an abnormal paste operation may result.  
For example, this problem occurs when data in the Point column is pasted in the Start column of the destination.
- Only numeric characters can be copied and pasted.
- Even when decimal data is cut, copied, and pasted in a hexadecimal column, it is not converted into hexadecimal data.  
However, when a decimal number "16" is copied into a hexadecimal column, it is handled as a decimal number "22."

3.4 Toolbar

The toolbar contains the menu items or the attributes of data types. To execute a menu item, move the cursor onto the icon, then click there.  
To display or hide the tool bar, select [View] → [Toolbar].

[Dialog Box]

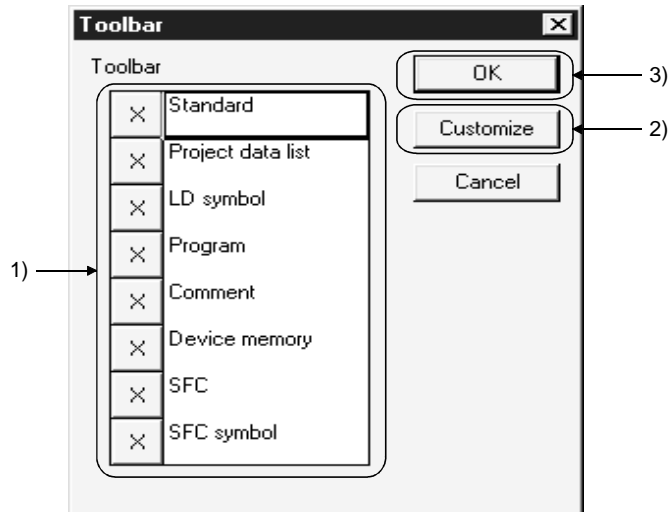

- 1) **Toolbar**  
Click here to display or hide the toolbar.  
Click to display the toolbar and click  to hide the tool bar.
- 2) **Customize**  
Click this button to add/delete a tool button to/from the toolbar.  
By default, all the tool buttons are displayed on the toolbar.

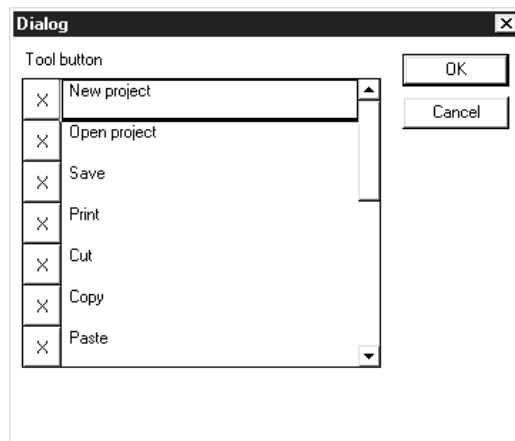

- 3) **OK** button  
Click this button after making necessary settings.

### 3.5 Status Bar

The status bar is displayed at the bottom of the application window to indicate GPPW status information.

To display or hide the status bar, select [View] → [Status bar].



[Description]



- 1) Indicates the status of the mouse cursor position.
- 2) Indicates the CPU type.
- 3) Indicates the destination CPU.
- 4) Indicates the current mode.
- 5) Indicates the status of the Caps Lock key.
- 6) Indicates the status of the Num Lock key.
- 7) Indicates the status of the Scroll Lock key.

### 3.6 Zooming in on or out of the Edit Screen

---

This section describes how to magnify (zoom in) or reduce (zoom out) the edit screen. The edit screen can be resized as necessary.

[Operating Procedure]

1. Select [View] → [Zoom], then select a magnification factor.  
Or click  or  to get the same result.
2. The edit screen is displayed according to the selected magnification factor.  
In addition, when Auto is selected, the width of the view of a circuit is automatically adjusted so that the entire circuit can be displayed on the window.

When  on the tool bar is selected, the edit screen is magnified.

In contrast, when  is selected, the edit screen is reduced.

Selection of a 50% display for reduction may make characters illegible.

### 3.7 Project Data List

A project data list contains project data according to the data types.  
 To directly display the edit screen, double-click on project data.  
 To display or hide the project data list, select [View] → [Project data list] or click  ( [Alt] + [O] ).

To add, copy, delete or rename project data, click the target project data with the right mouse button.  
 See Sections 5.8 to 5.11 for details on each operation.  
 Data names except the parameters can also be deleted with the **Delete** key.

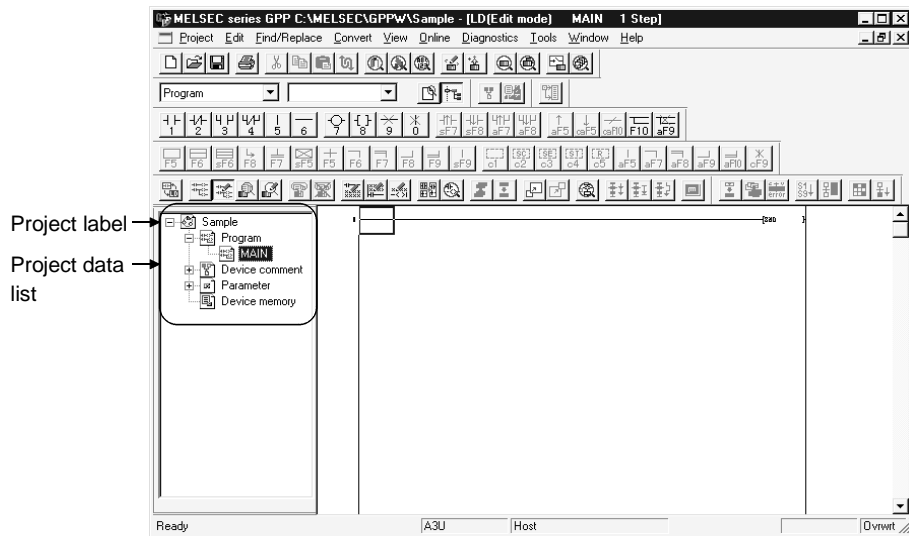

The project data list can be changed in size by floating it or can be hidden by clicking .

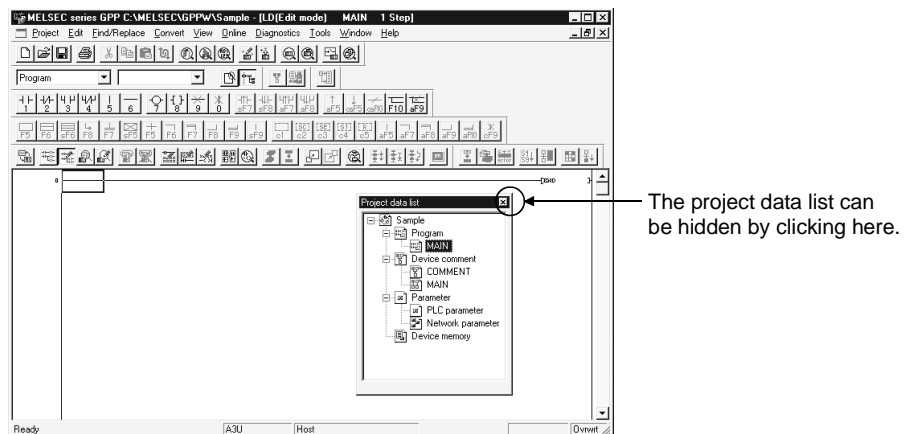

- You can change the edit screen from the toolbar.

1. Choose the data type.

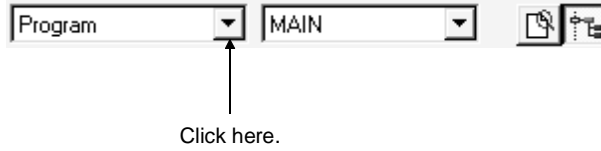

2. Choose the data type you want to change.

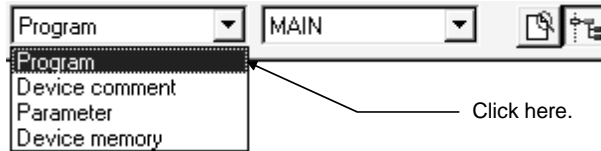

3. Choose the data name.



4. Choose the data you want to show.

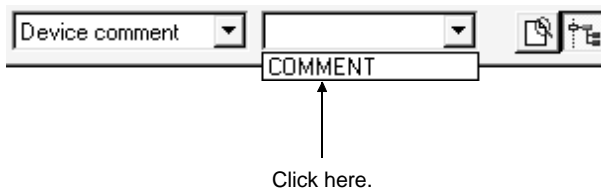

POINT
<p>If you opened multiple programs, comments, etc. or if you started multiple GPPWs, the screen may be changed in color or shape (displayed improperly). In such a case, close the other applications or program and comment screens.</p>

### 3.8 Comment Display

---

[Purpose]

Displays the created device comments on the circuit creation screen.

[Operating Procedure]

Select [View] → [Comment]

POINT
<ul style="list-style-type: none"> <li>When a common comment and a comment by program have been set for the same device, click &lt;&lt;Each program&gt;&gt; tab on the dialog box displayed by selecting [Tool] → [Option] tab to set a comment to be displayed. Refer to Section 16.11.</li> <li>The comment from the SW3D5-GPPW is displayed just beneath the circuit symbol. (It will be printed out just beneath the circuit symbol, if printed out.)</li> <li>Only when monitored, is it displayed with one line spaced.</li> </ul>



### 3.9 Statement Display

---

[Purpose]

Displays the created statement on the circuit creation screen.

[Operating Procedure]

Select [View] → [Statement]

POINT
<ul style="list-style-type: none"> <li>In the FXGP (DOS) and FXGP (WIN), "statement" is called the "circuit comment".</li> </ul>



### 3.10 Note Display

---

[Purpose]

Displays the created notes on the circuit creation screen.

[Operating Procedure]

Select [View] → [Note]

POINT
<ul style="list-style-type: none"> <li>In the FXGP (WIN), "note" is called the "coil comment".</li> </ul>



### 3.11 Device Name Display

---

[Purpose]

Displays the device name in circuit mode on the circuit creation screen.

[Operating Procedure]

Select [View] → [Device Level]

POINT
<ul style="list-style-type: none"><li>• Create the device name on the device comment edit screen. The device name cannot be written to the PLC CPU GPPA file if created for A series.</li></ul>

### 3.12 Comment Format

---

[Purpose]

To display comments in the ladder mode in 4 × 8 characters or 3 × 5 characters.

[Operating Procedure]

[View] → [Comment format]

## 4. INITIALIZATION

### 4.1 Creating a Project

#### [Purpose]

Designates the information required to create a project such as PLC series, PLC type and project name.

#### [Operating Procedure]

Select [Project] → [New project] or click  ( [Ctrl] + [N] ).

#### [Dialog Box]

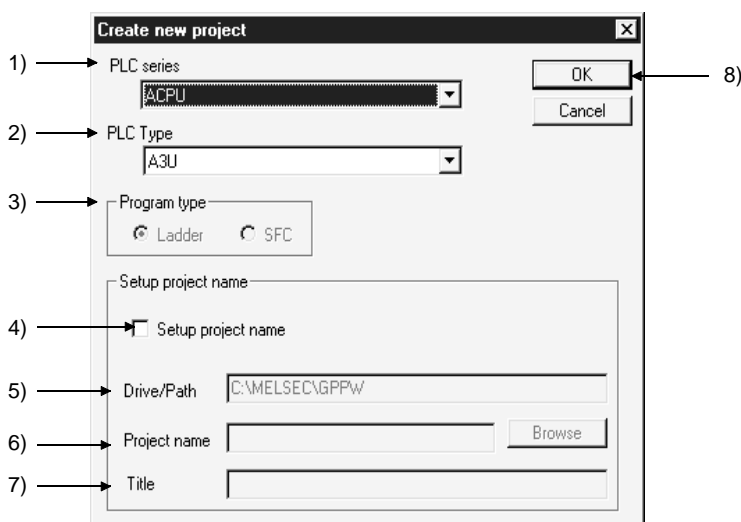

#### [Description]

- 1) PLC series  
Designates the PLC series of the project by selecting from QCPU(Qmode), QnA series, QCPU(Amode), A series, MOTION(SCPU) and FX series.
- 2) PLC type  
Designates the CPU type to be used by selecting from the list.  
For FX and FX2, select FXU.
- 3) Program type  
Choose either of ladder program or SFC program. When creating an SFC on the A series, make the following settings.
  1. Set the microcomputer value in the memory capacity setting of PLC parameters.
  2. Choose SFC in the project type on the [Project][Edit data][New] screen.
- 4) Set project name  
Designate a project name to save the created data.  
When designating a project name before creating a program, check the checkbox.  
The project name can be designated before and after program creation.  
When designating the project name after data creation, use the [Save As] menu.

See Section 5.4 "Naming and Saving a Project."

- 5) Drive/path
  - 6) Project name
  - 7) Title
  - 8)  button
- Click this button after making necessary settings.
- See Section 3.2 for setting these fields.

<b>POINTS</b>
<ul style="list-style-type: none"><li>• The following lists the data and data names in new project creation. Program : MAIN Comment : COMMENT (common comment) Parameter : PLC parameter                   : Network parameter (A series and QnA series only)</li><li>• In addition, see Sections 5.8 and 11.2 for device memory, and Section 5.8 and Chapter 12 for device initial values (QnA series only).</li><li>• If multiple programs are being created or multiple GPPWs are running, the screen may not be displayed properly due to the shortage of the personal computer resources. In this case, close GPPWs once or close other applications, if any.</li></ul>

## 5. HANDLING PROJECT FILES

This chapter describes how to add project files or read and write the other types of files (GPPA, GPPQ, and FXGP).

### 5.1 Opening the Existing Project File

A	Q/QnA	FX
<input type="radio"/>	<input type="radio"/>	<input type="radio"/>

[Purpose]

Reads the saved project file.

[Operating Procedure]

Select [Project] → [Open project] or click  ( **Ctrl** + **O** ).

[Dialog Box]

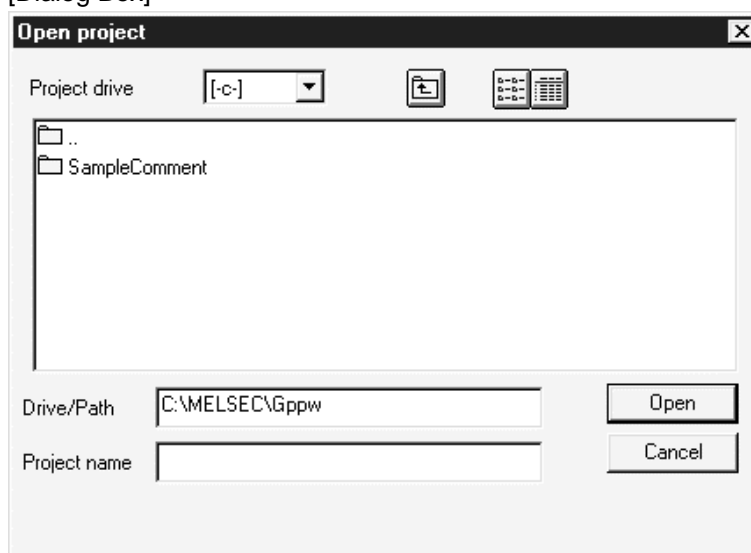

For details on how to designate the drive/path, project name, and project title, see Section 3.2.2.

<p><b>POINT</b></p> <ul style="list-style-type: none"> <li>• When the existing project is opened, GPPW starts in the screen status that the project was saved.                         <ul style="list-style-type: none"> <li>• GPPW screen position and size</li> <li>• Ladder monitor, registration monitor, batch monitor status (when connected with CPU)</li> </ul> </li> <li>However, the screen is not restored properly if the resolution is different.</li> <li>• From Ver. 20C of SW5D5-GPPW, a 32-bit constant can be used with the third device of the DTO instruction of the ACPU.</li> <li>* On Ver. 00A of SW3D5-GPPW, Ver. 10B of SW5D5-GPPW, and GPPA, note that only up to 16 bits of a constant may be used with the third device of the DTO instruction.</li> <li>Perform the following operation when using a constant with the third device of the DTO instruction of the ACPU on any of Ver. 00A of SW3D5-GPPW, Ver. 10B of SW5D5-GPPW, and GPPA.                         <ul style="list-style-type: none"> <li>• Re-enter the corresponding DTO instruction.</li> <li>• Perform write to PLC on SW5D5-GPPW Ver. 20C or later, and perform read from PLC on any of Ver. 00A of SW3D5-GPPW, Ver. 10B of SW5D5-GPPW, and GPPA.</li> </ul> </li> </ul>
---

## 5.2 Closing a Project File

---

A	Q/QnA	FX
<input type="radio"/>	<input type="radio"/>	<input type="radio"/>

**[Purpose]**

Closes the active project file.

**[Operating Procedure]**

Select [Project] → [Close project].

**[Description]**

When no project name has been designated or data has been edited, you will be prompted to save change to the project when you select [Close project].

To save the change to the project, click the **Yes** button.

To close the project without saving it, click the **No** button.

## 5.3 Saving a Project

---

A	Q/QnA	FX
<input type="radio"/>	<input type="radio"/>	<input type="radio"/>

**[Purpose]**

Saves the active project file with the designated name.

**[Operating Procedure]**

Select [Project] → [Save project] or click  ( **Ctrl** + **S** ).

**[Description]**

Selecting [Save project] causes data to be written onto the existing project file.

## 5.4 Saving a Project with a New Name

---

A	Q/QnA	FX
<input type="radio"/>	<input type="radio"/>	<input type="radio"/>

[Purpose]

Saves the active project with a new name.

[Operating Procedure]

Select [Project] → [Save as].

[Description]

Designate the project path, project name, and project title before saving the project.  
For details, see Section 3.2.1.

## 5.5 Deleting a Project

---

A	Q/QnA	FX
<input type="radio"/>	<input type="radio"/>	<input type="radio"/>

[Purpose]

Deletes the unnecessary project files.

[Operating Procedure]

Select [Project] → [Delete project].

[Description]

Select the project to be deleted, then click the Delete project button.

POINT
<p>When saving the existing project with a name, an old project must exist. (For example, if a project on an FD is opened and the FD is then removed, that project cannot be saved into another drive with a name.)</p>

## 5.6 Verifying Data in Projects

A	Q/QnA	FX
<input type="radio"/>	<input type="radio"/>	<input type="radio"/>

## [Purpose]

Verifies data between the PLC projects of the same PLC type.

## [Operating Procedure]

Select [Project] → [Verify].

## [Dialog Box]

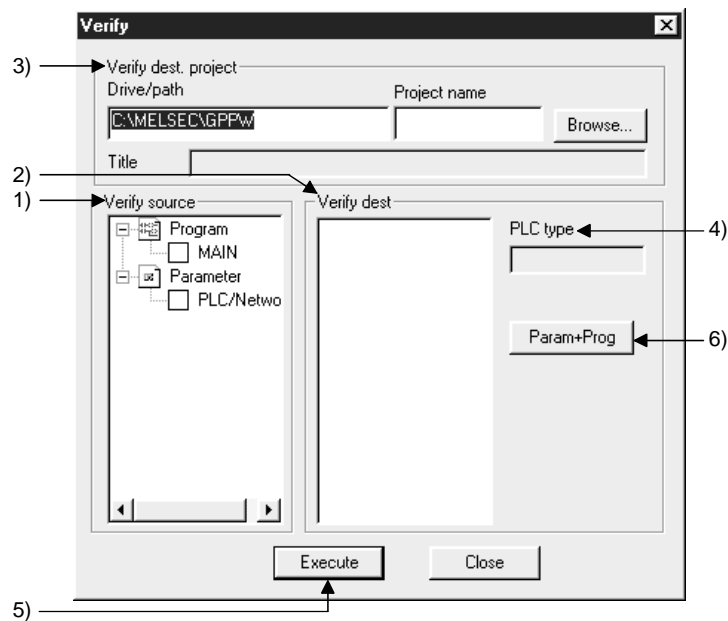

## [Description]

- 1) List of source verify source data for verification  
Lists the current project data.  
Check the checkbox of a data name to select it.
- 2) List verify dest  
Lists the project data of a destination.  
Check the checkbox of a data name to select it.
- 3) Drive/path, Project name  
Sets a drive path for the project data to be verified.  
See Section 3.2 for details on how to set the path.
- 4) PLC type  
Displays the PLC type of the project.
- 5) **Execute** button  
Click this button after making necessary settings.
- 6) **Param+prog** button  
Selects only the parameter data and program data of a source.

## [Operating Procedure]

1. Select a project name in the dialog box displayed by clicking the **Browse** button to designate a destination drive/path name and a project name.
2. Check a checkbox for source data name and a checkbox for destination data name to be verified.
3. Click the **Execute** button after making necessary settings.

**POINT**

- Multiple data can be selected in source and destination data for verification as shown below.

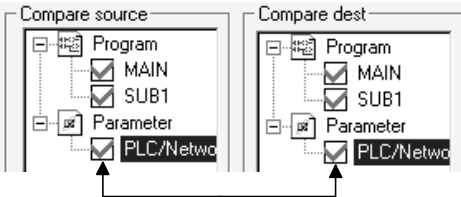

Check the checkbox of a data name to select it.



## 5.7 Copying a Project

A	Q/QnA	FX
<input type="radio"/>	<input type="radio"/>	<input type="radio"/>

## [Purpose]

Copies data between projects.

When the selected source data is already in the destination, the existing data in the destination is overwritten with the source data.

## [Operating Procedure]

Select [Project] → [Copy].

## [Dialog Box]

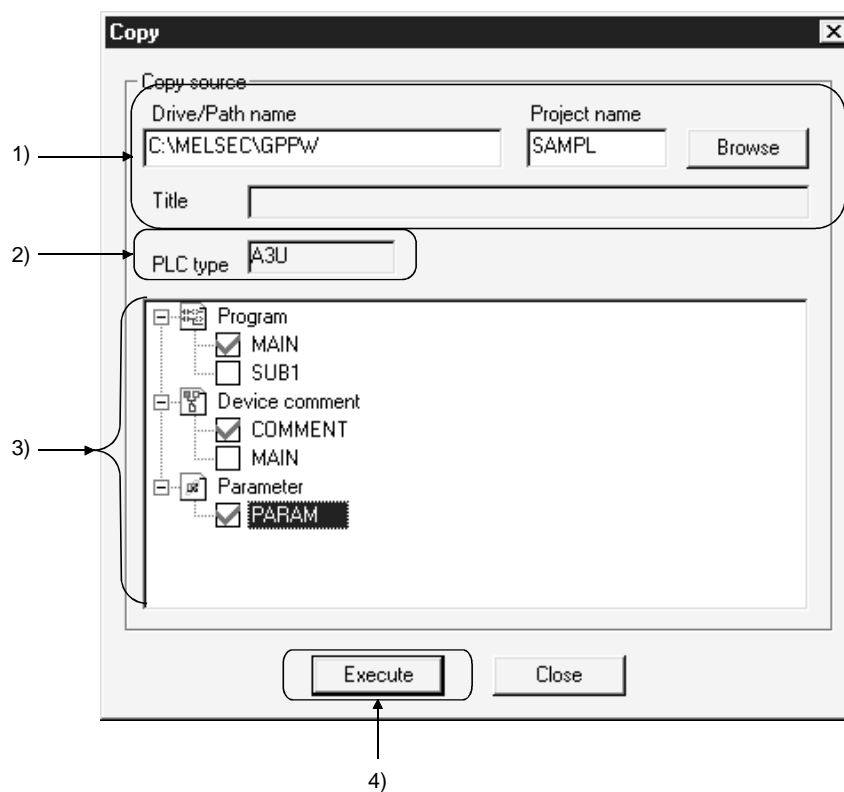

## [Description]

- 1) Drive/path name, Project name  
Designates a drive path for project data to be copied.
- 2) PLC type  
Displays the PLC type of the source project.
- 3) Source data list  
Lists source data.
- 4) **Execute** button  
Click this button after setting necessary settings.

[Operating Procedure]

1. Select a project in the dialog box displayed by clicking the **Browse** button to designate a source data drive/path name and a project name.
2. Check a checkbox for source data name.
3. Click the **Execute** button after making necessary settings.

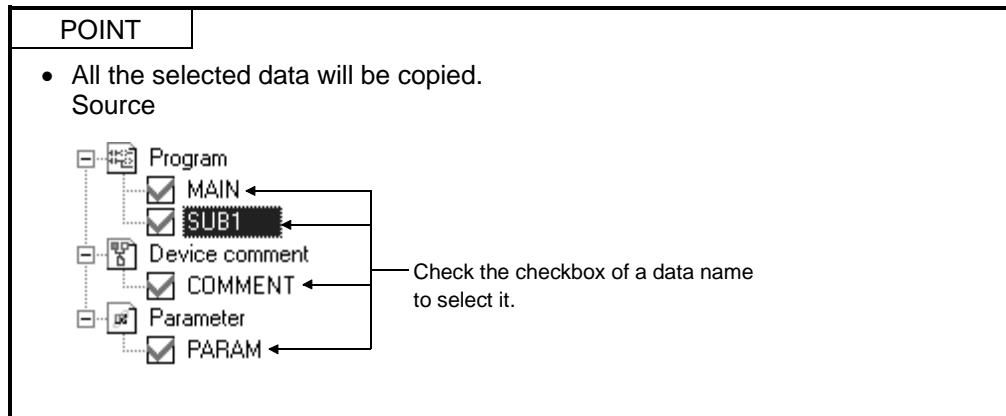

### 5.8 Adding Data to a Project

A	Q/QnA	FX
○	○	○

[Purpose]

Adds a program, common comment, comments by program, or device memory data to the project.

[Operating Procedure]

Select [Project] → [Edit data] → [New]

[Dialog Box]

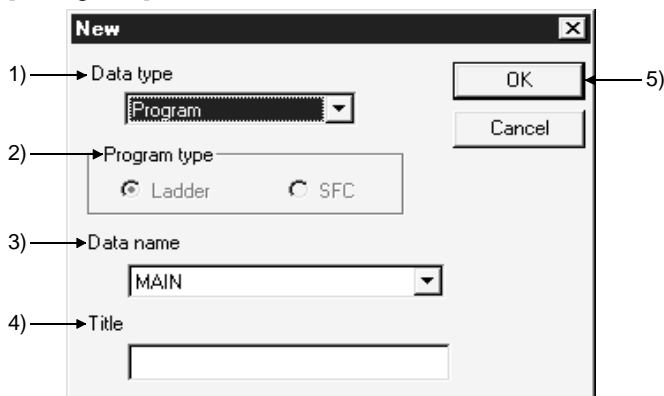

[Description]

- 1) Data type  
Designates the type of the data to be added (program, common comment, comments by program, or device memory).
- 2) Program type  
Choose either of ladder program or SFC program. When creating an SFC on the A series, make the following settings.
  1. Set the microcomputer value in the memory capacity setting of PLC parameters.
  2. Choose SFC in the project type on the [Project] → [Edit data] → [New] screen.
- 3) Data name of the data to be added  
Designates the name of the data to be added.  
If one of A series PLCs is set as the PLC type of the active project, the name is fixed as SUB1, SUB2, or SUB3. (If the PLC type is A4UCPU, comments by program, named SUB4, can also be added.)  
Name of subprograms can be designated after completing memory capacity setting for parameters.  
For Q/QnA series, the name should be designated within 8 characters.  
For FX series, MAIN is designated as the name.
- 4) Title  
Designates the title of the data in up to 32 characters.
- 5) **OK** button  
Click this button after setting necessary settings.

POINT
<ul style="list-style-type: none"> <li>• Multiple device memories/device comments can be created in a project.</li> </ul>

## 5.9 Copying Data within a Project

A	Q/QnA	FX
○	○	○

### [Purpose]

Copies the existing data within a project.

### [Operating Procedure]

Select [Project] → [Edit data] → [Copy].

### [Dialog Box]

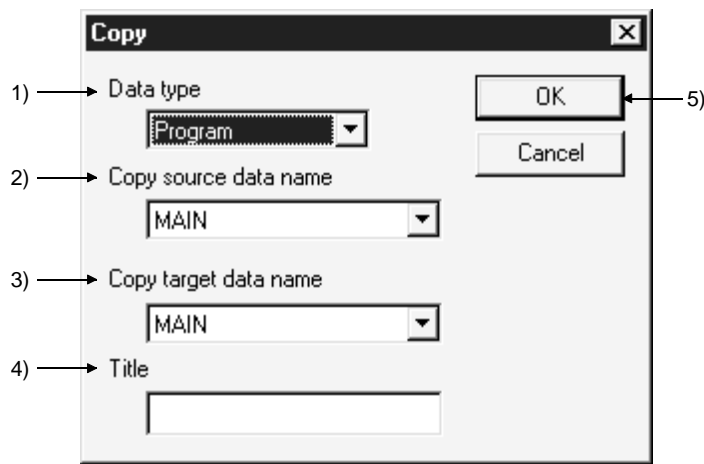

### [Description]

- 1) Data type  
Designates the data type (program, common comment, comments by program, device memory).
- 2) Source data name  
Designates the name of source data.
- 3) Destination data name  
Designates the new data name.  
If necessary, source data can also be overwritten onto an existing data.  
The data name must be designated in up to 8 characters.
- 4) Title  
Displays the set title of the data.  
If necessary, the title can be edited and stored.  
It must be designated in up to 32 characters.
- 5) **OK** button  
Click this button after making necessary settings.

## 5.10 Deleting Data in a Project

A	Q/QnA	FX
○	○	○

[Purpose]

Deletes an existing data in a project.

[Operating Procedure]

Select [Project] → [Edit data] → [Delete].

[Dialog Box]

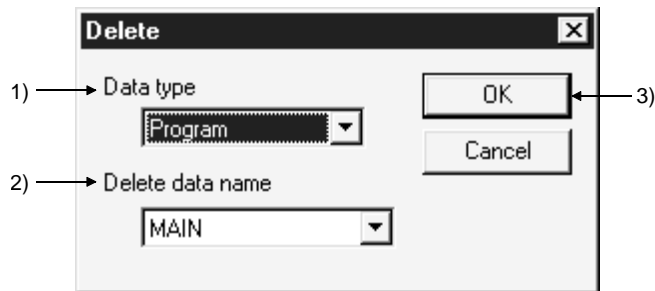

[Description]

- 1) Data type  
Designates the data type (program, common comment, comments by program, device memory).
- 2) Data to be deleted  
Designates the name of the data to be deleted.
- 3) **OK** button  
Click this button after making necessary settings.

5.11 Renaming Data in a Project

A	Q/QnA	FX
○	○	○

[Purpose]

Renames the existing data in a project.

[Operating Procedure]

Select [Project] → [Edit data] → [Rename].

[Dialog Box]

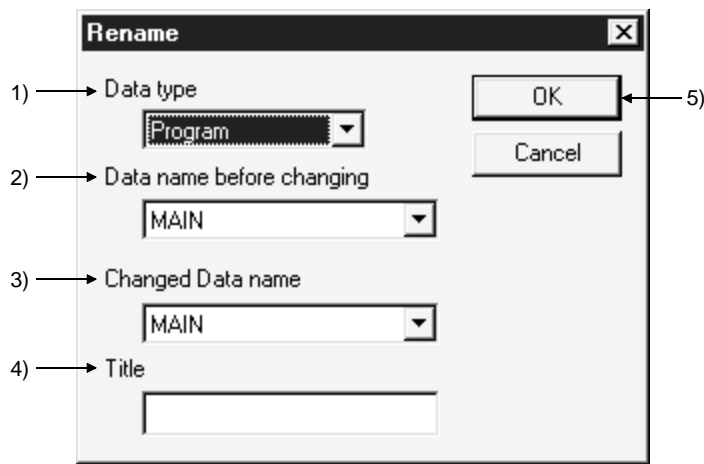

[Description]

- 1) Data type  
Designates the data type (program, common comment, comments by program, device memory).
- 2) Data name before renaming  
Designates the data name before renaming.
- 3) Renamed data name  
Designates the new data name after renaming.  
The data name must be designated in up to 8 characters.
- 4) Title  
Displays the set title of the data.  
If necessary, the title can be edited and stored.  
It must be designated in up to 32 characters.
- 5) **OK** button  
Click this button after making necessary settings.

<b>POINT</b>
<p>This operation cannot change the data name of comments by program to "COMMENT". For changing the comments by program to the common comment (COMMENT), refer to "Setting Comment Types" (Section 9.6).</p>

5.12 Changing the Ladder and SFC with each other

A	Q/QnA	FX
×	×	○

[Purpose]

Sets when the existing ladder program is changed to the SFC program, and vice versa.

[Operating Procedure]

Select [Project] → [Edit Data] → [Change program type].

[Dialog Box]

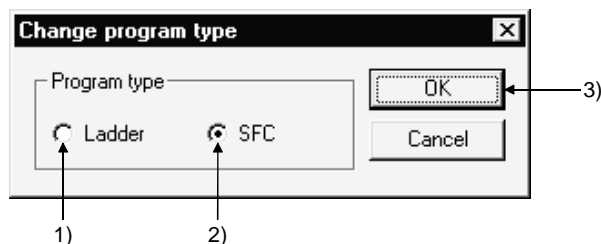

[Description]

- 1) Ladder  
Changes the SFC program being displayed to the ladder program.  
After the changing operation has been completed, editing of the ladder program is enabled.
- 2) SFC  
Changes the ladder program being displayed to the SFC program.  
After the changing operation has been completed, editing of the SFC program is enabled.
- 3) **OK** button  
Click this button after making necessary settings.

<b>POINTS</b>	<ul style="list-style-type: none"> <li>• For cautions on interchanging, refer to the SW5D5C-GPPW Operating Manual (SFC Version).</li> </ul>
---------------	---

### 5.13 Changing the PLC Type of a Project

A	Q/QnA	FX
<input type="radio"/>	<input type="radio"/>	<input type="radio"/>

[Purpose]

Changes the type of the existing data or the data being edited so that it can be used with another type or PLC series.

[Operating Procedure]

Select [Project] → [Change PLC type].

[Dialog Box]

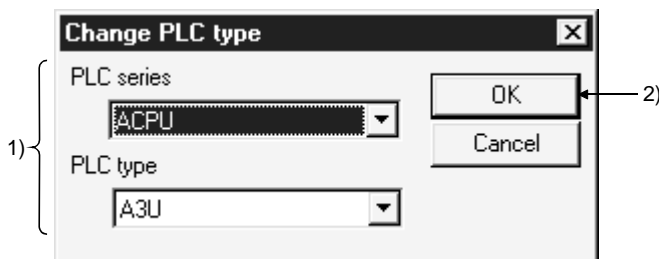

[Description]

- 1) PLC series/PLC type  
Designates the PLC series or PLC type to be changed.
- 2) **OK** button  
Click this button after making necessary settings.  
After the **OK** button is clicked, the following dialog box appears.

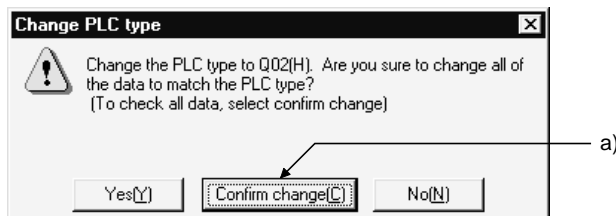

- a) By clicking the **Confirm change** button, you can change the parameter and other settings while simultaneously confirming them.  
When changing the PLC type between FX and FX, you can make corrections to the PLC parameter capacity within the specification range of the PLC type after change.

<b>POINTS</b>	<ul style="list-style-type: none"> <li>• For restrictions on changing each PLC series/PLC type, refer to the restrictions on PLC Change in Appendix 4.</li> <li>• When reading a project from an FD or the like, you cannot make a PLC type change if there is no source project. When changing the PLC type, do not remove the FD or the like nor delete the project.</li> <li>• Note that if SB and/or SW is used in CC-Link refresh setting, special module interrupt setting or the like, a Q → QnA change will cause the SB and/or SW in that part not to be refreshed or interrupt-processed.</li> <li>• PLC type cannot be changed during the monitoring of the circuit or device data in batch.</li> </ul>
---------------	--



5.14 Reading Other Format Files

5.14.1 Reading GPPQ, GPPA, FXGP(DOS) or FXGP(WIN) files

A	Q/QnA	FX
<input type="radio"/>	<input type="radio"/>	<input type="radio"/>

[Purpose]

Reads the existing GPPQ, GPPA, FXGP(DOS), and FXGP(WIN) data into GPPW. These data can be read according to the following procedure immediately after GPPW is started.

[Operating Procedure]

- Select [Project] → [Import file]
  - [Import from GPPQ format file]
  - [Import from GPPA format file]
  - [Import from FXGP(WIN) format file]
  - [Import from FXGP(DOS) format file]

[Dialog Box]

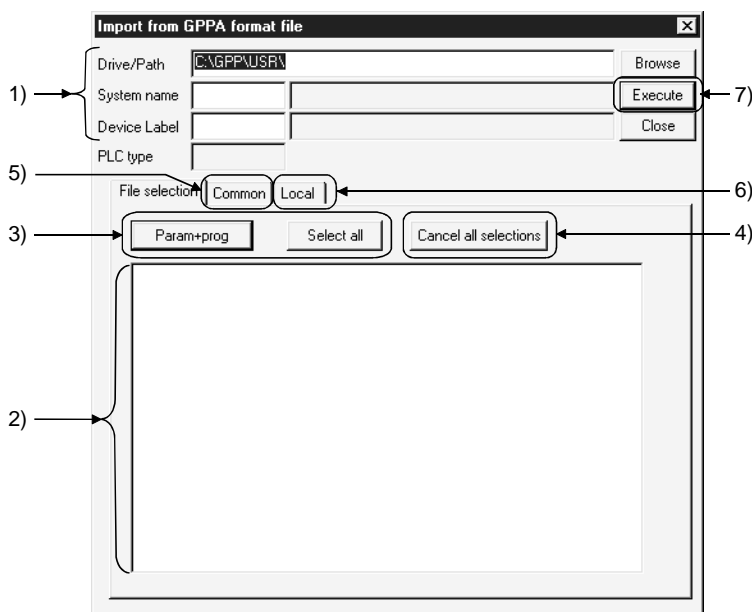

[Description]

- 1) Drive/path, System name, Machine name  
Designates the location of data created by GPPQ, GPPA, FXGP(DOS) or FXGP(WIN). Enter a system name and a machine name for the data specified in the drive path. When FXGP(DOS) or FXGP(WIN) data is read, a folder name is specified as the system name and a file name as a machine name. Also, specifying a file name from a root directory, the system name is left blank. For details, see Subsection 3.2.2.
- 2) Source data list  
Displays data created by GPPQ, GPPA, FXGP(DOS), and FXGP(WIN). Check the checkbox of data names to be selected. The selected comments can be edited in the program common tab or the program tab.

- 3) **Param+prog** button/ **Select all** button
  - **Param+prog** button  
Selects only the parameter data and program data of a source.
  - **Select all** button  
Selects all data in a source data list.  
comment2 is selected as comments in A series, and the device memories of the same quantity as the number of data are displayed.  
The first data name is selected for comments and file registers in QnA series.
- 4) **Cancel all selections** button  
Cancels all the selected data.
- 5) <<Common for programs>> sheet (A series)  
Click <<Common for programs>> tab to set a range for common comments and read data.

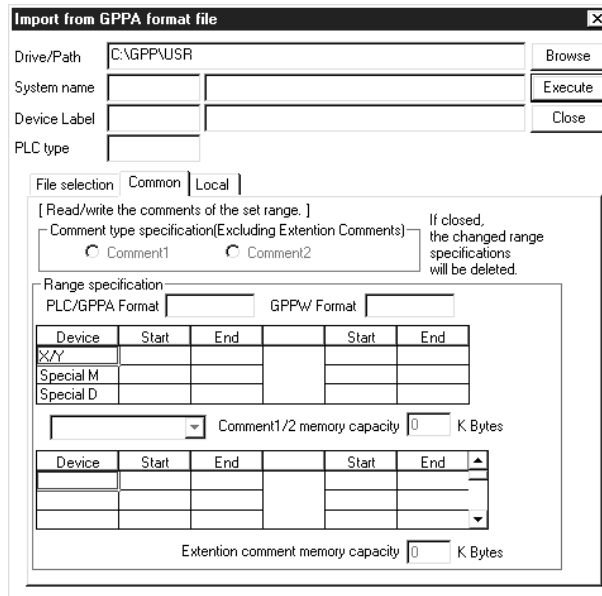

For the setting method for each PLC series, refer to Chapter 9 "SETTING DEVICE COMMENTS".

- 6) <<For each program>> sheet (A series)  
 Click <<For each program>> tab to set a range for comments by program and read data.  
 (Except the FX series)

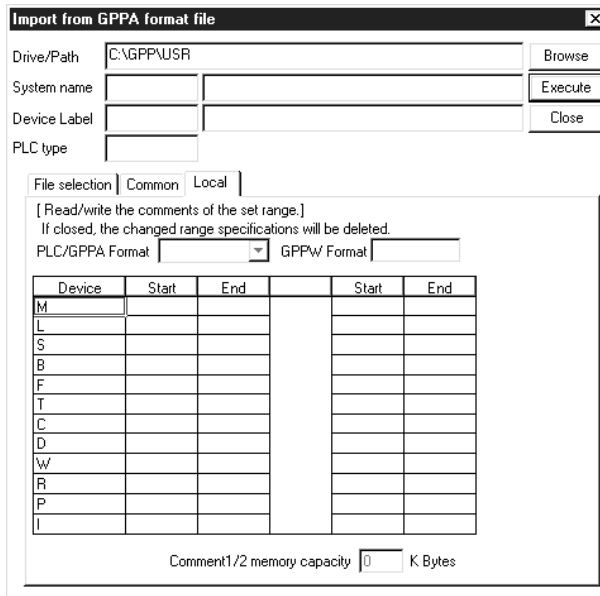

For the setting method for each PLC series, refer to Chapter 9 "SETTING DEVICE COMMENTS".

- 7) **Execute** button  
 Click this button after the setting is over.

[Setting Procedure]

- Data selection
  1. Set a drive/path for reading by GPPQ, GPPA, FX(DOS), or FX(WIN).
  2. Select a project name in the dialog box displayed by clicking the **Browse** button to designate a system name and machine name for the project to be read.
  3. Check the checkbox of data to be selected by using **Param+prog** button, **Select all** button, or the mouse.
  4. Click the **Execute** button after making necessary settings.
- Canceling data selection
  - (1) When canceling the selected data arbitrarily:
    - Clear the checkmark (✓) in the checkbox with the mouse or space key.
  - (2) When canceling all the selected data:
    - Click the **Cancel all selection** button.

Precautions for reading the other format files

For A series		
A6GPP, SW0S-GPPA format data	Read data with GPPW after performing the corresponding format conversion with GPPA. For the operating methods, refer to Type SW□SRXV/IVD-GPPA GPP Function Operating Manual (Details).	
For data selection	For device comment selection, you may only choose either comment 2 or comment 1.	
For GPPW format reading	Abandon the project data on GPPW and read the other format file. The area in excess of the program capacity is deleted when read. For the PLC type which cannot use subprograms, subprograms are deleted when read.	
For QnA series		
Ladder return positions	Returning places are different between GPPQ and GPPW. Because of this, if the total of return sources and return destinations exceeds 24 lines in a single ladder block, the program is not displayed properly. Corrective action: Add SM400 (normally ON contact) to adjust the return positions.	
For data selection	For the device memory and file register, you may select only one data name for each item.	
For FX series		
For data selection	Any item that does not exist in the source data is not displayed.	
Read range	For the A6GPP format, read the data after making conversion once with the FXGP(DOS) software. For the conversion method, refer to the SW1PC-FXGP/EE/AT Software Operating Manual. The data will disappear if it includes microcomputer programs other than SFC programs.	
For FXGP(DOS) format	Files to be read	<ul style="list-style-type: none"> <li>• Program file (.PMC) Parameter, program, comment, file register</li> <li>• Comment file (.COK) Comment</li> <li>• Device memory file Data register, file register, RAM file register, special register (.DMD, .DME, .DMF, .DMG)</li> </ul>
	Files not read	Circuit comment file (.COL), sampling trace file (.STA) Print title file (.PTL), comment file (.COH) Shared circuit file (.DAT)
For FXGP(WIN) format	Files to be read	<ul style="list-style-type: none"> <li>• Program file (.PMW) Parameter, program, comment, file register</li> <li>• Comment file (.COW) Device comment, circuit comment, coil comment, label</li> <li>• Device memory file (.DMW) Data register, special register, RAM file register</li> </ul>
	Files not read	Sampling trace file (.STW), print title file (.PTW) Registration monitor file (.RMW)
	Restrictions	<ul style="list-style-type: none"> <li>• Device comment Up to 50 characters can be input for FXGP(WIN) device comments, but only the first 32 characters are read because the maximum number of character is 32 in GPPW.</li> <li>• Statement Any number of characters can be input for FXGP(WIN) circuit comments, but only the first 64 characters are read because the maximum number of characters is 64 in GPPW.</li> <li>• Note Any number of characters can be input for FXGP(WIN) coil comments, but only the first 32 characters are read because the maximum number of characters is 32 in GPPW.</li> </ul>

5.14.2 Reading a MELSEC MEDOC format file (Printout)

A	Q/QnA	FX
○	×	○

[Purpose]  
 Reads the data output to a file with MELSEC MEDOC as print-out data.

[Operating Procedure]  
 [Project] → [Import file] → [Import from Melsec Medoc format file]

[Dialog Box]

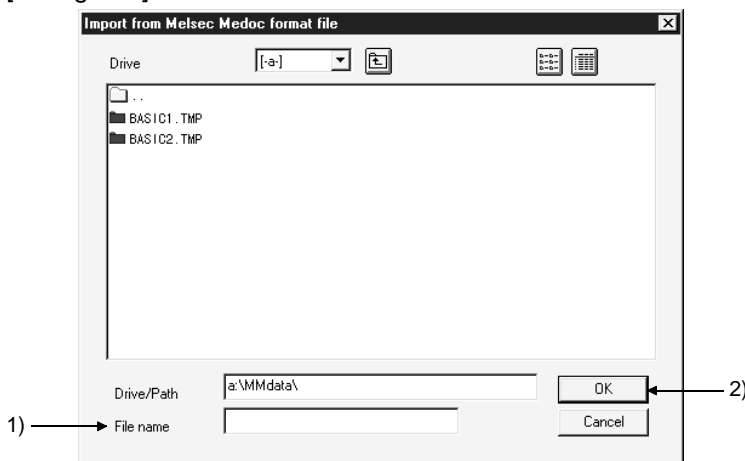

[Description]  
 1) File name  
 The data output to a file with MELSEC MEDOC as print-out data will be read. The MELSEC MEDOC data created with version Ver 2.3 or later will be read.  
 2) **OK** button  
 Click this button after the setting is over.

POINTS		
<ul style="list-style-type: none"> <li>• If print data created with the OS (MS-DOS) in other than English includes characters which cannot be handled by English Windows, reading the data to GPPW may not show them correctly.</li> <li>• The headers, parameters, programs and comments in the print-out data are read.</li> <li>• The parameters read are only the memory capacity, latch range and timer/counter range (except the FX series).</li> <li>• The instructions that cannot be converted are converted as abnormal instruction codes.</li> <li>• When reading the MELSEC MEDOC data with GPPW, always save it after adding the Printer Head (incompatible with the Small Header) on the MELSEC MEDOC side.</li> <li>• For the parameters, programs, etc., use the following table as reference.</li> </ul>		
	MELSEC MEDOC Print-out DataType	Condition
Program	Instr	Any
Comment	Name (Name is to be printed out, Comment is not to be printed out)	Any *1
Comment	parameter	Any *1
Parameter	parameter	Any *1

Any \*1: Only the print-out data for MAIN is valid.  
 Data existing in the print-out data for SUB is not read.

- Refer to Section 5.13.3.

## 5.14.3 Reading a MELSEC MEDOC format file

A	Q/QnA	FX
○	×	○

## [Purpose]

Reads the data created with MELSEC MEDOC.

## [Operating Procedure]

[Project] → [Import file] → [Import from Melsec Medoc format file]

## [Dialog Box]

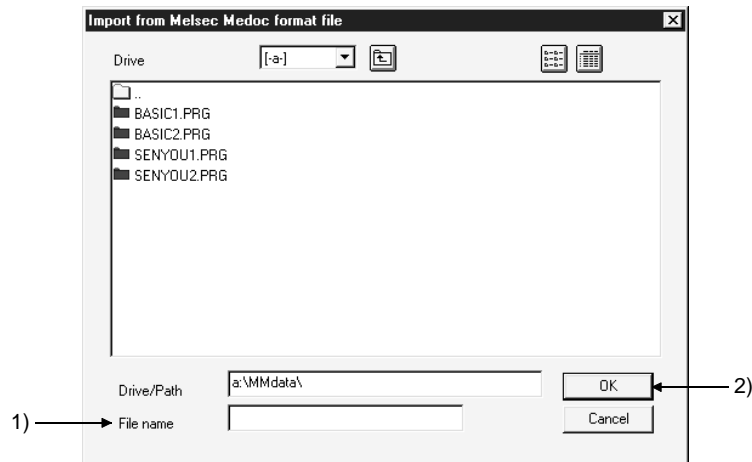

## [Description]

- 1) File name  
Choose the data created with MELSEC MEDOC.
- 2) **OK** button  
Click this button after the setting is over.

## POINTS

- If you want to read subprogram data but the subprogram memory capacity has not been set on the project side, an error occurs and the data is not read.  
Preset the memory capacity in the PLC parameter.
- Unconvertible instructions are converted as instruction code faults.
- The definition of a conversion error is displayed in the dialog box and can be saved in the file.  
The place where it will be saved is the drive/path where the data to be read is saved.
- Data having many statements cannot be displayed properly.  
Refer to Section 10.1.

## POINTS

- The MEMORY CAPACITY (Total memory-Sequence Program) parameter whose setting is step 0 in the sequence program created with MEDOC (PLC type: FX2N) will not be read properly.
- If you read the parameter where the set value devices are specified for the normal counters/timers other than the extended counters/extended timers in the sequence program created with MEDOC (PLC type: ACPU), the set value device numbers are deleted on GPPW.
- A line-to-line statement headed by ";" results in a conversion error. Change ";" to another character to enable read.
- The following ladder created with MEDOC will not be displayed.

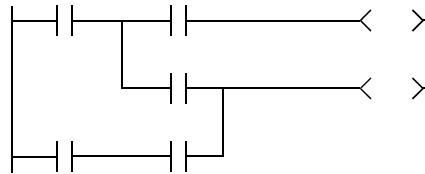

- When the MELSECNETII parameters have been set with MELSEC MEDOC, they will be written as MELSECNETII mixed parameters if they are written to the PLC CPU with the latter half setting screen merely opened and no settings made.  
If a MEDOC format file is read with GPPW, it is read as a MELSECNETII parameter file since the later half has not been set.  
Verifying the PLC and GPPW data in this status will result in a verify mismatch.
- When starting GPPW with Windows 98, do not start the following application at the same time.  
BarClock
- An error will occur if Swedish special characters are included in the ASC instruction of the MEDOC data.
- If lines of only line feed have been created in the program created with MEDOC, conversion to GPPW data will erase those lines.
- A line-to-line statement headed by "@Export:" results in a conversion error.

5.15 Exporting GPPQ, GPPA, FXGP(DOS) or FXGP(WIN) Files

A	Q/QnA	FX
<input type="radio"/>	<input type="radio"/>	<input type="radio"/>

[Purpose]

Saves GPPW data in a GPPQ, GPPA, FXGP(DOS) or FXGP(WIN) file so that it can be read and edited as a GPPQ, GPPA, FXGP(DOS), or FXGP(WIN) file.

[Operating Procedure]

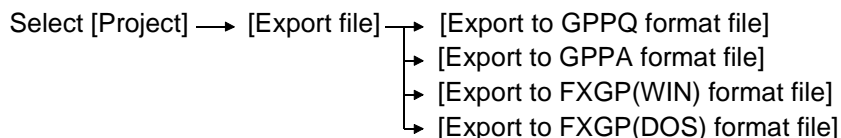

[Dialog Box]

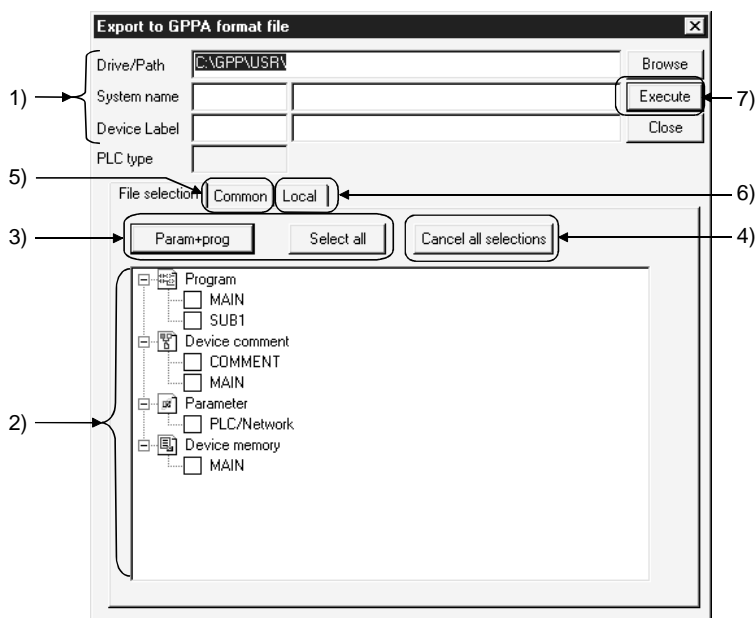

[Description]

- 1) Drive/path, System name, Machine name  
Designates a drive/path for writing a GPPQ, GPPA, FXGP(DOS), or FXGP(WIN) file.  
Enter a system name and a machine name for data specified in the project path.  
When data is written to an FXGP(DOS) or FXGP(WIN) file, a folder name must be designated as a system name and a program file name as a machine name. See Section 3.2 for details on operating methods.

Characters that can be set for data name setting

For A series

You must not use any characters other than alphanumeric characters and - (hyphen).

The first character should be "alphabetic" (a numeral will result in an error).



For QnA/FX series

Alphanumeric characters, \_, ^, \$, -, (tilde), !, #, %, &, (), -, { }, @, \*  
 (apostrophe), ' (single quotation)  
 Unusable characters

An error will occur in presence of any of:  
 " = | : ; , ¥ [ ] + \* ? < > . / (space)

- 2) Source data list  
 Selects data to be written to a GPPQ, GPPA, FXGP(DOS) or FXGP(WIN) file.  
 Check a checkbox of the data name to be selected.
- 3) **Param+Prog** button/ **Select all** button
  - **Param+Prog** button  
 Selects only the source parameter data and program data.
  - **Select all selection** button  
 Selects all the listed source data.
- 4) **Cancel all selection** button  
 Cancels all the selected data.
- 5) <<Common>> sheet (A series)  
 Click <<Common>> tab to set a range for common comments and write data.

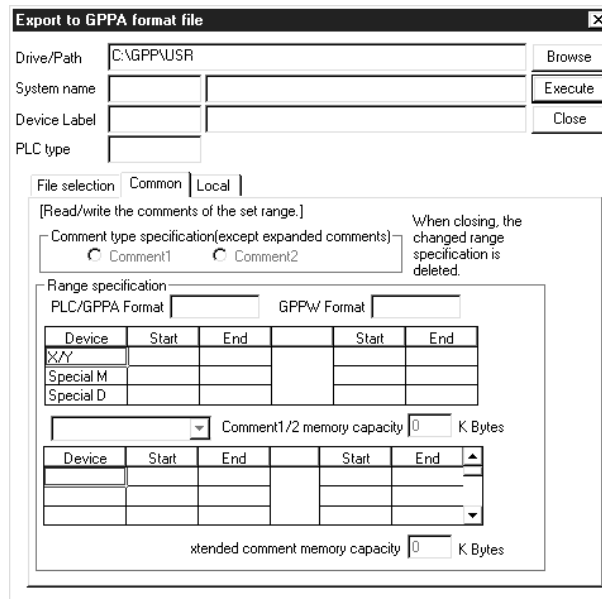

For the setting method for each PLC series, refer to Chapter 9 "SETTING DEVICE COMMENTS".

- 6) <<Local>> sheet (A series)  
Click <<Local>> tab to set a range for comments by program and write data.  
(Except the FX series)

Export to GPPA format file

Drive/Path: C:\GPPA\USR

System name:

Device Label:

PLC type:

File selection | Common | Local

[Read/write the comments of the set range. ]  
If closed, the changed range specifications will be deleted.

PLC/GPPA Format:  GPPW Format:

Device	Start	End	Start	End
M				
L				
S				
B				
F				
T				
C				
D				
W				
R				
P				
I				

Comment1/2 memory capacity:  K Bytes

For the setting method for each PLC series, refer to Chapter 9 "SETTING DEVICE COMMENTS".

- 7)  button  
Click this button after making necessary settings.

#### [Operating Procedure]

- Data selection
  1. Designate a drive/path for the project to be written.
  2. Select a project name in the dialog box displayed by clicking the  button to designate a system name and machine name for the project to be written.
  3. Check the checkbox of data to be selected by using  button,  button, or the mouse.
  4. When setting a range for comments to be written, set the details of the comment range. (See Chapter 9 for details on setting methods.)
  5. Click the  button after making necessary settings.
- Canceling data selection
  - (1) Canceling the selected data arbitrarily
    - Clear the checkmark  in the checkbox with the mouse or space key.
  - (2) Canceling all the selected data
    - Click the  button.

Precautions for writing the other format files

For A series, QnA series		
Program name	When writing programs in the GPPA format in A series, the program names other than MAIN, SUB1, SUB2 and SUB3 cannot be used.	
Statement, note	When statements/notes are created, they are written at the same time by selecting programs.	
Writing method	The QCPU-A data is written to the A4UCPU file.	
For FX series		
For data selection	For FXGP(DOS) and FXGP(WIN), the following items to be written are displayed, respectively. Note that any item that does not exist in the source data is not displayed.	
Write range	For reading the A6GPP format data, read the data with GPPW after making conversion once with the FXGP(DOS) software. For the conversion method, refer to the SW1PC-FXGP/AT Software Operating Manual. For reading the other format file, the file will disappear if it includes microcomputer programs other than SFC programs.	
For FXGP(DOS) format	Files to be written	<ul style="list-style-type: none"> <li>• Program file (.PMC) Parameter, program, comment, file register</li> <li>• Comment file (.COK) Comment</li> <li>• Device memory file Data register, file register, RAM file register, special register (.DMD, DME, .DMF, .DMG)</li> </ul>
	Files not written	Circuit comment file (.COL), sampling trace file (.STA) Print title file (.PTL), comment file (.COH) Shared circuit file (.DAT)
	Restrictions	<ul style="list-style-type: none"> <li>• Device comment Up to 32 characters can be input for GPPW device comments, but only the first 16 characters are written because the maximum number of character is 16 in FXGP(DOS).</li> <li>• Comment The maximum number of comments is 3400.</li> <li>• P, I statement P, I statement is not written.</li> </ul>
For FXGP(WIN) format	Files to be written	<ul style="list-style-type: none"> <li>• Program file (.PMW) Parameter, program, comment, file register</li> <li>• Comment file (.COW) Device comment, circuit comment, coil comment, label</li> <li>• Device memory file (.DMW) Data register, special register, RAM file register</li> </ul>
	Files not written	Sampling trace file (.STW), print title file (.PTW) Registration monitor file (.RMW)
	Restrictions	<ul style="list-style-type: none"> <li>• Label A GPPW label can be input in up to 8 characters, but only the alphanumeric characters and symbols (/ + - * / = . ? # \$ % &amp; ; : ; _ ) can be used in FXGP(WIN) (see Section 9.6.1). The label containing characters not written is deleted when writing the data.</li> <li>• P, I statement P, I statement is not written.</li> </ul>

5.16 About Macros

A	Q/QnA	FX
○	○	○

By naming any ladder pattern (macro name) and registering it in a file (macro registration), you can read the registered ladder pattern, and change and utilize the devices (macro utilization) in actual programming.

Macro registration

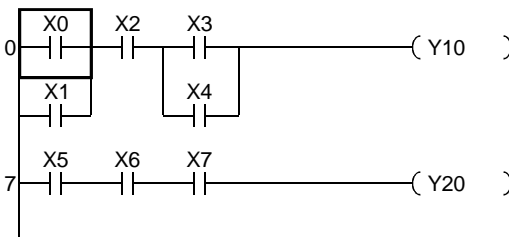

1. Choose the program area to be registered as a macro.
2. Set the devices and so on to be registered.
3. Set the file name of the macro to be registered.

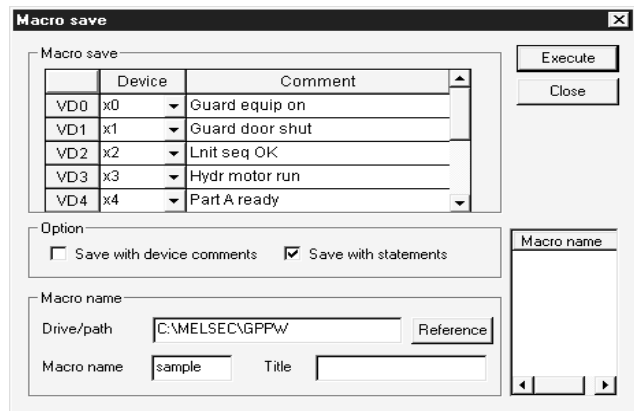

Macro utilization

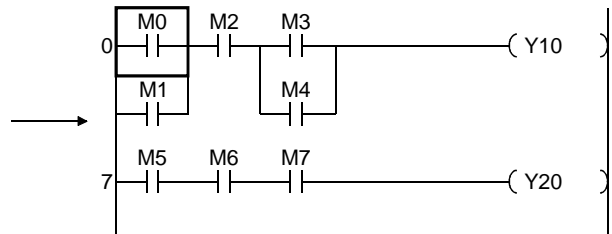
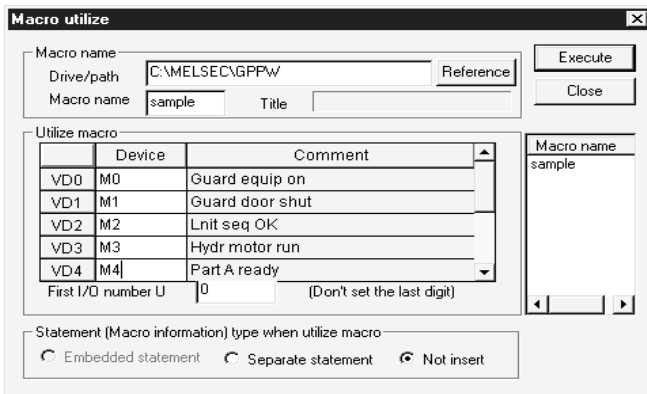

1. Specify the file name registered as a macro.
2. Set the devices to be changed.

Macro reference destination setting (Except the FX series)

If you have set a macro-registered file in macro reference destination setting, you can utilize the macro by entering a simple macro instruction.

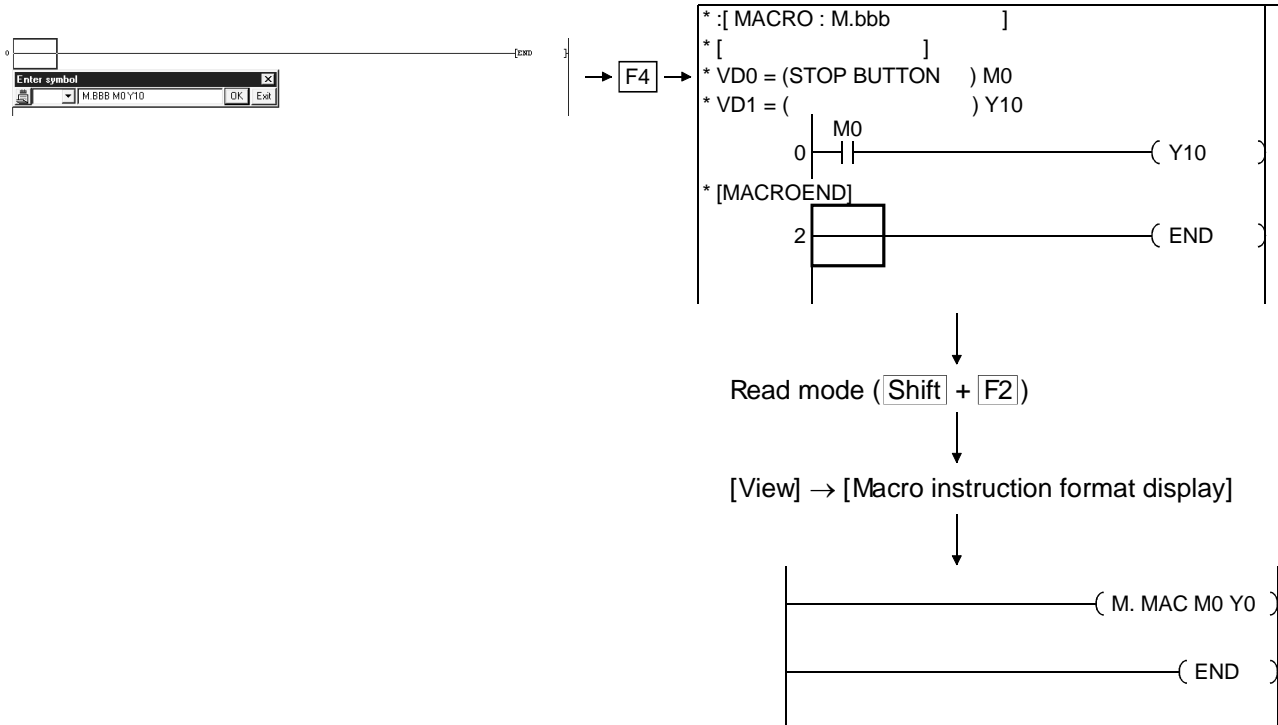

POINTS

Choosing [View] → [Macro instruction format display] in the read mode allows the developed macro instruction to be represented in the M.Macro VD0 VD1 VD2... instruction format.

Any macro name may be set.

(The macro instruction format display is compatible with the macros created with SW3D5-GPPW-E or later.)

Note the following to provide the macro instruction format display properly.

1. Do not make corrections, deletions or the like to macro programs which utilize macros.
2. When a macro-utilized ladder is displayed with statements, do not utilize macros within MACROEND.
3. Do not change the utilized devices which have been specified as VDs. (The device numbers remain as utilized at first.)

5.16.1 Registering a macro

A	Q/QnA	FX
○	○	○

[Purpose]

Registers part of a program to a file as a macro instruction.

The registered macro instruction can be used as an application instruction in a program.

[Operating Procedure]

[Project] → [Macro] → [Registration macros]

[Dialog Box]

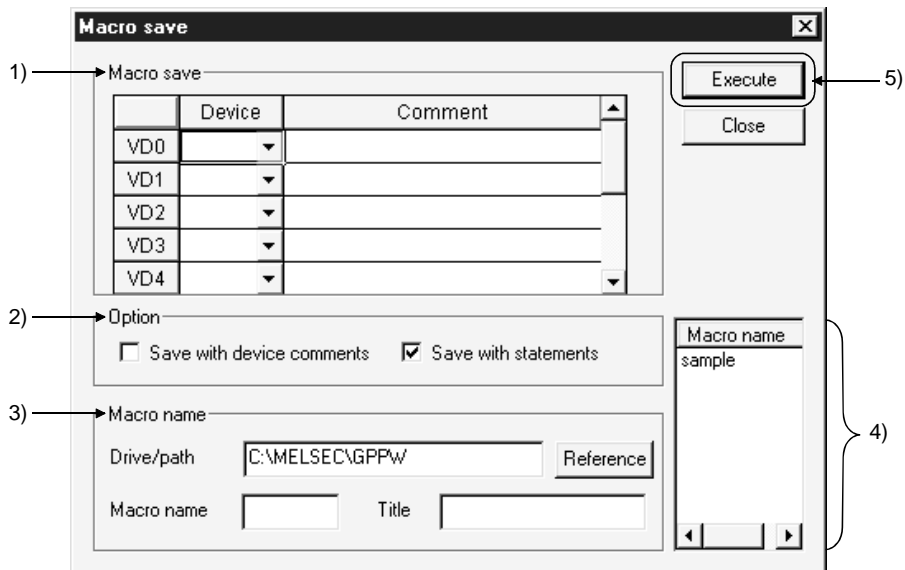

[Description]

1) Macro save

Among the devices in the area-specified ladder block, specify the devices you want to change for macro utilization as variable devices VD0 to VD9. The following example shows the devices registered.

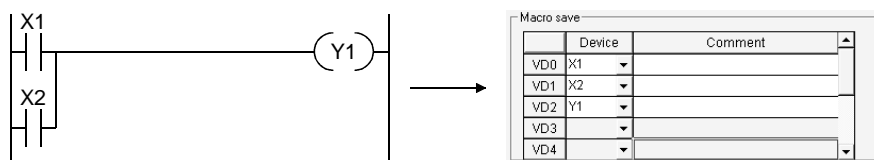

If the devices have been commented, the comments are automatically set. Also, comments may be edited. (Setting can be made independently of the number of comment characters in the option.)

2) Option

Set whether or not comments and statements will be registered together with the ladder for macro registration.

- 3) Macro name  
Set the drive/path and where the macro will be registered and the macro file name.  
The number of characters set to the title is within 32.
- 4) Macro name displays area  
The existing macro name appears.
- 5)  button  
Click this button after the setting is over.

The following devices may be registered to macros.

Device Type		Example	Device Registerability
Bit device	—	M0	<input type="radio"/>
	Digit designation	K4M0	<input type="radio"/>
Word device	—	D0Z0	<input type="radio"/>
	Indirect designation	@D0Z0	<input type="radio"/>
	Bit designation	D0.1	<input type="radio"/>
Extended designation (J, U, BL)	Bit	J1\B1Z0	<input type="radio"/> (J1B1 also possible) (J1) not possible for unit No. only. (B1Z0, B1) not possible for device only.
	Digit designation	J1\K1B1Z0	<input type="radio"/> (J1K1B1 also possible) (J1) not possible for unit No. only. (K1B1Z0, K1B1) not possible for device only.
	Word	J1\W0Z0	<input type="radio"/> (J1W0 also possible) (J1) not possible for unit No. only. (W0Z0, W0) not possible for device only.
	Indirect designation	@J1Z1\W0Z0	<input type="radio"/> (J1, J1Z1) not possible for unit No. only. (W0Z0, W0) not possible for device only.
	Bit designation	J1\W1.1	<input type="radio"/> (J1) not possible for unit No. only. (W1.1) not possible for device only.
Designation with digit		K4M0, J1\K1B1Z0	(K4) not possible for designation with digit only.
Index qualification		D0Z0, J1\K1B1Z0	(Z0) not possible for index qualification only.
Constant	Integer/real number	K10, H10, E0.1	<input type="radio"/>
	Character string	"Abcd"	×
Index		Z0	<input type="radio"/>
Pointer		P, I	<input type="radio"/>
Equipment name			<input type="radio"/> Also possible for other than display/equipment name display.

POINT
The macro registered as a ladder cannot be utilized in an SFC. Also, the macro registered as an SFC cannot be utilized in a ladder.

5.16.2 Utilizing a macro

A	Q/QnA	FX
○	○	○

Macros that may be utilized are only those of the same series as the PLC series at the utilization destination. (Macros cannot be set if the PLC series is the same but the PLC type is different.)  
However, macros can be utilized between the A series and MOTION(SCPU).

[Purpose]

Reads the macro-registered ladder block from the file, changes the devices registered, and utilizes the macro in any position of a ladder.

[Operating Procedure]

[Project] → [Macro] → [Macro utilize]

[Dialog Box]

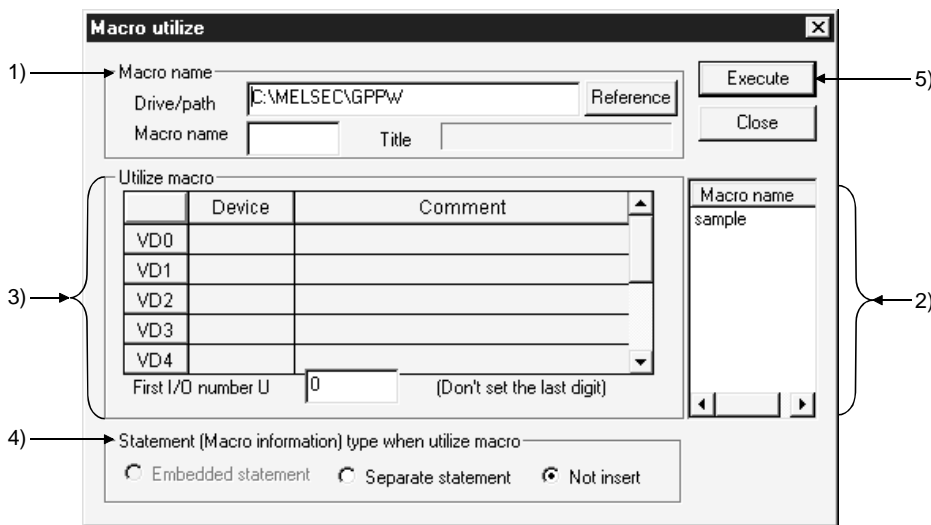

[Description]

- 1) Macro name  
Specify the drive/path where the macro is registered.  
The macro name can be specified from the Macro name displays area.
- 2) Macro name displays area  
The macro file names registered appears.  
Specify the macro name you want to utilize.



- 3) Utilize macro setting  
The devices specified as VD0 to VD9 for macro registration are changed to the devices specified here. (Only the variable devices specified for macro registration may be set.)

The devices specified as VD0 to VD9 should be those equivalent to the devices specified for macro registration.

You cannot specify a bit device as a word device and vice versa.

Specifying the first I/O number biases the X, Y and U device numbers by the specified number.

<Example>

When the first I/O number specified is U[1F], the X and Y devices are biased by +1F0 and the U devices by +1F.

- 4) Statement(Macro information)type when utilize macro  
Select whether macro development will be made with Embedded/Separate Line statement or without statements.  
If you have also registered statements during macro registration, development will be made under the registered conditions independently of this setting.
- 5)  button  
Click this button after the setting is over.  
The macro-utilized ladder is inserted in a place before the ladder block at the cursor position.

POINTS
<ul style="list-style-type: none"> <li>• A macro is utilized unchanged if it includes the instructions/devices that cannot be used in the utilization destination project or the devices that are outside the range. In that case, make a program check and correct the program.</li> <li>• Macros created with GPPW can be utilized. (QnA series only)</li> <li>• The device names assigned to VD during macro utilization are added after the statements. (For Embedded statement, the number of statement steps increases.)</li> <li>• If you have set "Save with device comments" during macro registration, the comment attached to the VD are utilized as comments. If the device comments used with the VD already exist in the existing program, they are overwritten by the comment of the VD.</li> <li>• When utilizing macros after MACROEND, utilize them in the list mode.</li> </ul>

5.16.3 Deleting a macro

A	Q/QnA	FX
<input type="radio"/>	<input type="radio"/>	<input type="radio"/>

[Purpose]  
Deletes the user-created macro file.

[Operating Procedure]  
[Project] → [Macro] → [Delete macros]

[Dialog Box]

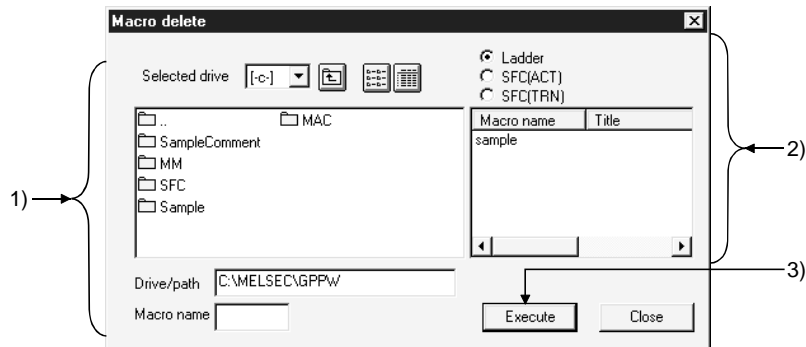

- [Description]
- 1) Directory name displays  
Specify the directory of the macro file to be deleted.
  - 2) Macro file delete selection  
Choose the object of deletion from the sequence program, SFC (ACT) and SFC (TRN), and specify the macro file name to be deleted.

	Deletion Destination Folder	Description
Sequence	MAC	For sequence program
SFC (ACT)	MAC. ACT	For SFC (operation output)
SFC (TRN)	MAC. TRN	For SFC (transition condition)

- 3) **Execute** button  
Click this button after the setting is over.

## 5.16.4 Displaying macro references

A	Q/QnA	FX
○	○	×

## [Purpose]

Enables GPPW to use the macro data created by GPPQ.  
For A series or FX series, this function cannot be used.

## [Operating Procedure]

Select [Project] → [Macro] → [Macro reference path].

## [Dialog Box]

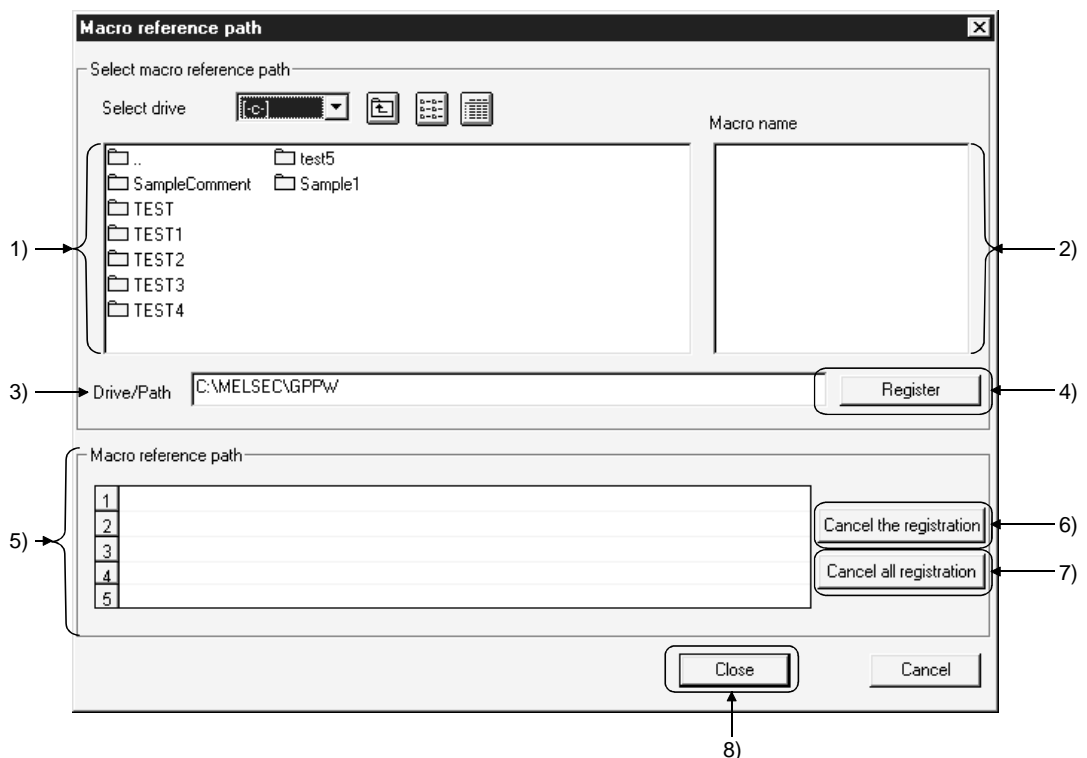

## [Description]

- 1) Folder name list  
Displays the macro names of a project designated in the Drive/path.
- 2) Macro file name list  
Displays the macro files that can be referenced when the current drive/path is set for macro reference.
- 3) Drive/Path  
Designates a drive/path for the macro to be referenced. (The machine name folder created by GPPQ must be designated here.)  
Even though the folder name list contains the entries MAC, MAC.ACT and MAC.TRN, they cannot be designated because there is no macro file in them.

- 4)  button  
Click this button to register macros in Macro reference path.  
The macros cannot be used unless they are registered in this field.
- 5) Macro reference path  
Up to five macro names with different drives/paths can be registered in this field.  
A maximum of 242 characters can be used to designate a drive/path. The number of characters of a drive/path listed in this reference field is 94 characters in large fonts and 103 characters in small fonts. Even when a macro name consists of more characters, it can be used though it cannot be displayed in this field.
- 6)  button  
Cancels the drive/paths displayed in Macro reference one by one.
- 7)  button  
Cancels all the drives/paths displayed in Macro reference at a time.
- 8)  button  
Click this button after making necessary settings.

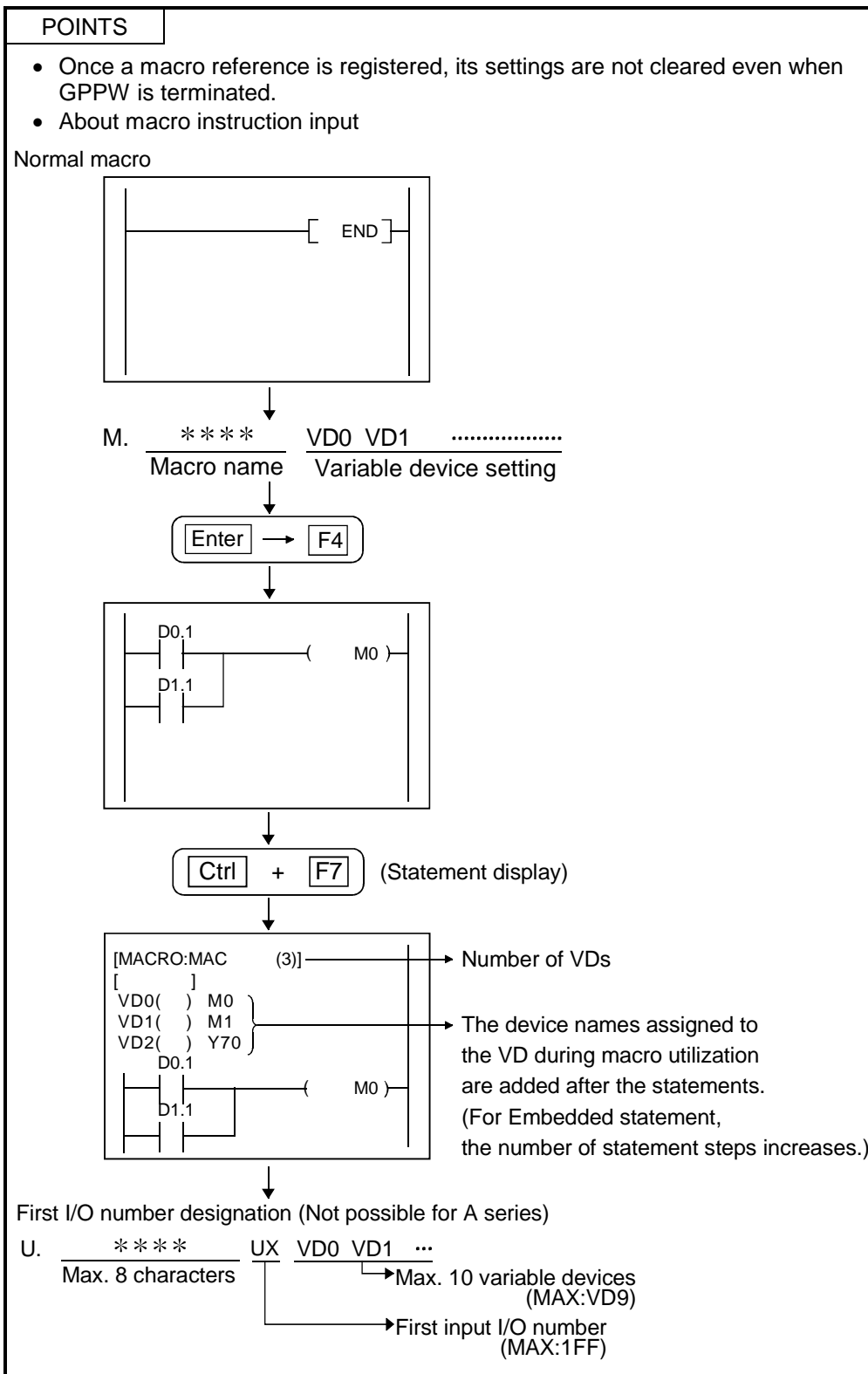

### 5.17 Starting Multiple Projects

A	Q/QnA	FX
○	○	○

[Purpose]

Starts and reads multiple projects so that data can be edited (cut, copied and pasted) among the projects.

[Operating Procedure]

Select [Project] → [Start new GPPW session].

[Description]

Once the window is displayed, open the projects and edit data.

### 5.18 Existing GPPW

A	Q/QnA	FX
○	○	○

[Purpose]

Exits GPPW.

[Operating Procedure]

Select [Project] → [End GPPW] or click .



[Description]

When no project name has been designated, clicking [End GPPW] causes a dialog box to be displayed for project name confirmation.

Click the **Yes** button to save the changes to the project.

For details on designating the project path and project name, see Section 3.2.

Click the **No** button not to save the changes to the project.

<b>POINTS</b>
<ul style="list-style-type: none"> <li>When exiting GPPW by clicking , click the button shown below.                     <div style="text-align: right; margin-right: 50px;">Click here.</div>  </li> <li>When closing only the open data without exiting GPPW, click  on the menu bar.</li> </ul>





## 6. CREATING CIRCUIT

POINTS		
<ul style="list-style-type: none"> <li>When creating comments, statements, notes, and device names for creating circuits, refer to the following table.</li> <li>Refer to Section 6.4 for finding and replacement.</li> </ul>		
	To edit	To display on edit window
Comment	Refer to Section 9.4.	Refer to Section 3.8.
Statement	Refer to Subsection 10.3.1 (1).	Refer to Section 3.9.
Note	Refer to Section 10.4.1.	Refer to Section 3.10.
Device name	Refer to Section 9.4.	Refer to Section 3.11.

- (1) Circuit creation method
- Input instruction list representations (mnemonic language) with the keyboard.
  - Use tool buttons on the tool bar.
  - Use function keys.
  - Use the tool bar menu.

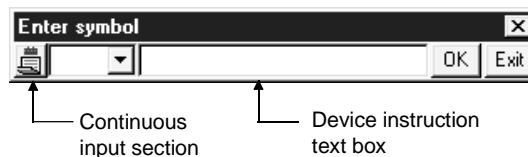
Once the above operation is started, the following circuit input dialog box is displayed.



Click  in the continuous input section so that the circuits or contacts can be input continuously without closing the circuit input dialog box.  
(This function will not apply to MEDOC style.)



- (2) Switching circuit and list modes (This operation also covers the SFC operation outputs and transition conditions.)

Used to switch the display modes of the edit window.

- (a) When switching from circuit edit window to list edit window:

Select [View] → [Instruction list] or click  (Alt + F1) to set the list mode.

- (b) When switching from list edit window to circuit edit window:

Select [View] → [Ladder], or click  (Alt + F1) to set the circuit mode.

- (3) Switching read and write modes

- (a) Read mode (to read a circuit)

Select [Edit] → [Read mode] or click  (Shift + F2).

If a device to be read, step No., or instruction is designated directly with the keyboard in read mode, a desired part of the circuit can be read.



Click here, and the search dialog box will be displayed for device designation

- (b) Write mode (to edit a circuit)

Select [Edit] → [Write mode] or click  (F2).

In write mode, sequence circuits can be edited (i.e., circuit creation or search and replacement can be performed.)

(4) Switching insert and write modes (Use **Insert** key to switch the mode.)

(a) Insert mode (Cursor: purple)

Used to insert contacts and application instructions into the existing circuits

1. Move the cursor to the following position.

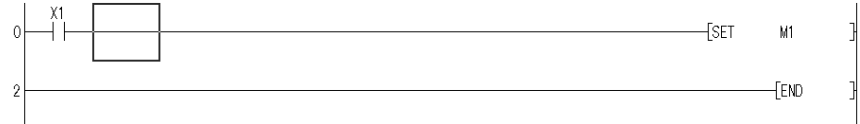

2. Enter "MOV K1 DO" with the keyboard, and the circuit input dialog box will be displayed. The entered data is written to the device instruction text box.

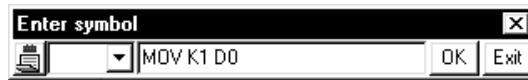

3. Press **Enter** key and click **OK** button to make input in the edit window.

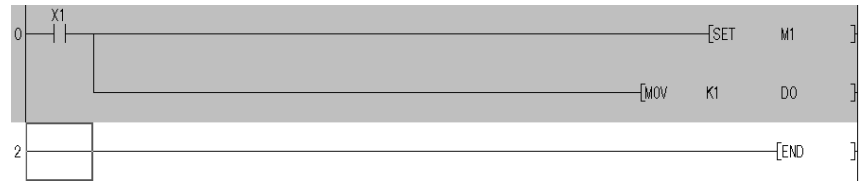

4. Press **F4** key and click  button for inputting.

(b) Overwrite mode (Cursor: blue)

Used to overwrite contacts and application instructions to the existing circuits

1. Move the cursor to the following position.

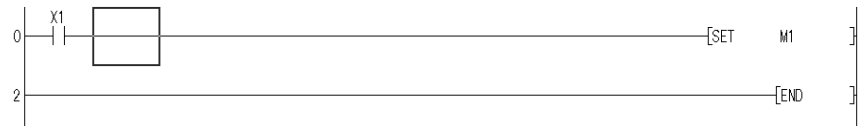



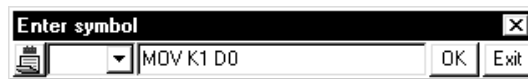



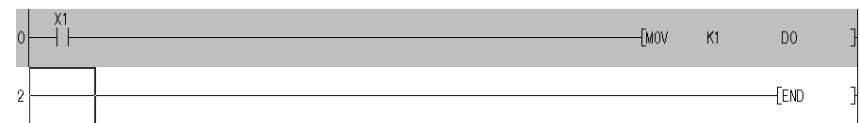



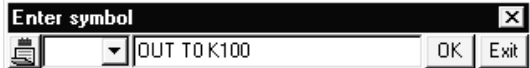

2. Enter "MOV K1 DO" with the keyboard, and the circuit input dialog box will be displayed. The entered data is written to the device instruction text box.

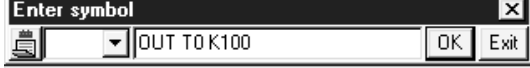

3. Press **Enter** key and click **OK** button to make input in the edit window.



POINTS	
<p>Tool buttons:</p> <ul style="list-style-type: none"> <li>• Tool buttons vary from model to model in the CPU series.</li> <li>• The key assignment can be changed by customizing the keys.</li> <li>• Refer to Section 16.10 for details.</li> </ul>	
<p>Function keys:</p> <ul style="list-style-type: none"> <li>• How to read function symbols shown on the tool buttons is shown below.</li> </ul>	
	
↑	↑
(Shift) + (F5)	(Ctrl) + (F9)
	
↑	↑
(Alt) + (F7)	(Ctrl) + (Alt) + (F5)
<p>Inputting for low speed timers, high speed timers, integrating timers, and edge relays</p> <ul style="list-style-type: none"> <li>• For Q /QnA series, input as follows.</li> </ul>	
<p>Low speed timer</p>	 
<p>High speed timer</p>	 
<p>High-speed integrating timer</p>	 
<p>Edge relay</p>	 
<p>Read/write modes</p> <ul style="list-style-type: none"> <li>• In the read mode, the sequence circuit cannot be edited.</li> <li>• In the write mode, searching by direct inputting cannot be performed.</li> <li>• The circuit input dialog box can also be displayed by double-clicking the cursor.</li> <li>• The contact or application instruction can be changed by pressing function keys (F5) ⇄ (F6) ⇄ (F7) ⇄ (F8) ⇄ (F9).</li> <li>(If the key assignment is customized to MEDOC style, it is not possible to change the contact or application instruction by these function keys.)</li> <li>• In the write mode, with the (Ctrl) key + arrow keys, the cursor position can be moved with the input dialog box opened.</li> </ul>	
<p>Ladder/list modes:</p> <ul style="list-style-type: none"> <li>• For switching from circuit edit window to list edit window Position the cursor at any contact on the circuit edit window and switch the screen. The circuit block where the cursor is positioned will be displayed at the top of the list edit window.</li> <li>• For switching from list edit window to circuit edit window Position the cursor at any list on the list edit window and switch the screen. The circuit block where the cursor is positioned will be displayed at the top of the circuit edit window.</li> </ul>	

## 6.1 Restrictions on Circuit Creation

This section describes the restrictions of the circuit display window and circuit edit window.

### 6.1.1 Restrictions in circuit display window

A	Q/QnA	FX
○	○	○

1. The maximum number of lines on one screen is 12. (at 800 x 600 pixels, 50% reduced screen)
2. A created circuit block must be less than 24 lines. Excess lines cause an error.
3. A circuit line can consist of 11 contacts plus 1 coil.
4. The following table lists the number of comment characters.

	No. of Input Characters	No. of Characters Displayed in Circuit Window
Device comment *1	32 characters	All characters (8 characters x 4 lines) are displayed.
Statement	64 characters	All specified characters are displayed.
Note	32 characters	
Device name	8 characters	

\*1: The number of device comment edit characters can be set to 16 characters or 32 characters. (see Section 16.10 for details.)

Note that only 16 characters can be used for writing data to PLC/GPPA files.  
 Note that only 16 characters can be used for writing data to FXGP(DOS) files.

6.1.2 Restrictions in circuit edit window

A	Q/QnA	FX
○	○	○

1. The maximum number of edit lines per circuit block is 24.
2. The maximum number of edit lines (24 lines/circuit block) is 48.
3. Data up to 48 lines can be cut.  
The maximum block size is 124k steps.
4. Data up to 48 lines can be copied.  
The maximum block unit is 124k steps.
5. Data cannot be cut, copied and pasted in read mode.
6. Master control (MC) can not be edited and displayed.  
The MC symbol appears in the read or monitor mode.  
(It does not appear in the write mode.)
7. When a series circuit with 12 contacts or more is created on one line, excess contacts are automatically wrapped and continued to the next line.  
Symbols K0 to K99 are used for wrapping and the same number is used for OUT(→) and IN(>-).
8. No circuits can be inserted between the lines OUT(→) and IN(>-).
9. When the circuit write function is used, wrapping symbols are assigned sequence numbers even when they are not within the same circuit block.  
However, the circuit blocks read by the read function are assigned sequence wrapping numbers beginning with 0 during display.

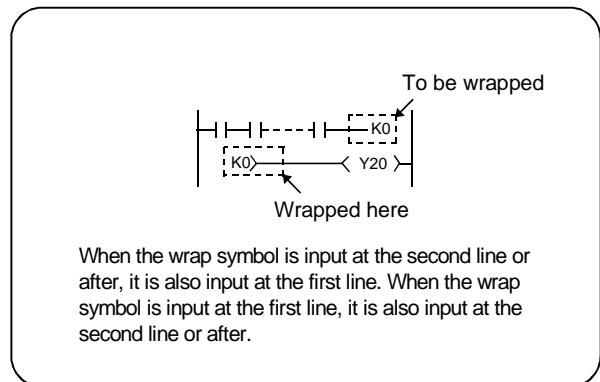
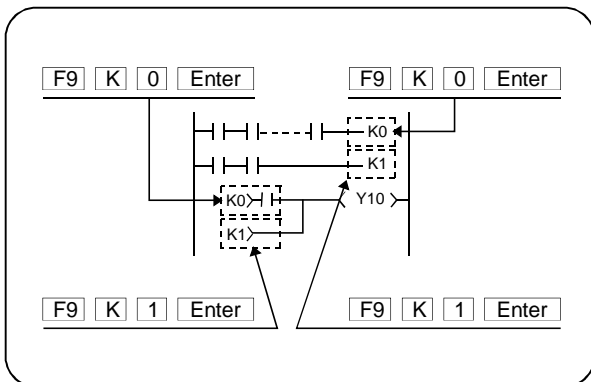

10. When an overwrite contact or coil extends over multiple contacts, the circuit cannot be edited in write (overwrite) mode.

<Example>

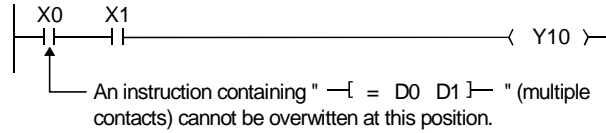

When the above change is made, "[ = D0 D1 ]" must be input in write mode (insert mode), then "LD X0" must be deleted with the **Delete** key.

11. When wrapping occurs for contact insertion to the first line of the circuit, the contact cannot be inserted.

<Example>

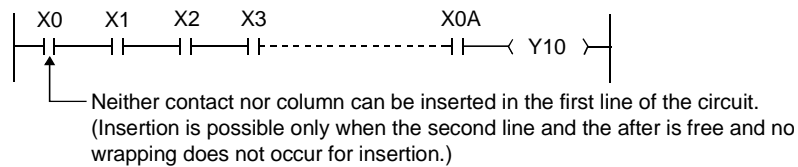

12. Line insertion processing is not possible if the insertion position is within an instruction.

<Example>

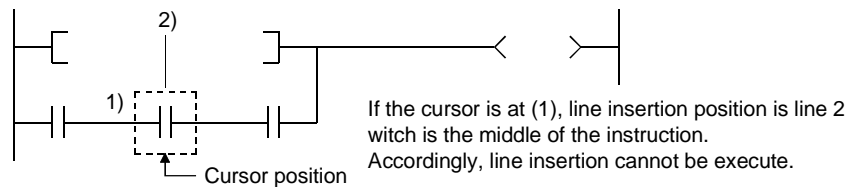

13. Since circuit symbol insertion is processed by the combination of rite flush and line insertion processing, insertion may be impossible depending on the circuit configuration.

<Example>

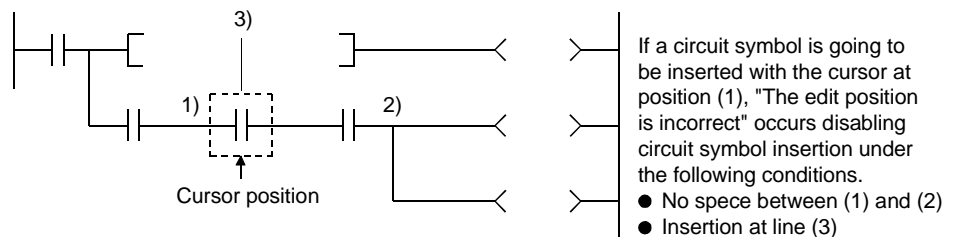

Note : Position (2) is the closest position to the cursor position among the branch symbols and the coil-equivalent instruction.

14. When inserting vertical lines in write (overwrite) mode according to specified number of lines/connecting lines, input the column in the second line and after with **Ctrl** + **Insert** keys, then insert the contact or column to the left of X0.
15. When a vertical line extends over a circuit symbol in writing the line in write (overwrite mode) according to the specified number of lines/connecting lines, writing takes place skipping the circuit symbol.

<Example>

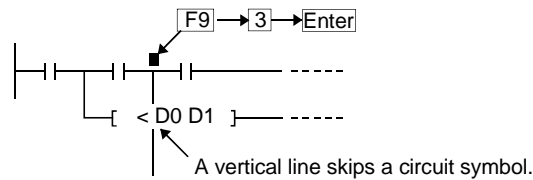

In the circuit edit stage, a vertical line is written skipping the circuit symbol, but such a circuit cannot be converted.  
 Make changes to prevent the vertical line from intersecting the circuit symbol, then perform circuit conversion.

16. When a circuit block consists of 2 lines or more and an instruction cannot be input in one line, the instruction must be wrapped as shown below for instruction input.

(Example) Input of ECALL abcdefg hP0 ZR12345Z1 ZR12345Z1 ZR12345Z1 ZR12345Z1 ZR12345Z1  
 Input can be made from the position 2).

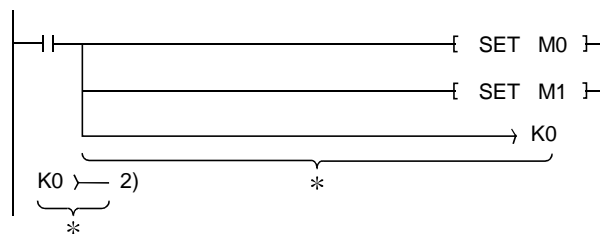

<When no circuit can be created>

The instruction shown in the above example cannot be created in 1).

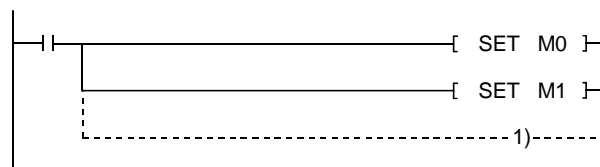

17. The instruction and device that can be input in the first line are shown below (for QnA series selection).

<Example>

U0\G12.1 → Use lines for one contact.  
 U0\G123.1 → Use lines for two contacts.

18. The representations of FX series step ladder instructions and cautions on programming

- Conventional representations in FXGP(DOS) and FXGP(WIN)

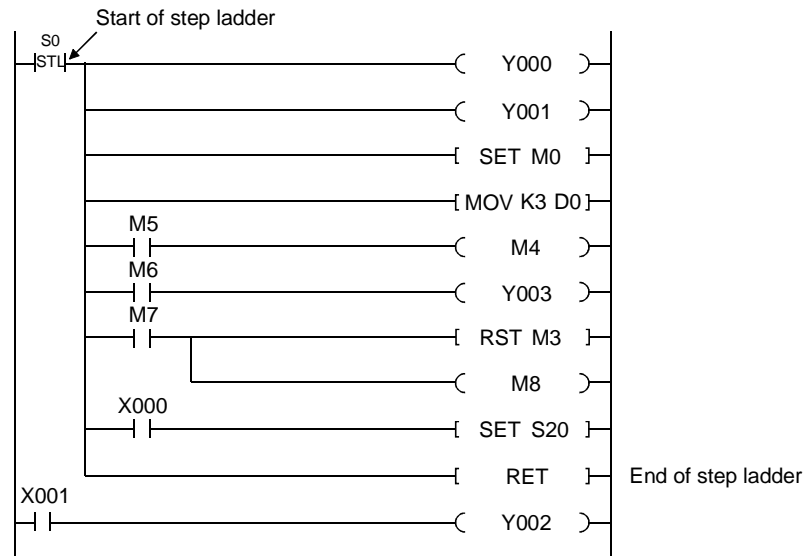

- Representations in GPPW and cautions on programming

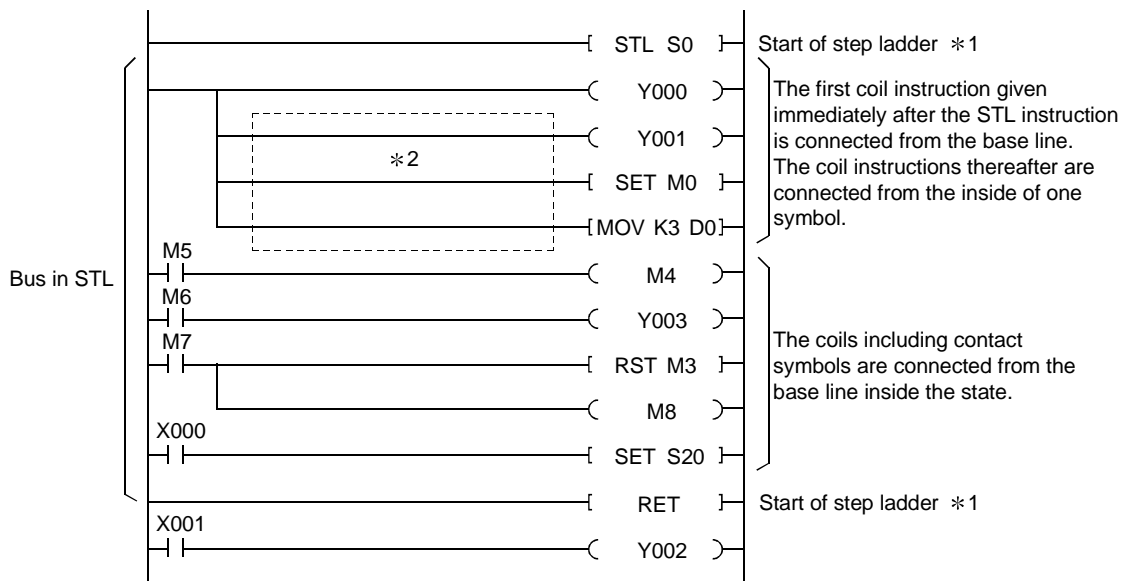



Though the FX series programming material gives descriptions using the above conventional representations, they must be given in a GPPW-specific style when the step ladder instructions are input by GPPW.

- \*1: When the programming is made to create the zoom circuit for SFC program, STL/RET instruction need not to be input.
- \*2: Do not enter the contact to the coil instruction subsequently from the first coil instruction given immediately after STL instruction. (The circuit into which contact is input cannot be displayed in FXGP (DOS) and FXGP (WIN).  
When entering contacts, enter from the base line.



## 6.2 Creating and Editing Circuits

A	Q/QnA	FX
○	○	○

POINTS
<p>Replacing</p> <ul style="list-style-type: none"> <li>Replace (<b>F4</b> / ) Replaces the program under editing.</li> <li>Replace (All programs under editing) (<b>Ctrl</b> + <b>Alt</b> + <b>F4</b> / ) Replaces all programs at a time under editing.</li> <li>Replace (Write during RUN) (<b>Shift</b> + <b>F4</b>) Refer to Section 17.11.</li> </ul> <p>Replacing SFC figures.</p> <ul style="list-style-type: none"> <li>Refer to the GPP Function Software Package SW5D5C-GPPW Operating Manual for Windows (SFC Version)</li> </ul>

### 6.2.1 Inputting contacts and application instructions

[Contact input procedure]

1. Move the cursor to an input position.

2. Enter the contact.

- For input with list representation  
Enter "LD X1" with the keyboard.



- For input with tool buttons  
Click , and enter "LD X1" with the keyboard.



- For input with function keys  
Press **F5** key with the keyboard to enter "X1".



- For input with menu  
Select [Edit] → [Ladder symbol] → [Open contact], and enter "X1" with the keyboard.



3. Press **Enter** key and click **OK** button to make input in the edit window.

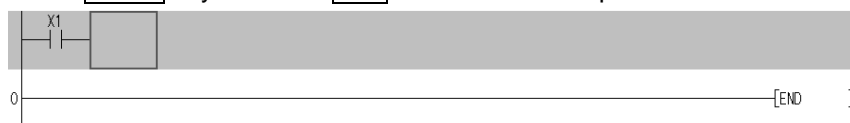

4. Press **F4** key and click  button for inputting.

POINT	
<ul style="list-style-type: none"> <li>The following shows the contacts that can be input with the tool buttons.</li> </ul>	
Type	Contact tool button
GPPA contact	
GPPQ contact	
When FX series is selected	<p>sF7, sF8, aF7, and aF8 are effective only when the selected PLC type is FX2N(C).</p>

[Application instruction input procedure]

1. Move the cursor to input position.  
The application instruction and device can be input to the following cursor position.



2. Enter the application instruction.
  - For input with list representation  
Enter "MOV X1 DO" with the keyboard.

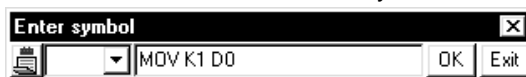

- For input with tool buttons /
- Click , and enter "MOV K1 DO" with the keyboard.

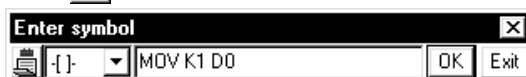

- For input with function keys  
Press the **[F8]** key with the keyboard to enter "MOV K1 DO".

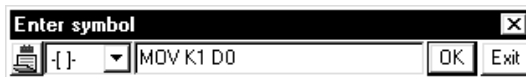

- For input with menu  
Select [Edit] → [Ladder symbol] → [Application instruction], and enter "MOV K1 DO" with the keyboard.

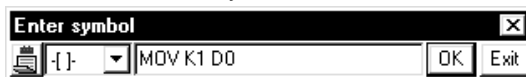

3. Press **[Enter]** key and click **[OK]** button to make input in the edit window.

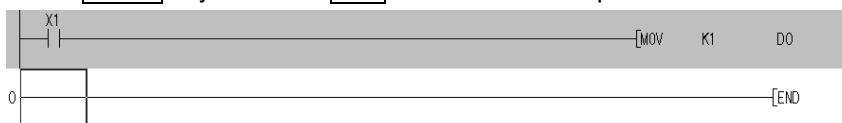

4. Press **[F4]** key and click button for inputting.

## 6.2.2 Inputting lines (vertical and horizontal)

## POINT

- Start drawing a connecting line from the upper left position of the connecting line.

## [Drawing lines]

1. Move the cursor to a connecting line input position.

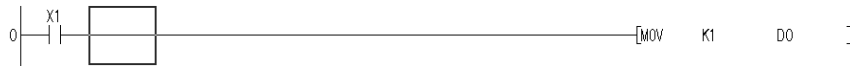

2. Draw a line.

- For input with tool buttons

Click and , and drag the cursor to draw a line.



- For input with function keys

Press key + key () , and draw a connecting line using key + arrow keys.



3. Press key and click button for inputting.

## [Drawing vertical line]

1. Move the cursor to a vertical line input position.

2. Draw a vertical line.

- For input with tool buttons

Click and , and enter the number of vertical lines to be input in the vertical line input window.

When the number of input lines is not designated, one vertical line is input.

- For input with function keys







Press ( + ) key to enter the number of vertical lines to be input in the vertical line input window.

When the number of input lines is not designated, one vertical line is input.



3. Press key and click button to make input in the edit window.

4. Press key and click button for inputting.

[Drawing horizontal line]

1. Move the cursor to a horizontal line input position.
2. Draw a horizontal line.
  - For input with tool buttons  
Click , and enter the number of horizontal lines to be input in the horizontal line input window.  
When the number of input lines is not designated, one horizontal line is input.
  - For input with function keys  
Press  key to enter the number of horizontal lines to be input in the horizontal line input window.  
When the number of input lines is not designated, one contact horizontal line is input.
3. Press  key and click  button to make input in the edit window.
4. Press  key and click  button for inputting.

POINT

- Connecting lines cannot be input when the END line immediately follows the cursor-positioned line.  
In this case, press  +  keys simultaneously to make free space in advance.

### 6.2.3 Deleting contacts and application instructions

[Deleting procedure]

1. Move the cursor to a contact or an application instruction to be deleted.
2. Press **Delete** key.  
For deletion in insert mode, forward justification takes place for circuits. However, forward justification does not take place on the wrapped line.

[Deleting all programs created]

1. Move the cursor to the outside of the left base line at the top of the program.

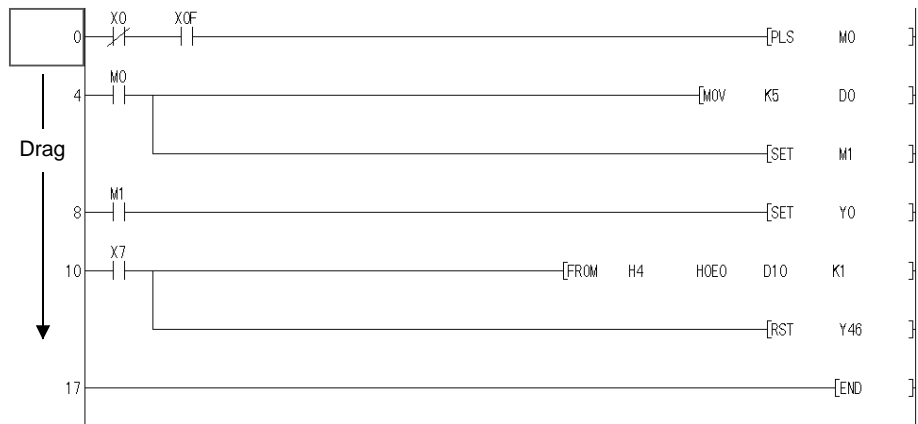

2. Drag the cursor just before the END instruction.



3. Press **Delete** key.

## 6.2.4 Deleting connecting lines

[Deleting procedure]

1. Move the cursor to a connecting line to be deleted.

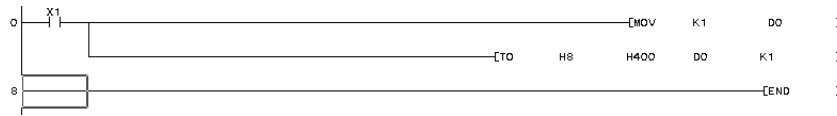

2. Delete the connecting line.

- For deletion with tool buttons

Click , and drag the cursor through a line to be deleted.

- For deletion with function keys

Press **[Alt]** key + **[F9]** key → **[Shift]** key + arrow keys to move the cursor through a line to be deleted.



## 6.2.5 Inserting and deleting in circuit blocks

(1) For line insertion (in one-circuit block)

[Operating procedure]

1. Move the cursor to a line to be inserted.



2. Insert the line.

- For insertion with function keys  
Press **[Shift]** key + **[Insert]** key to insert a line.
- For insertion with menu  
Select **[Edit]** → **[Insert Column]** to insert a line.



(2) For line deletion (in one-circuit block)

[Operating procedure]

1. Move the cursor to a line to be deleted.

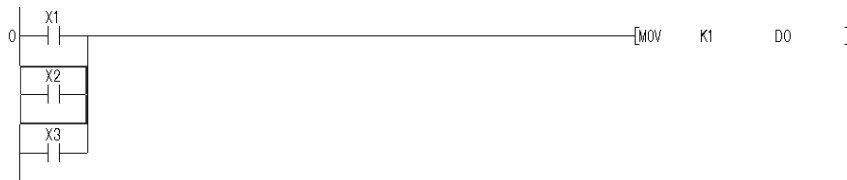

2. Delete the line.

- For deletion with function keys  
Press **[Shift]** key + **[Delete]** key to delete a line.
- For deletion with menu  
Select **[Edit]** → **[Delete Column]** to delete a line.



(3) For column insertion (in one-circuit block)

[Operating procedure]

1. Move the cursor to a column to be inserted.



2. Insert the column.

- For insertion with function keys  
Press **[Ctrl]** key + **[Insert]** key to insert a column.
- For insertion with menu  
Select **[Edit]** → **[Insert]** to insert a column.



(4) For column deletion (in one-circuit block)

[Operating procedure]

1. Move the cursor to a column to be deleted.

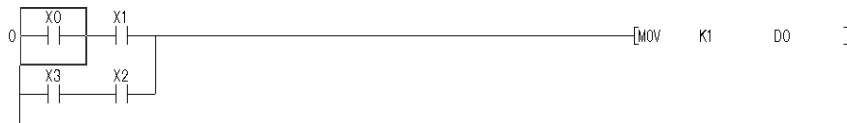

2. Delete the column.

- For deletion with function keys  
Press **[Ctrl]** key + **[Delete]** key to delete a column.
- For deletion with menu  
Select **[Edit]** → **[Delete]** to delete a column.





## 6.2.6 Inserting NOPs

A	Q/QnA	FX
○	○	○

**[Purpose]**

Inserts all NOPs (no operation instructions) to reserve space in a program for debugging.

**[Operating Procedure]**

Move the cursor to an insert line (at any location), then select [Edit] → [Insert NOP batch].

**[Dialog Box]**

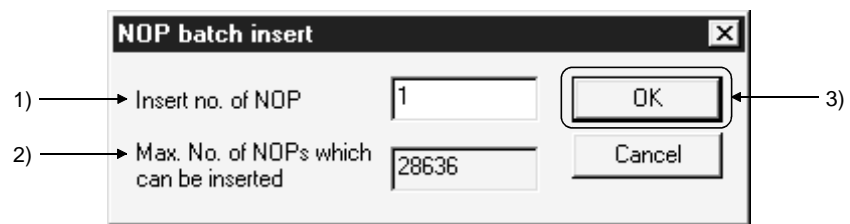

**[Description]**

- 1) Insert no. of NOP  
Designates the number of NOPs to be inserted.
- 2) Max. No. of NOPs which can be inserted  
Displays the maximum number of NOPs that can be inserted.
- 3) **OK** button  
Click this button after making necessary settings.

## 6.2.7 Deleting NOPs

A	Q/QnA	FX
○	○	○

**[Purpose]**

Deletes NOPs (no operation instructions).

**[Operating Procedure]**

Select [Edit] → [Delete NOP batch].





**[Description]**

If the **OK** button is clicked on the confirmation dialog box, all NOP instructions from step 0 to the END instruction are deleted.





## 6.2.8 Cutting, copying and pasting circuits

---

### (1) Pasting the circuits cut or copied by a specified range [Operating procedure]

1. Set to the Write mode.  
Select [Edit] → [Write mode] or click  (F2).
2. Click at the top of the circuit to be cut or copied to set the cursor there.  
Drag the mouse to designate a range to be cut or copied.  
The designated range is highlighted.
3. Cut or copy the specified range of circuit.
  - For cutting  
Select [Edit] → [Cut] or click  (Ctrl + X).
  - For copying  
Select [Edit] → [Copy] or click  (Ctrl + C).
4. Click the location in which the cut or copied circuit is to be pasted to set the cursor there.
5. Paste the circuit.  
Select [Edit] → [Paste] or click  (Ctrl + V).  
On completion of circuit paste, the pasted part is grayed.
6. Press F4 key and click  button for inputting.

### (2) Pasting the circuits cut or copied in circuit block [Operating procedure]

1. Set to the Write mode.  
Select [Edit] → [Write mode] or click  (F2).
2. Click a location in which the step No. of the circuit block to be cut or copied is being displayed to set the cursor there.  
Drag the mouse vertically to designate a range to be cut or copied.  
The designated range is highlighted.
3. Cut or copy the specified range of circuit block.
  - For cutting  
Select [Edit] → [Cut] or click  (Ctrl + X).
  - For copying  
Select [Edit] → [Copy] or click  (Ctrl + C).
4. Click any location within a circuit block at the lower stage of the location to be pasted to set the cursor there.
5. Paste the circuit.  
Select [Edit] → [Paste] or click  (Ctrl + V).  
The designated circuit is pasted at the designated location.
6. Press F4 key and click  button for inputting.

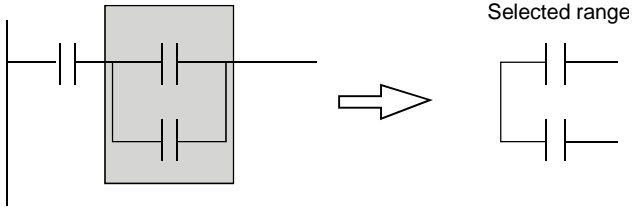
POINTS
<ul style="list-style-type: none"> <li>The cut, copy or paste menu can also be selected from the popup menu displayed by clicking the right mouse button.</li> </ul>  <ul style="list-style-type: none"> <li>Circuit paste takes place in overwrite or insert mode.</li> <li>When a range designation is given as follows, the vertical bar at the rightmost end is not selected.</li> </ul>

## 6.2.9 Undo the last operation

### [Purpose]

Cancels the last operation (cut, copy, or paste) and restores the previous state.

### [Operating Procedure]

- Select [Edit] → [Undo] or click  immediately after cutting, copying or pasting the circuit.

#### (1) The following states can be restored.

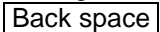
- Line insertion, line deletion
- Column insertion, column deletion
- Connecting line input, connecting line deletion
- Instruction input
- Cut and paste within a specified range
- Circuit deletion by  or  keys

#### (2) The following states cannot be restored.

- After circuit conversion
- Abandoning the circuit not converted yet
- Program change due to PLC reading, other format file reading, copying from another project
- Replacement, inserting or deleting NOPs at a time, or TC setting value change
- Search after cut or paste in units of circuit blocks
- Errors due to cut, etc.

### 6.3 Changing T/C Setting Values

A	Q/QnA	FX
○	○	○

**[Purpose]**

Lists the setting values of timers and counters used in the program so that they can be changed at a time.

For SFC, the set values of the timers and counters within the block being displayed are changed.

**[Operating Procedure]**

Select [Edit] → [Change TC setting]

**[Dialog Box]**

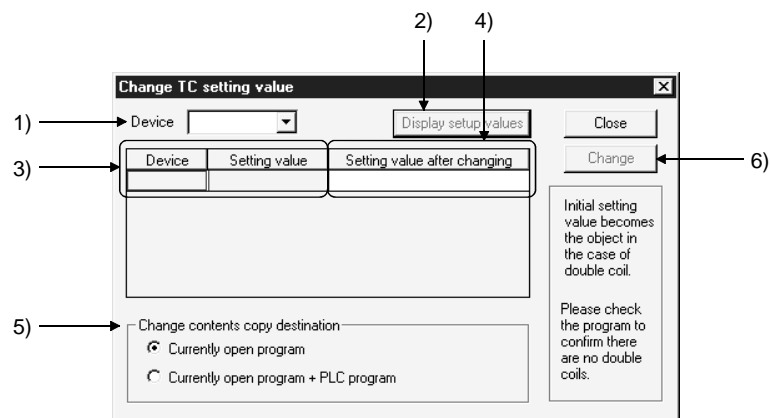

**[Description]**

1) Device

Designates the timer(s) or counter(s) for which the current setting values must be changed.

2) **Display setup values** button

Click this button to display the current setting values of the timers or counters designated by device input.

3) Device, Setting value

Displays the current setting values of the designated timer(s) or counter(s).

4) Setting value after changing

Designates the setting value of the timer or counter for which the current setting value is to be changed.

5) Change contents copy destination

Currently open program

Changes the setting values of the timers and counters in the open program at present.

Currently open program PLC program

Changes the setting values of the timers and counters in the open program at present and writes them to the PLC.

However, these setting values can be changed only between the constants.

6) **Change** button

Click this button for setting value change.

POINTS								
<ul style="list-style-type: none"><li>• Setting values can be changed from constant (K) to indirect designation (D) and vice versa.</li><li>• For a high-speed counter of the FX series, setting value change between constant(K) and indirect designation(D) is not allowed in the online state. (same as write Online change)</li><li>• Devices with index modification cannot be designated.</li><li>• To input the changed setting value to a PLC, the setting value change must be made only between the constants.<table><tbody><tr><td>K10 → K1234</td><td>Can be set</td></tr><tr><td>K10 → D10</td><td>Cannot be set</td></tr><tr><td>K10 → ZR100</td><td>Cannot be set</td></tr><tr><td>ZR100 → D100</td><td>Cannot be set</td></tr></tbody></table></li></ul>	K10 → K1234	Can be set	K10 → D10	Cannot be set	K10 → ZR100	Cannot be set	ZR100 → D100	Cannot be set
K10 → K1234	Can be set							
K10 → D10	Cannot be set							
K10 → ZR100	Cannot be set							
ZR100 → D100	Cannot be set							

## 6.4 Find and Replace

---

POINT
-------

Refer to the GPP Function Software Package SW5D5C-GPPW Operating Manual for Windows (SFC Version) for step No. and block No. finding and step No. replacement of SFC figures.
---

- (1) Common operations for finding
  - (a) Find direction
    - From top to bottom  
Searching takes place from step 0 to the END instruction.
    - From cursor to bottom  
Searching takes place from cursor position to the END instruction.
    - From cursor to top  
Searching takes place from cursor position to step 0.
  - (b) **Find Next** button  
Click this button to search for the next device.
- (2) Common operations for replacement
  - (a) Find direction
    - From top to bottom  
Searching takes place from step 0 to the END instruction.
    - From cursor to bottom  
Searching takes place from cursor position to the END instruction.
    - Range designation  
When a range to be replaced is designated, the step No. is set automatically.  
Click the radio button, and a step range to be found can be designated.  
A range to be replaced ranges from the head of a circuit block including a designated step No. to the end of the circuit block including the designated step No.
  - (b) **Find Next** button  
Click this button to search for the next target device without replacing a cursor-positioned device.
  - (c) **Replace** button  
Click this button to search for the next target device after replacing a cursor-positioned device.
  - (d) **Replace all** button  
Click this button to replace all the target devices in the designated search range.

- (3) Find/replace of the other programs  
Click **Find Next** button in each find and replace to find and replace the other programs.

[Operating procedure]

1. Find and replace the current open programs.
2. Click **Find Next** button to find and replace the other programs.  
A prompt to ask for find and replace of the other programs is displayed one time only.  
In searching for and replacing the other programs, searching takes place in the following order.

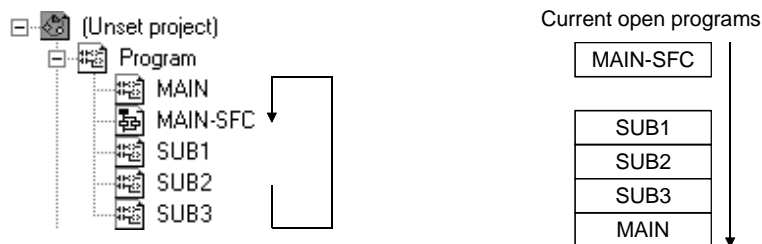

- SFC programs will also be search and replacement targets.
- When there is no search program, search and replace terminates without displaying a message for searching for the other programs.
- When there remains a search program, searching for the program takes place automatically.
- When a range is designated for program replacement, this range specification is effective only for open programs. Searching in the other programs takes place from the beginning.

POINT
-------

- |  |
|--|
| <ul style="list-style-type: none"> <li>• Devices and character strings found and replaced are saved as a log. However, it is cleared when exiting GPPW.</li> </ul> |
|--|

## 6.4.1 Finding a device

A	Q/QnA	FX
<input type="radio"/>	<input type="radio"/>	<input type="radio"/>

## [Purpose]

Searches for a device in the program.

In A series and QnA series, it is possible to search in other programs in the project.

## [Operating Procedure]

Select [Find/Replace] → [Find device] or click  .

## [Dialog Box]

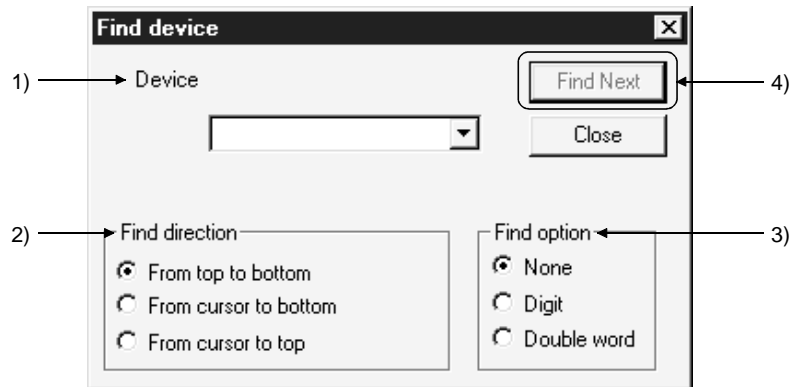

## [Description]

## 1) Device

Designates a device to be searched.

## 2) Find direction

Sets a search direction.

 Find from top to bottom

Searching takes place from step 0 to the END instruction.

 Find from cursor bottom

Searching takes place from the cursor position to the END instruction.

 Find from cursor to top

Searching takes place from the cursor position to step 0.



- 3) Find options
  - Sets the state of a search target.
  - None
    - Searches for a designated device.
  - With digit
    - Searches for bit devices with digits, including the designated device.
  - Double word
    - Searches for word devices including the designated device and double word devices (including the real number and indirect specification devices).
- 4)  button
  - Click this button to search for the next device.

POINTS														
	<ul style="list-style-type: none"> <li>• The following table shows device search examples.</li> </ul>													
	<table border="1" style="width: 100%; border-collapse: collapse;"> <thead> <tr> <th style="width: 33%;">Device Specification</th> <th style="width: 33%;">Search Device</th> <th style="width: 33%;">Search Example</th> </tr> </thead> <tbody> <tr> <td>B0</td> <td style="text-align: center;">(k* *)B0(Z* *)</td> <td>B0, K4B0, B0Z1, K4B0Z1</td> </tr> <tr> <td>K4B0</td> <td style="text-align: center;">K4B0(Z* *)</td> <td>K4B0, K4B0Z1</td> </tr> <tr> <td>J12\B0</td> <td style="text-align: center;">J12(Z* *)\ (K* *)B0(Z* *)</td> <td>J12/B0, J12B0Z1, J12Z2\K4B0, J12Z1\K4B0Z1</td> </tr> </tbody> </table>	Device Specification	Search Device	Search Example	B0	(k* *)B0(Z* *)	B0, K4B0, B0Z1, K4B0Z1	K4B0	K4B0(Z* *)	K4B0, K4B0Z1	J12\B0	J12(Z* *)\ (K* *)B0(Z* *)	J12/B0, J12B0Z1, J12Z2\K4B0, J12Z1\K4B0Z1	
Device Specification	Search Device	Search Example												
B0	(k* *)B0(Z* *)	B0, K4B0, B0Z1, K4B0Z1												
K4B0	K4B0(Z* *)	K4B0, K4B0Z1												
J12\B0	J12(Z* *)\ (K* *)B0(Z* *)	J12/B0, J12B0Z1, J12Z2\K4B0, J12Z1\K4B0Z1												
	<ul style="list-style-type: none"> <li>• If digit designation, e.g. K1X0, has been made in the BMOV/FMOV/FROM/TO instruction, X0 to XF included in K1 are to be searched for.</li> </ul>													

## 6.4.2 Finding an instruction

A	Q/QnA	FX
<input type="radio"/>	<input type="radio"/>	<input type="radio"/>

## [Purpose]

Searches for an instruction in the program.

## [Operating Procedure]

Select [Find/Replace] → [Find instruction] or click  .

## [Dialog Box]

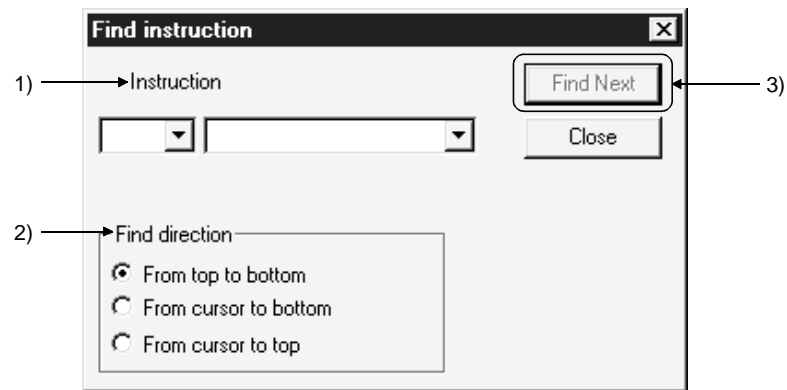

## [Description]

## 1) Instruction

Designates an instruction symbol and an instruction name for search.  
The following lists the symbols that can be designated.

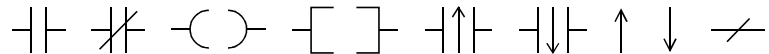

## 2) Find direction

Designates a search direction.

 Find from top to bottom

Searching takes place from step 0 to the END instruction.

 Find from cursor to bottom

Searching takes place from the cursor position to the END instruction.

 Find from cursor to top

Searching takes place from the cursor position to step 0.

3) Find Next button

Click this button to search for the next occurrence of the instruction.

POINTS		
<ul style="list-style-type: none"> <li>The following table shows instruction search examples.</li> </ul>		
Instruction specification	Search instruction	Search example
MOV	MOV(P)	MOV, MOVP
MOVP	MOVP	MOVP
MOV D0 K4Y0	MOV(P)D0(Z**) K4Y0(Z**)	MOV D0 K4Y0, MOVP D0Z1 K4Y0, MOV D0 K4Y0Z1, MOVP D0Z1 K4Y0Z1
MOVP D0 J1W0	MOVP D0(Z**) J1(Z**)\W0(Z**)	MOVP D0 J1W0, MOVP D0Z1 J1W0, MOVP D0 J1Z1W0Z1, MOVP D0Z1 J1Z1W0Z1
<ul style="list-style-type: none"> <li>When searching for the other programs, see Section 6.4.1.</li> </ul>		

6.4.3 Finding a step No.

A	Q/QnA	FX
○	○	○

[Purpose]

Searches for and displays a step No. during inter-line statement or note editing.

[Operating Procedure]

Select [Find/Replace] → [Find step No.].

[Dialog Box]

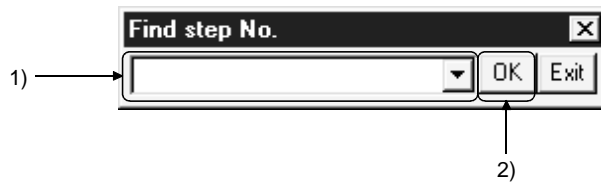

[Description]

- 1) Step No. text box  
Designates a step No. to be used for search.
- 2)  button  
Click this button to display a circuit with a designated step No.

POINTS

- Step Nos. used for searching are saved as a log. However, it is cleared when exiting GPPW.

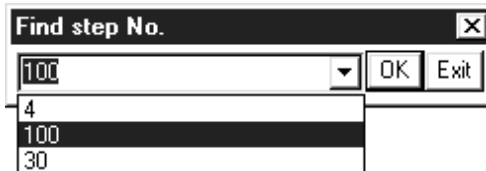

- When searching for a step No. in another program, see Subsection 6.4.1.

6.4.4 Finding a character string

A	Q/QnA	FX
<input type="radio"/>	<input type="radio"/>	<input type="radio"/>

[Purpose]

Searches for a character string in the edit window for programs, device comments, or device memories

[Operating Procedure]

On each edit window, select [Find/Replace] → [Find character string] or click  .

[Dialog Box]

Ladder/list edit window

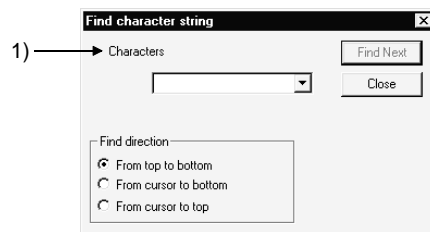

Device comment edit window

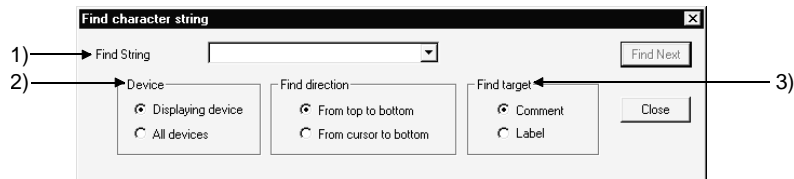

Device memory edit window

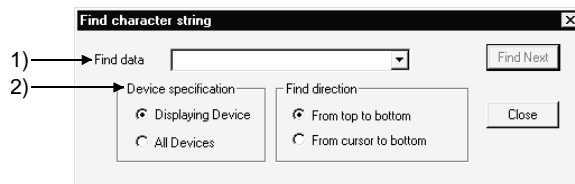

[Description]

- 1) Find character  
Enter a character string to be searched for in up to 64 characters.
- 2) Device
  - ⊙ Displaying devices  
Select this to search for only the devices being displayed in the window.
  - ⊙ All devices  
Select this to search also those devices not displayed in the window.
- 3) Find target  
Select a button to designate a comment or device name.

<b>POINT</b>
Device memory find direction <ul style="list-style-type: none"> <li>• Find from top to bottom Searching takes place from D0, W0, or R0 to the bottom.</li> </ul>

### 6.4.5 Finding a contact/coil

A	Q/QnA	FX
○	○	○

**[Purpose]**

Searches for a contact or coil corresponding to the device at the cursor position.

**[Operating Procedure]**

Select [Find/Replace] → [Find contact or coil]

**[Dialog Box]**

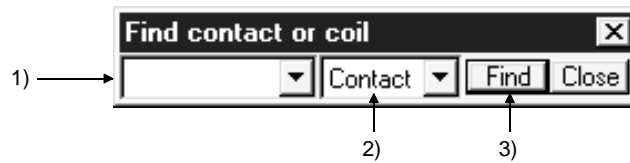

**[Description]**

- 1) Device text box  
Set the device you want to search for.
- 2) Contact or coil select  
Choose the contact or coil.
- 3) **[Find]** button  
Click this button to search for the specified device.  
A search starts from the beginning of the program.  
If there are two or more programs, the other programs will be searched.

## 6.4.6 Finding data

A	Q/QnA	FX
<input type="radio"/>	<input type="radio"/>	<input type="radio"/>

[Purpose]  
Searches the set numerical data.

[Operating Procedure]  
On the device memory edit window, select [Find/Replace] → [Find data].

[Dialog Box]

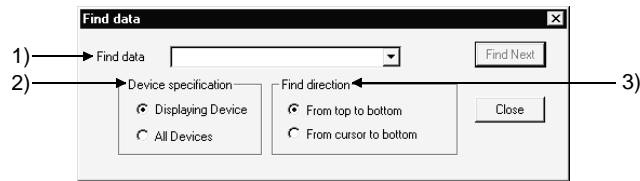

[Description]

- 1) Find data  
Enter the data to be searched for.
- 2) Device
  - Displaying devices  
Select this to search for only the devices being displayed in the window.
  - All devices  
Select this to search for also those devices not displayed in the window.
- 3) Find direction  
Select a button to designate whether to search for devices from the beginning or at the cursor position.
  - From top to bottom  
Searching takes place from D0, W0, or R0 to the bottom.
  - From cursor to bottom  
Searching takes place from the cursor position to bottom.

POINT
-------

Since the find and replace of a floating point and a fixed point are processed as actual data, a target of search may not be found due to a conversion error between the floating point/fixed point and the actual data.

Do not find and replace the floating point or fixed point after a 32-bit integer has been converted to a floating point. Find and replace in the input conditions.

## 6.4.7 Replacing a device

A	Q/QnA	FX
○	○	○

## [Purpose]

Replaces a device or character string constant in the program currently being edited.

## [Operating Procedure]

Select [Find/Replace] → [Replace device].

## [Dialog Box]

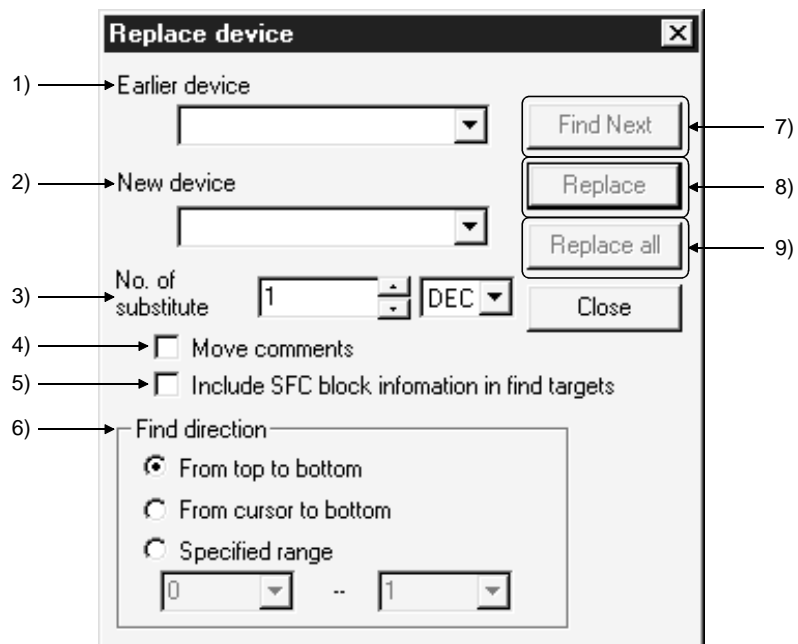

## [Description]

- 1) Previous device  
Designates a device or character string constant (before change) to be replaced.
- 2) New device  
Designates a device or character string constant (after change) for replacement.
- 3) No. of substitute  
Designates the number of devices to be replaced among the devices designated by old device setting.  
Alternatively, you can specify the substitute count in decimal or hexadecimal.
- 4) Move comments  
Designates whether to move the comments and device names attached to a device together.
- 5) Include SFC block information in find targets  
Set whether the device set in the block information of each block will be replaced or not.



- 6) Find direction  
Sets a search direction.
- Ⓐ Find from top to bottom  
Searching takes place from step 0 to the END instruction.
  - Ⓑ Find from cursor to bottom  
Searching takes place from the cursor position to the END instruction.
  - Ⓒ Range setting  
Choosing the replacement area in advance sets the step numbers automatically.  
Click a radio button to designate a range of steps in which searching takes place.  
A range from the top of a circuit block with a designated step No. to the end of a circuit block with a designated step No. is assumed as a range for replacement.
- 7) **Find Next** button  
Click this button to search for the next occurrence of the device without replacing a cursor-positioned device.
- 8) **Replace** button  
Click this button to search for the next occurrence of the device after replacing the cursor-positioned device.
- 9) **Replace all** button  
Click this button to replace all the target devices in the designated search range.

POINTS	
• Device specification	The following lists the devices that can be replaced.
• Word device	→ Word device
• Bit device	→ Bit device
• Though an extended specification can be given, digit, index, and indirect modifications cannot be made.	The table below lists the extended specification and word/bit device replacement examples
X0	→ J1\B0 ..... Replaceable
D0	→ U10\G0..... Replaceable
X0	→ D0.5 ..... Replaceable
D0.1	→ D1.1 ..... Replaceable
X0	→ D0 ..... Not Replaceable
X0	→ K4X0 ..... Not Replaceable
D0	→ D0.5..... Not Replaceable
• When replacing a device in other programs, see Subsection 6.4.1.	
• When a replacement range is given, it is effective only for open programs at present and searching for the other programs takes place from the beginning.	
• Restrictions on FX series	Device replacement cannot take place between the 16-bit counters and 32-bit counters.
• The replacement of the device used in the SFC block information is suspended with an error indication if the new device will be unusable.	

## 6.4.8 Replacing an instruction

A	Q/QnA	FX
○	○	○

## [Purpose]

Replaces an instruction in the program currently being edited.

## [Operating Procedure]

Select [Find/replace] → [Replace instruction].

## [Dialog Box]

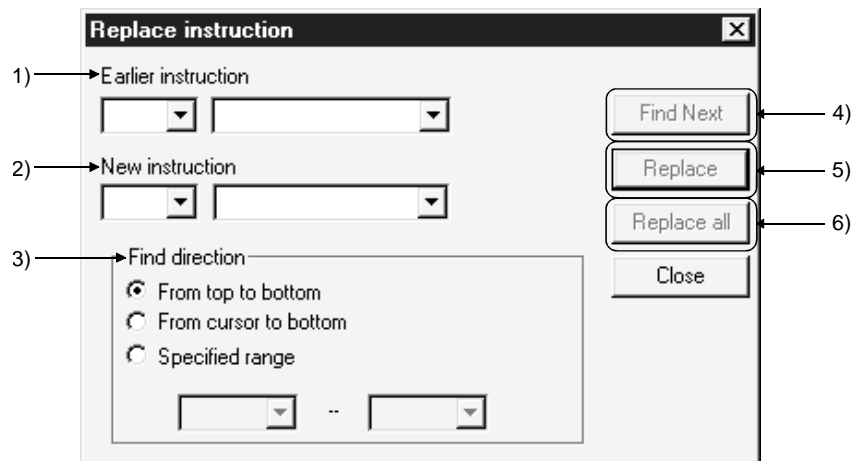

## [Description]

- 1) Earlier instruction  
Designates an instruction (before change) to be replaced.
- 2) New instruction  
Designates an instruction (after change) for replacement.
- 3) Find direction  
Designates a search direction.
  - ⊙ Find from top to bottom  
Searching takes place from step 0 to the END instruction.
  - ⊙ Find from current cursor position to bottom  
Searching takes place from the cursor position to the END instruction.
  - ⊙ Range setting  
Choosing the replacement area in advance sets the step numbers automatically.  
Click a radio button to designate a range of steps in which searching takes place.  
A range from the top of a circuit block with a designated step No. to the end of a circuit block with a designated step No. is assumed as a range for replacement.
- 4) Find Next button  
Click this button to search for the next occurrence of the instruction.

- 5) **Replace** button  
Click this button to search for the next occurrence of the instruction after replacing the cursor-positioned instruction.
- 6) **Replace all** button  
Click this button to replace all the target instructions in the designated range.

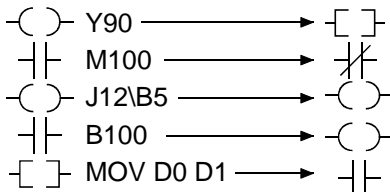
POINTS											
1. An instruction plus device can be designated for instruction input. Only the circuit symbol can also be designated.											
2. The replaced instruction is not executed unless it is logical.											
3. The number of steps changes for instruction replacement.											
4. The following shows the instruction replacement examples.											
	<table style="width: 100%; border-collapse: collapse;"> <tr> <td style="padding: 2px;">MOV D0 D1.....</td> <td style="padding: 2px;">Replaceable</td> </tr> <tr> <td style="padding: 2px;">D1.1.....</td> <td style="padding: 2px;">Replaceable</td> </tr> <tr> <td style="padding: 2px;">U3\G123.5.....</td> <td style="padding: 2px;">Replaceable</td> </tr> <tr> <td style="padding: 2px;">B100.....</td> <td style="padding: 2px;">Not replaceable</td> </tr> <tr> <td style="padding: 2px;">X0.....</td> <td style="padding: 2px;">Not replaceable</td> </tr> </table>	MOV D0 D1.....	Replaceable	D1.1.....	Replaceable	U3\G123.5.....	Replaceable	B100.....	Not replaceable	X0.....	Not replaceable
MOV D0 D1.....	Replaceable										
D1.1.....	Replaceable										
U3\G123.5.....	Replaceable										
B100.....	Not replaceable										
X0.....	Not replaceable										
<ul style="list-style-type: none"> <li>• When replacing an instruction in other programs, see Section 6.4.1.</li> <li>• The step numbers specified for the SFC operation outputs/transition conditions are those used when the SFC diagram is represented as an equivalent to a ladder.</li> <li>• For the replacement of a 16 bit (word) handling instruction by a 32 bit (double word) handling instruction in instruction replacement, if a constant has been specified for the device, it will be changed as follows.</li> </ul>											
<p>Negative constant of K (example: K-1) → Sign extension is made (K-1)</p> <p>For H, constant whose bit corresponding to the sign is ON (example: HFFFF) → sign extension is not made and the constant is converted as it is (H0000FFFF)</p>											
<table style="width: 100%; border-collapse: collapse;"> <tr> <td style="padding: 2px;">Example: MOV K-1 D0</td> <td style="padding: 2px;">(MOV replaced by DMOV)</td> <td style="padding: 2px;">DMOV K-1 D0</td> </tr> <tr> <td style="padding: 2px;">MOV K-200 D0</td> <td style="padding: 2px;">(MOV replaced by DMOV)</td> <td style="padding: 2px;">DMOV K-200 D0</td> </tr> <tr> <td style="padding: 2px;">MOV HFFFF D0</td> <td style="padding: 2px;">(MOV replaced by DMOV)</td> <td style="padding: 2px;">DMOV H0000FFFF D0</td> </tr> </table>	Example: MOV K-1 D0	(MOV replaced by DMOV)	DMOV K-1 D0	MOV K-200 D0	(MOV replaced by DMOV)	DMOV K-200 D0	MOV HFFFF D0	(MOV replaced by DMOV)	DMOV H0000FFFF D0		
Example: MOV K-1 D0	(MOV replaced by DMOV)	DMOV K-1 D0									
MOV K-200 D0	(MOV replaced by DMOV)	DMOV K-200 D0									
MOV HFFFF D0	(MOV replaced by DMOV)	DMOV H0000FFFF D0									
<p>For the replacement of a 32 bit handling instruction by a 16 bit handling instruction, the upper 16 bits are discarded.</p>											
<table style="width: 100%; border-collapse: collapse;"> <tr> <td style="padding: 2px;">Example: DMOV K-1 D0</td> <td style="padding: 2px;">(DMOV replaced by MOV)</td> <td style="padding: 2px;">MOV K-1 D0</td> </tr> <tr> <td style="padding: 2px;">DMOV K150000 D0</td> <td style="padding: 2px;">(DMOV replaced by MOV)</td> <td style="padding: 2px;">MOV K18928 D0</td> </tr> <tr> <td style="padding: 2px;">DMOV HFFFFFFF D0</td> <td style="padding: 2px;">(DMOV replaced by MOV)</td> <td style="padding: 2px;">MOV HFFFF D0</td> </tr> </table>	Example: DMOV K-1 D0	(DMOV replaced by MOV)	MOV K-1 D0	DMOV K150000 D0	(DMOV replaced by MOV)	MOV K18928 D0	DMOV HFFFFFFF D0	(DMOV replaced by MOV)	MOV HFFFF D0		
Example: DMOV K-1 D0	(DMOV replaced by MOV)	MOV K-1 D0									
DMOV K150000 D0	(DMOV replaced by MOV)	MOV K18928 D0									
DMOV HFFFFFFF D0	(DMOV replaced by MOV)	MOV HFFFF D0									

## 6.4.9 Changing A and B contacts

A	Q/QnA	FX
○	○	○

## [Purpose]

Changing the contacts (open contact/close contact) of the program currently being edited.

## [Operating Procedure]

Select [Find/Replace] → [Change open /close contact].

## [Dialog Box]

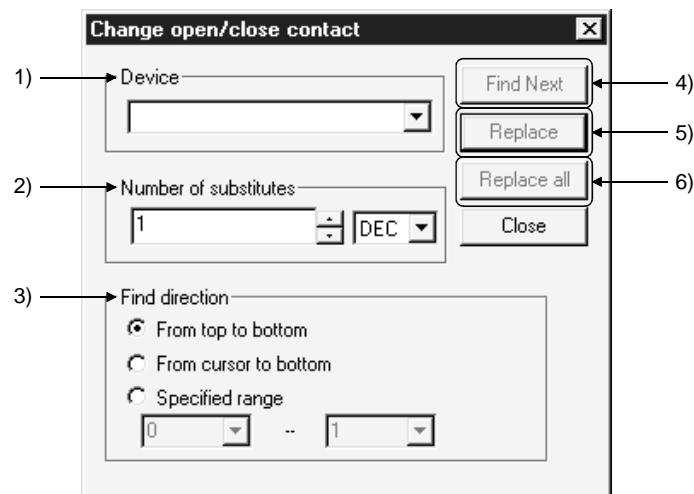

## [Description]

- 1) Device  
Designates a device for which contacts A and B are to be switched.
- 2) Number of substitutes  
Designates the number of consecutive devices (including a designated device) for which contacts A and B are to be switched.
- 3) Find direction  
Designates a search direction.  
Find from top to bottom  
Searching takes place from step 0 to the END instruction.
  - ⊙ Find from current cursor position to bottom  
Searching takes place from the cursor position to the END instruction.
  - ⊙ Area select  
Choosing the replacement area in advance sets the step numbers automatically.  
Click a radio button to designate a range of steps in which searching takes place.  
A range from the top of a circuit block with a designated step No. to the end of a circuit block with a designated step No. is assumed as a range for switching.

- 4) **Find Next** button  
Click this button to search for the next contact without switching the cursor-positioned contacts A and B.
- 5) **Replace** button  
Click this button to search for the next contact after switching the cursor-positioned contacts A and B.
- 6) **Replace all** button  
Click this button to switch all the target contacts in the designated range.

POINTS
<ul style="list-style-type: none"><li>• Device specification Extended specifications and bit No. modifications are valid for device specification, but index modifications are not valid.</li><li>• Device specification example X0, J1\B6, D0.5, U10\G0.3 → Can be specified X0Z3 → Cannot be specified (index modification is not possible.)</li><li>• The open contact and close contact of the following instructions can be switched. Open contact : LD, AND, OR, LDR, ANDP, ORP, EGP Close contact : LDI, ANI, ORI, LDF, ANDF, ORF, EGF</li><li>• When switching the open contact and close contact of other programs, see Section 6.4.1.</li><li>• The step numbers specified for the SFC operation outputs/transition conditions are those used when the SFC diagram is represented as an equivalent to a ladder.</li></ul>

6.4.10 Replacing a character string

A	Q/QnA	FX
○	○	○

POINTS
<ul style="list-style-type: none"> <li>• The step numbers specified for the SFC operation outputs/transition conditions are those used when the SFC diagram is represented as an equivalent to a ladder.</li> <li>• For an SFC, a note or SFC comment is the target of search.</li> </ul>

[Purpose]

Replaces the character string on each edit window for programs, device comments, or device memories.

[Operating Procedure]

On each edit window, select [Find/Replace] → [Replace character string].

[Dialog Box]

Ladder/list edit window

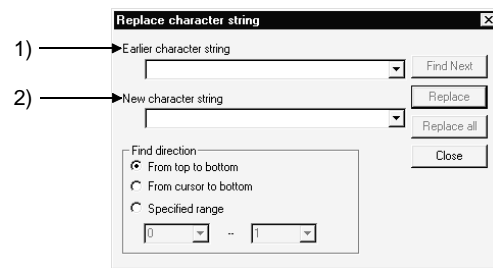

Device comment edit window

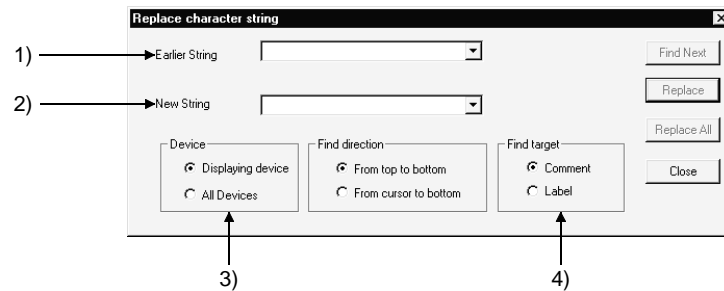

Device memory edit window

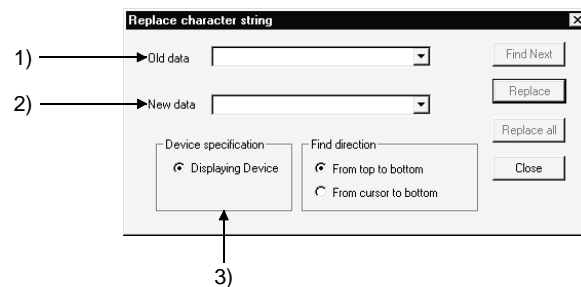

## [Description]

- 1) Earlier character string  
Enter a character string to be replaced (statement before change) in up to 64 characters.
- 2) New character string  
Enter a character string for replacement (statement after change).
- 3) Device
  - Device under display  
Select this to replace only the devices being displayed in the window.
  - All devices (device comment only)  
Select this to replace also those devices not displayed in the window.
- 4) Find target  
Select a button to designate a comment or a device name.

POINTS
<ul style="list-style-type: none"><li>• Search with <input type="button" value="Find Next"/> button Searches a device designated by earlier character string.</li><li>• Search with <input type="button" value="Replace"/> button Replaces for each device.</li></ul>

## 6.4.11 Changing the statement or note type

A	Q/QnA	FX
<input type="radio"/>	<input type="radio"/>	<input type="radio"/>

## [Purpose]

Changes the type of the statement or note currently being edited to the integrated or peripheral statement or note.

For details on the integrated/peripheral statement or note, see Sections 10.1 and 10.2.

## [Operating Procedure]

Select [Search/Replace] → [Replace statement/note type].

## [Dialog Box]

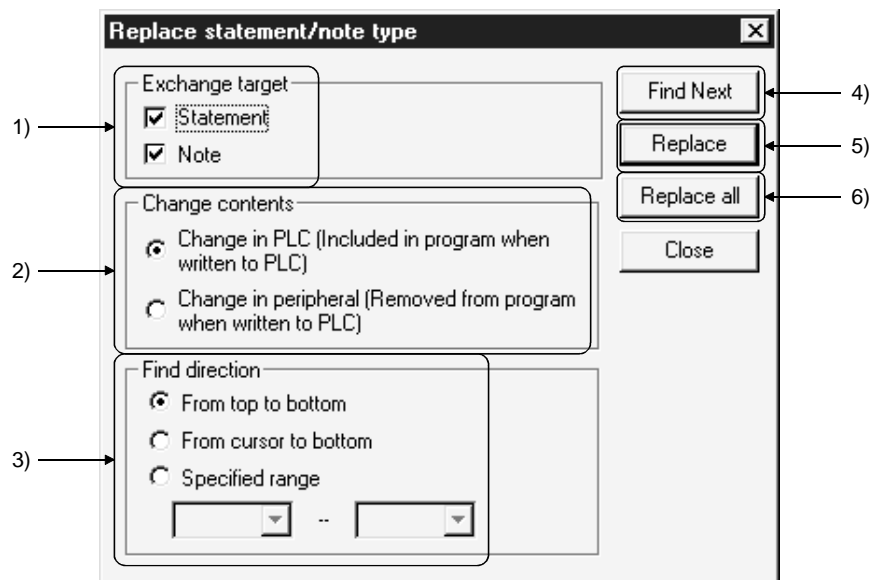

## [Description]

## 1) Exchange target

Designates a target to be replaced (statement or note).

## 2) Change contents

Change in PLC [Included in program when written to PLC]

Replaces a character string with an integrated statement or note.

PLC write/read processing takes place automatically for the character string.

Change in peripheral [Removed from program when written to PLC]

Replaces a character string with a peripheral statement or note.

PLC write/read processing does not take place for the character string.



- 3) Find direction  
Sets a search direction.
  - Ⓐ From top to bottom  
Searching takes place from step 0 to the END instruction.
  - Ⓑ From cursor to bottom  
Searching takes place from the cursor position to the END instruction.
  - Ⓒ Range specification (Find direction)  
Choosing the replacement area in advance sets the step numbers automatically.  
Click a radio button to designate a range of steps in which searching takes place.
- 4) **Find Next** button  
Click this button to search for the next character string without changing the cursor-positioned character string to the integrated /peripheral statement or note.
- 5) **Replace** button  
Click this button to search for the next character string after changing the cursor-positioned character string to the integrated/peripheral statement or note.
- 6) **Replace all** button  
Click this button to change all the target character strings in the designated range to the integrated/peripheral statements or notes.

POINTS
<ul style="list-style-type: none"><li>• Because only the peripheral statements and notes are set in A series, the statement and note types cannot be changed.</li><li>• When changing the statement or note type in other programs, see Subsection 6.4.1.</li><li>• The step numbers specified for the SFC operation outputs/transition conditions are those used when the SFC diagram is represented as an equivalent to a ladder.</li><li>• For an SFC, only the note will be changed. (There are no statements.)</li></ul>

## 6.4.12 Replacing data

A	Q/QnA	FX
<input type="radio"/>	<input type="radio"/>	<input type="radio"/>

## [Purpose]

Replaces the set numerical data.

## [Operating Procedure]

On the device memory edit window, select [Find/Replace] → [Replace data].

## [Dialog Box]

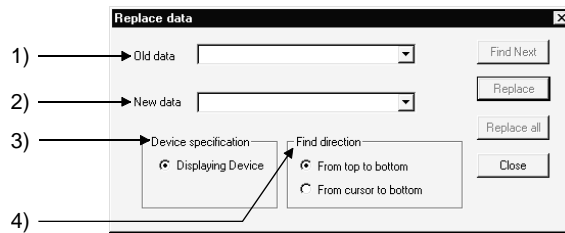

## [Description]

- 1) Old data  
Enter a numerical value to be replaced (statement before change).
- 2) New data  
Enter a numerical data for replacement (statement after change).
- 3) Device  
 Displaying device  
 Select this to designate only the devices being displayed in the window (fixed).

## POINTS

- Since the find and replace of a floating point and a fixed point are processed as actual data, a target of search may not be found due to a conversion error between the floating point/fixed point and the actual data. Do not find and replace the floating point or fixed point after a 32-bit integer has been converted to a floating point. Find and replace in the input conditions.
- A change mode cannot be replaced online.

## 6.4.13 Searching for a contact coil

A	Q/QnA	FX
<input type="radio"/>	<input type="radio"/>	<input type="radio"/>

## [Purpose]

Lists the step(s), instructions, and locations in which the designated instruction has been used.

## [Operating Procedure]

Select [Find/Replace] → [Cross reference list].

## [Dialog Box]

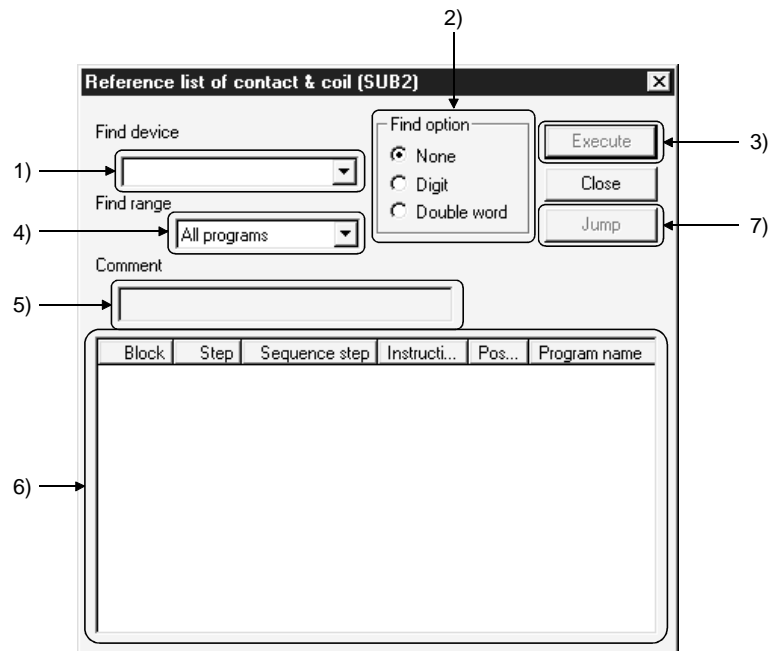

## [Description]

- 1) Find device  
Designates a device to be searched.
- 2) Find options  
Sets the state of a search target.  
The search options (with digit, double word, etc.) make it possible to search for a device which has not been coded in the program but is actually used.
  - None  
Searches for a designated device only.
  - Digit  
Searches for bit devices (including a designated device) with digits.
  - Double word  
Searches for word devices including a designated device and double word devices (including real numbers and indirect specifications).

- 3) **Execute** button  
Click this button after designating a device to be searched and a search option.  
A contact coil use list indicates all the step numbers, instructions and locations in which a device designated in Search device has been used.
- 4) Target the whole program  
For ladder  
Choose the program to be searched (by program, all programs).  
For SFC  
All programs: All programs in the project are searched.  
All blocks: All blocks of the SFC diagram being edited are searched.  
Inside block (SFC diagram): Only the block being displayed is searched.  
Inside block (Zoom diagram): Only the operation outputs/transition conditions being displayed are searched.
- 5) Comment  
Displays a comment assigned to a designated device.
- 6) Contact coil use list  
Block.....Lists the numbers with which the block No. designated in the SFC is used.  
Step .....Lists the numbers with which the step No. designated in the SFC is used.  
Sequence step. Lists the step numbers in which the designated device has been used.  
Instruction .....Lists the instructions in which the designated device has been used.  
Location .....Indicates by \* the byte positions in which the designated device has been used.  
(Example) .....In the case of "MOV K4Y0 D0", the DO position is indicated by "-\*."  
Program name. Lists the program names with which the specified device is used.  
Up to 500 items can be retrieved and displayed in this list.
- 7) **Jump** button  
Click any data in the contact coil use list, then click the [Jump] button to locate the cursor at the position where the corresponding contact coil is used within the sequence circuit.

6.4.14 Searching for a device-use instruction

A	Q/QnA	FX
<input type="radio"/>	<input type="radio"/>	<input type="radio"/>

[Purpose]

Lists the device use conditions in a program on a specified device basis. Specifying the device displays the ladder symbol used, the frequency of use, and whether an error has occurred or not

[Operating Procedure]

Select [Find/Replace] → [List of used device].

[Dialog Box]

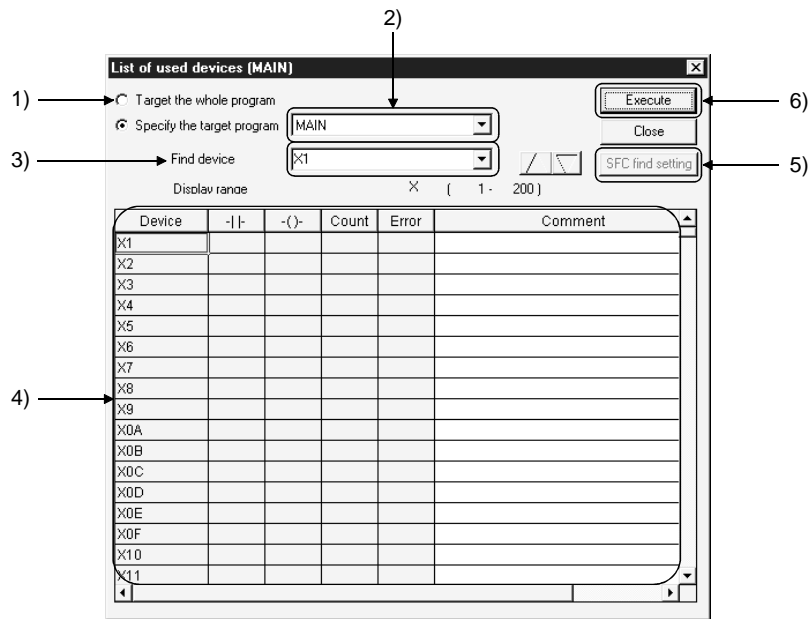

[Description]

- 1) Target the whole program  
Click the radio button to display a device-use list for all programs in the project.
- 2) Specify the target program  
Designates a program to be searched.
- 3) Find device  
Designates the first device to be searched for.  
Clicking the / button moves the screen up or down by 512 points.  
(Clicking the scroll bar moves the screen by 512 points.)  
In a single search, 512 points shown in the display area are searched.

- 4) Device-use Instruction list  
 Device..... Instruction lists devices in such a way that the device designated in the search device is listed first.  
 ┆┆..... Displays \* when the device has been used in the source of the instruction.  
 -( )..... Displays \* when the device has been used in the destination of the instruction.  
 Count..... Indicates the frequency of coil usage.  
 Error..... Displays "ERR" when the device has been used only in the source or the destination.  
 Comment..... Displays a comment attached to the device.  
 Clicking the scroll bar moves the screen by 512 points.
- 5) Specify whether all blocks or only the specified block will be searched.

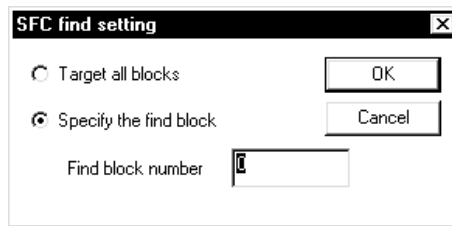

- 6) **Execute** button  
 Click this button after designating a search program or a search device.  
 A device-use list contains the instructions used and their frequency in such a way that the device designated in the search device comes first.

POINTS
<ul style="list-style-type: none"> <li>• When ZR is designated, 8,192 devices (including the designated device as the first one) are searched.                      To display out-of-range devices, the devices must be designated again.</li> <li>• Page scroll takes place within 8,192 devices listed.</li> </ul>



## 7. CREATING INSTRUCTION LIST

This chapter describes how to create, modify and read the sequence programs.

### 7.1 Common Notes on Instruction List Creation

This section describes the common items and restrictions on Instruction list creation, Instruction list display window, and Instruction list edit window.

1. Instruction list input dialog box  
Input alphanumeric characters.



2. Program display area
  - Display does not depend on the number of END instructions.  
In addition, programs may be input after the END instructions.  
When a new Instruction list is created, the END instruction appears at the first line.  
No display takes place for NOP only.
3. Modification of existing Instruction list  
For creating a new instruction list, move the cursor to an incorrect instruction location in the input (overwrite) mode, then input a correct instruction there.  
For adding Instruction list, move the cursor to a line insert step in the input (insert) mode, then input an instruction.  
To switch input modes (overwrite and insert modes), press **Insert** key.
4. Deletion in units of instructions  
Move the line to be deleted, then press **Delete** key or **Shift** + **Delete** key.
5. The preceding or subsequent page of the current page can be displayed during a read/write operation.  
Click **Page Up** key to display the preceding page.  
Click **Page Down** key to display the subsequent page.
6. The following table lists the modes that can be used in Instruction list mode.

Mode	Availability
Read mode	○
Write mode	○
Monitor mode	×
Monitor write mode	×

7. Circuit symbol buttons on the toolbar, monitor/write monitor, monitor start/stop, step run, partial run, skip are disabled.
8. Device comment display  
No device comments are displayed.



### 9. Display with statements or notes

When statements or notes have been created, they are always displayed (fixed processing).

In A series and FX series, no step numbers are displayed.

In QnA series, step numbers are displayed.

Statements and notes can be created in the same way as for operations on the circuit edit window

(see Section 10.3.1 and 10.4.1 for details.)

### 10. SFC programs (only for QnA series)

These programs cannot be edited but displayed.

SFC programs in FX series are represented as an instruction words Instruction list by step ladder instructions.

## 7.2 Creating a Program Instruction list

Sequence programs are input by the Instruction list instructions.

In addition, it is convenient to edit in the Instruction list mode the instructions that cannot be edited in the circuit mode.

For details on how to switch the Instruction list mode, see Section 6.5.5.

### 7.2.1 Inputting a contact or application instruction

A	Q/QnA	FX
<input type="radio"/>	<input type="radio"/>	<input type="radio"/>

- For contact input (insert mode)
  1. Press **Insert** key to set the insert mode.

```

0 END
1
    
```

2. Enter "LD X1", then the Instruction list input dialog box is displayed and entered data is displayed in the device instruction text box. Press **Enter** key to make input in the edit window.



```

0 LD X1
1 END
2
    
```

- For application instruction input
  1. Enter "MOV K1 D0", then the Instruction list input dialog box is displayed with the entered data being displayed in the device instruction text box. Press **Enter** to make input in the edit window.



```

0 LD X1
1 MOV K1 D0
6 END
7
    
```

7.2 2 Changing the existing program in overwrite mode

A	Q/QnA	FX
○	○	○

1. Confirm that the overwrite mode is indicated on the status bar. Press **Insert** key to switch the insert and overwrite modes.
2. Move the cursor onto the program to be corrected in overwrite mode. List input dialog box

```

0 LD      X2
1 OUT    Y70
2 OUT    T0      K600
6 SET    M0
7 LD     T0
8 OUT    C0      K3
12 RST   T0
16 LD    X3
17 OUT   Y71
18 OUT   T1      K100
22 SET   M1
23 OUT   Y40
24 LD    T1
25 OUT   C1      K6
29 RST   T1
33 LD    X4
34 OUT   Y72
35 OUT   T2      K1200
39 SET   M2
    
```

3. Enter an instruction or device (LD M10) for correction, then the list input dialog box is displayed with the entered data being displayed in the device instruction text box. Press **Enter** key to make input in the edit window.

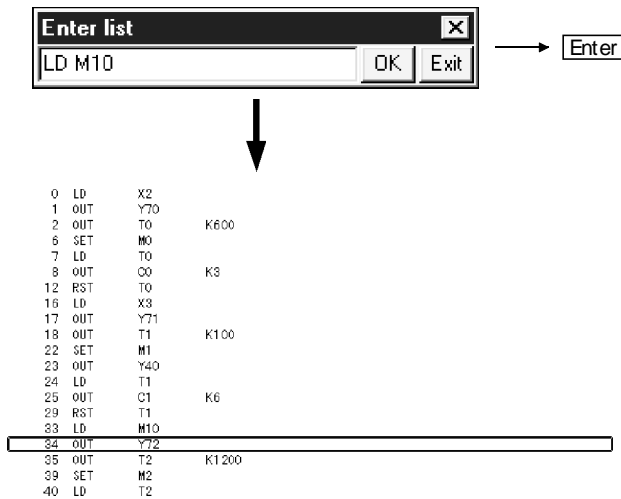

Input alphanumeric characters.

7.2.3 Inserting or adding the existing program

A	Q/QnA	FX
○	○	○

1. Confirm that the insert mode is indicated on the status bar.  
Press **Insert** key to switch the insert and overwrite modes.
2. Move the cursor to the position to insert or add a program.

```

0 LD      X2
1 OUT     Y70
2 OUT     T0      K600
6 SET     M0
7 LD      T0
8 OUT     C0      K3
12 RST    T0
16 LD     X3
17 OUT    Y71
18 OUT    T1      K100
22 SET    M1
23 OUT    Y40
24 LD     T1
25 OUT    C1      K6
29 RST    T1

---

33 LD     X4
34 OUT    Y72
35 OUT    T2      K1200
39 SET    M2
    
```

3. Enter an instruction to be inserted or added or device (LD M10), then the list input dialog box is displayed with the entered data being displayed in the device instruction text box.  
Press **Enter** key to make input in the edit window.

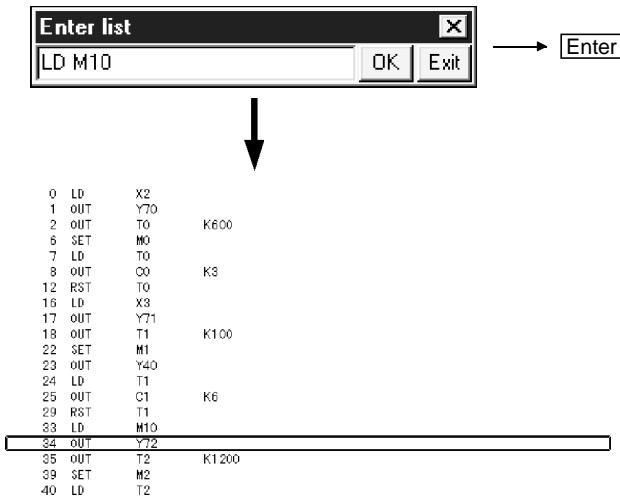

## 7.2.4 Deleting the existing program list

A	Q/QnA	FX
○	○	○

1. Move the cursor to a program to be deleted.
2. Press **Delete** key or **Shift** + **Delete** key to delete the program.

```

0 LD      X2
1 OUT     Y70
2 OUT     T0      K600
6 SET     M0
7 LD      T0
8 OUT     C0      K3
12 RST    T0
16 LD     X3
17 OUT    Y71
18 OUT    T1      K100
22 SET    M1
23 OUT    Y40
24 LD     T1
25 OUT    C1      K6
29 RST    T1
33 LD     X4
34 OUT    Y72
35 OUT    T2      K1200
39 SET    M2

```

## 7.2.5 Inserting NOPs

A	Q/QnA	FX
<input type="radio"/>	<input type="radio"/>	<input type="radio"/>

- Inserting NOPs in units of lines  
Move the cursor to a location for inserting a NOP, then press **[Shift] + [Insert]** key (The NOP is inserted in the line above the cursor.)
- Insert NOPs at a time  
Move the cursor to a location for inserting NOPs, then select **[Edit] → [insert NOP batch]**. The following dialog box is displayed for confirmation.

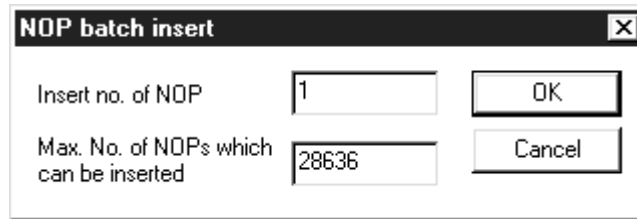

Input the number of NOPs to be inserted in insert no. of NOP text box, then click the **[OK]** button.

- A ladder may not be displayed if NOPs are inserted at any points in a ladder block and the number of ladder block steps exceeds about 4k steps.
- NOP insertion can take place even when the cursor has been positioned after the END line.

## 7.2.6 Deleting NOPs

A	Q/QnA	FX
<input type="radio"/>	<input type="radio"/>	<input type="radio"/>

- Deleting NOPs in units of lines  
Move the cursor to a location for deleting a NOP, then press **[Delete]** key or **[Shift] + [Delete]** key to delete it. (The NOP in the line above the cursor is deleted.)
- Deleting NOPs  
Press **[Enter]** key, and the program will be displayed in the list input dialog box. Select **[Edit] → [Delete NOP batch]**, and the following dialog box will be displayed.

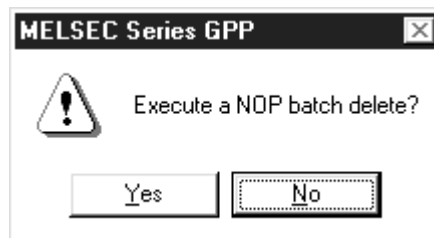

Click the **[Yes]** button, and NOPs will be deleted at a time.  
When there are NOPs after the END instruction, they are also deleted.

## 7.3 Find and Replace

---

### 7.3.1 Finding a device

---

See Section 6.4.1 for details.

A	Q/QnA	FX
<input type="radio"/>	<input type="radio"/>	<input type="radio"/>

### 7.3.2 Finding an instruction

---

See Section 6.4.2 for details..

A	Q/QnA	FX
<input type="radio"/>	<input type="radio"/>	<input type="radio"/>

### 7.3.3 Finding a step No.

---

See Section 6.4.3 for details.

A	Q/QnA	FX
<input type="radio"/>	<input type="radio"/>	<input type="radio"/>

### 7.3.4 Finding a character string

---

Searching for a statement or note takes place.  
See Section 6.4.4. for details.

A	Q/QnA	FX
<input type="radio"/>	<input type="radio"/>	<input type="radio"/>

### 7.3.5 Finding a contact/coil

---

See Section 6.4.5 for details.

A	Q/QnA	FX
<input type="radio"/>	<input type="radio"/>	<input type="radio"/>

### 7.3.6 Replacing a device

---

See Section 6.4.7 for details.

A	Q/QnA	FX
<input type="radio"/>	<input type="radio"/>	<input type="radio"/>

### 7.3.7 Replacing an instruction

---

See Section 6.4.8 for details.

A	Q/QnA	FX
<input type="radio"/>	<input type="radio"/>	<input type="radio"/>

### 7.3.8 Changing an A or B contact

---

See Section 6.4.9 for details.

A	Q/QnA	FX
○	○	○

### 7.3.9 Replacing a character string

---

See Section 6.4.10 for details.

A	Q/QnA	FX
○	○	○

### 7.3.10 Changing the statement or note type

---

See Section 6.4.11 for details.

A	Q/QnA	FX
×	○	×

### 7.3.11 Searching for a contact coil

---

See Section 6.4.13 for details.

A	Q/QnA	FX
○	○	○

### 7.3.12 Searching for an instruction using a device

---

See Section 6.4.14 for details.

A	Q/QnA	FX
○	○	○



7.4 Display

7.4.1 Displaying a device name

A	Q/QnA	FX
○	○	○

[Purpose]

Displays the created device name on the circuit edit window.

[Operating procedure]

1. Select [View] → [Device label] ( [Alt] + [Ctrl] + [F6] ).

0	LD	X2	
1	OUT	Y70	
2	OUT	T0	K600
6	SET	M0	
7	LD	T0	
8	OUT	C0	K3
12	RST	T0	
16	LD	X3	
17	OUT	Y71	
18	OUT	T1	K100
22	SET	M1	
23	OUT	Y40	
24	LD	T1	
25	OUT	C1	K6
29	RST	T1	
33	LD	M10	
34	OUT	Y72	
35	OUT	T2	K1200
39	SET	M2	

2. The device name is displayed in the window instead of the device.

0	LD	COVER	
1	OUT	Y70	
2	OUT	T0	K100
3	SET	M0	
4	LD	SAFTY	
5	OUT	C0	K3
6	RST	T0	
9	LD	READY	
10	OUT	Y71	
11	OUT	T1	K100
12	SET	M1	
13	OUT	Y40	
14	LD	PARTSB	
15	OUT	C1	K6
16	RST	T1	
19	LD	PARTSA	
20	OUT	Y72	
21	OUT	T2	K1200
22	SET	M2	

## 7.5 Switching Read and Write Modes

---

### 7.5.1 Switching to read mode

---

See Section 6.6.1 for details.

A	Q/QnA	FX
<input type="radio"/>	<input type="radio"/>	<input type="radio"/>

### 7.5.2 Switching to write mode

---

See Section 6.6.2 for details.

A	Q/QnA	FX
<input type="radio"/>	<input type="radio"/>	<input type="radio"/>

### 7.5.3 Switching to circuit mode

---

See Section 6.5.5 for details.

A	Q/QnA	FX
<input type="radio"/>	<input type="radio"/>	<input type="radio"/>

## 7.6 Changing T/C Setting Values

---

See Section 6.7 for details.

A	Q/QnA	FX
<input type="radio"/>	<input type="radio"/>	<input type="radio"/>



## 8. CONVERSION

---

There are three kinds of menu provided for conversion, [Convert], [Convert (All programs being edited)], and [Convert (Online change)].

This chapter describes normal conversion and batch program conversion.

For conversion from the [Convert (Online change)] menu, see Section 17.9.

### 8.1 Converting an Edit Program

---

A	Q/QnA	FX
○	○	○

[Purpose]

Converts the program currently being edited (in the active window).

[Operating Procedure]

Select [Convert] → [Convert].

### 8.2 Converting Multiple Edit Programs

---

A	Q/QnA	FX
○	○	×

[Purpose]

Converts multiple edit programs at a time.

[Operating Procedure]

Select [Convert] → [Convert (All programs being edited)].

[Description]

Edit programs are converted in the order that the sequence programs have been opened.

POINTS
<ul style="list-style-type: none"> <li>For the conversion operation for SFC diagram editing, refer to the following manual. GPP Function software for Windows SW5D5C-GPPW-E(V) Operating Manual(SFC)</li> </ul>

MEMO

---

---

---

---

---

---

---

---

---

---

---

---

---

---

---

---

---

---

---

---

---

---

---

---

---

---

---

---

## 9. SETTING DEVICE COMMENTS

This chapter describes the points to be noted on comment creation with GPPW. In addition, it describes how to input the device comments created with GPPW to ACPU, QnACPU or FXCPU and how to input the data created with GPPA, GPPQ, FXGP(DOS) or FXGP(WIN) to GPPW.

POINT	<ul style="list-style-type: none"> <li>Any FX project that was created with SW2D5-GPPW-E or later appears in the project list display when SW0D5-GPPW-E or SW1D5-GPPW-E is started, but it cannot be read.</li> </ul>
-------	---

### 9.1 Points to be Noted before Comment Creation with GPPW

A	Q/QnA	FX
○	○	×

This section describes the points to be noted and settings that vary depending on whether to handle comments only on peripheral devices or to input them to PLC.

- (1) Comments on special resistors and special relays  
 Since the comments on special resistors and special relays are created in the installed directory (MELSEC\GPPW\Sample Comment), it is useful to copy them to projects for which sequence programs will be created.
- (2) Extended comments  
 When AnNCPUs are selected, the extended comments can be created with GPPW, but cannot write them to the PLC CPU.

The extended comments 2 to 4 cannot be written to the ACPU/GPPA file.

The extended comments read from the ACPU/GPPA file to the GPPW are stored in the common comment.

- Sample-1 ACPU COMMENT SP.M SP.D
- Sample-2 A1FX COMMENT SP.M SP.D
- Sample-3 QnA COMMENT SM, SD, J1/SB, J1/SW
- Sample-4 FX CPU COMMENT SP.M SP.D
- Sample-5 Q COMMENT SM, SD, J1/SB, J1/SW
- Sample-6 Q (A Mode) (SP.M, SP.D)

(3) Device comments when GPPW and GPPA are used

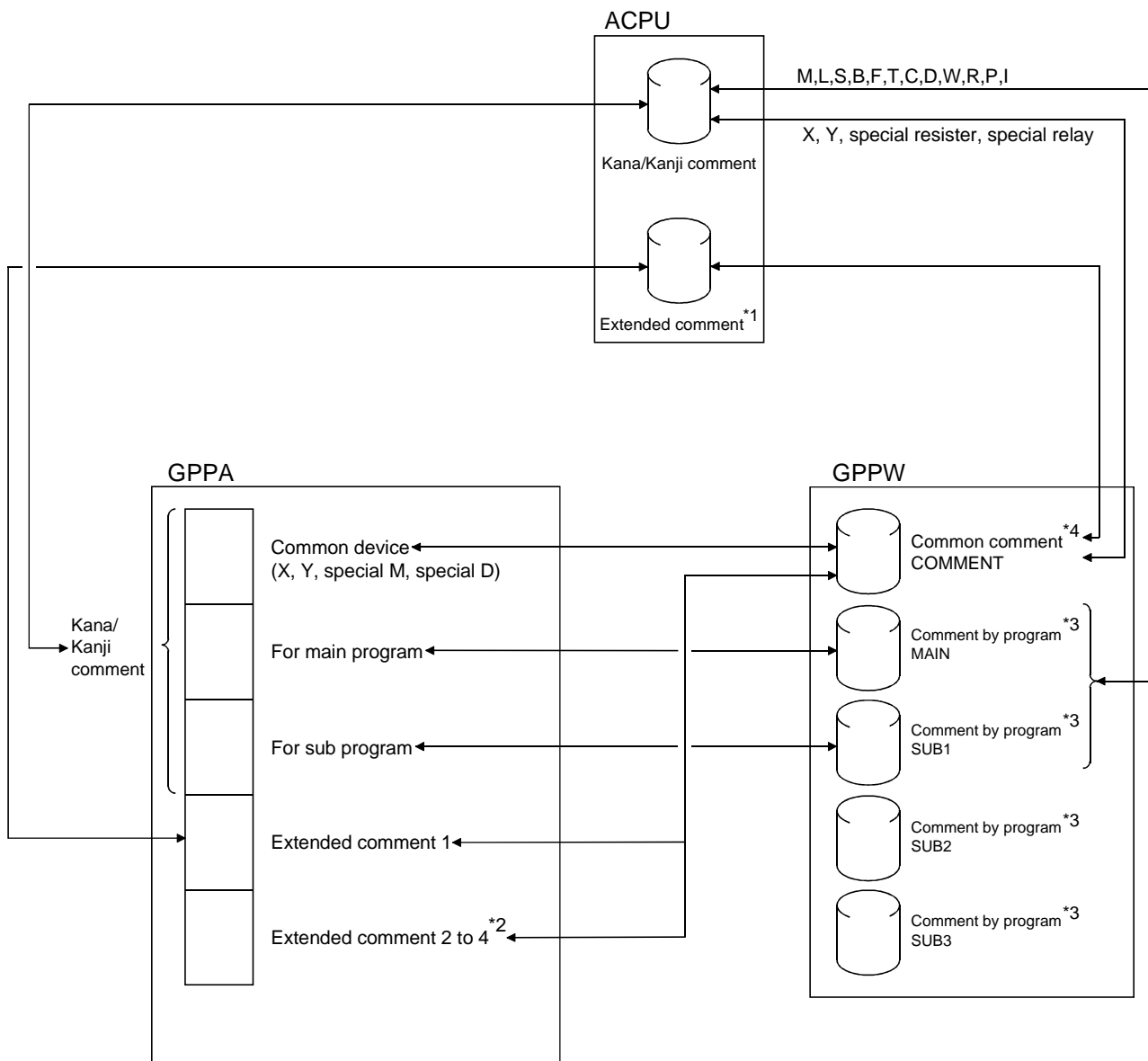

Precautions:

- \*1: Only AnA and AnUCPU can be written to the PLC CPU.
- \*2: The extended comments 2 to 4 cannot be written to the PLC CPU.
- \*3: The comments created in X, Y, special resistors, special relays, SUB2, and SUB3 among those created by program cannot be written to the ACPU/GPPA file.
- \*4: Those devices other than the X, Y, special resistors, and special relays created in COMMENT (common comment) can be written to the ACPU/GPPA file by setting them in the extended comment (Refer to Section 9.7).  
When a comment on the same device (X, Y, etc.) is created for a common device and an extended comment, the device comment set in the extended comment is read (Refer to Section 9.1.3 for details).

### 9.1.1 Editing comments only on peripheral devices

---

A	Q/QnA	FX
<input type="radio"/>	<input type="radio"/>	<input type="radio"/>

- (1) In A series, Q/QnA/A/FX series, the created comments can be saved. Neither parameter settings nor comment range settings are required.
- (2) Both common comments and comments by program can be created. Common comments can be created independent of comments for the main program and subprograms. (see Section 9.5 for details.)
- (3) The common comment data name is fixed to "COMMENT."
- (4) There are two methods for creating comments by program. The first method sets a comment data name according to the data name of a sequence program. The second method sets a data name different from the sequence program name. (see Sections 5.8 and 9.3 for details.)
- (5) The devices subject to comment creation are all displayed (for monitoring) or printed out.
- (6) When creating a device name in A series, note that it cannot be input to ACPU or GPPA files.



**POINT**

- When a common comment and a comment by program have been set for the same device, click <<Each program>> tab on the dialog box displayed by selecting [Tools] → [Option] to set a comment to be displayed in units of devices (see Section 16.10 for details.).

Device	Comment	Label
X0		
X1	START	
X2		

Device	Comment	Label
X0		
X1	SECURITY	
X2		

↓

<<Each program>> sheet

**MAIN**

**SUB1**

When either a common comment or a comment by program has been set for a device, the set comment is displayed automatically.

- The number of letters used in editing comment devices or used for display in the circuit mode can be changed from 16 to 32 and from 32 to 16. Click <<Whole data>> tab on the dialog box displayed by selecting [Tool] → [Option] (See Section 16.10).

### 9.1.2 Writing to ACPU/GPPA file

---

A	Q/QnA	FX
○	×	×

- (1) Writing to ACPU takes place according to the memory size setting (comment, extended comment) and write comment range setting (see Section 9.7) in the PLC parameter.  
Only comment1/2 and extended comment 1 can be input to the PLC (Extended comments 2 to 4 cannot be input.)
- (2) Comment1 (4032 comments x 15 character) can be input to ACPU while Comment2 (4032 comments x 16 character) can be input to ACPU.
- (3) Devices other than X, Y, SP.M (special relay), and SP.D (special register) must be saved in the extended comment 1 area.  
(See Sections 9.3 and 9.7 for details.)
- (4) When a comment has been created in more than 17 characters with GPPW, the comment part in the 18th character and after is not input to the PLC .
- (5) When X and Y areas are overlapping in a common comment, Y comment is not input because X takes precedence over Y.

9.1.3 Reading from ACPU/GPPA file

A	Q/QnA	FX
○	×	×

- (1) When the comments X and Y created by the PLC or GPPA are read into GPPW, they are pasted onto the edit windows X and Y respectively.
- (2) When comment1/2 and extended comments have been set for the existing data, both comments are read into GPPW common comments. In addition, when comment1/2 and extended comments are overlapping, the latter extended comments are read with precedence.

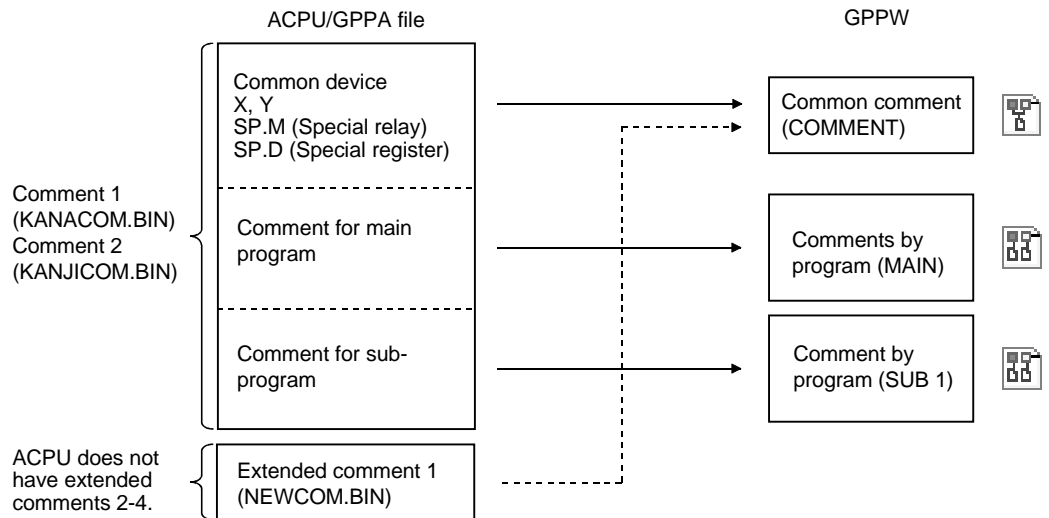

The comments for the main program and subprograms include the device comments, M, L, S, B, F, T, C, D, W, R, P, and I.

[Notes on reading and writing common comments]

When the common devices X0 to XF and extended comments Y0 to YF are overlapping (in files created on the preceding page) , if they are read into GPPW, then input to ACPU, care should be taken because the comments Y0 to YF read from the extended comments are input to the common devices and the original common device comments are overwritten.

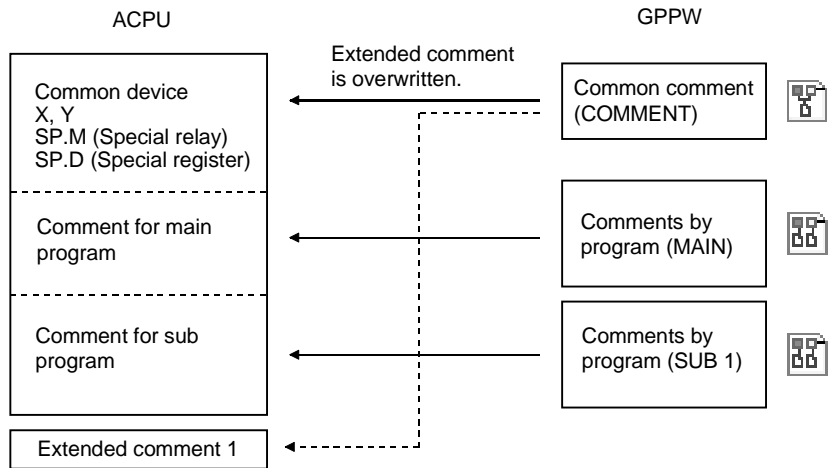

9.1.4 Writing to QCPU(Qmode) QnACPU/GPPQ file

A	Q/QnA	FX
×	○	×

- (1) Common comments or comments by program can be input to the PLC or GPPQ files according to the steps of editing.

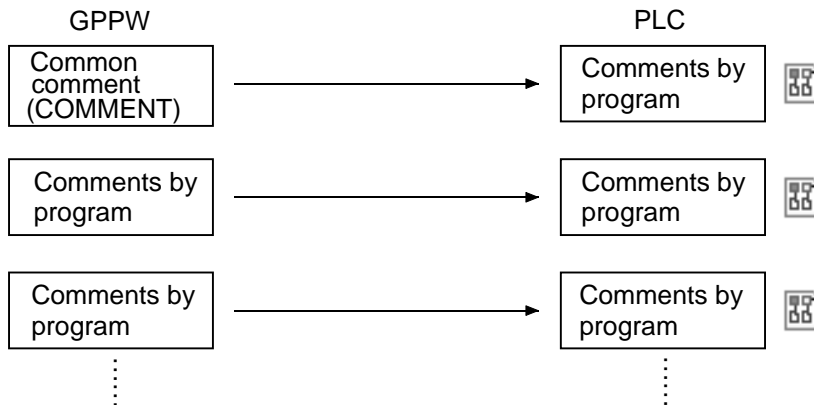

9.1.5 Reading from QCPU(Qmode) QnACPU

A	Q/QnA	FX
×	○	×

1. The comments created by GPPQ are read as they are. The GPPW common comments are not read.

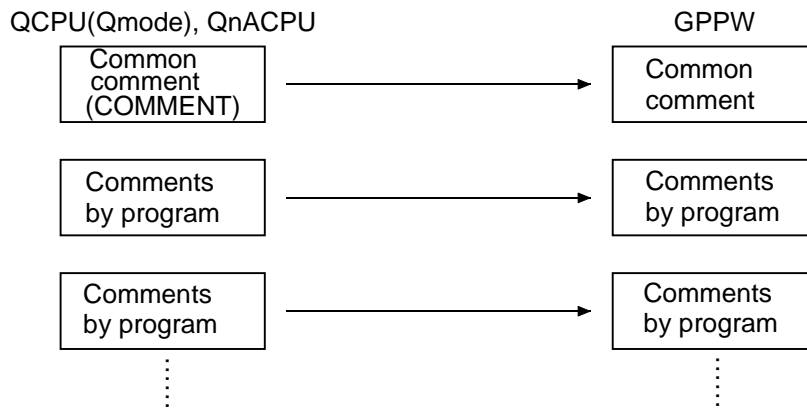

When the file "COMMENT" has been created as a QnACPU or GPPQ file, it is read into GPPW as a common comment.

9.1.6 Writing to FXCPU/FXGP(DOS), FXGP(WIN) file

A	Q/QnA	FX
×	×	○

- (1) Writing to FXCPU can take place according to the memory size setting (comment size) and write comment range setting (see Section 9.7.) in the PLC parameter.
- (2) Only common comments can be input to FXCPU as device comments. Comments by program cannot be input to the PLC (see Section 9.3.)

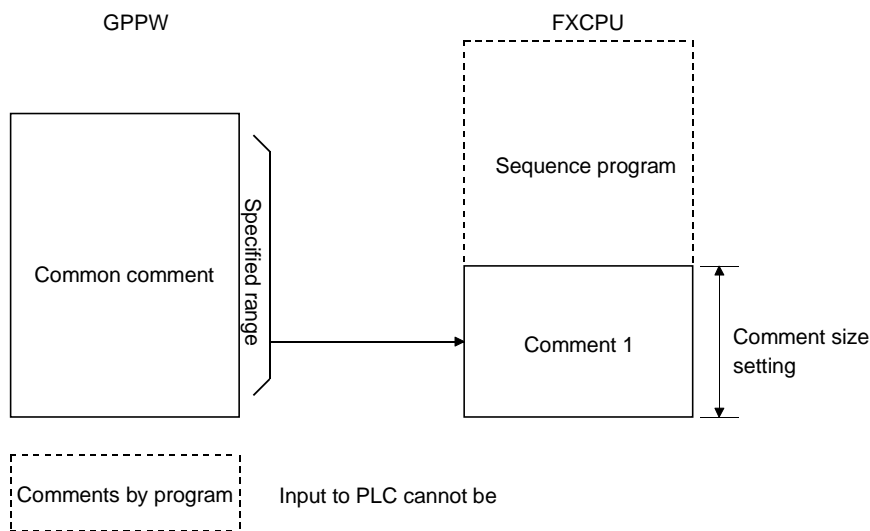

- (3) The number of comment1 characters that can be input to FXCPU from GPPW is 16 characters. Though GPPW allows comments of up to 32 characters, only 16 characters are input to the PLC. In addition, FXGP(DOS) allows only characters to be used for Comment1 and the maximum number of characters is 15. To display all comments normally by FXGP(DOS), device comments must be created in up to 15 characters.
- (4) The number of comment1 that can be input to FXCPU varies depending on the memory size setting in the PLC parameter.
- (5) All details of the common comment are written. For the device name, however, only the alphanumeric characters and symbols (•, +, -, \*, /, =, ., ?, #, \$, %, &, :, ;, \_ ) of half size are made valid (See Section 9.6.1). Those device names containing full size characters or unspecified characters will be deleted at the time of writing.

9.1.7 Reading from FXCPU/FXGP(DOS), FXGP(WIN) file

A	Q/QnA	FX
×	×	○

1. Comments in FXCPU are read as common comments as they are.

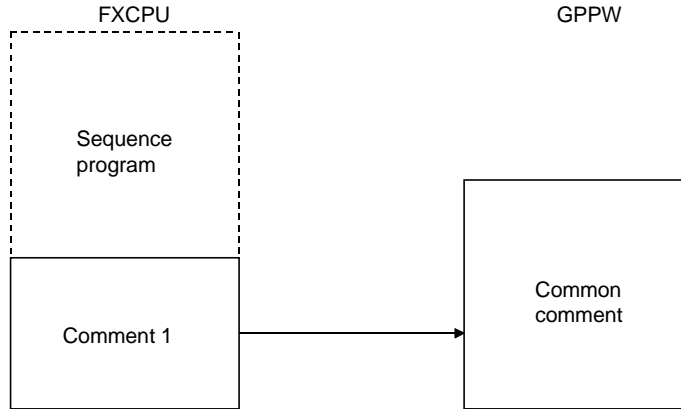

- (1) Reading an FXGP(DOS) file  
All comments are read.
- (2) Reading an FXGP(WIN) file  
Though FXGP(WIN) allows up to 50 characters to be input, only the first 32 characters are read for GPPW input.  
The number of comments is not limited and all comments are read.

9.2 List of Device Comments

A	Q/QnA	FX
○	×	×

The types of devices and the possibility of comment setting are listed below.

Device name	Symbol	Bit device	A	Q/QnA	FX
Bit device	Input/Output	XY	○	○	○
	Input/Output	DX/DY	—	○	—
	Internal relay	M	○	○	○
	Step relay	S	○	○	—
	Latch relay	L	○	○	—
	Annunciator	F	○	○	—
	Special relay	SP.M	○	—	—
		SM	—	○	—
		M	—	—	○
	FB Input/FB Output	FX	—	×	—
	Edge relay	V	—	○	—
	Link relay	B	○	○	—
	Link special relay	SB	—	○	—
	State	S	—	—	○
Timer/Counter	Timer	T	○	○	○
	Counter	C	○	○	○
	Count timer	ST	—	○	—
Word device	Data register	D	○	○	○
	Special register	SP.D	○	—	—
		SD	—	○	—
		D	—	—	○
	Link register	W	○	○	—
	File register	R	○	○	—
	(RAM) File register	D	—	—	○
	Sequence file R	ZR	—	○	—
Link special register	SW	—	○	—	
FB data	FD	—	×	—	
Others	Pointer	P	○	○	○
	Accumulator	A	○	—	—
	Interrupt pointer	I	○	○	○
	Nesting	N	×	×	—
Extended specification	Index	Z	×	×	×
	I/O No.	U	—	○	—
	Buffer register	G	—	—	—
	SFC block device	BL	—	○	—
	Step relay (Step relay with a block specification)	BL/S	—	○	—

\*: When the A1FXCPU is selected, S comment or extended comment cannot be created.



9.3 Common Comments and Comments by Program

A	Q/QnA	FX
○	○	○

[Device comment system]

Device comments include common comments and comments by program.

[Common comment]

A series

Settings are required when a common comment is assigned for all sequence programs in CPU types with subprograms.

Q/QnA series

Settings are required when single comment data is used in common for creation of multiple programs.

These settings can also be made even when multiple programs are not present.

FX series

Settings are required when a comment is assigned for the main program (MAIN).

In FX series connection, these settings are not related to subprograms (SUB) because only one program file is created.



The common comment name is fixed to COMMENT.  
The common comment can be changed to comments by program later.

[Comments by program]

A series

Settings are required when a comment is assigned for each program during main sequence program creation or sub-sequence program creation.

Q/QnA series

Settings are required when a comment is assigned for each program.

FX series

Settings are required when comments other than common comments are assigned for the main program (MAIN).

In FX series, only common comments are automatically created in new project creation.

When comments by program are required, they must be added newly. (see Section 5.8 for details.)

Comments by program cannot be input to FXCPU and FXGP(DOS) or FXGP(WIN) files. When input to FXCPU or FXGP(DOS) or FXGP(WIN) files is required, comments must be created as common comments or the comments by program must be changed to common comments for operation. (see Section 9.6 for details.)

[Setting of comment data by program]  
 See Section 5.8 for details on operation methods.

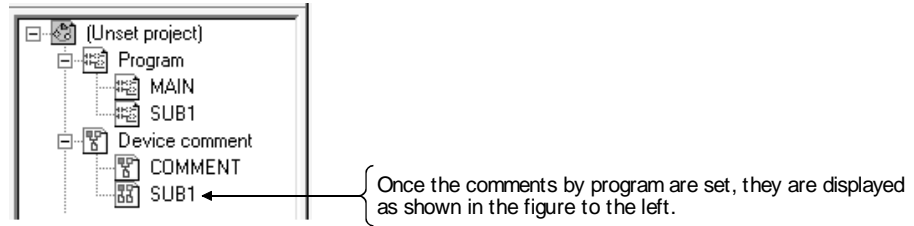

[Creation of only common comments]

Schematic diagram

A series (A4UCPU selection):

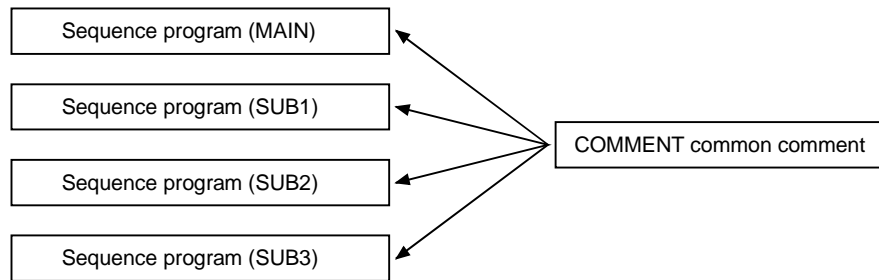

Q/QnA series:

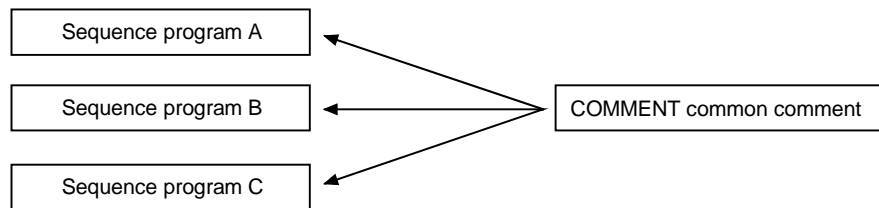

FX series:

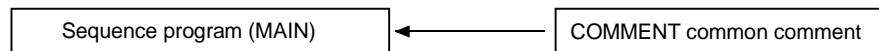

[Creation of only comments by program]

A series (A4UCPU selection):

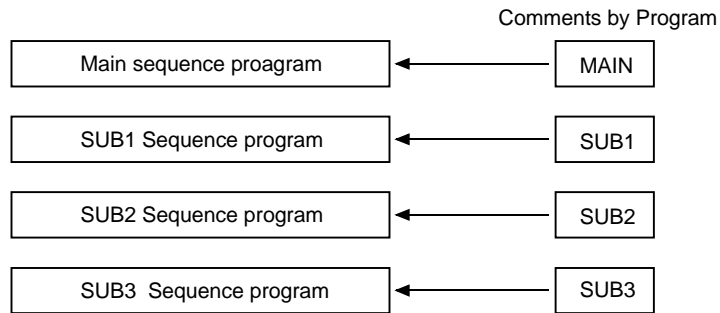

Q/QnA series:

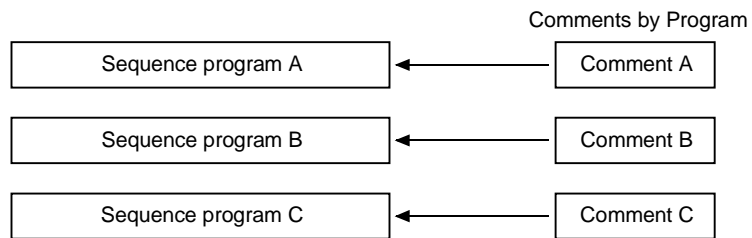

FX series:

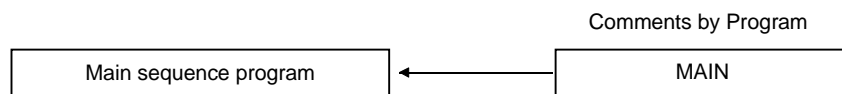

9.4 Creating Device Comments

9.4.1 Creating device comments on the device comment edit window

A	Q/QnA	FX
○	○	○

[Purpose]

Assigns the meaning for a device for easy-to-view programs. This function is helpful in creating the devices.

[Operating Procedure]

- For creation of common comments  
Device comment in the project data list → COMMENTO
- For creation of comments by program  
Set the data type (comments by program), name of new data to be added, and title in the dialog box displayed by selecting [Project] → [Edit data] → [New].

[Dialog Box]

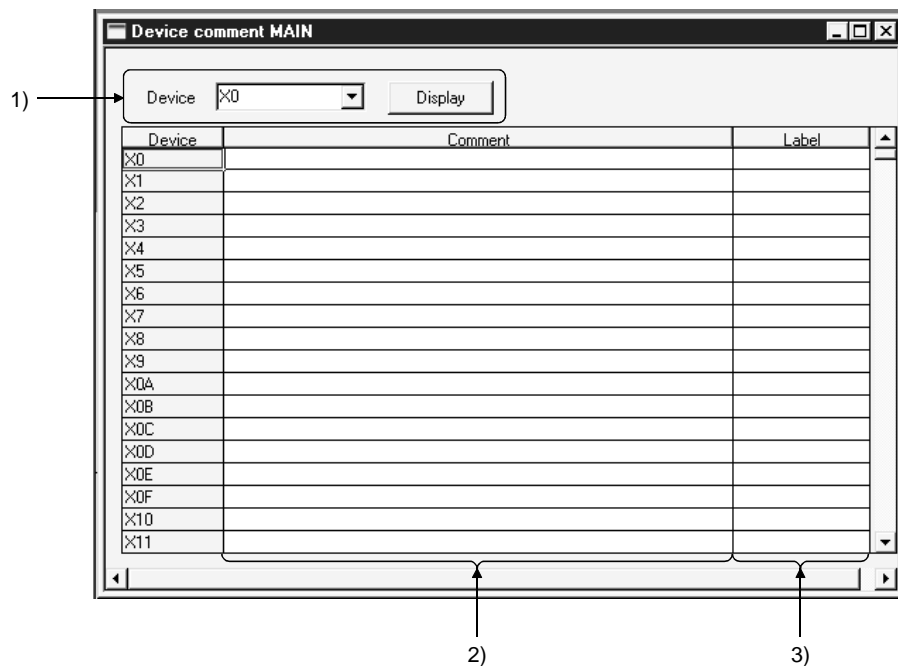

[Description]

1) Device

Designates a device for comment creation.  
 After device designation, click the **Display** button.  
 Once the device name is set, it is registered.  
 When creating SFC comments, specify the device names as follows.  
 Block title : BLm  
 Step comment : BLm\Sn  
 Transition comment : BLm\TRn  
 (m: block number, n: step, transition number)

2) Comment

Sets a comment for each device.

Comment1..... To be created in 15 characters.

(see APP.11.2 for comment setting in the FX PLC .)

Comment2..... To be created in 16 characters.

3) Label

To be used when a device is set as an actual switch name.

A device name must be set in up to 8 characters.

<Example> Difference in displaying the device name and device comment



When a device name has been created in A series, it cannot be input to an ACPUC/GPPA file even if input is attempted.

In such a case, the device name must be created again with GPPA.

However, the GPPA device name is effective only in printing and cannot be displayed on the circuit creation window.

POINTS
<ul style="list-style-type: none"> <li>• When either common comments or comments by program have already been created, the created device comments are displayed unconditionally.</li> <li>• When a device comment is input to an FXGP(WIN) file, it must be set only in alphanumeric characters and symbols ( . + - * / = . ? # \$ % &amp; ; ; _ ). Device names including the characters not permitted are deleted in writing them.</li> <li>• The number of comment characters can be changed to 32 characters in the &lt;&lt;Data&gt;&gt; sheet on the dialog box displayed by selecting [Tools] → [Options]. However, the number of comment characters is restricted as follows for input to ACPUC or FXCPU (Comment1 only).             <ul style="list-style-type: none"> <li>Comment1 ..... Up to 15 characters(For FX series, see Section Appendix 11.2)</li> <li>Comment2 ..... Up to 16 characters</li> </ul> </li> </ul>

9.4.2 Creating device comments for the created circuit

A	Q/QnA	FX
○	○	○

[Purpose]

Assigns the meaning for a device for easy-to-view programs.  
 This function is helpful in modifying or adding device comments.

[Operating Procedure]

1. Move the cursor to a device comment creation location.

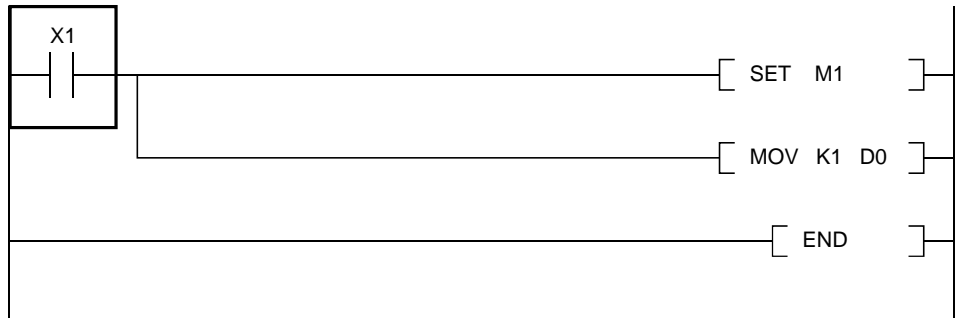

2. Press **Enter** key.



3. Make settings as follows for the circuit input dialog box. (Input two semicolons.)



4. Comment display takes place as follows.

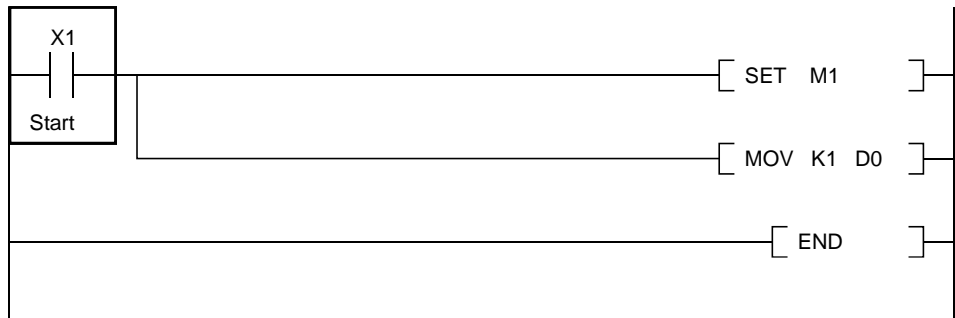

9.4.3 Creating device comments after creating a circuit

A	Q/QnA	FX
○	○	○

[Purpose]

Assigns the meaning for a device for easy-to-view programs.  
 This function is helpful to create device comments and the circuit at the same time.

[Operating Procedure]

1. Check the Device comment check box on the dialog box displayed by selecting [Tools] → [Options].
2. Move the cursor to a device comment creation location.



3. Enter a contact and/or a device and click the **OK** button.



4. Enter a device comment and click the **OK** button.



5. Comment display takes place as follows.

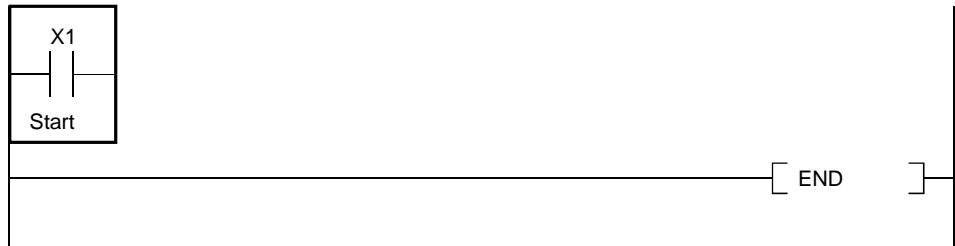

9.4.4 Editing comments on the ladder editing screen

A	Q/QnA	FX
○	○	○

[Purpose]

Comments the devices for ease of program viewing. This function is useful for device comment corrections/additions.

[Setting Procedure]

1. [Edit] → [Documentation] → [Comment] (  )
2. Move the cursor to the position where a device comment will be created.
3. Pressing [Enter] shows the following dialog box.



4. Enter a device comment and click the [OK] button.



5. Providing a comment display shows the following ladder.

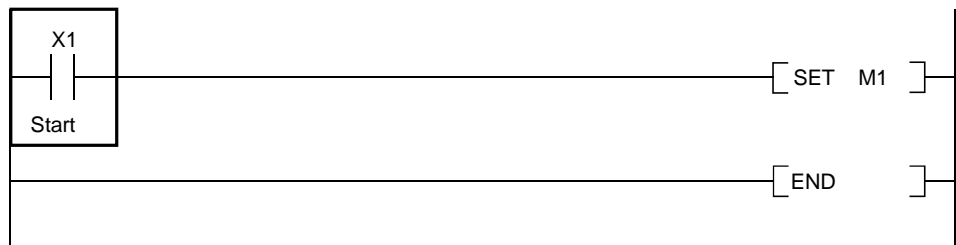

POINTS

- To cancel the comment edit mode, choose this menu again and uncheck the checked menu item.
- Note that comments of M, L and S can be created on the A series.
- For the FROM/TO and other instructions which can handle multiple devices, the number of devices used can be commented.



## 9.5 Deleting Device Comments

---

### 9.5.1 Deleting all device comments and device names

---

A	Q/QnA	FX
<input type="radio"/>	<input type="radio"/>	<input type="radio"/>

[Purpose]

Deletes all device comments and device names set so far.

[Operating Procedure]

Display the device comment edit window, then select [Edit] → [Clear all (all devices)].

### 9.5.2 Deleting display device comments and device names

---

A	Q/QnA	FX
<input type="radio"/>	<input type="radio"/>	<input type="radio"/>

[Purpose]

Deletes the device comments and device names being displayed.

[Operating Procedure]

Display the device comment edit window, then select [Edit] → [Clear all (displayed devices)].

9.6 Setting Comment Types

A	Q/QnA	FX
<input type="radio"/>	<input type="radio"/>	<input type="radio"/>

[Purpose]

Switches the comment type from common comments to comments by program and vice versa.

<Example>

Settings are required when common comments are changed to SUB1 (comments by program) or comments by program are changed to common comments (COMMENT).

Before change		After change
COMMENT (common comment)	→	SUB1 (comments by program)
MAIN (comments by program)	→	MAIN (comments by program)

[Operating Procedure]

Display the device comment edit window, then select [Edit] → [Setup comment].

[Dialog Box]

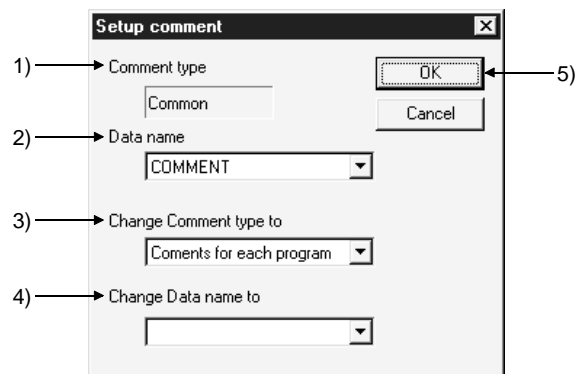



[Description]

- 1) Comment type  
Indicates the type of the data selected for Data name.
- 2) Data name  
Designates a data name for comment type change.
- 3) Change comment type to  
Classifies data set in the data name field into two categories: common comments and comments by program.
- 4) Change Data name to  
Changes the existing data name.  
This data name must be designated in up to 8 characters.
- 5) **OK** button  
Click this button after making necessary settings.

POINTS

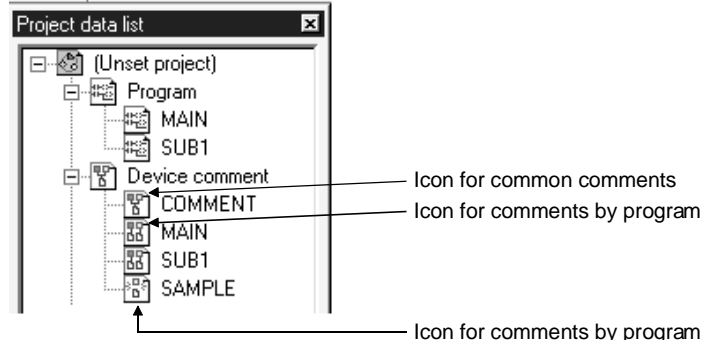
- Common comments and comments by program can be classified from the device comment icons in the project data list.



..... This icon is displayed for comments corresponding to the sequence programs.

..... This icon is displayed for comments not corresponding to the sequence programs.

- One common comment is allowed within one program.  
In addition, the common comment data name is fixed to "COMMENT."
- Up to 124 comments by program can be set.

9.7 Setting Comment Ranges

A	Q/QnA	FX
<input type="radio"/>	<input type="radio"/>	<input type="radio"/>

[Purpose]

Sets a data range when data created with GPPW is written to a PLC or when a GPPA, GPPQ, FXGP(DOS) or FXGP(WIN) file is written to the FD or HD.

[Operating Procedure]

Display the device comment edit window, then select [Edit] → [Setup comment range].

- When A series is started

[Dialog Box]

<<Common programs>> sheet

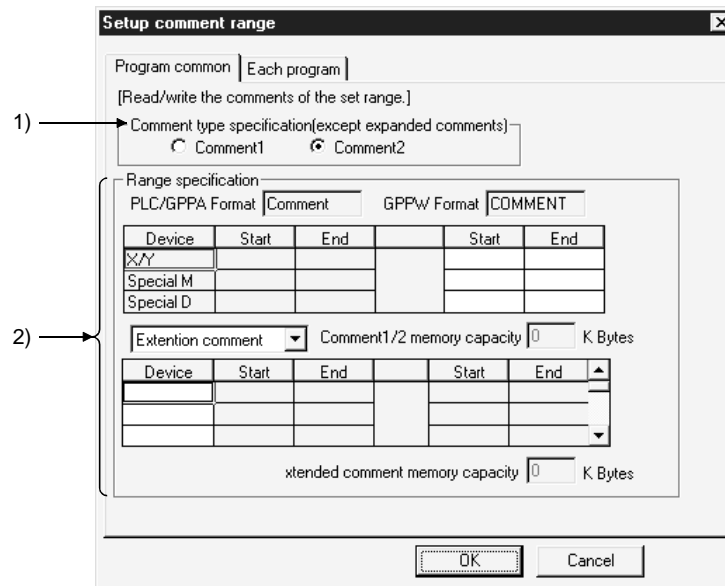

[Description]

- 1) Comment type specification

Comment1

To be selected when a device comment has been created as a Comment1.

Comment2

To be set when a device comment has been created as a Comment2.

2) Range specification

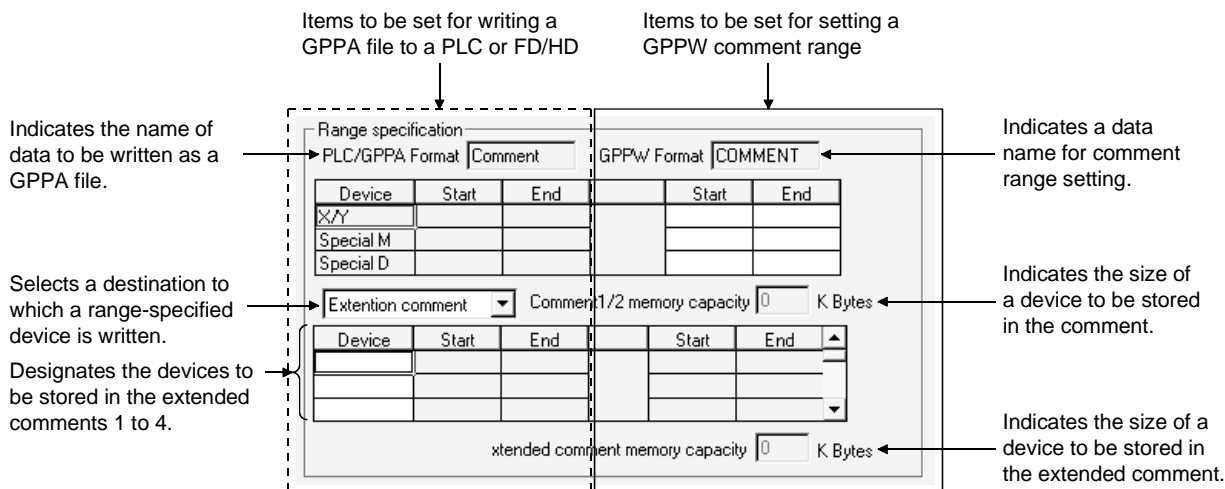

If the starting and end positions of a range are designated in GPPW files, they are reflected in the PLC /GPPA table.

[Dialog Box]

<<Each program>> sheet (for main program and subprograms)

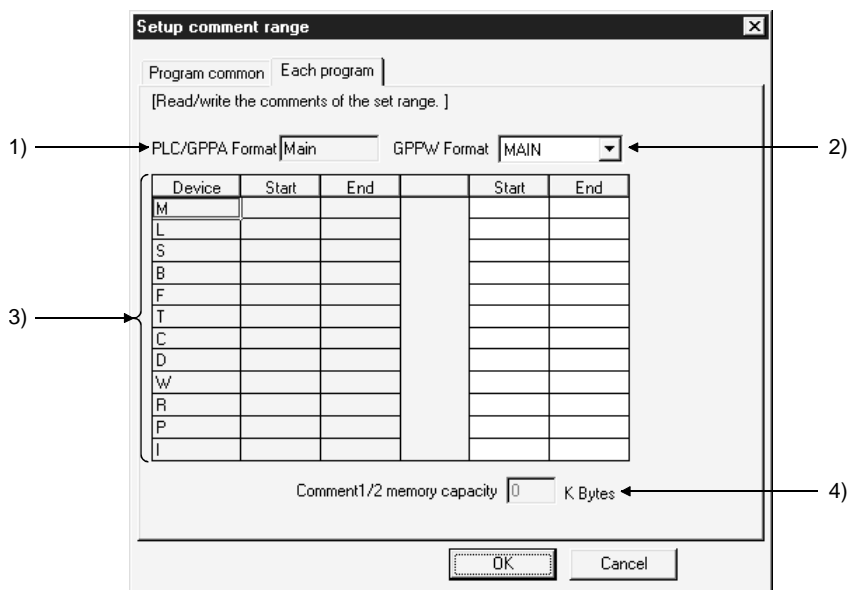

[Description]

- 1) PLC/GPPA Format  
Indicates the name of data to be written as a GPPA file.
- 2) GPPW Format  
Designates MAIN or SUB1.  
Even if SUB2, SUB3 or SUB4 is created with GPPW, it cannot be designated in this setting item.

- 3) Device range setting  
Designates a range of devices to be written to a PLC or a peripheral device.
- 4) Comment1/2 memory capacity  
Indicates the size of a device to be saved in the comment or extended comment.

[Operating Procedure]

- When QnA series is started

[Dialog Box]

<<Program common>> sheet

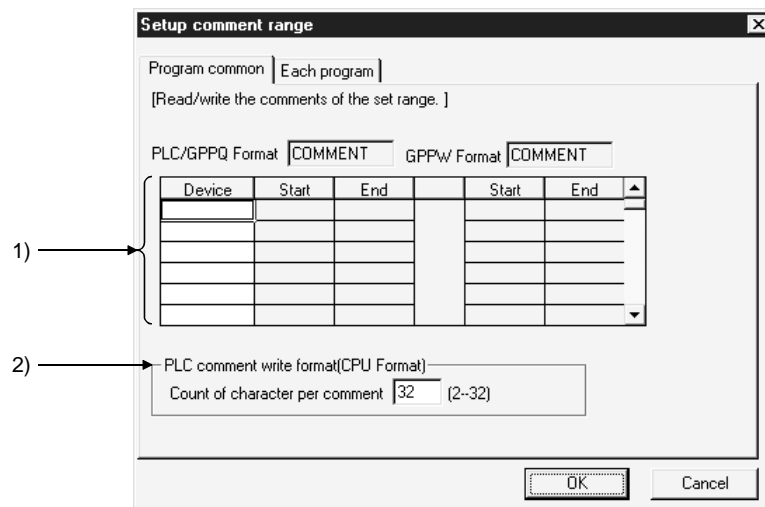

[Description]

1) Range setting

Designates the name of data to be written as a GPPQ file.

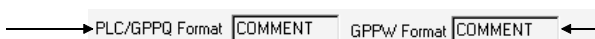

Indicates a data name for comment range setting.

Designates the devices to be written to a PLC or FD/HD.

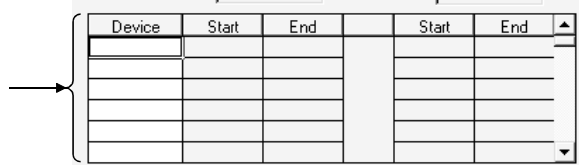

If the starting and end positions of a range are designated in GPPW files, they are reflected in the PLC /GPPA table.

- 2) PLC comment write format (PLC Format)  
Designates how many characters are to be written to a PLC.

[Dialog Box]  
 <<Each program>> sheet

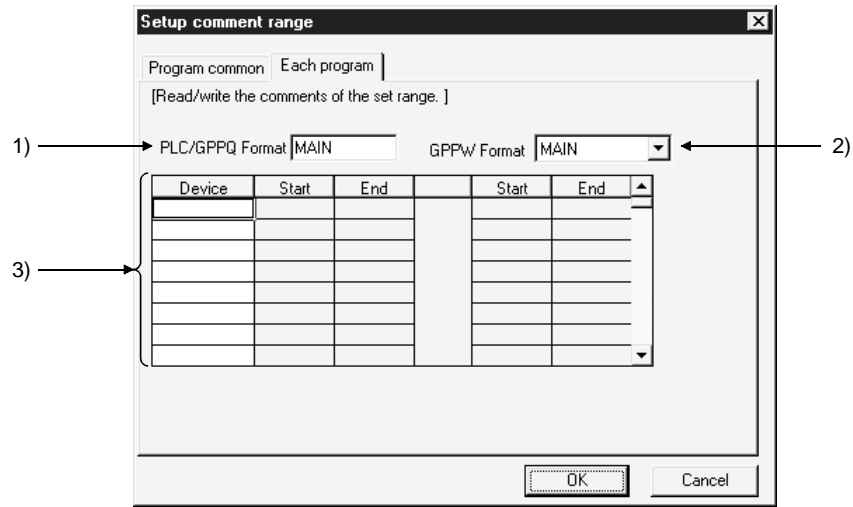

[Description]

- 1) PLC /GPPQ Format  
 Designates the name of data to be written as a GPPQ file.
- 2) GPPW Format  
 Indicates a data name for comment range setting.
- 3) Device range setting  
 Designates the devices to be written to a PLC or peripheral device.

POINT
<ul style="list-style-type: none"> <li>• To make input to ACPU, the comment1/2 memory size must be designated in the memory size parameter. (The memory size displayed here is not reflected to the parameter memory size.)                      If no size is designated, an error occurs.                      No settings are required when the other files are used for input.</li> </ul>

[Operating Procedure]

- When FX series is started

[Dialog Box]

<<Program common>> sheet

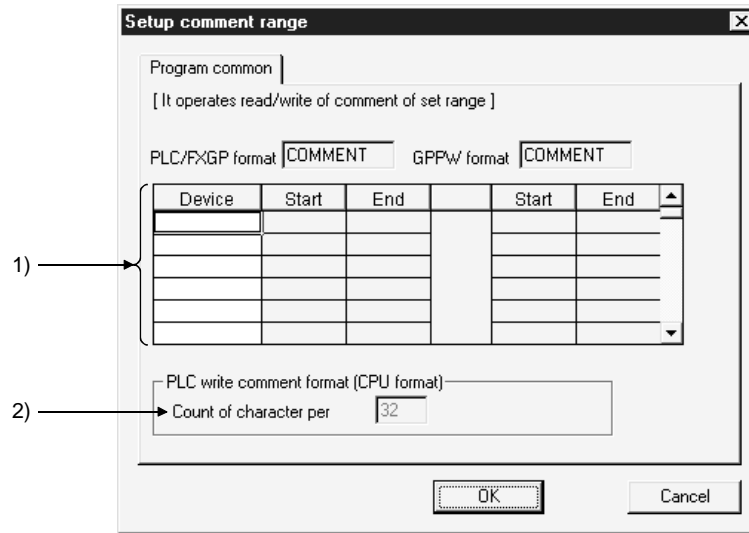

[Description]

1) Range setting

Designates the devices to be written to a PLC or Set

Set the comment range created by the GPPW.

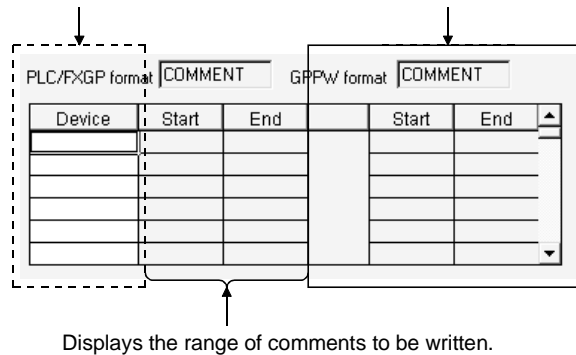

- 2) PLC write comment form (PLC form).  
Setting is not possible for the FX series.

POINT
<ul style="list-style-type: none"> <li>• Comments by program cannot be written to PLC and FD/HD (see Section 9.3).</li> </ul>





# 10. SETTING STATEMENTS AND NOTES

Comments are added to make the sequence program easier to understand.  
Note that the A series and the FX series do not have any integrated statement or integrated note function.

## 10.1 Statement

A	Q/QnA	FX
○	○	○

This section describes the statements created by the Q/QnA/A/FX series.  
 FXGP (DOS) and FXGP (WIN) call such statements "circuit statements".

	Number of Characters
Line statement	64 x n *2 lines
Peripheral statement	64 x 1 line
Integrated statement	64 x 1 line

- \*1: The Q/QnA series allows switching between the integrated and peripheral statements.
- \*2: Number of statement lines created in a single ladder block = 15 number of lines in a single ladder lock.  
 When creating multiple lines in one place, up to 64 characters are accepted in one line and an automatic return is not made.

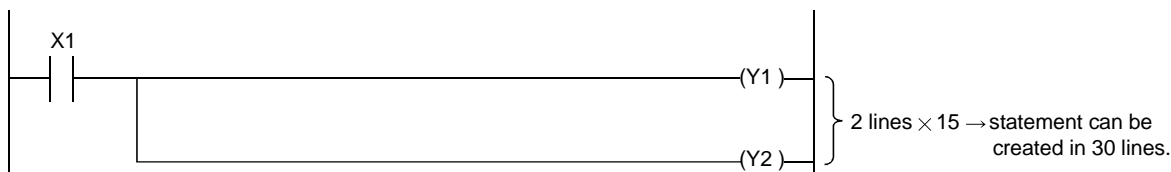

- **Integrated statement**  
 Since character strings are controlled as part of the sequence program, writing and reading statements to/from the PLC is automatically set.  
 However, the number of steps consumed will increase in proportion to the number of characters created.  
 Any space inserted in character strings will be counted as one character.  
 <Number of steps consumed>

$$2 + \frac{\text{Number of characters}}{2} \text{ steps (Round off decimals.)}$$

↑  
Fixed

Example of display with integrated statements

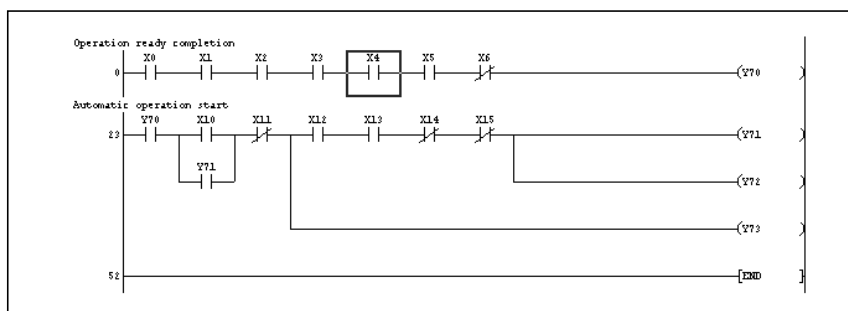

- Peripheral statement  
A peripheral statement is a character string controlled only by a peripheral device (it is writable and readable to/from the hard disk/floppy disk). When the sequence program is written to the PLC, "\*" will be added to the steps with a statement.

[A/FX series]

The steps of statements will not be consumed.  
However, statements will not be written to the PLC.  
Also, FX series P,I statement will not be written to FXGP(DOS) and FXGP(WIN).

[Q/QnA series]

The number of steps consumed is 1, regardless of the number of characters.  
However, statements will not be written to the PLC.

Example of displayed with peripheral statements

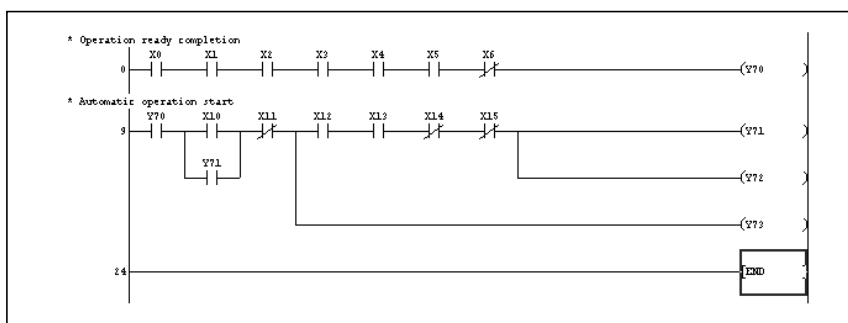

[Caution when reading statements from the PLC]

When overwriting a program without statements read from the PLC to the hard disk, the program stored in the hard disk will be overwritten by the program without statements. Before reading such a program, store the program (originally retained in the hard disk) in a floppy disk.  
If any program is edited on a peripheral device and written during running, program mismatching may occur.

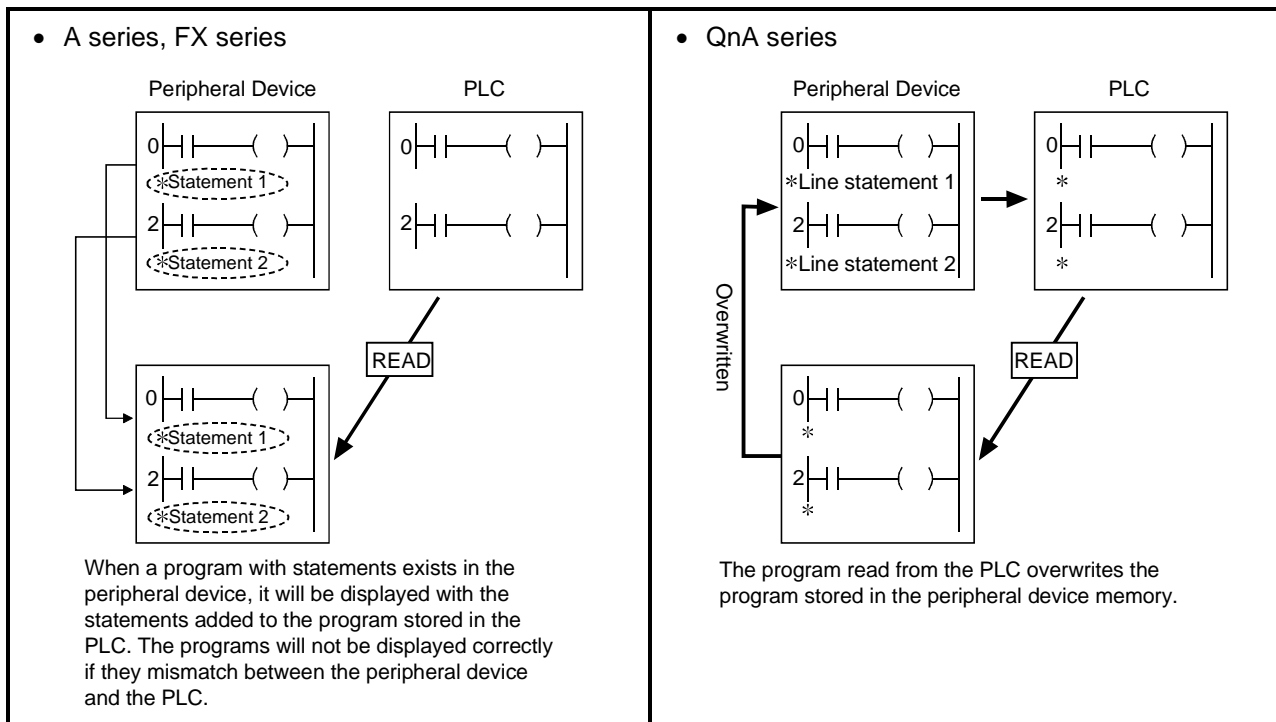

10.2 Note

A	Q/QnA	FX
○	○	○

This section describes the notes created by the Q/QnA/A/FX series. Notes can be created for each coil and application instruction. However, if notes are written to a peripheral device in the form of an ACPU or GPPA file, only the first note of a single circuit block will be written. FXGP (DOS) and FXGP (WIN) call such notes as "coil comments."

	Number of Characters
Note	32 characters x 1 line *1

\*1: The Q/QnA series allows switching between the integrated and peripheral statements.  
 \*2: Each note can be created within the range specified in the sequence program created.

- Integrated note  
 Since character strings are controlled as part of the sequence program, writing and reading notes to/from the PLC is automatically set. However, the number of steps consumed will increase in proportion to the number of characters created. Any space inserted in character strings will be counted as one character.

<Number of steps consumed>

$$\underset{\substack{\uparrow \\ \text{Fixed}}}{2} + \frac{\text{Number of characters}}{2} \text{ steps (Round off decimals.)}$$

Example of display with integrated notes

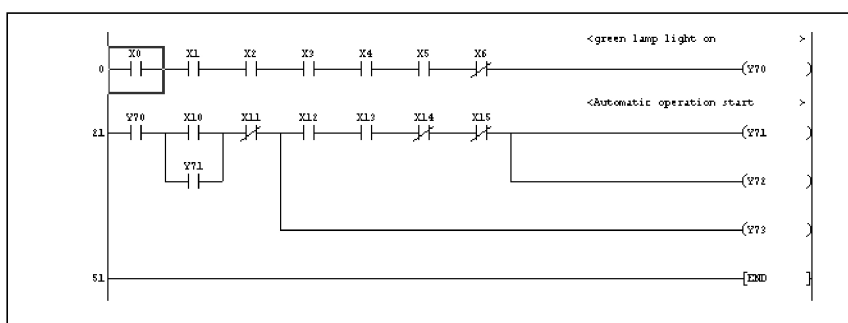

- Peripheral note  
A peripheral note is a character string controlled only by a peripheral device (it is writable and readable to/from the hard disk/floppy disk). When the sequence program is written to the PLC, "\*" will be added to the steps with a statement.

[A/FX series]

The steps of notes will not be consumed.  
However, notes will not be written to the PLC.

[Q/QnA series]

The number of steps consumed is 1, regardless of the number of characters.  
However, notes will not be written to the PLC.

Example of display with peripheral notes

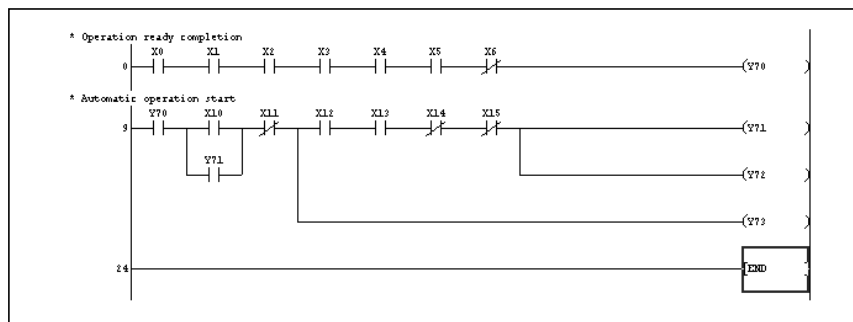

[Caution when reading notes from the PLC]

When overwriting a program without notes read from the PLC to the hard disk, the program stored in the hard disk will be overwritten by the program without notes. Before reading such a program, store the program, (originally retained on the hard disk) in a floppy disk.

If any program is edited on a peripheral device and written during running, program mismatching may occur.

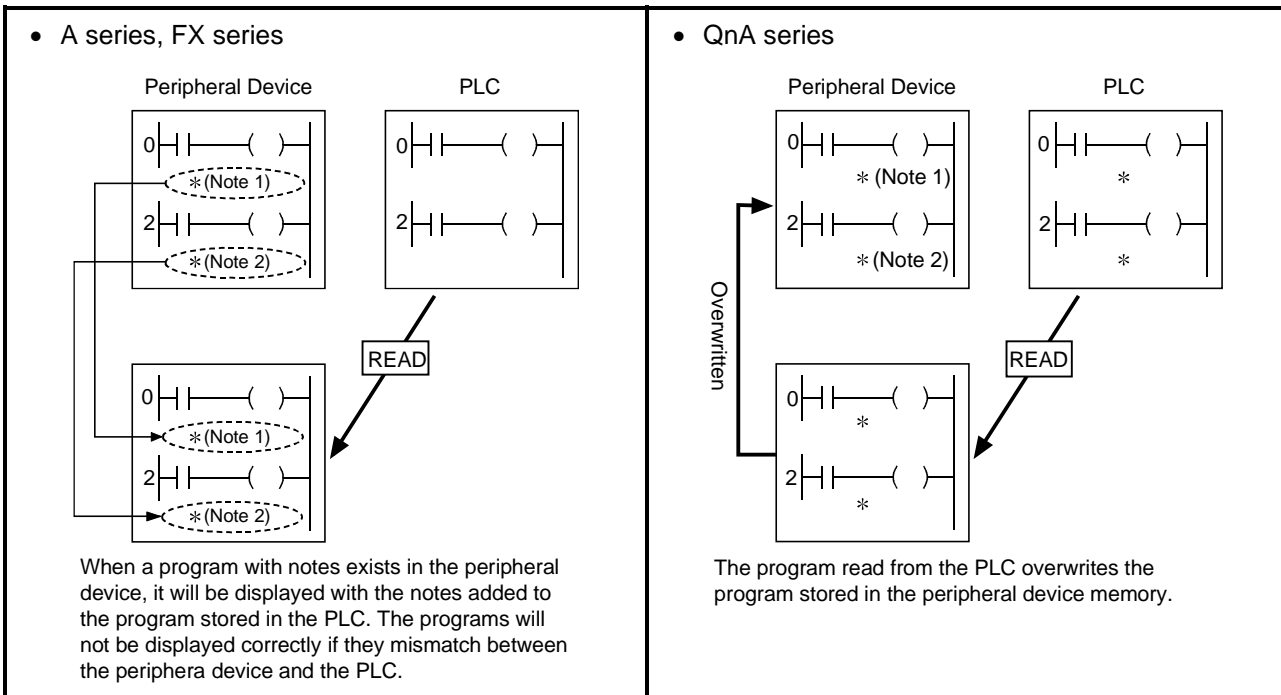

10.3 Creating and Deleting Statements

10.3.1 When editing the circuit window

10.3.1(1) Creating statements in the circuit edit window

A	Q/QnA	FX
○	○	○

[Operating Procedure]

1. Enter **[Insert]** key to set the insert mode.
2. Move the cursor to the position shown in the following figure.

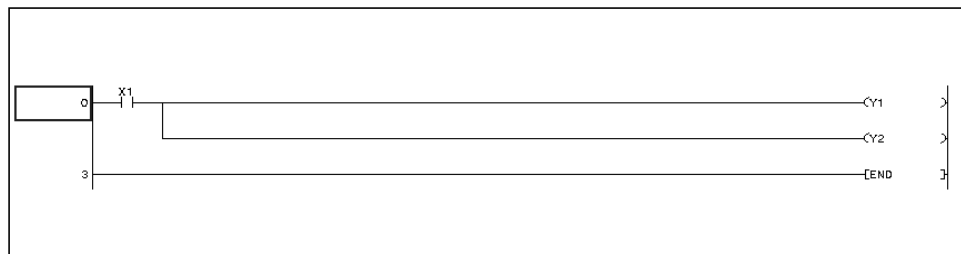

3. By entering a semicolon ";" the circuit input dialog box is displayed to enable the user to enter a statement.

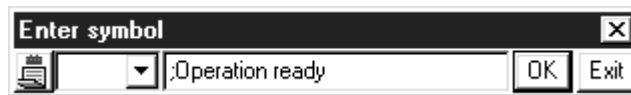

To enter a P or I statement, enter a semicolon (;) after entering a P or I pointer.  
(Example)

PI: P, I statement → **[ENTER]** key or **[OK]** key

↑  
Enter a desired statement.

4. After entering the statement, press **[Enter]** key or click the **[OK]** button.

<b>POINTS</b>
<ul style="list-style-type: none"> <li>• For switching integrated statements/peripheral statements on the Q/QnA series, see Section 6.4.10.</li> <li>• For displaying statements created, see Section 3.9.</li> </ul>

10.3.1(2) Deleting statements in the circuit edit window

A	Q/QnA	FX
○	○	○

[Operating procedure]

1. Move the cursor to the statement to be deleted, and press **Delete** key.

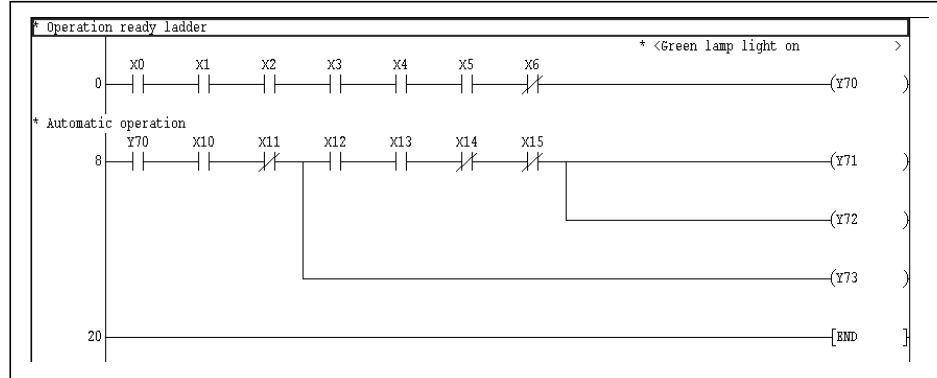

2. After the statement has been deleted, convert the program.

10.3.2 When editing the list window

10.3.2(1) Editing statements on the list edit window

A	Q/QnA	FX
○	○	○

1. Move the cursor to the head of the position to which a statement will be added.  
(Move the cursor to the head of the circuit block of a circuit.)
2. By entering a semicolon ";", the list input dialog box is displayed.



PI: P, I statement → **ENTER** key or **OK** key

↑  
Enter a desired statement.

3. Create a statement within up to 64 characters.  
Up to 255 characters can be entered in the text box.

<b>POINTS</b>
<ul style="list-style-type: none"> <li>• Statements will be displayed in the list mode at all times (it is impossible to not display statements).</li> <li>• For integrated statements and peripheral statements, see Section 10.1.</li> </ul>



10.3.2(2) Deleting statements on the list edit window

A	Q/QnA	FX
○	○	○

1. Move the cursor to the statement to be deleted.

```

;* Operation ready ladder
0 LD X1
1 MOV R0 K1M1
6 MOV R0 K4Y60
11 RST C1
14 LD X0
15 AND X4
16 AND X5
17 OR Y70
18 ANI X1
19 NC NO Y70
24 LD X2
25 MPS
26 ANI M1
27 ANI Y72
28 SET Y71
29 MPP
30 SET M1
31 LD Y71
32 ANI X2
33 OUT Y73
34 END
35
    
```

2. Press **Delete** key or **Shift** + **Delete** key.

```

0 LD X1
1 MOV R0 K1M1
6 MOV R0 K4Y60
11 RST C1
14 LD X0
15 AND X4
16 AND X5
17 OR Y70
18 ANI X1
19 NC NO Y70
24 LD X2
25 MPS
26 ANI M1
27 ANI Y72
28 SET Y71
29 MPP
30 SET M1
31 LD Y71
32 ANI X2
33 OUT Y73
34 END
35
    
```

10.3.3 Creating statements in the statement edit mode

A	Q/QnA	FX
○	○	○

[Purpose]  
Statements can be created easily

[Operating Procedure]

1. [Edit] → [Documentation] → [Statement] (  )
2. Move the cursor to the ladder block where you want to attach a statement.
3. Pressing **Enter** shows the following dialog box.

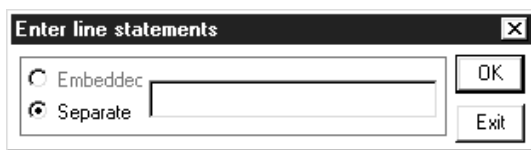

4. Enter a statement and click the **OK** button.

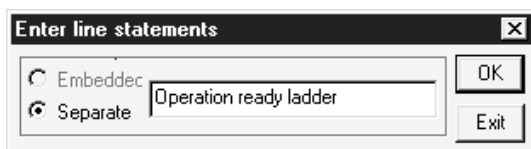

5. Providing a statement display shows the following ladder.

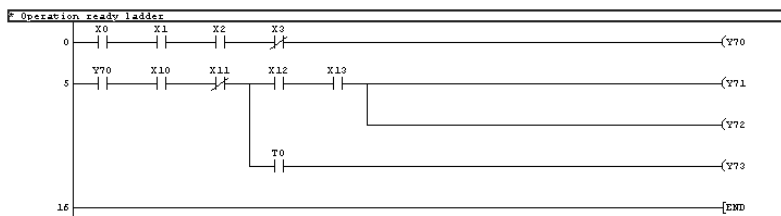

**POINT**

To cancel the statement edit mode, choose this menu again and uncheck the checked menu item.

10.4 Creating and Deleting Notes

10.4.1 Creating notes on the circuit edit window

10.4.1 (1) Creating notes on the circuit edit window

A	Q/QnA	FX
○	○	○

[Operating procedure]

1. Press **Insert** key to set the overwrite mode.  
Note that a circuit will be added by creating a note in the insert mode.
2. Move the cursor to the position shown in the following figure.

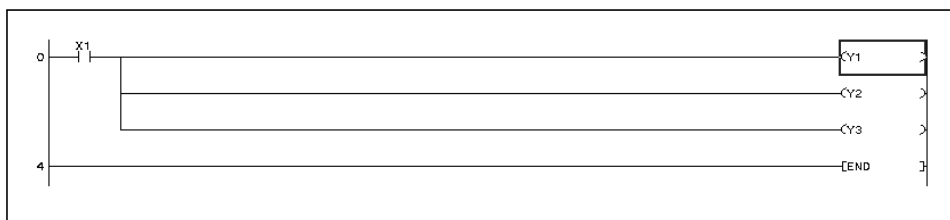

3. By pressing **Enter** key, the following dialog box is displayed.



4. Add a semicolon ";" after Y1, and enter a note.



5. After the note has been entered, press **Enter** key or click the **OK** button.

POINTS
<ul style="list-style-type: none"> <li>• For switching integrated notes and peripheral notes on the Q/QnA series, see Section 6.4.10.</li> <li>• For displaying notes created, see Section 3.10.</li> </ul>

10.4.1 (2) Deleting notes in the circuit edit window

A	Q/QnA	FX
○	○	○

[Operating procedure]

1. Press **Insert** key to set the overwrite mode.
2. Move the cursor to the note to be deleted, and press **Enter** key or double-click the **mouse** button.

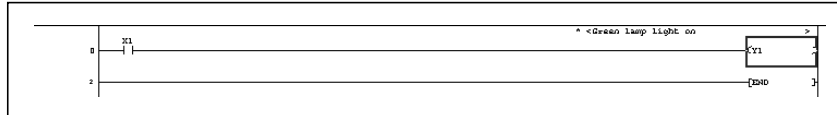

3. Delete the statement Green lamp lights when operation preparations are completed. after the semicolon ";".



4. After the statement has been deleted, press the **Enter** key or click the **OK** button.

## 10.4.2 Creating notes in the list edit window

---

### 10.4.2 (1) Creating notes in the list edit window

---

A	Q/QnA	FX
<input type="radio"/>	<input type="radio"/>	<input type="radio"/>

[Operating procedure]

1. Move the cursor to the head of the position to which a note will be added.  
(Move the cursor to the head of the circuit block of a circuit.)
2. By entering a semicolon ";", the list input dialog box appears.



3. Create a note within up to 64 characters.  
Up to 255 characters can be entered in the text box.

#### POINTS

- Notes will be displayed in the list mode at all times (it is impossible to not display statements).
- For integrated notes and peripheral notes, see Section 10.2.

10.4.2 (2) Deleting notes in the list edit window

A	Q/QnA	FX
○	○	○

[Operating Procedure]

1. Move the cursor to the note to be deleted.

```

: * Operation ready ladder
0 LD X1
1 MOV KO R1M1
6 MOV KO K4Y60
11 RST C1
14 LD X0
15 AND X4
16 AND X5
17 OR Y70
18 ANI X1
19 MC NO Y70
24 LD X2
25 MPS
26 ANI M1
27 ANI Y72
28 SET Y71
29 MPP
30 SET M1
31 LD Y71
32 ANI X2
33 OUT Y73
34 END
35
    
```

2. Press **Delete** key or **Shift** + **Delete** key.

```

0 LD X1
1 MOV KO K1M1
6 MOV KO K4Y60
11 RST C1
14 LD X0
15 AND X4
16 AND X5
17 OR Y70
18 ANI X1
19 MC NO Y70
24 LD X2
25 MPS
26 ANI M1
27 ANI Y72
28 SET Y71
29 MPP
30 SET M1
31 LD Y71
32 ANI X2
33 RST M1
34 SET M2
    
```

10.4.3 Creating notes in the note edit mode

A	Q/QnA	FX
<input type="radio"/>	<input type="radio"/>	<input type="radio"/>

[Purpose]  
Notes can be created easily

[Operating procedure]

1. [Edit] → [Documentation] → [Note] (  )
2. Move the cursor to the coil/application instruction where you want to attach a note.
3. Pressing **[Enter]** shows the following dialog box.

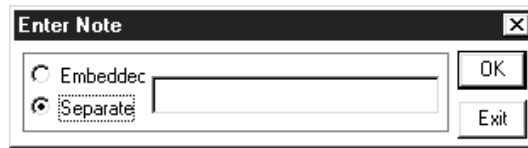

4. Enter a note and click the **[OK]** button.

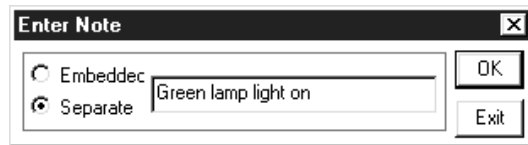

5. Providing a note display shows the following ladder.

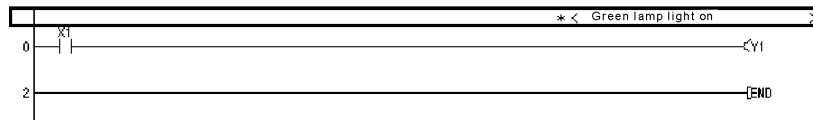

**POINT**

To cancel the note edit mode, choose this menu again and uncheck the  checked menu item.

# 11. SETTING DEVICE MEMORY (DWR SETTING)

## 11.1 Device Memory

A	Q/QnA	FX
○	○	○

Using device memory, data (for example, data registers, link registers, and file registers) can be set online or read from the PLC and edited.

Although setting data using device memory makes it unnecessary to create a program for initial setting using the sequence program, the original data will be overwritten with the operating values which will be written when the PLC is running. It is necessary to re-write data when the PLC mode is switched from reset to run.

- When data is not set using device memory

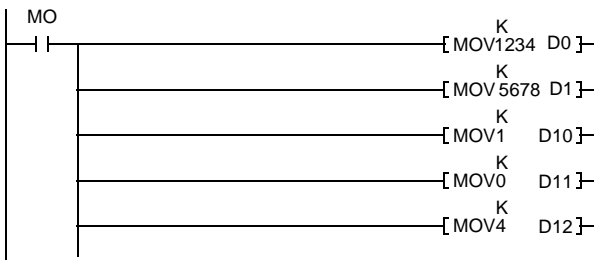

The above program is required.

- When device memory is set

Device Label:     Display:     DEC    D0-D25983

Device name	0	1	2	3	4	5	6	7	Character string
D0	0	0	0	0	0	0	0	0	.....
D8	0	0	0	0	0	0	0	0	.....
D16	0	0	0	0	0	0	0	0	.....
n>4	n	n	n	n	n	n	n	n	

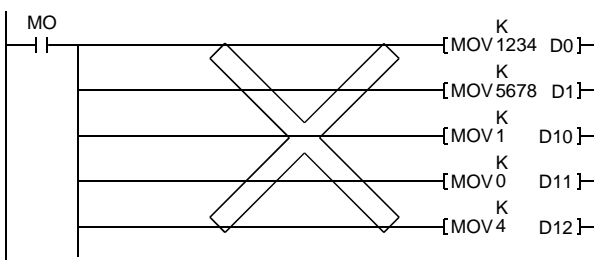

The above program is not required.

<b>POINT</b>
<ul style="list-style-type: none"> <li>• On the Q/QnA series, initial device values can be set using device memory. Refer to the following manuals for the device init.                      QnA series: QnA Programming Manual (Fundamentals)                      Q series : QCPU User's Manual (Function Explanations, Program Fundamentals)</li> </ul>



11.2 Device Value Input

A	Q/QnA	FX
○	○	○

[Purpose]  
Changes word device data in batch.

[Operating Procedure]  
Select [Project] → [Edit data] → [New], and set the data type (device memory), the name of the data to be added, and the comment.

[Dialog Box]

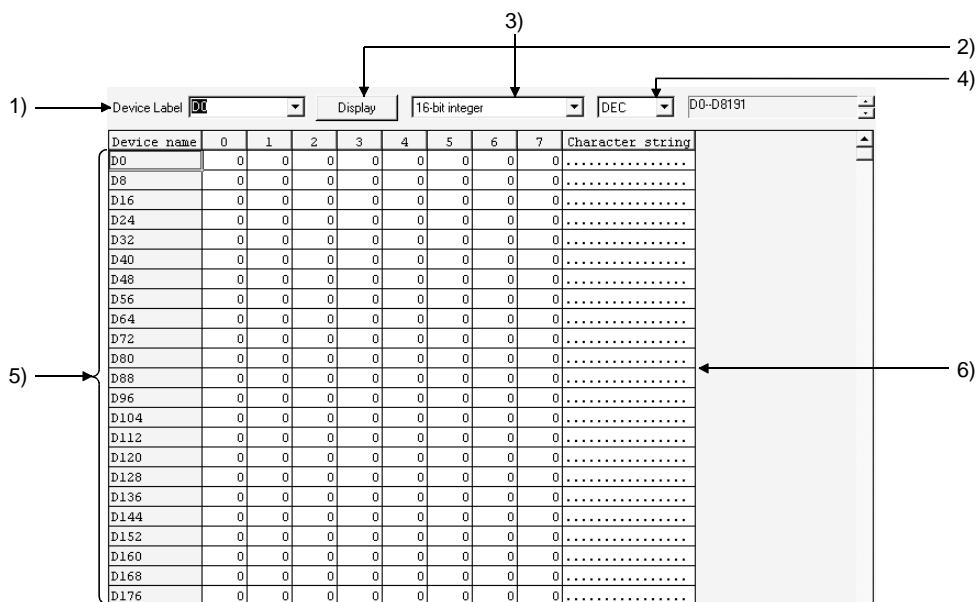

[Description]

1) Device name  
The types of devices that can be edited are listed below:

A series

Device Name	Symbol
Timer (Current value)	T
Counter (Current value)	C
Retentive timer	ST
Data register	D
Special register	SD
Link register	W
File register	R

Q/QnA series

Device Name	Symbol
Timer (Current value)	T
Counter (Current value)	C
Retentive timer (Current value)	ST
Data register	D
Special register	SD
Link register	W
Link special register	SW
File register	R
Through file register	ZR
I/O No. setting	U**/G***
Link No. setting	J**/W***
	J**/SW***

FX series

Device Name	Symbol	FX <sub>0</sub> FX <sub>0S</sub>	FX <sub>0N</sub>	FX <sub>1</sub>	FX, FX <sub>2</sub> FX <sub>2C</sub>	FX <sub>1S</sub>	FX <sub>1N</sub>	FX <sub>2N</sub> FX <sub>2NC</sub>
Data register	D	○	○	○	○	○	○	○
Special data register	D	○	○	○	○	○	○	○
File register	D	—	○	—	○	○	○	○
RAM file register	D	○	—	—	○	—	—	—

○ Can be edited — : No corresponding device.

- 2) Display button  
Click this button after a device has been set.
- 3) Display switching  
You can change the screen values to the 16-bit integer, 32 bit integer, fixed decimal point or floating decimal point.
- 4) Display switching  
Switches the display form on the edit screen between decimal and hexadecimal.
- 5) Device Value Input  
The device value input ranges are as follows.

Display Format Changing	Numeric Input Range	
16-bit integer	Decimal	-32768 to 32767
	Hexadecimal	0000 to FFFF
32-bit integer	Decimal	-2147483648 to 2147483647
	Hexadecimal	00000000 to FFFFFFFF
Fixed decimal point	According to the number of integer part digits <Example> If the number of integer part digits is 9 0, 0.01 to 999999999 -999999999 to -0.01	
Floating decimal point	-3.402823e+38 to 3.402823e+38	

To enter a character string (ASCII) in the device value input field, move the cursor to the desired device number and set the data.  
The number of characters accepted is 64.

POINTS
<ul style="list-style-type: none"> <li>• When setting device memory in a peripheral device Data can be edited or stored, irrespective of the parameter setting range.</li> <li>• When writing data to the PLC Data will be written within the parameter setting range.</li> </ul>

- 6) Character string input field  
Move the cursor to the position where you want to set data, and enter the characters or press the space key. The following dialog box then appears.



The maximum number of characters that may be entered is 64.

If there is the existing data, the 16 characters of the character string in the selected position appear as a default.

Enter the character string (ASCII) data as follows.

<Example> To set "Device memory input"

Entering "Device memory input" in the D0 to D7 position of the character string input column sets the data, starting from D0.

The first setting position of data is always the device number of a multiple of 8, e.g. D0, D8, D16 ...

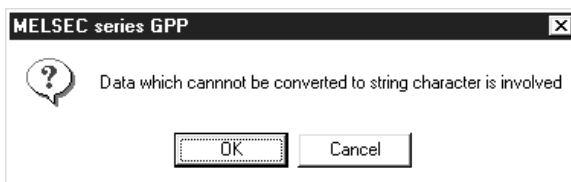

When copying/pasting the character string field that has no data, the following dialog box appears.

Note that clicking the **OK** button will set "." (2E2EH) as data.

- 7) Device number change (ZR only)  
When setting ZR, click the ▲ or ▼ button to change the device number in steps of 32K points.

POINTS
<ul style="list-style-type: none"> <li>• When setting the device memory on a peripheral device You can edit or save without following the parameter setting range.</li> <li>• When performing PC write Write the range set in the parameter.</li> <li>• Refer to Section 6.4 for retrieval and substitution of device memory.</li> <li>• A2N(S1), A2A(S1), A2U(S1), and A2US(S1) are set so that the default value of the device memory is 1024 points at the read/write to them. Change the range setting to within 512 points when data is read or written to A2N, A2A, A2U, or A2US.</li> </ul>

## 11.3 All Clear

---

### 11.3.1 Clearing all devices

---

A	Q/QnA	FX
<input type="radio"/>	<input type="radio"/>	<input type="radio"/>

[Purpose]

Clears all device values for which device memory is set.

[Operating Procedure]

Display the device memory edit window, and select [Edit] → [Clear all (all clear)].

### 11.3.2 Clearing all display devices

---

A	Q/QnA	FX
<input type="radio"/>	<input type="radio"/>	<input type="radio"/>

[Purpose]

Clears device values displayed in the window, for which device memory is set.

[Operating Procedure]

Display the device memory edit window, and select [Edit] → [Clear all (displayed devices)].

11.4 Making Fill Settings

A	Q/QnA	FX
<input type="radio"/>	<input type="radio"/>	<input type="radio"/>

[Purpose]

Writes the same data to consecutive devices in batch.

[Operating Procedure]

Display the device memory edit window, and select [Edit] → [FILL] or press  .

[Dialog Box]

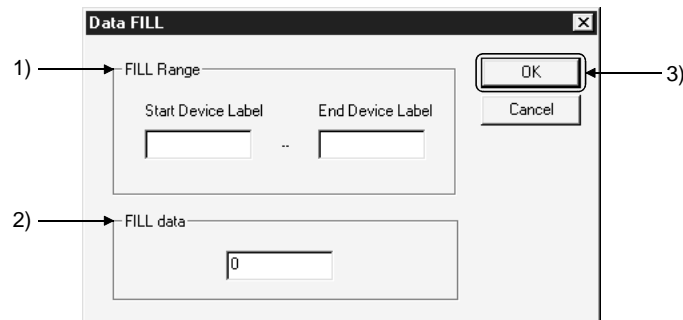

[Description]

- 1) FILL Range  
Designates the devices to which the same data will be batch-written.  
<Example of device designation>  
D10-D20, T0-T30
- 2) FILL data  
Designates the data to be batch-written.  
Designate the data in the numeric form on the device memory edit window.
- 3)  button  
Click this button after the setting has been completed.

# 12 SETTING DEVICE INITIALIZATION VALUES

A	Q/QnA	FX
×	○	×

**[Purpose]**

Utilizes the device values set in the device memory edit dialog box as device initial values.

**[Operating Procedure]**

Set the type and name of the data to be added in the dialog box displayed by selecting [Project] → [Edit data] → [New].

**[Dialog Box]**

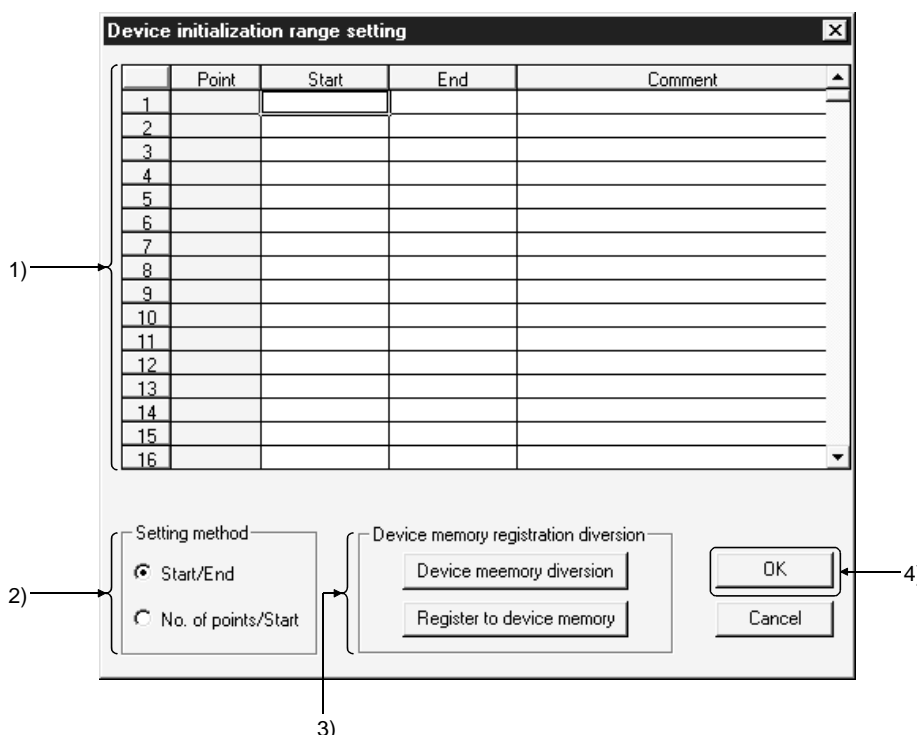

**[Description]**

1) Range to be set

Up to 8,000 points (8K words) can be set within a range.  
Each comment can be set within 32 characters.

The devices, which can be treated as initial values, are listed below:

Device Name	Device
Timer	The present value of T.
Retentive Timer	The present value of ST.
Counter	The present value of C.
Data register	D
Special register	SD
Link register	W
Link special register	SW
File register	R, ZR
Special direct device	U*/G*
Link direct device	J*/W*, J*/SW*

- 2) Setting method  
Set the range of the devices to be set for device initial values by specifying [Start/End] or [No. of point/start] Device
- 3) Device memory registration diversion  
 button
  - ⊙ All devices  
All devices set in the device initial value range setting dialog box are entered as device initial values.
  - ⊙ Range to be set  
Choose the necessary device range out of the devices set in the device initial value range setting dialog box, and enter it as device initial values.  
Since the devices set in the device initial value range setting dialog box can be candidates, the devices not entered cannot be set.  
<Example>  
D0-D10, W0-W30 button  
The data set to the device initial values are reflected on the device memory.  
The data not set to the device initial values are not reflected.
- 4)  button  
Click this button after the setting has been completed.

[Operating procedure] (Device data diversion)

1. Create new device memory.
2. Create device initial values in the device memory edit dialog box.
3. Create new device initial values.
4. Set the device initial values in the device initial value range setting dialog box.
5. Click the Device memory diversion button.
6. Choose All devices or Range to be set and click the Execute button.
7. Click the OK button in the device initial value range setting dialog box.  
If you click Cancel, the data are not reflected.

POINT
-------

- |   |
|---|
| <ul style="list-style-type: none"><li>• To treat each device value, to which the range is set, as an initial value when starting the PLC, use the PLC file setting function for PLC parameters.</li></ul> |
|---|

# 13. SETTING THE PLC PARAMETERS

This manual explains only operations for the parameters.

For any information or particular explanation required for parameter setting, refer to the corresponding CPU user's manual and programming manual to pre-design them.

The setting items are assigned to the tab screen purpose-by-purpose.

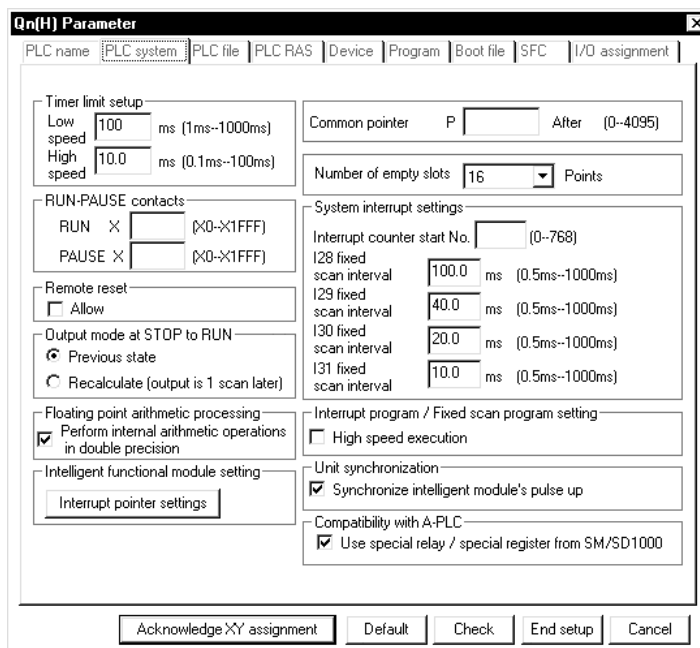

**REMARKS**

The following comparison table indicates the parameter item setting locations of GPPA and GPPW because of the differences between them.

GPPA		GPPW/GPPQ
LATCH RANGE		Device
Supplementary settings		
STEP RELAY, TIMER, COUNTER		Device
RUN-PAUSE contacts, Output mode at STOP to RUN, Interrupt counter		PLC system
WDT setup, Operating mode when there is an error, Annunciator display mode		PC RAS
Data communications request batch processing		PLC system
MINI automatic refresh setting		Network parameter
Network/link setting		Network parameter

The following comparison table indicates the parameter item setting locations of FXGP(DOS), FXGP(WIN) and GPPW because of the differences between them.

FXGP (DOS)	FXGP (WIN)	GPPW
Latch range	Latch range	Device setting
Program title setting	Print title setting	PLC name setting
PLC mode setting	PLC mode setting	PLC system setting (1)
Serial communication setting	Serial communication setting	PLC system setting (2)
—	Device assignment	I/O assignment setting



13.1 Common Notes on Parameters

A	Q/QnA	FX
○	○	○

[Parameter display]

This part describes the setting item tabs and network parameter setting items.

<Example>



The meanings of the symbols are the same also when displayed with network parameters.

Red : The PLC does not operate until data is set. (Data is not set.)

Blue : Data is set.

Magenta : The PLC operates without setting data or with the default. (Data is set.)

Dark blue : Data is set. (Data is set.)

[Common notes on parameters]

This part describes the settings common to PLC and network parameters.

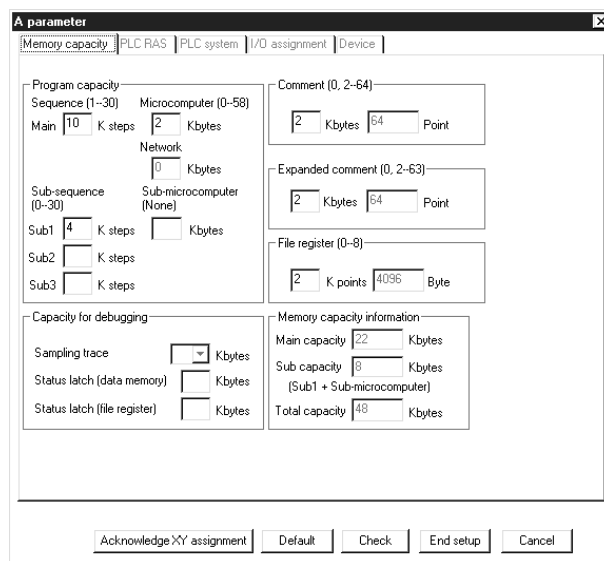

**Default** button

Returns all of the set items or values to the previous settings. This button is available only for the currently open tab.

**Check** button

Used to check the set items or values to see if they are correct. This button is available only for the currently open tab.

**End setup**

Defines the set items or values and terminates the setting.

**Cancel** button

Cancels the set items and terminates editing.

**Acknowledge X/Y Assignment** button

This button is available for the models A2ACPU(S1), A3ACPU, A2AS(S1), A2AS-S30, A2AS-S60, A2UCPU(S1), A2USCPU(S1), A2USHCPU(S1), A3UCPU, A4UCPU, and QnACPU.

It is used to confirm the X/Y assignment numbers of the data set in the I/O assignment setting.

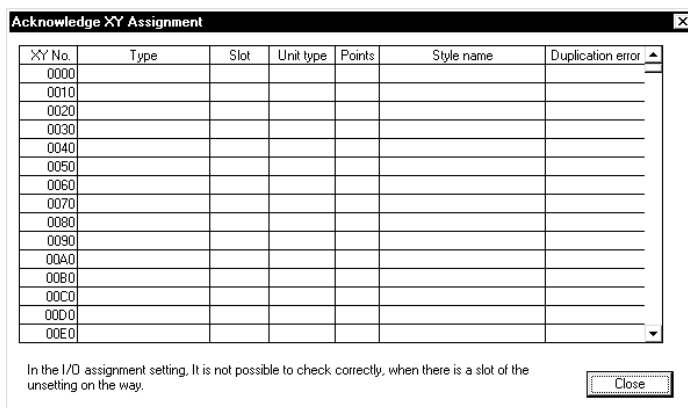

Display by type

Display	Description
I/O assignment	Displays I/O assignment information.
MINI	Displays I/O assignment information and MINI automatic refresh setting information.
CC-Link	Displays I/O assignment information and CC-Link automatic refresh setting information.
NET (II)	Master station : Displays I/O assignment information and refresh parameter information.
	Local station : Displays I/O assignment information and refresh parameter information.
NET/10	PLC-to-PLC network, remote I/O network : Displays network parameter information.

The priority of display is shown below:

1. I/O assignment (AnACPU, AnUCPU, QnA series)
2. Fourth MELSECNET network refresh parameter (AnUCPU, QnA series)
3. Third MELSECNET network refresh parameter (AnUCPU, QnA series)
4. Second MELSECNET network refresh parameter (AnUCPU, QnA series)
5. First MELSECNET network refresh parameter (AnUCPU, QnA series)
6. MELSECNET/MINI refresh (AnACPU, AnUCPU, QnA series)
7. CC-Link remote I/O (QnA series)

The Duplicate Error area displays the first duplicate item detected in checking the items according to the priority.

Duplicate Error	Description
First NET	First MELSECNET network parameter
Second NET	Second MELSECNET network parameter
Third NET	Third MELSECNET network parameter
Fourth NET	Fourth MELSECNET network parameter
MINI	MELSECNET/MINI refresh
CC-Link	CC-Link remote I/O

## 13.2 Setting the PLC Parameters

A	Q/QnA	FX
○	○	○

The following table lists the PLC parameter setting items on a series basis.  
Set the parameters as required.

	A	QnA	Q	FX
PLC name	×	○	○	○
PLC system	○	○	○	○
PLC file	×	○	○	×
PLC RAS	○	○	○	×
Device	○	○	○	○
Program	×	○	○	×
Boot file	×	○	○	×
SFC	×	○	○	×
I/O assignment	○	○	○	○
Memory capacity	○	×	×	○

13.3 PLC Parameter Item Lists

A	Q/QnA	FX
○	○	○

The PLC parameter items of each series are listed below.  
 (1) PLC parameter item list of the Q series

PLC name

- Device Label  
Set the CPU label.
- Comment  
Set the CPU comment.

PLC system

- Timer limit setup  
Set the time limits of the low-/high-speed timers.
- RUN-PAUSE contacts  
Make setting to control RUN/PAUSE of the CPU.
- Remote reset  
Set enable/disable of remote reset operation.
- Output mode at STOP to RUN  
Set the output mode at STOP to RUN.
- Floating point arithmetic processing  
Make setting to perform floating point arithmetic operation at high speed.
- Intelligent functional module setting  
Set the assignment of the interrupt pointers (I50 to I255) and the first I/O No. and first SI No. of the intelligent function unit.
- Common pointer  
Set the first No. of the common pointers.
- Number of empty slots  
Set the number of empty slots.
- System interrupt settings  
Set the first No. of the interrupt counters and the fixed scan intervals of the interrupt pointers.
- Interrupt program/Fixed scan program setting  
Set whether the interrupt/fixed scan program is run at high speed or not.
- Unit synchronization  
Set whether the start of the QCPU is synchronized with that of the intelligent function unit.
- Compatibility with A-PLC  
Set whether the special relays/special registers for MELSEC-A series (SM1000/SD1000 and later) are used or not.

PLC file

- File register  
Set the file register file to be used.
- Comment file used in a command  
Set the comment file to be used in a command.
- Device initial value  
Set the device initial value file to be used.
- File for local device  
Set the local device file to be used.

Device

- Dev. point  
Set the number of device points to be used.
- Latch [1] start  
Set the latch range valid for latch clear key operation.
- Latch [2] start  
Set the latch range invalid for latch clear key operation.
- Local dev. start  
Set the range of the device used as a local device.

**PLC RAS**

- WDT [Watchdog timer] setup
  - WDT setting
  - Initial execution
  - Low speed execution  
Make WDT settings of the CPU.
- Error check  
Set whether the specified error is to be detected or not.
- Operating mode when there is an error  
Set the display mode of the CPU on detection of an error.
- Constant scanning  
Set the constant scan time.
- Low speed program execution time  
Set the time for execution of a low-speed program.
- Breakdown history  
Set the storage target of the CPU's breakdown history.

**SFC**

- SFC  
Make various settings needed for an SFC program.

**I/O assignment**

- I/O assignment
  - Set each unit loading status of the system.
  - Make switch settings of the intelligent function unit.
- Standard setting  
Set the base model, power supply unit model, etc.

**Program**

- Program  
Set the execution type for use of multiple programs.

**Boot file**

- Boot file setup  
Set the boot-run file, etc.

(2) PLC parameter item list of the QnA series

PLC name

- Device label  
Set the CPU label.
- Comment  
Set the CPU comment.

PLC system

- Timer limit setup  
Set the time limits of the low-/high-speed timers.
- RUN-PAUSE contacts  
Make setting to control RUN/PAUSE of the CPU.
- Remote reset  
Set enable/disable of remote reset operation.
- Output mode at STOP to RUN  
Set the output mode at STOP to RUN.
- General data processing  
Set the number of units to be handled by single general data processing.
- Common pointer  
Set the first No. of the common pointers.
- Number of empty slots  
Set the number of empty slots.
- System interrupt settings  
Set the first No. of the interrupt counters and the fixed scan intervals of the interrupt pointers.

PLC file

- File register  
Set the file register file to be used.
- Comment file used in a command  
Set the comment file to be used in a command.
- Device initial value  
Set the device initial value file to be used.
- File for local device  
Set the local device file to be used.

Device

- Dev. point  
Set the number of device points to be used.
- Latch [1] start  
Set the latch range valid for latch clear key operation.
- Latch [2] start  
Set the latch range invalid for latch clear key operation.
- Local dev. start  
Set the range of the device used as a local device.

PLC RAS

- WDT [Watchdog timer] setup
  - WDT setting
  - Initial execution
  - Low speed execution  
Set the WDT timers of the CPU.
- Error check  
Set whether the specified error is to be detected or not.
- Operating mode when there is an error  
Set the display mode of the CPU on detection of an error.
- Constant scanning  
Set the constant scan time.
- Low speed program execution time  
Set the time for execution of a low-speed program.
- Annunciator display mode
  - Display F No.
  - Display comment
  - Display occurrence time
 Set the display mode established when the annunciator has turned on.
- Breakdown history  
Set the storage target of the CPU's breakdown history.

SFC

- SFC  
Make various settings needed for an SFC program.

I/O assignment

- I/O assignment  
Set each unit loading status of the system.
- Standard setting  
Set the base model, power supply unit model, etc.

Program

- Program  
Set the execution type for use of multiple programs.

Boot file

- Boot file setup  
Set the boot-run file, etc.

(3) PLC parameter item list of the A series

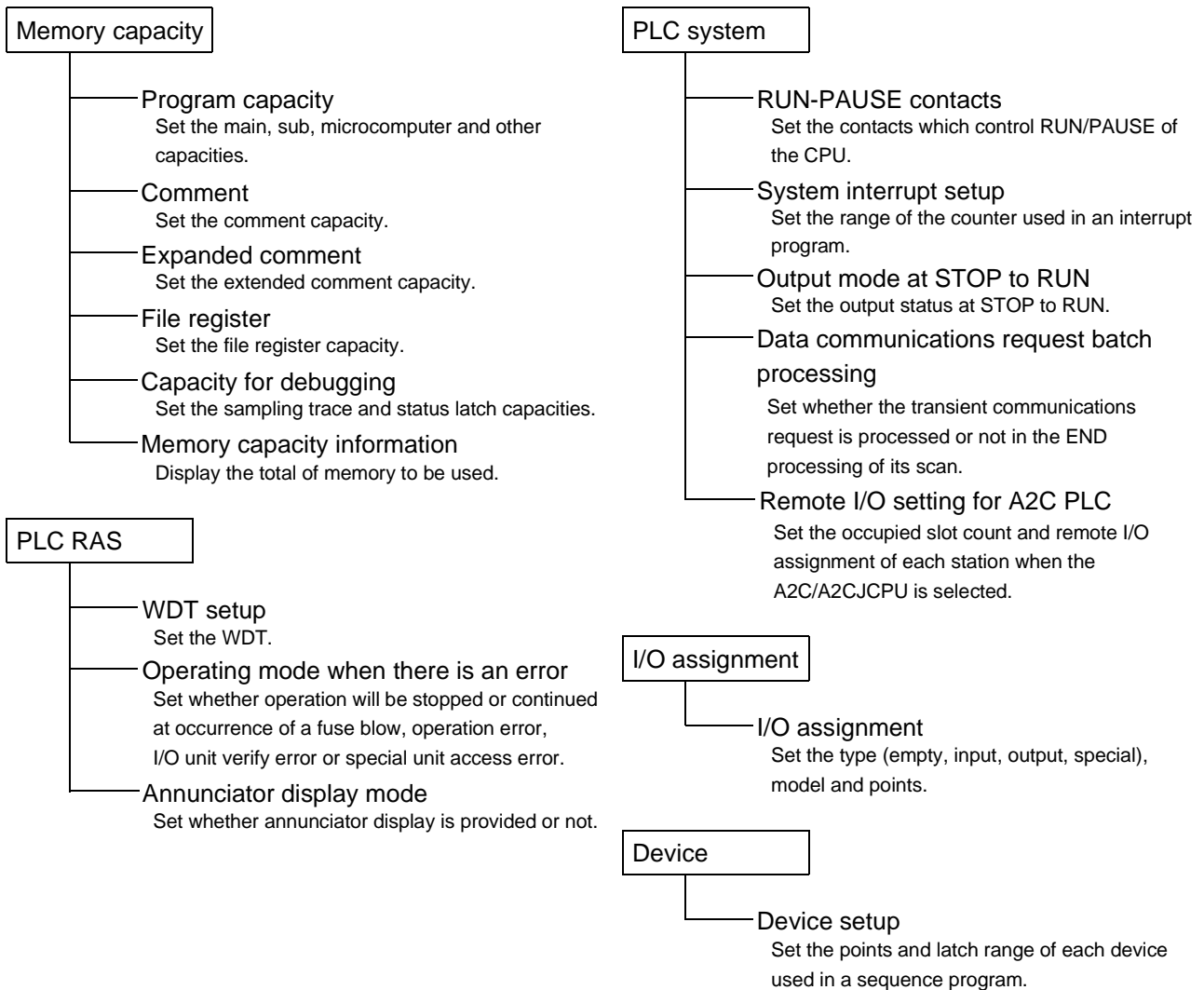



(4) PLC parameter item list of the FX series

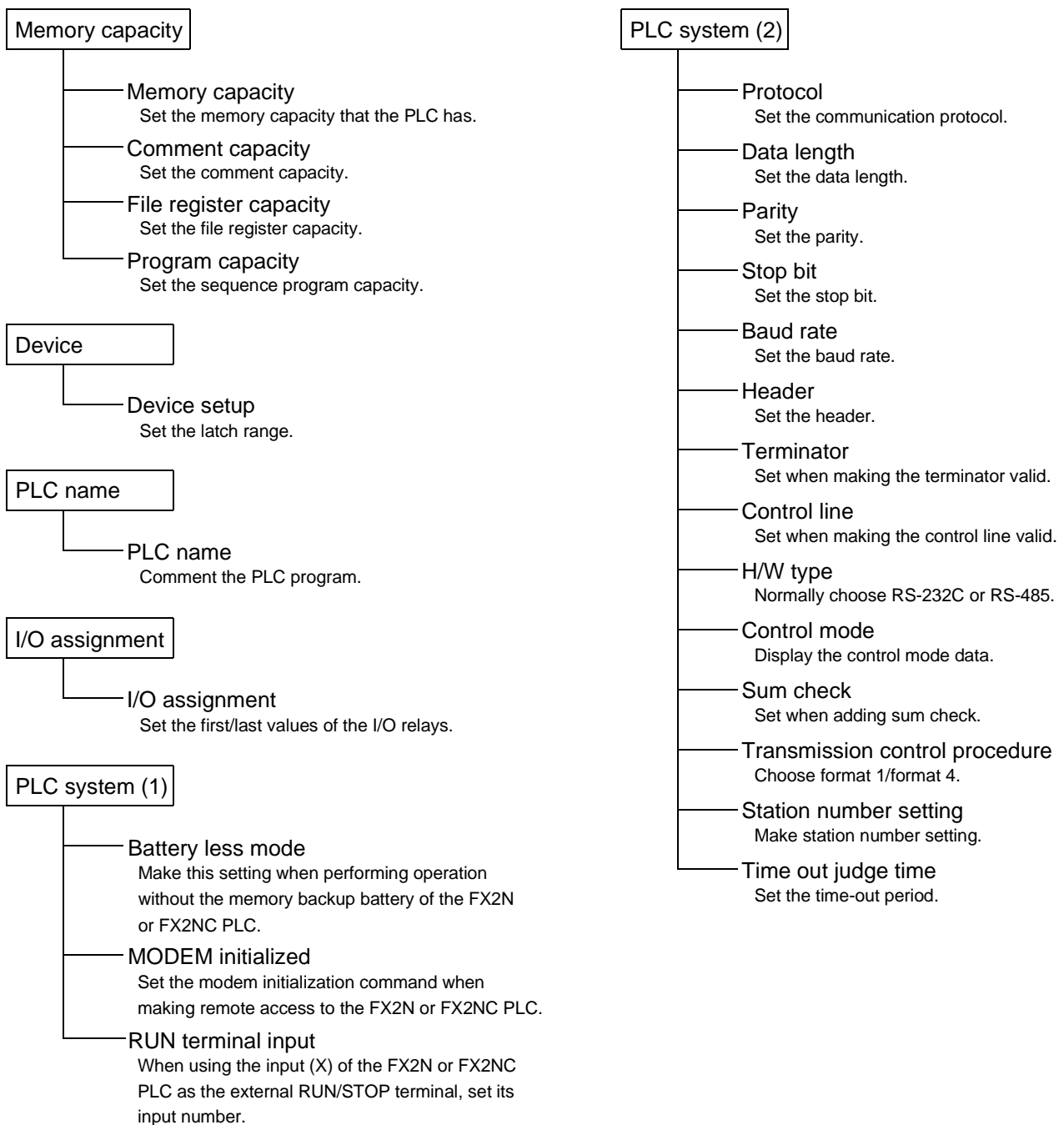

## 13.4 Explanations for PLC Parameter Setting Screen

A	Q/QnA	FX
×	○	×

The following items are related to network parameter setting.

1. **Read PLC data** button  
Location of Read PLC data button  
[PLC parameter] → (I/O assignment) tab

For Q series

The implementation status is read if the parameter file exists in the PLC.

If the unit model, first X/Y, base model, power supply unit model, extension cable model and slot count have been set on the peripheral device, the data will be deleted.

If the parameters have been set on GPPW, the following dialog box appears to ask you if the parameter data may be overwritten.

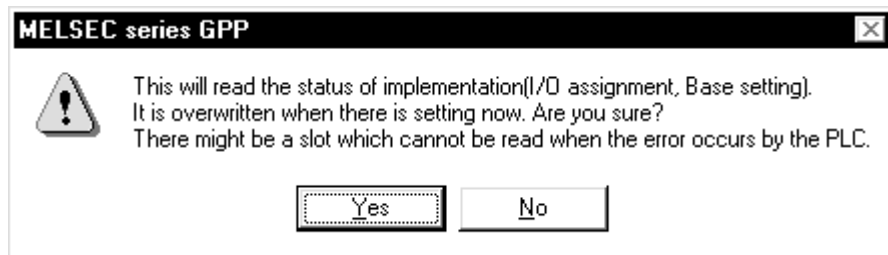

For QnA series

When the parameter file exists in the PLC

- The parameter file is read.

When the parameter file does not exist in the PLC (implementation read)

- After deleting the parameter file in the PLC, set the PLC from RESET to RUN and read the PLC data.  
If the unit model, first X/Y, base, power supply unit and extension cable have been set on the peripheral device, the data will be deleted.

# MEMO

---

---

---

---

---

---

---

---

---

---

---

---

---

---

---

---

---

---

---

---

---

---

---

---

---

---

---

---

---

---

# 14. SETTING THE NETWORK PARAMETERS

This manual explains only operations for the parameters. For any information or particular explanation required for parameter setting, refer to the corresponding CPU user's manual and programming manual.

## [MELSECNET/Ethernet setting screen] (for Q series)

	Unit 1	Unit 2	Unit 3	Unit 4
Network type	MNET/10H mode (Control station)	MNET/10H mode (Normal station)	MNET/10 mode (Control station)	Ethernet
Starting I/O No.	0000	0020	0040	0060
Network No.	1	2	3	4
Total stations	3	3	3	3
Group No.	0	0	0	0
Station No.				1
Mode	On line	On line	On line	On line
	Network range assignment	Station inherent parameters	Network range assignment	Operational settings
	Refresh parameters	Refresh parameters	Refresh parameters	Initial settings
	Interrupt settings	Interrupt settings	Interrupt settings	Open settings
	Return as control station		Return as control station	Routing information
				MNET/10 routing information
				FTP parameters
				E-mail settings
				Interrupt settings

Necessary setting: No setting / Already set | Set if it is needed: No setting / Already set

Start I/O No.:  Valid unit during other station access:

Intealink transmission parameters: Please input the starting I/O No. of the unit in Hexadecimal(16 bit) form

Acknowledge XY assignment | Routing parameters | Assignment image | Check | End setup | Cancel

## [MELSECNET/MINI setting screen] (for QnA series)

No. of boards in  Boards 0: MELSECNET MINI unit is not recognized. Blank: Operation is by the default values.

	1	2	3	4	5	6	7	8
Start I/O No.								
Model name	MINI-S3							
Station count								
Batch refresh receive data	X1000							
Batch refresh send data	Y1000							
Retrv	5							
Response	PLC							
Error data clear	Clear							
Abnormal station detection bit data								
Abnormal communication remote								
Circuit error check	Maintain							
STOP time operation	Stop							

Setting item

Acknowledge XY assignment | Clear | Check | End setup | Cancel

## [CC-Link setting screen] (for Q series)

No. of boards in  Boards Blank: no setting 0 boards: Set by the sequence program.

	1	2	3	4
Start I/O No.				
Operational settings	Operational settings			
Type	Master station			
Master station data link type	PLC parameter auto start			
Mode	Online (Remote net mode)			
All connectcount	64			
Remote input(PX)				
Remote output(PY)				
Remote register(RW)				
Remote register(RWw)				
Special relay(SB)				
Special register(SW)				
Retry count	3			
Automatic reconnection station count	1			
Wait master station No.				
PLC down select	Stop			
Scan mode setting	Asynchronous			
Delay information settings	0			
Station information settings	Station information			
Remote device station initial	Initial settings			
Interrupt settings	Interrupt settings			

Indispensable settings: No setting / Already set | Set if it is needed: No setting / Already set

Setup item details:

Acknowledge XY assignment | Clear | Check | End setup | Cancel

14.1 About Items Common to the Network Parameters

[Purpose]

This section describes operations common to the setting of data link system and network system parameters.

The setting examples use MELSECNET II comp (Master station) and MELSECNET/10 network range assignment parameters.

The following operations cannot be performed as those common to the parameters.

- Cut, copy, paste
- [Home] and [End] keys are invalid.

[Dialog Box]

<Example> MELSECNET II combined (master station) network range assignment parameter setting window

Setup common parameters

Assignment method

No. of points/Start

Start/End

Supplementary settings

Monitoring time  × 10ms

Total No. of link slave stations

Switch screens

L/R station No.	Send range for each station			Send range for each station			M station -> R station			M station <- R station		
	First half LB			First half LW			LW			LW		
	Point	Start	End	Point	Start	End	Point	Start	End	Point	Start	End
M 0												
L 1												
L 2												
L 3												

Specify local

Specify remote

Specify MNET II local

Assign the same point to each station

Clear

Check

End setup

Cancel

[Description]

[Specify local] / [Specify remote] / [Specify MNET II local] button

Move the cursor to the L/R station No. to be specified, and click the corresponding button.

[Assign the same point to each station] button

Used to assign the same point to each local station.

[Clear] button

Used to default the preset parameters.

[Check] button

Used to check the preset parameter data.

[End setup] button

Clicking this button at the end of data setting returns to the network setting screen.

[Dialog Box]

<Example> MELSECNET/10 network range assignment

Setup common and station inherent parameters.

Assignment method  
 No. of points/Start  
 Start/End

Supplementary settings  
 Monitoring time  ×10ms  
 No. of link slave stations

Parameter name

Switch screens

StationNo.	Send range for each station			Send range for each station								
	LB			LW								
	Point	Start	End	Point	Start	End	Point	Start	End	Point	Start	End
1												
2												

I/O Master station specification	Reserved station specification	Equal assignment	Identical point assignment	<input type="text" value=""/> Points	
Supplementary settings	Station inherent parameters	Clear	Check	End setup	Cancel

[Description]

**I/O Master station specification** button

Using Switch screens to choose LX/LY settings enables the I/O master station to be specified. To set the I/O master station, specify the station number with the cursor and click the **I/O Master station specification** button.

**Reserved station specification** button

Specify the reserved station No. and click this button.

**Equal assignment** button

Used to assign the link device points of all stations equally. The first and last stations can be set within the number of stations between the first and last equally assigned station numbers (total number of link stations - (first station number - 1)).

**Identical point assignment** button

Used to make simple assignment with the same points according to the preset total number of stations.

**Supplementary settings** button

Used to set the constant scan, max. number of reconnected stations during 1 scan, multiple transmission, communications error setting and transient setting.

**Station inherent parameters** button

Used to change the network unit storage locations of the link devices assigned to each station in the common parameters.

**Clear** button

Used to default the parameter settings.

**Check** button

Used to check the preset parameter data.

**End setup** button

Clicking this button at the end of data setting returns to the network setting screen.

## 14.2 Setting the Network Parameters

A	Q/QnA	FX
○	○	×

The following table lists the network parameter setting items on a series basis.  
Set the parameters as required.

	A			QnA	Q
	AnNCPU	AnACPU	AnUCPU QCPU (A mode)		
MELSECNET	○	○	○	○	×
MELSECNET II	×	○	○	○	×
MELSECNET/10	×	×	○	○	○
MELSECNET/10H	×	×	×	×	○
MELSECNET/MINI	○	×	○	○	×
CC-Link	×	×	×	○	○
Ethernet	×	×	×	○	○

### 14.3 Network Parameter Item Lists

The network parameter items of each series are listed below.  
 (1) Network parameter items of the Q series

**MELSECNET/10(H)**

- Network type  
Specify the MELSECNET/10H mode, MELSECNET/10 or Ethernet.
- Starting I/O No.  
Set the first I/O No.
- Network No.  
Set the network No.
- Total stations  
Set the total number of (slave) stations.
- Group No.  
Set the group No.
- Mode  
Set the mode.
- Network range type (Common parameters)
  - I/O Master station specification  
Set the I/O master station on the LX/LY setting screen.
  - Reserved station specification  
Specify the reserved station.
  - Equal assignment  
Set when assigning the link device points of the specified stations equally.
  - Identical point assignment  
Set the same points according to the preset total number of stations.
  - Supplementary settings  
Make the transient, low-speed cyclic and other settings.
  - Station inherent parameters  
Set the station inherent parameters.
- Refresh parameters  
Set the refresh parameters.
- Interrupt settings  
Set the device code, detection method, interrupt condition, interrupt (SI) No., etc.

**Ethernet**

- Network type  
Specify the MELSECNET/10H mode or Ethernet.
- Starting I/O No.  
Set the starting I/O No.
- Network No.  
Set the network No.
- Group No.  
Set the group No.
- Station No.  
Set the station number.
- Mode  
Set the mode.
- Operational settings  
Make the communications data code setting, initial timing setting and IP address setting.
- Initial settings  
Make the timer setting and DNS setting.
- Open settings  
Make the open settings.
- Routing information  
Set the router relay function, sub-net mask pattern, default router IP address, etc.
- MNET/10 routing information  
Set the MNET/10 routing system, net mask pattern, etc.
- FTP Parameters  
Set the login name, password, command input watchdog timer, CPU watchdog timer, etc.
- E-mail settings
  - General setting  
Set the password, mail address, etc.
  - Mail server name  
Set the SMTP server name and IP address.
  - Mail receive setting  
Set the POP server name and IP address.
  - Send mail address setting  
Set the mail address.
  - News setting  
Set the condition device, monitor condition, etc.
- Interrupt settings  
Set the detection method, interrupt condition, interrupt (SI) No., etc.



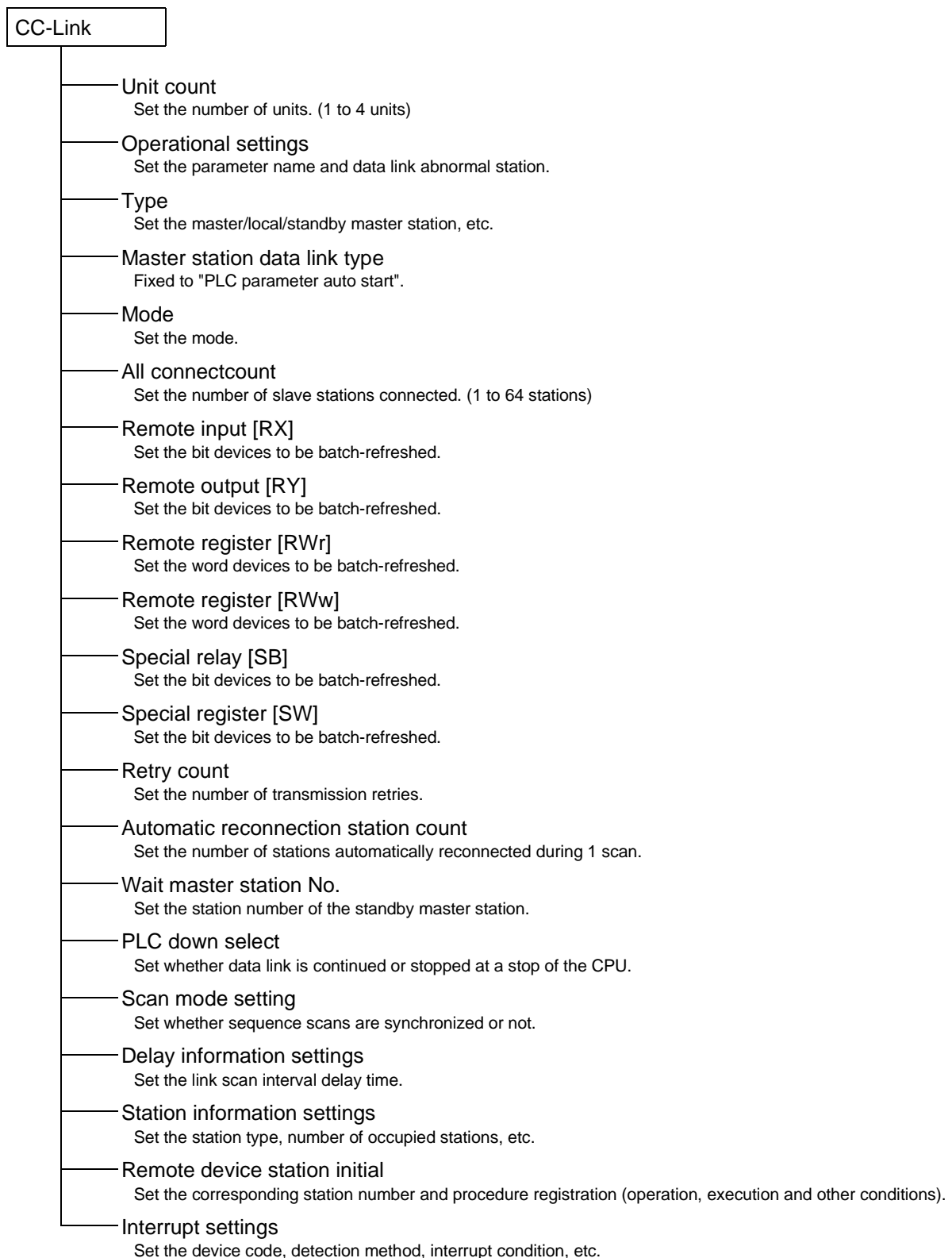

(2) Network parameter items of the QnA series

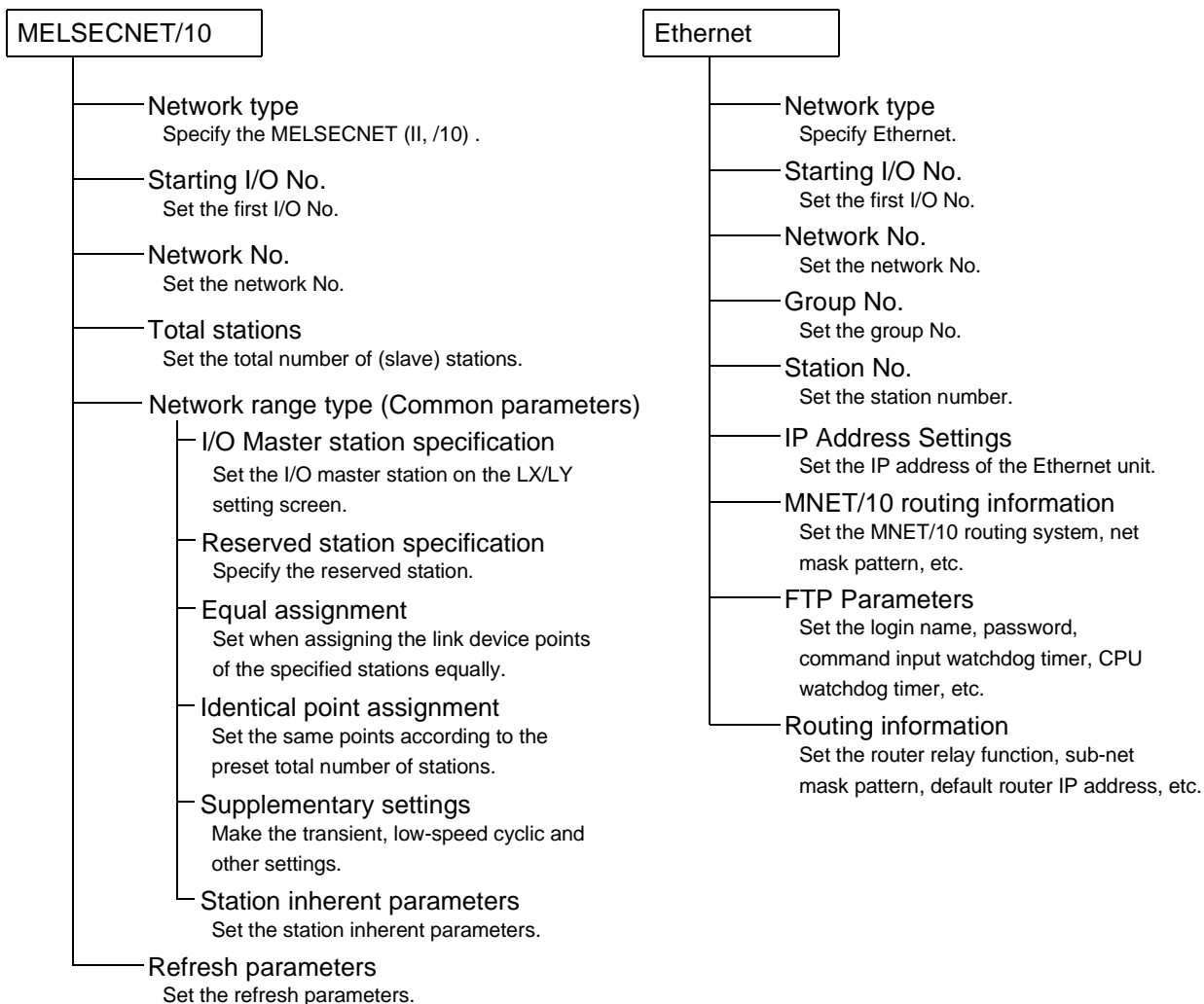

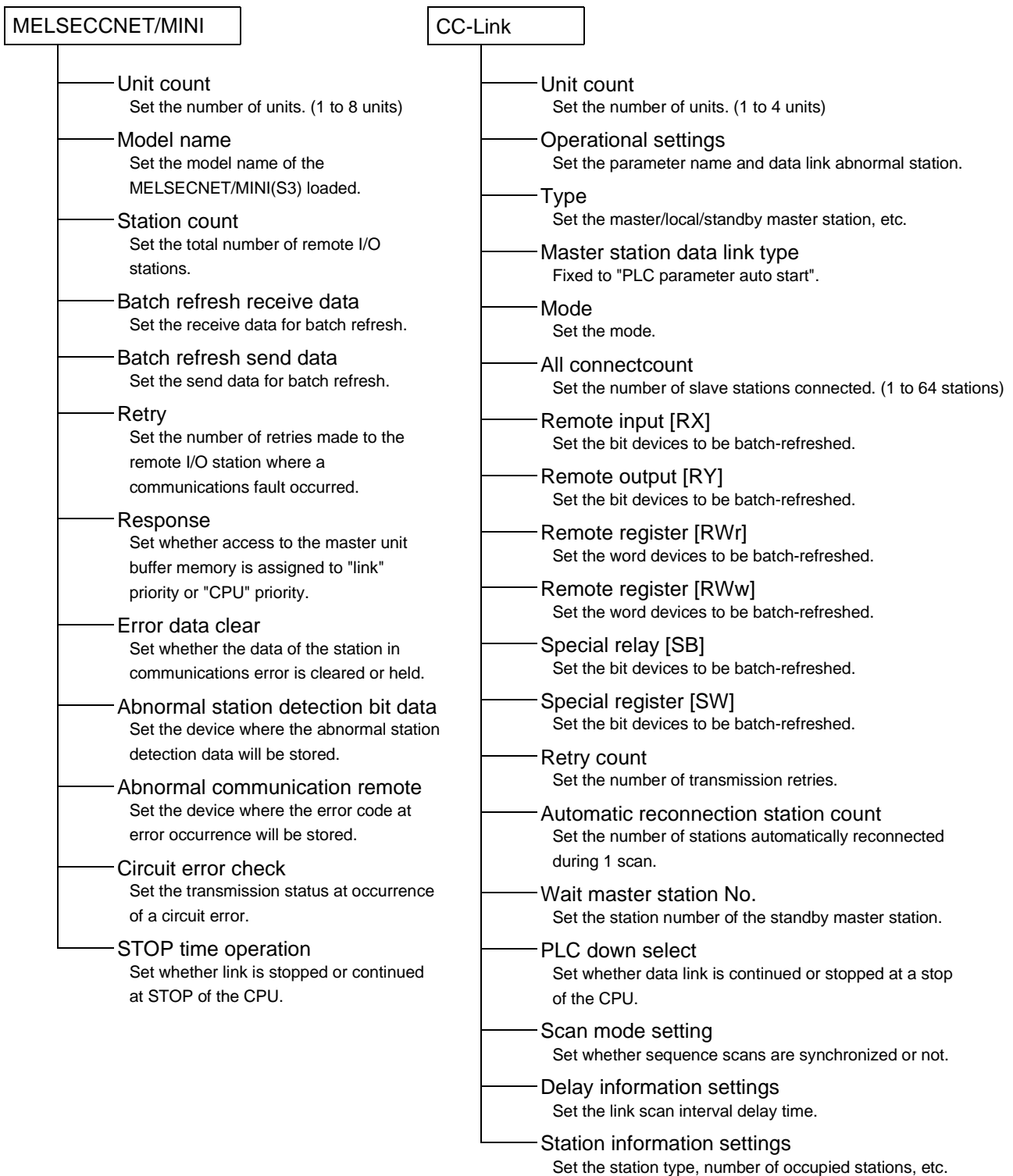

(3) Network parameter items of the A series

MELSECNET (II, /10)

- Network type  
Specify the MELSECNET (II, /10) .
- Starting I/O No.  
Set the first I/O No.
- Network No.  
Set the network No.
- Total stations  
Set the total number of (slave) stations.
- Network range type (Common parameters)
  - I/O Master station specification  
Set the I/O master station on the LX/LY setting screen.
  - Reserved station specification  
Specify the reserved station.
  - Equal assignment  
Set when assigning the link device points of the specified stations equally.
  - Identical point assignment  
Set the same points according to the preset total number of stations.
  - Supplementary settings  
Make the transient, link start indication and other settings.
  - Station inherent parameters  
Set the station inherent parameters.
- Refresh parameters  
Set the refresh parameters.

MELSECNET/MINI

- Unit count  
Set the number of units. (1 to 8 units)
- Model name  
Set the model name of the MELSECNET/MINI(S3) loaded.
- Station count  
Set the total number of remote I/O stations.
- Batch refresh receive data  
Set the receive data for batch refresh.
- Batch refresh send data  
Set the send data for batch refresh.
- Retry  
Set the number of retries made to the remote I/O station where a communications fault occurred.
- Response  
Set whether access to the master unit buffer memory is assigned to "link" priority or "CPU" priority.
- Error data clear  
Set whether the data of the station in communications error is cleared or held.
- Abnormal station detection bit data  
Set the device where the abnormal station detection data will be stored.
- Abnormal communication remote  
Set the device where the error code at error occurrence will be stored.
- Circuit error check  
Set the transmission status at occurrence of a circuit error.
- STOP time operation  
Cannot be set for the A series.

## 14.4 Explanations for Network Parameter Setting Screen

---

The following items are related to network parameter setting.

1. Unit valid for other station access  
This setting is made valid when there are multiple units which are used without specifying the network No. or when the network No. has not been set for access to the other station.
2. Read PLC data button  
Reads the implementation status.

For QnA series

Always delete the parameter file of the PLC before reading the implementation status.

The parameter file is read if the parameter file exists in the PLC.

### REMARKS

For the Q series, Read PLC data is not available for the network parameters.

## 15. PRINT

---

This chapter describes how to print data, including sequence programs created by a GPPW, device comments, and set parameters, on a printer from a peripheral device.

[Outline of operations to printing]

Shown below is the basic flow of steps to printing.

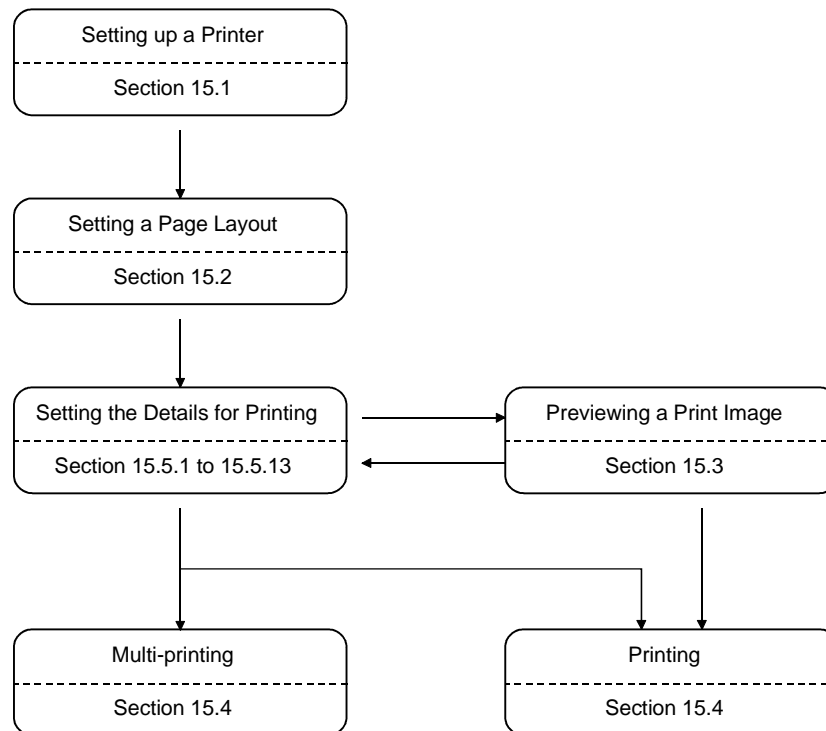

## 15.1 Setting Up a Printer

A	Q/QnA	FX
○	○	○

### [Purpose]

Selects a printer for printing and sets the paper size, the printing orientation, and other printing format-related items.

### [Operating procedure]

Select [Project] → [Printer setup] or click  ( [Ctrl] + [P] ) and the **Printer setup** button.

### [Dialog box]

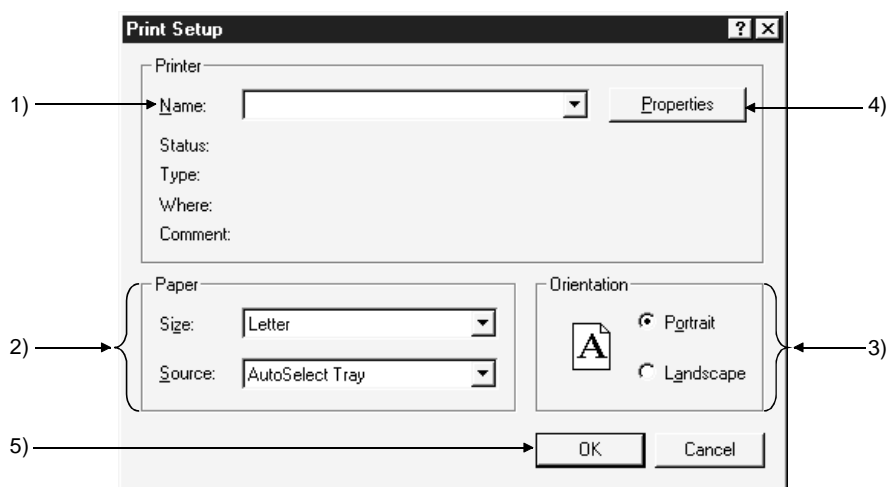

### [Description]

- 1) **Printer**  
Selects a printer for printing.
- 2) **Paper**  
Sets the size of the paper for printing and the paper feed method of the printer. The setting range depends on the printer.
- 3) **Orientation**
  - Portrait**  
Characters will be printed along the paper feed direction.
  - Landscape**  
Characters will be printed across the paper feed direction.
- 4) **Properties** button  
Clicking this button displays the properties dialog box. The printer property option is used to make the basic settings of the printer.
- 5) **OK** button  
Click this button after the printer setting is completed.

POINTS
--------

- A printer model operable, whose performance was verified by Mitsubishi, is available.  
HP Laser Jet 4000N
- Consult the operation manual for the selected printer for the printer properties that depend on the printer manufacturer and the printer model.
- To print large quantities of data, open the printer property window from the control panel of Windows 95, and select "Print directly to the printer" for the spool setting.



### 15.2 Setting a Page Layout

A	Q/QnA	FX
○	○	○

[Purpose]

Makes settings related paper, page number, header, and so on.

[Operating procedure]

Select [Project] → [Printing] and click the **Page setup** button, or click  ( **Ctrl** + **P** ) then the **Page setup** button.

[Dialog box]

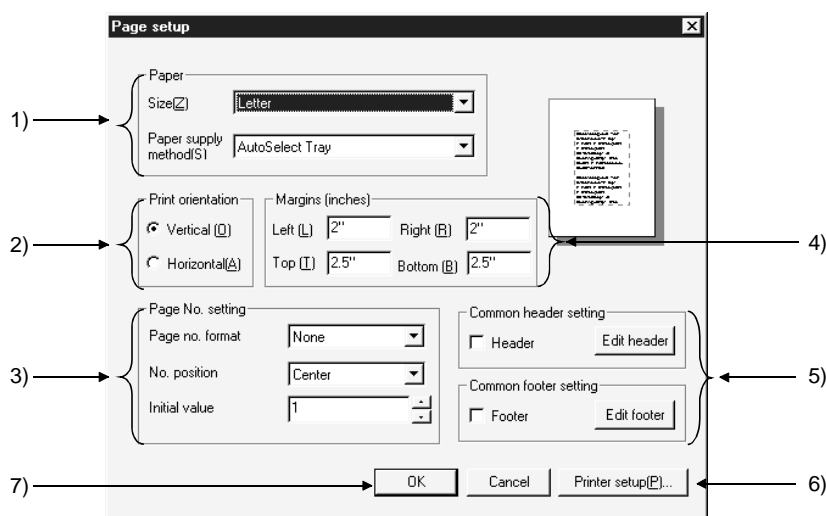

[Description]



- 1) Paper  
Sets paper size and paper feed method.
- 2) Print orientation  
Sets the orientation of printing on paper.
- 3) Page No. setting  
 Page no. form..... When page numbers are not required, set "None"  
 The symbol "-\* \*- " indicates that page numbers starting from the initial value will be printed by item. However, serial number will be printed when the data to be printed is more than one page long.  
 The symbol "\* \*- \* \*- " indicates that page numbers starting from the initial number will be printed according to the printing order set in the Multi-Printing dialog box.  
 No. position..... Sets the position of page numbers.  
 Initial value..... Sets the page number to be printed on the first page.

- 4) Margins  
Sets the margins of the page.
- 5) Common header setting  
By checking off the check box, a header will be printed on each page.  
Click the **Edit header** button, and the Header Edit dialog box as shown below will be displayed.



Alternatively, clicking the **Edit footer** button displays the Footer Edit dialog box like the Header Edit dialog box.  
The header (or footer) can be edited within the range of 64 characters x seven lines.  
Lines and images cannot be edited, and characters cannot be decorated.

- 6) **Printer setup** button  
By clicking this button, the printer dialog box will be displayed (see Section 15.1.).
- 7) **OK** button  
Click this button after the page setting is completed.

POINT
<ul style="list-style-type: none"> <li>• If the print characters are small, reduce the value of margin setting.</li> <li>• When the mouse button is clicked while the shape of the mouse pointer is , the window zooms in. When the mouse button is clicked while the shape of the mouse pointer is , the data is displayed in the standard scale.</li> </ul>

**POINTS**

- The printing date will be printed automatically in the header (footer) by setting "#YY-MM-DD#" in the Header (Footer) Edit dialog box.  
The PC type will also be printed automatically in the header (footer) by setting "#CPU#."

<Example>

#YY-MM-DD#  
#CPU#

<Printing example>

98-03-01  
A3U

- Entered character patterns and printed characters

Character Pattern	Function	Remarks
#YY-MM-DD#	Date (year-month-day)	/
#YYYY-MM-DD#	Date (year-month-day)	
#YY/MM/DD#	Date (year/month/day)	
#YYYY/MM/DD#	Date (year/month/day)	
#YY#	Year (last two digits)	
#YYYY#	Year (four digits)	
#MM#	Month	
#DD#	Day	
#CPU#	CPU model	When setting characters after the CPU model, the total length of characters including the CPU model must not exceed 64 characters. Otherwise the CPU model may not be printed.
#PROJECT#	Project name	/
#PROJ_COMMENT#	Quick reference title of project	
#DATA#	Data name (MAIN, SUB1, etc.)	
#DATA_COMMENT#	Quick reference title of data name	

To add a fixed character after the character pattern, insert a space after #CPU#.

<Example> Printed characters when A2USHCPU-S1 is selected

When no space is inserted after CPU

#CPU#\_ABCD → Print → A2USH-S1ABCD

↑  
Insert a space.

### 15.3 Previewing a Print Image

A	Q/QnA	FX
○	○	○

[Purpose]

The image of the entire page when it is printed will be displayed.

[Operating procedure]

Select [Project] → [Print] and click the **Print preview** button, or click  ( **Ctrl** + **P** ), then the **Print preview** button.

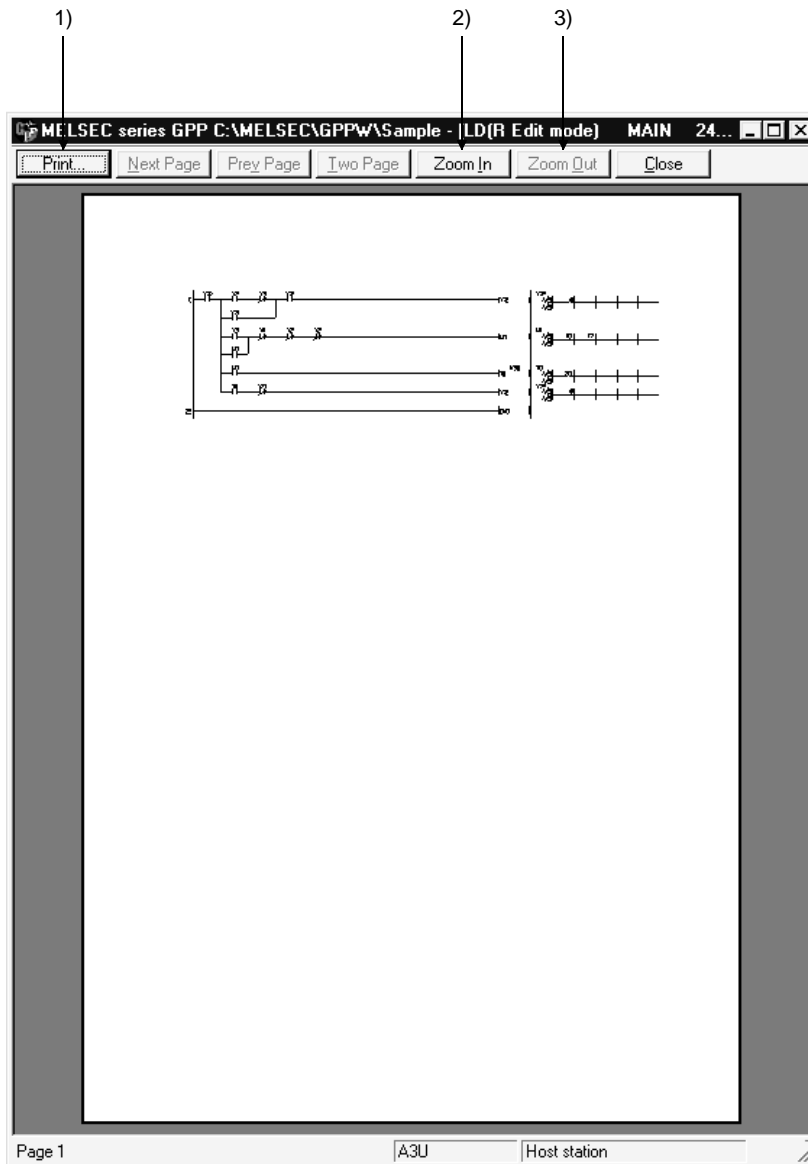

[Preview Window]



## [Description]

- 1) **Print** button  
The data displayed on the print preview window will be printed.
- 2) **Zoom In** button  
The displayed image will be enlarged by clicking this button.  
Data will be displayed in three different scales.
- 3) **Zoom Out** button  
The displayed image will be reduced by clicking this button.

POINT
-------

- The print preview may be displayed only on page 1.  
(It cannot be displayed on page 2 or later.)
- When the mouse button is clicked while the shape of the mouse pointer is , the window zooms in.  
When the mouse button is clicked while the shape of the mouse pointer is , the data is displayed in the standard scale.

### 15.4 Printing

A	Q/QnA	FX
<input type="radio"/>	<input type="radio"/>	<input type="radio"/>

[Purpose]

Prints data, such as sequence programs and device comments.

Data can be printed in two ways: each volume of data will be printed or two or more volumes of data will be printed at a time.

[Operating procedure]

Select [Project] → [Print], or click  ( [Ctrl] + [P] ), then the [Print preview] button.

[Dialog box]

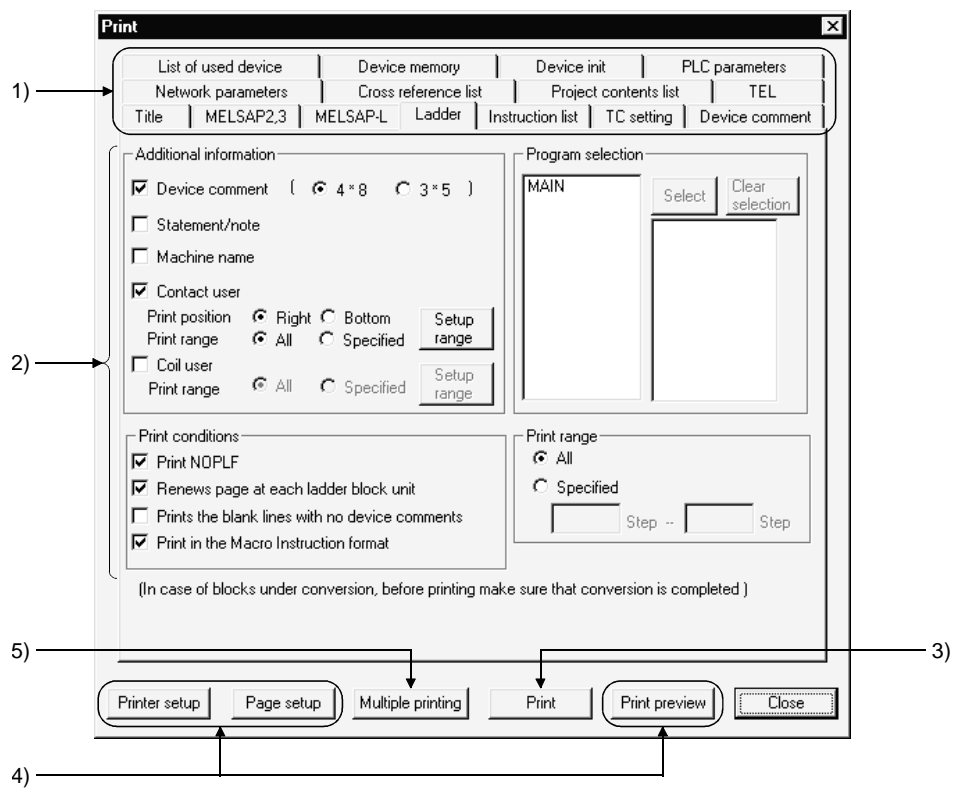

[Description]

- 1) Data print tabs  
Clicking the required tab switches to the detail setting screen.
- 2) Sheet  
Each sheet provides the items to be set to designate items and range of the data to be printed and other details.  
Select each item by checking the check box to the left.  
For details on each sheet, see Subsections 15.5.1 to 15.5.13.
- 3) [Print] button  
Click this button after details have been set on each sheet.  
The data of the displayed sheet will be printed.

- 4) **Related function**  
By clicking on each button, the corresponding dialog box related to printing will be displayed. (See Sections 15.1, 15.2, and 15.3.)
- 5) **Multiple printing** button  
By clicking this button, the Multiple Data Printing dialog box shown below will be displayed.  
Two or more volumes of data will be printed at a time.

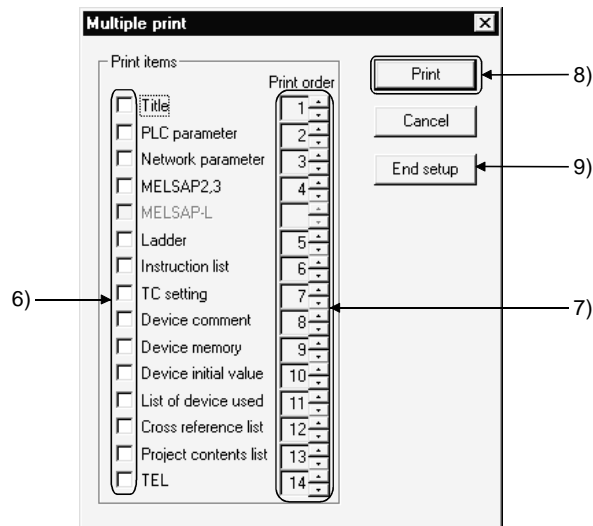

- 6) **Print items**  
Select the data items to batch-print by checking the check box.
- 7) **Print order**  
Sets the order in which each data will be printed.  
Set the order number of each item using   
The order number of any data, which is not set to be printed, will be ignored.
- 8) **Print** button  
By clicking this button, the data items with a checkmark ✓ will be batch-printed.  
Select data items to batch-print by checking their check boxes.
- 9) **End setup** button  
The data items to print will be set, and the initial setting dialog box will be displayed.

[Setting procedure]

1. After the printer setting is completed, display the print dialog box.
2. Open the page setting dialog box, and set the page format.
3. Open each sheet, and set details.
4. To confirm the image of the data when it is printed, click [Print preview].
5. Click the  button 3) when printing data one by one.  
The data displayed on the current sheet will be printed.  
To batch-print two or more volumes of data, click the  button 5).  
The multiple data printing dialog box will be displayed.
6. Set the items to print 6) and the printing orders 7).
7. By clicking the  button 8), the selected volumes of data will be batch-printed.

POINTS
--------

- |  |
|--|
| <ul style="list-style-type: none"><li>• In data-by-data printing, a ladder will be printed by clicking the <input type="button" value="Print"/> button when the &lt;&lt;Ladder&gt;&gt; sheet is displayed, or a device comment will be printed by clicking on the <input type="button" value="Print"/> button when the &lt;&lt;Device comment&gt;&gt; is displayed.</li><li>• When the page number form "-* *- " is set in page setting for multiple data printing, the data will be printed in the set printing order, and serial page numbers will be printed.</li><li>• Depending on the printer type, printer driver type/version, or set data, a part of the data may not be printed. If this problem occurs, change the setting of the printer driver.</li></ul> |
|--|



## 15.5 Setting the Details for Printing

Set details for printing, such as the range and contents of each data.  
For a printing example of each data, see Section 15.6.

### 15.5.1 Creating a title

A	Q/QnA	FX
<input type="radio"/>	<input type="radio"/>	<input type="radio"/>

#### [Purpose]

Creates a title for the project to be printed.

#### [Operating procedure]

Select [Project] → [Print] and click the <<Title>> tab, or click  ( [Ctrl] + [P] ), then the <<Title>> tab.

#### [Dialog box]

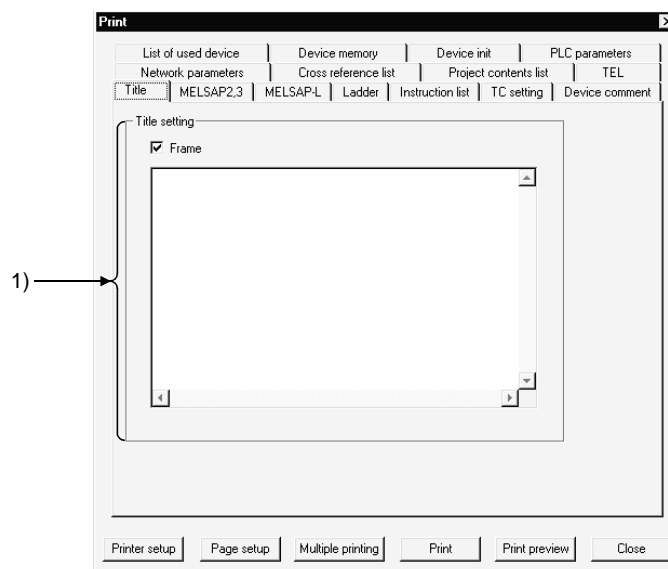

#### [Description of item]

##### 1) Title setting

Edit the title within 64 characters x nine lines.

Lines and images cannot be edited, and characters cannot be decorated.

By checking the check box, the title edited will be framed.

The date will be printed automatically when a character pattern, such as "#YY-MM-DD#", is set.

On this dialog box, the date (#YY-MM-DD#) and the CPU model (#CPU#) can be set.

For input characters patterns, see Section 15.2.

### 15.5.2 Setting a ladder print range

A	Q/QnA	FX
<input type="radio"/>	<input type="radio"/>	<input type="radio"/>

**[Purpose]**

Sets details about ladder printing, such as the ladder print range and additional information.

**[Operating procedure]**

Select [Project] → [Print] and click the <<Ladder>> tab, or click  (Ctrl + P), then the <<Ladder>> tab.

**[Dialog box]**

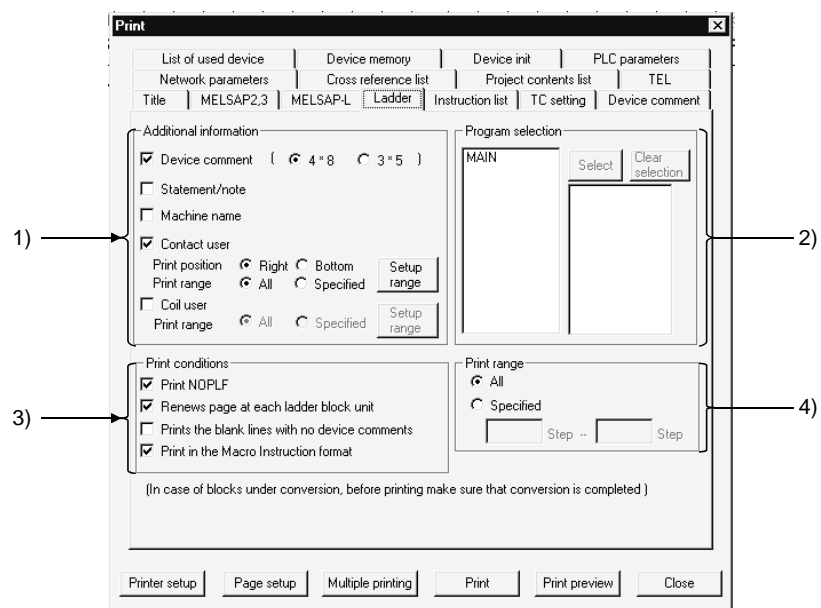

**[Description]**

1) Additional information

Any item with a checkmark ✓ will be added to the ladder to be printed. By clicking the **Setup range** button for contact using data or for coil using data, the following Device Range Setting dialog box appears. Set the head and final devices or the number of points and the head device of each range to be specified.

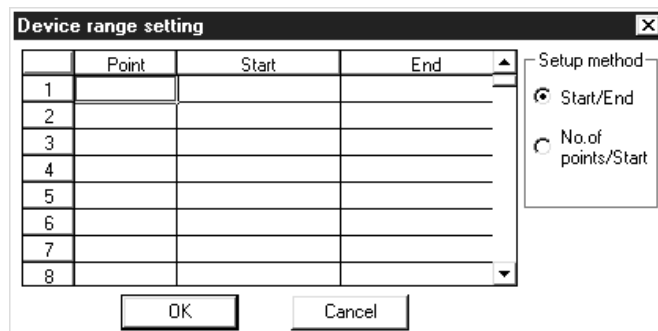

Destinations where contacts and coils are used

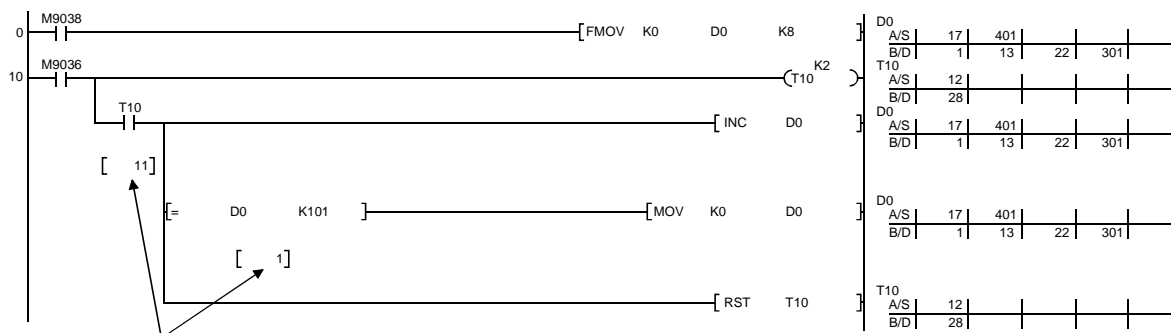

Indicate the number of steps at destination where coils are used.

- Destination where contacts are used

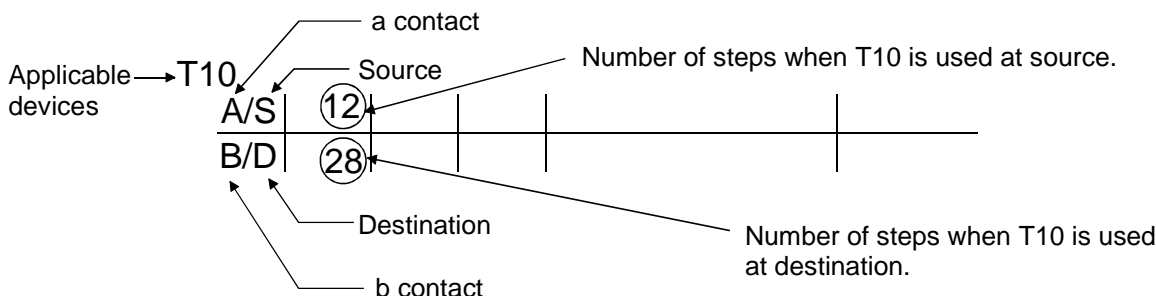

- 2) Program selection  
Using the mouse, select on the list a program to print, and click the Select button to set the selection.  
Also, you can select and batch-print multiple sequence programs.
- 3) Print conditions  
Sets the condition for printing the ladder.
  - Print NOPLF (Except the FX series)  
NOPLF will be printed by checking the check box.
  - Renews page at each ladder block unit  
Pages will be renewed by ladder block by checking the check box.  
When the check box is not checked, pages will be renewed by ladder line.
  - Prints the blank lines with no device comments  
Any line without a device comment will also be printed by checking the check box.
  - Printing in the macro instruction format (Except the FX series)  
Prints the macro-input instructions in the macro format.
- 4) Print range  
Sets the print range of the ladder.
  - Ⓐ All  
The entire range from step 0 to the END instruction of the program will be printed.
  - Ⓑ Specified  
The range between the specified steps will be printed.

**POINT**

- Precautions
  - Printing condition
  - Pages will be fed at the position following an NOPLF instruction even if the NOPLF check box is not checked. (Except the FX series)

If the program is read from the GPPA by selecting [Project] → [Import file], the number of contacts to be displayed on a line is different between the GPPW and the GPPA and the number of lines printed by the GPPA may therefore vary.

When feeding pages

List of used device	Device memory	Device init	PLC parameters
Network parameters	Cross reference list	Project contents list	TEL
Title	MELSAP2.3   MELSAP-L   Ladder	Instruction list	TC setting   Device comment

Additional information

Device comment (  4\*8  3\*5 )

Statement/note

Machine name

Contact user

Print position  Right  Bottom

Print range  All  Specified

Coil user

Print range  All  Specified

Program selection

MAIN

Print conditions

Print NOPLF

Renews page at each ladder block unit

Prints the blank lines with no device comments

Print in the Macro Instruction format

Print range

All  Specified

Step --  Step

(In case of blocks under conversion, before printing make sure that conversion is completed.)

Selected

Not selected

If there are two or more lines of contact using data under the above settings, pages will be fed in the middle of the lines. Pages will not be fed in the middle of the ladder and the coil using data.

### 15.5.3 Setting a Instruction list print range

A	Q/QnA	FX
<input type="radio"/>	<input type="radio"/>	<input type="radio"/>

[Purpose]

Sets details about Instruction list printing, such as the list print range and additional information.

[Operating procedure]

Select [Project] → [Print] and click the <<Instruction list>> tab, or click  ( **Ctrl** + **P** ), then the <<Instruction list>> tab.

[Dialog box]

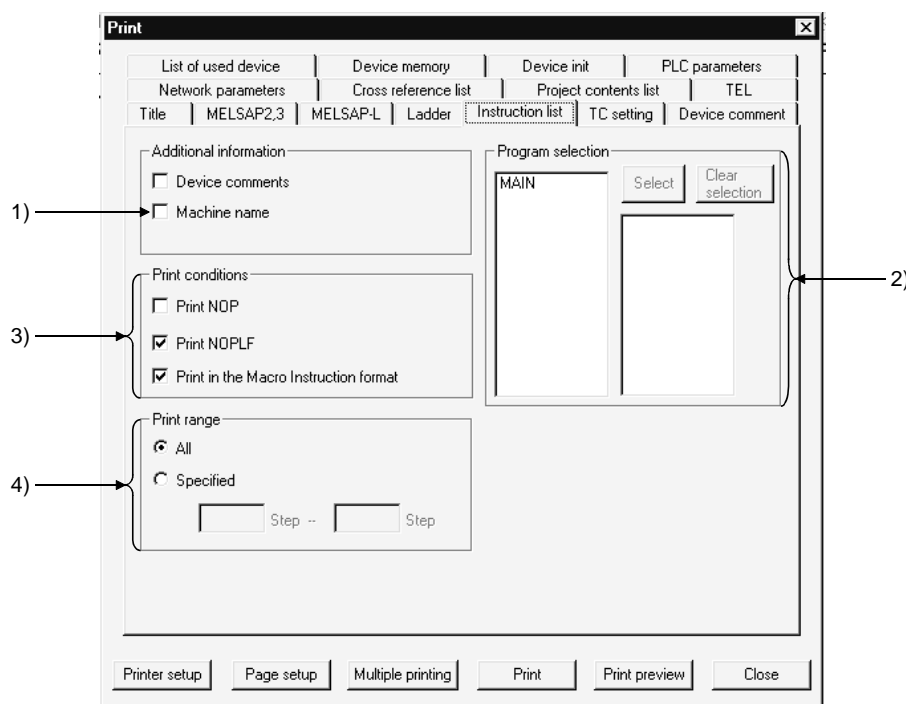

[Description]

- 1) Additional information  
A device name will be added to the Instruction list.  
Select this item by checking the check box.
- 2) Program selection  
Using the mouse, select on the list a program to print, and click the **Select** button to set the selection.  
Press the **Clear selection** button to clear the program selected.
- 3) Print conditions  
Prints NOP  
NOP will be printed by checking the check box.  
Print NOPLF (Except the FX series)  
NOPLF will be printed by checking the check box.  
Printing in the macro instruction format (Except the FX series)  
Prints the macro-input instructions in the macro format.

- 4) Print range
  - Set the print range of the list.
  - Ⓐ All
    - The entire range from step 0 to the END instruction of the program will be printed.
  - Ⓑ Specified
    - The range between the specified steps will be printed.

POINT																																
<ul style="list-style-type: none"> <li>• Precautions                             <ul style="list-style-type: none"> <li>Printing condition Pages will be fed at the position following an NOPLF instruction even if the Printing NOPLF check box is not checked. (Except the FX series)</li> </ul> </li> <li>Print range In setting the print range, enter both the start step and the end step, and the former must be larger than the latter. When two or more steps are specified as the start or end step for an instruction, or when the instruction includes the steps specified, the instruction will also be printed.</li> <li>When printing data on A4 portrait paper If the number of device characters of an instruction exceeds 80 on A4 portrait paper or 130 on A4 landscape paper, the excessive characters may not be printed. Any entire instruction or device within eight characters will be printed. If a device is more than eight characters long, the third device will not be printed completely. (All device characters will be printed on A3 landscape paper even if the number of characters is maximum.) &lt;Example&gt; Printing on A4 portrait paper</li> </ul>																																
<table border="1" style="width: 100%; border-collapse: collapse; margin: 10px 0;"> <thead> <tr> <th style="width: 12.5%;">1</th> <th style="width: 12.5%;">2</th> <th style="width: 12.5%;">3</th> <th style="width: 12.5%;">4</th> <th style="width: 12.5%;">5</th> <th style="width: 12.5%;">6</th> <th style="width: 12.5%;">7</th> <th style="width: 12.5%;">8</th> </tr> </thead> <tbody> <tr> <td>1234567890</td> <td>1234567890</td> <td>1234567890</td> <td>1234567890</td> <td>1234567890</td> <td>1234567890</td> <td>1234567890</td> <td>1234567890</td> </tr> <tr> <td>123 EFCALL</td> <td>"File001" P0</td> <td></td> <td>ZR1000Z0</td> <td>ZR1100Z0</td> <td>ZR1200Z1</td> <td>ZR1300Z0</td> <td>ZR1400Z0</td> </tr> <tr> <td>123 EFCALL</td> <td>"File001" P0</td> <td></td> <td>J123W100Z12</td> <td></td> <td>J123W100Z12</td> <td></td> <td>J123W100Z12</td> </tr> </tbody> </table>	1	2	3	4	5	6	7	8	1234567890	1234567890	1234567890	1234567890	1234567890	1234567890	1234567890	1234567890	123 EFCALL	"File001" P0		ZR1000Z0	ZR1100Z0	ZR1200Z1	ZR1300Z0	ZR1400Z0	123 EFCALL	"File001" P0		J123W100Z12		J123W100Z12		J123W100Z12
1	2	3	4	5	6	7	8																									
1234567890	1234567890	1234567890	1234567890	1234567890	1234567890	1234567890	1234567890																									
123 EFCALL	"File001" P0		ZR1000Z0	ZR1100Z0	ZR1200Z1	ZR1300Z0	ZR1400Z0																									
123 EFCALL	"File001" P0		J123W100Z12		J123W100Z12		J123W100Z12																									

### 15.5.4 Setting a TC setting value print range

A	Q/QnA	FX
<input type="radio"/>	<input type="radio"/>	<input type="radio"/>

[Purpose]

Sets details about timer or counter settings, such as the items to be printed and additional information.

[Operating procedure]

Select [Project] → [Print] and click the <<TC setting>> tab, or click  ( [Ctrl] + [P] ), then the <<TC setting>> tab.

[Dialog box]

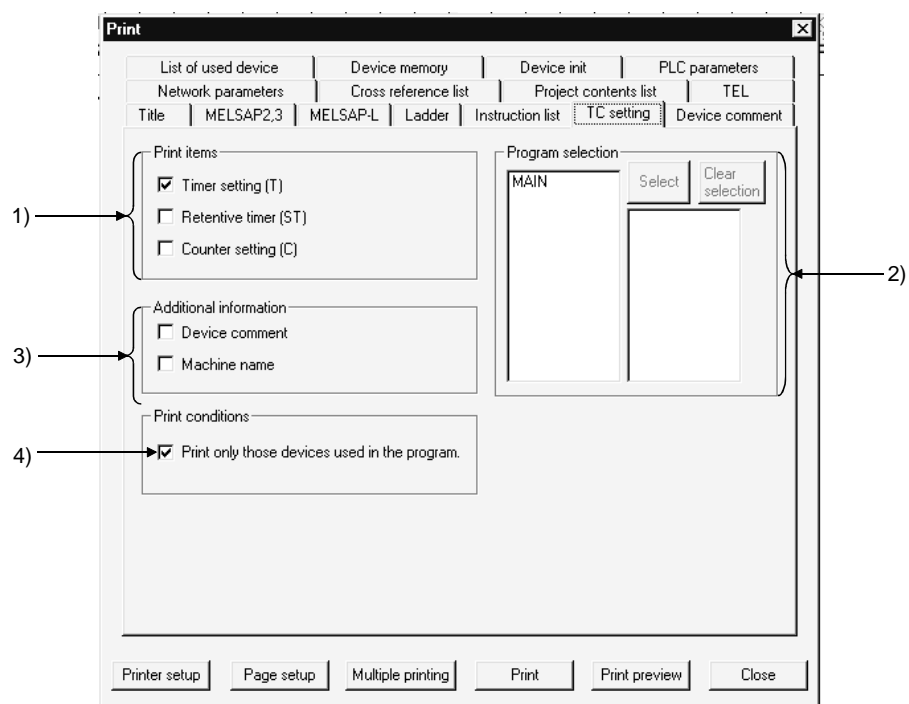

[Description]

- 1) Print items  
The item with a checkmark ✓ will be printed.
- 2) Program selection  
Select on the list a program for which timer or counter settings will be made, and click the Select button to set the selection.
- 3) Additional information  
The item with a checkmark ✓ will be added.
- 4) Print conditions  
Only the timer or counter used in the program will be printed by checking this check box.

### 15.5.5 Setting a device comment print range

A	Q/QnA	FX
<input type="radio"/>	<input type="radio"/>	<input type="radio"/>

[Purpose]

Sets the print range of device comments and so on.

[Operating procedure]

Select [Project] → [Print] and click the <<Device comment>> tab, or click  ( **Ctrl** + **P** ), then the <<Device comment>> tab.

[Dialog box]

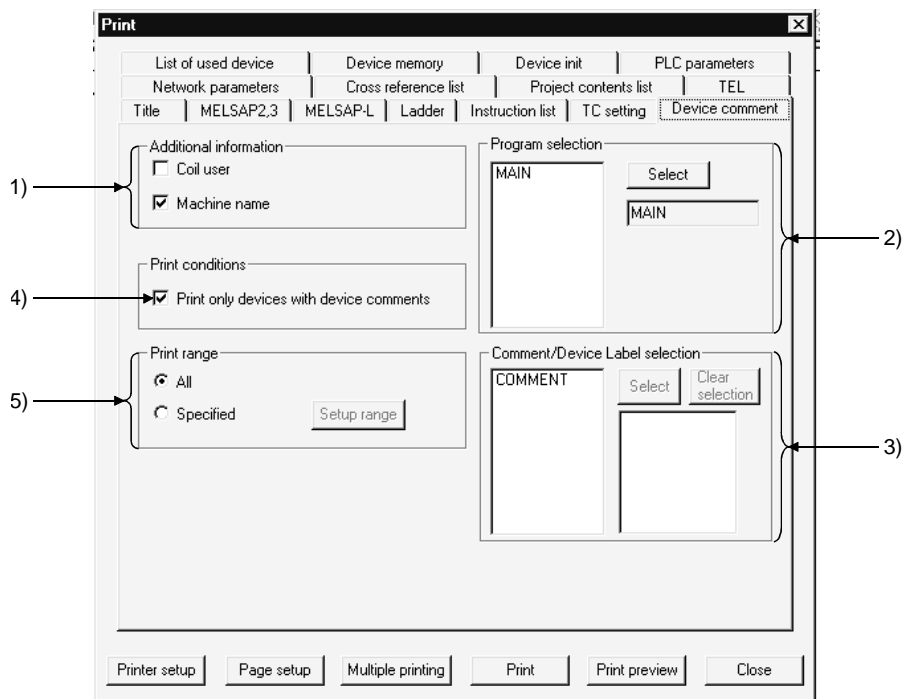

[Description]

- 1) **Additional information**  
Device comments will be printed with additional information. Check the desired check box.
- 2) **Program selection**  
Select on the list a program as the coil using data specified for Additional information, and click the **Select** button to set the selection.
- 3) **Comment/Device Label selection**  
Select on the list the device comment data to be printed, and click the **Select** button to set the selection.
- 4) **Print conditions**  
Only devices with a comment will be printed. Select this item by checking the check box.



## 5) Print range

Set the range of the device comments to be printed.

All

All device comments of the data selected will be printed.

Specified

The device comments within the specified range will be printed.

By clicking the **setup range** button, the Device Range Setting dialog box shown below will be displayed.

Set the head and final devices or the number of points and the head device of the range to be designated.

	Point	Start	End
1			
2			
3			
4			
5			
6			
7			
8			

Setup method

Start/End

No. of points/Start

OK Cancel

**POINT**

- Whenever device comments are read from the GPPA, GPPQ, FXGP(DOS) or FXGP(WIN) from the [Import file] menu, confirm before printing whether the data is read properly.  
If the data is not read properly, check whether the comment range is set according to Chapter 9 "Setting Device Comments."

## 15.5.6 Setting a device use list print range

A	Q/QnA	FX
<input type="radio"/>	<input type="radio"/>	<input type="radio"/>

## [Purpose]

Sets the print range of device using data and so on.

## [Operating procedure]

Select [Project] → [Print] and click the <<List of used device>> tab, or click  (**[Ctrl] + [P]**), then the <<List of used device>> tab.

## [Dialog box]

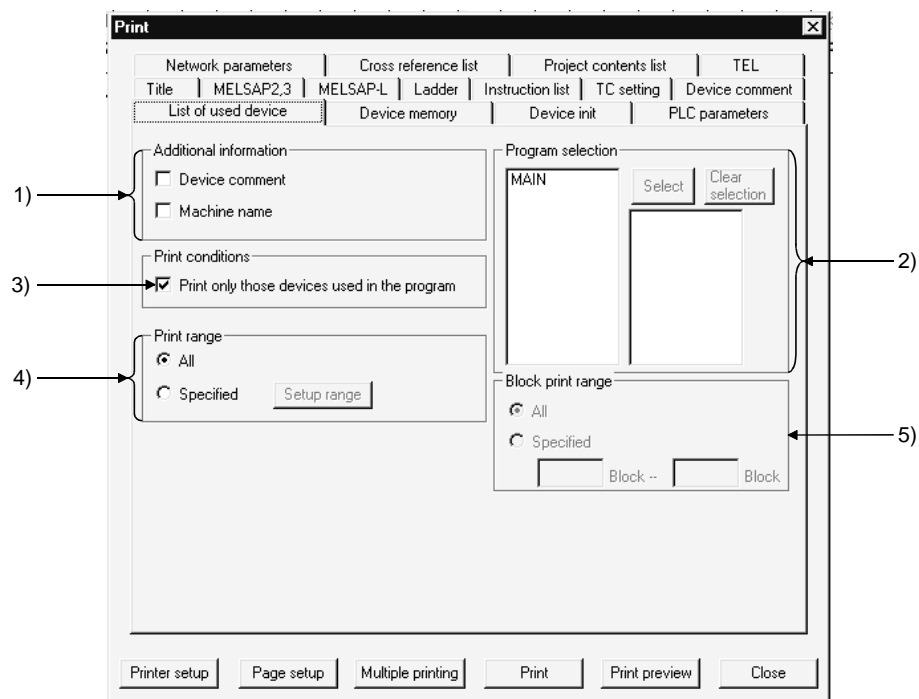

## [Description]

- 1) Additional information  
A device use list will be printed with additional information.  
Check the desired check box.
- 2) Program selection  
Select on the list a program as the device using data specified for Additional information, and click the **[Select]** button to set the selection.
- 3) Print conditions  
Prints only devices being used during the program.  
Select this item by checking the check box.

- 4) Print range
  - Sets the range of the device use list to be printed.
  - All
    - All device use lists of the data selected will be printed.
  - Specified
    - The device use lists within the specified range will be printed.
    - At the Device Range Setting dialog box displayed by clicking the setup range button, set the head and final devices or the number of points and the head device of the range to be designated.
  
- 5) Block print range (only for SFC selection)
  - Set when block printing SFC programs.

### 15.5.7 Setting a device memory print range

A	Q/QnA	FX
○	○	○

[Purpose]

Sets the print range of the device memory using data and so on.

[Operating procedure]

Select [Project] → [Print] and click the <<Device memory>> tab, or click  ( [Ctrl] + [P] ), then the <<Device memory>> tab.

[Dialog box]

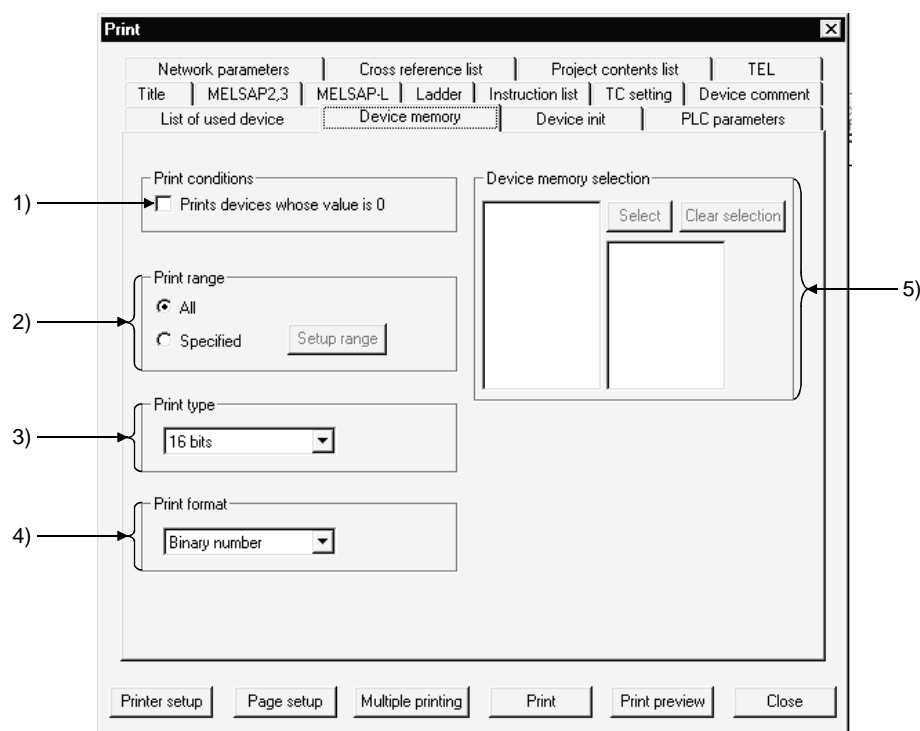

[Description]

- 1) Print conditions  
Any device whose value is "0" will also be printed.  
Select this item by checking the check box.
- 2) Print range  
Sets the print range of the device memory.
  - Ⓐ All  
The entire device memory will be printed.
  - Ⓑ Specified  
The specified range of the device memory will be printed.  
By clicking the [Specified range] button, the Device Range Setting dialog box will be displayed. Set the head and final devices or the number of points and the head device of the range to be designated.

- 3) Print type  
Set device memory values in 16-bit integers, 32-bit integers or real numbers.
- 4) Printing format  
Sets device memory values in binary, decimal or hexadecimal.
- 5) Device memory selection  
Allows multiple device memories to be selected.

### 15.5.8 Setting a device initial value print range

A	Q/QnA	FX
×	○	×

[Purpose]

Sets the print range of the QnA series device initial values and so on.

[Operating procedure]

Select [Project] → [Print] and click the <<Device init>> tab, or click  ( [Ctrl] + [P] ), then the <<Device init>> tab.

[Dialog box]

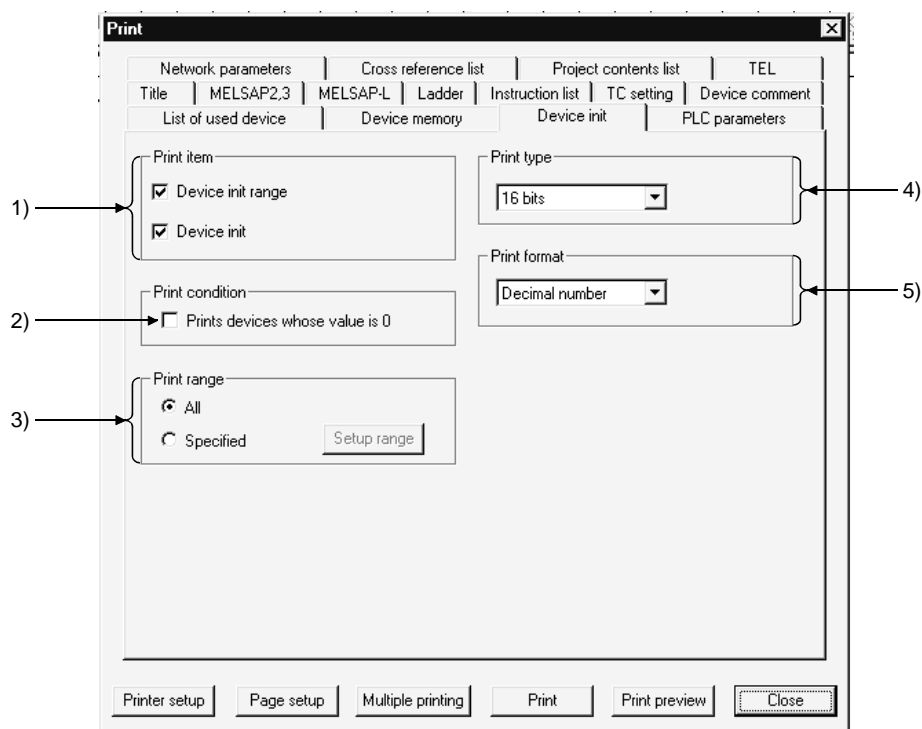

[Description]

- 1) Print item  
The items selected will be printed.  
Select the desired item by checking the check box.
- 2) Print condition  
Any device whose value is "0" will also be printed.  
Select this item by checking the check box.

- 3) Print range  
Sets the print range of the device initial values.
  - Ⓐ All  
All device initial values will be printed.
  - Ⓑ Specified  
The device initial values within the specified range will be printed.  
By clicking the Setup range button, the Device Range Setting dialog box will be displayed. Set the head and final devices or the number of points and the head device of the range to be designated.
- 4) Print type  
Sets device initial values in 16-bit integers, 32-bit integers or real numbers.
- 5) Print format  
Sets device initial values in binary, decimal or hexadecimal.

### 15.5.9 Setting a PLC parameter print item

A	Q/QnA	FX
○	○	○

**[Purpose]**

Sets the PLC parameter items to be printed.

**[Operating procedure]**

Select [Project] → [Print] and click the <<PLC parameters>> tab, or click  ( [Ctrl] + [P] ), then the <<PLC parameters>> tab.

**[Dialog box]**

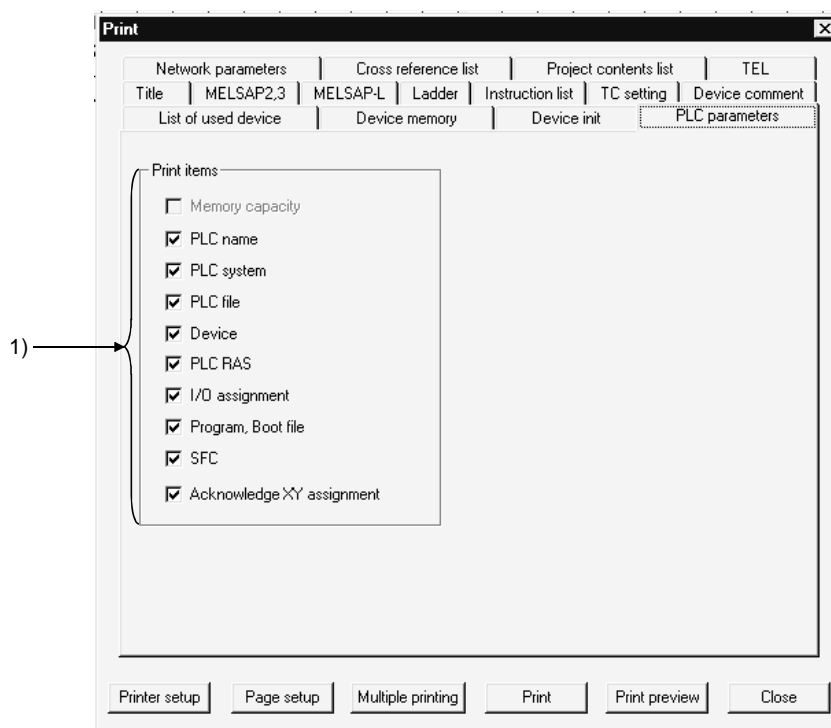

**[Description]**

1) Print items

The items selected will be printed.

Select each desired item by checking the check box.

PLC name setting, PLC file setting, Program setting/Boot file setting, and SFC setting are not required and cannot therefore be selected for the A series.

Memory capacity setting is not required and cannot therefore be selected for the Q/QnA series.

PLC file setting, PLC RAS setting, Program setting, Boot file setting, and SFC setting are not required and cannot therefore be selected for the FX series.

X/Y assignment check can be selected only for the AnA, AnU, Q, and QnA series.

15.5.10 Setting a network parameter print item

A	Q/QnA	FX
○	○	×

[Purpose]

Sets the network parameter items to be printed.

[Operating procedure]

Select [Project] → [Print] and click the <<Network parameters>> tab, or click  ( [Ctrl] + [P] ), then the <<Network parameters>> tab.

[Dialog box]

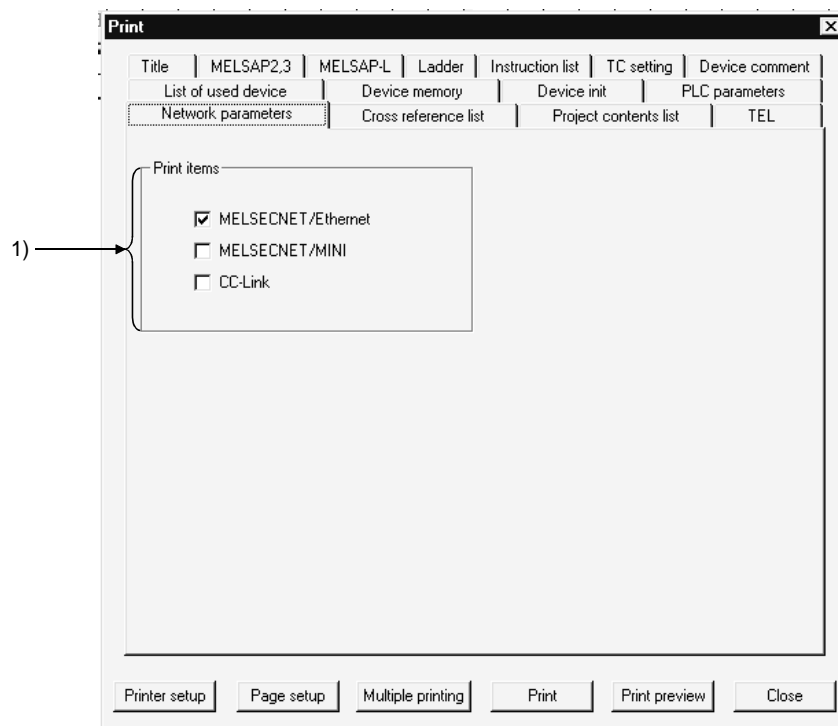

[Description]

1) Print items

The items selected will be printed.

Select each desired item by checking the check box.

CC-link setting is not available and cannot therefore be selected for the A series.



15.5.11 Setting a list of contact coil used

A	Q/QnA	FX
<input type="radio"/>	<input type="radio"/>	<input type="radio"/>

[Purpose]

Sets the print range of the devices used for contacts or coils and so on.

[Operating procedure]

Select [Project] → [Print] and click the <<List of contact coil used>> tab, or click  (**Ctrl** + **P**), then the <<List of contact coil used>> tab.

[Dialog box]

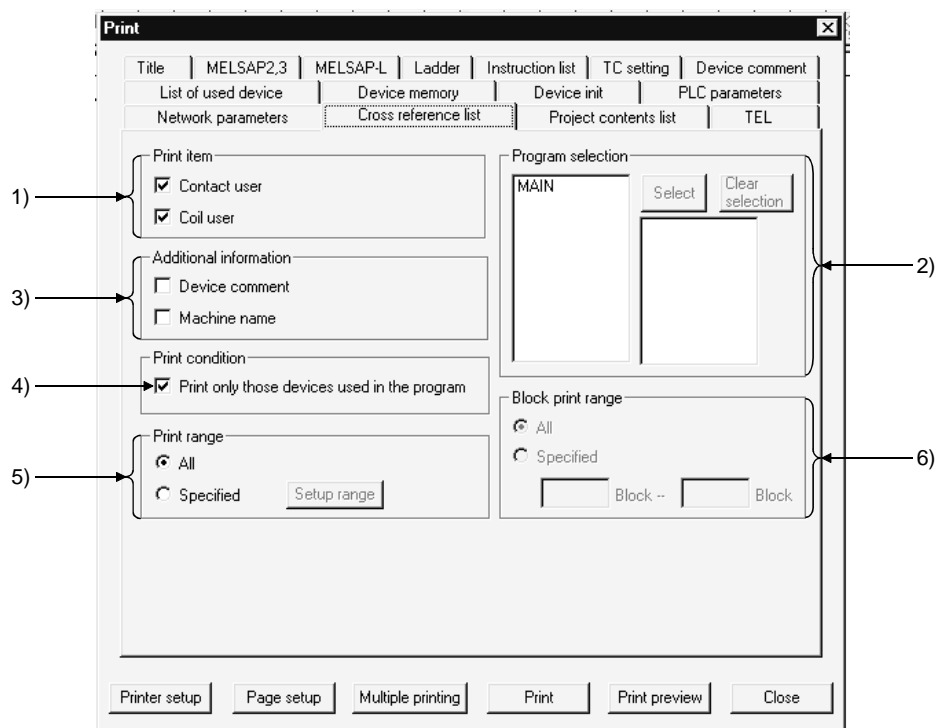

[Description]

- 1) **Print item**  
A list will be printed with the selected items added.  
Check the desired check box.
- 2) **Program selection**  
Select on the list a program as the contact or coil using data, and click the **Select** button to set the selection.
- 3) **Additional information**  
The list will be printed with additional information.  
Select this item by checking the check box.
- 4) **Print condition**  
Only devices used in the program selected will be printed.

- 5) Print range
  - Set the range of the contact/coil use list to be printed.
  - All
    - The entire range from step 0 to the END instruction of the program will be printed.
  - Specified
    - The range specified by the step numbers will be printed.
    - To specify the range, set the head and final devices or the number of points and the head device in the Device Range Setting dialog box.
  
- 6) Block print range (only for SFC selection)
  - Set when block printing SFC programs.

### 15.5.12 Displaying a project contents list

A	Q/QnA	FX
<input type="radio"/>	<input type="radio"/>	<input type="radio"/>

[Purpose]  
 Displays a list of project data.

[Operating procedure]  
 Select [Project] → [Print] and click the <<Project contents list>> tab, or click  (**Ctrl** + **P**), then the <<Project contents list>> tab.

[Dialog box]

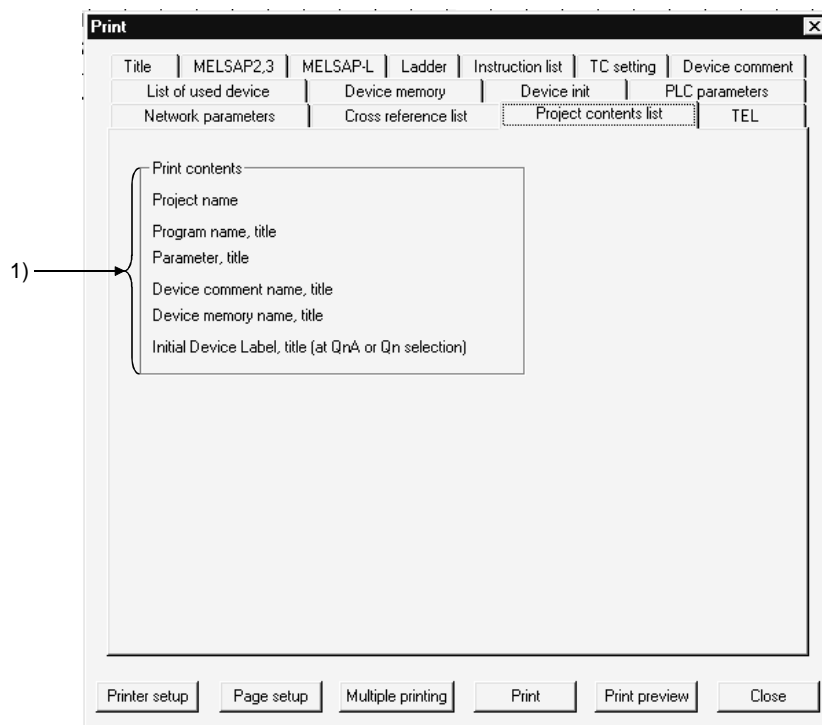

[Description]  
 1) Print contents  
 The items to be printed on a list of project data are displayed.

### 15.5.13 Setting the TEL data print area

A	Q/QnA	FX
○	○	×

**[Purpose]**

Prints the data set on the TEL data creation screen.

**[Operating Procedure]**

[Project] → [Print] → <<TEL>> tab or  ( **Ctrl** + **P** ) → <<TEL>> tab

**[Dialog Box]**

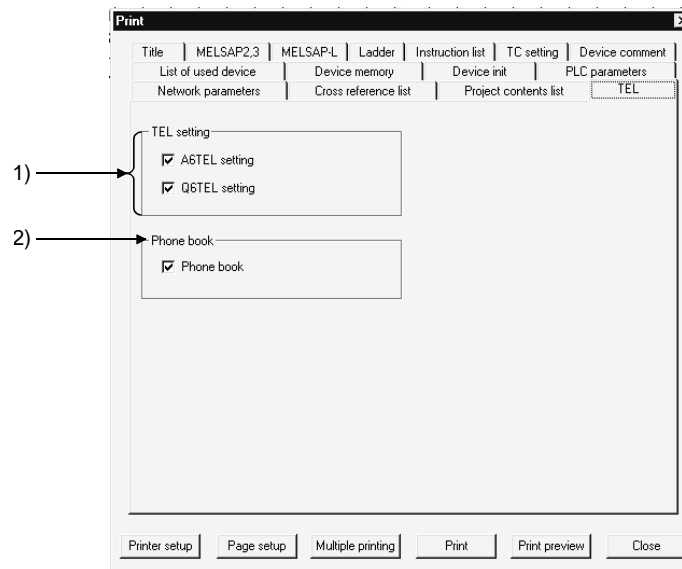

**[Description]**

- 1) TEL setting  
Prints the data set on the TEL data creation screen.
- 2) Phone book  
Prints the data registered on the phone number book setting screen.

15.6 Print Examples

A	Q/QnA	FX
○	○	○

Print examples are shown below.

<<Title>>

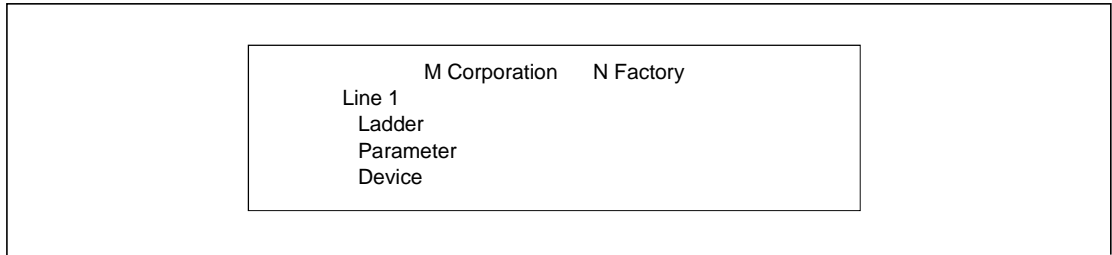

<<Ladder>>



<<TC setting>>

Time set val list		Device	Setting	Device	Setting	Device	Setting
T0	K1000						
T1	K120						
T2	K6000						
T3	K50						
T4	K850						

<<Device comment>>

Device comment list		
Device	Device comment	Dev Lbl
M10	Operation ready	
X0	Safety equipment	SAFETY
X1	Safety cover	COVER
X2	Operation ready	READY
X3	Oil pressure	OIL-M

<<List of used device>>

Device use list					
Device	Use/Not use	No.	Error	Device comment	Dev Lbl
X0	┆┆	0		Safety equipment	SAFETY
X2	┆┆	0		Cycle stop	READY
X3	┆┆	0		Sensor1	OIL-M
X7	┆┆	0		Safety cover	
Y70	┆┆	1	ERROR		
M10	┆┆┆┆	1		Operation ready	

<<Device memory>>

Device memory list									
Device	16 bits								Character string
	Type	decimal							
	+0	+1	+2	+3	+4	+5	+6	+7	
D0	7086	37	3786	898	3	8798	4641	1697	
D6	9678	8860	7697	35	4400	736	16	4	
D16	67	3	7376	767	2000	373	43	774	
D24	100	738	737	6767	7463	234	55	7799	
D32	1156	878	763	4343	800	7438	4	777	
D40	343	7895	64	867	364	343	360	3	
D48	8381	137	434	789	43	1587	7888	796	
D56	100	0	0	0	0	0	0	0	

<<Device init >>  
Q/QnA series only

Dev init set range				
No.	Items	Start device	End device	Comment
1	50 D0		D49	
2	100 D100		D199	

Device memory list										
	16 bit	Type	decimal							
Device	+0	+1	+2	+3	+4	+5	+6	+7	Character string	
D0	374	4687	6	746	76	37	3	387		
D6	354	37	3	76	64	35	76	37		
D16	697	879	6	78	3	3789	379	3794		
D24	3998	3687	489	1579	3794	874	679	7897		
D32	57	4	486	7	867	687	68	76		
D40	87	8676	87	7767	6	76	7	687		
D48	687	78								

<<PC parameters>>

Mem capcty set		
1	Sequence program capacity	
	Main	[ 6] K step
	Sub 1	[ 0] K step
	Sub 1	[ ] K step
2	Microcomputer program capacity	
	Main	[ 0] K step
	Sub	[ ] K step
3	Comment capacity	
	Comment	[ 0] K bytes [ 0] points
	Extension comment	[ 0] K bytes [ 0] points
4	File register capacity	[ 0] K bytes [ 0] points
5	Capacity for debug	
	Sampling trace	[ 0] K bytes
	Stat latch (data mem)	[ ] K bytes
	Stat latch (file reg)	[ ] K bytes
6	Total capacity	[ 16] K bytes

<<Network parameters>>  
Except the FX series

Set unit count	
1	MELSECNET (II/10) No. of units [2] Unit(s)
Unit 1	<MELSECNET/10 (Ctrl sta) >
Unit 2	<MELSECNET/10 (Ctrl sta) >
Unit 3	< >
Unit 4	< >
2	Valid unit accessing other st [1] (Older of unit)

Network setting				
	Unit 1 NET/10 Ctrl Sta	Unit 2 NET/10 Ctrl Sta	Unit 3	Unit 4
Start I/O No.	[ 0 ]	[ 30 ]	[ ]	[ ]
Network No.	[ 1 ]	[ 2 ]	[ ]	[ ]

<<List contact coil used>>

List of Contact-Coil				
Device	Step	Ld sym	Ins	Pos
X0	0	┆┆	LD	*
X2	4	┆┆	LDI	*
X3	5	┆┆	OR	*
X7	2	┆┆	ANI	*
Y70	7	( )	OUT	*
M10	1	┆┆	OR	*
M10	3	( )	OUT	*
M10	6	┆┆	AND	*

<<Project contents list>>

Drive/Path	A:\		
Project name	TESTA		
Title			

Data name	Size	Creation data	Title
• Program			
┆ MAIN	13KB	1998/ 9/19 16:22:50	
• Device comment			
┆ COMMENT	1KB	1998/ 9/19 16:22:54	
┆ MAIN	1KB	1998/ 9/19 16:40:56	
• Device memory			
┆ MAIN	1KB	1998/ 9/19 16:45:00	
• Parameter			
┆ PC parameter		1998/ 9/19 16:44:56	
┆ Network parameter		1998/ 9/19 16:44:56	

<<A6TEL/Q6TEL data list>>

A6TEL data list

Title	Modem
AT command	ATQ0E1V1X1S0=1
Line type	Tone
Main/Sub switching time	11min

NO.	Register item and condition					
1	Title	TEST DATA				
	Reporting	Report 1 time.				
	Report Information	Ma in	Call number	0123456789	An outside line number	
			Setting	Select time	Time	30sec
	Su b	Call number	--	An outside line number	--	
		Setting	--	Time	--	
	Trigger condition	Device	Word device C0			
		Condition	=	Value	Dec. 10	
Pager message			History	D100		



# MEMO

---

---

---

---

---

---

---

---

---

---

---

---

---

---

---

---

---

---

---

---

---

---

---

---

---

---

# 16. OTHER FUNCTIONS

## 16.1 Checking Programs

A	Q/QnA	FX
○	○	○

[Purpose]

Checks for logical errors and input errors in programs.

[Operating Procedure]

Select [Tools] → [Check program], or click .

[Dialog Box]

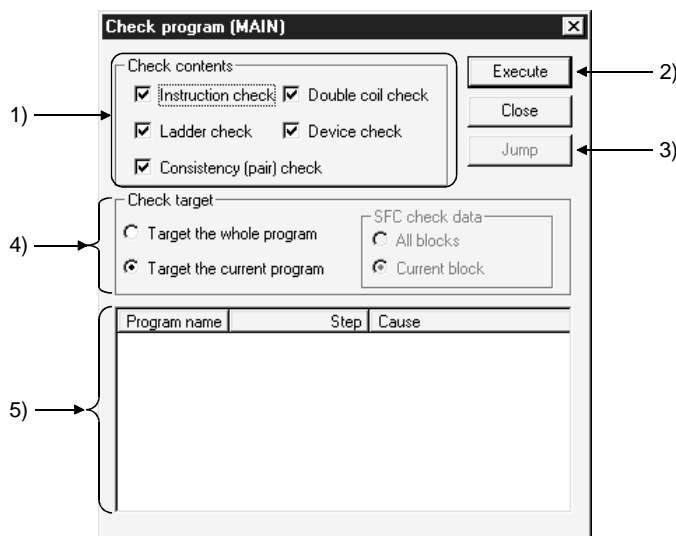

[Description]

1) Check contents

Selects the item to be checked.

The range for the check is from step 0 to the END instruction (or the end of the program if there is no END instruction).

- Instruction check  
Check the checkbox to check if instructions can be used, depending on the PC type.
- Ladder check  
Check the checkbox to check whether the program is a valid ladder.
- Consistency (pair) check  
Check the checkbox to check for consistency in the program, for example whether there are pointers at jump destinations and if there are RET instructions for subroutines.
- Double coil check  
Check the checkbox to check for duplicate coils.

- Device check  
Check the checkbox to check if device numbers are within the parameter range.  
For the A series, an error will not occur if the T/C outside the parameter range setting is used besides contacts and coils.
- 2)  button  
Click this button after making the necessary settings.
- 3)  button  
If there is a step with an error, designating the error in the check result and clicking this button moves the cursor to the relevant step of the ladder.
- 4) Check target
  - Target the whole program  
Checks all programs in the project.
  - Target the current program  
Checks only the currently open program.
- 5) Check result  
Displays the result of the project check.

16.2 Merging Programs

A	Q/QnA	FX
○	○	○

[Purpose]  
 Merges multiple programs/comment data.

[Operating Procedure]  
 [Tools] → [Merge data]

[Dialog Box]

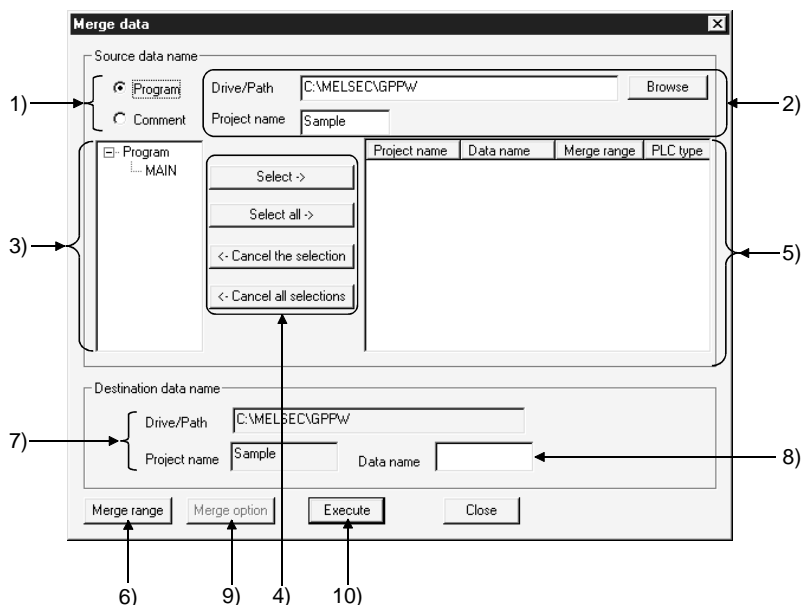

[Description]

- 1) Merged data type setting  
 Specify the data (programs/comments) to be merged.
- 2) Merge source drive/path, project name  
 Set the drive/path and project name of the data to be merged.  
 You can also set the drive/path and project name from the **Browse** button.
- 3) Merge source program list  
 Lists the programs of the merge source project.
- 4) Merged program selection buttons  
 Press the **Select** button to choose the data specified in the merge source data list.  
 Press the **Select all** button to choose all data in the merge source data list.  
 Press the **Cancel the selection** button to clear the selected data.  
 Press the **Cancel all selections** button to clear all selected data.
- 5) Merged data setting  
 Shows up to 128 pieces of data to be merged.  
 Data are merged in displayed order.

- 6) **Merge range** button (Program only)  
 Specifies the step numbers of the program specified as a merge source.  
 The default is All range.

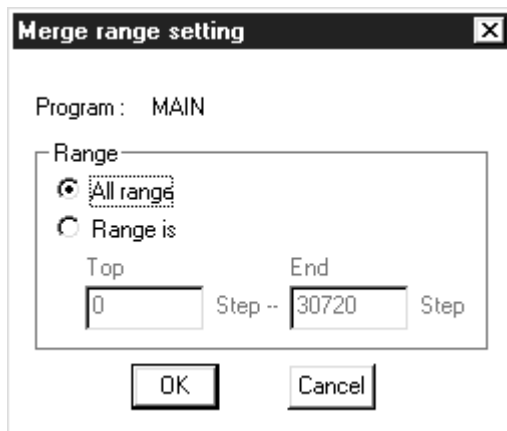

- 7) Merge destination drive/path, project list  
 Specifies the currently open project name and drive/path.
- 8) Merge destination data name  
 Set the data name used after merging.  
 If you specified the existing data name, the data overwrite confirmation dialog box appears.
- 9) **Merge option** button (Comment only)  
 Data are merged in the order of selected data names.  
 (Equipment names are not the object of an overlap check.)

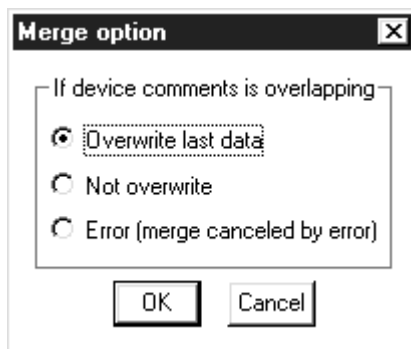

If the data to be merged include the data which exceeds the device range of the merge destination CPU, the comment data in the excess area is deleted.

For A series

The capacity set in the parameter/comment capacity setting of the merge destination is not checked. Data are merged after they are checked within the device range of the CPU.

For Q/QnA series

The device range of the merge destination is the maximum points of the CPU type of the merge destination project, and the range check by the device setting of the parameter is not performed.

Also, the number of ZR devices merged is up to 32k points.

10) **Execute** button

Click this button when the setting is finished.

When data are merged, the END instruction at any point in the program is deleted automatically and an END instruction is inserted at the end of the program.

[Setting Procedure] (When programs are merged in the entire range)

1. Choose the data type to be merged.
2. Set the drive/path and project name of the merge source data from the **Browse** button.
3. Choose the data to be merged at 5) from the data displayed at 3).
4. Repeat steps 1 and 2. When the data to be merged are all selected, set 8).
5. When the setting is over, click 10).

POINTS			
<ul style="list-style-type: none"> <li>Any programs not saved in the peripheral device cannot be merged.</li> <li>After programs are merged, make a program check.</li> <li>Programs cannot be merged between different PLC series, e.g. A series and QnA series. However, they can be merged between ACPU and QCPU(Amode).</li> <li>When merging programs of the A or FX series, the program capacity is as set in the parameter of the merge destination project.</li> <li>When merging the programs of the Q/QnA series, the maximum number of steps corresponds to the PLC type of the merge destination project.</li> </ul>			
QnACPU		QCPU(Qmode)	
PLC Type	Max. Number of Steps	PLC Type	Max. Number of Steps
Q2A, Q2AS(H)	28K	Q02(H)	28K
Q2AS1, Q2AS(H)S1	60K	Q06H	60K
Q3A	92K	Q12H	124K
Q4A, 4AR	124K	Q25H	252K
<ul style="list-style-type: none"> <li>If the capacity is exceeded after merging, data are merged on a program basis up to the capacity. (Data that may only be merged to a midway point are not merged.)</li> <li>SFC programs cannot be merged.</li> </ul>			

16.3 Checking Parameters

A	Q/QnA	FX
○	○	○

[Purpose]

Checks for errors in the parameter settings.

[Operating Procedure]

Select [Tools] → [Check parameter], or click .

[Dialog Box]

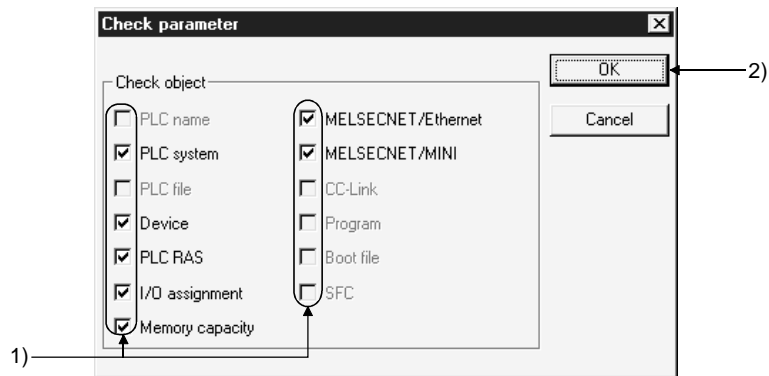

[Description]

1) Check object

Select the items you want to check by clicking the unchecked checkboxes of the items.

## 16.4 All-clearing the Parameters

A	Q/QnA	FX
○	○	○

### [Purpose]

Clears all parameter settings and sets their default values.

### [Operating Procedure]

Select [Tools] → [Clear all Parameters].

### [Dialog Box]

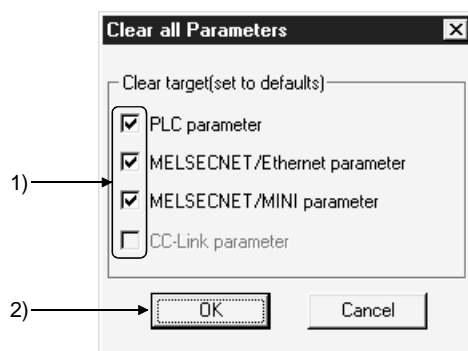

### [Description]

#### 1) Clear target

Select the items you want to clear by clicking the unchecked checkboxes of the items.



16.5 IC Memory Card (GPPW ↔ IC Memory Card)

A	Q/QnA	FX
×	○	×

Read/write the data of the IC memory card. (Q series only)

(1) IC memory card overview

(a) About driver

PLC	IC Memory Card	Function		Driver	
		Read	Write	Windows 95/98*3	Windows NT 4.0
Q series	SRAM	○*1	○*1	Using Windows driver	—
	ATA	○*2	○*2	Using Windows driver	—
	Linear flash	×	×	—	—

\*1: Depending on your personal computer or OS, the operations may not be performed.

\*2: If it takes a long time to read/write the ATA data from GPPW when Windows 95 is used, change the driver from Hardware Controller ([Start] → [Control Panel] → [Hardware]) to "SunDisk (SunDisk ATA FlashDisk)".

\*3: When using SRAM, set the driver to CONFIG.SYS.  
 (For details, refer to Windows help.)  
 When ATA is used, Windows recognizes it automatically.  
 If it is not recognized, set it after choosing [Control Panel] → [System].  
 Remove the driver for SRAM if it has been set to CONFIG.SYS.

(b) About loading of IC memory card into PLC card slot

An adaptor is required to load the IC memory card into the PLC card slot.

	Mitsubishi Electric Make (Model)
PLC card adaptor	Q2MEM-ADP

(c) About formatting of IC memory card

To format the IC memory card, choose [Online] → [Format PLC memory] on GPPW. (For more information, refer to Section 21.2.)

IC Memory Card	Memory Card Name on Setting Screen
SRAM	Memory card (RAM)
ATA	Memory card (ROM)

(2) About PLC user data

For read/write of PC user data from/to the IC memory card, GPPW cannot directly access the IC memory card.

Use Explorer of Windows or the like.

Refer to Section 17.10 for the operation to read/write PLC user data when the IC memory card is loaded in the PLC.

16.5.1 Reading the data of the IC memory card

A	Q/QnA	FX
×	○	×

This section explains the operation to read the data of the IC memory card with the personal computer which has a PLC card slot. (Q series only)  
 Refer to Section 17.5 for reading data when the IC memory card is loaded in the PLC.

[Purpose]

Reads the data of the IC memory card.

[Operating Procedure]

Select [Tools] → [IC memory card] → [Read IC memory card].

[Dialog Box]

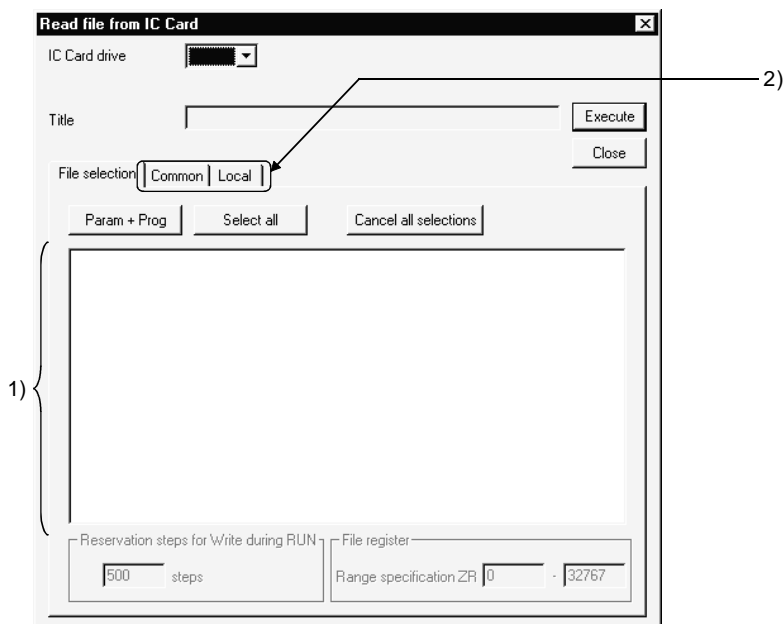

[Description]

- 1) Read data list  
Choose the data to be read.
- 2) <<Common>> tab, <<Local>> tab  
Choose either tab when setting a range to comments to read.  
For details, refer to Section 9.9.

<b>POINT</b>
<ul style="list-style-type: none"> <li>• When there is a password already set, the confirmation dialog box appears at the time of read execution. For details of the passwords, refer to Section 20.2.</li> </ul>

16.5.2 Writing data to the IC memory card

A	Q/QnA	FX
×	○	×

This section explains the operation to write data to the IC memory card with the personal computer which has a PLC card slot. (Q series only)  
 Refer to Section 17.5 for writing data when the IC memory card is loaded in the PLC.

[Purpose]

Writes data to the IC memory card.

[Operating Procedure]

Select [Tools] → [IC memory card] → [Write IC memory card].

[Dialog Box]

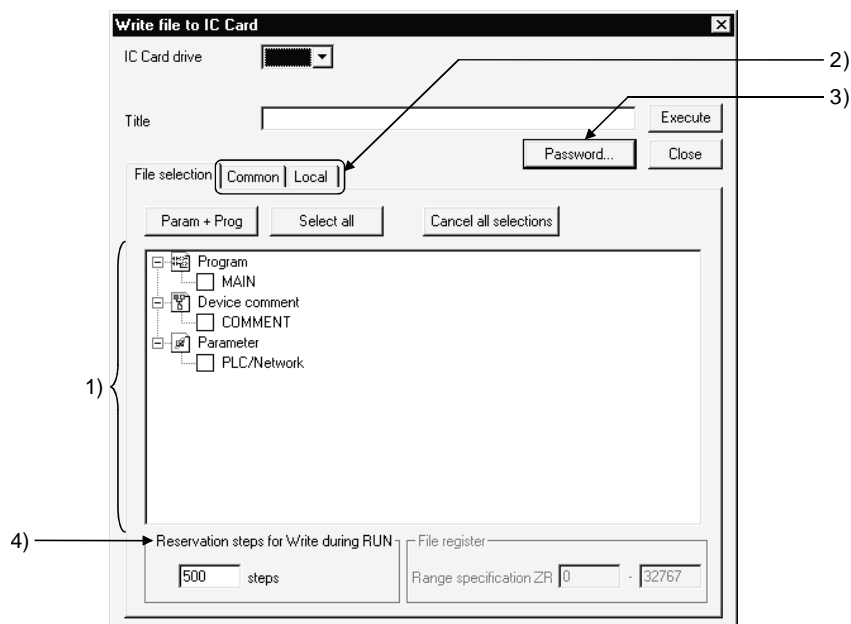

[Description]

- 1) Written data list  
Choose the data to be written.
- 2) <<Common>> tab, <<Local>> tab  
Choose either tab when setting a range to comments to read.  
For details, refer to Section 9.9.
- 3) Password button  
Sets the password from the password setting dialog box.  
For details, refer to Section 20.2.
- 4) Reservation steps for Write during RUN  
Reserves the area for the steps increased by Write during RUN.  
For Write during RUN, refer to Section 17.11.

**CAUTION**

If the same file name already exists, the overwrite confirmation dialog box appears. Click the Yes button to abandon and overwrite the existing data.

## 16.6 Intelligent Function Utility

A	Q/QnA	FX
×	○	×

The corresponding intelligent function utilities must be installed.

(1) Utility list (Q series only)

Show the utility list by selecting [Tools] → [Intelligent function utility] → [Utility list].

This displays the list of the intelligent function utilities required to edit the intelligent function utility parameters in the currently edited project.

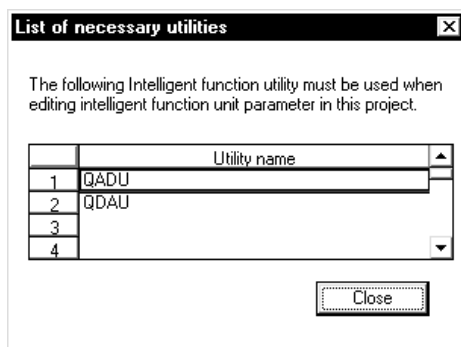

The list does not appear if the intelligent function utility parameters do not exist in the currently edited project or if the project name has not yet been set.

(2) Starting the intelligent function utilities (Q series only)

Start the intelligent function utilities by selecting [Tools] → [Intelligent function utility] → [Start].

(3) Intelligent function utility parameters on GPPW (Q series only)

The intelligent function utility parameters are not displayed in the project list. However, they are displayed in the Read from/Write to/Delete PLC, Copy project and Read/Write IC memory card dialog boxes.

In this case, if the **Param+Prog** button in the corresponding dialog box is used to make selection, the intelligent function utility parameters are also selected. (Except for copying the project)

- (4) Intelligent function utility parameters for operations (Q series only)  
 When the following operations are performed, the intelligent function utility parameters will be as described below.  
 If the intelligent function utilities have already used the intelligent function utility parameters, any of the following operations and others cannot be performed.  
 Start any operation after closing the intelligent function utilities.

Operation	Description
Read from PLC/Read IC memory card	The intelligent function utility parameters in the PLC/IC memory card are read to the GPPW project. If the project name has not yet been set, the intelligent function utility parameters cannot be read.
Write to PLC/Write IC memory card	The intelligent function utility parameters in the GPPW project are written to the PLC/IC memory card. If the project name has not yet been set, the intelligent function utility parameters cannot be written.
Newly read from PLC	Operation cannot be performed.
Password	Setting cannot be made.
Delete PLC data	The intelligent function utility parameters are deleted.
Verify PLC	Operation cannot be performed.
Save project	
Save	The intelligent function utility parameters are not changed.
Save as	The intelligent function utility parameters are added to the project to be saved.
Verify project	Operation cannot be performed.
Copy project	Copy cannot be performed if the copy source/destination is used in the intelligent function utilities.
Change PLC type	
Q series →Q series	The intelligent function utility parameters are retained intact.
Q series → other than Q series	The intelligent function utility parameters are deleted.
Delete intelligent function utility parameters saved in GPPW project	The intelligent function utility parameters cannot be deleted using GPPW. Use the intelligent function utilities to delete.

POINTS
<ul style="list-style-type: none"> <li>• Data in the PLC/IC memory card cannot be read/written directly from/to the intelligent function utilities. Use the corresponding read/write function of GPPW to read/write them to the intelligent function utilities.</li> <li>• For more information on the intelligent function utility parameters, refer to the corresponding module user's manual.</li> </ul>

16.7 Transferring ROM Data

A	Q/QnA	FX
○	×	○

Reads, writes, and verifies data from the GPPW, either with respect to the EP-ROM or E<sup>2</sup>P-ROM installed in an A series memory cassette, or an FX series memory cassette.

- (1) System configuration for ROM writer transfer  
 The system configuration for reading/writing/verification with a ROM writer is indicated below.

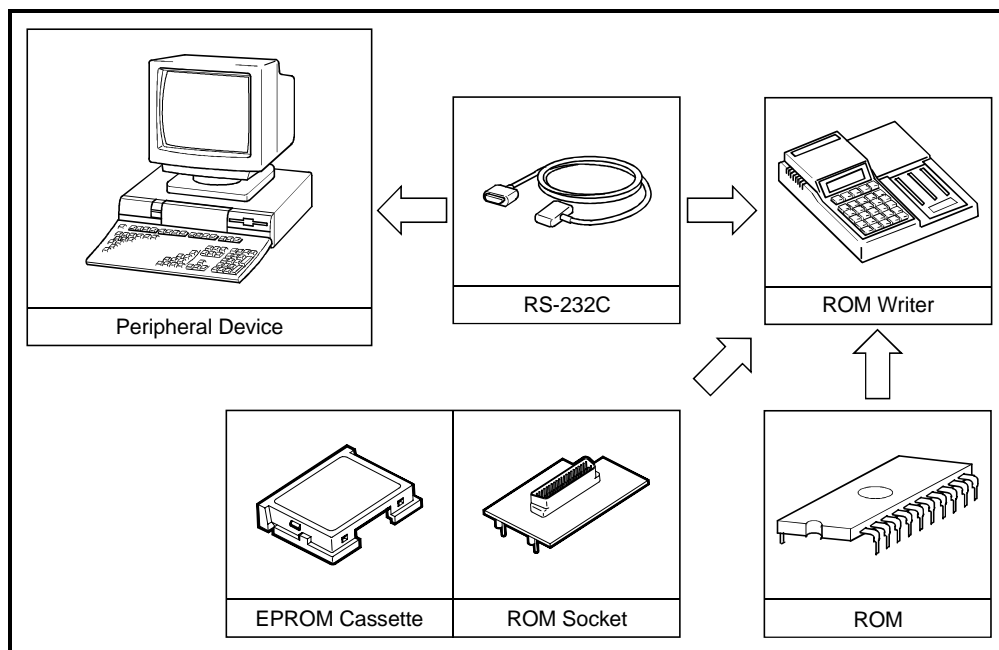

\*1: See Appendix 6 for an example of connecting cable wiring.

The correctness of the operation was confirmed for the ROM writers shown below.

- PECKER-10(PKW-1000)
- PECKER-11(PKW-1100)
- PECKER-30(PKW-3100)

- (2) Making settings at the ROM writer  
 Before reading/writing/verification with the ROM writer, make the following settings at it.

Item		Details
Data format	Data length	8-bit
	Stop bit	1 bit
	Parity	Odd
	Baud rate	9600 bps
X ON/OFF		Provided

## "A" series program memory configuration

- (1) Memory capacity setting  
 The data written to the ROM is classified into two types: main program and main + subprogram.  
 A memory capacity setting must be made for each data type.

- (a) Setting main program capacity  
 When a main program is set, the main program capacity set in the PLC parameters and automatically added parameters (fixed at 4K bytes) are written to the ROM.  
 Set the main program capacity in the PLC parameters so as to satisfy the following condition:

$$\boxed{\text{Main program capacity}} \leq \boxed{\text{Total memory capacity of ROM - parameters (4K bytes)}}$$

In the case of an AnUCPU, QCPU(Amode) for which network parameters are set, up to 16K bytes (a maximum of 4K bytes for each network unit) is added.

Check the memory capacity in the network parameters on the PLC parameter memory capacity setting dialog box, then set the main program capacity.

$$\boxed{\text{Main program capacity}} \leq \boxed{\text{Total memory capacity of ROM - parameters (4K bytes) - network parameters}}$$

If the writing capacity exceeds the capacity of the ROM, either make the setting for the main program memory capacity in the PLC parameters smaller, or replace the existing ROM with one with a larger capacity.

<Example> : Memory capacity setting for AnUCPU, QCPU(Amode) with network parameters set)

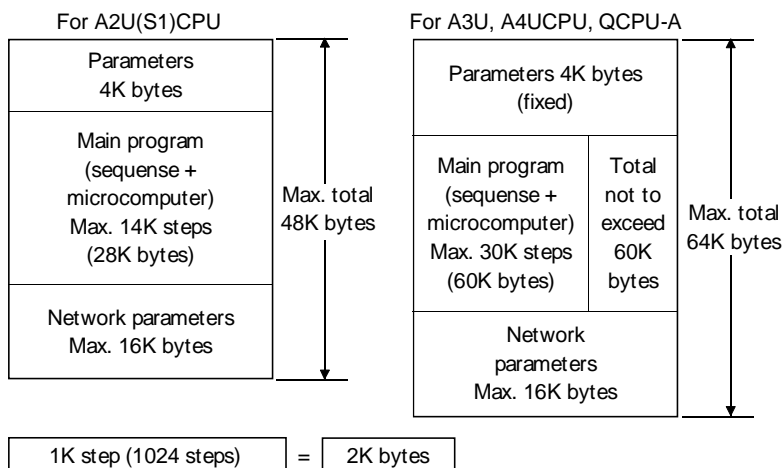



- (b) Setting main program + subprogram capacity  
 Write A3U/A4UCPU, QCPU(Amode) subprograms together with the main program. It is not possible to write a subprogram by itself.  
 When writing a main program + subprogram, the main program capacity set in the PLC parameters, the automatically added parameters (fixed at 4K bytes), and the subprogram capacity, are written to the ROM.  
 The subprogram capacity is automatically set at 64K bytes per subprogram.

Example: Memory capacity setting for A3U/A4UCPU, QCPU(Amode)

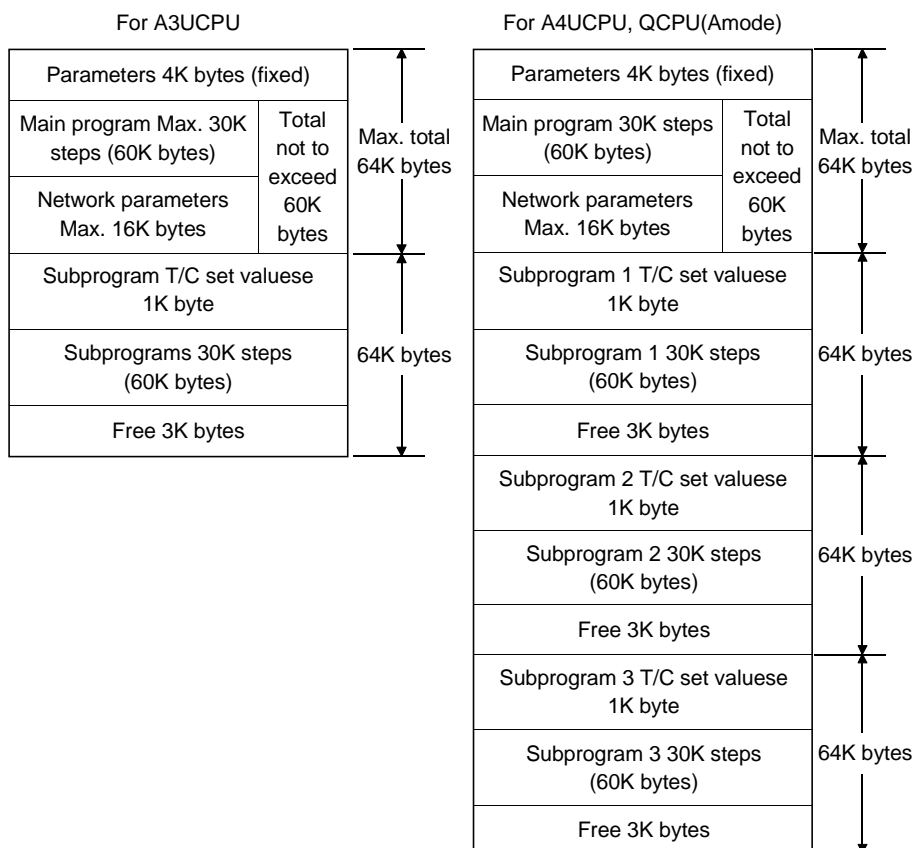

<b>POINT</b>	<ul style="list-style-type: none"> <li>The ROMs to which A3U/A4UCPU, QCPU(Amode) subprograms can be written are the 32KROM and the 64KROM. The 32KROM and 64KROM are capable of ROM operation with a subprogram written to them. The 32KROM and 64KROM can only be used with the A4UMCA-128 memory cassette.</li> </ul>
--------------	---

The total memory capacity, including main program and subprograms, for each ROM, is indicated below.

Model Name	ROM Type	Program Memory Capacity						
		A0J2H, A2C, A2CJ	A1N *1	A2N(S1), *1 A2A(S1), A2U(S1)	A3A, A3N *1	A3U, A4U *1 QCPU(Amode)	A1S, A1SJ, A1SH, A1SJH	A2S, A2US, A2USH-S1
4KROM	2764	2K steps (0 to 2046)	6K steps (0 to 6142)	6K steps (0 to 6142)	6K steps (0 to 6142)	6K steps (0 to 6142)	—	—
4KEROM	X2864A	—	6K steps (0 to 6142)	—	—	—	—	—
8KROM	27128	6K steps (0 to 6142)	—	14K steps (0 to 14334)	14K steps (0 to 14334)	14K steps (0 to 14334)	—	—
16KROM	27256	14K steps (0 to 14334)	—	14K steps (0 to 14334)	30K steps (0 to 30178)	30K steps (0 to 30718)	—	—
32KROM *2	27512	—	—	—	—	30K steps (0 to 30718) + 30K bytes	—	—
64KROM *3	27010	—	—	—	—	30K steps (0 to 30718) 30K + bytes x 3	—	—
A1SNMCA-8KP *4		—	—	—	—	—	8K steps (0 to 8190)	—
A2SMCA-14KP *5		—	—	—	—	—	—	14K steps (0 to 14334)

\*1: Two ROMs of the same model are used (for odd addresses and even addresses).

\*2: Only the A4UMCA-128 memory cassette can be installed.  
A main program and subprogram 1 can be written, and ROM operation with a subprogram is possible.

\*3: Only the A4UMCA-128 memory cassette can be installed.  
With A4UCPU, QCPU(Amode), a main program and subprograms 1, 2, 3 can be written, and ROM operation with a subprogram is possible.  
With A3UCPU, a main program and subprogram 1 can be written, and ROM operation with a subprogram is possible.

\*4: An A6WA-28P memory rewrite adapter is required.  
Only modls PECKER-11 and 30 can perform write function.  
Other ROM writers (including PECKER-10) cannot perform write function.  
For occasions such as reading and writing, set the ROM type as "27256."

\*5: An A2SWA-28P memory rewrite adapter is required.  
Only modls PECKER-11 and 30 can perform write function.  
Other ROM writers (including PECKER-10) cannot perform write function.  
For occasions such as reading and writing, set the ROM type as "27256."  
Switch between odd and even addresses with the ODD/EVEN setting pins of the A2SWA-28P rewrite adapter.

POINTS
<ul style="list-style-type: none"> <li>The A1SMCA-8KP conventional mode EP-ROM is not compatible with A1SHCPU. Note also that there is no EP-ROM cassette compatible with A2SHCPU.</li> <li>Since data writing with a ROM writer is not possible when using A1SNMCA-2KE/8KE or A2SNMCA-30KE E<sup>2</sup>P-ROM cassettes, write data using the PLC write function.</li> </ul>

(4) Address type

Depending on the CPU type, the ROM may have either of two address types (writing methods). The correspondence between CPU types and address types is indicated below.

Address Type	Writing Method	CPU Type
Odd *1 Even *1	Addresses are divided into odd and even, and the data written to two ROM's. *2	A1N, A2N(S1), A3N, A2A(S1), A3A, A2U(S1), A3U, A4U, A2S, A2SH, A2US(S1), A2USH-S1
Contiguous	Data is written to one ROM without division into odd and even addresses.	A0J2H, A1S, A1SJ, A1SH, A1SJH, A2C, A2CJ

\*1: Two EP-ROMs of the same model are used (one for odd, one for even)  
 However, note that the EP-ROM cassettes that can be used with A2S, A2SH, A2US(S1), and A2USH-S1 have two ROMs built in.

\*2: When there is one ROM writer socket, divide the data into odd and even addresses before writing to the ROM.  
 Note also that because the memory write adapter has to be switched over with A2S, A2SH, A2US(S1), and A2USH-S1, odd and even address data cannot be written at the same time.

<Example 1> : Writing the main program of an A1NCP (4K steps) to a 4KROM

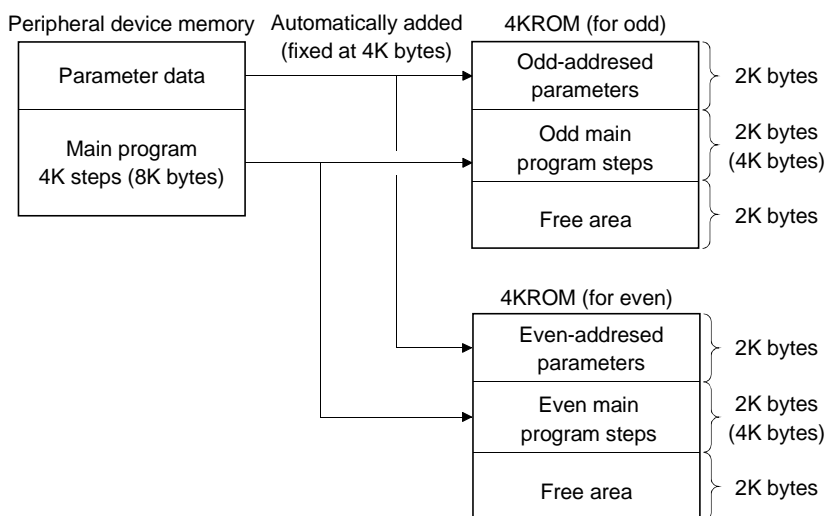

<Example 2> : Writing the main program of an A1S (CPU) to an A1S8MCA-8KP

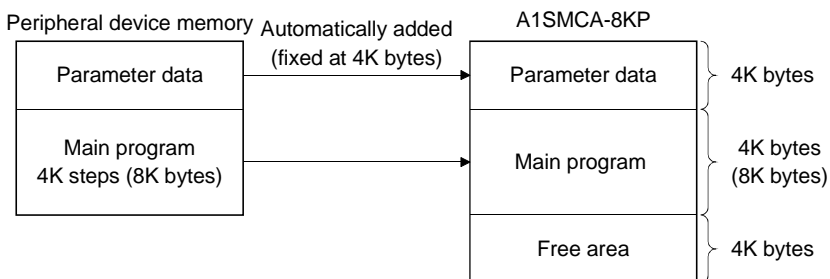

## Program memory configuration of the FX series

### (1) Memory capacity setting

The program memory of the PLC allows writing of sequence program (including parameters), file registers, and device comments.

The capacity setting ranges for each type of data are indicated below.

Type	Setting Details	Capacity Setting Range
FX0 FX0S	Sequence programs	800
	File registers	—
	Comments	—
	Total	800
FX0N	Sequence programs	500 to 2000
	File registers	0 to 1500
	Comments	0 to 1500
	Total	2000
FX1	Sequence programs	500 to 2000
	File registers	—
	Comments	0 to 4000 *1
	Total	2000
FX FX2 FX2C	Sequence programs	500 to 8000
	File registers	0 to 2000
	Comments	0 to 4000
	Total	Max. 8000, 200/4000 modes also possible
FX1S	Sequence programs	500 to 2000
	File registers	0 to 1500
	Comments	0 to 1500
	Total	2000
FX1N	Sequence programs	500 to 8000
	File registers	0 to 7000
	Comments	0 to 7500
	Total	Max. 8000, 2000/4000 modes also possible
FX2N FX2NC	Sequence programs	500 to 16000
	File registers	0 to 7000
	Comments	0 to 15500
	Total	Max. 16000 2000, 4000, 8000 modes also possible

(Units: steps)

\*1: The maximum program capacity is 2000 steps. However, when using a memory cassette it is possible to write comments up to 2000 steps outside the program area too.

16.7.1 ROM reading, writing, and verification

A	Q/QnA	FX
○	×	○

[Purpose]

Using a ROM writer connected to the peripheral device, reads from the ROM, writes to the ROM, or verifies the data in the peripheral device against the data in the ROM.

[Operating Procedure]

Select [Tools] → [Transfer ROM] → [Read] ([Write] / [Compare].)

[Dialog Box]

The dialog box for ROM reading is shown here; similar dialog boxes are displayed for writing and verification.

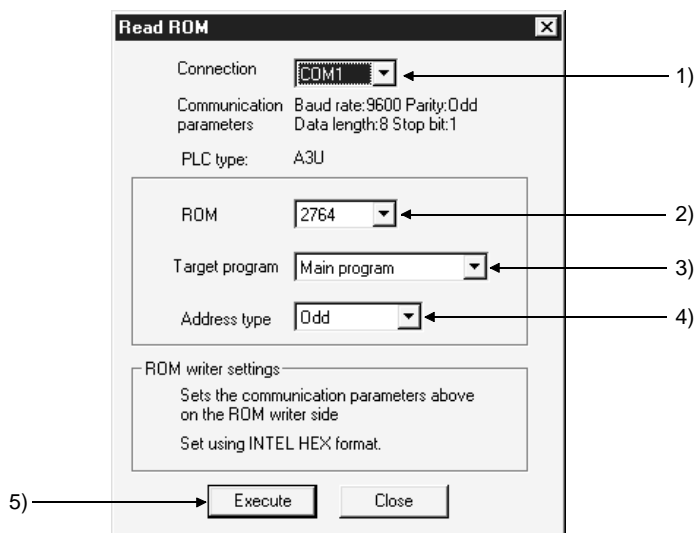

[Description]

- 1) Connection  
Selects the interface at the peripheral device connected to the ROM writer.
- 2) ROM (A series only)  
Selects the type of ROM used.  
"Automatic" cannot be selected for writing.
- 3) Target program (A series only)  
Selects the type of data to be read, written, or verified.
- 4) Address type (A series only)  
Sets the address type of the ROM.  
The address type is sequential for the following CPU types: A0J2H, A1S, A1S(S1) A1SJ, A1SH, A2C, A2CJ, and either odd or even for other CPU types.  
Note that when there are two ROM writer sockets it is possible to write simultaneously to odd and even addresses.  
However, when writing to an A2SMCA-14KP, ODD and EVEN settings are made at the memory write adapter, making simultaneous writing impossible.

- 5) **Execute** button  
Click this button after setting the necessary settings.

[Operating Procedure]

- For ROM reading/verification
  1. Install the ROM at the ROM writer, connect to the peripheral device and make the necessary settings.
  2. Set the memory capacity in the PLC parameters at the reading (verification) destination.
  3. Operate the ROM writer to read the ROM data into the buffer memory. \*1
  4. Set (1) through (4) in the ROM reading (verification) dialog box.
  5. Click (5) after setting the necessary settings.
- For ROM writing
  1. Install the ROM at the ROM writer, connect to the peripheral device and make the necessary settings.
  2. Set the memory capacity in the PLC parameters.
  3. Set (1) through (4) in the ROM writing dialog box.
  4. Click (5) after setting the necessary settings.
  5. Operate the ROM writer to write the buffer memory data to the ROM. \*1

\*1: For details on how to operate the ROM writer, refer to the instruction manual for the model used.

POINTS
<ul style="list-style-type: none"><li>• When data is written to the ROM, the ROM writer checks in advance whether the data in the ROM has been deleted.</li><li>• If the address type setting is incorrect, reading, writing and verification with the ROM writer will not be possible. Affix labels to ROMs or use some other method to distinguish among them.</li><li>• When the ROM type is set to automatic for reading or verification, an error will occur if there is a discrepancy between the memory capacity settings at the ROM side and peripheral device side. Alter the setting at the peripheral device side.</li></ul>

## 16.7.2 Writing to files in ROM format

A	Q/QnA	FX
○	×	○

## [Purpose]

Writes data to the HD, FD, etc., of a peripheral device in a file format like the address type for writing to a ROM.

## [Operating Procedure]

Select [Tools] → [Transfer ROM] → [Write to file].

## [Dialog Box]

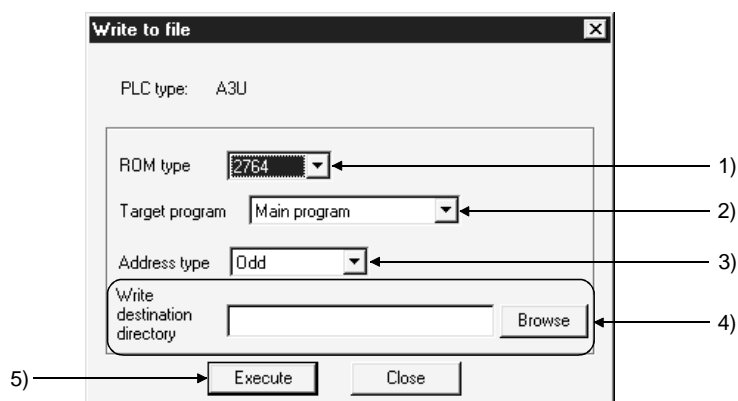

## [Description]

- 1) ROM type (A series only)  
Set the same type as the ROM used.
- 2) Target program (A series only)  
Selects the type of data for file writing.
- 3) Address type (A series only)  
Set the same address type as the ROM used  
If the CPU type is A0J2H, A1S, A1S(S1), A1SJ, A1SH, A2C, or A2CJ, the address type is "sequential."  
In other cases it is odd, even, or odd/even.
- 4) Write destination directory  
Sets the folder of file writing destinations.
- 5) **Execute** button  
Click this button after setting the necessary settings.

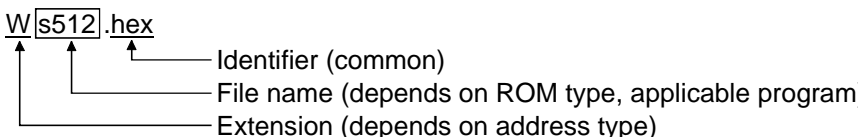
POINT
<ul style="list-style-type: none"><li>Some examples of how files are saved, and the address type-dependent extensions used, when file writing operations are executed are given below.</li></ul>
Saving example
 <p>W[s512].hex</p> <p>↑ Identifier (common) ↑ File name (depends on ROM type, applicable program) ↑ Extension (depends on address type)</p>
Extension
W..... Odd/even addresses
O..... Odd addresses
E..... Even addresses
S..... Sequential addresses



## 16.8 Batch-Deleting the Unused Device Comments

A	Q/QnA	FX
<input type="radio"/>	<input type="radio"/>	<input type="radio"/>

[Purpose]

Batch-deletes comments not used in the program.

[Operating Procedure]

[Tools] → [Delete unused comments]

[Description]

Comments to be deleted should satisfy the following conditions.

1. Comments attached to the devices not used in the program are batch-deleted.  
Device comments not searched for in the device use list, if any, by a device search are deleted.
2. Common comments of the devices not used in all programs are deleted.
3. Comments by program which are not used in the corresponding program are deleted.
4. Comments by program whose program does not exist are deleted together with data.
5. Common comments and comments by program which are set to the same device used are not deleted.
6. Click the  button to perform batch delete.

POINTS
<p>Device comments are batch-deleted under the following conditions.</p> <ul style="list-style-type: none"> <li>• Any device using index qualification is handled as not being qualified.</li> </ul> <p>&lt;Example&gt;</p> <p>(1) MOV D0 D100Z0 D0 and D100 will be the target of deletion and the device specified indirectly by Z0 will not be the target of deletion.</p> <p>(2) Two words of any indirectly specified device will be the target of deletion. MOV D0 @D10 D0, D10 and D11 will be the target of deletion, and the device number stored in D10 will not be the target of deletion.</p> <ul style="list-style-type: none"> <li>• Comments not deleted are indicated below. SP.M (A series), SP.D (A series), SM (QnA series), SD (QnA series), Jn\SB, Jn\SW</li> </ul>

## 16.9 Customizing Keys

A	Q/QnA	FX
<input type="radio"/>	<input type="radio"/>	<input type="radio"/>

### [Purpose]

Sets the key allocations for ladder creation as GPPA format, GPPQ format, or MEDOC format.

### [Operating Procedure]

Select [Tools] → [Customize keys].

### [Dialog Box]

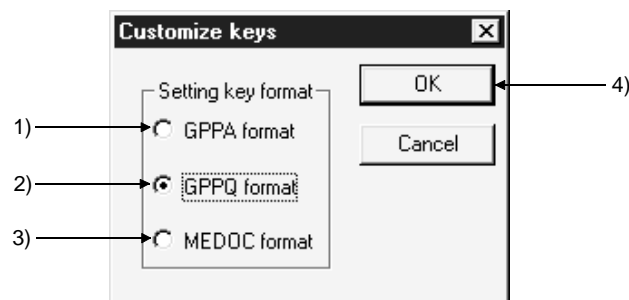

### [Description]

- 1) GPPA format  
Sets the key allocations corresponding to GPPA.
- 2) GPPQ format  
Sets the key allocations corresponding to GPPQ.
- 3) MEDOC format  
Sets the key allocations corresponding to MELSEC MEDOC. \*1
- 4) **OK** button  
Click this button after setting the necessary settings.

\*1: "MELSEC MEDOC" is a programming and document creation system retailed by Mitsubishi Electric Europe GMBH.

16.10 Setting Options

A	Q/QnA	FX
○	○	○

[Purpose]  
Sets the options for data creation.

[Operating Procedure]  
Select [Tools] → [Options].

[Dialog Box]  
<<Program common>> sheet

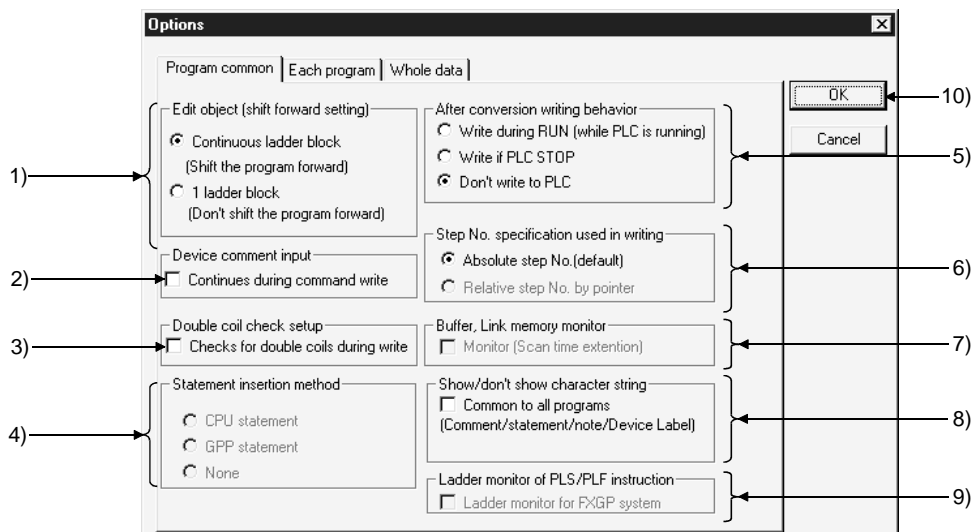

[Description]

- 1) Edit object (shift forward setting)
  - Continuous ladder block (Shift the program forward)  
If the edited ladder is shorter than it was before conversion, it is shifted forward on conversion.
  - 1 ladder block (Don't shift the program forward)  
If the edited ladder is shorter than it was before conversion, NOP instructions are written at the missing steps on conversion.
- 2) Device comment input  
Check the checkbox to select.  
After ladder input the comment input window opens, allowing device comments to be set.

## 3) Double coil check setup

Sets whether a duplicate coil check is to be performed at program creation.

The devices and instructions to which the duplicate coil check applies are indicated below.

## A series

	OUT	SET	SFT	PLS	PLF	MC
Y, M, L, B.F	○	○	○	○	○	○
T, C	○	—	—	—	—	—

○: Applicable —: Not applicable

## Q/QnA series

	OUT	SET	SFT	PLS	PLF	EGP, EGF	MC	FF	DELTA
Y, M, L, B.F.SM, DY, SB	○	○	○	○	○	—	○	○	○
D, SD, W, SW, R, ZR	○	—	○	○	○	—	○	○	○
T, C	○	—	—	—	—	—	—	—	—
Z	—	—	—	—	—	○	—	—	—

○: Applicable —: Not applicable

## FX series

	OUT	SET	PLS	PLF	MC
Y, M	○	○	○	○	○
S	○	○	○	○	—
T, C	○	—	—	—	—

○: Applicable —: Not applicable

It is possible to use the same coil, but attention must be paid to program operation.

In program editing by copying and pasting, no duplicate coil check is performed; for this reason you should perform a program check after editing.

See Section 16.1 for details of program checks.

## 4) Statement insertion method (Q/QnA series only)

At macro registration, regardless of the option, the statements registered together with ladder are expanded. If no statements have been registered, before expanding the macro select "CPU statement", "GPP statement", or "None".

## Ⓒ CPU statement

When writing to the PLC, the statements are written as part of the program. However, the number of steps taken up increases.

## Ⓒ GPP statement

The statements of the macro are displayed only at the peripheral device. The number of steps taken up does not increase, but the statements cannot be written to the PLC.

## Ⓒ None

Statements of the macro are not displayed.

- 5) After conversion writing behavior  
Sets writing of the program to the PLC after conversion.
- Ⓒ Write during RUN (while PLC is running)  
The program is unconditionally written to the PLC during the RUN status.  
"LD[R Edit mode]" is displayed to the Title bar.
  - Ⓒ Write if PLC is STOP  
The program is written to the PLC if its status is STOP (PAUSE).  
"LD[R Edit mode]" is displayed to the Title bar.
  - Ⓒ Don't write to PLC  
The program is not written to the PLC.

- 6) Step No. specification used in writing (Q/QnA series only)  
 Sets the method for online program change (write during RUN).
  - Ⓒ Absolute step No.(default)  
 Online program change (write during RUN) is executed based on absolute step numbers.
  - Ⓓ Relative step No. by pointer  
 Online program change (write during RUN) is executed based on relative step numbers, using pointers.

Only the pointer identified areas of a program created by several operators on a pointer-by-pointer basis can be written during RUN.  
 This method is useful when a program is to be debugged by several people.

Example:

Online program change (write during RUN) of the program at the peripheral device and the program in the PLC in different states, for example when a single program is being written and debugged by several people.

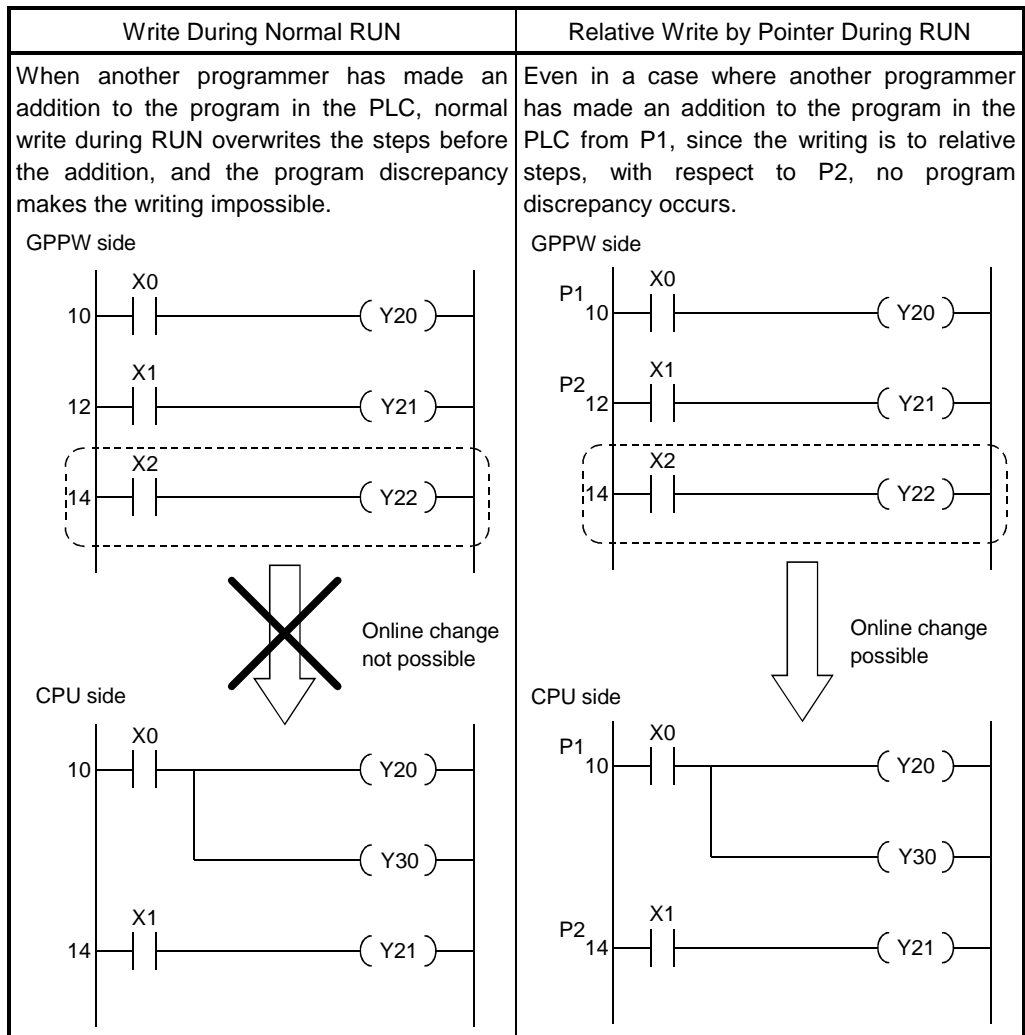

- 7) Buffer, Link memory monitor (Except FX series)  
Checking the checkbox causes monitoring of the buffer memory and link memory during ladder monitoring.  
When the buffer memory and link memory are monitored, the scan time of the PLC is further increased.
- 8) Show/don't show character string (Except FX series)  
Checking the checkbox causes display of comments/statements/notes/device names for all programs.
- 9) Ladder monitor of PLS/PLF instruction (FX series only)  
Checking the checkbox causes the monitor display of PLS/PLF instructions to be actuated in FXGP(DOS) and FXGP(WIN) formats. When the checkbox is cleared, monitor display is actuated in the GPPW format. The default is the GPPW format.  
(See Appendix 11.)
- 10)  button  
Click this button after setting all the necessary settings in each dialog box.

[Dialog Box]  
 <<Each program>> sheet

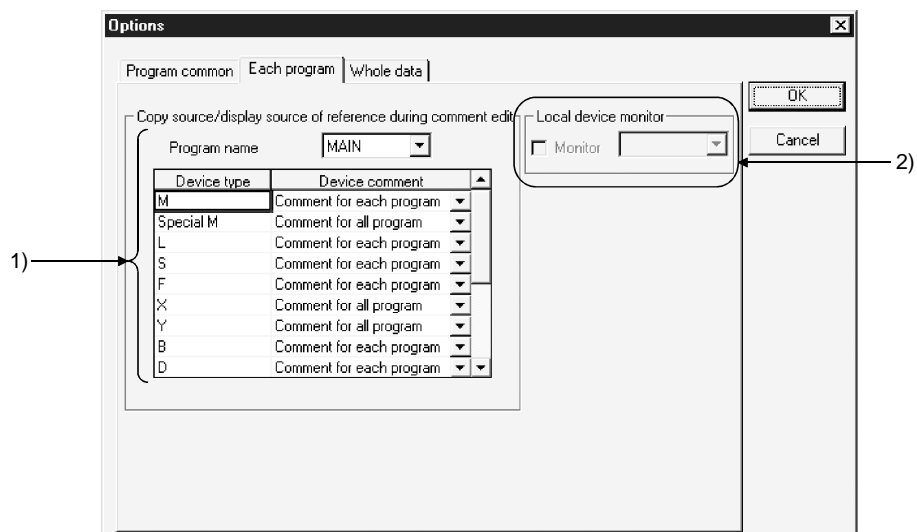

[Description]

- 1) Copy source/display source of reference during comment edit  
 When both a comment common to all programs and a comment specific to the individual program have been assigned to the same device, specifies which of these is to be displayed in the ladder window.  
 However, where only a comment common to all programs or only a program-specific comment is set for a device, the set comment is automatically displayed and therefore this setting is invalidated.
  
- 2) Local device monitor (Q/QnA series only)  
 Monitors the local devices of the selected program.  
 For the QnA series, the PLC of function version B or later must be used to perform local device monitor.  
 Refer to Appendix 7 for the way to identify the module version.



[Dialog Box]  
<<Whole data>> sheet

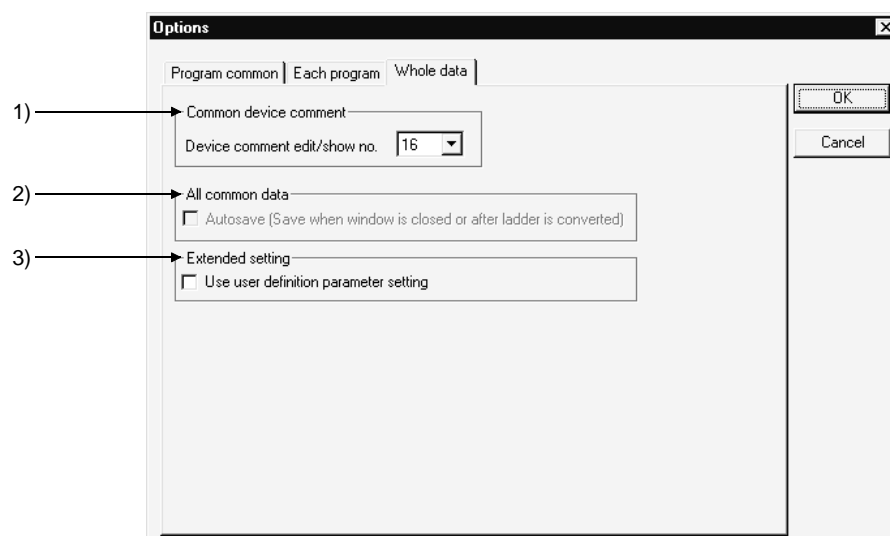

[Description]

- 1) Common device comment  
Sets the largest number of characters that can be set for a device comment as 16 characters or 32 characters.
- 2) All common data  
Checking this checkbox causes the data to be saved automatically when the window is closed.  
The data is also automatically saved when ladder changes are made.  
However, if no project name has been set when creating a new project this setting is not possible because there is no saving destination.
- 3) Extended setting  
Do not make this setting.

### 16.11 Displaying Multiple Windows

A	Q/QnA	FX
○	○	○

[Purpose]

Adjusts the size and position of windows when multiple windows are opened. However, when four or more windows are arranged horizontally or vertically, the number of lines and columns changes.

[Operating Procedure]

Select [Window] → [Cascade] ([Tile vertically], [Tile horizontally], [Arrange icons])

[Dialog Box]

This is an example where windows are displayed cascaded.

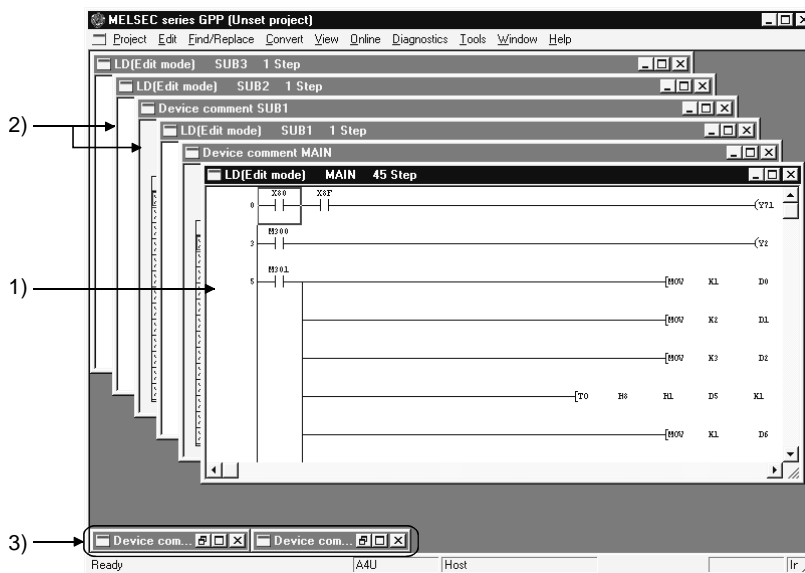

[Description]

- 1) Active window
  - If [Cascade] is selected, the sheet currently being edited is brought to the top.
  - When [Arrange horizontally] or [Arrange vertically] is selected, the window being edited is brought to the top left of the screen.
- 2) Non-active window
  - When [Cascade] is selected, windows that are not being edited are moved to the back.
- 3) Icon
  - When [Arrange icons] is executed, icons (minimized windows) are arranged on the bottom line of the screen.

### 16.12 Opening a Specific Project Using a Shortcut

A	Q/QnA	FX
○	○	○

[Purpose]

Creates the start setting file that is to act as the shortcut to a particular project. Just by opening the start setting file, or double-clicking an icon, GPPW can be started up and a project opened.

[Operating Procedure]

Select [Tools] → [Create Start-up setting file].

[Dialog Box]

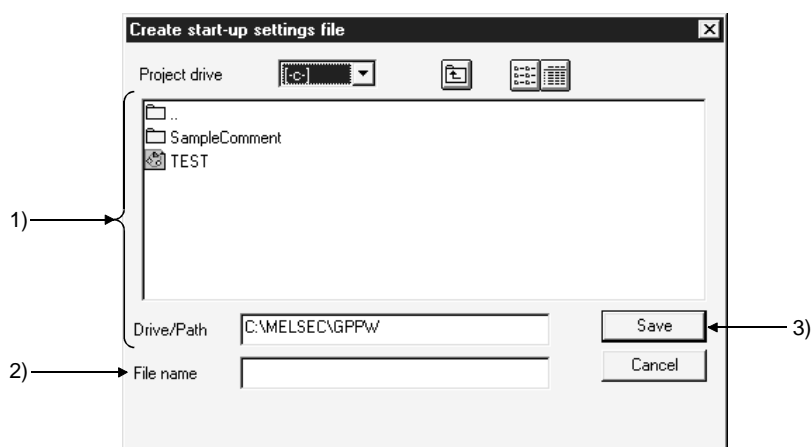

[Description]

- 1) Project drive, Drive/path  
Sets where the start setting file is saved.
- 2) File name  
Sets the start setting file name.
- 3) **Save** button  
Click this button after setting all the necessary settings.

<p><b>POINTS</b></p> <ul style="list-style-type: none"> <li>• It is convenient to set the start setting files of frequently opened projects in the desktop.</li> <li>• Initialization files have the extension ".GPS." The icon at initial setting is as follows.</li> </ul> <div style="text-align: center;">  <p>Test.gps</p> </div>
---

### 16.13 Starting the Ladder Logic Test Tool

A	Q/QnA	FX
○	○	○

[Purpose]

Starts the logic test function (LLT) from GPPW and carries out debugging offline.

[Operating Procedure]

Select [Tools] → [Start ladder logic test], or click .

[Description]

Starting the ladder logic test automatically places the ladder displayed on GPPW in the monitor mode.

See the Ladder Logic Test function software for windows SW5D5C-LLT-E(V), Operating Manual.

POINT
<ul style="list-style-type: none"> <li>The logic test function (LLT) is available as an option. It must be purchased separately to debug programs offline.</li> </ul>

### 16.14 Outline of Help Function

A	Q/QnA	FX
○	○	○

The help function reproduces some of the information in this manual and the PLC manual.

Information can be checked on the screen of the peripheral device during GPPW operations.

The help menu is explained below.

Help menu	Details
CPU error	Displays details of the error codes listed in the User's Manuals for each CPU and elsewhere. Error codes read during PLC diagnosis can be checked at the peripheral device.
Special relays/registers	Displays explanations of special relays and special registers, classified by function and device number. Allows you to check special relays and special registers during program creation and monitoring.
Shortcut key list	Displays shortcut keys for shortcuts to the menu in GPPW, and lists the key allocations for key customization for ladder creation.
Product information	Displays information about the product, such as the GPPW version.



# 17. CONNECTING A PLC

## 17.1 Specifying the Connection Target

### 17.1.1 When accessing the own station

A	Q/QnA	FX
<input type="radio"/>	<input type="radio"/>	<input type="radio"/>

[Purpose]  
Specify when making access to the own station.

[Operating Procedure]  
Select [Online] → [Transfer setup].

[Dialog Box]

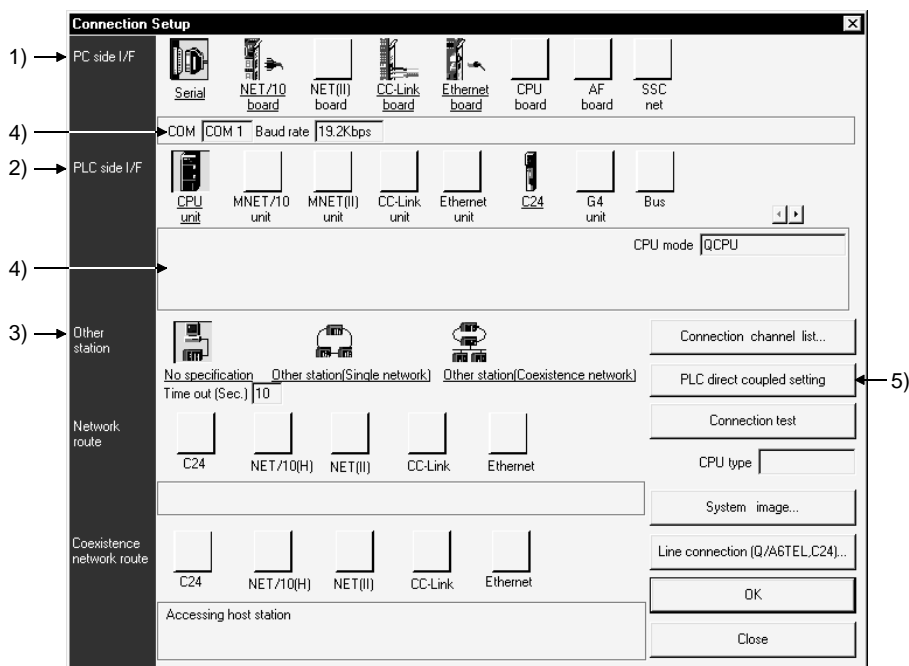

<b>POINT</b>
<p>An underline on the setting screen indicates that detailed setting can be made by double-clicking it.</p> <p>The icons displayed can be selected.</p> <p>The icon shown yellow means that it has already been selected.</p>

[Description]

- 1) PC side I/F  
For Q series

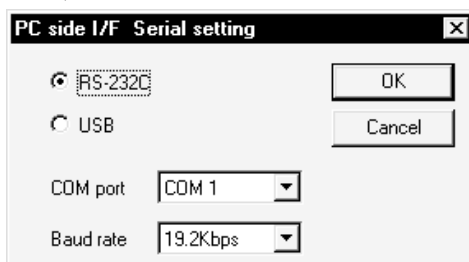

- USB may be set only when the QCPU (Q mode) has been selected.
- Precautions for communication at 115.2/57.6kbps  
Fast communication cannot be made if the peripheral device used is not compatible with the communication speed of 115.2/57.6kbps.  
If communications delay due to communications tries or a communication error occurs, reduce the baud rate setting and restart communication.
- Refer to (4), (5), (6) in POINT of Section 17.1.2 for precautions for making USB communication.

QnA/A/FX series

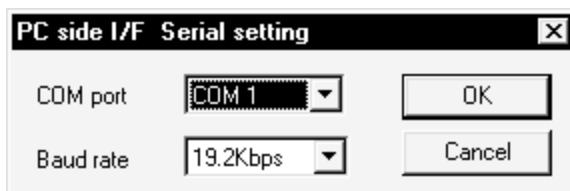

- The baud rate value that may be chosen differs between the PLC series and PLC types.
- For the QnA series, the CPU that can communicate at the communication speed of 38.4kbps is the QnACPU whose function version is B or later. Refer to Appendix 7 for the way to identify the unit version.

- 2) PLC side I/F  
Choose the PLC series of the PLC to be connected with GPPW.  
For A series

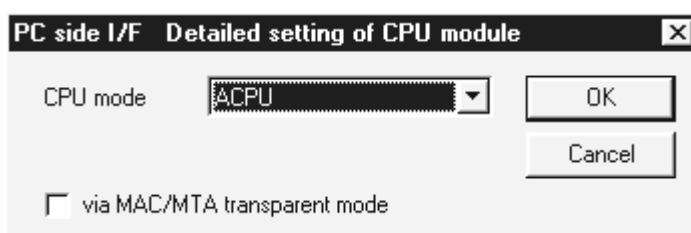

- Via MAC/MTA transparent mode (A/FX only)  
Please make settings only when using MAC/MTA.

- 3) Other station  
Choose No specification when specifying the own station.  
When power-off, hardware reset or the like of the PLC CPU is performed during ladder monitor, it will take time until a communications error appears.  
Until the error appears, during execution is displayed in Monitor status.  
The longest time until the error appears can be found by the following expression.  
 $(\text{Time specified for communications time check}) \times 3 \times (\text{Count specified for the number of retries} + 1)$   
For example, when the communications time check is specified as 30 seconds and the number of retries as 0 times, the resultant time is  $(30 \text{ seconds}) \times 3 \times (0 + 1) = 90 \text{ seconds}$ , and the error appears after a maximum of 90 seconds have elapsed.

- 4) Detailed settings display column  
Shows the setting status.
- 5) PLC direct coupled setting button  
This button is useful to change from Other station to the own station.

17.1.2 When accessing the other station

A	Q/QnA	FX
○	○	×

[Purpose]

Specify when making access to the other station.

[Operating Procedure]

Select [Online] → [Transfer Setup].

[Dialog Box]

When specifying the other station, it will be convenient to specify the connection target while looking at the connection channel diagram from Connection channel list.

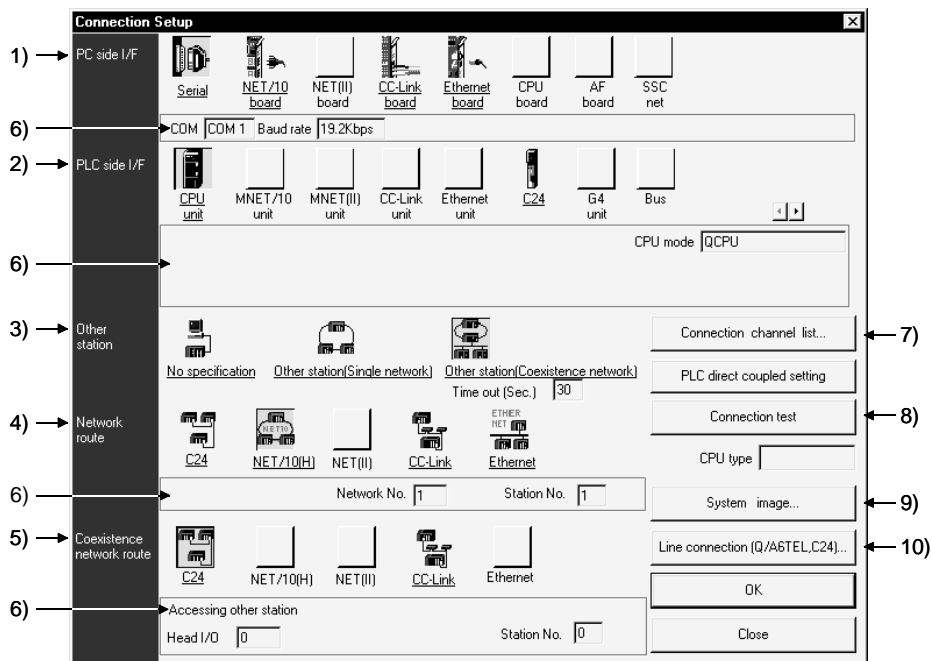

**POINT**

An underline on the setting screen indicates that detailed setting can be made by double-clicking it.  
 The icons displayed can be selected.  
 The icon shown yellow means that it has already been selected.

[Description]

- 1) PC side I/F  
Refer to Section 17.1.1
- 2) PLC side I/F  
Choose the unit to be connected with the peripheral device.



3) Other station

What is Single network?

It indicates a system which is configured by a single network and a multilevel system, e.g., only MELSECNET/10 or only Ethernet. (Since Ethernet is regarded as the MELSECNET/10, specify Single network for an MELSECNET/10 and Ethernet mixed system.)

What is Coexistence network?

Set this network when making access to the other station PLC via two different networks.

This network indicates a system which is made up of different networks, e.g. from MELSECNET/10 to CC-Link unit or from Q-compatible C24/QC24 to MELSECNET/10.

This network cannot be chosen for the A series.

4) Network route

When Single network is selected

Choose the network type, network No., station number and first I/O No. to be accessed.

The setting items depend on the network type that has been set.

When Coexistence network is selected

Choose this when making access to the network different from the one where the peripheral device is connected.

5) Coexistence network route

Choose the network type, network No., station number and first I/O No. to be accessed.

The setting items depend on the network type that has been set.

6) Detailed settings display column

Shows the setting status.

7) Connection channel list

You can set the connection target while looking at the Connection channel list. As clicking **OK** automatically sets the connection channel on the Connection Setup screen, settings can be made easily if a complicated system is configured. Set the network number, station number and others as desired according to the access target.

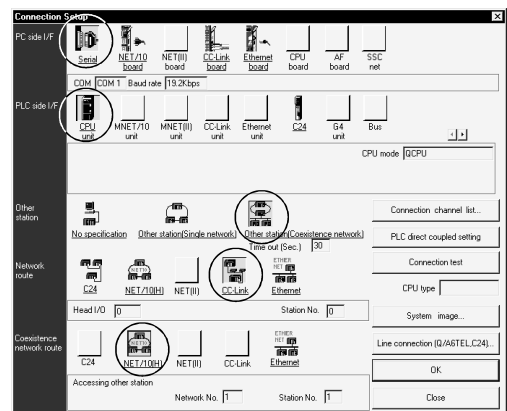
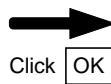
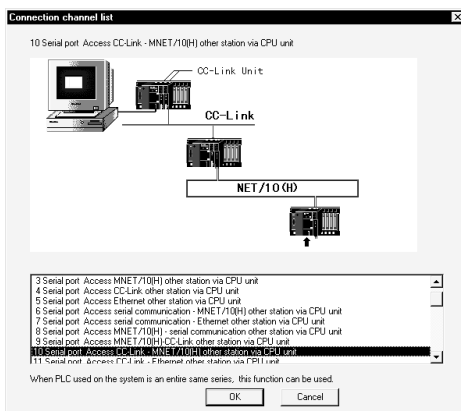

Clicking the **OK** button automatically sets the connection channel (areas enclosed by circles) on the Connection Setup screen.

- 8) Connection test  
Tests whether proper access can be made to the PLC set as the access target on the Connection Setup screen.  
If proper access can be made, the model name of the PLC as the access target appears in the CPU type field.
- 9) System image  
Illustrates the preset connection channel.
- 10) **Line connection (Q/A6TEL, C24)** button  
Set when using a telephone line to make communication.  
Refer to Section 23.4 for the way to set the Line connection setting screen.

Screen setting for MELSECNET/10 and Ethernet combined system (Single network)  
In an MELSECNET/10 and Ethernet mixed system configuration, specify Single network to access the other station. (Since Ethernet is equivalent to the MELSECNET/10)

An example of the Connection Setup setting screen is provided for the following system configuration (Q/QnA only).

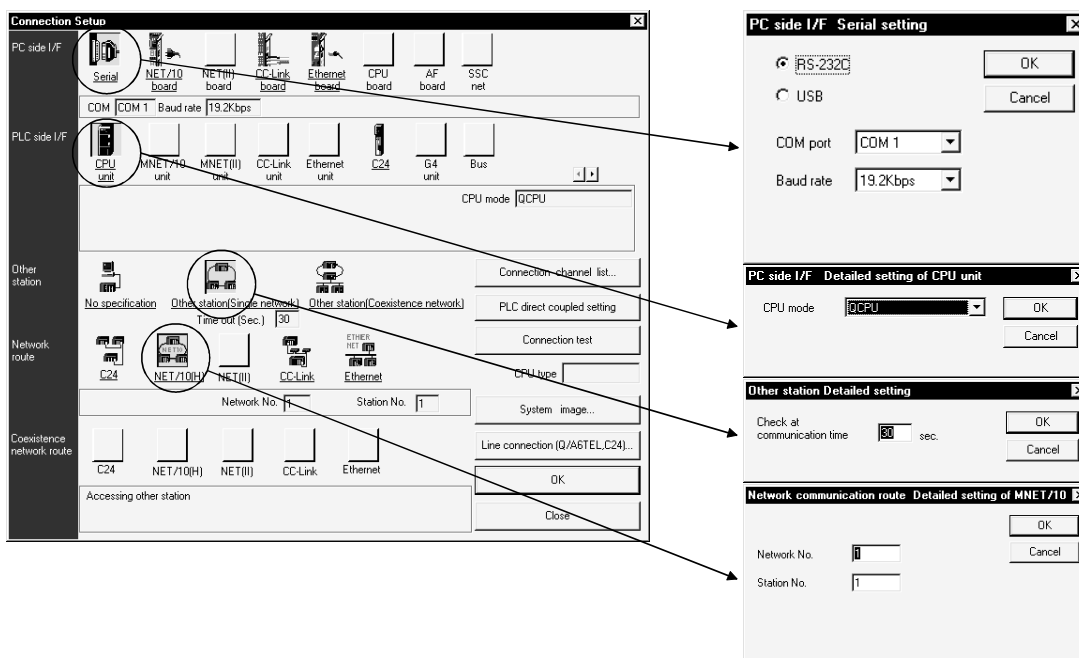
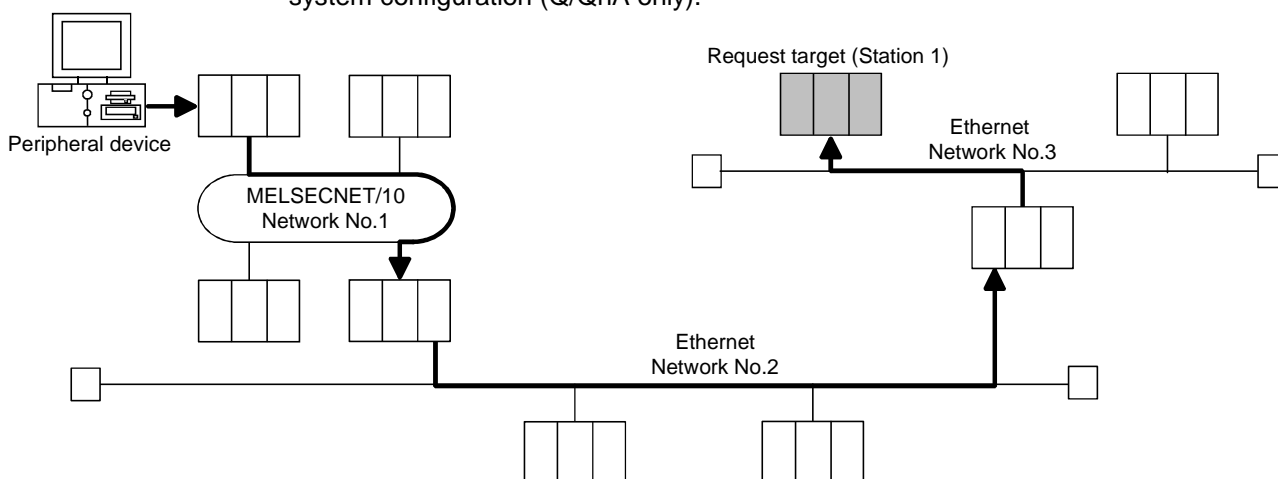

For access to the other station or multilevel system, not only the Connection Setup but also the routing parameters should be set to enable communications.

Screen setting for MELSECNET/10(H) and C24 mixed system (Coexistence network)

Specify Coexistence network when accessing the other station via different networks, e.g. from MELSECNET/10(H) to Q-compatible C24/QC24.

An example of the Connection Setup setting screen is provided for the following system configuration (Q/QnA only).

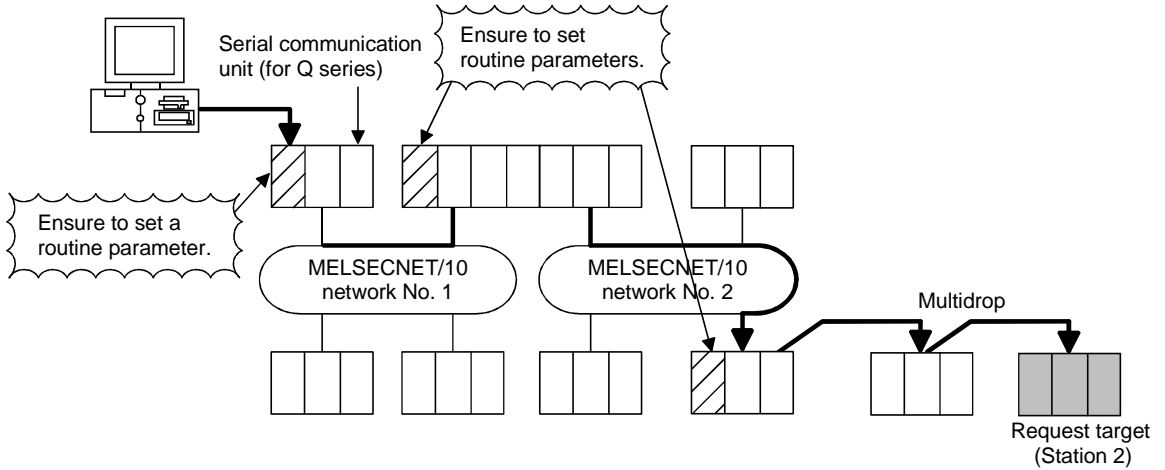

The screenshot shows the 'Connection Setup' software interface. The main window is divided into sections: PC side I/F, PLC side I/F, Other station, Network route, and Coexistence network route. The 'C24' option is selected under 'Other station' and 'Coexistence network route'. To the right, four detailed setting windows are shown:

- PC side I/F Serial setting:** Shows 'COM1' selected for the COM port and '19.2Kbps' for the Baud rate.
- PC side I/F detailed setting of C24:** Shows 'QJ71C24' as the CPU type, '0' as the Station No., 'Odd' as the Parity, and 'Existence' as the Sum check.
- Other station Detailed setting:** Shows a 'Check at communication time' of '30' seconds.
- Network communication route Detailed setting of MNET/10:** Shows '0' for the Network No. and '1' for the Station No.
- Coexistence network route Detailed setting of Computer li...:** Shows '0' for the Head I/O and '0' for the Station No.

Arrows from the main window point to these detailed settings: from 'Serial' to the serial setting window, from 'C24' to the C24 detailed setting window, from 'Other station (Coexistence network)' to the other station detailed setting window, and from 'C24' under 'Coexistence network route' to the coexistence network route detailed setting window.

**REMARKS**

Precautions for access to the other station in the following QCPU (Q mode), QnACPU and ACPU mixed system are as follows.

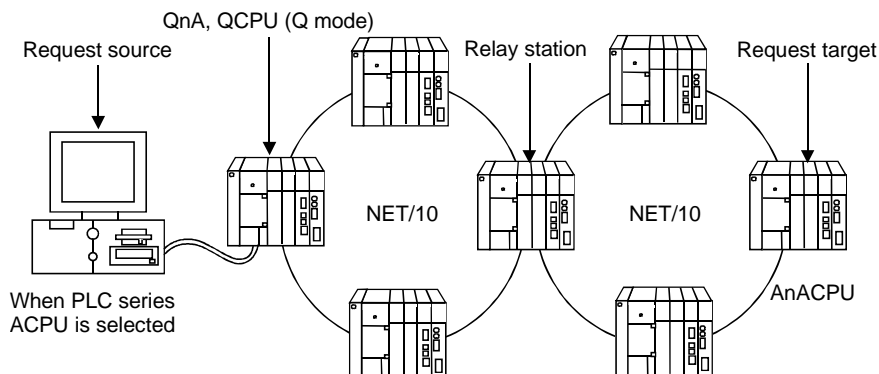

1. Change the peripheral device to the PLC type of the request target. Communication cannot be made if the PLC type differs.
2. The relay station used should be the QCPU (Q mode), QnACPU.
3. If the connection target of the peripheral device is the QnACPU and the request target is the ACPU, turn on SW1 of the QnACPU system setting switch 2 to ON (peripheral device for ACPU). No setting is required for connection to the QCPU (Q mode).

POINTS
<p>(1) Precautions for access to the other stations of the MELSECNET (II, /10) via the computer link unit (for A series) or E71 GPPW recognizes the MELSECNET/10 as the MELSECNET (II) when the other stations are to be accessed via the computer link unit (for A series) or E71. When the same station exists on the MELSECNET (II) and MELSECNET/10, the other stations beyond the MELSECNET/10 may not be accessed if Via MELSECNET/10 has been selected in Connection Setup. (Because communications from the station of the unit set in the "Unit valid for other station access" network parameter are executed.)</p>
<p>When you want to access all other stations via the computer link unit (for A series) or E71, do not set the same station number on the networks.</p>
<p>(2) When the MELSECNET/10 /CC-Link card is used, the time check is fixed to 30 seconds.</p>
<p>(3) Precautions for access to the motion controller (SCPU) via the MELSECNET (II, /10)</p> <ul style="list-style-type: none"><li>• Set the A171SH/A172SH as the A2SH.</li><li>• Set the A273UH(S3) as the A3U.</li></ul> <p>In this case, the instructions dedicated to the motion controller (SCPU) cannot be used.</p>
<p>(4) A communications error may occur if communications are made with the PLC after setting the resume function, suspend setting, power-saving function or standby mode of the personal computer. Hence, any of the above functions should not be set for making communications with the PLC.</p>
<p>(5) Connecting/disconnecting the USB cable, resetting the PLC, or switching power OFF/ON frequently during communications with the PLC can cause a communications error, from which recovery may not be made. Hence, place GPPW in an offline status* where possible before connecting/disconnecting the USB cable, resetting the PLC, or switching power OFF/ON. If recovery cannot be made from the communications error, completely disconnect the USB cable once and reconnect it in more than five seconds. (Even after this operation, an error may occur at the initial communication, but communications will be made properly at the second time and later.)</p> <p>*Offline status: Indicates the status other than PLC write/read, monitor, test and PLC diagnostic</p>
<p>(6) Communication errors may occur depending on the type of personal computer used or USB cable assembly In this case. Please execute communication again according to the error message contents.</p>
<p>(7) When fast communication is made after the baud rate has been changed on the personal computer's serial port (personal computer side interface), communications may not be made or communications retries may take place to delay communications, depending on the performance of the peripheral device. If communications cannot be made in fast communication, reduce the baud rate and make communication.</p>

17.2 Making access via Ethernet, CC-Link, G4 module, C24 or telephone line

17.2.1 Setting method for communication via the ethernet board

17.2.1 (1) For A series

A	Q/QnA	FX
○	×	×

For communication from GPPW via the E71, there are the following setting items and precautions. The explanations in this section will be made for the following system configuration.

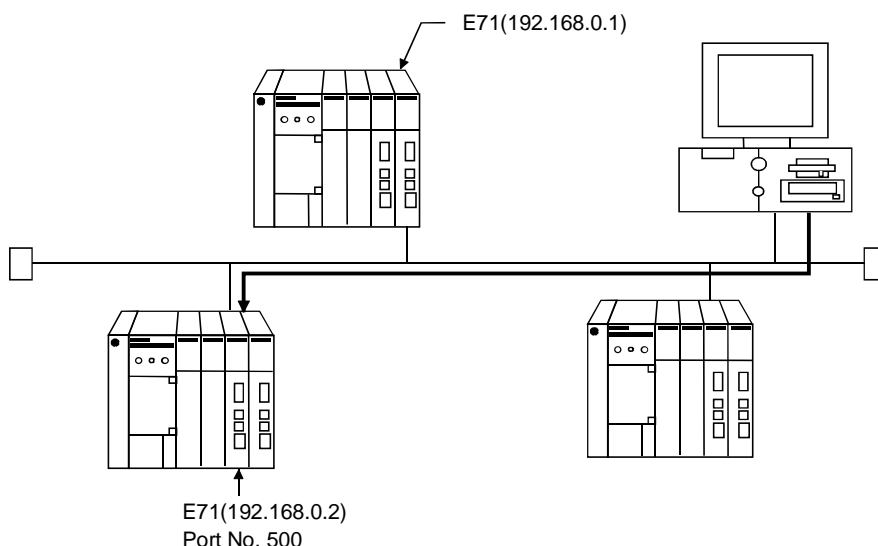

Procedure for communications via E71

Restrictions

- (a) When the AnUCPU type has been started on the peripheral device, change the PLC type to the AnACPU.
  - (b) Communications can be made only within the same segment. Communication cannot be made via the router or gateway.
- (1) Compatible models  
AJ71E71-S3, A1SJ71E71-B2-S3, A1SJ71E71-B5-S3
  - (2) E71 switch settings  
Operation mode setting switch.....0 (online mode)  
Communications condition setting switch .....SW2 ON (BIN) code  
CPU communications timing setting switch .....SW3 ON
  - (3) Sequence program  
Initial processing and communication open file sequence program is required. A sequence program example is shown below.

Setting Item	Setting	Setting Item	Setting
UDP/IP open system	100H (UDP, fixed buffer transmission)	Other node IP address	FFFFFFFF
E71's IP address	192. 168. 0. 2	Other node port number	FFFF
E71 port number	500H		

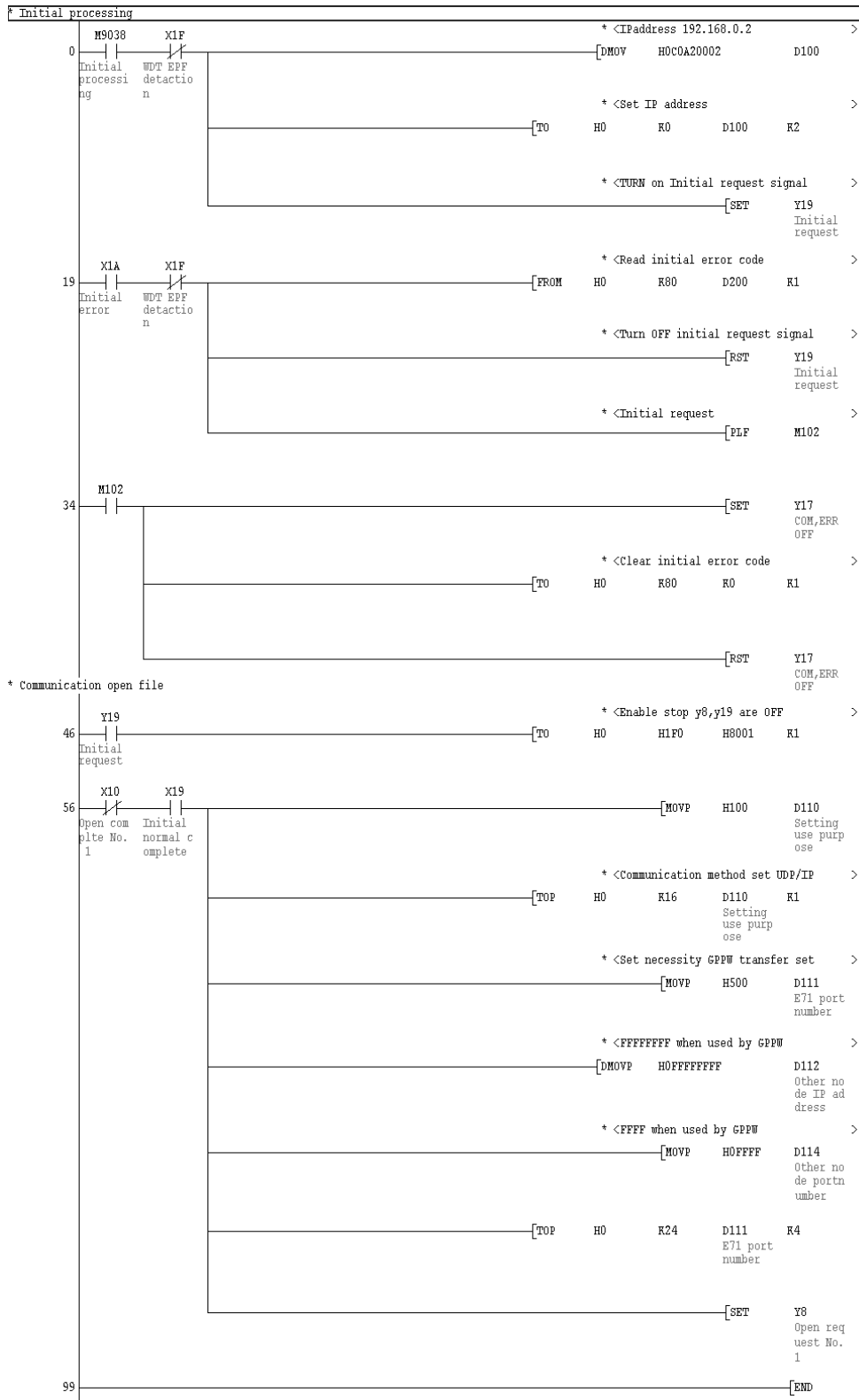

In a communications-ready status, the E71's RUN LED comes on and RDY LED flickers.

- (4) Setting on the peripheral device  
Set the IP address.
- (5) Communications check  
When the preparations for communications via the E71 are complete, execute ping in the MS-DOS mode to check connections before starting communications on GPPW.

When connections are OK  
C:\ping 192. 168. 0. 2  
Reply from 192. 168. 0. 2:bytes=32 time<10ms TTL=32

When connections are not good  
C:\>ping 192. 168. 0. 2  
Request timed out.

If ping does not pass through, check the cable and unit connections and Windows side IP address and other settings.

- (6) Connection Setup screen  
Setting screen for communication via Ethernet unit

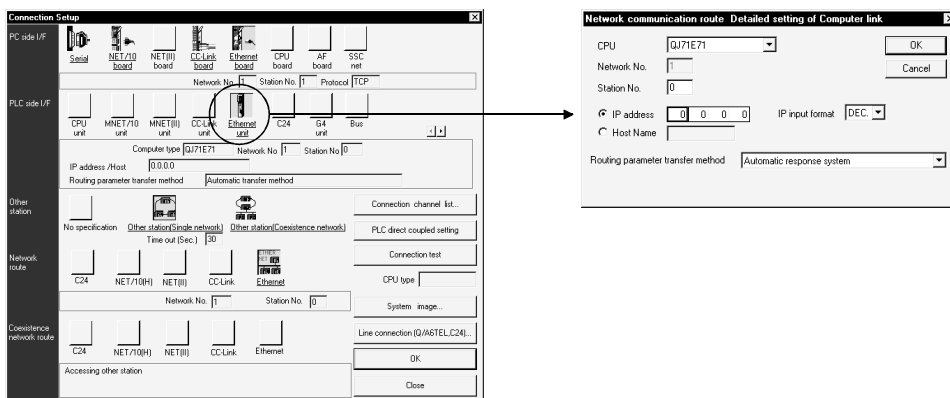

- (a) Double-click the Ethernet icon on PLC side I/F to choose the unit model to be connected.
- (b) The detail setting screen for the Ethernet unit to be connected opens.
  - 1) Set the IP address assigned to the E71 to be connected.  
(When the host name has been selected, specify the name preset in the hosts file within 64 characters.)
  - 2) As the port No., set the port No. of the connected E71 set in the sequence program.



POINT
-------

When connecting to the QCPU (A mode) or AnUCPU via Ethernet, set the PLC model name to the AnACPU using New project. (Choose the A171SH or A172SH for the motion controller (SCPU).)

Access can be made within the range that can be handled by the AnACPU, e.g. sequence program, device memory. Therefore, access cannot be made to the devices and network parameters which have been extended by subprogram 2/3, QCPU (A mode) or AnUCPU.

However, access to the AnUCPU via the QJ71E71 can be made within the range that can be handled by the AnUCPU.

17.2.1 (2) For QnA series

A	Q/QnA	FX
×	○	×

For communication from GPPW via the QE71, there are the following setting items and precautions. The explanations in this section will be made for the following system configuration.

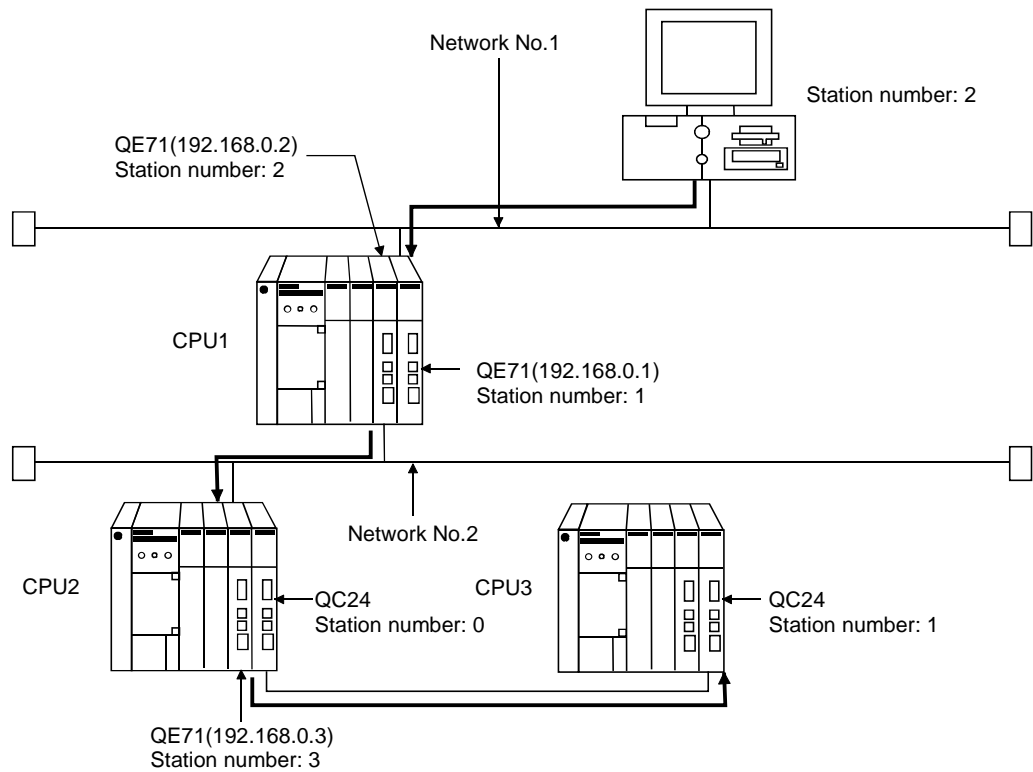

Procedure for communications via QE71

Restrictions

- (a) Communications cannot be made via the MELSECNET(II).
  - (b) Communications can be made only within the same segment.  
Communication cannot be made via the router or gateway.
- (1) Compatible models  
Use the QE71 and PLC whose function version is B or later.  
Communication from GPPW via the QE71 is not supported by Q4AR.

- (2) QE71 switch settings  
 Operation mode setting switch..... 0 (online)  
 Communications condition setting switch ..... SW2 OFF (BIN code)
- (3) Parameter setting  
 Parameter setting can be made from either the MELSECNET/ETHERNET network parameter setting screen or the sequence program.  
 The parameters are required for communications.  
 On the Ethernet parameter setting screen, set the network type, first I/O No., network No., group No., station number and IP address.

Setting Screen Examples																																		
CPU1	<p style="text-align: center;">Ethernet parameters</p> <table border="1"> <thead> <tr> <th></th> <th>Unit No.1</th> <th>Unit No.2</th> </tr> </thead> <tbody> <tr> <td>Network type</td> <td>Ethernet</td> <td>Ethernet</td> </tr> <tr> <td>Start I/O No.</td> <td>0040</td> <td>0060</td> </tr> <tr> <td>Network No.</td> <td>2</td> <td>1</td> </tr> <tr> <td>Total number of stations</td> <td></td> <td></td> </tr> <tr> <td>Group No.</td> <td>0</td> <td>0</td> </tr> <tr> <td>Station No.</td> <td>2</td> <td>1</td> </tr> <tr> <td>IP addressDEC</td> <td>192.168. 0. 2</td> <td>192.168. 0. 1</td> </tr> <tr> <td></td> <td>MNET/10 routing information</td> <td>MNET/10 routing information</td> </tr> <tr> <td></td> <td>FTP Parameters</td> <td>FTP Parameters</td> </tr> <tr> <td></td> <td>Routing information</td> <td>Routing information</td> </tr> </tbody> </table> <p style="text-align: center;">IP address setting</p>		Unit No.1	Unit No.2	Network type	Ethernet	Ethernet	Start I/O No.	0040	0060	Network No.	2	1	Total number of stations			Group No.	0	0	Station No.	2	1	IP addressDEC	192.168. 0. 2	192.168. 0. 1		MNET/10 routing information	MNET/10 routing information		FTP Parameters	FTP Parameters		Routing information	Routing information
		Unit No.1	Unit No.2																															
Network type	Ethernet	Ethernet																																
Start I/O No.	0040	0060																																
Network No.	2	1																																
Total number of stations																																		
Group No.	0	0																																
Station No.	2	1																																
IP addressDEC	192.168. 0. 2	192.168. 0. 1																																
	MNET/10 routing information	MNET/10 routing information																																
	FTP Parameters	FTP Parameters																																
	Routing information	Routing information																																
CPU2	<p style="text-align: center;">Ethernet parameters</p> <table border="1"> <thead> <tr> <th></th> <th>Unit No.1</th> <th>Unit No.2</th> </tr> </thead> <tbody> <tr> <td>Network type</td> <td>Ethernet</td> <td>None</td> </tr> <tr> <td>Start I/O No.</td> <td>0040</td> <td></td> </tr> <tr> <td>Network No.</td> <td>2</td> <td></td> </tr> <tr> <td>Total number of stations</td> <td></td> <td></td> </tr> <tr> <td>Group No.</td> <td>0</td> <td></td> </tr> <tr> <td>Station No.</td> <td>3</td> <td></td> </tr> <tr> <td>IP addressDEC</td> <td>192.168. 0. 3</td> <td></td> </tr> <tr> <td></td> <td>MNET/10 routing information</td> <td></td> </tr> <tr> <td></td> <td>FTP Parameters</td> <td></td> </tr> <tr> <td></td> <td>Routing information</td> <td></td> </tr> </tbody> </table> <p style="text-align: center;">IP address setting</p>		Unit No.1	Unit No.2	Network type	Ethernet	None	Start I/O No.	0040		Network No.	2		Total number of stations			Group No.	0		Station No.	3		IP addressDEC	192.168. 0. 3			MNET/10 routing information			FTP Parameters			Routing information	
		Unit No.1	Unit No.2																															
Network type	Ethernet	None																																
Start I/O No.	0040																																	
Network No.	2																																	
Total number of stations																																		
Group No.	0																																	
Station No.	3																																	
IP addressDEC	192.168. 0. 3																																	
	MNET/10 routing information																																	
	FTP Parameters																																	
	Routing information																																	
CPU3	Set the station number with the rotary switches of the unit.																																	

- (4) Routing parameter setting  
Set the routing parameters on the Ethernet parameter setting screen. Refer to Section 17.10 for the concept of the routing parameters.

		Setting Screen Examples			
CPU1		Target networkNo.	Relay networkNo.	Relay StationNo.	Via StationNo.
	1	1	2	2	
	2	2	1	1	
	3				
CPU2		Target networkNo.	Relay networkNo.	Relay StationNo.	Via StationNo.
	1	1	2	2	
	2				
	3				

After parameter setting is over, write the parameters to the PLC using Write to PLC. In a communications-ready status, the QE71's RUN LED comes on and RDY LED flickers.

- (5) Communications check  
Refer to Section 17.4.1 (1) for communications check.
- (6) Connection Setup screen

Item	Description
PC side I/F	Set the network No. and station number.
PLC side I/F	Set the model name, station number, IP address, etc. of the unit connected to the peripheral device.
Network route	As access is made to the other station via the Ethernet unit, choose "Other station in the same loop or access to multilevel system".
Coexistence network route	Set the first I/O address and station number of the station to be accessed.

17.2.1 (3) For Q series

A	Q/QnA	FX
×	○	×

For communication from GPPW via the Q-compatible E71, there are the following setting items and precautions. The explanations in this section will be made for the following system configuration.

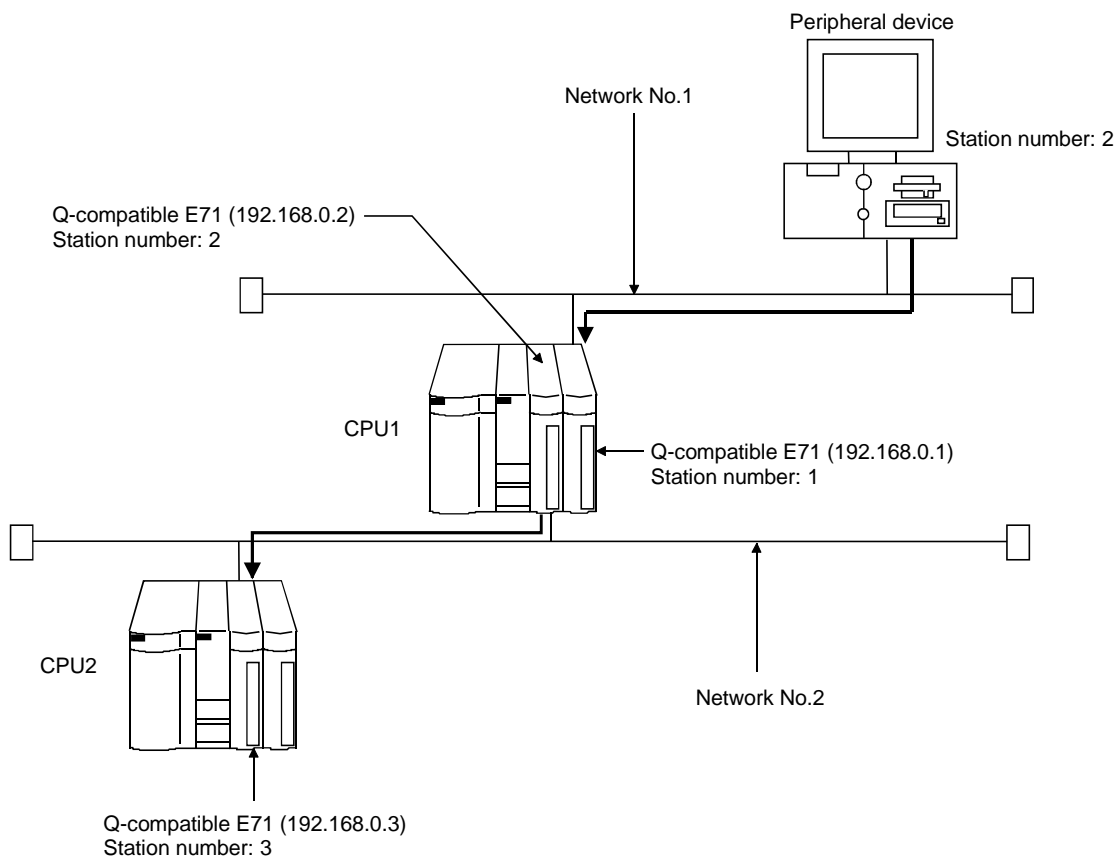

Procedure for and restrictions on communications via Q-compatible E71

Restrictions

Communications can be made only within the same segment.  
Communication cannot be made via the router or gateway.

- (1) Compatible models  
QJ71E71, QJ71E71-B2
- (2) Network parameter setting  
Parameter setting can be made from either the MELSECNET/ETHERNET network parameter setting screen or the sequence program.  
This section describes the way to use the network parameters.  
Set the network type, first I/O No., network No., group No., station number, mode and operation setting.

**Setting Screen Examples**

CPU1

**Ethernet parameters**

	Unit 1	Unit 2
Network type	Ethernet	Ethernet
Starting I/O No.	0000	0020
Network No.	2	1
Total stations		
Group No.	0	0
Station No.	2	1
Mode	On line	On line
	Operational settings	Operational settings
	Initial settings	Initial settings
	Open settings	Open settings
	Routing information	Routing information
	MNET/10 routing information	MNET/10 routing information
	FTP Parameters	FTP Parameters
	E-mail settings	E-mail settings
	Interrupt settings	Interrupt settings

**Operation setting**

**Ethernet operations**

Communication data code

Binary code

ASCII code

Initial Timing

Do not wait for OPEN ( Communications impossible at STOP time )

Always wait for OPEN ( Communication possible at STOP time )

IP Address

Input format: DEC.

IP address: 192 168 0 1

Enable Write at RUN time

End setup    Cancel

CPU2

**Ethernet parameters**

	Unit 1	Unit 2
Network type	Ethernet	None
Starting I/O No.	0000	
Network No.	2	
Total stations		
Group No.	0	
Station No.	3	
Mode	On line	
	Operational settings	
	Initial settings	
	Open settings	
	Routing information	
	MNET/10 routing information	
	FTP Parameters	
	E-mail settings	
	Interrupt settings	

**Operation setting**

**Ethernet operations**

Communication data code

Binary code

ASCII code

Initial Timing

Do not wait for OPEN ( Communications impossible at STOP time )

Always wait for OPEN ( Communication possible at STOP time )

IP Address

Input format: DEC.

IP address: 192 168 0 3

Enable Write at RUN time

End setup    Cancel

- (3) Routing parameter setting  
Set the routing parameters on the Ethernet parameter setting screen. Refer to Section 17.10 for the concept of the routing parameters.

Setting Screen Examples																	
CPU1	<table border="1"> <thead> <tr> <th></th> <th>Transfer to network No.</th> <th>Intermediate network No.</th> <th>Intermediate station No.</th> </tr> </thead> <tbody> <tr> <td>1</td> <td>1</td> <td>2</td> <td>2</td> </tr> <tr> <td>2</td> <td>2</td> <td>1</td> <td>1</td> </tr> <tr> <td>3</td> <td></td> <td></td> <td></td> </tr> </tbody> </table>		Transfer to network No.	Intermediate network No.	Intermediate station No.	1	1	2	2	2	2	1	1	3			
		Transfer to network No.	Intermediate network No.	Intermediate station No.													
	1	1	2	2													
	2	2	1	1													
3																	
CPU2	<table border="1"> <thead> <tr> <th></th> <th>Transfer to network No.</th> <th>Intermediate network No.</th> <th>Intermediate station No.</th> </tr> </thead> <tbody> <tr> <td>1</td> <td>1</td> <td>2</td> <td>2</td> </tr> <tr> <td>2</td> <td></td> <td></td> <td></td> </tr> <tr> <td>3</td> <td></td> <td></td> <td></td> </tr> </tbody> </table>		Transfer to network No.	Intermediate network No.	Intermediate station No.	1	1	2	2	2				3			
		Transfer to network No.	Intermediate network No.	Intermediate station No.													
	1	1	2	2													
	2																
3																	

After parameter setting is over, write the parameters to the PLC using Write to PLC. In a communications-ready status, the RUN LED and INIT. LED of the Q-compatible E71 are lit.

- (4) Communications check  
Refer to Section 17.4.1 (1) for communications check.
- (5) Connection Setup screen

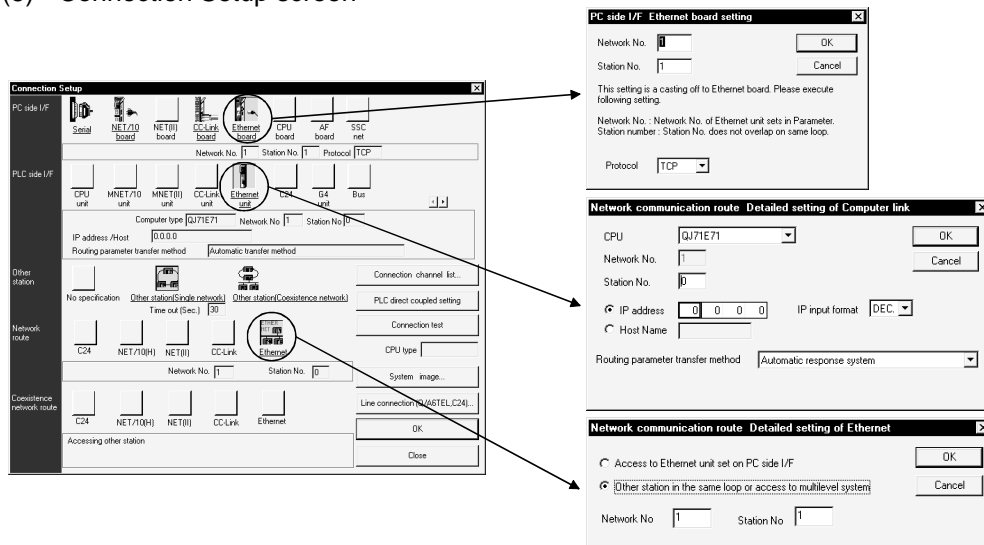

Item	Description
PC side I/F	Set the network No. and station number.
PLC side I/F	Set the model name, station number, IP address, etc. of the unit connected to the peripheral device.
Network route	Set the network number and station number of the station to be accessed.

**POINT**

When using TCP/IP to make communications, two or more GPPW devices cannot be connected.  
Use UDP/IP when connecting two or more GPPW devices to make communications.

17.2.2 Setting Method for Communication Via CC-Link (AJ65BT-G4)

17.2.2 (1) For A series

A	Q/QnA	FX
○	×	×

This section indicates the setting examples of the switches, parameters, program and others of the unit based on the following system configuration.

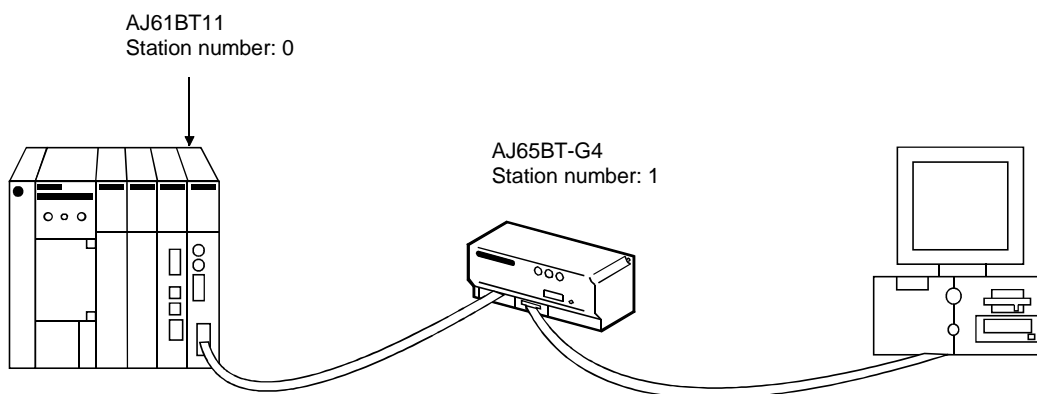

(1) Unit switch settings

Unit Name	Name		Setting	Description	
AJ61BT11	STATION No. (station number setting switches)		0	Station 0 (master station)	
	MODE (mode setting switch)		0	Online	
	B RATE (transmission speed setting switch)		4	10Mbps	
	Condition setting switches		All OFF	All OFF	
AJ65BT-G4	STATION No. (station number setting switches)		1	Station 1 (local station)	
	B RATE (data link transmission speed setting switch)		4	10Mbps	
	Operation setting DIP switches	Operation mode setting	SW1	OFF	A mode
		To-peripheral device transmission speed setting	SW2	OFF	Fixed to 9600bps
			SW3	OFF	
		Parity bit yes/no setting	SW4	OFF	Fixed
			SW5	OFF	
		Not used	SW6	OFF	--
Not used	SW7	OFF	--		
Test mode setting	SW8	OFF	Online mode		



(2) Cable connection

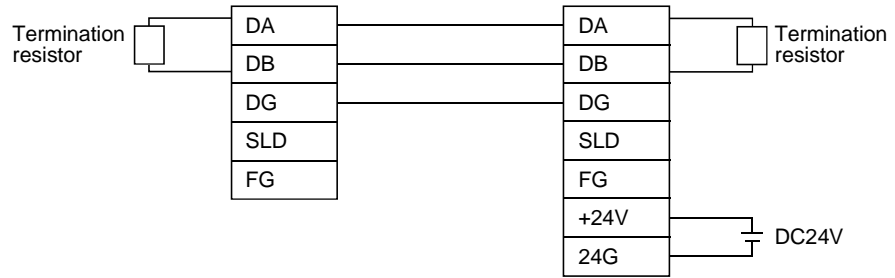

(3) Parameter setting

The parameter setting items and sequence program example for data link are given below.

Parameter setting items

Address	Item	Description	Setting
1H	Number of connected modules	Set the number of remote station/local station modules connected.	1H
20H	Station information	AJ65BT-G4	2101H

Sequence program

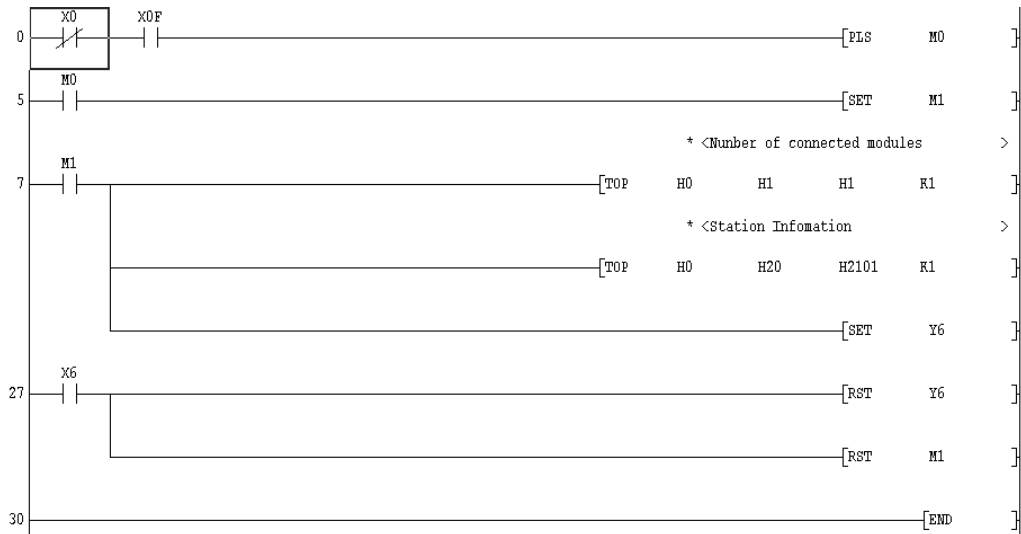

POINT

When the AJ65BT-G4 is connected, accessible stations are stations 0 to 64 in other station access via CC-Link.

17.2.2 (2) For QnA series

A	Q/QnA	FX
×	○	×

For the Q series, omit this section.  
 This section indicates the setting examples of the switches, parameters, program and others of the unit based on the following system configuration.

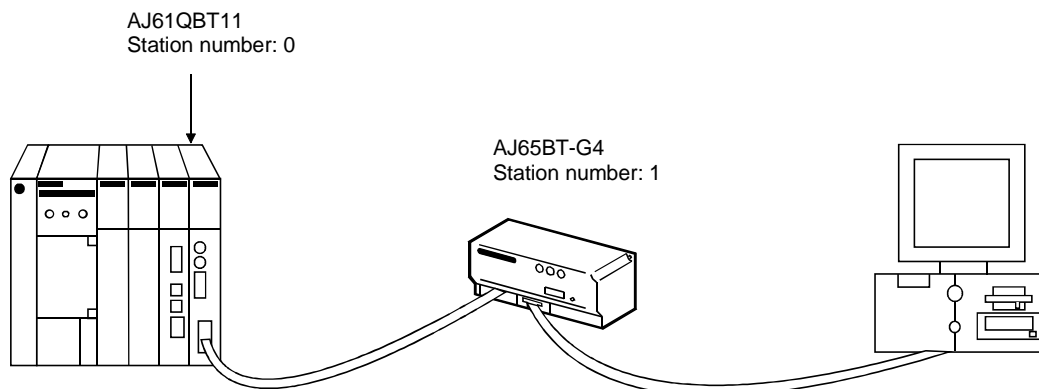

(1) Unit switch settings

Unit Name	Name		Setting	Description			
AJ61QBT11	STATION No. (station number setting switches)		0	Station 0 (master station)			
	MODE (mode setting switch)		0	Online			
	B RATE (transmission speed setting switch)		4	10Mbps			
	Condition setting switches		All OFF	All OFF			
AJ65BT-G4	STATION No. (station number setting switches)		1	Station 1 (local station)			
	B RATE (data link transmission speed setting switch)		4	10Mbps			
	Operation setting DIP switches	Operation mode setting	SW1	OFF	QnA mode		
		To-peripheral device transmission speed setting (Kbps)	SW2	9.6	19.2	Set to the same transmission speed as that of GPPW.	
				OFF	ON		OFF
				OFF	OFF		ON
		Parity bit yes/no setting	SW4	OFF	Fixed		
		Not used	SW5	OFF	—		
Not used		SW6	OFF	—			
Test mode setting	SW7	OFF	Online mode				

(2) Cable connection

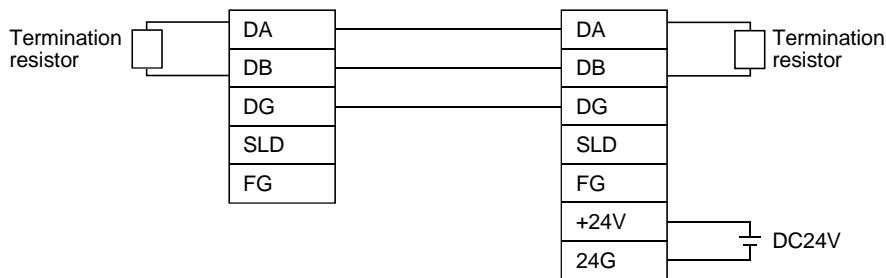

(3) Parameter setting

Parameter setting can be made from either the CC-Link network parameter setting screen or the sequence program.

(a) Setting the parameters on the CC-Link setting screen

Set the first I/O No., type, total number of connected units, and station information.

Set the other items as required.

CC-Link parameter setting screen

No. of boards in  Boards Blank: no setting 0 boards: Set by the sequence program.

	1	2	3	4
Start I/O No.	0000			
Type	Master station			
All connect count	1			
Remote input(RX)				
Remote output(RY)				
Remote register(RW/r)				
Remote register(RW/w)				
Special relay(SB)				
Special register(SW)				
Retry count	3			
Automatic reconnection station count	1			
Wait master station No.	0			
PLC down select	Stop			
Scan mode setting	Asynchronously			
Delay information setting	0			
Station information setting	Station information			

Station information setting screen

**CC-Link station information unit 1** ✕

StationNo.	Station type	Exclusive station count	Reserve/invalid station select	Intelligent buffer select(word)		
				Send	Receive	Automatic ic
1/1	Remote/I/O station	Exclusive station 1	No setting			

After setting the CC-Link parameters, write them to the PLC.

- (b) Setting the parameters in the sequence program  
 The parameter setting items and sequence program example for parameter setting in the sequence program are given below.

Parameter setting items

Address	Item	Description	Setting
1H	Number of connected modules	Set the number of remote station/local station modules connected.	1H
20H	Station information	AJ65BT-G4	2101H

When creating the network parameters in the sequence program, set the number of units to 0 on the CC-Link setting screen.

Sequence program

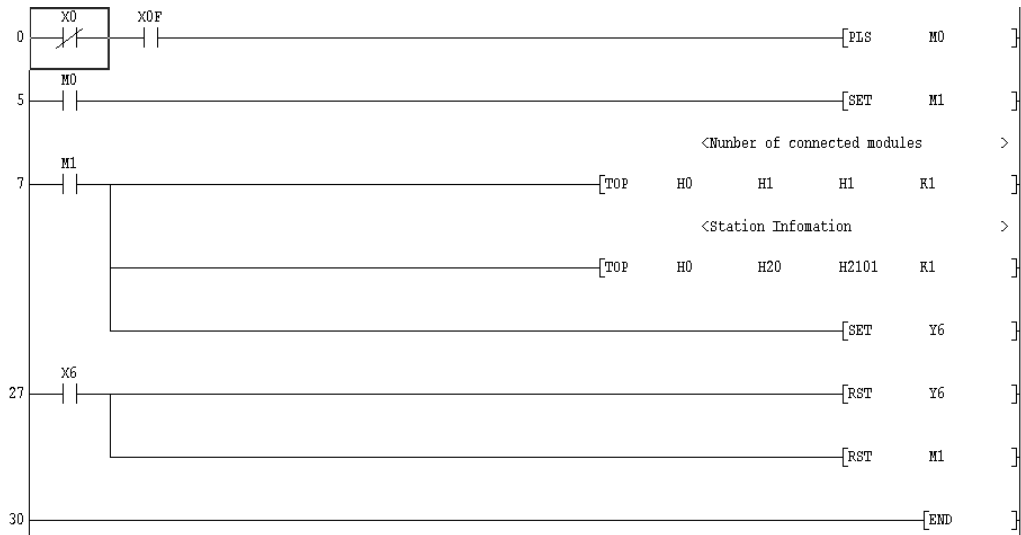

POINTS
<ul style="list-style-type: none"> <li>• When connection is made to the CPU directly or via computer link, accessible stations are stations 0 (master) to 63 in other station access via CC-Link.</li> <li>• When the AJ65BT-G4 is connected, accessible stations are stations 0 to 64 in other station access via CC-Link.</li> </ul>

17.2.3 Setting Method for Communication Via C24

17.2.3 (1) Connection in the form of one-for-one

A	Q/QnA	FX
○	○	×

This section indicates the setting examples of the switches and others of the unit based on the following system configuration.



(1) UC24 switch settings

Item	Setting
Mode setting switch	1
STATION No.	0
Main channel setting	RS-232C
Data bit setting	8
Transmission speed setting	9600bps
Parity bit yes/no setting	Odd
Stop bit setting	1
Sum check yes/no setting	Yes
Online change enable/disable setting	Enable
Computer link/multidrop link setting	Computer link (set computer link also for multidrop)

A cable of AC30N2A can be diverted for this connection.  
 Refer to Appendix 5.1 for the pin assignment of the cable.  
 When GPPW is connected to the 2) loaded UC24 and the 9-25 pin conversion connector + AC30N2A equivalent are used, write 1 (CD terminal not checked) to 10B of the buffer memory.

## (2) Serial communication unit (QnA series) switch settings

Item	Setting	Item	Setting
Mode setting switch	5	Sum check yes/no setting	Yes
STATION No.	0	Online change enable/disable setting	Enable
Operation setting	Independent setting	Setting change enable/disable setting	Enable
Data bit setting	8	Transmission speed setting	9600bps
Parity bit yes/no setting	Odd	—	SW13 to SW15 are all OFF.
Stop bit setting	1	—	—

A cable of AC30N2A can be diverted for this connection.  
Refer to Appendix 5.2 for the pin assignment of the cable.  
When an AC30N2A cable is connected, use the 9-25 pin conversion connector.

## (3) Serial communication unit (for Q series) switch settings

Make switch settings of the units on the GPPW I/O assignment setting screen.  
For details of switch settings, refer to the Q-compatible C24 serial communication unit user's manual (basic manual).

Item	Description		Setting
Switch 1	CH1 communication speed	CH1 transmission setting	0000H
Switch 2	—	CH1 communications protocol	0000H
Switch 3	CH2 communication speed	CH2 transmission setting	Set according to the application on CH2 side.
Switch 4	—	CH2 communications protocol	Set according to the application on CH2 side.
Switch 5	Unit station number		0000H

For the connection cable, refer to Appendix 5.3.

## Detailed description of settings

Item	Setting
Operation setting	Independent setting
Data bit setting	8
Parity bit yes/no setting	Yes
Odd/even parity bit	Odd
Stop bit setting	1
Sum check yes/no setting	Yes
Online change enable/disable setting	Enable
Setting change enable/disable setting	Disable
Transmission speed setting	19200bps
Communications protocol	GPPW link

(4) Connection target setting

The screen setting example for access from GPPW to C24 is given below.

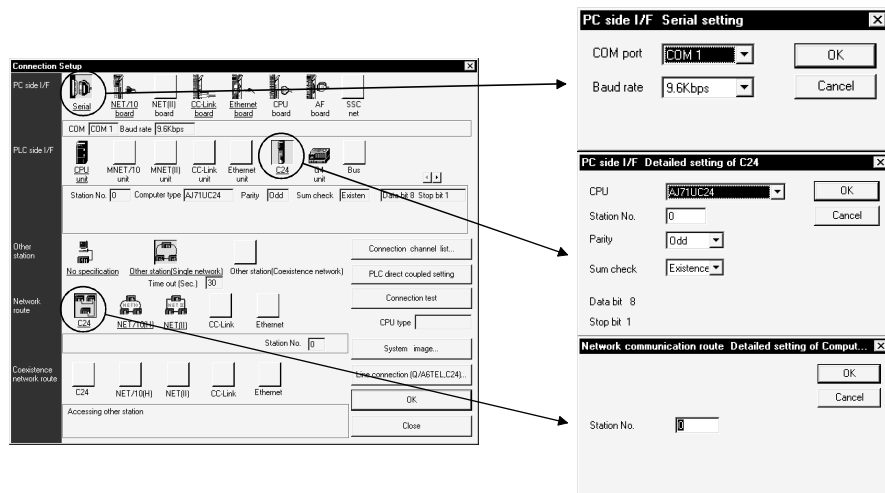

Item	Description
PC side I/F	Set the COM port and baud rate.
PLC side I/F	Set the model name, station number, etc. of the C24 connected.
Network route	Set the station number of the connection target C24.

17.2.3 (2) Connection in the form of multidrop

A	Q/QnA	FX
○	○	×

This section indicates the setting examples of the switches and others of the unit based on the following system configuration.

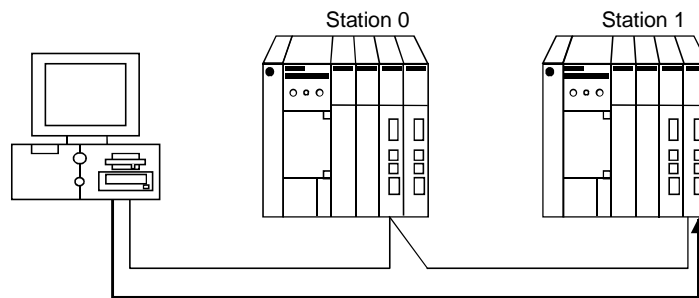

(1) AJ71UC24 switch settings  
Station 0

Item	Setting
Mode setting switch	A
STATION No.	0
Main channel setting	RS-232C
Data bit setting	8
Transmission speed setting	9600bps
Parity bit yes/no setting	Odd
Stop bit setting	1
Sum check yes/no setting	Yes
Online change enable/disable setting	Enable
Computer link/multidrop link setting	Computer link (set computer link also for multidrop)

A cable of AC30N2A can be diverted for this connection.

Refer to Appendix 5.1 for the pin assignment of the cable.

When GPPW is connected to the UC24 and the 9-25 pin conversion connector + AC30N2A are used, write 1 (CD terminal not checked) to 10B of the buffer memory.

## Station 1

Item	Setting
Mode setting switch	5
STATION No.	1
Main channel setting	RS-422
Data bit setting	8
Transmission speed setting	9600bps
Parity bit yes/no setting	Odd
Stop bit setting	1
Sum check yes/no setting	Yes
Online change enable/disable setting	Enable
Computer link/multidrop link setting	Computer link (set computer link also for multidrop)



(2) Switch settings for AJ71QC24(N), AJ71QC24(N)-R4, and A1SJ71QC24(N)  
Station 0

Item		Setting
Mode setting switch	CH1	0
	CH2	5
STATION No.		0
Operation setting		Interlock setting
Data bit setting		8
Parity bit yes/no setting		Odd
Stop bit setting		1
Sum check yes/no setting		Yes
Online change enable/disable setting		Enable
Setting change enable/disable setting		Enable
Transmission speed setting		9600bps

A cable of AC30N2A can be diverted for this connection.  
Refer to Appendix 5.2 for the pin assignment of the cable.  
When an AC30N2A cable is used, use a 9-25 pin conversion connector.

## Station 1

Item		Setting
Mode setting switch	CH1	Set to meet the application of CH1.
	CH2	5
STATION No.		1
Operation setting		Independent setting
Data bit setting		8
Parity bit yes/no setting		Odd
Stop bit setting		1
Sum check yes/no setting		Yes
Online change enable/disable setting		Enable
Setting change enable/disable setting		Enable
Transmission speed setting		9600bps

## (3) QJ71C24 switch settings

Make switch settings of the units on the GPPW I/O assignment setting window. For details of the switch settings, refer to the Q-compatible C24 serial communication unit user's manual (basic manual).

## Station 0

Item	Description		Setting
Switch 1	CH1 communication speed	CH1 transmission setting	0726H
Switch 2	—	CH1 communications protocol	0008H
Switch 3	CH2 communication speed	CH2 transmission setting	0727H
Switch 4	—	CH2 communications protocol	0000H
Switch 5	Unit station number		0000H

For the connection cable, refer to Appendix 5.3.

## Station 1

Item	Description		Setting
Switch 1	CH1 communication speed	CH1 transmission setting	0726H
Switch 2	—	CH1 communications protocol	0008H
Switch 3	CH2 communication speed	CH2 transmission setting	0727H
Switch 4	—	CH2 communications protocol	0000H
Switch 5	Unit station number		0001H

## Detailed description of settings

Item	Setting
Operation setting	Independent setting
Data bit setting	8
Parity bit yes/no setting	Yes
Odd/even parity bit	Odd
Stop bit setting	1
Sum check yes/no setting	Yes
Online change enable/disable setting	Enable
Setting change enable/disable setting	Disable
Transmission speed setting	19200bps
Communications protocol	GPPW link

- (4) Connection target setting  
 The screen setting example for access from GPPW to C24 is given below.

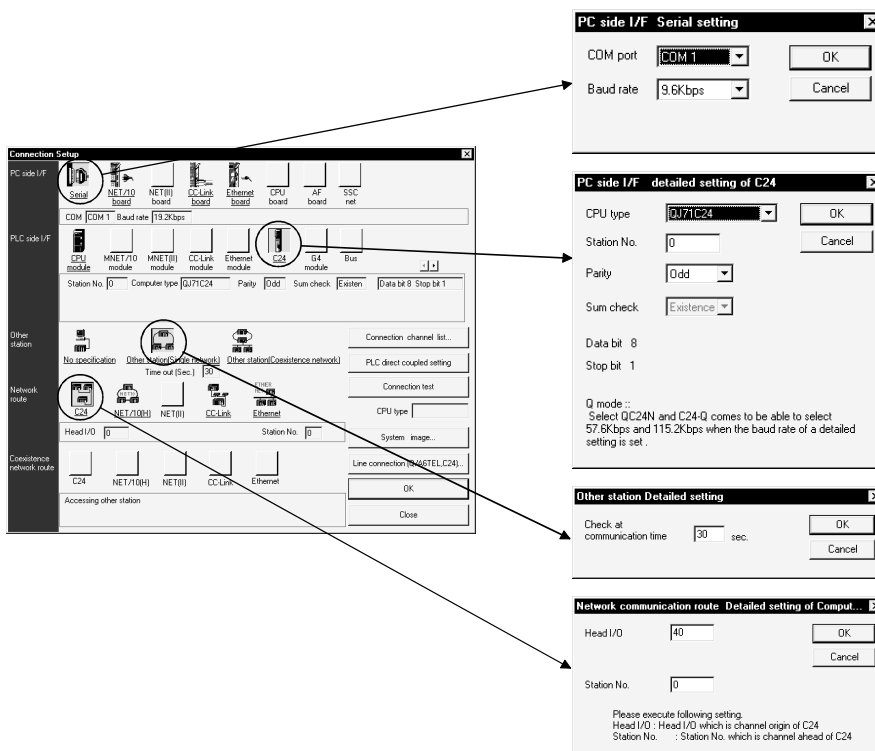

Item	Description
PC side I/F	Set the COM port and baud rate.
PLC side I/F*1	Set the model name, station number, etc. of the C24 connected.
Other station designation	Set the no specification of other station when not making access to the other station.
Network route	Set the top I/O number of a station connected to GPPW and a station number of the station to be accessed.

\*1: When making access to the other station with the computer link unit, designate a station number setting item of the PLC side I/F. The icons of the Network route cannot be selected.

17.2.4 Setting method for communication via a modem interface module

A	Q/QnA	FX
○	○	○

This section provides how to set the functions and information on line connection to line disconnection for use of the A6TEL modem interface module (hereafter called the A6TEL) and the Q6TEL modem interface module (hereafter called the Q6TEL). The A6TEL is a modem interface module designed to connect the A series PLC CPU and modem.

The Q6TEL is a modem interface module designed to connect the A/QnA series PLC CPU and modem. (The Q6TEL can connect to either the A CPU or QnACPU using the A mode/QnA mode select switch.)

The modems shown in the following system configuration include the external type, modem built in personal computer, PC card modem (PIMCIA) and TA (terminal adapter).

- (1) Between PLC and A6TEL/Q6TEL (A/QnA series only)
  - All functions included in the GPP functions, such as monitor, test and program transfer, via a telephone line can be performed in remote access.
  - For the operating procedure, refer to Sections 23.2.1 or 23.2.2.

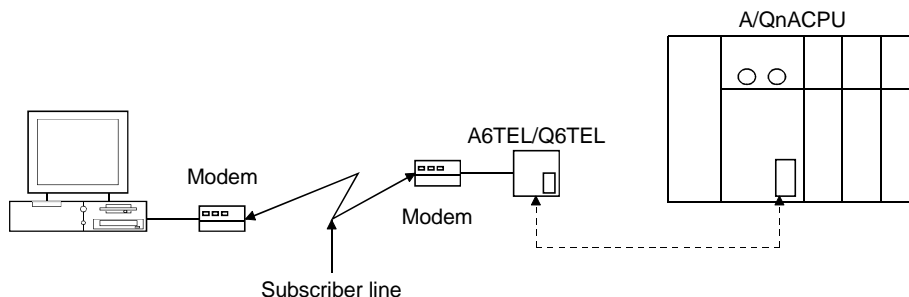

- (2) For access to FXCPU (FX series only)
  - By connecting the FX2N or FX2NC PLC to a telephone line by way of modems, all functions included in the GPP functions, such as monitor, test and program transfer, can be performed in remote access.
  - For the operating procedure, refer to Sections 23.2.3.

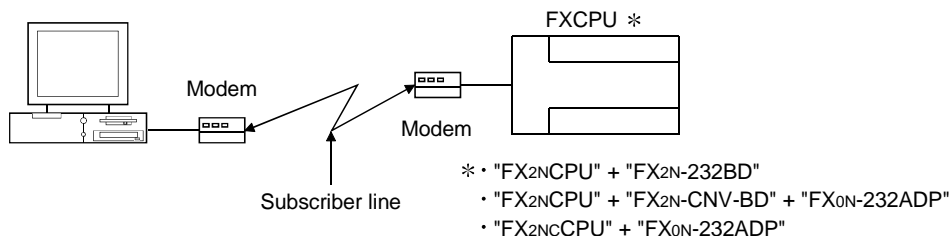

(3) When making access from peripheral device to serial communication module Q/QnA series only)

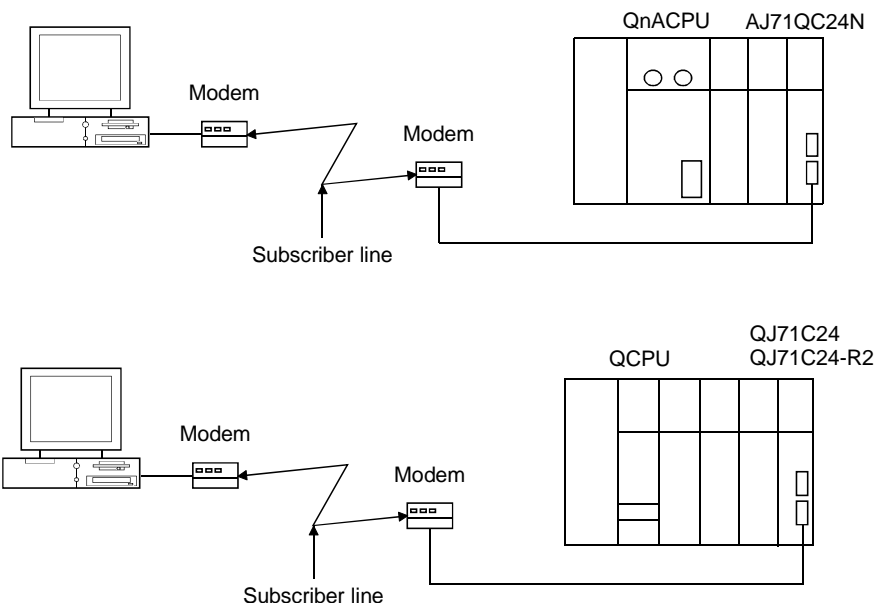

For access from the peripheral device to the serial communication module, choose [Tools] → [Set TEL data/Connect via modem] → [Connect]. Refer to Section 23.4 for the setting of items on the line connection screen. For the switch settings of the corresponding modules, refer to the following manuals.

- QnA series : Serial Communication Module User's Manual (Details Manual) (Additional modem function version)
- Q series : Q-compatible Serial Communication Module User's Manual (Application)

(a) Switch settings of serial communication module (Q series)

Item		Setting	
Switch 1	Transmission setting	Operation setting	Independent
		Data length	8
		Parity bit	No
		Even/odd parity	Odd
		Stop bit	1
		Sum check	Yes
		Online change	Enable
		Setting change	Disable
		Communication speed	Match to modem specifications
Switch 2	Communications protocol	5	

When using the QC24N, use the above settings as reference.

(b) Connection of QJ71C24 and modem

A program is needed to make the following buffer memory settings.

Buffer Memory Address	Name and Setting
2EH	Modem connection CH designation 0: None 1: CH1 2: CH2
34H *1	Initialization data No. designation 0H: Sending of initialization data specified in sending user registration frame designation area 7D0H to 7D4H: Initialization data No.
36H	GPPW link designation 0: No 1: Yes

\*1: The following initialization data have been registered to the QJ71C24.  
If the modem used is included in any of 7D0(2000) to 7DA(2010) of the initialization data, specify that registration No.  
If the modem used is other than the registered, you can use it after registering the AT command to the buffer memory address 1B00 of the serial communication module.

Registration No.		Initialization Command
Hexadecimal	Decimal	
7D0H	2000	ATQ0V1E1X1¥J0¥Q2¥V2¥N3S0=1
7D1H	2001	ATQ0V1E1X1¥Q2¥V2¥N3S0=1
7D2H	2002	ATQ0V1E1X1&K3¥N3S0=1
7D3H	2003	ATQ0V1E1X1&H1&R2&A3&D2S0=1
7D4H	2004	ATQ0V1E1X1¥J0¥Q2¥N3S0=1
7D5H	2005	ATE1Q0V1&C1&D2&H1&I0&R2&S0S0=1
7D6H	2006	ATE1Q0V1&C1&D2&K3&S0S0=1
7D7H	2007	ATE1Q0V1&C1&D2&K3&S1S0=1
7D8H	2008	ATE1Q0V1&C1&D2&K3&S0S0=1
7D9H	2009	ATE1Q0V1&C1&D1¥Q2&S0S0=1
7DAH	2010	ATE1Q0V1&C1&D2¥Q3&S0S0=1

Sample program

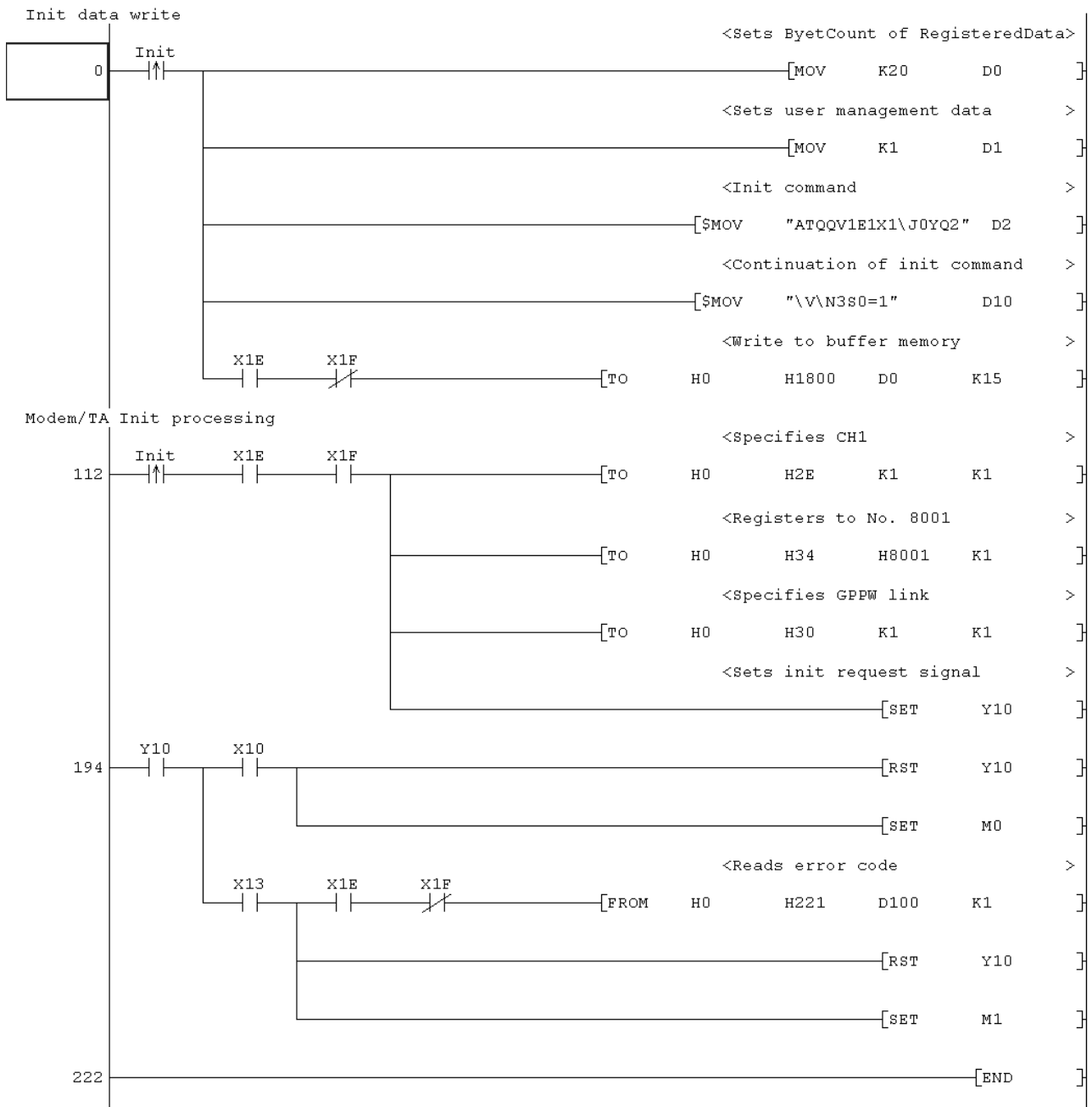

(4) Pager notice (A/QnA series only)

An on-the-spot trouble occurrence can be notified with a message.  
 For the A6TEL or the A mode of the Q6TEL, you can set up to 10 characters.  
 For the QnA mode of the Q6TEL, you can set up to 10 characters or notice data of up to 480 points of a word device. (Note that the number of characters displayed on the pager depends on the pager used.)  
 For the operating procedure, refer to Sections 23.2.1 and 23.2.2.)

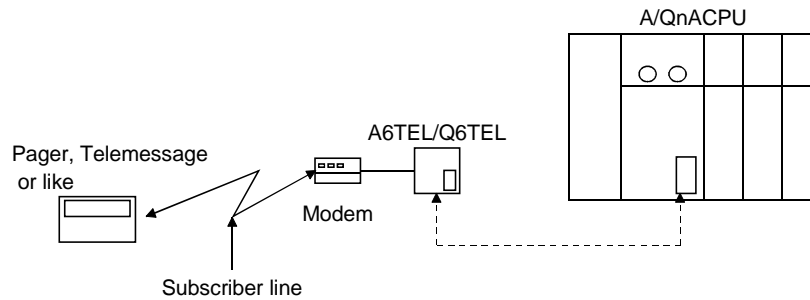

(5) Q6TEL-Q6TEL communication (only QnA mode of Q6TEL)

When the device condition set to the send side Q6TEL holds, the word device data of up to 480 words can be transferred to the device specified in the receive side PLC.  
 Local devices cannot be used as a transfer or trigger condition.  
 For the operating procedure, refer to Section 23.2.4.

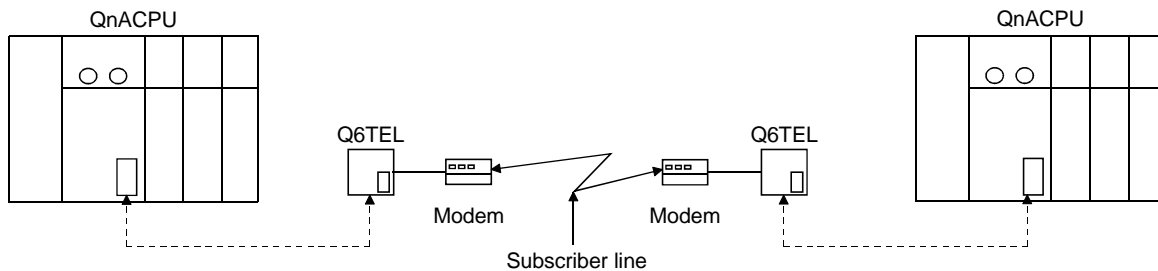

(6) Modem specifications

When using modems, choose the ones which satisfy the following specifications.  
 In addition, you can make communication from a personal computer with a built-in modem or a PC card modem (PCMCIA) for use in connection with a notebook personal computer.

(a) When using subscriber telephone line/private branch telephone

- AT command compatible (initialization command)
- Only the DR terminal can be turned ON (High) independently
- (Example: You cannot use the modem whose CD terminal turns on at the same time when only the DR terminal is turned on.)
- Communication standards: ITU-T V.90/V.34/V.32bis/V.32/V.22bis/V.22/V.21/V.FC  
Bell 212A/103

(b) Manual line connection (for connection via an operator)

- Specifications as in above (a)
- Switching can be made between the "ANS mode" and "ORG mode". (AIWA's some modems have the above mode switch.)

Communication may not be made depending on the line status.



<b>POINT</b>	<ul style="list-style-type: none"> <li>When a modem built in personal computer or the PC card (PCMCIA) is used to make communication, COM port setting is required on the connection destination specifying screen. Also, the COM port of the modem built in personal computer or the PC card (PCMCIA) is determined internally. For the setting method, refer to the personal computer manual.</li> <li>The standard AT command cannot be used in some modems. If the standard command is selected but the modem cannot connect with the line, the user should designate the AT command. For the standard and AT command designation setting, refer to Section 23.4.1.</li> </ul>
--------------	--

- (7) Connection cable  
For connection of the peripheral device and modem, use the RS-232C cable supplied with the modem or the specified cable.  
Since the peripheral device may have a different connector, check the specifications of the connector when purchasing the modem.
- (8) Modem setting  
Make modem setting.  
The following screen can be browsed using Line connection or AT command help for AT command registration.

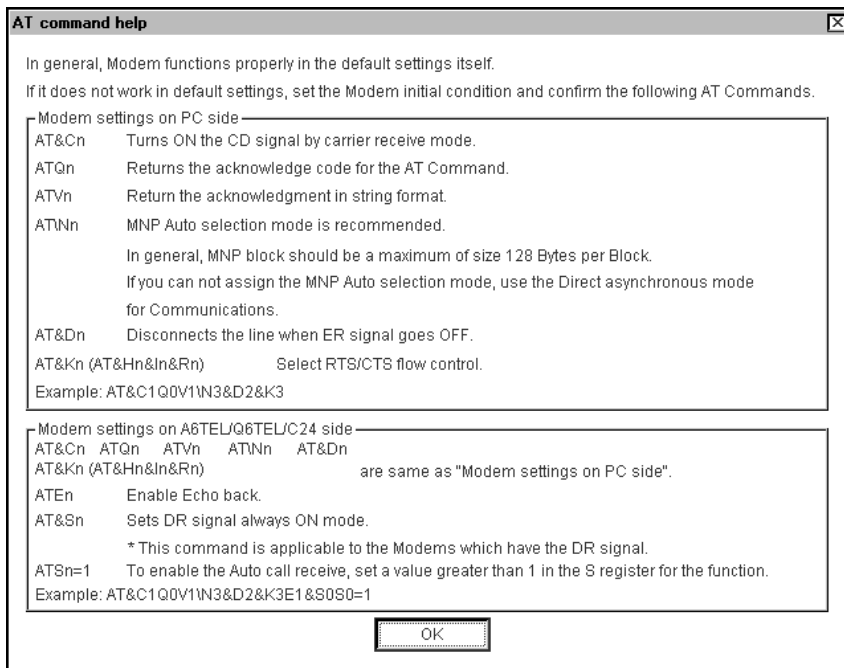

<b>POINT</b>	<ul style="list-style-type: none"> <li>When you used the modem for the other purpose previously, return the modem to the factory-set status using the following command. <b>AT&amp;F&amp;W</b></li> </ul>
--------------	---

(9) About RS-232C interface

When the TEL data set on GPPW is transferred from the peripheral device to the A6TEL/Q6TEL, the RS-232C interface specifications on the A6TEL/Q6TEL side are as follows.

Pin Number	Signal Abbreviation	Signal Name	Signal Direction	Modem Side
2	SD(TXD)	Send data	→	Equivalent to RD
3	RD(RXD)	Receive data	←	Equivalent to SD
4	ER(DTR)	Terminal ready notification	→	Equivalent to ER
5	SG	Signal ground	—	SG
6	DR(DSR)	Data equipment ready	←	Equivalent to DR
7	RS(RTS)	Request to send	→	Equivalent to RS
8	CS(CTS)	Clear to send	←	Equivalent to CS
9	RI(CI)	Receive indication (Call detection)	←	Equivalent to RI(CI)

The following wiring example is for proximate connection.

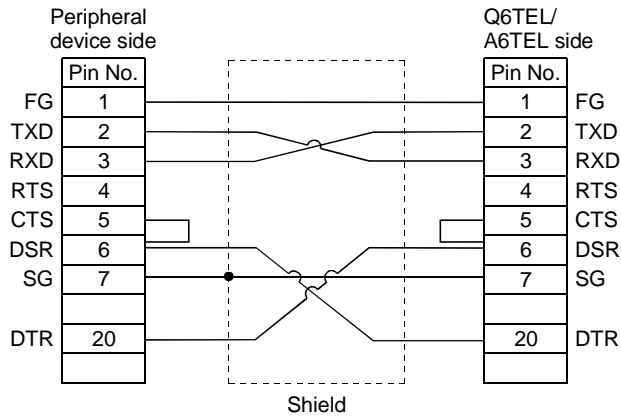

- (10) Restrictions on telephone line
- (a) Do not use the call-waiting phone line.  
On the call-waiting phone line, interruption ringers may corrupt the data or disconnect the telephone line.
  - (b) Avoid using a party line.  
If you pick up the receiver during telephone line connection, the telephone line may be disconnected.
  - (c) An analog two-wire type telephone line can be used.  
Note that a digital line can be connected by using a terminal adopter.

POINT
-------

<p>The telephone line of four wire type may not be connected depending on the modular jack wiring type.</p>
---

<p>For the four wire type, conduct a connection test in advance to check whether connection can be made or not.</p>
---

- (d) Instructions for cellular phones
  - 1) About the modem for radio communication using a cellular phone  
Though different makers call modems differently, this manual call them a cellular phone communication unit as a generic name.  
Choose the model according to the cellular phone used.  
For details, contact the company of the cellular phone you use.
  - 2) Although the cellular phone model which can automatically get an incoming call has no problems when it connects to the line, the model which cannot automatically get an incoming call cannot connect to the line if the modem is not provided with the ANS/ORG/TEL select switch.  
As the line connection procedure depends on the phone company or model, consult the maker of the phone you use.

### 17.3 Using PLC Read/Write

PLC read and PLC write access the PLC and read/write data.  
 Since the same kind of dialog box is used for PLC read and PLC write operations, a common explanation is given for both here.  
 Refer to Section 20.2 for the PLC read/write password for the Q series.

#### 17.3.1 Executing PLC read/PLC write

A	Q/QnA	FX
<input type="radio"/>	<input type="radio"/>	<input type="radio"/>

[Purpose]

Selects data and subjects it to a PLC read or PLC write operation.

[Operating Procedure]

Select [Online] → [Read from PLC] ([Write to PLC]), or click ( ).

[Dialog Box]

The Read from PLC screen is shown below. The Write to PLC screen has the addition of the **Password** button on the following screen.

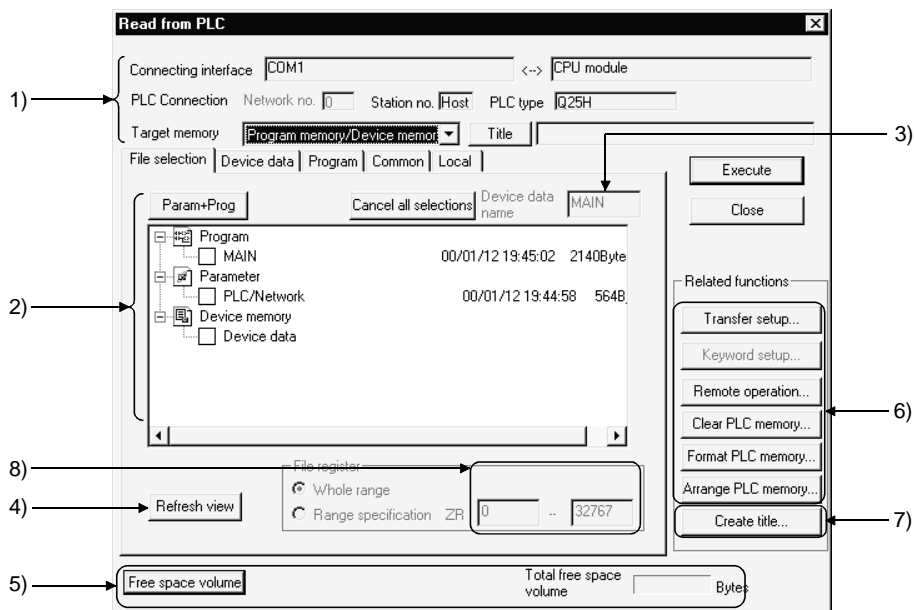

[Description]

Items in parentheses relate to "PLC write."

- 1) Connecting interface  
 Displays the connecting interface and accessed station.  
 With the Q/QnA series, the applicable memory is set.  
 On clicking the **Title** button, the label assigned to the Q/QnA series memory is displayed.

- 2) PLC data (active data)
 

For "PLC read", the list of data in the applicable memory is displayed.  
 For "PLC read", if there is no data for either comment 1/comment 2 or extension comment, nothing is displayed. Note that is not possible to select more than one data item each for file register and device initial value (when using Q/QnA series).  
 For "PLC write", a data list of the opened project is displayed.  
 Select the parameters and all programs of the project with the **Param + Prog** buttons.  
 Clear all data with the **Cancel all selections** button.
- 3) Device data name (read only)
 

Clicking this button sets a data name to be read when multiple device memories are present.
- 4) **Refresh view** button
 

Clicking this button updates the PLC data in the PLC read window.  
 This button is not featured with "PLC write."  
 When several peripheral devices are connected to the PLC, click the **Refresh view** button to check the latest PLC data before reading the PLC file.
- 5) **Freespace volume** button (Q/QnA series only)
 

Clicking this button shows the maximum contiguous area (QnA series only) and total free area of the applicable memory.  
 This button is not effective for the A series.
- 6) Related function
 

Clicking the buttons displays functions related to PLC read/PLC write.  
 See Section 17.1 Specifying the Connection Target  
 See Section 19.5 Operating the PLC Remotely  
 See Section 20.1 Registering New Entry Codes/Changing Entry Codes  
 See Section 21.1 Clearing the PLC Memory  
 See Section 21.2 Formatting a QCPU (Q mode), QnACPU  
 See Section 21.3 Sorting the QCPU (Q mode), QnACPU Memory
- 7) Create title
 

Creates a label for the applicable memory when using Q/QnA series.  
 Clicking this button displays the dialog box shown below.

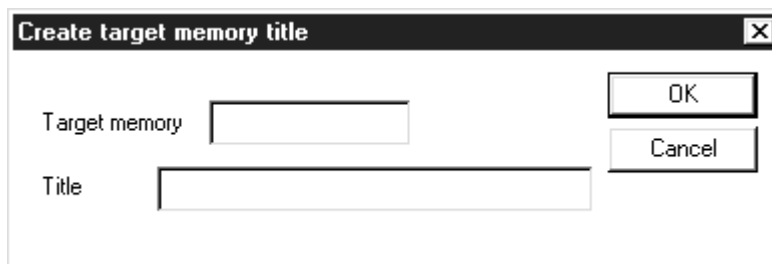

Set a label of up to 32 characters, then click the **OK** button.

8) Extension file register

For A series:

A block No. can be designated only if extension file register was selected at 2).

File register

File register

Extension file register

Block no.

For Q/QnA series:

Set any required file name at the PLC side.

The file name can be designated when writing. As a default, the GPPW device name is set.

Read from (write to) file registers may be performed within the 32k point range of data other than 0. An error will occur if the range specified is greater than 32k points.

In Range specification, set a range not greater than 32k points.

File register

Whole range

Range specification ZR  ..

For FX series:  
This setting is not possible with the FX series.

File register registration procedure

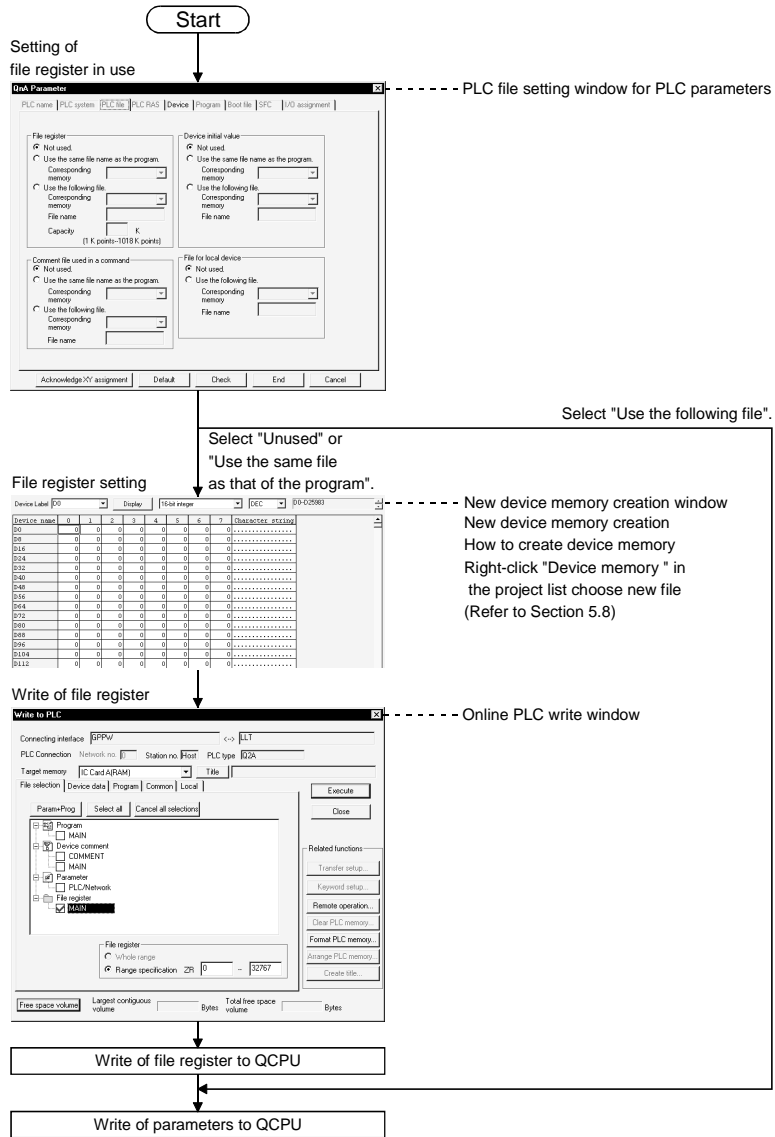

## [Operating Procedure]

1. Set the access destination as described in "Specifying the Connection Destination."
2. Display the PLC read (write) dialog box.
3. At 2), check the checkbox of the data name for which PLC read (write) is to be carried out.
4. When the file selection is a program, device comment, or device memory, set the range setting and other settings on the relevant tabbed sheet.
5. Click the  button.  
When the PLC is in the RUN mode, the After STOP remotely is the PLC writing executed? dialog box appears. Choose .  
At this time, check the peripheral and PLC side parameters.  
If the parameter check results in mismatch, read (write) is suspended.  
Also, if data of the same name exists at the read destination (write destination) on the Q/QnA series, the overwrite confirmation dialog box appears.  
When you click , the confirmation dialog box does not appear and you can perform batch read from (write to) PLC.  
When write to PLC is finished, the PLC state is STOP. Is remote-RUN executed? dialog box appears. Choose .



POINTS						
<ul style="list-style-type: none"> <li>• If online change is necessary, set this function by selecting [Tools] → [Options], and setting to the online change mode from the write mode or monitor mode. Alternatively, select [Convert] → [Convert (Online change)]. For details on online change, see Section 17.9. For details on online change settings, see Section 16.10.</li> <li>• With the A series, as long as the program capacity settings match, program reading (writing) is possible, even if there is a mismatch with, for example, the device comment capacity. However, if parameter reading (writing) is executed at the same time, no capacity mismatch will occur.</li> <li>• When writing to the E<sup>2</sup>PROM of a memory cassette with built-in RAM/E<sup>2</sup>PROM for AnUCPU (A4UMCA-8E, 32E, 128E), set the memory switch to "ROM."</li> <li>• The number of subprograms that can be written with an A4UCPU differs according to the installed memory cassette. The subprograms that can be written are indicated below.</li> </ul>						
	Memory Cassette	A3NMCA-0 to 56	A3AMCA-96	A4UMCA-128	A4UMCA-8E,32E	A4UMCA-128E
<ul style="list-style-type: none"> <li>• With the Q/QnA series, if a program with peripheral statements/notes appended is written, the statements/notes are not written to the PLC. Therefore, when reading out a program from the PLC, be careful not to save (by overwriting) the program with no statements or notes. Since the CPU/GPP setting is made when the statements/notes are created, see Section 10.1 or Section 10.2.</li> <li>• When using the Q/QnA series, it is not possible to write a device memory to an IC memory card. Similarly, it is not possible to write file registers to the built-in RAM.</li> <li>• When using the Q/QnA series, when multiple sequence programs are written to the memory using "PLC write", carry out program setting in the PLC parameters.</li> <li>• When batch writing data to an FX series model, set the PLC to the STOP status. If the PLC is in the RUN status, batch writing is not possible; in this case use the online change function described above.</li> <li>• If the program memory of an FX series model is an EPROM cassette, write programs with a ROM writer. If it is an EEPROM cassette, set the protect switch OFF before writing.</li> <li>• When the A171SH project of MOTION (SCPU) is open, performing PLC read/write to A172SH executes it as A171SH. When the A172SH project of MOTION (SCPU) is open, performing PLC read/write to A171SH executes it as A171SH.</li> <li>• PLC write cannot be performed if an instruction code error program exists after the END instruction. Delete it in the list mode.</li> </ul>	Writing possible Subprograms	Sub 1 only	Sub 1,2,3	Sub 1,2,3	Sub 1 only	Sub 1,2,3

17.3.2 Setting the read/write range for device data

A	Q/QnA	FX
○	○	○

[Purpose]

Sets the type, range, etc., of the devices to be read (written) when device memory has been selected on the <<File selection>> sheet. The device memory contents are not written to the program memory of the PLC. They are written to the device memory area.

[Operating Procedure]

Select [Online] → [Read from PLC] ([write to PLC]) → <<Device data>> tab, or click ( ) → then click the <<Device data>> tab

[Dialog Box]

The screen for "PLC read" is shown here; the screen for "PLC write" is of the same type.

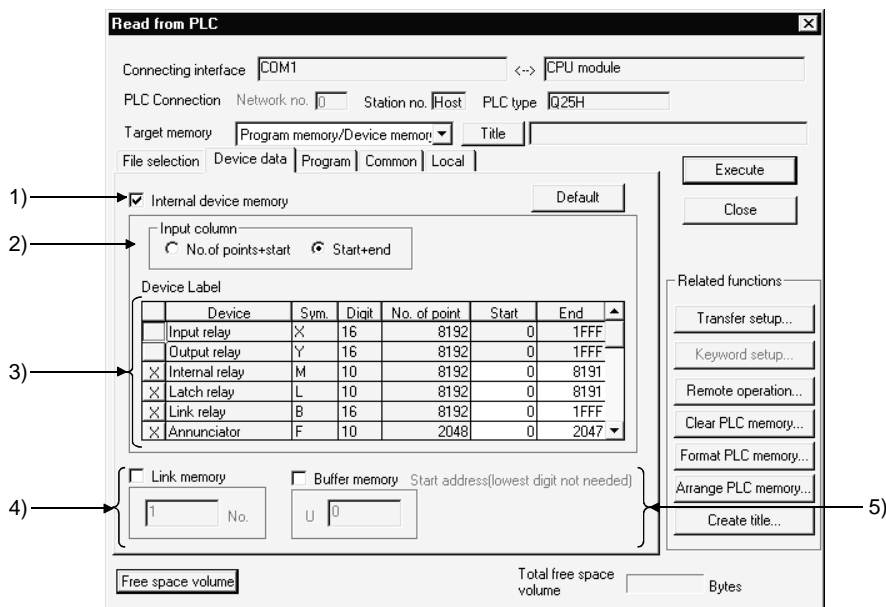

[Description]

- 1) Internal device memory  
 Reads (writes) the designated built-in device data.  
 Check the checkbox to select it.  
 If device memory has been selected in the <<File selection>> sheet, an error will be displayed if the Internal device data checkbox is cleared.
- 2) Input column (Q/QnA/A series only)  
 Sets the range designation method for the devices to be read (written).
  - No. of points + start  
 Set the number of device points and the first device number.
  - Start + end  
 Set the first device number and the final device number.

3) Device Laval

The default settings are for all device types, and the entire range of each. The devices that can be read (written) with the A series and QnA series are indicated below.

A series

Readable/writ able devices	M/L/S *1, B, F, T *2, C *2, D, W, A, Z, V
Readable devices	X, Y, special D, special M

Q/QnA series

Readable/writ able devices	M, L, B, F, SB, V, S, T *2, ST *2, C *2, D, W, SW, FX, FY, FD, Z
Readable devices	X, Y, SM, SD

\*1 : With the A series, a single range setting is made for the three device types M, L, and S.

\*2 : Three types - contact, coil, and present value - are read (written).

FX series

With the FX series, all the readable/writ able devices are designated.

4) Link memory Start address (Q/QnA series only)

Checking this checkbox with the Q/QnA series causes batch reading of the link memory of the designated data link module or network module.

The range of modules that can be designated is 1 to 4.

Since "PLC write" is not possible with a link memory, only reading can be designated.

The data can be read to J\*\W\*\* of the device memory.

For details on the device designation method, see the Q/QnACPU Programming Manual (Common Instructions).

This setting is not possible with the A series.

5) Buffer memory start address (Q/QnA series only)

Checking this checkbox with the Q/QnA series causes batch reading of the buffer memory of the designated special function module.

To designate the special function module, set the first output number (however, the lowest digit is unnecessary).

The setting range is 0 to 1FF.

Since "PLC write" is not possible with respect to a buffer memory, only reading can be set.

The data can be read to U\*\G\*\* of the device memory.

For details on the device designation method, see the Q/QnACPU Programming Manual (Common Instructions).

This setting is not possible with the A series.

<Setting Example>

Case where the first I/O number is 40 

U	4
---	---



17.3.3 Setting the program reading/writing range

A	Q/QnA	FX
<input type="radio"/>	<input type="radio"/>	<input type="radio"/>

[Purpose]

Sets the program range for reading/writing.

[Operating Procedure]

Select [Online] → [Read from PLC] ([Write to PLC]) → <<Program>> tab, or click (   ) → then click the <<Program>> tab.

[Dialog Box]

The dialog box for "PLC read" is shown here; the dialog box for "PLC write" is of the same type.

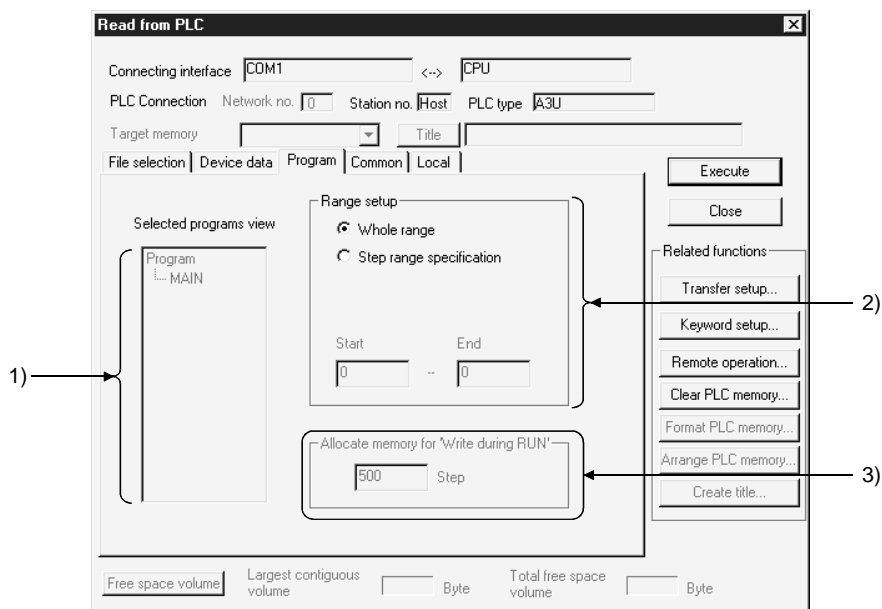

[Description]

- 1) Selected programs view  
Displays a list of programs selected for read (write) data using file selection.
- 2) Range setup  
Sets the range for programs selected for read (write) data.  
When multiple programs have been selected, the All range setting is automatically made.
  - Whole range  
The whole range is read (written).
  - Step range specification  
The range designated by first and final step numbers is read (written).
- 3) Allocate memory for "Write during RUN" (Q/QnA series only)  
With the Q/QnA series, to accommodate the increase in steps during online change, an area equivalent to the number of steps secured for online change is secured when a program is written to the PLC.  
For details on online change, see Section 17.9.  
This setting is not possible with the A series and FX series.

### 17.3.4 Setting the comment read/write range

A	Q/QnA	FX
○	○	○

[Operating Procedure]

- Reading (writing) comments common to all programs  
 Select [Online] → [Read from PLC] ([Write to PLC]) → <<Common>> tab, or click ( ), then click the <<Common>> tab.
- Reading (writing) program-specific comments  
 Select [Online] → [Read from PLC] ([Write to PLC]) → <<Local>> tab, or click ( ), then click the <<Local>> tab.

[Dialog Box]

A series PLC read the <<Common>> sheet and Q/QnA series PLC write. The <<Common>> sheet is shown here; the <<Local>> sheet is of the same type. (However, the A series <<Local>> sheet has no range setting for extension comments.)

- A series PLC read <<Common>> sheet:

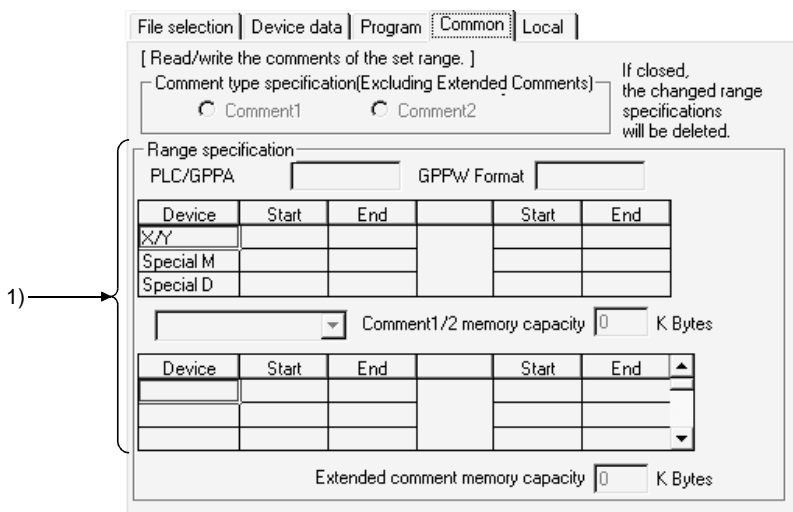

- Q/QnA series PLC write <<Common>> sheet:

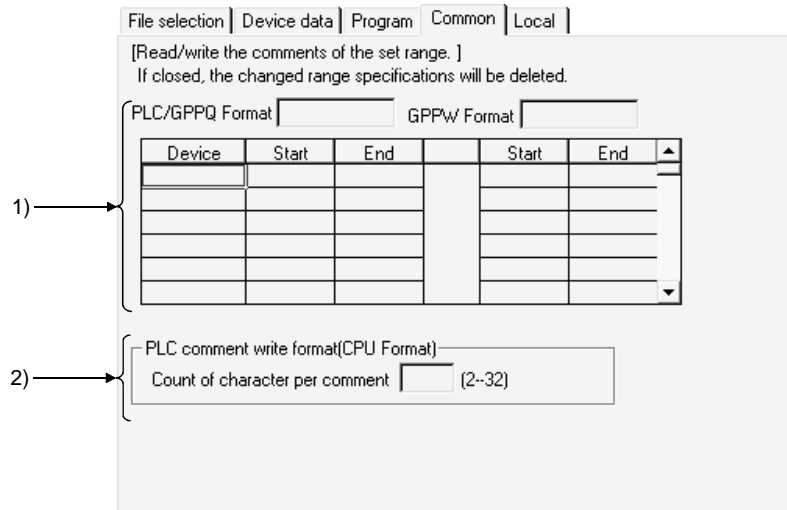

[Dialog Box]

The FX series PLC read <<Common>> sheet and PLC write <<Common>> sheet are shown here. With the FX series, there is no <<Local>> tab.

- FX series PLC read <<Common>> sheet:

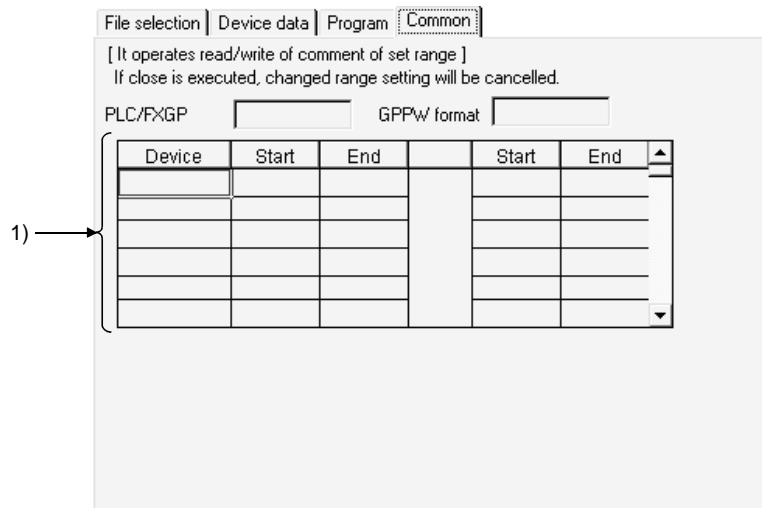

- FX series PLC write <<Common>> sheet:

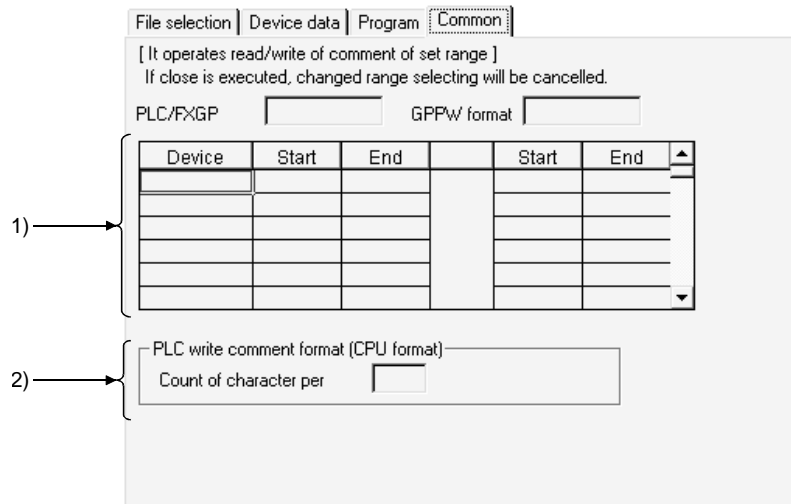

## [Description]

## 1) Device range setting

Sets the range of device comments to be read (written) when device comment data has been selected by file selection.

The details of comment range setting when editing device comments are set. If the read (write) range is incorrect, it is changed.

However, when the range is changed, the comment range setting for device comment editing is also automatically changed.

For details on comment range setting, see Section 9.7.

When writing with the A series, always carry out range setting. Note, however, that no range designation is required when the entire range is to be read.

When reading (writing) the entire range with the QnA series, no range designation is required.

For the Q series, up to 64k points can be written to the PLC. There are no restrictions on saving onto the HD/FD of the peripheral device.

When reading with the FX series, all that is required is to select the comment data file: range setting is not necessary.

## 2) PLC write comment form (Q/QnA series only)

Sets the number of characters of comments written to a Q/QnA series PLC.

In device comment editing, comments of up to 32 characters can be created, but memory capacity can be saved by reducing the number of characters written to the PLC.

The setting range is 2 to 32 characters.

There is no setting for reading.

This setting is not possible with the A series.

## POINTS

- There are two types of device comment: comments common to all programs and program-specific comments. This is not the case with previous packages (GPPA, GPPQ, FXGP(DOS), FXGP(WIN)). Therefore, first read Section 9 "SETTING DEVICE COMMENTS" before reading (writing) device comments.
- With the A series, it is not possible to read (write) device comments unless a comment memory capacity setting has been made. Make the PLC parameter memory capacity setting by referring to the comment capacity displayed under the range designation.
- With the Q/QnA series, device comment reading is CPU format.

17.4 Verifying the Peripheral Side and PLC Side Data

A	Q/QnA	FX
○	○	○

[Purpose]

Compares and verifies the program, parameters and device comments in the PLC CPU and the data on the peripheral device side.

[Operating Procedure]

[Online] → [Verify with PLC]

[Dialog Box]

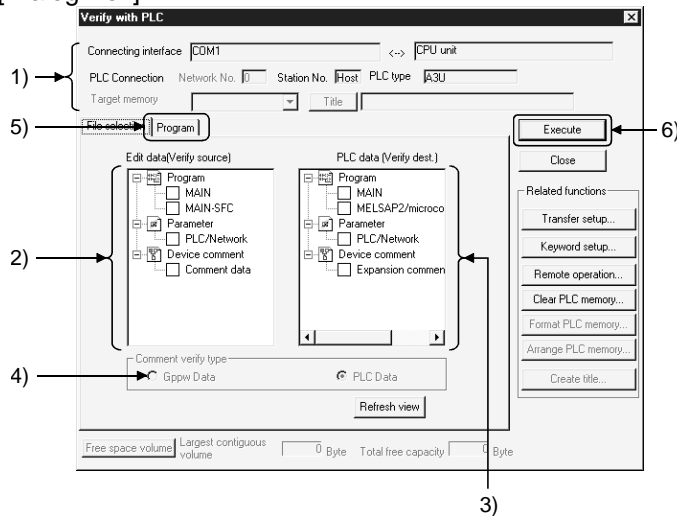

[Description]

- 1) Connection destination information  
Shows the connected interface and accessed station.  
For the QnA series, set the corresponding memory.
- 2) Edited data (verify source)  
Lists the programs and parameter data of the project.  
Check the data name check box to make selection.
- 3) PLC data (verify destination)  
Lists the programs and parameter data in the PLC CPU.  
Check the data name check box to make selection.  
If extended comments have not been written to the PLC CPU, the extended comment item does not appear.



- 4) Comment verify type  
 Select whether the device comments of the edited data (verify source) comments or those of the PLC data (verify destination) are used as the basis of verify.

The verify basis is indicted below.

PLC Data	
ACPU QCPU (A mode), Motion Controller	QCPU (Q mode), QnA
Edited data area=PLC data area ..... Comments outside the PLC data area are not verified.	
Edited data area=PLC data area ..... All devices will be the target of verify.	
Edited data area=PLC data area ..... Comment sections not existing in the edited data are handled as "no comment".	
Verify is executed in the device area set to the comments of the comment type (kana/kanji, extended) selected in the PLC data and written to the PLC CPU.	Verify is executed in the device area set to the comment file selected in the PLC data.

Gppw Data	
ACPU QCPU (A mode), Motion Controller	QCPU (Q mode), QnA
Edited data area=PLC data area ..... Comments outside the PLC data area are not verified.	
Edited data area=PLC data area ..... All devices will be the target of verify.	
Edited data area=PLC data area ..... Comment sections not existing in the edited data are handled as "no comment".	
Verify is executed in the device area set in the PLC write range setting of the comments of the comment type (kana/kanji, extended) selected in the PLC data. If PLC write range setting has not been made, verify is executed in the whole edit device area in GPPW.	Verify is executed in the device area set in the PLC write range setting of the comments selected in the edit data. If PLC write range setting has not been made, verify is executed in the whole edit device area in GPPW.

POINTS
<ul style="list-style-type: none"> <li>• The following instruction applies to the verify of comments on the QnA series. When selecting multiple comment files, verify the identical file names.</li> <li>• The M, L and S of the ACPU or QCPU (A mode) must be verified when the device range setting has been made with reference to the editing data range. Otherwise, the verify results of the M, L and S will be illegal.</li> </ul>

- 5) Program tab  
Click this tab to show the following screen.

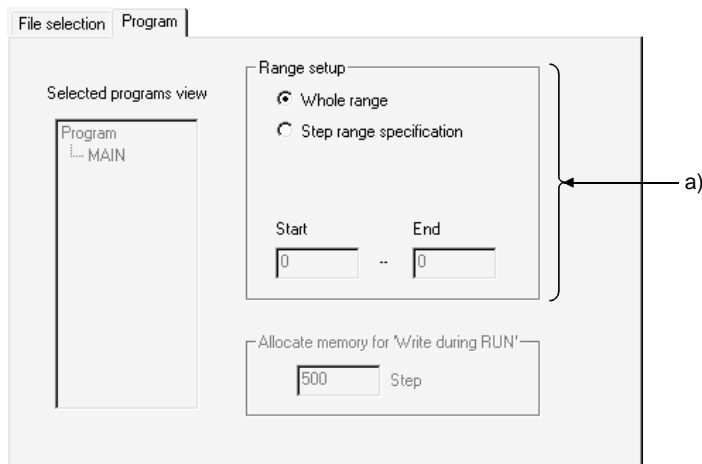

- a) Range setup  
Set the verify area of the program.
- Whole range  
All area of the selected programs is verified.
  - Step range specification  
Only the specified area of the selected programs is verified.  
Set the area with the first and last step numbers.

- 6) **Execute** button  
Click this button when the setting is finished.

[Setting Procedure]

1. Set the access destination in Transfer setup.
2. Show the PLC verify screen.
3. Check the desired data check boxes at 2) and 3) to make selection.
4. When verifying programs, set the area at 5).
5. After the setting is over, click 6).  
After completion, the verify result dialog box appears.

POINTS
<ul style="list-style-type: none"> <li>• When multiple pieces of data have been chosen in file selection, verify is performed between identical data names. Also, if the data names selected do not correspond between the verify source and destination, an error message appears. When sequence programs are to be verified one by one between the verify source and destination, you can specify different data names.</li> <li>• If more than 100 discrepancies are found in the verify results, the results of up to 100 discrepancies are displayed and verify is suspended at that point.</li> </ul>

17.5 Write to PLC (Flash ROM)

17.5.1 Write the program memory to ROM

A	Q/QnA	FX
×	○	×

[Purpose]

Batch-writes the data of the program memory to the standard ROM or linear flash ROM. (Q series only)

To write to the ATA, choose [Online] → [Write to PLC].

[Operating Procedure]

Select [Online] → [Write to PLC (Flash ROM)] → [Write the program memory to ROM].

[Dialog Box]

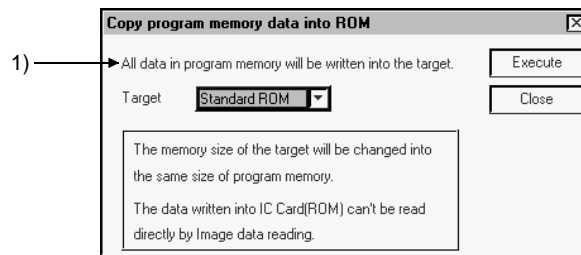

[Description]

1) Target

Choose Standard ROM or IC Card (ROM) (for linear flash ROM).

POINTS
<ul style="list-style-type: none"> <li>• Data of the program memory written to the ROM cannot be read in image data reading. Read it directly from the PLC.</li> <li>• If program memory data is written to the ROM, device memory data cannot be written to the ROM.</li> </ul>

17.5.2 Write to PLC (Flash ROM)

A	Q/QnA	FX
×	○	×

[Purpose]

Writes data to the standard ROM or flash ROM. (Q series only)  
 Since transfer/write may take time depending on the performance of the peripheral device, use the following menu to write a program to the ROM.

When writing the program memory data of the PLC to ROM  
 Select [Online] → [Write to PLC (Flash ROM)] → [Write the program memory to ROM].

When writing the project data to ROM (PLC card slot required)  
 Select [Tools] → [IC memory card] → [Write IC memory card].

To write to the ATA, choose [Online] → [Write to PLC].  
 As the corresponding memory, choose Memory card (ROM).

[Operating Procedure]

Select [Online] → [Write to PLC (Flash ROM)] → [Write to PLC (Flash ROM)].

[Dialog Box]

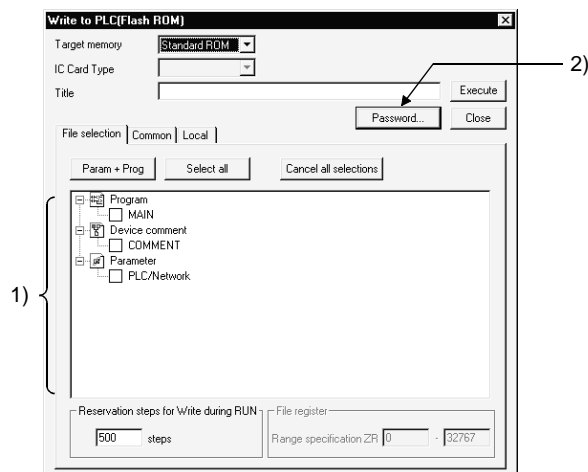

[Description]

- 1) PLC write setting  
 Refer to Section 17.5.
- 2) Password button  
 Refer to Section 20.2.

**POINT**

For Write to PLC (Flash ROM) with the other station specified, set the time check (seconds) to 45 seconds on the Transfer setup screen.

17.6 Deleting Data in the PLC

A	Q/QnA	FX
×	○	×

[Purpose]

Deletes data such as programs and parameters in the PLC when using the QnA series.

[Operating Procedure]

Select [Online] → [Delete PLC data].

[Dialog Box]

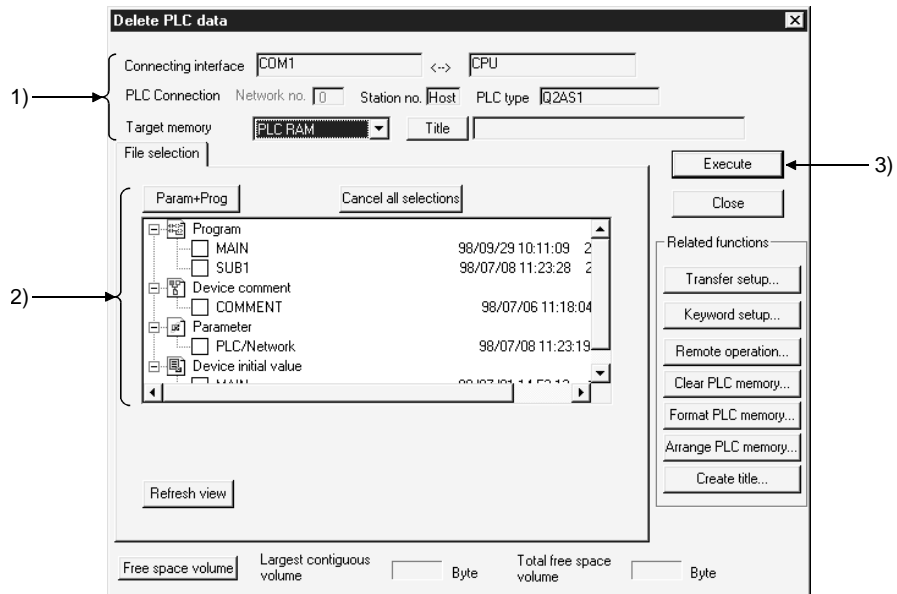

[Description]

- 1) Connection destination information  
Displays the connected interface/applicable station for access.  
Set the applicable memory.
- 2) PLC data  
Displays the list of data in the applicable memory.  
Check the checkbox for the data name to be deleted to select it.  
Select the project parameters and all programs by clicking the **Param + Prog** buttons.  
Cancel all data by clicking the **Cancel all selections** button.
- 3) **Execute** button  
Click this button after setting the necessary settings.

## [Operating Procedure]

1. Set the access destination as described in "Specifying the Connection Destination."
2. Display the PLC file delete dialog box.
3. Check the checkbox for the data name to be deleted in 2) to select it.
4. After making the necessary settings, click 3).

POINT
-------

- PLC file deletion is possible for the Q/QnA series only.  
When using the A series, select [Online] → [clear PLC memory] to all-clear the data in the memory cassette, then write only the necessary data again.  
For details on PLC memory clear, see Section 21.1.1.

### 17.7 Changing PLC Data Attributes

A	Q/QnA	FX
×	○	×

**[Purpose]**

Changes the attributes to "writing disabled" and "display disabled" in order to protect programs, parameter data and other data in QnA series PLC from unwanted access. (QnA series only)

**[Operating Procedure]**

Select [Online] → [Change PLC data attributes].

**[Dialog Box]**

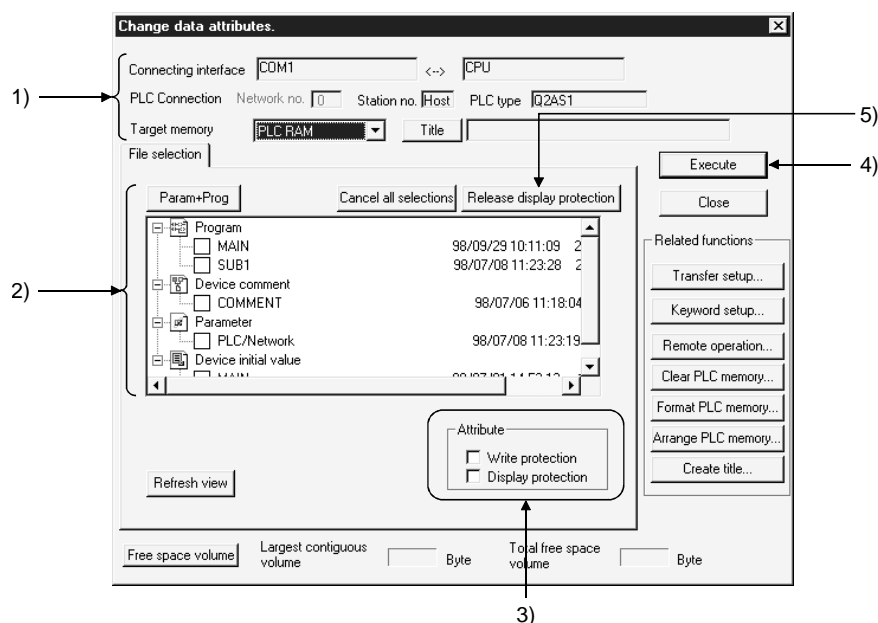

**[Description]**

- 1) Connection destination information  
Displays the connected interface/applicable station for access.  
Set the applicable memory.
- 2) PLC data  
Displays the list of data in the applicable memory.  
Check the checkbox for the data name whose attributes are to be changed to select it.  
Select the project parameters and all programs by clicking the **Param + Prog** buttons.  
Cancel all data by clicking the **Cancel all selections** button.

- 3) **Attribute**  
Sets the data attributes.  
If both the Display prohibited and Write prohibited checkboxes are selected by checking them, data is neither written nor displayed.
- When write disable is selected:  
Data cannot be written or deleted by access from a peripheral device.
  - When display disable is selected:  
The existence of the data is not indicated in the display on accessing from a peripheral device.
- 4) **Execute** button  
Click this button after setting the necessary settings.
- 5) **Release display prohibition** button  
Releases data for which the display disable or write disable status is set from the disabled status.  
On clicking the **Release display prohibition** button, the dialog box shown below is displayed.

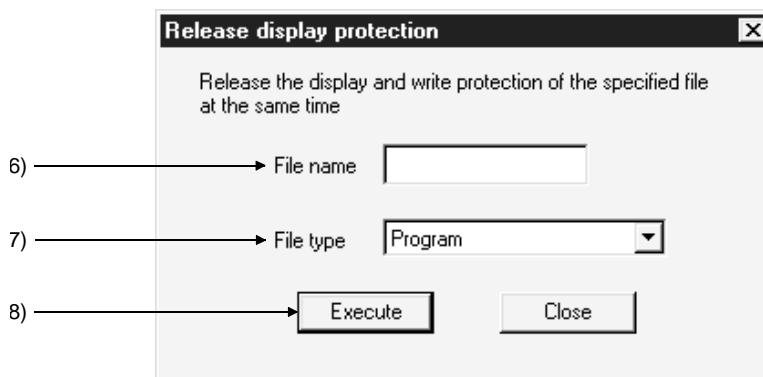

- 6) **File name**  
Set the file name for which the display disable or write disable status is to be canceled.  
If the file name for which the parameter has been changed and the set file name do not match, the "disabled" status cannot be released.
- 7) **File type**  
Set the file type for which the disabled status is to be cancelled.
- 8) **Execute** button  
After setting the file name and file type, click the **Execute** button.  
If the set file name or file type does not agree with that at the PLC side, the disabled status cannot be canceled.



## [Operating Procedure]

- Changing to the "write disabled"/"display disabled" status
  1. Set the access destination by as described in "Specifying the Connection Destination."
  2. Display the PLC data attribute change dialog box.
  3. Check the checkbox for the data name to be deleted at 2) to select it.
  4. Set the type of attribute at 3).
  5. Click 4).
- Canceling the write disabled or display disabled status
  1. Set the access destination as described in "Specifying the Connection Destination."
  2. Display the PLC data attribute change dialog box.
  3. Click 5) to display the display disabled cancellation dialog box.
  4. Set 6) and 7).
  5. After setting the necessary settings, click 8).

POINTS
--------

- |   |
|---|
| <ul style="list-style-type: none"><li>• Be sure not to forget a data name whose display has been disabled.<br/>If the correct data name cannot be set, it will not be possible to designate the data for access, making reading and writing impossible.<br/>To delete or change display disabled data when you have forgotten the name, initialize the memory by selecting [Online] → [format PLC memory], then write the necessary data again.<br/>See Section 21.2 for details on PLC memory formatting.</li><li>• It is possible to change the same attribute of several data at the same time, but disabled statuses have to be canceled one by one.</li><li>• If neither selection has been made in attribute designation, the write disabled status of the selected data is canceled.</li></ul> |
|---|

## 17.8 Reading/Writing PLC User Data

### 17.8.1 Reading

A	Q/QnA	FX
×	○	×

**[Purpose]**

Reads CSV format and other files written on the IC memory card to the peripheral device.

This function may be selected only for the Q series.

Refer to the following manual for the way to use the user data with the sequence program.

QCPU (Q mode)/QnA programming manual (common instructions manual)

**[Operating Procedure]**

Select [Online] → [PLC user data] → [Read PLC user data].

**[Dialog Box]**

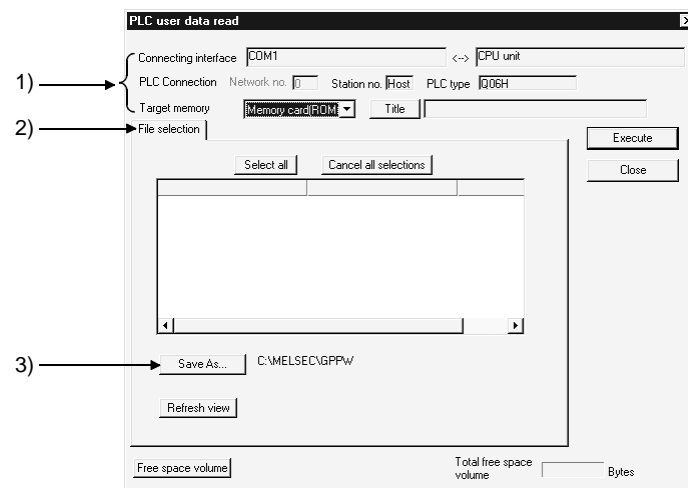

**[Description]**

- 1) Memory card read target setting  
Set the read destination of data.
- 2) Read data setting  
Refer to Section 17.3.
- 3) **Save As** button  
Set the save target of the read data.

**REMARKS**

Use Delete PLC user data to delete data.

17.8.2 Writing PLC user data

A	Q/QnA	FX
×	○	×

[Purpose]

Writes data created in the CSV format and others to the ATA.  
(Q series only)

[Operating Procedure]

Select [Online] → [PLC user data] → [Write PLC user data].

[Dialog Box]

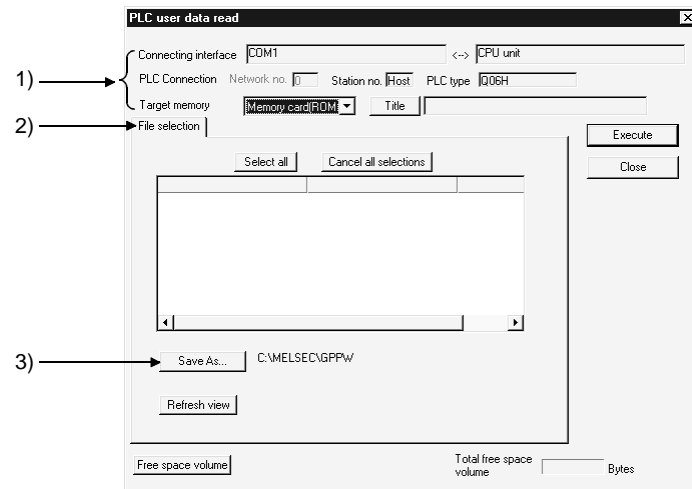

[Description]

- 1) Memory card write target setting  
Set the write destination of data.
- 2) Written data setting  
Refer to Section 17.3.
- 3) **Save As** button  
Set the save target of the written data.

<b>POINTS</b>
<ul style="list-style-type: none"> <li>• Use Format PLC memory to format the IC memory card.</li> <li>• The attributes (read only, hidden file) of a project file are invalid if they are set on Windows' Explorer or the like.</li> </ul>

## 17.9 Executing Online Change

A	Q/QnA	FX
○	○	○

### [Purpose]

In the ladder editing window, changes a part of a sequence program and then writes it to the PLC while it is in the RUN status.

Online change is possible in the write mode and in the monitor write mode.

Online change cannot be made when the PLC is in the STEP-RUN mode.

There are the following two types of online change.

- When making online change frequently  
Online change is executed by simply selecting [Tools] → [Options] to preset online change and then making conversion.
- When not making online change frequently  
Choose the [Convert (Online change)] menu at the time of program conversion to execute online change.

### [Operating Procedure]

- Setting online change by menu operation before conversion.
  1. Change and correct the program.
  2. Convert the program by selecting [Convert] → [Convert (Online change)] (**Shift** + **F4**).

Confirm online change in the dialog box shown below.
- Executing online change at program conversion by options setting
  1. Select [Tools] → [Options] → <<Common>> and then set the online change setting to "Write during RUN (while PLC is running)." See Section 16.10 for details on the online change setting.
  2. Change and correct the program.
  3. Convert the program by selecting [Convert] (**F4**).

Execute online change in the dialog box shown below.

Online change confirmation dialog box

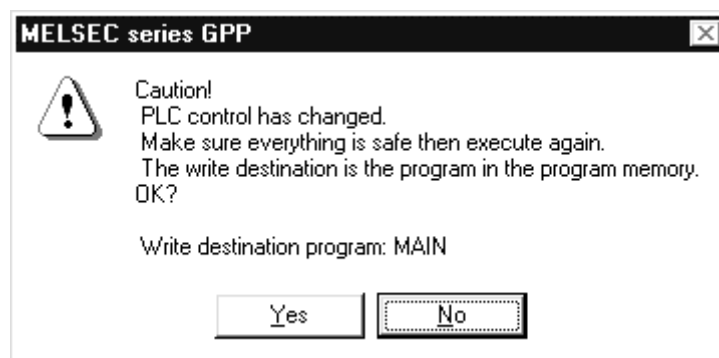

The following tables list precautions for making online change.  
 (1) For A series

Item	Description
EEP-ROM of other than AnUCPU	<ul style="list-style-type: none"> <li>Online change cannot be made to EEPROM of other than AnUCPU.</li> </ul>
Online change to other stations	<ul style="list-style-type: none"> <li>Online change can be made to other stations via the MELSECNET (II, /10). However, note that the sequence program will be corrupted if online change is made from multiple peripheral devices to a single PLC.</li> </ul>
A2CCPU, A2CJCPU	<ul style="list-style-type: none"> <li>To make online change, select [Tools] → [Options] → (Common) sheet and set the edit object (shift forward setting) to "1 ladder block (Don't shift the program forward)" on the (Common) sheet. Otherwise, an error will occur, bringing the PLC down. For shift forward setting, refer to Section 16.11.</li> </ul>
Deletion of corresponding device from program	<ul style="list-style-type: none"> <li>If a deletion during execution of the OUT instruction or changing a device No. has removed the corresponding device from the program, the output status is held. Force the unnecessary coil outputs for control to be switched off by selecting [Online] → [Debug] → [Device test]. For the device test, refer to Section 19.1 "Carrying Out a Device Test".</li> </ul>

(2) For Q/QnA series

Item	Description
Online change to other stations	<ul style="list-style-type: none"> <li>Online change can be made to other stations via the MELSECNET (II, /10).</li> </ul>
Online change to built-in RAM during boot operation	<ul style="list-style-type: none"> <li>If online change has been made to the built-in RAM during boot operation, write the converted program to the IC memory card after STOP using Write to PLC.</li> </ul>
Deletion of corresponding device from program	<ul style="list-style-type: none"> <li>If a deletion during execution of the OUT instruction or changing a device No. has removed the corresponding device from the program, the output status is held. Force the unnecessary coil outputs for control to be switched off by selecting [Online] → [Debug] → [Device test]. For the device test, refer to Section 19.1 "Carrying Out a Device Test".</li> </ul>

Steps secured for online change

QnA series	<ul style="list-style-type: none"> <li>Online change cannot be made beyond the number of steps set as those secured for online change on the (Sequence/SFC program) sheet after selecting [Online] → [Write to PLC] → (Sequence/SFC program) sheet. The number of secured steps for online change is reduced for each online change. If the currently set number of secured steps is exceeded by online change, convert the program offline and select [Online] → [Write to PLC].</li> <li>If the number of steps is greatly increased by online change, preset a large number of steps secured for online change during program write.</li> </ul>
Q series	<ul style="list-style-type: none"> <li>If the currently set number of secured steps is exceeded by online change, the following dialog box appears. Set new secured steps.</li> <li>If the number of secured steps is set to 0 in the following dialog box, only the sequence program which has exceeded the secured step range is written.</li> <li>If online change is made to the sequence program whose password has been set, the password deletion dialog box appears. Start online change after deleting the password. If the password cannot be deleted, online change cannot be made.</li> <li>The secured steps newly set in the following dialog box do not appear on the (program) sheet of Write to PLC.</li> </ul>

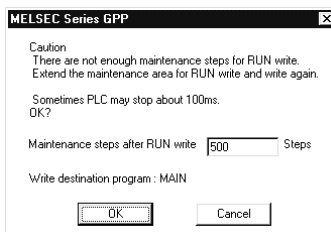

(3) For FX series

Item	Description	
CPU which can make online change		
Model name	FX2C series/FX2 series (version No. V2.1 or later), FX0N series (version No. V1.10 or later), FX2N/FX2NC series	
Memory type	FX2N series	Built-in RAM, optional RAM cassette or optional EEPROM cassette (protect switch OFF)
	FX2NC series	Built-in RAM or optional memory card (protect switch OFF)
	FX2/FX2C series	Built-in RAM or optional RAM cassette
	FX0N series	Built-in EEPROM
Use of FX0N, FX2, FX2C, FX2N, FX2NC	<ul style="list-style-type: none"> <li>Corrected ladders do not have additions, deletions and changes to labels P, I.</li> </ul>	
	<ul style="list-style-type: none"> <li>Change cannot be made if any ladder before or after corrections includes the output (OUT) instruction of high-speed counter C235 to 255 or the application instruction FNC90 to 98.</li> </ul>	
	<ul style="list-style-type: none"> <li>There should be no new 1ms retentive timers inserted.</li> </ul>	
Use of FX2 (V3.07 or later), FX2c	<ul style="list-style-type: none"> <li>A substitute instruction for a new instruction cannot be inserted into a program or rewritten.</li> </ul>	
	<ul style="list-style-type: none"> <li>If a substitute instruction has already been programmed, the function of this substitute instruction is lost by executing online change at that part.</li> <li>FNC10 to 12 (CMP, ZCP, MOV) and FNC20 to 25 (ADD, SUB, MUL, DIV, INC, DEC) instructions are increased in operation speed when neither a word device with digit designation nor index qualification is used. However, when online change or insertion is made, the high-speed processing function of this part is lost.</li> </ul>	
	<ul style="list-style-type: none"> <li>The OFF execution time of the application instructions of the FX2 (V3.07 or later) and FX2C is shortened. However, when online change or insertion is executed, the shortening function of this part is lost, and the value becomes approximately 60% of that of the FX2 (V2.30 or earlier) series.</li> </ul>	
Use of FX2 (V2.1 to V2.30)	<ul style="list-style-type: none"> <li>When additional application instructions and device numbers are written with the FX2 (V3.07 or later) PLC, these instructions are written directly to the program memory of the PLC. At this time, the PLC continues running, handling them as no operations. However, as soon as the operation mode of the PLC is switched from STOP to RUN, a program check is performed and the "PROG-E LED" flickers. In this case, change the incompatible application instructions and device numbers, then batch-transfer a correct program.</li> </ul>	
	<ul style="list-style-type: none"> <li>If a device number not supported by the FX2 (V2.1 to V2.30) is specified as the operand of an application instruction, this instruction is written directly to the program memory of the PLC. At this time, an operation error occurs because the device number for this instruction is outside the range, but the PLC continues running, handling it as a no operation. However, as soon as the operation mode of the PLC is switched from STOP to RUN, a program check is performed and the "PROG-E LED" flickers. In this case, batch-transfer a program with a correct operand set for the application instruction.</li> </ul>	
Use of FX0N (V1.10 or later)	<ul style="list-style-type: none"> <li>When a device number that is not compatible with the FX0N is written, the "It cannot write during RUN because order or device that cannot write in changed program during RUN is included" message appears and changes to the program are suspended.</li> </ul>	
	<ul style="list-style-type: none"> <li>Since the FX0N has no pulse execution type application instructions, writing this type of instruction displays the "Write bad" message and suspends changes to the program.</li> </ul>	

\*1: Each function is restored by switching the PLC from STOP to RUN after online change has been made.

POINTS			
	<p>The following numbers of steps can be written by a single online change.</p> <p>(1) Q/QnA/A series                      A series                      Number of program steps after editing (addition/deletion): Within 250 steps                      Q/QnA series                      Number of program steps after editing (addition/deletion): Within 512 steps                      However, if the existing program is not modified but a program is added to it by pasting and line insertion, the maximum number of steps cannot be written by a single online change.                      In this case, reduce the number of steps written at one time and make online change several times.                      Also be careful when the following corrections have been made.                      If a correction is made to step 2 in a program and an addition made to step 540, online change cannot be made since steps 2 to 540 will be the object of a single online change.                      In this case, perform online change every time a correction is made.</p> <p>(2) FX series (FX0N/FX2/FX2C/FX2N/FX2NC only)                      Ladder modification is made within a single ladder block once and the number of program steps after editing (addition/deletion) is within 127 steps.                      (Including the NOP immediately after the ladder block, but with the exception of the last ladder)                      Program modifications exceeding the above should be batch-transferred.</p> <p><b>Precautions for online change</b>                      The case where online change cannot be made and its correction method are described below.</p> <ul style="list-style-type: none"> <li>• If the ladder block has no NOP instructions and the number of steps is greater than 250 (ACPU)/512 (Q/QnACPU)/127 (FXCPU), delete unnecessary instructions before starting online change.</li> <li>• If NOP instructions exist after the ladder block and the online change range is exceeded, choose "Don't shift the program forward" and start online change. Refer to Section 16.10 for shift forward setting.                      Note that when step 0 (LD X1) of the following program is to be changed to LD X3, online change cannot be made if "Shift the program forward" has been selected.</li> </ul> <table style="width: 100%; border: none;"> <tr> <td style="width: 50%; vertical-align: top; padding: 5px;"> <p><b>Ladder mode</b></p> </td> <td style="width: 50%; vertical-align: top; padding: 5px;"> <p><b>List mode</b></p> <pre> 0 LD X1 1 OUT M0 2 NOP 3 NOP   to 600 NOP 601 LD X2 602 OUT M10                     </pre> </td> </tr> </table> <p>"Shift the program forward"                      Online change cannot be made as steps 0 to 600 will be the target of online change.</p> <p>"Don't shift the program forward"                      Online change can be made as steps 0 to 1 will be the target of online change.</p>	<p><b>Ladder mode</b></p>	<p><b>List mode</b></p> <pre> 0 LD X1 1 OUT M0 2 NOP 3 NOP   to 600 NOP 601 LD X2 602 OUT M10                     </pre>
<p><b>Ladder mode</b></p>	<p><b>List mode</b></p> <pre> 0 LD X1 1 OUT M0 2 NOP 3 NOP   to 600 NOP 601 LD X2 602 OUT M10                     </pre>		

POINTS				
<p>(3) When multiple sequence programs are specified for file write If there is an online change-disabled file, set the PLC to a remote stop and write to that file.</p> <p>For the Q series, online change can be made to the PLC program-by-program. This is useful when there are many corrections and additions in a program being debugged. However, if online change has made the memory area of the PLC short, STOP the PLC, then delete the program in the PLC, and perform write to PLC.</p> <p>(4) If there is a pulse instruction in the ladder block to be converted, that instruction is executed when the pulse execution condition turns from OFF to ON after online change. There are the following rise and fall instructions. Rise instructions ..... PLS, MOVP, LDP, MEP, FROMP, TOP, etc. Fall instructions..... PLF, LDF, MEF, EGF, FCALLP, etc.</p>				
	Rise Instruction		Fall Instruction	
Continuity at Online Change	RAM	EEPROM	RAM	EEPROM
OFF	Not executed		Only the pulse instruction to be edited is executed.	Pulse instructions having the numbers of the one to be edited and later are executed.
ON	Not executed		Not executed	



### 17.10 Concept of the Routing Parameters

A	Q/QnA	FX
○	○	○

The routing function is used by the station of the PLC in a multi-level system to make transient transmission to the station of another network No. To perform the routing function, the "Routing parameters" must be set to associate the network No.s and stations acting as bridges. For communication via the MELSECNET II, the routing function cannot be used.

- (1) The routing parameters must be set to the request source and relay station of the PLC.
  - (a) The request source must be set to make access to the request target.
  - (b) The relay station must be set to make access from the request source to the request target and to make access from the request target to the request source.
  - (c) The request target needs no setting.

For example, to make transient transmission from 1Ns3 to 3Ns4 in the following diagram, the routing parameters must be set to the PLC 1Ns3 which makes transient transmission, to the PLCs 1Ns4 and 2Mp1 which serve as bridges, and to the PLCs 2Ns4 and 3Ns5.

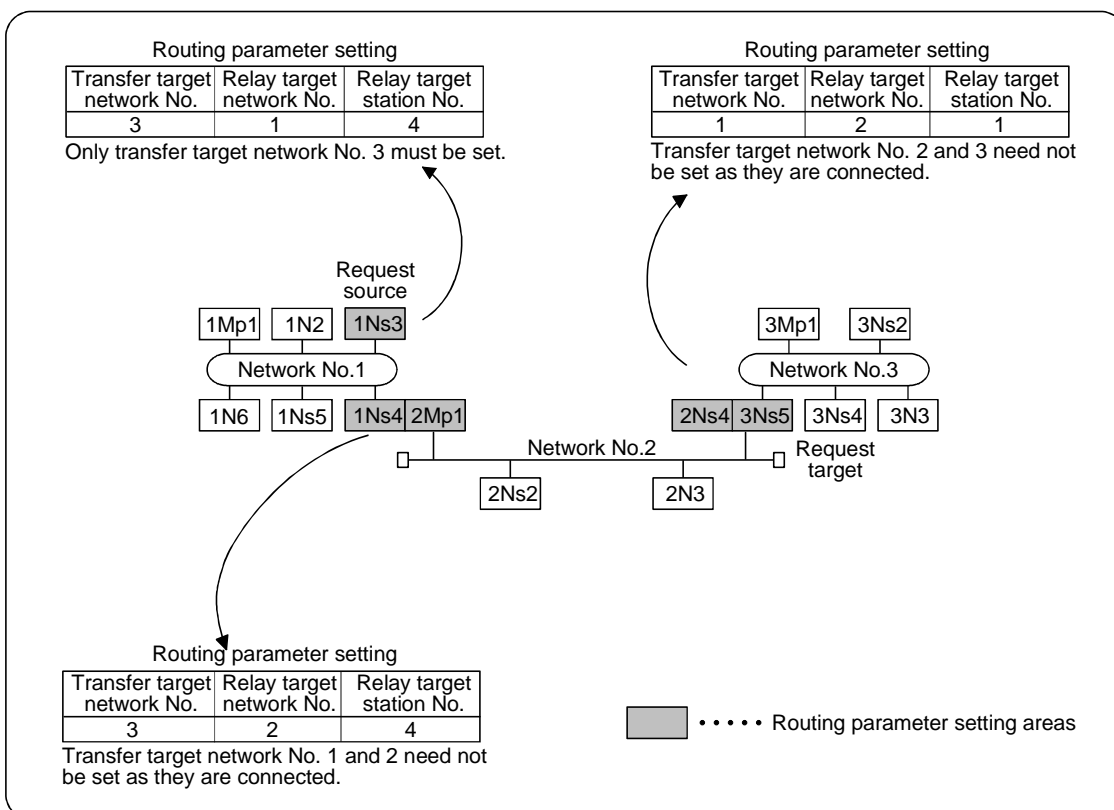

- (2) Up to 16 "transfer target network No.s" can be set to the PLC. 16 different network No.s allow the own station to be a request source or other stations to be accessed via the own station.

- (3) Routing parameter setting areas and data  
For transient transmission, the routing parameter setting areas depend on the system.

- (a) Two-level system

The routing parameters need not be set because transient transmission is made to within the same network.

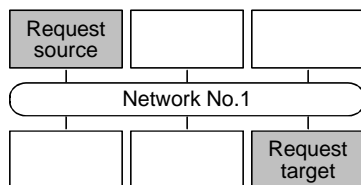

- (b) Multi-level 1 (two networks)

Set the routing parameters only to the station of the request source. To the request source, set the data to access the request target (network No. 2).

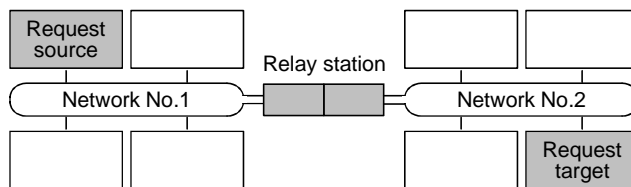

- (c) Multi-level 2 (three networks)

Set the routing parameters to the request source and relay stations. To the request source, set the data to access the request target (network No. 3). To the relay station 1), set the data to access the request target (network No. 3). To the relay station 2), set the data to access the request source (network No. 1).

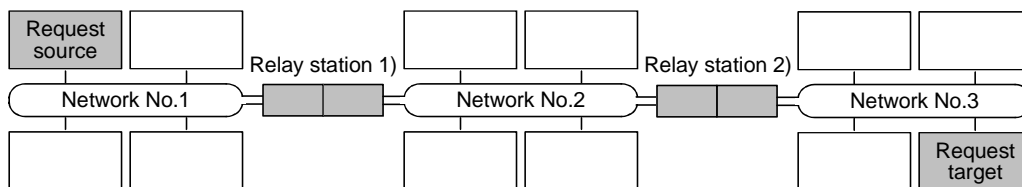

- (d) Multi-level 3 (four or more networks)

Set the routing parameters to the request source and relay stations. To the request source, set the data to access the request target (network No. 4). To the relay station 1) (the nearest relay station to the request source), set the data to access the request target (network No. 4). To the relay station 2) (the nearest relay station to the request target), set the data to access the request source (network No. 1). To the relay station 3) (relay station other than 1) and 2)), set the data to access the request target (network No. 4) and request source (network No. 1).

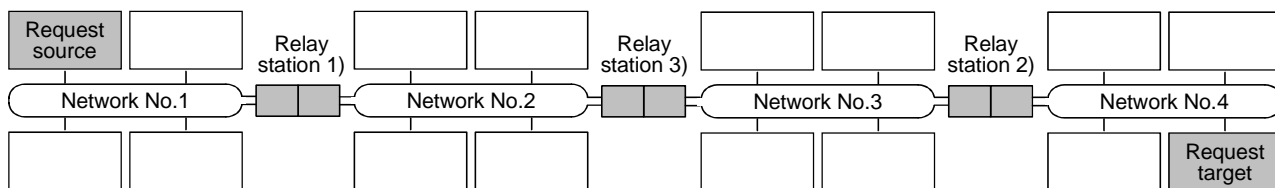



# 18. MONITORING

This section describes the monitoring of the operation processing of the PLC through an online connection between the peripheral device and PLC.

(1) Monitor mode

In the monitor mode, the monitor status dialog box shown below is displayed whether during monitoring or when monitoring it is stopped.

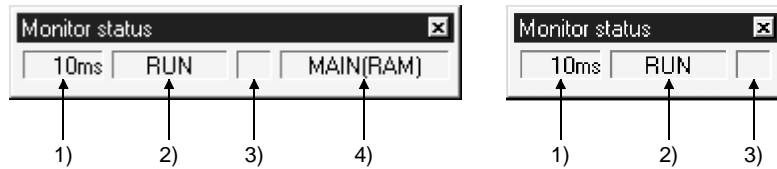

- 1) Scan time  
Indicates the maximum scan time of the monitored PLC.  
For the A series, it is in 10 ms units.  
For the QnA series, it is in 1ms units.  
For the Q series, it is in 0.1ms units.
- 2) PLC status  
Indicates the operating state of the PLC, as determined by the PLC key switch or by remote operation from a peripheral device.
- 3) Monitor execution status  
Flashes while monitoring is in progress.
- 4) Active program  
With the A series and FX series, the name of the program currently being executed at the PLC is displayed.  
With QCPU (Q mode)/QnA, nothing is displayed.

(2) ON/OFF status

The ladder ON/OFF status is determined as follows.

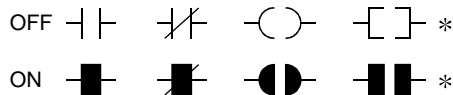

\* : Only comparison instructions which are equivalent to contacts, and SET, RST, PLS, PLF, SFT, SFTP, MC, FF, DELTA, DELTAP instructions, which are equivalent to coils, are supported.  
(FF, DELTA, and DELTAP are QnA series instructions.)

POINTS
<ul style="list-style-type: none"> <li>• The display of ON/OFF statuses and present values is maintained while monitoring is stopped.</li> <li>• The indication for the monitoring of RST instructions is the ON/OFF status of the device being reset. When the device to be reset is OFF   When the device to be reset is ON  </li> <li>• Note that the following functions will not be monitored properly if they are monitored from two or more peripheral devices simultaneously. Program monitor list, Interrupt program monitor list, Monitor condition setup, Monitor stop condition setup, Scan time measurement</li> <li>• For points to note about monitoring display when the FX series is selected see Appendix 11.</li> <li>• For the AnACPU or AnUCPU, the status at execution of the END instruction is monitored. For the AnACPU or AnUCPU, however, note that the status at any point during scan execution may be monitored. Though the monitor result may differ, the program run is not different.</li> </ul>

### 18.1 Monitoring, and Stopping/Resuming Monitoring



A	Q/QnA	FX
○	○	○

**[Purpose]**

Monitors the continuity, energized state, and ON/OFF states of contacts and coils while displaying the ladder.

Also stops monitoring and resumes monitoring after it has been stopped.

**[Operating Procedure]**

- For monitoring  
 Select [Online] → [Monitor] → [Monitor mode], or click  ( [F3] ).
- To stop monitoring  
 Select [Online] → [Monitor] → [Stop Monitor], or click  ( [Alt] + [F3] ).
- To resume monitoring  
 Select [Online] → [Monitor] → [Start Monitor], or click  ( [F3] ).

**[Window]**

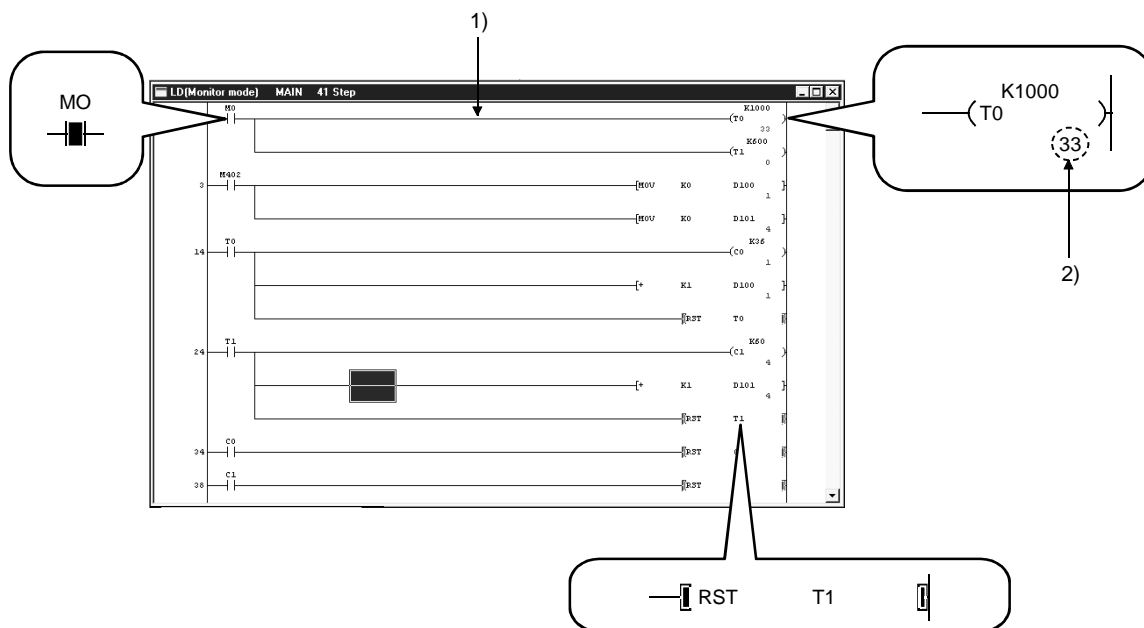

**[Description]**

1) LD

During monitoring, the ON/OFF states of contacts and coils and the present values of devices are displayed, and they change in accordance with the operating state of the PLC.

When monitoring is stopped the display is maintained, and is updated when monitoring is resumed.

## 2) Present value

Displays the present values of word devices.

The present values can be switched between decimal and hexadecimal.

For details on this switching of present values, see Section 18.4.

When monitoring a double word containing ten or more characters, it is displayed by making the characters smaller.

Present values can be displayed in double words or as real numbers in accordance with the data type used with an instruction.

## POINTS

- In the monitor mode, check whether the status is "monitoring in progress" or "monitoring stopped" either in the monitor status dialog box display or from the Tool button display shown below.

Monitoring in progress   Monitoring stopped  

- Contacts in the ladder monitor window can be forcibly switched ON/OFF by using **[Shift]** key + double click ( **[Enter]** ).
- When a word device being monitored is **[Shift]** key + double-clicked ( **[Enter]** ), the present value change dialog box shown below is displayed.

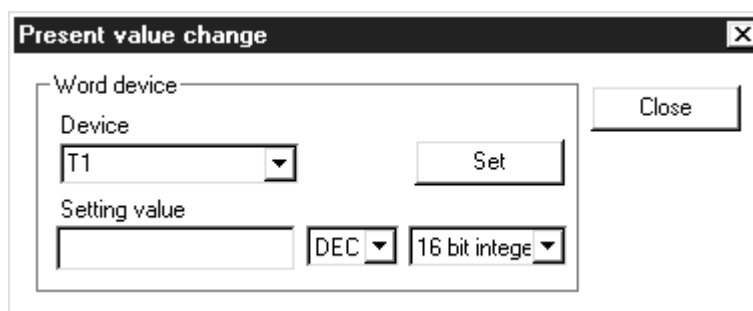

Enter the value to be changed, then click the **[Set]** button.

- The present values of double word instructions (DMOV, DFRO, etc.) are displayed as double words.  
Check the values of double words in device batch monitoring or registered device monitoring.  
For details on device batch monitoring, see Section 18.5.  
For details on registered device monitoring, see Section 18.6.
- The FD device is monitored as a word value.
- During the ladder monitoring or device batch-monitoring, connection setup and change of PLC type cannot be performed.

## 18.2 Monitoring/Stopping Monitoring in All Windows

A	Q/QnA	FX
○	○	○

**[Purpose]**

Starts monitoring in all open windows: ladder monitor, device batch monitor, registered device monitor, and buffer memory batch monitor.  
Also stops monitoring in all the windows where monitoring is in progress.

**[Operating Procedure]**

- To monitor in all windows:  
Select [Online] → [Monitor] → [Start monitor (All windows)].
- To stop monitoring in all windows:  
Select [Online] → [Monitor] → [Stop Monitor (All windows)].

**[Window]**

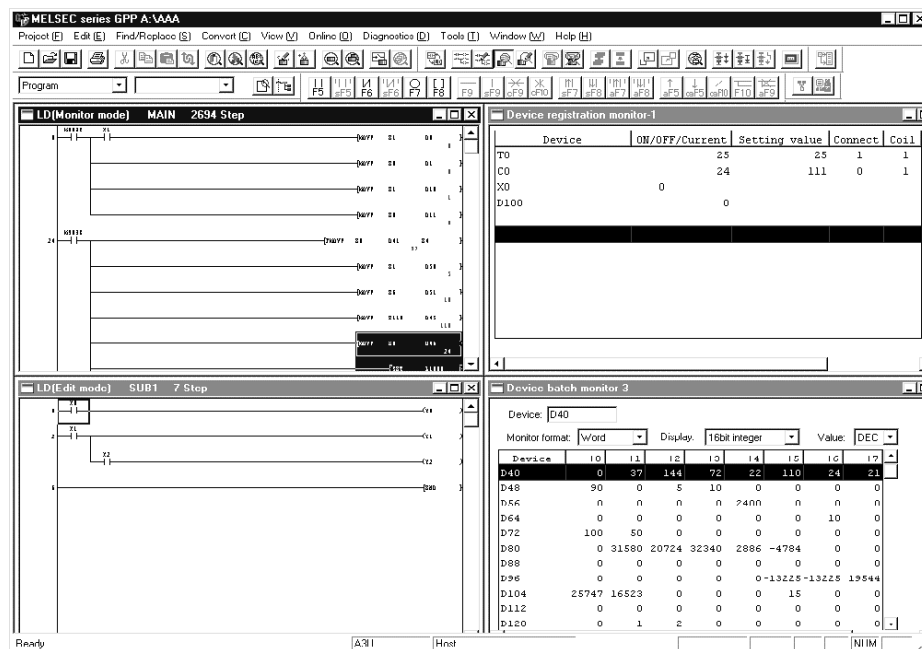

<b>POINT</b>
<ul style="list-style-type: none"> <li>• When monitoring multiple windows, if the windows are overlapped they are difficult to view. By selecting [Window] → [Tile horizontally] ([Tile vertically]), the windows are not overlapped and are easier to view.</li> </ul>

### 18.3 Editing Programs During Ladder Monitoring

A	Q/QnA	FX
○	○	○

[Purpose]

Allows programs to be edited while ladder monitoring is in progress by setting the ladder window to the monitor writing mode.

[Operating Procedure]

Select [Online] → [Monitor] → [Monitor (Write mode)], or click  ( [Shift] + [F3] ).

[Dialog Box]

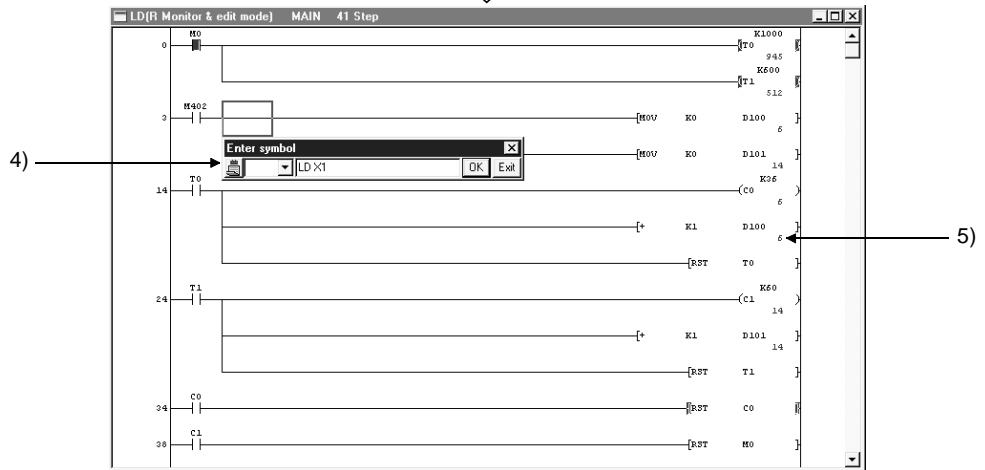
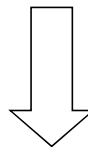
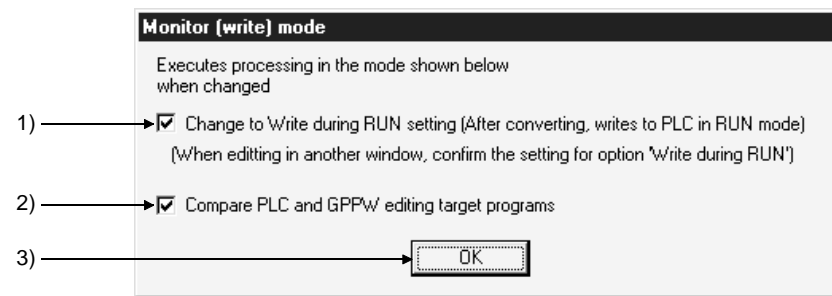

[Description]

- 1) Change to Write during RUN setting (while PLC is running)".  
When the checkbox is checked, on changing to the monitor write mode the online change setting is also changed simultaneously.  
See Section 17.9 for details on online change setting.
- 2) Compare PLC and GPPW editing target programs  
When the checkbox is checked, on changing to the monitor write mode the program in the connected PLC is verified against that at GPPW.  
By verifying the program in advance, it is possible to avoid program mismatches during online change.



- 3)  button  
Clicking this button sets the ladder window in the monitor write mode.
- 4) Ladder input window  
Opened to create, and change, ladder programs.  
See Section 6 "CREATING CIRCUITS"
- 5) Ladder (monitor write) window  
Allows ladder monitoring while displaying ON/OFF statuses and present values.

[Operating Procedure]

1. Use the "operating procedure" above while the ladder window is displayed to display the dialog box.
2. Click (1)/(2) as required.
3. Click (3).
4. The ladder window enters the monitor write mode.
5. Create/change the ladder program.
6. Convert the ladder.  
If the online change setting is "Write during RUN (while PLC is running)" at this time, online change is executed on pressing "convert" ().  
Online change can also be executed by pressing [Convert (Online change ( + ))].  
See Section 17.7 "Executing Online Program Change (Write During RUN)"

POINTS
<ul style="list-style-type: none"><li>• If, simultaneously with switching to the monitor write mode, the online change setting is made "Write during RUN (while PLC is running)", the online change (write during RUN) setting will remain in effect thereafter, even if the write mode is changed.</li><li>• When using the FX series, program editing during ladder monitoring is only possible when a PLC that supports online change is in the online change enabled status (see Section 17.1.1.).</li></ul>

### 18.4 Switching Present Values Between Decimal and Hexadecimal

A	Q/QnA	FX
<input type="radio"/>	<input type="radio"/>	<input type="radio"/>

**[Purpose]**

Displays the device present values in the ladder monitor window in decimal or in hexadecimal format.

**[Operating Procedure]**

- For display in decimal:  
Select [Online] → [Monitor] → [Change current value monitor (Decimal)].
- For display in hexadecimal:  
Select [Online] → [Monitor] → [Change current value monitor (Hexadecimal)].

**[Window]**

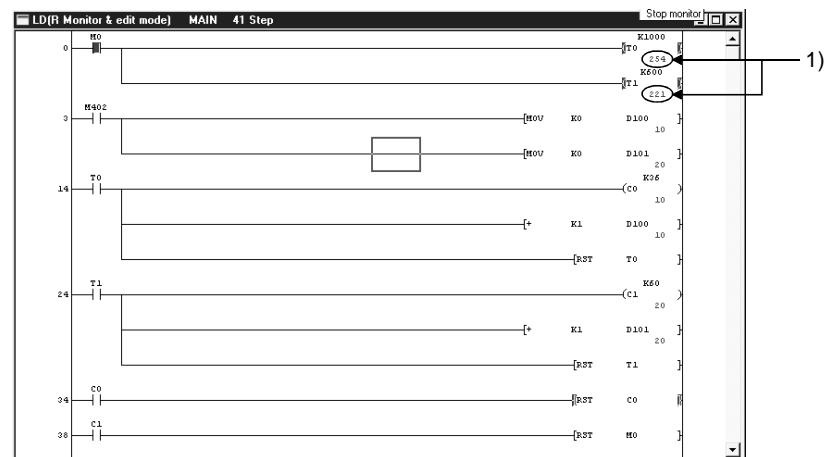

**[Description]**

- 1) Device present value  
Sets display in decimal or hexadecimal notation.

POINT
<ul style="list-style-type: none"> <li>• Convert numbers stored in binary coded decimal (BCD) to hexadecimal.</li> </ul>

18.5 Batch Monitoring Devices/Buffer Memories

A	Q/QnA	FX
<input type="radio"/>	<input type="radio"/>	<input type="radio"/>

[Purpose]

In device batch monitoring, one designated type of device is monitored.  
 In buffer memory batch monitoring, a special function module is designated and its buffer memory is monitored.  
 When using FXCPU, note that the only PLCs that support buffer memory monitoring are the FX2N series and the FX2NC series.  
 However, when the logic test function (LLT) is connected, buffer memory monitoring can also be done on FX2, FX2C and FX0N series.

[Operating Procedure]

- For device batch monitoring:  
 Select [Online] → [Monitor] → [Device batch], or click  .
- For buffer memory batch monitoring:  
 Select [Online] → [Monitor] → [Buffer memory batch].

[Dialog Box]

The dialog box for device batch monitoring is shown here; the dialog box for buffer memory batch monitoring is of the same type.

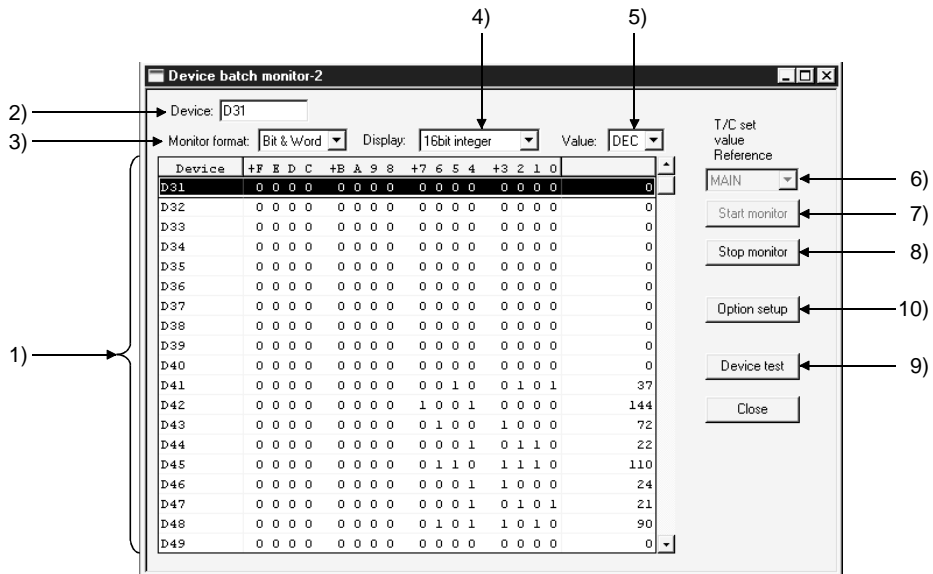

[Description]

Items in parentheses relate to buffer memory batch monitoring.

- 1) Device batch monitor (buffer memory batch monitor)  
 The designated device (buffer memory) is displayed in accordance with the monitor format, display, value, and option settings.  
 The range not currently displayed can also be monitored by using the scroll bar.  
 However, when T or C devices are designated for device batch monitoring, the timer/counter multi-point format is used.

## 2) Device (buffer memory) designation

- For device batch monitoring:  
Designate the device type and actual device number.  
Device designation by qualification (index, digit designation, and word device bit designation) is not possible.
- For buffer memory batch monitoring:  
The following is displayed for buffer memory batch monitoring.

Unit start address:

Buffer memory address:

Designate the first I/O number (lowest digit not required) of the special function module used for monitoring, and the buffer memory address (decimal/hexadecimal).

If using the FX series, enter the block number (0 to 7) of the special expansion device for the module's first address.

However, FX<sub>0N</sub>-3A, FX<sub>2N</sub>-2AD, and FX<sub>2N</sub>-2DA do not come into the scope of monitoring of the buffer memory.

For the buffer memory address, enter the BFM No. (0 to 32766).

## 3) Monitor format

Sets the monitoring format.

When T or C is designated for device batch monitoring, the format is automatically set as timer/counter multi-point format.

Bit & Word .....Devices (buffer memories) are monitored as both bits and words.

Bit multi-point .....Devices (buffer memories) are monitored as bits.

Word multi-point ..... Devices (buffer memories) are monitored as words.

## 4) Display

Sets the word device (buffer memory) display when monitoring in the Bit & Word or Word multi-point format.

16bit integer .....Displayed as 16-bit integers.

32bit integer .....Displayed as 32-bit integers.

Real number .....Displayed as real numbers.

ASCII .....Displayed as ASCII characters

## 5) Value

Sets the format of numbers to be displayed when monitoring in the 16bit integer or 32bit integer format.

Decimal .....Displayed in decimal notation.

Hexadecimal .....Displayed in hexadecimal notation.

## 6) T/C set value Reference

Designates the program whose set values are to be displayed when batch monitoring T or C devices.

- 7) **Start monitor** button  
Clicking this button after setting the device (buffer memory address) starts monitoring.
- 8) **Stop monitor** button  
Stops device (buffer memory) batch monitoring.
- 9) **Device test** button  
Clicking this button displays the device test dialog box.  
See Section 19.1 "Carrying Out a Device Test"

- 10) **Option setup** button  
Clicking this button displays the option setting dialog box shown below.

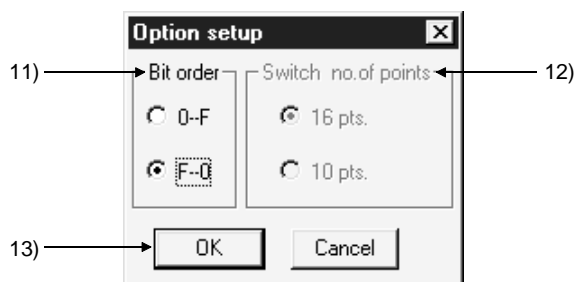

- 11) **Bit order**  
Sets the order in which the bit devices are arranged when "Bit & Word" is selected as the monitoring format.
- 0-F  
Display in ascending order from the right  
Suited to the monitoring of bit devices.
  - F-0  
Display in ascending order from the left  
Suited to the monitoring of the bits of word devices (buffer memories).
- 12) **Switch no. of point**  
Sets the number of bit device points displayed in the Bit & Word format for device batch monitoring.
- 16 pts.  
16 points are displayed  
Set when monitoring hexadecimal notation devices such as X and Y.
  - 10 pts.  
10 points are displayed  
Set when monitoring decimal notation devices such as M and L.
- 13) **OK** button  
Click this button after setting the option settings.

[Monitor format]

Indicates the monitoring format for device batch monitoring and buffer memory batch monitoring.

Bit & Word format

Device	+F E D C	+B A 9 8	+7 6 5 4	+3 2 1 0	^
D40	0 0 0 0	0 0 0 0	0 0 0 0	0 0 0 0	0
D41	0 0 0 0	0 0 0 0	0 0 1 0	0 1 0 1	37
D42	0 0 0 0	0 0 0 0	1 0 0 1	0 0 0 0	144
D43	0 0 0 0	0 0 0 0	0 1 0 0	1 0 0 0	72
D44	0 0 0 0	0 0 0 0	0 0 0 1	0 1 1 0	22
D45	0 0 0 0	0 0 0 0	0 1 1 0	1 1 1 0	110
...	...	...	...	...	...

A                                      B                                      C

Bit multi-point format

Device	+1 F E D C	B A 9 8	7 6 5 4	3 2 1 0	+0 F E D C	B A 9 8	7 6 5 4	3 2 1 0	^
D40	0000	0000	0010	0101	0000	0000	0000	0000	0000
D42	0000	0000	0100	1000	0000	0000	1001	0000	0000
D44	0000	0000	0110	1110	0000	0000	0001	0110	0000
D46	0000	0000	0001	0101	0000	0000	0001	1000	0000
D48	0000	0000	0000	0000	0000	0000	0101	1010	0000
D50	0000	0000	0000	1010	0000	0000	0000	0101	0000
...	...	...	...	...	...	...	...	...	...

A                                      B

Word multi-point format

Device	+0	+1	+2	+3	+4	+5	+6	+7	^
D40	0	37	144	72	22	110	24	21	
D48	90	0	5	10	0	0	0	0	
D56	0	0	0	0	2400	0	0	0	
D64	0	0	0	0	0	0	10	0	
D72	100	50	0	0	0	0	0	0	
D80	0	31580	20724	32340	2886	-4784	0	0	
...	...	...	...	...	...	...	...	...	

A                                      C

Timer/counter multi-point format (for device batch monitoring)

Device	Contact	Coil	Setting	Current	^
T0	1	1	25	25	
T1	0	1	25	3	
T2	0	0	-----	0	
T3	0	0	-----	0	
T4	0	0	-----	0	
T5	0	0	-----	0	
...	...	...	...	...	

A            D            E            F            G

- A ..... Indicates the device (buffer memory address)  
In the case of bit multi-point format and word multi-point format, this indicates the first number of each line.
- B ..... Indicates the bit ON/OFF status. (1 : ON 0 : OFF)
- C ..... Displays word device data as 16-bit integral values, 32-bit integral values, real numbers, or ASCII characters.
- D ..... Indicates the ON/OFF status of T or C contacts. (1 : ON 0 : OFF)
- E ..... Indicates the ON/OFF status of T or C coils. (1 : ON 0 : OFF)
- F ..... Indicates the set values of T or C coils.
- G ..... Indicates the present values of T or C coils.

**POINTS**

- [Shift] key+ doubling clicking ( [Enter] ) at the monitored part displays the device test dialog box, enabling devices to be forcibly turned ON or OFF, and their present values to be changed.  

See Section 19.1 "Carrying Out a Device Test"
- If device batch monitoring or buffer memory batch monitoring is started up several times, the time lapse until monitoring starts, and the monitoring interval, may become longer.
- The monitoring result is shown "FFFFH" if you specified the device which cannot be monitored during ladder monitoring (e.g. J □ \ □ ).

## 18.6 Monitoring after Registering Devices

A	Q/QnA	FX
○	○	○

### [Purpose]

Simultaneously monitors devices at some distance from each other within the ladder, or multiple types of device, in the same display.

### [Operating Procedure]

Select [Online] → [Monitor] → [Device registration], or click .

### [Dialog Box]

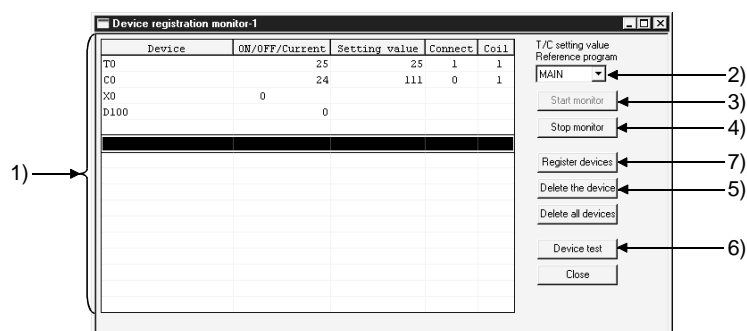

### [Description]

- 1) Registered device monitor  
Displays up to 64 registered device points in accordance with the device type.  
Doubling clicking ( Enter ) on a vacant field opens the device registration dialog box.  
T and C devices are displayed in the counter/timer format.  
32-bit integral values are displayed with "D" appended after the device as follows: D100 (D).  
For real values, (E) is appended and for ASCII characters, (S) is appended.  
For the QCPU/QnA, FD devices to be registered cannot be specified in the real number format.
- 2) T/C setting value Reference program  
Sets the program whose set values are to be displayed when T or C values are registered and monitored.
- 3) Start monitor button  
Click this button after completing device registration to start monitoring.
- 4) Stop monitor button  
Click this button to stop monitoring.
- 5) Delete all device button  
Clicking this button cancels the registration of a device.

- 6) **Device test** button  
Clicking this button displays the device test dialog box.  
See Section 19.1 "Carrying Out a Device Test"

- 7) **Register devices** button  
Clicking this button displays the device registration dialog box.

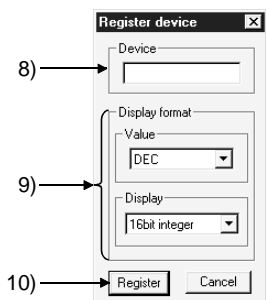

- 8) **Device**  
Sets the device to be registered.
- 9) **Display format**  
Set when word devices are monitored.  
Numeric values can be set in decimal or hexadecimal format.  
The available display settings are: 16-bit integral value, 32-bit integral value, real number, ASCII characters.
- 10) **Register** button  
Click this button after setting the necessary settings.

[Monitor format]

	Device	ON/OFF/Current	Setting value	Connect	Coil
Counter/timer format →	T0		25	1	1
	C0		24	111	1
Bit format →	X0	0			
Word format →	D100		0		
	A	B	C	D	

- A ..... Indicates the registered device.
- B ..... Indicates the ON/OFF status or present value of the registered device.  
(1 : ON 0 : OFF).
- C ..... When T or C devices are registered, the set value is indicated.
- D ..... When T or C devices are registered, the ON/OFF statuses of contacts and coils are indicated (1 : ON 0 : OFF)



[Operating Procedure]

1. Click 7) to display the device registration dialog box.
2. Set 8) and 9) in the device registration dialog box.
3. Click 10): the devices are displayed at 1).
4. By following steps 2 and 3, register all the devices to be monitored.
5. On completion of device registration, close the device registration dialog box.
6. Click 3).

**POINTS**

- When the ladder window is set to the read or monitor mode, devices can be registered by dropping and dragging with the **[Ctrl]** key pressed after the area to be registered has been selected. It is also possible to batch drag and drop a range selected by **[Shift]** key + clicking from the ladder cursor position.

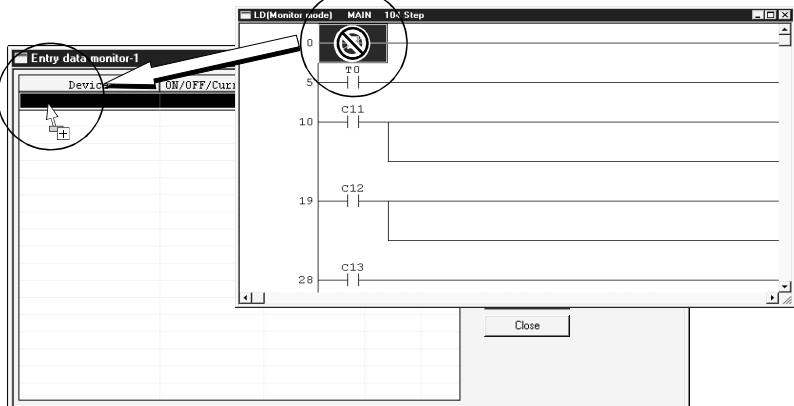

- When registered device monitoring, device batch monitoring, or buffer memory batch monitoring is started up several times, the time lapse until monitoring starts, and the monitoring interval, may become longer.
- **[Shift]** key + double clicking (**[Enter]** key) on a device name in the registration monitoring area displays the device test dialog box.  
See Section 19.1 "Carrying Out a Device Test"
- With the QnA series, apart from actual device numbers, it is also possible to register words with bit designations, bit designated within a word, index qualifications, and buffer memories. An example of device registration is given below.

Device to be Registered	Example
Monitoring M0 to M15 by digit designation	K4M0
D100F that monitors b15 of D100 using bit designation	D100.F
Monitoring Xn by index qualification with Z1	X0Z1
Monitoring a special function module buffer memory with first I/O number 40 and address K30(H2E)	U4\G30

See the QnACPU Programming Manual (Common Instructions).

- Setting a 32-bit integer/real number to the FD device will result in an error.

### 18.7 Setting Monitor Conditions/Stop Conditions

A	Q/QnA	FX
×	○	×

**[Purpose]**

Sets the conditions under which monitoring is started and stopped on the ladder monitor window.

This setting is not possible with the A series.

**[Operating Procedure]**

- For setting monitor conditions:  
Select [Online] → [Monitor] → [Monitor condition setup].
- For setting monitor stop conditions:  
Select [Online] → [Monitor] → [Monitor stop condition setup].

**[Dialog Box]**

Monitor condition dialog box

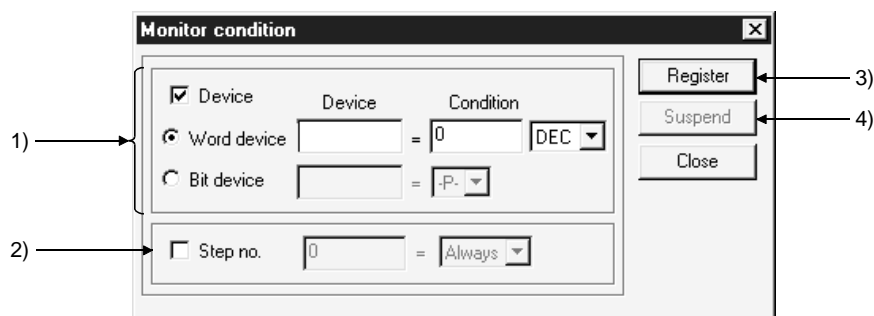

Monitor stop condition dialog box

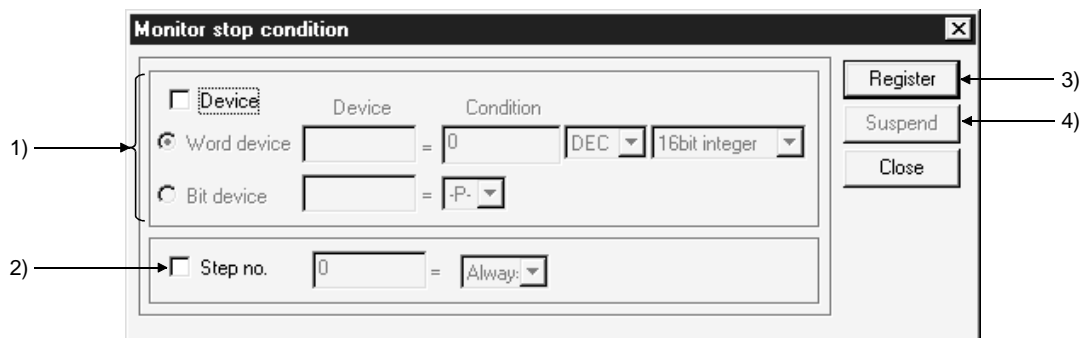

**[Description]**

1) Device

Sets a device condition as the monitor condition (monitor stop condition). The device that is to act as the condition can be a word device or bit device.

○ Word device

Set the word device and numeric value (decimal or hexadecimal integral value) that is to be the condition.

For a stop condition, set a 16-bit integral value, 32-bit integral value, or real number.

○ Bit device

Set a bit device and condition (-P- : at leading edge -F- : at trailing edge)

- 2) Step no.  
Sets, as the condition, the execution status of a designated step number in the program.  
Select the execution status from among the following:  
-P-..... Transition from OFF to ON  
-F-..... Transition from ON to OFF  
ON.....During ON status  
OFF.....During OFF status  
Always..... At all times during execution (if the relevant step is jumped the condition is not satisfied)
- 3)  button  
Clicking this button registers the set condition.
- 4)  button  
Clicking this button cancels the registered condition.

POINTS
<ul style="list-style-type: none"><li>• If both device and step No. conditions are set at the same time, the monitor condition (monitor stop condition) is met when both are satisfied.</li><li>• If the device condition has been designated (including when both device and step No. conditions are set at the same time), monitoring may not stop at the point when the condition is met first after condition designation.</li></ul>

### 18.8 Program List Monitor

A	Q/QnA	FX
×	○	×

[Purpose]

Displays the processing time of the program currently being executed.

[Operating Procedure]

Select [Online] → [Monitor] → [Program monitor list].

[Dialog Box]

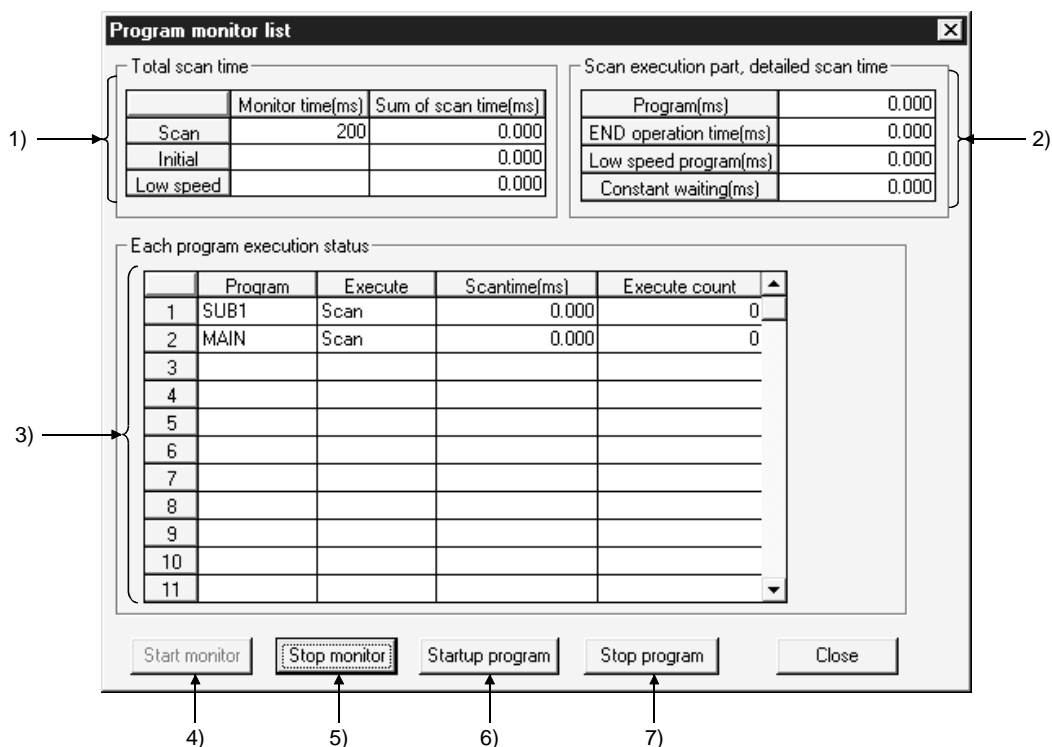

[Description]

1) Total scan time

Indicates the time set for the WDT setting in the PLC RAS settings of the PLC parameters.

- Monitor time

Indicates the WDT times for scan programs, initial programs, and low-speed programs.

If the scan time exceeds the indicated value, a WDT error is indicated at the CPU.

- However, the constant scan execution program is not displayed.

To display the scan time, use scan time measurement.

- Sum of scan time

Indicates the total time for each item in "Scan execution part detailed scan time."

2) Scan execution part, detailed scan time

Indicates the processing execution time for each item.

"Constant" indicates the constant scan waiting time when the setting is for constant scan.

However, if a low-speed program execution time is also set, this becomes 0.000 ms.

- 3) Each program execution status  
Indicates the execution status of the program set in program setting in the PLC parameters.
- Program  
Indicates program names in the order set in the parameters.
  - Execute  
Indicates the program type set in the parameters.
  - Scan time  
Indicates the actual scan time (present value). In the program stop (standby) status, the scan time is indicated as 0.000 ms.
  - Execute count  
Indicates the number of times a program has been executed, taking the count when counting starts to be "0."  
(When the maximum count of 65536 is reached, the count returns to 0.) The count is retained during the program stop status.
- 4) **Start Monitor** button  
Clicking this button starts a stopped program.
- 5) **Stop Monitor** button  
Stops monitoring.
- 6) **Startup program** button  
Clicking this button displays the dialog box shown below.

[Dialog Box]

Program startup dialog box

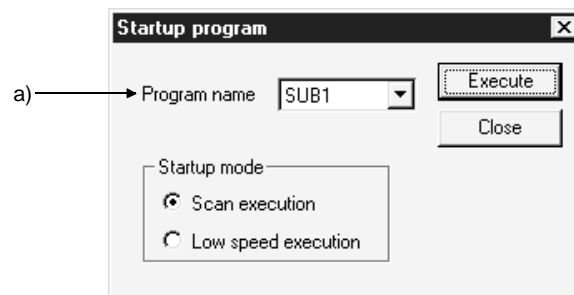

- a) Program name  
Only programs that have been set in PLC parameter program selection can be selected.  
It is not possible to type any required program name.

Program stop dialog box

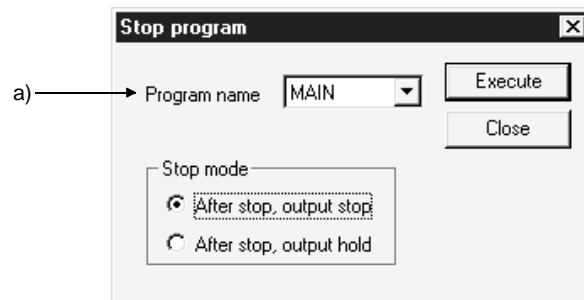

- a) Program name  
Only programs that have been set in PLC parameter program selection can be selected.  
It is not possible to type any required program name.

### 18.9 Monitoring the Interrupt Program List

A	Q/QnA	FX
×	○	×

**[Purpose]**

Indicates the number of times interrupt programs have been executed.

**[Operating Procedure]**

Select [Online] → [Monitor] → [Interrupt program monitor list].

**[Dialog Box]**

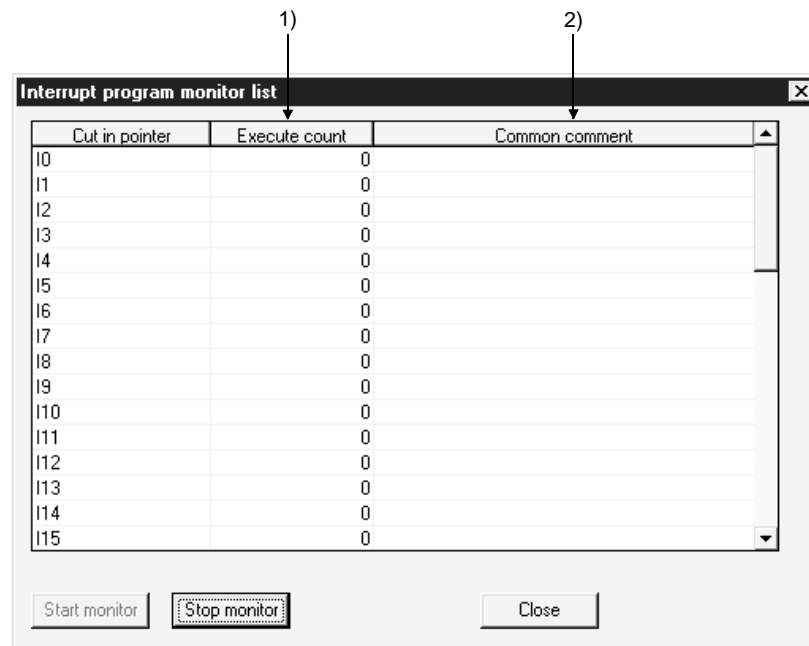

**[Description]**

1) Execute count

Indicates the number of times a program has been executed, taking the count when counting starts to be "0."

(When the maximum count of 65536 is reached, the count returns to 0.)

The count is cleared to zero when the operating state of the PLC is set to RUN.

2) Common comment

Indicates comments created as device comments.

Only common comments can be indicated.

## 18.10 Measuring Scan Time

A	Q/QnA	FX
×	○	×

## [Purpose]

Indicates the processing time for any required section of program.

## [Operating Procedure]

Select [Online] → [Monitor] → [Scan time measurement].

## [Dialog Box]

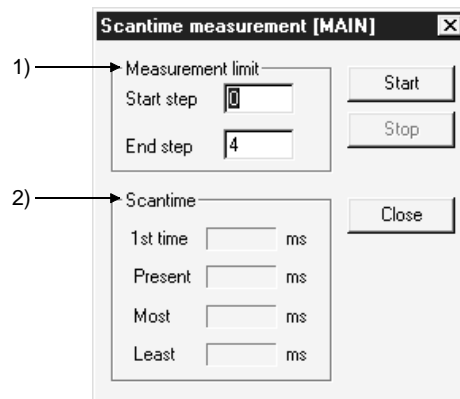

## [Description]

- 1) Measurement limit  
Set so that the start step is smaller than the end step.
- 2) Scantime  
It is not possible to measure times that straddle different program files.  
If the measured time is within 0.100 ms, it is indicated as 0.000 ms.

POINT
<p>Selection range</p> <ol style="list-style-type: none"> <li>1 Move the cursor to a position outside the left bus line and <b>[Shift]</b> key+ click to set the range. During dragging the selected range turns blue. (END instructions cannot be selected.)</li> <li>2 On selecting [Online] → [Monitor] → [Scan time measurement], the start step and end step are set in the part of the program defined by the selected range.</li> </ol>



## 18.11 Executing Sampling Trace

A	Q/QnA	FX
○	○	○

### [Purpose]

Samples the contents of the designated device (ON/OFF status and present value) at constant intervals, and stores the result in the sampling trace area of the memory.

Reads and displays this stored data.

By using this function, it is possible to follow changes in the data contents of the designated device, and to monitor the ON/OFF timing of contacts and coils.

### [Operating Procedure]

- 1 Set the trace count on the <<Conditions>> sheet.
- 2 Set the trace point on the <<Conditions>> sheet.
- 3 Set the trigger point on the <<Conditions>> sheet.  
(When executing an STRA instruction (A/QnA series) or when performing trigger operation at a peripheral device (Q/QnA series), set the TRACE instruction (Q series) or make detailed settings (Q/QnA series).)
- 4 Set the device setting on the <<Trace data>> sheet.
- 5 Write the set data to the PLC.
- 6 Select Start trace on the <<Execute and status>> sheet.
- 7 Write the execution result after tracing to the PLC.
- 8 Read the result with the Trace result button.

### POINTS

- When using AnNCPUs, set the memory capacity in the PLC parameters.
- The setting data and trace result data is in GPPW format and there is therefore no compatibility with GPPA or GPPQ data.
- When using the A series, it is not possible to set Execute trigger on the <<Execute and status>> sheet, or the Trace data (Conditions + Results) storing data.
- When using the A series, it is not possible to set the Information with trace or trigger point setting on the <<Conditions>> sheet.
- When using extension file registers with AnACPU or AnUCPU, there may be blocks that cannot be used, depending on the memory cassette.  
Block numbers other than No. 0 to 24, 29 to 40, and 45 to 48 of A3AMCA-96, A4AMCA-128, and A4AMCA-128E cannot be used.

18.11.1 Setting execution & status display

A	Q/QnA	FX
<input type="radio"/>	<input type="radio"/>	<input type="radio"/>

[Purpose]

Facilitates operations such as those for trace start and trigger execution when "When a peripheral trigger operations" is set for the trigger point setting in the trace condition settings.  
Sets the storage destination for trace data (condition + result).

[Operating Procedure]

Select [Online] → [Trace] → [Sampling trace].

[Dialog Box]

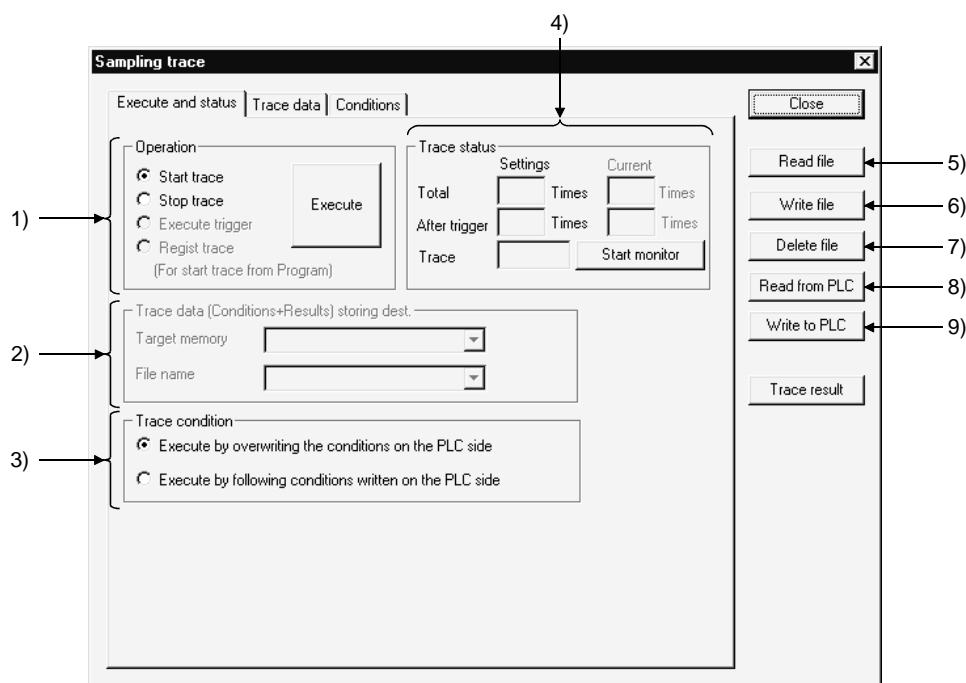

[Description]

- 1) Operation  
When using the A series, trigger execution cannot be set.  
The Q/QnA series allows a trace to be triggered from the sequence program.  
(Regist trace)  
Clicking the Execute button, starts trace status monitoring.
- 2) Trace data (Conditions + Results) storing data (QnA series only)  
Select the ROM, RAM of the IC memory card.  
Designate an arbitrary name for the file name for storage.  
The currently active sequence program name is displayed as the default.  
This setting is not possible with the FX series.
- 3) Trace condition  
Sets whether the trace is to be executed using the conditions set at the peripheral device or the settings at the PLC side.

- 4) Trace status  
Indicates the current trace status.  
<Total count>  
Indicates the setting count after the trigger presently being executed, and the present trace count.  
The count set at the GPPW side is displayed.  
In cases where, for example, "Execute by following conditions written on the PLC side" is selected, the field is blank.  
(For example when the count is undefined.)  
  
<Count after trigger>  
Indicates the setting count after the trigger currently being executed and the execution count after the present trigger.  
  
<Trace status>  
Indicates the execution status of the present trace.
- 5) Read file  
Reads the sampling trace condition + trace result.
- 6) Write file  
Writes the sampling trace condition + trace result.
- 7) Delete file  
Deletes the sampling trace condition + trace result.
- 8) Read from PLC  
Reads the sampling trace condition + trace result to the PLC.
- 9) Write to PLC  
Writes the sampling trace condition + trace result to the PLC.

POINTS
<ul style="list-style-type: none"><li>• Points to check at trace execution If sampling trace cannot be executed check the following points.  &lt;Common points&gt; If the communicating PLC is of a different type, the trace cannot be executed. Trace execution status check (trace execution command cannot be given during trace)  &lt;Check when conditions are overwritten at the PLC side&gt; Device check (checks for consistency with the parameter settings) Trace condition setting check (checks for omissions in trace condition setting, and inconsistency) Capacity check (checks if the trace result can be accommodated in the setting capacity) The PLC parameter and peripheral device parameter settings are checked. If there is a mismatch the trace cannot be executed. Applicable memory check (checks whether the selected applicable memory can be used or not) File name check (checks if a file name is set) Extension file register block use possibility check (checked for AnACPU and AnUCPU, QCPU(Amode)).</li><li>• When the PLC type is changed, the sampling trace data written to file (settings + results) are deleted. (Even if the project is not saved, they are deleted and cannot be recovered.)  Example: A2N → A3A Deleted           A2A → A3A Not deleted</li></ul>

18.11.2 Setting trace data

A	Q/QnA	FX
○	○	○

[Purpose]

Sets devices for sampling trace (bit devices, word devices).

[Operating Procedure]

Select [Online] → [Trace] → [Sampling trace] → <<Trace data>> sheet.

[Dialog Box]

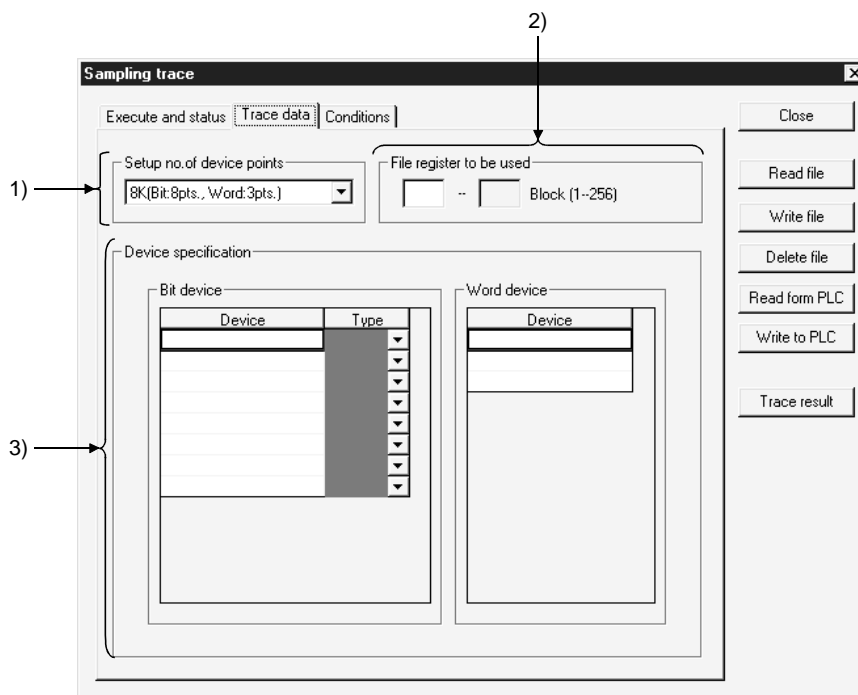

[Description]

1) Setup no. of device points

Set for AnACPU and AnUCPU, QCPU(Amode) only.

The relationship between the number of points and capacity in the settings is as follows.

- 8 K (8 bit points, 3 word points 1 block)
- 15 K (16 bit points, 6 word points 1 block)
- 23 K (16 bit points, 10 word points 2 blocks)

2) File register to be used

Designates the number of the extension file register used to store result data when executing an online sampling trace with AnACPU or AnUCPU, QCPU(Amode).

For the setting, designate the first number of the extension file register.

- 3) Device specification  
 Sets the devices (bit devices, word devices) for executing a trace.  
 The devices, and number of points, that can be set differ for each PLC.

	Bit Devices That can be Set	Word Devices That can be Set	Devices That can be Registered
AnNCPU	8 points	3 points	X,Y,M,L,S,B,F,T,C T,C,D,W,R,A,Z,V
AnACPU AnUCPU QCPU-A	Depends on the number of device points setting		
QnACPU Required memory capacity: up to 60K	50 points The maximum number of input characters is 16 characters (bit device)	50 points The maximum number of input characters is 17 characters (bit device)	
QCPU (Qmode)	50 points The maximum number of input characters is 16 characters (bit device)	50 points The maximum number of input characters is 17 characters (bit device)	X,Y, M, L, F, SM, FX, FY, V, DX, DY, T, C, ST, D, SD, FD, B, SB, W, SW, R, Z, RZ, constant, U□G, J□X, J□Y, J□B, J□SB, J□W, J□SW, BL□S, BL□TR Extension designation, bit designation for word devices with index qualification Digit designation for bit devices Indirect designation is not possible.
FXCPU *1	10 points	3 points	Contacts : X,Y,M,S,T,C Coils : T,C(Y,M *2) Present values : T,C,D,V,Z

\*1 : The PLCs that support sampling trace are the FX<sub>2</sub>, FX<sub>2C</sub>, FX<sub>2N</sub>, and FX<sub>2NC</sub> series.  
 \*2 : It is also possible to register Y and M as coils, but - depending on the details of operation of the PLC the ON/OFF operation of the coil may not be reflected in the sampling results.)  
 Therefore, Y and M are usually registered as contacts.

POINTS
<ul style="list-style-type: none"> <li>• About M, L, S of A series CPUs:                      When using an A/QCPU(Amode), M, L, and S devices are automatically corrected in accordance with the parameters when they are input and displayed in the device setting field.                      After registration, even if, for example, there are changes in the parameter settings, on redisplay the display is automatically corrected in accordance with the parameters.</li> <li>• About the type setting field:                      Setting is not possible if there has been no device input, or if devices other than T, C have been input.</li> </ul>

### 18.11.3 Setting trace conditions

A	Q/QnA	FX
○	○	○

[Purpose]

Sets trace counts, trace points, and trigger points.

[Operating Procedure]

Select [Online] → [Trace] → [Sampling trace] → <<Conditions>> sheet.

[Dialog Box]

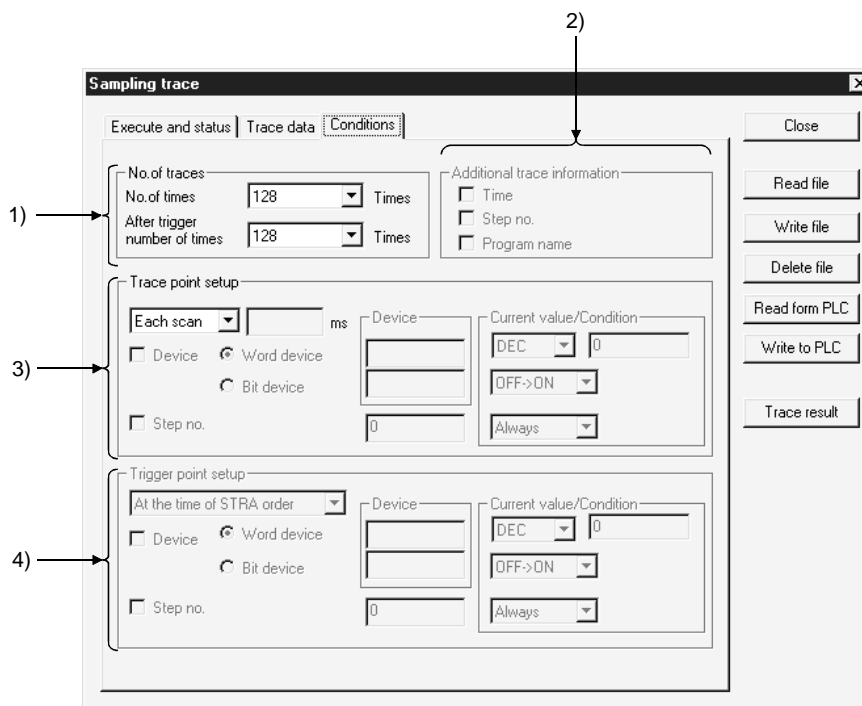

[Description]

1) No. of traces

Set so that the total count is larger than the count after the trigger.  
 When using the A series, the count can only be selected from the menu.  
 With the Q/QnA series, any required count up to 8192 can be set.  
 With the FX series, it is not possible to set a total count. The count after the trigger can be set in the range of 1 to 512 from the menu, or alternatively any required count can be set.

2) Additional trace Information (QnA series only)

As information when the trace is executed, the time, step, and program name can displayed with the results.

3) Trace point setup

With A series  
 The per time setting range is 10 to 2000 ms.  
 Settings can be made in 10 ms units.

**With QnA series**

The per time setting range is 5 to 10000 ms.  
Settings can be made in 5 ms units.

**With FX series**

When a per scan setting is made, it is not possible to make settings in the detailed setting field.

When per scan is designated, the execution of the END instruction by the PLC becomes the trace point.

The per time setting range is 10 to 2000 ms.  
Settings can be made in 10 ms units.

**Detailed setting**

It is possible to set both a device and step number as the trace point at the same time.

In this case, sampling trace is executed with an AND condition.

**4) Trigger point setup (QnA series, FX series only)**

Sets the trigger (condition) that is the origin (0 point) for trace execution.

In the input area, only those input areas that are required for the selected trigger condition are valid.

**With FX series**

Read the expressions associated with the sampling trace function of FXGP (DOS) or FXGP (WIN) and the expressions associated with GPPW in the following way.

FXGP (DOS), FXGP (WIN)	GPPW
Without trigger	→ Wintrigger actuated
Win trigger	→ Detailed settings

For details on the detailed settings, see the trace point settings.

**POINT**

- **Note on repeated execution of a sampling trace:**  
If a trace count of 2000 is set and the trace is actually completed at a count of 1000, note that the results of 1000 traces from the previous execution will remain.



### 18.12 Monitoring the Ladders Registered

A	Q/QnA	FX
○	○	○

[Purpose]

You can batch-monitor related multiple ladder blocks.

[Operating Procedure]

[Online] → [Monitor] → [Entry ladder monitor]

[Dialog Box]

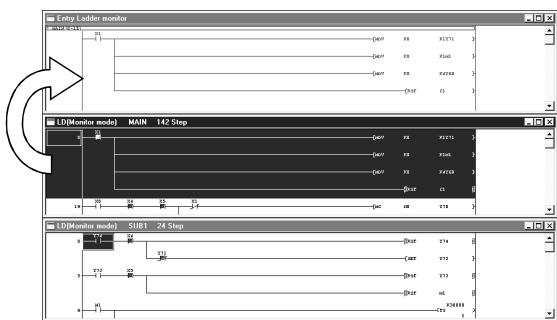

} Ladder registration monitor screen  
 \*The ladder block registered to the ladder registration screen is shown in blue.

[Description]

- You can register ladders by copy and paste or drag and drop.
- Registration may be made only from the ladder screen.  
 (Registration from the list screen or listing of the registered ladders cannot be made.)
- The registerable ladder size is up to 6K steps for any series.
- Functions that can be performed on the ladder registration screen
  1. Ladder deletion on ladder block basis
  2. Device search, instruction search, character string search
  3. Comment/statement/note display
  4. Device test
  5. Screen magnification/reduction
  6. Drag and drop to device registration monitor

### 18.13 Deleting All Ladders Registered

---

A	Q/QnA	FX
<input type="radio"/>	<input type="radio"/>	<input type="radio"/>

[Purpose]

You can batch-delete the ladder blocks registered.

[Operating Procedure]

[Online] → [Monitor] → [Delete all entry ladder]



# 19. DEBUGGING PROGRAMS

After a program has been written to the PLC, you can check it by carrying out a device test, partial operation, and step run. However, note that when using the FX series, the partial operation, step run and skip run functions are only valid when the logic test function (LLT) is connected.

Also note that if skip run is set before partial operation and step run, the program range designated for skip run will not be processed.

The following shows the operation status during partial operation and step run operation, and an example of the execution range when skip run is set.

For the Q series, you can use the ladder logic test (LLT) to perform partial execution, step execution or skip execution. (When it is connected to the PLC, partial execution, step execution and skip execution cannot be performed.)

### <Partial operation>

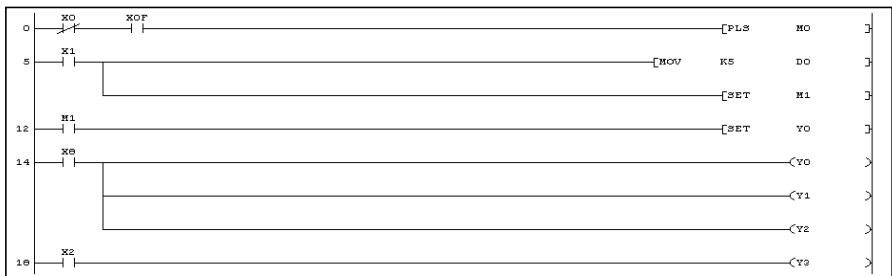

Runs the program from the designated step or pointer to the set stop condition.

See Section 19.2 "Carrying Out Partial Operation."

### <Step run>



Executes the designated program range one instruction at a time.

See Section 19.3 "Executing Step Run."

When skip run is set with the Q/QnA series or FX series, partial operation or step run is executed without processing the program range designated for this function.

### <Skip run>



Executes partial operation or step run while skipping (not processing) the part of the program between the designated steps.

See Section 19.4 "Setting the Scan Range."

### 19.1 Carrying Out a Device Test

A	Q/QnA	FX
○	○	○

[Purpose]

Forcibly turns ON/OFF the bit devices of the PLC, and changes the present values of word devices.

[Operating Procedure]

Select [Online] → [Debug] → [Device test], or click  ( [Alt] + [1] ).

[Dialog Box]

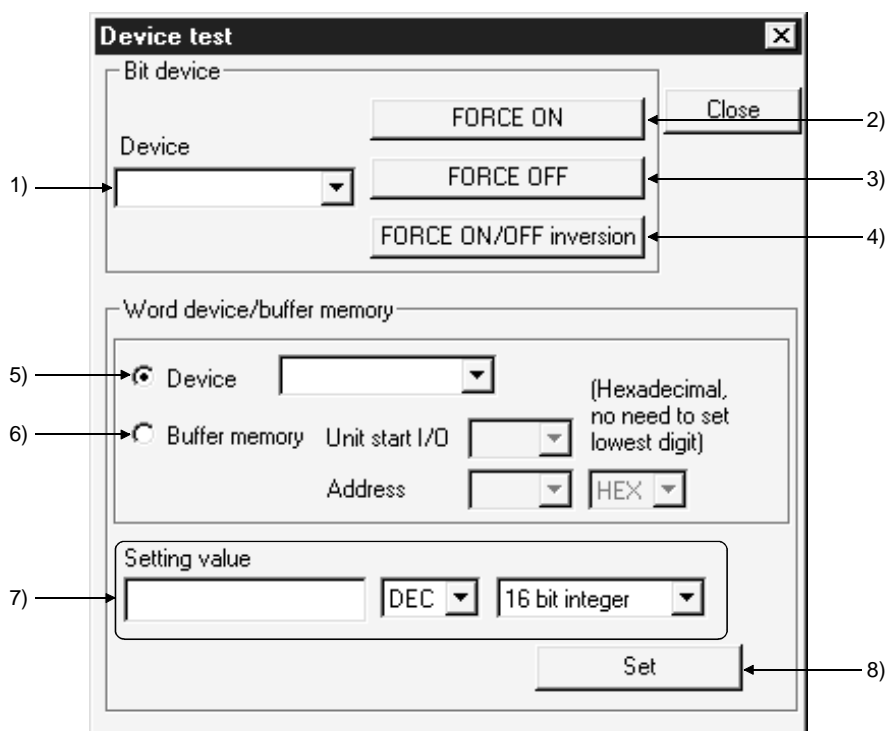

[Description]

- 1) Bit device  
Designates the bit device to be forcibly turned ON or OFF.
- 2) **FORCE ON** button  
Forcibly turns the designated bit device ON.
- 3) **FORCE OFF** button  
Forcibly turns the designated bit device OFF.
- 4) **FORCE ON/OFF inversion** button  
Forcibly inverts the ON/OFF statuses of designated bit devices.
- 5) Device  
Designates the word device whose present value is to be changed.
- 6) Buffer memory  
Designates the first I/O number (lowest digit unnecessary) and buffer memory address (decimal/hexadecimal) of the monitoring special function module.

- 7) Setting value  
Sets the value to be changed.  
Before setting the value, designate decimal or hexadecimal, and 16-bit integral value, 32-bit integral value, or real number.
- 8) **Set** button  
Click this button after making the necessary settings.  
The word device present value change operation is executed.

**POINTS**

- Executing a device may change the control of the PLC. Check safety carefully before executing the test.
- When a coil whose output condition input signal is OFF is forcibly turned ON while the PLC is in the RUN state, the execution of the program is given priority and the coil output comes ON only momentarily.
- Since the device designated for a device test is temporarily stored in memory, it can be selected the second and subsequent times with **▼** button while the project continues.

Device

D101 ▼

C1

Setting value

- With the Q/QnA series, a device test can be carried out by bit designation of word devices, or by digit designation of bit devices.  
In addition, a link module memory can be designated as follows "J\*\B\*\*" "J\*\W\*\*", and the buffer memory of a special function module can be designated as follows: "U\*\G\*\*."  
See the QnACPU Programming Manual (Common Instructions)
- **Shift** key + doubling-clicking (**Enter**) a contact in the ladder monitor window forcibly switches it between ON and OFF.
- **Shift** key + double-clicking (**Enter**) a word device that is being monitored displays the present value change dialog box shown below.

**Present value change** [X]

Word device

Device

T1 ▼ **Set**

Setting value

[ ] DEC ▼ 16 bit intege ▼

**Close**

After entering the value to be changed, click the **Set** button.

19.2 Carrying Out Partial Operation

A	Q/QnA	FX
○	○	○

[Purpose]

Executes a program from the designated step or pointer to the point where the set condition is established.

When Q/FX series is selected, only Ladder Logic Test Tool (LLT) is applicable.

[Operating Procedure]

1. Select [Online] → [Debug] → [Debug] (Choose the STEP-RUN mode).
2. Select [Online] → [Debug] → [Partial operation], or click  ( [Alt] + [3] ).

[Dialog Box]

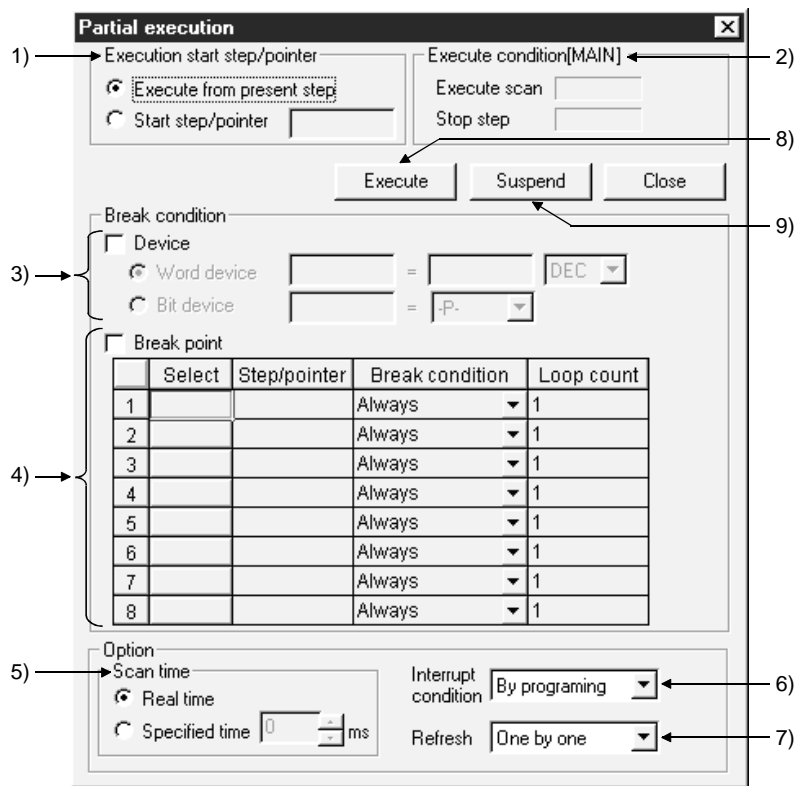

[Description]

1) Execution start step/pointer

○ Execution from present step

The program is executed from the step at which execution is presently stopped.

○ Start step/pointer

The program is executed from the designated step or pointer.

For step designation : \*\*

For pointer designation : P\*\*

I\*\*

\*\* = Number of designated step or pointer

- 2) Execution condition  
Indicates the execution status of the program.
- 3) Break condition  
Sets the device condition that stops partial operation.
  - ⊙ Word device  
The condition is satisfied when the set device has the same value as the set value.  
Set the device and numeric value (decimal or hexadecimal).
  - ⊙ Bit device  
The condition is satisfied when the set device is in the set condition.  
Set the device status (-P-: leading edge, -F-: trailing edge).
- 4) Break point  
Sets the break condition and loop count for a partial operation range.  
With the A series and FX series, the condition can only be "Always."

	Select	Step/pointer	Break	Loop
1	X	92	-P- ▼	2
2	X	137	ON ▼	2
3			Always ▼	1
4			Always ▼	1
5			Always ▼	1
6			Always ▼	1
7			Always ▼	1
8			Always ▼	1

A

B

C

D

- A: Selection  
Setting causes it to be executed as the break point.
- B: Step/pointer  
Set the step/pointer number that defines the range for partial operation.
- C: Break  
Set a status of the designated step/pointer as the break condition after the number of scans set by the loop count.
  - Always : On reaching the number of loops indicated by the designated count, execution stops.
  - ON : Execution stops when the designated step/pointer is ON.
  - OFF : Execution stops when the designated step/pointer is OFF.
  - ↑ : Execution stops when the status of the designated step/pointer changes from OFF to ON.
  - ↓ : Execution stops when the status of the designated step/pointer changes from ON to OFF.
- D: Loop  
Sets the number of scans until the break.  
The setting range is 1 to 32767.



- 5) Scan time (Q/QnA series only)  
Sets the processing time for a program that is executing partial operation.  
This setting is not possible with the A series and FX series.
- Ⓒ Real time  
The program is executed at intervals corresponding to normal RUN operation.
- Ⓒ Specified time  
The program is executed at the designated interval.  
The setting range is 10 ms to 2000 ms in 10 ms units.
- 6) Interrupt condition (Q/QnA series only)  
Sets whether or not the interrupt program is executed when an interrupt cause occurs during partial operation.  
This setting is not possible with the A series and FX series.  
By programming..... Depends on the execution results of EI and DI instructions.  
Prohibition..... The execution of the interrupt program is disabled.
- 7) Refresh (Q/QnA series only)  
Sets the refresh timing for I/O devices (X/Y).  
This setting is not possible for the A series and FX series.  
One by one..... Direct I/O refresh  
At the END..... Batch refresh at END processing
- 8)  button  
Click this button after setting the necessary settings.  
Partial operation is executed.
- 9)  button  
Aborts partial operation.

## [Operating Procedure]

1. Display the ladder monitor window.
2. Set the PLC to the STEP-RUN operating state by remote operation or with the key switch.
3. Set 1) through 7).
4. Click 8) to execute.
5. Operation stops when the break condition is established.
6. To quit, click the  button.  
A dialog box is displayed and the PLC returns to the RUN state.

POINTS
<ul style="list-style-type: none"><li>• When executing partial operation with a range encompassing several programs, if there is a break in a program that is not displayed, execution stops at the position of the same step number in the program that is displayed.</li><li>• When the PLC is switched from RUN to STEP-RUN, the final output status under RUN is held.</li><li>• When a break point is designated as a step, if the designated step is part way through an instruction, execution stops at the first step of the instruction.</li><li>• If a step designated as a stopped step is passed without execution in a conditional jump or interrupt program, the scan count cannot be counted as "1." For example, if the break point is set at step 1000, the scan count is set as 1, and there is an instruction for a conditional jump to step 1200 at step 800, execution cannot stop at step 1000.</li><li>• With the A series and FX series, it is not possible to set a device break condition and a step/pointer break point at the same time.</li><li>• With the Q/QnA series, it is possible to set a device break condition and a step/pointer break point at the same time. If they are set at the same time, partial operation stops when both conditions are satisfied.</li><li>• When more than one program is being executed with the Q/QnA series, partial operation starts from the program being monitored and is executed in the order in which programs are set in the PLC parameters.</li><li>• With the Q/QnA series the following types of setting are possible for a break condition: bit device digit designation, word device bit designation, index qualification.</li></ul>

19.3 Executing Step Run

A	Q/QnA	FX
○	○	○

[Purpose]

Executes the designated range of the PLC program one instruction at a time. When using the Q/FX series, step run is valid only when the logic test function (LLT) is connected.

[Operating Procedure]

1. Select [Online] → [Debug] → [Debug] (Choose the STEP-RUN mode).
2. Select [Online] → [Debug] → [Step execution], or click  ( [Alt] + [4] ).

[Dialog Box]

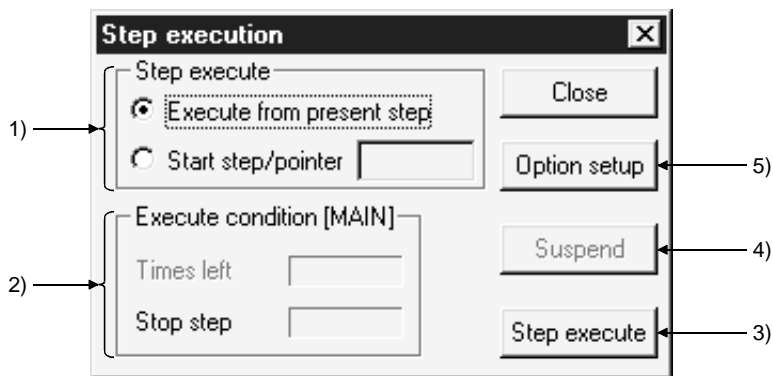

[Description]

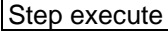
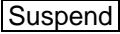
- 1) Step execute
  - Execute from present step  
Execute the program from the step where it is currently stopped.
  - Start step/pointer  
Execute the program from the designated step or pointer.  
For step designation :     \*\*  
For pointer designation :   P\*\*  
                                  I\*\*  
                                  \*\* = Number of designated step or pointer
- 2) Execute condition  
Indicates the execution status of the program.
- 3)  button  
Clicking this button starts execution of a number of steps corresponding to the repetition count set in the option dialog box. On completion of repetition count execution, clicking this button once causes execution of one instruction.
- 4)  button  
Aborts execution of step run.

- 5) **Option setup** button  
 Displays the step run option setting dialog box shown below.  
 Set the repetition count, repetition interval, and break point.

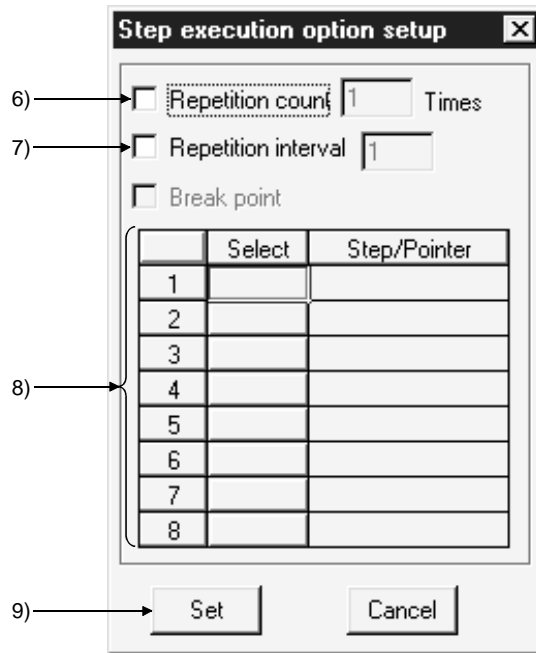

- 6) **Repetition count**  
 On checking the check box to select it, step run is executed for the number of instructions corresponding to the set count only.  
 After execution of this number of steps, each time the **Step execute** button is clicked program execution proceeds by one instruction.  
 The setting range is 1 to 32767.
- 7) **Repetition interval**  
 On checking the check box to select it, step run is executed at intervals of the set value. The unit for the interval is equivalent to the interval in which one interruption is issued from the peripheral device to the PLC. If step run is executed with only the repetition interval set in the option settings, execution proceeds with no limit on the repetition count.  
 The setting range is 1 to 32767.
- 8) **Break point**  
 Sets the step or pointer at which step run operation stops.  
 This setting is not possible for the A series or FX series.  
 Note also that if step run is executed with only the break point set and no repetition count setting, it will be executed from the start step to the break point.  
 After the break, program execution will proceed by one instruction each time the **Step execute** button is clicked.  
 For step designation :       \*\*  
 For pointer designation :   P\*\*  
                                       I\*\*  
 \*\* = Number of designated step or pointer
- 9) **Set** button  
 Click this button after making the necessary settings; the display returns to the step run dialog box.

[Operating Procedure]

1. Display the ladder monitor window.
2. Set the PLC to the STEP-RUN operating state by remote operation or with the key switch.
3. In the step run dialog box, set 1), and - as necessary - 6) to 8).
4. Click 3) to execute.
5. To quit, click the  button.  
A dialog box is displayed and the operating state of the PLC can be set to RUN in remote operation.

POINTS	
<ul style="list-style-type: none"> <li>• When executing step run with a range encompassing several programs, if there is a break in a program that is not displayed, execution stops at the position of the same step number in the program that is displayed.</li> <li>• The timer present values during step run are as follows.</li> </ul>	
10 ms timer	Incremented by one each scan
100 ms timer, 100 ms retentive timer	Incremented by one every ten scans
<ul style="list-style-type: none"> <li>• The special relay timing clocks during step run are as follows.</li> </ul>	
A series	
M9030 (0.1 second clock)	Goes ON/OFF every 5 scans
M9031 (0.2 second clock)	Goes ON/OFF every 10 scans
M9032 (1 second clock)	Goes ON/OFF every 50 scans
M9033 (2 second clock)	Goes ON/OFF every 100 scans
M9034 (1 minute clock)	Goes ON/OFF every 3000 scans
Q/QnA series	
SM410 (0.1 second clock)	Goes ON/OFF every 5 scans
SM411 (0.2 second clock)	Goes ON/OFF every 10 scans
SM412 (1 second clock)	Goes ON/OFF every 50 scans
SM413 (2 second clock)	Goes ON/OFF every 100 scans
SM414 (n second clock)	Goes ON/OFF every n x 50 scans

19.4 Setting the Scan Range

A	Q/QnA	FX
×	○	○

[Purpose]

Sets the range to be skipped (not processed) when executing partial operation or step run.

When using the Q/FX series, this setting is only effective when the logic test function (LLT) is connected.

[Operating Procedure]

1. Select [Online] → [Debug] → [Debug] (Choose the STEP-RUN mode).
2. Select [Online] → [Debug] → [Skip execution], or click  (Alt + 2).

[Dialog Box]

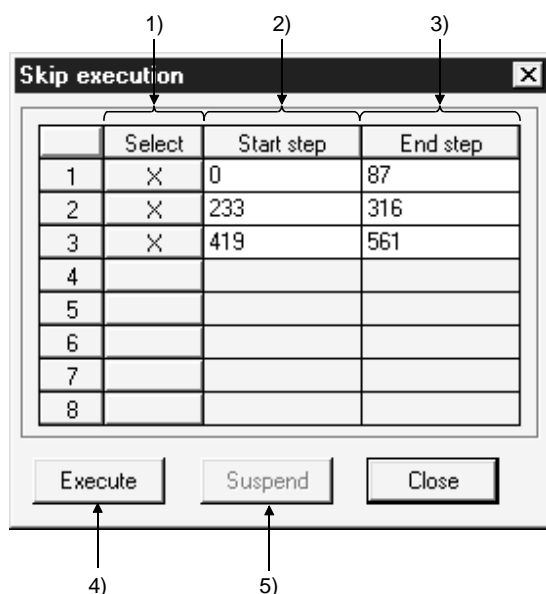

[Description]

- 1) Select  
On setting, the designated range is skipped.  
The skip range is in instruction units.
- 2) Start step  
Designates the beginning of the skip range.  
Set the first step number of the first instruction.  
Pre-selecting the area in the ladder and choosing the step execution menu sets the step number at the first step.

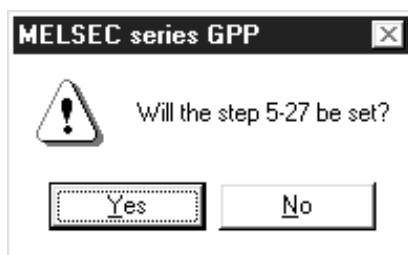

- 3) End step  
Designates the end of the skip range.  
Set the first step number of the final instruction.  
Pre-selecting the area in the ladder and choosing the step execution menu sets the step number at the last step.

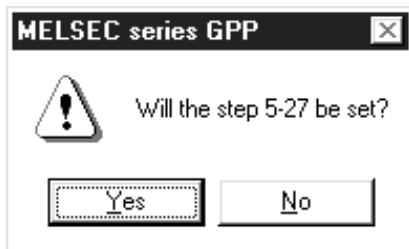

- 4) **Execute** button  
Registers the skip range.  
If the PLC is in an operating state other than STEP-RUN at this time, a dialog box allowing the state to be changed to STEP-RUN is displayed.  
To continue with partial operation or step run, set the state to STEP-RUN.  
However, if the PLC is in a state other than RUN it is not possible to change to STEP-RUN.
- 5) **Suspend** button  
Cancels registration of the skip range.

[Operating Procedure]

1. Display the ladder monitor window.
2. Set 1), 2), and 3) in the skip execution dialog box.
3. Click 4).  
A dialog box is displayed: to continue with partial operation or step run, set to STEP-RUN.
4. Close the skip execution window.
5. Execute partial operation or step run.

POINT
<ul style="list-style-type: none"> <li>• To cancel the STEP-RUN state, either turn the key switch momentarily to RESET, or change the state by remote operation.</li> </ul> <p style="text-align: right;">See Section 19.5 "Operating the PLC Remotely."</p>

### 19.5 Operating the PLC Remotely

A	Q/QnA	FX
○	○	○

**[Purpose]**

Switches the execution status of the PLC from the peripheral device. However, with the A series and the Q/QnA series, remote operation is possible only when the PLC is in the RUN state. When using the FX series, remember that only the FX1N FX2N and FX2NC support remote operation. Remote operation is possible when the CPU is in either the RUN or STOP state.

**[Operating Procedure]**

Select [Online] → [Remote operation] ( [Alt] + [6] ).

**[Dialog Box]**

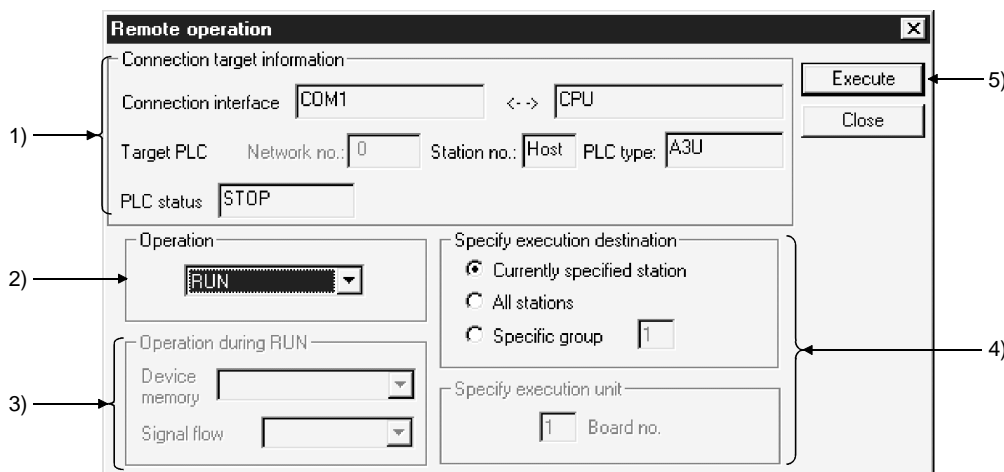

**[Description]**

- 1) Connection target information  
Indicates information on the connection destination designation. For details on the connection destination designation, see Section 17.2.
- 2) Operation  
Designates the operating state of the PLC. For the A series and Q/QnA series, the following designations are possible: STOP, PAUSE, STEP-RUN, RUN. With the Q/QnA series, RESET and latch clear can also be designated. With the FX series, STOP and RUN can be designated.
- 3) Operation during RUN,STEP-RUN  
Sets the operation with respect to the device memory and signal flow in the RUN and STEP-RUN states. This setting is not possible with the FX series.



- 4) Specify execution destination  
Sets the applicable station for remote operation.  
Currently specified station..... Executed only at the station with the connection destination designation.
- All stations..... Executed at all stations of the network designated as the presently designated station. 1 to 4 modules can be set for execution module designation.
- Specific group..... Executed in a specific group of the network designated as the presently designated station. Set 1 to 4 modules for execution module designation and set the group number.
- This setting is not possible with the FX series.
- 5)  button  
Click this button after setting the necessary settings.

POINTS																																																				
	<ul style="list-style-type: none"> <li>Remote operation is valid when the PLC is in the RUN state. However, since the remote operation setting is memorized when the key switch is set to STOP, on setting the key switch to RUN, the state set in remote operation applies. For example, if remote operation is set to STOP while the key switch is at STOP, the PLC will remain in the STOP state even if the key switch is set to RUN. Similarly, if STEP-RUN is set in remote operation while the key switch is set to STOP, when the key switch is set to RUN the PLC enters the STEP-RUN state. In this kind of case, the RUN state has to be established by remote operation. If there is any disagreement in the key switch, remote operation, and remote RUN/PAUSE contact operations at the PLC, the following order of priority applies.</li> </ul> <table border="1" style="margin: 10px auto; border-collapse: collapse;"> <thead> <tr> <th style="width: 60%;">Operations to the PLC</th> <th style="width: 40%;">Order of Priority</th> </tr> </thead> <tbody> <tr> <td>STOP</td> <td>1</td> </tr> <tr> <td>PAUSE</td> <td>2</td> </tr> <tr> <td>STEP-RUN</td> <td>3</td> </tr> <tr> <td>RUN</td> <td>4</td> </tr> </tbody> </table> <ul style="list-style-type: none"> <li>The PLC operation is determined by the combination of the key switch position and remote operation as follows.</li> </ul> <p style="margin-left: 20px;">A series</p> <table border="1" style="margin: 10px auto; border-collapse: collapse;"> <thead> <tr> <th style="width: 40%;">Remote operation \ Key switch</th> <th style="width: 15%;">RUN</th> <th style="width: 15%;">PAUSE</th> <th style="width: 15%;">STOP</th> </tr> </thead> <tbody> <tr> <td>RUN</td> <td>RUN</td> <td>PAUSE</td> <td>STOP</td> </tr> <tr> <td>STEP-RUN</td> <td>STEP-RUN</td> <td>PAUSE</td> <td>STOP</td> </tr> <tr> <td>PAUSE</td> <td>PAUSE</td> <td>PAUSE</td> <td>STOP</td> </tr> <tr> <td>STOP</td> <td>STOP</td> <td>STOP</td> <td>STOP</td> </tr> </tbody> </table> <p style="margin-left: 20px;">QnA series</p> <table border="1" style="margin: 10px auto; border-collapse: collapse;"> <thead> <tr> <th style="width: 10%;">Remote operation \ Key switch</th> <th style="width: 10%;">RUN</th> <th style="width: 10%;">STEP-RUN</th> <th style="width: 10%;">PAUSE</th> <th style="width: 10%;">STOP</th> <th style="width: 15%;">RESET *1</th> <th style="width: 15%;">Latch clear</th> </tr> </thead> <tbody> <tr> <td>RUN</td> <td>RUN</td> <td>STEP-RUN</td> <td>PAUSE</td> <td>STOP</td> <td>Operation not possible *2</td> <td>Operation not possible *2</td> </tr> <tr> <td>STOP</td> <td>STOP</td> <td>STOP</td> <td>STOP</td> <td>STOP</td> <td>RESET</td> <td>Latch clear</td> </tr> </tbody> </table> <p style="margin-left: 20px;">*1 : Remote reset must be enabled by PLC system setting in the PLC parameters. *2 : Operation possible when set to STOP by remote operation.</p> <ul style="list-style-type: none"> <li>In remote operation of the FX2N and FX2NC CPU, M8035 (forced RUN mode), M8036 (forced RUN) and M8037 (forced STOP) are controlled. Note that remote operation is possible regardless of the status of the RUN, STOP switches at the PLC side.</li> <li>When removing the memory card, switch on SM605. If you remove the memory card with removal not yet authorized, the PLC will result in an error.</li> </ul>	Operations to the PLC	Order of Priority	STOP	1	PAUSE	2	STEP-RUN	3	RUN	4	Remote operation \ Key switch	RUN	PAUSE	STOP	RUN	RUN	PAUSE	STOP	STEP-RUN	STEP-RUN	PAUSE	STOP	PAUSE	PAUSE	PAUSE	STOP	STOP	STOP	STOP	STOP	Remote operation \ Key switch	RUN	STEP-RUN	PAUSE	STOP	RESET *1	Latch clear	RUN	RUN	STEP-RUN	PAUSE	STOP	Operation not possible *2	Operation not possible *2	STOP	STOP	STOP	STOP	STOP	RESET	Latch clear
Operations to the PLC	Order of Priority																																																			
STOP	1																																																			
PAUSE	2																																																			
STEP-RUN	3																																																			
RUN	4																																																			
Remote operation \ Key switch	RUN	PAUSE	STOP																																																	
RUN	RUN	PAUSE	STOP																																																	
STEP-RUN	STEP-RUN	PAUSE	STOP																																																	
PAUSE	PAUSE	PAUSE	STOP																																																	
STOP	STOP	STOP	STOP																																																	
Remote operation \ Key switch	RUN	STEP-RUN	PAUSE	STOP	RESET *1	Latch clear																																														
RUN	RUN	STEP-RUN	PAUSE	STOP	Operation not possible *2	Operation not possible *2																																														
STOP	STOP	STOP	STOP	STOP	RESET	Latch clear																																														



## 20. REGISTERING KEYWORD/PASSWORDS

Entry code registration (for A/QnA/FX series) or password registration (for Q series) protects data in the PLC.

### 20.1 Registering Keyword

#### 20.1.1 Registering new keyword/changing keyword

A	Q/QnA	FX
<input type="radio"/>	<input type="radio"/>	<input type="radio"/>

[Purpose]

For the A/QnA/FX series, registers a new keyword to the PLC or changes the entry code.

[Operating Procedure]

Select [Online] → [Keyword setup] → [Register keyword].

[Dialog Box]

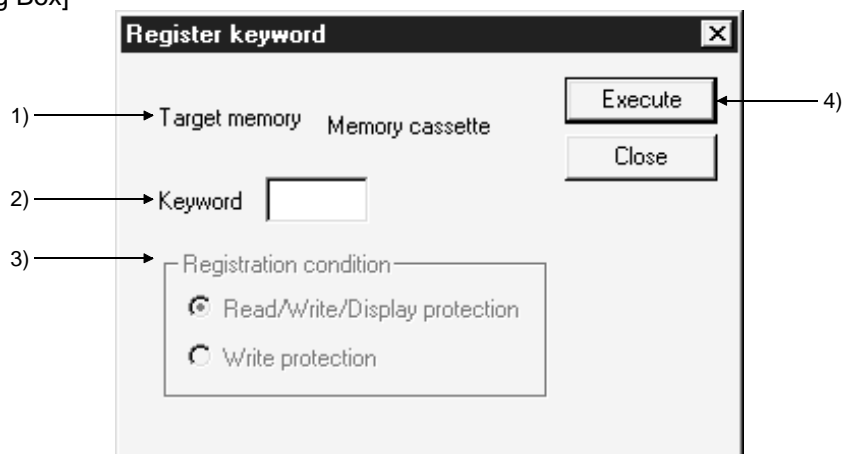

[Description]

- 1) Target memory (Except FX series)  
Sets the memory whose keyword is to be registered or changed.  
For the A series, this is a memory cassette.
- 2) Keyword  
A series : Set the keyword (6 numeric characters and A through F).  
QnA series : Set the keyword (6 numeric characters).  
FX series : Set the keyword (8 numeric characters and A through F).
- 3) Registration condition (Except FX series)  
Select the functions restricted by the keyword.  
For the A series this is reading/writing and disabling of the display only.
  - Ⓐ Read/Write/Display protection  
Writing, reading, verification, deletion, and list display are restricted by the keyword.
  - Ⓑ Write protection  
Writing is restricted by the keyword.

4) **Execute** button

Click this button after setting the necessary settings.

However, in the case of an keyword change or condition change, the dialog box shown below is displayed.

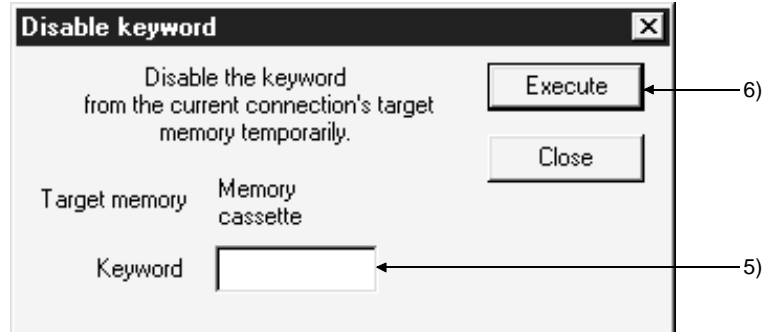
5) **Keyword**

Sets the keyword that has been registered for the PLC.

6) **Execute** button

Click this button after setting the necessary settings.

## [Operating Procedure]

1. Set 2) in the Register new keyword dialog box.  
With the QnA series, set 1) and 3) also.
2. Click 4).  
For an keyword change, the present keyword is now displayed in the dialog box.
3. Set 5) and click 6).

## POINTS

- If you forget the entry code when using the A series or FX series, all-clear the data in the memory cassette with "PLC all clear."  
With the QnA series, format the PLC memory.  
However, note that regardless of whether you are using the A series, QnA series or the FX series, all the data apart from the keyword is also deleted, and therefore all the data must be rewritten.
- On executing the registration condition function before releasing an keyword, the current entry code dialog box is automatically displayed.  
Enter the keyword and release it.
- Since the keyword is written directly into the PLC on registration, there is no need to write parameters or other data to the PLC.  
Note that the keyword becomes functional immediately after registration.
- With the A series and FX series, parameters for which an keyword is registered can be written to the ROM.

## POINT

- Password protection level designation for the FX series  
For devices capable of online operations with respect to the PLC, models such as the FX-10P and FX-20P permit the setting of three levels of protection for these operations. In cases where monitoring, setting changes, etc. are required to be done by an online device, set an entry code that takes this into consideration.
  - All operations prohibited (peripheral device operation disabled)  
:A□□□□□□ or ■□□□□□□□  
                                  ↑  
                                  Alphanumeric letter other than "A", "B", and "C"
  - Theft prevention (restricted to monitoring and changing the present value)  
:B□□□□□□□
  - Protection against erroneous writing (restricted to reading, monitoring and changing the present value)  
:C□□□□□□□

In the □ part of the keyword, designate 7 alphanumeric digits selected from among A to F and 0 to 9.

### 20.1.2 Canceling a keyword

A	Q/QnA	FX
○	○	○

**[Purpose]**

For the A/QnA/FX series, cancels (deletes) the keyword registered to the PLC.

**[Operating Procedure]**

Select [Online] → [Keyword setup] → [Delete keyword].

**[Dialog Box]**

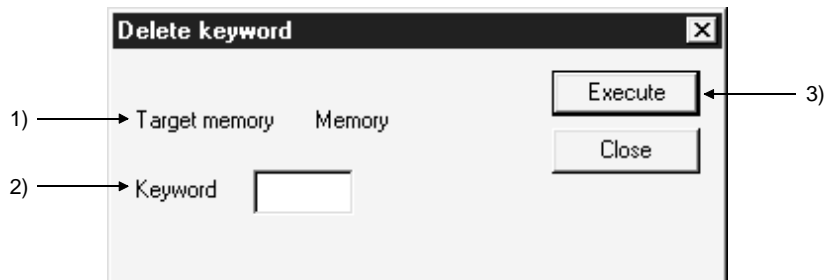

**[Description]**

- 1) Target memory (Except FX series)  
Sets the applicable memory for the keyword cancellation.  
For the A series, this is a memory cassette.
- 2) Keyword  
Sets the currently registered keyword.
- 3) **Execute** button  
Click this button after setting the necessary settings.

### 20.1.3 Releasing a keyword

A	Q/QnA	FX
○	○	○

**[Purpose]**

For the A/QnA/FX series, releases the lock imposed by a keyword in order to allow access to the PLC for which the keyword is registered.

After a keyword has been released, there is free access to the PLC until the project is quit.

**[Operating Procedure]**

Select [Online] → [Keyword setup] → [Disable keyword].

**[Dialog Box]**

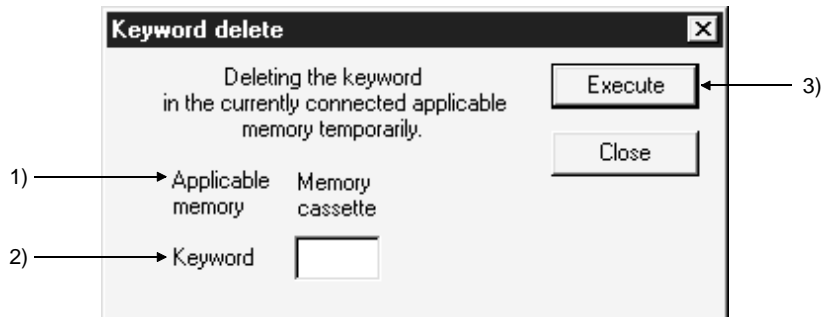

**[Description]**

- 1) Target memory (Except FX series)  
Indicates the currently connected memory.  
For the A series this is a memory cassette.
- 2) Keyword  
Sets the keyword registered for the PLC.
- 3) **Execute** button  
Click this button after setting the necessary settings.



20.2 Registering Passwords

A	Q/QnA	FX
×	○	×

For the Q series, you can set a password to each of the programs, comments and device inits in a project.

The passwords are set to the PLC and the project currently open on GPPW.

Statues of Passwords and Registration Conditions for Operations Performed

Operation	Statues of Password and Registration Condition
<b>Read from/Write to PLC</b>	
Read from PLC	If passwords exist in the read source PLC, the password settings are also read.
Write to PLC (to read source PLC)	Password settings are written to the write destination PLC.
Write to PLC (to other than read source PLC)	Password settings are written to the write destination PLC.
Write to PLC (read from IC card and write to PLC)	Password settings are written to the write destination PLC.
<b>Edit project</b>	
Open project	If passwords exist in the read source, the password settings are also read.
Save	If passwords exist in the save source, the password settings are also saved.
Save as	If passwords exist in the save source, the password settings are also saved.
Delete project	Passwords are deleted together with the project.
Copy project	If passwords exist in the copy source, the password settings are also copied.
Copy data	If passwords exist in the copy source, the password settings are also copied.
Save and write after data name change	If passwords exist in the old data name, the password settings are also saved.
Edit ladder (paste ladder to other GPPW)	Password settings are not added.
Merge data	Password settings are not added.
Automatic save	If passwords exist in the save source, the password settings are also saved.
<b>Change PLC type</b>	
Save and write after PLC type change QCPU → QCPU	If passwords exist in the old PLC type, the password settings are also saved.
Save and write after PLC type change QCPU → other than QCPU	Password settings are not added.
<b>Read/write IC card</b>	
Read IC card	If passwords exist in the read source IC card, the password settings are also read.
Write IC card (to read source IC card)	Password settings are written to the write destination IC card.
Write IC card (to other than read source IC card)	Password settings are written to the write destination IC card.
Write IC card (read from PLC and write to IC card)	Password settings are written to the write destination IC card.

## 20.2.1 Register new passwords/changing passwords

A	Q/QnA	FX
×	○	×

## [Purpose]

Registering passwords protects the data in the PLC (corresponding memory). (Q series only)

## [Operating Procedure]

Select [Online] → [Password setup] → [Register password].

## [Dialog Box]

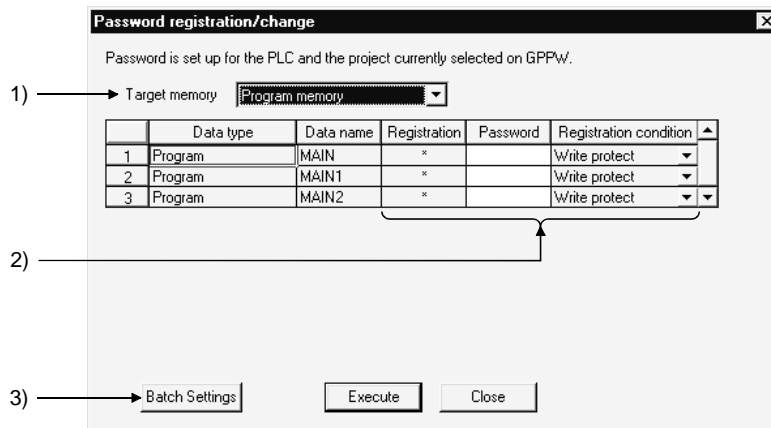

## [Description]

## 1) Target memory

Set the memory whose password is to be registered or changed.

## 2) Registration, Password, Registration condition

## ⊙ Registration condition

× appears if a password has already been registered.

If you have selected [Register password] in Password setup, the data written to the PLC appears.

If you have chosen [Write to PLC], [Write IC memory card] or [Write image data], the data opening on the peripheral device appears.

## ⊙ Password

Register four ASCII alphanumeric characters.

(Upper- and lower-case characters are differentiated.)

## ⊙ Registration condition

## • Write protect

Write operation is restricted by the password.

## • Read/Write protect

Write/read operation is restricted by the password.

## • Clear

Password is cleared.

## 3) Batch settings

Batch-sets the same password and registration condition to each data.

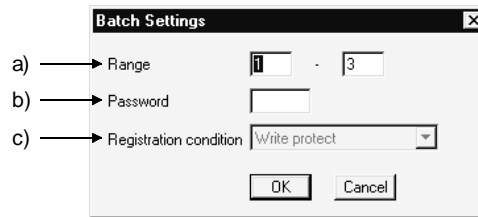

- a) Range  
Set the range where the same password will be batch-set.
- b) Password  
Register four alphanumeric characters in ASCII code.  
(Upper- and lower-case characters are differentiated.)
- c) Registration condition
- Write protect  
Write operation is restricted by the password.
  - Read/Write protect  
Write/read operation is restricted by the password.
  - Clear  
Password is cleared.

## POINTS

- When changing the password  
After setting a new password in the Register/Change password dialog box, set the old password in the Check password dialog box.
- If you forgot the password  
Format the PLC memory.  
However, this also clears all data including the passwords, all data should be written once more.
- When erasing the passwords in the project data  
Choose "Clear" as the registration condition in the password setting for Write IC memory card or Write to PLC, and save the project.
- "Checking password" appears during communications with the PLC, but it is also displayed when no password has been set.  
Checking password : Passwords and setting conditions of all files are checked.

20.2.2 Delete the passwords

A	Q/QnA	FX
×	○	×

[Purpose]

Deletes the passwords which have been set in the files within the PLC. (Q series only)

[Operating Procedure]

Select [Online] → [Password setup] → [Delete password].

[Dialog Box]

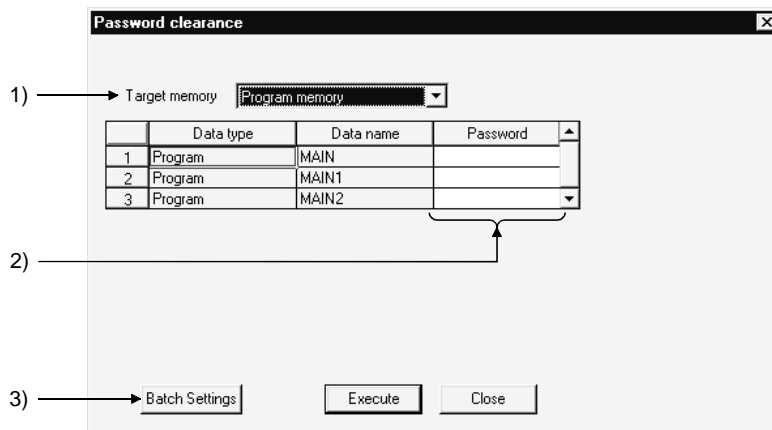

[Description]

- 1) Target memory  
Set the memory whose passwords will be deleted.
- 2) Password  
Set the passwords currently registered.
- 3) Batch settings  
Batch-deletes the passwords and registration conditions.

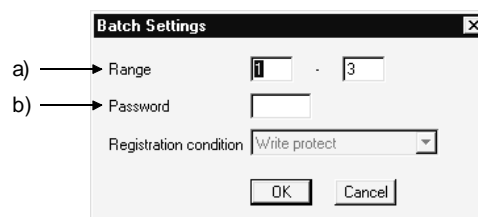

- a) Range  
Set the range where the passwords and registration conditions will be batch-deleted.
- b) Password  
Set the password currently registered.  
Take care to differentiate between the upper- and lower-case characters.

**POINT**

- If the same data name exists in the project, the password of the project data will also be deleted.

20.2.3 Disable the passwords

A	Q/QnA	FX
×	○	×

[Purpose]

Disables the passwords which have been set in the files within the PLC. Disabling does not delete the passwords which have been set to the data in the PLC. It enables access to the PLC. (Q series only)

[Operating Procedure]

Select [Online] → [Password setup] → [Disable password].

[Dialog Box]

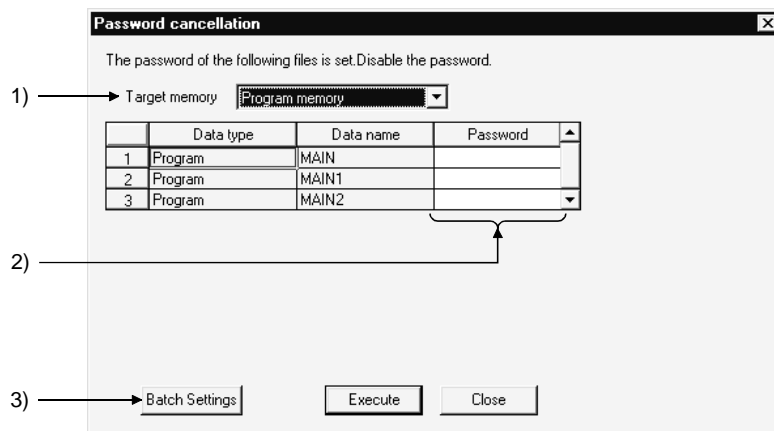

[Description]

- 1) Target memory  
Set the memory whose passwords will be disabled.
- 2) Password  
Set the passwords currently registered.
- 3) Batch settings  
Batch-disables the passwords and registration conditions.

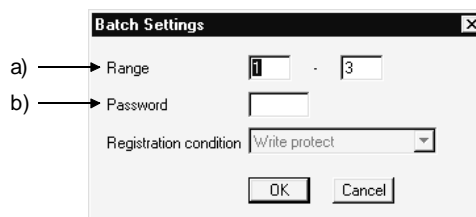

- a) Range  
Set the range where the passwords and registration conditions will be batch-disabled.
- b) Password  
Set the password currently registered.  
Take care to differentiate between the upper- and lower-case characters.

**POINT**  
Note that the password disable setting is not made valid unless the project where the passwords have been set is closed.

## 21. PLC MEMORY

This chapter describes PLC memory all-clear, formatting, memory area sorting, and time setting for the internal clock of the PLC.

### 21.1 Clearing the PLC Memory

#### 21.1.1 All-clearing on ACPU memory

A	Q/QnA	FX
○	×	×

[Purpose]

All-clears the device memory and memory cassette of A series PLCs.

[Operating Procedure]

Select [Online] → [Memory Clear PLC memory]

[Dialog Box]

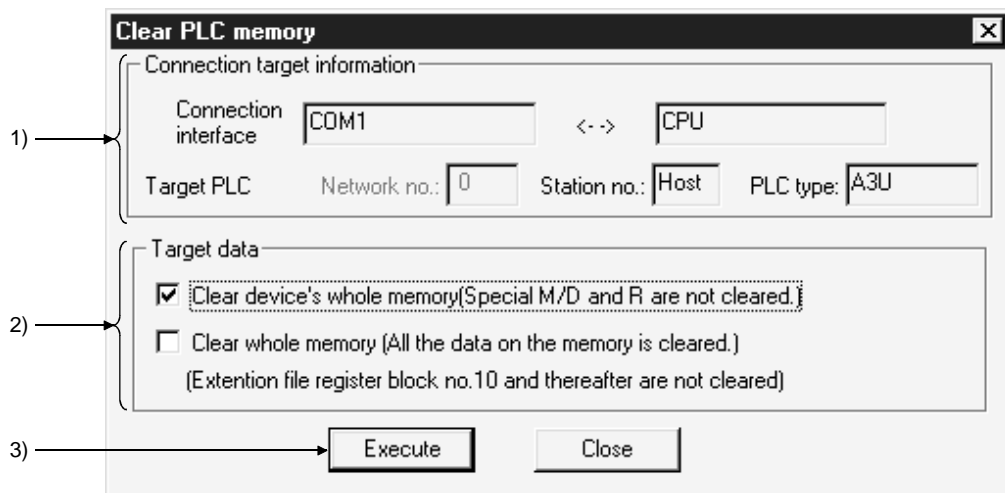

[Description]

- 1) Connection target information  
Indicates information on the connection destination designation.
- 2) Target data  
Clear device's whole memory (Social M/D and R are not cleared.)  
Checking this check box to select it clears all the data in the device memory in the PLC.  
However, special relays, special registers, and file registers are excepted.  
  
Clear whole memory (All the data on the memory is cleared.)  
Checking this check box to select it clears all the data in the memory cassette of the PLC with the exception of block No. 10 onward of the extension file registers.

- 3) **Execute** button  
Click this button after setting the necessary settings.

POINTS
<ul style="list-style-type: none"><li>• Device memory all clear can only be executed when the PLC is in the STOP state</li><li>• When the data in a memory cassette is all-cleared, the range cleared is 144K bytes. Data beyond the 144K byte range (from extension file register block 10 onward) is not cleared.</li><li>• After all-clearing the data in a memory cassette, all of the data values in the memory cassette are "1." When file registers (R) are set and read after all clear, the result is HFFF (K-1).</li></ul>

21.1.2 All-clearing the QCPU, QnACPU device memory

A	Q/QnA	FX
×	○	×

[Purpose]

All-clears the device memory of a Q/QnA series PLC.  
The flash ROM cannot be all-cleared.

[Operating Procedure]

Select [Online] → [Clear PLC memory].

[Dialog Box]

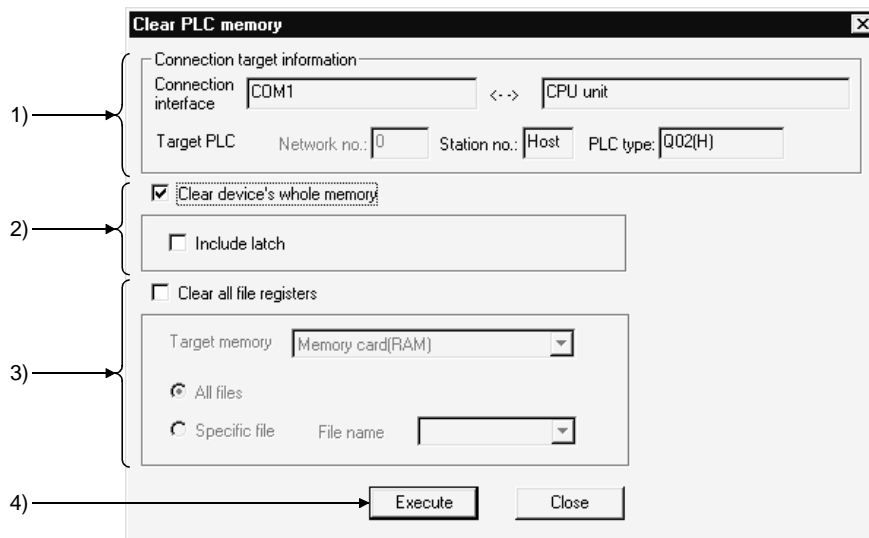

[Description]

- 1) **Connection target information**  
Indicates information on the connection destination designation.
- 2) **Clear device's whole memory**  
When this check box is checked to select it, the device memory is all-cleared.  
You can set whether or not the devices designated in latch range designation are cleared.
- 3) **Clear all file registers**  
Sets all file register data to "0."  
The area and file names are not cleared.  
To designate a file, designate the applicable memory and the file name.
- 4) **Execute button**  
Click this button after setting the necessary settings.

<b>POINTS</b>
<ul style="list-style-type: none"> <li>• If the latched range is included in the device memory all clear operation, the latch clear key invalid area is also cleared.</li> <li>• All clear is not possible when the PLC is in the RUN state.</li> </ul>



### 21.1.3 All-clearing an FXCPU memory

A	Q/QnA	FX
×	×	○

**[Purpose]**

All-clears the memory in an FX series PLC.

**[Operating Procedure]**

Select [Online] → [Clear PLC memory].

**[Dialog Box]**

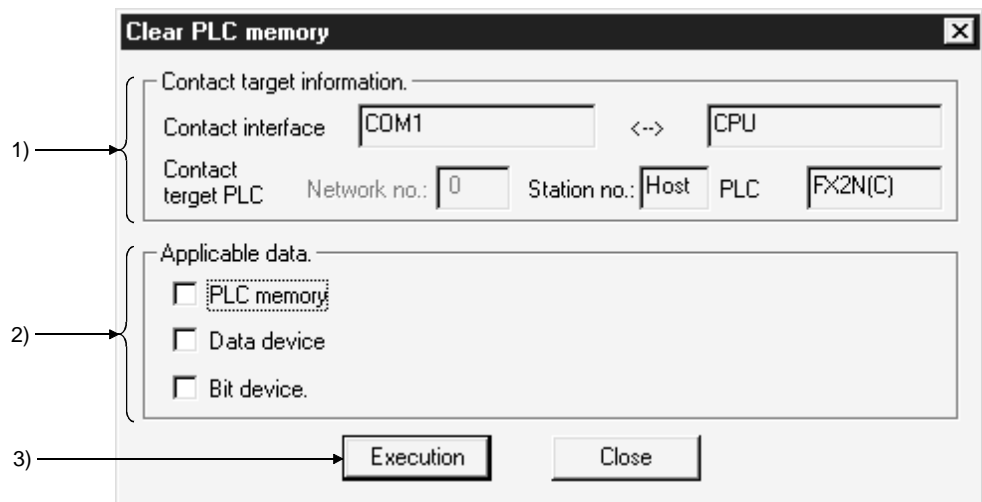

**[Description]**

- 1) **Connect target information**  
Indicates information about the connection destination designation.
- 2) **Applicable data**
  - PLC memory**  
When this check box is checked to select it, all of the data in the PLC is cleared. (Programs, comments, parameters, file registers, device memory)
  - Data device**  
When this check box is checked to select it, the registers in the PLC are cleared to "0."  
(Data registers, file registers, RAM file registers, special registers)
  - Bit device**  
When this check box is checked to select it, all of the bit devices in the PLC are turned OFF.  
(X, Y, M, S, T, C)  
The present values of T and C devices are also set to 0.
- 3) **Execution** button  
Click this button after setting the necessary settings.

POINTS
<p>Execution conditions</p> <ul style="list-style-type: none"><li>• PLC memory Memory : Internal memory, RAM/EEPROM (protect switch: OFF) cassette. All clear cannot be executed with an EEPROM (protect switch ON) or EPROM cassette.</li><li>• Data device Memory : Same as the execution conditions for "PLC memory."</li><li>• Bit device Memory : Can be executed with all memories</li></ul> <p>Operate the PLC in the STOP state. The memory cannot be cleared in the RUN state.</p>

## 21.2 Formatting a QCPU(Qmode), QnACPU Memory

A	Q/QnA	FX
×	○	×

**[Purpose]**

Formats the PLC internal RAM or IC memory card of Q/QnA series models.  
The flash ROM cannot be formatted.

**[Operating Procedure]**

Select [Online] → [Format PLC Memory].

**[Dialog Box]**

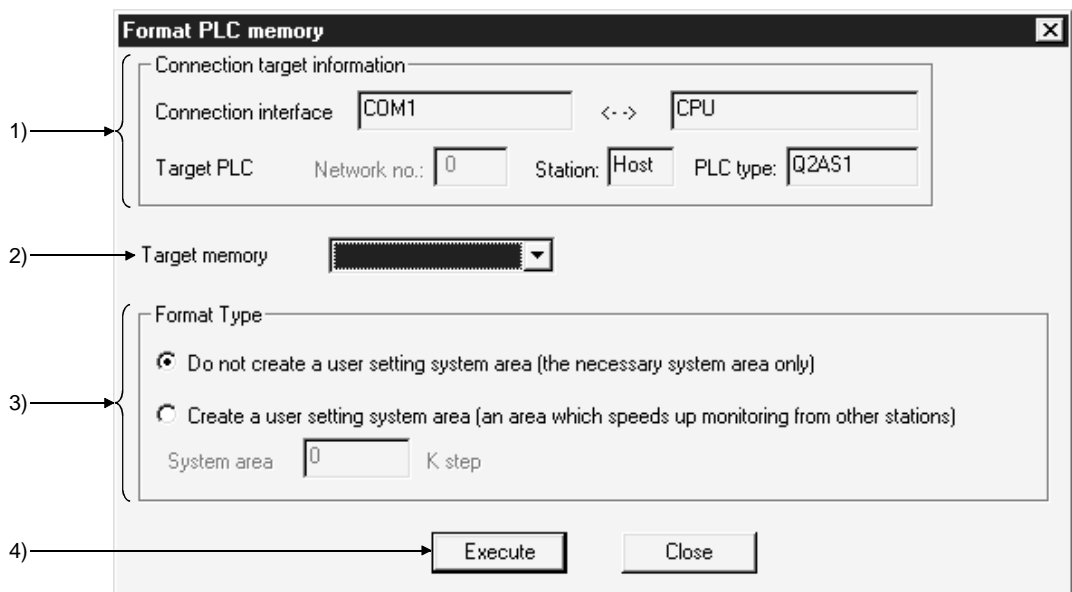

**[Description]**

- 1) **Connection target information**  
Indicates information on the connection destination designation.
- 2) **Target memory**  
Sets the object of PLC memory formatting.
- 3) **Format Type**
  - Do not create a user setting system area (the necessary system area only)  
Only the system area that is essential for the applicable memory is created.
  - Create a user setting system area (an area which speeds up monitoring from other stations)  
A mandatory system area and a system area for high-speed monitoring from other stations (user-set) are created.  
The setting range is 0 to 15K steps.
- 4) **Execute** button  
Click this button after setting the necessary settings.

POINTS	
<ul style="list-style-type: none"> <li>• There are two types of system area: "mandatory" and "user-set." The mandatory system area is automatically created during formatting, but the user-set system area is created according to the user's required settings.</li> <li>• When the user-set system area is created, the data storage area for sequence programs and other data is reduced. Check the data capacity before setting the range for the user-set system area.</li> </ul>	<p style="text-align: center;">QnACPU internal RAM</p>
<ul style="list-style-type: none"> <li>• Files in the system area cannot be displayed as a data list.</li> <li>• Create the user-set system area in the internal RAM. If it is set in an IC memory card, the speed of other station monitoring will not change.</li> </ul>	

21.3 Sorting the QCPU(Qmode), QnACPU Memory

A	Q/QnA	FX
×	○	×

[Purpose]

Sorts the data in the internal RAM or IC memory card of a Q/QnA series PLC to secure contiguous free memory.  
The flash ROM cannot be sorted.

[Operating Procedure]

Select [Online] → [Arrange PLC memory].

[Dialog Box]

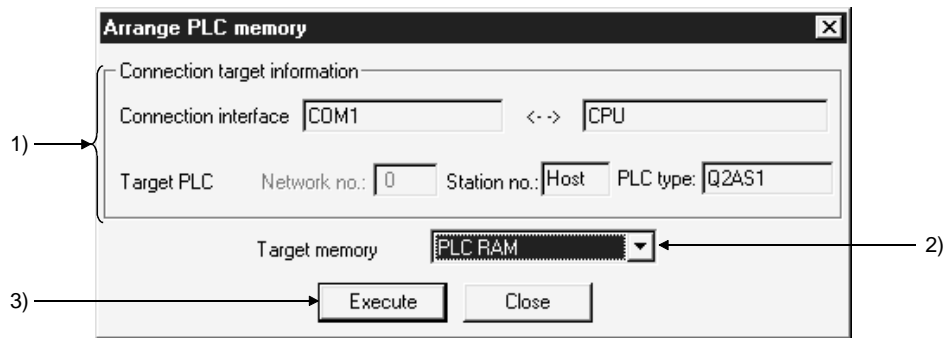

[Description]

- 1) Connection target information  
Indicates information on the connection destination designation.
- 2) Target memory  
Sets the PLC memory that is to be sorted.
- 3) **Execute** button  
Click this button after setting the necessary settings.

**POINT**

- An example of the execution of PLC memory sorting is given below.

28K	Program A 8K Program B 6K Program C 6K Free area 8K	→	Program A 8K Free area 6K Program C 6K Free area 8K	→	Program A 8K Program C 6K Free area 14K
		Program B deleted		PC memory sort	
	• Total free capacity 8K • Max. contiguous free area 8K		• Total free capacity 14K • Max. contiguous free area 8K		• Total free capacity 14K • Max. contiguous free capacity 14K

Note that PLC memory sorting is not possible in the following cases.

1. When the drive memory is faulty.
2. When one file is not stored in a single contiguous area.

## 21.4 Setting for the PLC's Clock

A	Q/QnA	FX
○	○	○

[Purpose]

Sets the time for the internal clock of the PLC.

[Operating Procedure]

Select [Online] → [Set time]

[Dialog Box]

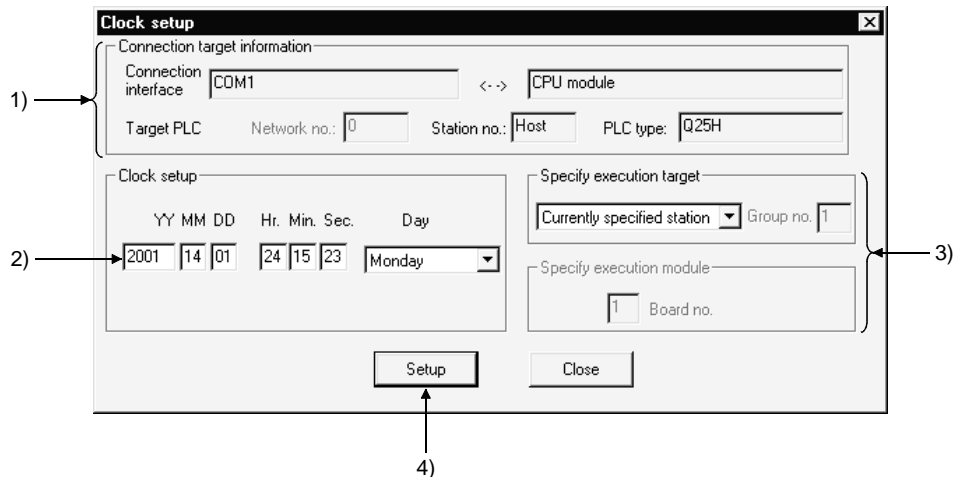

[Description]

- 1) Connection target information  
Indicates information on the connection destination designation.
- 2) Clock setup  
Sets the date, time, and day of the week.  
For the Q series, enter the year in four digits. (Example: 2000)  
You cannot set the year 2038 or later.
- 3) Specify execution target  
Sets the location where the clock setting is to be made.
 

Currently specified station	Executed only at the station with the connection destination designation.
Specify all station .....	Executed at all stations of the network designated as the presently designated station. 1 to 4 modules can be set for execution module designation.
Specify group .....	Executed in a specific group of the network designated as the presently designated station. Set 1 to 4 modules for execution module designation and set the group number.

This setting is not possible with the FX series.

4) **Setup** button

Click this button after setting the necessary settings.

With the A series, clock setting can only be executed when the PLC is in the STOP state.

With the Q/QnA series and FX series, it can be executed even when the PLC is in the RUN state.

**POINTS**

- Clock setting is not possible for A0J2HCPU, A2CCPU and A2CJCPU since they do not have a clock function.
- With the A series, when the applicable station is in the RUN state, first set it to the STOP state using remote operation or other means, then carry out clock setting.
- With the A series, clock setting is possible regardless of the ON/OFF setting of the special relay for clock setting "M9028."  
However, after execution, "M9208" goes OFF.
- With the Q/QnA series, clock setting is possible regardless of the ON/OFF status of the device for clock setting "SM1028."  
Note that the ON/OFF status of "SM1028" does not change after execution.
- The applicable PLCs in the FX series are as follows.  
FX<sub>2N</sub> series (internal clock)  
FX, FX<sub>2</sub>, FX<sub>2C</sub> (only when RTC cassette is mounted)
- With the FX series, clock setting is possible regardless of the ON/OFF status of the special relay for clock setting.
- Note that in clock setting, an error equivalent to the transmission time is generated.

## 22. DIAGNOSIS

Diagnosis displays the error statuses, fault history, etc. of the programmable controller, and carries out checks which depend on the network, including system status checks.

### 22.1 Diagnosing the PLC

#### 22.1.1 Diagnosing an ACPUCPU

A	Q/QnA	FX
○	×	×

[Purpose]

Displays the status and error codes of an A series CPU.  
 Present ERROR indicates the error normally monitored, and Error log indicates the history status when the PLC Diagnostics window has opened.

[Operating Procedure]

Select [Diagnostics] → [Diagnostics PLC].

[Dialog Box]

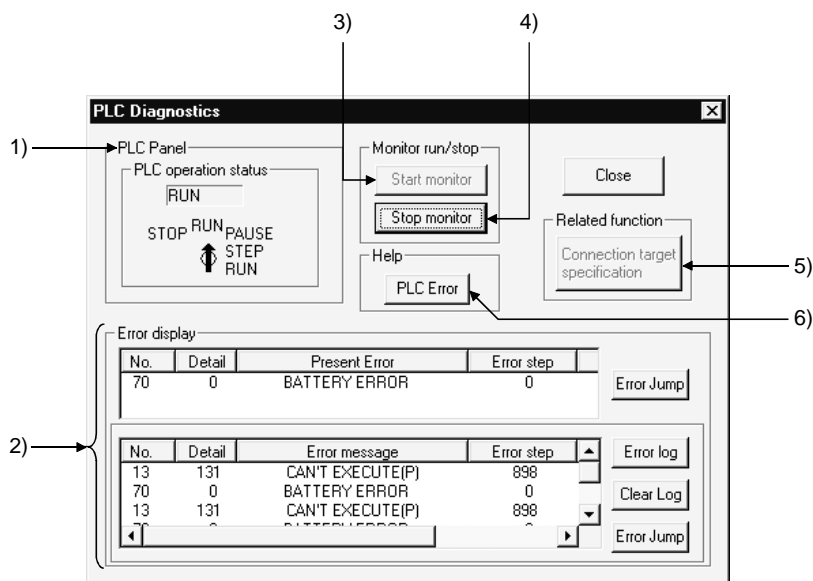

[Description]

- 1) CPU Panel  
Indicates the status of the PLC designated as the connection destination.



## 2) Error display explanation

The upper error display field shows the current error.

The lower error display field shows the error history.

No. indicates the error code and Detail indicates the detailed error code.

With the **PLC error** button, you can confirm the error detail.

For the QCPU-A, AnUCPU and AnACPU, clicking the **Error log** button displays up to 16 latest errors.

For the QCPU-A, AnUCPU and AnACPU, clicking the **Clear log** button clears the error history.

Choosing the error item and clicking the **Error Jump** button causes a jump to the corresponding sequence program. A jump takes place for any of the following errors that occurred from the ACPU.

10 INSTRUCT CODE ERR

13 CAN'T EXECUTE(P)

15 CAN'T EXECUTE(I)

46 SP. UNIT ERROR

50 OPERATION ERROR

A jump does not occur for SFC and SUB program errors.

The occurrence of a sequence program error causes a jump to MAIN.

3) **Start monitor** button

Clicking this button initiates communication with the PLC and updates the display.

On clicking the **Current error** button or the **Error log** button, monitoring is automatically stopped.

4) **Stop monitor** button

Clicking this button stops communication with the PLC and holds the display.

5) **Connection target specification** button

Clicking this button displays the connection destination designation dialog box.

See Section 17.2 "Specifying the Connection Destination."

6) **PLC Error** button

Opens details of PLC errors under "help."

If there is a present error, check the error code details.

## POINT

- Display and clearance of the error history is possible only with QCPU-A, AnACPU and AnUCPU.

22.1.2 Diagnosing a QCPU(Qmode), QnACPU

A	Q/QnA	FX
×	○	×

[Purpose]

Checks the status and errors of a Q/QnA PLC.

[Operating Procedure]

Select [Diagnostis] → [Diagnostics PLC]

[Diagnosis]

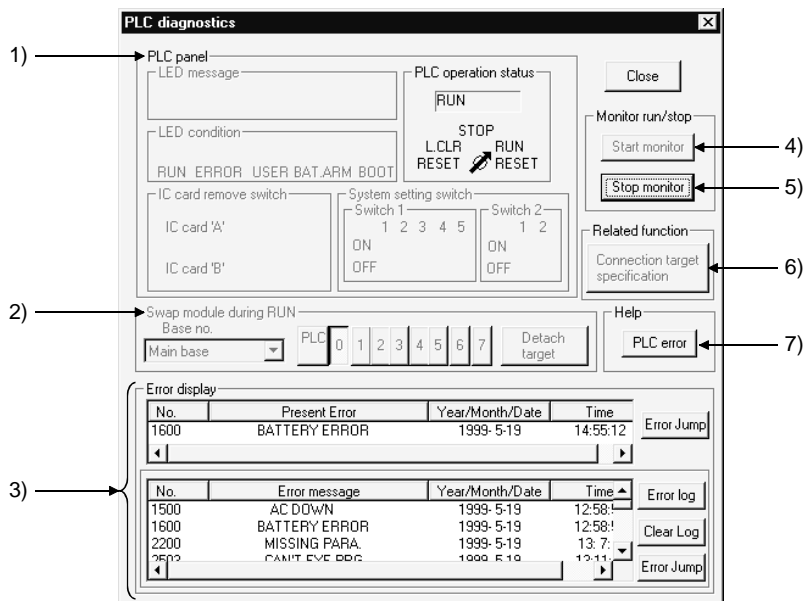

[Description]

- 1) CPU panel  
Indicates the status of the PLC designated as the connection destination.  
For the QCPU(Qmode), any status other than the PLC operation status is masked.
- 2) Swap module during RUN  
Set the base and slot number for the module to be mounted or removed in the RUN status, then click the **Detach target** button.  
Masked for the QCPU(Qmode).
- 3) Error display  
Clicking the **Error log** button displays up to 16 of the most recent errors.  
Clicking the **Clear log** button clears the error history in the PLC.  
Clicking the **Error jump** button causes a jump to the sequence program step number at which the currently selected error occurred.
- 4) **Start monitor** button  
Clicking this button initiates communication with the PLC and updates the panel display.

- 5) **Stop monitor** button  
 Clicking this button initiates communication with the PLC and updates the display.  
 On clicking the **Current error** button or the **Error log** button, monitoring stops automatically.
- 6) **Connection target specification** button  
 Clicking this button displays the connection destination designation dialog box.  
 See Section 17.2 "Specifying the Connection Destination."
- 7) **PLC error** button  
 Clicking this button opens help relating to PLC errors.  
 If there is a current error, check the details of the error code.

[Operating Procedure]

The procedure for mounting/removing a module in the RUN status is as follows.

1. Set the applicable base and slot at 2) and click the **Detach target** button: the RUN module mount/remove dialog box is displayed.
2. Mount or remove the module at the designated slot of the designated base.
3. After completing mounting/removal of the module, click the **End substitution** button in the RUN module mount/remove dialog box.

**POINT**

By double-clicking the current error in the error display list box, the Common error information dialog box opens and displays the contents of SD5 to 15 (common information for errors), and SD16 to 26 (information on an individual error) of the PLC.

No.	Error message	Year/Month...	Time
2110	SP.UNIT ERROR	98-9-28	18:13:27

Double-click the list item

**Error details** X

<b>Common error information</b>		<b>Individual error information</b>	
Unit no.	0	File name	MAIN .QPG
I/O No	0	SFC block	Nothing
		SFC step	Nothing
		SFC switching	Nothing
		Block no.	0
		Step	0
		Sequence step	30

### 22.1.3 Diagnosing an FXCPU

A	Q/QnA	FX
×	×	○

[Purpose]

Displays the status and error codes of an FX series PLC.

[Operating Procedure]

Select [Diagnostics] → [Diagnostics PLC].

[Dialog Box]

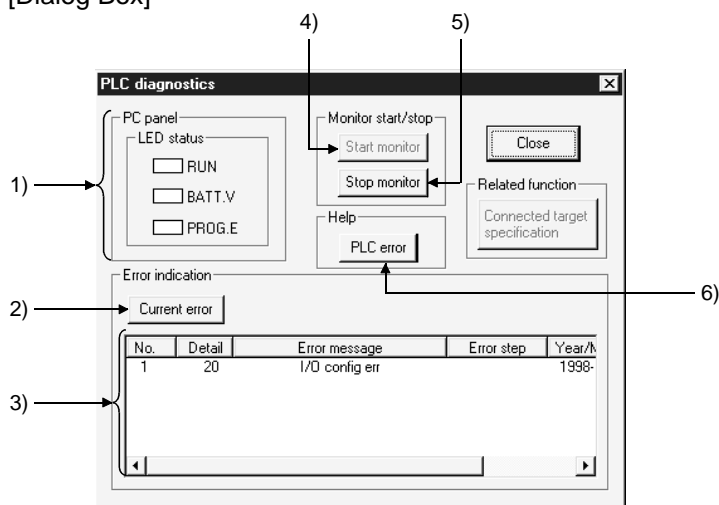

[Description]

- 1) **PLC Panel**  
Indicates the status of the connected PLC.  
 RUN : Lit in green when the PLC is in the RUN status.  
 BATT.V : Lit in red when the voltage of the battery for memory back up has dropped.  
 PROG.E : Lit in red when an error has occurred (when one of the following is ON: M8061, M8064, M8065, M8066).
- 2) **Current error** button  
Clicking this button displays errors that have occurred at the PLC. The date and time values are not those when the error occurred but when the **Current error** button was clicked.
- 3) **Error indication**  
Displays current errors at the PLC. The error details are displayed as the error code and error message.
- 4) **Start monitor** button  
Clicking this button initiates communication with the PLC and updates the display.
- 5) **Stop monitor** button  
Clicking this button initiates communication with the PLC and holds the display.
- 6) **PLC error** button  
Clicking this button opens help relating to PLC errors. If there is a present error, check the details of the error code.

## 22.2 Diagnosing a Network

A	Q/QnA	FX
○	○	×

**[Purpose]**

Checks the status of MELSECNET (II) or MELSECNET/10(H) from the host station, which is designated the connection destination.

**[Operating Procedure]**

Select [Diagnostics] → [Diagnostics network].

**[Dialog Box]**

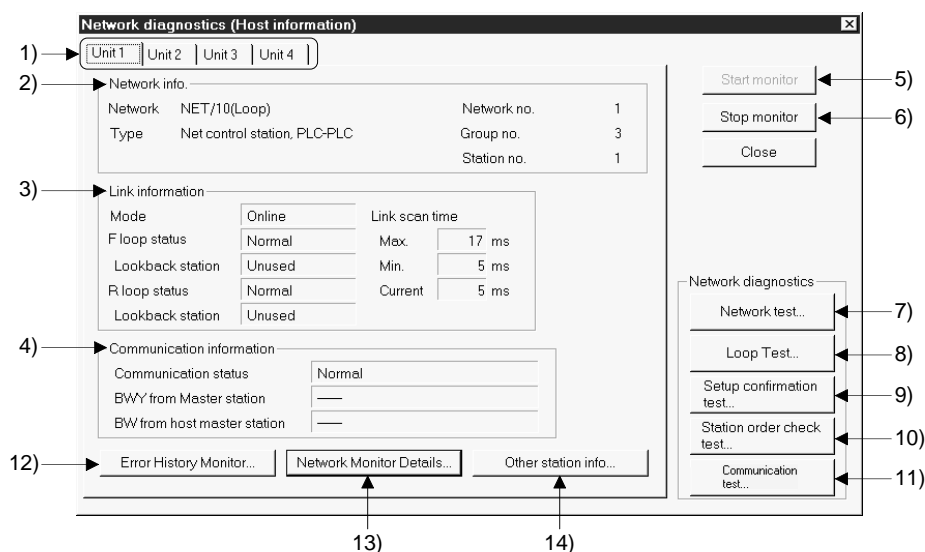

**[Description]**

- 1) Link module selection tabs  
Switch among network diagnosis result displays for the first to fourth link modules.  
With AnNCPU and AnACPU, there are only module 1 and module 2.
- 2) Network info.  
Indicates the network information of the host station set in connection destination designation.  
With MELSECNET (II), the network No. and group No. are not displayed.
- 3) Link information  
Indicates the network status.
- 4) Communication information  
Indicates the communication status of the applicable network.  
For MELSECNET/10(H), only the communication status is indicated.

- 5) **Start monitor** button  
Clicking this button starts network diagnostics.  
During monitoring, the indication is updated.
- 6) **Stop monitor** button  
Clicking this button stops network diagnostics.  
During a monitoring stop, the indication is held.
- 7) **Network test** button  
Refer to Section 22.2.1.
- 8) **Loop test** button  
Refer to Section 22.2.2.
- 9) **Setup confirmation test** button  
Refer to Section 22.2.3
- 10) **Station order check test** button  
Refer to Section 22.2.4
- 11) **Transmission Test** button  
Refer to Section 22.2.5
- 12) **Error History Monitor** button  
Refer to Section 22.2.6.
- 13) **Network Monitor Details** button  
Refer to Section 22.2.7.
- 14) **Other station info** button  
Refer to Section 22.2.8.

**POINTS**

- Indicates the number of link modules that can be mounted for each network type.  
MELSECNET (II) 2  
MELSECNET/10(H) 4
- The object of network diagnosis is the network of the connected host station.  
To change the network that is the object of diagnosis, change the applicable station in the connection destination designation.
- Network diagnosis is not possible if remote I/O stations are connected.
- About host station information and other station information:  
When the routing is through E71, an AnUCPU executes monitoring equivalent to that of an AnACPU, which means that MELSECNET (II) information can be monitored but MELSECNET/10(H) modules cannot be monitored.

### 22.2.1 Testing a network

A	Q/QnA	FX
○	○	×

[Purpose]

Starts/stops link operation for the MELSECNET/10(H) host station/designated station/ all stations.

[Operating Procedure]

Select [Diagnostics] → [Diagnostics network] → then click the [Network test] button.

[Dialog Box]

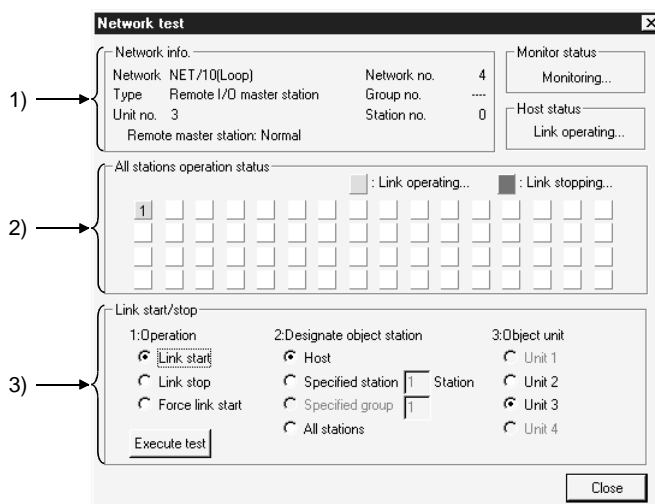

[Description]

- 1) Network info.  
Indicates the network information of the host station designated in the connection destination designation.
- 2) All stations operation status  
Indicates the link status of the modules for which the test is executed.
- 3) Link start/stop  
The order of priority for link start/stop is as follows:  
Link start < Link stop < Forced link start

<Start>

- Stations that have been stopped from the host station can be started.
- Stations that have been stopped from an other station cannot be started.

<Stop>

- Stations can be stopped from the host station or other stations.

<Forced start>

- Stations can be started regardless of whether they were stopped from the host station or an other station.  
However, forced starting in station units is not possible when all stations are stopped.
- Forced start is not possible when there is an other station designation for the connection destination.
- Whether or not execution is possible at a peripheral device can be checked by monitoring SB and SW; whether execution has been started/stopped at the host station can be checked by monitoring SW0000 to SW0004 and SB0000 to SB0003.
- When the connection destination is routed through C24, UC24, or QC24, execution is possible.
- Execution is not possible when using a MELSECNET (II)/MELSECNET/10 board.
- Execution is not possible with routing through E71/QE71.

### 22.2.2 Performing a loop test

A	Q/QnA	FX
○	○	×

**[Purpose]**

Checks the status of the MELSECNET/10(H) loop.

**[Operating Procedure]**

Select [Diagnostics] → [Diagnostics network] → **Loop test** button.

**[Dialog Box]**

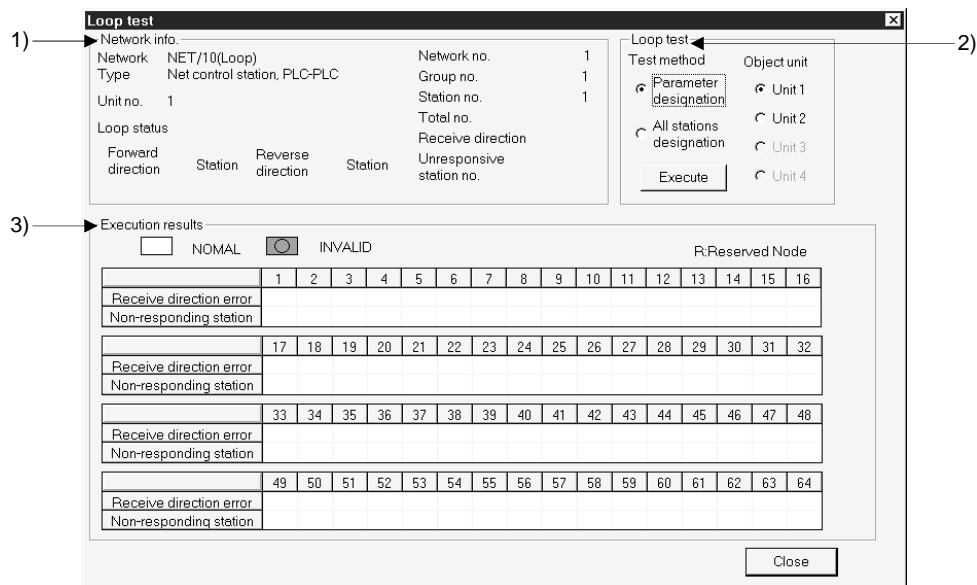

**[Description]**

- 1) Network Information
 

Shows own station's network information set in Connection destination specification.
- 2) Loop Test
 

Set the test enact method and target module, and click the **Execute** button to start a loop test.

A loop test made with connection of remote stations may be conducted only on the connected remote I/O network.

A change in target module will result in an error.

  - Test enact method
    - Parameter settings
 

Tests the parameter-set stations (except the reserved stations).

When there are no parameter settings, all stations will be tested.
    - Set all nodes
 

Tests all stations.
  - Object unit
 

Choose the module on which a loop test will be conducted.

The default is the module selected in line monitor (own station).
- 3) Execution Result
 

Shows the number of stations and results (normal/abnormal, reserved stations: R).



### 22.2.3 Performing a setting confirmation test

A	Q/QnA	FX
○	○	×

**[Purpose]**

Checks the status of the following settings made for each station: station number, network number, group number.

**[Operating Procedure]**

Select **[Diagnostics]** → **[Diagnostics network]** → then click the **[Setup confirmation test]** button.

**[Dialog Box]**

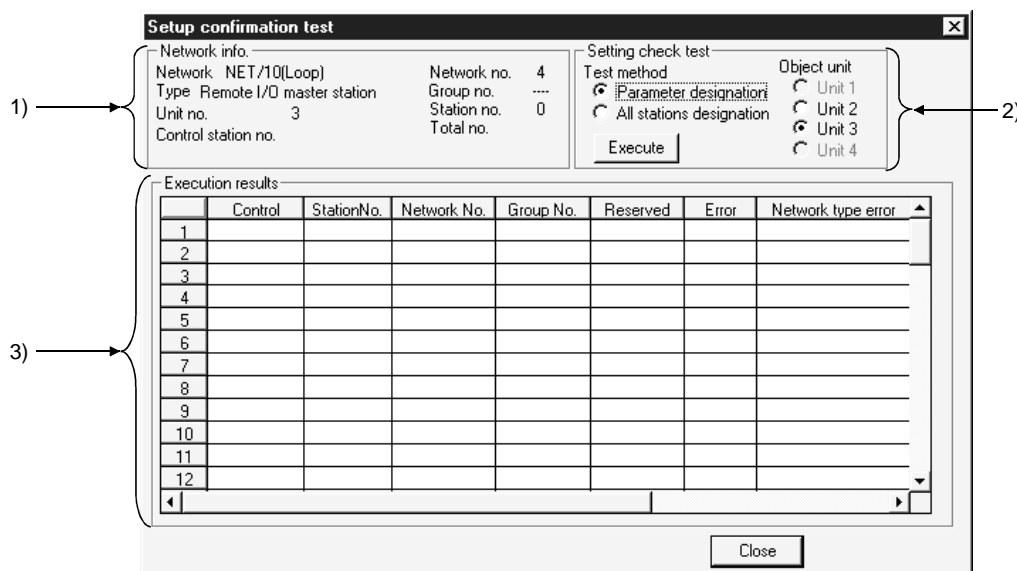

**[Description]**

- 1) Network info.  
Indicates the network information of an other station designated at the connection destination.
- 2) Setting check test
  - Test method
    - Parameter designation  
All the stations set in the parameters, with the exception of reserve stations, are subject to the setting confirmation test.  
If no network settings have been set (default), all stations are subject to the test.
    - All stations designation  
All stations are subject to the setting confirmation test.  
There is no number of stations designation.
  - Object unit  
The module selected for the line monitor (own station) is set as the default.  
If there is no MELSECNET/10(H) module, an error occurs.

## 3) Execution results

## &lt;Station No.&gt;

Indicates station numbers up to that subject to the setting confirmation test.  
Up to 64 stations are indicated.

## &lt;Control&gt;

If control stations have been set at two or more locations, " \* " is displayed.

## &lt;Station No.&gt;

If stations have been set at two or more locations, " \* " is displayed.

## &lt;Network No. &gt;

If the same station number has been set at two or more locations, " \* " is displayed.

Stations whose network number differs from the network number of the host station are indicated in red.

## &lt;Group No.&gt;

Indicates the group number of the station where the setting confirmation test is carried out.

In the case of a remote I/O net, the indication for stations with errors is blank.

## &lt;Reserve stations&gt;

" \* " is displayed for stations set as reserve stations in the parameters.

(Where "Parameter designation" has been set as the test execution designation.)

## &lt;Error&gt;

If a station is reserved in the parameter settings, or a module in all station designation is faulty, " \* " is displayed.

## &lt;Network type error&gt; QnA series only

" \* " is displayed for stations whose parameter setting and actual connection type do not agree.

## &lt;Multiplex remote master station duplication&gt; QnA series only

" \* " is displayed for stations where there is more than one submaster station of the same network.

## &lt;Parallel remote submaster station duplication&gt; QnA series only

" \* " is displayed for stations where there is more than one submaster station of the same network.

POINTS
--------

- |   |
|---|
| <ul style="list-style-type: none"><li>• The test cannot be executed at more than one station at the same time.</li><li>• Note that cyclic transmission is stopped while the test is being executed.</li></ul> |
|---|

### 22.2.4 Performing a station order confirmation test

A	Q/QnA	FX
○	○	×

**[Purpose]**

Confirms the station order in the forward/reverse loops of a MELSECNET/10(H) system.

**[Operating Procedure]**

Select [Diagnostics] → [Diagnostics network] → click the **Station order check test** button.

**[Dialog Box]**

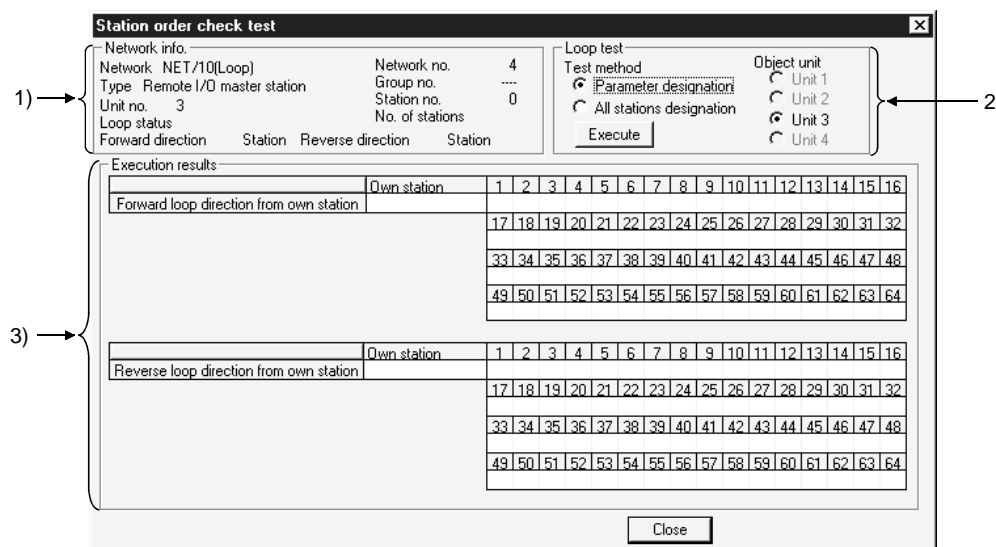

**[Description]**

- 1) Network info.
  - Indicates the network information of an other station designated at the connection destination.
  - For the loop status, the forward/reverse loop / forward loop / reverse loop / loopback status is indicated.
  - The total number of stations indicated is that determined by including the reserve stations in the test.
- 2) Loop test
  - Test method
    - Parameter designation
      - Stations set in the parameters, with the exception of reserve stations, are subject to the test.
      - If the network parameters have not been set (default), all stations are subject to the test.
    - All stations designation
      - All stations are subject to the station order confirmation test.
      - There is no number of stations designation.
  - Object unit
    - The module selected for the line monitor (own station) is set as the default.
    - If there is no MELSECNET/10(H) module, an error occurs.

## 3) Execution results

The order of stations in the forward loop direction and reverse loop direction, starting from the host station, is indicated.

For loopback, only the order in the forward loop direction from the host station is indicated.

The station numbers of reserve stations are not indicated.

POINTS
--------

- |   |
|---|
| <ul style="list-style-type: none"><li>• The test cannot be executed at more than one station at the same time.</li><li>• Note that cyclic transmission is stopped while the test is being executed.</li></ul> |
|---|

## 22.2.5 Performing a transmission test

A	Q/QnA	FX
○	○	×

### [Purpose]

Conducts a transmission test between networks on the MELSECNET/10(H).

### [Operating Procedure]

Select [Diagnostics] → [Diagnostics network] → **Transmission test** button.

### [Dialog Box]

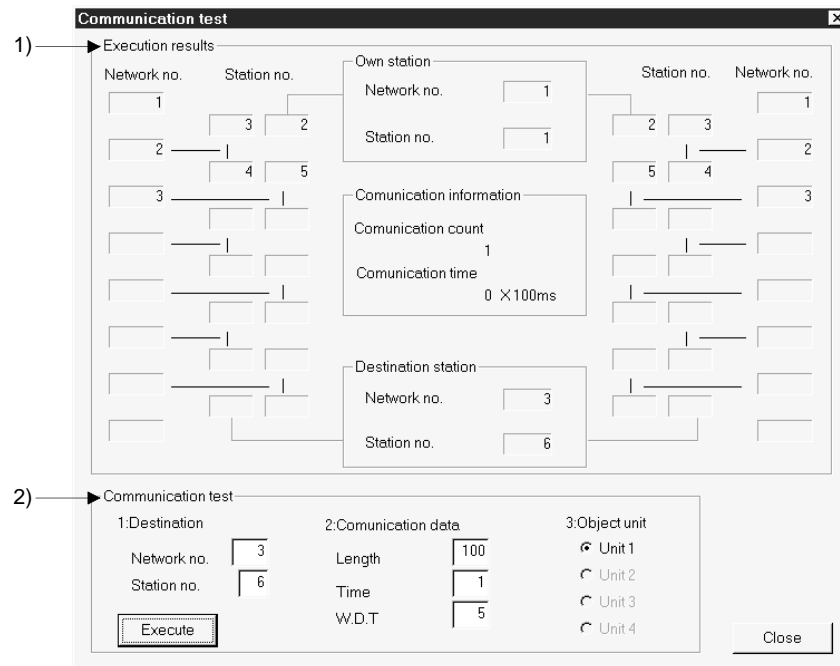

### [Description]

- 1) Execution Result
 

Shows the transmission test results between the networks.
- 2) Communication Test
 

Set Destination Setting, Transmission Data Setting and Target Module, and click the **Execute** button to start a transmission test.  
A change in target module will result in an error.

  - Destination Setting
 

Set the network No. (1 to 255 for A series, 1 to 239 for Q/QnA series) and station number (1 to 64).
  - Transmission Data Setting
 

Set Data length (1 to 900 bytes), Number of Transmission (1 to 100 times) and Transmission Inspection Time (1 to 100 seconds).
  - Target Module
 

Choose the module on which a transmission test will be made.  
The default is the module selected in line monitor (own station).

22.2.6 Monitoring the error history

A	Q/QnA	FX
○	○	×

[Purpose]

Shows the error history of the MELSECNET/10(H).

[Operating Procedure]

Select [Diagnostics] → [Diagnostics network] → **Error History Monitor** button.

[Dialog Box]

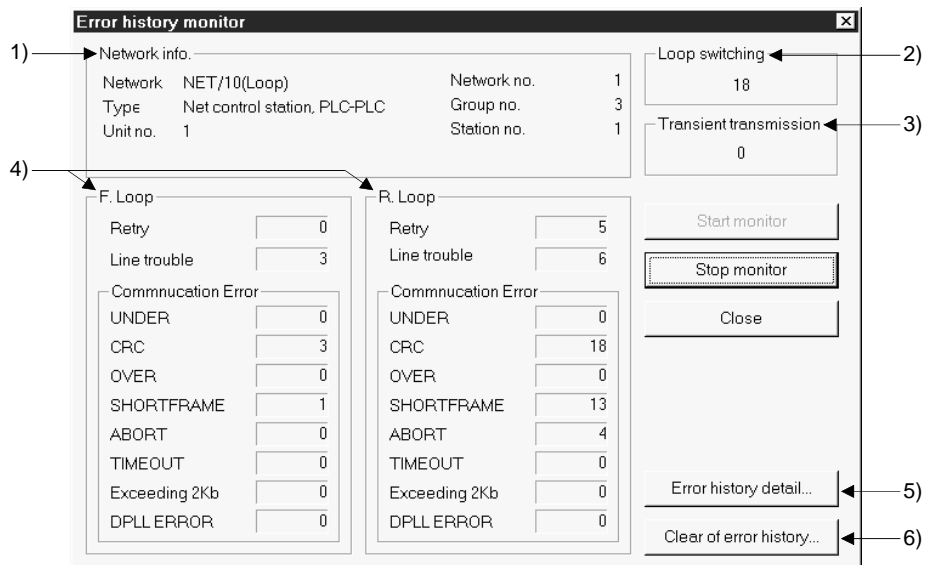

[Description]

- 1) Network Information  
Shows each information of the network.
- 2) Loop switching  
Shows the number of loop conversions.
- 3) Transient transmission  
Shows the number of transient transmission errors.
- 4) F Loop/R Loop  
Shows each item for monitoring execution.

- 5) **Error History Details** button  
Shows the details of Number of Loop Conversions and Peer to Peer Transmission Error.

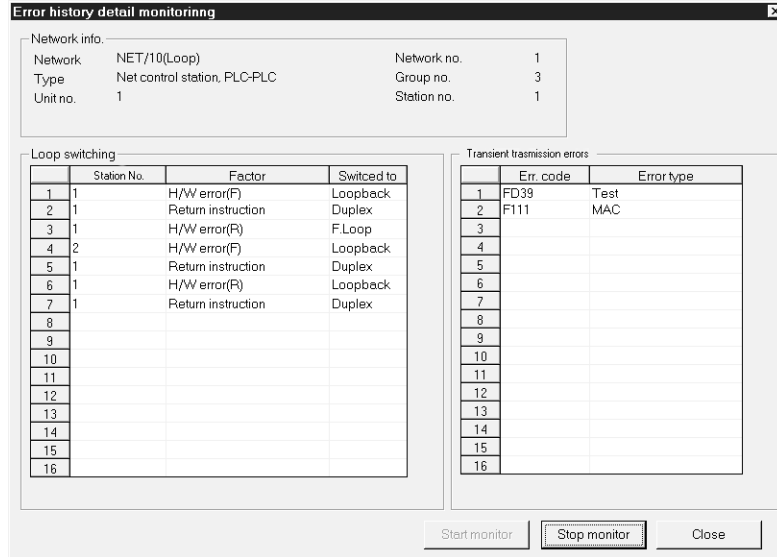

- 6) **Clear of Error History** button

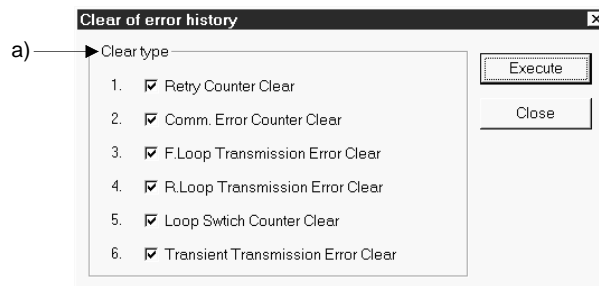

- a) Clear type  
Choose any item to be cleared.

22.2.7 Network monitor details

A	Q/QnA	FX
○	○	×

[Purpose]

Shows the network line status of the MELSECNET/10(H).

[Operating Procedure]

Select [Diagnostics] → [Diagnostics network] → **Network Monitor Details** button.

[Dialog Box]

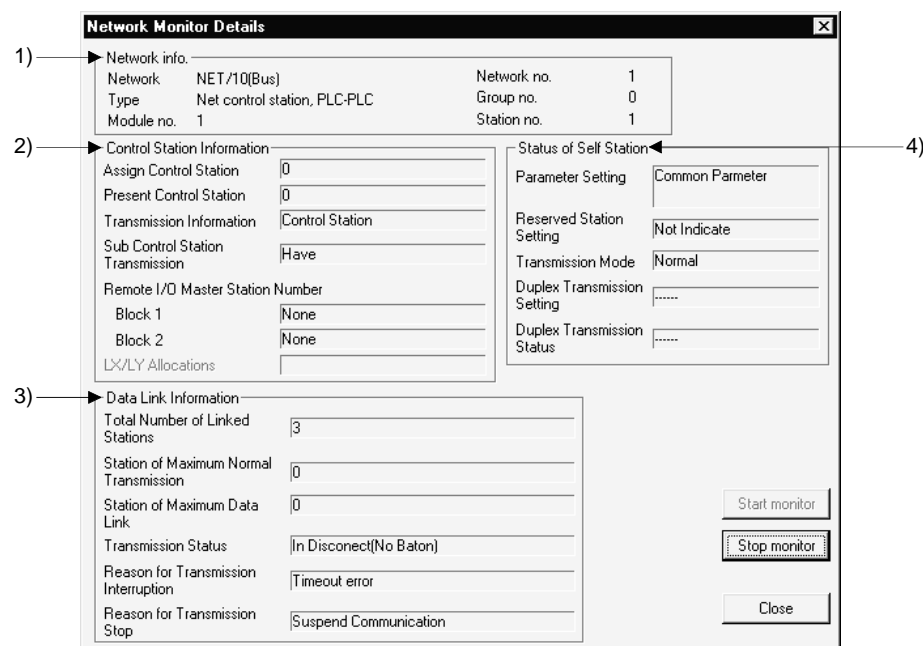

[Description]

- 1) **Network Information**  
Shows each information of the network.
- 2) **Control Node Information**  
Shows each information of the control station.  
Remote I/O master station appears only for the inter-PLC network.  
LX/LY assignment appears only for the remote I/O network.
- 3) **Data Link Information**  
Shows each information of data link.
- 4) **Status of self node**  
Shows each status of the own station.  
Parameter setting appears only for the inter-PLC network.



### 22.2.8 Monitoring other station information

A	Q/QnA	FX
○	○	×

[Purpose]

Monitors other stations connected to MELSECNET(II/10(H)).

[Operating Procedure]

Select [Diagnostics] → [Diagnostics network] → then click the [Other station information] button.

[Dialog Box]

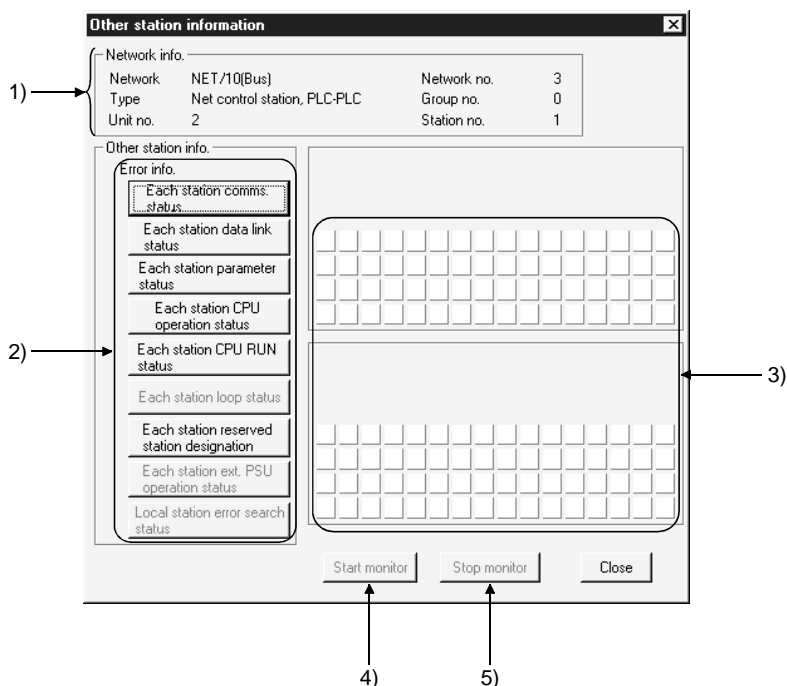

[Description]

- 1) Network info.  
Indicates the network information of the other station designated at the connection destination.
- 2) Error info.  
At each item, "ERR" is displayed in the error information display field when a faulty station, STOP station, reserve station, or station to which external power is being supplied, is detected.  
"ERR" is displayed in the error information display field.  
Details are displayed at 3) in response to button selection at each item.
- 3) Detailed error information display field  
When a station information item is selected, indicates the station status relevant to that item.
- 4) [Start monitor] button  
Starts monitoring if it is stopped.  
Not effective if monitoring is in progress.

- 5) Stop monitor button  
 Stops monitoring when it is in progress.  
 Not effective if monitoring is already stopped.

- The following other station information items cannot be selected with the A series.

		MELSECNET/10						MELSECNET(II)	
		MELSECNET/10				MELSECNET(II)		—	
		Control Station		Normal Station		Master Station		Master	Local
		Loop	Path	Loop	Path	Loop	Path	—	—
1	Communication status for each station	○	○	○	○	○	○	○	×
2	Data link status for each station	○	○	○	○	○	○	×	×
3	Parameter status for each station	○	○	×	×	○	○	○	×
4	CPU operating state for each station	○	○	○	○	×	×	×	×
5	CPU RUN state for each station	○	○	○	○	×	×	○	○
6	Loop status for each station	○	×	○	×	○	×	○	×
7	Reserve station designation for each station	○	○	○	○	○	○	×	×
8	External power supply operation status for each station	×	×	×	×	×	×	×	×
9	Local station error detection status	×	×	×	×	×	×	○	×

○: Can be selected    ×: Cannot be selected (mask display)  
 : Different selection to GPPA, GPPQ possible/not possible

- The following other station information items cannot be selected with the Q/QnA series.

		MELSECNET/10(H)						MELSECNET(II)	
		MELSECNET/10(H)				MELSECNET(II)		—	
		Control Station		Normal Station		Master Station		Master	Local
		Loop	Path	Loop	Path	Loop	Path	—	—
1	Communication status for each station	○	○	○	○	○	○	○	×
2	Data link status for each station	○	○	○	○	○	○	×	×
3	Parameter status for each station	○	○	×	×	○	○	○	×
4	CPU operating state for each station	○	○	○	○	×	×	×	×
5	CPU RUN state for each station	○	○	○	○	×	×	○	○
6	Loop status for each station	○	×	○	×	○	×	○	×
7	Reserve station designation for each station	○	○	○	○	○	○	×	×
8	External power supply operation status for each station	○	×	○	×	○	×	×	×
9	Local station error detection status	×	×	×	×	×	×	○	×

○: Can be selected ×: Cannot be selected (mask display)

■: Different selection from GPPA, GPPQ possible/not possible

### 22.3 Running CC-Link Diagnostics

CC-Link diagnostics monitor the network information of each station and diagnose and test the network status.

CC-Link diagnostics can be run via the PLC CPU when the CC-Link module is the master station/standby master station/local station.

POINTS
<ul style="list-style-type: none"> <li>• The QCPU diagnoses the QJ61BT11 only.</li> <li>• Use the AJ61BT11/A1SJ61BT11 module with the QCPU-A.</li> <li>• When refresh parameters have been created in a sequence program for the A series, Data link start and Monitoring Other station, Network test are disabled.</li> </ul>

#### 22.3.1 Monitoring the line (own station)

A	Q/QnA	FX
○	○	×

[Purpose]

Monitors the own station line of CC-Link connected to the PLC CPU.

[Operating Procedure]

Select [Diagnostics] → [CC-Link diagnostics].

[Dialog Box]

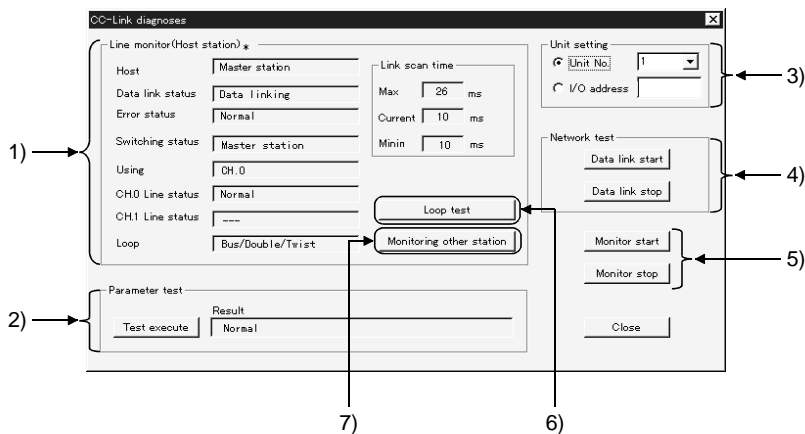

[Description]

- 1) Own station information  
The special M (SB) and special D (SW) assigned to the display items will be described below.
- 2) Acquire the setting information (A/QnA series only)  
Executing this item sets the CC-Link system status set to the work area of the CC-Link module.

- 3) Unit setting (A/QnA series only)  
 Set the module number or I/O address on which CC-Link diagnostics will be run.  
 Refer to the following restrictions and make confirmation before starting the diagnostics.  
 Refer to Appendix 7 for identification of the function version.

CPU	
QnA series	The function versions of the QnACPU, AJ61QBT11 and A1SJ61QBT11 should be B or later.
Q series	No restrictions.

- 4) Network test  
 A data link start/stop is made for the CC-Link modules (all stations specified) set in Unit setting.

**IMPORTANT**

In the following system configuration, making a "data link stop" for the master station disables communications from GPPW.  
 To make a data link start or resume communications from GPPW, the PLC CPU of the station whose data link was stopped must be reset.

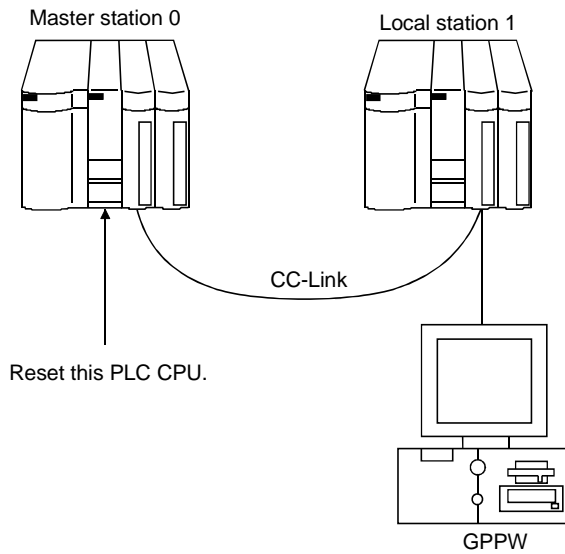

- 5) **Monitor start** / **stop** button  
 Used to start/stop the own station monitoring.
- 6) **Loop test** button  
 Refer to Section 22.3.2.
- 7) **Monitoring other station** button  
 Refer to Section 22.3.3.

22.3.2 Conducting a line test

A	Q/QnA	FX
○	○	×

[Purpose]

Tests all stations or the specified station.  
Valid only when the master station has been specified in Transfer setup.

[Operating Procedure]

Select [Diagnostics] → [CC-Link diagnostics]. → **Loop test** button.

[Dialog Box]

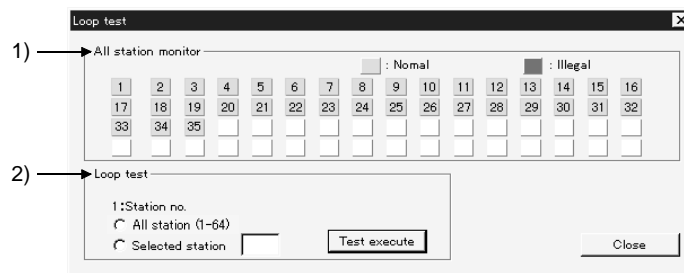

[Description]

1) All station monitor

Monitors the operating states of all CC-Link stations.  
Faulty stations are shown in red.

2) Loop test

A line test is made by specifying the own station or another station (station number).

All station: Test will be run on all 64 stations.

Selected station: Test will be conducted on the specified stations.

Specify the first one of the occupied stations.

<Example>

- When there are 4 and 2 occupied stations connected

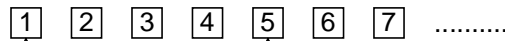

Specify 1

Specify 5

Specifying 2,3,4 or 6 will result in a faulty station.

### 22.3.3 Monitoring the lines (other stations)

A	Q/QnA	FX
○	○	×

**[Purpose]**

Monitors the other station lines of CC-Link connected to the PLC CPU.  
 Can be executed only during Linking Data.

**[Operating Procedure]**

Select [Diagnostics] → [CC-Link diagnostics] → **Monitoring other station** button.

**[Dialog Box]**

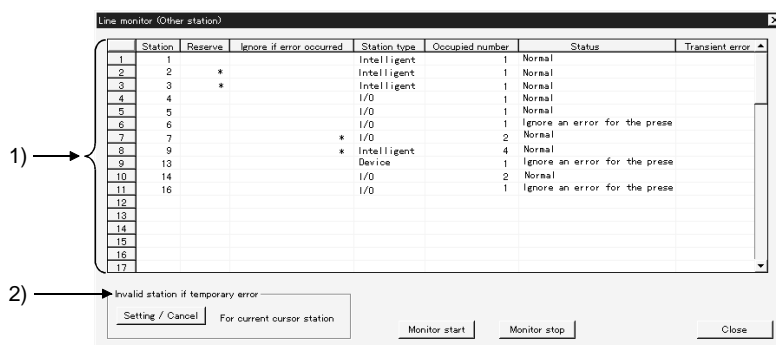

**[Description]**

- 1) Other station information  
 Shows the information on the other stations.  
 When the own station is a local station, the status of the CC-Link system is monitored in other station monitoring, and therefore no reserved stations are displayed.
- 2) Invalid station if temporary error  
 A module is changed without the corresponding remote station being error-detected while it is online.

The temporary error invalidation setting must be made by specifying the first station number.  
 Therefore, when there is no parameter setting, the status and transient error information is shown on the assumption that one station occupies 32 points, and you must make this setting by specifying the station number for which you want to make the invalidation setting.  
 (The invalidation setting is ignored if it is made for the station which is not in the first position of actual assignment.)

## 22.4 System Monitor

A	Q/QnA	FX
×	○	×

**[Purpose]**

Monitors the system status of the PLC.  
 This function may be selected for the Q series only.

**[Operating Procedure]**

[Diagnostics] → [System monitor].

**[Dialog Box]**

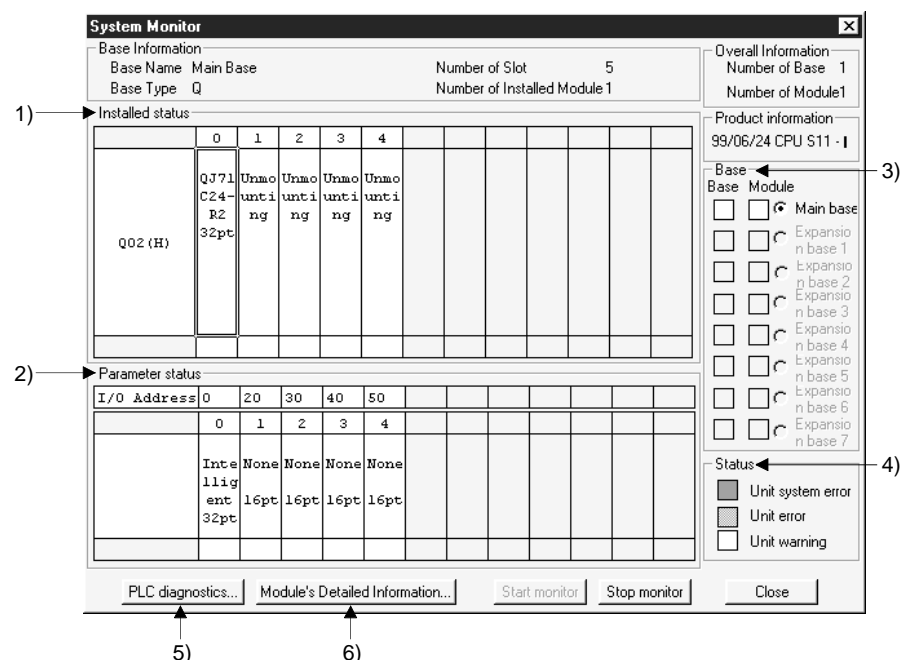

**[Description]**

- 1) **Installed status**  
 Shows the special and similar modules loaded to the base selected among the main base and extension bases 1 to 7. (Double-clicking the model name indication shows the module detail information dialog box.)  
 When the A series is added to connect the special function modules of the A, "A intelli" appears on the screen.
- 2) **Parameter status**  
 Shows the parameter settings written to the PLC. The parameters not set do not appear.
- 3) **Base**  
 Normal bases are shown white and abnormal bases red.  
 For the modules, refer to 4) Status.



- 4) Status
  - Unit system error  
Indicates that a module hardware fault (error equivalent to WDT error) has occurred or a module inoperative condition is detected.
  - Unit error  
Indicates that the environment required for the module to function is not completed. (Error equivalent to parameter error has occurred)
  - Unit warning  
Indicates inadequacy in user operation or sequence program (e.g. FROM, TO).

	Display Color	PLC Status
Unit normal	White	RUN
Unit system error	Red	STOP
Unit error	Orange	RUN
Unit warning	Yellow	RUN

- 5) **PLC diagnostics** button  
When starting the QnA/Q series, refer to Section 22.1.2.
- 6) **Module detail information** button  
When you choose the module model name displayed in Installed status, the following dialog box appears.

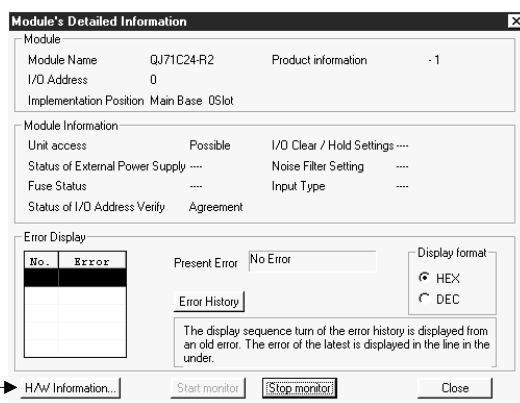

a) →

- a) **H/W Information** button  
 H/W LED Information: Shows the module front LED states and parameter settings.  
 H/W SW Information: Shows the hardware switch states and parameter settings.

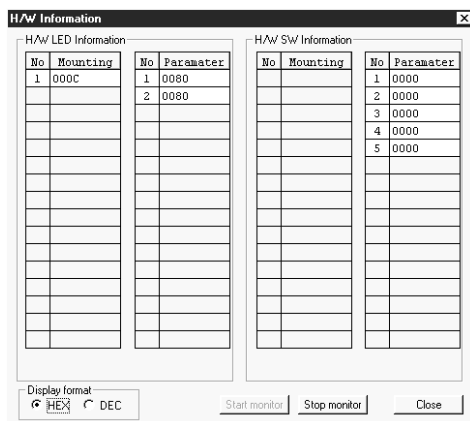

POINTS

- The following table appears if there are differences between PLC parameter I/O assignment and actual Installed status. Therefore, set the PLC parameter I/O assignment to meet the actual Installed status.

System monitor display status

Assignment	Actual Loading	Empty	Input	Output	Intelli
0 empty points	Installed status	Unmounting	m input points	m output points	m intelli points
	Parameter status	0 empty points	0 empty points	0 empty points	0 empty points
n empty points	Installed status	Unmounting	m input points	m output points	m intelli points
	Parameter status	n empty points	n empty points	n empty points	n empty points
0 input points	Installed status	Unmounting	m input points	m output points	m intelli points
	Parameter status	0 empty points	0 empty points	0 empty points	Assignment error
n input points	Installed status	Unmounting	m input points	m output points	m intelli points
	Parameter status	n empty points	n input points	n input points	Assignment error
0 output points	Installed status	Unmounting	m input points	m output points	m intelli points
	Parameter status	0 empty points	0 empty points	0 empty points	Assignment error
n output points	Installed status	Unmounting	m input points	m output points	m intelli points
	Parameter status	n empty points	n output points	n output points	Assignment error
0 intelli points	Installed status	Unmounting	m input points	m output points	m intelli points
	Parameter status	0 empty points	Assignment error	Assignment error	Assignment error
n intelli points	Installed status	Unmounting	m input points	m output points	m intelli points
	Parameter status	n empty points	Assignment error	Assignment error	n intelli points
No assignment	Installed status	Unmounting	m input points	m output points	m intelli points
	Parameter status	p empty points	m input points	m output points	m intelli points

n points : Number of assignment points  
 m points : Number of actual loading points  
 p points : Number of empty slot points

# MEMO

---

---

---

---

---

---

---

---

---

---

---

---

---

---

---

---

---

---

---

---

---

---

---

---

---

---

---

---

---

---

## 23 SETTING A6TEL/Q6TEL/FX<sub>2N</sub> DATA

The telephone line can be used for connection with the PLC. When the telephone line is used to make communication, it is made via the modem interface module (A6TEL/Q6TEL modem interface module), serial communication.

The following table lists the modules usable with each series. Modem Interface.

	interface module		Serial Communication	
	A6TEL	Q6TEL	QnA Series	Q Series
Qseries	—	—	○	—
QnAseries	—	○	—	○
Aseries	○	○	—	—
FXseries	—	—	—	—

\*1: Since the QCPU (A mode) cannot use the A6TEL/Q6TEL, make communication via the serial communication module (Q series).

\*2: Communication can be made by connecting a modem to the RS-232C connector of the FX<sub>2N</sub>.

REMARK
--------

For connection of telephone lines through QC24N and QJ71C24, refer to Section 17.2.4.

23.1 Function Setting Item List

A	Q/QnA	FX
○	○	○

(1) Q6TEL/A6TEL

The following setting item list indicates what data may be created and written to the peripheral device and A6TEL/Q6TEL when performing any function. (A/QnA series)

A6TEL/Q6TEL Connection Method		Proximate Connection	Remote Access	Pager Notice	Q6TEL-Q6TEL Communication
PLC side	A6TEL	1) Cable connection 2) Switch setting	1) AT command registration 2) Switch setting 3) Cable connection 4) TEL data registration (a) AT command (b) Phone number	1) AT command registration 2) Phone number book creation 3) Switch setting 4) Cable connection 5) TEL data registration (a) AT command (b) Phone number (c) Notice data	No setting
	Q6TEL	1) Cable connection 2) Switch setting	1) AT command registration 2) Switch setting 3) Cable connection 4) TEL data registration (a) AT command (b) Phone number	1) AT command registration 2) Phone number book creation 3) Switch setting 4) Cable connection 5) TEL data registration (a) AT command (b) Phone number (c) Notice data	1) AT command registration 2) Phone number book creation 3) Switch setting 4) Cable connection 5) TEL data registration (a) AT command (b) Phone number (c) Q6TEL-Q6TEL communication data registration
Peripheral device side (GPPW)		No setting	1) AT command registration 2) Phone number book creation	No setting	No setting

Switch setting: For the A6TEL/Q6TEL DIP switch setting, refer to Appendix 13. For connection cable details, refer to Section 2.1, 17.2.4.

(2) FXCPU series

Only remote access may be made. (Pager notices and Q6TEL-Q6TEL communication cannot be made.)

	Remote Access
PLC side	1) PC system setting (1) 2) PC system setting (2) 3) If you set modem initialization to the user registration mode in PC system setting (1), you must set the AT command in the sequence program.
Peripheral device side	1) AT command registration 2) Phone number registration

## 23.2 Preparations for Connecting the Telephone Line

This section provides the procedures to start the remote access function, notice function and Q6TEL-Q6TEL communication function (QnA mode only) in a system using the A6TEL/Q6TEL.

### 23.2.1 Making remote access/pager notice (for ACPU)

A	Q/QnA	FX
○	×	×

Since the A modes of the A6TEL and Q6TEL are the same, read "Q6TEL" as "A6TEL" when using the A6TEL.

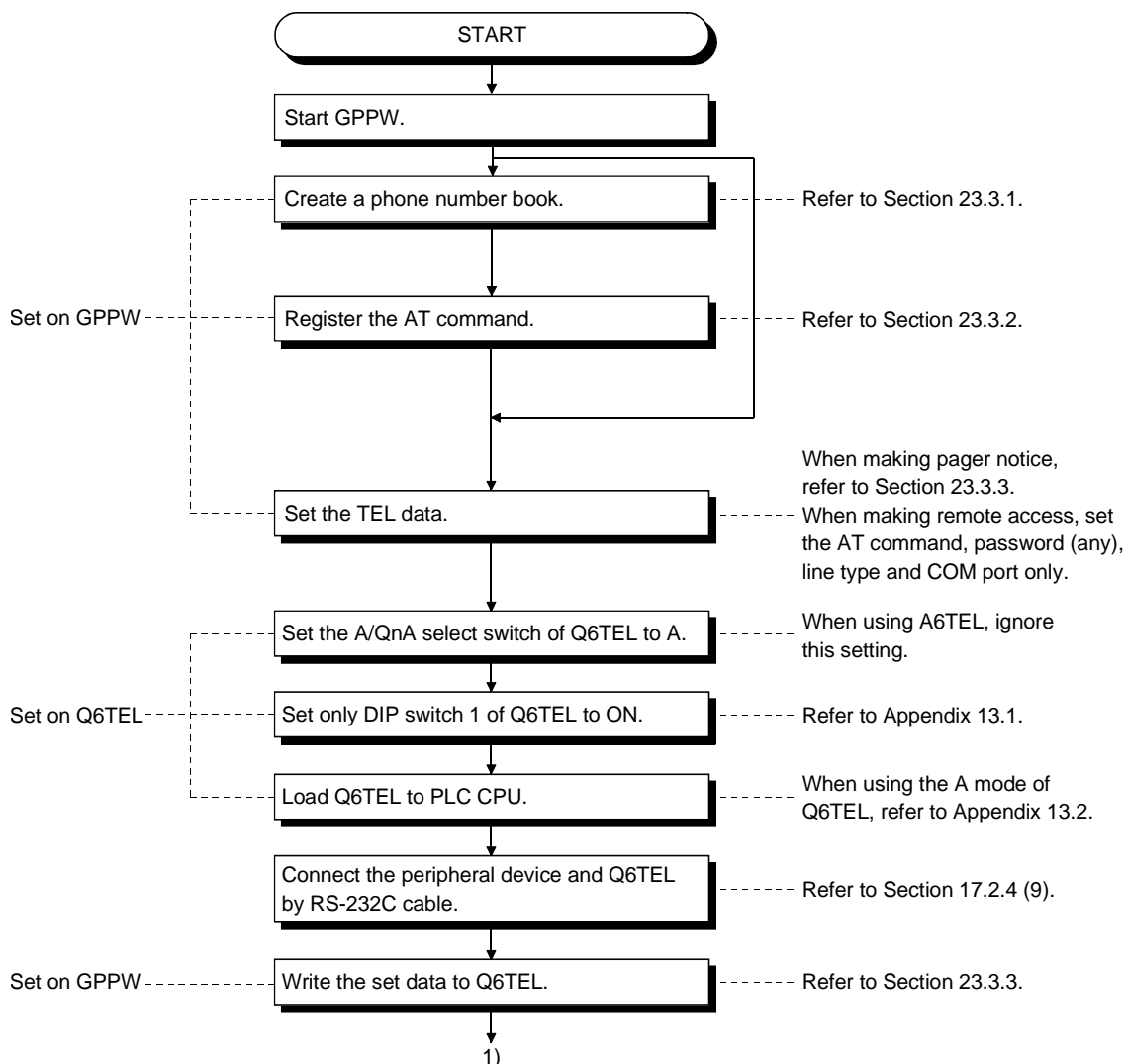

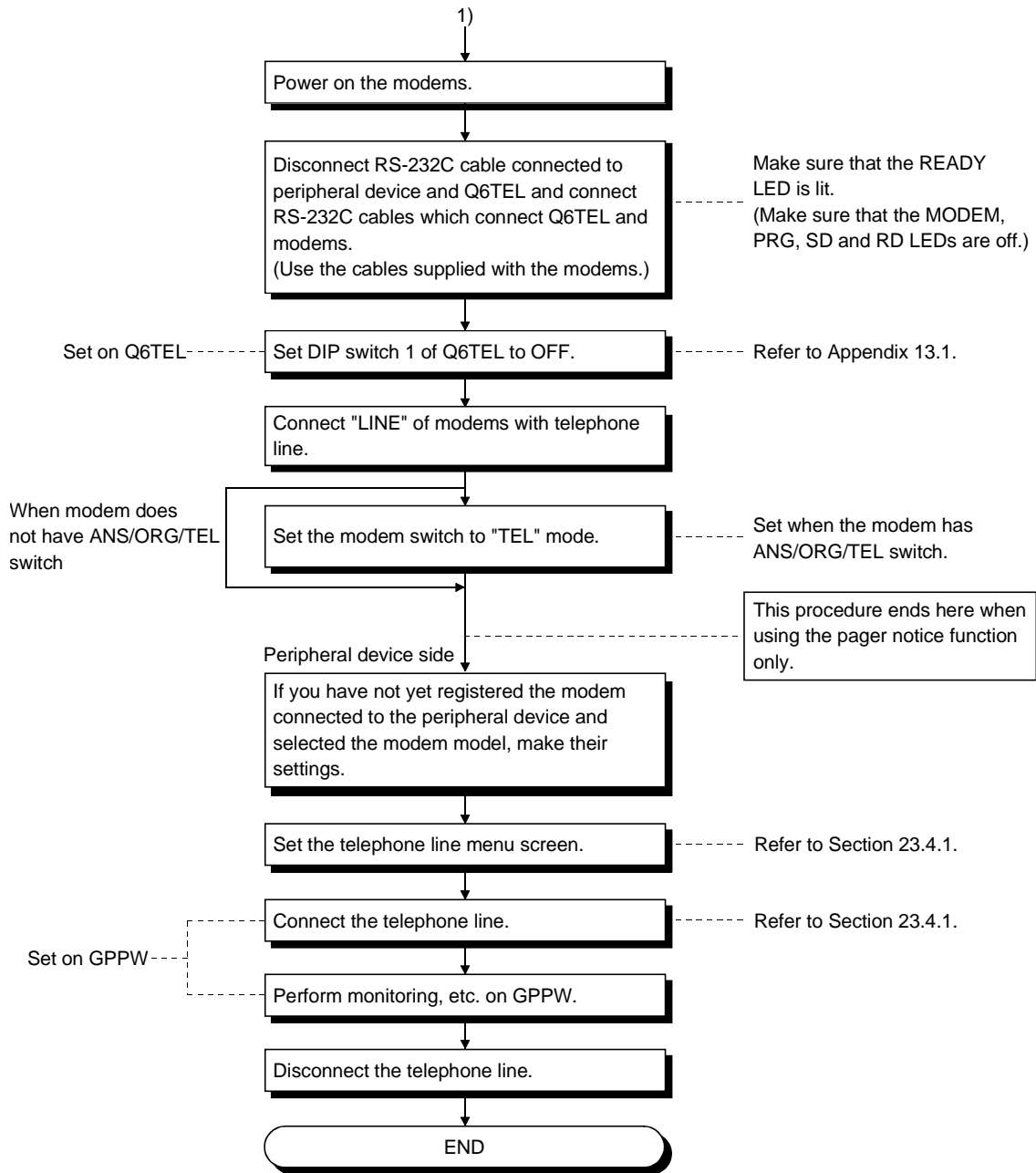

POINT	<ul style="list-style-type: none"> <li>Set the connection destination before connecting the telephone line.</li> </ul>
-------	--

23.2.2 Making remote access/pager notice (for QnACPU)

A	Q/QnA	FX
×	○	×

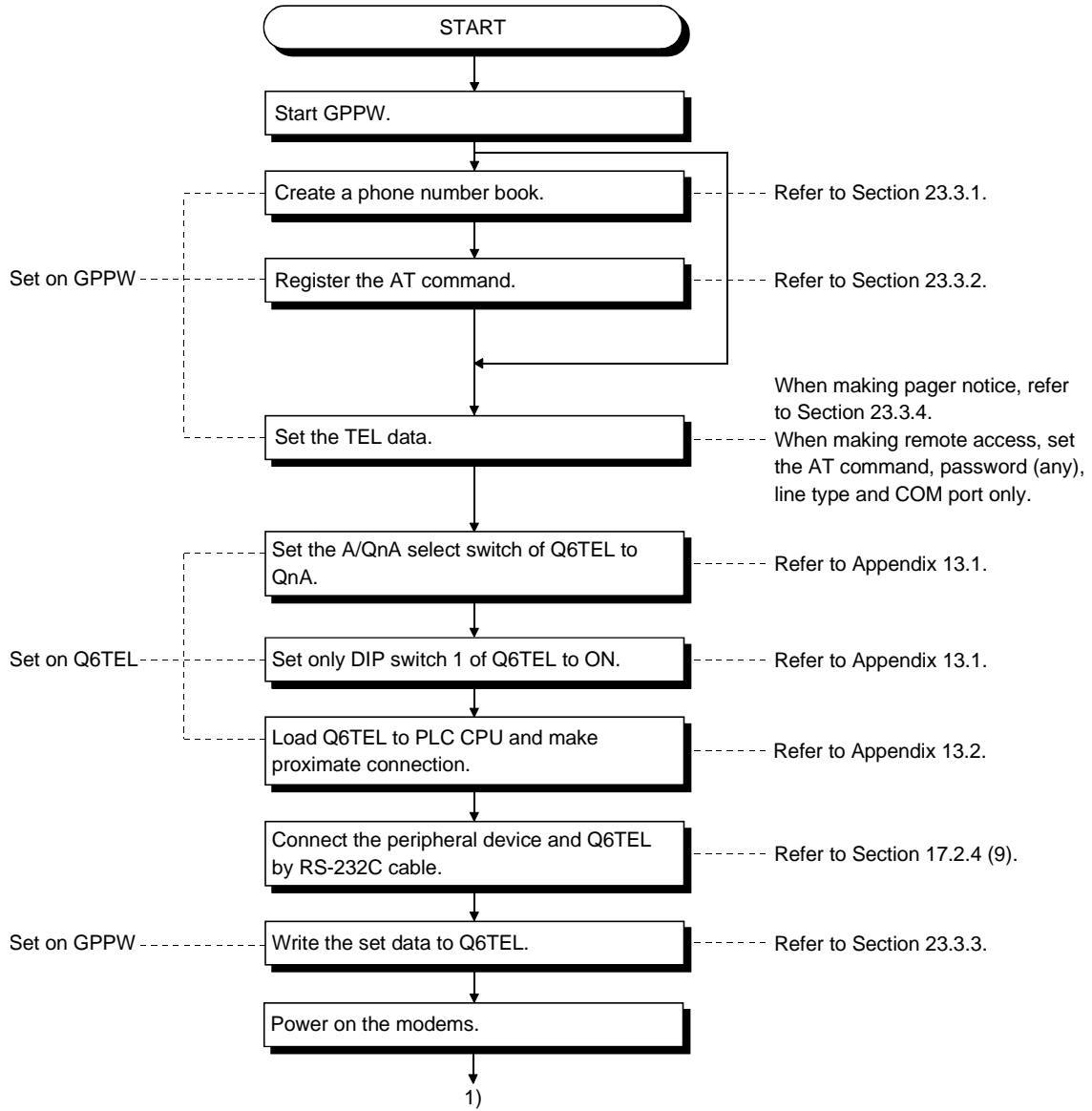



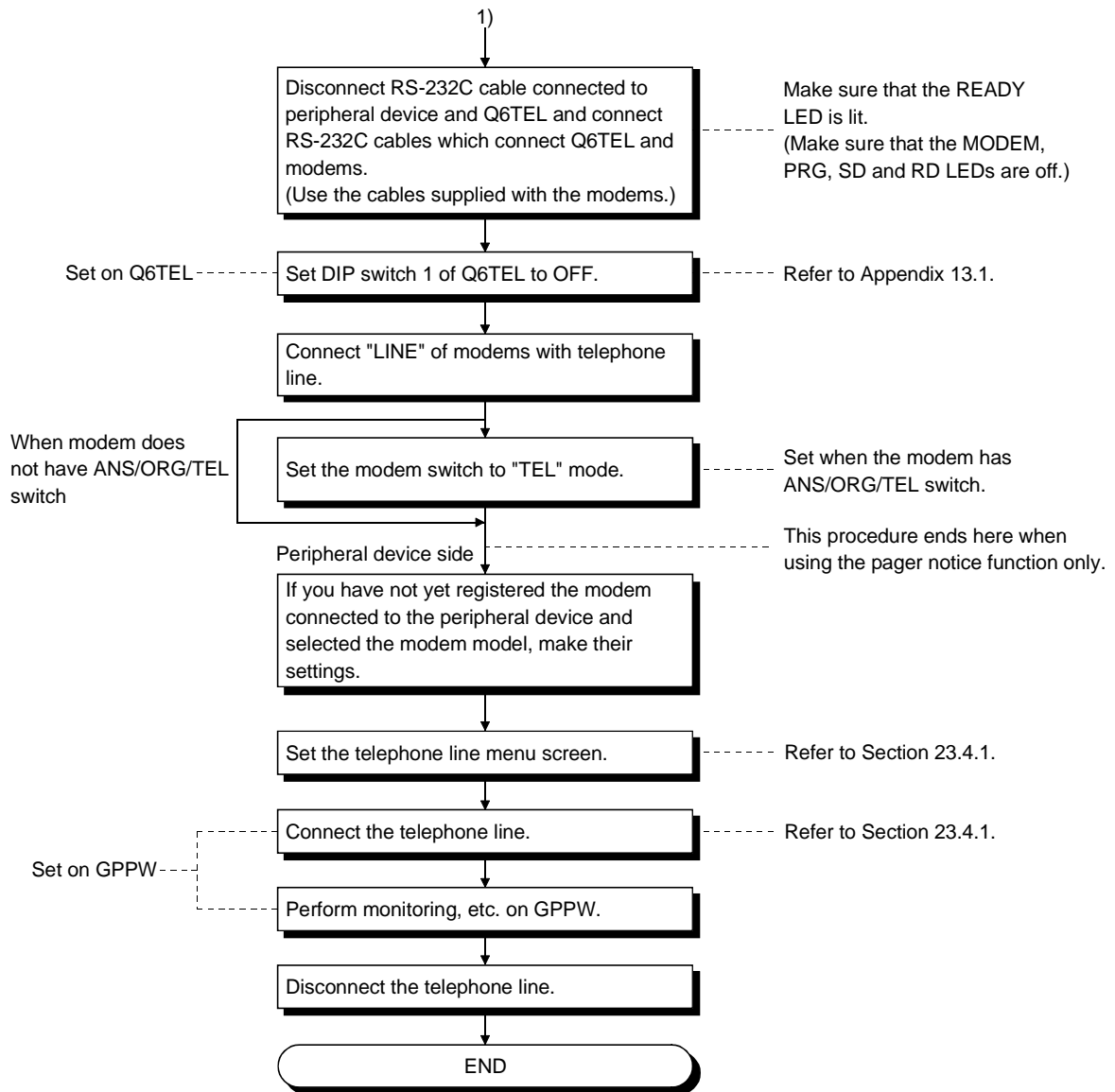

- |  |
|--|
| <b>POINT</b>   |
| <ul style="list-style-type: none"> <li>• Set the connection destination before connecting the telephone line.</li> </ul> |

23.2.3 Making remote access to FXCPU

A	Q/QnA	FX
×	×	○

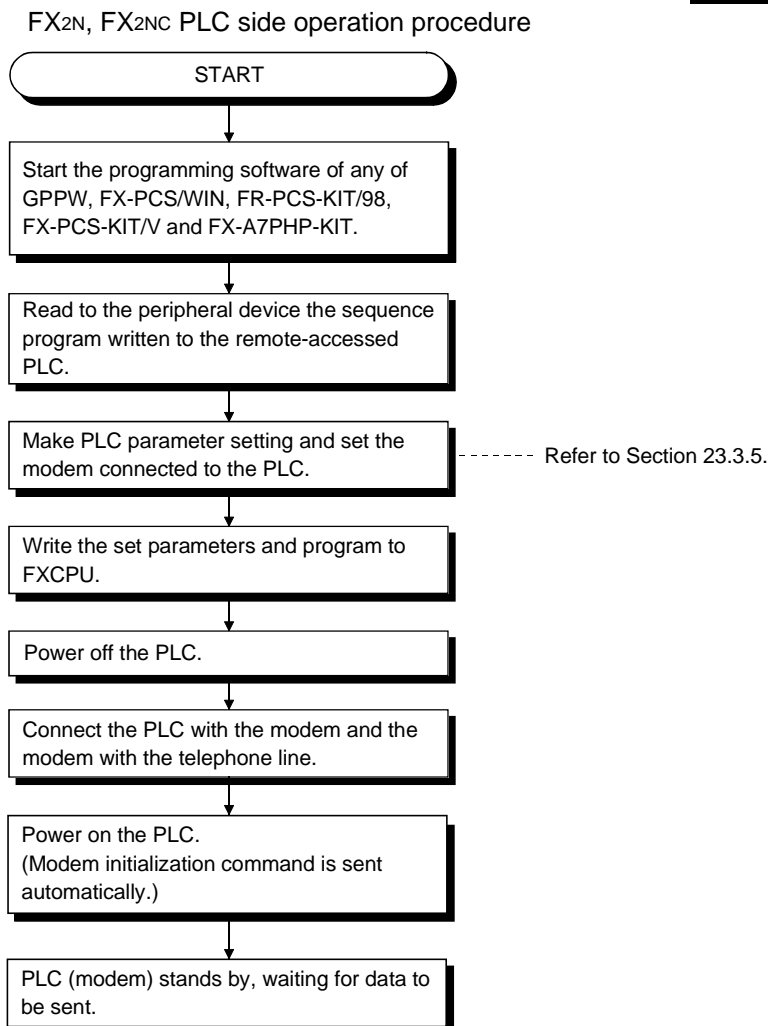

- Always power on in the modems and PLC in this order. If the PLC is powered on earlier than the modems, the initialization command sent to the modems at power-on of the PLC is made invalid, and a communication error will occur at the time of remote access. Also, if only the modems are powered on after power-on, the initialization command is cleared, resulting in a communication error similarly. In this case, switch power on again in the order of modems and PLC.
- The PLC which was placed in the standby status in this procedure can be remote-controlled by FX-PCS/WIN programming software.

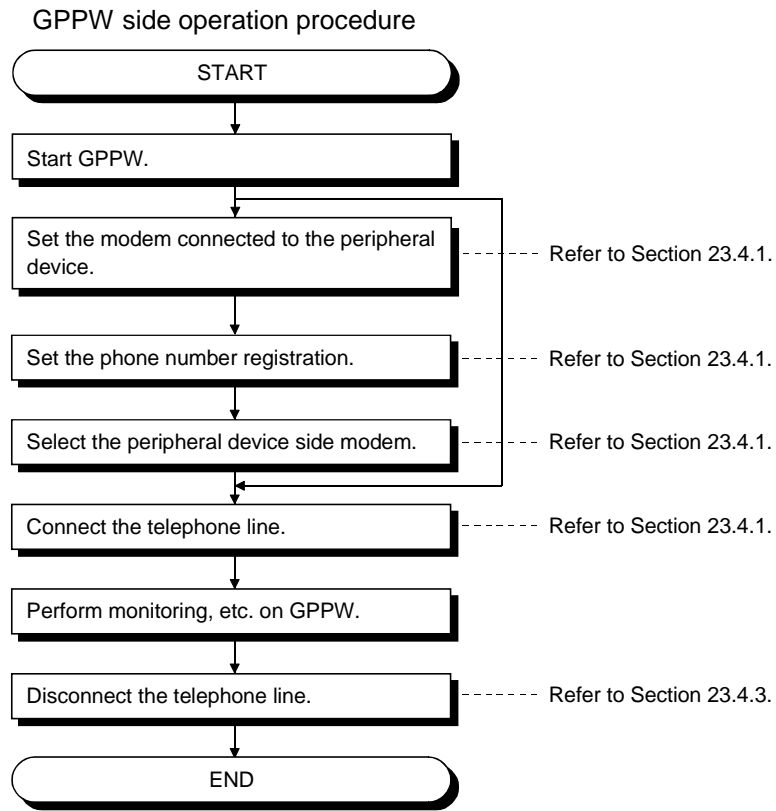

23.2.4 Making Q6TEL-Q6TEL communication

A	Q/QnA	FX
×	○	×

(1) Send side

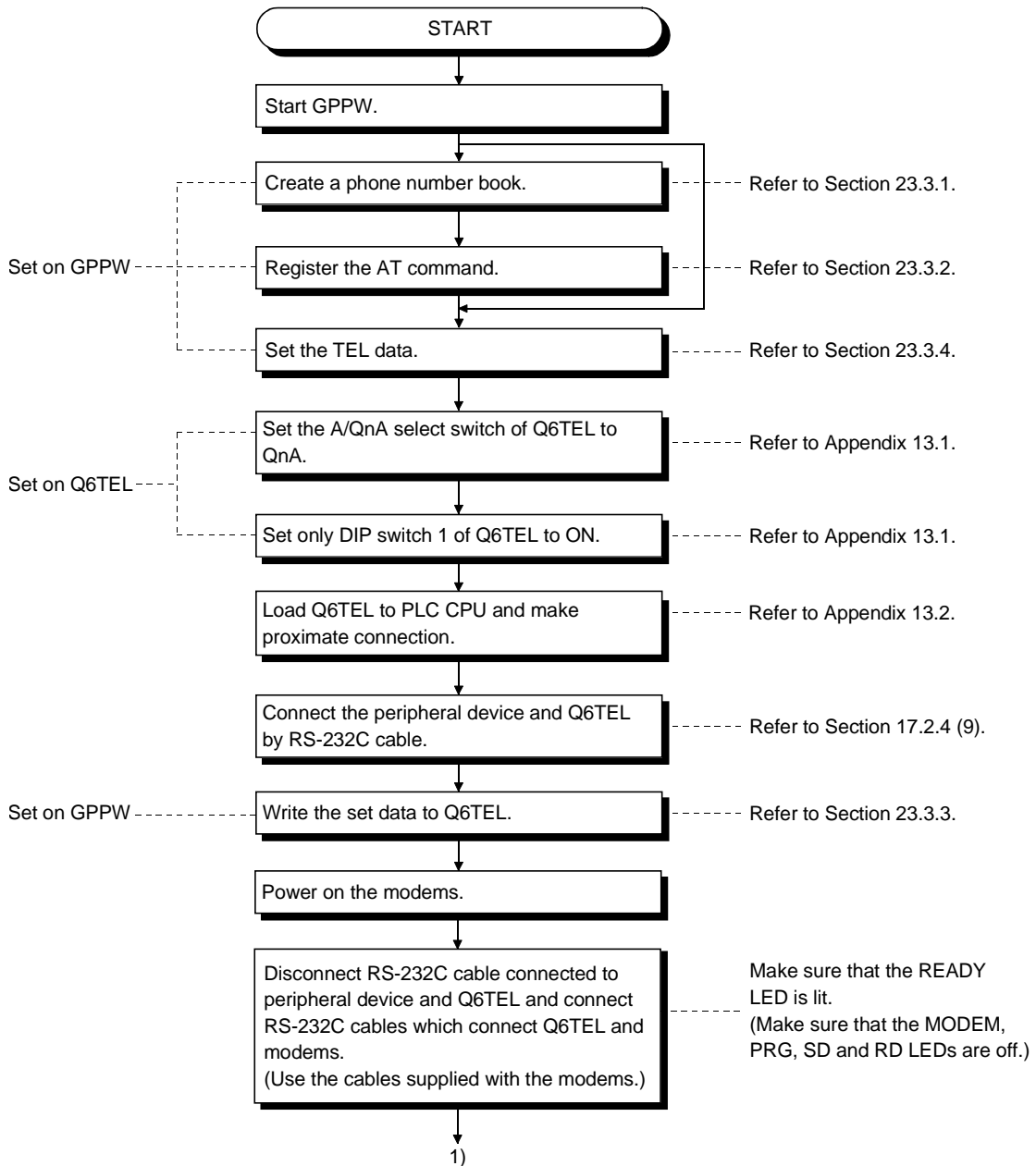

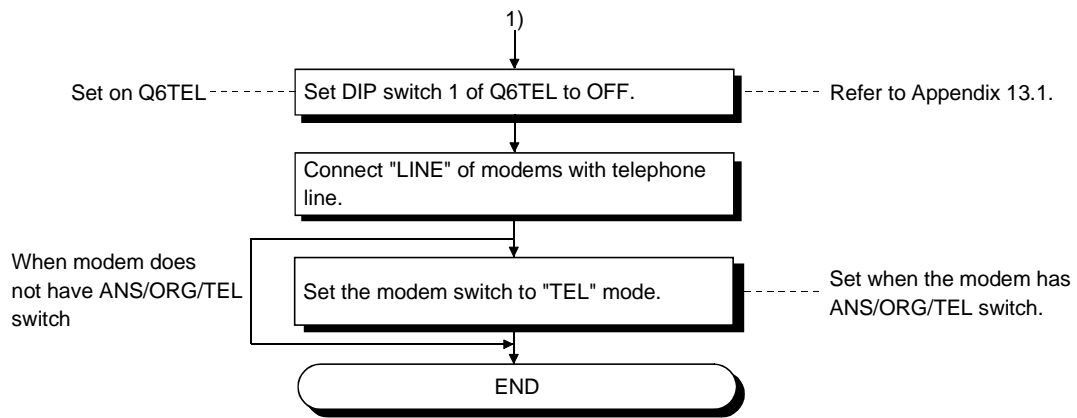

(2) Receive side

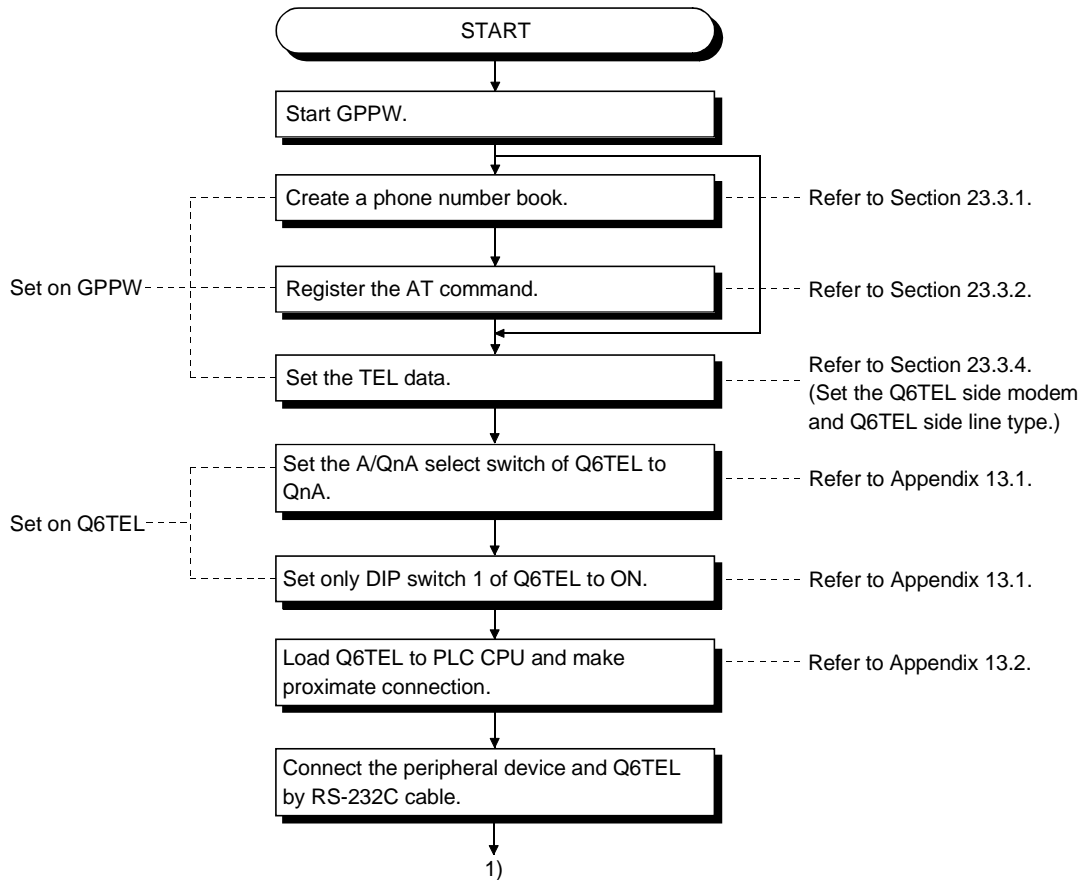

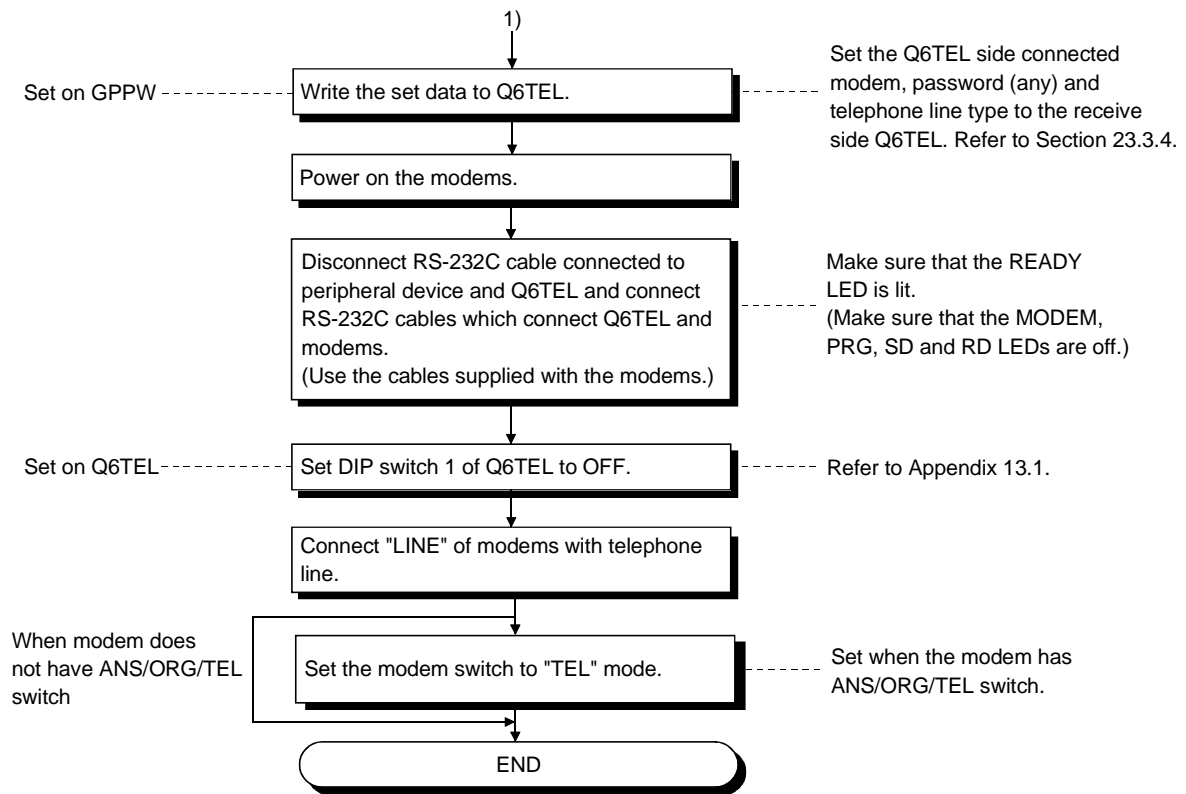

## 23.3 Making Initial Setting of Data

### 23.3.1 Creating a phone number book

A	Q/QnA	FX
○	○	○

[Purpose]  
Registers phone numbers.

[Operating Procedure]  
[Tools] → [Set TEL data] → [Call book]

[Window]

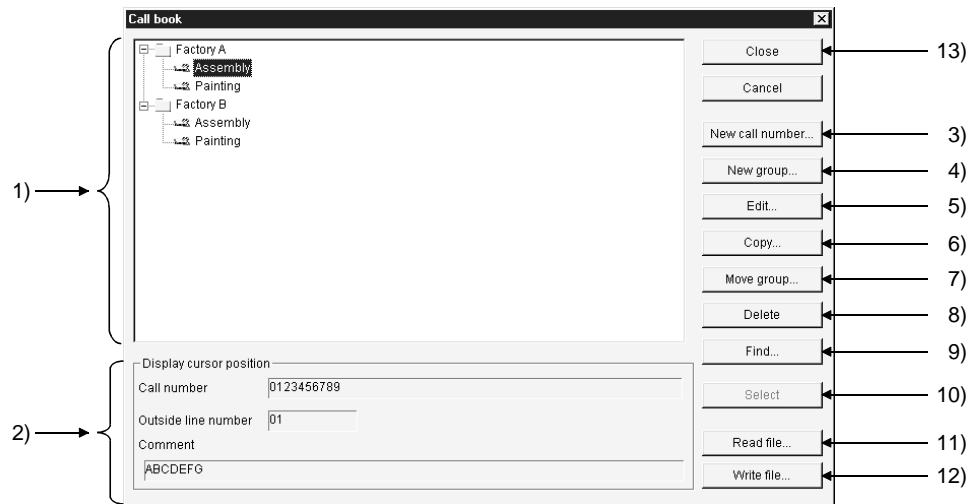

[Description]

- 1) Registered phone number display list  
Shows the group names and the other end names of the phone numbers.  
Registered phone number ..... 18 or more characters  
Outside line access number .....2 or more characters
- 2) Display cursor position field  
Shows the registered data selected in the registered phone number display list.

- 3) **New call number** button  
Register a new phone number.

The screenshot shows a 'Call number setting' dialog box with the following fields and labels:

- a) Group name: Factory A
- b) Destination name: Assembly
- c) Call number: 0123456789
- d) Outside line number: 01
- e) For only line connection: Password: \*\*\*\*
- f) Comment: ABCDEFGG
- g) OK button

- a) **Group name**  
Shows the group name of the registered number.
- b) **Destination name**  
Enter the other end name of the phone number to be set.  
The number of set characters is within 50.
- c) **Call number**  
Enter the phone number.  
The number of set characters is within 50.
- d) **Outside line number**  
Set the outside line access number.  
The number of set characters is within 10.
- e) **For only connection**  
When a password has been set to the A6TEL/Q6TEL, making this setting automatically starts password processing and connects the line.  
When a password has not been set to the A6TEL/Q6TEL, making this setting connects the line.
- f) **Comment**  
Enter the memo to the registered data.  
The number of set characters is within 60.
- g) **OK** button  
Click this button when the setting is finished.
- 4) **New group** button  
Create a new group.  
Clicking the New group button shows the group setting dialog box.  
Enter and set the group name.  
The number of set characters is within 50.



- 5) **Edit** button  
Edits the registered data.  
Choose the registered data you want to edit in the registered phone number display list.  
Clicking the Edit button shows the phone number setting dialog box.  
Edit each data.
- 6) **Copy** button  
Copies the registered phone numbers to another group.  
Choose the registered data you want to copy in the registered phone number display list.  
Clicking the Copy button shows the group setting dialog box.  
Choose the copy destination group and click the **OK** button.
- 7) **Move** group button  
Moves the registered phone numbers to another group.  
Choose the registered data you want to copy in the registered phone number display list.  
Clicking the Move group button shows the group setting dialog box.  
Choose the move destination group and click the **OK** button.
- 8) **Delete** button  
Deletes the registered group and phone numbers.  
(You cannot batch-delete on a group basis.)
- 9) **Find** button  
Searches for the registered phone number. (Search match condition is partial match.)  
All registered data are searched.
  - Searching advance  
When search conditions are entered into both the other end and phone number, data which satisfies both search conditions is searched for.
- 10) **Select** button  
Performs the phone number setting selection processing when the line connection dialog box is browsed.
- 11) **Read** file button  
Reads to GPPW the phone number data registered to GPPA or GPPQ.  
The operation method is the same as the TEL data creation file reading operation.
- 12) **Write** file button  
Writes the created phone number book to any folder specified.
- 13) **Close** button  
Saves the edited data and terminates the phone number book function.

[Setting Procedure]

1. Click the New group button. (When newly creating data)  
Enter the group name and create the group.
2. Choose the group where you want to register the phone number from the registered phone number display list.
3. Click the new phone number button.  
Enter and set each data (other end name, phone number, outside line access number, memo).

23.3.2 Registering the AT command

A	Q/QnA	FX
○	○	○

[Purpose]  
 Register the AT command.

[Operating Procedure]  
 [Tools] → [Set TEL data] → [AT command]

[Dialog Box]

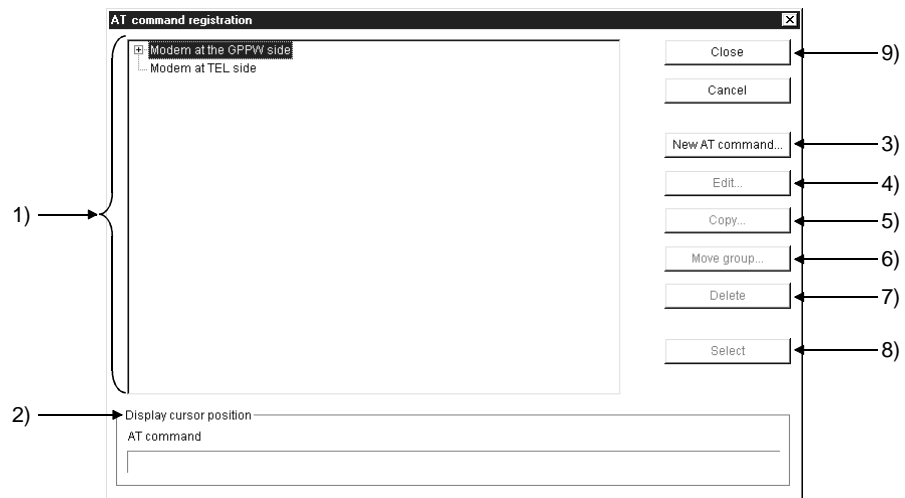

[Description]

- 1) Registered AT command display list  
 Shows the headings of the AT commands.
- 2) Display cursor position field  
 Shows the registered data selected in the registered AT command display list.

- 3) **New AT** command button  
Registers a new AT command.

The screenshot shows a dialog box titled "AT command registration". It contains three text input fields. The first field, labeled "Group name", contains the text "Modem at the GPPW side". The second field, labeled "Title", contains the text "ABCD Modem". The third field, labeled "AT command", contains the text "ATQ0E1VX1S0=1". Below the input fields are three buttons: "OK", "Cancel", and "Help of AT command...".

- a) **Group name**  
Shows the group name of the new command.
- b) **Heading**  
Enter the heading for the AT command to be registered.
- c) **AT command**  
Enter the AT command for modem initialization.  
The number of entered characters is up to 70 (70 for A6TEL/40 for Q6TEL).
- 4) **Edit** button  
Edits the registered data.  
Choose the registered data you want to edit in the registered AT command display list.  
Clicking the Edit button shows the AT command registration dialog box.  
Edit each data.
- 5) **Copy** button  
Copies the registered AT command to any other end.  
Choose the registered data you want to copy in the registered AT command display list.  
Clicking the Copy button shows the group specifying dialog box.  
Choose the copy destination (any other end) and click the **OK** button.
- 6) **Move group** button  
Moves the registered AT command to any other end.  
Choose the registered data you want to move in the registered AT command display list.  
Clicking the Move group button shows the group specifying dialog box.  
Choose the move destination (any other end) and click the **OK** button.

- 7) **Delete** button  
Deletes the registered AT commands.  
(You cannot batch-delete on a group basis.)
- 8) **Select** button  
Performs the AT command selection processing when the line connection dialog box or TEL data creation dialog box is browsed.
- 9) **Close** button  
Saves the edited data and terminates the AT command registration function.

[Setting Procedure]

1. Choose the side where you want to register the AT command from the registered AT command display list.
2. Click the New AT command button.  
Enter the heading and AT command to create the AT command.

23.3.3 Registering A6TEL data

A	Q/QnA	FX
○	×	×

[Purpose]  
Register the A6TEL data.

[Operating Procedure]  
[Tools] → [Set TEL data] → [TEL data]

[Dialog Box] (For use of A series)

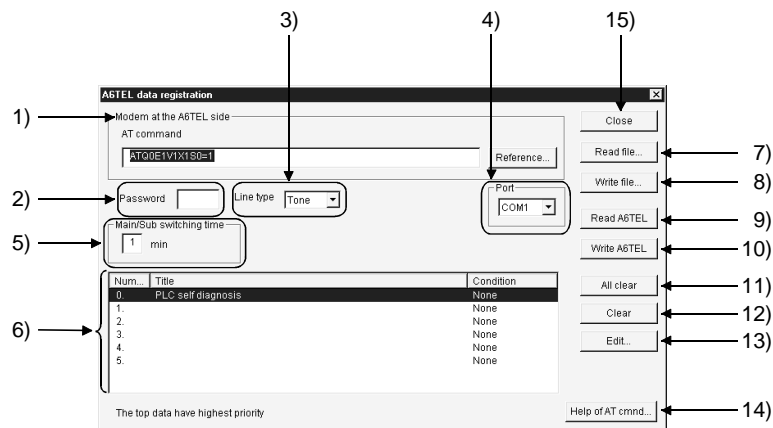

[Description] (For use of A series)

- 1) Modem at the A6TEL side  
Set the AT command of the A6TEL side modem.  
Direct input  
Enter directly. The number of set characters is 70.  
Browse (Only the AT command of the TEL side connection modem may be browsed)  
Clicking the Browse button shows the AT command dialog box.  
Choose the AT command you want to set, and click the Select button.
- 2) Password (Set any password)  
Set the password for access to the A6TEL.  
Set in four characters.
- 3) Line type  
Choose the tone or pulse.

- 4) Port  
Set the communication port number used to read/write the A6TEL data.

- 5) Main/Sub switching time  
Regular and sub phone numbers can be set.
  - Notice destination when the regular and sub phone numbers have been registered

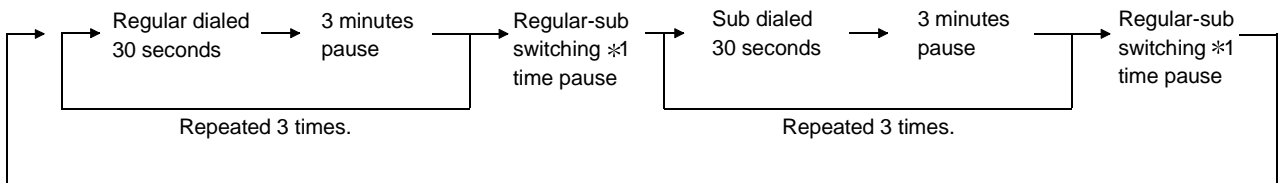

Repeated until the handset is made on-hook at notice destination.

- Notice destination when only the regular phone number has been registered

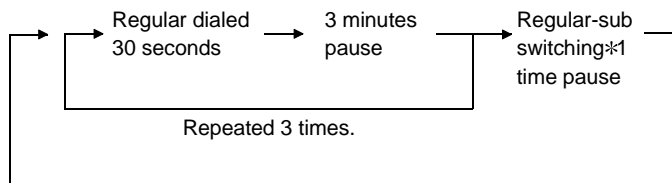

Permanent notice \*2

- \*1: Time can be set within the range 0 to 99 in increments of 1 minute.
- \*2: Notice continues if the handset is made off-hook at notice destination.  
Clear the permanent notice by
  - Placing the peripheral device and A6TEL online (telephone line connected), or
  - Moving the DIP switch 1 or 2 of the A6TEL from ON to OFF.

- 6) Notice data list  
Shows the titles and set conditions of the notice data.
- 7) **Read file** button  
Reads the A6TEL data file or GPPA format A6TEL data file.
- 8) **Write file** button  
Saves the TEL data created with GPPW onto HD, FD or the like.

- 9) **Read A6TEL** button  
Reads the TEL data set to the A6TEL.  
The read data appears on the screen.
- 10) **Write A6TEL** button  
Writes the TEL data created with GPPW to the A6TEL.
- 11) **Clear all** button  
Deletes all notice data registered.
- 12) **Clear** button  
Deletes only the notice data selected in the notice data list.
- 13) **Edit** button

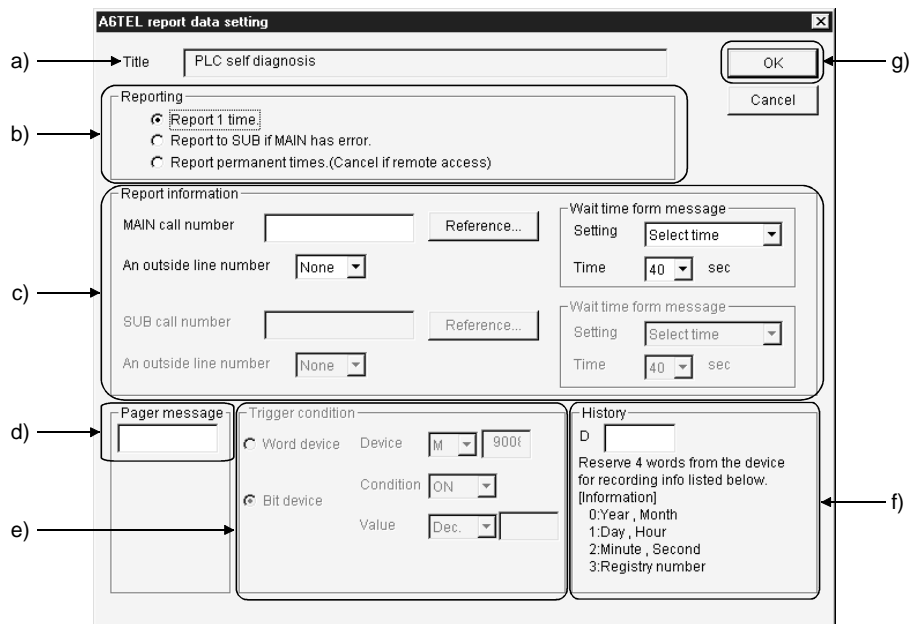

- a) **Heading**  
Sets the heading to the data to be set as the notice destination of the A6TEL.  
When the data written to the A6TEL once is reread, the heading is not displayed. (Since it is written to the peripheral device only.)  
The number of set characters is 60.
- b) **Reporting**  
Choose the processing performed after the trigger conditions hold.



- c) Notice destination information
  - Set the notice destination information.
  - Phone number
    - Set the phone number of the notice destination.
    - Only 0 to 9, \*, # and - may be used.
    - The number of set characters is 17.
  - Outside line access number
    - Set the outside line access number of the notice destination.
    - 0 to 9, # and \* may be selected.
  - Pager announcement time
    - Setting
      - Choose the time setting.
    - Set time (dial message pause time)
      - Set pause time when it is needed from when the A6TEL make a phone call until it sends a message.
      - The time that may be set is 0 to 99 seconds.
- d) Pager message
  - Set the message to be sent to the pager.
  - Message
    - Up to 10 characters may be set using 0 to 9, # and \*.
- e) Trigger condition
  - Set the trigger device, the device number, and the status (ON/OFF) for a bit device, or the device value for a word device, which are used when the A6TEL performs notice processing.
- f) History
  - Set the data registers which store the other end, date and time when the A6TEL notified the pager. The setting range is D0 to 25980.

	b15	to	b8	b7	to	b0
Dn	Year			Month		
Dn+1	Day			Hour		
Dn+2	Minute			Second		
Dn+3	Notice destination					

- g)  button
  - Click this button when the setting is over.
- 14)  button
  - Gives instructions for AT command setting.
- 15)  button
  - Saves the edited data and terminates the TEL data registration function.

23.3.4 Registering Q6TEL data

A	Q/QnA	FX
×	○	×

[Purpose]  
Register the TEL data.

[Operating Procedure]  
[Tools] → [Set TEL data] → [TEL data]

[Dialog Box] (For use of QnA series)

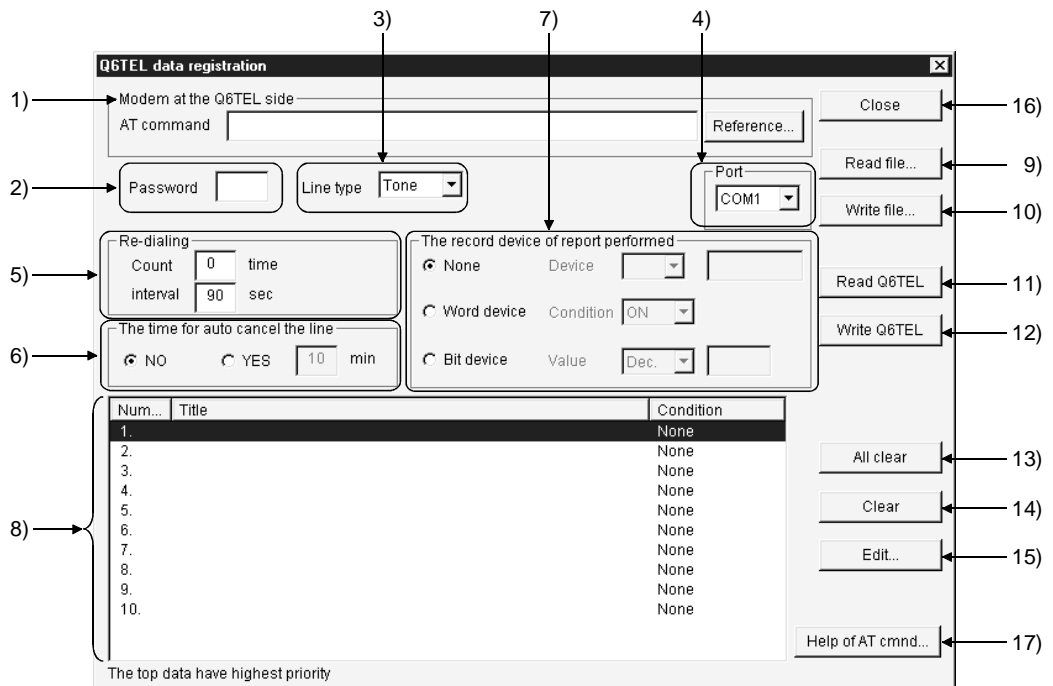

[Description] (For use of QnA series)

- 1) Modem at the Q6TEL side  
Set the AT command of the Q6TEL side modem.  
Direct input  
Enter directly.  
The number of set characters is 40.  
Browse (Only the AT command of the TEL side connection modem may be browsed)  
Clicking the Browse button shows the AT command dialog box.  
Choose the AT command you want to set, and click the Select button.
- 2) Password (may be omitted)  
Set the password for access to the Q6TEL.  
Set in four characters.
- 3) Line type  
Choose the tone, pulse or ISDN.

- 4) Port  
Set the communication port number used to read/write the Q6TEL data.
- 5) Redial  
Set the redialing function.  
Number of times that may be set  
Any number of times can be set between 1 and 99.  
Interval that may be set  
Any seconds can be set between 90 and 255 seconds.
- 6) The time for auto cancel the line  
Set the line disconnection time at no response.  
Time that may be set (The line is disconnected if there is no response after the set time has elapsed.)  
Any minutes can be set between 1 and 120 minutes.
- 7) The record device of report performed  
Set the device records of whether the Q6TEL has notified or not.
  - ⒶNo  
Device record is not made.
  - ⒷWord device  
The set value of the word device is used for recording.  
Set the device/device number and device value.  
Usable device/device number
    - D0 to D25983
    - R0 to 32767
    - W0 to 657F
    - ZR0 to 65535Usable device value
    - Decimal -32768 to 32767
    - Hexadecimal 0 to FFFF (K0 to K32767 for T/C)
  - ⒸBit device  
The set value of the bit device is used for recording.  
Set the device/device number and device status (ON, OFF).  
Usable device/device number
    - X0 to 1FFF
    - Y0 to 1FFF
    - M0 to 32767
    - L0 to 32767
    - B0 to B7FFF
    - F0 to 32767
    - D0.0 to 25983.F
    - W0.0 to 657F.F
    - R0.0 to 32767.F
    - ZR0.0 to 1042431.F
    - SM0 to 2047
    - SB0 to 7FF
    - SD0.0 to SD2047.F
    - SW0.0 to 7FF.F
- 8) Notice data list  
Shows the titles and set conditions of the notice data.
- 9) Read file button  
Reads the Q6TEL data file or GPPQ format Q6TEL data file.

- 10) **Write file** button  
Writes the Q6TEL data to a file as GPPW format Q6TEL data.
- 11) **Read Q6TEL** button  
Reads the TEL data set to the Q6TEL.  
The read data appears on the screen.
- 12) **Write Q6TEL** button  
Writes the TEL data created with GPPW to the Q6TEL.
- 13) **Clear all** button  
Deletes all notice data registered.
- 14) **Clear** button  
Deletes only the notice data selected in the notice data list.
- 15) **Edit** button

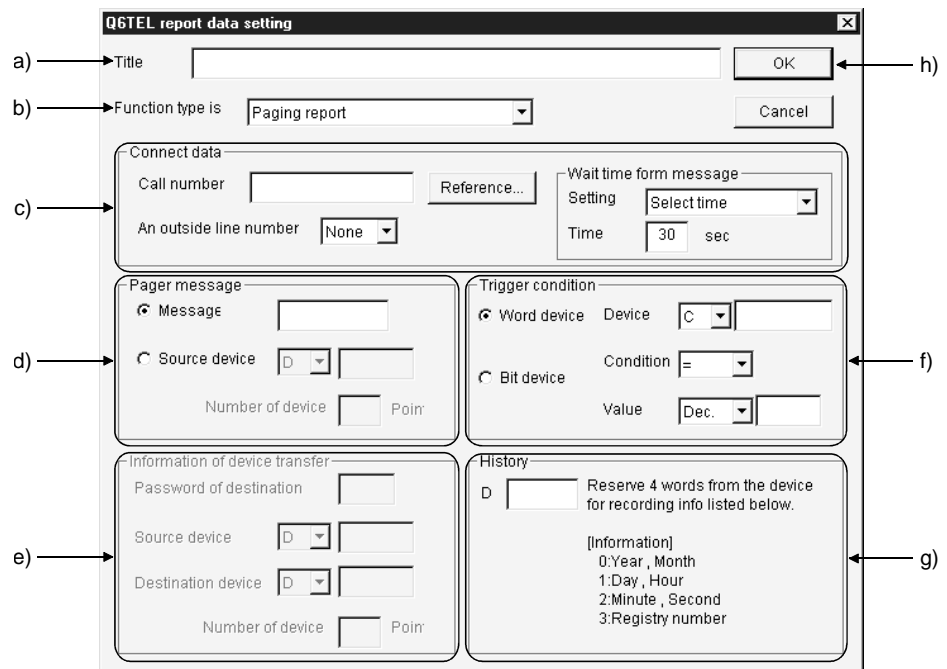

- a) **Heading**  
Sets the heading to the data to be set as the notice destination of the Q6TEL.  
When the data written to the Q6TEL once is reread, the heading is not displayed. (Since it is written to the peripheral device only.)  
The number of set characters is 60.
- b) **Function type is**  
Set the notice destination.

- c) Notice destination information  
Set the notice destination information.  
Phone number
- Set the phone number of the notice destination.
  - Only 0 to 9, \*, # and - may be used.  
(\* and # are used for ISDN sub-address)
  - The number of set characters is 17.
- Outside line access number
- Set the outside line access number of the notice destination.
- Pager announcement time
- Setting  
Choose the time setting.
  - Set time (dial message pause time)  
Set pause time when it is needed from when the Q6TEL make a phone call until it sends a message.  
The time that may be set is 0 to 99 seconds.
- d) Pager message  
Set the message to be sent to the pager.  
Message
- 0 to 9, # and \* may be selected.
  - Set within 10 characters.
- Transfer device
- When specifying the device, specify the first device of the transfer source and set how many points will be transferred.
- Transferable device
- D0 to D25983                      • ZR0 to ZR65535
  - W0 to 657F                         • R0 to R32767
- The number of device points set is between 1 to 480.  
Note that the number of characters displayed on the pager depends on the pager used.
- e) Device transfer information (may be set only when Q6TEL-Q6TEL communication is set)  
Set the device whose data will be transferred between the Q6TELS.
- D0 to D25983                      • R0 to R32767
  - ZR0 to ZR65535                   • W0 to 657F
- f) Trigger condition  
Set the trigger device, the device number, and the status (ON/OFF) for a bit device, or the device value for a word device, which are used when the Q6TEL performs notice processing.

- g) History  
 Set the data registers which store the other end, date and time when the Q6TEL notified the pager. The setting range is D0 to 25980.

	b15	to	b8	b7	to	b0
Dn	Year			Month		
Dn+1	Day			Hour		
Dn+2	Minute			Second		
Dn+3	Notice destination					

- h)  button  
 Click this button when the setting is over.

- 16)  command button  
 Gives instructions for AT command setting.

- 17)  button  
 Saves the edited data and terminates the TEL data registration function.

POINT
<ul style="list-style-type: none"> <li>Note that the device settings in the notice completion record device setting, transfer devices, device transfer information and history depend on the PLC parameter device setting.</li> </ul>

23.3.5 Setting the FX PLC

A	Q/QnA	FX
×	×	○

[Purpose]

Set the modem function of the FX<sub>1S</sub>, FX<sub>1N</sub>, FX<sub>2N</sub> or FX<sub>2NC</sub> PLC.

[Operating Procedure]

[PLC parameter] → <<PLC system (1)>>, <<PLC system (2)>> tab

[Dialog Box]

<<PLC system (1)>>

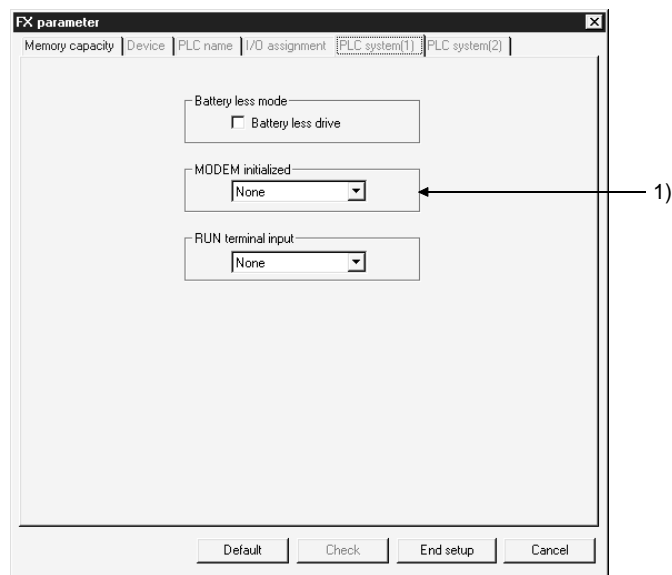

<<PLC system (2)>>

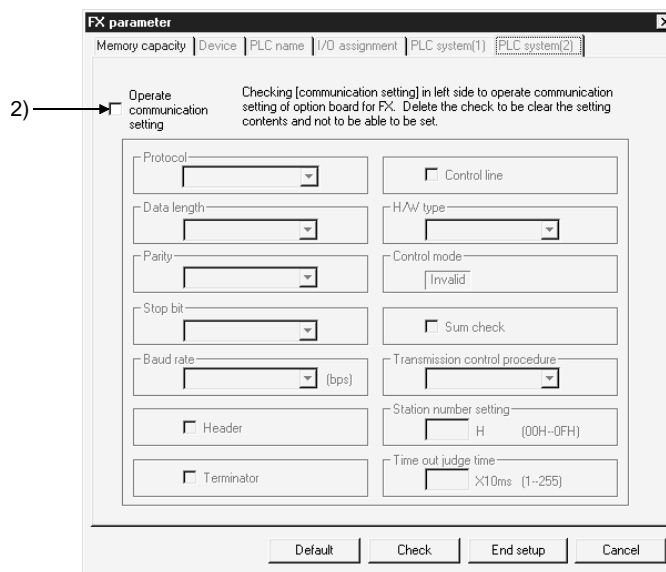

[Description]

- 1) MODEM initialized  
Set the command to initialize the PLC side modem used for remote access to the PLC.
  
- 2) Operate communication setting  
Uncheck the check box to set the PLC to be remote-accessed. (Refer to Section 13.22.)

[Instructions for sequence program]

To make remote access, the special data register D8120 (communication format) value of the PLC must be set to "0".

This setting can be cleared to "0" by unchecking the "Operate communication setting" check box in PLC system. However, remote access cannot be made if any value other than "0" is written in D8120 in the sequence program. In this case, correct the sequence program so that a specific value is not written to D8120.



[User setting of the modem]

If you set the modem initialization to the "user setting mode" in PLC system, set the AT command of the modem in the following procedure.

- Initialization command system  
To initialize the modem, use the AT command developed by Hayes, U.S.A. This command is generally represented in the following format.

A	T	Command+parameter	Command+parameter	Command+parameter	-----	CR	LF
---	---	-------------------	-------------------	-------------------	-------	----	----

Confirm the details of the AT command in the manual of the modem used.

- If you choose the "user registration mode" in the aforementioned "PLC mode setting", FX1N, FX2N, or FX2NC PLC transmits the contents of data registers D1000 to D1059 and FX1S transmits the contents of data registers D200 to D255 as the modem initialization command to the modem via the RS-232C communication device after it has sent the AT&F (initialization to factory setting) command at power-on of the PLC.

Write the user-specified modem initialization command in advance to data registers D1000 to D1059 (FX1N, FX2N, FX2NC) and D200 to D255 (FX1S) using the peripheral device's current value changing function or sequence program.

Initialization command entry example: ATE0S0=2Q1&D0&M4Q0JO&W

Register No.	ASCII	Hexadecimal	Register No.	ASCII	Hexadecimal
D1000	A	41	D1013	&	26
D1001	T	54	D1014	M	4D
D1002	E	45	D1015	4	34
D1003	0	30	D1016	\	5C
D1004	S	53	D1017	Q	51
D1005	0	30	D1018	0	30
D1006	=	3D	D1019	\	5C
D1007	2	32	D1020	J	4A
D1008	Q	51	D1021	0	30
D1009	1	31	D1022	&	26
D1010	&	26	D1023	W	57
D1011	D	44	D1024	CR	0D
D1012	0	30	D1025	LF	0A

The initialization command registered by the user may be specified in D1000 and subsequent (FX1N, FX2N, FXNC) and in D200 and subsequent (FX1S), but its transmission is ended as soon as "0" is read at any point during transmission.

In creating a sequence program, note that the input area of this initialization command for the modem should not overlap the area of the data registers used in a general sequence program.

- Settings of registered modem  
The following table lists the setting items and their data of the AT command of the modem pre-registered to the PLC.  
The setting items and their data may change with the modem. Confirm the actual settings in the manual of the modem used.

Setting Item	PV-AF288 (AIWA) ATE0S0=2Q1&D0&M5\Q0\JO&W	ME3314 (OMRON) * ATE0S0=2Q1&D0&H0&R1S15=8&W
Command echo setting	E0 (no)	E0 (no)
Number of automatic incoming call ringers	S0=2 (twice)	S0=2 (twice)
Result code indication	Q1 (no)	Q1 (no)
DTR control	&D0 (normally ON)	&D0 (normally ON)
Communication mode	&M5 (V.42bis)	S15=8 (V.42bis)
Terminal flow control system	\Q0 (no)	&R1 (no)
Send data flow control	—	&H0 (no)
Terminal speed fixed mode	\J0 (fixed)	—
Write to nonvolatile memory	&W	&W

\*: The setting of the AT command compatible with the ME3314 (OMRON) has been added to version V2.01 or later (serial No. 78 or later) of the FX<sub>2N</sub> PLC.  
The FX<sub>1S</sub>, FX<sub>1N</sub>, FX<sub>2NC</sub> PLC is compatible from its first products.

[Setting by programming software other than GPPW]

- The FX<sub>2N</sub> or FX<sub>2NC</sub> PLC side setting may also be made using any of the following programming software.  
FX-PCS/WIN Version V2.10 or later (for Windows)  
FX-PCS-KIT/98 Version V4.00 or later (for PC-9800)  
FX-PCS-KIT/V Version V2.00 or later (for DOS/V)  
FX-A7PHP-KIT Version V3.00 or later (for A7PHP)
- Set the modem to be used in the "PLC mode setting" of any software.
- If D8120 (communication format) must be cleared to zero in the software other than FX-PCS/WIN, clear all PLC parameters and then re-set the parameters other than [], the keywords, etc.
- Use the user setting method, etc. for the modem as described in this manual.

## 23.4 Connecting/Disconnecting the Line

### 23.4.1 Connecting the line automatically

A	Q/QnA	FX
○	○	○

**[Purpose]**

The connection method for remote access is described.

**[Operating Procedure]**

[Tools] → [Set TEL data] → [Connection]

**[Dialog Box]**

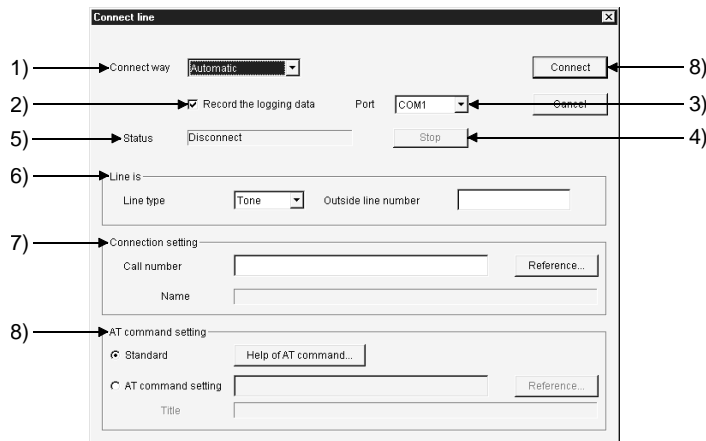

**[Description]**

1) Connect way

Choose the automatic or manual (line connection via switchboard) system. For manual connection, refer to Section 23.4.2.

2) Record the logging data

In the log file, you can check the line connection time, line disconnection time, line usage time, line connection destination name, other end phone number, and call back or normal connection.

The storage place and file name of the log file are as follows.

Storage place: GPPW installation destination\log (Default: Melsec\Gppw\log)

Log file name : Year/Month/Day.data (e.g. 980929.log)

- 3) Port  
Choose the COM port No. connected with the modem.
- 4)  button  
Suspends line connection during line connection.
- 5) Status  
Shows the connection status of the line.
- 6) Line designation  
Line type  
Choose the tone, pulse or ISDN.  
Outside line access number
- 7) Connection destination designation  
Set the phone number of the other end.  
Also, presetting the phone number in the phone number book allows the phone number of the other end to be set from the  button.
- 8) AT command designation
  - Standard  
Specify the standard command of the modem.
  - AT command designation  
If the line does not connect properly using the standard AT command, refer to the data displayed by pressing the  button and the manual of the modem, and create the AT command.  
When the FX PLC is connected, create the AT command in accordance with the information of Help.

[Setting Procedure]

1. Set the line connection system.
2. Set the port.
3. Set the line type.
4. Set the phone number of the other end.
5. Specify the AT command. (Normally set the standard command.)
6. Click the  button.

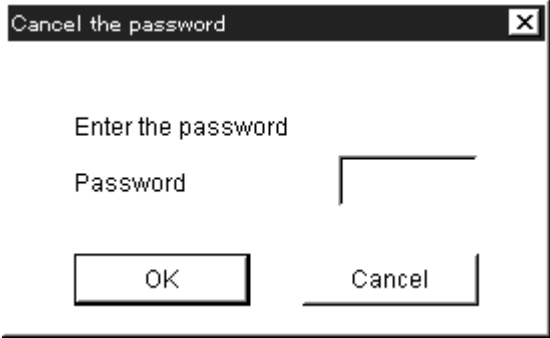
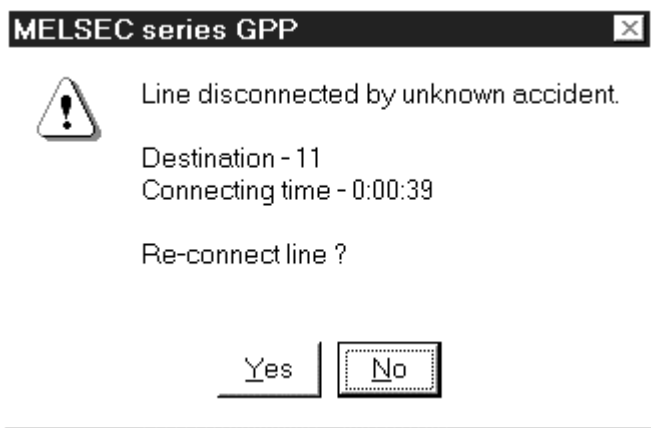
POINTS	<ul style="list-style-type: none"> <li>• Telephone line connection may also be made from "Online" → "Transfer setup".</li> <li>• If a password has been set to the A6TEL/Q6TEL, the following dialog box appears to clear the password. If the password is wrong, the line is not connected.</li> </ul> <div style="text-align: center; margin: 10px 0;">  </div> <ul style="list-style-type: none"> <li>• If the line being connected is disconnected due to disturbance, the following dialog box appears to select whether the line is to be connected or disconnected.</li> </ul> <div style="text-align: center; margin: 10px 0;">  </div> <ul style="list-style-type: none"> <li>• When the line is connected, the line usage time dialog box appears. The connection time is shown in increments of 5 seconds, and the dialog box closes after the line is disconnected. To select whether the dialog box is shown or hidden, use "View" → "Elapsed time".</li> <li>• If the connection destination is changed to another COM port or communication board (e.g. MELSECNET/10) by the connection destination designation during telephone line connection, the telephone line is kept connected and communication can be made in any communication path.</li> </ul>
--------	--

REMARKS

Serial communication (Q series)

	Remote Access
PLC	1) I/O assignment setting Set the following items by software switching setting. <ul style="list-style-type: none"> <li>• Baudrate, transmission specifications, transmission speed, mode, station number.</li> </ul> 2) Set the following items in a sequence program. <ul style="list-style-type: none"> <li>• Write the initialization command (ATS0=1).</li> <li>• Set the initialization request.</li> </ul> Write the initialization command (ATS0=1) in a sequence program.
Peripheral device	1) AT command registration 2) Telephone number registration

Serial communication (QnA series)

	Remote Access
PLC	1) Set the DIP switches of the module. 2) Set the following items in a sequence program. <ul style="list-style-type: none"> <li>• Write the initialization command (ATS0=1).</li> <li>• Set the initialization request.</li> </ul>
Peripheral device	1) AT command registration 2) Telephone number registration

### 23.4.2 Connecting the line via a switchboard (manual connection)

A	Q/QnA	FX
○	○	○

This section explains the way to connect to a private branch line via a switchboard. Manual line connection cannot be made if the modem does not have the ANS/ORG/TEL select switch.

#### (1) System configuration

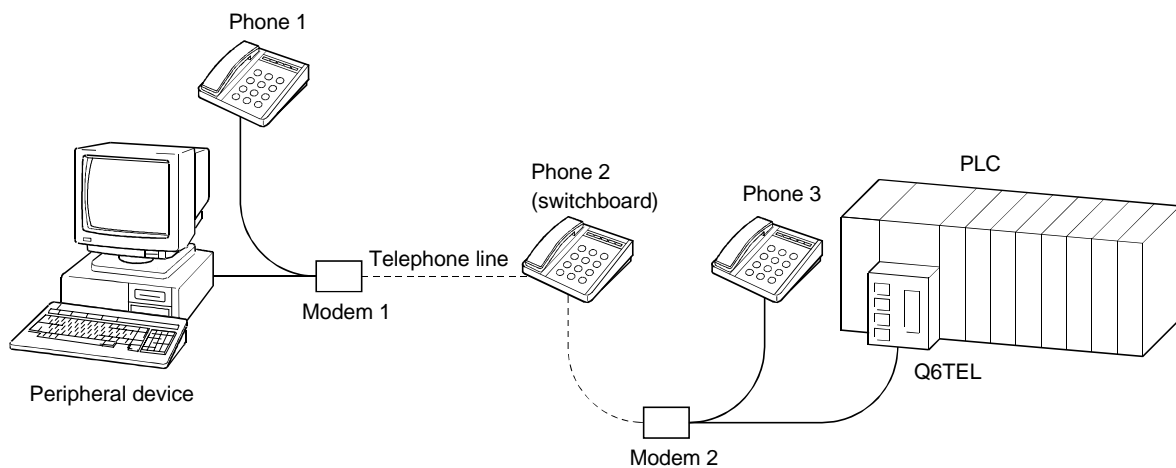

#### (2) Operation procedure

1. [Tools] → [Set TEL data] → [Connection]  
(Choose "Manual" as the line connection system in the line connection dialog box. For the operation procedure, refer to Section 23.4.1.)
2. Set modem 1 on the phone 1 side to the ORG mode and place modem 2 on the phone 3 side to the ANS mode.
3. Make a call from phone 1 to phone 2 (switchboard).
4. Connect phone 1 and phone 3 to the line at phone 2 (switchboard).
5. In conversation between phone 1 and phone 3, determine that the A6TEL/Q6TEL will be connected to the line.
6. Turn on the DATA switch of modem 2 on the phone 3 side.
7. After confirming the "beep" of modem 1 on the phone 1 side, turn on the DATA switch.
8. As soon as the "beep" of modem 1 on the phone 1 side has gone, press the Connection button of the peripheral device.

When the line is connected properly, the "Line connected" dialog box appears.

## (3) Instructions

- 1) The operation timings in steps 6 and 7 are delicate.  
If connection is not made well, repeat the operation several times to adjust the timings.
- 2) The modems for manual line connection must have the "ANS ↔ ORG" select switch.  
AIWA PV-AF3361WW
- 3) For manual line connection, the automatic incoming call mode must have been cleared in the A6TEL/Q6TEL/FX<sub>2N</sub> side modem.
  - For the modem which uses a switch to set to the automatic incoming call mode  
Set the automatic incoming call mode switch to the clear position.
  - Change "S0" to "S0=0" in the initialization command.  
When "S0" has already been set to other than 0, change it to "S0=0".
  - If the modem has been set to other than the user registration mode in the PC system setting (1) of the FX<sub>2N</sub> or FX<sub>2CN</sub> PLC, "S0=2" is set in the initialization command.  
When making manual line connection, place the modem in the user registration mode and program the initialization command including "S0=0" for D1000 to D1059.  
Refer to Section 23.3.5.



23.4.3 Disconnecting the line

A	Q/QnA	FX
○	○	○

[Purpose]

The disconnection of the telephone line being connected is described.

[Operating Procedure]

[Tools] → [Set TEL data] → [Disconnection]

[Dialog Box]



# APPENDICES

## Appendix 1 GPP Function Access Ranges in MELSECNET(II/10) Systems

### 1.1 Access Range with MELSECNET (II)

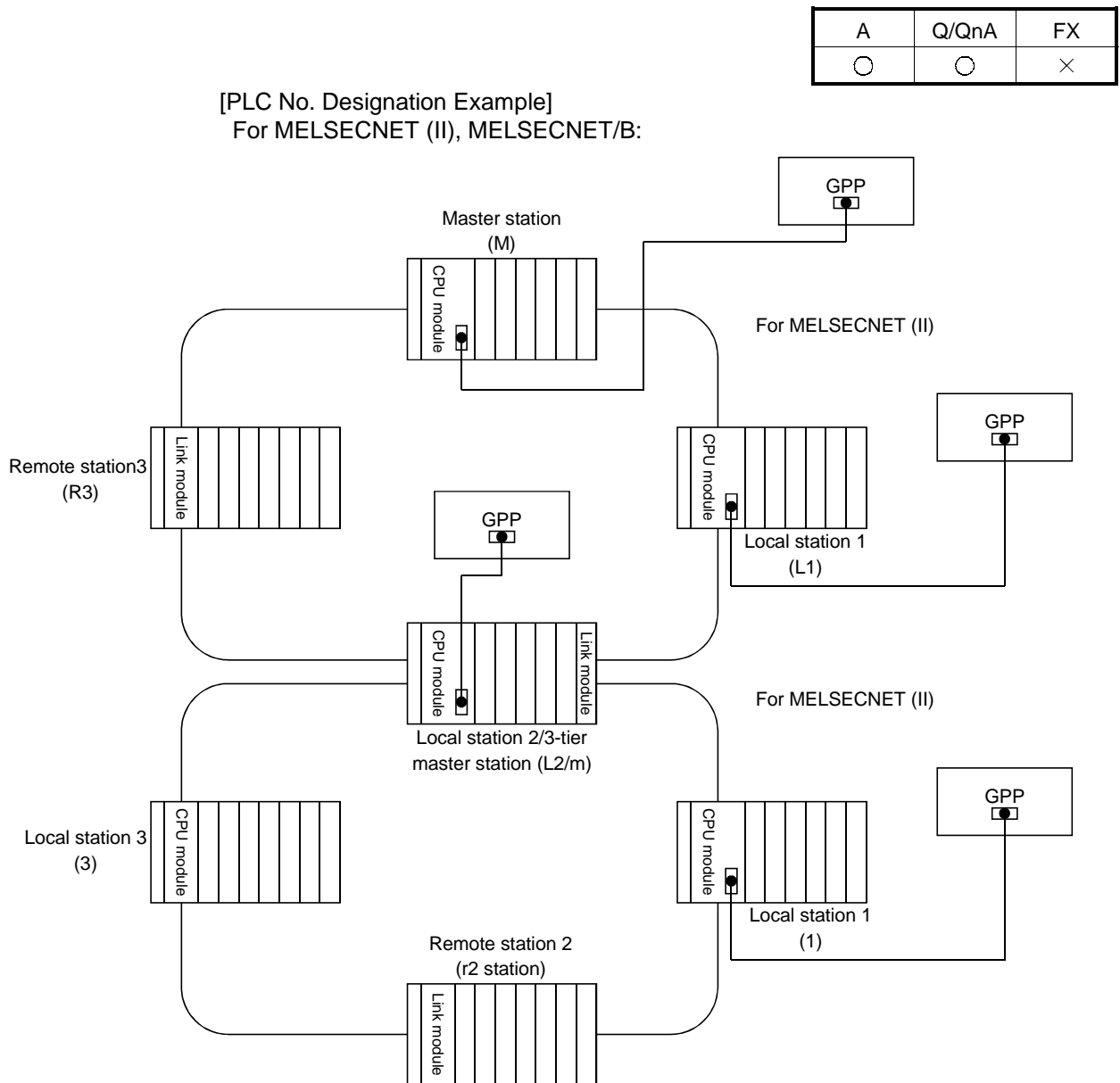

App.

Designated PLC number

GPP-connected Station	PLC Accessed by GPP						
	M	L1	L2/m	R3	I1	r2	I3
M	○	○	○	×	×	×	×
L1	○	○	×	×	×	×	×
L2/m	○	×	○	×	○	×	○
R3	○	×	×	×	×	×	×
I1	×	×	○	×	○	×	×
r2	×	×	○	×	×	×	×
I3	×	×	○	×	×	×	○

○ ... Designating the PLC number (station number) of the relevant programmable controller allows access to all devices.

<b>POINT</b>
<p>1. Even if any tier in the figure above is MELSECNET/B, the designated numbers are the same.</p>

## 1.2 Access Range for an A Series Start

A	Q/QnA	FX
○	○	×

For PLC to PLC network  
When using a MELSECNET/10 2-tier system:

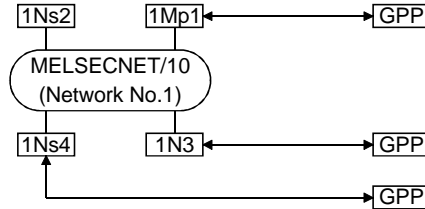

GPP-connected station	Station Accessible from GPP			
	1Mp1	1Ns2	1N3	1Ns4
1Mp1	FF	1-2	1-3	1-4
1N3	×	×	FF	×
1Ns4	1-1	1-2	1-3	FF

- [MELSECNET/10  
PLC to PLC network]
- Mp station...Control station
- Ns station...Normal station (AnUCPU)
- N station....Normal station (CPUs excluding AnU (AnA/AnNCPU))
- [MELSECNET (II)]
- M station....Master station
- L station.....Local station
- R station.....Remote station
- FF: Host station

• When using a MELSECNET/10 multi-tier system:

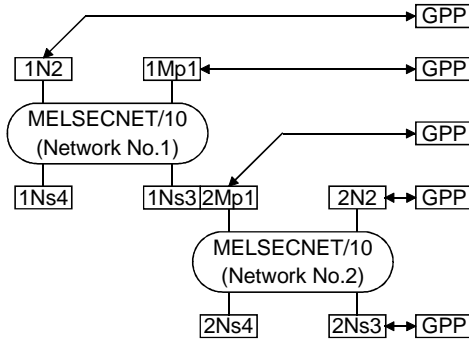

GPP-connected Station	Station Accessible from GPP						
	1Mp1	1N2	1Ns3/2Mp1	1Ns4	2N2	2Ns3	2Ns4
1Mp1	FF	1-2	1-3	1-4	2-2	2-3	2-4
1N2	×	FF	×	×	×	×	×
1Ns3/2Mp1	1-1	1-2	FF	1-4	2-2	2-3	2-4
2N2	×	×	×	×	FF	×	×
2Ns3	1-1	1-2	2-1	1-4	2-2	2-3	FF

• When using a MELSECNET/10 / MELSECNET(II) composite system:

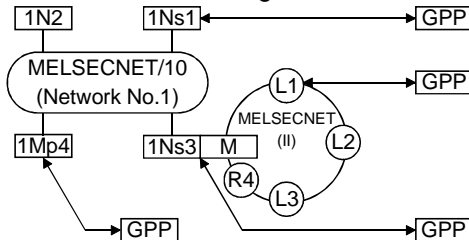

GPP-connected Station	Station Accessible from GPP							
	1Ns1	1N2	1Ns3/M	1Mp4	L1	L2	L3	R4
1Ns1	FF	1-2	1-3	1-4	×	×	×	×
1Ns3/M	1-1	1-2	FF	1-4	1	2	3	×
1Mp4	1-1	1-2	1-3	FF	×	×	×	×
L1	×	×	0	×	FF	×	×	×

"Station accessible from GPP" in the tables:  
<Example>

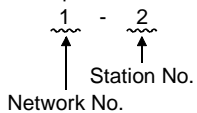

• When using an AnA/AnNCPU as an intermediate station:

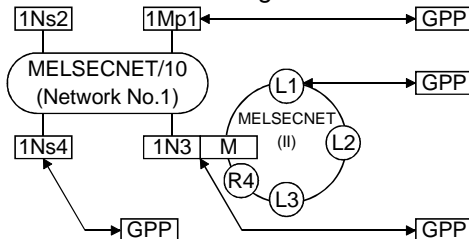

GPP-connected station	Station Accessible from GPP							
	1Mp1	1Ns2	1N3/M	1Ns4	L1	L2	L3	R4
1Mp1	FF	1-2	1-3	1-4	×	×	×	×
1N3/M	×	×	FF	×	1	2	3	×
1Ns4	1	2	3	FF	×	×	×	×
L1	×	×	0	×	FF	×	×	×

For remote I/O network

- When using a MELSECNET/10 2-tier system:

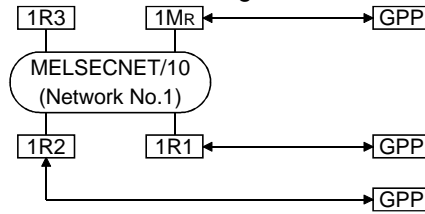

GPP-connected Station	Station Accessible from GPP			
	1Mr	1R1	1R2	1R3
1Mr	FF	×	×	×
1R1	0	×	×	×
1R2	0	×	×	×

- When using a MELSECNET/10 multi-tier system:

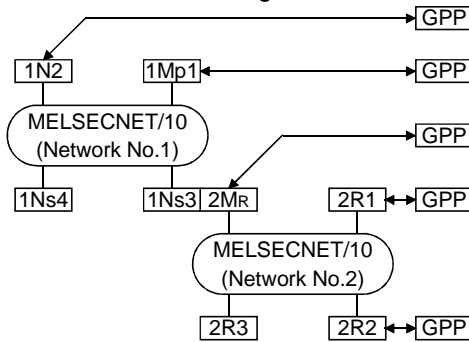

GPP-connected Station	Station Accessible from GPP						
	1Mp1	1N2	1Ns3/2Mr	1Ns4	2R1	2R2	2R3
1Mp1	FF	1-2	1-3	1-4	×	×	×
1N2	×	FF	×	×	×	×	×
1Ns3/2Mr	1-1	1-2	FF	1-4	×	×	×
2R1	1-1	1-2	0	1-4	×	×	×
2R2	1-1	1-2	0	1-4	×	×	×

- When using a MELSECNET/10, MELSECNET (II) composite system:

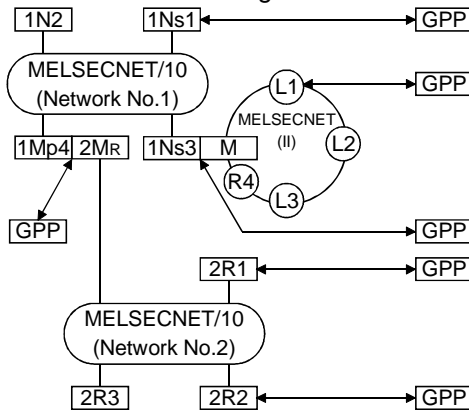

GPP-connected Station	Station Accessible from GPP										
	1Ns1	1N2	1Ns3/M	1Mp4/2Mr	2R1	2R2	2R3	L1	L2	L3	R4
1Ns1	FF	1-2	1-3	1-4	×	×	×	×	×	×	×
1Ns3/M	1-1	1-2	FF	1-4	×	×	×	1	2	3	×
1Mp4/2Mr	1-1	1-2	1-3	FF	×	×	×	×	×	×	×
2R1	1-1	1-2	1-3	0	×	×	×	×	×	×	×
2R2	1-1	1-2	1-3	0	×	×	×	×	×	×	×
L1	×	×	0	×	×	×	×	FF	×	×	×

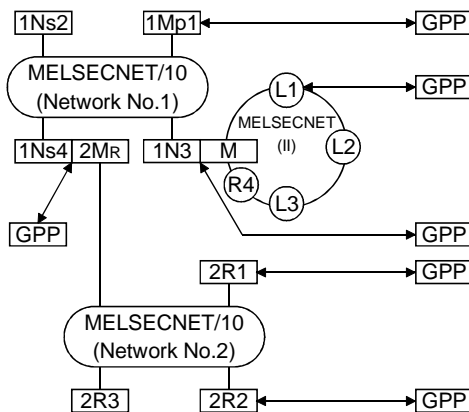

GPP-connected Station	Station Accessible from GPP										
	1Mp1	1Ns2	1Ns3/M	1Ns4/2Mr	2R1	2R2	2R3	L1	L2	L3	R4
1Mp1	FF	1-2	1-3	1-4	×	×	×	×	×	×	×
1Ns3/M	×	×	FF	×	×	×	×	1	2	3	×
1Ns4/2Mr	1-1	1-2	1-3	FF	×	×	×	×	×	×	×
2R1	1-1	1-2	1-3	0	×	×	×	×	×	×	×
2R2	1-1	1-2	1-3	0	×	×	×	×	×	×	×
L1	×	×	0	×	×	×	×	FF	×	×	×

### 1.3 Access Range for a QnA Series Start

A	Q/QnA	FX
×	○	×

For MELSECNET/10 PLC to PLC network

- When using a MELSECNET/10 2-tier system:

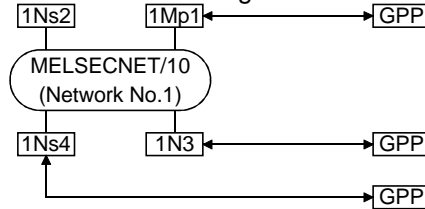

Designated PLC number

GPP-connected Station	Station Accessible from GPP			
	1Mp1	1Ns2	1N3	1Ns4
1Mp1	FF	1-2	×	1-4
1N3	×	×	×	×
1Ns4	1-1	1-2	×	FF

× : Access not possible

Mp station...Control station  
Ns station...Normal station (QnACPU)  
N station....Normal station (CPUs excluding QnA (AnU/AnA/AnNCPU))

In the figure to the right, the first digit for each station indicates the network number and the final line indicates the station number.  
FF: Host station

- When using a MELSECNET/10 multi-tier system:

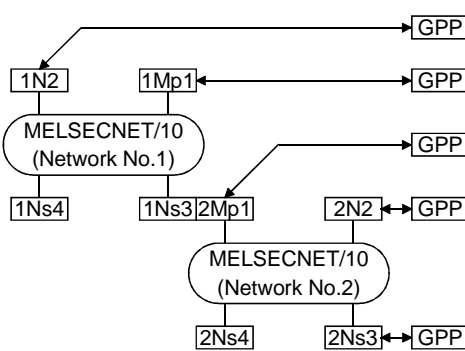

Designated PLC number

GPP-connected Station	Station Accessible from GPP						
	1Mp1	1N2	1Ns3/2Mp1	1Ns4	2N2	2Ns3	2Ns4
1Mp1	FF	×	1-3	1-4	×	2-3	2-4
1N2	×	×	×	×	×	×	×
1Ns3/2Mp1	1-1	×	FF	1-4	×	2-3	2-4
2N2	×	×	×	×	×	×	×
2Ns3	1-1	×	2-1	1-4	×	FF	2-4

× : Access not possible

- When using a MELSECNET/10, MELSECNET (II) composite system: (Intermediate station: QnACPU)

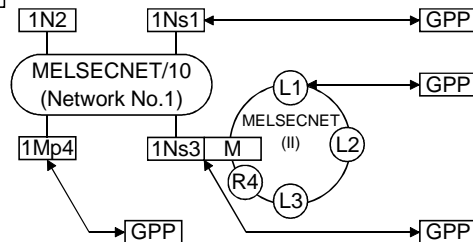

Designated PLC number

GPP-connected Station	Station Accessible from GPP							
	1Ns1	1N2	1Ns3/M	1Mp4	L1	L2	L3	R4
1Ns1	FF	×	1-3	1-4	×	×	×	×
1Ns3/M	1-1	×	FF	1-4	1	2	3	×
1Mp4	1-1	×	1-3	FF	×	×	×	×
L1	×	×	0	×	FF	×	×	×

× : Access not possible

"Station accessible from GPP" in the tables:  
<Example>

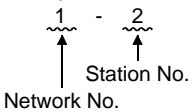

- (Intermediate station: AnU/AnA/AnNCPU)

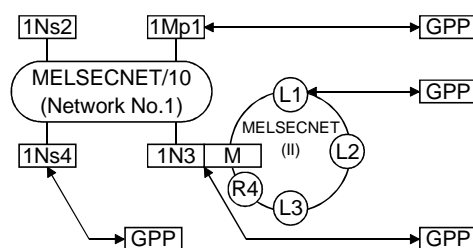

Designated PLC number

GPP-connected Station	Station Accessible from GPP							
	1Mp1	1Ns2	1Ns3/M	1Ns4	L1	L2	L3	R4
1Mp1	FF	1-2	×	1-4	×	×	×	×
1Ns3/M	×	×	×	×	×	×	×	×
1Ns4	1-1	1-2	×	FF	×	×	×	×
L1	×	×	×	×	FF	×	×	×

× : Access not possible

## POINT

- To access a PLC in another station, routing parameters must be set by using the GPP function.  
For details on setting network parameters, refer to the "online" manual.  
For details of the network parameters themselves, refer to the MELSECNET/10 Network System Reference Manual.

For MELSECNET/10 remote I/O network

• When using a MELSECNET/10 2-tier system

**[MELSECNET/10 PLC to PLC network]**  
 Mp station....Control station  
 Ns station....Normal station (QnACPU)  
 N station.....Normal station (CPUs excluding QnA) (AnU/AnA/AnNCPU)

**[MELSECNET/10 Remote I/O network]**  
 MR station...Master station (QnACPU)  
 R station.....Remote station

**[MELSECNET (II)]**  
 M station.....Master station  
 L station.....Local station  
 R station.....Remote station

In the figure to the right, the first digit for each station indicates the network number and the final line indicates the station number.  
 However, the station number of MR (master station) is not shown because it is "0."  
 FF: Host station

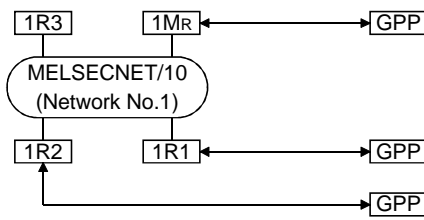

Designated PLC number

GPP-connected Station	Station Accessible from GPP			
	1MR	1R1	1R2	1R3
1MR	FF	×	×	×
1R1	0	×	×	×
1R2	0	×	×	×

× : Access not possible

1. The following devices of a remote I/O station connected to GPPW can be monitored: X, Y, B, W.
2. Ladder monitoring, status monitoring (in remote I/O stations connected to GPPQ, the CPU connected to the master station can be monitored).
3. Loop test, setting confirmation test, station order confirmation test, communication test (testing with a remote station treated as the host station is possible).

• When using a MELSECNET/10 multi-tier system:

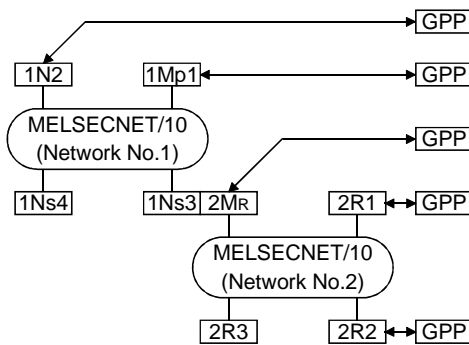

Designated PLC number

GPP-connected Station	Station Accessible from GPP						
	1Mp1	1N2	1Ns3/2MR	1Ns4	2R1	2R2	2R3
1Mp1	FF	×	1-3	1-4	×	×	×
1N2	×	×	×	×	×	×	×
1Ns3/2MR	1-1	×	FF	1-4	×	×	×
2R1	1-1	×	1-3	1-4	×	×	×
2R2	1-1	×	0	1-4	×	×	×

× : Access not possible

• When using a MELSECNET/10, MELSECNET (II) composite system:

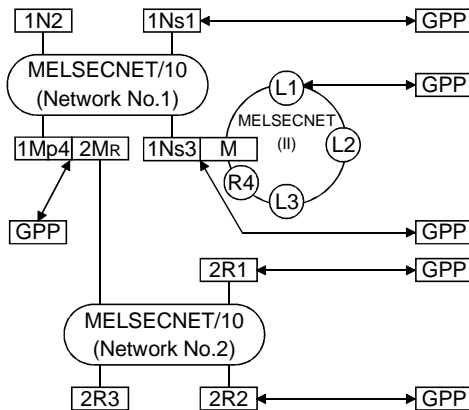

Designated PLC number

GPP-connected Station	Station Accessible from GPP											
	1Ns1	1N2	1Ns3/M	1Mp4/2MR	2R1	2R2	2R3	L1	L2	L3	R4	
1Ns1	FF	×	1-3	1-4	×	×	×	×	×	×	×	
1Ns3/M	1-1	×	FF	1-4	×	×	×	1	2	3	×	
1Mp4/2MR	1-1	×	1-3	FF	×	×	×	×	×	×	×	
2R1	1-1	×	1-3	0	×	×	×	×	×	×	×	
2R2	1-1	×	1-3	0	×	×	×	×	×	×	×	
L1	×	×	0	×	×	×	×	FF	×	×	×	

× : Access not possible

"Station accessible from GPP" in the tables:  
 <Example>

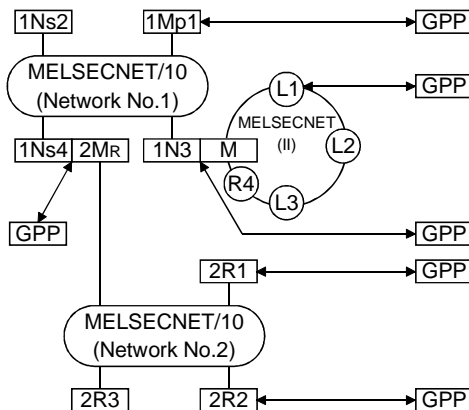
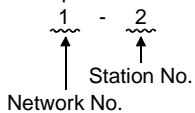

Designated PLC number

GPP-connected Station	Station Accessible from GPP											
	1Mp1	1Ns2	1N3/M	1Ns4/2MR	2R1	2R2	2R3	L1	L2	L3	R4	
1Mp1	FF	1-2	×	1-4	×	×	×	×	×	×	×	
1N3/M	×	×	×	×	×	×	×	×	×	×	×	
1Ns4/2MR	1-1	1-2	×	FF	×	×	×	×	×	×	×	
2R1	1-1	1-2	×	0	×	×	×	×	×	×	×	
2R2	1-1	1-2	×	0	×	×	×	×	×	×	×	
L1	×	×	0	×	×	×	×	FF	×	×	×	

× : Access not possible



### 1.4 Access Range at Q Series Start

A	Q/QnA	FX
×	○	×

For inter-PLC network of MELSECNET/10  
 • MELSECNET/10 two-tier system:

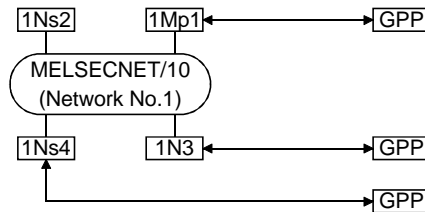

PLC numbers to be specified

GPP Connection Station	Station Accessible from GPP			
	1Mp1	1Ns2	1N3	1Ns4
1Mp1	FF	1-2	×	1-4
1N3	×	×	×	×
1Ns4	1-1	1-2	×	FF

× : Access not possible

Mp station...Control station  
 Ns station...Normal station (QCPU)  
 N station...Ordinary station  
 (CPU except Q/QnA (QCPU-A, AnU, AnA, AnNCPU))  
 The first digit of each station shown on the right indicates the network number, and the last digit the station number.

• MELSECNET/10 multi-tier system:

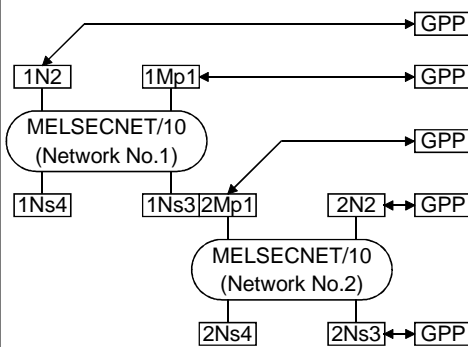

PLC numbers to be specified

GPP Connection Station	Station Accessible from GPP						
	1Mp1	1N2	1Ns3/2Mp1	1Ns4	2N2	2Ns3	2Ns4
1Mp1	FF	×	1-3	1-4	×	2-3	2-4
1N2	×	×	×	×	×	×	×
1Ns3/2Mp1	1-1	×	FF	1-4	×	2-3	2-4
2N2	×	×	×	×	×	×	×
2Ns3	1-1	×	2-1	1-4	×	FF	2-4

× : Access not possible

"Station accessible from GPP" in the tables:

<Example>

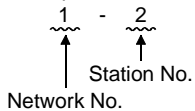

## Appendix 2 MELSECNET/10 Board Access Range

---

### 2.1 MELSECNET/10 Board

---

A	Q/QnA	FX
○	○	×

When using a MELSECNET/10 board, confirm the MELSECNET board model names and driver versions indicated below.

	Board	Driver
MELSECNET board for PC/AT	A70BDE-J71LP23GE(fiber optic cable)	SW11VDWT-10P

2.1.1 "A" series start

A	Q/QnA	FX
○	×	×

For MELSECNET/10 PLC-to-PLC network

- When using a MELSECNET/10 2-tier system:

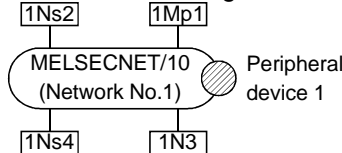

Designated PLC number

	Station Accessible from GPP			
	1Mp1	1Ns2	1N3	1Ns4
Peripheral device 1	1-1	1-2	1-3	1-4

× : Access not possible

- When using a MELSECNET/10 multi-tier system:

Mp station...Control station  
Ns station...Normal station (AnUCPU)  
N station...Normal station  
(CPUs excluding AnU) (AnA/AnNCPU)  
Peripheral devices 1 and 2 are peripheral devices that incorporate a MELSECNET/10 board.  
In the figure to the right, the first digit for each station indicates the network number and the final line indicates the station number.

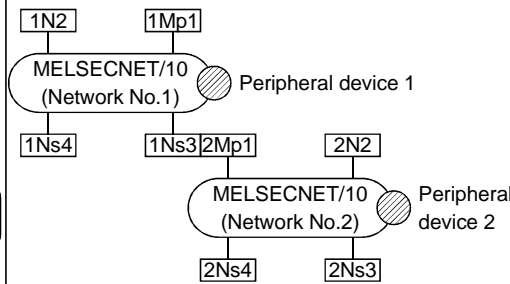

Designated PLC number

	Station Accessible from GPP								
	1Mp1	1N2	1Ns3/2Mp1	Peripheral Device 1	1Ns4	2N2	2Ns3	2Ns4	Peripheral Device 2
Peripheral device 1	1-1	1-2	1-3	×	1-4	2-2	2-3	2-4	×
Peripheral device 2	1-1	1-2	1-3	×	1-4	2-2	2-3	2-4	×

× : Access not possible

- When using a MELSECNET/10 / MELSECNET (II) composite system:

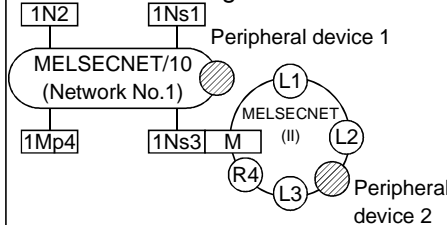

Designated PLC number

	Station Accessible from GPP								
	1Mp1	1N2	1Ns3/2Mp1	1Ns4	Peripheral Device 1	L1	L2	R4	Peripheral Device 2
Peripheral device 1	1-1	1-2	1-3	1-4	×	×	×	×	×
Peripheral device 2	×	×	×	×	×	×	×	×	×

× : Access not possible

"Station accessible from GPP" in the tables:

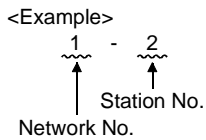

(Intermediate station: AnA/AnNCPU)

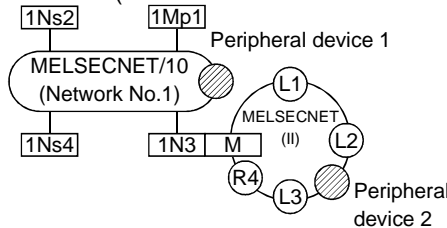

Designated PLC number

	Station Accessible from GPP								
	1Mp1	1N2	1Ns3/2Mp1	1Ns4	Peripheral Device 1	L1	L2	R4	Peripheral Device 2
Peripheral device 1	1-1	1-2	1-3	1-4	×	×	×	×	×
Peripheral device 2	×	×	×	×	×	×	×	×	×

× : Access not possible

<b>POINT</b>
<ul style="list-style-type: none"> <li>• To access a PLC in another station, routing parameters must be set by using the GPP function. For details of the network parameters themselves, refer to the MELSECNET/10 Network System Reference Manual.</li> </ul>

For MELSECNET/10 remote I/O network

- When using a MELSECNET/10 multi-tier system:

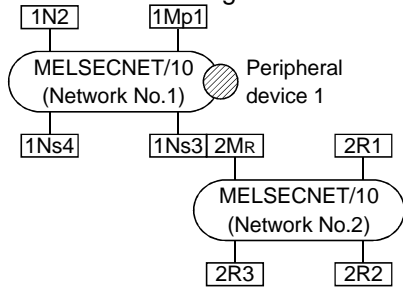

Designated PLC number

	Station Accessible from GPP						
	1Mp1	1N2	1Ns3/ 2Mr	1Ns4	2R1	2R2	2R3
Peripheral device 1	1-1	1-2	1-3	1-4	×	×	×

× : Access not possible

**[MELSECNET/10  
PLC to PLC network]**  
 Mp station....Control station  
 Ns station....Normal station (AnUCPU)  
 N station.....Normal station  
 (CPUs excluding AnU (AnA/AnNCPU))  
**[MELSECNET/10  
Remote I/O network]**  
 Mr station...Master station (AnUCPU)  
 R station.....Remote station  
  
**[MELSECNET (II)]**  
 M station.....Master station  
 L station.....Local station  
 R station.....Remote station  
  
 Peripheral devices 1 and 2 are peripheral devices that incorporate a MELSECNET/10 board.  
 In the figure to the right, the first digit for each station indicates the network number and the final line indicates the station number.  
 However, the station number of Mr (master station) is not shown because it is "0."

- MELSECNET/10 /MELSECNET (II) composite system

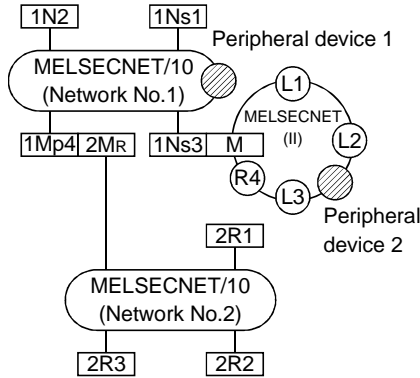

Designated PLC number

	Station Accessible from GPP										
	1Ns1	1N2	1Ns3/ M	1Mp4/ 2Mr	2R1	2R2	2R3	L1	L2	L3	R4
Peripheral device 1	1-1	1-2	1-3	1-4	×	×	×	×	×	×	×
Peripheral device 2	×	×	×	×	×	×	×	×	×	×	×

× : Access not possible

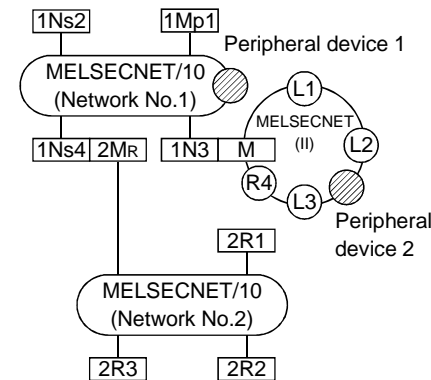

Designated PLC number

	Station Accessible from GPP										
	1Mp1	1Ns2	1N3/M	1Ns4/ 2Mr	2R1	2R2	2R3	L1	L2	L3	R4
Peripheral device 1	1-1	1-2	1-3	1-4	×	×	×	×	×	×	×
Peripheral device 2	×	×	×	×	×	×	×	×	×	×	×

× : Access not possible

"Station accessible from GPP" in the tables:  
 <Example>

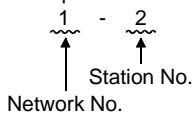

2.1.2 QnA series start

A	Q/QnA	FX
×	○	×

For MELSECNET/10 PLC-to-PLC network

- When using a MELSECNET/10 2-tier system:

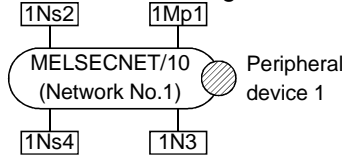

Designated PLC number

	Station Accessible from GPP			
	1Mp1	1Ns2	1N3	1Ns4
Peripheral device 1	1-1	1-2	×	1-4

× : Access not possible

Mp station...Control station  
Ns station...Normal station (QnACPU)  
N station....Normal station (CPUs excluding AnU (AnU/AnA/AnNCPU))  
Peripheral devices 1 and 2 are peripheral devices that incorporate a MELSECNET/10 board.  
In the figure to the right, the first digit for each station indicates the network number and the final line indicates the station number.

- When using a MELSECNET/10 multi-tier system:

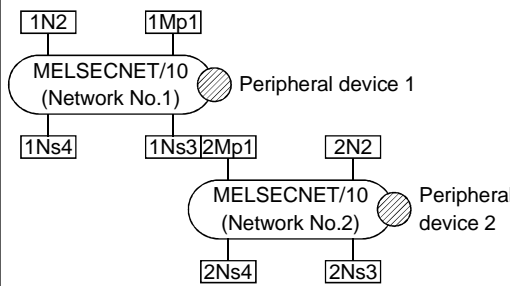

Designated PLC number

	Station Accessible from GPP								
	1Mp1	1N2	1Ns3/2Mp1	Peripheral Device 1	1Ns4	2N2	2Ns3	2Ns4	Peripheral Device 2
Peripheral device 1	1-1	×	1-3	×	1-4	×	2-3	2-4	×
Peripheral device 2	1-1	×	1-3	×	1-4	×	2-3	2-4	×

× : Access not possible

- When using a MELSECNET/10 / MELSECNET (II) composite system:

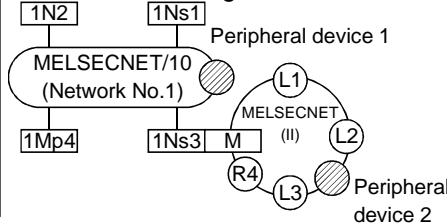

Designated PLC number

	Station Accessible from GPP								
	1Mp1	1N2	1Ns3/2Mp1	1Ns4	Peripheral Device 1	L1	L2	R4	Peripheral Device 2
Peripheral device 1	1-1	×	1-3	1-4	×	×	×	×	×
Peripheral device 2	×	×	×	×	×	×	×	×	×

× : Access not possible

"Station accessible from GPP" in the tables:

<Example>

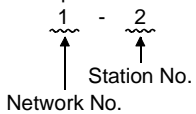

(Intermediate station: AnU/AnA/AnNCPU)

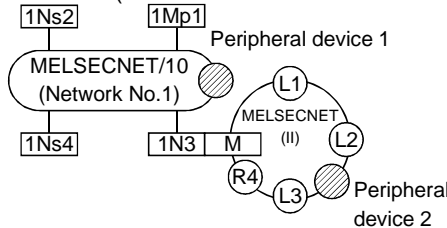

Designated PLC number

	Station Accessible from GPP								
	1Mp1	1Ns2	1Ns3/2Mp1	1Ns4	Peripheral Device 1	L1	L2	R4	Peripheral Device 2
Peripheral device 1	1-1	1-2	×	1-4	×	×	×	×	×
Peripheral device 2	×	×	×	×	×	×	×	×	×

× : Access not possible

<b>POINT</b>
<ul style="list-style-type: none"> <li>To access a PLC in another station, routing parameters must be set by using the GPP function. For details of the network parameters themselves, refer to the MELSECNET/10 Network System Reference Manual.</li> </ul>

For MELSECNET/10 remote I/O network

- When using a MELSECNET/10 multi-tier system:

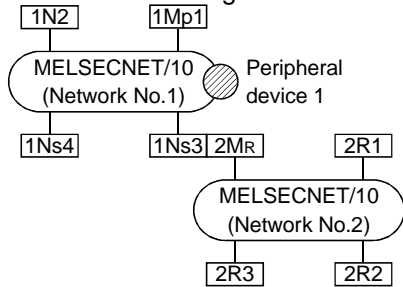

Designated PLC number

	Station Accessible from GPP						
	1Mp1	1N2	1Ns3/ 2M <sub>R</sub>	1Ns4	2R1	2R2	2R3
Peripheral device 1	1-1	×	1-3	1-4	×	×	×

× : Access not possible

**[MELSECNET/10  
PLC to PLC network]**  
 Mp station....Control station  
 Ns station....Normal station (QnACPU)  
 N station.....Normal station  
 (CPUs excluding QnA (AnU/AnA/AnNCPU))  
**[MELSECNET/10  
Remote I/O network]**  
 M<sub>R</sub> station...Master station (QnACPU)  
 R station.....Remote station  
**[MELSECNET (II)]**  
 M station.....Master station  
 L station.....Local station  
 R station.....Remote station  
 Peripheral devices 1 and 2 are peripheral devices that incorporate a MELSECNET/10 board.  
 In the figure to the right, the first digit for each station indicates the network number and the final line indicates the station number.  
 However, the station number of M<sub>R</sub> (master station) is not shown because it is "0."

- MELSECNET/10 /MELSECNET (II) composite system

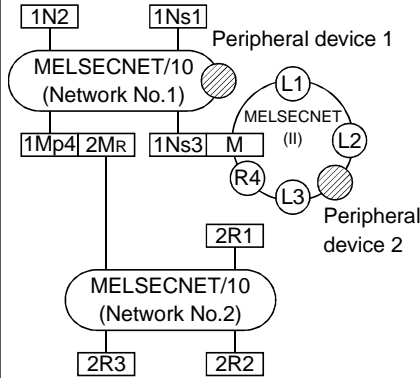

Designated PLC number

	Station Accessible from GPP										
	1Ns1	1N2	1Ns3/ M	1Mp4/ 2M <sub>R</sub>	2R1	2R2	2R3	L1	L2	L3	R4
Peripheral device 1	1-1	×	1-3	1-4	×	×	×	×	×	×	×
Peripheral device 2	×	×	×	×	×	×	×	×	×	×	×

× : Access not possible

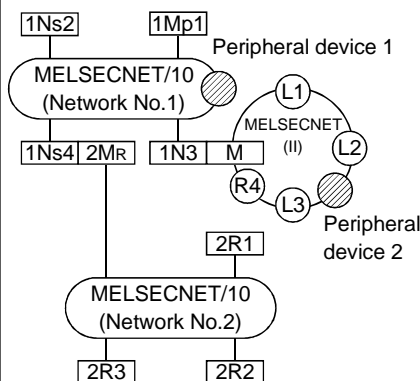

Designated PLC number

	Station Accessible from GPP										
	1Mp1	1Ns2	1N3/M	1Ns4/ 2M <sub>R</sub>	2R1	2R2	2R3	L1	L2	L3	R4
Peripheral device 1	1-1	1-2	×	1-4	×	×	×	×	×	×	×
Peripheral device 2	×	×	×	×	×	×	×	×	×	×	×

× : Access not possible

"Station accessible from GPP" in the tables:

<Example>

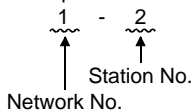

2.1.3 At Q series start

A	Q/QnA	FX
×	○	×

For inter-PLC network of MELSECNET/10

- MELSECNET/10 two-tier system:

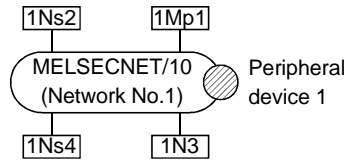

PLC numbers to be specified

	Station Accessible from GPP			
	1Mp1	1Ns2	1N3	1Ns4
Peripheral device 1	1-1	1-2	×	1-4

× : Access not possible

Mp station...Control station  
 Ns station...Ordinary station  
 QCPU  
 N station...Ordinary station  
 (CPU except Q/QnA (QCPU-A, AnU, AnA, AnNCPU))  
 Peripheral devices 1, 2 are those which have built-in MELSECNET/10 boards.  
 The first digit of each station shown on the right indicates the network number, and the last digit the station number.

- MELSECNET/10 multi-tier system:

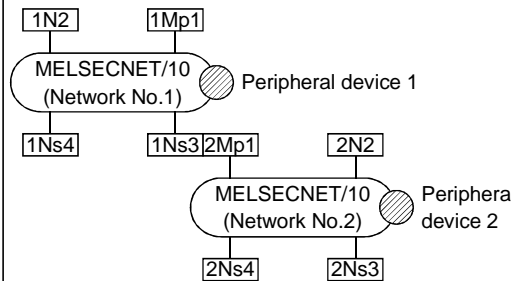

PLC numbers to be specified

	Station Accessible from GPP								
	1Mp1	1N2	1Ns3/ 2Mp1	Periph- eral Device 1	1Ns4	2N2	2Ns3	2Ns4	Periph- eral Device 2
Peripheral device 1	1-1	×	1-3	×	1-4	×	2-3	2-4	×
Peripheral device 2	1-1	×	1-3	×	1-4	×	2-3	2-4	×

× : Access not possible

<b>POINT</b>
<ul style="list-style-type: none"> <li>• To access the other station PLC, routing parameter setting must be made using the GPP function.                      For network parameter setting, refer to the Offline Manual.                      For details of the network parameters, refer to the MELSECNET/10 Network System Reference Manual.</li> </ul>

"Station accessible from GPP" in the tables:

<Example>

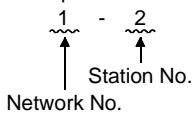

## 2.2 Access Range via an Ethernet Board

A	Q/QnA	FX
○	○	×

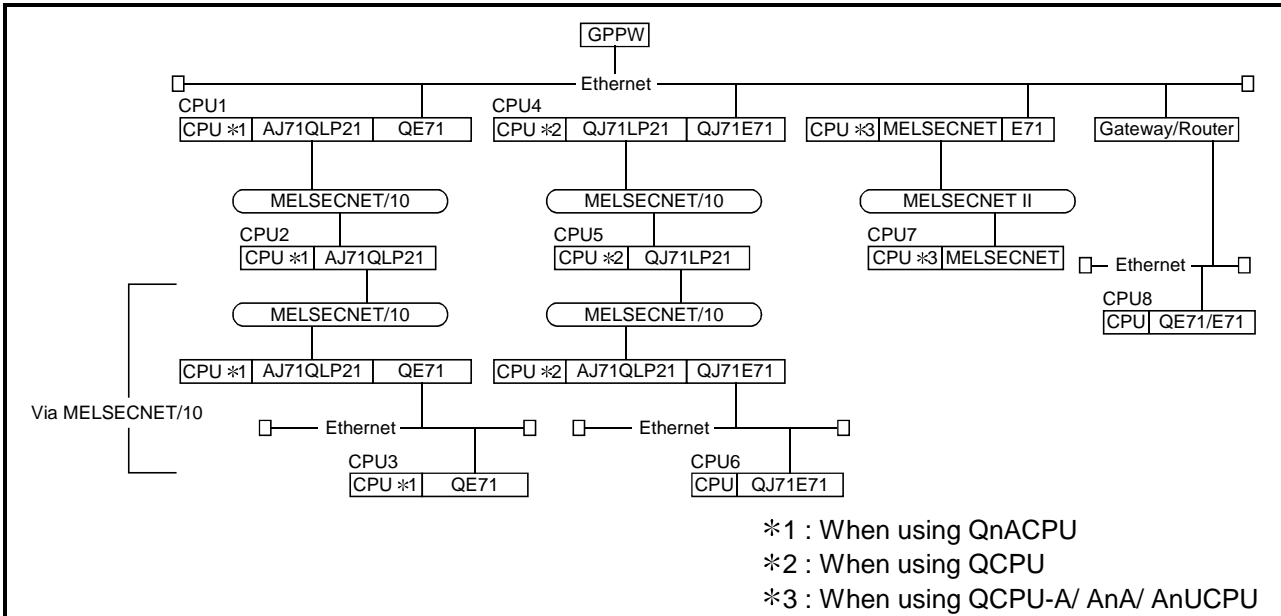



- The access range to master stations/local stations/remote stations/control stations/normal stations via MELSECNET (II)/MELSECNET/10 is the same as via a PLC direct link (via MELSECNET).

Function \ Applicable PLC	CPU1	CPU2	CPU3	CPU4	CPU5	CPU6	CPU7	CPU8
PLC read/write	○	○	○	○	○	○	○	×
Compare with PLC	○	○	○	○	○	○	○	×
Delete PLC *1	○	○	○	○	○	○	○	×
Change PLC data attributes *1	○	○	○	○	○	○	○	×
Keyword setup	○	○	○	○	○	○	○	×
Clear PLC memory	○	○	○	○	○	○	○	×
Format PLC memory *1	○	○	○	○	○	○	○	×
Arrange PLC memory *1	○	○	○	○	○	○	○	×
Set time	○	○	○	○	○	○	○	×
Remote operation	○	○	○	○	○	○	○	×
Ladder monitor	○	○	○	○	○	○	○	×
Batch monitor	○	○	○	○	○	○	○	×
Registration monitor	○	○	○	○	○	○	○	×
Buffer memory	○	○	○	○	○	○	○	×
Monitor condition/stop condition	×	×	×	×	×	×	×	×
Device test	○	○	○	○	○	○	○	×
Step execution	○	○	○	○	○	○	○	×
Partial execution	○	○	○	○	○	○	○	×
Skip execution *1	○	○	○	○	○	○	○	×
Sampling trace	○	○	○	○	○	○	○	×
Diagnostics PLC	○	○	○	○	○	○	○	×
Diagnostics network *2	○	○	○	○	○	○	○	×
Online change*1	○	○	○	○	○	○	○	×
Change TC setting	○	○	○	○	○	○	○	×

○: Access possible ×: Access not possible

\*1: Accessible only to Q/QnACPU.

\*2 Accessible only to network monitoring own and other stations.  
(AnUCPU is handled as equivalent to AnACPU.)

## A series

Corresponding Models	Corresponding Versions	Remarks
AJ71E71,AJ71E71-B5	Initially shipped version and later versions	If a remote I/O is installed, or during communication, the error LED lights.
A1SJ71QE71-B2,A1SJ71QE71-B5	Initially shipped version and later versions	

## QnA series

Corresponding Models	Corresponding Versions	Remarks
AJ71QE71,AJ71QE71-B5	E and later	—
A1SJ71QE71-B2,A1SJ71QE71-B5	E and later	—

- The following restrictions apply for access to AnUCPU via Ethernet.
  - (1) The PLC type must be set as "AnACPU."
  - (2) Sequence programs, device memories, etc. can be used with the AnACPU specification range.  
This means that subprogram 2, subprogram 3, devices extended with AnUCPU, and network parameters, cannot be accessed.

### 2.3 Access Range via CC-Link (AJ65BT-G4)

A	Q/QnA	FX
○	○	×

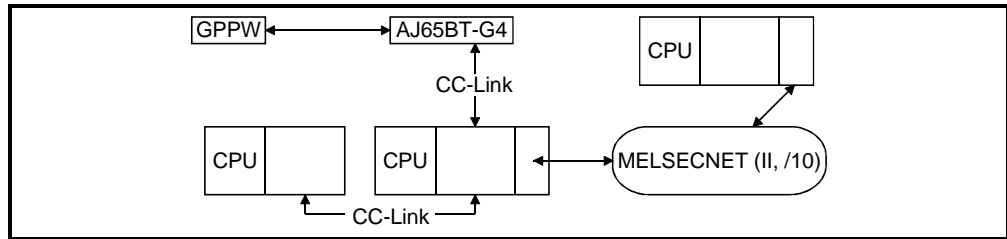

- The access range to master stations/local stations/remote stations/control stations/normal stations via MELSECNET (II)/MELSECNET/10 is the same as via a PLC direct link (via MELSECNET).
- When connecting to ACPU, routing through MELSECNET (II) or MELSECNET/10 is not possible.

○: Access possible    ×: Access not possible    – : Function not supported by ACPU

Applicable PLC Function	ACPU	QnACPU
PLC read/write	○	○
Compare with PLC	○	○
Delete PLC	–	○
Change PLC data attributes	–	○
Keyword setup	○	○
Clear PLC memory	○	○
Format PLC memory	–	○
Arrange PLC memory	–	○
Set time	○	○
Remote operation	○	○
Ladder monitor	○	○
Batch monitor	○	○
Registration monitor	○	○
Buffer memory	○	○
Monitor condition/stop condition	–	×
Device test	○	○
Step execution	○	○
Partial execution	○	○
Skip execution	–	○
Sampling trace	○	○
Diagnostics PLC	○	○
Diagnostics network	×	○ *1
Online change	○	○
Change TC setting	○	○

\*1: Only the network monitor host station and other stations can be accessed.  
(AnUCPU is treated as equivalent to AnACPU.)

Confirm that the AJ65BT-G4 is running one of the following software versions.

CPU	Module Name	AJ65BT-G4 Software Version
ACPU	AJ65BT-G4	A and later
QnACPU		B and later

## 2.4 Access Range via Computer Link

A	Q/QnA	FX
○	×	×

- The access range to master stations/local stations/remote stations/control stations/normal stations via MELSECNET (II)/MELSECNET/10 is the same as via a PLC direct link (via MELSECNET).

PLC	Computer Link Module
AnACPU	AJ71C24-S6/S8,A1SJ71C24-R2,A1SJ71C24-PRF
AnUCPU	AJ71UC24,A1SJ71UC24-R2,A1SJ71UC24-R4,A1SJ71UC24-PRF

Function	Applicable PLC	ACPU
PLC read/write		○
Compare with PLC		○
Delete PLC		—
Change PLC data attributes		—
Keyword setup		○
Clear PLC memory		×
Format PLC memory		—
Arrange PLC memory		—
Set time		○
Remote operation		○
Ladder monitor		○
Batch monitor		○
Registration monitor		○
Buffer memory		×
Monitor condition/stop condition		—
Device test		○
Step execution		×
Partial execution		×
Skip execution		—
Sampling trace		×
Diagnostics PLC		○
Diagnostics network		×
Online change		×
Change TC setting		○
Clear Log		×
Log		×

○: Access possible ×,—: Access not possible

## 2.5 Access Range via Serial Communication

A	Q/QnA	FX
×	○	×

The following table indicates whether each function that can be performed via serial communication is possible or not.

Function	Applicable PLC	QCPU	QnACPU
PLC read/write		○	○
Compare with PLC		○	○
Delete PLC		○	○
Change PLC data attributes		○	○
Keyword setup		—	○
Password setup		○	—
Clear PLC memory		○	○
Format PLC memory		○	○
Arrange PLC memory		○	○
Set time		○	○
Remote operation		○	○
Ladder monitor		○	○
Batch monitor		○	○
Registration monitor		○	○
Buffer memory		○	○
Monitor condition/stop condition		×	×
Device test		○	○
Step execution		○	○
Partial execution		○	○
Skip execution		○	○
Sampling trace		○	○
Diagnostics PLC		○	○
Diagnostics network		○	○
Online change		○	○
Change TC setting		○	○

○: Access possible

The restrictions when executing ladder monitoring, batch monitoring, registration monitoring, device tests, or TC set value changes from a PLC via a computer link module are indicated below.

Connected PLC \ Computer Link	For AnACPU *2	For AnUCPU
AnACPU	○	○
AnUCPU	Possible within AnACPU range *1	○
Other than AnACPU, AnUCPU	○	○

\*1 : Network parameters cannot be read.

\*2 : When for AnA (C24) has been designated in connection destination designation when using a computer link module for AnUCPU.

- Setting of transmission specification setting switch

The setting switches at the C24 side are shown below.

Setting Item	Setting Made	Remarks
Main channel setting	RS-232C	—
Data bit setting	8 bits	—
Transmission speed	Match with setting at GPPW	—
Parity yes/no setting	Match with setting at GPPW	—
Even/odd parity	Match with setting at GPPW	—
Stop bits	1 bit	—
Sum check yes/no	Match with setting at GPPW	—
Online program change (write during RUN) yes/no	Match with setting at GPPW	—
Send side terminal resistor yes/no	Depends on system configuration *1	—
Receive side terminal resistor yes/no	Depends on system configuration *1	—
Computer link/multidrop setting	Computer link	AJ71UC24 A1SJ71UC24-R4 A1SJ71C24-R4

\*1: Refer to the Computer Link/Multidrop Link Module User's Manual (Computer Link/Function, Printer Function).

## 2.6 Access Range for Mixed System

A	Q/QnA	FX
×	○	×

A combination example of Ethernet, MELSECNET/10 and CC-Link will be described. Set the network parameters (network numbers, station numbers, etc.) to CPU1 - CPU4, and write them to the PLC. (For parameter details, refer to Chapter 14.)

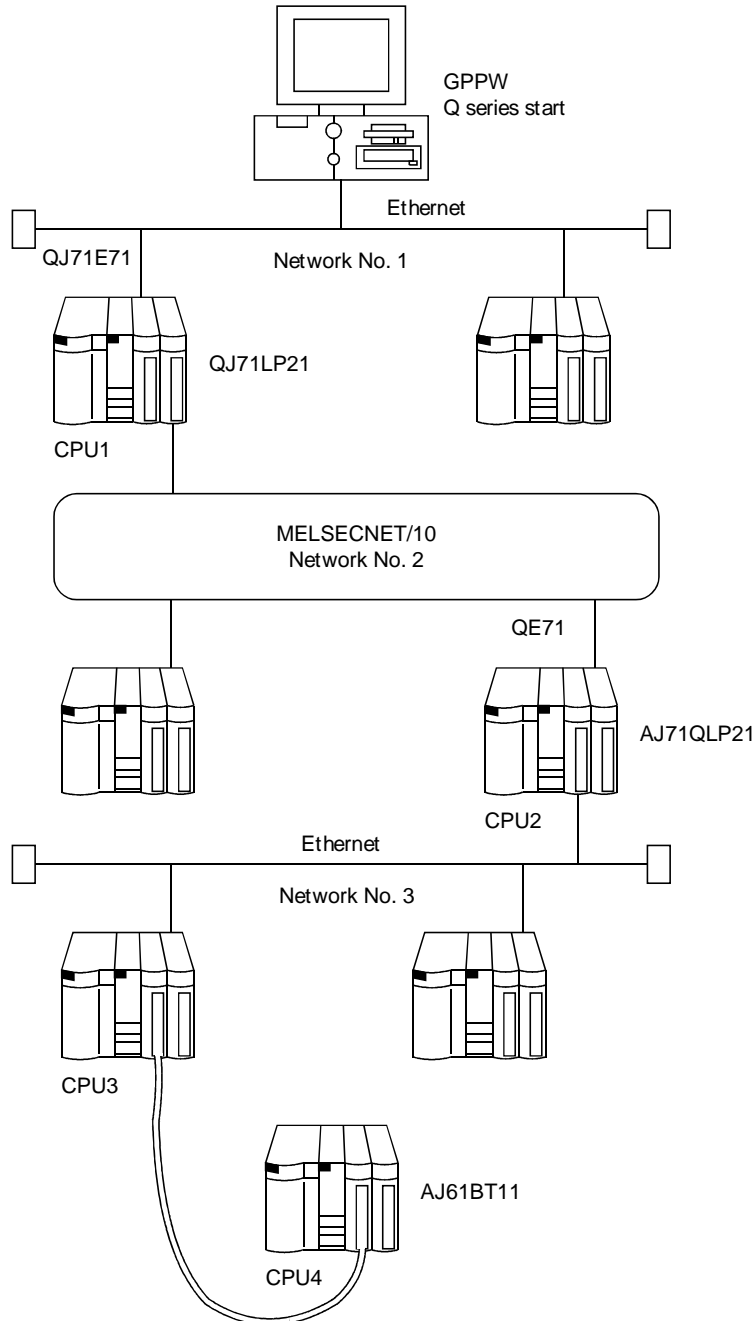

POINT
<ul style="list-style-type: none"> <li>• Ethernet is equivalent to MELSECNET/10. Set the network numbers and station numbers with the network parameters.</li> </ul>



Function \ Applicable PLC	CPU1	CPU2	CPU3	CPU4
PLC read/write	○	○	○	○
Compare with PLC	○	○	○	○
Delete PLC	○	○	○	○
Change PLC data attributes*1	○	○	○	○
Keyword setup	○	○	○	○
Clear PLC memory	○	○	○	○
Format PLC memory*1	○	○	○	○
Arrange PLC memory*1	○	○	○	○
Set time	○	○	○	○
Remote operation	○	○	○	○
Ladder monitor	○	○	○	○
Batch monitor	○	○	○	○
Registration monitor	○	○	○	○
Buffer memory	○	○	○	○
Monitor condition/stop condition	×	×	×	×
Device test	○	○	○	○
Step execution	○	○	○	○
Partial execution	○	○	○	○
Skip execution*1	○	○	○	○
Sampling trace	○	○	○	○
Diagnostics PLC	○	○	○	○
Diagnostics network*2	○	○	○	○
Online change*2	○	○	○	○
Change TC setting	○	○	○	○

○: Access possible  
 ×: Access not possible

**POINT**

- If the E71 module is connected to network No. 2 or No. 3, it cannot be accessed from GPPW.

## Appendix 3 Using Data of Other Applications

### 3.1 Using Excel Files as Device Comments

A	Q/QnA	FX
○	○	○

**[Purpose]**

Uses data created with Excel as device comments.

**[Operating Procedure]**

This explanation assumes that you have already started up Excel and GPPW.

- (1) Drag the Excel cell and designate the range that will enable it to be used as a comment in GPPW.

(Operation in Excel)

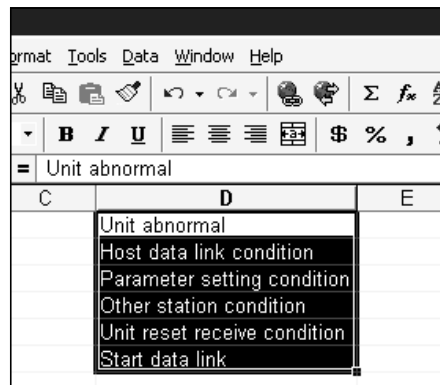

- (2) In Excel, select [Edit] → [Copy], or click ( [Ctrl] + [C] ).

- (3) Click the position where the comment is to be pasted and move the cursor.

(Operation at GPPW)

Device	X0	Display
Device	Comment	Label
X0		
X1		
X2		
X3		
X4		
X5		
X6		
X7		
X8		

(4) In GPPW, select [Edit] → [Paste], or click  ( [Ctrl] + [V] ) to paste the Excel comment to GPPW.

Device	Comment	Label	
X0	Unit abnormal		
X1	Host data link condition		
X2	Parameter setting condition		
X3	Other station condition		
X4	Unit reset receive condition		
X5	Start data link		
X6			
X7			
X8			

### 3.2 Using a Word File as a Device Comment

A	Q/QnA	FX
○	○	○

**[Purpose]**

Uses data created in Word as device comments.

**[Operating Procedure]**

This explanation assumes that you have already started up Word and GPPW.

(1) Enter the comments in Word.

After each device comment, press the **[Enter]** key to insert a carriage return.

(2) Drag the created comments and designate the range for their use as GPPW comments.

(Operation in Word)

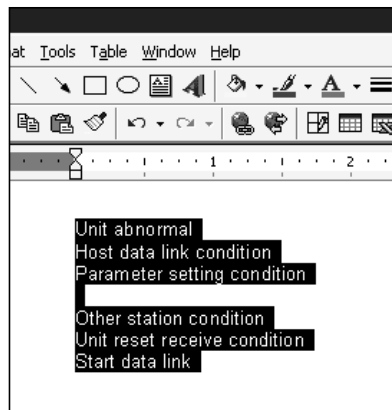

(2) In Word, select [Edit] → [Copy], or click ( **[Ctrl] + [C]** ).

(3) Click the location where the comment is to be pasted and move the cursor.

(Operation at GPPW)

Device	X0	Display
Device	Comment	Label
X0		
X1		
X2		
X3		
X4		
X5		
X6		
X7		
X8		

(4) In GPPW, select [Edit] → [Paste], or click  ( [Ctrl] + [V] ) to paste the Word comment in GPPW.

Device	X0	Display
Device	Comment	Label
X0	Unit abnormal	
X1	Host data link condition	
X2	Parameter setting condition	
X3		
X4	Other station condition	
X5	Unit reset receive condition	
X6	Start data link	
X7		
X8		

<b>POINTS</b>
<ul style="list-style-type: none"> <li>• When entering device comments, inserting a carriage return between two comments makes one line of the comment table blank.</li> <li>• When creating comments in Word, if they are entered continuously without carriage returns they are handled as a single comment: always insert carriage returns between individual comments.</li> </ul>

Appendix 4 Restrictions on PLC Type Change

A	Q/QnA	FX
○	○	○

When the PLC series/type is changed, there are the following restrictions.

(1) Restrictions on PLC series/type change

Refer to the following table for the restrictions on PLC series/type change.

After Change / Before Change	A	QnA	Q (A mode) *1	Q (Q mode) *2	Motion controller (SCPU) *3	FX
A	Table 1/Table 1.1	Table 2	Table 1 (A→A4U equivalent)	Table 2/ Table 3 *4 (A→QnA equivalent)	Table 1 (A→A equivalent)	Table 6
QnA	Table 2	No restrictions	Table 2 (QnA→A4U equivalent)	Table 4	Table 2 (QnA→A equivalent)	Change not possible
Q (A mode) *1	Table 1 (A4U→A equivalent)	Table 2 (A4U→QnA equivalent)	No restrictions	Table 2/ Table 3 *4 (A4U→QnA equivalent)	Table 1 (A4U→A equivalent)	Table 4 (A4U→FX equivalent)
Q (Q mode) *2	Table 2/ Table 3 *4 (QnA→A equivalent)	Table 4	Table 2/ Table 3 *4 (QnA→A4U equivalent)	No restrictions	Table 2/ Table 3 *4 (QnA→A4U equivalent)	Change not possible
Motion controller (SCPU) *3	Table 5 (A→A equivalent)	Table 5 (A→QnA equivalent)	Table 5 (A→A4U equivalent)	Table 5 (A→QnA equivalent)	Table 1 (A→A equivalent)	Table 5 (A→FX equivalent)
FX	Table 6	Change not possible	Table 4 (FX→A4U equivalent)	Change not possible	Table 4 (FX→A equivalent)	Table 7/Table 7.1

\*1: The QCPU-A has the specifications equivalent to those of the A4U.

For the restrictions on any change from/to the QCPU-A, regard it as the A4U and refer to the table.

\*2: The QCPU has the specifications equivalent to those of the QnA series.

For the restrictions on any change from/to the QCPU, regard it as the QnA series and refer to the table.

\*3: The motion controller (SCPU) has the specifications equivalent to those of the A series.

For the restrictions on any change from/to the motion controller (SCPU), regard it as the A series and refer to the table.

\*4: Refer to Table 2 (A↔QnA) and Table 3 (A↔QCPU) from the specifications as listed above (\*1, \*2, \*3).

(2) Unchangeable instructions/devices

Unchangeable instructions/devices are changed into M1255/D1255, etc.

In this case, refer to search/replacement or Appendix 12 and correct them to instructions/devices usable with the PC series/type after change.

POINT
<ul style="list-style-type: none"> <li>For CPU details, refer to the corresponding User's Manual.</li> </ul>

Table 1 Restrictions on PLC Type Change between ACPU and ACPU

Item	Restrictions																		
Programs	<ul style="list-style-type: none"> <li>If there are devices that are outside the PLC handling range, write a program to the PLC after making corrections. Devices outside the range may be displayed on the ladder display screen but an error will occur at the time of PLC RUN.</li> <li>When the PLC type after change is the one which cannot create subprograms, subprograms are deleted.</li> </ul>																		
PLC parameters																			
Memory capacity	<ul style="list-style-type: none"> <li>If the PLC type capacity before change is smaller than the PLC type capacity after change, the capacity of the PLC type before change is used.</li> <li>If the PLC type capacity before change is larger than the PLC type capacity after change, the capacity of the PLC type after change is used. In this case, part of the program before change may sometimes be deleted.</li> <li>When the PLC type after change is the one which cannot create subprograms, sub sequence programs are deleted.</li> <li>If the sequence + microcomputer program capacity exceeds the capacity of the PLC type after change, the microcomputer capacity is zeroed. Also, part of the program before change may sometimes be deleted.</li> </ul>																		
PLC RAS, PLC system, devices	<ul style="list-style-type: none"> <li>If the PLC type after change has the same item or range, the data of the PLC type before change is retained. However, if there are devices that cannot be used at the PLC type after change, the default is set.</li> </ul>																		
I/O allocation	<ul style="list-style-type: none"> <li>All cleared.</li> </ul>																		
Network parameters																			
MELSECNET, MELSECNET(II), MELSECNET(II) combination, MELSECNET/10, MELSECNET/MINI	<table border="1"> <thead> <tr> <th colspan="2" data-bbox="446 1131 750 1176">PLC Type</th> <th data-bbox="750 1131 1396 1176">Description</th> </tr> </thead> <tbody> <tr> <td data-bbox="446 1176 558 1332" rowspan="3">AnN</td> <td data-bbox="558 1176 638 1332" rowspan="3">→</td> <td data-bbox="638 1176 1396 1220">AnN • Settings are retained.</td> </tr> <tr> <td data-bbox="638 1220 1396 1265">AnA • Settings are retained.</td> </tr> <tr> <td data-bbox="638 1265 1396 1332">AnU • Settings are retained. However, the module's first I/O No. is set to 00H.</td> </tr> <tr> <td data-bbox="446 1332 558 1523" rowspan="3">AnA</td> <td data-bbox="558 1332 638 1523" rowspan="3">→</td> <td data-bbox="638 1332 1396 1411">AnN • MELSECNET master station settings are retained. Other station settings but the above are deleted.</td> </tr> <tr> <td data-bbox="638 1411 1396 1456">AnA • Settings are retained.</td> </tr> <tr> <td data-bbox="638 1456 1396 1523">AnU • Settings are retained. However, the module's first I/O No. is set to 00H.</td> </tr> <tr> <td data-bbox="446 1523 558 1904" rowspan="3">AnU</td> <td data-bbox="558 1523 638 1904" rowspan="3">→</td> <td data-bbox="638 1523 1396 1601">AnN • MELSECNET master station settings are retained. Other station settings but the above are deleted.</td> </tr> <tr> <td data-bbox="638 1601 1396 1713">AnA • MELSECNET master station, MELSECNET(II) combination master station and MELSECNET(II) settings are retained. Other station settings but the above are deleted.</td> </tr> <tr> <td data-bbox="638 1713 1396 1904">AnU • Settings are retained. However, if there is any one module whose setting of the network's first I/O No exceeds that of the actual I/O of the PLC after change, 0H, 20H, 40H or 60H is automatically assigned to the first I/O No.</td> </tr> </tbody> </table>	PLC Type		Description	AnN	→	AnN • Settings are retained.	AnA • Settings are retained.	AnU • Settings are retained. However, the module's first I/O No. is set to 00H.	AnA	→	AnN • MELSECNET master station settings are retained. Other station settings but the above are deleted.	AnA • Settings are retained.	AnU • Settings are retained. However, the module's first I/O No. is set to 00H.	AnU	→	AnN • MELSECNET master station settings are retained. Other station settings but the above are deleted.	AnA • MELSECNET master station, MELSECNET(II) combination master station and MELSECNET(II) settings are retained. Other station settings but the above are deleted.	AnU • Settings are retained. However, if there is any one module whose setting of the network's first I/O No exceeds that of the actual I/O of the PLC after change, 0H, 20H, 40H or 60H is automatically assigned to the first I/O No.
	PLC Type		Description																
	AnN	→	AnN • Settings are retained.																
			AnA • Settings are retained.																
			AnU • Settings are retained. However, the module's first I/O No. is set to 00H.																
	AnA	→	AnN • MELSECNET master station settings are retained. Other station settings but the above are deleted.																
			AnA • Settings are retained.																
			AnU • Settings are retained. However, the module's first I/O No. is set to 00H.																
	AnU	→	AnN • MELSECNET master station settings are retained. Other station settings but the above are deleted.																
			AnA • MELSECNET master station, MELSECNET(II) combination master station and MELSECNET(II) settings are retained. Other station settings but the above are deleted.																
			AnU • Settings are retained. However, if there is any one module whose setting of the network's first I/O No exceeds that of the actual I/O of the PLC after change, 0H, 20H, 40H or 60H is automatically assigned to the first I/O No.																

Table 1.1 PLC Parameter Settings for PLC Type Change between ACPU and ACPU

After Change Before Change	A0J2H	A1FX	A1N	A2N A2N-S1	A3N	A1S A1SJ	A1SH A1SJH	A2S	A2SH	A2C A2CJ	A2A A2A-S1	A3A	A2USH-S1	A2U A2U-S1 A2US A2US-S1	A3U	A4U
A0J2H	○	—	○	○	○	—	○	○	○	—	—	—	—	—	—	—
A1FX	—	○	—	○	○	—	○	○	○	—	—	—	—	—	—	—
A1N	○	—	○	○	○	○	○	○	○	—	—	—	—	—	—	—
A2N A2N-S1	—	—	—	○	○	—	○	○	○	—	—	—	—	—	—	—
A3N	—	—	—	—	○	—	—	—	—	—	—	—	—	—	—	—
A1S A1SJ	—	—	—	○	○	○	○	○	○	—	—	—	—	—	—	—
A1SH A1SJH	—	—	—	—	○	—	○	—	○	—	—	—	—	—	—	—
A2S	—	—	—	○	○	—	○	○	○	—	—	—	—	—	—	—
A2SH	—	—	—	—	○	—	○	○	○	—	—	—	—	—	—	—
A2C A2CJ	—	—	—	—	—	—	—	—	—	○	—	—	—	—	—	—
A2A A2A-S1	—	—	—	—	—	—	—	—	—	—	○	○	○	○	○	○
A3A	—	—	—	—	—	—	—	—	—	—	—	○	○	○	○	○
A2U A2U-S1 A2US A2US-S1	—	—	—	—	—	—	—	—	—	—	—	—	○	○	○	○
A2USH-S1	—	—	—	—	—	—	—	—	—	—	—	—	○	○	○	○
A3U	—	—	—	—	—	—	—	—	—	—	—	—	—	—	○	○
A4U	—	—	—	—	—	—	—	—	—	—	—	—	—	—	○	○

○: Settings of PLC type before change are retained

—: Default to settings of PLC type after change, or partial deletion



Table 2 Restrictions on PLC Type Change between ACPU and QnACPU

Item	Restrictions								
	A → QnA	QnA → A							
Programs	All programs are changed.	<ul style="list-style-type: none"> <li>Unchangeable data names (other than MAIN, SUB1, etc.) are deleted.</li> <li>If the maximum number of steps is exceeded, part of the program is deleted. Note that if the same instruction is used, the number of steps of the A series may become greater.</li> </ul>							
Instructions, devices	<ul style="list-style-type: none"> <li>Unchangeable instructions and devices are changed into M1255/D1255.</li> </ul>	<ul style="list-style-type: none"> <li>Unchangeable instructions and devices are changed into M9255/D9255.</li> </ul>							
	<ul style="list-style-type: none"> <li>Changeable only when "special module's first I/O number designation" or "network's other station number designation" has been constant specified using changeable dedicated instructions (e.g. ZCOM). &lt;Example&gt;</li> </ul> <table border="1" style="width: 100%; border-collapse: collapse;"> <thead> <tr> <th style="width: 50%;">Changeable</th> <th style="width: 50%;">Unchangeable</th> </tr> </thead> <tbody> <tr> <td>LEDA ZCOM</td> <td>LEDA ZCOM</td> </tr> <tr> <td>SUB H0</td> <td>LEDC D0 ..... Unchangeable since the network module's first</td> </tr> <tr> <td>LEDR</td> <td>LEDR I/O No. is device specified.</td> </tr> </tbody> </table>	Changeable	Unchangeable	LEDA ZCOM	LEDA ZCOM	SUB H0	LEDC D0 ..... Unchangeable since the network module's first	LEDR	LEDR I/O No. is device specified.
Changeable	Unchangeable								
LEDA ZCOM	LEDA ZCOM								
SUB H0	LEDC D0 ..... Unchangeable since the network module's first								
LEDR	LEDR I/O No. is device specified.								
Comments, device memories	<ul style="list-style-type: none"> <li>All of them are changed.</li> </ul>	<ul style="list-style-type: none"> <li>Device comments which exceed the device range of the PLC type after change and non-existing device comments are deleted. Comments other than the above are retained intact.</li> </ul>							
Device initial values	<ul style="list-style-type: none"> <li>Ignored as the ACPU has none.</li> </ul>	<ul style="list-style-type: none"> <li>Deleted as the ACPU has none.</li> </ul>							
Parameters									
Memory capacity	<ul style="list-style-type: none"> <li>No change</li> </ul>	<ul style="list-style-type: none"> <li>For any of MAIN, SUB1, SUB2 and SUB3, set the maximum capacity of the PLC after change.</li> <li>For comments, extension comments, etc., set them to the default.</li> </ul>							
Latch range	A	QnA	QnA	A					
	L	No change	B	B					
	Extension counters	No change	F	Not subject to change					
	Retentive timers	No change	V	Not subject to change					
	C latch range	C latch range	T	Low-speed timers					
	D latch range	D latch range	ST	Not subject to change					
	B latch range	B latch range	C	C					
	W latch range	W latch range	D	D					
	Lowest device number of: Low-speed timers High-speed timers Extension low-speed timers Extension high-speed timers	→	W	W					
	Highest device number of: Low-speed timers High-speed timers Extension low-speed timers Extension high-speed timers		Head of T latch range	→	End of T latch range				
		<ul style="list-style-type: none"> <li>Set the device numbers exceeding the ACPU's device ranges to the maximum values of the corresponding devices.</li> </ul>							
I/O allocation	Settings are retained intact.								

(To the next page)

Table 2 Restrictions on PLC Type Change between ACPU and QnACPU (Continue)

Item	Restrictions	
	A → QnA	QnA → A
Network parameters		
MELSECNET(II, 10)	AnA/AnN → QnA <ul style="list-style-type: none"> <li>• Settings are retained.</li> <li>• Module's first I/O No. is set to 00H because there is no module's first I/O No. in the network parameters of the AnN/AnA.</li> </ul> AnU → QnA <ul style="list-style-type: none"> <li>• Settings are retained.</li> </ul>	QnA → AnN <ul style="list-style-type: none"> <li>• MELSECNET master station settings are retained.</li> </ul> QnA → AnA <ul style="list-style-type: none"> <li>• MELSECNET master station, MELSECNET(II) combination master station and MELSECNET(II) settings are retained.</li> </ul> QnA → AnU <ul style="list-style-type: none"> <li>• Any of the following items set is deleted.                             <ul style="list-style-type: none"> <li>MELSECNET/10 (standby station)</li> <li>MELSECNET/10 (multiple remote master station)</li> <li>MELSECNET (parallel remote master station)</li> <li>MELSECNET/10 (multiple remote sub station)</li> <li>MELSECNET/10 (parallel remote sub station)</li> <li>Ethernet, CC-Link</li> </ul>                             Settings but the above are deleted.                         </li> </ul>
MELSECNET/MINI	<ul style="list-style-type: none"> <li>• Settings are retained.</li> </ul>	<ul style="list-style-type: none"> <li>• Settings are retained.</li> <li>• However, the transmission status at line error is deleted.</li> </ul>

Table 3 Restrictions on PLC Type Change between ACPU and QCPU

Item	Restrictions	
	A → Q (Q mode)	Q (Q mode) → A
Programs	<ul style="list-style-type: none"> <li>• All programs are changed.</li> </ul>	<ul style="list-style-type: none"> <li>• Unchangeable data names (other than MAIN, SUB1, etc.) are deleted.</li> <li>• If the maximum number of steps is exceeded, part of the program is deleted. Note that if the same instruction is used, the number of steps of the A series may become greater.</li> </ul>
Instructions, devices	<ul style="list-style-type: none"> <li>• Unchangeable instructions and devices are changed into M1255/D1255.</li> </ul>	<ul style="list-style-type: none"> <li>• Unchangeable instructions and devices are changed into M9255/D9255.</li> </ul>
Comments, device memories	<ul style="list-style-type: none"> <li>• All are changed.</li> </ul>	<ul style="list-style-type: none"> <li>• Unchangeable SD/SM are deleted.</li> </ul>
Parameters	<ul style="list-style-type: none"> <li>• All are changed.</li> </ul>	<ul style="list-style-type: none"> <li>• Unchangeable parameters are deleted. However, the type, points, model name, first I/O of I/O allocation are changed.</li> <li>• Also, when the base mode setting for the QCPU is 8 or more modules, the on-base positions and first I/O number may differ from the actual ones.</li> </ul>
Network parameters		
MELSECNET(II)	<ul style="list-style-type: none"> <li>• MELSECNET(II) parameters are deleted.</li> </ul>	-----
MELSECNET/10(H)	<ul style="list-style-type: none"> <li>• MELSECNET/10 parameters are changed into those in MELSECNET/10 mode.</li> </ul>	<ul style="list-style-type: none"> <li>• Setting of relay station number in MELSECNET/10(H) routing parameters is discarded.</li> </ul>
MELSECNET/MINI	<ul style="list-style-type: none"> <li>• MELSECNET/MINI parameters are deleted.</li> </ul>	-----
CC-Link	-----	<ul style="list-style-type: none"> <li>• CC-Link parameters are deleted.</li> </ul>
Ethernet	-----	<ul style="list-style-type: none"> <li>• Ethernet parameters are deleted.</li> </ul>

Table 4 Restrictions on PLC Type Change between QnACPU and QCPU

Item	Restrictions	
	QnA → Q (Q mode)	Q (Q mode) → QnA
Instructions	<ul style="list-style-type: none"> <li>Unchangeable instructions are changed into SM1255.</li> </ul>	
Devices, device comments	<ul style="list-style-type: none"> <li>All are changed.</li> </ul>	
Parameters	<ul style="list-style-type: none"> <li>All are changed.</li> </ul>	<ul style="list-style-type: none"> <li>Unchangeable parameters are deleted. However, only the type, points, model name, first I/O of I/O allocation are changed. Also, when the base mode setting for the QCPU is 8 or more modules, the on-base positions and first I/O number may differ from the actual ones.</li> </ul>
Network parameters		
MELSECNET(II)	<ul style="list-style-type: none"> <li>MELSECNET(II) parameters are deleted.</li> </ul>	—————
MELSECNET/10(H)	<ul style="list-style-type: none"> <li>MELSECNET/10 parameters are changed into those in MELSECNET/10 mode.</li> </ul>	<ul style="list-style-type: none"> <li>Setting of the relay station number in MELSECNET/10(H) routing parameters is discarded.</li> <li>Only 0 to 1FFF(H) of the MELSECNET/10(H) common parameters are changed. Station settings of 2000(H) and later are deleted.</li> </ul>
MELSECNET/MINI	<ul style="list-style-type: none"> <li>MELSECNET/MINI parameters are deleted.</li> </ul>	—————
CC-Link	<ul style="list-style-type: none"> <li>When the CC-Link parameters of 5 or more modules have been set, those of the fifth module and later are deleted.</li> </ul>	<ul style="list-style-type: none"> <li>Unchangeable CC-Link parameters are deleted.</li> </ul>
Ethernet	—————	<ul style="list-style-type: none"> <li>Ethernet parameters are deleted.</li> </ul>

Table 5 Restrictions on PLC Type Change between Motion Controller (SCPU) and Other CPU

The A171SHCPU has specifications equivalent to those of the A2HCPU, the A172SHCPU has specifications equivalent to those of the A2SHCPU memory or I/O enhancement, and the A273UHCPU(S3) has specifications equivalent to those of the A3UCPU.

Other CPU	Restrictions	
	Motion controller (SCPU) → Other PLC series	Other PLC series → Motion controller (SCPU)
A series	<ul style="list-style-type: none"> <li>Motion controller-dedicated instructions are changed as they are. However, making a program check results in instruction code error.</li> </ul>	Equivalent to A series → A series. Refer to Table 1.
QnA series/Q series	<ul style="list-style-type: none"> <li>Motion controller-dedicated instructions are changed into M1255.</li> </ul>	Equivalent to QnA series → A series. Refer to Table 2. Equivalent to Q series → A series. Refer to Tables 2 and 3.
FX series	<ul style="list-style-type: none"> <li>Motion controller-dedicated instructions are changed into M8255.</li> </ul>	Equivalent to FX series → A series. Refer to Table 6.

Table 6 Restrictions on PLC Type Change between ACPU and FXCPU

Item	Restrictions	
	A → FX	FX → A
Programs	<ul style="list-style-type: none"> <li>AnA and AnU dedicated instructions are deleted.</li> <li>Subprograms are deleted.</li> <li>Excess program part after change is deleted.</li> </ul>	
	<ul style="list-style-type: none"> <li>Unchangeable devices are changed into M8255/D8255.</li> <li>Unchangeable instructions are changed into OUT M8255.</li> </ul>	<ul style="list-style-type: none"> <li>Unchangeable devices are changed into M9255/D9255.</li> <li>Unchangeable instructions are changed into OUT M9255. However, LDP, LDF, ORP, ORF, ANDP and ANDF instructions become contact instructions without P and F, and devices are changed into M9255. Also, INV is changed into AND M9255, and STL into OUT M9255.</li> </ul>
	<ul style="list-style-type: none"> <li>The instructions and devices which have been changed into M9255/D9255 and M8255/D8255 should be corrected by the device check of the program check function. However, when the FX0(S), FX0N or FX1 PLC CPU has been selected, replacement for these device numbers cannot be made. In this case, execute the device check of the program check function.</li> </ul>	
Memory capacity	<ul style="list-style-type: none"> <li>Changed into the maximum capacity of the PLC type after change.</li> </ul>	
File register capacity, comment capacity	<ul style="list-style-type: none"> <li>Set to 0 blocks if the PLC type after change is not compatible with this function.</li> </ul>	<ul style="list-style-type: none"> <li>Set to the defaults of the PLC type after change.</li> </ul>
Network parameters	<ul style="list-style-type: none"> <li>Not changed because of absence in the FX.</li> </ul>	<ul style="list-style-type: none"> <li>Set to the defaults of the PLC type after change.</li> </ul>
Statements, notes	Settings are retained intact. However, the range in excess of the setting capacity is deleted.	
Device comments, device memories	Settings are retained intact. However, devices not existing in the PLC after change or the data in excess of the range are deleted.	

Table 7 Restrictions on PLC Type Change between FXCPU and FXCPU

Item	Restrictions
Programs	<ul style="list-style-type: none"> <li>Unchangeable element numbers and application instructions are not changed. Therefore, correct programs properly before or after change and make a program check. (If programs before corrections are transferred to the PLC, a program error will occur.)</li> <li>Excess program part is deleted.</li> <li>If the PLC type after change is the FX0/FX0sCPU, the memory capacity is set to 2000. The part exceeding this CPU's actual step count of 800 is deleted.</li> <li>For the file registers and RAM file registers, their settings are retained intact. After change, therefore, correct them by search/replacement to have proper device numbers.</li> </ul>
Memory capacity	<ul style="list-style-type: none"> <li>If the maximum capacity of the PLC type before change is larger than that of the PLC type after change, the maximum capacity of the PLC type after change is used.</li> </ul>
File register capacity, comment capacity	<ul style="list-style-type: none"> <li>Set to 0 blocks if the PLC type after change is not compatible with this function.</li> </ul>

Table 7.1 Changes Made between PLC Types (FXCPU ↔ FXCPU)

Change Type	Memory Capacity	Comment Capacity	File Register Capacity	Latch Range	Entry Code	Title	PLC mode: Serial Setting	I/O Allocations
FX <sub>1N</sub> → FX <sub>0</sub>	● (2000)	● (Block 0)	● (Block 0)	●	⊙	●	●	●
FX <sub>1N</sub> → FX <sub>0N</sub>	● (2000)	★ (Block 0 to 3)	★ (Block 0 to 3)	●	⊙	⊙	●	●
FX <sub>1N</sub> → FX <sub>1</sub>	★ (2000 to 4000)	★	● (Block 0)	●	⊙	⊙	●	●
FX <sub>1N</sub> → FX <sub>1S</sub>	● (2000)	★ (Block 0 to 3)	★ (Block 0 to 3)	●	⊙	⊙	⊙	●
FX <sub>1N</sub> → FX <sub>2</sub>	★ (2000 to 8000)	★	★	●	⊙	⊙	●	●
FX <sub>1N</sub> → FX <sub>2N</sub>	★ (2000 to 16000)	★	★	●	⊙	⊙	⊙	●
FX <sub>1S</sub> → FX <sub>0</sub>	● (2000)	● (Block 0)	● (Block 0)	●	⊙	●	●	●
FX <sub>1S</sub> → FX <sub>0N</sub>	● (2000)	★ (Block 0 to 3)	★ (Block 0 to 3)	●	⊙	⊙	●	●
FX <sub>1S</sub> → FX <sub>1</sub>	★ (2000 to 4000)	★	● (Block 0)	●	⊙	⊙	●	●
FX <sub>1S</sub> → FX <sub>1N</sub>	★ (2000 to 8000)	★	★	●	⊙	⊙	⊙	●
FX <sub>1S</sub> → FX <sub>2</sub>	★ (2000 to 8000)	★	★	●	⊙	⊙	●	●
FX <sub>1S</sub> → FX <sub>2N</sub>	★ (2000 to 16000)	★	★	●	⊙	⊙	⊙	●
FX <sub>0</sub> → FX <sub>0N</sub>	● (2000)	★ (Block 0 to 3)	★ (Block 0 to 3)	●	⊙	⊙	●	●
FX <sub>0</sub> → FX <sub>1</sub>	★ (2000 to 4000)	★	● (Block 0)	●	⊙	⊙	●	●
FX <sub>0</sub> → FX <sub>1N</sub>	★ (2000 to 8000)	★	★	●	⊙	⊙	●	●
FX <sub>0</sub> → FX <sub>1S</sub>	● (2000)	★ (Block 0 to 3)	★ (Block 0 to 3)	●	⊙	⊙	●	●
FX <sub>0</sub> → FX <sub>2</sub>	★ (2000 to 8000)	★	★	●	⊙	⊙	●	●
FX <sub>0</sub> → FX <sub>2N</sub>	★ (2000 to 16000)	★	★	●	⊙	⊙	●	●
FX <sub>0N</sub> → FX <sub>0</sub>	● (2000)	● (Block 0)	● (Block 0)	●	⊙	●	●	●
FX <sub>0N</sub> → FX <sub>1</sub>	★ (2000 to 4000)	★	● (Block 0)	●	⊙	⊙	●	●
FX <sub>0N</sub> → FX <sub>1S</sub>	● (2000)	★ (Block 0 to 3)	★ (Block 0 to 3)	●	⊙	⊙	●	●
FX <sub>0N</sub> → FX <sub>1N</sub>	★ (2000 to 8000)	★	★	●	⊙	⊙	●	●
FX <sub>0N</sub> → FX <sub>2</sub>	★ (2000 to 8000)	★	★	●	⊙	⊙	●	●
FX <sub>0N</sub> → FX <sub>2N</sub>	★ (2000 to 16000)	★	★	●	⊙	⊙	●	●
FX <sub>1</sub> → FX <sub>0</sub>	● (2000)	● (Block 0)	● (Block 0)	●	⊙	●	●	●
FX <sub>1</sub> → FX <sub>0N</sub>	● (2000)	★ (Block 0 to 3)	★ (Block 0 to 3)	●	⊙	⊙	●	●
FX <sub>1</sub> → FX <sub>1S</sub>	● (2000)	★ (Block 0 to 3)	★ (Block 0 to 3)	●	⊙	⊙	●	●
FX <sub>1</sub> → FX <sub>1N</sub>	★ (2000 to 8000)	★	★	●	⊙	⊙	●	●
FX <sub>1</sub> → FX <sub>2</sub>	★ (2000 to 8000)	★	★	●	⊙	⊙	●	●
FX <sub>1</sub> → FX <sub>2N</sub>	★ (2000 to 16000)	★	★	●	⊙	⊙	●	●
FX <sub>2</sub> → FX <sub>0</sub>	● (2000)	● (Block 0)	● (Block 0)	●	⊙	●	●	●
FX <sub>2</sub> → FX <sub>0N</sub>	● (2000)	★ (Block 0 to 3)	★ (Block 0 to 3)	●	⊙	⊙	●	●
FX <sub>2</sub> → FX <sub>1S</sub>	● (2000)	★ (Block 0 to 3)	★ (Block 0 to 3)	●	⊙	⊙	●	●
FX <sub>2</sub> → FX <sub>1N</sub>	★ (2000 to 8000)	★	★	●	⊙	⊙	●	●
FX <sub>2</sub> → FX <sub>2N</sub>	★ (2000 to 16000)	★	★	●	⊙	⊙	●	●

Change Type	Memory Capacity	Comment Capacity	File Register Capacity	Latch Range	Entry Code	Title	PLC mode: Serial Setting	I/O Allocations
FX <sub>2N</sub> → FX <sub>0</sub>	● (2000)	● (Block 0)	● (Block 0)	●	⊙	●	●	●
FX <sub>2N</sub> → FX <sub>0N</sub>	● (2000)	★ (Block 0 to 3)	★ (Block 0 to 3)	●	⊙	⊙	●	●
FX <sub>2N</sub> → FX <sub>1S</sub>	● (2000)	★ (Block 0 to 3)	★ (Block 0 to 3)	●	⊙	⊙	●	●
FX <sub>2N</sub> → FX <sub>1S</sub>	● (2000)	★ (Block 0 to 3)	★ (Block 0 to 3)	●	⊙	⊙	⊙	●
FX <sub>2N</sub> → FX <sub>1N</sub>	★ (2000 to 8000)	★	★	●	⊙	⊙	⊙	●
FX <sub>2N</sub> → FX <sub>2</sub>	★ (2000 to 8000)	★	★	●	⊙	⊙	●	●

⊙: Settings before change are retained.

●: Defaults of the CPU type after change are set.

★: Change can be designated in a dialog box.

When the comment or file register capacities can be changed in a dialog box, the range of setting may vary according to the memory capacity setting.

## Appendix 5 Examples of Wiring RS-232C Cable for Connection of C24 and Peripheral Device

### 5.1 A Series

A	Q/QnA	FX
○	○	×

- Connection of RS-232C interface

(1) When a 25-pin connector is used in a computer link module

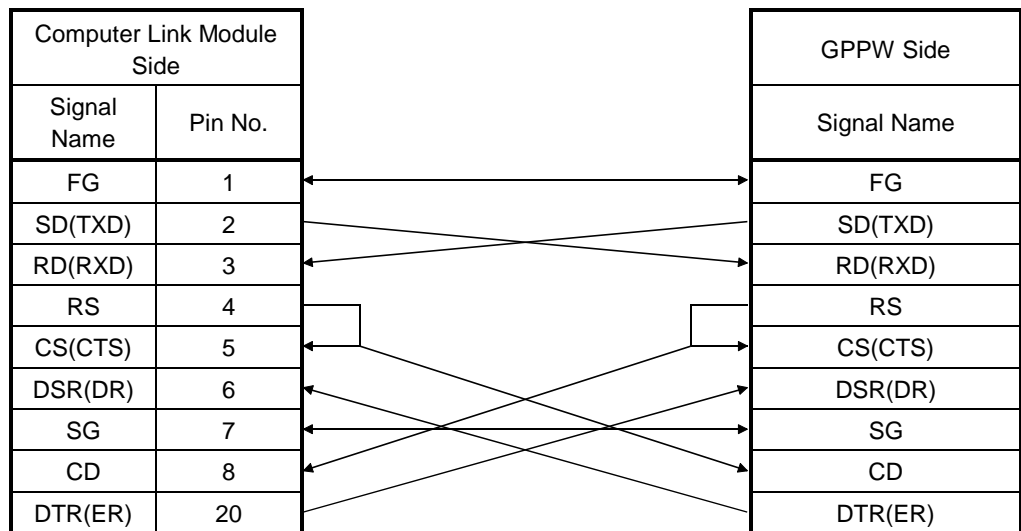

(2) When a 25-pin connector is used in a computer link module

If the connection between the computer link module and the GPPW is made in the manner shown below, designate "without CD terminal check".

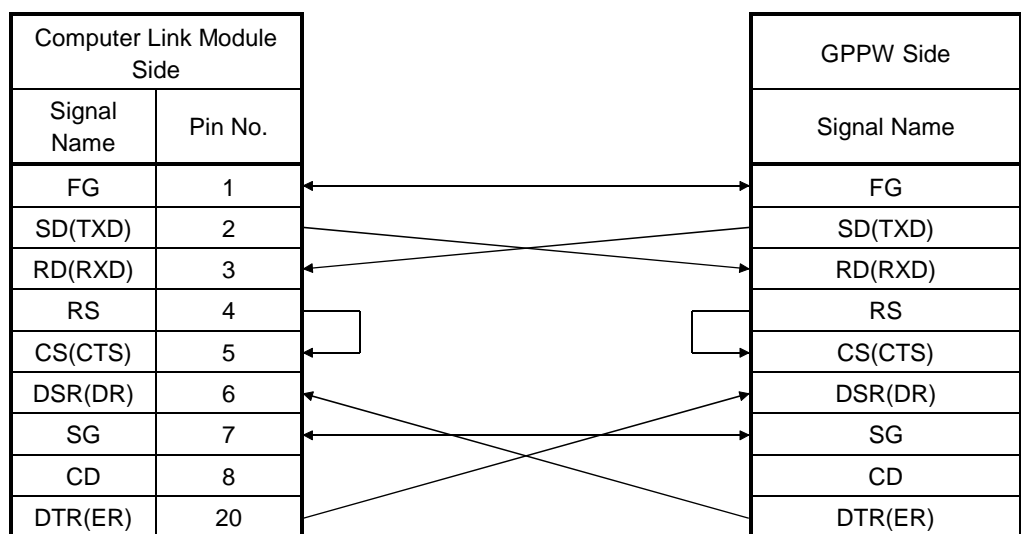

Buffer memory setting

CD terminal check (address 10Bh): Without check

DTR control (address 11Ah): Yes (C24-S8, UC24)

(3) When an 9-pin connector is used in a computer link module

(Example of connection)

Computer Link Module Side		Cable Connection and Signal Direction	External Device Side
Signal Name	Pin No.		Signal Name
CD	1		CD
RD(RXD)	2		RD(RXD)
SD(TXD)	3		SD(TXD)
DTR(ER)	4		DTR(ER)
SG	5		SG
DSR(DR)	6		DSR(DR)
RS(RTS)	7		RS(RTS)
CS(CTS)	8		CS(CTS)

Set "without CD terminal check".

(4) When an 9-pin connector is used in a computer link module

(Example of connection)

Computer Link Module Side		Cable Connection and Signal Direction	External Device Side
Signal Name	Pin No.		Signal Name
CD	1		CD
RD(RXD)	2		RD(RXD)
SD(TXD)	3		SD(TXD)
DTR(ER)	4		DTR(ER)
SG	5		SG
DSR(DR)	6		DSR(DR)
RS(RTS)	7		RS(RTS)
CS(CTS)	8		CS(CTS)

\*: DC code control or DTR/DSR control is enabled by connecting the DTR and DSR signals of the computer link module to an external device as shown above.



5.2 QnA Series

A	Q/QnA	FX
×	○	×

- (1) For large-scale QC24 (N)
  - (a) Example of connection to an external device that allows the CD signal (No. 8 pin) to be turned ON/OFF

Large-scale QC24 (N) Side		Cable Connection and Signal Direction (Full-/Half-Duplex Communication)	External Device Side
Signal Name	Pin No.		Signal Name
FG	1	↔	FG
SD(TXD)	2	↔	SD(TXD)
RD(RXD)	3	↔	RD(RXD)
RS	4	↔	RS
CS(CTS)	5	↔	CS(CTS)
DSR(DR)	6	↔	DSR(DR)
SG	7	↔	SG
CD	8	↔	CD
DTR(ER)	20	↔	DTR(ER)

DC code control or DTR/DSR control is enabled by connecting the QC24 (N) to an external device as shown above.

- (b) Example of connection to an external device that does not allow the CD signal (No. 8 pin) to be turned ON/OFF

Large-scale QC24 (N) Side		Cable Connection and Signal Direction (Full-Duplex Communication)	External Device Side
Signal Name	Pin No.		Signal Name
FG	1	↔	FG
SD(TXD)	2	↔	SD(TXD)
RD(RXD)	3	↔	RD(RXD)
RS	4	↔	RS
CS(CTS)	5	↔	CS(CTS)
DSR(DR)	6	↔	DSR(DR)
SG	7	↔	SG
CD	8	↔	CD
DTR(ER)	20	↔	DTR(ER)

DC code control or DTR/DSR control is enabled by connecting the QC24 (N) to an external device as shown above.

(2) For compact QC24 (N)

(a) Example of connection to an external device that allows the CD signal (No. 1 pin) to be turned ON/OFF

Compact QC24 (N) Side		Cable Connection and Signal Direction (Full- / Half-Duplex Communication)	External Device Side
Signal Name	Pin No.		Signal Name
CD	1		CD
RD(RXD)	2		RD(RXD)
SD(TXD)	3		SD(TXD)
DTR(ER)	4		DTR(ER)
SG	5		SG
DSR(DR)	6		DSR(DR)
RS(RTS)	7		RS(RTS)
CS(CTS)	8		CS(CTS)

DC code control or DTR/DSR control is enabled by connecting the QC24 (N) to an external device as shown above.

(b) Example of connection to an external device that does not allow the CD signal (No. 1 pin) to be turned ON/OFF

Large-scale QC24 (N) Side		Cable Connection and Signal Direction (Full-Duplex Communication)	External Device Side
Signal Name	Pin No.		Signal Name
CD	1		CD
RD(RXD)	2		RD(RXD)
SD(TXD)	3		SD(TXD)
DTR(ER)	4		DTR(ER)
SG	5		SG
DSR(DR)	6		DSR(DR)
RS(RTS)	7		RS(RTS)
CS(CTS)	8		CS(CTS)

DC code control or DTR/DSR control is enabled by connecting the QC24 (N) to an external device as shown above.

5.3 Q Series

A	Q/QnA	FX
×	○	×

The connector specifications are indicated below.

Pin Number	Signal Code	Signal Name	Signal Direction Q-compatible C24 ↔ external device
1	CD	Receive carrier detection	←
2	RD (RXD)	Receive data	←
3	SD (TXD)	Send data	→
4	DTR (ER)	Data terminal ready	→
5	SG	Send ground	↔
6	DSR (DR)	Data set ready	←
7	RS (RTS)	Request to send	→
8	CS (CTS)	Clear to send	←
9	RI (CI)	Call indication	←

(1) Connection example which can turn ON/OFF CD signal (No. 1 pin)

This Module Side		Cable Connection and Signal Direction (Connection example for full duplex/half duplex communication)	Other End Equipment Side
Signal Name	Pin No.		Signal Name
CD	1		CD
RD (RXD)	2		RD (RXD)
SD (TXD)	3		SD (TXD)
DTR (ER)	4		DTR (ER)
SG	5		SG
DSR (DR)	6		DSR (DR)
RS (RTS)	7		RS (RTS)
CS (CTS)	8		CS (CTS)
RI (CI)	9		

(2) Connection example which cannot turn ON/OFF CD signal (No. 1 pin)  
 Connection example for exercising DC code control or DTR/DSR control

This Module Side		Cable Connection and Signal Direction (Connection example for full duplex communication)	Other End Equipment Side
Signal Name	Pin No.		Signal Name
CD	1		CD
RD (RXD)	2		RD (RXD)
SD (TXD)	3		SD (TXD)
DTR (ER)	4		DTR (ER)
SG	5		SG
DSR (DR)	6		DSR (DR)
RS (RTS)	7		RS (RTS)
CS (CTS)	8		CS (CTS)
RI (CI)	9		

Appendix 6 ROM Writer Wiring Examples

A	Q/QnA	FX
○	×	○

The wiring of the RS-232C cable that connects a peripheral device and ROM writer is shown here.

Make the cable used for the wiring shown below yourself in accordance with the specifications of the ROM writer to be used.

Peripheral Device		Cable Connection and Signal Direction	ROM WRITER	
Signal Name	Pin No.		Pin No.	Signal Name
FG	-		1	FG
SD	3		2	SD
RD	2		3	RD
RST	7		4	RTS
CTS	8		5	CTS
DSR	6		6	DSR
SG	5		7	SG
DTR	4		20	DTR

An example of wiring of the RS-232C cable that connects a peripheral device and ROM writer is shown here.

If RTS and CTS are not used at the ROM writer side, short RTS and CTS at the peripheral device side.

Appendix 7 QnA Series Version Compatibility Table

A	Q/QnA	FX
×	○	×

Restrictions apply to each version of QnACPU (with the exception of Q4ARCPU) modules, Ethernet interface modules, and CC-Link system master and local modules with regard to the use of the following functions, which are described in this manual. If the module you are using is the version in the table or a later version, the corresponding function can be used.

Module	PLC	Ethernet	CC-Link
Function	Q2ACPU, Q2AS1CPU, Q3ACPU, Q4A CPU, Q2AS(H)CPU, Q2AS(H)S1	AJ71QE71(B5), A1SJ71QE71-B2, A1SJ71QE71-B5	AJ61QBT11, A1SJ61QBT11
Local device Monitoring/testing	9707B or later	—	—
High-speed communication	9707B or later	—	—
Ethernet parameters	9707B or later	9707B or later	—
CC-Link parameters	9707B or later	—	9707B or later

—: Irrelevant function

- Positioning of rating nameplate  
<Example> Large PLC

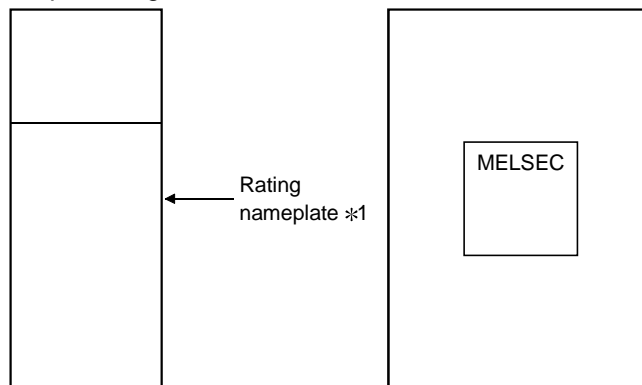

Front elevation of module

Right side elevation of module

\*1: Some compact PLC have the rating nameplate affixed to their left side.

**POINT**

- When using the functions above, use a module that has the following code (9707B or later) inscribed in the DATE entry on the ratings nameplate.

Year/month of manufacture      Function version

Year/month of manufacture      Function version

## Appendix 8 Restrictions and Cautions

A	Q/QnA	FX
○	○	×

The following is a list of restrictions and cautions to be observed when operating GPPW.

Read these restrictions before attempting GPPW operations.

The symbol "△" is appended to those restrictions in the list that also apply to GPPA/GPPQ.

Items in the list that are marked "<Caution>" are cautions relating to GPPW only.

[Interpreting the Lists]

Example:

GPPA	GPPQ
○	—

..... Indicates that the restriction when using ACPU with GPPW is the same as that which applies when using GPPA.

GPPA	GPPQ
○ <Caution>	—

..... Indicates that the caution when using ACPU with GPPW is the same as that which applies when using GPPA.

GPPA	GPPQ
— <Caution>	—

..... Indicates that the caution when using ACPU with GPPW is exclusive to GPPW.

Item	Restrictions/Cautions	GPPA	GPPQ
Comment reading/writing	When editing comments there is no particular need to set a comment capacity. However, an error is displayed on writing to the CPU if no capacity is found to be set on checking the parameters of the peripheral device.	— <Caution>	—
	When extension comments have been designated for a program created with GPPA (valid program setting), when these extension comments are read by GPPW, they are assigned to common comments regardless of the GPPA designation.	— <Caution>	—
	When a file created with ACPU or GPPA is written to GPPW, if there is any duplication between the comments for common devices and extension comments, the extension comments take priority and therefore the common device comments cannot be read.	—	—
	When comments created with GPPW are written in GPPA format to the FD or HD of a peripheral device, the comments can be written regardless of the comment capacity in the parameters. The comments can be used when GPPA is started up by carrying out comment memory capacity setting, then reading the comments in the file maintenance mode.	○	—
	With GPPW, device comments and device memories can be created within the ranges designated in the parameters, but even after completing writing to the GPPQ format, it may not be possible to write to GPPQ. In this case the size of the data to be written must be reduced.	—	—
	When second half M comments for main and sub use are read to GPPW, since the range setting is included in S, they are allocated to S.	—	—

Item	Restrictions/Cautions	GPPA	GPPQ
Comment reading/writing	If X/Y comments 2 are written without range setting at GPPW, reading is carried out in accordance with the X and Y attributes respectively.	—	—
	The restriction on sub-system names is up to 10 characters for GPPQ and up to 8 characters for GPPW. On reading subsystem names from GPPQ format, they are shortened to 8 characters. If these subsystem names are written back to GPPQ, they are written as 8 characters.	—	○
	When peripheral statements/notes created with GPPQ are written to a PLC, they cannot be read out with GPPW; they must be read with GPPQ.	—	— <Caution>
	When comments are written in GPPA format, one of the original files at the GPPA side is deleted. When writing comments 2, comments 1 are deleted; when writing comments 1, comments 2 are deleted.	— <Caution>	—
	When comments are written to an A1NCPU, if MAIN (program-classified comment) is selected when writing to the PLC, comments F0 to F127 are written unconditionally to the PLC, regardless of range selection. Reading is carried out in the same way.	— <Caution>	—
	When comments edited as comments 2 at GPPW are written to an ACPU/GPPA format file as comments 1, they are displayed as incorrect characters by GPPA.	— <Caution>	—
	When comments are written to an ACPU/GPPA format file, if a two-byte character starts at the 16th character (for comments 2)/15th character (for comments 1), writing is carried out with the 16th/15th character left blank.	—	—
Parameter setting	When using a memory cassette larger than A3MCA-18, if the total capacity - excluding extension comments - set in capacity setting in the parameters exceeds 144 K bytes, when the extension comments are written it may not be possible to write the second half. In this case the first half 1024 points must be divided into 64-point units.	○	—
	When local device or latch clear key valid/invalid designations are made in the parameters, set a range in device setting.	—	○
	When file registers are set, a file register capacity must be set in the parameters.	○	—
	When parameters for which no settings have been made with GPPA, or whose parameter screens have been opened in GPPA but then closed with "END" without making any settings, are verified - in GPPA - against GPPW parameters set in the same way, a verification mismatch may occur. The mismatch occurs due errors, for example, in the initial value data of blank items, but there is no difference in operation when the parameter data is written to a PLC and executed, so there is no problem in actual use.	—	—
	When file registers are designated in the MELSECNET/10 refresh parameter settings, a capacity setting must be made for file registers in the memory capacity settings.	○	—
	Since MELSECNET/10 network parameters store the time at which the parameter settings were made with GPPW, when network parameters are verified between GPPA/GPPQ and GPPW, the result may be a setting time mismatch even if the set data matches.	— <Caution>	○
	If MELSECNET/10 (multiplex remote master) or MNET/10 (parallel remote master) is set for four modules in the network parameters and these settings are written in GPPQ format and verified against the same parameter settings in GPPQ, a verification error will occur. Since the parameters themselves are correct, there is no problem in actual use.	—	—

Item	Restrictions/Cautions	GPPA	GPPQ								
Parameter settings	If a blanks are set for "refresh parameters" and "link parameter constant scan (GPPA only)" in the GPPA/GPPQ and GPPW parameters, this is the same as settings of "0 points" and "0 ms." respectively at GPPA.	—	—								
	When the device settings are changed, the following files that have already been written to the PLC must be written again: Sequence programs, SFC programs, monitor registration, sampling trace data, device initial values.	—	○								
	With regard to PLC data reading of the network parameters: 1. When parameters are set (written) in the PLC, the written parameters are read. 2. When parameters have not been set in the PLC, the actual link module mounting status detected by the PLC is read.	—	○								
	When verification against parameters created with SW0IVD-GPPQ or SW1IVD-GPPQ is executed, a "parameter mismatch" may occur even if the settings match. If this happens, first read the parameters with SW2IVD-GPPQ, then write the parameters again.	—	○								
	To create a subsequence, a capacity of 2K or more must be set in the parameter mode.	○	—								
Change PLC type	If a PLC type change is made to a PLC type that does not allow the creation of subprograms, subprograms are deleted.	— <Caution>	—								
	When a program is written to the PLC after changing the PLC type, out-of-range devices/instructions cause an error and cannot be written. When data is written to a GPPA format file and read with GPPA, instruction code abnormalities are displayed. The same applies when data is written to a GPPQ format file and read with GPPQ.	—	—								
	<p>If the PLC type is changed in the network system shown below, all the network parameters before the change are retained.</p> <p>However, in the case of AnUCPU, if there is even one module for which the first network I/O number exceeds the actual I/O range of the PLC type changed to, the first I/O numbers are automatically allocated to 0H, 20H, 40H, 60H (assuming there are four modules).</p> <p>(Where A4U changes to A3U, A4U changes to A2U, A3U changes to A2U)</p> <p>For changes between network systems, the changes are to the defaults.</p> <table border="1" data-bbox="453 1464 1174 1727"> <thead> <tr> <th data-bbox="453 1464 676 1507">Network system</th> <th data-bbox="676 1464 1174 1507">PLC system</th> </tr> </thead> <tbody> <tr> <td data-bbox="453 1507 676 1615">AnN systems</td> <td data-bbox="676 1507 1174 1615">A0J2H system, A1N system, A2N system, A3N system, A1S system, A1SH system, A2S system, A2SH system, A2C system</td> </tr> <tr> <td data-bbox="453 1615 676 1655">AnA systems</td> <td data-bbox="676 1615 1174 1655">A2A system, A3A system</td> </tr> <tr> <td data-bbox="453 1655 676 1727">AnU systems</td> <td data-bbox="676 1655 1174 1727">A2U system, A2USH-S1 system, A3U system, A4U system</td> </tr> </tbody> </table>	Network system	PLC system	AnN systems	A0J2H system, A1N system, A2N system, A3N system, A1S system, A1SH system, A2S system, A2SH system, A2C system	AnA systems	A2A system, A3A system	AnU systems	A2U system, A2USH-S1 system, A3U system, A4U system	—	—
	Network system	PLC system									
	AnN systems	A0J2H system, A1N system, A2N system, A3N system, A1S system, A1SH system, A2S system, A2SH system, A2C system									
AnA systems	A2A system, A3A system										
AnU systems	A2U system, A2USH-S1 system, A3U system, A4U system										
If microcomputer programs cannot be accommodated when a PLC type change is made, all microcomputer programs are deleted.	—	—									
<p>If the capacity before the change is smaller than the maximum capacity of the PLC type changed to, the memory capacity is set as that before the change.</p> <p>If it is larger than the maximum memory capacity of the PLC type to be changed to, the memory capacity is set as the maximum memory capacity of the PLC type changed to.</p>	○	—									

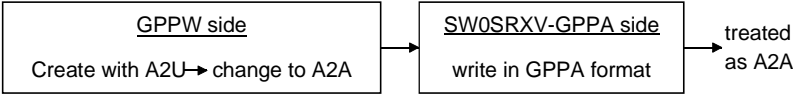
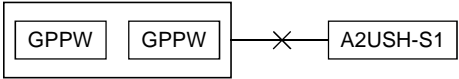

Item	Restrictions/Cautions	GPPA	GPPQ
Change PLC type	If the program capacity decreases, the programs are curtailed at the number of steps equivalent to the reduced capacity. (If this curtailment occurs part way through a ladder program, the entire block is eliminated.)	—	—
	If the sequence programs + microcomputer programs exceed the capacity of the PLC type changed to, the microcomputer program capacity is set to 0.	—	—
	To execute "PLC read" when connected to a CPU that is not in the PLC type list, carry out a PLC type change as follows. • When connecting to A1SCPU with a PLC type other than A1S at the GPPW side, read by changing the PLC type to A2N.	—	—
	When a PLC type change is executed, if there are devices that cannot be used at the PLC after the change, that range of devices is automatically deleted. (For the "A" series, this includes device comments.)	○	—
	When a PLC type change is executed, if a setting that exceeds the maximum device range for the PLC after the change is made, the setting is automatically changed to the maximum possible. (For the "A" series, this includes device comments.)	○	—
PLC type	A connected CPU that does not support A1, A2, or A3 is recognized as AnN but cannot be used.	—	—
Ladder input	The ladder block has 24 lines of parallel contacts and line insertion is not possible.	—	○
	The line return destination and source must have the same number. The same number cannot be used more than once. The line return numbers must be serial numbers. It is not possible to insert a ladder between the line return source and destination.	○	○
	If the contacts/coils to be overwritten straddle multiple contacts, ladder input is not possible.	—	○
	Inserting a contact in the first row does not make it possible to make an insertion at a line return.	—	○
	If a vertical line that crosses an instruction is drawn, conversion will not be possible.	—	○
	In a ladder block with two or more lines where an instruction cannot be accommodated on one line, you must create a line return and input the instruction on the next line.	—	—
	[Enter] When ladder information has been read into the key-in data field by pressing the [Enter] key, the cursor cannot be moved.	—	—
	The maximum number of instruction and device characters that can be written at one contact is eight. If the total number of characters is more than this, multiple rows must be used.	—	—
	If a vertical line that crosses a statement is drawn, a conversion error occurs on attempting conversion.	—	○
	A CHG instruction input check is not performed on programs of PLCs that do not allow the creation of subprograms, such as A2ACPU and A2UCPU. When the PLC is set to RUN an error occurs.	— <Caution>	—
Online change	When online change is executed with respect to an A4UMCA-128E memory cassette, the transmission may take several minutes. During the transmission, operation continues in accordance with the program before the change. After the transmission, sequence processing stops for a maximum of 2 seconds.	○	—
	When online change is executed with respect to an A3NCPU, the CHG instruction is automatically disabled. On completion of conversion, the CHG instruction is executed.	○	—
	During online change, RUN/STOP/PAUSE/STEP RUN key switch operations are prohibited.	○	○
	If there is a pulse instruction in the program to be written, the PLC does not execute this instruction after the PLC write operation. It is executed after its execution condition changes from OFF to ON.	○	○

Item	Restriction/Note	GPPA	GPPQ
Import file /Export file	Depending on the GPPA, there are versions that cannot be selected although the same model name exists in the PLC type list. If the PLC type is not represented with GPPA, change to a PLC type that is represented with GPPA (at GPPW) and then write the data. Example: 	—	—
	Since they are not represented in the PLC type list at the GPPA side, files created with models such as A3HCPU cannot be read with GPPW. (It is not possible to read or write files of incompatible PLCs.)	—	—
	When a GPPA/GPPQ format program that contains an END instruction part way through is read to GPPW, the part of the program up to the END instruction is read. The part after the END instruction is not read.	—	—
	On reading a device memory from ACPU/GPPA format with GPPW, the information of the preceding coils of T/C devices is not read out, and consequently when the data is written again to ACPU/GPPA format and verified at GPPA, a preceding coil mismatch occurs.	—	—
Device test	When a forced set/reset operation is executed while the PLC is in the RUN state, program execution at the PLC is given priority.	○	○
	When an input (X) is forcibly reset, the PLC operates as though it were ON even if program input is OFF. If a process input is ON the PLC will process it as ON even if a forced reset is executed.	○	○
	The local device test requires a range to be set in the parameters in advance.	—	○
	Even if the present value is set to a smaller value than the set value after time up of a timer or counter, the time up status is retained.	○	○
PLC write/read	When a ladder with peripheral statements is written to a PLC, the statements are not written to the PLC, and the ladder must therefore be stored in the HD.	○ <Caution>	○ <Caution>
	When the PLC read dialog box is opened again after writing a ladder to the PLC and displaying the list, and then using another programming tool (GPPW/GPPA/GPPQ, etc.) to, for example, delete PLC data, the contents of the data list may differ from the current status of the PLC data. In this case the list must be updated.	—	—
PLC communication	When communicating with a PLC, no distinction is made between A2US(S1)CPU and A2U(S1)CPU, and therefore access to a CPU when using an A2US(S1)/A2U(S1) is dealt with as access to A2U(S1)CPU.	—	—
	PLC communication is not possible with a GPPW started up. PLC communication is possible with one of these only, under the conditions indicated below. <ul style="list-style-type: none"> <li>• When GPPW is used, check if there is a system (control panel) COM port. If there is not, one must be registered. In this state, PLC communication using GPPA/GPPQ is not possible.</li> <li>• When using GPPA/GPPQ, eliminate the system (control panel) COM port. In this state, PLC communication using GPPW is not possible.</li> <li>• PLC communication with respect to A2USH-S1 with two GPPWs started up is not possible.</li> </ul> 	—	—

Item	Restriction/Note	GPPA	GPPQ
TC set value	When a TC set value change is applied twice, the change is made to the first set value. If there is a duplicated set value change, the program contents must be checked in a program data check.	—	—
	Since GPPA allows reading/writing of T/C set values alone, there are T/C set values that are not used in the program. Since GPPW only reads and writes set values for T/C values that exist in the program, set values that do not exist in the program cannot be handled. (When T/C set values are read and written, unused T/C set values at an ACPU are deleted.)	—	—
	T/C set values used in SAP2 are not handled by GPPW and they are therefore cleared to 0 when written to an APC/GPPA format file.	—	—
Printing	Data is not printed and displayed in accordance with PAGE n (the designated No. becomes the printed page number).	—	—
	GPPA/ACPU print titles are not read/written.	—	—
	Since #CPU# prints the data for the CPU type from the designated position, if the CPU type exceeds 5 characters, blanks must be created at the rear.	—	—
File reading/writing	For file reading/writing with respect to a GPPA that does not allow selection of the same PLC model name, the PLC is treated as a PLC type within the range supported by the GPPA.	—	—
	Reading/writing to files created with SW0S is not possible.	—	—
Note creation	Notes cannot be created for instructions that straddle multiple lines.	—	—
	Notes cannot be created for dedicated instructions.	—	—
	If the coil associated with a note is deleted, the note is also deleted.	—	○ <Caution>
	The note of the first coil in a ladder block is made to correspond to the first step of the ladder block. Other notes are written to the steps of individual coils.	—	—
Find/Replace	It is not possible to search for character strings in comments and device names in the ladder display window. (This is possible for notes and statements only.)	—	○
	When the device with the searched device name has both common and program-specific device name settings, the comment reflection destination/reference destination in the options is not followed.	—	—
	When an online change setting is made for a write conversion setting, the find/Replace menu cannot be selected.	—	○
Statements/notes	P/I statements that are not used in a program with GPPA are not written to GPPW.	—	—
	When multiple P,I statements have been created for the same P,I with GPPW, the first P,I statement encountered is written in GPPA format. The other, redundant, P,I statements are not written.	—	—
	When line statements/notes are created other than at the head of a ladder block with GPPA, statements at steps part way through a block are not written to GPPW.	—	—
	If a note is allocated to the first step of a ladder block, it is read in association with the first coil of the ladder block. For other notes, if the step they are assigned to is a coil, they are read in association with that coil.	—	—

Item	Restriction/Note	GPPA	GPPQ
Use of other packages at the same port	It is not possible to communicate with a PLC while using GPPA/GPPQ at the same port. Either use a different port or quit GPPA/GPPQ (close the DOS prompt too), before using the port.	—	—
	When using the Windows version of, for example, SW[ ]NIW-GOT800P, simultaneous access to the same port is not possible. Communication with one of the packages only is possible.	—	—
Step execution/ Partial execution	After the set break condition has been satisfied, the PLC breaks operation after running for several steps.	—	○
	Step run via A7BD-J71AP21/AR21 is only possible with A2ACPU and A3ACPU.	○	—
Fault history	If storing the fault history file at a location other than the internal RAM, use the drive name and file name.	—	○
Video card	When using an S3 TRIO64V+ video card, the display may not be normal; in this case "none" must be set for "hardware accelerator" in the graphics detailed setting dialog box.	—	—
Ladder display	Out-of-range devices can be displayed in the ladder display. However, an error occurs if an out-of-range designation is made in ladder editing. Out-of-range devices can be checked in the program check.	—	○ <Caution>
	For an illegal ladder that has no MPP corresponding to MPS, a ladder error is displayed by GPPA, but GPPW displays the ladder, treating this as a ladder creation fault.	—	—
Processing at GPPW	When operations that take some time, such as PLC memory clear, are executed, it may not be possible to redisplay the GPPW display, or the operation of another application may be held up.	—	—
Device memory clear	Since latch clear/non-clearance follows the latch range of the PLC parameters of the project that is currently opened at the personal computer, if there is a discrepancy between the parameters stored in the CPU and the latch range, the latch range may be cleared even if latched devices are designated as not included in the range for clearance.	—	—
Writing to a memory cassette	When using an A4UMCA-*E EEPROM, the memory setting switch must be set to the ROM side.	○	—
Device name registration	With GPPA, the first 8 characters of a comment are input as the device name, but with GPPW the device name must be registered. Similarly, when printing with device names, the device names must be registered.	—	—
Starting the initialization file	The maximum number of windows that can be automatically opened by starting program restart or initialization files is 20.	—	—
Instruction input by device name	When instructions are input in a ladder by using device names (LD, 'LS11), they are input by searching for the device that corresponds to the device name from the comment data, but when the same device name is set more than once, the device found first in the search is used.	—	—
Short cut keys	Numeric keys cannot be used as shortcut keys.	—	—
Windows	Up to ten monitor windows (ladder monitor, registration monitor, etc.) can be displayed. When more than one GPPW is started up, up to ten windows can be used with each GPPW.	—	—

Item	Restriction/Note	GPPA	GPPQ
Windows task bar	When GPPW is started up while "Always on Top" or "Auto hide" is not specified in the property settings of the Windows task bar, nothing can be displayed in front of the task bar. To display in front of the task bar, set " Always on Top " or " Auto hide " for the task bar.	—	—
Parameter mismatch	When the same data as parameter data written in GPPA format is created with GPPA, there may be a mismatch in the data contents. However, both are correct as parameters and can be used without problems.	—	—
Memory capacity setting	When A1NCPU is selected with GPPA, the default for the comment capacity in memory capacity setting is 64K bytes, but the GPPW default for comment capacity is 0K bytes.	—	—
Window No.	When the device batch monitor, registration monitor, or buffer memory batch monitor window is opened, the window whose number is one higher than the window last opened is displayed. Even if you close the open window and open another one, the number of the window opened last is counted up.	—	—
Compare	If verification is executed when there is an END instruction part way through the program in the PLC, the part of the program up to the END instruction is verified.	—	—
Duplicate coil result display	The duplicate coil check result display displays details of the step positions where duplicate coils were found in a search from the head of the program.	—	—
About access to remote I/O	When a cable is connected to a master station/control station/remote I/O and remote I/O is designated, communication is not possible. A master station/other station that is not remote I/O must be designated.	—	—
Printing	When printing with device names, device comments and contact use destinations appended on the right, characters in the final line of device comments may be missing, depending on the printer. This problem can be avoided by making the left and right margins smaller in page setting.	—	—
	When printing a large quantity of data, set the printer spool setting to "send printing data directly to the printer."	—	—
Monitoring	When ladder monitoring is executed after setting a monitor condition and monitor stop condition, it is not possible to carry out device test/batch/registration monitoring, or PLC diagnosis. When multiple GPPWs are started on the same personal computer and access to the same PLC is made from the same port, the following functions are not executed concurrently. Monitor values may become abnormal. • Program list monitor, monitoring the interrupt program list, setting monitor conditions, setting monitor stop conditions, measuring scan time.	—	—
Personal computer	Depending on the personal computer, the GPPW may be sent incorrect information on the remaining capacity of the main memory, leading to problems with starting and operation. In this case, you must close other applications and increase the free memory area.	—	—
Import file (reading immediately after starting GPPW)	This applies to A series. When a project has been created at the reading destination PLC type and the data is read (the status is "project name not set"), comments are read in accordance with the comment range at the GPPA side.	—	—
Monitoring with Ethernet	It is not possible to simultaneously monitor with another GPP via an Ethernet connection.	—	—

Item	Restriction/Note	GPPA	GPPQ
Open project	Read-only and write-protected (e.g. FD) projects cannot be opened. When a project which was saved when displayed in a large GPPW window on a personal computer with high resolution is opened on a low-resolution personal computer, it may be displayed at the original large window size and project off the screen. Projects that are saved in their maximized state present no problem.	—	—
Connection destination designation	QCPU-A is inaccessible in the following case. GPPW ↔ AF board or CPU board ↔ MELSECNET/10 other station QCPU-A	—	—

## Appendix 9 About SW D5-GPPW Compatibility

---

- (1) When opening the SW5D5-GPPW-E created data in the package of SW2D5-GPPW-E or earlier

Function, Data	Restrictions
SFC program	SFC data cannot be read.
Macro	Macro-registered (with device comments) device comments are developed as line-to-line comments.
Project name	If the project name of 9 or more characters has been set on SW4D5-GPPW-E, 8 and latter characters are not displayed when the project name is read on the version of SW2D5-GPPW-E or earlier.

- (2) When opening the SW5D5-GPPW-E created data in the package of SW3D5-GPPW-E or earlier

Function, Data	Restrictions
Comment display	Comment display format is fixed to 3×5. (Cannot be changed to 2×8 or 4×8)

- (3) When opening the SW5D5-GPPW created data in the package of SW4D5-GPPW or earlier

Function, Data	Restrictions
Device memory	If multiple device memories have been created with SW5D5C-GPPW, they cannot be handled on the version of SW4D5C-GPPW or earlier. (For details, refer to Section 2.4.)

## Appendix 10 GPPW and LLT Operations

---

The version combinations when the logic test function (LLT) is used with GPPW are indicated below.

		SW5D5-GPPW-E
Logic test function (LLT)	SW2D5-LLT-E	$\Delta (*1 *2 *3)$
	SW3D5-LLT-E	$\Delta (*2 *3)$
	SW4D5-LLT-E	$\Delta (*3)$
	SW5D5-LLT-E	$\bigcirc$

Note 1: When the A series is selected, buffer memory monitoring by LLT cannot be executed from GPPW.

Note 2: The Q series (Q mode, A mode) logic test function (LLT) cannot be started from GPPW.

Note 3: The LLT for FX<sub>1S</sub> and FX<sub>1N</sub> cannot be started from GPPW.



## Appendix 11 Notes on FX Series Programming

The points to note when programming with the FX series are given here. For general points of difference and notes, see Section 1.3.

### 11.1 Ladder Monitor Display

A	Q/QnA	FX
×	×	○

The differences between the FXGP(DOS)/FXGP(WIN) monitor display and GPPW monitor display are indicated here.

- Differences in monitor display of PLS and PLF instructions**  
 In GPPW, the GPPW format display method is set as the default, but if the "PLSPLF instruction ladder monitor" check box in the [Tools] → [Options] <<program common>> sheet is checked, display is in the FXGP(DOS) or FXGP(WIN) format. Whichever display is selected, there is no effect on the actual operation of FXCPU.

Example: Comparison of monitor displays according to setting contents

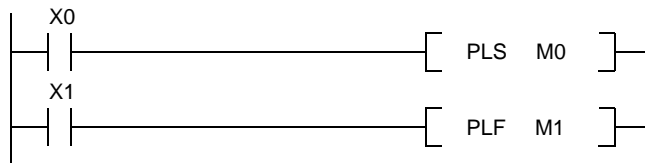

#### (1) Monitoring PLS instructions

- GPPW format display

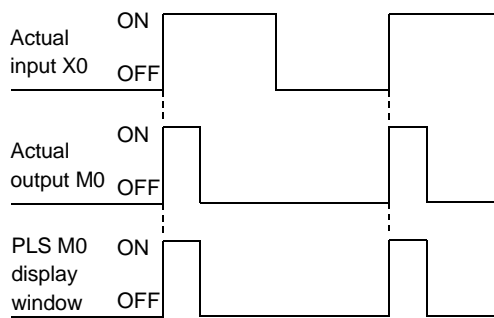

- FXGP(DOS), FXGP(WIN) format display

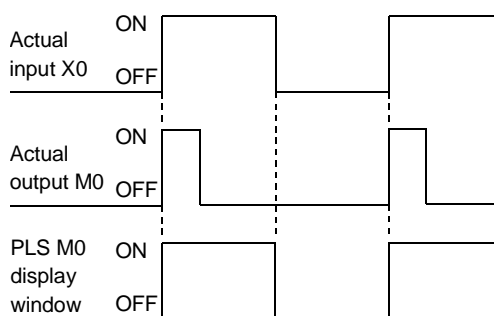

Monitoring PLF instructions

- GPPW format display

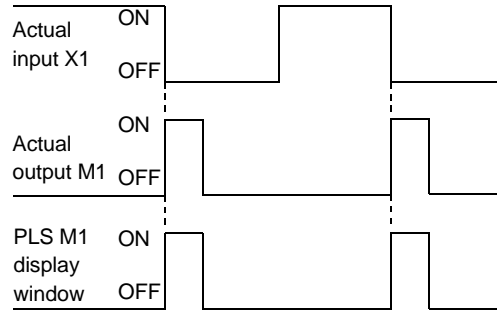

- FXGP(DOS), FXGP(WIN) format display

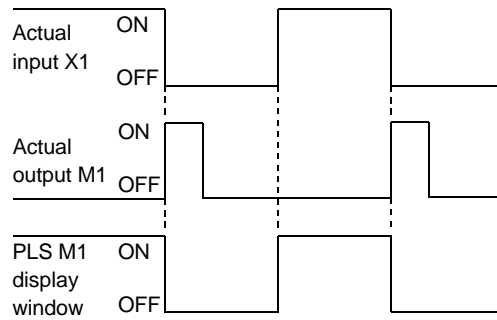

- Differences in monitoring OUT T and OUT C instructions  
The OUT coil monitor display on resetting timer and counter present values is different when using the "A" series or QnA series than it is when using the FX series.

- Display when using the "A" series or QnA series

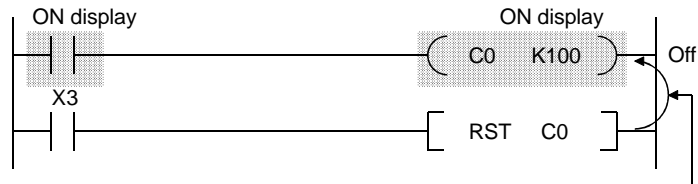

When RST C0 is driven with X3 ON, the present value of C0 is reset and the display of OUT C0 is also turned off.

- Display when using the FX series



When RST C0 is driven with X3 ON, the present value of C0 is reset but the display of OUT C0 remains unchanged. (ON display continues until the drive contact of OUT C0 goes OFF.)

## 11.2 Handling of Comments

A	Q/QnA	FX
×	×	○

- With FXGP(DOS), a distinction is made when entering comments: comments written in the PLC are called "comments 1", and comments held only at the peripheral device side are called "comments 2."  
With GPPW, all comments are managed as device comments, and the distinction between comments 1 and comments 2 does not exist.  
When device comments are written to a PLC, a comment capacity must be secured in "PLC parameter setting" (see Section 13.18), and the comment range among the device comments to be written to the PLC must be set in "comment range setting" (see Section 9.9.)
- Comments of up to 16 characters can be written to a PLC, but some models, such as FXGP(DOS) and A6GPP, can only handle up to 15 characters, which means that the 16th character cannot be displayed. When comments are used in common, enter device comments of up to 15 characters (see Section 9.1.2(3)).
- Comparison of comment configuration

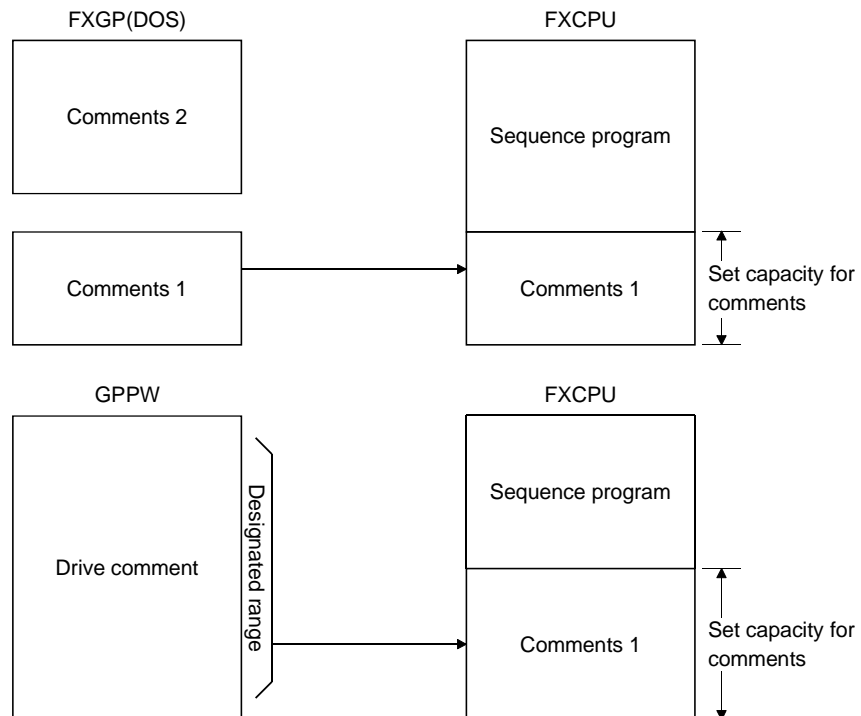

## Appendix 12 Instruction Conversion Lists

### 12.1 Instruction Conversion List for A ↔ Q/QnA Conversions

A	Q/QnA	FX
○	○	×

A ↔ Q/QnA conversions will not be successful under the following conditions: in these cases make the necessary correction after executing the conversion instruction by referring to the following lists.

The instruction conversion list for conversions from A to Q/QnA is given in pages 51 to 66. The instruction conversion list for conversions from Q/QnA to A is given in pages 67 to 79. The indications \*, \*1, \*2, \*3, \*4, \*5, \*6, and \*7 in the lists refer to sources and destinations.

Device correspondence table for A → QnA conversions

A Series	Q/QnA Series	Remarks
M	M	
M9000 to	SM1000 to	
L	L	
F	F	
S	M	
X	X	
Y	Y	
B	B	
D	D	
D9000 to	SD1000 to	
A0, 1	SD718, 719	
R	R	
W	W	
T	T, ST	ST is governed by the parameter settings
C	C	

Device correspondence table for A → Q/QnA conversions (continued)

A Series	QnA Series	Remarks
P	P	If out-of-range, the instruction becomes OUT SM1255
I	I	If out-of-range, the instruction becomes OUT SM1255
N	N	If out-of-range, the instruction becomes OUT SM1255
K	K	
H	H	
“ “	“ “	Character strings are handled
Z, Z1~Z6	Z0~Z6	
K	K	
V, V1 to V6	Z7 to Z13	

Devices that contain out-of-range device parts or extension parts are changed to SM1255 if bits and SD1255 if words.

Converting "A" standard instructions to Q/QnA series:

A Series	Q/QnA Series	Remarks
OUT T* *2	OUT T* *2	H(OUTH) and ST are governed by the parameter settings
	OUT ST* *2	
	OUT C* *2	
OUT C* *2	OUTH T* *2	
	OUTH ST* *2	
	OUTH C* *2	
SUB *1	OUT SM1255	A dedicated instructions are excepted.
CHG	OUT SM1255	
SUM *1	SUM *1 SD718	
DSUM *1	DSUM *1 SD718	
ASC *1 *2	OUT SM1255	
LRDP *1 *2 *3 *4	OUT SM1255	
LWTP *1 *2 *3 *4	OUT SM1255	
RFRP *1 *2 *3 *4	OUT SM1255	
RTOP *1 *2 *3 *4	OUT SM1255	

Converting "A" standard instructions to QnA series:

A Series	QnA Series	Remarks
LEDA *1	OUT SM1255	"A" dedicated instructions are excepted.
LEDB *2	OUT SM1255	"A" dedicated instructions are excepted.
CHK *1 *2	OUT SM1255	
STC	OUT SM1255	
CLC	OUT SM1255	

Converting structured program dedicated instructions to QnA series:

Refer to the QCPU (Q mode)/QnACPU Programming Manual (Common Instructions) (for AnACPU/AnUCPU)

A Series	Q/QnA Series	Remarks
LEDA(LEDB) IX LEDC *1 LEDR	OUT SM1255 LEDC *1 LEDR	Section 7.6.9 Index qualification of entire ladder
LEDA IXEND	OUT SM1255	
LEDA CHK	OUT SM1255	Section 7.10.1 Special format failure checks
LEDA CHKEND	OUT SM1255	Section 7.10.2 Changing check format of CHK instruction

Converting character string processing instructions to QnA series (for AnACPU/AnUCPU)

A Series	Q/QnA Series	Remarks
LEDA/LEDB SCMP LEDC *1 LEDC *2 LEDC *3 LEDR	OUT SM1255 LEDC *1 LEDC *2 LEDC *3 LEDR	Section 6.1.4 Character string data comparisons

Converting instructions for file registers to QnA series (for AnACPU/AnUCPU)

A Series	Q/QnA Series	Remarks
LEDA/LEDB RSET LEDC/SUB *1 LEDR	OUT SM1255 LEDC *1/OUT SM1255 LEDR	Section 7.14.1 Switching file register numbers
LEDA/LEDB BMOVR LEDC *1 LEDC *2 LEDC/SUB *3 LEDR	OUT SM1255 LEDC *1 LEDC *2 LEDC *3/OUT SM1255 LEDR	Section 6.4.5 Block 16-bit data transfers
LEDA/LEDB BXCHR LEDC *1 LEDC *2 LEDC/SUB *3 LEDR	OUT SM1255 LEDC *1 LEDC *2 LEDC *3/OUT SM1255 LEDR	Section 6.4.8 Block 16-bit data exchanges
LEDA/LEDB ZRRD	OUT SM1255	Section 7.18.3 Direct 1-byte read from file register
LEDA/LEDB ZRWR	OUT SM1255	Section 7.18.4 File register direct 1-byte write
LEDA/LEDB ZRRDB	OUT SM1255	Section 7.18.3 Direct 1-byte read from file register
LEDA/LEDB ZRWRB	OUT SM1255	Section 7.18.4 File register direct 1-byte write

Converting instructions for data link to Q/QnA series (for AnACPU/AnUCPU)

A Series	Q/QnA Series	Remarks
LEDA/LEDB LRDP SUB *1 LEDC *2 LEDC *3 SUB *4 LEDC *5 LEDR	OUT SM1255 OUT SM1255 LEDC *2 LEDC *3 OUT SM1255 LEDC *5 LEDR	Section 8.3.2 Reading device data from local stations (MELSECNET)
LEDA/LEDB LWTP SUB *1 LEDC *2 LEDC *3 SUB *4 LEDC *5 LEDR	OUT SM1255 OUT SM1255 LEDC *2 LEDC *3 OUT SM1255 LEDC *5 LEDR	Section 8.3.4 Writing data to devices at local stations (MELSECNET)
LEDA/LEDB ZNFR SUB K/H* SUB *1 LEDC *2 SUB *3 SUB *4 LEDC *5 LEDR	OUT SM1255 OUT SM1255 OUT SM1255 LEDC *2 OUT SM1255 OUT SM1255 LEDC *5 LEDR	Section 8.2.8 Reading data from special function modules at remote I/O stations
LEDA/LEDB ZNTO SUB K/H* SUB *1 LEDC *2 SUB *3 SUB *4 LEDC *5 LEDR	OUT SM1255 OUT SM1255 OUT SM1255 LEDC *2 OUT SM1255 OUT SM1255 LEDC *5 LEDR	Section 8.2.9 Writing data to special function module of remote I/O station



## Converting program switching instructions to Q/QnA series (for AnACPU/AnUCPU)

A Series	QnA Series	Remarks
LEDA ZCHG0	OUT SM1255	Model Q2AS(H) CPU(S1) User's Manual Appendix 4.5
LEDA ZCHG1	OUT SM1255	
LEDA ZCHG2	OUT SM1255	
LEDA ZCHG3	OUT SM1255	Q2A(S1)/Q3A/Q4ACPU User's Manual Appendix 4.5

## Converting instructions for CC-Link to Q/QnA series

Refer to the CC-Link System Master Local Module type AJ61QBT11 /A1SJQBT11 User's Manual (for AnSHCPU)

A Series	Q/QnA Series	Remarks
LEDA/LEDB RLPA SUB K/H* LEDC *1 LEDC *2 LEDR	OUT SM1255 OUT SM1255 LEDC *1 LEDC *2 LEDR	Q/QnACPU PROGRAMING MANUAL (Common Instructions) Section 7.8.1 Special function modules 1-and 2- word data read operations Section 7.8.2 Special function modules 1-and 2- word data write operations.
LEDA/LEDB RRPA SUB K/H* LEDC *1 LEDR	OUT SM1255 OUT SM1255 LEDC *1 LEDR	
LEDA/LEDB RITO SUB K/H* SUB *1 LEDC *2 LEDC *3 LEDR	OUT SM1255 OUT SM1255 OUT SM1255 LEDC *2 LEDC *3 LEDR	Section 15.6.9 RITO instruction
LEDA/LEDB RIWT SUB K/H* SUB *1 LEDC *2 LEDC *3 LEDR	OUT SM1255 OUT SM1255 OUT SM1255 LEDC *2 LEDC *3 LEDR	Section 15.6.5 RIWT instruction
LEDA/LEDB RIRCV SUB K/H* SUB *1 LEDC *2 LEDC *3 LEDC *4 LEDR	OUT SM1255 OUT SM1255 OUT SM1255 LEDC *2 LEDC *3 LEDC *4 LEDR	Section 15.6.7 RIRCV instruction

## Converting instructions for CC-Link to Q/QnA series (for AnSHCPU) (Continued)

A Series	Q/QnA Series	Remarks
LEDA/LEDB RISEND SUB K/H* SUB *1 LEDC *2 LEDC *3 LEDC *4 LEDR	OUT SM1255 OUT SM1255 OUT SM1255 LEDC *2 LEDC *3 LEDC *4 LEDR	Section 15.6.6 RISEND instruction
LEDA/LEDB RDGET SUB K/H* SUB *1 LEDC *2 LEDC *3 LEDR	OUT SM1255 OUT SM1255 OUT SM1255 LEDC *2 LEDC *3 LEDR	Section 15.6.10 RDGET instruction
LEDA/LEDB RDPUT SUB K/H* SUB *1 LEDC *2 LEDC *3 LEDR	OUT SM1255 OUT SM1255 OUT SM1255 LEDC *2 LEDC *3 LEDR	Section 15.6.11 RDPUT instruction
LEDA/LEDB RDMON SUB K/H* SUB *1 LEDC *2 LEDC *3 LEDR	OUT SM1255 OUT SM1255 OUT SM1255 LEDC *2 LEDC *3 LEDR	Section 15.6.12 RDMON instruction

Device correspondence table for Q/QnA → A conversions

Q/QnA Series	A Series	Remarks
M	M	
SM	M9255	
SM1000 to	M9000 to	
L	L	
F	F	
V	M9255	
S	M9255	
TR	M9255	
X	X	
Y	Y	
FX	M9255	
FY	M9255	
B	B	
SB	M9255	
DX	X	
DY	Y	
D	D	
SD	D9255	
SD718, 719	A0, 1	
SD1000 to	D9000 to	
FD	D9255	
G	D9255	
SG	D9255	
VD	D9255	
A	D9255	
R	R	
ZR0 to 8191	R0 to 8191	
ZR8192 to	D9255	
W	W	
SW	D9255	
T	T	
C	C	
ST	T	
Z0 to Z6	Z, Z1 to Z6	
Z7 to Z13	V, V1 to V6	
Z14 to	D9255	
P	P	If out-of-range, the instruction becomes OUT M9255
I	I	If out-of-range, the instruction becomes OUT M9255
N	N	If out-of-range, the instruction becomes OUT M9255
U	M9255	All instructions become OUT M9255
J	M9255	All instructions become OUT M9255
BL	M9255	All instructions become OUT M9255
K	K	
H	H	

Device correspondence table for Q/QnA → A conversions (Continued)

Q/QnA Series	A Series	Remarks
E	D9255	
“ “	“ “	
Z0 to Z6	Z, Z1 to Z6	If the device part is a device that cannot be converted, all devices containing this code become M9255 or D9255.
Z7 to Z13	V, V1 to V6	If the device part is a device that cannot be converted, all devices containing this code become M9255 or D255.
Z14 to	M9255, D9255	All devices containing this code become M9255 or D9255.
K	K	If the device part is a device that cannot be converted, all devices containing this code become M9255 or D255.
.	M9255, D9255	All devices containing this code become M9255 or D9255.
@	M9255, D9255	All devices containing this code become M9255 or D9255.
U	M9255, D9255	All devices containing this code become M9255 or D9255.
J	M9255, D9255	All devices containing this code become M9255 or D9255.
BL	M9255, D9255	All devices containing this code become M9255 or D9255.

Devices that contain out-of-range device parts or extension parts are changed to M9255 if bits and D9255 if words.

Converting Q/QnA series instructions to A series instructions

Q/QnA Series	A Series	
	Common Instructions	Dedicated Instructions (for AnA, AnUCPU)
LDP *1	LD M9255	
LDF *1	LD M9255	
ORP *1	OR M9255	
ORF *1	OR M9255	
ANDP *1	AND M9255	
ANDF *1	AND M9255	
EGP *1	AND M9255	
EGF *1	AND M9255	
MEP	AND M9255	
MEF	AND M9255	
INV	AND M9255	
OUT DY *	OUT M9255	LEDA DOUT LEDC Y* LEDR
OUT T/ST/C256 *2	OUT M9255	
OUTH T/ST/C256 *2	OUT M9255	
SET DY*	OUT M9255	LEDA/LEDB DSET LEDC Y* LEDR

Converting Q/QnA series instructions to A series instructions (continued)

Q/QnA Series	A Series	
	Common Instructions	Dedicated Instructions (for AnA, AnUCPU)
RST DY*	OUT M9255	LEDA/LEDB DRST LEDC Y* LEDR
FF *1	OUT M9255	LEDB FF LEDC *1 LEDR
DELTA *1	OUT M9255	
PAGE *1	OUT M9255	
LDE= *1 *2 ORE= *1 *2 ANDE= *1 *2	LD= D9255 D9255 OR= D9255 D9255 AND= D9255 D9255	
LDE<> *1 *2 ORE<> *1 *2 ANDE<> *1 *2	LD<> D9255 D9255 OR<> D9255 D9255 AND<> D9255 D9255	
LDE> *1 *2 ORE> *1 *2 ANDE> *1 *2	LD> D9255 D9255 OR> D9255 D9255 AND> D9255 D9255	
LDE>= *1 *2 ORE>= *1 *2 ANDE>= *1 *2	LD>= D9255 D9255 OR>= D9255 D9255 AND>= D9255 D9255	
LDE< *1 *2 ORE< *1 *2 ANDE< *1 *2	LD< D9255 D9255 OR< D9255 D9255 AND< D9255 D9255	
LDE<= *1 *2 ORE<= *1 *2 ANDE<= *1 *2	LD<= D9255 D9255 OR<= D9255 D9255 AND<= D9255 D9255	
LD\$= *1 *2 OR\$= *1 *2 AND\$= *1 *2	LD= D9255 D9255 OR= D9255 D9255 AND= D9255 D9255	
LD\$<> *1 *2 OR\$<> *1 *2 AND\$<> *1 *2	LD<> D9255 D9255 OR<> D9255 D9255 AND<> D9255 D9255	
LD\$> *1 *2 OR\$> *1 *2 AND\$> *1 *2	LD> D9255 D9255 OR> D9255 D9255 AND> D9255 D9255	
LD\$>= *1 *2 OR\$>= *1 *2 AND\$>= *1 *2	LD>= D9255 D9255 OR>= D9255 D9255 AND>= D9255 D9255	
LD\$< *1 *2 OR\$< *1 *2 AND\$< *1 *2	LD< D9255 D9255 OR< D9255 D9255 AND< D9255 D9255	
LD\$<= *1 *2 OR\$<= *1 *2 AND\$<= *1 *2	LD<= D9255 D9255 OR<= D9255 D9255 AND<= D9255 D9255	

Converting Q/QnA series instructions to A series instructions (continued)

Q/QnA Series	A Series	
	Common Instructions	Dedicated Instructions (for AnA, AnUCPU)
BKMP= *1 *2 *3 *4	OUT M9255	
BKMP<> *1 *2 *3 *4	OUT M9255	
BKMP> *1 *2 *3 *4	OUT M9255	
BKMP>= *1 *2 *3 *4	OUT M9255	
BKMP< *1 *2 *3 *4	OUT M9255	
BKMP<= *1 *2 *3 *4	OUT M9255	
E+ *1 *2	OUT M9255	
E+ *1 *2 *3	OUT M9255	LEDA/LEDB ADD LEDC *1 LEDC *2 LEDC *3 LEDR
E- *1 *2	OUT M9255	
E- *1 *2 *3	OUT M9255	LEDA/LEDB SUB LEDC *1 LEDC *2 LEDC *3 LEDR
E* *1 *2 *3	OUT M9255	LEDA/LEDB MUL LEDC *1 LEDC *2 LEDC *3 LEDR
E/ *1 *2 *3	OUT M9255	LEDA/LEDB DIV LEDC *1 LEDC *2 LEDC *3 LEDR
\$+ *1 *2	OUT M9255	
\$+ *1 *2 *3	OUT M9255	LEDA/LEDB SADD LEDC *1 LEDC *2 LEDC *3 LEDR
BK+ *1 *2 *3 *4	OUT M9255	
BK- *1 *2 *3 *4	OUT M9255	
INT *1 *2	OUT M9255	LEDA/LEDB INT LEDC *1 LEDC *2 LEDR
DINT *1 *2	OUT M9255	LEDA/LEDB DINT LEDC *1 LEDC *2 LEDR

Converting Q/QnA series instructions to A series instructions (continued)

Q/QnA Series	A Series	
	Common Instructions	Dedicated Instructions (for AnA, AnUCPU)
FLT *1 *2	OUT M9255	LEDA/LEDB FLOAT LEDC/SUB *1 LEDC *2 LEDR
DFLT *1 *2	OUT M9255	LEDA/LEDB DFLOAT LEDC/DXNR *1 LEDC *2 LEDR
DBL *1 *2	OUT M9255	
WORD *1 *2	OUT M9255	
GRY *1 *2	OUT M9255	
DGRY *1 *2	OUT M9255	
GBIN *1 *2	OUT M9255	
DGBIN *1 *2	OUT M9255	
DNEG *1	OUT M9255	
ENEG *1	OUT M9255	
BKBCD *1 *2 *3	OUT M9255	
BKBIN *1 *2 *3	OUT M9255	
EMOV *1 *2	OUT M9255	
\$MOV *1 *2	OUT M9255	LEDA/LEDB SMOV LEDC *1 LEDC *2 LEDR
BXCH *1 *2	OUT M9255	
SWAP *1	OUT M9255	LEDA/LEDB SWAP LEDC *1 LEDR
GOEND	OUT M9255	
RFS *1 *2	OUT M9255	
DAND *1 *2 *3	OUT M9255	
DOR *1 *2 *3	OUT M9255	
DXOR *1 *2 *3	OUT M9255	
DXNR *1 *2 *3	OUT M9255	
BKAND *1 *2 *3 *4	OUT M9255	
BKOR *1 *2 *3 *4	OUT M9255	
BKXOR *1 *2 *3 *4	OUT M9255	
BKXNR *1 *2 *3 *4	OUT M9255	
TEST *1 *2 *3	OUT M9255	LEDA/LEDB TEST LEDC *1 LEDC/SUB *2 LEDC *3 LEDR

Converting Q/QnA series instructions to A series instructions (continued)

Q/QnA Series	A Series	
	Common Instructions	Dedicated Instructions (for AnA, AnUCPU)
DTEST *1 *2 *3	OUT M9255	LEDA/LEDB DTEST LEDC *1 LEDC/SUB *2 LEDC *3 LEDR
BKRST *1 *2	OUT M9255	
DSER *1 *2 *3 *4	OUT M9255	LEDA/LEDB DSER LEDC *1 LEDC *2 LEDC/SUB *4 LEDR
NDIS *1 *2 *3	OUT M9255	LEDA/LEDB DIS LEDC *1 LEDC *2 LEDC *3 LEDR
NUNI *1 *2 *3	OUT M9255	LEDA/LEDB UNI LEDC *1 LEDC *2 LEDC *3 LEDR
WTOB *1 *2 *3	OUT M9255	LEDA/LEDB WTOB LEDC *1 LEDC *2 LEDC/SUB *3 LEDR
BTOW *1 *2 *3	OUT M9255	LEDA/LEDB BTOW LEDC *1 LEDC *2 LEDC/SUB *3 LEDR
MAX *1 *2 *3	OUT M9255	
DMAX *1 *2 *3	OUT M9255	
MIN *1 *2 *3	OUT M9255	
DMIN *1 *2 *3	OUT M9255	
SORT *1 *2 *3 *4 *5	OUT M9255	
DSORT *1 *2 *3 *4 *5	OUT M9255	
WSUM *1 *2 *3	OUT M9255	
DWSUM *1 *2 *3	OUT M9255	
BREAK *1 *2	OUT M9255	
CALL *1 *2	OUT M9255	
CALL *1 *2 *3	OUT M9255	
CALL *1 *2 *3 *4	OUT M9255	
CALL *1 *2 *3 *4 *5	OUT M9255	



Converting Q/QnA series instructions to A series instructions (continued)

Q/QnA Series	A Series	
	Common Instructions	Dedicated Instructions (for AnA, AnUCPU)
CALL *1 *2 *3 *4 *5 *6	OUT M9255	
FCALL *1	OUT M9255	
FCALL *1 *2	OUT M9255	
FCALL *1 *2 *3	OUT M9255	
FCALL *1 *2 *3 *4	OUT M9255	
FCALL *1 *2 *3 *4 *5	OUT M9255	
FCALL *1 *2 *3 *4 *5 *6	OUT M9255	
ECALL *1 *2	OUT M9255	
ECALL *1 *2 *3	OUT M9255	
ECALL *1 *2 *3 *4	OUT M9255	
ECALL *1 *2 *3 *4 *5	OUT M9255	
ECALL *1 *2 *3 *4 *5 *6	OUT M9255	
ECALL *1 *2 *3 *4 *5 *6 *7	OUT M9255	
EFCALL *1 *2	OUT M9255	
EFCALL *1 *2 *3	OUT M9255	
EFCALL *1 *2 *3 *4	OUT M9255	
EFCALL *1 *2 *3 *4 *5	OUT M9255	
EFCALL *1 *2 *3 *4 *5 *6	OUT M9255	
EFCALL *1 *2 *3 *4 *5 *6 *7	OUT M9255	
IXSET *1 *2	OUT M9255	
FPOP *1 *2	OUT M9255	
FINS *1 *2 *3	OUT M9255	
FDEL *1 *2 *3	OUT M9255	
CHKST	OUT M9255	
CHK	OUT M9255	
CHKCIR	OUT M9255	
CHKEND	OUT M9255	
PTRA	OUT M9255	
PTRAR	OUT M9255	
PTRAEXE	OUT M9255	
BINDA *1 *2	OUT M9255	LEDA/LEDB BINDA LEDC/SUB *1 LEDC *2 LEDR
DBINDA *1 *2	OUT M9255	LEDA/LEDB DBINDA LEDC/DXNR *1 LEDC *2 LEDR
BINHA *1 *2	OUT M9255	LEDA/LEDB BINHA LEDC/SUB *1 LEDC *2 LEDR

Converting Q/QnA series instructions to A series instructions (continued)

Q/QnA Series	A Series	
	Common Instructions	Dedicated Instructions (for AnA, AnUCPU)
DBINHA *1 *2	OUT M9255	LEDA/LEDB DBINHA LEDC/DXNR *1 LEDC *2 LEDR
BCDDA *1 *2	OUT M9255	LEDA/LEDB BCDDA LEDC/SUB *1 LEDC *2 LEDR
DBCDDA *1 *2	OUT M9255	LEDA/LEDB DBCDDA LEDC/DXNR *1 LEDC *2 LEDR
DABIN *1 *2	OUT M9255	LEDA/LEDB DABIN LEDC *1 LEDC *2 LEDR
DDABIN *1 *2	OUT M9255	LEDA/LEDB DDABIN LEDC *1 LEDC *2 LEDR
HABIN *1 *2	OUT M9255	LEDA/LEDB HABIN LEDC *1 LEDC *2 LEDR
DHABIN *1 *2	OUT M9255	LEDA/LEDB DHABIN LEDC *1 LEDC *2 LEDR
DABCD *1 *2	OUT M9255	LEDA/LEDB DABCD LEDC *1 LEDC *2 LEDR
DDABCD *1 *2	OUT M9255	LEDA/LEDB DDABCD LEDC *1 LEDC *2 LEDR
COMRD *1 *2	OUT M9255	LEDA/LEDB COMRD LEDC *1 LEDC *2 LEDR

Converting Q/QnA series instructions to A series instructions (continued)

Q/QnA Series	A Series	
	Common Instructions	Dedicated Instructions (for AnA, AnUCPU)
LEN *1 *2	OUT M9255	LEDA/LEDB LEN LEDC *1 LEDC *2 LEDR
STR *1 *2 *3	OUT M9255	LEDA/LEDB STR LEDC *1 LEDC/SUB *2 LEDC *3 LEDR
DSTR *1 *2 *3	OUT M9255	LEDA/LEDB DSTR LEDC *1 LEDC/DXNR *2 LEDC *3 LEDR
VAL *1 *2 *3	OUT M9255	LEDA/LEDB VAL LEDC *1 LEDC *2 LEDC *3 LEDR
DVAL *1 *2 *3	OUT M9255	LEDA/LEDB DVAL LEDC *1 LEDC *2 LEDC *3 LEDR
ESTR *1 *2 *3	OUT M9255	
EVAL *1 *2	OUT M9255	
ASC *1 *2 *3	OUT M9255	LEDA/LEDB ASC LEDC *1 LEDC *2 LEDC/SUB *3 LEDR
HEX *1 *2 *3	OUT M9255	LEDA/LEDB HEX LEDC *1 LEDC *2 LEDC/SUB *3 LEDR
RIGHT *1 *2 *3	OUT M9255	
LEFT *1 *2 *3	OUT M9255	
MIDR *1 *2 *3	OUT M9255	
MIDW *1 *2 *3	OUT M9255	
INSTR *1 *2 *3 *4	OUT M9255	
EMOD *1 *2 *3	OUT M9255	
EREXP *1 *2 *3	OUT M9255	

Converting Q/QnA series instructions to A series instructions (continued)

Q/QnA Series	A Series	
	Common Instructions	Dedicated Instructions (for AnA, AnUCPU)
SIN *1 *2	OUT M9255	LEDA/LEDB SIN LEDC *1 LEDC *2 LEDR
COS *1 *2	OUT M9255	LEDA/LEDB COS LEDC *1 LEDC *2 LEDR
TAN *1 *2	OUT M9255	LEDA/LEDB TAN LEDC *1 LEDC *2 LEDR
ASIN *1 *2	OUT M9255	LEDA/LEDB ASIN LEDC *1 LEDC *2 LEDR
ACOS *1 *2	OUT M9255	LEDA/LEDB ACOS LEDC *1 LEDC *2 LEDR
ATAN *1 *2	OUT M9255	LEDA/LEDB ATAN LEDC *1 LEDC *2 LEDR
RAD *1 *2	OUT M9255	LEDA/LEDB RAD LEDC *1 LEDC *2 LEDR
DEG *1 *2	OUT M9255	LEDA/LEDB DEG LEDC *1 LEDC *2 LEDR
SQR *1 *2	OUT M9255	LEDA/LEDB SQR LEDC *1 LEDC *2 LEDR
EXP *1 *2	OUT M9255	LEDA/LEDB EXP LEDC *1 LEDC *2 LEDR

Converting Q/QnA series instructions to A series instructions (continued)

Q/QnA Series	A Series	
	Common Instructions	Dedicated Instructions (for AnA, AnUCPU)
LOG *1 *2	OUT M9255	LEDA/LEDB LOG LEDC *1 LEDC *2 LEDR
BSQR *1 *2	OUT M9255	LEDA/LEDB BSQR LEDC/SUB *1 LEDC *2 LEDR
BDSQR *1 *2	OUT M9255	LEDA/LEDB BDSQR LEDC/DXNR *1 LEDC *2 LEDR
BSIN *1 *2	OUT M9255	LEDA/LEDB BSIN LEDC/SUB *1 LEDC *2 LEDR
BCOS *1 *2	OUT M9255	LEDA/LEDB BCOS LEDC/SUB *1 LEDC *2 LEDR
BTAN *1 *2	OUT M9255	LEDA/LEDB BTAN LEDC/SUB *1 LEDC *2 LEDR
BASIN *1 *2	OUT M9255	LEDA/LEDB BASIN LEDC *1 LEDC *2 LEDR
BACOS *1 *2	OUT M9255	LEDA/LEDB BACOS LEDC *1 LEDC *2 LEDR
BATAN *1 *2	OUT M9255	LEDA/LEDB BATAN LEDC *1 LEDC *2 LEDR
LIMIT *1 *2 *3 *4	OUT M9255	LEDA/LEDB LIMIT LEDC/SUB *1 LEDC/SUB *2 LEDC/SUB *3 LEDC *4 LEDR

Converting Q/QnA series instructions to A series instructions (continued)

Q/QnA Series	A Series	
	Common Instructions	Dedicated Instructions (for AnA, AnUCPU)
DLIMIT *1 *2 *3 *4	OUT M9255	LEDA/LEDB DLIMIT LEDC/DXNR *1 LEDC/DXNR *2 LEDC/DXNR *3 LEDC *4 LEDR
BAND *1 *2 *3 *4	OUT M9255	LEDA/LEDB BAND LEDC/SUB *1 LEDC/SUB *2 LEDC/SUB *3 LEDC *4 LEDR
DBAND *1 *2 *3 *4	OUT M9255	LEDA/LEDB DBAND LEDC/DXNR *1 LEDC/DXNR *2 LEDC/DXNR *3 LEDC *4 LEDR
ZONE *1 *2 *3 *4	OUT M9255	LEDA/LEDB ZONE LEDC/SUB *1 LEDC/SUB *2 LEDC/SUB *3 LEDC *4 LEDR
DZONE *1 *2 *3 *4	OUT M9255	LEDA/LEDB DZONE LEDC/DXNR *1 LEDC/DXNR *2 LEDC/DXNR *3 LEDC *4 LEDR
RSET *1	OUT M9255	
QDRSET *1	OUT M9255	
QCDSET *1	OUT M9255	
DATERD *1	OUT M9255	LEDA/LEDB DATERD LEDC *1 LEDR
DATEWR *1	OUT M9255	LEDA/LEDB DATEWR LEDC *1 LEDR
DATE+ *1 *2 *3	OUT M9255	
DATE- *1 *2 *3	OUT M9255	
SECOND *1 *2	OUT M9255	
HOUR *1 *2	OUT M9255	

Converting Q/QnA series instructions to A series instructions (continued)

Q/QnA Series	A Series	
	Common Instructions	Dedicated Instructions (for AnA, AnUCPU)
PIDINIT *1	OUT M9255	LEDA/LEDB PIDINIT LEDC *1 LEDR
PIDCONT *1	OUT M9255	LEDA PIDCONT LEDC *1 LEDR
PID57 *1 *2 *3	OUT M9255	LEDA PID57 SUB *1 LEDC/SUB *2 LEDC *3 LEDR
PIDSTOP *1	OUT M9255	
PIDRUN *1	OUT M9255	
PIDPRMW *1 *2	OUT M9255	
MSG *1	OUT M9255	
PKEY *1	OUT M9255	
PSTOP *1	OUT M9255	
POFF *1	OUT M9255	
PSCAN *1	OUT M9255	
PLOW *1	OUT M9255	
ZRRDB *1 *2	OUT M9255	
ZRWRB *1 *2	OUT M9255	
ADRSET *1 *2	OUT M9255	
KEY *1 *2 *3 *4	OUT M9255	LEDA KEY LEDC *1 LEDC *2 LEDC *3 LEDC *4 LEDR
UDCNT1 *1 *2 *3	OUT M9255	
UDCNT2 *1 *2 *3	OUT M9255	
TTMR *1 *2	OUT M9255	
STMR *1 *2 *3	OUT M9255	
ROTC *1 *2 *3 *4	OUT M9255	
RAMP *1 *2 *3 *4 *5	OUT M9255	
SPD *1 *2 *3	OUT M9255	
PLSY *1 *2 *3	OUT M9255	
PWM *1 *2 *3	OUT M9255	
MTR *1 *2 *3 *4	OUT M9255	
IMASK *1	OUT M9255	
IX *1	OUT M9255	
IXEND	OUT M9255	

Converting Q/QnA series instructions to A series instructions (continued)

Q/QnA Series	A Series	
	Common Instructions	Dedicated Instructions (for AnA, AnUCPU)
IXDEV	OUT M9255	
S. ****	OUT M9255	
Z. ****	OUT M9255	
G. ****	OUT M9255	
J. ****	OUT M9255	



12.2 A Instruction Conversion List for FX Series Conversions

A	Q/QnA	FX
○	×	○

The rules for device and instruction conversions when performing A ↔ FX conversions are given here.

For instructions that cannot be converted, make a correction after instruction conversion by referring to the lists.

The instruction conversion list for conversions from A to FX is given in pages 72 to 77.

The instruction conversion list for conversions from FX to A is given in pages 78 to 84.

The indications \*, \*1, \*2, \*3, \*4, \*5, \*6, and \*7 in the lists refer to sources and destinations.

Device correspondence table for A → FX conversions

A Series	FX Series	Remarks
M	M	
M9000 to	M8255	
L	M8255	
F	M8255	
S	S	
X	X	The hexadecimal input numbers of the "A" series are condensed as octal numbers headed by X0 for the FX series
Y	Y	The hexadecimal input numbers of the "A" series are condensed as octal numbers headed by X0 for the FX series
B	M8255	
D	D	
D9000 to	D8255	
A0□1	D8255	
R	D1000 to	
W	D8000 to	
T	T	
C	C	
Z, Z1 to Z6	Z, Z1 to Z6	
172.16.	V, V1 to V6	
P	P	If out-of-range, the instruction becomes OUT M8255
I	I	If out-of-range, the instruction becomes OUT M8255
N	N	If out-of-range, the instruction becomes OUT M8255
K	K	
H	H	
" "	" "	
Z, Z1 to Z6	Z, Z1 to Z6	
K	K	
V, V1 to V6	V, V1 to V6	

Devices that contain out-of-range device parts or extension parts are changed to M8255 if bits and D8255 if words.

Converting A series to FX series

A Series	FX Series	Remarks
NOP	NOP	
LD *1	LD *1	
LDI *1	LDI *1	
OR *1	OR *1	
ORI *1	ORI *1	
AND *1	AND *1	
ANI *1	ANI *1	
ORB	ORB	
ANB	ANB	
MPS	MPS	
MRD	MRD	
MPP	MPP	
OUT *1	OUT *1	
OUT T/C* *2	OUT T/C* *2	
SET *1	SET *1	
RST *1	RST *1	
PLS *1	PLS *1	
PLF *1	PLF *1	
SFT *1	OUT M8255	
SFTP *1	OUT M8255	
MC *1 *2	MC *1 *2	
STOP	OUT M8255	
MCR *1	MCR *1	
FEND	FEND	
END	END	
NOPLF	OUT M8255	
P*,I*	P*,I*	
LD= *1 *2	LD= *1 *2	
OR= *1 *2	OR= *1 *2	For models other than FX1S, FX1N, FX2N(C):
AND= *1 *2	AND= *1 *2	LD/OR/AND M8255
LD<> *1 *2	LD<> *1 *2	
OR<> *1 *2	OR<> *1 *2	For models other than FX1S, FX1N, FX2N(C):
AND<> *1 *2	AND<> *1 *2	LD/OR/AND M8255
LD> *1 *2	LD> *1 *2	
OR> *1 *2	OR> *1 *2	For models other than FX1S, FX1N, FX2N(C):
AND> *1 *2	AND> *1 *2	LD/OR/AND M8255
LD>= *1 *2	LD>= *1 *2	
OR>= *1 *2	OR>= *1 *2	For models other than FX1S, FX1N, FX2N(C):
AND>= *1 *2	AND>= *1 *2	LD/OR/AND M8255
LD< *1 *2	LD< *1 *2	
OR< *1 *2	OR< *1 *2	For models other than FX1S, FX1N, FX2N(C):
AND< *1 *2	AND< *1 *2	LD/OR/AND M8255

(continued on next page)

A Series	FX Series	Remarks
LD<= *1 *2	LD<= *1 *2	
OR<= *1 *2	OR<= *1 *2	For models other than FX1S, FX1N, FX2N(C):
AND<= *1 *2	AND<= *1 *2	LD/OR/AND M8255
LDD= *1 *2	LDD= *1 *2	
ORD= *1 *2	ORD= *1 *2	For models other than FX1S, FX1N, FX2N(C):
ANDD= *1 *2	ANDD= *1 *2	LD/OR/AND M8255
LDD<> *1 *2	LDD<> *1 *2	
ORD<> *1 *2	ORD<> *1 *2	For models other than FX1S, FX1N, FX2N(C):
ANDD<> *1 *2	ANDD<> *1 *2	LD/OR/AND M8255
LDD> *1 *2	LDD> *1 *2	
ORD> *1 *2	ORD> *1 *2	For models other than FX1S, FX1N, FX2N(C):
ANDD> *1 *2	ANDD> *1 *2	LD/OR/AND M8255
LDD>= *1 *2	LDD>= *1 *2	
ORD>= *1 *2	ORD>= *1 *2	For models other than FX1S, FX1N, FX2N(C):
ANDD>= *1 *2	ANDD>= *1 *2	LD/OR/AND M8255
LDD< *1 *2	LDD< *1 *2	
ORD< *1 *2	ORD< *1 *2	For models other than FX1S, FX1N, FX2N(C):
ANDD< *1 *2	ANDD< *1 *2	LD/OR/AND M8255
LDD<= *1 *2	LDD<= *1 *2	
ORD<= *1 *2	ORD<= *1 *2	For models other than FX1S, FX1N, FX2N(C):
ANDD<= *1 *2	ANDD<= *1 *2	LD/OR/AND M8255
+ *1 *2	ADD *1 *2 D8255	
+ *1 *2 *3	ADD *1 *2 *3	
- *1 *2	SUB *1 *2 D8255	
- *1 *2 *3	SUB *1 *2 *3	
D+ *1 *2	DADD *1 *2 D8255	
D+ *1 *2 *3	DADD *1 *2 *3	
D- *1 *2	DSUB *1 *2 D8255	
D- *1 *2 *3	DSUB *1 *2 *3	
* *1 *2 *3	MUL *1 *2 *3	
/ *1 *2 *3	DIV *1 *2 *3	
D* *1 *2 *3	DMUL *1 *2 *3	
D/ *1 *2 *3	DDIV *1 *2 *3	
B+ *1 *2	OUT M8255	
B+ *1 *2 *3	OUT M8255	
B- *1 *2	OUT M8255	
B- *1 *2 *3	OUT M8255	
DB+ *1 *2	OUT M8255	
DB+ *1 *2 *3	OUT M8255	
DB- *1 *2	OUT M8255	
DB- *1 *2 *3	OUT M8255	
B* *1 *2 *3	OUT M8255	
B/ *1 *2 *3	OUT M8255	

(continued on next page)

A Series	FX Series	Remarks
DB* *1 *2 *3	OUT M8255	
DB/ *1 *2 *3	OUT M8255	
INC *1	INC *1	
DINC *1	DINC *1	
DEC *1	DEC *1	
DDEC *1	DDEC *1	
BCD *1 *2	BCD *1 *2	
DBCD *1 *2	DBCD *1 *2	
BIN *1 *2	BIN *1 *2	
DBIN *1 *2	DBIN *1 *2	
NEG *1	NEG *1	FX <sub>1N</sub> , FX <sub>1S</sub> , FX <sub>1</sub> , FX <sub>0N</sub> , FX <sub>0</sub> : OUT M8255
MOV *1 *2	MOV *1 *2	
DMOV *1 *2	DMOV *1 *2	
CML *1 *2	CML *1 *2	For FX <sub>1N</sub> , FX <sub>1S</sub> , FX <sub>1</sub> , FX <sub>0N</sub> , FX <sub>0</sub> : OUT M8255
DCML *1 *2	DCML *1 *2	For FX <sub>1N</sub> , FX <sub>1S</sub> , FX <sub>1</sub> , FX <sub>0N</sub> , FX <sub>0</sub> : OUT M8255
BMOV *1 *2 *3	BMOV *1 *2 *3	For FX <sub>1N</sub> , FX <sub>1S</sub> , FX <sub>1</sub> , FX <sub>0</sub> : M8255
FMOV *1 *2 *3	FMOV *1 *2 *3	For FX <sub>1N</sub> , FX <sub>1S</sub> , FX <sub>1</sub> , FX <sub>0N</sub> , FX <sub>0</sub> : OUT M8255
XCH *1 *2	XCH *1 *2	For FX <sub>1N</sub> , FX <sub>1S</sub> , FX <sub>1</sub> , FX <sub>0N</sub> , FX <sub>0</sub> : OUT M8255
DXCH *1 *2	DXCH *1 *2	For FX <sub>1N</sub> , FX <sub>1S</sub> , FX <sub>1</sub> , FX <sub>0N</sub> , FX <sub>0</sub> : OUT M8255
CJ *1	CJ *1	
SCJ *1	CJ *1	
SUB *1	OUT M8255	
CHG	OUT M8255	
WAND *1 *2	WAND *1 *2 D8255	
WAND *1 *2 *3	WAND *1 *2 *3	
WOR *1 *2	WOR *1 *2 D8255	
WOR *1 *2 *3	WOR *1 *2 *3	
WXOR *1 *2	WXOR *1 *2 D8255	
WXOR *1 *2 *3	WXOR *1 *2 *3	
WXNR *1 *2	OUT M8255	
WXNR *1 *2 *3	OUT M8255	
DAND *1 *2	DAND *1 *2 D8255	
DOR *1 *2	DOR *1 *2 D8255	
DXOR *1 *2	DXOR *1 *2 D8255	
DXNR *1 *2	OUT M8255	
ROR *1	ROR D8255 *1	For FX <sub>1N</sub> , FX <sub>1S</sub> , FX <sub>1</sub> , FX <sub>0N</sub> , FX <sub>0</sub> : OUT M8255
RCR *1	RCR D8255 *1	For FX <sub>1N</sub> , FX <sub>1S</sub> , FX <sub>1</sub> , FX <sub>0N</sub> , FX <sub>0</sub> : OUT M8255
ROL *1	ROL D8255 *1	For FX <sub>1N</sub> , FX <sub>1S</sub> , FX <sub>1</sub> , FX <sub>0N</sub> , FX <sub>0</sub> : OUT M8255
RCL *1	RCL D8255 *1	For FX <sub>1N</sub> , FX <sub>1S</sub> , FX <sub>1</sub> , FX <sub>0N</sub> , FX <sub>0</sub> : OUT M8255
DROR *1	OUT M8255	
DRCR *1	OUT M8255	
DROL *1	OUT M8255	
DRCL *1	OUT M8255	

(continued on next page)

A Series	FX Series	Remarks
SFR *1 *2	OUT M8255	
SFL *1 *2	OUT M8255	
BSFR *1 *2	OUT M8255	
BSFL *1 *2	OUT M8255	
DSFR *1 *2	OUT M8255	
DSFL *1 *2	OUT M8255	
BSET *1 *2	OUT M8255	
BRST *1 *2	OUT M8255	
DECO *1 *2 *3	DECO *1 *2 *3	
ENCO *1 *2 *3	ENCO *1 *2 *3	
SEG *1 *2	SEGD *1 *2	For FX <sub>1N</sub> , FX <sub>1S</sub> , FX <sub>1</sub> , FX <sub>0N</sub> , FX <sub>0</sub> : OUT M8255
DIS *1 *2 *3	OUT M8255	
UNI *1 *2 *3	OUT M8255	
SER *1 *2 *3	SER *1 *2 D8255 *3	For FX <sub>1N</sub> , FX <sub>1S</sub> , FX <sub>1</sub> , FX <sub>0N</sub> , FX <sub>0</sub> : OUT M8255
SUM *1	SUM *1 D8255	For FX <sub>1N</sub> , FX <sub>1S</sub> , FX <sub>1</sub> , FX <sub>0N</sub> , FX <sub>0</sub> : OUT M8255
DSUM *1	DSUM *1 D8255	For FX <sub>1N</sub> , FX <sub>1S</sub> , FX <sub>1</sub> , FX <sub>0N</sub> , FX <sub>0</sub> : OUT M8255
ASC *1 *2	ASC *1 *2	For FX <sub>1N</sub> , FX <sub>1S</sub> , FX <sub>1</sub> , FX <sub>0N</sub> , FX <sub>0</sub> : OUT M8255
CALL *1	CALL *1	For FX <sub>1N</sub> , FX <sub>1S</sub> , FX <sub>0N</sub> , FX <sub>0</sub> : M8255
FIFW *1 *2	OUT M8255	
FIFR *1 *2	OUT M8255	
FROM *1 *2 *3 *4	FROM *1 *2 *3 *4	For FX <sub>1S</sub> , FX <sub>1</sub> , FX <sub>0</sub> : M8255
DFRO *1 *2 *3 *4	DFROM *1 *2 *3 *4	For FX <sub>1S</sub> , FX <sub>1</sub> , FX <sub>0</sub> : M8255
TO *1 *2 *3 *4	TO *1 *2 *3 *4	For FX <sub>1S</sub> , FX <sub>1</sub> , FX <sub>0</sub> : M8255
DTO *1 *2 *3 *4	DTO *1 *2 *3 *4	For FX <sub>1S</sub> , FX <sub>1</sub> , FX <sub>0</sub> : M8255
LRDP *1 *2 *3 *4	OUT M8255	
LWTP *1 *2 *3 *4	OUT M8255	
RFRP *1 *2 *3 *4	OUT M8255	
RTOP *1 *2 *3 *4	OUT M8255	
PR *1 *2	PR *1 *2	For FX <sub>1N</sub> , FX <sub>1S</sub> , FX <sub>0N</sub> , FX <sub>0</sub> : M8255
PRC *1 *2	OUT M8255	
LED *1	OUT M8255	
LEDC *1	OUT M8255	
LEDR	OUT M8255	
LEDA *1	OUT M8255	
LEDB *1	OUT M8255	
SLT	OUT M8255	
SLTR	OUT M8255	
STRA	OUT M8255	
STRAR	OUT M8255	
WDT	WDT	
DUTY *1 *2 *3	OUT M8255	
CHK *1 *2	OUT M8255	
STC	SET M8022	

(continued on next page)

A Series	FX Series	Remarks
CLC	RST M8022	
JMP *1	CJ *1	
DI	DI	
EI	EI	
IRET	IRET	
FOR *1	FOR *1	
NEXT	NEXT	
RET	SRET	For FX1, FX0: M8255
COM	OUT M8255	

Device correspondence table for FX → A conversions

FX Series	A Series	Remarks
M	M	
M8000 to	M9255	
S	M9255	The octal input numbers of the FX series are condensed as hexadecimal numbers headed by X0 for the "A" series
X	X	The octal input numbers of the FX series are condensed as hexadecimal numbers headed by X0 for the "A" series
Y	Y	
D	D	
D8000 to	D9255	
T	T	
C	C	
Z, Z1 to Z6	Z, Z1 to Z6	
V, V1 to V6	V, V1 to V6	
V7, Z7	D9255	
P	P	If out-of-range, the instruction becomes OUT M9255
I	I	If out-of-range, the instruction becomes OUT M9255
N	N	If out-of-range, the instruction becomes OUT M9255
K	K	
H	H	
""	""	
Z, Z1 to Z6	Z, Z1 to Z6	If the device part is a device that cannot be converted, all devices containing this code become M9255 or D255.
V, V1 to V6	V, V1 to V6	If the device part is a device that cannot be converted, all devices containing this code become M9255 or D255.
V7, Z7	M9255, D9255	All devices containing this code become M9255 or D9255.
K	K	If the device part is a device that cannot be converted, all devices containing this code become M9255 or D255.

Devices that contain out-of-range device parts or extension parts are changed to M9255 if bits and D9255 if words.

## Converting FX series to A series

FX Series	A Series	Remarks
NOP	NOP	
LD *1	LD *1	
LDI *1	LDI *1	
LDP *1	LD M9255	
LDF *1	LD M9255	
OR *1	OR *	
ORI *1	ORI *1	
ORP *1	OR M9255	
ORF *1	OR M9255	
AND *1	AND *1	
ANI *1	ANI *1	
ANDP *1	AND M9255	
ANDF *1	AND M9255	
INV	AND M9255	
ORB	ORB	
ANB	ANB	
MPS	MPS	
MRD	MRD	
MPP	MPP	
OUT *1	OUT *1	
OUT T/C0 to 199 *2	OUT T/C *2	
OUT C200 to *2	OUT M9255	32-bit counters are not changed.
SET *1	SET *1	
RST *1	RST *1	
PLS *1	PLS *	
PLF *1	PLF *	
MC *1 *2	MC *1 *2	
MCR *1	MCR *1	
FEND	FEND	
END	END	
P*,I*	P*,I*	
LD= *1 *2	LD= *1 *2	
OR= *1 *2	OR= *1 *2	
AND= *1 *2	AND= *1 *2	
LD<> *1 *2	LD<> *1 *2	
OR<> *1 *2	OR<> *1 *2	
AND<> *1 *2	AND<> *1 *2	
LD> *1 *2	LD> *1 *22	
OR> *1 *2	OR> *1 *2	
AND> *1 *2	AND> *1 *2	
LD>= *1 *2	LD>= *1 *2	
OR>= *1 *2	OR>= *1 *2	
AND>= *1 *2	AND>= *1 *2	

(continued on next page)



FX Series	A Series	Remarks
LD< *1 *2	LD< *1 *2	
OR< *1 *2	OR< *1 *2	
AND< *1 *2	AND< *1 *2	
LD<= *1 *2	LD<= *1 *2	
OR<= *1 *2	OR<= *1 *2	
AND<= *1 *2	AND<= *1 *2	
LDD= *1 *2	LDD= *1 *2	
ORD= *1 *2	ORD= *1 *2	
ANDD= *1 *2	ANDD= *1 *2	
LDD<> *1 *2	LDD<> *1 *2	
ORD<> *1 *2	ORD<> *1 *2	
ANDD<> *1 *2	ANDD<> *1 *2	
LDD> *1 *2	LDD> *1 *2	
ORD> *1 *2	ORD> *1 *2	
ANDD> *1 *2	ANDD> *1 *2	
LDD>= *1 *2	LDD>= *1 *2	
ORD>= *1 *2	ORD>= *1 *2	
ANDD>= *1 *2	ANDD>= *1 *2	
LDD< *1 *2	LDD< *1 *2	
ORD< *1 *2	ORD< *1 *2	
ANDD< *1 *2	ANDD< *1 *2	
LDD<= *1 *2	LDD<= *1 *2	
ORD<= *1 *2	ORD<= *1 *2	
ANDD<= *1 *2	ANDD<= *1 *2	
CMP	OUT M9255	
DCMP	OUT M9255	
ZCP	OUT M9255	
DZCP	OUT M9255	
DECMP	OUT M9255	
DEZCP	OUT M9255	
ADD *1 *2 *2	+ *1 *2 *3	
SUB *1 *2 *2	- *1 *2 *3	
DADD *1 *2 *2	D+ *1 *2 *3	
DSUB *1 *2 *2	D- *1 *2 *3	
MUL *1 *2 *3	* *1 *2 *3	
DIV *1 *2 *3	/ *1 *2 *3	
DMUL *1 *2 *3	D* *1 *2 *3	
DDIV *1 *2 *3	D/ *1 *2 *3	
DEADD *1 *2 *3	OUT M9255	
DESUB *1 *2 *3	OUT M9255	
DEMUL *1 *2 *3	OUT M9255	
DEDIV *1 *2 *3	OUT M9255	
INC *1	INC *1	
DINC *1	DINC *1	

(continued on next page)

FX Series	A Series	Remarks
DEC *1	DEC *1	
DDEC *1	DDEC *1	
BCD *1 *2	BCD *1 *2	
DBCD *1 *2	DBCD *1 *2	
BIN *1 *2	BIN *1 *2	
DBIN *1 *2	DBIN *1 *2	
INT *1 *2	OUT M9255	
DINT *1 *2	OUT M9255	
GRY *1 *2	OUT M9255	
DGRY *1 *2	OUT M9255	
GBIN *1 *2	OUT M9255	
DGBIN *1 *2	OUT M9255	
NEG *1	NEG *1	
DNEG *1	OUT M9255	
DEBCD	OUT M9255	
DEBIN	OUT M9255	
MOV *1 *2	MOV *1 *2	
DMOV *1 *2	DMOV *1 *2	
CML *1 *2	CML *1 *2	
DCML *1 *2	DCML *1 *2	
BMOV *1 *2 *3	BMOV *1 *2 *3	
FMOV *1 *2 *3	FMOV *1 *2 *3	
XCH *1 *2	XCH *1 *2	
DXCH *1 *2	DXCH *1 *2	
SWAP *1	OUT M9255	
SMOV	OUT M9255	
DSWAP *1	OUT M9255	
DFMOV *1 *2 *3	OUT M9255	
CJ *1	CJ *1	
REF	OUT M9255	
REFF	OUT M9255	
HSCS	OUT M9255	
DHSCS	OUT M9255	
HSCR	OUT M9255	
DHSCR	OUT M9255	
HSZ	OUT M9255	
DHSZ	OUT M9255	
WAND *1 *2 *3	WAND *1 *2 *3	
WOR *1 *2 *3	WOR *1 *2 *3	
WXOR *1 *2 *3	WXOR *1 *2 *3	
DAND *1 *2 *3	DAND *1 *2	
DOR *1 *2 *3	DOR *1 *2	
DXOR *1 *2 *3	DXOR *1 *2	

(continued on next page)

FX Series	A Series	Remarks
ROR *1 *2	ROR *2	
RCR *1 *2	RCR *2	
ROL *1 *2	ROL *2	
RCL *1 *2	RCL *2	
DROR *1 *2	DROR *2	
DRCR *1 *2	DRCR *2	
DROL *1 *2	DROL *2	
DRCL *1 *2	DRCL *2	
SFTR *1 *2 *3 *4	OUT M9255	
SFTL *1 *2 *3 *4	OUT M9255	
WSFR *1 *2 *3 *4	OUT M9255	
WSFL *1 *2 *3 *4	OUT M9255	
SFWR *1 *2 *3	OUT M9255	
SFRD *1 *2 *3	OUT M9255	
SER *1 *2 *3 *4	SER *1 *2 *4	
DSER *1 *2 *3 *4	OUT M9255	
DECO *1 *2 *3	DECO *1 *2 *3	
ENCO *1 *2 *3	ENCO *1 *2 *3	
SORT *1 *2 *3 *4 *5	OUT M9255	
ASC *1 *2	ASC *1 *2	
ZRST *1 *2	OUT M9255	
SUM *1 *2	SUM *1	
DSUM *1 *2	DSUM *1	
BON *1 *2 *3	OUT M9255	
DBON *1 *2 *3	OUT M9255	
MEAN *1 *2 *3	OUT M9255	
DMEAN *1 *2 *3	OUT M9255	
ANS *1 *2 *3	OUT M9255	
ANR	OUT M9255	
FLT *1 *2	OUT M9255	
DFLT *1 *2	OUT M9255	
CALL *1	CALL *1	
FROM *1 *2 *3 *4	FROM *1 *2 *3 *4	
DFROM *1 *2 *3 *4	DFRO *1 *2 *3 *4	
TO *1 *2 *3 *4	TO *1 *2 *3 *4	
DTO *1 *2 *3 *4	DTO *1 *2 *3 *4	
PR *1 *2	PR *1 *2	
HEX *1 *2 *3	OUT M9255	
ASCI *1 *2 *3	OUT M9255	
SQR *1 *2	OUT M9255	
DSQR	OUT M9255	
DESQR *1 *2	OUT M9255	

(continued on next page)

FX Series	A Series	Remarks
DSIN *1 *2	OUT M9255	
DCOS *1 *2	OUT M9255	
DTAN *1 *2	OUT M9255	
TCMP	OUT M9255	
TZCP	OUT M9255	
TADD	OUT M9255	
TSUB	OUT M9255	
TRD	OUT M9255	
TWR	OUT M9255	
PID	OUT M9255	
TKY	OUT M9255	
DTKY	OUT M9255	
HKY	OUT M9255	
DHKY	OUT M9255	
DSW	OUT M9255	
SEGD	OUT M9255	
SEGL	OUT M9255	
ARWS	OUT M9255	
RS	OUT M9255	
PRUN	OUT M9255	
DPRUN	OUT M9255	
CCD	OUT M9255	
VRRD	OUT M9255	
VRSC	OUT M9255	
MNET	OUT M9255	
ANRD	OUT M9255	
ANWR	OUT M9255	
RMST	OUT M9255	
RMWR	OUT M9255	
DRMWR	OUT M9255	
RMRD	OUT M9255	
DRMRD	OUT M9255	
RMMN	OUT M9255	
BLK	OUT M9255	
MCDE	OUT M9255	
WDT	WDT	
TTMR	OUT M9255	
STMR	OUT M9255	
ROTC	OUT M9255	
SPD	OUT M9255	
PLSY	OUT M9255	
PWM	OUT M9255	

(continued on next page)

FX Series	A Series	Remarks
MTR	OUT M9255	
DPLSY	OUT M9255	
IST	OUT M9255	
ABSD	OUT M9255	
DABSD	OUT M9255	
INCD	OUT M9255	
ALT	OUT M9255	
RAMP	OUT M9255	
PLSR	OUT M9255	
DPLSR	OUT M9255	
DI	DI	
EI	EI	
IRET	IRET	
SRET	RET	
FOR *1	FOR *1	
NEXT	NEXT	
STL *1	OUT M9255	
RET	OUT M9255	
DABS	OUT M9255	
ZRN	OUT M9255	
DZRN	OUT M9255	
PLSV	OUT M9255	
DPLSV	OUT M9255	
DRVI	OUT M9255	
DDRVI	OUT M9255	
DRVA	OUT M9255	
DDRVA	OUT M9255	
HOUR	OUT M9255	
DHOUR	OUT M9255	
RD3A	OUT M9255	
WR3A	OUT M9255	

## 12.3 List of Instruction Conversions for Change between Q Series and A/QnA Series

A	Q/QnA	FX
○	○	×

When the PC type is changed from QCPU to ACPU or from QCPU to QnACPU, the instructions added newly to the Q series are all changed into M9255 (A series) or SM1255 (QnA series).

The following instructions have become compatible with the Q series.

Instruction	Description
UNIRD	Reads module information
TRACE	Sets trace
TRACER	Resets trace
S.FWRITE	Writes binary data
S.FREAD	Reads binary data
S.FORMAT	Reads word devices from other PLC
G.READ	
G.SREAD	Writes word devices from other PLC
G.SWRITE	
S.REQ	Transient request from other PLC
GINT	Interrupt instruction from other PLC
PLOAD	Program load from memory card
PUNLOAD	Program unload from SPM
PSWAP	Load + unload
RBMMOV	High-speed file register block transfer

POINT
When the A series is changed to the Q series, any instruction existing in the QnA series but not existing in the Q series is changed as a single line (SM1255). Also, any instruction existing in the A series but not existing in the Q/QnA series is changed as more than one line.

Because of incompatibility with the Q series, the following instructions are changed into SM1255 when the QnA series is changed to the Q series.

	Description	Instruction Name
AD57/A58 control instructions	Display mode setting	G.MCODE
	Canvas screen display	G.CPS
	VRAM display address change	G.CPS1
	Canvas transfer	G.CPS2
	Screen clear	G.CMOV
	VRAM clear	G.CLS
	Scroll up/down	G.CLV
	Cursor display	G.CSCRU, G.CSCRD
	Cursor erasure	G.COFF
	Cursor locating	G.LOCATE
	Normal/reverse display of displayed characters	G.CNOR, G.CREV
	Character color designation	G.COLOR, G.CCDSP, G.CCDSPV
	ASCII character display	G.PRN, G.PR
	ASCII character write	G.PRNV, G.PRV
	Character display	G.EPRN, G.EPRV
	Character write	G.EPRNV, G.EPRV
	Continuous display of the same character	G.CR1, G.CR2, G.CC1, G.CC2
	Minus display	G.CINMP
	Hyphen display	G.CINHP
	Period display	G.CINTP
	Numeric character display	G.CIN0 to G.CIN9
	Alphabetic character display	G.CINA to G.CINZ
	Space display	G.CINP
	Designated field clear	G.CINCLR
	ASCII code conversion	G.INPUT
	VRAM data read	G.GET
	VRAM data write	G.PUT
Display status read	G.STAT	
PID monitor	G.PID57	
AJ71PT32-S3 control instructions	Key input from operation box	G.INPUT
	Data transmission of the specified number of bytes in no-protocol mode	G.PRN
	Data transmission up to 00H code in no-protocol mode	G.PR
	Data receive in no-protocol mode	G.INPUT
	Communication to/from remote terminal module	G.MINI
	Error reset to remote terminal module	G.MINIERR
	Communication status read	G.SPBUSY
	Forced suspension of communication processing	G.SPCLR

	Description	Instruction Name
AJ71C21(S1) control instructions	Data transmission of the specified number of bytes	G.PRN2, G.PRN4
	Data transmission up to 00H	G.PR2, G.PR4
	Data receive	G.INPUT2, G.INPUT4
	Access to RAM memory	G.GET, G.PUT
	Communication status read	G.SPBUSY
	Forced suspension of communication processing	G.SPCLR
AD59(S1) control instructions	Printer output	G.PRN, G.PR
	Data read/write from/to memory card	G.GET, G.PUT
Write to EEPROM	Write to EEPROM	EROMWR
Sampling trace, status latch related instructions	Sampling trace	STRA
	Sampling trace reset	STRAR
	Status latch set	SLT
	Status latch reset	SLTR
Program trace related instructions	Program trace trigger	PTRA
	Program trace reset	PTRAR
	Program trace execution	PTRAEXE
LED indication related instructions	LED indication of ASCII code	LED
	LED indication instruction for comment	LEDC
	LED indication of comment	LEDC



Appendix 13 About the A6TEL/Q6TEL

13.1 A6TEL/Q6TEL Switch Settings

(1) A6TEL

A6TEL right side face

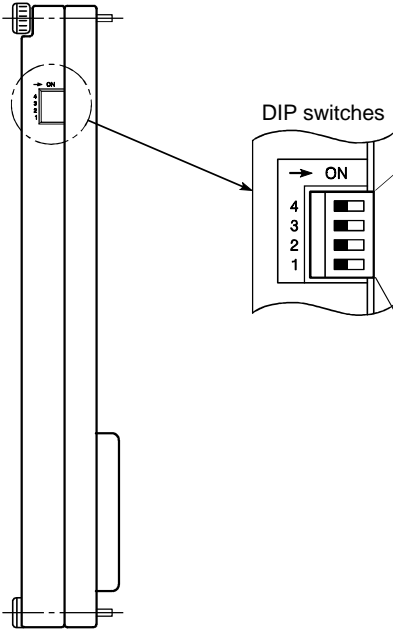

Switch No.	Setting	Description
4	—	Unused (kept in OFF)
3	OFF	Remote access enable mode (when telephone line connection is enabled from peripheral device)
	ON	Remote access disable mode (notice processing may be executed)
2	OFF	Notice processing execution mode
	ON	Proximate connection enable mode
1	OFF	Telephone line connection mode/proximate connection mode
	ON	EEPROM write mode (for initial setting, password, notice data write)

(2) Q6TEL

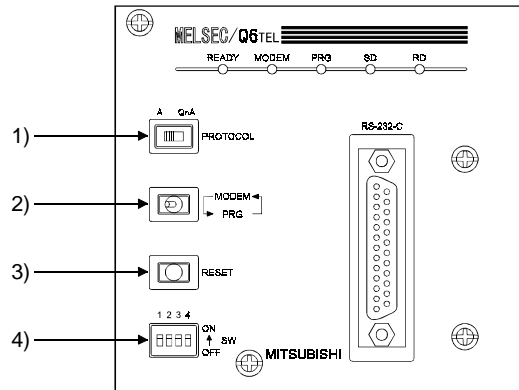

1) A/QnA select switch

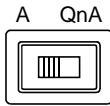

Setting	Description
QnA	When the connected CPU is QnACPU
A	When the connected CPU is ACPU

2) MODEM/PRG select switch

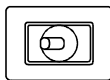

Setting	Description
MODEM/PRG (remote/proximate)	The switch is an alternate switch. The "MODEM" LED is lit to indicate remote access. The "PRG" LED is lit to indicate the proximate connection mode.

3) RESET switch

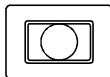

Resets the Q6TEL.

4) DIP switches

The following table explains the DIP switches for QnACPU access.



Switch No.	Setting	Description
1	OFF	Telephone line connection mode/GPP function (proximate connection mode)
	ON	Q6TEL data (E2PROM write) setting mode (for initial setting, password, notice data write)
2	—	—
3	—	—
4	—	—

Note: When "A" is selected with the A/QnA select switch, the description is the same as that of the DIP switches of the A6TEL.

The following table explains the DIP switch for ACPU access.

Switch No.	Setting	Description
1	OFF	Telephone line connection mode/proximate connection mode
	ON	A6TEL data (E <sup>2</sup> PROM write) setting mode (for initial setting, password, notice data write)
2	OFF	Notice processing execution mode (also set DIP switch 1 to OFF)
	ON	Proximate connection mode
3	OFF	Remote access enable mode (when telephone line connection from A7PHP/LM series/PC9800 is enabled)
	ON	Remote access disable mode (notice processing may be executed)
4	—	Unused (keep in OFF)

[Q6TL's DIP switch settings] (for ACPU access)

Switch No.	Remote Access	Notice Processing	E <sup>2</sup> PROM Mode	Proximate Connection
1	OFF	OFF	ON	OFF
2	OFF	OFF	ON/OFF	ON
3	OFF	ON/OFF	ON/OFF	ON/OFF
4	OFF			

ON/OFF indicates that the corresponding switch may either be ON or OFF.

## 13.2 How to Change the Proximate Mode of the Q6TEL

---

This section gives the way to choose the proximate connection mode with the Q6TEL fitted to the PLC CPU.

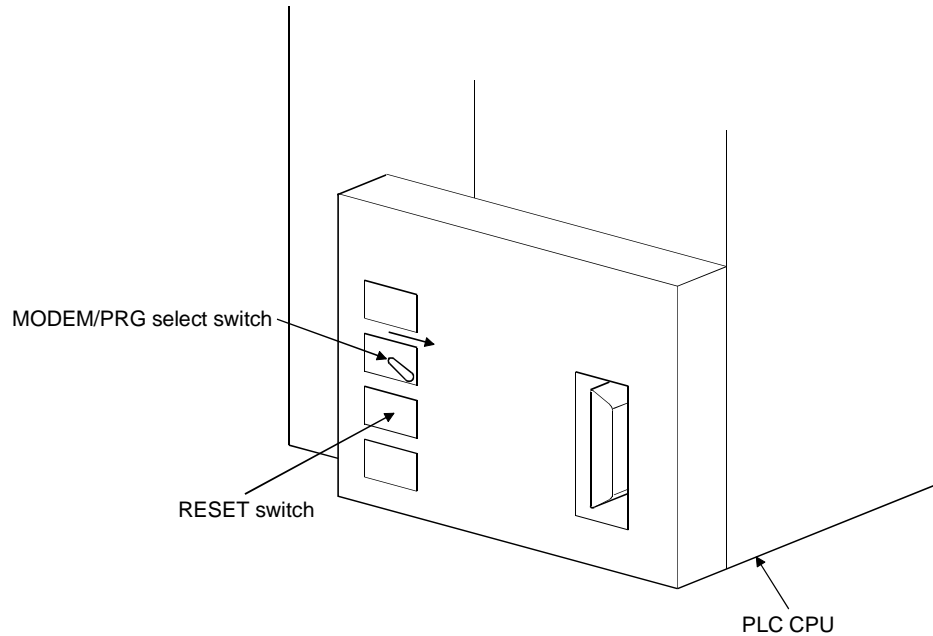

### Operation procedure

- 1) Hold the MODEM/PRG select switch in the right position and press the RESET switch.
- 2) Release only the RESET switch.
- 3) After making sure that the "READY" LED and "PRG" LED are lit (about 3 seconds until they turn on), release the MODEM/PRG select switch.  
This operation selects the proximate connection mode.

## Appendix 14 Functions Added to Update from SW4D5-GPPW

---

The following functions have been added to SW5D5-GPPW updated from SW4D5-GPPW.

Item	Description
Device memory	You can create and store multiple device memories. Data of 32 kB or more can be created.
Program type	MELSAP-L is supported by QCPU (Q mode). You can create FX-series SFC programs.
CC-Link board (A80BD-J61BT11)	Sets a master station and local stations.
PLC type	A173UH(S1), FX1S, and FX1N are added.

**GPP Function software for Windows**  
**SW5D5C-GPPW-E**  
**Operating Manual**

MODEL	SW5D5C-GPPW-E-OPE
MODEL CODE	13J975
SH(NA)-080062-C(0006)MEE	

 **MITSUBISHI ELECTRIC CORPORATION**

HEAD OFFICE : MITSUBISHI DENKI BLDG MARUNOUCHI TOKYO 100-8310 TELEX : J24532 CABLE MELCO TOKYO  
NAGOYA WORKS : 1-14, YADA-MINAMI 5, HIGASHI-KU, NAGOYA, JAPAN

When exported from Japan, this manual does not require application to the Ministry of International Trade and Industry for service transaction permission.

Specifications subject to change without notice.