

Programmable Controller

MELSEC iQ-R
series

MELSEC iQ-R Positioning Module User's Manual (Startup)

-RD75P2
-RD75P4
-RD75D2
-RD75D4



SAFETY PRECAUTIONS

(Read these precautions before using this product.)

Before using this product, please read this manual and the relevant manuals carefully and pay full attention to safety to handle the product correctly.

The precautions given in this manual are concerned with this product only. For the safety precautions of the programmable controller system, refer to the MELSEC iQ-R Module Configuration Manual.

In this manual, the safety precautions are classified into two levels: "⚠️ WARNING" and "⚠️ CAUTION".

 WARNING	Indicates that incorrect handling may cause hazardous conditions, resulting in death or severe injury.
 CAUTION	Indicates that incorrect handling may cause hazardous conditions, resulting in minor or moderate injury or property damage.

Under some circumstances, failure to observe the precautions given under "⚠️ CAUTION" may lead to serious consequences.

Observe the precautions of both levels because they are important for personal and system safety.

Make sure that the end users read this manual and then keep the manual in a safe place for future reference.

[Design Precautions]

WARNING

- Configure safety circuits external to the programmable controller to ensure that the entire system operates safely even when a fault occurs in the external power supply or the programmable controller. Failure to do so may result in an accident due to an incorrect output or malfunction.
 - (1) Emergency stop circuits, protection circuits, and protective interlock circuits for conflicting operations (such as forward/reverse rotations or upper/lower limit positioning) must be configured external to the programmable controller.
 - (2) When the programmable controller detects an abnormal condition, it stops the operation and all outputs are:
 - Turned off if the overcurrent or overvoltage protection of the power supply module is activated.
 - Held or turned off according to the parameter setting if the self-diagnostic function of the CPU module detects an error such as a watchdog timer error.
 - (3) All outputs may be turned on if an error occurs in a part, such as an I/O control part, where the CPU module cannot detect any error. To ensure safety operation in such a case, provide a safety mechanism or a fail-safe circuit external to the programmable controller. For a fail-safe circuit example, refer to "General Safety Requirements" in the MELSEC iQ-R Module Configuration Manual.
 - (4) Outputs may remain on or off due to a failure of a component such as a relay and transistor in an output circuit. Configure an external circuit for monitoring output signals that could cause a serious accident.
 - In an output circuit, when a load current exceeding the rated current or an overcurrent caused by a load short-circuit flows for a long time, it may cause smoke and fire. To prevent this, configure an external safety circuit, such as a fuse.
 - Configure a circuit so that the programmable controller is turned on first and then the external power supply. If the external power supply is turned on first, an accident may occur due to an incorrect output or malfunction.
 - For the operating status of each station after a communication failure, refer to manuals relevant to the network. Incorrect output or malfunction due to a communication failure may result in an accident.
-

[Design Precautions]

WARNING

- When connecting an external device with a CPU module or intelligent function module to modify data of a running programmable controller, configure an interlock circuit in the program to ensure that the entire system will always operate safely. For other forms of control (such as program modification, parameter change, forced output, or operating status change) of a running programmable controller, read the relevant manuals carefully and ensure that the operation is safe before proceeding. Improper operation may damage machines or cause accidents.
 - Especially, when a remote programmable controller is controlled by an external device, immediate action cannot be taken if a problem occurs in the programmable controller due to a communication failure. To prevent this, configure an interlock circuit in the program, and determine corrective actions to be taken between the external device and CPU module in case of a communication failure.
 - Do not write any data to the "system area" and "write-protect area" of the buffer memory in the module. Also, do not use any "use prohibited" signals as an output signal from the CPU module to each module. Doing so may cause malfunction of the programmable controller system. For the "system area", "write-protect area", and the "use prohibited" signals, refer to the user's manual for the module used.
 - If a communication cable is disconnected, the network may be unstable, resulting in a communication failure of multiple stations. Configure an interlock circuit in the program to ensure that the entire system will always operate safely even if communications fail. Failure to do so may result in an accident due to an incorrect output or malfunction.
 - To maintain the safety of the programmable controller system against unauthorized access from external devices via the network, take appropriate measures. To maintain the safety against unauthorized access via the Internet, take measures such as installing a firewall.
 - Configure safety circuits external to the programmable controller to ensure that the entire system operates safely even when a fault occurs in the external power supply or the programmable controller. Failure to do so may result in an accident due to an incorrect output or malfunction.
 - (1) Machine OPR (Original Point Return) is controlled by two kinds of data: an OPR direction and an OPR speed. Deceleration starts when the near-point dog signal turns on. If an incorrect OPR direction is set, motion control may continue without deceleration. To prevent machine damage caused by this, configure an interlock circuit external to the programmable controller.
 - (2) When the positioning module detects an error, the motion slows down and stops or the motion suddenly stops, depending on the stop group setting in parameter. Set the parameters to meet the specifications of the positioning control system used. In addition, set the OPR parameters and positioning data within the specified setting range.
 - (3) Outputs may remain on or off, or become undefined due to a failure of a component such as an insulation element and transistor in an output circuit, where the positioning module cannot detect any error. In a system where the incorrect outputs could cause a serious accident, configure an external circuit for monitoring output signals.
 - An absolute position restoration by the positioning module may turn off the servo-on signal (servo off) for approximately 60ms + scan time, and the motor may run unexpectedly. If this causes a problem, provide an electromagnetic brake to lock the motor during absolute position restoration.
-

[Design Precautions]

CAUTION

- Do not install the control lines or communication cables together with the main circuit lines or power cables. Keep a distance of 100mm or more between them. Failure to do so may result in malfunction due to noise.
 - During control of an inductive load such as a lamp, heater, or solenoid valve, a large current (approximately ten times greater than normal) may flow when the output is turned from off to on. Therefore, use a module that has a sufficient current rating.
 - After the CPU module is powered on or is reset, the time taken to enter the RUN status varies depending on the system configuration, parameter settings, and/or program size. Design circuits so that the entire system will always operate safely, regardless of the time.
 - Do not power off the programmable controller or reset the CPU module while the settings are being written. Doing so will make the data in the flash ROM undefined. The values need to be set in the buffer memory and written to the flash ROM again. Doing so also may cause malfunction or failure of the module.
 - When changing the operating status of the CPU module from external devices (such as the remote RUN/STOP functions), select "Do Not OPEN in Program" for "Open Method Setting" in the module parameters. If "OPEN in Program" is selected, an execution of the remote STOP function causes the communication line to close. Consequently, the CPU module cannot reopen the line, and external devices cannot execute the remote RUN function.
-

[Installation Precautions]

WARNING

- Shut off the external power supply (all phases) used in the system before mounting or removing the module. Failure to do so may result in electric shock or cause the module to fail or malfunction.
-

[Installation Precautions]

CAUTION

- Use the programmable controller in an environment that meets the general specifications in the Safety Guidelines included with the base unit. Failure to do so may result in electric shock, fire, malfunction, or damage to or deterioration of the product.
 - To mount a module, place the concave part(s) located at the bottom onto the guide(s) of the base unit, and push in the module until the hook(s) located at the top snaps into place. Incorrect interconnection may cause malfunction, failure, or drop of the module.
 - When using the programmable controller in an environment of frequent vibrations, fix the module with a screw.
 - Tighten the screws within the specified torque range. Undertightening can cause drop of the screw, short circuit, or malfunction. Overtightening can damage the screw and/or module, resulting in drop, short circuit, or malfunction.
 - When using an extension cable, connect it to the extension cable connector of the base unit securely. Check the connection for looseness. Poor contact may cause malfunction.
 - When using an SD memory card, fully insert it into the SD memory card slot. Check that it is inserted completely. Poor contact may cause malfunction.
 - Securely insert an extended SRAM cassette into the cassette connector of the CPU module. After insertion, close the cassette cover and check that the cassette is inserted completely. Poor contact may cause malfunction.
 - Do not directly touch any conductive parts and electronic components of the module, SD memory card, extended SRAM cassette, or connector. Doing so can cause malfunction or failure of the module.
-

[Wiring Precautions]

WARNING

- Shut off the external power supply (all phases) used in the system before installation and wiring. Failure to do so may result in electric shock or cause the module to fail or malfunction.
 - After installation and wiring, attach the included terminal cover to the module before turning it on for operation. Failure to do so may result in electric shock.
-

[Wiring Precautions]

CAUTION

- Individually ground the FG and LG terminals of the programmable controller with a ground resistance of 100 ohms or less. Failure to do so may result in electric shock or malfunction.
 - Use applicable solderless terminals and tighten them within the specified torque range. If any spade solderless terminal is used, it may be disconnected when the terminal screw comes loose, resulting in failure.
 - Check the rated voltage and signal layout before wiring to the module, and connect the cables correctly. Connecting a power supply with a different voltage rating or incorrect wiring may cause fire or failure.
 - Connectors for external devices must be crimped or pressed with the tool specified by the manufacturer, or must be correctly soldered. Incomplete connections may cause short circuit, fire, or malfunction.
 - Securely connect the connector to the module. Poor contact may cause malfunction.
 - Do not install the control lines or communication cables together with the main circuit lines or power cables. Keep a distance of 100mm or more between them. Failure to do so may result in malfunction due to noise.
 - Place the cables in a duct or clamp them. If not, dangling cable may swing or inadvertently be pulled, resulting in damage to the module or cables or malfunction due to poor contact. Do not clamp the extension cables with the jacket stripped. Doing so may change the characteristics of the cables, resulting in malfunction.
 - Check the interface type and correctly connect the cable. Incorrect wiring (connecting the cable to an incorrect interface) may cause failure of the module and external device.
 - Tighten the terminal screws or connector screws within the specified torque range. Undertightening can cause drop of the screw, short circuit, fire, or malfunction. Overtightening can damage the screw and/or module, resulting in drop, short circuit, fire, or malfunction.
 - When disconnecting the cable from the module, do not pull the cable by the cable part. For the cable with connector, hold the connector part of the cable. For the cable connected to the terminal block, loosen the terminal screw. Pulling the cable connected to the module may result in malfunction or damage to the module or cable.
 - Prevent foreign matter such as dust or wire chips from entering the module. Such foreign matter can cause a fire, failure, or malfunction.
 - A protective film is attached to the top of the module to prevent foreign matter, such as wire chips, from entering the module during wiring. Do not remove the film during wiring. Remove it for heat dissipation before system operation.
 - Programmable controllers must be installed in control panels. Connect the main power supply to the power supply module in the control panel through a relay terminal block. Wiring and replacement of a power supply module must be performed by qualified maintenance personnel with knowledge of protection against electric shock. For wiring, refer to the MELSEC iQ-R Module Configuration Manual.
 - For Ethernet cables to be used in the system, select the ones that meet the specifications in the user's manual for the module used. If not, normal data transmission is not guaranteed.
-

[Startup and Maintenance Precautions]

WARNING

- Do not touch any terminal while power is on. Doing so will cause electric shock or malfunction.
 - Correctly connect the battery connector. Do not charge, disassemble, heat, short-circuit, solder, or throw the battery into the fire. Also, do not expose it to liquid or strong shock. Doing so will cause the battery to produce heat, explode, ignite, or leak, resulting in injury and fire.
 - Shut off the external power supply (all phases) used in the system before cleaning the module or retightening the terminal screws, connector screws, or module fixing screws. Failure to do so may result in electric shock.
-

[Startup and Maintenance Precautions]

CAUTION

- When connecting an external device with a CPU module or intelligent function module to modify data of a running programmable controller, configure an interlock circuit in the program to ensure that the entire system will always operate safely. For other forms of control (such as program modification, parameter change, forced output, or operating status change) of a running programmable controller, read the relevant manuals carefully and ensure that the operation is safe before proceeding. Improper operation may damage machines or cause accidents.
 - Especially, when a remote programmable controller is controlled by an external device, immediate action cannot be taken if a problem occurs in the programmable controller due to a communication failure. To prevent this, configure an interlock circuit in the program, and determine corrective actions to be taken between the external device and CPU module in case of a communication failure.
 - Do not disassemble or modify the modules. Doing so may cause failure, malfunction, injury, or a fire.
 - Use any radio communication device such as a cellular phone or PHS (Personal Handy-phone System) more than 25cm away in all directions from the programmable controller. Failure to do so may cause malfunction.
 - Shut off the external power supply (all phases) used in the system before mounting or removing the module. Failure to do so may cause the module to fail or malfunction.
 - Tighten the screws within the specified torque range. Undertightening can cause drop of the component or wire, short circuit, or malfunction. Overtightening can damage the screw and/or module, resulting in drop, short circuit, or malfunction.
 - After the first use of the product, do not mount/remove the module to/from the base unit, and the terminal block to/from the module, and do not insert/remove the extended SRAM cassette to/from the CPU module more than 50 times (IEC 61131-2 compliant) respectively. Exceeding the limit may cause malfunction.
 - After the first use of the product, do not insert/remove the SD memory card to/from the CPU module more than 500 times. Exceeding the limit may cause malfunction.
 - Do not touch the metal terminals on the back side of the SD memory card. Doing so may cause malfunction or failure.
 - Do not touch the integrated circuits on the circuit board of an extended SRAM cassette. Doing so may cause malfunction or failure of the module.
 - Do not drop or apply shock to the battery to be installed in the module. Doing so may damage the battery, causing the battery fluid to leak inside the battery. If the battery is dropped or any shock is applied to it, dispose of it without using.
 - Startup and maintenance of a control panel must be performed by qualified maintenance personnel with knowledge of protection against electric shock. Lock the control panel so that only qualified maintenance personnel can operate it.
 - Before handling the module, touch a conducting object such as a grounded metal to discharge the static electricity from the human body. Failure to do so may cause the module to fail or malfunction.
 - Before testing the operation, set a low speed value for the speed limit parameter so that the operation can be stopped immediately upon occurrence of a hazardous condition.
 - Confirm and adjust the program and each parameter before operation. Unpredictable movements may occur depending on the machine.
-

[Operating Precautions]

CAUTION

- When changing data and operating status, and modifying program of the running programmable controller from an external device such as a personal computer connected to an intelligent function module, read relevant manuals carefully and ensure the safety before operation. Incorrect change or modification may cause system malfunction, damage to the machines, or accidents.
 - Do not power off the programmable controller or reset the CPU module while the setting values in the buffer memory are being written to the flash ROM in the module. Doing so will make the data in the flash ROM undefined. The values need to be set in the buffer memory and written to the flash ROM again. Doing so can cause malfunction or failure of the module.
 - Note that when the reference axis speed is specified for interpolation operation, the speed of the partner axis (2nd, 3rd, or 4th axis) may exceed the speed limit value.
 - Do not go near the machine during test operations or during operations such as teaching. Doing so may lead to injuries.
-

[Disposal Precautions]

CAUTION

- When disposing of this product, treat it as industrial waste.
 - When disposing of batteries, separate them from other wastes according to the local regulations. For details on battery regulations in EU member states, refer to the MELSEC iQ-R Module Configuration Manual.
-

[Transportation Precautions]

CAUTION

- When transporting lithium batteries, follow the transportation regulations. For details on the regulated models, refer to the MELSEC iQ-R Module Configuration Manual.
 - The halogens (such as fluorine, chlorine, bromine, and iodine), which are contained in a fumigant used for disinfection and pest control of wood packaging materials, may cause failure of the product. Prevent the entry of fumigant residues into the product or consider other methods (such as heat treatment) instead of fumigation. The disinfection and pest control measures must be applied to unprocessed raw wood.
-

CONDITIONS OF USE FOR THE PRODUCT

(1) Mitsubishi programmable controller ("the PRODUCT") shall be used in conditions;

- i) where any problem, fault or failure occurring in the PRODUCT, if any, shall not lead to any major or serious accident; and
- ii) where the backup and fail-safe function are systematically or automatically provided outside of the PRODUCT for the case of any problem, fault or failure occurring in the PRODUCT.

(2) The PRODUCT has been designed and manufactured for the purpose of being used in general industries.

MITSUBISHI SHALL HAVE NO RESPONSIBILITY OR LIABILITY (INCLUDING, BUT NOT LIMITED TO ANY AND ALL RESPONSIBILITY OR LIABILITY BASED ON CONTRACT, WARRANTY, TORT, PRODUCT LIABILITY) FOR ANY INJURY OR DEATH TO PERSONS OR LOSS OR DAMAGE TO PROPERTY CAUSED BY the PRODUCT THAT ARE OPERATED OR USED IN APPLICATION NOT INTENDED OR EXCLUDED BY INSTRUCTIONS, PRECAUTIONS, OR WARNING CONTAINED IN MITSUBISHI'S USER, INSTRUCTION AND/OR SAFETY MANUALS, TECHNICAL BULLETINS AND GUIDELINES FOR the PRODUCT.

("Prohibited Application")

Prohibited Applications include, but not limited to, the use of the PRODUCT in;

- Nuclear Power Plants and any other power plants operated by Power companies, and/or any other cases in which the public could be affected if any problem or fault occurs in the PRODUCT.
- Railway companies or Public service purposes, and/or any other cases in which establishment of a special quality assurance system is required by the Purchaser or End User.
- Aircraft or Aerospace, Medical applications, Train equipment, transport equipment such as Elevator and Escalator, Incineration and Fuel devices, Vehicles, Manned transportation, Equipment for Recreation and Amusement, and Safety devices, handling of Nuclear or Hazardous Materials or Chemicals, Mining and Drilling, and/or other applications where there is a significant risk of injury to the public or property.

Notwithstanding the above, restrictions Mitsubishi may in its sole discretion, authorize use of the PRODUCT in one or more of the Prohibited Applications, provided that the usage of the PRODUCT is limited only for the specific applications agreed to by Mitsubishi and provided further that no special quality assurance or fail-safe, redundant or other safety features which exceed the general specifications of the PRODUCTS are required. For details, please contact the Mitsubishi representative in your region.

INTRODUCTION

Thank you for purchasing the Mitsubishi Electric MELSEC iQ-R series programmable controllers.

This manual describes the specifications, procedures before operation, wiring, and programming of the relevant products listed below.

Before using this product, please read this manual and the relevant manuals carefully and develop familiarity with the functions and performance of the MELSEC iQ-R series programmable controller to handle the product correctly.

When applying the program examples provided in this manual to an actual system, ensure the applicability and confirm that it will not cause system control problems.

Please make sure that the end users read this manual.



Relevant products

RD75P2, RD75P4, RD75D2, RD75D4

COMPLIANCE WITH EMC AND LOW VOLTAGE DIRECTIVES

Method of ensuring compliance



To ensure that Mitsubishi Electric programmable controllers maintain EMC and Low Voltage Directives when incorporated into other machinery or equipment, certain measures may be necessary. Please refer to one of the following manuals.

-  MELSEC iQ-R Module Configuration Manual
-  Safety Guidelines (This manual is included with the base unit.)

The CE mark on the side of the programmable controller indicates compliance with EMC and Low Voltage Directives.

Additional measures

To ensure that this product maintains EMC and Low Voltage Directives, please refer to one of the following manuals.

-  MELSEC iQ-R Module Configuration Manual
-  Safety Guidelines (This manual is included with the base unit.)

CONTENTS

SAFETY PRECAUTIONS	1
CONDITIONS OF USE FOR THE PRODUCT	9
INTRODUCTION	9
COMPLIANCE WITH EMC AND LOW VOLTAGE DIRECTIVES	10
RELEVANT MANUALS	13
TERMS	14
GENERIC TERMS AND ABBREVIATIONS	14
PERIPHERALS	15
CHAPTER 1 PART NAMES	16
1.1 LED Display Specifications	16
CHAPTER 2 SPECIFICATIONS	18
2.1 Performance Specifications	18
2.2 Specifications of Input/output Interfaces with External Devices	20
Electrical specifications of I/O signals	20
CHAPTER 3 LIST OF FUNCTIONS	24
3.1 Control Function	24
3.2 Positioning Function	25
3.3 Main Functions	25
3.4 Sub Functions and Common Functions	27
3.5 Combination of Main and Sub Functions	29
3.6 Combination Among Sub Functions	34
CHAPTER 4 PROCEDURES BEFORE OPERATIONS	40
CHAPTER 5 SYSTEM CONFIGURATION	42
CHAPTER 6 WIRING	44
6.1 Wiring Precautions	44
Connectors for external devices	44
6.2 Connector for External Devices	47
Signal layouts of connectors for external devices	47
List of I/O signal details	49
Internal circuit of input/output interface	51
CHAPTER 7 OPERATION EXAMPLES	54
APPENDICES	62
Appendix 1 External Connection	62
The connection example with a servo amplifier manufactured by Mitsubishi	62
Appendix 2 Device List	63
Reference products	63
Appendix 3 Restrictions on Using a Stepping Motor	64
Appendix 4 External Dimensions	65

INDEX

66

REVISIONS68
WARRANTY69
TRADEMARKS70

RELEVANT MANUALS

Manual name [manual number]	Description	Available form
MELSEC iQ-R Positioning Module User's Manual (Startup) [SH-081243ENG] (this manual)	System configuration, specifications, procedures before operation, wiring, and operation examples of the positioning module	Print book e-Manual PDF
MELSEC iQ-R Module Configuration Manual [SH-081262ENG]	Common information on the hardware configuration of all modules, overview of each system configuration, and specifications of the power supply module, base unit, SD memory card, and battery	Print book e-Manual PDF
MELSEC iQ-R Positioning Module User's Manual (Application) [SH-081245ENG]	Functions, parameter settings, I/O signals, buffer memory, programming, and troubleshooting of the positioning module	Print book e-Manual PDF
MELSEC iQ-R Programming Manual (Module Dedicated Instructions) [SH-081976ENG]	Dedicated instructions for the intelligent function modules	e-Manual PDF
MELSEC iQ-R Positioning Module Function Block Reference [BCN-P5999-0377]	FBs of the positioning module	e-Manual PDF
GX Works3 Operating Manual [SH-081215ENG]	System configuration, parameter settings, and online operations of GX Works3	e-Manual PDF
MELSEC iQ-R Online Module Change Manual [SH-081501ENG]	The online module change, which allows a module to be changed without stopping the system for MELSEC iQ-R series programmable controllers	Print book e-Manual PDF

This manual does not include detailed information on the following:

- General specifications
- Applicable CPU modules and the number of mountable modules
- Installation

For details, refer to the following.

 MELSEC iQ-R Module Configuration Manual

This manual does not include information on the module function blocks.

For details, refer to the Function Block Reference for the module used.

Point

e-Manual refers to the Mitsubishi Electric FA electronic book manuals that can be browsed using a dedicated tool.

e-Manual has the following features:

- Required information can be cross-searched in multiple manuals.
- Other manuals can be accessed from the links in the manual.
- The hardware specifications of each part can be found from the product figures.
- Pages that users often browse can be bookmarked.
- Sample programs can be copied to an engineering tool.

TERMS

Unless otherwise specified, this manual uses the following terms.

Term	Description
Drive unit (servo amplifier)	A unit that amplifies pulses that are output from the positioning module to control a motor. The unit is provided with a servomotor or stepping motor. It is also called a servo amplifier.
Engineering tool	A tool used for setting up programmable controllers, programming, debugging, and maintenance
Global label	A label that is valid for all the program data when multiple program data are created in the project. The global label has two types: a module specific label (module label), which is generated automatically by GX Works3, and an optional label, which can be created for any specified device.
Module label	A label that represents one of memory areas (I/O signals and buffer memory areas) specific to each module in a given character string. For the module used, GX Works3 automatically generates this label, which can be used as a global label.

GENERIC TERMS AND ABBREVIATIONS

Unless otherwise specified, this manual uses the following generic terms and abbreviations.

Generic term/abbreviation	Description
RD75	The abbreviation for the MELSEC iQ-R series positioning module
RD75D□	A generic term for the positioning module, the RD75D2 and RD75D4
RD75P□	A generic term for the positioning module, the RD75P2 and RD75P4

PERIPHERALS

The following figure shows the peripherals when the RD75 is used.

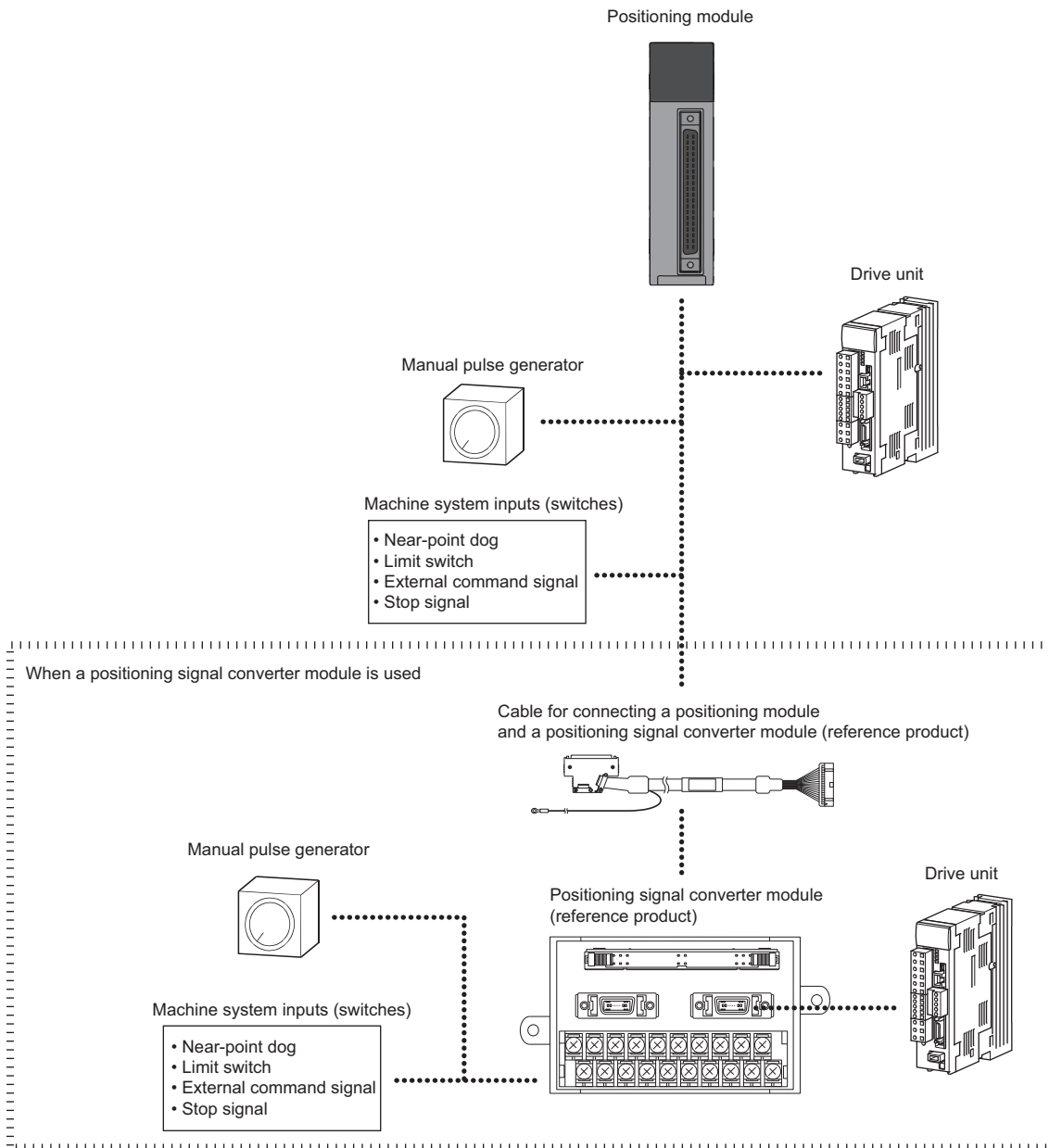

1 PART NAMES

This chapter describes the part names of the RD75.

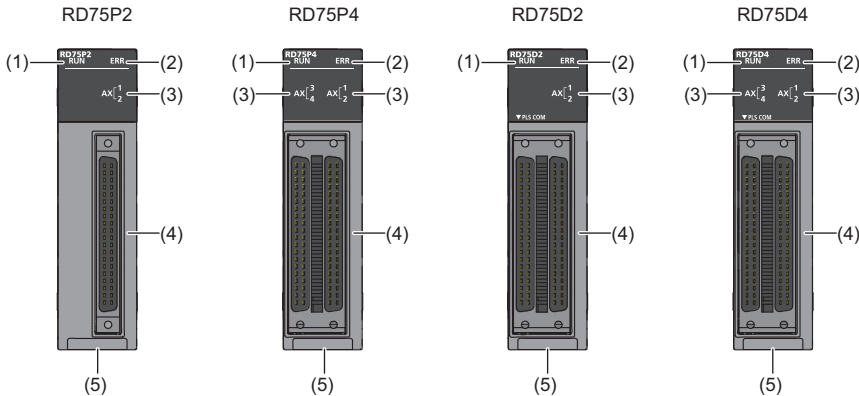

No.	Name	Description
(1)	RUN LED	For details, refer to the following.
(2)	ERR LED	☞ Page 16 LED Display Specifications
(3)	Axis display LED (AX1 to AX4)	
(4)	Connector for external devices	Connects to a drive unit, mechanical system input, or manual pulse generator. For the signal layout, refer to the following. ☞ Page 47 Signal layouts of connectors for external devices AX1: Axis 1, AX2: Axis 2, AX3: Axis 3, AX4: Axis 4
(5)	Production information marking	Shows the production information (16 digits) of the module.

1.1 LED Display Specifications

This section lists LED display specifications.

□: Off, ■: On, ●: Flashing (at 400ms intervals)

RD75 status	LED display	Description	
Normal operation	RUN: ■ AX3: □ AX4: □	ERR: □ AX1: □ AX2: □	<ul style="list-style-type: none"> The axes stopped The axes on standby
	RUN: ■ AX3: □ AX4: □	ERR: □ AX1: ■ AX2: □	The axis in operation
Operation failure	RUN: ■ AX3: □ AX4: □	ERR: ■ AX1: ● AX2: □	Minor error
	RUN: ■ AX3: □ AX4: □	ERR: ● AX1: □ AX2: □	Moderate error
	RUN: □ AX3: □ AX4: □	ERR: ■ AX1: □ AX2: □	
	RUN: □ AX3: □ AX4: □	ERR: □ AX1: □ AX2: □	
Online module change	RUN: ● AX3: □ AX4: □	ERR: □ AX1: □ AX2: □	When the target module is selected
	RUN: □ AX3: □ AX4: □	ERR: □ AX1: □ AX2: □	When the target module is ready to be replaced

2 SPECIFICATIONS

This chapter describes the performance specifications of the RD75.

2.1 Performance Specifications

This section lists the performance specifications of the RD75.

Item		RD75P2*1	RD75D2*1	RD75P4*1	RD75D4*1
Number of controlled axes		2 axes		4 axes	
Interpolation function		2-axis linear interpolation 2-axis circular interpolation		2-, 3-, or 4-axis linear interpolation 2-axis circular interpolation 3-axis helical interpolation	
Control method		PTP (Point To Point) control, path control (line, arc, and helix can be set), speed control, speed-position switching control, position-speed switching control			
Control unit		mm, inch, degree, pulse			
Positioning data		600 data/axis			
Module data backup function		Positioning data, and block start data can be saved on the flash ROM (battery-less backup)			
Positioning	Positioning system	PTP control: Incremental system/absolute system			
		Speed-position switching control: Incremental system/absolute system			
		Position-speed switching control: Incremental system			
		Path control: Incremental system/absolute system			
	Positioning range	In absolute system -214748364.8 to 214748364.7 μ m -21474.83648 to 21474.83647 inch 0 to 359.99999 degree -2147483648 to 2147483647 pulse In incremental system -214748364.8 to 214748364.7 μ m -21474.83648 to 21474.83647 inch -21474.83648 to 21474.83647 degree -2147483648 to 2147483647 pulse In speed-position switching control (INC mode)/position-speed switching control 0 to 214748364.7 μ m 0 to 21474.83647 inch 0 to 21474.83647 degree 0 to 2147483647 pulse In speed-position switching control (ABS mode)*2 0 to 359.99999 degree			
	Speed command	0.01 to 20000000.00mm/min 0.001 to 2000000.000inch/min 0.001 to 3000000.000 degree/min 1 to 5000000 pulse/s			
	Acceleration/deceleration processing	Trapezoidal acceleration/deceleration, S-curve acceleration/deceleration			
	Acceleration/deceleration time	1 to 8388608ms (Four patterns can be set for each of acceleration time and deceleration time.)			
	Sudden stop deceleration time	1 to 8388608ms			

Item		RD75P2*1	RD75D2*1	RD75P4*1	RD75D4*1
Start time ^{*3}	1-axis linear control	0.3ms (1.5ms) ^{*8}			
	1-axis speed control	0.3ms (1.5ms) ^{*8}			
	2-axis linear interpolation control (composite speed)	0.45ms (1.5ms) ^{*8}			
	2-axis linear interpolation control (reference axis speed)	0.45ms (1.5ms) ^{*8}			
	2-axis circular interpolation control	0.63ms (2.0ms) ^{*8}			
	2-axis speed control	0.63ms (1.5ms) ^{*8}			
	3-axis linear interpolation control (composite speed)	0.93ms (1.7ms) ^{*8}			
	3-axis linear interpolation control (reference axis speed)	0.93ms (1.7ms) ^{*8}			
	3-axis helical interpolation control	1.8ms (2.6ms) ^{*8}			
	3-axis speed control	0.93ms (1.7ms) ^{*8}			
	4-axis linear control	1.08ms (1.8ms) ^{*8}			
	4-axis speed control	1.08ms (1.8ms) ^{*8}			
Quick start function ^{*4}	Start with the positioning start signal	8μs			
	Start with the external command signal	20μs			
Start time adjustment function ^{*5}		0.00 to 10000.00ms (0.01ms unit)			
Start time when the inter-module synchronization function is used ^{*6}		8μs			
External connections		40-pin connector			
Applicable wire size ^{*7}	When A6CON1 or A6CON4 is used	0.088mm ² to 0.3mm ² (28 to 22 AWG) stranded wire			
	When A6CON2 is used	0.088mm ² to 0.24mm ² (28 to 24 AWG) stranded wire			
External wiring connector		A6CON1, A6CON2, A6CON4 (sold separately)			
Maximum output pulse		200000 pulse/s	5000000 pulse/s	200000 pulse/s	5000000 pulse/s
Manual pulse generator input maximum frequency		1000 pulse/s			
Manual pulse generator 1 pulse input magnification		1 to 10000 times			
Maximum connection distance between servos		2m	10m	2m	10m
Number of write accesses to a flash ROM		100000 times maximum			
Number of occupied I/O points		32 points (I/O assignment: Intelligent 32 points)			
Internal current consumption (5VDC)		0.38A	0.54A	0.42A	0.78A
External dimensions	Height	106mm			
	Width	27.8mm			
	Depth	110mm			
Weight		0.14kg	0.15kg	0.15kg	0.15kg

*1 The RD75P2 and RD75P4 are modules of transistor output system, and the RD75D2 and RD75D4 are modules of differential driver output system.

*2 The speed-position switching control (ABS mode) can be used only when the control unit is degree.

*3 Analysis time of positioning data varies depending on the operating status of the partner axis. The start time and operation timing described in this manual are for the case when all axes stop the operation.

*4 The start time of the quick start function indicates the period from the acceptance of the start trigger (positioning start signal, external command signal) to the start of pulse output, after the positioning data analysis is completed.

*5 The function can be set only when the quick start function is used.

*6 The start time of when the inter-module synchronization function is used is the period from the acceptance of the start trigger (start of inter-module synchronization cycle) to the start of pulse output, after the positioning data analysis is completed.

*7 Use cables with outside diameter of 1.3mm or shorter to connect 40 cables to the connector. In addition, consider the amount of current to be used and select appropriate cables.

*8 The value in parentheses indicates the start time of when Q compatible mode is set. For Q compatible mode, refer to the following.

 MELSEC iQ-R Positioning Module User's Manual (Application)

2.2 Specifications of Input/output Interfaces with External Devices

Electrical specifications of I/O signals

Input specifications

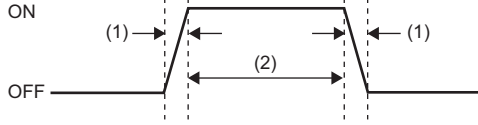
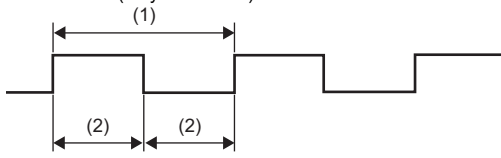
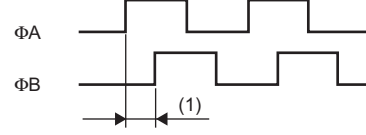
Signal name	Rated input voltage/ current	Operating voltage range	ON voltage/ current	OFF voltage/ current	Input resistance	Response time
Drive unit READY signal (READY) Stop signal (STOP) Upper limit signal (FLS) Lower limit signal (RLS)	24VDC/5mA	19.2 to 26.4VDC	17.5VDC or higher/3.5mA or higher	7VDC or lower/ 1.7mA or lower	Approx. 4.7kΩ	4ms or less
Zero signal (PG05/PG024)	5VDC/5mA	4.5 to 6.1VDC	2VDC or higher/ 2mA or higher	0.5VDC or lower/0.5mA or lower	Approx. 620Ω	1ms or less
	24VDC/5mA	12 to 26.4VDC	10VDC or higher/3mA or higher	3VDC or lower/ 0.2mA or lower	Approx. 4.7kΩ	1ms or less
 <p>(1) 3μs or less (2) 1ms or more</p> <p>Differential receiver equivalent to AM26LS32 (ON/OFF level ON: 1.8V or higher, OFF: 0.6V or lower)</p>						
Manual pulse generator connection Manual pulse generator A phase (PULSER A) Manual pulse generator B phase (PULSER B)	5VDC/5mA	4.5 to 6.1VDC	2.5VDC or higher/2mA or higher	1VDC or lower/ 0.1mA or lower	Approx. 1.1kΩ	1ms or less
<p>■ Pulse width (duty ratio: 50%)</p>  <p>(1) 4ms or more (2) 2ms or more</p> <p>■ Phase difference (When the A phase (φA) leads the B phase (φB), the positioning address (current value) increases.)</p>  <p>(1) 1ms or more</p>						
Near-point dog signal (DOG)	24VDC/5mA	19.2 to 26.4VDC	17.5VDC or higher/3.5mA or higher	7VDC or lower/ 1.7mA or lower	Approx. 4.3kΩ	1ms or less
External command signal (CHG)	24VDC/5mA	19.2 to 26.4VDC	19VDC or higher/2.7mA or higher	7VDC or lower/ 0.8mA or lower	Approx. 7.7kΩ	20μs

Output specifications

Signal name	Rated load voltage	Operating load voltage range	Maximum load current/ inrush current	Maximum voltage drop at ON	Leakage current at OFF	Response time
Deviation counter clear signal (CLEAR)	5 to 24VDC	4.75 to 30VDC	0.1A/1 point/ 0.4A 10ms or less	1VDC (TYP) 2.5VDC (MAX)	0.1mA or lower	2ms or less (resistive load)
RD75P□ Pulse output (PULSE F) Pulse output (PULSE R)	5 to 24VDC	4.75 to 30VDC	50mA/1 point/ 200mA 10ms or less	0.5VDC (TYP)	0.1mA or lower	—
RD75D□ Pulse output F (+) (PULSE F+/-) Pulse output R (+) (PULSE R+/-)	Differential driver equivalent to AM26C31					

■The relation of pulse output with [Pr.5] Pulse output mode and [Pr.23] Output signal logic selection

Pulse output mode (PULSE/SIGN, CW/CCW, A phase/B phase) can be selected in [Pr.5] Pulse output mode according to the drive unit specifications.

The logic of output signals (positive logic, negative logic) is selected in [Pr.23] Output signal logic selection as well.

The relation of pulse output with [Pr.5] Pulse output mode and [Pr.23] Output signal logic selection is shown below.

• RD75P□

The voltage of terminals having the PULSE COM terminal as a reference is shown. (☞ Page 51 Internal circuit of input/output interface)

(High → OFF, Low → ON)

"[Pr.5] Pulse output mode"	Terminal name	"[Pr.23] Output signal logic selection"			
		Positive logic		Negative logic	
		Forward run	Reverse run	Forward run	Reverse run
PULSE/SIGN	PULSE F				
	PULSE R				
CW/CCW	PULSE F				
	PULSE R				
A phase/ B phase	PULSE F				
	PULSE R				

• RD75D□

The voltage of terminals having the differential driver common terminal as a reference is shown. (☞ Page 51 Internal circuit of input/output interface)

"[Pr.5] Pulse output mode"	Terminal name	"[Pr.23] Output signal logic selection"			
		Positive logic		Negative logic	
		Forward run	Reverse run	Forward run	Reverse run
PULSE/SIGN	PULSE F+	High Low		High Low	
	PULSE F-	High Low		High Low	
	PULSE R+	High Low		High Low	
	PULSE R-	High Low		High Low	
CW/CCW	PULSE F+	High Low		High Low	
	PULSE F-	High Low		High Low	
	PULSE R+	High Low		High Low	
	PULSE R-	High Low		High Low	
A phase/ B phase	PULSE F+	High Low		High Low	
	PULSE F-	High Low		High Low	
	PULSE R+	High Low		High Low	
	PULSE R-	High Low		High Low	

■ [Pr.5] Pulse output mode and [Pr.23] Output signal logic selection

Set [Pr.5] Pulse output mode and [Pr.23] Output signal logic selection according to the specifications of a connected servo amplifier.

If not, the motor may rotate in the reverse direction or may not rotate at all.

Connection examples with a MELSERVO-J4 series servo amplifier are shown below.

• RD75P□

[Pr.5] Pulse output mode	RD75P□ ([Pr.23] Output signal logic selection)	Logic of servo amplifier, MR-J4-□A	Connection example
CW/CCW	Negative logic	Negative logic	
	Positive logic	Positive logic	
PULSE/SIGN	Negative logic	Negative logic	
	Positive logic	Positive logic	
A phase/B phase	Negative logic	Negative logic	
	Negative logic	Positive logic	
	Positive logic	Negative logic	
	Positive logic	Positive logic	

• RD75D□

[Pr.5] Pulse output mode	RD75D□ ([Pr.23] Output signal logic selection)	Logic of servo amplifier, MR-J4-□A	Connection example
CW/CCW	Negative logic	Positive logic	
	Positive logic	Negative logic	
PULSE/SIGN	Negative logic	Positive logic	
	Positive logic	Negative logic	
A phase/B phase	Negative logic	Negative logic	
	Negative logic	Positive logic	
	Positive logic	Negative logic	
	Positive logic	Positive logic	

3 LIST OF FUNCTIONS

3.1 Control Function

Several functions are provided for the RD75. For details on each function, refer to the following.

📖 MELSEC iQ-R Positioning Module User's Manual (Application)

In this manual and 📖 MELSEC iQ-R Positioning Module User's Manual (Application), the functions of the RD75 are classified as follows to explain the positioning module.

Positioning function

This function starts the positioning operation to a specified position by using the positioning data, block start data, and condition data.

Main functions

■OPR control

The OPR control function establishes a start point for performing the positioning control, and performs positioning toward that start point. This function is used to return a workpiece, located at a position other than the OP when the power is turned on or after the positioning stops, to the OP. The OPR control is preregistered in the RD75 as Positioning start data No.9001 (Machine OPR) or Positioning start data No.9002 (Fast OPR).

■Major positioning control

This control is performed using the positioning data stored in the RD75. The positioning controls, such as the position control and speed control, are executed by setting the required items in this Positioning data and starting that positioning data. Operation pattern can be set in this Positioning data, and with this whether to perform the control with continuous positioning data (ex.: positioning data No.1, No.2, No.3, ...) can be set.

■Advanced positioning control

This control executes the positioning data stored in the RD75 by using Block start data. The following types of applied positioning control can be performed.

- Random blocks, handling several continuing positioning data items as blocks, can be executed in the specified order.
- Condition judgment can be added to the position control and speed control.
- The operation of the positioning data that is set for multiple axes can be started simultaneously. (Pulses are output simultaneously to multiple servos.)
- The specified positioning data can be executed repeatedly.

■Manual control

By inputting a signal into the RD75 from an external source, the RD75 will output a random pulse train and perform control operations. Use this manual control to move the workpiece to a random position (JOG operation), and to finely adjust the positioning (including the inching operation, and manual pulse generator operation).

Sub function

When the main functions are executed, this function compensates and limits controls, or adds functions.

Common functions

These function perform common controls for when the RD75 is used, such as Module data initialization function and Module data backup function.

3.2 Positioning Function

The following table lists the start modes for the positioning function.

Positioning start mode	Description
Normal start	Starts positioning controls by the simplest procedure. Major positioning controls and advanced positioning controls can be started in this mode.
Quick start	Analyzes in advance the positioning data executed immediately after the current operation to quickly start the positioning control. Major positioning controls can be started in this mode.
Multiple axes simultaneous start	Starts the operation of multiple axes simultaneously according to the pulse output level.

3

3.3 Main Functions

The following table shows the overview of the main functions for positioning controls with the RD75.

Main functions	Description		
OPR control	Machine OPR control	Mechanically establishes the positioning start point using a near-point dog or stopper. In the data setting method, no axis movement occurs since the current position is set as OP. (Positioning start No.9001)	
	Fast OPR control	Positions a target to the OP address ([Md.21] Machine feed value) stored in the RD75 using OPR control. (Positioning start No.9002)	
Major positioning control	Position control	Linear control (1-axis linear control) (2-axis linear interpolation control) (3-axis linear interpolation control) (4-axis linear interpolation control)	Positions a target using a linear path to the address set in the positioning data or to the position specified with the movement amount.
		Fixed-feed control (1-axis fixed-feed control) (2-axis fixed-feed control) (3-axis fixed-feed control) (4-axis fixed-feed control)	Positions a target by the movement amount specified with the amount set in the positioning data. (With the fixed-feed control, [Md.20] Current feed value is set to 0 when the control is started. In the 2-axis fixed-feed control, 3-axis fixed-feed control, or 4-axis fixed-feed control, the fixed-feed is performed along a linear path obtained by interpolation.)
		2-axis circular interpolation control	Positions a target using an arc path to the address set in the positioning data, or to the position specified with the movement amount, sub point, or center point.
		3-axis helical interpolation control	Positions a target using a helical path to a specified position. (Specify the position by specifying the end point address directly or by specifying the relative distance from the current position (movement amount).)
	Speed control	Speed control (1-axis speed control) (2-axis speed control) (3-axis speed control) (4-axis speed control)	Continuously outputs the pulses corresponding to the command speed set in the positioning data.
	Speed-position switching control		Performs the speed control, and position control (Positioning with the specified address or movement amount) immediately after that by turning on Speed-position switching signal.
Position-speed switching control		Performs the position control, and speed control (Continuous output of the pulses corresponding to the specified command speed) immediately after that by turning on Position-speed switching signal.	

Main functions		Description	
Major positioning control	Other controls	Current value change	Changes [Md.20] Current feed value to the address set in the positioning data. The following two methods can be used. (Machine feed value cannot be changed.) <ul style="list-style-type: none"> • Current value change using positioning data • Current value change using the start No. for a current value change (No.9003)
		NOP instruction	A control method that is not executed. When the NOP instruction is set, the operation of the next data starts and this instruction is not executed.
		JUMP instruction	Unconditionally or conditionally jumps to the specified positioning data No.
		LOOP	Performs the loop control with repeated LOOP to LEND.
		LEND	Returns to the beginning of the loop control with repeated LOOP to LEND.
Advanced positioning control	Block start (Normal start)	With one start, executes the positioning data in a random block with the set order.	
	Condition start	Judges the condition set in Condition data for the specified positioning data, and executes Block start data. When the condition is established, Block start data is executed. When not established, that block start data is ignored, and the next point's block start data is executed.	
	Wait start	Judges the condition set in Condition data for the specified positioning data, and executes Block start data. When the condition is established, Block start data is executed. When not established, the control stops (waits) until the condition is established.	
	Simultaneous start	Simultaneously executes the positioning data having the number for the axis specified with Condition data (Outputs pulses at the same timing).	
	Repeated start (FOR loop)	Repeats the program from the block start data set with FOR loop to the block start data set in NEXT for the specified number of times.	
	Repeated start (FOR condition)	Repeats the program from the block start data set with FOR condition to the block start data set in NEXT until the conditions set in Condition data are established.	
Manual control	JOG operation	Outputs pulses to the drive unit while JOG start signal is on.	
	Inching operation	Outputs pulses corresponding to a minute movement amount by the manual operation to the drive unit. (Performs the fine adjustment with JOG start signal.)	
	Manual pulse generator operation	Outputs pulses commanded with the manual pulse generator to the drive unit. (Performs the fine adjustment and others at the pulse level.)	
Inter-module synchronization function (simultaneous start of multiple modules)		Starts pulse output at the same timing of inter-module synchronization cycle after the acceptance of a positioning start trigger.	

With Major positioning control (Advanced positioning control), whether or not to continuously execute the positioning data can be set with Operation pattern. The following shows the overview of Operation pattern.

[Da.1] Operation pattern	Description
Independent positioning control (Positioning complete)	When Independent positioning control is set for the operation pattern of the started positioning data, only the specified positioning data will be executed, and the positioning will end.
Continuous positioning control	When Continuous positioning control is set for the operation pattern of the started positioning data, after the specified positioning data is executed, the program will stop once, and the next following positioning data will be executed.
Continuous path control	When Continuous path control is set for the operation pattern of the started positioning data, the specified positioning data will be executed, and the next following positioning data will be executed without deceleration stop.

3.4 Sub Functions and Common Functions

Sub function

The following table shows the overview of the functions that assist positioning controls using the RD75.

Sub function	Description	
Sub functions specific to machine OPR	OPR retry function	Retries the machine OPR with the upper/lower limit switches during the machine OPR. This allows the machine OPR to be performed even if the axis is not returned to a position before the near-point dog with operations such as the JOG operation.
	OP shift function	After the machine OPR, this function compensates the position by the specified distance from the machine OP position and sets that position as the OP address.
Function to compensate control	Backlash compensation function	Compensates the backlash amount of the machine system. Feed pulses equivalent to the set backlash amount are output each time the movement direction changes.
	Electronic gear function	By setting the movement amount per pulse, this function can freely change the machine movement amount per commanded pulse. A flexible positioning system that matches the machine system can be structured with this function.
	Near pass function ^{*1}	Suppresses the machine vibration when the speed change is performed during the continuous path control in the interpolation control.
	Output timing selection of near pass control	This function allows the user to select the timing to output the difference (Δd) between the actual and the set positioning end addresses in the continuous path control, in which the difference (Δd) is output during the execution of the next positioning data.
Function to limit control	Speed limit function	If the command speed exceeds [Pr.8] Speed limit value during the control, this function limits the command speed to within the setting range of [Pr.8] Speed limit value.
	Torque limit function ^{*2}	If the torque generated in the servo motor exceeds [Pr.17] Torque limit setting value during the control, this function limits the generated torque to within the setting range of [Pr.17] Torque limit setting value.
	Software stroke limit function	If a command outside of the upper/lower limit stroke limit setting range, set in the parameters, is issued, this function will not execute the positioning for that command.
	Hardware stroke limit function	Performs the deceleration stop with the limit switch connected to the RD75's connector for external devices.
Functions that change control details	Speed change function	Changes the speed during positioning. Set the new speed in [Cd.14] New speed value, the speed change buffer memory area, and change the speed with [Cd.15] Speed change request.
	Override function	Changes the speed during positioning within a percentage of 0 to 300%. Execute this function using [Cd.13] Positioning operation speed override.
	Acceleration/deceleration time change function	Changes the acceleration/deceleration time at the speed change.
	Torque change function	Changes Torque limit value during the control.
	Target position change function	Changes the target position during positioning. The position and speed can be changed simultaneously.
Function related to positioning start	Pre-reading start function	If the positioning start is requested while Execution prohibition flag is on, no pulse is output, and when Execution prohibition flag is turned off and detected, outputting pulses is started within 0.88ms.
	Start time adjustment function	After the start trigger was input with the quick start function, this function starts outputting pulses after the preset time has passed.
Absolute position restoration function ^{*3}	Restores the absolute position of a specified axis.	

*1 The near pass function is featured as standard, and is valid only during the position control. The function cannot be set to be invalid with parameters.



*2 To perform Torque limit, a D/A converter module and a drive unit capable of the torque limit command with an analog voltage must be needed.

*3 An I/O module with arbitrary number of points and a drive unit capable of configuring an absolute position detection system (which is a Mitsubishi General-Purpose AC Servo and has an absolute position detection function (absolute position data transfer protocol) equivalent to that of MR-J3-□A) are needed.

Sub function		Description
Function related to positioning stop	Stop command processing for deceleration stop function	Selects a deceleration curve when a stop cause occurs during the deceleration stop processing to speed 0.
	Continuous operation interrupt function	Interrupts the continuous operation. When this request is accepted, the operation will stop at the completion of the positioning data being executed.
	Step function	Temporarily stops the operation to check the positioning operation during debugging and other operation. The operation can be stopped for each Automatic deceleration or Positioning data.
Other functions	Skip function	Pauses (decelerates to stop) the positioning being executed when Skip signal is input, and performs the next positioning.
	M code output function	Issues a command for a subsidiary work (such as stopping clamps or drills and changing tools) corresponding to each M code number (0 to 65535) that can be set to each positioning data.
	Teaching function	Stores the address positioned with the manual control into the positioning address of the specified positioning data No. ([Cd.39]).
	Command in-position function	Calculates the remaining distance for the RD75 to reach the positioning stop position, and sets Command in-position flag to 1 when the value is less than the set value. When performing another subsidiary work before the control ends, use this function as a trigger for the subsidiary work.
	Acceleration/deceleration processing function	Adjusts acceleration/deceleration of the control.
	Deceleration start flag function	To inform the stop timing, this function turns on Deceleration start flag when the speed status is changed from the constant speed or acceleration to deceleration during the position control whose operation pattern is Positioning complete.
	During uncompleted OPR operation setting function	Sets whether or not to execute the positioning control when OPR request flag is on.
	Interrupt function	Generates an interrupt request to the CPU module when an interrupt factor is detected, and starts an interrupt program.

Common functions

The following table shows the overview of the functions executed as necessary.

Common functions	Description
Module data initialization function	Returns module parameters and module extension parameters (positioning data and block start data) of the buffer memory and setting values of a module extension parameter file to the initial values set at the factory.
Module data backup function	Saves the module extension parameters (positioning data and block start data) of the buffer memory that are currently being used for control to a module extension parameter file.
External I/O signal logic switching function	Switches I/O signal logics according to the equipment connected to the RD75. For the system in which signals handled as normally closed contacts (such as Drive unit READY signal and limit signals) are not used, the parameter logic setting can be controlled without wiring if the setting is changed to Positive logic.
External I/O signal monitor function	Monitors External I/O signal using the module's detailed information which can be displayed on the system monitor of an engineering tool.
History monitor function	Monitors the error history, warning history, and start history of all axes.
Amplifier-less operation function	Performs positioning control without the drive unit being connected. This function is used for debugging of the user program at the start-up of the device or for simulating a positioning operation.
Online module change	Allows module replacement without stopping the system. For the procedure of the online module change, refer to the following.  MELSEC iQ-R Online Module Change Manual
Firmware update function	Enables users to update the firmware versions of modules by using firmware update files. (For the firmware update file, please consult your local Mitsubishi representative.) For details on this function, refer to the following.  MELSEC iQ-R Module Configuration Manual

Precautions

Check that output from the RD75 is stopped before performing the firmware update function. Performing the firmware update function without stopping the output may cause unintended operation of the module, resulting in failure of the system.

3.5 Combination of Main and Sub Functions

With positioning control using the RD75, the main functions and sub functions can be combined and used as necessary.

◎: Always combined, ○: Combination possible, △: Combination limited, ×: Combination not possible

Main function		Combination with operation pattern*1	Function specific to machine OPR		Function to compensate control		
			OPR retry function	OP shift function	Backlash compensation function	Electronic gear function	
OPR control	Machine OPR control	×	○	○	○	○	
	Fast OPR control	×	×	×	○	○	
Major positioning control	Position control	1-axis linear control	○	×	×	○	○
		2-/3-/4-axis linear interpolation control	○	×	×	○	○
		1-axis fixed-feed control	△ (Continuous path control cannot be set)	×	×	○	○
		2-/3-/4-axis fixed-feed control (Interpolation)	△ (Continuous path control cannot be set)	×	×	○	○
		2-axis circular interpolation control	○	×	×	○	○
		3-axis helical interpolation control	○	×	×	○	○
	Speed control (1- to 4-axis)		△ (Only independent positioning control can be set)	×	×	○	○
	Speed-position switching control		△	×	×	○	○
	Position-speed switching control		△ (Only independent positioning control can be set)	×	×	○	○
	Other controls	Current value change	△ (Continuous path control cannot be set)	×	×	×	○
		NOP instruction	×	×	×	×	×
JUMP instruction		×	×	×	×	×	
LOOP to LEND			×	×	×	×	
Manual control	JOG operation, Inching operation	×	×	×	○	○	
	Manual pulse generator operation	×	×	×	○	○	

*1 The operation pattern is one of the setting items for Positioning data.

Main functions		Function to compensate control		Function to limit control				Functions that change control details	
		Near pass function	Output timing selection of near pass control	Speed limit function	Torque limit function	Software stroke limit function	Hardware stroke limit function	Speed change function	
OPR control	Machine OPR control		*2	×	○	○	×	◎	△*3
	Fast OPR control			×	○	○	×	◎	○
Major positioning control	Position control	1-axis linear control		○	○	○	○	◎	○
		2-/3-/4-axis linear interpolation control		○	○	○	○	◎	○
		1-axis fixed-feed control		×	○	○	○	◎	○
		2-/3-/4-axis fixed-feed control (Interpolation)		×	○	○	○	◎	○
		2-axis circular interpolation control		○	○	○	○	◎	○
		3-axis helical interpolation control		○	○	○	○	◎	○
	Speed control (1- to 4-axis)			×	○	○	○	◎	○
	Speed-position switching control			×	○	○	○	◎	○
	Position-speed switching control			×	○	○	○	◎	○
	Other controls	Current value change		×	×	×	○	◎	×
NOP instruction		×		×	×	×	◎	×	
JUMP instruction		×		×	×	×	◎	×	
LOOP to LEND		×		×	×	×	◎	×	
Manual control	JOG operation, Inching operation		×	○	○	○	◎	△*4	
	Manual pulse generator operation		×	○	○	○	◎	×	

*2 The near pass function is featured as standard. The function is valid only when the continuous path control for position control operations is set.

*3 Invalid during creep speed.

*4 Combination with the inching operation is not available. (The inching operation does not perform acceleration/deceleration processing.)

Main functions		Functions that change control details				Function related to positioning start			
		Override function	Acceleration /deceleration time change function	Torque change function	Target position change function	Restart function	Pre-reading start function	Start time adjustment function	
OPR control	Machine OPR control	△*5	△*5	○	×	×	×	×	
	Fast OPR control	○	○	○	×	×	×	×	
Major positioning control	Position control	1-axis linear control	○	○	○	△*7	○	○	○
		2-/3-/4-axis linear interpolation control	○	○	○	×	○	○	○
		1-axis fixed-feed control	○	○	○	×	○	○	○
		2-/3-/4-axis fixed-feed control (Interpolation)	○	○	○	×	○	○	○
		2-axis circular interpolation control	○	○	○	×	○	○	○
		3-axis helical interpolation control	○	○	○	×	○	○	○
	Speed control (1- to 4-axis)	○	○	○	×	○	○	○	
	Speed-position switching control	○	○	○	×	○	○	○	
	Position-speed switching control	○	○	○	×	○	○	○	
	Other controls	Current value change	×	×	×	×	×	×	×
		NOP instruction	×	×	×	×	×	×	×
		JUMP instruction	×	×	×	×	×	×	×
		LOOP to LEND	×	×	×	×	×	×	×
Manual control	JOG operation, Inching operation	△*6	△*6	○	×	×	×	×	
	Manual pulse generator operation	×	×	○	×	×	×	×	

*5 Invalid during creep speed.

*6 Combination with the inching operation is not available. (The inching operation does not perform acceleration/deceleration processing.)

*7 Invalid while the continuous path control is in operation.

Main functions		Function related to positioning stop				Other functions			
		Step function	Stop command processing for deceleration stop function	Continuous operation interrupt function	Stop processing function	Skip function	M code output function	Teaching function	
OPR control	Machine OPR control	×	○	×	◎	×	×	×	
	Fast OPR control	×	○	×	◎	×	×	×	
Major positioning control	Position control	1-axis linear control	○	○	○	◎	○	○	×
		2-/3-/4-axis linear interpolation control	○	○	○	◎	○	○	×
		1-axis fixed-feed control	○	○	○	◎	○	○	×
		2-/3-/4-axis fixed-feed control (Interpolation)	○	○	○	◎	○	○	×
		2-axis circular interpolation control	○	○	○	◎	○	○	×
		3-axis helical interpolation control	○	○	○	◎	○	○	×
	Speed control (1- to 4-axis)	×	○	○	◎	×	○	×	
	Speed-position switching control	○	○	○	◎	○	○	×	
	Position-speed switching control	○	○	○	◎	×	○	×	
	Other controls	Current value change	○	×	×	×	○	△*9	×
		NOP instruction	×	×	×	×	×	×	×
		JUMP instruction	×	×	×	×	×	×	×
LOOP to LEND		×	×	×	×	×	×	×	
Manual control	JOG operation, Inching operation	×	×	×	△*8	×	×	○	
	Manual pulse generator operation	×	×	×	◎	×	×	○	

*8 Combination with the inching operation is not available. (The inching operation does not perform acceleration/deceleration processing.)

*9 Use the function for the current value change using positioning data. The function is not available for the current value change using the start No. for a current value change (No.9003).

Main functions		Other functions					
		Command in-position function	Acceleration/deceleration processing function	Deceleration start flag function	During uncompleted OPR operation setting function	Interrupt function ^{*13}	
OPR control	Machine OPR control	×	○	×	×	○	
	Fast OPR control	×	○	×	×	○	
Major positioning control	Position control	1-axis linear control	○	○	○	○	○
		2-/3-/4-axis linear interpolation control	○	○	△ ^{*11}	○	○
		1-axis fixed-feed control	○	○	○	○	○
		2-/3-/4-axis fixed-feed control (Interpolation)	○	○	△ ^{*11}	○	○
		2-axis circular interpolation control	○	○	×	○	○
		3-axis helical interpolation control	○	○	×	○	○
	Speed control (1- to 4-axis)	×	○	×	○	○	
	Speed-position switching control	○	○	△ ^{*12}	○	○	
	Position-speed switching control	○	○	△ ^{*12}	○	○	
	Other controls	Current value change	×	×	×	○	○
		NOP instruction	×	×	×	×	○
		JUMP instruction	×	×	×	×	○
		LOOP to LEND	×	×	×	×	○
Manual control	JOG operation, Inching operation	×	△ ^{*10}	×	×	○	
	Manual pulse generator operation	×	×	×	×	○	

*10 Combination with the inching operation is not available. (The inching operation does not perform acceleration/deceleration processing.)

*11 Valid for the reference axis only.

*12 Valid for only in the case where the deceleration start is made during position control.

*13 No limitation for combination use with other functions. Satisfaction judgment of interruption conditions is performed as needed.

3.6 Combination Among Sub Functions

The following shows the combinations of sub-functions and sub-functions during the control of the main functions.

○: Combination possible, △: Combination limited, ×: Combination not possible

Function name		Sub function to be combined				
		OPR retry function	OP shift function	Backlash compensation function	Electronic gear function	Near pass function
Function specific to machine OPR	OPR retry function	—	○	○	○	×
	OP shift function	○	—	○	○	×
Function to compensate control	Backlash compensation function	○	○	—	○	○
	Electronic gear function	○	○	○	—	○
	Near pass function	×	×	○	○	—
	Output timing selection of near pass control	×	×	○	○	○
Function to limit control	Speed limit function	○	○	○	○	○
	Torque limit function	○	○	○	○	○
	Software stroke limit function	×	×	○	○	○
	Hardware stroke limit function	○	○	○	○	○
Functions that change control details	Speed change function	△ ^{*1}	△ ^{*1}	○	○	○
	Override function	△ ^{*1}	△ ^{*1}	○	○	○
	Acceleration/deceleration time change function	○	○	○	○	○
	Torque change function	○	○	○	○	○
	Target position change function	×	×	○	○	○
Function related to positioning start	Start time adjustment function	×	×	○	○	○
	Restart function	×	×	○	○	○
	Pre-reading start function	×	×	○	○	○
Absolute position restoration function		×	×	○	○	×
Function related to positioning stop	Step function	×	×	○	○	○
	Stop command processing for deceleration stop function	×	×	○	○	○
	Continuous operation interrupt function	×	×	○	○	○
	Stop processing function	○	○	○	○	○
Other functions	Skip function	×	×	○	○	○
	M code output function	×	×	○	○	○
	Teaching function	×	×	×	×	×
	Command in-position function	×	×	○	○	○
	Acceleration/deceleration processing function	○	○	○	○	○
	Deceleration start flag function	×	×	○	○	○
	During uncompleted OPR operation setting function	○	○	○	○	○
	Interrupt function ^{*2}	○	○	○	○	○

*1 Speed cannot be changed to zero.

*2 No limitation for combination use with other functions. Satisfaction judgment of interruption conditions is performed as needed.

Function name		Sub function to be combined				
		Output timing selection of near pass control	Speed limit function	Torque limit function	Software stroke limit function	Hardware stroke limit function
Function specific to machine OPR	OPR retry function	×	○	○	×	○
	OP shift function	×	○	○	×	○
Function to compensate control	Backlash compensation function	○	○	○	○	○
	Electronic gear function	○	○	○	○	○
	Near pass function	○	○	○	○	○
	Output timing selection of near pass control	—	○	○	○	○
Function to limit control	Speed limit function	○	—	○	○	○
	Torque limit function	○	○	—	○	○
	Software stroke limit function	○	○	○	—	○
	Hardware stroke limit function	○	○	○	○	—
Functions that change control details	Speed change function	○	○	○	○	○
	Override function	○	○	○	○	○
	Acceleration/deceleration time change function	○	○	○	○	○
	Torque change function	○	○	○	○	○
	Target position change function	○	○	○	○	○
Function related to positioning start	Start time adjustment function	○	○	○	○	○
	Restart function	○	○	○	○	○
	Pre-reading start function	○	○	○	○	○
Absolute position restoration function		×	×	×	×	×
Function related to positioning stop	Step function	○	○	○	○	○
	Stop command processing for deceleration stop function	○	○	○	○	○
	Continuous operation interrupt function	○	○	○	○	○
	Stop processing function	○	○	○	○	○
Other functions	Skip function	○	○	○	○	○
	M code output function	○	○	○	○	○
	Teaching function	×	×	×	×	×
	Command in-position function	○	○	○	○	○
	Acceleration/deceleration processing function	○	○	○	○	○
	Deceleration start flag function	○	○	○	○	○
	During uncompleted OPR operation setting function	○	○	○	○	○
	Interrupt function ^{*3}	○	○	○	○	○

*3 No limitation for combination use with other functions. Satisfaction judgment of interruption conditions is performed as needed.

Function name		Sub function to be combined				
		Speed change function	Override function	Acceleration/deceleration time change function	Torque change function	Target position change function
Function specific to machine OPR	OPR retry function	△*4	△*4	○	○	×
	OP shift function	△*4	△*4	○	○	×
Function to compensate control	Backlash compensation function	○	○	○	○	○
	Electronic gear function	○	○	○	○	○
	Near pass function	○	○	○	○	○
	Output timing selection of near pass control	○	○	○	○	○
Function to limit control	Speed limit function	○	○	○	○	○
	Torque limit function	○	○	○	○	○
	Software stroke limit function	○	○	○	○	○
	Hardware stroke limit function	○	○	○	○	○
Functions that change control details	Speed change function	—	○	○	○	○
	Override function	○	—	○	○	○
	Acceleration/deceleration time change function	○	○	—	○	○
	Torque change function	○	○	○	—	○
	Target position change function	○	○	○	○	—
Function related to positioning start	Start time adjustment function	○	○	○	○	○
	Restart function	○	○	○	○	○
	Pre-reading start function	○	○	○	○	○
Absolute position restoration function		×	×	×	×	×
Function related to positioning stop	Step function	○	○	○	○	○
	Stop command processing for deceleration stop function	○	○	○	○	○
	Continuous operation interrupt function	○	○	○	○	○
	Stop processing function	○	○	○	○	○
Other functions	Skip function	△*5	○	○	○	○
	M code output function	○	○	○	○	○
	Teaching function	×	×	×	×	×
	Command in-position function	○	○	○	○	○
	Acceleration/deceleration processing function	○	○	○	○	○
	Deceleration start flag function	△*6	△*6	○	○	○
	During uncompleted OPR operation setting function	○	○	○	○	○
	Interrupt function*7	○	○	○	○	○

*4 Speed cannot be changed to zero.

*5 For the control using External command signal, only one of the functions can be used.

*6 Deceleration start flag does not turn on when the speed change function or override function is used to make deceleration.

*7 No limitation for combination use with other functions. Satisfaction judgment of interruption conditions is performed as needed.

Function name		Sub function to be combined				
		Start time adjustment function	Restart function	Pre-reading start function	Absolute position restoration function	Step function
Function specific to machine OPR	OPR retry function	×	×	×	×	×
	OP shift function	×	×	×	×	×
Function to compensate control	Backlash compensation function	○	○	○	○	○
	Electronic gear function	○	○	○	○	○
	Near pass function	○	○	○	×	○
	Output timing selection of near pass control	○	○	○	×	○
Function to limit control	Speed limit function	○	○	○	×	○
	Torque limit function	○	○	○	×	○
	Software stroke limit function	○	○	○	×	○
	Hardware stroke limit function	○	○	○	×	○
Functions that change control details	Speed change function	○	○	○	×	○
	Override function	○	○	○	×	○
	Acceleration/deceleration time change function	○	○	○	×	○
	Torque change function	○	○	○	×	○
	Target position change function	○	○	○	×	○
Function related to positioning start	Start time adjustment function	—	×	×	×	○
	Restart function	×	—	×	×	○
	Pre-reading start function	×	×	—	×	○
Absolute position restoration function		×	×	×	—	×
Function related to positioning stop	Step function	○	○	○	×	—
	Stop command processing for deceleration stop function	○	○	○	×	○
	Continuous operation interrupt function	○	○	○	×	○
	Stop processing function	○	○	○	×	○
Other functions	Skip function	○	○	○	×	○
	M code output function	○	○	○	×	○
	Teaching function	×	×	×	×	×
	Command in-position function	○	○	○	×	○
	Acceleration/deceleration processing function	○	○	○	×	○
	Deceleration start flag function	○	○	○	×	○
	During uncompleted OPR operation setting function	○	○	○	×	○
	Interrupt function* ⁸	○	○	○	○	○

*8 No limitation for combination use with other functions. Satisfaction judgment of interruption conditions is performed as needed.

Function name		Sub function to be combined				
		Stop command processing for deceleration stop function	Continuous operation interrupt function	Stop processing function	Skip function	M code output function
Function specific to machine OPR	OPR retry function	×	×	○	×	×
	OP shift function	×	×	○	×	×
Function to compensate control	Backlash compensation function	○	○	○	○	○
	Electronic gear function	○	○	○	○	○
	Near pass function	○	○	○	○	○
	Output timing selection of near pass control	○	○	○	○	○
Function to limit control	Speed limit function	○	○	○	○	○
	Torque limit function	○	○	○	○	○
	Software stroke limit function	○	○	○	○	○
	Hardware stroke limit function	○	○	○	○	○
Functions that change control details	Speed change function	○	○	○	△ ^{*9}	○
	Override function	○	○	○	○	○
	Acceleration/deceleration time change function	○	○	○	○	○
	Torque change function	○	○	○	○	○
	Target position change function	○	○	○	○	○
Function related to positioning start	Start time adjustment function	○	○	○	○	○
	Restart function	○	○	○	○	○
	Pre-reading start function	○	○	○	○	○
Absolute position restoration function		×	×	×	×	×
Function related to positioning stop	Step function	○	○	○	○	○
	Stop command processing for deceleration stop function	—	○	○	○	○
	Continuous operation interrupt function	○	—	○	○	○
	Stop processing function	○	○	—	○	○
Other functions	Skip function	○	○	○	—	△ ^{*10}
	M code output function	○	○	○	△ ^{*10}	—
	Teaching function	×	×	×	×	×
	Command in-position function	○	○	○	○	○
	Acceleration/deceleration processing function	○	○	○	○	○
	Deceleration start flag function	○	○	○	○	○
	During uncompleted OPR operation setting function	○	○	○	○	○
	Interrupt function ^{*11}	○	○	○	○	○

*9 For the control using External command signal, only one of the functions can be used.

*10 M code ON signals [X4, X5, X6, X7] do not turn on when the M code output is set to the AFTER mode (When 1: AFTER mode is set in [Pr.18] M code ON signal output timing).

*11 No limitation for combination use with other functions. Satisfaction judgment of interruption conditions is performed as needed.

Function name		Sub function to be combined					
		Teaching function	Command in-position function	Acceleration/deceleration processing function	Deceleration start flag	During uncompleted OPR operation setting function	Interrupt function
Function specific to machine OPR	OPR retry function	×	×	○	×	○	○
	OP shift function	×	×	○	×	○	○
Function to compensate control	Backlash compensation function	×	○	○	○	○	○
	Electronic gear function	×	○	○	○	○	○
	Near pass function	×	○	○	○	○	○
	Output timing selection of near pass control	×	○	○	○	○	○
Function to limit control	Speed limit function	×	○	○	○	○	○
	Torque limit function	×	○	○	○	○	○
	Software stroke limit function	×	○	○	○	○	○
	Hardware stroke limit function	×	○	○	○	○	○
Functions that change control details	Speed change function	×	○	○	△ ^{*12}	○	○
	Override function	×	○	○	△ ^{*12}	○	○
	Acceleration/deceleration time change function	×	○	○	○	○	○
	Torque change function	×	○	○	○	○	○
	Target position change function	×	○	○	○	○	○
Function related to positioning start	Start time adjustment function	×	○	○	○	○	○
	Restart function	×	○	○	○	○	○
	Pre-reading start function	×	○	○	○	○	○
Absolute position restoration function		×	×	×	×	×	○
Function related to positioning stop	Step function	×	○	○	○	○	○
	Stop command processing for deceleration stop function	×	○	○	○	○	○
	Continuous operation interrupt function	×	○	○	○	○	○
	Stop processing function	×	○	○	○	○	○
Other functions	Skip function	×	○	○	○	○	○
	M code output function	×	○	○	○	○	○
	Teaching function	—	×	×	×	×	○
	Command in-position function	×	—	○	○	○	○
	Acceleration/deceleration processing function	×	○	—	○	○	○
	Deceleration start flag function	×	○	○	—	○	○
	During uncompleted OPR operation setting function	×	○	○	○	—	○
	Interrupt function ^{*13}	○	○	○	○	○	—

*12 Deceleration start flag does not turn on when the speed change function or override function is used to make deceleration.

*13 No limitation for combination use with other functions. Satisfaction judgment of interruption conditions is performed as needed.

4 PROCEDURES BEFORE OPERATIONS

This chapter describes the procedures before operation.

1. Mounting the module

Mount the RD75 on the main base unit or extension base unit. For details, refer to the following.

 MELSEC iQ-R Module Configuration Manual

2. Wiring

Connect the RD75 to external devices.

3. Adding the module

Add the RD75 to the module map of the project using an engineering tool.

4. Module setting

Set values for the module setting using an engineering tool. For details, refer to the following.

 MELSEC iQ-R Positioning Module User's Manual (Application)

5. Auto refresh setting

Set values for the refresh settings using an engineering tool. For details, refer to the following.

 MELSEC iQ-R Positioning Module User's Manual (Application)

6. Checking connections

Check that the RD75 is connected to external devices correctly.

7. Programming

Create programs. For details, refer to the following.

 MELSEC iQ-R Positioning Module User's Manual (Application)

8. Test operation

Check that the positioning is correctly carried out as designed.

5 SYSTEM CONFIGURATION

For system configurations using the MELSEC iQ-R series modules, CPU modules that can be used with the positioning module, and the number of mountable modules, refer to the following.

 MELSEC iQ-R Module Configuration Manual

6 WIRING

This chapter describes the overall configuration of the system using the RD75, and lists the devices configuring the system.

6.1 Wiring Precautions

Check the terminal layouts and wire the RD75 correctly.

For the terminal layouts, refer to the following.

 Page 47 Signal layouts of connectors for external devices

Connectors for external devices

Precautions

- Tighten the connector screws within the specified torque range.

Screw	Tightening torque range
Connector screw (M2.6)	0.20 to 0.29N·m

- Use copper wire with a temperature rating of 75°C or higher for the connector.
- Use UL listed connectors if necessary for UL compliance.
- The positions of PULSE COM terminals differ between the QD75D□ and the RD75D□. Therefore, if the same 40-pin connectors for the QD75D□ are used for the RD75D□, additional wiring to the 40-pin connectors (2B20 and 2B19 pins) is required.

Applicable connectors

Connectors for external devices to be used for the RD75 are sold separately.

The following tables list the applicable connectors, and the reference product of a crimping tool.

■40-pin connectors

Type	Model	Applicable wire size
Soldering type connector (straight type)	A6CON1*1	0.088 to 0.3mm ² (28 to 22 AWG) (stranded wire)
Crimping type connector (straight type)	A6CON2	0.088 to 0.24mm ² (28 to 24 AWG) (stranded wire)
Soldering type connector (dual purpose (straight/oblique) type)	A6CON4*1	0.088 to 0.3mm ² (28 to 22 AWG) (stranded wire)

*1 Use wire with a sheath outside diameter of 1.3mm or less when the 40 pins are used.
Select appropriate cables according to the current value used.

Point

The A6CON3 (IDC type connector (straight type)) cannot be used.

■40-pin connector crimping tool

Type	Model	Contact
Crimping tool	FCN-363T-T005/H	FUJITSU COMPONENT LIMITED

For how to wire the connector and how to use the crimping tool, contact the manufacturer.

Wiring example when shielded cables are used

The following figure shows an example of the noise reduction measure when the connector (A6CON1) is used:

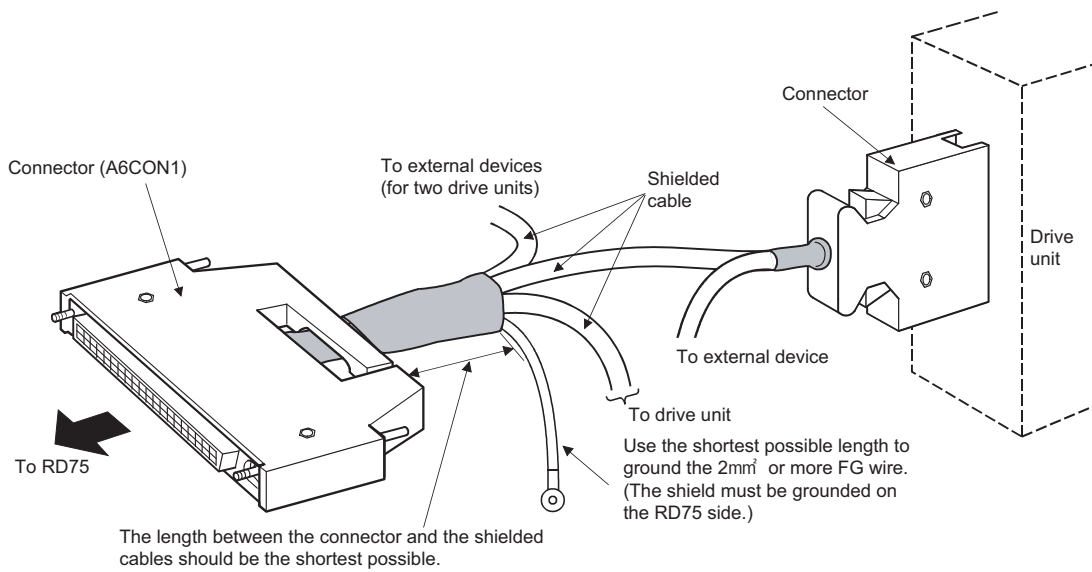

Example of shielded cable processing

The following figure shows an example of the noise reduction measure when the connector (A6CON1) is used:

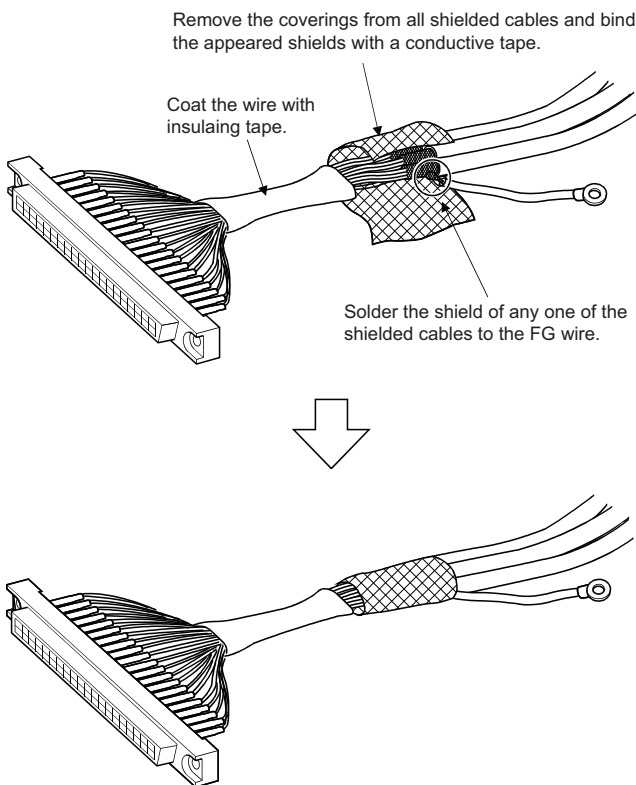

■Assembling of the connector (A6CON1)

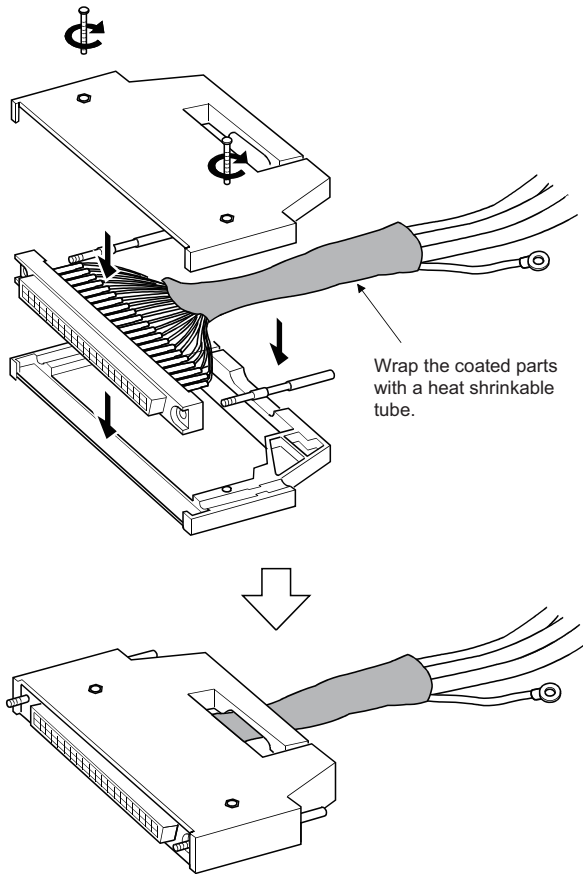

Wiring methods, and installation and removal procedures for the connectors

For the wiring methods, and installation and removal procedures, refer to the following.

📖 MELSEC iQ-R Module Configuration Manual

6.2 Connector for External Devices

Signal layouts of connectors for external devices

This section lists signal layouts of RD75 connectors for external devices.

- RD75P□

Pin layout (front view of the module)	Axis 4 (AX4)		Axis 3 (AX3)		Axis 2 (AX2)		Axis 1 (AX1)	
	Pin No.	Signal name	Pin No.	Signal name	Pin No.	Signal name	Pin No.	Signal name
2B20 □ □ 2A20 1B20 □ □ 1A20	2B20	Empty	2A20	Empty	1B20	PULSER B-	1A20	PULSER B+
2B19 □ □ 2A19 1B19 □ □ 1A19	2B19	Empty	2A19	Empty	1B19	PULSER A-	1A19	PULSER A+
2B18 □ □ 2A18 1B18 □ □ 1A18	2B18	PULSE COM	2A18	PULSE COM	1B18	PULSE COM	1A18	PULSE COM
2B17 □ □ 2A17 1B17 □ □ 1A17	2B17	PULSE R	2A17	PULSE R	1B17	PULSE R	1A17	PULSE R
2B16 □ □ 2A16 1B16 □ □ 1A16	2B16	PULSE COM	2A16	PULSE COM	1B16	PULSE COM	1A16	PULSE COM
2B15 □ □ 2A15 1B15 □ □ 1A15	2B15	PULSE F	2A15	PULSE F	1B15	PULSE F	1A15	PULSE F
2B14 □ □ 2A14 1B14 □ □ 1A14	2B14	CLRCOM	2A14	CLRCOM	1B14	CLRCOM	1A14	CLRCOM
2B13 □ □ 2A13 1B13 □ □ 1A13	2B13	CLEAR	2A13	CLEAR	1B13	CLEAR	1A13	CLEAR
2B12 □ □ 2A12 1B12 □ □ 1A12	2B12	RDYCOM	2A12	RDYCOM	1B12	RDYCOM	1A12	RDYCOM
2B11 □ □ 2A11 1B11 □ □ 1A11	2B11	READY	2A11	READY	1B11	READY	1A11	READY
2B10 □ □ 2A10 1B10 □ □ 1A10	2B10	PG0COM	2A10	PG0COM	1B10	PG0COM	1A10	PG0COM
2B9 □ □ 2A9 1B9 □ □ 1A9	2B9	PG05	2A9	PG05	1B9	PG05	1A9	PG05
2B8 □ □ 2A8 1B8 □ □ 1A8	2B8	PG024	2A8	PG024	1B8	PG024	1A8	PG024
2B7 □ □ 2A7 1B7 □ □ 1A7	2B7	COM	2A7	COM	1B7	COM	1A7	COM
2B6 □ □ 2A6 1B6 □ □ 1A6	2B6	COM	2A6	COM	1B6	COM	1A6	COM
2B5 □ □ 2A5 1B5 □ □ 1A5	2B5	CHG	2A5	CHG	1B5	CHG	1A5	CHG
2B4 □ □ 2A4 1B4 □ □ 1A4	2B4	STOP	2A4	STOP	1B4	STOP	1A4	STOP
2B3 □ □ 2A3 1B3 □ □ 1A3	2B3	DOG	2A3	DOG	1B3	DOG	1A3	DOG
2B2 □ □ 2A2 1B2 □ □ 1A2	2B2	RLS	2A2	RLS	1B2	RLS	1A2	RLS
2B1 □ □ 2A1 1B1 □ □ 1A1	2B1	FLS	2A1	FLS	1B1	FLS	1A1	FLS

• RD75D□

Pin layout (front view of the module)	Axis 4 (AX4)		Axis 3 (AX3)		Axis 2 (AX2)		Axis 1 (AX1)	
	Pin No.	Signal name	Pin No.	Signal name	Pin No.	Signal name	Pin No.	Signal name
2B20 □ □ 2A20 1B20 □ □ 1A20	2B20	PULSE COM	2A20	Empty	1B20	PULSER B-	1A20	PULSER B+
2B19 □ □ 2A19 1B19 □ □ 1A19	2B19	PULSE COM	2A19	Empty	1B19	PULSER A-	1A19	PULSER A+
2B18 □ □ 2A18 1B18 □ □ 1A18	2B18	PULSE R-	2A18	PULSE R-	1B18	PULSE R-	1A18	PULSE R-
2B17 □ □ 2A17 1B17 □ □ 1A17	2B17	PULSE R+	2A17	PULSE R+	1B17	PULSE R+	1A17	PULSE R+
2B16 □ □ 2A16 1B16 □ □ 1A16	2B16	PULSE F-	2A16	PULSE F-	1B16	PULSE F-	1A16	PULSE F-
2B15 □ □ 2A15 1B15 □ □ 1A15	2B15	PULSE F+	2A15	PULSE F+	1B15	PULSE F+	1A15	PULSE F+
2B14 □ □ 2A14 1B14 □ □ 1A14	2B14	CLRCOM	2A14	CLRCOM	1B14	CLRCOM	1A14	CLRCOM
2B13 □ □ 2A13 1B13 □ □ 1A13	2B13	CLEAR	2A13	CLEAR	1B13	CLEAR	1A13	CLEAR
2B12 □ □ 2A12 1B12 □ □ 1A12	2B12	RDYCOM	2A12	RDYCOM	1B12	RDYCOM	1A12	RDYCOM
2B11 □ □ 2A11 1B11 □ □ 1A11	2B11	READY	2A11	READY	1B11	READY	1A11	READY
2B10 □ □ 2A10 1B10 □ □ 1A10	2B10	PG0COM	2A10	PG0COM	1B10	PG0COM	1A10	PG0COM
2B9 □ □ 2A9 1B9 □ □ 1A9	2B9	PG05	2A9	PG05	1B9	PG05	1A9	PG05
2B8 □ □ 2A8 1B8 □ □ 1A8	2B8	PG024	2A8	PG024	1B8	PG024	1A8	PG024
2B7 □ □ 2A7 1B7 □ □ 1A7	2B7	COM	2A7	COM	1B7	COM	1A7	COM
2B6 □ □ 2A6 1B6 □ □ 1A6	2B6	COM	2A6	COM	1B6	COM	1A6	COM
2B5 □ □ 2A5 1B5 □ □ 1A5	2B5	CHG	2A5	CHG	1B5	CHG	1A5	CHG
2B4 □ □ 2A4 1B4 □ □ 1A4	2B4	STOP	2A4	STOP	1B4	STOP	1A4	STOP
2B3 □ □ 2A3 1B3 □ □ 1A3	2B3	DOG	2A3	DOG	1B3	DOG	1A3	DOG
2B2 □ □ 2A2 1B2 □ □ 1A2	2B2	RLS	2A2	RLS	1B2	RLS	1A2	RLS
2B1 □ □ 2A1 1B1 □ □ 1A1	2B1	FLS	2A1	FLS	1B1	FLS	1A1	FLS

List of I/O signal details

Signal name	Axis No.				Signal details (Negative logic is selected as the external I/O signal logic.)
	Axis 1	Axis 2	Axis 3	Axis 4	
Manual pulse generator A phase (PULSER A+)	1A19	—	—	—	<ul style="list-style-type: none"> The pulse signal from the manual pulse generator A phase and B phase is input. If the A phase (ϕA) leads the B phase (ϕB), the positioning address (P_a) increases at the rising and falling edges of each phase. If the B phase (ϕB) leads the A phase (ϕA), the positioning address (P_a) decreases at the rising and falling edges of each phase. <div style="display: flex; justify-content: space-around;"> <div style="text-align: center;"> <p>[When increased]</p> <p>P_a +1+1+1+1+1+1+1+1</p> </div> <div style="text-align: center;"> <p>[When decreased]</p> <p>P_a -1-1-1-1-1-1-1-1</p> </div> </div>
Manual pulse generator B phase (PULSER B+)	1A20	—	—	—	
Manual pulse generator A common (PULSER A-)	—	1B19	—	—	
Manual pulse generator B common (PULSER B-)	—	1B20	—	—	
Differential driver common (PULSE COM)	—	—	—	2B19 2B20	The potential difference between the common of differential driver of the RD75 and the common of the differential receiver of the drive unit (differential driver compatible) is equalized. (RD75D□ only)
Zero signal (+24V) (PG024)	1A8	1B8	2A8	2B8	<ul style="list-style-type: none"> The zero signal is input for machine OPR. The zero signal of pulse encoder is used. The signal is used as well when the machine OPR method is the stopper method and the OPR complete is input from an external source. The zero signal is detected when it turns on.
Zero signal (+5V) (PG05)	1A9	1B9	2A9	2B9	
Zero signal common (PG0COM)	1A10	1B10	2A10	2B10	Common for the zero signal (+5V) and zero signal (+24V)
Pulse output F (PULSE F)	1A15	1B15	2A15	2B15	The positioning pulses and pulse codes are output to the drive unit compatible with the transistor output system. (RD75P□ only)
Pulse output F common (PULSE COM)	1A16	1B16	2A16	2B16	
Pulse output R (PULSE R)	1A17	1B17	2A17	2B17	
Pulse output R common (PULSE COM)	1A18	1B18	2A18	2B18	
Pulse output F (+) (PULSE F+)	1A15	1B15	2A15	2B15	
Pulse output F (-) (PULSE F-)	1A16	1B16	2A16	2B16	The positioning pulses and pulse codes are output to the drive unit compatible with the differential driver output system. (RD75D□ only)
Pulse output R (+) (PULSE R+)	1A17	1B17	2A17	2B17	
Pulse output R (-) (PULSE R-)	1A18	1B18	2A18	2B18	
Upper limit signal (FLS)	1A1	1B1	2A1	2B1	<ul style="list-style-type: none"> The signal is input from the limit switch installed at the upper limit position of the stroke. Positioning stops when this signal turns off. When the OPR retry function is enabled, this becomes the upper limit to find the near-point dog signal.
Lower limit signal (RLS)	1A2	1B2	2A2	2B2	<ul style="list-style-type: none"> The signal is input from the limit switch installed at the lower limit position of the stroke. Positioning stops when this signal turns off. When the OPR retry function is enabled, this becomes the lower limit to find the near-point dog signal.
Near-point dog signal (DOG)	1A3	1B3	2A3	2B3	<ul style="list-style-type: none"> This signal is used to detect the near-point dog for machine OPR. The near-point dog signal is detected when it turns on.
Stop signal (STOP)	1A4	1B4	2A4	2B4	<ul style="list-style-type: none"> This signal is input to stop positioning. When this signal turns on, the RD75 stops the positioning being executed. After that, even if this signal is turned off, the system does not start.
External command signal (CHG)	1A5	1B5	2A5	2B5	<ul style="list-style-type: none"> A control switching signal is input during speed-position or position-speed switching control. This signal is used as the input signal of positioning start, speed change request, and skip request from an external source. Set the function to use with this signal in [Pr.42] External command function selection.
Common (COM)	1A6	1B6	2A6	2B6	Common for the upper/lower limit signal, near-point dog signal, stop signal, and external command signal.
	1A7	1B7	2A7	2B7	

Signal name	Axis No.				Signal details (Negative logic is selected as the external I/O signal logic.)
	Axis 1	Axis 2	Axis 3	Axis 4	
Drive unit READY signal (READY)	1A11	1B11	2A11	2B11	<ul style="list-style-type: none"> This signal turns on when the drive unit is normal and can accept the feed pulse. The RD75 checks the drive unit READY signal, and outputs the OPR request if the system is not in the READY state. This signal turns off if the drive unit is inoperable, like when the control power supply of the drive unit failed. If this signal is turned off during positioning, the system stops. The system does not start even if this signal is turned on again. When this signal turns off, the OPR complete signal also turns off.
Drive unit READY common (RDYCOM)	1A12	1B12	2A12	2B12	<ul style="list-style-type: none"> Common for the drive unit READY signal
Deviation counter clear signal (CLEAR)	1A13	1B13	2A13	2B13	<p>This signal is output during machine OPR. (Note that the signal is not output in the count method 2.) (Example) When machine OPR is carried out in the stopper method 2</p> <p>Speed Pr.46 OPR speed Pr.47 Creep speed Stopper Near-point dog Zero signal OFF ON Pr.55 Deviation counter clear signal output time CLEAR OFF ON After feed pulse output stops</p> <ul style="list-style-type: none"> Set the output time of the deviation counter clear signal in [Pr.55] Deviation counter clear signal output time. Use the drive unit that can reset the droop pulse amount in the deviation counter when the RD75 turns on this signal. <p>(Note) The deviation counter clear signal is output by the RD75 during machine OPR. A user cannot output the signal at will.</p>
Deviation counter clear common (CLRCOM)	1A14	1B14	2A14	2B14	Common for the deviation counter clear signal

Internal circuit of input/output interface

The internal circuit of interface with external devices (for the RD75, axis 1) is shown below.

Input (common to the RD75)

○: Wiring is necessary for positioning, △: Wiring is necessary depending on the situation

External wiring and internal circuit	Pin No.	Signal name	Need for wiring
	1A3	Near-point dog signal (DOG)	△
	1A1	Upper limit signal (FLS)	○
	1A2	Lower limit signal (RLS)	○
	1A4	Stop signal (STOP)	△
	1A5	External command signal (CHG)	△
	1A6	Common (COM)	○
	1A7		○
	(+) 1A19	Manual pulse generator A phase (PULSER A+)	△
	(-) 1B19	Manual pulse generator A common (PULSER A-)	
	(+) 1A20	Manual pulse generator B phase (PULSER B+)	△
	(-) 1B20	Manual pulse generator B common (PULSER B-)	
	1A11	Drive unit READY signal (READY)	○
	1A12	Drive unit READY common (RDY COM)	○
	1A8	Zero signal (+24V) (PG024)	△
	1A9	Zero signal (+5V) (PG05)	
	1A10	Zero signal common (PG0COM)	

*1 Wiring of when an upper limit switch is not used
 *2 Wiring of when a lower limit switch is not used
 *3 Either polarity can be connected to the common (COM).

■Input signal ON/OFF status

The input signal ON/OFF status is defined by the external wiring and logic setting.

The example using the near-point dog signal (DOG) is shown below.

(The operation is the same if the other input signals are used.)

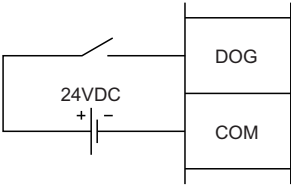
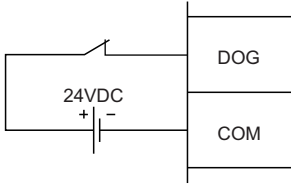
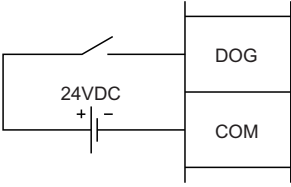
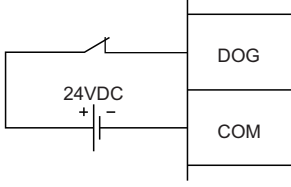
Logic setting ^{*1*2}	External wiring	ON/OFF status of the RD75
Negative logic (initial value)	When the voltage is not applied 	OFF
	When the voltage is applied 	ON
Positive logic	When the voltage is not applied 	ON
	When the voltage is applied 	OFF

*1 Set the logic in [Pr.22] Input signal logic selection. For details on the setting, refer to the following.

 MELSEC iQ-R Positioning Module User's Manual (Application)

*2 When using the upper limit signal (FLS) or the lower limit signal (RLS), wire it as b contact (normally closed contact) with the negative logic being set.

Positioning will stop when this signal turns off.

■Logic setting and internal circuit

For the RD75, the case where the internal circuit (photocoupler) is off with the negative logic being set is defined as input signal OFF.

Reversely, the case where the internal circuit (photocoupler) is off with the positive logic being set is defined as input signal ON.

The photocoupler ON/OFF status is shown below.

- When the voltage is not applied: Photocoupler OFF
- When the voltage is applied: Photocoupler ON

Output (RD75P□)

○: Wiring is necessary for positioning, △: Wiring is necessary depending on the situation

External wiring and internal circuit	Pin No.	Signal name	Need for wiring	
	1A13	Deviation counter clear signal (CLEAR)	△	
	1A14	Deviation counter clear common (CLEAR COM)		
	1A15	CW A phase PULSE	Pulse output F (PULSE F)	○
	1A16		Pulse output F common (PULSE COM)	
	1A17	CCW B phase SIGN	Pulse output R (PULSE R)	
	1A18		Pulse output R common (PULSE COM)	

Output (RD75D□)

○: Wiring is necessary for positioning, △: Wiring is necessary depending on the situation

External wiring and internal circuit	Pin No.	Signal name	Need for wiring	
	1A13	Deviation counter clear signal (CLEAR)	△	
	1A14	Deviation counter clear common (CLEAR COM)		
	1A15	CW A phase PULSE	Pulse output F (+) (PULSE F+)	○
	1A16		Pulse output F (-) (PULSE F-)	
	1A17	CCW B phase SIGN	Pulse output R (+) (PULSE R+)	
	1A18		Pulse output R (-) (PULSE R-)	
	2B19	Differential driver common (PULSE COM)		△
	2B20			

7 OPERATION EXAMPLES

This chapter describes the programming procedure and the basic programs of the RD75. When applying the program examples provided in this manual to an actual system, properly verify the applicability and reliability of the control on the system.

Overall configuration

The program examples show the programs of following operations.



- Machine OPR execution
- Execution of 1-axis linear control using axis 1
- JOG operation execution

The following table shows the overall configuration of the positioning control operation examples. Note that the programs in the list are the ones using the axis 1 only.

No.	Program name	Description
1	PLC READY signal [Y0] ON program	Notifies the RD75 that the CPU module is normal before the start of positioning control.
2	Positioning start No. setting program	Sets the positioning data that are executed with a positioning start program. The operation example is the case when the start No. is for machine OPR or the positioning data No.1 of the axis 1 is used.
3	Positioning start program	Starts the machine OPR or the positioning control using positioning data.
4	JOG operation setting program	Sets the JOG operation speed.
6	JOG operation execution program	Starts the JOG operation.

Programming procedure

Take the following steps to create a program for the positioning control:

1. Start creating the program.
2. Set the module parameters for the initial setting.
 Page 56 Module parameters
3. Set the module extension parameters for positioning data.
 Page 56 Module extension parameters
4. Program examples of each control

System configuration

The following figure shows the system configuration used for the program examples in this section.

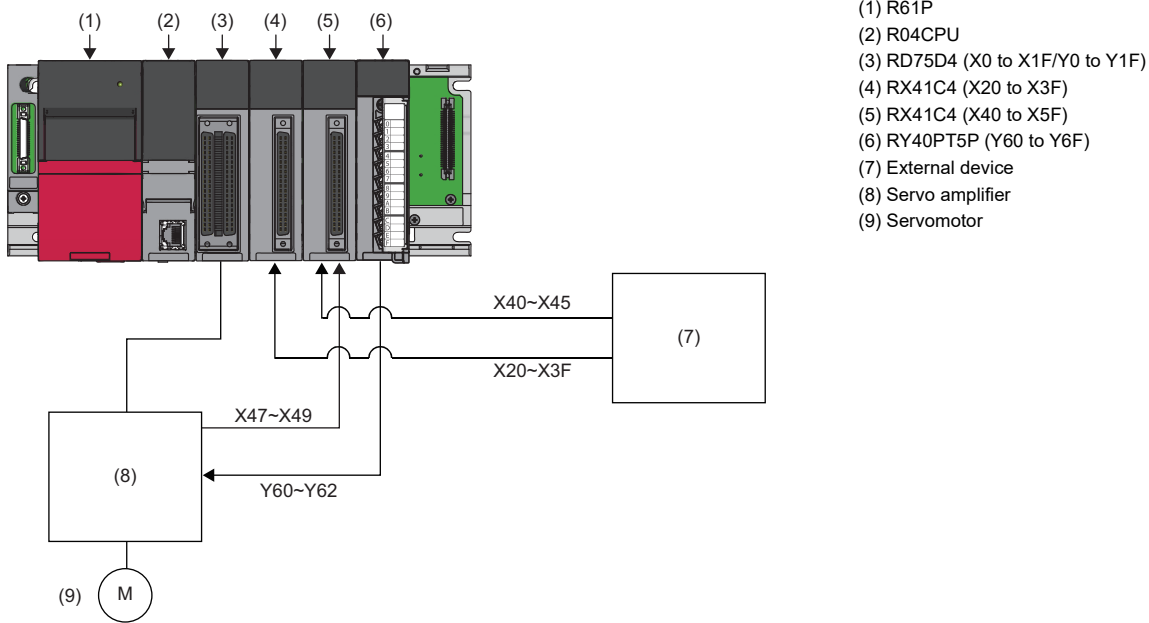

Parameter settings

Set the module parameters and module extension parameters with the engineering tool. Take the following steps.

1. Set the items as follows to create the project.

[Project] ⇒ [New]

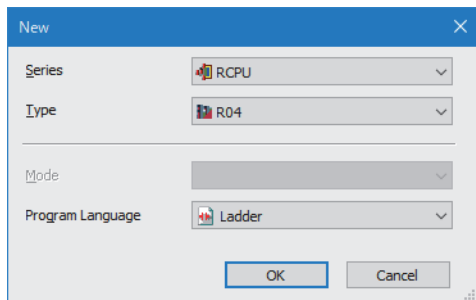

2. Click the [Setting Change] button and set the module to use the module label.
3. Click the [OK] button in the following window to add the module label of the CPU module.

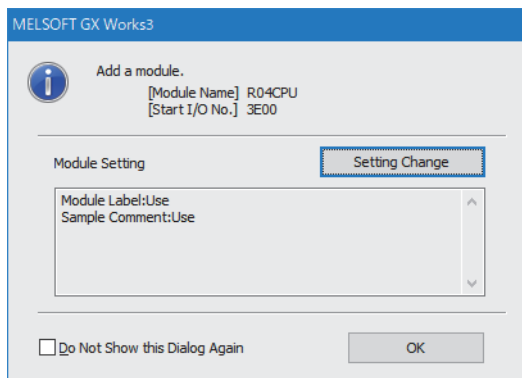

4. Add the RD75 to the project.

[Navigation] ⇒ [Parameter] ⇒ [Module Information] ⇒ Right-click ⇒ [Add New Module]

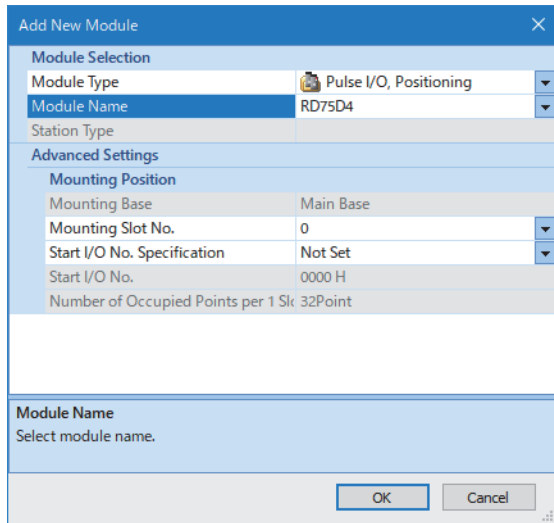

5. Set the following window to use the module labels and click [OK] button.

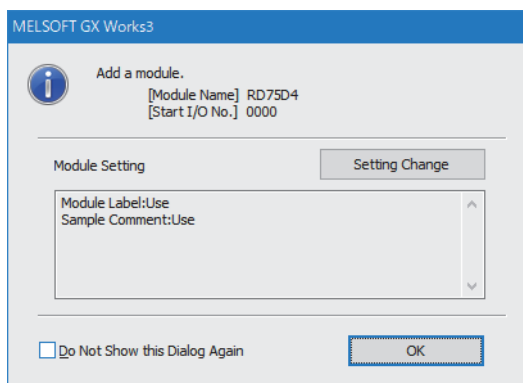

6. Set "Module Parameter" and "Module Extended Parameter".

7. Write the settings to the CPU module with the engineering tool.

[Online] ⇒ [Write to PLC]

8. The settings are reflected by resetting the CPU module or powering off and on the system.

■Module parameters

Set the items in "Module Parameter" as shown in the following table. Use the default values for the setting items not listed here or the setting items for the axes not described here.

Setting item		Setting value (Axis 1)
Basic parameter 1	Unit setting	0: mm
	Electronic gear selection	1: 32bit
	No. of pulses per rotation (32 bits)	150000 pulse
	Movement amount per rotation (32 bits)	250000.0 μm
	Bias speed at start	10.00 mm/min
OPR basic parameter	OPR speed	50.00mm/min
	Creep speed	15.00mm/min
	OPR retry	1: Perform the OPR retry with limit switches

■Module extension parameters

Set the items in "Module Extended Parameter" as shown in the following table. Use the default values for the setting items not listed here or the setting items for the axes not described here.

Setting item (Axis 1 Positioning data)	Setting value (positioning data No.1)
Operation pattern	0: Positioning complete

Setting item (Axis 1 Positioning data)	Setting value (positioning data No.1)
Control method	01H: ABS1 1-axis linear control (ABS)
Axis to be interpolated	—
Acceleration time No.	1: Acceleration time 1
Deceleration time No.	2: Deceleration time 2
Positioning address	1000000.0 μm
Arc address	—
Command speed	200000.00mm/min
Dwell time	300 ms
M code	0
M code ON signal output timing	0: Use the set value of M code ON signal output timing
ABS direction in degrees	0: Use the set value of ABS direction in degrees
Interpolation speed specification method	—

List of labels used

The following table lists the labels used for the program examples in this section. I/O signals or buffer memory areas of the modules shown in the system configuration are described in the programs using the labels.

For details on the global labels, refer to the following.

 MELSEC iQ-R Programming Manual (Program Design)

■Module label

The following table lists the module labels of the RD75 used for the program examples in this section.

Device name	Device Axis 1	Label Name	Signal name
I/O signals of the RD75	X0	RD75_1.bReady	RD75 READY signal
	X1	RD75_1.bModuleAccessFlag	Module access flag
	X8	RD75_1.bnErrorDetection_Axis[0]	Axis 1 Error detection signal
	XC	RD75_1.bnBusy_Axis[0]	Axis 1 BUSY signal
	X14	RD75_1.bnPositioningComplete_Axis[0]	Axis 1 Positioning complete signal
	Y0	RD75_1.bPLCReady	PLC READY signal

■Global label

The following table lists the global labels, which are created by a user if necessary, used for the program examples in this section. Set the following in the global label of the engineering tool.

Classification	Label name																																																																																				
Defined labels	Define global labels as shown below.																																																																																				
	<table border="1"> <thead> <tr> <th>Label Name</th> <th>Data Type</th> <th>Class</th> <th>Assign (Device/Label)</th> </tr> </thead> <tbody> <tr><td>bInputOPRStartReq</td><td>Bit</td><td>VAR_GLOBAL</td><td>X23</td></tr> <tr><td>bInputSetStartPositioningNoReq</td><td>Bit</td><td>VAR_GLOBAL</td><td>X25</td></tr> <tr><td>bInputStartPositioningReq</td><td>Bit</td><td>VAR_GLOBAL</td><td>X2B</td></tr> <tr><td>bInputSetJogSpeedReq</td><td>Bit</td><td>VAR_GLOBAL</td><td>X2D</td></tr> <tr><td>bInputForwardJogStartReq</td><td>Bit</td><td>VAR_GLOBAL</td><td>X2E</td></tr> <tr><td>bInputReverseJogStartReq</td><td>Bit</td><td>VAR_GLOBAL</td><td>X2F</td></tr> <tr><td>bInputFBErrResetReq</td><td>Bit</td><td>VAR_GLOBAL</td><td>X4E</td></tr> <tr><td>uPositioningStartNo</td><td>Word [Unsigned]/Bit String [16-bit]</td><td>VAR_GLOBAL</td><td></td></tr> <tr><td>bPositioningStartReq</td><td>Bit</td><td>VAR_GLOBAL</td><td></td></tr> <tr><td>uJogOperationSpeed</td><td>Double Word [Unsigned]/Bit String [32-bit]</td><td>VAR_GLOBAL</td><td></td></tr> <tr><td>uInchingMovementAmount</td><td>Word [Unsigned]/Bit String [16-bit]</td><td>VAR_GLOBAL</td><td></td></tr> <tr><td>bDuringJogInchingOperation</td><td>Bit</td><td>VAR_GLOBAL</td><td></td></tr> <tr><td>bStartPositioning_bErr</td><td>Bit</td><td>VAR_GLOBAL</td><td></td></tr> <tr><td>bStartPositioning_bENO</td><td>Bit</td><td>VAR_GLOBAL</td><td></td></tr> <tr><td>bStartPositioning_bOK</td><td>Bit</td><td>VAR_GLOBAL</td><td></td></tr> <tr><td>uStartPositioning_uErrId</td><td>Word [Unsigned]/Bit String [16-bit]</td><td>VAR_GLOBAL</td><td></td></tr> <tr><td>bJOG_bENO</td><td>Bit</td><td>VAR_GLOBAL</td><td></td></tr> <tr><td>bJOG_bOK</td><td>Bit</td><td>VAR_GLOBAL</td><td></td></tr> <tr><td>bJOG_bErr</td><td>Bit</td><td>VAR_GLOBAL</td><td></td></tr> <tr><td>uJOG_uErrId</td><td>Word [Unsigned]/Bit String [16-bit]</td><td>VAR_GLOBAL</td><td></td></tr> </tbody> </table>	Label Name	Data Type	Class	Assign (Device/Label)	bInputOPRStartReq	Bit	VAR_GLOBAL	X23	bInputSetStartPositioningNoReq	Bit	VAR_GLOBAL	X25	bInputStartPositioningReq	Bit	VAR_GLOBAL	X2B	bInputSetJogSpeedReq	Bit	VAR_GLOBAL	X2D	bInputForwardJogStartReq	Bit	VAR_GLOBAL	X2E	bInputReverseJogStartReq	Bit	VAR_GLOBAL	X2F	bInputFBErrResetReq	Bit	VAR_GLOBAL	X4E	uPositioningStartNo	Word [Unsigned]/Bit String [16-bit]	VAR_GLOBAL		bPositioningStartReq	Bit	VAR_GLOBAL		uJogOperationSpeed	Double Word [Unsigned]/Bit String [32-bit]	VAR_GLOBAL		uInchingMovementAmount	Word [Unsigned]/Bit String [16-bit]	VAR_GLOBAL		bDuringJogInchingOperation	Bit	VAR_GLOBAL		bStartPositioning_bErr	Bit	VAR_GLOBAL		bStartPositioning_bENO	Bit	VAR_GLOBAL		bStartPositioning_bOK	Bit	VAR_GLOBAL		uStartPositioning_uErrId	Word [Unsigned]/Bit String [16-bit]	VAR_GLOBAL		bJOG_bENO	Bit	VAR_GLOBAL		bJOG_bOK	Bit	VAR_GLOBAL		bJOG_bErr	Bit	VAR_GLOBAL		uJOG_uErrId	Word [Unsigned]/Bit String [16-bit]	VAR_GLOBAL	
Label Name	Data Type	Class	Assign (Device/Label)																																																																																		
bInputOPRStartReq	Bit	VAR_GLOBAL	X23																																																																																		
bInputSetStartPositioningNoReq	Bit	VAR_GLOBAL	X25																																																																																		
bInputStartPositioningReq	Bit	VAR_GLOBAL	X2B																																																																																		
bInputSetJogSpeedReq	Bit	VAR_GLOBAL	X2D																																																																																		
bInputForwardJogStartReq	Bit	VAR_GLOBAL	X2E																																																																																		
bInputReverseJogStartReq	Bit	VAR_GLOBAL	X2F																																																																																		
bInputFBErrResetReq	Bit	VAR_GLOBAL	X4E																																																																																		
uPositioningStartNo	Word [Unsigned]/Bit String [16-bit]	VAR_GLOBAL																																																																																			
bPositioningStartReq	Bit	VAR_GLOBAL																																																																																			
uJogOperationSpeed	Double Word [Unsigned]/Bit String [32-bit]	VAR_GLOBAL																																																																																			
uInchingMovementAmount	Word [Unsigned]/Bit String [16-bit]	VAR_GLOBAL																																																																																			
bDuringJogInchingOperation	Bit	VAR_GLOBAL																																																																																			
bStartPositioning_bErr	Bit	VAR_GLOBAL																																																																																			
bStartPositioning_bENO	Bit	VAR_GLOBAL																																																																																			
bStartPositioning_bOK	Bit	VAR_GLOBAL																																																																																			
uStartPositioning_uErrId	Word [Unsigned]/Bit String [16-bit]	VAR_GLOBAL																																																																																			
bJOG_bENO	Bit	VAR_GLOBAL																																																																																			
bJOG_bOK	Bit	VAR_GLOBAL																																																																																			
bJOG_bErr	Bit	VAR_GLOBAL																																																																																			
uJOG_uErrId	Word [Unsigned]/Bit String [16-bit]	VAR_GLOBAL																																																																																			

A device assignment setting is not required for labels where Assign (Device/Label) is blank because unused internal relay and data devices are automatically assigned to the labels.

Program example

The program examples use the module function blocks (FBs) and module labels displayed in "Module POU".

For details on module function blocks, refer to the following.

 MELSEC iQ-R Positioning Module Function Block Reference

■PLC READY signal [Y0] ON program

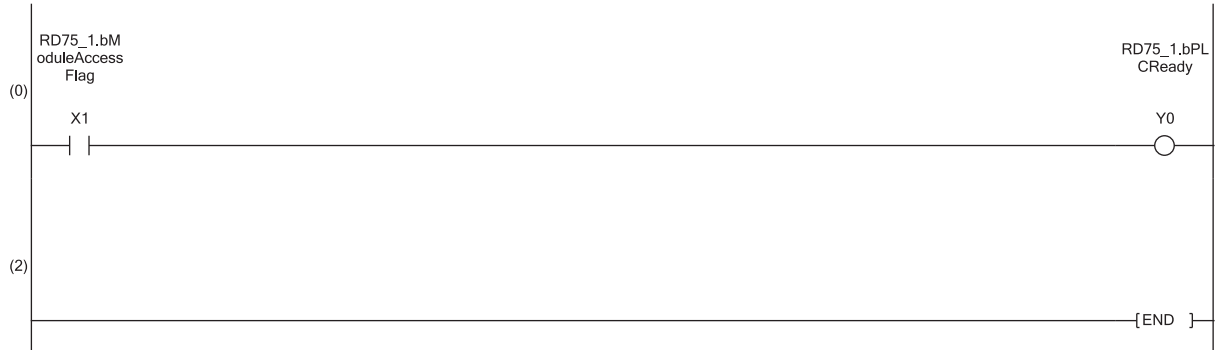

■Positioning start No. setting program

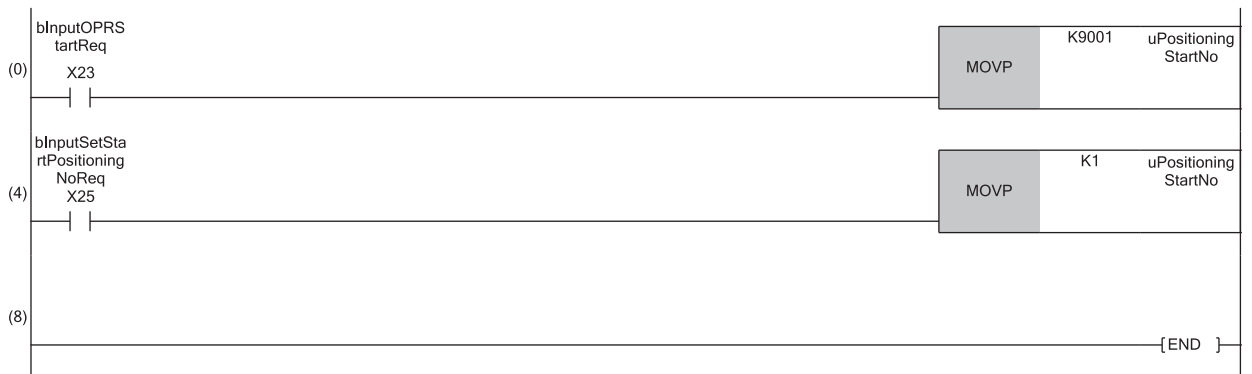

Positioning start program

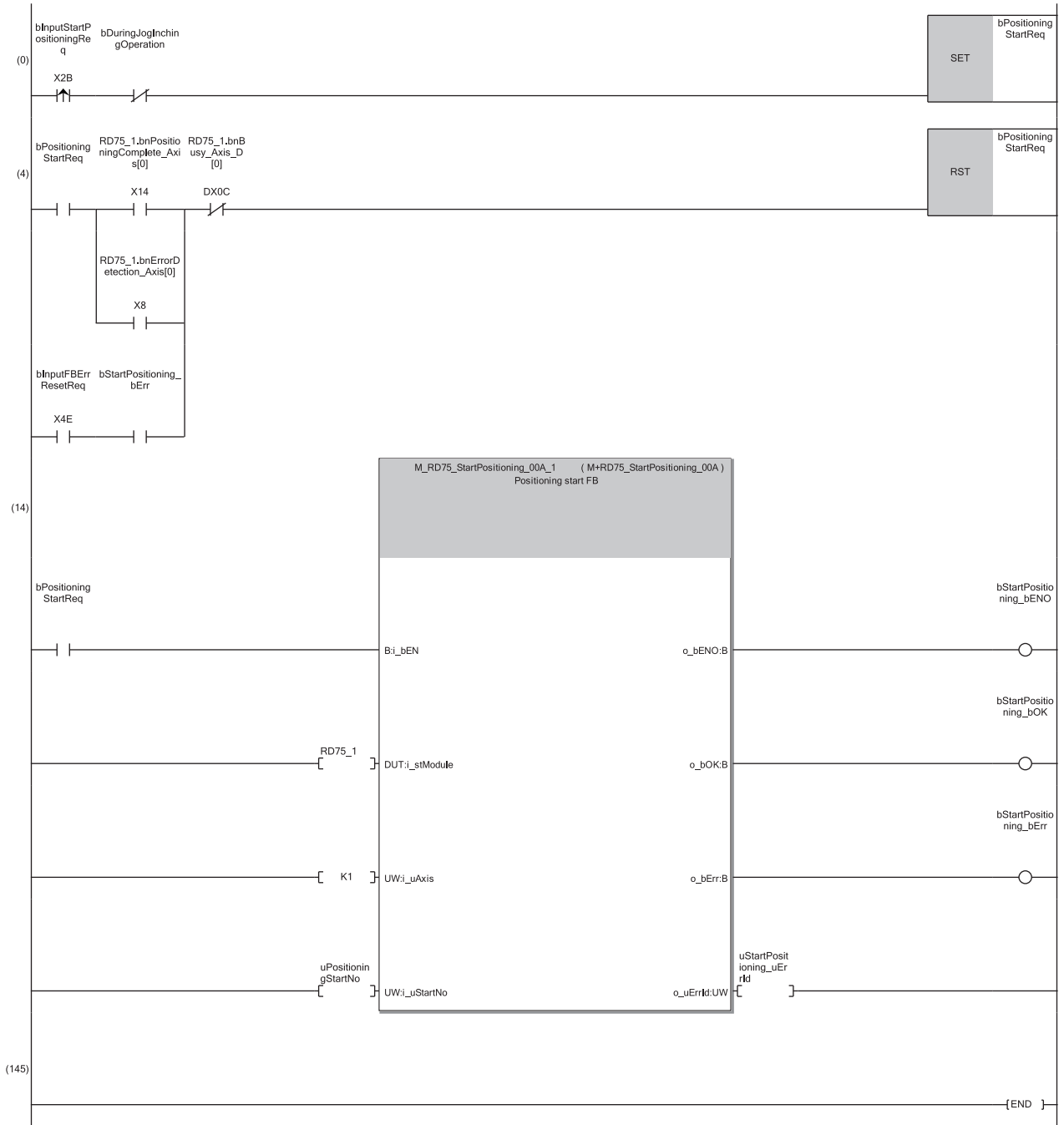

■JOG operation setting program

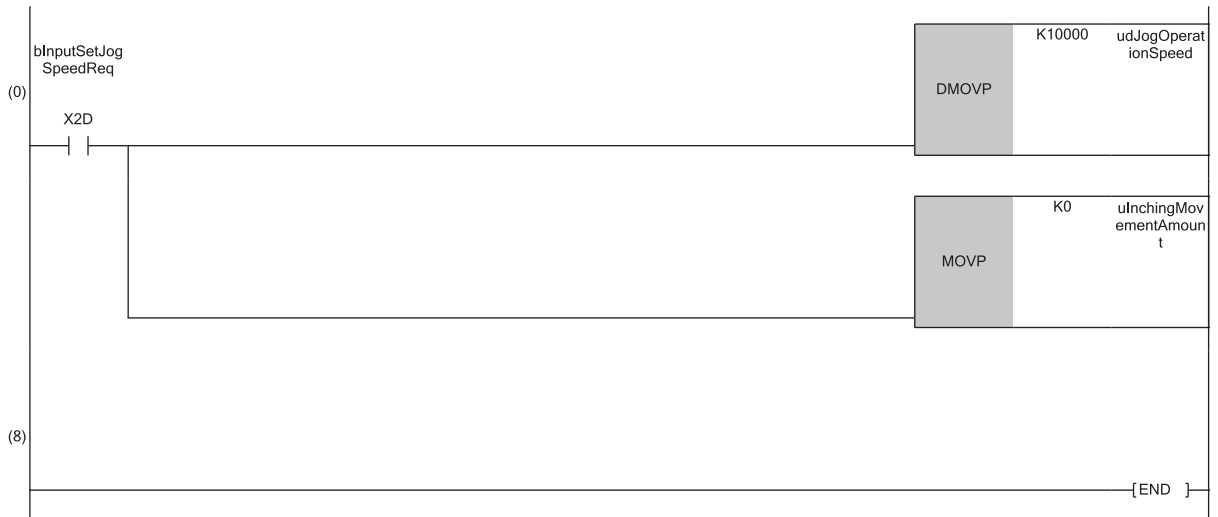

■JOG operation execution program

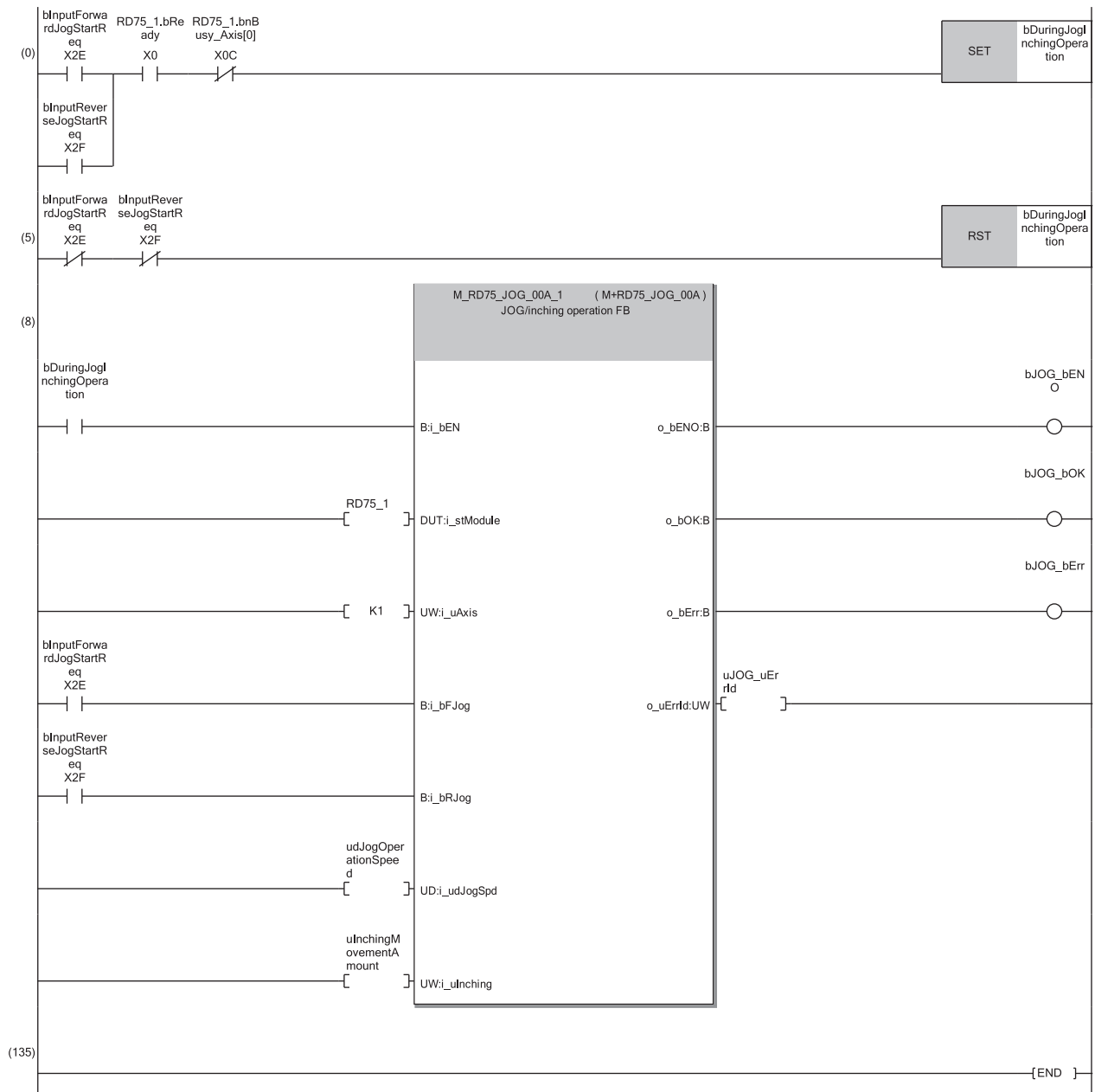

APPENDICES

Appendix 1 External Connection

The connection example with a servo amplifier manufactured by Mitsubishi

The connection example of the RD75D□ and the MR-J4-A

The differential driver connection is recommended because the maximum output pulse is faster and the maximum connection distance between servos is longer for the differential driver connection than for the transistor output connection. (Page 18 Performance Specifications)

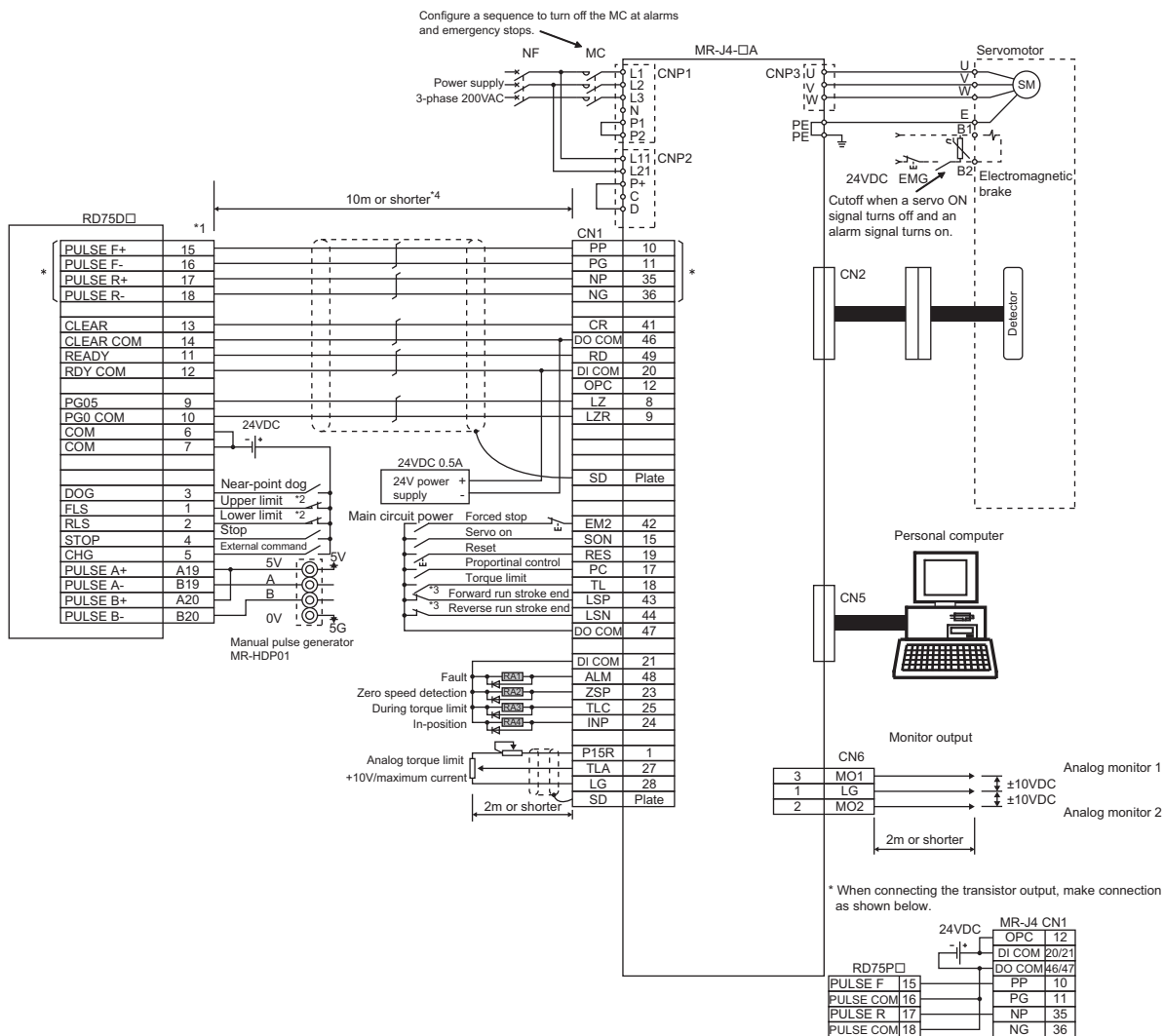

- *1 The logic of each I/O terminal can be changed with [Pr.22] Input signal logic selection and [Pr.23] Output signal logic selection of detailed parameter 1. (The negative logic is set for all terminals in the above example.)
- *2 The upper limit signal (FLS) and lower limit signal (RLS) of the RD75D□ are used for the OPR retry function. Set these signals on the inward side of the limit switches for the servo amplifier.
- *3 These are the limit switches for the servo amplifier (for stop).
- *4 This indicates the distance between the RD75D□ and the servo amplifier.
- *5 For logic for the RD75D□ and the servo amplifier, refer to the following.
Page 20 Specifications of Input/output Interfaces with External Devices
The RD75D□ is initially set to negative logic.

Appendix 2 Device List

The positioning system using the RD75 is configured with the following devices.

No.	Name	Model	Remarks
1	Positioning module	RD75P2 RD75P4 RD75D2 RD75D4	
2	Drive unit	—	Servo amplifier
3	Manual pulse generator	—	Recommended: MR-HDP01 (manufactured by Mitsubishi)
4	Connector for external devices	A6CON1	Soldering type (straight type)
		A6CON2	Crimping type
		A6CON4	Soldering type (dual purpose (straight/oblique) type)
5	Positioning signal converter module (reference product)	FA-LTBQ75DP	With this module, a terminal block can be used as the external interface for signals used for the positioning module. (Page 63 Positioning signal converter module)

Reference products

Positioning signal converter module

This module is used to change the external interface for signals used for the RD75 from a connector to a terminal block. Using this module simplifies wiring to external devices. (Use the module with products (2) and (3) listed below.)

For inquiries concerning these products, please consult your local Mitsubishi representative.

No.	Model	Connectable RD75	Remarks
(1)	FA-LTBQ75DP	RD75P□ RD75D□	Positioning signal converter module
(2)	FA-CBL05Q7 FA-CBL10Q7		Cable for connecting a positioning module and a positioning signal converter module
(3)	FA-CBLQ7PM1J3 FA-CBLQ7PM2J3	RD75P□	Cable for connecting a positioning signal converter module and a servo amplifier (for a servo amplifier of the MR-J3A/J4-A series manufactured by Mitsubishi)
	FA-CBLQ7DM1J3 FA-CBLQ7DM2J3 FA-CBLQ7DM3J3	RD75D□	
	FA-CBLQ7DG1 FA-CBLQ7DG2 FA-CBLQ7DG3	RD75P□ RD75D□	Cable for connecting a positioning signal converter module and a servo amplifier (for a general-purpose stepping motor and general-purpose servo amplifier)

A

Appendix 3 Restrictions on Using a Stepping Motor

This section describes restrictions on using a stepping motor.

When the S-curve acceleration/deceleration is used

For an axis where a stepping motor is connected, executing the S-curve acceleration/deceleration may cause step out. Before using the S-curve acceleration/deceleration, check that step out does not occur.

When the circular interpolation control or helical interpolation control is used

The circular interpolation control or 3-axis helical interpolation control cannot be used for an axis where a stepping motor is connected.

Use a servomotor when using the circular interpolation control or 3-axis helical interpolation control.

When the backlash compensation function is used

The backlash compensation function cannot be used for an axis where a stepping motor is connected. If the function is used, the motor may lose steps.

Appendix 4 External Dimensions

This section shows the external dimensions of the RD75.

RD75P2

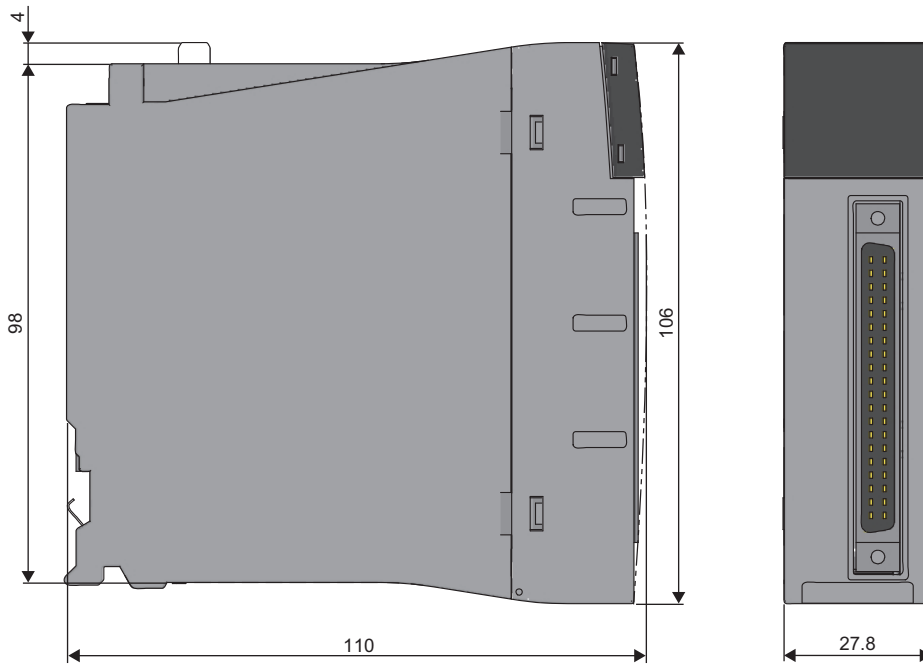

(Unit: mm)

RD75P4, RD75D2, and RD75D4

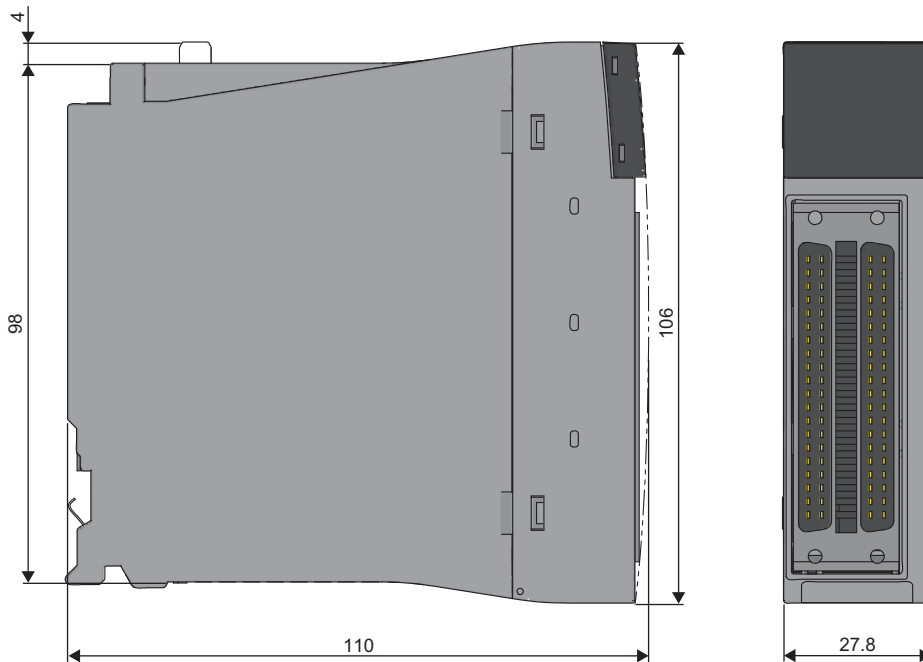

(Unit: mm)

A

INDEX

0 to 9

2-axis circular interpolation control	25
3-axis helical interpolation control	25
40-pin connector crimping tool	44
40-pin connectors	44

A

Absolute position restoration function	27
Acceleration/deceleration processing function . . .	28
Acceleration/deceleration time change function . .	27
Advanced positioning control	24
Amplifier-less operation function	28
Applicable connectors	44
Applicable wire size.	19,44
Axis display LED (AX1 to AX4).	16

B

Backlash compensation function.	27
Block start (Normal start).	26

C

Combination among sub functions	34
Combination of main and sub functions	29
Command in-position function	28
Common (COM)	49
Common functions	24
Condition start	26
Connector for external devices	16,44
Continuous operation interrupt function	28
Continuous path control.	26
Continuous positioning control	26
Current value change	26

D

Deceleration start flag function	28
Deviation counter clear common (CLRCOM)	50
Deviation counter clear signal (CLEAR).	50
Device List	63
Differential driver common (PULSE COM).	49
Drive unit READY common (RDYCOM).	50
Drive unit READY signal (READY)	50
During uncompleted OPR operation setting function	28

E

Electronic gear function	27
ERR LED	16
External command signal (CHG).	49
External connection.	62
External dimensions	65
External I/O signal logic switching function.	28
External I/O signal monitor function.	28
External wiring connector.	19

F

Fast OPR control	25
Fixed-feed control.	25

H

Hardware stroke limit function	27
History monitor function.	28

I

Inching operation	26
Independent positioning control (Positioning complete)	26
Inter-module synchronization function (simultaneous start of multiple modules).	26
Internal circuit.	51
Internal current consumption (5VDC)	19
Interrupt function	28

J

JOG operation	26
JUMP instruction	26

L

LEND	26
Linear control	25
LOOP	26
Lower limit signal (RLS).	49

M

M code output function	28
Machine OPR control	25
Major positioning control	24
Manual control	24
Manual pulse generator A common (PULSER A-)	49
Manual pulse generator A phase (PULSER A+)	49
Manual pulse generator B common (PULSER B-)	49
Manual pulse generator B phase (PULSER B+)	49
Manual pulse generator operation	26
Maximum connection distance between servos . . .	19
Maximum output pulse	19
Module data backup function	28
Module data initialization function	28
Multiple axes simultaneous start.	25

N

Near pass function	27
Near-point dog signal (DOG)	49
NOP instruction	26
Normal start	25
Number of controlled axes.	18
Number of occupied I/O points	19

O

Online module change	28
OP shift function	27
Operation examples	54
OPR control	24
OPR retry function	27
Output timing selection of near pass control	27
Override function	27

P

Performance specifications	18
Positioning start mode	25
Position-speed switching control	25
Pre-reading start function	27
Program example	59
Pulse output F (-) (PULSE F-)	49
Pulse output F (+) (PULSE F+)	49
Pulse output F (PULSE F)	49
Pulse output F common (PULSE COM)	49
Pulse output R (-) (PULSE R-)	49
Pulse output R (+) (PULSE R+)	49
Pulse output R (PULSE R)	49
Pulse output R common (PULSE COM)	49

Q

Quick start	25
-----------------------	----

R

Repeated start (FOR condition)	26
Repeated start (FOR loop)	26
Restrictions on using a stepping motor	64
RUN LED	16

S

Simultaneous start	26
Skip function	28
Software stroke limit function	27
Speed change function	27
Speed control	25
Speed limit function	27
Speed-position switching control	25
Start time adjustment function	27
Step function	28
Stop command processing for deceleration stop function	28
Stop signal (STOP)	49
Sub function	24

T

Target position change function	27
Teaching function	28
Torque change function	27
Torque limit function	27

U

Upper limit signal (FLS)	49
------------------------------------	----

W

Wait start	26
Weight	19
Wiring example when shielded cables are used	45

Z

Zero signal (+24V) (PG024)	49
Zero signal (+5V) (PG05)	49
Zero signal common (PG0COM)	49

REVISIONS

*The manual number is given on the bottom left of the back cover.

Revision date	*Manual number	Description
June 2014	SH(NA)-081243ENG-A	First edition
July 2014	SH(NA)-081243ENG-B	Correction regarding restrictions on using a stepping motor
January 2015	SH(NA)-081243ENG-C	<ul style="list-style-type: none"> ■ Added function Online module change ■ Added or modified parts RELEVANT MANUALS, Section 1.1, 3.4, 5.1, Appendix 2
December 2015	SH(NA)-081243ENG-D	<ul style="list-style-type: none"> ■ Added function Amplifier-less operation function ■ Added or modified parts RELEVANT MANUALS, Section 3.4
March 2016	SH(NA)-081243ENG-E	<ul style="list-style-type: none"> ■ Added or modified parts Section 2.2, 5.2, Appendix 4
January 2017	SH(NA)-081243ENG-F	<ul style="list-style-type: none"> ■ Added or modified part SAFETY PRECAUTIONS
March 2018	SH(NA)-081243ENG-G	<ul style="list-style-type: none"> ■ Added or modified parts RELEVANT MANUALS, Chapter 6
September 2018	SH(NA)-081243ENG-H	<ul style="list-style-type: none"> ■ Added or modified parts Section 5.2
May 2020	SH(NA)-081243ENG-I	<ul style="list-style-type: none"> ■ Added function Firmware update function ■ Added or modified parts RELEVANT MANUALS, TERMS, Section 3.4, Chapter 7, Addition of GENERIC TERMS AND ABBREVIATIONS and Chapter 5

Japanese manual number: SH-081242-I

This manual confers no industrial property rights or any rights of any other kind, nor does it confer any patent licenses. Mitsubishi Electric Corporation cannot be held responsible for any problems involving industrial property rights which may occur as a result of using the contents noted in this manual.

© 2014 MITSUBISHI ELECTRIC CORPORATION

WARRANTY

Please confirm the following product warranty details before using this product.

1. Gratis Warranty Term and Gratis Warranty Range

If any faults or defects (hereinafter "Failure") found to be the responsibility of Mitsubishi occurs during use of the product within the gratis warranty term, the product shall be repaired at no cost via the sales representative or Mitsubishi Service Company.

However, if repairs are required onsite at domestic or overseas location, expenses to send an engineer will be solely at the customer's discretion. Mitsubishi shall not be held responsible for any re-commissioning, maintenance, or testing on-site that involves replacement of the failed module.

[Gratis Warranty Term]

The gratis warranty term of the product shall be for one year after the date of purchase or delivery to a designated place. Note that after manufacture and shipment from Mitsubishi, the maximum distribution period shall be six (6) months, and the longest gratis warranty term after manufacturing shall be eighteen (18) months. The gratis warranty term of repair parts shall not exceed the gratis warranty term before repairs.

[Gratis Warranty Range]

- (1) The range shall be limited to normal use within the usage state, usage methods and usage environment, etc., which follow the conditions and precautions, etc., given in the instruction manual, user's manual and caution labels on the product.
- (2) Even within the gratis warranty term, repairs shall be charged for in the following cases.
 1. Failure occurring from inappropriate storage or handling, carelessness or negligence by the user. Failure caused by the user's hardware or software design.
 2. Failure caused by unapproved modifications, etc., to the product by the user.
 3. When the Mitsubishi product is assembled into a user's device, Failure that could have been avoided if functions or structures, judged as necessary in the legal safety measures the user's device is subject to or as necessary by industry standards, had been provided.
 4. Failure that could have been avoided if consumable parts (battery, backlight, fuse, etc.) designated in the instruction manual had been correctly serviced or replaced.
 5. Failure caused by external irresistible forces such as fires or abnormal voltages, and Failure caused by force majeure such as earthquakes, lightning, wind and water damage.
 6. Failure caused by reasons unpredictable by scientific technology standards at time of shipment from Mitsubishi.
 7. Any other failure found not to be the responsibility of Mitsubishi or that admitted not to be so by the user.

2. Onerous repair term after discontinuation of production

- (1) Mitsubishi shall accept onerous product repairs for seven (7) years after production of the product is discontinued. Discontinuation of production shall be notified with Mitsubishi Technical Bulletins, etc.
- (2) Product supply (including repair parts) is not available after production is discontinued.

3. Overseas service

Overseas, repairs shall be accepted by Mitsubishi's local overseas FA Center. Note that the repair conditions at each FA Center may differ.

4. Exclusion of loss in opportunity and secondary loss from warranty liability

Regardless of the gratis warranty term, Mitsubishi shall not be liable for compensation to:

- (1) Damages caused by any cause found not to be the responsibility of Mitsubishi.
- (2) Loss in opportunity, lost profits incurred to the user by Failures of Mitsubishi products.
- (3) Special damages and secondary damages whether foreseeable or not, compensation for accidents, and compensation for damages to products other than Mitsubishi products.
- (4) Replacement by the user, maintenance of on-site equipment, start-up test run and other tasks.

5. Changes in product specifications

The specifications given in the catalogs, manuals or technical documents are subject to change without prior notice.

TRADEMARKS

The company names, system names and product names mentioned in this manual are either registered trademarks or trademarks of their respective companies.

In some cases, trademark symbols such as [™] or [®] are not specified in this manual.

SH(NA)-081243ENG-I(2005)MEE

MODEL: RD75-U-IN-E

MODEL CODE: 13JX06

mitsubishi electric corporation

HEAD OFFICE : TOKYO BUILDING, 2-7-3 MARUNOUCHI, CHIYODA-KU, TOKYO 100-8310, JAPAN
NAGOYA WORKS : 1-14, YADA-MINAMI 5-CHOME, HIGASHI-KU, NAGOYA, JAPAN

When exported from Japan, this manual does not require application to the
Ministry of Economy, Trade and Industry for service transaction permission.

Specifications subject to change without notice.