

FATEC

INVERTER SCHOOL TEXT
INVERTER MAINTENANCE COURSE

● SAFETY PRECAUTIONS ●

(Always read these instructions before the use.)

When designing a system, always read the relevant manuals and give sufficient consideration to safety. During the training, pay full attention to the following points and handle the equipment correctly.

[Precautions during Training]

WARNING

- Do not touch the terminals while the power is on to prevent an electric shock.
- When opening the safety cover, turn the power off or conduct a sufficient check of safety before operation.
- Do not put your hand in the movable part.

CAUTION

- Follow the instructor's directions during the training.
- Do not remove the units of a demonstration machine or change the wiring without permission. Doing so may cause a failure, malfunction, injury and/or fire.
- When the demonstration machine emits an abnormal odor or noise, stop it by pressing the "power supply switch" or "emergency switch".
- When an error occurs, notify the instructor immediately.

CONTENTS

Chapter 1 IMPORTANCE OF PRODUCTIVE MAINTENANCE	1
1.1 Importance of Maintenance	1
1.2 Maintenance System	2
1.3 Maintenance Schedule	3
1.4 Management of Maintenance Document	4
1.5 Maintenance Record	4
1.6 Failure Stage	5
Chapter 2 UNDERSTANDING INVERTER SYSTEM	6
2.1 Configuration of the Demonstration Machine	6
2.2 External Appearance and Part Names of the Demonstration Machine	7
2.3 Precautions on Using the Demonstration Machine	9
2.4 Operating Inverter	10
2.4.1 Operation types	10
2.5 How to Use Operation Panel FR-DU07	12
2.5.1 Basic operation	12
2.5.2 Setting parameters	13
2.5.3 All parameter clear	14
2.5.4 Parameter copy	15
2.6 How to use the parameter unit FR-PU07	16
2.6.1 External appearance and part names of FR-PU07	16
2.6.2 How to change parameter settings	17
2.6.3 All parameter clear	18
2.6.4 Parameter unit operation (PU operation)	19
2.6.5 External operation	20
2.6.6 Monitor	21
2.6.7 Calibration of the Frequency Meter	22
2.6.8 Parameter copy	23
2.7 Inverter setup software	25
2.7.1 Function	25
2.7.2 Screen example	25
2.7.3 System configuration	26
2.7.4 Setup	28
2.7.5 Graph (Monitor Area)	34
Chapter 3 MAINTENANCE SYSTEM DESIGN	52
3.1 Preparation for Maintenance	52
3.2 Failsafe system which uses the inverter	53
Chapter 4 PREVENTIVE MAINTENANCE	56
4.1 Necessity of Preventive Maintenance	56
4.2 Maintenance and Inspection	57
4.2.1 Precautions for maintenance and inspection	57
4.2.2 Inspection item	57
4.2.3 Measurement of main circuit voltages, currents and powers	60

Chapter 5 BREAKDOWN MAINTENANCE

63

5.1	Troubleshooting	63
5.1.1	When the operation panel does not become powered	63
5.1.2	When parameter cannot be set	64
5.1.3	When the motor does not start	65
5.1.4	When the motor does not accelerate	66
5.1.5	When the motor speed does not become the set speed	67
5.1.6	When motor speed is unstable	68
5.1.7	When the motor does not decelerate and stop	69
5.1.8	When automatic restart after instantaneous power failure does not work	70
5.1.9	When unusual noise is generated from the motor	71
5.1.10	When the motor vibrates unusually	72
5.1.11	When OC alarm occurs	73
5.1.12	When OV alarm occurs	74
5.1.13	When analog input cannot be calibrated (When adjusting gain Pr. 903, Pr. 905)	75
5.2	Troubleshooting by the Demonstration Machine	76
5.2.1	Stall prevention (overcurrent) (OL display) [Demonstration]	76
5.2.2	Stall prevention stop (E.OLT display) [Demonstration]	77
5.2.3	Regeneration overvoltage trip during decelerating (E.OV3 display) [Demonstration]	78
5.2.4	Electronic thermal relay function pre-alarm (TH display) and Motor overload trip (electronic thermal relay function) (E.THM display) [Demonstration]	79
5.2.5	Output phase loss (E.LF display) [Demonstration]	81
5.2.6	24VDC power output short circuit (E.P24 display) [Demonstration]	83
5.2.7	Error (Err. display) [Demonstration]	84
5.2.8	Instantaneous power failure (E.IPF display), automatic restart after instantaneous power failure [Demonstration]	85
5.2.9	Overcurrent trip during acceleration (E.OC1 display) [Demonstration]	92
5.2.10	Undervoltage (E.UVT display) [Demonstration]	93
5.3	Appendices for Demonstration (Confirmation for Error Descriptions and Others)	94
5.3.1	Error setting	94
5.3.2	Error description	96
5.3.3	Error handling procedure	97

Chapter 6 CORRECTIVE MAINTENANCE

99

6.1	Improving the Maintainability of Equipment	99
-----	--	----

Chapter 7 REVISING INSTALLATION ENVIRONMENT

100

7.1	Power Supply of Inverter (Harmonic and Instantaneous Power Failure)	100
7.1.1	What is a harmonic?	100
7.1.2	Characteristics of rectifying circuit and generated harmonics	102
7.1.3	Split-flow path of harmonic current	103
7.1.4	Harmonic Suppression Guidelines	104
7.1.5	Overview of harmonic suppression technique	106
7.1.6	Influence to inverter during instantaneous power failure	107
7.1.7	Inverter peripheral circuit and inverter operation during instantaneous power failure	108
7.2	Noise	112
7.2.1	Occurring basis of noise	112
7.2.2	Types of noise and propagation path	113
7.2.3	Measures against noise	116

7.2.4	Leakage currents	122
7.2.5	Ground (Earth)	124
7.3	Problems and Measures When Using Inverter	126
7.3.1	Environment and installation condition	126
7.3.2	Connection of inverter	134
7.4	Precautions for storing inverter in an enclosure	143

Chapter 8 LIFE OF INVERTER PARTS 146

8.1	Replacement of Parts	146
8.2	Display of the Life of the Inverter Parts	148
8.3	Diagnosis using FR Configurator	153
8.3.1	Explanation of window	153
8.3.2	Procedure of main circuit capacitor life measuring	154

Chapter 9 REPLACEMENT PROCEDURE 156

9.1	Saving FREQROL-A500 Parameters and Replacing with FREQROL-A700 Parameters	156
9.2	Removing the FREQROL-A500	161
9.3	Installation of the FREQROL-A700	162
9.4	Setting the Parameters	164

Chapter 1 IMPORTANCE OF PRODUCTIVE MAINTENANCE

When a production system stops because of a failure or power failure, loss corresponding to the stop time occur. Therefore, [Stop due to failure] and [Stop due to power failure] in the equipment system must be prevented when designing.

If a production system stops, the priority is a quick recovery, so form a group of a maintenance personnel to improve the operation rate.

1.1 Importance of Maintenance

With remarkable progress of mechatronic machinery/equipment and complex, enhanced systems, equipment in recent production systems are getting black-boxed and relative maintenance levels are going down, making it difficult to improve the production rate.

This makes [Highly reliable products] and [Increased maintenance technique levels] strongly demanded.

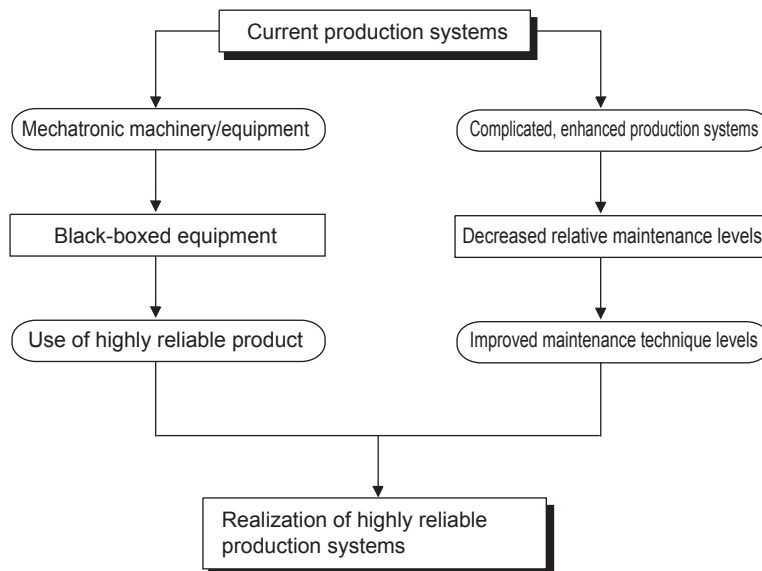

1.2 Maintenance System

To establish a highly reliable production system, it is significant to arrange a proper maintenance system.

The following chart outlines a maintenance system.

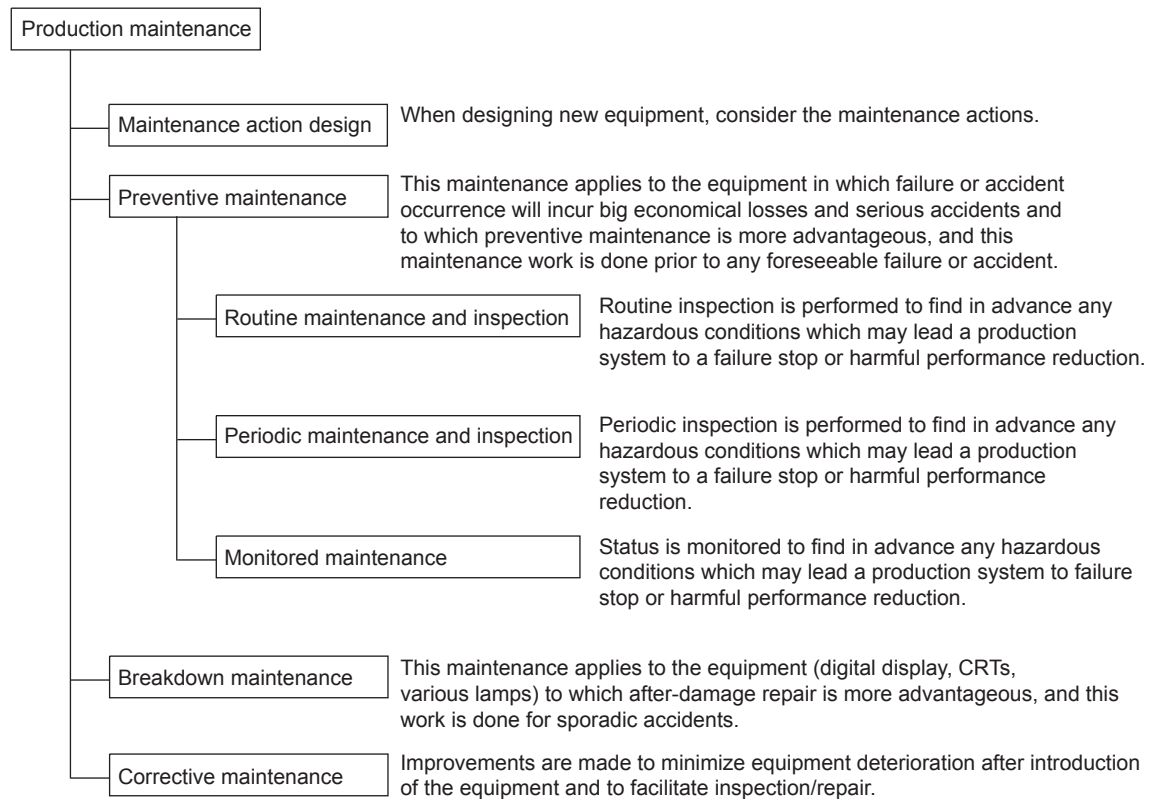

1 IMPORTANCE OF PRODUCTIVE MAINTENANCE

1.3 Maintenance Schedule

In a production system, examination of repair after failure occurrence can lead to a long repair time, making the production rate hard to increase.

Therefore, maintenance must be scheduled at the point of production system introduction to make it efficient.

If a failure occurs, maintenance must be performed as scheduled, to repair the system within a short time, as listed below.

Table 1.1 Maintenance schedule for the inverter system

Schedule item	Description	
Education about maintenance	Knowledge about inverter	<ul style="list-style-type: none"> •Fundamental knowledge of inverter, such as mechanism, function, performance or others •Characteristics of inverter •Position of inverter •Introduction status of inverter (how it is used in one's department) •Details of introduced (adopted) model (the model of an inverter, function, performance, characteristic or others)
	Maintenance range and maintenance technique	<ul style="list-style-type: none"> •Maintenance knowledge about inverter (maintenance characteristics of inverter and maintenance item of inverter) •Precautions for inverter maintenance (handling, key points or others)
	Training	<ul style="list-style-type: none"> •Functions about inverter maintenance • Functions about peripheral device maintenance (function of troubleshooting) •Practice of troubleshooting (operating peripheral devices, replacing hardware)
Maintenance timing	Clarify the difference between preventive maintenance and later maintenance, and determine the maintenance timing.	
Maintenance tool	Arrange the spares, members, indicators, and measuring apparatuses for the maintenance.	
Maintenance procedure	Arrange manuals to clarify how to perform maintenance and what to do.	
Maintenance personnel	Secure personnel and determine their posts and coverage.	
Maintenance method improvement	Examine improving maintenance methods.	
Grasping inverter manufacturer customer service and support system	After-sales service	<ul style="list-style-type: none"> •Service station (location, contact information, persons in charge) •Service range (such as applicable models, handling range) •Service time (such as start and end times, time required for arrival, emergency service) •Service period (warranty period, support service on commercial basis) • Service parts supply period (such as repair after production stop, supply period) •Actions for production stop (such as stop declaration, repair period) •Period for repair (such as standard, shortest and longest delivery times)
	Technical support	<ul style="list-style-type: none"> •Support locations (such as location, contact information, and persons in charge) •Support ranges (applicable models, hardware/software, system) •Support methods (telephone, FAX, visit, teaching, machine operation) •Manuals (effective for maintenance)

1	IMPORTANCE OF PRODUCTIVE MAINTENANCE
2	UNDERSTANDING INVERTER SYSTEM
3	MAINTENANCE SYSTEM DESIGN
4	PREVENTIVE MAINTENANCE
5	BREAKDOWN MAINTENANCE
6	CORRECTIVE MAINTENANCE
7	REVISITING INSTALLATION ENVIRONMENT
8	LIFE OF INVERTER PARTS

1.4 Management of Maintenance Document

To repair a failure in a short time, arrange and manage the documents below.

Table 1.2 Maintenance document to be managed

Category	Name	Description
System-specific documents	System/control specification	The functions and operations of the corresponding system/control are described. (Operation sequence/timing, operational conditions, operation procedure)
	Electric wiring diagrams	Developped connection diagrams (Such as power supply circuit, motor circuit, control circuit, operation circuit, and display circuit) Inter-device/inter-board and connection diagrams (Cabling diagram and grounding cabling diagram)
	Equipment layout diagrams	In-panel electrical equipment layout diagram, terminal block wire number layout diagram, connector pin connection assignment table (Diagrams which identify various instrument models, wire numbers)
	List of hardware used	List of electrical equipment used in a system (Types and specifications of all electrical equipment such as modules which comprise inverter system, peripheral devices, electrical parts in control board, I/O devices and software packages)
	Instruction manual of the control target and Maintenance/inspection manual	For handling (operating) the control target, and maintenance/inspection
General documents	Catalog of the used hardware	Provide model makeup, manufacturers
	Instruction manual and technical information of the used hardware	For troubleshooting of hardware and software

1.5 Maintenance Record

After repairing, manage the maintenance record for future reference.

Table 1.3 Maintenance record to manage

Record item	Description
Situation of errors and failures	Apparatus/equipment name, phenomenon, and circumstances
Stop period of the system	Occurrence time and stop period
Effect of the accident	Amount of loss, loss time, and influence
Cause	Cause finding method and cause including estimation
Repair method	Replacement, repair or other repair method
Recurrence prevention	Similar failure recurrence prevention and lessons
Failure record	Record of cause, remedy or others
Person in charge	

1.6 Failure Stage

Generally, how a complicated system fails is separated into three stages, initial failure, random failure, and wear-out failure, as shown in Figure 1-3. Initial failures are considered to be removed in the manufacturing and inspection processes of a manufacturer. Random failures are unforeseeable, sporadic failures which occur at any time prior to the progress of wear within the useful life of equipment, and are difficult to take technical measures. Therefore, at present, actions taken are only based on statistics.

Wear-out failures occur at nearly the end of useful life in the course of deterioration or as a result of wear, and increase abruptly with the elapse of time. Point t_b in Figure 1-3 indicates the years when parts will be changed. Preventive maintenance will be made appropriate by changing specific parts for new ones at this point.

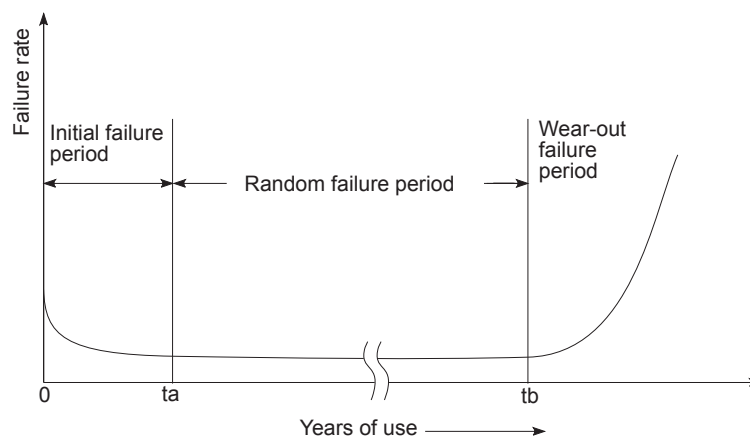

Fig.1.1 Bath-tub curve

2 UNDERSTANDING INVERTER SYSTEM

Chapter 2 UNDERSTANDING INVERTER SYSTEM

2.1 Configuration of the Demonstration Machine

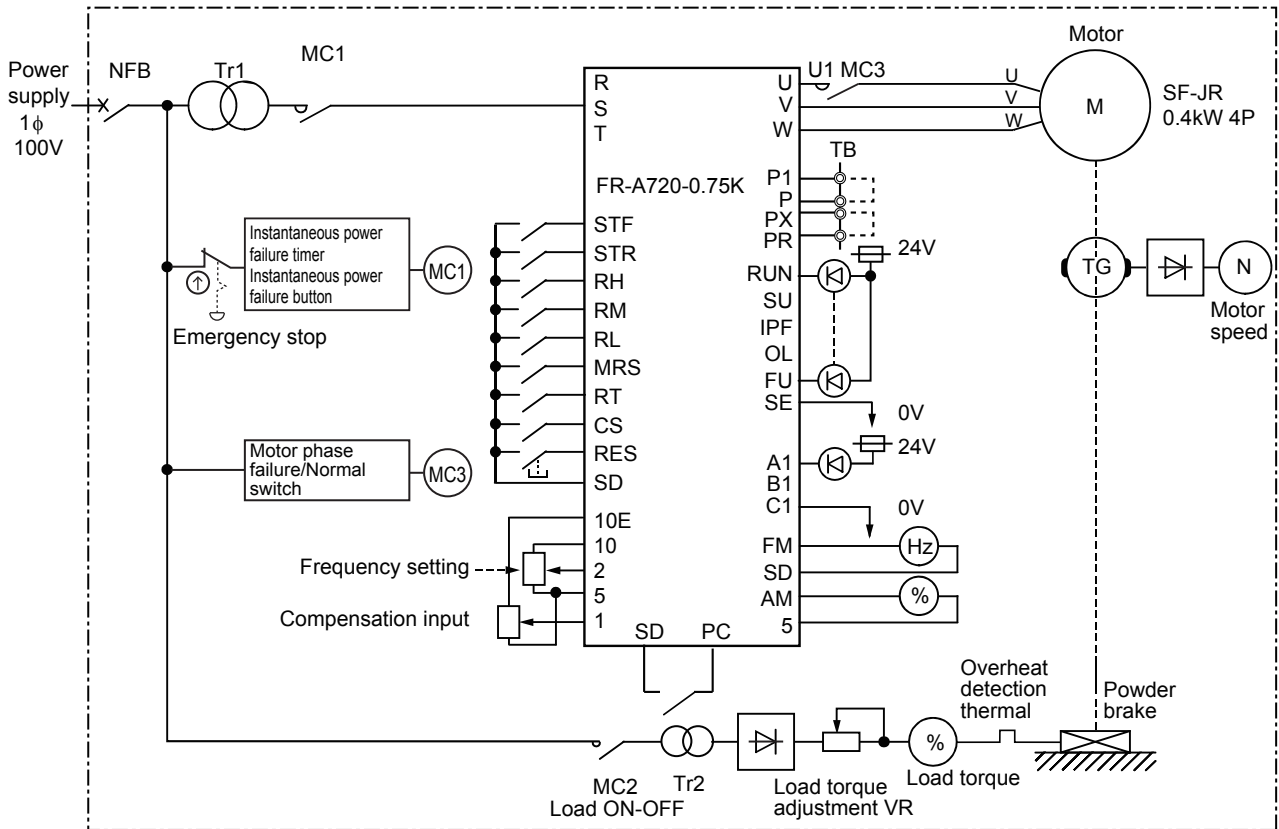

Figure 2.1 Expanded view of the inverter demonstration machine

2.2 External Appearance and Part Names of the Demonstration Machine

The following shows the external appearance of the inverter demonstration machine.

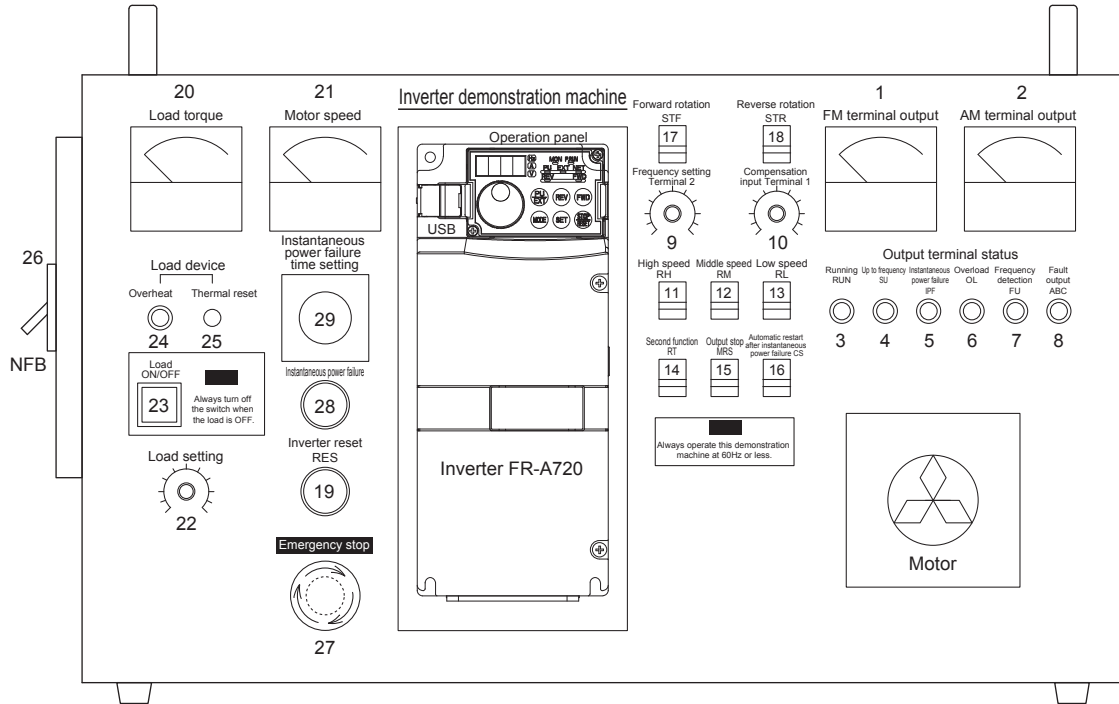

Figure 2.2 External appearance of the inverter demonstration machine

- 1) FM terminal output ... Displays the output frequency (pulse output) of the inverter.
- 2) AM terminal output ... Displays the output frequency (analog output) of the inverter.
- 3) Running RUN Displayed while the inverter is running and lit when the output frequency is equal to or higher than the starting frequency.
- 4) Up to frequency SU Displayed when the frequency is reached and lit when the output frequency reaches within the range of $\pm 10\%$.
- 5) Instantaneous power failure IPF
Displayed when the instantaneous power failure occurs and lit when an instantaneous power failure and under voltage protections are activated.
- 6) Overload OL A display for the warning the overload and lit when a stall prevention is activated.
- 7) Frequency detection FU
Displayed when a frequency is detected and lit when the inverter output frequency is equal to or higher than the preset detected frequency.
- 8) Fault output Lit when the inverter protective function is activated and the output stopped.
- 9) Frequency setting Terminal 2
A potentiometer for setting the frequency by analog voltage.

- 10) Compensation input Terminal 1
A potentiometer for setting the voltage which add to analog voltage of the frequency setting.
- 11) High speed RH Select "High speed" of the multi-speed setting. Up to seven speed selections are available with combing "Middle speed" and "Low speed".
- 12) Middle speed RM Select "Middle speed" of the multi-speed setting. Up to seven speed selections are available with combing "High speed" and "Low speed".
- 13) Low speed RL Select "Low speed" of the multi-speed setting. Up to seven speed selections are available with combing "High speed" and "Middle speed".
- 14) Second acceleration/deceleration RT
The second acceleration/deceleration time is selected.
- 15) Output stop MRS Stops the output of the inverter.
- 16) Selection of automatic restart after instantaneous power failure CS
When selecting the CS signal, the inverter restarts automatically at power restoration (Set parameter for automatic restart after instantaneous power failure).
- 17) Forward rotation STF ... The forward rotation start signal.
- 18) Reverse rotation STR ... The reverse rotation start signal.
- 19) Inverter reset RES Resets fault output provided when a fault occurs.
- 20) Load torque Displays the load torque applied to the motor.
- 21) Motor speed Displays the motor rotation speed.
- 22) Load setting Set the load applied to the motor.
- 23) Load ON/OFF The ON/OFF switch of load applied to the motor.
- 24) Overheat Lit when the load device (powder brake) to the motor is overheated.
- 25) Thermal reset Resets the thermal when the load device (powder brake) to the motor is overheated.
- 26) Power supply NFB A no fuse braker for turning on the power supply of the demonstration machine.
- 27) Emergency stop Turns off the power supply at an emergency.
- 28) Instantaneous power failure
Turns off of the power supply of the inverter.
- 29) Instantaneous power failure time setting
Set the instantaneous power failure time when pressing the instantaneous power failure button.

2 UNDERSTANDING INVERTER SYSTEM

2.3 Precautions on Using the Demonstration Machine

- (1) Set the frequency up to 60Hz.
 - (2) Set the acceleration/deceleration time to one second or longer.
 - (3) Do not leave the machine with the load ON/OFF switch turned on and the load setting VR turned up.
- Although users can set the frequency to 60Hz or more and the acceleration/deceleration time to one second or less, it may damage devices since a bowder brake, TG, and a timing belt are used.

1	IMPORTANCE OF PRODUCTIVE MAINTENANCE
2	UNDERSTANDING INVERTER SYSTEM
3	MAINTENANCE SYSTEM DESIGN
4	PREVENTIVE MAINTENANCE
5	BREAKDOWN MAINTENANCE
6	CORRECTIVE MAINTENANCE
7	REVISING INSTALLATION ENVIRONMENT
8	LIFE OF INVERTER PARTS

2.4 Operating Inverter

2.4.1 Operation types

A main character of inverter is that operation is enabled by various signals. This section explains the types of operation (start, stop, and varying speed) of the inverter demonstration machine.

(1) External operation using external signal (Pr.79=0,2)

Operate an inverter with the frequency setting potentiometer or the start switch which are connected to the control circuit terminal of the inverter.

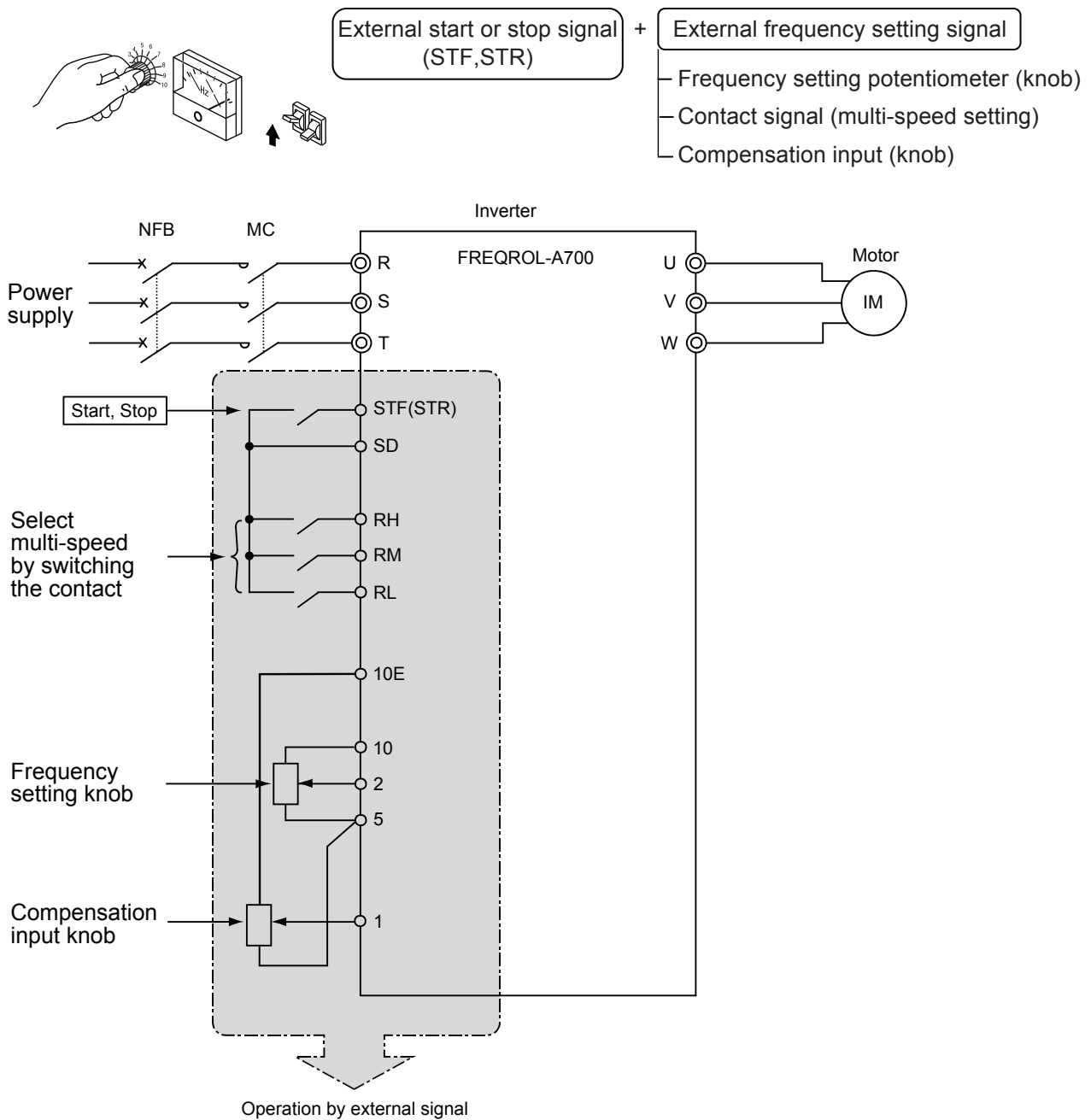

Figure 2.3 External operation

2 UNDERSTANDING INVERTER SYSTEM

- (2) **PU operation using the operation panel and the parameter unit (Pr.79=0,1)**
Operate an inverter by only the operation panel or key operations or a parameter unit.

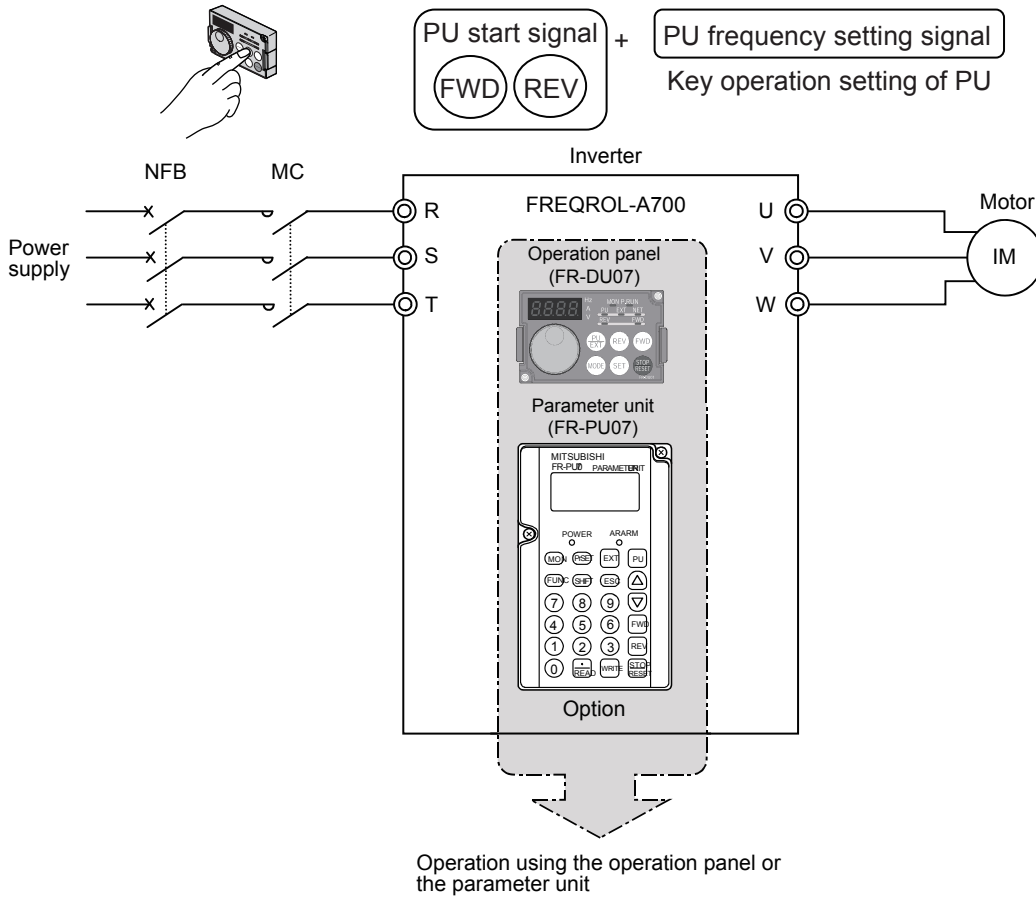

Figure 2.4 PU operation

- (3) **PU operation and external operation combined operation (Pr.79=3 or 4)**
In the case of Pr.79=3, set the frequency from the operation panel and the parameter unit, and input start command with the external start switch.
In the case of Pr.79=4, set the frequency from the external knob and the multi-speed, and input start command with the operation panel and the key operation of the parameter unit.

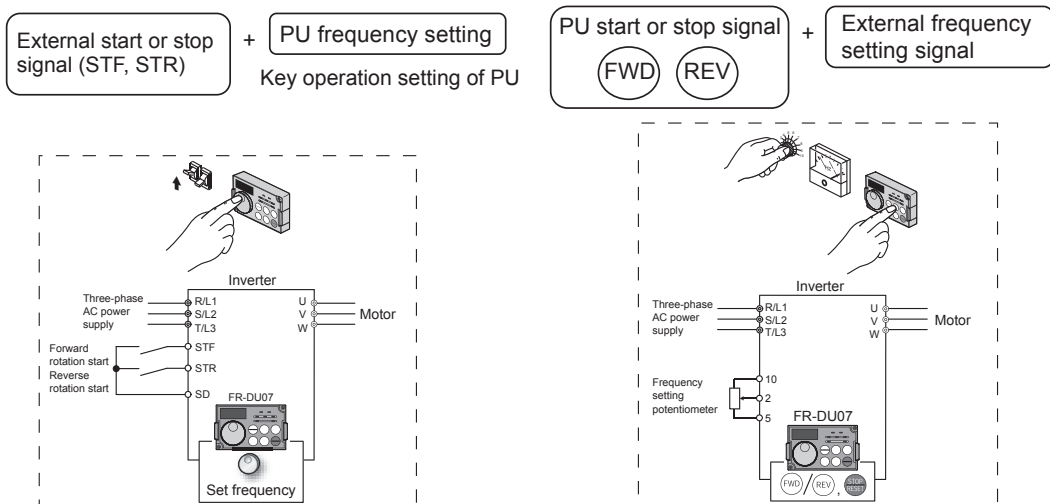
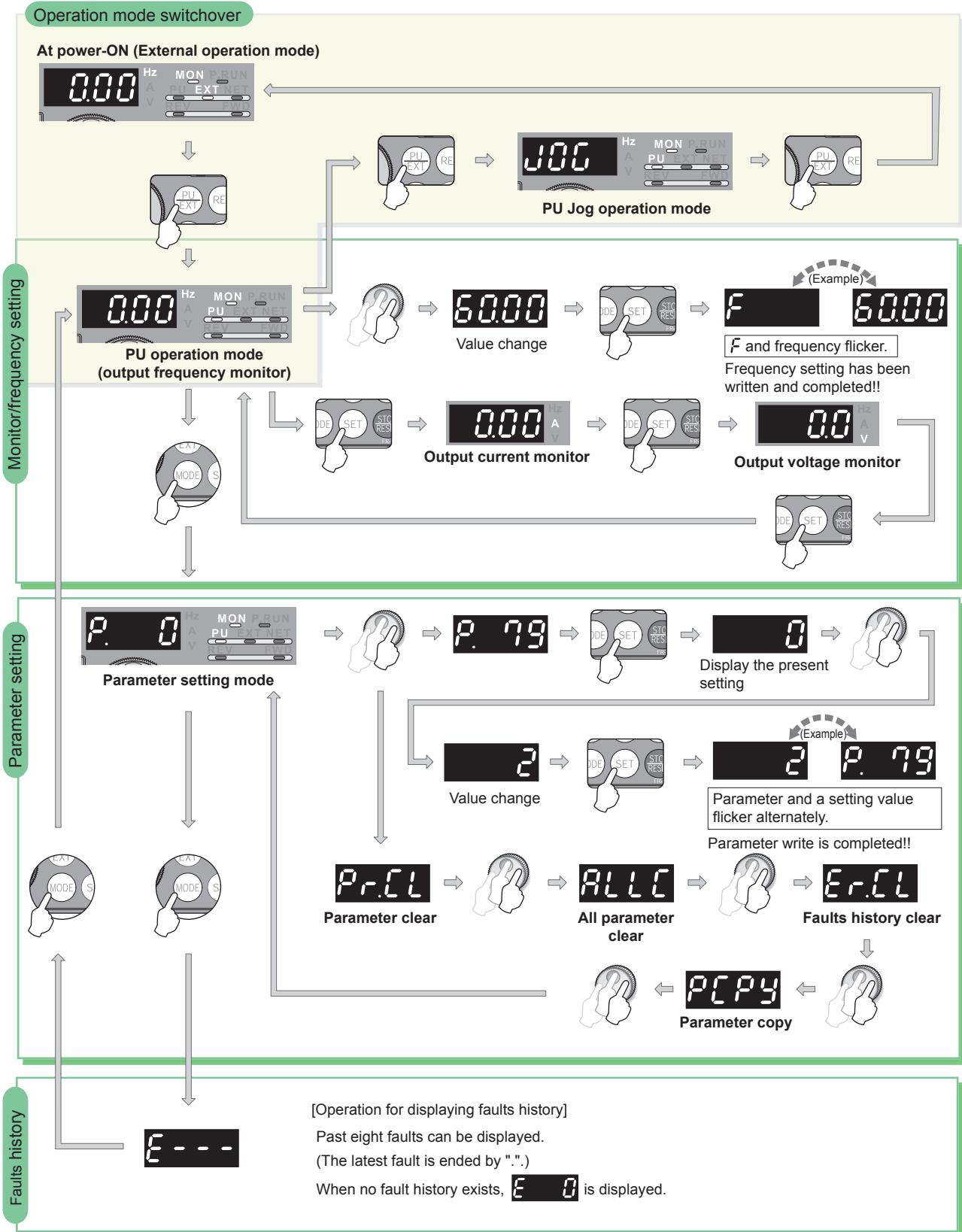

Figure 2.5 PU/External combined operation (Pr.79=3) Figure 2.6 PU/External combined operation (Pr.79=4)

2 UNDERSTANDING INVERTER SYSTEM

2.5 How to Use Operation Panel FR-DU07

2.5.1 Basic operation



2 UNDERSTANDING INVERTER SYSTEM

2.5.2 Setting parameters

As an example of changing parameter setting value, this section explains how to change the setting value of Pr.1 Maximum frequency from 120Hz to 60Hz.

Operation	Display
1. Screen at power-ON The monitor display appears.	
2. Press to choose the PU operation mode.	
3. Press to choose the parameter setting mode.	
4. Turn until P. 1 (Pr. 1) appears.	
5. Press to read the present set value. " 1200 " (initial value) appears.	
6. Turn to change it to the setting value " 6000 ".	
7. Press to set.	

Flicker...Parameter setting is completed!!

- By turning , you can read another parameter.
- Press to show the setting again.
- Press twice to show the next parameter.
- Press twice to return the monitor to frequency monitor.

Good to know for checking an inverter

Press the setting dial M () to display the current set frequency.

2.5.3 All parameter clear

Set "1" in ALLC All parameter clear to initialize all parameters.
 (Parameters are not cleared when "1" is set in Pr. 77 Parameter write selection.)

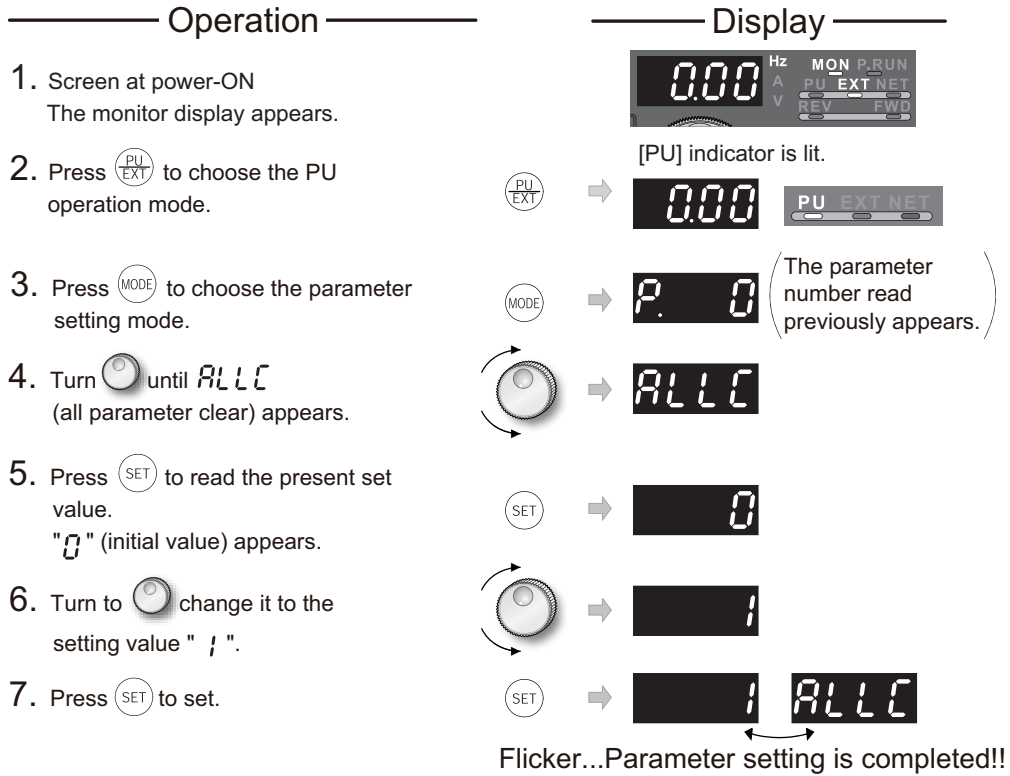















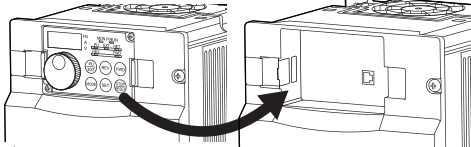

- By turning , you can read another parameter.
- Press to show the setting again.
- Press twice to show the next parameter.

2 UNDERSTANDING INVERTER SYSTEM

2.5.4 Parameter copy

Parameter setting values for one inverter can be copied to two or more inverters.

Operation	Display
1. Screen at power-ON The monitor display appears. ● Connect it during a stop.	
2. Press MODE to choose the parameter setting mode.	MODE → 
3. Turn  until "PCPY" (parameter copy) appears.	 → 
4. Press SET to read the currently set value. "0" (initial value) appears.	SET → 
5. Turn to  change it to the setting value "1".	 → 
6. Press SET to copy the source parameters to the operation panel.	SET →  flickers for about 30s
	After about 30s → 
	Flicker...Parameter copy is completed!!
7. Connect the operation panel to the copy source inverter.	
8. After performing steps 2 and 5, turn  to change it to "2".	 → 
9. Press SET to write the parameters copied to the operation panel to the destination inverter.	SET →  flickers for about 30s
10. "2" and "PCPY" flicker alternately after parameters are copied.	→ 
	Flicker...Parameter copy is completed!!
11. After writing the parameter values to the copy destination inverter, always reset the inverter, e.g. switch power off once, before starting operation.	

2 UNDERSTANDING INVERTER SYSTEM

2.6 How to use the parameter unit FR-PU07

2.6.1 External appearance and part names of FR-PU07

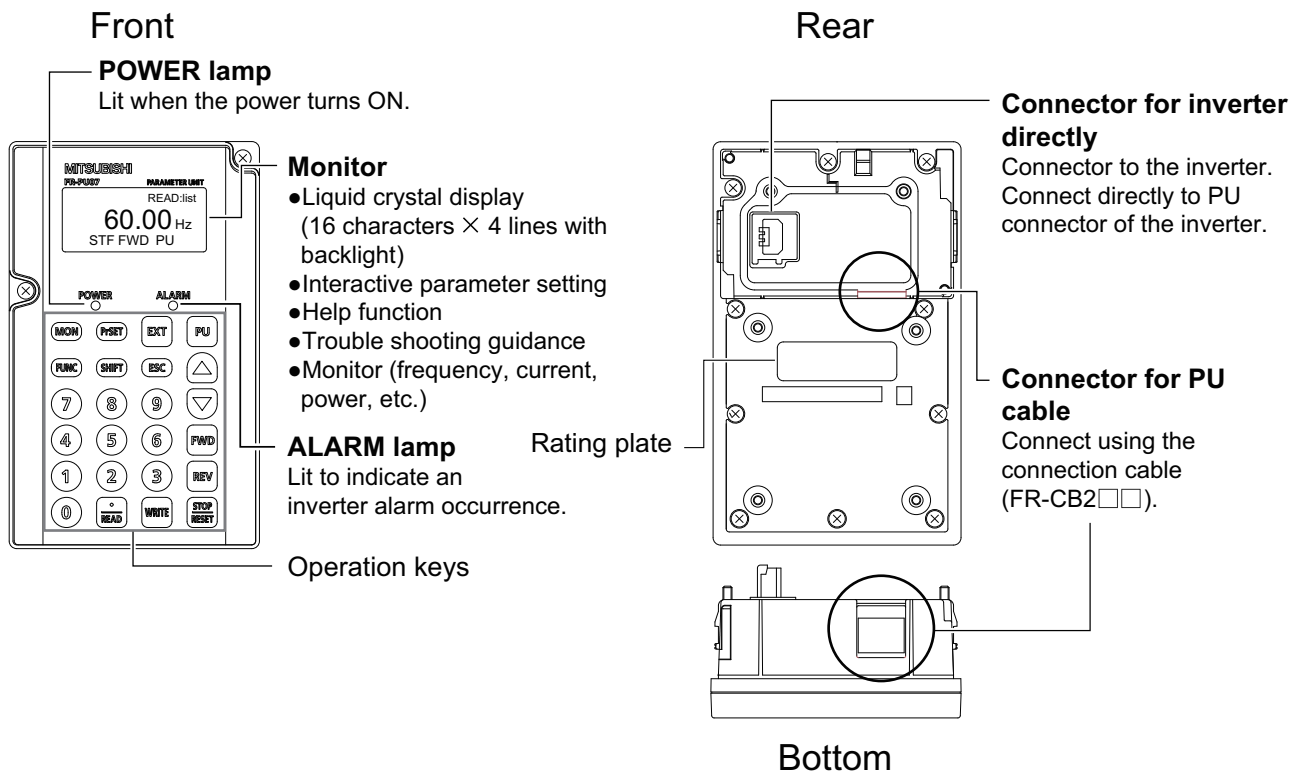

Figure 2.7 External appearance of FR-PU07

2 UNDERSTANDING INVERTER SYSTEM

2.6.2 How to change parameter settings

As an example of changing parameter setting value, this section explains how to change the setting value of Pr.8 Deceleration time from 5s to 180s.

Step	Operation	Screen
1	Press PU . The frequency setting screen appears, and operation mode changes to PU operation mode. (You need not press PU when the parameter unit is already in the PU operation mode.)	
2	Press PrSET . The parameter unit is in the parameter setting mode.	
3	Press 8 . Enter the desired parameter number.	
4	Press READ . The present setting appears.	
5	(1) Direct setting Press 1 8 0 .* Enter the desired value. Or (2) Step setting Press ▲ ▼ . Display "180" using ▲ ▼ .	
6	Press WRITE . The set value is changed.	
7	Press SHIFT to display the next parameter.	

* If you entered an incorrect value, press **ESC** to return to the pre-entry state.

Basic parameter setting

1) Maximum frequency (Pr.1)=60Hz

PU PrSET 1 READ 6 0 WRITE

2) Electronic thermal (Pr.9)=2.0A



PU PrSET 9 READ 2 READ 0 WRITE

2 UNDERSTANDING INVERTER SYSTEM

2.6.3 All parameter clear

Performing all parameter clear initializes all parameters.

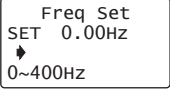
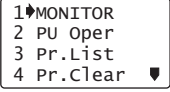
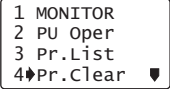
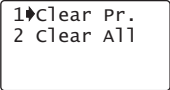
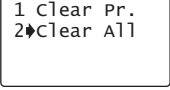
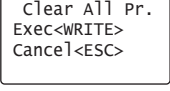



(Parameters are not cleared when "1" is set in Pr.77 Parameter write selection)

Step	Operation	Screen
1	Press PU . The frequency setting screen appears, and operation mode changes to PU operation mode. (You need not press PU when the parameter unit is already in the PU operation mode.)	
2	Press FUNC . The function menu is called.	
3	Using ▲ / ▼ , move the cursor to "4 Pr. Clear".	
4	Press READ . The parameter menu appears.	
5	Select the "Clear All". Using ▲ / ▼ , move the cursor to "2 Clear All" and press the READ .	
6	"Clear All" is selected, and the confirmation screen for clearing execution is displayed.	
7	Press WRITE . The parameters are initialized. When canceling the initialization, press ESC on the confirmation screen.	

2 UNDERSTANDING INVERTER SYSTEM

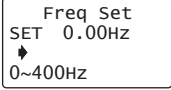
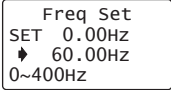
2.6.4 Parameter unit operation (PU operation)

Operate the inverter with the key operations of the parameter unit.
This section explains how to change the set frequency from 0Hz to 60Hz.

Step	Operation	Screen
1	Press PU . The frequency setting screen appears.	
2	Press 6 and 0 . Enter 60Hz. *	
3	Press WRITE . The 60Hz setting is complete.	
4	Press FWD / REV to perform forward or reverse rotation with the set frequency.	
5	Press STOP / RESET . The motor is decelerated to a stop.	

* If you entered an incorrect value, press **ESC** to return to the pre-entry state.

Good to know for checking an inverter

The frequency setting screen can be called only by pressing **PU**, and changing the set frequency is available.

1	IMPORTANCE OF PRODUCTIVE MAINTENANCE
2	UNDERSTANDING INVERTER SYSTEM
3	MAINTENANCE SYSTEM DESIGN
4	PREVENTIVE MAINTENANCE
5	BREAKDOWN MAINTENANCE
6	CORRECTIVE MAINTENANCE
7	REVISING INSTALLATION ENVIRONMENT
8	LIFE OF INVERTER PARTS

2 UNDERSTANDING INVERTER SYSTEM

2.6.5 External operation

Operate an inverter with the operating switch of the inverter demonstration machine.

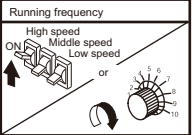
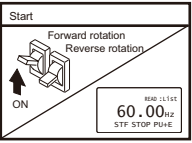
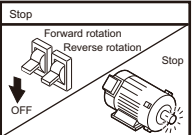





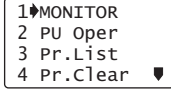

Step	Operation	Screen
1	Press EXT . The operation mode indication changes to [EXT] and the operation mode switches to the External operation mode.	
2	Enter the external frequency command. Select the multi-speed signal or turn the frequency setting potentiometer.*	
3	Set the start switch (STF or STR) to ON. The operation command indication changes to "STF" or "STR" and the operation status indication changes to the output (FWD or REV) indication. •If the forward and reverse rotation switches are both set to ON, the inverter will not start. Also, if these switches are both set to ON during operation, the motor is decelerated to a stop.	
4	Set the start switch (STF or STR) to OFF. The motor stops running.	

* When a command is input from the frequency setting potentiometer and multi-speed signal simultaneously, the command input from the multi-speed signal has a priority.

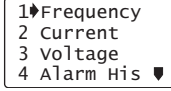
2 UNDERSTANDING INVERTER SYSTEM

2.6.6 Monitor

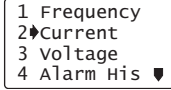
The monitoring list appears and you can change from one monitor screen to another and set the first priority screen.

Step	Operation	Screen
1	Press FUNC . The function menu is called.	
2	Make sure that the cursor is located at "1 MONITOR". If not, move the cursor with  /  .	
3	Press READ . The monitoring list is called.	
4	Press  or  to move the cursor to the desired item. Hold down SHIFT and press  /  to shift one screen.	
5	Press READ . The monitor screen selected by the cursor appears. Press WRITE to give the first priority to this monitor screen.	

Good to know for checking an inverter





The monitoring list can be called only with pressing **READ** in the monitoring mode.

2 UNDERSTANDING INVERTER SYSTEM

2.6.7 Calibration of the Frequency Meter

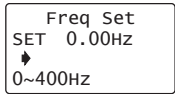
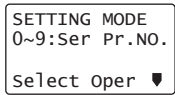
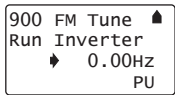
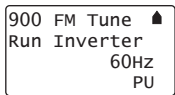
This section provides the way to calibrate the fullscale of meter connected to terminal FM using the parameter unit.

● Calibrating the meter at the running frequency of 60Hz

Step	Operation	Screen
1	Press PU . The frequency setting screen appears, and operation mode changes to PU operation mode.	
2	Press PrSET . The parameter unit is in the parameter setting mode.	
3	Enter 9 0 0 and press READ . The preset frequency is displayed.	
4	Enter 6 0 and press WRITE . 60Hz is set.	
5	Press FWD . Forward rotation is performed at 60Hz. You need not connect the motor.	
6	Using ▲/▼ , adjust the meter pointer to a predetermined position. The meter pointer moves. (It takes a long time before the pointer moves.)	
7	Press WRITE . Calibration is complete.	
8	Press MON to return to the main monitor screen.	

2 UNDERSTANDING INVERTER SYSTEM

2.6.8 Parameter copy

The settings of maximum three inverters can be stored in the FR-PU07.

- Reading the parameter settings of the inverter and storing them to FR-PU07.

Step	Operation	Screen
1	Connect the FR-PU07 to the copy source inverter.	
2	Press FUNC . The function menu appears.	
3	Select the "PRCpy set". Using ▲ / ▼ , move the cursor to "12 PRCpy set" and press READ .	
4	Select the copy area. The copy area selection screen is displayed. Then, move the cursor to any one of 1 to 3 and press READ . (Parameter settings of each inverter (three inverters in total) can be copied to the area 1, 2 or 3.)	
5	Select the "READ". Using ▲ / ▼ , move the cursor to "1 Read VFD" and press READ .	
6	Give a name. You can name each of copy areas 1 to 3. Select the characters with ▲ / ▼ and set them with READ . Press WRITE to set the name for the area.	
7	Write to the copy area of FR-PU07. The screen for confirming the overwriting of the data in the FR-PU07 is displayed.	
8	Press WRITE . The parameter settings of the inverter are stored. When canceling, press ESC .	

2 UNDERSTANDING INVERTER SYSTEM

● Writing the parameter setting stored in FR-PU07 to the inverter

Step	Operation	Screen
1	Connect the FR-PU07 to the copy destination inverter.	
2	Press FUNC . The function menu appears.	
3	Select the "PRCpy set". Using ▲ / ▼ , move the cursor to "12 PRCpy set" and press READ .	
4	Select the copy area. Point the cursor to the copy area that stores the parameter settings to be written to the inverter, and press READ .	
5	Select the "WRITE". Using ▲ / ▼ , point the cursor to "2 Write VFD" and press READ .	
6	Writing the parameter settings is selected, and the confirmation screen for writing is displayed.	
7	Press WRITE . The parameter settings stored in the FR-PU07 are copied to the copy destination inverter.	
8	Reset the inverter.	

2 UNDERSTANDING INVERTER SYSTEM

2.7 Inverter setup software

FR Configurator(FR-SW3-SETUP-WE)

Inverter setup software, as an assistance tool from setting up an inverter to the maintenance, provides a comfortable inverter operation environment.

Through the Windows screen of a personal computer, the parameter setting, monitoring, and other operations can be done effectively.

2.7.1 Function

- Startup (Desired function can be performed soon after starting up of this software)
- Easy Setup (From station number to parameter setting, setting with wizard style dialog (interactive) is available)
- Setting Wizard (Function setting without regard to parameter number)
- Tuning (Available from Setting wizard. Inverters with tuning function only)
- Troubleshooting (Estimating cause and counter measure at trouble occurrence)
- Parameter List (Displaying parameter list, functional list, initial value change list and editing of the parameters are available)
- Convert (Converting a parameter setting of the conventional model into 700 series parameter setting)
- Diagnosis (Displaying faults history and parts life, and measuring main circuit capacitor life)
- Graph (Monitoring by High Speed sampling or Monitor sampling, and displays in graph form)
- Batch Monitor (Displaying monitor items of the inverter at the same time)
- I/O Terminal Monitor (Monitoring the state of input and output terminal)
- I/O Terminal Assignment (Signal assignment of input and output terminal)
- Test Operation (Send a start/stop command, or change the set frequency as if using the operation panel of the inverter)
- Machine Analyzer (Resonance point and anti-resonance point of the machine system can be obtained) (For FRA700, A701 with vector control)
- Help (Instruction manual of the inverter and this software can be displayed in a window)

2.7.2 Screen example

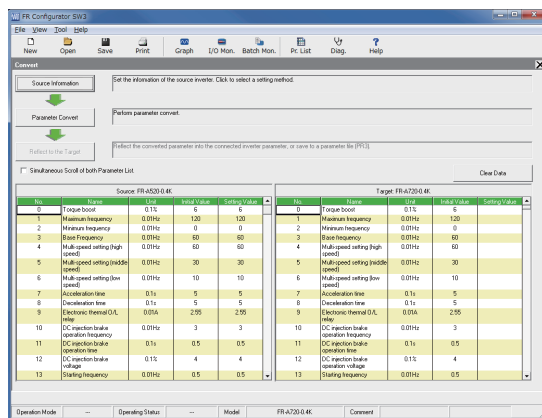

Figure 2.8 Screen example of convert function

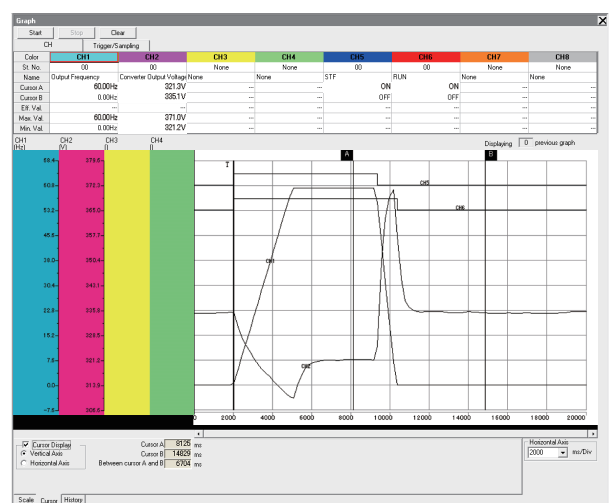
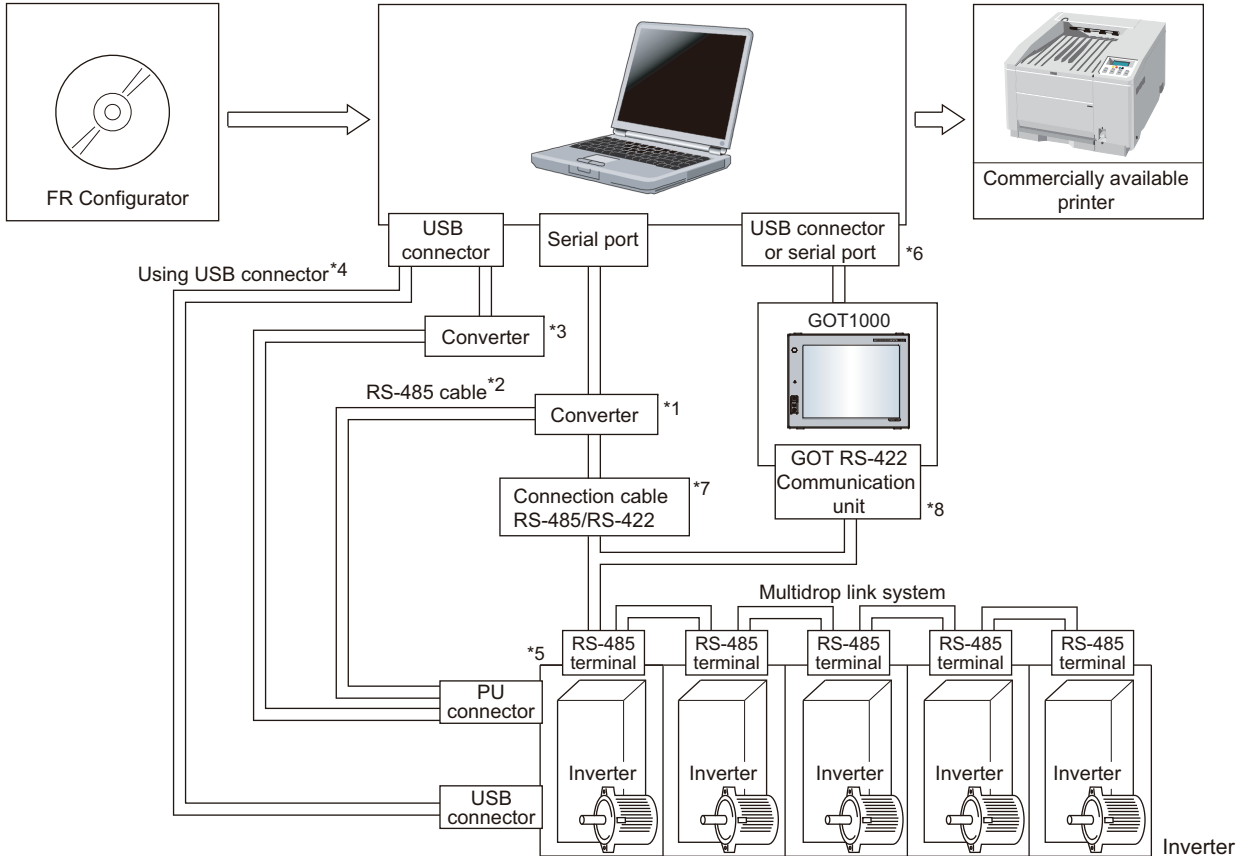

Figure 2.9 Screen example of graph display

2 UNDERSTANDING INVERTER SYSTEM

2.7.3 System configuration

The following devices are required to use FR Configurator. Setup the system in accordance with the instruction manual of each device.



*1 When using serial port of a personal computer, a commercially available converter is required.
Examples of product available on the market (as of January 2010)
Model: DINV-CABV (with connectors and cable)
Diatrend Corp.
The converter cable cannot connect two or more inverters (the computer and inverter are connected on a 1:1 basis). This is a RS-232C/RS-485 conversion cable with built-in converter. No additional cable or connector is required. Contact a manufacturer for details of the product.

*2 Connection cable
Examples of product available on the market (as of January 2010)
Connector: RJ45 connector
Example: Tyco Electronics
5-554720-3
Cable: Cable in compliance with EIA568 (such as 10BASE-T cable)
Example: Mitsubishi Cable Industries, Ltd.
SGLPEV-T (Cat5e/300m) 24AWG x 4P

*3 USB/RS-485 convert cable
Examples of product available on the market (as of January 2010)
Model: DINV-U4
Diatrend Corp.
Refer to page 49 for the communication setting with DINV-U4.
When using USB/RS-485 convert cable, use the newest driver software. For a product details or the newest driver software, contact the cable manufacturer.

*4 Recommended USB cable for computer-inverter connection (For FR-E700)
Examples of product available on the market (as of January 2010)

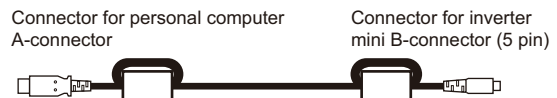

*5 Communication with PU connector, RS-485 terminal, or USB connector (FR-A700, A701, B, B3, E700 series only) is available.

*6 Available communication port is USB or serial port (one of port 1 to 63), and set in Communication settings screen of FR Configurator. (Using multiple ports at the same time is unavailable) Connection of a computer to GOT is 1:1 connection.
When using USB for connecting with GOT, use dedicated cable GT09-C30USB-5P or GT09-C20USB-5P.

*7 Overall length of connection cable: 500m

*8 GOT RS-422 communication unit (GT15-RS4-9S) is required. The number of connectable inverter depends on GOT. Refer to GOT1000 series connection manual for details of RS-422 connection and compatible version of GOT.

	Product	Type	Manufacturer
1)	10BASE-T cable	SGLPEV-T (Cat5e/300m) 24AWG x 4P	Mitsubishi Cable Industries, Ltd.
2)	RJ-14 connector	5-554720-3	Tyco Electronics

2 UNDERSTANDING INVERTER SYSTEM

[Connection example between a USB cable and a USB connector]

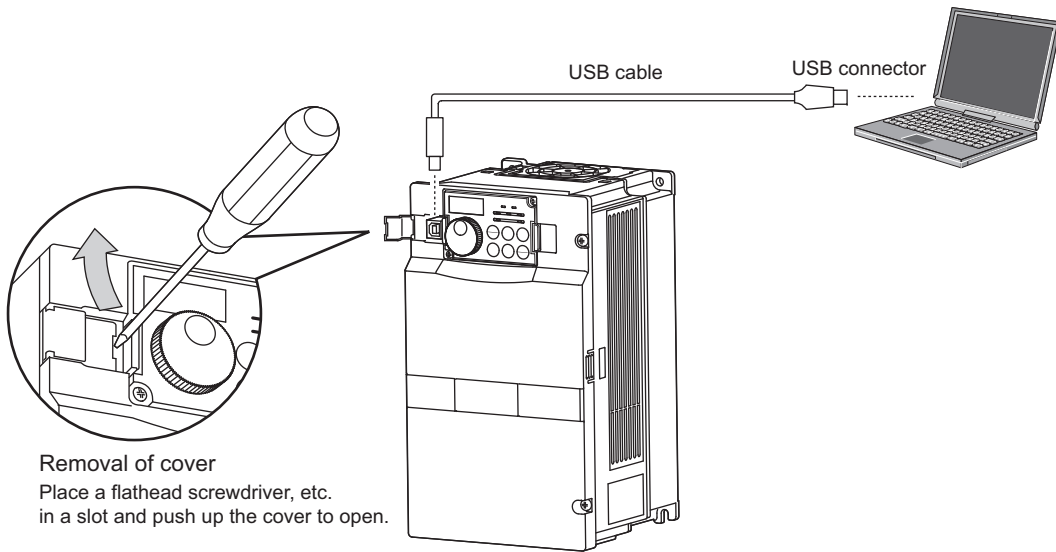

Connecting demonstration machine

Use a USB cable for a demonstration machine. Connect the inverter to a personal computer with a USB cable.

1

IMPORTANCE OF
PRODUCTIVE
MAINTENANCE

2

UNDERSTANDING
INVERTER SYSTEM

3

MAINTENANCE
SYSTEM DESIGN

4

PREVENTIVE
MAINTENANCE

5

BREAKDOWN
MAINTENANCE

6

CORRECTIVE
MAINTENANCE

7

REVISING
INSTALLATION
ENVIRONMENT

8

LIFE OF INVERTER
PARTS

2 UNDERSTANDING INVERTER SYSTEM

2.7.4 Setup

(1) Operation mode setting

To operate an inverter with FR Configurator (such as changing parameter, auto tuning, test operation), set the operation FR mode of the inverter. Use a toolbar to select an operation mode.

Communication Port		Operation Mode *1	Parameter Setting *2 (For FREQROL-A700 series)	
Direct connection between FR Configurator and an inverter	PU connector (RS-485 connector)	PU	Pr. 122 PU communication check time interval ≠ 0 (initial value = 9999) Pr. 123 PU communication waiting time setting = 9999 (initial value)	
	RS-485 terminals	PU	Pr.551 PU mode operation command source selection = 2 (initial value)	Pr.336 RS-485 communication check time interval ≠ 0
		NET	Pr.551 PU mode operation command source selection = 1	Pr.337 RS-485 communication waiting time setting = 9999 (initial value)
	USB connector	PU	Pr.548 USB communication check time interval ≠ 0 (initial value = 9999) Pr.551 PU mode operation command source selection = 3	
Connection through GOT	PU connector (RS-485 connector)	PU	Pr. 123 PU communication waiting time setting = 0 Pr.551 PU mode operation command source selection = 2 (initial value)	
	RS-485 terminals	PU	Pr.551 PU mode operation command source selection = 2 (initial value)	Pr.336 RS-485 communication check time interval ≠ 0
		NET	Pr.551 PU mode operation command source selection = 1	Pr.337 RS-485 communication waiting time setting = 0

*1 Select this operation mode when writing parameter and inputting run command with FR Configurator.

*2 The changed setting value of Pr.551 is valid when turning off and on the power or resetting the inverter.

Setting of demonstration machine

For a demonstration machine connected with a USB cable, use the setting of in the table above.

- 1) Set an inverter to PU operation mode.
- 2) Set 3 to Pr.551.
(Leave the setting Pr.548=9999 (initial value) as it is)
- 3) Turn off the power, and turn it on again.

● ● ● After demonstration ● ● ●

Perform all parameter clear and initialize Pr.551.

2 UNDERSTANDING INVERTER SYSTEM

(2) System setting

The screen below is displayed when setting up FR Configurator.

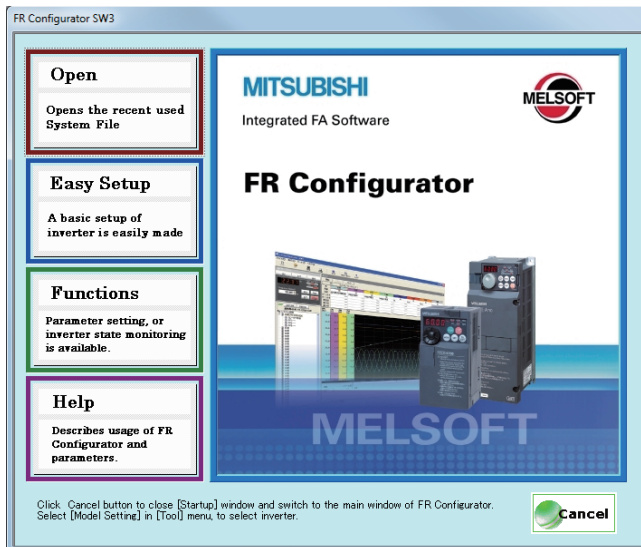

(a) Input an information for creating a system file.

Type a system name (up to 32 one byte characters) for this system file.

Click after inputting the system name.

When is clicked, the screen proceeds to "Communication Setting".

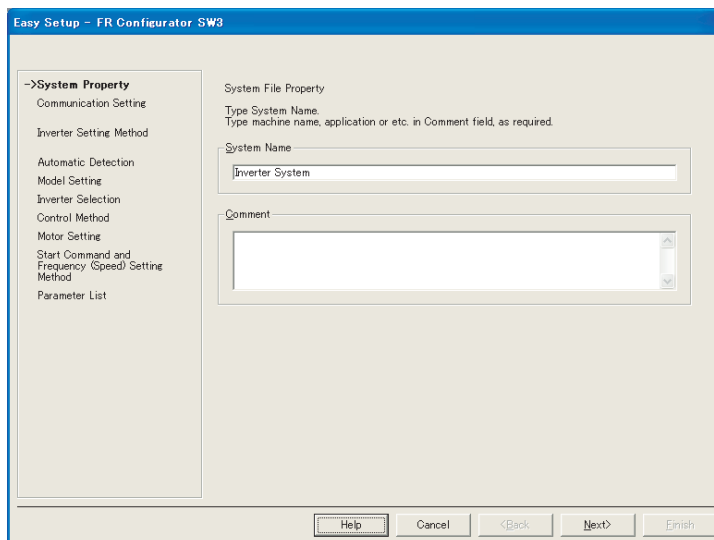

2 UNDERSTANDING INVERTER SYSTEM

- (b) Adjust the communication setting between a personal computer and inverter.
When communicating with inverter using an USB port of the personal computer, select "USB" in "PC side Port" field, and click .
When communicating with inverter using a serial port of the personal computer, select "RS-232C" in "PC side Port" field.

☒ POINT

Default communication setting is matching to an initial value of inverter.
Check the personal computer side port (RS-232C/USB) and personal computer port number (1 to 63).

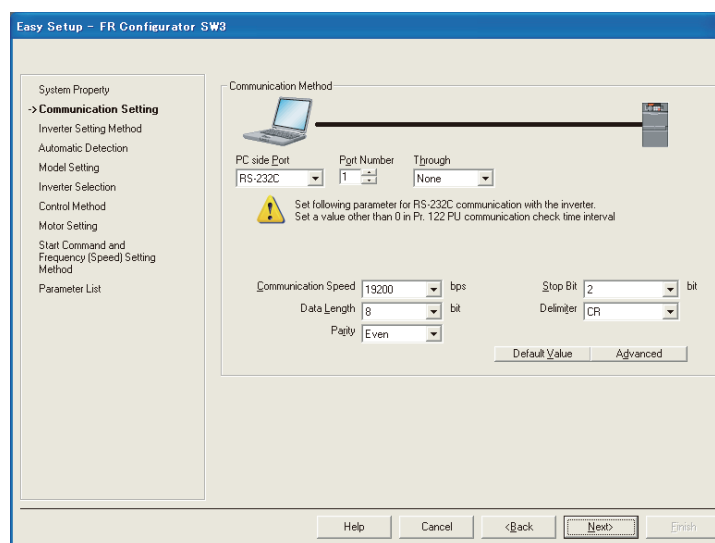

Setting of demonstration machine

Set the personal computer side port to USB. Do not change the other items.

2 UNDERSTANDING INVERTER SYSTEM

- (c) Select inverter setting method between automatic recognition of the connected inverter, or manually model setting for this system.

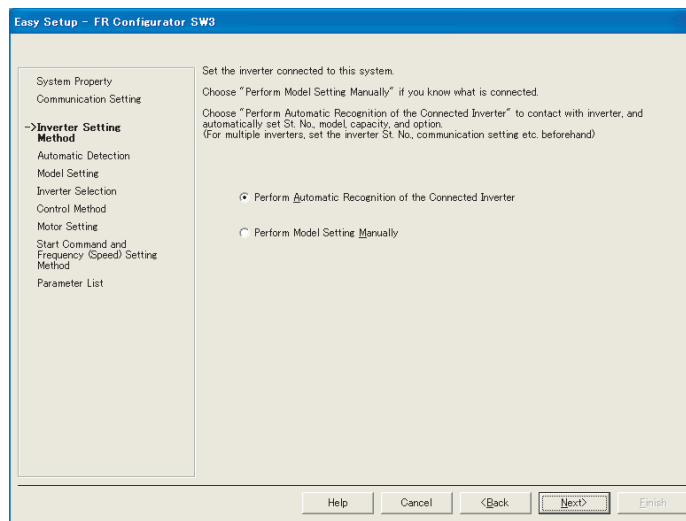

2 UNDERSTANDING INVERTER SYSTEM

When selecting Automatic Detection

Click to detect inverter of which communication is available.

After finishing the automatic detection of the inverter, the window proceeds to "Inverter Selection".

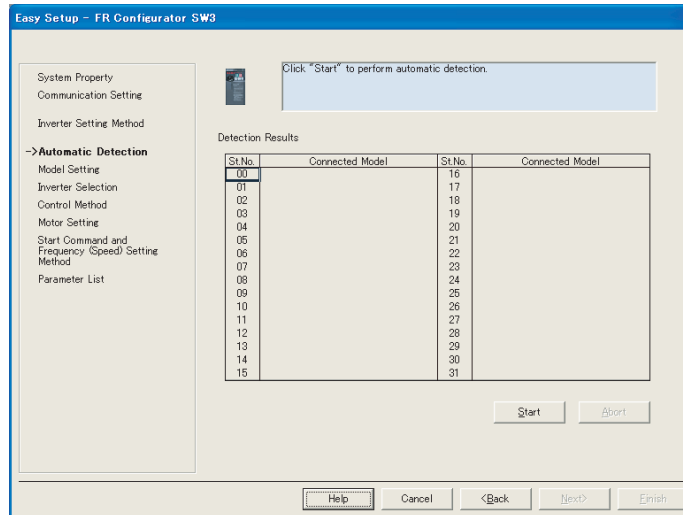

When selecting Model Setting manually

Set the inverter station number, model, capacity, and plug-in option to be connected.

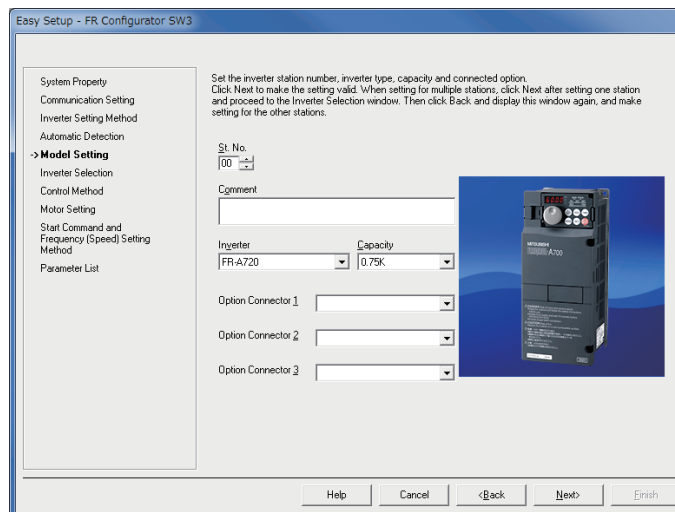

Setting of demonstration machine

Set the inverter station number to "00", capacity to "0.75", option 1 to 3 to "Not used (blank)", and click to proceed to "Inverter Selection".

2 UNDERSTANDING INVERTER SYSTEM

(d) Click **Register System Setting** to register the system setting, and then parameter setting becomes available.

Choose an inverter (station number) for parameter setting, and click **Next>**. After parameter setting is finished, the window returns to "Inverter Selection" again.

Click **Finish** to close Easy Setup, and proceeds to the Main frame window. System setting is completed.

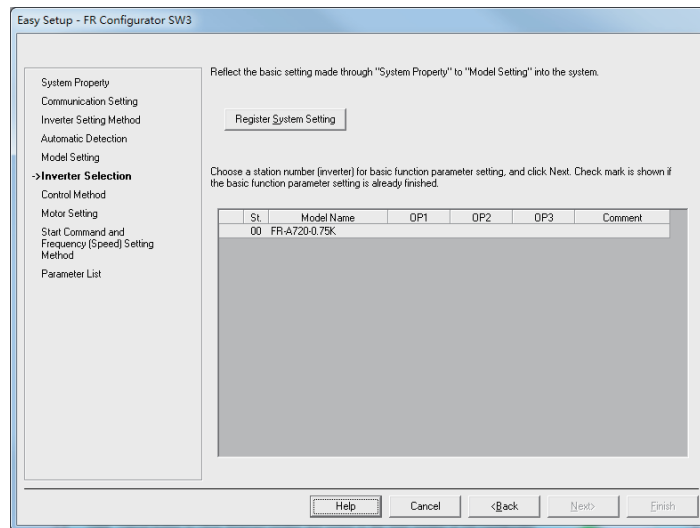

Setting of demonstration machine

Setting parameters is unnecessary in this operation. Click **Register System Setting** to reflect model settings and then click **Finish** at last.

After the message box below is displayed, click **Yes**.

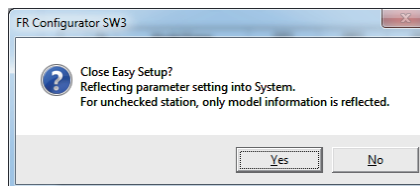

2 UNDERSTANDING INVERTER SYSTEM

2.7.5 Graph (Monitor Area)

Sampling the output frequency or current, etc. of the inverter and displays the data in graph form (wave form). The sampling data can be saved in a file (Export to *.bmp or *.gp3). And the saved sampling data can be read and displayed (Import from *.gp3).



Select [Graph] under [View] menu, or click  on the tool bar to display "Graph".

There are two sampling methods.

- High Speed sampling (only when the FR-E700 series is connected with USB without connecting through GOT)
Able to sample a data with minimum sampling interval of about 1 [ms]. One station can be sampled.
- Monitor sampling
Able to sample a data from multiple stations at the same time. Sampling interval varies depending on communication setting (communication speed and communication port) and a number of sampling items.

	Specifications
Sampling point	Sampling is available up to 10000 points per each CH
Sampling interval	High Speed sampling: Setting available from about 1 [ms] (mask count: 1) to 20 [ms] (mask count: 40) Monitor sampling: Setting available from about 50 [ms] to 540000 [ms] (varies depending on communication speed, communication port or number of sampling items)
Sampling time [ms]	High Speed sampling: Maximum sampling interval × 8000 Monitor sampling: Maximum sampling interval × 10000
Analog data	Sampling of 1CH to 4CH (4CHs) analog data is available.
Digital data	Sampling of 5CH to 8CH (4CHs) digital data is available.

POINTS for understanding !

- During High Speed sampling, if other application is running or performing file handling with personal computer, communication error (Error code 0x8002007, 0x8002008) or buffer overflow error may occur, and the data cannot be displayed correctly. In this case, take measures such as, to close the other application, to refrain FR Configurator operation, or to set larger value in Mask count of sampling interval.
- Test operation (, ) does not function during graph sampling of two or more stations by communication through GOT (FA transparent function).

2 UNDERSTANDING INVERTER SYSTEM

- (1) Basic flow of sampling
 - (a) Sampling setting

Set sampling items. Changing of the sampling mode (High Speed or Monitor), sampling interval or sampling time, etc. is available for your purpose. When starting sampling with using a trigger, make a trigger setting.
 - (b) Start sampling

Click to start the sampling when sampling item is set already. If the trigger is set, sampling starts when the trigger condition is satisfied during "Waiting for Trigger" state which comes after "Sampling Pre-trigger Data" state.
 - (c) Sampling complete

Sampling stops in the following condition.

 - When elapsed time from the beginning of the monitoring exceeds the sampling time
 - When is clicked
 - (d) Graph display

You can change a scale of the graph, show a numeric value of a wave at where cursors is laid, or show effective value of between any 2 points, maximum value, and minimum value. Exporting of graph data (Refer to page 94) for saving as a file is also available.

☒ POINTS for understanding !

If an normal communication is not maintained (communication error, etc.), the sampling stops.

If an fault occurs during sampling, sampling continues.

During sampling, other communication tasks such as parameter reading are unavailable.

2 UNDERSTANDING INVERTER SYSTEM

(2) Explanation of window

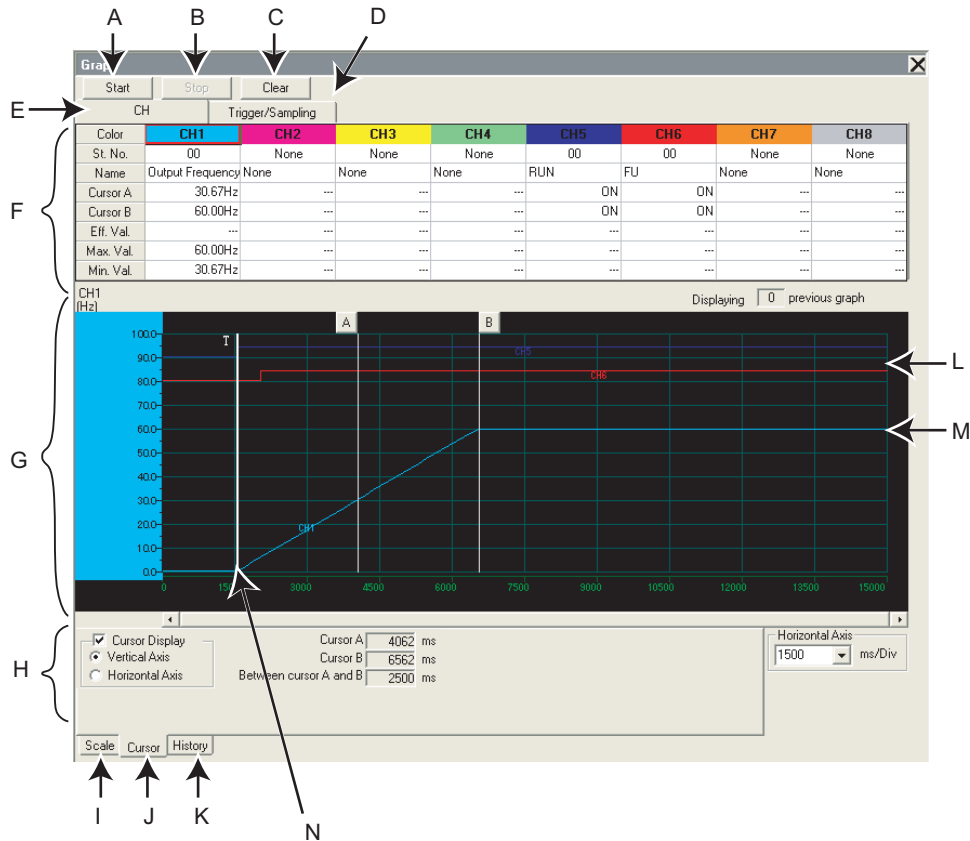

No.	Name	Function and description
A	Start	Starts sampling.
B	Stop	Stops sampling.
C	Clear	Clears the graph. If a graph has been displayed, data history is also cleared. If a graph has not been displayed yet, the setting of sampling item is cleared.
D	Trigger/Sampling	Click Trigger/Sampling to display trigger/sampling setting section. (Refer to (4) in this section)
E	CH	Click CH to display sampling item setting section. (Refer to (3) in this section)
F	Sampling item setting section (Trigger/sampling setting section)	Click tabs to switch displaying Sampling item setting section (Refer to (3) in this section) and Trigger/sampling setting section (Refer to (4) in this section).
G	Graph area	Shows sampling data in graph form.
H	Scale changing section (Cursor function section, History display section)	Click tabs to switch displaying Scale changing section (Refer to (6) in this section), Cursor function section (Refer to (7) in this section) and History display section (Refer to (8) in this section).
I	Scale	Click Scale to display Scale changing section. (Refer to (6) in this section)
J	Cursor	Click Cursor to display Cursor function section. (Refer to (7) in this section)
K	History	Click History to display History display section. (Refer to (8) in this section)
L	Graph (digital data)	Digital data drawn in graph form (CH5 to CH8). OFF is drawn on a grid line, and ON is drawn between the grid lines.
M	Graph (analog data)	Analog data drawn in graph form (CH1 to CH4). Graph is drawn based on the setting of Vertical Axis scale and 0 position adjust. Vertical Axis scale of each data (CH) can be changed separately.
N	Trigger Line	Shows a position of trigger start. "T" is displayed on top of Trigger Line.

☒ POINTS for understanding !

Each graph displays their own CH number. Though when a graph data is out from Graph area, CH number may not be displayed. Adjust with 0 position adjust and scale changing to make a data visible inside of Graph area.

2 UNDERSTANDING INVERTER SYSTEM

(3) Sampling item setting

Click to display Sampling item setting section. Set station number and item for sampling. Analog data is set in CH1 to CH4, and digital data is set in CH5 to CH8.

	Start	Stop	Clear								
	CH		Trigger/Sampling								
A	Color	CH1	CH2	CH3	CH4	CH5	CH6	CH7	CH8		
B	St. No.	00	None	None	None	None	None	None	None		
C	Name	Frequency Settin	None	None	None	None	None	None	None		
D	Cursor A		
E	Cursor B		
E	Eff. Val.		
F	Max. Val.		
F	Min. Val.		

For Analog data
For Digital data

No.	Name	Function and description
A	Color	Shows the color of the graph drawing.
B	St. No.	Select station number for sampling. For High Speed sampling, only CH1 is available for setting. CH2 to CH8 has the same station number as the one set in CH1.
C	Name	Select sampling item. Four analog data (CH1 to CH4), and four digital data (CH5 to CH8) are available.
D	Cursor A (Cursor B)	Shows measured value of cursor A and B on a wave form.
E	Eff. Val.	Shows calculated effective value between cursor A and B. (Effective value is displayed when U, V, W phase output current are sampled in High Speed sampling.)
F	Max. Val. (Min. Val.)	Shows maximum value and minimum value between cursor A and B while cursor is displayed in Vertical Axis.

2 UNDERSTANDING INVERTER SYSTEM

- Sampling item list

Refer to the Inverter Instruction Manual for details of monitor item.

Refer to Inverter Instruction Manual for details of digital data sampling items.

Model name	Sampling mode	Sampling item
FR-A700	Monitor	Output Frequency, Output Current, Output Voltage, Frequency Setting Value, Running Speed, Motor Torque, Converter Output Voltage, Regenerative Brake Duty, Electronic Thermal Relay Function Load Factor, Output Current Peak Value, Converter Output Voltage Peak Value, Input Power, Output Power, Load Meter, Motor Excitation Current, Position Pulse, Cumulative Energization Time, Orientation Status, Actual Operation Time, Motor Load Factor, Cumulative Power, Torque Command, Torque Current Command, Motor Output, Feedback Pulse, Power Saving Effect, Cumulative Saving Power, PID Set Point, PID Measured Value, PID Deviation

☒ POINTS for understanding !

- Change the sampling mode (Monitor/High Speed) before setting sampling items. Since some monitor items are different between the sampling mode, the setting of uncommon sampling item is cleared when changing the sampling mode. (Refer to (4) in this section)
- When making sampling item setting, set analog data (CH1 to CH4) in ascending order from CH1, and digital data (CH5 to CH8) in ascending order from CH5.
- When sampling terminal 2, terminal 4, and terminal 1 of voltage input while Pr. 241 Analog input display is set to "0" (% display), the sampled data appear as 10V=100%.
Example: Pr. 73 = 1 (terminal 2 input is 0 to 5V), Pr. 241 = 0 (% display)
Sampling data in the graph appear as 50% when 5V is input to terminal 2.

2 UNDERSTANDING INVERTER SYSTEM

(4) Sampling setting

Click Trigger/Sampling to display Sampling setting section. Setting sampling mode, Single/Continuous setting, and sampling time are available.

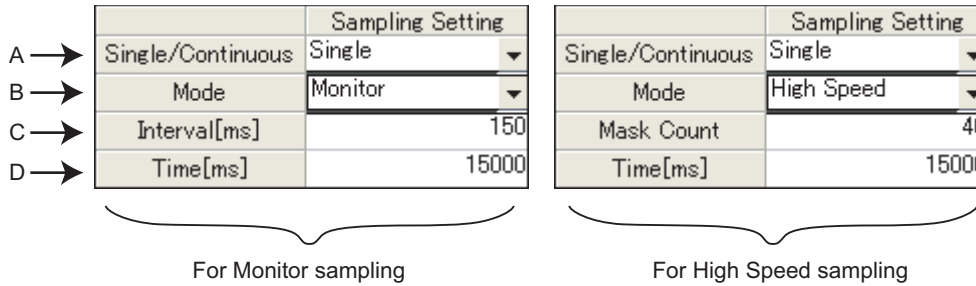

No.	Name	Function and description
A	Single/Continuous	Select between Single sampling or Continuous sampling. <ul style="list-style-type: none"> Single: Sampling from start to end is performed only once. Continuous: Sampling from start to end is performed continuously. When sampling ends, the data is added to History, and starts the next sampling. (Refer to (8) in this section)
B	Mode	Select between High Speed sampling or Monitor sampling. High speed sampling is available when an FR-E700 series model is connected via USB (not available when the inverter is connected via GOT.) Since some monitor items are different between the sampling mode, the setting of uncommon sampling item is cleared when changing the sampling mode
C	Interval [ms]	Set interval (cycle) of data sampling. Sampling interval is fixed depending on a number of sampling items and communication setting.
	Mask Count	Set interval (cycle) of data sampling. For High Speed sampling, set Mask count (available from 1 to 40) for the sampling interval. Refer to the following formula for sampling interval. <p style="text-align: center;">Sampling interval is approximately equal to $(\text{Mask Count} + 1) \times 0.5\text{ms}$</p> <p>Example: when the Mask Count is 1 Sampling interval is approximately equal to $(1 + 1) \times 0.5\text{ms} = \text{About } 1\text{ms}$</p>
D	Time [ms]	Set maximum sampling time. When elapsed time exceeds the sampling time, sampling stops. Maximum sampling time can be set as follows. <p>High Speed sampling: Maximum sampling interval \times 8000 Monitor sampling: Maximum sampling interval \times 10000</p> <p>Example: when the Mask Count is 1 for High Speed sampling Maximum sampling time = 8000ms</p>

2 UNDERSTANDING INVERTER SYSTEM

- Setting range and setting increments of "Sampling Interval" and "Sampling Time"
Setting range of "Sampling Interval" and "Sampling Time" are different between High Speed sampling and Monitor sampling.

(a) For High Speed sampling (only when using USB connection)

Sampling interval can be set from about 1 [ms] (Mask Count: 1) to about 20 [ms] (Mask Count: 40), and sampling time can be set up to "setting sampling interval × 8000".

(b) For Monitor sampling

Setting range of "Sampling Interval" and "Sampling Time" varies according to communication setting. The minimum sampling interval is "number of sampling items × Lower limit of sampling interval". Refer to the following table for Lower limit of sampling interval.

Communication port	Communication speed [bps]	Lower limit of sampling interval [ms] *
Serial port	4800	250
	9600	150
	19200	100
	38400	100
USB	-	50

* When making a communication through GOT (FA transparent function), minimum value of the sampling interval is 200ms regardless of communication speed.

Refer to the following table for the maximum value, the minimum value, and the setting increments of "Sampling Interval" and "Sampling Time" when the measuring conditions are actually set.

	Maximum value	Minimum value	Increments
Sampling interval [ms]	540000	Lower limit of sampling interval × the number of the sampling items *	50
Sampling time [ms]	Sampling interval × 10000	Sampling interval × 100	Sampling interval

* If a fault trigger is set, the fault trigger is also added to the measuring items.

Example: When connecting with serial port, Communication Speed is 19200bps, and monitoring 3 items, "Output Frequency", "Output Current", and "Output Voltage".

Lower limit of sampling interval = 100 [ms]

Maximum value of sampling interval = 540000 [ms] (540 [s])

Minimum value of sampling interval = 100 × 3 = 300 [ms]

Setting increments of sampling interval = 100 [ms]

Maximum value of sampling time = 540000 × 10000 = 5400000000 [ms] (1500 [h])

Minimum value of sampling time = 300 × 100 = 30000 [ms] (30 [s])

Setting increments of sampling time = 300 [ms]

2 UNDERSTANDING INVERTER SYSTEM

(5) Trigger setting

With making Trigger setting, sampling can be started at a fault occurrence or when sampling item meets a trigger condition.

Trigger	
A → Type	Inside
B → CH	CH01
C → Start At	Rise
D → Level	2.00
E → Position [%]	10

No.	Name	Function and description
A	Type	Select a trigger type for sampling start. You can select the trigger type from the following three. <ul style="list-style-type: none"> Not used Inside (Sampling starts when sampling item meets a trigger condition) Fault (Sampling starts at a fault occurrence)
B	CH/St. No.	Selecting item is different according to the trigger type. <ul style="list-style-type: none"> For Inside trigger: Select a trigger item (CH1 to CH8). For Fault trigger: Select a station number for checking a fault. Station number from which sampling item is already set can be selected.
C	Start At	Select a trigger meeting condition from Rise or Fall. (Only "Rise" can be selected for Fault trigger.) <ul style="list-style-type: none"> Rise For analog data: Starts when a value exceeds more than a setting of Trigger Level For digital data: Starts when a signal turns ON from OFF Fall For analog data: Starts when a value falls lower than a setting of Trigger Level For digital data: Starts when a signal turns OFF from ON
D	Level	Set a level of trigger meeting condition for analog signal. (Setting is available only when Inside trigger is set, and analog data is selected.)
E	Position [%]	Set a percentage for an amount of data before trigger meets the condition. The amount based on the specified percentage of total sampling data is assigned for the data before trigger meets the condition. Value is 10% increments and can be set from 10% to 90%.

Remark

- For starting with analog data

If the trigger condition has already met when is clicked, sampling will not start. Sampling starts only when a value exceeds more than the setting of "Level" when "Rise" is selected, or when the value falls lower than the setting of "Level" when "Fall" is selected.

Example: when trigger starts at "Rise", and "3" is set for Level

If the value is already 4 at sampling start, then this case does not meet trigger condition. If the value lower than 3 exceeds more than 3, then the case meets trigger condition, and starts sampling.

- When monitor display is changed to the machine speed with a value other than 0 is set in Pr. 37 Speed display When setting "Output Frequency" or "Frequency Setting" for Inside trigger, set machine speed for trigger level directly into "Level" field. For example, if 1800 is set in Pr. 37 Speed display, sampling "Output Frequency", and want to meet trigger condition at 900, then you can set 900 directly into "Level" field.

2 UNDERSTANDING INVERTER SYSTEM

• About trigger waiting state

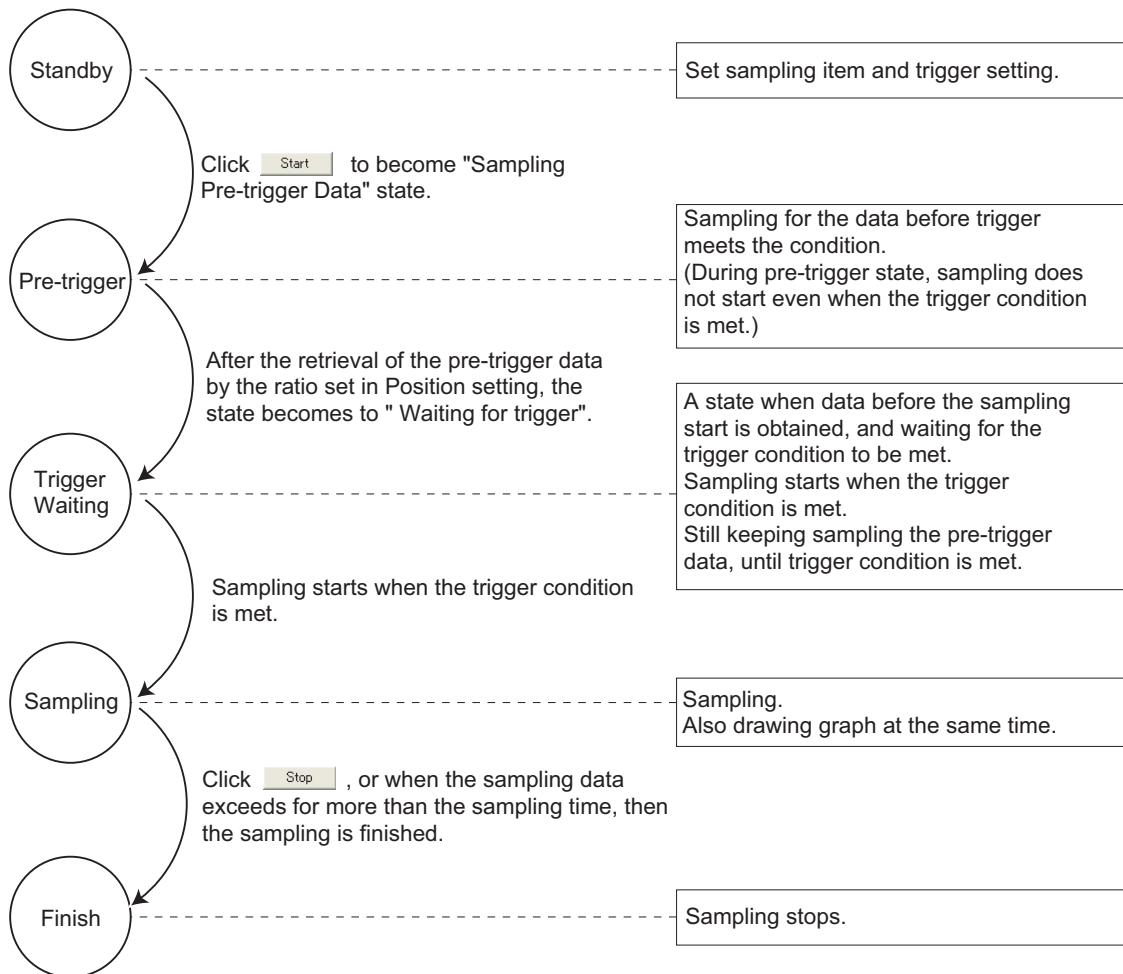

2 UNDERSTANDING INVERTER SYSTEM

(6) Scale changing

Scale changing of the displayed graph is available. Graph area is divided into vertical 10 grids and horizontal 10 grids. Scale of vertical axis and horizontal axis can be changed by setting a value of each one grid.

Selected graph can be moved upper or lower with changing 0 position adjust.

Scale value shown on vertical axis changes along with the vertical scale setting.

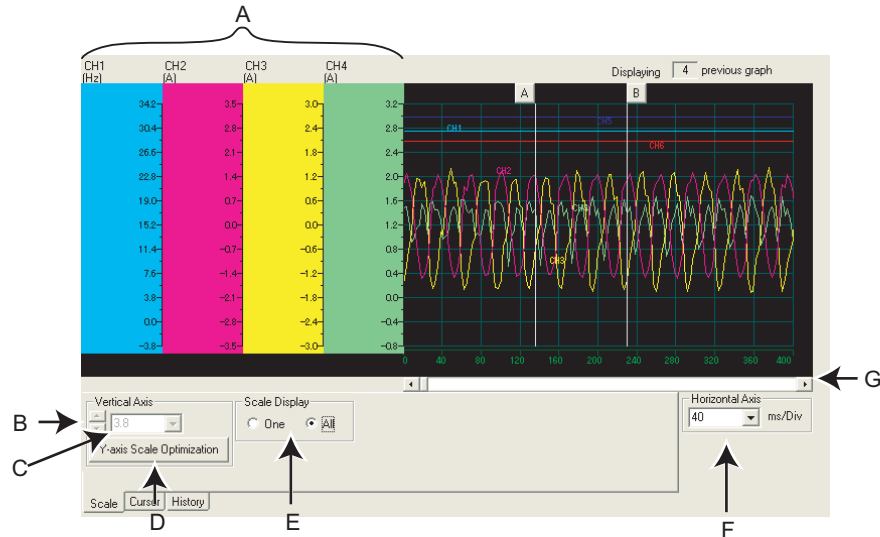

No.	Name	Function and description
A	Vertical Scale	Shows vertical axis scale of each CH. Scale of each analog data can be set separately.
B	▲ / ▼ (0 position adjust)	Click ▲ / ▼ to move the 0 position of the selected graph upper or low
C	Vertical Axis	Vertical scale of the selected CH can be changed. To change the scale, set a graph value proportional for each grid. (Each CH can be changed separately.) Unavailable to change when digital data is selected.
D	Y-axis Scale Optimization	Click button to adjust the wave form of each analog data of graph to fit in the window.
E	Scale display switching	Switches the display of the vertical axis between the selected CH only or the vertical axis of all analog data (or all digital data). (When showing all vertical axis, scale changing and 0 position adjust are unavailable.)
F	Horizontal Scale changing	Horizontal scale of the displayed graph can be changed. To change the scale, set a graph value proportional for each grid. Setting is available between "sampling interval * 10" to "sampling time/10".
G	Horizontal Axis scroll	Scrolls the graph to right and left

2 UNDERSTANDING INVERTER SYSTEM

(7) Cursor function

Shows a numeric value of the waveform where the cursors are, or shows effective value of between any 2 points, maximum value, and minimum value.

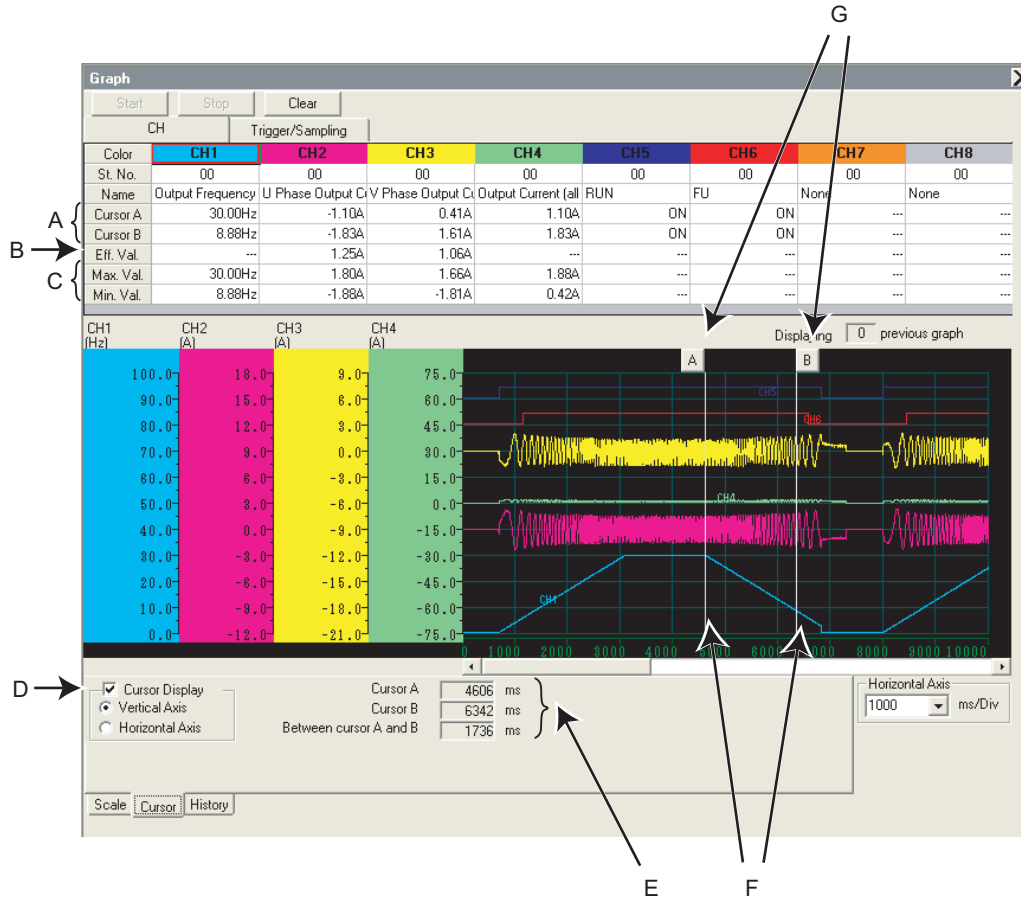

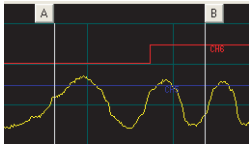
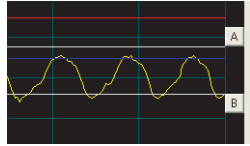
No.	Name	Function and description
A	Cursor A (Cursor B)	Shows measured value of cursor A and B of the graph.
B	Eff. Val.	Shows calculated effective value between cursor A and B.
C	Max. Val. (Min. Val.)	Shows maximum value and minimum value between cursor A and B while cursor is displayed in Vertical Axis.
D	Cursor Display	Switches the cursor displaying or hiding with a check box. Selecting Vertical Axis or Horizontal Axis switches the cursor display.
E	Cursor time	Shows time of cursor A and cursor B, and time between cursor A and B when cursor is displayed in Vertical Axis.
F	Cursor Line	Shows the position of cursor A and B. Move the mouse near around the cursor line and click to move the cursor line to the mouse position. Cursor Line can be also moved with dragging. Dragging the cursor with Shift key pressed can move the both cursor A and B simultaneously. <div style="display: flex; justify-content: space-around; align-items: center;"> <div style="text-align: center;">  <p>Vertical Axis</p> </div> <div style="text-align: center;">  <p>Horizontal Axis</p> </div> </div> <p>The position of cursor A and B does not switch.</p>
G	Cursor mark (A, B)	The numeric value of the waveform where the cursors are is displayed in Sampling item field (Cursor A, B).

2 UNDERSTANDING INVERTER SYSTEM

(8) History display

The past 5 sampling data (including the current data) can be saved in History, and can be available to display again. When sampling ends, the graph data and comment is added to History. If there are already 5 data when adding to History, the oldest data is erased.

When there are several data in the history, two graphs can be drawn at the same time. When overwriting graphs, the graph currently displayed is shown in each CH color and the one for overwriting is shown in gray.

Click History tab to display History section.

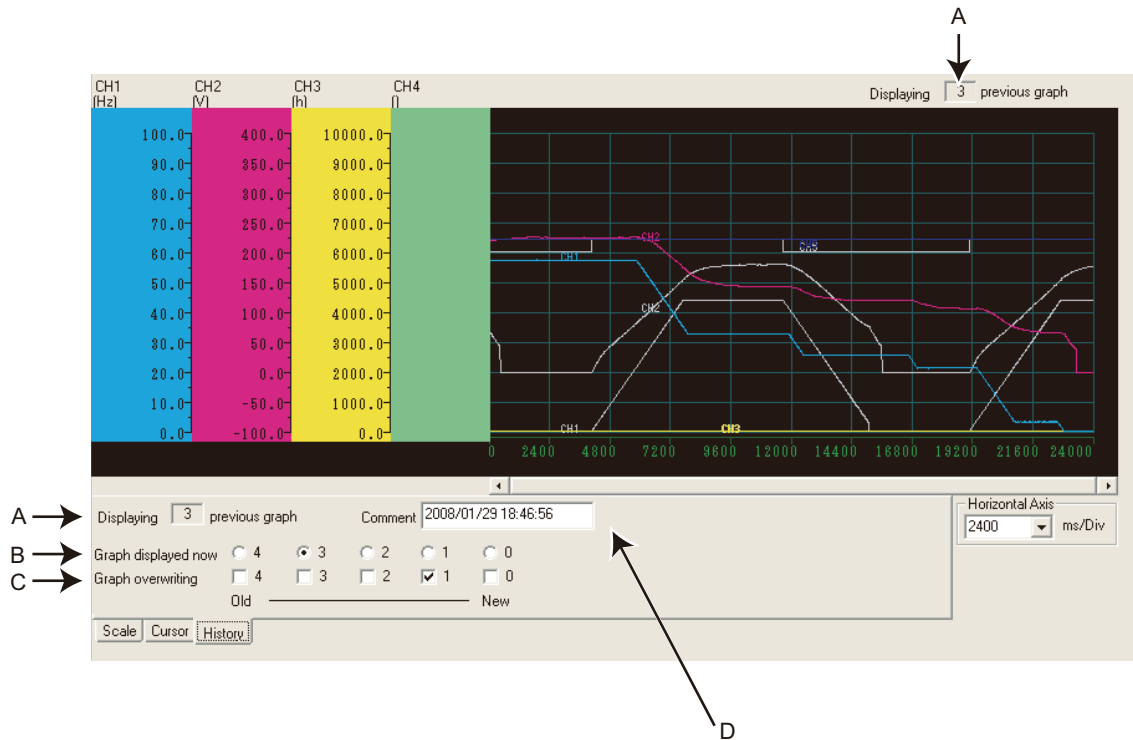

No.	Name	Function and description
A	History display	Shows how old the displaying graph is from the newest graph.
B	Graph displayed now	Click the number to display the responding graph of that number.
C	Graph overwriting	Checked graphs are displayed in layer.
D	Comment	A field for comments. Sampling date and time is automatically inputted when the sampling is finished and saved to History. Available to write up to 128 characters.

Remark

- For Continuous sampling, the data is added to History sequentially, and starts the next sampling.
- When overwriting graphs, cursor function is valid only for the currently displayed graph.
- Clearing of graph also deletes the History data.

2 UNDERSTANDING INVERTER SYSTEM

(9) Example of graph sampling (monitoring output frequency, converter output voltage, terminal STF, and terminal RUN)

- When sampling without trigger

(a) Select "00" at St. No. field.

Then select "Output Frequency" at CH1 No. field, "Converter Output Voltage" at CH2 No. field, "STF" at CH5, and "RUN" at CH6.

The screenshot shows the 'Graph' configuration window with the following settings:

CH	Color	St. No.	Name	Cursor A	Cursor B	Eff. Val.	Max. Val.	Min. Val.
CH1	Blue	00	Output Frequency
CH2	Purple	00	Converter Output Voltage
CH3	Yellow	None	None
CH4	Green	None	None
CH5	Dark Blue	00	STF
CH6	Red	00	RUN
CH7	Orange	None	None
CH8	Grey	None	None

Annotations in the image point to the 'St. No.' field (labeled 'Select "00"'), and the Name fields for CH1, CH2, CH5, and CH6 (labeled 'Select "Output Frequency"', 'Select "Converter Output Voltage"', 'Select "STF"', and 'Select "RUN"' respectively).

(b) Select "Not used" at Type field for trigger setting.

Set sampling interval and sampling time.

The screenshot shows the 'Trigger/Sampling' configuration window with the following settings:

Trigger	Sampling Setting
Type: Not used	Single/Continuous: Single
CH: ---	Mode: Monitor
Start At: ---	Interval[ms]: 300
Level: 0.00	Time[ms]: 30000
Position[0]: 10	

Annotations include: 'Select "Not used"' pointing to the Type field, 'Set "Sampling Interval"' pointing to the Interval[ms] field, and 'Set "Sampling Time"' pointing to the Time[ms] field.

(c) Click to start sampling.

The screenshot shows the 'Trigger/Sampling' configuration window with the 'Start' button highlighted by an arrow and the text 'Click Start'.

(d) Click , or the sampling time has passed, and the sampling is finished.

The screenshot shows the 'Trigger/Sampling' configuration window with the 'Stop' button highlighted by an arrow and the text 'Click Stop'.

2 UNDERSTANDING INVERTER SYSTEM

(e) Graph is adjustable for a better viewing.

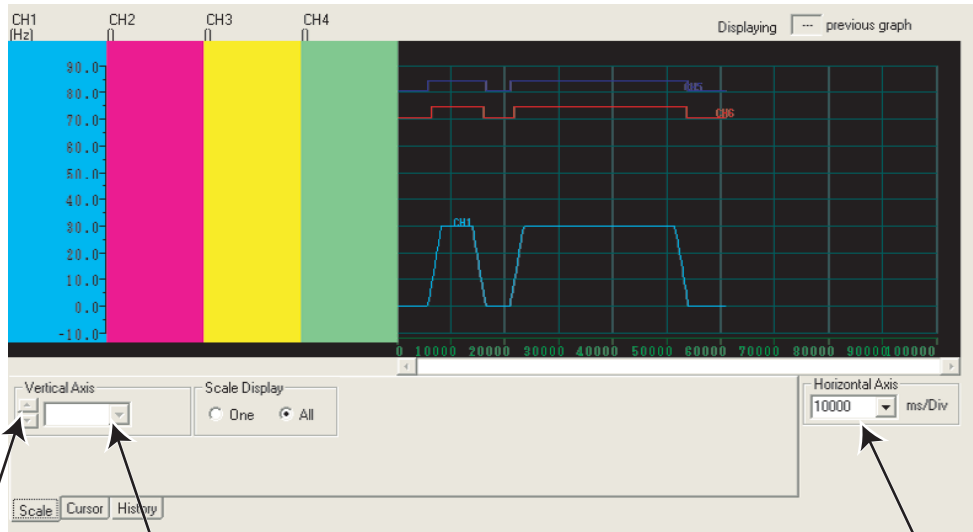

Move the 0 position of the selected graph upper or lower

Set a value of each one vertical grid

Set a value of each one horizontal grid

1	IMPORTANCE OF PRODUCTIVE MAINTENANCE
2	UNDERSTANDING INVERTER SYSTEM
3	MAINTENANCE SYSTEM DESIGN
4	PREVENTIVE MAINTENANCE
5	BREAKDOWN MAINTENANCE
6	CORRECTIVE MAINTENANCE
7	REVISING INSTALLATION ENVIRONMENT
8	LIFE OF INVERTER PARTS

2 UNDERSTANDING INVERTER SYSTEM

- When sampling with Inside trigger, starting at the Rise of terminal RUN, with 10% of sampling data before the trigger meets the condition

(a) Select "00" at St. No. field.

Then select "Output Frequency" at CH1 No. field, "Converter Output Voltage" at CH2 No. field, "STF" at CH5, and "RUN" at CH6.

CH	Color	St. No.	Name
CH1	Red	00	Output Frequency
CH2	Purple	00	Converter Output Voltage
CH3	Yellow	None	None
CH4	Green	None	None
CH5	Blue	00	STF
CH6	Red	00	RUN
CH7	Orange	None	None
CH8	Grey	None	None

Select "00" → CH1 St. No.

Select "Output Frequency" → CH1 Name

Select "Converter Output Voltage" → CH2 Name

Select "STF" → CH5 Name

Select "RUN" → CH6 Name

(b) Make trigger setting as follows:

Select "Inside" at Type field.

Select "CH5" at CH field.

Select "Rise" at Start At field.

Set "10" at Position [%] field.

Set sampling interval and sampling time.

Trigger	Sampling Setting
Type: Inside	Single/Continuous: Single
CH: CH05	Mode: Monitor
Start At: Rise	Interval[ms]: 300
Level: 0.00	Time[ms]: 30000
Position[%]: 10	

Select "Inside" → Type

Select "CH5" → CH

Select "Rise" → Start At

Set "10" → Position

Set Sampling Interval → Interval

Set Sampling Time → Time

(c) Click **Start** to show "Sampling Pre-trigger Data", and retrieves the data before the trigger meets condition (10% of whole sampling time).

After the retrieval of the data before the trigger meets condition, then the screen shows "Waiting for Trigger" and becomes the trigger waiting state.

Click **Start**

Sampling Pre-trigger Data → Waiting for Trigger

2 UNDERSTANDING INVERTER SYSTEM

- (d) When trigger meets the condition (Rise of terminal STF), sampling starts automatically.
- (e) Click , or the sampling time has passed, and the sampling is finished.

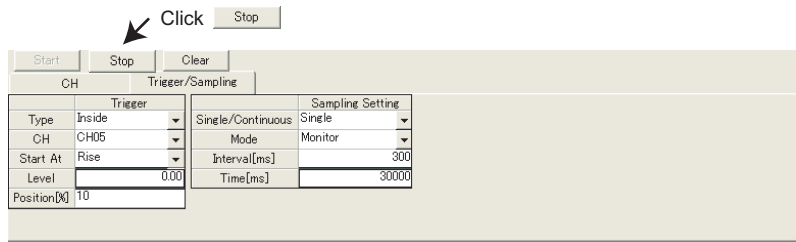

- (f) Graph is adjustable for a better viewing.



Remark

In this example, "Position [%]" is set to "10%". The Rise of terminal STF during the 10% of the whole sampling time after clicking (during Pre-Trigger state) is ignored, and sampling is not started.

2 UNDERSTANDING INVERTER SYSTEM

- When sampling with Fault trigger, starting at a fault occurrence, with 90% of sampling data before the fault occurrence

(a) Select "00" at St. No. field.

Then select "Output Frequency" at CH1 No. field, "Converter Output Voltage" at CH2 No. field, "STF" at CH5, and "RUN" at CH6.

CH	CH1	CH2	CH3	CH4	CH5	CH6	CH7	CH8
St. No.	00	00	None	None	00	00	None	None
Name	Output Frequency	Converter Output Voltage	None	None	STF	RUN	None	None
Cursor A
Cursor B
Eff. Val.
Max. Val.
Min. Val.

(b) Make trigger setting as follows:

Select "Fault" at Type field.

Select "00" at St. No. field.

Input "90" at Position [%] field.

Set sampling interval and sampling time.

Trigger	Sampling Setting
Type: Fault	Single/Continuous: Single
St. No.: 00	Mode: Monitor
Start At: Rise	Interval [ms]: 400
Level: 0.00	Time [ms]: 40000
Position [%]: 90	

(c) Click **Start** to show "Sampling Pre-trigger Data", and retrieves the data before the trigger meets condition.

After the retrieval of the data before the trigger meets condition, then the screen shows "Waiting for Trigger" and becomes the trigger waiting state.

Sampling Pre-trigger Data → Waiting for Trigger

(d) When inverter fault occurs, sampling starts automatically.

2 UNDERSTANDING INVERTER SYSTEM

(e) Click , or the sampling time has passed, and then the sampling is finished.

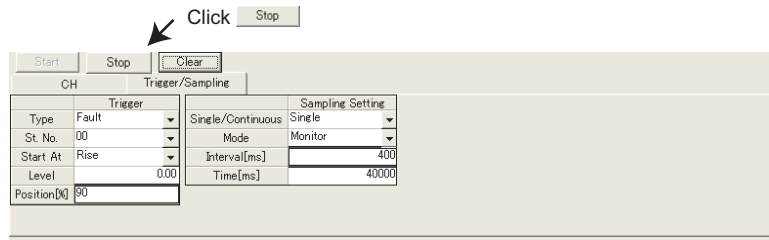

(f) Graph is adjustable for a better viewing.

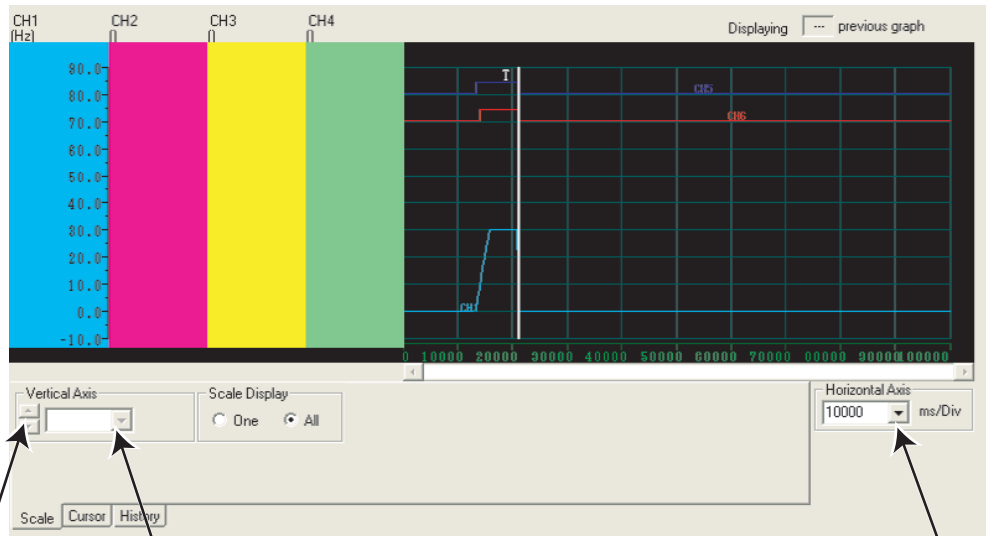

Move the 0 position of the selected graph upper or lower

Set a value of each one vertical grid

Set a value of each one horizontal grid

Remark

In this example, "Position [%]" is set to "90%". The fault occurrence during the 90% of the sampling time after clicking (during Pre-Trigger state) is ignored, and sampling is not started.

Chapter 3 MAINTENANCE SYSTEM DESIGN

It is necessary to consider maintenance as a planning stage for automation projects to reduce breakdowns or accidents and give maintenance staff an easy to follow maintenance work plan.

3.1 Preparation for Maintenance

(1) Use products without much failure

In simple terms, this means using highly reliable products but the following points must also be considered.

- 1) Are the manufacturer's products reliable?
- 2) Does it conform to recognized local and international standards?
- 3) Is the design simple?
- 4) Are low failure rates for the product based on real results?
- 5) Does the product have a good reputation in it's related industry?

(2) Good system planning for maintainability

When planning for a system that can be easily maintained, consider the following points.

- 1) Use an inverter that has easily obtainable spares or replacement modules.
- 2) Use an inverter that has high maintainability with functions like self-diagnostics.
- 3) Use an inverter that allows easy program reading, modification and storage.
- 4) Design so that failure is displayed automatically.
- 5) Plan for space to make maintenance inspection and repair operations easy.
- 6) Plan for making changes in parts, products, and wiring as easy as possible.

3 MAINTENANCE SYSTEM DESIGN

3.2 Failsafe system which uses the inverter

When a fault occurs, the inverter trips to output a fault signal. However, a fault output signal may not be output at an inverter fault occurrence when the detection circuit or output circuit fails, etc. Although Mitsubishi assures best quality products, provide an interlock which uses inverter status output signals to prevent accidents such as damage to machine when the inverter fails for some reason and at the same time consider the system configuration where failsafe from outside the inverter, without using the inverter, is enabled even if the inverter fails.

(1) Interlock method which uses the inverter status output signals

By combining the inverter status output signals to provide an interlock as shown below, an inverter alarm can be detected.

No	Interlock Method	Check Method	Check Method
1)	Inverter protective function operation	Operation check of an alarm contact error detection by negative logic	Fault output signal ALM signal
2)	Inverter running status	Operation ready signal check	Operation ready signal (RY signal)
3)	Inverter running status	Logic check of the start signal and running signal	Start signal (STF signal, STR signal) Running signal (RUN signal)
4)	Inverter running status	Logic check of the start signal and output current	Start signal (STF signal, STR signal) Output current detection signal Y12 signal

1) Checking by the output of the inverter fault signal

When the inverter's protective function activates and the inverter trips, the fault output signal (ALM signal) is output. (ALM signal is assigned to terminal A1B1C1 in the initial setting).

With this signal, you can check if the inverter is operating properly. In addition, negative logic can be set (ON when the inverter is normal, OFF when the fault occurs).

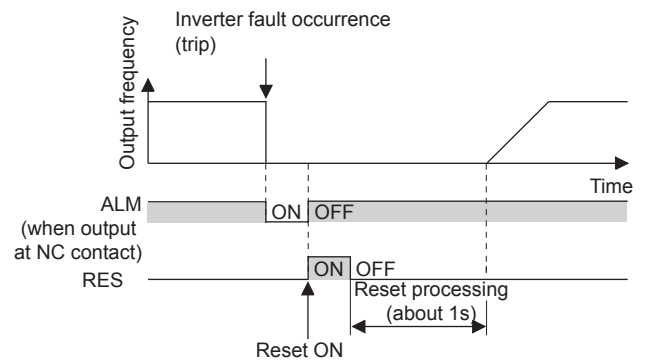

3 MAINTENANCE SYSTEM DESIGN

- 2) Checking the inverter operating status by the inverter operation ready completion signal
 Operation ready signal (RY signal) is output when the inverter power is ON and the inverter becomes operative.
 Check if the RY signal is output after powering ON the inverter.

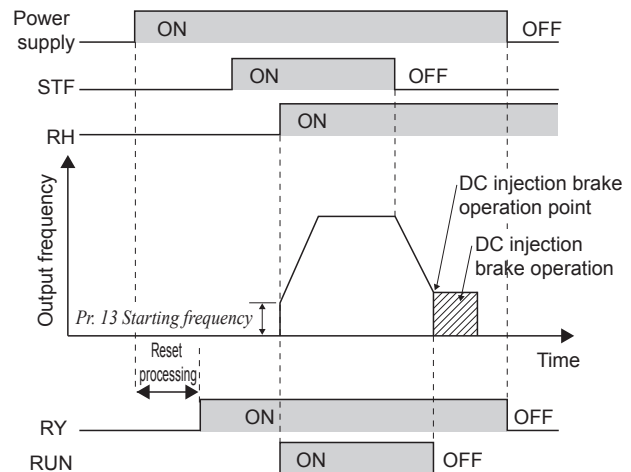

- 3) Checking the inverter operating status by the start signal input to the inverter and inverter running signal.
 The inverter running signal (RUN signal) is output when the inverter is running (RUN signal is assigned to terminal RUN in the initial setting).
 Check if RUN signal is output when inputting the start signal to the inverter (forward signal is STF signal and reverse signal is STR signal). For logic check, note that RUN signal is output for the period from the inverter decelerates until output to the motor is stopped, configure a sequence considering the inverter deceleration time.
- 4) Checking the motor operating status by the start signal input to the inverter and inverter output current detection signal.
 The output current detection signal (Y12 signal) is output when the inverter operates and currents flows in the motor.
 Check if Y12 signal is output when inputting the start signal to the inverter (forward signal is STF signal and reverse signal is STR signal). Also, adjust the current level that outputs Y12 signal by Pr.150 output current detection level around 20%, using the no-load current of the motor.
 For logic check, as same as the inverter running signal (RUN signal), the inverter outputs for the period from the inverter decelerates until output to the motor is stopped, configure a sequence considering the inverter deceleration time.

Output signal	Output terminal function selection parameter setting value	
	Positive logic	Negative logic
ALM	99	199
RY	11	111
RUN	0	100
Y12	12	112

•When using each signal, refer to the left table to assign function to the output terminal.

☒ POINTS for understanding !

- Changing the terminal assignment using output terminal function selection may affect the other functions. Make setting after confirming the function of each terminal.

3 MAINTENANCE SYSTEM DESIGN

(2) Backup method outside the inverter

Even if the interlock is provided by the inverter status signal, enough failsafe is not ensured depending on the failure status of the inverter itself. For example, when the inverter CPU fails, even if the interlock is provided using the inverter fault signal, start signal and RUN signal, there is a case where a fault signal is not output and RUN signal is kept output even if an inverter fault occurs.

Provide a speed detector to detect the motor speed and current detector to detect the motor current and consider the backup system such as checking up as below according to the level of importance of the system.

- 1) Start signal and actual operation check
Check the motor running and motor current while the start signal is input to the inverter by comparing the start signal to the inverter and detected speed of the speed detector or detected current of the current detector. Note that the motor current runs as the motor is running for the period until the motor stops since the inverter starts decelerating even if the start signal turns off. For the logic check, configure a sequence considering the inverter deceleration time. In addition, it is recommended to check the three-phase current when using the current detector.

- 2) Command speed and actual operation check
Check if there is no gap between the actual speed and commanded speed by comparing the inverter speed command and detected speed of the speed detector.

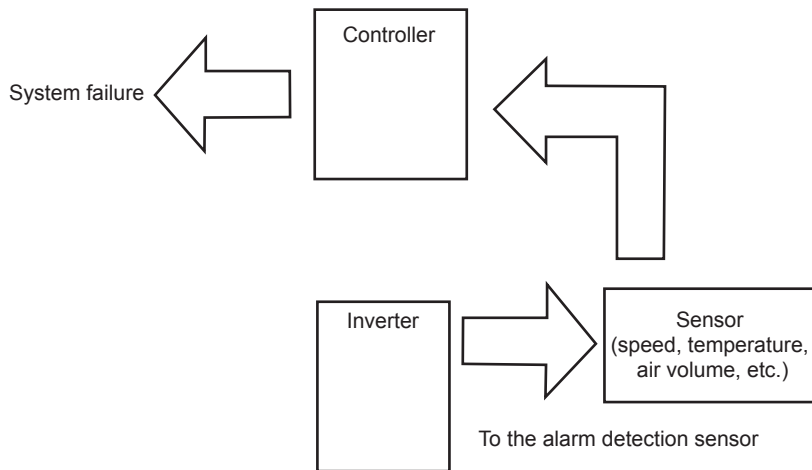

4 PREVENTIVE MAINTENANCE

Chapter 4 PREVENTIVE MAINTENANCE

Preventive maintenance is consisted of daily maintenance and periodic maintenance.

4.1 Necessity of Preventive Maintenance

After a production system breaks down and is under repair, high productivity of equipment cannot be achieved.

While the highest priority is to have equipment that will not fail or stop, if preventive maintenance is carried out critical breakdowns will be less frequent and in event of a breakdown repair time is shorter.

4 PREVENTIVE MAINTENANCE

4.2 Maintenance and Inspection

The inverter is a static unit mainly consisting of semiconductor devices. Daily inspection must be performed to prevent any fault from occurring due to the adverse effects of the operating environment, such as temperature, humidity, dust, dirt and vibration, changes in the parts with time, service life, and other factors.

4.2.1 Precautions for maintenance and inspection

When accessing the inverter for inspection, a high voltage remains in the smoothing capacitor for some short time after the power is switched off. Wait until the charge lamp turns off, then make sure that the voltage across the main circuit terminals P/+ and N/- of the inverter is not more than 30VDC using a tester.

4.2.2 Inspection item

(1) Daily inspection

- Basically, check for the following faults during operation.
 - 1) Motor operation fault
 - 2) Improper installation environment
 - 3) Cooling system fault
 - 4) Unusual vibration and noise
 - 5) Unusual overheat and discoloration

(2) Periodic inspection

- Check the areas inaccessible during operation and requiring periodic inspection.
 - 1) Check for cooling system fault Clean the air filter, etc.
 - 2) Tightening check and retightening The screws and bolts may become loose due to vibration, temperature changes, etc.
 - 3) Check the conductors and insulating materials for corrosion and damage.
 - 4) Measure insulation resistance.
 - 5) Check and change the cooling fan and relay.

(Note) Understand that the contents of the power supply display that indicates the inverter is running or an error (fault) display that indicates a trouble on general inverter. Also check the electron thermal and the accelerating/decleration time, etc from the parameter unit, and record the normal setting value.

Refer to the table on the next page for the daily and periodic maintenance item, and judgement criteria.

1	IMPORTANCE OF PRODUCTIVE MAINTENANCE
2	UNDERSTANDING INVERTER SYSTEM
3	MAINTENANCE SYSTEM DESIGN
4	PREVENTIVE MAINTENANCE
5	BREAKDOWN MAINTENANCE
6	CORRECTIVE MAINTENANCE
7	REVISING INSTALLATION ENVIRONMENT
8	LIFE OF INVERTER PARTS

4 PREVENTIVE MAINTENANCE

Daily and periodic inspection

Area of Inspection	Inspection Item	Description	Interval		Corrective Action at Alarm Occurrence	Customer's Check	
			Daily	Periodic *2			
General	Surrounding environment	Check the surrounding air temperature, humidity, dirt, corrosive gas, oil mist, etc.	<input type="radio"/>		Improve environment		
	Overall unit	Check for unusual vibration and noise.	<input type="radio"/>		Check alarm location and retighten		
	Power supply voltage	Check that the main circuit voltages and control voltages are normal.*1	<input type="radio"/>		Inspect the power supply		
Main circuit	General	(1) Check with megger (across main circuit terminals and earth (ground) terminal). (2) Check for loose screws and bolts. (3) Check for overheat traces on parts. (4) Check for stains.		<input type="radio"/>	Contact the manufacturer Retighten Contact the manufacturer Clean		
	Conductors, cables	(1) Check conductors for distortion. (2) Check cable sheaths for breakage and deterioration (crack, discoloration, etc.).		<input type="radio"/>	Contact the manufacturer Contact the manufacturer		
	Transformer/reactor	Check for unusual odors and abnormal increase in whining sound.	<input type="radio"/>		Stop the device and contact the manufacturer.		
	Terminal block	Check for damage.		<input type="radio"/>	Stop the device and contact the manufacturer.		
	Smoothing aluminum electrolytic capacitor	(1) Check for liquid leakage. (2) Check for safety valve projection and bulge. (3) Visual check and judge by the life check of the main circuit capacitor.		<input type="radio"/>	Contact the manufacturer Contact the manufacturer		
	Relay/contactors	Check that the operation is normal and no chatter is heard.		<input type="radio"/>	Contact the manufacturer		
	Relay/contactors	(1) Check for crack in resistor insulation. (2) Check for a break in the cable.		<input type="radio"/> <input type="radio"/>	Contact the manufacturer Contact the manufacturer		
Control circuit protective circuit	Operation check	(1) Check that the output voltages across phases with the inverter operated alone is balanced. (2) Check that no fault is found in protective and display circuits in a sequence protective operation test.		<input type="radio"/> <input type="radio"/>	Contact the manufacturer Contact the manufacturer		
	Parts check	Overall	(1) Check for unusual odors and discoloration. (2) Check for serious rust development.		<input type="radio"/> <input type="radio"/>	Stop the device and contact the manufacturer. Contact the manufacturer	
		Aluminum electrolytic capacitor	(1) Check for liquid leakage in a capacitor and deformation trace. (2) Visual check and judge by the life check of the control circuit capacitor.		<input type="radio"/> <input type="radio"/>	Contact the manufacturer	
Cooling system	Cooling fan	(1) Check for unusual vibration and noise. (2) Check for loose screws and bolts. (3) Check for stains.	<input type="radio"/>	<input type="radio"/> <input type="radio"/> <input type="radio"/>	Replace the fan Retighten Clean		
	Heatsink	(1) Check for clogging. (2) Check for stains.		<input type="radio"/> <input type="radio"/>	Clean Clean		
	Air filter, etc.	(1) Check for clogging. (2) Check for stains.		<input type="radio"/> <input type="radio"/>	Clean or replace Clean or replace		

4 PREVENTIVE MAINTENANCE

Daily and periodic inspection

Area of Inspection	Inspection Item	Description	Interval		Corrective Action at Alarm Occurrence	Customer's Check
			Daily	Periodic *2		
Display	Indication	(1) Check that display is normal. (2) Check for stains.	<input type="radio"/>	<input type="radio"/>	Clean or replace Clean	
	Meter	Check for stains.	<input type="radio"/>		Stop the device and contact the manufacturer.	
Load motor	Operation check	Check for vibration and abnormal increase in operation noise.	<input type="radio"/>		Stop the device and contact the manufacturer.	

*1 It is recommended to install a device to monitor voltage for checking the power supply voltage to the inverter.

*2 One to two years of periodic inspection cycle is recommended. However, it differs according to the installation environment. For periodic maintenance, consult your local Mitsubishi service center.

1	IMPORTANCE OF PRODUCTIVE MAINTENANCE
2	UNDERSTANDING INVERTER SYSTEM
3	MAINTENANCE SYSTEM DESIGN
4	PREVENTIVE MAINTENANCE
5	BREAKDOWN MAINTENANCE
6	CORRECTIVE MAINTENANCE
7	REVISING INSTALLATION ENVIRONMENT
8	LIFE OF INVERTER PARTS

4 PREVENTIVE MAINTENANCE

4.2.3 Measurement of main circuit voltages, currents and powers

- Measuring method of voltage and current of each part
 Since voltage and current on the inverter power supply and output sides include harmonics, measurement data depends on circuits measured.
 When instruments for commercial frequency are used for measurement, measure voltage and current using the following circuits with the instruments on the next page.
- When installing meters etc. on the inverter output side
 When the inverter-to-motor wiring length is large, especially in the 400V class, small-capacity models, the meters and CTs may generate heat due to line-to-line leakage current. Therefore, choose the equipment which has enough allowance for the current rating.
 When measuring and indicating the output voltage and output current of the inverter, it is recommended to utilize the terminals AM and FM output function of the inverter.

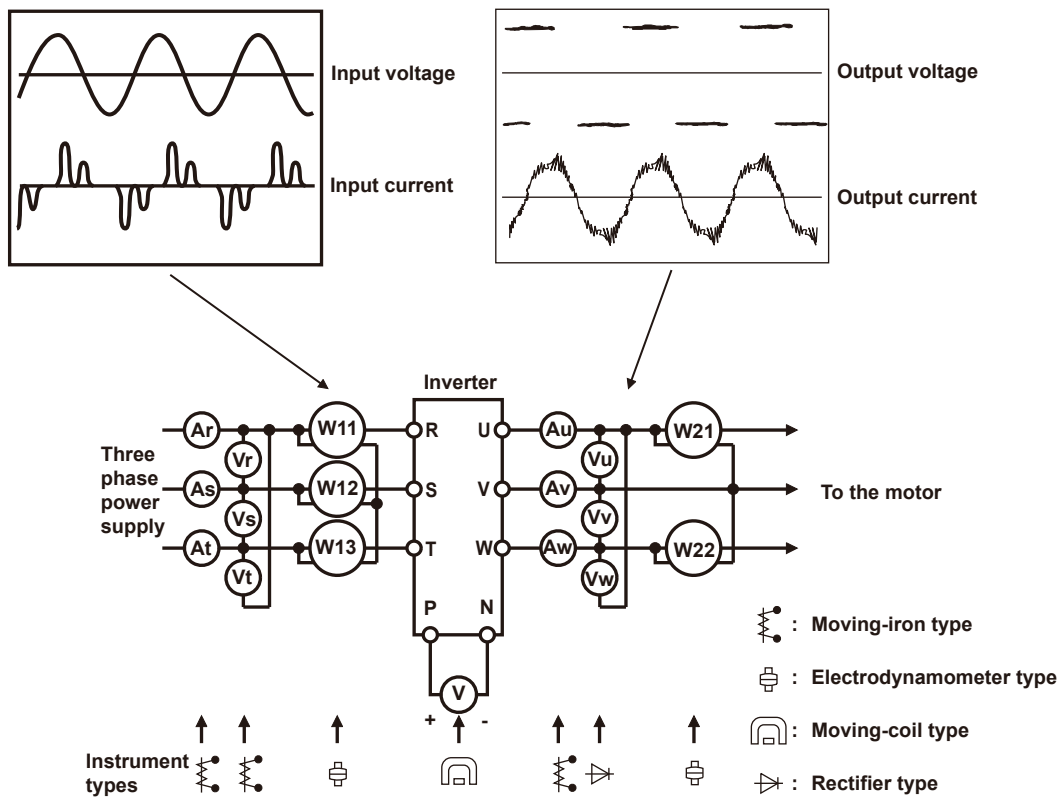

Examples of Measuring Points and Instruments

4 PREVENTIVE MAINTENANCE

Measuring points and instruments

Item	Measuring Point	Measuring Point	Remarks (Reference Measured Value)
Power supply voltage V ₁	Across R and S, S and T, T and R	Moving-iron type AC voltmeter *4	Commercial power supply Within permissible AC voltage fluctuation (Refer to the Instruction Manual of inverter)
Power supply side current I ₁	R, S, and T line currents	Moving-iron type AC ammeter *4	
Power supply side power P ₁	R, S, T and R and S, S and T, T and R	Electrodynamic type single- phase wattmeter	P ₁ =W ₁₁ +W ₁₂ +W ₁₃ (3-wattmeter method)
Power supply side power factor Pf ₁	Calculate after measuring power supply voltage, power supply side current and power supply side power. $Pf_1 = \frac{P_1}{\sqrt{3} V_1 \times I_1} \times 100\%$		
Output side voltage V ₂	Across U and V, V and W, W and U	Rectifier type AC voltage meter *1*4 (Moving-iron type cannot measure)	Difference between the phases is within ±1% of the maximum output voltage.
Output side current I ₂	U, V and W line currents	Moving-iron type AC ammeter *2*4	Difference between the phases is 10% or lower of the rated inverter current.
Output side power P ₂	U, V, W and U and V, V and W	Electrodynamic type single- phase wattmeter	P ₂ =W ₂₁ +W ₂₂ 2-wattmeter method (or 3-wattmeter method)
Output side power factor Pf ₂	Calculate in similar manner to power supply side power factor. $Pf_2 = \frac{P_2}{\sqrt{3} V_2 \times I_2} \times 100\%$		
Converter output	Across P and N	Moving-coil type (such as tester)	POWER lamp ON 1.35 × V ₁ Maximum during regeneration 380VDC (760VDC) *3

1
IMPORTANCE OF
PRODUCTIVE
MAINTENANCE

2
UNDERSTANDING
INVERTER SYSTEM

3
MAINTENANCE
SYSTEM DESIGN

4
PREVENTIVE
MAINTENANCE

5
BREAKDOWN
MAINTENANCE

6
CORRECTIVE
MAINTENANCE

7
REVISING
INSTALLATION
ENVIRONMENT

8
LIFE OF INVERTER
PARTS

4 PREVENTIVE MAINTENANCE

Measuring points and instruments

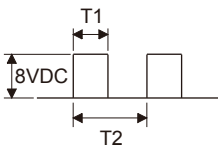
Item	Measuring Point	Measuring Point	Remarks (Reference Measured Value)							
Frequency setting signal	Across 2(+) and 5		0 to 5VDC/0 to 10VDC							
	Across 1(+) and 5		0 to ±5VDC, 0 to ±10VDC							
	Across 4(+) and 5		4 to 20mA							
Frequency setting power supply	Across 10 (+) and 5		5VDC							
	Across 10E(+) and 5		10VDC							
Frequency meter signal	Across AM(+) and 5	(Tester and such may be used) (Internal resistance: 50kΩ or larger)	Approximately 10VDC at maximum frequency (without frequency meter)							
	Across FM(+) and SD		Approximately 5VDC at maximum frequency (without frequency meter)  Pulse width T1: Adjusted by Pr. 900 Pulse cycle T2: Set by Pr. 55 (Valid for frequency monitoring only)							
Start signal	Across SD and the following: STF, STR, RH, RM, RL, JOG, RT, AU, STOP, CS (+)		When open 20 to 30VDC Reset Across RES (+) and SD ON voltage: 1V or less							
Select signal										
Reset	Across RES (+) and SD									
Output stop	Across MRS (+) and SD									
Fault signal	Across A and C	Moving-coil type (such as tester)	Conduction check							
	Across B and C		<table border="0"> <tr> <td></td> <td><Abnormal></td> <td><Normal></td> </tr> <tr> <td>Across A and C</td> <td>No conduction</td> <td>Conduction</td> </tr> <tr> <td>Across B and C</td> <td>Conduction</td> <td>No conduction</td> </tr> </table>		<Abnormal>	<Normal>	Across A and C	No conduction	Conduction	Across B and C
	<Abnormal>	<Normal>								
Across A and C	No conduction	Conduction								
Across B and C	Conduction	No conduction								

*1 Use an FFT to measure the output voltage accurately. A tester or general measuring instrument cannot measure accurately.

*2 When the carrier frequency exceeds 5kHz, do not use this instrument since using it may increase eddy-current losses produced in metal parts inside the instrument, leading to burnout. If the wiring length between the inverter and motor is long, the instrument and CT may generate heat due to line-to-line leakage current.

*3 The value inside brackets shows the value of 400V-class.

*4 A digital power meter (designed for inverter) can also be used to measure.

Chapter 5 BREAKDOWN MAINTENANCE

Troubles by failure or accidents can be caused even though preventive maintenance is performed. If the inverter becomes faulty by any unexpected reason and the production system stops, corrective maintenance is required.

5.1 Troubleshooting

The following charts show the troubleshooting flow for each phenomenon. Perform an appropriate troubleshooting depending on each trouble content.

"Pr." in a troubleshooting flow shows parameters. For example, "Pr.0" shows the parameter No. 0.

5.1.1 When the operation panel does not become powered

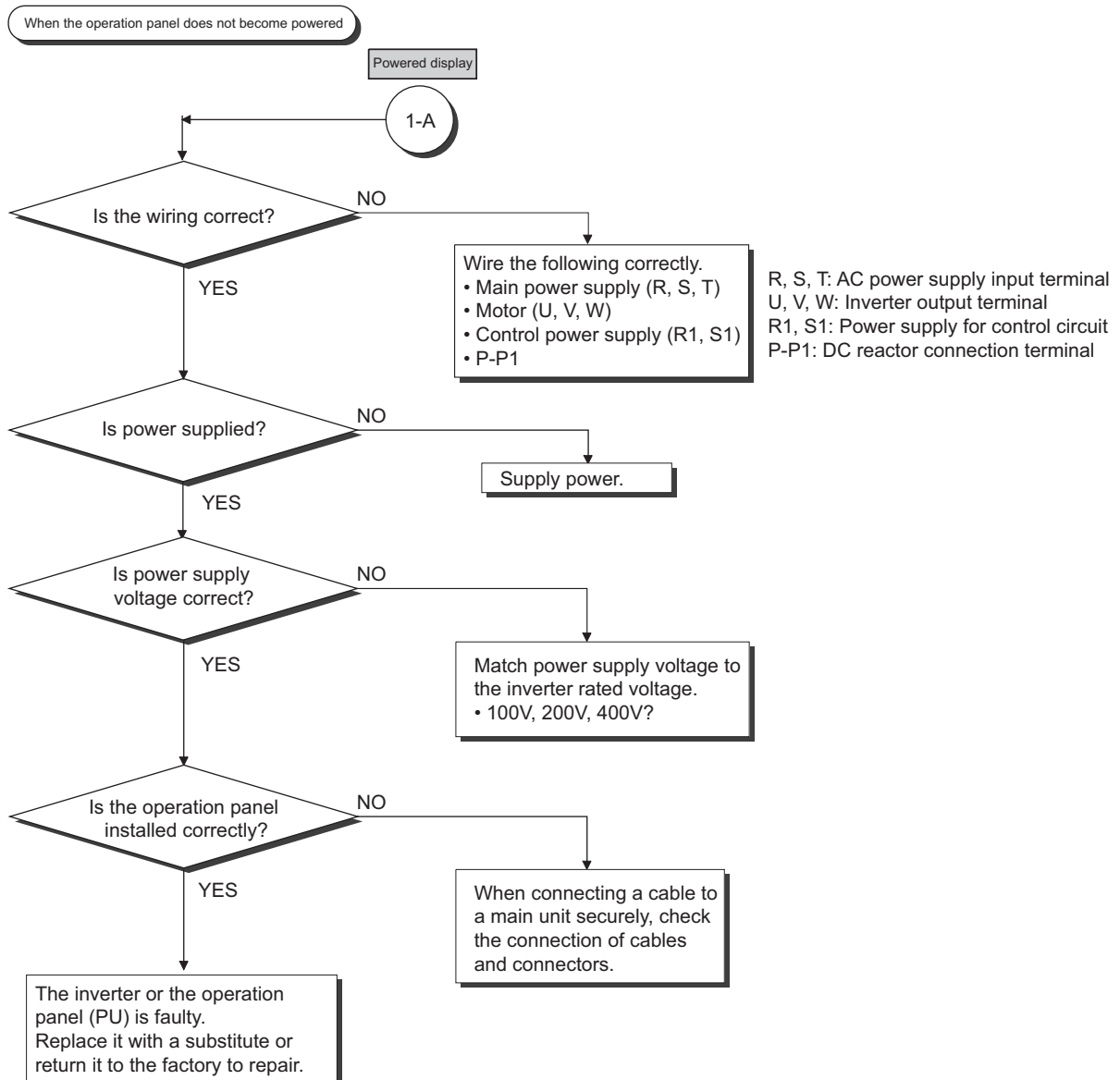

5.1.2 When parameter cannot be set

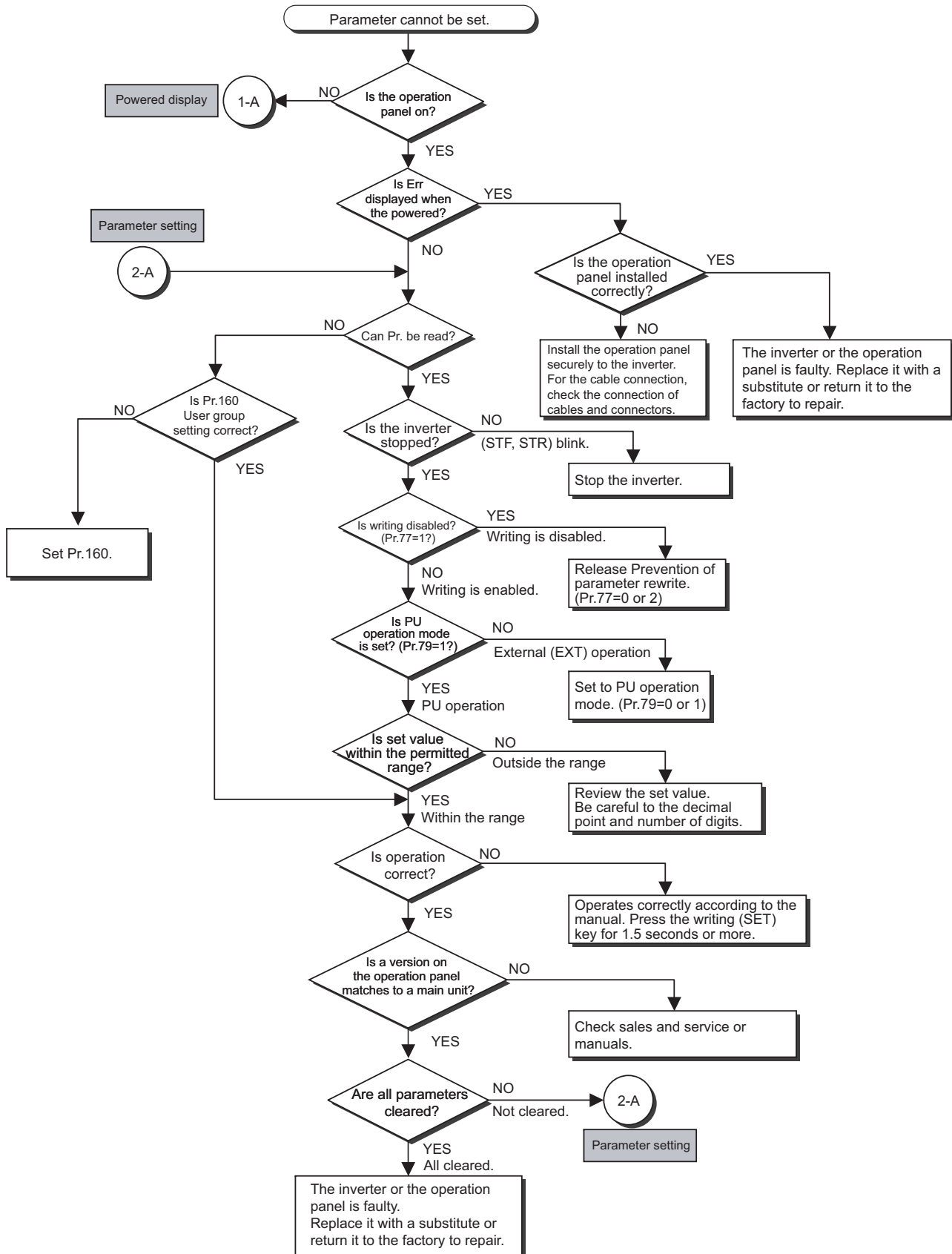

5 BREAKDOWN MAINTENANCE

5.1.3 When the motor does not start

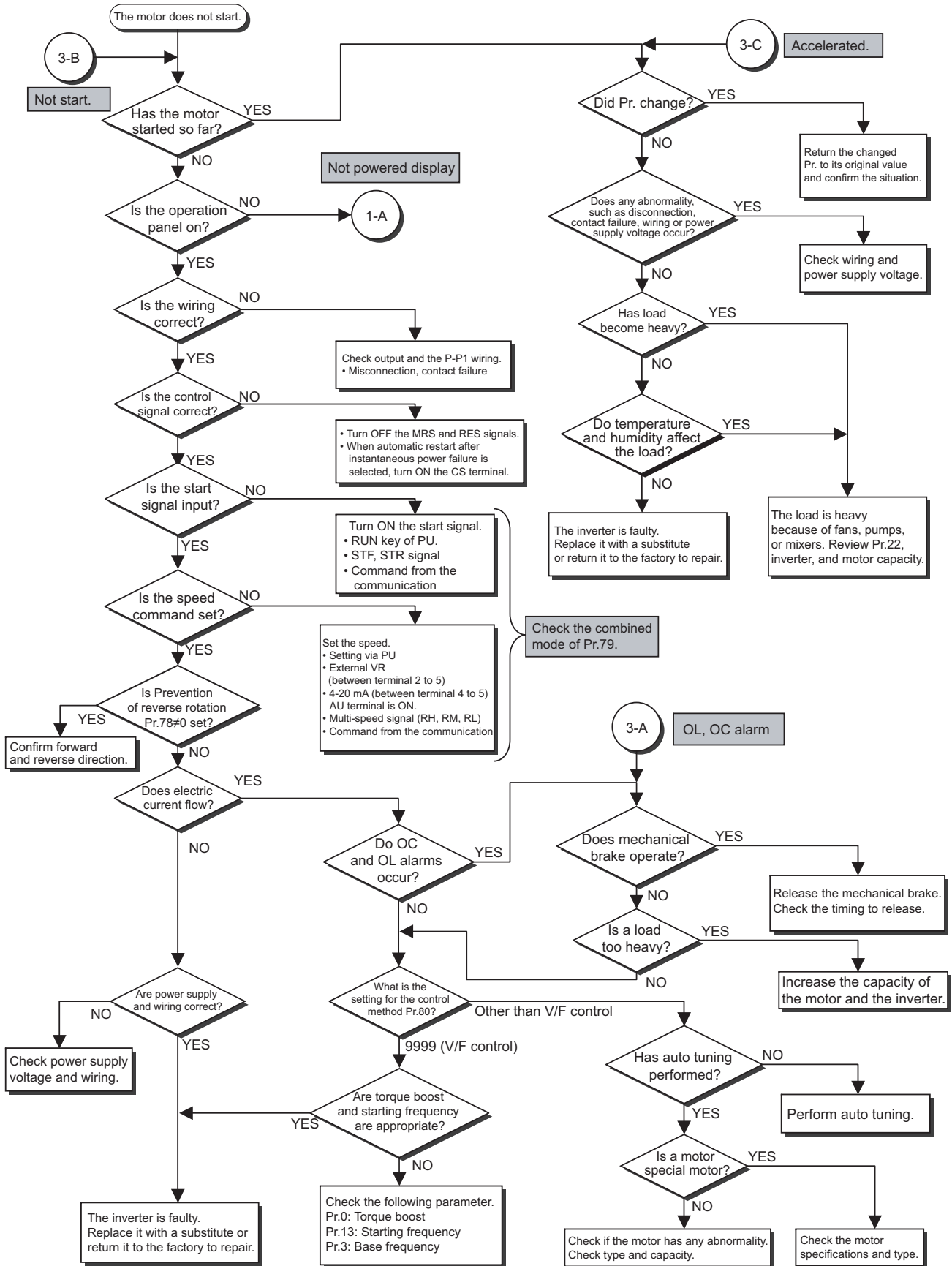

1 IMPORTANCE OF PRODUCTIVE MAINTENANCE
 2 UNDERSTANDING INVERTER SYSTEM
 3 MAINTENANCE SYSTEM DESIGN
 4 PREVENTIVE MAINTENANCE
 5 **BREAKDOWN MAINTENANCE**
 6 CORRECTIVE MAINTENANCE
 7 REVISING INSTALLATION ENVIRONMENT
 8 LIFE OF INVERTER PARTS

5.1.4 When the motor does not accelerate

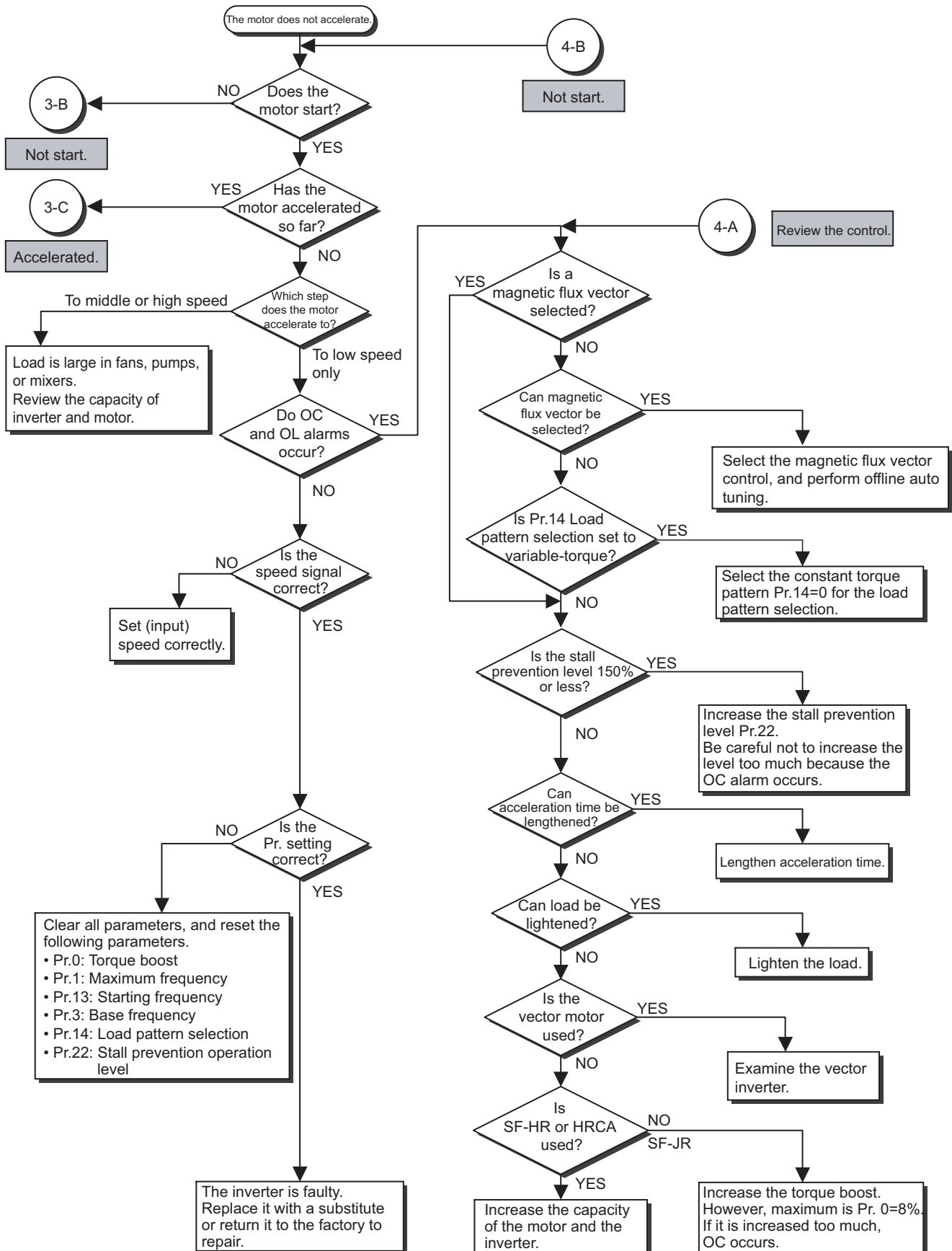

5 BREAKDOWN MAINTENANCE

5.1.5 When the motor speed does not become the set speed

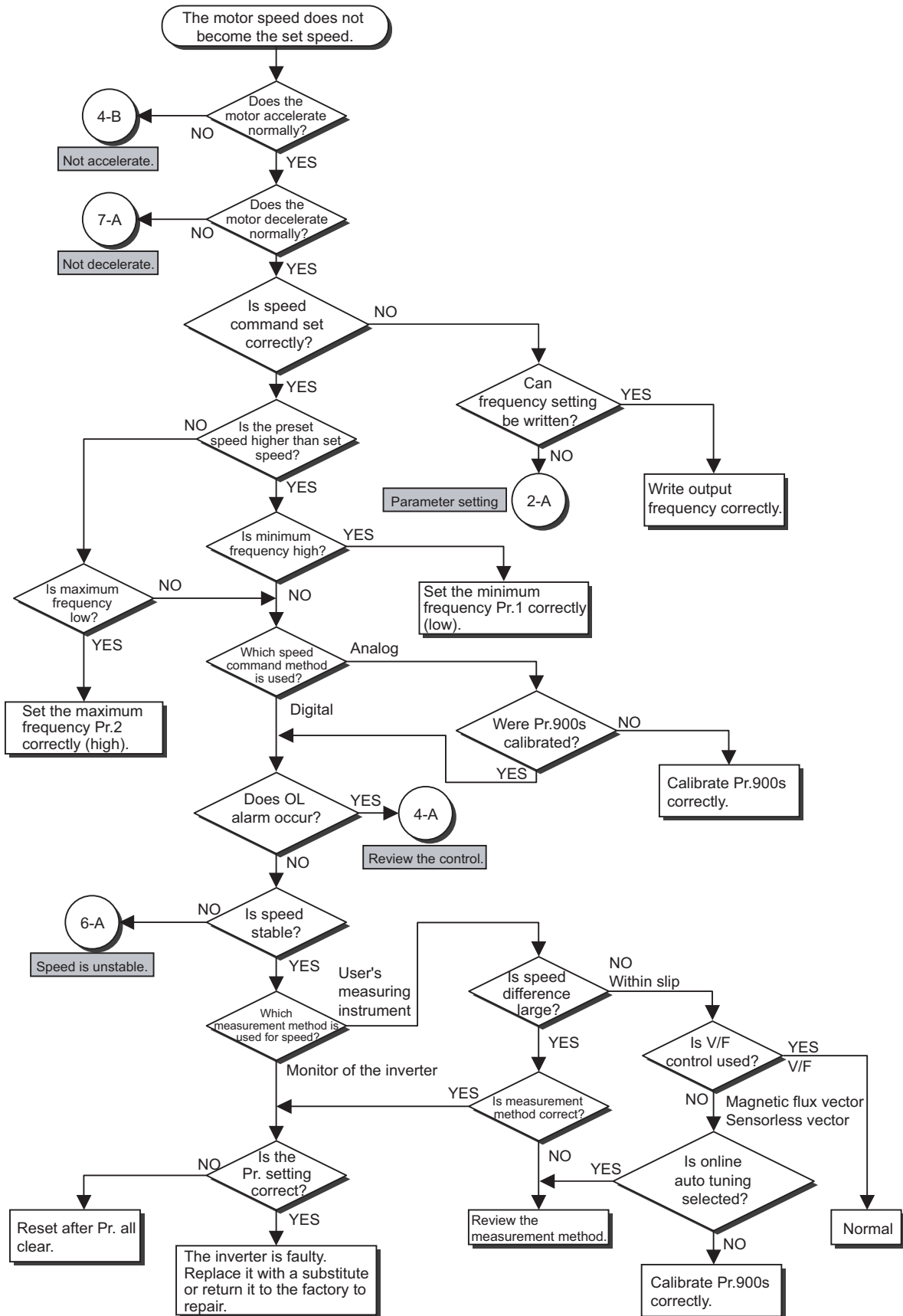

1 IMPORTANCE OF PRODUCTIVE MAINTENANCE
 2 UNDERSTANDING INVERTER SYSTEM
 3 MAINTENANCE SYSTEM DESIGN
 4 PREVENTIVE MAINTENANCE
 5 **BREAKDOWN MAINTENANCE**
 6 CORRECTIVE MAINTENANCE
 7 REVISING INSTALLATION ENVIRONMENT
 8 LIFE OF INVERTER PARTS

5.1.6 When motor speed is unstable

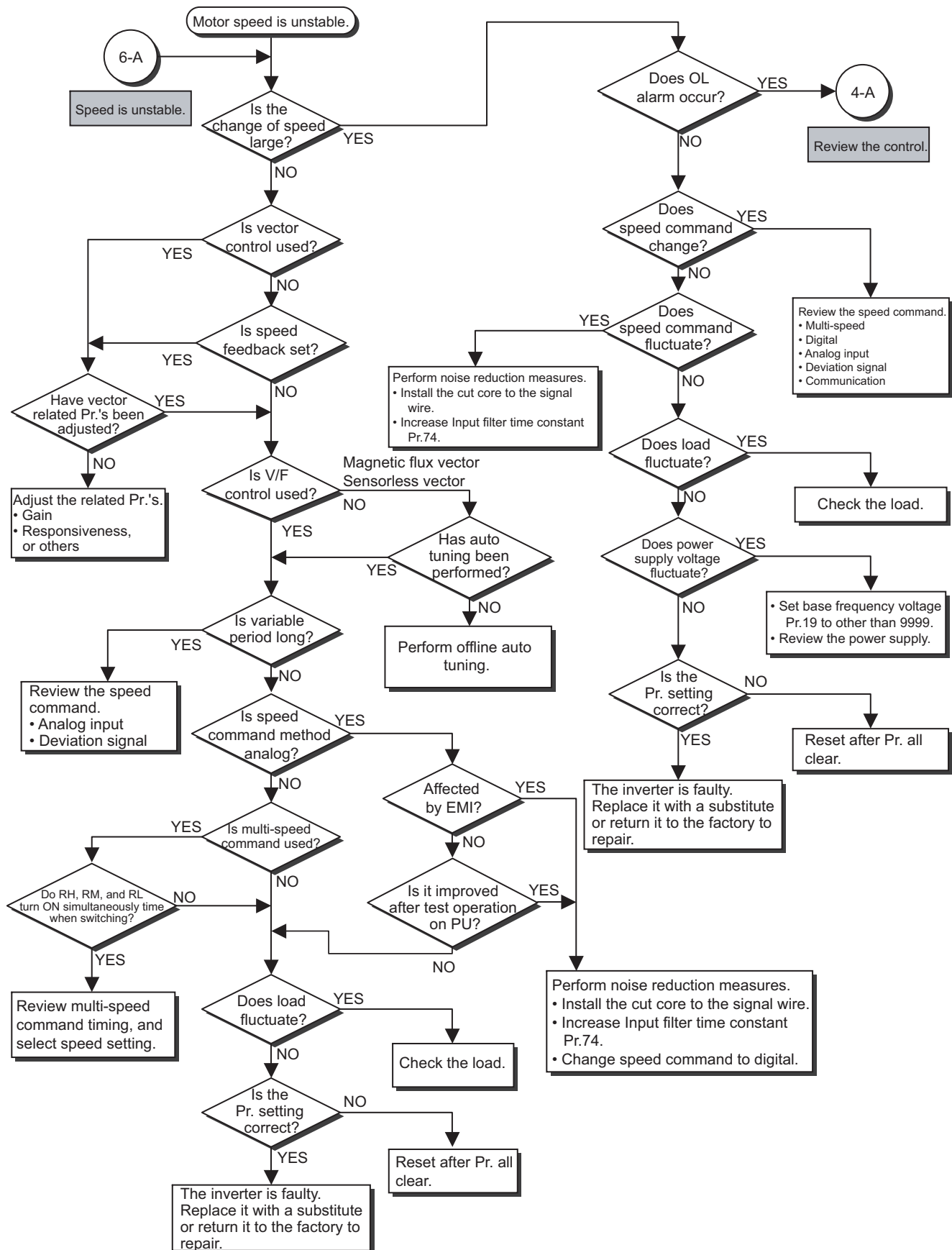

5 BREAKDOWN MAINTENANCE

5.1.7 When the motor does not decelerate and stop

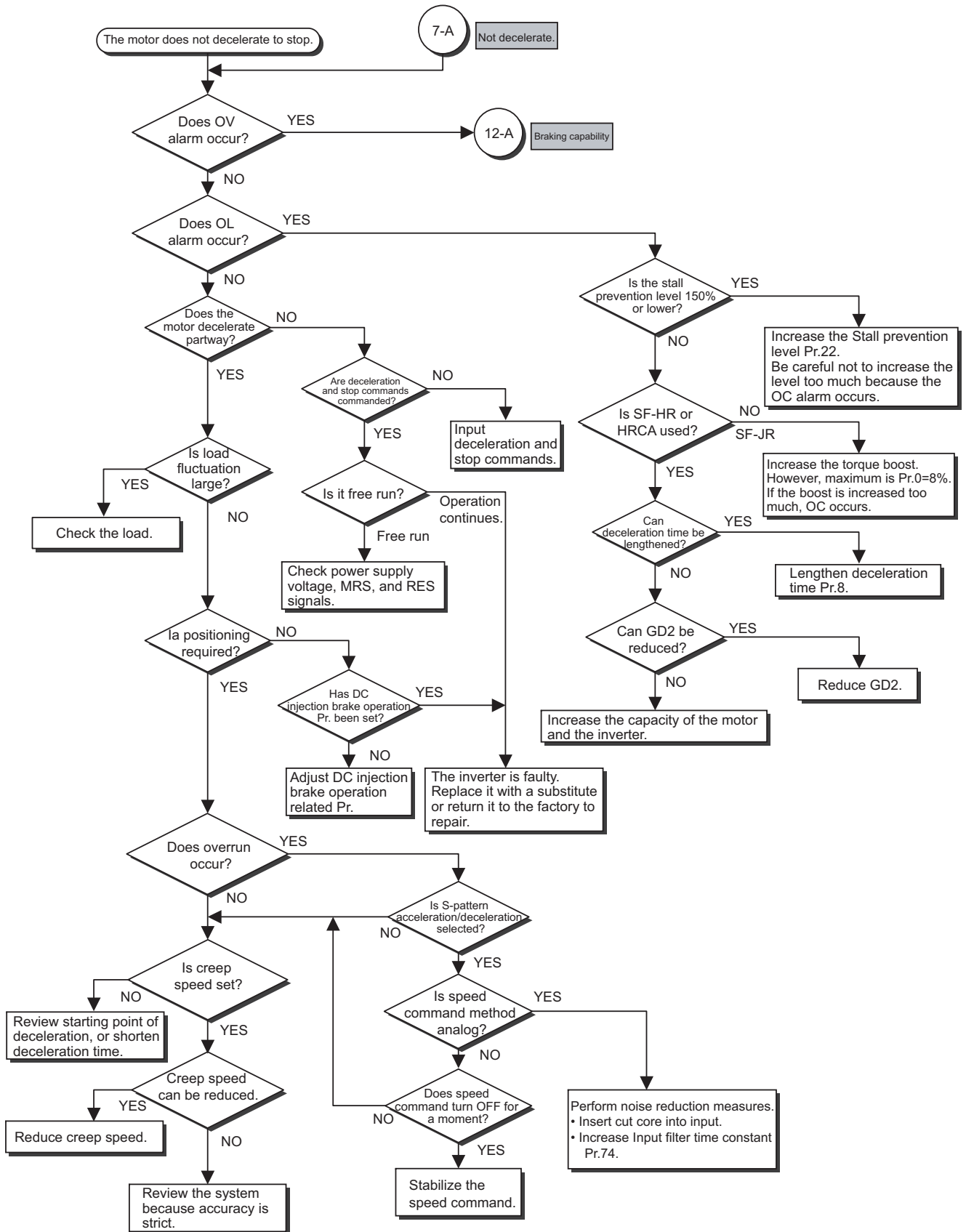

1 IMPORTANCE OF PRODUCTIVE MAINTENANCE
 2 UNDERSTANDING INVERTER SYSTEM
 3 MAINTENANCE SYSTEM DESIGN
 4 PREVENTIVE MAINTENANCE
 5 BREAKDOWN MAINTENANCE
 6 CORRECTIVE MAINTENANCE
 7 REVISING INSTALLATION ENVIRONMENT
 8 LIFE OF INVERTER PARTS

5.1.8 When automatic restart after instantaneous power failure does not work

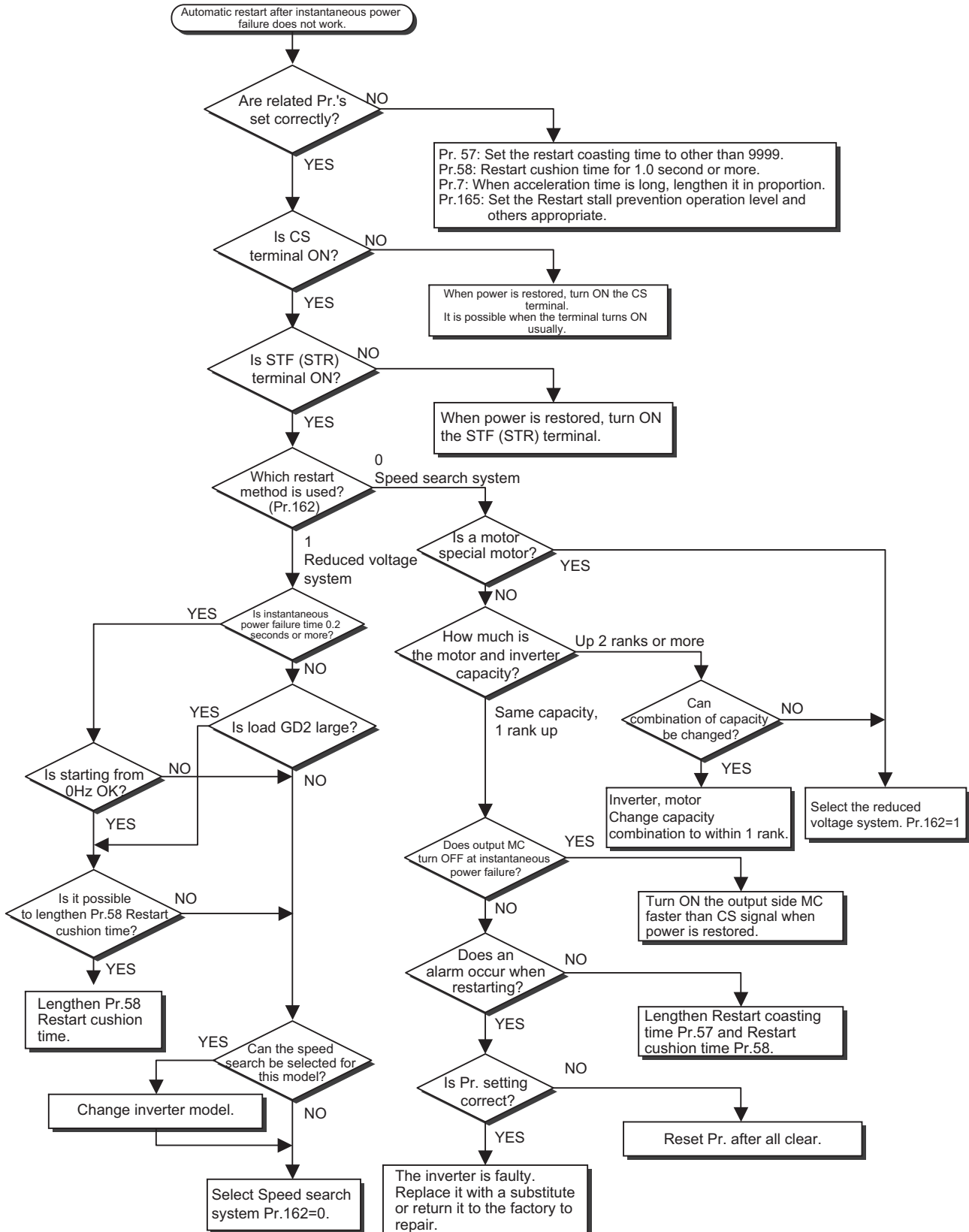

5 BREAKDOWN MAINTENANCE

5.1.9 When unusual noise is generated from the motor

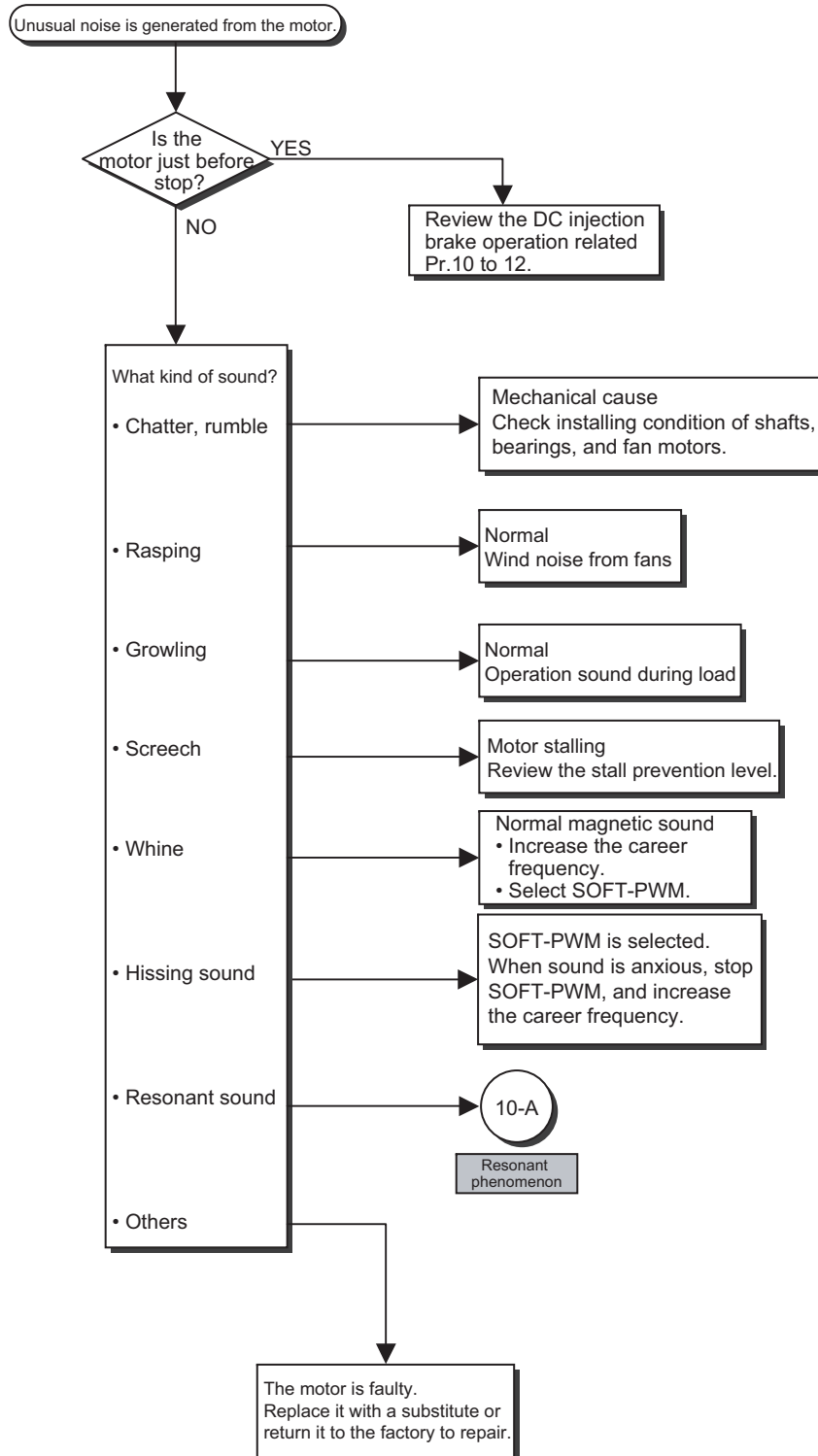

5.1.10 When the motor vibrates unusually

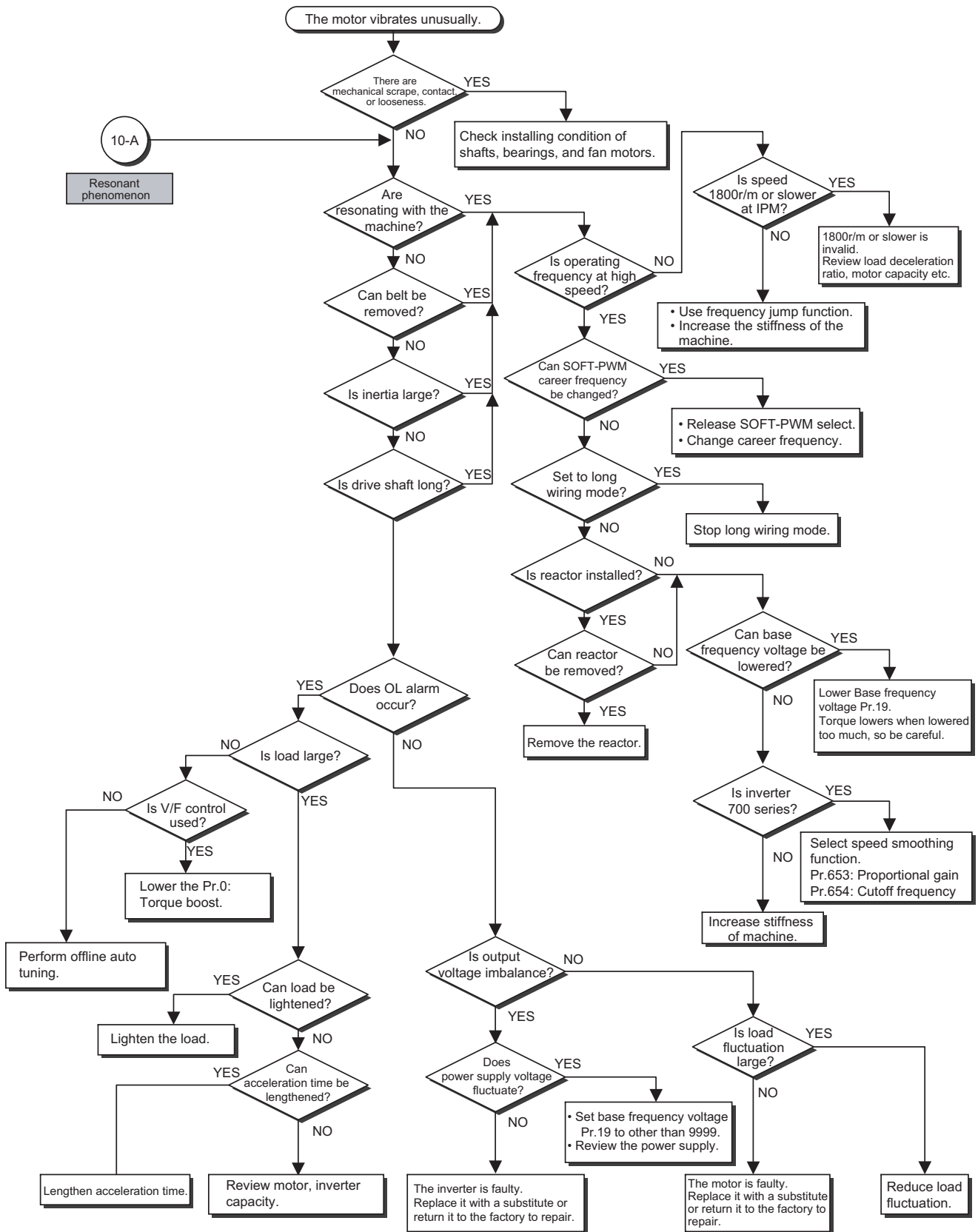

5 BREAKDOWN MAINTENANCE

5.1.11 When OC alarm occurs

1 IMPORTANCE OF PRODUCTIVE MAINTENANCE
 2 UNDERSTANDING INVERTER SYSTEM
 3 MAINTENANCE SYSTEM DESIGN
 4 PREVENTIVE MAINTENANCE
 5 BREAKDOWN MAINTENANCE
 6 CORRECTIVE MAINTENANCE
 7 REVISING INSTALLATION ENVIRONMENT
 8 LIFE OF INVERTER PARTS

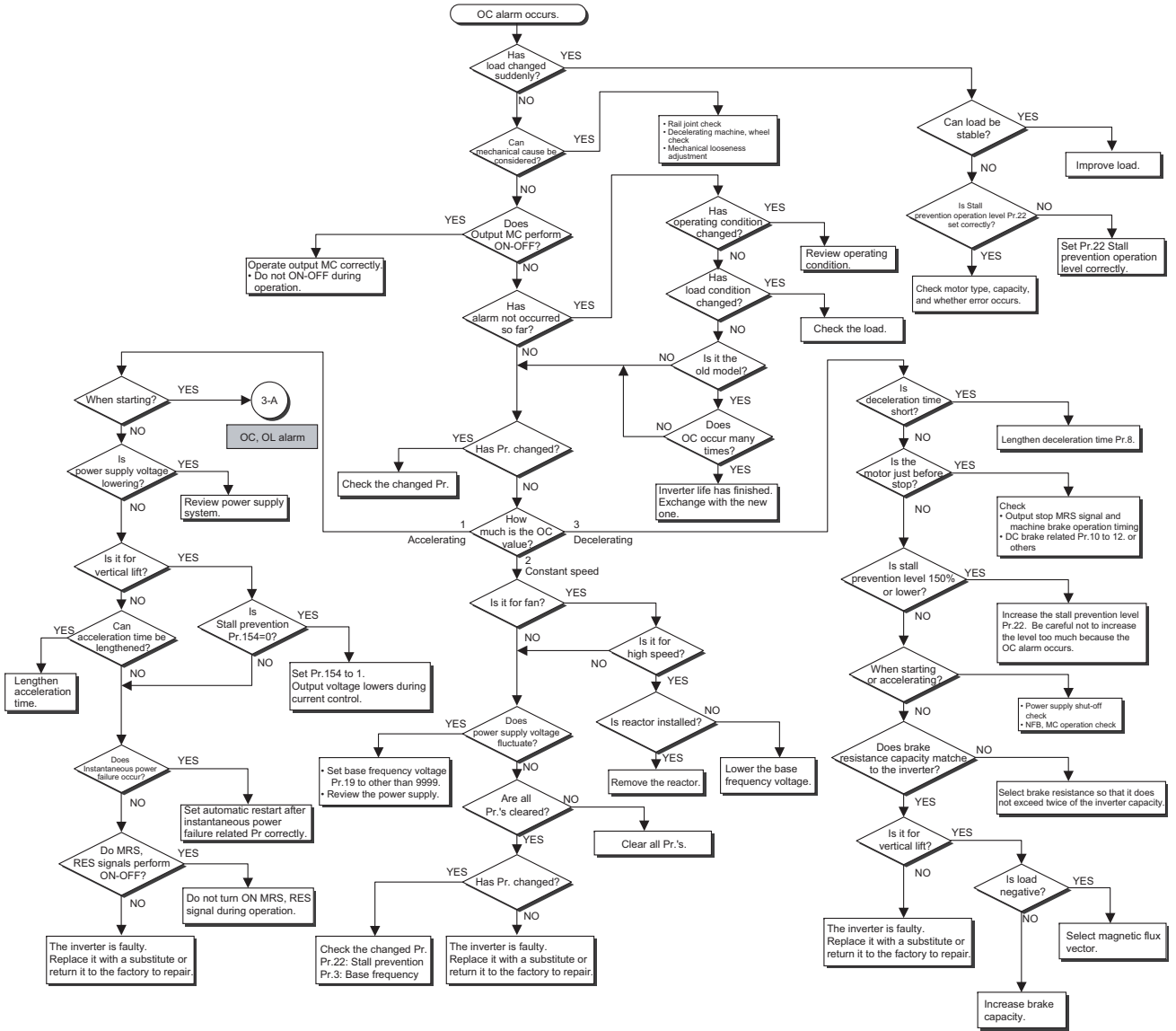

5.1.12 When OV alarm occurs

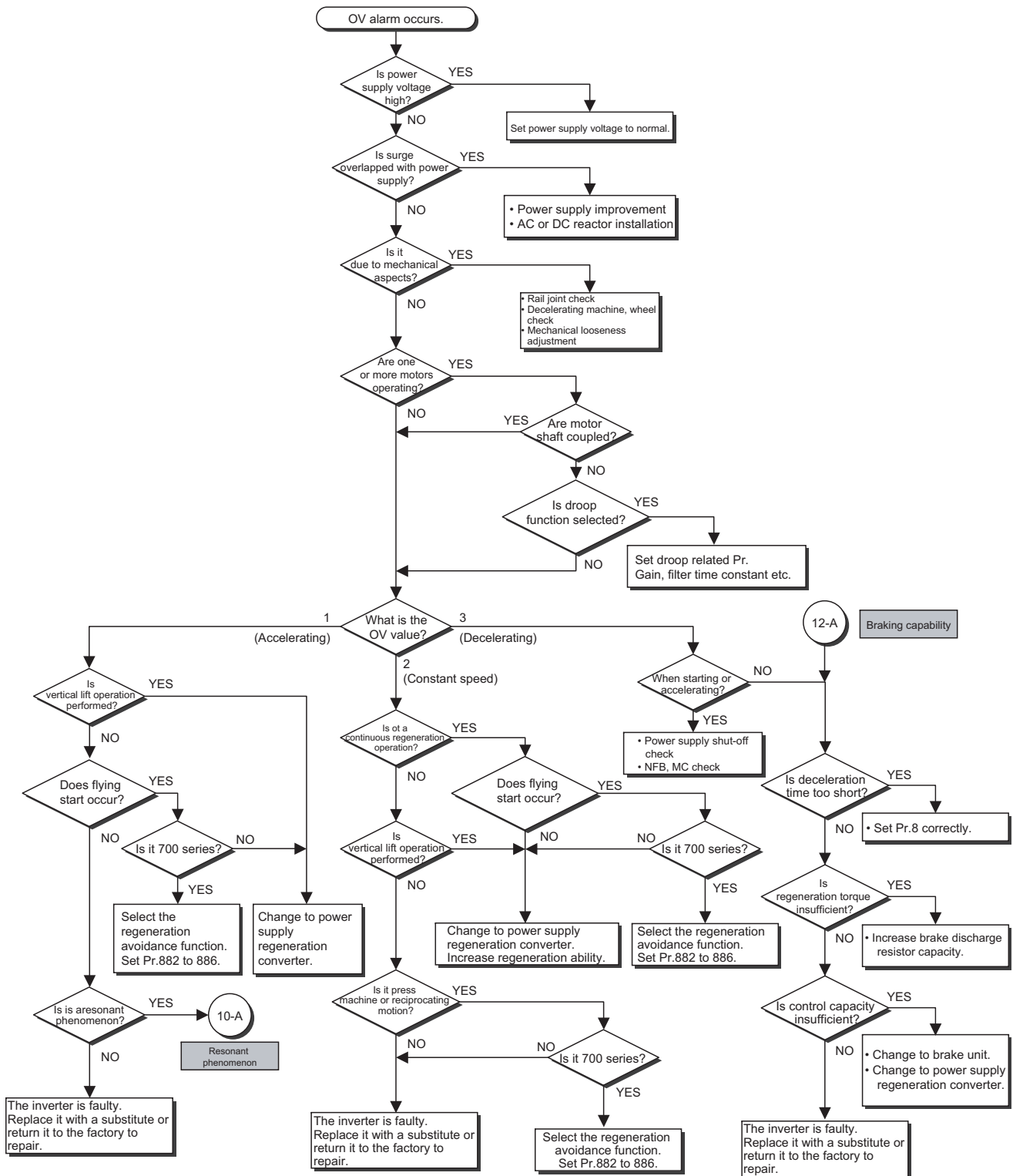

5 BREAKDOWN MAINTENANCE

5.1.13 When analog input cannot be calibrated (When adjusting gain Pr. 903, Pr. 905)

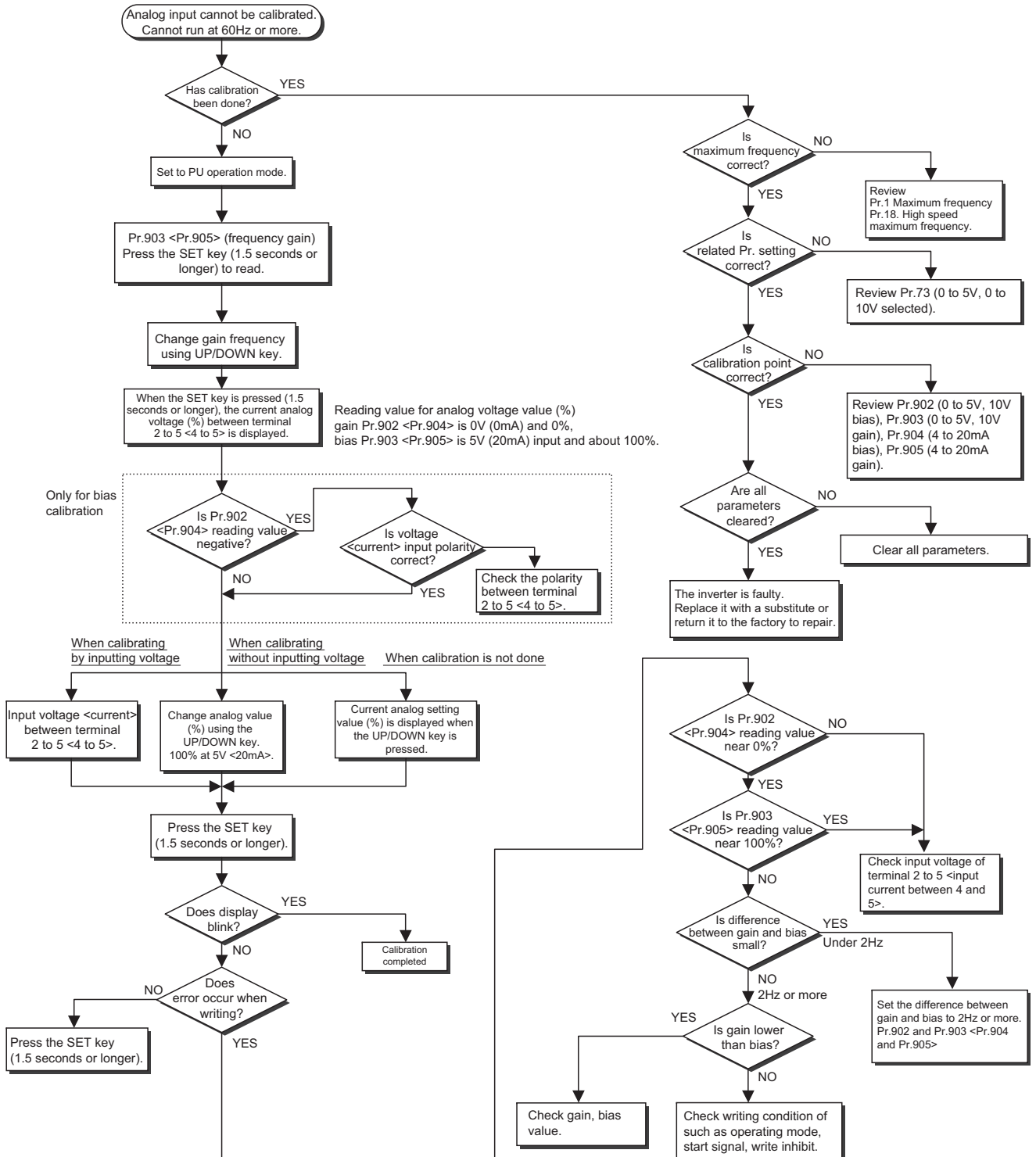

1 IMPORTANCE OF PRODUCTIVE MAINTENANCE
 2 UNDERSTANDING INVERTER SYSTEM
 3 MAINTENANCE SYSTEM DESIGN
 4 PREVENTIVE MAINTENANCE
5 BREAKDOWN MAINTENANCE
 6 CORRECTIVE MAINTENANCE
 7 REVISING INSTALLATION ENVIRONMENT
 8 LIFE OF INVERTER PARTS

5.2 Troubleshooting by the Demonstration Machine

Troubleshoot using the demonstration machine. Operate according to the described procedures. Check the symptom and take measures.

5.2.1 Stall prevention (overcurrent) (OL display) [Demonstration]

Change Pr.22 (Stall prevention operation level) from initial value 150% to 45%, and set STF and high speed RH (ON). Turn the knob of the load setting to the right as far as it goes from 60Hz display. Operate with load (ON) load torque 150%. Check that the OL display appears and the motor stops.

(1) Procedure

- 1) Use FR Configurator and check the output current value.

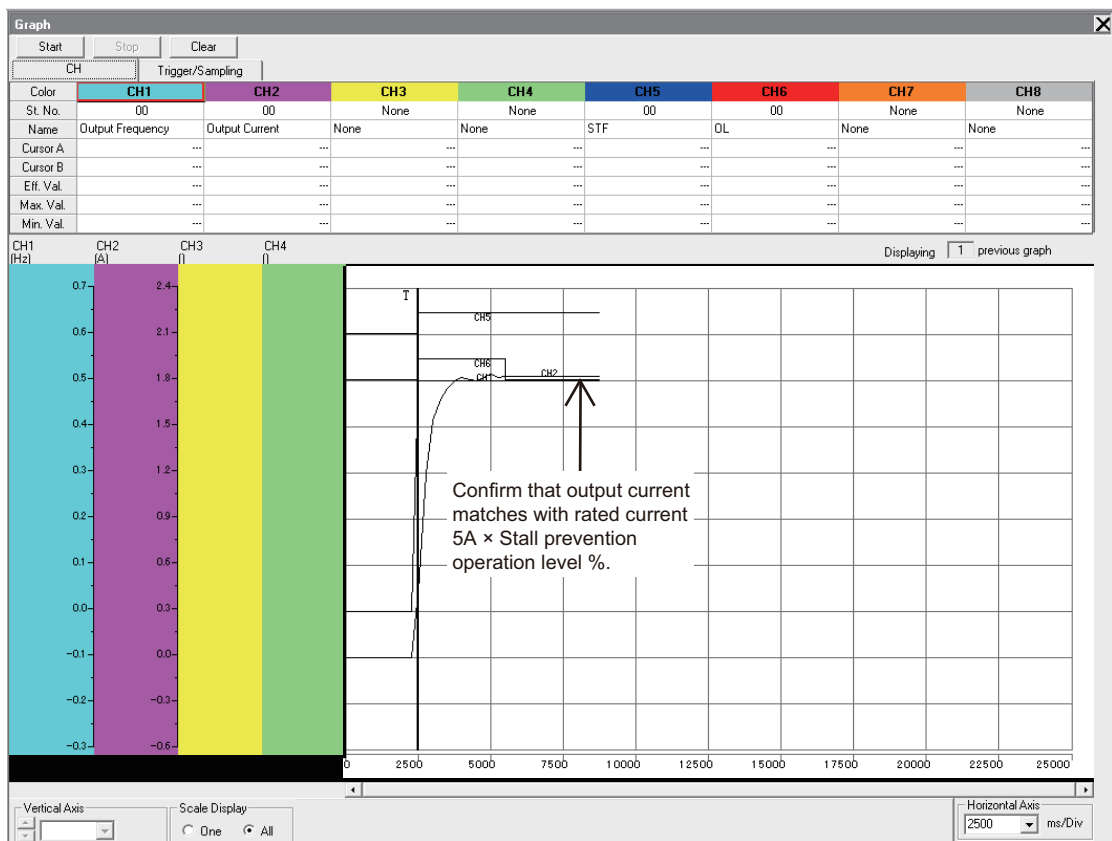

- 2) Check that the stall prevention (overcurrent) (OL display) occurs when the value is higher than the current that is set on P.22.

Task 1 Change Pr.22 (Stall prevention operation level) and obtain the threshold of the existence or non-existence of OL display.

Task 2 Adjust the volume of the load setting, and obtain the setting value that the stall prevention (overcurrent) (OL display) occurs.

5 BREAKDOWN MAINTENANCE

5.2.2 Stall prevention stop (E.OLT display) [Demonstration]

Check that the stop by the stall prevention (E.OLT display) occurs.

Change Pr.22 (Stall prevention operation level) from initial value 150% to 10%, and set STF and high speed RH (ON). Check that E.OLT is displayed 3 or 4 seconds later.

(1) Procedure

- 1) Use FR Configurator to check the output current value.

CH		Trigger/Sampling	
		Trigger	Sampling Setting
Type	Inside	Single/Continuous	Single
CH	CH05	Mode	Monitor
Start At	Rise	Interval[ms]	150
Level	0.00	Time[ms]	15000
Position[%]	50		

Start position of trigger and sampling are set to 50% in the chart below.

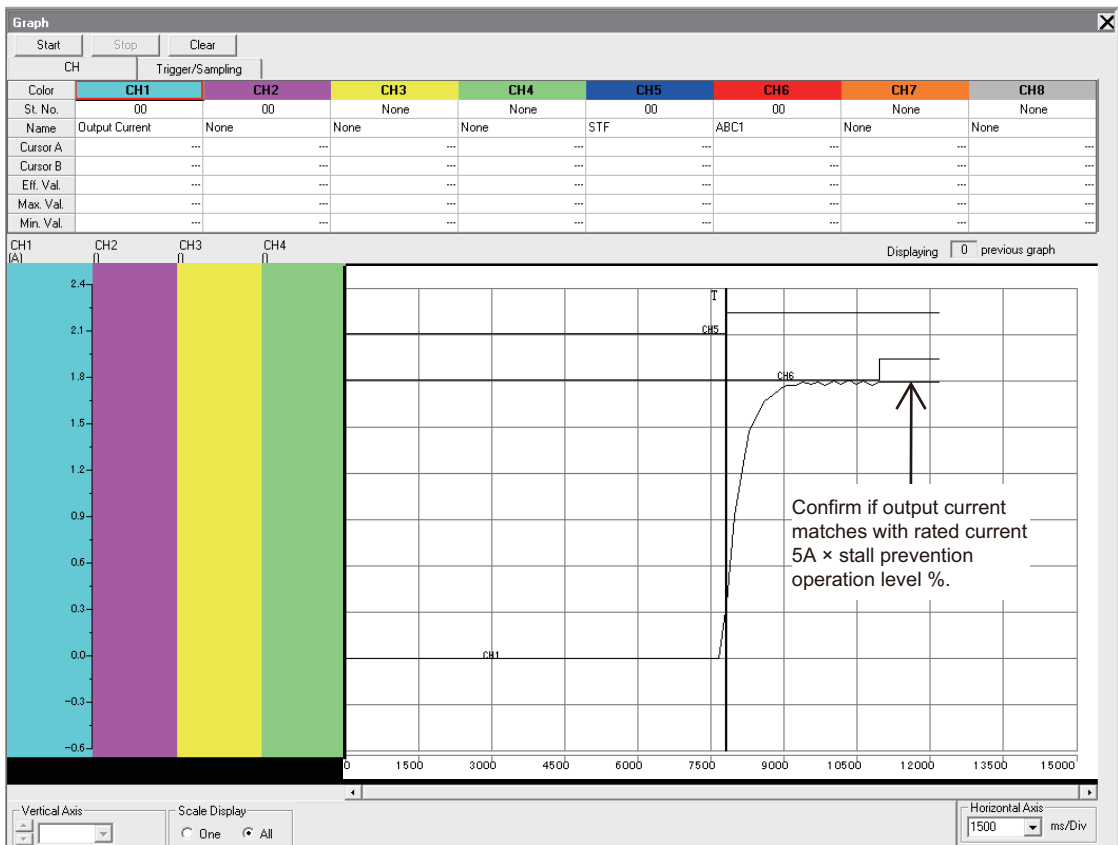

- 2) Check that the stop by the stall prevention (E.OLT display) occurs at the output current that is lower than the normal value.

Task 1 Change Pr.22 (Stall prevention operation level) and obtain the setting value that the stop by the stall prevention (overcurrent) (E.OLT display) occurs.

• • • After the demonstration • • •

Put the Pr.22 (Stall prevention operation level) back to the initial value 150%.

5 BREAKDOWN MAINTENANCE

5.2.3 Regeneration overvoltage trip during decelerating (E.OV3 display) [Demonstration]

Change initial value of Pr.8 (Deceleration time) from 5 seconds to 1 second. Set STF, high speed RH (ON), and set STF (OFF) on 60Hz. Check that E.OV3 is displayed.

(1) Procedure

- 1) Use FR Configurator and measure the timing when regeneration over voltage trip during deceleration (E.OV3 display) occurs, and the level of the converter output voltage.

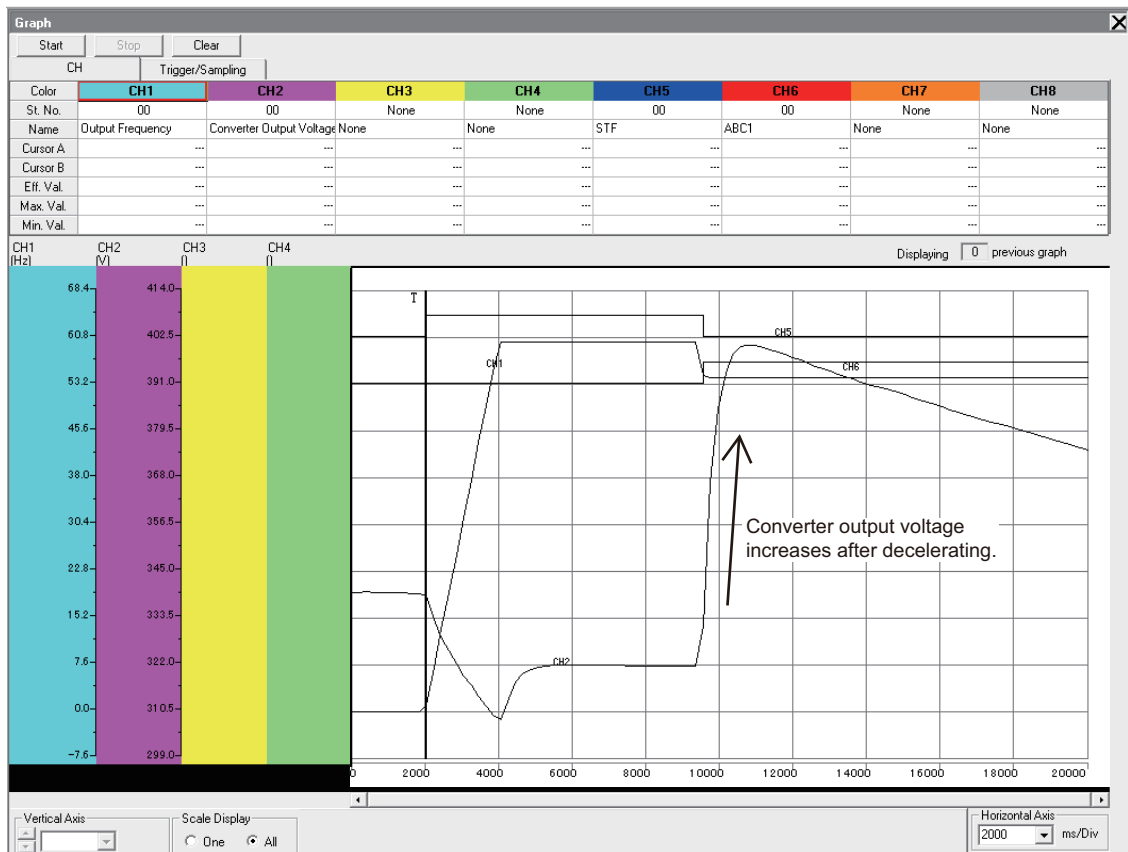

Task 1 | Change Pr.8 (Deceleration time) and obtain the setting value that E.OV3 display occurs and does not occur, and the level of the converter output voltage.

Task 2 | When setting Pr.8 (Deceleration time) longer, the display changes from E.OV3 display to OL warning display. Obtain the setting value that changes the display at that time and the level of the converter output voltage.

Task 3 | Turn the knob to the right with the load setting ON, and compare the changes on the levels of tasks 1 and 2.

• • • After the demonstration • • •

Put the setting of Pr.8 (Seceleration time) back to the setting without warning or error.

5 BREAKDOWN MAINTENANCE

5.2.4 Electronic thermal relay function pre-alarm (TH display) and Motor overload trip (electronic thermal relay function) (E.THM display) [Demonstration]

Change Pr.9 (Electronic thermal O/L relay) from 2.0 to 1.00 (electronic thermal relay function setting value for the demonstration machine). Set STF, high speed RH (ON) and turn the knob of the load setting to the right as far as it goes from 60Hz display. Operate with the load (ON) load torque 150%. Check that TH display appears approximately 30 seconds later and E.THM display appears approximately 50 seconds later and that it is on the free run condition.

(1) Procedure

- 1) Use FR Configurator and measure the output current when the electronic thermal relay function pre-alarm (TH display) and motor overload trip (electronic thermal relay function) (E.THM display) occurs.

Start		Stop		Clear	
CH		Trigger/Sampling			
Type	Inside	Single/Continuous	Sampling Setting		
CH	CH06	Mode	Monitor		
Start At	Rise	Interval[ms]	250		
Level	0.00	Time[ms]	25000		
Position[%]	90				

Start position of trigger and sampling are set to 90% in the chart below.

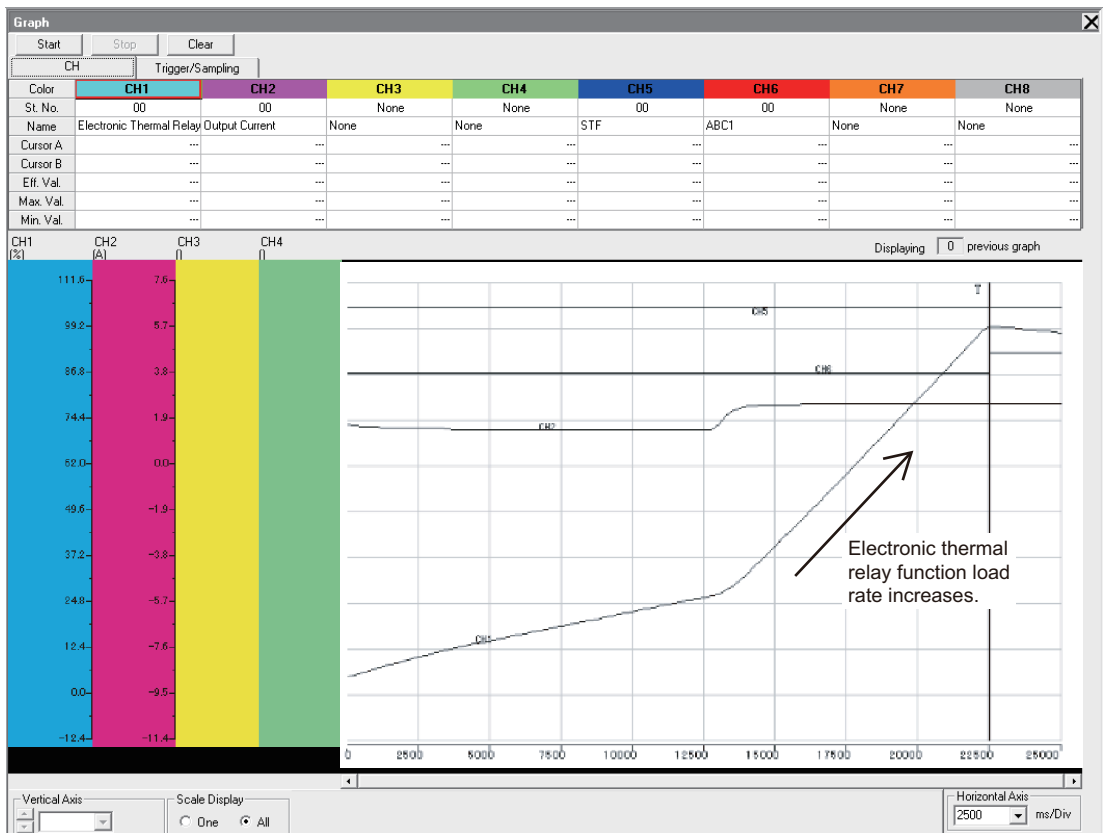

Task 1 Change Pr.9 (Electronic thermal O/L relay) and compare the timings when the output current and E.THM display appear.

5 BREAKDOWN MAINTENANCE

• • • After the demonstration • • •

Put Pr.9 (Electronic thermal O/L relay) back to 2.0 (electronic thermal relay function setting value for the demonstration machine).

☒ POINTS for understanding !

Electronic thermal relay function operation characteristic (THM)

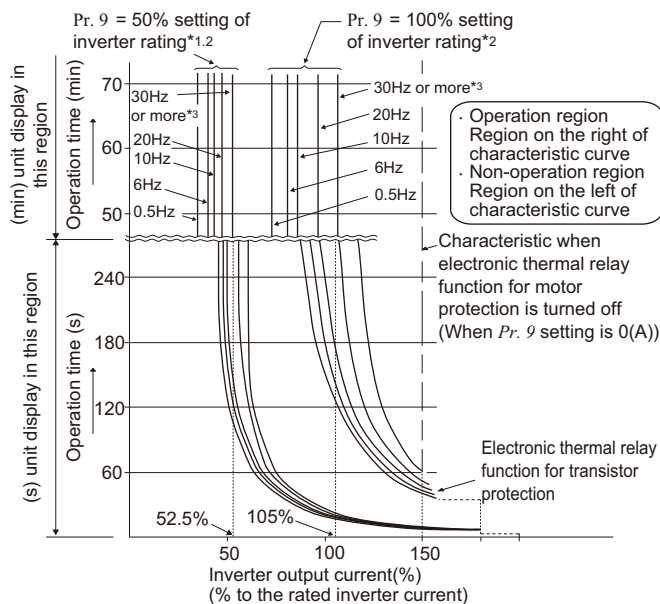

This function detects the overload (overheat) of the motor, stops the operation of the inverter's output transistor, and trips.

(The operation characteristic is shown on the left)

- Set the rated current [A] of the motor in Pr. 9. (If the motor has both 50Hz and 60Hz rating and the Pr. 3 Base frequency is set to 60Hz, set the 1.1 times of the 60Hz rated motor current.)
- Set "0" in Pr. 9 when you do not want to activate the electronic thermal relay function, e.g. when using an external thermal relay with the motor. (Note that the output transistor protection of the inverter functions (E.THT).)

*1 When 50% of the rated inverter current (current value) is set in Pr. 9

*2 The % value denotes the percentage to the rated inverter current. It is not the percentage to the motor rated current.

*3 When you set the electronic thermal relay function dedicated to the Mitsubishi constant-torque motor, this characteristic curve applies to operation at 6Hz or higher. (Refer to page 187 for the operation characteristic.)

5 BREAKDOWN MAINTENANCE

5.2.5 Output phase loss (E.LF display) [Demonstration]

Check that E.LF is displayed due to the U phase loss, a few seconds after switching the left switch on the rear side to the motor phase loss side, and STF, high speed RH (ON) is set.

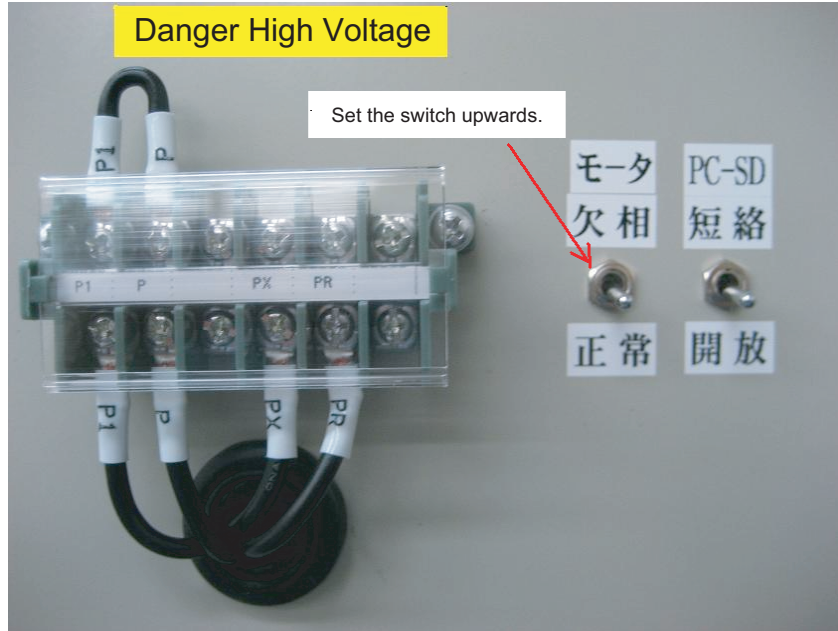

1

IMPORTANCE OF
PRODUCTIVE
MAINTENANCE

2

UNDERSTANDING
INVERTER SYSTEM

3

MAINTENANCE
SYSTEM DESIGN

4

PREVENTIVE
MAINTENANCE

5

**BREAKDOWN
MAINTENANCE**

6

CORRECTIVE
MAINTENANCE

7

REVISING
INSTALLATION
ENVIRONMENT

8

LIFE OF INVERTER
PARTS

5 BREAKDOWN MAINTENANCE

(1) Procedure

- 1) Use FR Configurator and check the output voltage, output current. Compare them with the normal value.

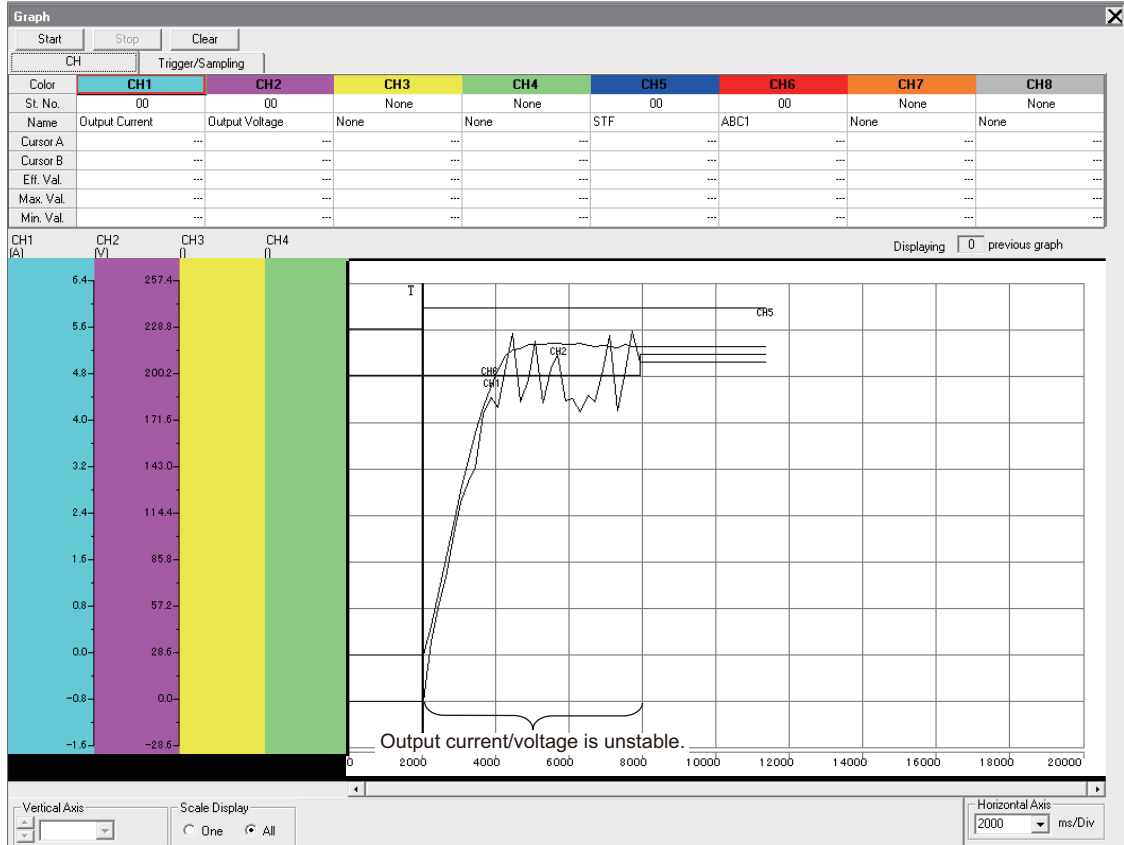

- 2) Switch the Motor phase loss/Normal switch on the rear side of the demonstration machine to Normal.

5 BREAKDOWN MAINTENANCE

5.2.6 24VDC power output short circuit (E.P24 display) [Demonstration]

Switch the right switch on the rear side to PC-SD short circuit, and check that E.P24 is displayed immediately.

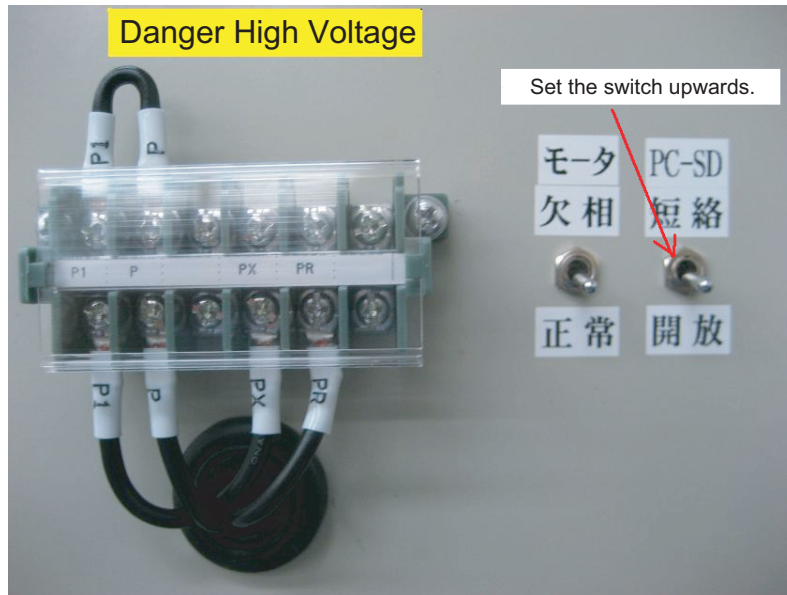

(1) Procedure

- 1) Switch the PC-SD short circuit/Release switch on the back side of the demonstration machine to Release.
- 2) Turn OFF/ON the power supply NFB of the demonstration machine and check that the display of the 24VDC power supply output short circuit (E.P24 display) is cleared.

5.2.7 Error (Err. display) [Demonstration]

Press and hold the RESET button while ON, and check that Err. display blinks.

(1) Procedure

- 1) Use FR Configurator and check that the error signal is ON.
- 2) Press the inverter reset RES button of the demonstration machine, and release the RESET button to turn OFF.

5 BREAKDOWN MAINTENANCE

5.2.8 Instantaneous power failure (E.IPF display), automatic restart after instantaneous power failure [Demonstration]

Set STF, high speed RH (ON) and display on 60Hz. Turn the load button (ON) and turn the knob of the load setting to the right as far as it goes. Set the load torque to 150%. Set the timer of the instantaneous power failure to 0.03 to 0.05 seconds, and press the instantaneous power failure button. Check that E.IPF is displayed.

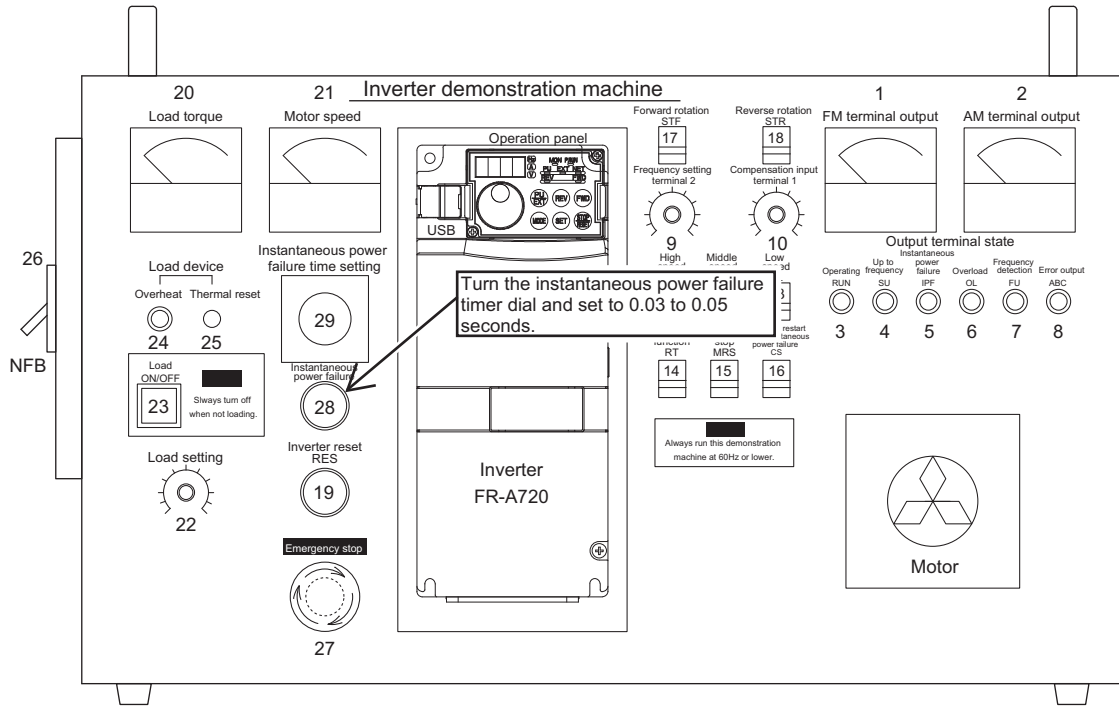

1	IMPORTANCE OF PRODUCTIVE MAINTENANCE
2	UNDERSTANDING INVERTER SYSTEM
3	MAINTENANCE SYSTEM DESIGN
4	PREVENTIVE MAINTENANCE
5	BREAKDOWN MAINTENANCE
6	CORRECTIVE MAINTENANCE
7	REVISING INSTALLATION ENVIRONMENT
8	LIFE OF INVERTER PARTS

5 BREAKDOWN MAINTENANCE

(1) Procedure on the instantaneous power failure

- 1) Use FR Configurator and check the graph when E.IPF is displayed.

Start		Stop		Clear	
CH		Trigger/Sampling			
Type	Inside	Single/Continuous	Single	Sampling Setting	
CH	CH05	Mode	Monitor		
Start At	Rise	Interval[ms]	150		
Level	0.00	Time[ms]	15000		
Position[%]	50				

Start position of trigger and sampling are set to 50% in the chart below.

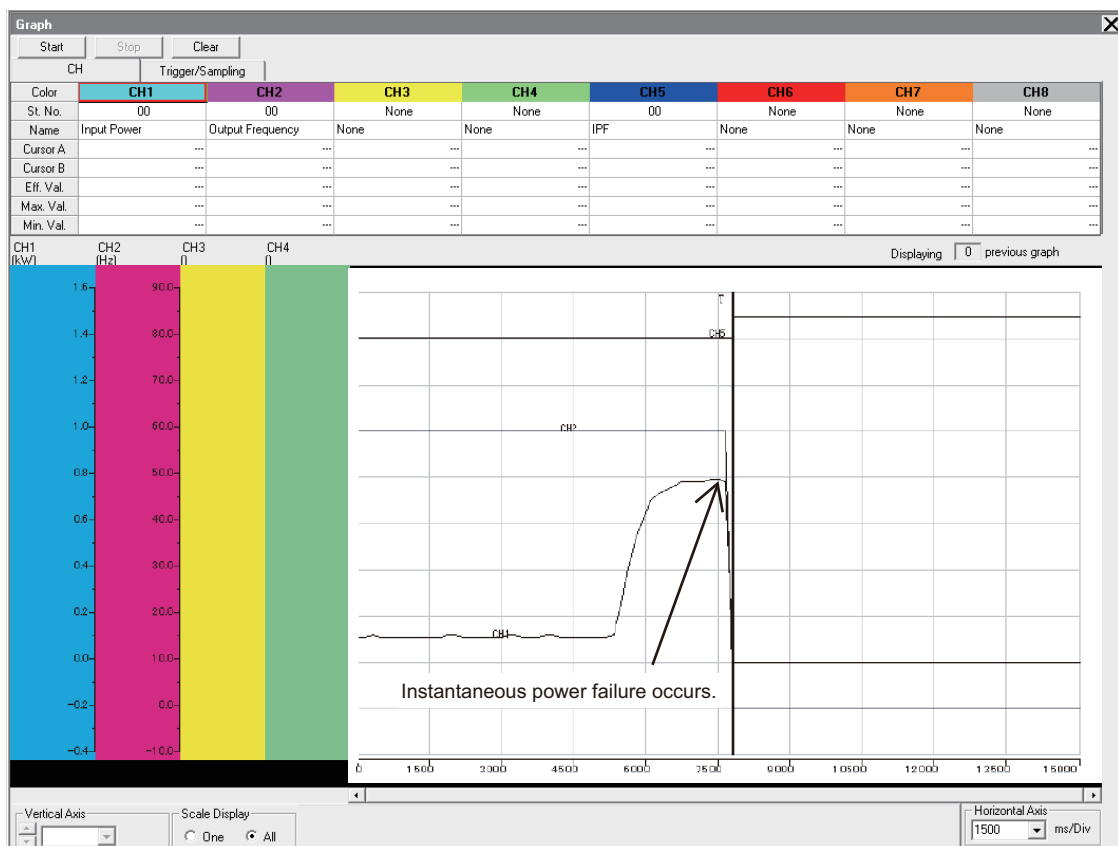

- 2) Check that the operation continues when setting the instantaneous power failure timer to 0 second and pressing the instantaneous power failure button.
- 3) Use FR Configurator to check the period of time that Err. display continues after restarting, when setting the instantaneous power failure timer to 0.1 seconds or more and pressing the instantaneous power failure button.
- 4) To prevent instantaneous power failure, stable power supply is required (such as installing UPS, switching to DC auxiliary power supply).

5 BREAKDOWN MAINTENANCE

☒ POINTS for understanding !

The time chart when instantaneous power failure occurs to the inverter

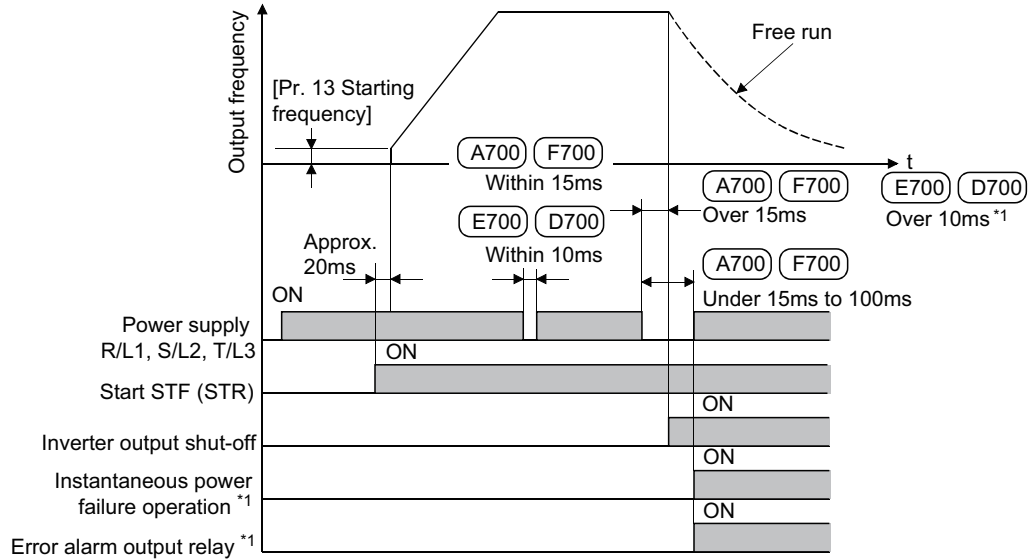

- *1 (A700) (F700) operate when power is restored within 15 to 100ms. However, when set value of Automatic restart after instantaneous power failure function [Pr. 57] is 0 or 0.1 to 5 seconds for a capacity 55K or less, 0.1 to 30 seconds for a capacity 75K or more, automatic restart after instantaneous power failure function is activated, and error output signal is not activated.
(E700) (D700) does not output an error even restarted after inverter output shut-off, and restart operation from starting frequency. However, when Automatic restart after instantaneous power failure function [Pr.57] is set to 0 or 0.1 to 5s, automatic restart after instantaneous power failure is activated.
- *2 Instantaneous power failure longer for 100ms or longer is the same as long time power failure. If the start signal is on, the inverter restarts when power restores.

5 BREAKDOWN MAINTENANCE

(2) Setting the automatic restart after instantaneous power failure

When the automatic restart after instantaneous power failure function is set, the motor restarts when restored from the instantaneous power failure. (E.IPF does not operate.)

Change Pr.57 (Restart coasting time) from initial value 9999 to 0, and set the automatic restart after instantaneous power failure CS (ON) and press the instantaneous power failure button. Check that it restarts after instantaneous power failure.

- 1) Use FR Configurator and check the graph when restarted after the instantaneous power failure.

Start		Stop		Clear	
CH		Trigger/Sampling			
Type	Inside	Single/Continuous	Sampling Setting		
CH	CH02	Mode	Monitor		
Start At	Rise	Interval[ms]	150		
Level	10.00	Time[ms]	15000		
Position[%]	50				

Start position of trigger and sampling are set to 50% in the chart below.

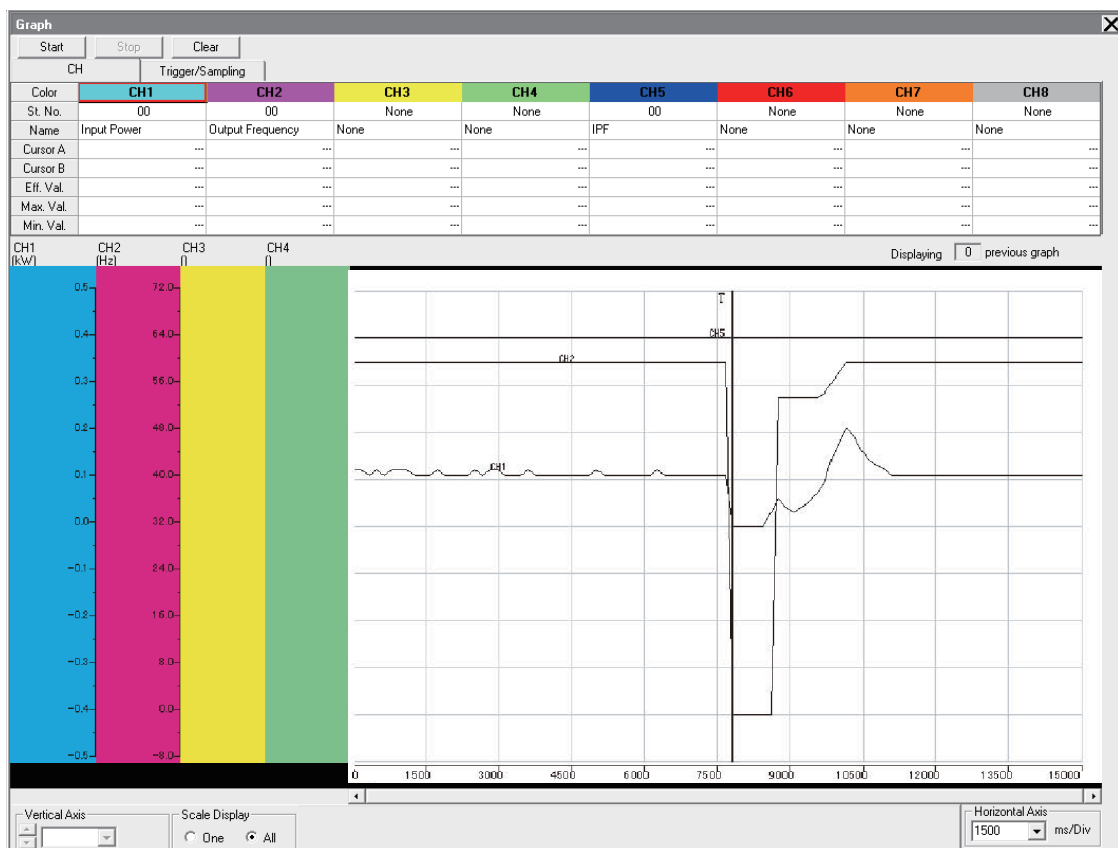

5 BREAKDOWN MAINTENANCE

(3) Setting Decelerate the motor to a stop at instantaneous power failure function (Pr.261 to Pr.266, Pr.294)

Change Pr.261 (Power failure stop selection) to 2 (no UV evacuation, accelerates again when restored) from initial value (0) to restart without E.IPF display.

By the power failure deceleration stop function, when power failure or insufficient voltage occurs, decelerates and stops the motor to prevent the free run.

This setting is effective to stop the motor when power failure occurs for the hazard prevention of machine tool or other machinery..

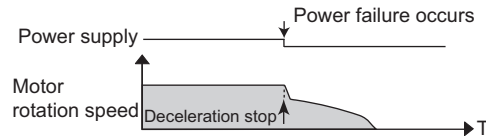

Parameter Number	Name	Initial Value	Setting Range	Description
261	Power failure stop selection	0	0	Coasting to stop When undervoltage or power failure occurs, the inverter output is shut off.
			1	Without under voltage avoidance When undervoltage or a power failure occurs, the inverter can be decelerated to a stop.
			11	With under voltage avoidance
			2	Without under voltage avoidance When undervoltage or a power failure occurs, the inverter can be decelerated to a stop.
			12	With under voltage avoidance If power is restored during a power failure, the inverter accelerates again.
262	Subtracted frequency at deceleration start	3Hz	0 to 20Hz	Normally operation can be performed with the initial value unchanged. But adjust the frequency according to the magnitude of the load specifications (moment of inertia, torque).
263	Subtraction starting frequency	60Hz	0 to 120Hz	When output frequency \geq Pr. 263 Decelerate from the speed obtained from output frequency minus Pr. 262. When output frequency $<$ Pr. 263 Decelerate from output frequency
			9999	Decelerate from the speed obtained from output frequency minus Pr. 262.
264	Power-failure deceleration time 1	5s	0 to 3600/ 360s *	Set a deceleration slope down to the frequency set in Pr. 266.
265	Power-failure deceleration time 2	9999	0 to 3600/ 360s *	Set a deceleration slope below the frequency set in Pr. 266.
			9999	Same slope as in Pr. 264
266	Power failure deceleration time switchover frequency	60Hz	0 to 400Hz	Set the frequency at which the deceleration slope is switched from the Pr. 264 setting to the Pr. 265 setting.
294	UV avoidance voltage gain	100%	0 to 200%	Adjust the response level during undervoltage avoidance operation. A larger setting will improve responsiveness to the bus voltage change.

* When the setting of Pr. 21 Acceleration/deceleration time increments is "0" (initial value), the setting range is "0 to 3600s" and the setting increments are "0.1s", and when the setting is "1", the setting range is "0 to 360s" and the setting increments are "0.01s"

5 BREAKDOWN MAINTENANCE

(a) Connection and parameter setting

- Remove the jumpers across terminals R/L1-R1/L11 and across terminals S/L2-S1/L21, and connect terminals R1/L11 and P/+ and terminals S1/L21 and N/-.
- When setting of Pr. 261 is not "0", the motor decelerates to a stop if an undervoltage, power failure or input phase loss (when Pr. 872 ="1"(input phase loss enabled)) occurs.

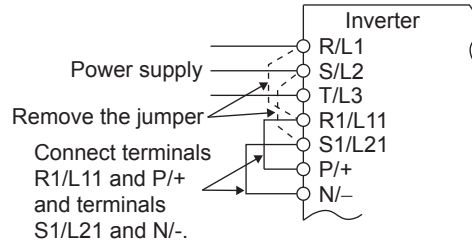

(b) Operation outline of deceleration to stop at power failure

- If an undervoltage or power failure occurs, the output frequency is dropped by the frequency set in Pr. 262 .
- Deceleration is made in the deceleration time set in Pr. 264. (The deceleration time setting is the time required from Pr. 20 Acceleration/deceleration reference frequency to a stop.)
- When the frequency is low and enough regeneration energy is not provided, for example, the deceleration time (slope) from Pr. 265 to a stop can be changed.

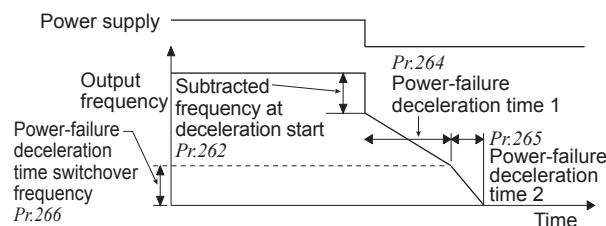

(c) Power failure stop function (Pr. 261 = "1, 11")

- If power is restored during power failure deceleration, deceleration to a stop is continued and the inverter remains stopped. To restart, turn OFF the start signal once, then turn it ON again.

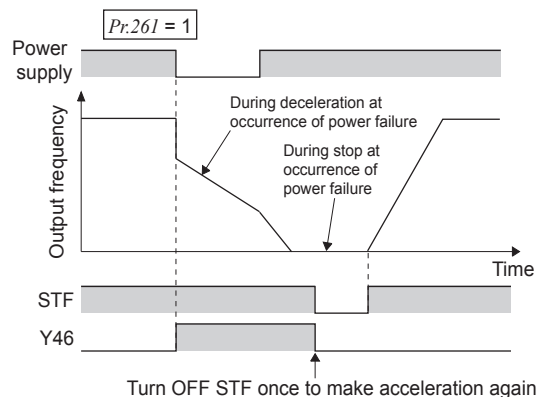

5 BREAKDOWN MAINTENANCE

Remark

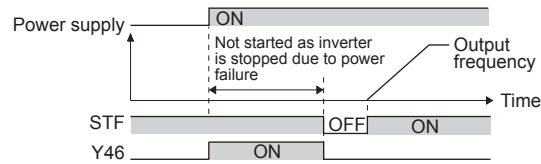

- When automatic restart after instantaneous power failure is selected (Pr. 57 ≠ "9999"), deceleration to stop function is invalid and the restart after instantaneous power failure operation is performed.
- After the inverter is stopped due to power failure, it does not start by turning ON the power with the start signal (STF/STR) being input. Turn OFF the start signal once after turning ON the power supply then turn ON the start signal.

1	IMPORTANCE OF PRODUCTIVE MAINTENANCE
2	UNDERSTANDING INVERTER SYSTEM
3	MAINTENANCE SYSTEM DESIGN
4	PREVENTIVE MAINTENANCE
5	BREAKDOWN MAINTENANCE
6	CORRECTIVE MAINTENANCE
7	REVISING INSTALLATION ENVIRONMENT
8	LIFE OF INVERTER PARTS

5 BREAKDOWN MAINTENANCE

5.2.9 Overcurrent trip during acceleration (E.OC1 display) [Demonstration]

Perform this demonstration with the demonstration machine for instructors.

(1) Setting

- 1) Turn ON the forward rotation STF switch and high speed RH switch of the demonstration machine, and check that the overcurrent trip during accelerating (E.OC1 display) occurs.

(2) Procedure

- 1) Use FR Configurator and measure the timing that the overcurrent trip during accelerating (E.OC1 display) occurs and the output frequency.

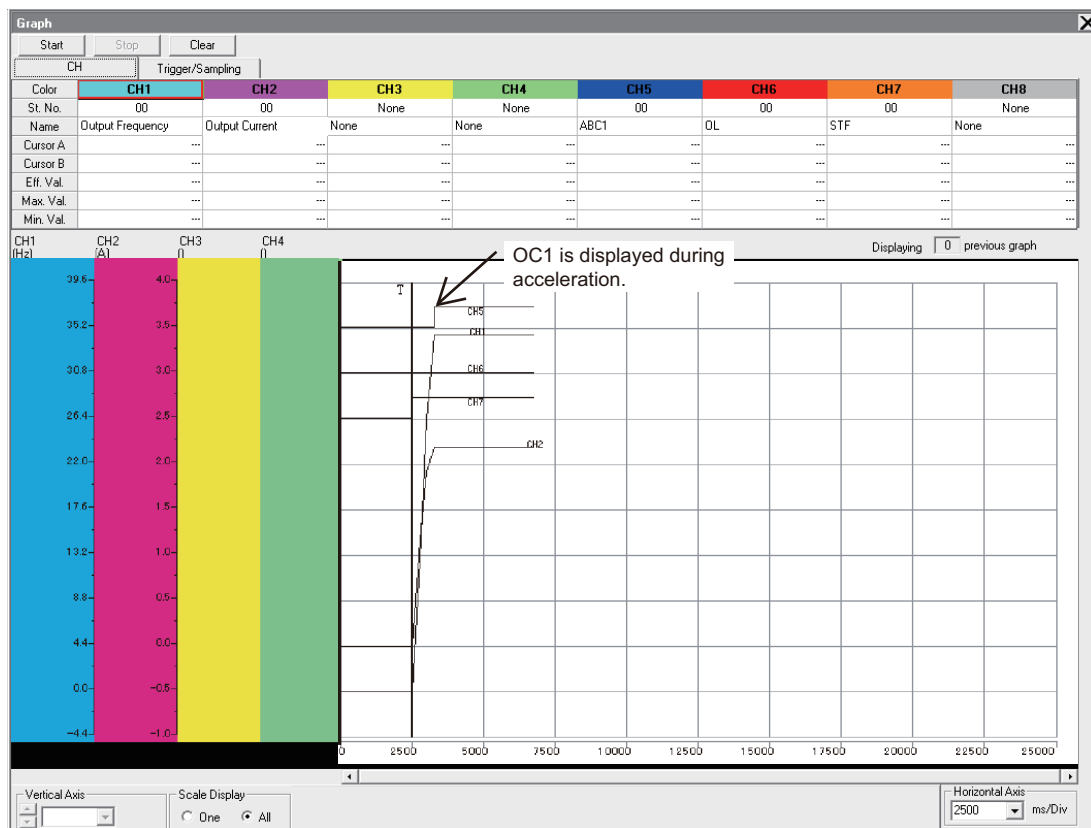

- 2) Change Pr.7 (Acceleration time) and measure the acceleration time that does not cause the overcurrent trip during accelerating (E.OC1 display).
- 3) Change Pr.7 (Acceleration time) to the initial value (5 seconds).

5 BREAKDOWN MAINTENANCE

5.2.10 Undervoltage (E.UVT display) [Demonstration]

The shorting bar between P and P1 on the terminal block that is on the rear side of the demonstration machine is removed.

Check that E.UVT is displayed right after the power of the inverter is turned on due the low bus power voltage.



1

IMPORTANCE OF
PRODUCTIVE
MAINTENANCE

2

UNDERSTANDING
INVERTER SYSTEM

3

MAINTENANCE
SYSTEM DESIGN

4

PREVENTIVE
MAINTENANCE

5

**BREAKDOWN
MAINTENANCE**

6

CORRECTIVE
MAINTENANCE

7

REVISING
INSTALLATION
ENVIRONMENT

8

LIFE OF INVERTER
PARTS

5.3 Appendices for Demonstration (Confirmation for Error Descriptions and Others)

Following the previous Section 5.2 Troubleshooting by the Demonstration Machine, basic error displays are described here.

Check each content along the flow "Error setting", "Error description", "Error handling procedure" in this order.

5.3.1 Error setting

- (1) **Prevention of reverse rotation <When the prevention of reverse rotation is valid>**
Change Pr.78 (Prevention of reverse rotation of the motor) to the initial value 0 to 1 (reverse rotation disabled), and set to STR (ON). Check that the REV of the parameter unit blinks and the motor does not rotate in the reverse direction.
- (2) **Maximum frequency setting**
Change the Pr.1 (Maximum frequency) from 120Hz to 55Hz, and set STF, high speed RH (ON). Then, check that 55Hz is displayed although the high speed RH is set to 60Hz, and that the frequency goes only up to 55Hz.
- (3) **E.OHT display <External thermal relay operation>**
Change Pr.186 (CS terminal function selection) from 6 (Automatic restart after instantaneous power failure selection) to 7 (Exterior thermal relay input) and make CS - SD terminal open. Check that E.OHT is displayed.
- (4) **E.OPT display <Option fault>**
Change Pr.30 (Regenerative function selection) from 0 (Built-in brake) to 2 (high efficiency converter or power supply regeneration common converter connection), and check that E.OPT is displayed.
- (5) **E.PUE display <PU disconnection>**
Change Pr.75 (PU disconnection detection) from 14 (Continuous operation after PU disconnection) to 2 (Inverter output trip when PU is disconnected) and set STF, high speed RH (ON). Disconnect PU on 60Hz display and stop the inverter output and check that E.PUE is displayed.
- (6) **E.CDO display <Output current detection value exceeded>**
Change Pr.167 (Output current detection operation selection) from 0 to 1, Pr.150 (Output current detection level) from 150 to 50, and set STF, high speed RH (ON). Check that E.CDO is displayed at the start up.
- (7) **E.USB display <USB communication fault>**
Change Pr.548 (USB communication check time interval) from 9999 to 1, and check that E.USB is displayed when disconnecting USB with FR Configurator being online.

5 BREAKDOWN MAINTENANCE

(8) E.RET display <Retry count excess>

Change Pr.68 (Retry waiting time) from 1 to 5 seconds and change Pr.67 (Number of retries at fault occurrence) from 0 to 3 times. Check that E.LF is displayed after 1 second since setting STF, high speed RH(ON) after turning OFF MC5 that is added by the alteration due to U phase loss. However, three retries are performed without abnormal output and E.RET is displayed.

(9) MT display <Maintenance signal output>

Change Pr.504 (Maintenance timer alarm output set time) from 9999 to 0 and check that MT is displayed.

(10) PS display <PU stop>

During operation on the external operation mode EXT, press the STOP/RESET button on the operation panel and check that PS is displayed.

1

IMPORTANCE OF
PRODUCTIVE
MAINTENANCE

2

UNDERSTANDING
INVERTER SYSTEM

3

MAINTENANCE
SYSTEM DESIGN

4

PREVENTIVE
MAINTENANCE

5

**BREAKDOWN
MAINTENANCE**

6

CORRECTIVE
MAINTENANCE

7

REVISING
INSTALLATION
ENVIRONMENT

8

LIFE OF INVERTER
PARTS

5.3.2 Error description

- (1) **The motor does not rotate.**
The motor does not rotate when setting STR (ON).
- (2) **The frequency does not rise to the set value.**
Set STF, high speed RH (ON) and 55Hz is displayed. * When high speed RH 60Hz is required.
- (3) **E.OHT display <External thermal relay operation>**
E.OHT is displayed.
- (4) **E.OPT display <Option fault>**
E.OPT is displayed.
- (5) **E.PUE display <PU disconnection>**
E.PUE is displayed.
- (6) **E.CDO display <Output current detection value exceeded>**
Set STF, high speed RH (ON) and display E.CDO at starting.
- (7) **E.USB display <USB communication fault>**
E.USB is displayed.
- (8) **E.RET display <Retry count excess>**
When setting STF, high speed RH (ON), E.LF is displayed. However, three retries are performed after the automatic reset without abnormality output and E.RET is displayed.
- (9) **MT display <Maintenance signal output>**
MT is displayed.
- (10) **PS display <PU stop>**
PS is displayed.

5 BREAKDOWN MAINTENANCE

5.3.3 Error handling procedure

- (1) **Prevention of reverse rotation <When the prevention of reverse rotation is valid>**
According to the flow on Subsection 5.1.3 When the motor does not start, check that signals of STR and high speed RH (ON) are input by FR Configurator. Change Pr.78 (Reverse rotation prevention selection) to the initial value 0.
- (2) **Maximum frequency setting**
According to the flow on Subsection 5.1.5 When the motor speed does not become the set speed, check that the output frequency does not match with the command by FR Configurator. Change Pr.1 (Maximum frequency setting) to 120Hz.
- (3) **E.OHT display <External thermal relay operation>**
Change Pr.186 (CS terminal function selection) to 6 (Automatic restart after instantaneous power failure selection) and put the CS - SD terminal back to close.
- (4) **E.OPT display <Option fault>**
Change Pr.30 (Regenerative function selection) to 0 (Built-in brake).
- (5) **E.PUE display <PU disconnection>**
Put PU back to the original position.
- (6) **E.CDO display <Output current detection value exceeded>**
 - 1) Use FR Configurator to check the output current when the value is more than the output current detection value.

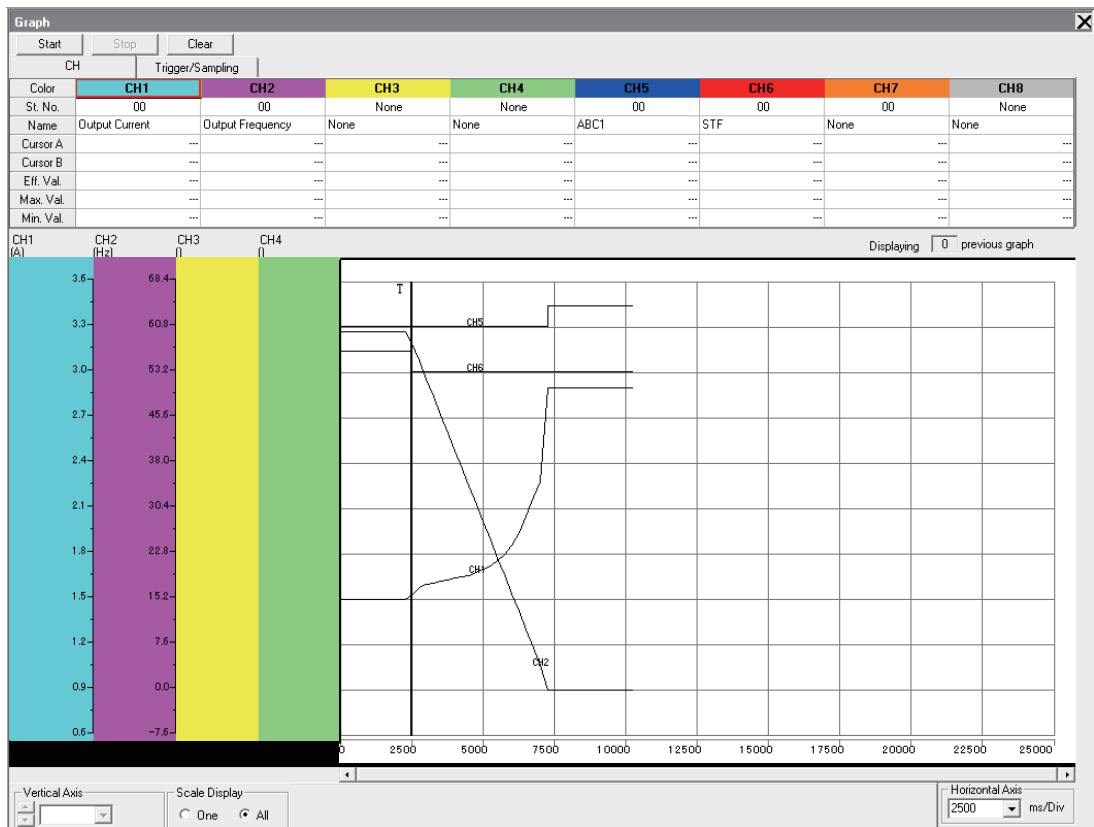

5 BREAKDOWN MAINTENANCE

- 2) Change Pr.167 (Output current detection operation selection) to initial value 0 (Continuous operation when output current detection value is over).
- 3) Change Pr.150 (Output current detection level) to 150% of the initial value.

(7) E.USB display <USB communication fault>

Change Pr.548 (USB communication check time interval) to 9999, and put the USB cable back.

(8) E.RET display <Retry count excess>

- 1) With FR Configurator, measure the graph since the output phase loss (E.LF display) occurs until three retries are performed 5 seconds later.

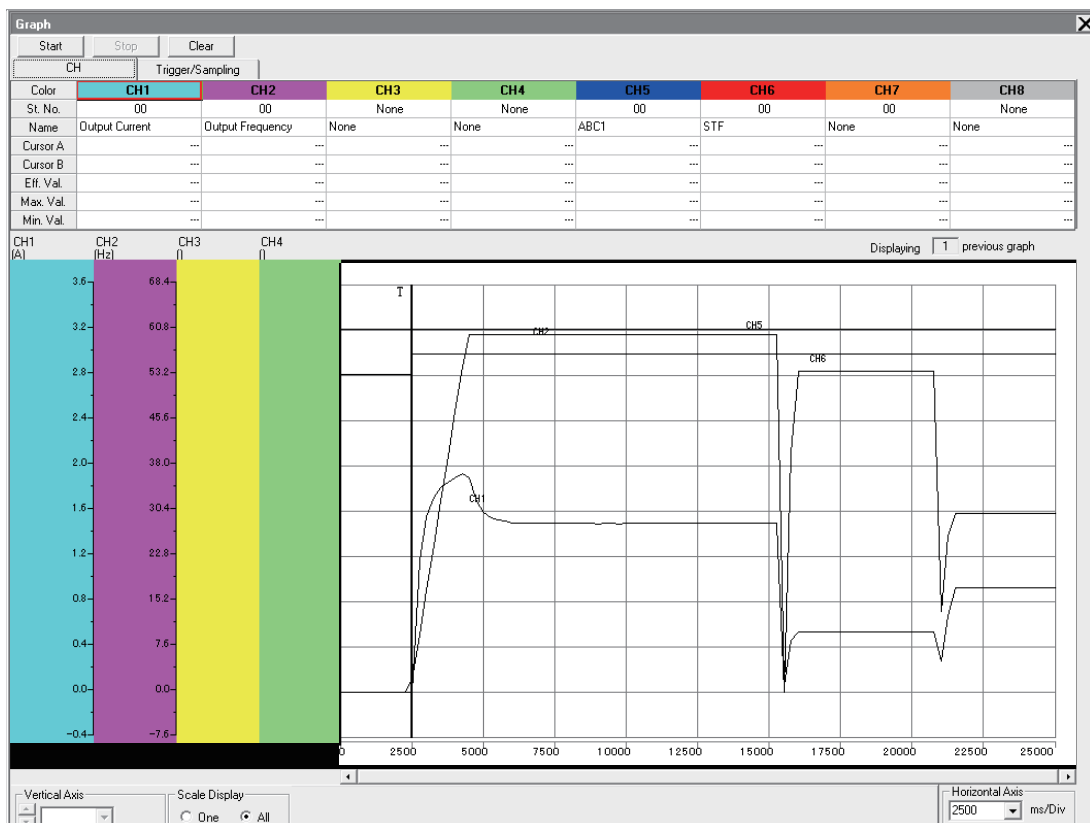

- 2) Check that the graph that is measured on 1) and Pr.68 (Retry waiting time), Pr.67 (Number of retries at fault occurrence) match.
- 3) Switch the Motor phase loss/Normal switch on the rear side of the demonstration machine to Normal.

(9) MT display <Maintenance signal output>

On the self-diagnosis function of FR Configurator, check the actual operation time. Change Pr.504 (Maintenance timer alarm output set time) to 9999.

(10) PS display <PU stop>

Turn OFF the start signal, and then press the PU/EXT button to release.

Chapter 6 CORRECTIVE MAINTENANCE

To improve maintainability of the production system, it is important to reduce deterioration of the equipment and to facilitate the maintenance performance.

6.1 Improving the Maintainability of Equipment

(1) To reduce deterioration of the equipment

- 1) Check the surrounding environment and give air conditioning or ventilation to avoid the equipment from deteriorating abnormally.
- 2) Provide controls of dust, moisture, and vibration to avoid the equipment from deteriorating abnormally.
- 3) Replace the equipment which is presumably deteriorated rapidly with the one which has high durability.

(2) To facilitate the maintenance performance

- 1) Improve the structure of the equipment.
- 2) Maintain an adequate space where the maintenance can be performed easily.
- 3) Replace the equipment with the one which facilitates the maintenance performance.

(3) Replacing the equipment with new one

- 1) Replace it with a product which has high reliability and less incidence of breakdown.

Chapter 7 REVISING INSTALLATION ENVIRONMENT

7.1 Power Supply of Inverter (Harmonic and Instantaneous Power Failure)

This section explains how the power source and its system which connect an inverter are influenced by the harmonic generated from the inverter. From the generated harmonic amount of the inverter, determining influence to the peripherals and considering specific harmonic suppression technique becomes possible.

This section also explains the influence to the inverter caused by variation of power source (instantaneous power failure, voltage drop, etc) . It is important to understand the movement of an inverter and motor.

☒ POINTS for understanding !

1. Difference between harmonic and noise
2. Inflow path and the size of harmonic current
3. Harmonic suppression guideline and its correspondence
4. Movements of the inverter and the motor during an instantaneous power failure (including instantaneous voltage drop)

7.1.1 What is a harmonic?

It is defined that a harmonic has a frequency that is an integral multiple of the fundamental wave (generally the power supply frequency). The composition of a single fundamental wave and several harmonics is called a distorted wave. (Refer to Fig.7.2)

A distorted wave generally includes harmonics in a high-frequency region (kHz to MHz order), but harmonics in a power distribution system are usually of up to 40th to 50th degrees (to 3kHz).

Harmonics are different in nature from high-frequency problems which is usually random. For example, problems such as noise and electromagnetic interference from the computer (refer to Section 7.2) are local problems which are closely related to hard devices, and it is difference from harmonics which covers electrical power network in its influences and measures. This must be defined first.

$$i = i_0 + \sum_{n=1}^{\infty} i_n \cdot \sin(2\pi f n t + \phi_n) \dots\dots\dots(7.1)$$

n = 1, 2, 3,

f = Fundamental frequency

7 REVISING INSTALLATION ENVIRONMENT

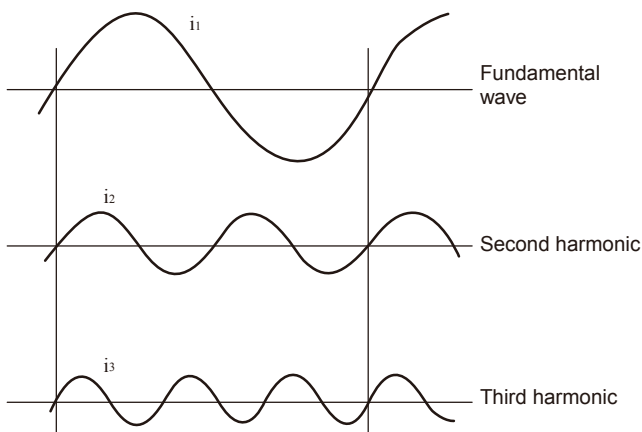

Fig.7.1 Fundamental wave and harmonics

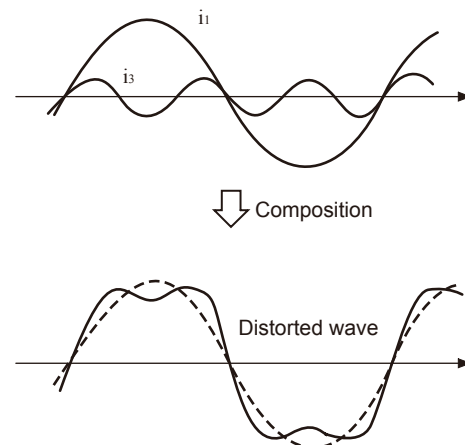

Fig.7.2 Distorted wave

Table7.1 Difference between harmonic and noise

Item	Harmonics	Noise
Frequency	Normally number 40 to 50 max. (3kHz or less)	High frequency (several 10kHz to MHz order)
Source	Converter circuit	Inverter circuit
Cause	Rectifying circuit commutation	Transistor switching
Environment	To-electric channel, power impedance	To-space, distance, wiring path
Quantitative understanding	Theoretical calculation possible	Random occurrence, quantitative grasping difficult
Generated amount	Nearly proportional to load capacity	Depending on the current fluctuation ratio (larger as switching is faster)
Affected equipment immunity	Specified in standard per equipment	Different depending on maker's equipment specifications
Suppression example	Provide reactor (L).	Increase distance (l).

1
IMPORTANCE OF
PRODUCTIVE
MAINTENANCE

2
UNDERSTANDING
INVERTER SYSTEM

3
MAINTENANCE
SYSTEM DESIGN

4
PREVENTIVE
MAINTENANCE

5
BREAKDOWN
MAINTENANCE

6
CORRECTIVE
MAINTENANCE

7
REVISING
INSTALLATION
ENVIRONMENT

8
LIFE OF INVERTER
PARTS

7.1.2 Characteristics of rectifying circuit and generated harmonics

The source of harmonic is rectifier, AC power adjuster, etc. The converter circuit of transistorized inverters consists of a rectifying circuit, and generates much harmonic current.

There are various types of rectifying circuits depending on main circuit method. For a transistorized inverter, three-phase bridge method is the most popular.

Generated ordinal numbers "n" of the harmonic current is theoretically $n = PK \pm 1$ ($P = \text{pulse}$, $K = 1, 2, 3, \dots$), and in case of the inverter of three-phase bridge method ($P = 6$, as 6 pulse converter is used), $6K \pm 1$ st (5, 7, 11, 13th.....) harmonic current are generated. Then the magnitude of the harmonic current (harmonic content) becomes $1/n$, and as the ordinal numbers of harmonic current increases, the generated amount decreases. In case of the inverter of the single-phase power supply input, $4K \pm 1$ st (3, 5, 7, 9th.....) harmonic current is generated.

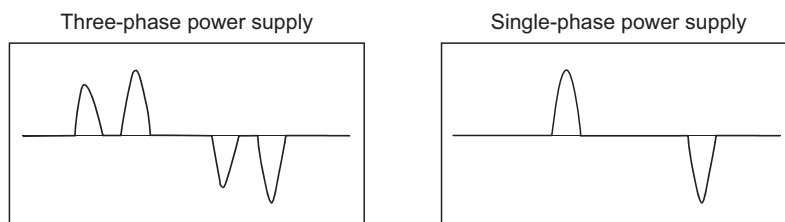

Fig.7.3 Inverter input current waveform (harmonic current)

7.1.3 Split-flow path of harmonic current

When harmonic current is used in the power distribution system, the power supply of the harmonic current is different from general commercial power supply; the source of harmonic (the converter circuit for an inverter) becomes the power supply, and the commercial power supply (low and high voltage power transformer) becomes one of load against harmonic. Therefore, as indicated in the example of Fig.7.4, the harmonic current " I_n " generated from the inverter ($I_n = I_2 + I_3 + I_4 + \dots$ (n stands for ordinal numbers)) split-flows in proportion to impedance of power transformer ($\dot{Z}_L = R_L + jnX_L$) and the device connected in parallel with it (in the example of Fig.7.4, the motor B and the capacitor), i.e. the reciprocal ratio $1/Z$ between the impedance of the motor B ($\dot{Z}_M = R_M + jnX_M$) and the impedance of the capacitor ($\dot{Z}_C = jnX_r - jXC / n$).

Since frequency is higher in harmonics than in the power supply, the impedance of the capacitor decreases so that the harmonic current tends to concentrate on the capacitor.

As a result, the capacitor may be overheated or damaged.

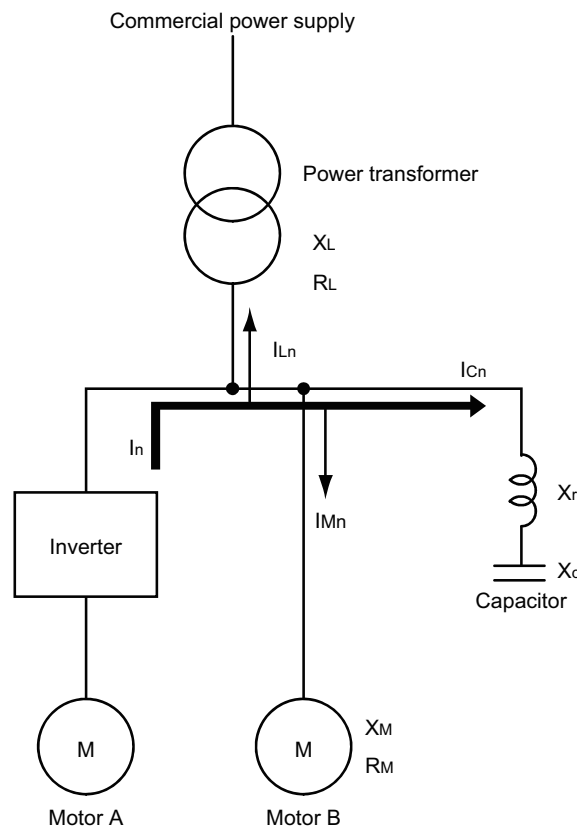

Fig.7.4 Power distribution system

☒ Good to know for checking an inverter

- Current tends to flow into smaller impedance, and the harmonic may increase when there are capacitive impedance elements (a power factor correction capacitor, etc). Therefore, in harmonic problems:

- 1) Since impedance at the power supply side " \dot{Z}_s " is popular for short capacity, the larger the power supply capacity is, the less the other influence is.
- 2) Inductive load can be ignored since it becomes high-impedance against harmonics.
- 3) Only examining capacitive load such as power factor correction capacitor is sufficient.

7.1.4 Harmonic Suppression Guidelines

Harmonic currents flow from the inverter to a power receiving point via a power transformer. The Harmonic Suppression Guidelines were established to protect other consumers from these outgoing harmonic currents.

The three-phase 200V input specifications 3.7kW or less are previously covered by "Harmonic Suppression Guidelines for Household Appliances and General-purpose Products" and other models are covered by "Harmonic Suppression Guidelines for Consumers Who Receive High Voltage or Special High Voltage". However, the general-purpose inverter has been excluded from the target products covered by "Harmonic Suppression Guidelines for Household Appliances and General-purpose Products" in January 2004. Later, this guideline was repealed on 6 September 2004. All capacities and all models of general-purpose inverters used by specific consumers are covered by "Harmonic suppression guideline for consumers who receive high voltage or special high voltage".

"Harmonic suppression guideline for consumers who receive high voltage or special high voltage"

This guideline sets forth the maximum values of harmonic currents outgoing from a high-voltage or especially highvoltage consumer who will install, add or renew harmonic generating equipment. If any of the maximum values is exceeded, this guideline requires that consumer to take certain suppression measures.

However, we ask to connect a DC reactor or an AC reactor as usual for the users who are not covered by the guideline.

For compliance with the "Harmonic suppression guideline for consumers who receive high voltage or special high voltage"

Input power supply	Target capacity	Measures
Three-phase 200V	All capacities	Make a judgment based on "Harmonic suppression guideline for consumers who receive high voltage or special high voltage" issued by the Japanese Ministry of Economy, Trade and Industry (formerly Ministry of International Trade and Industry) in September 1994 and take measures if necessary.
Three-phase 400V		

7 REVISING INSTALLATION ENVIRONMENT

Whether or not a harmonic suppression technique is required by the "Harmonic suppression guideline for consumers who receive high voltage or special high voltage" is examined in the following procedure:

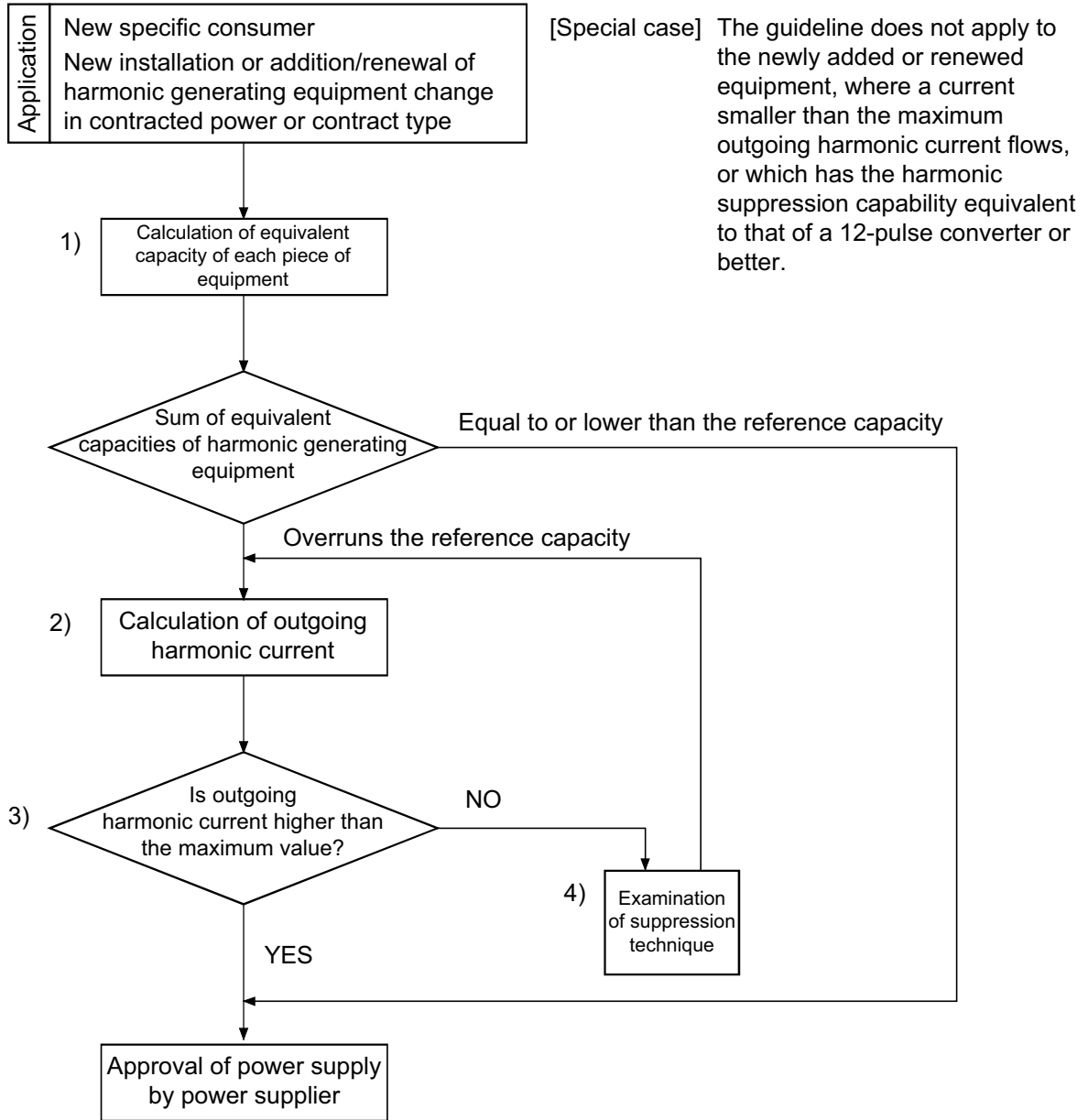

Fig.7.5 Harmonic examination flowchart

7 REVISING INSTALLATION ENVIRONMENT

7.1.5 Overview of harmonic suppression technique

For suppressing and absorbing the harmonic method, the overview of the basis, characteristics, etc, are mentioned below.

No.	Item	Description	Effects, etc.
1)	Reactors for inverter (FR-HAL, HEL)	Connect an AC reactor on the power supply side of the inverter or a DC reactor on its DC side or both to increase the circuit impedance, suppressing harmonic currents.	Harmonic currents are suppressed to about half.
2)	High power factor converter (FR-HC)	This converter trims the current waveform to be a sine waveform by switching the converter module. Doing so suppresses the harmonic current significantly. Connect it to the DC area of an inverter.	Harmonic current is suppressed to almost zero.
3)	Installation of power factor improving capacitor	A power factor improving capacitor is small in impedance to high frequency components. When used with a series reactor, it has an effect of absorbing harmonic currents. This capacitor may be installed in either a high or low voltage side.	The absorbing effect is greater in the low voltage line.
4)	Installation of power factor improving capacitor	When two or more transformers are used, connecting them with a phase angle difference of 30° as in Y-Δ, Δ-Δ combination will cause a timing shift to suppress peak currents, providing an effect, equivalent to that of a 12-pulse bridge.	If the capacity of the Y-Δ, Δ-Δ combination differs, an effect equivalent to that of a 12-pulse bridge can be expected for the smaller one, and harmonic currents can be suppressed to about half.
5)	AC filter	As in a power factor improving capacitor, a capacitor and series reactor are used together to reduce impedance to a specific frequency (degree), absorbing harmonic currents greatly.	Produces a great suppression effect. (Can satisfy the requirements of the guideline.)
6)	Active filter	This filter detects the current of a circuit generating a harmonic current and generates a harmonic current equivalent to a difference between that current and a fundamental wave current to suppress a harmonic current at a detection point.	Produces a great suppression effect. (Can satisfy the requirements of the guideline.) As this filter corrects the whole waveform, a power factor improving effect is also expected.

* The techniques above are advantageous in the following order (highest to lowest):

- For suppression effect: 6) or 2), 5), 4), 3) and 1).
- For cost: 1), 2), 3), 4), 5) and 6).

7.1.6 Influence to inverter during instantaneous power failure

When an instantaneous power failure occurs, the power supply voltage of the control circuit to control the inverter results in power loss. To prevent malfunction of control due to this power failure, operate instantaneous power failure protection to stop the inverter output, and maintain this status. This protective operation differs depending on the time of instantaneous power failure. The FREQROL-A700 series is used as an example here.

(1) Operation of inverter by the difference of instantaneous power failure time

- (a) When the instantaneous power failure time is within 15ms
Protective function is not activated, and keeps on driving normally.

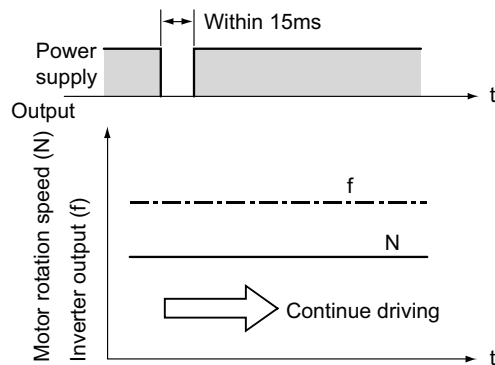

Fig.7.6 Instantaneous power failure of 15ms or lower

- (b) When the time is over 15ms and under 100ms
Protective function is activated and the inverter stops outputting. (Motor is coasted to a stop)

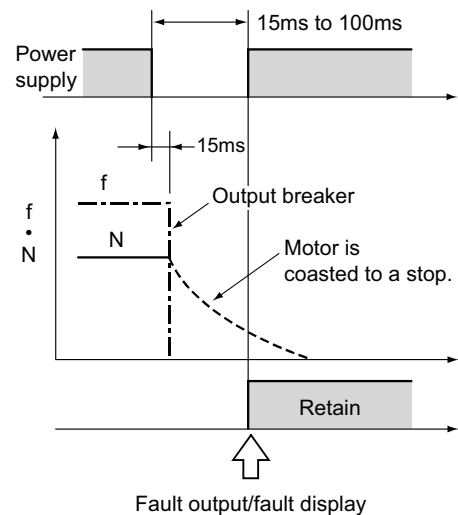

Fig.7.7 Instantaneous power failure from 15ms to 100ms

- (c) Power failure of 100ms or higher
The failure is reset automatically with the power supply restarts, and the inverter restart is available.

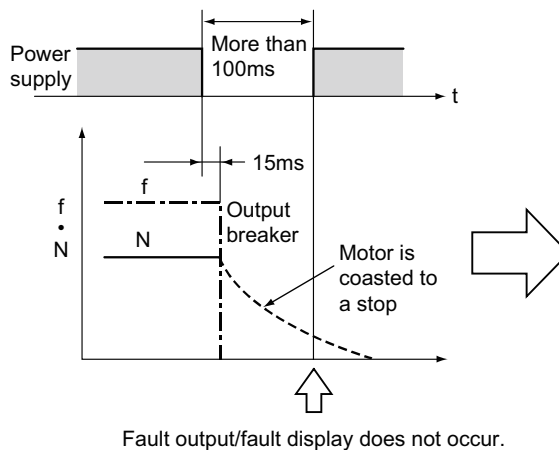

Fig.7.8 Instantaneous power failure over 100ms

[Note]
When the start signal (STF, STR) is ON, the inverter restarts by power supply restart. At this time, when the motor is during free run, overvoltage or overcurrent protection may activate, and come to trip. To restart automatically at power restoration, use the instantaneous power failure function. (Normally the function equipped in the FREQROL-A700 series. However, the restart function is not selected in factory setting. Set parameter Pf.57 to "0". For details of the instantaneous power failure restart operation, refer to (3).

7 REVISING INSTALLATION ENVIRONMENT

7.1.7 Inverter peripheral circuit and inverter operation during instantaneous power failure

(1) When magnetic contactor (MC) is at the inverter primary side

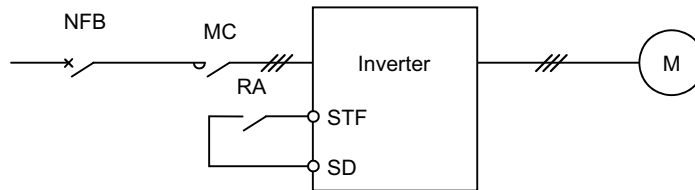

When the instantaneous power failure time is short and the magnetic contactor MC and relay RA are not down (start signal STF remains ON), the operation is as mentioned in Subsection 7.1.6.

When only the magnetic contactor MC is down, the motor is coasted to a stop. Therefore, when restarting after power supply restart, after motor is coasted to a stop (coasting interlock timer is necessary), turn on MC again or use the instantaneous power failure function.

(2) When magnetic contactor (MC) is at both the inverter primary side and the secondary side

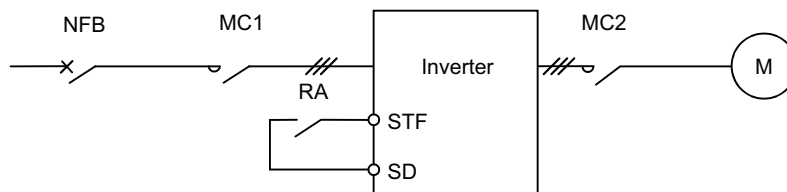

When the instantaneous power failure time is short and the magnetic contactor MC1 and relay RA are not down (start signal STF remains ON), the operation is as mentioned in Subsection 7.1.6.

When only the magnetic contactor MC1 is down, the motor is coasted to a stop. Therefore, when restarting after power supply restart, after motor is coasted to a stop (coasting interlock timer is necessary), turn on MC1 again or use the instantaneous power failure function .

When only the magnetic contactor MC2 is down, the motor is coasted to a stop. However, the inverter keeps on outputting depending on the instantaneous power failure time, or the inverter restarts after resetting by the power supply restart. Therefore, when MC2 is turned on again, the motor starts directly with the inverter output frequency, and this may cause the inverter to trip by overcurrent.

☒ Good to know for checking an inverter

- 1) Even though instantaneous power failure occurs at the receiving end, (complete) instantaneous power failure does not always occur at the low voltage side inverter input terminal (R, S, T). In most cases, an instantaneous drop of voltage occurs. (Under voltage protection operations)
- 2) An inverter contains an instantaneous power failure protective function and an under voltage protection. The protection function for undervoltage works when the DC circuit voltage of the inverter is under a constant value for a certain time. Therefore, even though instantaneous drop of power occurs, the protection function may activate for inverters whose load output is large, and continues driving when load output is small.
- 3) On the other hand, the magnetic contactors or relays are not always down due to instantaneous voltage drop, once turned on. In general, it is down at the voltage lower than 30% to 50% from the rated coil.

(3) Instantaneous power failure restart control

- (a) Commercial power-supply switchover, instantaneous power failure restart function

NOTE This function is available only when one motor is connected to the inverter. It does not function when two or more motors are used.

- Commercial power-supply switchover.....When switching from commercial drive to inverter drive, inverter can be started in coasting without stopping the motor.
- Instantaneous power failure restartWhen instantaneous power failure occurs, or when restarting, the inverter continues driving without stopping the motor once.

7 REVISING INSTALLATION ENVIRONMENT

(b) Operation of instantaneous power failure restart

- 1) When instantaneous power failure occurs during driving, the motor becomes coasting.
- 2) After restarting, when applying DC voltage from the inverter to the motor under coasting, DC flows into the motor. (Refer to Fig.7.9 ①)
This DC includes ripple cycle ratable to the rotation speed of the motor.
- 3) Input the signal from the current detector to the CPU, count the ripple cycle, and determine the rotation speed of the motor.
- 4) The inverter outputs with the frequency according to the rotation speed of the motor. (Refer to Fig.7.9 ②) After that, the inverter operation restarts with the output voltage increased gradually to control the starting current of the motor.

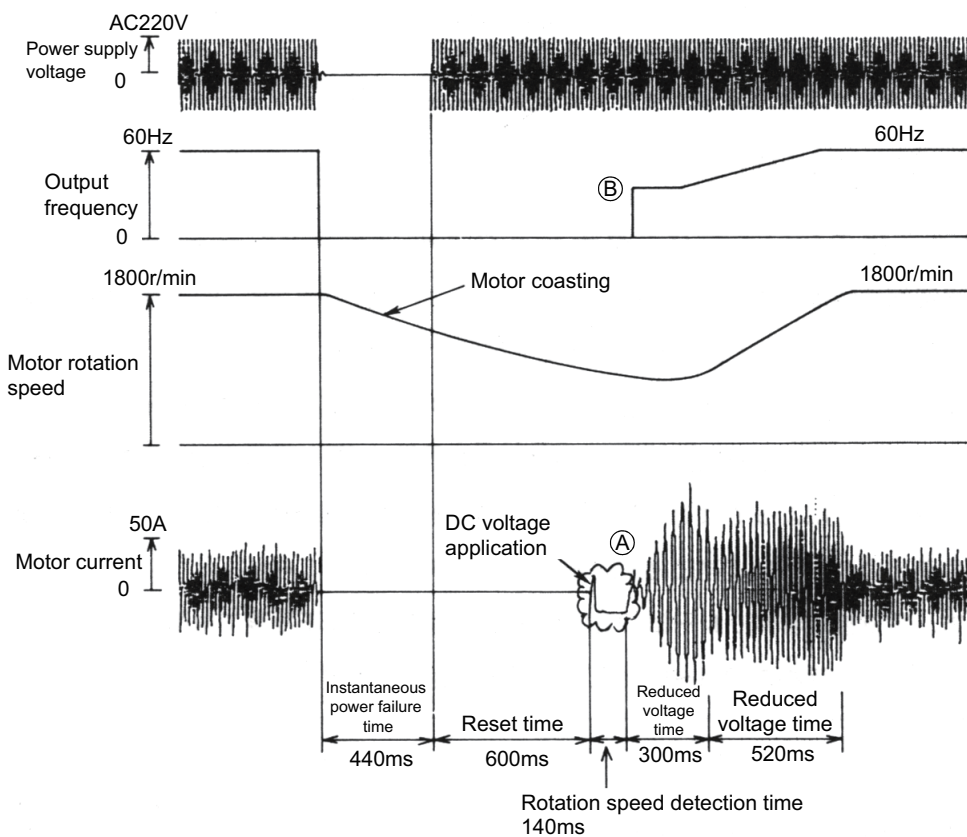

Fig.7.9 Example of instantaneous power failure restart operation

When an instantaneous power failure restart function is equipped (e.g. FREQROL-A₇₀₀ series)
When an instantaneous power failure restart function is used, CS-SD is shorten.

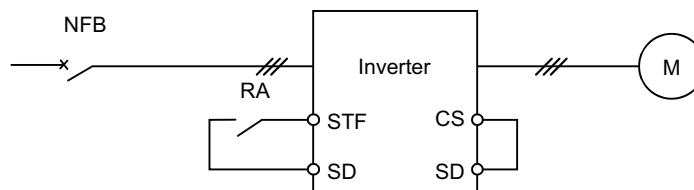
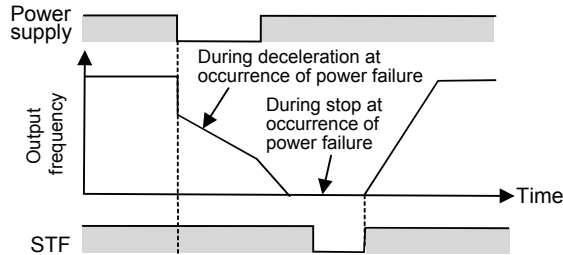

Fig.7.10 Wiring of instantaneous power failure restart operation

☒ Good to know for checking an inverter

Power failure-time deceleration-to-stop function

Usually, when power failure occurs, the motor becomes coasting. However, if the power failure deceleration stop function is used, with regenerative energy, the motor can be decelerated in a relatively short time. Even though the start signal is ON, it does not restart by power supply restart. If restarted during power failure-time deceleration, the reacceleration mode can be selected as well.



Original operation continuation at instantaneous power failure function

When an instantaneous power failure is detected, the operation continues by using regenerative energy which occurs when decelerating, and accelerates until reaching command frequency after restart.

When load inertia is small, trip may occur due to undervoltage, since regenerative energy from the motor is not provided.

In this case, use an instantaneous power failure restart operation.

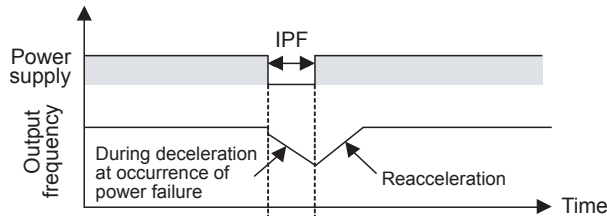

7.2 Noise

As electronic devices became widely used, troubles due to noise tend to increase. An inverter makes noise from its operating principle, therefore, it may affect adjacent devices. The degree of the effect relates to such as the inverter control method, noise capacity of the opposite equipment, wiring status, installation interval, grounding (earthing) method, and cannot be defined uniformly. However, when installing devices mentioned below around the inverter, it is recommended to proceed these measures according to the circumstances.

[Devices that must consider measures against noise]

Sensor (close switch etc.), video camera (ITV, image scanner etc.), wireless communications device (including AM radio), sound equipment (microphone, video, audio etc.), CRT display device, Medical device

[Devices that are recommended to consider measures against noise]

Measurement equipment, internal telephone

7.2.1 Occurring basis of noise

The inverter controls output voltage waveform by switching the DC voltage in a high speed. For precipitous rise and falling of output waveform include a lot of harmonic elements. These harmonic elements are the source of noises.

The noise in this section and the harmonic mentioned in Section 7.1 are sometimes confused since they may affect other electronic devices. However, harmonics are generally 40 to 50 ordinal numbers (2.4 to 3kHz), and noise is 10kHz or more.

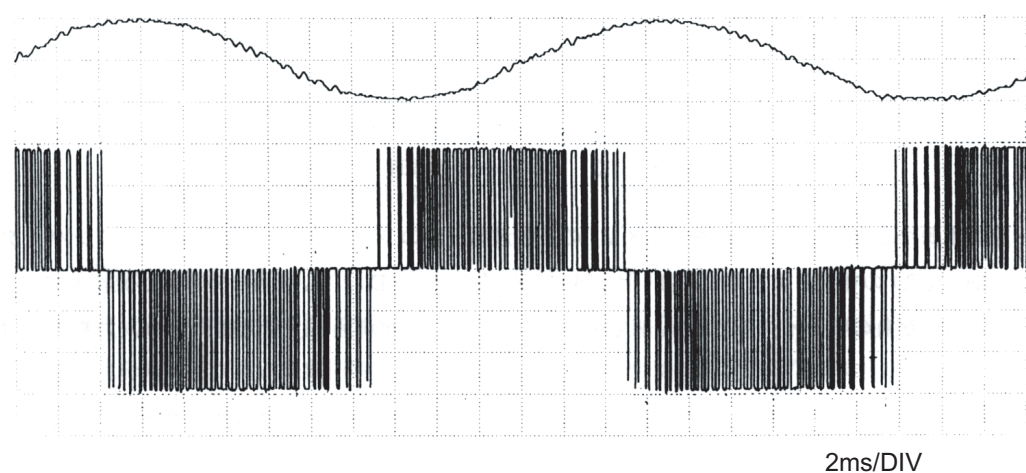

Fig.7.11 Example of output current, voltage waveform actual measurement of the inverter FREQROL-A 700 series (When carrier frequency is 2kHz)

7 REVISING INSTALLATION ENVIRONMENT

7.2.2 Types of noise and propagation path

Inverter-generated noises are largely classified into those radiated by the cables connected to the inverter and inverter main circuits (I/O), those electromagnetically and electrostatically induced to the signal cables of the peripheral devices close to the main circuit power supply, and those transmitted through the power supply cables.

Fig.7.12 shows the types of noise, and Fig.7.13 shows the path of noise.

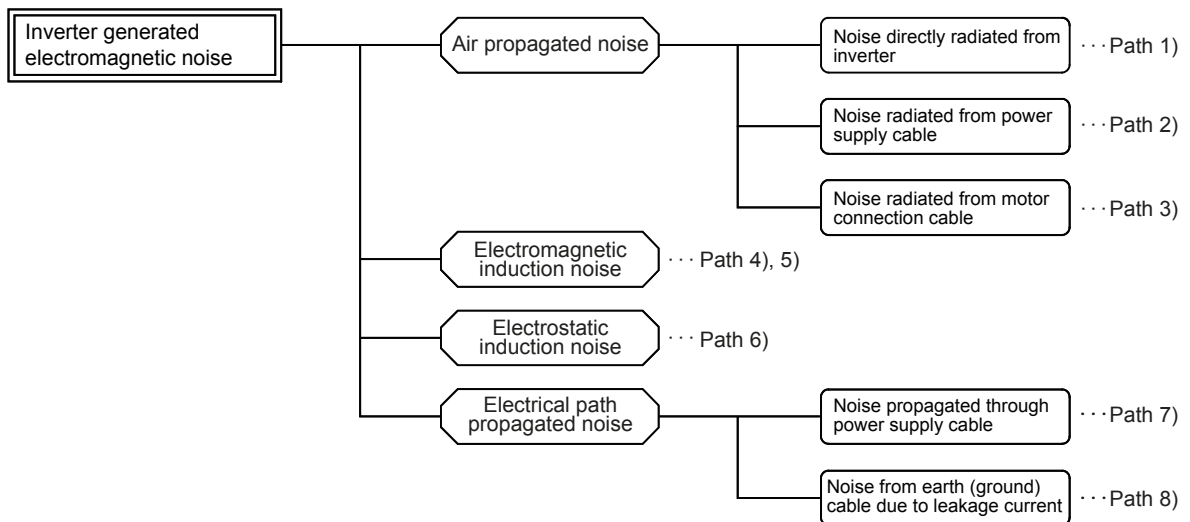

Fig.7.12 Types of noise

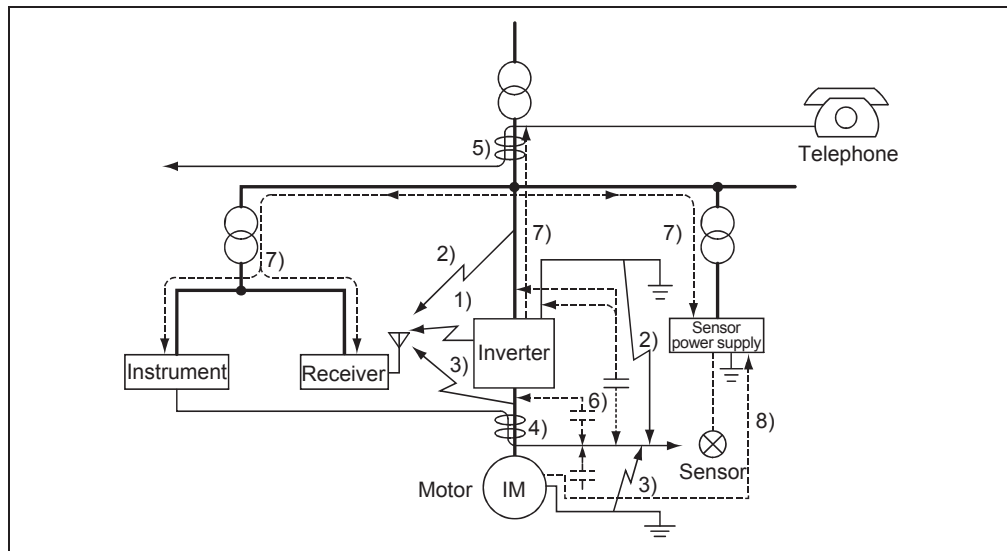

Fig.7.13 Path of noise

The noise level of these noises tends to lower as frequency band raises. In general, frequency band of 30MHz or more has a low level and problems do not occur.

Therefore, it does not affect much to some televisions or FM radios that use frequency over 30MHz. but it affects to low frequency band radios such as AM radios (0.5 to 10MHz).

For this reason, it is reasonable to examine measures keeping the frequency band in mind.

7 REVISING INSTALLATION ENVIRONMENT

(1) Air propagated noise (Path 1) to 3))

The noise occurred in an inverter radiates in the air to transfer. These paths are divided into three types shown in Fig.7.14.

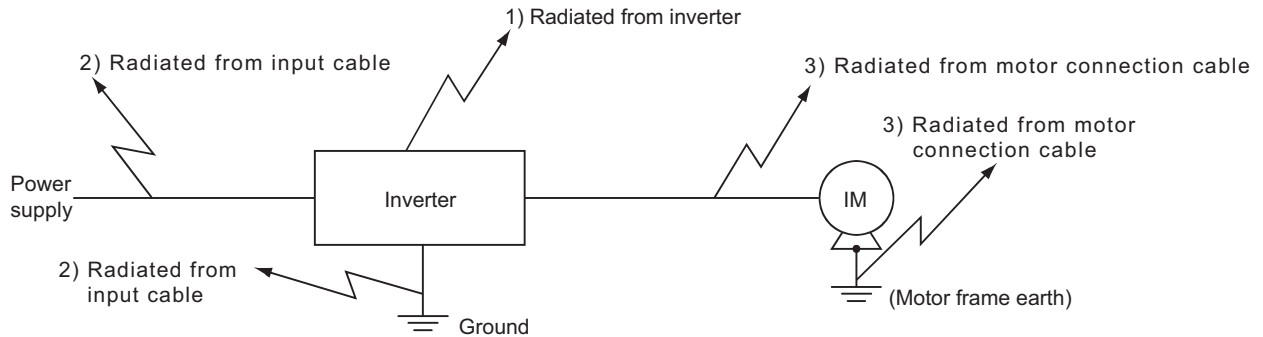

Fig.7.14 Air propagated noise

(2) Electromagnetic induction noise (Path 4), 5))

Transfers when the power supply cables and signal cables intersects with the magnetic field which occurred from the I/O side current of the inverter. (Refer to Fig.7.15)

When both become close and is parallel, or when the loop area of each cable is large, induced noise becomes large.

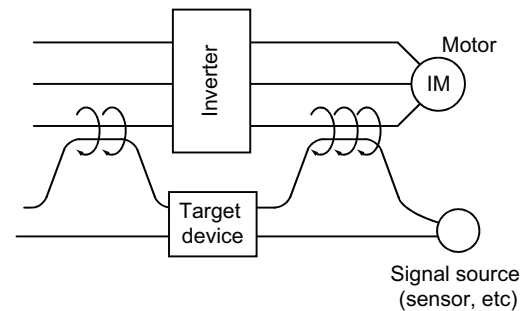

Fig.7.15 Electromagnetic induction noise

(3) Electrostatic induction noise (Path 6))

Transfers when the electric field occurred from I/O cables of the inverter passes static capacitance through the signal cables and associates. (Refer to Fig.7.16)

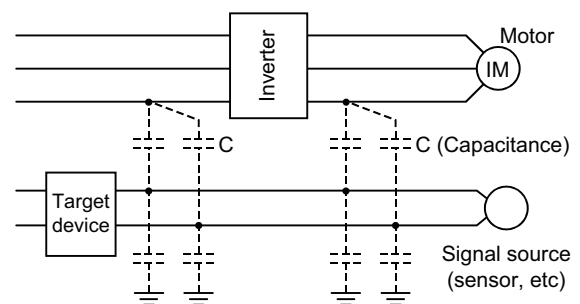

Fig.7.16 Electrostatic induction noise

(4) Electrical path propagated noise (Path 7))

Transfers to the peripherals when harmonic noise is generated via cables at the power supply side. (Refer to Fig.7.17)

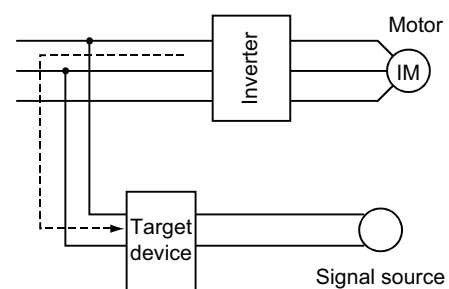

Fig.7.17 Electrical path propagated noise

7 REVISING INSTALLATION ENVIRONMENT

❏ POINT

Failure example: Noise

[Failure content]

When using an inverter for the sprinkler in a golf course, an electric cart stopped.

[Cause of failure]

The noise of the inverter affected the power supply of the electric cart (supplied from the rail).



[Measures against failure]

Measures against noise are performed.

1	IMPORTANCE OF PRODUCTIVE MAINTENANCE
2	UNDERSTANDING INVERTER SYSTEM
3	MAINTENANCE SYSTEM DESIGN
4	PREVENTIVE MAINTENANCE
5	BREAKDOWN MAINTENANCE
6	CORRECTIVE MAINTENANCE
7	REVISING INSTALLATION ENVIRONMENT
8	LIFE OF INVERTER PARTS

7.2.3 Measures against noise

(1) Stance of measures against noise

As mentioned in Subsection 7.2.2, there are many paths which noise propagates. However, occurring source can be divided into following three types, as shown in Fig.7.12 and Fig.7.13.

- 1) Conduction, induction, or radiation from the input power supply cable
- 2) Induction or radiation from the motor connection cable
- 3) Radiation from the inverter

The noise level of these noises tends to lower as frequency band raises. In general, frequency band of 30MHz or more has a low level and problems do not occur.

Therefore, it does not affect much to some televisions or FM radios that use frequency over 30MHz. but it affects to low frequency band radios such as AM radios. For this reason, it is reasonable to examine measures keeping the frequency band in mind.

(a) Reduction of noise that leaks into the power supply cables

It is effective to insert a filter between an inverter and the power supply cable.

Filter types are mentioned below.

Usage and its effects are explained.

1) Radio noise filter FR-BIF (200V class), FR-BIF (400V class)

Discrimination between 200V and 400V in this filter is necessary. However, it is common among all capacities. Connect to the power supply input terminal as shown in Fig.7.18. When the connection cable between the filter and the inverter becomes long, this part becomes the radiation antenna of noise, and the effects are inadequate. Therefore, connect the connection cable including the ground (earth) cable directly to the inverter terminal, and make it as short as possible.

Also, when the distance between the inverter ground terminal and the earth is long, the effects may be inadequate. Therefore, always make the ground terminal as short as possible. This filter is effective under a couple of MHz, therefore effective to lower noise to AM radios.

Since capacitor is included in this filter, it will break when connected to the output side of the inverter. Be sure not to mis-connect.

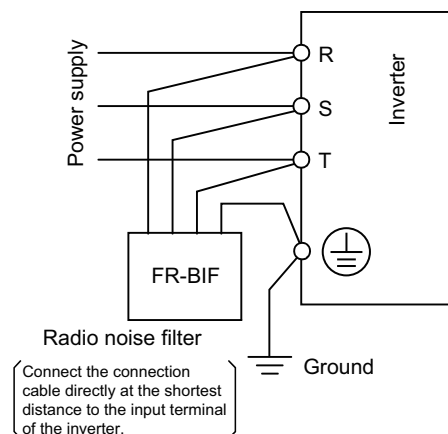

Fig.7.18 Installation of the radio noise filter FR-BIF

7 REVISING INSTALLATION ENVIRONMENT

2) Line noise filter FR-BSF01, FR-BLF

This filter is composed only by core. Therefore, it can be used to all models regardless of power supply voltage or capacity.

Insert the three-phase cables to the inverter power input side, twisting all in the same direction, as shown in Fig.7.19. Increasing the twisting times increases the effect, therefore, twist as much as possible, at least three times (4T) or more.

When twisting more than three times (4T) is not possible since the cable is too thick, use two filters so that the twisting times becomes three times (4T) or more. (Inverter input side)

Use two types for each cable size.

This filter is effective over a couple of 100kHz. However, this filter can also be used at the inverter output side. When inserting to the inverter output side, the twisting time must be within three times (4T).

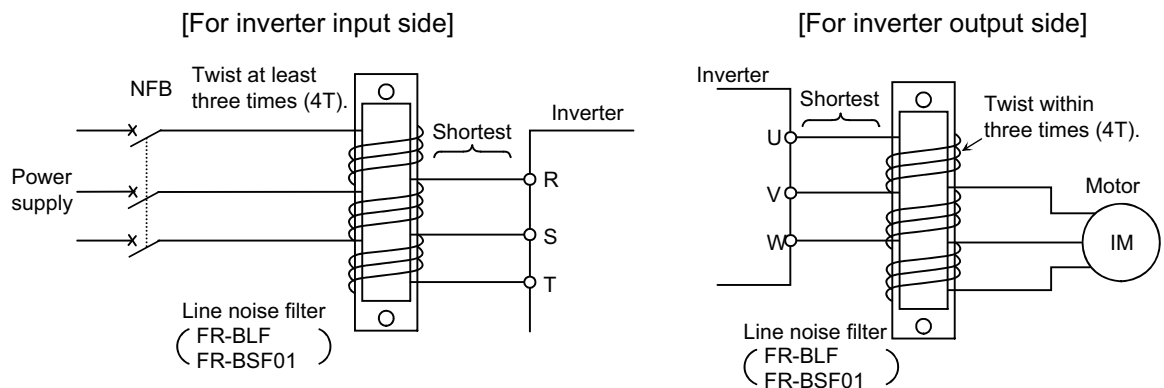
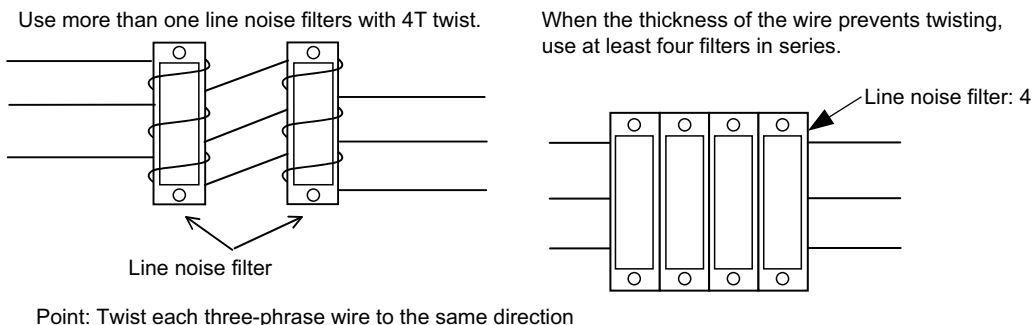
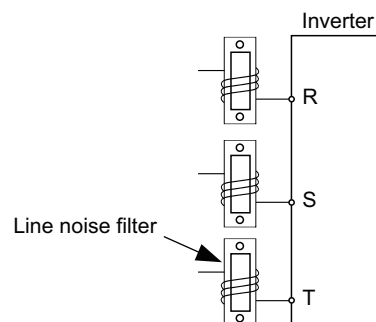

Fig.7.19 Installation of the line nose filter FR-BSF01, FR-BLF



Point: Twist each three-phase wire to the same direction

Fig.7.20 How to use two or more line nose filters



Point: Twist wire to three-phase to the same line noise filter

Fig.7.21 False usage of line nose filter

7 REVISING INSTALLATION ENVIRONMENT

Table7.2 Cable used and number of turns

•FR-BSF01

Cable used (mm ²)	Number of tuning wire (T)
2	4
3.5	4
5.5	3
8	2
14	2
22	1
38 to 150	× Unavailable

When the wire is thick (5.5mm² or more)



As wire cannot be turned for four times (4T) to one filter, it is recommended to use two or more filters to twist wire at four times in total.

Use which is mentioned above, or FR-BLF type line noise filter.

•FR-BLF

Cable used (mm ²)	Number of tuning wire (T)
2 to 22	4
30 to 60	3
80	2
100 to 150	1

When the wire is thick (30mm² or more)



As wire cannot be turned for four times (4T) to one filter, it is recommended to use two or more filters to twist wire at four times in total.

3) Using FR-BIF (-H) and FR-BLF, FR-BSF01 together

As mentioned above, FR-BIF is effective to low frequency noise, and FR-BLF to high frequency. Therefore, combining both models provides better results.

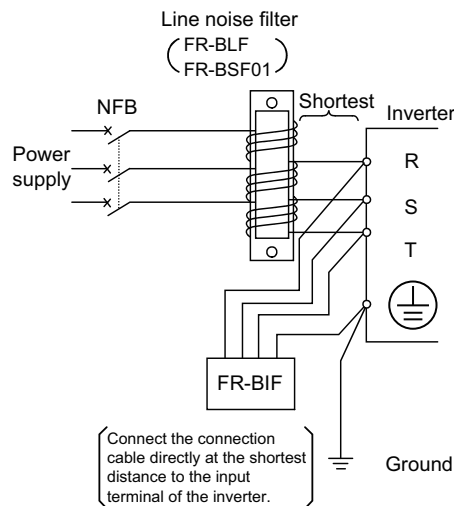

Fig.7.22 Using FR-BIF and FR-BLF, FR-BSF01 together

☒ POINTS for understanding !

FREQROL-A700, F700P series under 55kW include what is equivalent to line noise filter and radio noise filter of the input side.

Those of 55kW or more include what is equivalent to only radio noise filter.

4) Noise cut transformer

Noise cut transformer is a transformer which the magnetic and electrostatic combining of the first and the second coil is highly-miniaturized. This is effective to lowering noise.

7 REVISING INSTALLATION ENVIRONMENT

- (b) Reduction of noise radiated from wire between the inverter and the motor
A method to insert FR-BLF, FR-BSF01 line noise filter to the inverter output side is provided. However, as shown in Fig.7.23, metal conduit or shield cable generally reduces radiation noise. For motor grounding (earthing), using one cable within the four-core cables and proceeding in the inverter side is recommended. When the thickness of the conduit is 2mm or more, good effects are provided. Similar effects are provided when wiring inside the concrete pit in the place of metal conduit, or when storing in a concrete room.

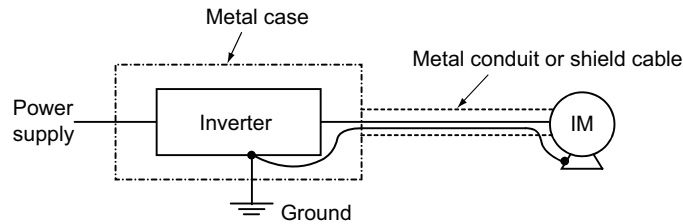

Fig.7.23 Conduit conduct of motor connection cable

- (c) Reduction of noise radiated from the inverter
In general, noise radiated from an inverter is comparatively small, and problems do not easily occur. However, store the inverter in a metal case (as shown in Fig.7.24) when you need to install the inverter near a device which easily receives noise failure. Also install noise filter to the power supply side, and connect the output side to the case as a metal conduit.

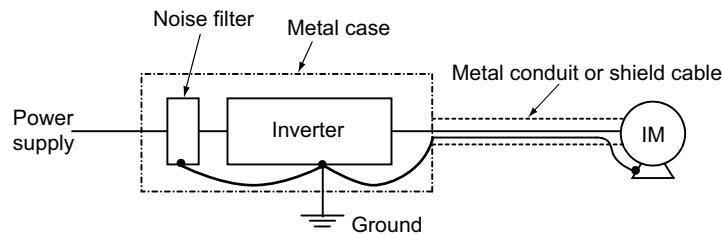
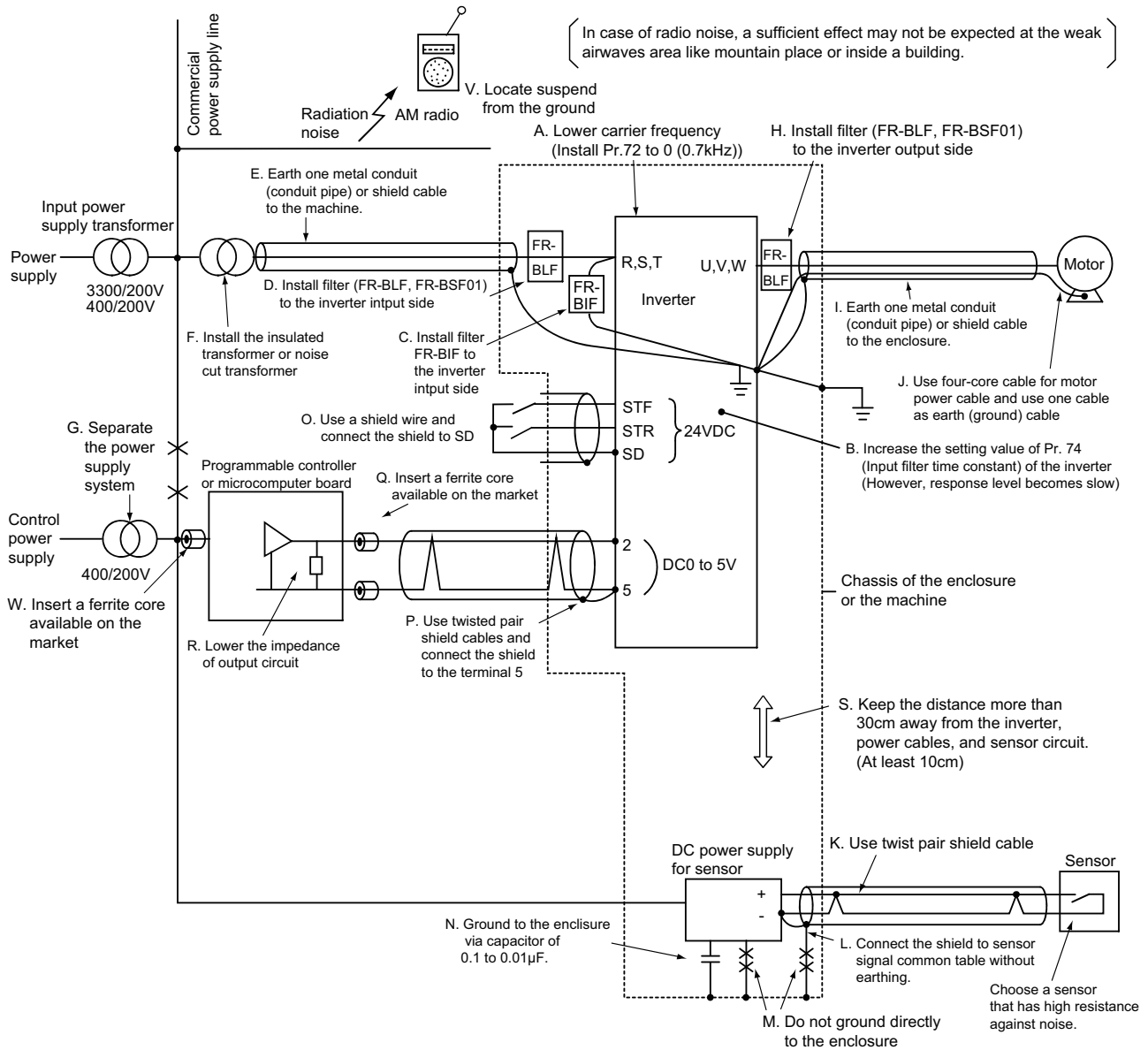

Fig.7.24 Reduction of noise radiated from the inverter

1	IMPORTANCE OF PRODUCTIVE MAINTENANCE
2	UNDERSTANDING INVERTER SYSTEM
3	MAINTENANCE SYSTEM DESIGN
4	PREVENTIVE MAINTENANCE
5	BREAKDOWN MAINTENANCE
6	CORRECTIVE MAINTENANCE
7	REVISING INSTALLATION ENVIRONMENT
8	LIFE OF INVERTER PARTS

(2) Examples of specific measures

Effective methods as an inverter noise measure are mentioned below.



Wiring method inside the enclosure

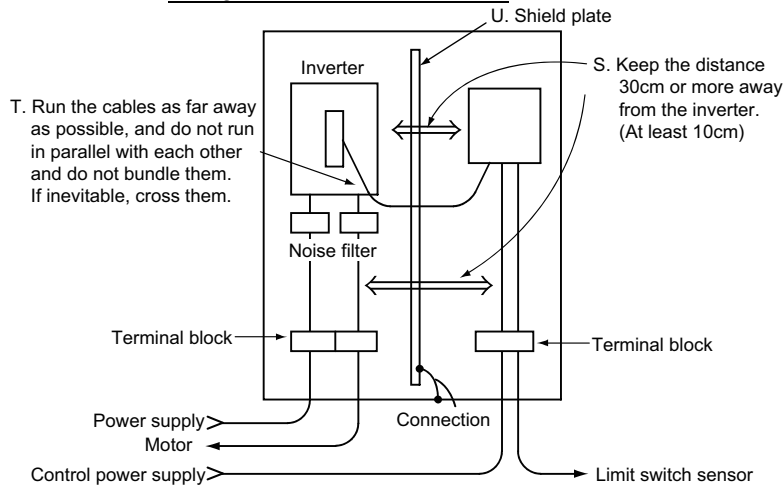

Fig.7.25 Example of measures against noise

7 REVISING INSTALLATION ENVIRONMENT

For each measure operation example (refer to the previous page), the expected effective level (estimated value) is mentioned below. Refer to the table when deciding priorities of actually proceeding measures.

Meaning of sign
 ✓ : Great effect
 ○ : Effective
 △ : Small effect
 — : No effect

Table7.3 Results of measures against noise

Place	Measure symbol	Measure method	Propagation method of noise						
			Aerial propagation noise			Electromagnetic induction noise	Electrostatic induction noise	Electrical path propagated noise	
			Radiation from inverter	Radiation from power supply cables	Radiation from motor cables			Power supply cables	Undesirable current of ground cables
Inverter	A	Lower Carrier frequency (Pr.72)	✓	✓	✓	✓	✓	✓	✓
	B	Higher Input filter time constant (Pr.74)	△	△	△	○	△	—	—
Input side	C	Install the radio noise filter FR-BIF(-H).	—	✓	—	—	—	✓	—
	D	Install the line noise filter FR-BSF01 or FR-BLF.	—	✓	—	—	—	✓	△
	E	Wire the power supply cable with the one metal conduit or shield cable	—	✓	—	—	—	✓	—
	F	Install the insulated transformer or noise cut transformer	—	△	—	—	—	✓	—
	G	Separate the power supply system.	—	—	—	—	—	✓	✓
Output side	H	Install the line noise filter FR-BSF01 or FR-BLF.	—	—	✓	△	△	—	✓
	I	Wire the output cable with the one metal conduit or shield cable	—	—	✓	○	○	—	—
	J	Use four-core cable for motor power cable and use one cable as ground cable	—	—	△	△	△	—	✓
Target device	K	Use twisted pair shield cables for the signal sensor	○	○	○	✓	✓	—	—
	L	Connect the shield to sensor signal common table.	—	—	—	✓	✓	—	✓
	M	Do not ground the sensor power supply unit directly to the enclosure	—	—	—	—	—	△	✓
	N	Ground the sensor power supply unit by capacitor	—	—	—	—	—	△	○
	O	Use a shield wire to input signals and connect the shield to common (input terminal) SD.	△	△	△	○	✓	—	△
	P	Use twisted pair shield cables for speed command and connect the shield to the terminal	○	○	○	✓	✓	—	△
	Q	Insert a ferrite core available on the market to the speed command cable (input side of target	△	△	△	○	—	—	—
	R	Lower the impedance of output circuit of target device	△	△	△	○	—	—	—
	S	Keep the distance 30cm or more away from the inverter, power cables, and sensor circuit.	✓	✓	✓	✓	✓	—	—
	T	Do not run cables in parallel with each other and do not bundle them	△	△	△	✓	✓	—	—
	U	Install the shield plate	○	△	△	△	△	—	—
V	Suspend from the ground	△	○	○	△	△	—	—	
W	Insert a ferrite core available on the market to the input side of target device	—	—	—	—	—	○	△	

1 IMPORTANCE OF PRODUCTIVE MAINTENANCE
 2 UNDERSTANDING INVERTER SYSTEM
 3 MAINTENANCE SYSTEM DESIGN
 4 PREVENTIVE MAINTENANCE
 5 BREAKDOWN MAINTENANCE
 6 CORRECTIVE MAINTENANCE
 7 REVISING INSTALLATION ENVIRONMENT
 8 LIFE OF INVERTER PARTS

7 REVISING INSTALLATION ENVIRONMENT

7.2.4 Leakage currents

Capacitances exist between the inverter I/O cables, other cables and earth and in the motor, through which a leakage current flows. Since its value depends on the static capacitances, carrier frequency, etc., low acoustic noise operation at the increased carrier frequency of the inverter will increase the leakage current. Therefore, take the following measures. Select the earth leakage circuit breaker according to its rated sensitivity current, independently of the carrier frequency setting.

(1) To-earth (ground) leakage currents

Table7.4 Effects and measures of to-earth (ground) leakage currents

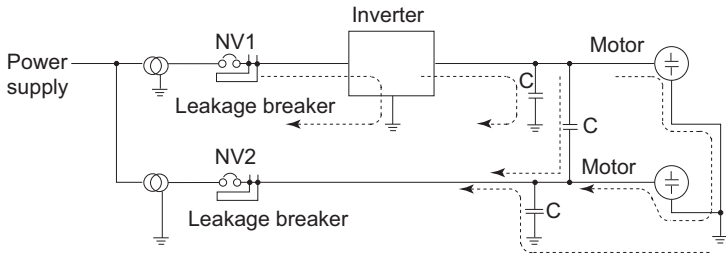
Type	Effects and measures
Effects and measures	<ul style="list-style-type: none"> •Leakage currents may flow not only into the inverter's own line but also into the other lines through the earth (ground) cable, etc. These leakage currents may operate earth (ground) leakage circuit breakers and earth leakage relays unnecessarily. ● Suppression technique •If the carrier frequency setting is high, decrease the Pr. 72 PWM frequency selection setting. Note that motor noise increases. Selecting Pr. 240 Soft-PWM operation selection makes the sound inoffensive. •If the carrier frequency setting is high, decrease the Pr. 72 PWM frequency selection setting. Note that motor noise increases. Selecting Pr. 240 Soft-PWM operation selection makes the sound inoffensive.
Undesirable path	

7 REVISING INSTALLATION ENVIRONMENT

(2) Line-to-line leakage currents

Table 7.5 Effects and measures of line-to-line leakage currents

Type	Effects and measures
Effects and measures	<ul style="list-style-type: none"> • This leakage current flows via a static capacitance between the inverter output cables. • The external thermal relay may be operated unnecessarily by the harmonics of the leakage current. When the wiring length is long (50m or more) for the 400V class small-capacity model (7.5K or lower), the external thermal relay is likely to operate unnecessarily because the ratio of the leakage current to the rated motor current increases. <p>● Measures</p> <ul style="list-style-type: none"> • Use Pr. 9 Electronic thermal O/L relay. • If the carrier frequency setting is high, decrease the Pr. 72 PWM frequency selection setting. Note that motor noise increases. Selecting Pr. 240 Soft-PWM operation selection makes the sound inoffensive. To ensure that the motor is protected against line-to-line leakage currents, it is recommended to use a temperature sensor to directly detect motor temperature.
Undesirable current path	<p>The diagram shows a power supply connected to an NFB (No-Fuse Breaker) and MC (Main Circuit) switch. The output of the switch goes to an inverter. The inverter's output passes through a thermal relay to a motor (IM). The diagram highlights the 'Line-to-line leakage currents path' which occurs through 'Line-to-line static capacitances' between the inverter output cables and the motor. Arrows indicate the direction of leakage current flow through these capacitances.</p>

1
IMPORTANCE OF
PRODUCTIVE
MAINTENANCE

2
UNDERSTANDING
INVERTER SYSTEM

3
MAINTENANCE
SYSTEM DESIGN

4
PREVENTIVE
MAINTENANCE

5
BREAKDOWN
MAINTENANCE

6
CORRECTIVE
MAINTENANCE

7
REVISING
INSTALLATION
ENVIRONMENT

8
LIFE OF INVERTER
PARTS

7.2.5 Ground (Earth)

Generally, an electrical apparatus has an earth (ground) terminal, which must be connected to the ground before use.

An electrical circuit is usually insulated by an insulating material and encased. However, it is impossible to manufacture an insulating material that can shut off a leakage current completely, and actually, a slight current flow into the case. The purpose of earthing (grounding) the case of an electrical apparatus is to prevent operator from getting an electric shock from this leakage current when touching it.

To avoid the influence of external noises, this earthing (grounding) is important to audio equipment, sensors, computers and other apparatuses that handle low-level signals or operate very fast.

As mentioned above, earthing (grounding) has two completely different types, and problem occurs when these are earthed together. Therefore, earthing (grounding) must be divided into a dirty earth which prevents electrification, and a clean earth which prevents noise.

However, when the inverter is used, the output voltage is no longer a sine waveform but a precipitous waveform. Therefore, the charge-discharge current to the static capacitance which exists in the isolated section flows as a leak current.

Furthermore, similar charge-discharge leak current flows in the motor which the output voltage of this inverter is applied. There are more harmonic elements and the current value becomes larger compared to when driving in commercial power supply as shown in Fig.7.27. The higher the carrier frequency of the inverter, the stronger this inclination is.

(1) Earthing (grounding) methods and earthing (grounding) work

As described previously, earthing (grounding) is roughly classified into an electrical shock prevention type and a noise-affected malfunction prevention type.

Therefore, to clearly discriminate this earthing (grounding), and not to let the leak current full of harmonic elements flow into earthing to prevent mis-operating, conducting as mentioned below is necessary.

- (a) Earthing (grounding) of the inverter is for exclusive use as much as possible. (Refer to Fig.7.26)

When Independent earthing (grounding) is not available (same figure (I)), use the common earthing (grounding) connected with other devices at the earth point (same figure (II)).

Common earthing (grounding) which use earth (ground) cable commonly with other devices as the same figure (III) must be avoided.

Especially, common earthing with large power devices such as motors or transformers must be avoided.

A leakage current including many high frequency components flows in the earth (ground) cables of the inverter and inverter-driven motor. Therefore, use the independent earthing (grounding) and separate the earthing (grounding) cable of the inverter from equipment sensitive to EMI.

In a high building, it may be effective to use the EMI prevention type earthing (grounding) connecting to an iron structure frame, and electric shock prevention type earthing (grounding) with the independent earthing (grounding) together.

7 REVISING INSTALLATION ENVIRONMENT

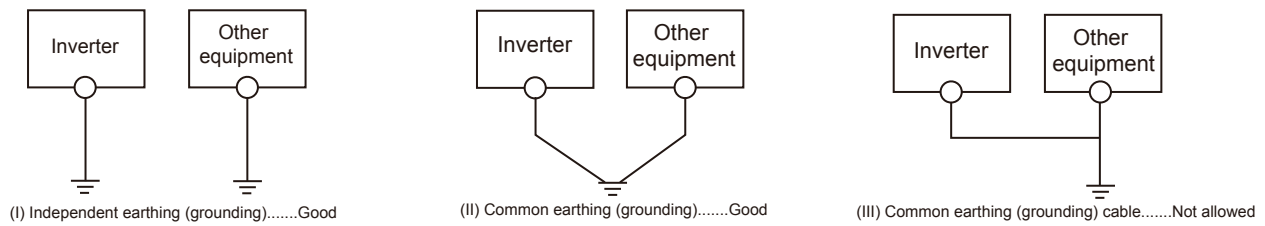

Fig.7.26 Grounding method

- (b) This inverter must be earthed (grounded). Earthing (Grounding) must conform to the requirements of national and local safety regulations and electrical codes. (NEC section 250, IEC 536 class 1 and other applicable standards).
- (c) Use the earth (ground) cable as thick as possible. Use a bigger earth (ground) cable in size than that of mentioned in the instruction manual.
- (d) The earthing (grounding) point should be as close as possible to the inverter, and the earth (ground) wire length should be as short as possible.
- (e) Run the earth (ground) cable as far away as possible from the I/O wiring of equipment sensitive to noises and run them in parallel in the minimum distance.
- (f) For motor grounding, use one cable within the four-core cables and proceed in the inverter side.

When earthing the inverter, the motor grounding which is driven in the inverter and earthing such as audio, sensor, computer are connected together, this leak current becomes the noise source and provides bad effect.

To resolve this problem, earth construction to separate the dirty earth such as the inverter and the clean such as audio, sensor, computer is necessary.

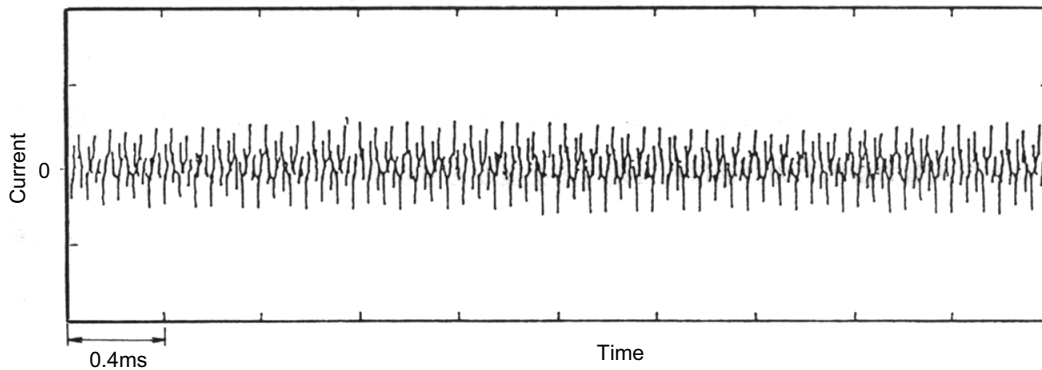

Fig.7.27 Example of earth (ground) cable current of the motor when driven by inverter (Inverter: 200V class 0.75K, Motor: SF-JR 0.75kW 4P)

7.3 Problems and Measures When Using Inverter

This section explains especially considered precautions depending on the installation environment of the inverter and the service condition.

Circuit design, cautions when wiring and driving procedure in use of the inverter is also explained.

7.3.1 Environment and installation condition

(1) Reliability of the inverter and temperature

Reliability of the inverter is affected by temperature. When surrounding air temperature is high or defect when installing, the temperature inside the inverter increases due to mis-selecting the installing place or bad installation. Therefore, unexpected troubles such as failure or damage, etc may occur.

The possible causes are mentioned below.

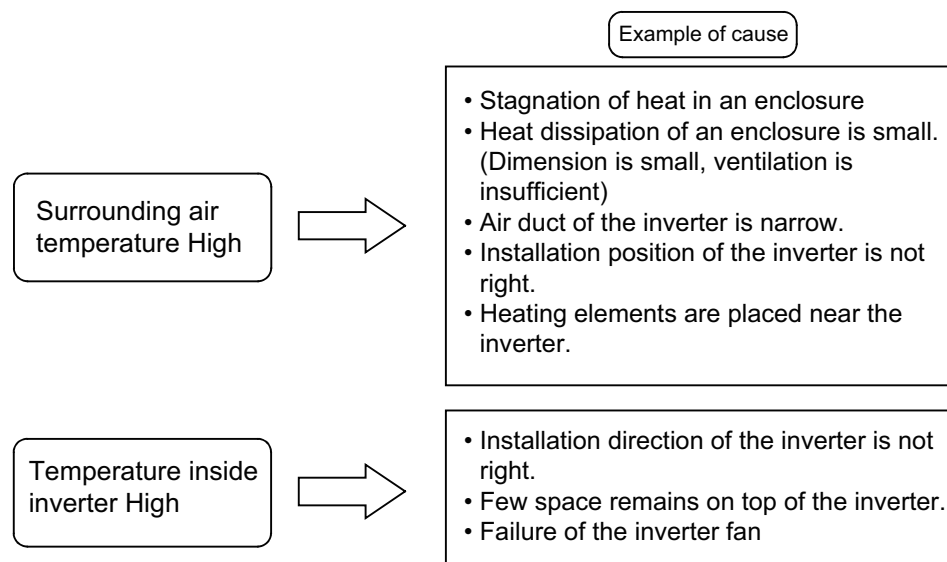

(2) Surrounding air temperature

Surrounding air temperature of an inverter is the temperature very close to where the inverter is installed.

- 1) Measure the temperature at the position shown in Fig.7.28.
- 2) The permissible temperature is from -10°C to $+50^{\circ}\text{C}$. (Trouble may occur whether it is too high or too low.)
- 3) When enclosure temperature is $+50^{\circ}\text{C}$ or lower, consider that the surrounding temperature of the enclosure is 40°C or lower.

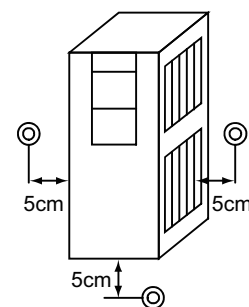

Fig.7.28 Measuring surrounding air temperature

☒ Good to know for checking an inverter

Life

For the smoothing electrolytic capacitor used for the inverter, the life becomes 1/2 when the surrounding air temperature increases 10°C, and it is one of parts that is applicable to "Arrhenius law".

The life of other parts also depend much on the temperature.

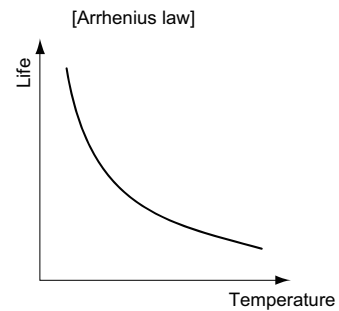

Relation between failure occurrence rate and temperature

The inverter is composed by many electronic parts such as chips. There is near relation between surrounding temperature and failure rate for these parts. The point to lower failure rate is to use in a low temperature as possible.

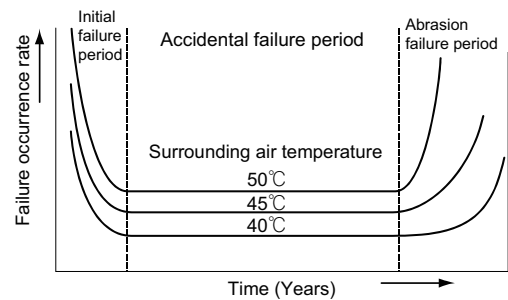

(3) Heat of an inverter

Generated heat amount of the inverter depends on the inverter capacity or the motor loading rate.

Options stored in the enclosure with the inverter such as AC reactor, DC reactor and brake unit (including discharge resistor) have heat amount quite high. These heat must be considered when designing the enclosure. Generated heat amount is shown in Table 7.6. When using the heatsink protrusion attachment, and getting the chip heat release fin section and the built-in brake discharge resistor out, about 70% of the inverter heat amount can be released outside the enclosure. Refer to Fig. 7.29 for how to use the heatsink protrusion attachment.

7

REVISING INSTALLATION ENVIRONMENT

Table7.6 Heat value of inverter and reactor

Rating time

Motor capacity (kW)	FREQROL-A700		Reactor heat value (W)			
	Inverter heat value (W)		FR-HEL		FR-HAL	
	200V	400V	200V	400V	200V	400V
0.4	50	50	6	6	10	16
0.75	70	65	7	7	14	23
1.5	110	75	8	8	20	30
2.2	140	100	11	11	24	43
3.7	190	150	13	13	33	46
5.5	260	200	17	17	40	52
7.5	360	250	19	19	46	52
11	520	300	23	23	60	60
15	670	400	26	26	75	60
18.5	770	550	29	29	74	76
22	940	650	34	34	82	74
30	1050	800	38	38	97	91
37	1270	1100	47	47	120	97
45	1610	1300	47	47	140	140
55	1880	1550	52	52	140	150
75	2530	1900	130	130	170	180
90	3110	2400	130	130		
110		2500	160	140	280	200
132		3000		140		
160		4000		170		
185		4200		230		400
220		5000		240		
250		5500		270		
280		6500		300		490
315		7000		360		
355		8000		360		530
400		9000		450		
450		10500		450		
500		11500		470		
560				500		1080

(Note) Generated heat amount of the built-in brake discharge resistor under 7.5K is not included.

7 REVISING INSTALLATION ENVIRONMENT

(4) Interference of heat inside the enclosure and ventilation

The inverter and the location of the ventilation fan are one of the points to be careful when storing the enclosure. When storing more than one inverters in the enclosure, or when installing the ventilation fan, surrounding temperature of the inverter increases, or lowers ventilation effects depending on the installing position.

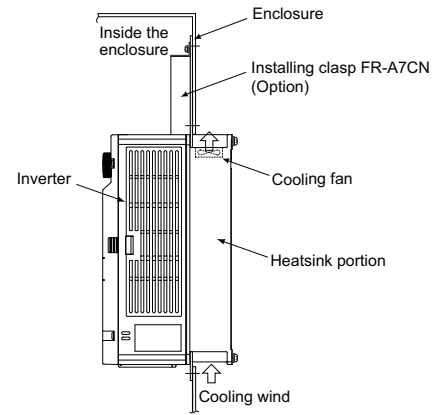

Fig.7.29 How to use heatsink protrusion attachment

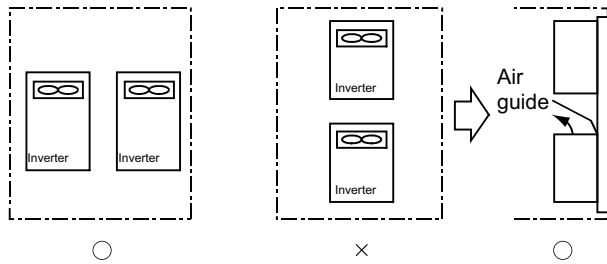

Fig.7.30 When storing two or more inverters

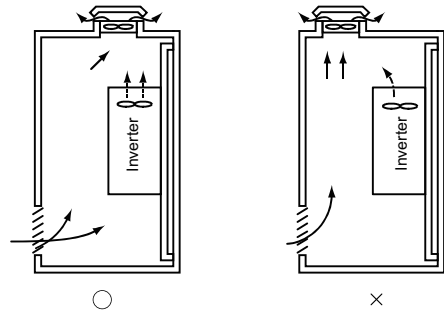

Fig.7.31 Location of the ventilation fan

(5) Installation of electrical-discharge resistor

When electrical-discharge resistor or high-duty brake resistor of external installation (FR-ABR) is used, proceeding heat measures from the discharge resistor is necessary.

Recognize the discharge resistor as a heater and consider its cooling.

It is recommended to locate the electrical-discharge resistor outside the enclosure.

Caution: The surface of the discharge resistor may reach up to about 300°C. Therefore, be careful of the material of the installation side and the location when using two or more discharge resistors.

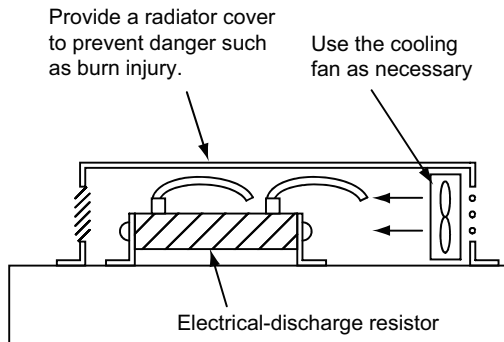

Fig.7.32 Installing method of the discharge resistor

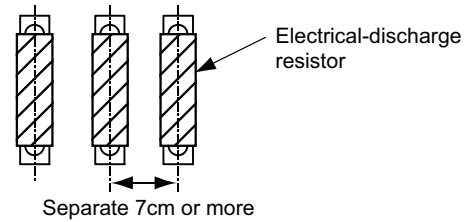

Fig.7.33 Placement of the discharge resistor

(6) Installing direction of the inverter

If the installing direction is not correct, radiation effect of the inverter lowers significantly, and the generated heat remains inside the inverter. (The printed plate of the control circuit is not cooled by a cooling fan.)

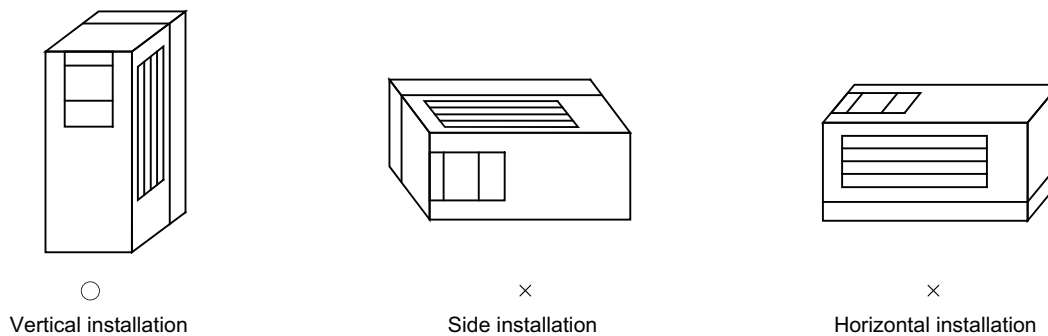

Fig.7.34 Installing direction of the inverter

(7) Normal specification of the installation environment (FREQR0L-A700 series for 200V class)

Item	Description
Surrounding air temperature	-10 to +50°C (non-freezing)
Ambient humidity	90% RH maximum (non-condensing)
Atmosphere	Indoors/Free from corrosive gas, explosive gas, flammable gas. Free from dust and dirt, oil mist.
Maximum Altitude	Altitude: 1000m or less
Vibration	5.9m/s ² or less * at 10 to 55Hz (directions of X, Y, Z axes)
AC voltage/frequency	Three-phase 200 to 220V 50Hz, 200 to 240V 60Hz
Permissible AC voltage fluctuation	170 to 242V 50Hz, 170 to 264V 60Hz
Permissible frequency fluctuation	±5%

7 REVISING INSTALLATION ENVIRONMENT

● Temperature

(a) Measures against high temperature

- 1) Use a forced ventilation system or similar cooling system. (Refer to (4).)
- 2) Install the enclosure in an air-conditioned electrical chamber.
- 3) Block direct sunlight.
- 4) Provide a shield or similar plate to avoid direct exposure to the radiated heat and wind of a heat source.
- 5) Ventilate the area around the enclosure well.

☒ POINT

Failure example: Rise in temperature

[Failure content]

Enclosure inverter installed outside stopped during daytime in summer. The inverter displays "Fin overheat".

[Cause of failure]

Although there is no problem with surrounding air temperature in the enclosure, the protrusion of the heatsink is exposed to sunlight.

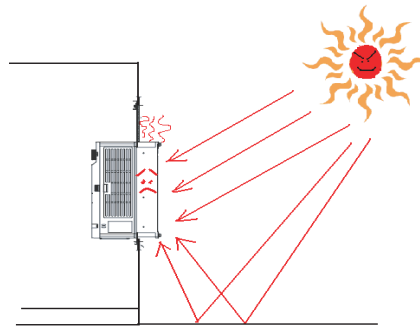

■ Protrusion of the heatsink

When encasing the inverter in an enclosure, the generated heat amount in an enclosure can be greatly reduced by installing the heatsink portion of the inverter outside the enclosure. When downsizing enclosure etc, this installing method is recommended. For an inverter with 160K or more, heatsink protrusion can be get out of the enclosure without using the attachment.

- When using a heatsink protrusion attachment (FR-A7CN)
For the FR-A720-1.5K to 90K, FR-A740-0.4K to 132K, a heatsink can be protruded outside the enclosure using a heatsink protrusion attachment (FR-A7CN). Refer to the instruction manual of heatsink protrusion attachment (FR-A7CN) for details.

1

IMPORTANCE OF
PRODUCTIVE
MAINTENANCE

2

UNDERSTANDING
INVERTER SYSTEM

3

MAINTENANCE
SYSTEM DESIGN

4

PREVENTIVE
MAINTENANCE

5

BREAKDOWN
MAINTENANCE

6

CORRECTIVE
MAINTENANCE

7

REVISING
INSTALLATION
ENVIRONMENT

8

LIFE OF INVERTER
PARTS

7 REVISING INSTALLATION ENVIRONMENT

● Dimensional drawing after installing the attachment (when FR-A7CN is used)

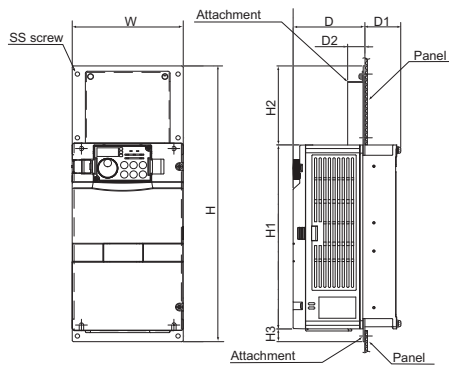

Model	W	H	H1	H2	H3	D	D1	D2	S
FR-A7CN01	150	389.5	260	111.5	18	97	48.4	23.3	M5
FR-A7CN02	245	408.5	260	116.5	32	86	89.4	12.3	M5
FR-A7CN03	245	448.5	300	116.5	32	89	106.4	20	M5
FR-A7CN04	280	554	400	122	32	88.5	110.6	45.3	M8
FR-A7CN05	338	645	480	130	35	123.5	71.5	105	M8
FR-A7CN06	338	645	480	130	35	123.5	71.5	83.5	M8
FR-A7CN07	451	650	465	145	40	96	154	55	M10
FR-A7CN08	510	725	535	150	40	116.5	183.5	45	M10
FR-A7CN09	510	725	535	150	40	116.5	183.5	45	M10
FR-A7CN10	510	845	655	150	40	176.5	183.5	45	M10
FR-A7CN11	510	805	615	150	40	97	153	45	M10

(Unit: mm)

[Measures against failure]

Installed a shield plate to provide shade.

(b) Measures against low temperature

- 1) Provide a space heater in the enclosure.
- 2) Do not power OFF the inverter. (Keep the start signal of the inverter OFF.)

(c) Sudden temperature changes

- 1) Select an installation place where temperature does not change suddenly.
- 2) Avoid installing the inverter near the air outlet of an air conditioner.
- 3) If temperature changes are caused by opening/closing of a door, install the inverter away from the door.

● Humidity

Normally operate the inverter within the 45 to 90% range of the ambient humidity. Too high humidity will pose problems of reduced insulation and metal corrosion. On the other hand, too low humidity may produce a spatial electrical breakdown.

The insulation distance specified in JEM1103 "Control Equipment Insulator" is defined as humidity 45 to 85%.

(a) Measures against high humidity

- 1) Make the enclosure enclosed, and provide it with a hygroscopic agent.
- 2) Take dry air into the enclosure from outside.
- 3) Provide a space heater in the enclosure.

(b) Measures against low humidity

What is important in fitting or inspection of the unit in this status is to discharge your body (static electricity) beforehand and keep your body from contact with the parts and patterns, besides blowing air of proper humidity into the enclosure from outside.

(c) Measures against condensation

Condensation may occur if frequent operation stops change the in-enclosure temperature suddenly or if the outside air temperature changes suddenly.

Condensation causes such faults as reduced insulation and corrosion.

- 1) Take the measures against high humidity in (a).
- 2) Do not power OFF the inverter. (Keep the start signal of the inverter OFF.)

7 REVISING INSTALLATION ENVIRONMENT

(8) When driving explosion-proof motor with inverter

For using an explosion-proof motor and driving inverter together, pass a test. Perform installation taking care of the precautions below.

- (a) For an existing explosion-proof motor for commercial power supply drive and a safety explosion-proof motor, inverter operation is not available.
An explosion-proof test of the motor and inverter together by Health, Labor and Welfare Ministry is necessary. This test is conducted by Technology Institution of Industrial Safety Foundation.
The combination of the explosion-proof motor and the inverter which has acquired the test in advance can be used. However, this is effective only for inverters which have the same model as when the test has been acquired. Furthermore, usable driving range is limited within the certified terms.
Mitsubishi prepare a dedicated explosion-proof type motor/inverter for driving inverter. Refer to the catalog for details.
- (b) When desiring use rate is not within the certified terms, or when using non-tested models, take another test.
- (c) When using the inverter option together, refer to the instruction manual.
- (d) Using a safety explosion-proof motor combing with an inverter is not cost-effective including the examination fee, because the driving condition (lowering occurring loss, improving cooling effect, etc) is strictly restricted.
It is recommended to use a tested explosion-proof motor.
- (e) The inverter itself is a non-explosion proof structure. Always install it in a non-explosion location.

1	IMPORTANCE OF PRODUCTIVE MAINTENANCE
2	UNDERSTANDING INVERTER SYSTEM
3	MAINTENANCE SYSTEM DESIGN
4	PREVENTIVE MAINTENANCE
5	BREAKDOWN MAINTENANCE
6	CORRECTIVE MAINTENANCE
7	REVISING INSTALLATION ENVIRONMENT
8	LIFE OF INVERTER PARTS

7.3.2 Connection of inverter

(1) Terminal connection diagram

Connection of each terminal to operate an inverter is described in a catalog. Specifications, points when using are explained below taking FR-A700 series as an example.

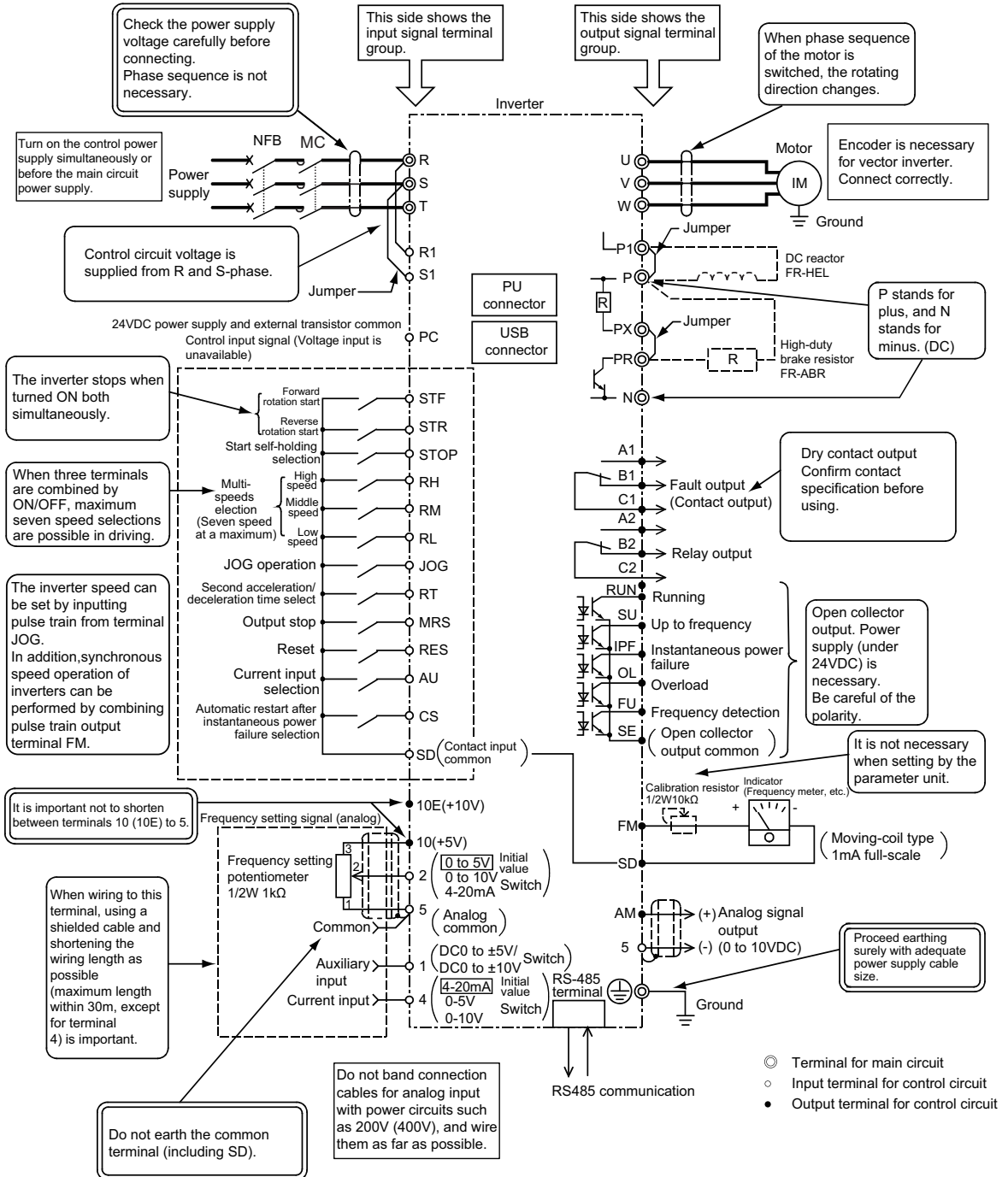

Fig.7.35 Terminal connection

7 REVISING INSTALLATION ENVIRONMENT

POINT

Failure example 1: Wiring power supply

[Failure content]

Nothing is displayed on the monitor when power of the inverter is turned on.

[Cause of failure]

Commercial power supply input R/L1, S/L2, T/L3 is connected to the output terminal of the inverter U, V, W. The display of the power supply itself is wrong.

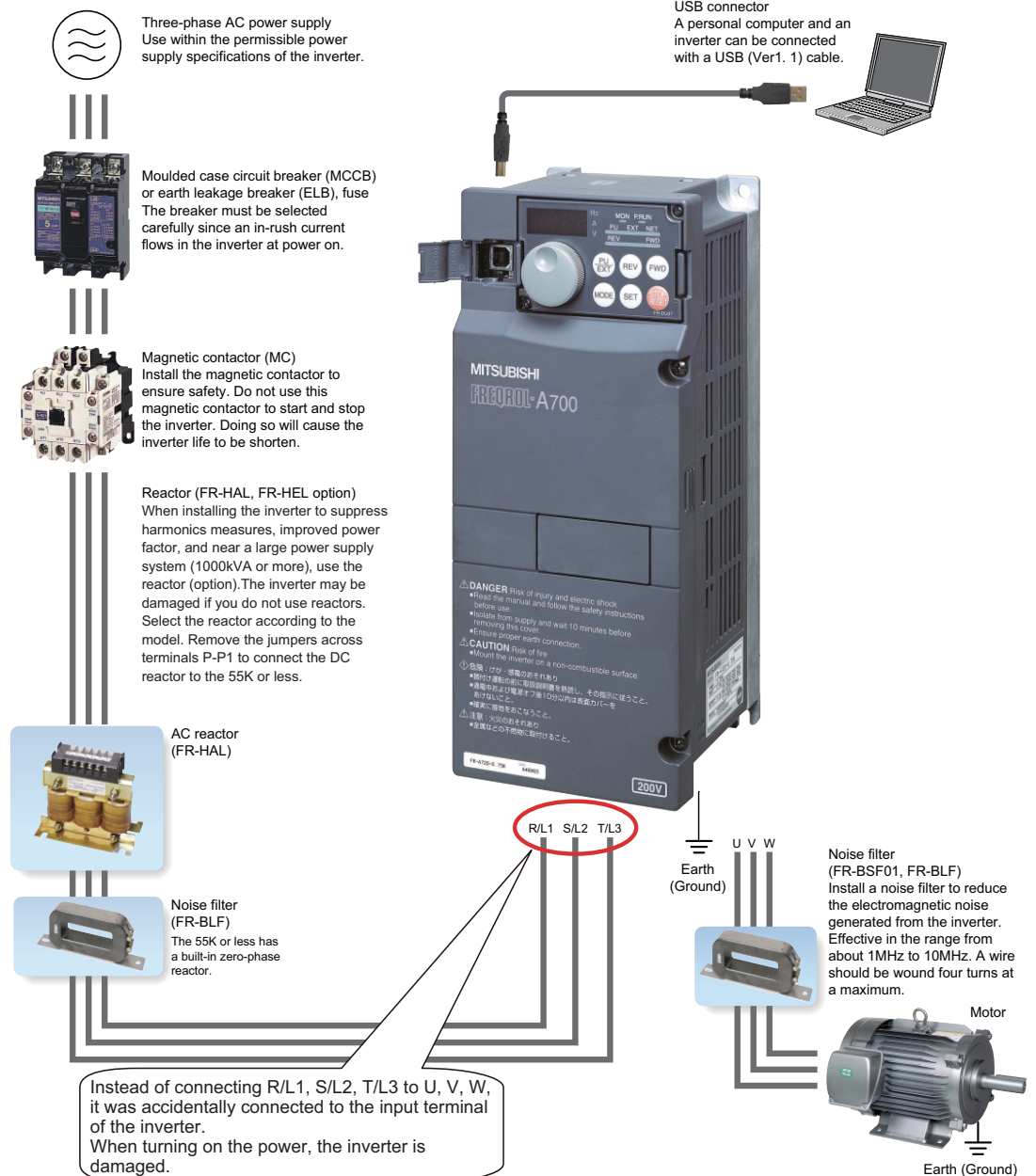

1
IMPORTANCE OF
PRODUCTIVE
MAINTENANCE

2
UNDERSTANDING
INVERTER SYSTEM

3
MAINTENANCE
SYSTEM DESIGN

4
PREVENTIVE
MAINTENANCE

5
BREAKDOWN
MAINTENANCE

6
CORRECTIVE
MAINTENANCE

7
REVISING
INSTALLATION
ENVIRONMENT

8
LIFE OF INVERTER
PARTS

7 REVISING INSTALLATION ENVIRONMENT

Failure example 2: DC reactor mis-connecting

[Failure content]

At a motor test drive, OV is displayed and the reactor burned out.

[Cause of failure]

Instead of connecting DC reactor to P/+, P1, it was connected to P/+, PR terminal of the brake resistor.

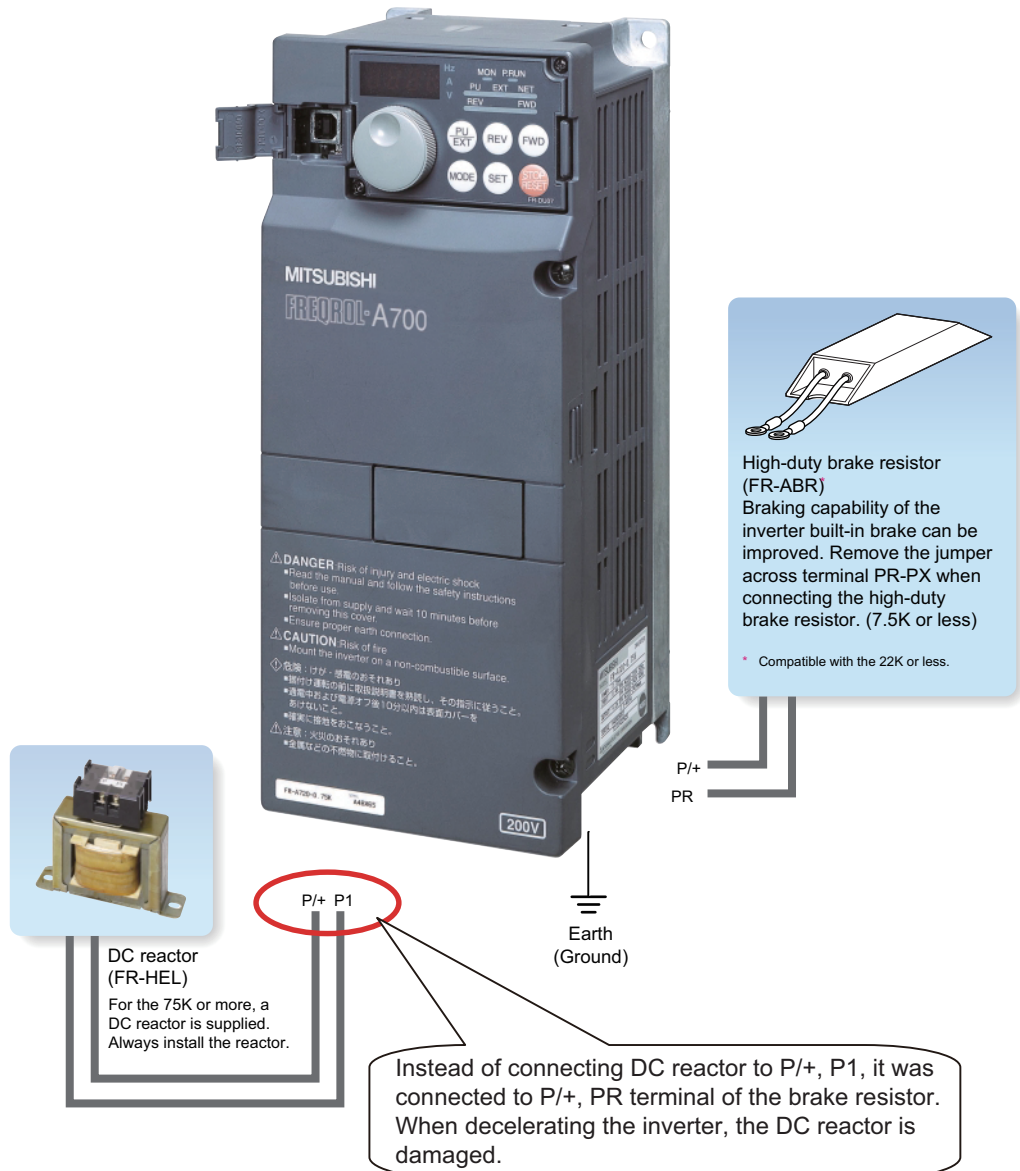

7 REVISING INSTALLATION ENVIRONMENT

(2) Connection of main circuit

As a main circuit is a power circuit, connecting incorrectly may not only damage the inverter, but also be dangerous to workers. Precautions are mentioned below.

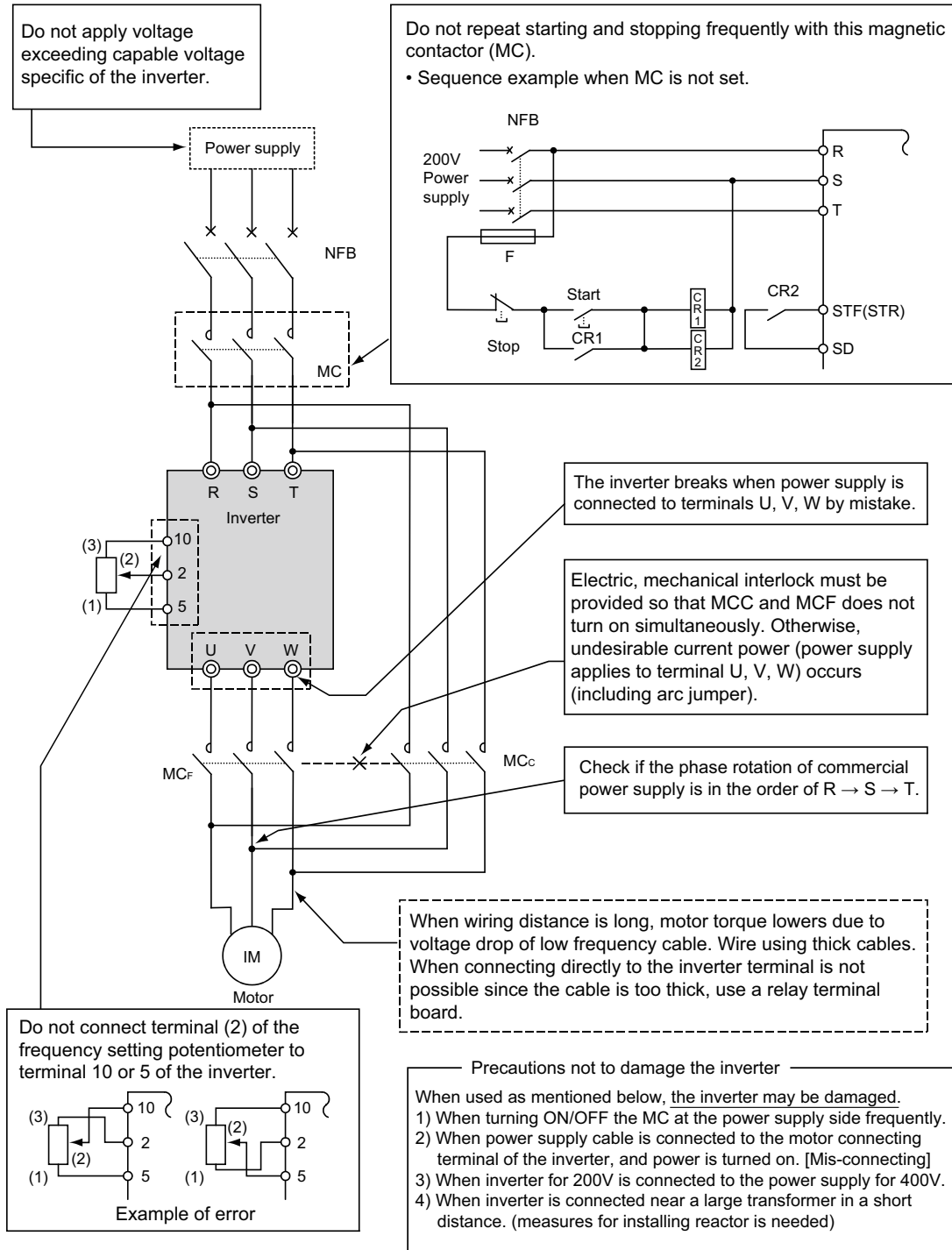

Fig.7.36 Main circuit connection

7 REVISING INSTALLATION ENVIRONMENT

(3) Connection of the control circuit

Format of I/O terminal which the inverter equips and common terminal are mentioned below.

Terminal	Form	Example of terminal	Common terminal
Input terminal	Contact (or open collector)	Start signal (STF, STR) Selection signal (RH, RM, RL, AU, etc)	SD or PC (power supply ⊕ common)
	Analog	Frequency setting signal (2, 1, 4, etc)	5
Output terminal	Contact	Fault output (A, B)	C
	Open collector	Running signal (RUN, SU, OL, IPF, FU)	SE
	Pulse train	For an indicator (frequency meter) (FM)	SD
	Analog	For analog signal output (AM)	5

(a) Connection to input terminal

1) Contact or open collector input terminal (insulated from the inverter internal circuit)

Function of each terminal is proceeded within the short of common terminal SD. Since the power distribution current is micro-currents (4VDC to 6mA), use switches or relays for micro-currents (twin contacts, etc) to prevent a contact faults.

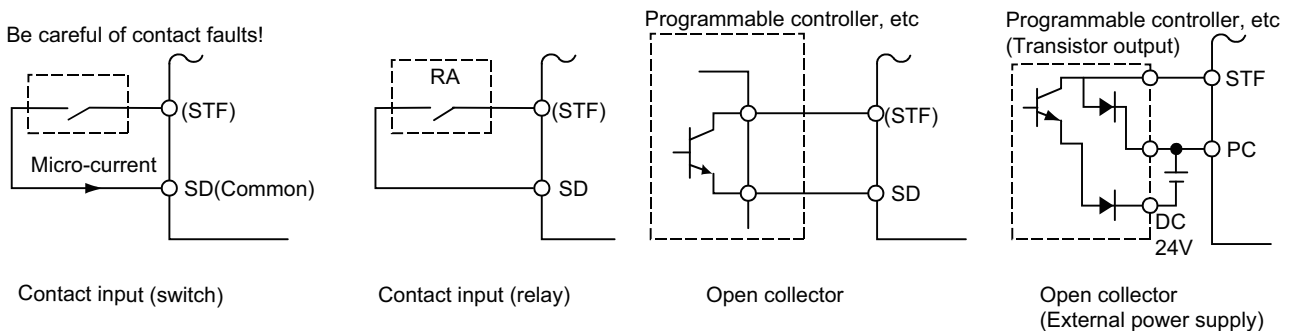

Fig.7.37 Connection of input signal

2) Analog input terminal (not insulated from the inverter internal circuit)

Perform wiring separating with power circuit cables of 200V (400V), etc, so as not to band with them. Using a shield wire is also necessary for external noise measures.

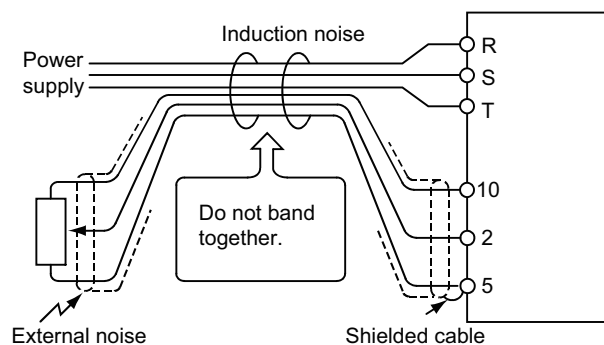

Fig.7.38 Connection example of frequency setting input terminal

7 REVISING INSTALLATION ENVIRONMENT

- 3) Correct connection of frequency setting potentiometer
 There is a terminal code for each frequency setting potentiometer, and connecting incorrectly occurs an inverter failure.
 The discharge value is also an important point when selecting.
 <Specification> 2W 1kΩ Wire-wound variable discharge resistor type B characteristic

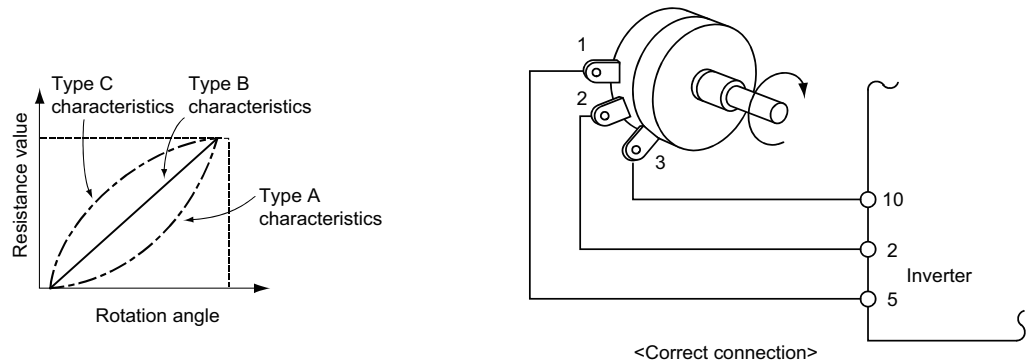
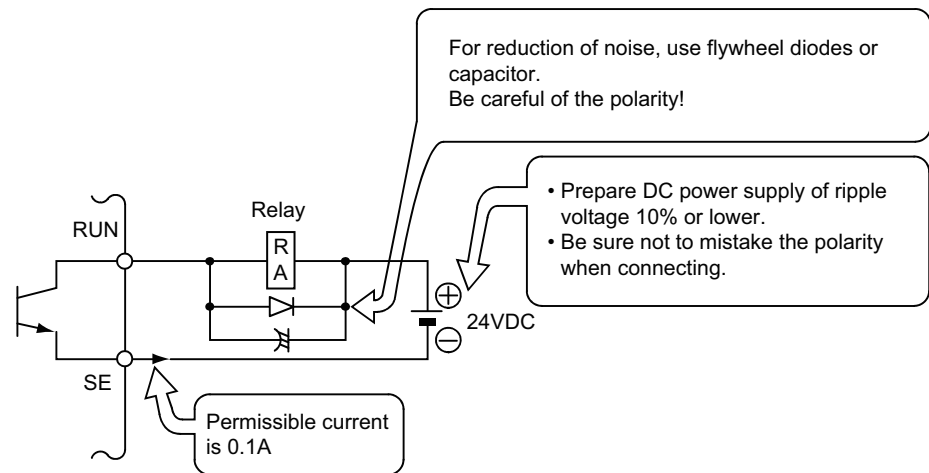

Fig.7.39 Connection of frequency setting potentiometer

- (b) Connection to output terminal
 1) Open collector output terminal



- 2) Pulse train output terminal

- 3) Analog signal output (0 to 10VDC)

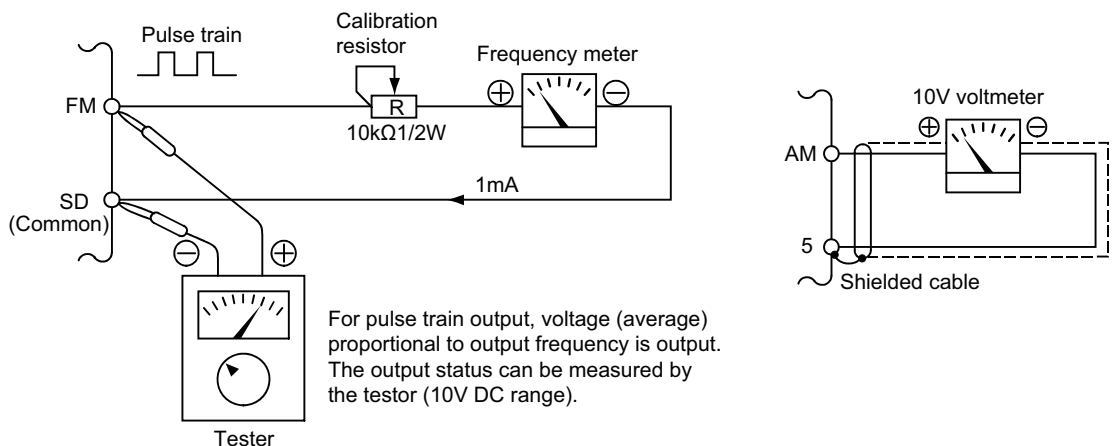

Fig.7.40 Connection of output signal terminal

1 IMPORTANCE OF PRODUCTIVE MAINTENANCE
 2 UNDERSTANDING INVERTER SYSTEM
 3 MAINTENANCE SYSTEM DESIGN
 4 PREVENTIVE MAINTENANCE
 5 BREAKDOWN MAINTENANCE
 6 CORRECTIVE MAINTENANCE
 7 REVISING INSTALLATION ENVIRONMENT
 8 LIFE OF INVERTER PARTS

(4) Wiring distance of I/O cable

Each I/O terminal differs its restriction. Especially, control signal proceeds photocoupler insulation at the input part for noise resistance, but on the other hand, analog input is not insulated.

Therefore, be careful of wiring the frequency setting signal in particular, and take measures not to be affected by external noise, such as by shortening the wire length as possible. A guide of the permissible wire length against each signal and a measure if exceeding this length are shown in Fig.7.41.

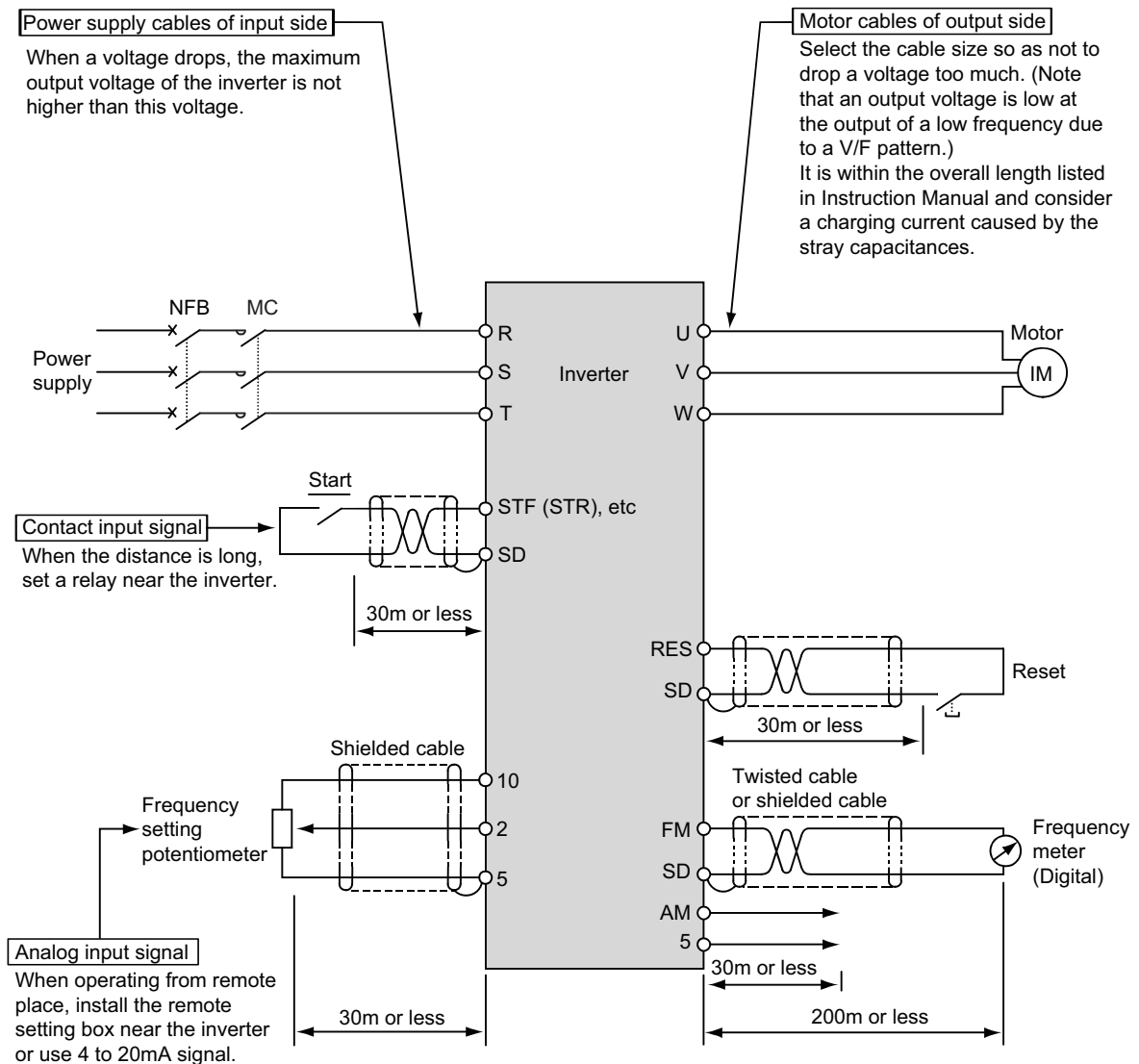

Fig.7.41 Wiring length of I/O cables

7 REVISING INSTALLATION ENVIRONMENT

(5) Wiring of FR-BU2 brake unit

Wire FR-BU2 brake unit and the electrical-discharge resistor or the discharge resistor unit as a couple. Connect it to the inverter terminal P/+, N/-.

(a) FR-BU2 brake unit and the electrical-discharge resistor

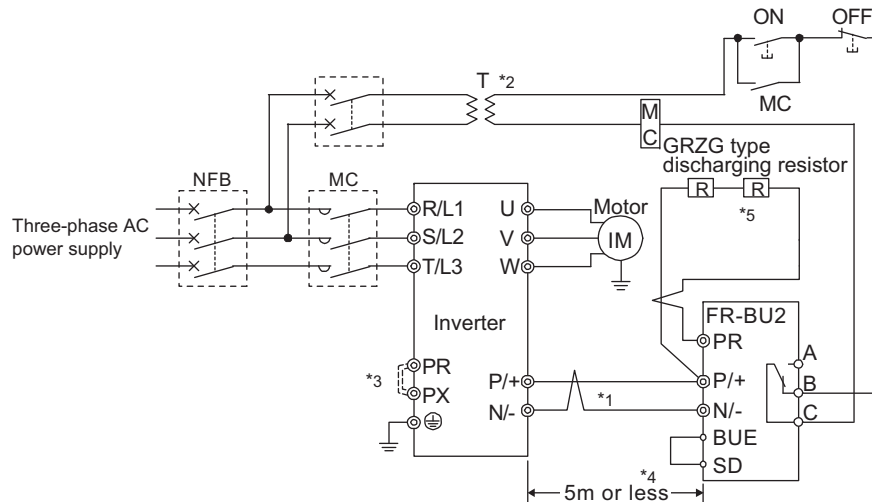

- *1 Connect the inverter terminals (P/+, N/-) and brake unit (FR-BU2) terminals so that their terminal names match with each other. (Incorrect connection will damage the inverter and brake unit.)
- *2 When the power supply is 400V class, install a step-down transformer.
- *3 Remove the jumper across terminals PR and PX when using the FR-BU2 with the inverter FREQROL-A700 series of 7.5K or lower and the inverter FREQROL-V500 series of 5.5K or lower.
- *4 Keep a wiring distance of within 5m between the inverter, brake unit (FR-BU2) and discharging resistor. Even when the wiring is twisted, the cable length must not exceed 10m.
- *5 It is recommended to install an external thermal relay to prevent overheating of discharging resistors.

Fig.7.42 Wiring method of the brake unit (GRZG electrical-discharge resistor)

(b) FR-BU2 brake unit and FR-BR discharge resistor unit

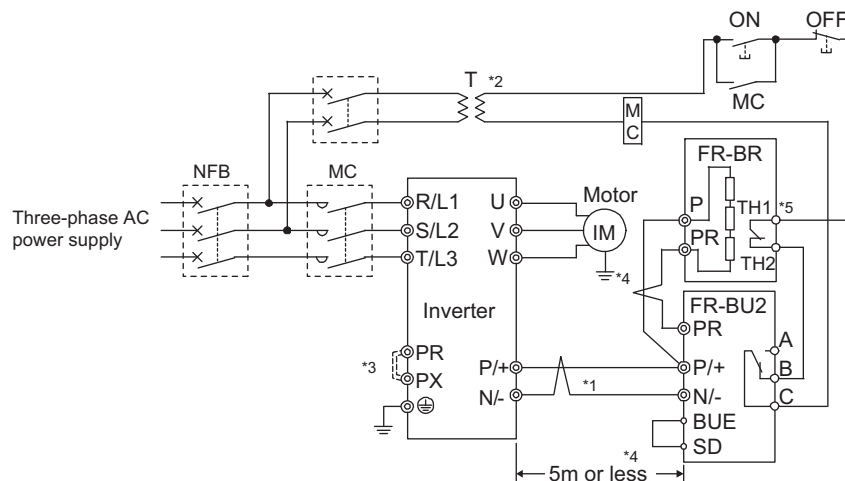

- *1 Connect the inverter terminals (P/+, N/-) and brake unit (FR-BU2) terminals so that their terminal names match with each other. (Incorrect connection will damage the inverter and brake unit.)
- *2 When the power supply is 400V class, install a step-down transformer.
- *3 Remove the jumper across terminals PR and PX when using the FR-BU2 with the inverter FREQROL-A700 series of 7.5K or lower and the inverter FREQROL-V500 series of 5.5K or lower.
- *4 The wiring distance between the inverter, brake unit (FR-BU) and resistor unit (FR-BR) should be within 5m. Even when the wiring is twisted, the cable length must not exceed 10m.
- *5 The contact between TH1 and TH2 is closed in the normal status and is open at a fault.
- *6 MT-For details of MT-BR5 type resistor unit, refer to the optional catalog.

Fig.7.43 Wiring method of the brake unit (FR-BR discharge resistor unit)

7 REVISING INSTALLATION ENVIRONMENT

(6) Wiring of high-duty brake resistor (FR-ABR)

Internal brake discharge resistor is connected to terminal P, PX. When operating high frequency, remove the jumper between terminals PR-PX and connect the high-duty brake resistor to terminal P, PR, only when heat ability is low in the internal brake discharge resistor.

(Note) • Do not connect discharge resistors other than high-duty brake resistor.

- There is no terminal PX in models which do not include brake resistor.
- High-duty brake resistor cannot be connected with models which do not include brake transistor.

When the regenerative brake transistor is damaged, the following sequence is recommended to prevent overheat and burnout of the brake resistor.

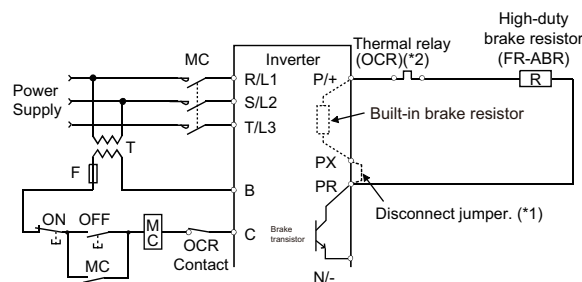

- *1 Since the inverter without built-in brake resistor is not provided with the PX terminal, a jumper is not need to be removed.
 *2 Refer to the table below for the type number of each capacity of thermal relay and the diagram below for the connection.
 (Always install a thermal relay when using the 11K or higher)

Power Supply Voltage	High-Duty Brake Resistor	Thermal Relay Type (Mitsubishi product)	Contact Rating
200V	FR-ABR-0.4K	TH-N20CXHZ-0.7A	AC110V 5A, AC220V 2A (AC11 class) DC110V 0.5A, DC220V 0.25A (DC11 class)
	FR-ABR-0.75K	TH-N20CXHZ-1.3A	
	FR-ABR-2.2K	TH-N20CXHZ-2.1A	
	FR-ABR-3.7K	TH-N20CXHZ-3.6A	
	FR-ABR-5.5K	TH-N20CXHZ-5A	
	FR-ABR-7.5K	TH-N20CXHZ-6.6A	
	FR-ABR-11K	TH-N20CXHZ-11A	
	FR-ABR-15K	TH-N20CXHZ-11A	
	FR-ABR-22K	TH-N60-22A	
400V	FR-ABR-H0.4K	TH-N20CXHZ-0.24A	
	FR-ABR-H0.75K	TH-N20CXHZ-0.35A	
	FR-ABR-H1.5K	TH-N20CXHZ-0.9A	
	FR-ABR-H2.2K	TH-N20CXHZ-1.3A	
	FR-ABR-H3.7K	TH-N20CXHZ-2.1A	
	FR-ABR-H5.5K	TH-N20CXHZ-2.5A	
	FR-ABR-H7.5K	TH-N20CXHZ-3.6A	
	FR-ABR-H11K	TH-N20CXHZ-6.6A	
	FR-ABR-H15K	TH-N20CXHZ-6.6A	
	FR-ABR-H22K	TH-N20-9A	

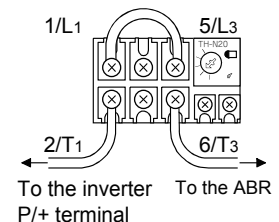

7 REVISING INSTALLATION ENVIRONMENT

7.4 Precautions for storing inverter in an enclosure

Refer to Fig.7.44 for precautions of enclosure storing.

Install a device which generates large heat with enough distance from the inverter.

(3.7K or less: 1cm or more
55K or less: 5cm or more
75K or more: 10cm or more)

Install to the best position where surrounding temperature of enclosure and the inverter does not increase. Be sure that performance is not poor.

Install the other devices so as not to interrupt cooling wind. Do not install a device which is easily affected by heat to this position.

(55K or less: 10cm or more
75K or more: 20cm or more)

Install in the correct direction.

Install electrical-discharge resistors which occurs large amount of heat outside the enclosure.

Take enough space so that the wiring duct does not obstruct cool wind.

(55K or less: 10cm or more
75K or more: 20cm or more)

Wire the control signal cable separate from the main circuit (power circuit) to avoid them from being banded together.

Air filter
Perform periodic cleaning and inspection to prevent clogging.

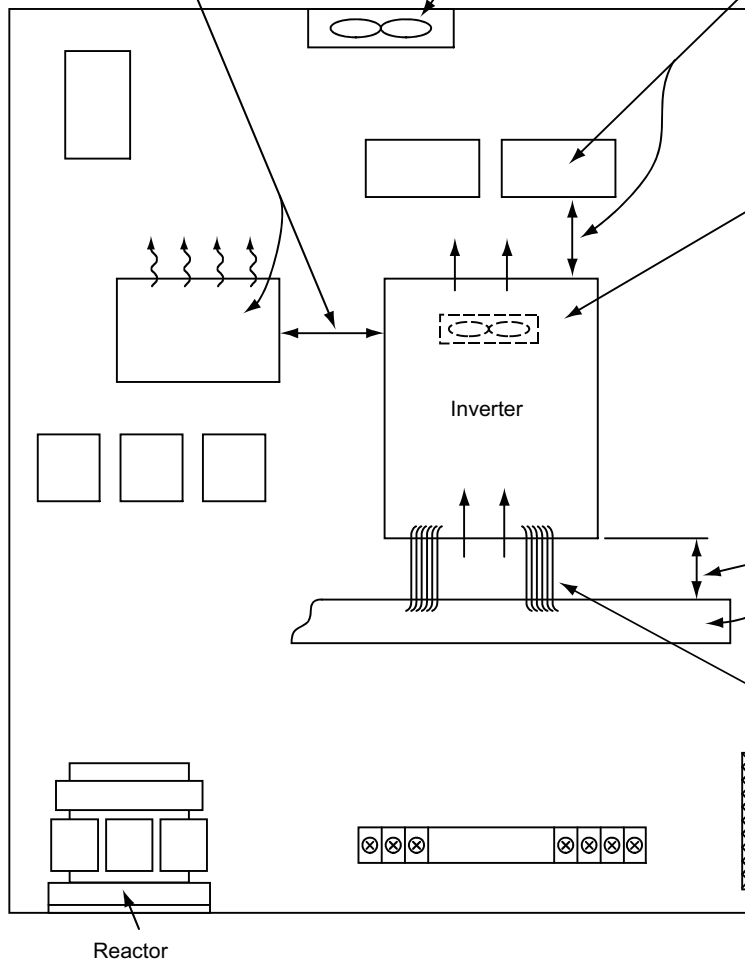

Fig.7.44 Precautions of enclosure storage

7 REVISING INSTALLATION ENVIRONMENT

☒ POINTS for understanding !

Failure example 1: Inverter failure due to leaking

[Failure content]

Enclosure inverter installed outside stopped on a rainy day.

[Cause of failure]

When the enclosure inverter was examined, the internal plate had been short out.

When examined carefully, rain came in the inverter via the accordion hose (for storing wires).



Failure example 2: Inverter failure due to foreign object

[Failure content]

Nothing is displayed on the monitor (LED display) when power is turned on in the enclosure inverter.

[Cause of failure]

When the enclosure inverter was examined, the internal plate had been short out. When asking to the enclosure manufacturer, after installing the inverter, it has been processed in addition due to upper conduit increase of enclosure, and powder appeared.

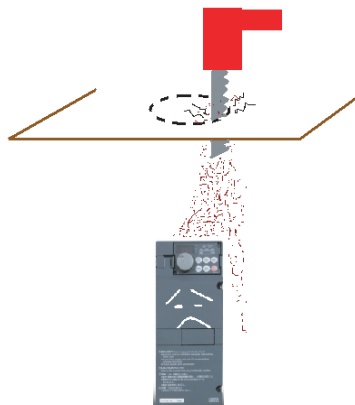

[Similar failure]

When processing cables, after baring with the stripper, the cut chip touches the inverter when conducting wire is adjusted.



- Dust, dirt, oil mist

Dust and dirt will cause such faults as poor contact of contact points, reduced insulation or reduced cooling effect due to moisture absorption of accumulated dust and dirt, and in-enclosure temperature rise due to clogged filter.

In the atmosphere where conductive powder floats, dust and dirt will cause such faults as malfunction, deteriorated insulation and short circuit in a short time.

Since oil mist will cause similar conditions, it is necessary to take adequate measures.

Countermeasures

- (a) Place in a totally enclosed enclosure.

Take measures if the in-enclosure temperature rises.
 - (b) Purge air.

Pump clean air from outside to make the in-enclosure pressure higher than the outside-air pressure.
- Corrosive gas, salt damage

If the inverter is exposed to corrosive gas or to salt near a beach, the printed board patterns and parts will corrode or the relays and switches will result in poor contact.

In such places, take the measures given in Section (3).
 - Explosive, flammable gases

As the inverter is non-explosion proof, it must be contained in an explosion proof enclosure.

In places where explosion may be caused by explosive gas, dust or dirt, an enclosure cannot be used unless it structurally complies with the guidelines and has passed the specified tests. This makes the enclosure itself expensive (including the test charges).

The best way is to avoid installation in such places and install the inverter in a non-hazardous place.
 - Highland

Use the inverter at the altitude of within 1000m.

If it is used at a higher place, it is likely that thin air will reduce the cooling effect and low air pressure will deteriorate dielectric strength.
 - Vibration, impact

Vibration bearing force of the inverter is from 10 to 55Hz (each direction of X, Y, Z), acceleration up to 5.9m/s^2 .*

Vibration or impact, if less than the specified value, applied for a long time may make the mechanism loose or cause poor contact to the connectors. * 2.9m/s^2 depending on the capacity.

Especially when impact is imposed repeatedly, caution must be taken as the part pins are likely to break.

Countermeasures

- (a) Provide the enclosure with rubber vibration isolators.
- (b) Strengthen the structure to prevent the enclosure from resonance.
- (c) Install the enclosure away from sources of vibration.

Chapter 8 LIFE OF INVERTER PARTS

8.1 Replacement of Parts

The inverter consists of many electronic parts such as semiconductor devices.

The following parts may deteriorate with age because of their structures or physical characteristics, leading to reduced performance or fault of the inverter. For preventive maintenance, the parts must be replaced periodically.

For 700 series inverters, the life check function can be a guidance of parts replacement.

(1) Cooling fan

The estimated lifespan of the bearing of the cooling fan used for cooling the heat generating parts such as the main circuit semiconductor is 87600 hours (in the case of 700 series inverters). Therefore, the parts including the cooling fan in continuous operation should usually be replaced once in every 10 years. However, if unusual noise or vibration is found during the inspection, the cooling fan must be replaced immediately.

For 700 series inverters, there is a function which can control the on/off setting of the cooling fan. This function makes the cooling fan life longer. Also, a cassette type cooling fan is used and allows you to replace the fan easily.

(2) Smoothing capacitors

A large-capacity aluminum electrolytic capacitor is used for smoothing in the main circuit DC section, and an aluminum electrolytic capacitor is used for stabilizing the control power in the control circuit. Their characteristics are deteriorated by the adverse effects of ripple currents, etc. The replacement intervals greatly vary with the surrounding air temperature and operating conditions. When the inverter is operated in air-conditioned, normal environment conditions, replace the capacitors about every 10 years (in the case of 700 series inverters).

The capacitors are deteriorated rapidly since a certain time period has passed. Therefore, perform the inspection at least once in every year (once in every half-year is recommended in the case the capacitor's life nears to the end).

The appearance criteria for inspection are as follows:

- 1) Case: Check the side and bottom faces for expansion
- 2) Sealing plate: Check for remarkable warp and extreme crack.
- 3) Explosion-proof valve: Check for remarkable expansion and operation.
- 4) Check for external crack, discoloration, fluid leakage, etc. Judge that the capacitor has reached its life when the measured capacitance of the capacitor reduced below 85% of the rating.

8 LIFE OF INVERTER PARTS

(3) Relays

To prevent a contact fault, etc., relays must be replaced according to the cumulative number of switching times (switching life).

Refer to the table below for the replacement criteria of inverter parts. The other parts which have a short lifespan, such as lamps, must be replaced with new ones when performing the periodic inspection.

Replacement parts of inverter (700 series)

Part Name	Estimated lifespan *1	Description
Cooling fan	10 years	Replace (as required)
Main circuit smoothing capacitor	10 years *2	Replace (as required)
On-board smoothing capacitor	10 years	Replace the board (as required)
Relays	-	as required

*1 Estimated lifespan for when the yearly average surrounding air temperature is 40°C (without corrosive gas, flammable gas, oil mist, dust and dirt etc)

*2 Differs depending on the model, output current, or the motor rated current. Refer to the technical information for more details.

8.2 Display of the Life of the Inverter Parts

Degrees of deterioration of main circuit capacitor, control circuit capacitor, cooling fan and inrush current limit circuit can be diagnosed by monitor.

When any part has approached the end of its life, an alarm can be output by self diagnosis to prevent a fault.

(Use the life check of this function as a guideline since the life except the main circuit capacitor is calculated theoretically.)

For the life check of the main circuit capacitor, the alarm signal (Y90) will not be output if a measuring method of (4) is not performed.

Parameter Number	Name	Initial Value	Setting Range	Description
255	Life alarm status display	0	(0 to 15)	Display whether the control circuit capacitor, main circuit capacitor, cooling fan, and each parts of the inrush current limit circuit has reached the life alarm output level or not. Reading only
256	Inrush current limit circuit life display	100%	(0 to 100%)	Display the deterioration degree of the inrush current limit circuit. Reading only
257	Control circuit capacitor life display	100%	(0 to 100%)	Display the deterioration degree of the control circuit capacitor. Reading only
258	Main circuit capacitor life display	100%	(0 to 100%)	Display the deterioration degree of the main circuit capacitor. Reading only The value measured by Pr. 259 is displayed.
259	Main circuit capacitor life measuring	0	0, 1 (2, 3, 8, 9)	Setting "1" and switching the power supply OFF starts the measurement of the main circuit capacitor life. When the Pr. 259 value is "3" after powering ON again, the measuring is completed. Read the deterioration degree in Pr. 258.

POINTS for understanding !

Since repeated inrush currents at power ON will shorten the life of the converter circuit, frequent starts and stops of the magnetic contactor must be avoided.

8 LIFE OF INVERTER PARTS

(1) Life alarm display and signal output (Y90 signal, Pr. 255)

- Whether any of the control circuit capacitor, main circuit capacitor, cooling fan and inrush current limit circuit has reached the life alarm output level or not can be checked by Pr. 255 Life alarm status display and life alarm signal (Y90).

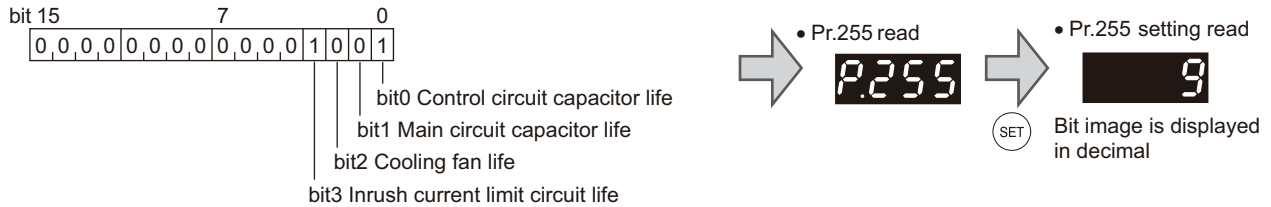

Pr. 255 (decimal)	Bit (binary)	Inrush Current Limit Circuit Life	Cooling Fan Life	Main Circuit Capacitor Life	Control Circuit Capacitor Life
15	1111	○	○	○	○
14	1110	○	○	○	×
13	1101	○	○	×	○
12	1100	○	○	×	×
11	1011	○	×	○	○
10	1010	○	×	○	×
9	1001	○	×	×	○
8	1000	○	×	×	×
7	0111	×	○	○	○
6	0110	×	○	○	×
5	0101	×	○	×	○
4	0100	×	○	×	×
3	0011	×	×	○	○
2	0010	×	×	○	×
1	0001	×	×	×	○
0	0000	×	×	×	×

○: With warnings, ×: Without warnings

- The life alarm signal (Y90) turns ON when any of the control circuit capacitor, main circuit capacitor, cooling fan and inrush current limit circuit reaches the life alarm output level.
- For the terminal used for the Y90 signal, set "90" (positive logic) or "190" (negative logic) to any of Pr. 190 to Pr. 196 (output terminal function selection).

Remark

The digital output option (FR-A7AY, FR-A7AR, FR-A7NC and FR-A7NCE) allows the control circuit capacitor life signal (Y86), main circuit capacitor life signal (Y87), cooling fan life signal (Y88) and inrush current limit circuit life signal (Y89) to be output individually.

☒ POINTS for understanding !

When terminal assignment is changed using Pr. 190 to Pr. 196 (output terminal function selection), the other functions may be affected. Set parameters after confirming the function of each terminal.

(2) Life display of the inrush current limit circuit (Pr. 256)

- The life of the inrush current limit circuit (relay, contactor and inrush resistor) is displayed in Pr. 256.
- The number of contact (relay, contactor, thyristor) ON times is counted, and it is counted down from 100% (0 time) every 1%/10,000 times. As soon as 10% (900,000 times) is reached, Pr. 255 bit 3 is turned ON and also an alarm is output to the Y90 signal.

(3) Control circuit capacitor life display (Pr. 257)

- The deterioration degree of the control circuit capacitor is displayed in Pr. 257 as a life.
- In the operating status, the control circuit capacitor life is calculated from the energization time and temperature, and is counted down from 100%. As soon as the control circuit capacitor life falls below 10%, Pr. 255 bit 0 is turned ON and also an alarm is output to the Y90 signal.

(4) Main circuit capacitor life display (Pr. 258, Pr. 259)

- The deterioration degree of the main circuit capacitor is displayed in Pr. 258 as a life.
- On the assumption that the main circuit capacitor capacitance at factory shipment is 100%, the capacitor life is displayed in Pr. 258 every time measurement is made. When the measured value falls to or below 85%, Pr. 255 bit 1 is turned ON and also an alarm is output to the Y90 signal.
- Measure the capacitor capacity according to the following procedure and check the deterioration level of the capacitor capacity.
 - 1) Check that the motor is connected and at a stop.
 - 2) Set "1" (measuring start) in Pr. 259.
 - 3) Switch power OFF. The inverter applies DC voltage to the motor to measure the capacitor capacity while the inverter is OFF.
 - 4) After making sure that the power lamp is OFF, switch ON the power supply again.
 - 5) Check that "3" (measuring completion) is set in Pr. 259, read Pr. 258, and check the deterioration degree of the main circuit capacitor.

Pr.259	Description	Remarks
0	No measurement	Initial value
1	Measurement start	Measurement starts when the power supply is switched OFF.
2	During measurement	Only displayed and cannot be set
3	Measurement complete	
8	Forced end	
9	Measurement error	

Remark

- When the main circuit capacitor life is measured under the following conditions, "forced end" (Pr. 259 = "8") or "measuring error" (Pr. 259 = "9") occurs or it remains in "measuring start" (Pr. 259 = "1").
When measuring, avoid the following conditions beforehand. In addition, even when "measurement completion" (Pr. 259 = "3") is confirmed under the following conditions, proper measurement cannot be taken.
 - (a) The FR-HC, MT-HC, FR-CV or sine wave filter is connected.
 - (b) Terminals R1/L11, S1/L21 or DC power supply is connected to the terminal P/+ and N/-.
 - (c) Switch power ON during measuring.
 - (d) The motor is not connected to the inverter.
 - (e) The motor is running. (The motor is coasting.)
 - (f) The motor capacity is two rank smaller as compared to the inverter capacity.
 - (g) The inverter is tripped or a fault occurred when power is OFF.
 - (h) The inverter output is shut off with the MRS signal.
 - (i) The start command is given while measuring.
 - (j) The parameter unit (FR-PU04/FR-PU07) is connected. (FR-D700, E700, and F700PJ series only)
 - (k) PC terminal is used as the power supply. (FR-D700, E700, and F700PJ series only)
 - (l) An I/O terminal of the control terminal block or the plug-in option is ON (continuity). (FR-D700, E700, and F700PJ only)
 - (m) The plug-in option is mounted. (FR-E700 series (the capacity is 0.75K or lower) only)
- Operating environment: Surrounding air temperature (annual average 40°C (free from corrosive gas, flammable gas, oil mist, dust and dirt))
F700/D700...Output current (80% of the inverter rated current)
A700/E700...Output current (Motor rated current)

POINT

For the accurate life measuring of the main circuit capacitor, perform after more than 3h passed since the turn OFF of the power as it is affected by the capacitor temperature.

WARNING

⚠ When measuring the main circuit capacitor capacity (Pr. 259 Main circuit capacitor life measuring = "1"), the DC voltage is applied to the motor for 1s at powering OFF. Never touch the motor terminal, etc. right after powering OFF to prevent an electric shock.

(5) Cooling fan life display

The cooling fan speed of 50% or less is detected and "FN" is displayed on the operation panel (FR-DU07) and parameter unit (FR-PU04/FR-PU07). As an alarm display, Pr. 255 bit 2 is turned ON and also an alarm is output to the Y90 signal.

Remark

When the inverter is mounted with two or more cooling fans, "FN" is displayed with one or more fans with speed of 50% or less.
.....

☒ POINTS for understanding ! _____

For replacement of each part, contact your local Mitsubishi (Electric System) Service.

8.3 Diagnosis using FR Configurator

"Diagnosis" displays fault information and parts life information of the inverter. Use "Diagnosis" to operate the following functions. (Available only when ONLINE.)

Select [Diagnosis] under [View] menu, or click  on the tool bar to display "Diagnosis".

- Displays the faults history and monitor value of each fault occurrence.
- Inverter reset
- Faults history clear
- Measuring of the main circuit capacitor life
- Display of parts life and alarm
- File output of diagnosis data

8.3.1 Explanation of window

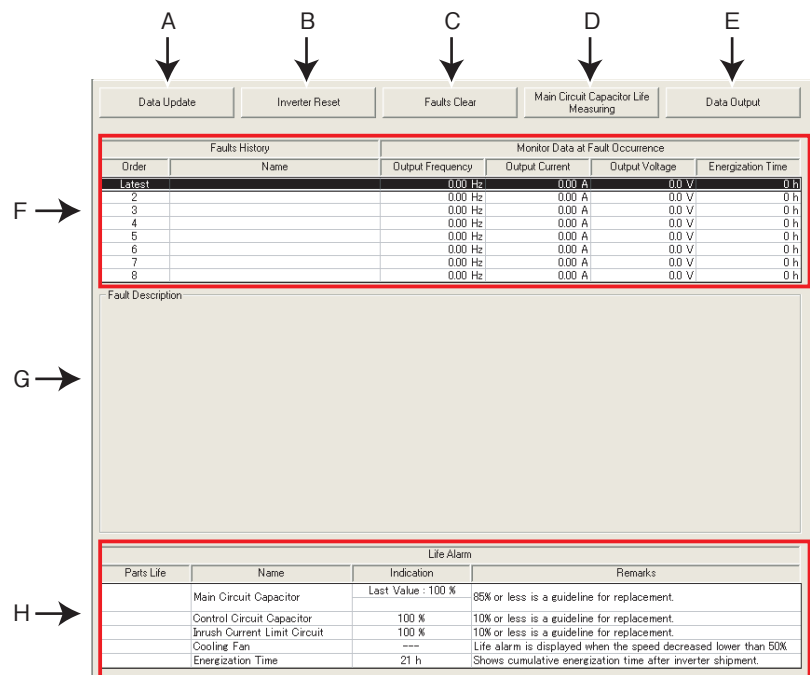

No.	Name	Function/description
A	Data Update	Reads faults history and parts life information from the selected inverter and updates display. (Available only when ONLINE.)
B	Inverter Reset	Resets the selected inverter. Confirmation window appears. Click <input type="button" value="OK"/> to proceed. (Available only when ONLINE.)
C	Faults Clear	Clears the faults history of the selected station. Confirmation window appears. Click <input type="button" value="OK"/> to proceed. (Available only when ONLINE.)
D	Main Circuit Capacitor Life Measuring	Starts life measuring of the main circuit capacitor. Refer to 154 page for the measuring procedure.
E	Data Output	Outputs diagnosis data of the selected inverter to a file (text format). Specify the file name and save the diagnosis data file.
F	Faults history	Displays faults history read from the inverter in a list. Also displays output frequency, output current, output voltage, and energization time of fault occurrence.
G	Faults description	Displays description of the selected fault.
H	Parts life information	Displays parts life information read from the inverter. A check mark is shown in the parts life alarm field for the parts recommended to be replaced.

8.3.2 Procedure of main circuit capacitor life measuring

- (1) Confirmation window appears before measuring. Check the following items, and click

- Motor is connected?
- Motor is stopped?
- Enough time has been passed after the motor operation?

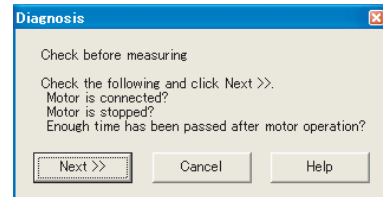

- (2) Performs parameter setting for measuring the main circuit capacitor life. Click .

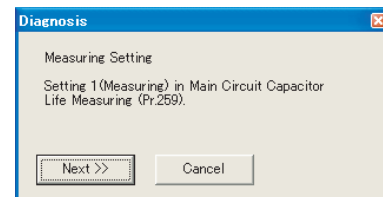

- (3) Click , and then turn the inverter power OFF.

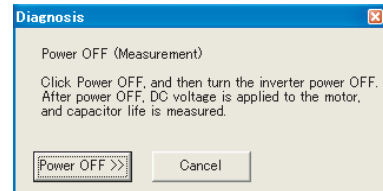

- (4) After making sure that the POWER lamp of the inverter is OFF, switch ON the power supply again. Click after powering ON the inverter.

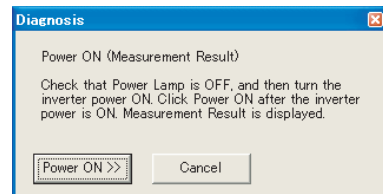

- (5) Displays the measuring result of the main circuit capacitor life in "Measured Value". A check mark is shown at the life information field of main circuit capacitor if the main circuit capacitor is recommended to be replaced. (Displays a previous value in "Last Value" if the main circuit capacitor life value measured last time is stored in the inverter when updating diagnostic information.)

Measurement Result is displayed

Parts Life	Name	Life Alarm		Remarks
		Indication		
	Main Circuit Capacitor	Last Value: 100 % Measured Value: 100 %	✓	65% or less is a guideline for replacement.
	Control Circuit Capacitor	100 %	✓	10% or less is a guideline for replacement.
	Inrush Current Limit Circuit	100 %	✓	10% or less is a guideline for replacement.
	Cooling Fan	—	—	Life alarm is displayed when the speed decreased lower than 50%.
	Energization Time	14 h	—	Shows cumulative energization time after inverter shipment.

Remark

When the main circuit capacitor life is measured under the following conditions, "forced end" (Pr. 259 = "8") or "measuring error" (Pr. 259 = "9") occurs or it remains in "measuring start" (Pr. 259 = "1"). Therefore, do not measure in such case. Proper measurement is not performed when "measuring" (Pr. 259 = "3") appears under the following conditions.

- (a) FR-HC, MT-HC, FR-CV, or a sine wave filter is connected.
 - (b) Terminals R1/L11, S1/L21 or DC power supply is connected to the terminal P/+ and N/-.
 - (c) The power supply is switched ON during measurement.
 - (d) The motor is not connected to the inverter.
 - (e) The motor is running (coasting)
 - (f) The motor capacity is two ranks smaller as compared to the inverter capacity.
 - (g) The inverter is tripped or a fault occurred when power is OFF.
 - (h) The inverter output is shut off with the MRS signal.
 - (i) The start command is given while measuring.
 - (j) The parameter unit (FR-PU04/FR-PU07) is connected (FR-D700, E700, F700PJ series only)
 - (k) Terminal PC is used as power supply (FR-D700, E700, F700PJ series only)
 - (l) An I/O terminal of the control terminal block or the plug-in option is ON (continuity) (FR-D700, E700, F700PJ series only)
 - (m) A plug-in option is fitted. (only for the 0.75K or less of the FR-E700 series)
- Turning the power ON during measuring before LED of the operation panel turns OFF, it may remain in "measuring" (Pr. 259 = "2") status. In such a case, perform life measurement again.

1

IMPORTANCE OF PRODUCTIVE MAINTENANCE

2

UNDERSTANDING INVERTER SYSTEM

3

MAINTENANCE SYSTEM DESIGN

4

PREVENTIVE MAINTENANCE

5

BREAKDOWN MAINTENANCE

6

CORRECTIVE MAINTENANCE

7

REVISING INSTALLATION ENVIRONMENT

8

LIFE OF INVERTER PARTS

Chapter 9 REPLACEMENT PROCEDURE

This chapter describes how to replace the parameter settings of Mitsubishi inverter FREQROL-A500 series with FREQROL-A700 series.

9.1 Saving FREQROL-A500 Parameters and Replacing with FREQROL-A700 Parameters

- (1) Prepare a personal computer where FR Configurator (FR-SW3-SETUP) is installed, cables, and a converter (RS232C ↔ 485) for inverter connection.
- (2) Turn ON the FREQROL-A500, and set "9999" in Pr.122.
- (3) Connect the personal computer with the FREQROL-A500.

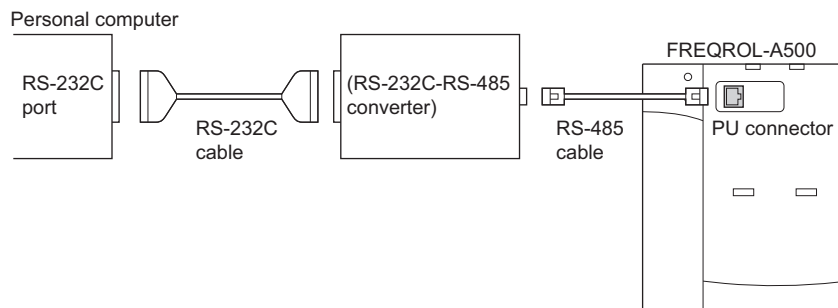

- (4) Turn ON the computer and start up the FR Configurator (FR-SW3-SETUP). Click [Convert] in [Functions] to display the convert window.

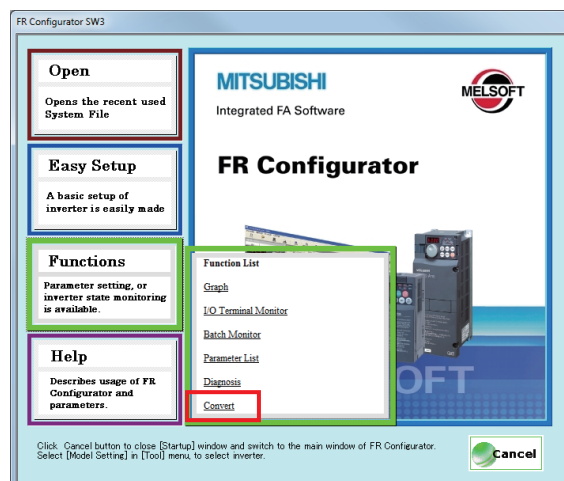

9 REPLACEMENT PROCEDURE

- (5) **Select [Tools] - [Options] to open the communication setting window.**
Set the port number for RS-232C port on the computer, and click the [OK] button.
(This setting activates the communication between the computer and the inverter unless the communication parameters of the inverter are not changed.)

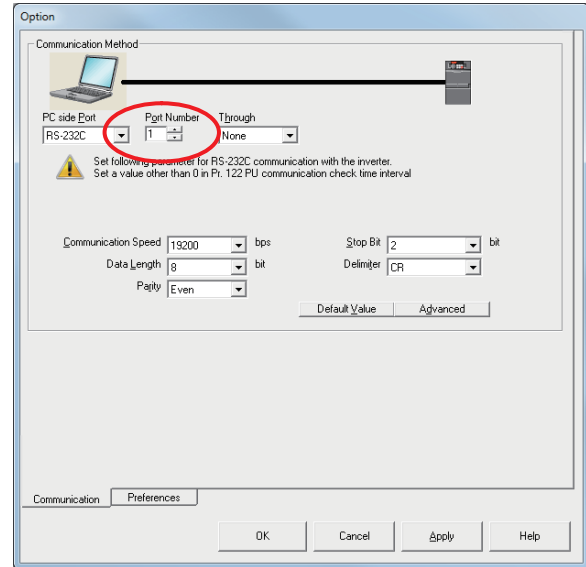
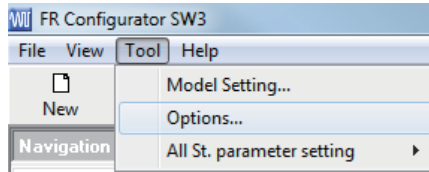

- (6) **Check that FR Configurator is ONLINE. (Click ONLINE in "System Setting" to switch to ONLINE. Perform during an inverter stop. Do not input a start command.?)**
- (7) **Click Source Information in "Convert" window to display "Convert Method".**

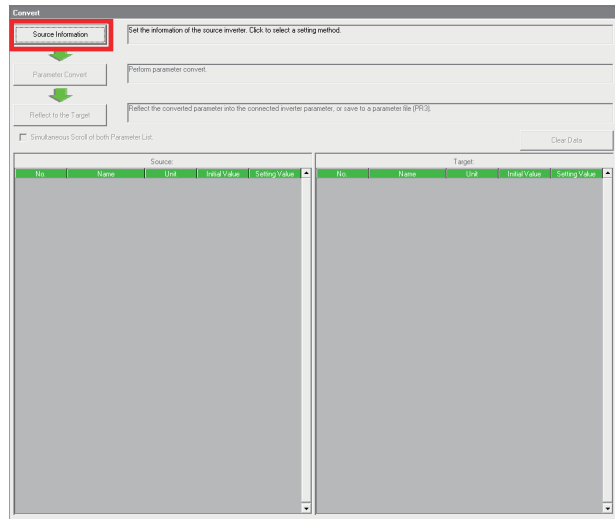

9 REPLACEMENT PROCEDURE

- (8) Choose "Convert from the Connected Inverter through Communication". Click **Next>** after selecting.

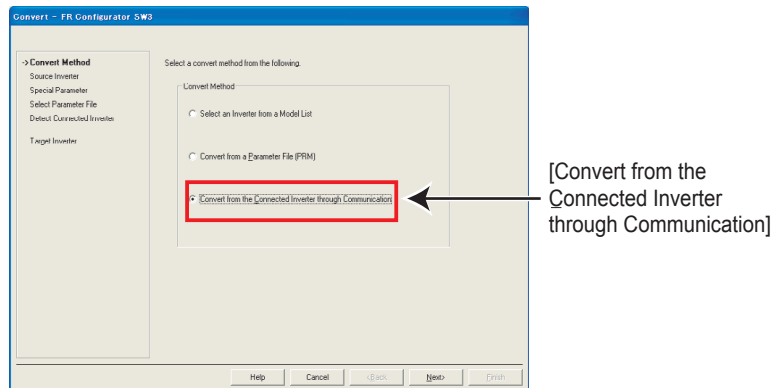

- (9) Click **Detect Inverter** in "Connected Inverter Detection" window. Check the inverter detection result, and click **Next>**.
(The station number is the setting value of Pr.117. (0 is set as the factory setting.))

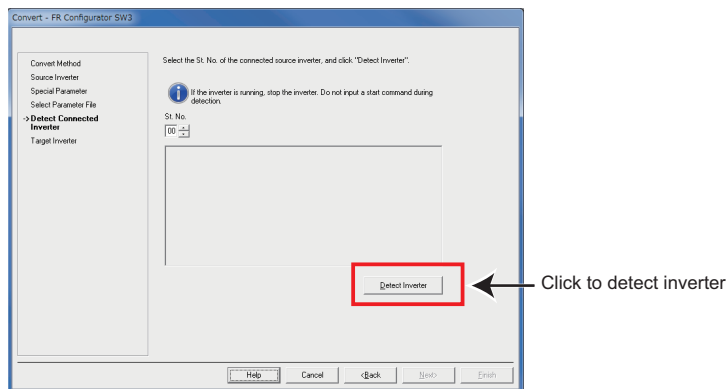

- (10) Select the target inverter on the "Target Inverter" window, and the convert setting is finished. Click **Finish**.

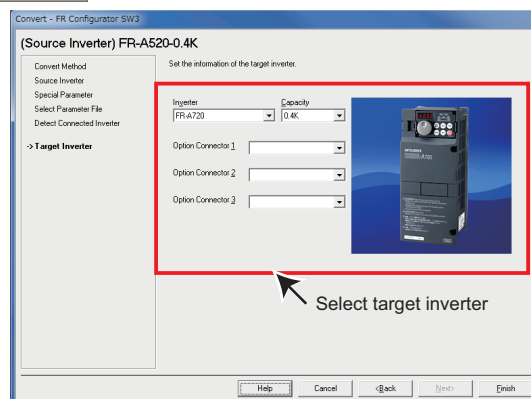

9 REPLACEMENT PROCEDURE

(11) The value of some of the source parameter is available for changing. When changing the parameter setting value, enter a changed value in Setting field.

When the convert setting is finished, **Parameter Convert** in "Convert" window becomes available. Click **Parameter Convert** to display "Convert Confirmation".

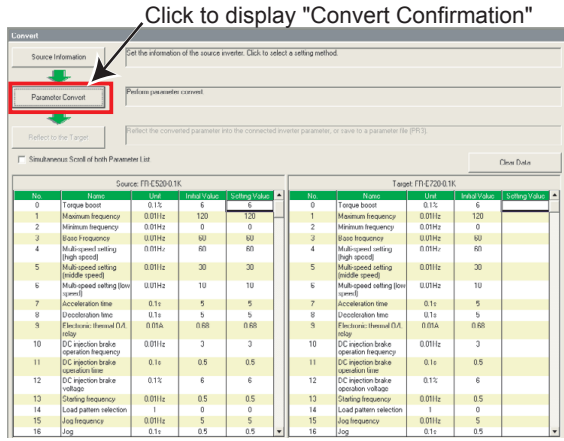

(12) Check the information of the source inverter and target inverter. Click **Convert** and the parameter conversion starts.

Click **Finish** when "Parameter converting is finished." is displayed.

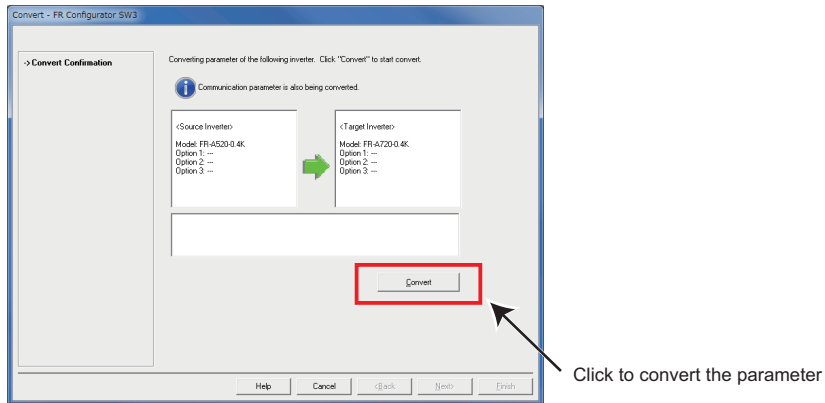

(13) Results of parameter converting is shown in "Convert" window.

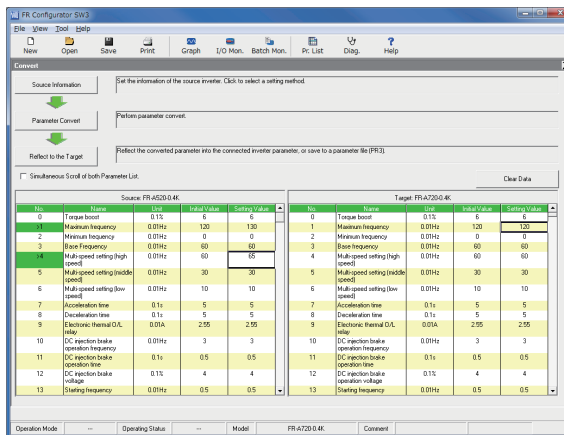

9 REPLACEMENT PROCEDURE

(14) Click **Reflect to the Target** in "Convert" window to display "Parameter Saving".

Check "Save As". Specify the file location, and click **Finish** to save the converted parameter setting into a parameter file (PR3).

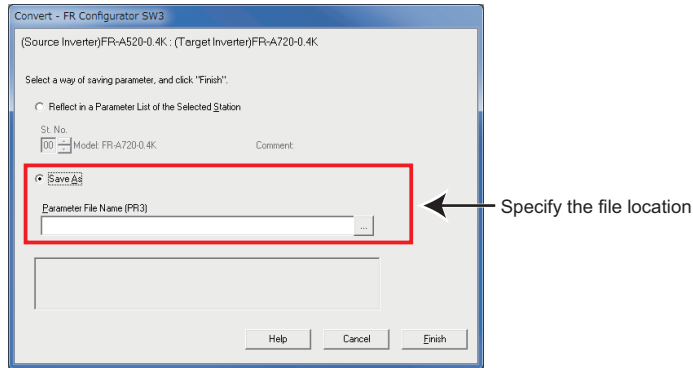

[Converting without a personal computer]

If you cannot prepare a personal computer, you need to create the parameter setting values for FREQROL-A700 series. The parameter numbers are almost the same as for FREQROL-A500(L) series, but some of the setting values differ. Please refer to "FR-A500(L) series reference for replacement (BCN-C21002-087C(ENG))" and create the parameter setting values for FREQROL-A700 series.

9 REPLACEMENT PROCEDURE

9.2 Removing the FREQROL-A500

- (1) Turn OFF the inverter.
- (2) Remove the front cover of the FREQROL-A500.
Loosen the installation screws on both ends of the control circuit terminal block, and pull down the terminal block from behind the control circuit terminals. (Leave the cables connected on the terminal block.)

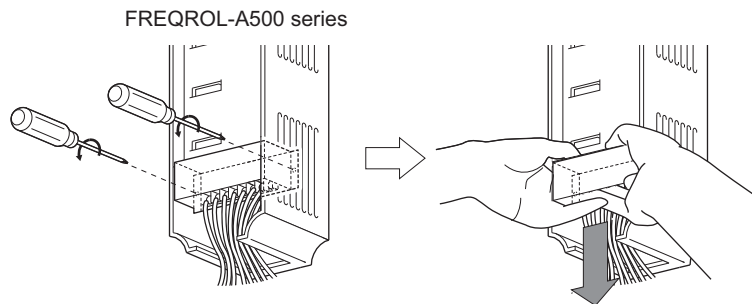

Note 1: The wiring cover of the FREQROL-A500 cannot be installed on the FREQROL-A700. If the FREQROL-A500 has a wiring cover, disconnect the cables from the terminal block instead.

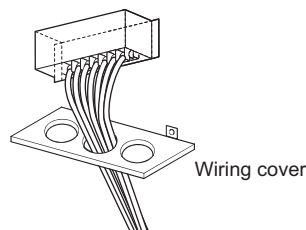

Note 2: Relay output 2 (A2, B2, C2) specific for the FR-A700 series cannot be used on the FR-A500 series terminals.

- (3) Disconnect the main circuit wires.
- (4) Remove the FREQROL-A500 inverter main unit from the enclosure.

9 REPLACEMENT PROCEDURE

9.3 Installation of the FREQROL-A700

(1) Install the FREQROL-A700 inverter main unit to the enclosure.

- FR-A720-0.4K to 90K, FR-A740-0.4K to 7.5K, 18.5K to 55K, 110K, 160K are compatible in mounting dimensions. For the FR-A740-11K, 15K, an optional intercompatibility attachment FR-AAT24 is necessary.
- For models that the inverter capacity is 75kW or more, no optional intercompatibility attachment is available. Also a DC reactor supplied may not have compatibility with FREQROL-A700.
- Heatsink protrusion attachment may not have compatibility with FREQROL-A700.
- If they have no compatibility, modification such as drilling holes on the enclosure is necessary.

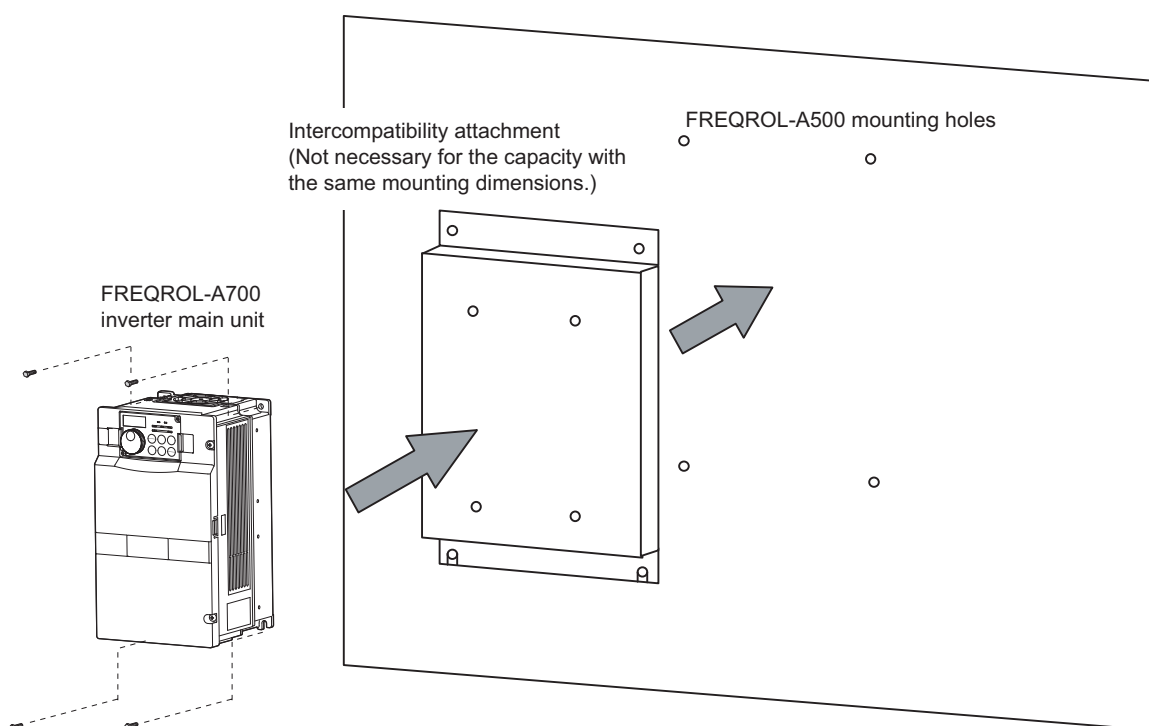

(2) Open the front cover and route the main circuit wires.

9 REPLACEMENT PROCEDURE

- (3) Replace the terminal block of the FREQROL-A700 with the one for the FREQROL-A500. (Leave the cables connected on the terminal block.) However, if the cables are disconnected from the terminal block of the FREQROL-A500, connect them back to the same name terminals on the FREQROL-A700 terminal block respectively.

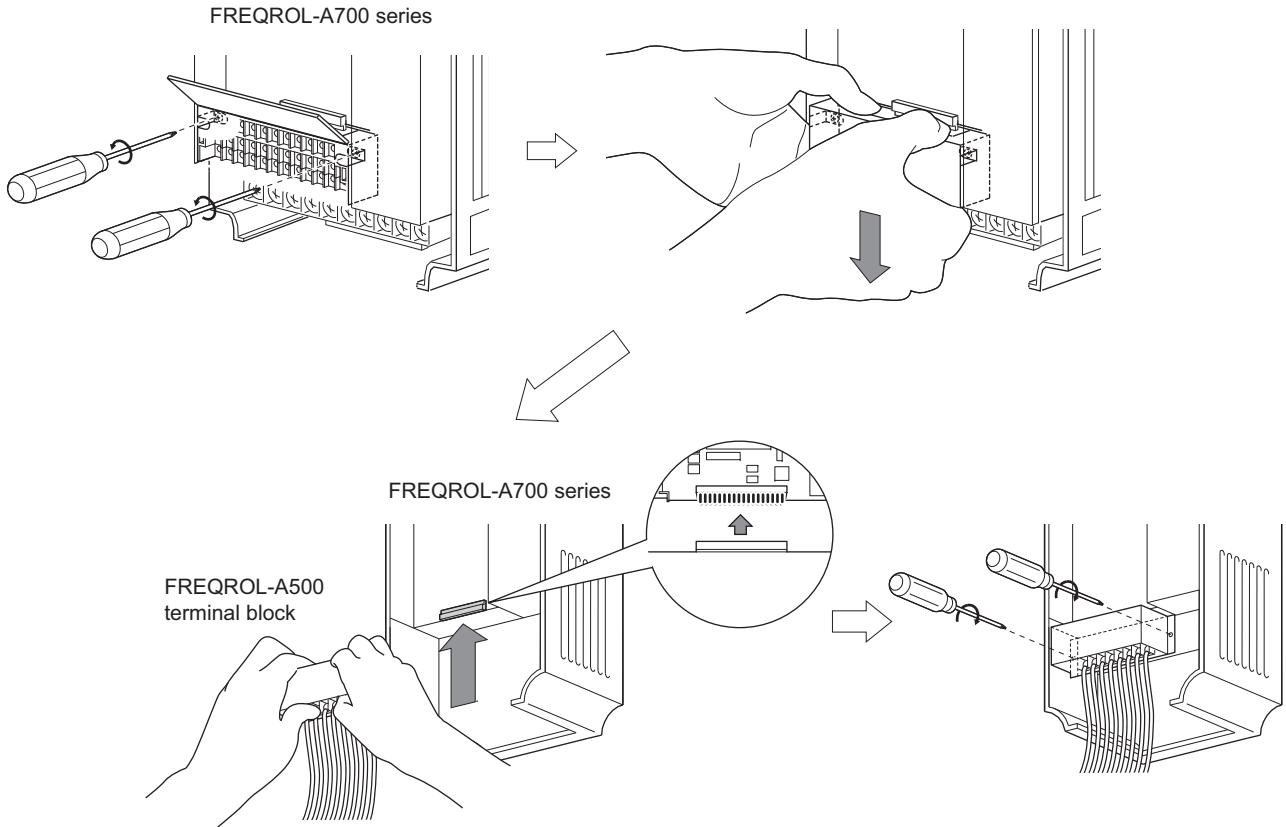

- (4) Install the front cover.

9 REPLACEMENT PROCEDURE

9.4 Setting the Parameters

- (1) Prepare a personal computer where FR Configurator (FR-SW3-SETUP) is installed, cables, and a converter (RS232C ↔ 485) for inverter connection.
- (2) Turn ON the FREQROL-A700.
- (3) Connect the personal computer with the FREQROL-A700.

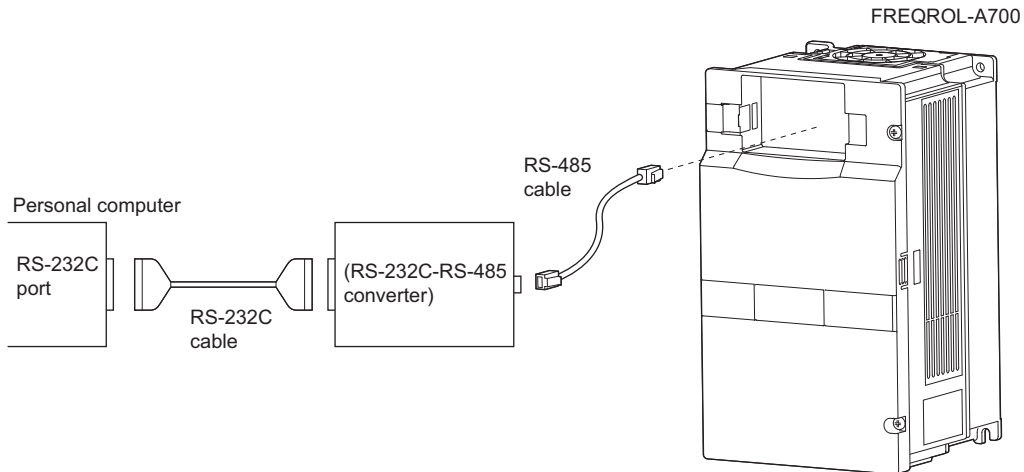

- (4) Turn ON the computer and start up the FR Configurator (FR-SW3-SETUP). Click [Parameter List] in [Functions].

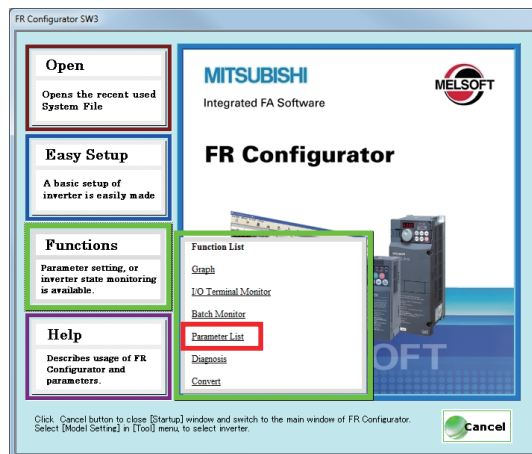

9 REPLACEMENT PROCEDURE

- (5) When the "Model Setting" window is displayed, select the station number (default value: 0), model, capacity, option, and click [OK].

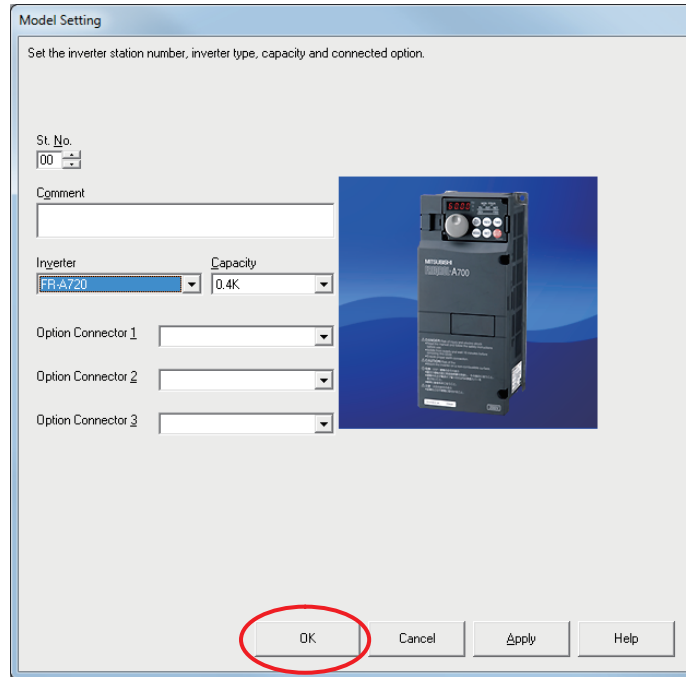

- (6) If the settings are made correctly, the set values (model, capacity, option) are displayed on the tree view of the selected station number.

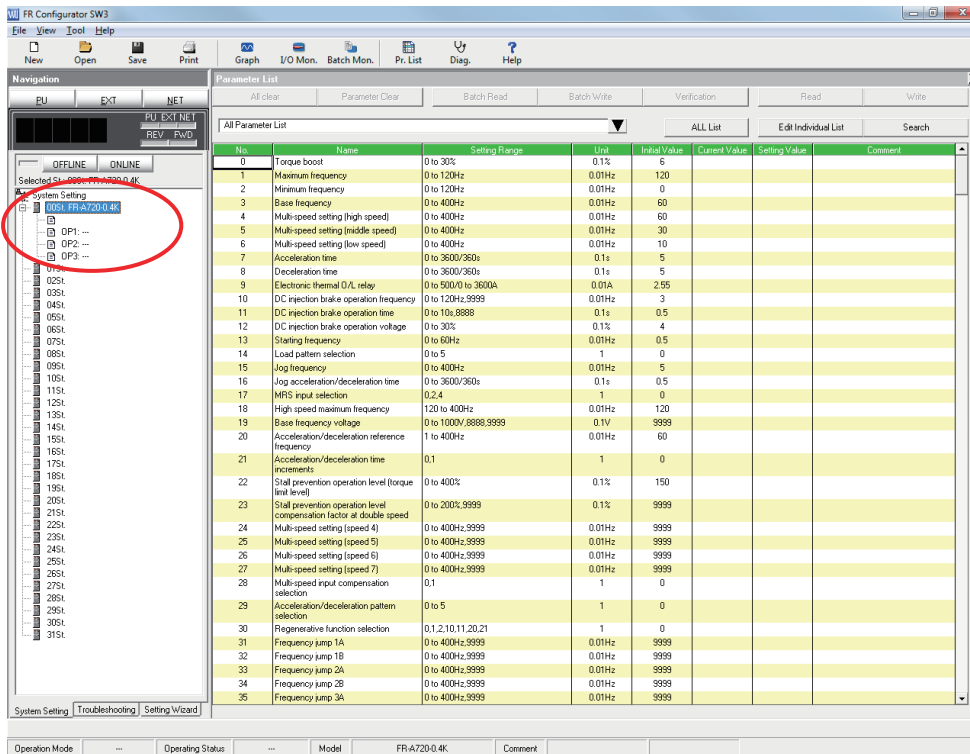

9 REPLACEMENT PROCEDURE

- (7) Select [Tool] - [Options] to open the communication setting window.
Set the port number for RS-232C port on the computer, and click the [OK] button.
(This setting activates the communication between the personal computer and inverter unless the communication parameters of the inverter are not changed.)

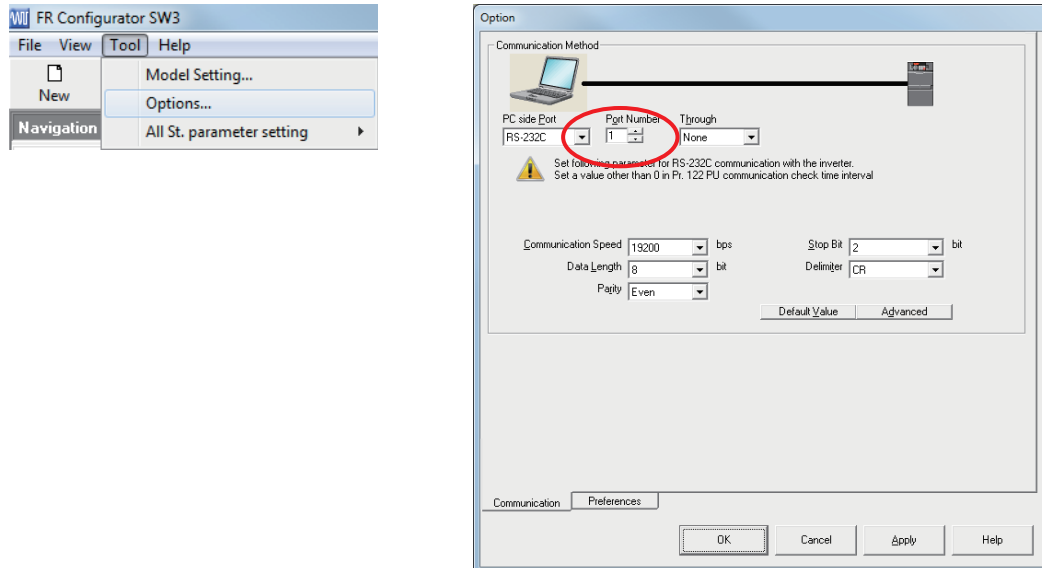

- (8) Select [File] - [Import], and open the parameter file saved in Section 9.1(14).
Note: Select parameter file (*.pr3) for the file format.

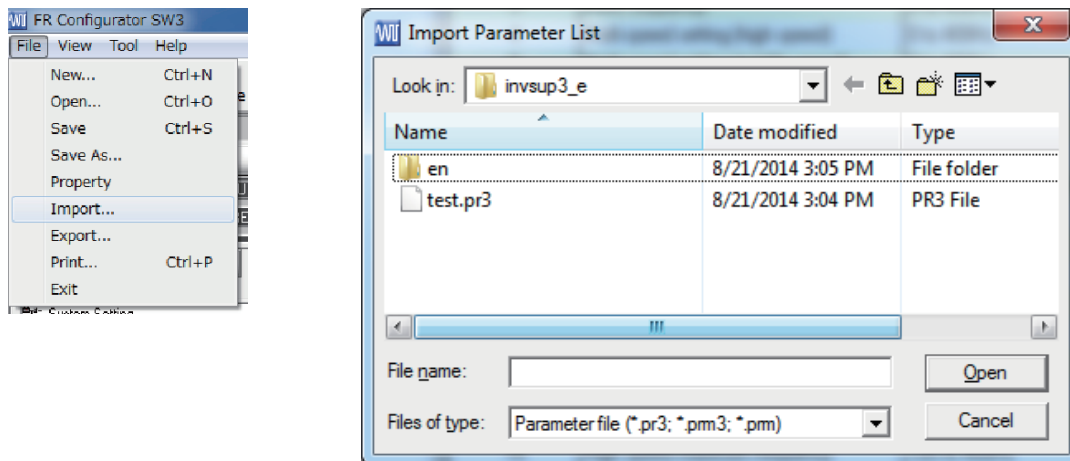

- (9) When the file is opened, the following window appears, and select [Setting Value].

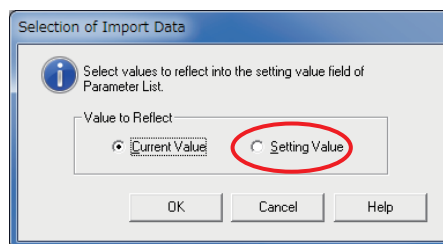

9 REPLACEMENT PROCEDURE

(10) Parameters converted for the FREQROL-A700 are listed on the [Setting Value] column.

No.	Name	Setting Range	Unit	Initial Value	Current Value	Setting Value	Comment
0	Torque boost	0 to 30%	0.1%	6		6	
1	Maximum frequency	0 to 120Hz	0.01Hz	120			
2	Minimum frequency	0 to 120Hz	0.01Hz	0		0	
3	Base frequency	0 to 400Hz	0.01Hz	60		60	
4	Multi-speed setting (high speed)	0 to 400Hz	0.01Hz	60		65	
5	Multi-speed setting (middle speed)	0 to 400Hz	0.01Hz	30		30	
6	Multi-speed setting (low speed)	0 to 400Hz	0.01Hz	10		10	
7	Acceleration time	0 to 3600/360s	0.1s	5		5	
8	Deceleration time	0 to 3600/360s	0.1s	5		5	
9	Electronic thermal O/L relay	0 to 500/0 to 3600A	0.01A	2.55		2.55	
10	DC injection brake operation frequency	0 to 120Hz,9999	0.01Hz	3		3	
11	DC injection brake operation time	0 to 10s,8888	0.1s	0.5		0.5	

(11) Check if the computer is online. (To go online, click **ONLINE** from [System Setting].)

(12) Click [PU] to change the operation mode to PU.



(13) Check and write down the setting values of Pr.77 and Pr.79.

If the setting value of Pr.77 is 1, change the value to 0.

If the setting value of Pr.79 is other than 0 or 1, change the value to 0.

To change a setting value, click the target value on the [Setting Value] column once.

No.	Name	Setting Range	Unit	Initial Value	Current Value	Setting Value	Comment
76	Fault code output selection	0,1,2	1	0		0	
77	Parameter write selection	0,1,2	1	0		1	
78	Reverse rotation prevention selection	0,1,2	1	0		0	
79	Operation mode selection	0,1,2,3,4,6,7	1	0		2	
80	Motor capacity	0.4 to 55kW,9999/0 to 3600kW,9999	0.01kW	9999		9999	
81	Number of motor poles	2,4,6,8,10,12,14,16,18,20,9999	1	9999		9999	
82	Motor excitation current	0 to 500A,9999/0 to 3600A,9999	0.01A	9999		9999	
83	Rated motor voltage	0 to 1000V	0.1V	200		200	

No.	Name	Setting Range	Unit	Initial Value	Current Value	Setting Value	Comment
76	Fault code output selection	0,1,2	1	0		0	
77	Parameter write selection	0,1,2	1	0		0	
78	Reverse rotation prevention selection	0,1,2	1	0		0	
79	Operation mode selection	0,1,2,3,4,6,7	1	0		0	
80	Motor capacity	0.4 to 55kW,9999/0 to 3600kW,9999	0.01kW	9999		9999	
81	Number of motor poles	2,4,6,8,10,12,14,16,18,20,9999	1	9999		9999	
82	Motor excitation current	0 to 500A,9999/0 to 3600A,9999	0.01A	9999		9999	
83	Rated motor voltage	0 to 1000V	0.1V	200		200	

9 REPLACEMENT PROCEDURE

(14) Click [Batch Write] to write the parameters on the FREQROL-A700.

No.	Name	Setting Range	Unit	Initial Value	Current Value	Setting Value	Comment
76	Fault code output selection	0,1,2	1	0		0	
77	Parameter write selection	0,1,2	1	0		0	
78	Reverse rotation prevention selection	0,1,2	1	0		0	
79	Operation mode selection	0,1,2,3,4,6,7	1	0		0	
80	Motor capacity	0.4 to 55kW,9999/0 to 3600kW,9999	0.01kW	9999		9999	
81	Number of motor poles	2,4,6,8,10,12,14,16,18,20,9999	1	9999		9999	
82	Motor excitation current	0 to 500A,9999/0 to 3600A,9999	0.01A	9999		9999	
83	Rated motor voltage	0 to 1000V	0.1V	200		200	

(15) Turn OFF the personal computer then turn OFF the inverter. (Note that some parameter setting values are not reflected without turning off or resetting the inverter once.)
Mount the operation panel.

(16) If the setting values of Pr.77 and Pr.79 are changed in step (13), turn ON the inverter and set the values you wrote down earlier, and then turn OFF the inverter.

[Precautions for converting]

There are adjustment parameters and parameters which cannot be converted. Read the instruction manual of FR Configurator [FR-SW3-SETUP] carefully before converting the parameters.

9 REPLACEMENT PROCEDURE

Remark

The unit below is useful when converting parameters between the FREQROL-A700 series.

Parameter unit with a battery pack (FR-PU07BB) A700 F700P E700

Parameter check and setting change are available without connecting a power supply to the inverter. Use AA battery x 4 for the power supply. 100VAC power supply* can be used. (* AC adapter is sold separately.)



FR-PU07BB

Item	Specifications
Power supply	<ul style="list-style-type: none"> •When using batteries : AA battery x4 (Nickel metal hydride (NiMH)/Alkaline) •When using an external power supply (100VAC) : AC adapter (sold separately*) •Supplied from the inverter : Supplied through the PU connector on the inverter.
Battery life (In case of using continuously)	<ul style="list-style-type: none"> •FREQROL-A700/F700 series <ul style="list-style-type: none"> Nickel metal hydride (NiMH) battery: Apporx. 120 min Alkaline battery : Apporx. 90 min •FREQROL-E700 series <ul style="list-style-type: none"> Nickel metal hydride (NiMH) battery: Apporx. 300 min Alkaline battery : Apporx. 150 min
Switch/Connector	Battery ON/OFF switch Modular connector (for connecting to inverter), AC adapter connector
Display function	Battery exhaustion warning LED. The other display functions are the same as for FR-PU07.
Accessory	AA alkaline battery (for operation check) x4 Connection cable (FR-CB203) x1

* AC adapter (100VAC) (sold separately): Model: TAS2900-PUA
Manufacturer: Mitsubishi Electric System & Service Co., Ltd.

INVERTER SCHOOL TEXT

INVERTER MAINTENANCE COURSE

MITSUBISHI ELECTRIC CORPORATION

HEAD OFFICE: TOKYO BUILDING 2-7-3, MARUNOUCHI, CHIYODA-KU, TOKYO 100-8310, JAPAN

When exported from Japan, this manual does not require application to the Ministry of Economy, Trade and Industry for service transaction permission.