

Programmable Controller

MELSEC iQ-R
series

MELSEC iQ-R MELSECWinCPU Module User's Manual

-R102WCPU-W



SAFETY PRECAUTIONS

(Read these precautions before using this product.)

Before using this product, please read this manual and the relevant manuals carefully and pay full attention to safety to handle the product correctly. If the equipment is used in a manner not specified by the manufacturer, the protection provided by the equipment may be impaired.

The precautions given in this manual are concerned with this product only. For the safety precautions of the programmable controller system, refer to the MELSEC iQ-R Module Configuration Manual.

In this manual, the safety precautions are classified into two levels: "⚠ WARNING" and "⚠ CAUTION".

 WARNING	Indicates that incorrect handling may cause hazardous conditions, resulting in death or severe injury.
 CAUTION	Indicates that incorrect handling may cause hazardous conditions, resulting in minor or moderate injury or property damage.

Under some circumstances, failure to observe the precautions given under "⚠ CAUTION" may lead to serious consequences.

Observe the precautions of both levels because they are important for personal and system safety.

Make sure that the end users read this manual and then keep the manual in a safe place for future reference.

[Considerations for using this manual]

- For fail-safe circuits for a MELSECWinCPU module, refer to the following:
 👉 Page 296 General Safety Requirements

[Design Precautions]

WARNING

- Configure safety circuits external to the programmable controller to ensure that the entire system operates safely even when a fault occurs in the external power supply or the programmable controller. Failure to do so may result in an accident due to an incorrect output or malfunction.
 - (1) Emergency stop circuits, protection circuits, and protective interlock circuits for conflicting operations (such as forward/reverse rotations or upper/lower limit positioning) must be configured external to the programmable controller.
 - (2) When the programmable controller detects an abnormal condition, it stops the operation and all outputs are:
 - Turned off if the overcurrent or overvoltage protection of the power supply module is activated.
 - Held or turned off according to the parameter setting if the self-diagnostic function of the CPU module detects an error such as a watchdog timer error.
 - (3) All outputs may be turned on if an error occurs in a part, such as an I/O control part, where the CPU module cannot detect any error. To ensure safety operation in such a case, provide a safety mechanism or a fail-safe circuit external to the programmable controller. For a fail-safe circuit example, refer to the MELSEC iQ-R Module Configuration Manual.
 - (4) Outputs may remain on or off due to a failure of a component such as a relay and transistor in an output circuit. Configure an external circuit for monitoring output signals that could cause a serious accident.
 - In an output circuit, when a load current exceeding the rated current or an overcurrent caused by a load short-circuit flows for a long time, it may cause smoke and fire. To prevent this, configure an external safety circuit, such as a fuse.
 - Configure a circuit so that the programmable controller is turned on first and then the external power supply. If the external power supply is turned on first, an accident may occur due to an incorrect output or malfunction.
 - For the operating status of each station after a communication failure, refer to manuals for the network used. For the manuals, please consult your local Mitsubishi representative. Incorrect output or malfunction due to a communication failure may result in an accident.
 - When connecting an external device with a CPU module or intelligent function module to modify data of a running programmable controller, configure an interlock circuit in the program to ensure that the entire system will always operate safely. For other forms of control (such as program modification, parameter change, forced output, or operating status change) of a running programmable controller, read the relevant manuals carefully and ensure that the operation is safe before proceeding. Improper operation may damage machines or cause accidents. When a Safety CPU is used, data cannot be modified while the Safety CPU is in SAFETY MODE.
 - Especially, when a remote programmable controller is controlled by an external device, immediate action cannot be taken if a problem occurs in the programmable controller due to a communication failure. To prevent this, configure an interlock circuit in the program, and determine corrective actions to be taken between the external device and CPU module in case of a communication failure.
-

[Design Precautions]

WARNING

[Precautions for using MELSECWinCPU modules]

- The execution of a user application may be delayed on Windows® 10 IoT Enterprise LTSC 2019 due to the effect of operating system scheduling. Do not use this product in a situation that requires a fixed-cycle operation and a high-speed response.

In addition, the execution of a user application may be delayed when any of the following operations is performed:

- Connecting or disconnecting a HDMI connector cable
 - Mounting or removing a device connected to a USB connector
 - Inserting an SD memory card into the SD memory card slot
 - Unlocking a Windows lock screen
 - Signing in to Windows
 - Signing out of Windows
 - Remote desktop connection
 - Starting other applications
-

[Design Precautions]

CAUTION

- Do not install the control lines or communication cables together with the main circuit lines or power cables. Doing so may result in malfunction due to electromagnetic interference. Keep a distance of 100mm or more between those cables.
- During control of an inductive load such as a lamp, heater, or solenoid valve, a large current (approximately ten times greater than normal) may flow when the output is turned from off to on. Therefore, use a module that has a sufficient current rating.

[Precautions for using MELSECWinCPU modules]

- After the MELSECWinCPU module is powered on or the hardware or a bus is reset, the time taken to enter the READY status varies depending on the system configuration, parameter settings, and/or program size. Design circuits so that the entire system will always operate safely, regardless of the time.
-

[Security Precautions]

WARNING

- To maintain the security (confidentiality, integrity, and availability) of the programmable controller and the system against unauthorized access, denial-of-service (DoS) attacks, computer viruses, and other cyberattacks from external devices via the network, take appropriate measures such as firewalls, virtual private networks (VPNs), and antivirus solutions.
-

[Installation Precautions]

WARNING

- Shut off the external power supply (all phases) used in the system before mounting or removing the module. Failure to do so may result in electric shock or cause the module to fail or malfunction.
-

[Installation Precautions]

CAUTION

- Use the programmable controller in an environment that meets the general specifications in the MELSEC iQ-R Module Configuration Manual. Failure to do so may result in electric shock, fire, malfunction, or damage to or deterioration of the product.
 - To mount a module, place the concave part(s) located at the bottom onto the guide(s) of the base unit, and push in the module until the hook(s) located at the top snaps into place. Incorrect interconnection may cause malfunction, failure, or drop of the module.
 - When using an extension cable, connect it to the extension cable connector of the base unit securely. Check the connection for looseness. Poor contact may cause malfunction.
 - Use a CFast card in an environment that meets the general specifications in the MELSEC iQ-R Module Configuration Manual. Failure to do so may result in electric shock, fire, malfunction, or damage to or deterioration of the product.
 - When using an SD memory card and CFast card, fully insert them into the card slots. Check that they are inserted completely. Poor contact may cause malfunction.
 - Do not directly touch any conductive parts and electronic components of the module, SD memory card, CFast card, or connector. Doing so can cause malfunction or failure of the module.
-

[Wiring Precautions]

WARNING

- Shut off the external power supply (all phases) used in the system before installation and wiring. Failure to do so may result in electric shock or cause the module to fail or malfunction.
- After installation and wiring, attach a blank cover module (RG60) to each empty slot before powering on the system for operation. Also, attach an extension connector protective cover^{*1} to each unused extension cable connector as necessary. Directly touching any conductive parts of the connectors while power is on may result in electric shock.

*1 For details, please consult your local Mitsubishi Electric representative.

[Wiring Precautions]

CAUTION

- Individually ground the FG and LG terminals of the programmable controller with a ground resistance of 100 ohms or less. Failure to do so may result in electric shock or malfunction.
 - Check the rated voltage and signal layout before wiring to the module, and connect the cables correctly. Connecting a power supply with a different voltage rating or incorrect wiring may cause fire or failure.
 - Connectors for external devices must be crimped or pressed with the tool specified by the manufacturer, or must be correctly soldered. Incomplete connections may cause short circuit, fire, or malfunction.
 - Securely connect the connector to the module. Poor contact may cause malfunction.
 - Do not install the control lines or communication cables together with the main circuit lines or power cables. Doing so may result in malfunction due to noise. Keep a distance of 100mm or more between those cables.
 - Place the cables in a duct or clamp them. If not, dangling cables may swing or inadvertently be pulled, resulting in malfunction or damage to modules or cables.
In addition, the weight of the cables may put stress on modules in an environment of strong vibrations and shocks.
Do not clamp the extension cables with the jacket stripped. Doing so may change the characteristics of the cables, resulting in malfunction.
 - Check the interface type and correctly connect the cable. Incorrect wiring (connecting the cable to an incorrect interface) may cause failure of the module and external device.
 - When disconnecting the cable from the module, do not pull the cable by the cable part. For the cable with connector, hold the connector part of the cable. For the cable connected to the terminal block, loosen the terminal screw. Pulling the cable connected to the module may result in malfunction or damage to the module or cable.
 - Prevent foreign matter such as dust or wire chips from entering the module. Such foreign matter can cause a fire, failure, or malfunction.
 - When a protective film is attached to the top of the module, remove it before system operation. If not, inadequate heat dissipation of the module may cause a fire, failure, or malfunction.
 - Programmable controllers must be installed in control panels. Connect the main power supply to the power supply module in the control panel through a relay terminal block. Wiring and replacement of a power supply module must be performed by qualified maintenance personnel with knowledge of protection against electric shock. For wiring, refer to the MELSEC iQ-R Module Configuration Manual.
-

[Startup and Maintenance Precautions]

WARNING

- Do not touch any terminal while power is on. Doing so will cause electric shock or malfunction.
 - Correctly connect the battery connector. Do not charge, disassemble, heat, short-circuit, solder, or throw the battery into the fire. Also, do not expose it to liquid or strong shock. Doing so will cause the battery to produce heat, explode, ignite, or leak, resulting in injury and fire.
 - Shut off the external power supply (all phases) used in the system before cleaning the module or retightening the terminal screws, connector screws, or module fixing screws. Failure to do so may result in electric shock.
-

[Startup and Maintenance Precautions]

CAUTION

- When connecting an external device with a CPU module or intelligent function module to modify data of a running programmable controller, configure an interlock circuit in the program to ensure that the entire system will always operate safely. For other forms of control (such as program modification, parameter change, forced output, or operating status change) of a running programmable controller, read the relevant manuals carefully and ensure that the operation is safe before proceeding. Improper operation may damage machines or cause accidents.
 - Do not disassemble or modify the modules. Doing so may cause failure, malfunction, injury, or a fire.
 - Do not disassemble or modify the CFast cards. Doing so may cause failure, malfunction, injury, or a fire.
 - Use any radio communication device such as a cellular phone or PHS (Personal Handy-phone System) more than 25cm away in all directions from the programmable controller. Failure to do so may cause malfunction.
 - Shut off the external power supply (all phases) used in the system before mounting or removing the module. Failure to do so may cause the module to fail or malfunction.
 - After the first use of the product, do not perform each of the following operations more than 50 times (IEC 61131-2/JIS B 3502 compliant).
Exceeding the limit may cause malfunction.
 - Mounting/removing the module to/from the base unit
 - After the first use of the product, do not insert/remove the SD memory card to/from the CPU module more than 500 times. Exceeding the limit may cause malfunction.
 - After the first use of the product, do not insert/remove the CFast card to/from the CPU module more than 10,000 times. Exceeding the limit may cause malfunction.
 - Do not touch the metal terminals on the back side of the SD memory card and CFast card. Doing so may cause malfunction or failure of the module.
 - Do not drop or apply shock to the battery to be installed in the module. Doing so may damage the battery, causing the battery fluid to leak inside the battery. If the battery is dropped or any shock is applied to it, dispose of it without using.
 - Before handling the module, touch a conducting object such as a grounded metal to discharge the static electricity from the human body. Wearing a grounded antistatic wrist strap is recommended. Failure to discharge the static electricity may cause the module to fail or malfunction.
 - Before handling the CFast card, touch a conducting object such as a grounded metal to discharge the static electricity from the human body. Wearing a grounded antistatic wrist strap is recommended. Failure to discharge the static electricity may cause the CFast card to fail or malfunction.
-

[Operating Precautions]

CAUTION

[Precautions for using MELSECWinCPU modules]

- Do not perform any of the following operations while writing parameters to a MELSECWinCPU module.
 - Powering off and on
 - Resetting the hardware
 - Resetting the bus
 - Restarting Windows forcibly
 - Shutting down Windows
-

[Disposal Precautions]

CAUTION

- When disposing of this product, treat it as industrial waste.
 - When disposing of batteries, separate them from other wastes according to the local regulations. For details on battery regulations in EU member states, refer to the MELSEC iQ-R Module Configuration Manual.
-

[Transportation Precautions]

CAUTION

- When transporting lithium batteries, follow the transportation regulations. For details on the regulated models, refer to the MELSEC iQ-R Module Configuration Manual.
-

CONDITIONS OF USE FOR THE PRODUCT

- (1) MELSEC programmable controller ("the PRODUCT") shall be used in conditions;
- i) where any problem, fault or failure occurring in the PRODUCT, if any, shall not lead to any major or serious accident; and
 - ii) where the backup and fail-safe function are systematically or automatically provided outside of the PRODUCT for the case of any problem, fault or failure occurring in the PRODUCT.
- (2) The PRODUCT has been designed and manufactured for the purpose of being used in general industries. MITSUBISHI ELECTRIC SHALL HAVE NO RESPONSIBILITY OR LIABILITY (INCLUDING, BUT NOT LIMITED TO ANY AND ALL RESPONSIBILITY OR LIABILITY BASED ON CONTRACT, WARRANTY, TORT, PRODUCT LIABILITY) FOR ANY INJURY OR DEATH TO PERSONS OR LOSS OR DAMAGE TO PROPERTY CAUSED BY the PRODUCT THAT ARE OPERATED OR USED IN APPLICATION NOT INTENDED OR EXCLUDED BY INSTRUCTIONS, PRECAUTIONS, OR WARNING CONTAINED IN MITSUBISHI ELECTRIC USER'S, INSTRUCTION AND/OR SAFETY MANUALS, TECHNICAL BULLETINS AND GUIDELINES FOR the PRODUCT.
- ("Prohibited Application")
- Prohibited Applications include, but not limited to, the use of the PRODUCT in;
- Nuclear Power Plants and any other power plants operated by Power companies, and/or any other cases in which the public could be affected if any problem or fault occurs in the PRODUCT.
 - Railway companies or Public service purposes, and/or any other cases in which establishment of a special quality assurance system is required by the Purchaser or End User.
 - Aircraft or Aerospace, Medical applications, Train equipment, transport equipment such as Elevator and Escalator, Incineration and Fuel devices, Vehicles, Manned transportation, Equipment for Recreation and Amusement, and Safety devices, handling of Nuclear or Hazardous Materials or Chemicals, Mining and Drilling, and/or other applications where there is a significant risk of injury to the public or property.
- Notwithstanding the above restrictions, Mitsubishi Electric may in its sole discretion, authorize use of the PRODUCT in one or more of the Prohibited Applications, provided that the usage of the PRODUCT is limited only for the specific applications agreed to by Mitsubishi Electric and provided further that no special quality assurance or fail-safe, redundant or other safety features which exceed the general specifications of the PRODUCTS are required. For details, please contact the Mitsubishi Electric representative in your region.
- (3) Mitsubishi Electric shall have no responsibility or liability for any problems involving programmable controller trouble and system trouble caused by DoS attacks, unauthorized access, computer viruses, and other cyberattacks.

CONSIDERATIONS FOR USE

For products manufactured by Microsoft[®] Corporation in the United States

This product is equipped with Windows 10 IoT Enterprise manufactured by Microsoft Corporation in the United States as OS. For using this product, our company does not have any responsibility for problems and damage caused by a product manufactured by Microsoft Corporation in the United States.

For the problems or specifications of the Microsoft Corporation product, refer to the corresponding manual or consult Microsoft Corporation.

Contact information is available on the following website:

- Microsoft Corporation: support.microsoft.com/en-us/contactus

INTRODUCTION

Thank you for purchasing the Mitsubishi Electric MELSEC iQ-R series programmable controllers.

This manual describes the performance specifications, procedure before operation, wiring, and communication examples to use the module listed below.

Before using this product, please read this manual and the relevant manuals carefully and develop familiarity with the performance of the MELSEC iQ-R series programmable controller to handle the product correctly.

When applying the program examples provided in this manual to an actual system, ensure the applicability and confirm that it will not cause system control problems.

Note that the menu names and operating procedures may differ depending on an operating system in use and its version.

When reading this manual, replace the names and procedures with the applicable ones as necessary.

Please make sure that the end users read this manual.



Relevant product

R102WCPU-W

COMPLIANCE WITH EMC AND LOW VOLTAGE DIRECTIVES

Method of ensuring compliance



To ensure that Mitsubishi programmable controllers maintain EMC and Low Voltage Directives when incorporated into other machinery or equipment, certain measures may be necessary. Please refer to one of the following manuals.

-  MELSEC iQ-R Module Configuration Manual(SH-081262ENG)
-  Safety Guidelines (IB-0800525)

The CE mark on the side of the programmable controller indicates compliance with EMC and Low Voltage Directives.

Additional measures

To ensure that this product maintains EMC and Low Voltage Directives, please refer to one of the following manuals.

-  MELSEC iQ-R Module Configuration Manual(SH-081262ENG)
-  Safety Guidelines (IB-0800525)

In addition, compliance with the noise immunity standards for Ethernet cable, RS-232 connection cable, USB cable, and HDMI cable is required.

■Ethernet cable

For a twisted pair cable to be connected to the connector of 10BASE-T/100BASE-TX/1000BASE-T, use a shielded twisted pair cable. Moreover, be sure to ground the shield part of a shield cable.

■RS-232 connection cable

For an RS-232 connection cable, be sure to ground the shield part of a shield cable.

■USB cable

Use shielded cables.

■HDMI cable

Use shielded cables. Moreover, be sure to ground the shield part of a shield cable.

CONTENTS

SAFETY PRECAUTIONS	1
CONDITIONS OF USE FOR THE PRODUCT	8
CONSIDERATIONS FOR USE	8
INTRODUCTION	9
COMPLIANCE WITH EMC AND LOW VOLTAGE DIRECTIVES	9
RELEVANT MANUALS	16
TERMS	17
GENERIC TERMS AND ABBREVIATIONS	17

PART 1 PRODUCT INTRODUCTION

CHAPTER 1 PART NAMES	20
-----------------------------------	-----------

CHAPTER 2 SPECIFICATIONS	25
---------------------------------------	-----------

2.1 Performance Specifications	25
2.2 Operational Specifications	27
Operation start timing	27
Operation mode	27
Y output status	29
Operation when a momentary power failure occurs	30
Considerations	30

CHAPTER 3 FUNCTION LIST	31
--------------------------------------	-----------

CHAPTER 4 PROCEDURES BEFORE OPERATION	33
--	-----------

4.1 Outline	33
4.2 Installing a Battery (FX3U-32BL)	34
4.3 Setting up Windows	35
Operation after the setup	41
Windows default settings	50
Restrictions	52
4.4 Setting Parameters	53
4.5 Writing Parameters to this Product	55
4.6 Applying Parameters	55
4.7 Creating and Registering a User Program	56
Development environment	56
Environment configuration	56
Creating and registering a user program	57

CHAPTER 5 POWER OFF AND RESET	58
--	-----------

5.1 Turning OFF the Power of this Product	58
Shutting down Windows	58
5.2 Resetting this Product	59
Resetting this product as a whole	59
Resetting the Windows function	59
Resetting the MELSEC functions	59

CHAPTER 6	SYSTEM CONFIGURATION	60
6.1	Hardware Configuration	60
	Calculation for the current consumption value of a USB device	61
6.2	Software Configuration	63
	Operating system	63
	Applications	63
	Folder configuration	66
	Memory configuration	66
6.3	Peripheral Device Configuration	67
	SD memory card	67
	CFast card	67
6.4	Considerations for Configuring a System	68
	Development environment (Visual Studio)	68
	SD memory card	68
	CFast card	69
	Extension base unit	69
	Ethernet port	70
	IP address settings	71
CHAPTER 7	WIRING	72
7.1	USB Connector	72
7.2	Ethernet Connector	74
7.3	HDMI Connector	76
7.4	RS-232 Connector	77
7.5	Measure to Prevent a Cable from Falling Out	79
CHAPTER 8	INSERTION/REMOVAL OF SD MEMORY CARD AND CFast CARD	80
8.1	SD Memory Card	80
	Insertion	80
	Removal	81
8.2	CFast Card	82
	Insertion	82
	Removal	83
	Initialization (format)	85
CHAPTER 9	MAINTENANCE AND INSPECTION	89
9.1	Daily Inspection	89
9.2	Periodic Inspection	90
	Replacing a battery	91
9.3	BIOS Setup	93
	Starting the setup	93
	Setup menus	93
9.4	Windows Recovery	100
	Creating recovery data	100
	Performing a recovery	102

PART 2 Windows FUNCTION

CHAPTER 10 Windows FUNCTION	106
10.1 Windows Services	106
10.2 Events Registered by Windows Service	107

PART 3 MELSEC FUNCTIONS

CHAPTER 11 PROGRAMMABLE CONTROLLER DEVICE MEMORY FUNCTION	110
11.1 Access with MELSEC Data Link Functions	111
11.2 Access via a Bus or Factory Automation Network	111
11.3 Access from MELSOFT Products or GOTs	111

CHAPTER 12 BUS ACCESS FUNCTION	112
12.1 Device Access	112
Access with MELSEC data link functions	113
Access from MELSOFT products or GOTs	113
12.2 Data Communication Between CPU Modules	114
Memory used	115
Data communication with CPU buffer memory	119
Data communication with fixed scan communication area	120
Data assurance for accessing CPU buffer memory	124
12.3 Interrupt Notification Reception	125
Interrupt from a C Controller module (another CPU)	126
Interrupt from a programmable controller CPU module (another CPU module)	128
Interrupt from a module	132

CHAPTER 13 MELSOFT CONNECTION FUNCTION	133
13.1 Connection Method	134
Firewall settings	134
CW Configurator settings	136
External device configuration	141

CHAPTER 14 TIME SYNCHRONIZATION FUNCTION	145
14.1 Single CPU System	147
14.2 Multiple CPU System	147
Setting this product as CPU No.1	149
Setting this product as CPU No.2, No.3, or No.4	150
When not synchronizing time	150

CHAPTER 15 MULTIPLE CPU SYSTEM FUNCTION	151
15.1 Out-of-Group I/O Fetch	152
Access to controlled modules	152
Access to non-controlled modules	152
15.2 Multiple CPU Synchronous Startup Setting	154
15.3 Fixed Scan Communication Setting	155
15.4 CPU Number-Based Data Assurance Setting	155

CHAPTER 16 NETWORK MODULE ACCESS FUNCTION	156
16.1 Cyclic Transmission	157
Accessible link devices	157
Method for accessing link devices	158
Cyclic data assurance	164
Refresh cycle	165
16.2 Transient Transmission	166
Access to the same network	167
Access to a different network	171
Message communication (network module dedicated instructions)	172
16.3 Processing Time	174
Link refresh time	174
Refresh cycle	176
Reduction of link refresh time	177
Transmission delay time of cyclic transmission	178
16.4 MELSEC Data Link Function Setting Function	179
CHAPTER 17 LABEL COMMUNICATION FUNCTION	180
CHAPTER 18 FIXED CYCLE PROCESSING FUNCTION	183
PART 4 MODULE OPERATION FUNCTIONS	
CHAPTER 19 REMOTE OPERATION FUNCTION	186
CHAPTER 20 HARDWARE RESET FUNCTION	189
CHAPTER 21 INDIVIDUAL RESET FUNCTION	191
21.1 Bus Reset	192
21.2 Windows Forced Restart	193
CHAPTER 22 Windows SHUTDOWN FUNCTION	195
CHAPTER 23 Windows FORCED RESTART AT ERROR FUNCTION	197
CHAPTER 24 Y OUTPUT CONTROL FUNCTION	199
CHAPTER 25 INFORMATION LED OPERATION FUNCTION	201
PART 5 DIAGNOSTICS AND MAINTENANCE FUNCTIONS	
CHAPTER 26 BUS ACCESS DIAGNOSTICS FUNCTION	204
CHAPTER 27 WATCHDOG TIMER FUNCTION	206
CHAPTER 28 SELF-DIAGNOSTICS FUNCTION	208
28.1 Self-diagnostics Timing	208
28.2 Error Status Check	208
28.3 Error Detection Setting	209

28.4	Operation Setting When an Error is Detected	210
28.5	Current Consumption Monitoring Function	213

CHAPTER 29 ERROR CLEAR FUNCTION **215**

CHAPTER 30 EVENT HISTORY FUNCTION **217**

30.1	Event Information to be Registered	217
30.2	Registration Destination for Event Information	218

CHAPTER 31 PARAMETER/EVENT HISTORY INITIALIZATION FUNCTION **219**

PART 6 TROUBLESHOOTING

CHAPTER 32 TROUBLESHOOTING **222**

32.1	Checking Errors with LEDs	223
32.2	Checking Events with the Event Viewer	225
32.3	Checking Errors in CW Configurator	226

CHAPTER 33 ERROR CODE LIST **229**

33.1	Error Codes for Self-diagnostics	229
33.2	Other Error Codes	252

CHAPTER 34 TROUBLESHOOTING BY SYMPTOM **256**

34.1	Ethernet Communication between a Personal Computer and this Product Fails	256
	The PING command responds abnormally	256
	The PING command responds normally	256
34.2	MELSOFT Connection cannot be Established	257
34.3	Specific Communication Port cannot be Opened by a User Application	257
34.4	Communication Error Occurs during Ethernet Communication	257
34.5	Date and Time Gap Occurs between the Event History Time and Windows Clock	258
34.6	Different Date and Time is Displayed in Event History and "Logged" of Event Log	258
34.7	The Windows Forced Restart Function cannot be Performed	258
34.8	The Windows Shutdown Function cannot be Performed	259
34.9	The Bus Reset Function cannot be Performed	259
34.10	The Priority of a Boot Device cannot be Switched	260
34.11	The Y Device Assigned to "Y Output Setting while Windows is Restarting" is not Turned ON	260
34.12	The Y Device Assigned to "Y Output Setting when Windows Shut Down" is not Turned ON	260
34.13	The OS LED does not Turn OFF after Windows is Shut Down	261
34.14	Windows cannot be Restarted	261
34.15	The Windows Forced Restart at Error Function is Performed even when no System Error Occurs	261
34.16	A USB Device does not Operate	262
34.17	The Mouse or Keyboard do not Operate	263
34.18	The Display is not Showing Windows	263
34.19	An SD Memory Card cannot be Accessed	263
34.20	A CFast Card cannot be Accessed	264
34.21	Device Data cannot be Displayed in GOT	264
34.22	RS-232 Communication cannot be Performed	264
34.23	Installation of a MELSOFT Product Fails	264
34.24	The Message 'Something happened, and we couldn't install a feature' is Displayed	265
34.25	Date and Time in "Logged" of Event Log is Different from Actual Registration Time	265

34.26	Error Message of RuntimeBroker.exe 'The group or resource is not in the correct state to perform the requested operation.' Appears	265
34.27	A License cannot be Authorized	265
34.28	An Execution Delay Occurs in Applications.....	266
34.29	Time Zone Set with the Time Synchronization Function is Displayed in a Different Language from Windows Display Language.....	266
34.30	A Value Cannot Be Read By the Out-of-Group I/O Fetch Function.....	266

APPENDIX 267

Appendix 1	Event List	267
	How to read the event list	267
	Event list	268
Appendix 2	Windows Event List.....	270
Appendix 3	Device List	273
Appendix 4	Special Relay List	275
Appendix 5	Special Register List	279
Appendix 6	Buffer Memory List	291
Appendix 7	Parameter List	292
	System parameter	292
	CPU parameter	293
	Module parameter	293
Appendix 8	How to Use MELSEC-Q Series Modules	294
	Window change in CW Configurator	294
	Setting procedure	295
	Considerations.....	295
Appendix 9	General Safety Requirements.....	296
	When the $\overline{\text{ERR}}$ contact of a power supply module is not used.....	296
	When the $\overline{\text{ERR}}$ contact of a power supply module is used.....	298
	Fail-safe measures when a system of this product fails	299
Appendix 10	External Dimensions	300

INDEX 302

REVISIONS.....	304
WARRANTY	305
INFORMATION AND SERVICES	306
TRADEMARKS.....	306
COPYRIGHTS.....	306

RELEVANT MANUALS

Manual name [manual number]	Description	Available form
MELSEC iQ-R MELSECWinCPU Module User's Manual [SH-082431ENG] (this manual)	Performance specifications, procedure before operation, functions, devices, parameters, and troubleshooting of a MELSECWinCPU module	Print book e-Manual PDF
MELSEC iQ-R MELSECWinCPU Module Programming Manual [SH-082433ENG]	Programming specifications and dedicated function library of a MELSECWinCPU module	e-Manual PDF
CW Configurator Operating Manual [SH-081382ENG]	System configuration, parameter settings, and operation methods for the online function of CW Configurator	e-Manual PDF
MELSEC iQ-R Module Configuration Manual [SH-081262ENG]	The combination of the MELSEC iQ-R series modules, common information on the installation/wiring in the system, and specifications of the power supply module, base unit, SD memory card, and battery	Print book e-Manual PDF

Point

e-Manual refers to the Mitsubishi Electric FA electronic book manuals that can be browsed using a dedicated tool.

e-Manual has the following features:

- Required information can be cross-searched in multiple manuals.
- Other manuals can be accessed from the links in the manual.
- Hardware specifications of each part can be found from the product figures.
- Pages that users often browse can be bookmarked.
- Sample programs can be copied to an engineering tool.

This manual does not include detailed information on the following:

- General specifications
- Applicable combinations of CPU modules and the other modules, and the number of mountable modules
- Applicable combinations of remote head modules and the other modules, and the number of mountable modules
- Installation

For details, refer to the following:

 MELSEC iQ-R Module Configuration Manual

TERMS

Unless otherwise specified, this manual uses the following terms.

Term	Description
Bus control	A processing unit that can control communication with another CPU module or a control module via a bus
C Controller module dedicated function	A dedicated function library provided by this product. In this product, it is used to clear errors and acquire module configuration information.
Intelligent function module	A module that has functions other than an input or output, such as an A/D converter module and D/A converter module
MELSEC data link function	A dedicated function library provided by this product. It is used to access this product and another CPU module which is set as a connection target via network or in a multiple CPU system.
Target device	A personal computer, GOT, or another CPU module to connect for data communication
USB Mass Storage Class-compliant device	A USB device that is compliant with the standard for recognizing as a memory device (USB Mass Storage Class)

GENERIC TERMS AND ABBREVIATIONS

Unless otherwise specified, this manual uses the following generic terms and abbreviations.

Generic term/abbreviation	Description
CC-Link IE TSN master/local module	RJ71GN11-T2
CC-Link IE TSN module	A CC-Link IE TSN master/local module
CC-Link IE Controller Network module	Includes the following: <ul style="list-style-type: none"> • RJ71GP21-SX CC-Link IE Controller Network module • RJ71GP21S-SX CC-Link IE Controller Network module
CC-Link IE module	A CC-Link IE Controller Network module and a CC-Link IE TSN module
CC-Link module	RJ61BT11
CPU module	A MELSEC iQ-R series CPU module
GOT	Mitsubishi Graphic Operation Terminal
R102WCPU-W	An R102WCPU-W MELSECWinCPU module
MELSECWinCPU module	A MELSEC iQ-R series MELSECWinCPU module
Network module	Includes the following: <ul style="list-style-type: none"> • CC-Link IE Controller Network module • CC-Link IE TSN module • CC-Link module
Bus interface	A MELSEC iQ-R bus interface
Bus interface communication	MELSEC iQ-R bus interface communication
Bus interface function	A dedicated function library provided by MELSEC-Q series MELSECWinCPU modules
Base unit	A main base unit, an extension base unit, and an RQ extension base unit
Dedicated function library	C Controller module dedicated functions and MELSEC data link functions
Power supply module	A MELSEC iQ-R series power supply module
I/O module	An input module, an output module, an I/O combined module, and an interrupt module

MEMO

This part comprises the following chapters.

1 PART NAMES

2 SPECIFICATIONS

3 FUNCTION LIST

4 PROCEDURES BEFORE OPERATION

5 POWER OFF AND RESET

6 SYSTEM CONFIGURATION

7 WIRING

8 INSERTION/REMOVAL OF SD MEMORY CARD AND CFast CARD

9 MAINTENANCE AND INSPECTION

1 PART NAMES

This chapter shows the part names of this product.

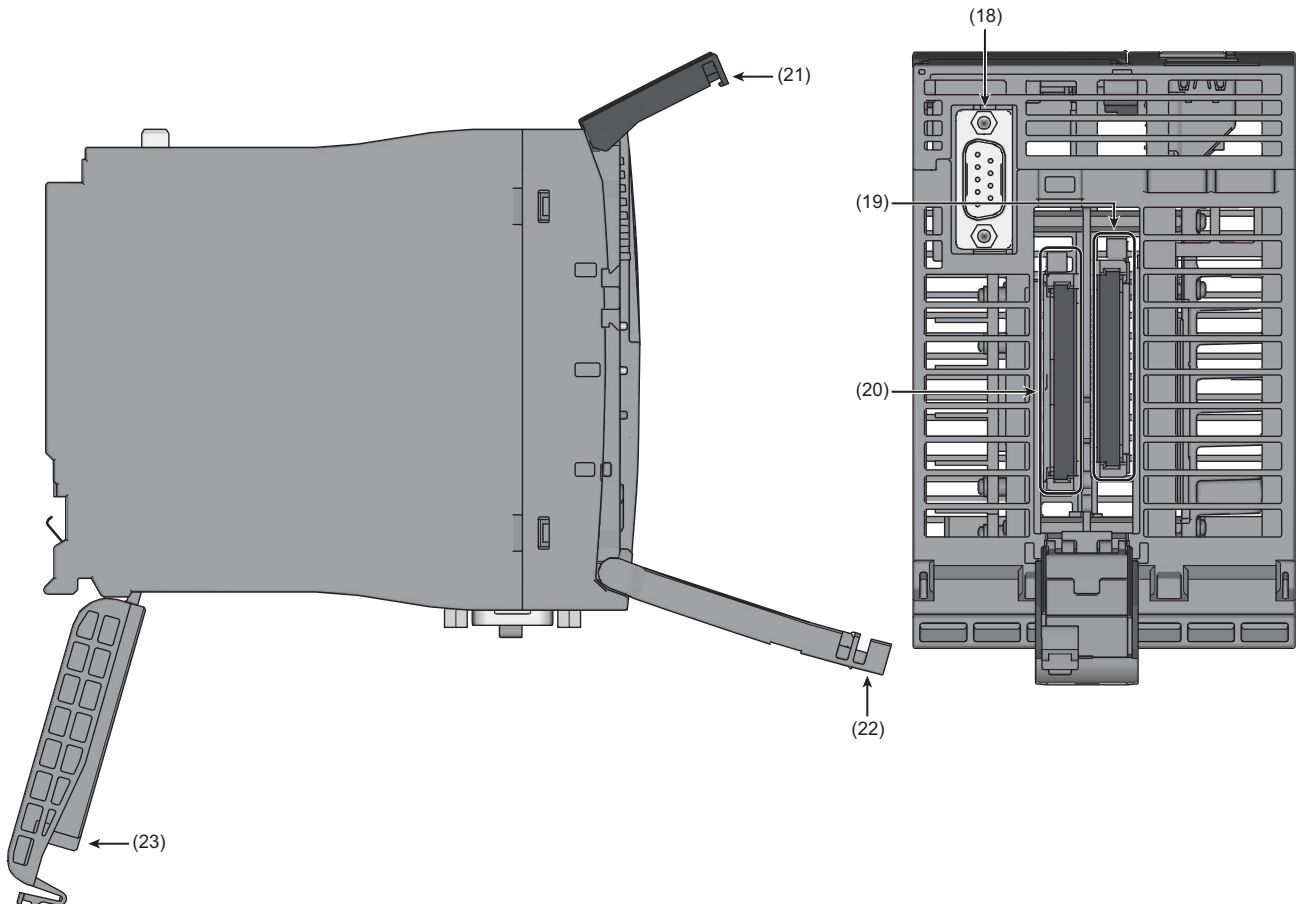
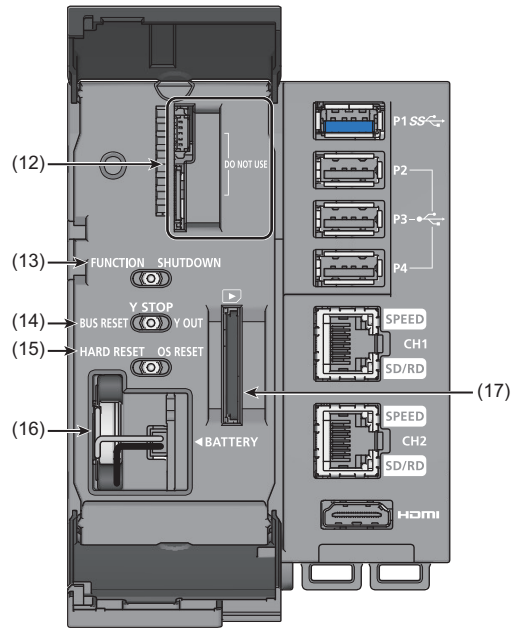
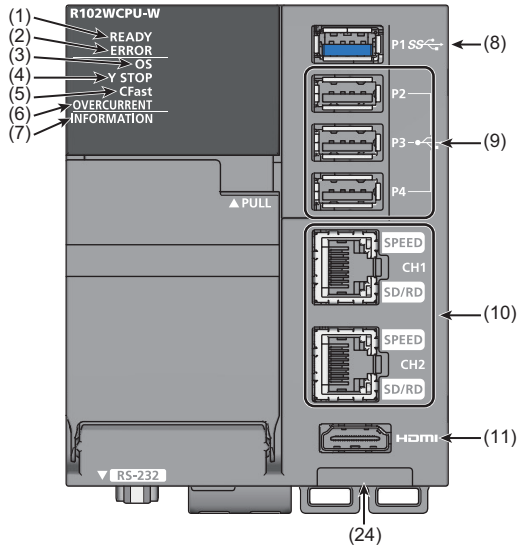

No.	Name	Description
(1)	READY LED ^{*1}	<p>Indicates the operating status of this product.</p> <p>■Normal mode^{*2}</p> <p>The operating status of the bus control is displayed.</p> <ul style="list-style-type: none"> • ON (green): Operating normally • Slow flashing (green): Initializing • OFF: Major error or resetting <p>■Maintenance mode^{*2}</p> <ul style="list-style-type: none"> • ON (orange): Operating in the maintenance mode^{*3} <p>■USB boot mode^{*2}</p> <ul style="list-style-type: none"> • ON (orange): Operating in the USB boot mode^{*3}
(2)	ERROR LED ^{*1}	<p>Indicates the error status of this product.</p> <p>■Normal mode^{*2}</p> <ul style="list-style-type: none"> • ON (red): Minor error (if the READY LED is ON) or major error (if the READY LED is OFF) • Flashing (red): Moderate error (if the READY LED is ON) or major error (if the READY LED is OFF) • OFF: Operating normally <p>■Maintenance mode^{*2}</p> <ul style="list-style-type: none"> • ON (red): Major error • Flashing (red): Maintenance mode completed with an error • OFF: No error <p>■USB boot mode^{*2}</p> <ul style="list-style-type: none"> • ON (red): Minor error or major error • Flashing (red): Moderate error or major error • OFF: Operating normally
(3)	OS LED ^{*1*4}	<p>Indicates the operating status of Windows or this product when the bus access diagnostics is performed.</p> <p>■Normal mode^{*2}, USB boot mode^{*2}</p> <ul style="list-style-type: none"> • ON (green): Windows running^{*5} • Flashing (green): Windows preparing (starting up, shutting down, or restarting) • OFF: Windows stopped <p>■Maintenance mode^{*2}</p> <p>This LED is always OFF except for when the bus access diagnostics is performed.</p> <ul style="list-style-type: none"> • ON (green): Bus access diagnostics being selected or completed normally • Flashing (green): Bus access diagnostics being performed • OFF: Bus access diagnostics completed with an error
(4)	Y STOP LED ^{*1}	<p>Indicates the output (Y) status of this product or the operating status of this product when the parameter/event history initialization is performed.</p> <p>■Normal mode^{*2}</p> <ul style="list-style-type: none"> • ON (orange): Y output status in the Y STOP state (where the Y output cannot be controlled or data cannot be written to the buffer memory from a user program (if the READY LED is ON)) or major error (if the READY LED is OFF) • Flashing (orange): Y output status in the PAUSE state (where the Y output cannot be controlled or data cannot be written to the buffer memory from a user program) • OFF: Y output status in the Y OUT state (where the Y output can be controlled or data can be written to the buffer memory from a user program) <p>■Maintenance mode^{*2}</p> <p>This LED is always OFF except for when the parameter/event history initialization is performed or when a major error occurs.</p> <ul style="list-style-type: none"> • ON (orange): Parameter/event history initialization being selected or completed normally, or major error • Flashing (orange): Parameter/event history initialization being performed • OFF: Parameter/event history initialization completed with an error <p>■USB boot mode^{*2}</p> <ul style="list-style-type: none"> • ON (orange): A state where the Y output cannot be controlled or data cannot be written to the buffer memory from a user program, or major error • Flashing (orange): A state where the Y output cannot be controlled or data cannot be written to the buffer memory from a user program • OFF: A state where the Y output can be controlled or data can be written to the buffer memory from a user program
(5)	CFast LED ^{*1}	<p>Indicates the access status of a CFast card.</p> <p>■Normal mode^{*2}, USB boot mode^{*2}</p> <ul style="list-style-type: none"> • Flashing (green): Being accessed • OFF: Not accessed <p>■Maintenance mode^{*2}</p> <ul style="list-style-type: none"> • Always OFF

No.	Name	Description
(6)	OVERCURRENT LED* ¹	Indicates the current consumption status of this product. ■Normal mode ^{*2} , USB boot mode ^{*2} <ul style="list-style-type: none"> • ON (red): Current consumption error (warning) • Slow flashing (red): Current consumption error (USB port 1 forced stop) • Flashing (red): Current consumption error (all USB ports forced stop) • OFF: Operating normally ■Maintenance mode ^{*2} <ul style="list-style-type: none"> • Always OFF
(7)	INFORMATION LED	■Normal mode ^{*2} <ul style="list-style-type: none"> • Controls the display status using a user program. For details on the INFORMATION LED, refer to the following: ☞ Page 201 INFORMATION LED OPERATION FUNCTION ■Maintenance mode ^{*2} <ul style="list-style-type: none"> • Always OFF ■USB boot mode ^{*2} <ul style="list-style-type: none"> • ON (green): Operating in the USB boot mode
(8)	USB connector (P1)	A USB connector for a USB3.0 device.
(9)	USB connectors (P2) to (P4)	USB connectors for USB2.0 devices.
(10)	Ethernet connectors	Connectors for Ethernet devices.
	SPEED LED	Indicates the Ethernet communication status. <ul style="list-style-type: none"> • ON (orange): Linking-up (1 Gbps) • ON (green): Linking-up (100 Mbps) • OFF: Linking-up (10 Mbps) or linking-down
	SD/RD LED	Indicates the data sending/receiving status in Ethernet. <ul style="list-style-type: none"> • ON (green): Being sent/received • OFF: Not being sent/received
(11)	HDMI connector	An image output connector for liquid crystal displays, etc.
(12)	Service connector	A connector used for Mitsubishi Electric service. Do not use this connector.
(13)	FUNCTION/ SHUTDOWN switch* ⁶	FUNCTION ■Normal mode ^{*2} , USB boot mode ^{*2} The stopped USB port(s) is/are released when there is a current consumption error (the OVERCURRENT LED is ON, flashing, or flashing slowly). For details on the current consumption errors, refer to the following: ☞ Page 61 Calculation for the current consumption value of a USB device ■Maintenance mode ^{*2} A menu of the maintenance mode is selected.
		SHUTDOWN ■Normal mode ^{*2} , USB boot mode ^{*2} Windows is shut down if this switch is held on the SHUTDOWN position (for 1.0 second or longer).
(14)	BUS RESET/Y STOP/Y OUT switch* ⁶	BUS RESET ■Normal mode ^{*2} , USB boot mode ^{*2} The bus control of this product is forcibly reset if this switch is held on the BUS RESET position (for 1.0 second or longer). ^{*7}
		Y STOP ■Normal mode ^{*2} , USB boot mode ^{*2} The Y output status is set in the Y STOP state. For details on the Y output status, refer to the following: ☞ Page 29 Y output status
		Y OUT ■Normal mode ^{*2} , USB boot mode ^{*2} The Y output status is set in the Y OUT state. For details on the Y output status, refer to the following: ☞ Page 29 Y output status ■Maintenance mode ^{*2} A function selected in the maintenance mode is performed.
(15)	HARD RESET/OS RESET switch* ⁶	HARD RESET ■Normal mode ^{*2} This product is reset if this switch is held on the HARD RESET position (for 1.0 second or longer). ^{*7} ■Maintenance mode ^{*2} , USB boot mode ^{*2} This product is reset and started in the normal mode if this switch is held on the HARD RESET position (for 1.0 second or longer). ^{*7}
		OS RESET ■Normal mode ^{*2} , USB boot mode ^{*2} Windows is forcibly restarted if this switch is held on the OS RESET position (for 1.0 second or longer). If Windows has been shut down, it is started. For details on the Windows forced restart, refer to the following: ☞ Page 193 Windows Forced Restart
(16)	Battery slot	A slot for a battery
	Battery	A backup power source to retain clock data
(17)	SD memory card slot	A slot for an SD memory card
(18)	RS-232 connector	A connector for an RS-232 device

No.	Name	Description
(19)	Primary CFast card slot ^{*8}	A slot for a CFast card for the operating system startup
(20)	Secondary CFast card slot ^{*9}	A slot for a CFast card for extension
(21)	Service connector cover	A protective cover for the service connector
(22)	Switch cover	A protective cover for the switches. It also protects the battery slot and SD memory card slot.
(23)	CFast cover ^{*10}	A protective cover for the CFast card slots
(24)	Product information marking	Displays the product information (16 digits) of a module.

- *1 Flashing occurs at the following intervals:
 - Flashing: 200 ms
 - Slow flashing: 1 sec
- *2 For details on each operation mode, refer to the following:
 - ☞ Page 27 Operation mode
- *3 The LED does not turn OFF even when a major error occurs because the mode display takes priority.
- *4 In the normal mode, the LED is OFF or flashes depending on parameters of the Windows forced restart at error function.
- *5 The LED does not turn ON when a recovery media is used in the USB boot mode.
- *6 Operate the switch by a fingertip. Using tools such as a screwdriver may cause damage to the switch.
- *7 After the reset, put the switch back to the center position. The reset state is not released until the switch is put back to the center position.
- *8 Only the CFast card provided with this product can be used.
- *9 For available CFast cards, refer to the following:
 - ☞ Page 67 Peripheral Device Configuration
- *10 Use a spring clamp terminal block tool (KD-5339) to open and close the CFast cover.

2 SPECIFICATIONS

2.1 Performance Specifications

This section shows the performance specifications of this product.

Item	Description		
Hardware	Endian format	Little endian	
	MPU	Intel® Atom™ E3930 Dual Core	
	Memory capacity	Main memory	4 GB
		CFast	60 GB
	CFast life	5000 writes	
	Battery life	3.83 years (ambient temperature 70°C, Operation rate 0%)	
Software	Operating system	Windows® 10 IoT Enterprise LTSC 2019	
	Programming language	C/C++, Visual Basic, C#	
Extended SSD	Interface	CFast (SATA III)	
	Maximum capacity	64 GB	
	Number of slots	1	
	Power supply	+3.3 VDC, up to 0.5 A	
Ethernet	Interface	10BASE-T/100BASE-TX/1000BASE-T	
	Number of channels	2	
	Communication method	Full-duplex/half-duplex	
	Transmission method	Base band	
	Data transmission speed	1000BASE-T	1 Gbps
		100BASE-TX	100 Mbps
		10BASE-T	10 Mbps
	Number of cascade connections*1	1000BASE-T	Consult the manufacturer of the repeater hub used.
		100BASE-TX	2 levels maximum
		10BASE-T	4 levels maximum
	Maximum segment length	100 m	
Applicable connector for external wiring	RJ45		
Supported function	<ul style="list-style-type: none"> • Auto-negotiation function (automatic recognition of the communication speed/communication method) • Auto-MDI/MDIX function (automatic recognition of a straight/crossover cable) 		
USB	Interface	USB3.0, USB2.0	
	Number of channels	<ul style="list-style-type: none"> • USB3.0: 1 • USB2.0: 3 	
	Connector	Type A	
	Transfer rate	<ul style="list-style-type: none"> • USB3.0: 5 Gbps (Super Speed) • USB2.0: 480 Mbps (High Speed) 	
	Power supply	<ul style="list-style-type: none"> • USB3.0: Bus power +5 VDC, up to 900 mA • USB2.0: Bus power +5 VDC, up to 500 mA 	
	Cable length	<ul style="list-style-type: none"> • USB3.0: Up to 2 m • USB2.0: Up to 3 m 	
	Complied standard	According to the installed operating system	

Item		Description	
RS-232	Interface	RS-232-compliant	
	Number of channels	1	
	Communication method	Full duplex/half duplex	
	Synchronization method	Asynchronous tracking mode	
	Transmission rate	9600 bps, 14400 bps, 19200 bps, 28800 bps, 38400 bps, 57600 bps, 115200 bps	
	Transmission distance	Up to 15 m	
	Data format	Start bit	1
		Data bit	7/8
		Parity bit	1/None
		Stop bit	1/2
	Parity check	Yes (Even/Odd)/None	
	Sum check code	Yes/None	
	Transmission control	Flow control (RS/CS control)	
	Applicable connector for external wiring	D-sub 9 pin connector	
Display I/F	Interface	HDMI 1.4b	
	Number of ports	1	
	Resolution	Up to 3840 × 2160 @ 30 Hz	
	Display color	Up to 48 bits	
	Audio output	Supported	
	Connector	HDMI TypeA connector	
	Cable length	Up to 2 m	
SD memory card	Number of slots	1	
	Interface	SDHC High Speed	
	Power supply	+3.3 VDC, 220 mA	
Clock function	Displayed information	Year, month, day, hour, minute, second, day of week (automatic leap year detection)	
	Precision	Daily error: -24.72 to +2.78 seconds (0 to 55°C) Daily error: -2.60 to +2.78 seconds (25°C)	
Allowable momentary power failure time	According to the power supply module		
5 VDC internal current consumption	4.4 A		
External dimensions	Height	112 mm (Base unit mounting side: 98 mm)	
	Width	84.2 mm	
	Depth	131 mm	
Weight	0.63 kg		

*1 For a repeater hub. For a switching hub, consult the manufacturer of the hub used.



Wait for five seconds or longer after power-off and power on the system again. If the interval between the power-off and the power-on is short, the module may not start up.

2.2 Operational Specifications

This section shows the operational specifications of this product.

Operation start timing

The following processing of this product is performed after the READY LED and OS LED are turned ON.

- Processing of user programs that use functions provided by this product
- Response to access from other stations and peripheral devices

Access this product after both of the LEDs turn ON.

To operate a system according to the operation start timing, create an interlock with special relays or special registers. If other modules cannot access special relays or special registers, create a program which copies values to other devices and CPU buffer memory.

Special relay or special register	Description
LED status (SD201)	The operation start of this product can be confirmed by checking the READY LED status and the OS LED status.
Special relays or special registers of each network module	The status of communication between this product and a target station can be checked.

Precautions

This product cannot respond to other stations and peripheral devices until the READY LED turns ON. Therefore, depending on parameters and system configurations, the response time of this product may be delayed because parameter check and the initial processing of each module may take time for the READY LED to turn ON.

Operation mode

This product has the following three modes to operate in: normal mode, maintenance mode, and USB boot mode.

Mode	Description
Normal mode	A mode when operating normally
Maintenance mode ^{*1*2}	A mode to select when performing the following functions: <ul style="list-style-type: none">• Bus access diagnostics (☞ Page 204 BUS ACCESS DIAGNOSTICS FUNCTION)• Parameter/event history initialization function (☞ Page 219 PARAMETER/EVENT HISTORY INITIALIZATION FUNCTION)
USB boot mode ^{*1*2}	A mode to select when performing the following function: <ul style="list-style-type: none">• Windows recovery (☞ Page 100 Windows Recovery)

*1 Only the function(s) shown in the right column can be performed when selecting the maintenance mode or USB boot mode.

*2 To start this product in the normal mode, turn the power of this product OFF and ON.

When using a function in each operation mode, make sure to turn the power of this product OFF and ON after the operation of the function completes. If turning the power OFF while the function is in progress, this product may not operate properly.

Point

To perform the bus access diagnostics and a Windows recovery, configure a system which only includes a power supply, a base unit, and this product. In addition, to operate this product in the normal mode after performing the bus access diagnostics or a Windows recovery, check in advance that this product operates normally.

LED display in the maintenance mode

The bus access diagnostics function and the parameter/event history initialization function can be selected in the maintenance mode. The following shows the LED display when each function is performed.

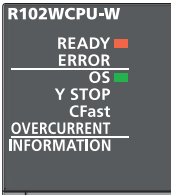
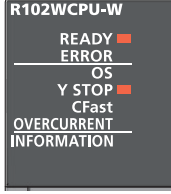
Item	LED status	
Bus access diagnostics	 <p>The LED display shows the following status: R102WCPU-W, READY (orange LED on), ERROR, OS (green LED on), Y STOP, CFast, OVERCURRENT, and INFORMATION.</p>	<ul style="list-style-type: none"> • READY LED: ON (orange) • OS LED: ON (green) • Other LEDs: OFF
Parameter/event history initialization	 <p>The LED display shows the following status: R102WCPU-W, READY (orange LED on), ERROR, OS, Y STOP (orange LED on), CFast, OVERCURRENT, and INFORMATION.</p>	<ul style="list-style-type: none"> • READY LED: ON (orange) • Y STOP LED: ON (orange) • Other LEDs: OFF

Y output status

The following explains the Y output status of this product.

For details on the Y output control, refer to the following:

 Page 199 Y OUTPUT CONTROL FUNCTION

Output status	Description
Y OUT	A state where performing output (Y) to each module and writing data to the buffer memory from a user program are enabled by the BUS RESET/Y STOP/Y OUT switch, remote operation, or dedicated functions
Y STOP	A state where performing output (Y) to each module and writing data to the buffer memory from a user program* ¹ are disabled by the BUS RESET/Y STOP/Y OUT switch, remote operation, dedicated functions, or stop error
PAUSE	A state where performing output (Y) to each module and writing data to the buffer memory from a user program* ¹ are disabled by a remote operation or dedicated functions

*1 One using the following MELSEC data link functions:

- mdBdDevSetEx function
- mdBdDevRstEx function
- mdBdSendEx function
- mdBdRandWEx function

Regardless of the Y output status, the output (Y) can be performed and data can be written to the buffer memory from a user program and engineering tool that use a dedicated function other than above.

Point

- A value just before changing the Y output status is retained in devices other than the output (Y).
- A user program running on Windows keeps running regardless of the Y output status (Y OUT, Y STOP, or PAUSE) of this product. To change the program processing according to the Y output status, create a program that reads the value of the special register (SD203) and determines the Y output status.

The Y output status of this product is equivalent to the operation status of CPU modules other than this product.

Terms used for other modules that indicate the operation status of a CPU module are replaced with the following terms:

Before replacement (the operation status of a CPU module)	After replacement (Y output status)
RUN state	Y OUT
STOP state	Y STOP
PAUSE state	PAUSE

Output when the Y output status is changed

The following explains the output (Y) to each module when the Y output status is changed.

Output status	Description
Changed to the Y OUT state	Whether to output the output (Y) status before STOP or to clear the status can be set in parameters. When the status is changed from the PAUSE state to Y OUT state, the output (Y) status before PAUSE is output.
Changed to the Y STOP state	The output status is saved and all outputs (Y) are turned OFF.
Changed to the PAUSE state	The ON/OFF state of the output (Y) is retained.

Operation when a momentary power failure occurs

The following explains the operation when a momentary power failure occurs.

When a momentary power failure within the allowable time is detected

- The values in the buffer memory are retained when a momentary power failure occurs.
- After the power is restored, error information is registered in the event history. (At the first detection)
- The number of momentary power failures is retained in the special register (SD53).

When a momentary power failure longer than the allowable time is detected

This product operates in the same manner as when the following operations are performed:

- Turning the power of this product OFF and ON
- Resetting the hardware by using the HARD RESET/OS RESET switch

Considerations

The following shows the considerations for operating the product.

Operation when temperature becomes high

The primary CFast card of this product has the thermal throttling function to protect itself from heat.

The thermal throttling function is enabled when the internal temperature of a primary CFast card exceeds 70°C, and limits the speed for accessing the primary CFast card.

If this function is enabled, it remains enabled until the internal temperature of the primary CFast card drops below 50°C.

Operation when the CPU usage rate on Windows is high

If this product is used while the CPU usage rate on Windows is high, the following processing may not run properly.

- User program using a library provided by this product
- Access from an external device via Ethernet

If a timeout occurs in a user program or external device, take the following corrective actions:

- Increase the timeout time.
- Reduce the CPU usage rate on Windows.
- Terminate an unnecessary process.

Operation when Windows Update runs

The processing load on Windows becomes high while downloading Windows Update data and updating Windows by using the downloaded data. Therefore, this product may not operate normally.

In this case, perform the operation again after Windows Update is completed.

3 FUNCTION LIST

This chapter shows the function list of this product.

Function		Description
Windows function		To use Windows functions with Windows 10 IoT Enterprise LTSC 2019 installed on this product
MELSEC functions	Programmable controller device memory function	To enable access to devices and buffer memory of this product from Windows applications in this product and external devices via a bus and Ethernet
	Bus access function	To link with another module using the bus driver of this product
	MELSOFT connection function	To connect MELSOFT products (up to 16 products) on a network using the Ethernet port of this product
	Time synchronization function	To synchronize time between this product (Windows) and the CPU module (CPU No.1) when configuring a multiple CPU system
	Multiple CPU system function	To allow each CPU module on a base unit to control an I/O module and an intelligent function module
	Network module access function	To communicate data with devices on a network via a network module controlled by this product
	Label communication function	To read/write data from/to labels stored in a CPU module on another station
	Fixed cycle processing function	To refresh with a network module and perform data communication with an external device
Module operation functions	Remote operation function	To change the operating status of this product by changing the Y output status and resetting a bus with peripheral devices and user programs
	Hardware reset function	To reset hardware
	Individual reset function	To reset (restart) Windows and the bus control in this product individually
	Windows shutdown function	To shut down Windows in this product by using a switch or input of an I/O module
	Windows forced restart at error function	To restart Windows in this product automatically when the Windows freezes or a system error occurs in the Windows
	Y output control function	To control the Y output status (Y STOP/Y OUT/PAUSE) with the BUS RESET/Y STOP/Y OUT switch or a MELSEC data link function
	INFORMATION LED operation function	To operate the display status of the INFORMATION LED from a user program
Diagnostics and maintenance functions	Bus access diagnostics function	To diagnose whether there are failures in hardware used for the bus access function of this product
	Watchdog timer function	To monitor and detect a bus control failure with the watchdog timer (WDT), which is an internal timer of this product, and to notify an error if the failure occurs
	self-diagnostics function	To diagnose whether there are any errors in this product
	Error clear function	To clear all the continuation errors in this product
	Event history function	To collect and save the following information: errors detected by this product, operations performed for this product, and errors occurred on a network
	Parameter/event history initialization function	To return this product to the factory default state by initializing the parameters and bus control event history of this product

MEMO

4 PROCEDURES BEFORE OPERATION

This chapter shows the startup procedure and program execution of this product.

4.1 Outline

This section explains the procedure outline.

1. Installing a battery (FX3U-32BL)

Install a battery in this product. (☞ Page 34 Installing a Battery (FX3U-32BL))

2. Mounting modules

Mount modules on the base unit, and wire for each device. (📖 MELSEC iQ-R Module Configuration Manual)

3. Connecting peripheral devices

Connect a monitor, keyboard, and mouse to this product to set up Windows.

For connecting and wiring peripheral devices, refer to the manual of devices to be used.

4. Setting a date and time

Set a date and time by using the Main menu of BIOS in this product. (☞ Page 93 BIOS Setup)

5. Setting up Windows

Set up Windows. (☞ Page 35 Setting up Windows)

6. Wiring and connecting system components

Wire and connect devices to configure the system of this product. (☞ Page 60 SYSTEM CONFIGURATION, Page 72 WIRING)

7. Setting parameters

Set system parameters, CPU parameters, and module parameters for this product in CW Configurator. (☞ Page 53 Setting Parameters)

8. Writing the parameters to this product

Write the set parameters to this product. (☞ Page 55 Writing Parameters to this Product)

9. Applying the parameters

Reset the bus control of this product to apply the parameters. (☞ Page 55 Applying Parameters)

10. Checking the operating status

If the ERROR LED of this product is ON or flashing after setting parameters, an error has occurred.

Take a corrective action by following the descriptions for troubleshooting. (☞ Page 222 TROUBLESHOOTING)

11. Installing or developing applications

Install or develop necessary applications according to the purpose of use.

For the applications that are pre-installed in this product, refer to the following:

☞ Page 63 Applications

To develop an application to run on this product, refer to the following:

☞ Page 57 Creating and registering a user program

4.2 Installing a Battery (FX3U-32BL)

This section shows the procedure for installing a battery. A battery must be installed before using this product.

Point

A battery connector is not connected to this product at factory.

Precautions

- Turn OFF the power of this product before installing a battery.
- When closing the switch cover, ensure that the battery cable is not caught.
- The message 'CMOS RAM Battery Failure' appears before Windows starts when turning ON the power of this product while the battery connector is disconnected from the connector of this product, or when reconnecting the battery connector, which has been disconnected once, to the connector of this product. It does not affect the operation of this product because the message is just to notify that the battery is disconnected after turning OFF this product or that the battery power supply voltage is low.

Installation procedure

The following shows the procedure for installing a battery.

1. Open the switch cover.
2. Insert a battery (2) into the battery holder (1).

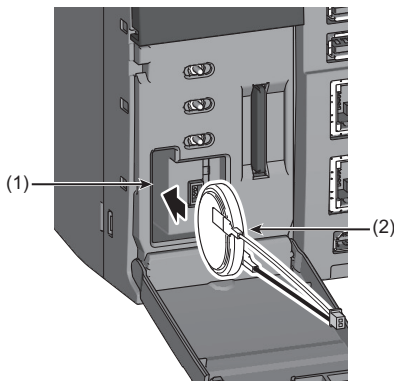

3. Insert the battery connector (3) into the connector of this product (4).

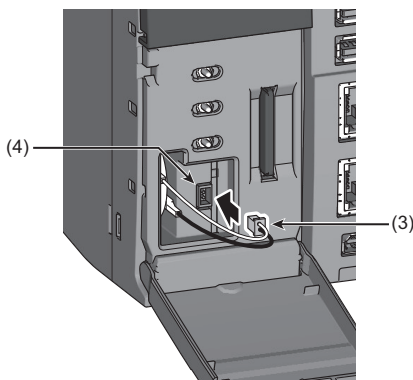

Ensure that the battery connector is fully inserted with its red cable facing up.

4. Close the switch cover until it clicks.

4.3 Setting up Windows

This section shows the setup procedure for Windows. The Windows setup starts when starting this product for the first time. Follow Windows Setup Wizard to set up Windows.

Precautions

- Do not shutdown or restart Windows (except for a restart by system) and do not turn the power of this product ON and OFF until the Windows setup is completed. Otherwise, Windows may not be setup properly.
- If setting up Windows while this product is connected to the Internet, a displayed screen may be different from the one shown in the procedure below. Do not connect this product to the Internet when setting up Windows.
- Some screen transitions may differ depending on the firmware version used.

Operating procedure

1. Select the language to use in Windows.

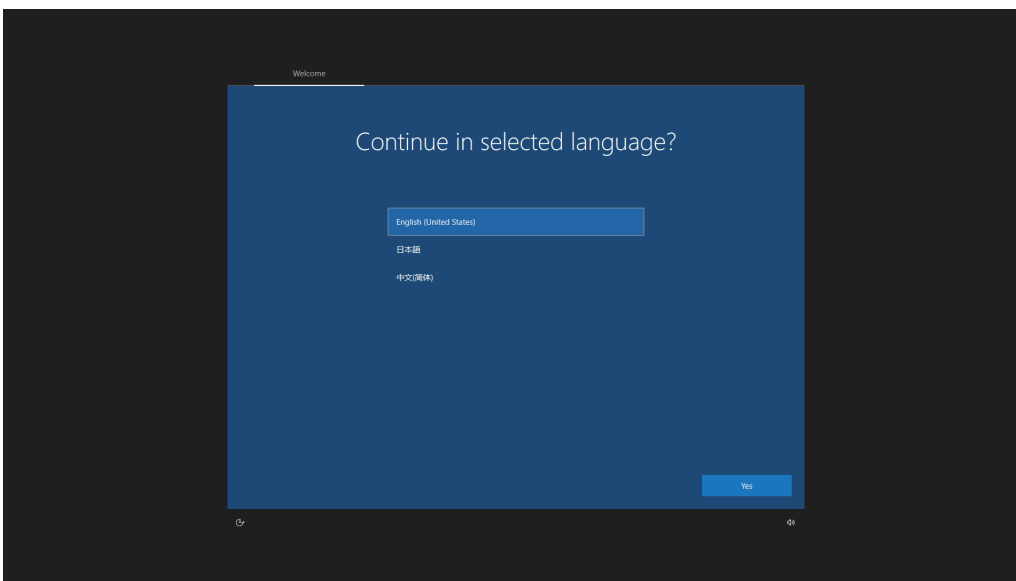

2. Select a region.

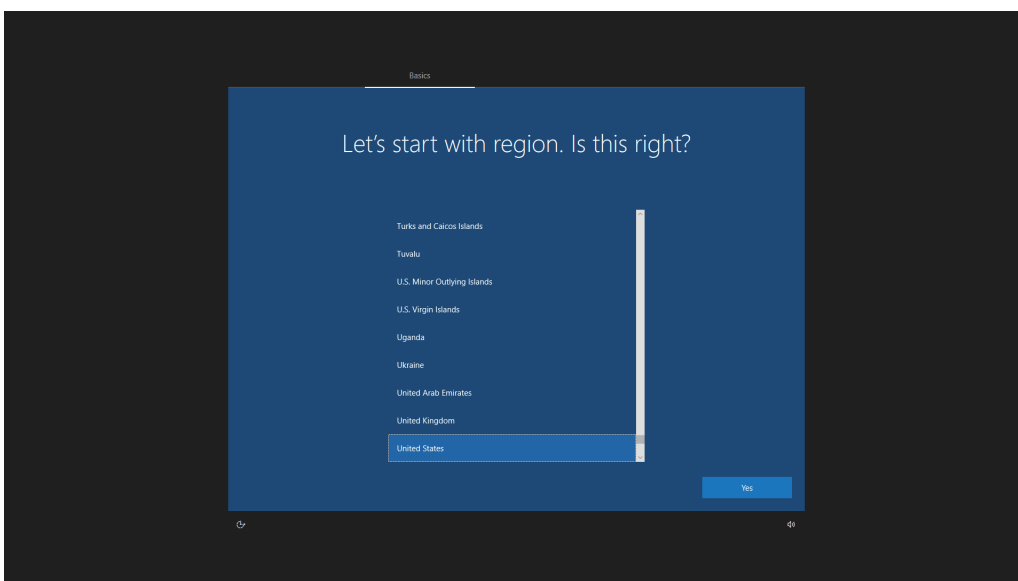

3. Select a keyboard layout to use.

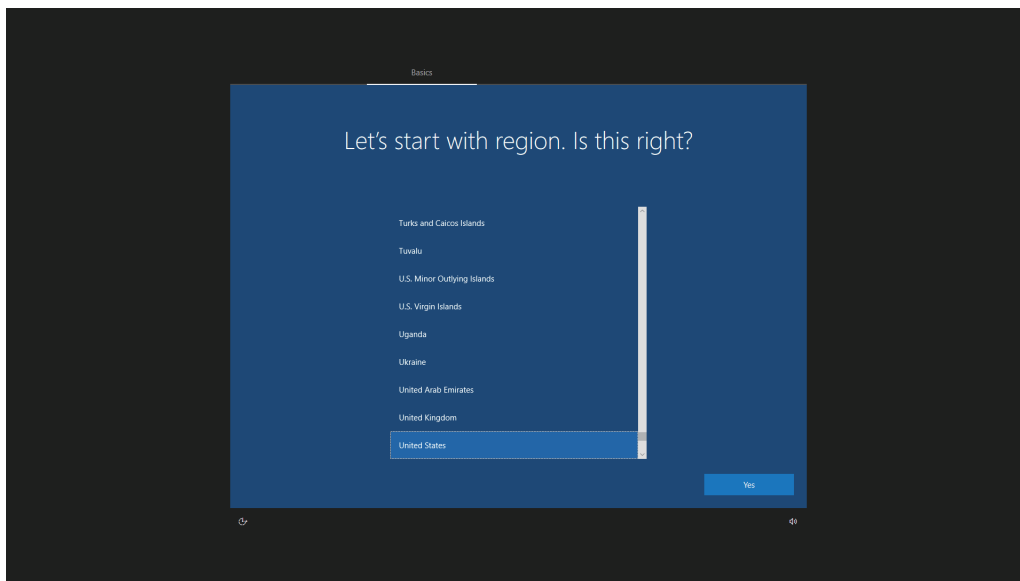

Point 

- If Japanese is selected, the layout cannot be changed from Microsoft IME.
- After selecting the first keyboard layout, a screen for setting the second keyboard layout is displayed. Click the [Skip] button if it is not necessary.

4. Click the [Skip for now] button.

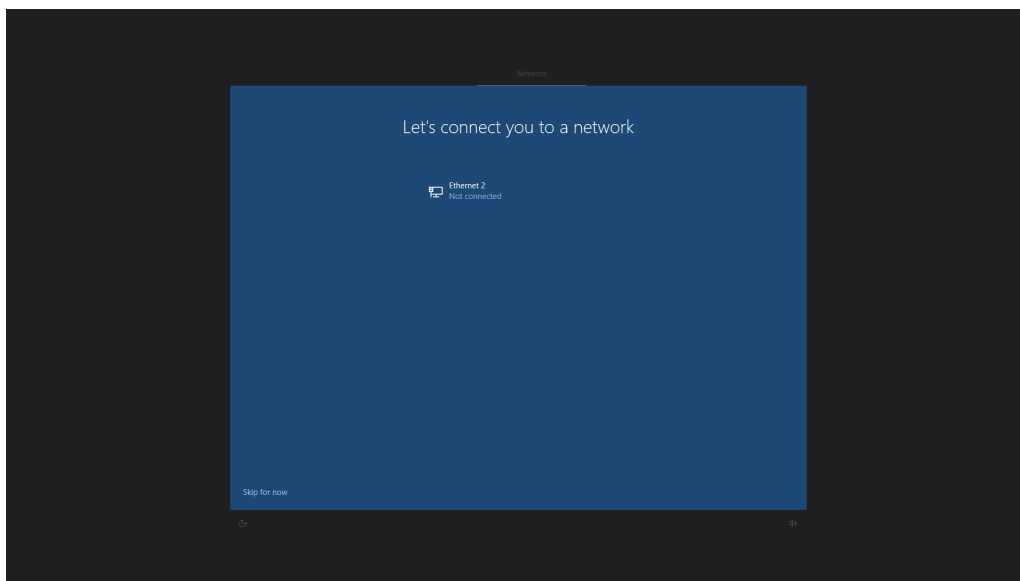

Point 

- Even when an Ethernet cable is connected to an Ethernet connector of this product, it is displayed as unconnected if this product is not connected to the Internet.
- Either of Ethernet or Ethernet2 is displayed depending on the connection status of a LAN cable. Click the [Skip for now] button even if connectable Ethernet adapters are displayed.

5. Click the [No] button.

When selecting a language other than "English(United States)" in Windows, the screen darkens temporarily after clicking [No] button and returns to the screen shown in step 4.

Perform step 4 and step 5 according to the setup procedure.

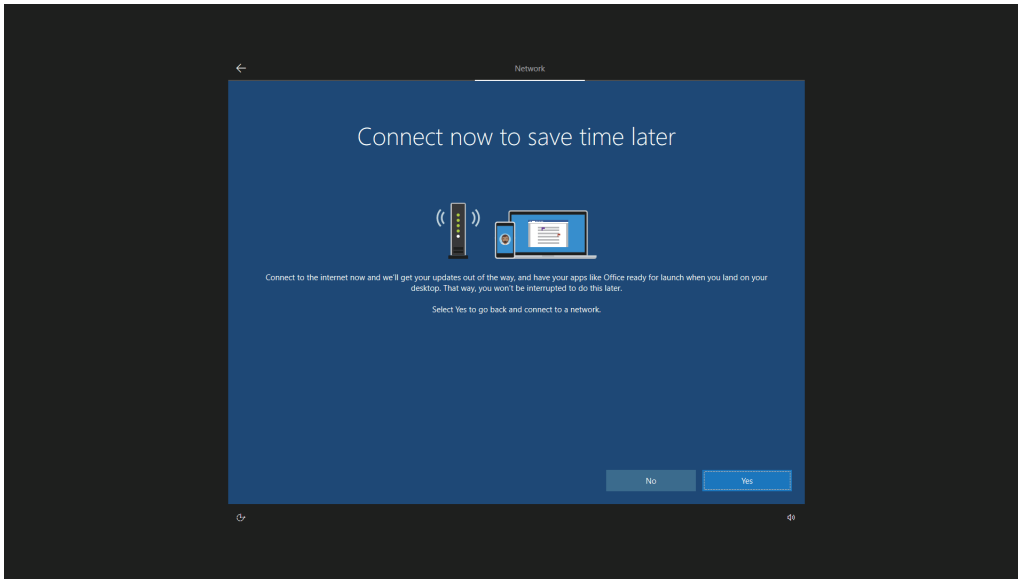

6. Read the license terms, and click the [Accept] button.



7. Set a user name.

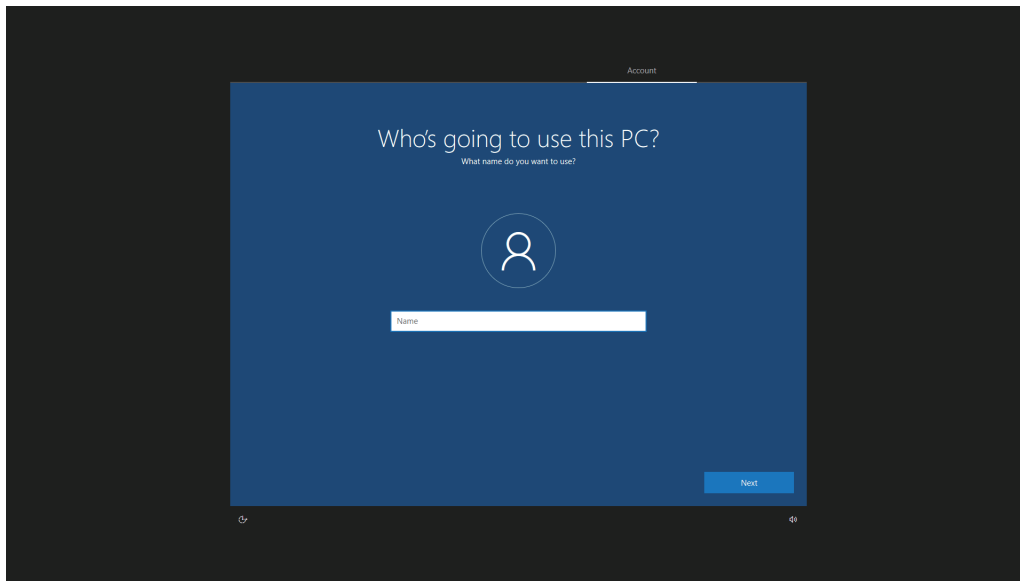

8. Set a password.

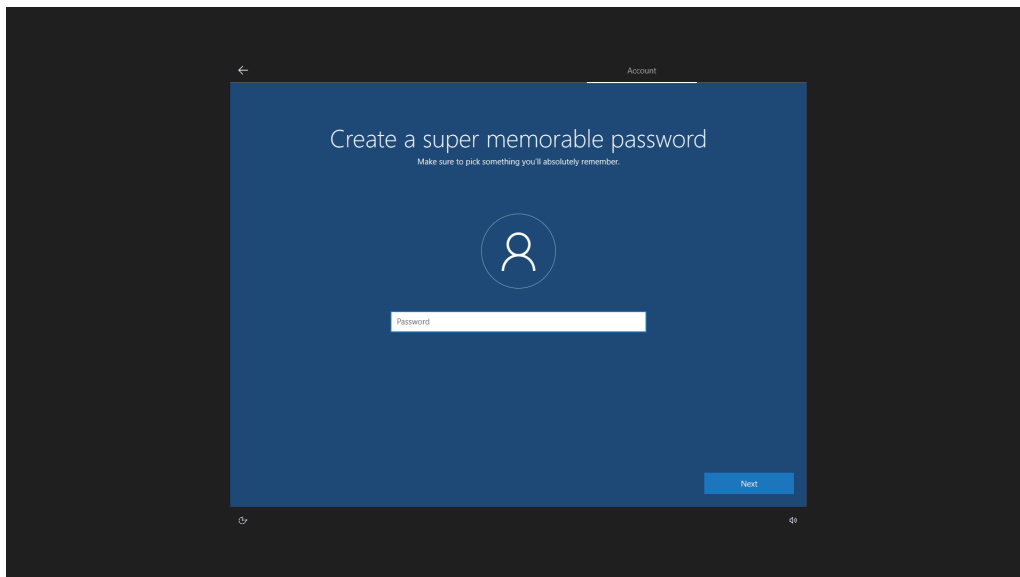

Point 

An account that does not require a password to log in can be created by clicking the [Next] button without setting a password.

9. Enter the password for confirmation.

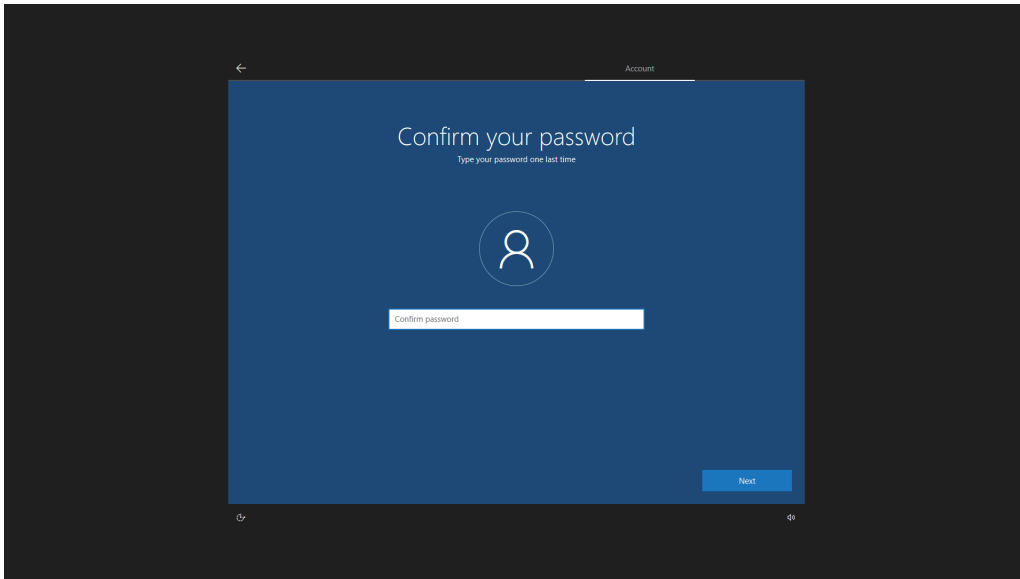

4

10. Set a security question.

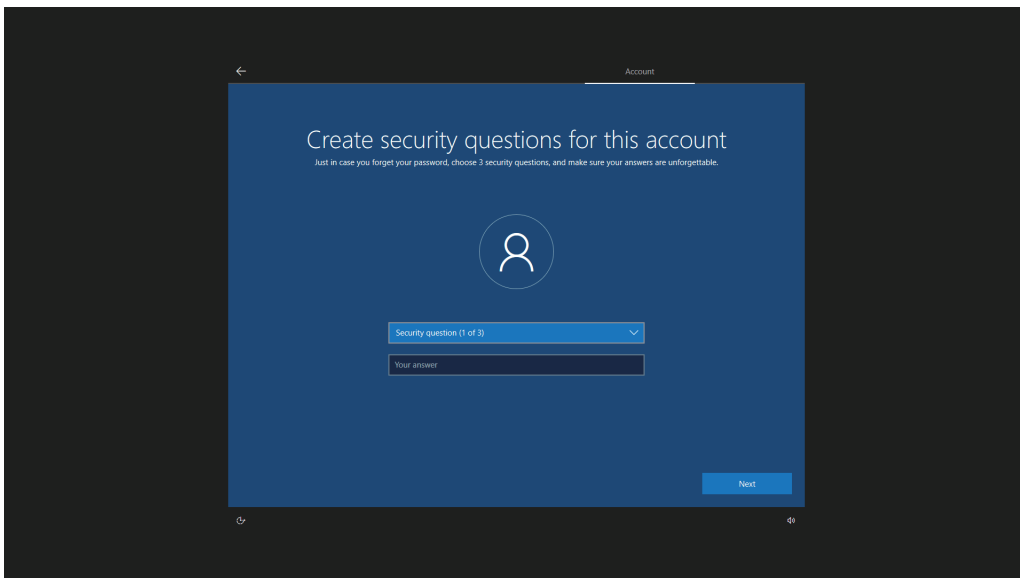

11. Check the displayed content and click the [Yes] or [No] button.

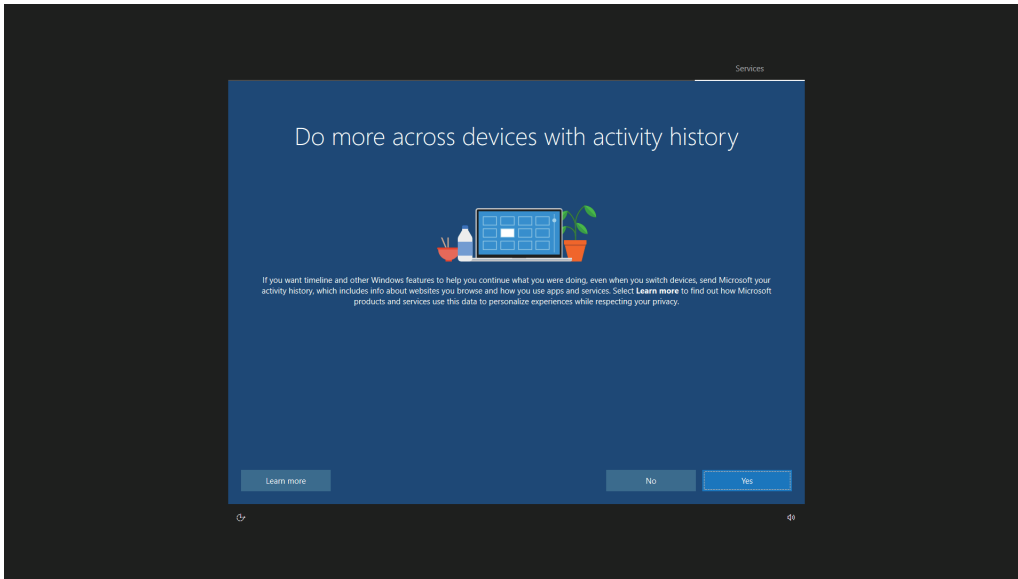

12. Set each item and click the [Accept] button.

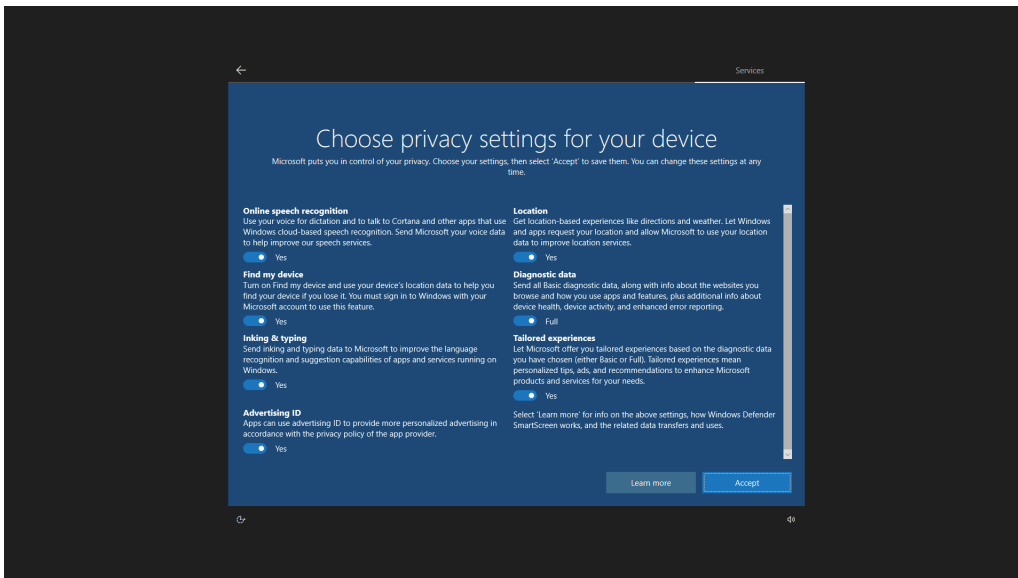

13. Wait for a while. The screen changes and the desktop appears.

The Windows setup is completed.

Point 

To connect this product to the Internet, performing Windows Update manually is recommended to apply Security Update for Windows.

After Windows Update, restart Windows manually when prompted by Windows. Otherwise, Security Update content may not be applied because an automatic restart after Windows Update is disabled in this product.

Operation after the setup

Perform the operation shown below after setting up Windows.

After performing the operations, turn the power of this product OFF. (☞ Page 58 Turning OFF the Power of this Product)

Creating Windows recovery data

Create recovery data (recovery drive and system image) for Windows so that Windows in this product can be restored when an error occurs in the Windows.

For the method, refer to the following:

☞ Page 100 Windows Recovery

Precautions

Ensure to create Windows recovery data after setting up Windows.

License authentication

Perform Windows license authentication.

The license is authorized at connection to the Internet.

If the license is not authorized even when connected to the Internet, perform the following operation:

Operating procedure

☞ Windows Start ⇒ [Settings] ⇒ [Update & Security] ⇒ [Activation] ⇒ [Troubleshoot]

Point

Windows update programs cannot be acquired when using this product without license authentication.

The following message appears:

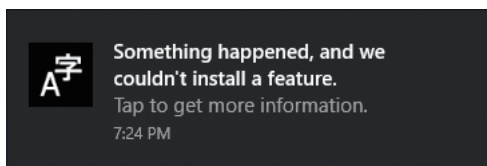

IP filter settings using the Windows firewall

Adding settings to the Windows firewall allows the IP address of an access source to be identified, and therefore can prevent unauthorized access.

Set the settings to enable a function which is equivalent to the security function (IP filter function) of MELSEC products.

Point

The IP filter is one method of preventing illegal access (such as a program or data destruction) from an external device; therefore, it does not completely prevent unauthorized access. To maintain the security (confidentiality, integrity, and availability) of the programmable controller and the system against unauthorized access, denial-of-service (DoS) attacks, computer viruses, and other cyberattacks from external devices, take appropriate measures such as firewalls, virtual private networks (VPNs), and antivirus solutions.

Our company is not responsible for any problems that occur in the programmable controller and system due to a DoS attack, unauthorized access, computer virus, or other cyber attacks.

Examples of measures for unauthorized access are given below:

- Installing a firewall or VPN
- Installing a personal computer as a relay station and controlling the relay of send/receive data with an application program
- Installing an external device for which the access rights can be controlled as a relay station (Contact the network service provider or equipment dealer for details on the external devices for which access rights can be controlled.)

The IP filter can be implemented by setting the IP address of an access source to the Windows Firewall and then allowing or blocking the connection.

Create 'New Rule' for the inbound rules of the Windows firewall and set a target IP address to be allowed or blocked by the IP filter. To set multiple IP filter settings, add multiple rules or combine the settings into one rule. When adding multiple rules, make sure that the IP address range to be blocked is not duplicated with the range to be allowed.

Precautions

- Whether to allow or block a connection must be determined for all the IP addresses connected to the same network. If there is a CPU module in which the IP filter function is enabled in the network where a MELSECWinCPU module is connected, allow or block a connection from an IP address specified by the IP filter function of the CPU module.
- By setting the IP filter setting, access from a product other than MELSOFT products is also blocked. To use this setting, access an Ethernet port from an IP address which is not blocked.
- If there is a proxy server in the LAN line, block the IP address for the proxy server. If the IP address is allowed, it will not be possible to prevent access from personal computers that access the proxy server.
- To block access from an external device to another station, block access to a connected station (a station connected directly to an external device) by using the IP filter.

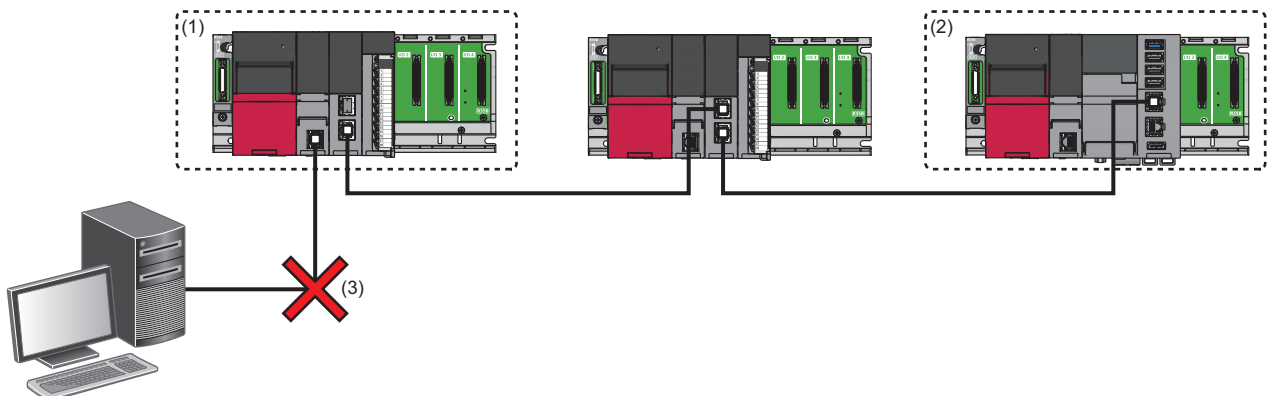

- (1) Connected station
(2) Another station
(3) Access to the connected station is blocked.

Operating procedure

To change the Windows firewall settings, log on a personal computer as a user with the administrator authority.

1. Select "Windows Defender Firewall with Advanced Security" under "Windows Administrative Tools."

Windows Start ⇒ [Windows Administrative Tools] ⇒ [Windows Defender Firewall with Advanced Security]

2. Select "Inbound Rules" from "Windows Defender Firewall with Advanced Security on Local Computer" in the "Windows Defender Firewall with Advanced Security" screen.

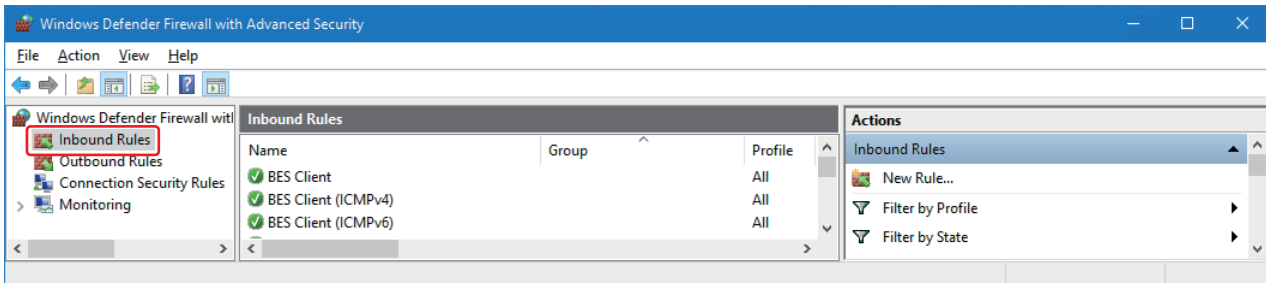

3. Select "New Rule" in "Actions."

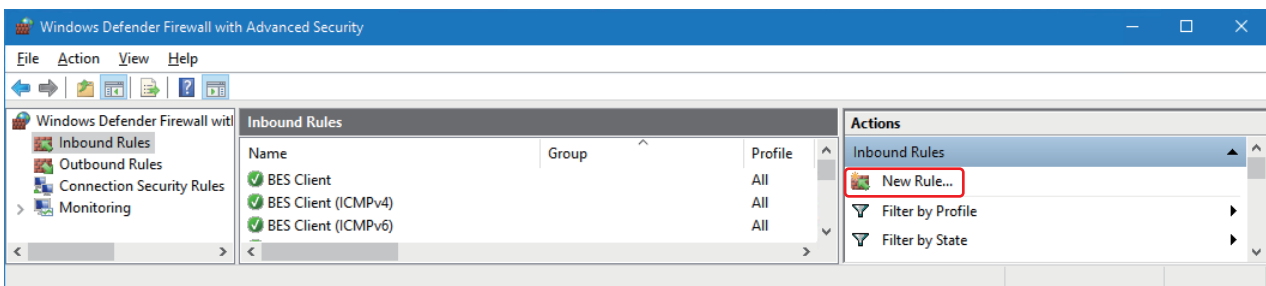

The "New Inbound Rule Wizard" screen appears.

4. Select "Custom" for "Rule Type," and click the [Next] button.

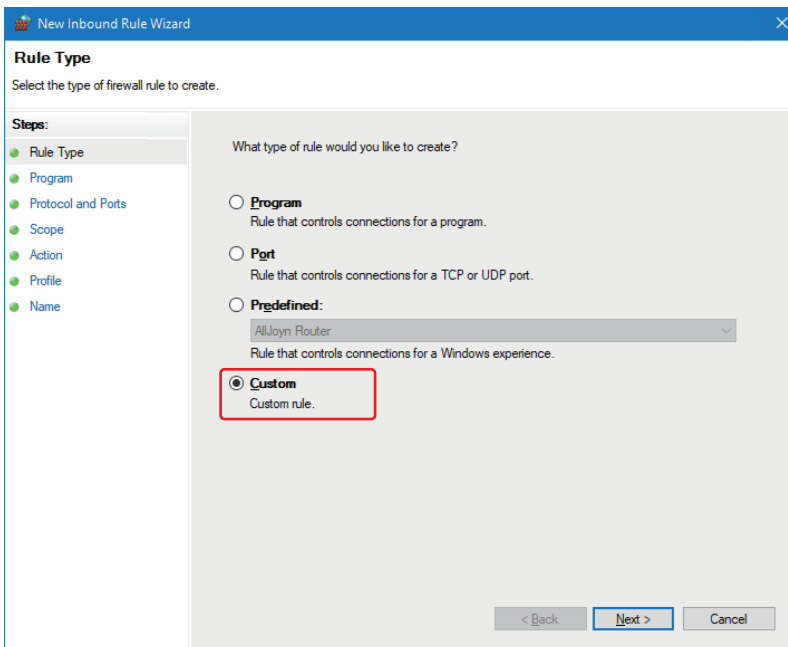

5. Select "All programs," and click the [Next] button.

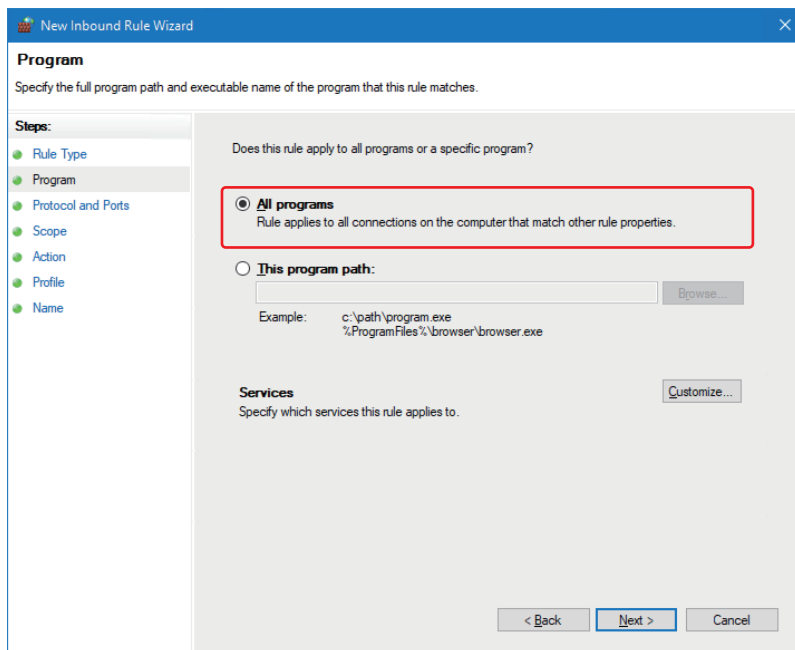

6. Check that "Any" is selected for "Protocol type," and click the [Next] button.

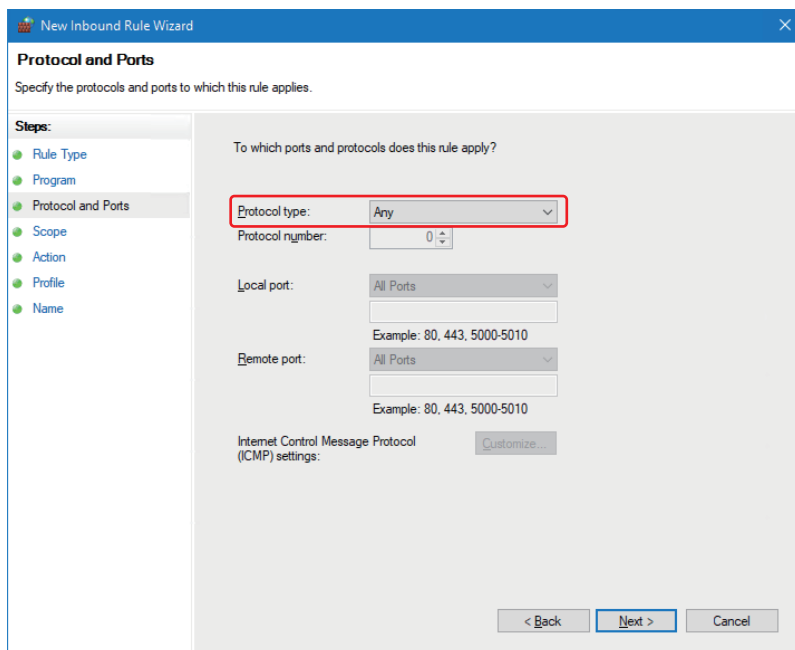

7. Select "These IP addresses" for the remote IP address setting, and click the [Add] button.

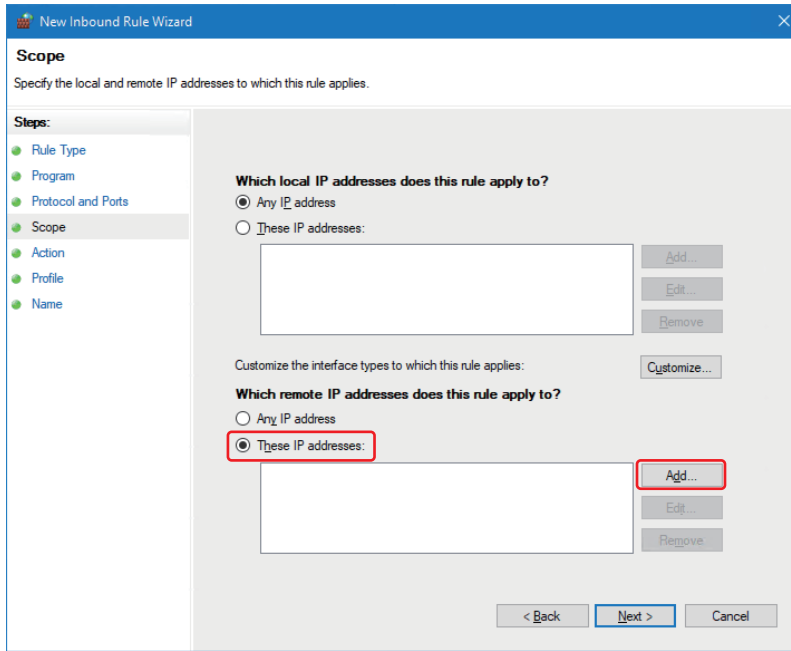

The "IP Address" screen appears.

8. Specify an IP address, and click the [OK] button.

To block access, specify all the IP addresses to be blocked.

To allow access, specify all the IP addresses other than that to be allowed.

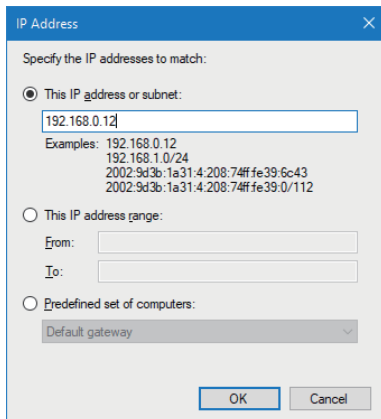

To specify a specific IP address, specify it in "This IP address or subnet."

To specify an IP address range, specify the lower and upper limit in "This IP address range."

9. Check that the specified IP address is registered, and click the [Next] button.

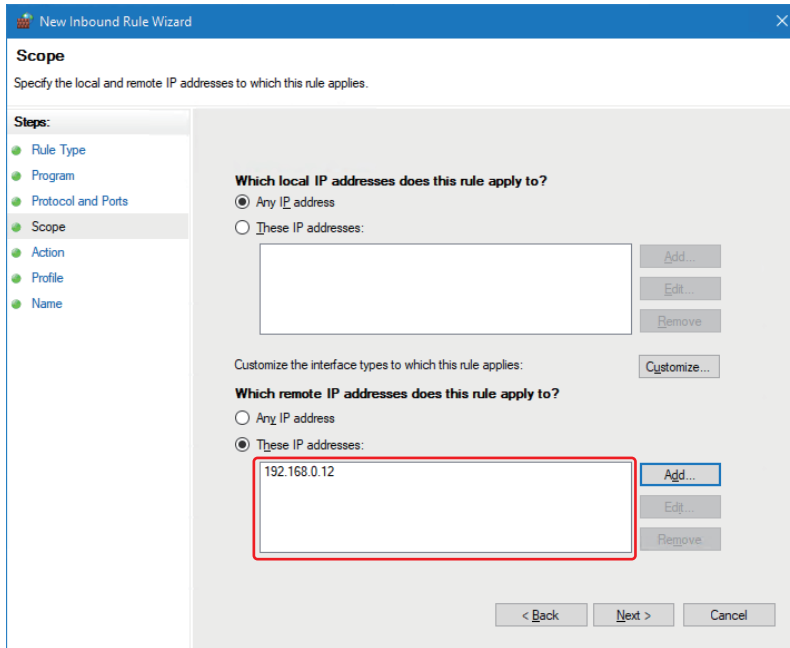

To specify multiple IP addresses, click the [Add] button.

- Specifying an exception from the specified IP address range

To exclude a specific IP address from a specified IP address range, divide the range setting into two or more. If the setting cannot be divided further in the rule, add a new rule.

Example: Excluding only '192.168.3.10' from the range from '192.168.3.5' to '192.168.3.20'

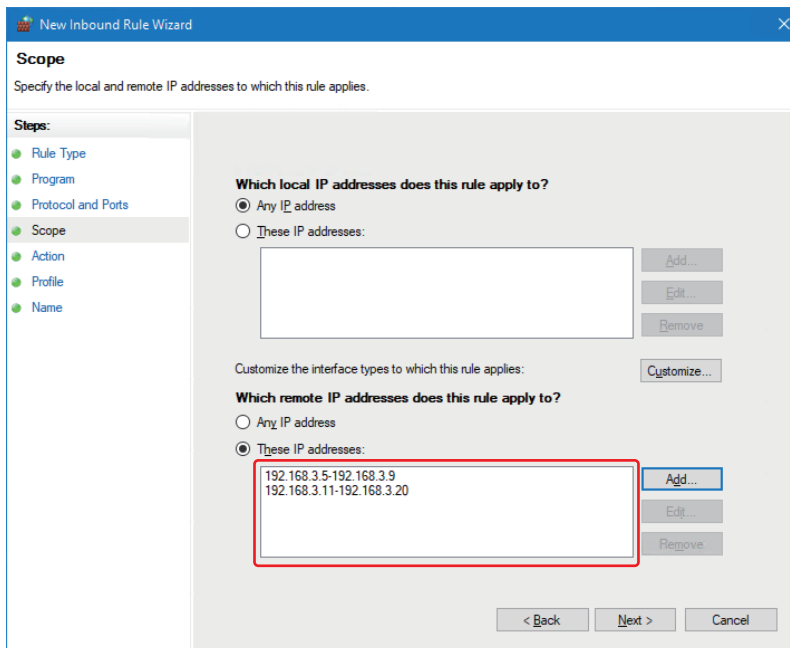

Divide the range into two. One is from '192.168.3.5' to '192.168.3.9,' and the other one is from '192.168.3.11' to '192.168.3.20.'

10. Select "Block the connection," and click the [Next] button.

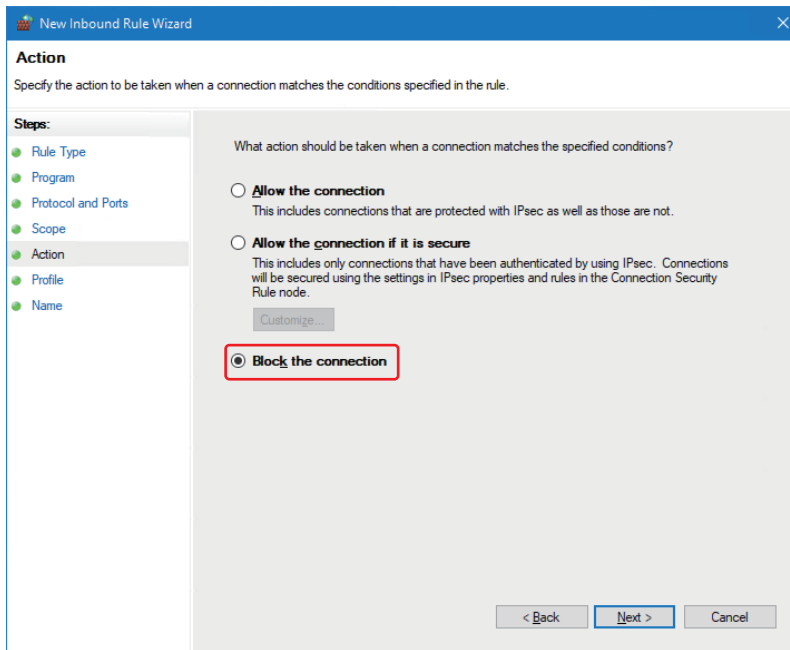

11. Click the [Next] button.

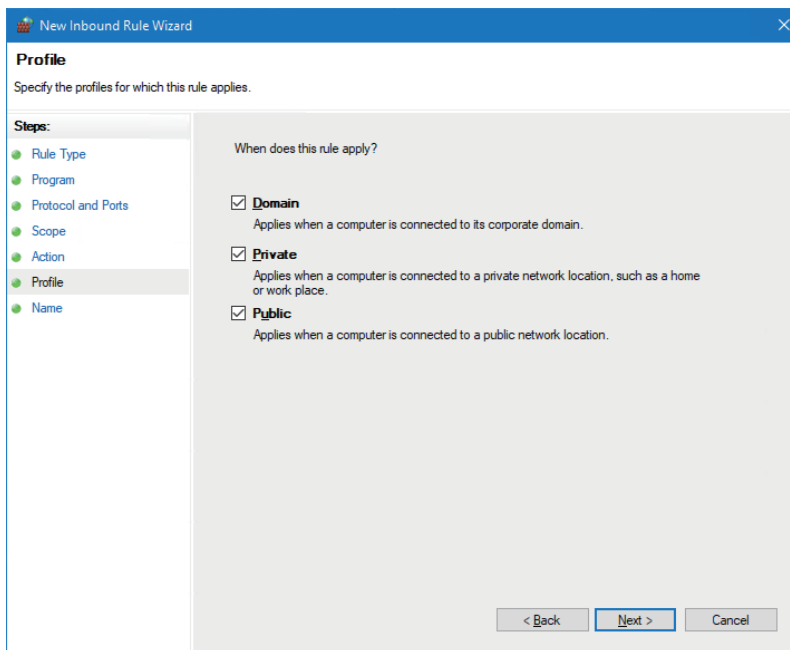

12. Add any name and description, and click the [Finish] button.

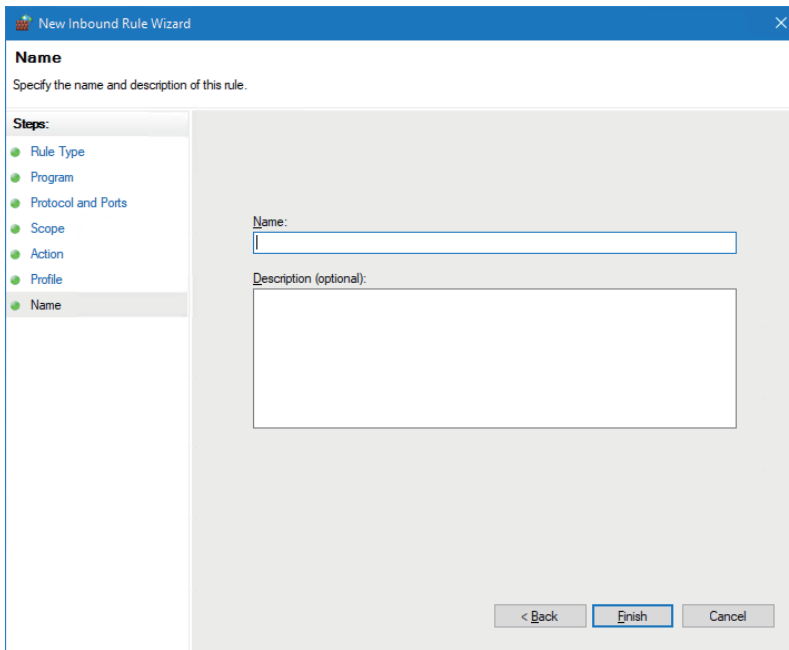

Ex.

The following shows an example for setting Windows Defender Firewall that is equivalent to the following IP filter setting of CPU modules.

- "Access from IP Address below": Allow
- Target IP addresses: 192.168.3.180 and 192.168.3.100 to 192.168.3.140 (excluding 192.168.3.120)

No.	Range Setting	IP Address	IP Address Excluded from Range
1	<input type="checkbox"/>	192.168.3.180	
2	<input checked="" type="checkbox"/>	192.168.3.100 - 192.168.3.140	192.168.3.120
3	<input type="checkbox"/>		

Add the following IP addresses in the remote IP address setting shown in step 7.

- 0.0.0.1 (lower limit) to 192.168.3.99 (upper limit)
- 192.168.3.120
- 192.168.3.141 (lower limit) to 192.168.3.179 (upper limit)
- 192.168.3.181 (lower limit) to 223.255.255.254 (upper limit)

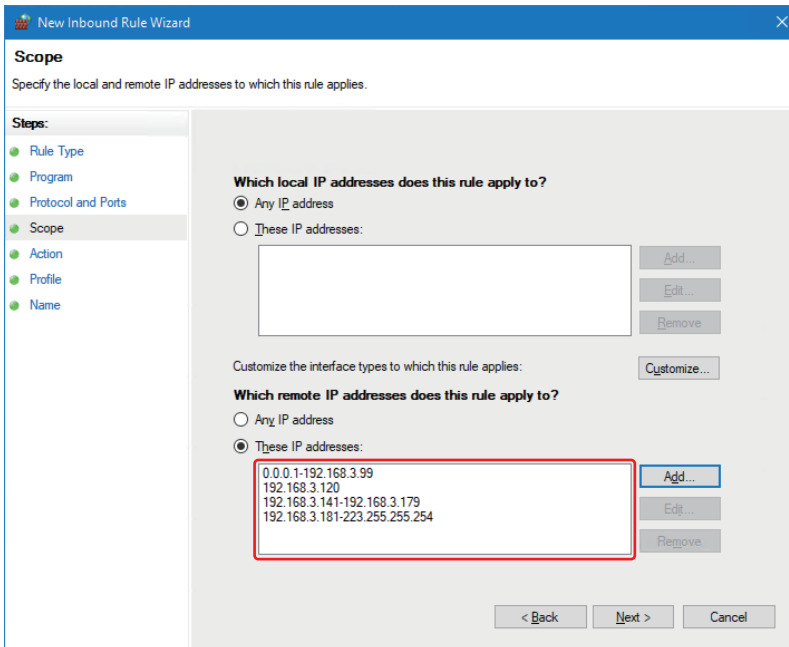

Point

When "Deny" is set for "Access from IP Address below," add the following IP addresses to the remote IP address setting:

- 192.168.3.180
- 192.168.3.100 (lower limit) to 192.168.3.119 (upper limit)
- 192.168.3.121 (lower limit) to 192.168.3.140 (upper limit)

Windows default settings

Change the following setting items as necessary.

After changing the settings, turn the power of this product OFF. (☞ Page 58 Turning OFF the Power of this Product)

Setting a keyboard layout

If Japanese is selected during the Windows setup, the keyboard is set to the English layout (101).

To use the Japanese layout, change the keyboard layout.

Operating procedure

☞ Windows Start ⇒ [Settings] ⇒ [Time & Language] ⇒ [Language] ⇒ click Japanese (Windows display language) ⇒ [Options] ⇒ [Hardware keyboard layout]

Setting a time zone

The default time zone of this product is Japan (UTC+9:00 Osaka, Sapporo, Tokyo).

Change the setting as necessary.

Operating procedure

☞ Windows Start ⇒ [Settings] ⇒ [Time & Language] ⇒ [Date & time] ⇒ [Time zone]

Precautions

Do not change time zone by the following operation:

- Selecting "Time zone" in the "Date & time" screen with the **Tab** key, and changing time zone with the **↑** or **↓** key.

The time of the selected time zone is applied immediately to the Windows time and the following events and errors may be registered multiple times:

- Daylight saving time start/end (450H)
- Clock setting error (1841H or 1842H)

Windows Update settings

To prevent an automatic restart of Windows by an automatic update of Windows Update while this product is in operation (a user is logged into Windows part), change the following group policy from the Windows default settings.

Group policy	Setting after change
No auto-restart with logged on users for scheduled automatic updates installations	Enabled

To change the Windows Update settings, log on a personal computer as a user with the administrator authority.

Operating procedure

To change the Windows Update settings, follow the procedure below:

1. Select "Run."

 Windows Start ⇒ [Windows System] ⇒ [Run]

The "Run" screen appears.

2. Enter 'gpedit.msc' for "Open:," and click the [OK] button.

The "Local Group Policy Editor" screen appears.

3. Select "No auto-restart with logged on users for scheduled automatic updates installations" in the "Local Group Policy Editor" screen.

 [Local Computer Policy] ⇒ [Computer Configuration] ⇒ [Administrative Templates] ⇒ [Windows Components] ⇒ [Windows Update] ⇒ [No auto-restart with logged on users for scheduled automatic updates installations]

The "No auto-restart with logged on users for scheduled automatic updates installations" screen appears.

4. Select "Enabled" or "Disabled," and click the [OK] button.

Restrictions

The following shows the restrictions for Windows.

Unified Write Filter

Windows Unified Write Filter is not available in this product.

To turn the power of this product OFF or reset the hardware, ensure to shut down Windows. (☞ Page 58 POWER OFF AND RESET)

Setting of Intel® Graphics Power Plan

Do not change the setting of Intel Graphics Power Plan from Maximum Battery Life.

Changing the setting from Maximum Battery Life may result in a temperature error in a CPU module due to increase in the GPU power consumption.

Power saving function of Windows

The 'Sleep' and 'Hibernate' options of the power saving functions and the 'Turn off the display' option of the plan settings of power options on Windows are not supported.

Therefore, the 'Sleep' and 'Hibernate' options as well as the 'Turn off the display' option are disabled on Windows installed on this product.

■Setting the power saving function of Windows

In this product, the following group policy is changed from the default value.

Group policy	Setting after change
Turn off the display (plugged in)	Status: Enabled Option: 0 seconds

Do not change the above setting. Otherwise this product may not operate properly.

By this setting, the message 'Some settings are managed by your system administrator.' is displayed in the "Edit Plan Settings" screen of power options. In addition, the message 'Some settings are hidden or managed by your organization.' is displayed in the "Power and sleep settings" screen.

Update of a driver

Updating a driver installed on Windows may result in malfunction of this product.

If updating a driver, perform a test run of the system of this product and check that there is no problem with its operation before starting the system.

Task scheduler settings

Do not delete or disable any tasks created by "MITSUBISHI ELECTRIC CORPORATION" from Windows task scheduler. Otherwise, this product may not operate normally.

Enabling an FTP server

To access an FTP server of this product from a target device (an FTP client), do not use an FTP access function with the Windows standard explorer. Doing so may cause that the file update time on the explorer does not match the time of this product, or that the file is displayed in the previous state even after it is overwritten.

4.4 Setting Parameters

This section shows the procedure for setting parameters of this product in CW Configurator.

Creating a project

Operating procedure

1. Start CW Configurator.
2. Select [Project] ⇒ [New].
The "New" screen appears.
3. Select "R102WCPU-W" for "Type."

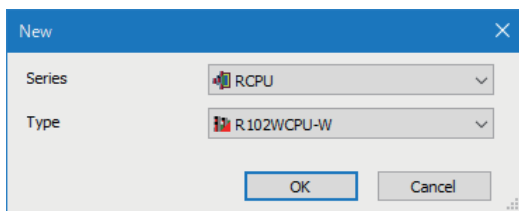

4. Click the [OK] button.

Setting parameters for the system and modules

Set parameters for the system and modules.

■When CW Configurator is connected to the actual system configuration

Read the actual system configuration to the module configuration diagram of CW Configurator to set parameters.

Operating procedure

1. Select [Module Configuration] in the navigation window.
The module configuration diagram opens.
2. Select [Online] ⇒ [Read Module Configuration from PLC].
The system parameters are set automatically, and the actual system configuration is displayed on the module configuration diagram.
3. Double-click a CPU module, I/O module, or intelligent function module.
The parameter editor for the module is displayed.
4. Set parameters.
5. Click the [Apply] button.

Precautions

An RQ extension base unit, MELSEC-Q series extension base unit, or modules mounted on these extension base units cannot be read. For the units and modules unable to be read, create the module configuration by dragging each unit/module from the element selection window and dropping it on the module configuration diagram.

■When CW Configurator is not connected to the actual system configuration

Create the module configuration manually to set parameters.

Operating procedure

1. Select a base unit to be used from the element selection window, and drag and drop it onto the module configuration diagram.
2. Drag each module to be used and drop it onto the base unit placed in the diagram.
3. Select [Edit] ⇒ [Parameter] ⇒ [Fix].
4. Double-click a module to display the parameter editor for the module.
Set parameters.
5. Click the [Apply] button.

■Parameter settings from the navigation window

Set the following parameters from the navigation window.

Parameter	Description
System parameter	To change the number of slots of a base unit or the number of occupied points for a module as well as to configure the multiple CPU setting or synchronization setting, the system parameter is set from the navigation window. • [Navigation window] ⇒ [Parameter] ⇒ [System Parameter]
Module parameter of a CPU module	To use a built-in Ethernet function for a CPU module, setting the module parameter for the CPU module is required. • [Navigation window] ⇒ [Parameter] ⇒ [(CPU module)] ⇒ [Module Parameter]
Multiple module parameters and module extended parameter	Some intelligent function modules may require parameter settings for multiple modules or module extended parameter setting. • [Navigation window] ⇒ [Parameter] ⇒ [Module Information] ⇒ [(each intelligent function module)] ⇒ [Module Extended Parameter] or [Module Parameter]

Point

Settings with the module configuration diagram and settings by system parameter are used properly as follows depending on their usage.

- Module configuration diagram: Module-specific information such as the number of occupied points is used without changing.
- System parameter: The number of slots of a base unit or the number of occupied points for a module is changed.

4.5 Writing Parameters to this Product

This section shows the procedure for writing the set parameters to this product.

Operating procedure

1. Select [Online] ⇨ [Write to PLC].
2. Select "System Parameter/CPU Parameter" and "Module Parameter."
3. Click the [Execute] button.

Parameters are written to this product.

4. Click the [Close] button.

Point

- The following parameters must be written: system parameters and CPU parameters to operate this product, and module parameters and module extended parameters to use an I/O module or an intelligent function module.
 - If a new parameter is set or any parameters are changed, reset this product.
-

4.6 Applying Parameters

This section shows the procedure for applying parameters to this product.

Parameters are applied at the following timing. (☞ Page 58 POWER OFF AND RESET)

- Turning the power of this product OFF and ON
- Resetting the hardware
- Resetting the bus

4.7 Creating and Registering a User Program

This section shows the procedure for creating a user program and registering the user program to this product with dedicated functions provided by this product.

For details on dedicated functions and programming, refer to the following:

📖 MELSEC iQ-R MELSECWinCPU Module Programming Manual

Development environment

The development environment of this product is the cross development environment which regards this product as a target system (a MELSECWinCPU module). Therefore, this product is connected to a host system, which is a development personal computer where user programs are developed, via Ethernet. To debug a program, perform remote debugging via Ethernet. Use Visual Studio 2019 or Visual Studio 2017 for developing programs and remote debugging. However, to perform remote debugging, an edition (such as Professional Edition) which supports remote debugging is required. For the methods for remote debugging, refer to the Microsoft website or documents for Visual Studio.

Environment configuration

The following figure shows the configuration of a development environment for an application to run on this product.

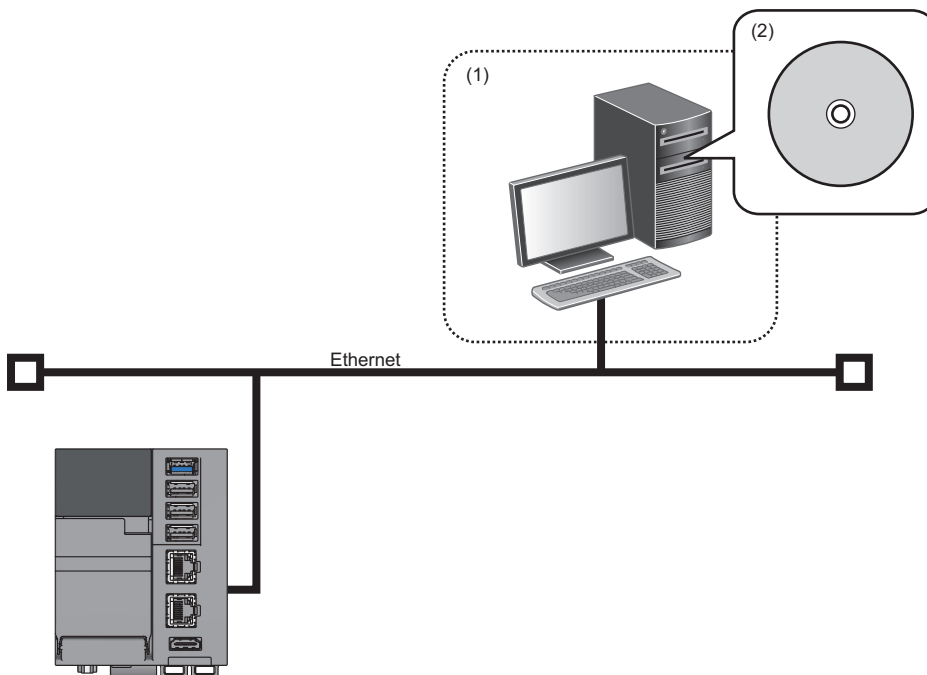

(1) Development environment (personal computer)

(2) Development tool (Visual studio[®])

To develop an application, a personal computer for development is required.

In addition, header files and library files that are stored in this product need to be copied to the personal computer.

Creating and registering a user program

The following shows the procedure for creating and registering a user program.

1. Copy header files and library files that are stored in this product to the personal computer in a development environment. The header files and library files are stored in the following locations:

Drive name	Folder name	Description	
C:	WinCPU	INCLUDE	Folder to store header files
		LIB	Folder to store library files

Required header files and library files differ depending on the development environment and language.

2. Create a user program with dedicated functions.
3. Copy the user program to this product and check the operation. The operation can be checked by performing remote debugging from the development personal computer via Ethernet.
4. Store the user program (.exe) in the startup folder of Windows in this product.

By registering the user program in the startup folder, the program runs when turning the power of this product ON (when starting Windows).

Therefore, store a user program in the startup folder only to run the program when the power is turned ON.

5 POWER OFF AND RESET

This chapter explains the method for turning the power of this product OFF and resetting this product.

Precautions

To turn the power of this product OFF or reset the hardware, ensure to follow the procedure described in this chapter. Otherwise, Windows may not start normally, data in a user drive may be corrupted, or a file system error may occur.

5.1 Turning OFF the Power of this Product

This section shows the procedure for turning the power of this product OFF.

Operating procedure

1. Shut down Windows in this product.

Before shutting down, close all the running programs, etc. that access files if any.

2. Check that the OS LED is turned OFF.

3. Turn the power of this product OFF.

Shutting down Windows

Windows in this product can be shut down by either of the following methods:

Execution method	Description
Windows Start	Shut down Windows from Windows Start.
Windows shutdown function	A function that can shut down Windows by using a switch or X input. For details on the Windows shutdown function, refer to the following:  Page 195 Windows SHUTDOWN FUNCTION

Point

If the Windows shutdown function does not run due to a WDT error or other issues, shut down Windows from Windows Start.

5.2 Resetting this Product

This product can be reset as a whole or by either of the following functions: Windows function or MELSEC functions. When resetting only either of the functions, it can be reset without affecting the other function(s).

○: Can be reset, ×: Cannot be reset

Operation	Windows function	MELSEC functions
Resetting this product as a whole	○	○
Resetting the Windows function	○	×
Resetting the MELSEC functions	×	○

Select an operation according to the function(s) to be reset.

Resetting this product as a whole

Reset this product as a whole when the product is in the error status (such as a hardware failure). For the method, refer to the following:

☞ Page 189 HARDWARE RESET FUNCTION

Resetting the Windows function

Reset the Windows function when Windows cannot be restarted by the Windows operation because Windows freezes or a system error occurs.

The MELSEC functions are not reset; therefore, Windows can be restarted without causing any errors in a programmable controller system.

For the method, refer to the following:

☞ Page 193 Windows Forced Restart

Resetting the MELSEC functions

Reset the MELSEC functions to apply parameters after writing them in CW Configurator.

The Windows function is not reset; therefore, parameters can be applied without shutting down Windows.

For the method, refer to the following:

☞ Page 192 Bus Reset

6 SYSTEM CONFIGURATION

For system configurations applicable for the MELSEC iQ-R series, modules that can be used with each CPU module, the number of mountable modules, installation, and wiring, refer to the following:

📖 MELSEC iQ-R Module Configuration Manual

6.1 Hardware Configuration

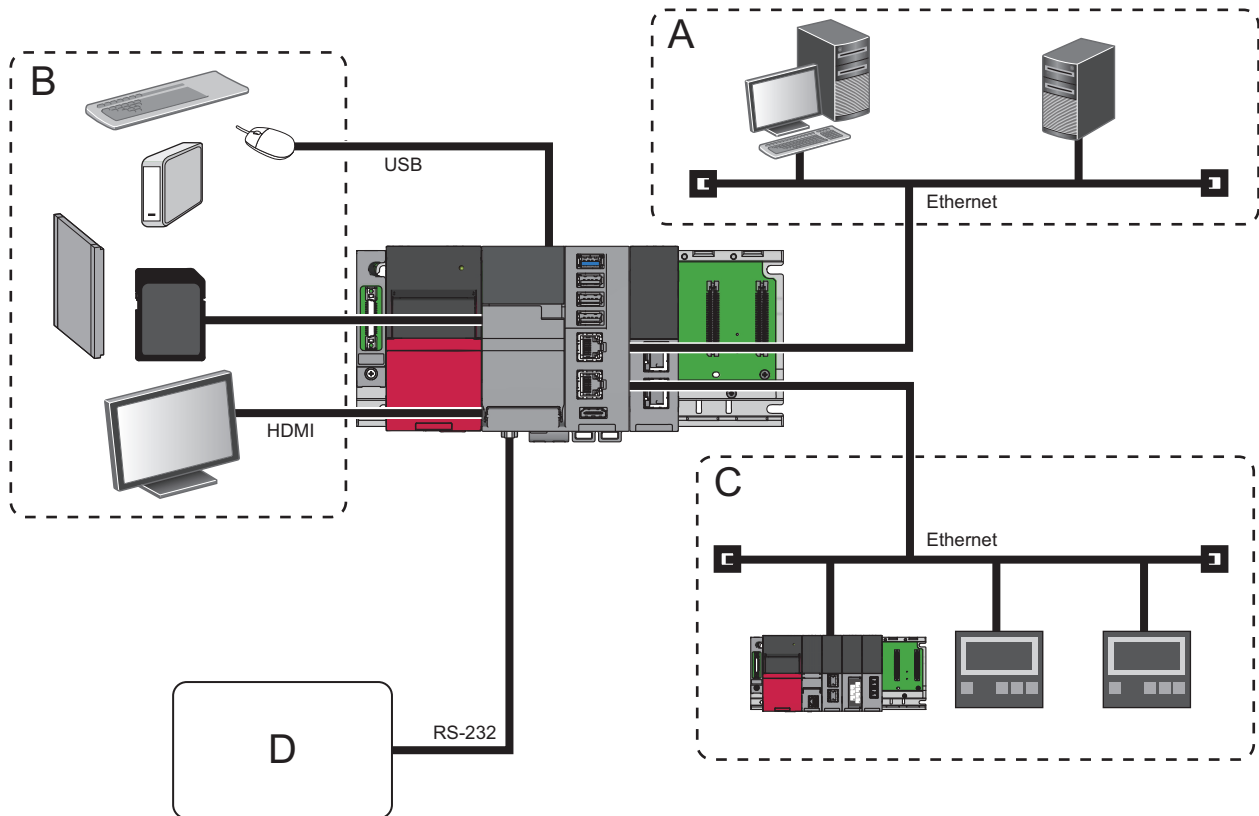

A: Personal computer, file/mail server, cloud, etc.

B: Peripheral devices (monitor, CFast card, SD memory card, and USB device)

C: Ethernet devices

D: RS-232 devices (barcode reader, etc.)

Calculation for the current consumption value of a USB device

Depending on a device connected to a USB port of this product, the upper limit of the current consumption value of this product (threshold value of a current consumption error (USB port forced stop)) may be exceeded. When connecting a peripheral device, ensure that it is used within a range that does not exceed the threshold value of a current consumption error (warning). (Page 213 Current Consumption Monitoring Function)

If the threshold value of a current consumption error (USB port forced stop) is exceeded, this product stops the supply of current and communication to a USB port.

Term	Description
Current consumption value	A total of the current consumption value of the SD memory card and CFast cards (primary and secondary) of this product and the one supplied to peripheral devices from the USB ports
Threshold value of a current consumption error (USB port forced stop)	A threshold value (4.35 A) to stop the communication and the supply of current to a USB port
Threshold value of a current consumption error (warning)	A threshold value (4.17 A) to notify that the margin between the current consumption value and the threshold value of a current consumption error (USB forced stop) is reduced

If the supply of current to a USB device increases, the current consumption value of a module may exceed the threshold value of a current consumption error (USB port forced stop). Construct a system so that the current consumption value of the module is equal to or below the threshold value of a current consumption error (warning).

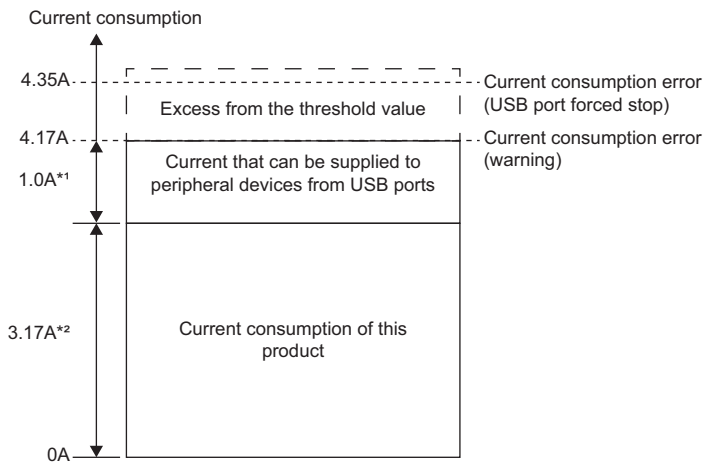

*1 The current value that can be supplied to a peripheral device from a USB port varies according to the current consumption of this product.
 *2 The current value when the maximum load is on this product. It may be 3.17 A or lower depending on the connection of an SD memory card and CFast card or the CPU load status.

As examples, the following peripheral devices consume large current:

- USB-connected camera
- External DVD drive
- Portable HDD

Procedure for configuring a system

1. Selecting USB devices

Select peripheral devices so that the total value of current to be supplied to the devices from the USB ports of this product is 1.0 A or lower. If the current consumption value exceeds 1.0 A, review the devices being used (such as self-powered devices), or change the configuration so that a self-powered USB hub is used.

Point

The current consumption of this product and peripheral devices change depending on the condition of use and environment. When constructing a system, check the current consumption under the condition similar to that of the actual operation.

2. Connecting to this product

Connect peripheral devices to USB connectors of this product.

For the wiring procedure, refer to the following:

 Page 72 USB Connector

3. Turning the power of the system ON

4. Checking the ERROR LED status of this product

If the ERROR LED is neither ON nor flashing, connecting peripheral devices is completed.

■When the ERROR LED is ON or flashing

Take a corrective action by following the procedure below:

1. Checking the OVERCURRENT LED status

Lighting status	Corrective action
OFF	An error different from the ones for the configuration of current consumption. Take a corrective action according to description for the occurring error in the error code list.
ON or flashing	Disconnect all devices connected to the USB ports.

2. Clearing the error (Page 214 Method for clearing an error)

If a current consumption error cannot be cleared by the instructed operation, a hardware failure may occur in this product. Please contact your local Mitsubishi Electric sales office or representative.

3. Reviewing USB devices

Review the USB devices (such as self-powered devices), or change the configuration so that a self-powered USB hub is used.

Then, restart from connecting devices to this product.

6.2 Software Configuration

This section shows the software configuration of this product.

Operating system

Windows 10 IoT Enterprise LTSC 2019 is installed on this product.

Windows 10 IoT Enterprise LTSC 2019

Windows 10 IoT Enterprise LTSC 2019 is an operating system provided by Microsoft Corporation in the United States.



Japanese, English, and Chinese are supported.

Precautions

This product is not compatible with UEFI, so functions that require UEFI are not supported.

Applications

The following shows applications (including partner software and middleware) that run on Windows in this product.

Applications can be installed according to the purpose of a user.



Manuals of pre-installed applications may be provided in PDF format. To view the PDF data, Adobe Reader is required.

Adobe Reader can be downloaded from the Adobe Systems Incorporated web site.

Precautions

The display language of a pre-installed application depends on the Windows display language.

- Windows display language is Japanese: Japanese
- Windows display language is English: English
- Windows display language is Chinese: Chinese (Simplified)*1

*1 Displayed in English in CW Configurator.

■When starting applications for the first time from Windows Start

The following applications are displayed in English:

- e-Manual Viewer
- MR Configurator2

■When over installing or uninstalling software

The screen that is displayed when over installing or uninstalling the following applications is displayed in English.

- CW Configurator
- Edgecross Basic Software
- SLMP Data Collector

■When reinstalling the preinstalled applications

- Enter the name and company name by using alphanumeric characters only.
- Store the applications in their respective default folders.

Page 66 Folder configuration of pre-installed applications and included products

Pre-installed applications

The following applications are pre-installed on Windows in this product.

■MELSEC iQ-R series compatible MELSECWinCPU module driver software package

- MELSEC data link functions

MELSEC data link functions are an integrated communication library which is independent of communication protocols.

A program for accessing devices of this product and accessing the device memory of another programmable controller CPU can be created.

- C Controller module dedicated functions

C Controller module dedicated functions are a dedicated function library to control this product.

In this product, the functions are used for clearing errors, acquiring module configuration information, etc.

- Drivers and services for a MELSECWinCPU module

Windows services and drivers for using hardware and MELSEC functions from Windows in this product

- Firmware for a MELSECWinCPU module

Firmware where the MELSEC functions, which are for controlling this product as a MELSEC iQ-R series CPU module, run.

■MELSOFT applications

- CW Configurator (SW1DND-RCCPU-E) ( CW Configurator Operating Manual)

The English version is pre-installed. To update CW Configurator, use a product DVD or an installer of the updated version for English.

- Edgecross Basic Software (SW1DNN-ECBS-M)^{*1}
- SLMP Data Collector (SW1DND-DCSLMP-M) ( SLMP Data Collector User's Manual)^{*1}

*1 Running multiple software applications may increase the load (such as a high CPU usage rate) on the product and may affect its behavior. Refer to the manual of software to be used to prevent excessive load on the product.



The installer of the updated version of CW Configurator can be downloaded from the Mitsubishi Electric FA website.

www.MitsubishiElectric.com/fa

Precautions

To install other MELSOFT products, install the English version of the products.

To install products in a language other than English, uninstall all the pre-installed applications shown below:

- CW Configurator
- Motion Control Setting
- MR Configurator2
- Simple Motion Module Setting

After uninstalling the applications, install them in a language to be used.

■ Microsoft Visual C++ runtime library

The version of the pre-installed runtime library is as shown below:

- 14.26.28720.3 (x64)
- 14.16.27033.0 (x86)

The version of the installed runtime library can be checked in the "Programs and Features" screen on Windows.

 Windows Start ⇒ [Windows System] ⇒ [Control Panel] ⇒ [Programs] ⇒ [Programs and Features]

Precautions

Do not uninstall the Microsoft Visual C++ runtime library as it is necessary to run drivers and libraries that control this product. If the runtime library is uninstalled, reinstall it again with the installer stored in this product. ( Page 66 Folder configuration of pre-installed applications and included products)

User applications

Applications (user programs) created by a user. To create an application (user program), refer to the following:

 Page 56 Creating and Registering a User Program

Folder configuration

The following table shows the folder configuration of this product.

Drive name	Folder name		Description
C:	WinCPU	—	Folder to store product related files
		INCLUDE	Folder to store the header files of MELSEC data link functions and C Controller module dedicated functions
		LIB	Folder to store the library files of MELSEC data link functions and C Controller module dedicated functions
	Windows		Windows system folder

Folder configuration of pre-installed applications and included products

The following table shows the folder configuration of pre-installed applications and included products.

Drive name	Folder name		Description
C:	WinCPU	Drivers	Folder to store the installer of a driver installed on this product
		RuntimeLibrary	Folder to store the installer of Microsoft Visual C++ Runtime Library
		Edgecross	Folder to store the installer of Edgecross Basic Software
		DataCollector	Folder to store the installer of SLMP Data Collector
	Edgecross	Edgecross Basic Software	Folder to store installed Edgecross Basic Software and SLMP Data Collector
	Program Files (x86)	MELSOFT	Folder to store installed CW Configurator and e-Manual Viewer

Memory configuration

This product contains the area (data memory) for storing parameter files.

Data can be written to/read from the data memory only with CW Configurator.*¹

*¹ The drive name "Data Memory" is displayed in the "Event History" screen of CW Configurator.

Precautions

The data memory cannot be referred to from Windows.

Files to be stored in the data memory

The following shows the files to be stored in the data memory.

File name	Description
SYSTEM.PRM	System parameter
CPU.PRM	CPU parameter
UNIT.PRM	Module parameter
UEXmmmn.PRM* ¹	Module extended parameter
SLAVEmmnnxxx.NSP* ²	CC-Link IE TSN slave station parameter file

*¹ The 'mmm' represents the start I/O number of a module (the first three digits in four-digit hexadecimal representation). Note that the number of a CPU module is fixed to 3FFH. In addition, the 'nn' represents the sequential serial number (two-digit hexadecimal representation) of module extended parameters of each module.

*² The 'mmm' represents the start I/O number of the master station on CC-Link IE TSN (the first three digits in four-digit hexadecimal representation), the 'nnn' represents the number of modules set in the network configuration settings (in three-digit hexadecimal representation), and the 'xxx' represents the sequential serial number of the parameter (in four-digit hexadecimal representation).

6.3 Peripheral Device Configuration

This section shows the peripheral devices of this product.

SD memory card

For available SD memory cards manufactured by Mitsubishi Electric, refer to the following:

📖 MELSEC iQ-R Module Configuration Manual

Precautions

Only use an SD memory card that is described above. Using another SD card may cause a problem, such as damage to data in the card and a system operation stop.

CFast card

For available CFast cards manufactured by Mitsubishi Electric, refer to the following:

📖 MELSEC iQ-R Module Configuration Manual

Precautions

Only use a CFast card that is described above. Using another CFast card may cause a problem, such as damage to data in the card and a system operation stop.

6.4 Considerations for Configuring a System

This section shows the considerations for configuring a system of this product.

Development environment (Visual Studio)

Visual Studio 2017 and Visual Studio 2019 cannot be installed on Windows 10 IoT Enterprise LTSC 2019 that is pre-installed on this product. Another personal computer is required as the development environment to create a user program. When installing Visual Studio, check the system requirements and the support status such as supported operating system and hardware in advance.

SD memory card

The following shows the considerations for using an SD memory card.

Available SD memory cards

For SD memory cards available for this product, refer to the following:

 Page 67 Peripheral Device Configuration

Only use an SD memory card that is described above. Using another SD card may cause a problem, such as damage to data in the card and a system operation stop.

Note the following when using an SD memory card:

- Data in an SD memory card may corrupt or a file system error may occur if any of the following operations is performed while accessing the SD memory card: turning OFF the power of this product, resetting the hardware, or restarting Windows forcibly. Perform the operation after stopping access to the SD memory card.

SD memory card life

For the number of writable times of an SD memory card, check the manual provided with the SD memory card. When the number of writable times is exceeded, replace the SD memory card. ( Page 80 SD Memory Card)

CFast card

The following shows the considerations for using a CFast card.

Available CFast cards

For CFast cards available for this product, refer to the following:

 Page 67 Peripheral Device Configuration

Only use a CFast card that is described above. Using another CFast card may cause a problem, such as damage to data in the card and a system operation stop.

Note the following when using a CFast card.

- Turn OFF the power of this product before inserting or removing a CFast card.
- Data in a CFast card may corrupt or a file system error may occur if any of the following operations is performed while accessing the CFast card: turning OFF the power of this product, resetting the hardware, or restarting Windows forcibly. Perform the operation after stopping access to the CFast card.

CFast card life

For the number of writable times of a CFast card, check the manual provided with the CFast card. When the number of writable times is exceeded, replace the CFast card. ( Page 82 CFast Card)

Extension base unit

In a configuration that an RQ extension base unit or an extension base unit is connected to the main base unit on which this product is mounted, when turning OFF the power of a base unit other than the main base unit, the hardware of this product will be reset.

Make sure to shut down Windows in this product before turning OFF the power of the base units. ( Page 58 Shutting down Windows)

Otherwise, Windows may not start normally, data in a user drive may be corrupted, or a file system error may occur.

Ethernet port

When enabling multiple Ethernet ports (network interfaces) and using a function which connects to this product from an external personal computer via Ethernet, the Ethernet adapter that returns a response depends on the metric setting on Windows. Therefore, some functions may not be available.

Function to be affected

The following functions of CW Configurator may not be available.

- Ethernet port direct connection in the connection destination specification
- CPU search in the connection destination specification

Corrective actions

To use a function that uses an Ethernet port, take either of the following corrective actions.

- Connect only one Ethernet cable to this product.
- Check the Ethernet adapter with the highest priority metric, then configure a system so that this product is directly connected to an external personal computer that is in the network connected to the Ethernet adapter.

■Setting an interface metric

The following shows the procedure for setting an interface metric.

1. Open the "Network Connections" screen.

 Windows Start ⇒ [Windows System] ⇒ [Control Panel] ⇒ [Network and Internet] ⇒ [Network and Sharing Center] ⇒ [Change adapter settings]

2. Select a network connection connected to CW Configurator.

3. Right-click the selected network connection, and select [Properties] from the shortcut menu.

The "Ethernet Properties" screen appears.

4. Select "Internet Protocol Version 4 (TCP/IPv4)" in the [Networking] tab, and click the [Properties] button.

The "Internet Protocol Version 4 (TCP/IPv4) Properties" screen appears.

5. Click the [Advanced] button in the [General] tab.

The "Advanced TCP/IP Settings" screen appears.

6. Unselect the checkbox of "Automatic metric" in the [IP Settings] tab.

7. Set '1' for "Interface metric."

8. Click the [OK] button.

■Alternative method for the interface metric setting

Select "Connection via HUB," and specify "IP Address" in the "PLC side I/F Detailed Setting of PLC Module" screen of CW Configurator.

1. Open a project in CW Configurator.

 Select [Project] ⇒ [New]. Alternatively, select an existing project from [Project] ⇒ [Open].

2. Open the "Specify Connection Destination" screen.

 [Online] ⇒ [Current Connection Destination]

3. Select "Ethernet Board" for "PC side I/F."

4. Select "PLC Module" for "PLC side I/F."

5. Double-click the selected "PLC Module" icon.

IP address settings

When setting an IP address with the same network segment (subnet) for multiple Ethernet ports (network interfaces), the Ethernet ports access the same network. Therefore, the Ethernet communication with external devices may be unstable. If the communication becomes unstable, take the following corrective action.

Corrective action

Check the TCP/IPv4 setting for each adapter and change the network segment (subnet) so that each adapter has a different network segment.

 Windows Start ⇒ [Settings] ⇒ [Network and Internet] ⇒ [Network and Sharing Center] ⇒ [Change adapter settings]

7 WIRING

This chapter explains the wiring methods to this product.

Point

The bend radius of the cable near the connector or port should be at least four times longer than the cable's outside diameter.

7.1 USB Connector

This section shows the wiring for a USB connector.

USB cable

Use a USB cable supplied with a connected device.

A cable with type A connector can be connected to this product.

Wiring procedure

■Connection

Check the insertion direction, and insert a USB cable into a connector.

After connecting the cable, take a measure to prevent it from falling out.

 Page 79 Measure to Prevent a Cable from Falling Out

■Disconnection

Pull out the USB cable from the connector.

When a measure to prevent the cable from falling out is taken, remove the cable tie from a mounting base in advance.

Considerations

- If it is necessary to prevent dirt and dust from entering an unused connector, attach a dust-proof cover for USB connector^{*1}.
- *1 Please contact your local Mitsubishi Electric sales office or representative.
- Connected devices must be installed in a control panel.
- For devices connected to this product, using the same power source is recommended.
- When a device to be connected has a 3-pin power plug or when the device or its power plug has a grounding wire, connect the plug to a grounding receptacle or ground the grounding wire with a ground resistance of 100 ohms or less.
- Do not turn the power of the system/this product OFF, reset the hardware, restart Windows in this product forcibly, or unmount/eject the USB Mass Storage Class-compliant device while accessing the files in a USB Mass Storage Class-compliant device. Doing so may result in data corruption in the USB Mass Storage Class-compliant device or file system error.
- If overcurrent occurs in a USB port used, some of the USB ports stop according to the port where overcurrent occurs.
( Page 73 Operation when overcurrent occurs)
- Do not connect a USB device with large current consumption and one of which data may be corrupted if disconnected during operation (such as USB Mass Storage Class-compliant device) to ports in the same group if possible. If the current consumption of USB devices is close to the maximum supply current, it is recommended to connect the devices via a self-powered USB hub.
- When connecting multiple USB devices of which data may be corrupted if disconnected during operation, do not connect them to ports in the same group if possible. Otherwise, when overcurrent occurs in the other group, such USB devices may be required to be disconnected during operation for the recovery operation.

■Connecting a self-powered device

Install a self-powered device by the following procedure.

1. Check that a device to be connected is unplugged from the AC receptacle.
2. Connect the device to this product with a USB cable.
3. Plug the device to the AC receptacle.

■Operation when overcurrent occurs

The following table shows changes in the operating status of each port. Refer to this table when connecting a USB cable.

Port where overcurrent occurs	Port of which the operating status changes	
	USB port 1, 2	USB port 3, 4
USB port 1	Stopped	Operating
USB port 2	Stopped	Operating
USB port 3	Operating	Stopped
USB port 4	Operating	Stopped

7.2 Ethernet Connector

This section shows the wiring for an Ethernet connector.

Ethernet cable and hub

Use an Ethernet cable and hub that meet the following conditions.

■ Ethernet cable

Standard	Specification	Communication speed	Connector
1000BASE-T	Category 5e or higher, straight cable (shielded, STP)	1 Gbps	RJ45
	Category 5e or higher, crossover cable (shielded, STP)		
100BASE-TX	Category 5 or higher, straight cable (shielded, STP)	100 Mbps	
	Category 5 or higher, crossover cable (shielded, STP)		
10BASE-T	Category 3 or higher, straight cable (shielded, STP)	10 Mbps	
	Category 3 or higher, straight cable (UTP)		
	Category 3 or higher, crossover cable (shielded, STP)		
	Category 3 or higher, crossover cable (UTP)		

■ Hub

Use a hub that can handle the communication speed in an Ethernet configuration.

Point

1000BASE-T/100BASE-TX/10BASE-T, and full-duplex/half-duplex communication mode are identified by an Ethernet-equipped module depending on the hub. For connection with a hub not having the auto-negotiation function, set the setting on the hub side according to the communication mode.

Wiring procedure

■ Connection

1. Check the insertion direction, and insert an Ethernet cable into an Ethernet connector of this product until it clicks.
2. Lightly pull the Ethernet cable to check that it is securely connected.
3. Check that the SPEED LED for the Ethernet connector is ON.

Point

- The time required from when an Ethernet cable is connected to when the SPEED LED turns ON may vary. Normally, it turns ON in a few seconds. However, it may take longer because the linking-up processing is repeated due to the device condition on the line.
- When the SPEED LED does not turn ON, check if the connected Ethernet cable has any failure. Replacing the cable may solve this problem.
- The SPEED LED turns OFF when connecting with an Ethernet device on the network the communication speed of which is 10 Mbps. Check the communication status by performing the PING test, etc.

■ Disconnection

Pull out the Ethernet cable while pinching a clip on the connector.

Considerations

■ Considerations for Ethernet device connection

- When this product has been replaced and also IP address has been changed, then reset the Ethernet device too. If the Ethernet device holds the Ethernet address (MAC address) of the communication target, continuous communication may not be performed since the module replacement will change the Ethernet address (MAC address).
- Perform the troubleshooting in accordance with the manual for the Ethernet device when an error occurred on the Ethernet device.
- If it is necessary to prevent dirt and dust from entering an unused connector, attach a dust-proof cover for Ethernet connector^{*1}.

*1 Please contact your local Mitsubishi Electric sales office or representative.

- Place an Ethernet cable in a duct or clamp it. Otherwise, the dangling cable may swing or inadvertently be pulled. It may cause a module or the cable to damage or malfunction due to poor contact.
- Protect the core wire in the connector of an Ethernet cable or a module to prevent touching by hand and sticking dirt or dust. If any oil from your hand, dirt or dust sticks the core wire, it may increase the transmission loss and fail communication.
- Check if an Ethernet cable used is disconnected, a short-circuit is generated, and the connector is properly connected.
- Do not use an Ethernet cable with a broken clip. Doing so may cause the unplugged cable or malfunction.
- Hold the connector of an Ethernet cable when connecting or disconnecting it. If the cable is pulled while being connected to a module, it may cause the module or Ethernet cable to damage or malfunction due to poor contact.
- The maximum segment length of an Ethernet cable is 100 m. However, the length may be shorter depending on the use environment of the cable. For details, contact the manufacturer of the cable used.
- The bend radius of an Ethernet cable is limited. For details, check the specifications of the Ethernet cable used.
- For the cascade connection of a repeater hub, check the specifications of this product before use. (📖 Page 25 SPECIFICATIONS)

For the number of connectable levels for a switching hub, consult the manufacturer of the hub used.

■ Considerations for 1000BASE-T/100BASE-TX connection

In a high-speed data communication (1 Gbps/100 Mbps) via 1000BASE-T/100BASE-TX connection, a communication error may occur due to the effect of high frequency noise generated from the equipment other than this product, depending on the installation environment.

Take the following countermeasures on this product to eliminate the effect of high frequency noise when constructing a network system.

- Do not bundle a cable with the main circuit or power cable, or do not place it near those lines.
- Place cables in a duct.
- In the environment where a cable is susceptible to noise, use the shielded STP cable.
- In an environment where the system is susceptible to noise, include a retry processing in a user program.
- Change the settings of a device that is connected to this product to decrease the communication speed.

7.3 HDMI Connector

This section shows the wiring for an HDMI connector.

HDMI cable

Use an HDMI cable that meets both of the following conditions.

- With shielding
- HDMI 1.4b compliant

Wiring procedure

■Connection

Check the insertion direction, and insert an HDMI cable into an HDMI connector.

After connecting the cable, take a measure to prevent it from falling out.

 Page 79 Measure to Prevent a Cable from Falling Out

■Disconnection

Pull out the HDMI cable from the connector.

When a measure to prevent the cable from falling out is taken, remove the cable tie from a mounting base in advance.

Considerations

- If it is necessary to prevent dirt and dust from entering an unused connector, attach a dust-proof cover for HDMI connector^{*1}.

^{*1} Please contact your local Mitsubishi Electric sales office or representative.

- Check if an HDMI cable is disconnected, a short-circuit is generated, and the connector is properly connected.

7.4 RS-232 Connector

This section shows the wiring for an RS-232 connector.

Connector

The following shows the specifications of an RS-232 connector.

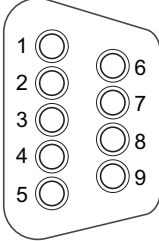
Connector	Pin No.	Signal abbreviation	Signal name	Signal direction (This product ↔ RS-232 device)
	1	CD (DCD)	Data carrier detect	←
	2	RD (RXD)	Received data	←
	3	SD (TXD)	Transmitted data	→
	4	ER (DTR)	Data terminal ready	→
	5	SG (GND)	Signal ground	↔
	6	DR (DSR)	Data set ready	←
	7	RS (RTS)	Request to send	→
	8	CS (CTS)	Clear to send	←
	9	CI (RI)	Ring indicator	←

Use the following product as the connector of an RS-232 connection cable.

Model name	Manufacturer	Connector
17JE-13090-02 (D8C) (-CG)	DDK Ltd. (www.ddknet.co.jp)	D-sub connector (Solder-connection type)

For mating screws used for a connector shell, use ones that are tightened by hand.

Wiring procedure

■Connection

1. Check the insertion direction, and insert an RS-232 connection cable into an RS-232 connector.
2. Tighten the connector screws.
 - Connector mating screws (#4-40UNC): tightening torque range 0.15 to 0.20 N·m

■Disconnection

1. Loosen the connector screws.
2. Pull out the RS-232 connection cable from the connector.

Considerations

- Make sure that the RS-232 connection cable shield is single-point grounded.
- For the connection method of a peripheral device, check the specifications of the peripheral device.
- Do not short-circuit the FG and SG signals of the RS-232 connection cable. When the FG and SG signals are connected inside of the peripheral device, do not connect the FG signal to this product.
- For devices connected to this product, using the same power source is recommended.
- When a device to be connected has a 3-pin power plug or when the device or its power plug has a grounding wire, connect the plug to a grounding receptacle or ground the grounding wire with a ground resistance of 100 ohms or less.

■Connecting the FG signal and shield

Connect the FG signal and shield of a connection cable as follows:

Connection cable	Connection to this product
FG signal of the cable	Connect the FG signal of the cable to the connector housing of this product.

- Do not short-circuit the FG and SG signals of a connection cable.
- When the FG and SG signals are connected inside of the peripheral device, do not connect the FG signal to this product.

■Connecting an AC-powered device that does not have a grounding wire

When connecting an AC-powered device that does not have a grounding wire, install the device by the following procedure.

1. Check that a device to be connected is unplugged from the AC receptacle.
2. Connect the device to this product with an RS-232 connection cable.
3. Plug the device to the AC receptacle.

7.5 Measure to Prevent a Cable from Falling Out

This section shows a measure to prevent a cable from falling out. Take the measure when wiring a USB cable or HDMI cable.

1. Pass a cable tie through the cable tie mounting structure (1) that is on the bottom of this product.
It is recommended to use a cable tie with the width of 6 to 8 mm and thickness of 1 mm or less.

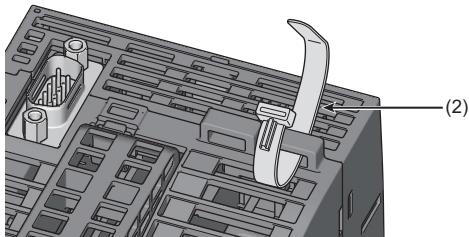
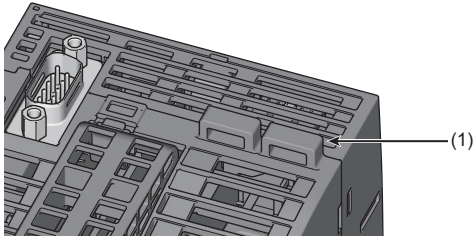

2. Pass a cable (3) through the cable tie (2).

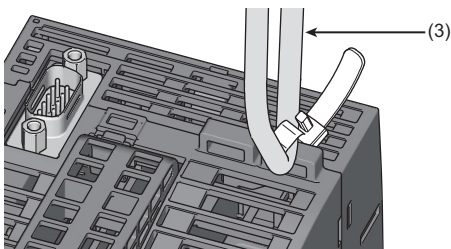

3. Tighten the cable tie.

8 INSERTION/REMOVAL OF SD MEMORY CARD AND CFAST CARD

This chapter explains the method for inserting and removing an SD memory card and CFast card.

8.1 SD Memory Card

This section shows the procedure for inserting and removing an SD memory card.

Precautions

Insert or remove an SD memory card by following the procedure below. Otherwise, data in the SD memory card may be corrupted or a file system error may occur.

Insertion

1. Open the switch cover.
2. Insert an SD memory card (1) straight into the SD memory card slot (2) with its cutout pointed down.

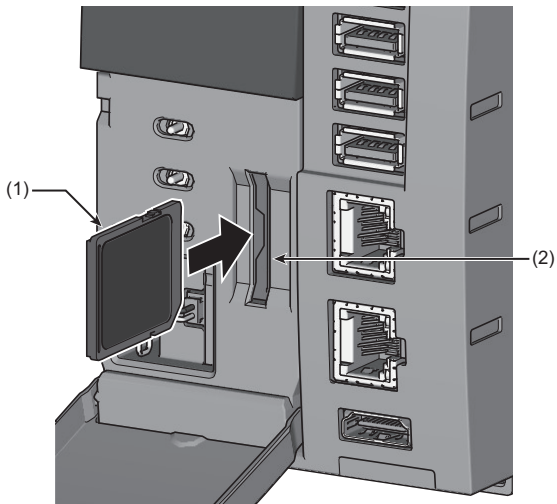

Make sure it is not uplifted after inserting it.

3. Check that the SD memory card is recognized by Windows.
4. Close the switch cover.

Removal

1. Unmount an SD memory card for safe removal in Windows.
2. Open the switch cover.
3. Push the SD memory card (1) in once, and pull it out straight from the SD memory card slot.

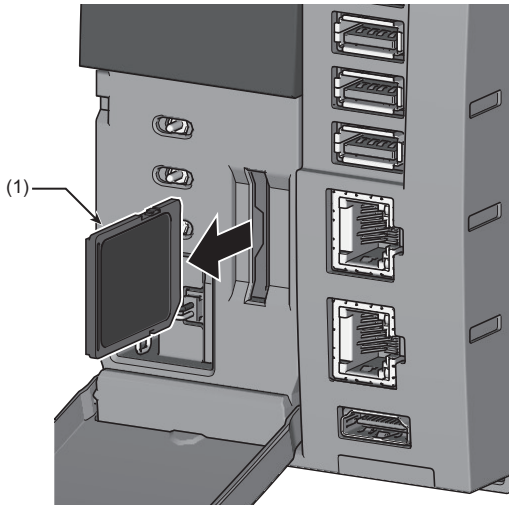

4. Close the switch cover.

8.2 CFast Card

This section shows the procedure for inserting and removing a CFast card.

Precautions

- Unmount this product from a base unit before inserting or removing a CFast card.
- If a CFast card is inserted while the power of this product is ON, it will not be recognized.
- Do not turn the power of this product OFF or remove a CFast card during file writing to the CFast card. Doing so may result in data corruption in the CFast card or file system error.
- Initialize (format) a CFast card before use if it is not initialized.
- Close the CFast cover while the power of this product is ON or it is operating to prevent malfunction.

Insertion

1. Open the CFast cover (1) with a spring clamp terminal block tool (KD-5339) (2).

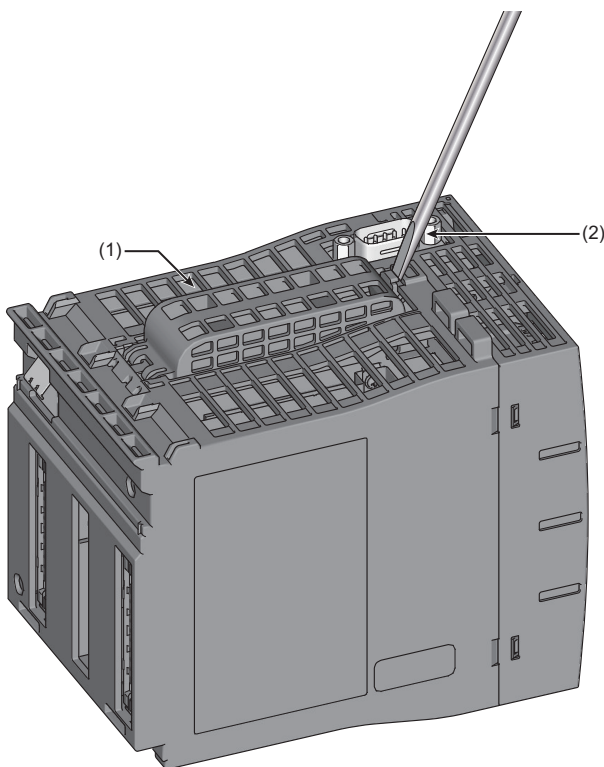

2. Check the insertion direction, and insert a CFast card (3) straight into a CFast card slot (4).

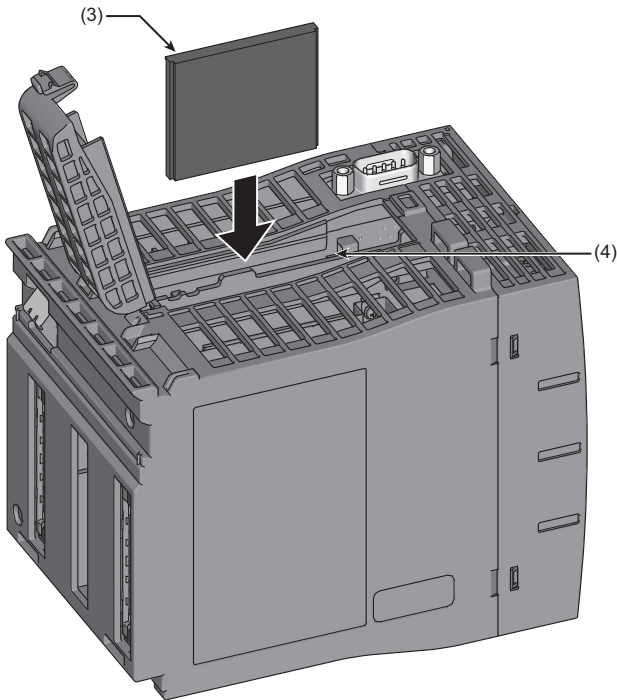

3. Close the CFast cover.

Removal

1. Open the CFast cover (1) with a spring clamp terminal block tool (KD-5339) (2).

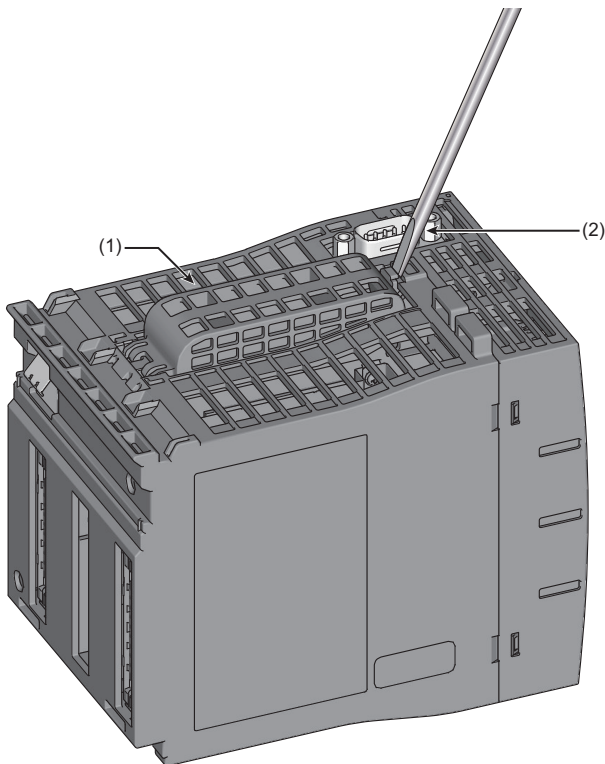

2. Press the eject button (3).

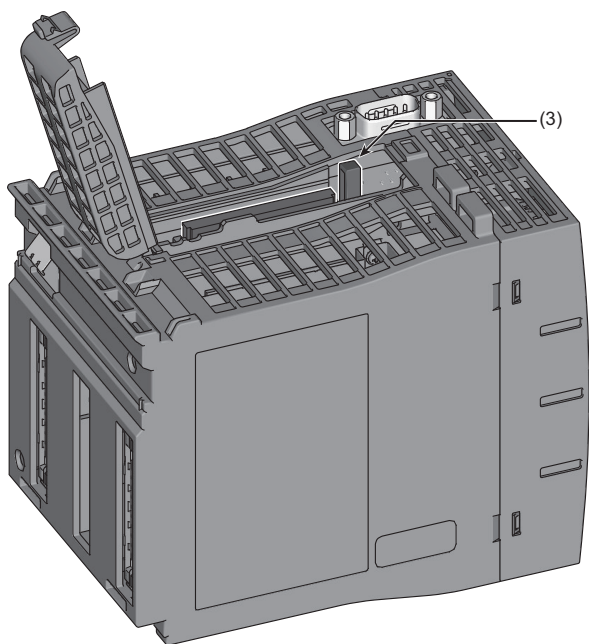

Press the eject button vertically. Otherwise, it may break.

3. Pull the CFast card (5) out straight from the CFast card slot (4).

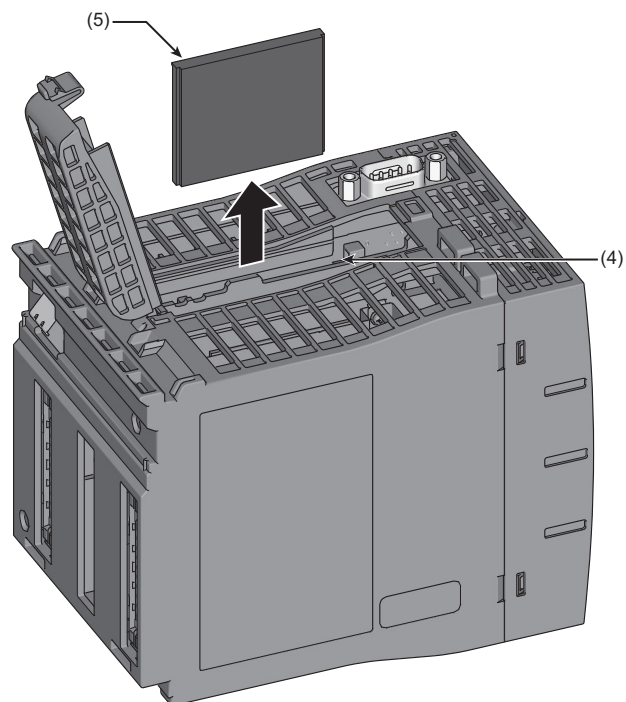

4. Close the CFast cover.

Initialization (format)

When using a CFast card for the first time, initialization of the card is required. Initialize a CFast card by the following procedure.



Do not insert any memory device other than a CFast card when performing the procedure below.

1. Insert a CFast card into a CFast card slot of this product.
2. Right-click Windows Start, and select "Disk Management."
Check that 'Disk 1 (Not Initialized)' is displayed in the "Disk Management" screen.
If the "Initialize Disk" screen appears at the same time with the "Disk Management" screen, go on to step 4.
3. Right-click "Disk 1," and select [Initialize Disk] in the shortcut menu.

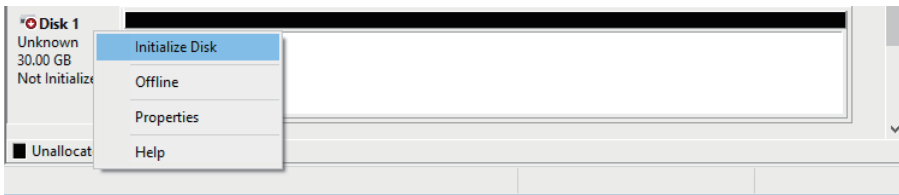

4. In the "Initialize Disk" screen, select MBR (Master Boot Record) or GPT (GUID Partition Table), and click the [OK] button.

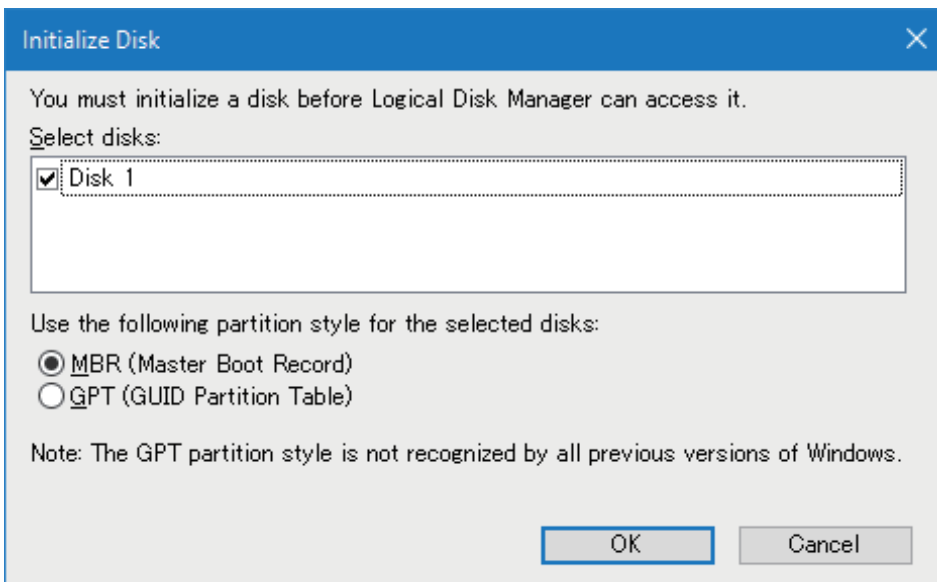

5. Right-click the area in "Disk 1," and select [New Simple Volume] in the shortcut menu.

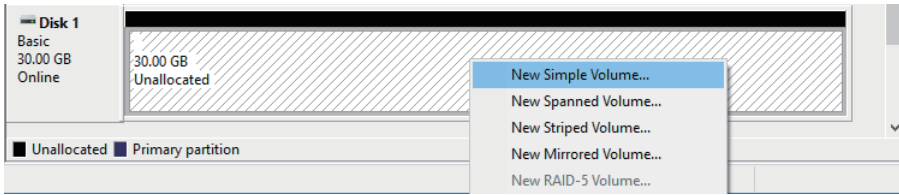

6. Click the [Next] button.

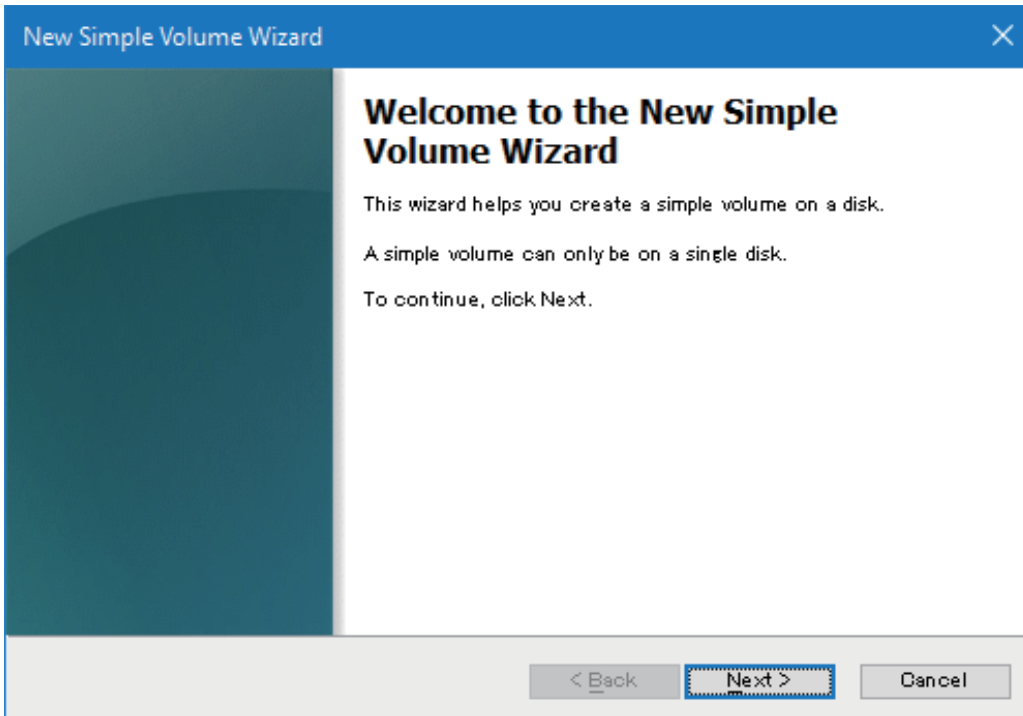

7. Specify the size for a new simple volume in "Simple volume size in," and click the [Next] button.

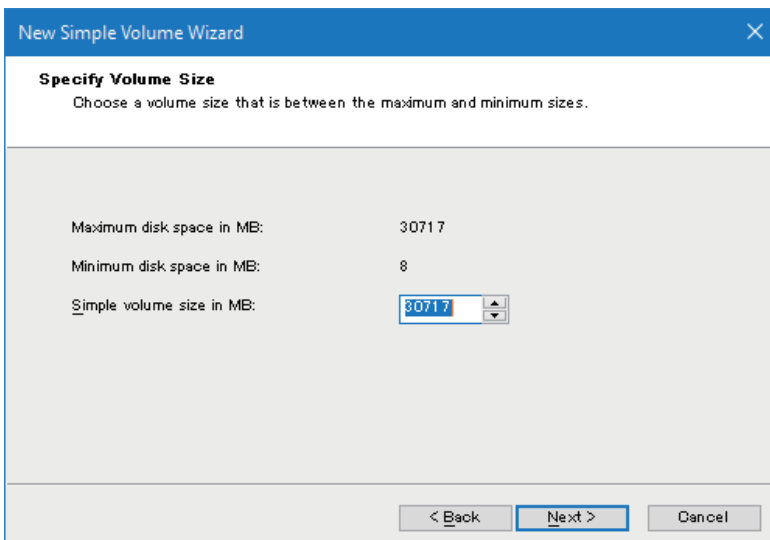

8. Select a drive letter to be assigned to the new simple volume from "Assign the following drive letter," and click the [Next] button.

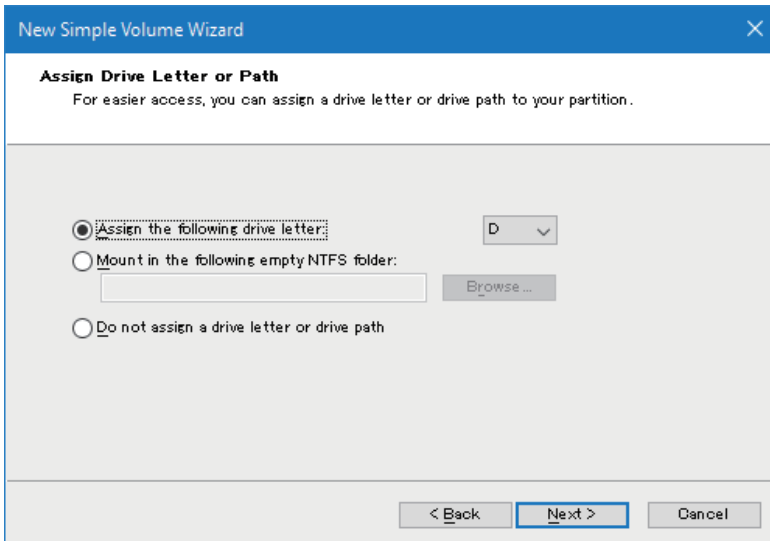

9. Select a format setting in "Format Partition," and click the [Next] button.

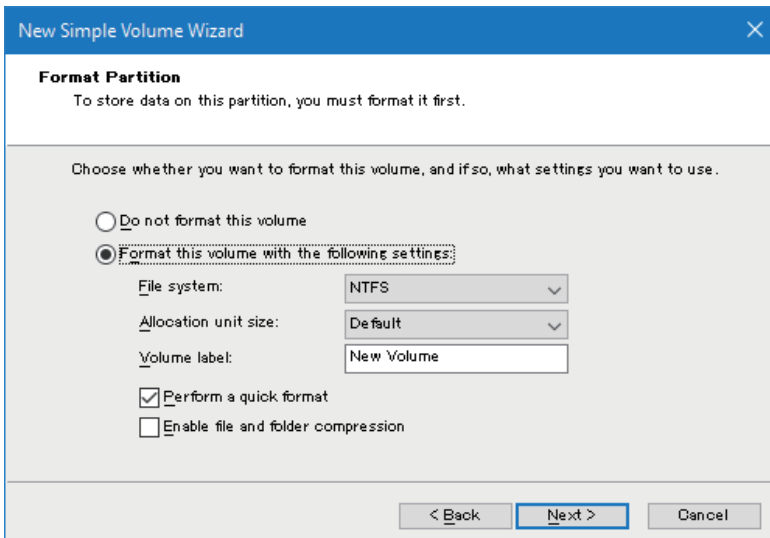

10. Click the [Finish] button.

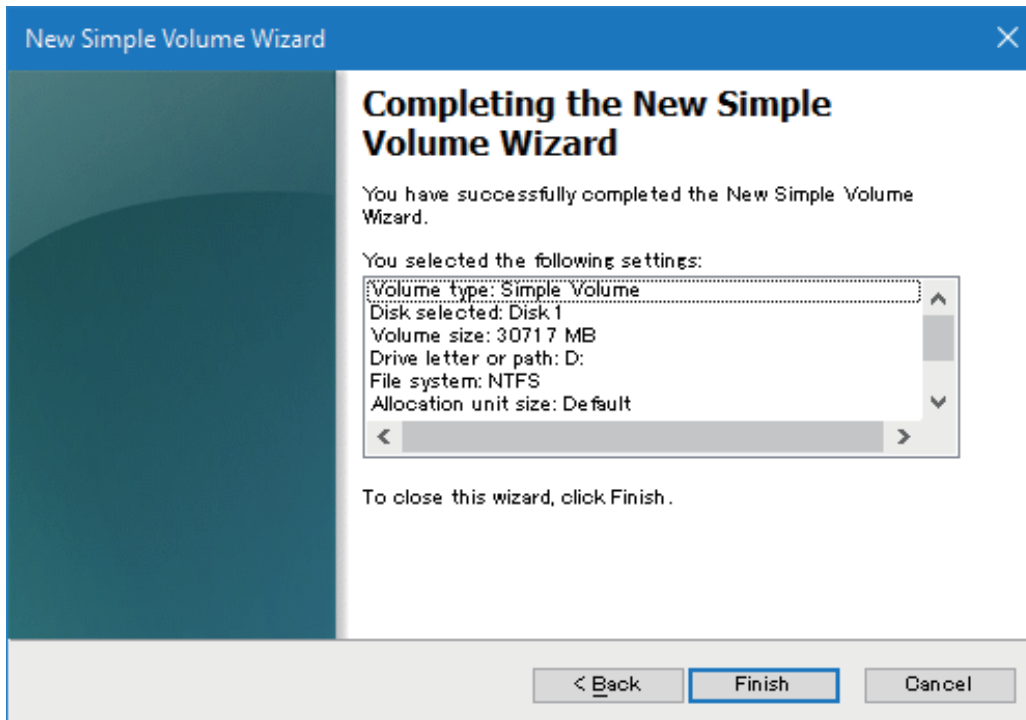

9 MAINTENANCE AND INSPECTION

This chapter shows items that should be maintained or inspected daily or periodically to use this product properly and in optimal condition at all times.

9.1 Daily Inspection

This section shows items that should be inspected daily.

Inspection item		Inspection method	Judgment criteria	Corrective action
Mounting status of a base unit	Looseness	Check that mounting screws are not loose and the cover is not dislocated.	The base unit must be fixed securely.	Retighten the screws.
Mounting status of a module	Looseness	Check that the module is mounted and the module fixing hook is fixed securely on the base unit.	The module must be mounted securely.	Fix the module fixing hook securely on the base unit.
Connection status	Terminal screw looseness	Check for the terminal screw looseness.	The terminal screws must not be loose.	Retighten the terminal screws.
	Clearance between the solderless terminals	Check the clearance between the solderless terminals.	The proper clearance must be provided between solderless terminals.	Provide the proper clearance.
	Connector looseness	Check for the cable connector looseness.	The cable connector must not be loose.	Connect the connector with no loosening securely.
LED status	POWER LED (Power supply module)	Check the lighting status.	ON (Failure if it is OFF)	 Page 223 Checking Errors with LEDs
	READY LED		ON (Failure if it is OFF)	
	ERROR LED		OFF (Failure if it is ON or flashing)	
	OVERCURRENT LED		OFF (Failure if it is ON or flashing)	
	I/O indicator LED (I/O module)		<ul style="list-style-type: none"> • I/O signal is ON: The LED is ON. • I/O signal is OFF: The LED is OFF. 	

9.2 Periodic Inspection

This section shows items that should be inspected once or twice every six months to a year.

Also, check these items when the equipment has been relocated or modified, or wiring layout has been changed.

Inspection item		Inspection method	Judgment criteria	Corrective action
Ambient environment	Ambient temperature* ¹	Measure the temperature by using a thermometer.	0 to 55°C	Create the environment that satisfies the judgment criteria.
	Ambient humidity	Measure the humidity by using a hygrometer.	5 to 95 %RH	
	Atmosphere	Measure corrosive gases.	No corrosive gases	
Power supply voltage check		Measure a voltage between the 100-240 VAC terminals and/or between the 24 VDC terminals.	85 to 264 VAC	Change the power supply.
			15.6 to 31.2 VDC	
Mounting status	Looseness and backlash	Touch the module to check for the looseness and rattling.	The module must be mounted securely.	Fix the module with screws. If the module is loose, retighten the screws.
	Attachment of dirt and foreign material	Check visually.	Dirt and foreign matter must not be attached.	Remove any dirt or foreign material.
Connection status	Terminal screw looseness	Check for the terminal screw looseness.	The terminal screws must not be loose.	Retighten the terminal screws.
	Clearance between the solderless terminals	Check the clearance between the solderless terminals.	The proper clearance must be provided between solderless terminals.	Provide the proper clearance between the solderless terminals.
	Connector looseness	Check for the cable connector looseness.	The cable connector must not be loose.	Connect the connector without looseness.
Battery		Check the length of time after purchase of the battery.	The battery must not be used more than five years.	Replace the battery if it has been used more than five years.

*1 The temperature in the control panel installed a programmable controller is called the ambient temperature.

Replacing a battery

The following shows the procedure for replacing a battery.

Point

It is recommended to replace a battery while the power of this product is ON. If replacing a battery when the power is OFF, set the clock and BIOS again.

1. Open the switch cover.
2. Pull out the connector of the old battery (2) from the connector of this product (1).

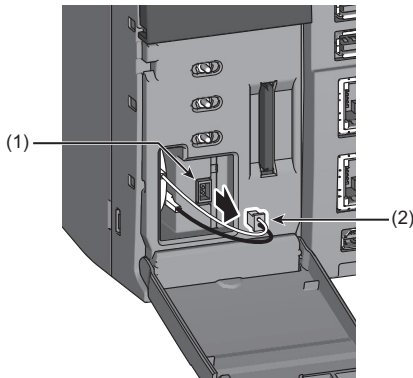

3. Pull out the old battery (4) from the battery holder (3).

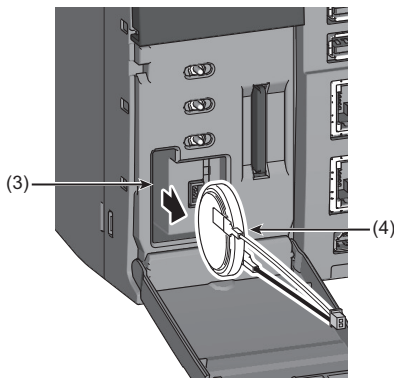

4. Insert a new battery (5) into the battery holder (3).

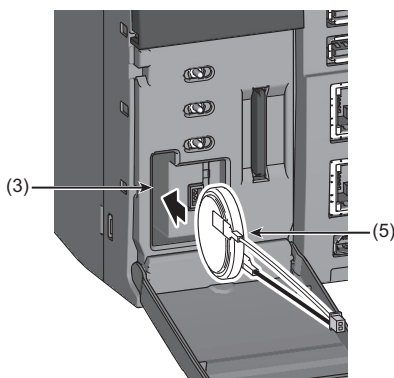

5. Insert the connector of the new battery (6) into the connector of this product (1).

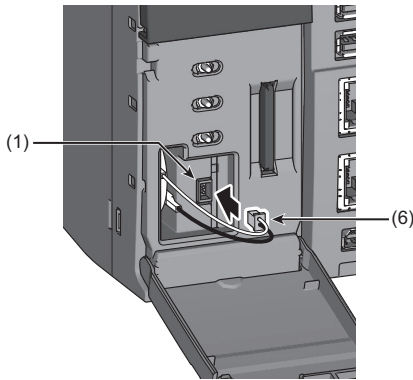

Ensure that the battery connector is fully inserted with its red cable facing up.

6. Close the switch cover until it clicks.

7. Clear a battery error by performing the module diagnostics using CW Configurator.

If the battery error is not cleared, the battery may not be installed properly. Check the installation condition of the battery. If the error is still not cleared, a hardware failure may occur in the battery. Replace it with another battery.

Precautions

- When closing the switch cover, ensure that the battery cable is not caught.
- If a battery error occurs, ensure to replace a battery. Failure to do so may result in corruption of clock data.

Point

Write the date to replace the battery next time on the seal 'Precautions' that is on the back of the switch cover.

9.3 BIOS Setup

This section explains the setup procedure for BIOS and the menus to be displayed.

Precautions

- Do not change the factory default settings except for the date and time. Note that the operation when settings other than the date and time are changed is not verified by Mitsubishi Electric. When changing any settings other than the date and time, confirm that there is no problem with the operation before use.
- Misconfiguration in the BIOS setup causes a serious trouble such as that a system does not start or operate normally. Pay close attention when changing BIOS settings.*¹
- Ensure that this product and a display are connected before setting up BIOS. No screens appear on a display if connecting this product and the display after starting the BIOS setup. In this case, turn the power of this product OFF and ON again.
- The BIOS setup settings are recorded in the built-in flash memory. If the power supply from the battery stops, the setting values are reset to the initial values.

*¹ If any problems occur due to changes in the BIOS settings, execute "Restore Default" in "Save & Exit" to initialize the settings.

Starting the setup

After turning the power of this product ON, a splash screen is displayed until the operating system is booted.

The BIOS setup starts by pressing the **Delete** or **F2** key while the splash screen is displayed.

Point

The time displayed in a splash screen can be changed in "Setup Pre-Delay" in "System Configuration." Set the time within the range of 0 to 10 seconds.

Setup menus

The following explains the menus displayed in the setup screen.

Main

The current date and time and the device information are displayed.

Item	Description
BIOS Version	The version of BIOS is displayed.
Build Date and Time	The date and time when BIOS was built is displayed.
(Processor name)	The name of a processor is displayed.
CPUID	The CPUID of a processor is displayed.
Microcode Revision	The revision of microcode is displayed.
Total Memory	The capacity of the installed memory is displayed.
Memory Speed	The operating frequency of the installed memory is displayed.
System Date	The current date (day of the week/month/day/year) is displayed. (Initial value: Thu 04/01/2021) To change the date, move the cursor with the Tab key and enter a date with the number keys or with the Space , + , and - keys.
System Time	The current time (hour:minute:second) is displayed. (Initial value: 00:00:00) To change the time, move the cursor with the Tab key and enter a time with the number keys or with the Space , + , and - keys.

Advanced

The sub menus for a system and devices are displayed.

■System Configuration

Settings for a system are displayed.

Item	Description
NumLock	Set the NumLock status of a keyboard. <ul style="list-style-type: none">• On: NumLock is turned ON (the numeric keypad works as number keys). (Default)• Off: NumLock is turned OFF (the numeric keypad works as arrow keys).
Setup Pre-Delay	Set the reception time for a startup key for the BIOS setup. <ul style="list-style-type: none">• 0 to 10: The reception time can be set within the range of 0 to 10 seconds. (Default: 2)
Above 4GB MMIO	Set the memory space for PCI Express. <ul style="list-style-type: none">• Enabled: The PCI Express memory is set in 64-bit space.• Disabled: The PCI Express memory is not set in 64-bit space. (Default)

■Processor Configuration

Settings for a processor are displayed.

Item	Description
Active Processor Cores	Set the number of cores in a processor. <ul style="list-style-type: none">• All: All cores are used. (Default)• 1: One core is used.
Intel(R) VT	Set whether to enable Intel Virtualization Technology. <ul style="list-style-type: none">• Disabled: Intel Virtualization Technology is disabled.• Enabled: Intel Virtualization Technology is enabled. (Default)
Processor Power Management	The sub menus for the processor power management are displayed.

• Processor Power Management

Item	Description
Intel(R) SpeedStep(tm)	Set whether to enable Enhanced Intel SpeedStep(R) Technology. <ul style="list-style-type: none">• Disabled: Enhanced Intel SpeedStep(R) Technology is disabled.• Enabled: Enhanced Intel SpeedStep(R) Technology is enabled. (Default)
Boot Performance Mode	Set the operating frequency of a processor on boot. <ul style="list-style-type: none">• Max Performance: A processor is set to operate at the rated frequency on boot. (Default)• Max Battery: A processor is set to operate at the minimum frequency on boot.
Turbo Mode	Set whether to enable Turbo Boost Technology. <ul style="list-style-type: none">• Disabled: Turbo Boost Technology is disabled.• Enabled: Turbo Boost Technology is enabled. (Default)

■ Graphics Configuration

Settings for graphics are displayed.

Item	Description
GTT Size	Set the size of graphics memory used before the OS boot. <ul style="list-style-type: none"> • 2MB: The size is set to 2 MB. • 4MB: The size is set to 4 MB. • 8MB: The size is set to 8 MB. (Default)
Aperture Size	Set the aperture size (memory space). <ul style="list-style-type: none"> • 128MB: The size is set to 128 MB. • 256MB: The size is set to 256 MB. (Default) • 512MB: The size is set to 512 MB.
DVMT Pre-Allocated	Set the minimum value for a memory used by a graphics driver. <ul style="list-style-type: none"> • 64MB: The minimum value is set to 64 MB. (Default) • 128MB: The minimum value is set to 128 MB. • 256MB: The minimum value is set to 256 MB. • 512MB: The minimum value is set to 512 MB.
DVMT Total Gfx Mem	Set the maximum value for a memory used by a graphics driver. <ul style="list-style-type: none"> • 128MB: The maximum value is set to 128 MB. • 256MB: The maximum value is set to 256 MB. (Default) • MAX: The maximum value is set to 1 GB.

■ PCI Configuration

Settings for PCI are displayed.

Item	Description
PCI SERR# Detection	Set whether to detect PCI SERR# in a device connected to PCI Express. <ul style="list-style-type: none"> • Disabled: The PCI SERR# detection is disabled. • Enabled: The PCI SERR# detection is enabled. (Default)
Fatal Error	Set whether to detect a fatal error in a device connected to PCI Express. <ul style="list-style-type: none"> • Disabled: The fatal error detection is disabled. • Enabled: The fatal error detection is enabled. (Default)
Non Fatal Error	Set whether to detect a non-fatal error in a device connected to PCI Express. <ul style="list-style-type: none"> • Disabled: The non-fatal error detection is disabled. (Default) • Enabled: The non-fatal error detection is enabled.
Correctable Error	Set whether to detect a correctable error in a device connected to PCI Express. <ul style="list-style-type: none"> • Disabled: The correctable error detection is disabled. (Default) • Enabled: The correctable error detection is enabled.

■ ATA Configuration

Settings for Serial ATA are displayed.

Item	Description
SATA1 (CFast1)	The name of CFast1 is displayed.
SATA2 (CFast2)	The name of CFast2 is displayed.
SATA Transfer Rate	Set the transfer rate of CFast. <ul style="list-style-type: none"> • 1.5Gbps: The transfer rate is limited to up to 1.5 Gbps. • 3.0Gbps: The transfer rate is limited to up to 3.0 Gbps. • 6.0Gbps: The transfer rate is limited to up to 6.0 Gbps. (Default)
SATA1 (CFast1)	Set whether to enable CFast1. <ul style="list-style-type: none"> • Disabled: CFast1 is disabled. • Enabled: CFast1 is enabled. (Default)
SATA2 (CFast2)	Set whether to enable CFast2. <ul style="list-style-type: none"> • Disabled: CFast2 is disabled. • Enabled: CFast2 is enabled. (Default)

■ Network Configuration

Settings for a network are displayed.

Item	Description
LAN Controller 1	Set whether to enable the Ethernet controller 1. <ul style="list-style-type: none">• Disabled: The Ethernet controller 1 is disabled.• Enabled: The Ethernet controller 1 is enabled. (Default)
LAN Controller 2	Set whether to enable the Ethernet controller 2. <ul style="list-style-type: none">• Disabled: The Ethernet controller 2 is disabled.• Enabled: The Ethernet controller 2 is enabled. (Default)

■ Precautions

After changing these settings, configure the Windows network settings again.

■ Audio Configuration

A setting for an audio is displayed.

Item	Description
Audio Controller	Set whether to enable an audio controller. <ul style="list-style-type: none">• Disabled: An audio controller is disabled.• Enabled: An audio controller is enabled. (Default)

■ I/O Device Configuration

A setting for a serial port is displayed.

Item	Description
Serial Port	Set whether to enable a serial port. <ul style="list-style-type: none">• Disabled: A serial port is disabled.• Enabled: A serial port is enabled. (Default)

■ Event Logging

Settings for event logs are displayed.



Item	Description
Event Log Capacity	The status of a log area is displayed. <ul style="list-style-type: none">• Full: No space is left in a log area.• Space Available: New logs can be recorded.
View Event Log	Log data is displayed.
Clears All Event Logs	Log data is deleted by restarting this product with this item set to "Yes." This item is set back to "No" after the restart. <ul style="list-style-type: none">• No: Log data is not deleted. (Default)• Yes: Log data is deleted.
Event Logging	Set whether to record event logs. <ul style="list-style-type: none">• Disabled: Event logs are not recorded.• Enabled: Event logs are recorded. (Default)

- Log data

Log data is displayed by selecting View Event Log and pressing the  key.

Log data and the date and time when the log data is recorded are displayed on the left side of the screen. The date and time is displayed in the format of 'mm/dd/yyyy hh:mm:ss (month/date/year hour:minute:second).'

Log data can be scrolled with the / key.

In addition, some log data has its details on the upper right of the screen. The details can be scrolled with the / key.

Item		Description
Log data (on the left side of the screen)	Details (on the upper right of the screen)	
CMOS RAM Battery Failure	Not displayed	A battery backup is drained.
RTC Time Not Set	Not displayed	An error has occurred in the time of a real time clock.
Onboard LAN Error	Not displayed	An error has occurred in an Ethernet controller.
PCI System Error	Bus: bb, Device dd. Function: f Device Status: xxxx Secondary Status: yyyy PCI Express Capability Device Status: zzzz Advanced Error Reporting Offset 00h: aaaa Offset 04h: aaaa ...	A PCI system error has occurred. <ul style="list-style-type: none"> • bb: Bus number of PCI (decimal) • dd: Device number of PCI (decimal) • f: Function number of PCI (decimal) • xxxx: Device Status of PCI • yyyy: Secondary Status • zzzz: Device Status of PCI Express • aaaa: Advanced Error Reporting of PCI Express

■ Console Redirection

Settings for the console redirection are displayed.

Item	Description
Console Redirection	Set whether to enable the console redirection. <ul style="list-style-type: none"> • Disabled: The console redirection is disabled. (Default) • Enabled: The console redirection is enabled.
Terminal Type	Set the emulation type for a terminal. <ul style="list-style-type: none"> • VT100: VT100 emulation is used. (Default) • VT100+: VT100+ emulation is used. • VT-UTF8: VT-UTF8 emulation is used. • ANSI: ANSI emulation is used.
Baud Rate	Set the communication baud rate (bps) for the console redirection. <ul style="list-style-type: none"> • 9600: Communication is performed at 9600 bps. (Default) • 19200: Communication is performed at 19200 bps. • 38400: Communication is performed at 38400 bps. • 57600: Communication is performed at 57600 bps. • 115200: Communication is performed at 115200 bps.

Security

Settings for a setup password are displayed.



Item	Description
Administrator Password	Set a password to start the BIOS setup. Follow the rules listed below: <ul style="list-style-type: none">• The number of characters must be between 1 and 20.• Only alphabets and numbers are available.• Alphabet characters are not case-sensitive.
Secure Boot	Set whether to enable the secure boot. <ul style="list-style-type: none">• Disabled: The secure boot is disabled. (Default)• Enabled: The secure boot is enabled.

■ Procedure for setting a password



1. Enter the current password in the "Enter Current Password" screen and press the  key.
The "Create New Password" screen appears.

Point

If no password has been set, the "Create New Password" screen appears. Start from step 2.

2. Enter a new password in the "Create New Password" screen and press the  key.
The "Confirm New Password" screen appears.
3. Enter the password set in step 2 in the "Confirm New Password" screen and press the  key.

■ Procedure for deleting a password

1. Enter the current password in the "Enter Current Password" screen and press the  key.
2. Enter nothing in the "Create New Password" screen and press the  key.
The confirmation screen for deleting the password appears.
3. Select "Yes" for "Clear Old Password. Continue?" and press the  key.

Boot

Settings for the boot priority are displayed.

Item	Description
SATA1 (CFast1)	Boot the operating system of CFast1. The name of a product is displayed when CFast that can boot the operating system is connected.
USB1	Boot the operating system of a storage connected to the USB1. The name of a product is displayed when a storage that can boot the operating system is connected.
USB2	Boot the operating system of a storage connected to the USB2. The name of a product is displayed when a storage that can boot the operating system is connected.
USB3	Boot the operating system of a storage connected to the USB3. The name of a product is displayed when a storage that can boot the operating system is connected.
USB4	Boot the operating system of a storage connected to the USB4. The name of a product is displayed when a storage that can boot the operating system is connected.
SATA2 (CFast2)	Boot the operating system of CFast2. The name of a product is displayed when CFast that can boot the operating system is connected.

Point

When starting this product in the USB boot mode, the priority is different from the one when starting normally. For details on the USB boot mode, refer to the following:

 Page 103 USB boot mode

Save & Exit

The following operations can be performed: saving settings, reading factory default values, and ending the setup.

9.4 Windows Recovery

This section shows the procedures for creating recovery data for Windows and for recovering Windows by using the recovery data.

Point

To recover Windows, both a recovery drive and a system image are required.
Make sure to create a recovery drive and a system image.

Precautions

When Windows is recovered by using a Windows 10 function, services necessary for this product and pre-installed applications may be deleted; therefore, the functions of this product cannot be used. Do not recover Windows by using the following function of Windows 10.

 Windows Start ⇒ [Settings] ⇒ [Update & Security] ⇒ [Recovery] ⇒ [Reset this PC]

Creating recovery data

The following explains the methods for creating recovery data (recovery drive and system image).

Precautions

After creating Windows recovery data, hold the FUNCTION/SHUTDOWN switch on the SHUTDOWN position to shut down Windows. Then, turn the power of this product OFF.

Recovery drive

The procedure for creating a recovery drive is as follows.

Point

It takes approximately three hours to create a recovery drive.

1. Connect a USB memory (with a capacity of 16 GB or more) to this product.
2. Perform [Recovery Drive].

 Windows Start ⇒ [Windows Administrative Tools] ⇒ [Recovery Drive]

3. Check that the checkbox of "Back up system files to the recovery drive." is selected, and click the [Next] button.
4. Check that the connected USB memory is displayed as an available drive, and create a recovery drive.

System image

The procedure for creating a system image is as follows.

Point

It takes approximately 15 minutes to create a system image.
However, the time may be longer depending on the C drive usage capacity.

1. Connect a memory device (64 GB or more), such as HDD, to a USB connector of this product.
2. Perform [Backup and Restore (Windows 7)].
 Windows Start ⇒ [Control Panel] ⇒ [System and Security] ⇒ [Backup and Restore (Windows 7)]
3. Select [Create a system image].
The screen for selecting a backup destination appears.
4. Select the connected memory device, and click the [Next] button.
5. Click the [Start backup] button.

Precautions

- A system image cannot be created for a USB memory.
- For a memory device to create a system image, format the file system in NTFS.

Performing a recovery

The following shows the procedure for recovering Windows.

To recover Windows, configure a system which only includes a power supply module, a base unit, and this product.

After recovering Windows, start this product and check that no error occurs.

Point

It takes approximately 15 minutes to recover Windows.

However, the time may be longer depending on the C drive usage capacity when creating a system image.

1. Turn the power of this product OFF.
2. Connect the USB memory where a recovery drive is created and the memory device where a system image is created to this product.
3. Hold the BUS RESET/Y STOP/Y OUT switch on the BUS RESET position to turn the power of this product ON. This product starts in the USB boot mode and the "Choose the language" screen appears.
4. Select a language.
The "Choose your keyboard layout" screen appears.
5. Select an appropriate keyboard.
The "Choose an option" screen appears.
6. Select "Troubleshoot."
The "Troubleshoot" screen appears.
7. Select "Advanced options."
The "Advanced options" screen appears.
8. Select "System image recovery."
The "Select a system image backup" screen appears.
9. Select "Use the latest available system image (recommended)," and click the [Next] button.
The "Choose additional restore options" screen appears.
10. Click the [Next] button.
"Your computer will be restored from the following system image : " is displayed.
11. Check each item and click the [Finish] button.
 - Date and time when a system image to be used for recovery was created
 - Computer name to be created
 - Location of a drive to restore"All data on the drives to be restored will be replaced with the data in the system image. Are you sure you want to continue?" is displayed.
12. Click the [Yes] button.
"Windows is restoring your computer from the system image. This might take from a few minutes to a few hours." is displayed. A recovery of a selected drive starts. Wait until the recovery is completed.
13. After recovering Windows, turn the power of this product OFF.

Precautions

Once Windows is recovered, the version of a driver package will be the one when the backup data was created. If a driver package of this product was updated by using the update function of this product, update the version of the driver package again after Windows recovery.

USB boot mode

This mode boots data from a USB device connected to a USB connector when recovering Windows.

The following shows the procedure for starting the USB boot mode.

1. Turn the power of this product OFF.
2. Connect a USB device to boot from to any of the USB connectors (P1 to P4) of this product.

To recover Windows, connect the following devices:

- A USB memory where a recovery drive is created
- A memory device where a system image is created

When starting the USB boot mode without connecting these devices, follow the procedure from the beginning.



3. Hold the BUS RESET/Y STOP/Y OUT switch on the BUS RESET position to turn the power of this product ON.

This product starts in the USB boot mode.

In the USB boot mode, the READY LED and INFORMATION LED turn ON.

- READY LED: ON (orange)
- INFORMATION LED: ON (green)

Point

- To recover Windows, a USB memory where a recovery drive is created is required in advance. In addition, a memory device (such as HDD) where a system image is created must be connected to this product. ( Page 100 Creating recovery data)
- When the USB boot mode is started at the same time as the maintenance mode, the maintenance mode takes priority to start. ( Page 27 Operation mode)

Start priority

The following table shows the start priority on USB boot.

Boot order	When starting the USB boot mode	When starting normally ^{*1}
1	"USB1" (USB P1)	"SATA1(CFast1)" (Primary CFast card slot)
2	"USB2" (USB P2)	"USB1" (USB P1)
3	"USB3" (USB P3)	"USB2" (USB P2)
4	"USB4" (USB P4)	"USB3" (USB P3)
5	"SATA2(CFast2)" (Secondary CFast card slot)	"USB4" (USB P4)
6	"SATA1(CFast1)" (Primary CFast card slot)	"SATA2(CFast2)" (Secondary CFast card slot)

*1 The boot order can be changed in BIOS.

This part comprises the following chapter.

10 Windows FUNCTION

10 Windows FUNCTION

This product uses Windows functions with Windows 10 IoT Enterprise LTSC 2019 installed on this product.

10.1 Windows Services

This product uses Windows services and implements a part of MELSEC functions.

Services

The following table shows Windows services registered in this product.

Service name	Overview	Corresponding MELSEC function
MELSOFT Communication Service	To communicate with devices set for the external device configuration	☞ Page 133 MELSOFT CONNECTION FUNCTION
Time Synchronization Service	To synchronize clock information between Windows and a programmable controller system	☞ Page 145 TIME SYNCHRONIZATION FUNCTION
Self Diagnosis Service	To detect an error at the start or during operation of this product	☞ Page 208 SELF-DIAGNOSTICS FUNCTION
Event Log Service	To register an event, which occurs at the start or during operation of this product, to Windows Event Viewer	☞ Page 217 EVENT HISTORY FUNCTION
Parameter Service	To set parameters when turning the power of this product ON or resetting a bus	—

Precautions

When stopping Windows service, this product may not operate properly.

10.2 Events Registered by Windows Service

When any problems occur in the service of this product, operation information of the service will be registered to Windows Event Viewer.

For details on events registered by Windows service, refer to the following:

☞ Page 270 Windows Event List

Registration destination and source name for each service name are as shown below:

Service name	Registration destination*1 of application and service log	
	MELSEC Service	MELSEC Bus Event
MELSOFT Communication Service	WinCPU MELSOFT Communication	Not registered
Time Synchronization Service	WinCPU Time Synchronization	
SelfDiagnosis Service	WinCPU Self-diagnostic	
Event Log Service	WinCPU Event Log	WinCPU Bus Event
Parameter Service	WinCPU Parameter	Not registered

*1 Register the following items when registering an event to Windows Event Viewer.

Log name: 'MELSEC Service' or 'MELSEC Bus Event'

Source: Corresponding source name

Precautions

When shutting down or restarting Windows, some events may not be registered depending on the timing.

This part comprises the following chapters.

11 PROGRAMMABLE CONTROLLER DEVICE MEMORY FUNCTION

12 BUS ACCESS FUNCTION

13 MELSOFT CONNECTION FUNCTION

14 TIME SYNCHRONIZATION FUNCTION

15 MULTIPLE CPU SYSTEM FUNCTION

16 NETWORK MODULE ACCESS FUNCTION

17 LABEL COMMUNICATION FUNCTION

18 FIXED CYCLE PROCESSING FUNCTION

11 PROGRAMMABLE CONTROLLER DEVICE MEMORY FUNCTION

This function enables access to devices and buffer memory of this product from Windows applications in this product and external devices via a bus and Ethernet.

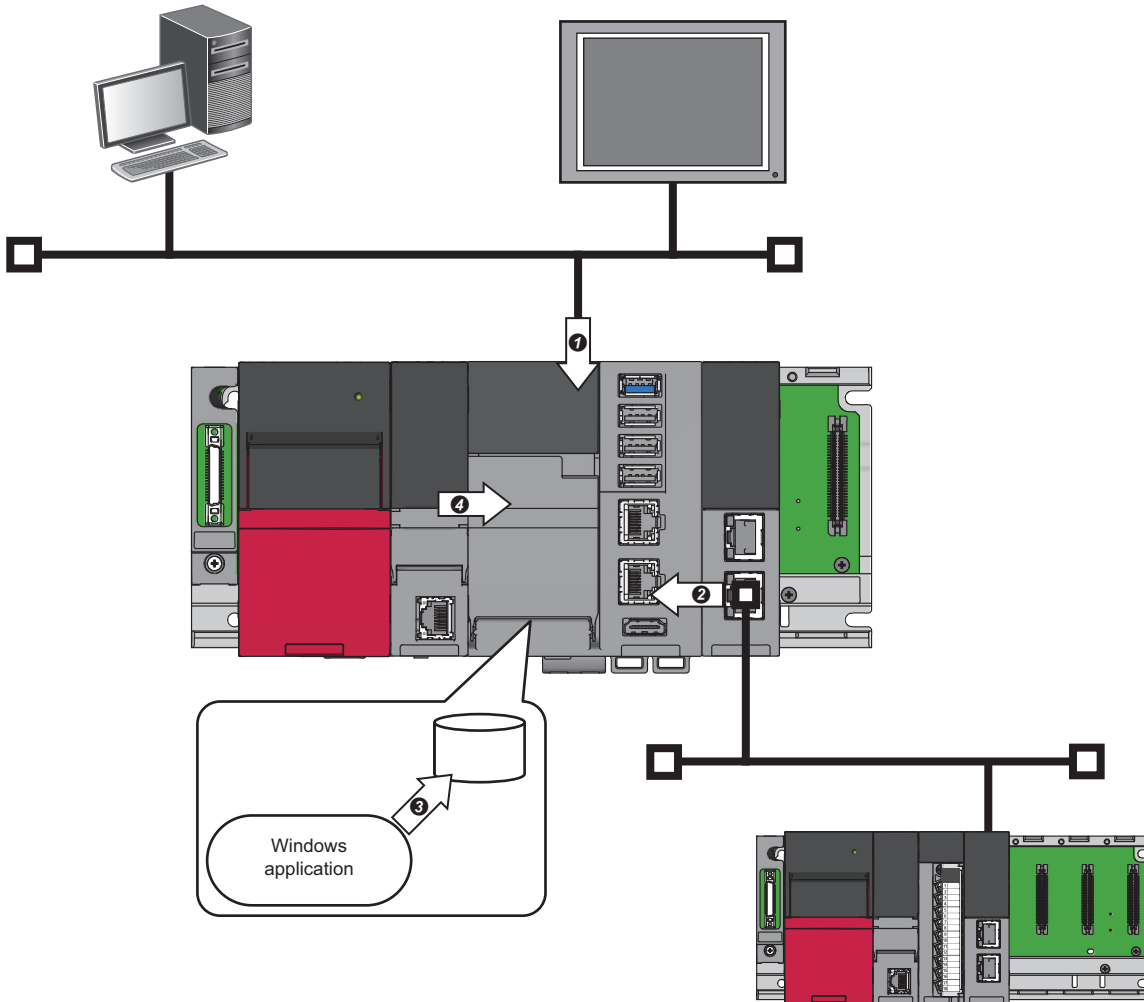

Systems available to access this product

Devices on the following systems can access this product.

- ❶ MELSOFT products or GOTs on a network
- ❷ Network modules on a factory automation network
- ❸ Windows applications in this product
- ❹ Another CPU module in a multiple CPU system

Accessible devices

For details on accessible devices of this product, refer to the following:

☞ Page 273 Device List

Access to devices

Devices are accessed by any of the following methods:

- ☞ Page 111 Access with MELSEC Data Link Functions
- ☞ Page 111 Access via a Bus or Factory Automation Network
- ☞ Page 111 Access from MELSOFT Products or GOTs

11.1 Access with MELSEC Data Link Functions

Devices are accessed from a user program, which runs on this product, with MELSEC data link functions provided by this product.

For details on functions and creating user programs, refer to the following:

📖 MELSEC iQ-R MELSECWinCPU Module Programming Manual

Function list

The following table shows functions to be used in a user program.

Function name	Purpose
mdBdDevRstEx	To reset (turn OFF) bit devices on the own station
mdBdDevSetEx	To set (turn ON) bit devices on the own station
mdBdRandREx	To read data from devices on the own station randomly
mdBdRandWEx	To write data to devices on the own station randomly
mdBdReceiveEx	To read data from devices on the own station in a batch
mdBdSendEx	To write data to devices on the own station in a batch
mdDevRstEx	To reset bit devices
mdDevSetEx	To set bit devices
mdRandREx	To read data from devices randomly
mdRandWEx	To write data to devices randomly
mdReceiveEx	To read data from devices in a batch
mdSendEx	To write data to devices in a batch

11.2 Access via a Bus or Factory Automation Network

Devices are accessed via another CPU module or a network module.

Access from another CPU module

CPU buffer memory access devices of this product are accessed directly from another CPU module via a bus. By communicating data between CPU modules, data of another CPU module can be synchronized with data in the access devices of the fixed scan communication area. (📖 Page 114 Data Communication Between CPU Modules)

Access via a factory automation network

Devices of this product are accessed via a network module.

For details, refer to the manual of a network module. (📖 Manual of a module used)

11.3 Access from MELSOFT Products or GOTs



Devices and buffer memory of this product are accessed from MELSOFT products and GOTs which are connected to this product or from MELSOFT products which run on Windows in this product.

For details, refer to the manual of a product used. (📖 Manual of a product used)

12 BUS ACCESS FUNCTION

This function links with another module using the bus driver of this product.

The following functions are available with the bus driver.

-  Page 112 Device Access
-  Page 114 Data Communication Between CPU Modules
-  Page 125 Interrupt Notification Reception

12.1 Device Access

This function accesses devices of another module via a bus.

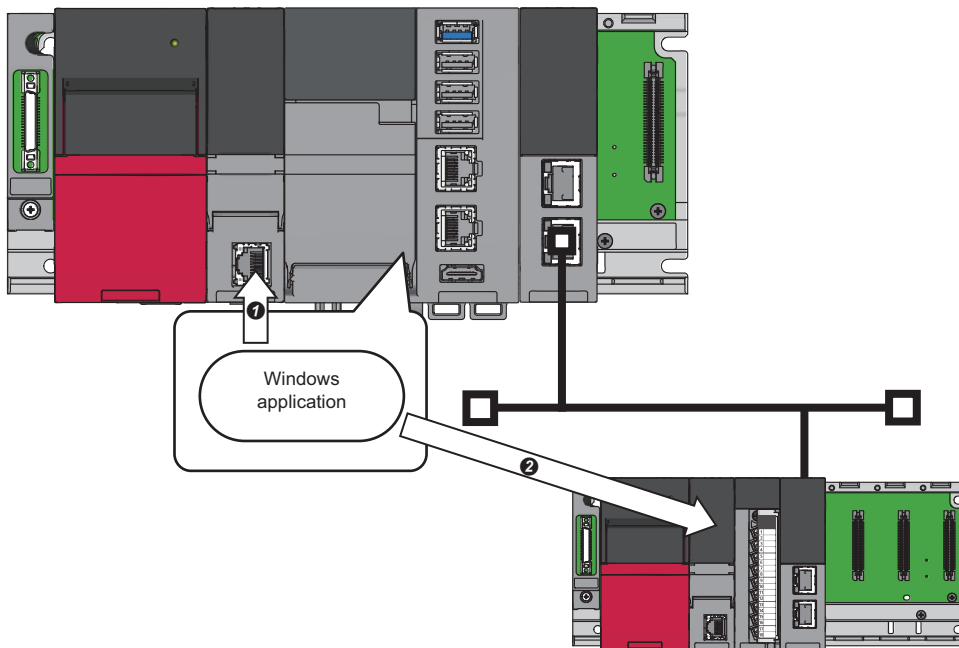

- ❶ Accesses devices of another CPU module or an intelligent function module.
- ❷ Accesses devices of a CPU module on another station via a network module.

Access with MELSEC data link functions

Devices are accessed from a user program, which runs on this product, with MELSEC data link functions provided by this product.

For details on functions and creating user programs, refer to the following:

 MELSEC iQ-R MELSECWinCPU Module Programming Manual

Function list

The following table shows functions to be used in a user program.

Function name	Purpose
mdDevRstEx	To reset (turn OFF) bit devices
mdDevSetEx	To set (turn ON) bit devices
mdGetLabelInfo	To acquire device information corresponding to a label name ^{*1}
mdRandREx	To read data from devices randomly
mdRandRLabelEx	To read data from devices corresponding to labels randomly ^{*1}
mdRandWEx	To write data to devices randomly
mdRandWLabelEx	To write data to devices corresponding to labels randomly ^{*1}
mdReceiveEx	To read data from devices in a batch
mdSendEx	To write data to devices in a batch

*1 Data is read from/written to labels stored in a CPU module on another station. ( Page 180 LABEL COMMUNICATION FUNCTION)

Access to file registers

File registers can be accessed by specifying 'R' or 'ZR' in a MELSEC data link function.

When a file register of an access target CPU module consists of multiple blocks (when accessing file registers having more than 32K points), specify 'ZR' that is a device code of the serial number method.

For details on accessing file registers by the serial number method, refer to the following:

 MELSEC iQ-R CPU Module User's Manual (Application)

Precautions

A file register that "Use File Register of Each Program" is set for "File Register Setting" in CPU parameters of a CPU module cannot be accessed.

Access from MELSOFT products or GOTs

Devices or buffer memory of another module can be accessed via this product from a MELSOFT product or GOT which is connected to this product or from a MELSOFT product which runs on Windows in this product.

For details, refer to the manual of a product used. ( Manual of a product used)

12.2 Data Communication Between CPU Modules

Data can be sent or received between CPU modules in a multiple CPU system.

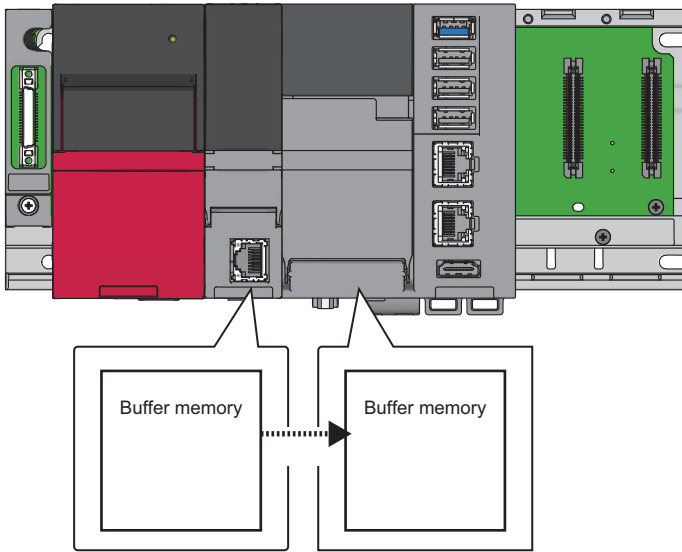

The direct access communication enables data writing or reading between CPU modules.

The methods for the data communication are as follows:

Communication method	Purpose	Description
Data communication with CPU buffer memory	Use this method when sending or receiving data at the timing of each CPU module.	The sending side CPU module writes data to the CPU buffer memory in the host CPU. The receiving side CPU module reads data from the CPU buffer memory of the send target CPU module (another CPU module). For the communication method, refer to the following: ☞ Page 119 Data communication with CPU buffer memory
Data communication with fixed scan communication area	Use this method when sending or receiving data with adjusting the timing between CPU modules.	The sending side CPU module writes data to the fixed scan communication area (send area) in the host CPU. The receiving side CPU module reads data from the fixed scan communication area (receive area) in the CPU module of the send source CPU module.

Memory used

The following describes the memory configuration of CPU buffer memory to be used for data communication.

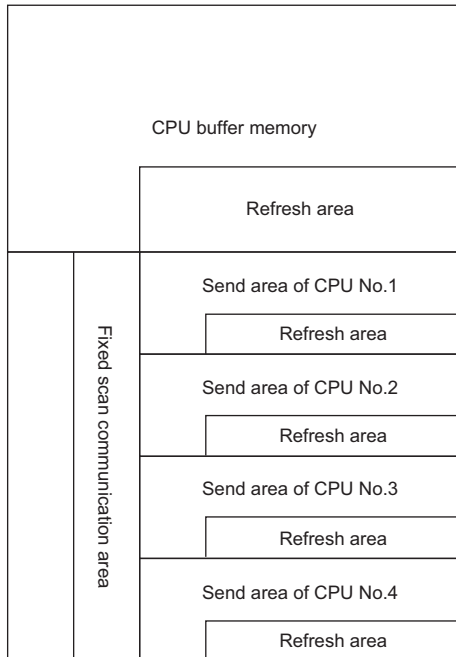

Memory	Communication method	Description	Area size
CPU buffer memory	Communication by direct access	This area reads/writes data from/to the areas of the host CPU or another CPU module.	512K words fixed
Refresh area in CPU buffer memory			
Fixed scan communication area	Communication by direct access ^{*1}	This area reads/writes data from/to the fixed scan communication area of the host CPU, and is used when the host CPU area and another CPU module transfer the data at the fixed scan communication intervals. Accessibility to the fixed scan communication area depends on the combination between the fixed scan communication function and the inter-module synchronization function. (Page 115 Accessibility to the fixed scan communication area)	It is possible to change within the range of 0 to 24K words in total. The send area as per unit can be set within the range of 0 to 12K words.
Refresh area in the fixed scan communication area			

*1 Data cannot be read or written by the multiple CPU synchronous interrupt (I45); therefore, data between CPU modules cannot be assured when communicating data using the fixed scan communication area. Make sure to assure data using methods such as setting a completion flag in write data.

Point

Data between CPU modules must be communicated by direct access because this product does not support data communication with CPU buffer memory through refresh.

Accessibility to the fixed scan communication area

The following table shows the accessibility to the fixed scan communication area.

○: Accessible, ×: Inaccessible, —: Cannot be set

Inter-module synchronization setting	Multiple CPU setting		Access to the fixed scan communication area
	"Fixed Scan Communication Function"	"Fixed Scan Communication Function and Inter-module Synchronization Function"	
Use	Use	Cooperate	× ^{*1}
		Not cooperated	○
	Not use	—	×

Inter-module synchronization setting	Multiple CPU setting		Access to the fixed scan communication area
	"Fixed Scan Communication Function"	"Fixed Scan Communication Function and Inter-module Synchronization Function"	
"Use Inter-module Synchronization Function in System"	Use	Not cooperated (fixed)	○
	Not use	—	×

*1 When setting "Cooperate" for "Fixed Scan Communication Function and Inter-module Synchronization Function," only modules in which the inter-module synchronization function is set to "Synchronize" can access the fixed scan communication area. If the inter-module synchronization function is set to "Do not Synchronize," an error occurs when accessing the area. An error occurs in this product when accessing the fixed scan communication area because the product does not support the inter-module synchronization function.

Checking memory configuration

The following describes the CPU buffer memory configuration of each CPU.

[System Parameter] ⇒ [Multiple CPU Setting] ⇒ [Communication Setting between CPUs] ⇒ [CPU Buffer Memory Setting] ⇒ [<Detailed Setting>]

Window

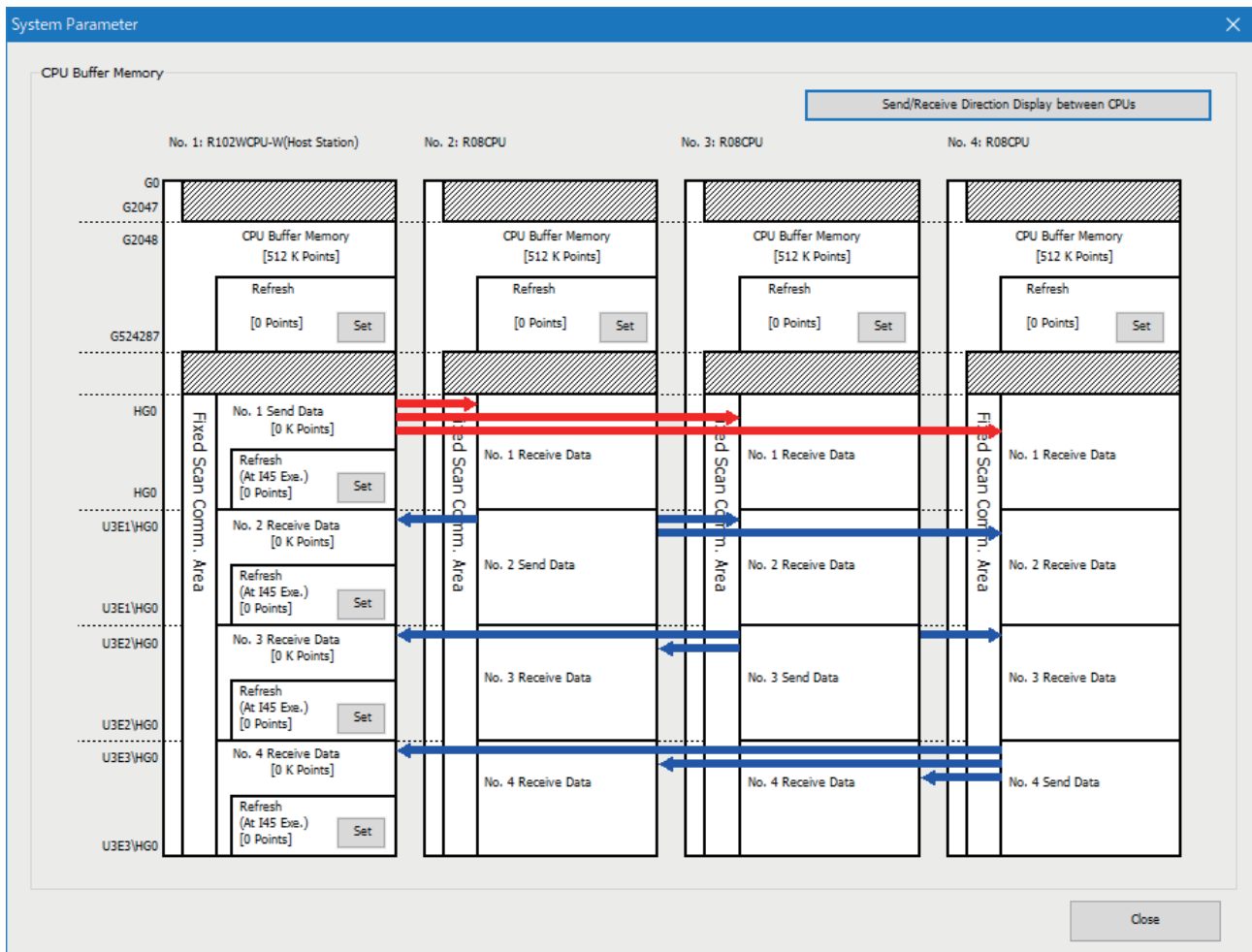

12

Displayed items

Item	Description
[Send/Receive Direction Display between CPUs] button	Click this to display arrows that indicate the send/receive direction.
[Set] button in each refresh area	Click this to display the "Refresh Setting" screen. (Page 118 Refresh setting)

Refresh setting

This product does not have a function that runs with the set refresh area. However, to use refresh areas, the refresh area settings for CPU modules in a multiple CPU system must be set to unify the settings in all CPUs.

☞ [System Parameter] ⇒ [Multiple CPU Setting] ⇒ [Communication Setting between CPUs] ⇒ [CPU Buffer Memory Setting] ⇒ [Detailed Setting] ⇒ [Set]

Window

Setting No.	Device		
	Points	Start	End
☐ No. 1(Send)			
☐ Total	0/522240 Points		
1			
2			
3			
4			
5			
6			
7			
8			
9			

Explanation
Set the display setting.

Check Restore the Default Settings OK Cancel

For the number of points for refresh areas in the host CPU (this product), set items as shown below:

- Refresh (At the END): 0 points
- Refresh (At I45 Exe.): 0 points

For the number of points for refresh areas in another CPU module, set items as below:

Another CPU module (communication destination)	Description
Programmable controller CPU	<ul style="list-style-type: none"> • Refresh (At the END): The same number of points as programmable controller CPU (communication destination) • Refresh (At I45 Exe.): The same number of points as programmable controller CPU (communication destination)
C Controller module	<ul style="list-style-type: none"> • Refresh (At the END): 0 points • Refresh (At I45 Exe.): 0 points

Data communication with CPU buffer memory

This method writes device data of the host CPU to the CPU buffer memory of the host CPU with MELSEC data link functions. Device data that is written to the CPU buffer memory is transferred when the following processing is performed in another CPU module.

Data communication flow

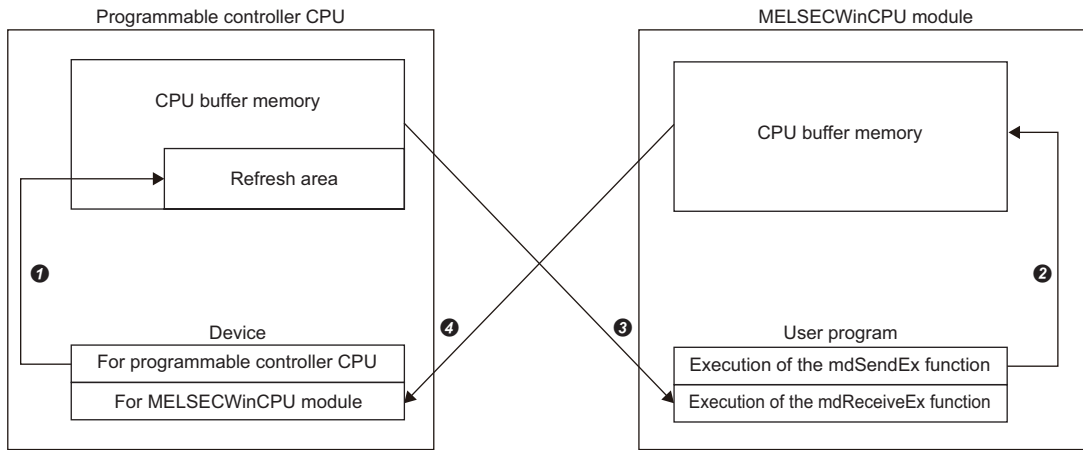

■ Processing contents of the END processing in a programmable controller CPU

- ①: Device data for a programmable controller CPU is transferred to the refresh area.
- ④: Device data of the CPU buffer memory in this product is transferred to devices for MELSECWinCPU module in the programmable controller CPU.

■ Processing contents when a function of this product is executed

- ②: Device data of a user program is written to the CPU buffer memory with the mdSendEx function.
- ③: Device data in the CPU buffer memory of the programmable controller CPU is read to the user program with the mdReceiveEx function.

Data communication with fixed scan communication area

This method writes device data of each CPU to the fixed scan communication area of the host CPU in a cycle set in the fixed scan communication setting. Device data that is written to the fixed scan communication area is sent to that area of another CPU module, and then is read by the module.

Data communication flow

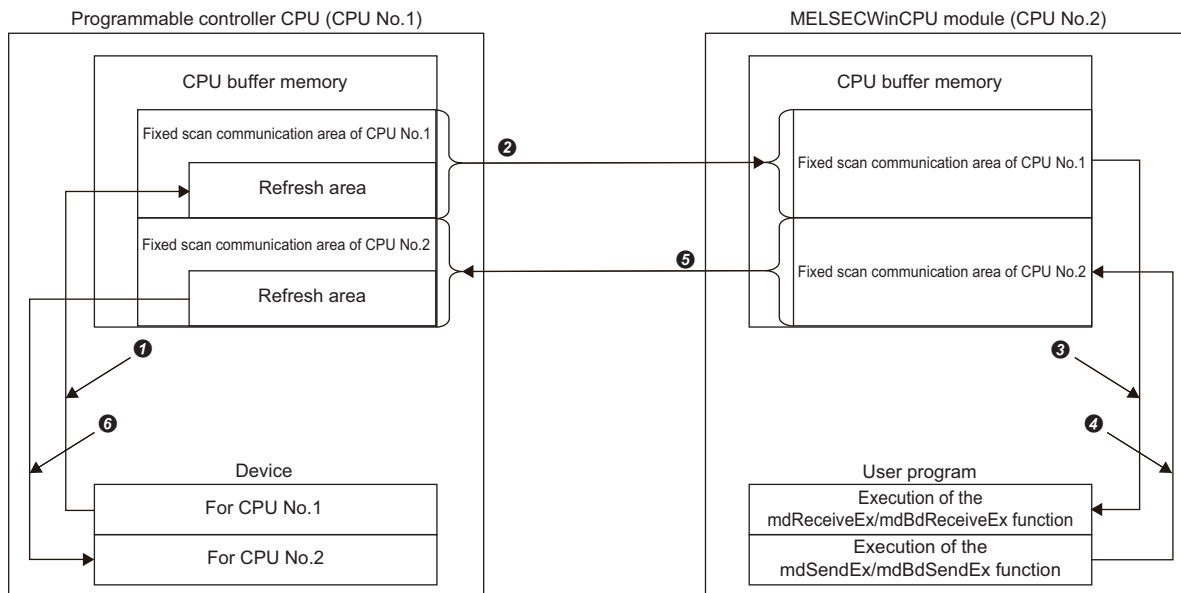

■ Processing contents of the END processing in a programmable controller CPU

- ①: Device data for CPU No.1 is transferred to the refresh area of the fixed scan communication area.
- ②: Device data in the fixed scan communication area of CPU No.1 is sent to CPU No.2.
- ⑥: Device data stored in the refresh area of the fixed scan communication area is transferred to devices for CPU No.2.

■ Processing contents when a function of this product is executed

- ③: Device data in the fixed scan communication area is read to the user program with the mdReceiveEx function or the mdBdReceiveEx function.
- ④: Device data of the user program is written to the fixed scan communication area with the mdSendEx function or the mdBdSendEx function.
- ⑤: Device data in the fixed scan communication area of CPU No.2 is sent to CPU No.1.

Data communication settings

The following shows the settings for performing data communication using the fixed scan communication area.

■Use of the setting

To communicate data using the fixed scan communication area, select "Use" for "Fixed Scan Communication Function."

 [System Parameter] ⇒ [Multiple CPU Setting] ⇒ [Communication Setting between CPUs] ⇒ [Fixed Scan Communication Function]

Window

Communication Setting between CPUs	
CPU Buffer Memory Setting	<Detailed Setting>
PLC Unit Data	Disable(Not notified the reading completion to other PLC)
Fixed Scan Communication Function	Not Use

12

Displayed items

Item	Description	Setting range	Default
Fixed Scan Communication Function	Set whether to 'Use' or 'Not Use' other PLC and data communication function (fixed scan communication function) regularly in specified interval. PLC which using fixed scan communication function should be set as same.	<ul style="list-style-type: none"> • Not Use • Use 	Not Use

■Fixed scan communication area setting

Set the send area range (the total of areas used for direct access communication) for each CPU in the fixed scan communication area. The range of the fixed scan communication area can only be changed in the parameter settings. The other areas cannot be changed.

 [System Parameter] ⇒ [Multiple CPU Setting] ⇒ [Communication Setting between CPUs] ⇒ [Fixed Scan Communication Area Setting]

Window

Fixed Scan Communication Area Setting	
Total [K Word]	0 K Word
PLC No. 1 [Start XY: U3E0]	0 K Word
PLC No. 2 [Start XY: U3E1]	0 K Word
PLC No. 3 [Start XY: U3E2]	0 K Word
PLC No. 4 [Start XY: U3E3]	0 K Word

Displayed items

Item	Description	Setting range	Default
Total [K Word]	The total value is displayed.	Entire system: 0 to 24K words ^{*1}	—
PLC No.1 [Start XY: U3E0]	Set the send area size for CPU No.1.	0 to 12K words	0 K word
PLC No.2 [Start XY: U3E1]	Set the send area size for CPU No.2.		
PLC No.3 [Start XY: U3E2]	Set the send area size for CPU No.3.		
PLC No.4 [Start XY: U3E3]	Set the send area size for CPU No.4.		

*1 The maximum area size which can be set in the fixed scan communication area setting varies depending on the fixed scan interval.
( Page 123 Fixed scan interval setting)

Fixed scan communication cycle	Maximum area size which can be set in the fixed scan communication area
0.10 ms	12K words
0.15 ms	20K words
Other than above	24K words

Even if a CPU which does not use the fixed scan communication function exists, it will not cause an error by setting the send area of the fixed scan communication area for the CPU with the fixed scan communication function set to "Not Use" (that is, unset) in the host CPU parameter setting. This is because the unset CPU is regarded as a reserved CPU for future setting.

(Example) When the host CPU is set as CPU No.1 and "Fixed Scan Communication Function" is set to "Not Use" for CPU No.4 in a system configured with four CPUs

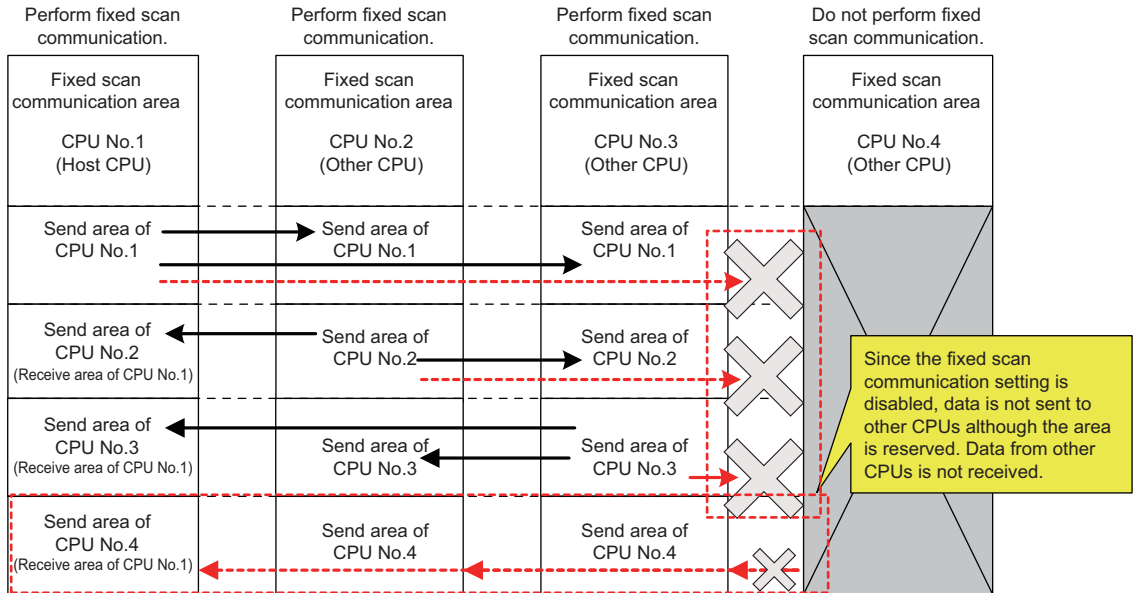

■Fixed scan interval setting

This product does not have a function that runs in the set fixed scan interval. However, to use the fixed scan communication area, the interval for data transmission between CPU modules in a multiple CPU system must be set to unify the setting in all CPUs.

🔗 [System Parameter] ⇒ [Multiple CPU Setting] ⇒ [Communication Setting between CPUs] ⇒ [Fixed Scan Communication Setting] ⇒ [Fixed Scan Interval Setting of Fixed Scan Communication]

Window



Displayed items

Item	Description	Setting range	Default
0.05ms Unit Setting	Set whether to 'Set' or 'Not Set' fixed scan interval of fixed scan communication in 0.05 ms unit.	<ul style="list-style-type: none"> • Not Set • Set 	Not Set
Fixed Scan Interval Setting (Not set in 0.05ms unit)	Set the fixed scan interval of fixed scan communication. Please set the same setting for the PLC No. using fixed scan communication function.	<ul style="list-style-type: none"> • 0.222ms • 0.444ms • 0.888ms • 1.777ms • 3.555ms • 7.111ms 	0.888ms
Fixed Scan Interval Setting (Set in 0.05ms unit)* ¹	Set the fixed scan interval of fixed scan communication in 0.05 ms unit. Please set the same setting for the PLC No. using fixed scan communication function.	0.10 to 10.00ms	0.10ms
Fixed Scan Communication Function and Inter-module Synchronization Function	Set whether to 'Cooperate' or 'Not cooperated' fixed scan communication function and inter-module synchronization function operation or not. Fixed scan communication operate by fixed scan interval of synchronization between set modules in synchronization setting between modules when setting combination. (Unable to set fixed scan interval in fixed scan communication setting)	<ul style="list-style-type: none"> • Not Cooperated • Cooperate 	Not Cooperated

*1 The maximum area size which can be set in the fixed scan communication area setting varies depending on the fixed scan interval.
(🔗 Page 121 Fixed scan communication area setting)

Point

The send image for the fixed scan communication can be checked by selecting "Fixed Scan Communication Function Operation Image Display."

Data assurance for accessing CPU buffer memory

The methods for data assurance when accessing CPU buffer memory are as follows:

Restriction

This product does not support CPU number-based data assurance; therefore, the data inconsistency control cannot be performed by a system. To prevent data inconsistency, perform the method described in 'Prevention of 64-bit data inconsistency' or 'Data assurance by program.'

Note that, however, setting CPU number-based data assurance is required for all CPUs in a multiple CPU system because the setting of the CPUs must be the same. (Page 155 CPU Number-Based Data Assurance Setting)

Prevention of 64-bit data inconsistency

To prevent 64-bit data inconsistency, access the specified start address of the CPU buffer memory in multiples of four similarly to the device to be specified.

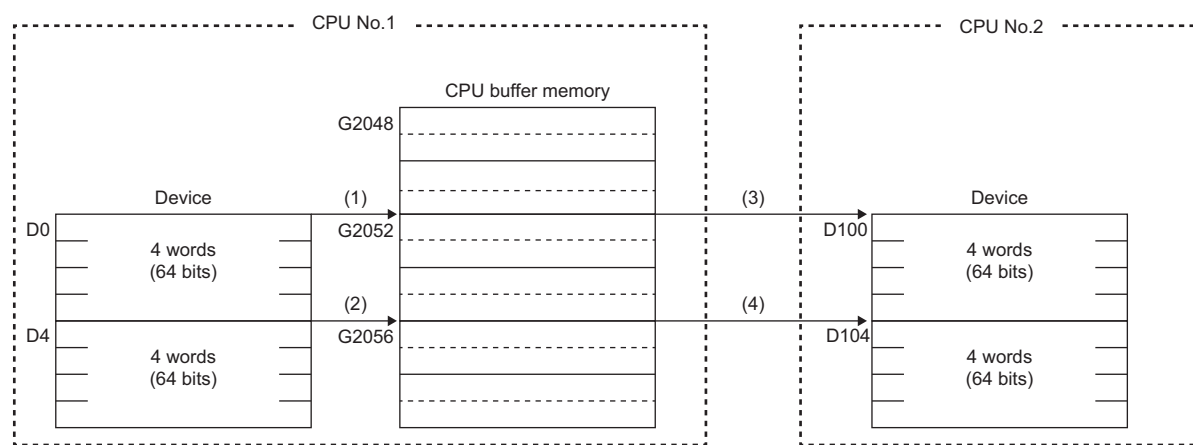

(1) and (2): The 64-bit data is assured and written to CPU buffer memory.
 (3) and (4): The 64-bit data is assured and read from CPU buffer memory.

Data assurance by program

To prevent data inconsistency, set a device for interlock when accessing CPU buffer memory.

Memory	Description
CPU buffer memory	A program reads data in order from the start address of the CPU buffer memory (excluding the refresh area). For the write instruction, a program writes send data in order from the end address to the start address of the CPU buffer memory (excluding the refresh area). Therefore, data inconsistency can be prevented by setting a device for interlock at the head of data to be communicated.
Fixed scan communication area	Create an interlock in the same way as when accessing CPU buffer memory.

12.3 Interrupt Notification Reception

This function waits for interrupt event notification from another CPU module, input module, intelligent function module, or interrupt module.

By receiving interrupt event notification, this function can restart the processing of a user program that is waiting for an interrupt event.

For details on functions and creating user programs, refer to the following:

 MELSEC iQ-R MELSECWinCPU Module Programming Manual

Point

When executing an interrupt request, module parameters of each module need to be set.
For details on the setting, refer to the user's manual of each module.

Function list

The following table shows functions to be used in a user program.

Function name	Purpose
CCPU_WaitEvent	To wait for an interrupt event notification from another CPU module*1*2
CCPU_WaitUnitEvent	To wait for an interrupt event notification from modules

- *1 For an interrupt from a programmable controller CPU module (another CPU module), an interrupt request is issued by the D(P).GINT instruction (a dedicated instruction that uses the CPU buffer memory (the fixed scan communication area)) or the M(P).GINT instruction (a dedicated instruction that uses the CPU buffer memory).
For an interrupt from a C Controller module (another CPU module), an interrupt request is issued by the CCPU_DedicatedDInst function (a function that uses the CPU buffer memory (the fixed scan communication area)) or the CCPU_DedicatedMInt function (a function that uses the CPU buffer memory).
- *2 An interrupt request that uses the fixed scan communication area can be used when this product is accessible to the area. ( Page 115 Accessibility to the fixed scan communication area)

Interrupt pointer number and interrupt factor

The following table shows the interrupt factor for each interrupt pointer number.

Interrupt pointer number	Factor	Description
I0 to I15, I50 to I1023	Interrupt from a module	A pointer used in the module which has an interrupt function.

Interrupt from a C Controller module (another CPU)

The following explains the method for restarting a user program that is waiting for an interrupt event by the interrupt from a C Controller module (another CPU module).

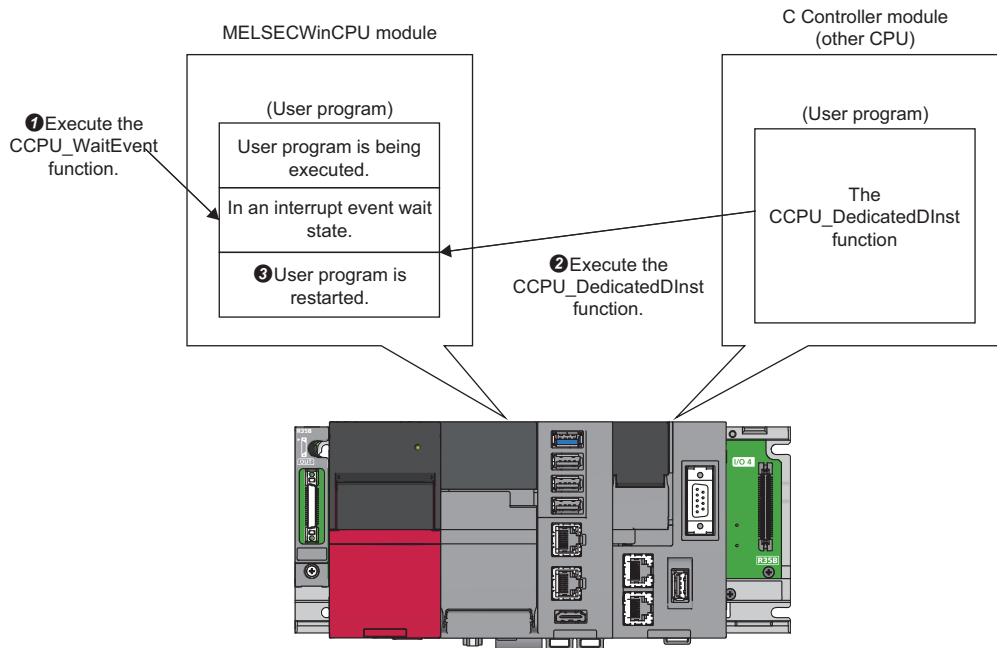

- ❶: Execute the CCPU_WaitEvent function with the user program of this product. The user program will be in the interrupt event wait state.
- ❷: Execute the CCPU_DedicatedDInst function with a user program of a C Controller module (another CPU module). An interrupt event is notified to this product.
- ❸: After this product receives the interrupt event notification, the user program restarts.

Operation timing

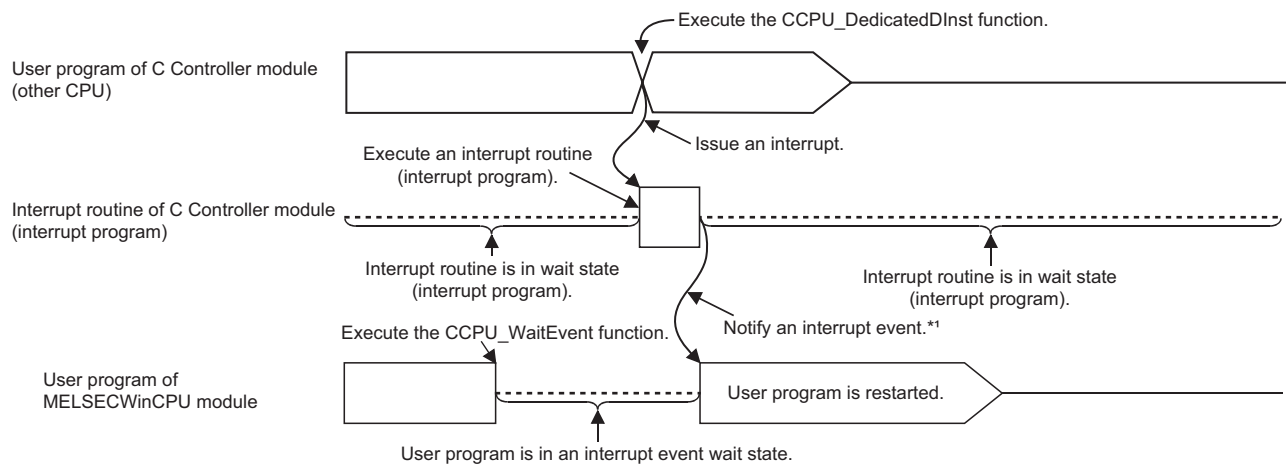

*1: The interrupt event is notified after the interrupt routine (interrupt program) is completed.

Precautions

- When an interrupt event has already been notified from a C Controller module (another CPU) at the time of the CCPU_WaitEvent function execution, the user program is restored from the interrupt event wait state at the same time as the function execution. In addition, when multiple interrupt events have been notified to the same interrupt event number at the time of the CCPU_WaitEvent function execution, the user program processes them as a single interrupt event notification.
- If the same CPU number and the same interrupt event number are set in more than one user program, it will be undefined which one of the user programs receives the interrupt event.

Interrupt from a programmable controller CPU module (another CPU module)

The following explains the method for restarting a user program that is waiting for an interrupt event by the interrupt from a programmable controller CPU module (another CPU module).

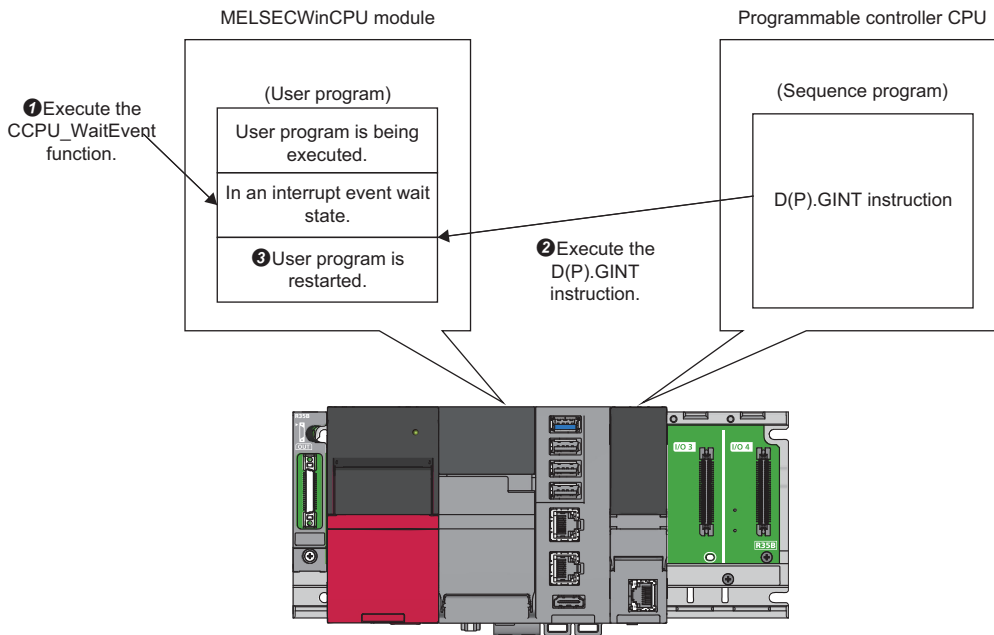

- ❶: Execute the CCPU_WaitEvent function with the user program of this product. The user program will be in the interrupt event wait state.
- ❷: Execute the D(P).GINT instruction with a sequence program of a programmable controller CPU (another CPU module). An interrupt event is notified to this product.
- ❸: After this product receives the interrupt event notification, the user program restarts.

Operation timing

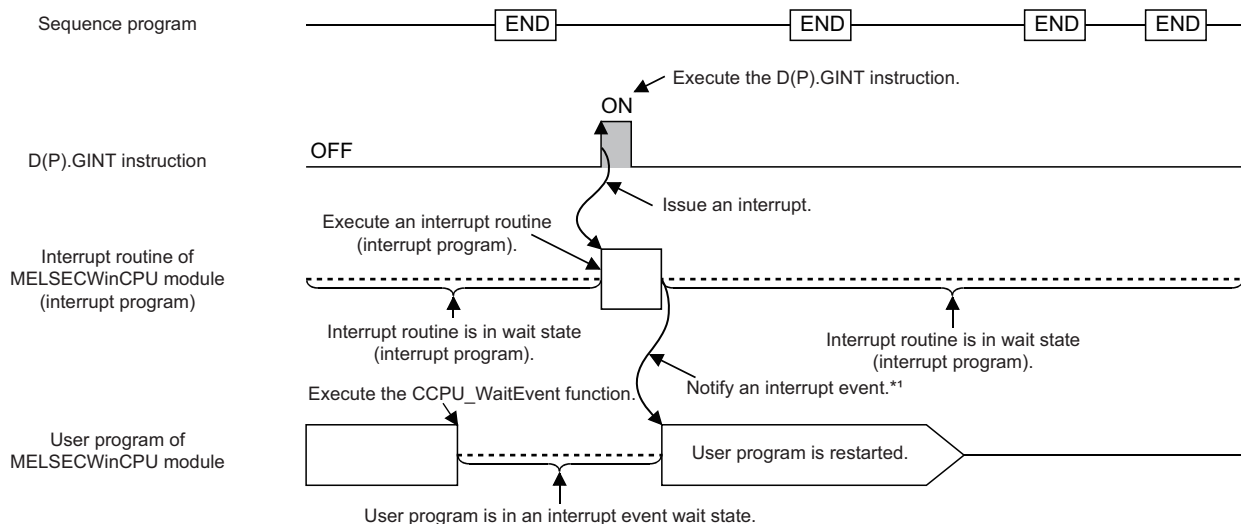

*1: The interrupt event is notified after the interrupt routine (interrupt program) is completed.

Dedicated instruction

The dedicated instructions used for an interrupt from a programmable controller CPU are shown below.

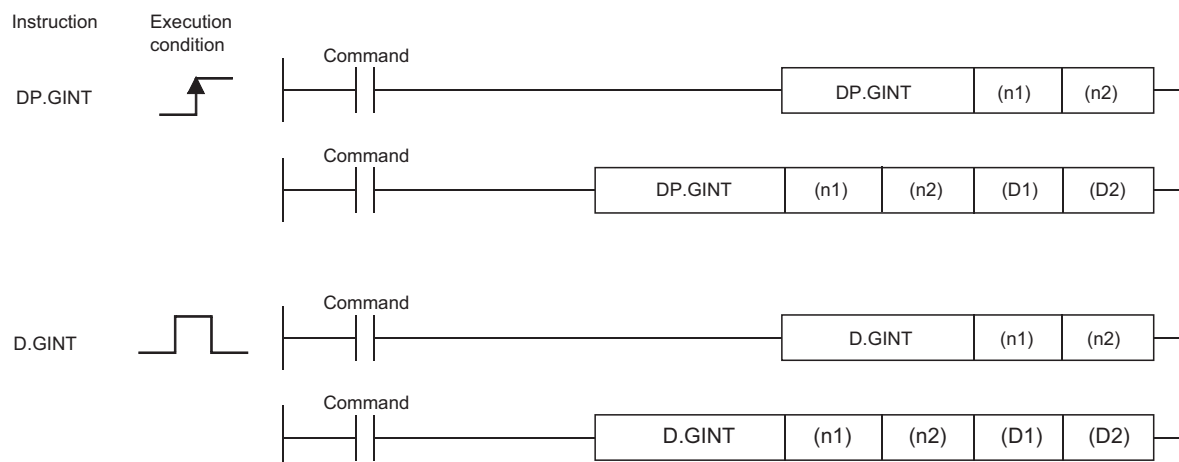

○: Available, △: Partly available

Setting data ^{*1}	Available device											
	Internal device (System, user)		File register		Link direct device J□□		Module access device J□□		Index register Z□	Constant		Others
	Bit	Word	Bit	Word	Bit	Word	Bit	Word		Dec K, Hex H	Float, string	
(n1)	—	○	—	○	—	—	—	—	—	○	—	—
(n2)	—	○	—	○	—	—	—	—	—	○	—	—
(D1) ^{*2}	△ ^{*3}	—	△ ^{*3}	—	—	—	—	—	—	—	—	—
(D2) ^{*2}	—	△ ^{*3}	—	△ ^{*3}	—	—	—	—	—	—	—	—

*1 Can be index-modified. (Constant is excluded.)

*2 Can be omitted only when both of (D1) and (D2) are omitted.

*3 Local devices cannot be used.

Setting data

Setting data	Setting content	Setting side	Data type
(n1)	The start I/O number of the target CPU divided by 16 The values to be specified actually are as follows: CPU No.1: 3E0H, CPU No.2: 3E1H, CPU No.3: 3E2H, CPU No.4: 3E3H	User	BIN16 bits
(n2)	Interrupt pointer number (0 to 15)	User	BIN16 bits
(D1) ^{*1}	(D1+0): Device that is turned ON for one scan upon completion of the instruction processing (D1+1): Device that is turned ON for one scan upon abnormal completion of the instruction processing (For abnormal completion, D1+0 also turns ON.)	System	Bit
(D2) ^{*1}	Device where the completion status is stored.	System	Word

*1 Can be omitted only when both of (D1) and (D2) are omitted.

■Control details

Create a sequence program so that an interrupt occurs in this product when the execution command of the D(P).GINT instruction rises (OFF → ON).

When received an interrupt from a programmable controller CPU, this product restarts a user program which is waiting for an interrupt event with the CCPU_WaitEvent function.

■Error details

In either of the following cases, an interrupt completes abnormally, and an error code is stored in the device specified with the completion status storage device (D2).

Error code*1	Description	Corrective action
0010H	The instruction request from the programmable controller CPU to this product exceeds the allowable value.	Check and correct the sequence program.
2282H	The interrupt pointer number set with the D(P).GINT instruction is out of the range of 0 to 15.	

*1 "0000H" is stored when the processing is normally completed.

In any of the following cases, an operation error occurs and the latest self-diagnostic error (SM0) turns ON. Then, an error code is stored in the latest self-diagnostic error code (SD0).

Error code	Description	Corrective action
4350	The specified target CPU module is wrong. <ul style="list-style-type: none"> A CPU number set as reserved has been specified. A CPU number of which module is not mounted has been specified. The start I/O number of the target CPU module divided by 16 (n1) is out of the range of 3E0H to 3E3H. 	Check and correct the sequence program.
4351	The instruction cannot be executed on the specified target CPU module. <ul style="list-style-type: none"> The instruction name is wrong. An instruction which is not supported by the target CPU module was specified. 	
4352	The number of devices of the specified instructions is incorrect.	
4353	An unavailable device is specified in the specified instruction.	

■Program example

- Program in which the completion device and completion status are omitted

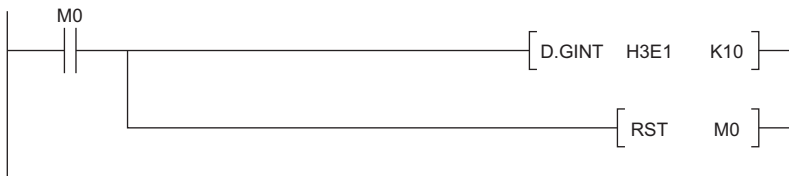

- Program in which the completion device and completion status are used

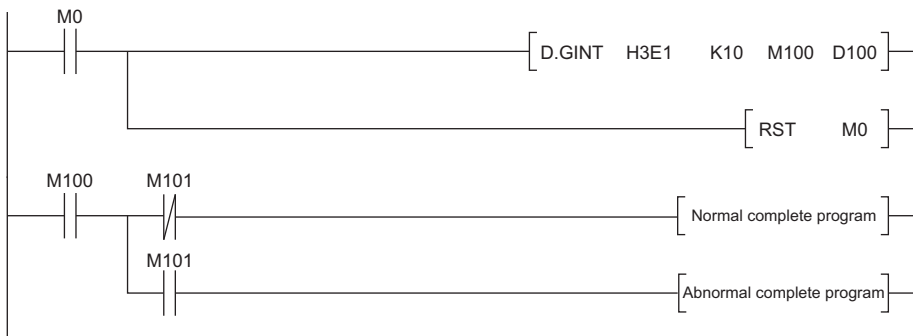

Precautions

- When an interrupt event has already been notified from a programmable controller CPU module (another CPU module) at the time of the CCPU_WaitEvent function execution, the user program is restored from the interrupt event wait state at the same time as the function execution. In addition, when multiple interrupt events have been notified to the same interrupt event number at the time of the CCPU_WaitEvent function execution, the user program processes them as a single interrupt event notification.
- If the same CPU number and the same interrupt event number are set in more than one user program, it will be undefined which one of the user programs receives the interrupt event.

Interrupt from a module

The following explains the method for restarting a user program that is waiting for an interrupt event by the interrupt from a module.

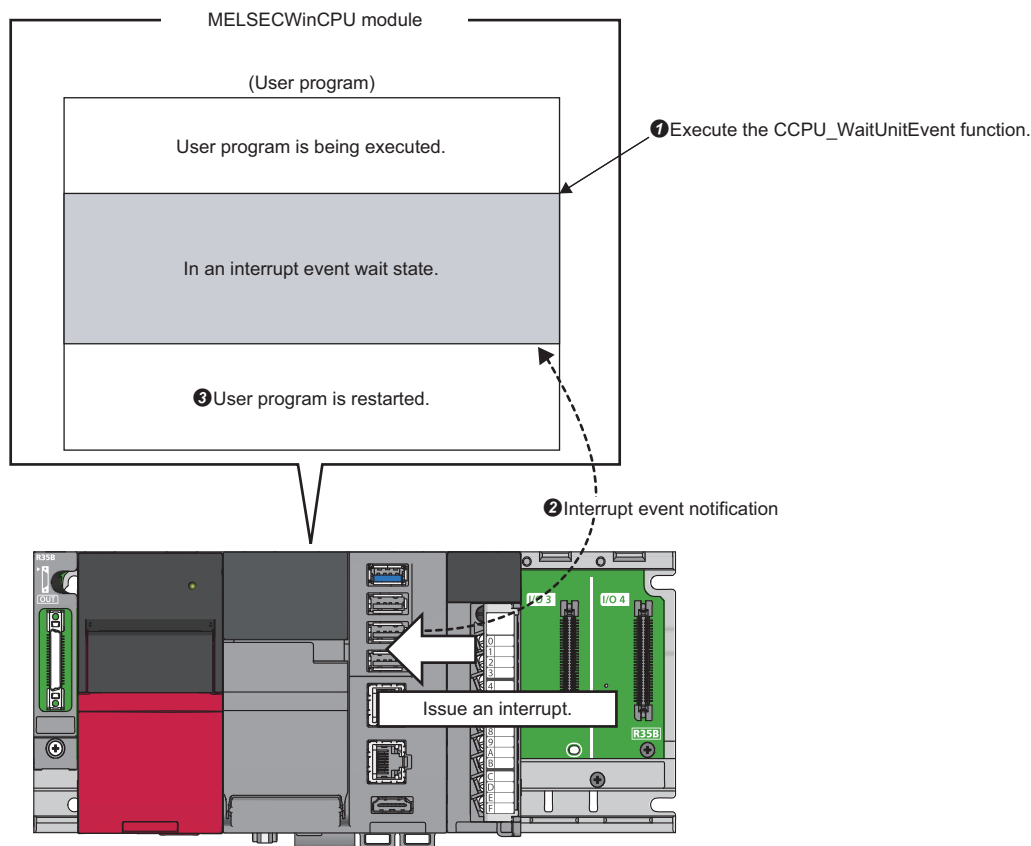

1: Execute the CCPU_WaitUnitEvent function with the user program of this product.

The user program will be in the interrupt event wait state.

2: Issue an interrupt request with an input module, intelligent function module, or interrupt module.

An interrupt event is notified to this product.

3: After this product receives the interrupt event notification, the user program restarts.

Precautions

- When an interrupt event has already been notified from a module at the time of the CCPU_WaitUnitEvent function execution, the user program is restored from the interrupt event wait state at the same time as the function execution. In addition, when multiple interrupt events have been notified to the same interrupt event number at the time of the CCPU_WaitUnitEvent function execution, the user program processes them as a single interrupt event notification.
- If the same CPU number and the same interrupt event number are set in more than one user program, it will be undefined which one of the user programs receives the interrupt event.

13 MELSOFT CONNECTION FUNCTION

This function connects MELSOFT products on a network and this product by using the Ethernet port of this product.



CW Configurator which runs on this product is connected by using the MELSOFT connection function.

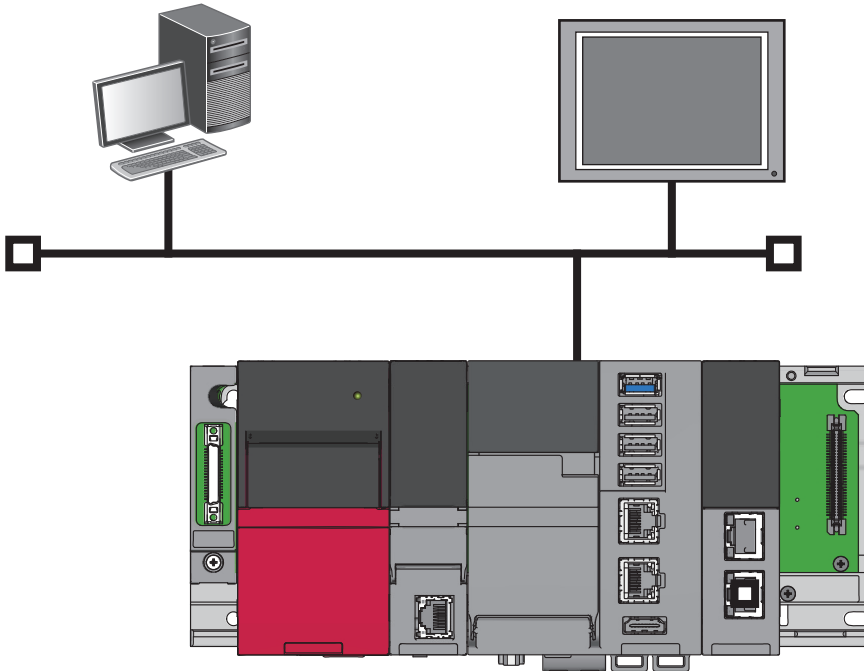

Precautions

■Windows operating status and function operation

The MELSOFT connection function does not run when Windows installed on this product is not running (such as during restart and shutdown).

■Operation when resetting a bus

When resetting a bus, all of the MELSOFT products connected to this product will be disconnected. After the READY LED turns ON, reconnect them after a while.

■Ethernet port to be used

Do not use the Ethernet port that is used for the MELSEC connection function for other applications.

Port number		Purpose
Dec	Hex	
5006	138EH	MELSOFT transmission port (UDP/IP)
5007	138FH	MELSOFT transmission port (TCP/IP)
5008	1390H	MELSOFT direct connection port
5100	13ECH	For system
50300	C47CH	For system

■Connection destination specification in GX Works3

When specifying a connection destination in GX Works3, a CPU search is not available for an Ethernet connected route.

13.1 Connection Method

This section explains the method for connecting MELSOFT products.

1. Allow the MELSOFT connection function in the firewall settings. (Page 134 Firewall settings)
2. Set the connection configuration for a target device in CW Configurator. (Page 136 CW Configurator settings)

Firewall settings

At factory default settings of this product, the MELSOFT connection function is blocked by a firewall for security.

To connect MELSOFT products from an external personal computer using the MELSOFT connection function, allow the communication with Windows Defender Firewall or antivirus software used.

For Windows Defender Firewall, enable the 'Inbound Rules' for the following items.

- File and Printer Sharing (Echo Request - ICMPv4-In)*1
- File and Printer Sharing (Echo Request - ICMPv6-In)*1
- MELSOFT Communication Service

*1 To connect this product to a network configured by a single network segment (subnet), enable 'Inbound Rules' where a network profile is set to 'Private.'

To connect this product to a corporate network or the Internet, consult the corresponding network administrator for an internet protocol (IPv4 or IPv6) and a network profile (private, public, or domain) for which 'Inbound Rules' can be enabled.

Procedure for enabling 'Inbound Rules' in Windows Defender Firewall

The following shows the example of enabling 'File and Printer Sharing (Echo Request - ICMPv4-In).'

1. Select "Windows Defender Firewall with Advanced Security" under "Windows Administrative Tools."
- Windows Start ⇒ [Windows Administrative Tools] ⇒ [Windows Defender Firewall with Advanced Security]
2. Select "Inbound Rules" from "Windows Defender Firewall with Advanced Security on Local Computer" in the "Windows Defender Firewall with Advanced Security" screen.

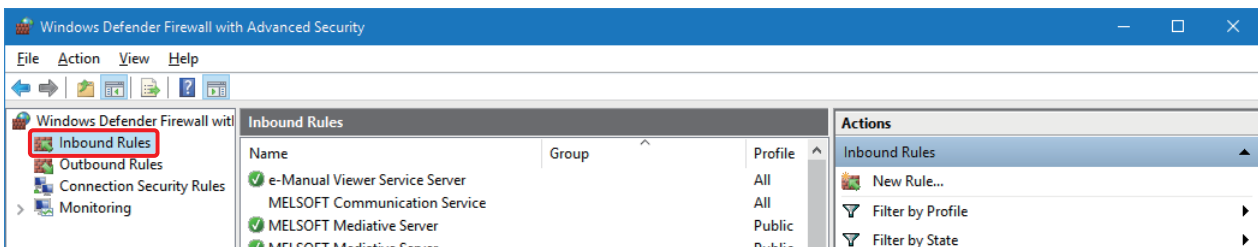

3. Select "File and Printer Sharing (Echo Request - ICMPv4-In)" from the [Inbound Rules] view, and select "Enable Rule" in the [Actions] view.

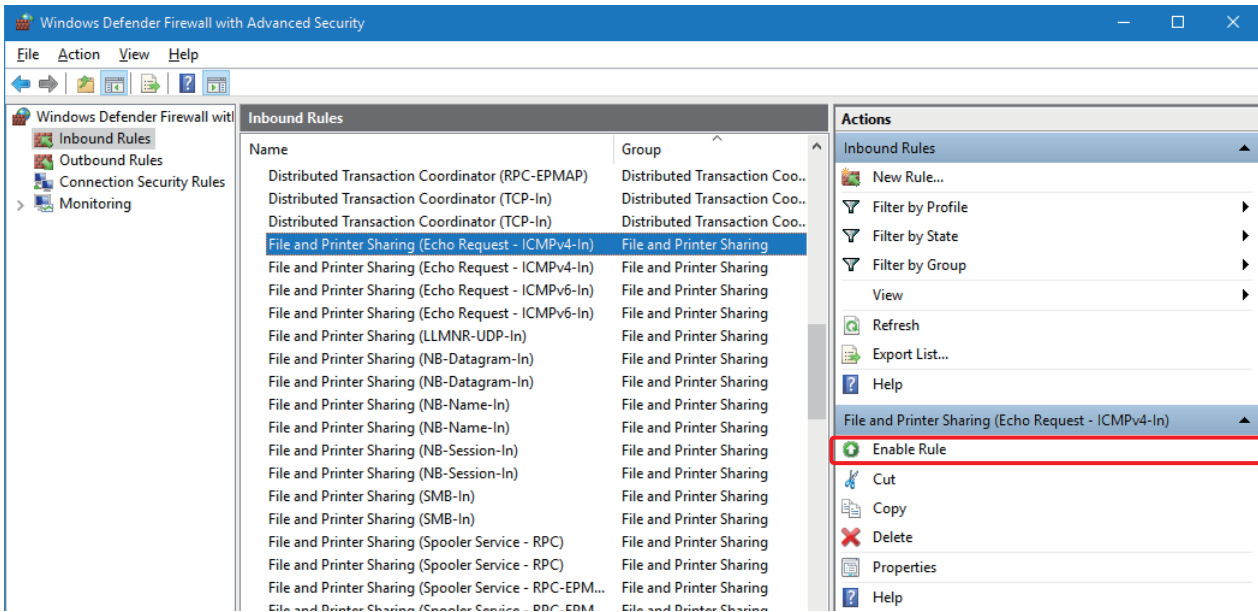

4. Check that the selected "File and Printer Sharing (Echo Request - ICMPv4-In)" is enabled (marked with a check mark) in the [Inbound Rules] view.

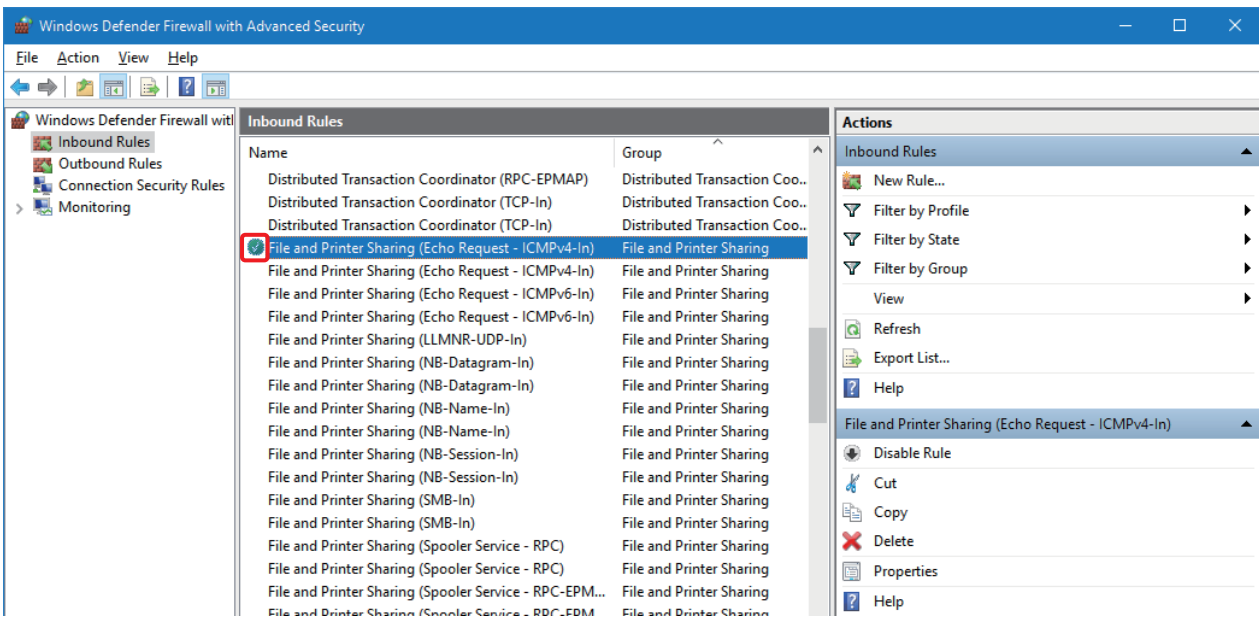

CW Configurator settings

The following explains the settings of CW Configurator.

Connection method	Description
Connection via a hub (specifying an IP address)	<ul style="list-style-type: none"> Connecting with a MELSECWinCPU module that has no network number and station number Connecting with multiple MELSOFT products or GOTs
Direct connection (without specifying an IP address, network number, and station number)	<ul style="list-style-type: none"> Connecting with a target device on 1:1 basis by using one Ethernet cable without a hub Connecting with a MELSECWinCPU module of which IP address is unknown

Connection via a hub

The following explains the setting procedure when connecting a MELSECWinCPU module with target devices via a hub. To use this connection method, set "MELSOFT Connection Module" in the external device configuration. ( Page 141 External device configuration)

Point

When connecting multiple MELSOFT products with TCP/IP connection, drag "MELSOFT Connection Module" from "Module List" in the external device configuration and drop it onto the device list or device map area for the number of MELSOFT products to be connected. ( Page 137 Connecting a target device (with the same IP address as this product) and this product by using multiple MELSOFT connections (TCP/IP) simultaneously)

Operating procedure

1. Set "Ethernet Board" for "PC side I/F" in the "Specify Connection Destination" screen.

 [Online] ⇒ [Current Connection Destination]

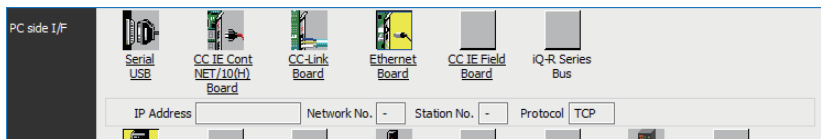

2. Double-click "Ethernet Board."

The "PC side I/F Detailed Setting of Ethernet Board" screen is displayed.

3. Select "TCP" or "UDP" for "Protocol."

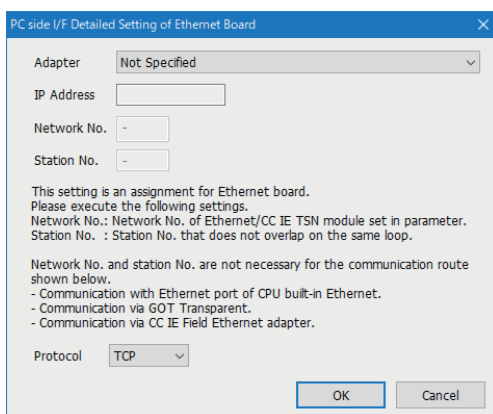

4. Set a module to be connected for "PLC side I/F."

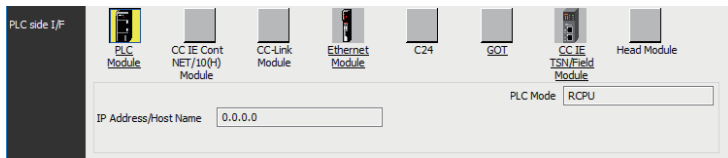

5. Double-click the icon for the set module.

The "PLC side I/F Detailed Setting" screen is displayed.

6. Select "Connection via HUB," and enter the IP address or host name of this product.

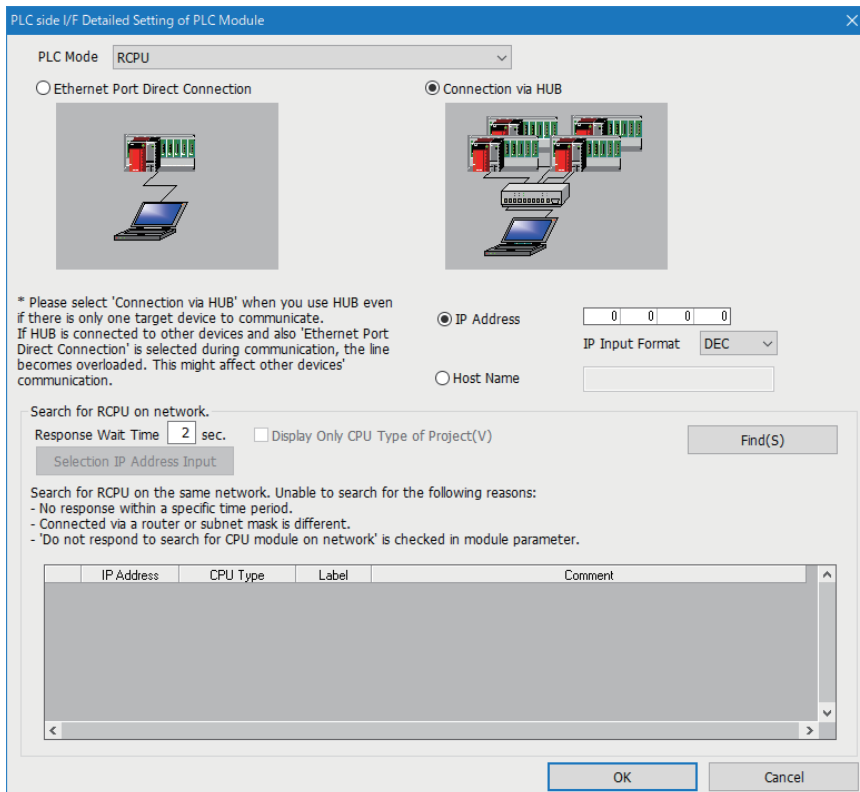

7. Click the [OK] button.

8. Set "Other Station Setting" and "Network Communication Route" as necessary.

Precautions

■Connecting a target device (with the same IP address as this product) and this product by using multiple MELSOFT connections (TCP/IP) simultaneously

Even when setting multiple MELSOFT connections (TCP/IP) in the external device configuration, some of the connections may not be established.

To use multiple MELSOFT connections, set the following setting for the connection destination of MELSOFT products.

Condition	Setting content
All the MELSOFT products to be connected simultaneously can specify an Ethernet board adapter for their connection destination settings.	Specify the same Ethernet board adapter for the connection destination settings.
Some of the MELSOFT products to be connected simultaneously cannot specify an Ethernet board adapter for their connection destination settings.	Specify "Not Specified" for the adapter setting in the connection destination setting of all MELSOFT products to be connected.*1

*1 For MELSOFT products which cannot specify an adapter, the setting will be the same as that of when "Not Specified" is specified for the adapter setting.

Direct connection

The following explains the setting procedure when connecting a MELSECWinCPU module and a target device. To use this connection method, set "Enable" for "Disable Direct Connection with MELSOFT."

[Module Parameter] ⇒ [Application Settings] ⇒ [Security] ⇒ [Disable Direct Connection with MELSOFT]

Window

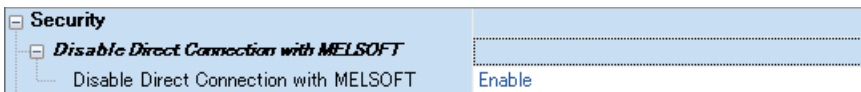

Displayed items

Item	Description	Setting range	Default
Disable Direct Connection with MELSOFT	Select whether to disable the direct connection (easy connection) with the engineering tool.	<ul style="list-style-type: none"> • Disable • Enable 	Enable

Operating procedure

1. Set "Ethernet Board" for "PC side I/F" in the "Specify Connection Destination" screen.

[Online] ⇒ [Current Connection Destination]

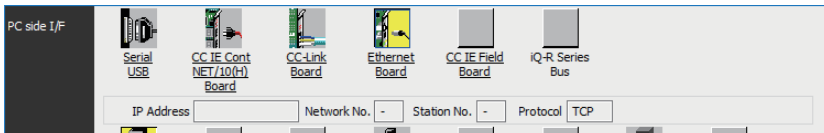

2. Double-click "Ethernet Board."

The "PC side I/F Detailed Setting of Ethernet Board" screen is displayed.

3. Select "TCP" or "UDP" for "Protocol."

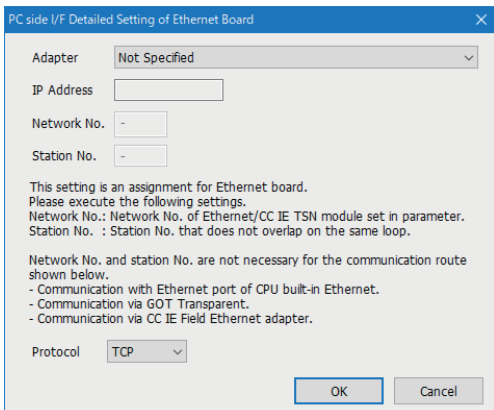

4. Set a module to be connected for "PLC side I/F."

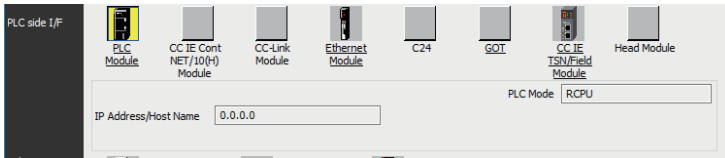

- 5.** Double-click the icon for the set module.
The "PLC side I/F Detailed Setting" screen is displayed.

6. Select "Ethernet Port Direct Connection."

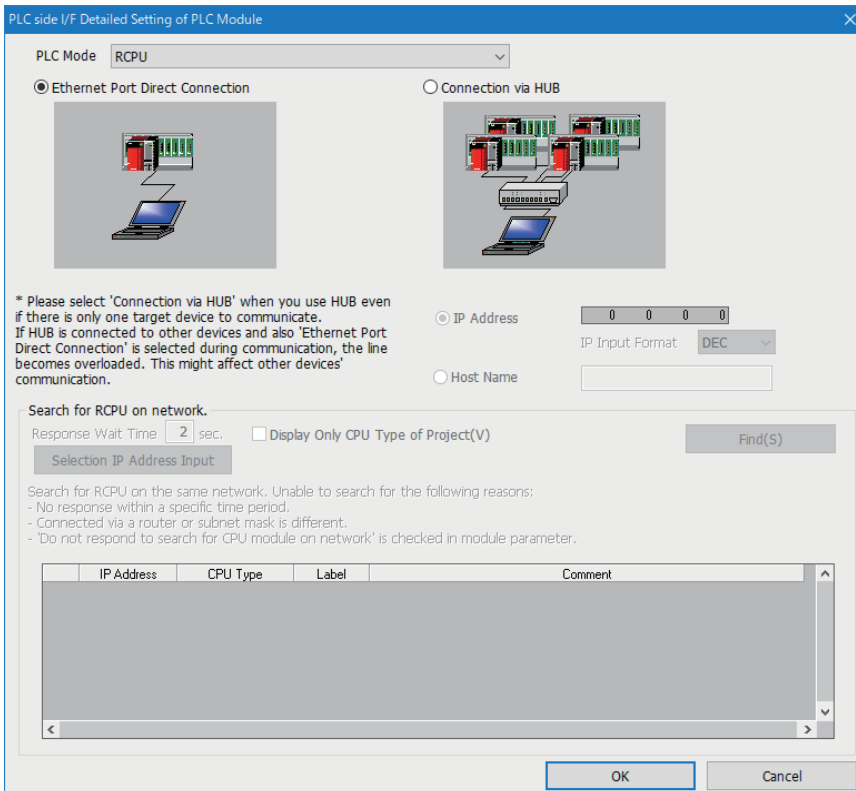

7. Click the [OK] button.

Precautions

■Connection with LAN

Do not connect with LAN and set the direct connection. Since the data will be sent to all the target devices on the LAN, this may increase the line load and affect communication with other target devices.

■Connections not corresponding to direct connection

- Do not create a configuration in which this product and a target device are connected via a hub. Otherwise, a direct connection will not be established.
- If two or more Ethernet ports are set to "Enable" in the network setting on the personal computer, a direct connection cannot be established. Review the setting of the personal computer so that only one Ethernet port to be used for the direct connection is set to "Enable", and the other Ethernet ports are set to "Disable."

■Conditions that cannot communicate with a direct connection

A direct connection may not be established if any of the following conditions are satisfied. In this case, review the settings.

The examples of the error occurrence are as follows:

- When all the bits of the IP address of this product that correspond to 0 part of the personal computer-side subnet mask are ON or OFF

Item	Description
IP address of this product	64.64.255.255
IP address of a personal computer	64.64.1.1
Subnet mask of a personal computer	255.255.0.0

- When all the bits of the IP address of this product that correspond to the host address of each class of the personal computer-side IP address are ON or OFF

Item	Description
IP address of this product	64.64.255.255
IP address of a personal computer	192.168.0.1
Subnet mask of a personal computer	255.0.0.0

External device configuration

Select the method and protocol used for communicating with a target device.

[Module Parameter] ⇒ [Basic Settings] ⇒ [External Device Configuration] ⇒ [<Detailed Setting>]



Only MELSOFT connection modules are supported.

Window

No.	Model Name	Communication Method	Protocol	Fixed Buffer Send/Receive Setting	PLC		r/D
					IP Address	Port No.	
	Host Station						
1	MELSOFT Connection Modul	MELSOFT Connec	TCP				
2	MELSOFT Connection Modul	MELSOFT Connec	TCP				
3	MELSOFT Connection Modul	MELSOFT Connec	TCP				

Displayed items

Item	Description	Setting range
No.	A connection number to distinguish settings for each user connection.	The number is set in the following range starting with 1. 1 to 16
Model Name	The name of a target device is displayed.	—
Communication Method	Set the method for communication with a target device.	<ul style="list-style-type: none"> • Broadcast Send^{*1} • Broadcast Receive^{*1} • Fixed Buffer (Procedure Exist)^{*1} • Fixed Buffer (No Procedure)^{*1} • Random Access Buffer^{*1} • Predefined Protocol^{*1} • Socket Communication^{*1} • MELSOFT Connection • SLMP^{*1}
Protocol	Select the communication protocol for a target device.	<ul style="list-style-type: none"> • TCP^{*2} • UDP^{*3}
Fixed Buffer Send/Receive Setting	Not required.	—
PLC	IP Address	Not required.
	Port No. ^{**1*4}	Set the port number for each connection of Ethernet-equipped module. 1 to 4999, 5010 to 65534 (Default: Blank)
Sensor/Device	MAC Address	Not required.
	Host Name	Not required.
	IP Address ^{*1}	Set the IP address of a target device. 0.0.0.1 to 223.255.255.254 (Default: Blank)
	Port No. ^{*1}	Set the port number of a target device. To send data to all the port numbers, set '65535.' 1 to 65534, 65535 (Default: Blank)
	Subnet Mask	Not required.
	Default Gateway	Not required.

*1 Cannot be set in this product.

*2 In TCP/IP connection, the module can be connected up to the number calculated by the following formula: (the maximum number of connections in the setting for external device configuration) - (the number of connections whose communication methods are not "MELSOFT Connection") + 1. When a device is connected via multiple connection routes, it is counted as one device for each connection route. For MELSOFT products on a personal computer, each connected MELSOFT product is counted as one device even if they are connected via the same connection route. (When connecting CW Configurator which runs on this product, it is also counted as one device.)

*3 In UDP/IP connection, there is no restriction on the number of connections. However, because simultaneous communication from multiple connected devices can overload network, communication may not be established in such overloaded network conditions.

*4 Own station port numbers 1 to 1023 are numbers for reserved in general (WELL KNOWN PORT NUMBERS), and port numbers 61440 to 65534 are numbers used for other communication functions. Using the port number within the range of 1024 to 4999 or 5010 to 61439 is recommended.

Comment can be set in the "Properties" screen displayed by right-clicking the module in "List of devices" or "Device map area" and selecting "Properties." The following can be performed depending on the selected device.

- Changing the image
- Creating association with a file or application

Existence Confirmation

When this product has not communicated with an external device for a certain period of time while the connection is open, an alive check message is sent from this device to the external device. Whether the external device is alive can be checked if the device can respond to the message.

Item	Protocol	Description
KeepAlive ^{*1}	TCP/IP	This method is used for a connection opened using TCP/IP. This product performs an alive check by sending an alive check ACK message to the target device with which communications have not been performed for a certain period of time and waiting to see whether the response is received. The connection will be automatically closed when the open state is not continued. ^{*2}
UDP	UDP/IP	This method is used for a connection opened using UDP/IP. This product performs an alive check by sending the PING command (ICMP echo request/response function) to the target device with which communications have not been performed for a certain period of time and waiting to see whether the response is received. ^{*3}
Do not confirm existence	TCP/IP, UDP/IP	Alive check is not performed.

*1 Sends a presence confirmation message 22 seconds after the last message is received from a target device, and checks if there is a response from the target device. If there is no response, then presence confirmation messages are sent in 1 second intervals. If responses cannot be confirmed after 8 seconds (30 seconds after the final message was received), then the target device will be considered not present, and the connection will be disconnected.

*2 If the target device does not support the TCP KeepAlive function (response to KeepAlive ACK message), the connection will be disconnected.

*3 If an Ethernet-equipped module receives a PING command echo request command, an echo response packet will be sent in response automatically. (Even if the connection used for data communications with the target device is closed, this will send a response to the received PING command.)

In TCP connections, if there is no ACK response of the TCP/IP protocol to the transmission from a target device, the retransmission processing will be performed at the retransmission count and interval which are shown below. If there is no ACK response of the TCP/IP protocol in 60 seconds after the last retransmission, the target device will be considered faulty and the connection will be disconnected.

- Retransmission count^{*1}: 12 times
- Retransmission interval^{*2}: $(\text{The number of retransmissions} \times \text{the number of retransmissions} \times \text{RTO}^{\ast 3}) \div 1024$ (seconds)

*1 After 30 seconds from the establishment of the connection, a destination device error is assumed and the connection is disconnected even if the number of retransmissions does not reach 12 times.

*2 The maximum value of the retransmission time is 60 seconds.

*3 RTO (retransmission timeout) is a value that increases exponentially based on RTT (round-trip time).

Setting method

- From "Module List," select a target device to be connected, and then drag and drop (3) it to the device list (1) or device configuration (2).

- Set each item.
- Click the [Close with Reflecting the Setting] button.

Restriction

Setting a target device from connection No.1 is required in the external device configuration.

If using a specific connection number, set "MELSOFT connected device" to the target device with the unused connection number.

- When using only the connection No.5

14 TIME SYNCHRONIZATION FUNCTION

This function synchronizes time between this product (Windows) and the CPU module (CPU No.1) when configuring a multiple CPU system.

Point

By synchronizing time with the CPU module (CPU No.1), the entire system can be managed with synchronized time. This enables this product to troubleshoot errors easily according to the occurrence time.

Time synchronization setting

To synchronize time, set "Time Synchronization Setting" to "Synchronize."

[CPU Parameter] ⇒ [Operation Related Setting] ⇒ [Time Setting] ⇒ [Time Synchronization Setting with Multiple CPU (PLC No.1)]

Window

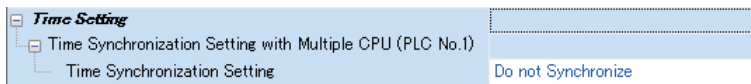

Displayed items

Item	Description	Setting range	Default
Time Synchronization Setting	Set whether to 'Synchronize' or 'Do not Synchronize' the time of the Windows part with the time of the CPU module of PLC No.1. If 'Synchronize' is set, the time of the Windows part is changed to the time of the CPU No.1. If 'Do not Synchronize' is set, the time of the Windows part will not be changed.	<ul style="list-style-type: none"> Do not Synchronize Synchronize 	Do not Synchronize

Point

When setting "Time Synchronization Setting" to "Do not Synchronize," the time of this product will be different from that of a programmable controller system. This causes a time mismatch between the event history and the system which may result in inconsistency in error occurrence time. (Page 150 When not synchronizing time)

When setting time synchronization, the "Date & time" setting on Windows of this product is as follows:

Time synchronization setting	"Date & time" on Windows		
	Current date and time	Time zone	Adjust for daylight saving time automatically
Do not synchronize	Windows time	Time zone of Windows	Complies with time zone
Synchronize	Synchronizes with multiple CPU (CPU No.1)	Synchronizes with the time zone of multiple CPU (CPU No.1)	OFF

Precautions

When setting "Do not Synchronize" for the time synchronization setting, Windows daylight saving time settings are enabled for the time on the programmable controller system of this product. The following conditions must be satisfied to set the Windows daylight saving time settings.

- An area where the time is adjusted for one hour for daylight savings
- An area where daylight saving time starts or ends at 00 minutes.

If the conditions are not satisfied, an error will occur.*1

When using this product in the area where the condition is not satisfied (the time is adjusted for more than one hour), turn OFF "Set time zone automatically" in the 'Date and Time' of Windows to disable Windows daylight saving time settings.

The time data range of programmable controller system for this product is as shown below:

- 1980/1/1 0:00:00 to 2079/12/31 23:59:59

When the time data exceeds the upper range limit, it returns to 1980/1/1 0:00:00. Make sure to operate the system so that Windows time information is within the range.

The time zone range of this product is as shown below:

- -12 hours to +13 hours

Operate the system so that the setting is within the range. Setting a time zone out of range causes an error.*1

*1 When performing the error clear function, the error will not be detected again. To detect the error, take the following measures:

- Restarting Windows
- Resetting the bus
- Turning the power of this product OFF → ON
- Resetting the hardware

14.1 Single CPU System

The time of a programmable controller system will be equal to the time of this product (Windows).
Time information of this product is added to target data as a time stamp.

Data to which a time stamp is added

System	Data to which a time stamp is added	Added time stamp
Programmable controller system	<ul style="list-style-type: none"> Event history Error history 	Windows time
Windows	Event log	

Point

- The time synchronization setting will be ignored even if "Synchronize" is selected for "Time Synchronization Setting."
- Windows time can be set in 'Date and Time' on Windows.

14.2 Multiple CPU System

The time of a programmable controller system to be synchronized varies depending on the CPU number of this product. The overview of operation according to the combination of the time synchronization setting and the 'Date and Time' settings on Windows is as shown below:

Time synchronization setting with multiple CPU (PLC No.1)	Windows setting		CPU No. of this product	
	Set the time automatically	Set time zone automatically	CPU No.1	CPU No.2 or later
Synchronize	ON (Default)	Not required	<ul style="list-style-type: none"> The time is set automatically by Windows. The Windows time zone setting is applied without change. 	When this product is mounted as CPU No.2 or later, do not set the time synchronization setting. When using this product as CPU No.2 or later, set the Windows setting to OFF. (Page 148 Windows setting)
	OFF		<ul style="list-style-type: none"> The time set by a user is set. The Windows time zone setting is applied without change. 	This product synchronizes with CPU No.1.
Do not Synchronize (Default)	ON (Default)	Not required	<ul style="list-style-type: none"> The time is set automatically by Windows. The Windows time zone setting is applied without change. 	
	OFF		<ul style="list-style-type: none"> The time set by a user is set. The Windows time zone setting is applied without change. 	

When this product is set as CPU No.2 or later, time will automatically be synchronized with CPU No.1. Therefore, unified time information can be handled in a system by setting the time of CPU No.1 only. However, note that the time information between this product and CPU No.1 will be different if "Do not Synchronize" is set for "Time Synchronization Setting."

Precautions

The following shows the considerations for the time synchronization setting in a multiple CPU system.

■Windows setting

To synchronize time in this product (CPU No.2 or later), change the following settings to 'Off' in 'Date & Time' on Windows.

- "Set the time automatically"
- "Set time zone automatically"*1

*1 The "Time zone" setting in 'Date and Time' on Windows will automatically change to the one on the CPU No.1 module.

■Windows time zone setting

When synchronizing time with a programmable controller system, the 'Date and Time' settings on Windows will be as follows:

- "Time zone": (UTCXXX) MELSEC iQ-R series CPU*1*2*3*4
- "Adjust the daylight saving time automatically": OFF

The following shows the examples of time zone.

- UTC+9: (UTC+09:00) MELSEC iQ-R series CPU
- UTC-12: (UTC-12:00) MELSEC iQ-R series CPU

*1 XXX: Complies with time zone of the CPU module (CPU No.1)

*2 The "(UTCXXX) MELSEC iQ-R series CPU" is added to the list of "Time zone." If the "Time zone" setting is changed manually while this product is in use, the time zone which is added to the list at time synchronization will be applied.

*3 If the time zone setting of the CPU module (CPU No.1) is changed, the changed time zone will be applied when synchronizing time. The time zone which is added before changing the setting will be deleted from the list.

*4 The added time zone cannot be deleted manually. If the time synchronization function is disabled, the time zone which is added at last will remain on the time zone list.

The setting name of Windows time zone, which is added by this product, is determined depending on the language selected at the Windows setup.

Language of Windows	Setting name
Japanese	(UTCXXX) MELSEC iQ-R series CPU
Other than Japanese	(UTCXXX) MELSEC iQ-R series CPU Module

Even if the Windows display language is changed, the setting name of the time zone will not be changed from the language selected at the Windows setup. Therefore, the following cases may occur:

- The setting name is displayed in Japanese while the Windows display language is other than Japanese.
- The setting name is displayed in English while the Windows display language is Japanese.

To match the setting name with the current Windows display language, perform the following procedure:

1. Select "Region" in the Control Panel.

The "Region" screen appears.

2. Select the [Administrative] tab.

3. Click the [Copy settings] button in "Welcome screen and new user accounts."

The "Welcome screen and new user accounts" screen appears.

4. Check the status of "Current user," and select the checkbox of "Welcome screen and system accounts" displayed at the bottom of the screen.

5. Click the [OK] button.

6. Restart Windows.

Setting this product as CPU No.1

When setting this product as CPU No.1, the other CPU modules (CPU No.2 to No.4) in a multiple CPU system synchronize the time of this product.

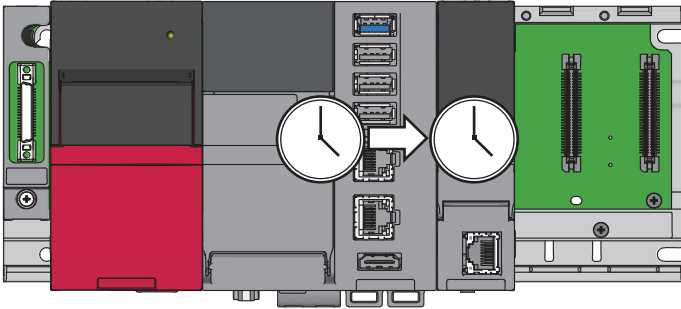

The time of a programmable controller system will be equal to the time of this product (Windows).
Time information of this product is added to target data as a time stamp.

Data to which a time stamp is added

Data to which a time stamp is added is as shown below:

System	Data to which a time stamp is added	Added time stamp
Programmable controller system	<ul style="list-style-type: none">• Event history• Error history	Windows time
Windows	Event log	

14

Point

- The time synchronization setting will be ignored even if "Synchronize" is selected for "Time Synchronization Setting."
- Windows time can be set in 'Date and Time' on Windows.

Setting this product as CPU No.2, No.3, or No.4

When selecting "Synchronize" for "Time Synchronization Setting," this product synchronizes the time of the CPU No.1 module.

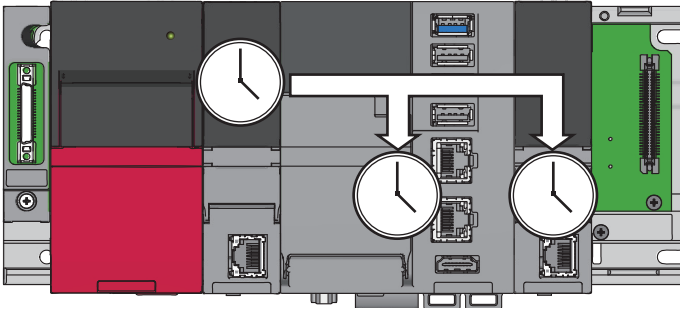

The time of a programmable controller system will be equal to the time of the CPU No.1 module. Time information of the CPU No.1 module is added to target data as a time stamp.

Data to which time information (a time stamp) is added

Data to which a time stamp is added is as shown below:

System	Data to which a time stamp is added	Added time stamp
Programmable controller system	<ul style="list-style-type: none"> Event history Error history 	Windows time (Time of the synchronized CPU No.1 module)
Windows	Event log	

When not synchronizing time

This product does not synchronize time with the CPU No.1 module when the following conditions are satisfied: this product is set as CPU No.2, No.3, or No.4 and "Do not Synchronize" is selected for "Time Synchronization Setting."

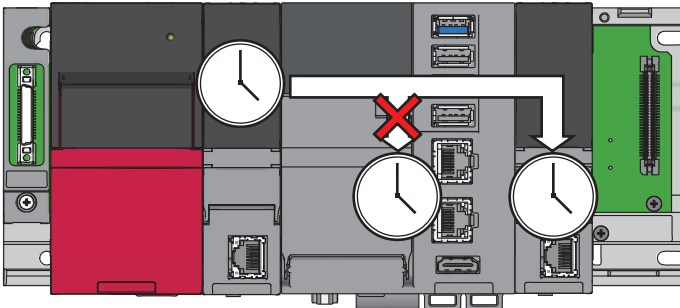

When not synchronizing time, this indicates that two clock-times exist in a programmable controller system, one on the CPU No.1 module and the other on Windows.

In this case, each piece of time information is added to target data as a time stamp.

Data to which time information (a time stamp) is added

Data to which a time stamp is added is as shown below:

System	Data to which a time stamp is added	Added time stamp
Programmable controller system	<ul style="list-style-type: none"> Event history Error history 	Time of the CPU No.1 module
Windows	Event log	Windows time





Windows time can be set in 'Date and Time' on Windows.

15 MULTIPLE CPU SYSTEM FUNCTION

This function allows each CPU module on a base unit to control an I/O module and an intelligent function module. The data communication among CPU modules on a base unit can also be performed.

Point

- For the concept of the multiple CPU system (system configuration specifications such as mounting position of CPU modules and assignment of CPU number and I/O number), refer to the following:
( MELSEC iQ-R Module Configuration Manual)
- For the start-up (settings and operating procedure) of a multiple CPU system, refer to the following:
( CW Configurator Operating Manual)

Restriction

- The startup time of the multiple CPU system may be long depending on the system configuration of the installed modules, boot operation, the configuration of the system parameters and CPU parameters. When the SD memory card diagnostics is performed due to the operation such as power OFF during the access to the SD memory card, the startup time of the multiple CPU system may be long as well.
- Create a program so that only one CPU module accesses a MELSEC-Q series module when possible. If multiple CPU modules access a MELSEC-Q series module simultaneously, the program execution processing (including the execution processing of interrupt programs) may be extended due to the access waiting time.

15.1 Out-of-Group I/O Fetch

This function can import input and output data from an I/O module controlled by another CPU module and can access the buffer memory of an intelligent function module controlled by another CPU module.

In a multiple CPU system, modules controlled by the host CPU (controlled modules) can be accessed; however, not for modules which are controlled by another CPU module (non-controlled modules). Data of non-controlled modules can be imported using the out-of-group I/O fetch function.

Note that data cannot be imported from an inter-module synchronization target module.

Access to controlled modules

The I/O refresh for the controlled module and writing/reading data to/from the buffer memory of an intelligent function module can be performed within the same access range as a single CPU system.

Access to non-controlled modules

Only the buffer memory of an intelligent function module can be read.

However, by setting "I/O Setting Outside Group," the input (X) and output (Y) data of a non-controlled module can also be read.

○: Accessible, ×: Not accessible

Access target		I/O setting outside group	
		Import	Not imported
Input (X)	Read data from another CPU module	○	×*1
Output (Y)	Write data to another CPU module	×*1	×*1
	Read data from another CPU module	○	×*1
Buffer memory of an intelligent function module	Read data	○	
	Write data	×*2	

*1 An error code and behavior differ depending on a function used.

The md functions: No processing

The mdBd functions: An error (9013H or 9027H), no processing ( Page 153 Outputting data to an output module and intelligent function module)

*2 An error code and behavior differ depending on a function used.

The md functions: No processing

The mdBd functions: An error (9012H, 414AH, FF02H, or FFFDH)

I/O setting outside group

To access a non-controlled module, set "Import" for "I/O Setting Outside Group."

 [System Parameter] ⇒ [Multiple CPU Setting] ⇒ [Other PLC Control Module Setting] ⇒ [I/O Setting Outside Group]

Window



Other PLC Control Module Setting	
I/O Setting Outside Group	
Input Status Outside Group	Not Imported
Output Status Outside Group	Not Imported

Displayed items

Item	Description	Setting range	Default
Input Status Outside Group	Set whether to 'Import' or 'Not Imported' input (X) of controlled module (outside group) of other PLC.	• Not Imported • Import	Not Imported
Output Status Outside Group	Set whether to 'Import' or 'Not Imported' output (Y) of controlled module (outside group) of other PLC.		

■Importing input (X) data

When setting "Import" for "Input Status Outside Group," the ON/OFF data can be imported from an input module and intelligent function module which are controlled by another CPU module.

The data can be imported from the following modules mounted on the main or extension base unit.

- Input module
- I/O combined module *1
- Intelligent function module

*1 For MELSEC iQ-R series, the areas assigned to the output portion (unused area) are not imported. The ON/OFF state is retained. Data of an input module controlled by another CPU module and data of an intelligent function module can be read with the following functions:

Function name	Purpose
mdBdRandREx	To read data from devices on the own station randomly
mdBdReceiveEx	To read data from devices on the own station in a batch

For details on functions and creating user programs, refer to the following:

📖 MELSEC iQ-R MELSECWinCPU Module Programming Manual

■Importing output (Y) data

When setting "Import" for "Output Status Outside Group," the ON/OFF data can be imported from an output module and intelligent function module which are controlled by another CPU module.

The data can be imported from the following modules mounted on the main or extension base unit.

- Output module *1
- I/O combined module *1
- Intelligent function module *1

*1 Data cannot be imported from MELSEC-Q series modules.

Data of an input module controlled by another CPU module and data of an intelligent function module can be read with the following functions:

Function name	Purpose
mdBdRandREx	To read data from devices on the own station randomly
mdBdReceiveEx	To read data from devices on the own station in a batch

For details on functions and creating user programs, refer to the following:

📖 MELSEC iQ-R MELSECWinCPU Module Programming Manual

■Reading data from the buffer memory of an intelligent function module

Data in the buffer memory of an intelligent function module can be read with the following functions:

Function name	Purpose
mdRandREx	To read data from devices randomly
mdReceiveEx	To read data from devices in a batch

For details on functions and creating user programs, refer to the following:

📖 MELSEC iQ-R MELSECWinCPU Module Programming Manual

Precautions

■Outputting data to an output module and intelligent function module

The ON/OFF data cannot be output to non-controlled modules.

If the output status of the non-controlled module is turned ON/OFF by a user program, the output status of the MELSECWinCPU module is changed, however not for the non-controlled module.

■Writing data to the buffer memory of an intelligent function module

Data cannot be written to the buffer memory of an intelligent function module controlled by another CPU module.

15.2 Multiple CPU Synchronous Startup Setting

By synchronizing the start-up time of each CPU module, data can be accessed among multiple CPUs at the time unified in a system.

Point

There is no need for an interlock program that monitors the startup time of another CPU module when accessing the module. Note, however, that the startup of the entire system delays because the system starts up with the last CPU module.

Precautions

This setting can synchronize the start-up time of each CPU module; however, it does not synchronize the Windows start-up of this product.

To send/receive data (including returned data) to/from another CPU module in a multiple CPU system, an interlock program is required for monitoring the start-up of Windows on which a user program runs. Execute an interlock program which notifies the Windows start-up (such as when data is written from the Windows side user programs).

Synchronous startup setting

To synchronize the startup time, set "Synchronize" for "Synchronous Startup Setting."

[System Parameter] ⇒ [Multiple CPU Setting] ⇒ [Operation Mode Setting] ⇒ [Synchronous Startup Setting]

Window

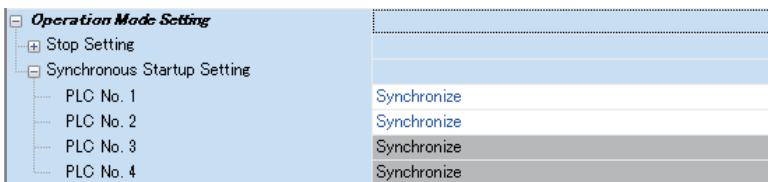

Displayed items

Item	Description	Setting range	Default
PLC No.1	Set whether to 'Synchronize' or 'Do not Synchronize' rising of PLC No.1	• Synchronize • Do not Synchronize	Synchronize
PLC No.2	Set whether to 'Synchronize' or 'Do not Synchronize' rising of PLC No.2.		
PLC No.3	Set whether to 'Synchronize' or 'Do not Synchronize' rising of PLC No.3.		
PLC No.4	Set whether to 'Synchronize' or 'Do not Synchronize' rising of PLC No.4.		

Point

- Group setting for synchronous startup is available. For example, a setting in which only CPU No.1 and No.2 start synchronously in a multiple CPU system with four CPU modules is possible.
- If a reserved (empty) CPU is specified to synchronize, the reserved CPU is ignored and the other CPU will be started.

15.3 Fixed Scan Communication Setting

Since this product cannot perform a fixed-cycle operation and respond with high-speed, it cannot operate in a cycle unit set in the fixed scan interval setting. However, to use the fixed scan communication area, the interval for data transmission between CPU modules must be set to unify the setting in all CPUs.

Fixed scan communication interval setting

To set the fixed scan communication interval, refer to the following:

☞ Page 123 Fixed scan interval setting

15.4 CPU Number-Based Data Assurance Setting

This product does not support data assurance on a CPU basis using a system. However, data assurance must be set on a CPU basis in a multiple CPU because the setting must be the same in all CPUs.

To assure data, refer to the following:

☞ Page 124 Data assurance for accessing CPU buffer memory

Point

In a multiple CPU system where the CPU-number based data assurance is enabled, the following operation is performed:

- In the CPU buffer memory (excluding the fixed cycle communication area), the next data is not sent or received until the data read completion notification is received from another CPU. The data send/receive timing of CPU No.1 coincides with the update interval of a CPU module that takes the longest time among the following: the scan time of a programmable controller CPU, the refresh cycle of a C Controller module, and the refresh cycle of this product.
- This product notifies the completion of data read at the timing set in the refresh cycle setting of the fixed cycle processing function. (☞ Page 183 FIXED CYCLE PROCESSING FUNCTION)

15

CPU number-based data assurance setting

To assure the CPU number-based data, set "Enable" for "PLC Unit Data."

☞ [System Parameter] ⇒ [Multiple CPU Setting] ⇒ [Communication Setting between CPUs]

Window

Communication Setting between CPUs	
CPU Buffer Memory Setting	<Detailed Setting>
PLC Unit Data	Disable(Not notified the reading completion to other PLC)
Fixed Scan Communication Function	Not Use

Displayed items

Item	Description	Setting range	Default
PLC Unit Data	<p>Set the data 'Assure' (Notification of reading completed will be sent) or 'Not Assured' (Notification of reading completed will not be sent) in PLC module.</p> <p>Transmit read timing of PLC module to ensure operation of other module.</p> <p>MELSECWinCPU refresh function will not be able to ensure operation of other module. When a configuration is multi-CPU with PLC, read timing of other module is transmitted in case PLC does not transmit read timing and PLC refresh operation is stopped.</p> <p>Timing of MELSECWinCPU is sent to other module to match the timing of periodic execution (Refresh cycle). The MELSECWinCPU can not read and write , during the execution of matching periodic time (Refresh cycle).</p>	<ul style="list-style-type: none"> • Disable(Not notified the reading completion to other PLC) • Enable(notify the read completion to other PLC) 	Disable(Not notified the reading completion to other PLC)

16 NETWORK MODULE ACCESS FUNCTION

This function communicates data with devices on a network via a network module controlled by this product.

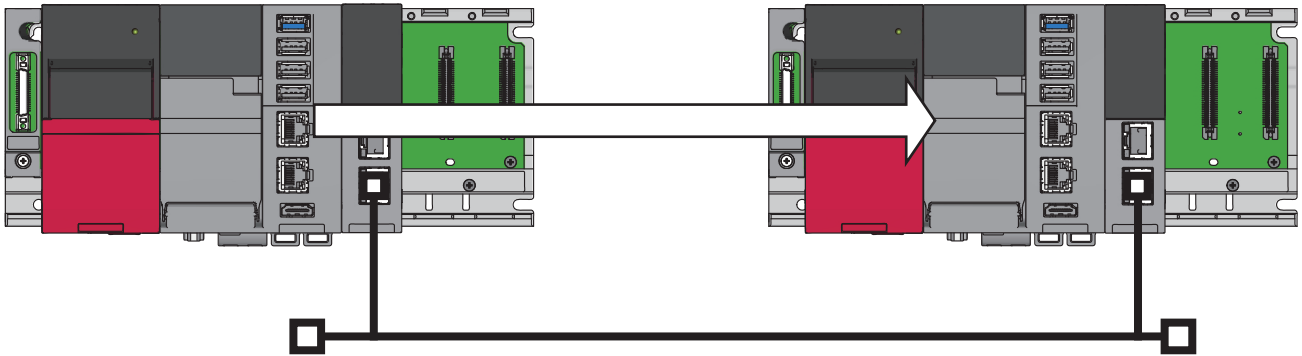

Precautions

In a multiple CPU system configuration, the access via a network module which is controlled by another CPU is not available. Use a network module controlled by this product.

Network module

Network modules that can be controlled by this product are as shown below:

- CC-Link IE Controller Network module
- CC-Link IE TSN module
- CC-Link module

■Network module functions

This product supports network module functions to communicate data.

The supported network module functions are as shown below:

Function		Description
Cyclic transmission	Communication with other stations	To exchange data periodically among stations on the network using link devices
	Link refresh	To automatically transfer data between the link devices of a network module and devices of this product
	Direct access to link devices	To directly access the link devices of a network module from a program
	Cyclic data assurance	To assure the cyclic data integrity in units of 32 bits or station-based units
Transient transmission	Communication within the same network	To read/write data from/to devices of another station on the same network
	Communication with a different network	To read/write data from/to devices of another station on different networks
	Dedicated instruction (SEND instruction and RECV instruction)	To execute network module dedicated instructions

16.1 Cyclic Transmission

The following shows the data flow at cyclic transmission when using this product.

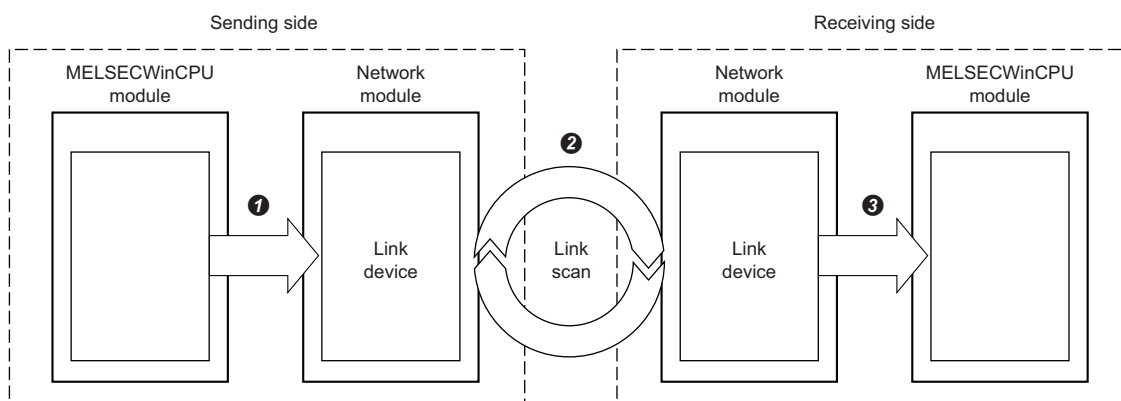

- ① The sending side MELSECWinCPU module writes data to a link device of the network module.
- ② Data of the sending side link device is stored to the receiving side link device by link scan.
- ③ The receiving side MELSECWinCPU module reads data from a link device of the network module.

Point

A network module transmits data by link scan.

Accessible link devices

Link devices are used for sharing data in a network module with other stations on the network.

Link devices available for this product are as shown below:

○: Accessible, ×: Not accessible

Device name (device)	CC-Link IE Controller Network	CC-Link IE TSN	CC-Link
Link input (LX)	○	×	×
Link output (LY)	○	×	×
Link relay (LB)	○	○	×
Link register (LW)	○	○	×
Remote input (RX)	×	○	○
Remote output (RY)	×	○	○
Remote register (RWw)	×	○	○
Remote register (RWr)	×	○	○
Link special relay (SB)	○	○	○
Link special register (SW)	○	○	○

For the number of points and details on each link device, refer to the manual of a network module. (Manual of a module used)

Method for accessing link devices

Link devices of a network module can be accessed by any of the following methods:

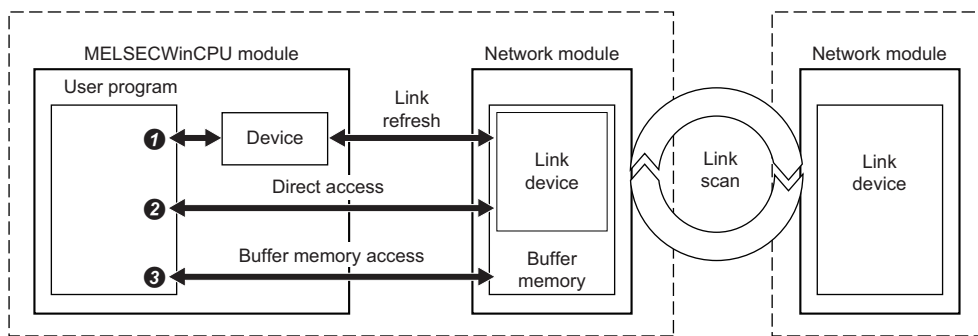

○: Accessible, ×: Not accessible

Access method	CC-Link IE Controller Network	CC-Link IE TSN	CC-Link
① Communication by link refresh (Reading/Writing data from/to devices)	○	○	○
② Communication by direct access	○	○	×
③ Communication by using buffer memory	×	○	○

Point

Excluding rarely used link devices from link refresh device area may reduce link refresh time.

Communication by link refresh

This method is used for communicating data by accessing data with a user program and performing link refresh of a network module.

Link scan with other stations, link refresh with a network module, and access by a user program are performed asynchronously.

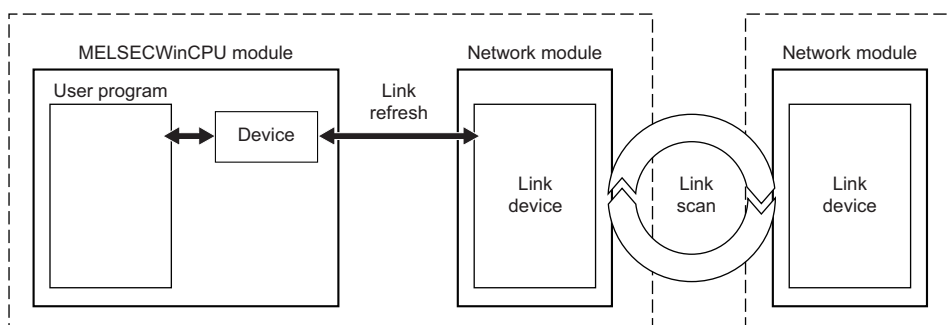

To send/receive data to/from a network module on other stations, access link refresh target devices using a user program. Perform the following processing in accordance with the refresh cycle of this product.

- Write device values of a MELSECWinCPU module to link devices of a network module.
- Read values from link devices of a network module to devices of a MELSECWinCPU module.

The device access range can be specified in the following settings of a network module. (Manual of a module used)

- Network range assignment setting/Network configuration settings
- Refresh setting

Precautions

Settings for pairing and shared groups are not available in the network range assignment setting and network configuration setting.

Available devices and their ranges

Devices that can be specified for refresh and their available ranges are as shown below:

Device name (device)	Number of points	Available range
Internal relay (M)	61440	M0 to 61439
Link relay (B)	655360	B0 to 9FFFF
Data register (D)	4184064	D0 to 4184063
Link register (W)	1048576	W0 to FFFF

Precautions

In the refresh setting, link special relays (SB) and link special registers (SW) cannot be specified for devices on the link side. Acquire the values of link special relays (SB) and link special registers (SW) by direct access to link devices or buffer memory access.

Any available devices except for link special relays (SB) and link special registers (SW) can be specified for devices on the link side.

Refresh range

Refresh is performed for the range set in "Refresh Setting" and "Network Range Assignment" ("Network Configuration Settings"). For the access by link refresh, specify the devices within the refresh range.

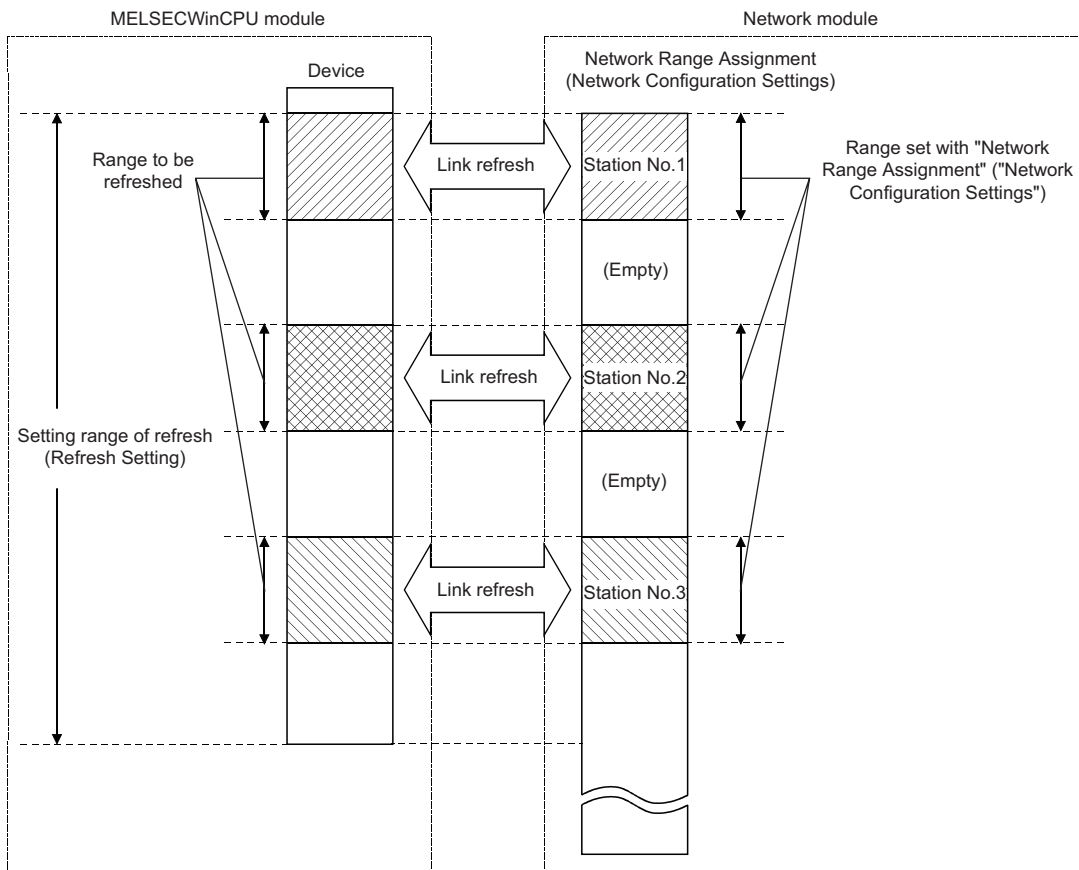

■Function list

The following table shows functions to be used in a user program.

Function name	Purpose
mdBdDevRstEx	To reset (turn OFF) bit devices on the own station
mdBdDevSetEx	To set (turn ON) bit devices on the own station
mdBdRandREx	To read data from devices on the own station randomly
mdBdRandWEx	To write data to devices on the own station randomly
mdBdReceiveEx	To read data from devices on the own station in a batch
mdBdSendEx	To write data to devices on the own station in a batch
mdDevRstEx	To reset (turn OFF) bit devices
mdDevSetEx	To set (turn ON) bit devices
mdRandREx	To read data from devices randomly
mdRandWEx	To write data to devices randomly
mdReceiveEx	To read data from devices in a batch
mdSendEx	To write data to devices in a batch

Point

The access timing with a user program is not synchronized with the timing of link scan and link refresh. Create an interlock program as necessary.

Communication by direct access

This method is used for direct access to link devices of a network module from a user program.

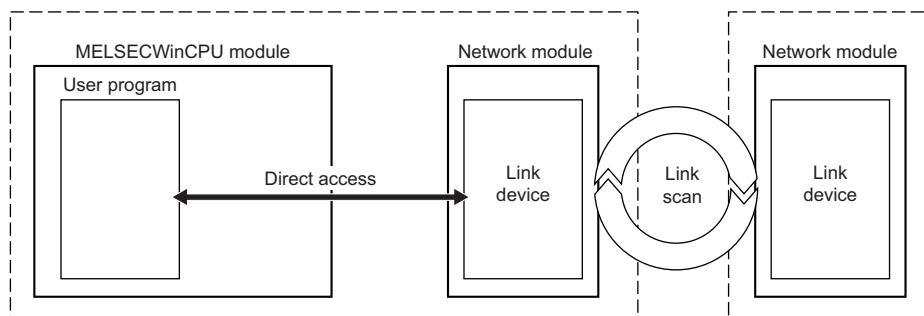

Function list

The following table shows functions to be used in a user program.

Function name	Purpose
mdBdWriteLinkDeviceEx	To write data to own station link devices of CC-Link IE Controller Network module and CC-Link IE TSN module
mdBdReadLinkDeviceEx	To read data from own station link devices of CC-Link IE Controller Network module and CC-Link IE TSN module

Specification method for devices

To directly access a link device, access it as a link direct device (Jn\□).

For the link register 16 (W10) on network No.2, the device 'J2\W10' is accessed.

To access the link device with a user program, specify the following device types:

Device (device name)	Device type ^{*1}
Link input (Jn\X)	DevLX (1 to 255)
Link output (Jn\Y)	DevLY (1 to 255)
Link relay (Jn\B)	DevLB (1 to 255)
Link special relay (Jn\SB)	DevLSB (1 to 255)
Link register (Jn\W)	DevLW (1 to 255)
Link special register (Jn\SW)	DevLSW (1 to 255)

*1 For a number in parentheses, specify 'n' (network number) indicated in a link direct device (Jn\□).

Ex.

When accessing the link direct device (J2\W10)

- Device type: DevLW (2)
- Start device number: 10

Point

- Accessible link devices vary depending on network modules. For the accessible devices, refer to the manual of a network module. (Manual of a module used)
- Some network modules allow their multiple link devices to be accessed with one device name. For the method for specifying devices when accessing link devices directly, refer to the manual of a network module. (Manual of a module used)

To access a control network module using a user program, specify the following device types:

Device (device name)	Device type
Link input (Jn\X)	DevLX (0)
Link output (Jn\Y)	DevLY (0)
Link relay (Jn\B)	DevLB (0)
Link special relay (Jn\SB)	DevLSB (0)
Link register (Jn\W)	DevLW (0)
Link special register (Jn\SW)	DevLSW (0)

■ Link direct device mode setting

When using the following module, "Extended Mode (iQ-R Series Mode)" needs to be specified for the link direct device setting in CPU parameters. (The default is "Q Series Compatible Mode.")

- CC-Link IE TSN master/local module

Point

When specifying a link direct device, if the following module (even single module) exists among the network modules controlled by this product, set the link direct device setting to "Extended Mode (iQ-R Series Mode)."

- CC-Link IE TSN master/local module

Note that other modules than the above operate in both modes.

The device range available for the link direct device setting is as shown below:

Setting	Device range
Q series compatible mode	<ul style="list-style-type: none"> • Link input: 16K points • Link output: 16K points • Link relay: 32K points • Link special relay: 512 points • Link register: 128K points • Link special register: 512 points
Extended mode (iQ-R series mode)	<ul style="list-style-type: none"> • Link input: 160K points • Link output: 160K points • Link relay: 640K points • Link special relay: 5120 points • Link register: 2560K points • Link special register: 5120 points

For the devices that can be used for this product, refer to the following:

 Page 273 Device List

The mode setting of link direct devices can be set in the following setting:

 [CPU Parameter] ⇒ [Memory/Device Setting] ⇒ [Link Direct Device Setting]

Window



Displayed items

Item	Description	Setting range	Default
Link Direct Device Setting	<p>Set 'Q Series Compatible Mode' or 'Extended Mode (iQ-R Series Mode)' for link direct device.</p> <p>Set "Extended Mode (iQ-R Series Mode)" if the following module (even single module) exists among the network modules controlled by this product.</p> <ul style="list-style-type: none"> • CC-Link IE TSN master/local module 	<ul style="list-style-type: none"> • Q Series Compatible Mode • Extended Mode (iQ-R Series Mode) 	Q Series Compatible Mode

Communication by using buffer memory

This method is used for accessing the buffer memory of a network module from a user program.

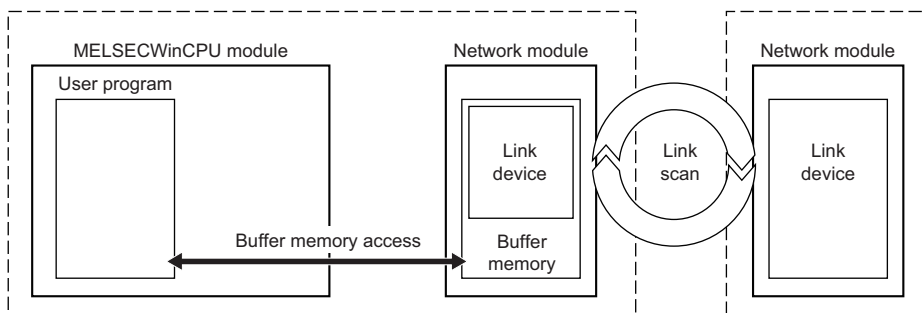

Function list

The following table shows functions to be used in a user program.

Function name	Purpose
mdBdRandREx	To read data from devices on the own station randomly
mdBdRandWEx	To write data to devices on the own station randomly
mdBdReceiveEx	To read data from devices on the own station in a batch
mdBdSendEx	To write data to devices on the own station in a batch
mdRandREx	To read data from devices randomly
mdRandWEx	To write data to devices randomly
mdReceiveEx	To read data from devices in a batch
mdSendEx	To write data to devices in a batch

Specification method for devices

To access the buffer memory, access it as a module access device (Un\G).

For the buffer memory (the memory address is 1000) of a module whose start I/O number is '020H,' the device 'U2\G1000' is accessed.

To access the buffer memory with a user program, specify the following device type:

Device (device name)	Device type
Module access device (Un\G)	DevSPG (0) to DevSPG (255)*1

*1 For a number in parentheses, specify a value calculated by converting the start I/O number of an access target module to decimal and dividing the converted number by 16.

Ex.

When accessing the module access device (U0\G0)

- Device type: DevSPG (0)
- Start device number: 0

Point

The address of buffer memory where link devices are stored vary depending on network modules. For details on buffer memory, refer to the manual of a network module. (Manual of a module used)

Cyclic data assurance

This function assures the cyclic data integrity in units of 32 bits or station-based units.

The methods for assuring the cyclic data are as follows:

○: Available, ×: Not available

Method		Description	Availability of assurance		
			Link refresh	Direct access	Buffer memory access
32-bit data assurance		To assure data in 32-bit units. Data is automatically assured by satisfying assignment conditions of link devices.	○	○	×
More than 32-bit data assurance	Station-based block data assurance	To assure data in station-based units. Data is assured by enabling the station-based block data assurance in the parameter setting.	○	×	×
	Interlock program	To assure data of more than 32 bits. Data is assured by creating interlocks on programs.	○	○	○

32-bit data assurance

This method assures link device data in 32-bit units.

However, conditions for data assurance vary depending on network modules. To assure 32-bit data, refer to the manual of a network module. (Manual of a module used)

■ Access by a user program

When accessing devices with a user program, the 32-bit data can be assured by satisfying the following conditions:

- Access size is 4 byte (32 bits).
- The start device of a target device or the start address of buffer memory is 0 or a multiple of 2. (when a target device is a bit device, the start device will be 0 or a multiple of 20H.)

Station-based block data assurance

This method assures cyclic data for each station by handshake between this product and a network module for a link refresh. For details on functions of the station-based block data assurance, refer to the manual of each network module.

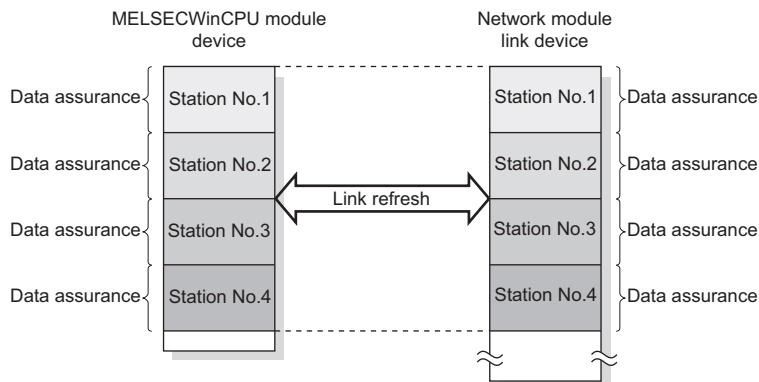

Access by a user program

Link refresh and device access from a user program are performed asynchronously.

To read and write the assured station-based block data, satisfy the following conditions:

- Refresh devices on the CPU side are assigned continuously to one device.
- Data is read/written from/to devices in a batch to access internal user devices.^{*1}

^{*1} To read or write data from/to devices in a batch, use the `mdBdSendEx`, `mdBdReceiveEx`, `mdBdRandWEx`, or `mdBdRandREx` function. Only up to 65,000 bytes can be accessed per time. To access a device with the size exceeding 65,000 bytes, create an interlock program. Note that using any of the following functions may cause data inconsistency: the `mdSendEx`, `mdReceiveEx`, `mdRandWEx`, `mdRandREx`, `mdRandRLabelEx`, and `mdRandWLabelEx` functions.

Interlock program

This method assures data of more than 32 bits without using the station-based block data assurance setting.

Define devices for handshake and read or write data from/to devices by setting the defined devices as a link refresh target and handshaking with other stations.

Refresh cycle

Link refresh with a network module is performed in the refresh cycle of the fixed cycle processing function.

For the length of time for link refresh in each network module, refer to the following:

☞ Page 174 Processing Time

16.2 Transient Transmission

When receiving requests from a user program which uses dedicated functions or from CW Configurator, this function communicates with other stations on the same or different network via a network module controlled by this product.

Precautions

■Executing a MELSEC data link function simultaneously from multiple user programs

When executing a MELSEC data link function simultaneously from multiple user programs, a request for the transient transmission processing of the next user program is sent after that processing of the previously executed user program is completed. Therefore, executing multiple user programs simultaneously may lead to extended time from the execution to the completion of a MELSEC data link function in some of the user programs.

Corresponding MELSEC data link functions are shown as below:

- mdControl function
- mdDevRstEx function
- mdDevSetEx function
- mdGetLabelInfo function
- mdRandREx function
- mdRandRLabelEx function
- mdRandWEx function
- mdRandWLabelEx function
- mdReceiveEx function
- mdSendEx function
- mdTypeRead function

■Communication timeout value of the MELSEC data link function setting function

A communication timeout value which is set using the MELSEC data link function setting function is not a timeout time from the execution to the completion of a MELSEC data link function. It is a timeout time to monitor the time taken from when a request is sent to an access target to when the response is returned via transient transmission. Set an appropriate time according to the time when an access target system returns the response.

Corresponding MELSEC data link functions are shown as below:

- mdControl function
- mdDevRstEx function
- mdDevSetEx function
- mdGetLabelInfo function
- mdRandREx function
- mdRandRLabelEx function
- mdRandWEx function
- mdRandWLabelEx function
- mdReceiveEx function
- mdSendEx function
- mdTypeRead function

Access to the same network

The transient transmission function accesses devices of a CPU module on other stations as well as link devices of a network module and buffer memory of an intelligent function module, both of which modules are controlled by a CPU module on other stations.

Access method

■Function list

The following table shows functions to be used in a user program.

Function name	Purpose
mdDevRstEx	To reset (turn OFF) bit devices
mdDevSetEx	To set (turn ON) bit devices
mdRandREx	To read data from devices randomly
mdRandRLabelEx ^{*1}	To read data from devices corresponding to labels randomly
mdRandWEx	To write data to devices randomly
mdRandWLabelEx ^{*1}	To write data to devices corresponding to labels randomly
mdReceiveEx	To read data from devices in a batch
mdSendEx	To write data to devices in a batch

*1 Use in combination with the mdGetLabelInfo function. (📖 Page 180 LABEL COMMUNICATION FUNCTION)

■Specification method for devices

Link devices of network modules

Specify a link direct device (Jn\□) to directly access link devices of a network module.

For the link register 16 (W10) on network No.2, the device 'J2\W10' is accessed.

To access the link device with a user program, specify the following device types:

Device (device name)	Device type ^{*1}
Link input (Jn\X)	DevLX (1) to (255)
Link output (Jn\Y)	DevLY (1) to (255)
Link relay (Jn\B)	DevLB (1) to (255)
Link special relay (Jn\SB)	DevLSB (1) to (255)
Link register (Jn\W)	DevLW (1) to (255)
Link special register (Jn\SW)	DevLSW (1) to (255)

*1 A number in parentheses corresponds to 'n' (network number) indicated in a link direct device. Specify the network number of a network module to be accessed.

Ex.

When accessing the link device (J1\W0)

- Device type: DevLW (1)
- Start device number: 0

Point

- Accessible link devices vary depending on network modules. For the accessible devices, refer to the manual of a network module. (📖Manual of a module used)
- Some network modules allow their multiple link devices to be accessed with one device name. For the method for specifying devices when accessing link devices directly, refer to the manual of a network module. (📖Manual of a module used)

Buffer memory of a module controlled by another CPU

Specify a module access device or intelligent function module device to access buffer memory of a module controlled by another CPU.

For the buffer memory (the memory address is 1000) of a module whose start I/O number is '020H,' the device 'U2\G1000' is accessed.

To access the buffer memory with a user program, specify the following device type:

Device (device name)	Device type ^{*1}
Module access device (Un\G)	DevSPG (0) to (255)
Intelligent function module device (Un\G)	

*1 For a number in parentheses, specify a value calculated by converting the start I/O number of an access target module to decimal and dividing the converted number by 16.

Ex.

When accessing the module access device (U2\G0)

- Device type: DevSPG (2)
- Start device number: 0

CPU module buffer memory

Specify a CPU buffer memory access device (U3En\G or U3En\HG) to access the buffer memory of a CPU module.

For the CPU No.2 module with the buffer memory address of '4095,' the device 'U3E1\G4095' is accessed.

To access the buffer memory with a user program, specify the following device types:

Device (device name)	Device type ^{*1}
CPU buffer memory access device (U3En\G)	DevSPB1 to 4
CPU buffer memory access device (U3En\HG) ^{*2}	DevHSPB1 to 4

*1 The numbers 1 to 4 corresponds to a CPU module number. Specify a number according to the CPU module to be accessed.

*2 A device for accessing CPU buffer memory (the fixed scan communication area)

Ex.

When accessing the CPU buffer memory access device (U3E2\G0)

- Device type: DevSPB3
- Start device number: 0

Method for accessing another CPU module in a multiple CPU system

Specify the local station number set in the target settings to access another CPU module in a multiple CPU system from a target station.



Set target settings with a network module controlled by this product.

■Target settings

[Navigation window] ⇒ [Parameter] ⇒ [Module Information] ⇒ (a target module) ⇒ [Application Settings] ⇒ [Target settings]

Window

	Logical station No.	Network No.	Station No.	Target CPU
1				▼
2				▼
3				▼
4				▼
5				▼
6				▼
7				▼
8				▼

Displayed items

Item	Description	Setting range	Default
Local station No.	Set number of the logical station.	65 to 239	Blank
Network number	Set the network No.	<ul style="list-style-type: none"> ■ Other than CC-Link 1 to 239 ■ CC-Link N/A 	
Station No.	Set the station No.	<ul style="list-style-type: none"> ■ Other than CC-Link 0 to 120 ■ CC-Link 0 to 63 	
Target CPU	Select the target CPU.	<ul style="list-style-type: none"> • PLC No.1 • PLC No.2 • PLC No.3 • PLC No.4 	

Ex.

Accessing another CPU module (CPU No.1) from the target station (station No.5) controlled by the CPU module (CPU No.2)

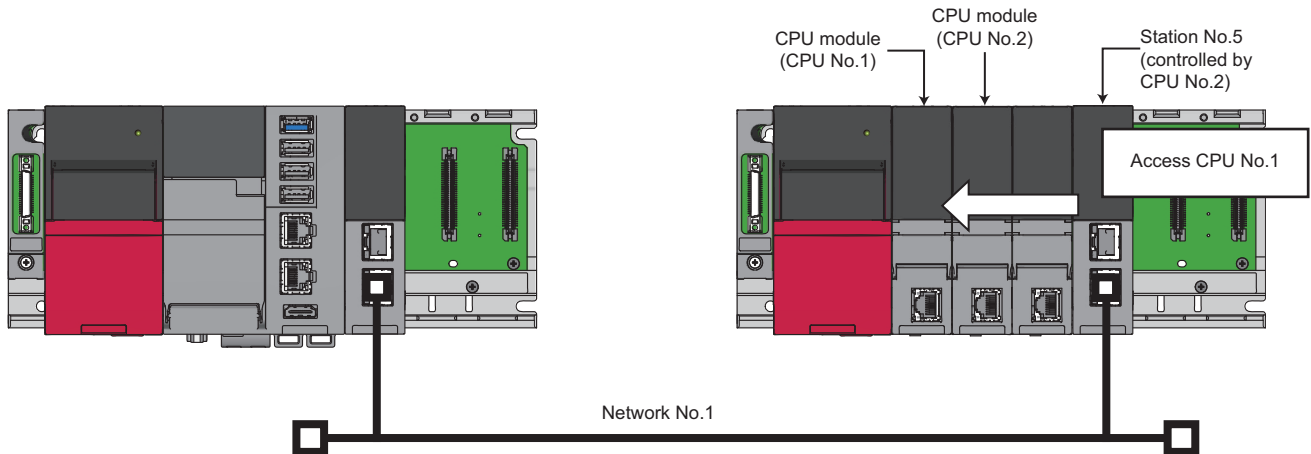

Set the following items in the target settings.

- Logical station No.: 65
- Network No.: 1
- Station No.: 5
- Target CPU: CPU No.1

By specifying a logical station number which is set in the target settings in user programs, another CPU module (CPU No.1) can be accessed via a network.

Access to a different network

The transient transmission function accesses devices of a CPU module on other networks and link devices and buffer memory of a network module via other stations.

Point

Communication can be established with stations up to eight networks apart (number of relay stations: 7).

Access method

Accessible devices and access methods are the same as when accessing other stations on the same network.

For details, refer to the following:

☞ Page 167 Access method

Settings for communication route

To access a different network, settings for a communication route are required.

Set the following items in the routing setting: the network number and the station number of the own network (relay station) which will be passed through to another network, and the network number of the final arrival network (destination station).

Restriction

This product does not support dynamic routing. Therefore, when accessing a different network, ensure to set a communication route in the routing setting.

Routing setting

☞ [CPU Parameter] ⇒ [Routing Setting] ⇒ [Routing Setting] ⇒ [<Detailed Setting>]

16

Window

No.	Relay Station		➔	Target Station
	Network No.	Station No.		Network No.
1				
2				
3				
4				
5				

Displayed items

Item	Description	Setting range	Default
Relay Station	Network No.	1 to 239	Blank
	Station No.	0 to 120	
Target Station	Network number	1 to 239	

Message communication (network module dedicated instructions)

This function can read or write data using the channel of a network module controlled by this product.

Using this function allows data communication similar to the following link dedicated instructions of a network module.

Dedicated instruction		Description
Sending data to a programmable controller on other stations	JP.SEND	To send data to a programmable controller on other stations
	GP.SEND	
Receiving data from a programmable controller on other stations	JP.RECV	To read data received from a programmable controller on other stations
	GP.RECV	

For details on link dedicated instructions, refer to the following:

MELSEC iQ-R Programming Manual (Module Dedicated Instructions)

Precautions

This function cannot be performed for network modules which do not support link dedicated instructions.

Data flow for message communication

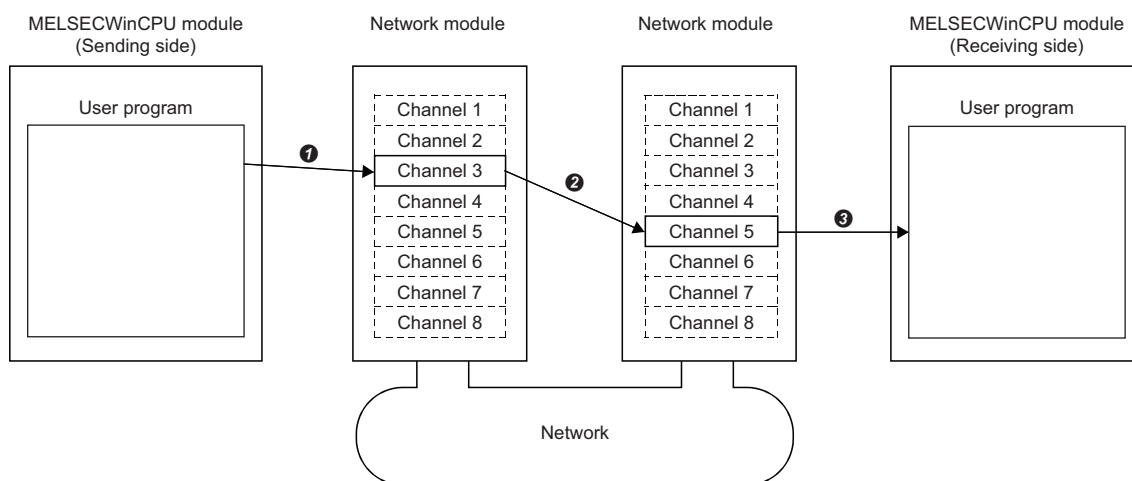

① Specify channels used in the own station and the target station to send data. (The sending side MELSECWinCPU module)
When specifying the used channels in a user program, specify the channel numbers of both the sending and receiving side network modules.

② From the sending side channel, data is sent to the receiving side channel.

③ Messages are read from the receiving side channel. (The receiving side MELSECWinCPU module)

When specifying the used channels in a user program, specify the channel numbers specified on the sending side network module.

Point

- The message communication function can be used even if a CPU module on the sending station or receiving station is other than a MELSECWinCPU module. For the target CPU module, use the SEND/RECV link dedicated instruction or a function equivalent to it.
- When sending data to the same channel of the receiving station with arrival confirmation, make sure to send the data after the receiving station reads the previously sent data with the message receive function (or the RECV instruction). Otherwise, an error will occur. If an error is detected, send the data again after a while.
- When specifying the same own station channel using the message communication function, execute the function after the previously executed function is completed. If the message communication function is executed simultaneously from multiple programs by specifying the same own station channel, an error will occur in the function executed later.

Function list

The following table shows functions to be used in a user program.

Function name	Purpose
mdReceiveEx	To receive messages (RECV function)
mdSendEx	To send messages (SEND function)

Channel

The number of available channels for message communication varies for each network module.

■ Network modules and the number of their available channels

Network module	The number of channels (specifiable channel No.)
CC-Link IE Controller Network module	8 (channel 1 to channel 8)
CC-Link IE TSN module	8 (channel 1 to channel 8)

16.3 Processing Time

This section shows the processing time of the cyclic transmission related to network module access. For the processing time of the transient transmission, refer to the processing time of each function.

Link refresh time

The following shows the processing time of link refresh.

CC-Link IE Controller Network

The processing time when using CC-Link IE Controller Network is as follows:

- β_T : Total link refresh time (sending side)
- β_R : Total link refresh time (receiving side)
- KM1, KM2: Constant

Network module mounting position	KM1	KM2
Main base unit	1.0	0.36×10^{-3}
Extension base unit	1.0	0.97×10^{-3}

- LB: Total number of points of link relays to be refreshed^{*1}
- LX: Total number of points of link inputs to be refreshed^{*1}
- LY: Total number of points of link outputs to be refreshed^{*1}
- LW: Total number of points of link registers to be refreshed^{*1}

*1 The total number of points of link devices set for the setting range of "Refresh Setting" and "Network Range Assignment" ("Network Configuration Settings"). The number of points assigned to a reserved station is not included.

Link refresh time can be calculated by the following formula with the number of assigned points of link devices.

Time	Formula
Link refresh time (ms)	$\beta_T, \beta_R = KM1 + KM2 \times \{((LB+LX+LY) \div 16) + LW\}$

CC-Link IE TSN

The processing time when using CC-Link IE TSN is as follows:

- β_T : Total link refresh time (sending side)
- β_R : Total link refresh time (receiving side)
- KM1, KM2: Constant

Network module mounting position	KM1	KM2
Main base unit	1.0	0.41×10^{-3}
Extension base unit	1.0	0.99×10^{-3}

- RX: Total number of points of remote inputs to be refreshed^{*1}
- RY: Total number of points of remote outputs to be refreshed^{*1}
- RWw, RWr: Total number of points of remote registers to be refreshed^{*1}
- LB: Total number of points of link relays to be refreshed^{*1}
- LW: Total number of points of link registers to be refreshed^{*1}

*1 The total number of points of link devices set for the setting range of "Refresh Setting" and "Network Range Assignment" ("Network Configuration Settings"). The number of points assigned to a reserved station is not included.

Link refresh time can be calculated by the following formula with the number of assigned points of link devices.

Time	Formula
Link refresh time (ms)	$\beta_T, \beta_R = KM1 + KM2 \times \{((RX+RY+LB) \div 16) + RWr + RWw + LW\}$

CC-Link Network

The processing time when using CC-Link Network is as follows:

- β_T : Total link refresh time (sending side)
- β_R : Total link refresh time (receiving side)
- KM1, KM2: Constant

Network module mounting position	KM1	KM2
Main/extension base unit	1.0	0.36×10^{-3}

- RX: Total number of points of remote inputs to be refreshed^{*1}
- RY: Total number of points of remote outputs to be refreshed^{*1}
- RWw, RWr: Total number of points of remote registers to be refreshed^{*1}

*1 The total number of points of link devices set for the setting range of "Refresh Setting" and "Network Range Assignment" ("Network Configuration Settings"). The number of points assigned to a reserved station is not included.

Link refresh time can be calculated by the following formula with the number of assigned points of link devices.

Time	Formula
Link refresh time (ms)	$\beta_T, \beta_R = KM1 + KM2 \times \{((RX+RY) \div 16) + RWw + RWr\}$

Refresh cycle

The following shows how to calculate the refresh cycle.

For the setting method of refresh cycle, refer to the following:

☞ Page 183 FIXED CYCLE PROCESSING FUNCTION

How to decide the refresh cycle

Follow the procedure below to decide the refresh cycle.

1. Calculation of the total link refresh time
2. Preliminary decision of the refresh cycle
3. Pre-operation of a system of this product
4. Decision of the refresh cycle

■Calculation of the total link refresh time

The total link refresh time is equal to the sum of the link refresh time of all of the network modules controlled by this product. The total link refresh time of the system of this product in operation can be checked with the special registers (SD526 to SD531).

For the calculation method of link refresh time for each network module, refer to the following:

☞ Page 174 Link refresh time

■Preliminary decision of the refresh cycle

Set the value which satisfies the following relational expression to the refresh cycle and total link refresh time.

- Refresh cycle > Total link refresh time

■Pre-operation of a system

Confirm whether the system of this product operates correctly by the refresh cycle which is decided preliminarily.

If the processing of this product cannot be completed within the refresh cycle, a 'refresh cycle exceeded (1846H)' error occurs.

Take the corrective actions shown below in order for the system to operate correctly when the system of this product operates abnormally.

Corrective action	Description
Increase the refresh cycle setting value.	Set the refresh cycle again by using the link refresh time (the maximum value) as a reference so that the following relational expression is satisfied. <ul style="list-style-type: none">• Measured value of link refresh time (maximum value) < Refresh cycle
Reduce the number of set refresh points.	Review the number of refresh points in refresh parameter settings.

Reduction of link refresh time

The link refresh time can be shortened by reducing refresh points for this product by setting "Refresh Setting" or "Network Range Assignment" ("Network Configuration Settings") and accessing link devices directly.

Method for reducing refresh points

■Reducing refresh points using parameters

In "Refresh Setting," set only the necessary range to be refreshed. The refresh of only necessary range can reduce the link refresh time.

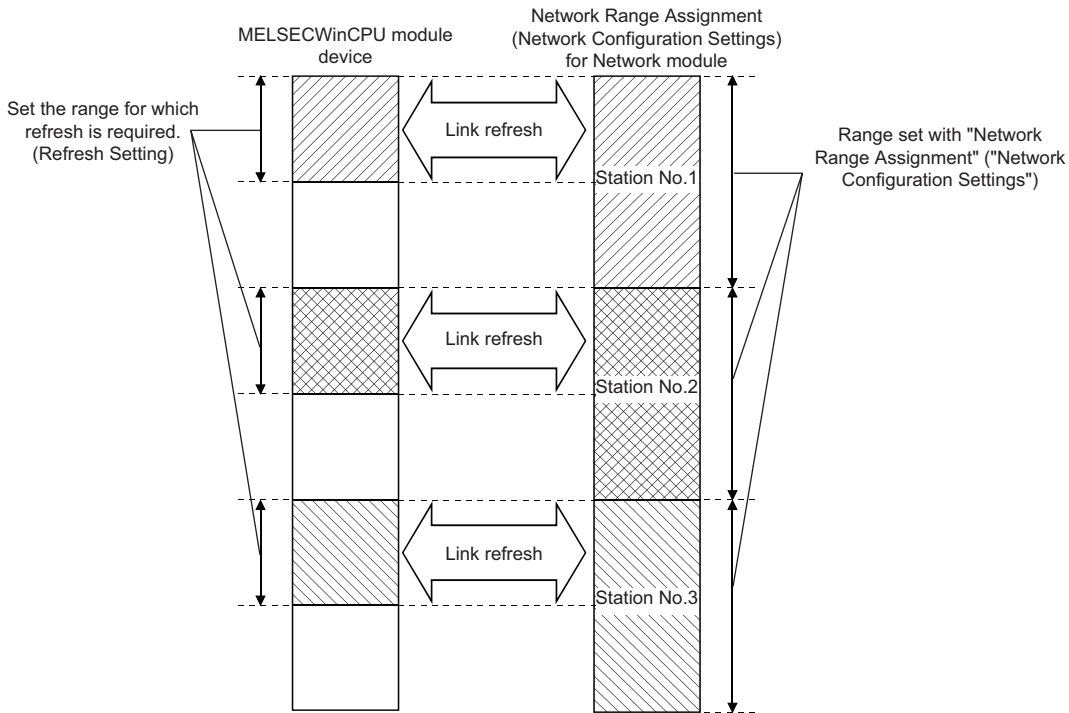

■Reducing refresh points using direct access/buffer memory access

Excluding the rarely used link devices on the own station from the link refresh range and using direct access or buffer memory access instead can reduce the link refresh time.

Transmission delay time of cyclic transmission

The following explains the transmission delay time of cyclic transmission.

A cyclic transmission delay time indicates a time taken until changed data is transmitted to a target station.

- Transmission delay time: Sequence scan time on sending side + link scan time + sequence scan time on receiving side
- For a MELSECWinCPU module, a transmission delay time can be calculated by a link refresh time and a refresh cycle because the module does not have a sequence scan.

Precautions

A cyclic transmission delay time indicates a time shown below. It does not include the processing delay time caused by a user program.

- This product is on the sending side: A time taken from when data is written to the devices of this product to when the data is applied to the devices of a target station
- This product is on the receiving side: A time taken from when data is written to the devices of a target station to when the data is applied to the devices of this product

CC-Link IE Controller Network

For the calculation formula of a transmission delay time on CC-Link IE Controller Network, refer to the following:

📖 MELSEC iQ-R CC-Link IE Controller Network User's Manual (Application)

When a MELSECWinCPU module is set as a target module on the sending or receiving side, replace 'sequence scan time on sending side (ST)' and 'sequence scan time on receiving side (SR)' into the following terms:

- LT: Refresh cycle of a MELSECWinCPU module (sending side)
- LR: Refresh cycle of a MELSECWinCPU module (receiving side)

CC-Link IE TSN

For information on the calculation formula for transmission delay time when using CC-Link IE TSN, refer to the following:

📖 MELSEC iQ-R CC-Link IE TSN User's Manual (Application)

With reference to above mentioned manual, substitute the sequence scan time of the master station (SM) and the sequence scan time of the local station (SL) with the following processing time.

$SM, SL = P = R + \alpha$

- P: Processing time on a MELSECWinCPU module system
- R: Refresh cycle
- α : Link refresh time

CC-Link Network

For information on the calculation formula for transmission delay time when using CC-Link Network, refer to the following:

📖 MELSEC iQ-R CC-Link System Master/Local Module User's Manual (Application)

With reference to above mentioned manual, substitute the sequence scan time of the master station (SM) and the sequence scan time of the local station (SL) with the following processing time.

$SM, SL = P = R + \alpha$

- P: Processing time on a MELSECWinCPU module system
- R: Refresh cycle
- α : Link refresh time

16.4 MELSEC Data Link Function Setting Function

Set necessary items when using MELSEC data link functions.

Channel number

Set a channel number to be used when opening a communication line (a channel) with the mdOpen function.

 [Navigation window] ⇒ [Parameter] ⇒ [Module Information] ⇒ a target module ⇒ [Required Settings] ⇒ [Channel Number]

For details on channel numbers, refer to the following:

 MELSEC iQ-R MELSECWinCPU Module Programming Manual

Point

A bus interface channel number is not required to be set because the number is fixed to '12.'

Precautions

Make sure the set channel numbers are not duplicated.

Communication timeout value

Set a timeout value used for monitoring the time taken from when a request is sent to an access target on every network to when the response is received via transient transmission using a MELSEC data link function.

For considerations when using a MELSEC data link function at transient transmission, refer to the following:

 Page 166 Transient Transmission

 [CPU Parameter] ⇒ [MELSEC data link function settings] ⇒ [Communication Timeout value setting]

Window

Communication Timeout value setting	
iQ-R series bus interface(Channel No.12)	15 sec
CC-Link IE Controller Network(Channel No.151 to 158)	15 sec
CC-Link(Channel No.81 to 88)	30 sec
CC-Link IE TSN (Channel No.281-288)	15 sec

Displayed items

Item	Description	Setting range	Default
iQ-R series bus interface(Channel No.12)	Set the Communication timeout value of the iQ-R series bus interface (Channel No.12).	1 to 360 sec (1 second units)	15 sec
CC-Link IE Controller Network (Channel No.151 to 158)	Set the Communication timeout value of the CC-Link IE Controller Network (Channel No.151 to 158).		15 sec
CC-Link(Channel No.81 to 88)	Set the Communication timeout value of the CC-Link (Channel No.81 to 88).		30 sec
CC-Link IE TSN (Channel No.281 to 288)	Set the Communication timeout value of the CC-Link IE TSN (Channel No.281-288).		15 sec

17 LABEL COMMUNICATION FUNCTION

This function reads/writes data from/to labels stored in a CPU module on another station.

Label communication flow

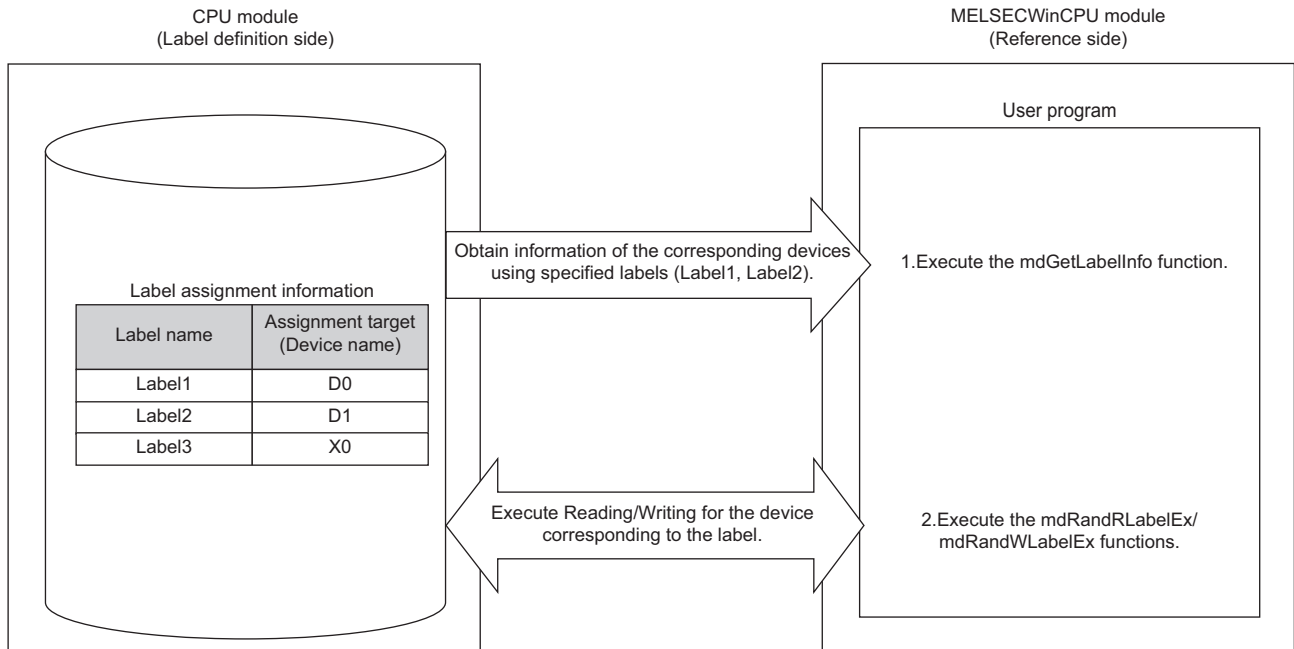

1. Acquire label assignment information (device information) of the specified label with the mdGetLabelInfo function.
2. Read/Write data from/to a device based on the acquired label assignment information (device information) with the mdRandRLabelEx function or the mdRandWLabelEx function.

Point

- In the label communication, a CPU module can be accessed without changing a user program by acquiring label assignment information again even if the label assignment information of the CPU module is changed.
- The label assignment information (device information) acquired by using the mdGetLabelInfo function does not need to be acquired for each execution of the mdRandRLabelEx function or the mdRandWLabelEx function. However, if the label assignment information (device information) stored in a CPU module is changed, acquire it again by using the mdGetLabelInfo function. (Otherwise, an error response is returned.)

Functions to be used

The following table shows functions to be used for label communication.

Function name	Description
mdGetLabelInfo	To acquire device information corresponding to a label name
mdRandRLabelEx	To read data from devices corresponding to labels randomly
mdRandWLabelEx	To write data to devices corresponding to labels randomly

Accessible CPU modules

The following table shows the accessible CPU modules.

Product name	Model name
Programmable controller CPU	R04CPU, R04ENCPU, R08CPU, R08ENCPU, R16CPU, R16ENCPU, R32CPU, R32ENCPU, R120CPU, and R120ENCPU
Process CPU	R08PCPU, R16PCPU, R32PCPU, and R120PCPU

Label types which can be referred to

The following table shows the label types that can be referred to from this product.

○: Available, ×: Not available, —: Not applicable

Label type	Selection status of "Access from External Device"	Availability*1
Global label	Selected	○
	Unselected	×
Local label	—	
System label		

*1 The availability of the label differs depending on the device type assigned to the label.

For the device type, refer to the following:

 MELSEC iQ-R MELSECWinCPU Module Programming Manual

Point

For referring to a label, select "Access from External Device" in GX Works3.

( GX Works3 Operating Manual)

Specification method for label names

The following shows the specification method for accessible label names.

Label type	Specification method	Specification example
Label ^{*1} of a simple data type	Specify the label name.	Label1
Element specification ^{*1} of an array label	Specify in the following format: <ul style="list-style-type: none"> One-dimensional array: Label name [m] Two-dimensional array: Label name [m, n] Three-dimensional array: Label name [m, n, l] 	<ul style="list-style-type: none"> One-dimensional array: Label1 [10] Two-dimensional array: Label2 [10, 20] Three-dimensional array: Label3 [10, 20, 30]
Member ^{*1} of a structure label	Specify in the following format: Label name.Element name. to Element name	Str1.Elem1. to Elem3
Array member ^{*1} of a structure label	Specify in the following format: Label name.Element name [m]	Str1.Elem [10]
Label of timer type, retentive timer type, and counter type	Specify in the following format: <ul style="list-style-type: none"> Contact: Label name.S Coil: Label name.C Current value: Label name.N 	<ul style="list-style-type: none"> Contact: Label1.S Coil: Label2.C Current value: Label3.N

*1 Cannot be accessed by the following specification:

Label type	Description	Specification example
Bit specification of a label	Bit cannot be specified for a label name.	Label1.3
Digit specification of a label	Digits cannot be specified for a label name.	K4Label1
Label of array specified type	A label name cannot be specified for the element number of an array.	<ul style="list-style-type: none"> Label1 [Str1] Label1 [Str1, Str2] Label1 [Str1, Str2, Str3]
Label of structured type	The label name of a structured type that is not the end member cannot be specified.	<p>■When defining the structure label 'Str1' and defining 'Elem1' and 'Elem2' for members Specifying only 'Str1' is not available. To specify the structured type label, specify 'Str1.Elem1' or 'Str1.Elem2.'</p>
	Specifying a label which has the following conditions is not available: a device is manually assigned and the label type is a structured type which has a member of a structured type label.	Str1.Elem1.Elem2 (Only for a label to which a device is manually assigned)

18 FIXED CYCLE PROCESSING FUNCTION

This function refreshes with a network module and performs data communication with an external device. It is performed by the following processing order:

No.	Processing
①	Refresh processing with a network module (link refresh)
②	INFORMATION LED display processing
③	Judgment processing of I/O modules (Windows forced restart and Windows shutdown)
④	Completion processing of dedicated instructions

Setting a cycle for fixed cycle processing

The following shows the setting method for the cycle that the fixed cycle processing function runs.

 [CPU Parameter] ⇒ [Operation Related Setting] ⇒ [Refresh Cycle Setting]

Window



Displayed items

Item	Description	Setting range	Default
Refresh Cycle	Set the refresh cycle.	1 to 2000 ms (1 ms units)	100 ms

Precautions

■Link refresh time

Set a value that satisfies the following condition for a refresh cycle which is set by using this function.

- Total refresh time < Refresh cycle

For link refresh time for each network module, refer to the following:

 Page 174 Link refresh time

■Fixed cycle processing other than link refresh

This function is performed at intervals of refresh cycle.

Increasing a value of refresh cycle according to link refresh time affects the fixed cycle processing other than link refresh.

Consider a refresh cycle when changing a value of link devices (input) or special relays.

The conditions of the following processing are judged in each refresh cycle.

- INFORMATION LED display processing
- Judgment processing of I/O modules (Windows forced restart and Windows shutdown)

When turning a device from OFF to ON to OFF in a shorter time than the set period of refresh cycle, a change in the device value when the device is turned from OFF to ON may not be detected.

- Condition judgment in a refresh cycle of 100 ms

In the figure below, bit data turns ON twice. At the first time, conditions are not satisfied (the ON state cannot be detected) because the bit data turns ON outside of the refresh cycle. At the second time, the conditions are satisfied because the bit data turns ON during the refresh cycle.

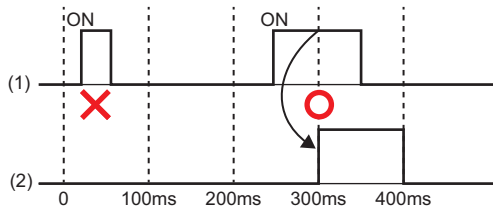

(1) Bit data
(2) Judging conditions in the refresh cycle of 100 ms

In addition, condition judgment and condition satisfaction judgment are performed in every refresh cycle. Therefore, maximum two refresh cycles need to be considered for satisfying certain conditions.

- Condition judgment when setting a refresh cycle to 600 ms and turning an input signal ON for one second

When the input ON state is detected at 600 ms, a condition that an input signal turns ON for one second will be detected at 1800 ms where condition satisfaction judgment is performed. If the input signal turns OFF before 1800 ms, the condition will not be satisfied.

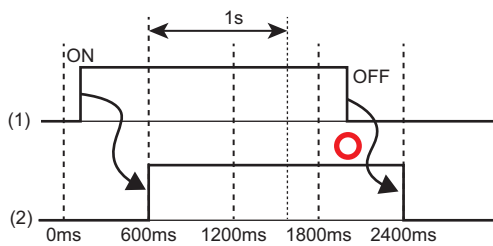

(1) Bit data
(2) Judging conditions in the refresh cycle of 600 ms

Checking the interval

The following shows the method for checking the interval (maximum value/minimum value/current value) at which the fixed cycle processing function runs.

■Checking with special registers

The interval at which the function runs is stored in special registers (SD520 to SD525). (☞ Page 279 Special Register List)

This part comprises the following chapters.

19 REMOTE OPERATION FUNCTION

20 HARDWARE RESET FUNCTION

21 INDIVIDUAL RESET FUNCTION

22 Windows SHUTDOWN FUNCTION

23 Windows FORCED RESTART AT ERROR FUNCTION

24 Y OUTPUT CONTROL FUNCTION

25 INFORMATION LED OPERATION FUNCTION

19 REMOTE OPERATION FUNCTION

This function changes the operating status of this product by changing the Y output status and resetting a bus with peripheral devices and a user program.

The following types of remote operation are available:

Remote type	Description
Remote Y OUT	To change the status of this product to the Y STOP/Y OUT/PAUSE state from an external device while the BUS RESET/Y STOP/Y OUT switch of this product is in the Y OUT position. These can be used when this product is located in an inaccessible place or when changing the status of this product, which is placed in a control panel, to the Y STOP/Y OUT/PAUSE state with an external signal.
Remote Y STOP	
Remote PAUSE	
Remote BUS RESET	To reset the bus of this product through an external operation when this product is in the Y STOP state. Even if the BUS RESET/Y STOP/Y OUT switch is in the Y OUT position, a reset is possible when this product is stopped due to an error or other reasons.



The remote BUS RESET resets the bus of this product. Use a switch to reset the hardware. (Page 189 HARDWARE RESET FUNCTION)

Terms used for other modules that indicate remote operation can be replaced with the following terms:

Before replacement	After replacement
Remote RUN	Remote Y OUT
Remote STOP	Remote Y STOP
Remote PAUSE	Remote PAUSE
Remote RESET	Remote BUS RESET

Precautions

■Remote Y OUT/Y STOP

Since this product gives priority to the Y STOP state, observe the following considerations.

Item	Description
Y STOP timing	This product will be in the Y STOP state when remote Y STOP is performed from either of a user program or CW Configurator. ■When changing the remote Y STOP state to Y OUT again Perform remote Y OUT.
Retaining the output (Y) status during Y STOP	When "Output Mode Setting at Y STOP to Y OUT" is set to "Output the Output (Y) Status before Y STOP" in CW Configurator, the output (Y) status is output when the state is changed from Y OUT to Y STOP at remote Y OUT.
User program during Y STOP	The user program continues to run even if this product is set to the Y STOP state. To change the processing according to the operating status of this product, create a program which reads a value of the special register (SD203) and determines the Y output status.

■Remote PAUSE

The user program continues to run even if this product is set to the PAUSE state.

To change the processing according to the operating status of this product, create a program which reads a value of the special register (SD203) and determines the Y output status.

■Remote BUS RESET

Observe the following considerations.

Item	Description
Status after the completion of remote BUS RESET	When performing the remote BUS RESET operation, the Y output status of this product will be in the status set by the BUS RESET/Y STOP/Y OUT switch. (Page 29 Y output status)
Performing remote BUS RESET at error stop	When performing the remote BUS RESET operation while this product in a single CPU system is stopped due to an error, the Y output status of this product will be in the status set by the BUS RESET/Y STOP/Y OUT switch. (Page 29 Y output status)
Performing remote BUS RESET with CW Configurator	After the remote RESET is performed, the communication between CW Configurator and this product will be disconnected. In this case, reconnect the connection between CW Configurator and this product.
Using the C Controller module dedicated function (CCPU_Reset) in a multiple CPU system	When this product is set to other than the bus master CPU (CPU No.1) in a multiple CPU system, a bus cannot be reset using the C Controller module dedicated function (CCPU_Reset). Check that a MELSECWinCPU module where the bus reset is to be performed with the CCPU_Reset function is set to the bus master CPU.

Performing remote operations

The following shows the methods for performing remote operation.

When resetting a bus (BUS RESET), the "Remote Bus Reset Setting" must be enabled.

Execution method	Description
Engineering tool	Perform remote Y OUT, Y STOP, PAUSE, or BUS RESET from the "Remote Operation" screen of CW Configurator. (CW Configurator Operating Manual)
User program	Perform a remote operation using a dedicated function library provided by this product. (MELSEC iQ-R MELSECWinCPU Module Programming Manual) <ul style="list-style-type: none"> Use the MELSEC data link function (mdControl) to perform remote RUN, STOP or PAUSE. Use the C Controller module dedicated function (CCPU_Reset) to reset the bus of MELSECWinCPU module (CPU No.1).
Dedicated instructions from a module	Use dedicated instructions of a network module. (Manual of a module used)

■Remote BUS RESET setting

[CPU Parameter] ⇒ [Operation Related Setting] ⇒ [Remote Bus Reset Setting]

Window

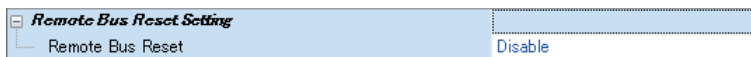

Displayed items

Item	Description	Setting range	Default
Remote BUS RESET	'Enable' to Remote Bus Reset, set the 'Disable.' It is possible to Remote Bus Reset when set the 'Enable.'	<ul style="list-style-type: none"> Disable Enable 	Disable

Status after performing remote operation

The following shows the relationship between remote operations and changes in the Y output status of this product.

—: No status change

Before remote operation			After remote operation			
Factor to determine the Y output status	Y output status	Switch status	Remote operation			
			Remote Y OUT	Remote Y STOP	Remote PAUSE	Remote BUS RESET
BUS RESET/Y STOP/Y OUT switch	Y STOP	Y STOP	—	—	—	BUS RESET
	Y OUT	Y OUT	—	Y STOP	PAUSE	—
Remote operation from CW Configurator or a module	Y STOP	Y STOP	—	—	—	BUS RESET
	PAUSE (The actual operating status is Y STOP.)	Y STOP	—	—	—	BUS RESET
	Y OUT (The actual operating status is Y STOP.)	Y STOP	—	—	—	BUS RESET
	Y STOP	Y OUT	Y OUT	—	PAUSE	BUS RESET
	PAUSE	Y OUT	Y OUT	Y STOP	—	—
	Y OUT	Y OUT	—	Y STOP	PAUSE	—
User program	Y STOP	Y STOP	—	—	—	BUS RESET
	PAUSE (The actual operating status is Y STOP.)	Y STOP	—	—	—	BUS RESET
	Y OUT (The actual operating status is Y STOP.)	Y STOP	—	—	—	BUS RESET
	Y STOP	Y OUT	Y OUT	—	PAUSE	BUS RESET
	PAUSE	Y OUT	Y OUT	Y STOP	—	—
	Y OUT	Y OUT	—	Y STOP	PAUSE	—
Stop error occurred	Y STOP	Y STOP	— (Error STOP)	— (Error STOP)	— (Error STOP)	BUS RESET
	Y STOP	Y OUT	— (Error STOP)	— (Error STOP)	— (Error STOP)	BUS RESET

20 HARDWARE RESET FUNCTION

This function resets hardware.

Reset a system when this product is in the error status such as a hardware error.

Preparation

Perform the Windows shutdown function to shutdown Windows.

For details on the Windows shutdown function, refer to the following:

☞ Page 195 Windows SHUTDOWN FUNCTION

Execution of reset

The following shows the procedure for resetting hardware.

20

Operating procedure

1. Hold the HARD RESET/OS RESET switch on the HARD RESET position (for 1.0 second or longer).
The hardware is reset.
2. Release the HARD RESET/OS RESET switch and put it back to the center position.

Precautions

Ensure to reset the hardware after shutting down Windows.

Otherwise, Windows may not start normally, data in a user drive may be corrupted, or a file system error may occur.

21 INDIVIDUAL RESET FUNCTION

This function resets (restarts) Windows and the bus control in this product individually.

- Restarting Windows only (Windows forced restart)
- Resetting the bus control only (bus reset)

Point

When restarting Windows for reasons such as to add applications and recover from an error, this function can restart only Windows without any effect on the bus control. In addition, this function can reset the bus control and apply parameters without restarting Windows.

Extent of effect from an individual reset

The following table shows the extent of effect on targets by performing an individual reset.

Target	Individual reset	
	Windows forced restart	Bus reset
Windows in this product	Restarted	Not affected
User applications which run on Windows	Ended	Not affected
Parameters of this product and a module which is controlled by this product	Not affected	The latest written parameters are applied.
READY LED	Not affected	Flashing slowly in green during the initial processing of the bus control
OS LED	Flashing or turns OFF according to the Windows status.	Not affected
ERROR LED	Not affected	OFF*1
Y STOP LED	Not affected	ON
Devices and buffer memory	The output (Y) set for "Y Output Setting while Windows is Restarting" turns ON.	Zero clear
Other modules on the same base unit	Not affected	Reset

*1 If an error is not cleared, the ERROR LED will turn ON or flash again.

21.1 Bus Reset

This function resets the bus control. Perform this function when applying parameters written in CW Configurator or when an error occurs (such as when the ERROR LED turns ON).

Execution of reset

The bus can be reset by any of the following methods:

■Switch operation

Hold the BUS RESET/Y STOP/Y OUT switch on the BUS RESET position (for 1.0 second or longer).

■Remote operation

Perform BUS RESET from the "Remote Operation" screen of CW Configurator. (📖 Page 186 REMOTE OPERATION FUNCTION)

■User program

Use the CCPU_Reset function. (📖 MELSEC iQ-R MELSECWinCPU Module Programming Manual)

Point

When resetting the bus via a remote operation or from a user program, the remote BUS RESET must be enabled in the "Remote Bus Reset Setting" of CPU parameters. (📖 Page 187 Remote BUS RESET setting)

Operation after execution

When the bus is reset, this product operates as follows:

- The READY LED flashes slowly in green and turns ON after the bus reset is completed.
- The ERROR LED turns OFF. However, the LED will turn ON or flash again after the bus reset if an error is not cleared.
- When the Y output status is Y OUT, the Y STOP LED turns ON during the bus reset. The Y STOP LED turns OFF after the reset completes.
- After the bus reset is completed, this product operates with parameters which are written just before the reset.
- This product initializes values of its devices and buffer memory.
- The INFORMATION LED retains the status before the bus reset.

Precautions

- Do not reset the bus if this product is set to a CPU (CPU No.2, No.3, or No.4) other than the bus master CPU (CPU No.1) in a multiple CPU system. Otherwise, an error may occur in another CPU module. To apply parameters, reset the bus master CPU (CPU No.1).
- Executing a MELSEC data link function during the bus reset may cause an error in the function.
- If a major error such as a hardware failure occurs, the bus reset may not be completed. If such a case occurs, reset the hardware or turn the power of the entire system OFF and ON.

21.2 Windows Forced Restart

This function shuts down Windows in this product forcibly without performing Windows shutdown processing and restarts it by using a switch or input (X) of an I/O module.

The function can be used for shutting down Windows forcibly and restarting it by using a switch or inputs of I/O modules when the Windows cannot be restarted from Windows Start because it freezes or a system error occurs.

Furthermore, when shutting down Windows by mistake, this function can start only Windows without turning the power of the system OFF and ON.

Execution of reset

Windows can be forcibly restarted by either of the following methods:

■Switch operation

Hold the HARD RESET/OS RESET switch on the OS RESET position (for 1.0 second or longer).

■Using an I/O module (input (X))

Turn ON an input (X) device specified in the parameter for one second or longer by using an input module.*1

*1 The status of the input device is detected at a refresh cycle. However, the status is not detected if the input device is turned from ON to OFF at an interval shorter than the refresh cycle. Consider the refresh cycle when turning the input from ON to OFF. (Page 183 FIXED CYCLE PROCESSING FUNCTION)

An input (X) can be set in the following parameter:

[CPU Parameter] ⇒ [Operation Related Setting] ⇒ [Windows Setting]

Window



Displayed items

Item	Description	Setting range	Default
X Input Setting to Forced Restart Windows	Set the X device for requesting the Windows forced restart. Windows will forcibly be restarted by turning ON the X device specified in parameters for one second or longer.	X0 to FFFH*1	Blank

*1 The same device as the one in "X Input Setting to Shut Down Windows" cannot be set.

Point

In "X Input Setting to Forced Restart Windows," set an input of a module controlled by this product. To set an input of a module controlled by another CPU module, configure the settings so that the input status of other groups is imported. (Page 152 Out-of-Group I/O Fetch)

Precautions

If Windows is forcibly restarted without shutting down Windows, Windows may not start normally, data in a user drive may be corrupted, or a file system error may occur. Ensure to take measures to prevent the files from being corrupted (for example, stop user applications) before forcibly restarting Windows.

Operation after execution

When restarting Windows forcibly, this product operates as follows:

- The OS LED flashes, and turns ON after Windows is restarted.
- If an output (Y) is set in "Y Output Setting while Windows is Restarting," the output (Y) turns ON and then turns OFF after Windows is restarted.

An output (Y) can be set in the following parameter:

 [CPU Parameter] ⇒ [Operation Related Setting] ⇒ [Windows Setting]

Window

Windows Setting	
Y Output Setting while Windows is Restarting	
Y Output Setting when Windows Shut Down	
X Input Setting to Forced Restart Windows	
X Input Setting to Shut Down Windows	

Displayed items

Item	Description	Setting range	Default
Y Output Setting while Windows is Restarting*1	Set the Y device to turn ON when Windows restarted. The device will be ON while the OS LED is flashing due to the restart operation. The device will not turn ON when the OS LED is flashing due to the power-ON or shutdown operation.	Y0 to FFFH*2	Blank

*1 To use this setting, set the Y output status to the Y OUT state by using the Y output control function. If the status is in the Y STOP or PAUSE state, the Y output does not turn ON. ( Page 199 Y OUTPUT CONTROL FUNCTION)

*2 The device set in "Y Output Setting when Windows Shut Down" cannot be set.

22 Windows SHUTDOWN FUNCTION

This function shuts down Windows in this product by using a switch or input of an I/O module.

The shutdown processing of this function is the same as the one when shutting down Windows from Windows Start.

Execution of shutdown

Windows can be shut down by either of the following methods.

■Switch operation

Hold the FUNCTION/SHUTDOWN switch on the SHUTDOWN position (for 1.0 second or longer).

■Using an I/O module (input (X))

Turn ON an input (X) device specified in the parameter for one second or longer by using an input module.*1

*1 The status of the input device is detected at a refresh cycle. However, the status is not detected if the input device is turned from ON to OFF at an interval shorter than the refresh cycle. Consider the refresh cycle when turning the input from ON to OFF. (Page 183 FIXED CYCLE PROCESSING FUNCTION)

An input (X) can be set in the following parameter:

 [CPU Parameter] ⇒ [Operation Related Setting] ⇒ [Windows Setting]

Window



Displayed items

Item	Description	Setting range	Default
X Input Setting to Shut Down Windows	Set the X device for requesting the Windows shutdown. Windows will be shut down by turning ON the X device specified in this parameter for one second or longer.	X0 to FFFH*1	Blank

*1 The device set in "X Input Setting to Forced Restart Windows" cannot be set.

Point

In "X Input Setting to Shut Down Windows," set an input of a module controlled by this product. To set an input of a module controlled by another CPU module, configure the settings so that the input status of other groups are imported. (Page 152 Out-of-Group I/O Fetch)

Precautions

The shutdown processing of this function is the same as the one when shutting down Windows from Windows Start. Therefore, if Windows cannot shut down, this function cannot shut down Windows. In such case, the OS LED of this product may remain flashing.

This function cannot shut down Windows in any of the following cases:

- Windows freezes or a system error occurs.
- Windows is starting up (from when Windows is started by turning the power ON to when the login screen is displayed).
- Window is locked.
- Applications are running on Windows.
- A MELSECWinCPU module is starting in a mode other than the normal mode.
- A major error (such as a WDT error or CRAM CRC error) occurs in a MELSECWinCPU module.

If this function cannot shut down Windows, take the following corrective actions:

- Check if there are any problems in Windows that prevent Windows from shutting down or completing the shutdown processing, such as when the shutdown is performed while a program is running or a file is overwritten. If any problems are found, shut down Windows again after solving the problems.
- Shut down Windows after the startup completes.

If the shutdown problem is not solved by the corrective actions above, turn the power of this product OFF and ON, reset the hardware, or restart Windows forcibly.

Operation after execution

When Windows is shut down, this product operates as follows:

- The OS LED flashes, and turns OFF after Windows is shut down.
- If an output (Y) device is set in "Y Output Setting when Windows Shut Down," the device turns ON after Windows is shut down.

An output (Y) can be set in the following parameter:

 [CPU Parameter] ⇒ [Operation Related Setting] ⇒ [Windows Setting]

Window

Windows Setting	
Y Output Setting while Windows is Restarting	
Y Output Setting when Windows Shut Down	
X Input Setting to Forced Restart Windows	
X Input Setting to Shut Down Windows	

Displayed items

Item	Description	Setting range	Default
Y Output Setting when Windows Shut Down ^{*1}	Set the device to turn ON when the Windows shutdown operation is completed. The device will turn ON when the OS LED turns OFF.	Y0 to FFFH ^{*2}	Blank

*1 To use this setting, set the Y output status to the Y OUT state by using the Y output control function. If the status is in the Y STOP or PAUSE state, the Y output does not turn ON. (Page 199 Y OUTPUT CONTROL FUNCTION)

*2 The device set in "Y Output Setting while Windows is Restarting" cannot be set.

Point

The output that is turned ON by this setting is not turned OFF automatically. After performing the Windows shutdown function, turn OFF the output as necessary such as when forcibly restarting Windows.

23 Windows FORCED RESTART AT ERROR FUNCTION

This function restarts Windows in this product automatically when the Windows freezes or a system error occurs in the Windows.

This product determines the operating status of Windows; therefore, Windows can be restarted even when there is an error that cannot be resolved by Windows automatic restart performed on a system error.

Forced restart settings

Set "Windows Forced Restart" to "Restart" to forcibly restart Windows when an error occurs.

🔗 [CPU Parameter] ⇒ [RAS Setting] ⇒ [Windows Operation Setting of CPU Module at Error Detected]

Window



Displayed items

Item	Description	Setting range	Default
Windows Forced Restart	Set whether to forcibly 'Restart' or 'Do Not Restart' when an error occurs in Windows of the CPU module.	• Restart • Do Not Restart	Do Not Restart
Monitoring time	Set the time to detect an error in Windows of the CPU module.	1 to 600 [sec] (1 sec unit)	5 Second

23

Precautions

■Value for monitoring time

Windows is determined to be frozen even when a service of this product cannot run because the load on Windows is high. When temporarily operating a system under a high load, set a large value for the time to detect an error. If this function runs even when setting the maximum value for the time to detect an error, adjust the system to shorten the high load time.

■Restarting Windows forcibly when an error occurs

If Windows is restarted forcibly without shutting down Windows, Windows may not start normally, data in a user drive may be corrupted, or a file system error may occur. Ensure to create a backup for recovering Windows before restarting Windows forcibly. (🔗 Page 100 Windows Recovery)

■Restarting Windows automatically when a system error occurs

If Windows automatic restart is enabled and also "Restart" is selected for "Windows Forced Restart," this product may restart repeatedly. When selecting "Restart," disable Windows automatic restart.

🔗 Windows Start ⇒ [Windows System Tools] ⇒ [Control Panel] ⇒ [System and Security] ⇒ [System] ⇒ [Advanced system settings] ⇒ [Advanced] ⇒ [Startup and Recovery] ⇒ [Settings] ⇒ [System failure] ⇒ [Automatically restart]

■Starting Windows in the safe mode

If Windows is forcibly restarted multiple times, the screen for selecting whether to start in the safe mode appears.

If Windows starts in the safe mode, Windows is not forcibly restarted even when an error occurs.

■Lightning or flashing status of the OS LED

When selecting "Restart" for "Windows Forced Restart," the OS LED flashes because Windows attempts to restart even if the Windows freezes or a system error occurs.

The OS LED also flashes when selecting "Automatically restart" in the "System failure" section of the automatic restart setting on Windows because Windows attempts to restart even if "Do Not Restart" is selected for "Windows Forced Restart" in CW Configurator.

The OS LED turns OFF if Windows freezes or an system error occurs only when "Do Not Restart" is selected for "Windows Forced Restart" in CW Configurator and the restart setting on Windows is set to not automatically restart.

MEMO

24 Y OUTPUT CONTROL FUNCTION

This function controls the Y output status (Y STOP/Y OUT/PAUSE) with the BUS RESET/Y STOP/Y OUT switch or a MELSEC data link function.

For details on the Y output status of this product, refer to the following:

☞ Page 29 Y output status

Changing the Y output status

The following table shows the methods for changing the Y output status.

Method	Operation	Y STOP LED status	Y output status
Switch operation	Change the BUS RESET/Y STOP/Y OUT switch from Y OUT to Y STOP.	ON in orange	Y STOP state
	Change the BUS RESET/Y STOP/Y OUT switch from Y STOP to Y OUT.	OFF	Y OUT state
MELSEC data link function	Specify STOP with the mdControl function.	ON in orange	Y STOP state
	Specify RUN with the mdControl function.	OFF	Y OUT state
	Specify PAUSE with the mdControl function.	Flashing in orange	PAUSE state
Remote operation from another station	Specify Y STOP with a remote operation. *1	ON in orange	Y STOP state
	Specify Y OUT with a remote operation. *1	OFF	Y OUT state
	Specify PAUSE with a remote operation.	Flashing in orange	PAUSE state

*1 Specify STOP (Y STOP) or RUN (Y OUT) when performing the remote operation from a tool other than CW Configurator.

Point

- The switch operation takes priority to set the Y output status. When the BUS RESET/Y STOP/Y OUT switch is set to Y STOP, the Y output status cannot be changed to Y OUT state with a MELSEC data link function and remote operation.
- If the Y output status is changed to the Y STOP state by remote operation, it can be changed to Y OUT state only from a tool or another station that performs the remote operation.

Y output status when an error occurs

Refer to the following:

☞ Page 210 Operation Setting When an Error is Detected

Y output status when a switch is operated or a stop error occurs

—: No status change

Factor to determine the Y output status	Y output status before change		Y output status after change		
	Y output status	Switch status	BUS RESET/Y STOP/Y OUT switch		Stop error occurred
			Y OUT	Y STOP	
BUS RESET/Y STOP/Y OUT switch	Y STOP	Y STOP	Y OUT	—	—
	Y OUT	Y OUT	—	Y STOP	Y STOP
Remote operation from CW Configurator or a module	Y STOP	Y STOP	—	—	—
	PAUSE (The actual operating status is Y STOP.)	Y STOP	PAUSE	—	—
	Y OUT (The actual operating status is Y STOP.)	Y STOP	Y OUT	—	—
	Y STOP	Y OUT	—	—	—
	PAUSE	Y OUT	—	Y STOP	Y STOP
	Y OUT	Y OUT	—	Y STOP	Y STOP

Y output status before change			Y output status after change		
Factor to determine the Y output status	Y output status	Switch status	BUS RESET/Y STOP/Y OUT switch		Stop error occurred
			Y OUT	Y STOP	
User program	Y STOP	Y STOP	—	—	—
	PAUSE (The actual operating status is Y STOP.)	Y STOP	PAUSE	—	—
	Y OUT (The actual operating status is Y STOP.)	Y STOP	Y OUT	—	—
	Y STOP	Y OUT	—	—	—
	PAUSE	Y OUT	—	Y STOP	Y STOP
	Y OUT	Y OUT	—	Y STOP	Y STOP
Stop error occurred	Y STOP	Y STOP	— (Error STOP)	—	—
	Y STOP	Y OUT	—	— (Error STOP)	—

Output mode setting when the Y output status is changed from Y STOP to Y OUT

When the Y output status is changed from the Y OUT or other state to the Y STOP state, this product saves the output (Y) status and turns OFF all outputs (Y).

In this setting, whether to output the output (Y) status just before the status is changed to the Y STOP state or to clear all the outputs (Y) can be selected.

 [CPU Parameter] ⇒ [Operation Related Setting] ⇒ [Output Mode Setting at Y STOP to Y OUT]

Window



Displayed items

Item	Description	Setting range	Default
Output Mode at Y STOP to Y OUT	Set 'output the output (Y) status before Y STOP' and 'clear the output (Y)' when the status is switched from Y STOP to Y OUT.	<ul style="list-style-type: none"> Output the Output (Y) Status before Y STOP Clear the Output (Y) 	Output the Output (Y) Status before Y STOP

25 INFORMATION LED OPERATION FUNCTION

This function operates the display status of the INFORMATION LED from a user program.

Display specifications of the INFORMATION LED

The following table shows the display specifications of the INFORMATION LED.

LED name	Display specification
INFORMATION LED	OFF
	ON (red)
	Slow flashing (red) ^{*1}
	Flashing (red) ^{*1}
	ON (green)
	Slow flashing (green) ^{*1}
	Flashing (green) ^{*1}

*1 Flashing occurs at the following intervals:

- Flashing: 200 ms
- Slow flashing: 1 sec

Operation method

The display status of the INFORMATION LED can be operated by turning the special relay (SM680) and special register (SD680) from OFF to ON with MELSEC data link functions. The result is stored in the special register (SD681). (Page 275 Special Relay List, Page 279 Special Register List)

1. Store a value to specify the LED display status to SD680.
2. Turn SM680 from OFF to ON at a desired time to turn ON or OFF the INFORMATION LED.

When SM680 turns ON, the INFORMATION LED is turned ON or OFF. After the INFORMATION LED turns ON or OFF, the result is stored in SD681 then SM680 is turned from ON to OFF.

Point

The INFORMATION LED is turned ON or OFF by checking the status of SM680 at a refresh cycle. Therefore, if SM680 is turned from OFF to ON then back to OFF within the refresh cycle, the INFORMATION LED status does not change. (Page 183 FIXED CYCLE PROCESSING FUNCTION)

3. Check if the INFORMATION LED is operated correctly.
 - When operated correctly, SD681 has the same value as SD680.
 - When operated incorrectly, SD681 has a different value from SD680.

Precautions

If a value out of range is stored in SD680, the LED is not operated correctly. To check if it is operated correctly, compare the values between SD680 and SD681 and check that the values match.

MEMO

PART 5

DIAGNOSTICS AND MAINTENANCE FUNCTIONS

This part comprises the following chapters.

26 BUS ACCESS DIAGNOSTICS FUNCTION

27 WATCHDOG TIMER FUNCTION

28 SELF-DIAGNOSTICS FUNCTION

29 ERROR CLEAR FUNCTION

30 EVENT HISTORY FUNCTION

31 PARAMETER/EVENT HISTORY INITIALIZATION FUNCTION

26 BUS ACCESS DIAGNOSTICS FUNCTION

This function diagnoses whether there are failures in hardware used for the bus access function of this product.

For details on the bus access function, refer to the following:

☞ Page 112 BUS ACCESS FUNCTION

Perform the bus access diagnostics in the following case:

- Troubleshooting when a failure occurs in the bus access function

Point

It takes approximately five minutes to perform the bus access diagnostics.

Precautions

- Do not turn the power of this product ON and OFF or reset this product during the bus access diagnostics. (☞ Page 58 POWER OFF AND RESET)
Doing so may result in this product not being able to start normally. If this product does not start normally, perform the parameter/event history initialization function. (☞ Page 219 PARAMETER/EVENT HISTORY INITIALIZATION FUNCTION)
- An error may occur in another CPU module if the bus access diagnostics is performed in a multiple CPU system. To perform the bus access diagnostics, configure a system which only includes a power supply module, a base unit, and this product. Cables and devices do not need to be disconnected from this product.

Performing diagnostics

The following shows the procedure for performing diagnostics.

1. Turn the power of this product OFF.
2. Set the BUS RESET/Y STOP/Y OUT switch to the Y STOP position.
3. Hold the FUNCTION/SHUTDOWN switch on the FUNCTION position to turn the power of this product ON.

This product starts in the maintenance mode.

In the maintenance mode, the READY LED is ON in orange.

- READY LED: ON (orange)

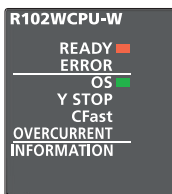

4. Release the FUNCTION/SHUTDOWN switch and put it back to the center position.
 5. Set the FUNCTION/SHUTDOWN switch to the FUNCTION position to select the bus access diagnostics.
- Every time the FUNCTION/SHUTDOWN switch is set to the FUNCTION position, the operation to be performed is changed.

Item	LED status
Bus access diagnostics	<ul style="list-style-type: none"> • READY LED: ON (orange) • OS LED: ON (green) • Other LEDs: OFF

For the other function which can be selected in the maintenance mode, refer to the following:

☞ Page 27 Operation mode

6. Set the BUS RESET/Y STOP/Y OUT switch to the Y OUT position.

The bus access diagnostics is performed.

The OS LED flashes in green during the diagnostics.



7. Check the LED statuses.

- When the bus access diagnostics is completed normally, the OS LED turns ON in green.



- When the bus access diagnostics is completed with an error, the ERROR LED flashes in red.

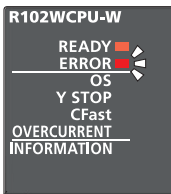

If the bus access diagnostics is completed with an error, turn the power of this product OFF and perform the diagnostics again.

If it is completed with an error again, a hardware failure may occur in this product. Please contact your local Mitsubishi Electric sales office or representative.

8. Turn the power of this product OFF.

27 WATCHDOG TIMER FUNCTION

This function monitors and detects a bus control failure using the watchdog timer (WDT) and notifies an error if the failure occurs. The watchdog timer (WDT) is an internal timer of this product.

Point

- The function does not monitor for Windows in this product.
- It does not affect the operation of Windows. However, a Windows service that uses the MELSEC functions of this product may not operate properly.

Monitoring time setting

Set the monitoring time for the watchdog timer.

[CPU Parameter] ⇒ [RAS Setting] ⇒ [WDT (Watchdog Timer) Setting] ⇒ [System WDT Setting]

Window



Displayed items

Item	Description	Setting range	Default
Monitoring time	Set the monitoring time of the system WDT.	20 to 2000 [ms] (10 ms units)	1000 ms

Watchdog timer error (timeout of the watchdog timer)

If system processing is suspended for a long time because of a hardware failure, etc., the watchdog timer cannot be reset and timeout will occur.

When the watchdog timer times out, an error indicating that the monitoring time set in the WDT (watchdog timer) setting has been exceeded (watchdog timer error) occurs.

State of this product

If an error occurs, this product will be in the following state.

Item	Description
LED status	LED statuses change to as follows: <ul style="list-style-type: none"> • READY LED: OFF • ERROR LED: ON (red) • Y STOP LED: ON (orange) The statuses of other LEDs do not change.
Output	This product is in the Y STOP state. The Y output status follows the output mode setting when the status is changed from Y STOP to Y OUT. (Page 199 Y OUTPUT CONTROL FUNCTION)
User program	A user program does not stop. However, an error is returned when executing the following functions: <ul style="list-style-type: none"> • mdBdDevSetEx function • mdBdDevRstEx function • mdBdSendEx function • mdBdReceiveEx function • mdBdRandWEx function • mdBdRandREx function • mdBdWriteLinkDeviceEx function • mdBdReadLinkDeviceEx function • CCPU_ClearError function

28 SELF-DIAGNOSTICS FUNCTION

This function diagnoses whether there are any errors in this product.

Precautions

Depending on the error occurrence status, errors may not be detected by the self-diagnostics function. Configure safety circuits external to the system to ensure that the entire system operates safely even when this product is not stopped by the function.

28.1 Self-diagnostics Timing

If an error occurs at the start or during operation of this product, the detected error information is displayed.

An error is detected even when Windows is shut down or stopped.

28.2 Error Status Check

A detected error can be checked by the following methods.

Special relays or special registers

When an error is detected, the special relays (SM0, SM1) are turned ON, and an error code corresponding to the error is stored in the special register (SD0). If more than one error are detected, the latest error code is stored in the special register (SD0).

Up to 16 error codes (latest errors occurred on the system) will be stored in the special registers (SD10 to SD25).

CW Configurator

The error occurrence of the entire system, latest errors occurred, and event history can be checked in the module diagnostics screen. (📖 CW Configurator Operating Manual)

Up to 16 latest errors occurred in this product can be displayed. In addition, if an additional error occurs after a stop error, the error information is not updated.

Error logs can be checked in the event history. (👉 Page 217 EVENT HISTORY FUNCTION)

Point

Up to 15 continuation errors and 2 stop errors can be displayed. If 15 continuation errors are displayed, new continuation errors will not be displayed. In addition, if the new error has the same error code as the already displayed error, the error occurrence date/time and its detailed information will not be updated.

28.3 Error Detection Setting

For specific errors, whether to detect the errors can be set.

Error detection setting

[CPU Parameter] ⇒ [RAS Setting] ⇒ [Error Detections Setting]

Window

<i>Error Detection Setting</i>	
Battery Error	Detect
Module Verification Error	Detect
Fuse Blown	Detect

Displayed items

Item	Description	Setting range	Default
Battery Error	Set 'detect' or 'not detect' the battery error when battery voltage drop and the like.	<ul style="list-style-type: none"> • Detect • Not Detected 	Detect
Module Verification Error	Set whether to 'Detect' or 'Not Detect' the module verify error such as different module detection from the one when power is ON.		
Fuse Blown	Set 'Detect' or 'Not Detect' the fuse blown of control module.		

28.4 Operation Setting When an Error is Detected

For specific errors, the operation when the errors occur can be set.

Point

A user program running on Windows keeps running regardless of when the Y output status is changed to Y STOP in this product. To change the program processing according to the Y output status, create a program that reads the value of the special register (SD203) and determines the Y output status. (Page 279 Special Register List)

Operation setting for a CPU module when an error is detected

Set the operation of this product when an error is detected.

[CPU Parameter] ⇒ [RAS Setting] ⇒ [CPU Module Operation Setting at Error Detected]

Window

CPU Module Operation Setting at Error Detection	
Module Verification Error	Change to the Y STOP State
Fuse Blown	Change to the Y STOP State

Displayed items

Item	Description	Setting range	Default
Module Verification Error	Set whether to 'Change to the Y STOP State' or 'Do Not Change the Output State' for the CPU module when module verify error was detected.	• Change to the Y STOP State • Do Not Change the Output State	Change to the Y STOP State
Fuse Blown	Set whether to 'Change to the Y STOP state' or 'Do Not Change the Output State' for the CPU module when fuse blown error was detected.		

Point

If "Do Not Change the Output State" is set, the following errors are treated as minor:

- Module Verification Error: 2400H, 2401H
- Fuse Blown: 2420H

Therefore, the above errors are included in the targets of the LED display setting and can be cleared.

Operation setting when an error is detected in each module

Set whether to change the operating status of this product when an error occurs in a module controlled by this product.

 [System Parameter] ⇒ [I/O Assignment Setting] ⇒ [CPU Module Operation Setting at Error Detection]

Window

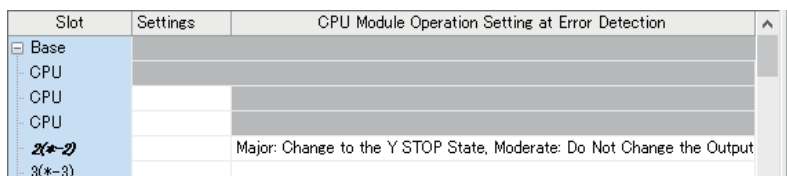

28

Displayed items

Item	Description	Setting range	Default
CPU Module Operation Setting at Error Detection	Set the operation of CPU module whether to change the state to Y STOP or not to change the output state when a major or moderate error is detected in the set module. When using the multiple CPU function, please set it if the PLC No. set in the control PLC settings is the host station.	<ul style="list-style-type: none"> Major: Change to the Y STOP State, Moderate: Do Not Change the Output State Major: Change to the Y STOP State, Moderate: Change to the Y STOP State Major: Do Not Change the Output State, Moderate: Do Not Change the Output State 	Major: Change to the Y STOP State, Moderate: Do Not Change the Output State

Point

If an option including "Do Not Change the Output State" is selected, the following errors are treated as minor:

- Module moderate error: 1200H
- Module major error: 2441H, 2442H, and 2450H

If an option including "Change to the Y STOP State" is selected, the following error is treated as moderate:

- Module moderate error: 1200H

Operation setting for all CPUs when an error is detected

Set whether to stop the operation of all CPUs when a major or moderate error occurs in any of the CPUs in a multiple CPU system.

 [System Parameter] ⇒ [Multiple CPU Setting] ⇒ [Operation Mode Setting] ⇒ [Stop Setting]

Window

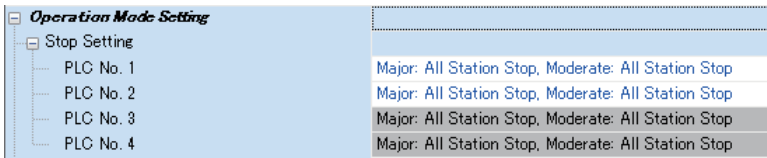

Displayed items

Item	Description	Setting range	Default
PLC No.1	Set the operation of all stations when major or moderate error is detected in the PLC No. 1.	<ul style="list-style-type: none"> Major: All Station Stop, Moderate: All Station Stop Major: All Station Stop, Moderate: All Station Stop Major: All Station Stop, Moderate: All Station Continue Major: All Station Continue, Moderate: All Station Continue 	Major: All Station Stop, Moderate: All Station Stop
PLC No.2	Set the operation of all stations when major or moderate error is detected in the PLC No. 2.		
PLC No.3	Set the operation of all stations when major or moderate error is detected in the PLC No. 3.		
PLC No.4	Set the operation of all stations when major or moderate error is detected in the PLC No. 4.		

Point

If an option including "All Station Continue" is selected, the following errors are treated as minor:

- Another CPU module major error: 2461H, 2462H, and 2470H

If an option including "All Station Stop" is selected, the following error is treated as moderate:

- Another CPU module moderate error: 1220H

LED display setting when a minor error occurs

Set whether to turn ON the ERROR LED when a minor error (continuation error) occurs.

 [CPU Parameter] ⇒ [RAS Setting] ⇒ [LED Display Setting] ⇒ [ERROR LED]

Window



Displayed items

Item	Description	Setting range	Default
Minor Error (Continue Error)	Set whether to 'display' or 'do not display' ERROR LED when minor error (continue error) was detected.	<ul style="list-style-type: none"> • Display • Do Not Display 	Display

Point

If "Do Not Display" is selected, the ERROR LED status, special relays, special registers, etc. are not updated even if a minor error occurs; however, the minor error is registered in the event history.

28.5 Current Consumption Monitoring Function

This function monitors the current consumption value of an entire module and sends a notification if the threshold value of current consumption is exceeded. If the current consumption does not drop below the threshold value for the certain amount of time after the notification, this function stops the current that is supplied to USB ports in phases. Doing so can prevent the power supply module from detecting overcurrent and stopping the power supply to the entire system.

Operation of the monitoring function

This function operates according to the following phases if it detects excessive current consumption by monitoring the current consumption of a module.

Phase		Operation of this product			
		USB port to be stopped	ERROR LED	OVERCURRENT LED	Error code to be registered
Phase 1	The threshold value of a current consumption error (warning) is exceeded.	N/A	ON	ON	1855H
Phase 2	The threshold value of a current consumption error (USB port forced stop) is exceeded.	USB3.0 (USB connector (P1))	ON	Slow flashing (at 1 sec interval)	1856H
Phase 3	The threshold value of a current consumption error (USB port forced stop) is still exceeded even after USB3.0 stops.	USB2.0 (USB connectors (P2 to P4))	ON	Flashing (200 ms interval)	1857H

For details on the error codes, refer to the following:

📖 Page 229 ERROR CODE LIST

Point

If the current consumption value varies, the possibility that the threshold value of a current consumption error (USB port forced stop) may be exceeded is notified. (In phase 1)

The following figure shows the operation when the threshold value of a current consumption error (USB port forced stop) is still exceeded even after USB3.0 stops.

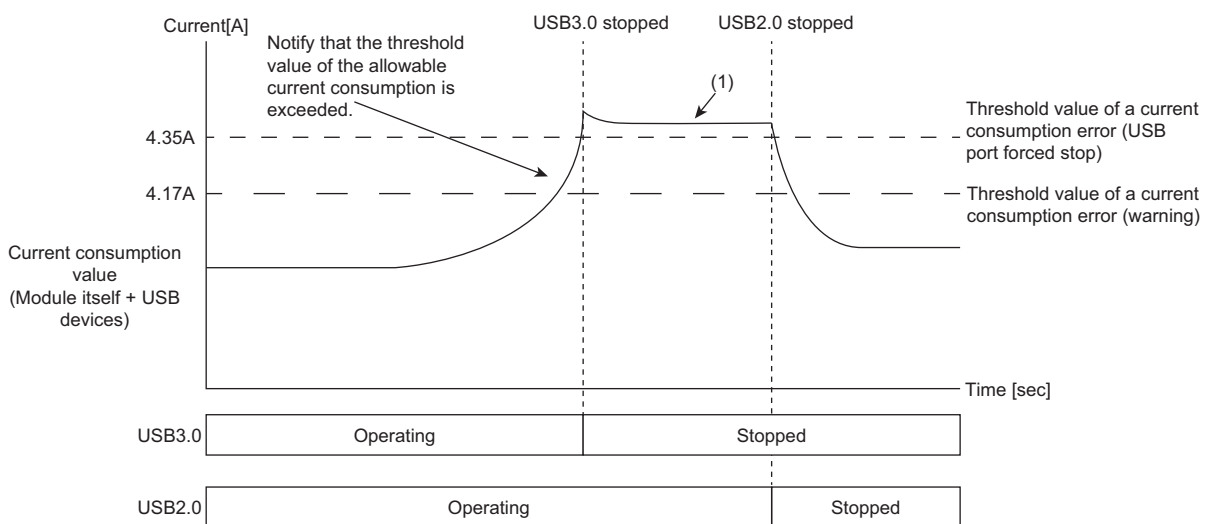

(1) USB2.0 stops because the threshold value is still exceeded even after USB3.0 stops.

Current value of current consumption

The current value of current consumption can be checked in 'Current consumption value' (Un\G103). (Unit: mA)

Method for clearing an error

The following shows the procedure for clearing an error.

1. Disconnect peripheral devices from the USB ports of this product.
2. Hold the FUNCTION/SHUTDOWN switch on the FUNCTION position (for 1.0 second or longer).

The current consumption error (warning) or current consumption error (USB port forced stop), which was detected because its threshold value was exceeded, is cleared.

Precautions

If clearing an error while the current consumption value of a module exceeds the threshold value of a current consumption error (warning) or that of a current consumption error (USB port forced stop), the same error is detected again.

29 ERROR CLEAR FUNCTION

This function clears all the continuation errors in this product.

Precautions

- Since this function clears all the continuation errors at once, unintended errors may also get cleared.
- Errors cleared by this function are not removed from the event history.
- Any errors occurred in a module other than this product cannot be cleared by this function.

Using CW Configurator

Clear errors by performing the module diagnostics in CW Configurator. ( CW Configurator Operating Manual)

Using a user program

Clear errors with a MELSEC data link function.

- 1.** Check the detected continuation errors with special registers (SD10 to SD25).
- 2.** Clear the cause of the continuation errors.
- 3.** Execute the CCPU_ClearError function.

MEMO

30 EVENT HISTORY FUNCTION

This function collects and saves the following information: errors detected by this product, operations performed for this product, and errors occurred on a network.

Saved information about errors and operations can be checked in chronological order using Windows Event Viewer and CW Configurator.

Precautions

The save destination for an event history file cannot be changed. The storage capacity for the event history is 128 KB.

30.1 Event Information to be Registered

This section shows the event information that are registered by using the event history function and its registration destination.

Event	Registration destination	
	Windows event log	Bus control event history
Service and driver event information	Registered.	<ul style="list-style-type: none">• Error: Registered.• Event: Not registered.
Bus control event information	Only specified events are registered.*1 (☞ Page 218 Registration Destination for Event Information)	Registered.

*1 An error may occur between the actual occurrence date and the date logged in the Windows event log.

Service and driver event information

This information refers to errors and events that are detected by services and drivers of this product running on Windows. Registered event information can be checked in Windows Event Viewer. (☞ Page 225 Checking Events with the Event Viewer)

☞ [Event Viewer] ⇒ [Applications and Services Logs] ⇒ [MELSEC Service]

Bus control event information

This information refers to errors and events for the bus control that are detected by this product or other modules controlled by this product.

Registered event information can be checked in the event history screen of CW Configurator. (☞ Page 226 Checking Errors in CW Configurator)

If this information is registered in the Windows event log, it can be checked by selecting the following menu in Windows Event Viewer.

☞ [Event Viewer] ⇒ [Applications and Services Logs] ⇒ [MELSEC Bus Event]

Precautions

- A bus control event is registered in Windows Event Viewer after Event Log Service is started. Note that the event is not registered when turning the power of this product OFF and ON or when Event Log Service is not running. To check a bus control event while Event Log Service is not running, check the event in the event history screen of CW Configurator.
- Due to processing for registering an event to Windows Event Viewer, the date and time displayed in the "Logged" of an event log, which is registered in Windows Event Viewer, may be different from the occurrence date and time of an event displayed in the bus control event history. To check whether the same event is registered, compare the following items:
'An event code in the bus control event history'
'An event code in the dialog box of an event registered in Windows Event Viewer'
- When changing a time zone on Windows, the time in the "Logged" of event logs, which are registered in Windows Event Viewer, is corrected according to the changed time zone. Therefore, the date and time of the event logs may be different from that of events in the event history because time in the event history is not corrected by the changed time zone.

30.2 Registration Destination for Event Information

Events occurred in the bus control can be registered to the Windows event log.

Registration destination setting

Set the following items when registering bus control event information to the Windows event log.

 [CPU Parameter] ⇒ [RAS Setting] ⇒ [Event History Setting] ⇒ [Registration Destination Setting]

Window

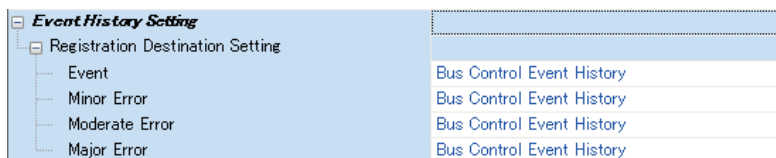

Displayed items

Item	Description	Setting range	Default
Event	Set the destination to register event information for which event classification is not an error.	<ul style="list-style-type: none"> • Bus Control Event History • Bus Control Event History and Windows Event Log 	Bus Control Event History
Minor Error	Set the destination to register information on minor errors.		
Moderate Error	Set the destination to register information on moderate errors.		
Major Error	Set the destination to register information on major errors.		

■ Items displayed in Windows Event Viewer

The following table shows which information in the bus control event history is displayed in which item in Windows Event Viewer.

Bus control event history	Item in Windows Event Viewer
Occurrence Date	___*1*2
Event Type	Level
Status	Level Each type of error and an event are categorized as follows: <ul style="list-style-type: none"> • Major error and moderate error: Error • Minor error: Warning • Event: Information
Event Code	"Event code" in the dialog box*2
Overview	___*2
Cause	___*2
Corrective Action	___*2
Detailed Information	___*2

*1 The time when an event is registered in the Windows event log is displayed in "Logged." If the time differs between the clock on Windows and that on the MELSEC functions, an error occurs in each occurrence time.

*2 In Event Viewer, an error/event code and the link to a manual are registered in the dialog box. Refer to the link to check the overview, cause, and corrective action for the event.

31 PARAMETER/EVENT HISTORY INITIALIZATION FUNCTION

This function returns this product to the factory default state by initializing the parameters and bus control event history of this product.

This function can be used for recovering this product by using switches when parameters cannot be written, etc. due to an error in this product such as a parameter error.

Targets

Parameters and the bus control event history become as follows after initialization:

Item	Description
Parameters	Default values are set.
Bus control event history	Only an event indicating that the parameter/event history initialization was performed is registered.

Point

- Back up necessary parameters in advance. The parameter settings are deleted after initialization.
- Only the parameters and bus control event history that are stored in this product are initialized. Therefore, data on Windows is not deleted.

To initialize Windows, refer to the following:

(☞ Page 100 Windows Recovery)

31

Procedure

The following shows the procedure for initialization.

1. Turn the power of this product OFF.
2. Set the BUS RESET/Y STOP/Y OUT switch to the Y STOP position.
3. Hold the FUNCTION/SHUTDOWN switch on the FUNCTION position to turn the power of this product ON.

This product starts in the maintenance mode.

In the maintenance mode, the READY LED is ON in orange.

- READY LED: ON (orange)

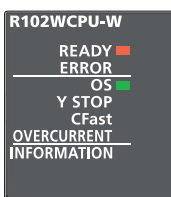

4. Release the FUNCTION/SHUTDOWN switch and put it back to the center position.

5. Set the FUNCTION/SHUTDOWN switch to the FUNCTION position to select the parameter/event history initialization. Every time the FUNCTION/SHUTDOWN switch is set to the FUNCTION position, the operation to be performed is changed.

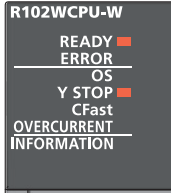
Item	LED status	
Parameter/event history initialization		<ul style="list-style-type: none"> • READY LED: ON (orange) • Y STOP LED: ON (orange) • Other LEDs: OFF

For the other function which can be selected in the maintenance mode, refer to the following:

☞ Page 27 Operation mode

6. Set the BUS RESET/Y STOP/Y OUT switch to the Y OUT position.

The parameter/event history initialization is performed.

The Y STOP LED flashes in orange during the initialization.

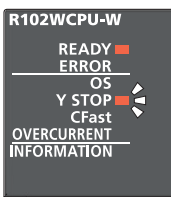

7. Check the LED statuses.

When the parameter/event history initialization is completed normally, the Y STOP LED turns ON in orange.

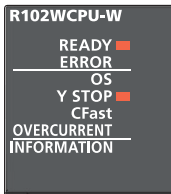

When the parameter/event history initialization is completed with an error, the ERROR LED flashes in red.



If the parameter/event history initialization is completed with an error, turn the power of this product OFF and perform the initialization again.

8. Turn the power of this product OFF.

This part comprises the following chapters.

32 TROUBLESHOOTING

33 ERROR CODE LIST

34 TROUBLESHOOTING BY SYMPTOM

32 TROUBLESHOOTING

This chapter explains the content, causes, and corrective actions of errors that occur when the system is used.

For troubleshooting of individual modules, refer to the manual of each module.

If the errors cannot be resolved with the actions described in this manual, contact your local Mitsubishi Electric sales office or representative.

1. Check the LEDs of the power supply module and check whether an error has occurred.

For the display specifications and troubleshooting of the LEDs, refer to the following:

📖 MELSEC iQ-R Module Configuration Manual

2. Check the LEDs of this product. (👉 Page 223 Checking Errors with LEDs)
3. Check the LEDs of an I/O module and intelligent function module. (📖 The manual of each module)
4. Check whether an error has occurred by using the system monitor function or performing module diagnostics using CW Configurator, and take the corresponding action. (👉 Page 226 Checking Errors in CW Configurator)
5. Check an event code with Windows Event Viewer, and take the corresponding action. (👉 Page 225 Checking Events with the Event Viewer)
6. Check an error code of a dedicated function offered by this product, and take the corresponding action.

For the dedicated functions offered by this product, refer to the following:

📖 MELSEC iQ-R MELSECWinCPU Module Programming Manual

7. If the error cause cannot be specified by the step 1 to step 6, perform troubleshooting by symptom. (👉 Page 256 TROUBLESHOOTING BY SYMPTOM)

Point

For Windows-related troubleshooting, also refer to 'FAQ' in MITSUBISHI ELECTRIC FA Global Website.

- www.mitsubishielectric.com/fa/
-

8. If no error corresponding to the above troubleshooting has occurred, perform any of the following operations:
 - Reset the bus.
 - Write parameters in CW Configurator, and reset the bus.
 - Restart Windows in this product.
 - Restart a MELSECWinCPU module.
9. If the same error occurs even if the operation above is performed, perform the bus access diagnostics function. (👉 Page 204 BUS ACCESS DIAGNOSTICS FUNCTION)

32.1 Checking Errors with LEDs

The following table shows check items with LEDs on the front of this product.

For the display specifications of each LED, refer to the following:

 Page 20 PART NAMES





The READY LED is not ON in green

Check item	Corrective action
Is the ERROR LED ON?	<ul style="list-style-type: none"> • Turn the power of the system OFF and ON. • Take a corrective action according to the description of an event registered in the event history. <p>If the same error occurs again, a hardware failure may occur. Please contact your local Mitsubishi Electric sales office or representative.</p>
Is the ERROR LED flashing?	Take a corrective action according to the description of an event registered in the event history.
Is this product mounted on CPU No.2, No.3, or No.4 in a multiple CPU system and is CPU No.1 reset?	Turn the power of the system OFF and ON.
Is the INFORMATION LED ON in green?	Turn the power of the system OFF and ON.

The OS LED is OFF

Check item	Corrective action
Is Windows shut down?	<ul style="list-style-type: none"> • Turn the power of the system OFF and ON. • Restart Windows forcibly.
Check if the system was powered on immediately after power-off?	Wait for five seconds or longer after power-off and power on the system again.

The OS LED is flashing

Check item	Corrective action
Has the Windows startup screen been displayed for a long time?	<ul style="list-style-type: none"> • Turn the power of the system OFF and ON. • Restart Windows forcibly. • Start Windows in the safe mode, and repair it. • If the same symptom occurs repeatedly, recover Windows. ( Page 100 Windows Recovery) <p>If the recovery fails, a hardware failure may occur in this product. Please contact your local Mitsubishi Electric sales office or representative.</p>
Is 'Operating System not found' displayed in the display?	<ul style="list-style-type: none"> • Turn the power of the system OFF and ON. • Restart Windows forcibly. • Check if a CFast card is inserted correctly. • Recover Windows. ( Page 100 Windows Recovery) <p>If the recovery fails, a hardware failure may occur in this product. Please contact your local Mitsubishi Electric sales office or representative.</p>
Is the Windows in this product initialized by a method other than Windows recovery? Example) Windows Start ⇒ [Settings] ⇒ [Update & Security] ⇒ [Recovery] ⇒ [Reset this PC]	Recover Windows according to the procedure for recovering Windows in this product. ( Page 100 Windows Recovery) When Windows fails to recover or when a recovery drive and a system image are not created, please contact your local Mitsubishi Electric sales office or representative.
Is there nothing displayed on the display?	Turn the power of the system OFF and ON. If the problem is not solved, a hardware failure may occur in this product. Please contact your local Mitsubishi Electric sales office or representative.
Is the Windows shutdown function of this product performed?	Check the considerations for the Windows shutdown function, and take corrective actions if Windows cannot shut down. ( Page 195 Windows SHUTDOWN FUNCTION)
Check if the system was powered on immediately after power-off?	Wait for five seconds or longer after power-off and power on the system again.

The OVERCURRENT LED is ON or flashing

Check item	Corrective action
Is the amount of the current consumption of the peripheral devices connected to a USB port large?	Check the specifications (current consumption value) of the peripheral devices to make sure that the devices can be connected to this product. If the specification exceeds the allowable current consumption of this product, review the devices being used (such as self-powered devices), or change the configuration so that a self-powered USB hub is used. Clear an error after reviewing the configuration. ( Page 61 Calculation for the current consumption value of a USB device)

32.2 Checking Events with the Event Viewer

An occurred event log can be checked with Windows Event Viewer.

For events registered by Windows service, refer to the following:

☞ Page 107 Events Registered by Windows Service

🔗 Windows Start ⇒ [Windows Administrative Tools] ⇒ [Event Viewer] ⇒ [Applications and Services Logs] ⇒ [MELSEC Service] or [MELSEC Bus Event]

Window

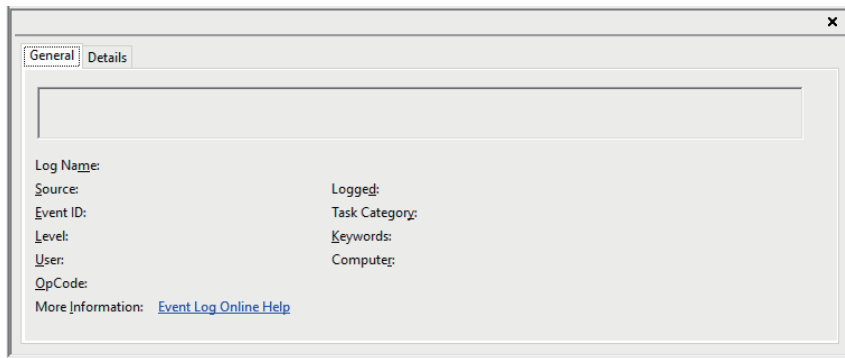

Displayed items

Item	Description
Dialog box	Detailed information about the error message and error cause is displayed.
Log Name	The log name of the event is displayed. ^{*1}
Source	The source name of the service that recorded the event to a log is displayed.
Event ID	A unique number which is assigned to the event is displayed.
Level	The event log type is displayed. The following events are displayed. <ul style="list-style-type: none"> • Information: Operation information including start/stop of Windows service • Warning: Minor errors including communication failure • Error: Major errors including operating system, device drivers and Windows service start errors
User	The name of the user who wrote the event is displayed. ^{*2}
OpCode	The operation that was performed when the event was generated by an application is displayed.
More Information	"Event Log Online Help" is displayed.
Logged ^{*3}	The date and time of when the event was written is displayed.
Task Category	The category of the event is displayed. ^{*4}
Keywords	"Classic" is displayed.
Computer	The computer name is displayed.

*1 An event log occurred in this product is displayed as 'MELSEC Service' or 'MELSEC Bus Event.'

*2 'N/A' is displayed for this product.

*3 Date and time is corrected according to the time zone set on Windows. To refer to an event log on a personal computer with a different time zone, check the log by considering the difference in the time zones.

*4 'None' is displayed for this product.

32.3 Checking Errors in CW Configurator

Check an occurred error and error history, and identify the error cause by using CW Configurator. The detailed information such as error causes and corrective actions obtained from CW Configurator is more helpful than those obtained visually. CW Configurator has the following functions to support troubleshooting:

Function	Description
System monitor	To display the module configuration, detailed information for each module, and the error status
Module diagnostics	To diagnose the operating status of each module (module information, existence of an error, or error logs, etc.)
Event history	To display the event information, such as errors occurred in each module, performed operations, and errors on the network

For details on each function of CW Configurator, refer to the following:

 CW Configurator Operating Manual

Precautions

When the operation mode is other than the normal mode, errors cannot be checked in CW Configurator. ( Page 27 Operation mode)



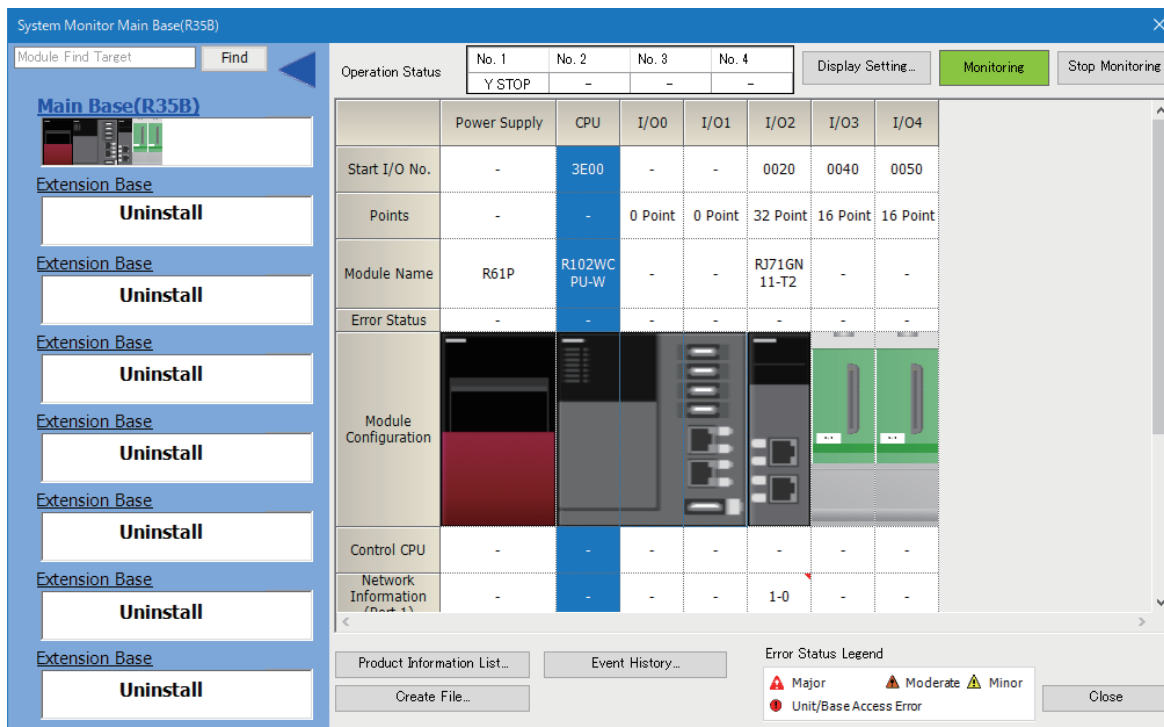

System monitor

The system monitor function displays the module configuration, detailed information of each module, and the error status.

 [Diagnostics] ⇒ [System Monitor]

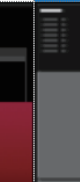

Operation Status	No. 1	No. 2	No. 3	No. 4
Y STOP	-	-	-	-

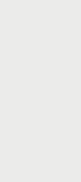
	Power Supply	CPU	I/O0	I/O1	I/O2	I/O3	I/O4
Start I/O No.	-	3E00	-	-	0020	0040	0050
Points	-	-	0 Point	0 Point	32 Point	16 Point	16 Point
Module Name	R61P	R102WC PU-W	-	-	R71GN 11-T2	-	-
Error Status	-	-	-	-	-	-	-
Module Configuration							
Control CPU	-	-	-	-	-	-	-
Network Information (Port 1)	-	-	-	-	1-0	-	-

Precautions

- When this product is operating in other than normal mode, this product is displayed as a 0 point unidentified module with the system monitor function of GX Works3 connected to another CPU module in a multiple CPU system.
- The IP address of this product is not displayed in "IP Address (Port1 IPv4)" and "IP Address (Port2 IPv4)" on the system monitor. Check the address from the network setting of Windows.

Module diagnostics

The module diagnostics function diagnoses the operating status of each module (module status, existence of an error, or error history, etc.).

It displays an error occurred, detailed status, causes, and corrective actions, so information necessary for troubleshooting can be checked.

In the [Module Information List] tab, the current LED information or switch information of the corresponding module can be checked.

 [Diagnostics] ⇒ [System Monitor] ⇒ double-click an arbitrary module

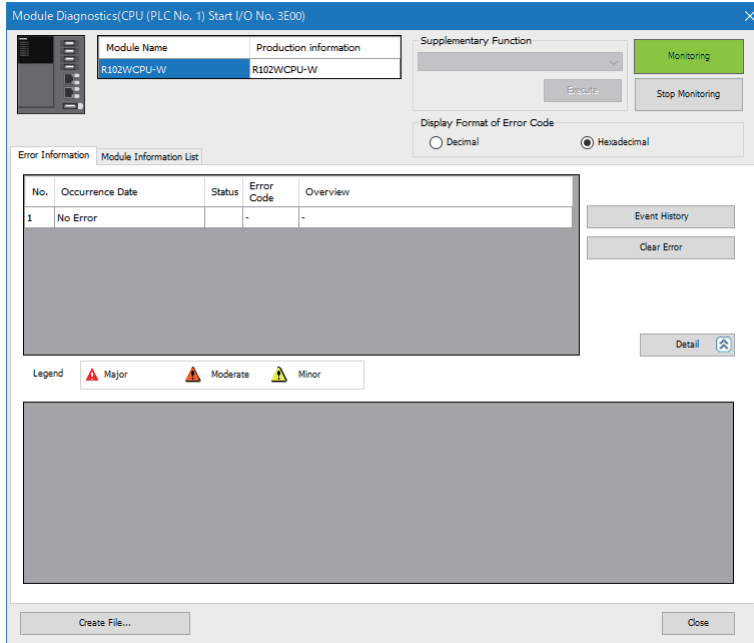

Restriction

In a multiple CPU system configuration, when the I/O assignment setting in the system parameter is different from the configuration of the mounted module, the correct information may not be displayed in "Module Information List."

Precautions

The SD memory card status of this product is not displayed in "Module Information List."

Event history

The event history function displays the event information, such as errors occurred in each module, performed operations, and errors on the network.

Information collected before turning the power OFF or resetting this product can be saved; therefore, this function can be used to identify the error cause from the past operations and error occurrence trends. The displayed information can be saved in the CSV file format as well.

 [Diagnostics] ⇒ [System Monitor] ⇒ [Event History]

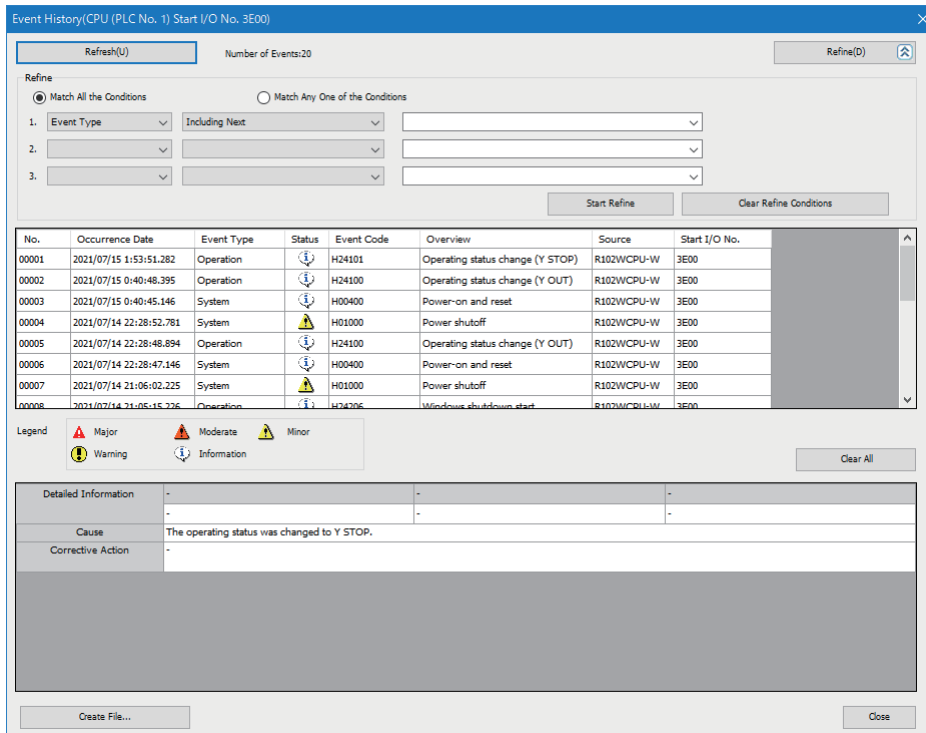

Event History(CPU (PLC No. 1) Start I/O No. 3E00)

Refresh(U) Number of Events:20 Refine(D)

Refine









Match All the Conditions Match Any One of the Conditions

1. Event Type Including Next []



2. [] [] []



3. [] [] []

Start Refine Clear Refine Conditions

No.	Occurrence Date	Event Type	Status	Event Code	Overview	Source	Start I/O No.
00001	2021/07/15 1:53:51.282	Operation		H24101	Operating status change (Y STOP)	R102WCPU-W	3E00
00002	2021/07/15 0:40:48.395	Operation		H24100	Operating status change (Y OUT)	R102WCPU-W	3E00
00003	2021/07/15 0:40:45.146	System		H00400	Power-on and reset	R102WCPU-W	3E00
00004	2021/07/14 22:28:52.781	System		H01000	Power shutoff	R102WCPU-W	3E00
00005	2021/07/14 22:28:48.894	Operation		H24100	Operating status change (Y OUT)	R102WCPU-W	3E00
00006	2021/07/14 22:28:47.146	System		H00400	Power-on and reset	R102WCPU-W	3E00
00007	2021/07/14 21:06:02.225	System		H01000	Power shutoff	R102WCPU-W	3E00
00008	2021/07/14 21:05:15.226	Operation		H24206	Windows shutdown start	R102WCPU-W	3E00

Legend

 Major  Moderate  Minor

 Warning  Information

Clear All

Detailed Information

Cause The operating status was changed to Y STOP.

Corrective Action

Create File... Close

For details on the function or information collected with the event history function, refer to the following:

 Page 217 EVENT HISTORY FUNCTION

Point

- For checking error occurrence status for all modules, and clarifying the causes of malfunction which occurred on the facilities/equipment
- For checking when and from where a parameter of a user program has been changed
- For checking if any unauthorized access from a third party has been tried

33 ERROR CODE LIST

This chapter shows the error code lists of this product.

33.1 Error Codes for Self-diagnostics

The following table shows the error codes detected by self-diagnostics.

Error code	Error name	Error details and cause	Corrective action	Stop/continue	Diagnostic timing
1000H	Power shutoff	<ul style="list-style-type: none"> A momentary power failure has occurred. The power supply has been shut off. 	<ul style="list-style-type: none"> Check the power supply status. 	Continue	Always
1080H	ROM write count error	<ul style="list-style-type: none"> The number of writes to the flash ROM (data memory, program memory, and system memory) exceeded 10,000 times. (Number of writes > 10,000) 	<ul style="list-style-type: none"> Replace the CPU module. 	Continue	Power-on, hardware reset, bus reset At write
1090H	Battery error	<ul style="list-style-type: none"> The voltage of the battery built in the CPU module has dropped below the specified value. The connector of the battery built in the CPU module is disconnected. The connector of the battery built in the CPU module is not securely connected. 	<ul style="list-style-type: none"> Replace the battery. Check the connection status of the battery connector. If it is loose, securely connect the connector. 	Continue	At interrupt occurrence
112EH	Connection establishment failed	<ul style="list-style-type: none"> A connection could not be established in the open processing. Connection requests more than the number of set connections are sent to the same port from multiple target devices with different IP addresses. 	<ul style="list-style-type: none"> Check the operation of the external device. Check if the open processing has been performed in the external device. Review the port number of the module, IP address/port number of the external device, opening method, and number of connections. Check the number of connections in the external device configuration setting of module parameters. When the firewall is set in the external device, check if the access is permitted. Check if the Ethernet cable is disconnected. 	Continue	Always
1165H	UDP/IP send failed	<ul style="list-style-type: none"> Data was not sent correctly with UDP/IP. 	<ul style="list-style-type: none"> Check the settings for connection with the external device. Check the operation of the external device or switching hub. Since there may be congestion of packets on the line, send data after a certain period of time. Check if the connection cable is disconnected. Check that there is no connection failure with the switching hub. 	Continue	Always
1166H	TCP/IP send failed	<ul style="list-style-type: none"> Data was not sent correctly with TCP/IP. 	<ul style="list-style-type: none"> Check the settings for connection with the external device. Check the operation of the external device or switching hub. Since there may be congestion of packets on the line, send data after a certain period of time. Check if the connection cable is disconnected. Check that there is no connection failure with the switching hub. 	Continue	Always

Error code	Error name	Error details and cause	Corrective action	Stop/continue	Diagnostic timing
1200H	Module moderate error	<ul style="list-style-type: none"> A moderate error has been notified from the intelligent function module connected. 	<ul style="list-style-type: none"> Check the detailed information (system configuration information) of the error by executing module diagnostics using CW Configurator, identify the error module, and eliminate the error cause. 	Continue/stop	Always
1210H	Module moderate error	<ul style="list-style-type: none"> An inter-module synchronous signal error has been notified from the intelligent function module connected. 	<ul style="list-style-type: none"> Check the detailed information (system configuration information) of the error by executing module diagnostics using CW Configurator, identify the error module, and eliminate the error cause. 	Continue	Always
1220H	Another CPU module moderate error	<ul style="list-style-type: none"> A moderate error has been notified from another CPU module. 	<ul style="list-style-type: none"> Check the detailed information (system configuration information) of the error by executing module diagnostics using CW Configurator, identify the error module, and eliminate the error cause. Check the mounting status and reset status of other CPU modules. 	Continue/stop	Always
1260H	Multiple CPU synchronization processing error	<ul style="list-style-type: none"> A multiple CPU synchronization error has been detected. 	<ul style="list-style-type: none"> Check the detailed information (time information) of the error by executing module diagnostics using CW Configurator, and set the fixed scan interval in the system parameters larger than the displayed time (setting value). 	Continue	At interrupt occurrence
1262H	Multiple CPU synchronization processing error	<ul style="list-style-type: none"> A multiple CPU synchronization error has been detected. 	<ul style="list-style-type: none"> Check the detailed information (time information) of the error by executing module diagnostics using CW Configurator, and set the fixed scan interval in the system parameters larger than the displayed time (setting value). 	Continue	At interrupt occurrence
1830H	Receive queue full	<ul style="list-style-type: none"> Number of reception requests of transient transmission exceeded upper limit of simultaneously processable requests. 	<ul style="list-style-type: none"> Lower the transient transmission usage frequency, and then perform again. 	Continue	Always
1831H	Receive processing error	<ul style="list-style-type: none"> Transient reception failed. 	<ul style="list-style-type: none"> Lower the transient transmission usage frequency, and then perform again. 	Continue	Always
1832H	Transient data error	<ul style="list-style-type: none"> Too many processings of transient transmission and cannot perform transient transmission. 	<ul style="list-style-type: none"> Correct the transient transmission execution count. 	Continue	Always
1840H	SD memory card error	<ul style="list-style-type: none"> An error has been detected in the SD memory card. 	<ul style="list-style-type: none"> Replace the SD memory card. Take measures to reduce noise. Turn the power of the CPU module OFF and ON or reset the hardware. <p>If the same error code is displayed again, the possible cause is a hardware failure of the CPU module. Please contact your local Mitsubishi Electric sales office or representative.</p>	Continue	Always
1841H	Clock setting error	<ul style="list-style-type: none"> The time zone is set to +14 hours. 	<ul style="list-style-type: none"> Do not set the Windows time zone to +14 hours. 	Continue	Always
1842H	Clock setting error	<ul style="list-style-type: none"> Daylight saving time has been enabled for an area where the offset for daylight saving time is not an hour. Daylight saving time has been enabled for an area where daylight saving time does not start/end at 00 minutes. 	<ul style="list-style-type: none"> Turn OFF the following Windows setting: "Adjust for daylight saving time automatically" 	Continue	Always

Error code	Error name	Error details and cause	Corrective action	Stop/continue	Diagnostic timing
1846H	Refresh cycle over	<ul style="list-style-type: none"> The refresh time exceeds the set refresh cycle. <p>(1) The refresh cycle value is too short. (2) The number of set refresh points is excessive.</p>	<ul style="list-style-type: none"> Increase the refresh cycle value. Decrease the number of set refresh points. 	Continue	Always
184AH	End of primary CFast card life reached	<ul style="list-style-type: none"> The number of writes to a primary CFast card reached 5,000 times. (Number of writes \geq 5,000) Alternatively, the number of remaining spare blocks is 10 or less. (Number of remaining spare blocks \leq 10) 	<ul style="list-style-type: none"> Replace the MELSECWinCPU. 	Continue	Always
1855H	Current consumption error (warning)	<ul style="list-style-type: none"> The current consumption value of this product exceeded the allowable value (4.17 A). 	<ul style="list-style-type: none"> Disconnect the peripheral devices connected to the USB ports, review the devices in use (such as self-powered devices), or change the configuration so that a self-powered USB hub is used. <p>Then, turn OFF the OVERCURRENT LED by the following procedure:</p> <ol style="list-style-type: none"> Hold the FUNCTION/SHUTDOWN switch on the FUNCTION position. Check that the OVERCURRENT LED turns OFF. Put the FUNCTION/SHUTDOWN switch back to the center position. 	Continue	Always
1856H	Current consumption error (USB port 1 forced stop)	The current consumption value of this product exceeded the limit (4.35 A), therefore the USB 3.0 port (P1) is stopped.	<ul style="list-style-type: none"> Disconnect the peripheral devices connected to the USB ports, review the devices in use (such as self-powered devices), or change the configuration so that a self-powered USB hub is used. <p>Then, release the stopped USB port and turn OFF the OVERCURRENT LED by the following procedure:</p> <ol style="list-style-type: none"> Hold the FUNCTION/SHUTDOWN switch on the FUNCTION position. Check that the OVERCURRENT LED turns OFF. Put the FUNCTION/SHUTDOWN switch back to the center position. 	Continue	At interrupt occurrence
1857H	Current consumption error (All USB ports forced stop)	The current consumption value of this product exceeded the limit (4.35 A), therefore the USB ports (P1 to P4) are stopped.	<ul style="list-style-type: none"> Disconnect the peripheral devices connected to the USB ports, review the devices in use (such as self-powered devices), or change the configuration so that a self-powered USB hub is used. <p>Then, release the stopped USB ports and turn OFF the OVERCURRENT LED by the following procedure:</p> <ol style="list-style-type: none"> Hold the FUNCTION/SHUTDOWN switch on the FUNCTION position. Check that the OVERCURRENT LED turns OFF. Put the FUNCTION/SHUTDOWN switch back to the center position. 	Continue	At interrupt occurrence
1858H	Temperature error	<ul style="list-style-type: none"> The temperature of this product is high. 	<ul style="list-style-type: none"> Check the ambient temperature. If the same error code is displayed again, the possible cause is a hardware failure. <p>Please contact your local Mitsubishi Electric sales office or representative.</p>	Continue	Always

Error code	Error name	Error details and cause	Corrective action	Stop/continue	Diagnostic timing
185AH	USB port fault	<ul style="list-style-type: none"> An overcurrent to the USB port has been detected. 	<ul style="list-style-type: none"> Unplug the connected USB device and check if the device has any failure. If any, replace it. Click the 'Power surge on the USB port' icon, which is displayed on the task tray, then click the 'Reset' button in the window appeared. If clicking the 'Close' button, the USB port stops working until Windows is restarted. If the same error code is displayed again even with a self-powered USB hub, the possible cause is a hardware failure of the CPU module. Please contact your local Mitsubishi Electric sales office or representative. 	Continue	Always
185BH	HDMI error	<ul style="list-style-type: none"> An overcurrent to the HDMI has been detected. 	<ul style="list-style-type: none"> Replace the HDMI device. Turn the power of the CPU module OFF and ON or reset the hardware. If the same error code is displayed again, the possible cause is a hardware failure of the CPU module. Please contact your local Mitsubishi Electric sales office or representative. 	Continue	Always
185CH	Secondary CFast card error	<ul style="list-style-type: none"> An overcurrent to the secondary CFast card has been detected. 	<ul style="list-style-type: none"> Replace the secondary CFast card. Turn the power of the CPU module OFF and ON or reset the hardware. If the same error code is displayed again, the possible cause is a hardware failure of the CPU module. Please contact your local Mitsubishi Electric sales office or representative. 	Continue	Always
185DH	Already open error	<ul style="list-style-type: none"> A port number that is already opened was attempted to be opened again. (For TCP/IP) 	<ul style="list-style-type: none"> Restart Windows. If the same error code is displayed again, the possible cause is a hardware failure of the CPU module. Please contact your local Mitsubishi Electric sales office or representative. 	Continue	Always
185EH	Already open error	<ul style="list-style-type: none"> A port number that is already opened was attempted to be opened again. (For UDP/IP) 	<ul style="list-style-type: none"> Restart Windows. If the same error code is displayed again, the possible cause is a hardware failure of the CPU module. Please contact your local Mitsubishi Electric sales office or representative. 	Continue	Always
185FH	Communication error	<ul style="list-style-type: none"> Generating the Listen socket failed. 	<ul style="list-style-type: none"> Restart Windows. If the same error code is displayed again, the possible cause is a hardware failure of the CPU module. Please contact your local Mitsubishi Electric sales office or representative. 	Continue	Always
1860H	Communication error	<ul style="list-style-type: none"> Generating the server socket failed. 	<ul style="list-style-type: none"> Restart Windows. If the same error code is displayed again, the possible cause is a hardware failure of the CPU module. Please contact your local Mitsubishi Electric sales office or representative. 	Continue	Always
1861H	Communication error	<ul style="list-style-type: none"> Generating the server socket failed. 	<ul style="list-style-type: none"> Restart Windows. If the same error code is displayed again, the possible cause is a hardware failure of the CPU module. Please contact your local Mitsubishi Electric sales office or representative. 	Continue	Always
1862H	Communication error	<ul style="list-style-type: none"> A port number that is already opened was attempted to be opened again. 	<ul style="list-style-type: none"> Restart Windows. If the same error code is displayed again, the possible cause is a hardware failure of the CPU module. Please contact your local Mitsubishi Electric sales office or representative. 	Continue	Always

Error code	Error name	Error details and cause	Corrective action	Stop/continue	Diagnostic timing
1863H	Memory error	<ul style="list-style-type: none"> Reserving sufficient memory failed. 	<ul style="list-style-type: none"> Restart Windows. If the same error code is displayed again, the possible cause is a hardware failure of the CPU module. Please contact your local Mitsubishi Electric sales office or representative. 	Continue	Always
1864H	Service error	<ul style="list-style-type: none"> Starting a Windows service failed. 	<ul style="list-style-type: none"> Restart Windows. If the same error code is displayed again, the possible cause is a hardware failure of the CPU module. Please contact your local Mitsubishi Electric sales office or representative. 	Continue	Always
1865H	Service error	<ul style="list-style-type: none"> A Windows service ended with an error. 	<ul style="list-style-type: none"> Restart Windows. If the same error code is displayed again, the possible cause is a hardware failure of the CPU module. Please contact your local Mitsubishi Electric sales office or representative. 	Continue	Always
1866H	Communication error	<ul style="list-style-type: none"> A socket error occurred. 	<ul style="list-style-type: none"> Restart Windows. If the same error code is displayed again, the possible cause is a hardware failure of the CPU module. Please contact your local Mitsubishi Electric sales office or representative. 	Continue	Always
1867H	Service error	<ul style="list-style-type: none"> An error occurred in a Windows service. 	<ul style="list-style-type: none"> Restart Windows. If the same error code is displayed again, the possible cause is a hardware failure of the CPU module. Please contact your local Mitsubishi Electric sales office or representative. 	Continue	Always
1868H	Service error	<ul style="list-style-type: none"> Starting a Windows service failed. 	<ul style="list-style-type: none"> Restart Windows. If the same error code is displayed again, the possible cause is a hardware failure of the CPU module. Please contact your local Mitsubishi Electric sales office or representative. 	Continue	Always
1869H	Service error	<ul style="list-style-type: none"> An error occurred in a Windows service. 	<ul style="list-style-type: none"> Restart Windows. If the same error code is displayed again, the possible cause is a hardware failure of the CPU module. Please contact your local Mitsubishi Electric sales office or representative. 	Continue	Always
2000H	Module configuration error	<ul style="list-style-type: none"> The module type set in the system parameters (I/O assignment setting) differs from that of the module actually mounted. 	<ul style="list-style-type: none"> Re-set the module type in the system parameters in accordance with the CPU module or intelligent function module actually mounted. 	Stop	Power-on, hardware reset, bus reset
2001H	Module configuration error	<ul style="list-style-type: none"> The I/O numbers set in the system parameters (I/O assignment setting) are overlapping between modules. 	<ul style="list-style-type: none"> Re-set the I/O numbers in the system parameters in accordance with the intelligent function module or I/O module actually mounted. 	Stop	Power-on, hardware reset, bus reset
2002H	Module configuration error	<ul style="list-style-type: none"> The number of points assigned to the intelligent function module in the system parameters (I/O assignment setting) is smaller than that of the module actually mounted. 	<ul style="list-style-type: none"> Re-set the number of points in the system parameters in accordance with the intelligent function module actually mounted. 	Stop	Power-on, hardware reset, bus reset
2004H	Module configuration error	<ul style="list-style-type: none"> Nine or more CC-Link IE Controller Network* and MELSECNET/H modules are mounted in the entire system. * The CC-Link IE built-in Ethernet interface module is included if the module is used as a CC-Link IE Controller Network module. Five or more MELSECNET/H modules are mounted in the entire system. 	<ul style="list-style-type: none"> Reduce the number of CC-Link IE Controller Network* and MELSECNET/H modules to eight or less in the entire system. * The CC-Link IE built-in Ethernet interface module is included if the module is used as a CC-Link IE Controller Network module. Reduce the number of MELSECNET/H modules to four or less in the entire system. 	Stop	Power-on, hardware reset, bus reset

Error code	Error name	Error details and cause	Corrective action	Stop/continue	Diagnostic timing
2006H	Module configuration error	<ul style="list-style-type: none"> A module is mounted on the 64th slot or later. 	<ul style="list-style-type: none"> Remove the module mounted on the 64th slot or later. 	Stop	Power-on, hardware reset, bus reset
2007H	Module configuration error	<ul style="list-style-type: none"> A module is mounted on the slot whose number is later than that specified in parameter (I/O assignment setting). 	<ul style="list-style-type: none"> Remove the module mounted on the slot whose number is later than that specified in system parameter (I/O assignment setting). 	Stop	Power-on, hardware reset, bus reset
2008H	Module configuration error	<ul style="list-style-type: none"> A module is mounted over or across the maximum number of I/O points (4096). 	<ul style="list-style-type: none"> Remove the module mounted over or across the maximum number of I/O points (4096). Replace the module mounted on the last slot to the one that does not exceed the maximum number of I/O points (4096). 	Stop	Power-on, hardware reset, bus reset
2009H	Module configuration error	<ul style="list-style-type: none"> There is no response from the I/O module or intelligent function module accessed. 	<ul style="list-style-type: none"> Check and correct the I/O assignment setting in the system parameters. Take measures to reduce noise. Reset the bus. If the same error code is displayed again, the possible cause is a hardware failure of the I/O module or intelligent function module accessed. Please contact your local Mitsubishi Electric sales office or representative. 	Stop	Always
2020H	Module configuration error	<ul style="list-style-type: none"> There is a mounted module that is not supported, or there is a mounted module that is not supported by the network type (module model name) set in system parameters ("I/O Assignment Setting"). 	<ul style="list-style-type: none"> Remove the unsupported module if any. Check whether modules are supported by the network type (module model name) set in the system parameters. If all the modules are supported, the possible cause is a hardware failure of the CPU module, base unit, I/O module, or intelligent function module. Please contact your local Mitsubishi Electric sales office or representative. 	Stop	Power-on, hardware reset, bus reset
2021H	Module configuration error	<ul style="list-style-type: none"> In the multiple CPU system, the control CPU of the Q series intelligent function module incompatible with the multiple CPU system is set to other than CPU No.1. 	<ul style="list-style-type: none"> Replace the Q series intelligent function module with the one (function version B) compatible with the multiple CPU system. Set the control CPU of the Q series intelligent function module incompatible with the multiple CPU system to CPU No.1. 	Stop	Power-on, hardware reset, bus reset
2040H	CPU module configuration error	<ul style="list-style-type: none"> The number of CPU modules set in the system parameters (I/O assignment setting) differs from the number of CPU modules actually mounted. The CPU module is mounted on the slot different from the one specified in the system parameters (I/O assignment setting). 	<ul style="list-style-type: none"> Correctly set the number of CPU modules (including the empty setting) in the system parameters in accordance with the number of CPU modules actually mounted. Correctly set the system parameters so that the setting and actual CPU module mounting status will be the same. 	Stop	Power-on, hardware reset, bus reset
2041H	CPU module configuration error	<ul style="list-style-type: none"> The CPU module is not mounted on the slot that is set for the CPU module in the system parameters (I/O assignment setting). The CPU module is mounted on the slot that is set as "Empty" in the system parameters (I/O Assignment Setting). An I/O module or intelligent function module is mounted between the CPU modules. 	<ul style="list-style-type: none"> Correctly set the number of CPU modules (including the empty setting) in the system parameters in accordance with the number of CPU modules actually mounted. Remove the I/O module or intelligent function module mounted between the CPU modules. 	Stop	Power-on, hardware reset, bus reset

Error code	Error name	Error details and cause	Corrective action	Stop/continue	Diagnostic timing
2043H	CPU module configuration error	<ul style="list-style-type: none"> The CPU module is mounted on the inapplicable slot. 	<ul style="list-style-type: none"> Mount the CPU module on the applicable slot (CPU slot or I/O slot 0 to 6). Remove the CPU module from the inapplicable slot. 	Stop	Power-on, hardware reset, bus reset
2044H	CPU module configuration error	<ul style="list-style-type: none"> The host CPU No. set in the system parameters (I/O assignment setting) differs from the one determined by the mounting position of the CPU module. 	<ul style="list-style-type: none"> Re-set the host CPU No. in the system parameters in accordance with the mounting position of the CPU module. 	Stop	Power-on, hardware reset, bus reset
2050H	CPU module configuration error	<ul style="list-style-type: none"> An unsupported CPU module is mounted. 	<ul style="list-style-type: none"> Remove the unsupported CPU module. If all the CPU modules are supported, the possible cause is a hardware failure of the CPU module or base unit. Please contact your local Mitsubishi Electric sales office or representative. 	Stop	Power-on, hardware reset, bus reset
2060H	Base unit configuration error	<ul style="list-style-type: none"> Eight or more extension base units are connected. 	<ul style="list-style-type: none"> Reduce the number of extension base units to seven or less. 	Stop	Power-on, hardware reset, bus reset
2061H	Base unit configuration error	<ul style="list-style-type: none"> Any of the following base units is connected: QA1S3□B, QA1S5□B/ QA1S6□B, QA6□B, QA6ADP+A5□B/A6□B, QA1S6ADP+A1S5□B/A1S6□B. 	<ul style="list-style-type: none"> Remove the inapplicable base unit. 	Stop	Power-on, hardware reset, bus reset
2063H	Base unit configuration error	<ul style="list-style-type: none"> Extension base unit levels are overlapping. 	<ul style="list-style-type: none"> Check and correct the level setting of the extension base units. 	Stop	Power-on, hardware reset, bus reset
2070H	Base unit configuration error	<ul style="list-style-type: none"> An unsupported base unit is connected. A GOT is bus-connected to the Q series extension base unit. 	<ul style="list-style-type: none"> Disconnect the unsupported base unit. If all the base units are supported, the possible cause is a hardware failure of the CPU module or base unit. Please contact your local Mitsubishi Electric sales office or representative. Disconnect the GOT bus-connected to the Q series extension base unit. 	Stop	Power-on, hardware reset, bus reset
2080H	Inter-module synchronization configuration error	<ul style="list-style-type: none"> An inter-module synchronization signal error has been detected. 	<ul style="list-style-type: none"> The possible cause is a hardware failure of the CPU module, base unit, or module (I/O module or intelligent function module) connected. Please contact your local Mitsubishi Electric sales office or representative. 	Stop	Power-on, hardware reset, bus reset
20E0H	Invalid module	<ul style="list-style-type: none"> A module that the CPU module cannot recognize is mounted. In the multiple CPU system, the module cannot be recognized because the settings of the control CPU in the system parameters differ from those of other CPU modules. 	<ul style="list-style-type: none"> Mount only applicable modules. Correct the system parameter settings for the CPU No.2 and later in accordance with those of the CPU No.1. The possible cause is a hardware failure of the I/O module or intelligent function module accessed. Please contact your local Mitsubishi Electric sales office or representative. 	Stop	Always
2180H	Invalid file	<ul style="list-style-type: none"> An invalid file has been detected. 	<ul style="list-style-type: none"> Check the detailed information (drive/file information) of the error by executing module diagnostics using CW Configurator, select the correct file name, and write the specified file to the CPU module. If the same error code is displayed again, the possible cause is a hardware failure of the CPU module. Please contact your local Mitsubishi Electric sales office or representative. 	Stop	Power-on, hardware reset, bus reset

Error code	Error name	Error details and cause	Corrective action	Stop/continue	Diagnostic timing
21A2H	File specification error	<ul style="list-style-type: none"> The CPU module model set to the file using CW Configurator differs from that of the CPU module actually mounted. 	<ul style="list-style-type: none"> Check the detailed information (drive/file information) of the error by executing module diagnostics using CW Configurator, and correct the CPU module model set to the file in accordance with that of the CPU module actually mounted. 	Stop	At write Power-on, hardware reset, bus reset
2200H	Parameter error	<ul style="list-style-type: none"> The system parameter file and CPU parameter file do not exist. 	<ul style="list-style-type: none"> Write the system parameter file and CPU parameter file to the CPU module. 	Stop	Power-on, hardware reset, bus reset
2220H	Parameter error	<ul style="list-style-type: none"> The parameter setting is corrupted. 	<ul style="list-style-type: none"> Check the detailed information (parameter information) of the error by executing module diagnostics using CW Configurator, and write the displayed parameter setting to the module. If the same error code is displayed again, the possible cause is a hardware failure of the data memory in the CPU module, memory card, or module (I/O module or intelligent function module) connected. Please contact your local Mitsubishi Electric sales office or representative. 	Stop	Power-on, hardware reset, bus reset
2221H	Parameter error	<ul style="list-style-type: none"> The set value is out of range. 	<ul style="list-style-type: none"> Check the detailed information (parameter information) of the error by executing module diagnostics using CW Configurator and correct the parameter setting corresponding to the displayed number. If the same error code is displayed again, the possible cause is a hardware failure of the data memory in the CPU module, memory card, or module (I/O module or intelligent function module) connected. Please contact your local Mitsubishi Electric sales office or representative. 	Stop	At fixed cycle processing execution At module access At instruction execution Power-on, hardware reset, bus reset
2222H	Parameter error	<ul style="list-style-type: none"> Use of the function that is not supported by the module is enabled in parameter. 	<ul style="list-style-type: none"> Check the detailed information (parameter information) of the error by executing module diagnostics using CW Configurator and correct the parameter setting corresponding to the displayed number. If the same error code is displayed again, the possible cause is a hardware failure of the data memory in the CPU module, memory card, or module (I/O module or intelligent function module) connected. Please contact your local Mitsubishi Electric sales office or representative. 	Stop	Power-on, hardware reset, bus reset
2225H	Parameter error	<ul style="list-style-type: none"> The CPU module model set to the project using CW Configurator differs from that of the CPU module actually mounted. 	<ul style="list-style-type: none"> Correct the CPU module model set to the project in accordance with the CPU module actually mounted. 	Stop	At write Power-on, hardware reset, bus reset

Error code	Error name	Error details and cause	Corrective action	Stop/continue	Diagnostic timing
2240H	Parameter error (module)	<ul style="list-style-type: none"> In the multiple CPU system, the I/O module or intelligent function module controlled by another CPU module is specified in the module parameters. 	<ul style="list-style-type: none"> Check the detailed information (parameter information) of the error by executing module diagnostics using CW Configurator and correct the parameter setting corresponding to the displayed number. If the same error code is displayed again, the possible cause is a hardware failure of the data memory in the CPU module or the module (I/O module or intelligent function module) connected. Please contact your local Mitsubishi Electric sales office or representative. 	Stop	Power-on, hardware reset, bus reset
2241H	Parameter error (module)	<ul style="list-style-type: none"> The I/O numbers set in the system parameters differ from those of the module actually mounted. The target module is not mounted on the slot where the system parameters and module parameters are set. The module type set in parameter differs from that of the module actually mounted. 	<ul style="list-style-type: none"> Check if the system configuration displayed on the system monitor window of CW Configurator matches the actual system configuration. Check the detailed information (parameter information) of the error by executing module diagnostics using CW Configurator and correct the parameter setting corresponding to the displayed number. If the same error code is displayed again, the possible cause is a hardware failure of the data memory in the CPU module or the module (I/O module or intelligent function module) connected. Please contact your local Mitsubishi Electric sales office or representative. 	Stop	At fixed cycle processing execution At module access At instruction execution Power-on, hardware reset, bus reset
2242H	Parameter error (module)	<ul style="list-style-type: none"> The intelligent function module has detected a module parameter error. 	<ul style="list-style-type: none"> Check the detailed information (system configuration information) of the error by executing module diagnostics using CW Configurator, and check the module corresponding to the displayed I/O number. If the same error code is displayed again, the possible cause is a hardware failure of the data memory in the CPU module or the intelligent function module connected. Please contact your local Mitsubishi Electric sales office or representative. 	Stop	Power-on, hardware reset, bus reset
2260H	Parameter error (network)	<ul style="list-style-type: none"> Network numbers are overlapping. 	<ul style="list-style-type: none"> Check the detailed information (parameter information) of the error by executing module diagnostics using CW Configurator and correct the parameter setting corresponding to the displayed number. If the same error code is displayed again, the possible cause is a hardware failure of the data memory in the CPU module or the intelligent function module connected. Please contact your local Mitsubishi Electric sales office or representative. 	Stop	Power-on, hardware reset, bus reset

Error code	Error name	Error details and cause	Corrective action	Stop/continue	Diagnostic timing
2261H	Parameter error (network)	<ul style="list-style-type: none"> Different network types (CC IE Control extended mode/normal mode) are set between the control station and the normal station. 	<ul style="list-style-type: none"> Check the detailed information (parameter information) of the error by executing module diagnostics using CW Configurator and correct the parameter setting corresponding to the displayed number. If the same error code is displayed again, the possible cause is a hardware failure of the data memory in the CPU module or the intelligent function module connected. Please contact your local Mitsubishi Electric sales office or representative. 	Stop	Power-on, hardware reset, bus reset
2263H	Parameter error (network)	<ul style="list-style-type: none"> Even though the CC-Link IE module is mounted, a different module is set in the system parameters (I/O assignment setting), or CC-Link IE module parameter is not set. 	<ul style="list-style-type: none"> Set the system parameters and module parameters. If the same error code is displayed again, the possible cause is a hardware failure of the data memory in the CPU module or the intelligent function module connected. Please contact your local Mitsubishi Electric sales office or representative. 	Stop	Power-on, hardware reset, bus reset
2280H	Parameter error (refresh)	<ul style="list-style-type: none"> The refresh setting is not set correctly. (Data were refreshed exceeding the file register capacity.) The refresh settings (number of points) differ among CPU modules. 	<ul style="list-style-type: none"> Check the detailed information (parameter information) of the error by executing module diagnostics using CW Configurator, and correct the parameter setting corresponding to the displayed number so that the data are refreshed within the specified device range. (Take the following actions: increase the number of file register points, create a file register file having a capacity for all of the target data to be refreshed, or reduce the refresh device range.) Rewrite the refresh settings (number of points) in the CPU parameters for all the CPU modules. (Use the same number of points in the refresh settings for all the CPU modules.) 	Stop	At fixed cycle processing execution At module access At instruction execution Power-on, hardware reset, bus reset
2281H	Parameter error (refresh)	<ul style="list-style-type: none"> A device that cannot be used as a refresh device is specified. 	<ul style="list-style-type: none"> Check the detailed information (parameter information) of the error by executing module diagnostics using CW Configurator and correct the parameter setting corresponding to the displayed number. Write the CPU parameters and module parameters simultaneously. (Match the CPU parameters and module parameters.) 	Stop	Power-on, hardware reset, bus reset
2282H	Parameter error (refresh)	<ul style="list-style-type: none"> The number of specified refresh points is invalid. 	<ul style="list-style-type: none"> Check the detailed information (parameter information) of the error by executing module diagnostics using CW Configurator and correct the parameter setting corresponding to the displayed number. 	Stop	Power-on, hardware reset, bus reset
2283H	Parameter error (refresh)	<ul style="list-style-type: none"> The total number of refresh points exceeded the maximum limit. 	<ul style="list-style-type: none"> Check the detailed information (parameter information) of the error by executing module diagnostics using CW Configurator and correct the parameter setting corresponding to the displayed number. 	Stop	Power-on, hardware reset, bus reset

Error code	Error name	Error details and cause	Corrective action	Stop/continue	Diagnostic timing
22E0H	Parameter verification error	<ul style="list-style-type: none"> In the multiple CPU system, the system parameter settings of the host CPU module differ from those of other CPU modules. In the multiple CPU system, the system parameter settings are overwritten only to the host CPU module, and the settings differ from those of other CPU modules. 	<ul style="list-style-type: none"> Check the detailed information (parameter information) of the error by executing module diagnostics using CW Configurator, and correct the system parameter settings corresponding to the displayed number for the CPU No.2 and later. The settings need to be the same among all the CPU modules. (The module synchronization setting and fixed scan communication setting need to be the same between the CPU modules that use these functions.) When the system parameter settings are changed, update the settings of all the CPU modules connected. (The system parameter settings must be same in all the CPU modules.) 	Stop	At write Power-on, hardware reset, bus reset
2400H	Module verification error	<ul style="list-style-type: none"> The module information at power-on differs from the information of modules actually mounted. The I/O module or intelligent function module is not mounted properly or was removed during operation. 	<ul style="list-style-type: none"> Check the detailed information (system configuration information) of the error by executing module diagnostics using CW Configurator and check the module corresponding to the displayed slot number. Take measures to reduce noise. Reset the bus. If the same error code is displayed again, the possible cause is a hardware failure of the error module. Please contact your local Mitsubishi Electric sales office or representative. 	Stop/continue	Always
2401H	Module verification error	<ul style="list-style-type: none"> A CPU module, I/O module, or intelligent function module was mounted on the base unit during operation. 	<ul style="list-style-type: none"> Check the detailed information (system configuration information) of the error by executing module diagnostics using CW Configurator and check the module corresponding to the displayed slot number. Do not mount a CPU module, I/O module, nor intelligent function module during operation . Take measures to reduce noise. Reset the bus. If the same error code is displayed again, the possible cause is a hardware failure of the error module. Please contact your local Mitsubishi Electric sales office or representative. 	Stop/continue	Always
2420H	Fuse blown	<ul style="list-style-type: none"> The output module with a blown fuse has been detected. 	<ul style="list-style-type: none"> Check the FUSE LED of each output module, and replace the one with the FUSE LED ON. Check the detailed information (system configuration information) of the error by executing module diagnostics using CW Configurator, and replace the module corresponding to the displayed slot number. 	Stop/continue	Always
2440H	Module major error	<ul style="list-style-type: none"> In the multiple CPU system, the settings of the control CPU in the system parameters differ from those of other CPU modules. An error has been detected in the I/O module or intelligent function module during the initial processing of the bus control. 	<ul style="list-style-type: none"> Correct the system parameter settings for the CPU No.2 and later in accordance with those of the CPU No.1. Take measures to reduce noise. Reset the bus. If the same error code is displayed again, the possible cause is a hardware failure of the error module. Please contact your local Mitsubishi Electric sales office or representative. 	Stop	Power-on, hardware reset, bus reset

Error code	Error name	Error details and cause	Corrective action	Stop/continue	Diagnostic timing
2441H	Module major error	<ul style="list-style-type: none"> An error has been detected in the intelligent function module when the function was executed. 	<ul style="list-style-type: none"> Take measures to reduce noise. Reset the bus. If the same error code is displayed again, the possible cause is a hardware failure of the error module. Please contact your local Mitsubishi Electric sales office or representative. 	Stop/continue	At instruction execution
2442H	Module major error	<ul style="list-style-type: none"> An error was detected in the intelligent function module when a function was executed. 	<ul style="list-style-type: none"> Take measures to reduce noise. Reset the bus. If the same error code is displayed again, the possible cause is a hardware failure of the error module. Please contact your local Mitsubishi Electric sales office or representative. 	Stop/continue	At module access
2443H	Module major error	<ul style="list-style-type: none"> An error was detected in the I/O module or intelligent function module. 	<ul style="list-style-type: none"> Take measures to reduce noise. Reset the bus. If the same error code is displayed again, the possible cause is a hardware failure of the error module. Please contact your local Mitsubishi Electric sales office or representative. 	Stop	At module access
2450H	Module major error	<ul style="list-style-type: none"> A major error has been notified from the intelligent function module connected. The I/O module or intelligent function module is not mounted properly or was removed during operation. 	<ul style="list-style-type: none"> Take measures to reduce noise. Check the connection status of the extension cable. Check the detailed information (system configuration information) of the error by executing module diagnostics using CW Configurator and check the module corresponding to the displayed slot number. Reset the bus. If the same error code is displayed again, the possible cause is a hardware failure of the error module. Please contact your local Mitsubishi Electric sales office or representative. 	Stop/continue	Always
2460H	Another CPU module major error	<ul style="list-style-type: none"> An error has been detected in another CPU module during the initial processing of the bus control. 	<ul style="list-style-type: none"> Take measures to reduce noise. Reset the bus. If the same error code is displayed again, the possible cause is a hardware failure of the host CPU module or another CPU module where the error has been detected. Please contact your local Mitsubishi Electric sales office or representative. 	Stop	Power-on, hardware reset, bus reset
2461H	Another CPU module major error	<ul style="list-style-type: none"> An error has been detected in another CPU module when the function was executed. 	<ul style="list-style-type: none"> Take measures to reduce noise. Reset the bus. If the same error code is displayed again, the possible cause is a hardware failure of the host CPU module or another CPU module where the error has been detected. Please contact your local Mitsubishi Electric sales office or representative. 	Stop/continue	At instruction execution
2462H	Another CPU module major error	<ul style="list-style-type: none"> An error has been detected in another CPU module when the function was executed. 	<ul style="list-style-type: none"> Take measures to reduce noise. Reset the bus. If the same error code is displayed again, the possible cause is a hardware failure of the host CPU module or another CPU module where the error has been detected. Please contact your local Mitsubishi Electric sales office or representative. 	Stop/continue	At fixed cycle processing execution
2463H	Another CPU module major error	<ul style="list-style-type: none"> An error has been detected in another CPU module. 	<ul style="list-style-type: none"> Take measures to reduce noise. Reset the bus. If the same error code is displayed again, the possible cause is a hardware failure of the host CPU module or another CPU module where the error has been detected. Please contact your local Mitsubishi Electric sales office or representative. 	Stop	Power-on, hardware reset, bus reset

Error code	Error name	Error details and cause	Corrective action	Stop/continue	Diagnostic timing
2470H	Another CPU module major error	<ul style="list-style-type: none"> A major error has been notified from another CPU module. 	<ul style="list-style-type: none"> Take measures to reduce noise. Reset the bus. If the same error code is displayed again, the possible cause is a hardware failure of the host CPU module or another CPU module where the error has been detected. Please contact your local Mitsubishi Electric sales office or representative. 	Stop/continue	Always
2480H	Multiple CPU error	<ul style="list-style-type: none"> In the multiple CPU system, an error has been detected in the CPU module where "Stop" is set in the operation mode setting parameter. Any CPU module other than CPU No.1 is mounted in the inapplicable slot. <p>(An error occurs in the CPU module mounted in the inapplicable slot.)</p>	<ul style="list-style-type: none"> Check the detailed information (system configuration information) of the error by executing module diagnostics using CW Configurator, identify the error module, and eliminate the error cause. Remove the CPU module from the inapplicable slot. 	Stop	Always
2481H	Multiple CPU error	<ul style="list-style-type: none"> In the multiple CPU system, any CPU module other than CPU No.1 was disconnected from the base unit during operation. Or, any CPU module other than CPU No.1 or its bus was reset. 	<ul style="list-style-type: none"> Check the mounting status and reset status of the CPU modules other than CPU No.1. 	Stop	Always
24C0H	System bus error	<ul style="list-style-type: none"> An error was detected on the system bus. 	<ul style="list-style-type: none"> Take measures to reduce noise. Reset the bus. If the same error code is displayed again, the possible cause is a hardware failure of the CPU module, base unit, extension cable, or module (I/O module or intelligent function module) connected. Please contact your local Mitsubishi Electric sales office or representative. 	Stop	At module access
24C1H	System bus error	<ul style="list-style-type: none"> An error was detected on the system bus. 	<ul style="list-style-type: none"> Take measures to reduce noise. Reset the bus. If the same error code is displayed again, the possible cause is a hardware failure of the CPU module, base unit, extension cable, or module (I/O module or intelligent function module) connected. Please contact your local Mitsubishi Electric sales office or representative. 	Stop	At module access
24C2H	System bus error	<ul style="list-style-type: none"> The I/O module or intelligent function module is not mounted properly or was removed during operation. An error was detected on the system bus. 	<ul style="list-style-type: none"> Check the detailed information (system configuration information) of the error by executing module diagnostics using CW Configurator and check the module corresponding to the displayed slot number. Check the connection status of the extension cable. Take measures to reduce noise. Reset the bus. If the same error code is displayed again, the possible cause is a hardware failure of the CPU module, base unit, extension cable, or module (I/O module or intelligent function module) connected. Please contact your local Mitsubishi Electric sales office or representative. 	Stop	Always At module access
24C3H	System bus error	<ul style="list-style-type: none"> An error was detected on the system bus. 	<ul style="list-style-type: none"> Take measures to reduce noise. Reset the bus. If the same error code is displayed again, the possible cause is a hardware failure of the CPU module, base unit, extension cable, or module (I/O module or intelligent function module) connected. Please contact your local Mitsubishi Electric sales office or representative. 	Stop	At module access

Error code	Error name	Error details and cause	Corrective action	Stop/continue	Diagnostic timing
24C4H	System bus error	<ul style="list-style-type: none"> An error was detected on the system bus. 	<ul style="list-style-type: none"> Take measures to reduce noise. Reset the bus. If the same error code is displayed again, the possible cause is a hardware failure of the base unit, extension cable, or module (I/O module or intelligent function module) connected. Please contact your local Mitsubishi Electric sales office or representative. 	Stop	At module access
24C5H	System bus error	<ul style="list-style-type: none"> An error was detected on the system bus. 	<ul style="list-style-type: none"> Take measures to reduce noise. Reset the bus. If the same error code is displayed again, the possible cause is a hardware failure of the base unit, extension cable, or module (I/O module or intelligent function module) connected. Please contact your local Mitsubishi Electric sales office or representative. 	Stop	At module access
24C6H	System bus error	<ul style="list-style-type: none"> An error was detected on the system bus. 	<ul style="list-style-type: none"> Take measures to reduce noise. Reset the bus. If the same error code is displayed again, the possible cause is a hardware failure of the CPU module or extension cable. Please contact your local Mitsubishi Electric sales office or representative. 	Stop	At module access
24C8H	System bus error	<ul style="list-style-type: none"> An error was detected on the system bus. 	<ul style="list-style-type: none"> Take measures to reduce noise. Reset the bus. If the same error code is displayed again, the possible cause is a hardware failure of the extension cable, or module (I/O module or intelligent function module) connected. Please contact your local Mitsubishi Electric sales office or representative. 	Stop	Power-on, hardware reset, bus reset
24D0H	System bus error	<ul style="list-style-type: none"> The extension level setting of the Q series extension base unit is overlapping with that of any other extension base units. An error was detected on the system bus. 	<ul style="list-style-type: none"> Check and correct the level setting of the Q series extension base unit. Check the connection status of the extension cable. Take measures to reduce noise. Reset the bus. If the same error code is displayed again, the possible cause is a hardware failure of the CPU module, base unit, or extension cable. Please contact your local Mitsubishi Electric sales office or representative. 	Stop	Always At module access
24E0H	System bus error	<ul style="list-style-type: none"> An error was detected on the system bus. 	<ul style="list-style-type: none"> Take measures to reduce noise. Reset the bus. If the same error code is displayed again, the possible cause is a hardware failure of the CPU module or base unit. Please contact your local Mitsubishi Electric sales office or representative. 	Stop	Always
2520H	Invalid interrupt	<ul style="list-style-type: none"> Even though an interrupt was requested, there is no interrupt factor. 	<ul style="list-style-type: none"> Take measures to reduce noise. Reset the bus. If the same error code is displayed again, the possible cause is a hardware failure of the CPU module, base unit, or module (I/O module or intelligent function module) connected. Please contact your local Mitsubishi Electric sales office or representative. 	Stop	At interrupt occurrence

Error code	Error name	Error details and cause	Corrective action	Stop/continue	Diagnostic timing
2521H	Invalid interrupt	<ul style="list-style-type: none"> Even though an interrupt was requested, there is no interrupt factor. 	<ul style="list-style-type: none"> Take measures to reduce noise. Reset the bus. If the same error code is displayed again, the possible cause is a hardware failure of the CPU module, base unit, or module (I/O module or intelligent function module) connected. Please contact your local Mitsubishi Electric sales office or representative. 	Stop	At interrupt occurrence
2522H	Invalid interrupt	<ul style="list-style-type: none"> An interrupt was requested from the module with no interrupt pointer setting. 	<ul style="list-style-type: none"> Check and correct the interrupt pointer setting in the module parameters. Take measures so that no interrupt is requested from the module with no interrupt pointer setting. Check and correct the interrupt setting in the buffer memory of the intelligent function module. 	Stop	At interrupt occurrence
2610H	Inter-module synchronization signal error	<ul style="list-style-type: none"> An inter-module synchronization error has been detected. 	<ul style="list-style-type: none"> Check the module set as the inter-module synchronous master. Take measures to reduce noise. Reset the bus. If the same error code is displayed again, the possible cause is a hardware failure of the CPU module, base unit, extension cable, or module (I/O module or intelligent function module) connected. Please contact your local Mitsubishi Electric sales office or representative. 	Stop/continue	Always
2611H	Inter-module synchronization signal error	<ul style="list-style-type: none"> An inter-module synchronization error has been detected. The module set as the inter-module synchronous master has detected a module parameter error. 	<ul style="list-style-type: none"> Take measures to reduce noise. Correct the inter-module synchronous master settings. Reset the bus. If the same error code is displayed again, the possible cause is a hardware failure of the CPU module, base unit, extension cable, or module (I/O module or intelligent function module) connected. Please contact your local Mitsubishi Electric sales office or representative. 	Stop	Power-on, hardware reset, bus reset At fixed cycle processing execution
2630H	Multiple CPU synchronization signal error	<ul style="list-style-type: none"> A multiple CPU synchronization error has been detected. 	<ul style="list-style-type: none"> Take measures to reduce noise. Reset the bus. If the same error code is displayed again, the possible cause is a hardware failure of the CPU module or base unit. Please contact your local Mitsubishi Electric sales office or representative. 	Stop/continue	Always
2631H	Multiple CPU synchronization signal error	<ul style="list-style-type: none"> A multiple CPU synchronization error has been detected. 	<ul style="list-style-type: none"> Take measures to reduce noise. Reset the bus. If the same error code is displayed again, the possible cause is a hardware failure of the CPU module or base unit. Please contact your local Mitsubishi Electric sales office or representative. 	Stop	Power-on, hardware reset, bus reset At fixed cycle processing execution
3451H	Hardware failure	<ul style="list-style-type: none"> A hardware failure has been detected. 	<ul style="list-style-type: none"> Take measures to reduce noise. Turn the power of the CPU module OFF and ON or reset the hardware. If the same error code is displayed again, the possible cause is a hardware failure of the CPU module. Please contact your local Mitsubishi Electric sales office or representative. 	Stop	Always

Error code	Error name	Error details and cause	Corrective action	Stop/continue	Diagnostic timing
3452H	Hardware failure	<ul style="list-style-type: none"> A hardware failure has been detected. 	<ul style="list-style-type: none"> Take measures to reduce noise. Turn the power of the CPU module OFF and ON or reset the hardware. If the same error code is displayed again, the possible cause is a hardware failure of the CPU module. Please contact your local Mitsubishi Electric sales office or representative. 	Stop	Always
3453H	Windows stop	<ul style="list-style-type: none"> Stop (no response) status was detected by Windows blue screen etc. 	<ul style="list-style-type: none"> Review the applications on Windows. Check Device Manager. If any invalid devices are connected, take corrective actions so that they operate normally or disconnect them. Review the user program. End a process using a lot of CPU to reduce the CPU usage rate. Reduce the frequency of access from external devices. Alternatively, disconnect the external devices. Reset the bus. If the same error code is displayed again, the possible cause is a hardware failure of the CPU module. Please contact your local Mitsubishi Electric sales office or representative. 	Continue	Always
3C00H	Hardware failure	<ul style="list-style-type: none"> A hardware failure has been detected. 	<ul style="list-style-type: none"> Take measures to reduce noise. Turn the power of the CPU module OFF and ON or reset the hardware. If the same error code is displayed again, the possible cause is a hardware failure of the CPU module. Please contact your local Mitsubishi Electric sales office or representative. Check the event history, if major errors occurred at another CPU module, I/O module, or intelligent function module, take measures according to the error codes. 	Stop	Always
3C01H	Hardware failure	<ul style="list-style-type: none"> A hardware failure has been detected. 	<ul style="list-style-type: none"> Take measures to reduce noise. Turn the power of the CPU module OFF and ON or reset the hardware. If the same error code is displayed again, the possible cause is a hardware failure of the CPU module. Please contact your local Mitsubishi Electric sales office or representative. 	Stop	Always
3C02H	Hardware failure	<ul style="list-style-type: none"> A hardware failure has been detected. 	<ul style="list-style-type: none"> Take measures to reduce noise. Turn the power of the CPU module OFF and ON or reset the hardware. If the same error code is displayed again, the possible cause is a hardware failure of the CPU module. Please contact your local Mitsubishi Electric sales office or representative. 	Stop	Power-on, hardware reset, bus reset At fixed cycle processing execution At interrupt occurrence
3C03H	Hardware failure	<ul style="list-style-type: none"> A hardware failure has been detected. 	<ul style="list-style-type: none"> Take measures to reduce noise. Turn the power of the CPU module OFF and ON or reset the hardware. If the same error code is displayed again, the possible cause is a hardware failure of the CPU module. Please contact your local Mitsubishi Electric sales office or representative. 	Stop	Always Power-on, hardware reset, bus reset At interrupt occurrence

Error code	Error name	Error details and cause	Corrective action	Stop/continue	Diagnostic timing
3C0FH	Hardware failure	<ul style="list-style-type: none"> A hardware failure has been detected. 	<ul style="list-style-type: none"> Take measures to reduce noise. Turn the power of the CPU module OFF and ON or reset the hardware. If the same error code is displayed again, the possible cause is a hardware failure of the CPU module. Please contact your local Mitsubishi Electric sales office or representative. 	Stop	Always
3C10H	Hardware failure	<ul style="list-style-type: none"> A hardware failure has been detected. 	<ul style="list-style-type: none"> Take measures to reduce noise. Turn the power of the CPU module OFF and ON or reset the hardware. If the same error code is displayed again, the possible cause is a hardware failure of the CPU module. Please contact your local Mitsubishi Electric sales office or representative. 	Stop	Power-on, hardware reset, bus reset
3C11H	Hardware failure	<ul style="list-style-type: none"> A hardware failure has been detected. 	<ul style="list-style-type: none"> Take measures to reduce noise. Turn the power of the CPU module OFF and ON or reset the hardware. If the same error code is displayed again, the possible cause is a hardware failure of the CPU module. Please contact your local Mitsubishi Electric sales office or representative. 	Stop	At fixed cycle processing execution At instruction execution
3C12H	Hardware failure	<ul style="list-style-type: none"> The waveform of the voltage out of the specified range has been detected in the power supply module. A hardware failure has been detected in the power supply module, CPU module, base unit, or extension cable. 	<ul style="list-style-type: none"> Check the waveform of the voltage applied to the power supply module. Turn the power of the CPU module OFF and ON or reset the hardware. If the same error code is displayed again, the possible cause is a hardware failure of the power supply module, CPU module, base unit, or extension cable. Please contact your local Mitsubishi Electric sales office or representative. 	Stop	Always
3C13H	Hardware failure	<ul style="list-style-type: none"> A hardware failure has been detected. 	<ul style="list-style-type: none"> Take measures to reduce noise. Turn the power of the CPU module OFF and ON or reset the hardware. If the same error code is displayed again, the possible cause is a hardware failure of the CPU module. Please contact your local Mitsubishi Electric sales office or representative. 	Stop	Always
3C14H	Hardware failure	<ul style="list-style-type: none"> A hardware failure has been detected. 	<ul style="list-style-type: none"> Take measures to reduce noise. Turn the power of the CPU module OFF and ON or reset the hardware. If the same error code is displayed again, the possible cause is a hardware failure of the CPU module. Please contact your local Mitsubishi Electric sales office or representative. 	Stop	Always
3C20H	Memory error	<ul style="list-style-type: none"> An error has been detected in the memory. 	<ul style="list-style-type: none"> Take measures to reduce noise. Turn the power of the CPU module OFF and ON or reset the hardware. If the same error code is displayed again, the possible cause is a hardware failure of the CPU module. Please contact your local Mitsubishi Electric sales office or representative. 	Stop	Power-on, hardware reset, bus reset
3C21H	Memory error	<ul style="list-style-type: none"> An error has been detected in the memory. 	<ul style="list-style-type: none"> Take measures to reduce noise. Turn the power of the CPU module OFF and ON or reset the hardware. If the same error code is displayed again, the possible cause is a hardware failure of the CPU module. Please contact your local Mitsubishi Electric sales office or representative. 	Stop	Power-on, hardware reset, bus reset At fixed cycle processing execution

Error code	Error name	Error details and cause	Corrective action	Stop/continue	Diagnostic timing
3C22H	Memory error	<ul style="list-style-type: none"> An error has been detected in the memory. 	<ul style="list-style-type: none"> Take measures to reduce noise. Turn the power of the CPU module OFF and ON or reset the hardware. If the same error code is displayed again, the possible cause is a hardware failure of the CPU module. Please contact your local Mitsubishi Electric sales office or representative. 	Stop	Power-on, hardware reset, bus reset At fixed cycle processing execution
3C2FH	Memory error	<ul style="list-style-type: none"> An error has been detected in the memory. 	<ul style="list-style-type: none"> Take measures to reduce noise. Turn the power of the CPU module OFF and ON or reset the hardware. If the same error code is displayed again, the possible cause is a hardware failure of the CPU module. Please contact your local Mitsubishi Electric sales office or representative. 	Stop	Always
3C30H	Memory error	<ul style="list-style-type: none"> An error has been detected in the memory. 	<ul style="list-style-type: none"> Take measures to reduce noise. Format the memory. Write all files to the CPU module. Then, turn the power of the CPU module OFF and ON or reset the hardware. If the same error code is displayed again, the possible cause is a hardware failure of the CPU module. Please contact your local Mitsubishi Electric sales office or representative. 	Stop	At instruction execution
3C31H	Memory error	<ul style="list-style-type: none"> An error has been detected in the memory. 	<ul style="list-style-type: none"> Take measures to reduce noise. Format the memory. Write all files to the CPU module. Then, turn the power of the CPU module OFF and ON or reset the hardware. If the same error code is displayed again, the possible cause is a hardware failure of the CPU module. Please contact your local Mitsubishi Electric sales office or representative. 	Stop	Always
3C32H	Memory error	<ul style="list-style-type: none"> An error has been detected in the memory. 	<ul style="list-style-type: none"> Take measures to reduce noise. Turn the power of the CPU module OFF and ON or reset the hardware. If the same error code is displayed again, the possible cause is a hardware failure of the CPU module. Please contact your local Mitsubishi Electric sales office or representative. 	Stop	Always
3E40H	Memory error	<ul style="list-style-type: none"> An error has been detected in the memory. 	<ul style="list-style-type: none"> Take measures to reduce noise. Turn the power of the CPU module OFF and ON or reset the hardware. If the same error code is displayed again, the possible cause is a hardware failure of the CPU module. Please contact your local Mitsubishi Electric sales office or representative. 	Stop	Always

Error code	Error name	Error details and cause	Corrective action	Stop/continue	Diagnostic timing
3E41H	WDT error	<ul style="list-style-type: none"> The system watchdog timer controlled by the system detected an error. (1) The system WDT monitoring time is too short. (2) An operation that increases the CPU utilization by the system task (writing parameter) was executed. (3) At a stop error occurrence, the station using block data assurance per station of the network was accessed. (4) The initial processing of the bus control took time. (5) CPU module drives recklessly or it breaks down. (Malfunction by noise etc. and Hardware error)	<ul style="list-style-type: none"> Turn the power of the CPU module OFF and ON or reset the hardware. Prolong the system WDT monitoring time. Review the user program not to access the station that is used block data assurance per station of the network at a stop error occurrence. Take measures to reduce noise. Check that the MELSECWinCPU is securely installed in the base unit, and the ambient environment is within the general specification range. If the error occurs even after the above checks, the possible cause is a hardware failure of the CPU module. Please contact your local Mitsubishi Electric sales office or representative.	Stop	Always
3E45H	Hardware failure	<ul style="list-style-type: none"> A hardware failure has been detected. 	<ul style="list-style-type: none"> Take measures to reduce noise. Turn the power of the CPU module OFF and ON or reset the hardware. If the same error code is displayed again, the possible cause is a hardware failure of the CPU module. Please contact your local Mitsubishi Electric sales office or representative. 	Stop	Always
3E48H	Memory error	<ul style="list-style-type: none"> An error has been detected in the memory. 	<ul style="list-style-type: none"> Take measures to reduce noise. Format the memory. Write all files to the CPU module. Then, turn the power of the CPU module OFF and ON or reset the hardware, and run it again. If the same error code is displayed again, the possible cause is a hardware failure of the CPU module. Please contact your local Mitsubishi Electric sales office or representative. 	Stop	Always
3E49H	Memory error	<ul style="list-style-type: none"> An error has been detected in the memory. 	<ul style="list-style-type: none"> Take measures to reduce noise. Format the memory. Write all files to the CPU module. Then, turn the power of the CPU module OFF and ON or reset the hardware, and run it again. If the same error code is displayed again, the possible cause is a hardware failure of the CPU module. Please contact your local Mitsubishi Electric sales office or representative. 	Stop	Always
3E4AH	Memory error	<ul style="list-style-type: none"> An error has been detected in the memory. 	<ul style="list-style-type: none"> Take measures to reduce noise. Format the memory. Write all files to the CPU module. Then, turn the power of the CPU module OFF and ON or reset the hardware, and run it again. If the same error code is displayed again, the possible cause is a hardware failure of the CPU module. Please contact your local Mitsubishi Electric sales office or representative. 	Stop	Always

Error code	Error name	Error details and cause	Corrective action	Stop/continue	Diagnostic timing
3E50H	Memory error	<ul style="list-style-type: none"> An error has been detected in the memory. 	<ul style="list-style-type: none"> Take measures to reduce noise. Format the memory. Write all files to the CPU module. Then, turn the power of the CPU module OFF and ON or reset the hardware, and run it again. If the same error code is displayed again, the possible cause is a hardware failure of the CPU module. Please contact your local Mitsubishi Electric sales office or representative. 	Stop	Power-on, hardware reset, bus reset
3E51H	Memory error	<ul style="list-style-type: none"> An error has been detected in the memory. 	<ul style="list-style-type: none"> Take measures to reduce noise. Turn the power of the CPU module OFF and ON or reset the hardware. If the same error code is displayed again, the possible cause is a hardware failure of the CPU module. Please contact your local Mitsubishi Electric sales office or representative. 	Stop	Power-on, hardware reset, bus reset
3E52H	Memory error	<ul style="list-style-type: none"> An error has been detected in the memory. 	<ul style="list-style-type: none"> Take measures to reduce noise. Turn the power of the CPU module OFF and ON or reset the hardware. If the same error code is displayed again, the possible cause is a hardware failure of the CPU module. Please contact your local Mitsubishi Electric sales office or representative. 	Stop	Power-on, hardware reset, bus reset
3E53H	Hardware failure	<ul style="list-style-type: none"> A hardware failure has been detected. 	<ul style="list-style-type: none"> Take measures to reduce noise. Turn the power of the CPU module OFF and ON or reset the hardware. If the same error code is displayed again, the possible cause is a hardware failure of the CPU module. Please contact your local Mitsubishi Electric sales office or representative. 	Stop	Power-on, hardware reset, bus reset
3E54H	Memory error	<ul style="list-style-type: none"> An error has been detected in the memory. 	<ul style="list-style-type: none"> Take measures to reduce noise. Turn the power of the CPU module OFF and ON or reset the hardware. If the same error code is displayed again, the possible cause is a hardware failure of the CPU module. Please contact your local Mitsubishi Electric sales office or representative. 	Stop	Power-on, hardware reset, bus reset
3E55H	Hardware failure	<ul style="list-style-type: none"> A hardware failure has been detected. 	<ul style="list-style-type: none"> Take measures to reduce noise. Initialize parameters and the event history. If the same error code is displayed again, the possible cause is a hardware failure of the CPU module. Please contact your local Mitsubishi Electric sales office or representative. 	Stop	Power-on, hardware reset, bus reset
3E56H	Hardware failure	<ul style="list-style-type: none"> A hardware failure has been detected. 	<ul style="list-style-type: none"> Take measures to reduce noise. Turn the power of the CPU module OFF and ON or reset the hardware. If the same error code is displayed again, the possible cause is a hardware failure of the CPU module. Please contact your local Mitsubishi Electric sales office or representative. 	Stop	Power-on, hardware reset, bus reset
3E57H	Memory error	<ul style="list-style-type: none"> An error has been detected in the memory. 	<ul style="list-style-type: none"> Take measures to reduce noise. Turn the power of the CPU module OFF and ON or reset the hardware. If the same error code is displayed again, the possible cause is a hardware failure of the CPU module. Please contact your local Mitsubishi Electric sales office or representative. 	Stop	Power-on, hardware reset, bus reset

Error code	Error name	Error details and cause	Corrective action	Stop/continue	Diagnostic timing
3E58H	Hardware failure	<ul style="list-style-type: none"> A hardware failure has been detected. 	<ul style="list-style-type: none"> Take measures to reduce noise. Turn the power of the CPU module OFF and ON or reset the hardware. If the same error code is displayed again, the possible cause is a hardware failure of the CPU module. Please contact your local Mitsubishi Electric sales office or representative. 	Stop	Power-on, hardware reset, bus reset
3E59H	Hardware failure	<ul style="list-style-type: none"> A hardware failure has been detected. 	<ul style="list-style-type: none"> Take measures to reduce noise. Turn the power of the CPU module OFF and ON or reset the hardware. If the same error code is displayed again, the possible cause is a hardware failure of the CPU module. Please contact your local Mitsubishi Electric sales office or representative. 	Stop	Always
3E5AH	Hardware failure	<ul style="list-style-type: none"> A hardware failure has been detected. 	<ul style="list-style-type: none"> Take measures to reduce noise. Turn the power of the CPU module OFF and ON or reset the hardware. If the same error code is displayed again, the possible cause is a hardware failure of the CPU module. Please contact your local Mitsubishi Electric sales office or representative. 	Stop	Always
3E5BH	Hardware failure	<ul style="list-style-type: none"> A hardware failure has been detected. 	<ul style="list-style-type: none"> Take measures to reduce noise. Turn the power of the CPU module OFF and ON or reset the hardware. If the same error code is displayed again, the possible cause is a hardware failure of the CPU module. Please contact your local Mitsubishi Electric sales office or representative. 	Stop	Always
3E5CH	Hardware failure	<ul style="list-style-type: none"> A hardware failure has been detected. 	<ul style="list-style-type: none"> Take measures to reduce noise. Turn the power of the CPU module OFF and ON or reset the hardware. If the same error code is displayed again, the possible cause is a hardware failure of the CPU module. Please contact your local Mitsubishi Electric sales office or representative. 	Stop	Always
3E5EH	Hardware failure	<ul style="list-style-type: none"> A hardware failure has been detected. 	<ul style="list-style-type: none"> Take measures to reduce noise. Turn the power of the CPU module OFF and ON or reset the hardware. If the same error code is displayed again, the possible cause is a hardware failure of the CPU module. Please contact your local Mitsubishi Electric sales office or representative. 	Stop	Always
3E5FH	Hardware failure	<ul style="list-style-type: none"> A hardware failure has been detected. 	<ul style="list-style-type: none"> Turn the power of the CPU module OFF and ON or reset the hardware. If the same error code is displayed again, the possible cause is a hardware failure of the CPU module. Please contact your local Mitsubishi Electric sales office or representative. 	Stop	Always
3E60H	Hardware failure	<ul style="list-style-type: none"> A hardware failure has been detected. 	<ul style="list-style-type: none"> Take measures to reduce noise. Turn the power of the CPU module OFF and ON or reset the hardware. If the same error code is displayed again, the possible cause is a hardware failure of the CPU module. Please contact your local Mitsubishi Electric sales office or representative. 	Stop	Always

Error code	Error name	Error details and cause	Corrective action	Stop/continue	Diagnostic timing
3E61H	Hardware failure	• A hardware failure has been detected.	<ul style="list-style-type: none"> • Take measures to reduce noise. • Turn the power of the CPU module OFF and ON or reset the hardware. If the same error code is displayed again, the possible cause is a hardware failure of the CPU module. Please contact your local Mitsubishi Electric sales office or representative. 	Stop	Always
3E62H	Hardware failure	• A hardware failure has been detected.	<ul style="list-style-type: none"> • Take measures to reduce noise. • Turn the power of the CPU module OFF and ON or reset the hardware. If the same error code is displayed again, the possible cause is a hardware failure of the CPU module. Please contact your local Mitsubishi Electric sales office or representative. 	Stop	Always
3E63H	Hardware failure	• A hardware failure has been detected.	<ul style="list-style-type: none"> • Take measures to reduce noise. • Turn the power of the CPU module OFF and ON or reset the hardware. If the same error code is displayed again, the possible cause is a hardware failure of the CPU module. Please contact your local Mitsubishi Electric sales office or representative. 	Stop	Always
3E64H	Hardware failure	• A hardware failure has been detected.	<ul style="list-style-type: none"> • Take measures to reduce noise. • Turn the power of the CPU module OFF and ON or reset the hardware. If the same error code is displayed again, the possible cause is a hardware failure of the CPU module. Please contact your local Mitsubishi Electric sales office or representative. 	Stop	Always
3E65H	Hardware failure	• A hardware failure has been detected.	<ul style="list-style-type: none"> • Take measures to reduce noise. • Turn the power of the CPU module OFF and ON or reset the hardware. If the same error code is displayed again, the possible cause is a hardware failure of the CPU module. Please contact your local Mitsubishi Electric sales office or representative. 	Stop	Always
3E66H	Hardware failure	• A hardware failure has been detected.	<ul style="list-style-type: none"> • Take measures to reduce noise. • Turn the power of the CPU module OFF and ON or reset the hardware. If the same error code is displayed again, the possible cause is a hardware failure of the CPU module. Please contact your local Mitsubishi Electric sales office or representative. 	Stop	Always
3E67H	Hardware failure	• A hardware failure has been detected.	<ul style="list-style-type: none"> • Take measures to reduce noise. • Turn the power of the CPU module OFF and ON or reset the hardware. If the same error code is displayed again, the possible cause is a hardware failure of the CPU module. Please contact your local Mitsubishi Electric sales office or representative. 	Stop	Always Power-on, hardware reset, bus reset
3E68H	Hardware failure	• A hardware failure has been detected.	<ul style="list-style-type: none"> • Take measures to reduce noise. • Turn the power of the CPU module OFF and ON or reset the hardware. If the same error code is displayed again, the possible cause is a hardware failure of the CPU module. Please contact your local Mitsubishi Electric sales office or representative. 	Stop	Always

Error code	Error name	Error details and cause	Corrective action	Stop/continue	Diagnostic timing
3E69H	Hardware failure	<ul style="list-style-type: none"> A hardware failure has been detected. 	<ul style="list-style-type: none"> Take measures to reduce noise. Turn the power of the CPU module OFF and ON or reset the hardware. If the same error code is displayed again, the possible cause is a hardware failure of the CPU module. Please contact your local Mitsubishi Electric sales office or representative. 	Stop	Always
3E6AH	Memory error	<ul style="list-style-type: none"> An error has been detected in the memory. 	<ul style="list-style-type: none"> Take measures to reduce noise. Turn the power of the module OFF and ON. If the same error code is displayed again, the possible cause is a hardware failure of the CPU module. Please contact your local Mitsubishi Electric sales office or representative. 	Stop	Power-on, hardware reset, bus reset
3E6BH	Memory error	<ul style="list-style-type: none"> An error has been detected in the memory. 	<ul style="list-style-type: none"> Take measures to reduce noise. Turn the power of the module OFF and ON. If the same error code is displayed again, the possible cause is a hardware failure of the CPU module. Please contact your local Mitsubishi Electric sales office or representative. 	Stop	Always
3E6CH	Memory error	<ul style="list-style-type: none"> An error has been detected in the memory. 	<ul style="list-style-type: none"> Take measures to reduce noise. Turn the power of the module OFF and ON. If the same error code is displayed again, the possible cause is a hardware failure of the CPU module. Please contact your local Mitsubishi Electric sales office or representative. 	Stop	Power-on, hardware reset, bus reset
3E6DH	Memory error	<ul style="list-style-type: none"> An error has been detected in the memory. 	<ul style="list-style-type: none"> Take measures to reduce noise. Turn the power of the module OFF and ON. If the same error code is displayed again, the possible cause is a hardware failure of the CPU module. Please contact your local Mitsubishi Electric sales office or representative. 	Stop	Power-on, hardware reset, bus reset
3E6EH	Hardware failure	<ul style="list-style-type: none"> A hardware failure has been detected. 	<ul style="list-style-type: none"> Take measures to reduce noise. Turn the power of the CPU module OFF and ON or reset the hardware. If the same error code is displayed again, the possible cause is a hardware failure of the CPU module. Please contact your local Mitsubishi Electric sales office or representative. 	Stop	Always Power-on, hardware reset, bus reset
3EA6H	Hardware failure	<ul style="list-style-type: none"> A hardware failure has been detected. 	<p>Immediately turn the power OFF, and take the following measures.</p> <ul style="list-style-type: none"> Check the ambient temperature. If the same error code is displayed again, the possible cause is a hardware failure. Please contact your local Mitsubishi Electric sales office or representative. 	Stop	Always

33.2 Other Error Codes

The following table shows the error codes detected by other than self-diagnostics.

Error code	Error name	Error details and cause	Corrective action
4001H	Common error	<ul style="list-style-type: none"> An unsupported request was executed. (The request was issued to CPU module which does not support the request.) 	<ul style="list-style-type: none"> Check the command data of SLMP/MC protocol. Check the CPU module name selected with an engineering tool. Check the target CPU module name.
4002H	Common error	<ul style="list-style-type: none"> An unsupported request was executed. 	<ul style="list-style-type: none"> Check the command data of SLMP/MC protocol. Check the CPU module name selected with an engineering tool. Execute the request again. If the same error code is displayed again, the possible cause is a hardware failure of the CPU module. Please contact your local Mitsubishi Electric sales office or representative.
4003H	Common error	<ul style="list-style-type: none"> Command for which a global request cannot be performed was executed. 	<ul style="list-style-type: none"> Check the command data of SLMP/MC protocol.
4004H	Common error	<ul style="list-style-type: none"> A request was issued to the system file. 	<ul style="list-style-type: none"> Check the command data of SLMP/MC protocol.
4005H	Common error	<ul style="list-style-type: none"> The volume of data to be handled by the specified request is too large. 	<ul style="list-style-type: none"> Check the command data of SLMP/MC protocol.
4008H	Common error	<ul style="list-style-type: none"> The CPU module is BUSY. (The buffer is not empty.) 	<ul style="list-style-type: none"> Execute the request again after arbitrary period of time has elapsed.
4010H	CPU module operation related error	<ul style="list-style-type: none"> Because the CPU module is in the Y OUT state, the request cannot be executed. 	<ul style="list-style-type: none"> Execute the request after setting the CPU module to the Y STOP state.
4013H	CPU module operation related error	<ul style="list-style-type: none"> Because the CPU module is not in the Y STOP state, the request cannot be executed. 	<ul style="list-style-type: none"> Execute the request after setting the CPU module to the Y STOP state.
4021H	File related error	<ul style="list-style-type: none"> The specified drive (memory) does not exist, or has an error. 	<ul style="list-style-type: none"> Check the status of the specified drive (memory). Back up the data in the CPU module, and then initialize the memory.
4022H	File related error	<ul style="list-style-type: none"> The file with the specified file name or file number does not exist. 	<ul style="list-style-type: none"> Check the specified file name and file number.
4023H	File related error	<ul style="list-style-type: none"> The file name and file number of the specified file do not match. 	<ul style="list-style-type: none"> Delete the file, and then create a file again.
4024H	File related error	<ul style="list-style-type: none"> The specified file cannot be handled. 	<ul style="list-style-type: none"> Do not access the specified file.
4025H	File related error	<ul style="list-style-type: none"> The specified file is currently processing a request from another engineering tool. 	<ul style="list-style-type: none"> Forcibly execute the request. Or, execute it again once the processing from another engineering tool has been completed.
4026H	File related error	<ul style="list-style-type: none"> Specifying the file password set to the target drive (memory) is required. 	<ul style="list-style-type: none"> Specify the file password set to the target drive (memory), and access it.
4027H	File related error	<ul style="list-style-type: none"> The specified range exceeded the file size. 	<ul style="list-style-type: none"> Check the specified range, and access within the range.
4028H	File related error	<ul style="list-style-type: none"> The same file already exists. 	<ul style="list-style-type: none"> Forcibly execute the request. Or, change the file name and execute the request again.
4029H	File related error	<ul style="list-style-type: none"> The specified file capacity cannot be reserved. 	<ul style="list-style-type: none"> Review the specified file capacity, and execute the request again.
402AH	File related error	<ul style="list-style-type: none"> The specified file has an error. 	<ul style="list-style-type: none"> Back up the data in the CPU module, and then initialize the memory.
402BH	File related error	<ul style="list-style-type: none"> The request cannot be executed in the specified drive (memory). 	<ul style="list-style-type: none"> Execute the request again after placing the CPU module into the Y STOP state.
402CH	File related error	<ul style="list-style-type: none"> The request cannot be executed currently. 	<ul style="list-style-type: none"> Execute it again after a while.
4030H	Device specification error	<ul style="list-style-type: none"> The specified device name cannot be handled. 	<ul style="list-style-type: none"> Check the specified device name.
4031H	Device specification error	<ul style="list-style-type: none"> The specified device number is out of range. The CPU module does not support the specified device name. 	<ul style="list-style-type: none"> Check the specified device number. Check the device assignment of the CPU module. Check the specified device name.
4032H	Device specification error	<ul style="list-style-type: none"> The specified device modification is incorrect. Or, the device names (TS, TC, SS, SC, CS, or CC) which cannot be used for random read/random write (in word units)/monitor registration/monitor command of SLMP/MC protocol have been specified. 	<ul style="list-style-type: none"> Check the specified device modification method. Check the specified device name.

Error code	Error name	Error details and cause	Corrective action
4033H	Device specification error	• Data cannot be written to the specified device since it is for system use.	• Do not write data to the specified device. Or, do not turn it ON/OFF.
4040H	Intelligent function module specification error	• The request cannot be executed to the specified intelligent function module.	• Check whether the specified module is an intelligent function module which has the buffer memory.
4041H	Intelligent function module specification error	• The access range exceeded the buffer memory range of the specified intelligent function module.	• Check the start address and number of access points, and access within the range that exists in the intelligent function module.
4042H	Intelligent function module specification error	• The specified intelligent function module cannot be accessed.	• Check whether the specified intelligent function module operates normally. • Check whether the specified module has hardware failure.
4043H	Intelligent function module specification error	• The specified intelligent function module does not exist.	• Check the I/O number of the specified intelligent function module.
4044H	Intelligent function module specification error	• A bus error occurred during the access to an intelligent function module.	• Check whether the specified intelligent function module, other modules, or base unit have hardware failure.
4052H	Protect error	• Data cannot be written since the specified file attribute is the read-only.	• Do not write data to the specified file. Or, change the file attribute.
4053H	Protect error	• An error occurred when writing data to the specified drive (memory).	• Check the specified drive (memory). Or, write data again after changing the target drive (memory).
4054H	Protect error	• An error occurred when deleting data from the specified drive (memory).	• Check the specified drive (memory). Or, delete data again after changing the target drive (memory).
4080H	Other error	• Request data error	• Check the specified request data.
4082H	Other error	• The specified command cannot be executed since it is being executed.	• Execute the command again once the request from another engineering tool has been completed.
408BH	Other error	• A remote request cannot be executed.	• Execute the request again after placing the CPU module in the state where a remote request can be executed. • For the remote BUS RESET operation, set "Enable" for "Remote Bus Reset Setting" with the parameter.
4121H	File related error	• The specified drive (memory) or file does not exist.	• Check the specified drive (memory) or file, and execute the request again.
4122H	File related error	• The specified drive (memory) or file does not exist.	• Check the specified drive (memory) or file, and execute the request again.
4123H	File related error	• The specified drive (memory) has an error.	• Initialize the memory, and restore the drive (memory) to its normal state.
4124H	File related error	• The specified drive (memory) has an error.	• Initialize the memory, and restore the drive (memory) to its normal state.
4125H	File related error	• The specified drive (memory) or file is currently being processed.	• Execute it again after a while.
4129H	File related error	• The request cannot be executed since the specified drive (memory) is ROM.	• Change the target drive (memory), and execute the request again.
412AH	File related error	• The request cannot be executed since the specified drive (memory) is ROM.	• Change the target drive (memory), and execute the request again.
412BH	File related error	• The specified drive (memory) is write-prohibited.	• Change the write-protect conditions or drive (memory), and execute the request again.
412DH	File related error	• The specified drive (memory) does not have enough free space.	• Increase the free space of the drive (memory), and execute the request again.
412EH	File related error	• The specified drive (memory) does not have enough free space.	• Increase the free space of the drive (memory), and execute the request again.
412FH	File related error	• The drive (memory) capacity differs between the copy destination and the copy source.	• Check the copy destination and copy source drive (memory), and execute the request again.
4130H	File related error	• The drive (memory) type differs between the copy destination and the copy source.	• Check the copy destination and copy source drive (memory), and execute the request again.
4131H	File related error	• The file name of the copy destination is the same as the one of the copy source.	• Check the file name, and execute the request again.
4132H	File related error	• The specified number of files does not exist.	• Check the specified data, and execute the request again.

Error code	Error name	Error details and cause	Corrective action
4133H	File related error	<ul style="list-style-type: none"> The specified device (memory) has no free space. 	<ul style="list-style-type: none"> Increase the free space of the drive (memory), and execute the request again.
4134H	File related error	<ul style="list-style-type: none"> The attribute specification data for a file is incorrect. 	<ul style="list-style-type: none"> Check the specified data, and execute the request again.
4136H	File related error	<ul style="list-style-type: none"> The specified file already exists. 	<ul style="list-style-type: none"> Check the specified file name, and execute the request again.
4137H	File related error	<ul style="list-style-type: none"> The specified file is read-only. 	<ul style="list-style-type: none"> Change the conditions for the specified file, and execute the request again.
4138H	File related error	<ul style="list-style-type: none"> Simultaneously accessible files exceeded the maximum. 	<ul style="list-style-type: none"> Reduce the file operation, and execute the request again.
4139H	File related error	<ul style="list-style-type: none"> The specified file exceeded the file size range of the file already exists. 	<ul style="list-style-type: none"> Check the size of the specified file, and execute the request again.
413AH	File related error	<ul style="list-style-type: none"> The specified file exceeded the file size of the file already exists. 	<ul style="list-style-type: none"> Check the size of the specified file, and execute the request again.
413EH	File related error	<ul style="list-style-type: none"> Operation is disabled for the specified drive (memory). 	<ul style="list-style-type: none"> Change the target drive (memory), and execute the request again.
413FH	File related error	<ul style="list-style-type: none"> Writing to the file storage area is prohibited for the file. 	<ul style="list-style-type: none"> Change the specified drive (memory), and execute the request again.
414AH	Intelligent function module specification error	<ul style="list-style-type: none"> Operation was performed to the intelligent function module outside of the control group in a multiple CPU system. 	<ul style="list-style-type: none"> Perform the operation from the control CPU module for the target module.
414CH	Intelligent function module specification error	<ul style="list-style-type: none"> Inaccessible buffer memory address was specified. 	<ul style="list-style-type: none"> Check the buffer memory address, and execute the request again.
4150H	File related error	<ul style="list-style-type: none"> An attempt was made to initialize the drive protected by the system. 	<ul style="list-style-type: none"> Do not initialize the target drive (memory) since it cannot be initialized.
4151H	File related error	<ul style="list-style-type: none"> An attempt was made to delete the file/folder protected by the system. 	<ul style="list-style-type: none"> Do not delete the target file/folder since it cannot be deleted.
41C5H	File related error	<ul style="list-style-type: none"> The specified file does not exist. An attempt was made to write data to a read-only file. 	<ul style="list-style-type: none"> Check the file, and execute the request again.
41F8H	File related error	<ul style="list-style-type: none"> The same data is being accessed with another engineering tool. 	<ul style="list-style-type: none"> The function to write data to the program memory, or the function to transfer data to backup memory is being performed. <p>Check the completion of the above functions, and execute the request again.</p>
41FBH	File related error	<ul style="list-style-type: none"> The specified file has been operated with the same engineering tool. 	<ul style="list-style-type: none"> Execute the request again once the currently performed operation has been completed.
41FDH	File related error	<ul style="list-style-type: none"> Data is not written to the data memory. 	<ul style="list-style-type: none"> Write all the required files to the programmable controller.
4269H	Other error	<ul style="list-style-type: none"> The remote Y OUT or remote RUN operation cannot be performed. 	<ul style="list-style-type: none"> Perform the remote Y OUT or remote RUN operation again after a while.
433CH	Maintenance related error	<ul style="list-style-type: none"> Clearing error failed. (The error clear function has been performed while an error is being cleared.) 	<ul style="list-style-type: none"> Execute it again after a while. <p>If the same error code is displayed again, the possible cause is a hardware failure of the target module. Please contact your local Mitsubishi Electric sales office or representative.</p>
433DH	Maintenance related error	<ul style="list-style-type: none"> The target module does not support the error clear function. 	<ul style="list-style-type: none"> Check the target module of the error clear function. (Check the module on which an error occurred.)
4A00H	Network related error	<ul style="list-style-type: none"> The specified network number and station number are incorrect. The specified station cannot be accessed because the routing parameters have not been set to the start source CPU and the relay CPU module. The control CPU module for the network module to which data is routed has not started for routing via a multiple CPU system. The CPU module that relays IP packets is not the control CPU module for the CC-Link IE module on the path where IP packets travel. 	<ul style="list-style-type: none"> Correct the network number and station number of a user program. Set the routine parameters to the related stations for accessing the specified station. Retry it after a while. Or, check the startup of the system that relays data, and start communication. Set the CPU module that relays IP packets to the control CPU module for the CC-Link IE module on the path where IP packet travel.

Error code	Error name	Error details and cause	Corrective action
4A01H	Network related error	<ul style="list-style-type: none"> The network with the number set to the routing parameters does not exist. The specified CPU module cannot be communicated via the network that is not supported by the specified CPU module. 	<ul style="list-style-type: none"> Check the routing parameters set to the related stations, and correct them. Perform data communication using the communication route supported by the specified CPU module.
4A02H	Network related error	<ul style="list-style-type: none"> The specified station cannot be accessed. 	<ul style="list-style-type: none"> Check whether any error occurred on the network module, or it is offline. Check whether the settings for the network number and station number are correct.
4A03H	Network related error	<ul style="list-style-type: none"> A request for network test was issued. 	<ul style="list-style-type: none"> Check the request data of SLMP/MC protocol.
4B00H	Target module related error	<ul style="list-style-type: none"> An error occurred on the access destination or the relay station. The connection destination specification (the I/O number of the requested module) is invalid. 	<ul style="list-style-type: none"> Check the error occurred on the specified access destination or relay station to the station to be accessed, and take the corrective actions. Check the connection destination specification (Request destination module I/O No. or PC No.) for the request data of SLMP/MC protocol. Check the stop error, and take the corrective actions.
4B02H	Target module related error	<ul style="list-style-type: none"> The request is not the one addressed to the CPU module. 	<ul style="list-style-type: none"> Perform the operation to the module that can perform the specified function.
4B03H	Target module related error	<ul style="list-style-type: none"> The specified route is not supported by the version of the specified CPU module. The communication target CPU module is not mounted. 	<ul style="list-style-type: none"> Check whether the specified route is supported. Check the mounting status of the CPU module. Check the stop error, and take the corrective actions.
4B04H	Target module related error	<ul style="list-style-type: none"> The connection destination specification (I/O number of the requested module) is not supported. 	<ul style="list-style-type: none"> Invalid value has been set to the start I/O number for the module in "Target settings." Change the start I/O number to the one for the target module, and perform data communication again.
C709H	Target module related error	A communication error occurred with MELSOFT direct connection.	<ul style="list-style-type: none"> Specify a direct connection only when MELSOFT is connected directly. Do not turn the power of the CPU module OFF, reset the CPU module or bus, or disconnect the cable during communication by direct connection.

34 TROUBLESHOOTING BY SYMPTOM

If a function of this product does not run properly, check the following items and perform troubleshooting.

34.1 Ethernet Communication between a Personal Computer and this Product Fails

Issue a ping from the personal computer to this product, and confirm the response.

The PING command responds abnormally

Check item	Corrective action
Is the Ethernet cable wired correctly?	Wire the Ethernet cable correctly.
Is the Ethernet cable broken?	Replace the Ethernet cable.
Is communication blocked by the security function such as firewall?	Allow Ping communication by the Windows firewall or used antivirus software.
Are the IP address segment of the personal computer and this product different?	Set the IP addresses of the personal computer and this product to the same segment. If another LAN segment is relayed via a gateway, contact the network administrator of the connected LAN.
Does the duplicated IP address with the personal computer and this product exist in the connected LAN?	Contact the LAN network administrator to eliminate the IP address duplication.
Does the PING command respond abnormally after replacing this product?	Reset all devices on the network to which this product is connected.
Is the IP address out of the range specified?	Check the following items and specify a right IP address. <ul style="list-style-type: none">• The IP address starts with a value from 1 to 233, excluding 127.• No space is included in the IP address.
Is the network in the overloaded conditions?	Disconnect other Ethernet devices from the network, and connect this product only.
Is the OS LED OFF or flashing?	If the OS LED is OFF, start Windows. If the OS LED is flashing, Windows is preparing; therefore, wait until Windows starts the operation (The LED turns ON in green).

The PING command responds normally

The READY LED is OFF

Refer to the following:

 Page 223 The READY LED is not ON in green

CW Configurator connection fails

Check item	Corrective action
Is the connection destination of CW Configurator set to a different route?	Set the connection destination of CW Configurator, via Ethernet.
Is Ethernet port direct connection selected in the connection destination setting?	Check the connection of the Ethernet cable.

If an error cannot be resolved by the above corrective actions, refer to the following:

 Page 257 MELSOFT Connection cannot be Established

34.2 MELSOFT Connection cannot be Established

Check item	Corrective action
Is the port number used for the MELSOFT connection function used by another application?	Check whether another application uses the same port number used for the MELSOFT connection function, and restart the MELSOFT connection service after closing the application. For the port number used for the MELSOFT connection function, refer to the following: ☞ Page 133 MELSOFT CONNECTION FUNCTION
Is communication blocked by the security function such as firewall?	Allow communication by the Windows firewall or antivirus software being used. For the procedure to allow communication by the Windows firewall, refer to the following: ☞ Page 133 MELSOFT CONNECTION FUNCTION
Are multiple target devices with different IP addresses connected?	Add connections in the external device configuration.
Are a target device (with the same IP address as this product) and this product connected by using multiple MELSOFT connections (TCP/IP) simultaneously?	Specify the same Ethernet board adapter for the connection destination settings. If any MELSOFT products that cannot specify an Ethernet board adapter are included, specify "Not Specified" for the adapter setting in the connection destination setting of all MELSOFT products to be connected.
Is the READY LED flashing slowly in green by turning the power of this product OFF and ON or resetting the bus?	After the READY LED turns ON, reconnect this product and the MELSOFT product after a while.
Is a TCP/IP connection established from multiple Mitsubishi Electric products?	<ul style="list-style-type: none"> • Add settings of the MELSOFT connection in the external device configuration. • Reduce the number of connections for products that use the MELSOFT connection.
Is this product communicated from multiple connection destinations simultaneously?	<ul style="list-style-type: none"> • Try again after a while. • Try again after disconnecting other connections.
Is the ERROR LED flashing?	Change the system configuration to one that only includes a power supply module, a base unit, and this product. After that, try again.

When taking corrective actions for the error, check the following section as well:

☞ Page 256 The PING command responds abnormally

When checking the section, replace the term 'personal computer' with 'MELSOFT connection module.'

34.3 Specific Communication Port cannot be Opened by a User Application

Check item	Corrective action
Is the same port number used for the MELSOFT connection function specified?	Check the port number used for the MELSOFT connection function, and if the same communication port is used, change the setting so that another port is used. For the port number used for the MELSOFT connection function, refer to the following: ☞ Page 133 MELSOFT CONNECTION FUNCTION
Is communication blocked by the security function such as firewall?	Allow communication by the Windows firewall or antivirus software being used.

34.4 Communication Error Occurs during Ethernet Communication

Check item	Corrective action
Does Ethernet communication error occur when idle status (no input operation by the mouse or keyboard is performed) lasts for 10 minutes after Windows starts?	Set the startup type of 'DMWapPushService' in Windows service to automatic. Due to the specification of Windows 10 IoT Enterprise LTSC 2019, communication with the connection destination may be temporarily interrupted when the idle status lasts for 10 minutes after Windows starts. This can be avoided by the Windows service settings.

34.5 Date and Time Gap Occurs between the Event History Time and Windows Clock

Check item	Corrective action
Are the following setting and configuration set? <ul style="list-style-type: none"> • "Time Synchronization Setting with Multiple CPU (PLC No.1)" is set to "Synchronize" for the time synchronization function. • This product is set as CPU No.2, No.3, or No.4 in a multiple CPU system. 	Disable the following settings of "Date and Time" on Windows: <ul style="list-style-type: none"> • "Set time automatically" • "Set time zone automatically"
Are the following setting and configuration set? <ul style="list-style-type: none"> • "Time Synchronization Setting with Multiple CPU (PLC No.1)" is set to "Do not Synchronize" for the time synchronization function. • This product is set as CPU No.2, No.3, or No.4 in a multiple CPU system. 	Change the time synchronization function setting to "Synchronize."

34.6 Different Date and Time is Displayed in Event History and "Logged" of Event Log

Check item	Corrective action
Is the time zone setting on Windows changed?	Check the date and time displayed in the "Logged" of an event log by considering the difference in the Windows time zone, and then check the event history.

34.7 The Windows Forced Restart Function cannot be Performed

Check item	Corrective action
Is the input (X) set to "X Input Setting to Forced Restart Windows" turned ON?	Check the parameters, and turn the set input (X) ON.
Is the input (X) of a module controlled by the host CPU set to "X Input Setting to Forced Restart Windows"?	Check the parameters, and take the following actions: <ul style="list-style-type: none"> • Review the setting so that the input is to be the one of a module controlled by the host CPU, and perform the Windows forced restart function again. • Set the setting to import the input of a module controlled by another CPU module.
Is the input (X) set to "X Input Setting to Forced Restart Windows" turned from ON to OFF in a period shorter than the refresh cycle or within 1 second?	Review the system so that the input (X) turns ON for a period longer than the refresh cycle and 1 second or more.

34.8 The Windows Shutdown Function cannot be Performed

Check item	Corrective action
Is the input (X) set to "X Input Setting to Shut Down Windows" turned ON?	Check the parameters, and turn the set input (X) ON.
Is the input (X) of a module controlled by the host CPU set to "X Input Setting to Shut Down Windows"?	Check the parameters, and take the following actions: <ul style="list-style-type: none"> • Review the setting so that the input is to be the one of a module controlled by the host CPU, and perform the Windows shutdown function again. • Set the setting to import the input of a module controlled by another CPU module.
Is the input (X) set to "X Input Setting to Shut Down Windows" turned from ON to OFF in a period shorter than the refresh cycle or within 1 second?	Review the system so that the input (X) turns ON for a period longer than the refresh cycle and 1 second or more.
Is an error message displayed on Windows?	Check if there are any problems in Windows that prevent Windows from shutting down or completing the shutdown processing, such as when the shutdown is performed while a program is running or a file is overwritten. If any problems are found, shut down Windows again after solving the problems.
Is Windows starting up or shutting down?	Shut down Windows after the startup completes. When Windows is shutting down, wait until the shutdown completes.
Is Windows locked?	Shut down Windows after unlocking the Windows lock screen.
Does Windows freeze, or does a system error occur?	Shut down Windows after restarting Windows forcibly.
Is this product started in a mode other than the normal mode?	Turn the power of this product OFF and ON or reset the hardware.
Does a major error (such as a WDT error) occur in this product?	Shut down Windows after Windows starts.

34.9 The Bus Reset Function cannot be Performed

Check item	Corrective action
Is this product mounted on CPU No.2, No.3, or No.4 in a multiple CPU system?	Reset CPU No.1.
Is the remote BUS RESET setting enabled?	Perform the bus reset function again after setting "Enable" for the "Remote Bus Reset Setting" in CPU parameters.
Has any major error such as hardware failure occurred?	If such a major error occurs, reset the hardware or turn the power of the system OFF and ON.

34.10 The Priority of a Boot Device cannot be Switched

Check item	Corrective action
Is the switch damaged?	Start this product in the USB boot mode, and then check if "CFast1" is at the bottom in the "Boot" screen of BIOS setup. If the boot device priority is still not switched, a hardware failure may occur. Please contact your local Mitsubishi Electric sales office or representative.
Is a boot media installed?	Make sure that a boot media is installed in a boot device other than CFast1. If a boot media is not installed, install it.

34.11 The Y Device Assigned to "Y Output Setting while Windows is Restarting" is not Turned ON

Check item	Corrective action
Check if any of the following conditions is satisfied: <ul style="list-style-type: none">• Is this product changed into the Y STOP state? (Y STOP LED is ON)• Is this product changed into the PAUSE state? (Y STOP LED is flashing)• Has a stop error occurred? (Y STOP LED is ON)	Set the Y output status of this product to the Y OUT state. (Y STOP LED is OFF)

34.12 The Y Device Assigned to "Y Output Setting when Windows Shut Down" is not Turned ON

Check item	Corrective action
Check if any of the following conditions is satisfied: <ul style="list-style-type: none">• Is this product changed into the Y STOP state? (Y STOP LED is ON)• Is this product changed into the PAUSE state? (Y STOP LED is flashing)• Has a stop error occurred? (Y STOP LED is ON)	Set the Y output status of this product to the Y OUT state. (Y STOP LED is OFF)

34.13 The OS LED does not Turn OFF after Windows is Shut Down

Check item	Corrective action
Is the output to the display turned OFF?	Turn the power of the system OFF.
Has a graphics driver been updated?	Return the graphics driver version to the factory default.*1

*1 Install a graphics driver with an installer shipped with the product which is stored in the C drive. (☞ Page 66 Folder configuration of pre-installed applications and included products)
 Installer: C:\WinCPU\Drivers\win64_25.20.100.6373.exe

34.14 Windows cannot be Restarted

Check item	Corrective action
Is the output to the display turned OFF?	<ul style="list-style-type: none"> • Turn the power of the system OFF. • Restart Windows forcibly with the OS RESET switch.
Has a graphics driver been updated?	Return the graphics driver version to the factory default.*1

*1 Install a graphics driver with an installer shipped with the product which is stored in the C drive. (☞ Page 66 Folder configuration of pre-installed applications and included products)
 Installer: C:\WinCPU\Drivers\win64_25.20.100.6373.exe

34.15 The Windows Forced Restart at Error Function is Performed even when no System Error Occurs

Check item	Corrective action
Is the Windows CPU usage rate, etc. in the overloaded conditions?	<ul style="list-style-type: none"> • Disconnect the connected external devices. • Lower the access frequency from an external device. • Reduce the load by closing an application and user program. • Set a large value for the time to detect an error.

34.16 A USB Device does not Operate

Check item	Corrective action
Is the USB device connected to a USB port?	Reconnect the connected USB device to the USB port again and check if the device operates normally.
Is the USB port in use broken?	Connect the USB device to another USB port and check if the device operates normally. If the USB device operates normally, there may be a failure in the target USB port. If the USB device does not operate, there may be a problem with the usage of the device.
Are conditions for using the USB device satisfied?	Refer to the manual of the USB device in use and check if the usage is correct.
Is the interval for turning the power of the USB device OFF and ON short?	Turn the power of the USB device OFF and then ON again after a sufficient time has passed. After that, check if the USB device operates normally. (An interval of at least five seconds is required for turning the power of this product OFF and ON.)
Does the current consumption of the USB device exceed the maximum value of the bus power supply?	The USB device may consume larger current than the maximum value of the bus power supply. When the USB device is connected to the USB 2.0 port, reconnect it to the USB 3.0 port. Alternatively, connect the USB device via a self-powered USB hub.
Are there any failures in the USB device in use?	Check that there is no failure in the USB device. If any, replace it.
Are any USB3.0 devices being used?	Connect to a USB port supporting USB3.0.
Is an error related to the power surge on the USB port displayed on the Windows display?	The USB device may have a malfunction or the used USB devices may consume larger current than the maximum value of the bus power supply. <ul style="list-style-type: none"> • Disconnect the connected USB device, and check if an error has occurred in the connected device. If there is an error, replace the USB device. • Click the 'Power surge on the USB port' icon, then click the 'Reset' button in the window appeared. If clicking the 'Close' button, the USB port stops working until Windows is restarted. • Reconnecting the USB device. If the same error occurs even after reconnecting the USB device, the USB device may consume larger current than the maximum allowable current value of this product. Use a self-powered USB hub. <p>■'Power surge on the USB port' error Although sometimes the error may be continuously displayed, it will not be displayed when a certain time has passed after removing a malfunctioning USB device. The USB device can be used again by clicking the 'Power surge on the USB port' icon and clicking the 'Reset' button in the window appeared.</p>

34.17 The Mouse or Keyboard do not Operate

Check item	Corrective action
Does the mouse cursor move?	<ul style="list-style-type: none"> • Try the operation again after a while. • Check that a mouse is connected to a USB port. • Connect a mouse that has once been connected to the USB port. If it does not work, then replace the mouse. • Connect the mouse to another USB port, and check whether the mouse is operable. If the mouse can be operated, error related to the power surge on the USB port may occur. If the mouse cannot be operated, the mouse may have a failure.
Is an error related to the power surge on the USB port displayed on the Windows display?	<p>The USB device may have a malfunction or the used USB devices may consume larger current than the maximum value of the bus power supply. Take a corrective action by following the following descriptions:</p> <p>☞ Page 262 A USB Device does not Operate</p>
Does the keyboard react?	<ul style="list-style-type: none"> • Try the operation again after a while. • Check that the keyboard is connected to a USB port. • Connect a keyboard that has once been connected to the USB port. If it does not work, then replace the keyboard.
Is input from the keyboard possible?	Connect a keyboard that has once been connected to the USB port. If it does not work, then replace the keyboard.
Are any USB3.0 devices being used?	Connect to a USB port supporting USB3.0.

34.18 The Display is not Showing Windows

Check item	Corrective action
Is the HDMI cable connected correctly?	Connect the HDMI cable correctly.
Is the HDMI cable broken?	Replace the HDMI cable.
Is the display broken?	Replace the display.
Is an HDMI device whose bus power supply is out of the specification connected?	The HDMI device may consume larger current than the maximum value of the bus power supply. Replace the HDMI device.

34.19 An SD Memory Card cannot be Accessed

Check item	Corrective action
Is an SD memory card inserted into the SD memory card slot?	Turn the power of this product OFF and insert an SD memory card into the SD memory card slot.
Is the drive name of the SD memory card displayed correctly?	Format the SD memory card in Windows. Use an SD memory card that is compatible with this product.
Is the SD memory card broken?	Replace the SD memory card.

34.20 A CFast Card cannot be Accessed

Check item	Corrective action
Is a CFast card inserted into the CFast card slot?	Turn the power of this product OFF, and insert or reinsert a CFast card into the CFast card slot.
Has the CFast card been removed from the CFast card slot while the power of this product is ON?	
Has the CFast card been inserted into the CFast card slot while the power of this product is ON?	Turn the power of this product OFF, then turn ON the power again.
Has the CFast card been formatted?	Format the CFast card.
Is the CFast card broken?	Replace the CFast card.

34.21 Device Data cannot be Displayed in GOT

Check item	Corrective action
Is 'SLMP' selected for the communication method?	To connect to a GOT, set the communication method to "MELSOFT Connection" in the external device configuration.

34.22 RS-232 Communication cannot be Performed

Check item	Corrective action
Is the RS-232 cable wired incorrectly?	Wire the RS-232 cable correctly.
Is the RS-232 cable disconnected?	Replace the RS-232 cable.
Are the communication settings between this product and connected devices the same?	Set the same communication settings.

34.23 Installation of a MELSOFT Product Fails

Check item	Corrective action
Is an installer other than the English version used?	Install the product with the English version installer. To install products in a language other than English, uninstall all the pre-installed applications shown below: <ul style="list-style-type: none">• CW Configurator• Motion Control Setting• MR Configurator2• Simple Motion Module Setting After uninstalling the applications, install them in a language to be used.

34.24 The Message 'Something happened, and we couldn't install a feature' is Displayed

Check item	Corrective action
Is the Windows license authorized?	Check the Windows license authentication status. If the license is not authorized, perform the license authentication.

34.25 Date and Time in "Logged" of Event Log is Different from Actual Registration Time

Check item	Corrective action
Is the event log referred to Windows with different time zone?	<ul style="list-style-type: none"> Refer to the event log by considering the difference in the time zones. Match the time zone setting on Windows where event logs are displayed with the time zone on Windows where event logs are recorded.

34.26 Error Message of RuntimeBroker.exe 'The group or resource is not in the correct state to perform the requested operation.' Appears

Check item	Corrective action
Is a Windows standard application activated consecutively? Example: [Settings] is activated twice from Windows Start by double-clicking it. ([Settings] can be activated by a single click.)	<p>The application may be executed multiple times due to the consecutive start of the application. Click the [OK] button to close the message, and use the application.</p> <p>If the error message appears persistently even when not performing the continuous start of the application, a system may be corrupted. In this case, recover Windows.</p>

34.27 A License cannot be Authorized

Check item	Corrective action
Is this product connected to the Internet?	<p>Troubleshoot the network by the following procedure:</p> <ul style="list-style-type: none"> Windows Start ⇒ [Settings] ⇒ [Network & Internet] ⇒ [Network troubleshooter]
Is the license authorized while the Internet is connected?	<p>Authorize the license by the following procedure:</p> <ul style="list-style-type: none"> Windows Start ⇒ [Settings] ⇒ [Update & Security] ⇒ [Activation] ⇒ [Troubleshoot]

34.28 An Execution Delay Occurs in Applications

Check item	Corrective action
Is the CPU usage rate in Windows increased?	<p>Terminate other applications and try again after reducing the CPU usage rate.</p> <p>If any of the following operations is in progress, try again after the operation is completed.</p> <ul style="list-style-type: none">• Connecting or disconnecting a HDMI connector cable• Mounting or removing a device connected to a USB connector• Inserting an SD memory card into the SD memory card slot• Unlocking a Windows lock screen• Signing in to Windows• Signing out of Windows• Remote desktop connection

34.29 Time Zone Set with the Time Synchronization Function is Displayed in a Different Language from Windows Display Language

Check item	Corrective action
Is the Windows display language changed from the one set at the Windows setup? ^{*1}	<p>Perform the following procedure:</p> <ol style="list-style-type: none">1 Select "Region" in the Control Panel. The "Region" screen appears.2 Select the [Administrative] tab.3 Click the [Copy settings] button in "Welcome screen and new user accounts." The "Welcome screen and new user accounts" screen appears.4 Check the status of "Current user," and select the checkbox of "Welcome screen and system accounts" displayed at the bottom of the screen.5 Click the [OK] button.6 Restart Windows.

*1 When using the language other than Japanese, the time zone is displayed in English. (Page 147 Multiple CPU System)

34.30 A Value Cannot Be Read By the Out-of-Group I/O Fetch Function

Check item	Corrective action
Is the I/O setting outside group setting set to "Not Imported"?	Set "Import" for the I/O setting outside group.
Is the module where the input (X) and output (Y) are assigned set to "Synchronize" using the inter-module synchronization function?	Change the inter-module synchronization function of a target module to "Do not Synchronize."

APPENDIX

Appendix 1 Event List

This product collects information from each module including errors detected by the module, operations performed for the module, and errors occurred on the network.

When an event occurs, its event code and description can be checked using CW Configurator.

How to read the event list

The event list contains the following information.

Item	Description
Event code	ID number assigned to an event <ul style="list-style-type: none">• System code: Event code for the event type "System"• Security code: Event code for the event type "Security"• Operation code: Event code for the event type "Operation"
Event type	Type of an event
Event category	Category of an event
Detected event	Description of a detected event
Detailed information 1 to 3	Details of a detected event

Detailed information

The following shows the description of the information in the detailed information 1 to 3.

Detailed information	Item	Description
Detailed information 1	Operation initiator information	Information on the operation source <ul style="list-style-type: none">• Connection port (such as Ethernet and USB)• I/O number• CPU number (a number assigned to CPU modules in a multiple CPU system)• Network number• Station number• IP address
	Event history file information	Information on the event history file
	Daylight saving time status	Information on the daylight saving time status (start/end)
Detailed information 2	Communication speed and communication mode	Information on the communication speed and the communication mode
	Communication status	Information on the communication status
	Drive and file information	Information on the corresponding drive name and file name
	Copy source drive and file information	Information on the corresponding drive name and file name
	Operation target information	Information on the operation target: I/O number
	Clock information (before change)	Clock information before change
	Remote operation type information	Information on the remote operation type
Detailed information 3	Device and label information	Information on the corresponding device and label
	Clock information (after change)	Clock information after change
	Copy destination drive and file information	Information on the corresponding drive name and file name

Event list

The following table shows the events for a MELSECWinCPU module.

Event code	Event type	Event category	Detected event	Description	Detailed information		
					Detailed information 1	Detailed information 2	Detailed information 3
0400H	System	Information	Power-on/hardware reset/bus reset	The CPU module has been power-on or the hardware or the bus was reset.	—	—	—
0420H	System	Information	Event history file generation	A event history file has been generated.	Event history file information	—	—
0450H	System	Information	Daylight saving time start/end	Started daylight saving time or ended daylight saving time.	Daylight saving time status	—	—
0470H	System	Information	Windows restart	Windows has been restarted.	—	—	—
1000H to 3FFFH	System	Error	When a self-diagnostic error occurs, the error information is stored as an event.				
20100H	Operation	Information	Error clear	Error clear was performed.	Operation initiator information	Operation target information	—
20200H	Operation	Information	Event history clear	The event history was cleared.	Operation initiator information	—	—
24001H	Operation	Information	Remote operation request accepted	A remote request (Y OUT, Y STOP, or PAUSE) was accepted.	Operation initiator information	Remote operation type information	—
24100H	Operation	Information	Operating status change (Y OUT)	The operating status was changed to Y OUT.	—	—	—
24101H	Operation	Information	Operating status change (Y STOP)	The operating status was changed to Y STOP.	—	—	—
24102H	Operation	Information	Operating status change (PAUSE)	The operating status was changed to PAUSE.	—	—	—
24200H	Operation	Information	Creation of new folders, writes to files/folders	<ul style="list-style-type: none"> A new folder was created. A new file was created or data was written to a file. 	Operation initiator information	Drive and file information	—
24201H	Operation	Information	File copy	A file was copied.	—	Copy source (SRC) drive and file information	Copy destination (DST) drive and file information
24202H	Operation	Information	Folder/file rename	A folder name or file name was changed.	—	Copy source (SRC) drive and file information	Copy destination (DST) drive and file information
24203H	Operation	Information	Windows forced restart request	A request to force restart Windows was accepted.	Operation initiator information	—	—
24204H	Operation	Information	Windows forced restart start	Windows forced restart was started.	—	—	—
24205H	Operation	Information	Windows shutdown request	A request to shut down Windows was accepted.	Operation initiator information	—	—
24206H	Operation	Information	Windows shutdown start	Windows shutdown was started.	—	—	—
24207H	Operation	Information	Bus reset request	A request to reset bus was accepted.	Operation initiator information	—	—

Event code	Event type	Event category	Detected event	Description	Detailed information		
					Detailed information 1	Detailed information 2	Detailed information 3
24208H	Operation	Information	Bus reset start	Bus reset was started.	—	—	—
2A200H	Operation	Warning	Memory initialization	The memory was initialized.	Operation initiator information	Drive and file information	—
2A201H	Operation	Warning	Device/label zero clear	A device or label was cleared to zero.	Operation initiator information	Device and label information	—
2A202H	Operation	Warning	Folder/file deletion	A folder or file was deleted.	Operation initiator information	Drive and file information	—

Appendix 2 Windows Event List

This sections shows the list of events that occur on Windows in this product.

Event ID	Event type	Event category	Description	Corrective action
0010	System	Information	A service was started.	—
0011	System	Information	A service was ended.	—
0032	System	Information	A service was ended.	—
0064	System	Information	An event of the MELSEC function was registered.	For details, refer to the manual displayed as a link.
0096	System	Information	Parameters have been updated.	—
0097	System	Information	Windows was started or the bus was reset.	—
0512	System	Information	The number of connected MELSOFT connection modules exceeded the maximum number.	—
0513	System	Information	The TCP connection time-out was detected.	—
0576	System	Information	The Windows time has changed.	—
0704	System	Information	A notification of parameter update was received.	—
0768	System	Information	Current consumption of a USB port exceeded the threshold.	—
0769	System	Information	A USB port has stopped working because its current consumption exceeded the threshold.	—
0770	System	Information	All the USB ports have stopped working because their current consumption exceeded the threshold.	—
0771	System	Information	A current consumption error was cleared.	—
2048	System	Warning	Sending data failed.	Reset the bus and restart Windows. If the same event is registered again, the possible cause is a hardware failure. Please contact your local Mitsubishi Electric sales office or representative.
2049	System	Warning	Receiving data timed out.	Try again after a while. If the same event is registered again, reset the bus and restart Windows. If the problem is still not resolved, the possible cause is a hardware failure. Please contact your local Mitsubishi Electric sales office or representative.
2050	System	Warning	Receiving data failed.	Reset the bus and restart Windows. If the same event is registered again, the possible cause is a hardware failure. Please contact your local Mitsubishi Electric sales office or representative.
2080	System	Warning	A minor error of the MELSEC function was registered.	For details, refer to the manual displayed as a link.
2560	System	Warning	An invalid frame (packet) was received from a MELSOFT connection module.	Check if the connected modules and Windows applications use any of the following system port numbers: • 5006 to 5100 If so, take the following corrective actions and try again. • Review the port number of the module. • End the application.
2561	System	Warning	A unicast frame (packet) was received on the broadcast UDP port.	Check if the connected modules and Windows applications use any of the following system port numbers: • 5006 to 5100 If so, take the following corrective actions and try again. • Review the port number of the module. • End the application.
2562	System	Warning	Receiving a frame (packet) from a MELSOFT connection module failed.	• A line may be congested with packets. Try again after a while. • Check if there is any error in the connection of the cable and switching hub. • Check if the cable is disconnected.

Event ID	Event type	Event category	Description	Corrective action
2563	System	Warning	Sending a frame (packet) to a MELSOFT connection module failed.	<ul style="list-style-type: none"> • A line may be congested with packets. Try again after a while. • Check if there is any error in the connection of the cable and switching hub. • Check if the cable is disconnected.
2752	System	Warning	Acquiring parameters failed.	<ul style="list-style-type: none"> • Set parameters again, and reset the bus.
6237	System	Error	A port number that is already opened was attempted to be opened again. (For TCP/IP)	Restart Windows. If the same error code is displayed again, the system port may be used by another application. End the application and try again.
6238	System	Error	A port number that is already opened was attempted to be opened again. (For UDP/IP)	Restart Windows. If the same error code is displayed again, the system port may be used by another application. End the application and try again.
6239	System	Error	Generating the Listen socket failed.	Restart Windows. If the same error code is displayed again, the possible cause is a hardware failure of the CPU module. Please contact your local Mitsubishi Electric sales office or representative.
6240	System	Error	Generating the server socket failed.	Restart Windows. If the same error code is displayed again, the possible cause is a hardware failure of the CPU module. Please contact your local Mitsubishi Electric sales office or representative.
6241	System	Error	Generating the server socket failed.	Restart Windows. If the same error code is displayed again, the possible cause is a hardware failure of the CPU module. Please contact your local Mitsubishi Electric sales office or representative.
6242	System	Error	A port number that is already opened was attempted to be opened again.	Restart Windows. If the same error code is displayed again, the possible cause is a hardware failure of the CPU module. Please contact your local Mitsubishi Electric sales office or representative.
6243	System	Error	Reserving sufficient memory failed.	Restart Windows. If the same error code is displayed again, the possible cause is a hardware failure of the CPU module. Please contact your local Mitsubishi Electric sales office or representative.
6244	System	Error	Starting a service failed.	Restart Windows. If the same error code is displayed again, the possible cause is a hardware failure of the CPU module. Please contact your local Mitsubishi Electric sales office or representative.
6245	System	Error	A service ended with an error.	Restart Windows. If the same error code is displayed again, the possible cause is a hardware failure of the CPU module. Please contact your local Mitsubishi Electric sales office or representative.
6246	System	Error	A socket error occurred.	Restart Windows. If the same error code is displayed again, the possible cause is a hardware failure of the CPU module. Please contact your local Mitsubishi Electric sales office or representative.
6247	System	Error	An error occurred in a service.	Restart Windows. If the same error code is displayed again, the possible cause is a hardware failure of the CPU module. Please contact your local Mitsubishi Electric sales office or representative.
6248	System	Error	Starting a service failed.	Restart Windows. If the same error code is displayed again, the possible cause is a hardware failure of the CPU module. Please contact your local Mitsubishi Electric sales office or representative.



Event ID	Event type	Event category	Description	Corrective action
6249	System	Error	An error occurred in a service.	Restart Windows. If the same error code is displayed again, the possible cause is a hardware failure of the CPU module. Please contact your local Mitsubishi Electric sales office or representative.
16383	System	Error	A moderate/major error of the MELSEC function was registered.	For details, refer to the manual displayed as a link.
24576	Operation	Information	Stopping a service was requested.	—

Appendix 3 Device List

This section shows the name of available devices and the range of use.

Category	Type	Device name	Default value			Number of points setting	Setting range
			Number of points	Range of use			
User device	Bit device	Input ^{*1}	4096	X0 to FFF	Hex	N/A	—
		Output	4096	Y0 to FFF	Hex		
	Bit device	Internal relay	61440	M0 to 61439	Dec	N/A	—
		Link relay	655360	B0 to 9FFFF	Hex		
	Word device	Data register	4184064	D0 to 4184063	Dec	N/A	—
		Link register	1048576	W0 to FFFFF	Hex		
System device	Bit device	Special relay	4096	SM0 to 4095	Dec	N/A	—
	Word device	Special register	4096	SD0 to 4095	Dec		
Link direct device ^{*2}	Bit device	Link input	163840 ^{*3}	Jn\X0 to 27FFF	Hex	N/A	—
		Link output	163840 ^{*3}	Jn\Y0 to 27FFF	Hex		
		Link relay	655360 ^{*3}	Jn\B0 to 9FFFF	Hex		
		Link special relay	5120 ^{*3}	Jn\SB0 to 13FF	Hex		
	Word device	Link register	2621440 ^{*3}	Jn\W0 to 27FFFF	Hex		
		Link special register	5120 ^{*3}	Jn\SW0 to 13FF	Hex		
Module access device ^{*2}	Word device	Module access device	268435456	Un\G0 to 268435455	Dec	N/A	—
CPU buffer memory access device	Word device	CPU buffer memory access device ^{*2}	268435456	U3En\G0 to 268435455	Dec	N/A	—
	Word device	Fixed scan communication area access device ^{*4}	0	—	Dec	Available	U3En\HG0 to 12287

*1 This device can only be monitored in the "Device/Buffer Memory Batch Monitor" screen.

*2 The number of points and the range of use for a device vary depending on the modules to be used. For details, refer to the manual of each module. (Manual of a module used)

*3 The maximum number of points when setting "Extended Mode (iQ-R Series Mode)" in "Link Direct Device Setting." (Page 162 Link direct device mode setting)

*4 The number of points and range of use can be set in "Fixed Scan Communication Area Setting." (Page 121 Fixed scan communication area setting)



Do not use any devices that are not listed in the device list.

Clearing devices

The devices of this product (Y, M, B, D, and W) can be cleared to '0' in the "CPU Memory Operation" screen of CW Configurator.

 [Online] ⇨ [CPU Memory Operation]

For details on the "CPU Memory Operation" screen, refer to the following:

 CW Configurator Operating Manual

■ Execution of clearing devices

The devices may not be cleared depending on the Y output status of this product. ( Page 29 Y output status)

○: Can be executed, ×: Cannot be executed

Y output status	Clearing devices
Y OUT	×
Y STOP	○
PAUSE	○

Point

The status of the BUS RESET/Y STOP/Y OUT switch and Y output status may differ depending on the remote operations.

Check the Y output status with the special register (SD203). ( Page 279 Special Register List)

Appendix 4 Special Relay List

The following table shows how to read the list of special relays (SM).

Item	Description
No.	The number of the special relay is indicated.
Name	The name of the special relay is indicated.
Content	The content of the special relay is indicated.
Details	The details of the special relay is indicated.
Set by (when to set)	<p>The timing to set each device by system and/or user is indicated.</p> <p>(Set by)</p> <ul style="list-style-type: none"> • S: Set by a system • U: Set by a user (by a program, engineering tool, GOT, or test function from an external device). • U/S: Set by both a user and system. <p>(When to set)</p> <ul style="list-style-type: none"> • Error occurrence: Set when an error occurs. • Status change: Set only when the status is changed.



Do not change the special relays which are to be set by the system by performing operations such as program execution and device test. Doing so may result in system down or disconnection of communication.

Diagnostics information

The special relays for diagnostics information are as follows.

No.	Name	Description	Details	Set by (when to set)
SM0	Latest diagnostics error	OFF: No error ON: Error	This relay turns ON when the diagnostics error occurs. The ON state is retained even after the error is cleared later.	S (error occurrence)
SM1	Latest self-diagnostics error	OFF: No error ON: Error	This relay turns ON when the self-diagnostics error occurs. The ON state is retained even after the error is cleared later.	S (error occurrence)
SM53	AC/DC DOWN	OFF: AC/DC DOWN not detected ON: AC/DC DOWN detected	<ul style="list-style-type: none"> • This relay turns ON when a momentary power failure within 20 ms is detected while the AC power supply module is in use. This relay is reset after the power is turned OFF and ON. • This relay turns ON when a momentary power failure within 10 ms is detected while the DC power supply module is in use. This relay is reset after the power is turned OFF and ON. 	S (error occurrence)
SM60	Fuse Blown	OFF: Normal ON: Module with blown fuse	<ul style="list-style-type: none"> • This relay turns ON when at least one output module is in fuse blown state. The ON state is retained even after the error is cleared later. • The fuse blown state check is also performed for output modules on the remote I/O station. 	S (error occurrence)
SM61	I/O module verify error	OFF: Normal ON: Error	<ul style="list-style-type: none"> • This relay turns ON when the state of the I/O module is different from the one registered during power ON. The ON state is retained even after the error is cleared later. • I/O module verification is also performed for modules on the remote I/O station. 	S (error occurrence)
SM80	Detailed information 1 in-use flag	OFF: Not used ON: In use	This relay turns ON if the detailed information 1 exists when SM0 turns ON.	S (status change)
SM112	Detailed information 2 in-use flag	OFF: Not used ON: In use	This relay turns ON if the detailed information 2 exists when SM0 turns ON.	S (status change)

System information

The special relays for system information are as follows.

No.	Name	Description	Details	Set by (when to set)
SM217	Daylight saving time status flag	OFF: Not during daylight saving time ON: During daylight saving time	This relay turns ON when the time setting is in the daylight saving time by using daylight saving time function. This relay turns OFF when the time setting is not in the daylight saving time.	S (status change)
SM220 ^{*1*2}	CPU No.1 preparation completed	OFF: CPU No.1 preparation not completed ON: CPU No.1 preparation completed	This relay turns ON when the access from another CPU module to the CPU No.1 is enabled after turning the power ON or resetting the module.*3	S (status change)
SM221 ^{*1*2}	CPU No.2 preparation completed	OFF: CPU No.2 preparation not completed ON: CPU No.2 preparation completed	This relay turns ON when the access from another CPU module to the CPU No.2 is enabled after turning the power ON or resetting the module.*3	S (status change)
SM222 ^{*1*2}	CPU No.3 preparation completed	OFF: CPU No.3 preparation not completed ON: CPU No.3 preparation completed	This relay turns ON when the access from another CPU module to the CPU No.3 is enabled after turning the power ON or resetting the module.*3	S (status change)
SM223 ^{*1*2}	CPU No.4 preparation completed	OFF: CPU No.4 preparation not completed ON: CPU No.4 preparation completed	This relay turns ON when the access from another CPU module to the CPU No.4 is enabled after turning the power ON or resetting the module.*3	S (status change)
SM230	CPU No.1 error flag	OFF: CPU No.1 normal ON: CPU No.1 stop error state	<ul style="list-style-type: none"> This relay turns OFF when the CPU No.1 is normal (including a continuation error status). This relay turns ON when the CPU No.1 is in stop error state. 	S (status change)
SM231	CPU No.2 error flag	OFF: CPU No.2 normal ON: CPU No.2 stop error state	<ul style="list-style-type: none"> This relay turns OFF when the CPU No.2 is normal (including a continuation error status). This relay turns ON when the CPU No.2 is in stop error state. 	S (status change)
SM232	CPU No.3 error flag	OFF: CPU No.3 normal ON: CPU No.3 stop error state	<ul style="list-style-type: none"> This relay turns OFF when the CPU No.3 is normal (including a continuation error status). This relay turns ON when the CPU No.3 is in stop error state. 	S (status change)
SM233	CPU No.4 error flag	OFF: CPU No.4 normal ON: CPU No.4 stop error state	<ul style="list-style-type: none"> This relay turns OFF when the CPU No.4 is normal (including a continuation error status). This relay turns ON when the CPU No.4 is in stop error state. 	S (status change)
SM240 ^{*2}	CPU No.1 reset flag	OFF: CPU No.1 not being reset ON: CPU No.1 being reset	<ul style="list-style-type: none"> This relay turns OFF when the CPU No.1 is not being reset. This relay turns ON while the CPU No.1 is being reset (including the case when the CPU module is removed from the base unit). Other CPUs also will be in the reset state. 	S (status change)
SM241 ^{*2}	CPU No.2 reset flag	OFF: CPU No.2 not being reset ON: CPU No.2 being reset	<ul style="list-style-type: none"> This relay turns OFF when the CPU No.2 is not being reset. This relay turns ON while the CPU No.2 is being reset (including the case when the CPU module is removed from the base unit). Errors occur in the other CPU modules. 	S (status change)
SM242 ^{*2}	CPU No.3 reset flag	OFF: CPU No.3 not being reset ON: CPU No.3 being reset	<ul style="list-style-type: none"> This relay turns OFF when the CPU No.3 is not being reset. This relay turns ON while the CPU No.3 is being reset (including the case when the CPU module is removed from the base unit). Errors occur in the other CPU modules. 	S (status change)

No.	Name	Description	Details	Set by (when to set)
SM243 ^{*2}	CPU No.4 reset flag	OFF: CPU No.4 not being reset ON: CPU No.4 being reset	<ul style="list-style-type: none"> • This relay turns OFF when the CPU No.4 is not being reset. • This relay turns ON while the CPU No.4 is being reset (including the case when the CPU module is removed from the base unit). Errors occur in the other CPU modules. 	S (status change)

*1 These relays are used as an interlock to access each CPU when the multiple CPU synchronization setting is configured with asynchronous mode.

*2 When the target CPU is the MELSECWinCPU module, replace terms as follows:

Resetting: Hardware reset or bus reset

Being reset: Bus being reset

*3 When the target CPU is a MELSECWinCPU module, the relay turns ON at the timing when the bus control operates. (The operating status of Windows is not included.)

Special relay for a MELSECWinCPU module

The special relay for this product is as follow:

No.	Name	Description	Details	Set by (when to set)
SM680	INFORMATION LED ON/ OFF instruction	OFF→ON: ON/OFF instruction send OFF→ON: ON/OFF instruction completed	The INFORMATION LED turns ON or OFF depending on the ON/OFF status of SD680 when this relay turns from OFF to ON. (Execute the operation while SM680 is OFF.) When turning ON this relay and then OFF within the refresh cycle of the fixed cycle processing function, the INFORMATION LED does not turn ON or OFF.	U/S (status change)

Appendix 5 Special Register List

The following table shows how to read the list of special registers (SD).

Item	Description
No.	The number of the special register is indicated.
Name	The name of the special register is indicated.
Content	The content of the special register is indicated.
Details	The details of the special register is indicated.
Set by (when to set)	<p>The timing to set each device by system and/or user is indicated.</p> <p>(Set by)</p> <ul style="list-style-type: none">• S: Set by a system• U: Set by a user (by a program, engineering tool, GOT, or test function from an external device). <p>(When to set)</p> <ul style="list-style-type: none">• System: Set when a fixed cycle or the status is changed in the system.• Initial: Set only when any of the following operations is performed: turning the power OFF and ON, resetting the hardware, or resetting the bus. (It is not required for a Windows restart.)• Status change: Set only when the status is changed.• Error occurrence: Set when an error occurs.• Key switch change: Set when the key switch is changed.

Point 

Do not change the special registers which are to be set by the system by performing operations such as program execution and device test. Doing so may result in system down or disconnection of communication.

Diagnostics information

The special registers for diagnostics information are as follows.

No.	Name	Description	Details	Set by (when to set)
SD0	Latest self-diagnostics error code	Latest self-diagnostics error code	Error codes are stored in hexadecimal when an error is detected with the diagnostics. • The same information as the latest information displayed on the error history is displayed.	S (error occurrence)
SD1	Self-diagnostics error occurrence time	Self-diagnostics error occurrence time	The year (four digits) when SD0 data was updated is stored as a BIN code.	S (error occurrence)
SD2			The month when SD0 data was updated is stored as a BIN code.	
SD3			The date when SD0 data was updated is stored as a BIN code.	
SD4			The hour when SD0 data was updated is stored as a BIN code.	
SD5			The minute when SD0 data was updated is stored as a BIN code.	
SD6			The second when SD0 data was updated is stored as a BIN code.	
SD7			The day of the week when SD0 data was updated is stored as a BIN code. (0: Sun, 1: Mon, 2: Tue, 3: Wed, 4: Thu, 5: Fri, 6: Sat)	
SD10	Self-diagnostics error code	Self-diagnostics error code 1	Up to 16 types of error codes are stored to SD10 and higher when the diagnostics detects errors. (The same error code as the one already stored in SD10 and later is not stored.) The 17th and succeeding error codes are not stored, in addition to the case that 16 types of error codes have already been stored to SD10 to SD25.	S (error occurrence)
SD11		Self-diagnostics error code 2		
SD12		Self-diagnostics error code 3		
SD13		Self-diagnostics error code 4		
SD14		Self-diagnostics error code 5		
SD15		Self-diagnostics error code 6		
SD16		Self-diagnostics error code 7		
SD17		Self-diagnostics error code 8		
SD18		Self-diagnostics error code 9		
SD19		Self-diagnostics error code 10		
SD20		Self-diagnostics error code 11		
SD21		Self-diagnostics error code 12		
SD22		Self-diagnostics error code 13		
SD23		Self-diagnostics error code 14		
SD24		Self-diagnostics error code 15		
SD25		Self-diagnostics error code 16		
SD53	AC/DC DOWN	Number of times for AC/DC DOWN detection	A value is incremented by one each time when input voltage drops to 85% (AC power)/65% (DC power) or less of the rated value while this product is in operation, and stored as a BIN code. A counting cycle from 0 → 65535 → 0 is repeated.	S (error occurrence)
SD60	Number of module with blown fuse	Number of module with blown fuse	The lowest I/O number of module in which a fuse blew is stored.	S (error occurrence)
SD61	I/O module verify error module number	I/O module verify error module number	The lowest I/O number of the module in which an I/O module verification error has been detected is stored.	S (error occurrence)

No.	Name	Description	Details	Set by (when to set)																																																						
SD80	Detailed information 1 information category	Detailed information 1 information category code	<p>Detailed information 1 information category code is stored.</p> <table border="1" style="width: 100%; border-collapse: collapse;"> <tr> <td style="width: 33%; text-align: center;">b15</td> <td style="width: 33%; text-align: center;">b8b7</td> <td style="width: 33%; text-align: center;">b0</td> </tr> <tr> <td style="text-align: center;">(2)</td> <td style="text-align: center;">(1)</td> <td></td> </tr> </table> <p>(1) Information category code (2) Not used (fixed to 0)</p> <p>The following codes are stored into the information category code.</p> <ul style="list-style-type: none"> • 0: N/A • 1: N/A • 2: Drive number and file name • 4: Parameter information • 5: System configuration information • 6: Frequency information • 7: Time information • 24: Failure information 	b15	b8b7	b0	(2)	(1)		S (error occurrence)																																																
b15	b8b7	b0																																																								
(2)	(1)																																																									
SD81 to SD111	Detailed information 1	Detailed information 1	<ul style="list-style-type: none"> • Detailed information 1 corresponding to the error code (SD0) is stored. • There are six types of information to be stored as shown in (2), (4) to (7), and (24). • The type of the detailed information 1 can be acquired from SD80. (The value of the "Detailed information 1 information category code" which is to be stored in SD80 corresponds to the number (2), (4) to (7), and (24) in the following.) <p>■(2) Drive number and file name</p> <table border="1" style="width: 100%; border-collapse: collapse;"> <tr> <td style="width: 33%; text-align: center;">b15</td> <td style="width: 33%;"></td> <td style="width: 33%; text-align: center;">b0</td> </tr> <tr> <td>SD81</td> <td style="text-align: center;">With or without specification</td> <td></td> </tr> <tr> <td>SD82</td> <td style="text-align: center;">Drive No.</td> <td></td> </tr> <tr> <td>SD83</td> <td style="text-align: center;">File name</td> <td style="text-align: right;">1st character</td> </tr> <tr> <td style="text-align: center;">⋮</td> <td style="text-align: center;">(first eight characters of Unicode string)</td> <td style="text-align: center;">⋮</td> </tr> <tr> <td style="text-align: center;">⋮</td> <td></td> <td style="text-align: center;">⋮</td> </tr> <tr> <td>SD90</td> <td></td> <td style="text-align: right;">8th character</td> </tr> </table> <p>The following information is stored in SD81.</p> <ul style="list-style-type: none"> • b0: Drive No. • b1: File name <p>■(4) Parameter information</p> <table border="1" style="width: 100%; border-collapse: collapse;"> <tr> <td style="width: 33%; text-align: center;">b15</td> <td style="width: 33%;"></td> <td style="width: 33%; text-align: center;">b0</td> </tr> <tr> <td>SD81</td> <td colspan="2" style="text-align: center;">With or without specification</td> </tr> <tr> <td>SD82</td> <td style="text-align: center;">Parameter storage destination</td> <td style="text-align: center;">Parameter type</td> </tr> <tr> <td>SD83</td> <td colspan="2" style="text-align: center;">I/O No.</td> </tr> <tr> <td>SD84</td> <td colspan="2" style="text-align: center;">Parameter No.</td> </tr> <tr> <td>SD85</td> <td colspan="2" style="text-align: center;">Network No.</td> </tr> <tr> <td>SD86</td> <td colspan="2" style="text-align: center;">Station No.</td> </tr> <tr> <td>SD87</td> <td colspan="2"></td> </tr> <tr> <td style="text-align: center;">⋮</td> <td colspan="2" style="text-align: center;">System information</td> </tr> <tr> <td style="text-align: center;">⋮</td> <td colspan="2"></td> </tr> <tr> <td>SD97</td> <td colspan="2"></td> </tr> </table> <p>The following information is stored in SD81.</p> <ul style="list-style-type: none"> • b0: Parameter type • b1: Parameter storage destination • b2: I/O No. • b3: Parameter No. • b4: Network No. • b5: Station No. • b6: System information <p>The parameter type is stored in SD82 (b0 to b7).</p> <ul style="list-style-type: none"> • 1: System parameter • 2: CPU parameter • 3: Module parameter • 4: Module extended parameter • 5: Memory card parameter <p>The parameter storage destination is stored in SD82 (b8 to b15).</p> <ul style="list-style-type: none"> • 2: SD memory card • 4: Data memory <p>The I/O No. is stored in SD83. (0xFFFFH if an I/O No. is not assigned.) The network No. (0 to 120) is stored in SD85. (0 for a master station)</p>	b15		b0	SD81	With or without specification		SD82	Drive No.		SD83	File name	1st character	⋮	(first eight characters of Unicode string)	⋮	⋮		⋮	SD90		8th character	b15		b0	SD81	With or without specification		SD82	Parameter storage destination	Parameter type	SD83	I/O No.		SD84	Parameter No.		SD85	Network No.		SD86	Station No.		SD87			⋮	System information		⋮			SD97			S (error occurrence)
b15		b0																																																								
SD81	With or without specification																																																									
SD82	Drive No.																																																									
SD83	File name	1st character																																																								
⋮	(first eight characters of Unicode string)	⋮																																																								
⋮		⋮																																																								
SD90		8th character																																																								
b15		b0																																																								
SD81	With or without specification																																																									
SD82	Parameter storage destination	Parameter type																																																								
SD83	I/O No.																																																									
SD84	Parameter No.																																																									
SD85	Network No.																																																									
SD86	Station No.																																																									
SD87																																																										
⋮	System information																																																									
⋮																																																										
SD97																																																										



No.	Name	Description	Details	Set by (when to set)																																																																																
SD81 to SD111	Detailed information 1	Detailed information 1	<p>■(5) System configuration information</p> <table border="1"> <tr> <td>SD81</td> <td colspan="2">With or without specification</td> <td>b15</td> <td>b0</td> </tr> <tr> <td>SD82</td> <td colspan="2">I/O No.*¹</td> <td colspan="2"></td> </tr> <tr> <td>SD83</td> <td>Base unit No.*²</td> <td>Slot No.*³</td> <td colspan="2"></td> </tr> <tr> <td>SD84</td> <td>CPU No.*⁴</td> <td>Power supply module No.*⁵</td> <td colspan="2"></td> </tr> <tr> <td>SD85</td> <td colspan="2">Network No.*⁶</td> <td colspan="2"></td> </tr> <tr> <td>SD86</td> <td colspan="2">Station No.*⁷</td> <td colspan="2"></td> </tr> </table> <p>Without specification: *1: 0xFFFF *2,*3,*4: 0xFF *5,*6,*7: 0</p> <p>The following information is stored in SD81.</p> <ul style="list-style-type: none"> • b0: I/O No. • b1: Slot No. • b2: Base unit No. • b3: Power supply module No. • b4: CPU No. • b5: Network No. • b6: Station No. <p>The slot No. (0 to 11) is stored in SD83 (b0 to b7). The base No. is stored in SD83 (b8 to b15).</p> <ul style="list-style-type: none"> • 0: Main base unit • 1 to 7: Extension base unit, level 1 to 7 • 8: Extension base unit, level 8 (when the number of base is exceeded) <p>The power No. (1 to 2) is stored in SD84 (b0 to b7). The CPU No. (1 to 4) is stored in SD84 (b8 to b15). The network No. (0 to 120) is stored in SD85. (0 for a master station)</p> <p>■(6) Frequency information</p> <table border="1"> <tr> <td>SD81</td> <td colspan="2">With or without specification</td> <td>b15</td> <td>b0</td> </tr> <tr> <td>SD82</td> <td>Number of times*¹</td> <td></td> <td></td> <td>L</td> </tr> <tr> <td>SD83</td> <td>(set value)</td> <td></td> <td></td> <td>H</td> </tr> <tr> <td>SD84</td> <td>Number of times*²</td> <td></td> <td></td> <td>L</td> </tr> <tr> <td>SD85</td> <td>(measured value)</td> <td></td> <td></td> <td>H</td> </tr> </table> <p>*1: When the number of times (set value) is not specified, 0 is stored. *2: When the number of times (measured value) is not specified, 0 is stored.</p> <p>The following information is stored in SD81.</p> <ul style="list-style-type: none"> • b0: Number of times (Set value) • b1: Number of times (Measured value) <p>■(7) Time information</p> <table border="1"> <tr> <td>SD81</td> <td colspan="2">With or without specification</td> <td>b15</td> <td>b0</td> </tr> <tr> <td>SD82</td> <td colspan="2">Time (set value) (ms)¹</td> <td colspan="2"></td> </tr> <tr> <td>SD83</td> <td colspan="2">Time (set value) (μs)¹</td> <td colspan="2"></td> </tr> <tr> <td>SD84</td> <td colspan="2">Time (measured value) (ms)²</td> <td colspan="2"></td> </tr> <tr> <td>SD85</td> <td colspan="2">Time (measured value) (μs)²</td> <td colspan="2"></td> </tr> </table> <p>*1: When the time (set value) is not specified, 0 is stored. *2: When the time (measured value) is not specified, 0 is stored.</p> <p>The following information is stored in SD81.</p> <ul style="list-style-type: none"> • b0: Time (Set value) [ms] • b1: Time (Set value) [μs] • b2: Time (Measured value) [ms] • b3: Time (Measured value) [μs] <p>■(24) Failure information The failure information is a part of system information.</p>	SD81	With or without specification		b15	b0	SD82	I/O No.* ¹				SD83	Base unit No.* ²	Slot No.* ³			SD84	CPU No.* ⁴	Power supply module No.* ⁵			SD85	Network No.* ⁶				SD86	Station No.* ⁷				SD81	With or without specification		b15	b0	SD82	Number of times* ¹			L	SD83	(set value)			H	SD84	Number of times* ²			L	SD85	(measured value)			H	SD81	With or without specification		b15	b0	SD82	Time (set value) (ms) ¹				SD83	Time (set value) (μs) ¹				SD84	Time (measured value) (ms) ²				SD85	Time (measured value) (μs) ²				S (error occurrence)
SD81	With or without specification		b15	b0																																																																																
SD82	I/O No.* ¹																																																																																			
SD83	Base unit No.* ²	Slot No.* ³																																																																																		
SD84	CPU No.* ⁴	Power supply module No.* ⁵																																																																																		
SD85	Network No.* ⁶																																																																																			
SD86	Station No.* ⁷																																																																																			
SD81	With or without specification		b15	b0																																																																																
SD82	Number of times* ¹			L																																																																																
SD83	(set value)			H																																																																																
SD84	Number of times* ²			L																																																																																
SD85	(measured value)			H																																																																																
SD81	With or without specification		b15	b0																																																																																
SD82	Time (set value) (ms) ¹																																																																																			
SD83	Time (set value) (μs) ¹																																																																																			
SD84	Time (measured value) (ms) ²																																																																																			
SD85	Time (measured value) (μs) ²																																																																																			

No.	Name	Description	Details	Set by (when to set)																																						
SD112	Detailed information 2 information category	Detailed information 2 information category code	<p>Detailed information 2 information category code is stored.</p> <table border="1" style="margin-left: 20px;"> <tr> <td style="text-align: center;">b15</td> <td style="text-align: center;">b8b7</td> <td style="text-align: center;">b0</td> </tr> <tr> <td style="text-align: center;">(2)</td> <td style="text-align: center;">(1)</td> <td></td> </tr> </table> <p>(1) Information category code (2) Not used (fixed to 0)</p> <p>The following codes are stored into the information category code.</p> <ul style="list-style-type: none"> • 0: N/A • 2: Drive number and file name • 3: N/A • 4: Parameter information • 5: System configuration information 	b15	b8b7	b0	(2)	(1)		S (error occurrence)																																
b15	b8b7	b0																																								
(2)	(1)																																									
SD113 to SD143	Detailed information 2	Detailed information 2	<ul style="list-style-type: none"> • Detailed information 2 corresponding to the error code (SD0) is stored. • There are three types of information to be stored as shown in (2), (4), and (5). • The type of the detailed information 2 can be acquired from SD112. (The value of the "Detailed information 2 information category code" which is to be stored to SD112 corresponds to the number (2), (4), and (5) in the following.) <p>■(2) Drive number and file name</p> <table border="1" style="margin-left: 20px;"> <tr> <td style="text-align: center;">b15</td> <td style="text-align: center;">b0</td> </tr> <tr> <td>SD113</td> <td style="text-align: center;">With or without specification</td> </tr> <tr> <td>SD114</td> <td style="text-align: center;">Drive No.</td> </tr> <tr> <td>SD115</td> <td style="text-align: center;">File name</td> </tr> <tr> <td style="text-align: center;">⋮</td> <td style="text-align: center;">(first eight characters of Unicode string)</td> </tr> <tr> <td style="text-align: center;">⋮</td> <td style="text-align: center;">1st character</td> </tr> <tr> <td style="text-align: center;">⋮</td> <td style="text-align: center;">8th character</td> </tr> <tr> <td>SD122</td> <td></td> </tr> </table> <p>The following information is stored in SD113.</p> <ul style="list-style-type: none"> • b0: Drive No. • b1: File name <p>■(4) Parameter information</p> <table border="1" style="margin-left: 20px;"> <tr> <td style="text-align: center;">b15</td> <td style="text-align: center;">b0</td> </tr> <tr> <td>SD113</td> <td style="text-align: center;">With or without specification</td> </tr> <tr> <td>SD114</td> <td style="text-align: center;">Parameter storage destination Parameter type</td> </tr> <tr> <td>SD115</td> <td style="text-align: center;">I/O No.</td> </tr> <tr> <td>SD116</td> <td style="text-align: center;">Parameter No.</td> </tr> <tr> <td>SD117</td> <td style="text-align: center;">Network No.</td> </tr> <tr> <td>SD118</td> <td style="text-align: center;">Station No.</td> </tr> <tr> <td>SD119</td> <td style="text-align: center;">System information</td> </tr> <tr> <td style="text-align: center;">⋮</td> <td></td> </tr> <tr> <td style="text-align: center;">⋮</td> <td></td> </tr> <tr> <td>SD129</td> <td></td> </tr> </table> <p>The following information is stored in SD113.</p> <ul style="list-style-type: none"> • b0: Parameter type • b1: Parameter storage destination • b2: I/O No. • b3: Parameter No. • b4: Network No. • b5: Station No. • b6: System information <p>The parameter type is stored in SD114 (b0 to b7).</p> <ul style="list-style-type: none"> • 1: System parameter • 2: CPU parameter • 3: Module parameter • 4: Module extended parameter • 5: Memory card parameter <p>The parameter storage destination is stored in SD114 (b8 to b15).</p> <ul style="list-style-type: none"> • 2: SD memory card • 4: Data memory <p>The I/O No. is stored in SD115. (0xFFFFH if an I/O No. is not assigned.) The network No. (0 to 120) is stored in SD117. (0 for a master station)</p>	b15	b0	SD113	With or without specification	SD114	Drive No.	SD115	File name	⋮	(first eight characters of Unicode string)	⋮	1st character	⋮	8th character	SD122		b15	b0	SD113	With or without specification	SD114	Parameter storage destination Parameter type	SD115	I/O No.	SD116	Parameter No.	SD117	Network No.	SD118	Station No.	SD119	System information	⋮		⋮		SD129		S (error occurrence)
b15	b0																																									
SD113	With or without specification																																									
SD114	Drive No.																																									
SD115	File name																																									
⋮	(first eight characters of Unicode string)																																									
⋮	1st character																																									
⋮	8th character																																									
SD122																																										
b15	b0																																									
SD113	With or without specification																																									
SD114	Parameter storage destination Parameter type																																									
SD115	I/O No.																																									
SD116	Parameter No.																																									
SD117	Network No.																																									
SD118	Station No.																																									
SD119	System information																																									
⋮																																										
⋮																																										
SD129																																										



No.	Name	Description	Details	Set by (when to set)														
SD113 to SD143	Detailed information 2	Detailed information 2	<p>■(5) System configuration information</p> <table border="1"> <tr> <td style="text-align: right;">b15</td> <td style="text-align: right;">b0</td> </tr> <tr> <td>SD113</td> <td>With or without specification</td> </tr> <tr> <td>SD114</td> <td>I/O No.</td> </tr> <tr> <td>SD115</td> <td>Base unit No. Slot No.</td> </tr> <tr> <td>SD116</td> <td>CPU No. Power supply module No.</td> </tr> <tr> <td>SD117</td> <td>Network No.</td> </tr> <tr> <td>SD118</td> <td>Station No.</td> </tr> </table> <p>The following information is stored in SD113.</p> <ul style="list-style-type: none"> • b0: I/O No. • b1: Slot No. • b2: Base unit No. • b3: Power supply module No. • b4: CPU No. • b5: Network No. • b6: Station No. <p>The slot No. (0 to 11) is stored in SD115 (b0 to b7).</p> <p>The base No. is stored in SD115 (b8 to b15).</p> <ul style="list-style-type: none"> • 0: Main base unit • 1 to 7: Extension base unit, level 1 to 7 • 8: Extension base unit, level 8 (when the number of base is exceeded) <p>The power No. (1 to 2) is stored in SD116 (b0 to b7).</p> <p>The CPU No. (1 to 4) is stored in SD116 (b8 to b15).</p> <p>The network No. (0 to 120) is stored in SD117. (0 for a master station)</p>	b15	b0	SD113	With or without specification	SD114	I/O No.	SD115	Base unit No. Slot No.	SD116	CPU No. Power supply module No.	SD117	Network No.	SD118	Station No.	S (error occurrence)
b15	b0																	
SD113	With or without specification																	
SD114	I/O No.																	
SD115	Base unit No. Slot No.																	
SD116	CPU No. Power supply module No.																	
SD117	Network No.																	
SD118	Station No.																	

System information

The special registers for system information are as follows.

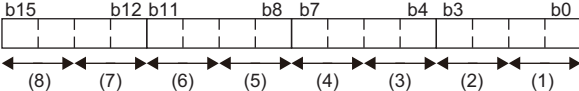
No.	Name	Description	Details	Set by (when to set)
SD160	Firmware version	Firmware version	The firmware version is stored.	S (initial)
SD200	Switch status	CPU switch status (BUS RESET/Y STOP/Y OUT switch)	The switch status of the CPU module is stored as follows: 0: Y OUT, 1: Y STOP	S (key switch change)
SD201	LED status	CPU-LED status	<p>The information that indicates the LED status of the CPU module is stored in the following bit patterns. 0: OFF, 1: ON, 2: Flashing (high speed/low speed)</p>  <p>(1) READY (2) ERROR (3) OS (4) Y STOP (5) CFast (6) OVERCURRENT (7) INFORMATION (8) Reserved</p>	S (status change)
SD203	Y output status	Y output status	The Y output status of this product is stored as follows: 0: Y OUT, 1: Reserved, 2: Y STOP, 3: PAUSE	S (system)
SD218	Time zone setting value	Time zone (minute)	The value of the set time zone converted to minutes is stored. (Example) When the time zone setting value is 'UTC+9,' 9×60 (minute) = 540	S (status change)

No.	Name	Description	Details	Set by (when to set)														
SD228	Multiple CPU system information	Number of CPU modules	The number of CPU modules in the multiple CPU system is stored (one to four, including empty CPU).	S (initial)														
SD229		CPU module number in multiple CPU system	The host station CPU number is stored when a multiple CPU system is configured. <ul style="list-style-type: none"> • CPU No.1: 1 • CPU No.2: 2 • CPU No.3: 3 • CPU No.4: 4 	S (initial)														
SD230		CPU No.1 operating status	<p>The operation information for each CPU number is stored. (Information for a number of multiple CPUs which is indicated in SD228 is stored.)</p> <table border="1" style="width: 100%; border-collapse: collapse;"> <tr> <td style="text-align: center;">b15b14</td> <td style="text-align: center;">~</td> <td style="text-align: center;">b8 b7</td> <td style="text-align: center;">b6 b5</td> <td style="text-align: center;">b4b3</td> <td style="text-align: center;">~</td> <td style="text-align: center;">b0</td> </tr> <tr> <td style="text-align: center;">(4)</td> <td></td> <td style="text-align: center;">(3)</td> <td style="text-align: center;">(2)</td> <td style="text-align: center;">(1)</td> <td></td> <td></td> </tr> </table> <p>(1) The operating status is stored in b0 to b3. <ul style="list-style-type: none"> • 0: RUN • 2: STOP • 3: PAUSE • 4: Initial • FH: Reset </p> <p>(2) The classification is stored in b4 and b5. However, minor or moderate errors will be those set in the CPU parameter RAS settings, system parameter I/O assignment settings, and multiple CPU settings. <ul style="list-style-type: none"> • 0: Normal • 1: Minor error • 2: Moderate error • 3: Major error </p> <p>(3) The stop error flag is stored in b7. <ul style="list-style-type: none"> • 0: No stop error • 1: Stop error </p> <p>(4) The mounting status of the CPU module is stored in b15. <ul style="list-style-type: none"> • 0: Not mounted • 1: Mounted </p> <p>■When the target CPU is this product Replace terms with other terms as shown below: <ul style="list-style-type: none"> • Operating status → Y output status • RUN→Y OUT • STOP→Y STOP • Initializing → Initializing the bus control • Reset → Bus reset </p>	b15b14	~	b8 b7	b6 b5	b4b3	~	b0	(4)		(3)	(2)	(1)			S (error occurrence)
b15b14		~		b8 b7	b6 b5	b4b3	~	b0										
(4)				(3)	(2)	(1)												
SD231	CPU No.2 operating status																	
SD232	CPU No.3 operating status																	
SD233	CPU No.4 operating status																	
SD241	Number of extension base units	0: Main base unit only 1 to 7: Number of extension base units	The maximum number of the mounted extension base units is stored.	S (initial)														
SD242	Determination of mountability of MELSEC-Q series module	Identification of the base type 0: MELSEC-Q series module is not mountable. (There is no base unit on which MELSEC-Q series module can be mounted.) 1: MELSEC-Q series module is mountable. (There is a base unit on which MELSEC-Q series module can be mounted.)	Whether or not MELSEC-Q series module can be mounted is determined. When no module is mounted, the value is fixed to 0. <table border="1" style="width: 100%; border-collapse: collapse;"> <tr> <td style="text-align: center;">b15</td> <td style="text-align: center;">b8 b7</td> <td style="text-align: center;">b3 b2</td> <td style="text-align: center;">b1 b0</td> </tr> <tr> <td style="text-align: center;">(5)</td> <td style="text-align: center;">(4)</td> <td style="text-align: center;">(3)(2)</td> <td style="text-align: center;">(1)</td> </tr> </table> <p>(1) Main base unit (fixed to 0) (2) Extension base unit, level 1 (MELSEC-Q series modules are mountable.) (3) Extension base unit, level 2 (MELSEC-Q series modules are mountable.) (4) Extension base unit, level 3 to 7 (MELSEC-Q series modules are mountable.) (5) Fixed to 0</p>	b15	b8 b7	b3 b2	b1 b0	(5)	(4)	(3)(2)	(1)	S (initial)						
b15	b8 b7	b3 b2	b1 b0															
(5)	(4)	(3)(2)	(1)															

No.	Name	Description	Details	Set by (when to set)																		
SD243 SD244	Number of base slots	Number of base slots	<p>The number of slots of the base unit, which is specified in the base/power supply/extension cable setting in the system parameters, is stored. When the number of slots of the base unit is not specified in the system parameter, that of the mounted base unit is stored.</p> <table border="1"> <tr> <td></td> <td>b15</td> <td>b12b11</td> <td>b8b7</td> <td>b4b3</td> <td>b0</td> </tr> <tr> <td>SD243</td> <td>3</td> <td>2</td> <td>1</td> <td>0</td> <td></td> </tr> <tr> <td>SD244</td> <td>7</td> <td>6</td> <td>5</td> <td>4</td> <td></td> </tr> </table> <ul style="list-style-type: none"> • 0: Base unit • 1 to 7: Extension base unit 1 to 7 		b15	b12b11	b8b7	b4b3	b0	SD243	3	2	1	0		SD244	7	6	5	4		S (initial)
	b15	b12b11	b8b7	b4b3	b0																	
SD243	3	2	1	0																		
SD244	7	6	5	4																		
SD250	Latest I/O for mounted module	Latest I/O number for mounted module	<p>The value of the last I/O number of the mounted module + 1 which is divided by 16 is stored.</p> <p>Example 1: Last input number: 010FH</p> <ul style="list-style-type: none"> • SD250: 0011H <p>Example 2: Last input number: 0FFFH</p> <ul style="list-style-type: none"> • SD250: 0100H 	S (initial)																		
SD260 SD261	Number of points assigned for bit devices	Number of points assigned for X (L)	The number of points of the device X currently set is stored as 32-bit data.	S (initial)																		
		Number of points assigned for X (H)																				
SD262 SD263		Number of points assigned for Y (L)	The number of points of the device Y currently set is stored as 32-bit data.	S (initial)																		
		Number of points assigned for Y (H)																				
SD264 SD265		Number of points assigned for M (L)	The number of points of the device M currently set is stored as 32-bit data. The number of points assigned is stored even when the number of points assigned to M is 32K points or less.	S (initial)																		
		Number of points assigned for M (H)																				
SD266 SD267		Number of points assigned for B (L)	The number of points of the device B currently set is stored as 32-bit data. The number of points assigned is stored even when the number of points assigned to B is 32K points or less.	S (initial)																		
		Number of points assigned for B (H)																				
SD280 SD281	Number of points assigned for word devices	Number of points assigned for D (L)	The number of points of the device D currently set is stored as 32-bit data. The number of points assigned is stored even when the number of points assigned to D is 32K points or less.	S (initial)																		
		Number of points assigned for D (H)																				
SD282 SD283		Number of points assigned for W (L)	The number of points of the device W currently set is stored as 32-bit data. The number of points assigned is stored even when the number of points assigned to W is 32K points or less.	S (initial)																		
		Number of points assigned for W (H)																				



Fixed cycle function information

The special registers for fixed cycle function information are as follows.

No.	Name	Description	Details	Set by (when to set)
SD520	Current fixed cycle processing time ^{*1}	Current fixed cycle processing time (unit: ms)	The current fixed cycle processing time is stored in SD520 and SD521. (Measured in 1 μ s.) • SD520: Stores an ms digit. (Storage range: 0 to 65535) • SD521: Stores a μ s digit. (Storage range: 0 to 999) When the current fixed cycle processing time is 23.6 ms; for example, it is stored as follows: • SD520 = 23 (ms) • SD521 = 600 (μ s)	S (system)
SD521		Current fixed cycle processing time (unit: μ s)		
SD522	Minimum fixed cycle processing time ^{*1}	Minimum fixed cycle processing time (unit: ms)	The minimum fixed cycle processing time is stored in SD522 and SD523. (Measured in 1 μ s.) • SD522: Stores an ms digit. (Storage range: 0 to 65535) • SD523: Stores a μ s digit. (Storage range: 0 to 999) When the minimum fixed cycle processing time is 23.6 ms; for example, it is stored as follows: • SD522 = 23 (ms) • SD523 = 600 (μ s)	S (system)
SD523		Minimum fixed cycle processing time (unit: μ s)		
SD524	Maximum fixed cycle processing time ^{*1}	Maximum fixed cycle processing time (unit: ms)	The maximum fixed cycle processing time is stored in SD524 and SD525. (Measured in 1 μ s.) • SD524: Stores an ms digit. (Storage range: 0 to 65535) • SD525: Stores a μ s digit. (Storage range: 0 to 999) When the maximum fixed cycle processing time is 23.6 ms; for example, it is stored as follows: • SD524 = 23 (ms) • SD525 = 600 (μ s)	S (system)
SD525		Maximum fixed cycle processing time (unit: μ s)		
SD526	Current link refresh processing time	Current link refresh processing time (unit: ms)	The current link refresh processing time is stored in SD526 and SD527. (Measured in 1 μ s.) • SD526: Stores an ms digit. (Storage range: 0 to 65535) • SD527: Stores a μ s digit. (Storage range: 0 to 999) When the current link refresh processing time is 23.6 ms; for example, it is stored as follows: • SD526 = 23 (ms) • SD527 = 600 (μ s)	S (system)
SD527		Current link refresh processing time (unit: μ s)		
SD528	Minimum link refresh processing time	Minimum link refresh processing time (unit: ms)	The minimum link refresh processing time is stored in SD528 and SD529. (Measured in 1 μ s.) • SD528: Stores an ms digit. (Storage range: 0 to 65535) • SD529: Stores a μ s digit. (Storage range: 0 to 999) When the minimum link refresh processing time is 23.6 ms; for example, it is stored as follows: • SD528 = 23 (ms) • SD529 = 600 (μ s)	S (system)
SD529		Minimum link refresh processing time (unit: μ s)		
SD530	Maximum link refresh processing time	Maximum link refresh processing time (unit: ms)	The maximum link refresh processing time is stored in SD530 and SD531. (Measured in 1 μ s.) • SD530: Stores an ms digit. (Storage range: 0 to 65535) • SD531: Stores a μ s digit. (Storage range: 0 to 999) When the maximum link refresh processing time is 23.6 ms; for example, it is stored as follows: • SD530 = 23 (ms) • SD531 = 600 (μ s)	S (system)
SD531		Maximum link refresh processing time (unit: μ s)		

*1 For details on the fixed cycle processing, refer to the following:

 Page 183 FIXED CYCLE PROCESSING FUNCTION

Special registers for a MELSECWinCPU module

The special registers for this product are as follows:

No.	Name	Description	Details	Set by (when to set)
SD672	CCIETSN module channel number (1st module)	CCIETSN module channel number (1st module)	Channel number (281 to 288) ^{*1} of the CC-Link IE TSN module (1st module) controlled	S (initial)
SD673	CCIETSN module channel number (2nd module)	CCIETSN module channel number (2nd module)	Channel number (281 to 288) ^{*1} of the CC-Link IE TSN module (2nd module) controlled	S (initial)
SD674	CCIETSN module channel number (3rd module)	CCIETSN module channel number (3rd module)	Channel number (281 to 288) ^{*1} of the CC-Link IE TSN module (3rd module) controlled	S (initial)
SD675	CCIETSN module channel number (4th module)	CCIETSN module channel number (4th module)	Channel number (281 to 288) ^{*1} of the CC-Link IE TSN module (4th module) controlled	S (initial)
SD676	CCIETSN module channel number (5th module)	CCIETSN module channel number (5th module)	Channel number (281 to 288) ^{*1} of the CC-Link IE TSN module (5th module) controlled	S (initial)
SD677	CCIETSN module channel number (6th module)	CCIETSN module channel number (6th module)	Channel number (281 to 288) ^{*1} of the CC-Link IE TSN module (6th module) controlled	S (initial)
SD678	CCIETSN module channel number (7th module)	CCIETSN module channel number (7th module)	Channel number (281 to 288) ^{*1} of the CC-Link IE TSN module (7th module) controlled	S (initial)
SD679	CCIETSN module channel number (8th module)	CCIETSN module channel number (8th module)	Channel number (281 to 288) ^{*1} of the CC-Link IE TSN module (8th module) controlled	S (initial)
SD680	INFORMATION LED operation indication	INFORMATION LED operation indication	<p>The setting of the INFORMATION LED status of this product is stored.^{*2}</p> <ul style="list-style-type: none"> • 0: OFF • 1: ON (Red) • 2: Slow flashing (red) • 3: Flashing (Red) • 4: ON (Green) • 5: Slow flashing (green) • 6: Flashing (Green) <p>The setting is applied when turning SM680 from OFF to ON. If SD680 has a value out of the range, the INFORMATION LED is not operated correctly. To check if the LED is operated correctly, compare a value specified in SD680 and a value of SD681 and check that the values match.</p>	U
SD681	INFORMATION LED operation indication result	INFORMATION LED operation indication result	<p>The INFORMATION LED status of this product is stored as follows^{*2}:</p> <ul style="list-style-type: none"> • 0: OFF • 1: ON (Red) • 2: Slow flashing (red) • 3: Flashing (Red) • 4: ON (Green) • 5: Slow flashing (green) • 6: Flashing (Green) <p>The setting is applied when turning SM680 from OFF to ON. If SD680 has a value out of the range, the status is not stored.</p>	S (status change)
SD1570	CC-Link module channel number (1st module)	CC-Link module channel number (1st module)	Channel number (81 to 88) ^{*1} of the CC-Link module (1st module) controlled	S (initial)
SD1571	CC-Link module channel number (2nd module)	CC-Link module channel number (2nd module)	Channel number (81 to 88) ^{*1} of the CC-Link module (2nd module) controlled	S (initial)
SD1572	CC-Link module channel number (3rd module)	CC-Link module channel number (3rd module)	Channel number (81 to 88) ^{*1} of the CC-Link module (3rd module) controlled	S (initial)
SD1573	CC-Link module channel number (4th module)	CC-Link module channel number (4th module)	Channel number (81 to 88) ^{*1} of the CC-Link module (4th module) controlled	S (initial)
SD1574	CC-Link module channel number (5th module)	CC-Link module channel number (5th module)	Channel number (81 to 88) ^{*1} of the CC-Link module (5th module) controlled	S (initial)

No.	Name	Description	Details	Set by (when to set)
SD1575	CC-Link module channel number (6th module)	CC-Link module channel number (6th module)	Channel number (81 to 88) ^{*1} of the CC-Link module (6th module) controlled	S (initial)
SD1576	CC-Link module channel number (7th module)	CC-Link module channel number (7th module)	Channel number (81 to 88) ^{*1} of the CC-Link module (7th module) controlled	S (initial)
SD1577	CC-Link module channel number (8th module)	CC-Link module channel number (8th module)	Channel number (81 to 88) ^{*1} of the CC-Link module (8th module) controlled	S (initial)
SD1578	CC-Link IE Controller Network module channel number (1st module)	CC-Link IE Controller Network module channel number (1st module)	Channel number (151 to 158) ^{*1} of the CC-Link IE Controller Network module (1st module) controlled	S (initial)
SD1579	CC-Link IE Controller Network module channel number (2nd module)	CC-Link IE Controller Network module channel number (2nd module)	Channel number (151 to 158) ^{*1} of the CC-Link IE Controller Network module (2nd module) controlled	S (initial)
SD1580	CC-Link IE Controller Network module channel number (3rd module)	CC-Link IE Controller Network module channel number (3rd module)	Channel number (151 to 158) ^{*1} of the CC-Link IE Controller Network module (3rd module) controlled	S (initial)
SD1581	CC-Link IE Controller Network module channel number (4th module)	CC-Link IE Controller Network module channel number (4th module)	Channel number (151 to 158) ^{*1} of the CC-Link IE Controller Network module (4th module) controlled	S (initial)
SD1582	CC-Link IE Controller Network module channel number (5th module)	CC-Link IE Controller Network module channel number (5th module)	Channel number (151 to 158) ^{*1} of the CC-Link IE Controller Network module (5th module) controlled	S (initial)
SD1583	CC-Link IE Controller Network module channel number (6th module)	CC-Link IE Controller Network module channel number (6th module)	Channel number (151 to 158) ^{*1} of the CC-Link IE Controller Network module (6th module) controlled	S (initial)
SD1584	CC-Link IE Controller Network module channel number (7th module)	CC-Link IE Controller Network module channel number (7th module)	Channel number (151 to 158) ^{*1} of the CC-Link IE Controller Network module (7th module) controlled	S (initial)
SD1585	CC-Link IE Controller Network module channel number (8th module)	CC-Link IE Controller Network module channel number (8th module)	Channel number (151 to 158) ^{*1} of the CC-Link IE Controller Network module (8th module) controlled	S (initial)
SD1594	Switch status	Switch status (FUNCTION/SHUTDOWN switch)	The switch status (FUNCTION/SHUTDOWN switch) is stored as follows: 0: Neutral 1: FUNCTION 2: SHUTDOWN	S (key switch change)
SD1595		Switch status (HARD RESET/OS RESET switch)	The switch status (HARD RESET/OS RESET switch) is stored as follows: 0: Neutral 1: HARD RESET 2: OS RESET	S (key switch change)

*1 Only the channel number in use can be checked. A module cannot be specified.

*2 Flashing occurs at the following intervals:

- Flashing: 200 ms
- Slow flashing: 1 sec

Appendix 6 Buffer Memory List

This section shows the buffer memory of this product.

Buffer memory values are returned to their defaults (initial values) when the power of this product is turned OFF.

Buffer Memory

Address	Name
Un\G0 to Un\G1023	System area

Precautions

Do not write any data in the "system area" of the buffer memory.

Doing so may cause malfunction of this product.

Appendix 7 Parameter List

This section shows the list of parameters.

System parameter

The list of system parameters is shown below.

Item		Parameter No.	
I/O Assignment	Base/Power/Extension Cable Setting	Setting of base/power supply module/extension cable	0203H
		Number of slots	0201H
	I/O Assignment Setting	Setting of type/number of points/start XY/module status	0200H
		Module Name	0203H
		Control PLC Settings	0202H
Setting of Points Occupied by Empty Slot		0100H	
Multiple CPU Setting	Setting for Number of CPU Modules		0301H
	Communication Setting between CPUs	Refresh Setting	0303H
		CPU Buffer Memory Setting (when refresh END)	0304H
		CPU Buffer Memory Setting (when refresh I45 is executed)	0308H
		PLC Unit Data	0309H
		Fixed Scan Communication Function	—
		Fixed Scan Communication Area Setting	0307H
	Fixed Scan Communication Setting	Fixed Scan Interval Setting of Fixed Scan Communication	0306H
		Fixed Scan Communication Function and Inter-module Synchronization Function	0306H
	Operation Mode Setting	Stop Setting	0302H
Synchronous Startup Setting		030AH	
Other PLC Control Module Setting	I/O Setting Outside Group	0305H	
Inter-module Synchronization Setting	Use Inter-module Synchronization Function in System		—
	Select Inter-module Synchronization Target Module		0101H
	Fixed Scan Interval Setting of Inter-module Synchronization		0101H
	Inter-module Synchronization Master Setting		0102H

Point

The system parameters must be unified in all CPUs that use the fixed scan communication function and the inter-module synchronization function.

The CPUs, in which "Not Use" is selected for the fixed scan communication function or inter-module synchronization function, are not regarded as the same system parameters. Set the same system parameter settings in all CPUs in the multiple CPU configuration.

CPU parameter

The list of CPU parameters is shown below.

Item		Parameter No.	
Name Setting	Title Setting	3100H	
	Comment Setting	3101H	
Operation Related Setting	Remote Bus Reset Setting*1	3202H	
	Output Mode Setting at Y STOP to Y OUT	3203H	
	Module Synchronous Setting	3207H	
	Time Synchronization Setting with Multiple CPU (PLC No.1)	6E12H	
	Refresh Cycle Setting	6E02H	
	Windows Setting	Y Output Setting while Windows is Restarting	6E24H
		Y Output Setting when Windows Shut Down	6E24H
X Input Setting to Forced Restart Windows		6E23H	
X Input Setting to Shut Down Windows		6E23H	
Memory/Device Setting	Link Direct Device Setting	340DH	
RAS Setting	WDT(Watchdog Timer) Setting	3500H	
	Error Detection Setting	3501H	
	CPU Module Operation Setting at Error Detection	3501H	
	LED Display Setting	3502H	
	Event History Setting	3504H	
	Registration Destination Setting	6E25H	
Refresh Setting between Multiple CPUs	Refresh Setting (At the END)	3901H	
	Refresh Setting (At I45 Exe.)	3902H	
I/O Assignment Setting	CPU Module Operation Setting at Error Detection	3600H	
Routing Setting	Routing Setting	3800H	
MELSEC data link function settings	Communication Timeout value setting	iQ-R series bus interface (Channel No.12)	6E03H
		CC-Link IE Controller Network (Channel No.151 to 158)	6E06H
		CC-Link (Channel No.81 to 88)	6E04H
		CC-Link IE TSN (Channel No.281 to 288)	6E08H

*1 The remote BUS RESET in this product is equivalent to the remote RESET in a CPU module.
Therefore, the parameter name is "Remote Reset Setting" in other modules.

Module parameter

The list of module parameters is shown below.

Item		Parameter No.
Basic Settings	External Device Configuration	A031H
Application Settings	Security	A034H

A

Appendix 8 How to Use MELSEC-Q Series Modules



This section explains how to use MELSEC-Q series modules.

Window change in CW Configurator





Setting items in MELSECWinCPU setting utility used for MELSEC-Q series are changed to the following windows in CW Configurator.

Parameter items

■"Points," "Start XY," and "H/W error time CPU operation mode" in "I/O assignment setting"

MELSECWinCPU setting utility	CW Configurator
 [I/O assignment setting] tab	 [Navigation window] ⇒ [Parameter] ⇒ [System Parameter] ⇒ [I/O Assignment] tab
 [I/O assignment setting] tab ⇒ [Detail setting] button	



■"Switch setting" and "Error time output mode" in "I/O assignment setting" , and intelligent function module parameters

MELSECWinCPU setting utility	CW Configurator
 [I/O assignment setting] tab ⇒ [Switch setting] button	 [Navigation window] ⇒ [Parameter] ⇒ [Module Information] ⇒ [(module name)] ⇒ [Module Parameter]
 [I/O assignment setting] tab ⇒ [Detail setting] button	
 [System setting] tab	

■Interrupt pointer setting

In CW Configurator, the setting for interrupt pointer is changed as follows.

- Setting the SI No. for an interrupt module is not required.
- "Interrupt Pointer" of an interrupt module must be sequential numbers. (Set I51 and I52 to No.2 and No.3 respectively when I50 is set to No.1, for example.)

MELSECWinCPU setting utility	CW Configurator
 [System setting] tab ⇒ [Interrupt event setting] button	 [Navigation window] ⇒ [Parameter] ⇒ [Module Information] ⇒ [(module name)] ⇒ [Module Parameter]

Setting procedure

The setting procedure for a MELSEC-Q series module in CW Configurator is shown below.

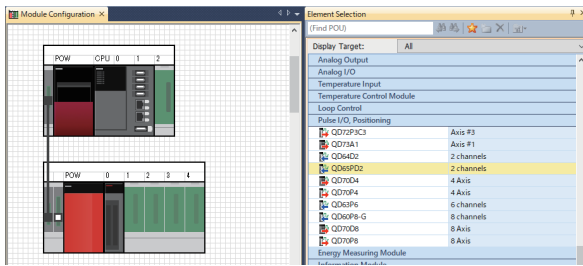

1. Create a module configuration diagram according to the actual configuration by dragging each MELSEC-Q series module from the "Element Selection" window and dropping it onto the "Module Configuration" window.

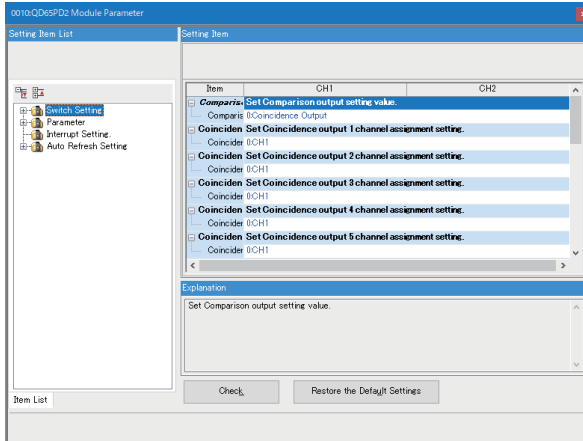

2. Set the parameters of each module.

Point

- When CW Configurator can be connected to the actual system configuration, the configuration can be read by selecting [Online] ⇒ [Read Module Configuration from PLC]. For modules of which configuration cannot be read, drag each module from the "Element Selection" window and drop it onto the "Module Configuration" window.
- To change "Points," "Start XY," "Control PLC Settings," or "CPU Module Operation Setting at Error Detected," set the parameters in "System Parameter."

A

Considerations

The modules requiring particular attentions are shown below.

For details, refer to the manual of each module.

AnyWireASLINK master module and AnyWire DB A20 master module

When AnyWire DB A20 master module is used, select the following model displayed on the "Module Configuration."

Module name	Model name displayed on CW Configurator
QJ51AW12D2	MELSEC_Partner

Q series large type extension base unit (AnS series size)

Select the module which can be mounted on the actual each extension base unit in the "Module Configuration." When a Q series large type blank cover is used, select the module mounted on the Q series large type blank cover.

Appendix 9 General Safety Requirements

When turning the power of this product OFF and ON, the control output may not be performed temporarily due to differences in the delay and startup time between the power supply for this product and the external power supply (especially, DC power) for the control module.

In addition, signals also may not be output correctly when the external power supply or this product fails. In terms of fail-safe and to prevent any incorrect output signals from causing the entire system failure, configure safety circuits (such as emergency stop circuits, protection circuits, and interlock circuits) external to this product for the parts where the incorrect output may cause damage to the machines or accidents.

When the ERR. contact of a power supply module is not used

AC power

AC and DC power

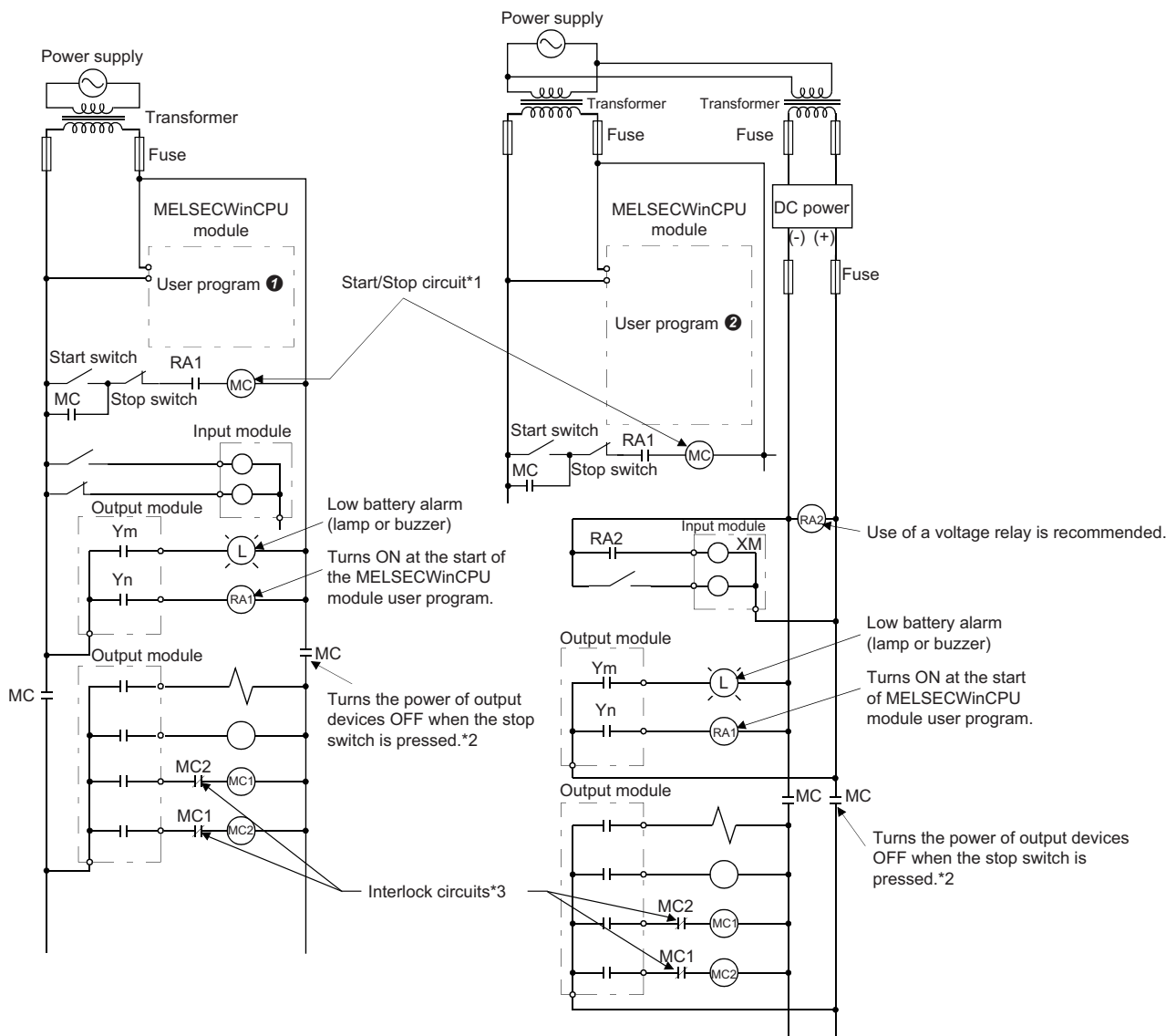

- *1 This product starts when RA1 (control starting output) turns ON.
- *2 A stop caused by pressing an emergency stop switch or a limit switch
- *3 Configure external interlock circuits for conflicting operations such as forward/reverse rotations and the parts where the incorrect output may cause damage to the machines or accidents.

AC power

1. Turn the power of this product ON.
2. Change the operating status of this product to the Y OUT state.
3. Turn the start switch ON.
4. The output devices are activated by the user program ① when the relay (MC) turns ON.

AC and DC power

1. Turn the power of this product ON.
2. Change the operating status of this product to the Y OUT state.
3. RA2 turns ON when DC power is established.
4. XM turns ON when RA2 turns ON, and the processing is started by the user program ② after DC input signal is fully established.
5. Turn the start switch ON.
6. The output devices are activated by a user program when the relay (MC) turns ON.

User program ①

Create a program to perform the following operations when this product starts.

■Turning Ym ON when the battery voltage drop is detected

Use the mdBdReceiveEx function and the mdBdDevSetEx function.

■Turning Yn ON when the user program is started

Use the mdBdReceiveEx function and the mdBdDevSetEx function.

User program ②

Create a program to perform the following operations when this product starts.

■Turning Ym ON when the battery voltage drop is detected

Use the mdBdReceiveEx function and the mdBdDevSetEx function.

■Turning Yn ON when the user program is started

Use the mdBdReceiveEx function and the mdBdDevSetEx function.

■Starting the system processing once XM turns ON and the DC input signal is established (after DC input signal settling time)

Create a program that starts the system processing once the DC input signal settling time has passed after XM turns ON. The ON status of XM can be checked with the mdBdReceiveEx function. (The DC input signal settling time indicates a time from when RA2 turns ON to when the DC input signal is fully established. The time must be set to 0.5 seconds.)

However, the DC input signal settling time does not need to be set on the user program when using a voltage relay for RA2.

When the ERR. contact of a power supply module is used

AC and DC power

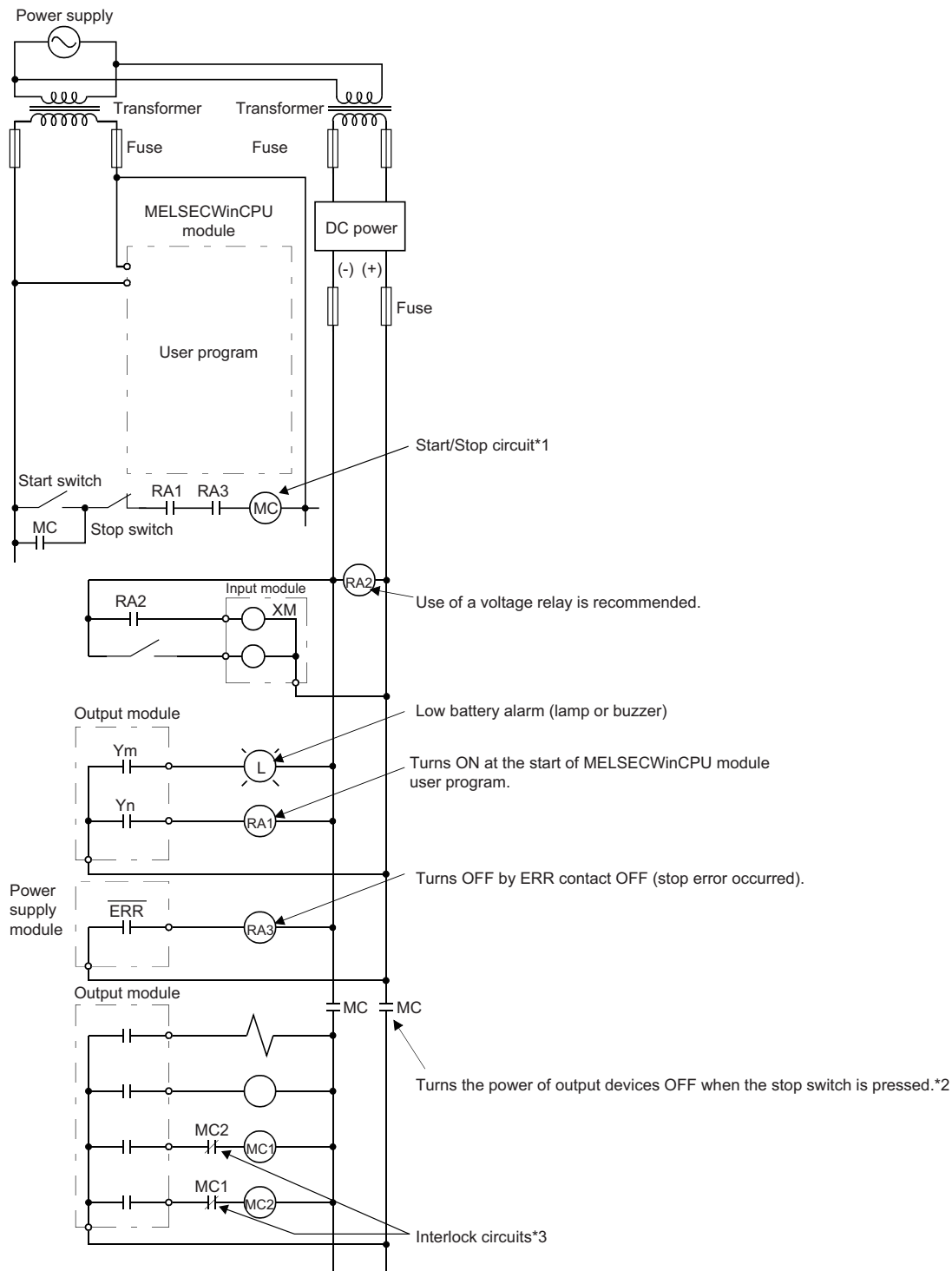

*1 This product starts when RA1 (control starting output) turns ON.

*2 A stop caused by pressing an emergency stop switch or a limit switch or when turning OFF the ERR. contact

*3 Configure external interlock circuits for conflicting operations such as forward/reverse rotations and the parts where the incorrect output may cause damage to the machines or accidents.

AC and DC power

1. Turn the power of this product ON.
2. Change the operating status of this product to the Y OUT state.
3. RA2 turns ON when DC power is established.
4. XM turns ON when RA2 turns ON, and the processing is started by a user program after DC input signal is fully established.
5. Turn the start switch ON.
6. The output devices are activated by a user program when the relay (MC) turns ON.

User program

Create a program to perform the following operations when this product starts.

■Turning Ym ON when the battery voltage drop is detected

Use the mdBdReceiveEx function and the mdBdDevSetEx function.

■Turning Yn ON when the user program is started

Use the mdBdReceiveEx function and the mdBdDevSetEx function.

■Starting the system processing once XM turns ON and the DC input signal is established (after DC input signal settling time)

Create a program that starts the system processing once the DC input signal settling time has passed after XM turns ON. The ON status of XM can be checked with the mdBdReceiveEx function. (The DC input signal settling time indicates a time from when RA2 turns ON to when the DC input signal is fully established. The time must be set to 0.5 seconds.)

However, the DC input signal settling time does not need to be set on the user program when using a voltage relay for RA2.

Fail-safe measures when a system of this product fails

Failures of this product can be detected with the self-diagnostics function; however, failures which occur in a part, such as an I/O control part, may not be detected.

In this case, all inputs or outputs may turn ON or OFF, or normal operation and safety of the control-target device may not be ensured depending on the failure.

Even though Mitsubishi programmable controllers are manufactured under strict quality control, they may fail due to some reasons. Configure fail-safe circuits external to this product so that no machine is damaged and no accident occurs.

A

Appendix 10 External Dimensions

The following figures show the external dimensions of this product.

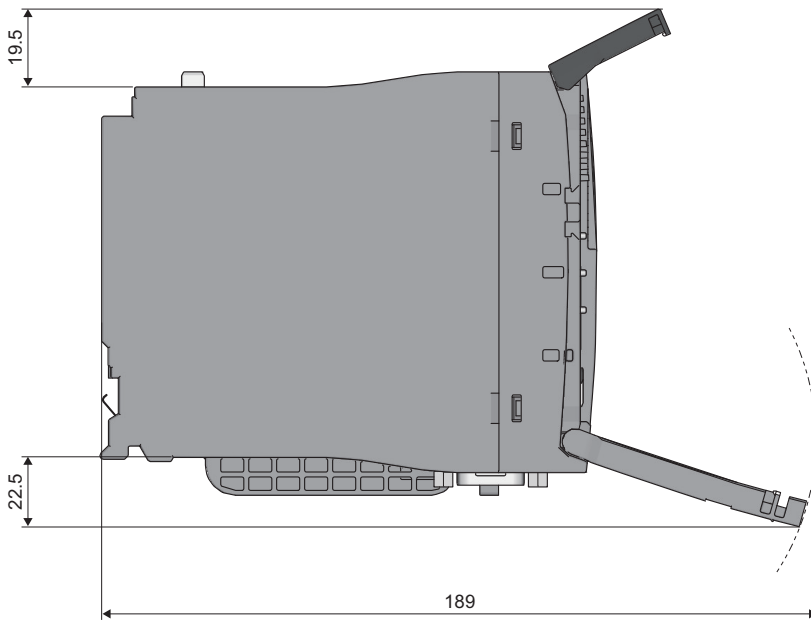
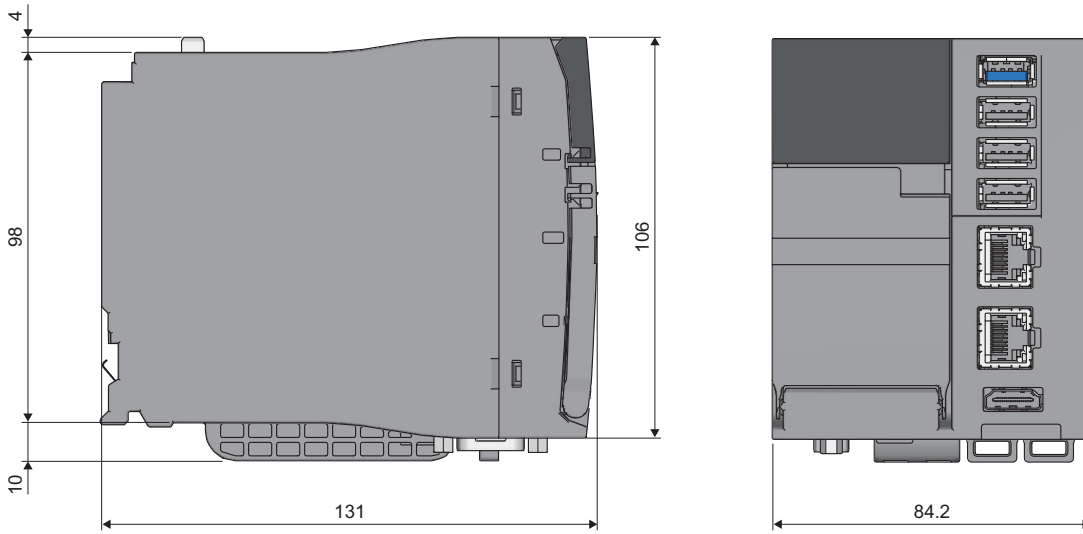

(Unit: mm)

MEMO

A

INDEX

C

- Connection via a hub 136
- Current consumption value 61

D

- Data assurance by program 124
- Direct connection 138

M

- Maintenance mode 27

N

- Normal mode 27

P

- Parameter No. 292
- PAUSE 29
- Pre-installed applications 64
- Prevention of 64-bit data inconsistency 124

T

- Threshold value of a current consumption error
(USB port forced stop) 61
- Threshold value of a current consumption error
(warning) 61

U

- USB boot mode 27
- User applications 65

W

- Windows 10 IoT Enterprise LTSC 2019 63

Y

- Y OUT 29
- Y STOP 29

MEMO

REVISIONS

*The manual number is given on the bottom left of the back cover.

Revision date	*Manual number	Description
January 2022	SH(NA)-082431ENG-A	First edition
February 2022	SH(NA)-082431ENG-B	■Added or modified parts Chapter 1, Section 2.1, Section 6.3, Section 6.4, Section 13.1, Section 32.1, Section 34.2, Section 34.16
January 2024	SH(NA)-082431ENG-C	■Added or modified parts SAFETY PRECAUTIONS, COMPLIANCE WITH EMC AND LOW VOLTAGE DIRECTIVES, Section 4.3, Section 6.2, Section 7.1, Section 7.2, Section 7.3

Japanese manual number: SH-082428-C

This manual confers no industrial property rights or any rights of any other kind, nor does it confer any patent licenses. Mitsubishi Electric Corporation cannot be held responsible for any problems involving industrial property rights which may occur as a result of using the contents noted in this manual.

© 2022 MITSUBISHI ELECTRIC CORPORATION

WARRANTY

Please confirm the following product warranty details before using this product.

1. Gratis Warranty Term and Gratis Warranty Range

If any faults or defects (hereinafter "Failure") found to be the responsibility of Mitsubishi occurs during use of the product within the gratis warranty term, the product shall be repaired at no cost via the sales representative or Mitsubishi Service Company.

However, if repairs are required onsite at domestic or overseas location, expenses to send an engineer will be solely at the customer's discretion. Mitsubishi shall not be held responsible for any re-commissioning, maintenance, or testing on-site that involves replacement of the failed module.

[Gratis Warranty Term]

The gratis warranty term of the product shall be for one year after the date of purchase or delivery to a designated place. Note that after manufacture and shipment from Mitsubishi, the maximum distribution period shall be six (6) months, and the longest gratis warranty term after manufacturing shall be eighteen (18) months. The gratis warranty term of repair parts shall not exceed the gratis warranty term before repairs.

[Gratis Warranty Range]

- (1) The range shall be limited to normal use within the usage state, usage methods and usage environment, etc., which follow the conditions and precautions, etc., given in the instruction manual, user's manual and caution labels on the product.
- (2) Even within the gratis warranty term, repairs shall be charged for in the following cases.
 1. Failure occurring from inappropriate storage or handling, carelessness or negligence by the user. Failure caused by the user's hardware or software design.
 2. Failure caused by unapproved modifications, etc., to the product by the user.
 3. When the Mitsubishi product is assembled into a user's device, Failure that could have been avoided if functions or structures, judged as necessary in the legal safety measures the user's device is subject to or as necessary by industry standards, had been provided.
 4. Failure that could have been avoided if consumable parts (battery, backlight, fuse, etc.) designated in the instruction manual had been correctly serviced or replaced.
 5. Failure caused by external irresistible forces such as fires or abnormal voltages, and Failure caused by force majeure such as earthquakes, lightning, wind and water damage.
 6. Failure caused by reasons unpredictable by scientific technology standards at time of shipment from Mitsubishi.
 7. Any other failure found not to be the responsibility of Mitsubishi or that admitted not to be so by the user.

2. Onerous repair term after discontinuation of production

- (1) Mitsubishi shall accept onerous product repairs for seven (7) years after production of the product is discontinued. Discontinuation of production shall be notified with Mitsubishi Technical Bulletins, etc.
- (2) Product supply (including repair parts) is not available after production is discontinued.

3. Overseas service

Overseas, repairs shall be accepted by Mitsubishi's local overseas FA Center. Note that the repair conditions at each FA Center may differ.

4. Exclusion of loss in opportunity and secondary loss from warranty liability

Regardless of the gratis warranty term, Mitsubishi shall not be liable for compensation to:

- (1) Damages caused by any cause found not to be the responsibility of Mitsubishi.
- (2) Loss in opportunity, lost profits incurred to the user by Failures of Mitsubishi products.
- (3) Special damages and secondary damages whether foreseeable or not, compensation for accidents, and compensation for damages to products other than Mitsubishi products.
- (4) Replacement by the user, maintenance of on-site equipment, start-up test run and other tasks.

5. Changes in product specifications

The specifications given in the catalogs, manuals or technical documents are subject to change without prior notice.

INFORMATION AND SERVICES

For further information and services, please contact your local Mitsubishi Electric sales office or representative.
Visit our website to find our locations worldwide.

MITSUBISHI ELECTRIC Factory Automation Global Website
Locations Worldwide
www.MitsubishiElectric.com/fa/about-us/overseas/

TRADEMARKS

Microsoft, Visual Studio and Windows are trademarks of the Microsoft group of companies.

Adobe, Acrobat, and Reader are either registered trademarks or trademarks of Adobe Systems Incorporated in the United States and/or other countries.

The company names, system names and product names mentioned in this manual are either registered trademarks or trademarks of their respective companies.

In some cases, trademark symbols such as [™] or [®] are not specified in this manual.

COPYRIGHTS

The screens (screenshots) are used in accordance with the Microsoft Corporation guideline.

SH(NA)-082431ENG-C(2401)KWIX

MODEL: R102WCPU-W-U-E

MODEL CODE: 13JX5F

MITSUBISHI ELECTRIC CORPORATION

HEAD OFFICE: TOKYO BLDG., 2-7-3, MARUNOUCHI, CHIYODA-KU, TOKYO 100-8310, JAPAN
NAGOYA WORKS: 1-14, YADA-MINAMI 5-CHOME, HIGASHI-KU, NAGOYA 461-8670, JAPAN

When exported from Japan, this manual does not require application to the
Ministry of Economy, Trade and Industry for service transaction permission.

Specifications subject to change without notice.