

Electronic Multi-Measuring Instrument

MODEL

# ME96SSRB-MB

User's Manual: Detailed Edition



- Before use, you should read this user's manual carefully to properly operate this instrument.  
Be sure to forward the manual to the end user.

## Check your delivery

The following table shows a list of the instrument accessories.  
When unpacking your package, check all the contents.

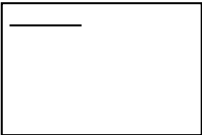
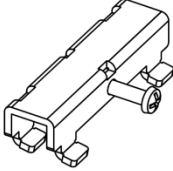
Contents	Quantity	Specification
User's Manual (Digest version)	1	 A3 size
Attachment lug (with a screw)	2	

## Optional plug-in module

The following table shows a list of optional plug-in modules available for this product.  
Installing the optional plug-in module enables various input or output. If you need it, consult with your supplier.  
ME-4201-NS96, ME-0052-NS96, and ME-0040C-NS96, which are optional plug-in modules for ME96NSR and ME96NSR-MB, are not available for ME96SSRB-MB.

Model type	I/O specifications					
	Analog output	Pulse/Alarm output	Digital input	Digital output	Communication	Logging function
ME-4210-SS96B	4 ch	2 ch	1 ch	—	—	—
ME-0040C-SS96	—	—	4 ch	—	CC-Link	—
ME-0052-SS96	—	—	5 ch	2 ch	—	—
ME-0000MT-SS96	—	—	—	—	MODBUS TCP	—
ME-0000BU-SS96	—	—	—	—	—	6 items
ME-0000BU25-SS96	—	—	—	—	—	25 items

I/O Parts	Specifications	Model type
Analog output	Output: 4 mA to 20 mA Load resistance: 600 Ω or less	ME-4210-SS96B
Pulse/Alarm output	No-voltage a-contact Contact Capacity: 35 V DC, 0.1 A or less	ME-4210-SS96B
Digital input	Contact Capacity: 24 V DC (19 V DC to 30 V DC), 7 mA or less Input Pulse Width: 30 ms or more	ME-4210-SS96B ME-0040C-SS96 ME-0052-SS96
Digital output	No-voltage a-contact Contact Capacity: 35 V DC, 0.2 A or less	ME-0052-SS96

In this manual, the operation is also explained when the optional plug-in module is installed.

## Features

- The instrument measures load status by wiring the secondary sides of VT (Voltage Transformer) and CT (Current Transformer) in the power receiving and distribution system and displays various measured values.
- The instrument supports Active Energy Class 0.5S and harmonic measurement (1st to 19th).
- Active energy can be measured by dividing into three time periods such as peak, off-peak, and shoulder. (Periodic Active Energy)
- This instrument enables measurement of active energy/reactive energy/ apparent energy for any period (interval). (Rolling demand active power/Rolling demand reactive power/Rolling demand apparent power)
- The password protection prevents undesired setting change and measured data deletion.
- The transmission function (MODBUS RTU communication, CC-Link communication, or MODBUS TCP communication) transmits measured data to superior monitoring systems.
  - \*CC-Link communication is available when ME-0040C-SS96 (optional plug-in module) is installed.
  - \*MODBUS TCP communication is available when ME-0040C-SS96 (optional plug-in module) is installed.
- The logging function enables to back up measured values in a SD memory card even when a MODBUS RTU communication error occurs.
  - \*It is available when ME-0000BU-SS96 or ME-0000BU25-SS96 (optional plug-in module) is installed.
- This instrument itself can output key measuring elements such as current, voltage, active power, power factor, and active energy at the power receiving point by installing an optional plug-in module with analog output/pulse output function. It is ideal for remote monitoring.
  - \*It is available when ME-4210-SS96B (optional plug-in module) is installed
- The built-in logging function provides the logging of measured values, alarm logs, and system logs into this instrument.
- The standard complies with the requirements of CE marking, UL standards, KC mark, and FCC/IC.
- The support function for checking input wiring enables to determine the wiring condition in the test mode. When either a voltage input or current input are incorrectly wired, the incorrect wiring part is displayed on the screen and it also shows a current phase angle, a voltage phase angle, and each value of active power, voltage, and current.

## Trademark

MODBUS is a trademark of Schneider Electric USA Inc.

Other company and product names herein are trademarks or registered trademarks of their respective owners. In the text, trademark symbols such as 'TM' and '®' may not be written.

## Table of Contents

Check your delivery .....	1
Optional plug-in module.....	1
Features.....	2
Trademark .....	2
Table of Contents .....	3
Safety Precautions.....	5
EMC Directive Instruction .....	9
Precautions for KC mark.....	9
Table for measuring element code .....	10
1. Name and Function of Each Section.....	11
1.1. Name of Each Part .....	11
1.2. LCD Function.....	14
1.3. Function of Operation Buttons.....	15
1.4. LED Display of Optional Plug-in Module .....	17
2. Each Mode Function.....	19
3. How to Set up .....	20
3.1. Setting Flow .....	20
3.2. Setting Menu 1: Basic Setup (Settings for Phase Wire System, Display Pattern, VT/Direct Voltage, and CT Primary Current) .....	22
3.3. Setting Menu 2: Communication Settings (MODBUS RTU Communication Settings) .....	26
3.4. Setting Menu 2: Communication Settings (CC-Link Communication Settings) .....	27
3.5. Setting Menu 2: Communication Settings (MODBUS TCP Communication Settings).....	28
3.6. Setting Menu 3: Display Settings (Settings for Active/Reactive Energy and Harmonic Measurement).....	30
3.7. Setting Menu 4: LCD Settings (Settings for Model Display, Version Display, Backlight, and Display Update Time).....	32
3.8. Setting Menu 5: Pulse/Alarm Settings (Settings for Upper/Lower Limit Alarm, Motor Starting Current Mask Function, and Pulse Output) .....	33
3.9. Setting Menu 6: Built-in Logging Settings .....	38
3.10. Setting Menu 6: Analog Output Settings .....	41
3.11. Setting Menu 6: Optional Logging settings.....	45
3.12. Setting Menu 7: Settings for Periodic active Energy, Rolling Demand, and Digital Input/Output .....	47
3.13. Setting Menu 8: Special Settings (Settings for Operating Time, IEC Mode, and CO <sub>2</sub> equivalent).....	49
3.14. Setting Menu CL: Preset Time Settings .....	51
3.15. Setting Confirmation Menu 1 to 9: Confirming the Settings in the Setting Menu 1 to 8 and 9 Test Mode .....	53
3.16. Initialization of Related Items by Changing a Setting .....	54
3.17. Initialization of All Settings.....	55
3.18. Settings for Special Display Pattern P00.....	56
3.19. Example for Easy Setup .....	58
4. How to Use Test Mode .....	60
4.1. Test Menu 1: Communication Test .....	61
4.2. Test Menu 2: Alarm Output/Digital Output Test .....	62
4.3. Test Menu 3: Zero/Span Adjustment for Analog Output .....	63
4.4. Test Menu 4: Analog Output Test .....	64
4.5. Test Menu 5: Pulse Output Test.....	65
4.6. Test Menu 6: Function for Determining Incorrect Wiring.....	66
4.6.1. Incorrect Wiring Patterns Detected by <span style="border: 1px solid black; padding: 0 2px;">①</span> Pattern display of incorrect wiring.....	69
5. Operation .....	72
5.1. Basic Operation .....	72
5.1.1. How to Switch the Measurement Screen.....	72
5.1.2. How to Switch Phase Display .....	72
5.1.3. How to Display the Cyclic Mode .....	73
5.1.4. Harmonics Display .....	74
5.1.5. Maximum/Minimum Value Display.....	75
5.1.6. How to Display Maximum/Minimum Value .....	75
5.1.7. How to Clear Maximum/Minimum Value.....	75
5.1.8. Active Energy/Reactive Energy/Apparent Energy Display .....	76
5.1.9. How to Change the Display Digit of Active/Reactive/Apparent Energy .....	76
5.1.10. How to Reset Active/Reactive/Apparent Energy to Zero.....	77
5.1.11. How to Measure Reactive Energy (2 quadrant/4 quadrant measurement) .....	77
5.1.12. Each Measuring Item Display during Power Transmission .....	78

# Table of Contents

5.1.13.	Demand Time Period and Demand Value of Current demand.....	78
5.2.	Usage Depending on the Application (Alarm, Periodic Active Energy, Rolling Demand, Operating Time, Password, etc.).....	79
5.2.1.	Upper/Lower Limit Alarm Display and Action .....	79
5.2.2.	How to Cancel the Upper/Lower Limit Alarm.....	81
5.2.3.	How to Stop Backlight Blinking Caused by the Upper/Lower Limit Alarm Generation.....	81
5.2.4.	Upper/Lower Limit Alarm Item on the Alarm Contact .....	81
5.2.5.	Periodic Active Energy Display.....	82
5.2.6.	How to Reset Periodic Active Energy to Zero .....	82
5.2.7.	Rolling Demand Display and Calculation.....	83
5.2.8.	Rolling Demand Predict Value.....	84
5.2.9.	Rolling Demand Time Period Adjustment.....	84
5.2.10.	How to Clear the Rolling Demand Peak Value .....	84
5.2.11.	Operating Time Display .....	85
5.2.12.	How to Reset Operating Time to Zero .....	85
5.2.13.	CO <sub>2</sub> Equivalent Display.....	85
5.2.14.	How to Clear the CO <sub>2</sub> Equivalent.....	85
5.2.15.	Digital Input/Output Status Display and Action .....	86
5.2.16.	How to Cancel the Latch for Digital Input .....	86
5.2.17.	How to Prevent Maximum Value Update by Motor Starting Current .....	86
5.2.18.	Password Protection Setting.....	87
5.2.19.	Built-in Logging Function .....	88
6.	Others.....	89
6.1.	Display Pattern List.....	89
6.2.	Standard Value.....	92
6.3.	Measuring Items and the Corresponding Display/Output .....	96
6.4.	Instrument Operation.....	98
6.5.	Troubleshooting.....	99
7.	Installation.....	102
7.1.	Dimensions.....	102
7.2.	How to Install .....	104
7.2.1.	Mounting Hole Dimensions.....	104
7.2.2.	Mounting Position .....	104
7.2.3.	Mounting and Fixing.....	104
7.2.4.	Optional Plug-in Module Installation .....	104
7.3.	How to Connect Wiring.....	105
7.3.1.	Specifications on the Applicable Electrical Wire.....	105
7.3.2.	Wiring of this Instrument .....	105
7.3.3.	Wiring of the Optional Plug-in Module .....	105
7.3.4.	Check the Connection.....	105
7.4.	Wiring Diagram.....	107
7.5.	How to insert/remove SD memory card .....	115
8.	Specifications.....	116
8.1.	Product Specifications .....	116
8.2.	Compatible Standards.....	119
8.3.	MODBUS RTU Communication Specifications.....	119
8.4.	CC-Link Communication Specifications for optional plug-in module .....	120
8.5.	MODBUS TCP Communication Specifications for optional plug-in module .....	120
8.6.	Logging Specifications for optional plug-in module.....	121
8.7.	Setting Table (Factory Default Settings and Customer's Notes Settings) .....	122
9.	Appendix.....	125
9.1.	ME96SS Calculation Method (3-Phase Unbalanced System with Neutral).....	125
9.2.	Optional parts .....	126
9.3.	A List of Examples for Incorrect Wiring Display .....	127
9.3.1.	3-phase 4-wire System .....	127
9.3.2.	3-phase 3-wire System .....	136
9.3.3.	1-phase 3-wire System .....	143

## Safety Precautions

Before use, read these instructions carefully to properly operate the instrument.

Be sure to follow the precautions described here for personnel and product safety.

Keep this manual ready to hand and accessible for future use at all times.

Be sure to forward the manual to the end user.

If you consider using the instrument for a special purpose such as nuclear power plants, aerospace, medical care, or passenger vehicles, consult with our sales representative.

The instructional icon in the manual is described as follows.



The caution icon ( $\Delta$ ) on the main unit indicates that incorrect handling may cause hazardous conditions. Always follow the subsequent instructions ( $\Delta_{\text{CAUTION}}$ ) because they are important to personal safety. Failure to follow them may result in an electric shock, a fire, erroneous operation, or damage to the instrument. If the instrument is used in a manner not specified by the manufacturer, the protection provided by the instrument may be impaired.



The terminals of auxiliary power (MA, MB) and voltage input (P1, P2, P3, PN) have hazards of electric shock, explosion, or arc flash. Turn off the power supply of auxiliary power and input circuit and then handle the instrument.

### ■ Precautions on use environment and conditions

Do not use the instrument in the following places:

Failure to follow the instruction may cause a malfunction or reduced product life time.

- The ambient temperature exceeds the range  $-5^{\circ}\text{C}$  to  $+55^{\circ}\text{C}$ .
- The average daily temperature exceeds  $+35^{\circ}\text{C}$ .
- The relative humidity exceeds the range 0 to 85% RH, or condensing.
- The altitude exceeds 2000 m.
- Pollution Degree: more than 2 \*Note 1
- Exposed to much dust, corrosive gas, salty environment, or oil mist
- Transient over voltage: 4000 V \*Note 1
- Exposed to excessive vibration or impact
- Exposed to rain or water drops
- Exposed to direct sunlight
- Pieces of metal or inductive substances are scattered.
- Exposed to strong magnetic fields or large exogenous noise

Note1: For details about the Pollution Degree and the Transient over voltage category, refer to EN61010-1:2010.

Grit, dust, and small insects cause poor contact or a failure such as insulation decline that caused by deposition and moisture absorption. Furthermore, in the area where the air contains conductive dust, a failure such as a product malfunction or insulation deterioration occurs in a relatively short time. In this case, you must take measures against it such as putting the instrument in an enclosed board. In addition, if the temperature inside the board rises, the measures must be undertaken as well.

## Safety Precautions

### ■ Precautions on Installation and wiring

Be sure to read the instructions carefully before installation and wiring.

- A qualified electrician must install and wire the instrument for safety.
- Supply power to the instrument after completing its assembly work on a cabinet door.
- The instrument is to be mounted on the cabinet door. All connections must be kept inside the cabinet.
- The following table shows the specifications on the input/output terminal.

#### ■ Auxiliary power supply and measuring elements

Auxiliary power supply		100 V AC to 240 V AC ( $\pm 15\%$ ) 50 Hz to 60 Hz 100 V DC to 240 V DC ( $-30\%$ +15%)	MA, MB terminals
Measuring element	Voltage	3-phase 4-wire: max 277/480 V AC 3-phase 3-wire: (DELTA) max 220 V AC (STAR) max 440 V AC 1-phase 3-wire: max 220/440 V AC 1-phase 2-wire: (DELTA) max 220 V AC (STAR) max 440 V AC	Category III P1, P2, P3, PN terminals
	Current	5 A (CT secondary side), max 30 V AC	Category III +C1, C1, +C2, C2, +C3, C3 terminals
	Frequency	50 Hz or 60 Hz	

The current input terminals must be connected to a CT, external equipment, with basic insulation.

Be sure to continuously connect the terminals for voltage-measuring purpose and current-measuring purpose during operation.

#### ■ Others

MODBUS RTU communication	T/R+, T/R-, SG terminals	max 35 V DC
MODBUS TCP communication	Ethernet terminal	
CC-Link communication	DA, DB, DG terminals	
Digital input	DI1, DI2, DI3, DI4, DI COM, DI+, DI-, DI1+, DI1-, DI2+, DI2-, DI3+, DI3-k, DI4+, DI4-, DI5+, DI5-terminals	
Digital output	DO1+, DO1-, DO2+, DO2- terminals	
Analog output	CH1+, CH1-, CH2+, CH2-, CH3+, CH3-, CH4+, CH4-terminals	
Pulse/Alarm output	C1A/A1, C1B/COM1, C2A/A2, C2B/COM2 terminals	



- Keep the protection sheet affixed to the front of the instrument during installation and wiring.
- Do not drop the instrument from high place. If it is dropped and the display cracks, do not touch the liquid leaking from the broken LCD or do not get it in your mouth. If you touched the liquid, rinse it off with soapy water at once.
- Do not work under live-line condition. Otherwise, an instrument failure, an electric shock, or a fire may be caused.
- When tapping or wiring, take care not to enter any foreign objects such as chips or wire pieces into the instrument.
- If you pulled the wires with a strong force when connecting them to the terminals, the terminals might come off. (Tensile load: 39.2 N or less)
- Check the wiring diagram carefully. Inappropriate wiring can cause a failure of the instrument, an electric shock, or a fire.
- Use appropriate size wires. The use of an inappropriate size wire can cause a fire due to heat generation.
- Use crimp-type terminals compatible with the wire size. For details, refer to **7.3.1 Specifications on the Applicable Electrical Wire**. The use of an inappropriate terminal can cause a malfunction, failure, or burnout of the instrument or a fire due to damage to the terminal or poor contact.
- Tighten the terminal screws with a specified torque and use a suitable pressure connector. For details, refer to **7.3.1 Specifications on the Applicable Electrical Wire**. Excessive tightening can cause damage to the terminals and screws.
- Be sure to confirm the wiring connections strictly after the connection. Poor connection can cause a malfunction of the instrument, an electric shock, or a fire.

Continued to the next page.

## Safety Precautions

	<ul style="list-style-type: none"> <li>● In order to prevent invasion of noise, MODBUS RTU communication cables, auxiliary power supply cables, and other signal cables must not be placed close to or bound together with power lines or high voltage lines. When lying parallel to the power lines or high voltage lines, refer to the following table for the separation distance. (Except the input part of the terminal block)</li> </ul>						
	<table border="1"> <thead> <tr> <th>Conditions</th> <th>Distance</th> </tr> </thead> <tbody> <tr> <td>Power lines of 600 V or less</td> <td>300 mm or more</td> </tr> <tr> <td>Other power lines</td> <td>600 mm or more</td> </tr> </tbody> </table>	Conditions	Distance	Power lines of 600 V or less	300 mm or more	Other power lines	600 mm or more
	Conditions	Distance					
Power lines of 600 V or less	300 mm or more						
Other power lines	600 mm or more						

### ■ Precautions on preparation before use

- Observe the use conditions and environment requirements for installation place.
- You must set up the instrument before use. Read the manual carefully to set it up correctly. If the setup is incorrectly done, the instrument will not be properly operated.
- Check the power rating of the instrument and then apply proper voltage.

### ■ Precautions on how to use

- When operating the instrument, check that active bare wires do not exist around it. If any bare wire existed, stop the operation immediately and then take appropriate action such as insulation protection.
- If a power outage occurred during the setup, the instrument would not be set up correctly. Set it up again after power recovery.

	<ul style="list-style-type: none"> <li>● Do not disassemble or modify the instrument to use. Otherwise, a failure, an electric shock, or a fire can be caused.</li> <li>● Use the instrument within the rating specified in the manual. If you used it outside the rating, it might cause not only a malfunction or failure of the instrument but also ignition or burnout.</li> <li>● Do not open the CT secondary side while the primary current is energized. When the CT secondary side circuit is open, the primary current flows. However, the secondary current does not flow. Therefore, a high voltage is generated at the CT secondary side and the temperature rises, resulting in insulation breakdown in the CT secondary winding. It may lead to burnout.</li> <li>● When external equipment is connected to the external terminals, the instrument and external equipment must not be powered and be used after the definitive assembly on a cabinet door.</li> <li>● The rating of the terminal of external equipment should satisfy that of the external terminal of the instrument.</li> </ul>
---	--

### ■ Precautions on maintenance

- Wipe dirt off the surface with a soft dry cloth.
- Do not leave a chemical cloth in contact with the instrument for a long time or do not wipe it with benzene, thinner, or alcohol.
- In order to properly use the instrument for a long time, conduct the following inspections:
  - (1) Daily maintenance
    - ① No damage in the instrument
    - ② No abnormality with LCD indicator
    - ③ No abnormal noise, smell or heat generation
  - (2) Periodical maintenance
 

Inspect the following item every six months to once a year.

    - ① No looseness of installation and terminal block connection

	<p>Be sure to conduct periodic inspection under the electric outage condition. Failure to follow the instruction may cause a failure of the instrument, an electric shock, or a fire. Tighten the terminals regularly to prevent a fire.</p>
---	--



## Safety Precautions

### ■ Precautions on storage

To store the instrument, turn off the power supplies of auxiliary power and input circuit, remove the wires from the terminals, and then put them in a plastic bag.

For long-time storage, avoid the following places. Otherwise, there is danger of an instrument failure or reduced product life time.

- The ambient temperature exceeds the range  $-25^{\circ}\text{C}$  to  $+75^{\circ}\text{C}$ .
- The average daily temperature exceeds  $+35^{\circ}\text{C}$ .
- The relative humidity exceeds the range 0 to 85% RH, or condensing.
- Exposed to much dust, corrosive gas, salty environment, or oil mist.
- Exposed to excessive vibration or impact.
- Exposed to rain or water drops.
- Exposed to direct sunlight.
- Pieces of metal or inductive substances are scattered.

### ■ Warranty

- The warranty period is for one year from the date of your purchase or 18 months after the manufacturing date, whichever is earlier.
- During the warranty period, if any failure occurred in standard use that the product is used in the condition, method, and environment followed by the conditions and precautions described in the catalog and user's manual, we would repair the product without charge.
- Even within the warranty period, non-free repair is applied to the following cases.
  - ① Failures caused by the customer's improper storage, handling, carelessness, or fault.
  - ② Failures caused by faulty workmanship
  - ③ Failures due to faults in use or undue modification
  - ④ Failures due to force majeure such as a fire or abnormal voltage or due to natural disasters such as earthquakes, windstorms, or floods.
  - ⑤ Failures caused by the problem in question that could not be predicted with the technology available at the time the product was shipped.
- Our company shall not be liable to compensate for any loss arising from events not attributable to our company, customers' opportunity loss or lost earnings due to failure of the product, any loss, secondary loss, or accident caused by a special reason regardless of our company's predictability, damage to other products besides our products, or other operations

### ■ Replacement cycle of the product

It is recommend that you renew the product every ten years although it depends on your use condition. The long-term use of the product may cause discoloration of the LCD or a product malfunction.

### ■ Disposal

- Treat the product properly as industrial waste.
- ME-0000BU-SS96 or ME-0000BU25-SS96 (optional plug-in module) is equipped with a lithium battery. The lithium battery is disposed of according to the local regulation.
- In EU member states, there is a separate collection system for waste batteries. Dispose of batteries properly at the local community waste collection/recycling center.  
For ME-0000BU-SS96 or ME-0000BU25-SS96, the following symbol mark is printed on the packaging.



Note: This symbol is for EU member states only.

The symbol is specified in Article 20 'Information for end-users' of the new EU Battery Directive (2006/66/EC) and the Annex II.

The above symbol indicates that batteries need to be disposed of separately from other wastes.



ME-0000BU-SS96 or ME-0000BU25-SS96 (optional plug-in module) is equipped with a lithium battery. Therefore, if it is thrown in fire, heat generation, burst, or ignition may occur. The lithium battery is disposed of according to the local regulation.

### ■ Packaging materials and user's manual

For reduction of environment load, cardboard is used for packaging materials and the manual is printed with recycled papers.

## EMC Directive Instruction

This section summarizes the precautions to have the cabinet constructed with the instrument conform to the EMC Directive.

However, the method of conformance to the EMC Directive and the judgment on whether or not the cabinet conforms to the EMC Directive must be determined finally by the manufacturer.

This instrument complies with part 15 of the FCC Rules. Operation is subject to the following two conditions: (1) This instrument may not cause harmful interference, and (2) this instrument must accept any interference received, including interference that may cause undesired operation.

### 1. EMC Standards

- EN 61326-1
- EN 61000-3-2
- EN 61000-3-3

### 2. Installation (EMC directive)

The instrument is to be mounted on the panel of a cabinet.

Therefore, the installation to the cabinet is important not only for safety but also for conformance to EMC.

The instrument is examined in the following conditions.

- A conductive cabinet must be used.
- The conductivity of the six surfaces of the cabinet must be all ensured.
- The cabinet must be grounded by thick wires for low impedance.
- The hole drilling dimensions on the cabinet must be 10 cm or less in diameter.
- The terminals for protective earth and functional earth must be grounded by thick wires for low impedance. The use of the terminal for protective earth is important not only for safety but also for conformance to EMC.
- The connecting part of the terminal must be all placed inside the cabinet.
- Wiring outside the cabinet must be conducted with shielded cables, and the cables must be fixed to the panel with clamps. (Strip the covering of shielded cable by a portion of clamp installation and then mask the grounding part of the panel and clamp so as not to be painted.)

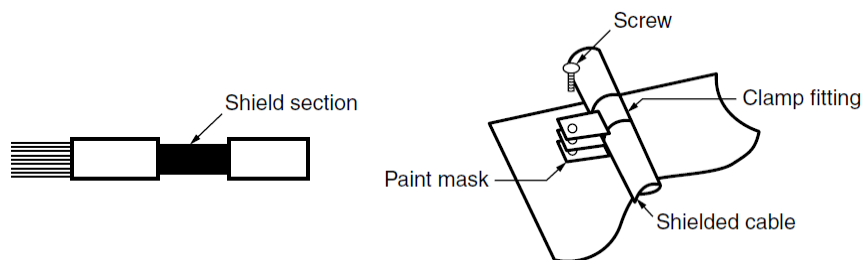

## Precautions for KC mark

### 사용자안내문

기종별	사용자안내문
A급 기기(업무용 방송통신기자재)	이 기기는 업무용(A급) 전자파적합기기로서 판매자 또는 사용자는 이 점을 주의하시기 바라며, 가정외의 지역에서 사용하는 것을 목적으로 합니다.

#### ■ Precautionary note written in Korean

Distributors and users must understand that this product meets the electromagnetic compatibility requirements and is designed for industrial use (Class A).  
Do not use the product in a residential area.

#### ■ Applicant for KC mark : MITSUBISHI ELECTRIC AUTOMATION KOREA CO.,LTD

#### ■ Manufacturer : MITSUBISHI ELECTRIC CORPORATION

Note 1: This is the notification for the KC mark (Korea Certification)

## Table for measuring element code

The following table shows a list of measuring element codes used in the manual.

Measuring element code	Measuring element name
A1	Current, 1-phase
A2	Current, 2-phase
A3	Current, 3-phase
AN	Current, N-phase
A <sub>AVG</sub>	Current, average
DA1	Current demand, 1-phase
DA2	Current demand, 2-phase
DA3	Current demand, 3-phase
DAN	Current demand, N-phase
DA <sub>AVG</sub>	Current demand, average
V12	Voltage, between 1-2 lines
V23	Voltage, between 2-3 lines
V31	Voltage, between 3-1 lines
V <sub>AVG</sub> (L-L)	Voltage, average, line to line
V1N	Voltage, 1N-phase
V2N	Voltage, 2N-phase
V3N	Voltage, 3N-phase
V <sub>AVG</sub> (L-N)	Voltage, average, line to neutral
W1	Active power, 1-phase
W2	Active power, 2-phase
W3	Active power, 3-phase
ΣW	Active power, total
var1	Reactive power, 1-phase
var2	Reactive power, 2-phase
var3	Reactive power, 3-phase
Σvar	Reactive power, total
VA1	Apparent power, 1-phase
VA2	Apparent power, 2-phase
VA3	Apparent power, 3-phase
ΣVA	Apparent power, total
PF1	Power factor, 1-phase
PF2	Power factor, 2-phase
PF3	Power factor, 3-phase
ΣPF	Power factor, total
Hz	Frequency
Wh	Active energy
varh	Reactive energy
VAh	Apparent energy
DW	Rolling demand active power
Dvar	Rolling demand reactive power
DVA	Rolling demand apparent power
HI	Harmonic current
HI <sub>N</sub>	Harmonic current, N-phase
HV	Harmonic voltage
THDi	Harmonic current total distortion ratio
THDv	Harmonic voltage total distortion ratio
Aunb	Current unbalance rate
Vunb	Voltage unbalance rate
DI	Digital input
DO	Digital output

# 1. Name and Function of Each Section

## 1.1. Name of Each Part

### <The instrument>

#### ■ The front of the unit

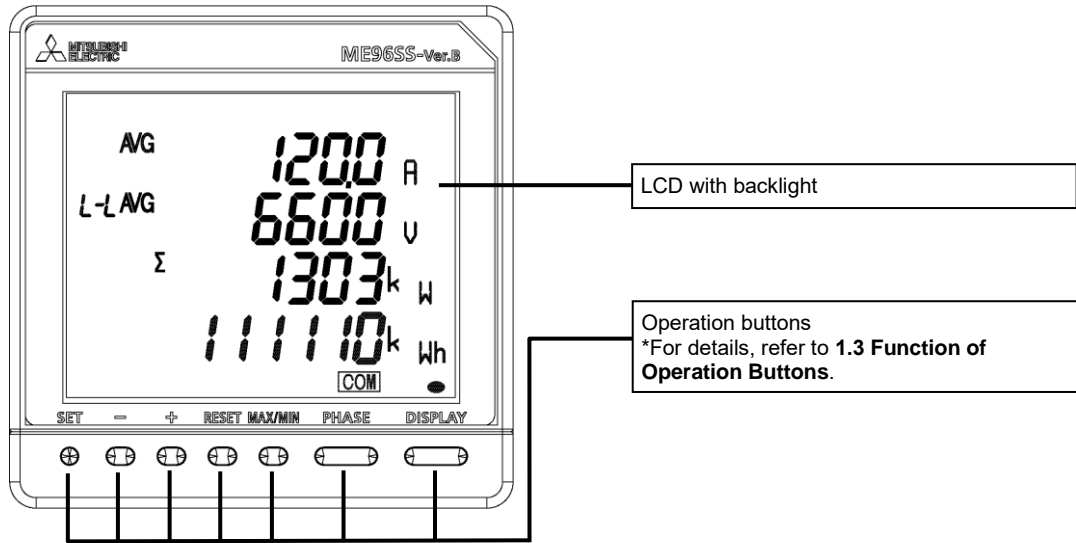

#### ■ The back of the unit

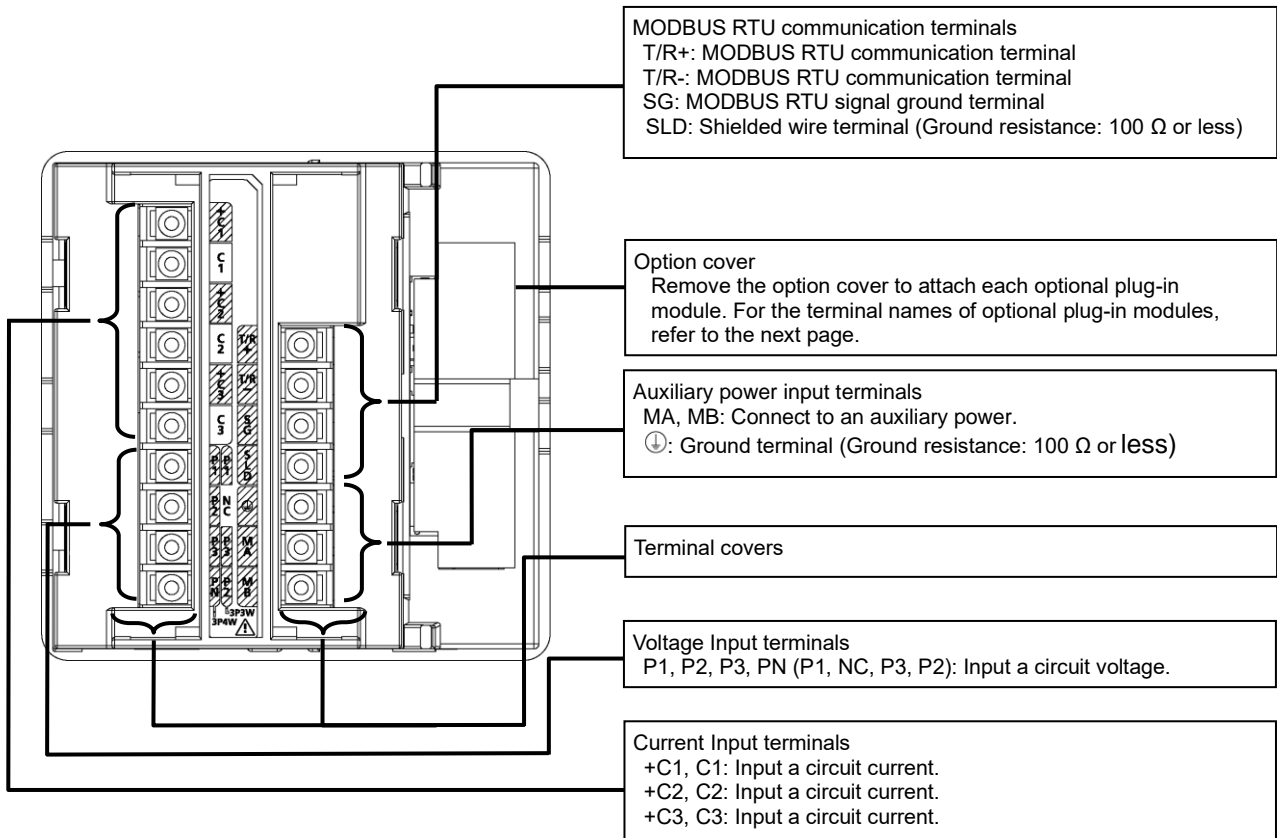

# 1. Name and Function of Each Section

## 1.1. Name of Each Part

### <The optional plug-in module>

■ The back view (Model type: ME-4210-SS96B, ME-0040C-SS96, ME-0052-SS96)

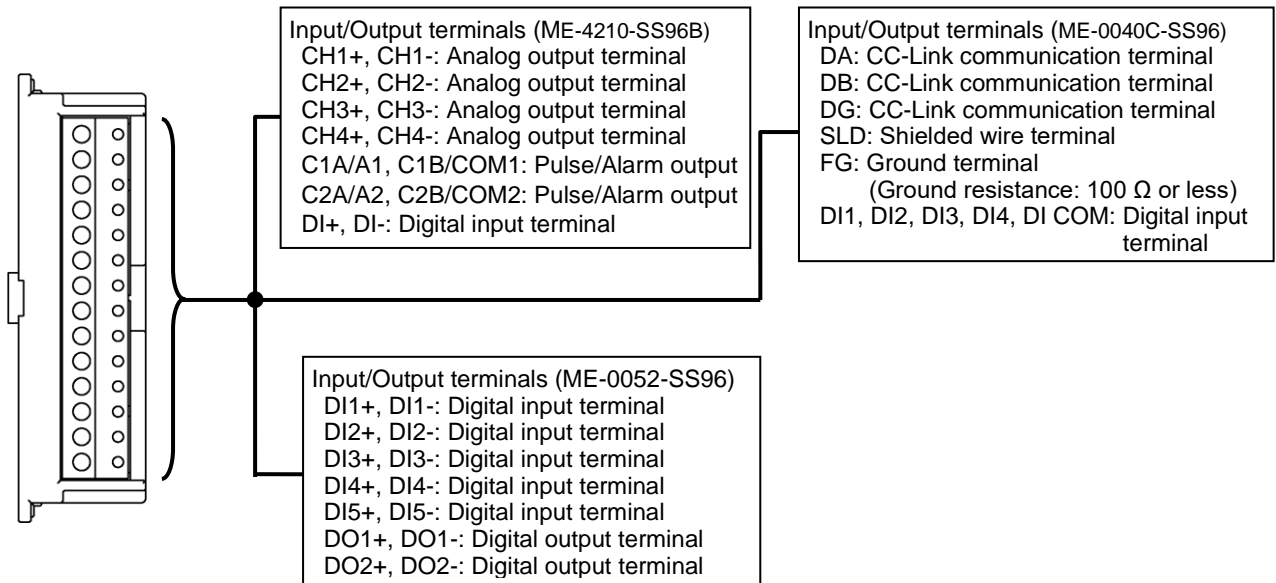

■ The side/back view ((Model type: ME-0000MT-SS96)

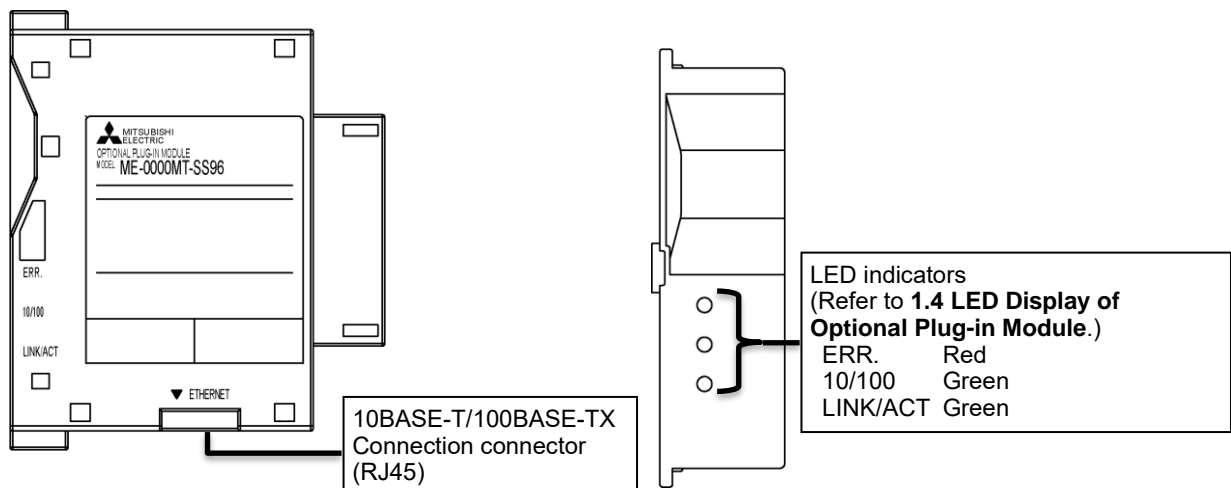

■ The side/back view (Model type: ME-0000BU-SS96)

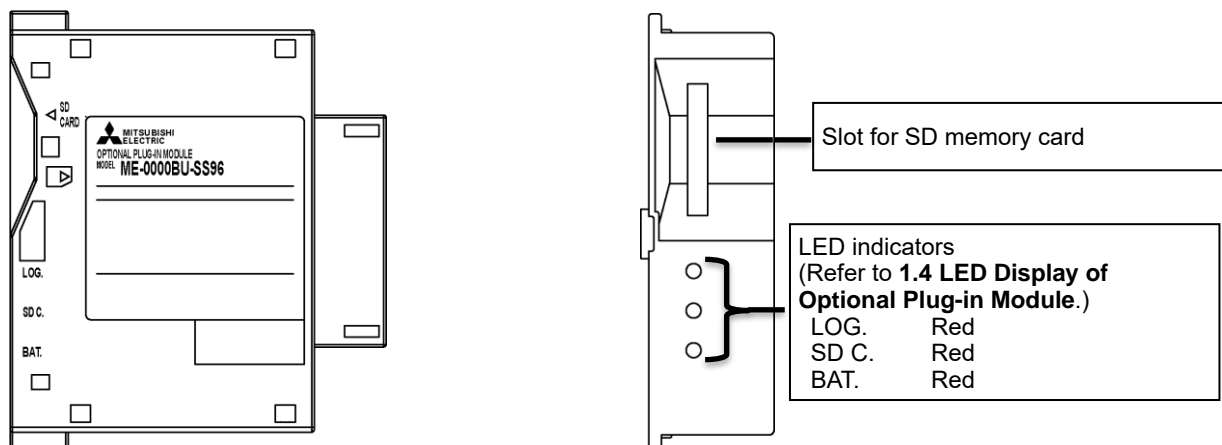

# 1. Name and Function of Each Section

## 1.1. Name of Each Part

■ The side/back view (Model type: ME-0000BU25-SS96)

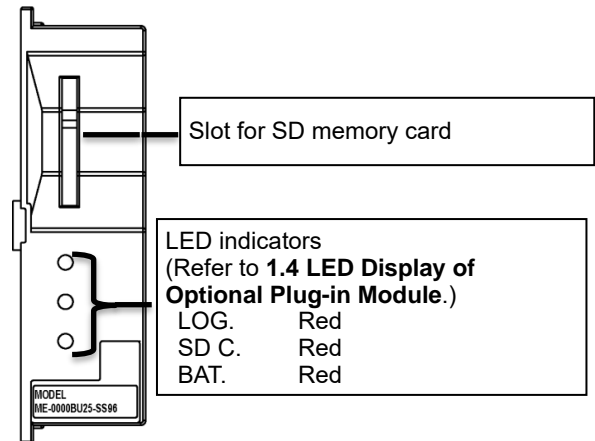
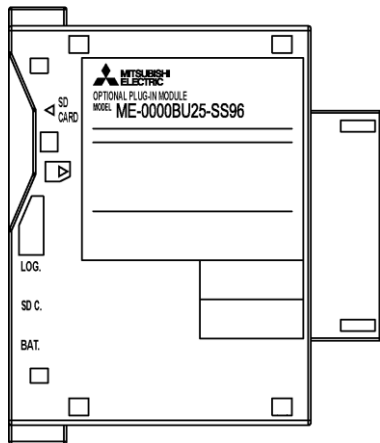

# 1. Name and Function of Each Section

## 1.2. LCD Function

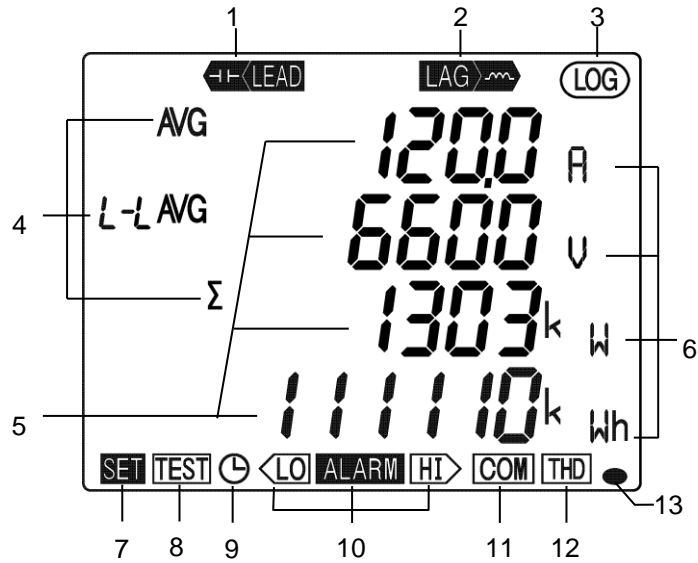

Note: The above display is an example for explanation.

No.	Name of each part	Function																
1	LEAD status	Light up on the reactive energy (imported lead)/ (exported lead) screen.																
2	LAG status	Light up on the reactive energy (imported lag)/ (exported lag) screen.																
3	Built-in logging status	Light up when the built-in logging function is operating																
4	Digital element display	Display measuring elements expressed in digital numbers																
5	Digital display	Display measured values in digital numbers																
6	Unit	Display the units of measured values																
7	Setup status	Light up in the setting mode Blink in the setting confirmation mode																
8	Test mode status	Light up in the test mode																
9	Clock status	Light up when the present time is set.																
10	Upper/lower limit alarm status	Blink when the upper/lower limit alarm is generating																
11	Communication/ Option logging status display	<table border="1"> <thead> <tr> <th>Specification</th> <th>ON</th> <th>Blink</th> <th>OFF</th> </tr> </thead> <tbody> <tr> <td>CC-Link communication</td> <td>Normal</td> <td>CC-Link version mismatches Hardware abnormality</td> <td>Hardware abnormality</td> </tr> <tr> <td>MODBUS RTU communication MODBUS TCP communication</td> <td>Normal</td> <td>Communication error such as wrong address*1</td> <td>Hardware abnormality</td> </tr> <tr> <td>Option logging function</td> <td>Normal</td> <td>Error occurrence such as setting abnormality, SD memory card error, or battery voltage drop *1</td> <td>Hardware abnormality</td> </tr> </tbody> </table> <p>*1. For details, refer to <b>6.5 Troubleshooting</b>.</p>	Specification	ON	Blink	OFF	CC-Link communication	Normal	CC-Link version mismatches Hardware abnormality	Hardware abnormality	MODBUS RTU communication MODBUS TCP communication	Normal	Communication error such as wrong address*1	Hardware abnormality	Option logging function	Normal	Error occurrence such as setting abnormality, SD memory card error, or battery voltage drop *1	Hardware abnormality
Specification	ON	Blink	OFF															
CC-Link communication	Normal	CC-Link version mismatches Hardware abnormality	Hardware abnormality															
MODBUS RTU communication MODBUS TCP communication	Normal	Communication error such as wrong address*1	Hardware abnormality															
Option logging function	Normal	Error occurrence such as setting abnormality, SD memory card error, or battery voltage drop *1	Hardware abnormality															
12	Harmonics	Light up when harmonic is displayed																
13	Metering status	Blink when Imported active energy is measured *Note 1 *It appears on the imported active energy display screen only																

Note 1: The blinking cycle is constant regardless of measuring input size.

# 1. Name and Function of Each Section

## 1.3. Function of Operation Buttons

The function of each operation button varies depending on how to press the button.

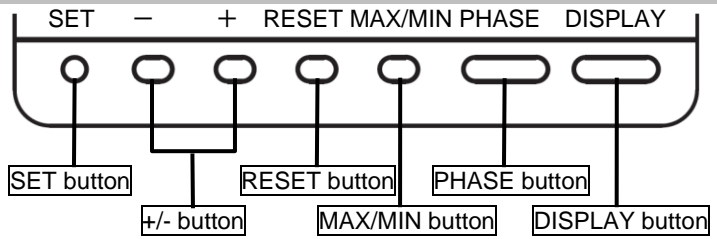

<Meaning of marks>

○: Press, □: Press for 1 second or more, ⊙: Press for 2 seconds or more, —: Press simultaneously

Operation Mode	Button name							Function				
	SET	-	+	RESET	MAX/MIN	PHASE	DISPLAY					
Operating mode	Display switching							○	Switch the measurement screen.			
			○	—					○	Switch the measurement screen in the reverse direction.		
								○		Switch phase display. Switch between the harmonic RMS value and distortion ratio. (Available on the harmonics display screen)		
						○				Enter/Exit the Max/Min value screen.		
			○	○						Switch the harmonic degree on the harmonics display screen.		
									⊙	Enter the cyclic display mode of measurement screen. Refer to 5.1.3.		
									⊙	Enter the cyclic display mode of phase. Refer to 5.1.3. Switch between the harmonic RMS value and distortion ratio screen in cyclic mode. (Available on the harmonics display)		
				⊙	⊙					Change the units of Wh, varh, and VAh or display the lower-digit enlarged view. Refer to 5.1.9.		
	Measured value clear/ Alarm reset				⊙					Clear the Max/Min values displayed on the screen. They are available on the Max/Min value screen.		
					⊙	⊙				Clear Max/Min values for every item in every screen.		
			⊙	—	⊙	—	⊙			Reset Wh, varh, and VAh to zero. All measured values are reset to zero simultaneously.		
					⊙	⊙				Reset periodic active energy to zero. (The periodic active energy displayed on the screen only)		
				⊙	⊙					Set the rolling demand time period on the rolling demand screen.		
					⊙	⊙				Clear the rolling demand peak value on the rolling demand screen.		
					⊙					Reset operating time to zero. (The operating time displayed on the screen only)		
					⊙	⊙				Reset CO <sub>2</sub> equivalent to zero on the CO <sub>2</sub> equivalent display.		
					○					Reset the alarm. (For the item displayed on the screen) They are available only when set to manual alarm cancellation.		
					⊙					Reset all alarms at once. (For every item in every screen)		
	Mode switch				○					Stop the backlight blinking caused by alarm. (Available only when set to backlight blinking)		
					⊙					Release the latch for digital input at once on the digital input screen.		
			⊙	—	⊙					Enter the setting mode.		
			⊙							Enter the setting confirmation mode.		
					⊙	—	⊙			Enter the password protection screen.		
		Setting operation/ Setting confirmation mode	Setting operation	○							Determine the settings and then shift to the next settings.	
										○	Return to the previous setting item.	
					○	○						Round up/down the setting value. (Pressing for 1 second or more enables fast forward.)
				□								Skip the settings and return to the setting menu screen.
				○								Reflect the setting change. (Available on the END screen)
○									Cancel the setting change. (Available on the CANCEL screen)			
Special operation						□	□			Restart the instrument. (Available on the CANCEL screen)		
				⊙	—	⊙			Initialize to the factory default settings. (Available on the CANCEL screen) Refer to 3.16.			



## 1. Name and Function of Each Section

### 1.3. Function of Operation Buttons

Note: During backlight off mode, pressing any operation button first turns on the backlight. In addition, pressing any button again enables the use of the functions in the above table.

 CAUTION	<ul style="list-style-type: none"><li>● When you execute a function such as 'Reset Max/Min value' or 'Reset Wh, varh, and VAh to zero', past data is deleted. If you need to keep the data, record the data before the reset operation.</li><li>● When you execute 'Restart the instrument', the entire measurement function (measurement display, communication) will stop for a few seconds.</li></ul>
---	--

# 1. Name and Function of Each Section

## 1.4. LED Display of Optional Plug-in Module

### ■ LED (ME-0000MT-SS96)

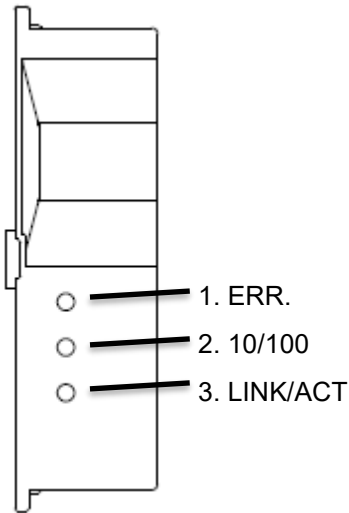

No.	Name	Function
1	ERR. LED	Indicate the communication status of ME-0000MT-SS96.
	OFF	Normal
	ON	The following MODBUS TCP communication errors occur: <ul style="list-style-type: none"> <li>• There is an abnormality in the MODBUS TCP application protocol head part.</li> <li>• LED becomes off when normal messages are received such as function code for serial.</li> </ul>
2	10/100 LED	Indicate transmission speed
	ON	100 Mbps or unconnected
	OFF	10 Mbps
3	LINK/ACT LED	Indicate the link status
	ON	The link is established.
	Blink	Blink when sending or receiving.
	OFF	The link is not established.

### ■ LED (ME-0000BU-SS96)

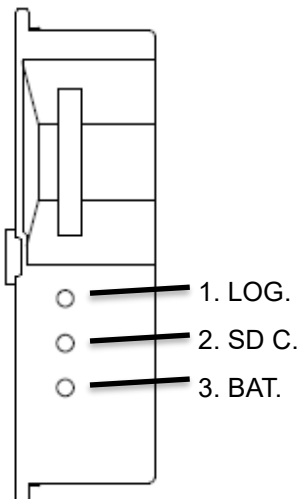

No.	Name	Function
1	LOG. LED	Indicate the logging operation status
	ON	Logging is operating.
	OFF	Logging operation stops
	Low-speed blinking (0.5 sec: on/ 0.5 sec: off)	The setting change of logging conditions has been completed. Blink for 5 seconds.
	High-speed blinking (0.25 sec: on/ 0.25 sec: off)	When the logging element pattern is LP00, the setting file in the SD memory card is abnormal. Continue blinking until it turns to normal.
2	SD C. LED	Indicate the communication status of SD memory card.
	ON	Communicating
	OFF	Communication stops
	High-speed blinking (0.25 sec: on/ 0.25 sec: :off)	It is a SD memory card error Check that the SD memory card is not in 'write protect' status and that there is available capacity.
3)	BAT. LED	Indicate the battery voltage status.
	OFF	Normal battery voltage
	ON	Battery voltage drop

# 1. Name and Function of Each Section

## 1.4. LED Display of Optional Plug-in Module

■ LED (ME-0000BU25-SS96)

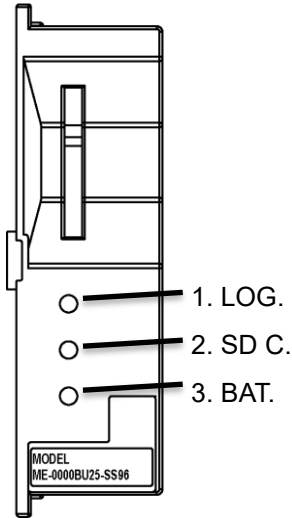

No.	Name	Function
1	LOG. LED	Indicate the logging operation status
	ON	Logging is operating.
	OFF	Logging operation stops
	Low-speed blinking (0.5 sec: on/ 0.5 sec: off)	The setting change of logging conditions has been completed. Blink for 5 seconds.
2	High-speed blinking (0.25 sec: on/ 0.25 sec: off)	When the logging element pattern is LP00, the setting file in the SD memory card is abnormal. Continue blinking until it turns to normal.
	SD C. LED	Indicate the communication status of SD memory card.
	ON	Communicating
	OFF	Communication stops
3)	High-speed blinking (0.25 sec: on/ 0.25 sec: :off)	It is a SD memory card error Check that the SD memory card is not in 'write protect' status and that there is available capacity.
	BAT. LED	Indicate the battery voltage status.
	OFF	Normal battery voltage
	ON	Battery voltage drop



### 3. How to Set up

#### 3.1. Setting Flow

For measurement, you must set settings such as phase wire system, VT/Direct voltage, and CT primary current in the setting mode.

From the operating mode, enter the setting mode and then set necessary items. Any items not set remain in the factory default.

For normal use, you can use the instrument by completing the settings in the setting menu 1 only. For details on the settings, refer to **3.2 Setting Menu 1: Basic Setup (Settings for Phase Wire System, Display Pattern, VT/Direct Voltage, and CT Primary Current)**.

For details on the factory default settings, refer to **8.7**.

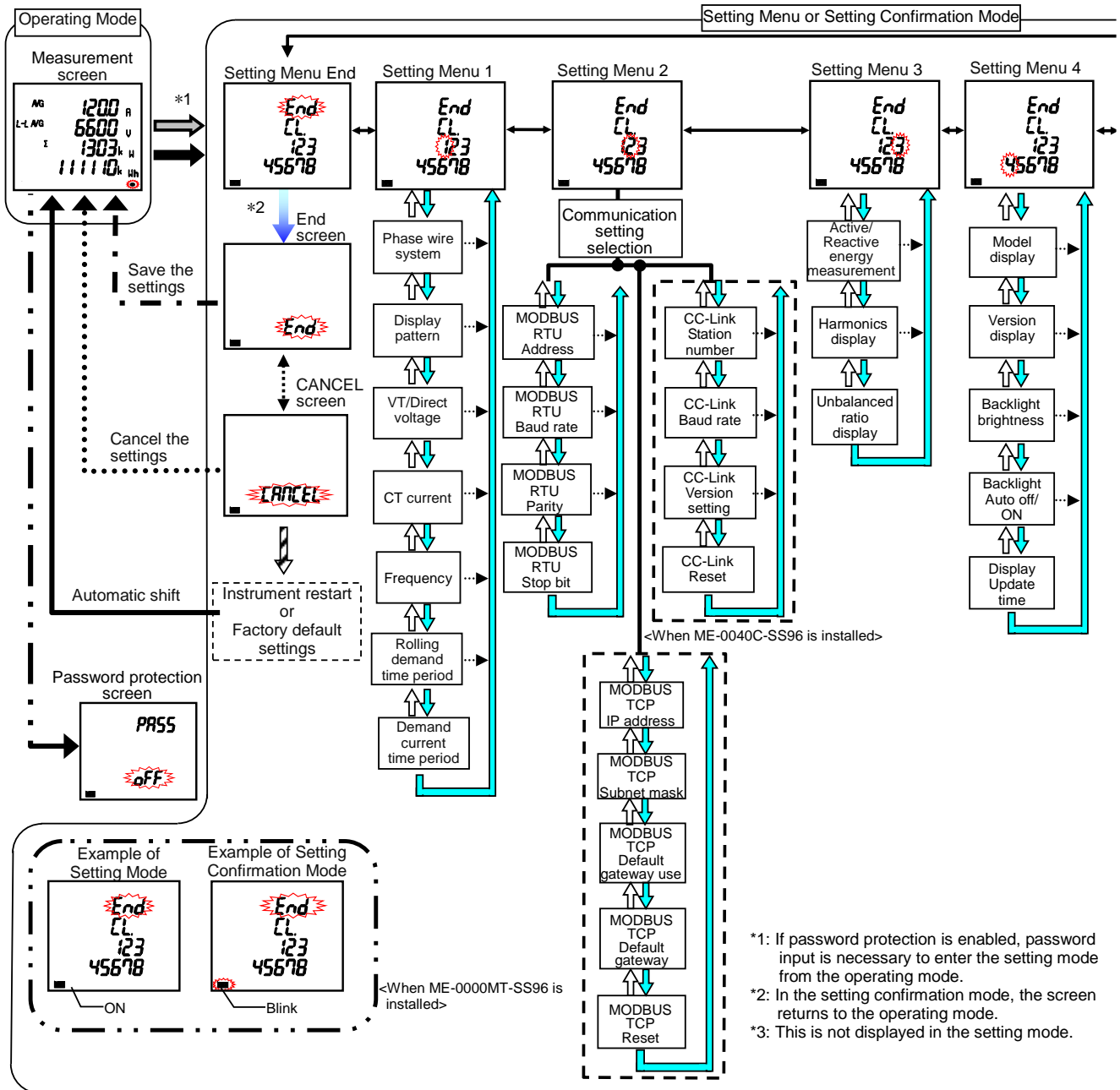

**CAUTION** When you change a setting, the related setting items and measured data will be initialized. Therefore, check that beforehand. For details on the initialization, refer to **3.16 Initialization of Related Items by Changing a Setting**.

### 3. How to Set up

#### 3.1. Setting Flow

##### <Setting Procedure>

- ① Press the (SET) and (RESET) buttons simultaneously for 2 seconds to enter the setting mode.
- ② Select the setting menu number with the (+) or (-) button.
- ③ Press the (SET) button to determine the setting menu number.
- ④ Set each setting item. (Refer to 3.2 to 3.14.)
- ⑤ After completing all the settings, select **End** in the setting menu and then press the (SET) button.
- ⑥ When the **End** screen appears, press the (SET) button again.

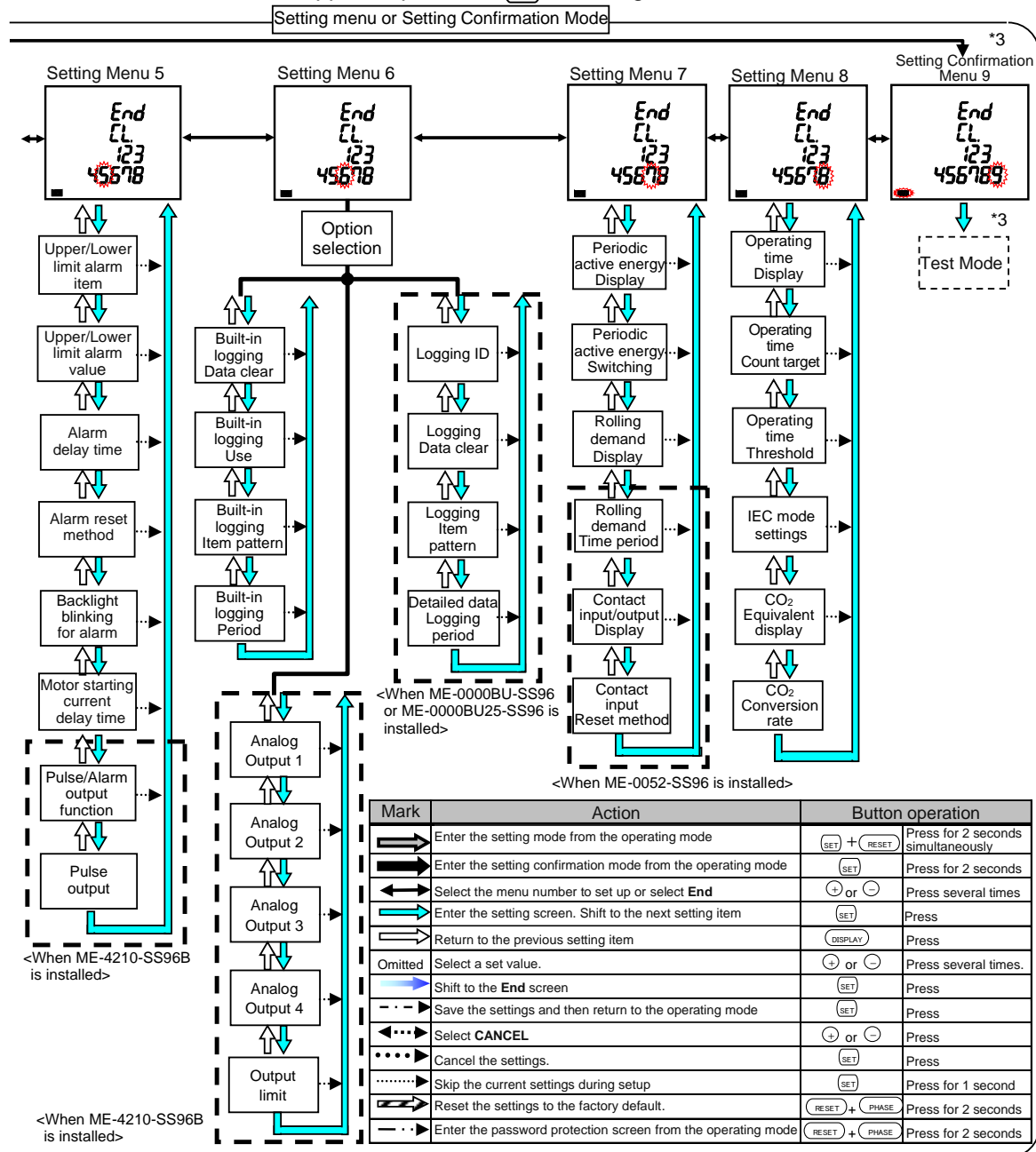

#### ■ Basic operation for settings

The following table shows a list of basic operations for settings.

Function	Operation	Note
Select a setting	Press (+) or (-) button	Fast-forward by pressing for 1 second or more
Determine a setting	Press (SET) button	When the setting is determined, the screen switches to the next setting item.
Return to the previous setting item	Press (DISPLAY) button	The setting before return is enabled.
Return to the setting menu during setup	Press (SET) button for 1 second	







### 3. How to Set up

#### 3.2 Setting Menu 1: Basic Setup (Settings for Phase Wire System, Display Pattern, VT/Direct Voltage, and CT Primary Current)

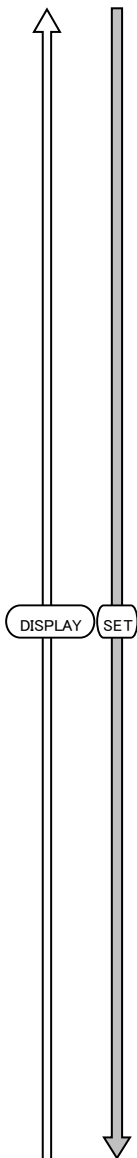

Continued from the previous page.

(2) For measurement with VT

<Secondary voltage setting>

(a) When set to 3-phase 4-wire system (Phase voltage)

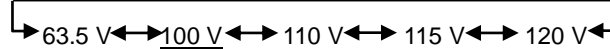

(b) When set to 3-phase 3-wire (2CT, 3CT) /1-phase 2-wire system (Line voltage)

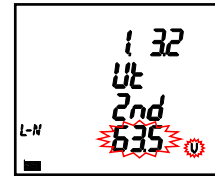

<Primary voltage setting>

The factory default settings:

- For 3-phase 4-wire system ⇒ 200 V (Phase voltage)
- For 3-phase 3-wire/1-phase 2-wire system ⇒ 10000 V (Line voltage)

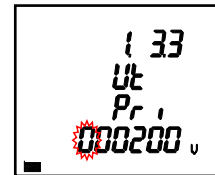

- From the upper digit, set the blinking digit with (+) or (-).
- By pressing (SET), move the setting item, blinking one, to a lower digit.
- By pressing (DISPLAY), move the setting item, blinking one, to an upper digit.
- The setting ranges from 60 V to 750000 V. The setting unit is V.  
\*If you set out of range, the error message (E05) will appear.  
If the error message appears, press (SET) and then review the setting to set it again.
- By pressing (SET) at the lowest digit, shift to the next setting item.

Set the settings for CT.

You will set the primary and secondary current of CT.

<Secondary current setting>

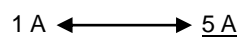

Note: CT is Current Transformer.

<Primary current setting>

The factory default setting: 5.0 A

- From the upper digit, set the blinking digit with (+) or (-).
- By pressing (SET), move the setting item, blinking one, to a lower digit.
- By pressing (DISPLAY), move the setting item, blinking one, to an upper digit.
- The setting ranges from 1.0 A to 30000.0 A. The setting unit is A.  
\*If you set out of range, the error message (E05) will appear.  
If the error message appears, press (SET) and then review the setting to set it again.
- By pressing (SET) at the lowest digit, shift to the next setting item.

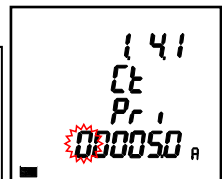
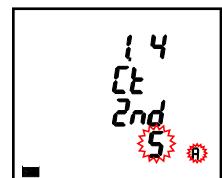

④CT current

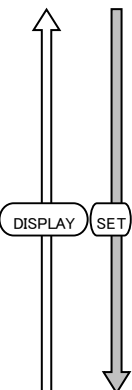

Set the frequency.



⑤Frequency

### 3. How to Set up

#### 3.2 Setting Menu 1: Basic Setup (Settings for Phase Wire System, Display Pattern, VT/Direct Voltage, and CT Primary Current)

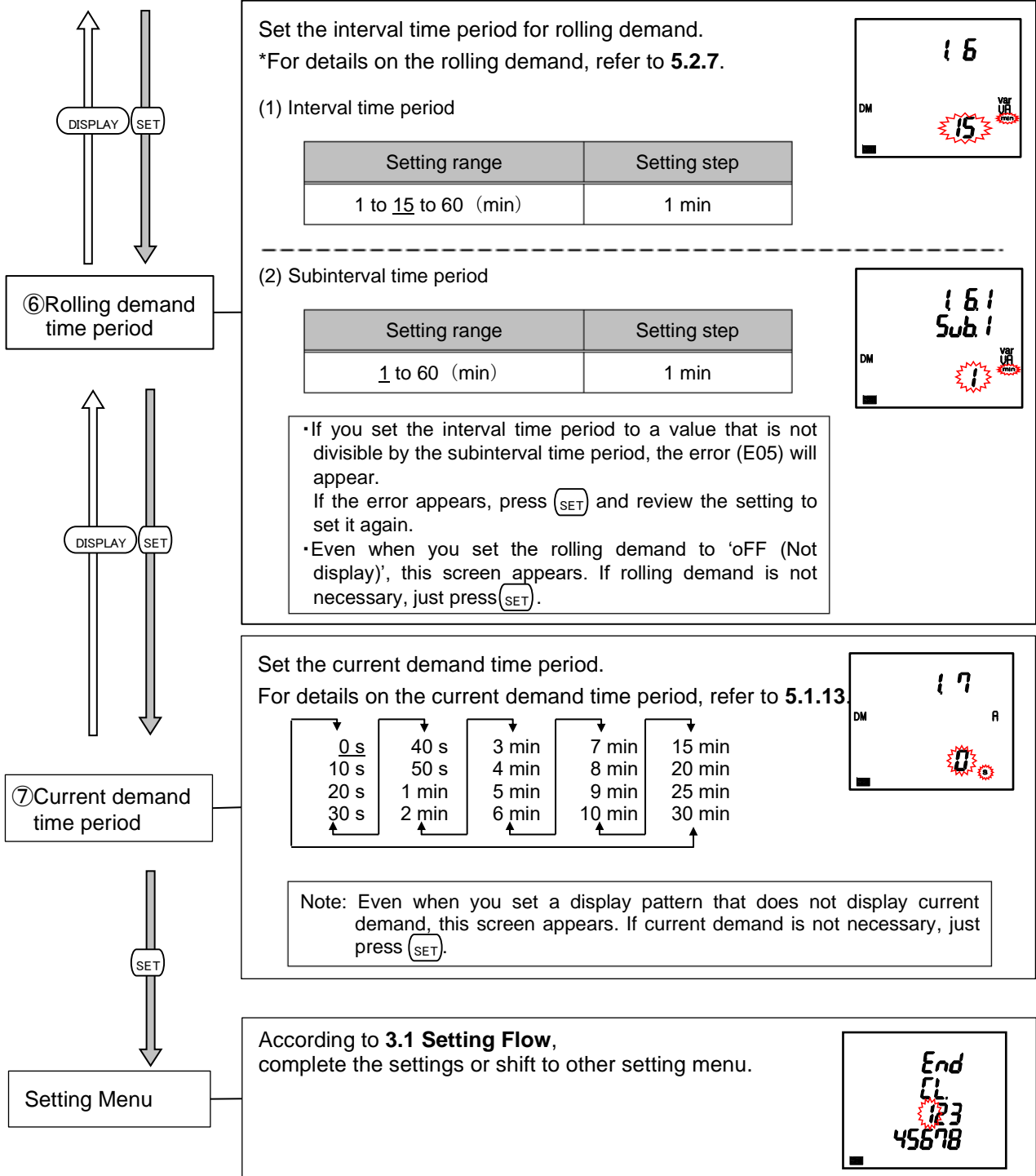

If you set the settings only in the setting menu 1 to use, move to **5 Operation**.  
If you use an additional function, set it in the setting menu 2 to 8.

<b>Note</b>	<p>If you change a setting in the setting menu 1, the maximum and minimum values of the related measuring elements will be reset. However, active/reactive/apparent energy value will not be reset.</p> <p>For details, refer to <b>3.16 Initialization of Related Items by Changing a Setting</b>.</p>
-------------	---

### 3. How to Set up

#### 3.3. Setting Menu 2: Communication Settings (MODBUS RTU Communication Settings)

<The installation conditions for optional plug-in module>  
No installation

In the operating mode, press (SET) and (RESET) simultaneously for 2 seconds or more to enter the following operation.

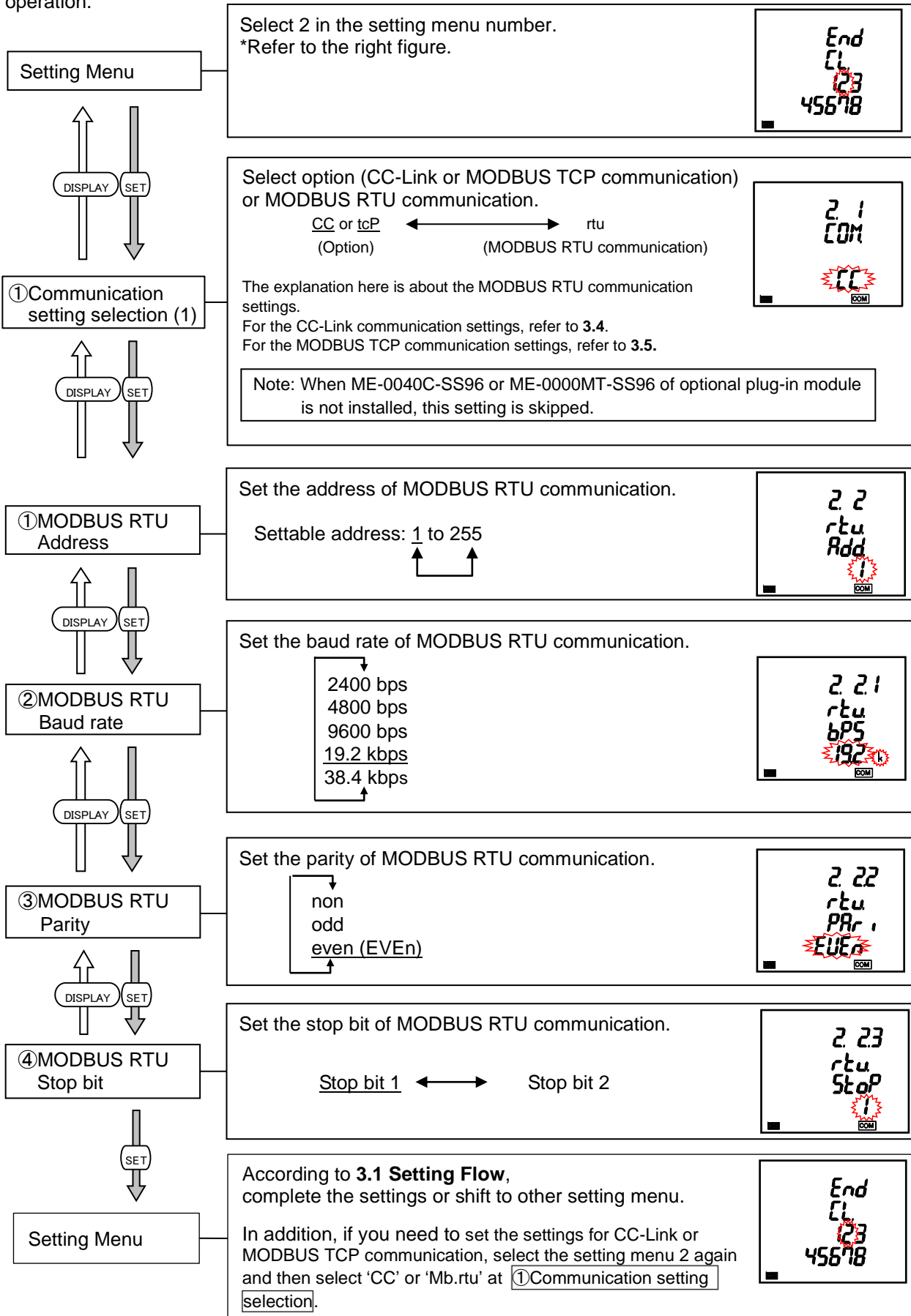

### 3. How to Set up

#### 3.4. Setting Menu 2: Communication Settings (CC-Link Communication Settings)

<The installation conditions for optional plug-in module>  
ME-0040C-SS96 installation

In the operating mode, press **SET** and **RESET** simultaneously for 2 seconds or more to enter the following operation.

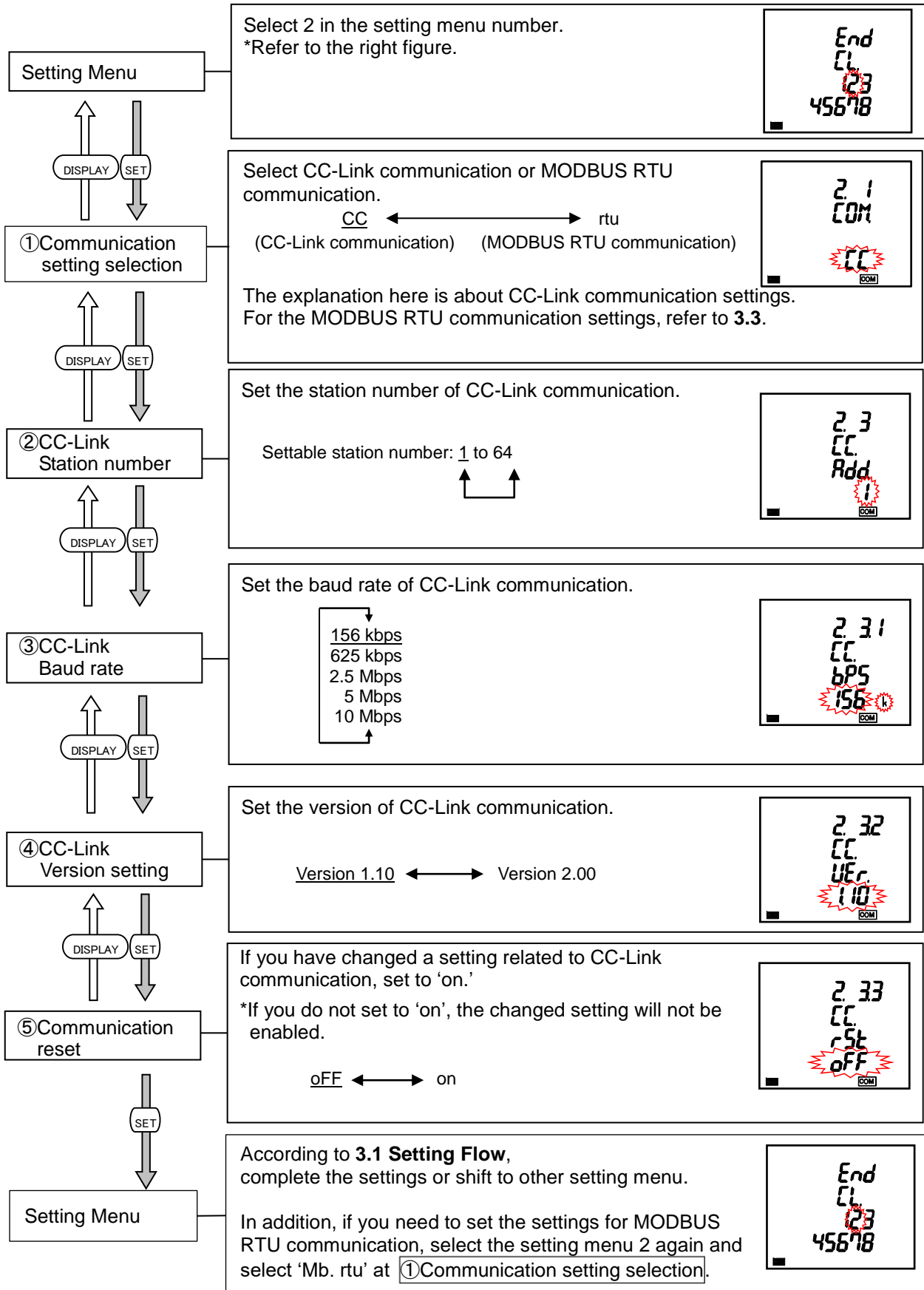

### 3. How to Set up

#### 3.5. Setting Menu 2: Communication Settings (MODBUS TCP Communication Settings)

<The installation conditions for optional plug-in module>  
ME-0000MT-SS96 installation

In the operating mode, press (SET) and (RESET) simultaneously for 2 seconds or more to enter the following operation.

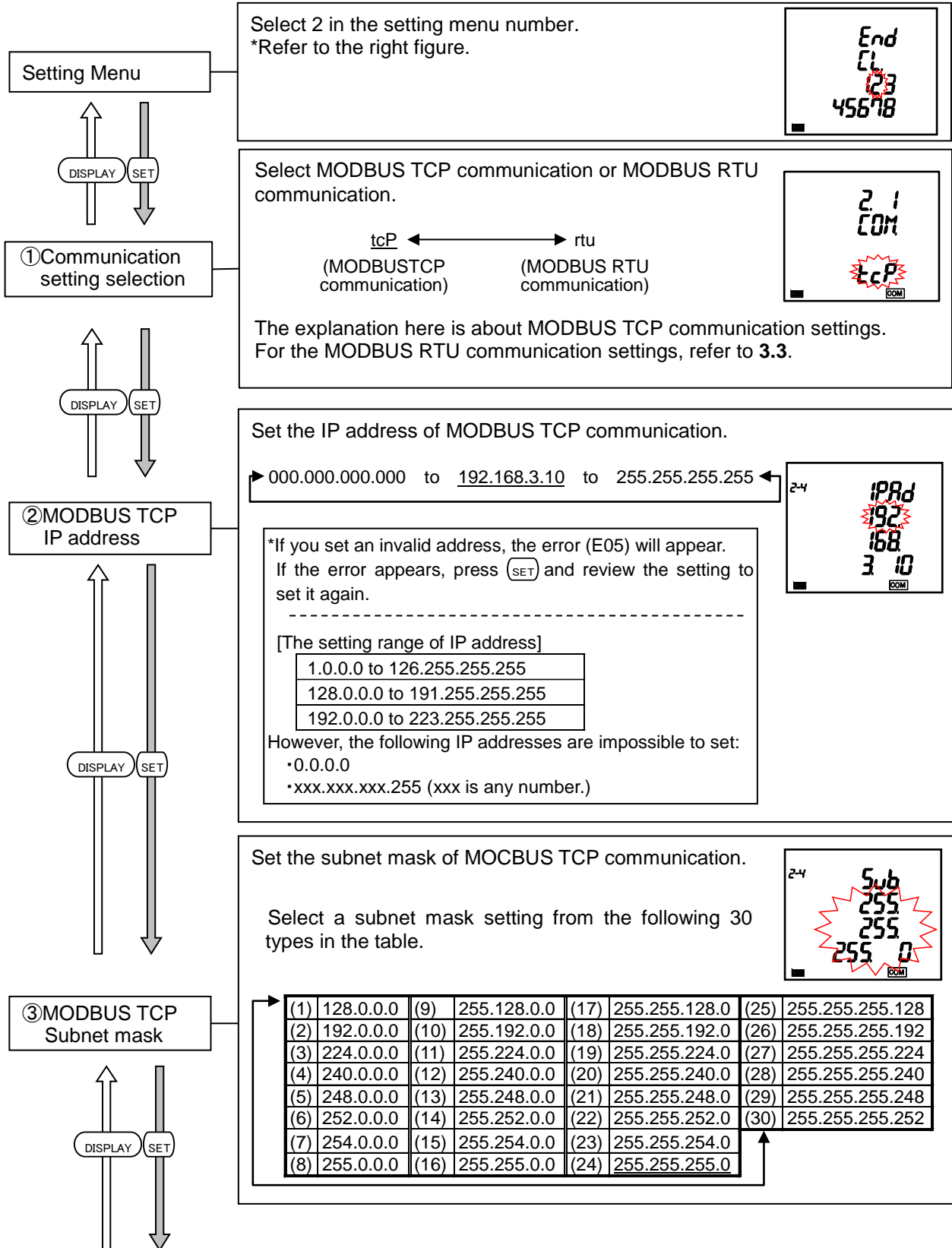

### 3. How to Set up

#### 3.5. Setting Menu 2: Communication Settings (MODBUS TCP Communication Settings)

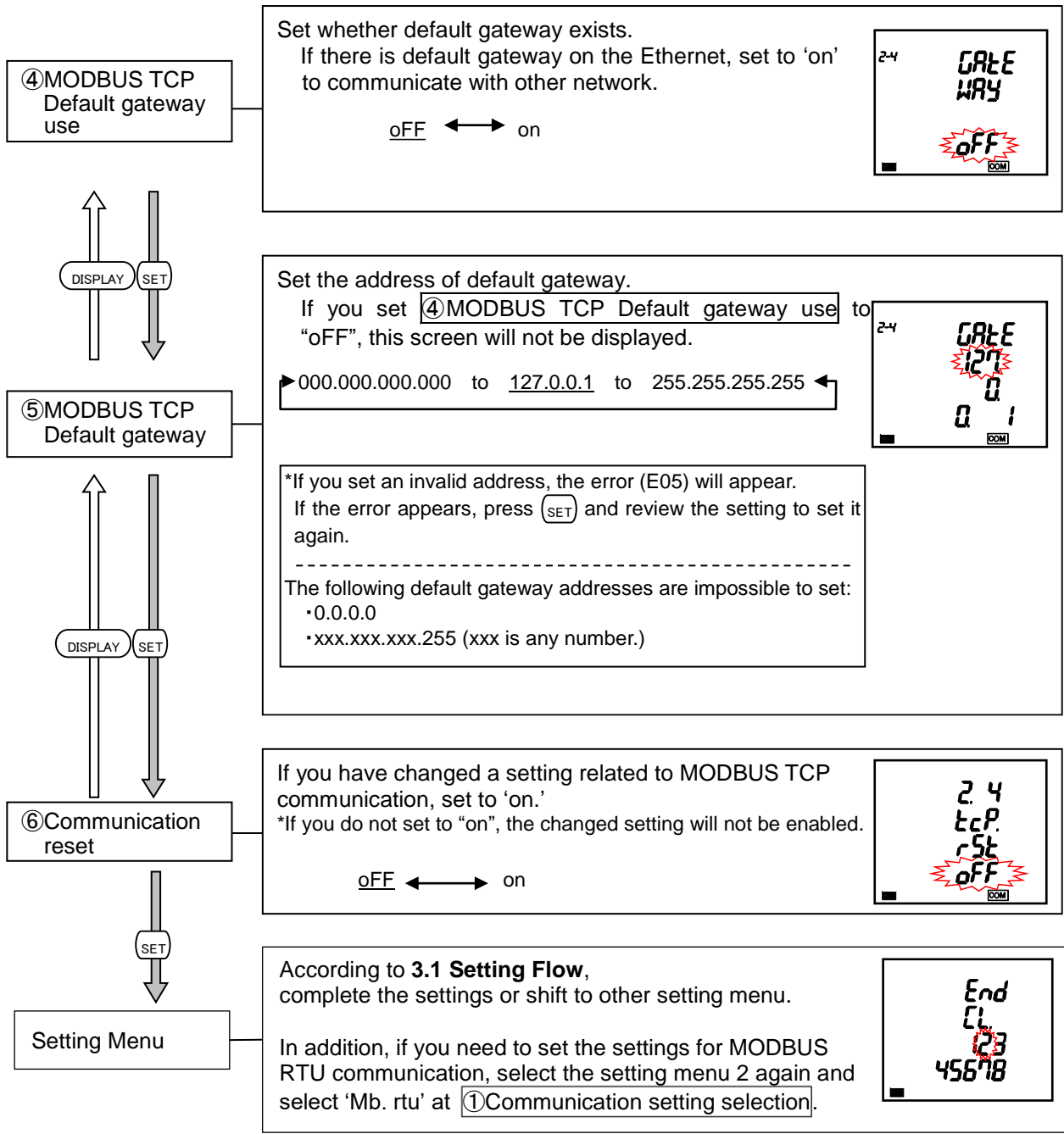

### 3. How to Set up

#### 3.6. Setting Menu 3: Display Settings (Settings for Active/Reactive Energy and Harmonic Measurement)

This section describes how to set the special measurement of active/reactive energy and harmonic display. In the operating mode, press **SET** and **RESET** simultaneously for 2 seconds or more to enter the following operation.

Setting Menu

↑

↓

DISPLAY

SET

① Active/Reactive Energy measurement

↑

↓

DISPLAY

SET

② Harmonics display

↑

↓

Select 3 in the setting menu number.  
\*Refer to the right figure.

Set the display combination of active energy and reactive energy (imported/exported, lag/lead) and the measurement method of reactive energy.

Combination (Setting)	Active energy (Wh)		Reactive energy (varh)				Reactive energy measurement method
	Imported	Exported	Imported lag	Imported lead	Exported lag	Exported lead	
I	○		○				2 quadrant measurement
II	○		○	○			
III	○	○	○		○		4 quadrant measurement
IV	○	○	○	○	○	○	

Note: For details on how to measure reactive energy, refer to 5.1.11.

Combination I, II ⇒ They are suitable for measuring systems without a private power generator or measuring reactive power of capacitor load where power factor is around zero generally.

Combination III, IV ⇒ They are suitable for measuring systems with a private power generator.

<Display examples>

Combination I

Combination II

Combination III

Combination IV

in Imported out Exported LEAD varh (lead) LAG varh (lag)

When 'Wh' or 'varh' is selected in the display pattern of P00, it is displayed.

Set the harmonic display.

on ←→ off  
(Display) (Not display)

When you set to 'on (Display)', harmonic measured values are displayed on the additional screen of display pattern.

### 3. How to Set up

#### 3.6 Setting Menu 3: Display Settings (Settings for Active/Reactive Energy and Harmonic Measurement)

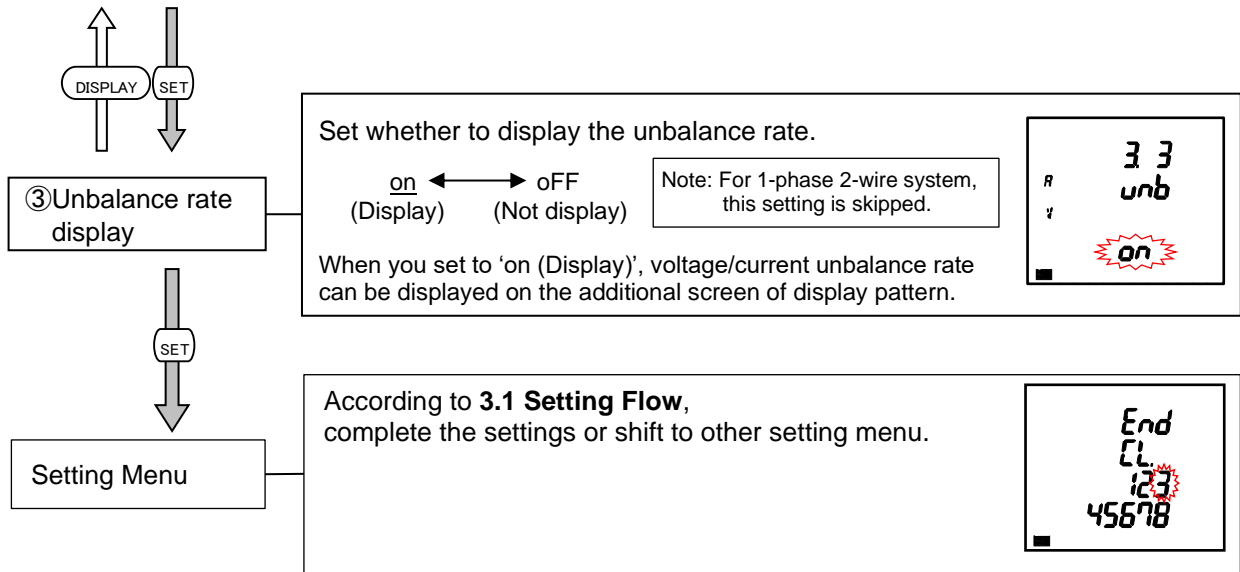

<b>Note</b>	<p>Even when you select a display pattern that does not display active/reactive power or active/reactive energy, the setting items of <b>⑥ Active/Reactive energy measurement</b> are displayed because the symbol can be displayed as appropriate for 2 quadrant/4 quadrant measurement of reactive power/power factor according to the settings of <b>⑥ Active/Reactive energy measurement</b>.</p>
-------------	---



### 3. How to Set up

#### 3.7. Setting Menu 4: LCD Settings (Settings for Model Display, Version Display, Backlight, and Display Update Time)

This section describes how to check the model and set the backlight and display update time functions. These settings are not necessary for normal use.

In the operating mode, press (SET) and (RESET) simultaneously for 2 seconds or more to enter the following operation.

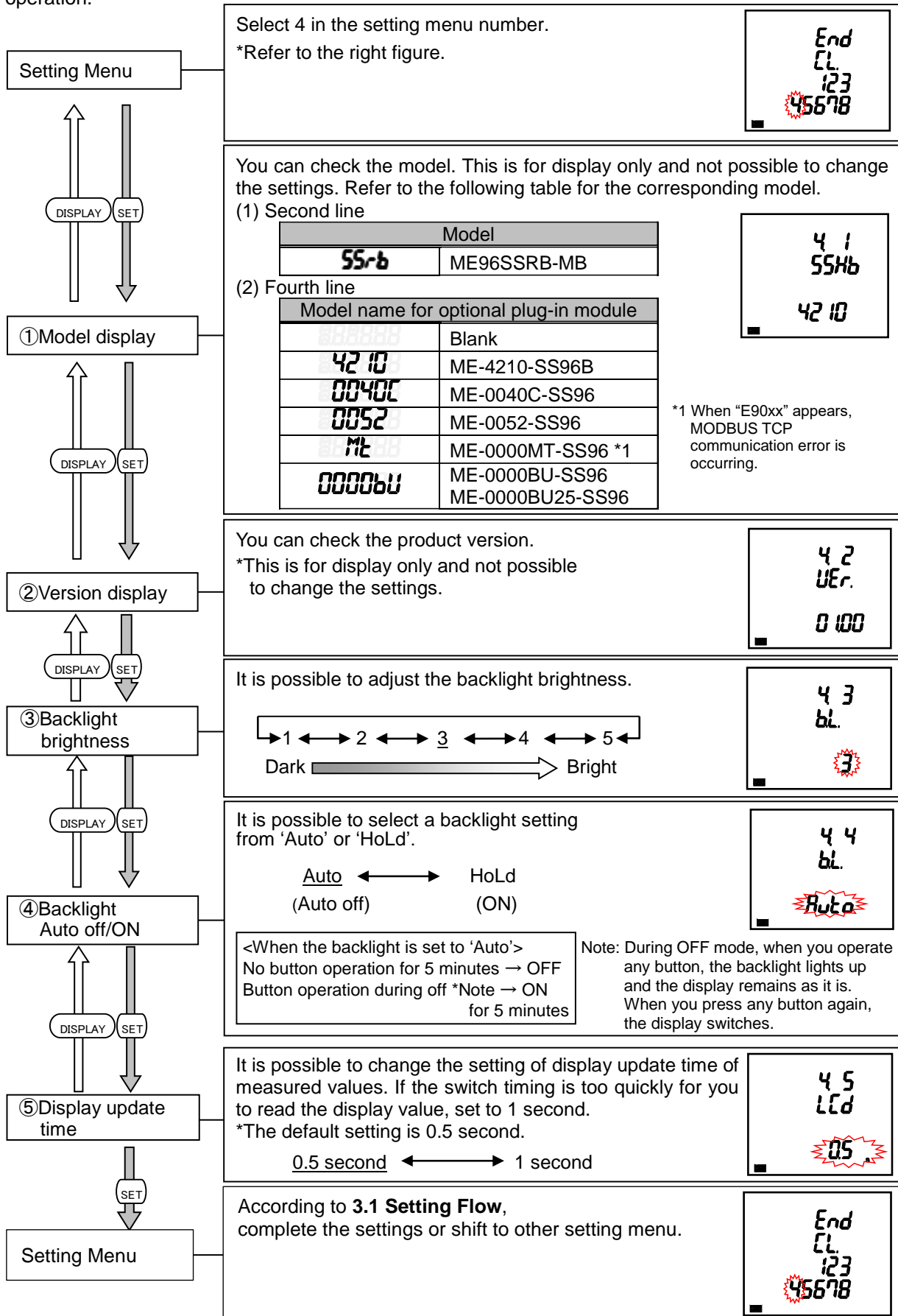

### 3. How to Set up

#### 3.8. Setting Menu 5: Pulse/Alarm Settings (Settings for Upper/Lower Limit Alarm, Motor Starting Current Mask Function, and Pulse Output)

This section describes how to set the upper/lower limit alarm, backlight blinking during alarm, motor starting current, pulse output, and alarm output.

In the operating mode, press **SET** and **RESET** simultaneously for 2 seconds or more to enter the following operation.

For details about each function, refer to the following:

- Upper/lower limit alarm → See 5.2.1 to 5.2.3.
- Motor starting current → See 5.2.17.

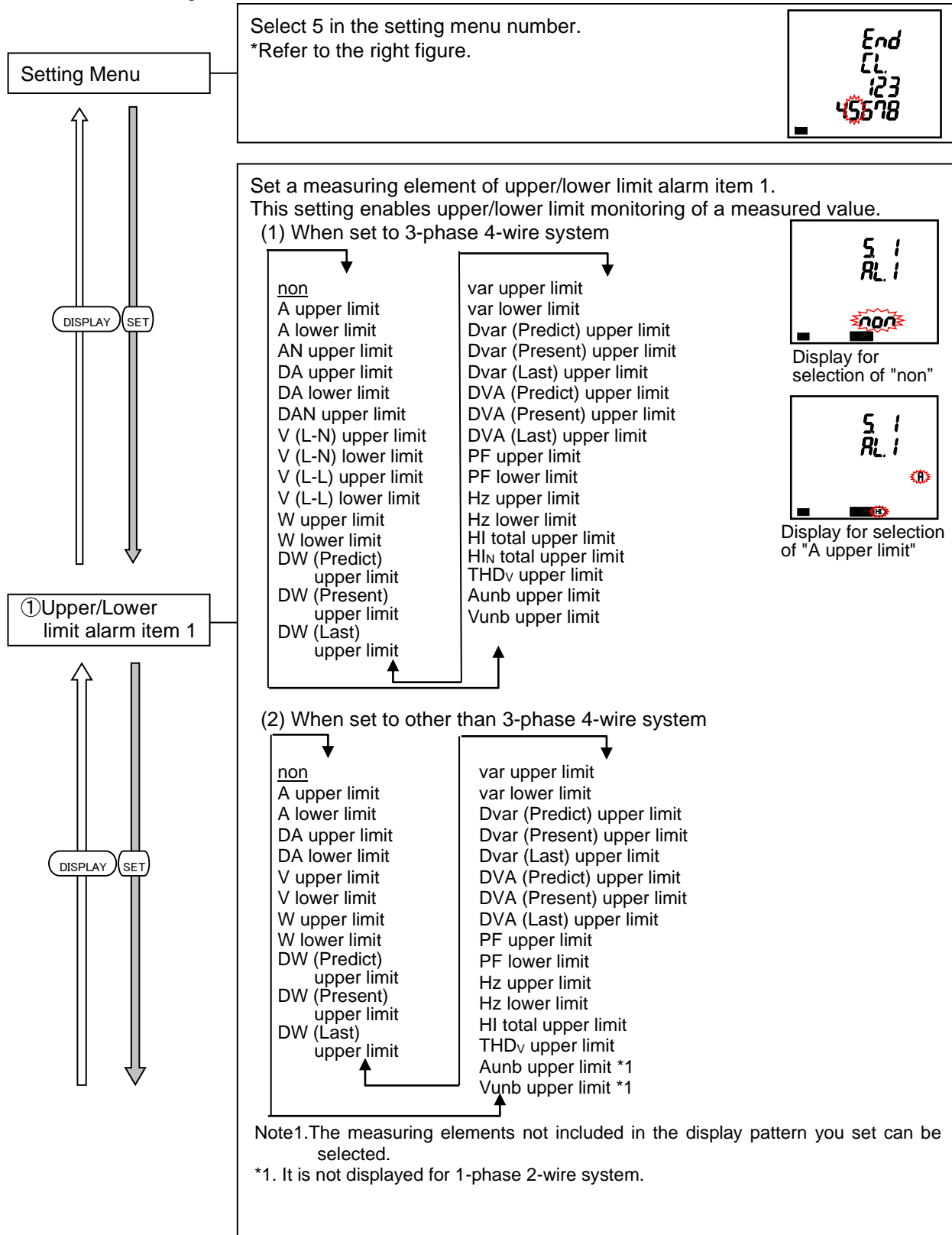

### 3. How to Set up

#### 3.8 Setting Menu 5: Pulse/Alarm Settings (Settings for Upper/Lower Limit Alarm, Motor Starting Current Mask Function, and Pulse Output)

Set the alarm value of upper/lower limit alarm item 1.

The following table shows the setting range.

Measuring element	Setting range	Setting Step *
A, AN, DA, DAN upper limit	5 to 100 to 120 (%)	1%
A, DA lower limit	3 to 10 to 95 (%)	1%
V (L-N), V (L-L) upper limit	25 to 110 to 135 (%)	1%
V (L-N), V (L-L) lower limit	20 to 70 to 95 (%)	1%
W, var upper limit	-95 to 100 to 120 (%)	1%
W, var lower limit	-120 to 3 to 95 (%)	1%
DW, Dvar, DVA upper limit	5 to 100 to 120 (%)	1%
PF upper limit	-0.05 to 1 to 0.05	0.05
PF lower limit	-0.05 to -0.5 to 0.05	0.05
Hz upper limit	45 to 65 (Hz)	1Hz
Hz lower limit	45 to 65 (Hz)	1Hz
HI total upper limit	1 to 35 to 120 (%)	1%
HI <sub>N</sub> total upper limit	1 to 35 to 120 (%)	1%
THD <sub>V</sub> upper limit	0.5 to 3.5 to 20.0 (%)	0.5%
Aunb upper limit	1 to 30 to 99 (%)	1%
Vunb upper limit	1 to 3 to 99 (%)	1%

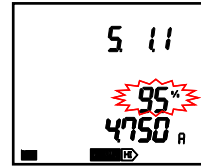

② Upper/Lower limit alarm value 1

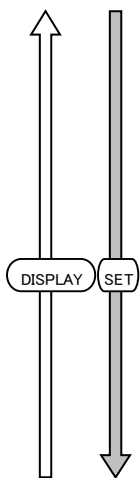

\*Note: W, var, DW, Dvar, and DVA show the percentage ratio of a standard value. For details on how to calculate the standard value, refer to 6.2 Standard Value.

A, AN, DA, DAN, HI total RMS value, and HI<sub>N</sub> total RMS value show the percentage ratio of the CT primary current setting.

V shows the percentage ratio of the VT primary voltage (or direct voltage).

\*For 1-phase 3-wire system, V shows the percentage ratio of the phase voltage. For 12-phase or 31-phase, alarm monitoring is executed based on twice the set upper/lower limit alarm value.

③ Upper/Lower limit alarm item 2 to 4

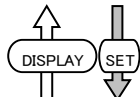

Set a measuring element of each of upper/lower limit alarm item 2 to 4. The item you have already selected is not available repeatedly.

The setting method is the same as ① Upper/Lower limit alarm item 1.

④ Upper/Lower limit alarm value 2 to 4

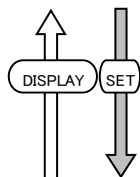

Set the alarm value of each of upper/lower limit alarm item 2 to 4.

The setting method is the same as ② Upper/Lower limit alarm value 1.

⑤ Alarm delay time

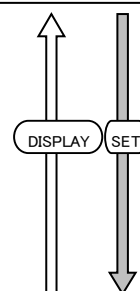

Set the alarm delay time if you want to prevent an alarm caused by momentary overload or noise.

If you set this setting, an alarm will occur only when the upper/lower limit alarm value is exceeded and the situation continues for a period of alarm delay time.

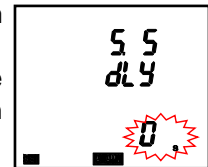

0 s	30 s	2 min
5 s	40 s	3 min
10 s	50 s	4 min
20 s	1 min	5 min

Note: When ① Upper/Lower limit alarm item 1 and ③ Upper/Lower limit alarm item 2 to 4 are all set to "non", this setting is skipped.

### 3. How to Set up

#### 3.8 Setting Menu 5: Pulse/Alarm Settings (Settings for Upper/Lower Limit Alarm, Motor Starting Current Mask Function, and Pulse Output)

⑥ Alarm reset method

↑

DISPLAY

↓

SET

↓

⑦ Backlight blinking for alarm

↑

DISPLAY

↓

SET

↓

⑧ Motor starting current delay time

↑

DISPLAY

↓

SET

↓

↑

DISPLAY

↓

SET

↓

↑

DISPLAY

↓

SET

↓

↑

DISPLAY

↓

SET

↓

↑

DISPLAY

↓

SET

↓

↑

DISPLAY

↓

SET

↓

↑

DISPLAY

↓

SET

↓

↑

DISPLAY

↓

SET

↓

↑

DISPLAY

↓

SET

↓

↑

DISPLAY

↓

SET

↓

↑

DISPLAY

↓

SET

↓

↑

DISPLAY

↓

SET

↓

↑

DISPLAY

↓

SET

↓

↑

DISPLAY

↓

SET

↓

↑

DISPLAY

↓

SET

↓

↑

DISPLAY

↓

SET

↓

↑

DISPLAY

↓

SET

↓

↑

DISPLAY

↓

SET

↓

↑

DISPLAY

↓

SET

↓

↑

DISPLAY

↓

SET

↓

↑

DISPLAY

↓

SET

↓

↑

DISPLAY

↓

SET

↓

↑

DISPLAY

↓

SET

↓

↑

DISPLAY

↓

SET

↓

↑

DISPLAY

↓

SET

↓

↑

DISPLAY

↓

SET

↓

↑

DISPLAY

↓

SET

↓

↑

DISPLAY

↓

SET

↓

↑

DISPLAY

↓

SET

↓

↑

DISPLAY

↓

SET

↓

↑

DISPLAY

↓

SET

↓

↑

DISPLAY

↓

SET

↓

↑

DISPLAY

↓

SET

↓

↑

DISPLAY

↓

SET

↓

↑

DISPLAY

↓

SET

↓

↑

DISPLAY

↓

SET

↓

↑

DISPLAY

↓

SET

↓

↑

DISPLAY

↓

SET

↓

↑

DISPLAY

↓

SET

↓

↑

DISPLAY

↓

SET

↓

↑

DISPLAY

↓

SET

↓

↑

DISPLAY

↓

SET

↓

↑

DISPLAY

↓

SET

↓

↑

DISPLAY

↓

SET

↓

↑

DISPLAY

↓

SET

↓

↑

DISPLAY

↓

SET

↓

↑

DISPLAY

↓

SET

↓

↑

DISPLAY

↓

SET

↓

↑

DISPLAY

↓

SET

↓

↑

DISPLAY

↓

SET

↓

↑

DISPLAY

↓

SET

↓

↑

DISPLAY

↓

SET

↓

↑

DISPLAY

↓

SET

↓

↑

DISPLAY

↓

SET

↓

↑

DISPLAY

↓

SET

↓

↑

DISPLAY

↓

SET

↓

↑

DISPLAY

↓

SET

↓

↑

DISPLAY

↓

SET

↓

↑

DISPLAY

↓

SET

↓

↑

DISPLAY

↓

SET

↓

↑

DISPLAY

↓

SET

↓

↑

DISPLAY

↓

SET

↓

↑

DISPLAY

↓

SET

↓

↑

DISPLAY

↓

SET

↓

↑

DISPLAY

↓

SET

↓

↑

DISPLAY

↓

SET

↓

↑

DISPLAY

↓

SET

↓

↑

DISPLAY

↓

SET

↓

↑

DISPLAY

↓

SET

↓

↑

DISPLAY

↓

SET

↓

↑

DISPLAY

↓

SET

↓

↑

DISPLAY

↓

SET

↓

↑

DISPLAY

↓

SET

↓

↑

DISPLAY

↓

SET

↓

↑

DISPLAY

↓

SET

↓

↑

DISPLAY

↓

SET

↓

↑

DISPLAY

↓

SET

↓

↑

DISPLAY

↓

SET

↓

↑

DISPLAY

↓

SET

↓

↑

DISPLAY

↓

SET

↓

↑

DISPLAY

↓

SET

↓

↑

DISPLAY

↓

SET

↓

↑

DISPLAY

↓

SET

↓

↑

DISPLAY

↓

SET

↓

↑

DISPLAY

↓

SET

↓

↑

DISPLAY

↓

SET

↓

↑

DISPLAY

↓

SET

↓

↑

DISPLAY

↓

SET

↓

↑

### 3. How to Set up

#### 3.8 Setting Menu 5: Pulse/Alarm Settings (Settings for Upper/Lower Limit Alarm, Motor Starting Current Mask Function, and Pulse Output)

⑨ Pulse/Alarm output function 1

↑

DISPLAY

↓

⑩ Pulse output 1 Output item

↑

DISPLAY

↓

⑪ Pulse output 1 Pulse unit

↑

DISPLAY

↓

⑪ Pulse output 1 Pulse unit

Set the function of pulse/alarm output 1.

When ME-4210-SS96B (optional plug-in module) is not installed, this screen is not displayed.  
For alarm items at selecting alarm output, refer to 5.2.45.1.4.

PULSE  
(Pulse output)

↔

AL  
(Alarm output)

5 9  
out. 1

PULSE

Set the output item of pulse output 1.

When ME-4210-SS96B (optional plug-in module) is not installed or when ⑨ Pulse/Alarm output function 1 is not set to pulse output, this screen is not displayed.

Setting item	Display		
	A	B	C
Active energy (Imported)	8888	Wh	OFF
Active energy (Exported)	8888	Wh	OFF
Reactive energy (Imported lag)	8888	varh	LAG
Reactive energy (Imported lead)	8888	varh	← LEAD
Reactive energy (Exported lag)	8888	varh	LAG
Reactive energy (Exported lead)	8888	varh	← LEAD
Apparent energy	8888	VAh	OFF
Periodic active energy 1	Wh18	Wh	OFF
Periodic active energy 2	Wh28	Wh	OFF
Periodic active energy 3	Wh38	Wh	OFF
non (No output)	8888	OFF	OFF

5 9 1  
PULS  
1

PULSE

Note: According to the selected item, the segment in the left table blinks.

Set the pulse unit of pulse output 1.

The pulse unit is selected from the following table according to full-load power.

When ME-4210-SS96B (optional plug-in module) is not installed or when ⑨ Pulse/Alarm output function 1 is not set to pulse output, this screen is not displayed.

$$\text{Full-load power [kW]} = \frac{\alpha \times (\text{VT primary voltage}) \times (\text{CT primary voltage})}{1000}$$

$\alpha$ : 1    1-phase 2-wire  
 2    1-phase 3-wire  
 $\sqrt{3}$     3-phase 2-wire  
 3    3-phase 4-wire

\*1: For 3-phase 4-wire system, the VT primary voltage and direct voltage are calculated using phase voltage.  
 \*2: For 1-phase 3-wire system, the VT primary voltage is calculated using phase voltage.  
 \*3: For the direct voltage setting, direct voltage is used for the calculation instead of VT primary voltage.

Full-load power [kW]	Settable pulse unit				
	1	0.1	0.01	0.001	
Below 10	1	0.1	0.01	0.001	kWh/pulse
10 or more and below 100	10	1	0.1	0.01	
100 or more and below 1000	100	10	1	0.1	
1000 or more and below 10000	1	0.1	0.01	0.001	MWh/pulse
10000 or more and below 100000	10	1	0.1	0.01	
100000 or more	100	10	1	0.1	

Note1: When ⑪ Pulse output 1 Output item is set to 'non', this setting is skipped.  
 Note2: The factory default setting is the minimum value of settable pulse unit.  
 Note3: For reactive power, read 'kW' and 'kWh' of the above table as 'kvar' and 'kvarh' respectively.  
 Note4: For apparent power, read 'kW' and 'kWh' of the above table as 'kVA' and 'kVAh' respectively.

### 3. How to Set up

#### 3.8 Setting Menu 5: Pulse/Alarm Settings (Settings for Upper/Lower Limit Alarm, Motor Starting Current Mask Function, and Pulse Output)

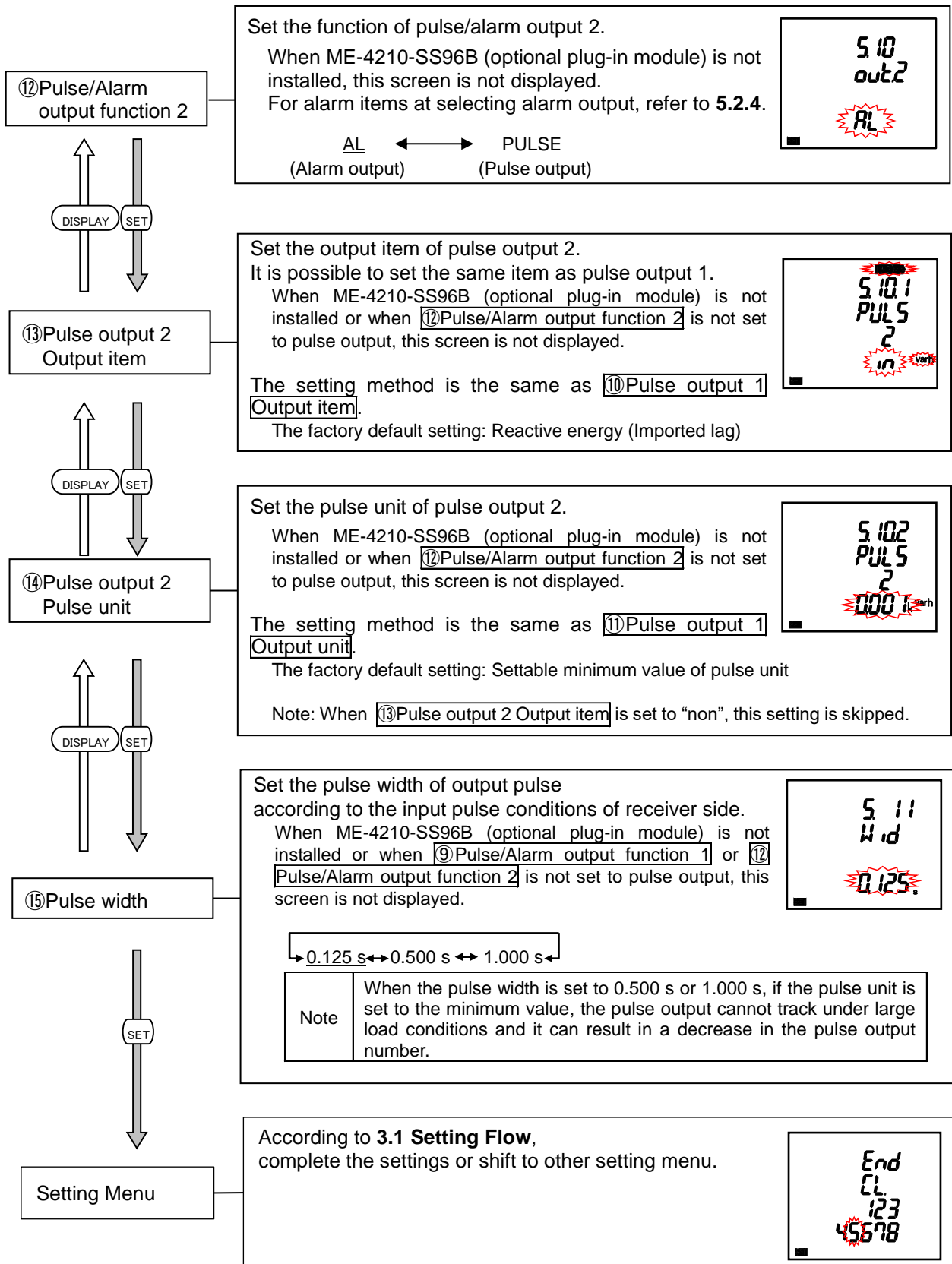

### 3. How to Set up

#### 3.9. Setting Menu 6: Built-in Logging Settings

You will set the built-in logging.

In the operating mode, press **(SET)** and **(RESET)** simultaneously for 2 seconds or more to enter the following operation.

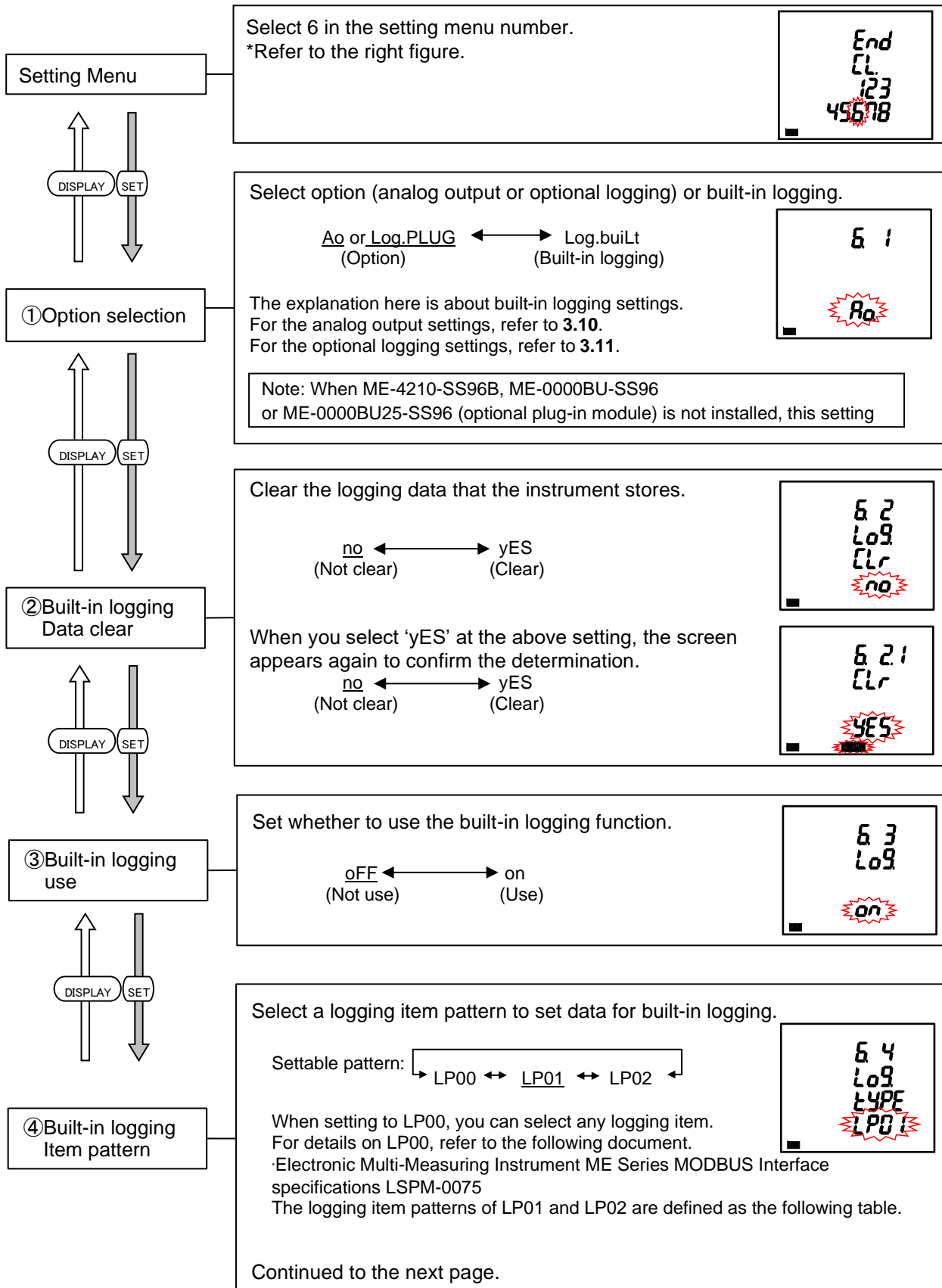

### 3. How to Set up

#### 3.9 Setting Menu 6: Built-in Logging Settings

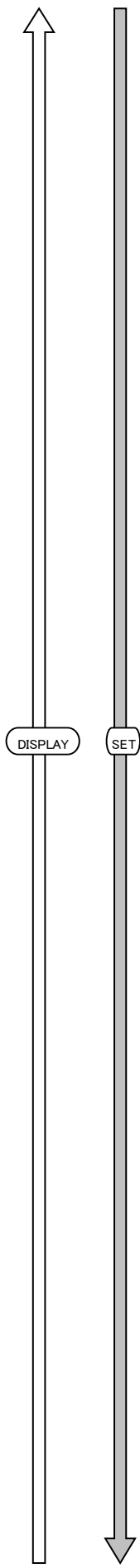

(1) Phase wire system: 3-phase 4-wire		
Logging item pattern	LP01	LP02
Logging measuring data (Integrated value data) 1	Wh (Imported)	Wh (Imported)
Logging measuring data (Integrated value data) 2	Wh (Exported)	Wh (Exported)
Logging measuring data (Integrated value data) 3	varh (Imported lag)	varh (Imported lag)
Logging measuring data (Integrated value data) 4	varh (Imported lead)	varh (Imported lead)
Logging measuring data (Integrated value data) 5	VAh	VAh
Logging measuring data (Data other than integrated value) 1	$\Sigma W$	$\Sigma W$
Logging measuring data (Data other than integrated value) 2	$\Sigma PF$	$\Sigma PF$
Logging measuring data (Data other than integrated value) 3	Hz	Hz
Logging measuring data (Data other than integrated value) 4	$\Sigma var$	$A_{AVG}$
Logging measuring data (Data other than integrated value) 5	$\Sigma VA$	$V_{AVG} (L-L)$
Logging measuring data (Data other than integrated value) 6	$A_{AVG}$	A1
Logging measuring data (Data other than integrated value) 7	$V_{AVG} (L-L)$	A2
Logging measuring data (Data other than integrated value) 8	DW (Last)	A3
Logging measuring data (Data other than integrated value) 9	Dvar (Last)	AN
Logging measuring data (Data other than integrated value) 10	DVA (Last)	V12
Logging measuring data (Data other than integrated value) 11	DW (Peak)	V23
Logging measuring data (Data other than integrated value) 12	Dvar (Peak)	V31
Logging measuring data (Data other than integrated value) 13	DVA (Peak)	V1N
Logging measuring data (Data other than integrated value) 14	HI1 (total)	V2N
Logging measuring data (Data other than integrated value) 15	THD <sub>V1N</sub>	V3N

  

(2) Phase wire system: 3-phase 3-wire (2CT)/ 3-phase 3-wire (3CT)/ 1-phase 3-wire		
Logging item pattern	LP01	LP02
Logging measuring data (Integrated value data) 1	Wh (Imported)	Wh (Imported)
Logging measuring data (Integrated value data) 2	Wh (Exported)	Wh (Exported)
Logging measuring data (Integrated value data) 3	varh (Imported lag)	varh (Imported lag)
Logging measuring data (Integrated value data) 4	varh (Imported lead)	varh (Imported lead)
Logging measuring data (Integrated value data) 5	VAh	VAh
Logging measuring data (Data other than integrated value) 1	$\Sigma W$	$\Sigma W$
Logging measuring data (Data other than integrated value) 2	$\Sigma PF$	$\Sigma PF$
Logging measuring data (Data other than integrated value) 3	Hz	Hz
Logging measuring data (Data other than integrated value) 4	$\Sigma var$	$A_{AVG}$
Logging measuring data (Data other than integrated value) 5	$\Sigma VA$	$V_{AVG} (L-L)$
Logging measuring data (Data other than integrated value) 6	$A_{AVG}$	A1
Logging measuring data (Data other than integrated value) 7	$V_{AVG} (L-L)$	A2
Logging measuring data (Data other than integrated value) 8	DW (Last)	A3
Logging measuring data (Data other than integrated value) 9	Dvar (Last)	-
Logging measuring data (Data other than integrated value) 10	DVA (Last)	V12
Logging measuring data (Data other than integrated value) 11	DW (Peak)	V23
Logging measuring data (Data other than integrated value) 12	Dvar (Peak)	V31
Logging measuring data (Data other than integrated value) 13	DVA (Peak)	-
Logging measuring data (Data other than integrated value) 14	HI1 (total)	-
Logging measuring data (Data other than integrated value) 15	THD <sub>V12</sub>	-



### 3. How to Set up

#### 3.9 Setting Menu 6: Built-in Logging Settings

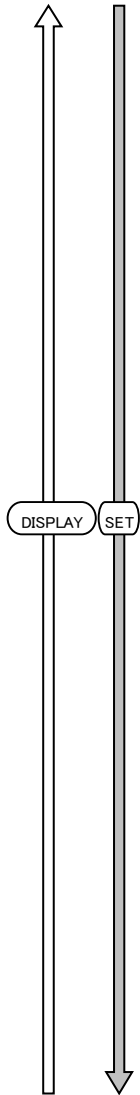

Continued from the previous page.

(3) Phase wire system: 1-phase 2-wire

Logging item pattern	LP01	LP02
Logging measuring data (Integrated value data) 1	Wh (Imported)	Wh (Imported)
Logging measuring data (Integrated value data) 2	Wh (Exported)	Wh (Exported)
Logging measuring data (Integrated value data) 3	varh (Imported lag)	varh (Imported lag)
Logging measuring data (Integrated value data) 4	varh (Imported lead)	varh (Imported lead)
Logging measuring data (Integrated value data) 5	VAh	VAh
Logging measuring data (Data other than integrated value) 1	$\Sigma W$	$\Sigma W$
Logging measuring data (Data other than integrated value) 2	$\Sigma PF$	$\Sigma PF$
Logging measuring data (Data other than integrated value) 3	Hz	Hz
Logging measuring data (Data other than integrated value) 4	$\Sigma var$	-
Logging measuring data (Data other than integrated value) 5	$\Sigma VA$	-
Logging measuring data (Data other than integrated value) 6	$A_{AVG}$	A1
Logging measuring data (Data other than integrated value) 7	$V_{AVG}$ (L-L)	-
Logging measuring data (Data other than integrated value) 8	DW (Last)	-
Logging measuring data (Data other than integrated value) 9	Dvar (Last)	-
Logging measuring data (Data other than integrated value) 10	DVA (Last)	V12
Logging measuring data (Data other than integrated value) 11	DW (Peak)	-
Logging measuring data (Data other than integrated value) 12	Dvar (Peak)	-
Logging measuring data (Data other than integrated value) 13	DVA (Peak)	-
Logging measuring data (Data other than integrated value) 14	HI1 (total)	-
Logging measuring data (Data other than integrated value) 15	$THD_{V12}$	-

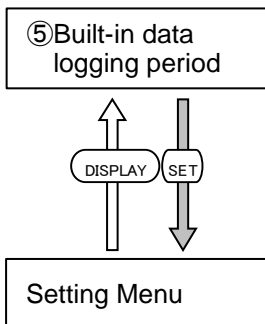

Set the logging period of the built-in logging.

→ 15 min ↔ 30 min ↔ 60 min ←

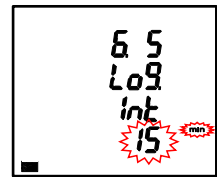

According to **3.1 Setting Flow**, complete the settings or shift to other setting menu.



### 3. How to Set up

#### 3.10. Setting Menu 6: Analog Output Settings

<The installation conditions for optional plug-in module>  
ME-4210-SS96B installation

You will set the analog output.

In the operating mode, press **(SET)** and **(RESET)** simultaneously for 2 seconds or more to enter the following operation.

Setting Menu

↑

DISPLAY

↓

SET

① Option selection

↑

DISPLAY

↓

SET

② Analog output CH1 output item

↑

DISPLAY

↓

SET

Select 6 in the setting menu number.  
\*Refer to the right figure.

Select option (analog output) or built-in logging.

$A_o$  (Option) ← → Log.built (Built-in logging)

The explanation here is about analog output settings.  
For the built-in logging settings, refer to 3.9.

Set the output item of analog output CH1.  
Select an output measuring item from the following table.

(1) When set to 3-phase 4-wire system

3-phase 4-wire system		
non	V <sub>12</sub>	PF <sub>1</sub>
A <sub>1</sub>	V <sub>23</sub>	PF <sub>2</sub>
A <sub>2</sub>	V <sub>31</sub>	PF <sub>3</sub>
A <sub>3</sub>	V <sub>AVG</sub> (L-L)	<u>PF<sub>Σ</sub> (CH4)</u>
A <sub>N</sub>	W <sub>1</sub>	Hz
<u>A<sub>AVG</sub> (CH1)</u>	W <sub>2</sub>	HI <sub>1</sub>
DA <sub>1</sub>	W <sub>3</sub>	HI <sub>2</sub>
DA <sub>2</sub>	<u>W<sub>Σ</sub> (CH3)</u>	HI <sub>3</sub>
DA <sub>3</sub>	var <sub>1</sub>	HI <sub>N</sub>
DA <sub>N</sub>	var <sub>2</sub>	THD <sub>V1N</sub>
DA <sub>AVG</sub>	var <sub>3</sub>	THD <sub>V2N</sub>
V <sub>1N</sub>	var <sub>Σ</sub>	THD <sub>V3N</sub>
V <sub>2N</sub>	VA <sub>1</sub>	
V <sub>3N</sub>	VA <sub>2</sub>	
<u>V<sub>AVG</sub> (L-N) (CH2)</u>	VA <sub>3</sub>	
	VA <sub>Σ</sub>	

AVG: Average value, Σ: Total RMS value

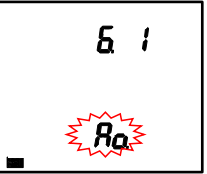
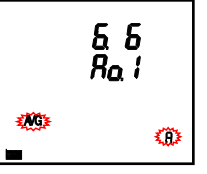
Note1: The same measuring item can be set for each CH.

Note2: The measuring items not included in the display pattern you set can be selected.

Note3: Channels set to 'non' have the minimum output (4mA). In addition, it proceeds to the next CH setting.

Note4: The underlined measuring items represent the factory default settings assigned to each CH

Note5: VA is output with a scaling of 0 to 100% (the percentage of a standard value). For details on how to calculate the standard value, refer to 6.2.

Note6: Hz is output with a scaling of 40 Hz to 50 Hz to 55 Hz for 50 Hz setting and 55 Hz to 60 Hz to 65 Hz for 60 Hz setting.

Note7: For HI, the harmonic current total RMS value is output with a scaling of 0 to 60% (the percentage of the primary current setting). For THD<sub>v</sub>, the harmonic voltage total distortion ratio is output with a scaling of 0 to 20%.

Continued to the next page.

### 3. How to Set up

#### 3.10 Setting Menu 6: Analog Output Settings

(2) When set to other than 3-phase 4-wire system

3-phase 3-wire	1-phase 3-wire (1N2 display)	1-phase 3-wire (1N3 display)	1-phase 2-wire
non	non	non	non
<u>A<sup>1</sup> (CH1)</u>	<u>A<sup>1</sup> (CH1)</u>	<u>A<sup>1</sup> (CH1)</u>	<u>A (CH1)</u>
A <sub>2</sub>	A <sub>N</sub>	A <sub>N</sub>	DA
A <sub>3</sub>	A <sub>2</sub>	A <sub>3</sub>	<u>V (CH2)</u>
A <sub>AVG</sub>	A <sub>AVG</sub>	A <sub>AVG</sub>	<u>W (CH3)</u>
DA <sub>1</sub>	DA <sub>1</sub>	DA <sub>1</sub>	var
DA <sub>2</sub>	DA <sub>2</sub>	DA <sub>2</sub>	VA
DA <sub>3</sub>	DA <sub>3</sub>	DA <sub>3</sub>	<u>PF (CH4)</u>
DA <sub>N</sub>	DA <sub>N</sub>	DA <sub>N</sub>	Hz
DA <sub>AVG</sub>	DA <sub>AVG</sub>	DA <sub>AVG</sub>	HI
<u>V<sub>12</sub> (CH2)</u>	<u>V<sub>1N</sub> (CH2)</u>	<u>V<sub>1N</sub> (CH2)</u>	THD <sub>v</sub>
V <sub>23</sub>	V <sub>2N</sub>	V <sub>3N</sub>	
V <sub>31</sub>	V <sub>12</sub>	V <sub>13</sub>	
V <sub>AVG</sub>	V <sub>AVG</sub>	V <sub>AVG</sub>	
<u>W (CH3)</u>	<u>W (CH3)</u>	<u>W (CH3)</u>	
var	var	var	
VA	VA	VA	
<u>PF (CH4)</u>	<u>PF (CH4)</u>	<u>PF (CH4)</u>	
Hz	Hz	Hz	
HI <sub>1</sub>	HI <sub>1</sub>	HI <sub>1</sub>	
HI <sub>3</sub>	HI <sub>2</sub>	HI <sub>3</sub>	
THD <sub>v12</sub>	THD <sub>v1N</sub>	THD <sub>v1N</sub>	
THD <sub>v23</sub>	THD <sub>v2N</sub>	THD <sub>v3N</sub>	

② Analog output CH1 output item

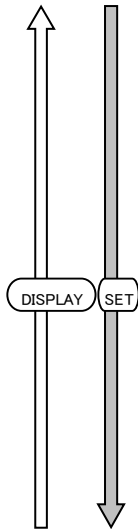

Note1: The same measuring item can be set for each CH. AVG: Average value

Note2: The measuring items not included in display pattern you set can be selected.

Note3: Channels set to 'non' have the minimum output (4mA). In addition, it proceeds to the next CH setting.

Note4: The underlined measuring items represent the factory default settings assigned to each CH

Note5: VA is output with a scaling of 0 to 100% (the percentage of a standard value). For details on how to calculate the standard value, refer to 6.2.

Note6: Hz is output with a scaling of 40 Hz to 50 Hz to 55 Hz for 50 Hz setting and 55 Hz to 60 Hz to 65 Hz for 60 Hz setting.

Note7: For HI, the harmonic current total RMS value is output with a scaling of 0 to 60% (the percentage of the primary current setting).

For THD<sub>v</sub>, the harmonic voltage total distortion ratio is output with a scaling of 0 to 20%.

### 3. How to Set up

#### 3.10 Setting Menu 6: Analog Output Settings

Set the details for analog output CH1.

\*The following settings can be set separately from measuring items included in the display pattern.

This setting is necessary when [2 Analog output CH1 Output item] is set to current, demand current, voltage, active power, reactive power, or power factor. If it is set to other element, the setting will be skipped.

(1) When the output item is set to current or demand current.

(a) Select the CT primary current value or a special primary current value to set the max output value of analog output.

Output item	Setting range
A	CT primary current value ←→ SP.
DA	(Setting menu 1.4.1 Primary current setting value) (Special primary current value)

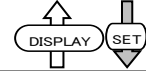
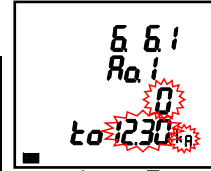

(b) When selecting 'SP' at (a), select a max output value from the following range.

Output item	Setting range *1
A	+ 3 STEP (Approximately 120% of CT primary current setting value)
DA	± 0 STEP (100%: CT primary current setting value)
	- 10 STEP (Approximately 40% of CT primary current setting value)

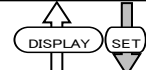
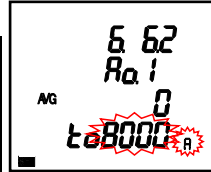

To the next CH setting

\*1: For details on how to calculate STEP and setting range, refer to 6.2.

③ Analog output CH1 detailed settings

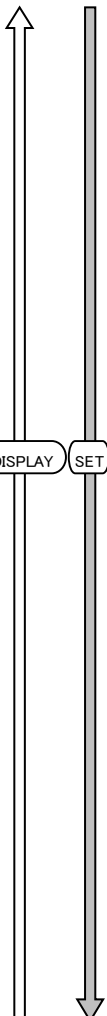

(2) When the output item is set to voltage, select a max output value from the following range.

Output item	Setting range *1
V	+ 10 STEP (Approximately 250% of standard value)
	± 0 STEP (100%: Standard value)
	- 18 STEP (Approximately 20% of standard value)

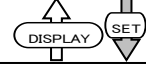
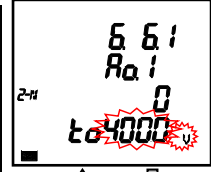

To the next CH setting

\*1: For details on how to calculate the standard value and STEP, refer to 6.2.

(3) When the output item is set to active power or reactive power.

(a) Select a max output value from the following range.

Output item	Setting range *1
W var	+ 3 STEP (Approximately 120% of standard value)
	± 0 STEP (100%: Standard value)
	- 18 STEP (Approximately 20% of standard value)

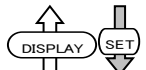
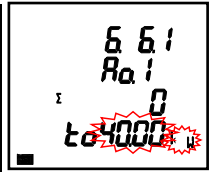

\*1: For details on how to calculate the standard value and STEP, refer to 6.2.

(b) When the output item is set to active power, select single deflection or double deflection for analog output. (When the output item is reactive power, the double deflection only is available.)

Output item	Setting range
W	Single deflection ←→ Double deflection

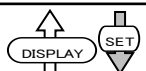
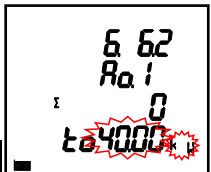

To the next CH setting

<Relationship with input and output>

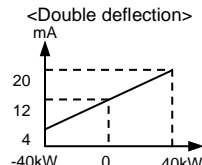
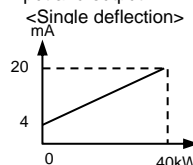

### 3. How to Set up

#### 3.10 Setting Menu 6: Analog Output Settings

Continued from the previous page.

(4) When the output item is set to power factor, select an output range.

Output item	Setting range
PF	-0.5 to 1 to 0.5 ← → -0 to 1 to 0

<Relationship with input and output>

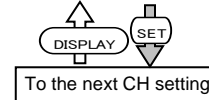
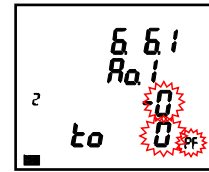
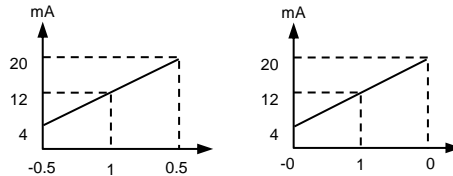

④ Analog output CH2 to 4 output item

Set the output item of each of analog output CH2 to 4. The setting method is the same as ② Analog output CH1 output item.

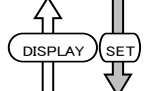

⑤ Analog output CH2 to 4 detailed settings

Set the details of each of analog output CH2 to 4. The setting method is the same as ③ Analog output CH1 detailed settings.



⑥ Analog output limit

Set the limit of analog output in case of excess of full scale. (Every CH is the same setting.)

Setting	Description
oFF (No limited)	For span value, the upper limit output is +5% and the lower limit output is -5%.
on (Limited)	For span value, the upper limit output is +1% and the lower limit output is -1%.

Note: When every analog output CH is set to "non", this setting is skipped.

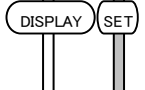

Setting Menu

According to 3.1 Setting Flow, complete the settings or shift to other setting menu.

### 3. How to Set up

#### 3.11. Setting Menu 6: Optional Logging settings

<The installation conditions for optional plug-in module>  
 ME-0000BU-SS96 or ME-0000BU25-SS96 installation

You will set the optional logging.

In the operating mode, press **SET** and **RESET** simultaneously for 2 seconds or more to enter the following operation.

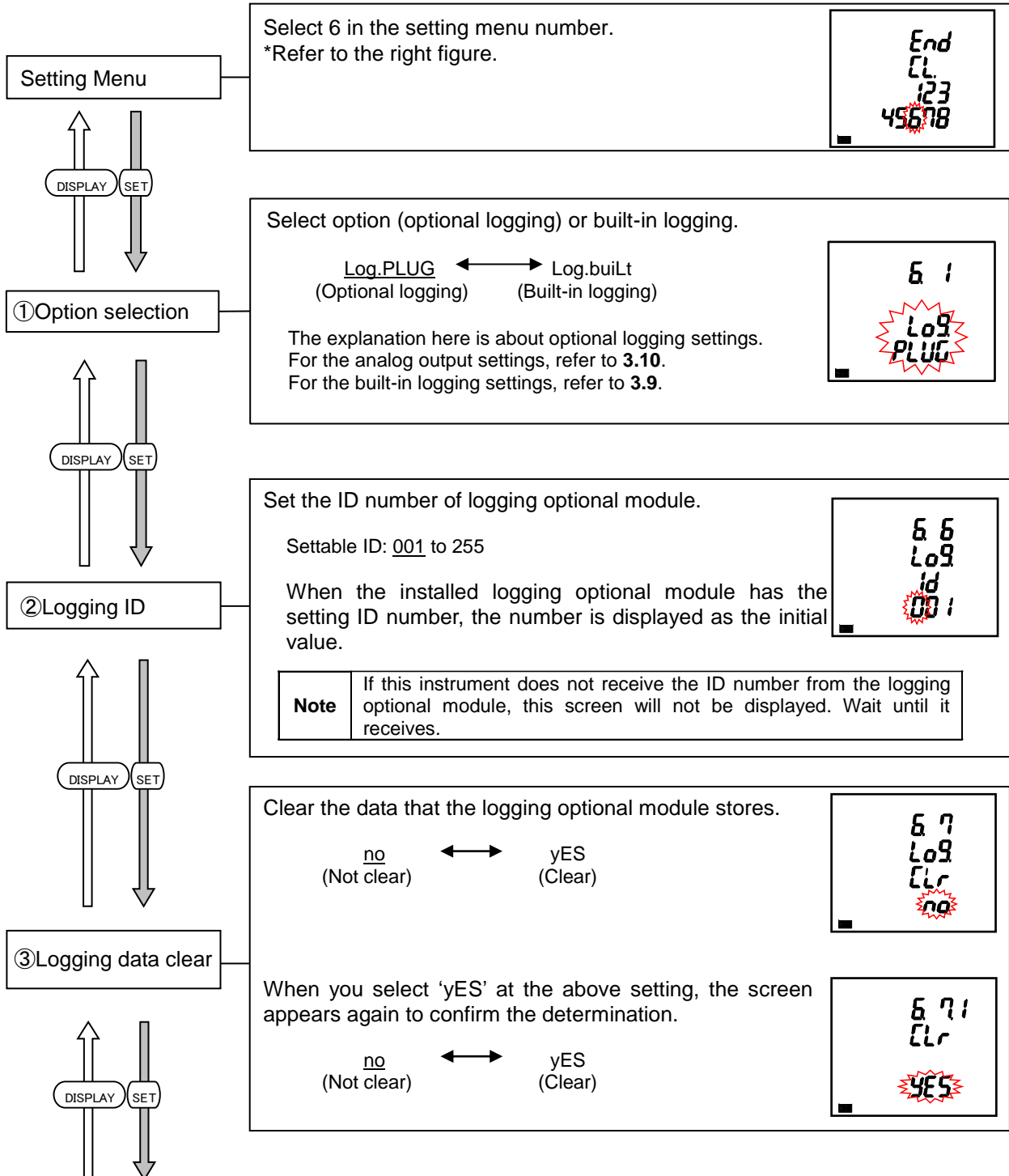

### 3. How to Set up

#### 3.11 Setting Menu 6: Optional Logging settings

④ Logging item pattern

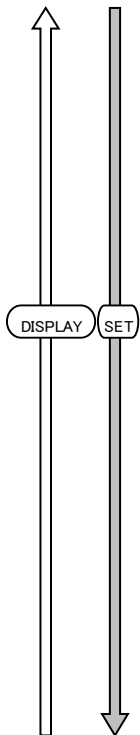

⑤ Detailed data Logging period



Setting Menu

Select a logging item pattern to set data for logging.

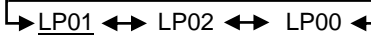
Settable pattern: 

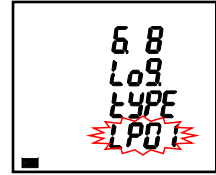

When setting to LP00, you can select any logging item.  
For details on LP00, refer to the following document.

- ME-0000BU-SS96 Logging function specifications—LSPM-0092
- ME-0000BU25-SS96 Logging function specifications—LSPM-0106

For LP01 and LP02, the logging item pattern is defined as the following table.  
The detailed data is recorded in a period shorter than 1-hour data. The logging period of the detailed data is set at **⑤ Detailed data logging period**.

Phase wire system: 3-phase 4-wire

Logging item pattern	LP01		LP02	
	Detailed data	1-hour data	Detailed data	1-hour data
Data 1	Wh (Imported)	Wh (Imported)	Wh (Imported)	Wh (Imported)
Data 2	varh (Imported lag)	Wh (Exported)	A <sub>AVG</sub>	Wh (Exported)
Data 3	VAh	varh (Imported lag)	V <sub>AVG</sub> (L-L)	varh (Imported lag)
Data 4	DW (Last value)	varh (Imported lead)	ΣW	varh (Imported lead)
Data 5	Dvar (Last value)	VAh	ΣPF	VAh
Data 6	DVA (Last value)	Non	Hz	Non

Phase wire system: 3-phase 3-wire\_2CT, 3-phase 3-wire\_3CT, 1-phase 3-wire

Logging item pattern	LP01		LP02	
	Detailed data	1-hour data	Detailed data	1-hour data
Data 1	Wh (Imported)	Wh (Imported)	Wh (Imported)	Wh (Imported)
Data 2	varh (Imported lag)	Wh (Exported)	A <sub>AVG</sub>	Wh (Exported)
Data 3	VAh	varh (Imported lag)	V <sub>AVG</sub>	varh (Imported lag)
Data 4	DW (Last value)	varh (Imported lead)	W	varh (Imported lead)
Data 5	Dvar (Last value)	VAh	PF	VAh
Data 6	DVA (Last value)	Non	Hz	Non

Phase wire system: 1-phase 2-wire

Logging item pattern	LP01		LP02	
	Detailed data	1-hour data	Detailed data	1-hour data
Data 1	Wh (Imported)	Wh (Imported)	Wh (Imported)	Wh (Imported)
Data 2	varh (Imported lag)	Wh (Exported)	A1	Wh (Exported)
Data 3	VAh	varh (Imported lag)	V12	varh (Imported lag)
Data 4	DW (Last value)	varh (Imported lead)	W	varh (Imported lead)
Data 5	Dvar (Last value)	VAh	PF	VAh
Data 6	DVA (Last value)	Non	Hz	Non

Set the logging period for detailed data of LP01 or LP02 of logging item pattern.

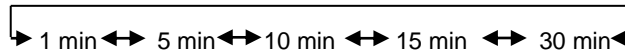

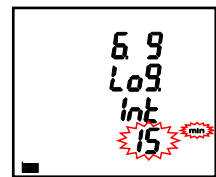

According to **3.1 Setting Flow**, complete the settings or shift to other setting menu.



### 3. How to Set up

#### 3.12. Setting Menu 7: Settings for Periodic active Energy, Rolling Demand, and Digital Input/Output

You will set the periodic active energy, rolling demand, and digital input/output.

In the operating mode, press **SET** and **RESET** simultaneously for 2 seconds or more to enter the following operation.

For details about each function, refer to the corresponding section.

Periodic active energy ⇒ See 5.2.5 to 5.2.6.

Rolling demand ⇒ See 5.2.7 to 5.2.10.

Digital input/output ⇒ See to 5.2.155.2.15 to 5.2.165.2.16.

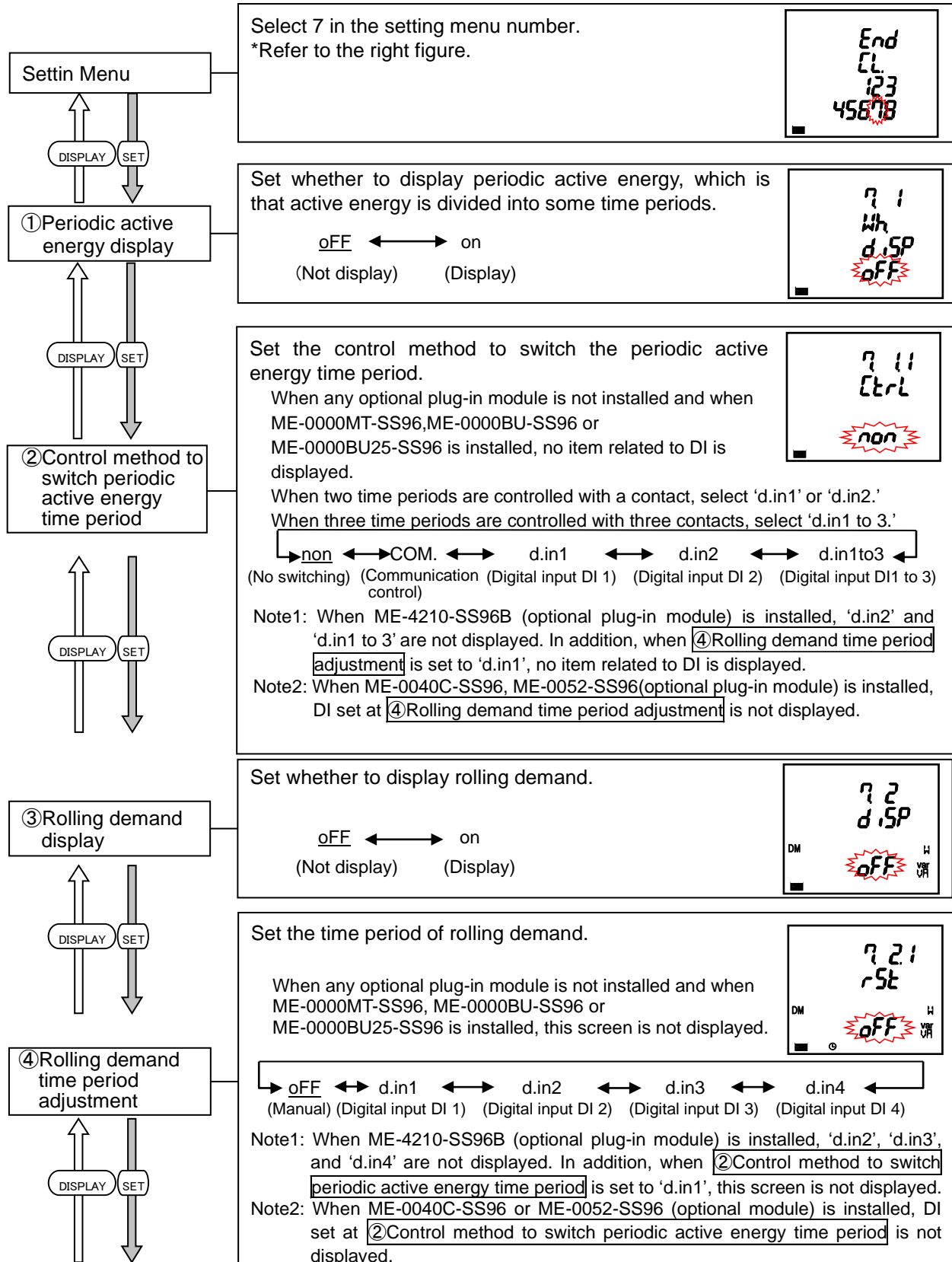



### 3. How to Set up

#### 3.12 Setting Menu 7: Settings for Periodic active Energy, Rolling Demand, and Digital Input/Output

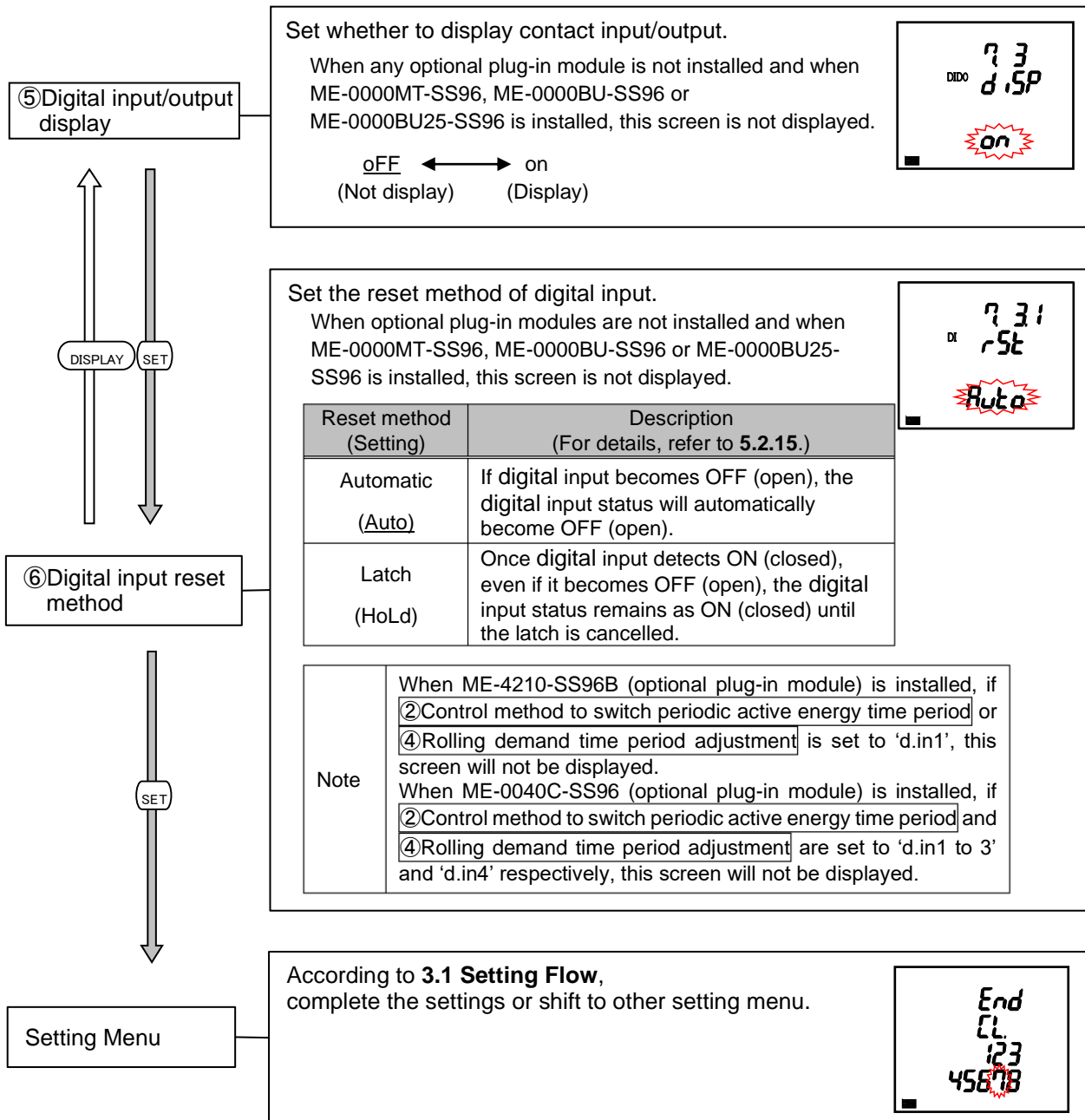

### 3. How to Set up

#### 3.13. Setting Menu 8: Special Settings (Settings for Operating Time, IEC Mode, and CO<sub>2</sub> equivalent)

You will set the operating time and IEC mode.

In the operating mode, press (SET) and (RESET) simultaneously for 2 seconds or more to enter the following operation.

For details about each function, refer to the corresponding section.  
 Operating time ⇒ See 5.2.11 to 5.2.12.

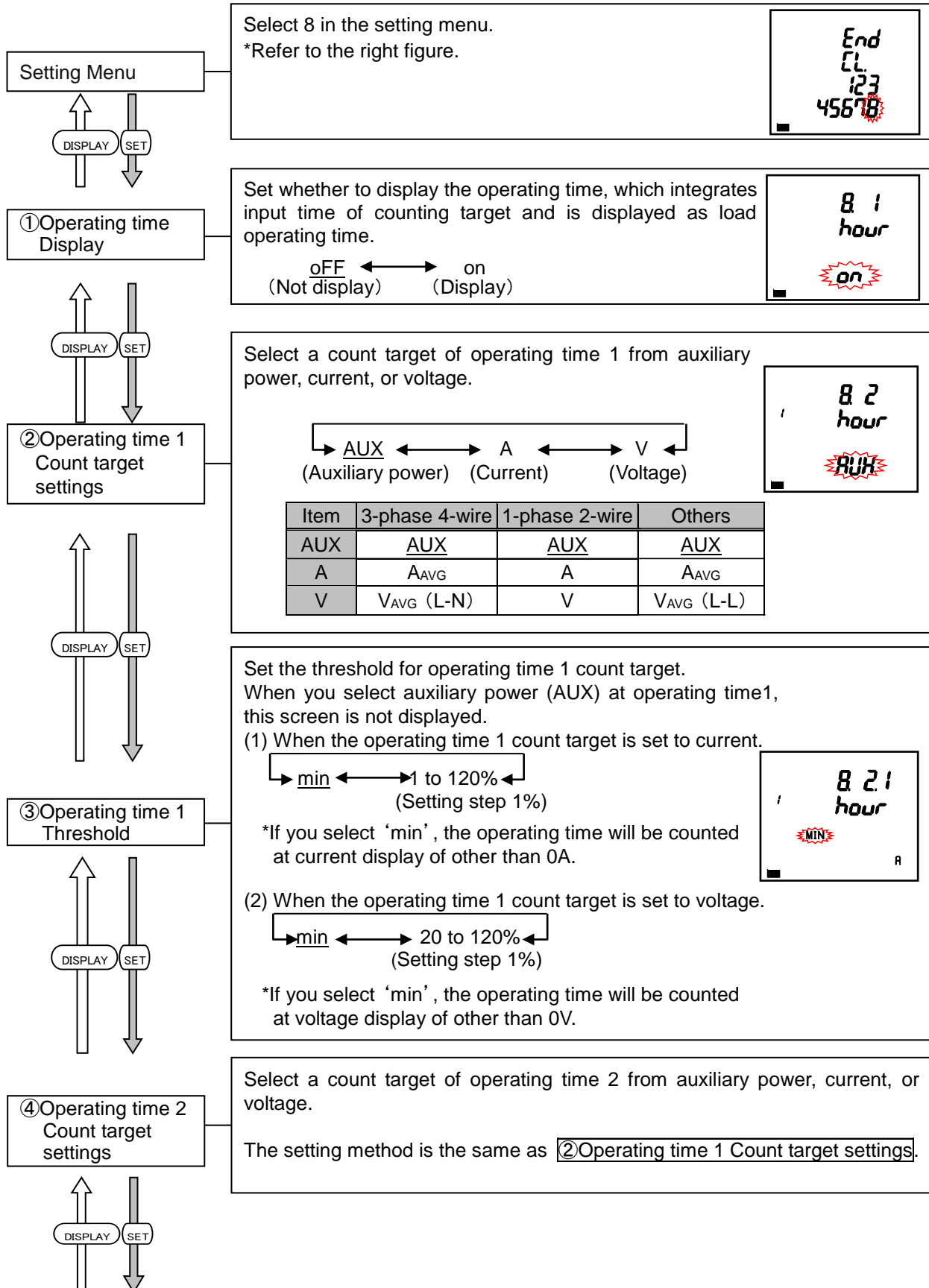

### 3. How to Set up

#### 3.13. Setting Menu 8: Special Settings (Settings for Operating Time, IEC Mode, and CO<sub>2</sub> equivalent)

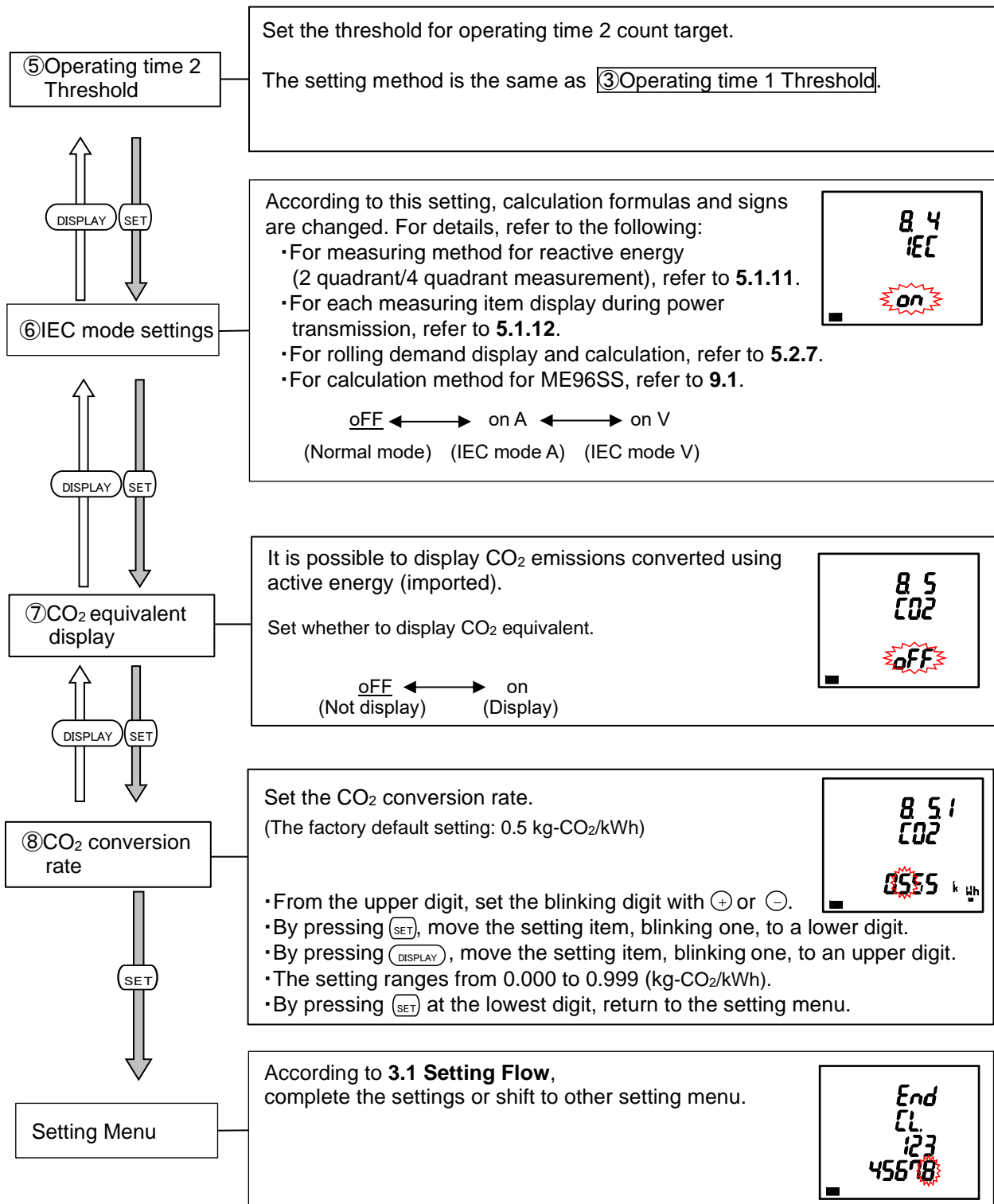

### 3. How to Set up

#### 3.14. Setting Menu CL: Preset Time Settings

You will set the time necessary when data logging is executed.  
 When the built-in logging function is set to 'oFF (Not use)', and when ME-0000BU-SS96 or ME-0000BU25-SS96 (optional plug-in module) is not installed, this menu is not displayed.  
 In the operating mode, press **SET** and **RESET** simultaneously for 2 seconds or more to enter the following operation.

	<p>If the present time were changed from the time displayed at ①Current time display to the date before/after 31 days, all logging data in ME-0000BU-SS96 or ME-0000BU25-SS96 (optional plug-in module) would be deleted. If you change the present time, output the logging data to a SD memory card beforehand, confirm that the data is correctly stored on a PC, and change the settings.</p>
---	---

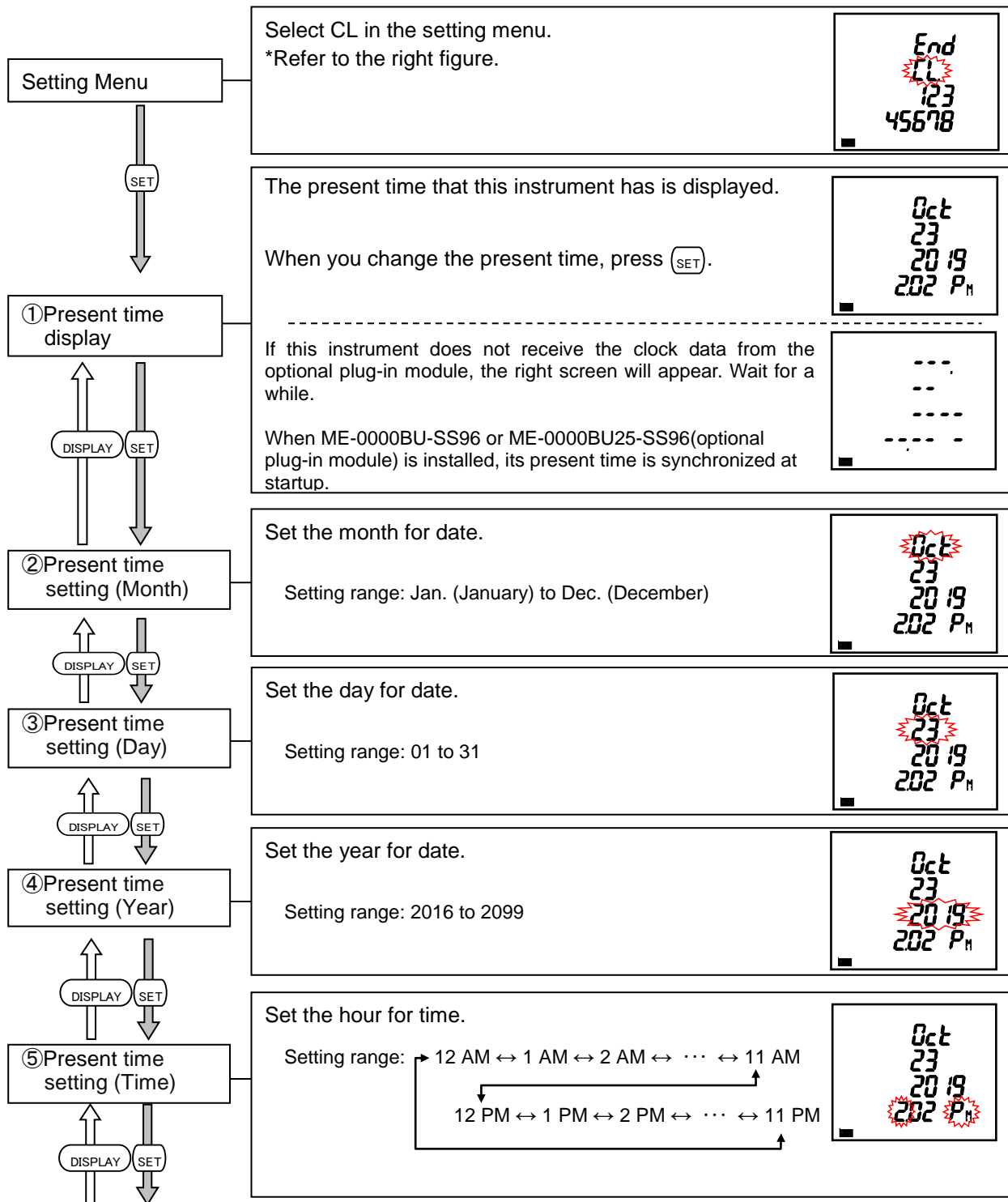

### 3. How to Set up

#### 3.14. Setting Menu CL: Current Time Settings

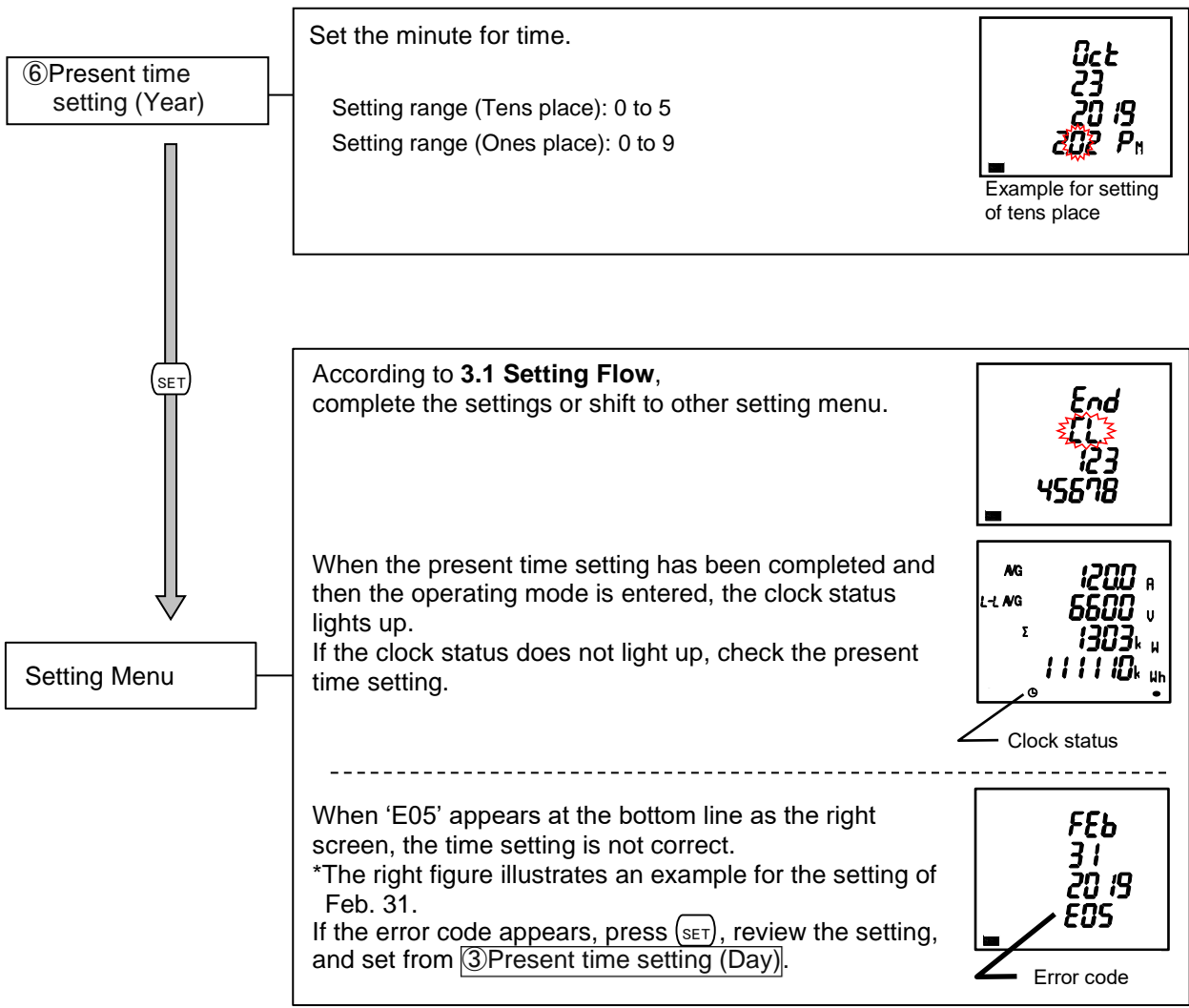

<b>Note</b>	<ol style="list-style-type: none"> <li>1. The present time can be set with MODBUS RTU or MODBUS TCP communication. For details on the setting, refer to Electronic Multi-Measuring Instrument ME Series MODBUS Interface specifications (Ref. No. LSPM-0075).</li> <li>2. The clock accuracy is <math>\pm 1</math> minute per month, typical (at +25°C). To adjust the clock drift, regularly perform the present time setting.</li> <li>3. In order to use the built-in logging function, be sure to set the present time. Otherwise, the function will not operate.</li> <li>4. The clock of the built-in logging function is not equipped with power interruption backup. After the startup, be sure to set the present time setting. When an optional plug-in module of ME-0000BU-SS96 or ME-0000BU25-SS96 is installed, the power interruption backup of the clock operation is executed because it has the built-in battery for backup.</li> <li>5. After the present time setting, when an optional plug-in module of ME-0000BU-SS96 or ME-0000BU25-SS96 is installed, set the present time again.</li> </ol>
-------------	--

### 3. How to Set up

#### 3.15. Setting Confirmation Menu 1 to 9: Confirming the Settings in the Setting Menu 1 to 8 and 9 Test Mode

##### ●Setting Confirmation

In the operating mode, press  for 2 seconds or more to execute the operation.

Setting confirmation menu

In the setting confirmation menu, the screen switching and operation methods are the same as the setting menu 1 to 8. For details, refer to each setting menu.

Note: In the setting confirmation mode, setting change is not possible.



##### ●Test Mode

In the operating mode, press  for 2 seconds or more and then set the setting confirmation menu number to 9 to enter the test mode.

For details about how to use the test mode, refer to **4 How to Use Test Mode**.

### 3. How to Set up

#### 3.16. Initialization of Related Items by Changing a Setting

When you change a setting, the related setting items and measuring data (maximum and minimum values) are initialized. For details, refer to the following table.

Setting item to be changed		Menu 1		Menu 2		Menu 5	Menu 6			Menu 8		Optional module change								
		Phase wire system *1	VT/Direct voltage	CT secondary current	CT primary current	Default gateway use	Communication reset	Upper/Lower limit alarm item	Analog output item	Built-in logging function ON/OFF	Built-in logging item pattern		Built-in logging period	Operating time 1 count target	Operating time 2 count target	IEC mode settings				
Setting item	Menu 1	Phase wire system																		
		Display pattern	●																	
		VT/Direct voltage	○																	
	Menu 2	Default gateway				●														
	Menu 5	Upper/Lower limit alarm item	●																	
		Upper/Lower limit alarm value	●					●												
	Menu 6	Analog output item	●																	
		Current value	●			●			●											
		Current demand value	●			●			●											
		Voltage value	●	●					●											
		Active power value	●	●		●			●											
		Active power single/double deflection	●						●											
		Reactive power value	●	●		●			●											
	Power factor -0.5 to 1 to 0.5/-0 to 1 to 0	●						●												
	Menu 7	Method to switch periodic active energy time period																		●
		Rolling demand digital input time period																		●
	Menu 8	Threshold of Operating time 1 count target											●							
		Threshold of Operating time 2 count target												●						
	Measuring value	Current, Maximum/Minimum value	●		●	●														
		Current demand Maximum/Minimum value	●		●	●														
Voltage Maximum/Minimum value		●	●																	
Active power Maximum/Minimum value		●	●	●	●															
Reactive power Maximum/Minimum value		●	●	●	●														●	
Apparent power Maximum/Minimum value		●	●	●	●														●	
Power factor Maximum/Minimum value		●	●	●	●														●	
Frequency, Maximum/Minimum value		●																		
Harmonic current Maximum value		●		●	●															
Harmonic voltage Maximum value		●	●																	
Rolling demand active power Peak/Predict/Last/Present value		●	●	●	●														●	
Rolling demand reactive power Peak/Predict/Last/Present value		●	●	●	●														●	
Rolling demand apparent power Peak /Predict/Last/Present value		●	●	●	●														●	
Current unbalance rate Maximum value		●		●	●															
Voltage unbalance rate Maximum value		●	●																	
Built-in logging Measurement data		●							●	●	●									
Built-in logging Alarm data									●											
Built-in logging items	●								●											
Communication option unit reset *Note2	●	●		●		●														

●: It turns to the default setting.

○: It turns to the default setting according to the phase wire system.

Note1: For 1-phase 3-wire system, the setting change between '1N2 display' and '1N3 display' does not cause initialization.

Note2: The communication option unit is reset.

### 3. How to Set up

#### 3.17. Initialization of All Settings

The following operation enables to reset all settings to the factory default. It is only for the settings. Measured active energy, reactive energy, and operating time are not changed.

For details on the initialization of maximum and minimum values, refer to **3.16 Initialization of Related Items by Changing a Setting**.

\*For example, if the phase wire system setting is changed by initializing all settings, all maximum and minimum values will be reset.

To initialize all settings, display the CANCEL screen in the setting mode and then execute the following operation.

For details on how to display the CANCEL screen, refer to **3.1 Setting Flow**.

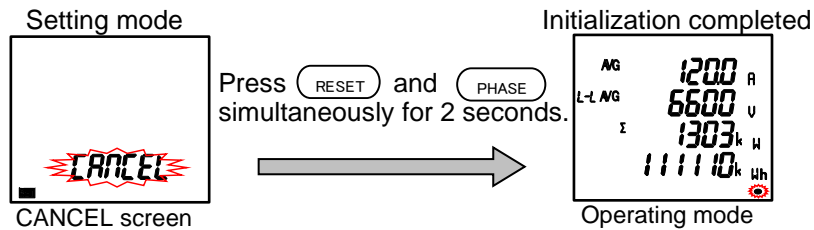
**Note**

When all settings are initialized, back up the logging data before the initialization.



### 3. How to Set up

#### 3.18. Settings for Special Display Pattern P00

If you want to set a display pattern other than P01 or P02, P00 is available to freely set display items. This setting is conducted in the setting menu 1. The explanation here begins with the settings for P00 at **②Display pattern** in the setting menu 1. For other operations, which are not explained here, refer to **3.2 Setting Menu 1**.

(1) Max four screens are available and 16 measuring items can be displayed.

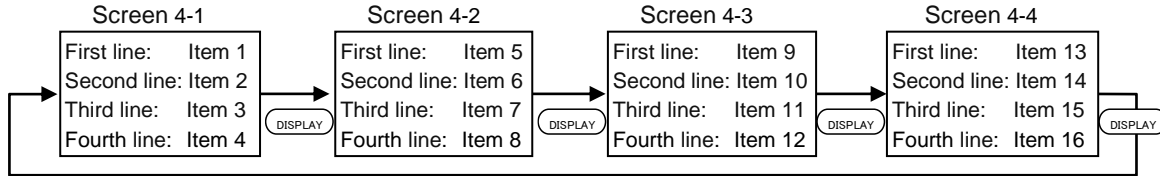

From the first line to the third line, each selectable item is A, DA, V, W, var, VA, PF, or Hz. At the fourth line, Wh, -Wh, varh, and VAh are selectable.

(2) As an example, the following display pattern is used for explanation.

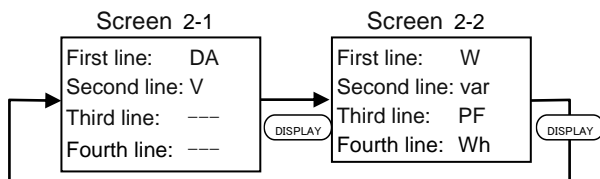

(3) How to set up

**②Display pattern**

You will set up a display pattern.

- (1) Select 'P00.'  
Select 'P00' with (+) or (-) and then press (SET).
- (2) Set the first line to 'DM A' in the screen 4-1.  
Select 'DM A' with (+) or (-) and then press (SET).
- (3) Set the second line to 'V' in the screen 4-1.  
Select 'V' with (+) or (-) and then press (SET).
- (4) Set the third line to no display in the screen 4-1.  
Select '---' with (+) or (-) and then press (SET).
- (5) Set the fourth line to no display in the screen 4-1.  
Select '---' with (+) or (-) and then press (SET).

### 3. How to Set up

#### 3.18. Settings for Special Display Pattern P00

Continued form the previous page

- (6) You will set up the display of screen 4-2.  
Select 'yES' with (+) or (-) and then press (SET).

\*When the screen 2 is not necessary to display,  
select 'no' and press (SET).

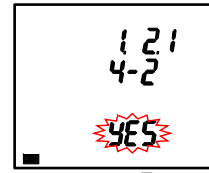

- (7) Set the first line to 'W' in the screen 4-2.  
Select 'W' with (+) or (-) and then press (SET).

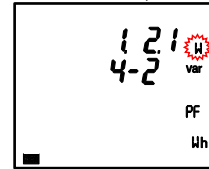

- (8) Set the second line to 'var' in the screen 4-2.  
Select 'var' with (+) or (-) and then press (SET).

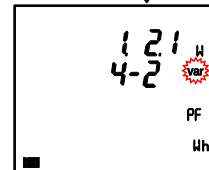

- (9) Set the third line to 'PF' in the screen 4-2.  
Select 'PF' with (+) or (-) and then press (SET).

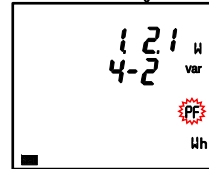

- (10) Set the fourth line to 'Wh' in the screen 4-2.  
Select 'Wh' with (+) or (-) and then press (SET).

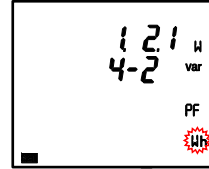

- (11) Set the screen 4-3 to hidden.  
Select 'no' with (+) or (-) and then press (SET).



Note: When you set the screen 4-3 to hidden,  
the screen 4-4 is automatically set to hidden.

Return to the settings  
of the upper line in  
the screen 4-1.

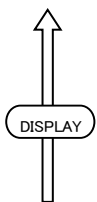

③VT/Direct voltage

(Hereafter same as the setting menu 1)

<b>Note</b>	<p>1. The following measuring items cannot be set in the display pattern of P00. Set them in the setting menu 3 and 8.</p> <ul style="list-style-type: none"> <li>•Harmonic current, Harmonic voltage, Current unbalance rate, Voltage unbalance rate, Operating time, CO<sub>2</sub> equivalent</li> </ul> <p>2. It is not possible to specify phases of current and voltage. In the operating mode, press (PHASE) to switch the phase.</p> <p>3. The following measuring items can be set for 3-phase 4-wire system only.</p> <ul style="list-style-type: none"> <li>•Current N-phase, Current demand N-phase</li> </ul>
-------------	--

### 3. How to Set up

#### 3.19. Example for Easy Setup

The following example illustrates an easy setup.

##### ■ Setting Example

- Model: ME96SSRB-MB (without optional plug-in module)
- Phase wire system: 3-phase 4-wire
- Measuring element: A, V, W, PF
- Input Voltage: 220/380 V
- CT primary current: 200 A
- CT Secondary current: 5 A
- Frequency: 50 Hz
- MODBUS RTU: Address: 1, Baud rates: 19.2 kbps, Parity: even, Stop bit: 1

##### ■ Setting Procedure

 shows the item where setting change is necessary.

Note: For details on the settings, refer to 3.2.

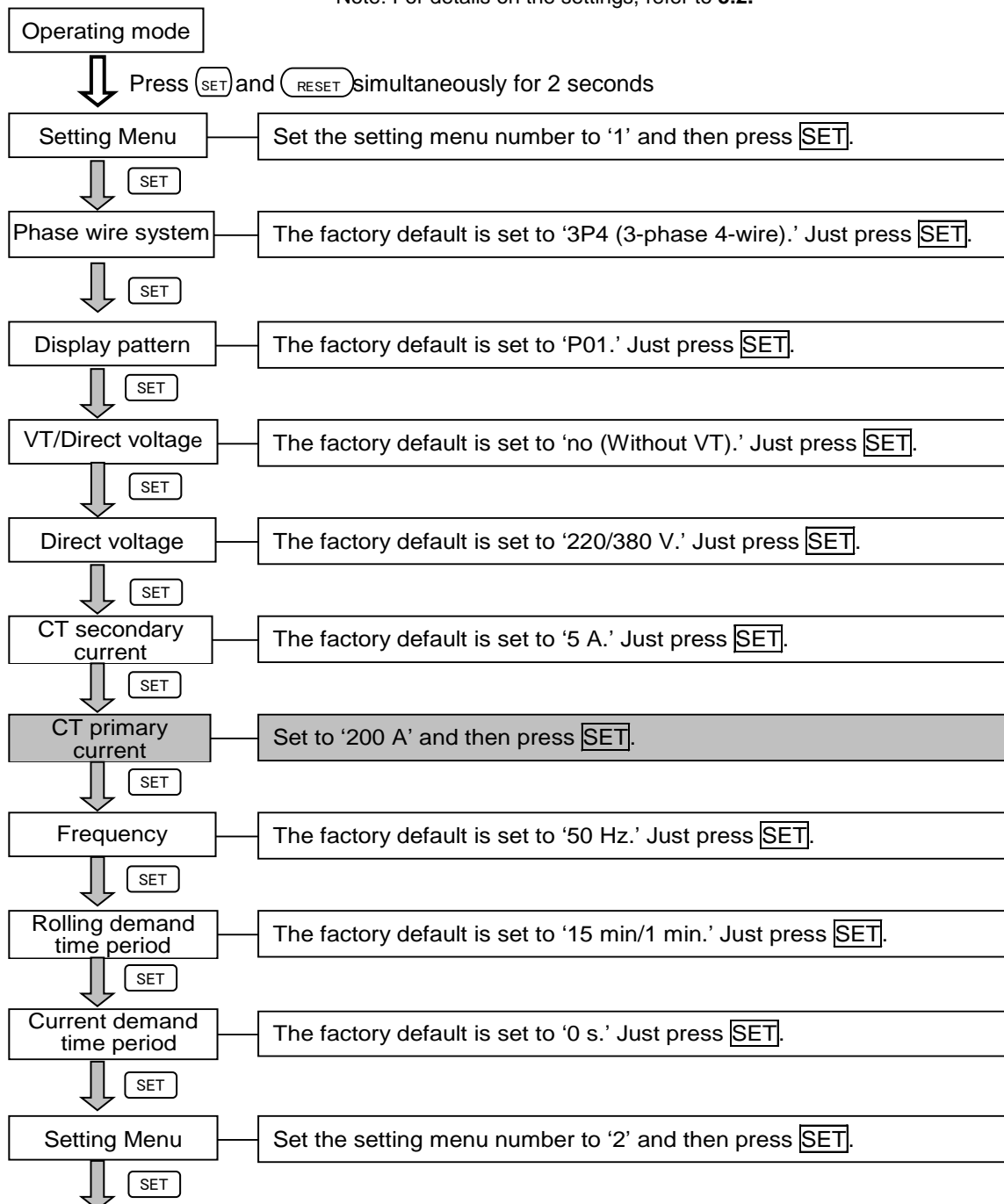

### 3. How to Set up

#### 3.19. Example for Easy Setup

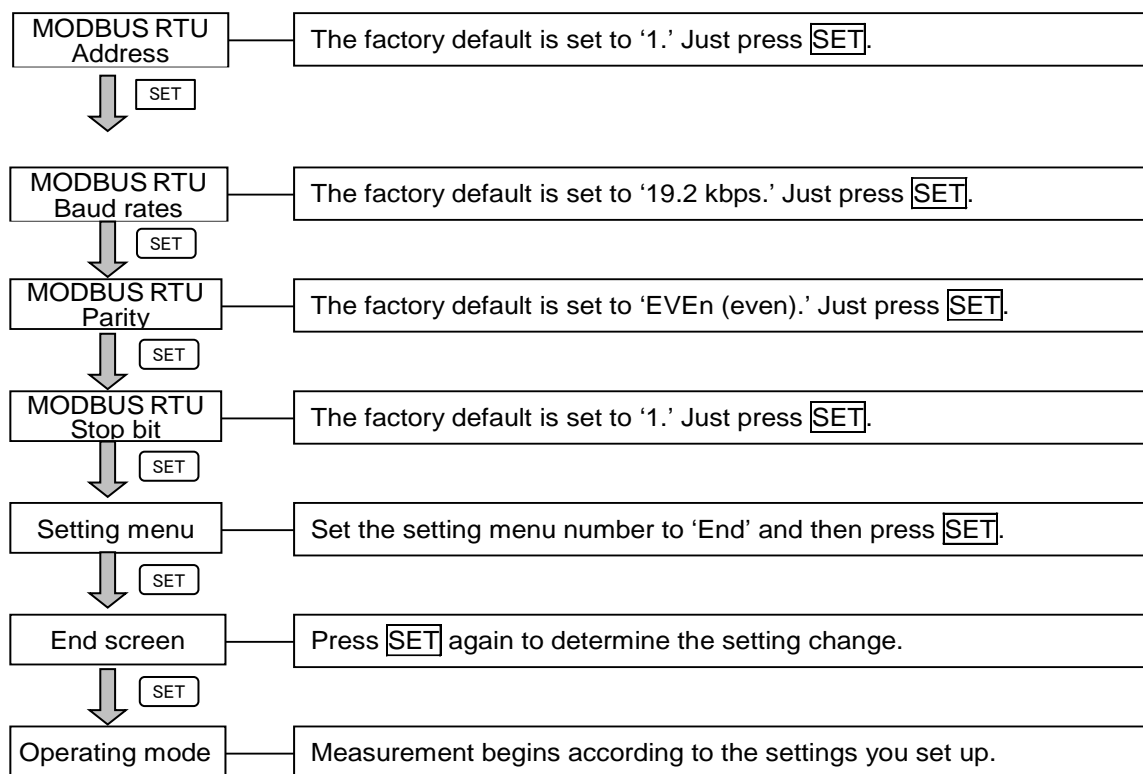

## 4. How to Use Test Mode

The test mode has function useful for startup of equipment.  
The following table shows a list of functions in the test mode.

Test menu	Description
1. Communication test	For models with communication function, without measurement (voltage/current) input, it is possible to return fixed numerical data. Use this for checking with the host system.
2. Alarm output/ Digital output test	For models with alarm/digital output function, without measurement (voltage/current) input, it is possible to check alarm output (digital output) operation. Use the check of connection with the destination.
3. Zero/Span adjustment for analog output	For the model with analog output function, zero/span adjustment is possible for analog output. Use it for adjustment to the receiver side or output change.
4. Analog output test	For the model with analog output function, without measurement (voltage/current) input, it is possible to check analog output operation. Use the check for connection with the receiver side.
5. Pulse output test	For the model with pulse output function, without measurement (voltage/current) input, it is possible to check pulse output operation. Use the check for connection with the receiver side.
6. Functions for determining incorrect wiring	<p>①Pattern display for incorrect wiring When either a voltage input or current input is incorrectly wired, this function automatically determines incorrect wiring and displays its part on the screen. It is easier to find out the incorrect part and useful to check the connection. *Note</p> <p>②Support display for determining incorrect wiring This function displays a current phase angle, a voltage phase angle, and active power, voltage, and current value of each phase. By checking each display and <b>9.3 A List of Examples for Incorrect Wiring Display</b>, it is easier to determine incorrect wiring of measurement (voltage/current) input.</p>

\*Note: The function cannot determine all incorrect wiring. If both a voltage input and current input are incorrectly wired, a different pattern may be displayed.

### Test procedure

- ① Press **SET** for 2 seconds to enter the setting confirmation mode.
- ② With **+** or **-**, select '9' in the setting confirmation menu number
- ③ Press **SET** to enter the test mode.
- ④ Execute the test in each test menu.

### Test mode flow

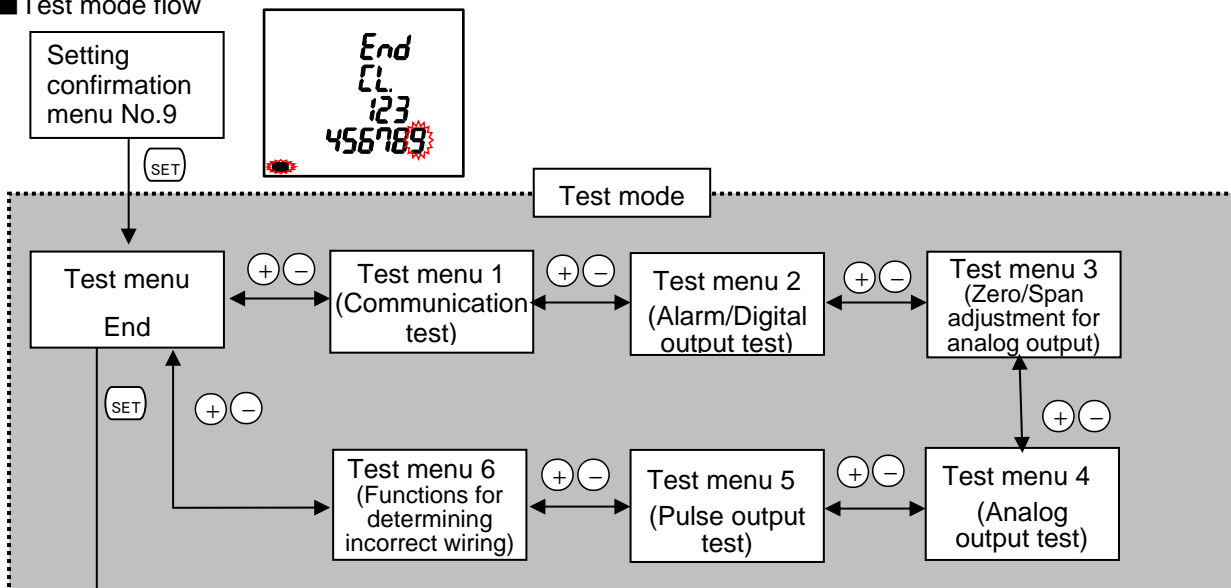

Note: The screen momentarily goes off.

### Operating mode

#### Note

1. When ME-0000BU-SS96 or ME-0000BU25-SS96 is activated, entering the test mode causes the power outage of ME-0000BU-SS96 or ME-0000BU25-SS96 so as not to log the test data. As a result, the system log is recorded for power outage and **COM** of the LED blinks.
2. Entering from the test mode to the operating mode restarts this instrument. Therefore, if the built-in logging function is activated, the system log for startup will be recorded. In addition, the present time setting is required again.

## 4. How to Use Test Mode

### 4.1. Test Menu 1: Communication Test

Set the setting confirmation menu number to 9 to enter the test mode  
 In the test mode, the following operation is available.

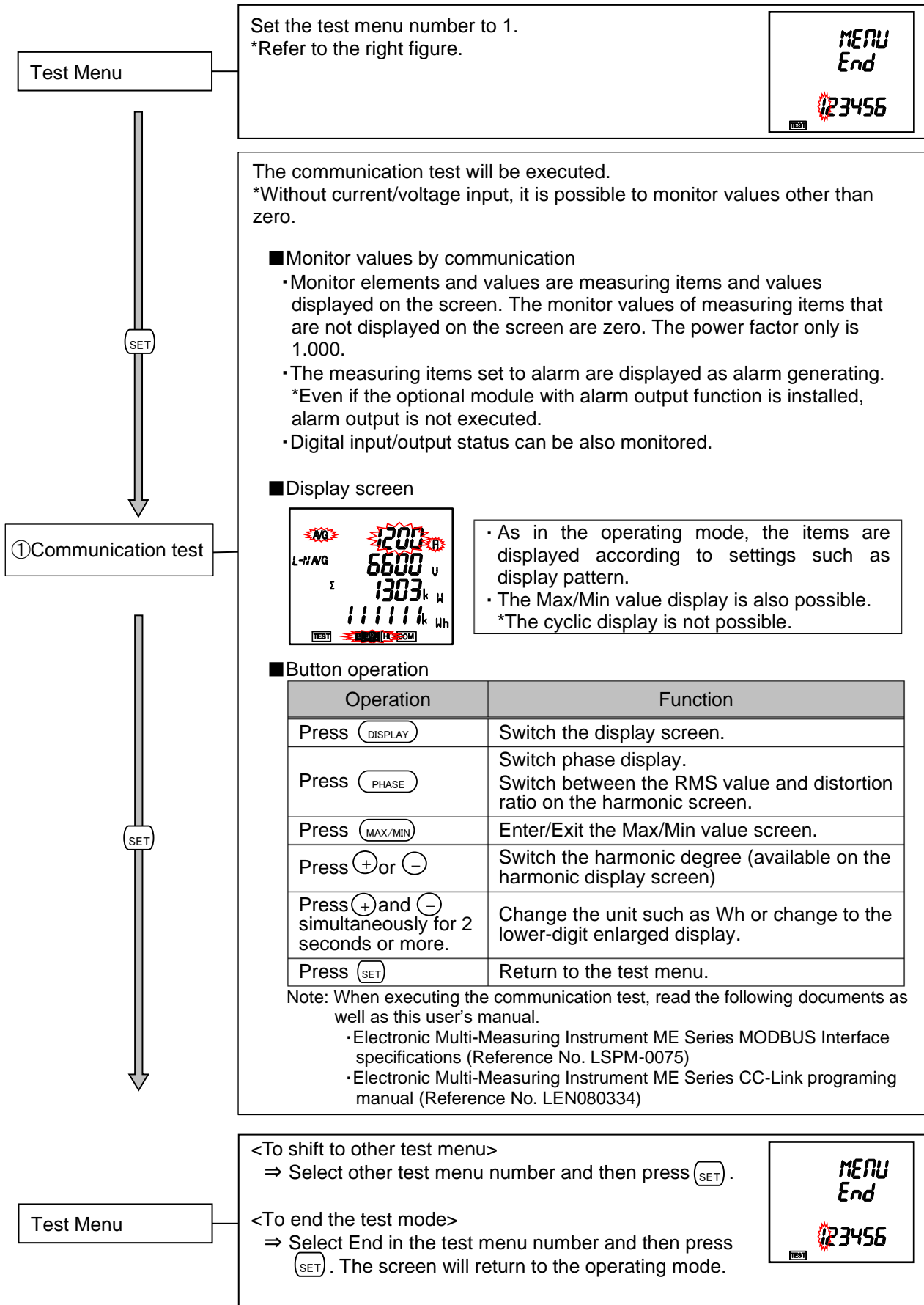

## 4. How to Use Test Mode

### 4.2. Test Menu 2: Alarm Output/Digital Output Test

In the test mode, the following operation is available.

- When ME-4210-SS96B or ME-0052-SS96 (optional plug-in module) is not installed, this menu is not displayed.
- Even when ME-4210-SS96B (optional plug-in module) is installed, if alarm output is not set at the setting menu 5: Pulse/Alarm output function, this menu will not be displayed.
- When ME-4210-SS96B (optional plug-in module) is installed, if alarm output is set for CH1 only at the setting menu 5: Pulse/Alarm output function, the screen for **②Alarm/Digital output CH2 test** will not be displayed. Likewise, if alarm output is set for CH2 only, the screen for **①Alarm/Digital output CH1 test** will not be displayed.

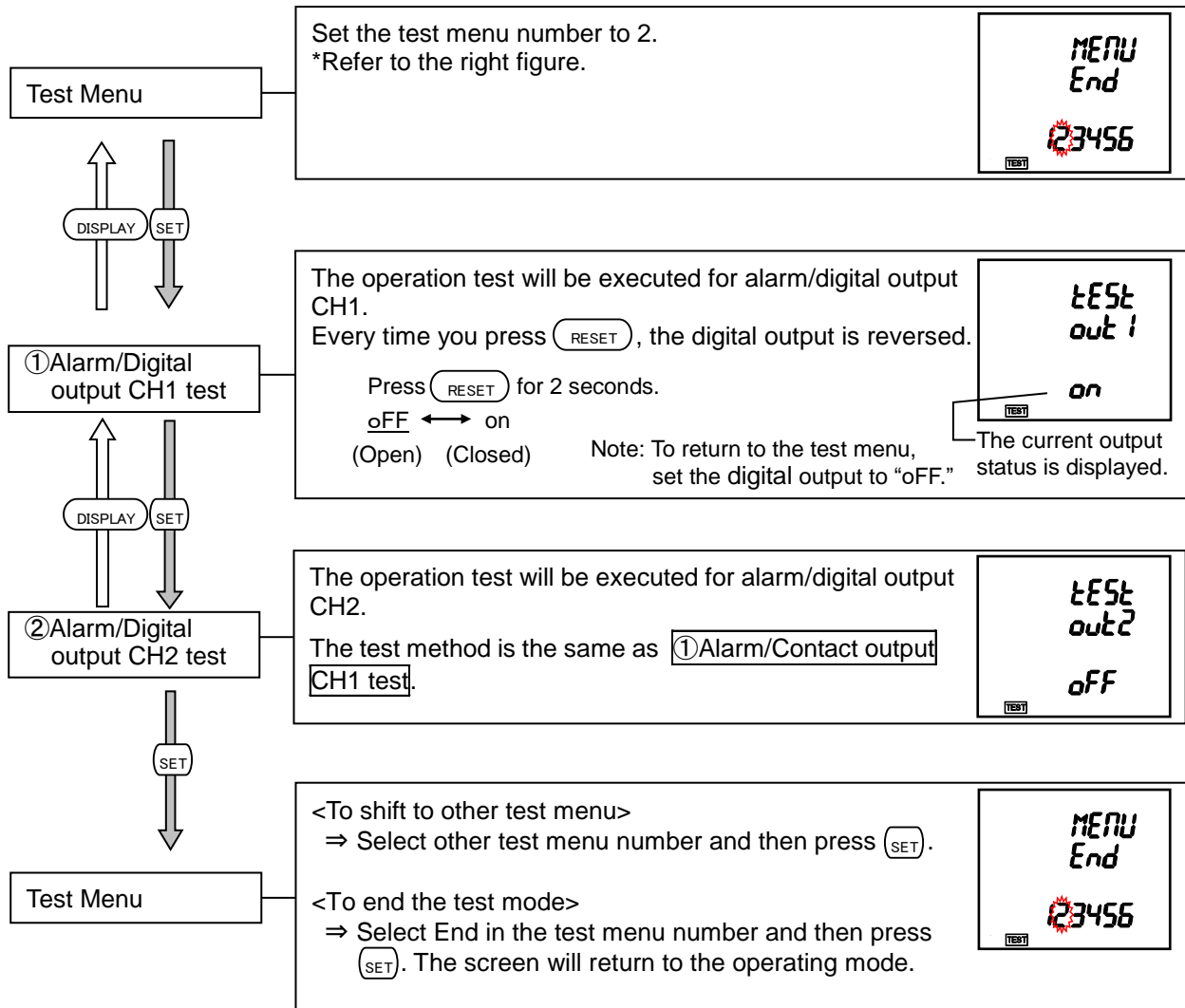

## 4. How to Use Test Mode

### 4.3. Test Menu 3: Zero/Span Adjustment for Analog Output

In the test mode, the following operation is available.

When ME-4210-SS96B (optional plug-in module) is not installed, this screen is not displayed.

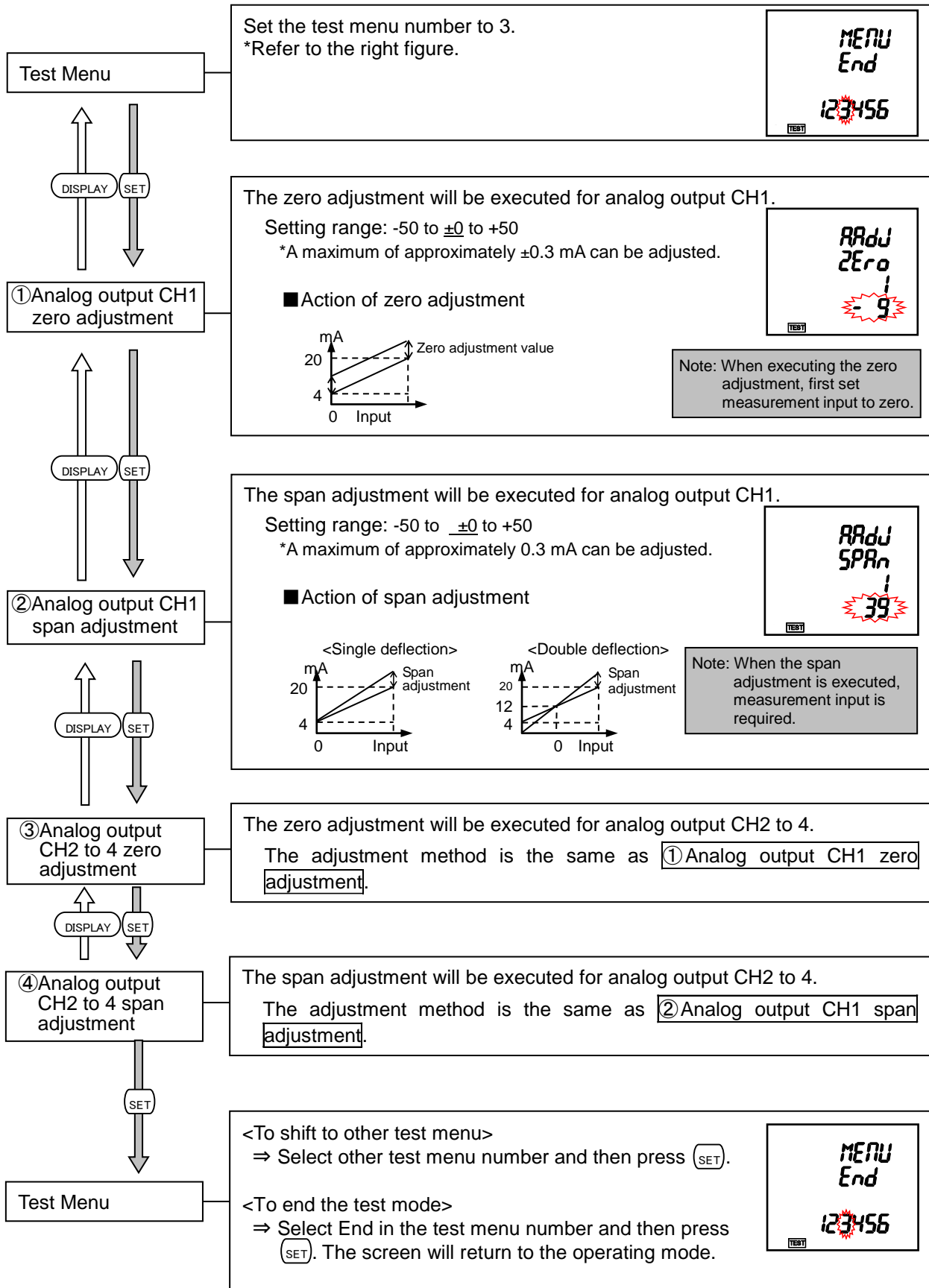



## 4. How to Use Test Mode

### 4.4. Test Menu 4: Analog Output Test

In the test mode, the following operation is available.

When ME-4210-SS96B (optional plug-in module) is not installed, this menu is not displayed.

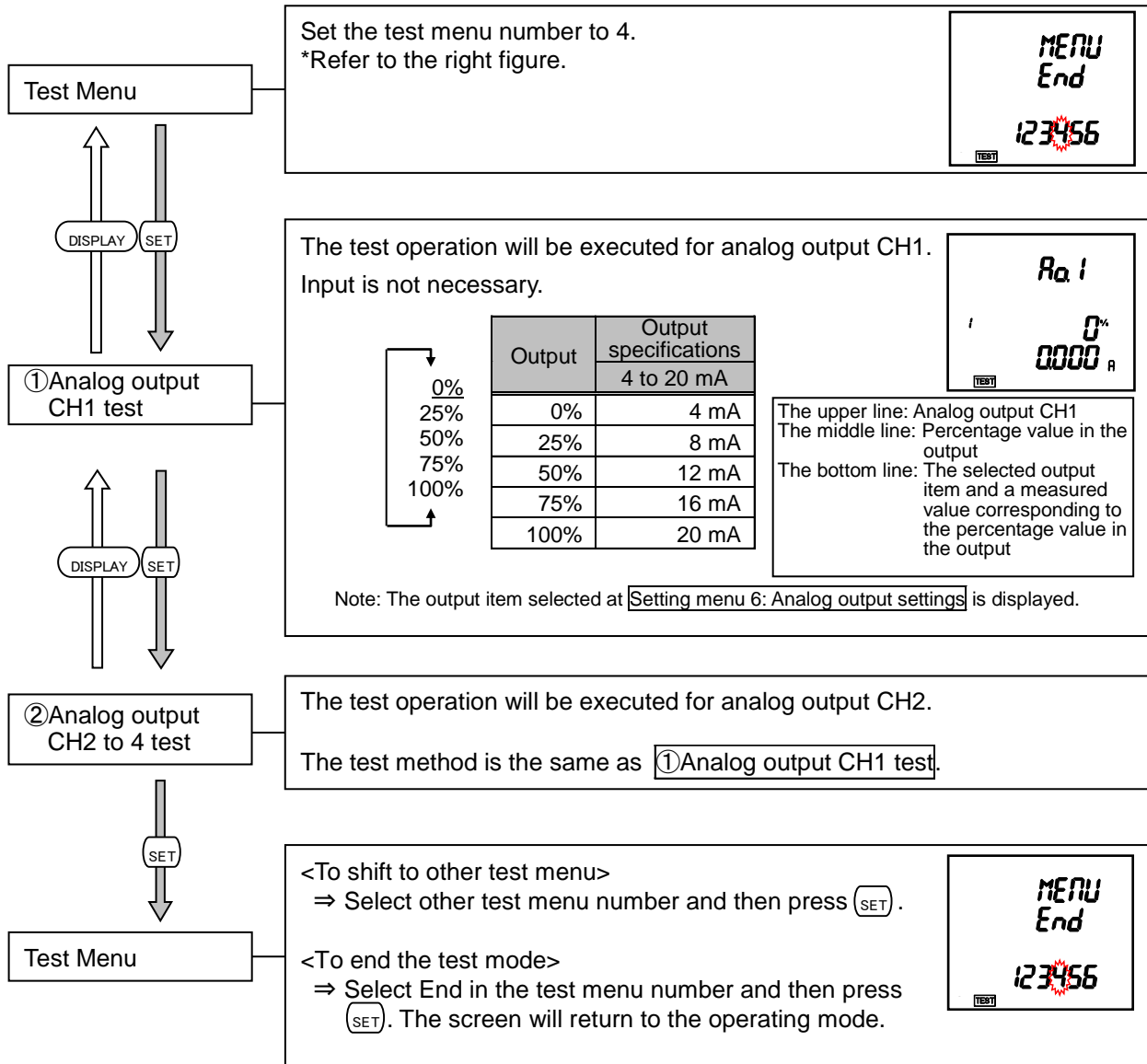

## 4. How to Use Test Mode

### 4.5. Test Menu 5: Pulse Output Test

In the test mode, the following operation is available.

- When ME-4210-SS96B (optional plug-in module) is not installed, this menu is not displayed.
- Even when ME-4210-SS96B (optional plug-in module) is installed, if pulse output is not set at the setting menu 5: Pulse/Alarm output function, this menu will not be displayed.
- When ME-4210-SS96B (optional plug-in module) is installed, if pulse output is set for CH1 only at the setting menu 5: Pulse/Alarm output function, the screen for **②Pulse output CH2 test** will not be displayed. Likewise, if pulse output is set for CH2 only, the screen for **①Pulse output CH1 test** will not be displayed.

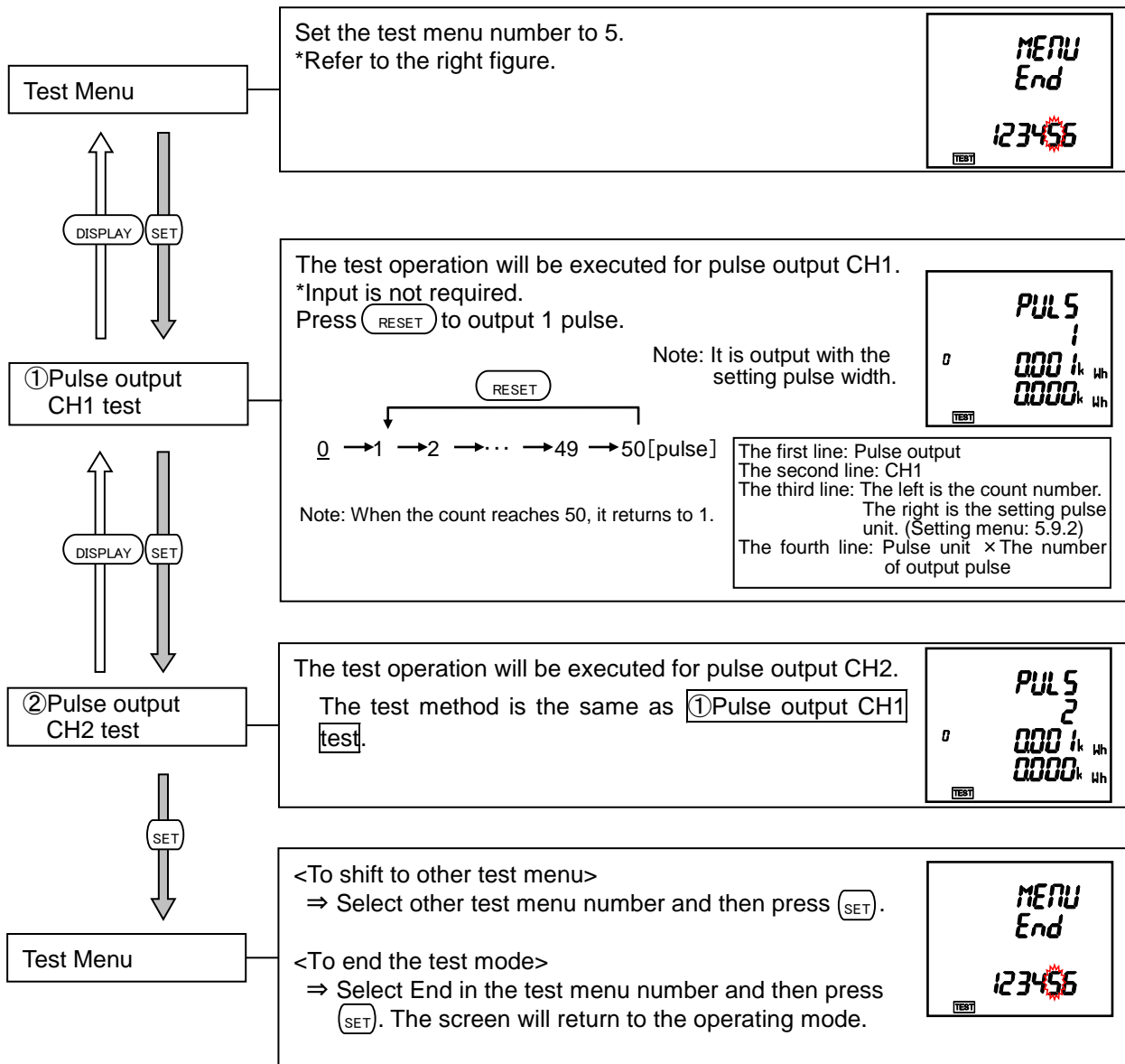

## 4. How to Use Test Mode

### 4.6. Test Menu 6: Function for Determining Incorrect Wiring

In the test mode, the following operation is available.

Test Menu

Set the test menu number to 6.  
\*Refer to the right figure.

MENU  
End

123456

↑

↓

DISPLAY

SET

When either a voltage input or a current input is incorrectly wired, this function automatically determines incorrect wiring and the incorrect part is displayed on the screen. After checking it, press (SET) to return to the test menu.

Example of correct wiring

Example of incorrect wiring:  
Reverse connection of 1 side CT

The incorrect wiring part blinks.  
\*1  
The correct one is ON.  
The number of incorrect wiring pattern appears.  
\*For details on the pattern, refer to 4.6.1.

\*1. For 3-phase 3-wire system, the PN terminal is displayed as 'P2' on the screen. Read as 'PN.'

■ Select a power factor condition (For 3-phase 3-wire system)  
For 3-phase 3-wire system, the following screen may be displayed to select a power factor condition according to the incorrect wiring situation.  
With (+) or (-), select a power factor condition and then press (SET).  
When the settings are determined, the incorrect wiring part is displayed on the screen.

Power factor: LAG

+

→

←

-

Power factor: Around 1

+

→

←

-

Power factor: LEAD

Note: Select a power factor condition by referring to the following points:

- Power factor: LAG → Power factor is lagging for load of inductive machines. Assume 1 to lag 0.5.
- Power factor: Around 1 → Power factor is around 1 due to resistance load or power factor improvement. Assume lead 0.866 to lag 0.866.
- Power factor: LEAD → Power factor is leading for capacitor panel. Assume lead 0 to 1.

\*If the Err display appears at the bottom line of the LCD, press (-) and then select the power factor condition again.

■ Check multiple alternatives (For 3-phase 3-wire/1-phase 3-wire/1-phase 2-wire system)  
There may be multiple patterns of incorrect wiring according to the incorrect wiring situation. For the above three systems, press (DISPLAY) to switch the screen and check the incorrect wiring patterns.

Display the first pattern in the three patterns.

DISPLAY

→

DISPLAY

→

■ There are multiple incorrect wiring parts. (For 3-phase 4-wire system)  
For this phase wire system, multiple incorrect wiring parts of voltage or those of current are detected and displayed on each screen.

Example of voltage

Example of current

① Pattern display of incorrect wiring

## 4. How to Use Test Mode

### 4.6. Test Menu 6: Function for Determining Incorrect Wiring

Continued from the previous page.

- It is not possible to detect incorrect wiring  
If the screen is displayed as the following, it is not possible to detect incorrect wiring.  
Check measurement (voltage/current) input or press (+) to check **②Support display for determining incorrect wiring.**

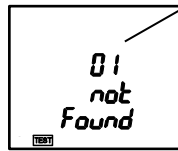

Display	Description
01	This is low voltage. Apply about 70 percent or more of the direct voltage or secondary voltage setting.
02	This is low current. Apply about 5 percent or more of the rated current of the instrument.
03	This is in an unbalanced state. For 3-phase 3-wire system, it is not possible to detect incorrect wiring if there is a 10 percent or more difference between values in 1-phase and 3-phase of current.
04	There may be multiple incorrect wiring parts. Check <b>②Support display for determining incorrect wiring.</b>

Phase angle, active power, voltage, and current are displayed.

<For 3-phase 4-wire system>

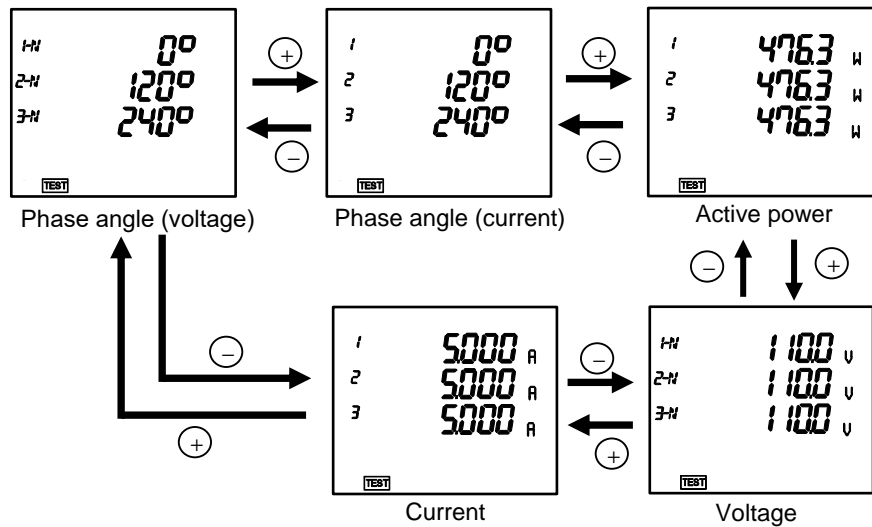

**②Support display for determining incorrect wiring**

<For 3-phase 3-wire system>

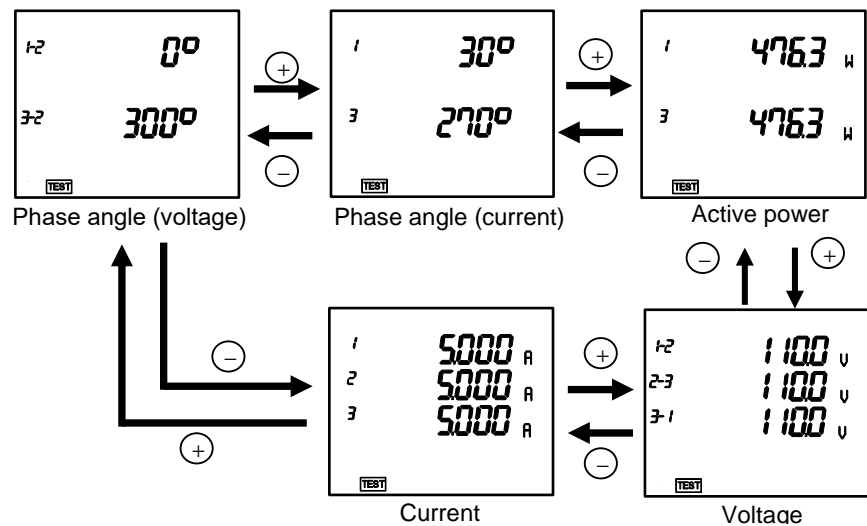

Continued to the next page.

## 4. How to Use Test Mode

### 4.6. Test Menu 6: Function for Determining Incorrect Wiring

Continued from the previous page.

#### ■ Phase angle

The phase angle is displayed clockwise based on  $V_{12}$  (0 degree).

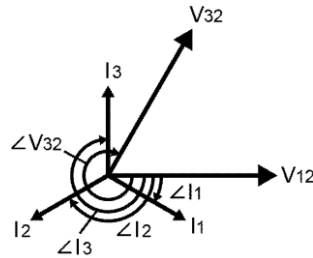

$\angle V_{32}$ -phase angle between  $V_{32}$  and  $V_{12}$

$\angle I_{1}$ -phase angle between  $I_1$  and  $V_{12}$

$\angle I_{3}$ -phase angle between  $I_3$  and  $V_{12}$

Note: For 1-phase 3-wire, read the phase as follows.

$V_{12} \rightarrow V_{1N}$

$V_{32} \rightarrow V_{3N}$

$I_3 \rightarrow I_2$  or  $I_3$

#### ■ Display examples of incorrect wiring support function

For display examples of each incorrect wiring, refer to **9.3 A List of Examples for Incorrect Wiring Display**.

<To shift to other test menu>

⇒ Select other test menu number and then press **SET**.

Test Menu

<To end the test mode>

⇒ Select End in the test menu number and then press **SET**.

The screen will return to the operating mode.

## 4. How to Use Test Mode

### 4.6. Test Menu 6: Function for Determining Incorrect Wiring

#### 4.6.1. Incorrect Wiring Patterns Detected by ① Pattern display of incorrect wiring

This function is designed with the assumption that either a current input or a voltage input is incorrectly wired in positive phase sequence. It is not possible to determine all incorrect wiring. Dashed lines indicate incorrect wiring parts.

■ For 3-phase 4-wire system

No.	Wiring diagram	No.	Wiring diagram	No.	Wiring diagram	No.	Wiring diagram
1	Normal 	3	Reverse connection of 2 side CT 	8	Reverse connection of 1 side CT, 2 side CT, and 3 side CT 	13	Reverse connection between terminals P2 and P3 
	Reversed phase sequence 1*1 	4	Reverse connection of 3 side CT 	9	Switch between 1 side CT and 2 side CT 	14	Reverse connection between terminals P1 and P3 
	Reversed phase sequence 2*1 	5	Reverse connection of 1 side CT and 2 side CT 	10	Switch between 2 side CT and 3 side CT 	15	Reverse connection between terminals P1 and PN 
	Reversed phase sequence 3*1 	6	Reverse connection of 2 side CT and 3 side CT 	11	Switch between 1 side CT and 3 side CT 	16	Reverse connection between terminals P2 and PN 
2	Reverse connection of 1 side CT 	7	Reverse connection of 1 side CT and 3 side CT 	12	Reverse connection between terminals P1 and P2 	17	Reverse connection between terminals P3 and PN 

\*1. Correct measurement is possible even in reversed phase sequence.

\*2. For low voltage circuits, it is not necessary to ground the VT and CT secondary side circuits.

## 4. How to Use Test Mode

### 4.3. Test Menu 6: Functions for Determining Incorrect Wiring

#### 4.3.1. Incorrect wiring patterns detected by ① Pattern display of incorrect wiring

■ For 3-phase 3-wire system

No.	Wiring diagram	No.	Wiring diagram	No.	Wiring diagram
1	<p>Normal</p>	6	<p>Reverse connection between terminals P1 and P2</p>	11	<p>Reverse connection of 1 side VT</p>
2	<p>Reverse connection of 1 side CT</p>	7	<p>Reverse connection between terminals P2 and P3</p>	12	<p>Reverse connection of 3 side VT</p>
3	<p>Reverse connection of 3 side CT</p>	8	<p>Reverse connection between terminals P1 and P3</p>	13	<p>Reverse connection of 1 side VT and 3 side VT</p>
4	<p>Reverse connection of 1 side and 3 side CT</p>	9	<p>P2, P3, and P1 terminals of VT are connected to P1, P2, and P3 terminals of the instrument in that order.</p>	14	<p>Reversed phase sequence *1</p>
5	<p>Switch between 1 side CT and 3 side CT</p>	10	<p>P3, P1, and P2 terminals of VT are connected to P1, P2, and P3 terminals of the instrument in that order</p>		

\*1. Correct measurement is possible even in reversed phase sequence.

\*2. For low voltage circuits, it is not necessary to ground the VT and CT secondary side circuits.

## 4. How to Use Test Mode

### 4.3. Test Menu 6: Functions for Determining Incorrect Wiring

#### 4.3.1. Incorrect wiring patterns detected by ①Pattern display of incorrect wiring

■ For 1-phase 3-wire system \*1

No.	Wiring diagram	No.	Wiring diagram	No.	Wiring diagram
1	<p>Normal</p>	5	<p>Switch between 1 side CT and 3 side CT</p>	8	<p>Reverse connection between terminals P1 and P3</p>
2	<p>Reverse connection of 1 side CT</p>	6	<p>Reverse connection between terminals P1 and PN</p>	9	<p>PN, P2, and P1 are connected to P1, PN, and P3 terminals of the instrument in that order.</p>
3	<p>Reverse connection of 3 side CT</p>	7	<p>Reverse connection between terminals PN and P3</p>	10	<p>P3, P1, and PN are connected to P1, PN, and P3 terminals of the instrument in that order.</p>
4	<p>Reverse connection of 1 side and 3 side CT</p>				

\*1. On the screen, the PN terminal is displayed as 'P2.' Read as 'PN.'

■ For 1-phase 2-wire system

No.	Wiring diagram	No.	Wiring diagram
1	<p>Normal</p>	2	<p>Reverse connection of 1 side CT</p>



## 5. Operation

### 5.1. Basic Operation

The following charts illustrate how to use basic operation.

#### 5.1.1. How to Switch the Measurement Screen

Press **DISPLAY** to switch the measurement screen.

In addition, by pressing **DISPLAY** and **+** or **-**, the measurement screen is switched in reverse.

The display item and order vary depending on the phase wire system, display pattern, and additional screen. For details on the display pattern, refer to **6.1 Display Pattern List**.

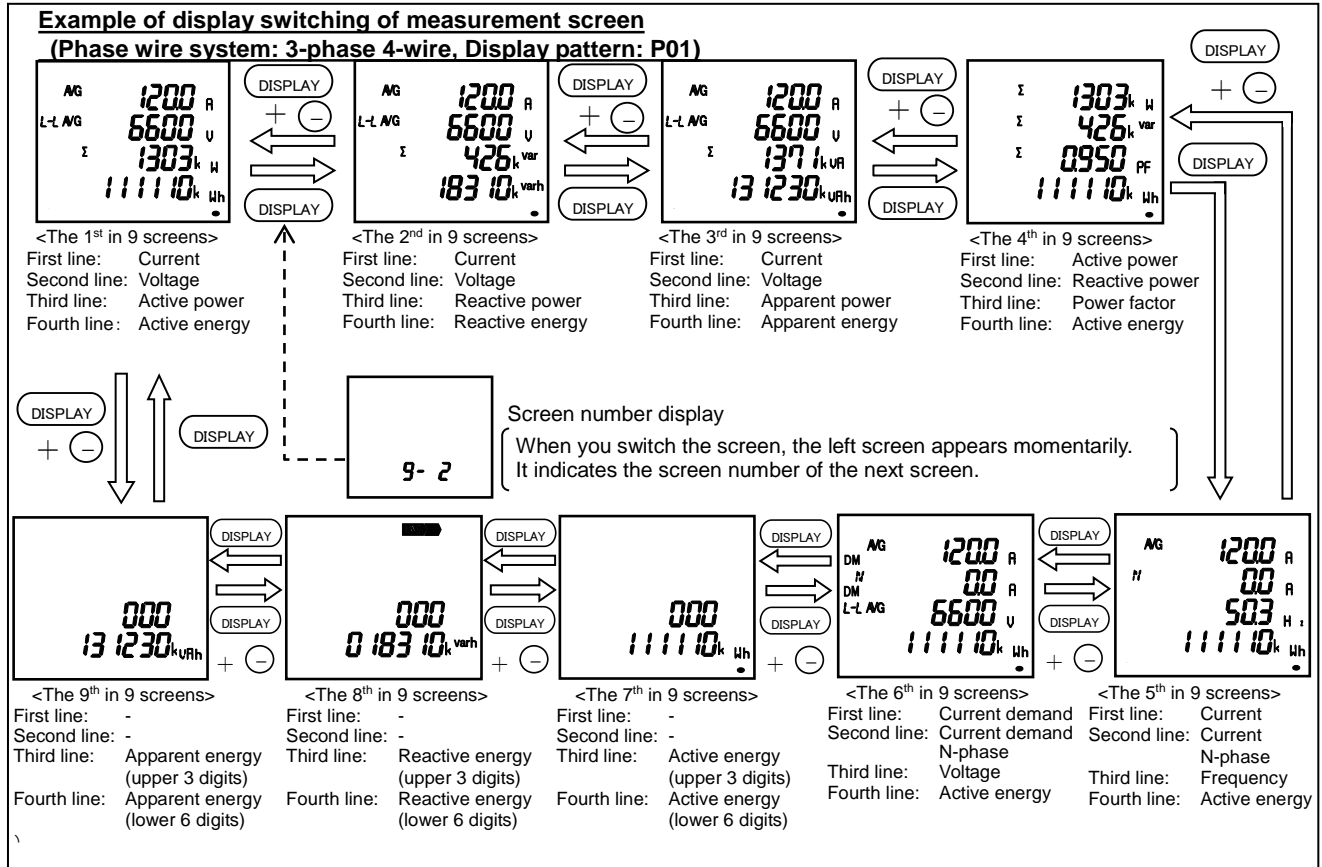

#### 5.1.2. How to Switch Phase Display

Press **PHASE** to switch the phase of voltage/current.

The phase switching is not available in the following cases:

- Measuring element without phase (Frequency)
- Active power, reactive power, apparent power, and power factor for other than 3-phase 4-wire system
- 1-phase 2-wire system setting

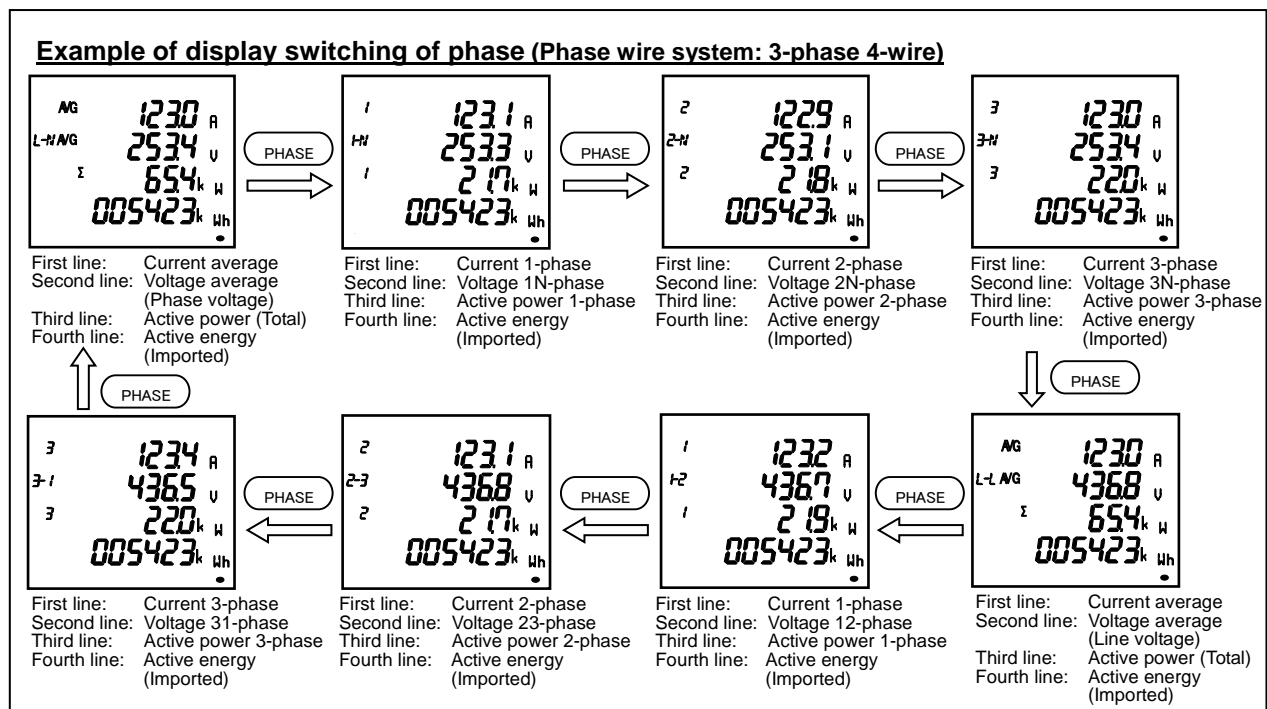

## 5. Operation

### 5.1. Basic Operation

#### 5.1.3. How to Display the Cyclic Mode

In the cyclic mode, the measurement screen or phase display automatically switches every 5 seconds. When you press **DISPLAY** for 2 seconds, the screen enters the cyclic display mode of measurement screen. Pressing **PHASE** for 2 seconds enters the cyclic display mode of phase. To end the cyclic mode, press any button other than **SET**.

Note 1: Before shift to the cyclic mode, the screen blinks 3 times.

Note 2: In the cyclic display mode of measurement screen, the screen number is not displayed at switching display.

Note 3: On the Max/Min value screen, the cyclic mode is available.

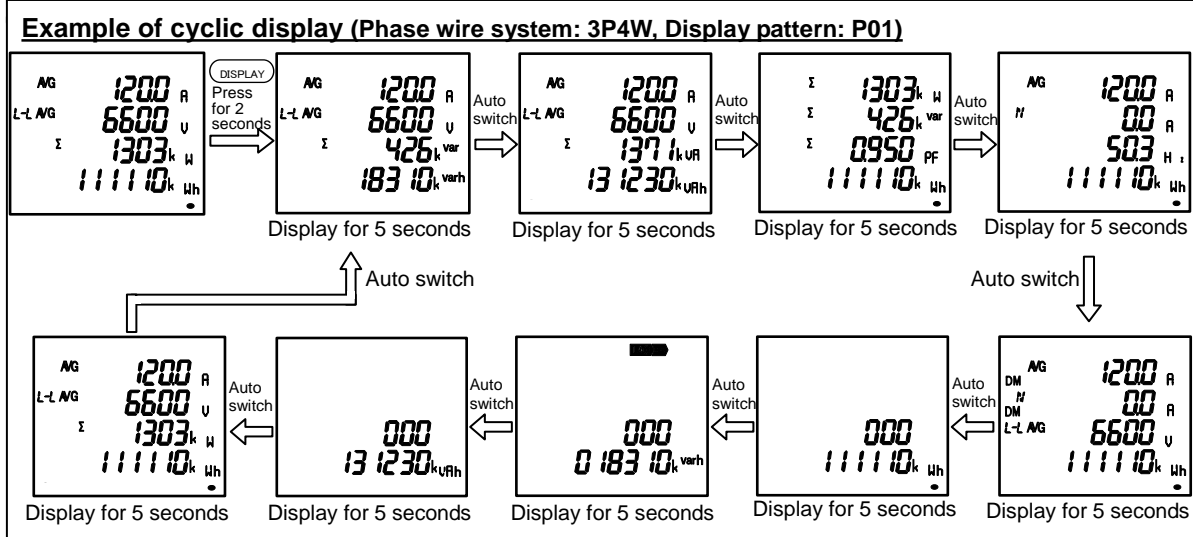

## 5. Operation

### 5.1. Basic Operation

#### 5.1.4. Harmonics Display

The harmonic RMS value and distortion ratio (content rate) can be displayed.

To display them, you must set the harmonics display. For details on the settings, refer to 3.6.

#### ■ Measuring elements

Degree	Harmonic current		Harmonic current N-phase		Harmonic voltage	
	RMS value	Distortion ratio (Content rate)	RMS value	Distortion ratio (Content rate)	RMS value	Distortion ratio (Content rate)
Harmonic total	○	○	○	—	○	○
1 <sup>st</sup> (Fundamental wave)	○	—	○	—	○	—
3 <sup>rd</sup> , 5 <sup>th</sup> , 7 <sup>th</sup> , 9 <sup>th</sup> , 11 <sup>th</sup> , 13 <sup>th</sup> , 15 <sup>th</sup> , 17 <sup>th</sup> , 19 <sup>th</sup>	○	○	○	—	○	○

#### ■ Display examples

<Harmonic current total>

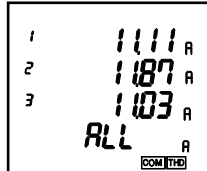

<Harmonic voltage 5th>

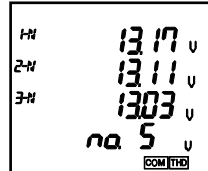

First line: 1-phase RMS value  
Second line: 2-phase RMS value  
Third line: 3-phase RMS value  
Fourth line: Degree

Note: Degree total is displayed as 'ALL.'

#### ■ How to switch the degree (Phase wire system: 3-phase 4-wire)

Press (+) or (-) to switch the degree.

By pressing (PHASE), the RMS value and distortion ratio (content rate) are switched.

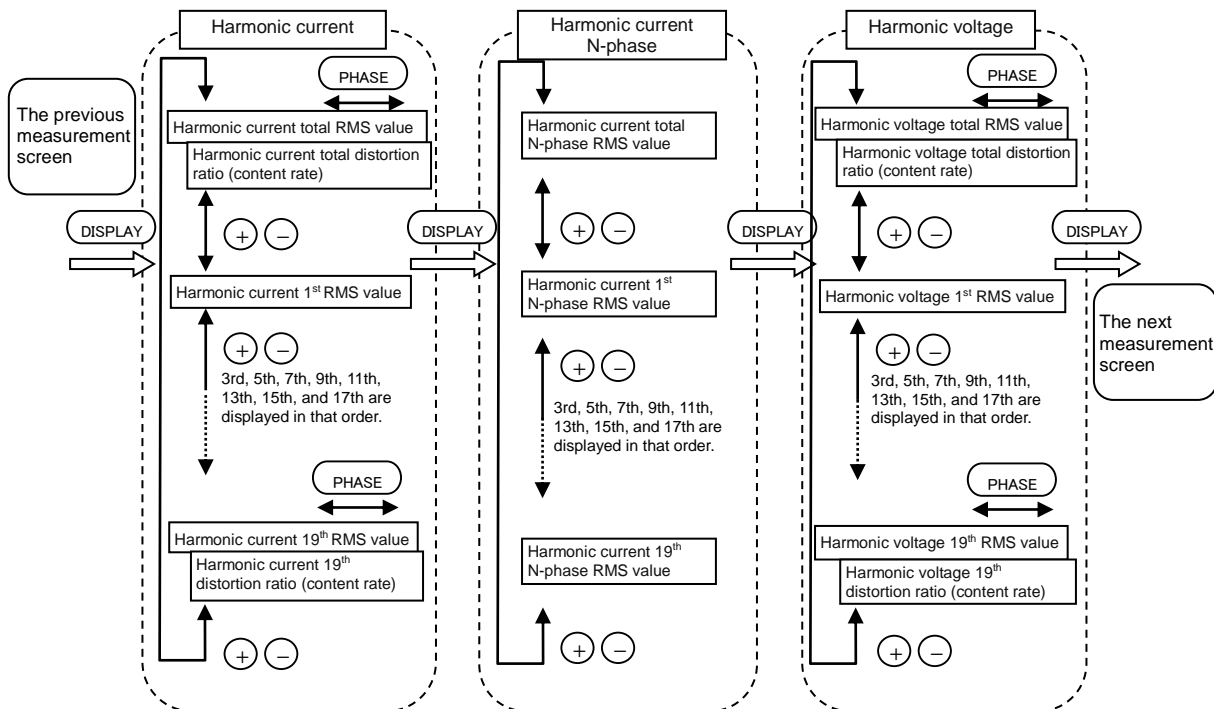

Note: The following table shows no phases in harmonic measurement display.

Phase wire system		Harmonic current	Harmonic voltage
3-phase 3-wire	3CT	—	31-phase
	2CT	2-phase	31-phase
1-phase 3-wire	1N2 display	N-phase	12-phase
	1N3 display	N-phase	13-phase

## 5. Operation

### 5.1. Basic Operation

#### 5.1.5. Maximum/Minimum Value Display

On the Max/Min value screen, a maximum value, present value, and minimum value are displayed in one screen by measuring item.

However, for harmonics, the following maximum values only are displayed.

- Harmonic current: The total/1<sup>st</sup> to 19<sup>th</sup> RMS value of the phase where a value was the largest in every phase.
- Harmonic voltage: The total distortion ratio/1<sup>st</sup> RMS value/3<sup>rd</sup> to 19<sup>th</sup> content rate of the phase where a value was the largest in every phase.

#### ■ Display examples

<Example of Current>



First line: Maximum value  
Second line: Present value  
Third line: Minimum value  
Fourth line: -

<Example of Harmonic current>

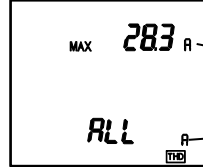

Maximum value

Harmonic degree

#### 5.1.6. How to Display Maximum/Minimum Value

When you press (MAX/MIN), the screen switches to the Max/Min value display.

Pressing (MAX/MIN) again returns to the present value display.

Example of display switching between the present value and Max/Min value

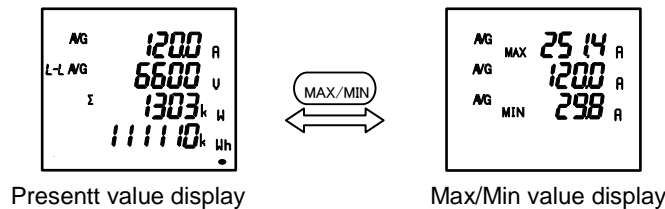

Present value display

Max/Min value display

On the Max/Min value screen, the following display switching is available as the present value screen.

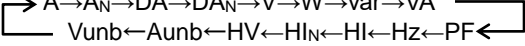
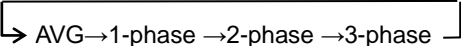
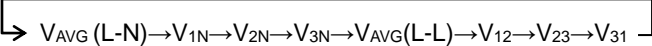
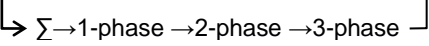
Button operation	Function
Press (DISPLAY)	Measuring items are switched in the following order. However, measuring items that are not included in the phase wire system, display pattern, and additional screen are not displayed.  Pressing (←) and (→) switches the above item in the reverse direction.
Press (PHASE)	For 3-phase 4-wire system, the phases of the measuring items are switched as follows: <ul style="list-style-type: none"> <li>• A, DA: </li> <li>• V: </li> <li>• W, var, VA, PF: </li> </ul> • AN, DAN, and Hz do not have phase switching. For 3-phase 3-wire/1-phase 3-wire system, the phases of A, DA and V are switched. For 1-phase 2-wire system, no phase is switched.
Press (+) or (-)	Switch the harmonic degree (available on the harmonics display screen)
Press (DISPLAY) for 2 seconds	Enter the cyclic display mode of measurement screen
Press (PHASE) for 2 seconds	Enter the cyclic display mode of phase

#### 5.1.7. How to Clear Maximum/Minimum Value

On the Max/Min value screen, pressing (RESET) for 2 seconds clears the maximum and minimum values of the displayed measuring item and turns to the present values.

In addition, pressing (RESET) and (+) simultaneously for 2 seconds on the screen clears all maximum and minimum values and turns to the present values.

When password protection is enabled, the maximum and minimum values are cleared after you enter the password. Communication function also enables to clear all maximum and minimum values. In this case, password input is not necessary.

## 5. Operation

### 5.1. Basic Operation

#### 5.1.8. Active Energy/Reactive Energy/Apparent Energy Display

##### ■ Display type

The following table shows the display type of active/reactive/apparent energy based on the full-load power.

$$\text{Full-load power [kW]} = \frac{\alpha \times (\text{VT primary voltage}) \times (\text{CT primary current})}{1000}$$

$\left( \begin{array}{l} \alpha: 1 \\ 2 \\ \sqrt{3} \\ 3 \end{array} \right)$	1-phase 2-wire
	1-phase 3-wire
	3-phase 3-wire
	3-phase 4-wire

- \*1. For 3-phase 4-wire system, the VT primary voltage and direct voltage are calculated using phase voltage.
- \*2. For 1-phase 3-wire system, the VT primary voltage is calculated using phase voltage.
- \*3. For the direct voltage setting, direct voltage is used for calculation instead of VT primary voltage.
- \*4. For reactive energy and apparent energy, 'kW' in the above equation is read as 'kvar' and 'kVA' respectively.

Full-load power [kW, kvar, kVA]	Display type	
	Digital display	Unit
Below 10	888888	kWh, kvarh, kVAh *The unit can be changed to 'M or none.'
10 or more and below 100		
100 or more and below 1000		
1000 or more and below 10000		
10000 or more and below 100000		
100000 or more		MWh, Mvarh, MVAh *The unit can be changed to 'k or none.'

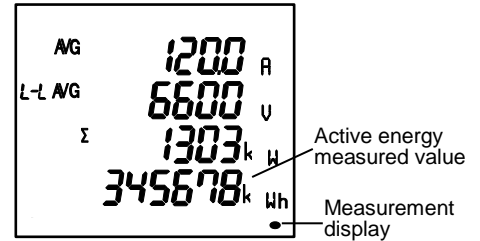

The measurement display blinks when active energy (imported) is measured. It goes off at no measuring point.

##### ■ Display examples

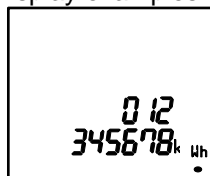

Active energy (imported)

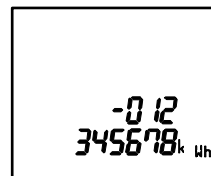

Active energy (exported)\*1

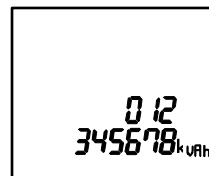

Apparent energy

To display the screen of \*1, you must change the settings for active/reactive energy measurement in 3.6.

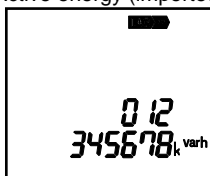

Reactive energy (imported lag)

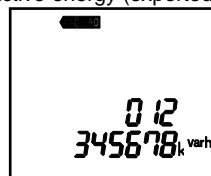

Reactive energy (imported lead)\*1

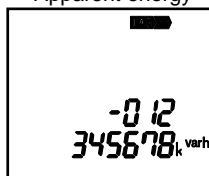

Reactive energy (exported lag)\*1

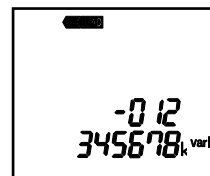

Reactive energy (exported lead)\*1

#### 5.1.9. How to Change the Display Digit of Active/Reactive/Apparent Energy

By changing the unit (M, k, or none) of active/reactive/apparent energy or by displaying the lower enlarged view, you can check the upper or lower digit of a measured value.

Press (+) and (-) simultaneously for 2 seconds to switch.

Example of switching active energy (imported): 012,345,678,901,234.567Wh

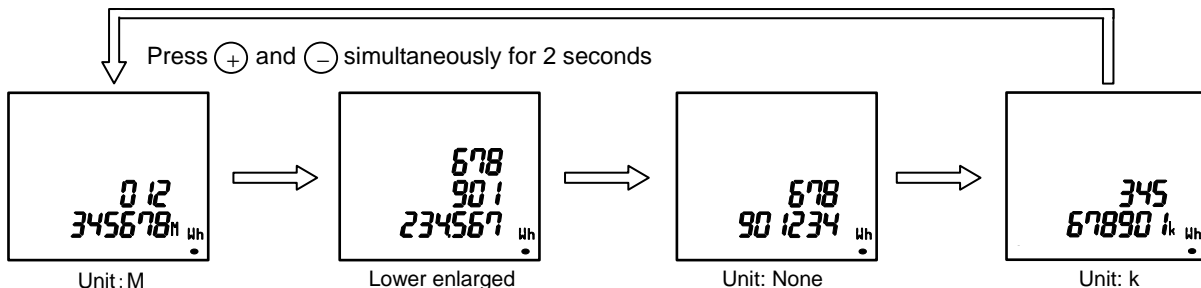

Note1: Active, reactive, and apparent energy that are not displayed on the screen will be all changed to the same unit.

Note2: If the set value of VT primary voltage or that of CT primary current is large, the lower digit less than the measurement range will indicate '0.'

## 5. Operation

### 5.1. Basic Operation

#### 5.1.10. How to Reset Active/Reactive/Apparent Energy to Zero

When you press (SET), (RESET), and (PHASE) simultaneously for 2 seconds, active, reactive, and apparent energy values will be reset to zero.

When password protection is enabled, the values are reset after you enter the password.

In addition, communication function enables to reset all active, reactive, and apparent energy values to zero.

In this case, password input is not necessary.

Note1: This function is available on the present value screen only.

Note2: The values of active, reactive, and apparent energy that are not displayed on the screen will be also all reset to zero.

Note3: Periodic active energy can be separately reset to zero. Refer to 5.2.6.

#### 5.1.11. How to Measure Reactive Energy (2 quadrant/4 quadrant measurement )

For measurement of reactive energy, there are two types on how to take a quadrant as follows.

The measurement method of reactive energy can be switched at the active/reactive energy measurement settings in the setting menu 3.

In addition, when you set to IEC mode in the setting menu 8, 2 quadrant measurement is executed even if you set to 'Combination III' or 'Combination IV', which executes 4 quadrant measurement, at the active/reactive energy measurement settings.

When you select 4 quadrant measurement and IEC mode at each setting, 'Imported lag' and 'Exported lead' of reactive energy are displayed on the additional screen. However, they are not integrated.

For details on how to switch the 2 quadrant/4 quadrant measurement, refer to 3.6.

For details on how to switch the IEC mode setting, refer to 3.13.

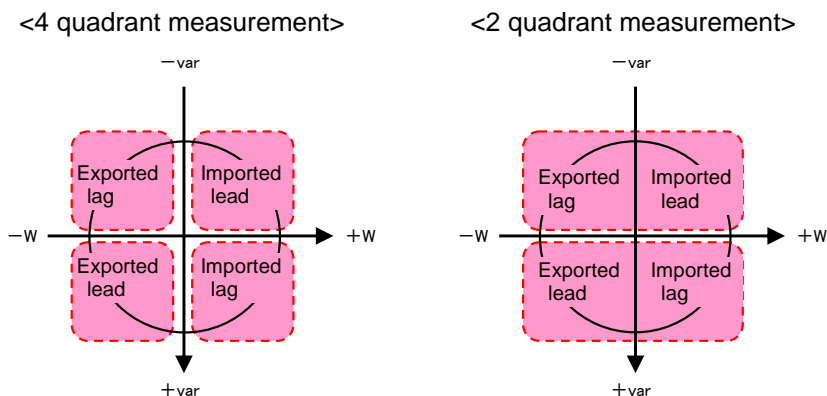

Measurement method	Description
4 quadrant measurement	Each of four quadrants (Imported lag, Imported lead, Exported lag, and Exported lead) is measured as one division. It is suitable to measure systems with a private power generator. However, a dead region occurs at the boundary of each division. Accordingly, reactive energy cannot be measured at where power factor is near 1 or zero.
2 quadrant measurement	'Imported lag' and 'Exported lead' are measured as one division, and in the same way, 'Imported lead' and 'Exported lag' are measured as one division. Therefore, a dead region does not occur at where power factor is near zero and reactive energy can be measured even there. It is suitable to measure systems without a private power generator and reactive energy of capacitor load where power factor is zero generally.

## 5. Operation

### 5.1. Basic Operation

#### 5.1.12. Each Measuring Item Display during Power Transmission

The following table shows symbol display ( $\pm$ ) for each measured value according to the power transmission state.

For details on how to switch the 2 quadrant/4 quadrant measurement, refer to 3.6.

For details on how to switch IEC mode, refer to 3.13.

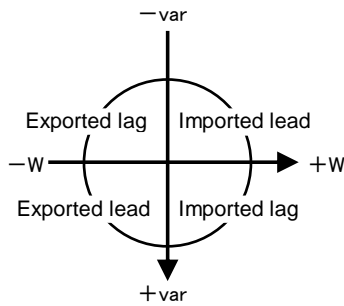

Measuring item		Power transmission state				
		Imported lag	Imported lead	Exported lag	Exported lead	
A, DA, AN, DAN, V, Hz, VA, HI, HIN, HV		Unsigned				
W		Unsigned		'-' sign		
var	Normal mode ( 2 quadrant measurement)	Unsigned	'-' sign	'-' sign	Unsigned	
	Normal mode ( 4 quadrant measurement)	Unsigned	'-' sign	Unsigned	'-' sign	
	IEC (V) mode	Unsigned	'-' sign	'-' sign	Unsigned	
	Each phase	IEC (A) mode	Unsigned	'-' sign	'-' sign	Unsigned
			Unsigned	Unsigned	Unsigned	Unsigned
Total		Unsigned	Unsigned	Unsigned	Unsigned	
PF	Normal mode ( 2 quadrant measurement)	Unsigned	'-' sign	'-' sign	Unsigned	
	Normal mode ( 4 quadrant measurement)	Unsigned	'-' sign	Unsigned	'-' sign	
	IEC (V) mode	Unsigned	'-' sign	'-' sign	Unsigned	
	IIEC (A) mode	Unsigned	'-' sign	'-' sign	Unsigned	

#### 5.1.13. Demand Time Period and Demand Value of Current demand

The demand time period ( $t_0$ ) represents a time period until a measured value ( $I_0$ ) displays 95% of the input ( $I$ ) when continuously energized by constant input ( $I$ ). To display 100% of the input ( $I$ ), approximately three times the time period ( $t_0$ ) is required.

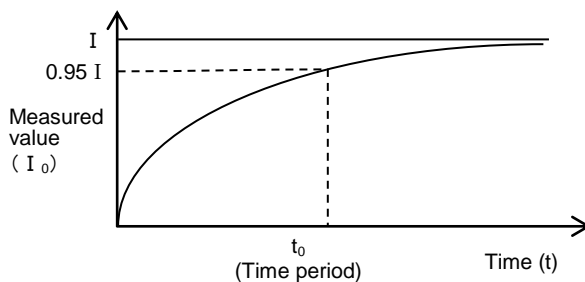

The demand value represents a measured display value with the above feature on time period and it indicates the overall average value within the demand time period.

The demand value changes over a relatively long time period. Therefore, it is not affected by input change for a short time. Accordingly, it is suitable to monitor overload of transformer.

## 5. Operation

### 5.2. Usage Depending on the Application (Alarm, Periodic Active Energy, Rolling Demand, Operating Time, Password, etc.)

The following shows how to use the instrument depending on the application.

#### 5.2.1. Upper/Lower Limit Alarm Display and Action

When the set upper/lower limit alarm value is exceeded, the display starts to blink and an alarm is output.

\*For details on how to set the upper/lower limit alarm, refer to 3.8.

##### ■ Action for alarm

Alarm generating: When the set alarm value is exceeded, the display blinks and alarm contact is closed.

\*Note

Alarm cancellation: When an alarm is cancelled, the display turns to the normal mode and alarm contact is open.

Note: When you set the alarm delay time, an alarm will generate if the set upper/lower limit alarm value is exceeded and this situation continues for the alarm delay time.

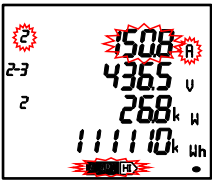
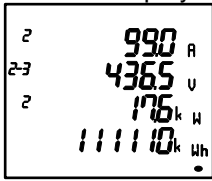
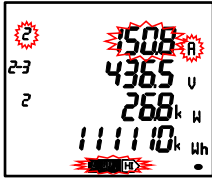
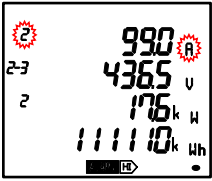
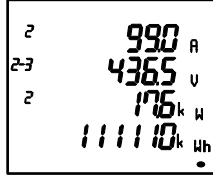
Alarm reset method		Measured value > Upper limit alarm value Measured value < Lower limit alarm value	Measured value < Upper limit alarm value Measured value > Lower limit alarm value
Automatic (Auto)	Screen	<p><b>ALARM</b> and <b>HI</b> or <b>LO</b> blink</p> 	<p>Normal display</p> 
Manual (HoLd)	Screen	<p><b>ALARM</b> and <b>HI</b> or <b>LO</b> blink</p>  <p>(Alarm generating)</p>	<p><b>ALARM</b> and <b>HI</b> or <b>LO</b> light up</p>  <p>(Alarm retention)</p> <p>RESET →</p> <p>Normal display</p>  <p>(Alarm cancellation)</p>

Note1: If measuring items of alarm generating are displayed on the screen, the digital value, unit (A, V, W, var, PF, Hz, %, DM, and THD), and phase (1, 2, 3, and N) will be displayed according to the alarm status as the following table.

Alarm status	Digital value	Unit	Phase
Alarm generating	Blink*	Blink	Blink*
Alarm retention	Light up	Blink	Blink*
Alarm cancellation	Light up	Light up	Light up

\*When the phase of no alarm is displayed on the screen, it does not blink.

Note2: When the backlight blinking for alarm is set to 'on', the backlight blinks at generating alarm.

Note3: On the Max/Min value screen, the present value, which is displayed at the middle line of digital display,

**ALARM** and **HI** or **LO** blink.



## 5. Operation

### 5.2. Usage Depending on the Application (Alarm, Periodic Active Energy, Rolling Demand, Operating Time, Password, etc.)

■ Monitored phase of upper/lower limit alarm item

The phase for monitoring the upper/lower limit alarm varies depending on the measuring item.

For details, refer to the following table.

Upper/Lower limit alarm item	Monitored phase			
	3-phase 4-wire	3-phase 3-wire (3CT, 2CT)	1-phase 3-wire (1N2)	1-phase 3-wire (1N3)
A upper limit, DA upper limit	1, 2, 3	1, 2, 3	1, N, 2	1, N, 3
A lower limit, DA lower limit	1, 2, 3	1, 2, 3	1, 2	1, 3
AN upper limit, DAN upper limit	N	—	—	—
V (L-L) upper limit *Note1	12, 23, 31	12, 23, 31	1N, 2N, 12	1N, 3N, 31
V (L-L) lower limit *Note1	12, 23, 31	12, 23, 31	1N, 2N, 12	1N, 3N, 31
V (L-N) upper limit	1N, 2N, 3N	—	—	—
V (L-N) lower limit	1N, 2N, 3N	—	—	—
W upper limit, var upper limit, PF upper limit	Total	Total	Total	Total
W lower limit, var lower limit, PF lower limit	Total	Total	Total	Total
Hz upper limit	1N	12	1N	1N
Hz lower limit	1N	12	1N	1N
HI total RMS value upper limit	1, 2, 3	1, 2, 3 *Note2	1, 2	1, 3
HI <sub>N</sub> total RMS value upper limit	N	—	—	—
THD <sub>v</sub> upper limit	1N, 2N, 3N	12, 23	1N, 2N	1N, 3N
DW (Predict/Present/Last value) upper limit	Total	Total	Total	Total
Dvar (Predict/Present/Last value) upper limit	Total	Total	Total	Total
DVA (Predict/Present/Last value) upper limit	Total	Total	Total	Total

Note1: For 12-phase or 31-phase of 1-phase 3-wire system, alarm monitoring is executed based on twice the set upper/lower limit alarm value.

Note2: Harmonic current 2-phase is measured for 3-phase 3-wire system (3CT) only.

## 5. Operation

### 5.2. Usage Depending on the Application (Alarm, Periodic Active Energy, Rolling Demand, Operating Time, Password, etc.)

#### 5.2.2. How to Cancel the Upper/Lower Limit Alarm

The alarm cancellation method differs depending on the alarm reset setting. In addition to the following methods, communication function is available to cancel the upper and lower limit alarm.

Alarm reset method	How to cancel
Automatic (Auto)	When a measured value is below the set upper/lower limit alarm value, the alarm is automatically reset.
Manual (HoLd)	<p>Even after a measured value is below the set upper/lower limit alarm value, the alarm is retained. After the measured value is below the alarm value, operate the following alarm reset.</p> <p>Note: On the Max/Min value screen and on the digital input screen, the alarm reset operation is not possible.</p> <p>&lt;To cancel the alarm of a selected item&gt;            Display the item of alarm generating and then press <b>RESET</b> to cancel the alarm.            ( For the item that has phases such as current or voltage, you must press <b>RESET</b> on each phase display to cancel the alarm. )</p> <p>&lt;To cancel alarms of all items&gt;            In the operating mode, press <b>RESET</b> for 2 seconds to cancel all alarms at once.            Note: When the backlight is blinking, first stop the blinking backlight and then execute the alarm cancellation operation.</p>

Note: To prevent chattering, the determination whether a measured value is below the upper/lower limit alarm value is conducted out of dead region below the setting step of the alarm value.

#### 5.2.3. How to Stop Backlight Blinking Caused by the Upper/Lower Limit Alarm Generation

Press **RESET** to stop the backlight blinking.

#### 5.2.4. Upper/Lower Limit Alarm Item on the Alarm Contact

Settings		Alarm item for alarm output	
Digital output function 1	Digital output function 2	C1A, C1B terminals	C2A, C2B terminals
Alarm output	Alarm output	Alarm item 1	Alarm item 2 to 4 (output in a batch at one of them)
Alarm output	Pulse output	Alarm item 1 to 4 (output in a batch at one of them)	No alarm
Pulse output	Alarm output	No alarm	Alarm item 1 to 4 (output in a batch at one of them)
Pulse output	Pulse output	No alarm	No alarm

## 5. Operation

### 5.2. Usage Depending on the Application (Alarm, Periodic Active Energy, Rolling Demand, Operating Time, Password, etc.)

#### 5.2.5. Periodic Active Energy Display

Active energy can be measured by dividing into a maximum of three time periods.

Even when the periodic active energy display is set to 'oFF (Not display)', the periodic active energy is measured.

\*For details on the settings, refer to **3.13 Setting Menu 8: Special Settings (Settings for Operating Time, IEC Mode, and CO<sub>2</sub> equivalent)**.

The time period is switched by communication or by digital input (DI) according to the settings. It is not possible to switch it manually (by button operation).

##### (1) The two-time period control by communication control or with one contact

<For communication control>

- When the selection bit is ON (1), active energy (imported) is accumulated to periodic active energy n. (n=1, 2)
- When the selection bit is OFF (0), active energy (imported) is not accumulated to periodic active energy n. (n=1, 2)

<For digital input (DI) control>

- Without digital input (DI), active energy (imported) is accumulated to periodic active energy 1 and not accumulated to periodic active energy 2.
- With digital input (DI), active energy (imported) is not accumulated to periodic active energy 1 and accumulated to periodic active energy 2.

<The setting of no switching>

- Active energy (imported) is accumulated to periodic active energy 1 and periodic active energy 2. (No switching of time period)

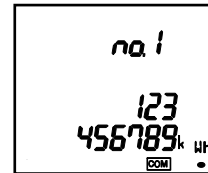

Periodic active energy 1

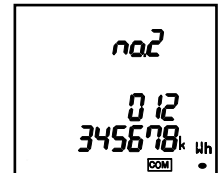

Periodic active energy 2

##### (2) The three-time period control by communication control or with three contacts

<For communication control>

- When the selection bit is ON (1), active energy (imported) is accumulated to periodic active energy n. (n=1, 2, 3)
- When the selection bit is OFF(0), active energy (imported) is not accumulated to periodic active energy n. (n=1, 2, 3)

<For digital input (DI) control>

- With digital input (DI1), active energy (imported) is accumulated to periodic active energy 1 and not accumulated to periodic active energy 2 or periodic active energy 3.
- With digital input (DI2), active energy (imported) is accumulated to periodic active energy 2 and not accumulated to periodic active energy 1 or periodic active energy 3.
- With digital input (DI3), active energy (imported) is accumulated to periodic active energy 3 and not accumulated to periodic active energy 1 or periodic active energy 2.

When multiple digital inputs (DI) are activated, each periodic active energy is accumulated.

Example: When (DI1) and (DI3) of digital input are activated, active energy (imported) is accumulated to periodic active energy 1 and periodic active energy 3 and not accumulated to periodic active energy 2.

<The setting of no switching>

- Active energy (imported) is accumulated to periodic active energy 1, periodic active energy 2 and active energy 3. (No switching of time period)

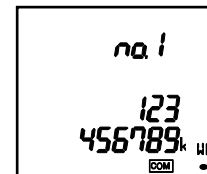

Periodic active energy 1

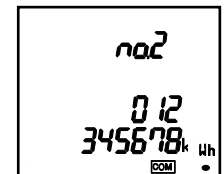

Periodic active energy 2

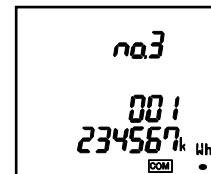

Periodic active energy 3

In the operating mode, when you are switching the measurement screen with **DISPLAY**, the periodic active energy is displayed.

#### 5.2.6. How to Reset Periodic Active Energy to Zero

When you display either of the periodic active energy 1, 2, or 3 on the screen and then press **+** and **RESET** for 2 seconds, the periodic active energy displayed on the screen only is reset to zero.

When password protection is enabled, it is reset to zero after you enter the password.

In addition, communication function enables to reset the periodic active energy to zero separately or simultaneously. In this case, password input is not necessary.

## 5. Operation

### 5.2. Usage Depending on the Application (Alarm, Periodic Active Energy, Rolling Demand, Operating Time, Password, etc.)

#### 5.2.7. Rolling Demand Display and Calculation

Rolling demand is calculated by dividing the active/reactive/apparent energy during a specified period (interval) \*1 by the length of that period.

For block interval demand, you specify a period of time interval (or block) that this instrument uses for the demand calculation.

\*For details on the rolling demand display settings, refer to 3.12.

The following two types can be selected for rolling demand action according to the settings.

##### ① Rolling block

Select an interval and a subinterval from 1 to 60 minutes in 1-minute increments.

The interval must be divided into subintervals with equal length.

The rolling demand is updated at the end of each subinterval.

<Example of interval: 15 minutes, subinterval: 5 minutes>

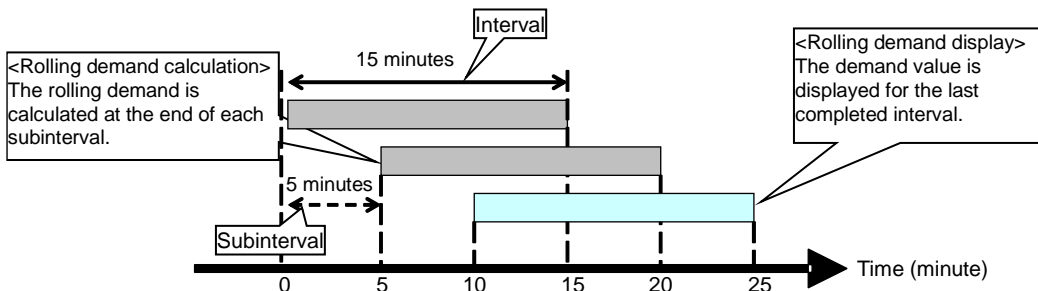

Note: When the rolling demand time period adjustment is executed, the timing of time period begins with 0 minute.

##### ② Fixing block

Select an interval from 1 to 60 minutes in 1-minute increments.

The rolling demand is calculated and updated at the end of each interval.

To be fixing block, set the same time to both the interval and subinterval.

< Example of interval: 15 minutes, subinterval: 15 minutes >

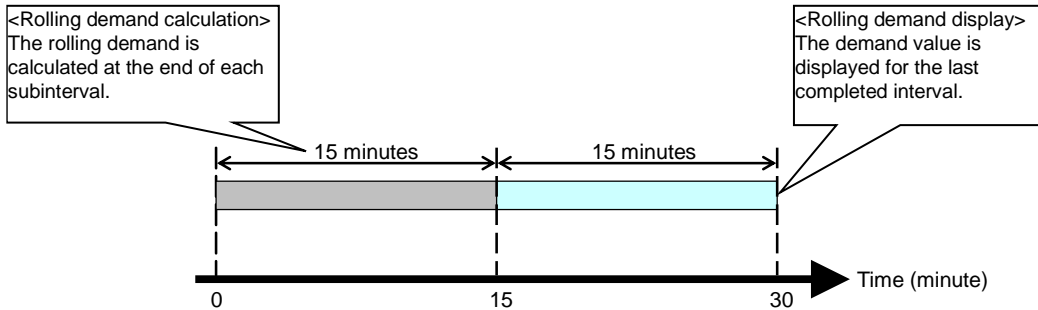

Note: When the rolling demand time period adjustment is executed, the timing of time period begins with 0 minute.

In the operating mode, when you are switching the measurement screen with **DISPLAY**, the rolling demand is displayed.

\*1: The following table shows the accumulated values used for rolling demand calculation.

Item	IEC mode setting		Note
	Normal mode	IEC mode	
Rolling demand active power (DW)	Active energy (Imported)	Active energy (Imported) - Active energy (Exported)	
Rolling demand reactive power (Dvar)	Reactive energy (Imported lag) + Reactive energy (Exported lead)	[Reactive energy (Imported lag) + Reactive energy (Exported lead)] - [Reactive energy (Exported lag) + Reactive energy (Imported lead)]	Refer to the following diagram
Rolling demand apparent power (DVA)	Apparent energy		

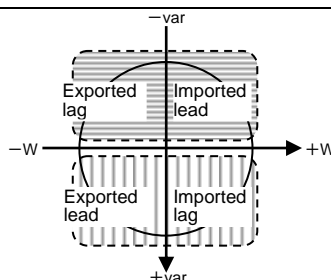

## 5. Operation

### 5.2. Usage Depending on the Application (Alarm, Periodic Active Energy, Rolling Demand, Operating Time, Password, etc.)

#### 5.2.8. Rolling Demand Predict Value

The rolling demand provides present, last, predict, and peak demand values.

The predicted demand value is calculated for the end of the present interval for each rolling demand, taking into account the energy consumption so far within the present (partial) interval and the present rate of consumption. The following illustration shows how a change in load can affect the predicted demand value for the interval. In this example, the interval is set to 15 minutes.

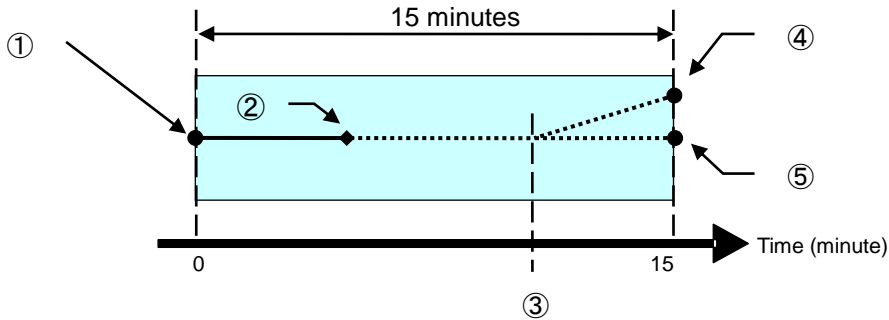

Item	Explanation
①	End of the last completed demand interval/ Beginning of the present interval
②	Partial interval
③	Change in load
④	Predicted demand value if load is added during interval; predicted demand value increases to reflect increased demand.
⑤	Predicted demand value if no load is added

#### 5.2.9. Rolling Demand Time Period Adjustment

When the rolling demand is displayed on the screen, pressing (+) and (-) simultaneously for two seconds or more enables the rolling demand time period adjustment.

\*Even when the time period adjustment is set to digital input, it is available with manual operation (button operation).

When password protection is enabled, it is available after you enter the password.

Although there is no item of the time period adjustment setting, communication function enables the rolling demand time period adjustment. In this case, password input is not necessary.

■ Select 'Execute' or 'Not execute' for the time period adjustment.

no ←→ yES  
(Not execute) (Execute)

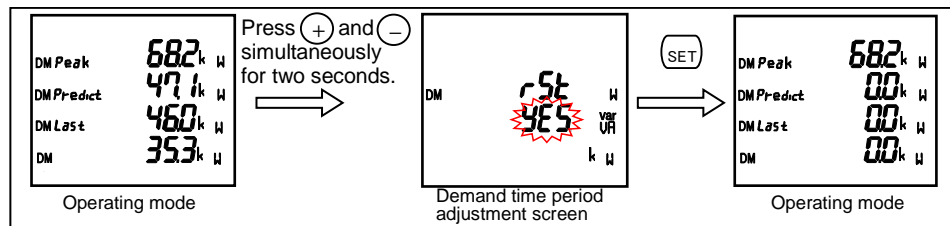

#### 5.2.10. How to Clear the Rolling Demand Peak Value

When the rolling demand is displayed on the screen, press (+) and (RESET) simultaneously for two seconds to clear the rolling demand peak value.

When password protection is enabled, it is cleared after you enter the password.

Communication function also enables to clear it. In this case, password input is not necessary.

## 5. Operation

### 5.2. Usage Depending on the Application (Alarm, Periodic Active Energy, Rolling Demand, Operating Time, Password, etc.)

#### 5.2.11. Operating Time Display

According to the value set to the operating time count target (AUX, A, or V), measuring time is counted and displayed as operating time of load. To display it, you must set the operating time display.

Even when the operating time display is set to 'oFF (Not display)', operating time is counted.

\*For details on the settings, refer to **3.13 Setting Menu 8: Special Settings (Settings for Operating Time, IEC Mode, and CO<sub>2</sub> equivalent)**.

When the threshold of the set operating time count target is exceeded, operating time 1 and 2 are counted.

Item	3-phase 4-wire	1-phase 2-wire	Others
AUX (Auxiliary power)	AUX	AUX	AUX
A (Current)	A <sub>AVG</sub>	A	A <sub>AVG</sub>
V (Voltage)	V <sub>AVG</sub> (L-N)	V	V <sub>AVG</sub> (L-L)

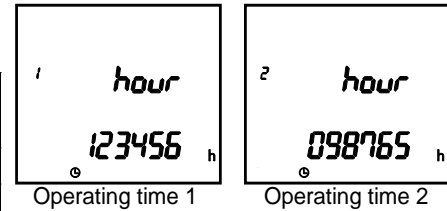

In the operating mode, when you are switching the measurement screen with **DISPLAY**, operating time is displayed.

#### 5.2.12. How to Reset Operating Time to Zero

When operating time 1 or operating time 2 is displayed on the screen, press **RESET** for 2 seconds to reset the operating time to zero.

\*The operating time displayed on the screen only is reset to zero.

When password protection is enabled, it is reset to zero after you enter the password.

In addition, communication function enables to reset all operating times to zero. In this case, password input is not necessary.

#### 5.2.13. CO<sub>2</sub> Equivalent Display

The CO<sub>2</sub> emissions that are converted from imported active energy can be displayed. To display them, you must set the CO<sub>2</sub> equivalent display. For the display settings, refer to **3.13 Setting Menu 8: Special Settings (Settings for Operating Time, IEC Mode, and CO<sub>2</sub> equivalent)**.

The display format for CO<sub>2</sub> equivalent varies depending on the full-load power as the following table.

Full-load power [kW]		Display format		
		Digital display	Unit	
Below 10		3 <sup>rd</sup> line	-	kg
		4 <sup>th</sup> line	8888.88	
10 or more	Below 100	3 <sup>rd</sup> line	-	kg
		4 <sup>th</sup> line	88888.8	
100 or more	Below 1000	3 <sup>rd</sup> line	-	kg
		4 <sup>th</sup> line	888888	
1000 or more	Below 10000	3 <sup>rd</sup> line	888	kg
		4 <sup>th</sup> line	8888.88	
10000 or more	Below 100000	3 <sup>rd</sup> line	888	kg
		4 <sup>th</sup> line	88888.8	
10000 or more		3 <sup>rd</sup> line	888	kg
		4 <sup>th</sup> line	888888	

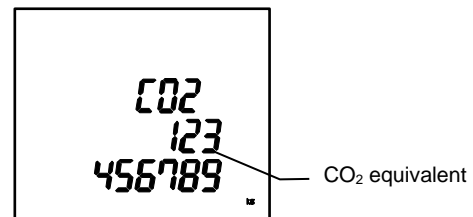

Note: The CO<sub>2</sub> equivalent is calculated based on the following calculating formula:

$$[\text{CO}_2 \text{ equivalent} = \text{Active energy (imported)} \times \text{CO}_2 \text{ conversion rate setup value}]$$

It is not an integrated value. If the CO<sub>2</sub> conversion rate setting is changed, the value of CO<sub>2</sub> emissions will be changed.

On the present value display, when you are switching the measurement screen with **DISPLAY**, the CO<sub>2</sub> equivalent is displayed.

#### 5.2.14. How to Clear the CO<sub>2</sub> Equivalent

When the CO<sub>2</sub> equivalent is displayed on the screen, press **+** and **RESET** for two seconds to clear the CO<sub>2</sub> equivalent.

When password protection is enabled, it is reset to zero after you enter the password.

Communication function also enables to clear it separately or simultaneously. In this case, password input is not necessary.

## 5. Operation

### 5.2. Usage Depending on the Application (Alarm, Periodic Active Energy, Rolling Demand, Operating Time, Password, etc.)

#### 5.2.15. Digital Input/Output Status Display and Action

The contact status can be displayed by signal inputs such as the opening/closing signal of breaker or the alarm signal of overcurrent relay to the digital input (DI) terminal.

For the digital output (DO) terminal, the contact is open/closed by communication control.

To display the digital input/output status, the setting is necessary.

\*For details on the setting, refer to 3.12.

#### ■ Display examples

<When ME-0052-SS96 (optional plug-in module) is installed>

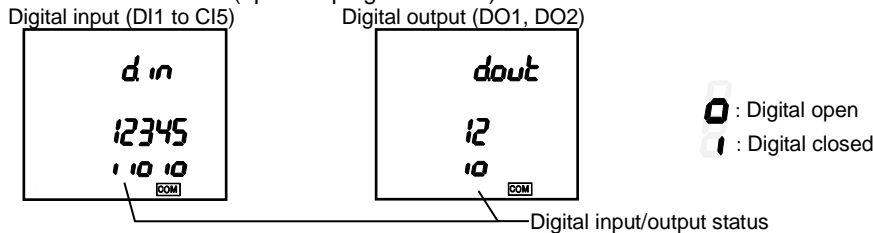

In the operating mode, when you are switching the measurement screen with **DISPLAY**, the digital input/output status is displayed.

#### ■ Digital input reset method

The method how to retain the digital input status varies depending on the digital input reset method.

Reset method	How to cancel
Automatic (Auto)	If the digital input becomes OFF (open), the digital input status will automatically become OFF (open).
Latch (HoLd)	Once the digital input detects ON (closed), even if it becomes OFF (open), the digital input status remains as ON (closed) until the latch is cancelled. (For example, When an alarm contact such as ACB is input, even if an alarm stops, the instrument retains the alarm state. Therefore, you will not overlook alarm generating.)

#### ■ Digital input conditions

The following table shows the digital input conditions.

Input conditions	DI terminal
Switch rating (Contact capacity)	24 V DC (19 V DC to 30 V DC), 7 mA or less
ON (closed)/OFF (open) time	Both of ON and OFF: 30 ms or more

#### 5.2.16. How to Cancel the Latch for Digital Input

On the digital input (DI) display screen, pressing **RESET** for two seconds enables to cancel the latch for digital input (DI) in a batch.

Communication function also enables the cancellation.

#### 5.2.17. How to Prevent Maximum Value Update by Motor Starting Current

For motor current monitoring, using the motor starting current delay function prevents the maximum value update of current, active power, reactive power, apparent power, power factor, and current unbalance rate and the alarm generating that are caused by motor starting current. To use the motor starting current delay function, you must set it. For details on the settings, refer to 3.8.

#### ■ The action with motor starting current delay function

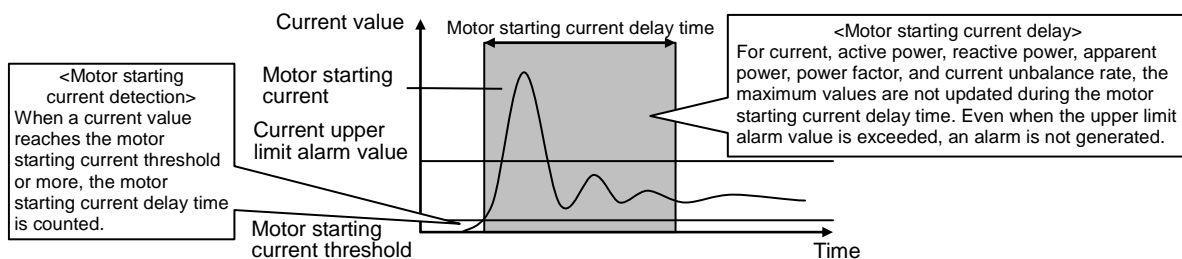

Note1: For the motor starting current threshold, set a value lower than the lower limit value, considering a change in load current during operation.

Note2: When input current is below the motor starting current threshold, the minimum value update stops.

## 5. Operation

### 5.2. Usage Depending on the Application (Alarm, Periodic Active Energy, Rolling Demand, Operating Time, Password, etc.)

#### 5.2.18. Password Protection Setting

In the operating mode, when you press **RESET** and **PHASE** simultaneously for 2 seconds or more and then enter the password, the password protection can be set.

The password of the factory default is '0000.' If you enter the wrong password, the screen will return to the password input display, where the highest digit blinks.

To switch the screen from the password input display to the operating mode, press **DISPLAY** at the highest digit in password input.

When password protection is enabled, you must input the password when executing the following item such as setting mode switching or Max/Min value reset.

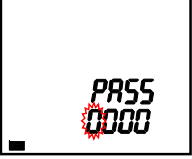
■ Password input		■ Password protected item	
Password input screen 	<ul style="list-style-type: none"> <li>• Set the number of the blinking digit from the highest digit by pressing <b>+</b> or <b>-</b>.</li> <li>• Press <b>SET</b> to move the setting digit, blinking one, to a lower digit.</li> <li>• Press <b>DISPLAY</b> to move the setting digit, blinking one, to an upper digit.</li> <li>• Press <b>SET</b> at the lowest digit to enable the items in the right table.</li> <li>• If you enter the wrong password, the screen will return to the display where the highest digit is blinking.</li> </ul>	No.	Item
		1	Enter the setting mode
		2	Clear maximum and minimum values
		3	Reset Wh, var, etc. to zero
		4	Reset periodic active energy to zero
		5	Adjust rolling demand time period
		6	Clear rolling demand peak value
		7	Reset operating time to zero

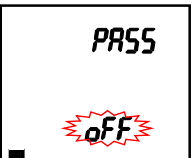
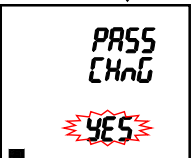
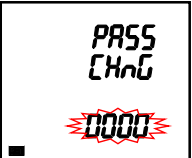
<b>■ Password protection setting</b> (1) Set the password protection. off ←→ on (Note protected) (Protected)  (2) Change the password. no ←→ yES (Not change) (Change)  Note1: When you select "no", the screen returns to the operating mode. Note2: When you select "yES", the password appears.  (3) Input a new password. <ul style="list-style-type: none"> <li>• Set the number of the blinking digit from the highest digit by pressing <b>+</b> or <b>-</b>.</li> <li>• Press <b>SET</b> to move the setting digit, blinking one, to a lower digit.</li> <li>• Press <b>DISPLAY</b> to move the setting digit, blinking one, to a higher digit.</li> <li>• Press <b>SET</b> at the lowest digit to determine the password change.</li> <li>• The setting ranges from 0000 to 9999.</li> </ul>	
	
	

#### Important

If you forgot your password, you could not unlock the password by yourself in the field. Please contact your supplier.



## 5. Operation

### 5.2. Usage Depending on the Application (Alarm, Periodic Active Energy, Rolling Demand, Operating Time, Password, etc.)

#### 5.2.19. Built-in Logging Function

This built-in logging function stores measured data as logging data in the internal non-volatile memory. The data to be stored as events occurred in this instrument are alarm data, the recorded time of the Max/Min value, and system log data. The stored data can be read from MODBUS RTU communication. To use this function, MODBUS RTU communication is required. It is not available with MODBUS TCP communication.

#### ■ Built-in logging data type

The following table shows the logging data type used in this built-in logging function.

Type	Details				
Measurement data	The measurement and time data are stored at the logging period you set.				
	<table border="1"> <tr> <td>The number of logging items</td> <td> <ul style="list-style-type: none"> <li>• Accumulated value data: 5 items</li> <li>• Data other than accumulated value: 15 items</li> </ul>                     Total: Max. 20 items                 </td> </tr> <tr> <td>Internal memory logging period</td> <td> <ul style="list-style-type: none"> <li>• 30 days (logging period: 15 minutes)</li> <li>• 60 days (logging period: 30 minutes)</li> <li>• 120 days (logging period: 60 minutes)</li> </ul> </td> </tr> </table>	The number of logging items	<ul style="list-style-type: none"> <li>• Accumulated value data: 5 items</li> <li>• Data other than accumulated value: 15 items</li> </ul> Total: Max. 20 items	Internal memory logging period	<ul style="list-style-type: none"> <li>• 30 days (logging period: 15 minutes)</li> <li>• 60 days (logging period: 30 minutes)</li> <li>• 120 days (logging period: 60 minutes)</li> </ul>
	The number of logging items	<ul style="list-style-type: none"> <li>• Accumulated value data: 5 items</li> <li>• Data other than accumulated value: 15 items</li> </ul> Total: Max. 20 items			
	Internal memory logging period	<ul style="list-style-type: none"> <li>• 30 days (logging period: 15 minutes)</li> <li>• 60 days (logging period: 30 minutes)</li> <li>• 120 days (logging period: 60 minutes)</li> </ul>			
	The storing timing is as follows:				
Logging period	Storing timing				
15 min	00/15/30/45 minutes past every hour				
30 min	00/30 minutes past every hour				
60 min	Every hour on the hour				
Alarm data	For each alarm item set at the upper/lower limit alarm item 1 to 4, the alarm item and its time data are stored when each event of alarm generating/cancellation or waiting for alarm cancellation occurs. Max. 100 records				
The recorded time of the Max/Min value	The time data of when the Max or Min value is updated is stored. 1 record for each item				
System log data	The time data of when an event such as setting change occurs is stored. Max. 100 records				

Note: The measurement data for logging has been grouped as LP01 and LP02 at this instrument side. Selecting the group determines the logging items. If you want to set a pattern other than LP01 or LP02, LP00 is available for selecting any logging items to set up.

#### ■ Before using the built-in logging function

The present time and built-in logging settings are required beforehand.

For the present time setting and built-in logging setting, refer to **3.14** and **3.9** respectively.

#### ■ How to read the built-in logging data

The built-in logging data is read from MODBUS RTU communication.

For the method, refer to Electronic Multi-Measuring Instrument ME Series MODBUS Interface specifications (Ref. No. LSPM-0075)

 <b>Caution</b>	<p>If the following settings are changed, the measurement data for built-in logging will be deleted. Before the change, output the logging data, check that the data is correctly stored, and execute the setting change.</p> <ul style="list-style-type: none"> <li>• Setting change of phase wire system</li> <li>• Built-in logging data clear</li> <li>• Logging item change in LP00 of the built-in logging item pattern</li> <li>• Setting change of the present time over the logging period</li> </ul> <p>When the present time is changed over the storing timing, a processing is executed to complement the measurement data of the corresponding time. Therefore, it is recommended to avoid the storing timing when the present time is changed. If the measurement data for built-in logging is monitored during the complemented processing, the data will be 0. After a while, execute it again.</p>
--	--

## 6. Others

### 6.1. Display Pattern List

When you set the display pattern in the setting menu 1 and the additional screens in the setting menu 3, 7, and 8, the screen is switched from No.1 in the following table in ascending order by pressing DISPLAY

[When set to 3-phase 4-wire system]

Display pattern	Screen set by display pattern										
	No.1	No.2	No.3	No.4	No.5	No.6	No.7	No.8	No.9	No.10	
P01	1st	A	A	A	W	A	DA				
	2nd	V	V	V	var	AN	DAN				
	3rd	W	var	VA	PF	Hz	V				
	4th	Wh	varh	VAh	Wh	Wh	Wh				
P02	1st	A1	DA1	V1N	W1	var1	VA1	PF1	A	A	DA
	2nd	A2	DA2	V2N	W2	var2	VA2	PF2	Hz	AN	DAN
	3rd	A3	DA3	V3N	W3	var3	VA3	PF3	W	var	VA
	4th	Aavg	DAavg	VNavg	WΣ	varΣ	VAΣ	PFΣ	Wh	varh	VAh
P00	1st	Arbitrary 1	Arbitrary 1	Arbitrary 1	Arbitrary 1						
	2nd	Arbitrary 1	Arbitrary 1	Arbitrary 1	Arbitrary 1						
	3rd	Arbitrary 1	Arbitrary 1	Arbitrary 1	Arbitrary 1						
	4th	Arbitrary 2	Arbitrary 2	Arbitrary 2	Arbitrary 2						

Note1: For arbitrary 1, the selectable items are A, AN, DA, DAN, V, W, var, VA, PF, and Hz.  
For arbitrary 2, Wh, -Wh, varh, and VAh are selectable.

Display pattern	Additional screen (Set in the setting menu 1, 3, 7, or 8)													
	No.11	No.12	No.13	No.14	No.15	No.16	No.17	No.18	No.19	No.20	No.21	No.22	No.23	
	Wh	Wh exported	varh	varh imported lead	varh exported lag	varh exported lead	VAh	Periodic Wh1	Periodic Wh2	Periodic Wh3	Rolling demand			
											DW	Dvar	DVA	
Display patterns from P00 to P02	1st	-	-	-	-	-	-	No.1	No.2	No.3	Peak value			
	2nd										DW Predict	Dvar Predict	DVA Predict	
	3rd	Wh	Wh exported	varh	varh imported lead	varh exported lag	varh exported lead	VAh	Periodic Wh1	Periodic Wh2	Periodic Wh3	DW Last	Dvar Last	DVA Last
	4th											DW Present	Dvar Present	DVA Present

Display pattern	Additional screen (Set in the setting menu 1, 3, 7, or 8)									
	No.24	No.25	No.29	No.26	No.27	No.28	No.30	No.31	No.32	
	HI	HI <sub>N</sub>	HV	Unbalance rate	DI Status	DO Status	Operating time 1	Operating time 2	CO <sub>2</sub> equivalent	
Display patterns from P00 to P02	1st	1-phase value	N-phase value	1-phase value	-	DI	DO	-	-	-
	2nd	2-phase value	-	2-phase value	Aunb	-	-	hour 1	hour 2	CO <sub>2</sub>
	3rd	3-phase value	-	3-phase value	Vunb	DI No.	DO No.	-	-	Equivalent
	4th	Degree	Degree	Degree	unb	Contact status	Contact status	Operating time	Operating time	

Note 2: When you add an additional screen, the screen number is added.

Note 3: In the table, 'Wh' and 'varh' indicate active energy (imported) and reactive energy (imported lag) respectively.

Note 4: The additional screens of Wh, varh, and VAh of P00 are displayed by setting each item as display element.

## 6. Others

### 6.1. Display Pattern List

[When set to other than 3-phase 4-wire system]

Display pattern		Screen set by display pattern					
		No.1	No.2	No.3	No.4	No.5	No.6
P01	1st	A	A	A	W	A	
	2nd	V	V	V	var	DA	
	3rd	W	var	VA	PF	Hz	
	4th	Wh	varh	VAh	Wh	Wh	
P02	1st	A1	DA1	V12	W	A	A
	2nd	A2	DA2	V23	var	Hz	V
	3rd	A3	DA3	V31	PF	var	VA
	4th	Aavg	DAavg	Vavg	Wh	varh	VAh
P00	1st	Arbitrary 1	Arbitrary 1	Arbitrary 1	Arbitrary 1		
	2nd	Arbitrary 1	Arbitrary 1	Arbitrary 1	Arbitrary 1		
	3rd	Arbitrary 1	Arbitrary 1	Arbitrary 1	Arbitrary 1		
	4th	Arbitrary 2	Arbitrary 2	Arbitrary 2	Arbitrary 2		

Note1: For 1-phase 2-wire system, the display pattern of P02 is not selectable.

Note2: For arbitrary 1, the selectable items are A, DA, V, W, var, VA, PF, and Hz.

For arbitrary 2, Wh, -Wh, varh, and VAh are selectable.

Note3: The phase shown in the display pattern of P02 is displayed on the screen according to the phase wire system setting as the following table.

Phase wire system Phase display		1-phase 3-wire (1N2)			1-phase 3-wire (1N3)			3-phase 3-wire		
		1	2	3	1N	2N	3N	12	23	31
Current	1	1			1			1		
	2	N			N			2		
	3	2			3			3		
Voltage	12	1N			1N			12		
	23	2N			3N			23		
	31	12			13			31		

Display pattern		Additional screen (Set in the setting menu 1, 3, 7, or 8)												
		No.7	No.8	No.9	No.10	No.11	No.12	No.13	No.14	No.15	No.16	No.21	No.22	No.23
		Wh	Wh exported	varh	varh imported lead	varh exported lag	varh exported lead	VAh	Periodic Wh1	Periodic Wh2	Periodic Wh3	Rolling demand		
Display patterns from P00 to P02	1st	-	-	-	-	-	-	-	No.1	No.2	No.3	Peak value		
	2nd											DW Predict	Dvar Predict	DVA Predict
	3rd	Wh	Wh exported	varh	varh imported lead	varh exported lag	varh exported lead	VAh	Periodic Wh1	Periodic Wh2	Periodic Wh3	DW Last	Dvar Last	DVA Last
	4th											DW Present	Dvar Present	DVA Present

Display pattern		Additional screen (Set in the setting menu 1, 3, 7, or 8)										
		No.17	No.18	No.19	No.20	No.21	No.22	No.23	No.24	No.25	No.26	No.27
		Rolling demand			HI	HV	Unbalance rate	DI Status	DO Status	Operating time 1	Operating time 2	CO <sub>2</sub> equivalent
Display patterns from P00 to P02	1st	Peak value			1-phase value	1-phase value	-	DI	DO	-	-	-
	2nd	DW Predict	Dvar Predict	DVA Predict	2-phase value	2-phase value	Aunb	-	-	hour 1	hour 2	CO <sub>2</sub>
	3rd	DW Last	Dvar Last	DVA Last	3-phase value	-	Vunb	DI No.	DO No.	-	-	Equivalent
	4th	DW Present	Dvar Present	DVA Present	Degree	Degree	unb	Contact status	Contact status	Operating time	Operating time	

## 6. Others

### 6.1. Display Pattern List

Note4: When you add an additional screen, the screen number is added.

Note5: In the table, 'Wh' and 'varh' indicate active energy (imported) and reactive energy (imported lag) respectively.

Note6: The additional screens of Wh, varh, and VAh of P00 are displayed by setting each item as display element.

Note7: The display of additional screens of No.20 and 21 in the above table varies depending on the setting of the phase wire system as the following table.

Phase display		Phase wire system	1-phase 2-wire	1-phase 3-wire	3-phase 3-wire _2CT	3-phase 3-wire _3CT
Harmonic current	1-phase value		○	○	○	○
	2-phase value		—	—	—	○
	3-phase value		—	○	○	○
Harmonic voltage	1-phase value		○	○	○	○
	3-phase value		—	○	○	○

## 6. Others

### 6.2. Standard Value

The standard value is calculated according to the measuring item as the following table.

#### ■ Standard value for each measuring item

Measuring element		Standard value *Note2		
Current, Current demand		CT primary current setup value		
Voltage	With VT	1-phase 2-wire, 3-phase 3-wire	VT primary voltage $\times 150/110$	
		3-phase 4-wire	VT primary voltage (Phase) $\times 150/110$ VT primary voltage (Line) $\times \sqrt{3} \times 150/110$	
	Direct input	1-phase 2-wire, 3-phase 3-wire	110 V	150 V
			220 V	300 V
			440 V	600 V
		1-phase 3-wire (Phase voltage/ Line voltage)	110/220 V	150 V/300 V
			220/440 V	300 V/600 V
			3-phase 4-wire (Phase voltage/ Line voltage)	63.5/110 V
	100/173 V 110/190 V	150/300 V		
	220/380 V 230/400 V 240/415 V 254/440 V	300/600 V		
277/480 V	400/640 V			
Active power, Rolling demand active power *Note1		VT ratio $\times$ CT ratio $\times$ Intrinsic power (100%) kW		
Reactive power, Rolling demand reactive power *Note1		VT ratio $\times$ CT ratio $\times$ Intrinsic power (100%) kvar		
Apparent power, Rolling demand apparent power *Note1		VT ratio $\times$ CT ratio $\times$ Intrinsic power (100%) kVA		

Note1: For the setting of 'Without VT (Direct measurement input)', the VT ratio is 1. For intrinsic power, refer to the right table.

Note2: The calculated value is round to the nearest number as the table in the next page.

#### ■ Intrinsic power value

Phase wire system	CT secondary current	Rated voltage		Intrinsic power value (100%)	
1-phase 2-wire	5 A	Direct input (Line voltage)	110 V	0.5 kW	
			220 V	1.0 kW	
		440 V	2.0 kW		
	1 A	With VT (Line voltage)	100 V, 110 V	0.5 kW	
			220 V	1.0 kW	
		Direct input (Line voltage)	110 V	0.1 kW	
220 V	0.2 kW				
440 V	0.4 kW				
1-phase 3-wire	5 A	Without VT (Line voltage)	220 V	1.0 kW	
			440 V	2.0 kW	
	1 A		220 V	0.2 kW	
			440 V	0.4 kW	
3-phase 3-wire	5 A	Direct input (Line voltage)	110 V	1.0 kW	
			220 V	2.0 kW	
		440 V	4.0 kW		
	1 A	With VT (Line voltage)	100 V, 110 V	1.0 kW	
			220 V	2.0 kW	
		Direct input (Line voltage)	110 V	0.2 kW	
	220 V	0.4 kW			
	440 V	0.8 kW			
	3-phase 4-wire	5 A	Direct input	63.5/110 V	1.0 kW
				100/173 V 110/190 V	2.0 kW
220/380 V 230/400 V 240/415 V 254/440 V				4.0 kW	
277/480 V		5.0 kW			
With VT (Phase voltage)		63.5 V		1.0 kW	
		100 V, 110 V, 115 V, 120 V		2.0 kW	
1 A		Direct input	63.5/110 V	0.2 kW	
			100/173 V 110/190 V	0.4 kW	
			220/380 V 240/415 V 254/440 V	0.8 kW	
		277/480 V	1.0 kW		
With VT (Phase voltage)	63.5 V	0.2 kW			
100 V, 110 V, 115 V, 120 V	0.4 kW				

Note: For reactive power and apparent power, read 'kW' in the above table as 'kvar' and 'kVA' respectively.

## 6. Others

### 6.2. Standard Value

■ Standard value for current/current demand and STEP

Setting range: -10STEP to +3STEP

<Example> When the standard value is 100 A (0STEP), the range is 45 A (-10STEP) to 160 A (+3STEP).

Current standard value (1/3)

STEP	Unit: A
1	1 A
2	1.2 A
3	1.5 A
4	1.6 A
5	1.8 A
6	2 A
7	2.2 A
8	2.4 A
9	2.5 A
10	3 A
11	3.2 A
12	3.6 A
13	4 A
14	4.5 A
15	4.8 A
16	5 A
17	6 A
18	6.4 A
19	7.2 A
20	7.5 A
21	8 A
22	9 A
23	9.6 A
24	10 A
25	12 A
26	15 A
27	16 A
28	18 A
29	20 A
30	22 A
31	24 A
32	25 A
33	30 A
34	32 A
35	36 A
36	40 A
37	45 A
38	48 A
39	50 A
40	60 A
41	64 A
42	72 A
43	75 A
44	80 A
45	90 A
46	96 A
47	100 A
48	120 A
49	150 A
50	160 A

Current standard value (2/3)

STEP	Unit: A	Unit: kA
51	180 A	
52	200 A	
53	220 A	
54	240 A	
55	250 A	
56	300 A	
57	320 A	
58	360 A	
59	400 A	
60	450 A	
61	480 A	
62	500 A	
63	600 A	
64	640 A	
65	720 A	
66	750 A	
67	800 A	
68	900 A	
69	960 A	
70	1000 A	
71	1200 A	
72	1500 A	
73	1600 A	
74	1800 A	
75	2000 A	
76	2200 A	
77	2400 A	
78	2500 A	
79	3000 A	
80	3200 A	
81	3600 A	
82	4000 A	
83	4500 A	
84	4800 A	
85	5000 A	
86	6000 A	
87	6400 A	
88	7200 A	
89	7500 A	
90	8000 A	
91		9 kA
92		9.6 kA
93		10 kA
94		12 kA
95		15 kA
96		16 kA
97		18 kA
98		20 kA
99		22 kA
100		24 kA

Current standard value (3/3)

STEP	Unit: kA
101	25 kA
102	30 kA
103	32 kA
104	36 kA
105	40 kA

## 6. Others

### 6.2. Standard Value

■ Standard value for voltage and STEP

Setting range: -18STEP to +10STEP

<Example> When the standard value is 100 V (0STEP), the range is 20 V (-18STEP) to 320 V (+10STEP).

Voltage standard value (1/3)

STEP	Unit: V
1	15 V
2	16 V
3	18 V
4	20 V
5	22 V
6	24 V
7	25 V
8	30 V
9	32 V
10	36 V
11	40 V
12	45 V
13	48 V
14	50 V
15	60 V
16	64 V
17	72 V
18	75 V
19	80 V
20	90 V
21	96 V
22	100 V
23	120 V
24	150 V
25	160 V
26	180 V
27	200 V
28	220 V
29	240 V
30	250 V
31	300 V
32	320 V
33	360 V
34	400 V
35	450 V
36	480 V
37	500 V
38	600 V
39	640 V
40	720 V
41	750 V
42	800 V
43	900 V
44	960 V
45	1000 V
46	1200 V
47	1500 V
48	1600 V
49	1800 V
50	2000 V

Voltage standard value (2/3)

STEP	Unit: V	Unit: kV
51	2200 V	
52	2400 V	
53	2500 V	
54	3000 V	
55	3200 V	
56	3600 V	
57	4000 V	
58	4500 V	
59	4800 V	
60	5000 V	
61	6000 V	
62	6400 V	
63		7.2 kV
64		7.5 kV
65		8 kV
66		9 kV
67		9.6 kV
68		10 kV
69		12 kV
70		15 kV
71		16 kV
72		18 kV
73		20 kV
74		22 kV
75		24 kV
76		25 kV
77		30 kV
78		32 kV
79		36 kV
80		40 kV
81		45 kV
82		48 kV
83		50 kV
84		60 kV
85		64 kV
86		72 kV
87		75 kV
88		80 kV
89		90 kV
90		96 kV
91		100 kV
92		120 kV
93		150 kV
94		160 kV
95		180 kV
96		200 kV
97		220 kV
98		240 kV
99		250 kV
100		300 kV

Voltage standard value (3/3)

STEP	Unit: kV
101	320 kV
102	360 kV
103	400 kV
104	450 kV
105	480 kV
106	500 kV
107	600 kV
108	640 kV
109	720 kV
110	750 kV
111	800 kV
112	900 kV
113	960 kV
114	1000 kV
115	1200 kV
116	1500 kV
117	1600 kV
118	1800 kV
119	2000 kV
120	2200 kV

## 6. Others

### 6.2. Standard Value

■ Standard value for active/reactive/apparent power and STEP

Setting range: -18STEP to +3STEP

<Example> When the standard value is 1000 W (0STEP), the range is 200 W (-18STEP) to 1600 W (+3STEP).

Active power standard value (1/5)

STEP	Unit: W
1	8 W
2	9 W
3	9.6 W
4	10 W
5	12 W
6	15 W
7	16 W
8	18 W
9	20 W
10	22 W
11	24 W
12	25 W
13	30 W
14	32 W
15	36 W
16	40 W
17	45 W
18	48 W
19	50 W
20	60 W
21	64 W
22	72 W
23	75 W
24	80 W
25	90 W
26	96 W
27	100 W
28	120 W
29	150 W
30	160 W
31	180 W
32	200 W
33	220 W
34	240 W
35	250 W
36	300 W
37	320 W
38	360 W
39	400 W
40	450 W
41	480 W
42	500 W
43	600 W
44	640 W
45	720 W
46	750 W
47	800 W
48	900 W
49	960 W
50	1000 W

Active power standard value (2/5)

STEP	Unit: W	Unit: kW
51	1200 W	
52	1500 W	
53	1600 W	
54	1800 W	
55	2000 W	
56	2200 W	
57	2400 W	
58	2500 W	
59	3000 W	
60	3200 W	
61	3600 W	
62	4000 W	
63	4500 W	
64	4800 W	
65	5000 W	
66	6000 W	
67	6400 W	
68	7200 W	
69	7500 W	
70	8000 W	
71		9 kW
72		9.6 kW
73		10 kW
74		12 kW
75		15 kW
76		16 kW
77		18 kW
78		20 kW
79		22 kW
80		24 kW
81		25 kW
82		30 kW
83		32 kW
84		36 kW
85		40 kW
86		45 kW
87		48 kW
88		50 kW
89		60 kW
90		64 kW
91		72 kW
92		75 kW
93		80 kW
94		90 kW
95		96 kW
96		100 kW
97		120 kW
98		150 kW
99		160 kW
100		180 kW

Active power standard value (3/5)

STEP	Unit: kW	Unit: MW
101	200 kW	
102	220 kW	
103	240 kW	
104	250 kW	
105	300 kW	
106	320 kW	
107	360 kW	
108	400 kW	
109	450 kW	
110	480 kW	
111	500 kW	
112	600 kW	
113	640 kW	
114	720 kW	
115	750 kW	
116	800 kW	
117	900 kW	
118	960 kW	
119	1000 kW	
120	1200 kW	
121	1500 kW	
122	1600 kW	
123	1800 kW	
124	2000 kW	
125	2200 kW	
126	2400 kW	
127	2500 kW	
128	3000 kW	
129	3200 kW	
130	3600 kW	
131	4000 kW	
132	4500 kW	
133	4800 kW	
134	5000 kW	
135	6000 kW	
136	6400 kW	
137	7200 kW	
138	7500 kW	
139	8000 kW	
140		9 MW
141		9.6 MW
142		10 MW
143		12 MW
144		15 MW
145		16 MW
146		18 MW
147		20 MW
148		22 MW
149		24 MW
150		25 MW

Active power standard value (4/5)

STEP	Unit: MW
151	30 MW
152	32 MW
153	36 MW
154	40 MW
155	45 MW
156	48 MW
157	50 MW
158	60 MW
159	64 MW
160	72 MW
161	75 MW
162	80 MW
163	90 MW
164	96 MW
165	100 MW
166	120 MW
167	150 MW
168	160 MW
169	180 MW
170	200 MW
171	220 MW
172	240 MW
173	250 MW
174	300 MW
175	320 MW
176	360 MW
177	400 MW
178	450 MW
179	480 MW
180	500 MW
181	600 MW
182	640 MW
183	720 MW
184	750 MW
185	800 MW
186	900 MW
187	960 MW
188	1000 MW
189	1200 MW
190	1500 MW
191	1600 MW
192	1800 MW
193	2000 MW
194	2200 MW
195	2400 MW
196	2500 MW
197	3000 MW
198	3200 MW
199	3600 MW
200	4000 MW

Active power standard value (5/5)

STEP	Unit: MW
201	4500 MW
202	4800 MW
203	5000 MW
204	6000 MW
205	6400 MW
206	7200 MW
207	7500 MW
208	8000 MW

Note: For reactive power and apparent power, read 'W' in the above table as 'var' and 'VA' respectively.



## 6. Others

### 6.3. Measuring Items and the Corresponding Display/Output

The following table shows measuring items and the corresponding display/output.

O: Display/output is possible. Blank: Display/output is not possible. Inst: Instantaneous value

Measuring item		Display item											Analog				Pulse	Communication	
		3-phase 4-wire			3-phase 3-wire (3CT)			3-phase 3-wire (2CT) 1-phase 3-wire			1-phase 2-wire			3-phase 4-wire	3-phase 3-wire (3CT)	3-phase 3-wire (2CT) 1-phase 3-wire			1-phase 2-wire
		Inst	Max	Min	Inst	Max	Min	Inst	Max	Min	Inst	Max	Min						
Current	1-phase	O	O	O	O	O	O	O	O	O	O	O	O	O	O	O	O		
	2-phase	O	O	O	O	O	O	O	O	O				O	O	O			
	3-phase	O	O	O	O	O	O	O	O	O				O	O	O			
	AVG	O	O	O	O	O	O	O	O	O				O	O	O			
	N-phase	O	O	O										O					
Current demand	1-phase	O	O	O	O	O	O	O	O	O	O	O	O	O	O	O	O		
	2-phase	O	O	O	O	O	O	O	O	O				O	O	O			
	3-phase	O	O	O	O	O	O	O	O	O				O	O	O			
	AVG	O	O	O	O	O	O	O	O	O				O	O	O			
	N-phase	O	O	O										O					
Voltage	1-N-phase	O	O	O										O					
	2-N-phase	O	O	O										O					
	3-N-phase	O	O	O										O					
	AVG (L-N)	O	O	O										O					
	1-2-phase	O	O	O	O	O	O	O	O	O	O	O	O	O	O	O	O		
	2-3-phase	O	O	O	O	O	O	O	O	O				O	O	O			
	3-1-phase	O	O	O	O	O	O	O	O	O				O	O	O			
Active power	AVG (L-L)	O	O	O	O	O	O	O	O	O	O	O	O	O	O	O			
	1-phase	O	O	O										O					
	2-phase	O	O	O										O					
	3-phase	O	O	O										O					
	Σ	O	O	O	O	O	O	O	O	O	O	O	O	O	O	O	O		
Reactive power	1-phase	O	O	O										O					
	2-phase	O	O	O										O					
	3-phase	O	O	O										O					
	Σ	O	O	O	O	O	O	O	O	O	O	O	O	O	O	O	O		
Apparent power	1-phase	O	O	O										O					
	2-phase	O	O	O										O					
	3-phase	O	O	O										O					
	Σ	O	O	O	O	O	O	O	O	O	O	O	O	O	O	O	O		
Power factor	1-phase	O	O	O										O					
	2-phase	O	O	O										O					
	3-phase	O	O	O										O					
	Σ	O	O	O	O	O	O	O	O	O	O	O	O	O	O	O	O		
Frequency		O	O	O	O	O	O	O	O	O	O	O	O	O	O	O	O		
Harmonic current *Note1	RMS value	1-phase	O	Max Phase	O	Max Phase	O	Max Phase	O	O			Total	Total	Total	Total			
		2-phase	O		O		O												
		3-phase	O		O		O												
		N-phase	O		O														
	Content rate	1-phase	O		O		O		O	O									
		2-phase	O		O		O												
		3-phase	O		O		O												
		N-phase																	
Harmonic voltage *Note1	RMS value	1-N-phase	O	1st Max phase															
		2-N-phase	O																
		3-N-phase	O																
		1-2-phase				O	1st Max phase	O	1st Max phase	O	1st								
	Content rate	2-3-phase			O	1st Max phase	O	1st Max phase											
		3-1-phase																	
		1-N-phase	O	Max Phase										Total					
		2-N-phase	O		Total														
3-N-phase	O	Total																	
1-2-phase			O		Max Phase	O	Max Phase	O	O				Total	Total	Total				
Active energy	2 quadrant	Imported				O		O									O		
		Exported				O		O									O		
	4 quadrant	Imported				O		O										O	
		Exported				O		O										O	
Active energy (Imported)	Period	1				O		O										O	
		2				O		O									O		
		3				O		O										O	
Reactive energy	2 quadrant	Imported lag *Note2				O		O										O	
		Imported lead *Note2				O		O										O	
		Exported lag				O		O										O	
	4 quadrant	Imported lag				O		O											O
		Imported lead				O		O											O
		Exported lead				O		O											O
Apparent energy		Imported + Exported				O		O										O	
Rolling demand active power			O	O		O	O		O	O		O	O						
Rolling demand reactive power			O	O		O	O		O	O		O	O						
Rolling demand apparent power			O	O		O	O		O	O		O	O						
Operating time	1		O			O		O				O							
	2		O			O		O				O							
CO <sub>2</sub> equivalent			O			O		O				O							
Current unbalance rate			O	O		O	O		O	O									
Voltage unbalance rate			O	O		O	O		O	O									
Phase angle *Note4			O			O		O				O							

O \*Note3

## 6. Others

### 6.3. Measuring Items and the Corresponding Display/Output

Note1: Each harmonic degree represents the odd degrees of the 1st to 31st RMS value and the 3rd to 31st content rate.

Note2: The imported lag and imported lead include the exported lead and exported lag respectively.

Note3: For the measuring items monitored by communication function, refer to the specifications of each communication function.

Note4: Phase angle can be measured only with the support function for determining incorrect wiring.

Note5: For 1-phase 3-wire system, the phases of measuring items are read as the following table.

Phase wire system	1-phase	2-phase	3-phase	12-phase	23-phase	31-phase
1-phase 3-wire (1N2)	1-phase	N-phase	2-phase	1N-phase	2N-phase	12-phase
1-phase 3-wire (1N3)	1-phase	N-phase	3-phase	1N-phase	3N-phase	13-phase

## 6. Others

### 6.4. Instrument Operation

#### ■ The instrument operation in other than operating mode

Situation	Measurement	Display	Analog output	Alarm contact	Pulse output
For a few seconds just after turning on the auxiliary power *The backlight lights up and the LCD is off.	Not measure	Not display	There may be approximately 100% or more output until the internal voltage is stable.	Open	Not output
In the setting mode/ In the setting confirmation mode/ In the password protection screen	The action is the same in the operating mode	Not display measured values	The action is the same in the operating mode	The state before entering the setting mode or setting confirmation mode is retained.	The action is the same in the operating mode
Under power outage	Not measure	Not display	Not output	Open	Not output

#### ■ The instrument operation under measurement input

Measuring element	Instrument action	
Current (A) Current demand (DA)	The CT secondary current setting is 5 A: When input current is below 0.005 A (0.1%), 0 A is displayed.  The CT secondary current setting is 1 A: When input current is below 0.005 A (0.5%), 0 A is displayed.	When the upper limit of display range (9999) is exceeded, the upper limit (9999) is displayed.
Voltage (V)	When input voltage (Line voltage) is below 11 V, 0 V is displayed. •In 1-phase 3-wire system, when the voltage between P1 and P3 is below 22 V, 0 V is displayed. •In 3-phase 4-wire system, when phase voltage is below 11 V or line voltage is below 19 V, 0 V is displayed.	When the upper limit of display range (9999) is exceeded, the upper limit (9999) is displayed.
Active power (W) Reactive power (var) Apparent power (VA)	•When each of three phases of current is 0 A or when each of three phases of voltage is 0 V, 0 W, 0 var, and 0 VA are displayed. •When current N-phase is 0 A or when voltage N-phase is 0 V, 0 W, 0 var, and 0 VA are displayed for each N-phase.	When the upper limit of display range (9999) is exceeded, the upper limit (9999) is displayed.
Power factor (PF)	•When each of three phases of current is 0 A or when each of three phases of voltage is 0 V, 1.0 is displayed. •When current N-phase is 0 A or when voltage N-phase is 0 V, 1.0 is displayed for each N-phase.	
Frequency (Hz)	•When voltage 1-phase is low voltage, - - - - is displayed. Apply a voltage above approximately 22 V.	When frequency is below 44.5 Hz and above 99.5 Hz, - - - - is displayed.
Harmonic current	For RMS value measurement: •When current is 0 A, 0 A is displayed. (for each phase) •When voltage 1-phase is 0 V or when frequency is below 44.5 Hz, - - - - is displayed for every phase.	For distortion ratio (content ratio) measurement: •When harmonic current 1 <sup>st</sup> is 0 A, 0 A is displayed. (for each phase) •When voltage 1-phase is 0 V or when frequency is below 44.5 Hz, - - - - is displayed for every phase.
Harmonic voltage	For RMS value measurement: •When voltage is 0 V, 0 V is displayed. (for each phase) •When voltage 1-phase is 0 V or when frequency is below 44.5 Hz, - - - - is displayed for every phase.	For distortion ratio (content ratio) measurement: •When voltage is 0 V, - - - - is displayed. (for each phase) •When voltage 1-phase is 0 V or when frequency is below 44.5 Hz, - - - - is displayed for every phase.
Operating Time	When the time is over 999999-hour, it is fixed at 999999-hour.	

Note1: Current/voltage/active power input represents input to the instrument. It does not input to the primary side of VT/CT.

Note2: The expression of 'When current is 0 A' includes the case when the measured value described in the item of Current (A) is 0 A.

Note3: The expression of 'When voltage is 0 V' includes the case when the measured value described in the item of Voltage (V) is 0 V.

Note4: Use the instrument within the rating of the instrument.

#### ■ Analog output action

Output setting	Output range
Output limit is set	-1% to 101% of span
Output limit is not set	-5% to 105% of span

## 6. Others

### 6.5. Troubleshooting

If you observe abnormal sound, odor, smoke, or heat generation from the instrument, turn off the power at once. In addition, if you are considering sending the instrument in for repair, check the following points before it.

	Situation	Possible cause	Solution
Display	The display does not light up.	Auxiliary power is not applied to MA and MB terminals.	Apply auxiliary power supply.
	When the auxiliary power is applied, the display does not light up for a short time.	This is not an error. For a few seconds after charging the auxiliary power, the internal circuit is being initialized.	Use it as it is.
	The backlight does not light up.	The backlight may be set to auto off (Auto). *When it lights up by pressing any operation button, it is set to auto off.	When it is set to auto off, it automatically goes off in 5 minutes. Use it as it is or change the setting to ON (Hold). For details, refer to 3.7.
	The display becomes black.	It may become black due to static electricity.	It will go off after a while.
	The 'End' display remains.	It is in the setting mode.	Press the <b>SET</b> button.
Measurement error	The current and voltage errors are large.	The settings for VT/Direct voltage and CT primary current may be incorrect.	Check the settings for VT/Direct voltage and CT primary current.
	The current and voltage are correct, but the active power and power factor errors are large.	The wiring for VT/CT and this instrument may be incorrect.	Check the wiring for VT/CT and this instrument.
	The power factor error is large.	If input current is smaller than the rating, the error will become large. (approximately 5% or less of the rated current)	This is not an error. Use it as it is, or if the error is troublesome, change the CT according to the actual current.
	The displayed active power is different from that calculated by multiplying the displayed current, voltage, and power factor.	If the current and voltage AC waveforms distort due to harmonics, the value will not be the same as the calculated value. (For current waveforms without harmonics, the calculated value matches with the displayed value.)	Use the instrument as it is.
	The total RMS value of harmonic current is quite different from the current value.	The distortion ratio (content rate) is well over 100%. (For measurement of inverter secondary side output)	Check the measured item.
	The current value measured by this instrument is different from that measured by other measuring instrument, such as a clamp meter. The difference exceeds an acceptable level.	If the comparative measuring instrument uses the average value method, the AC waveform will distort due to harmonics and the error of the comparative instrument will become large. (This instrument uses the RMS value method.)	Compare with a current value of a measuring instrument that uses the RMS value method.
	The analog output error is large.	When the wiring with the receiver side is long, the error may become large.	Execute zero/span adjustment for analog output. Refer to 4.3 Test Menu 3: Zero/Span Adjustment for Analog Output.
	The pulse output error is large.	When the pulse width is set to 0.500 s or 1.000 s, if the pulse unit is set to the minimum value, the pulse output cannot track under large load conditions and it can result in a decrease in the pulse output number.	Review the settings for pulse unit and width.
	On the Max/Min value screen, a present value is displayed beyond the range of maximum and minimum values.	During the starting current delay time, the maximum value is not updated. Therefore, the displayed present value may exceed the maximum value.	Use the instrument as it is.

## 6. Others

### 6.5. Troubleshooting

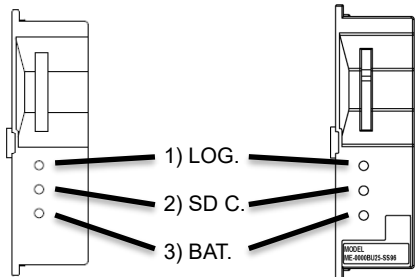
	Situation	Possible cause	Solution
Operation	In the setting mode, setting change is not possible.	When <b>SET</b> blinks at the bottom left of the screen, it is in the setting confirmation mode. Therefore, setting change is not possible.	Enter the setting mode to change settings.
	When the screen enters the setting mode, the PASS 0000 display appears	The password protection is enabled.	Enter the password you set up. The factory default password is '0000.' For details, refer to <b>5.2.18 Password Protection Setting</b> .
Others	Maximum and minimum values change.	The values will be cleared if you change a setting such as phase wire system, VT/Direct voltage, or CT primary current.	It is necessary to record the data before changing the setting.
	The settings you have not altered are changed.	If you change a setting such as phase wire system, VT/Direct voltage, or CT primary current, some items will be reset to the default settings.	Change the reset settings to your settings. For details, refer to <b>3.16 Initialization of Related Items by Changing a Setting</b> .
	When maximum and minimum values or active energy are cleared, the PASS 0000 display appears.	The password protection is enabled.	Enter the password you set up. The factory default password is '0000.' For details, refer to <b>5.2.18 Password Protection Setting</b> .
Communication/Logging	<b>COM</b> on the LCD blinks. (ON for 0.25 second/OFF for 0.25 second)	Communication errors may be occurring in MODBUS RTU such as register address error or communication rate setting error.	Check the register address and communication settings. If a correct MODBUS RTU communication message is received, <b>COM</b> will light up.
	<b>COM</b> on the LCD blinks. (ON for 1 second/OFF for 1 second)	<When ME-0000MT-SS96 is used> Communication errors may be occurring in MODBUS TCP such as header data error or register address error.	Check the header data error and register address. If a correct MODBUS RTU communication message is received, <b>COM</b> will light up.
		<When ME-0000BU-SS96 or ME-0000BU25-SS96 is used> Communication errors may be occurring in ME-0000BU-SS96 or ME-0000BU25-SS96 such as setting error, SD memory card error, or battery voltage drop.	Check the LEDs of ME-0000BU-SS96 or ME-0000BU25-SS96.  1) LOG LED fast blinking When the logging item pattern is set to LP00, an error may be occurring in the setting data file, which must be stored in a SD memory card. Check the setting data file. 2) SDC LED fast blinking Check if the SD memory card is not write protected or if there is available capacity in the SD card. 3) BAT LED lighting The voltage of the built-in lithium battery is dropped. The customer cannot replace the battery by himself/herself. Accordingly, please consider the renewal.

## 6. Others

### 6.5. Troubleshooting

	Situation	Possible cause	Solution
Communication/Logging	Although <b>LOG</b> on the LCD lights up, the clock status goes off.	The present time is not set.	Set the present time, and the clock status will light up. After this instrument restarts by applying the auxiliary power or by shifting from the test mode to the operating mode, the present time setting is necessary. For details, refer to <b>3.14 Setting Menu CL: Preset Time Settings</b> .

## 7. Installation

### 7.1. Dimensions

#### ■ ME96SSRB-MB

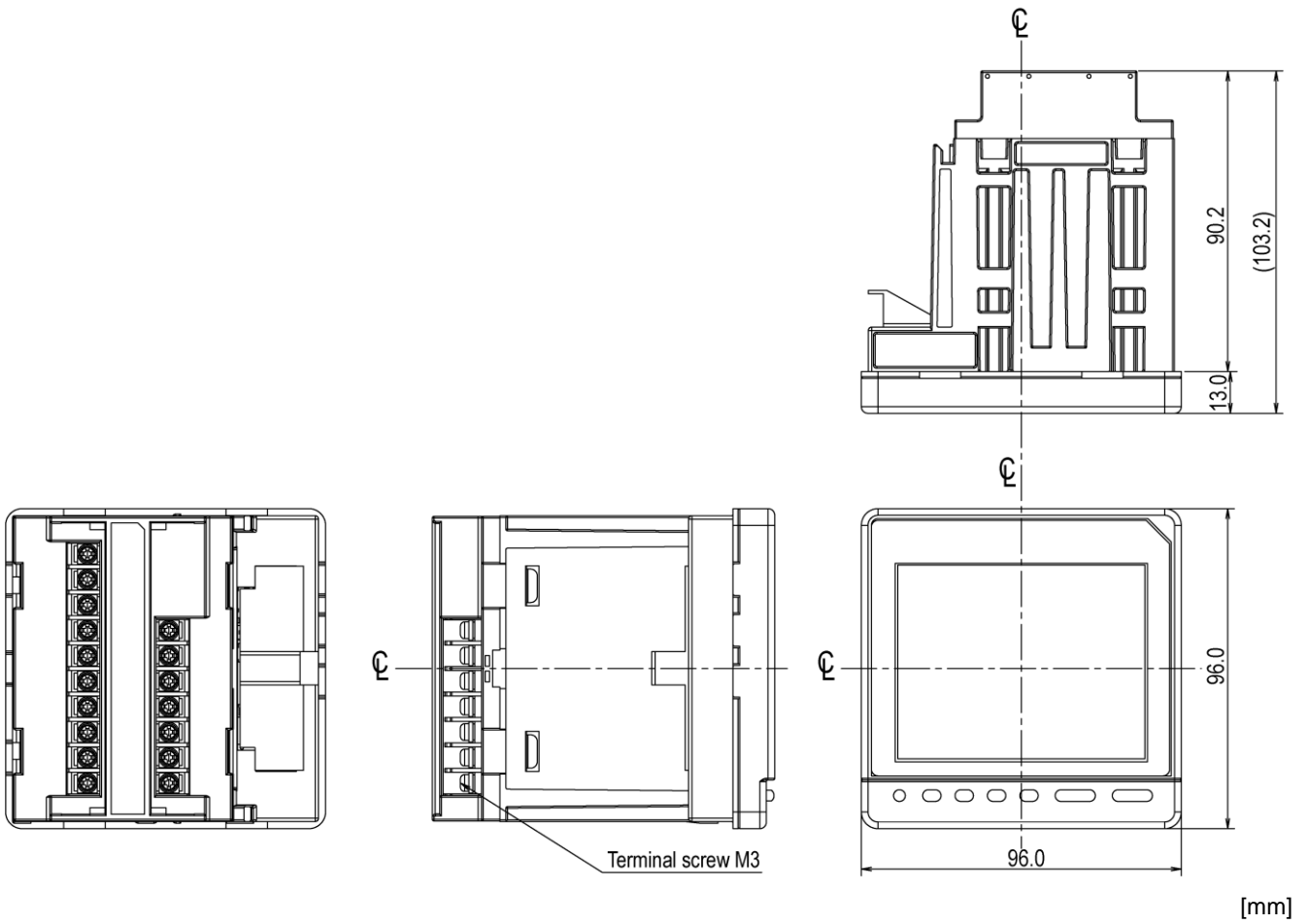

#### ■ Optional plug-in module

ME-4210-SS96B

ME-0040C-SS96

ME-0052-SS96

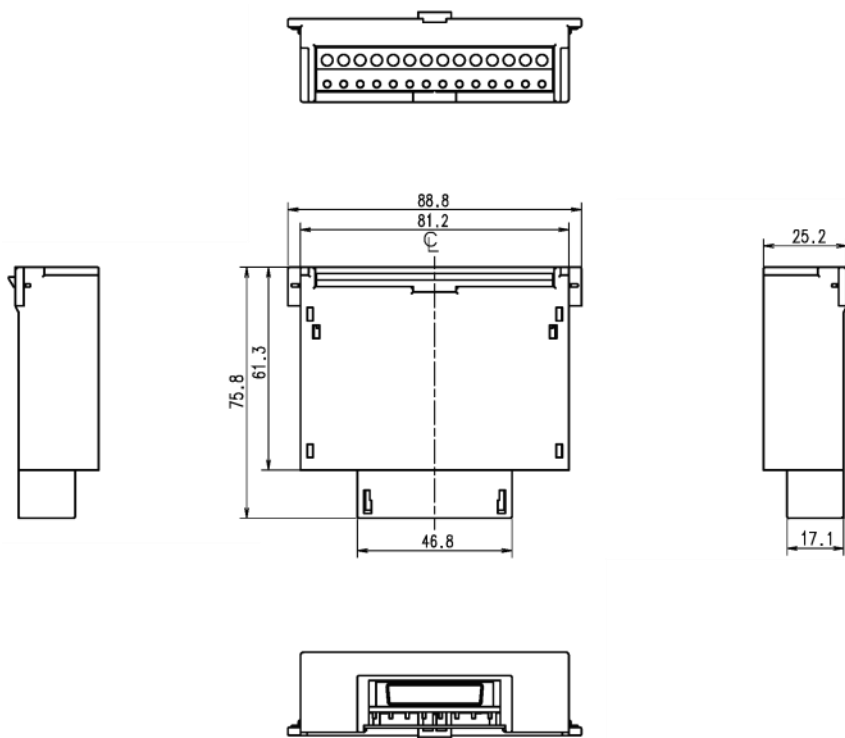

## 7. Installation

### 7.1. Dimensions

■ Optional plug-in module  
ME-0000MT-SS96

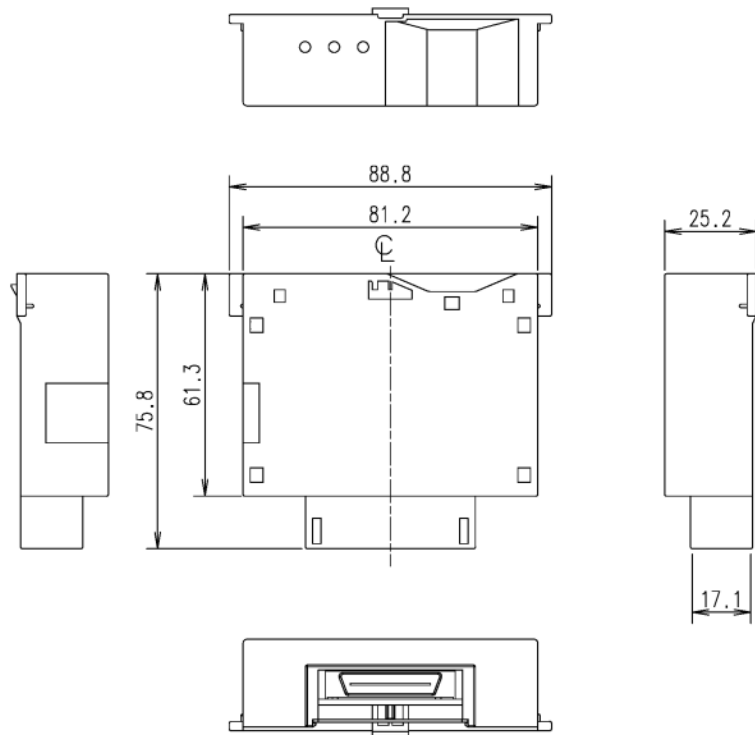

[mm]

■ Optional plug-in module  
ME-0000BU-SS96  
ME-0000BU25-SS96

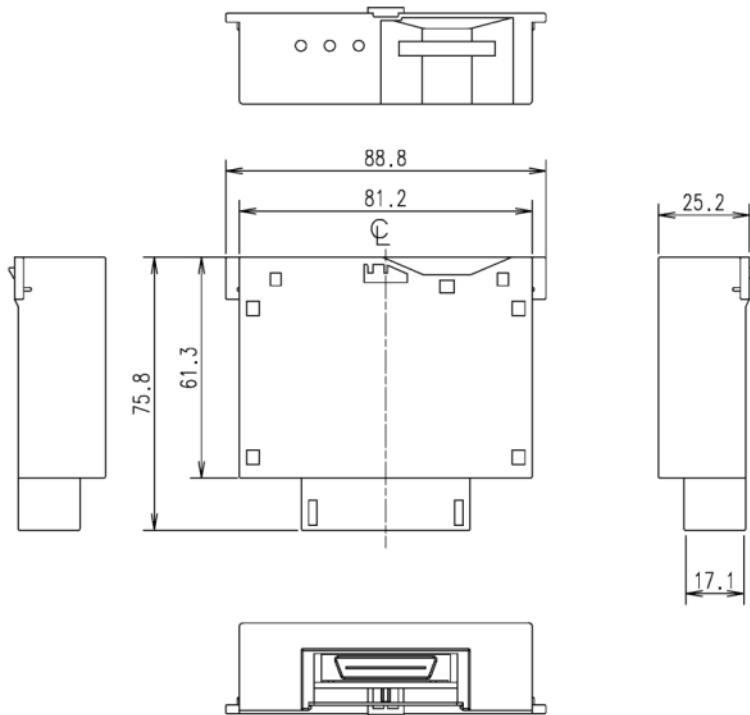

[mm]



## 7. Installation

### 7.2. How to Install

#### 7.2.1. Mounting Hole Dimensions

The right figure shows the hole drilling dimensions of the panel. Use a panel with a thickness of 1.6 mm to 4.0 mm for installation.

#### 7.2.2. Mounting Position

The contrast of LCD display changes depending on the angle of view. Install the instrument in a location where you can easily see it.

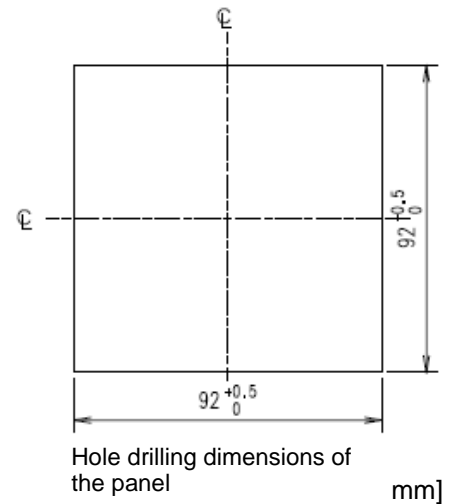
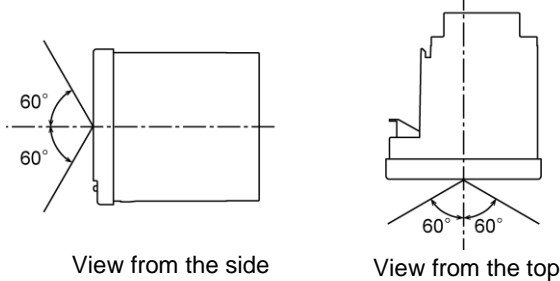

#### 7.2.3. Mounting and Fixing

You will install the instrument on a panel according to the following procedure.

- ① Install the two attachment lugs on the top and bottom of the unit.
- ② Tighten the screws of the attachment lugs to fix them to the panel.

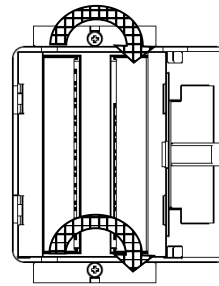
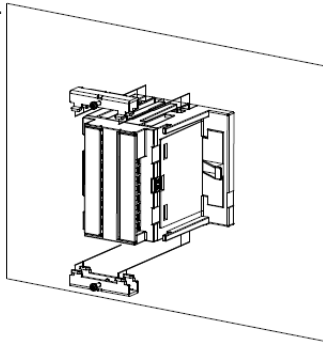

The mounting screw type: M3

**Note**  
To prevent damage to the panel and screws, do not overtighten the screws. Tighten the two screws evenly. The recommended torque for this product is 0.3 N•m to 0.5 N•m (about half the normal torque).

#### 7.2.4. Optional Plug-in Module Installation

You will install the optional plug-in module to the instrument according to the following procedure.

- ① Remove the option cover.
- ② Install the optional plug-in module to the unit.

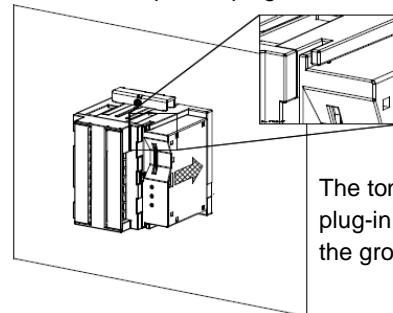
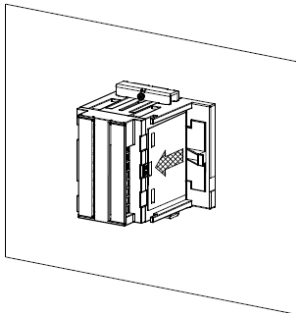

The tongue of the optional plug-in module is fitted into the groove of the unit.

<b>Note</b>	<b>Protection sheet</b>
	The protection sheet is attached to the LCD display to prevent scratches on the display during installation. Before starting operation, remove the sheet. When you remove the sheet, the LCD display may light up due to static electricity generation. However, this is not abnormal. After a while, the lighting goes off due to self-discharge.
	<b>Mounting position</b>
	When you install the instrument on the edge of the panel, check the work space for wiring to determine the mounting position.
	<b>Optional plug-in module</b>
	Before installing the optional plug-in module, turn off the power supply of auxiliary power. If you install it under power distribution, the instrument will not recognize it. In this case, you should get auxiliary power distribution/recovery or restart the instrument and then the instrument will recognize the optional plug-in module.

## 7. Installation

### 7.3. How to Connect Wiring

#### 7.3.1. Specifications on the Applicable Electrical Wire

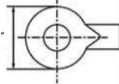
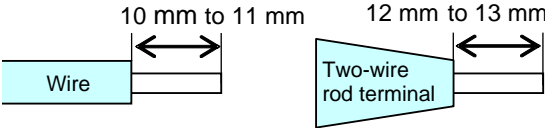
Parts	Screw type	Wire for use	Tightening torque
The terminals of this instrument: • Auxiliary power • Voltage input • Current input • MODBUS RTU communication	M3	• Used with crimp-type terminals: AWG 26 to 14 *Two-wire connection is possible. Applicable crimp-type terminals: For M3 screw with an outer diameter of 6.0 mm or less.  Outer diameter 	0.8 N·m
The terminals of optional plug-in module: • ME-0052-SS96 • ME-0040C-SS96 • ME-4210-SS96B	Screwless	• Solid wire, stranded wire: AWG 24 to 14 *Stranded wires can be used with rod terminals. Wire stripping length: 10 mm to 11 mm *1: To support the UL standard, use it in accordance with the following conditions. • Solid wire, stranded wire: AWG 24 to 18 • Rod terminals cannot be used. *2: For the use of a two-wire rod terminal, select it by referring that the insertion depth of the terminal block is 12 mm to 13 mm.  	-

#### 7.3.2. Wiring of this Instrument

Be sure to securely tighten the terminal screws to the terminal block.

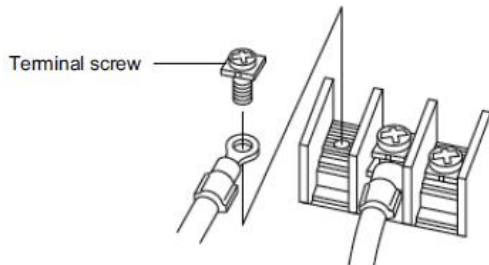

	<ul style="list-style-type: none"> <li>Do not connect three or more electric wires to one terminal. Otherwise, imperfect contact can cause heat generation or a fire.</li> <li>If you use a bare crimp-type terminal, you should secure a necessary insulation distance using an insulation tube not to expose the charging part for prevention of electric shock and short circuits.</li> </ul>
---	--

#### 7.3.3. Wiring of the Optional Plug-in Module

- ① Peel the wire tip or pressure-weld a rod terminal.
- ② Insert the wire with the lever pressed and then release the lever to connect.

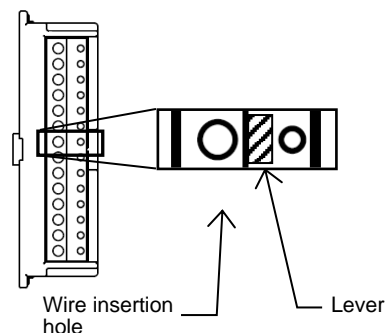

#### 7.3.4. Check the Connection

After wiring, check the following points:

- The electric wires are securely connected.
- There is no wrong wiring.

## 7. Installation

### 7.3. How to Connect Wiring

#### ⚠ CAUTION

Do not work under live wires.

Do not connect the terminals or RJ 45 connectors under live line conditions. In addition, do not insert or remove a SD memory card under hot line conditions. Otherwise, there is danger of electric shock, burn injury, burnout of the instrument, or a fire.

We recommend that protection fuses be installed for VT and auxiliary power unit.

Do not open the secondary side of the CT circuit.

Connect the CT secondary-side signal correctly to the terminal for CT. If the CT were incorrectly connected or if the CT secondary side were open, it could result in a high voltage generation at the CT secondary side and insulation breakdown in the CT secondary winding. It might cause burnout.

Do not short the secondary side of the VT circuit.

Connect the VT secondary-side signal correctly to the terminal for VT. If the VT were incorrectly connected or if a short occurred at the VT secondary side, an overcurrent would flow through the VT secondary side and it would cause burnout in the VT secondary winding. The burnout could spread to insulation breakdown in the primary winding. Finally, it might cause short circuit between phases.

Securely connect to the connection terminal.

Connect electrical wires properly to the connection terminal. Otherwise, heat generation or measurement errors may occur.

Do not forget the connecting wires of C<sub>1</sub>, C<sub>2</sub> and C<sub>3</sub>.

When a common wire is used for L side (load side) of CT circuit of three-phase instrument, it is necessary to short-circuit the C<sub>1</sub>, C<sub>2</sub>, and C<sub>3</sub> terminals of this instrument.

Do not use improper electrical wires.

Be sure to use an appropriate size wire compatible with the rated current and voltage. The use of an inappropriate size wire may cause a fire.

Do not pull connecting wires with a strong force.

If you pulled the terminal wires with a strong force, the input/output terminal part might come off. (Tensile load: 39.2N or less)

Do not apply an abnormal voltage.

If a high-pressure device is subjected to the pressure test, ground the input lines of CT and VT secondary sides in order to prevent damage to this instrument. If a high voltage of 2000 V AC were applied to the instrument for over one minute, it might cause a failure.

Do not connect to Non-Connection (NC) terminal.

Do not connect to the Non-Connection (NC) terminal for the purpose of relay.

Supply voltage properly to the auxiliary power source.

Supply proper voltage to the auxiliary power terminal.

If an improper voltage were applied, it might cause a failure of the instrument or a fire.

## 7. Installation

### 7.4. Wiring Diagram

#### ■ Rated voltage by phase wire system

Phase wire system	Type	Rated voltage	Figure
3-phase 4-wire	STAR	max 277 V AC (L-N) /480 V AC (L-L)	Figure 1
3-phase 3-wire	DELTA	max 220 V AC (L-L)	Figure 2
	STAR	max 440 V AC (L-L)	Figure 3
1-phase 3-wire	—	max 220 V AC (L-N) /440 V AC (L-L)	Figure 4
1-phase 2-wire *Note1	DELTA	max 220 V AC (L-L)	Figure 5
	STAR	max 440 V AC (L-L)	Figure 6

Note1: For the DELTA connection circuit of 3-phase 3 wire system and transformer circuit of 1-phase 2-wire system, the maximum rating is 220 V AC.  
 For the STAR connection circuit of 3-phase 4-wire/3-phase 3-wire system and 1-phase 3-wire circuit, the maximum rating is 440 V AC.

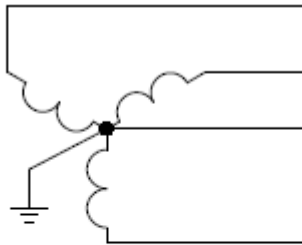

Figure1. 3-PHASE 4-WIRE(STAR)

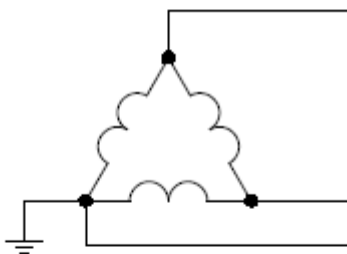

Figure2. 3-PHASE 3-WIRE(DELTA)

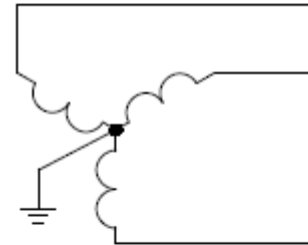

Figure3. 3-PHASE 3-WIRE(STAR)

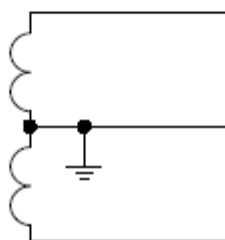

Figure4. 1-PHASE 3-WIRE

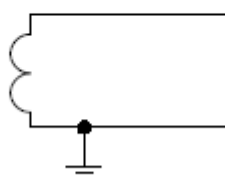

Figure5. 1-PHASE 2-WIRE(DELTA)

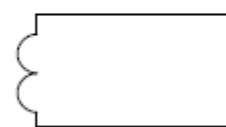
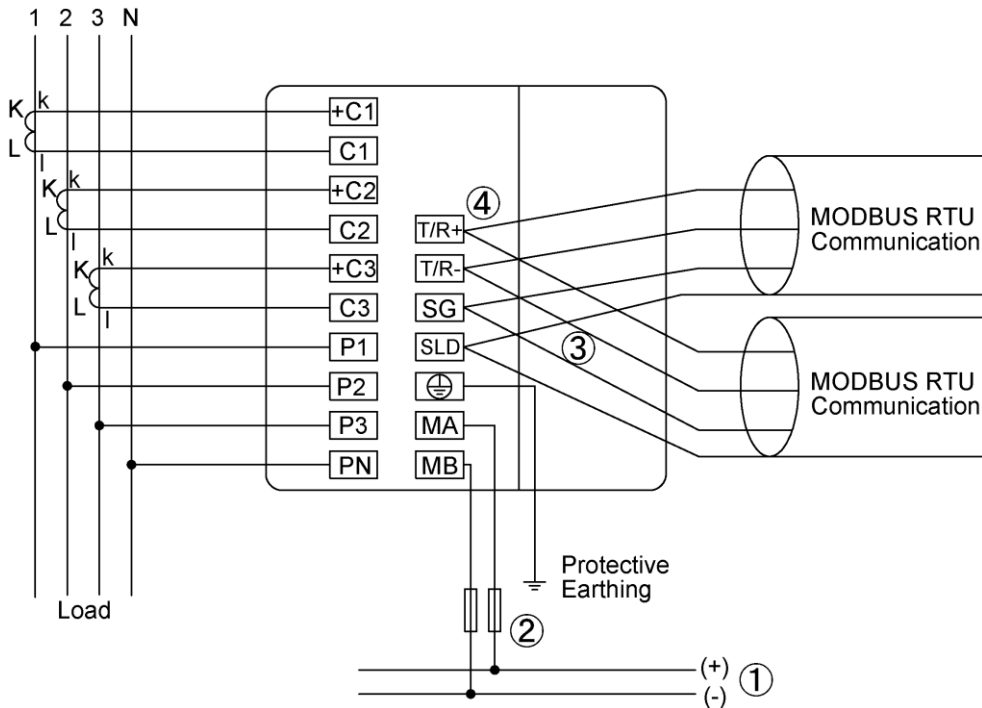

Figure6. 1-PHASE 2-WIRE(STAR)

## 7. Installation

### 7.4. Wiring Diagram

#### ■ 3-phase 4-wire system, Direct input



① Auxiliary power supply

100 V AC to 240 V AC or 100 V DC to 240 V DC

② Fuse (recommendation)

Rated current: 0.5 A, Rated breaking capacity: 250 V AC 1,500 A / 250 V DC 1,500 A (a UL certified product)

③ If MODBUS RTU devices do not have the SG terminal, the wiring between SG terminals is not necessary.

④ Install 120-Ohm terminating resistors between terminals 'T/R+' and 'T/R-' for devices at both ends of MODBUS RTU communication line.

Note1: For low voltage circuits, it is not necessary to ground the VT and CT secondary sides.

#### ■ 3-phase 4-wire system, With VT

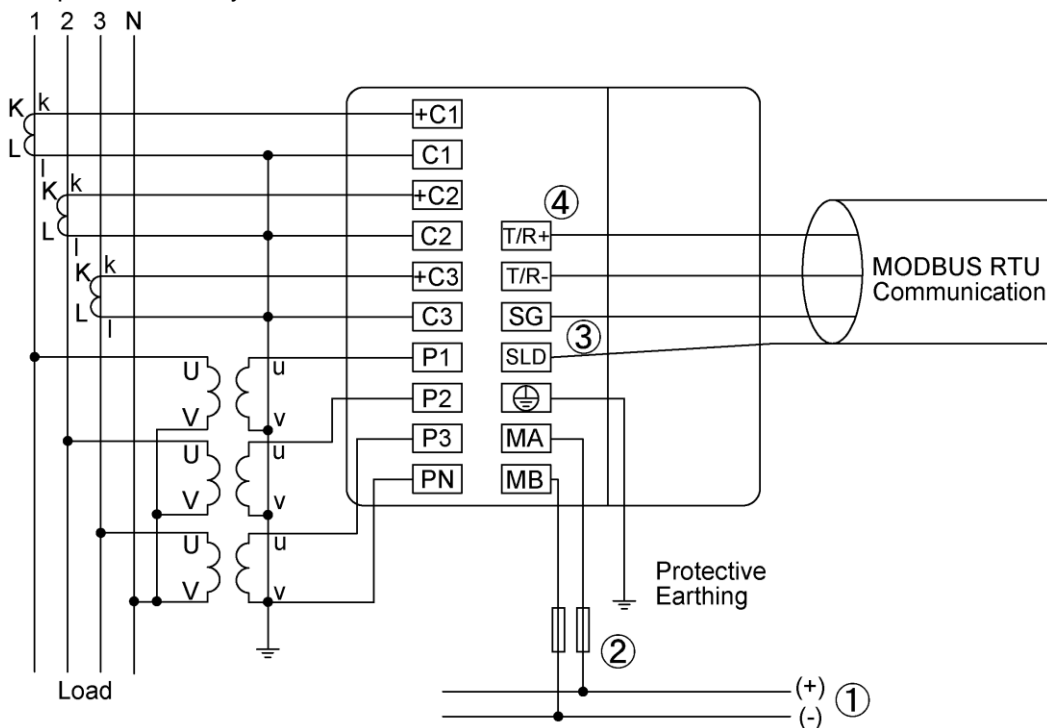

① Auxiliary power supply

100 V AC to 240 V AC or 100 V DC to 240 V DC

② Fuse (recommendation)

Rated current: 0.5 A, Rated breaking capacity: 250 V AC 1,500 A / 250 V DC 1,500 A (a UL certified product)

③ If MODBUS RTU devices do not have the SG terminal, the wiring between SG terminals is not necessary.

④ Install 120-Ohm terminating resistors between terminals 'T/R+' and 'T/R-' for devices at both ends of MODBUS RTU communication line.

Note1: For low voltage circuits, it is not necessary to ground the VT and CT secondary sides.

## 7. Installation

### 7.4. Wiring Diagram

#### ■ 3-phase 3-wire system, Direct input, 2CT

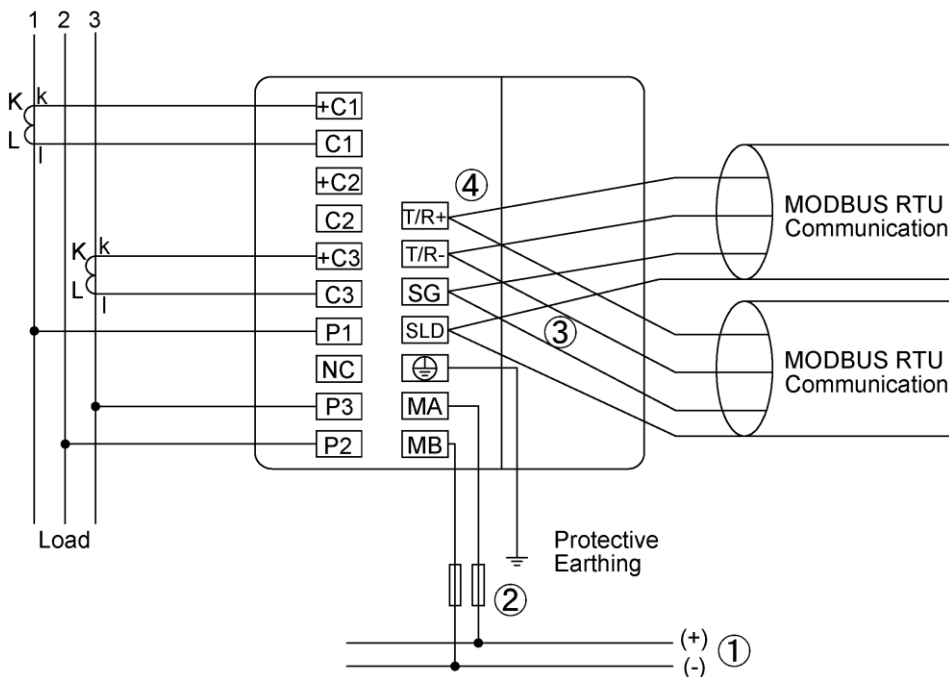

①Auxiliary power supply

100 V AC to 240 V AC or 100 V DC to 240 V DC

②Fuse (recommendation)

Rated current: 0.5 A, Rated breaking capacity: 250 V AC 1,500 A / 250 V DC 1,500 A (a UL certified product)

③If MODBUS RTU devices do not have the SG terminal, the wiring between SG terminals is not necessary.

④Install 120-Ohm terminating resistors between terminals 'T/R+' and 'T/R-' for devices at both ends of MODBUS RTU communication line.

Note1: For low voltage circuits, it is not necessary to ground the VT and CT secondary sides.

Note2: Do not connect the NC terminal.

#### ■ 3-phase 3-wire system, With VT, 3CT

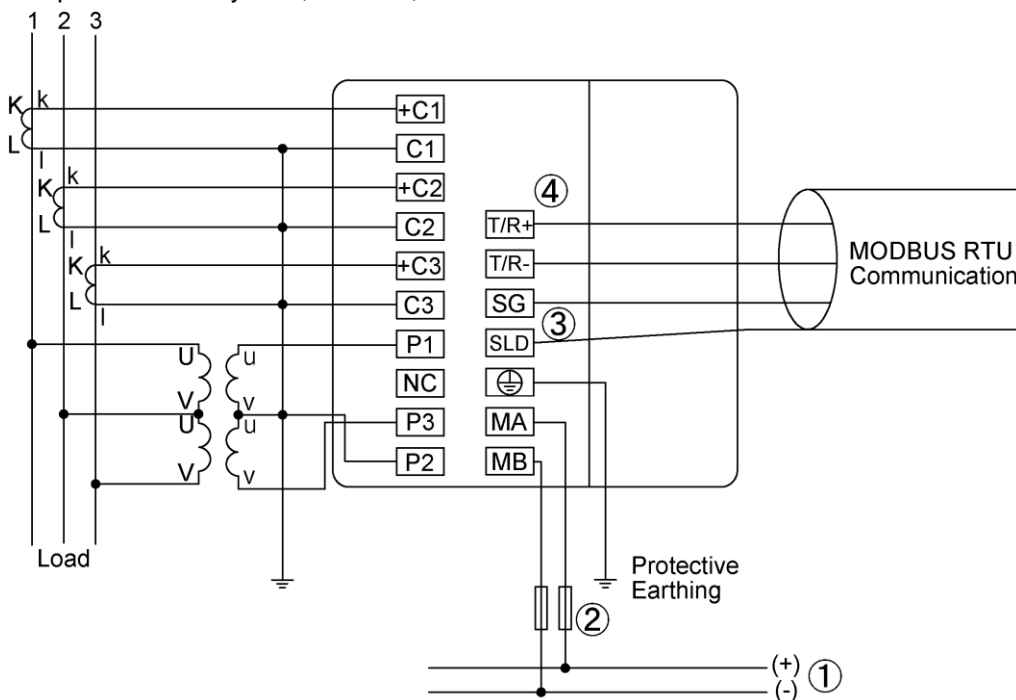

①Auxiliary power supply

100 V AC to 240 V AC or 100 V DC to 240 V DC

②Fuse (recommendation)

Rated current: 0.5 A, Rated breaking capacity: 250 V AC 1,500 A / 250 V DC 1,500 A (a UL certified product)

③If MODBUS RTU devices do not have the SG terminal, the wiring between SG terminals is not necessary.

④Install 120-Ohm terminating resistors between terminals 'T/R+' and 'T/R-' for devices at both ends of MODBUS RTU communication line.

Note1: For low voltage circuits, it is not necessary to ground the VT and CT secondary sides.

Note2: Do not connect the NC terminal.

## 7. Installation

### 7.4. Wiring Diagram

#### ■ 1-phase 3-wire system

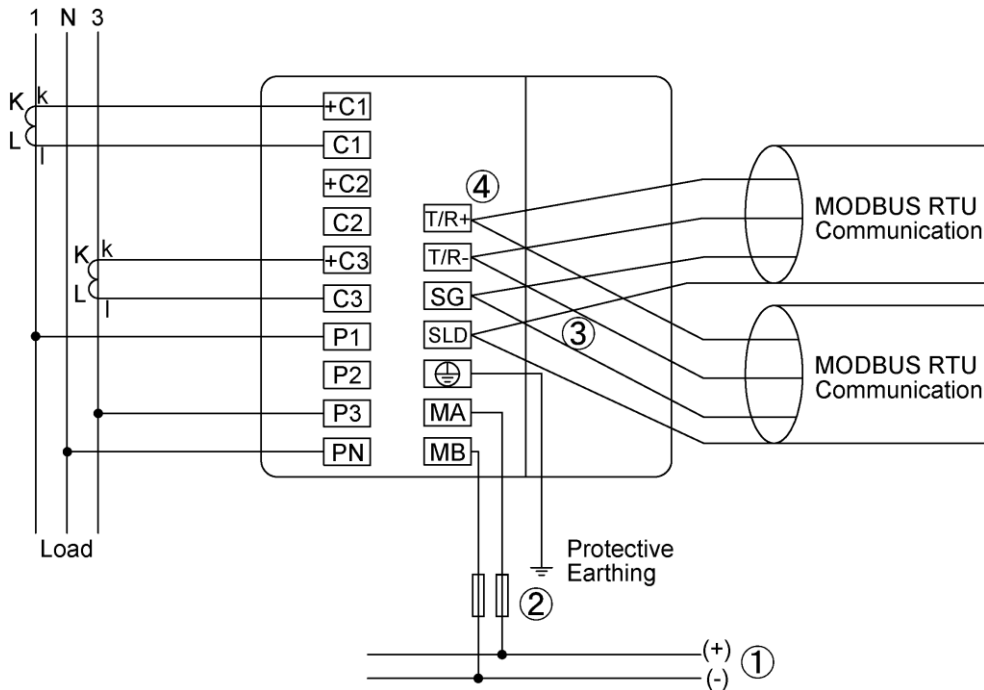

①Auxiliary power supply

100 V AC to 240 V AC or 100 V DC to 240 V DC

②Fuse (recommendation)

Rated current: 0.5 A, Rated breaking capacity: 250 V AC 1,500 A / 250 V DC 1,500 A (a UL certified product)

③If MODBUS RTU devices do not have the SG terminal, the wiring between SG terminals is not necessary.

④Install 120-Ohm terminating resistors between terminals 'T/R+' and 'T/R-' for devices at both ends of MODBUS RTU communication line.

Note1: For low voltage circuits, it is not necessary to ground the VT and CT secondary sides.

Note2: Do not connect the NC terminal.

#### ■ 1-phase 2-wire system, With VT

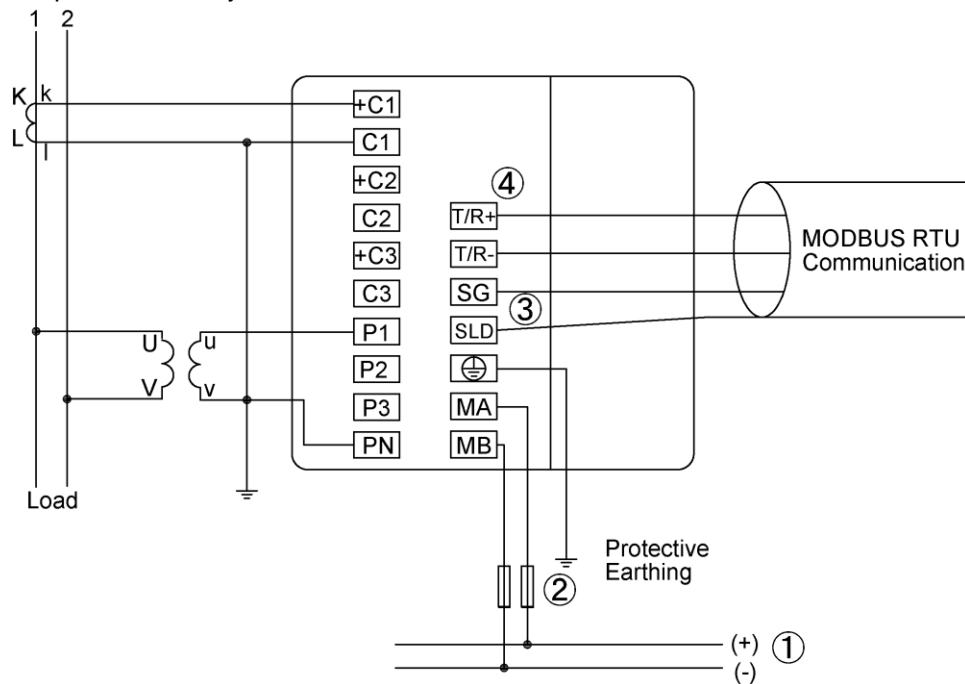

①Auxiliary power supply

100 V AC to 240 V AC or 100 V DC to 240 V DC

②Fuse (recommendation)

Rated current: 0.5 A, Rated breaking capacity: 250 V AC 1,500 A / 250 V DC 1,500 A (a UL certified product)

③If MODBUS RTU devices do not have the SG terminal, the wiring between SG terminals is not necessary.

④Install 120-Ohm terminating resistors between terminals 'T/R+' and 'T/R-' for devices at both ends of MODBUS RTU communication line.

Note1: For low voltage circuits, it is not necessary to ground the VT and CT secondary sides.

Note2: Do not connect the NC terminal.

## 7. Installation

### 7.4. Wiring Diagram

■ Optional plug-in module: ME-4210-SS96B

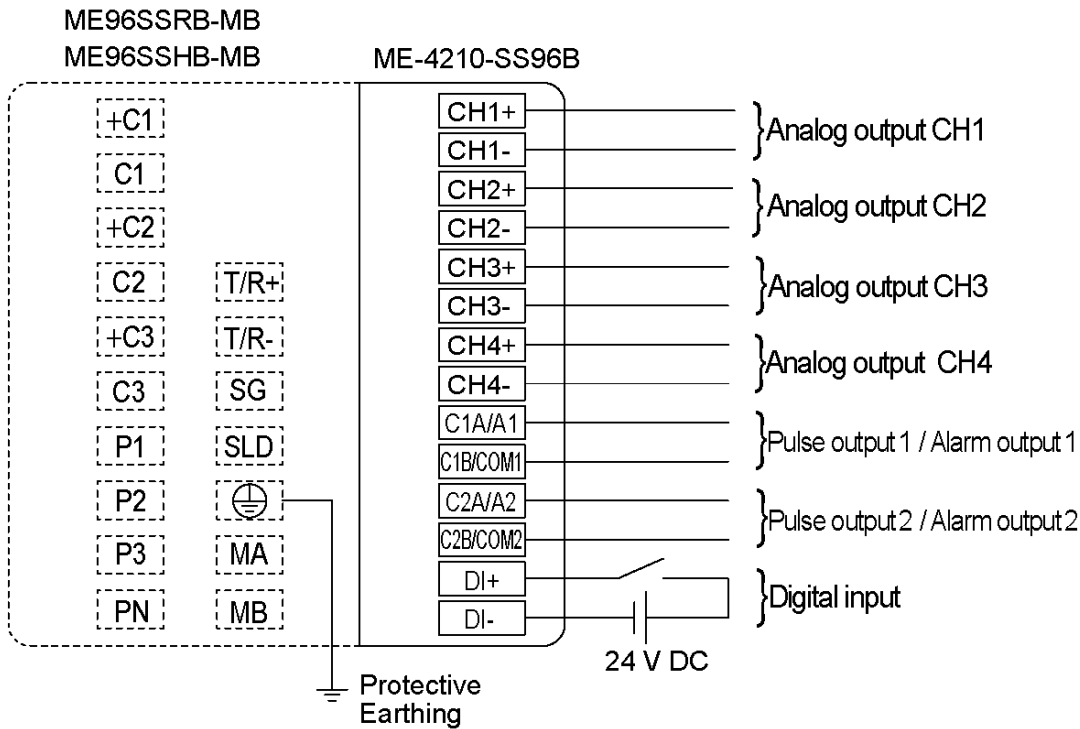

■ Optional plug-in module: ME-0040C-SS96

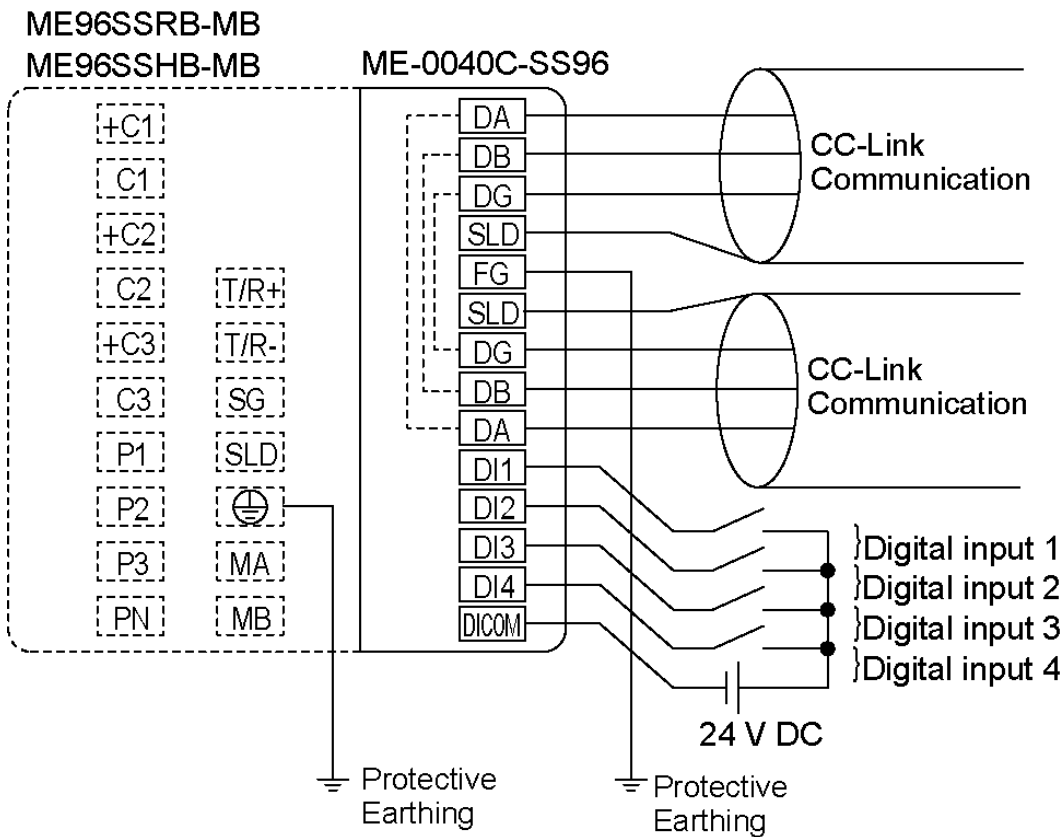



## 7. Installation

### 7.4. Wiring Diagram

■ Optional plug-in module: ME-0052-SS96

ME96SSRB-MB

ME96SSHB-MB

ME-0052-SS96

24 V DC

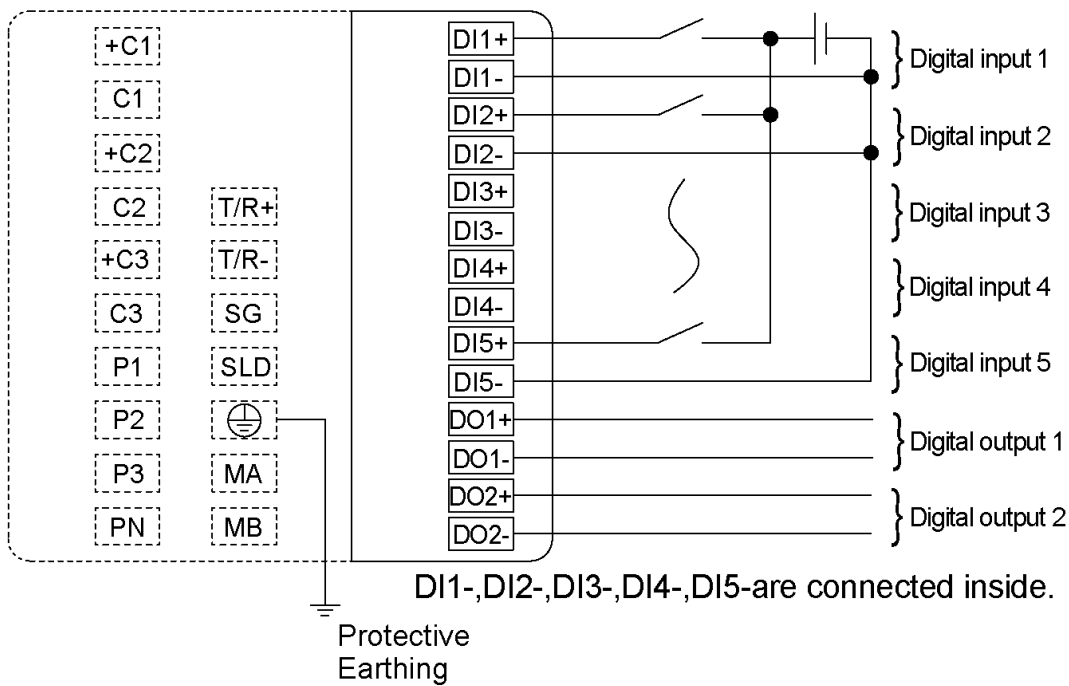

D1-, D2-, D3-, D4-, D5- are connected inside.

Protective Earthing

■ Optional plug-in module: ME-0000MT-SS96

ME96SSRB-MB

ME96SSHB-MB

ME-0000MT-SS96

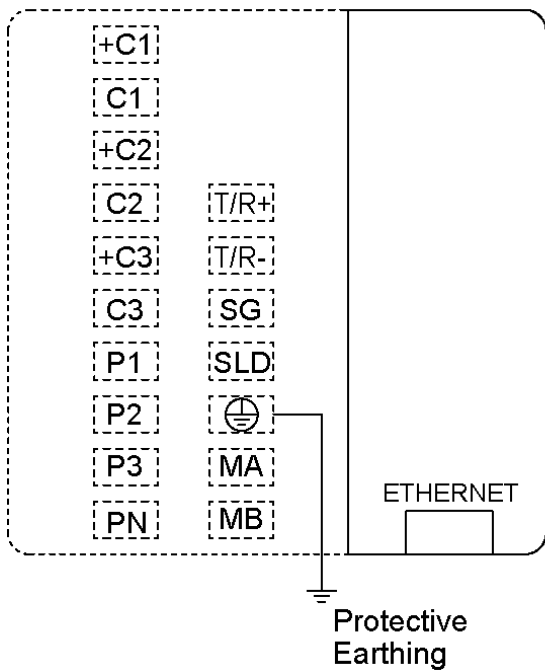

Protective Earthing

■ Optional plug-in module: ME-0000BU-SS96

ME-0000BU25-SS96

ME96SSRB-MB

ME-0000BU-SS96

ME96SSHB-MB

ME-0000BU25-SS96

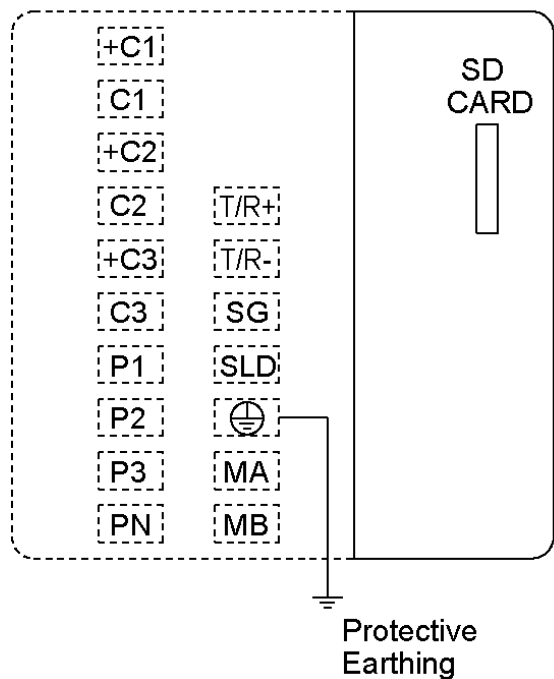

Protective Earthing

## 7. Installation

### 7.4. Wiring Diagram

#### For Input

<b>Note</b>	<ol style="list-style-type: none"><li>1. The voltage input terminals of 3-phase 3-wire system are different from those of other systems.</li><li>2. If the VT and CT polarities are incorrect, measurement will not be correctly executed.</li><li>3. Do not wire the NC terminal.</li><li>4. For low voltage, it is not necessary to ground the VT and CT secondary sides.</li><li>5. Be sure to ground the earth terminal (⊕) to use. The ground resistance is 100 ohm or less. Improper ground may cause a malfunction.</li></ol>
-------------	--

#### For Output

<b>Note</b>	<ol style="list-style-type: none"><li>1. Pulse output lines, alarm output lines, and digital input/output lines must not be placed close to or bound together with power lines or high voltage lines. When lying parallel to the power lines or high voltage lines, refer to the following table for the separation distance.<table border="1" data-bbox="427 698 1026 801"><thead><tr><th>Conditions</th><th>Distance</th></tr></thead><tbody><tr><td>Power lines of 600 V or less</td><td>300 mm or more</td></tr><tr><td>Other power lines</td><td>600 mm or more</td></tr></tbody></table></li><li>2. Analog output lines must not be placed close to or bound together with other power lines or input lines (for VT, CT, and auxiliary power supply). Use a shielded cable or twisted pair cable not to be affected by noise, surge, or induction. The connecting wires should be as short as possible.</li><li>3. The MODBUS RTU communication section and ME-4210-SS96B (optional plug-in module) are not insulated.</li></ol>	Conditions	Distance	Power lines of 600 V or less	300 mm or more	Other power lines	600 mm or more
Conditions	Distance						
Power lines of 600 V or less	300 mm or more						
Other power lines	600 mm or more						

#### For MODBUS RTU Communication

<b>Note</b>	<ol style="list-style-type: none"><li>1. Use a shielded twisted pair cable for transmission signal line. *For recommended cables, refer to <b>8.3 MODBUS RTU Communication Specifications</b>.</li><li>2. Install 120-Ohm terminating resistors between terminals 'T/R+' and 'T/R-' for devices at both ends of MODBUS RTU communication line.</li><li>3. Connect with wires as thick as possible to ground for low impedance.</li><li>4. The transmission signal lines of MODBUS RTU communication must not be placed close to or bound together with high voltage lines.</li><li>5. Perform one point grounding for the SLD terminal.</li></ol>
-------------	---

#### For CC-Link Communication

<b>Note</b>	<ol style="list-style-type: none"><li>1. Use a specified cable for CC-Link connection. For details, refer to <b>8.4 CC-Link Communication Specifications</b>. It is not possible to mix dedicated cables and CC-Link dedicated high-performance cables. If they were mixed, correct data transmission would not be ensured. For termination resistor, the resistance value varies depending on the dedicated cable type.</li><li>2. Connect the shielded wire of CC-Link connection cable to 'SLD' and ground 'FG' (The ground resistance: 100 Ω or less.). 'SLD' and 'FG' are connected inside the unit.</li><li>3. The CC-Link transmission line is with a small signal circuit. Install it separately from a strong electric circuit by 100 mm or more. When long wires lie parallel to each other, keep a distance of 300 mm or more. For use, ground the terminals.</li><li>4. Be sure to use a dedicated cable for CC-Link transmission line. According to the communication speed, observe the conditions for total wiring distance, inter-station distance, and termination resistance value. If the dedicated cable were not used or if the wiring conditions were not fulfilled, correct communication might not be executed. For the dedicated cable and the wiring conditions, refer to the user's manual of CC-Link master unit.</li><li>5. For units at both ends of CC-Link transmission line, be sure to install the termination resistors that come with the CC-Link master unit.</li><li>6. The CC-Link communication section and MODBUS RTU communication section are not insulated.</li></ol>
-------------	---

## 7. Installation

### 7.4. Wiring Diagram

For MODBUS TCP Communication

<b>Note</b>	<p>1. For 100 Mbps communication with 100 BASE-TX connection, a communication error may occur depending on the installation environment due to the effect of high frequency noise from devices other than this instrument. To prevent the effect of high frequency noise, take the following measures against it when configuring a network system.</p> <p>(1) Wiring connection</p> <ul style="list-style-type: none"><li>• Twisted pair cables must not be placed close to or bound together with the main circuit or power lines.</li><li>• Put the twisted pair cable in a duct.</li></ul> <p>(2) Communication method</p> <ul style="list-style-type: none"><li>• Increase the communication retry count as necessary.</li><li>• Replace with a 10 Mbps hub for connection use and communicate with a data transmission speed of 10 Mbps.</li></ul>
-------------	--

## 7. Installation

### 7.5. How to insert/remove SD memory card

■ When inserting the SD memory card:

Insert the SD memory card straight into the SD memory slot until you hear a click.

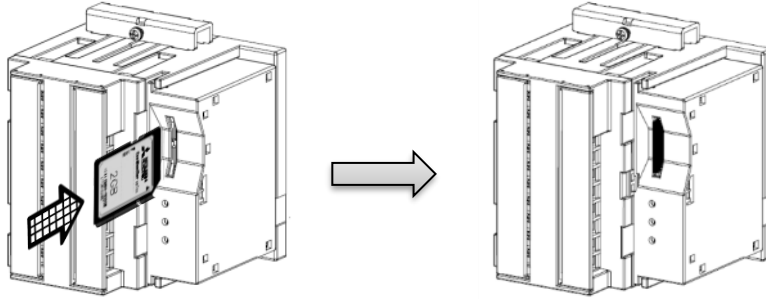

**CAUTION**

- Be sure to use a SD memory card, EMU4-SD2GB, produced by Mitsubishi Electric Corporation. Using a SD memory card not produced by Mitsubishi Electric Corporation may cause a trouble such as data corruption in the card or system stop.
- Insert the SD memory card with the write protect switch OFF. If the write protect switch is ON, the logging unit will not communicate with the card.

■ When removing the SD memory card:

- ① Check that SD C.LED is OFF.
- ② Insert the SD memory card until you hear a click.
- ③ The SD memory card comes out automatically.

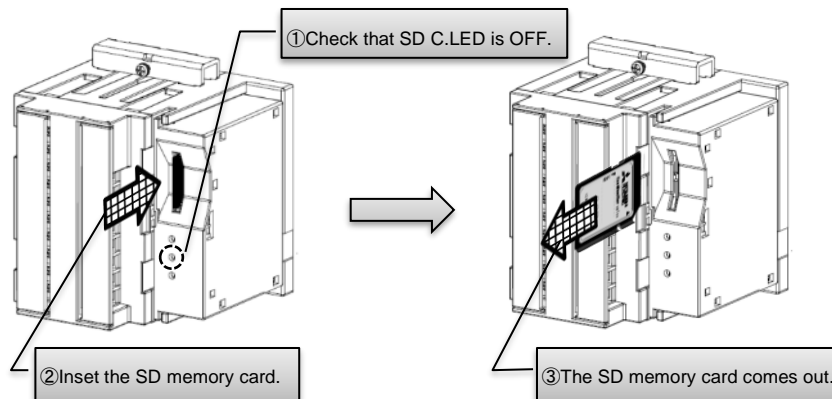

**CAUTION**

If you removed the SD memory card while the instrument communicates with the card, this might cause data corruption in the card or failure of the instrument or card. After checking that SD C.LED is OFF, remove the card.

## 8. Specifications

### 8.1. Product Specifications

Type		ME96SSHB-MB	
Phase wire system		3-phase 4-wire, 3-phase 3- wire (3CT, 2CT), 1-phase 3- wire, 1-phase 2- wire (common use)	
Rating	Current	5 A AC, 1 A AC (common use)	
	Voltage	3-phase 4- wire: max 277/480 V AC 3-phase 3- wire: (DELTA) max 220 V AC, (STAR) max 440 V AC 1-phase 3- wire: max 220/440 V AC 1-phase 2- wire: (DELTA) max 220 V AC, (STAR) max 440 V AC	
	Frequency	50 Hz or 60 Hz (common use)	
Item		Measuring Item	Accuracy Class
Measuring element	Current (A)	A1, A2, A3, AN, A <sub>AVG</sub>	±0.2%
	Current Demand (DA)	DA1, DA2, DA3, DAN, DA <sub>AVG</sub>	
	Voltage (V)	V12, V23, V31, V <sub>AVG</sub> (L-L), V1N, V2N, V3N, V <sub>AVG</sub> (L-N)	
	Active Power (W)	W1, W2, W3, ΣW	±0.5%
	Reactive Power (var)	var1, var2, var3, Σvar	
	Apparent Power (VA)	VA1, VA2, VA3, ΣVA	
	Power Factor (PF)	PF1, PF2, PF3, ΣPF	
	Frequency (Hz)	Hz	±0.1%
	Active Energy (Wh)	Imported, Exported	Class 0.5S (IEC62053-22)
	Reactive Energy (varh)	Imported lag, Imported lead, Exported lag, Exported lead	Class 1S (IEC62053-24)
	Apparent Energy (VAh)	Imported + Exported	±2.0%
	Harmonic Current (HI)	Total, Individual (Odd)	±1.0%
	Harmonic Voltage (HV)	Total, Individual (Odd)	
	Rolling Demand Active Power (DW)	Rolling block, Fixing block (Select either of them according to the settings.)	±0.5%
	Rolling Demand Reactive Power (Dvar)	Rolling block, Fixing block (Select either of them according to the settings.)	±1.0%
	Rolling Demand Apparent Power (DVA)	Rolling block, Fixing block (Select either of them according to the settings.)	
	Periodic Active Energy (Wh)	Periodic active energy 1, Periodic active energy 2, Periodic active energy 3	Class 0.5S
	Operating Time (h)	Operating time 1, Operating time 2	(Reference)
Current Unbalance Rate (Aunb)	Aunb	(Reference)	
Voltage Unbalance Rate (Vunb)	Vunb	(Reference)	
CO <sub>2</sub> Equivalent	kg	(Reference)	
Item		Specifications	
Analog output response time		1 second or less (Hz: 2 seconds or less, HI, HV: 5 seconds or less)	
Measuring method	Instantaneous Value	A, V: RMS value calculation; W, var, VA, Wh, varh, VAh: Digital multiplication; PF: Power ratio calculation; Hz: Zero-cross; HI, HV: FFT	
	Demand Value	DA: Thermal type calculation, DW, Dvar, DVA: Rolling demand calculation	
Display	Display type	LCD with LED backlight	
	Number of display digits or segments	Digital section	First to third line indication: 4 digits, Fourth line indication: 6 digits A, DA, V, W, var, VA, PF, DW, Dvar, DVA, Aunb, Vunb: 4 digits; Hz: 3 digits; Wh, varh, VAh: 9 digits (6-digit or 12-digit is also available.); Harmonic distortion ratio/content rate: 4 digits; Harmonic RMS value: 4 digits; Operating time: 6 digits; CO <sub>2</sub> equivalent: 6 digits or 9 digits; Digital input/output: I/O
	Display update time interval	0.5 s, 1 s (selectable)	
Communication		MODBUS RTU communication	
Built-in logging	Logging mode	Automatic overwrite update	
	Logging data type	Measurement data *1	Measuring data and time data are stored at a data logging period specified. (15 min, 30 min, 60 min)
		Alarm data	Time data at alarm generating/cancellation and at waiting for alarm cancellation
	The recorded time of the Max/Min value	Time data of when the maximum and minimum values are updated.	

## 8. Specifications

### 8.1. Product Specifications

Item		Specifications	
Built-in logging	Number of logging items	Measurement data	Integrated value data: 5 items, Data other than integrated value: 15 items, Total: Max. 20 items
		Alarm data	The number of the set alarms
		The recorded time of the Max/Min value	The total is 19 elements: Current Max/Min (AVG), Line voltage Max/Min (AVG), Phase voltage Max/Min (AVG), Total active power Max/Min (AVG), Total power factor Max/Min (AVG), Frequency Max/Min (AVG), Total reactive power Max/Min, Total apparent power Max/Min, Total harmonic current RMS Max value, Harmonic line voltage distortion ratio Max total, Harmonic phase voltage distortion ratio Max total
	Internal memory logging period	Measurement data	30 days (Logging period: 15 minutes), 60 days (Logging period: 30 minutes), 120 days (Logging period: 60 minutes),
		Alarm data	100 records
		The recorded time of the Max/Min value	1 record for each Max/Min value
	System log data		100 records
	How to acquire logging data and system log data		Acquire the logging data via MODBUS RTU Communication
	Clock setting		By button operation on the screen, By MODBUS RTU communication, By acquiring the data from the logging unit
	Clock accuracy		± 1 minute per month, typical
	Power interruption backup	Setup value, Logging data, System log data	The non-volatile memory is used.
		Clock operation	The timing operation stops under power outage. The timing operation after power recovery is as follows: ·When no ME-0000BU-SS96 or ME-0000BU25-SS96 is installed, the timing starts at the time before power outage. ·When ME-0000BU-SS96 or ME-0000BU25-SS96 is installed, the timing starts at the time of the logging module.
	Connectable optional plug-in module		ME-4210-SS96B, ME-0040C-SS96, ME-0052-SS96, ME-0000MT-SS96, ME-0000BU-SS96, ME-0000BU25-SS96
Analog output	Output specifications (Load)	4 mA to 20 mA DC (0 Ω)to 600 Ω)	
Pulse/Alarm output	Switch type	Semiconductor relay/No-voltage a-contact	
	Contact capacity	35 V DC, 0.1 A	
	Pulse width	0.125 s, 0.5 s, 1.0 s	
Digital input (DI)	Contact capacity	24 V DC (19 V DC to 30 V DC), 7 mA or less	
	Signal width	30 ms or more	
Digital output (DO)	Switch type	Mechanical relay/No-voltage a-contact	
	Contact capacity	35 V DC, 0.2 A	
Power interruption backup		Non-volatile memory is used. (Item: Setup value, Max/Min value, Active energy, Reactive energy, Apparent energy, Periodic active energy, Rolling demand, Operating time)	
VA Consumption	Voltage circuit	0.1 VA/phase (at 110 V AC), 0.2 VA/phase (at 220 V AC), 0.4 VA/phase (at 440 V AC)	
	Current circuit	0.1 VA / phase	
	Auxiliary power circuit	13 VA (at 110 V AC), 14 VA (at 220 V AC), 9 W (at 100 V DC)	
Auxiliary power		100 to 240 V AC (±15%), 100 to 240 V DC (-30% +15%)	
Weight		0.5 kg	
Dimensions W × H × D [protrusion from cabinet]		96 × 96 × 90 mm (depth of meter from housing mounting flange) [13 mm]	
Mounting method		Embedded type	
Operating temperature/humidity		-5°C to +55°C (Daily average temperature: 35°C or less), 0 to 85% RH, Non condensing	
Storage temperature/ humidity		-25°C to +75°C (Daily average temperature: 35°C or less), 0 to 85% RH, Non condensing	

## 8. Specifications

### 8.1. Product Specifications

Note1: The accuracy class value represents the ratio to the rated value (100%).

Note2: For measurement where the harmonic distortion ratio (content rate) is 100% or more, the class can exceed  $\pm 1.0\%$ .

Note3: Harmonic current cannot be measured without voltage input.

Note4: If the conventional ME-4210-SS96 (Optional plug-in module) is used, the safety certification requirements of CE marking and UL standards cannot be met.

\*1. Integrated values (Wh, varh, and VAh) are measured values in ME96SS. They are not differential values by logging period.

PMD characteristics (specified by IEC61557-12)

Type of characteristic	Characteristic value	Other complementary characteristic
Power quality assessment function according to 4.3	PMD- II	-
Classification of PMD according to 4.4	SD	-
Temperature	K55	-
Humidity + altitude	Standard conditions	-
Active power or active energy function (If function available) performance class	0.5	-

## 8. Specifications

### 8.2. Compatible Standards

Electromagnetic Compatibility	
Emissions	
Radiated Emission	EN61326-1/ EN 55011/CISPR 11, FCC Part15 Subpart B Class A
Conducted Emission	EN61326-1/ EN 55011/CISPR 11 FCC Part15 Subpart B Class A
Harmonics Measurement	EN61000-3-2
Flicker Meter Measurement	EN61000-3-3
Immunity	
Electrostatic discharge Immunity	EN61326-1,EN IEC 61000-6-2/EN61000-4-2
Radio Frequency Electromagnetic field Immunity	EN61326-1,EN IEC 61000-6-2/EN61000-4-3
Electrical Fast Transient/Burst Immunity	EN61326-1,EN IEC 61000-6-2/EN61000-4-4
Surge Immunity	EN61326-1,EN IEC 61000-6-2/EN61000-4-5
Conducted Disturbances, Induced By Radio Frequency Fields Immunity	EN61326-1,EN IEC 61000-6-2/EN61000-4-6
Power Frequency Magnetic Field Immunity	EN61326-1,EN IEC 61000-6-2/EN61000-4-8
Voltage Dips and Short Interruptions	EN61326-1,EN IEC 61000-6-2/EN61000-4-11

Safety	
Europe	CE, as per EN61010-1: 2010 (3 <sup>rd</sup> Edition)
U.S. and Canada	UL, cUL Recognized as per UL61010-1: 2012 (3 <sup>rd</sup> Edition) IEC61010-1: 2010 (3 <sup>rd</sup> Edition)
Installation Category	III
Measuring Category	III
Pollution Degree	2

### 8.3. MODBUS RTU Communication Specifications

Item	Specifications
Physical interface	RS-485 2wires half duplex
Protocol	RTU mode
Synchronization method	Start-stop synchronization
Transmission wiring type	Multi-point bus (either directly on the trunk cable, forming a daisy-chain)
Baud rate	2400 bps, 4800 bps, 9600 bps, 19200 bps, 38400 bps (Default is 19200 bps)
Data bit	8
Stop bit	1 or 2 (Default is 1)
Parity	ODD,EVEN or NONE (Default is EVEN)
Slave address	1 to 255 (FFh) (Default is 1, 0 is for broadcast mode) (248 to 255 are reserved)
Distance	1200 m
Max. number	31
Response time	1 s or less (time to response after query data is received)
Terminate	120 $\Omega$ 1/2 W
Recommended cable	Shielded twisted pair cable, AWG 24 to 14

■ Read the following document as well as this user's manual.

•Electronic Multi-Measuring Instrument ME Series MODBUS Interface specifications (Ref. No. LSPM-0075)



## 8. Specifications

### 8.4. CC-Link Communication Specifications for optional plug-in module

Item	Specifications	
CC-Link version	Ver. 1.10	Ver. 2.00
Number of occupied stations	1 station, remote device station	
Expanded cyclic setting	-	Octuple
Remote station number	1 to 64	
Transmission speed	156 k, 625 k, 2.5 M, 5 M, 10 Mbps	
Maximum number of stations per master station	42 stations (In case of connecting only remote device station occupied by 1 station) For details, refer to the specifications of the master station.	
Connection cable	Use a dedicated cable. The termination resistance value varies depending on the dedicated cable type.	

The maximum transmission distance varies depending on the transmission speed and CC-Link version.

For details, refer to the following website:

CC-Link Partner Association: <http://www.cc-link.org/>

For the programming, refer to the following documents:

- Electronic Multi-Measuring Instrument Programming Manual (CC-Link) For ver.1 remote device station (Ref. No. LEN080334)
- Electronic Multi-Measuring Instrument Programming Manual (CC-Link) For ver.2 remote device station (Ref. No. LEN130391)

### 8.5. MODBUS TCP Communication Specifications for optional plug-in module

Item	Specifications	
Interface	1 port (10BASE-T/100BASE-TX)	
Transmission method	Base band	
Number of cascade connection stages *1	Max. 4 stages (10BASE-T) Max. 2 stages (100BASE-TX)	
Maximum node-to-node distance	200 m	
Maximum segment length *2	100 m	
Connector applicable for external wiring	RJ45	
Cable	10BASE-T	Cable compliant with the IEEE802.3 10BASE-T Standard *Unshielded twisted pair cable (UTP cable), Category 3 or more
	100BASE-TX	Cable compliant with the IEEE802.3 100BASE-TX Standard *Shielded twisted pair cable (STP cable), Category 5 or more
Protocol	MODBUS TCP (Port number 502)	
Number of simultaneously connection	Max. 4	
Supported function	Autonegotiation (10BASE-T/100BASE-TX automatically detected) Auto MDIX function (straight/crossover cable automatically detected)	

\*1. It is for the use of repeater hubs. When using switching hubs, check the specifications of the hub you use.

\*2. It is a distance between a hub and a node.

■ Read the following document as well as this user's manual.

- Electronic Multi-Measuring Instrument ME Series MODBUS Interface specifications (Ref. No. LSPM-0075)

## 8. Specifications

### 8.6. Logging Specifications for optional plug-in module

Item		Specifications	
Model		ME-0000BU-SS96	ME-0000BU25-SS96
Logging mode		Automatic overwrite update	
Logging data type *1	Detailed data	Measuring data is stored at a detailed data logging period specified. (1 min, 5 min, 10 min, 15 min, 30 min) *Output as detailed data file	
	1-hour data	Measuring data is stored in a 1-hour period. *Output as 1-hour data file and 1-day data file	
Number of logging items	Detailed data	Max. 6 items	Max. 25 items
	1-hour data	Max. 6 items	
Internal memory logging period	Detailed data	Logging period:1 minute      2 days Logging period:5 minutes      10 days Logging period:10 minutes      20 days Logging period:15 minutes      30 days Logging period:30 minutes      60 days	Logging period:1 minute      1 days Logging period:5 minutes      5 days Logging period:10 minutes      10 days Logging period:15 minutes      15 days Logging period:30 minutes      30 days
	1-hour data	400 days (about 13 months)	250 days (about 8 months)
SD memory card (2GB) Logging period *2		10 years or more	
System log data		1200 records	
Logging data/System log data output format		CSV format (ASCII code)	
Power interruption backup		Backup with the built-in lithium battery Cumulative power interruption backup time: 5 years (Daily average temperature: 35°C or less) *The lithium battery service life time: 10 years (Daily average temperature: 35°C or less) It is not possible to replace the lithium battery, and you should consider the renewal.	
Setup values (Logging ID, Logging items, Detailed data logging period)		Stored in the non-volatile memory *Even if power failure occurs in battery voltage drop (BAT.LED is ON), data is not deleted.	
Logging data System log data		Stored in the volatile memory *When power failure occurs in battery voltage drop (BAT.LED is ON), data is deleted.	
Clock operation		*When power failure occurs in battery voltage drop (BAT.LED is ON), timing operation stops. After power recovery, the timing starts at 00:00 Jan. 1, 2016.	
Clock accuracy		± 1 minute per month, typical	
Destination storage medium *3		SD memory card (SD, SDHC)	
Optional supplies		SD memory card (EMU4-SD2GB) *3*4	

\*1. Integrated values (Wh, varh, and VAh) are measured values in ME96SS. They are not differential values calculated by logging period.

\*2. It represents a period until a 2 GB SD memory card capacity is exceeded under the constant connection.

\*3. Be sure to use a SD memory card, EMU4-SD2GB, produced by Mitsubishi Electric Corporation. Using other SD memory cards not produced by Mitsubishi Electric Corporation may cause a trouble such as data corruption in the card or system stop. Regarding the use of commercially available SD memory cards, access our FA website. Note that the customer is responsible for verifying safe use of those SD memory cards.

\*4. If you need some optional supplies, please consult with your supplier.

■ Read the following document as well as this user's manual.

•ME-0000BU-SS96 Logging function specifications (Ref. No. LSPM-0092)

•ME-0000BU25-SS96 Logging function specifications (Ref. No. LSPM-0106)

## 8. Specifications

### 8.7. Setting Table (Factory Default Settings and Customer's Notes Settings)

Setting menu No.	Setting item	Factory default setting	Customer's notes	
1	1.1	Phase wire system	3P4 (3-phase 4-wire)	
	1.2	Display pattern	P01	
		1.2.1	Pattern P00	—
	1.3	VT/Direct voltage	no (Without VT)	
		1.3.1	Direct voltage	220/380 V
		1.3.2	VT secondary voltage	—
		1.3.3	VT primary voltage	—
	1.4	CT secondary current	5 A	
		1.4.1	CT primary current	5 A
	1.5	Frequency	50 Hz	
1.6	Rolling demand time period (Interval time period)	15 min		
	1.6.1	Subinterval time period	1 min	
1.7	Current demand time period	0 s		
2	2.1	Communication method selection (When ME-0040C-SS96 or ME-0000MT-SS96 is installed)	CC or tcP (By option)	
	2.2	MODBUS RTU address	1	
		2.2.1	MODBUS RTU baud rate	19.2 kbps
		2.2.2	MODBUS RTU parity	EVEn (even)
		2.2.3	MODBUS RTU stop bit	1
	2.3	CC-Link station number	1	
		2.3.1	CC-Link baud rate	156 kbps
		2.3.2	CC-Link version setting	1.10
		2.3.3	Communication reset	oFF (Without reset)
	2.4	MODBUS TCP IP address	192.168.3.10	
		MODBUS TCP subnet mask	255.255.255.0	
		MODBUS TCP default gateway use	oFF (Not use)	
		MODBUS TCP default gateway address	127.0.0.1	
Communication reset		oFF (Without reset)		
3	3.1	Active/Reactive Energy measurement	Combination I	
	3.2	Harmonics display	on (Display)	
	3.3	Unbalance rate	on (Display)	
4	4.1	Model display	(By model)	
	4.2	Version display	(By version)	
	4.3	Backlight brightness	3	
	4.4	Backlight Auto off/ON	Auto (Auto off)	
	4.5	Display update time	0.5 s	
5	5.1	Upper/Lower limit alarm item 1	non	
		5.1.1	Upper/Lower limit alarm value 1	—
	5.2	Upper/Lower limit alarm item 2	non	
		5.2.1	Upper/Lower limit alarm value 2	—
	5.3	Upper/Lower limit alarm item 3	non	
		5.3.1	Upper/Lower limit alarm value 3	—
	5.4	Upper/Lower limit alarm item 4	non	
		5.4.1	Upper/Lower limit alarm value 4	—
5.5	Alarm delay time	—		
5.6	Alarm reset method	—		
5.7	Backlight blinking for alarm	—		

## 8. Specifications

### 8.7. Setting Table (Factory Default Settings and Customer's Notes Settings)

Setting menu No.	Setting item	Factory default setting	Customer's notes
5	5.8	Motor starting current delay function	oFF (Not display)
	5.8.1	Motor starting current threshold	—
	5.8.2	Motor starting p current delay time	—
	5.9	Pulse/Alarm output function 1 *When ME-4210-SS96B is installed.	PULSE (Pulse output)
	5.9.1	Pulse/Alarm output 1 output item	Active energy (Imported)
	5.9.2	Pulse/Alarm output 1 pulse unit	0.001 kWh/pulse
	5.10	Pulse/Alarm output function 2 *When ME-4210-SS96B is installed.	AL (Alarm output)
	5.10.1	Pulse/Alarm output 2 output item	—
	5.10.2	Pulse/Alarm output 2 pulse unit	—
	5.11	Pulse width	0.125 s
6	6.1	Option selection * When ME-4210-SS96B, ME-0000BU-SS96 or ME-0000BU25-SS96 is installed.	Ao or Log.PLUG (By option)
	6.2	Built-in logging data clear	no
	6.2.1	Reconfirmation to clear	no
	6.3	Built-in logging use	on
	6.4	Built-in logging item pattern	LP01
	6.5	Built-in data logging period	15 min
	6.6	Analog output CH1 output item * When ME-4210-SS96B is installed.	A <sub>AVG</sub>
	6.6.1	Detailed settings (1)	5 A (CT primary current)
	6.6.2	Detailed settings (2)	—
	6.7	Analog output CH2 output item * When ME-4210-SS96B is installed.	V <sub>AVG</sub> (L-N)
	6.7.1	Detailed settings (1)	300 V (±0 STEP)
	6.7.2	Detailed settings (2)	—
	6.8	Analog output CH3 output item * When ME-4210-SS96B is installed.	ΣW
	6.8.1	Detailed settings (1)	4000 W (±0 STEP)
	6.8.2	Detailed settings (2)	Single deflection
	6.9	Analog output CH4 output item * When ME-4210-SS96B is installed.	ΣPF
	6.9.1	Detailed settings (1)	0.5 (-0.5 to 1 to 0.5)
	6.9.2	Detailed settings (2)	—
	6.10	Analog output limit	oFF (No limit)
	6.6	Logging ID * When ME-0000BU-SS96 or ME-0000BU25-SS96 is installed.	001
6.7	Logging data clear * When ME-0000BU-SS96 or ME-0000BU25-SS96 is installed.	no (Not clear)	
6.7.1	Reconfirmation to clear logging data	no (Not clear)	
6.8	Logging item pattern * When ME-0000BU-SS96 or ME-0000BU25-SS96 is installed.	LP01	
6.9	Detailed logging data Logging period * When ME-0000BU-SS96 or ME-0000BU25-SS96 is installed.	15 min	

## 8. Specifications

### 8.7. Setting Table (Factory Default Settings and Customer's Notes Settings)

Setting menu No.	Setting item	Factory default setting	Customer's notes
7	7.1	Periodic active energy display	oFF (Not display)
	7.1.1	Periodic active energy switching settings	non (Non-switching)
	7.2	Rolling demand display	oFF (Not display)
	7.2.1	Rolling demand time period	oFF (Manual)
	7.3	Digital input/output display	oFF (Not display)
	7.3.1	Digital input reset method	Auto (Automatic)
8	8.1	Operating time display	oFF (Not display)
	8.2	Operating time 1 count target	AUX (Auxiliary power)
	8.2.1	Operating time 1 threshold	—
	8.3	Operating time 2 count target	AUX (Auxiliary power)
	8.3.1	Operating time 2 threshold	—
	8.4	IEC mode settings	oFF (Normal mode)
8.5		CO <sub>2</sub> equivalent display	oFF (Not display)
	8.5.1	CO <sub>2</sub> conversion rate	0.5 kg- CO <sub>2</sub> /kWh

## 9. Appendix

### 9.1. ME96SS Calculation Method (3-Phase Unbalanced System with Neutral)

The following table shows general calculation definitions of electric energy measurement this instrument employs.

Item	Normal mode	IEC (A) mode	IEC (V) mode	Notes
RMS current in phase $p$	$I_p = \sqrt{\frac{\sum_{k=0}^{M-1} i_{pk}^2}{M}}$			
Calculated RMS neutral current	$I_N = \sqrt{\frac{\sum_{k=0}^{M-1} (i_{1k} + i_{2k} + i_{3k})^2}{M}}$			
Phase $p$ to neutral RMS voltage	$V_p = \sqrt{\frac{\sum_{k=0}^{M-1} v_{pk}^2}{M}}$			
Phase $p$ to phase $g$ RMS voltage	$U_{pg} = \sqrt{\frac{\sum_{k=0}^{M-1} (v_{pk}^2 - v_{gk}^2)^2}{M}}$			
Active power for phase $p$	$P_p = \frac{1}{M} \cdot \sum_{k=0}^{M-1} (v_{pk} \times i_{pk})$			
Apparent power for phase $p$	$S_p = V_p \times I_p$			
Reactive power for phase $p$	$Q_p = Q_{pquad} = \frac{1}{M} \cdot \sum_{k=0}^{M-1} (v_{p_{k-N/4}} \times i_{pk})$	$Q_p = \sqrt{S_p^2 - P_p^2}$		For the sign, refer to <b>5.1.12.</b>
Power factor for phase $p$	$PF_p = \frac{P_p}{\sqrt{P_p^2 + Q_p^2}}$	$PF_p = \frac{P_p}{S_p}$		For the sign, refer to <b>5.1.12.</b>
Total active power	$P = \sum_{p=1}^{N_{ph}} P_p$			
Total reactive power	$Q = \sum_{p=1}^{N_{ph}} Q_p$	$Q = \sqrt{S^2 - P^2}$	$Q = \sum_{p=1}^{N_{ph}} Q_p$	For the sign, refer to <b>5.1.12.</b>
Total apparent power	$S = \sum_{p=1}^{N_{ph}} S_p$	$S = \sum_{p=1}^{N_{ph}} S_p$	$S = \sqrt{P^2 + Q^2}$	
Total power factor	$PF = \frac{P}{\sqrt{P^2 + Q^2}}$	$PF = \frac{P}{S}$		For the sign, refer to <b>5.1.12.</b>

## 9. Appendix

### 9.2. Optional parts

#### ■ SD memory card

Item	Specifications
Model	EMU4-SD2GB
Memory capacity	2 GB
Weight	2 g

Note: The unit of number is 'mm.'

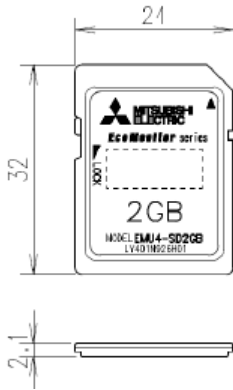

## 9. Appendix

### 9.3. A List of Examples for Incorrect Wiring Display

#### 9.3.1. 3-phase 4-wire System

\*The shaded parts indicate influential parts caused by incorrect wiring.  
The dashed lines show incorrect wiring parts.

No.	Power Factor (Input)	Phase Angle Display						At balanced load ( $V_{1N}=V_{2N}=V_{3N}$ , $I_1=I_2=I_3$ )									Connection (Note 1)																	
								Active Power Display			Voltage Display			Current Display			Voltage			Current			Connection											
		$\angle V_{1N}$	$\angle V_{2N}$	$\angle V_{3N}$	$\angle I_1$	$\angle I_2$	$\angle I_3$	$W_1$	$W_2$	$W_3$	$V_{1N}$	$V_{2N}$	$V_{3N}$	$I_1$	$I_2$	$I_3$	1	2	3	N	1 side CT	2 side CT		3 side CT										
1	LEAD 0.707	0	120	240	315	75	195	$W_1=W_2=W_3$	$V_{1N}=V_{2N}=V_{3N}$	$I_1=I_2=I_3$	P1	P2	P3	PN	+C1-C1 Normal	+C2-C2 Normal	+C3-C3 Normal																	
	LEAD 0.866				330	90	210																											
	1.000				0	120	240												0	120	240													
	LAG 0.866				30	150	270																											
	LAG 0.707				45	165	285																											
	LEAD 0.707				0	240	120												315	195	75	$W_1=W_2=W_3$	$V_{1N}=V_{2N}=V_{3N}$	$I_1=I_2=I_3$	P1	P3	P2	PN	+C1-C1 Normal	+C3-C3 Normal	+C2-C2 Normal			
	LEAD 0.866																		330	210	90													
	1.000																		240	120	0												240	120
	LAG 0.866																		30	270	150													
	LAG 0.707																		45	285	165													
LEAD 0.707	0	240	120	315				255	195	$W_1=$ Negative value $W_2=$ Positive value $W_3=$ Positive value	$V_{1N}=V_{2N}=V_{3N}$	$I_1=I_2=I_3$	P1	P2	P3	PN	+C1-C1 Reverse	+C2-C2 Normal	+C3-C3 Normal															
LEAD 0.866				150				90	210																									
1.000				180				120	240																									
LAG 0.866				210				150	270																									
LAG 0.707				225				165	285																									
LEAD 0.707				0	120	240	315	255	195												$W_1=$ Positive value $W_2=$ Negative value $W_3=$ Positive value	$V_{1N}=V_{2N}=V_{3N}$	$I_1=I_2=I_3$	P1	P2	P3	PN	+C1-C1 Normal	+C2-C2 Reverse	+C3-C3 Normal				
LEAD 0.866							330	270	210																									
1.000							0	300	240																									
LAG 0.866							30	330	270																									
LAG 0.707							45	345	285																									



## 9. Appendix

### 9.3. A List of Examples for Incorrect Wiring Display

#### 9.3.1. 3-phase 4-wire System

No.	Power Factor (Input)	Phase Angle Display						At balanced load ( $V_{1N}=V_{2N}=V_{3N}$ , $I_1=I_2=I_3$ )									Connection (Note 1)						
		$\angle V_{1N}$	$\angle V_{2N}$	$\angle V_{3N}$	$\angle I_1$	$\angle I_2$	$\angle I_3$	Active Power Display			Voltage Display			Current Display			Voltage			Current			Connection
								$W_1$	$W_2$	$W_3$	$V_{1N}$	$V_{2N}$	$V_{3N}$	$I_1$	$I_2$	$I_3$	1	2	3	N	1 side CT	2 side CT	
4	LEAD 0.707	0	120	240	315	75	15	$W_1$ =Positive value $W_2$ =Positive value $W_3$ =Negative value	$V_{1N}=V_{2N}=V_{3N}$	$I_1=I_2=I_3$	P1	P2	P3	PN	+C1-C1 Normal	+C2-C2 Normal	+C3-C3 Reverse						
	LEAD 0.866				330	90	30																
	1.000				0	120	60																
	LAG 0.866				30	150	90																
	LAG 0.707				45	165	105																
5	LEAD 0.707	0	120	240	135	255	195	$W_1$ =Negative value $W_2$ =Negative value $W_3$ =Positive value	$V_{1N}=V_{2N}=V_{3N}$	$I_1=I_2=I_3$	P1	P2	P3	PN	+C1-C1 Reverse	+C2-C2 Reverse	+C3-C3 Normal						
	LEAD 0.866				150	270	210																
	1.000				180	300	240																
	LAG 0.866				210	330	270																
	LAG 0.707				225	345	285																
6	LEAD 0.707	0	120	240	315	255	15	$W_1$ =Positive value $W_2$ =Negative value $W_3$ =Negative value	$V_{1N}=V_{2N}=V_{3N}$	$I_1=I_2=I_3$	P1	P2	P3	PN	+C1-C1 Normal	+C2-C2 Reverse	+C3-C3 Reverse						
	LEAD 0.866				330	270	30																
	1.000				0	300	60																
	LAG 0.866				30	330	90																
	LAG 0.707				45	345	105																
7	LEAD 0.707	0	120	240	135	75	15	$W_1$ =Negative value $W_2$ =Positive value $W_3$ =Negative value	$V_{1N}=V_{2N}=V_{3N}$	$I_1=I_2=I_3$	P1	P2	P3	PN	+C1-C1 Reverse	+C2-C2 Normal	+C3-C3 Reverse						
	LEAD 0.866				150	90	30																
	1.000				180	120	60																
	LAG 0.866				210	150	90																
	LAG 0.707				225	165	105																
8	LEAD 0.707	0	120	240	135	255	15	$W_1$ =Negative value $W_2$ =Negative value $W_3$ =Negative value	$V_{1N}=V_{2N}=V_{3N}$	$I_1=I_2=I_3$	P1	P2	P3	PN	+C1-C1 Reverse	+C2-C2 Reverse	+C3-C3 Reverse						
	LEAD 0.866				150	270	30																
	1.000				180	300	60																
	LAG 0.866				210	330	90																
	LAG 0.707				225	345	105																
9	LEAD 0.707	0	120	240	75	315	195	$W_1$ =Positive value $W_2$ =Negative value $W_3$ =Positive value $W_1=0$	$V_{1N}=V_{2N}=V_{3N}$	$I_1=I_2=I_3$	P1	P2	P3	PN	+C2-C2 Normal	+C1-C1 Normal	+C3-C3 Normal						
	LEAD 0.866				90	330	210																
	1.000				120	0	240																
	LAG 0.866				150	30	270																
	LAG 0.707				165	45	285																

## 9. Appendix

### 9.3. A List of Examples for Incorrect Wiring Display

#### 9.3.1. 3-phase 4-wire System

No.	Power Factor (Input)	Phase Angle Display						At balanced load ( $V_{1N}=V_{2N}=V_{3N}$ , $I_1=I_2=I_3$ )															Connection (Note 1)		
		$\angle V_{1N}$	$\angle V_{2N}$	$\angle V_{3N}$	$\angle I_1$	$\angle I_2$	$\angle I_3$	Active Power Display			Voltage Display			Current Display			Voltage			Current			Connection		
								$W_1$	$W_2$	$W_3$	$V_{1N}$	$V_{2N}$	$V_{3N}$	$I_1$	$I_2$	$I_3$	1	2	3	N	1 side CT	2 side CT		3 side CT	
10	LEAD 0.707	0	120	240	315	195	75	$W_1$ =Positive value	$V_{1N}=V_{2N}=V_{3N}$	$I_1=I_2=I_3$	P1	P2	P3	PN	+C1-C1 Normal	+C3-C3 Normal	+C2-C2 Normal	Switch between 2 side CT and 3 side CT							
	LEAD 0.866				330	210	90	$W_1$ =Positive value											$W_2$ =0						
	1.000				0	240	120	$W_1$ =Positive value											$W_2$ =Negative value						
	LAG 0.866				30	270	150	$W_1$ =Positive value											$W_2$ =Negative value						
	LAG 0.707				45	285	165	$W_1$ =Positive value											$W_2$ =Negative value						
11	LEAD 0.707	0	120	240	195	75	315	$W_1$ =Negative value	$V_{1N}=V_{2N}=V_{3N}$	$I_1=I_2=I_3$	P1	P2	P3	PN	+C3-C3 Normal	+C2-C2 Normal	+C1-C1 Normal	Switch between 1 side CT and 3 side CT							
	LEAD 0.866				210	90	330	$W_1$ =Negative value											$W_2$ =Positive value						
	1.000				240	120	0	$W_1$ =Negative value											$W_2$ =Positive value						
	LAG 0.866				270	150	30	$W_1$ =Negative value											$W_2$ =Positive value						
	LAG 0.707				285	165	45	$W_1$ =Negative value											$W_2$ =Positive value						
12	LEAD 0.707	0	240	120	195	315	75	$W_1$ =Negative value	$V_{1N}=V_{2N}=V_{3N}$	$I_1=I_2=I_3$	P2	P1	P3	PN	+C1-C1 Normal	+C2-C2 Normal	+C3-C3 Normal	Reverse connection between terminals P1 and P2							
	LEAD 0.866				210	330	90	$W_1$ =Negative value											$W_2$ =Positive value						
	1.000				240	0	120	$W_1$ =Negative value											$W_2$ =Positive value						
	LAG 0.866				270	30	150	$W_1$ =Negative value											$W_2$ =Positive value						
	LAG 0.707				285	45	165	$W_1$ =Negative value											$W_2$ =Positive value						
13	LEAD 0.707	0	240	120	315	75	195	$W_1$ =Positive value	$V_{1N}=V_{2N}=V_{3N}$	$I_1=I_2=I_3$	P1	P3	P2	PN	+C1-C1 Normal	+C2-C2 Normal	+C3-C3 Normal	Reverse connection between terminals P2 and P3							
	LEAD 0.866				330	90	210	$W_1$ =Positive value											$W_2$ =Negative value						
	1.000				0	120	240	$W_1$ =Positive value											$W_2$ =Negative value						
	LAG 0.866				30	150	270	$W_1$ =Positive value											$W_2$ =Negative value						
	LAG 0.707				45	165	285	$W_1$ =Positive value											$W_2$ =Negative value						
14	LEAD 0.707	0	240	120	75	195	315	$W_1$ =Positive value	$V_{1N}=V_{2N}=V_{3N}$	$I_1=I_2=I_3$	P3	P2	P1	PN	+C1-C1 Normal	+C2-C2 Normal	+C3-C3 Normal	Reverse connection between terminals P1 and P3							
	LEAD 0.866				90	210	330	$W_1$ =Positive value											$W_2$ =Negative value						
	1.000				120	240	0	$W_1$ =Positive value											$W_2$ =Negative value						
	LAG 0.866				150	270	30	$W_1$ =Positive value											$W_2$ =Negative value						
	LAG 0.707				165	285	45	$W_1$ =Positive value											$W_2$ =Negative value						
15	LEAD 0.707	0	330	30	135	255	15	$W_1$ =Negative value	$V_{1N} < V_{2N} = V_{3N}$	$I_1=I_2=I_3$	PN	P2	P3	P1	+C1-C1 Normal	+C2-C2 Normal	+C3-C3 Normal	Reverse connection between terminals P1 and PN							
	LEAD 0.866				150	270	30	$W_1$ =Negative value											$W_2$ =Positive value						
	1.000				180	300	60	$W_1$ =Negative value											$W_2$ =Positive value						
	LAG 0.866				210	330	90	$W_1$ =Negative value											$W_2$ =Positive value						
	LAG 0.707				225	345	105	$W_1$ =Negative value											$W_2$ =Positive value						

## 9. Appendix

### 9.3. A List of Examples for Incorrect Wiring Display

#### 9.3.1. 3-phase 4-wire System

No.	Power Factor (Input)	Phase Angle Display						At balanced load ( $V_{1N}=V_{2N}=V_{3N}$ , $I_1=I_2=I_3$ )															Connection (Note 1)		
		Voltage Display			Current Display			Voltage			Current			Connection											
		$\angle V_{1N}$	$\angle V_{2N}$	$\angle V_{3N}$	$\angle I_1$	$\angle I_2$	$\angle I_3$	$W_1$	$W_2$	$W_3$	$V_{1N}$	$V_{2N}$	$V_{3N}$	$I_1$	$I_2$	$I_3$	1	2	3	N	1 side CT	2 side CT	3 side CT		
16	LEAD 0.707	0	330	300	345	105	225	$W_1$ =Positive value $W_2$ =Negative value $W_3$ =Positive value	$V_{1N}=V_{3N}>V_{2N}$	$I_1=I_2=I_3$	P1	PN	P3	P2	+C1-C1 Normal	+C2-C2 Normal	+C3-C3 Normal	Reverse connection between terminals P2 and PN 							
	LEAD 0.866				0	120	240																		
	1.000				30	150	270																		
	LAG 0.866				60	180	300																		
	LAG 0.707				75	195	315																		
17	LEAD 0.707	0	60	30	285	45	165	$W_1$ =Positive value $W_2$ =Positive value $W_3$ =Negative value	$V_{1N}=V_{2N}>V_{3N}$	$I_1=I_2=I_3$	P1	P2	PN	P3	+C1-C1 Normal	+C2-C2 Normal	+C3-C3 Normal	Reverse connection between terminals P3 and PN 							
	LEAD 0.866				300	60	180																		
	1.000				330	90	210																		
	LAG 0.866				0	120	240																		
	LAG 0.707				15	135	255																		
18	LEAD 0.707	0	240	120	15	315	75	$W_1$ =Positive value $W_2$ =Positive value $W_3$ =Positive value $W_1$ =Positive value $W_2$ =0	$V_{1N}=V_{2N}=V_{3N}$	$I_1=I_2=I_3$	P2	P1	P3	PN	+C1-C1 Reverse	+C2-C2 Normal	+C3-C3 Normal	P1 and P2 terminals are reversed and the connection 1 side CT reversed 							
	LEAD 0.866				30	330	90																		
	1.000				60	0	120																		
	LAG 0.866				90	30	150																		
	LAG 0.707				105	45	165																		
19	LEAD 0.707	0	240	120	135	75	195	$W_1$ =Negative value $W_2$ =Negative value $W_3$ =Positive value $W_1$ =Negative value $W_2$ =Negative value $W_3$ =0	$V_{1N}=V_{2N}=V_{3N}$	$I_1=I_2=I_3$	P1	P3	P2	PN	+C1-C1 Reverse	+C2-C2 Normal	+C3-C3 Normal	P2 and P3 terminals are reversed and the connection 1 side CT reversed 							
	LEAD 0.866				150	90	210																		
	1.000				180	120	240																		
	LAG 0.866				210	150	270																		
	LAG 0.707				225	165	285																		
20	LEAD 0.707	0	240	120	255	195	315	$W_1$ =Negative value $W_2$ =Positive value $W_3$ =Negative value $W_1$ =0	$V_{1N}=V_{2N}=V_{3N}$	$I_1=I_2=I_3$	P3	P2	P1	PN	+C1-C1 Reverse	+C2-C2 Normal	+C3-C3 Normal	P1 and P3 terminals are reversed and the connection 1 side CT reversed 							
	LEAD 0.866				270	210	330																		
	1.000				300	240	0																		
	LAG 0.866				330	270	30																		
	LAG 0.707				345	285	45																		
21	LEAD 0.707	0	330	30	315	255	15	$W_1$ =Positive value $W_2$ =Positive value $W_3$ =Positive value	$V_{1N}<V_{2N}=V_{3N}$	$I_1=I_2=I_3$	PN	P2	P3	P1	+C1-C1 Reverse	+C2-C2 Normal	+C3-C3 Normal	P1 and PN terminals are reversed and the connection 1 side CT reversed 							
	LEAD 0.866				330	270	30																		
	1.000				0	300	60																		
	LAG 0.866				30	330	90																		
	LAG 0.707				45	345	105																		

## 9. Appendix

### 9.3. A List of Examples for Incorrect Wiring Display

#### 9.3.1. 3-phase 4-wire System

No.	Power Factor (Input)	Phase Angle Display						At balanced load ( $V_{1N}=V_{2N}=V_{3N}$ , $I_1=I_2=I_3$ )															Connection (Note 1)		
		Voltage Display			Current Display			Voltage			Current			Connection											
		$\angle V_{1N}$	$\angle V_{2N}$	$\angle V_{3N}$	$\angle I_1$	$\angle I_2$	$\angle I_3$	$W_1$	$W_2$	$W_3$	$V_{1N}$	$V_{2N}$	$V_{3N}$	$I_1$	$I_2$	$I_3$	1	2	3	N	1 side CT	2 side CT	3 side CT		
22	LEAD 0.707	0	330	300	165	105	225	$W_1$ =Negative value $W_2$ =Negative value $W_3$ =Positive value	$V_{1N}=V_{2N}>V_{3N}$	$I_1=I_2=I_3$	P1	PN	P3	P2	+C1-C1 Reverse	+C2-C2 Normal	+C3-C3 Normal								
	LEAD 0.866				180	120	240																		
	1.000				210	150	270																		
	LAG 0.866				240	180	300																		
	LAG 0.707				255	195	315																		
23	LEAD 0.707	0	60	30	105	45	165	$W_1$ =Negative value $W_2$ =Positive value $W_3$ =Negative value	$V_{1N}=V_{2N}>V_{3N}$	$I_1=I_2=I_3$	P1	P2	PN	P3	+C1-C1 Reverse	+C2-C2 Normal	+C3-C3 Normal								
	LEAD 0.866				120	60	180																		
	1.000				150	90	210																		
	LAG 0.866				180	120	240																		
	LAG 0.707				195	135	255																		
24	LEAD 0.707	0	240	120	195	135	75	$W_1$ =Negative value $W_2$ =Negative value $W_3$ =Positive value $W_2=0$ $W_1$ =Positive value $W_1$ =Negative value $W_2$ =Positive value $W_1$ =Positive value $W_1=0$	$V_{1N}=V_{2N}=V_{3N}$	$I_1=I_2=I_3$	P2	P1	P3	PN	+C1-C1 Normal	+C2-C2 Reverse	+C3-C3 Normal								
	LEAD 0.866				210	150	90																		
	1.000				240	180	120																		
	LAG 0.866				270	210	150																		
	LAG 0.707				285	225	165																		
25	LEAD 0.707	0	240	120	315	255	195	$W_1$ =Positive value $W_2$ =Positive value $W_3$ =Positive value $W_3=0$ $W_1$ =Positive value $W_2$ =Positive value $W_1$ =Negative value $W_1$ =Positive value $W_2=0$	$V_{1N}=V_{2N}=V_{3N}$	$I_1=I_2=I_3$	P1	P3	P2	PN	+C1-C1 Normal	+C2-C2 Reverse	+C3-C3 Normal								
	LEAD 0.866				330	270	210																		
	1.000				0	300	240																		
	LAG 0.866				30	330	270																		
	LAG 0.707				45	345	285																		
26	LEAD 0.707	0	240	120	75	15	315	$W_1$ =Positive value $W_2$ =Negative value $W_3$ =Negative value $W_1=0$ $W_2$ =Negative value $W_1$ =Negative value $W_2$ =Negative value $W_1$ =Negative value $W_1$ =Negative value $W_2=0$	$V_{1N}=V_{2N}=V_{3N}$	$I_1=I_2=I_3$	P3	P2	P1	PN	+C1-C1 Normal	+C2-C2 Reverse	+C3-C3 Normal								
	LEAD 0.866				90	30	330																		
	1.000				120	60	0																		
	LAG 0.866				150	90	30																		
	LAG 0.707				165	105	45																		
27	LEAD 0.707	0	330	30	135	75	15	$W_1$ =Negative value $W_2$ =Negative value $W_3$ =Positive value	$V_{1N}<V_{2N}=V_{3N}$	$I_1=I_2=I_3$	PN	P2	P3	P1	+C1-C1 Normal	+C2-C2 Reverse	+C3-C3 Normal								
	LEAD 0.866				150	90	30																		
	1.000				180	120	60																		
	LAG 0.866				210	150	90																		
	LAG 0.707				225	165	105																		

## 9. Appendix

### 9.3. A List of Examples for Incorrect Wiring Display

#### 9.3.1. 3-phase 4-wire System

No.	Power Factor (Input)	Phase Angle Display						At balanced load ( $V_{1N}=V_{2N}=V_{3N}$ , $I_1=I_2=I_3$ )															Connection (Note 1)		
		$\angle V_{1N}$ $\angle V_{2N}$ $\angle V_{3N}$			$\angle I_1$ $\angle I_2$ $\angle I_3$			Active Power Display			Voltage Display			Current Display			Voltage			Current			Connection		
		$W_1$	$W_2$	$W_3$	$V_{1N}$	$V_{2N}$	$V_{3N}$	$I_1$	$I_2$	$I_3$	1	2	3	N	1 side CT	2 side CT	3 side CT								
28	LEAD 0.707	0	330	300	345	285	225	$W_1$ =Positive value $W_2$ =Positive value $W_3$ =Positive value	$V_{1N}=V_{2N}>V_{2N}$	$I_1=I_2=I_3$	P1	PN	P3	P2	+C1-C1 Normal	+C2-C2 Reverse	+C3-C3 Normal	<p>P2 and PN terminals are reversed and the connection 2 side CT reversed</p>							
	LEAD 0.866				0	300	240																		
	1.000				30	330	270																		
	LAG 0.866				60	0	300																		
	LAG 0.707				75	15	315																		
29	LEAD 0.707	0	60	30	285	225	165	$W_1$ =Positive value $W_2$ =Negative value $W_3$ =Negative value	$V_{1N}=V_{2N}>V_{3N}$	$I_1=I_2=I_3$	P1	P2	PN	P3	+C1-C1 Normal	+C2-C2 Reverse	+C3-C3 Normal	<p>P3 and PN terminals are reversed and the connection 2 side CT reversed</p>							
	LEAD 0.866				300	240	180																		
	1.000				330	270	210																		
	LAG 0.866				0	300	240																		
	LAG 0.707				15	315	255																		
30	LEAD 0.707	0	240	120	195	315	255	$W_1$ =Negative value $W_2$ =Positive value $W_3$ =Negative value $W_1$ =Negative value $W_2$ =0	$V_{1N}=V_{2N}=V_{3N}$	$I_1=I_2=I_3$	P2	P1	P3	PN	+C1-C1 Normal	+C2-C2 Normal	+C3-C3 Reverse	<p>P1 and P2 terminals are reversed and the connection 3 side CT reversed</p>							
	LEAD 0.866				210	330	270																		
	1.000				240	0	300																		
	LAG 0.866				270	30	330																		
	LAG 0.707				285	45	345																		
31	LEAD 0.707	0	240	120	315	75	15	$W_1$ =Positive value $W_2$ =Negative value $W_3$ =Negative value $W_1$ =Positive value $W_2$ =Negative value $W_3$ =0	$V_{1N}=V_{2N}=V_{3N}$	$I_1=I_2=I_3$	P1	P3	P2	PN	+C1-C1 Normal	+C2-C2 Normal	+C3-C3 Reverse	<p>P2 and P3 terminals are reversed and the connection 3 side CT reversed</p>							
	LEAD 0.866				330	90	30																		
	1.000				0	120	60																		
	LAG 0.866				30	150	90																		
	LAG 0.707				45	165	105																		
32	LEAD 0.707	0	240	120	75	195	135	$W_1$ =Positive value $W_2$ =Positive value $W_3$ =Positive value $W_1$ =0	$V_{1N}=V_{2N}=V_{3N}$	$I_1=I_2=I_3$	P3	P2	P1	PN	+C1-C1 Normal	+C2-C2 Normal	+C3-C3 Reverse	<p>P1 and P3 terminals are reversed and the connection 3 side CT reversed</p>							
	LEAD 0.866				90	210	150																		
	1.000				120	240	180																		
	LAG 0.866				150	270	210																		
	LAG 0.707				165	285	225																		
33	LEAD 0.707	0	330	30	135	255	195	$W_1$ =Negative value $W_2$ =Positive value $W_3$ =Negative value	$V_{1N}<V_{2N}=V_{3N}$	$I_1=I_2=I_3$	PN	P2	P3	P1	+C1-C1 Normal	+C2-C2 Normal	+C3-C3 Reverse	<p>P1 and PN terminals are reversed and the connection 3 side CT reversed</p>							
	LEAD 0.866				150	270	210																		
	1.000				180	300	240																		
	LAG 0.866				210	330	270																		
	LAG 0.707				225	345	285																		

## 9. Appendix

### 9.3. A List of Examples for Incorrect Wiring Display

#### 9.3.1. 3-phase 4-wire System

No.	Power Factor (Input)	Phase Angle Display						At balanced load ( $V_{1N}=V_{2N}=V_{3N}$ , $I_1=I_2=I_3$ )															Connection (Note 1)		
		Active Power Display			Voltage Display			Current Display			Voltage			Current			Connection								
		$W_1$	$W_2$	$W_3$	$V_{1N}$	$V_{2N}$	$V_{3N}$	$I_1$	$I_2$	$I_3$	1	2	3	N	1 side CT	2 side CT		3 side CT							
34	LEAD 0.707	0	330	300	345	105	45	$W_1$ =Positive value $W_2$ =Negative value $W_3$ =Negative value	$V_{1N}=V_{3N}>V_{2N}$	$I_1=I_2=I_3$	P1	PN	P3	P2	+C1-C1 Normal	+C2-C2 Normal	+C3-C3 Reverse	<p>P2 and PN terminals are reversed and the connection 3 side CT reversed</p>							
	LEAD 0.866				0	120	60																		
	1.000				30	150	90																		
	LAG 0.866				60	180	120																		
	LAG 0.707				75	195	135																		
35	LEAD 0.707	0	60	30	285	45	345	$W_1$ =Positive value $W_2$ =Positive value $W_3$ =Positive value	$V_{1N}=V_{2N}>V_{3N}$	$I_1=I_2=I_3$	P1	P2	PN	P3	+C1-C1 Normal	+C2-C2 Normal	+C3-C3 Reverse	<p>P3 and PN terminals are reversed and the connection 3 side CT reversed</p>							
	LEAD 0.866				300	60	0																		
	1.000				330	90	30																		
	LAG 0.866				0	120	60																		
	LAG 0.707				15	135	75																		
36	LEAD 0.707	0	240	120	75	315	195	$W_1=W_2=W_3$	$V_{1N}=V_{2N}=V_{3N}$	$I_1=I_2=I_3$	P1	P3	P2	PN	+C2-C2 Normal	+C1-C1 Normal	+C3-C3 Normal	<p>P2 and P3 terminals are reversed and 1 side CT and 2 side CT are switched</p>							
	LEAD 0.866				90	330	210																		
	1.000				120	0	240																		
	LAG 0.866				150	30	270																		
	LAG 0.707				165	45	285																		
36	LEAD 0.707	0	240	120	75	315	195	$W_1=W_2=W_3$	$V_{1N}=V_{2N}=V_{3N}$	$I_1=I_2=I_3$	P3	P2	P1	PN	+C1-C1 Normal	+C3-C3 Normal	+C2-C2 Normal	<p>P1 and P3 terminals are reversed and 2 side CT and 3 side CT are switched</p>							
	LEAD 0.866				90	330	210																		
	1.000				120	0	240																		
	LAG 0.866				150	30	270																		
	LAG 0.707				165	45	285																		
36	LEAD 0.707	0	240	120	75	315	195	$W_1=W_2=W_3$	$V_{1N}=V_{2N}=V_{3N}$	$I_1=I_2=I_3$	P2	P1	P3	PN	+C3-C3 Normal	+C2-C2 Normal	+C1-C1 Normal	<p>P1 and P2 terminals are reversed and 1 side CT and 3 side CT are switched</p>							
	LEAD 0.866				90	330	210																		
	1.000				120	0	240																		
	LAG 0.866				150	30	270																		
	LAG 0.707				165	45	285																		

## 9. Appendix

### 9.3. A List of Examples for Incorrect Wiring Display

#### 9.3.1. 3-phase 4-wire System

No.	Power Factor (Input)	Phase Angle Display						At balanced load ( $V_{1N}=V_{2N}=V_{3N}$ , $I_1=I_2=I_3$ )									Connection (Note 1)					
		Voltage Display			Current Display			Voltage			Current			Connection								
		$\angle V_{1N}$	$\angle V_{2N}$	$\angle V_{3N}$	$\angle I_1$	$\angle I_2$	$\angle I_3$	$W_1$	$W_2$	$W_3$	$V_{1N}$	$V_{2N}$	$V_{3N}$				$I_1$	$I_2$	$I_3$	1	2	3
37	LEAD 0.707				195	75	315	$W_1=W_2=W_3$	$V_{1N}=V_{2N}=V_{3N}$	$I_1=I_2=I_3$	P3	P2	P1	PN	+C2-C2 Normal	+C1-C1 Normal	+C3-C3 Normal	<p>P1 and P3 terminals are reversed and 1 side CT and 2 side CT are switched</p>				
	LEAD 0.866				210	90	330												<p>P1 and P2 terminals are reversed and 2 side CT and 3 side CT are switched</p>			
	1.000	0	240	120	240	120	0													<p>P2 and P3 terminals are reversed and 1 side CT and 3 side CT are switched</p>		
	LAG 0.866				270	150	30															
	LAG 0.707				285	165	45															
38	LEAD 0.707	0	330	30	255	135	15	$W_1$ =Negative value $W_2$ =Negative value $W_3$ =Positive value $W_1=0$	$V_{1N}<V_{2N}=V_{3N}$	$I_1=I_2=I_3$	PN	P2	P3	P1	+C2-C2 Normal	+C1-C1 Normal	+C3-C3 Normal	<p>P1 and PN terminals are reversed and 1 side CT and 2 side CT are switched</p>				
	LEAD 0.866				270	150	30												<p>P2 and PN terminals are reversed and 1 side CT and 2 side CT are switched</p>			
	1.000				300	180	60															
	LAG 0.866				330	210	90															
	LAG 0.707				345	225	105															
39	LEAD 0.707	0	330	300	105	345	225	$W_1$ =Negative value $W_2$ =Positive value $W_3$ =Positive value	$V_{1N}=V_{2N}>V_{3N}$	$I_1=I_2=I_3$	P1	PN	P3	P2	+C2-C2 Normal	+C1-C1 Normal	+C3-C3 Normal	<p>P2 and PN terminals are reversed and 1 side CT and 2 side CT are switched</p>				
	LEAD 0.866				120	0	240															
	1.000				150	30	270															
	LAG 0.866				180	60	300															
	LAG 0.707				195	75	315															
40	LEAD 0.707	0	60	30	45	285	165	$W_1$ =Positive value $W_2$ =Negative value $W_3$ =Negative value	$V_{1N}=V_{2N}>V_{3N}$	$I_1=I_2=I_3$	P1	P2	PN	P3	+C2-C2 Normal	+C1-C1 Normal	+C3-C3 Normal	<p>P3 and PN terminals are reversed and 1 side CT and 2 side CT are switched</p>				
	LEAD 0.866				60	300	180															
	1.000				90	330	210															
	LAG 0.866				120	0	240															
	LAG 0.707				135	15	255															

## 9. Appendix

### 9.3. A List of Examples for Incorrect Wiring Display

#### 9.3.1. 3-phase 4-wire System

No.	Power Factor (Input)	Phase Angle Display						At balanced load ( $V_{1N}=V_{2N}=V_{3N}$ , $I_1=I_2=I_3$ )															Connection (Note 1)		
		Voltage Display			Current Display			Voltage			Current			Connection											
		$\angle V_{1N}$	$\angle V_{2N}$	$\angle V_{3N}$	$\angle I_1$	$\angle I_2$	$\angle I_3$	$W_1$	$W_2$	$W_3$	$V_{1N}$	$V_{2N}$	$V_{3N}$		$I_1$	$I_2$	$I_3$	1	2	3	N	1 side CT	2 side CT	3 side CT	
41	LEAD 0.707	0	330	30	135	15	255	$W_1$ =Negative value $W_2$ =Positive value $W_3$ =Negative value	$V_{1N} < V_{2N} = V_{3N}$	$I_1 = I_2 = I_3$	PN	P2	P3	P1	+C1-C1 Normal	+C3-C3 Normal	+C2-C2 Normal	P1 and PN terminals are reversed and 2 side CT and 3 side CT are switched							
	LEAD 0.866				150	30	270																		
	1.000				180	60	300																		
	LAG 0.866				210	90	330																		
	LAG 0.707				225	105	345												$W_1$ =Negative value $W_2=0$ $W_3=0$						
42	LEAD 0.707	0	330	300	345	225	105	$W_1$ =Positive value $W_2$ =Negative value $W_3$ =Negative value $W_4$ =Negative value	$V_{1N} = V_{3N} > V_{2N}$	$I_1 = I_2 = I_3$	P1	PN	P3	P2	+C1-C1 Normal	+C3-C3 Normal	+C2-C2 Normal	P2 and PN terminals are reversed and 2 side CT and 3 side CT are switched							
	LEAD 0.866				0	240	120																		
	1.000				30	270	150																		
	LAG 0.866				60	300	180																		
	LAG 0.707				75	315	195												$W_1$ =Positive value $W_2$ =Positive value $W_3$ =Negative value						
43	LEAD 0.707	0	60	30	285	165	45	$W_1$ =Positive value $W_2$ =Negative value $W_3$ =Positive value	$V_{1N} = V_{2N} > V_{3N}$	$I_1 = I_2 = I_3$	P1	P2	PN	P3	+C1-C1 Normal	+C3-C3 Normal	+C2-C2 Normal	P3 and PN terminals are reversed and 2 side CT and 3 side CT are switched							
	LEAD 0.866				300	180	60																		
	1.000				330	210	90																		
	LAG 0.866				0	240	120																		
	LAG 0.707				15	255	135												$W_1$ =Positive value $W_2$ =Negative value $W_3$ =Negative value $W_4$ =Negative value						
44	LEAD 0.707	0	330	30	15	255	135	$W_1$ =Positive value $W_2$ =Positive value $W_3$ =Negative value	$V_{1N} < V_{2N} = V_{3N}$	$I_1 = I_2 = I_3$	PN	P2	P3	P1	+C3-C3 Normal	+C2-C2 Normal	+C1-C1 Normal	P1 and PN terminals are reversed and 1 side CT and 3 side CT are switched							
	LEAD 0.866				30	270	150																		
	1.000				60	300	180																		
	LAG 0.866				90	330	210																		
	LAG 0.707				105	345	225												$W_1=0$ $W_2$ =Positive value $W_3$ =Negative value $W_4$ =Negative value						
45	LEAD 0.707	0	330	300	225	105	345	$W_1$ =Negative value $W_2$ =Negative value $W_3$ =Positive value	$V_{1N} = V_{3N} > V_{2N}$	$I_1 = I_2 = I_3$	P1	PN	P3	P2	+C3-C3 Normal	+C2-C2 Normal	+C1-C1 Normal	P2 and PN terminals are reversed and 1 side CT and 3 side CT are switched							
	LEAD 0.866				240	120	0																		
	1.000				270	150	30																		
	LAG 0.866				300	180	60																		
	LAG 0.707				315	195	75												$W_1=0$ $W_2$ =Negative value $W_3$ =Negative value						
46	LEAD 0.707	0	60	30	165	45	285	$W_1$ =Negative value $W_2$ =Positive value $W_3$ =Negative value $W_4$ =Negative value	$V_{1N} = V_{2N} > V_{3N}$	$I_1 = I_2 = I_3$	P1	P2	PN	P3	+C3-C3 Normal	+C2-C2 Normal	+C1-C1 Normal	P3 and PN terminals are reversed and 1 side CT and 3 side CT are switched							
	LEAD 0.866				180	60	300																		
	1.000				210	90	330																		
	LAG 0.866				240	120	0																		
	LAG 0.707				255	135	15												$W_1$ =Negative value $W_2$ =Positive value $W_3$ =Positive value						

Note1: The above examples for incorrect wiring are typical. Extreme cases are excluded such as burnout or destruction of the instrument, VT, or CT caused by voltage application to a current circuit or current application to a voltage circuit.

Note : The active power polarity may be displayed in reverse depending on the load status (low power factor, unbalanced load) even when the connection is correct.



## 9. Appendix

### 9.3. A List of Examples for Incorrect Wiring Display

#### 9.3.2. 3-phase 3-wire System

\*The shaded parts indicate influential parts caused by incorrect wiring.  
The dashed lines show incorrect wiring parts.

No.	Power Factor (Input)	At balanced load ( $V_{12}=V_{23}$ , $I_1=I_3$ )										Connection (Note 7)						
		Phase Angle Display				Active Power Display		Voltage Display			Current Display			Voltage		Current		Connection
		$\angle V_{12}$	$\angle V_{32}$	$\angle I_1$	$\angle I_3$	$W_1$	$W_3$	$V_{12}$	$V_{23}$	$V_{31}$	$I_1$	$I_2$	$I_3$	1	2	3	1 side CT	
1	LEAD 0.707	0	300	345	225	$W_1 > W_3$	$V_{12}=V_{23}=V_{31}$		$I_1=I_2=I_3$	P1	P2	P3	+C1-C1 Normal	+C3-C3 Normal	Normal			
	LEAD 0.866			0	240												$W_1 = W_3$	
	1.000			30	270	$W_1 < W_3$												
	LAG 0.866			60	300													
	LAG 0.707			75	315													
2	LEAD 0.707	0	300	165	225	$W_1 = \text{Negative value}$ $W_3 = \text{Positive value}$	$V_{12}=V_{23}=V_{31}$		$I_1=I_3 < I_2$	P1	P2	P3	+C1-C1 Reverse	+C3-C3 Normal	Reverse connection of 1 side CT			
	LEAD 0.866			180	240													
	1.000			210	270													
	LAG 0.866			240	300													
	LAG 0.707			255	315													
3	LEAD 0.707	0	300	345	45	$W_1 = \text{Positive value}$ $W_3 = \text{Negative value}$	$V_{12}=V_{23}=V_{31}$		$I_1=I_3 < I_2$	P1	P2	P3	+C1-C1 Normal	+C3-C3 Reverse	Reverse connection of 3 side CT			
	LEAD 0.866			0	60													
	1.000			30	90													
	LAG 0.866			60	120													
	LAG 0.707			75	135													
4	LEAD 0.707	0	300	165	45	$W_1 = \text{Negative value}$ $W_3 = \text{Negative value}$	$V_{12}=V_{23}=V_{31}$		$I_1=I_2=I_3$	P1	P2	P3	+C1-C1 Reverse	+C3-C3 Reverse	Reverse connection of 1 side VT and 3 side VT			
	LEAD 0.866			180	60													
	1.000			210	90													
	LAG 0.866			240	120													
	LAG 0.707			255	135													

## 9. Appendix

### 9.3. A List of Examples for Incorrect Wiring Display

#### 9.3.2. 3-phase 3-wire System

No.	Power Factor (Input)	At balanced load ( $V_{12}=V_{23}, I_1=I_3$ )											Connection (Note 7)							
		Phase Angle Display				Active Power Display			Voltage Display				Current Display			Voltage		Current		Connection
		$\angle V_{12}$	$\angle V_{32}$	$\angle I_1$	$\angle I_3$	$W_1$	$W_3$	$V_{12}$	$V_{23}$	$V_{31}$	$I_1$	$I_2$	$I_3$	1	2	3	1 side CT	3 side CT		
5	LEAD 0.707	0	300	225	345	$W_1$ =Negative value $W_3$ =Positive value	$V_{12}=V_{23}=V_{31}$		$I_1=I_2=I_3$	P1	P2	P3	+C3-C3 Normal	+C1-C1 Normal	Switch between 1 side CT and 3 side CT					
	LEAD 0.866			240	0															
	1.000			270	30	$W_1=W_3=0$														
	LAG 0.866			300	60	$W_1$ =Positive value $W_3$ =Negative value														
	LAG 0.707			315	75															
6	LEAD 0.707	0	60	165	45	$W_1$ =Negative value $W_3$ =Positive value	$V_{12}=V_{23}=V_{31}$		$I_1=I_2=I_3$	P2	P1	P3	+C1-C1 Normal	+C3-C3 Normal	Reverse connection between terminals P1 and P2					
	LEAD 0.866			180	60															
	1.000			210	90															
	LAG 0.866			240	120															
	LAG 0.707			255	135															
7	LEAD 0.707	0	60	285	165	$W_1$ =Positive value $W_3$ =Negative value	$V_{12}=V_{23}=V_{31}$		$I_1=I_2=I_3$	P1	P3	P2	+C1-C1 Normal	+C3-C3 Normal	Reverse connection between terminals P2 and P3					
	LEAD 0.866			300	180															
	1.000			330	210															
	LAG 0.866			0	240															
	LAG 0.707			15	255															
8	LEAD 0.707	0	60	45	285	$W_1$ =Positive value $W_3$ =Negative value	$V_{12}=V_{23}=V_{31}$		$I_1=I_2=I_3$	P3	P2	P1	+C1-C1 Normal	+C3-C3 Normal	Reverse connection between terminals P1 and P3					
	LEAD 0.866			60	300															
	1.000			90	330	$W_1=W_3=0$														
	LAG 0.866			120	0	$W_1$ =Negative value $W_3$ =Positive value														
	LAG 0.707			135	15															

## 9. Appendix

### 9.3. A List of Examples for Incorrect Wiring Display

#### 9.3.2. 3-phase 3-wire System

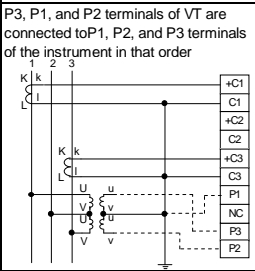
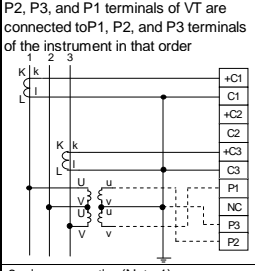
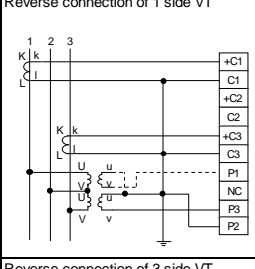
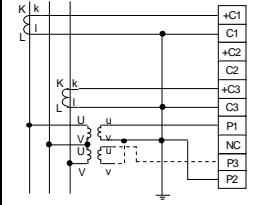
No.	Power Factor (Input)	At balanced load ( $V_{12}=V_{23}$ , $I_1=I_3$ )										Connection (Note 7)						
		Phase Angle Display				Active Power Display		Voltage Display			Current Display			Voltage		Current		Connection
		$\angle V_{12}$	$\angle V_{32}$	$\angle I_1$	$\angle I_3$	$W_1$	$W_3$	$V_{12}$	$V_{23}$	$V_{31}$	$I_1$	$I_2$	$I_3$	1	2	3	1 side CT	
9	LEAD 0.707			225	105	$W_1$ =Negative value $W_3$ =Negative value	$V_{12}=V_{23}=V_{31}$		$I_1=I_2=I_3$	1	2	3	P3	P1	P2	+C1-C1 Normal	+C3-C3 Normal	<p>P3, P1, and P2 terminals of VT are connected to P1, P2, and P3 terminals of the instrument in that order</p> 
	LEAD 0.866			240	120													
	1.000	0	300	270	150	$W_1=0$ $W_3$ =Negative value												
	LAG 0.866			300	180	$W_1$ =Positive value $W_3$ =Negative value												
	LAG 0.707			315	195													
10	LEAD 0.707			105	345	$W_1$ =Negative value $W_3$ =Positive value	$V_{12}=V_{23}=V_{31}$		$I_1=I_2=I_3$	2	3	P1	P2	P3	+C1-C1 Normal	+C3-C3 Normal	<p>P2, P3, and P1 terminals of VT are connected to P1, P2, and P3 terminals of the instrument in that order</p> 	
	LEAD 0.866			120	0													
	1.000	0	300	150	30	$W_1$ =Negative value $W_3=0$												
	LAG 0.866			180	60	$W_1$ =Negative value $W_3$ =Negative value												
	LAG 0.707			195	75													
11	LEAD 0.707			165	45	$W_1$ =Negative value $W_3$ =Positive value	$V_{12}=V_{23}<V_{31}$		$I_1=I_2=I_3$	Reverse connection of 1 side VT *Refer to the right diagram.	1	2	3	+C1-C1 Normal	+C3-C3 Normal	<p>Reverse connection of 1 side VT</p> 		
	LEAD 0.866			180	60													
	1.000	0	120	210	90													
	LAG 0.866			240	120													
	LAG 0.707			255	135													
12	LEAD 0.707			345	225	$W_1$ =Positive value $W_3$ =Negative value	$V_{12}=V_{23}<V_{31}$		$I_1=I_2=I_3$	Reverse connection of 3 side VT *Refer to the right diagram.	1	2	3	+C1-C1 Normal	+C3-C3 Normal	<p>Reverse connection of 3 side VT</p> 		
	LEAD 0.866			0	240													
	1.000	0	120	30	270													
	LAG 0.866			60	300													
	LAG 0.707			75	315													

## 9. Appendix

### 9.3. A List of Examples for Incorrect Wiring Display

#### 9.3.2. 3-phase 3-wire System

No.	Power Factor (Input)	At balanced load ( $V_{12}=V_{23}$ , $I_1=I_3$ )										Connection (Note 7)					
		Phase Angle Display				Active Power Display			Voltage Display			Current Display			Voltage	Current	Connection
		$\angle V_{12}$	$\angle V_{32}$	$\angle I_1$	$\angle I_3$	$W_1$	$W_3$	$V_{12}$	$V_{23}$	$V_{31}$	$I_1$	$I_2$	$I_3$	1			
13	LEAD 0.707	0	300	165	45	$W_1$ =Negative value $W_3$ =Negative value	$V_{12}=V_{23}=V_{31}$	$I_1=I_2=I_3$	Each of 1 side VT terminal and 3 side VT terminal is reversed. *Refer to the right diagram.	+C1-C1 Normal	+C3-C3 Normal						
	LEAD 0.866			180	60												
	1.000			210	90												
	LAG 0.866			240	120												
	LAG 0.707			255	135												
14	LEAD 0.707	0	60	285	45	$W_1 < W_3$	$V_{12}=V_{23}=V_{31}$	$I_1=I_2=I_3$	P3	P2	P1	+C3-C3 Normal	+C1-C1 Normal				
	LEAD 0.866			300	60												
	1.000			330	90												
	LAG 0.866			0	120												
	LAG 0.707			15	135												
15	LEAD 0.707	0	60	345	45	$W_1=W_3$	$V_{12}=V_{23}=V_{31}$	$I_1=I_3 < I_2$	P2	P1	P3	+C1-C1 Reverse	+C3-C3 Normal				
	LEAD 0.866			0	60												
	1.000			30	90												
	LAG 0.866			60	120												
	LAG 0.707			75	135												
16	LEAD 0.707	0	60	165	225	$W_1$ =Negative value $W_3$ =Negative value	$V_{12}=V_{23}=V_{31}$	$I_1=I_3 < I_2$	P2	P1	P3	+C1-C1 Normal	+C3-C3 Reverse				
	LEAD 0.866			180	240												
	1.000			210	270												
	LAG 0.866			240	300												
	LAG 0.707			255	315												
17	LEAD 0.707	0	60	345	225	$W_1$ =Positive value $W_3$ =Negative value	$V_{12}=V_{23}=V_{31}$	$I_1=I_2=I_3$	P2	P1	P3	+C1-C1 Reverse	+C3-C3 Reverse				
	LEAD 0.866			0	240												
	1.000			30	270												
	LAG 0.866			60	300												
	LAG 0.707			75	315												
18	LEAD 0.707	0	60	105	165	$W_1=W_3$ =Negative value	$V_{12}=V_{23}=V_{31}$	$I_1=I_3 < I_2$	P1	P3	P2	+C1-C1 Reverse	+C3-C3 Normal				
	LEAD 0.866			120	180												
	1.000			150	210												
	LAG 0.866			180	240												
	LAG 0.707			195	255												

## 9. Appendix

### 9.3. A List of Examples for Incorrect Wiring Display

#### 9.3.2. 3-phase 3-wire System

No.	Power Factor (Input)	At balanced load ( $V_{12}=V_{23}, I_1=I_3$ )										Connection (Note 7)								
		Phase Angle Display				Active Power Display		Voltage Display			Current Display			Voltage		Current		Connection		
		$\angle V_{12}$	$\angle V_{32}$	$\angle I_1$	$\angle I_3$	$W_1$	$W_3$	$V_{12}$	$V_{23}$	$V_{31}$	$I_1$	$I_2$	$I_3$	1	2	3	1 side CT		3 side CT	
19	LEAD 0.707	0	60	285	345	$W_1 > W_3$	$V_{12}=V_{23}=V_{31}$	$I_1=I_3 < I_2$	P1	P3	P2	+C1-C1 Normal	+C3-C3 Reverse	<p>P2 and P3 terminals are reversed and 3 side CT reversed</p>						
	LEAD 0.866			300	0															
	1.000			330	30	$W_1 = W_3$														
	LAG 0.866			0	60	$W_1 < W_3$														
	LAG 0.707			15	75															
20	LEAD 0.707	0	60	225	285	$W_1 = W_3 = \text{Negative value}$	$V_{12}=V_{23}=V_{31}$	$I_1=I_3 < I_2$	P3	P2	P1	+C1-C1 Reverse	+C3-C3 Normal	<p>P1 and P3 terminals are reversed and 1 side CT reversed</p>						
	LEAD 0.866			240	300															
	1.000			270	330	$W_1 = W_3 = 0$														
	LAG 0.866			300	0	$W_1 = W_3 = \text{Positive value}$														
	LAG 0.707			315	15															
21	LEAD 0.707	0	60	45	105	$W_1 = W_3 = \text{Positive value}$	$V_{12}=V_{23}=V_{31}$	$I_1=I_3 < I_2$	P3	P2	P1	+C1-C1 Normal	+C3-C3 Reverse	<p>P1 and P3 terminals are reversed and 3 side CT reversed</p>						
	LEAD 0.866			60	120															
	1.000			90	150	$W_1 = W_3 = 0$														
	LAG 0.866			120	180	$W_1 = W_3 = \text{Negative value}$														
	LAG 0.707			135	195															
22	LEAD 0.707	0	120	345	45	$W_1 > W_3$	$V_{12}=V_{23} < V_{31}$	$I_1=I_3 < I_2$	Reverse connection of 1 side VT *Refer to the right diagram.			+C1-C1 Reverse	+C3-C3 Normal	<p>1 side VT reversed and 1 side CT reversed</p>						
	LEAD 0.866			0	60															
	1.000			30	90	$W_1 = W_3$														
	LAG 0.866			60	120	$W_1 < W_3$														
	LAG 0.707			75	135															
23	LEAD 0.707	0	120	165	225	$W_1 = \text{Negative value}$ $W_3 = \text{Negative value}$	$V_{12}=V_{23} < V_{31}$	$I_1=I_3 < I_2$	Reverse connection of 1 side VT *Refer to the right diagram.			+C1-C1 Normal	+C3-C3 Reverse	<p>1 side VT reversed and 3 side CT reversed</p>						
	LEAD 0.866			180	240															
	1.000			210	270															
	LAG 0.866			240	300										Reverse connection of 3 side VT *Refer to the right diagram.			+C1-C1 Reverse	+C3-C3 Normal	<p>3 side VT reversed and 1 side CT reversed</p>
	LAG 0.707			255	315															

## 9. Appendix

### 9.3. A List of Examples for Incorrect Wiring Display

#### 9.3.2. 3-phase 3-wire System

No.	Power Factor (Input)	At balanced load ( $V_{12}=V_{23}, I_1=I_3$ )										Connection (Note 7)					
		Phase Angle Display			Active Power Display		Voltage Display			Current Display			Voltage		Current		Connection
		$\angle V_{12}$	$\angle V_{32}$	$\angle I_1$	$\angle I_3$	$W_1$	$W_3$	$V_{12}$	$V_{23}$	$V_{31}$	$I_1$	$I_2$	$I_3$	1	2	3	
24	LEAD 0.707	0	120	285	165	$W_1 < W_3$	$V_{12}=V_{23} < V_{31}$		$I_1=I_2=I_3$	Reverse connection of 1 side VT *Refer to the right diagram.	Refer to the right figure	1 side VT reversed and 3 wire connection(Note1)					
	LEAD 0.866			300	180	$W_1 = W_3$											
	1.000			330	210	$W_1 > W_3 = 0$											
	LAG 0.866			0	240	$W_1 = \text{Positive value}$ $W_3 = \text{Negative value}$											
	LAG 0.707			15	255												
25	LEAD 0.707	0	120	105	345	$W_1 = \text{Negative value}$ $W_3 = \text{Negative value}$	$V_{12}=V_{23} < V_{31}$		$I_1=I_2=I_3$	Reverse connection of 3 side VT *Refer to the right diagram.	Refer to the right figure	3 side VT reversed and 3 wire connection(Note1)					
	LEAD 0.866			120	0	$W_1 = \text{Negative value}$ $W_3 = 0$											
	1.000			150	30	$W_1 = \text{Negative value}$ $W_3 = 0$											
	LAG 0.866			180	60	$W_1 = \text{Negative value}$ $W_3 = \text{Positive value}$											
	LAG 0.707			195	75												
26	LEAD 0.707	0	300	105	225	$W_1 = \text{Negative value}$ $W_3 = \text{Positive value}$	$V_{12}=V_{23}=V_{31}$		$I_1=I_2=I_3$	P1 P2 P3	Refer to the right figure	3 wire connection(Note3)					
	LEAD 0.866			120	240												
	1.000			150	270												
	LAG 0.866			180	300												
	LAG 0.707			195	315												
27	LEAD 0.707	0	300	345	105	$W_1 = \text{Positive value}$ $W_3 = \text{Negative value}$	$V_{12}=V_{23}=V_{31}$		$I_1=I_2=I_3$	P1 P2 P3	Refer to the right figure	3 wire connection(Note4)					
	LEAD 0.866			0	120												
	1.000			30	150												
	LAG 0.866			60	180												
	LAG 0.707			75	195												
28	LEAD 0.707	0	300	15	225	$W_1 > W_3$	$V_{12}=V_{23}=V_{31}$		$I_2=I_3 < I_1$	P1 P2 P3	Refer to the right figure	3 wire connection(Note5)					
	LEAD 0.866			30	240												
	1.000			60	270												
	LAG 0.866			90	300												
	LAG 0.707			105	315												
29	LEAD 0.707	0	300	345	195	$W_1 = \text{Positive value}$ $W_3 = \text{Negative value}$	$V_{12}=V_{23}=V_{31}$		$I_1=I_2 < I_3$	P1 P2 P3	Refer to the right figure	3 wire connection(Note6)					
	LEAD 0.866			0	210												
	1.000			30	240												
	LAG 0.866			60	270												
	LAG 0.707			75	285												

## 9. Appendix

### 9.3. A List of Examples for Incorrect Wiring Display

#### 9.3.2. 3-phase 3-wire System

No.	Power Factor (Input)	At balanced load ( $V_{12}=V_{23}, I_1=I_3$ )										Connection (Note 7)						
		Phase Angle Display				Active Power Display		Voltage Display			Current Display			Voltage		Current		Connection
		$\angle V_{12}$	$\angle V_{32}$	$\angle I_1$	$\angle I_3$	$W_1$	$W_3$	$V_{12}$	$V_{23}$	$V_{31}$	$I_1$	$I_2$	$I_3$	1	2	3	1 side CT	
30	LEAD 0.707			45	105	$W_1$ =Positive value $W_3$ =Negative value	$V_{12}=V_{23}=V_{31}$				$I_1=I_3 < I_2$		P3	P1	P2	+C1-C1 Reverse	+C3-C3 Normal	
	LEAD 0.866			60	120													
	1.000	0	300	90	150	$W_1=0$ $W_3$ =Negative value												
	LAG 0.866			120	180	$W_1$ =Negative value $W_3$ =Negative value												
	LAG 0.707			135	195													
31	LEAD 0.707			225	285	$W_1$ =Negative value $W_3$ =Positive value	$V_{12}=V_{23}=V_{31}$				$I_1=I_3 < I_2$		P3	P1	P2	+C1-C1 Normal	+C3-C3 Reverse	
	LEAD 0.866			240	300													
	1.000	0	300	270	330	$W_1=0$ $W_3$ =Positive value												
	LAG 0.866			300	0	$W_1=W_3$												
	LAG 0.707			315	15	$W_1 > W_3$												
32	LEAD 0.707			285	345	$W_1 < W_3$	$V_{12}=V_{23}=V_{31}$				$I_1=I_3 < I_2$		P2	P3	P1	+C1-C1 Reverse	+C3-C3 Normal	
	LEAD 0.866			300	0	$W_1=W_3$												
	1.000	0	300	330	30	$W_1$ =Positive value $W_3=0$												
	LAG 0.866			0	60	$W_1$ =Positive value $W_3$ =Negative value												
	LAG 0.707			15	75													
33	LEAD 0.707			105	165	$W_1$ =Negative value $W_3$ =Negative value	$V_{12}=V_{23}=V_{31}$				$I_1=I_3 < I_2$		P2	P3	P1	+C1-C1 Normal	+C3-C3 Reverse	
	LEAD 0.866			120	180													
	1.000	0	300	150	210	$W_1$ =Negative value $W_3=0$												
	LAG 0.866			180	240	$W_1$ =Negative value $W_3$ =Positive value												
	LAG 0.707			195	255													

Note1: When the terminals 'C1' and '+C1' of CT are connected to the terminals '+C1' and 'C1' of the instrument in that order.

Note2: When the terminals 'C3' and '+C3' of CT are connected to the terminals '+C3' and 'C3' of the instrument in that order.

Note3: When 1 side CT and 3 side CT switch to each other, and in addition, the terminals 'C3' and '+C3' of CT are connected to the terminals '+C1' and 'C1' of the instrument in that order.

Note4: When 1 side CT and 3 side CT switch to each other, and in addition, the terminals 'C1' and '+C1' of CT are connected to the terminals '+C3' and 'C3' of the instrument in that order.

Note5: When '+C1' and 'C3' of CT are connected and it is connected to the '+C1' terminal of the instrument.

Note6: When 'C1' and '+C3' of CT are connected and it is connected to the '+C3' terminal of the instrument.

Note7: The above examples for incorrect wiring are typical. Extreme cases are excluded such as burnout or destruction of the instrument, VT, or CT caused by voltage application to a current circuit or current application to a voltage circuit.

Note : The active power polarity may be displayed in reverse depending on the load status (low power factor, unbalanced load) even when the connection is correct.

Note : The above table shows incorrect wiring display examples of 3-phase 3-wire system (2CT). Those of 3-phase 3-wire system (3CT) are also the same. However, it is not possible to detect the incorrect wiring of the CT secondary side.

## 9. Appendix

### 9.3. A List of Examples for Incorrect Wiring Display

#### 9.3.3. 1-phase 3-wire System

\*The shaded parts indicate influential parts caused by incorrect wiring.

The dashed lines show incorrect wiring parts.

No.	Power Factor (Input)	At balanced load ( $V_{1N}=V_{3N}$ (or $V_{2N}$ ), $I_1=I_3$ (or $I_2$ ))											Connection (Note 1)					
		Phase Angle Display				Active Power Display		Voltage Display			Current Display			Voltage		Current		Connection
		$\angle V_{1N}$	$\angle V_{3N}$	$\angle I_1$	$\angle I_3$	$W_1$	$W_3$	$V_{1N}$	$V_{3N}$	$V_{13}$	$I_1$	$I_3$	$I_N$	1	N	3	1 side CT	
1	LEAD 0.707			315	135	$W_1=W_3$		$V_{1N}=V_{3N}<V_{13}$	$I_1=I_3$ $I_N=0$	P1	PN	P3	+C1-C1 Normal	+C3-C3 Normal	Normal			
	LEAD 0.866			330	150										Reversed phase sequence			
	1.000	0	180	0	180										Reverse connection of 1 side CT			
	LAG 0.866			30	210										Reverse connection of 3 side CT			
	LAG 0.707			45	225										Reverse connection of 1 side CT and 3 side CT			
2	LEAD 0.707			135	135	$W_1$ =Negative value $W_3$ =Positive value	$V_{1N}=V_{3N}<V_{13}$	$I_1=I_3<I_N$	P1	PN	P3	+C1-C1 Reverse	+C3-C3 Normal	Reverse connection of 1 side CT and 3 side CT				
	LEAD 0.866			150	150									Switch between 1 side CT and 3 side CT				
	1.000	0	180	180	180									Reverse connection between terminals P1 and PN				
	LAG 0.866			210	210													
	LAG 0.707			225	225													
3	LEAD 0.707			315	315	$W_1$ =Positive value $W_3$ =Negative value	$V_{1N}=V_{3N}<V_{13}$	$I_1=I_3<I_N$	P1	PN	P3	+C1-C1 Normal	+C3-C3 Reverse	Reverse connection between terminals P1 and PN				
	LEAD 0.866			330	330													
	1.000	0	180	0	0													
	LAG 0.866			30	30													
	LAG 0.707			45	45													
4	LEAD 0.707			135	315	$W_1$ =Negative value $W_3$ =Negative value	$V_{1N}=V_{3N}<V_{13}$	$I_1=I_3$ $I_N=0$	P1	PN	P3	+C1-C1 Reverse	+C3-C3 Reverse	Reverse connection between terminals P1 and PN				
	LEAD 0.866			150	330													
	1.000	0	180	180	0													
	LAG 0.866			210	30													
	LAG 0.707			225	45													
5	LEAD 0.707			135	315	$W_1$ =Negative value $W_3$ =Negative value	$V_{1N}=V_{3N}<V_{13}$	$I_1=I_3$ $I_N=0$	P1	PN	P3	+C3-C3 Normal	+C1-C1 Normal	Reverse connection between terminals P1 and PN				
	LEAD 0.866			150	330													
	1.000	0	180	180	0													
	LAG 0.866			210	30													
	LAG 0.707			225	45													
6	LEAD 0.707			135	315	$W_1$ =Negative value $W_3$ =Positive value	$V_{1N}=V_{13}<V_{3N}$	$I_1=I_3$ $I_N=0$	PN	P1	P3	+C1-C1 Normal	+C3-C3 Normal	Reverse connection between terminals P1 and PN				
	LEAD 0.866			150	330													
	1.000	0	0	180	0													
	LAG 0.866			210	30													
	LAG 0.707			225	45													



## 9. Appendix

### 9.3. A List of Examples for Incorrect Wiring Display

#### 9.3.3. 1-phase 3-wire System

No.	Power Factor (Input)	At balanced load ( $V_{1N}=V_{3N}$ (or $V_{2N}$ ), $I_1=I_3$ (or $I_2$ ))											Connection (Note 1)					
		Phase Angle Display				Active Power Display		Voltage Display			Current Display			Voltage		Current		Connection
		$\angle V_{1N}$	$\angle V_{3N}$	$\angle I_1$	$\angle I_3$	$W_1$	$W_3$	$V_{1N}$	$V_{3N}$	$V_{13}$	$I_1$	$I_N$	$I_3$	1	N	3	1 side CT	
7	LEAD 0.707	0	0	315	135	$W_1$ =Positive value $W_3$ =Negative value	$V_{1N}>V_{3N}=V_{13}$	$I_1=I_3$ $I_N=0$	P1	P3	PN	+C1-C1 Normal	+C3-C3 Normal	Reverse connection between terminals P3 and PN 				
	LEAD 0.866			330	150													
	1.000			0	180													
	LAG 0.866			30	210													
	LAG 0.707			45	225													
8	LEAD 0.707	0	180	135	315	$W_1$ =Negative value $W_3$ =Negative value	$V_{1N}=V_{3N}<V_{13}$	$I_1=I_3$ $I_N=0$	P3	PN	P1	+C1-C1 Normal	+C3-C3 Normal	Reverse connection between terminals P1 and P3 				
	LEAD 0.866			150	330													
	1.000			180	0													
	LAG 0.866			210	30													
	LAG 0.707			225	45													
9	LEAD 0.707	0	0	315	135	$W_1$ =Positive value $W_3$ =Negative value	$V_{1N}=V_{13}<V_{3N}$	$I_1=I_3$ $I_N=0$	P3	P1	PN	+C1-C1 Normal	+C3-C3 Normal	Voltage are connected the order of P3, P1, and PN terminals 				
	LEAD 0.866			330	150													
	1.000			0	180													
	LAG 0.866			30	210													
	LAG 0.707			45	225													
10	LEAD 0.707	0	0	135	315	$W_1$ =Negative value $W_3$ =Positive value	$V_{1N}>V_{3N}=V_{13}$	$I_1=I_3$ $I_N=0$	PN	P3	P1	+C1-C1 Normal	+C3-C3 Normal	Voltage are connected the order of PN, P3, and P1 terminals 				
	LEAD 0.866			150	330													
	1.000			180	0													
	LAG 0.866			210	30													
	LAG 0.707			225	45													
11	LEAD 0.707	0	0	135	135	$W_1$ =Negative value $W_3$ =Negative value	$V_{1N}>V_{3N}=V_{13}$	$I_1=I_3<I_N$	P1	P3	PN	+C1-C1 Reverse	+C3-C3 Normal	P3 and PN terminals are reversed and 1 side CT is reversed. 				
	LEAD 0.866			150	150													
	1.000			180	180													
	LAG 0.866			210	210													
	LAG 0.707			225	225													
12	LEAD 0.707	0	0	315	315	$W_1>W_3$	$V_{1N}>V_{3N}=V_{13}$	$I_1=I_3<I_N$	P1	P3	PN	+C1-C1 Normal	+C3-C3 Reverse	P3 and PN terminals are reversed and 3 side CT is reversed. 				
	LEAD 0.866			330	330													
	1.000			0	0													
	LAG 0.866			30	30													
	LAG 0.707			45	45													
13	LEAD 0.707	0	0	135	315	$W_1$ =Negative value $W_3$ =Positive value	$V_{1N}>V_{3N}=V_{13}$	$I_1=I_3$ $I_N=0$	P1	P3	PN	+C1-C1 Reverse	+C3-C3 Reverse	P3 and PN terminals are reversed, and both of CTs are reversed. 				
	LEAD 0.866			150	330													
	1.000			180	0													
	LAG 0.866			210	30													
	LAG 0.707			225	45													

## 9. Appendix

### 9.3. A List of Examples for Incorrect Wiring Display

#### 9.3.3. 1-phase 3-wire System

No.	Power Factor (Input)	At balanced load ( $V_{1N}=V_{3N}$ (or $V_{2N}$ ), $I_1=I_3$ (or $I_2$ ))											Connection (Note 1)									
		Phase Angle Display				Active Power Display		Voltage Display			Current Display			Voltage		Current		Connection				
		$\angle V_{1N}$	$\angle V_{3N}$	$\angle I_1$	$\angle I_3$	$W_1$	$W_3$	$V_{1N}$	$V_{3N}$	$V_{13}$	$I_1$	$I_N$	$I_3$	1	N	3	1 side CT		3 side CT			
14	LEAD 0.707	0	0	0	0	$W_1 < W_3$	$V_{1N} = V_{13} < V_{3N}$	$I_1 = I_3 < I_N$	PN	P1	P3	+C1-C1 Reverse	+C3-C3 Normal	<p>P1 and PN terminals are reversed and 1 side CT is reversed.</p>								
	LEAD 0.866																		315	315	330	330
	1.000																		30	30	45	45
	LAG 0.866																					
	LAG 0.707																					
15	LEAD 0.707	0	0	180	180	$W_1 = \text{Negative value}$ $W_3 = \text{Negative value}$	$V_{1N} = V_{13} < V_{3N}$	$I_1 = I_3 < I_N$	PN	P1	P3	+C1-C1 Normal	+C3-C3 Reverse	<p>P1 and PN terminals are reversed and 3 side CT is reversed.</p>								
	LEAD 0.866																		135	135	150	150
	1.000																		210	210	225	225
	LAG 0.866																					
	LAG 0.707																					
16	LEAD 0.707	0	0	0	180	$W_1 = \text{Positive value}$ $W_3 = \text{Negative value}$	$V_{1N} = V_{13} < V_{3N}$	$I_1 = I_3$ $I_N = 0$	PN	P1	P3	+C1-C1 Reverse	+C3-C3 Reverse	<p>P1 and PN terminals are reversed and both of CTs reversed.</p>								
	LEAD 0.866																		315	135	330	150
	1.000																		30	210	45	225
	LAG 0.866																					
	LAG 0.707																					
17	LEAD 0.707	0	0	0	180	$W_1 = \text{Negative value}$ $W_3 = \text{Negative value}$	$V_{1N} = V_{13} < V_{3N}$	$I_1 = I_3 < I_N$	P3	P1	PN	+C1-C1 Reverse	+C3-C3 Normal	<p>Voltage are connected the order of P3, P1, and PN terminals, and 1 side CT is reversed.</p>								
	LEAD 0.866																		135	135	150	150
	1.000																		210	210	225	225
	LAG 0.866																					
	LAG 0.707																					
18	LEAD 0.707	0	0	0	0	$W_1 < W_3$	$V_{1N} = V_{13} < V_{3N}$	$I_1 = I_3 < I_N$	P3	P1	PN	+C1-C1 Normal	+C3-C3 Reverse	<p>Voltage are connected the order of P3, P1, and PN terminals, and 3 side CT is reversed.</p>								
	LEAD 0.866																		315	315	330	330
	1.000																		30	30	45	45
	LAG 0.866																					
	LAG 0.707																					
19	LEAD 0.707	0	0	180	0	$W_1 = \text{Negative value}$ $W_3 = \text{Positive value}$	$V_{1N} = V_{13} < V_{3N}$	$I_1 = I_3$ $I_N = 0$	P3	P1	PN	+C1-C1 Reverse	+C3-C3 Reverse	<p>Voltage are connected the order of P3, P1, and PN terminals, and Both of CTs are reversed.</p>								
	LEAD 0.866																		135	315	150	330
	1.000																		210	30	225	45
	LAG 0.866																					
	LAG 0.707																					
20	LEAD 0.707	0	0	0	0	$W_1 > W_3$	$V_{1N} > V_{3N} = V_{13}$	$I_1 = I_3 < I_N$	PN	P3	P1	+C1-C1 Reverse	+C3-C3 Normal	<p>Voltage are connected the order of PN, P3, and P1 terminals, and 1 side CT is reversed.</p>								
	LEAD 0.866																		315	315	330	330
	1.000																		30	30	45	45
	LAG 0.866																					
	LAG 0.707																					

## 9. Appendix

### 9.3. A List of Examples for Incorrect Wiring Display

#### 9.3.3. 1-phase 3-wire System

No.	Power Factor (Input)	At balanced load ( $V_{1N}=V_{3N}$ (or $V_{2N}$ ), $I_1=I_3$ (or $I_2$ ))											Connection (Note 1)					
		Phase Angle Display				Active Power Display		Voltage Display			Current Display			Voltage		Current		Connection
		$\angle V_{1N}$	$\angle V_{3N}$	$\angle I_1$	$\angle I_3$	$W_1$	$W_3$	$V_{1N}$	$V_{3N}$	$V_{13}$	$I_1$	$I_N$	$I_3$	1	N	3	1 side CT	
21	LEAD 0.707	0	0	135	135	$W_1$ =Negative value $W_3$ =Negative value	$V_{1N}>V_{3N}=V_{13}$	$I_1=I_3<I_N$	PN	P3	P1	+C1-C1 Normal	+C3-C3 Reverse	<p>Voltage are connected the order of PN, P3, and P1 terminals, and 3 side CT is reversed.</p>				
	LEAD 0.866			150	150													
	1.000			180	180													
	LAG 0.866			210	210													
	LAG 0.707			225	225													
22	LEAD 0.707	0	0	315	135	$W_1$ =Positive value $W_3$ =Negative value	$V_{1N}>V_{3N}=V_{13}$	$I_1=I_3$ $I_N=0$	PN	P3	P1	+C1-C1 Reverse	+C3-C3 Reverse	<p>Voltage are connected the order of PN, P3, and P1 terminals, and both of CTs are reversed.</p>				
	LEAD 0.866			330	150													
	1.000			0	180													
	LAG 0.866			30	210													
	LAG 0.707			45	225													
23	LEAD 0.707	0	180	315	315	$W_1$ =Positive value $W_3$ =Negative value	$V_{1N}=V_{3N}<V_{13}$	$I_1=I_3<I_N$	P3	PN	P1	+C1-C1 Reverse	+C3-C3 Normal	<p>P1 and P3 terminals are reversed and 1 side CT is reversed.</p>				
	LEAD 0.866			330	330													
	1.000			0	0													
	LAG 0.866			30	30													
	LAG 0.707			45	45													
24	LEAD 0.707	0	180	135	135	$W_1$ =Negative value $W_3$ =Positive value	$V_{1N}=V_{3N}<V_{13}$	$I_1=I_3<I_N$	P3	PN	P1	+C1-C1 Normal	+C3-C3 Reverse	<p>P1 and P3 terminals are reversed and 3 side CT is reversed.</p>				
	LEAD 0.866			150	150													
	1.000			180	180													
	LAG 0.866			210	210													
	LAG 0.707			225	225													
25	LEAD 0.707	0	180	315	135	$W_1=W_3$	$V_{1N}=V_{3N}<V_{13}$	$I_1=I_3$ $I_N=0$	P3	PN	P1	+C1-C1 Reverse	+C3-C3 Reverse	<p>P1 and P3 terminals are reversed and both of CTs are reversed.</p>				
	LEAD 0.866			330	150													
	1.000			0	180													
	LAG 0.866			30	210													
	LAG 0.707			45	225													
26	LEAD 0.707	0	180	135	135	$W_1$ =Negative value $W_3$ =Positive value	$V_{1N}=V_{3N}<V_{13}$	$I_1=I_3<I_N$	P1	PN	P3	+C3-C3 Normal	+C1-C1 Reverse	<p>Both of CTs switch to each other, and the terminals '+C1' and 'C1' are reversed.</p>				
	LEAD 0.866			150	150													
	1.000			180	180													
	LAG 0.866			210	210													
	LAG 0.707			225	225													
27	LEAD 0.707	0	180	315	315	$W_1$ =Positive value $W_3$ =Negative value	$V_{1N}=V_{3N}<V_{13}$	$I_1=I_3<I_N$	P1	PN	P3	+C3-C3 Reverse	+C1-C1 Normal	<p>Both of CTs switch to each other, and the terminals '+C3' and 'C3' are reversed.</p>				
	LEAD 0.866			330	330													
	1.000			0	0													
	LAG 0.866			30	30													
	LAG 0.707			45	45													

## 9. Appendix

### 9.3. A List of Examples for Incorrect Wiring Display

#### 9.3.3. 1-phase 3-wire System

No.	Power Factor (Input)	At balanced load ( $V_{1N}=V_{3N}$ (or $V_{2N}$ ), $I_1=I_3$ (or $I_2$ ))											Connection (Note 1)					
		Phase Angle Display				Active Power Display		Voltage Display			Current Display			Voltage		Current		Connection
		$\angle V_{1N}$	$\angle V_{3N}$	$\angle I_1$	$\angle I_3$	$W_1$	$W_3$	$V_{1N}$	$V_{3N}$	$V_{13}$	$I_1$	$I_N$	$I_3$	1	N	3	1 side CT	
28	LEAD 0.707			315	135	$W_1=W_3$	$V_{1N}=V_{3N}<V_{13}$	$I_1=I_3$	$I_N=0$	P1	PN	P3	+C3-C3 Reverse	+C1-C1 Reverse	Both of CTs are switched and reversed each other.			
	LEAD 0.866			330	150													
	1.000	0	180	0	180													
	LAG 0.866			30	210													
	LAG 0.707			45	225													
29	LEAD 0.707			135	315	$W_1$ =Negative value $W_3$ =Positive value	$V_{1N}>V_{3N}=V_{13}$	$I_1=I_3$	$I_N=0$	P1	P3	PN	+C3-C3 Normal	+C1-C1 Normal	P3 and PN terminals are reversed, and both of CTs are switched to each other.			
	LEAD 0.866			150	330													
	1.000	0	0	180	0													
	LAG 0.866			210	30													
	LAG 0.707			225	45													
30	LEAD 0.707			135	135	$W_1$ =Negative value $W_3$ =Negative value	$V_{1N}>V_{3N}=V_{13}$	$I_1=I_3<I_N$		P1	P3	PN	+C3-C3 Reverse	+C1-C1 Normal	P3 and PN are reversed, in addition, both of CTs are switched to each other, and the '+C3' and 'C3' are reversed.			
	LEAD 0.866			150	150													
	1.000	0	0	180	180													
	LAG 0.866			210	210													
	LAG 0.707			225	225													
31	LEAD 0.707			315	315	$W_1>W_3$	$V_{1N}>V_{3N}=V_{13}$	$I_1=I_3<I_N$		P1	P3	PN	+C3-C3 Normal	+C1-C1 Reverse	P3 and PN are reversed, in addition, both of CTs are switched to each other, and the '+C1' and 'C1' are reversed.			
	LEAD 0.866			330	330													
	1.000	0	0	0	0													
	LAG 0.866			30	30													
	LAG 0.707			45	45													
32	LEAD 0.707			315	135	$W_1$ =Positive value $W_3$ =Negative value	$V_{1N}>V_{3N}=V_{13}$	$I_1=I_3$	$I_N=0$	P1	P3	PN	+C3-C3 Reverse	+C1-C1 Reverse	P3 and PN are reversed, in addition, both of CTs are switched and reversed each other.			
	LEAD 0.866			330	150													
	1.000	0	0	0	180													
	LAG 0.866			30	210													
	LAG 0.707			45	225													
33	LEAD 0.707			315	135	$W_1$ =Positive value $W_3$ =Negative value	$V_{1N}=V_{3N}<V_{13}$	$I_1=I_3$	$I_N=0$	PN	P1	P3	+C3-C3 Normal	+C1-C1 Normal	P1 and PN terminals are reversed, and both of CTs are switched to each other.			
	LEAD 0.866			330	150													
	1.000	0	0	0	180													
	LAG 0.866			30	210													
	LAG 0.707			45	225													
34	LEAD 0.707			315	315	$W_1<W_3$	$V_{1N}=V_{13}<V_{3N}$	$I_1=I_3<I_N$		PN	P1	P3	+C3-C3 Reverse	+C1-C1 Normal	P1 and PN are reversed, in addition, both of CTs are switched to each other, and the '+C3' and 'C3' are reversed.			
	LEAD 0.866			330	330													
	1.000	0	0	0	0													
	LAG 0.866			30	30													
	LAG 0.707			45	45													

## 9. Appendix

### 9.3. A List of Examples for Incorrect Wiring Display

#### 9.3.3. 1-phase 3-wire System

No.	Power Factor (Input)	At balanced load ( $V_{1N}=V_{3N}$ (or $V_{2N}$ ), $I_1=I_3$ (or $I_2$ ))											Connection (Note 1)						
		Phase Angle Display				Active Power Display		Voltage Display			Current Display			Voltage		Current			Connection
		$\angle V_{1N}$	$\angle V_{3N}$	$\angle I_1$	$\angle I_3$	$W_1$	$W_3$	$V_{1N}$	$V_{3N}$	$V_{13}$	$I_1$	$I_N$	$I_3$	1	N	3	1 side CT	3 side CT	
35	LEAD 0.707	0	0	135	135	$W_1$ =Negative value $W_3$ =Negative value	$V_{1N}=V_{13}<V_{3N}$	$I_1=I_3<I_N$	PN	P1	P3	+C3-C3 Normal	+C1-C1 Reverse	<p>P1 and PN are reversed, in addition, both of CTs are switched to each other, and the '+C1' and 'C1' are reversed.</p>					
	LEAD 0.866			150	150														
	1.000			180	180														
	LAG 0.866			210	210														
	LAG 0.707			225	225														
36	LEAD 0.707	0	0	135	315	$W_1$ =Negative value $W_3$ =Positive value	$V_{1N}=V_{13}<V_{3N}$	$I_1=I_3$ $I_N=0$	PN	P1	P3	+C3-C3 Reverse	+C1-C1 Reverse	<p>P1 and PN are reversed, in addition, both of CTs are switched and reversed each other.</p>					
	LEAD 0.866			150	330														
	1.000			180	0														
	LAG 0.866			210	30														
	LAG 0.707			225	45														
37	LEAD 0.707	0	0	135	315	$W_1$ =Negative value $W_3$ =Positive value	$V_{1N}=V_{13}<V_{3N}$	$I_1=I_3$ $I_N=0$	P3	P1	PN	+C3-C3 Normal	+C1-C1 Normal	<p>Voltage are connected the order of P3- P1- PN, and both of CTs are switched to each other.</p>					
	LEAD 0.866			150	330														
	1.000			180	0														
	LAG 0.866			210	30														
	LAG 0.707			225	45														
38	LEAD 0.707	0	0	135	135	$W_1$ =Negative value $W_3$ =Negative value	$V_{1N}=V_{13}<V_{3N}$	$I_1=I_3<I_N$	P3	P1	PN	+C3-C3 Reverse	+C1-C1 Normal	<p>Voltage are connected the order of P3- P1- PN, both of CTs switch to each other, and '+C3' and 'C3' are reversed.</p>					
	LEAD 0.866			150	150														
	1.000			180	180														
	LAG 0.866			210	210														
	LAG 0.707			225	225														
39	LEAD 0.707	0	0	315	315	$W_1<W_3$	$V_{1N}=V_{13}<V_{3N}$	$I_1=I_3<I_N$	P3	P1	PN	+C3-C3 Normal	+C1-C1 Reverse	<p>Voltage are connected the order of P3- P1- PN, both of CTs switch to each other, and '+C3' and 'C3' are reversed.</p>					
	LEAD 0.866			330	330														
	1.000			0	0														
	LAG 0.866			30	30														
	LAG 0.707			45	45														
40	LEAD 0.707	0	0	315	135	$W_1$ =Positive value $W_3$ =Negative value	$V_{1N}=V_{13}<V_{3N}$	$I_1=I_3$ $I_N=0$	P3	P1	PN	+C3-C3 Reverse	+C1-C1 Reverse	<p>Voltage are connected the order of P3- P1- PN, both of CTs are switched and reversed each other.</p>					
	LEAD 0.866			330	150														
	1.000			0	180														
	LAG 0.866			30	210														
	LAG 0.707			45	225														
41	LEAD 0.707	0	0	315	135	$W_1$ =Positive value $W_3$ =Negative value	$V_{1N}>V_{3N}=V_{13}$	$I_1=I_3$ $I_N=0$	PN	P3	P1	+C3-C3 Normal	+C1-C1 Normal	<p>Voltage are connected the order of PN-P3- P1, and both of CTs are switched to each other.</p>					
	LEAD 0.866			330	150														
	1.000			0	180														
	LAG 0.866			30	210														
	LAG 0.707			45	225														

## 9. Appendix

### 9.3. A List of Examples for Incorrect Wiring Display

#### 9.3.3. 1-phase 3-wire System

No.	Power Factor (Input)	At balanced load ( $V_{1N}=V_{3N}$ (or $V_{2N}$ ), $I_1=I_3$ (or $I_2$ ))											Connection (Note 1)					
		Phase Angle Display				Active Power Display		Voltage Display			Current Display			Voltage		Current		Connection
		$\angle V_{1N}$	$\angle V_{3N}$	$\angle I_1$	$\angle I_3$	$W_1$	$W_3$	$V_{1N}$	$V_{3N}$	$V_{13}$	$I_1$	$I_N$	$I_3$	1	N	3	1 side CT	
42	LEAD 0.707			315	315	$W_1 > W_3$	$V_{1N} > V_{3N} = V_{13}$	$I_1 = I_3 < I_N$	PN	P3	P1	+C3-C3 Reverse	+C1-C1 Normal	<p>Voltage are connected the order of PN-P3-P1, both of CTs switch to each other, and '+C3' 'C3' are reversed.</p>				
	LEAD 0.866			330	330													
	1.000	0	0	0	0													
	LAG 0.866			30	30													
	LAG 0.707			45	45													
43	LEAD 0.707			135	135	$W_1 = \text{Negative value}$ $W_3 = \text{Negative value}$	$V_{1N} > V_{3N} = V_{13}$	$I_1 = I_3 < I_N$	PN	P3	P1	+C3-C3 Normal	+C1-C1 Reverse	<p>Voltage are connected the order of PN-P3-P1, both of CTs switch to each other, and '+C1' 'C1' are reversed.</p>				
	LEAD 0.866			150	150													
	1.000	0	0	180	180													
	LAG 0.866			210	210													
	LAG 0.707			225	225													
44	LEAD 0.707			135	315	$W_1 = \text{Negative value}$ $W_3 = \text{Positive value}$	$V_{1N} > V_{3N} = V_{13}$	$I_1 = I_3$ $I_N = 0$	PN	P3	P1	+C3-C3 Reverse	+C1-C1 Reverse	<p>Voltage are connected the order of PN-P3-P1, both of CTs are switched and reversed each other.</p>				
	LEAD 0.866			150	330													
	1.000	0	0	180	0													
	LAG 0.866			210	30													
	LAG 0.707			225	45													
45	LEAD 0.707			315	315	$W_1 = \text{Positive value}$ $W_3 = \text{Negative value}$	$V_{1N} = V_{3N} < V_{13}$	$I_1 = I_3 < I_N$	P3	PN	P1	+C3-C3 Reverse	+C1-C1 Normal	<p>P1 and P3 are reversed, in addition, both of CTs are switched to each other, and the '+C3' and 'C3' are reversed.</p>				
	LEAD 0.866			330	330													
	1.000	0	180	0	0													
	LAG 0.866			30	30													
	LAG 0.707			45	45													
46	LEAD 0.707			135	135	$W_1 = \text{Negative value}$ $W_3 = \text{Positive value}$	$V_{1N} = V_{3N} < V_{13}$	$I_1 = I_3 < I_N$	P3	PN	P1	+C3-C3 Normal	+C1-C1 Reverse	<p>P1 and P3 are reversed, in addition, both of CTs are switched to each other, and the '+C1' and 'C1' are reversed.</p>				
	LEAD 0.866			150	150													
	1.000	0	180	180	180													
	LAG 0.866			210	210													
	LAG 0.707			225	225													
47	LEAD 0.707			135	315	$W_1 = \text{Negative value}$ $W_3 = \text{Negative value}$	$V_{1N} = V_{3N} < V_{13}$	$I_1 = I_3$ $I_N = 0$	P3	PN	P1	+C3-C3 Reverse	+C1-C1 Reverse	<p>P1 and P3 are reversed, in addition, both of CTs are switched and reversed each other.</p>				
	LEAD 0.866			150	330													
	1.000	0	180	180	0													
	LAG 0.866			210	30													
	LAG 0.707			225	45													

Note1: The above examples for incorrect wiring are typical. Extreme cases are excluded such as burnout or destruction of the instrument, VT, or CT caused by voltage application to a current circuit or current application to a voltage circuit.

# MITSUBISHI Electronic Multi-Measuring Instrument

## Service Network

Country/Region	Corporation Name	Address	Telephone
Australia	Mitsubishi Electric Australia Pty. Ltd.	348 Victoria Road, Rydalmere, N.S.W. 2116, Australia	+61-2-9684-7777
Algeria	Mec Casa	Rue I N 125 Hay-Es-Salem, 02000, W-Chief, Algeria	+213-27798069
Bangladesh	PROGRESSIVE TRADING CORPORATION	HAQUE TOWER 2ND FLOOR, 610/11, JUBILEE ROAD, CHITTAGONG, BANGLADESH	+880-31-624307
	ELECTRO MECH AUTOMATION & ENGINEERING LTD.	SHATABDI CENTER, 12TH FLOOR, SUITES: 12-B, 292, INNER CIRCULAR ROAD, FAKIRA POOL, MOTIJHEEL, DHAKA-1000, BANGLADESH	+88-02-7192826
Belarus	Tehnikon	Oktyabrskaya 19, Off. 705, BY-220030 Minsk, Belarus	+375 (0)17 / 210 46 26
Belgium	Koning & Hartman B.V.	Woluwelaan 31, BE-1800 Vilvoorde, Belgium	+32 (0)2 / 2570240
Brazil	Mitsubishi Electric do Brasil Comércio e Serviços Ltda.	Avenida Adelino Cardana, 293 21 andar Bethaville, Barueri SP, Brasil	+55-11-4689-3000
Cambodia	DHINIMEX CO.,LTD	#245, St. Tep Phan, Phnom Penh, Cambodia	+855-23-997-725
Central America	Automation International LLC	7050 W. Palmetto Park Road Suite #15 PMB #555, Boca Raton, FL 33433	+1-561-237-5228
Chile	Rhona S.A. (Main office)	Vte. Agua Santa 4211 Casilla 30-D (P.O. Box) Vina del Mar, Chile	+56-32-2-320-600
China	Mitsubishi Electric Automation (China) Ltd.	Mitsubishi Electric Automation Building, No.1386 Hongqiao Road, Shanghai, China 200336	+86-21-2322-3030
	Mitsubishi Electric Automation (China) Ltd. Beijing	5/F, ONE INDIGO, 20 Jiuxianqiao Road Chaoyang District, Beijing, China 100016	+86-10-6518-8830
	Mitsubishi Electric Automation (China) Ltd. ShenZhen	Level 8, Galaxy World Tower B, 1 Yabao Road, Longgang District, Shenzhen, China 518129	+86-755-2399-8272
	Mitsubishi Electric Automation (China) Ltd. GuangZhou	Rm.1006, A1 Times E-Park, No.276-282, Hanxi Road East, Zhongcun Street, Panyu Distric, Guangzhou, China 510030	+86-20-8923-6730
	Mitsubishi Electric Automation (China) Ltd. ChengDu	1501-1503, 15F, Guang-hua Centre Building-C, No.98 North Guang Hua 3th Rd Chengdu, China 610000	+86-28-8446-8030
	Mitsubishi Electric Automation (Hong Kong) Ltd.	20/F., Cityplaza One, 1111 King's Road, Taikoo shing, Hong Kong	+852-2510-0555
Colombia	Proelectrico Representaciones S.A.	Carrera 42 No 75 – 367 Bodega 109, Itagüí, Medellín, Antioquia, Colombia	+57-4-4441284
Czech Republic	AUTOCONT CONTROL SYSTEMS S.R.O	Technologická 374/6, CZ-708 00 Ostrava - Pustkovec	+420 595 691 150
Denmark	BEIJER ELECTRONICS A/S	LYKKEGÅRDSVEJ 17, DK-4000 ROSKILDE, Denmark	+45 (0)46 / 75 76 66
Egypt	Cairo Electrical Group	9, Rostoum St. Garden City P.O. Box 165-11516 Maglis El-Shaab, Cairo - Egypt	+20-2-27961337
France	Mitsubishi Electric Europe B.V. French Branch	FR-92741 Nanterre Cedex	+33 (0)1 55 68 57 01
Germany	Mitsubishi Electric Europe B.V.	Mitsubishi-Electric-Platz 1, 40882 Ratingen, Germany	+49 (0) 2102 4860
Greece	KALAMARAKIS - SAPOUNAS S.A.	IONIAS & NEROMILOU STR., CHAMOMILOS ACHARNES, ATHENS, 13678 Greece	+30-2102 406000
	UTECCO	5, MAVROGENOUS STR., 18542 PIRAEUS, Greece	+30-211-1206-900
Hungary	Meltrade Ltd.	Fertő utca 14, HU-1107 Budapest, Hungary	+36 (0)1-431-9726
India	Mitsubishi Electric India Private Limited	2nd Floor, Tower A&B, Cyber Greens, DLF Cyber City, DLF Phase-III, Gurgaon - 122 022 Haryana, India	+91-124-4630300
	Mitsubishi Electric India Private Limited Pune Sales Office	ICC-Devi Gaurav Technology Park, Unit no. 402, Fourth Floor, Survey no. 191-192 (P), Opp. Vallabh Nagar Bus Depot, Pune – 411018, Maharashtra, India	+91-20-68192100
	Mitsubishi Electric India Private Limited FA Center	204-209, 2nd Floor, 31FIVE, Corporate Road, Prahladnagar, Ahmedabad 380015, Gujarat, India	+91-79677-77888
Indonesia	PT.Mitsubishi Electric Indonesia	Gedung Jaya 8th floor, J.L.MH. Thamrin No.12 Jakarta Pusat 10340, Indonesia	+62-21-3192-6461
	P.T. Sahabat Indonesia	P.O.Box 5045 Kawasan Industri Perodangan, Jakarta, Indonesia	+62-(0)21-6610651-9
Ireland	Mitsubishi Electric Europe B.V.	Westgate Business Park, Ballymount, IRL-Dublin 24, Ireland	+353 (0)1-4198800
Israel	Gino Industries Ltd.	26, Ophir Street IL-32235 Haifa, Israel	+972 (0)4-867 0656
Italy	Mitsubishi Electric Europe B.V.	Viale Colleoni 7, I-20041 Agrate Brianza (MI), Italy	+39 039-60531
Kazakhstan	Kazpromavtomatika	Ul. Zhambyla 28, KAZ - 100017 Karaganda	+7-7212-501000
Korea	Mitsubishi Electric Automation Korea Co., Ltd	9F Gangseo Hangang xi-tower A, 401 Yangcheon-ro, Gangseo-gu, Seoul 07528 Korea	+82-2-3660-9573
Laos	AROUNKIT CORPORATION IMPORT-EXPORT SOLE CO.,LTD	SAPHANMO VILLAGE. SAYSETHA DISTRICT, VIENTIANE CAPITAL, LAOS	+856-20-415899
Lebanon	Comptoir d'Electricite Generale-Liban	Cebaco Center - Block A Autostrade Dora, P.O. Box 11-2597 Beirut - Lebanon	+961-1-240445
Lithuania	Rifas UAB	Tinklu 29A, LT-5300 Panevezys, Lithuania	+370 (0)45-582-728
Malaysia	Mitric Sdn Bhd	No. 5 Jalan Pemberita U1/49, Temasya Industrial Park, Glenmarie 40150 Shah Alam, Selangor, Malaysia	+603-5569-3748
Malta	ALFATRADE LTD	99 PAOLA HILL, PAOLA PLA 1702, Malta	+356 (0)21-697-816
Marocco	SCHIELE MAROC	KM 7.2 NOUVELLE ROUTE DE RABAT AIN SEBAA, 20600 Casablanca, Marocco	+212 661 45 15 96
Myanmar	Peace Myanmar Electric Co.,Ltd.	NO137/139 Botahtaung Pagoda Road, Botahtaung Town Ship 1161, Yangon, Myanmar	+95-(0)1-202589
Nepal	Watt&Volt House	KHA 2-65, Volt House Dillibazar Post Box:2108, Kathmandu, Nepal	+977-1-4411330
Netherlands	Imtech Marine & Offshore B.V.	Sluisjesdijk 155, NL-3087 AG Rotterdam, Netherlands	+31 (0)10-487-19 11
North America	Mitsubishi Electric Automation, Inc.	500 Corporate Woods Parkway, Vernon Hills, IL 60061 USA	+847-478-2100
Norway	Scanelec AS	Leirvikasen 43B, NO-5179 Godvik, Norway	+47 (0)55-506000
Mexico	Mitsubishi Electric Automation, Inc. Mexico Branch	Blvd. Miguel de Cervantes Saavedra 301, Torre Norte Piso 5, Col. Ampliación Granada, Miguel Hidalgo, Ciudad de México, CP 11520, México	+52-55-3067-7511
Middle East Arab Countries & Cyprus	Comptoir d'Electricite Generale-International-S.A.L.	Cebaco Center - Block A Autostrade Dora P.O. Box 11-1314 Beirut - Lebanon	+961-1-240430
Pakistan	Prince Electric Co.	2-P GULBERG II, LAHORE, 54600, PAKISTAN	+92-42-575232, 5753373
Peru	Rhona S.A. (Branch office)	Avenida Argentina 2201, Cercado de Lima	+51-1-464-4459
Philippines	MELCO Factory Automation Philippines Inc.	128, Lopez Rizal St., Brgy. Highway Hills, Mandaluyong City, Metro Manila, Philippines	+63-(0)2-256-8042
	Edison Electric Integrated, Inc.	24th Fl. Galleria Corporate Center, Edsa Cr. Ortigas Ave., Quezon City Metro Manila, Philippines	+63-(0)2-634-8691
Poland	Mitsubishi Electric Europe B.V. Polish Branch	Krakowska 48, 32-083 Balice, Poland	+48 12 347 65 00
Republic of Moldova	Intehsis SRL	bld. Traian 23/1, MD-2060 Kishinev, Moldova	+373 (0)22-66-4242
Romania	Sirius Trading & Services SRL	RO-060841 Bucuresti, Sector 6 Aleea Lacul Morii Nr. 3	+40-(0)21-430-40-06
Russia	Mitsubishi Electric (Russia) LLC	2 bld.1, Letnikovskaya street, Moscow, 115114, Russia	+7 495 721-2070
Saudi Arabia	Center of Electrical Goods	Al-Shuwayer St. Side way of Salahuddin Al-Ayoubi St. P.O. Box 15955 Riyadh 11454 - Saudi Arabia	+966-1-4770149
Singapore	Mitsubishi Electric Asia Pte. Ltd.	307 Alexandra Road, Mitsubishi Electric Building, Singapore 159943	+65-6473-2308
Slovakia	PROCONT, Presov	Kupelna 1/, SK - 08001 Presov, Slovakia	+421 (0)51 - 7580 611
	SIMAP	Jana Derku 1671, SK - 91101 Trenčin, Slovakia	+421 (0)32 743 04 72
Slovenia	Inea RBT d.o.o.	Stegne 11, SI-1000 Ljubljana, Slovenia	+386 (0)1-513-8116
South Africa	CBI-electric: low voltage	Private Bag 2016, ZA-1600 Isando Gauteng, South Africa	+27-(0)11-9282000
Spain	Mitsubishi Electric Europe B.V. Spanish Branch	Carretera de Rubi 76-80, E-08190 Sant Cugat del Vallés (Barcelona), Spain	+34 (0)93-565-3131
Sweden	Mitsubishi Electric Europe B.V. (Scandinavia)	Hedvig Möllers gata 6, 223 55 Lund, Sweden	+46 (0)8-625-10-00
	Euro Energy Components AB	Järnvägsqatan 36, S-434 24 Kungälv, Sweden	+46 (0)300-690040
Switzerland	TriElec AG	Muehentalstrasse 136, CH-8201 Schaffhausen, Switzerland	+41-(0)52-6258425
Taiwan	Setsuyo Enterprise Co., Ltd	5th Fl., No.105, Wu Kung 3rd, Wu-Ku Hsiang, Taipei, Taiwan, R.O.C.	+886-(0)2-2298-8889
Thailand	United Trading & Import Co., Ltd.	77/12 Bamrungmuang Road, Klong Mahanak Pomprab Bangkok Thailand	+66-223-4220-3
Tunisia	MOTRA Electric	3, Résidence Imen, Avenue des Martyrs Mourouj III, 2074 - El Mourouj III Ben Arous, Tunisia	+216-71 474 599
Turkey	Mitsubishi Electric Turkey A.S.	Şerifali Mahallesi Kale Sokak No: 41, 34775 Ümraniye, İstanbul, Turkey	+90-216-969-2666
United Kingdom	Mitsubishi Electric Europe B.V.	Travellers Lane, UK-Hatfield, Herts. AL10 8XB, United Kingdom	+44 (0)1707-276100
Uruguay	Fierro Vignoli S.A.	Avda. Uruguay 1274 Montevideo Uruguay	+598-2-902-0808
Vietnam	Mitsubishi Electric Vietnam Co.,Ltd. Head Office	11th & 12th Floor, Viettel Tower B, 285 Cach Mang Thang 8 Street, Ward 12, District 10, Ho Chi Minh City, Vietnam	+84-28-3910-5945
	Mitsubishi Electric Vietnam Co.,Ltd. Hanoi Branch	24th Floor, Handico Tower, Pham Hung Road, khu do thi moi Me Tri Ha, Nam Tu Liem District, Hanoi City, Vietnam	+84-24-3937-8075

**MITSUBISHI ELECTRIC CORPORATION**  
HEAD OFFICE: TOKYO BUILDING, 2-7-3, MARUNOUCHI, CHIYODA-KU, TOKYO 100-8310, JAPAN