

Mitsubishi Electric AC Servo System

MITSUBISHI ELECTRIC SERVO SYSTEM  
**MELSERVO-*JET***

Rotary Servo Motor  
User's Manual  
(HG-KNS/HG-SNS)

---

-HG-KNS\_  
-HG-SNS\_





# SAFETY INSTRUCTIONS

---

(Please read the instructions carefully before using the equipment.)

To use the equipment correctly, do not attempt to install, operate, maintain, or inspect the equipment until you have read through this manual, installation guide, and appended documents carefully. Do not use the equipment until you have a full knowledge of the equipment, safety information and instructions.





In this manual, the safety instruction levels are classified into "WARNING" and "CAUTION".

 <b>WARNING</b>	Indicates that incorrect handling may cause hazardous conditions, resulting in death or severe injury.
 <b>CAUTION</b>	Indicates that incorrect handling may cause hazardous conditions, resulting in medium or slight injury.

Note that the CAUTION level may lead to a serious consequence depending on conditions.

Please follow the instructions of both levels because they are important to personnel safety.

Forbidden actions and required actions are indicated by the following diagrammatic symbols.

	Indicates a forbidden action. For example, "No Fire" is indicated by  .
	Indicates a required action. For example, grounding is indicated by  .

In this manual, precautions for hazards that can lead to property damage, instructions for other functions, and other information are shown separately in the "POINT" area.

After reading this guide, keep it accessible to the operator.

## [Installation/wiring]

---

### **WARNING**

- To prevent an electric shock, turn off the power and wait for 15 minutes or more before starting wiring and/or inspection.
  - To prevent an electric shock, ground the rotary servo motor securely.
  - To prevent an electric shock, any person who is involved in wiring should be fully competent to do the work.
  - To prevent an electric shock, do not attempt to wire the rotary servo motor until it has been mounted.
  - To prevent an electric shock, do not touch the conductive parts.
- 

## [Installation/wiring]

---

### **CAUTION**

- To prevent injury, do not touch the rotor of the rotary servo motor during operation.
  - To prevent injury, transport the products correctly according to their mass.
  - To prevent injury, do not touch any sharp edges such as the sharp edges of the rotary servo motor with bare hands when handling the rotary servo motor.
- 

## [Maintenance]

---

### **WARNING**

- To prevent an electric shock, any person who is involved in inspection should be fully competent to do the work.
- 

## DISPOSAL OF WASTE

---

Please dispose of this product and other options according to your local laws and regulations.

## CABLES USED FOR WIRING

---

Wires mentioned in this manual are selected based on the ambient temperature of 40 °C.

## U.S. CUSTOMARY UNITS

---

U.S. customary units are not shown in this manual. Convert the values if necessary according to the following table.

Quantity	SI (metric) unit	U.S. customary unit
Mass	1 [kg]	2.2046 [lb]
Length	1 [mm]	0.03937 [inch]
Torque	1 [N·m]	141.6 [oz·inch]
Moment of inertia	1 [(× 10 <sup>-4</sup> kg·m <sup>2</sup> )]	5.4675 [oz·inch <sup>2</sup> ]
Load (thrust load/axial load)	1 [N]	0.2248 [lbf]
Temperature	N [°C] × 9/5 + 32	N [°F]



# CONTENTS

SAFETY INSTRUCTIONS .....	1
DISPOSAL OF WASTE .....	2
CABLES USED FOR WIRING .....	2
U.S. CUSTOMARY UNITS .....	2
<b>CHAPTER 1 INTRODUCTION</b> .....	<b>6</b>
1.1 Model designation .....	6
1.2 Rating plate .....	7
1.3 Environment .....	8
1.4 Parts identification .....	9
1.5 Electromagnetic brake .....	10
1.6 Rotary servo motor shaft shapes .....	12
1.7 Instructions on storage .....	13
1.8 Instructions on maintenance .....	13
1.9 Instructions on protection .....	13
<b>CHAPTER 2 INSTALLATION</b> .....	<b>14</b>
2.1 Mounting direction .....	15
2.2 Load mounting/dismounting precautions .....	16
2.3 Permissible load for the shaft .....	16
2.4 Protection from oil and water .....	17
2.5 Cable .....	17
2.6 Rotary servo motors with an oil seal .....	18
2.7 Inspection items .....	18
Periodic inspection .....	18
2.8 Parts with a service life .....	19
2.9 Machine accuracy .....	19
2.10 Mounting rotary servo motors .....	20
2.11 Restrictions when using this product at an altitude exceeding 1000 m and up to 2000 m .....	20
<b>CHAPTER 3 CONNECTORS USED FOR ROTARY SERVO MOTOR WIRING</b> .....	<b>21</b>
3.1 Selection of connectors .....	21
3.2 Wiring connectors (connector configurations A/B/C) .....	22
3.3 Wiring connectors (connector configurations D/E/F/G) .....	23
<b>CHAPTER 4 CONNECTION OF SERVO AMPLIFIER AND ROTARY SERVO MOTOR</b> .....	<b>27</b>
4.1 Precautions for wiring .....	28
4.2 Wiring .....	29
HG-KNS series .....	29
HG-SNS series .....	31
4.3 Selection example of wires .....	34
<b>CHAPTER 5 WIRING OPTION</b> .....	<b>35</b>
5.1 Cable/connector sets .....	35
Combinations of cable/connector sets .....	35
Cable and connector list .....	37
5.2 Encoder cable/connector sets .....	40

MR-J3ENCBL_M-_-	40
MR-J3JCBL03M-_-L	42
MR-J3JSCBL03M-_-L	44
MR-EKCBL_M-	46
MR-J3ENSCBL_M-	50
<b>5.3 Servo motor power cable</b>	<b>54</b>
<b>5.4 Electromagnetic brake cable</b>	<b>56</b>
<b>5.5 Wires for option cables</b>	<b>58</b>
<b>5.6 Shield procedure of CN2 side connectors</b>	<b>60</b>
<b>CHAPTER 6 HG-KNS SERIES</b>	<b>61</b>
<hr/>	
<b>6.1 Standard specifications</b>	<b>61</b>
Standard specifications list	61
Torque characteristics	62
<b>6.2 Combinations of servo amplifiers and rotary servo motors</b>	<b>63</b>
<b>6.3 Characteristics of electromagnetic brake</b>	<b>64</b>
<b>6.4 Rotary servo motors with special shafts</b>	<b>65</b>
Keyed shaft (with double round-ended key)	65
D cut shaft	65
<b>6.5 Rotary servo motors with an oil seal</b>	<b>66</b>
<b>6.6 Mounting connectors</b>	<b>67</b>
<b>6.7 Dimensions</b>	<b>68</b>
Standard (without an electromagnetic brake)	68
With an electromagnetic brake	73
<b>CHAPTER 7 HG-SNS SERIES</b>	<b>77</b>
<hr/>	
<b>7.1 Standard specifications</b>	<b>77</b>
Standard specifications list	77
Torque characteristics	79
<b>7.2 Combinations of servo amplifiers and rotary servo motors</b>	<b>80</b>
<b>7.3 Characteristics of electromagnetic brake</b>	<b>81</b>
<b>7.4 Rotary servo motors with special shafts</b>	<b>82</b>
Keyed shaft (without key)	82
<b>7.5 Rotary servo motors with an oil seal</b>	<b>83</b>
<b>7.6 Dimensions</b>	<b>84</b>
Standard (without an electromagnetic brake)	84
With an electromagnetic brake	87
<b>CHAPTER 8 COMPLIANCE WITH EACH REGION</b>	<b>90</b>
<hr/>	
<b>8.1 Compliance with CE marking</b>	<b>90</b>
CE marking	90
For compliance	90
<b>8.2 Compliance with UL/CSA standard</b>	<b>91</b>
Flange size	91
Selection example of wires	91
<b>CHAPTER 9 APPENDIX</b>	<b>92</b>
<hr/>	
<b>9.1 Rotary servo motor ID codes</b>	<b>92</b>
<b>9.2 Selection example of rotary servo motor power cable</b>	<b>93</b>
<b>9.3 Connector dimensions</b>	<b>94</b>

<b>9.4 Fabrication of the encoder cable</b> .....	<b>100</b>
REVISIONS.....	102
WARRANTY.....	103
TRADEMARKS.....	104

# 1 INTRODUCTION

## 1.1 Model designation

The following describes model designation. Not all combinations of the symbols are available.

HG - KNS 1 3 B J D

HG	KNS	1	3	B	J	D	Shaft type	
							Symbol	Shaft shape
							None	Standard (straight shaft)
							D	D cut shaft
							K	Keyed shaft *1
							Oil seal	
							Symbol	Oil seal
							None	Not attached
							J	Attached
							Electromagnetic brake	
Symbol	Electromagnetic brake							
None	Not attached							
B	Attached							
Rated speed								
Symbol	Rated speed [r/min]							
2	2000							
3	3000							
Rated output								
Symbol	Rated output [kW]							
1	0.1							
2	0.2							
4	0.4							
5	0.5							
7	0.75							
10	1.0							
15	1.5							
20	2.0							
30	3.0							
Series	Feature							
HG-KNS	Low inertia/small capacity							
HG-SNS	Medium inertia/medium capacity							

\*1 For the HG-SNS series, the key is not included.

# 1.2 Rating plate

Products applied by Certification Bodies are marked. The mark depends on the Certification Bodies.

The production year and month of the rotary servo motor are indicated in the serial number on the rating plate.







The year and month of manufacture are indicated by the last two digits of the year and one digit of the month [1 to 9, X (10), Y (11), and Z (12)].

For October 2019, the serial number would be "SER. \_\_\_\_\_ 19X".



The following shows an example of the rating plate for explanation of each item.

	→	 <b>MITSUBISHI ELECTRIC</b>	AC SERVO MOTOR SERVO MOTEUR AC
	→	HG-KNS13J	
Model	→	HG-KNS13J	
Input power supply, Rated current, Rated output	→	3AC 112 V 0.8 A 100W	
Mass, Insulation class	→	0.57 kg Cl.B, A(UL) CONT	
Rated speed	→	3000 r/min 0-250Hz	
Induced voltage constant, Maximum ambient temperature	→	31 mV/min <sup>-1</sup> 40°C	
Power factor, IP rating	→	P.F. 98% IP65	
Serial number	→	SER.M00001234 19X	
Country of origin, Conforming standards	→	MADE IN JAPAN IEC60034-1 FABRIQUE AU JAPON IEC61800-3	
Manufacturer	→	MITSUBISHI ELECTRIC CORPORATION TOKYO 100-8310 JAPAN	

		
		

# 1.3 Environment

Condition	Operation	Storage
Ambient temperature	0 °C to 40 °C (non-freezing)	-15 °C to 70 °C (non-freezing)
Ambient humidity	10 %RH to 80 %RH (non-condensing)	10 %RH to 90 %RH (non-condensing)
Ambience *1	Indoors (no direct sunlight); no corrosive gas, inflammable gas, oil mist or dust	
Altitude	2000 m or less *2	
Vibration resistance	Refer to the following.  Page 61 Standard specifications  Page 77 Standard specifications	

\*1 Do not use in an environment where there is exposure to oil mist, oil, and water.

\*2 Refer to the following for restrictions on using this product at an altitude exceeding 1000 m above sea level.

 Page 20 Restrictions when using this product at an altitude exceeding 1000 m and up to 2000 m

# 1.4 Parts identification

## HG-KNS series

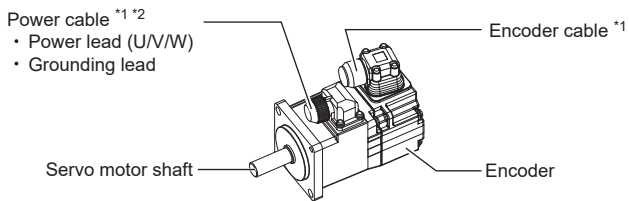

\*1 The encoder cable and power supply cable are options.

\*2 An electromagnetic brake cable is also required for servo motors with an electromagnetic brake.

## HG-SNS series

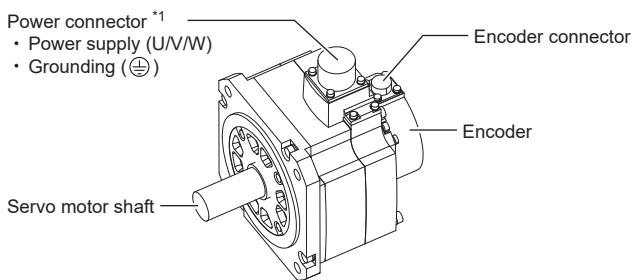

\*1 An electromagnetic brake connector is also provided for servo motors with an electromagnetic brake.

# 1.5 Electromagnetic brake

The rotary servo motor with an electromagnetic brake can be used to prevent a drop in vertical lift applications or to ensure double safety at an emergency stop, for example. When operating the rotary servo motor, supply power to the electromagnetic brake to release the brake. Switching power off enables the electromagnetic brake.

## Precautions

- The electromagnetic brake on the rotary servo motor is designed to hold the motor shaft and should not be used for ordinary braking.
- Incorrect wiring, service life, or the mechanical structure (e.g. where a ball screw and the rotary servo motor are coupled via a timing belt) may cause the electromagnetic brake to be unable to hold the motor shaft. To ensure safety, install a stopper on the machine side.
- If it is assumed that a power failure or product malfunction may result in a hazardous situation, use a rotary servo motor with an electromagnetic brake or provide an external brake system for holding purpose to prevent such hazard.
- Configure an electromagnetic brake circuit which is interlocked with an external emergency stop switch.

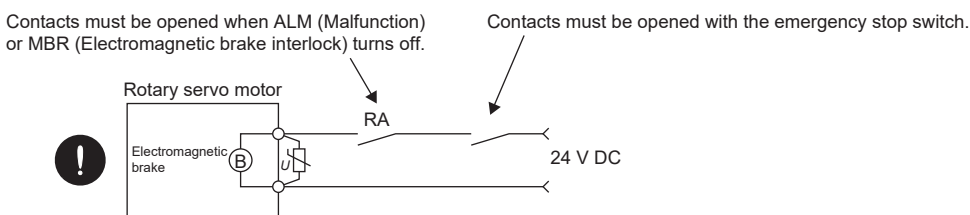

- The electromagnetic brake is provided to prevent a drop at a power failure or servo alarm occurrence during vertical drive or to hold a shaft at a stop. Do not use it for normal braking (including braking at servo-lock).
- The electromagnetic brake has a time lag. Ensure enough time between releasing the electromagnetic brake and starting the rotary servo motor. Be sure to check the operation delay time with an actual machine.
- For details of the circuit configuration and timing chart, refer to the following.

### MR-JET User's Manual (Hardware)

- When the electromagnetic brake is released, the temperature of the rotary servo motor may increase regardless of driving.
- The service life of the brake may be shortened under sudden acceleration/deceleration conditions.

## Electromagnetic brake power supply

Prepare the following power supply for use with the electromagnetic brake only. The electromagnetic brake terminals (B1 and B2) have no polarity.

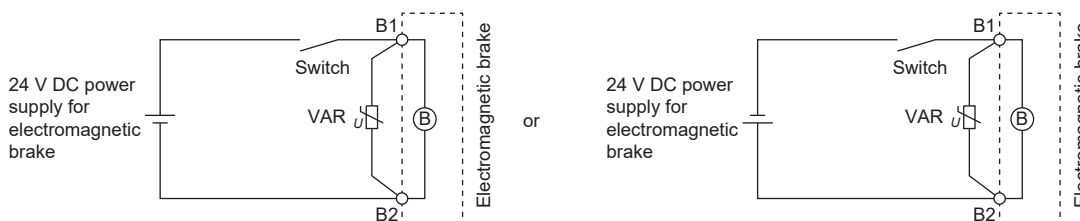

A surge absorber (VAR) must be installed between B1 and B2. For a selection example of surge absorbers, refer to the "Characteristics of electromagnetic brake" section appropriate for the rotary servo motor series being used.

When a diode is used as a surge absorber, the electromagnetic braking time becomes longer.

## Sound generation

The brake lining may rattle during a low-speed operation; however, it poses no functional problem.

The noise may be reduced or eliminated by the machine resonance suppression filter set with the servo amplifier parameters. For details, refer to "Machine resonance suppression filter" in the following manual.

### MR-JET User's Manual (Adjustment)



## Selection of surge absorbers for electromagnetic brake circuit

The following shows an example of how to select a varistor as a surge absorber.

### ■ Selection condition

Item	Condition
Electromagnetic brake specification	R [Ω]: Resistance L [H]: Inductance Vb [V]: Power supply voltage
Desired suppression voltage	Vs [V] or less
Durable surge application time	N times

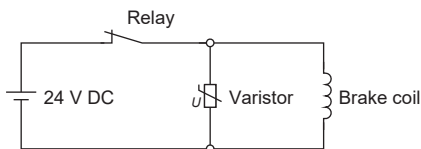

### ■ Tentative selection and verification of surge absorber

- Maximum permissible circuit voltage of varistor

Tentatively select a varistor whose maximum permissible voltage is larger than Vb [V].

- Brake current (Ib)

$$I_b = \frac{V_b}{R} \text{ [A]}$$

- Energy (E) generated by brake coil

$$E = \frac{L \times I_b^2}{2} \text{ [J]}$$

- Varistor limit voltage (Vi)

From the energy (E) generated in the brake coil and the varistor characteristic diagram, calculate the varistor limit voltage (Vi) when the brake current (Ib) flows into the tentatively selected varistor during opening of the circuit.

Vi is favorable when the varistor limit voltage (Vi) [V] is smaller than the desired suppressed voltage (Vs) [V].

If Vi is not smaller than Vs, reselect a varistor or improve the withstand voltage of devices.

- Surge current width (τ)

Given that the varistor absorbs all energies, the surge current width (τ) is as follows.

$$\tau = \frac{E}{V_i \times I_b} \text{ [S]}$$

- Examining surge life of varistor

From the varistor characteristic diagram, find the guaranteed current value (Ip) in which the number of the surge application life is N at the surge current width (τ). Calculate the guaranteed current value (Ip) ratio (Ip/Ib) to brake current (Ib).

If a sufficient margin is ensured for Ip/Ib, the number of the surge application life N [time] can be considered as favorable.

### Other precautions

A leakage magnetic flux occurs at the shaft end of the servo motor with an electromagnetic brake. Note that chips, screws, and other debris are attracted.

# 1.6 Rotary servo motor shaft shapes

There are three shaft shape types for the rotary servo motor: keyed shaft (with double round-ended key), keyed shaft (without key), and D cut shaft.

To prevent damage to the shaft, do not use the keyed shaft (with double round-ended key), keyed shaft (without key), and D cut shaft for frequent start/stop applications. Use a friction coupling or the like when coupling the shaft with a machine.

## Keyed shaft (with double round-ended key)

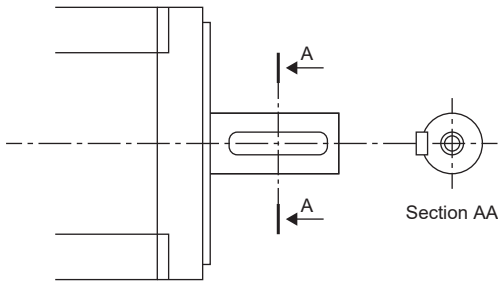

## Keyed shaft (without key)

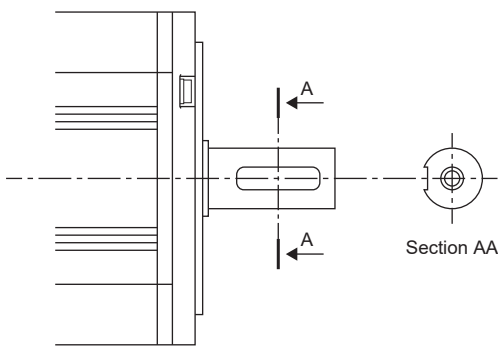

## D cut shaft

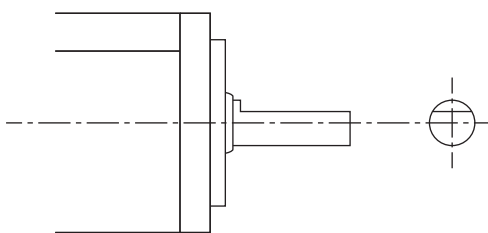

## Straight shaft

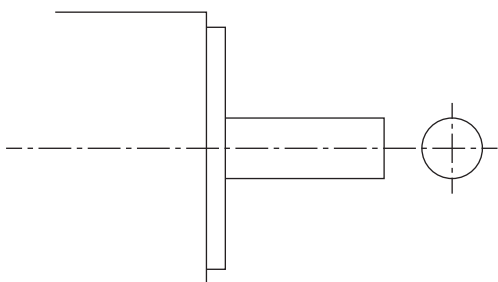

## 1.7 Instructions on storage

---

### Precautions

Note the following when storing the rotary servo motor for an extended period of time (guideline: three or more months).

- Always store the linear servo motor indoors, in a clean and dry place.
- When storing in a dusty and humid area, take measures such as covering the whole product.
- If the insulation resistance of the winding decreases, check how to store the equipment.
- Although the servo motor has been given rust prevention treatment with paint and preventive oil before shipment, rust may still appear depending on the storage period and conditions. If the servo motor is to be stored for longer than six months, apply rust prevention oil again, especially to the machined surfaces of the shaft and other parts.
- Before using the product after storage for an extended period of time, hand-turn the rotary servo motor output shaft, and check to ensure that there is no abnormality. For the rotary servo motor with an electromagnetic brake, check it after releasing the electromagnetic brake with the brake power supply.
- When the product has been stored for an extended period of time, contact your local sales office.

## 1.8 Instructions on maintenance

---

### Precautions

- To prevent the scuffed surface, do not scratch the coated surface with hard objects nor clean the coated surface with an organic solvent.
- For repair and parts replacement, contact your local sales office.

## 1.9 Instructions on protection

---

### Precautions

- Provide an adequate protection to prevent unexpected restart after an instantaneous power failure.

# 2 INSTALLATION

---

## Precautions

- Install the rotary servo motor on incombustible material. Installing them directly or close to combustibles will lead to smoke or a fire.
- Provide an adequate protection to prevent screws and other conductive matter, oil and other combustible matter from entering the rotary servo motor.
- The temperature of the rotary servo motor may exceed 100 °C depending on the operating method. Take safety measures such as providing covers.
- The eyebolts of the rotary servo motor are only for transportation of the rotary servo motor.
- Do not use them to transport the rotary servo motor when it is mounted on a machine.
- Do not overtighten the eyebolts of the rotary servo motor. To prevent damage to the tap, avoid tightening too hard.
- Stacking in excess of the specified number of product packages is not allowed.
- Do not hold the cables, connectors, shaft, or encoder when carrying the rotary servo motor. Otherwise, it may drop.
- Install the rotary servo motor in a load-bearing place in accordance with the user's manual.
- Do not install or operate the rotary servo motor which has been damaged or have any parts missing.
- Securely fix the rotary servo motor to a machine. If attached insecurely, the motor may come off during operation.
- To prevent a connection failure, malfunction, or similar problem, do not strike the connector.
- Be sure to measure the motor vibration level with the rotary servo motor mounted on a machine when checking the vibration level. A great vibration may cause early damage to a bearing, encoder, and brake. The great vibration may also cause the poor connector connection or bolt looseness.
- For the gain adjustment at the equipment startup, check the torque waveform and the speed waveform with a measurement device to check that no vibration occurs. If the vibration occurs due to high gain, the vibration may cause early damage to the rotary servo motor.
- Use the product within the specified environment. For the environment conditions, refer to the specifications of the rotary servo motor series.
- To prevent a malfunction on the encoder, do not apply shocks, e.g. hit with a hammer, when coupling the shaft end of the rotary drive motor.
- To prevent the shaft from being broken, do not subject the shaft of the rotary servo motor to more than the permissible load.
- To prevent the shaft from being broken and bearing from being worn out, do not use a rigid coupling when coupling a load to the rotary servo motor.
- To prevent vibration during rotary servo motor operation, or the cause of a damage to the bearings and encoder, the balance level of the load needs to be as even as possible.
- To prevent a malfunction, do not use the rotary servo motor where the shaft-through portion may be subject to pressure (e.g. compressed air).
- Take safety measures such as provide covers, to prevent accidental access to the rotor of the rotary servo motor during operation.
- Do not get on or put heavy load on the equipment.
- Do not drop or strike the rotary servo motor.
- To prevent a fire or injury from occurring in case of an earthquake or other natural disasters, securely install, mount, and wire the linear servo motor in accordance with the user's manual.
- Do not disassemble, repair, or modify the product.
- The equipment must be installed in the specified direction.

## 2.1 Mounting direction

The mounting direction of the rotary servo motor is shown in the following table.

Rotary servo motor series	Mounting direction
HG-KNS HG-SNS	All directions

It is recommended that the connector section be set downward for mounting the rotary servo motor in the horizontal direction. Examine the cable clamping method, and give a gentle slack to the connection cable, to prevent excessive load from being applied to the connector and cable connection part.

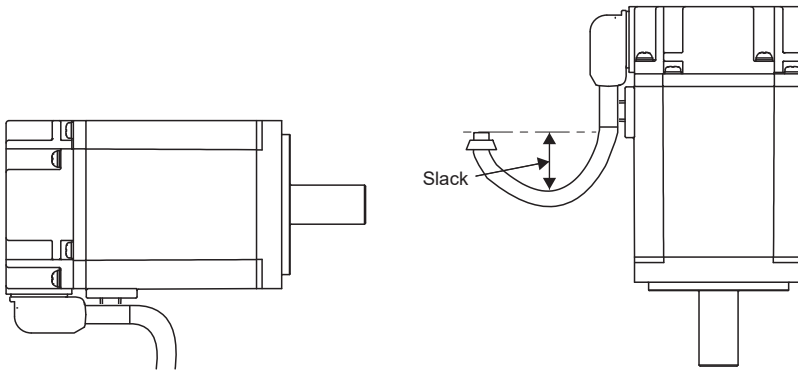

### Rotary servo motor with an electromagnetic brake

The rotary servo motor with an electromagnetic brake can also be mounted in the same directions as the one without an electromagnetic brake. When the servo motor with an electromagnetic brake is mounted with the shaft end upward, the brake plate may generate sliding sound but it is not a fault.

## 2.2 Load mounting/dismounting precautions

- When mounting a pulley to the rotary servo motor with a keyed shaft, use the screw hole in the shaft end. To fit the pulley, first insert a double-end bolt into the screw hole of the shaft, put a washer against the end face of the coupling, and insert and tighten a nut to force the pulley in.

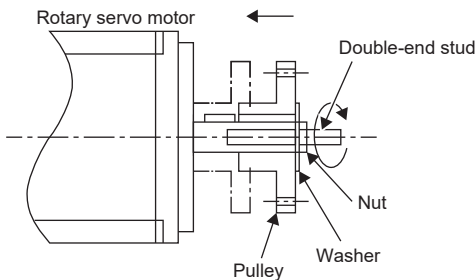

- For shafts without a keyway, use a friction coupling or the like for coupling the rotary servo motor with a load.
- When removing the pulley, use a pulley remover to protect the shaft from excessive load and impact.
- To ensure safety, fit a protective cover or the like on the rotary area, such as the pulley, mounted to the shaft.
- When a threaded shaft end part is needed to mount a pulley on the shaft, please contact your local sales office.
- The direction of the encoder on the rotary servo motor cannot be changed.
- When mounting the rotary servo motor, use spring washers or similar parts and fully tighten the bolts so that they do not become loose due to vibration.

### Precautions

- To prevent a malfunction on the encoder, the shaft end must not be hammered during assembling.

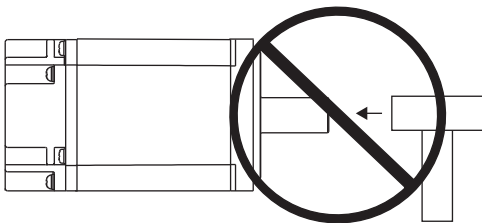

- Do not process the shaft to avoid damage to the encoder and bearing.

## 2.3 Permissible load for the shaft

For the permissible load for the shaft specific to the rotary servo motor, refer to the chapter of the rotary servo motor series.

- Use a flexible coupling and adjust the misalignment of the shaft to less than the permissible radial load.
- When using a pulley, sprocket, or timing belt, keep the radial load within the permissible value.
- Exceeding the permissible load can cause deterioration of the bearing and damage to the shaft.
- The load indicated in this section is static load in a single direction and does not include eccentric load. To prevent the rotary servo motor being damaged, make eccentric load as small as possible.

### Precautions

Do not use a rigid coupling as it may apply excessive bending load to the shaft of the rotary servo motor, leading the shaft to break and the bearing to wear out.

## 2.4 Protection from oil and water

Provide adequate protection to prevent foreign matter, such as oil from entering the rotary servo motor shaft. When installing the rotary servo motor, consider the items in this section.

- Do not use the rotary servo motor with its cable soaked in oil or water.

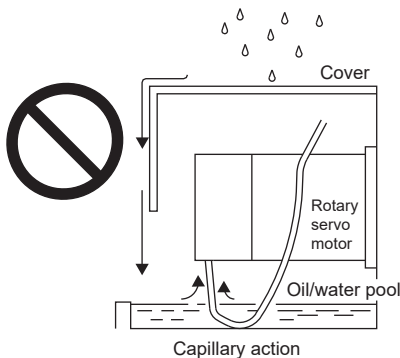

- When the servo motor is to be installed with the shaft end upward, provide measures so that it is not exposed to oil and water entering from the machine side, gear box, etc.

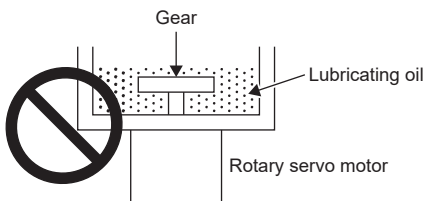

- If oil such as cutting oil splashes on the servo motor, the sealant, packing, cable, and other parts may be affected depending on the oil type.
- In the environment where the rotary servo motor is exposed to oil mist, oil, or water, the rotary servo motor of the standard specifications may not be usable. Please contact your local sales office.

## 2.5 Cable

The power supply and encoder cables routed from the rotary servo motor should be fixed to the rotary servo motor to keep them unmovable. Otherwise, the cable may be disconnected. In addition, do not modify the connectors, terminals, and other areas at the ends of the cables.

### Precautions

The cables should not be damaged, stressed, loaded, or pinched.

## 2.6 Rotary servo motors with an oil seal

For rotary servo motors with an oil seal, the oil seal prevents the entry of oil into the rotary servo motor. Make sure to install it in accordance with this section.

Even if the oil seal on the rotary servo motor makes noises during operation, it does not indicate a problem with the functions.

### Pressure and oil level

Install the rotary servo motor horizontally, and set the oil level in the gear box to be always lower than the oil seal lip. If the oil level is higher than the oil seal lip, the oil enters the rotary servo motor and may cause a malfunction. Refer to the chapter of the rotary servo motor series for the height above oil level.

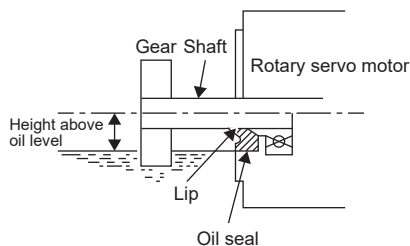

High pressure against the oil seal causes abrasion and shortens the service life of the product. Keep constant internal pressure by equipping a ventilator to the gear box.

### Temperature

If the lip reaches a high temperature, the service life of the oil seal will be shortened. Maximum applicable temperature of material of the oil lip is 100 °C, and the temperature of the oil lip increases by 10 °C to 15 °C at maximum rotation. Keep high-temperature oil away from the oil lip.

## 2.7 Inspection items

- To prevent a malfunction, do not perform an insulation resistance test (megger test) on the rotary servo motor.
- Do not disassemble and/or repair the equipment on customer side.

### Periodic inspection

Perform the following inspections.

- Check the bearings, brake section, and the like for unusual noise.
- Check the cables and the like for scratches or cracks. Especially when the cables are movable, perform periodic inspections according to operating conditions.
- Check the rotary servo motor shaft and coupling for misalignment.
- Check the power connector and encoder connector tightening screws for looseness.



## 2.8 Parts with a service life

The service life of the following parts is listed below. If any fault is found in a part, replace it immediately because its service life varies. For parts replacement, please contact your local sales office.

Part name	Recommended service life
Bearings	20000 hours to 30000 hours
Encoder	20000 hours to 30000 hours
Oil seal	5000 hours

2

### Bearings

When the motor is run at rated speed and at rated load, bearings should be changed in 20000 to 30000 hours as a guideline. As this differs depending on the operating conditions, the bearings must also be changed if unusual noise or vibration occurs during inspection.

### Oil seal

Oil seals must be changed in 5000 hours of operation at rated speed as a guideline. This differs depending on the operating conditions. The oil seals must also be changed if oil leakage a similar problem is found during inspection. Even if the oil seal on the rotary servo motor makes noises during operation, it does not indicate a problem with the functions.

## 2.9 Machine accuracy

The following table shows the machine accuracy of the output shaft and mounting parts of the rotary servo motor.

Accuracy [mm]	Measuring position	Flange size		
		□Less than 100	□130	□176
Runout of flange surface to output shaft	a)	0.05	0.06	0.08
Runout of fitting OD of flange surface	b)	0.04	0.04	0.06
Runout of output shaft end	c)	0.02	0.02	0.03

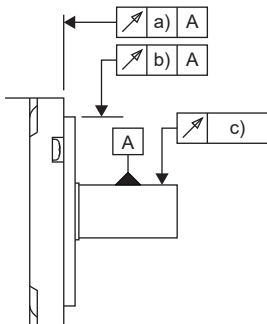

## 2.10 Mounting rotary servo motors

Be sure to use the rotary servo motor within the specified environment, and mount the rotary servo motor on a machine having the equivalent heat dissipation effect as the following aluminum flange.

The temperature of the rotary servo motor increases differently depending on its mounting environment, operating conditions, and other factors. Check the temperature with an actual machine.

Flange size [mm]	Rotary servo motor	
	HG-KNS	HG-SNS
250 × 250 × 6	13 23	—
250 × 250 × 12	43	52 102 152
300 × 300 × 12	73	—
300 × 300 × 20	—	202 302

## 2.11 Restrictions when using this product at an altitude exceeding 1000 m and up to 2000 m

As heat dissipation effects decrease in proportion to decreasing air density, use the product within the effective load ratio and regenerative load ratio shown in the following figure.

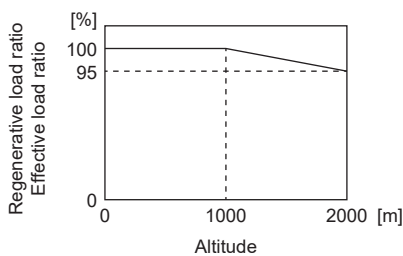

# 3 CONNECTORS USED FOR ROTARY SERVO MOTOR WIRING

## Precautions

- The indicated IP rating is the connector's protection against ingress of dust and water when the connector is connected to a rotary servo motor. If the IP rating of the connector and rotary servo motor varies, the overall IP rating depends on the lowest IP rating of all components.

## 3.1 Selection of connectors

Use the connector configuration products given in the table as the connectors for connection with the rotary servo motor.

Refer to the following for the compatible connector configuration products.

- ☞ Page 22 Wiring connectors (connector configurations A/B/C)
- ☞ Page 23 Wiring connectors (connector configurations D/E/F/G)

### HG-KNS series

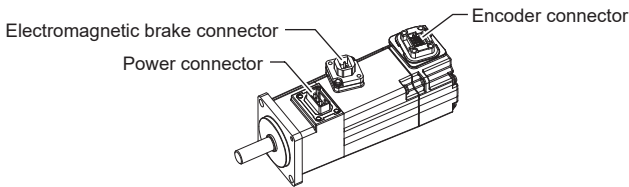

Rotary servo motor	Wiring connector		
	For encoder	For power supply	For electromagnetic brake
HG-KNS_	Connector configuration A	Connector configuration B	Connector configuration C

### HG-SNS series

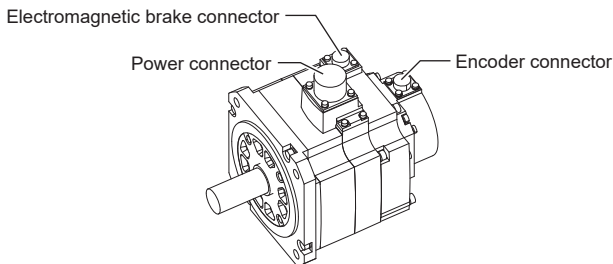

Rotary servo motor	Wiring connector		
	For encoder	For power supply	For electromagnetic brake
HG-SNS52 HG-SNS102 HG-SNS152	Connector configuration D	Connector configuration E	Connector configuration F
HG-SNS202 HG-SNS302		Connector configuration G	

## 3.2 Wiring connectors (connector configurations A/B/C)

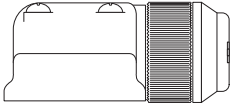

Connector configuration	Feature	Connector	Crimping tool	Rotary servo motor encoder connector *1
A (for encoder)	IP65	Connector: 2174053-1 (TE Connectivity)	For ground clip: 1596970-1 For receptacle contact: 1596847-1 (TE Connectivity)	1674339-1 (TE Connectivity)

\*1 The connector to be mated.

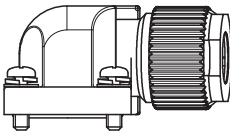

Connector configuration	Feature	Connector	Crimping tool	Rotary servo motor power connector *1
B (for power supply)	IP65	Connector: KN4FT04SJ1-R Hood/socket insulator/bushing/ground nut Contact: ST-TMH-S-C1B-100(A534G) (JAE)	CT170-14-TMH5B (JAE)	JN4AT04NJ1 (JAE)

\*1 The connector to be mated.

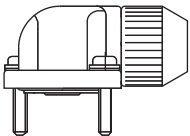

Connector configuration	Feature	Connector	Crimping tool	Rotary servo motor electromagnetic brake connector *1
C (for electromagnetic brake)	IP65	Connector: JN4FT02SJ1-R Hood/socket insulator/bushing/ground nut Contact: ST-TMH-S-C1B-100(A534G) (JAE)	CT170-14-TMH5B (JAE)	JN4AT02PJ1 (JAE)

\*1 The connector to be mated.

# 3.3 Wiring connectors (connector configurations D/E/F/G)

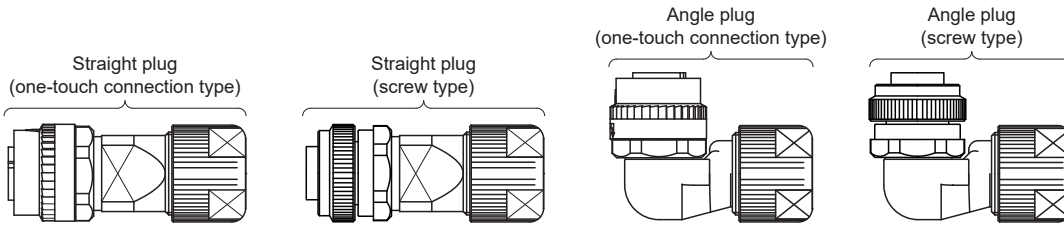

Connector configuration	Feature	Plug (DDK)					Rotary servo motor encoder connector *1	
		Type	Plug	Socket contact	Contact shape	Cable OD [mm] (reference)		
D (for encoder)	IP67	Straight	CMV1-SP10S-M1 (One-touch connection type) CMV1S-SP10S-M1 (Screw type)	CMV1-#22ASC-S1-100	Solder type Applicable wire size: AWG 20 or less	5.5 to 7.5	CMV1-R10P	
				CMV1-#22ASC-C1-100	Crimping type Applicable wire size: AWG 24 to 20 The crimping tool (357J-53162T) is required.			
				CMV1-#22ASC-C2-100	Crimping type Applicable wire size: AWG 28 to 24 The crimping tool (357J-53163T) is required.			
			CMV1-SP10S-M2 (One-touch connection type) CMV1S-SP10S-M2 (Screw type)	CMV1-#22ASC-S1-100	Solder type Applicable wire size: AWG 20 or less			7.0 to 9.0
				CMV1-#22ASC-C1-100	Crimping type Applicable wire size: AWG 24 to 20 The crimping tool (357J-53162T) is required.			
				CMV1-#22ASC-C2-100	Crimping type Applicable wire size: AWG 28 to 24 The crimping tool (357J-53163T) is required.			
		Angle	CMV1-AP10S-M1 (One-touch connection type) CMV1S-AP10S-M1 (Screw type)	CMV1-#22ASC-S1-100	Solder type Applicable wire size: AWG 20 or less	5.5 to 7.5		
				CMV1-#22ASC-C1-100	Crimping type Applicable wire size: AWG 24 to 20 The crimping tool (357J-53162T) is required.			
				CMV1-#22ASC-C2-100	Crimping type Applicable wire size: AWG 28 to 24 The crimping tool (357J-53163T) is required.			
			CMV1-AP10S-M2 (One-touch connection type) CMV1S-AP10S-M2 (Screw type)	CMV1-#22ASC-S1-100	Solder type Applicable wire size: AWG 20 or less			7.0 to 9.0
				CMV1-#22ASC-C1-100	Crimping type Applicable wire size: AWG 24 to 20 The crimping tool (357J-53162T) is required.			
				CMV1-#22ASC-C2-100	Crimping type Applicable wire size: AWG 28 to 24 The crimping tool (357J-53163T) is required.			

\*1 The connector to be mated.

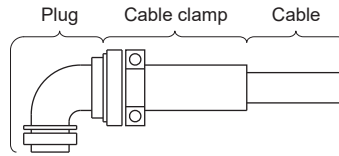
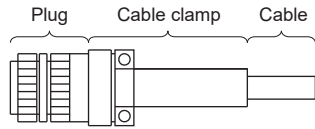

Connector configuration	Feature	Plug (DDK)		Cable clamp (DDK)		Rotary servo motor power connector *2
		Type	Model	Cable OD [mm] (reference)	Model	
E (for power supply)	IP67 EN compliant	Straight	CE05-6A18-10SD-D-BSS Applicable wire size: AWG 14 to 12	8.5 to 11	CE3057-10A-2-D	MS3102A18-10P
				10.5 to 14.1	CE3057-10A-1-D	
		Angle	CE05-8A18-10SD-D-BAS Applicable wire size: AWG 14 to 12	8.5 to 11	CE3057-10A-2-D	
				10.5 to 14.1	CE3057-10A-1-D	
	General environment *1	Straight	D/MS3106B18-10S Applicable wire size: AWG 14 to 12	14.3 or less (Bushing ID)		
Angle						D/MS3108B18-10S Applicable wire size: AWG 14 to 12

\*1 Does not comply with EN.

\*2 The connector to be mated.

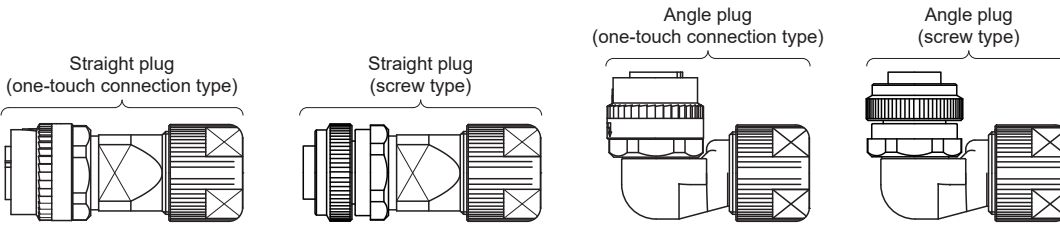

Connector configuration	Feature	Plug (DDK)					Rotary servo motor electromagnetic brake connector *1
		Type	Plug	Socket contact	Contact shape	Cable OD [mm] (reference)	
F (for electromagnetic brake)	IP67	Straight	CMV1-SP2S-S (One-touch connection type) CMV1S-SP2S-S (Screw type)	CMV1-#22BSC-S2-100	Solder type Applicable wire size: AWG 16 or less	4.0 to 6.0	CMV1-R2P
				CMV1-#22BSC-C3-100	Crimping type Applicable wire size: AWG 20 to 16 The crimping tool (357J-53164T) is required.		
			CMV1-SP2S-M1 (One-touch connection type) CMV1S-SP2S-M1 (Screw type)	CMV1-#22BSC-S2-100	Solder type Applicable wire size: AWG 16 or less	5.5 to 7.5	
				CMV1-#22BSC-C3-100	Crimping type Applicable wire size: AWG 20 to 16 The crimping tool (357J-53164T) is required.		
			CMV1-SP2S-M2 (One-touch connection type) CMV1S-SP2S-M2 (Screw type)	CMV1-#22BSC-S2-100	Solder type Applicable wire size: AWG 16 or less	7.0 to 9.0	
				CMV1-#22BSC-C3-100	Crimping type Applicable wire size: AWG 20 to 16 The crimping tool (357J-53164T) is required.		
		CMV1-SP2S-L (One-touch connection type) CMV1S-SP2S-L (Screw type)	CMV1-#22BSC-S2-100	Solder type Applicable wire size: AWG 16 or less	9.0 to 11.6		
			CMV1-#22BSC-C3-100	Crimping type Applicable wire size: AWG 20 to 16 The crimping tool (357J-53164T) is required.			
		Angle	CMV1-AP2S-S (One-touch connection type) CMV1S-AP2S-S (Screw type)	CMV1-#22BSC-S2-100	Solder type Applicable wire size: AWG 16 or less	4.0 to 6.0	
				CMV1-#22BSC-C3-100	Crimping type Applicable wire size: AWG 20 to 16 The crimping tool (357J-53164T) is required.		
			CMV1-AP2S-M1 (One-touch connection type) CMV1S-AP2S-M1 (Screw type)	CMV1-#22BSC-S2-100	Solder type Applicable wire size: AWG 16 or less	5.5 to 7.5	
				CMV1-#22BSC-C3-100	Crimping type Applicable wire size: AWG 20 to 16 The crimping tool (357J-53164T) is required.		
			CMV1-AP2S-M2 (One-touch connection type) CMV1S-AP2S-M2 (Screw type)	CMV1-#22BSC-S2-100	Solder type Applicable wire size: AWG 16 or less	7.0 to 9.0	
				CMV1-#22BSC-C3-100	Crimping type Applicable wire size: AWG 20 to 16 The crimping tool (357J-53164T) is required.		
CMV1-AP2S-L (One-touch connection type) CMV1S-AP2S-L (Screw type)	CMV1-#22BSC-S2-100	Solder type Applicable wire size: AWG 16 or less	9.0 to 11.6				
	CMV1-#22BSC-C3-100	Crimping type Applicable wire size: AWG 20 to 16 The crimping tool (357J-53164T) is required.					

\*1 The connector to be mated.

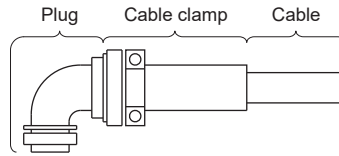
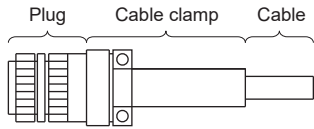

Connector configuration	Feature	Plug (DDK)		Cable clamp (DDK)		Rotary servo motor power connector *2	
		Type	Model	Cable OD [mm] (reference)	Model		
G (for power supply)	IP67 EN compliant	Straight	CE05-6A22-22SD-D-BSS Applicable wire size: AWG 10 to 8	9.5 to 13	CE3057-12A-2-D	MS3102A22-22P	
				12.5 to 16	CE3057-12A-1-D		
		Angle	CE05-8A22-22SD-D-BAS Applicable wire size: AWG 10 to 8	9.5 to 13	CE3057-12A-2-D		
				12.5 to 16	CE3057-12A-1-D		
	General environment *1	Straight	D/MS3106B22-22S Applicable wire size: AWG 10 to 8	15.9 or less (Bushing ID)			D/MS3057-12A

\*1 Does not comply with EN.

\*2 The connector to be mated.



# 4 CONNECTION OF SERVO AMPLIFIER AND ROTARY SERVO MOTOR

## Precautions

- Insulate the conductive parts of the terminals.
- To prevent unexpected operation of the rotary servo motor, wire the equipment correctly and securely.
- Make sure to connect the cables and connectors by using the fixing screws and the locking mechanism. Otherwise, the cables and connectors may be disconnected during operation.
- To prevent abnormal operation and malfunction, connect the servo amplifier power output (U/V/W) to the rotary servo motor power input (U/V/W) directly. Do not connect a magnetic contactor or the like between the servo amplifier power output and the rotary servo motor power input.

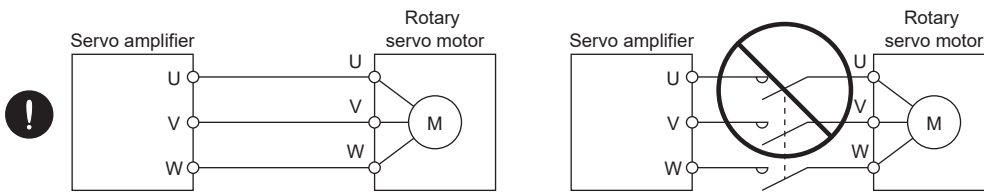

- To prevent a malfunction, do not connect AC power supply directly to the rotary servo motor.
- When the wires are not tightened enough to the terminal block, the wires or terminal block may generate heat because of the poor contact. Be sure to tighten the wires with specified torque.
- Use the rotary servo motor with the specified servo amplifier.
- Do not modify the equipment.
- To prevent malfunction, eliminate static electricity before wiring, switch operation, or similar operations.
- To prevent failure and malfunction, only the power/signal specified in the user's manual should be connected to each terminal.
- We recommend using HIV wires to connect the servo amplifier to the rotary servo motor. Therefore, the recommended wire sizes may be different from those of the wires used for previous generation rotary servo motors.

# 4.1 Precautions for wiring

For grounding, connect the grounding lead wire from the servo motor to the protective earth (PE) terminal of the servo amplifier, and then connect the wire from the servo amplifier to the ground via the protective earth of the cabinet. Do not connect the wire directly to the protective earth (PE) terminal of the cabinet.

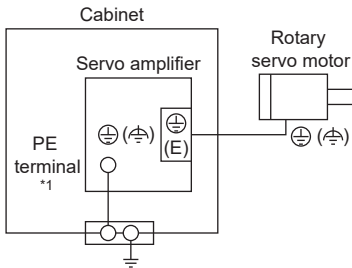

\*1 The number of PE terminals of the servo amplifier differs depending on the servo amplifier.

## Precautions

- Do not install a power capacitor, surge killer, or radio noise filter (optional FR-BIF) on the servo amplifier output side.
- To avoid a malfunction, connect the wires to the correct phase terminals (U/V/W) of the servo amplifier and the rotary servo motor.
- Do not use the 24 V DC interface power supply for the electromagnetic brake. To prevent malfunction, use the power supply designed exclusively for the electromagnetic brake.
- Refer to the following for the selection of encoder cables.

☞ Page 35 WIRING OPTION

- Refer to the chapter of the rotary servo motor series for the selection of a surge absorber for the electromagnetic brake.

## 4.2 Wiring

To wire to the servo amplifier, use connectors packed with the servo amplifier or optional connectors. For connectors, refer to "Wiring CNP1" in the following manual.

MR-JET User's Manual (Hardware)

### HG-KNS series

#### Servo motor power supply cable wiring diagrams

##### ■When cable length is 10 m or less

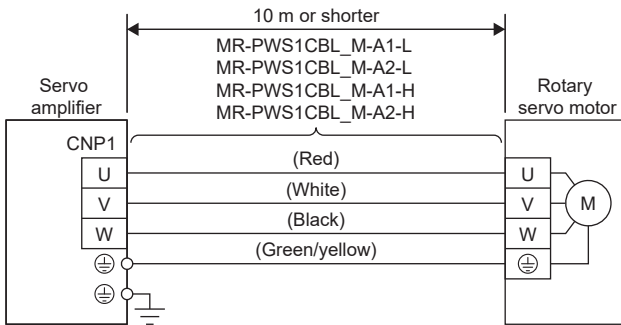

##### ■When cable length exceeds 10 m

Fabricate an extension cable as shown below. In addition, the motor power supply cable running from the rotary servo motor should be within 2 m.

Refer to the following for the wires used for the extension cable.

Page 34 Selection example of wires

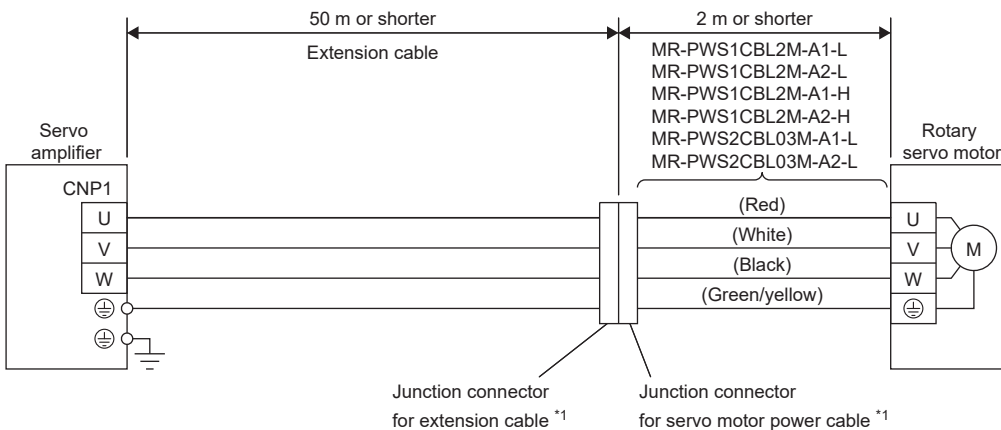

\*1 Use of the following connectors is recommended when ingress protection (IP65) is necessary.

Junction connector	Description	IP rating
Junction connector for extension cable	Connector: RM15WTPZ-4P(71) Cord clamp: JR13WCC-5(72) (Hirose Electric)      The number varies depending on the cable OD.	IP65
Junction connector for motor power cable	Connector: RM15WTJZ-4S(81) Cord clamp: JR13WCC-8(72) (Hirose Electric)      The number varies depending on the cable OD.	IP65

## Electromagnetic brake cable wiring diagrams

### ■When cable length is 10 m or less

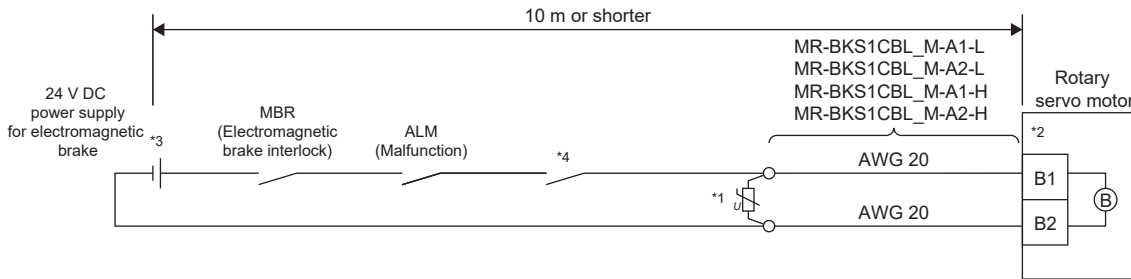

- \*1 Connect a surge absorber as close to the servo motor as possible.
  - \*2 The electromagnetic brake terminals (B1 and B2) have no polarity.
  - \*3 Do not use the 24 V DC interface power supply for the electromagnetic brake.
  - \*4 Configure a circuit which shuts off by being interlocked with the emergency stop switch.
- When fabricating electromagnetic brake cable MR-BKS1CBL\_M-, refer to the following.

- ☞ Page 54 Servo motor power cable
- ☞ Page 58 Wires for option cables

### ■When cable length exceeds 10 m

Fabricate an extension cable as shown below. In addition, the electromagnetic brake cable running from the rotary servo motor should be within 2 m.

Refer to the following for the wires used for the extension cable.

- ☞ Page 34 Selection example of wires

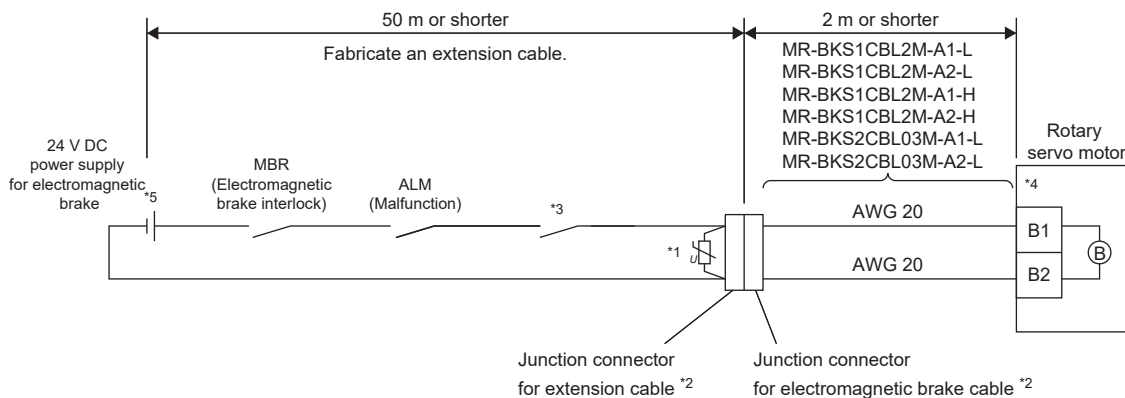

- \*1 Connect a surge absorber as close to the rotary servo motor as possible.
- \*2 Use of the following connectors is recommended when ingress protection (IP65) is necessary.

Junction connector	Description	IP rating
Junction connector for extension cable	CM10-CR2P- (DDK) └ Wire size: S, M, L	IP65
Junction connector for electromagnetic brake cable	CMV1-SP2S- (DDK) └ Wire size: S, M1, M2, L	IP65

- \*3 Configure a circuit which shuts off by being interlocked with the emergency stop switch.
- \*4 The electromagnetic brake terminals (B1 and B2) have no polarity.
- \*5 Do not use the 24 V DC interface power supply for the electromagnetic brake.

# HG-SNS series

Refer to the following for the wires used for wiring.

☞ Page 34 Selection example of wires

## Wiring diagram

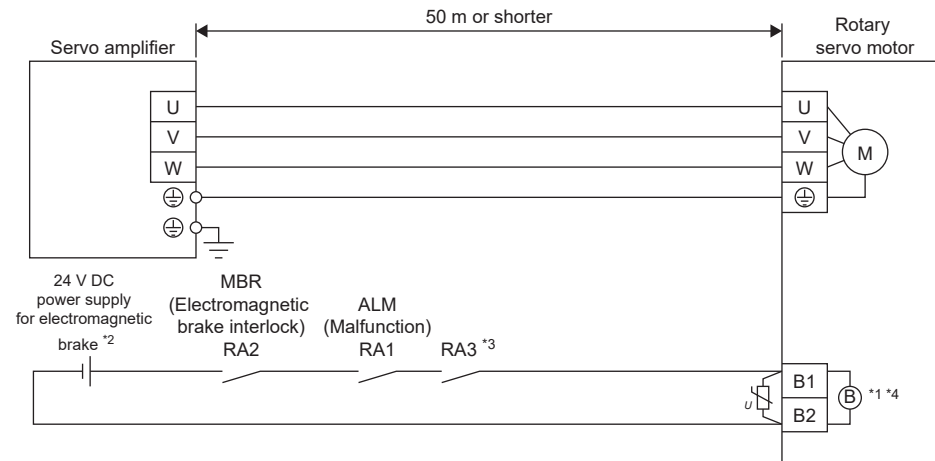

- \*1 The electromagnetic brake terminals (B1 and B2) have no polarity.
- \*2 Do not use the 24 V DC interface power supply for the electromagnetic brake.
- \*3 Configure a circuit which shuts off by being interlocked with the emergency stop switch.
- \*4 Some rotary servo motors do not have an electromagnetic brake. Refer to the chapter of the rotary servo motor series.

## Rotary servo motor terminal section

The rotary servo motor terminal section is shown in the following table.

Refer to the following for the details of the connectors.

☞ Page 32 Details of the rotary servo motor connectors

The connector fitting the rotary servo motor is prepared as options.

Refer to the following for details of the options.

☞ Page 35 WIRING OPTION

For types other than those prepared as options, refer to the following.

☞ Page 21 CONNECTORS USED FOR ROTARY SERVO MOTOR WIRING

### ■HG-SNS series

Rotary servo motor	Rotary servo motor terminal section		
	Encoder	Power supply	Electromagnetic brake
HG-SNS52 HG-SNS102 HG-SNS152	Connector A	Connector B	Connector D
HG-SNS202 HG-SNS302		Connector C	

## Details of the rotary servo motor connectors

The following figures show the encoder connector, power connector, and electromagnetic brake connector which are viewed from the connection side.

### ■Connector A

Encoder connector

CMV1-R10P

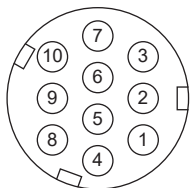

Terminal No.	Signal
1	MR
2	MRR
3	—
4	BAT
5	LG
6	—
7	—
8	P5
9	—
10	SHD

### ■Connector B

Power connector  
MS3102A18-10P

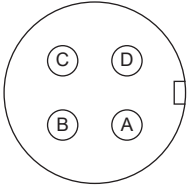

Terminal No.	Signal
A	U
B	V
C	W
D	⊖ (PE)

### ■Connector C

Power connector  
MS3102A22-22P

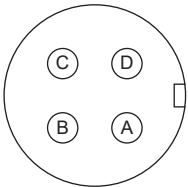

Terminal No.	Signal
A	U
B	V
C	W
D	⊖ (PE)

### ■Connector D

Electromagnetic brake connector  
CMV1-R2P

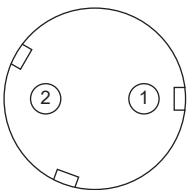

Terminal No.	Signal
1	B1 *1
2	B2 *1

\*1 Supply electromagnetic brake power (24 V DC). There is no polarity.

## 4.3 Selection example of wires

### Point

Wires indicated in this section are separated wires. When using a cable for power line (U/V/W) between the servo amplifier and rotary servo motor, use a 600 V grade EP rubber insulated chloroprene sheath cab-tire cable (2PNCT). For cable selection, refer to the following.

☞ Page 93 Selection example of rotary servo motor power cable

To comply with the UL/CSA standard, use the wires shown in the following for wiring.

☞ Page 91 Compliance with UL/CSA standard

To comply with other standards, use wires that comply with each standard.

Selection conditions of wire size are as follows.

- Construction condition: Single wire set in midair
- Wiring length: 30 m or shorter

The following shows the wires used for wiring. Use the wires given in this section or equivalent wires.

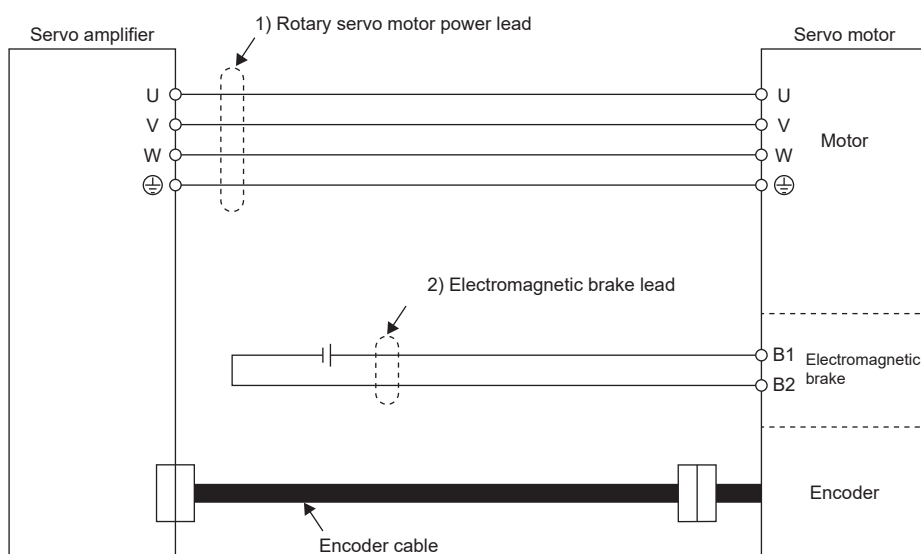

Wire size selection examples for the 600 V Grade heat-resistant polyvinyl chloride insulated wire (HIV wire) are indicated below.

Even when the maximum torque is increased, the applicable wire sizes are the same.

Rotary servo motor	Wire [mm <sup>2</sup> ]	
	1) U/V/W/⊕	2) B1/B2
HG-KNS13	0.75 (AWG 18) *1	0.5 (AWG 20) *1
HG-KNS23		
HG-KNS43		
HG-KNS73		
HG-SNS52	1.25 (AWG 16)	1.25 (AWG 16)
HG-SNS102		
HG-SNS152		
HG-SNS202		
HG-SNS302	3.5 (AWG 12)	

\*1 This applies when the wire length is 10 m. When fabricating an extension cable, use 1.25 mm<sup>2</sup> (AWG 16).



# 5 WIRING OPTION

## Precautions

- Use specified options. Otherwise, it may cause a malfunction or fire.
- MR-J3SCNS(A) and MR-ENCNS2(A) connector sets are packed with a plug and contacts. As using contacts for other plugs may damage the connector, use the enclosed contacts.
- Correctly wire options and peripheral equipment, etc. in the correct combination.
- We recommend using HIV wires to wire the rotary servo motors, options, and peripheral equipment. Therefore, the recommended wire sizes may be different from those of the used wires for the previous rotary servo motors.

## 5.1 Cable/connector sets

### Point

The indicated IP rating is the cable and connector's protection against ingress of dust and water when the cable and connector are connected to a rotary servo motor. If the IP rating of the cable, connector, and rotary servo motor varies, the overall IP rating depends on the lowest IP rating of all components.

Please purchase the cable and connector options indicated in this section for the rotary servo motor. When fabricating an encoder cable, refer to the following.

☞ Page 100 Fabrication of the encoder cable

## Combinations of cable/connector sets

### HG-KNS series

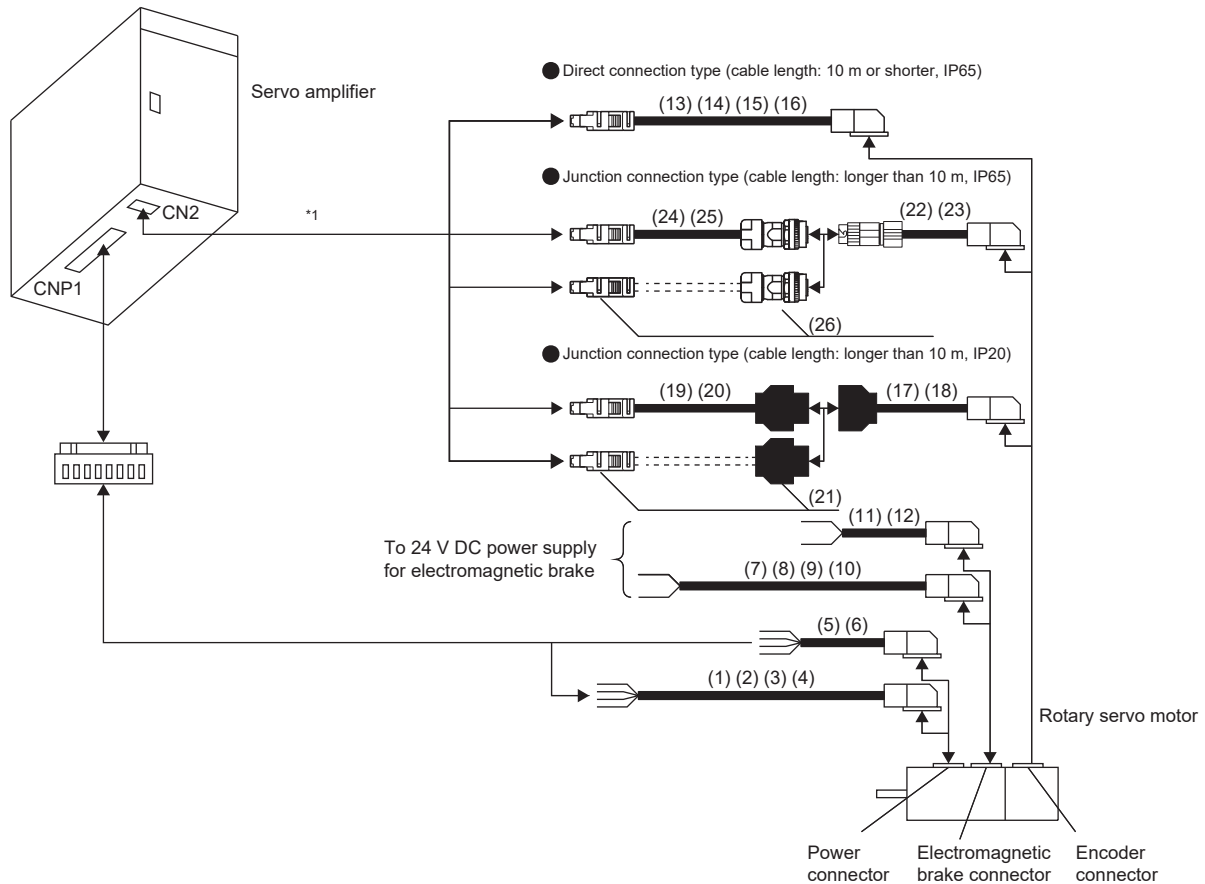



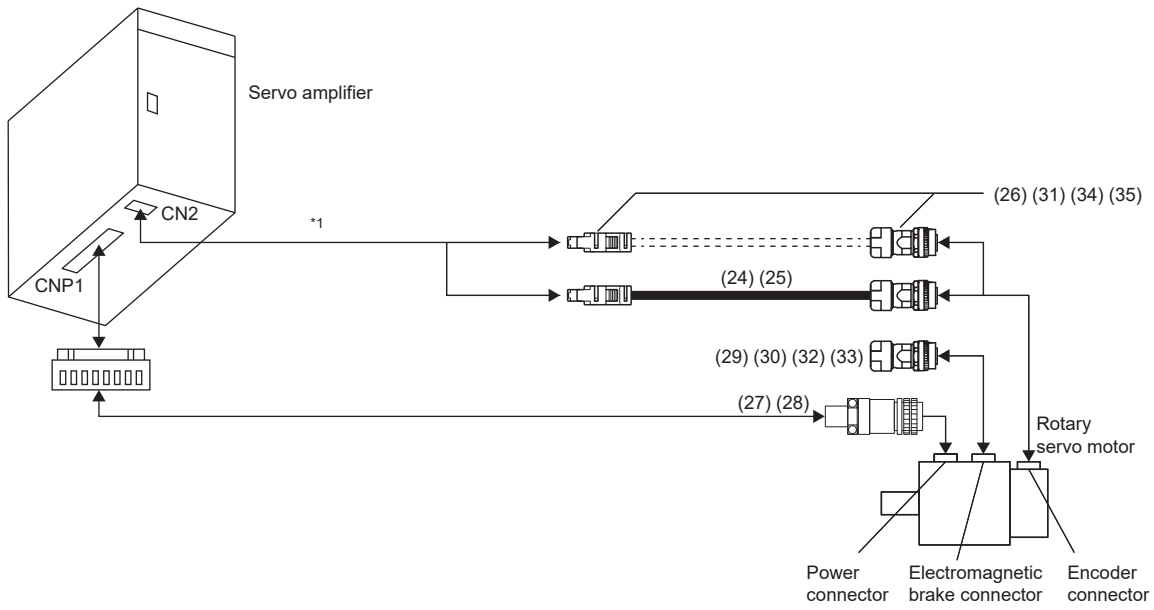



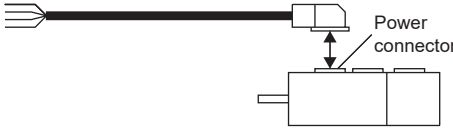
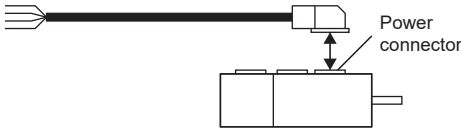
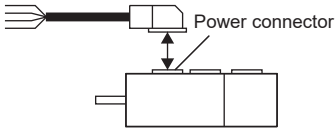
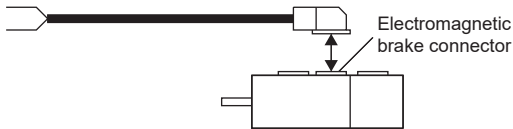
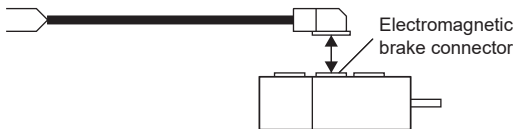
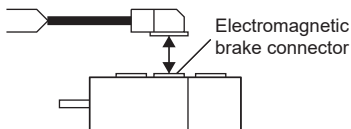

\*1 The battery (available in the near future) is required when constructing an absolute position detection system.

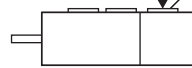

\*1 The battery (available in the near future) is required when constructing an absolute position detection system.

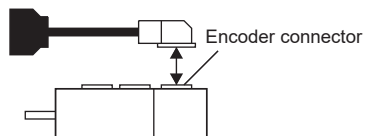
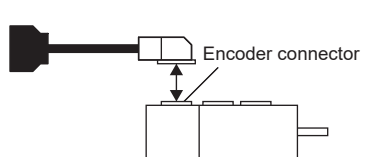
# Cable and connector list

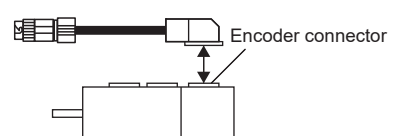
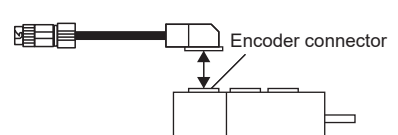
No.	Product name	Model	Description	Remark
(1)	Servo motor power cable	MR-PWS1CBL_M-A1-L *1 Cable length: 2/5/10 m	 <p>Page 54 Servo motor power cable</p>	IP65 Load-side lead
(2)	Servo motor power cable	MR-PWS1CBL_M-A1-H *1 Cable length: 2/5/10 m		IP65 Load-side lead Long bending life
(3)	Servo motor power cable	MR-PWS1CBL_M-A2-L *1 Cable length: 2/5/10 m	 <p>Page 54 Servo motor power cable</p>	IP65 Lead in opposite direction of load side
(4)	Servo motor power cable	MR-PWS1CBL_M-A2-H *1 Cable length: 2/5/10 m		IP65 Lead in opposite direction of load side Long bending life
(5)	Servo motor power cable	MR-PWS2CBL03M-A1-L *1 Cable length: 0.3 m	 <p>Page 54 Servo motor power cable</p>	IP55 Load-side lead
(6)	Servo motor power cable	MR-PWS2CBL03M-A2-L *1 Cable length: 0.3 m		IP55 Lead in opposite direction of load side
(7)	Electromagnetic brake cable	MR-BKS1CBL_M-A1-L Cable length: 2/5/10 m	 <p>Page 56 Electromagnetic brake cable</p>	IP65 Load-side lead
(8)	Electromagnetic brake cable	MR-BKS1CBL_M-A1-H Cable length: 2/5/10 m		IP65 Load-side lead Long bending life
(9)	Electromagnetic brake cable	MR-BKS1CBL_M-A2-L Cable length: 2/5/10 m	 <p>Page 56 Electromagnetic brake cable</p>	IP65 Lead in opposite direction of load side
(10)	Electromagnetic brake cable	MR-BKS1CBL_M-A2-H Cable length: 2/5/10 m		IP65 Lead in opposite direction of load side Long bending life
(11)	Electromagnetic brake cable	MR-BKS2CBL03M-A1-L Cable length: 0.3 m	 <p>Page 56 Electromagnetic brake cable</p>	IP55 Load-side lead
(12)	Electromagnetic brake cable	MR-BKS2CBL03M-A2-L Cable length: 0.3 m		IP55 Lead in opposite direction of load side

No.	Product name	Model	Description	Remark
(13)	Encoder cable	MR-J3ENCBL_M-A1-L *1 Cable length: 2/5/10 m		IP65 Load-side lead
(14)	Encoder cable	MR-J3ENCBL_M-A1-H *1 Cable length: 2/5/10 m	 ☞ Page 40 MR-J3ENCBL_M-_-	IP65 Load-side lead Long bending life
(15)	Encoder cable	MR-J3ENCBL_M-A2-L *1 Cable length: 2/5/10 m		IP65 Lead in opposite direction of load side
(16)	Encoder cable	MR-J3ENCBL_M-A2-H *1 Cable length: 2/5/10 m	 ☞ Page 40 MR-J3ENCBL_M-_-	IP65 Lead in opposite direction of load side Long bending life
(17)	Encoder cable	MR-J3JCBL03M-A1-L *1 Cable length: 0.3 m	 ☞ Page 42 MR-J3JCBL03M-_-L	IP20 Load-side lead
(18)	Encoder cable	MR-J3JCBL03M-A2-L *1 Cable length: 0.3 m	 ☞ Page 42 MR-J3JCBL03M-_-L	IP20 Lead in opposite direction of load side
(19)	Encoder cable	MR-EKCBL_M-L Cable length: 20/30 m		IP20
(20)	Encoder cable	MR-EKCBL_M-H Cable length: 20/30/40/50 m		☞ Page 46 MR-EKCBL_M-_ IP20 Long bending life
(21)	Encoder connector set	MR-ECNM	 ☞ Page 46 MR-EKCBL_M-_-	IP20
(22)	Encoder cable	MR-J3JSCBL03M-A1-L *1 Cable length: 0.3 m	 ☞ Page 44 MR-J3JSCBL03M-_-L	IP65 Load-side lead
(23)	Encoder cable	MR-J3JSCBL03M-A2-L *1 Cable length: 0.3 m	 ☞ Page 44 MR-J3JSCBL03M-_-L	IP65 Load-side lead
(24)	Encoder cable	MR-J3ENSCBL_M-L *1 Cable length: 2/5/10/20/30 m	 ☞ Page 50 MR-J3ENSCBL_M-_-	IP67 Standard bending life
(25)	Encoder cable	MR-J3ENSCBL_M-H *1 Cable length: 2/5/10/20/30/40/50 m		☞ Page 50 MR-J3ENSCBL_M-_- IP67 Long bending life
(26)	Encoder connector set	MR-J3SCNS *1	 ☞ Page 50 MR-J3ENSCBL_M-_-	IP67

No.	Product name	Model	Description	Remark
(27)	Power connector set	MR-PWCNS4	 <p>HG-SNS52 HG-SNS102 HG-SNS152 Plug: CE05-6A18-10SD-D-BSS Cable clamp: CE3057-10A-1-D (DDK) Applicable cable Applicable wire size: 2 mm<sup>2</sup> to 3.5 mm<sup>2</sup> (AWG 14 to 12) Cable OD: 10.5 mm to 14.1 mm</p>	IP67 EN compliant
(28)	Power connector set	MR-PWCNS5	 <p>HG-SNS202 HG-SNS302 Plug: CE05-6A22-22SD-D-BSS Cable clamp: CE3057-12A-1-D (DDK) Applicable cable Applicable wire size: 5.5 mm<sup>2</sup> to 8 mm<sup>2</sup> (AWG 10 to 8) Cable OD: 12.5 mm to 16 mm</p>	IP67 EN compliant
(29)	Electromagnetic brake connector set	MR-BKCNS1 *1	 <p>Straight plug: CMV1-SP2S-L Socket contact: CMV1-#22BSC-S2-100 (DDK)</p>	IP67
(30)	Electromagnetic brake connector set	MR-BKCNS1A *1	 <p>Angle plug: CMV1-AP2S-L Socket contact: CMV1-#22BSC-S2-100 (DDK)</p>	IP67
(31)	Encoder connector set	MR-J3SCNSA *1	  <p> Page 50 MR-J3ENSCBL_M_</p>	IP67
(32)	Electromagnetic brake connector set	MR-BKCNS2	 <p>Straight plug: CMV1S-SP2S-L Socket contact: CMV1-#22BSC-S2-100 (DDK)</p>	IP67
(33)	Electromagnetic brake connector set	MR-BKCNS2A	 <p>Angle plug: CMV1S-AP2S-L Socket contact: CMV1-#22BSC-S2-100 (DDK)</p>	IP67
(34)	Encoder connector set	MR-ENCNS2	  <p> Page 50 MR-J3ENSCBL_M_</p>	IP67
(35)	Encoder connector set	MR-ENCNS2A	  <p> Page 50 MR-J3ENSCBL_M_</p>	IP67

\*1 The cable and the connector set may contain different connectors but still usable.

# 5.2 Encoder cable/connector sets

Encoder cables are not subject to European Low Voltage Directive (50 V AC to 1000 V AC and 75 V DC to 1500 V DC).

## MR-J3ENCBL\_M-\_-

These cables are motor cables for the HG-KNS series rotary servo motors.

### Model

The following describes what each block of a model name indicates. Not all combinations of the symbols are available.

MR - J 3 ENC B L 2 M - A 1 - L

Bending life

Symbol	Bending life
L	Standard
H	Long bending life

Cable direction

Symbol	Cable direction
A1	Load-side lead
A2	Lead in opposite direction of load side

Cable length

Symbol	Cable length [m]
2	2
5	5
10	10

### Connection of servo amplifier and rotary servo motor

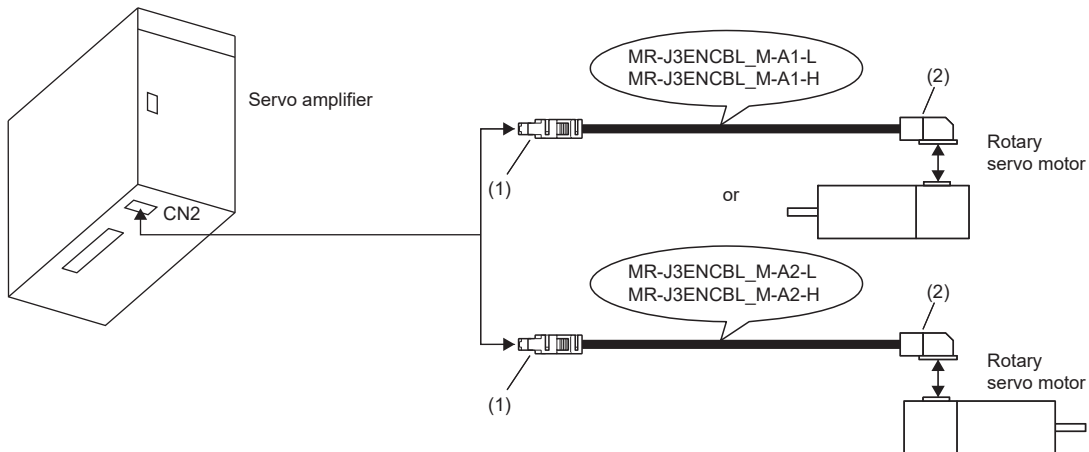

## CN2-side connector (1)

The following shows the view from the wiring side. Do not connect anything to the pins shown with a diagonal line. Securely connect the external conductor of the shielded cable to the ground plate and fix it to the connector shell.

☞ Page 60 Shield procedure of CN2 side connectors

Receptacle: 36210-0100PL

Shell kit: 36310-3200-008

(3M or equivalent)

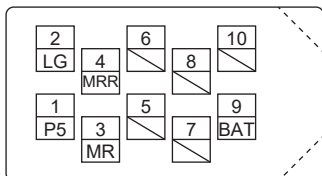

Connector set: 54599-1019

(Molex)

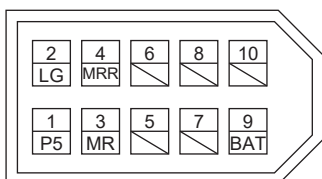

5

## Encoder-side connector (2)

The following shows the view from the wiring side. Do not connect anything to the pins shown with a diagonal line.

Connector: 2174053-1

Crimping tool for ground clip: 1596970-1

Crimping tool for receptacle contact: 1596847-1

(TE Connectivity)

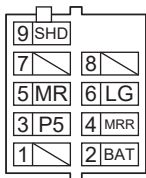

## Cable internal wiring diagram

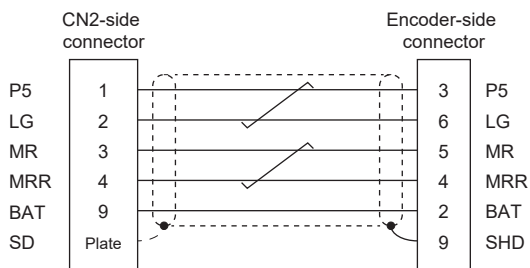

# MR-J3JCBL03M-\_-L

These cables are motor cables for the HG-KNS series rotary servo motors. The servo amplifier and the rotary servo motor cannot be connected by these cables alone. The servo motor-side encoder cable (MR-EKCBL\_M-\_) is required.

## Model

The following describes what each block of a model name indicates. Not all combinations of the symbols are available.

MR - J 3 J C B L 0 3 M - A 1 - L

Bending life

Symbol	Bending life
L	Standard

Cable direction

Symbol	Cable direction
A1	Load-side lead
A2	Lead in opposite direction of load side

Cable length

Symbol	Cable length [m]
03	0.3

## Connection of servo amplifier and rotary servo motor

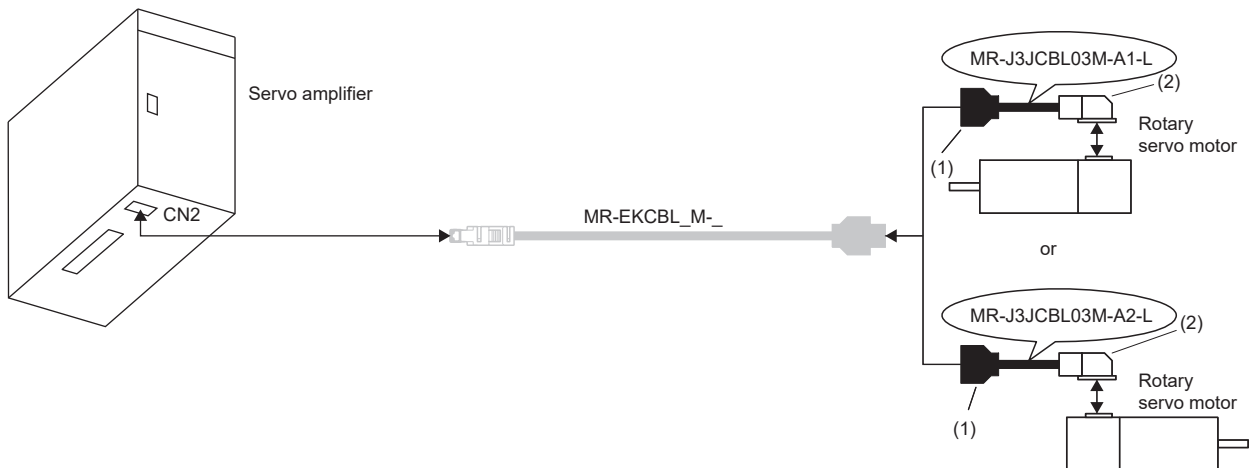



## Junction connector (1)

The following shows the view from the wiring side. Do not connect anything to the pins shown with a diagonal line.

Housing: 1-172169-9

Contact: 1473226-1

Cable clamp: 316454-1

Crimping tool: 91529-1

(TE Connectivity)

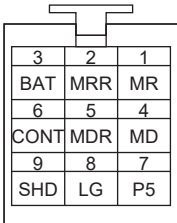

5

## Encoder-side connector (2)

The following shows the view from the wiring side. Do not connect anything to the pins shown with a diagonal line.

Connector: 2174053-1

Crimping tool for ground clip: 1596970-1

Crimping tool for receptacle contact: 1596847-1

(TE Connectivity)

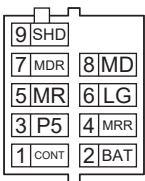

## Cable internal wiring diagram

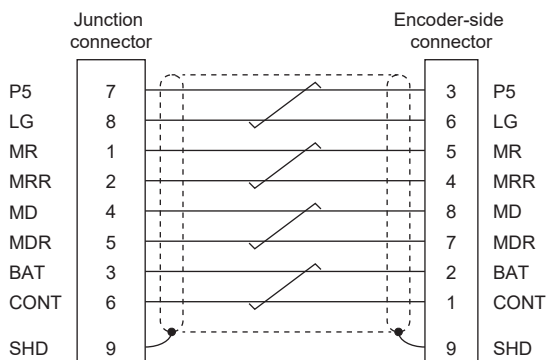

# MR-J3JSCBL03M-\_-L

These cables are motor cables for the HG-KNS series rotary servo motors. The servo amplifier and the rotary servo motor cannot be connected by these cables alone. The servo motor-side encoder cable (MR-J3ENSCBL\_M-\_) is required.

## Model

The following describes what each block of a model name indicates. Not all combinations of the symbols are available.

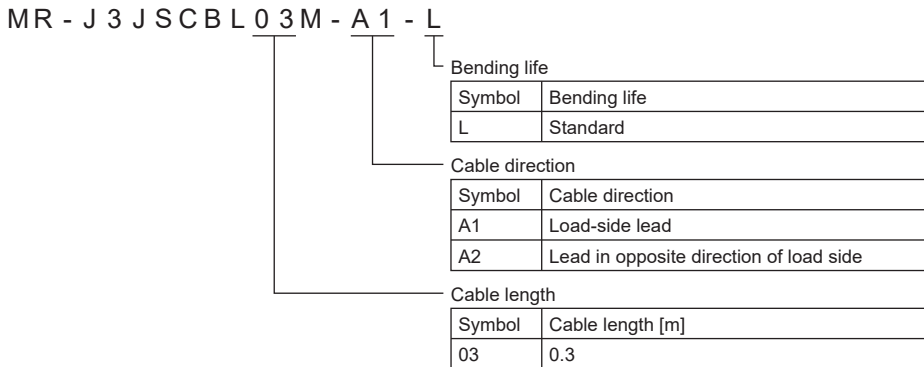

## Connection of servo amplifier and rotary servo motor

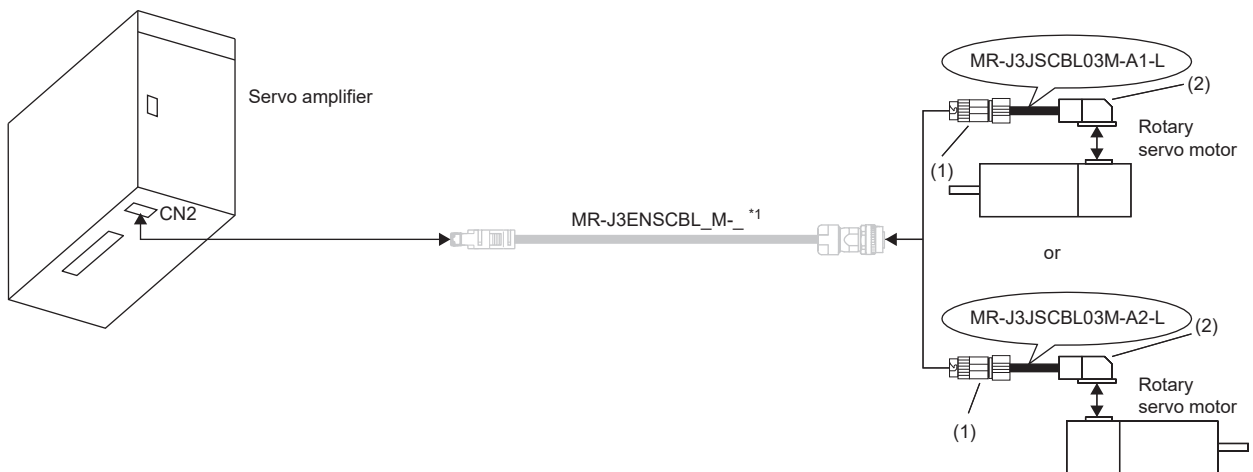

\*1 For details of this cable, refer to the following.  
 ☞ Page 50 MR-J3ENSCBL\_M-\_

## Junction connector (1)

The following shows the view from the wiring side. Do not connect anything to the pins shown with a diagonal line.

Receptacle: CM10-CR10P-M

(DDK)

Applicable wire size: AWG 20 or lower

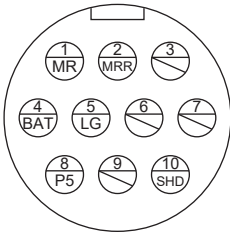

## Encoder-side connector (2)

The following shows the view from the wiring side. Do not connect anything to the pins shown with a diagonal line.

Connector: 2174053-1

Crimping tool for ground clip: 1596970-1

Crimping tool for receptacle contact: 1596847-1

(TE Connectivity)

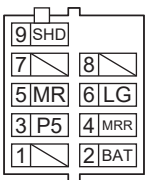

## Cable internal wiring diagram

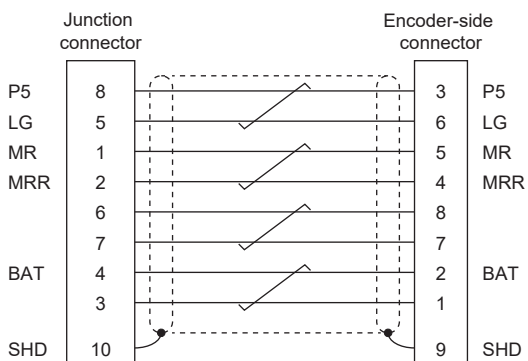

# MR-EKCBL\_M-

## Point

The following encoder cables are of four-wire type.

- MR-EKCBL30M-L
- MR-EKCBL30M-H
- MR-EKCBL40M-H
- MR-EKCBL50M-H

When using any of these encoder cables, refer to the user's manual (parameters) and select "four-wire type" for the corresponding servo parameter.

The servo amplifier and the rotary servo motor cannot be connected by these cables alone. Motor cables for rotary servo motors (MR-J3JCBL03M-\_L) are needed.

## Model

The following describes what each block of a model name indicates. Not all combinations of the symbols are available.

MR - E K C B L 2 0 M - L

Bending life

Symbol	Bending life
L	Standard
H	Long bending life

Cable length

Symbol	Cable length [m]
20	20
30	30
40	40
50	50

## Connection of servo amplifier and rotary servo motor

This connection is for when electromagnetic brake cable is included.

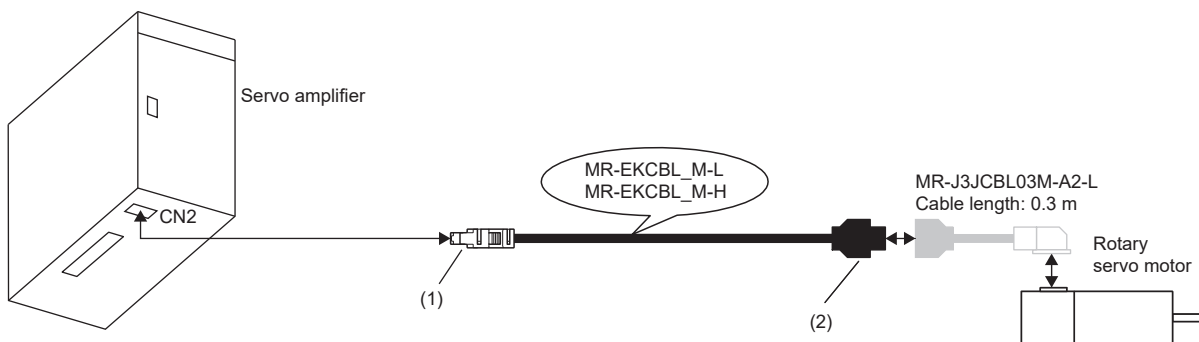

## CN2-side connector (1)

The following shows the view from the wiring side. Do not connect anything to the pins shown with a diagonal line. Securely connect the external conductor of the shielded cable to the ground plate and fix it to the connector shell.

☞ Page 60 Shield procedure of CN2 side connectors

Receptacle: 36210-0100PL

Shell kit: 36310-3200-008

(3M or equivalent)

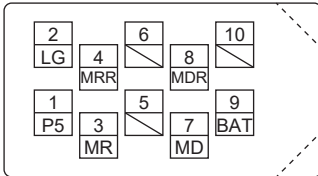

Connector set: 54599-1019

(Molex)

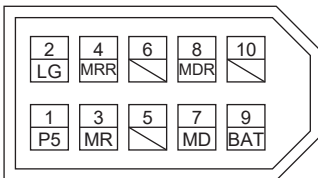

## Junction connector (2)

The following shows the view from the wiring side. Do not connect anything to the pins shown with a diagonal line.

Housing: 1-172161-9

Connector pin: 170359-1

Crimping tool: 91529-1

(TE Connectivity or equivalent)

Cable clamp: MTI-0002

(Toa Electric Industrial)

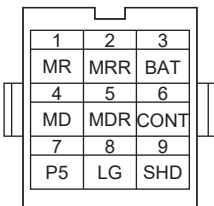

## Internal wiring diagram

When fabricating the cable, use the wiring diagram corresponding to the length indicated below.

Cable bending life	Applicable wiring diagram	
	Less than 30 m	30 m to 50 m
Standard	MR-EKCBL20M-L	MR-EKCBL30M-L
Long bending life	MR-EKCBL20M-H	MR-EKCBL30M-H MR-EKCBL40M-H MR-EKCBL50M-H

### ■MR-EKCBL20M-L

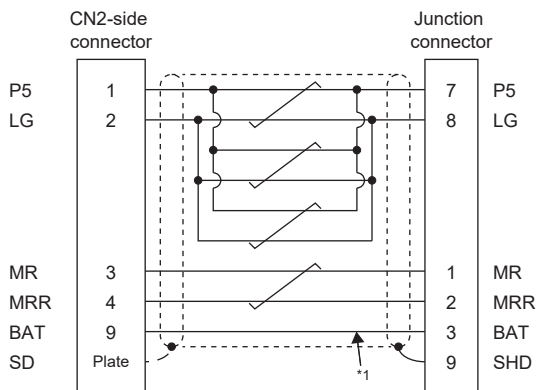

\*1 Always make connection for use in an absolute position detection system. Wiring is not necessary for use in an incremental system.

### ■MR-EKCBL30M-L

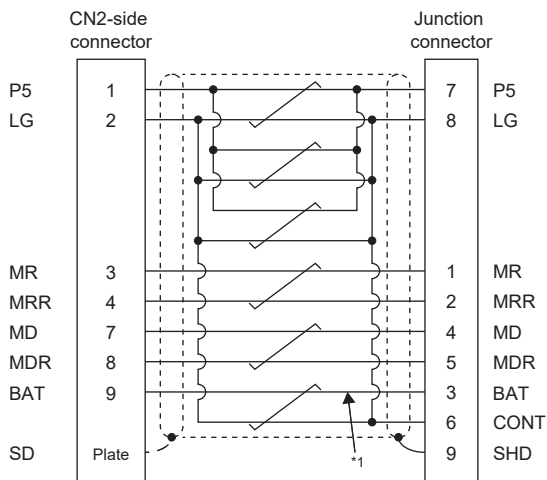

\*1 Always make connection for use in an absolute position detection system. Wiring is not necessary for use in an incremental system.

**MR-EKCBL20M-H**

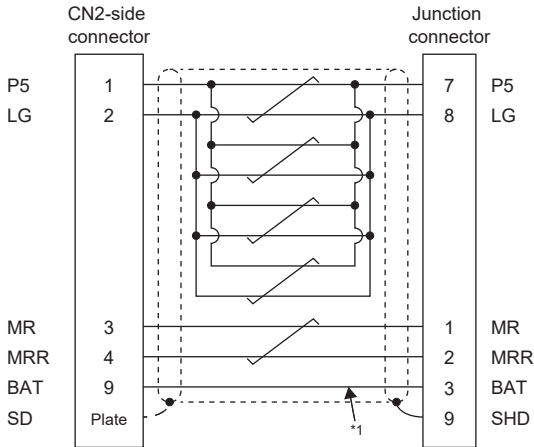

\*1 Always make connection for use in an absolute position detection system. Wiring is not necessary for use in an incremental system.

**MR-EKCBL30M-H/MR-EKCBL40M-H/MR-EKCBL50M-H**

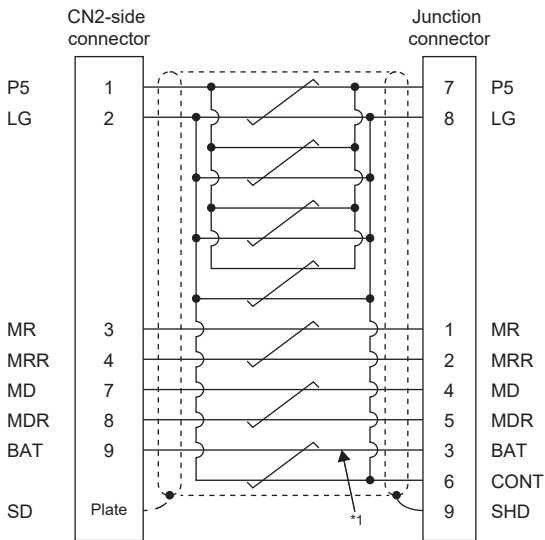

\*1 Always make connection for use in an absolute position detection system. Wiring is not necessary for use in an incremental system.



**When fabricating an encoder cable**

Prepare the following parts, and fabricate the cable in accordance with the following.

☞ Page 48 Internal wiring diagram

Refer to the following for the specifications of the cable to use.

☞ Page 58 Wires for option cables

Parts (Connector set)	Description	
	CN2-side connector	Junction connector
MR-ECNM	 Receptacle: 36210-0100PL Shell kit: 36310-3200-008 (3M) or Connector set: 54599-1019 (Molex)	 Housing: 1-172161-9 Connector pin: 170359-1 (TE Connectivity or equivalent) Cable clamp: MT1-0002 (Toa Electric Industrial)

# MR-J3ENSCBL\_M-\_\_

These cables are encoder cables for the HG-KNS/HG-SNS series rotary servo motors.

## Model

The following describes what each block of a model name indicates. Not all combinations of the symbols are available.

MR - J 3 E N S C B L 2 M - L

Bending life	
Symbol	Bending life
L	Standard
H	Long bending life

Cable length	
Symbol	Cable length [m]
2	2
5	5
10	10
20	20
30	30
40	40
50	50

## Connection of servo amplifier and rotary servo motor

This connection is for when electromagnetic brake cable is included.



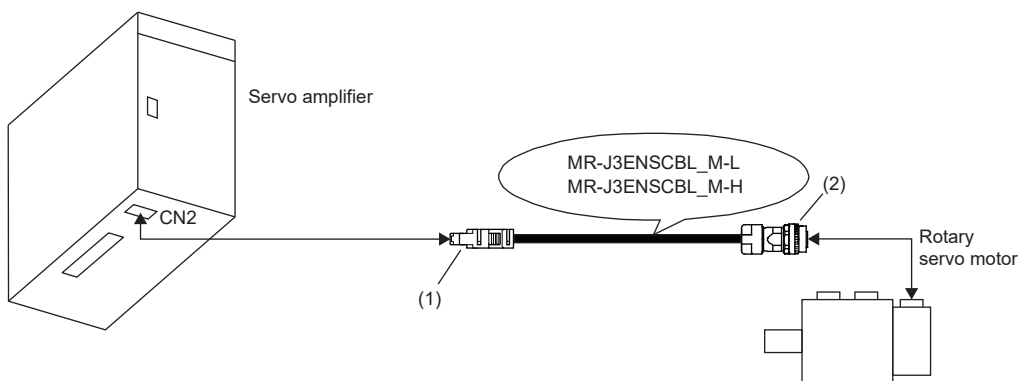

## CN2-side connector (1)

The following shows the view from the wiring side. Do not connect anything to the pins shown with a diagonal line. Securely connect the external conductor of the shielded cable to the ground plate and fix it to the connector shell.

☞ Page 60 Shield procedure of CN2 side connectors

Receptacle: 36210-0100PL

Shell kit: 36310-3200-008

(3M)

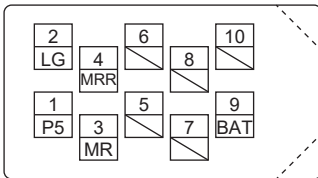

or

Connector set: 54599-1019

(Molex)

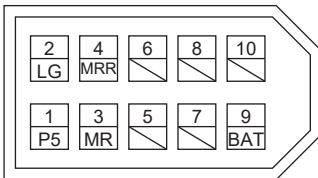

## Junction connector (2)

Cable length	Bending life	Plug (DDK)	
		Straight plug	Socket contact
10 m or shorter	Long bending life	CMV1-SP10S-M1	CMV1-#22ASC-C1-100 Applicable wire size: AWG 24 to 20 Crimping tool: 357J-53162T
	Standard		
20 m or longer	Long bending life	CMV1-SP10S-M1	CMV1-#22ASC-C2-100 Applicable wire size: AWG 28 to 24 Crimping tool: 357J-53163T
	Standard	CMV1-SP10S-M2	

The following shows the view from the wiring side. Do not connect anything to the pins shown with a diagonal line.

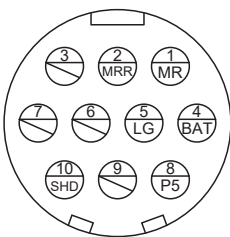

## Cable internal wiring diagram

### ■MR-J3ENSCBL2M-L/MR-J3ENSCBL5M-L/MR-J3ENSCBL10M-L/MR-J3ENSCBL2M-H/MR-J3ENSCBL5M-H/MR-J3ENSCBL10M-H

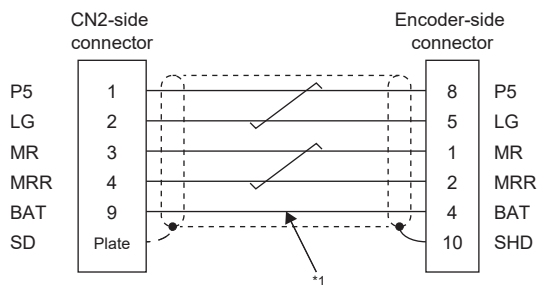

\*1 Always make connection for use in an absolute position detection system. Wiring is not necessary for use in an incremental system.

### ■MR-J3ENSCBL20M-L/MR-J3ENSCBL30M-L

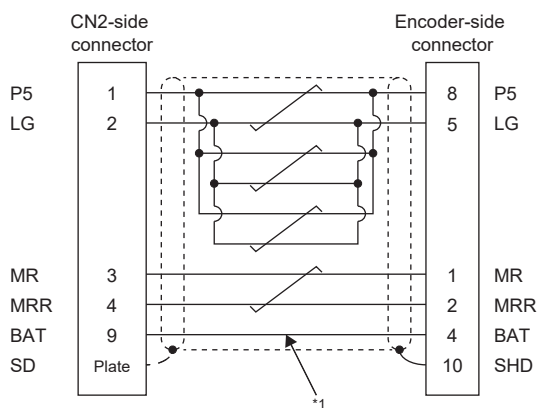

\*1 Always make connection for use in an absolute position detection system. Wiring is not necessary for use in an incremental system.

### ■MR-J3ENSCBL20M-H/MR-J3ENSCBL30M-H/MR-J3ENSCBL40M-H/MR-J3ENSCBL50M-H

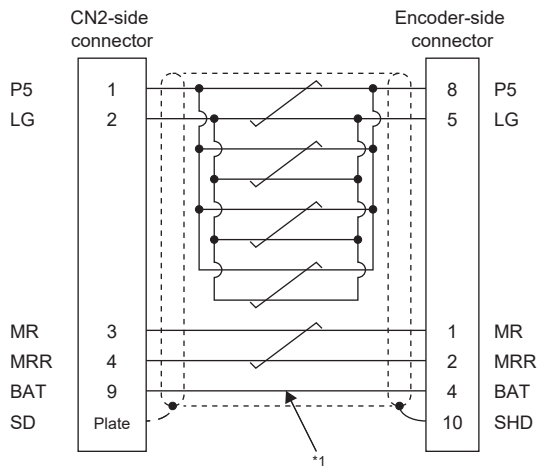

\*1 Always make connection for use in an absolute position detection system. Wiring is not necessary for use in an incremental system.





## When fabricating an encoder cable

Prepare the following parts, and fabricate the cable in accordance with the following diagram.

☞ Page 52 Cable internal wiring diagram

Refer to the following for the specifications of the cable to use.

☞ Page 58 Wires for option cables

Parts (Connector set)	Description	
	Servo amplifier-side connector	Encoder-side connector (DDK)
MR-J3SCNS (One-touch connection type) *1	 Receptacle: 36210-0100PL Shell kit: 36310-3200-008 (3M) or Connector set: 54599-1019 (Molex)	 Straight plug: CMV1-SP10S-M2 Socket contact: CMV1-#22ASC-S1-100 Applicable wire size: AWG 20 or lower
MR-ENCNS2 (Screw type) *1		 Straight plug: CMV1S-SP10S-M2 Socket contact: CMV1-#22ASC-S1-100 Applicable wire size: AWG 20 or lower
MR-J3SCNSA (One-touch connection type) *1		 Angle plug: CMV1-AP10S-M2 Socket contact: CMV1-#22ASC-S1-100 Applicable wire size: AWG 20 or lower
MR-ENCNS2A (Screw type) *1		 Angle plug: CMV1S-AP10S-M2 Socket contact: CMV1-#22ASC-S1-100 Applicable wire size: AWG 20 or lower

\*1 Cable clamps and bushings for cables with an outer diameter of 5.5 mm to 7.5 mm and 7.0 mm to 9.0 mm are included.

## 5.3 Servo motor power cable

These cables are servo motor power cables for the HG-KNS series servo motors.

Refer to the following for details regarding wiring.

☞ Page 35 HG-KNS series

### Model

The following describes what each block of a model name indicates. Not all combinations of the symbols are available.

MR - PWS 1 C B L 2 M - A 1 - L

Bending life

Symbol	Bending life
L	Standard
H	Long bending life

Cable direction

Symbol	Cable direction
A1	Load-side lead
A2	Lead in opposite direction of load side

Cable length

Symbol	Cable length [m]
03	0.3
2	2
5	5
10	10

IP rating

Symbol	IP rating
S1	IP65
S2	IP55

## Connection of servo amplifier and rotary servo motor

5

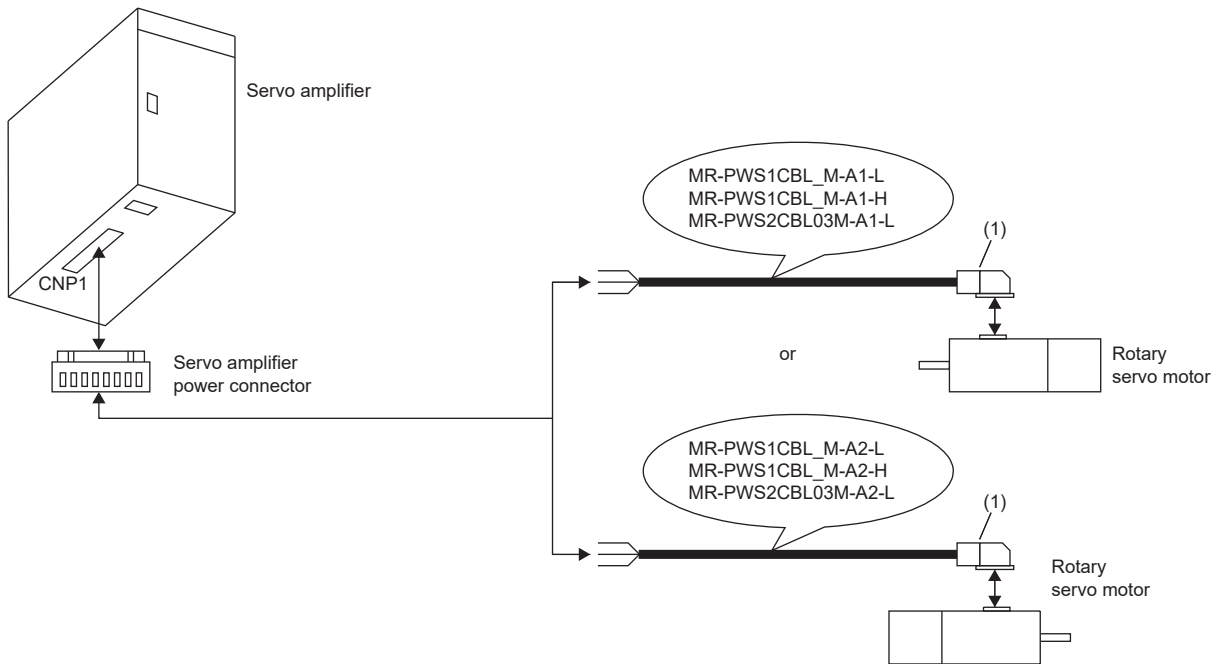

Cable model	Servo motor power-side connector (1)	
MR-PWS1CBL_M-A1-L	Connector: KN4FT04SJ1-R	<p>View from the wiring side</p>
MR-PWS1CBL_M-A2-L	Hood/socket insulator	
MR-PWS1CBL_M-A1-H	Bushing/ground nut	
MR-PWS1CBL_M-A2-H	Contact: ST-TMH-S-C1B-100-(A534G)	
MR-PWS2CBL03M-A1-L	Crimping tool: CT170-14-TMH5B (JAE)	
MR-PWS2CBL03M-A2-L	Connector: KN4FT04SJ2-R	
	Hood/socket insulator	
	Bushing/ground nut	
	Contact: ST-TMH-S-C1B-100-(A534G)	
	Crimping tool: CT170-14-TMH5B (JAE)	

## Internal wiring diagram

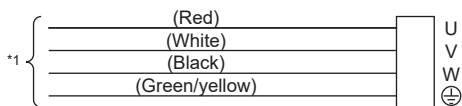

\*1 These are not shielded cables.

# 5.4 Electromagnetic brake cable

These cables are electromagnetic brake cables for the HG-KNS series servo motors. Refer to the following for details regarding wiring.

☞ Page 35 HG-KNS series

## Model

The following describes what each block of a model name indicates. Not all combinations of the symbols are available.

MR - BK S 1 C B L 2 M - A 1 - L

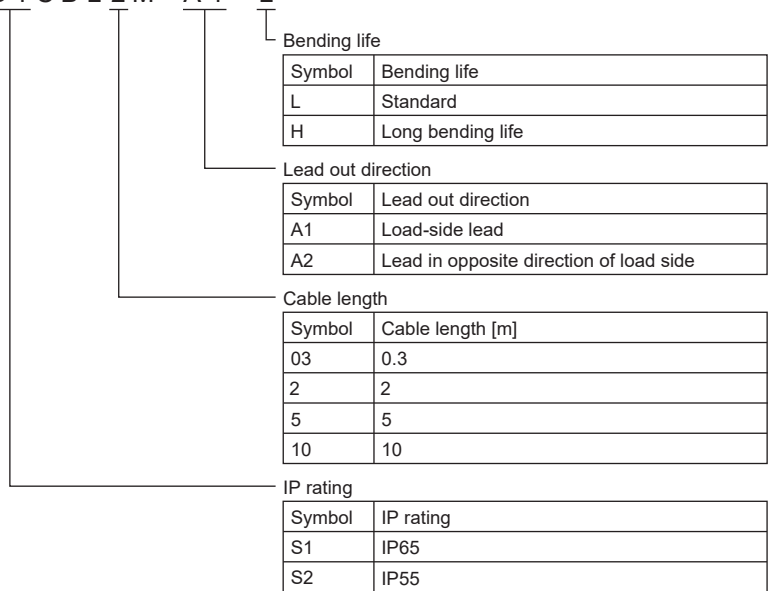

## Connecting the electromagnetic brake power supply and the rotary servo motor

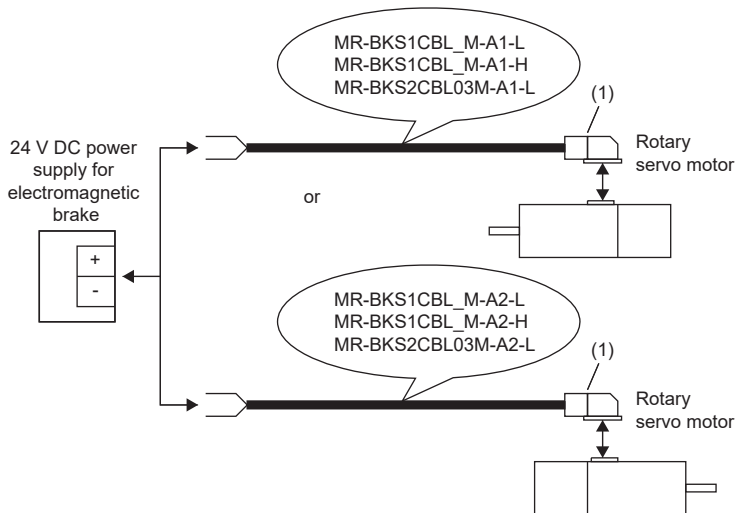

5

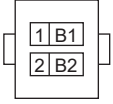
Cable model	Connector for electromagnetic brake (1)	
MR-BKS1CBL_M-A1-L	Connector: JN4FT02SJ1-R	 <p>View from the wiring side</p>
MR-BKS1CBL_M-A2-L	Hood/socket insulator	
MR-BKS1CBL_M-A1-H	Bushing/ground nut	
MR-BKS1CBL_M-A2-H	Contact: ST-TMH-S-C1B-100-(A534G)	
MR-BKS2CBL03M-A1-L	Crimping tool: CT170-14-TMH5B (JAE)	
MR-BKS2CBL03M-A2-L	Connector: JN4FT02SJ2-R	
	Hood/socket insulator	
	Bushing/ground nut	
	Contact: ST-TMH-S-C1B-100-(A534G)	
	Crimping tool: CT170-14-TMH5B (JAE)	

### Internal wiring diagram

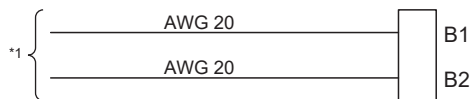

\*1 These are not shielded cables.

## 5.5 Wires for option cables

List of applicable recommended wires

Type	Model	Length [m]	Core size	Number of cores	Characteristics of one core			Cable OD [mm] <sup>*2</sup>	Recommended wire model (manufacturer)
					Structure [Wires/mm]	Conductor resistance [ $\Omega$ /mm]	Insulator outer diameter (d) [mm] <sup>*1</sup>		
Encoder cable	MR-J3ENCBL_M-A1-L	2 to 10	AWG 22	6 (3 pairs)	7/0.26	53 or less	1.18	7.1	VSVP 7/0.26 (AWG #22 or equivalent)-3PKB-1655-2 (Bando Densen) <sup>*3</sup>
	MR-J3ENCBL_M-A2-L								
	MR-J3ENCBL_M-A1-H	2 to 10	AWG 22	6 (3 pairs)	70/0.08	56 or less	1.17	7.1	TPE•SVP 70/0.08 (AWG #22 or equivalent)-3PKB-2237-2 (Bando Densen) <sup>*3</sup>
	MR-J3ENCBL_M-A2-H								
	MR-J3JCBL03M-A1-L	0.3	AWG 26	8 (4 pairs)	30/0.08	233 or less	1.2	7.1 $\pm$ 0.3	T/2464-1061/IIA-SB 4P $\times$ 26AWG (Taiyo Cabletec)
	MR-J3JCBL03M-A2-L								
	MR-EKCBL_M-L	2 to 10	AWG 28	4 (2 pairs)	7/0.127	232 or less	1.18	7.0	20276 composite 6-core shielded cable Ban-gi-shi-16395-1 (Bando Densen) <sup>*3</sup>
			AWG 22	2	17/0.16	28.7 or less	1.50		
		20/30	AWG 23	12 (6 pairs)	12/0.18	63.6 or less	1.2	8.2 $\pm$ 0.3	20276 VSVP AWG#23 $\times$ 6P KB-0492 (Bando Densen) <sup>*3</sup>
	MR-EKCBL_M-H	2 to 10	0.2 mm <sup>2</sup>	12 (6 pairs)	40/0.08	105 or less	0.88	7.2	A14B2343 6P (Junkosha) <sup>*3</sup>
		20	AWG 24	12 (6 pairs)	40/0.08	105 or less	0.88	7.2	TPE•SVP 40/0.08 (AWG #24 or equivalent)-6PKB-1928-2 (Bando Densen) <sup>*3</sup>
		30 to 50	AWG 24	14 (7 pairs)	40/0.08	105 or less	0.88	8.0	TPE•SVP 40/0.08 (AWG #24 or equivalent)-7PKB-1929-2 (Bando Densen) <sup>*3</sup>
	MR-J3JSCBL03M-A1-L	0.3	AWG 26	8 (4 pairs)	7/0.16	146 or less	1.0	7.1 $\pm$ 0.3	VSVP 7/0.16 (AWG #26 or equivalent)-4P Ban-gi-shi-16822 (Bando Densen) <sup>*3</sup>
	MR-J3JSCBL03M-A2-L								
MR-J3ENSCBL_M-L	2 to 10	AWG 22	6 (3 pairs)	7/0.26	53 or less	1.18	7.1	VSVP 7/0.26 (AWG #22 or equivalent)-3PKB-1655-2 (Bando Densen) <sup>*3</sup>	
	20/30	AWG 23	12 (6 pairs)	12/0.18	63.3 or less	1.2	8.2 $\pm$ 0.3	20276 VSVP AWG#23 $\times$ 6P KB-0492 (Bando Densen) <sup>*3</sup>	
MR-J3ENSCBL_M-H	2 to 10	AWG 22	6 (3 pairs)	70/0.08	56 or less	1.17	7.1	TPE•SVP 70/0.08 (AWG #22 or equivalent)-3PKB-2237-2 (Bando Densen) <sup>*3</sup>	
	20 to 50	AWG 24	12 (6 pairs)	40/0.08	105 or less	0.88	7.2	TPE•SVP 40/0.08 (AWG #24 or equivalent)-6PKB-1928-2 (Bando Densen) <sup>*3</sup>	



Type	Model	Length [m]	Core size	Number of cores	Characteristics of one core			Cable OD [mm] <sup>*2</sup>	Recommended wire model (manufacturer)
					Structure [Wires/mm]	Conductor resistance [ $\Omega$ /mm]	Insulator outer diameter (d) [mm] <sup>*1</sup>		
Servo motor power cable	MR-PWS1CBL_M-A1-L	2 to 10	AWG 18	4	34/0.18	21.8 or less	1.71	6.2 $\pm$ 0.3	HRZFEV-A(CL3) AWG 18 4 cores (Dyden) <sup>*4</sup>
	MR-PWS1CBL_M-A2-L	2 to 10							
	MR-PWS1CBL_M-A1-H	2 to 10	AWG 19 (0.75 mm <sup>2</sup> )	4	150/0.08	29.1 or less	1.63	5.7 $\pm$ 0.5	RMFES-A(CL3X) AWG 19 4 cores (Dyden) <sup>*4</sup>
	MR-PWS1CBL_M-A2-H	2 to 10							
	MR-PWS2CBL03M-A1-L	0.3	AWG 19	4	30/0.18	25.8 or less	1.64	—	J11B2330 UL10125 (Junkosha) <sup>*3*5</sup>
	MR-PWS2CBL03M-A2-L	0.3							
Electromagnetic brake cable	MR-BKS1CBL_M-A1-L	2 to 10	AWG 20	2	21/0.18	34.6 or less	1.35	4.7 $\pm$ 0.1	HRZFEV-A(CL3) AWG 20 2 cores (Dyden) <sup>*4</sup>
	MR-BKS1CBL_M-A2-L	2 to 10							
	MR-BKS1CBL_M-A1-H	2 to 10	AWG 20	2	110/0.08	39.0 or less	1.37	4.5 $\pm$ 0.3	RMFES-A(CL3X) AWG 20 2 cores (Dyden) <sup>*4</sup>
	MR-BKS1CBL_M-A2-H	2 to 10							
	MR-BKS2CBL03M-A1-L	0.3	AWG 20	2	19/0.203	32.0 or less	1.42	—	J11B2331 UL10125 (Junkosha) <sup>*3*5</sup>
	MR-BKS2CBL03M-A2-L	0.3							

\*1 Details regarding the outer diameter (d) are shown below.

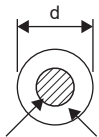

Conductor Insulator

\*2 Standard OD. Maximum OD is about 10 % greater for the dimensions without tolerances.

\*3 Supplier: Toa Electric Industrial

\*4 Supplier: Taisei Co., Ltd.

\*5 These models are solid wire models. The color of the wire must be specified separately.

## 5.6 Shield procedure of CN2 side connectors

For the CN2 side connector, securely connect the shielded external conductor of the cable to the ground plate and fix it to the connector shell.

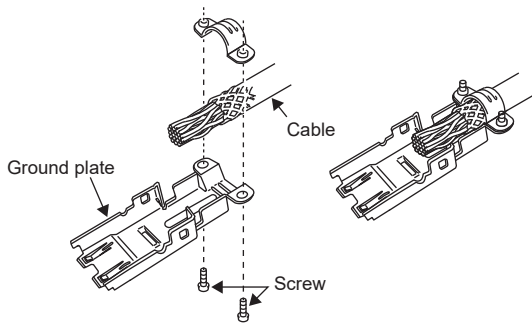

# 6 HG-KNS SERIES

This chapter provides information on the rotary servo motor specifications and characteristics. If using the HG-KNS series rotary servo motor, read chapters 1 to 5 and the Safety Instructions at the front of this manual in addition to this chapter.

## 6.1 Standard specifications

### Standard specifications list

Series		HG-KNS (Low inertia/small capacity)			
Flange size		□40	□60	□80	
Rotary servo motor model HG-KNS		HG-KNS13_ HG-KNS13_J	HG-KNS23_ HG-KNS23_J	HG-KNS43_ HG-KNS43_J	HG-KNS73_ HG-KNS73_J
Power supply capacity		Refer to "Power supply capacity and generated loss" in the following manual. □MR-JET User's Manual (Hardware)			
Power supply voltage [V]		200 V AC (3-phase 200 V AC to 240 V AC)			
Continuous running duty *1	Rated output [kW]	0.1	0.2	0.4	0.75
	Rated torque [N•m]	0.32	0.64	1.3	2.4
Maximum torque [N•m]		0.95	1.9	3.8	7.2
Rated speed *1[r/min]		3000			
Maximum speed *1[r/min]		6000			
Power rate at continuous rated torque [kW/s]	Standard	12.9	18.0	43.2	44.5
	With an electromagnetic brake	12.0	16.4	40.8	41.0
Rated current [A]		0.8	1.3	2.6	4.8
Maximum current [A]		2.4	3.9	7.8	14
Moment of inertia J [ $\times 10^{-4}$ kg•m <sup>2</sup> ]	Standard	0.0783	0.225	0.375	1.28
	With an electromagnetic brake	0.0843	0.247	0.397	1.39
Recommended load to motor inertia ratio *2		15 times or less			
Speed/position detector		22-bit encoder common to absolute position and incremental detection systems (resolution per rotary servo motor revolution: 4194304 pulses/rev)			
Oil seal	HG-KNS_	Not attached			
	HG-KNS_J	Attached			
Insulation class		130 (B)			
Structure		Totally enclosed, natural cooling (IP rating: IP65) *3			
Vibration resistance *4		X, Y: 49 m/s <sup>2</sup>			
Vibration rank *5		V10			
Permissible load for the shaft *6	L [mm]	25	30	40	
	Radial [N]	88	245	392	
	Thrust [N]	59	98	147	
Mass [kg] (Without oil seal) [Not offered in China]	Standard	0.54	0.91	1.4	2.8
	With an electromagnetic brake	0.74	1.3	1.8	3.8
Mass [kg] (With oil seal)	Standard	0.57	0.98	1.5	3.0
	With an electromagnetic brake	0.77	1.4	1.9	4.0

\*1 When the power supply voltage drops, the continuous running duty and the speed cannot be guaranteed.

\*2 If the load to motor inertia ratio exceeds the indicated value, contact your local sales office.

\*3 Except for the shaft-through portion. IP classifies the degrees of protection provided against the intrusion of solid objects and water in electrical enclosures.

\*4 The vibration directions are shown in the following figure. The value is the one at the part that indicates the maximum value (normally the opposite to load-side bracket). When the rotary servo motor stops, fretting is likely to occur at the bearing. Therefore, suppress the vibration to about half of the permissible value.

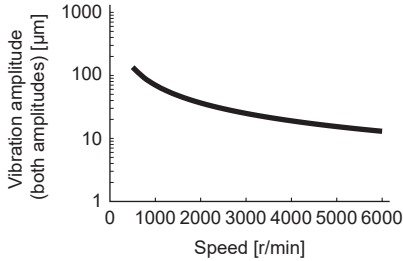
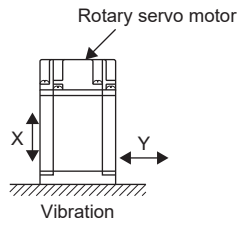

\*5 V10 indicates that the amplitude of a single rotary servo motor is 10  $\mu\text{m}$  or less. The following figure shows the rotary servo motor mounting position for measurement and the measuring position.

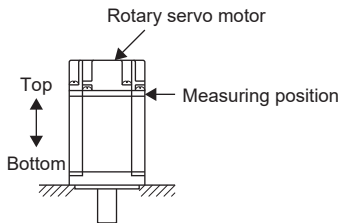

\*6 The following shows permissible load for the shaft. Do not subject the shaft to loads greater than the value in the specifications list. The value assumes that the load is applied independently.

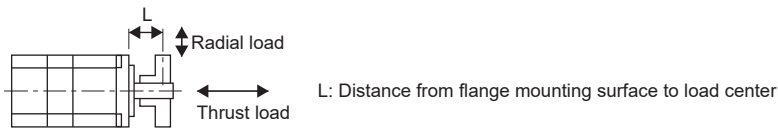

## Torque characteristics

- For the system where the unbalanced torque occurs, such as a vertical axis, the unbalanced torque of the machine should be kept at 70 % or lower of the rated torque.
- When the power supply voltage drops, the torque decreases.

When the power supply input of the servo amplifier is 3-phase 200 V AC or 1-phase 230 V AC, the torque characteristic is indicated by the heavy line.

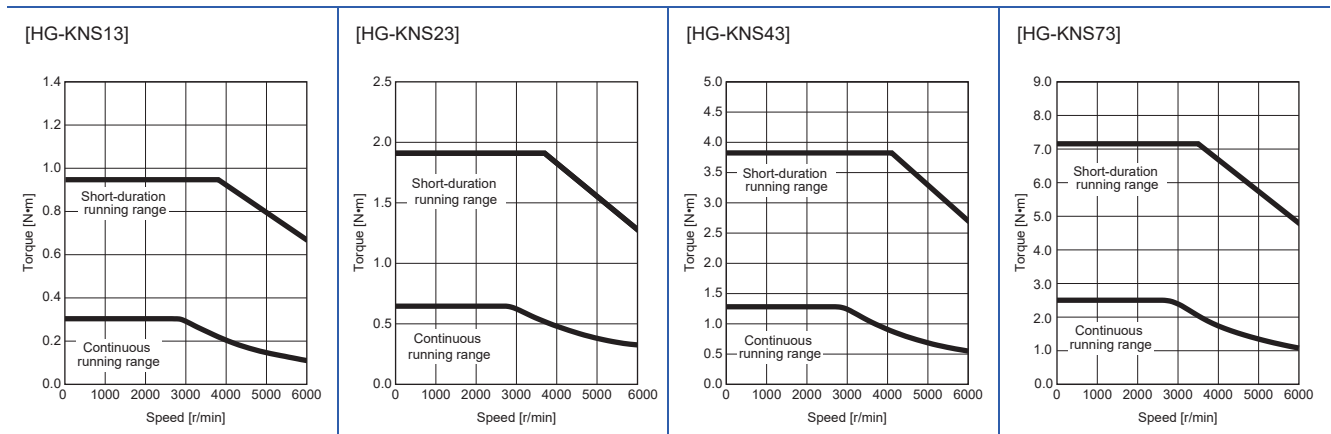

## 6.2 Combinations of servo amplifiers and rotary servo motors

Rotary servo motor	Servo amplifier
HG-KNS13	MR-JET-10G_
HG-KNS23	MR-JET-20G_
HG-KNS43	MR-JET-40G_
HG-KNS73	MR-JET-70G_

## 6.3 Characteristics of electromagnetic brake

### Point

Before operating the servo motor, confirm that the electromagnetic brake operates properly.  
The operation time of the electromagnetic brake varies depending on the power supply circuit being used.  
Check the operation delay time with an actual machine.

The characteristics of the electromagnetic brake provided for the rotary servo motor with an electromagnetic brake are shown below.

Item	HG-KNS series			
	13B_	23B_	43B_	73B_
Type *1	Spring actuated type safety brake			
Rated voltage *4	24 V DC (-10 % to 0 %)			
Power consumption at 20 °C [W]	6.3	7.9		10
Coil resistance *6[Ω]	91.0	73.0		57.0
Inductance *6[H]	0.15	0.18		0.13
Brake static friction torque *7[N•m]	0.32 or more	1.3 or more		2.4 or more
Release delay time *2[s]	0.03	0.03		0.04
Braking delay time [s]	DC off *2	0.01	0.02	0.02
Permissible braking work [J]	Per braking	5.6	22	64
	Per hour	56	220	640
Brake looseness at servo motor shaft *5[degree]	2.5	1.2		0.9
Brake life *3	Number of braking times [times]	20000		
	Work per braking [J]	5.6	22	64
Selection example of surge absorbers to be used *6	For the suppressed voltage 125 V	TND20V-680KB (Manufactured by Nippon Chemi-Con Corporation)		
	For the suppressed voltage 350 V	TND10V-221KB (Manufactured by Nippon Chemi-Con Corporation)		

- \*1 This type does not have a manual release mechanism. Use a 24 V DC power supply to release the brake electrically.
- \*2 The value for initial on gap at 20 °C.
- \*3 Brake lining wear due to braking will increase the brake gap, but the gap is not adjustable. Therefore, the brake life indicates the number of times the brake can be applied before gap adjustment becomes necessary.
- \*4 Prepare a power supply exclusively for the electromagnetic brake.
- \*5 The values are design values. These are not the guaranteed values.
- \*6 Select the electromagnetic brake control relay properly, in consideration of the characteristics of the electromagnetic brake and surge absorber. When a diode is used as a surge absorber, the electromagnetic braking time becomes longer.
- \*7 The value of the brake static friction torque is the lower limit in the initial state at 20 °C.

# 6.4 Rotary servo motors with special shafts

There are two shaft shape types for the rotary servo motor: keyed shaft (with double round-ended key) and D cut shaft.

Rotary servo motor	Shaft shape	
	Keyed shaft (with double round-ended key)	D cut shaft
HG-KNS13_	—	D
HG-KNS23_ HG-KNS43_ HG-KNS73_	K	—

## Keyed shaft (with double round-ended key)

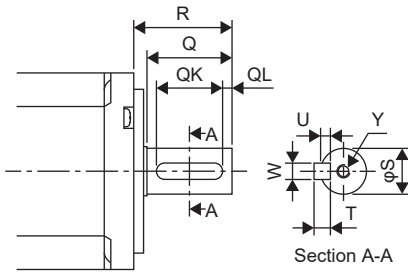

[Unit: mm]

Rotary servo motor	Variable dimensions								
	S	R	Q	W	QK	QL	U	T	Y
HG-KNS23_K HG-KNS43_K	14 <sup>0</sup> <sub>-0.011</sub>	30	26	5	20	3	3	5	M4 Screw hole depth 15
HG-KNS73_K	19 <sup>0</sup> <sub>-0.013</sub>	40	36	6	25	5	3.5	6	M5 Screw hole depth 20

## D cut shaft

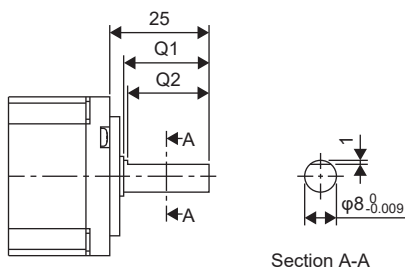

[Unit: mm]

Rotary servo motor	Variable dimensions	
	Q	Q2
HG-KNS13_D	21.5	20.5

## 6.5 Rotary servo motors with an oil seal

The oil seal prevents the entry of oil into the rotary servo motor.

Install the rotary servo motor horizontally, and set the oil level in the gear box to be always lower than the oil seal lip.

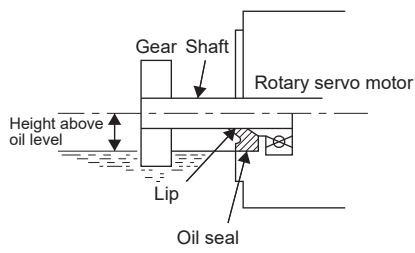

Rotary servo motor	Height (h) from the surface of the oil [mm]
HG-KNS13_J	10
HG-KNS23_J	19
HG-KNS43_J	
HG-KNS73_J	



## 6.6 Mounting connectors

If the connector is not fixed securely, it may come off or may not produce a splash-proof effect during operation. To achieve the IP rating IP65, pay attention to the following points when installing the connectors.

- When screwing the connector, hold the connector still and gradually tighten the screws in a crisscross pattern.

Connector for power, connector for encoder

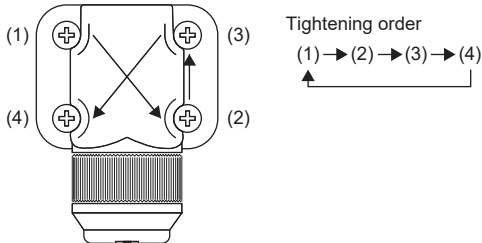

Connector for electromagnetic brake

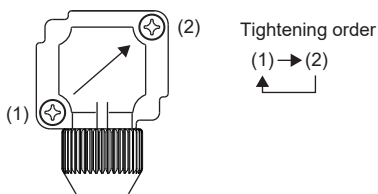

- Tighten the screws evenly. Tightening torques are as indicated below.

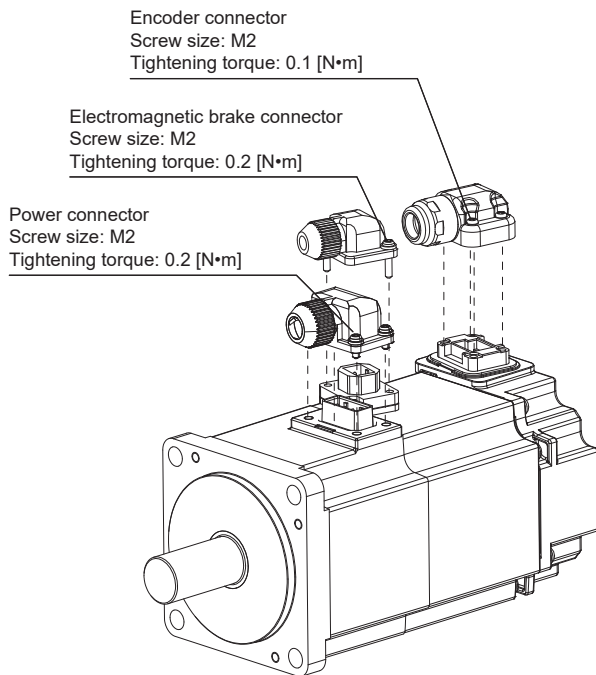

- The rotating servo motor fitting part of each connector is provided with a splash-proof seal (O ring). When mounting a connector, use care to prevent the seal (O ring) from dropping and being pinched. If the seal (O ring) has dropped or is pinched, a splash-proof effect is not produced.

# 6.7 Dimensions

- When running the cables to the load side, take care to avoid interference with the machine.
- Not all parts are created the exact same size or assembled in precisely the same manner. Therefore, the actual dimensions of rotary servo motors may be a maximum of approximately 3 mm larger than those in the drawings. In addition, the described dimensions and dimensional tolerances are the values at 20 °C. Since the values of the dimensions may vary depending on the ambient temperature, allow some margin when designing the machine side.
- Use a friction coupling for coupling the servo motor with a load.
- Use hexagon socket head cap screws to mount the rotary servo motor.

## Standard (without an electromagnetic brake)

### With oil seal

#### ■HG-KNS13J

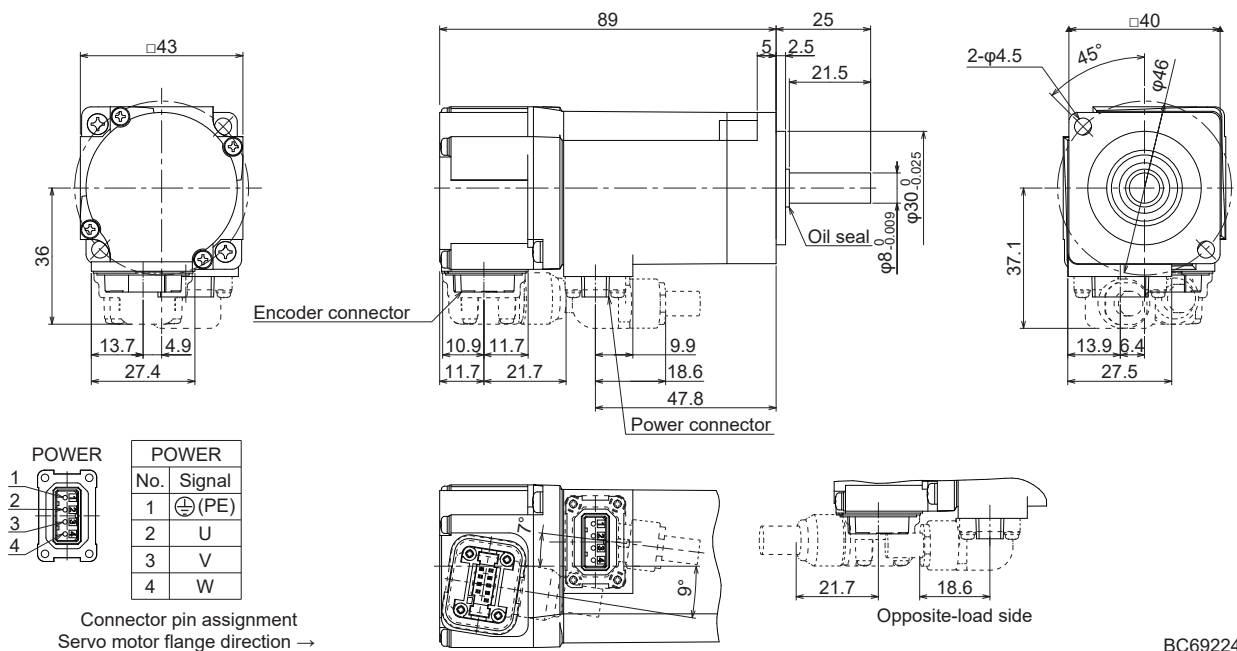

[Unit: mm]

BC69224\*

## ■HG-KNS23J

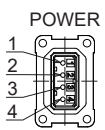
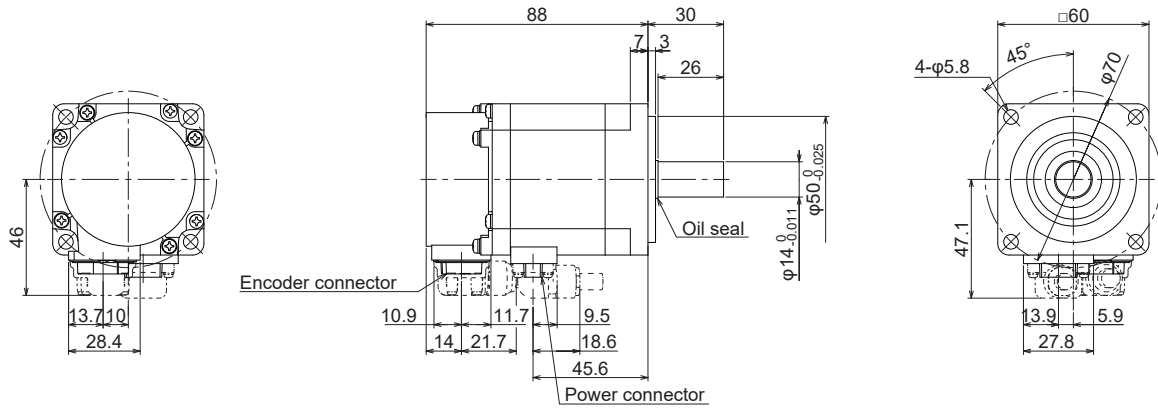

POWER	
No.	Signal
1	⊕ (PE)
2	U
3	V
4	W

Connector pin assignment  
Servo motor flange direction →

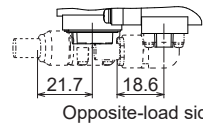
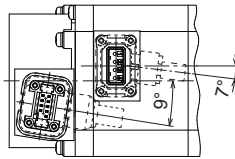

Opposite-load side

BC69225\*

[Unit: mm]

## ■HG-KNS43J

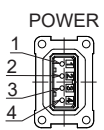
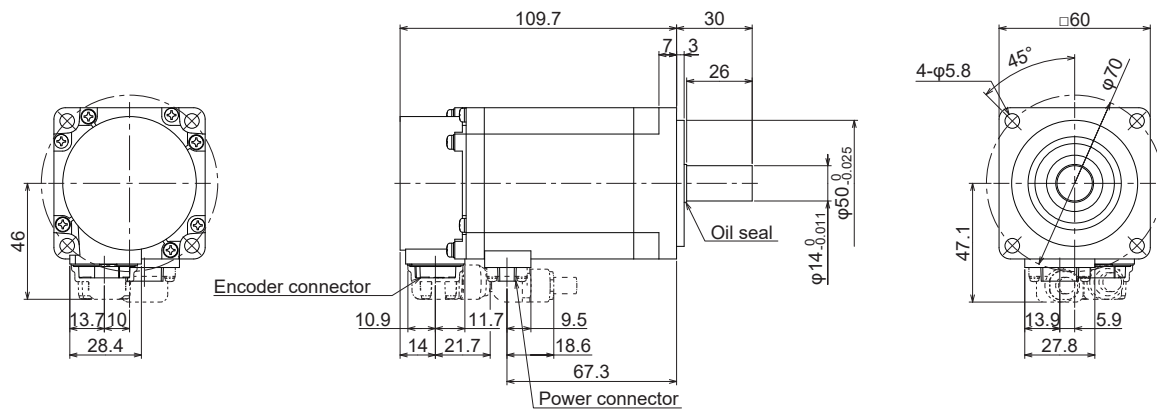

POWER	
No.	Signal
1	⊕ (PE)
2	U
3	V
4	W

Connector pin assignment  
Servo motor flange direction →

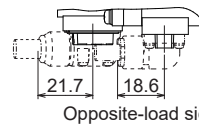
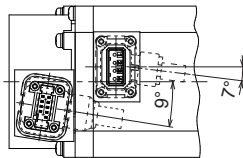

Opposite-load side

BC69226\*

[Unit: mm]

## ■HG-KNS73J

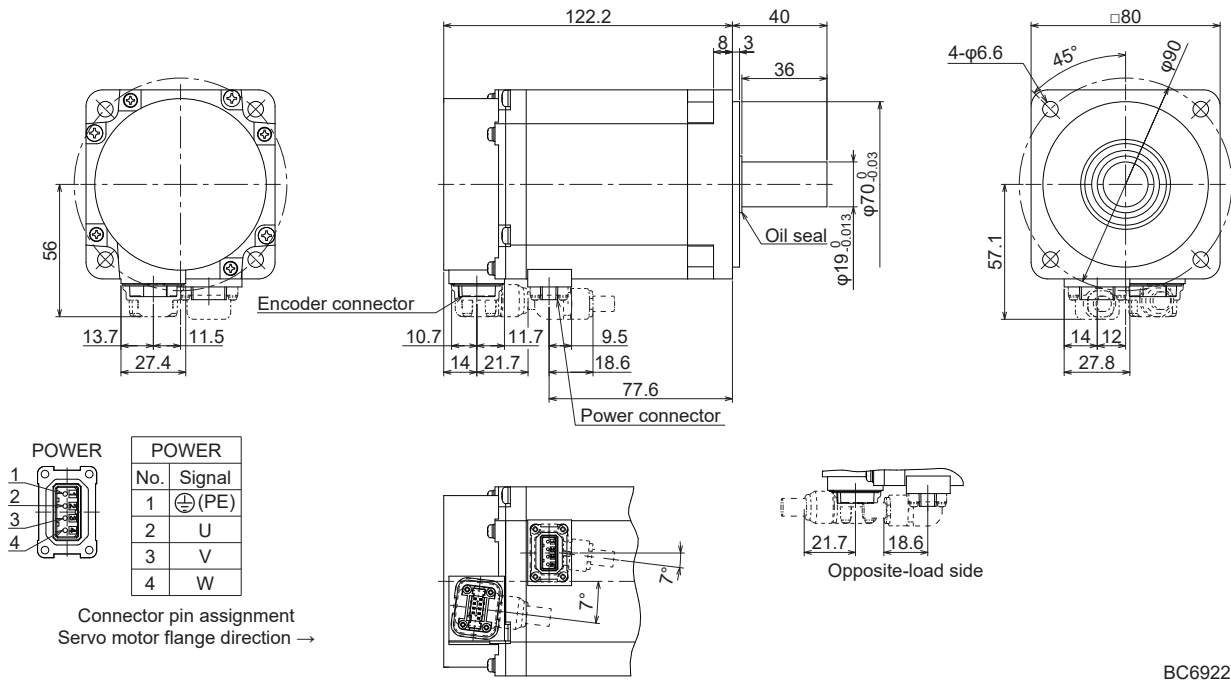

[Unit: mm]

## Without oil seal

## ■HG-KNS13

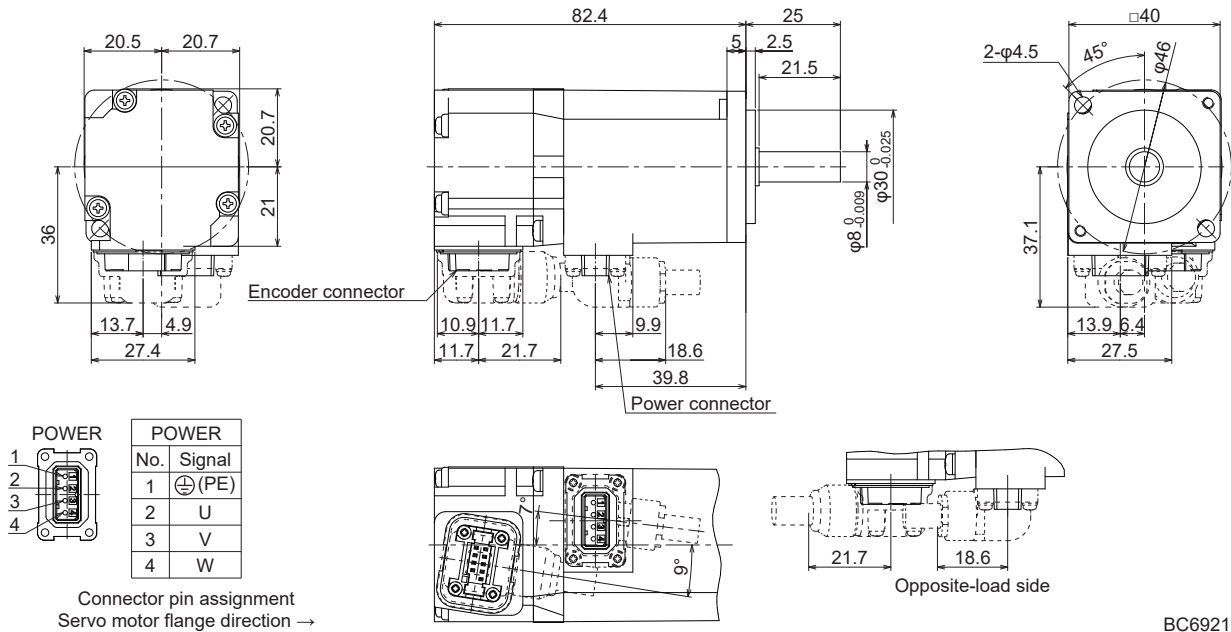

[Unit: mm]

## ■HG-KNS23

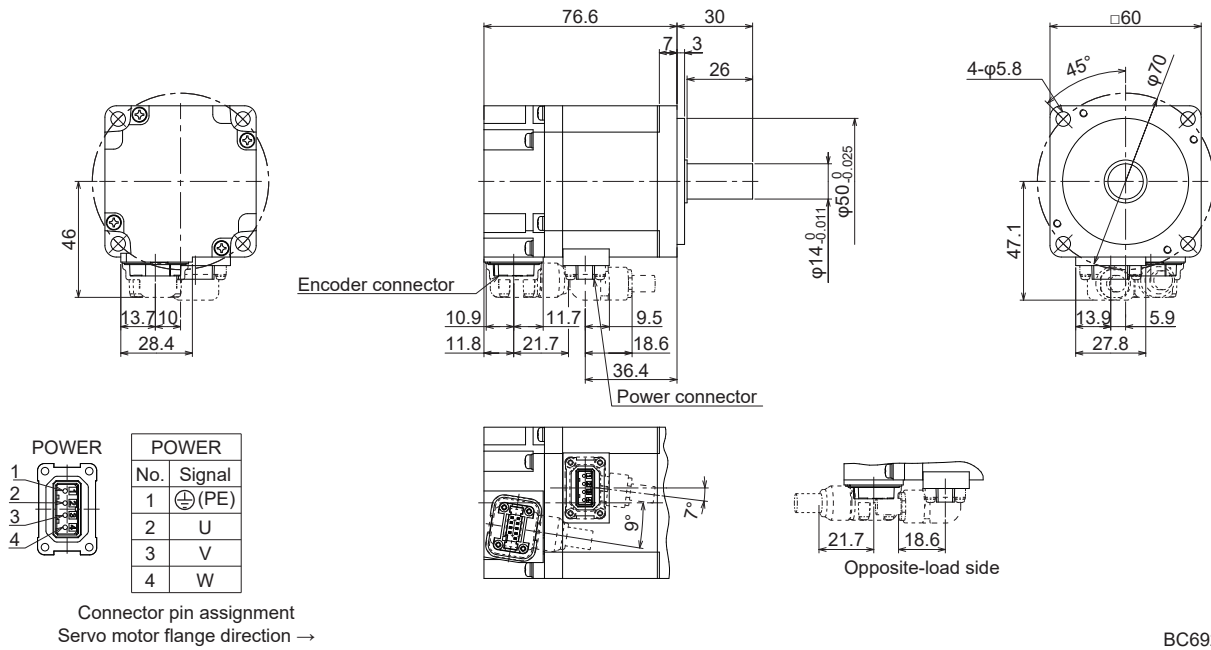

[Unit: mm]

## ■HG-KNS43

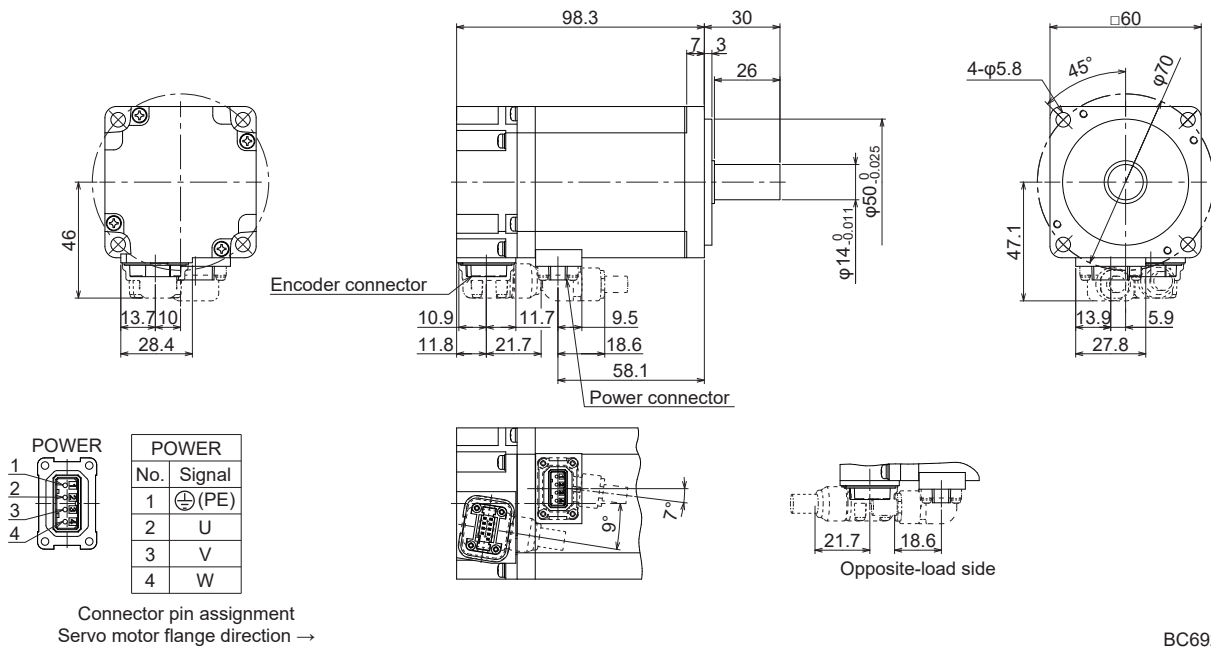

[Unit: mm]

■HG-KNS73

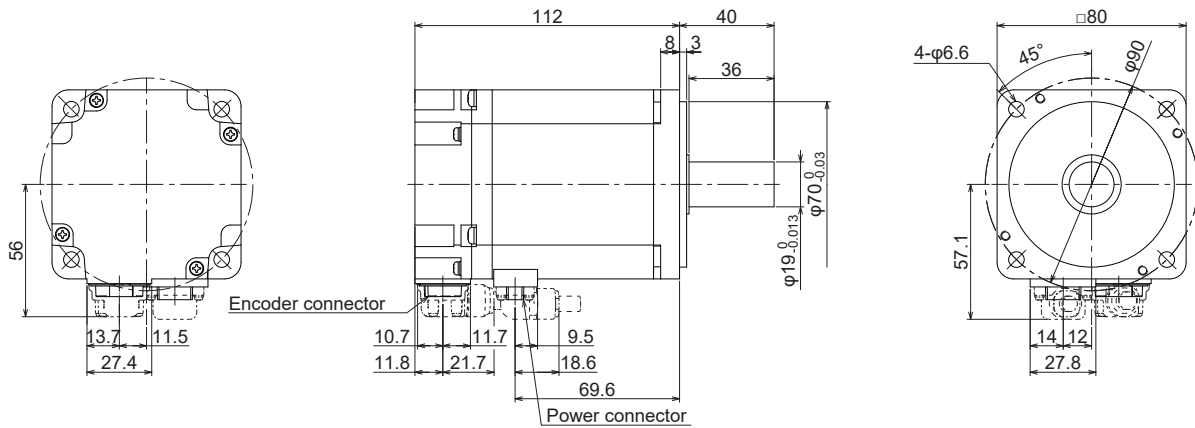

POWER

No.	Signal
1	⊕ (PE)
2	U
3	V
4	W

Connector pin assignment  
Servo motor flange direction →

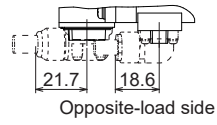
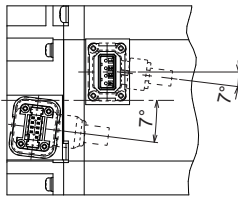

BC69219\*

[Unit: mm]

# With an electromagnetic brake

## With oil seal

### ■HG-KNS13BJ

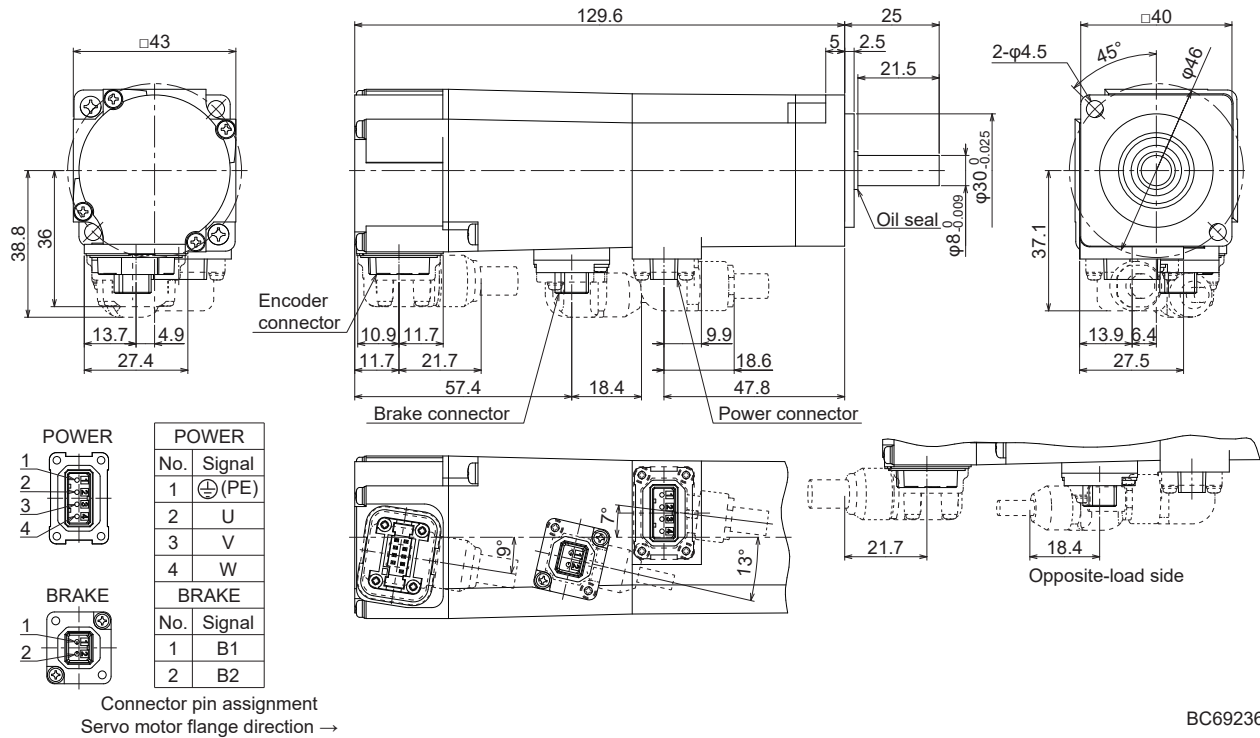

[Unit: mm]

### ■HG-KNS23BJ

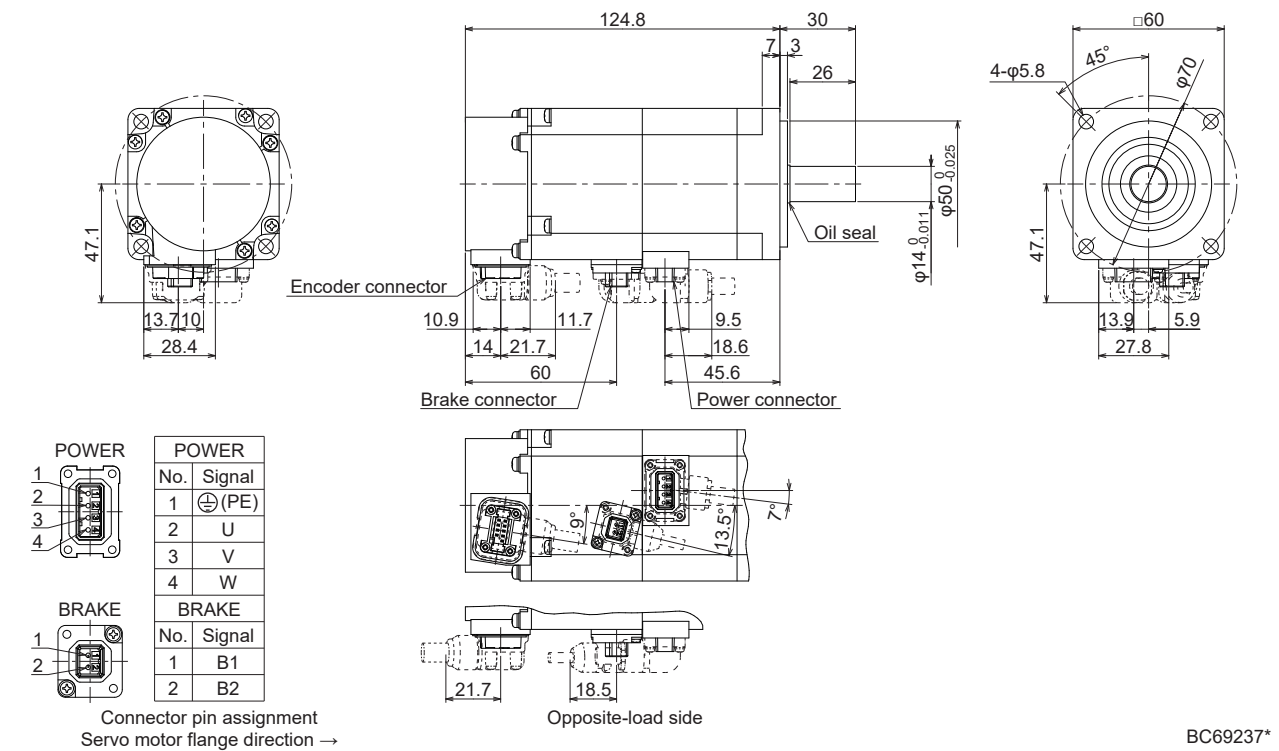

[Unit: mm]

## ■HG-KNS43BJ

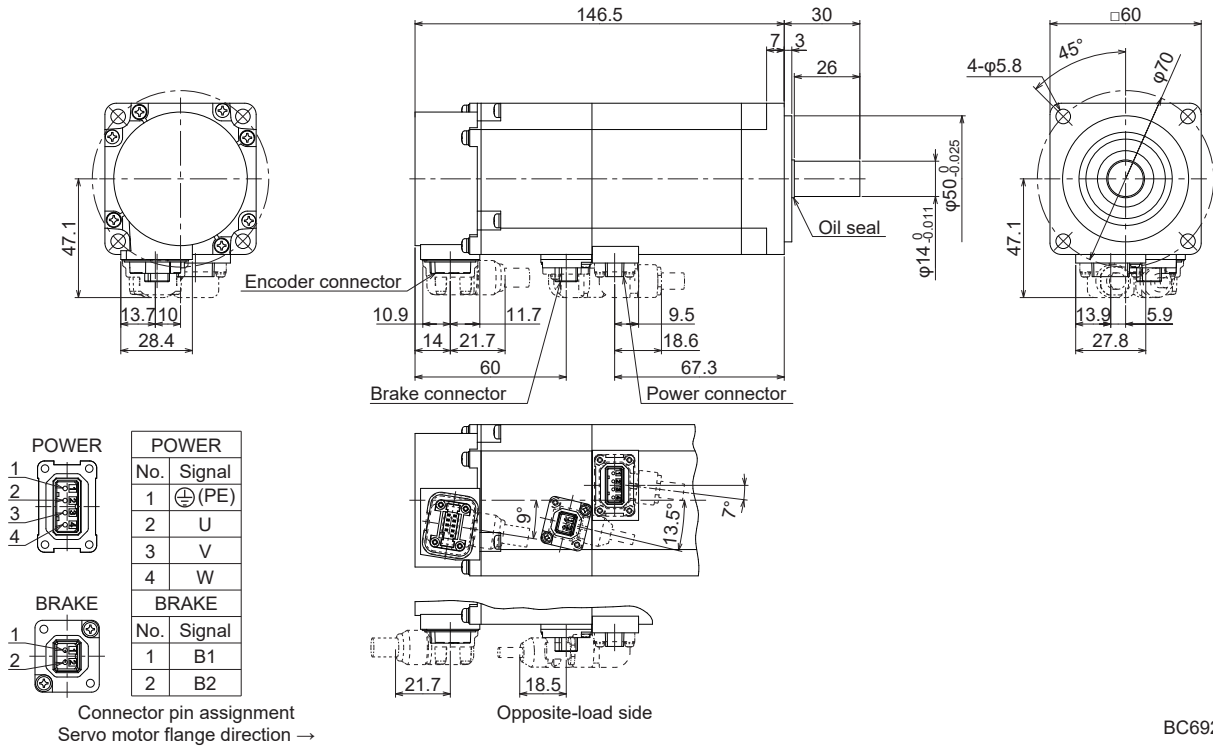

[Unit: mm]

## ■HG-KNS73BJ

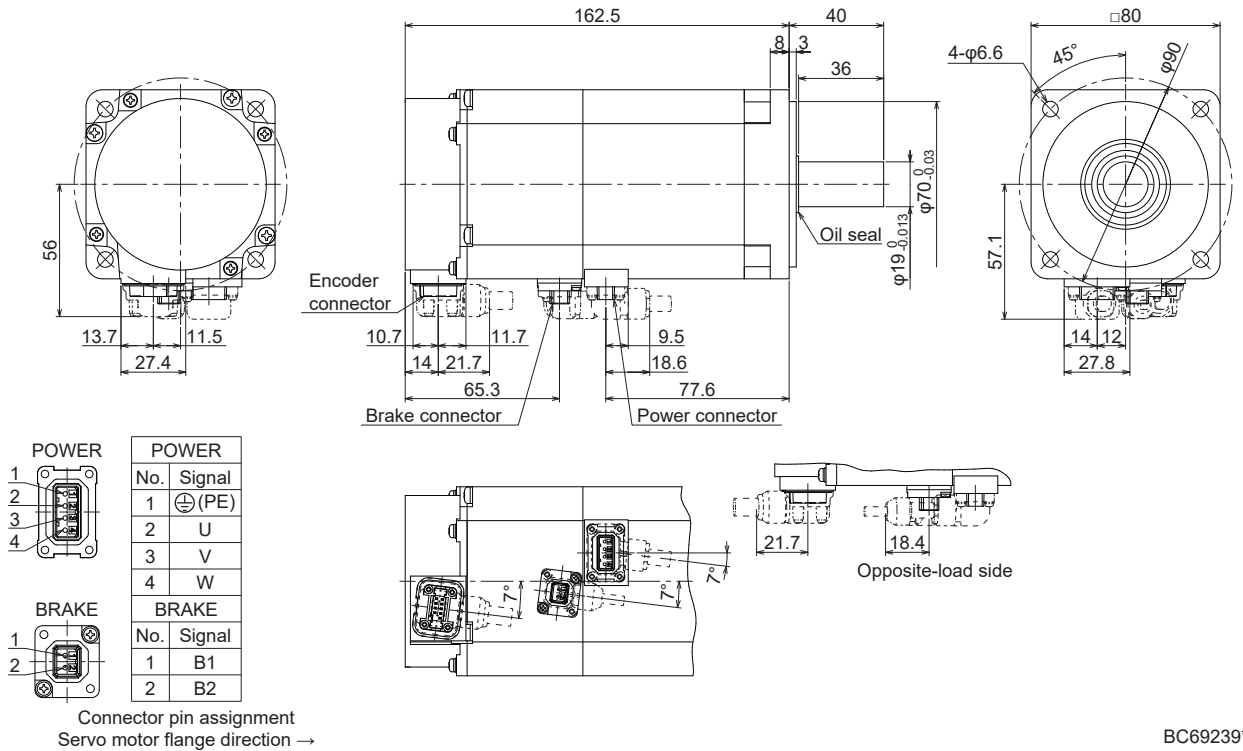

[Unit: mm]



# Without oil seal

## ■HG-KNS13B

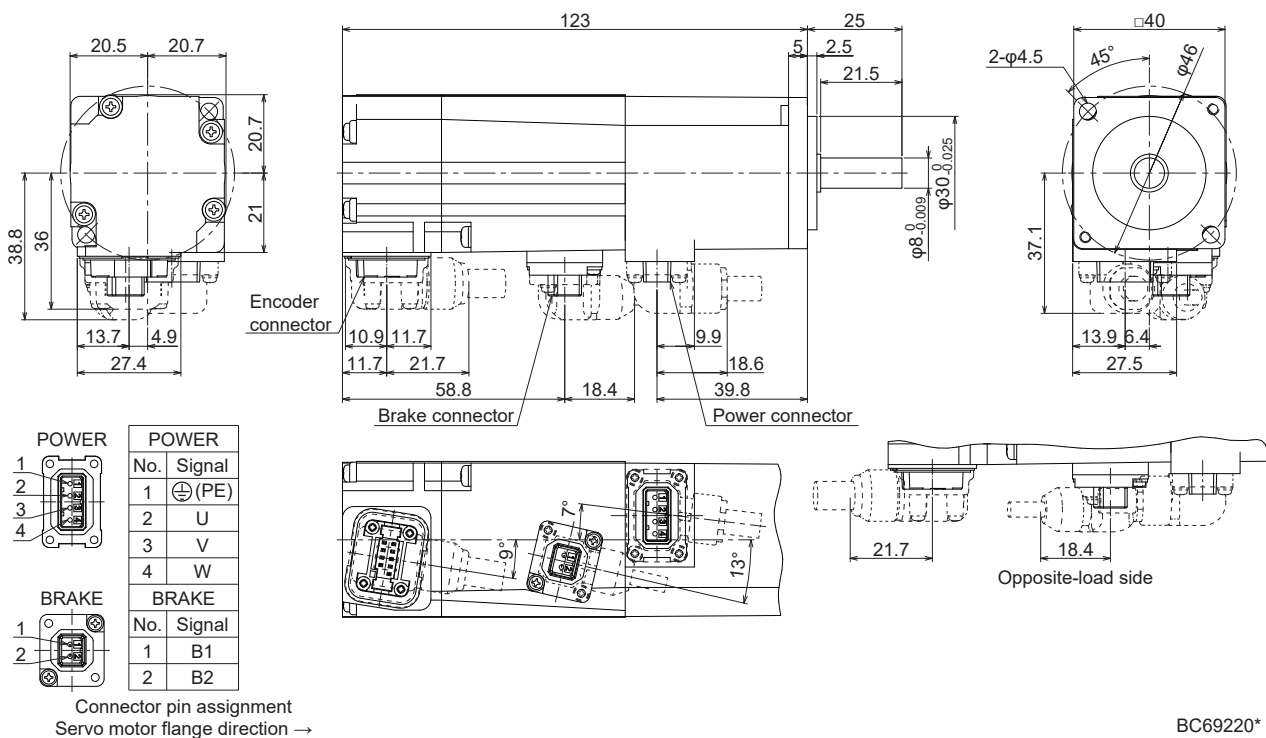

[Unit: mm]

## ■HG-KNS23B

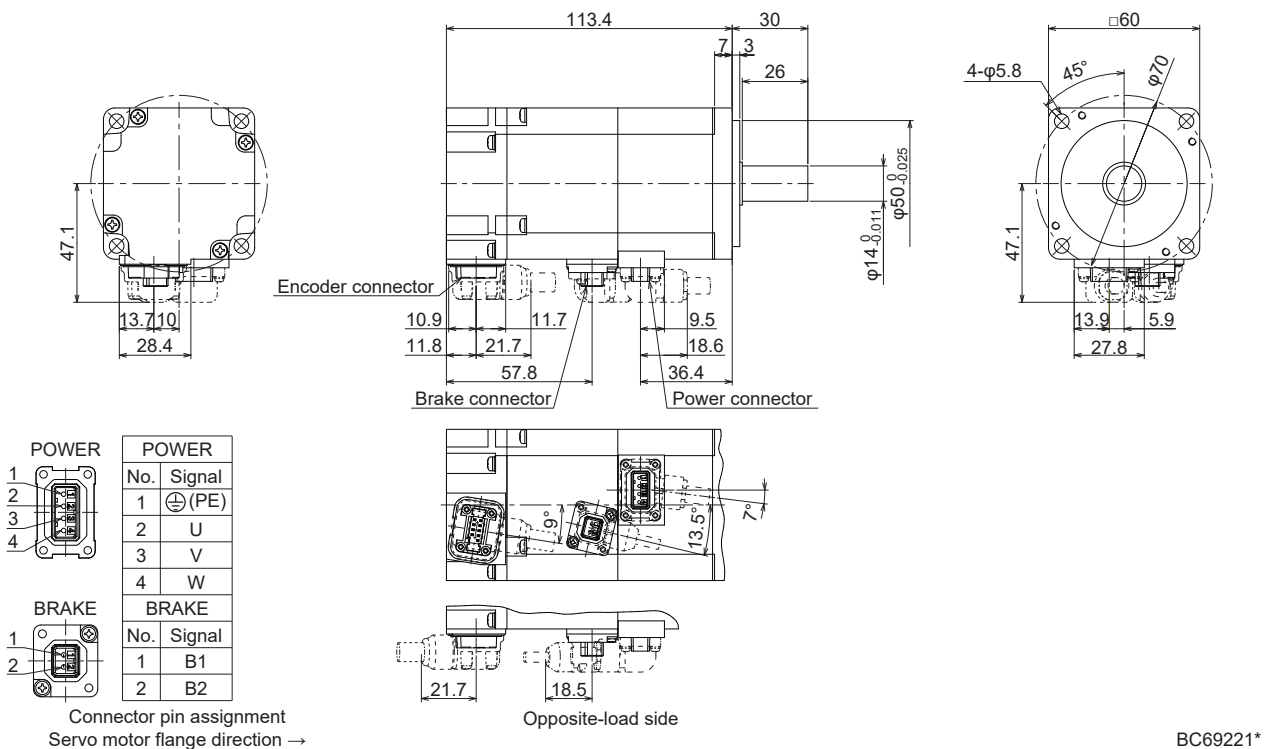

[Unit: mm]

## ■HG-KNS43B

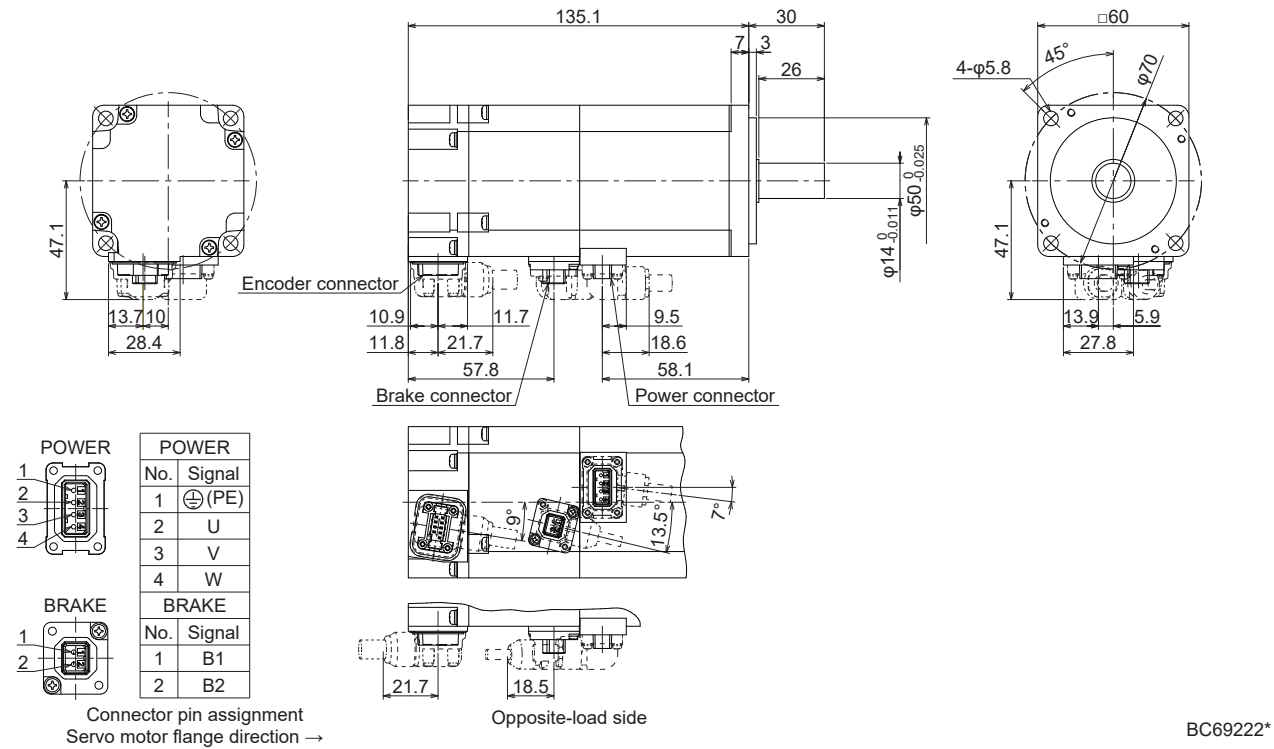

[Unit: mm]

## ■HG-KNS73B

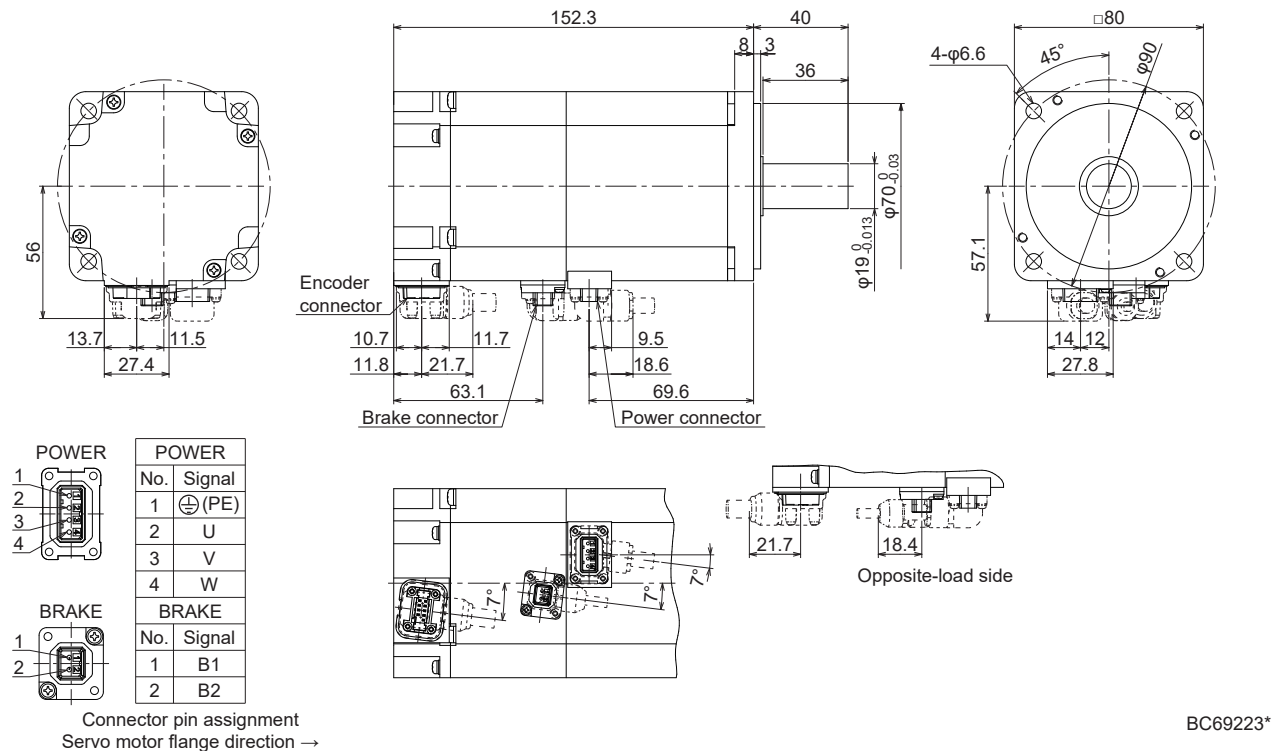

[Unit: mm]

# 7 HG-SNS SERIES

This chapter provides information on the rotary servo motor specifications and characteristics. If using the HG-SNS series rotary servo motor, read chapters 1 to 5 and the Safety Instructions at the front of this manual in addition to this chapter.

## 7.1 Standard specifications

### Standard specifications list

Series		HG-SNS (Medium inertia/medium capacity)				
Flange size		□130			□176	
Rotary servo motor model HG-SNS		HG-SNS52_ HG-SNS52_J	HG-SNS102_ HG-SNS102_J	HG-SNS152_ HG-SNS152_J	HG-SNS202_ HG-SNS202_J	HG-SNS302_ HG-SNS302_J
Power supply capacity		Refer to "Power supply capacity and generated loss" in the following manual. MR-JET User's Manual (Hardware)				
Power supply voltage [V]		200 V AC (3-phase 200 V AC to 240 V AC)				
Continuous running duty *1	Rated output [kW]	0.5	1.0	1.5	2.0	3.0
	Rated torque [N·m]	2.39	4.77	7.16	9.55	14.3
Maximum torque [N·m]		7.16	14.3	21.5	28.6	42.9
Rated speed *1[r/min]		2000				
Maximum speed *1[r/min]		3000				2500
Power rate at continuous rated torque [kW/s]	Standard	7.85	19.7	32.1	19.5	26.1
	With an electromagnetic brake	6.01	16.5	28.2	16.1	23.3
Rated current [A]		2.9	5.6	9.4	9.6	11.0
Maximum current [A]		9.0	17	29	31	33
Moment of inertia J [ $\times 10^{-4}$ kg·m <sup>2</sup> ]	Standard	7.26	11.6	16.0	46.8	78.6
	With an electromagnetic brake	9.48	13.8	18.2	56.5	88.2
Recommended load to motor inertia ratio *2		15 times or less				
Speed/position detector		22-bit encoder common to absolute position and incremental detection systems (resolution per rotary servo motor revolution: 4194304 pulses/rev)				
Oil seal	HG-SNS_	Not attached				
	HG-SNS_J	Attached				
Insulation class		155 (F)				
Structure		Totally enclosed, natural cooling (IP rating: IP67) *3				
Vibration resistance *4		X, Y: 24.5 m/s <sup>2</sup>			X: 24.5 m/s <sup>2</sup> Y: 49 m/s <sup>2</sup>	
Vibration rank *5		V10				
Permissible load for the shaft *6	L [mm]	55			79	
	Radial [N]	980			2058	
	Thrust [N]	490			980	
Mass [kg]	Standard	4.8	6.2	7.3	11	16
	With an electromagnetic brake	6.7	8.2	9.3	17	22

\*1 When the power supply voltage drops, the continuous running duty and the speed cannot be guaranteed.

\*2 If the load to motor inertia ratio exceeds the indicated value, contact your local sales office.

\*3 Except for the shaft-through portion. IP classifies the degrees of protection provided against the intrusion of solid objects and water in electrical enclosures.

\*4 The vibration directions are shown in the following figure. The value is the one at the part that indicates the maximum value (normally the opposite to load-side bracket). When the rotary servo motor stops, fretting is likely to occur at the bearing. Therefore, suppress the vibration to about half of the permissible value.

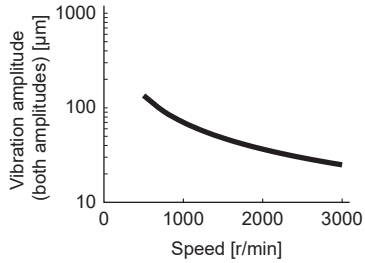
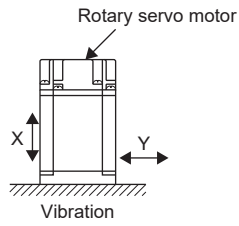

\*5 V10 indicates that the amplitude of a single rotary servo motor is 10 μm or less. The following figure shows the rotary servo motor mounting position for measurement and the measuring position.

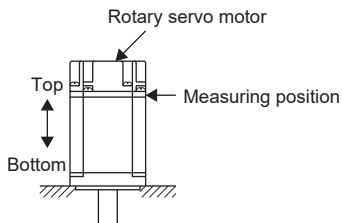

\*6 The following shows permissible load for the shaft. Do not subject the shaft to loads greater than the value in the specifications list. The value assumes that the load is applied independently.

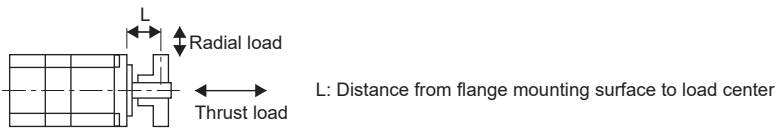

# Torque characteristics

- For the system where the unbalanced torque occurs, such as a vertical axis, the unbalanced torque of the machine should be kept at 70 % or lower of the rated torque.
- When the power supply voltage drops, the torque decreases.

When the power supply input of the servo amplifier is 3-phase 200 V AC or 1-phase 230 V AC, the torque characteristic is indicated by the heavy line. The 1-phase power input is applicable to HG-SNS52, HG-SNS102, HG-SNS152, and HG-SNS202.

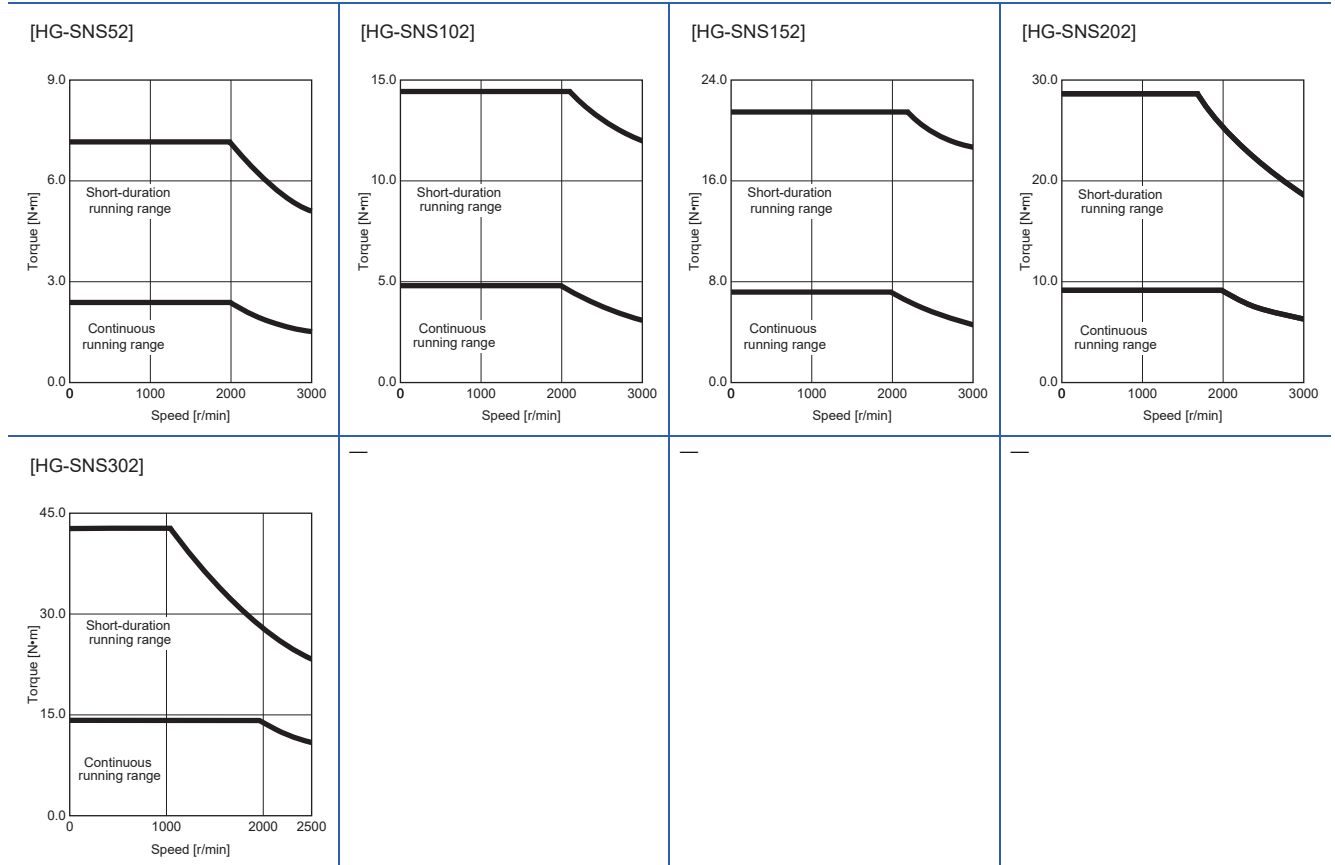

## 7.2 Combinations of servo amplifiers and rotary servo motors

Rotary servo motor	Servo amplifier
HG-SNS52	MR-JET-70G_
HG-SNS102	MR-JET-100G_
HG-SNS152 HG-SNS202	MR-JET-200G_
HG-SNS302	MR-JET-300G_

## 7.3 Characteristics of electromagnetic brake

### Point

Before operating the servo motor, confirm that the electromagnetic brake operates properly.  
The operation time of the electromagnetic brake varies, depending on the power supply circuit being used.  
Check the operation delay time with an actual machine.

The characteristics of the electromagnetic brake provided for the rotary servo motor with an electromagnetic brake are shown below.

Item	HG-SNS series	
	52B_/102B_/152B_	202B_/302B_
Type *1	Spring actuated type safety brake	
Rated voltage *4	24 V DC (-10 % to 0 %)	
Power consumption at 20 °C [W]	20	34
Coil resistance *5[Ω]	29.0	16.8
Inductance *5[H]	0.80	1.10
Brake static friction torque *7[N•m]	8.5 or more	44.0 or more
Release delay time *2[s]	0.04	0.1
Braking delay time [s]	DC off *2	0.03
Permissible braking work	Per braking [J]	400
	Per hour [J]	4000
Brake looseness at servo motor shaft *5[degree]	0.2 to 0.6	0.2 to 0.6
Brake life *3	Number of braking times [times]	20000
	Work per braking [J]	200
Selection example of surge absorbers to be used *6	Suppressed voltage of 125 V	TND20V-680KB (Manufactured by Nippon Chemi-Con Corporation)
	Suppressed voltage of 350 V	TND10V-221KB (Manufactured by Nippon Chemi-Con Corporation)

- \*1 This type does not have a manual release mechanism. Use a 24 V DC power supply to release the brake electrically.
- \*2 The value for initial on gap at 20 °C.
- \*3 Brake lining wear due to braking will increase the brake gap, but the gap is not adjustable. Therefore, the brake life indicates the number of times the brake can be applied before gap adjustment becomes necessary.
- \*4 Prepare a power supply exclusively for the electromagnetic brake.
- \*5 The values are design values. These are not the guaranteed values.
- \*6 Select the electromagnetic brake control relay properly, in consideration of the characteristics of the electromagnetic brake and surge absorber. When a diode is used as surge absorber, the electromagnetic braking time becomes longer.
- \*7 The value of the brake static friction torque is the lower limit in the initial state at 20 °C.

# 7.4 Rotary servo motors with special shafts

The shaft shape for the rotary servo motor is keyed shaft (without key)-type.

Rotary servo motor	Shaft shape
	Keyed shaft (without key)

HG-SNS\_K K

## Keyed shaft (without key)

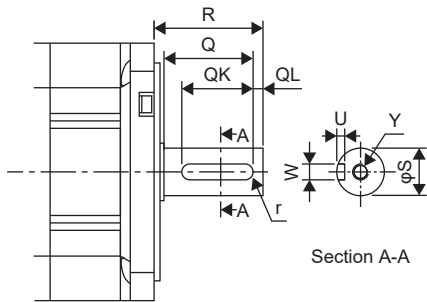

[Unit: mm]

Rotary servo motor	Variable dimensions								
	S	R	Q	W	QK	QL	U	r	Y
HG-SNS52_K HG-SNS102_K HG-SNS152_K	24 <sup>0</sup> <sub>-0.013</sub>	55	50	8 <sup>0</sup> <sub>-0.036</sub>	36	5	4 <sup>+0.2</sup> <sub>0</sub>	4	M8 Screw hole depth 20
HG-SNS202_K HG-SNS302_K	35 <sup>+0.010</sup> <sub>0</sub>	79	75	10 <sup>0</sup> <sub>-0.036</sub>	55	5	5 <sup>+0.2</sup> <sub>0</sub>	5	M8 Screw hole depth 20



## 7.5 Rotary servo motors with an oil seal

The oil seal prevents the entry of oil into the rotary servo motor.

Install the rotary servo motor horizontally, and set the oil level in the gear box to be always lower than the oil seal lip.

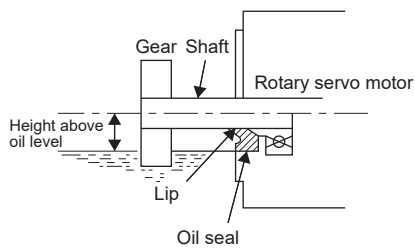

Rotary servo motor	Height (h) from the surface of the oil [mm]
HG-SNS52_J HG-SNS102_J HG-SNS152_J	23
HG-SNS202_J HG-SNS302_J	31

# 7.6 Dimensions

- Not all parts are created the exact same size or assembled in precisely the same manner. Therefore, the actual dimensions of rotary servo motors may be a maximum of approximately 3 mm larger than those in the drawings. In addition, the described dimensions and dimensional tolerances are the values at 20 °C. Since the values of the dimensions may vary depending on the ambient temperature, allow some margin when designing the machine side.
- Use a friction coupling for coupling the servo motor with a load.
- Use hexagon socket head cap screws to mount the rotary servo motor.
- The HG-SNS series with an oil seal and those without an oil seal have the same dimensions.

## Standard (without an electromagnetic brake)

### HG-SNS52/HG-SNS52J

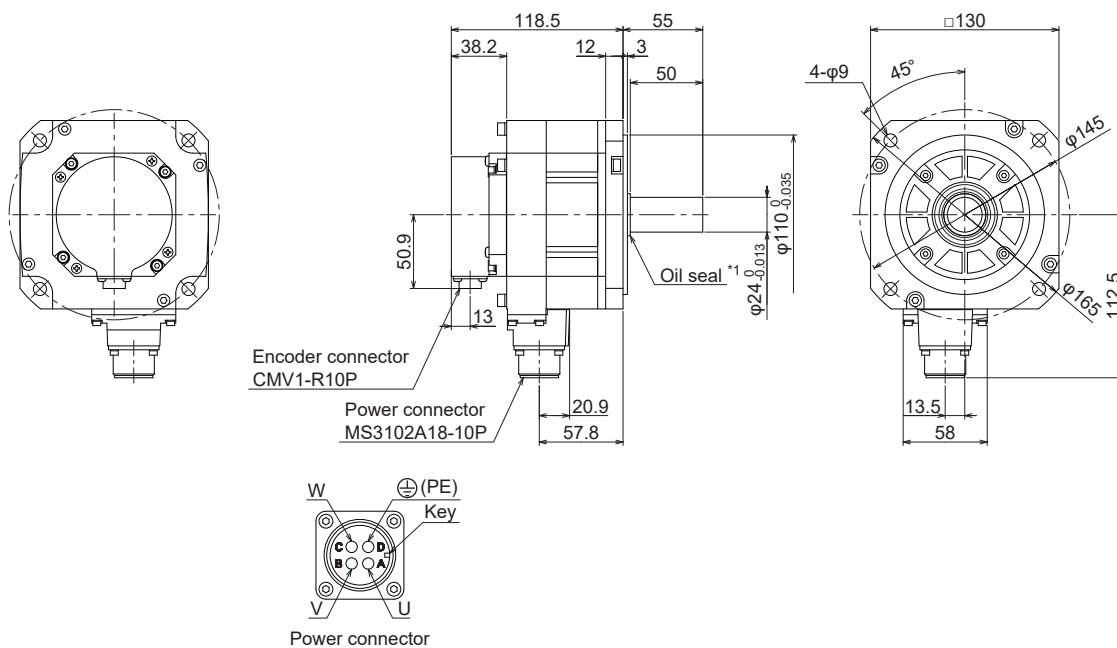

Servo motor flange direction →

BC69252\*

[Unit: mm]

\*1 For the servo motor with an oil seal

## HG-SNS102/HG-SNS102J

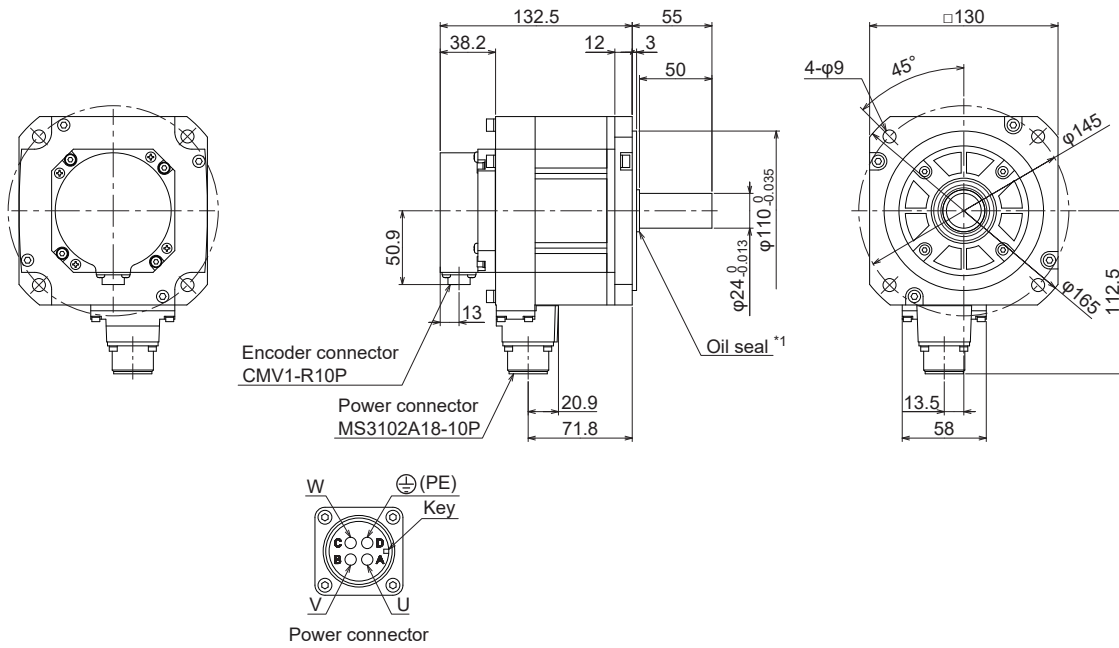

Servo motor flange direction →

BC69253\*

[Unit: mm]

\*1 For the servo motor with an oil seal

7

## HG-SNS152/HG-SNS152J

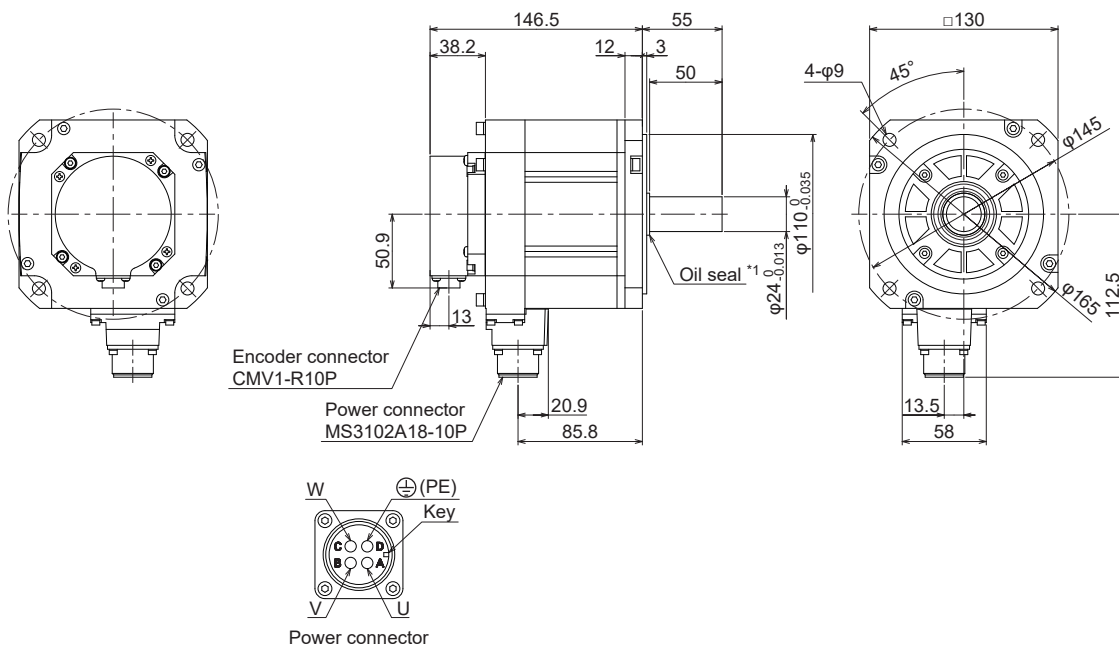

Servo motor flange direction →

BC69254\*

[Unit: mm]

\*1 For the servo motor with an oil seal

## HG-SNS202/HG-SNS202J

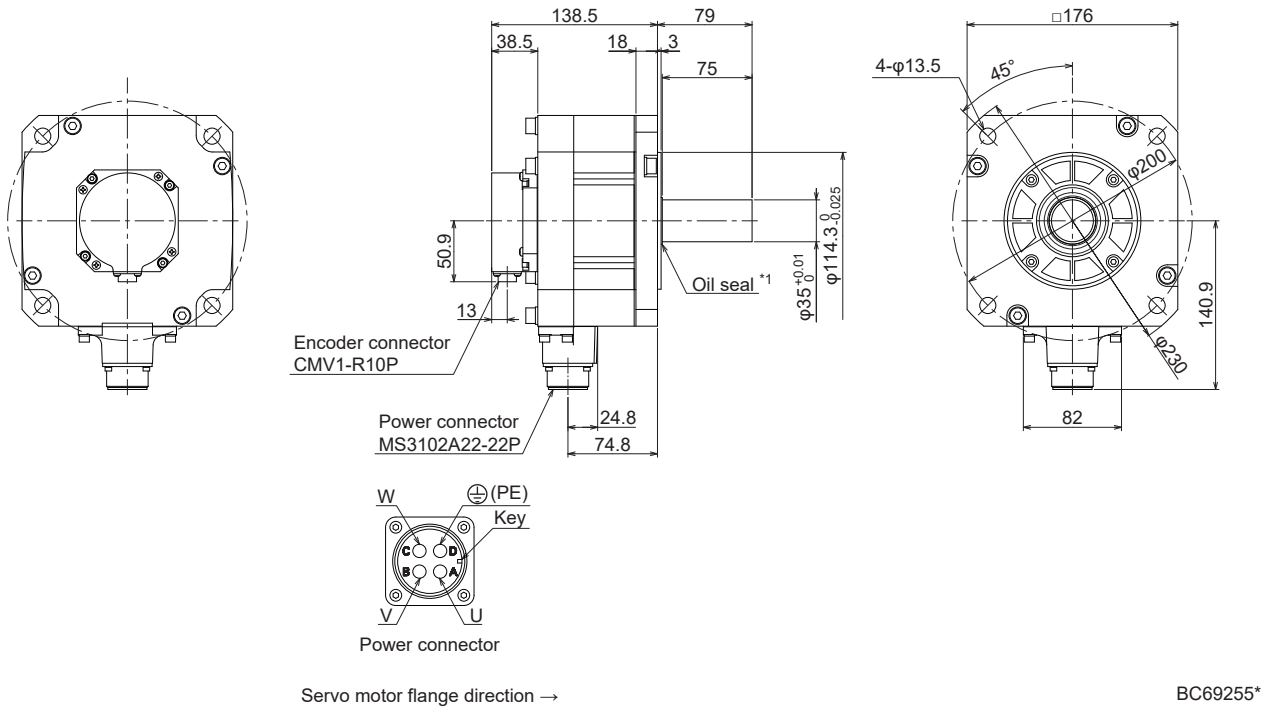

[Unit: mm]

\*1 For the servo motor with an oil seal

## HG-SNS302/HG-SNS302J

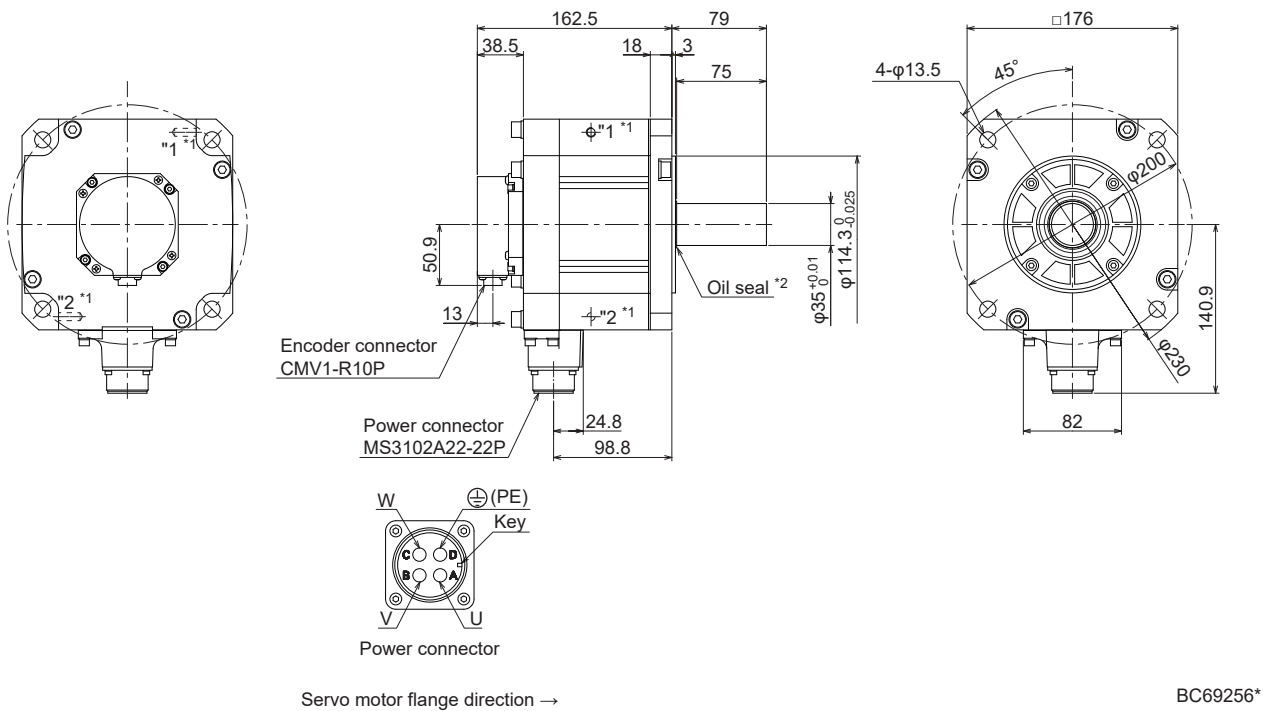

[Unit: mm]

\*1 Screw hole for eyebolt (M8)

\*2 For the servo motor with an oil seal

# With an electromagnetic brake

## HG-SNS52B/HG-SNS52BJ

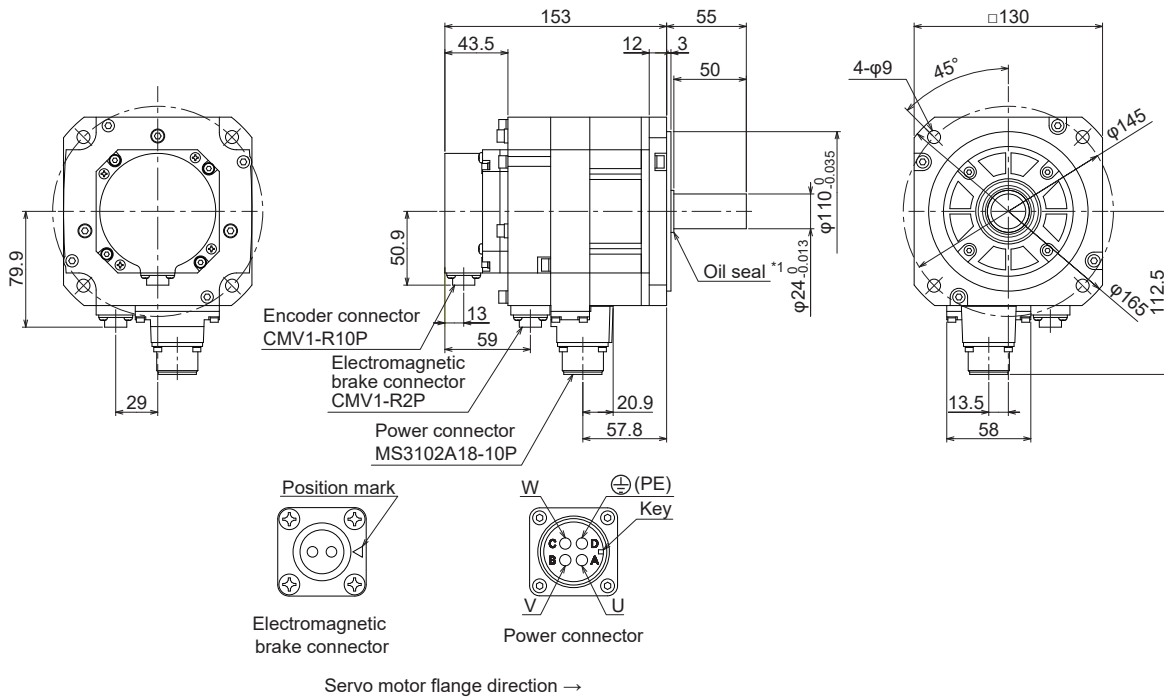

[Unit: mm]

\*1 For the servo motor with an oil seal

## HG-SNS102B/HG-SNS102BJ

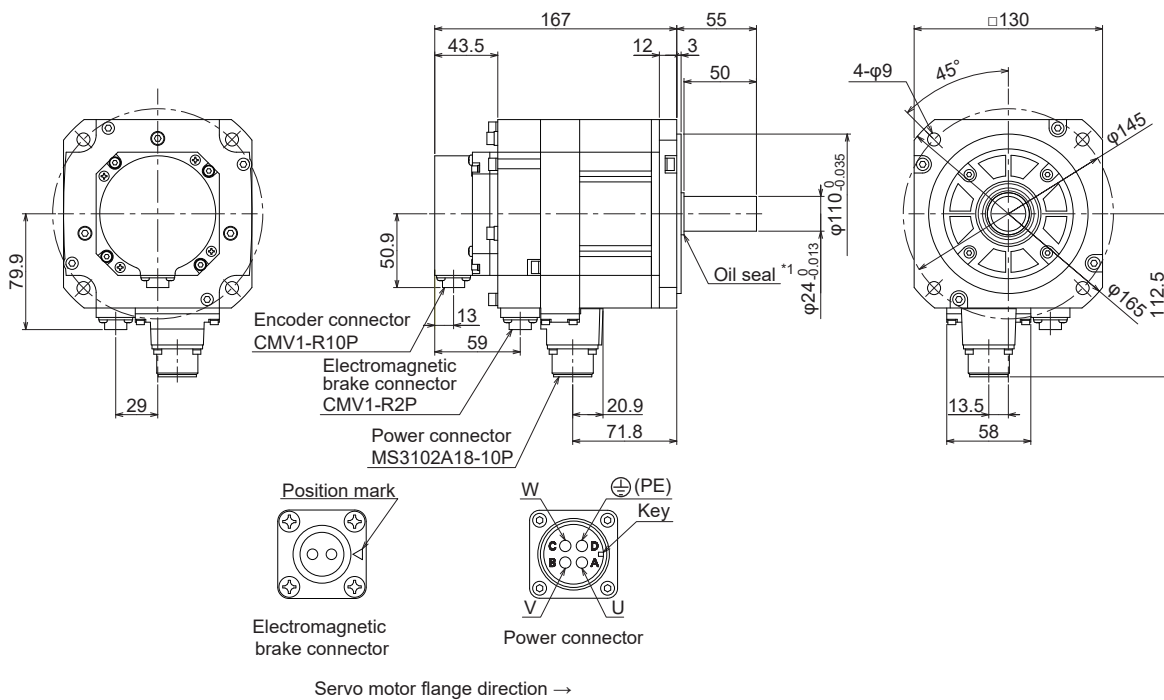

[Unit: mm]

\*1 For the servo motor with an oil seal

## HG-SNS152B/HG-SNS152BJ

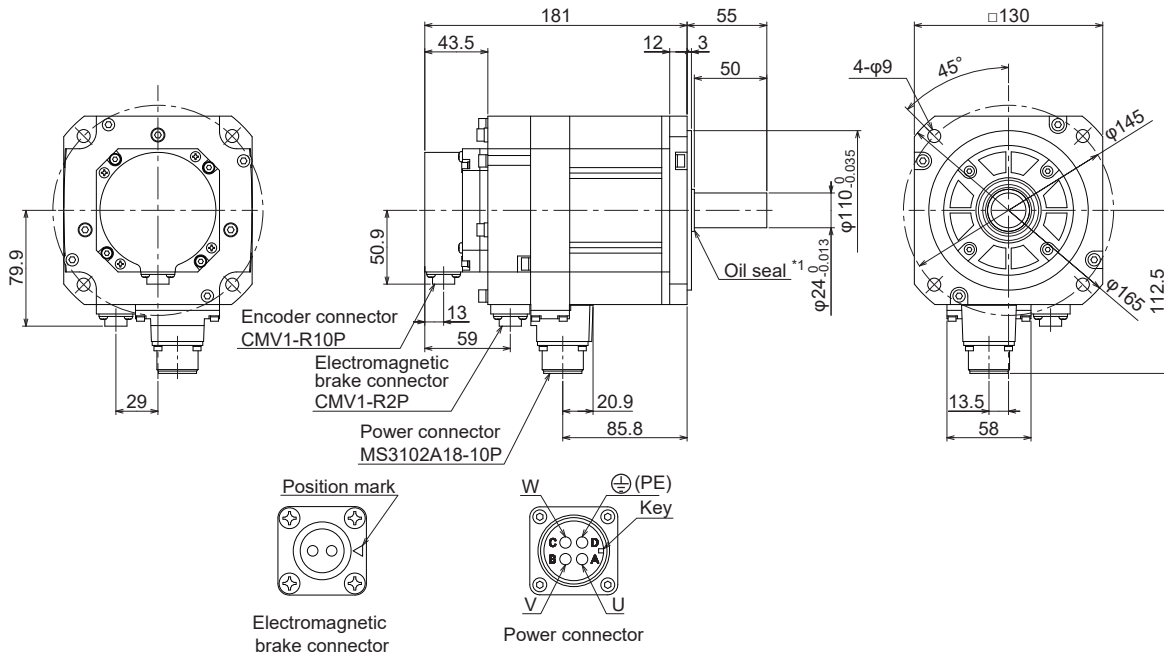

BC69259\*

[Unit: mm]

\*1 For the servo motor with an oil seal

## HG-SNS202B/HG-SNS202BJ

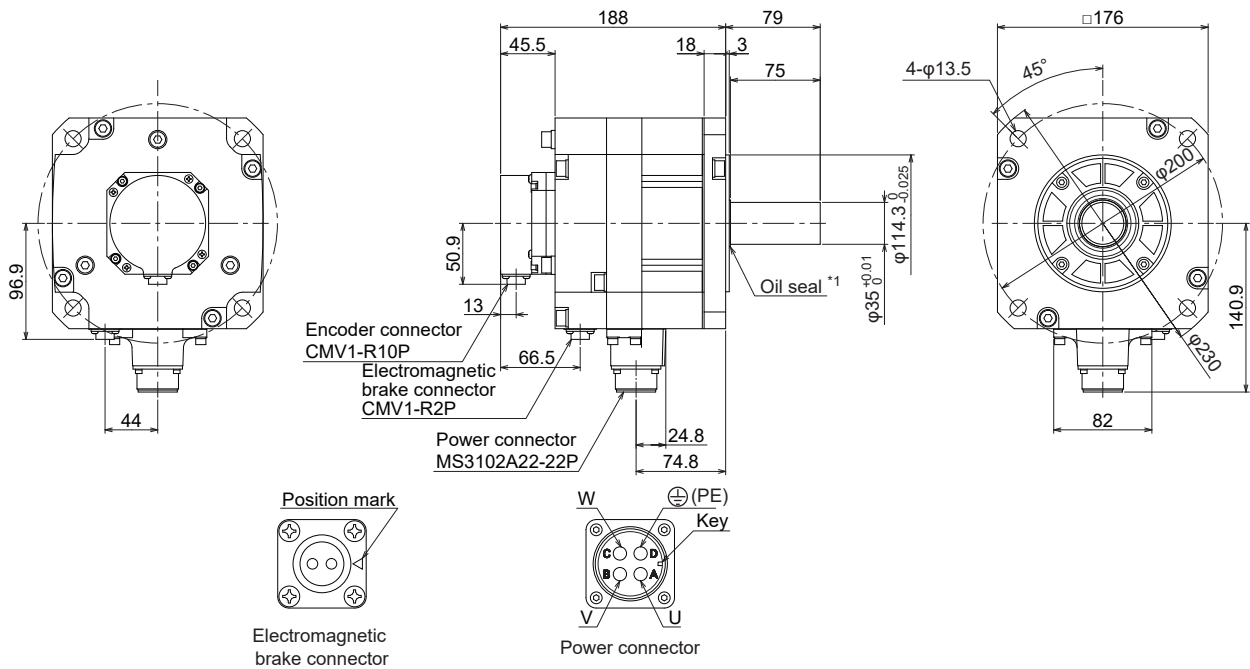

BC69260\*

[Unit: mm]

\*1 For the servo motor with an oil seal

# HG-SNS302B/HG-SNS302BJ

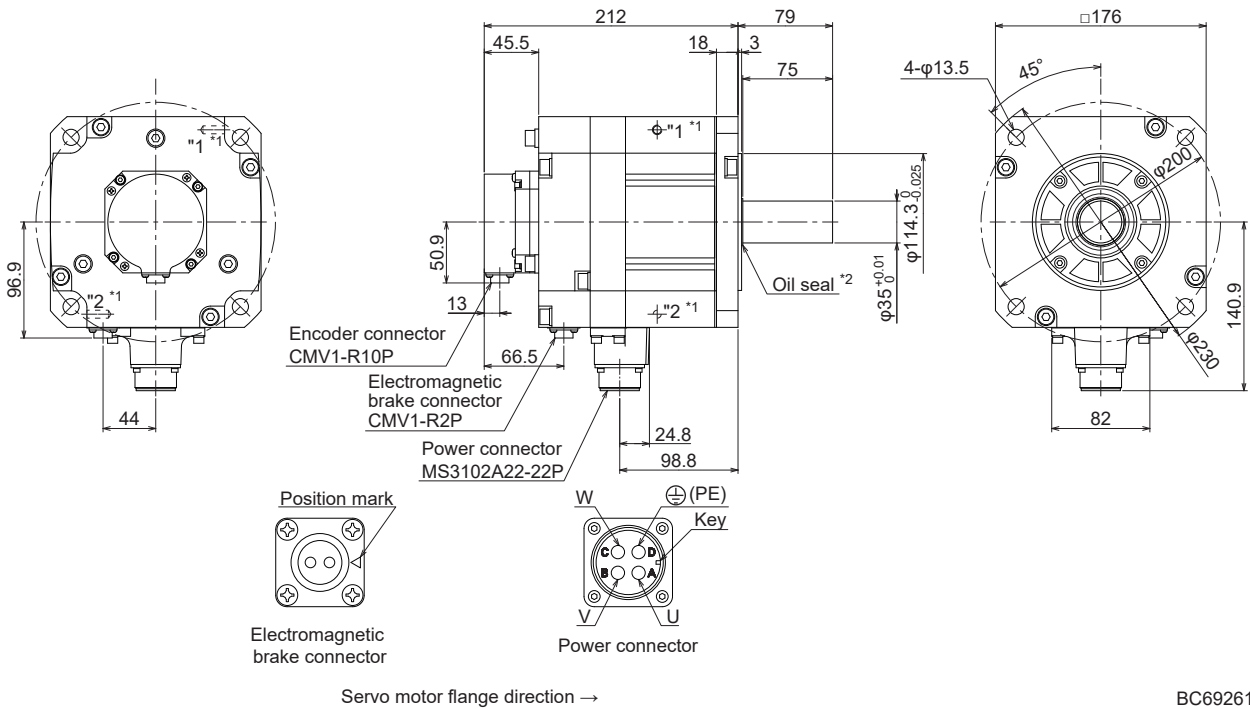

BC69261\*

[Unit: mm]

\*1 Screw hole for eyebolt (M8)

\*2 For the servo motor with an oil seal

# 8 COMPLIANCE WITH EACH REGION

## 8.1 Compliance with CE marking

### CE marking

The CE marking is mandatory and must be affixed to specific products placed on the European Union. When a product conforms to the requirements, the CE marking must be affixed to the product. CE marking also incorporates the machines and equipments that are for sale with the servo motors in the European Union area. Each manual is available in different languages. For details, refer to our website or contact our local sales office.

#### EMC directive

The EMC directive applies to the rotary servo motor alone. Therefore, the rotary servo motor is designed to comply with the EMC directive. The EMC directive also applies to machines and equipment incorporating rotary servo motors. HG-KNS and HG-SNS series comply with EN61800-3 Category 3. These series are not intended to be used on a low-voltage public network which supplies domestic premises; When used on such network, radio frequency interference may occur. The installer must provide a guide for installation and use, including the recommended mitigation devices.

#### Low voltage directive

The low voltage directive also applies to the rotary servo motor alone. The rotary servo motor is designed to comply with the low voltage directive.

#### Machinery directive

The rotary servo motor as a single unit does not comply with the Machinery directive due to correspondence with Article 1.2 (k). However, the Machinery directive applies to machines and equipment incorporating rotary servo motors. Please check if the machines and equipment as a whole are in conformity.

### For compliance

Be sure to perform an appearance inspection of every unit before installation. In addition, have a final performance inspection on the entire machine, and keep the inspection record.

#### Wiring

Use wiring which complies with EN for the rotary servo motor power. Products in compliance with EN are available as options. For options, refer to the following.

☞ Page 35 WIRING OPTION

#### Performing EMC tests

When EMC tests are run on a machine and equipment into which the servo amplifier and rotary servo motor have been installed, it must conform to the electromagnetic compatibility (immunity/emission) standards after it has satisfied the operating environment and electrical equipment specifications. For EMC directive conforming methods about servo amplifiers and rotary servo motors, refer to "EMC Installation Guidelines".



## 8.2 Compliance with UL/CSA standard

Use the UL/CSA standard-compliant model of rotary servo motor. For the latest information of compliance, contact your local sales office. Unless otherwise specified, the handling, performance, specifications, etc., of the UL/CSA compliant products are the same as those of the standard models.

### Flange size

The rotary servo motor is compliant with the UL/CSA standard when it is mounted on the flanges made of aluminum whose sizes are indicated in the following table. The rated torque of the rotary servo motor under the UL/CSA standard indicates the continuous permissible torque value that can be generated when the motor is mounted on the flange specified in this table, and used in the environment of specified ambient temperature (0 °C to 40 °C). Therefore, to conform to the UL/CSA standard, mount the direct drive motor on a machine with a heat radiating effect equivalent to that of this flange.

#### Insulation class 105 (A) [UL]

Flange size [mm]	HG-KNS
500 × 500 × 20	13
	23
	43
600 × 600 × 30	73

#### Insulation class 155 (F)

Flange size [mm]	HG-SNS
250 × 250 × 12	52
	102
	152
300 × 300 × 20	202 302

### Selection example of wires

To comply with the UL/CSA standard, use UL-approved copper wires rated at 75 °C for wiring.

The following table shows wires [AWG] rated at 75 °C.

Rotary servo motor	Wire [AWG]	
	U/V/W/⊕	B1/B2
HG-KNS13	14 *1	16 *1
HG-KNS23		
HG-KNS43		
HG-KNS73		
HG-SNS52	14	16
HG-SNS102		
HG-SNS152		
HG-SNS202		
HG-SNS302	12	

\*1 This is used for fabricating extension cables.

# 9 APPENDIX

## 9.1 Rotary servo motor ID codes

Rotary servo motor series ID	Rotary servo motor type ID	Rotary servo motor encoder ID	Rotary servo motor
0117	FF13	0044	HG-KNS13
	FF23		HG-KNS23
	FF43		HG-KNS43
	FF73		HG-KNS73
012B	FF52		HG-SNS52
	F102		HG-SNS102
	F152		HG-SNS152
	F202		HG-SNS202
	F302		HG-SNS302

## 9.2 Selection example of rotary servo motor power cable

### Point

Selection conditions of wire size are as follows.

Wiring length: 30 m or less

As some cables do not fit in the optional or recommended cable clamp, select cable clamps applicable to the cable diameters.

Selection example when using the 600 V grade EP rubber insulated chloroprene sheath cab-tire cable (2PNCT) for rotary servo motor power (U/V/W) is indicated below.

Rotary servo motor	Wire size [mm <sup>2</sup> ]
HG-SNS52	1.25
HG-SNS102	1.25
HG-SNS152	2
HG-SNS202	2
HG-SNS302	3.5

## 9.3 Connector dimensions

The connector dimensions for wiring the rotary servo motor are shown below.

### TE Connectivity

#### ■2174053-1

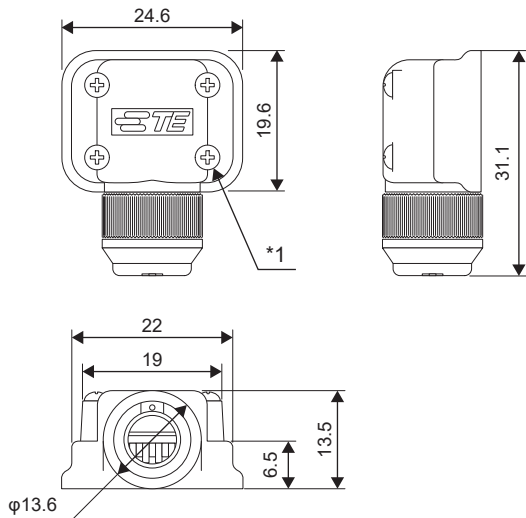

[Unit: mm]

\*1 The recommended screw tightening torque is 0.1 N•m.

Crimping tool: 1596970-1 (for ground clip)

1596847-1 (for receptacle contact)

### JAE

#### ■JN4FT02SJ1-R

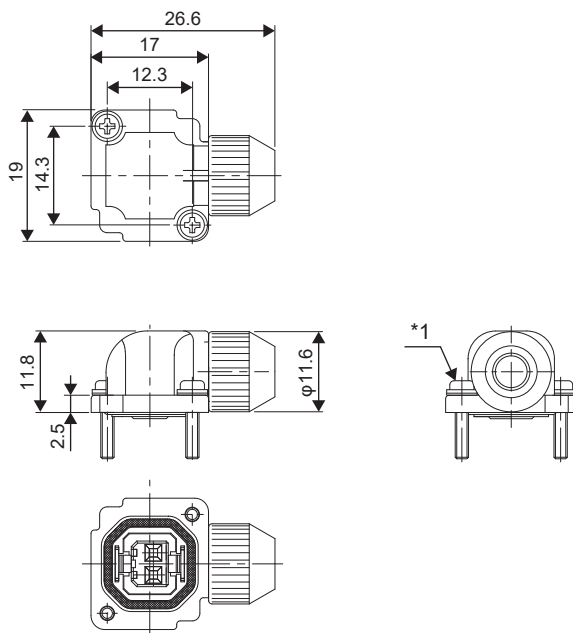

[Unit: mm]

\*1 The recommended screw tightening torque is 0.2 N•m.

Crimping tool: CT170-14-TMH5B

## ■KN4FT04SJ1-R

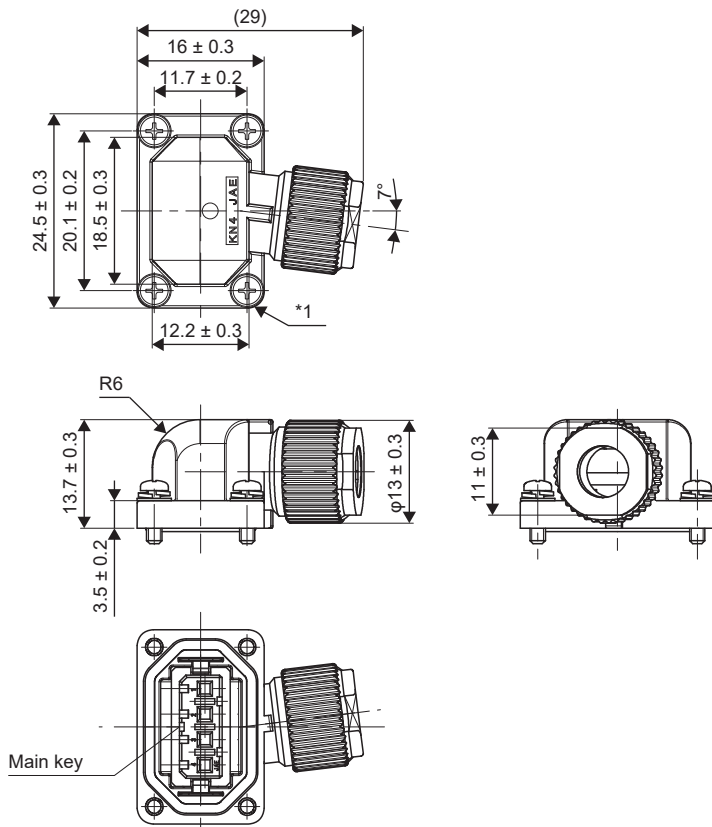

[Unit: mm]

\*1 The recommended screw tightening torque is 0.2 N•m.  
Crimping tool: CT170-14-TMH5B

■CMV1-SP10S-M\_/CMV1-SP2S-\_  
 Refer to the following for details of the crimping tool.

☞ Page 23 Wiring connectors (connector configurations D/E/F/G)

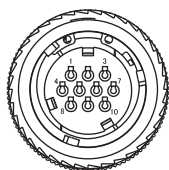
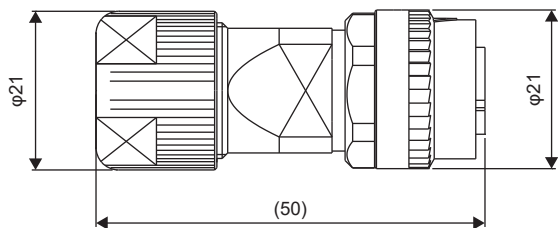

For CMV1-SP10S-M\_

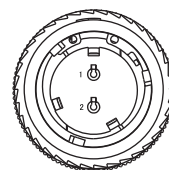

For CMV1-SP2S-\_  
 [Unit: mm]

■CMV1-AP10S-M\_/CMV1-AP2S-\_  
 Refer to the following for details of the crimping tool.

☞ Page 23 Wiring connectors (connector configurations D/E/F/G)

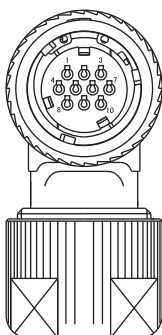
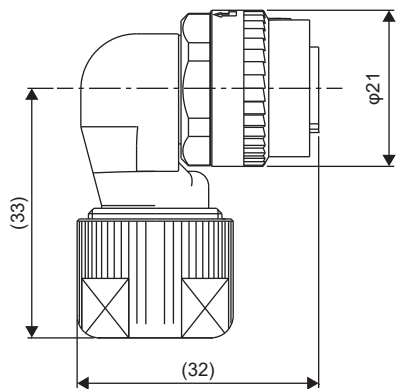

For CMV1-AP10S-M\_

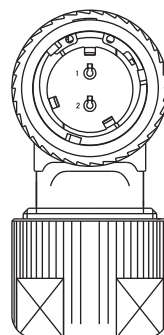

For CMV1-AP2S-\_  
 [Unit: mm]

■CMV1S-SP10S-M\_/CMV1S-SP2S-\_  
 Refer to the following for details of the crimping tool.

☞ Page 23 Wiring connectors (connector configurations D/E/F/G)

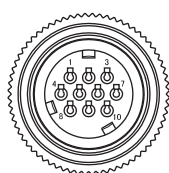
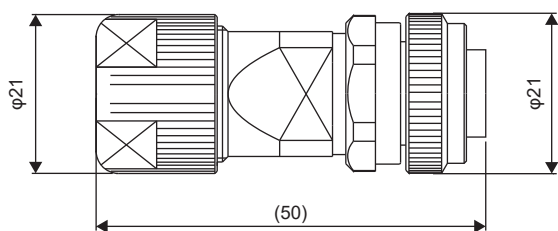

For CMV1S-SP10S-M\_

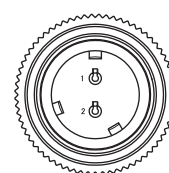

For CMV1S-SP2S-\_  
 [Unit: mm]

■CMV1S-AP10S-M\_/CMV1S-AP2S-

Refer to the following for details of the crimping tool.

☞ Page 23 Wiring connectors (connector configurations D/E/F/G)

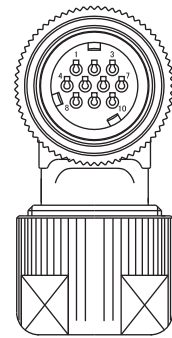
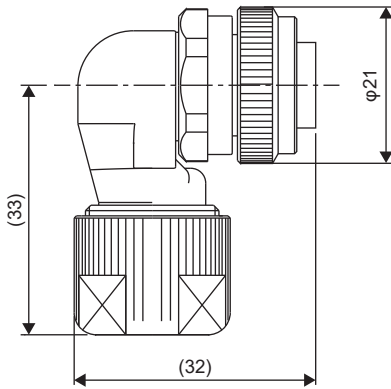

For CMV1S-AP10S-M\_

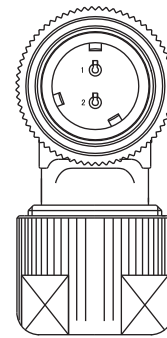

For CMV1S-AP2S-

[Unit: mm]

■CE05-6A\_-SD-D-BSS

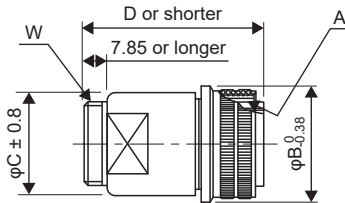

[Unit: mm]

Model	A	B	C	D	W
CE05-6A18-10SD-D-BSS	1 1/8-18UNEF-2B	34.13	32.1	57	1-20UNEF-2A
CE05-6A22-22SD-D-BSS	1 3/8-18UNEF-2B	40.48	38.3	61	1 3/16-18UNEF-2A

■CE05-8A\_-SD-D-BAS

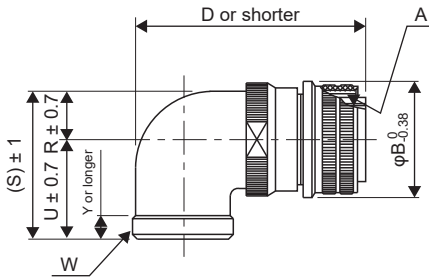

[Unit: mm]

Model	A	B	D	W	R	U	(S)	Y
CE05-8A18-10SD-D-BAS	1 1/8-18UNEF-2B	34.13	69.5	1-20UNEF-2A	13.2	30.2	43.4	7.5
CE05-8A22-22SD-D-BAS	1 3/8-18UNEF-2B	40.48	75.5	1 3/16-18UNEF-2A	16.3	33.3	49.6	7.5

### ■CE3057-A---D

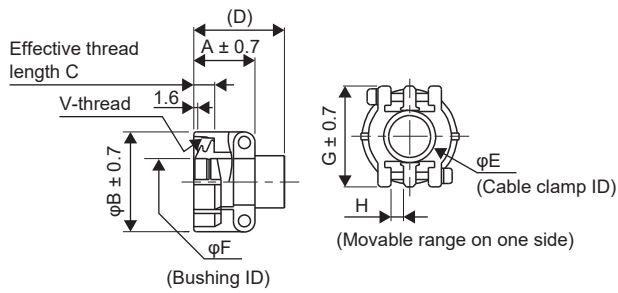

[Unit: mm]

Model	Shell size	A	B	C	D	E	F	G	H	V	Bushing	Cable OD
CE3057-10A-1-D	18	23.8	30.1	10.3	41.3	15.9	14.1	31.7	3.2	1-20UNEF-2B	CE3420-10-1	10.5 to 14.1
CE3057-10A-2-D							11.0				CE3420-10-2	8.5 to 11
CE3057-12A-1-D	22	23.8	35	10.3	41.3	19	16.0	37.3	4.0	1 3/16-18UNEF-2B	CE342012-1	12.5 to 16
CE3057-12A-2-D							13.0				CE342012-2	9.5 to 13

### ■D/MS3106B---S

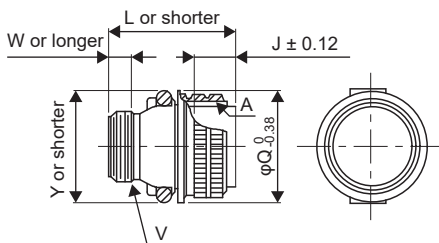

[Unit: mm]

Model	A	J	L	Q	V	W	Y
D/MS3106B18-10S	1 1/8-18UNEF	18.26	52.37	34.13	1-20UNEF	9.53	42
D/MS3106B22-22S	1 3/8-18UNEF	18.26	56.57	40.48	1 3/16-18UNEF	9.53	50

### ■D/MS3108B---S

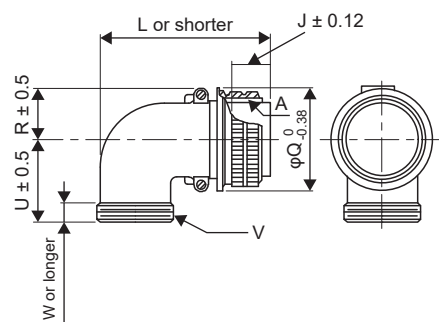

[Unit: mm]

Model	A	J	L	Q	R	U	V	W
D/MS3108B18-10S	1 1/8-18UNEF	18.26	68.27	34.13	20.5	30.2	1-20UNEF	9.53
D/MS3108B22-22S	1 3/8-18UNEF	18.26	76.98	40.48	24.1	33.3	1 3/16-18UNEF-2A	9.53



■D/MS3057-A

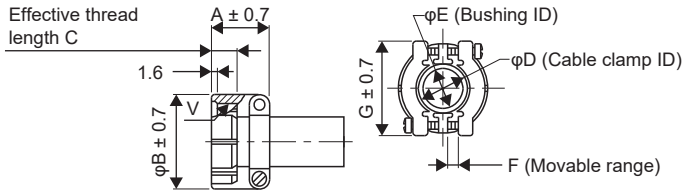

[Unit: mm]

Model	Shell size	A	B	C	D	E	F	G	V	Bushing
D/MS3057-10A	18	23.8	30.1	10.3	15.9	14.3	3.2	31.7	1-20UNEF	AN3420-10
D/MS3057-12A	22	23.8	35.0	10.3	19.0	15.9	4.0	37.3	1 3/16-18UNEF-2A	AN3420-12

■CE05-6A32-17SD-D

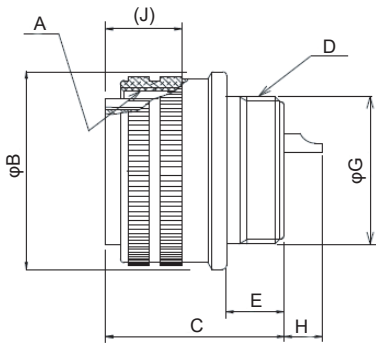

[Unit: mm]

Model	A	B	C	D	E	G	H	J
CE05-6A32-17SD-D	2-18UNS-2B	56.33	37.0	1 7/8-16UN-2A	13.14	45.3	9.2	19.4

## 9.4 Fabrication of the encoder cable

### Point

It is recommended to use options indicated in the following section for the encoder cable.

 Page 35 WIRING OPTION

When fabricating an encoder cable, use the recommended products described in the following sections.

 Page 21 CONNECTORS USED FOR ROTARY SERVO MOTOR WIRING

 Page 27 CONNECTION OF SERVO AMPLIFIER AND ROTARY SERVO MOTOR

 Page 35 WIRING OPTION

When fabricating encoder cables, note the descriptions in this section, in order to ensure the reliability of communication. Fabricate cables with the following procedure.

### 1. Selection of connectors

- Check the cable clamp size.

 Page 21 CONNECTORS USED FOR ROTARY SERVO MOTOR WIRING

 Page 27 CONNECTION OF SERVO AMPLIFIER AND ROTARY SERVO MOTOR

- Obtain the specification, wiring guide for the connector, and other documents from the manufacturer.
- Purchase assembly jigs and similar parts as necessary.

### 2. Selection of cables

- Select a recommended wire or equivalent indicated in chapter 5.
- Select a shielded twisted pair cable.
- Select a cable with a diameter that can be clamped with the connector cable clamp.
- Select a cable whose length, diameter, and bending life are appropriate.

### 3. Assembly of the cable

- Check the wiring guide of the connector manufacturer to connect the connector properly.
- Check internal wiring described in chapter 5 to connect it properly.
- Perform a shielding process on the encoder cable properly.
- Do not connect anything to unused pins.
- When wiring the CN2 side connector, connect the external conductor of the shielded cable to the ground plate and fix it to the connector shell.
- When wiring the connector on the rotary servo motor-side, connect the external conductor of the shielded cable to the SHD terminal.
- Check if the pin arrangement is correct.
- Connect the twisted pair cable in correct combination.
- Check if the number of pairs of P5/LG wiring connected in parallel is correct.
- Fix the cable to the connector with a proper clamping torque.

### 4. Inspection

- After assembly, perform conduction, insulation, and other inspections to check if the connection is correct.
- Check the surface for scratches and contamination.
- Check the connector pins for a distortion, bending, dent, and other problems.
- Check the connector pins for foreign matter adhesion, contamination, and discoloration.

### 5. Complete



# REVISIONS

---

\*The manual number is given on the bottom left of the back cover.

Revision date	*Manual number	Description
November 2019	IB(NA)-0300488ENG-A	First edition

---

This manual confers no industrial property rights or any rights of any other kind, nor does it confer any patent licenses. Mitsubishi Electric Corporation cannot be held responsible for any problems involving industrial property rights which may occur as a result of using the contents noted in this manual.

---

© 2019 MITSUBISHI ELECTRIC CORPORATION

# WARRANTY

---

## Warranty

### **1. Warranty period and coverage**

We will repair any failure or defect hereinafter referred to as "failure" in our FA equipment hereinafter referred to as the "Product" arisen during warranty period at no charge due to causes for which we are responsible through the distributor from which you purchased the Product or our service provider. However, we will charge the actual cost of dispatching our engineer for an on-site repair work on request by customer in Japan or overseas countries. We are not responsible for any on-site readjustment and/or trial run that may be required after a defective unit are repaired or replaced.

[Term]

For terms of warranty, please contact your original place of purchase.

[Limitations]

(1) You are requested to conduct an initial failure diagnosis by yourself, as a general rule.

It can also be carried out by us or our service company upon your request and the actual cost will be charged. However, it will not be charged if we are responsible for the cause of the failure.

(2) This limited warranty applies only when the condition, method, environment, etc. of use are in compliance with the terms and conditions and instructions that are set forth in the instruction manual and user manual for the Product and the caution label affixed to the Product.

(3) Even during the term of warranty, the repair cost will be charged on you in the following cases;

1. a failure caused by your improper storing or handling, carelessness or negligence, etc., and a failure caused by your hardware or software problem
2. a failure caused by any alteration, etc. to the Product made on your side without our approval
3. a failure which may be regarded as avoidable, if your equipment in which the Product is incorporated is equipped with a safety device required by applicable laws and has any function or structure considered to be indispensable according to a common sense in the industry
4. a failure which may be regarded as avoidable if consumable parts designated in the instruction manual, etc. are duly maintained and replaced
5. any replacement of consumable parts (battery, fan, smoothing capacitor, etc.)
6. a failure caused by external factors such as inevitable accidents, including without limitation fire and abnormal fluctuation of voltage, and acts of God, including without limitation earthquake, lightning and natural disasters
7. a failure generated by an unforeseeable cause with a scientific technology that was not available at the time of the shipment of the Product from our company
8. any other failures which we are not responsible for or which you acknowledge we are not responsible for

### **2. Term of warranty after the stop of production**

(1) We may accept the repair at charge for another seven (7) years after the production of the product is discontinued. The announcement of the stop of production for each model can be seen in our Sales and Service, etc.

(2) Please note that the Product (including its spare parts) cannot be ordered after its stop of production.

### **3. Service in overseas countries**

Our regional FA Center in overseas countries will accept the repair work of the Product. However, the terms and conditions of the repair work may differ depending on each FA Center. Please ask your local FA center for details.

### **4. Exclusion of loss in opportunity and secondary loss from warranty liability**

Regardless of the gratis warranty term, Mitsubishi shall not be liable for compensation to:

- (1) Damages caused by any cause found not to be the responsibility of Mitsubishi.
- (2) Loss in opportunity, lost profits incurred to the user by Failures of Mitsubishi products.
- (3) Special damages and secondary damages whether foreseeable or not, compensation for accidents, and compensation for damages to products other than Mitsubishi products.
- (4) Replacement by the user, maintenance of on-site equipment, start-up test run and other tasks.

### **5. Change of Product specifications**

Specifications listed in our catalogs, manuals or technical documents may be changed without notice.

### **6. Application and use of the Product**

- (1) For the use of our AC Servo, its applications should be those that may not result in a serious damage even if any failure or malfunction occurs in AC Servo, and a backup or fail-safe function should operate on an external system to AC Servo when any failure or malfunction occurs.
- (2) Our AC Servo is designed and manufactured as a general purpose product for use at general industries. Therefore, applications substantially influential on the public interest for such as atomic power plants and other power plants of electric power companies, and also which require a special quality assurance system, including applications for railway companies and government or public offices are not recommended, and we assume no responsibility for any failure caused by these applications when used.  
In addition, applications which may be substantially influential to human lives or properties for such as airlines, medical treatments, railway service, incineration and fuel systems, man-operated material handling equipment, entertainment machines, safety machines, etc. are not recommended, and we assume no responsibility for any failure caused by these applications when used. We will review the acceptability of the abovementioned applications, if you agree not to require a specific quality for a specific application. Please contact us for consultation.

# TRADEMARKS

---

MELSERVO is a trademark or registered trademark of Mitsubishi Electric Corporation in Japan and/or other countries. All other product names and company names are trademarks or registered trademarks of their respective companies.



IB(NA)-0300488ENG-A(1911)MEE

MODEL:

MODEL CODE:

## **mitsubishi electric corporation**

HEAD OFFICE : TOKYO BUILDING, 2-7-3 MARUNOUCHI, CHIYODA-KU, TOKYO 100-8310, JAPAN  
NAGOYA WORKS : 1-14, YADA-MINAMI 5-CHOME, HIGASHI-KU, NAGOYA, JAPAN

When exported from Japan, this manual does not require application to the  
Ministry of Economy, Trade and Industry for service transaction permission.

Specifications are subject to change without notice.