



for a greener tomorrow

FACTORY AUTOMATION

INVERTER FR-E700

All-rounder with a compact body
(Addition of Ethernet communication function models)



- Top level of driving performance in compact body
- Easy operability
- Extensive option lineup
- Ensured maintenance
- Compact and space-saving
- Supporting various applications

GLOBAL IMPACT OF MITSUBISHI ELECTRIC



Through Mitsubishi Electric's vision, "Changes for the Better" are possible for a brighter future.

Changes for the Better

We bring together the best minds to create the best technologies. At Mitsubishi Electric, we understand that technology is the driving force of change in our lives. By bringing greater comfort to daily life, maximizing the efficiency of businesses and keeping things running across society, we integrate technology and innovation to bring changes for the better.

Mitsubishi Electric is involved in many areas including the following

Energy and Electric Systems

A wide range of power and electrical products from generators to large-scale displays.

Electronic Devices

A wide portfolio of cutting-edge semiconductor devices for systems and products.

Home Appliance

Dependable consumer products like air conditioners and home entertainment systems.

Information and Communication Systems

Commercial and consumer-centric equipment, products and systems.

Industrial Automation Systems

Maximizing productivity and efficiency with cutting-edge automation technology.

Features	4
Connection example	9
Standard Specifications	10
Outline Dimensions	14
Terminal Connection Diagram, Terminal Specifications	23
Operation panel, Parameter unit, FR Configurator	35
Parameter List	39
Explanations of Parameters	48
Protective Functions	71
Option and Peripheral Devices	72
Precautions for Operation/Selection, Precautions for Peripheral Device Selection	87
Application to Motor	92
FR-E500 Series Compatibility	97
Warranty	99

Evolution in all functions

1

Top level of driving performance in compact body

The inverter became more powerful.

(1) High torque 200%/0.5Hz is realized by Advanced magnetic flux vector control (3.7K or lower)

By the advancement of General-purpose magnetic flux vector control to Advanced magnetic flux vector control, top level of driving performance became possible. Since V/F control and General-purpose magnetic flux vector control operations are available, operation after replacement of the conventional model (FR-E500 series) is ensured.

For the 5.5K to 15K, 150%/0.5Hz torque is realized.

Speed/torque characteristics example

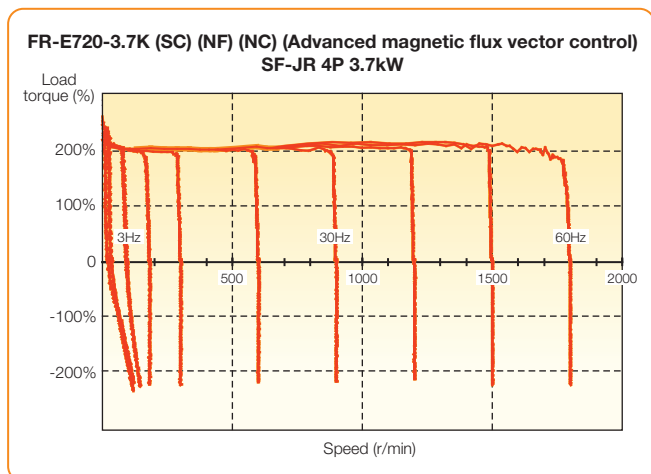

Advanced auto tuning

Many kinds of three phase induction motors can be optimally controlled with Mitsubishi Electric's original "non-rotation" auto tuning function. High precision tuning is enabled even when a test operation of a machine cannot be performed at parameter adjustment.

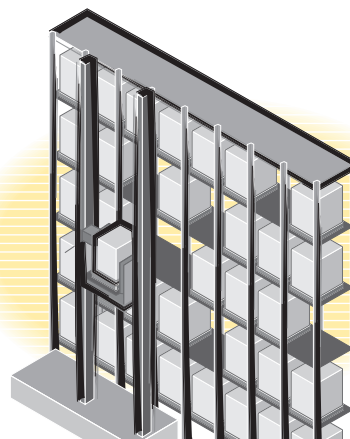

Advanced magnetic flux vector control is ideal for a lift in an automated-storage system which requires high torque at low speed.

(2) Short time overload capacity is increased (200% 3s)

Short time overload capacity is increased to 200% 3s (200% 0.5s for the conventional model). Overcurrent trip is less likely to occur.

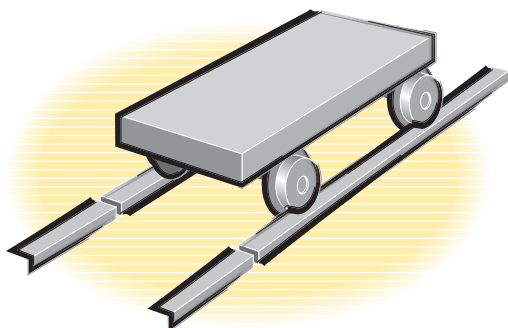

When a bogie runs over a bump, the impact can be beared by this function.

(3) Torque limit/current limit function

Improved torque limit/current limit function provides a machine protection, load limit, and stop-on-contact operation.

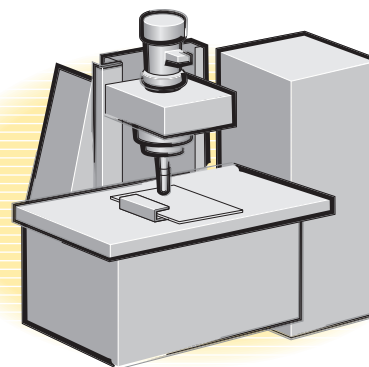

Using the torque limit function, machine breakage from overload can be avoided. For example, edge chipping of a tool can be avoided.

(4) Improved regeneration capability

A brake transistor is built-in to the 0.4K to 15K. Connecting an optional brake resistor increases regeneration capability.

Easy/powerful compact inverter

2

Excellent usability

Usability was thoroughly pursued.

(1) Improved setting dial

Easy setting with the Mitsubishi Electric setting dial.

- Displayed numbers can be jumped by turning the setting dial quickly, and numbers can be changed one by one by turning it slowly, enabling speedy parameter setting.
- The nonslip setting dial is easier to turn.



(2) Easy setting mode

According to the desired command sources for start frequency and speed, Pr.79 can be set in simple steps.

Operation method	Panel display			
Start command	Speed command			
Monitor	LED			
RUN button	Setting dial	79-1	PU Blinking	EXT
External terminal STF/STR	Analog voltage input	79-2	PU Blinking	EXT
External terminal STF/STR	Setting dial	79-3	PU ON	EXT Blinking
RUN button	Analog voltage input	79-4	PU Blinking	EXT ON

Setting complete and 79-3 and 79-4 blink

(3) With a provided USB connector, setting is easily done from a personal computer using FR Configurator

An USB connector (mini-B connector) is provided as standard. The inverter can be easily connected without a USB-RS-485 converter. Wizard (interactive) function of FR Configurator (inverter setup software) provides setting support. In addition, a high-speed graph function with USB enables high speed sampling display.

Setting wizard function (example: acceleration/deceleration time setting)

Acceleration/deceleration pattern setting

Acceleration/deceleration time setting

Parameter list display

Expanded advanced operability with USB and FR Configurator

High speed graph function

FR Configurator

USB cable

Mini-B connector

Inverter

(4) Enclosure surface operation panel FR-PA07 (option)

Optional enclosure surface operation panel (FR-PA07) can be connected.

In addition, an operation panel for conventional model (FR-E500 series) can be connected.

The operation panel of the inverter cannot be removed. A parameter unit connection cable (FR-CB20□) is separately required.



(5) Parameter unit FR-PU07/FR-PU07BB(-L) (option)

The FR-PU07/FR-PU07BB(-L), an optional parameter unit, can be connected as well.

A parameter unit connection cable (FR-CB20□) is separately required. (Parameter unit connection cable FR-CB203 (3m) is enclosed with FR-PU07BB(-L).)

- Setting such as direct input method with a numeric keypad, operation status indication, and help function are useful. The display language can be selected from 8 languages.
- Parameter settings of maximum of three inverters can be stored.
- A battery pack type (FR-PU07BB(-L)) allows parameter setting and parameter copy without power-ON the inverter.

To use a parameter unit with battery pack outside Japan, order the FR-PU07BB-L (model indicated with "L" at the end).



• Features

• Connection example

• Standard Specifications

• Outline Dimension Drawings

• Terminal Connection Diagram
• Terminal Specification Explanation

• Operation panel
• Parameter unit
• FR Configurator

• Parameter List

• Explanations of Parameters

• Protective Functions

• Option and Peripheral Devices

• Precautions for Operation/Selection
• Precautions for Peripheral Device Selection

• Application to Motor

• Main Differences and Compatibilities with the FR-E500 Series

• Warranty

• Service
• International FA Center

3

Enhanced expandability

Mitsubishi Electric inverters offer the expandability that answers to every need

(1) A variety of plug-in options are mountable

Plug-in options supporting digital input, analog output extension, and a variety of communications provide extended functions which is almost equivalent to the FR-A700 series. (One type of plug-in option can be mounted.)

[For the standard control circuit terminal model, order the FR-A7□ E kit, which contains an option board FR-A7□ and its dedicated front cover.]

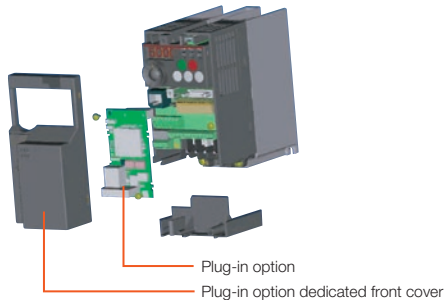

The FR-A7□ E kit can be used for the standard control circuit terminal model only.
For the safety stop function model, use an FR-A7□ and a separate dedicated front cover.

Compatible Plug-in Options

- FR-A7AX (E kit) ... 16-bit digital input
- FR-A7AY (E kit) ... Digital output
Extension analog output
- FR-A7AR (E kit) ... Relay output
- FR-E7DS 24VDC input*1
- FR-A7NC (E kit) ... CC-Link
- FR-A7ND (E kit) ... DeviceNet
- FR-A7NP (E kit) ... PROFIBUS-DP
- FR-A7NL (E kit) ... LONWORKS
- E7NECT_2P*2 EtherCAT

*1: This option is available for the safety stop function model only. The dedicated front cover is enclosed with the option.
*2: Manufactured by HMS Industrial Networks AB. (Only compatible with dedicated EtherCAT communication models)

(2) Safety stop function (FR-E700-SC/NF/NC)

- Spring clamp terminals are adopted as control circuit terminals. Spring clamp terminals are highly reliable and can be easily wired.
- The FR-E700-SC series is compliant to the EU Machinery Directive without the addition of previously required external devices. Operation of an external Emergency Stop device results in a highly reliable immediate shutoff of the D700's output to the motor. This safety stop function conforms to the following standards.

EN ISO 13849-1 Category 3 / PLd
EN62061 / IEC61508 SIL2

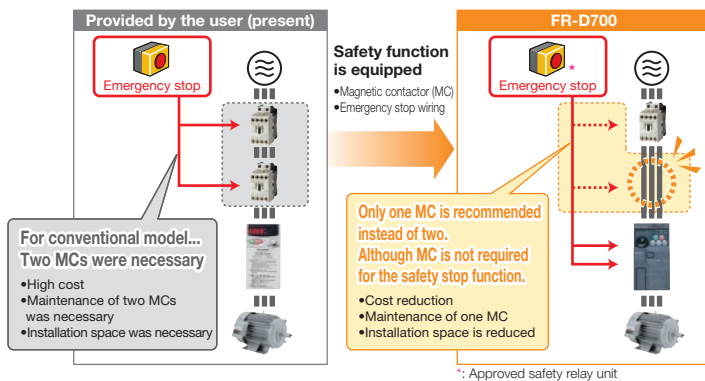

(3) Control terminals are selectable according to applications

For the customers who need more than the standard terminals, the control terminal option, RS-485 2 port terminal block, is available.

A terminal card is removable and can be easily replaced from a standard terminal card.

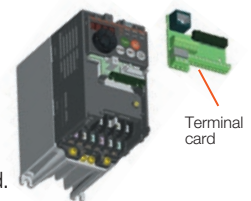

(4) Various kinds of networks are supported

- EIA-485 (RS-485), MODBUS®RTU (equipped as standard), CC-Link, PROFIBUS-DP, DeviceNet™, LONWORKS®, EtherCAT® (optional)
- Network-compatible inverters, the CC-Link communication model (FR-E700-NC) and the FL remote communication model (FR-E700-NF), are also available.
- A network compatible inverter, the Ethernet communication function model (FR-E700-NE) is now available. CC-Link IE Field Network Basic, MELSOFT / FA product connection and MODBUS/TCP supported.

(5) Environment-conscious filter options

- Filterpack FR-BFP2 (the package of the power factor improving DC reactor, common mode choke, and capacitive filter) is available for compliance with the Japanese harmonic suppression guidelines.
- A noise filter option for compliance with the EMC Directive (EN61800-3 2nd Environment Category C3) is also available.

4

Compact and space saving

Compact design expands flexibility of enclosure design.

(1) Compact body with high performance function

Installation size is the same as the conventional mode (FR-E500 series) in consideration of intercompatibility. (7.5K or lower)



(2) Side by side installation saves space

Space can be saved by side by side no clearance installation*.

*: Use the inverter at the surrounding air temperature of 40°C or less.



Mitsubishi Electric magnetic contactors

- Offer a selection of small frames
- Support with low-level load (auxiliary contact)
- Offer a line-up of safety contactors
- Support many international regulations as a standard model

Refer to page 85 for the selection.



5

Easy servicing for peace of mind

The 700 series is the pioneer of long life and high reliability.

(1) Long-life design

- The design life of the cooling fan has been extended to 10 years*1. The life of the fan can be further extended utilizing the it's ON/OFF control.
- The design life of the capacitors has been extended to 10 years*1+2 by adopting a capacitor that endures about 5000 hours at 105°C surrounding air temperature.

*1: Surrounding air temperature : annual average 40°C (free from corrosive gas, flammable gas, oil mist, dust and dirt) Since the design life is a calculated value, it is not a guaranteed value.

*2: Output current : 80% of the inverter rated current

- Estimated service lifespan of the long-life parts

Components	Estimated lifespan of the FR-E700	Guideline of JEMA*3
Cooling fan	10 years	2 to 3 years
Main circuit smoothing capacitor	10 years	5 years
Printed board smoothing capacitor	10 years	5 years

*3: Excerpts from "Periodic check of the transistorized inverter" of JEMA (Japan Electrical Manufacturer's Association)

(2) Advanced life check function

- Degrees of deterioration of main circuit capacitor, control circuit capacitor, and inrush current limit circuit can be monitored.
- Trouble can be avoided with the self-diagnostic alarm*4 that is output when the life span is near.

*4: Any one of main circuit capacitor, control circuit capacitor, inrush current limit circuit or cooling fan reaches the output level, an alarm is output. Capacity of the main circuit capacitor can be measured by setting parameter at a stop and turning the power from off to on. Measuring the capacity enables an alarm to be output.

(3) Easy replacement of cooling fans

A cooling fan is provided on top of the inverter for all capacities requiring a cooling fan*.

Cooling fans can be easily replaced without disconnecting main circuit wires.

*: Cooling fans are equipped with models of 1.5K and above. (single phase 200V class 0.75K and above)



(4) Combed shaped wiring cover

Wiring is easy as the wiring cover can be installed after wiring is complete.



(5) Removable control terminal block

Wiring of the control circuit when replacing the same series inverter can be done by changing the terminal block.

6

Full of useful functions

Enhanced functions for all sorts of applications

- Automatic restart after instantaneous power failure function with frequency search

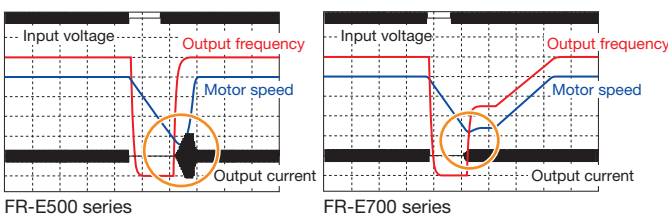

Detection of coasting speed (frequency search function) prevents the motor speed from decreasing at a restart, starting the motor smoothly with less output current.

- Power-failure deceleration stop function/operation continuation at instantaneous power failure function
The motor can be decelerated to a stop when a power failure or undervoltage occurs to prevent the motor from coasting. This function is useful to stop a motor at power failure as a fail safe of machine tool, etc. With the new operation continuation function at instantaneous power failure, the motor continues running without coasting even if an instantaneous power failure occurs during operation.

*: The inverter may trip and the motor may coast depending on the load condition.

- Brake sequence mode is useful for mechanical brake control of a lift.
- Regeneration avoidance function prevents regenerative overvoltage in a pressing machine.
- Main circuit power supply DC input can be connected to DC power supply.
- Enhanced I/O terminal function supports switchover of analog input (voltage / current).
- Password function is effective for parameter setting protection. and so on

Energy saving for fans and pumps

- Load pattern selection (Pr. 14)
Optimal output characteristics (V/F characteristics) for application or load characteristics can be selected.
- Optimum excitation control (Pr. 60)
With Optimum excitation control to achieve the highest motor efficiency, further energy saving can be achieved.

Refer to page 70

Lineup

FR-E720 [] -0.1K [] []

Symbol	Voltage	Symbol	Number of Power Phases	Symbol	Inverter Capacity	Symbol	Control circuit terminal specification	Symbol	Function
1	100V class	None	Three-phase input	0.1K	Represents the inverter capacity "kW".	None	Standard control circuit terminal model (screw type)	None	Standard type
2	200V class	S	Single-phase input	to 15K		SC	Safety stop function model	-NE*2	Ethernet communication*1
4	400V class	W	Single-phase input (double voltage output)			NF	FL remote communication model	-TM*3	Dedicated EtherCAT communication model
						NC	CC-Link communication model		

Inverter type	Safety stop function	Voltage class	Inverter model	Inverter Capacity											
				0.1K	0.2K	0.4K	0.75K	1.5K	2.2K	3.7K	5.5K	7.5K	11K	15K	
Standard control circuit terminal model	NO	Three-phase 200V class	FR-E720-[] []	●	●	●	●	●	●	●	●	●	●	●	
		Three-phase 400V class	FR-E740-[] []	—	—	●	●	●	●	●	●	●	●	●	
		Single-phase 200V class	FR-E720S-[] []*4	●	●	●	●	●	●	—	—	—	—	—	
		Single-phase 100V class	FR-E710W-[] []*4	●	●	●	●	—	—	—	—	—	—	—	
Safety stop function model	YES	Three-phase 200V class	FR-E720-[] []JSC	●	●	●	●	●	●	●	●	●	●		
		Three-phase 400V class	FR-E740-[] []JSC	—	—	●	●	●	●	●	●	●	●		
		Single-phase 200V class	FR-E720S-[] []JSC*4	●	●	●	●	●	●	—	—	—	—		
Communication model	NO	Three-phase 200V class	FR-E720-[] []-NE*2	●	●	●	●	●	●	●	●	●	●		
		Three-phase 400V class	FR-E740-[] []-NE*2	—	—	●	●	●	●	●	●	●	●		
	YES	Three-phase 200V class	FR-E720-[] []JNF	●	●	●	●	●	●	●	●	●	●		
			FR-E720-[] []JNC	●	●	●	●	●	●	●	●	●	●		
		Three-phase 400V class	FR-E720-[] []JSC-TM*3	●	●	●	●	●	●	●	●	●	●		
			FR-E740-[] []JNF	—	—	●	●	●	●	●	●	●	●		
FR-E740-[] []JNC	—	—	●	●	●	●	●	●	●	●					
FR-E740-[] []JSC-TM*3	—	—	●	●	●	●	●	●	●	●					

*1: CC-Link IE Field Network Basic supported (refer to page 6). ●: Available models — : Not available
 *2: Standard control circuit terminal model only.
 *3: Safety stop function model only. By installing the EtherCAT communication option (E7NECT_2P manufactured by HMS Industrial Networks AB), EtherCAT communication is possible.
 *4: The output of the single-phase 200V and single-phase 100V input models is three-phase 200V.



Complies with UL, cUL, and EC Directives (CE marking), and the Radio Waves Act (South Korea) (KC marking). It is also certified as compliant with the Eurasian Conformity (EAC).

The single-phase 100V power input model is not compliant with the EMC Directive.

The inverters are compliant with the EU RoHS Directive (Restriction of the Use of Certain Hazardous Substances in Electrical and Electronic Equipment), friendly to people and to the environment.



Connectivity



AC power supply

Use within the permissible power supply specifications of the inverter.
To ensure safety, use a molded case circuit breaker, earth leakage circuit breaker or magnetic contactor to switch power ON/OFF.



Molded case circuit breaker (MCCB) or earth leakage current breaker (ELB), fuse

The breaker must be selected carefully since an in-rush current flows in the inverter at power on.



Magnetic contactor (MC)

Install the magnetic contactor to ensure safety. Do not use this magnetic contactor to start and stop the inverter. Doing so will cause the inverter life to be shortened.

Reactor (FR-HAL, FR-HEL option)

Install reactors to suppress harmonics and to improve the power factor.
A reactor (option) is required when installing the inverter near a large power supply system (500kVA or more).
The inverter may be damaged if you do not use reactors. Select the reactor according to the model. Remove the jumpers across terminals P/+ - P1 to connect the DC reactor.

AC reactor (FR-HAL)



DC reactor (FR-HEL)*1



Noise filter (ferrite core)*1 (FR-BSF01, FR-BLF)

Install a noise filter to reduce the electromagnetic noise generated from the inverter. Effective in the range from about 1MHz to 10MHz. When more wires are passed through, a more effective result can be obtained. A wire should be wound four turns or more.



Noise filter (capacitor)*1 (FR-BIF)

Reduces radio noise.



Noise filter (ferrite core) (FR-BSF01, FR-BLF)

Install a noise filter to reduce the electromagnetic noise generated from the inverter. Effective in the range from about 1MHz to 10MHz. A wire should be wound four turns at a maximum.



Parameter unit (FR-PU07/FR-PU07BB(-L))

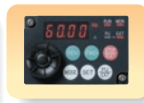

Enclosure surface operation panel (FR-PA07)

Connect a connection cable (FR-CB2) to the PU connector to use the FR-PA07, FR-PU07/FR-PU07BB(-L)*2.

USB connector

A personal computer and an inverter can be connected with a USB (Ver1.1) cable.



Approved safety relay module

Required for compliance with safety standard.
The module can be used for the safety stop function model, FL remote communication model, and CC-Link communication model.

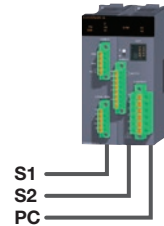

Brake resistor (FR-ABR, MRS, MYS)

Braking capability can be improved. (0.4K or higher)
Always install a thermal relay when using a brake resistor whose capacity is 11K or higher.



P/+ P1

R/L1 S/L2 T/L3

P/+N/- Earth (Ground)

P/+ PR

U V W

*1: Filterpack (FR-BFP2), which contains DC reactor and noise filter in one package, is also available.



High power factor converter (FR-HC2)
Power supply harmonics can be greatly suppressed. Install this as required.*2



Power regeneration common converter (FR-CV)
Great braking capability is obtained. Install this as required.*2



Resistor unit (FR-BR) Discharging resistor (GZG, GRZG)
The regenerative braking capability of the inverter can be exhibited fully. Install this as required.

Brake unit (FR-BU2)

Devices connected to the output

Do not install a power factor correction capacitor, surge suppressor or radio noise filter on the output side of the inverter. When installing a molded case circuit breaker on the output side of the inverter, contact each manufacturer for selection of the molded case circuit breaker.

Earth (Ground)

To prevent an electric shock, always earth (ground) the motor and inverter. For reduction of induction noise from the power line of the inverter, it is recommended to wire the earth (ground) cable by returning it to the earth (ground) terminal of the inverter.

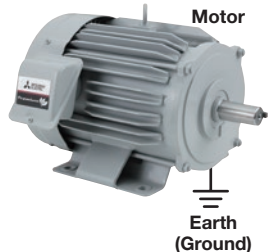

*2: The converter is used for the standard control circuit terminal model or the safety stop function model.

- Features
- Connection example
- Standard Specifications
- Outline Dimension Drawings
- Terminal Connection Diagram Terminal Specification Explanation
- Operation panel Parameter unit FR Configurator
- Parameter List
- Explanations of Parameters
- Protective Functions
- Options
- Instructions
- Motor
- Compatibility
- Warranty
- Inquiry

Standard specifications

Rating

● Three-phase 200V power supply

Model FR-E720-□K (SC) ^{*9} (NF) ^{*10} (NC) ^{*11} (-NE) ^{*12} (-TM) ^{*13}		0.1	0.2	0.4	0.75	1.5	2.2	3.7	5.5	7.5	11	15
Applicable motor capacity (kW) ^{*1}		0.1	0.2	0.4	0.75	1.5	2.2	3.7	5.5	7.5	11	15
Output	Rated capacity (kVA) ^{*2}	0.3	0.6	1.2	2.0	3.2	4.4	7.0	9.5	13.1	18.7	23.9
	Rated current (A) ^{*7}	0.8 (0.8)	1.5 (1.4)	3 (2.5)	5 (4.1)	8 (7)	11 (10)	17.5 (16.5)	24 (23)	33 (31)	47 (44)	60 (57)
	Overload current rating ^{*3}	150% 60s, 200% 3s (inverse-time characteristics)										
	Rated voltage ^{*4}	Three-phase 200 to 240V										
	Regenerative braking torque ^{*5}	150%			100%			50%			20%	
Power supply	Rated input AC (DC) voltage/frequency	Three-phase 200 to 240V 50Hz/60Hz (283 to 339VDC ^{*8})										
	Permissible AC (DC) voltage fluctuation	170 to 264V 50Hz/60Hz (240 to 373VDC ^{*8})										
	Permissible frequency fluctuation	±5%										
	Power supply capacity (kVA) ^{*6}	0.4	0.8	1.5	2.5	4.5	5.5	9	12	17	20	28
Protective structure (JEM1030)	Enclosed type (IP20) Open type (IP00) for the FL remote communication model, CC-Link communication model, and the dedicated EtherCAT communication model.											
Cooling system	Natural					Forced air						
Approximate mass (kg)	0.5	0.5	0.7	1.0	1.4	1.4	1.7	4.3	4.3	6.5	6.5	

● Three-phase 400V power supply

Model FR-E740-□K (SC) ^{*9} (NF) ^{*10} (NC) ^{*11} (-NE) ^{*12} (-TM) ^{*13}		0.4	0.75	1.5	2.2	3.7	5.5	7.5	11	15	
Applicable motor capacity (kW) ^{*1}		0.4	0.75	1.5	2.2	3.7	5.5	7.5	11	15	
Output	Rated capacity (kVA) ^{*2}	1.2	2.0	3.0	4.6	7.2	9.1	13.0	17.5	23.0	
	Rated current (A) ^{*7}	1.6 (1.4)	2.6 (2.2)	4.0 (3.8)	6.0 (5.4)	9.5 (8.7)	12	17	23	30	
	Overload current rating ^{*3}	150% 60s, 200% 3s (inverse-time characteristics)									
	Rated voltage ^{*4}	Three-phase 380 to 480V									
	Regenerative braking torque ^{*5}	100%			50%			20%			
Power supply	Rated input voltage/frequency	Three-phase 380 to 480V 50Hz/60Hz (537 to 679VDC ^{*8})									
	Permissible AC voltage fluctuation	325 to 528V 50Hz/60Hz (457 to 740VDC ^{*8})									
	Permissible frequency fluctuation	±5%									
	Power supply capacity (kVA) ^{*6}	1.5	2.5	4.5	5.5	9.5	12	17	20	28	
Protective structure (JEM1030)	Enclosed type (IP20) Open type (IP00) for the FL remote communication model, CC-Link communication model, and the dedicated EtherCAT communication model.										
Cooling system	Natural				Forced air						
Approximate mass (kg)	1.4	1.4	1.9	1.9	1.9	3.2	3.2	6.0	6.0		

- *1 The applicable motor capacity indicated is the maximum capacity applicable for use of the Mitsubishi Electric 4-pole standard motor.
- *2 The rated output capacity indicated assumes that the output voltage is 230V for three-phase 200V class and 440V for three-phase 400V class.
- *3 The % value of the overload current rating indicated is the ratio of the overload current to the inverter's rated output current. For repeated duty, allow time for the inverter and motor to return to or below the temperatures under 100% load.
- *4 The maximum output voltage does not exceed the power supply voltage. The maximum output voltage can be changed within the setting range. However, the pulse voltage value of the inverter output side voltage remains unchanged at about $\sqrt{2}$ that of the power supply.
- *5 The braking torque indicated is a short-duration average torque (which varies with motor loss) when the motor alone is decelerated from 60Hz in the shortest time and is not a continuous regenerative torque. When the motor is decelerated from the frequency higher than the base frequency, the average deceleration torque will reduce. Since the inverter does not contain a brake resistor, use the optional brake resistor when regenerative energy is large. A brake unit (FR-BU2) may also be used. (Option brake resistor cannot be used for 0.1K and 0.2K.)
- *6 The power supply capacity varies with the value of the power supply side inverter impedance (including those of the input reactor and cables).
- *7 Setting 2kHz or more in Pr: 72 P_{WM} frequency selection to perform low acoustic noise operation in the surrounding air temperature exceeding 40°C, the rated output current is the value in parenthesis.
- *8
 - Connect DC power supply to terminal P/+ and N/-. Connect the plus side of the power supply to terminal P/+ and minus side to terminal N/-.
 - When energy is regenerated from the motor, the voltage between terminals P/+ and N/- may rise to 415V or more for the 200V class, or 810V or more for the 400V class. Use a DC power supply resistant to the regenerative voltage/energy.
 - If using the power supply which cannot withstand voltage/energy during regeneration, insert diodes in series for reverse current prevention.
- *9 Although the FR-E700 series has the built-in inrush current limit circuit, select the DC power supply considering the inrush current at power-ON as the inrush current four times of the rated inverter flows at power-ON.
- *10 Since the power supply capacity depends on the output impedance of the power, select the power supply capacity which has enough allowance according to the AC power supply system capacity.
- *9 The safety stop function model is indicated with SC.
- *10 "NF" indicates the FL remote communication function model.
- *11 "NC" indicates the CC-Link communication model.
- *12 "-NE" indicates the Ethernet communication function model.
- *13 "-TM" indicates the dedicated EtherCAT communication model. (Only for inverters that support the safety stop function.)

● Single-phase 200V power supply

Model FR-E720S-□K (SC)*10(-NE)*11		0.1	0.2	0.4	0.75	1.5	2.2
Applicable motor capacity (kW)*1		0.1	0.2	0.4	0.75	1.5	2.2
Output	Rated capacity (kVA)*2	0.3	0.6	1.2	2.0	3.2	4.4
	Rated current (A)*7	0.8 (0.8)	1.5 (1.4)	3.0 (2.5)	5.0 (4.1)	8.0 (7.0)	11.0 (10.0)
	Overload current rating*3	150% 60s, 200% 3s (inverse-time characteristics)					
	Rated voltage*4	Three-phase 200 to 240V					
	Regenerative braking torque*5	150%		100%		50%	20%
Power supply	Rated input AC voltage/frequency	Single-phase 200 to 240V 50Hz/60Hz					
	Permissible AC voltage fluctuation	170 to 264V 50Hz/60Hz					
	Permissible frequency fluctuation	Within ±5%					
	Power supply capacity (kVA)*6	0.5	0.9	1.5	2.5	4.0	5.2
Protective structure (JEM1030)		Enclosed type (IP20)					
Cooling system		Natural			Forced air		
Approximate mass (kg)		0.6	0.6	0.9	1.4	1.5	2.0

● Single-phase 100V power supply

Model FR-E710W-□K		0.1	0.2	0.4	0.75
Applicable motor capacity (kW)*1		0.1	0.2	0.4	0.75
Output	Rated capacity (kVA)*2	0.3	0.6	1.2	2.0
	Rated current (A)*7	0.8 (0.8)	1.5 (1.4)	3.0 (2.5)	5.0 (4.1)
	Overload current rating*3	150% 60s, 200% 3s (inverse-time characteristics)			
	Rated voltage	Three-phase 200 to 230V*8, *9			
	Regenerative braking torque*5	150%		100%	
Power supply	Rated input AC voltage/frequency	Single-phase 100 to 115V 50Hz/60Hz			
	Permissible AC voltage fluctuation	90 to 132V 50Hz/60Hz			
	Permissible frequency fluctuation	Within ±5%			
	Power supply capacity (kVA)*6	0.5	0.9	1.5	2.5
Protective structure (JEM1030)		Enclosed type (IP20)			
Cooling system		Natural			
Approximate mass (kg)		0.6	0.7	0.9	1.5

- *1 The applicable motor capacity indicated is the maximum capacity applicable for use of the Mitsubishi Electric 4-pole standard motor.
- *2 The rated output capacity indicated assumes that the output voltage is 230V.
- *3 The % value of the overload current rating indicated is the ratio of the overload current to the inverter's rated output current. For repeated duty, allow time for the inverter and motor to return to or below the temperatures under 100% load. If the automatic restart after instantaneous power failure function (Pr. 57) or power failure stop function (Pr. 261) is set and power supply voltage is low while load becomes bigger, the bus voltage decreases to power failure detection level and load of 100% or more may not be available.
- *4 The maximum output voltage does not exceed the power supply voltage. The maximum output voltage can be changed within the setting range. However, the pulse voltage value of the inverter output side voltage remains unchanged at about $\sqrt{2}$ that of the power supply.
- *5 The braking torque indicated is a short-duration average torque (which varies with motor loss) when the motor alone is decelerated from 60Hz in the shortest time and is not a continuous regenerative torque. When the motor is decelerated from the frequency higher than the base frequency, the average deceleration torque will reduce. Since the inverter does not contain a brake resistor, use the optional brake resistor when regenerative energy is large. A brake unit (FR-BU2) may also be used. (Option brake resistor cannot be used for 0.1K and 0.2K.)
- *6 The power supply capacity varies with the value of the power supply side inverter impedance (including those of the input reactor and cables).
- *7 Setting 2kHz or more in Pr. 72 PWM frequency selection to perform low acoustic noise operation with the surrounding air temperature exceeding 40°C, the rated output current is the value in parenthesis.
- *8 For single-phase 100V power input model, the maximum output voltage is twice the amount of the power supply voltage and cannot be exceeded.
- *9 In a single-phase 100V power input model, the output voltage may fall down when the load is heavy, and larger output current may flow compared to a three-phase input model. Use the motor with less load so that the output current is within the rated motor current range.
- *10 The safety stop function model is indicated with SC.
- *11 "-NE" indicates the Ethernet communication function model.

- Features
- Connection example
- Standard Specifications
- Outline Dimension Drawings
- Terminal Connection Diagram Terminal Specification Explanation
- Operation panel Parameter unit FR Configurator
- Parameter List
- Explanations of Parameters
- Protective Functions
- Options
- Instructions
- Motor
- Compatibility
- Warranty
- Inquiry

Common specifications

Control specifications	Control method		Soft-PWM control/high carrier frequency PWM control (V/F control, Advanced magnetic flux vector control, General-purpose magnetic flux vector control, Optimum excitation control are available)
	Output frequency range		0.2 to 400Hz
	Frequency setting resolution	Analog input *10*13	0.06Hz/60Hz (terminal2, 4: 0 to 10V/10bit) 0.12Hz/60Hz (terminal2, 4: 0 to 5V/9bit) 0.06Hz/60Hz (terminal4: 0 to 20mA/10bit)
		Digital input	0.01Hz
	Frequency accuracy	Analog input *10*13	Within ±0.5% of the max. output frequency (25°C ±10°C)
		Digital input	Within 0.01% of the set output frequency
	Voltage/frequency characteristics		Base frequency can be set from 0 to 400Hz, Constant-torque/variable torque pattern can be selected
	Starting torque		200% or more (at 0.5Hz)...when Advanced magnetic flux vector control is set (3.7K or lower)
	Torque boost		Manual torque boost
	Acceleration/deceleration time setting		0.01 to 360s, 0.1 to 3600s (acceleration and deceleration can be set individually), linear or S-pattern acceleration/deceleration modes are available.
DC injection brake		Operation frequency (0 to 120Hz), operation time (0 to 10s), operation voltage (0 to 30%) can be changed.	
Stall prevention operation level		Operation current level can be set (0 to 200% adjustable), whether to use the function or not can be selected	
Operation specifications	Frequency setting signal	Analog input *10*13	Two terminals Terminal 2: 0 to 10V, 0 to 5V can be selected Terminal 4: 0 to 10V, 0 to 5V, 4 to 20mA can be selected
		Digital input	Input from the operation panel or parameter unit. (Instead of the input from the parameter unit, input via the FL remote network is available for the FL remote communication model, and input via the CC-Link network is available for the CC-Link communication model.) Frequency setting increment is selectable. 4 digit BCD or 16bit binary data (when the option FR-A7AX E kit is used)
	Start signal		Forward and reverse rotation or start signal automatic self-holding input*10*13 (3-wire input) can be selected.
	Input signal*10*14 (Standard control circuit terminal model: Seven terminals Safety stop function model: Six terminals)		The following signals can be assigned to Pr.178 to Pr.184 (input terminal function selection): multi-speed selection, remote setting, stop-on contact selection, second function selection, terminal 4 input selection*13, JOG operation selection*13, PID control valid terminal, brake opening completion signal, external thermal input*13, PU-External operation switchover*13, V/F switchover, output stop, start self-holding selection*13, forward rotation, reverse rotation command*13, inverter reset*13, PU-NET operation switchover*13, External-NET operation switchover*13, command source switchover*13, inverter operation enable signal*13, and PU operation external interlock*13
	Operational functions		Maximum/minimum frequency setting, frequency jump operation, external thermal relay input selection*10*13, automatic restart after instantaneous power failure operation, forward/reverse rotation prevention, remote setting, brake sequence*10, second function, multi-speed operation, stop-on contact control, droop control, regeneration avoidance, slip compensation, operation mode selection, offline auto tuning function, PID control*10, computer link operation (RS-485)*10*13
	Safety stop function*3		Safety shutoff signal can be input from terminals S1 and S2. (compliant with EN ISO 13849-1 Category 3 / PLD EN62061 / IEC61508 SIL2)
	Output signal*11 Open collector output (Two terminals) Relay output (One terminal)		The following signals can be assigned to Pr.190 to Pr.192 (output terminal function selection): inverter operation, up-to-frequency, overload alarm, output frequency detection, regenerative brake prealarm, electronic thermal relay function prealarm, inverter operation ready, output current detection, zero current detection, PID lower limit, PID upper limit, PID forward/reverse rotation output, brake opening request, fan alarm*1, heatsink overheat prealarm, deceleration at an instantaneous power failure, PID control activated, safety monitor output*2, safety monitor output2*3, 24V external power supply operation*3, during retry, life alarm, current average value monitor, remote output, alarm output, fault output, fault output 3, and maintenance timer alarm
	For meter Pulse train output (Max. 2.4kHz: one terminal)*10		The following signals can be assigned to Pr.54 FM terminal function selection: output frequency, motor current (steady), output voltage, frequency setting, motor torque, converter output voltage, regenerative brake duty, electronic thermal relay function load factor, output current peak value, converter output voltage peak value, reference voltage output, motor load factor, PID set point, PID measured value*10, PID deviation*10, inverter I/O terminal monitor, I/O terminal option monitor*10*13, output power, cumulative power, motor thermal load factor, and inverter thermal load factor.
	Operating status		The following operating status can be displayed: output frequency, motor current (steady), output voltage, frequency setting, cumulative energization time, actual operation time, motor torque, converter output voltage, regenerative brake duty, electronic thermal relay function load factor, output current peak value, converter output voltage peak value, motor load factor, PID set point*10, PID measured value*10, PID deviation*10, inverter I/O terminal monitor, I/O terminal option monitor*10*13, output power, cumulative power, motor thermal load factor, and inverter thermal load factor.
	Indication	Operation panel Parameter unit (FR-PU07)*10*13	Operating status
Fault record			Fault record is displayed when a fault occurs. Past 8 fault records (output voltage/current/frequency/cumulative energization time right before the fault occurs) are stored
Interactive guidance*10*13			Function (help) for operation guide*4
Protective/warning function	Protective functions	Protective functions	Overcurrent during acceleration, overcurrent during constant speed, overcurrent during deceleration, overvoltage during acceleration, overvoltage during constant speed, overvoltage during deceleration, inverter protection thermal operation, motor protection thermal operation, heatsink overheat, input phase failure*6, stall prevention stop, output side earth (ground) fault overcurrent at start*5, output short circuit, output phase failure, external thermal relay operation*5*10*13, option fault*5, parameter error, internal board fault, PU disconnection*10*13, retry count excess*5, CPU fault, brake transistor alarm, inrush resistance overheat, communication error, analog input error*10*13, USB communication error*9*13, brake sequence error 4 to 7*5*10, safety circuit fault*3
		Warning functions	Fan alarm*1, overcurrent stall prevention, overvoltage stall prevention, PU stop, parameter write error, regenerative brake prealarm*5, electronic thermal relay function prealarm, maintenance output*5, undervoltage, operation panel lock, password locked*5, inverter reset, safety stop*3, 24V external power supply in operation*12
Environment	Surrounding air temperature		-10°C to +50°C (non-freezing)*7
	Ambient humidity		90%RH or less (non-condensing)
	Storage temperature*8		-20°C to +65°C
	Atmosphere		Indoors (free from corrosive gas, flammable gas, oil mist, dust and dirt etc.)
	Altitude/vibration		Maximum 1000m, 5.9m/s ² or less at 10 to 55Hz (directions of X, Y, Z axes)

- *1 This function is not available for models of 0.75K or less. (0.4K or less for single-phase 200V class)
- *2 This function is available for the safety stop function model and the CC-Link communication model.
- *3 This function is not available for the standard control circuit terminal model.
- *4 This operation guide is only available with option parameter unit (FR-PU07).
- *5 This protective function is not available in the initial status.
- *6 This protective function is available with the three-phase power input model only.
- *7 When using the inverters at the surrounding air temperature of 40°C or less, the inverters can be installed closely attached (0cm clearance).
- *8 Temperatures applicable for a short time, e.g. in transit.
- *9 This function is not available for the FL remote communication model.
- *10 This function is not available for the FL remote communication model and the dedicated EtherCAT communication model.
- *11 The output signal of the FL remote communication model, CC-Link communication model, and Dedicated EtherCAT communication model have only one open collector output terminal. For the FL remote communication model, the terminal is used only for the safety monitor output signal (not selectable).
- *12 This function is available for the safety stop function model (when equipped with the FR-E7DS), FL remote communication model, CC-Link communication model, and dedicated EtherCAT communication model.
- *13 This function is not available for the CC-Link communication model.
- *14 For the CC-Link communication model, input signals can be assigned to the input virtual terminals for CC-Link communication.

- Features
- Connection example
- Standard Specifications
- Outline Dimension Drawings
- Terminal Connection Diagram Terminal Specification Explanation
- Operation panel Parameter unit FR Configurator
- Parameter List
- Explanations of Parameters
- Protective Functions
- Options
- Instructions
- Motor
- Compatibility
- Warranty
- Inquiry

Outline Dimensions

- FR-E720-0.1K(SC) to 0.75K(SC)
- FR-E720S-0.1K(SC) to 0.4K(SC)
- FR-E710W-0.1K to 0.4K

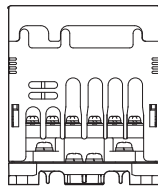
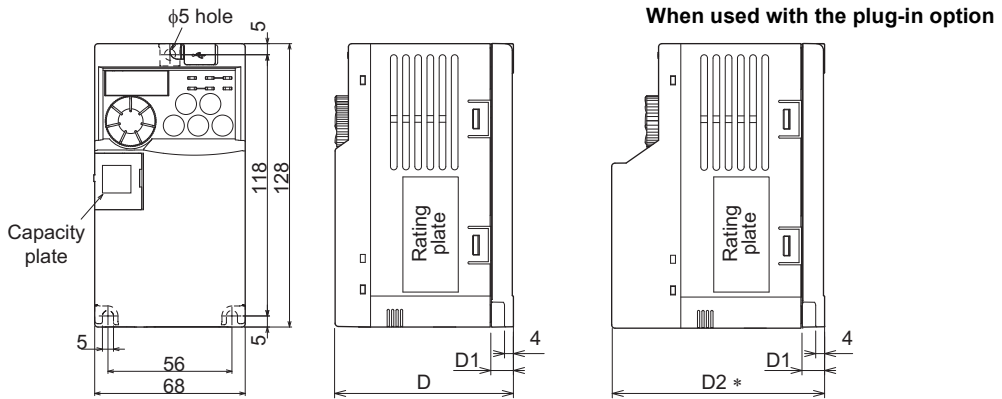

Inverter Model	D	D1	D2 *
FR-E720-0.1K, 0.2K	80.5	10	95.6
FR-E720S-0.1K, 0.2K			
FR-E710W-0.1K			
FR-E720-0.1KSC, 0.2KSC	86.5	10	108.1
FR-E720S-0.1KSC, 0.2KSC			
FR-E710W-0.2K	110.5	10	125.6
FR-E720-0.4K	112.5	42	127.6
FR-E720-0.4KSC	118.5		140.1
FR-E720-0.75K	132.5	62	147.6
FR-E720-0.75KSC	138.5		160.1
FR-E720S-0.4K	142.5	42	157.6
FR-E710W-0.4K			
FR-E720S-0.4KSC	148.5		

* When the FR-A7NC (E kit) is used for the standard control terminal model, or the FR-A7NC and the FR-A7NC E kit safety cover SC is used for the safety stop function model, a terminal block protrudes forward, increasing the depth by about 2mm (up to 2.8mm).

(Unit: mm)

- FR-E720-1.5K(SC), 2.2K(SC)
- FR-E720S-0.75K(SC), 1.5K(SC)
- FR-E710W-0.75K

When used with the plug-in option

*1 FR-E710W-0.75K are not provided with the cooling fan.

Inverter Model	D	D1	D2 *2
FR-E720-1.5K, 2.2K	135.5	60	150.6
FR-E720S-0.75K			163.1
FR-E720-1.5KSC, 2.2KSC	141.5	60	176.1
FR-E720S-0.75KSC			188.6
FR-E720S-1.5K	161		176.1
FR-E720S-1.5KSC	167		188.6
FR-E710W-0.75K	155	54	170.1

*2 When the FR-A7NC (E kit) is used for the standard control terminal model, or the FR-A7NC and the FR-A7NC E kit safety cover SC is used for the safety stop function model, a terminal block protrudes forward, increasing the depth by about 2mm (up to 2.8mm).

(Unit: mm)

- FR-E720-3.7K(SC)

When used with the plug-in option

Inverter Model	D	D1 *
FR-E720-3.7K	142.5	157.6
FR-E720-3.7KSC	148.5	170.1

* When the FR-A7NC (E kit) is used for the standard control terminal model, or the FR-A7NC and the FR-A7NC E kit safety cover SC is used for the safety stop function model, a terminal block protrudes forward, increasing the depth by about 2mm (up to 2.8mm).

(Unit: mm)

- Features
- Connection example
- Standard Specifications
- Outline Dimension Drawings
- Terminal Connection Diagram Terminal Specification Explanation
- Operation panel Parameter unit FR Configurator
- Parameter List
- Explanations of Parameters
- Protective Functions
- Options
- Instructions
- Motor
- Compatibility
- Warranty
- Inquiry

●FR-E720-5.5K(SC) to 15K(SC)

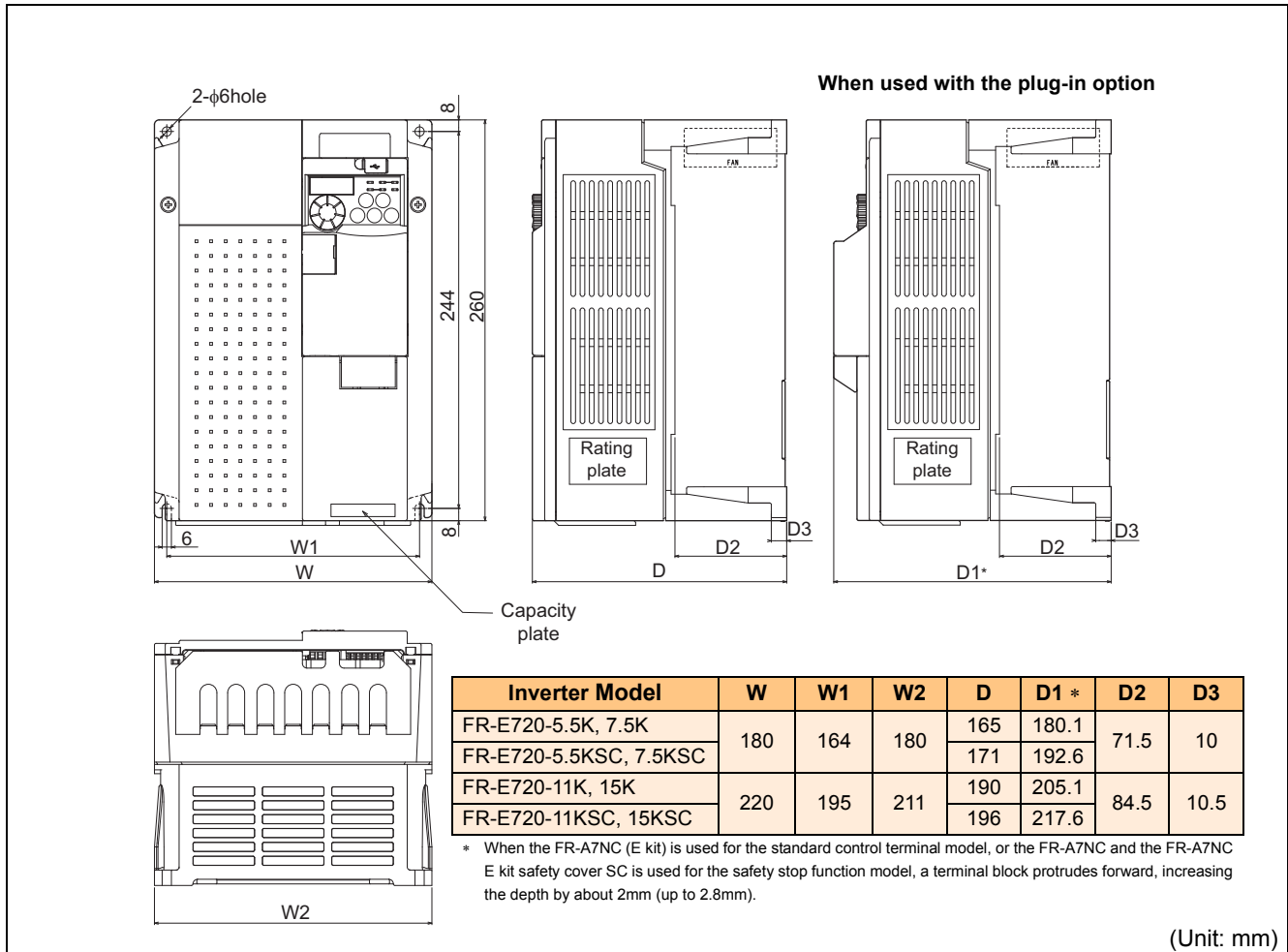

- FR-E740-0.4K(SC) to 3.7K(SC)
- FR-E720S-2.2K(SC)

When used with the plug-in option

Inverter Model	D	D1	D2 *2
FR-E740-0.4K, 0.75K	114	39	129.1
FR-E740-0.4KSC, 0.75KSC	120	39	141.6
FR-E740-1.5K to 3.7K	135	60	150.1
FR-E740-1.5KSC to 3.7KSC	141		162.6
FR-E720S-2.2K	155.5		170.6
FR-E720S-2.2KSC	161.5		183.1

*1 FR-E740-0.4K, 0.75K are not provided with the cooling fan.

*2 When the FR-A7NC (E kit) is used for the standard control terminal model, or the FR-A7NC and the FR-A7NC E kit safety cover SC is used for the safety stop function model, a terminal block protrudes forward, increasing the depth by about 2mm (up to 2.8mm).

(Unit: mm)

- FR-E740-5.5K(SC), 7.5K(SC)

When used with the plug-in option

Inverter Model	D	D1 *
FR-E740-5.5K, 7.5K	147	162.1
FR-E740-5.5KSC, 7.5KSC	153	174.6

* When the FR-A7NC (E kit) is used for the standard control terminal model, or the FR-A7NC and the FR-A7NC E kit safety cover SC is used for the safety stop function model, a terminal block protrudes forward, increasing the depth by about 2mm (up to 2.8mm).

(Unit: mm)

- Features
- Connection example
- Standard Specifications
- Outline Dimension Drawings
- Terminal Connection Diagram
- Terminal Specification Explanation
- Operation panel Parameter unit FR Configurator
- Parameter List
- Explanations of Parameters
- Protective Functions
- Options
- Instructions
- Motor
- Compatibility
- Warranty
- Inquiry

●FR-E740-11K(SC), 15K(SC)

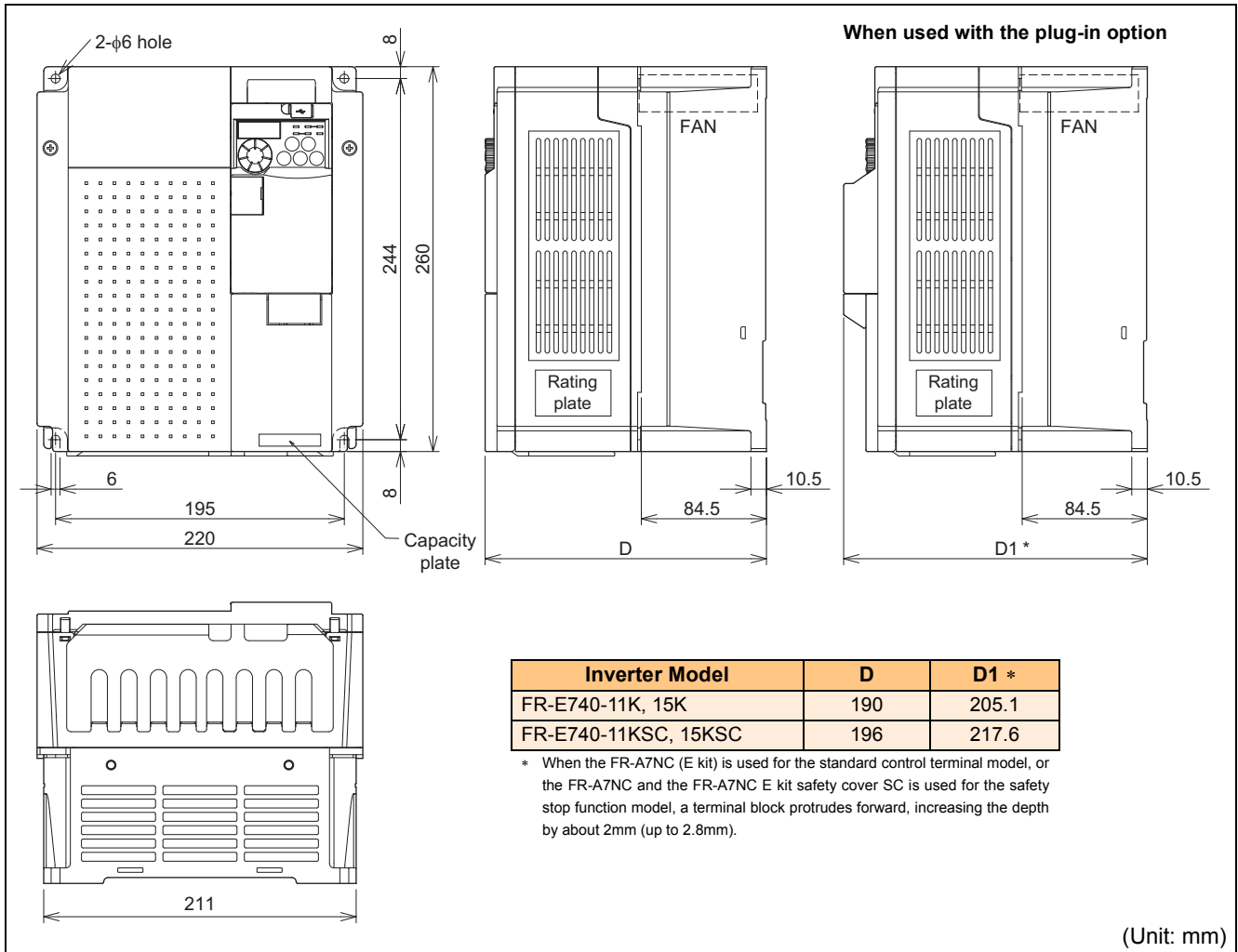

●FL remote communication model

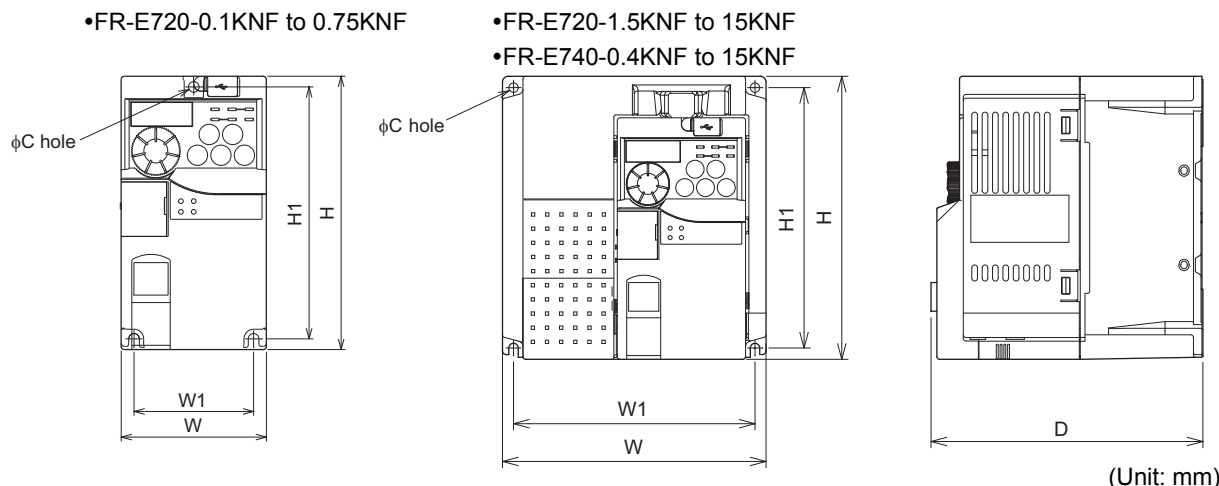

(Unit: mm)

● Three-phase 200V class

Inverter Model	W	W1	H	H1	D	C
FR-E720-0.1KNF	68	56	128	118	89.5	5
FR-E720-0.2KNF					121.5	
FR-E720-0.4KNF					141.5	
FR-E720-0.75KNF					144.5	
FR-E720-1.5KNF	108	96	260	244	174	6
FR-E720-2.2KNF	170	158			151.5	
FR-E720-3.7KNF	180	164			174	
FR-E720-5.5KNF	180	164	260	244	199	6
FR-E720-7.5KNF	220	195			199	
FR-E720-11KNF	220	195				
FR-E720-15KNF						

● Three-phase 400V class

Inverter Model	W	W1	H	H1	D	C
FR-E740-0.4KNF	140	128	150	138	123	5
FR-E740-0.75KNF					144	
FR-E740-1.5KNF					144	
FR-E740-2.2KNF					144	
FR-E740-3.7KNF	220	208	260	244	156	6
FR-E740-5.5KNF					156	
FR-E740-7.5KNF					156	
FR-E740-11KNF	220	195	260	244	199	6
FR-E740-15KNF					199	

●CC-Link communication model

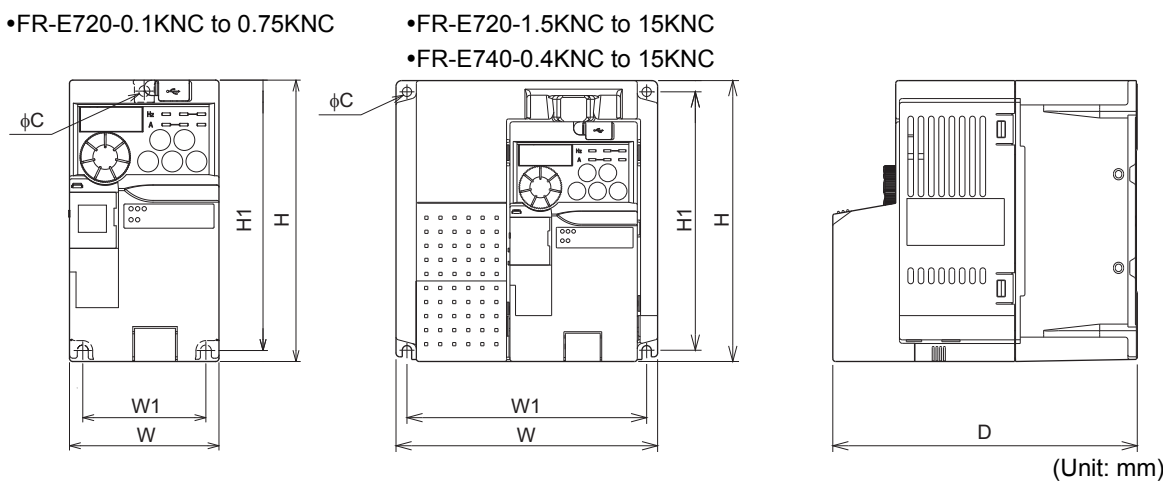

(Unit: mm)

● Three-phase 200V class

Inverter Model	W	W1	H	H1	D	C
FR-E720-0.1KNC	68	56	128	118	108	5
FR-E720-0.2KNC					140	
FR-E720-0.4KNC					160	
FR-E720-0.75KNC					163	
FR-E720-1.5KNC	108	96	260	244	170	6
FR-E720-2.2KNC	170	158			192.5	
FR-E720-3.7KNC	180	164			192.5	
FR-E720-5.5KNC	180	164	260	244	217.5	6
FR-E720-7.5KNC	220	195			217.5	
FR-E720-11KNC	220	195				
FR-E720-15KNC						

● Three-phase 400V class

Inverter Model	W	W1	H	H1	D	C
FR-E740-0.4KNC	140	128	150	138	141.5	5
FR-E740-0.75KNC					162.5	
FR-E740-1.5KNC					162.5	
FR-E740-2.2KNC					162.5	
FR-E740-3.7KNC	220	208	260	244	174.5	6
FR-E740-5.5KNC					174.5	
FR-E740-7.5KNC					174.5	
FR-E740-11KNC	220	195	260	244	217.5	6
FR-E740-15KNC					217.5	

Features

Connection example

Standard Specifications

Outline Dimension Drawings

Terminal Connection Diagram Terminal Specification Explanation

Operation panel Parameter unit FR Configurator

Parameter List

Explanations of Parameters

Protective Functions

Options

Instructions

Motor

Compatibility

Warranty

Inquiry

● Ethernet communication function model

- FR-E720-0.1K to 0.75K-NE
- FR-E720S-0.1K to 0.4K-NE

- FR-E720-1.5K to 15K-NE
- FR-E740-0.4K to 15K-NE
- FR-E720S-0.75K to 2.2K-NE

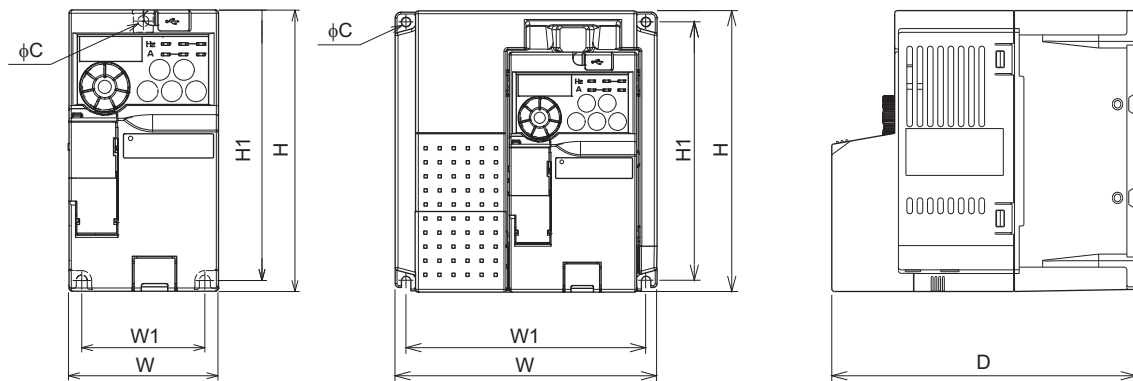

(Unit: mm)

● Three-phase 200V class

Inverter Model	W	W1	H	H1	D	C
FR-E720-0.1K-NE	68	56	128	118	108	5
FR-E720-0.2K-NE					140	
FR-E720-0.4K-NE					160	
FR-E720-0.75K-NE					163	
FR-E720-1.5K-NE	108	96	260	244	170	6
FR-E720-2.2K-NE	170	192.5				
FR-E720-3.7K-NE	180	217.5				
FR-E720-5.5K-NE	164					
FR-E720-7.5K-NE	220	195				
FR-E720-11K-NE						
FR-E720-15K-NE						

● Three-phase 400V class

Inverter Model	W	W1	H	H1	D	C
FR-E740-0.4K-NE	140	128	150	138	141.5	5
FR-E740-0.75K-NE					162.5	
FR-E740-1.5K-NE					174.5	
FR-E740-2.2K-NE					174.5	
FR-E740-3.7K-NE	220	195	260	244	217.5	6
FR-E740-5.5K-NE					174.5	
FR-E740-7.5K-NE					217.5	
FR-E740-11K-NE					217.5	
FR-E740-15K-NE						

● Single-phase 200V class

Inverter Model	W	W1	H	H1	D	C
FR-E720S-0.1K-NE	68	56	128	118	108	5
FR-E720S-0.2K-NE					170	
FR-E720S-0.4K-NE					163	
FR-E720S-0.75K-NE	108	96	150	138	188.5	
FR-E720S-1.5K-NE	140	128			183	
FR-E720S-2.2K-NE						

●Dedicated EtherCAT communication model

By installing the EtherCAT communication option (E7NECT_2P manufactured by HMS Industrial Networks AB), EtherCAT communication is possible.

●FR-E720-0.1K to 0.75KSC-TM

●FR-E720-1.5K to 15KSC-TM
●FR-E740-0.4K to 15KSC-TM

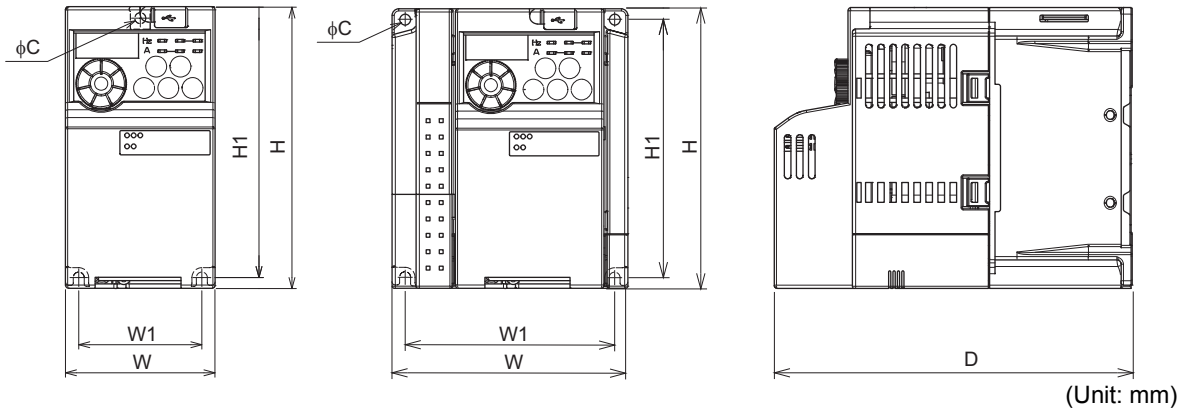

● Three-phase 200V class

Inverter Model	W	W1	H	H1	D	C
FR-E720-0.1KSC-TM	68	56	128	118	108	5
FR-E720-0.2KSC-TM					140	
FR-E720-0.4KSC-TM					160	
FR-E720-0.75KSC-TM					163	
FR-E720-1.5KSC-TM	108	96	260	244	170	6
FR-E720-2.2KSC-TM	170	158			192.5	
FR-E720-3.7KSC-TM	180	164			217.5	
FR-E720-5.5KSC-TM	180	164	260	244	217.5	6
FR-E720-7.5KSC-TM	220	195				
FR-E720-11KSC-TM	220	195				
FR-E720-15KSC-TM						

● Three-phase 400V class

Inverter Model	W	W1	H	H1	D	C
FR-E740-0.4KSC-TM	140	128	150	138	141.5	5
FR-E740-0.75KSC-TM					162.5	
FR-E740-1.5KSC-TM					174.5	
FR-E740-2.2KSC-TM					174.5	
FR-E740-3.7KSC-TM	220	208	260	244	217.5	6
FR-E740-5.5KSC-TM					217.5	
FR-E740-7.5KSC-TM					217.5	
FR-E740-11KSC-TM						
FR-E740-15KSC-TM						

Features

Connection example

Standard Specifications

Outline Dimension Drawings

Terminal Connection Diagram Terminal Specification Explanation

Operation panel Parameter unit FR Configurator

Parameter List

Explanations of Parameters

Protective Functions

Options

Instructions

Motor

Compatibility

Warranty

Inquiry

●Parameter unit (option) (FR-PU07)

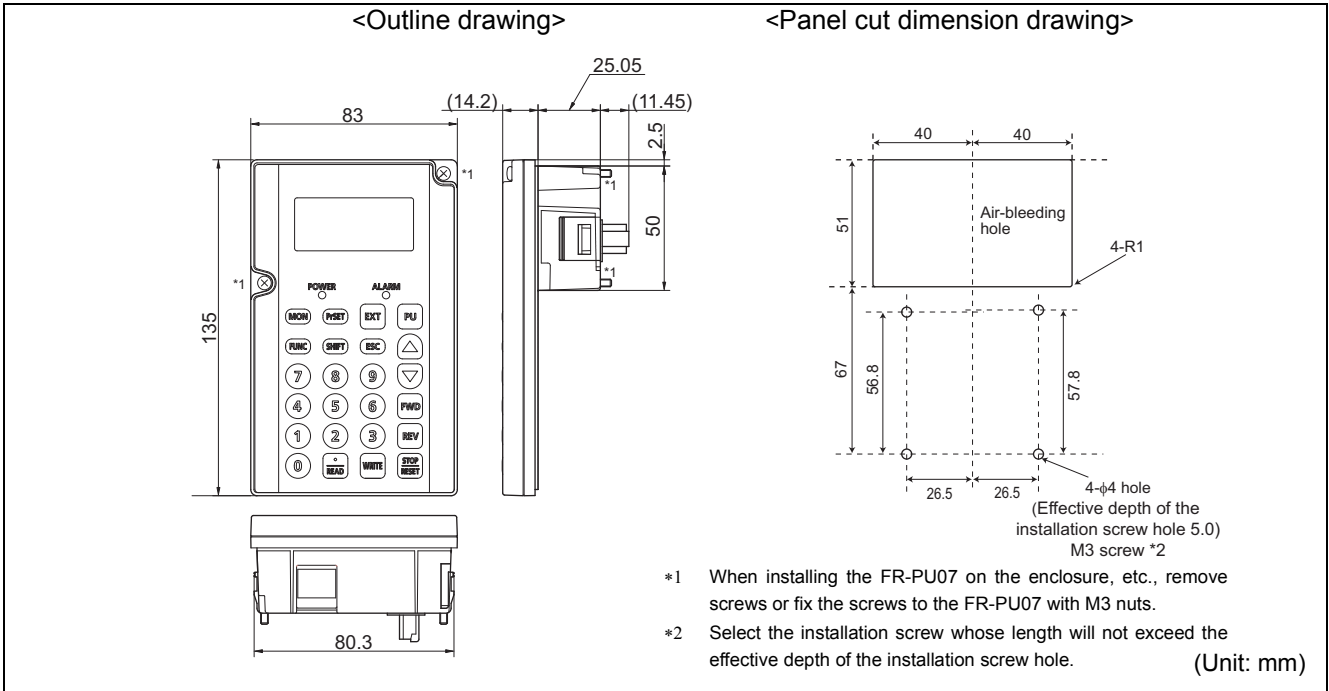

●Parameter unit with battery pack (option) (FR-PU07BB)

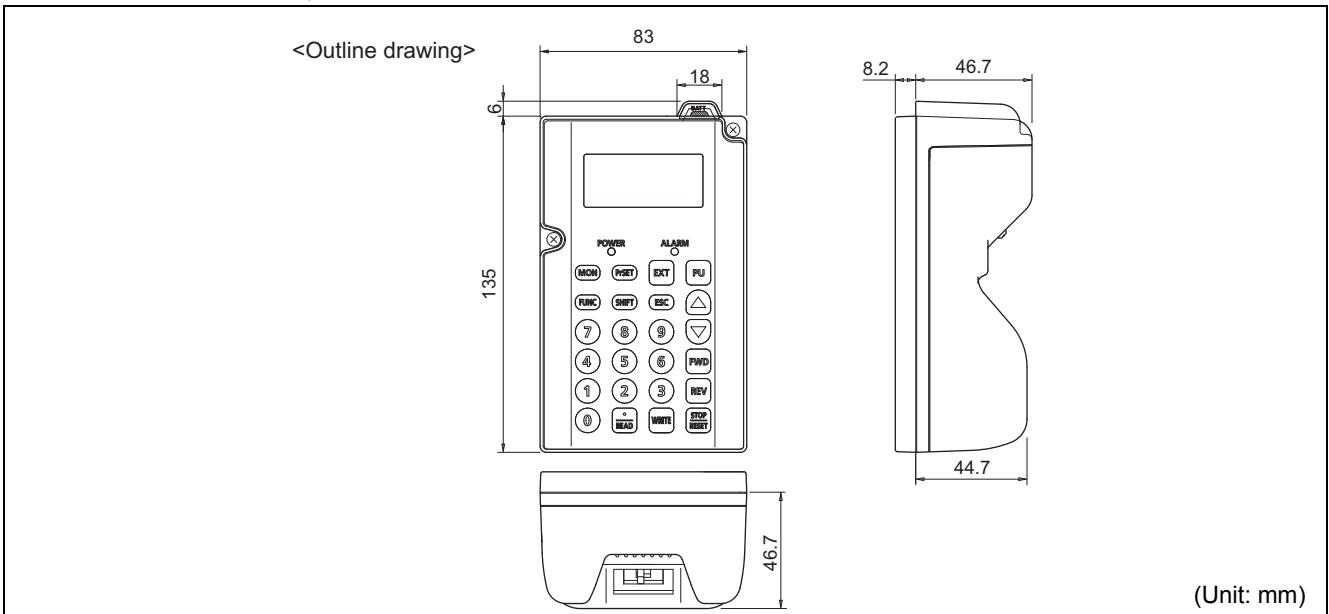

●Enclosure surface operation panel (option) (FR-PA07)

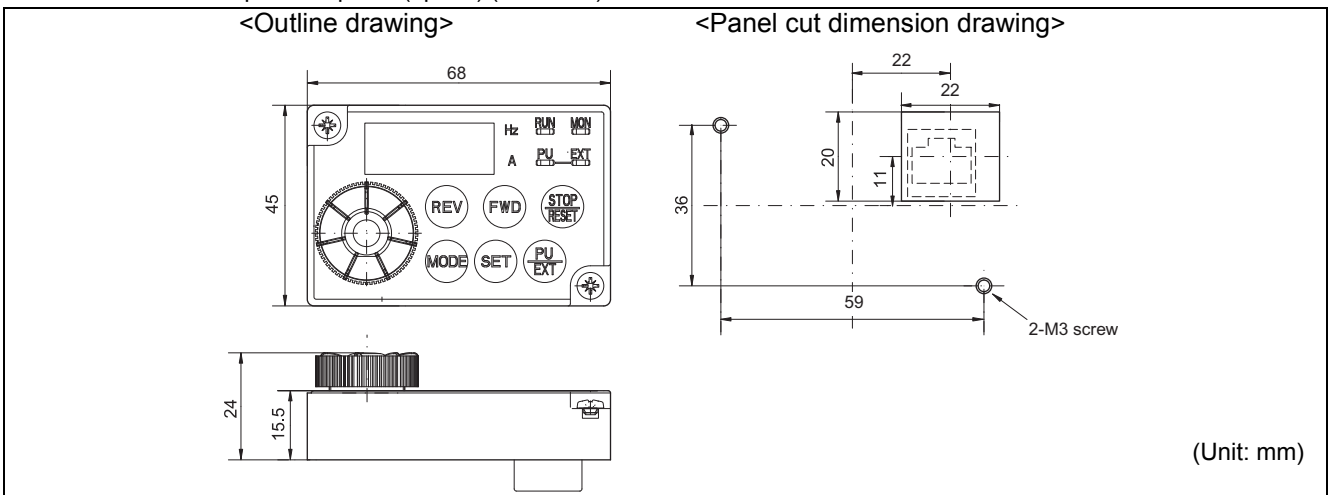

Terminal Connection Diagram

(1) Standard control circuit terminal model

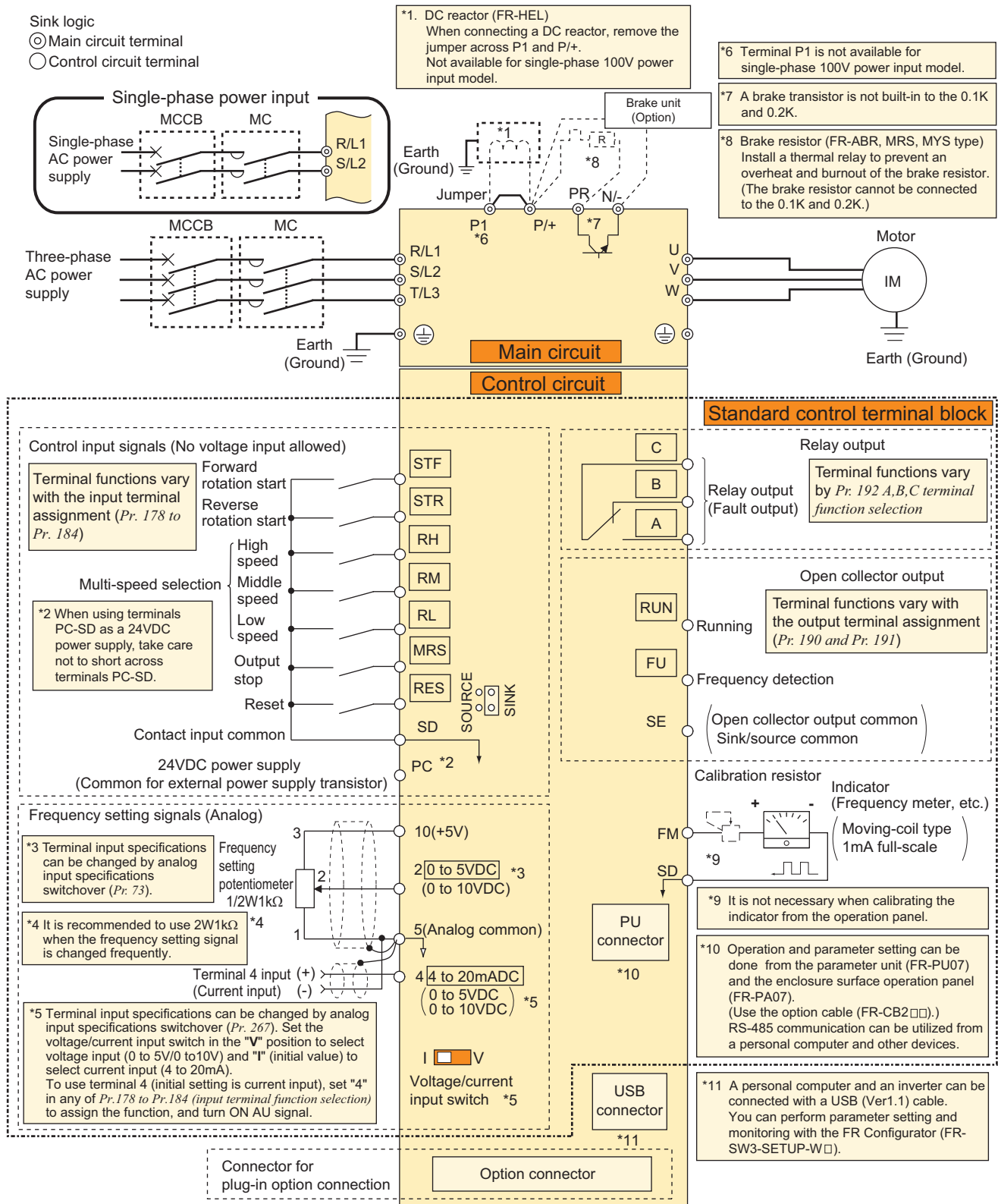

Note

- To prevent a malfunction caused by noise, separate the signal cables more than 10cm from the power cables. Also separate the main circuit wire of the input side and the output side.
- After wiring, wire offcuts must not be left in the inverter.
 Wire offcuts can cause an alarm, failure or malfunction. Always keep the inverter clean. When drilling mounting holes in an enclosure etc., take care not to allow chips and other foreign matter to enter the inverter.
- The output of the single-phase power input model is three-phase 200V.

Features
 Connection example
 Standard Specifications
 Outline Dimension Drawings
 Terminal Connection Terminal Specification Explanation
 Operation panel Parameter unit FR Configurator
 Parameter List
 Explanations of Parameters
 Protective Functions
 Options
 Instructions
 Motor
 Compatibility
 Warranty
 Inquiry

(2) Safety stop function model

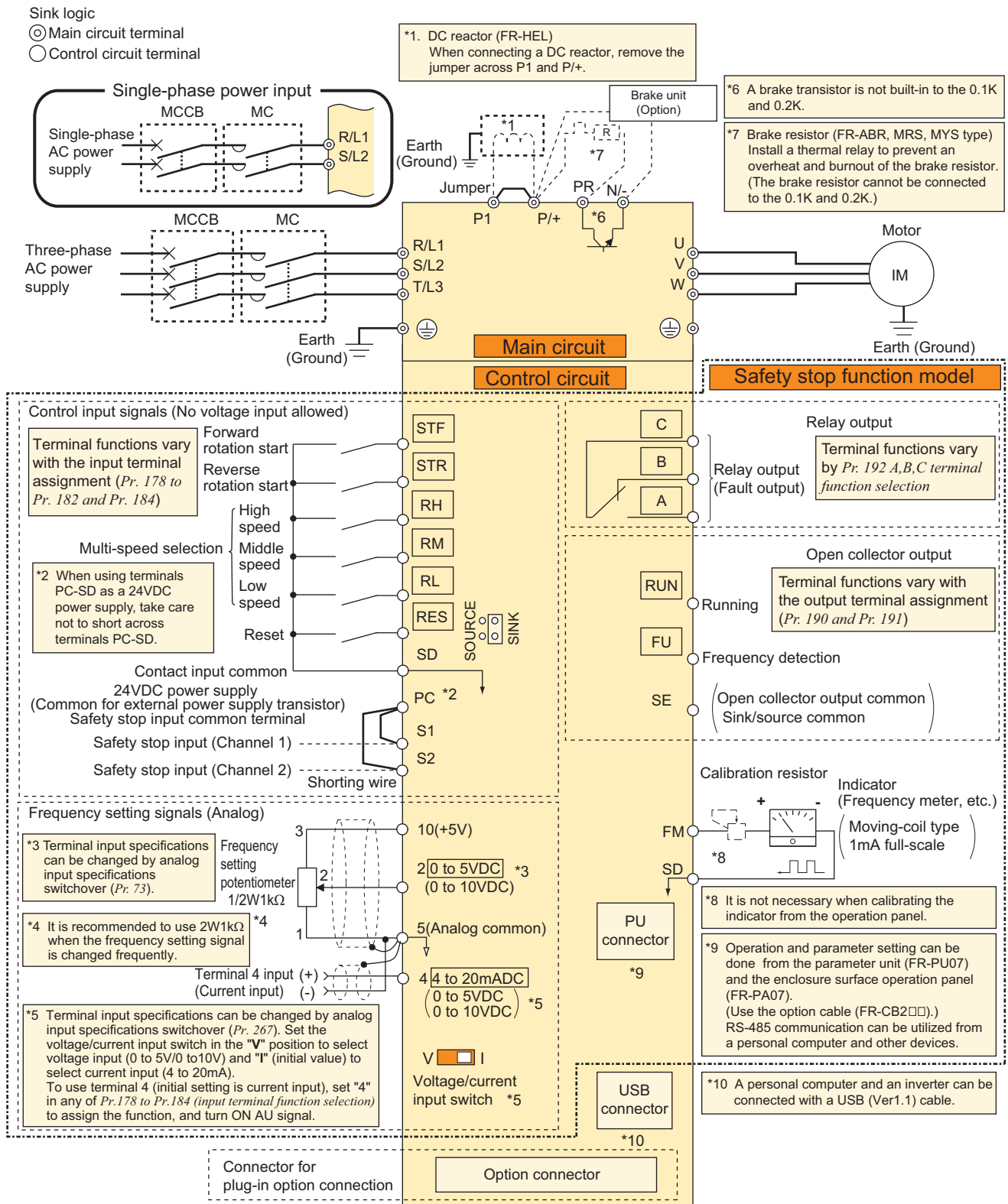

Note

- To prevent a malfunction caused by noise, separate the signal cables more than 10cm from the power cables. Also separate the main circuit wire of the input side and the output side.
- After wiring, wire offcuts must not be left in the inverter.
Wire offcuts can cause an alarm, failure or malfunction. Always keep the inverter clean. When drilling mounting holes in an enclosure etc., take care not to allow chips and other foreign matter to enter the inverter.
- The output of the single-phase power input model is three-phase 200V.

(3) FL remote communication model (NF)

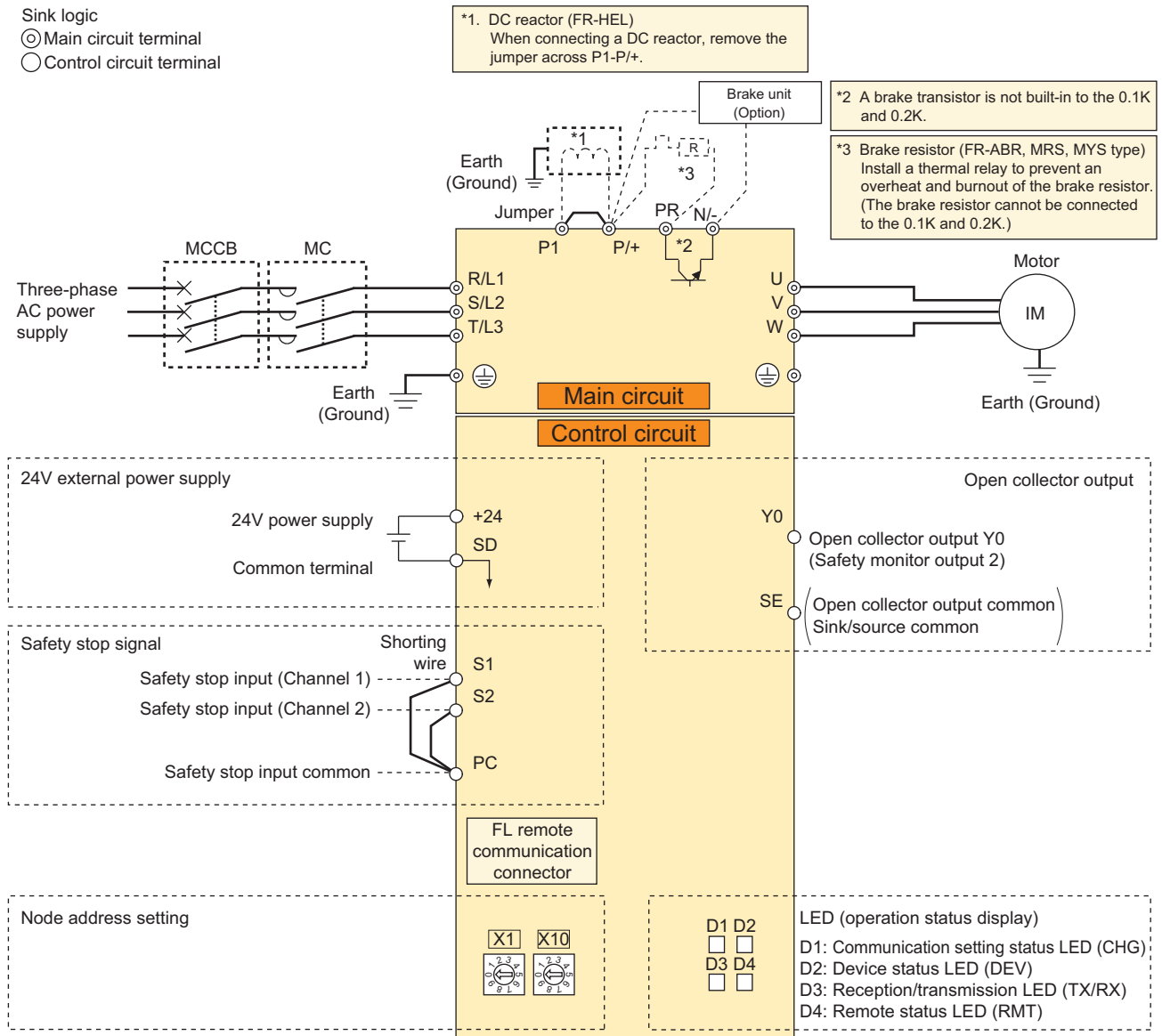

Note

- To prevent a malfunction caused by noise, separate the signal cables more than 10cm from the power cables. Also separate the main circuit wire of the input side and the output side.
- After wiring, wire offcuts must not be left in the inverter.
 Wire offcuts can cause an alarm, failure or malfunction. Always keep the inverter clean. When drilling mounting holes in an enclosure etc., take care not to allow chips and other foreign matter to enter the inverter.

Features

Connection example

Standard Specifications

Outline Dimension Drawings

Terminal Connection Diagram

Terminal Specification Explanation

Operation panel Parameter unit FR Configurator

Parameter List

Explanations of Parameters

Protective Functions

Options

Instructions

Motor

Compatibility

Warranty

Inquiry

(4) CC-Link communication model (NC)

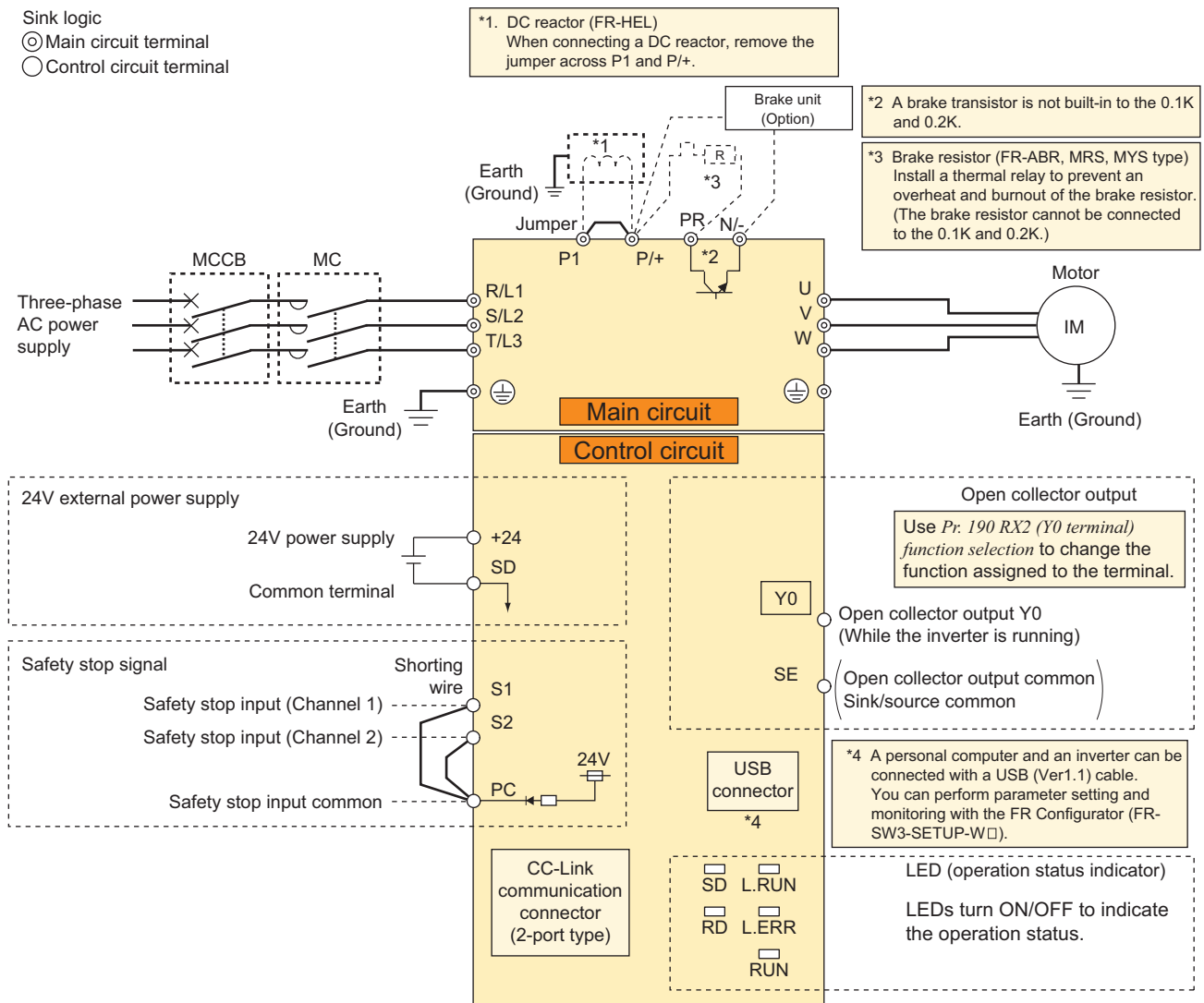

Note

- To prevent a malfunction caused by noise, separate the signal cables more than 10cm from the power cables. Also separate the main circuit wire of the input side and the output side.
- After wiring, wire offcuts must not be left in the inverter. Wire offcuts can cause an alarm, failure or malfunction. Always keep the inverter clean. When drilling mounting holes in an enclosure etc., take care not to allow chips and other foreign matter to enter the inverter.

(5) Ethernet communication function model (-NE)

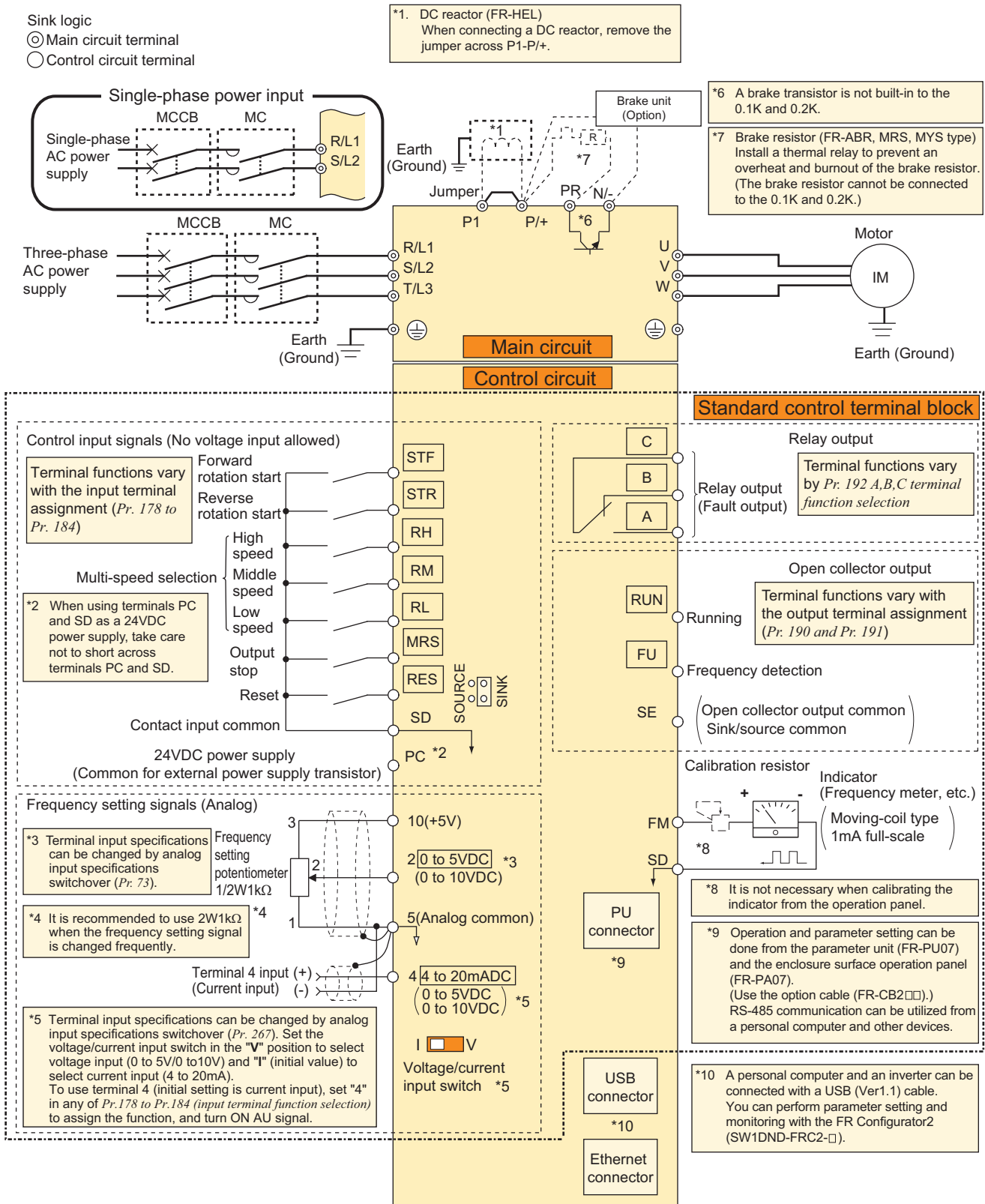

Note

- To prevent a malfunction caused by noise, separate the signal cables more than 10cm from the power cables. Also separate the main circuit wire of the input side and the output side.
- After wiring, wire offcuts must not be left in the inverter. Wire offcuts can cause an alarm, failure or malfunction. Always keep the inverter clean. When drilling mounting holes in an enclosure etc., take care not to allow chips and other foreign matter to enter the inverter.
- The output of the single-phase power input model is three-phase 200V.

Features

Connection example

Standard Specifications

Outline Dimension Drawings

Terminal Connection Diagram

Terminal Specification Explanation

Operation panel Parameter unit FR Configurator

Parameter List

Explanations of Parameters

Protective Functions

Options

Instructions

Motor

Compatibility

Warranty

Inquiry

(6) Dedicated EtherCAT communication model (-TM)

By installing the EtherCAT communication option (E7NECT_2P manufactured by HMS Industrial Networks AB), EtherCAT communication is possible.

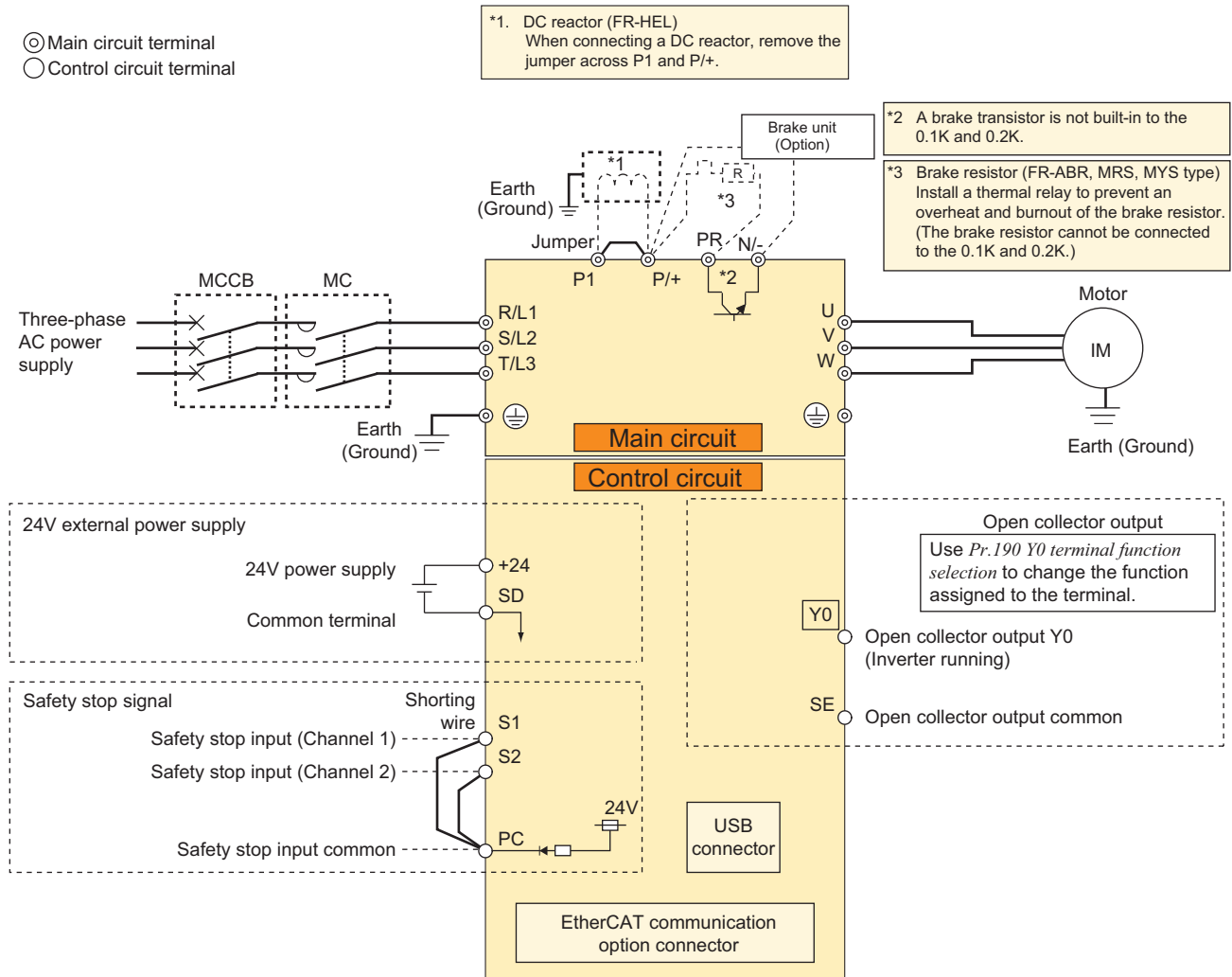

Note

- To prevent a malfunction caused by noise, separate the signal cables more than 10cm from the power cables. Also separate the main circuit wire of the input side and the output side.
- After wiring, wire offcuts must not be left in the inverter. Wire offcuts can cause an alarm, failure or malfunction. Always keep the inverter clean. When drilling mounting holes in an enclosure etc., take care not to allow chips and other foreign matter to enter the inverter.

Terminal Specifications

(1) Standard control circuit terminal model, safety stop function model (SC)

Type	Terminal Symbol	Terminal Name	Description		
Main circuit	R/L1, S/L2, T/L3 *	AC power input	Connect to the commercial power supply. Keep these terminals open when using the high power factor converter (FR-HC2) or power regeneration common converter (FR-CV). * When using single-phase power input, terminals are R/L1 and S/L2.		
	U, V, W	Inverter output	Connect a three-phase squirrel-cage motor.		
	P/+, PR	Brake resistor connection	Connect a brake transistor (MRS type, MYS type, FR-ABR) across terminals P/+-PR. (The brake resistor cannot be connected to the 0.1K or 0.2K)		
	P/+, N/-	Brake unit connection	Connect the brake unit (FR-BU2), power regeneration common converter (FR-CV) or high power factor converter (FR-HC2).		
		DC power input	Connect the plus side of the power supply to terminal P/+ and minus side to terminal N/-.		
	P/+, P1 *	DC reactor connection	Remove the jumper across terminals P/+-P1 and connect a DC reactor. Single-phase 100V power input model is not compatible with DC reactor. * Terminal P1 is not available for single-phase 100V power input model.		
	Earth (Ground)	For earthing (grounding) the inverter chassis. Must be earthed (grounded).			
Control circuit/input signal	STF	Forward rotation start	Turn on the STF signal to start forward rotation and turn it off to stop.	When the STF and STR signals are turned on simultaneously, the stop command is given.	
	STR	Reverse rotation start	Turn on the STR signal to start reverse rotation and turn it off to stop.		
	RH, RM, RL	Multi-speed selection	Multi-speed can be selected according to the combination of RH, RM and RL signals.		
	MRS *	Output stop	Turn on the MRS signal (20ms or more) to stop the inverter output. Use to shut off the inverter output when stopping the motor by electromagnetic brake. * Terminal MRS is only available for the standard control circuit terminal model.		
	RES	Reset	Use to reset alarm output provided when protective circuit is activated. Turn on the RES signal for more than 0.1s, then turn it off. It is possible to set the initial setting to "always enabled". By setting Pr. 73, reset can be set enabled only at fault occurrence. Recover about 1s after reset is cancelled.		
	SD	Contact input common (sink) (initial setting)	Common terminal for contact input terminal (sink logic) and terminal FM.		
		External transistor common (source)	Connect this terminal to the power supply common terminal of a transistor output (open collector output) device, such as a programmable controller, in the source logic to avoid malfunction by undesirable currents.		
		24VDC power supply common	Common output terminal for 24VDC 0.1A power supply (PC terminal). Isolated from terminals 5 and SE.		
	PC	External transistor common (sink) (initial setting)	Connect this terminal to the power supply common terminal of a transistor output (open collector output) device, such as a programmable controller, in the sink logic to avoid malfunction by undesirable currents.		
		Contact input common (source)	Common terminal for contact input terminal (source logic).		
		24VDC power supply	Can be used as 24VDC 0.1A power supply.		
	Frequency setting	10	Frequency setting power supply	Used as power supply when connecting potentiometer for frequency setting (speed setting) from outside of the inverter.	5VDC permissible load current 10mA
				2	Frequency setting (voltage)
		4	Frequency setting (current)	Inputting 0 to 20mADC (or 0 to 5V / 0 to 10V) provides the maximum output frequency at 20mA makes input and output proportional. This input signal is valid only when the AU signal is on (terminal 2 input is invalid). To use terminal 4 (initial setting is current input), set "4" to any of Pr.178 to Pr.184 (input terminal function selection), and turn AU signal ON. Use Pr. 267 to switch from among input 4 to 20mA (initial setting), 0 to 5VDC and 0 to 10VDC. Set the voltage/current input switch in the "V" position to select voltage input (0 to 5V/0 to 10V).	Voltage input: Input resistance 10kΩ ± 1kΩ Permissible maximum voltage 20VDC Current input: Input resistance 233Ω ± 5Ω Maximum permissible current 30mA.
				Standard control circuit terminal model	
			Current input (initial status) Voltage input	Current input (initial status) Voltage input	
5	Frequency setting common	Common terminal for the frequency setting signals (terminals 2 or 4). Do not earth (ground).			
Safety stop	S1	Safe stop input (Channel 1) *	S1/S2 are safe stop signals for use with in conjunction with an approved external safety unit. Both S1/S2 must be used in dual channel form. Inverter output is shutoff depending on shorting/opening between S1 and PC, S2 and PC. In the initial status, terminal S1 and S2 are shorted with terminal PC by shortening wire.		
	S2	Safe stop input (Channel 2) *	Remove the shortening wire and connect the safety relay module when using the safety stop function. * Terminals S1 and S2 are provided on the safety stop function model. For details, refer to the Safety stop function instruction manual (BCN-A211508-004).		
			Input resistance 4.7kW Voltage when contacts are open 21 to 26VDC Current when contacts are short-circuited 4 to 6mADC		

- Features
- Connection example
- Standard Specifications
- Outline Dimension Drawings
- Terminal Connection Terminal Specification Explanation
- Operation panel Parameter unit FR Configurator
- Parameter List
- Explanations of Parameters
- Protective Functions
- Options
- Instructions
- Motor
- Compatibility
- Warranty
- Inquiry

Type	Terminal Symbol	Terminal Name	Description
Control circuit/output signal	Relay	A, B, C	Relay output (fault output) 1 changeover contact output indicates that the inverter fault occurs. Fault: discontinuity across B-C (continuity across A-C), Normal: continuity across B-C (discontinuity across A-C) Contact capacity 230VAC 0.3A (power factor = 0.4) 30VDC 0.3A
	Open collector	RUN	Inverter running The output is in LOW state when the inverter output frequency is equal to or higher than the starting frequency (initial value: 0.5Hz). The output is in HIGH state during stop or DC injection brake operation. *
		FU	Frequency detection The output is in LOW state when the inverter output frequency is equal to or higher than the preset detection frequency, and is in HIGH state when it is less than the preset detection frequency. *
		SE	Open collector output common Common terminal of terminal RUN and FU.
	Pulse	FM	For meter Select one e.g. output frequency from monitor items. (Not output during inverter reset.) The output signal is proportional to the magnitude of the corresponding monitoring item.
Communication	—	PU connector With the PU connector, RS-485 communication can be made. · Conforming standard: EIA-485 (RS-485) · Transmission format: Multi-drop link · Communication speed: 4800 to 38400bps · Overall extension: 500m	
	—	USB connector USB connection with a personal computer can be established. Setting, monitoring and testing of the inverter can be performed using FR Configurator. · Interface: conforms to USB1.1 · Transmission Speed: 12Mbps · Connector: USB mini B connector (receptacle mini B type)	

Note



- Set Pr. 267 and a voltage/current input switch correctly, then input an analog signal in accordance with the setting. Applying a voltage with voltage/current input switch in "I" position (current input is selected) or a current with switch in "V" position (voltage input is selected) could cause component damage of the inverter or analog circuit of output devices.
- The inverter will be damaged if power is applied to the inverter output terminals (U, V, W). Never perform such wiring.
- indicates that terminal functions can be selected using Pr. 178 to Pr. 192 (I/O terminal function selection).
- Terminal names and terminal functions are those of the factory set.
- When connecting the DC power supply, be sure to connect the plus side of the power supply to terminal P/+ and minus side to terminal N/-. Opposite polarity will damage the inverter.

(2) FL remote communication model (NF), CC-Link communication model (NC)

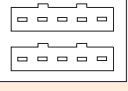
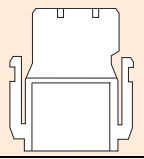
Type	Terminal Symbol	Terminal Name	Description																		
Main circuit	R/L1, S/L2, T/L3	AC power input	Connect to a commercial power supply.																		
	U, V, W	Inverter output	Connect a three-phase squirrel-cage motor.																		
	P/+, PR	Brake resistor connection	Connect a brake resistor (FR-ABR, MRS type, MYS type) across terminals P/+ and PR. (The brake resistor cannot be connected to the 0.1K or 0.2K.)																		
	P/+, N/-	Brake unit connection	Connect the brake unit (FR-BU2).																		
	P/+, P1	DC reactor connection	Remove the jumper across terminals P/+ and P1 and connect a DC reactor.																		
		Earth (Ground)	For earthing (grounding) the inverter chassis. Must be earthed (grounded).																		
Control circuit	24V external power supply	+24	24V external power supply	Even when the main circuit power supply is OFF, FL-net communication continues with the input from the 24V external power supply. Input voltage 23.5 to 26.5VDC Input current 0.7A or less																	
		SD	24V external power supply common terminal	Common terminal for the terminal +24																	
	Safety stop function	S1	Safety stop input (Channel 1)	Terminal S1/S2 are safety stop signals for use with in conjunction with an approved external safety unit. Both terminal S1/S2 must be used in dual channel form. Inverter output is shutoff depending on shorting/opening between S1 and PC, S2 and PC.	Input resistance 4.7kΩ Voltage when contacts are open 21 to 26VDC Current when contacts are short-circuited 4 to 6mADC																
		S2	Safety stop input (Channel 2)	In the initial status, terminal S1 and S2 are shorted with terminal PC by shorting wire. Remove the shorting wire and connect the safety relay module when using the safety stop function.																	
		PC	Safety stop input terminal common	Common terminal for safety stop input terminals S1 and S2.																	
	Open collector	Y0	FL remote communication model (NF)		Permissible load 24VDC (maximum 27VDC) 0.1A (a voltage drop is 3.4V maximum when the signal is on) * The open collector transistor is ON (conductive) in LOW state. The transistor is OFF (not conductive) in HIGH state.																
			Open collector output Y0 (safety monitor output 2)	The output is switched to HIGH state to activate the safety stop function when the safety circuit fault (E.SAF) occurs. Otherwise, the output is in LOW state. *																	
		CC-Link communication model (NC)		The output is in LOW state when the inverter output frequency is equal to or higher than the starting frequency (initial value: 0.5Hz). The output is in HIGH state during stop or DC injection brake operation. * Use Pr. 190 RX2 (terminal Y0) function selection to change the function assigned to the terminal.																	
		Open collector output Y0 (Inverter running)																			
	SE	Open collector output common	Common terminal of terminal Y0.																		
Communication	FL-net	FL remote communication model (NF)																			
		FL remote communication connector	With the FL remote communication connector, FL remote communication can be performed.																		
	CC-Link	CC-Link communication model (NC)																			
		CONA CONB	CC-Link communication connector	<p>Pin arrangement</p> <p>5 4 3 2 1</p>  <table border="1"> <tr> <td>Pin number</td> <td>5</td> <td>4</td> <td>3</td> <td>2</td> <td>1</td> </tr> <tr> <td>Signal name</td> <td>SLD</td> <td>NC</td> <td>DG</td> <td>DB</td> <td>DA</td> </tr> </table> <p>One-touch connector for CC-Link communication</p> <table border="1"> <tr> <td>Model name</td> <td>Manufacturer</td> </tr> <tr> <td>A6CON-L5P</td> <td>Mitsubishi Electric Corporation</td> </tr> <tr> <td>35505-6000-B0M GF</td> <td>3M Japan Limited</td> </tr> </table> 	Pin number	5	4	3	2	1	Signal name	SLD	NC	DG	DB	DA	Model name	Manufacturer	A6CON-L5P	Mitsubishi Electric Corporation	35505-6000-B0M GF
Pin number		5	4	3	2	1															
Signal name	SLD	NC	DG	DB	DA																
Model name	Manufacturer																				
A6CON-L5P	Mitsubishi Electric Corporation																				
35505-6000-B0M GF	3M Japan Limited																				
—	USB connector	<p>The FR Configurator can be operated by connecting the inverter to the personal computer through USB.</p> <ul style="list-style-type: none"> Interface: conforms to USB1.1 Transmission Speed: 12Mbps Connector: USB mini B connector (receptacle mini B type) 																			



Note

- The inverter will be damaged if power is applied to the inverter output terminals (U, V, W). Never perform such wiring.
- When connecting the DC power supply, be sure to connect the plus side of the power supply to terminal P/+ and minus side to terminal N/-. Opposite polarity will damage the inverter.

Features

Connection example

Standard Specifications

Outline Dimension Drawings

Terminal Connection Diagram Terminal Specification Explanation

Operation panel Parameter unit FR Configurator

Parameter List

Explanations of Parameters

Protective Functions

Options

Instructions

Motor

Compatibility

Warranty

Inquiry

(3) Ethernet communication function model (-NE)

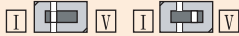
Type	Terminal Symbol	Terminal Name	Description			
Main circuit	R/L1, S/L2, T/L3 *	AC power input	Connect to the commercial power supply. Keep these terminals open when using the high power factor converter (FR-HC2) or power regeneration common converter (FR-CV).			
	U, V, W	Inverter output	Connect a three-phase squirrel-cage motor.			
	P/+, PR	Brake resistor connection	Connect a brake resistor (MRS type, MYS type, FR-ABR) across terminals P/+ and PR. (The brake resistor cannot be connected to the 0.1K or 0.2K)			
	P/+, N/-	Brake unit connection	Connect the brake unit (FR-BU2), power regeneration common converter (FR-CV) or high power factor converter (FR-HC2).			
		DC power input	Connect the plus side of the power supply to terminal P/+ and minus side to terminal N/-.			
	P/+, P1	DC reactor connection	Remove the jumper across terminals P/+ and P1 and connect a DC reactor.			
		Earth (Ground)	For earthing (grounding) the inverter chassis. Must be earthed (grounded).			
Control circuit/input signal	Contact input	STF	Forward rotation start	Turn ON the STF signal to start forward rotation and turn it OFF to stop.	When the STF and STR signals are turned ON simultaneously, the stop command is given.	
		STR	Reverse rotation start	Turn ON the STR signal to start reverse rotation and turn it OFF to stop.		
		RH, RM, RL	Multi-speed selection	Multi-speed can be selected according to the combination of RH, RM and RL signals.		
		MRS	Output stop	Turn ON the MRS signal (20ms or more) to stop the inverter output. Use to shut off the inverter output when stopping the motor by electromagnetic brake.		
		RES	Reset	Used to reset alarm output provided when protective circuit is activated. Turn ON the RES signal for more than 0.1s, then turn it OFF. Initial setting is for reset always. By setting Pr. 75, reset can be set to enabled only at fault occurrence. Recover about 1s after reset is cancelled.		
	SD	Contact input common (sink) (initial setting)		Common terminal for contact input terminal (sink logic) and terminal FM.		
		External transistor common (source)		Connect this terminal to the power supply common terminal of a transistor output (open collector output) device, such as a programmable controller, in the source logic to avoid malfunction by undesirable current.		
		24VDC power supply common		Common output terminal for 24VDC 0.1A power supply (PC terminal). Isolated from terminals 5 and SE.		
		PC	External transistor common (sink) (initial setting)		Connect this terminal to the power supply common terminal of a transistor output (open collector output) device, such as a programmable controller, in the sink logic to avoid malfunction by undesirable current.	
			Contact input common (source)		Common terminal for contact input terminal (source logic).	
			24VDC power supply		Can be used as 24VDC 0.1A power supply.	
	Frequency setting	10	Frequency setting power supply	Used as power supply when connecting potentiometer for frequency setting (speed setting) from outside of the inverter.	5VDC permissible load current 10mA	
		2	Frequency setting (voltage)	Inputting 0 to 5VDC (or 0 to 10V) provides the maximum output frequency at 5V (10V) and makes input and output proportional. Use Pr. 73 to switch between input 0 to 5VDC (initial setting) and 0 to 10VDC input.	Input resistance 10kΩ ± 1kΩ Permissible maximum voltage 20VDC	
		4	Frequency setting (current)	Inputting 0 to 20mADC (or 0 to 5V / 0 to 10V) provides the maximum output frequency at 20mA and makes input and output proportional. This input signal is valid only when the AU signal is ON (terminal 2 input is invalid). To use terminal 4 (initial setting is current input), set "4" to any of Pr.178 to Pr.184 (input terminal function selection), and turn AU signal ON. Use Pr. 267 to switch among input 4 to 20mA (initial setting), 0 to 5VDC, and 0 to 10VDC. Set the voltage/current input switch in the "V" position to select voltage input (0 to 5V/0 to 10V). Current input (initial status) Voltage input 	Voltage input: Input resistance 10kΩ ± 1kΩ Permissible maximum voltage 20VDC Current input: Input resistance 233Ω ± 5Ω Maximum permissible current 30mA.	
		5	Frequency setting common	Common terminal for the frequency setting signals (terminals 2 and 4). Do not earth (ground).		

Type	Terminal Symbol	Terminal Name	Description
Control circuit/output signal	Relay	A, B, C	Relay output (fault output) 1 changeover contact output indicates that the inverter fault occurs. Fault: discontinuity across B-C (continuity across A-C), Normal: continuity across B-C (discontinuity across A-C) Contact capacity 230VAC 0.3A (power factor = 0.4) 30VDC 0.3A
	Open collector	RUN	Inverter running Switched Low when the inverter output frequency is equal to or higher than the starting frequency (initial value 0.5Hz). Switched High during stop or DC injection brake operation.*
		FU	Frequency detection Switched Low when the inverter output frequency is equal to or higher than the preset detected frequency and High when less than the preset detected frequency.*
		SE	Open collector output common Common terminal of terminal RUN and FU.
Pulse	FM	For meter Used to output a selected monitored item (such as Output frequency) among several monitored items. (Not output during inverter reset.) The output signal is proportional to the magnitude of the corresponding monitoring item.	Permissible load current 1mA 1440 pulses/s at 60Hz
Communication	—	Ethernet connector	Communication can be made via Ethernet. · Category: 100BASE-TX/10BASE-T · Data transmission speed: 100Mbps (100BASE-TX) / 10Mbps (10BASE-T) · Transmission method: Baseband · Maximum segment length: 100m between the hub and the inverter · Number of cascade connection stages: Up to 2 (100BASE-TX) / up to 4 (10BASE-T) · Interface: RJ-45 · Number of interfaces available: 1 · IP version: IPv4
	—	PU connector	With the PU connector, RS-485 communication can be established. · Conforming standard: EIA-485 (RS-485) · Transmission format: Multi-drop link · Communication speed: 4800 to 38400bps · Overall extension: 500m
	—	USB connector	Use the USB connector to communicate with a personal computer. Setting and monitoring of the inverter is enabled using FR Configurator2. · Interface: conforms to USB1.1 · Transmission Speed: 12Mbps · Connector: USB mini B connector (receptacle mini B type)



Note

- Set Pr. 267 and a voltage/current input switch correctly, then input an analog signal in accordance with the setting. Applying a voltage with voltage/current input switch in "I" position (current input is selected) or a current with switch in "V" position (voltage input is selected) could cause component damage of the inverter or analog circuit of output devices.
- The inverter will be damaged if power is applied to the inverter output terminals (U, V, W). Never perform such wiring.
- indicates that terminal functions can be selected using Pr. 178 to Pr. 184 and Pr. 190 to Pr. 192 (I/O terminal function selection).
- Terminal names and terminal functions are those of the factory set.
- When connecting the DC power supply, be sure to connect the plus side of the power supply to terminal P/+ and minus side to terminal N/-. Opposite polarity will damage the inverter.

- Features
- Connection example
- Standard Specifications
- Outline Dimension Drawings
- Terminal Connection Terminal Specification Explanation
- Operation panel Parameter unit FR Configurator
- Parameter List
- Explanations of Parameters
- Protective Functions
- Options
- Instructions
- Motor
- Compatibility
- Warranty
- Inquiry

(4) Dedicated EtherCAT communication model (-TM)

By installing the EtherCAT communication option (E7NECT_2P manufactured by HMS Industrial Networks AB), EtherCAT communication is possible.

Type	Terminal Symbol	Terminal Name	Description		
Main circuit	R/L1, S/L2, T/L3	AC power input	Connect to the commercial power supply.		
	U, V, W	Inverter output	Connect a three-phase squirrel-cage motor.		
	P/+, PR	Brake resistor connection	Connect a brake resistor (FR-ABR, MRS type, MYS type) across terminals P/+ and PR. (The brake resistor cannot be connected to the 0.1K or 0.2K.)		
	P/+, N/-	Brake unit connection	Connect the brake unit (FR-BU2).		
	P/+, P1	DC reactor connection	Remove the jumper across terminals P/+ and P1 and connect a DC reactor.		
		Earth (Ground)	For earthing (grounding) the inverter chassis. Must be earthed (grounded).		
Control circuit	24V external power supply	+24	24V external power supply	Even when the main circuit power supply is OFF, EtherCAT communication continues with the input from the 24V external power supply.	Input voltage 23.5 to 26.5VDC Input current 0.7A or less
		SD	24V external power supply common terminal	Common terminal for the terminal +24	
	Safety stop function	S1	Safety stop input (Channel 1)	Terminal S1/S2 are safety stop signals for use with in conjunction with an approved external safety unit. Both terminal S1/S2 must be used in dual channel form. Inverter output is shutoff depending on shorting/opening between S1 and PC, S2 and PC. In the initial status, terminal S1 and S2 are shorted with terminal PC by shorting wire. Remove the shorting wire and connect the safety relay module when using the safety stop function.	Input resistance 4.7kΩ Voltage when contacts are open 21 to 26VDC Current when contacts are short-circuited 4 to 6mADC
		S2	Safety stop input (Channel 2)		
		PC	Safety stop input terminal common	Common terminal for safety stop input terminals S1 and S2.	
	Open collector	Y0	Open collector output Y0 (Inverter running)	Switched low when the inverter output frequency is equal to or higher than the starting frequency (initial value 0.5Hz). Switched high during stop or DC injection brake operation. (Low indicates that the open collector output transistor is ON (conducts). High indicates that the transistor is OFF (does not conduct).) Use Pr.190 Y0 terminal function selection to change the function assigned to the terminal.	Permissible load 24VDC (maximum 27VDC) 0.1A (a voltage drop is 3.4V maximum when the signal is ON)
		SE	Open collector output common	Common terminal of terminal Y0.	
USB	—	USB connector	Use this connector for communication with a personal computer. • Interface: conforms to USB1.1 • Transmission speed: 12Mbps • Connector: USB mini B connector (receptacle mini B type)		



Note

- The inverter will be damaged if power is applied to the inverter output terminals (U, V, W). Never perform such wiring.
- When connecting the DC power supply, be sure to connect the plus side of the power supply to terminal P/+ and minus side to terminal N/-. Opposite polarity will damage the inverter.

Explanation of the Operation Panel

The operation panel cannot be removed from the inverter.

Operation mode indicator *1

PU: Lit to indicate PU operation mode.
 EXT: Lit to indicate External operation mode.
 (Lit at power-ON at initial setting.)
 NET: Lit to indicate Network operation mode.
 PU, EXT: Lit to indicate External/PU combined operation mode 1, 2.
 These turn OFF when command source is not on operation panel.

Unit indicator

Hz: Lit to indicate frequency.
 (Blinks when the set frequency monitor is displayed.)
 A: Lit to indicate current.
 (Both "Hz" and "A" turn OFF when other than the above is displayed.)

Monitor (4-digit LED)

Shows the frequency, parameter number, etc.

Setting dial

(Setting dial: Mitsubishi Electric inverter dial)
 Used to change the frequency setting and parameter settings.
 Press to display the following.

- Displays the set frequency in the monitor mode
- Present set value is displayed during calibration
- Displays the order in the fault history mode

Mode switchover

Used to change each setting mode.
 Pressing **PU/EXT** simultaneously changes the operation mode.
 Pressing for a while (2s) can lock operation.

Determination of each setting

If pressed during operation, monitor changes as below;

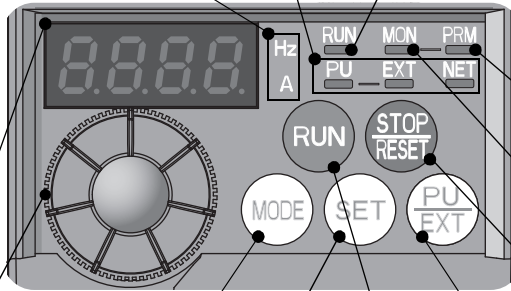
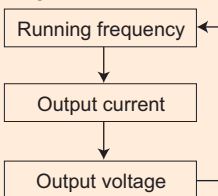

Operating status indicator

Lit or blink during inverter operation. *

* Lit: When the forward rotation operation is being performed.
 Slow blinking (1.4s cycle):
 When the reverse rotation operation is being performed.
 Fast blinking (0.2s cycle):
 When **RUN** was pressed or the start command was given, but the operation cannot be made.

- When the frequency command is less than the starting frequency.
- When the MRS signal is input.

Parameter setting mode

Lit to indicate parameter setting mode.

Monitor indicator

Lit to indicate monitoring mode.

Stop operation

Used to stop Run command.
 Fault can be reset when protective function is activated (fault).

Operation mode switchover *1*2

Used to switch between the PU and External operation mode.
 When using the External operation mode (operation using a separately connected frequency setting potentiometer and start signal), press this key to light up the EXT indication.
 (Press **MODE** simultaneously (0.5s) or change *Pr: 79* setting to change to combined mode.)
 PU: PU operation mode
 EXT: External operation mode
 Cancels PU stop also.

Start command

The rotation direction can be selected by setting *Pr: 40*.

*1 The External operation mode cannot be selected for the FL remote communication model, the CC-Link communication model, and the dedicated EtherCAT communication model. (The EXT LED is OFF.) The NET LED turns ON at power-ON in the initial setting.

*2 The operation is switched between the PU and NET modes for the FL remote communication model, the CC-Link communication model, and the dedicated EtherCAT communication model.

- Features
- Connection example
- Standard Specifications
- Outline Dimension Drawings
- Terminal Connection Diagram
- Terminal Specification Explanation
- Operation panel Parameter unit FR Configurator
- Parameter List
- Explanations of Parameters
- Protective Functions
- Options
- Instructions
- Motor
- Compatibility
- Warranty
- Inquiry

Basic operation of the operation panel

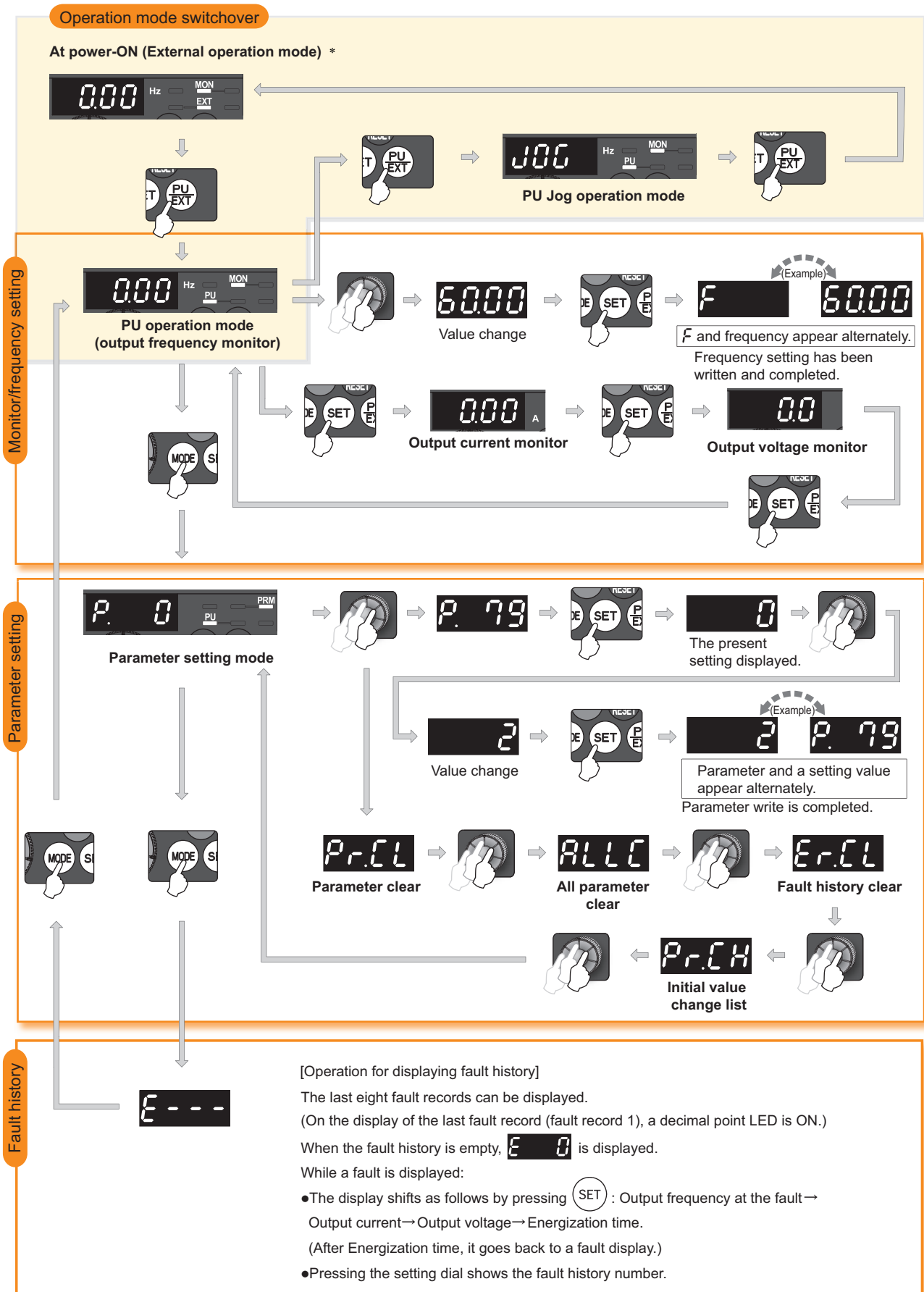

* The External operation mode cannot be selected for the FL remote communication model, the CC-Link communication model, and the dedicated EtherCAT communication model. (The EXT LED is OFF.) The NET LED turns ON at power-ON in the initial setting.

Explanations of Parameter unit

Parameter unit (FR-PU07), parameter unit with battery pack (FR-PU07BB(-L))

- The parameter unit is a convenient tool for inverter setting such as direct input method with a numeric keypad, operation status indication, and help function.
- Eight languages can be displayed.
- Parameter setting values of maximum of three inverters can be stored.
- With the FR-PU07BB(-L), parameter check and setting change can be made without connecting a power supply to the inverter. For the power supply, use AA nickel metal hydride batteries, AA alkaline batteries, or an AC adapter.
- Since the shape is specially designed for portable use, it is easy to work with the FR-PU07BB(-L) in hand.
- * The parameter unit connection cable FR-CB20□ is required for connecting to the inverter. (Parameter unit connection cable FR-CB203(3m) is enclosed with FR-PU07BB(-L).)
- * To use a parameter unit with battery pack (FR-PU07BB) outside Japan, order a "FR-PU07BB-L" (parameter unit type indicated on the package has L at the end). Since enclosed batteries may conflict with laws in countries to be used (new EU Directive on batteries and accumulators, etc.), batteries are not enclosed with an FR-PU07BB-L.
- * The parameter units (FR-PU07 or FR-PU07BB) cannot be used for the FL remote communication model, the CC-Link communication model, and the dedicated EtherCAT communication model.

Key	Description
PrSET	Use for parameter setting Press to choose the parameter setting mode.
MON	First priority monitor is displayed. In the initial setting, the output frequency is displayed.
ESC	Operation cancel key
FUNC	Used to display the function menu. A variety of functions can be used on the function menu.
SHIFT	Used to shift to the next item in the setting or monitoring mode.
0 to 9	Used to enter a frequency, parameter number or set value.
EXT	Inverter operates in the External operation mode.
PU	Used to select the PU operation mode to display the frequency setting screen.
▲ ▼	<ul style="list-style-type: none"> • Used to keep on increasing or decreasing the running frequency. Hold down to vary the frequency. • Press either of these keys on the parameter setting mode screen to change the parameter setting value sequentially. • On the selecting screen, these keys are used to move the cursor. • Hold down (SHIFT) and press either of these keys to advance or return the display screen one page.
FWD	Forward rotation command key.
REV	Reverse rotation command key.
STOP RESET	<ul style="list-style-type: none"> • Stop command key. • Used to reset the inverter when an alarm occurs.
WRITE	<ul style="list-style-type: none"> • Used to write a set value in the setting mode. • Used as a clear key in the all parameter clear or alarm history clear mode.
• READ	<ul style="list-style-type: none"> • Used as a decimal point when entering numerical value. • Used as a parameter number read key in the setting mode. • Used as an item select key on the menu screen such as parameter list or monitoring list. • Used as an alarm definition display key in the alarm history display mode. • Used as a command voltage read key in the calibration mode.

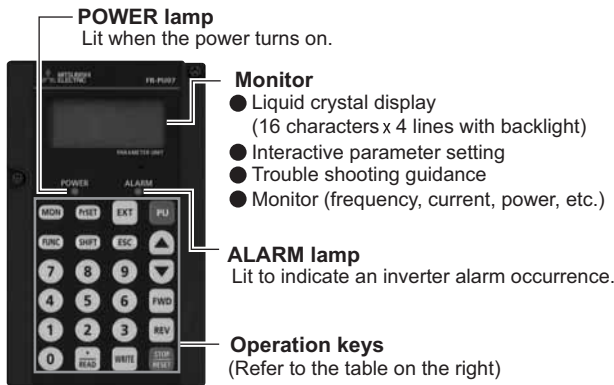

FR-PU07



FR-PU07BB(-L)

● Main functions

Function	Description
Monitor	6 types of monitors appear by simply pressing (SHIFT) .
Frequency setting	For PU operation mode and External/PU combined operation mode (<i>Pr:79 = "3"</i>), frequency setting is available. Settings is performed by the direct setting, which sets frequency directly by (0) to (9) , and the step setting, which sets frequency continuously by (▲) (▼) .
Parameter Setting	Reading parameter and changing setting values are easily done. To change the setting value of a parameter, specify the parameter number, or select a parameter from the functional parameter list.
Batch copy	FR-PU07 (PU07BB) reads parameter settings of an inverter, and stores three different parameter settings. FR-PU07 (PU07BB) can also copy the stored parameter setting to another inverter of the same series, or verify its stored parameter setting against the parameter setting stored in an inverter.
Operation	Switching between External operation mode [EXT] and PU operation mode [PU] is easy. Start/stop is enabled during PU operation mode and External/PU operation mode (<i>Pr:79 = "3"</i>).

* Available function differs by the inverter. Please refer to the instruction manual of the inverter and the parameter unit.

Features
Connection example
Standard Specifications
Outline Dimension Drawings
Terminal Connection Diagram Terminal Specification Explanation
Operation panel Parameter unit FR Configurator
Parameter List
Explanations of Parameters
Protective Functions
Options
Instructions
Motor
Compatibility
Warranty
Inquiry

FR Configurator (INVERTER SETUP SOFTWARE)

FR-SW3-SETUP-WE *1

(Support for Windows® 10, Windows® 8.1/Pro/Enterprise, Windows® 8, Windows® 7 (32-bit/64-bit), and Windows Vista® SP1 and above (32-bit))

FR Configurator software offers an easy operating environment. Can be utilized effectively from inverter setting up to maintenance. Parameter setting, monitoring, etc. can be performed on a display of Windows personal computer.

A personal computer and an inverter can be easily connected with a USB cable. (RS-485 communication *2 using PU connector is also available.)

The inverter on the CC-Link network can be set up via a programmable controller. (FR-SW3-SETUP-WE CC-Link Seamless)



FR Configurator

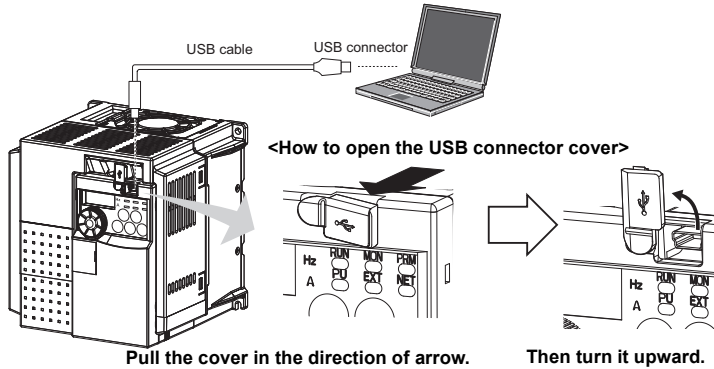
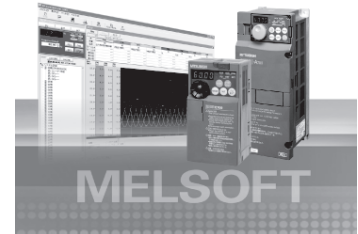

- *1 The FL remote communication model, the Ethernet communication function model, and the dedicated EtherCAT communication model do not support FR Configurator.
- *2 RS-485↔RS-232C converter is required.

Startup

Desired functions can be performed soon after start-up of the software.

- (1) Open the recent used System File
- (2) Perform Easy Setup
- (3) Perform each function
- (4) Help



Easy Setup

From station number to parameter setting, setting with wizard style dialog (interactive) is available.

Procedure for Easy Setup

- (1) System File setting
- (2) Communication setting
- (3) Inverter recognition
- (4) Control method selection
- (5) Motor setting
- (6) Start command, frequency command setting
- (7) Parameter setting



Navigation area

In Navigation area, switching ONLINE/OFFLINE and changing operation mode can be performed.

- (1) Frequency setting and forward/reverse rotation * [Test operation]
- (2) Display the connected inverter in tree view [System List]
- (3) Function setting without regard to parameter number [Basic setting]
- (4) Estimates the cause of trouble, and suggest counteraction. [Troubleshooting] *



* This function is not available with FR-SW3-SETUP-WE CC-Link Seamless.

Monitor area

In Monitor area, inverter status can be monitored.

- (1) Displays monitor data in waveform
Displays current waveform with High Speed graph function [Graph] *
- (2) Monitors the status of I/O terminals. [I/O Terminal Monitor]
- (3) Displays multiple data in batch. [Batch Monitor]

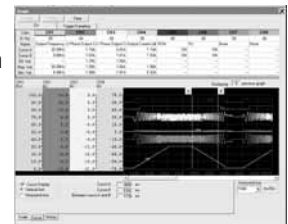

System area

In System area, parameter setting, Diagnosis, Troubleshooting, etc. can be performed.

- (1) Parameter reading, writing, verification, Functional List and Individual List display are available.
[Parameter List]
- (2) Displays alarm history and monitor value at each alarm occurrence.
[Diagnosis]
- (3) Parameter setting conversion from conventional models [Convert] *



Setting wizard

Setting wizard can set parameters with wizard style dialog (interactive). Inputting or selecting required items for each function, parameter setting can be made, without regard to parameter number.

Help

Displays operating instructions and details of each parameters.

FR-SW3-SETUP-WE is available for download (free of charge) from the below URL on the internet. FR Configurator SW3 (FR-SW3-SETUP-WE or FR-SW1-SETUP-WE) needs to be installed to the personal computer prior to updating the software. Also, user registration is required for the download (free of charge.) (Registration is free of charge.)

Homepage address www.MitsubishiElectric.co.jp/fa

FR-SW3-SETUP-WE (for 700 series) and FR-SW1-SETUP-WE (500 series) can be installed from the FR Configurator SW3.

The FR-E700-NE supports FR Configurator2.

Parameter List

For simple variable-speed operation of the inverter, the initial setting of the parameters may be used as they are. Set the necessary parameters to meet the load and operational specifications. Parameter setting, change and check can be made from the operation panel. For details of parameters, refer to the instruction manual.



REMARKS

- Ⓣ indicates simple mode parameters. (initially set to extended mode)
- The shaded parameters in the table allow its setting to be changed during operation even if "0" (initial value) is set in Pr. 77 Parameter write selection.
(The setting value of Pr. 77 cannot be changed via communication for the FL remote communication model or CC-Link communication model.)

Function	Parameter	Name	Setting Range	Minimum Setting Increments	Initial Value	Refer to Page	Customer Setting
Basic functions	Ⓣ 0	Torque boost	0 to 30%	0.1%	6/4/3/2% *1	48	
	Ⓣ 1	Maximum frequency	0 to 120Hz	0.01Hz	120Hz	48	
	Ⓣ 2	Minimum frequency	0 to 120Hz	0.01Hz	0Hz	48	
	Ⓣ 3	Base frequency	0 to 400Hz	0.01Hz	60Hz	48	
	Ⓣ 4	Multi-speed setting (high speed)	0 to 400Hz	0.01Hz	60Hz	48	
	Ⓣ 5	Multi-speed setting (middle speed)	0 to 400Hz	0.01Hz	30Hz	48	
	Ⓣ 6	Multi-speed setting (low speed)	0 to 400Hz	0.01Hz	10Hz	48, 66	
	Ⓣ 7	Acceleration time	0 to 3600/360s	0.1/0.01s	5/10/15s *2	49	
	Ⓣ 8	Deceleration time	0 to 3600/360s	0.1/0.01s	5/10/15s *2	49	
	Ⓣ 9	Electronic thermal O/L relay	0 to 500A	0.01A	Inverter rated current	49	
DC injection brake	10	DC injection brake operation frequency	0 to 120Hz	0.01Hz	3Hz	49	
	11	DC injection brake operation time	0 to 10s	0.1s	0.5s	49	
	12	DC injection brake operation voltage	0 to 30%	0.1%	6/4/2% *3	49	
—	13	Starting frequency	0 to 60Hz	0.01Hz	0.5Hz	49	
—	14	Load pattern selection	0 to 3	1	0	50	
JOG operation	15	Jog frequency	0 to 400Hz	0.01Hz	5Hz	50	
	16	Jog acceleration/deceleration time	0 to 3600/360s	0.1/0.01s	0.5s	50	
—	17	MRS input selection	0, 2, 4	1	0	50	
—	18	High speed maximum frequency	120 to 400Hz	0.01Hz	120Hz	48	
—	19	Base frequency voltage	0 to 1000V, 8888, 9999	0.1V	9999	48	
Acceleration/ deceleration time	20	Acceleration/deceleration reference frequency	1 to 400Hz	0.01Hz	60Hz	49	
	21	Acceleration/deceleration time increments	0, 1	1	0	49	
Stall prevention	22	Stall prevention operation level	0 to 200%	0.1%	150%	51	
	23	Stall prevention operation level compensation factor at double speed	0 to 200%, 9999	0.1%	9999	51	
Multi-speed setting	24	Multi-speed setting (speed 4)	0 to 400Hz, 9999	0.01Hz	9999	48	
	25	Multi-speed setting (speed 5)	0 to 400Hz, 9999	0.01Hz	9999	48	
	26	Multi-speed setting (speed 6)	0 to 400Hz, 9999	0.01Hz	9999	48	
	27	Multi-speed setting (speed 7)	0 to 400Hz, 9999	0.01Hz	9999	48	
—	29	Acceleration/deceleration pattern selection	0, 1, 2	1	0	51	
—	30	Regenerative function selection	0, 1, 2 *22	1	0	51, 54	
Frequency jump	31	Frequency jump 1A	0 to 400Hz, 9999	0.01Hz	9999	52	
	32	Frequency jump 1B	0 to 400Hz, 9999	0.01Hz	9999	52	
	33	Frequency jump 2A	0 to 400Hz, 9999	0.01Hz	9999	52	
	34	Frequency jump 2B	0 to 400Hz, 9999	0.01Hz	9999	52	
	35	Frequency jump 3A	0 to 400Hz, 9999	0.01Hz	9999	52	
	36	Frequency jump 3B	0 to 400Hz, 9999	0.01Hz	9999	52	
—	37 *12	Speed display	0, 0.01 to 9998	0.001	0	52	

- Features
- Connection example
- Standard Specifications
- Outline Dimension Drawings
- Terminal Connection Diagram
- Terminal Specification Explanation
- Operation panel Parameter unit FR Configurator
- Parameter List
- Explanations of Parameters
- Protective Functions
- Options
- Instructions
- Motor
- Compatibility
- Warranty
- Inquiry

Function	Parameter	Name	Setting Range	Minimum Setting Increments	Initial Value	Refer to Page	Customer Setting
—	40	RUN key rotation direction selection	0, 1	1	0	52	
Frequency detection	41	Up-to-frequency sensitivity	0 to 100%	0.1%	10%	52	
	42	Output frequency detection	0 to 400Hz	0.01Hz	6Hz	52	
	43	Output frequency detection for reverse rotation	0 to 400Hz, 9999	0.01Hz	9999	52	
	44	Second acceleration/deceleration time	0 to 3600/360s	0.1/0.01s	5/10/15s *2	49	
Second functions	45	Second deceleration time	0 to 3600/360s, 9999	0.1/0.01s	9999	49	
	46	Second torque boost	0 to 30%, 9999	0.1%	9999	48	
	47	Second V/F (base frequency)	0 to 400Hz, 9999	0.01Hz	9999	48	
	48	Second stall prevention operation current	0 to 200%, 9999	0.1%	9999	51, 66	
	51	Second electronic thermal O/L relay	0 to 500A, 9999	0.01A	9999	49	
	Monitor functions	52	DU/PU main display data selection	0, 5, 7 to 12, 14, 20, 23 to 25, 52 to 56 *22, 57 *22, 61, 62, 100	1	0	53
54 *13*15		FM terminal function selection	1 to 3, 5, 7 to 12, 14, 21, 24, 52, 53, 61, 62	1	1	53	
55 *13*15		Frequency monitoring reference	0 to 400Hz	0.01Hz	60Hz	53	
56 *13*15		Current monitoring reference	0 to 500A	0.01A	Inverter rated current	53	
Automatic restart functions	57	Restart coasting time	0, 0.1 to 5s, 9999	0.1s	9999	54	
	58	Restart cushion time	0 to 60s	0.1s	1s	54	
—	59	Remote function selection	0, 1, 2, 3	1	0	55	
—	60	Energy saving control selection	0, 9	1	0	55	
Automatic acceleration/deceleration	61	Reference current	0 to 500A, 9999	0.01A	9999	55	
	62	Reference value at acceleration	0 to 200%, 9999	1%	9999	55	
	63	Reference value at deceleration	0 to 200%, 9999	1%	9999	55	
—	65	Retry selection	0 to 5	1	0	56	
—	66	Stall prevention operation reduction starting frequency	0 to 400Hz	0.01Hz	60Hz	51	
Retry	67	Number of retries at fault occurrence	0 to 10, 101 to 110	1	0	56	
	68	Retry waiting time	0.1 to 360s	0.1s	1s	56	
	69	Retry count display erase	0	1	0	56	
—	70	Special regenerative brake duty	0 to 30%	0.1%	0%	51	
—	71	Applied motor	0, 1, 3 to 6, 13 to 16, 23, 24, 40, 43, 44, 50, 53, 54	1	0	56	
—	72	PWM frequency selection	0 to 15	1	1	57	
—	73 *13*15	Analog input selection	0, 1, 10, 11	1	1	57	
—	74 *13*15	Input filter time constant	0 to 8	1	1	57	
—	75	Reset selection/disconnected PU detection/PU stop selection	0 to 3, 14 to 17	1	14	57	
—	77 *11	Parameter write selection	0, 1, 2	1	0	57	
—	78	Reverse rotation prevention selection	0, 1, 2	1	0	57	
—	© 79 *12*14	Operation mode selection	0, 1, 2, 3 *22, 4 *22, 6, 7 *22	1	0	58	

Function	Parameter	Name	Setting Range	Minimum Setting Increments	Initial Value	Refer to Page	Customer Setting
Motor constants	80	Motor capacity	0.1 to 15kW, 9999	0.01kW	9999	59	
	81	Number of motor poles	2, 4, 6, 8, 10, 9999	1	9999	59	
	82	Motor excitation current	0 to 500A (0 to ****), 9999 *5	0.01A (1) *5	9999	59	
	83	Rated motor voltage	0 to 1000V	0.1V	200V/400V *4	59	
	84	Rated motor frequency	10 to 120Hz	0.01Hz	60Hz	59	
	89	Speed control gain (Advanced magnetic flux vector)	0 to 200%, 9999	0.1%	9999	59	
	90	Motor constant (R1)	0 to 50Ω (0 to ****), 9999 *5	0.001Ω (1) *5	9999	59	
	91	Motor constant (R2)	0 to 50Ω (0 to ****), 9999 *5	0.001Ω (1) *5	9999	59	
	92	Motor constant (L1)/d-shaft inductance	0 to 1000mH (0 to 50Ω, 0 to ****), 9999 *5	0.1mH (0.001Ω, 1) *5	9999	59	
	93	Motor constant (L2)/q-shaft inductance	0 to 1000mH (0 to 50Ω, 0 to ****), 9999 *5	0.1mH (0.001Ω, 1) *5	9999	59	
	94	Motor constant (X)	0 to 100% (0 to 500Ω, 0 to ****), 9999 *5	0.1% (0.01Ω, 1) *5	9999	59	
96	Auto tuning setting/status	0, 1, 11, 21	1	0	59		
PU connector communication	117 *13*15	PU communication station number	0 to 31 (0 to 247)	1	0	60	
	118 *13*15	PU communication speed	48, 96, 192, 384	1	192	60	
	119 *13*15	PU communication stop bit length	0, 1, 10, 11	1	1	60	
	120 *13*15	PU communication parity check	0, 1, 2	1	2	60	
	121 *13*15	Number of PU communication retries	0 to 10, 9999	1	1	60	
	122 *13*15	PU communication check time interval	0, 0.1 to 999.8s, 9999	0.1s	0	60	
	123 *13*15	PU communication waiting time setting	0 to 150ms, 9999	1ms	9999	60	
	124 *13*15	PU communication CR/LF selection	0, 1, 2	1	1	60	
—	Ⓢ 125 *13	Terminal 2 frequency setting gain frequency/frequency setting gain frequency *18	0 to 400Hz	0.01Hz	60Hz	61	
—	Ⓢ 126 *13*15	Terminal 4 frequency setting gain frequency	0 to 400Hz	0.01Hz	60Hz	61	
PID operation	127 *13	PID control automatic switchover frequency	0 to 400Hz, 9999	0.01Hz	9999	61	
	128 *13	PID action selection	0, 20, 21, 40 to 43, 50, 51, 60, 61	1	0	61	
	129 *13	PID proportional band	0.1 to 1000%, 9999	0.1%	100%	61	
	130 *13	PID integral time	0.1 to 3600s, 9999	0.1s	1s	61	
	131 *13	PID upper limit	0 to 100%, 9999	0.1%	9999	61	
	132 *13	PID lower limit	0 to 100%, 9999	0.1%	9999	61	
	133 *13*15	PID action set point	0 to 100%, 9999	0.01%	9999	61	
134 *13	PID differential time	0.01 to 10.00s, 9999	0.01s	9999	61		
PU	145 *13*15	PU display language selection	0 to 7	1	0	61	
—	146 *8*13*15	Built-in potentiometer switching	0, 1	1	1	61	
—	147	Acceleration/deceleration time switching frequency	0 to 400Hz, 9999	0.01Hz	9999	49	
Current detection	150	Output current detection level	0 to 200%	0.1%	150%	62	
	151	Output current detection signal delay time	0 to 10s	0.1s	0s	62	
	152	Zero current detection level	0 to 200%	0.1%	5%	62	
	153	Zero current detection time	0 to 1s	0.01s	0.5s	62	
—	154	Voltage reduction selection during stall prevention operation	1, 11	1	1	51	
—	156	Stall prevention operation selection	0 to 31, 100, 101	1	0	51	
—	157	OL signal output timer	0 to 25s, 9999	0.1s	0s	51	
—	Ⓢ 160	User group read selection	0, 1, 9999	1	0	62	
—	161	Frequency setting/key lock operation selection	0, 1, 10, 11	1	0	62	

- Features
- Connection example
- Standard Specifications
- Outline Dimension Drawings
- Terminal Connection Diagram Terminal Specification Explanation
- Operation panel Parameter unit FR Configurator
- Parameter List
- Explanations of Parameters
- Protective Functions
- Options
- Instructions
- Motor
- Compatibility
- Warranty
- Inquiry

Function	Parameter	Name	Setting Range	Minimum Setting Increments	Initial Value	Refer to Page	Customer Setting	
Automatic restart functions	162	Automatic restart after instantaneous power failure selection	0, 1, 10, 11	1	1	54		
	165	Stall prevention operation level for restart	0 to 200%	0.1%	150%	54		
—	168	Parameter for manufacturer setting. Do not set.						
—	169							
Cumulative monitor clear	170	Watt-hour meter clear	0, 10, 9999	1	9999	53		
	171	Operation hour meter clear	0, 9999	1	9999	53		
User group	172 *12	User group registered display/batch clear	9999, (0 to 16)	1	0	62		
	173	User group registration	0 to 999, 9999	1	9999	62		
	174	User group clear	0 to 999, 9999	1	9999	62		
Input terminal function assignment	178 *13*15	STF terminal function selection	0 to 5, 7, 8, 10, 12, 14 to 16, 18, 24, 25, 60, 62, 65 to 67, 9999	1	60	63		
	179 *13*15	STR terminal function selection	0 to 5, 7, 8, 10, 12, 14 to 16, 18, 24, 25, 61, 62, 65 to 67, 9999	1	61	63		
	180 *13	RL terminal function selection/RX4 function selection *18	0 to 5, 7, 8, 10, 12, 14 to 16, 18, 24, 25, 62, 65 to 67, 9999	1	0	63		
	181 *13	RM terminal function selection/RX3 function selection *18		1	1	63		
	182 *13	RH terminal function selection/RX2 function selection *18		1	2	63		
	183 *13	MRS terminal function selection/RX9 function selection *18		1	24	63		
	184 *13	RES terminal function selection/RX7 function selection *18		1	62	63		
Output terminal function assignment	190 *14	RUN terminal function selection/RX2 (terminal Y0) function selection *18		0, 1, 3, 4, 7, 8, 11 to 16, 20, 25, 26, 46, 47, 64, 68 *7, 80 *6, 81 *6, 90, 91, 93, 95, 96, 98, 99, 100, 101, 103, 104, 107, 108, 111 to 116, 120, 125, 126, 146, 147, 164, 168 *7, 180 *6, 181 *6, 190, 191, 193, 195, 196, 198, 199, 9999	1	0	63	
	191 *13	FU terminal function selection/RX6 function selection *18		1	4	63		
	192 *13	A,B,C terminal function selection/RX7 function selection *18	0, 1, 3, 4, 7, 8, 11 to 16, 20, 25, 26, 46, 47, 64, 68 *7, 80 *6, 81 *6, 90, 91, 95, 96, 98, 99, 100, 101, 103, 104, 107, 108, 111 to 116, 120, 125, 126, 146, 147, 164, 168 *7, 180 *6, 181 *6, 190, 191, 195, 196, 198, 199, 9999	1	99	63		
Multi-speed setting	232 *13	Multi-speed setting (speed 8)	0 to 400Hz, 9999	0.01Hz	9999	48		
	233 *13	Multi-speed setting (speed 9)	0 to 400Hz, 9999	0.01Hz	9999	48		
	234 *13	Multi-speed setting (speed 10)	0 to 400Hz, 9999	0.01Hz	9999	48		
	235 *13	Multi-speed setting (speed 11)	0 to 400Hz, 9999	0.01Hz	9999	48		
	236 *13	Multi-speed setting (speed 12)	0 to 400Hz, 9999	0.01Hz	9999	48		
	237 *13	Multi-speed setting (speed 13)	0 to 400Hz, 9999	0.01Hz	9999	48		
	238 *13	Multi-speed setting (speed 14)	0 to 400Hz, 9999	0.01Hz	9999	48		
	239 *13	Multi-speed setting (speed 15)	0 to 400Hz, 9999	0.01Hz	9999	48		
—	240	Soft-PWM operation selection	0, 1	1	1	57		
—	241 *13*15	Analog input display unit switchover	0, 1	1	0	61		
—	244	Cooling fan operation selection	0, 1	1	1	64		

Function	Parameter	Name	Setting Range	Minimum Setting Increments	Initial Value	Refer to Page	Customer Setting
Slip compensation	245	Rated slip	0 to 50%, 9999	0.01%	9999	64	
	246	Slip compensation time constant	0.01 to 10s	0.01s	0.5s	64	
	247	Constant-power range slip compensation selection	0, 9999	1	9999	64	
—	249	Earth (ground) fault detection at start	0, 1	1	0	64	
—	250	Stop selection	0 to 100s, 1000 to 1100s *22, 8888 *22, 9999	0.1s	9999	64	
—	251	Output phase loss protection selection	0, 1	1	1	64	
Life diagnosis	255	Life alarm status display	(0 to 15)	1	0	65	
	256	Inrush current limit circuit life display	(0 to 100%)	1%	100%	65	
	257	Control circuit capacitor life display	(0 to 100%)	1%	100%	65	
	258	Main circuit capacitor life display	(0 to 100%)	1%	100%	65	
	259	Main circuit capacitor life measuring	0, 1 (2, 3, 8, 9)	1	0	65	
Power failure stop	261	Power failure stop selection	0, 1, 2	1	0	65	
—	267 *13*15	Terminal 4 input selection	0, 1, 2	1	0	57	
—	268	Monitor decimal digits selection	0, 1, 9999	1	9999	53	
—	269	Parameter for manufacturer setting. Do not set.					
—	270	Stop-on contact control selection	0, 1	1	0	66	
Stop-on contact control	275	Stop-on contact excitation current low-speed multiplying factor	0 to 300%, 9999	0.1%	9999	66	
	276	PWM carrier frequency at stop-on contact	0 to 9, 9999	1	9999	66	
—	277	Stall prevention operation current switchover	0, 1	1	0	51	
Brake sequence function	278 *13	Brake opening frequency	0 to 30Hz	0.01Hz	3Hz	66	
	279 *13	Brake opening current	0 to 200%	0.1%	130%	66	
	280 *13	Brake opening current detection time	0 to 2s	0.1s	0.3s	66	
	281 *13	Brake operation time at start	0 to 5s	0.1s	0.3s	66	
	282 *13	Brake operation frequency	0 to 30Hz	0.01Hz	6Hz	66	
283 *13	Brake operation time at stop	0 to 5s	0.1s	0.3s	66		
Droop control	286	Droop gain	0 to 100%	0.1%	0%	67	
	287	Droop filter time constant	0 to 1s	0.01s	0.3s	67	
—	292	Automatic acceleration/deceleration	0, 1, 7, 8, 11	1	0	55, 66	
—	293	Acceleration/deceleration separate selection	0 to 2	1	0	55	
—	295	Magnitude of frequency change setting	0, 0.01, 0.1, 1, 10	0.01	0	62	
Password function	296	Password lock level	0 to 6, 99, 100 to 106, 199, 9999	1	9999	67	
	297	Password lock/unlock	(0 to 5), 1000 to 9998, 9999	1	9999	67	
—	298	Frequency search gain	0 to 32767, 9999	1	9999	59	
—	299	Rotation direction detection selection at restarting	0, 1, 9999	1	0	54	
Output terminal function assignment	© 313 *17	RX9 function selection	0, 1, 3, 4, 7, 8, 11 to 16, 20, 25, 26, 46, 47, 64, 68 *20, 80 *20, 81 *20, 90, 91, 93, 95, 96, 98, 99, 100, 101, 103, 104, 107, 108, 111 to 116, 120, 125, 126, 146, 147, 164, 168 *20, 180 *20, 181 *20, 190, 191, 193, 195, 196, 198, 199, 9999	1	9999	—	
	© 314 *17	RXA function selection		1	9999	—	
	© 315 *17	RXB function selection		1	9999	—	

- Features
- Connection example
- Standard Specifications
- Outline Dimension Drawings
- Terminal Connection Diagram
- Terminal Specification Explanation
- Operation panel Parameter unit FR Configurator
- Parameter List
- Explanations of Parameters
- Protective Functions
- Options
- Instructions
- Motor
- Compatibility
- Warranty
- Inquiry

Function	Parameter	Name	Setting Range	Minimum Setting Increments	Initial Value	Refer to Page	Customer Setting
RS-485 communication	338 *13*15	Communication operation command source	0, 1	1	0	68	
	339 *13*15	Communication speed command source	0, 1, 2	1	0	68	
	340 *13*15	Communication startup mode selection	0, 1, 10	1	0	58	
	342 *13	Communication EEPROM write selection	0, 1	1	0	60	
	343 *13*15	Communication error count	—	1	0	60	
—	Ⓞ 349 *17	Communication reset selection	0, 1	1	0	—	
Ethernet communication	Ⓞ 442 *23	Default gateway address 1	0 to 255	1	0	—	
	Ⓞ 443 *23	Default gateway address 2	0 to 255	1	0	—	
	Ⓞ 444 *23	Default gateway address 3	0 to 255	1	0	—	
	Ⓞ 445 *23	Default gateway address 4	0 to 255	1	0	—	
Second motor constant	450	Second applied motor	0, 1, 9999	1	9999	56	
Output	495 *13	Remote output selection	0, 1, 10, 11	1	0	68	
	496 *13	Remote output data 1	0 to 4095	1	0	68	
	497 *13*15	Remote output data 2	0 to 4095	1	0	68	
Communication error	Ⓞ 500 *16	Communication error execution waiting time	0 to 999.8s	0.1s	0s	—	
	(Ⓞ) 501 *19	Communication error occurrence count display	0	1	0	—	
	502 *13	Stop mode selection at communication error	0, 1, 2, 3	1	0	60	
Maintenance	503	Maintenance timer	0 (1 to 9998)	1	0	68	
	504	Maintenance timer alarm output set time	0 to 9998, 9999	1	9999	68	
CC-Link	Ⓞ 541 *17	Frequency command sign selection (CC-Link)	0, 1	1	0	—	
	Ⓞ 542 *16	Communication station number (CC-Link)	1 to 64	1	1	—	
	Ⓞ 543 *16	Baud rate selection (CC-Link)	0 to 4	1	0	—	
	Ⓞ 544 *17	CC-Link extended setting	0, 1, 12, 14, 18	1	0	—	
USB	547 *13*15	USB communication station number	0 to 31	1	0	69	
	548 *13*15	USB communication check time interval	0 to 999.8s, 9999	0.1s	9999	69	
Communication	549 *13*15	Protocol selection	0, 1	1	0	60	
	550 *13*15	NET mode operation command source selection	0, 2, 9999	1	9999	68	
	551 *14*15	PU mode operation command source selection	2 *22, 3, 4, 9999	1	9999	68	
Current average time monitor	555 *13	Current average time	0.1 to 1.0s	0.1s	1s	69	
	556 *13	Data output mask time	0 to 20s	0.1s	0s	69	
	557 *13	Current average value monitor signal output reference current	0 to 500A	0.01A	Inverter rated current	69	
—	563	Energization time carrying-over times	(0 to 65535)	1	0	53	
—	564	Operating time carrying-over times	(0 to 65535)	1	0	53	
—	571	Holding time at a start	0 to 10s, 9999	0.1s	9999	49	
—	611	Acceleration time at a restart	0 to 3600s, 9999	0.1s	9999	54	

Function	Parameter	Name	Setting Range	Minimum Setting Increments	Initial Value	Refer to Page	Customer Setting
EtherCAT communication	⊙ 629 to 635, 637 to 639 *21	Option information1 to 10	—	—	—	—	
	—	653	Speed smoothing control	0 to 200%	0.1%	0%	69
	—	665	Regeneration avoidance frequency gain	0 to 200%	0.1%	100%	69
EtherCAT communication	⊙ 690 to 697, 738 to 746, 753 to 768 *21	Option parameter1 to 33	0 to 65535	1	0	—	
	—	800	Control method selection	20, 30	1	20	59
Ethernet communication	⊙ 805 *23	Ethernet IP address 1	0 to 255	1	192	—	
	⊙ 806 *23	Ethernet IP address 2	0 to 255	1	168	—	
	⊙ 807 *23	Ethernet IP address 3	0 to 255	1	50	—	
	⊙ 808 *23	Ethernet IP address 4	0 to 255	1	1	—	
	⊙ 809 *23	Subnet mask 1	0 to 255	1	255	—	
	⊙ 810 *23	Subnet mask 2	0 to 255	1	255	—	
	⊙ 811 *23	Subnet mask 3	0 to 255	1	255	—	
	⊙ 812 *23	Subnet mask 4	0 to 255	1	0	—	
	⊙ 830 *23	Ethernet communication network number	1 to 239	1	1	—	
	⊙ 831 *23	Ethernet communication station number	1 to 120	1	1	—	
	⊙ 832 *23	Link speed and duplex mode selection	0 to 4	1	0	—	
	⊙ 833 *23	Ethernet function selection 1	0, 10, 20, 30, 31, 36, 38, 9999	1	31	—	
	⊙ 834 *23	Ethernet function selection 2		1	20	—	
	⊙ 835 *23	Ethernet function selection 3		1	9999	—	
	⊙ 837 *23	Ethernet IP filter address 1	0 to 255	1	0	—	
	⊙ 838 *23	Ethernet IP filter address 2	0 to 255	1	0	—	
	⊙ 839 *23	Ethernet IP filter address 3	0 to 255	1	0	—	
	⊙ 840 *23	Ethernet IP filter address 4	0 to 255	1	0	—	
	⊙ 841 *23	Ethernet IP filter address 2 range specification	0 to 255, 9999	1	9999	—	
	⊙ 842 *23	Ethernet IP filter address 3 range specification	0 to 255, 9999	1	9999	—	
	⊙ 843 *23	Ethernet IP filter address 4 range specification	0 to 255, 9999	1	9999	—	
	⊙ 844 *23	Ethernet command source selection IP address 1	0 to 255	1	0	—	
	⊙ 845 *23	Ethernet command source selection IP address 2	0 to 255	1	0	—	
	⊙ 846 *23	Ethernet command source selection IP address 3	0 to 255	1	0	—	
	⊙ 847 *23	Ethernet command source selection IP address 4	0 to 255	1	0	—	
⊙ 848 *23	Ethernet command source selection IP address 3 range specification	0 to 255, 9999	1	9999	—		
⊙ 849 *23	Ethernet command source selection IP address 4 range specification	0 to 255, 9999	1	9999	—		
⊙ 850 *23	Ethernet TCP disconnection time coefficient	1 to 7200	1	3600	—		
⊙ 851 *23	Ethernet signal loss detection function selection	0, 2, 3	1	3	—		
⊙ 852 *23	Ethernet communication check time interval	0 to 999.8s, 9999	0.1s	1.5s	—		
—	859	Torque current	0 to 500A (0 to ****) , 9999 *5	0.01A (1) *5	9999	59	

- Features
- Connection example
- Standard Specifications
- Outline Dimension Drawings
- Terminal Connection Diagram Terminal Specification Explanation
- Operation panel Parameter unit FR Configurator
- Parameter List
- Explanations of Parameters
- Protective Functions
- Options
- Instructions
- Motor
- Compatibility
- Warranty
- Inquiry

Function	Parameter	Name	Setting Range	Minimum Setting Increments	Initial Value	Refer to Page	Customer Setting
Protective functions	872 *10	Input phase loss protection selection	0, 1	1	1	64	
	882	Regeneration avoidance operation selection	0, 1, 2	1	0	69	
Regeneration avoidance function	883	Regeneration avoidance operation level	300 to 800V	0.1V	400VDC/ 780VDC *4	69	
	885	Regeneration avoidance compensation frequency limit value	0 to 10Hz, 9999	0.01Hz	6Hz	69	
	886	Regeneration avoidance voltage gain	0 to 200%	0.1%	100%	69	
	888	Free parameter 1	0 to 9999	1	9999	69	
Free parameter	889	Free parameter 2	0 to 9999	1	9999	69	
	C0 (900) *9*13*15	FM terminal calibration	—	—	—	70	
Calibration parameters	C2 (902) *9*13	Terminal 2 frequency setting bias frequency/frequency setting bias frequency *18	0 to 400Hz	0.01Hz	0Hz	61	
	C3 (902) *9*13*15	Terminal 2 frequency setting bias	0 to 300%	0.1%	0%	61	
	125 (903) *9*13	Terminal 2 frequency setting gain frequency/frequency setting gain frequency *18	0 to 400Hz	0.01Hz	60Hz	61	
	C4 (903) *9*13*15	Terminal 2 frequency setting gain	0 to 300%	0.1%	100%	61	
	C5 (904) *9*13*15	Terminal 4 frequency setting bias frequency	0 to 400Hz	0.01Hz	0Hz	61	
	C6 (904) *9*13*15	Terminal 4 frequency setting bias	0 to 300%	0.1%	20%	61	
	126 (905) *9*13*15	Terminal 4 frequency setting gain frequency	0 to 400Hz	0.01Hz	60Hz	61	
	C7 (905) *9*13*15	Terminal 4 frequency setting gain	0 to 300%	0.1%	100%	61	
	Calibration parameters	C22 (922) *8*9*13*15	Frequency setting voltage bias frequency (built-in potentiometer)	0 to 400Hz	0.01Hz	0Hz	61
C23 (922) *8*9*13*15		Frequency setting voltage bias (built-in potentiometer)	0 to 300%	0.1%	0%	61	
C24 (923) *8*9*13*15		Frequency setting voltage gain frequency (built-in potentiometer)	0 to 400Hz	0.01Hz	60Hz	61	
C25 (923) *8*9*13*15		Frequency setting voltage gain (built-in potentiometer)	0 to 300%	0.1%	100%	61	
PU	990 *13*15	PU buzzer control	0, 1	1	1	70	
	991 *13*15	PU contrast adjustment	0 to 63	1	58	70	

Function	Parameter	Name	Setting Range	Minimum Setting Increments	Initial Value	Refer to Page	Customer Setting
Clear parameters Initial value change list	Ⓒ Pr.CL	Parameter clear	0, 1	1	0	70	
	Ⓒ ALLC	All parameter clear	0, 1	1	0	70	
	Ⓒ Er.CL	Fault history clear	0, 1	1	0	70	
	Ⓒ Pr.CH	Initial value change list	—	—	—	70	

- *1 Differ according to capacities.
6%: 0.75K(SC) or lower
4%: 1.5K(SC) to 3.7K(SC)
3%: 5.5K(SC), 7.5K(SC)
2%: 11K(SC), 15K(SC)
- *2 Differ according to capacities.
5s: 3.7K(SC) or lower
10s: 5.5K(SC), 7.5K(SC)
15s: 11K(SC), 15K(SC)
- *3 Differ according to capacities.
6%: 0.1K(SC), 0.2K(SC)
4%: 0.4K(SC) to 7.5K(SC)
2%: 11K(SC), 15K(SC)
- *4 The initial value differs according to the voltage class. (100V, 200V class/400V class)
- *5 The range differs according to the Pr. 71 setting.
- *6 The setting is available for the safety stop function model, the CC-Link communication model, and the dedicated EtherCAT communication model.
- *7 The setting is available for the safety stop function model (when equipped with the FR-E7DS), the CC-Link communication model, and the dedicated EtherCAT communication model.
- *8 Set this parameter when calibrating the operation panel built-in potentiometer for the FR-E500 series operation panel (PA02) connected with cable.
- *9 The parameter number in parentheses is the one for use with the operation panel (PA02) for the FR-E500 series or parameter unit (FR-PU07).
- *10 Available only for the three-phase power input model.
- *11 The settings of this parameter cannot be changed via communication on the FL remote communication model, the CC-Link communication model, and the dedicated EtherCAT communication model.
- *12 The settings of this parameter cannot be changed via communication on the dedicated EtherCAT communication model.
- *13 This parameter in the FL remote communication model and the dedicated EtherCAT communication model is for manufacturer setting. Do not set.
- *14 This parameter in the FL remote communication model is for manufacturer setting. Do not set.
- *15 This parameter in the CC-Link communication model is for manufacturer setting. Do not set.
- *16 The parameter can be set only for the CC-Link communication model. For details, refer to the Instruction Manual of the CC-Link communication model inverter.
- *17 This parameter in the CC-Link communication model and Ethernet communication function model can be set. For the details, refer to the Instruction Manual of the relevant model.
- *18 The name differs depending on the model (standard control circuit terminal model, safety stop function model, CC-Link communication model, EtherCAT communication model). For the details, refer to the Instruction Manual of the relevant model.
- *19 This setting is available for the FL remote communication model, the CC-Link communication model, and the dedicated EtherCAT communication model (other than the FL remote communication model this is a simple mode parameter). For the details, refer to the Instruction Manual of the relevant model.
- *20 This setting is not available for the Ethernet communication function model.
- *21 Setting of the dedicated EtherCAT communication model is possible with the EtherCAT communication option (E7NECT_2P manufactured by HMS Industrial Networks AB) installed. For the details, refer to the dedicated EtherCAT communication model or the EtherCAT communication option Instruction Manual.
- *22 This parameter in the dedicated EtherCAT communication model is for manufacturer setting. Do not set.
- *23 This parameter is only available for the Ethernet communication function model. For details, refer to the Ethernet communication function model Instruction Manual.

- Features
- Connection example
- Standard Specifications
- Outline Dimension Drawings
- Terminal Connection Diagram Terminal Specification Explanation
- Operation panel Parameter unit FR Configurator
- Parameter List
- Explanations of Parameters
- Protective Functions
- Options
- Instructions
- Motor
- Compatibility
- Warranty
- Inquiry

Explanations of Parameters

The abbreviations in the explanations below indicate **V/F** ...V/F control, **AD MFVC** ...advanced magnetic flux vector control, **GP MFVC** ...general-purpose magnetic flux vector control. (Parameters without any indication are valid for all control)

Pr. 0, 46

Manual torque boost **V/F**

Pr. 0 Torque boost Pr. 46 Second torque boost

You can compensate for a voltage drop in the low-frequency region to improve motor torque reduction in the low-speed region.

- Motor torque in the low-frequency range can be adjusted to the load to increase the starting motor torque.
- Two kinds of starting torque boost can be switched by using RT signal.
- This function is valid for V/F control only.

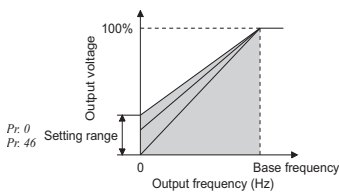

Pr. 0 Initial Value		When Using the Mitsubishi Electric Constant Torque Motor	
0.1K to 0.75K	6%	←	
1.5K to 3.7K	4%	←	
5.5K, 7.5K	3%	2%*	
11K, 15K	2%	←	

* If the Pr. 71 initial value is changed to the setting for use with a constant-torque motor, the Pr. 0 setting changes to the corresponding value in the above table.

Pr. 1, 2, 18

Maximum/minimum frequency

Pr. 1 Maximum frequency Pr. 2 Minimum frequency
Pr. 18 High speed maximum frequency

Motor speed can be limited.

- Clamp the upper and lower limits of the output frequency.
 - To perform operation above 120Hz, set the maximum output frequency in Pr. 18.
- (When Pr. 18 is set, Pr. 1 is automatically changed to the frequency set in Pr. 18. Also, when Pr. 1 is set, Pr. 18 is automatically changed to the frequency set in Pr. 1.)

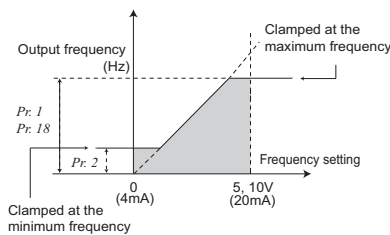

Pr. 3, 19, 47

Base frequency, voltage **V/F**

Pr. 3 Base frequency Pr. 19 Base frequency voltage
Pr. 47 Second V/F (base frequency)

- Used to adjust the inverter outputs (voltage, frequency) to the motor rating.
- When running the standard motor, generally set the rated frequency of the motor in Pr. 3 Base frequency. When running the motor using electronic bypass operation, set Pr. 3 to the same value as the power supply frequency.
- When you want to change the base frequency when switching two types of motors with one inverter, use the Pr. 47 Second V/F (base frequency).
- Use Pr. 19 Base frequency voltage to set the base voltage (e.g. rated motor voltage).
- This function is valid for V/F control only.

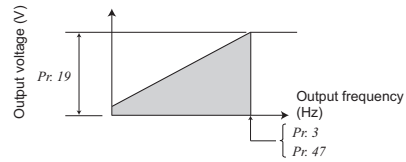

Pr. 4 to 6, 24 to 27, 232 to 239

Multi-speed setting operation

Pr. 4 Multi-speed setting (high speed) Pr. 5 Multi-speed setting (middle speed)
Pr. 6 Multi-speed setting (low speed) Pr. 24 Multi-speed setting (speed 4)
Pr. 25 Multi-speed setting (speed 5) Pr. 26 Multi-speed setting (speed 6)
Pr. 27 Multi-speed setting (speed 7) Pr. 232 Multi-speed setting (speed 8)
Pr. 233 Multi-speed setting (speed 9) Pr. 234 Multi-speed setting (speed 10)
Pr. 235 Multi-speed setting (speed 11) Pr. 236 Multi-speed setting (speed 12)
Pr. 237 Multi-speed setting (speed 13) Pr. 238 Multi-speed setting (speed 14)
Pr. 239 Multi-speed setting (speed 15)

Can be used to change the preset speed in the parameter with the contact signals.

Any speed can be selected by merely turning on-off the contact signals (RH, RM, RL, REX signals).

- Operation is performed at the frequency set in Pr. 4 when the RH signal turns on, Pr. 5 when the RM signal turns on, and Pr. 6 when the RL signal turns on.
- Frequency from 4 speed to 15 speed can be set according to the combination of the RH, RM, RL and REX signals. Set the running frequencies in Pr. 24 to Pr. 27, Pr. 232 to Pr. 239 (In the initial value setting, speed 4 to speed 15 are unavailable)

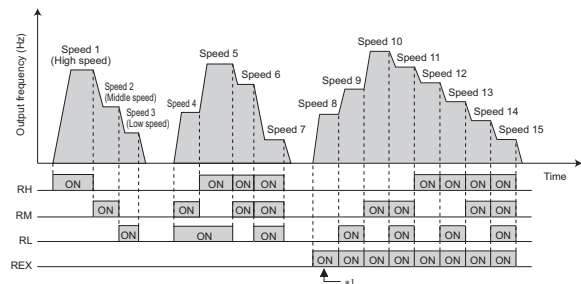

*1 When "9999" is set in Pr. 232 Multi-speed setting (speed 8), operation is performed at frequency set in Pr. 6 when RH, RM and RL are turned OFF and REX is turned ON.

Pr. 7, 8, 20, 21, 44, 45, 147

Acceleration/deceleration time setting

- Pr. 7 Acceleration time Pr. 8 Deceleration time
- Pr. 20 Acceleration/deceleration reference frequency Pr. 21 Acceleration/deceleration time increments
- Pr. 44 Second acceleration/deceleration time Pr. 45 Second deceleration time
- Pr. 147 Acceleration/deceleration time switching frequency

Used to set motor acceleration/deceleration time.
Set a larger value for a slower speed increase/decrease or a smaller value for a faster speed increase/decrease.

- Use *Pr. 7 Acceleration time* to set the acceleration time to reach *Pr. 20 Acceleration/deceleration reference frequency* from 0Hz
- Use *Pr. 8 Deceleration time* to set the deceleration time taken to reach 0Hz from *Pr. 20 Acceleration/deceleration reference frequency*.
- When RT signal is off, automatic switching of the acceleration/deceleration time is available with *Pr. 147*.

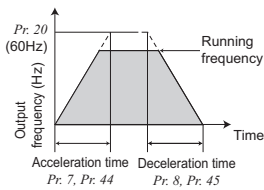

Pr. 21 Setting	Description	
0 (initial value)	Increments: 0.1s Range: 0 to 3600s	Increments and setting range of acceleration/ deceleration time setting can be changed.
1	Increments: 0.01s Range: 0 to 360s	

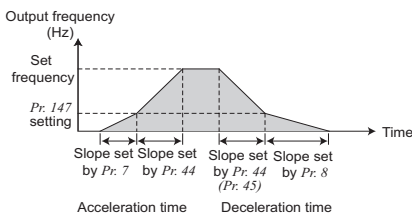

Pr. 9, 51

Motor protection from overheat (electronic thermal relay function)

- Pr. 9 Electronic thermal O/L relay Pr. 51 Second electronic thermal O/L relay

Set the current of the electronic thermal relay function to protect the motor from overheat. This feature provides the optimum protective characteristics, including reduced motor cooling capability, at low speed.

- This function detects the overload (overheat) of the motor, stops the operation of the inverter's output transistor, and stops the output.
- Set the rated current [A] of the motor in *Pr. 9*.
(If the motor has both 50Hz and 60Hz rating and the *Pr. 3 Base frequency* is set to 60Hz, set the 1.1 times of the 60Hz rated motor current.)
- Set "0" in *Pr. 9* to make the electronic thermal relay function invalid when using a motor with an external thermal relay, etc. (Note that the output transistor protection of the inverter functions (E.THT).)
- When using a Mitsubishi Electric constant-torque motor
 - 1) Set any of "1, 13 to 16, 50, 53, 54" in *Pr. 71*. (This provides a 100% continuous torque characteristic in the low-speed range.)
 - 2) Set the rated current of the motor in *Pr. 9*.
- When the RT signal is on, thermal protection is provided based on the *Pr. 51* setting.

Use this function when running two motors of different rated currents individually by a single inverter. (When running two motors together, use external thermal relays.)

Pr. 10 to 12

DC injection brake

- Pr. 10 DC injection brake operation frequency Pr. 11 DC injection brake operation time
- Pr. 12 DC injection brake operation voltage

The DC injection brake can be operated at a motor stop to adjust the stop timing and braking torque.

When 0 is set in *Pr. 11* or *Pr. 12*, DC injection brake is not performed.

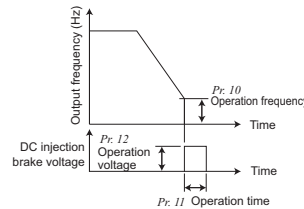

Pr. 12 Initial Value	When Using the Mitsubishi Electric Constant Torque Motor	
0.1K, 0.2K	6%	←
0.4K to 3.7K	4%	←
5.5K, 7.5K	4%	2%*
11K, 15K	2%	←

* If the *Pr. 71* initial value is changed to the setting for use with a constant-torque motor, the *Pr. 12* setting changes to the corresponding value in the above table.

Pr. 13, 571

Starting frequency

- Pr. 13 Starting frequency Pr. 571 Holding time at a start

You can set the starting frequency and hold the set starting frequency for a certain period of time.

Set these functions when you need the starting torque or want smooth motor drive at a start.

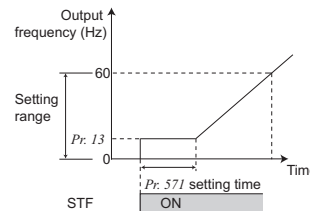

Pr. 14 V/F pattern matching applications

Pr. 14 Load pattern selection

You can select the optimum output characteristic (V/F characteristic) for the application and load characteristics. This function is valid for V/F control only.

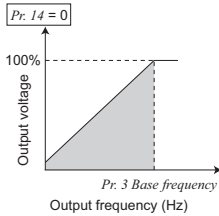

- Constant-torque load application (setting "0", initial value)
 - At or less than the base frequency, the output voltage varies linearly with the output frequency.
 - Set this value when driving the load whose load torque is constant even if the speed varies, e.g. conveyor, cart or roll drive.

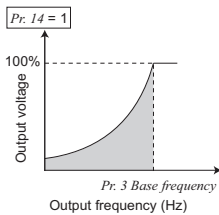

- Variable-torque load application (setting "1")
 - At or less than the base frequency, the output voltage varies with the output frequency in a square curve.
 - Set this value when driving the load whose load torque varies in proportion to the square of the speed, e.g. fan or pump.

- Constant-torque load application (setting "2, 3")
 - Set "2" when a vertical lift load is fixed as power driving load at forward rotation and regenerative load at reverse rotation.
 - Pr. 0 Torque boost is valid during forward rotation and torque boost is automatically changed to "0%" during reverse rotation. Pr. 46 Second torque boost is valid when the RT signal turns ON.
 - Set "3" for an elevated load that is in the driving mode during reverse rotation and in the regenerative load mode during forward rotation according to the load weight, e.g. counterweight system.
 - To assign the RT signal to a terminal, set "3" in any of Pr. 178 to 184 (input terminal function selection).

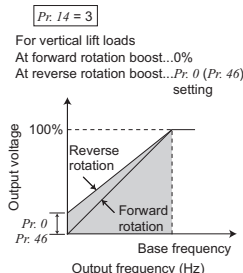
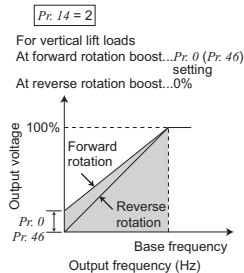

Pr. 15, 16 Jog operation

Pr. 15 Jog frequency Pr. 16 Jog acceleration/deceleration time

You can set the frequency and acceleration/deceleration time for jog operation. Jog operation can be performed from either of the external or the PU operation mode. Can be used for conveyor positioning, test operation, etc.

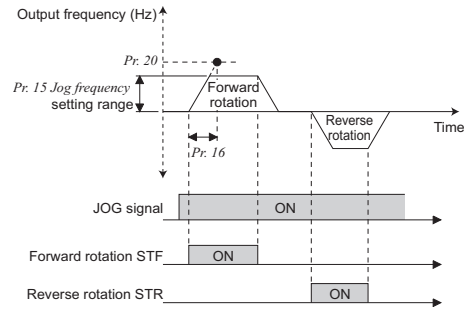

Pr. 17 Logic selection of output stop signal (MRS)

Pr. 17 MRS input selection

The inverter output can be shut off by the MRS signal. Also, logic for the MRS signal can be selected. When Pr. 17 is set to "4", the MRS signal from external terminal (output stop) can be changed to the normally closed (NC) contact input, and the MRS signal from communication can be changed to the normally open (NO contact) input.

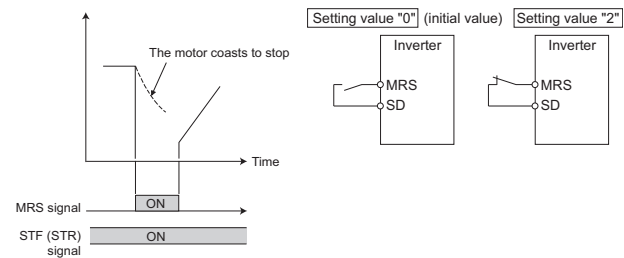

Pr. 18 → Refer to the section about Pr. 1.

Pr. 19 → Refer to the section about Pr. 3.

Pr. 20, 21 → Refer to the section about Pr. 7.

Pr. 22, 23, 48, 66, 154, 156, 157, 277

Stall prevention operation

- Pr. 22 Stall prevention operation level
- Pr. 23 Stall prevention operation level compensation factor at double speed
- Pr. 48 Second stall prevention operation current
- Pr. 66 Stall prevention operation reduction starting frequency
- Pr. 154 Voltage reduction selection during stall prevention operation
- Pr. 156 Stall prevention operation selection
- Pr. 157 OL signal output timer
- Pr. 277 Stall prevention operation current switchover

This function monitors the output current and automatically changes the output frequency to prevent the inverter from tripping due to overcurrent, overvoltage, etc. It can also limit stall prevention and fast-response current limit operation during acceleration/deceleration, driving or regeneration.

In addition, torque limit which limits the output torque to the predetermined value can be selected.

- **Stall prevention**
If the output current exceeds the stall prevention operation level, the output frequency of the inverter is automatically varied to reduce the output current.
- **Fast-response current limit**
If the current exceeds the limit value, the output of the inverter is shut off to prevent an overcurrent.
- **Set in Pr. 22** the percentage of the output current to the inverter rated current at which stall prevention operation will be performed. Normally set this parameter to 150% (initial value).
- **During high-speed operation** above the rated motor frequency, acceleration may not be made because the motor current does not increase. If operation is performed in a high frequency range, the current at motor lockup becomes smaller than the rated output current of the inverter, and the protective function (OL) is not executed even if the motor is at a stop.
To improve the operating characteristics of the motor in this case, the stall prevention level can be reduced in the high frequency range. This function is effective for performing operation up to the high-speed range on a centrifugal separator etc. Normally, set 60Hz in Pr. 66 and 100% in Pr. 23.
- **By setting "9999"** (initial value) in Pr. 23 Stall prevention operation level compensation factor at double speed, the stall prevention operation level is constant at the Pr. 22 setting up to 400Hz.

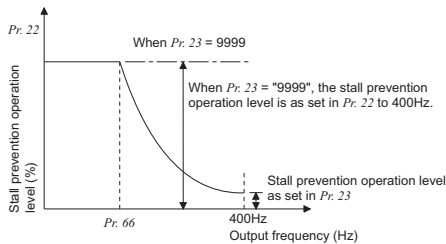

- Set Pr.154 = "11" when the overvoltage protective function (E.OV) activates during stall prevention operation in an application with large load inertia. Note that turning OFF the start signal (STF/STR) or varying the frequency signal during stall prevention operation may delay the acceleration/deceleration start.
- Stall prevention operation and fast response current limit function can be restricted according to the operation condition using Pr. 156.
- When Pr. 277 = "1", torque limit can be set. Torque limit level can be set using Pr. 22.

Pr. 24 to 27 ➔ Refer to the section about Pr. 4.

Pr. 29

Acceleration/deceleration pattern

Pr. 29 Acceleration/deceleration pattern selection

You can set the acceleration/deceleration pattern suitable for application.

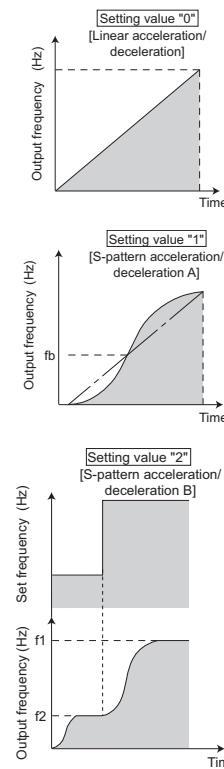

- **Linear acceleration/deceleration** (setting "0", initial value)
For the inverter operation, the output frequency is made to change linearly (linear acceleration/deceleration) to prevent the motor and inverter from excessive stress to reach the set frequency during acceleration, deceleration, etc. when frequency changes.
- **S-pattern acceleration/deceleration A** (setting "1")
For machine tool spindle applications, etc. Used when acceleration/deceleration must be made in a short time to a high-speed range of not lower than Pr. 3 Base frequency (fb).
- **S-pattern acceleration/deceleration B** (setting "2")
For prevention of load shifting in conveyor and other applications. Since acceleration/deceleration is always made in an S shape from current frequency (f2) to target frequency (f1), this function eases shock produced at acceleration/deceleration and is effective for load collapse prevention, etc.

Pr. 30, 70

Selection of regeneration unit

Pr. 30 Regenerative function selection Pr. 70 Special regenerative brake duty

- When making frequent starts/stops, use the optional brake resistor to increase the regeneration capability. (0.4K or higher)
- Use a power regeneration common converter (FR-CV) for continuous operation in regeneration status.
Use a high power factor converter (FR-HC2) for harmonic suppression and power factor improvement.
(The FR-CV/FR-HC2 can be used for the standard control circuit terminal model or the safety stop function model.)

Pr. 30 Set Value	Pr. 70 Set Value	Regeneration Unit
0 (initial value)	*1	Brake resistor (MRS type, MYS type) Brake unit (FR-BU2) Power regeneration common converter (FR-CV) High power factor converter (FR-HC2)
1	6%	Brake resistor (MYS type) (When using at 100% torque 6%ED) *3
	10/6% *2	High-duty brake resistor (FR-ABR)
2	—	High power factor converter (FR-HC2) (when an automatic restart after instantaneous power failure is selected)

*1 The brake duty varies according to the inverter capacity.
*2 7.5K or lower/11K or higher
*3 Available only for the FR-E720-3.7K

Pr. 31 to 36

Avoid mechanical resonance points (frequency jump)

- Pr. 31 Frequency jump 1A* *Pr. 32 Frequency jump 1B*
- Pr. 33 Frequency jump 2A* *Pr. 34 Frequency jump 2B*
- Pr. 35 Frequency jump 3A* *Pr. 36 Frequency jump 3B*

When it is desired to avoid resonance attributable to the natural frequency of a mechanical system, these parameters allow resonant frequencies to be jumped.

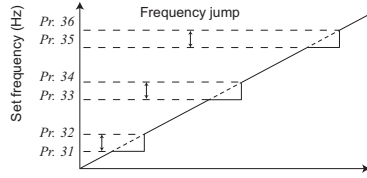

- Up to three areas may be set, with the jump frequencies set to either the top or bottom point of each area.
- The settings of frequency jumps 1A, 2A, 3A are jump points, and operation is performed at these frequencies in the jump areas.
- Frequency jump is not performed if the initial value is set to "9999".
- During acceleration/deceleration, the running frequency within the set area is valid.

Pr. 37

Speed display

Pr. 37 Speed display

The monitor display and frequency setting of the PU (FR-PU07) can be changed to the machine speed.

- To display the machine speed, set in *Pr. 37* the machine speed for 60Hz operation.

<i>Pr. 37 Setting</i>	Output Frequency Monitor	Set Frequency Monitor	Frequency Setting	Parameter Setting
0 (initial value)	Hz	Hz	Hz	Hz
0.01 to 9998	Machine speed *1	Machine speed *1	Machine speed *1	

*1 Machine speed conversion formula.....Pr.37 x frequency/60Hz
 *2 Hz is displayed in 0.01Hz increments and machine speed is in 0.001.

Pr. 40

RUN key rotation direction selection

Pr. 40 RUN key rotation direction selection

- Used to choose the direction of rotation by operating the RUN key of the operation panel.

<i>Pr. 40 Setting</i>	Description
0	Forward rotation
1	Reverse rotation

Pr. 41 to 43

Detection of output frequency (SU, FU signal)

- Pr. 41 Up-to-frequency sensitivity* *Pr. 42 Output frequency detection*
- Pr. 43 Output frequency detection for reverse rotation*

The inverter output frequency is detected and output at the output signals.

- The *Pr. 41* value can be adjusted within the range 0% ±100% on the assumption that the set frequency is 100%.
- This parameter can be used to ensure that the running frequency has been reached to provide the operation start signal etc. for related equipment.

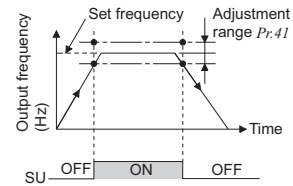

- When the output frequency rises to or above the *Pr. 42* setting, the output frequency detection signal (FU) is output. This function can be used for electromagnetic brake operation, open signal, etc.
- When the detection frequency is set in *Pr. 43*, frequency detection used exclusively for reverse rotation can also be set. This function is effective for switching the timing of electromagnetic brake operation between forward rotation (rise) and reverse rotation (fall) during vertical lift operation, etc.

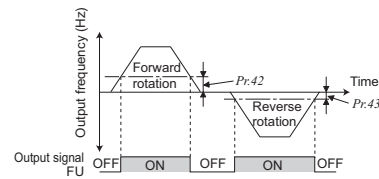

Pr. 44, 45 ➡ Refer to the section about *Pr. 7*.

Pr. 46 ➡ Refer to the section about *Pr. 0*.

Pr. 47 ➡ Refer to the section about *Pr. 3*.

Pr. 48 ➡ Refer to the section about *Pr. 22*.

Pr. 51 ➡ Refer to the section about *Pr. 9*.

Pr. 52, 54, 170, 171, 268, 563, 564

**Change of DU/PU monitor descriptions
Cumulative monitor clear**

- Pr. 52 DU/PU main display data selection Pr. 54 FM terminal function selection
- Pr. 170 Watt-hour meter clear Pr. 171 Operation hour meter clear
- Pr. 268 Monitor decimal digits selection Pr. 563 Energization time carrying-over times
- Pr. 564 Operating time carrying-over times

The monitor to be displayed on the main screen of the control panel and PU (FR-PU07) can be selected.

Types of Monitor	Unit	Pr. 52 Setting		Pr. 54 (FM) Set Value	Full-scale Value
		Operation Panel LED	PU Main Monitor		
Output frequency	0.01Hz	0/100		1	Pr. 55
Output current	0.01A	0/100		2	Pr. 56
Output voltage	0.1V	0/100		3	100V, 200V class: 400V 400V class: 800V
Fault or alarm indication	—	0/100		—	—
Frequency setting value	0.01Hz	5	*1	5	Pr. 55
Motor torque *2	0.1%	7	*1	7	Rated torque of the applied motor × 2
Converter output voltage	0.1V	8	*1	8	100V, 200V class: 400V 400V class: 800V
Regenerative brake duty	0.1%	9	*1	9	Brake duty set in Pr. 30 and Pr. 70
Electronic thermal O/L relay load factor	0.1%	10	*1	10	Electronic thermal relay function operation level
Output current peak value	0.01A	11	*1	11	Pr. 56
Converter output voltage peak value	0.1V	12	*1	12	100V, 200V class: 400V 400V class: 800V
Output power	0.01kW	14	*1	14	Rated inverter power × 2
Input terminal status	—	—	*1	—	—
Output terminal status	—	—	*1	—	—
Cumulative energization time *3	1h	20		—	—
Reference voltage output	—	—	—	21	—
Actual operation time *3, *4	1h	23		—	—
Motor load factor	0.1%	24		24	200%
Cumulative power	0.01kWh *5	25		—	—
PID set point	0.1%	52		52	100%
PID measured value	0.1%	53		53	100%
PID deviation	0.1%	54		—	—
Inverter I/O terminal monitor	—	55	—	—	—
Option input terminal status *6	—	56	—	—	—
Option output terminal status *6	—	57	—	—	—
Motor thermal load factor	0.1%	61		61	Thermal relay operation level (100%)
Inverter thermal load factor	0.1%	62		62	Thermal relay operation level (100%)

*1 Selected by the PU (FR-PU07)
 *2 The motor torque display remains "0" under V/F control.
 *3 The cumulative energization time and actual operation time are accumulated from 0 to 65535 hours, then cleared, and accumulated again from 0. When the operation panel is used, the time is displayed up to 65.53 (65530h) on the assumption that 1h = 0.001, and thereafter, it is added up from 0.

*4 The actual operation time is not added up if the cumulative operation time before power supply-off is less than 1h.
 *5 When using the PU (FR-PU07), "kW" is displayed.
 *6 The setting is available for the standard control circuit terminal model or the safety stop function model.

- Writing "0" in Pr. 170 clears the cumulative power monitor.
- You can check the numbers of cumulative energization time monitor exceeded 65535h with Pr. 563 and the numbers of actual operation time monitor exceeded 65535h with Pr. 564.
- Writing "0" in Pr. 171 clears the actual operation time monitor.

Pr. 268 Setting	Description
9999 (initial value)	No function
0	For the first or second decimal places (0.1 increments or 0.01 increments) of the monitor, numbers in the first decimal place and smaller are rounded to display an integral value (1 increments). The monitor value smaller than 0.99 is displayed as 0.
1	When 2 decimal places (0.01 increments) are monitored, the 0.01 decimal place is dropped and the monitor displays the first decimal place (0.1 increments). When the monitor display digit is originally in 1 increments, it is displayed unchanged in 1 increments.

- When Pr. 52 is set to "100", the set frequency monitor is displayed during a stop and the output frequency monitor is displayed during operation. (The Hz LED blinks when stopping and is lit during operation.)

	Pr. 52		
	0	100	
	During running/stop	During stop	During running
Output frequency	Output frequency	Set frequency *	Output frequency
Output current	Output current		
Output voltage	Output voltage		
Fault or alarm indication	Fault or alarm indication		

* The set frequency displayed indicates the frequency to be output when the start command is on. Different from the frequency setting displayed when Pr. 52 = "5", the value based on maximum/minimum frequency and frequency jump is displayed.

Pr. 55, 56

Reference of the monitor output from terminal FM

- Pr. 55 Frequency monitoring reference Pr. 56 Current monitoring reference

Set the full-scale value of the monitor value output from terminal FM.

Monitor	Reference Parameter	Initial Value
Frequency	Pr. 55	60Hz
Current	Pr. 56	Inverter rated current

* Refer to the section about Pr. 52 for monitor names.

Pulse speed (terminal FM)

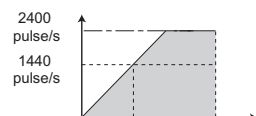

Output frequency reference Pr.55 400Hz
 Output current reference Pr.56 500A

- Features
- Connection example
- Standard Specifications
- Outline Dimension Drawings
- Terminal Connection Diagram Terminal Specification Explanation
- Operation panel Parameter unit FR Configurator
- Parameter List
- Explanations of Parameters
- Protective Functions
- Options
- Instructions
- Motor
- Compatibility
- Warranty
- Inquiry

Pr. 30, 57, 58, 162, 165, 299, 611

Automatic restart operation after instantaneous power failure/flying start

- Pr. 30 Regenerative function selection* *Pr. 57 Restart coasting time*
- Pr. 58 Restart cushion time* *Pr. 162 Automatic restart after instantaneous power failure selection*
- Pr. 165 Stall prevention operation level for restart* *Pr. 299 Rotation direction detection selection at restarting*
- Pr. 611 Acceleration time at a restart*

You can restart the inverter without stopping the motor in the following cases:

- When power comes back on after an instantaneous power failure
- When motor is coasting at start

Pr. Number	Setting Range	Description
30	0 (initial value), 1	When MRS (X10) turns ON then OFF The motor starts at the starting frequency
	2	When MRS (X10) turns ON then OFF Automatic restart operation
57	0	1.5K or lower 1s, 2.2K to 7.5K 2s, 11K or higher 3s The above times are coasting time.
	0.1 to 5s	Set the waiting time for inverter-triggered restart after an instantaneous power failure.
	9999 (initial value)	No restart
58	0 to 60s	Set a voltage starting time at restart.
162	0	Frequency search only performed at the first start
	1 (initial value)	Reduced voltage start only at the first start (no frequency search)
	10	Frequency search at every start
	11	Reduced voltage start at every start (no frequency search)
165	0 to 200%	Considers the inverter rated current as 100% and sets the stall prevention operation level during restart operation.
299	0 (initial value)	Without rotation direction detection
	1	With rotation direction detection
	9999	When Pr. 78 = 0, the rotation direction is detected. When Pr. 78 = 1, 2, the rotation direction is not detected.
611	0 to 3600s	Acceleration time to reach Pr. 20 <i>Acceleration/deceleration reference frequency at a restart.</i>
	9999 (initial value)	Acceleration time for restart is the normal acceleration time (e.g. Pr. 7).

- When Pr. 162 = "1" (initial value) or "11", automatic restart operation is performed in a reduced voltage system, where the voltage is gradually risen with the output frequency unchanged from prior to an instantaneous power failure independently of the coasting speed of the motor.

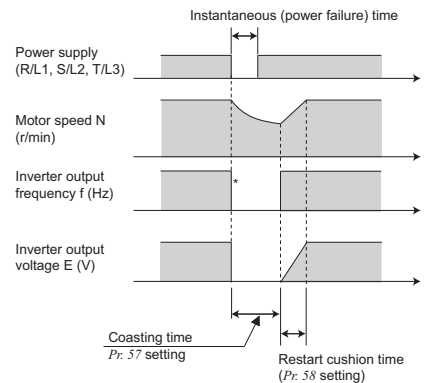

* The output shut off timing differs according to the load condition.

- When "0" or "10" is set in Pr. 162, the inverter smoothly starts after detecting the motor speed upon power restoration. (The motor capacity should be equal to or one rank lower than the inverter capacity)
When using the frequency search, perform offline auto tuning. Also be noted that there is a wiring length limit. (Refer to page 89)
- Even when the motor is rotating in the opposite direction, the inverter can be restarted smoothly as the direction of rotation is detected. (You can select whether to make rotation direction detection or not with Pr. 299 Rotation direction detection selection at restarting.)

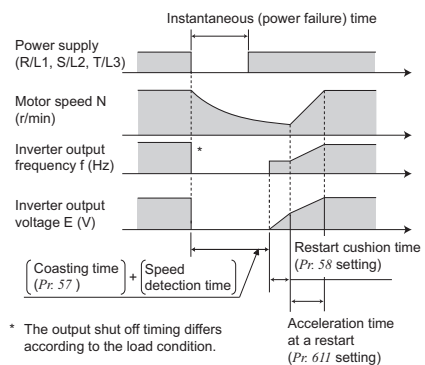

* The output shut off timing differs according to the load condition.

- Restart operation after turning MRS (X10) signal ON then OFF can be selected using Pr. 30. Set when restart operation after instantaneous power failure is selected while using the high power factor converter (FR-HC2).
(The FR-HC2 can be used for the standard control circuit terminal model or the safety stop function model.)

Pr. 59

Remote setting function

Pr. 59 Remote function selection

- If the operation panel is located away from the enclosure, you can use contact signals to perform continuous variable-speed operation, without using analog signals.
- By merely setting this parameter, you can use the acceleration, deceleration and setting clear functions of the motorized speed setter (FR-FK).

Pr. 59 Setting	Description	
	RH, RM, RL signal function	Frequency setting storage function
0 (initial value)	Multi-speed setting	—
1	Remote setting	With
2	Remote setting	Not used
3	Remote setting	Not used (Turning off STF/STR clears remotely set frequency)

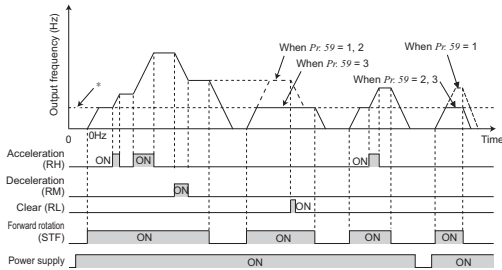

* External running frequency (other than multi-speed) or PU running frequency

Pr. 60

Energy saving control selection V/F

Pr. 60 Energy saving control selection

Without a fine parameter setting, the inverter automatically performs energy saving operation. This function is optimum for fan and pump applications. This function is valid for V/F control only.

Pr. 60 Setting	Description
0 (initial value)	Normal operation mode
9	Optimum excitation control mode The optimum excitation control mode is a control system which controls excitation current to improve the motor efficiency to maximum and determines output voltage as an energy saving system. *

* Output current may slightly increase, since output voltage is controlled.

Pr. 61 to 63, 292, 293

Automatic acceleration/deceleration

Pr. 61 Reference current

Pr. 62 Reference value at acceleration

Pr. 63 Reference value at deceleration

Pr. 292 Automatic acceleration/deceleration

Pr. 293 Acceleration/deceleration separate selection

The inverter automatically sets appropriate parameters for operation.

- The inverter operates in the same conditions as when appropriate values are set in each parameter even if acceleration/deceleration time and V/F pattern are not set. This operation mode is useful when you just want to operate, etc. without fine parameter setting.
- If the automatic acceleration/deceleration has been selected, inputting the jog or RT (second function selection) signal during an inverter stop will switch to the normal operation and give priority to JOG operation or second function selection.
After automatic acceleration/deceleration operation has been started, none of JOG signal and RT signal are accepted.

Pr. 292 Setting	Operation	Automatic Setting Parameter
0 (initial value normal mode)	—	—
1 (shortest acceleration/deceleration mode)	Without brake resistor and brake unit	Set when you want to accelerate/ decelerate the motor for the shortest time. (stall prevention operation level 150%) Pr. 7, Pr. 8
11 (shortest acceleration/deceleration mode)	With brake resistor and brake unit	
7 (brake sequence mode 1)	With mechanical brake opening completion signal input	Operation mode in which a mechanical brake operation timing signal for vertical lift applications is output. (The setting is not available for the FL remote communication model.) —
8 (brake sequence mode 2)	Without mechanical brake opening completion signal input	

- Use *Pr. 61 to Pr. 63* to change the reference current for the shortest acceleration/deceleration mode and optimum acceleration/deceleration mode.
- Calculation of acceleration/deceleration can be performed individually. This function is made valid in the shortest acceleration/deceleration mode.

Pr. 293 Setting	Description
0 (initial value)	Both acceleration/deceleration time is calculated.
1	Only acceleration time is calculated.
2	Only deceleration time is calculated.

Pr. 65, 67 to 69

Retry function at fault occurrence

Pr. 65 Retry selection Pr. 67 Number of retries at fault occurrence
Pr. 68 Retry waiting time Pr. 69 Retry count display erase

If a fault occurs, the inverter resets itself automatically to restart. You can also select the fault description for a retry.

When you have selected automatic restart after instantaneous power failure (Pr. 57 Restart coasting time ≠ 9999), restart operation is performed at the retry operation time which is the same of that of a power failure.

- Use Pr. 65 to select the fault to be activated for retries.
"●" indicates the alarms selected for retry.

Fault Display for Retry	Pr. 65 Setting					
	0	1	2	3	4	5
E.OC1	●	●		●	●	●
E.OC2	●	●		●	●	
E.OC3	●	●		●	●	●
E.OV1	●		●	●	●	
E.OV2	●		●	●	●	
E.OV3	●		●	●	●	
E.THM	●					
E.THT	●					
E. BE	●				●	
E. GF	●				●	
E.OHT	●					
E.OLT	●				●	
E.OP1	●				●	
E. PE	●				●	
E.MB4	●				●	
E.MB5	●				●	
E.MB6	●				●	
E.MB7	●				●	
E.USB	●				●	
E.ILF	●				●	

- Set the number of retries at fault occurrence in Pr. 67.

Pr. 67 Setting	Description
0 (initial value)	No retry function
1 to 10	Set the number of retries at fault occurrence. A fault output is not provided during retry operation.
101 to 110	Set the number of retries at fault occurrence. (The setting value of minus 100 is the number of retries.) A fault output is provided during retry operation.

- Use Pr. 68 to set the waiting time from when the inverter trips until a retry is made in the range 0.1 to 360s.
- Reading the Pr. 69 value provides the cumulative number of successful restart times made by retry. (Use setting value "0" to clear.)

Pr. 66 ➔ Refer to the section about Pr. 22.

Pr. 67 to 69 ➔ Refer to the section about Pr. 65.

Pr. 70 ➔ Refer to the section about Pr. 30.

Pr. 71, 450

Motor selection (applied motor)

Pr. 71 Applied motor Pr. 450 Second applied motor

Setting of the used motor selects the thermal characteristic appropriate for the motor. Setting is required to use a constant-torque motor. Thermal characteristic of the electronic thermal relay function suitable for the motor is set.

Pr. 71, Pr. 450 Setting		Used Motor	Thermal Characteristic of the Electronic Thermal Relay Function	
Pr. 71	Pr. 450		Standard	Constant-torque
0	—	Standard motor (such as SF-JR) (Pr. 71 initial value)	○	
1	—	Mitsubishi Electric constant-torque motor (such as SF-JRCA)		○
40	—	Mitsubishi Electric high-efficiency motor (SF-HR)	○	
50	—	Mitsubishi Electric constant-torque motor (SF-HRCA)		○
3	—	Standard motor	○	
13	—	Constant-torque motor		○
23	—	Mitsubishi Electric standard motor (SF-JR 4P 1.5kW or lower)	Select "Offline auto tuning setting"	○
43	—	Mitsubishi Electric high efficiency motor (SF-HR)		○
53	—	Mitsubishi Electric constant-torque motor (SF-HRCA)		○
4	—	Standard motor		○
14	—	Constant-torque motor	Auto tuning data can be read, changed, and set.	○
24	—	Mitsubishi Electric standard motor (SF-JR 4P 1.5kW or lower)		○
44	—	Mitsubishi Electric high efficiency motor (SF-HR)		○
54	—	Mitsubishi Electric constant-torque motor (SF-HRCA)	Direct input of motor constants is enabled	○
5	—	Standard motor *1		○
15	—	Constant-torque motor *1		○
6	—	Standard motor *2		○
16	—	Constant-torque motor *2	○	○
—	9999	Without second applied motor (Pr. 450 initial value)		

*1 Star connection
*2 Delta connection

- For the 5.5K and 7.5K, the Pr. 0 Torque boost and Pr. 12 DC injection brake operation voltage settings are automatically changed according to the Pr. 71 settings as follows.

Automatic Change Parameter	Standard Motor Setting *1	Constant-torque Motor Setting *2
Pr. 0	3%	2%
Pr. 12	4%	2%

*1 Pr. 71 setting: 0, 3 to 6, 23, 24, 40, 43, 44
*2 Pr. 71 setting: 1, 13 to 16, 50, 53, 54

Pr. 72, 240

Carrier frequency and Soft-PWM selection

Pr. 72 PWM frequency selection Pr. 240 Soft-PWM operation selection

You can change the motor sound.

Pr. Number	Setting Range	Description
72	0 to 15	PWM carrier frequency can be changed. The setting is in [kHz]. Note that 0 indicates 0.7kHz and 15 indicates 14.5kHz.
240	0	Soft-PWM is invalid
	1	When Pr. 72 = "0 to 5", Soft-PWM is valid.

Pr. 73, 267

Analog input selection

Pr. 73 Analog input selection Pr. 267 Terminal 4 input selection

- You can select the function that switches between forward rotation and reverse rotation according to the analog input terminal specifications and analog input level.
- Either voltage input (0 to 5V, 0 to 10V) or current input (4 to 20mA) can be selected for terminals 4 used for analog input. Set the voltage/current input switch in the "V" position to select voltage input (0 to 5V/0 to 10V) and "I" position to select current input (4 to 20mA), and change the parameter setting (Pr. 267). (indicates main speed setting)

Pr. 73 Setting	Terminal 2 Input	Terminal 4 Input	Reversible Operation
0	0 to 10V	When the AU signal is off	Not function
1 (initial value)	0 to 5V		
10	0 to 10V		
11	0 to 5V	When the AU signal is on According to Pr. 267 setting 0.4 to 20mA (initial value)	Yes
0	×		
1 (initial value)	×		
10	×	1:0 to 5V 2:0 to 10V	Yes
11	×		

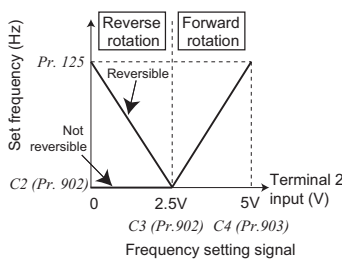

Pr. 74

Response level of analog input and noise elimination

Pr. 74 Input filter time constant

- The time constant of the primary delay filter can be set for the external frequency command (analog input (terminal 2, 4) signal).
 - Effective for filtering noise in the frequency setting circuit.
 - Increase the filter time constant if steady operation cannot be performed due to noise. A larger setting results in slower response. (The time constant can be set between approximately 5ms to 1s with the setting of 0 to 8.)

Pr. 75

Reset selection, disconnected PU detection

Pr. 75 Reset selection/disconnected PU detection/PU stop selection

You can select the reset input acceptance, disconnected PU (FR-PU07) connector detection function and PU stop function.

Pr. 75 Setting	Reset Selection	Disconnected PU Detection	PU Stop Selection
0	Reset input normally enabled	If the PU is disconnected, operation will be continued.	Pressing decelerates the motor to a stop only in the PU operation mode.
1	Reset input is enabled only when a fault occurs.		
2	Reset input normally enabled	When the PU is disconnected, the inverter output is shut off.	
3	Reset input is enabled only when a fault occurs.	If the PU is disconnected, operation will be continued.	Pressing decelerates the motor to a stop in any of the PU, external and communication operation modes.
14 (initial value)	Reset input normally enabled		
15	Reset input is enabled only when a fault occurs.		
16	Reset input normally enabled		
17	Reset input is enabled only when a fault occurs.	When the PU is disconnected, the inverter output is shut off.	

- Reset selection**
You can select the operation timing of reset function (RES signal, reset command through communication) input.
- Disconnected PU detection**
This function detects that the PU (FR-PU07) has been disconnected from the inverter for longer than 1s and causes the inverter to provide a fault output (E.PUE) and come to trip. (This function cannot be used for the FL remote communication model and the CC-Link communication model.)
- PU stop selection**
In any of the PU operation, External operation and Network operation modes, the motor can be stopped by pressing of the PU.

Pr. 77

Prevention of parameter rewrite

Pr. 77 Parameter write selection

You can select whether write to various parameters can be performed or not. Use this function to prevent parameter values from being rewritten by misoperation.

Pr. 77 Setting	Description
0 (initial value)	Write is enabled only during a stop.
1	Parameter cannot be written.
2	Parameter writing is enabled in any operation mode regardless of operation status. (There are some parameters that cannot be written.)

Pr. 78

Prevention of reverse rotation of the motor

Pr. 78 Reverse rotation prevention selection

This function can prevent reverse rotation fault resulting from the incorrect input of the start signal.













Pr. 78 Setting	Description
0 (initial value)	Both forward and reverse rotations allowed
1	Reverse rotation disabled
2	Forward rotation disallowed

Pr. 79, 340

Operation mode selection

Pr. 79 Operation mode selection Pr. 340 Communication startup mode selection

- Used to select the operation mode of the inverter. Mode can be changed as desired between operation using external signals (external operation), operation from the PU (FR-PU07), combined operation of PU operation and external operation (external/PU combined operation), and network operation (when RS-485 communication or a communication option is used) (For the CC-Link communication model, the operation can be switched between the NET and PU modes.)

Pr. 79 Setting	Description	LED Indication : OFF : ON
0 (initial value)	Use external/PU switchover mode (press ) to switch between the PU and External operation mode. At power on, the inverter is placed in the External operation mode.	PU operation mode  External operation mode  NET operation mode 
1	Fixed to PU operation mode	PU operation mode 
2	Fixed to External operation mode Operation can be performed by switching between the external and Net operation mode.	External operation mode  NET operation mode 
3	External/PU combined operation mode 1	
	Frequency command Operation panel and PU (FR-PU07) setting or external signal input (multi-speed setting, across terminals 4-5 (valid when AU signal turns on)).	Start command External signal input (terminal STF, STR)
4	External/PU combined operation mode 2	
	Frequency command External signal input (terminal 2, 4, JOG, multi-speed selection, etc.)	Start command Input from the operation panel and the PU (FR-PU07) 
6	Switchover mode Switch among PU operation, external operation, and NET operation while keeping the same operating status.	PU operation mode  External operation mode  NET operation mode 
7	External operation mode (PU operation interlock) X12 signal ON Operation mode can be switched to the PU operation mode. (output stop during external operation) X12 signal OFF Operation mode cannot be switched to the PU operation mode.	External operation mode  NET operation mode 

- Specify the operation mode at power on (Pr. 340)
 - When power is switched on or when power comes back on after instantaneous power failure, the inverter can be started up in the Network operation mode. After the inverter has started up in the Network operation mode, parameter write and operation can be performed from a program.
Set this mode for communication operation using the inverter RS-485 communication or communication option.
 - You can set the operation mode at power on (reset) according to the Pr. 79 and Pr. 340 settings.

Pr. 340 Setting	Pr. 79 Setting	Operation Mode at Power-on, Power Restoration, Reset	Operation Mode Switching
0 (initial value)	As set in Pr. 79.		
1	0	NET operation mode	Can be switched to external, PU or NET operation mode*1
	1	PU operation mode	Fixed to PU operation mode
	2	NET operation mode	Switching between the external and NET operation mode is enabled Switching to PU operation mode disabled
	3, 4	External/PU combined operation mode	Operation mode switching disabled
	6	NET operation mode	Switching among the external, PU, and NET operation mode is enabled while running.
	7	X12 (MRS) signal ON ..NET operation mode	Can be switched to external, PU or NET operation mode*1
		X12 (MRS) signal ON ..External operation mode	Fixed to External operation mode (forcibly switched to External operation mode)
10	0	NET operation mode	Switching between the PU and Net operation mode is enabled*2
	1	PU operation mode	Fixed to PU operation mode
	2	NET operation mode	Fixed to NET operation mode
	3, 4	External/PU combined operation mode	Operation mode switching disabled
	6	NET operation mode	Switching between the PU and NET operation mode is enabled while running*2
	7	External operation mode	Fixed to External operation mode (forcibly switched to External operation mode)

*1 Operation mode cannot be directly changed between the PU operation mode and Network operation mode

*2 Operation mode can be changed between the PU operation mode and Network operation mode with  key of the operation panel and X65 signal.

Pr. 80, 81, 89, 800

Selection of control method and control mode AD MFVC GP MFVC

Pr. 80 Motor capacity *Pr. 81 Number of motor poles*
Pr. 89 Speed control gain (Advanced magnetic flux vector) *Pr. 800 Control method selection*

Advanced magnetic flux vector control and general-purpose magnetic flux vector control can be selected by setting the motor capacity, number of poles in *Pr. 80 and Pr. 81*. Selection of advanced magnetic flux vector control or general-purpose magnetic flux vector control can be made by *Pr. 800*.

Parameter Number	Setting Range	Description
80	0.1 to 15kW	Set the applied motor capacity.
	9999 (initial value)	V/F control
81	2, 4, 6, 8, 10	Set the number of motor poles.
	9999 (initial value)	V/F control
800	20 (initial value)	Advanced magnetic flux vector control *
	30	General-purpose magnetic flux vector control *

- * Set a value other than "9999" in *Pr. 80* and *Pr. 81*.
- The motor speed fluctuation at load fluctuation can be adjusted using *Pr. 89*.

Pr. 82 to 84, 90 to 94, 96, 298, 859

Offline auto tuning

<i>Pr. 82 Motor excitation current</i>	<i>Pr. 83 Rated motor voltage</i>
<i>Pr. 84 Rated motor frequency</i>	<i>Pr. 90 Motor constant (R1)</i>
<i>Pr. 91 Motor constant (R2)</i>	<i>Pr. 92 Motor constant (L1)/d-shaft inductance</i>
<i>Pr. 93 Motor constant (L2)/q-shaft inductance</i>	<i>Pr. 94 Motor constant (X)</i>
<i>Pr. 96 Auto tuning setting/status</i>	<i>Pr. 298 Frequency search gain</i>
<i>Pr. 859 Torque current</i>	

Offline auto tuning operation for automatic calculation of motor constants can be executed when using advanced magnetic flux vector control and general-purpose magnetic flux vector control. When offline auto tuning is performed under V/F control, *Pr. 298 Frequency search gain* necessary for frequency search for automatic restart after instantaneous power failure is set as well as the motor constants (R1).

Parameter Number	Setting Range	Description
96	0 (initial value)	Without offline auto tuning
	1	Offline auto tuning for advanced magnetic flux vector control
	11	Offline auto tuning for general-purpose magnetic flux vector control (compatible with FR-E500 series)
	21	Offline auto tuning for V/F control (automatic restart after instantaneous power failure (with frequency search))

- You can copy the offline auto tuning data (motor constants) to another inverter with the PU (FR-PU07).
- Even if a motor other than the Mitsubishi Electric standard motor (SF-JR 0.2kW or higher), high-efficiency motor (SF-HR 0.2kW or higher), or Mitsubishi Electric constant-torque motor (SF-JRCA 4P, SF-HRCA 0.2 to 15kW) (such as other manufacturer's motor or SF-JRC motor) is used, or the wiring length is long (30m or more as a reference), a motor can run with the optimum operation characteristics by using the offline auto tuning function.
- Offline auto tuning conditions
 - A motor should be connected.
 - The motor capacity is equal to or one rank lower than the inverter capacity.
(note that the capacity should be 0.1kW or more)
 - The maximum frequency is 120Hz.
 - A high-slip motor, high-speed motor and special motor cannot be tuned.
- As the motor may run slightly, fix the motor securely with a mechanical brake or make sure that there will be no problem in safety if the motor runs.
 - * This instruction must be followed especially in elevator.
 - Note that if the motor runs slightly, tuning performance is unaffected.

Pr. 89 ➡ Refer to the section about *Pr. 80*.

- Features
- Connection example
- Standard Specifications
- Outline Dimension Drawings
- Terminal Connection Diagram Terminal Specification Explanation
- Operation panel Parameter unit FR Configurator
- Parameter List
- Explanations of Parameters
- Protective Functions
- Options
- Instructions
- Motor
- Compatibility
- Warranty
- Inquiry

Pr. 117 to 124, 342, 343, 502, 549

Communication initial setting

<i>Pr. 117 PU communication station number</i>	<i>Pr. 118 PU communication speed</i>
<i>Pr. 119 PU communication stop bit length</i>	<i>Pr. 120 PU communication parity check</i>
<i>Pr. 121 Number of PU communication retries</i>	<i>Pr. 122 PU communication check time interval</i>
<i>Pr. 123 PU communication waiting time setting</i>	<i>Pr. 124 PU communication CR/LF selection</i>
<i>Pr. 342 Communication EEPROM write selection</i>	<i>Pr. 343 Communication error count</i>
<i>Pr. 502 Stop mode selection at communication error</i>	<i>Pr. 549 Protocol selection</i>

(1) Initial settings and specifications of RS-485 communication (Pr. 117 to Pr. 124)

Used to perform required settings for RS-485 communication between the inverter and personal computer.

- Use PU connector of the inverter for communication.
- You can perform parameter setting, monitoring, etc. using the Mitsubishi inverter protocol or MODBUS RTU protocol.
- To make communication between the personal computer and inverter, initialization of the communication specifications must be made to the inverter.

Data communication cannot be made if the initial settings are not made or there is any setting error.

Pr. Number	Setting Range	Description
117	0 to 31 (0 to 247) *1	Specify the inverter station number. Set the inverter station numbers when two or more inverters are connected to one personal computer.
118	48, 96, 192, 384	Set the communication speed. The setting value × 100 equals the communication speed. For example, the communication speed is 19200bps when the setting value is 192.
119	0 1 (initial value) 10 11	Stop bit length
		1bit
		2bit
		7bit
120	0 1 2 (initial value)	Without parity check
		With odd parity check
		With even parity check
121	0 to 10	Set the permissible number of retries at occurrence of a data receive error. If the number of consecutive errors exceeds the permissible value, the inverter trips.
	9999	If a communication error occurs, the inverter will not come to trip.
122	0 (initial value)	RS-485 communication can be made. Note that a communication error (E.PUE) occurs as soon as the inverter is switched to the operation mode with control source.
	0.1 to 999.8s	Sets the interval of communication check time. If a no-communication state persists for longer than the permissible time, the inverter trips.
	9999	No communication check
123	0 to 150ms	Set the waiting time between data transmission to the inverter and response.
	9999 (initial value)	Set with communication data.
124	0	Without CR/LF
	1 (initial value)	With CR
	2	With CR/LF

Pr. Number	Setting Range	Description			
		At alarm occurrence	Indication	Error output	At error removal
502	0 (initial value) 3	Coasts to stop.	E.PUE	Output	Stop (E.PUE)
	1	Decelerates to stop	After stop E.PUE	Output after stop	Stop (E.PUE)
	2	Decelerates to stop	After stop E.PUE	Without output	Automatic restart functions

*1 When making communication through MODBUS RTU protocol (Pr. 549 = "1"), the setting range within parenthesis is applied.

(2) Communication EEPROM write selection (Pr. 342)

When parameter write is performed from the inverter PU connector, USB communication, and communication option, parameters storage device can be changed from EEPROM + RAM to RAM only. Set when a frequent parameter change is necessary.

(3) MODBUS RTU communication specifications (Pr. 343, Pr. 549)

Pr. Number	Setting Range	Description
343	—	Displays the number of communication errors during MODBUS RTU communication. (Reading only)
549	0 (initial value)	Mitsubishi inverter (computer link operation) protocol
	1	MODBUS RTU protocol

Pr. 125, 126, 241, C2 (902) to C7 (905), C22 (922) to C25 (923)

Analog input frequency change and adjustment (calibration)

- Pr. 125 Terminal 2 frequency setting gain frequency
- Pr. 241 Analog input display unit switchover
- C3 (Pr. 902) Terminal 2 frequency setting bias
- C5 (Pr. 904) Terminal 4 frequency setting bias frequency
- C7 (Pr. 905) Terminal 4 frequency setting gain
- C23 (Pr. 922) Frequency setting voltage bias (built-in potentiometer)
- C25 (Pr. 923) Frequency setting voltage gain (built-in potentiometer)
- Pr. 126 Terminal 4 frequency setting gain frequency
- C2 (Pr. 902) Terminal 2 frequency setting bias frequency
- C4 (Pr. 903) Terminal 2 frequency setting gain
- C6 (Pr. 904) Terminal 4 frequency setting bias
- C22 (Pr. 922) Frequency setting voltage bias frequency (built-in potentiometer)
- C24 (Pr. 923) Frequency setting voltage gain frequency (built-in potentiometer)

You can set the magnitude (slope) of the output frequency as desired in relation to the frequency setting signal (0 to 5VDC, 0 to 10V or 4 to 20mA).

C22 (Pr. 922) to C25 (Pr. 923) is available when the operation panel (PA02) for the FR-E500 series is connected with cable. You can calibrate the operation panel built-in potentiometer.

(1) Change the frequency at maximum analog input (Pr. 125, Pr. 126)

Set Pr. 125 (Pr. 126) when changing only frequency setting (gain) of the maximum analog input voltage (current). (Other settings need not be changed.)

(2) Analog input bias/gain calibration (C2 (Pr. 902) to C7 (Pr. 905))

- The "bias" and "gain" functions are designed to adjust the relationships between the output frequency and the setting input signal, e.g. 0 to 5VDC/0 to 10VDC or 4 to 20mADC entered from outside the inverter.

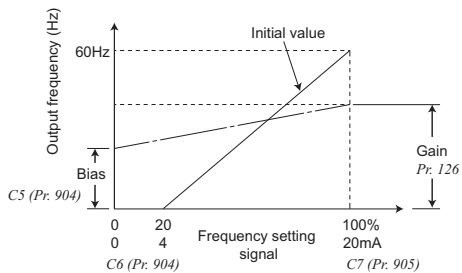
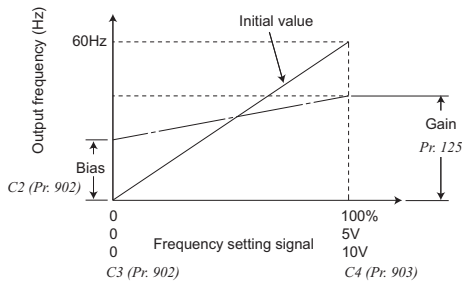

(3) Analog input display unit changing (Pr. 241)

- You can change the analog input display unit (%V/mA) for analog input bias/gain calibration.

Pr. 127 to 134

PID control, dancer control

- Pr. 127 PID control automatic switchover frequency
- Pr. 129 PID proportional band
- Pr. 131 PID upper limit
- Pr. 133 PID action set point
- Pr. 128 PID action selection
- Pr. 130 PID integral time
- Pr. 132 PID lower limit
- Pr. 134 PID differential time

- The inverter can be used to exercise process control, e.g. flow rate, air volume or pressure.

The terminal 2 input signal or parameter setting is used as a set point and the terminal 4 input signal used as a feedback value to constitute a feedback system for PID control.

- Pr. 128 = "20, 21" (measured value input)

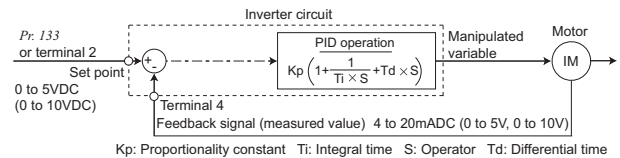

- Performs PID control by feedbacking the position signal of the dancer roller, controlling the dancer roller is in the specified position. Performs dancer control by setting 40 to 43 in Pr. 128 PID action selection. The main speed command is the speed command of each operation mode (external, PU, communication). Performs PID control by the position detection signal of the dancer roller, then the result is added to the main speed command.

Pr. 145

PU display language selection

Pr. 145 PU display language selection

You can switch the display language of the PU (FR-PU07) to another.

Pr. 145 Setting	Description
0 (initial value)	Japanese
1	English
2	German
3	French
4	Spanish
5	Italian
6	Swedish
7	Finnish

Pr. 146

Built-in potentiometer switching

Pr. 146 Built-in potentiometer switching

When connecting the operation panel (PA02) of the FR-E500 series with a cable, use Pr. 146 Built-in potentiometer switching for selecting the operation using the built-in frequency setting potentiometer, or using [UP/DOWN] key.

Pr. 146 Setting	Description
0	Built-in frequency setting potentiometer gain
1 (initial value)	Digital frequency setting by the [UP/DOWN] key.
9999	Frequency setting with the built-in frequency setting potentiometer is available when the frequency set by [UP/DOWN] key is "0Hz".

Pr. 147 → Refer to the section about Pr. 7.

Pr. 150 to 153

**Detection of output current (Y12 signal)
Detection of zero current (Y13 signal)**

Pr. 150 Output current detection level *Pr. 151 Output current detection signal delay time*
Pr. 152 Zero current detection level *Pr. 153 Zero current detection time*

The output power during inverter running can be detected and output to the output terminal.

(1) Output current detection (Y12 signal, Pr. 150, Pr. 151)

- The output current detection function can be used for excessive torque detection, etc.
- If the output current remains at the *Pr. 150* setting or higher during inverter operation for the time set in *Pr. 151* or longer, the output current detection (Y12) signal is output from the inverter's open collector or relay output terminal.

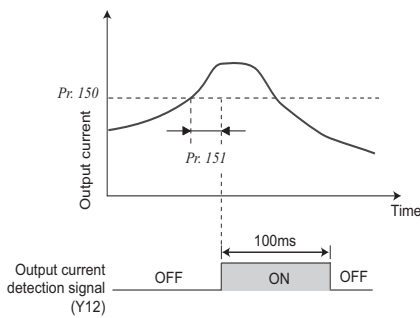

(2) Zero current detection (Y13 signal, Pr. 152, Pr. 153)

- If the output current remains at the *Pr. 152* setting or lower during inverter operation for the time set in *Pr. 153* or longer, the output current detection (Y13) signal is output from the inverter's open collector or relay output terminal.

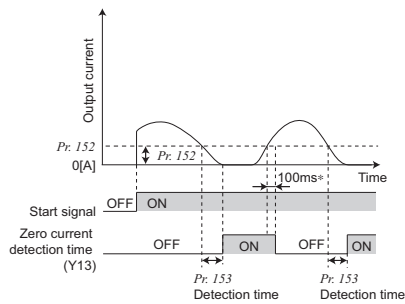

Pr. 154, 156, 157 ➔ Refer to the section about *Pr. 22*.

Pr. 160, 172 to 174

User group function

Pr. 160 User group read selection *Pr. 172 User group registered display/batch clear*
Pr. 173 User group registration *Pr. 174 User group clear*

- Parameter which can be read from the operation panel and PU (FR-PU07) can be restricted.
The inverter is set to display all parameters with initial setting.

Pr. 160 Setting	Description
0 (initial value)	All parameters are displayed.
1	Only the parameters registered in the user group can be displayed.
9999	Only the simple mode parameters can be displayed.

- User group function (*Pr. 160, Pr. 172 to Pr. 174*)
 - The user group function is designed to display only the parameters necessary for setting.
 - From among all parameters, a maximum of 16 parameters can be registered in the user group. When "1" is set in *Pr. 160*, only parameters registered in the user group can be accessed for reading and writing. (The parameters not registered in the user group cannot be read.)
 - Set parameter numbers in *Pr. 173* to register parameters in the user group.
 - To delete a parameter from the user group, set its parameter number in *Pr. 174*. To batch-delete the registered parameters, set *Pr. 172* to "9999".

Pr. 161, 295

Operation selection of the operation panel

Pr. 161 Frequency setting/key lock operation selection *Pr. 295 Magnitude of frequency change setting*

- The setting dial of the operation panel can be used for setting like a potentiometer.
- The key operation of the operation panel can be disabled.

Pr. 161 Setting	Description	
0 (initial value)	Setting dial frequency setting mode	Key lock invalid
1	Setting dial potentiometer mode	
10	Setting dial frequency setting mode	Key lock valid
11	Setting dial potentiometer mode	

- When setting the set frequency with the setting dial, the frequency setting increments of the setting dial can be changed, in proportion as the rotated amount of the setting dial (speed).

Pr. 162, 165 ➔ Refer to the section about *Pr. 57*.

Pr. 168, 169 Parameter for manufacturer setting. Do not set.

Pr. 170, 171 ➔ Refer to the section about *Pr. 52*.

Pr. 172 to 174 ➔ Refer to the section about *Pr. 160*.

Pr. 178 to 184

Function assignment of input terminal

- [Pr. 178 STF terminal function selection](#)
- [Pr. 179 STR terminal function selection](#)
- [Pr. 180 RL terminal function selection](#)
- [Pr. 181 RM terminal function selection](#)
- [Pr. 182 RH terminal function selection](#)
- [Pr. 183 MRS terminal function selection](#)
- [Pr. 184 RES terminal function selection](#)

Use these parameters to select/change the input terminal functions.

Pr. 178 to Pr. 184 Setting*4	Signal	Functions	
		Pr. 59 = 0 (initial value)	Pr. 59 ≠ 0 *1
0	RL	Pr. 59 = 0 (initial value)	Low-speed operation command
		Pr. 59 ≠ 0 *1	Remote setting (setting clear)
		Pr. 270 = 1 *2	Stop-on contact selection 0
1	RM	Pr. 59 = 0 (initial value)	Middle-speed operation command
		Pr. 59 ≠ 0 *1	Remote setting (deceleration)
2	RH	Pr. 59 = 0 (initial value)	High-speed operation command
		Pr. 59 ≠ 0 *1	Remote setting (acceleration)
3	RT	Second function selection	
		Pr. 270 = 1 *2	Stop-on contact selection 1
4	AU	Terminal 4 input selection *5	
5	JOG	Jog operation selection *5	
7	OH	External thermal relay input *3*5	
8	REX	15-speed selection (combination with three speeds RL, RM, RH)	
10	X10	Inverter operation enable signal (FR-HC2/FR-CV connection) *5	
12	X12	PU operation external interlock *5	
14	X14	PID control valid terminal	
15	BRI	Brake opening completion signal	
16	X16	PU-external operation switchover *5	
18	X18	V/F switchover (V/F control is exercised when X18 is ON)	
24	MRS	Output stop	
25	STOP	Start self-holding selection *5	
60	STF	Forward rotation command (assigned to STF terminal (Pr. 178) only) *5	
61	STR	Reverse rotation command (assigned to STR terminal (Pr. 179) only) *5	
62	RES	Inverter reset *5	
65	X65	PU/NET operation switchover *5	
66	X66	External/NET operation switchover *5	
67	X67	Command source switchover *5	
9999	—	No function	

- *1 When Pr. 59 Remote function selection ≠ "0", the functions of the RL, RM and RH signals change as listed above.
- *2 When Pr. 270 = "1", the functions of the RL and RT signals change as listed above.
- *3 The OH signal turns on when the relay contact "opens".
- *4 For the safety stop function model, the setting in Pr. 183 MRS terminal function selection is valid only during the communication operation.
- *5 The setting is not available for the CC-Link communication model.

Pr. 190 to 192

Terminal assignment of output terminal

- [Pr. 190 RUN terminal function selection](#)
- [Pr. 191 FU terminal function selection](#)
- [Pr. 192 A,B,C terminal function selection](#)

You can change the functions of the open collector output terminal and relay output terminal.

Pr. 190 to Pr. 192 Setting		Signal	Functions
Positive logic	Negative logic		
0	100	RUN	Inverter running
1	101	SU	Up to frequency
3	103	OL	Overload alarm
4	104	FU	Output frequency detection
7	107	RBP	Regenerative brake pre-alarm
8	108	THP	Electronic thermal O/L relay pre-alarm
11	111	RY	Inverter operation ready
12	112	Y12	Output current detection
13	113	Y13	Zero current detection
14	114	FDN	PID lower limit
15	115	FUP	PID upper limit
16	116	RL	PID forward/reverse rotation output
20	120	BOF	Brake opening request
25	125	FAN	Fan fault output
26	126	FIN	Heatsink overheat pre-alarm
46	146	Y46	During deceleration due to instantaneous power failure (retained until release)
47	147	PID	During PID control activated
64	164	Y64	During retry
68	168	EV	24V external power supply operation *1
80	180	SAFE	Safety monitor output *2
81	181	SAFE2	Safety monitor output 2 *2
90	190	Y90	Life alarm
91	191	Y91	Fault output 3 (power-off signal)
93	193	Y93	Current average value monitor signal
95	195	Y95	Maintenance timer signal
96	196	REM	Remote output
98	198	LF	Alarm output
99	199	ALM	Fault output
9999		—	No function

- *1 The setting is available for the safety stop function model (with the FR-E7DS) and CC-Link communication model.
- *2 The setting is available for the safety stop function model and CC-Link communication model.

Pr. 232 to 239 ➔ Refer to the section about Pr. 4.

Pr. 240 ➔ Refer to the section about Pr. 72.

Pr. 241 ➔ Refer to the section about Pr. 125.

- Features
- Connection example
- Standard Specifications
- Outline Dimension Drawings
- Terminal Connection Diagram
- Terminal Specification Explanation
- Operation panel Parameter unit FR Configurator
- Parameter List
- Explanations of Parameters
- Protective Functions
- Options
- Instructions
- Motor
- Compatibility
- Warranty
- Inquiry

Pr.244

Increase cooling fan life

Pr. 244 Cooling fan operation selection

You can control the operation of the cooling fan (FR-E720-1.5K or higher, FR-E740-1.5K or higher, FR-E720S-0.75K or higher) built in the inverter.

Pr. 244 Setting	Description
0	Operates in power-on status. Cooling fan on/off control invalid (the cooling fan is always on at power on)
1 (initial value)	Cooling fan on/off control valid The fan is always on while the inverter is running. During a stop, the inverter status is monitored and the fan switches on-off according to the temperature.

Pr.245 to 247

Slip compensation



Pr. 245 Rated slip

Pr. 246 Slip compensation time constant

Pr. 247 Constant-power range slip compensation selection

The inverter output current may be used to assume motor slip to keep the motor speed constant.

Pr.249

Earth (ground) fault detection at start

Pr. 249 Earth (ground) fault detection at start

You can choose whether to make earth (ground) fault detection at start valid or invalid. Earth (ground) fault detection is executed only right after the start signal is input to the inverter.

Pr. 249 Setting	Description
0 (initial value)	Without earth (ground) fault detection
1	With earth (ground) fault detection*

- * As detection is executed at start, output is delayed for approx. 20ms every start.
- If an earth (ground) fault is detected with "1" set in Pr. 249, fault output (E.GF) is displayed and the output is shut off.
- Protective function will not activate if an earth (ground) fault occurs during operation.
- If the motor capacity is smaller than the inverter capacity for the 5.5K or higher, earth (ground) fault detection may not be provided.

Pr.250

Selection of motor stopping method and start signal

Pr. 250 Stop selection

Used to select the stopping method (deceleration to a stop or coasting) when the start signal turns off.

Used to stop the motor with a mechanical brake, etc. together with switching off of the start signal.

You can also select the operations of the start signals (STF/STR).

Pr. 250 Setting	Description	
	Start signal (STF/STR)	Stop operation
0 to 100s	STF signal: Forward rotation start STR signal: Reverse rotation start	The motor is coasted to a stop when the preset time elapses after the start signal is turned off.
1000s to 1100s	STF signal: Start signal STR signal: Forward/reverse signal	The motor is coasted to a stop (Pr. 250 - 1000)s after the start signal is turned off.
9999	STF signal: Forward rotation start STR signal: Reverse rotation start	When the start signal is turned off, the motor decelerates to stop.
8888	STF signal: Start signal STR signal: Forward/reverse signal	

When "9999 (initial value) or 8888" is set in Pr. 250

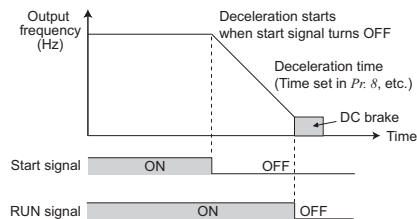

When a value other than "9999" (initial value) or "8888" is set in Pr. 250

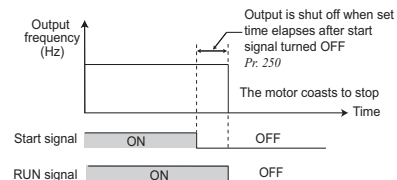

Pr.251, 872

Input/output phase failure protection selection

Pr. 251 Output phase loss protection selection

Pr. 872 Input phase loss protection selection

You can disable the output phase failure protection function that stops the inverter output if one of the inverter output side (load side) three phases (U, V, W) opens. Input phase failure protection, which stops inverter output when one of three phases (R, S, T) on the inverter's input side is lost, can be disabled.

Pr. Number	Setting Range	Description
251	0	Without output phase failure protection
	1 (initial value)	With output phase failure protection
872 *	0	Without input phase failure protection
	1 (initial value)	With input phase failure protection

* The setting is available for three-phase power input models.

Pr. 255 to 259

Display of the life of the inverter parts

Pr. 255 Life alarm status display *Pr. 256 Inrush current limit circuit life display*
Pr. 257 Control circuit capacitor life display *Pr. 258 Main circuit capacitor life display*
Pr. 259 Main circuit capacitor life measuring

Degrees of deterioration of main circuit capacitor, control circuit capacitor or inrush current limit circuit and cooling fan can be diagnosed by monitor. When any part has approached the end of its life, an alarm can be output by self diagnosis to prevent a fault. (Use the life check of this function as a guideline since the life except the main circuit capacitor is calculated theoretically.)

Pr. Number	Setting Range	Description
255	(0 to 15)	Displays whether the control circuit capacitor, main circuit capacitor, cooling fan, and each parts of the inrush current limit circuit has reached the life alarm output level or not. (Reading only)
256	(0 to 100%)	Displays the deterioration degree of the inrush current limit circuit. (Reading only)
257	(0 to 100%)	Displays the deterioration degree of the control circuit capacitor. (Reading only)
258	(0 to 100%)	Displays the deterioration degree of the main circuit capacitor. (Reading only) The value measured by <i>Pr. 259</i> is displayed.
259	0, 1	Setting "1" and turning the power supply off starts the measurement of the main circuit capacitor life. When the <i>Pr. 259</i> value is "3" after power-ON again, the measuring is completed. Displays the deterioration degree in <i>Pr. 258</i> .

Pr. 261

Operation at instantaneous power failure

Pr. 261 Power failure stop selection

When a power failure or undervoltage occurs, the inverter can be decelerated to a stop or can be decelerated and re-accelerated to the set frequency.

Pr. Number	Setting Range	Description
261	0 (initial value)	Coasts to stop. When undervoltage or power failure occurs, the inverter output is shut off.
	1	When undervoltage or a power failure occurs, the inverter can be decelerated to a stop.
	2	When undervoltage or a power failure occurs, the inverter can be decelerated to a stop. If power is restored during a power failure, the inverter accelerates again.

(1) Power failure stop function (Pr. 261 = "1")

- If power is restored during power failure deceleration, deceleration to a stop is continued and the inverter remains stopped. To restart, turn the start signal off, then turn it on again.

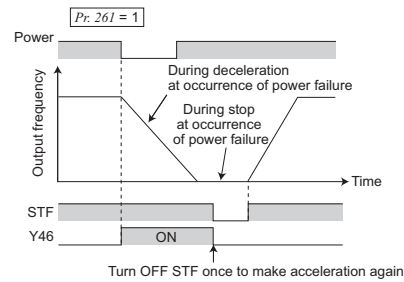

(2) Original operation continuation at instantaneous power failure function (Pr. 261 = "2")

- When power is restored during deceleration after a power failure, acceleration is made again up to the set frequency.

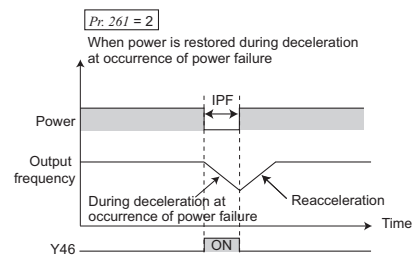

Pr. 267 → Refer to the section about *Pr. 73*.

Pr. 268 → Refer to the section about *Pr. 52*.

Pr. 269 Parameter for manufacturer setting. Do not set.

Pr. 270, 275, 276, 6, 48

Stop-on-contact control AD MFVC GP MFVC

- Pr. 270 Stop-on contact control selection
- Pr. 275 Stop-on contact excitation current low-speed multiplying factor
- Pr. 276 PWM carrier frequency at stop-on contact
- Pr. 6 Multi-speed setting (low speed)
- Pr. 48 Second stall prevention operation current

To ensure accurate positioning at the upper limit etc. of a lift, stop-on-contact control causes a mechanical brake to be closed while the motor is developing a holding torque to keep the load in contact with a mechanical stopper etc.

This function suppresses vibration which is liable to occur when the load is stopped upon contact in vertical motion applications, ensuring steady precise positioning.

Pr. 270 Setting	Description
0 (initial value)	Without stop-on-contact control
1	Stop-on-contact control

- Select advanced magnetic flux vector control or general-purpose magnetic flux vector control.

When both the RT and RL signals are switched on, the inverter enters the stop-on contact mode, in which operation is performed at the frequency set in Pr. 6 Multi-speed setting (low speed) independently of the preceding speed.

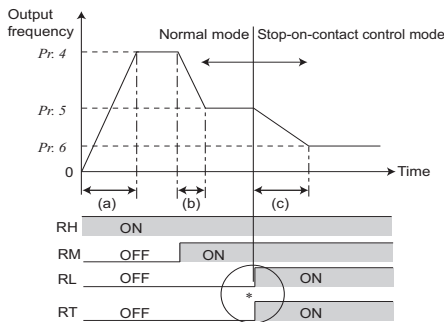

- * Goes into stop-on-contact control when both RL and RT switch ON. RL and RT may be switched on in any order with any time difference.
- (a) Acceleration time (Pr. 7) (b) Deceleration time (Pr. 8)
- (c) Second deceleration time (Pr. 44/Pr. 45)

Pr. Number	Setting Range	Description
6	0 to 400Hz	Sets the output frequency for stop-on-contact control. The frequency should be as low as possible (about 2Hz). If it is set to more than 30Hz, the operating frequency will be 30Hz.
48	0 to 200%	Sets the stall prevention operation level for stall prevention operation level. (Pr. 22 when Pr. 48 = "9999")
275	0 to 300%	Usually set a value between 130% and 180%. Set the force (holding torque) for stop-on-contact control.
	9999	Without compensation.
276	0 to 9	Sets a PWM carrier frequency for stop-on-contact control.
	9999	As set in Pr. 72 PWM frequency selection.

Pr. 278 to 283, 292

Brake sequence function AD MFVC GP MFVC

- Pr. 278 Brake opening frequency
- Pr. 279 Brake opening current
- Pr. 280 Brake opening current detection time
- Pr. 281 Brake operation time at start
- Pr. 282 Brake operation frequency
- Pr. 283 Brake operation time at stop
- Pr. 292 Automatic acceleration/deceleration

This function is used to output from the inverter the mechanical brake operation timing signal in vertical lift and other applications. This function prevents the load from dropping with gravity at a start due to the operation timing error of the mechanical brake or an overcurrent alarm from occurring at a stop, ensuring secure operation.

<Operation example>

- At start: When the start signal is input to the inverter, the inverter starts running. When the internal speed command reaches the value set in Pr. 278 and the output current is not less than the value set in Pr. 279, the inverter outputs the brake opening request signal (BOF) after the time set in Pr. 280 has elapsed.

When the time set in Pr. 281 elapses after the brake opening completion signal (BRI) was activated*, the inverter increases the output frequency to the set speed.

- At stop: When the speed has decreased to the frequency set in Pr. 282, the brake opening request signal (BOF) is turned off. When the time set in Pr. 283 elapses after the brake operation confirmation signal (BRI) was activated*, the inverter output is switched off.

* If Pr. 292 = "8" (mechanical brake opening completion signal not input), this time is the time after the brake opening request signal is output.

1) Pr. 292 = "7" (brake opening completion signal input)

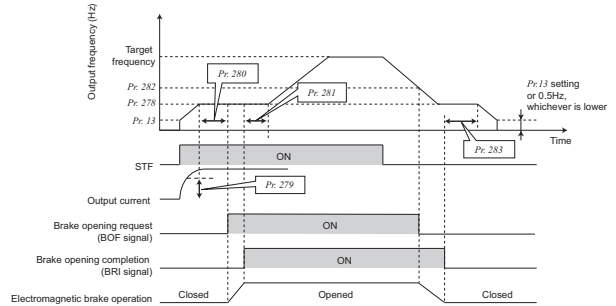

2) Pr. 292 = "8" (brake opening completion signal not input)

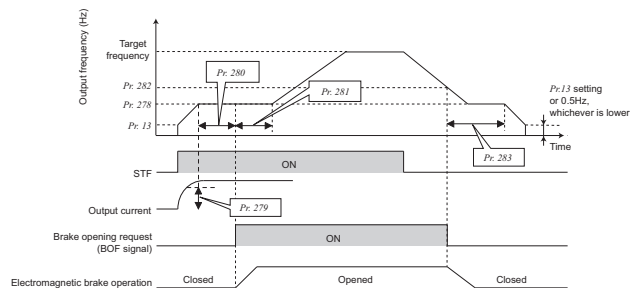

Pr. Number	Setting Range	Description
278	0 to 30Hz	Set to the rated slip frequency of the motor + about 1.0Hz. This parameter may be set only if $Pr. 278 \leq Pr. 282$.
279	0 to 200%	Generally, set this parameter to about 50 to 90%. If the setting is too low, the load is liable to drop due to gravity at start. Suppose that the inverter rated current is 100%.
280	0 to 2s	Generally, set this parameter to about 0.1 to 0.3s.
281	0 to 5s	$Pr. 292 = 7$: Set the mechanical delay time until the brake is loosened. $Pr. 292 = 8$: Set the mechanical delay time until the brake is loosened + about 0.1 to 0.2s.
282	0 to 30Hz	At this frequency, the brake opening request signal (BOF) is switched off. Generally, set this parameter to the $Pr. 278$ setting + 3 to 4Hz. This parameter may be only set if $Pr. 282 \geq Pr. 278$.
283	0 to 5s	$Pr. 292 = 7$: Set the mechanical delay time until the brake is closed + 0.1s. $Pr. 292 = 8$: Set the mechanical delay time until the brake is closed + 0.2 to 0.3s.
292	0, 1, 7, 8, 11	Brake sequence function is made valid when a setting is "7" or "8".

Pr. 286, 287

Droop control AD MFVC

Pr. 286 Droop gain

Pr. 287 Droop filter time constant

This function is designed to balance the load in proportion to the load torque to provide the speed drooping characteristic.

This function is effective for balancing the load when using multiple inverters

Pr. Number	Setting Range	Description
286	0 (initial value)	Droop control is invalid
	0.1 to 100%	Set the drooping amount at the rated torque as a percentage with respect to the rated motor frequency.
287	0.00 to 1.00s	Set the time constant of the filter applied on the torque amount current.

● Droop control

This control is valid when a value other than "0" is set in $Pr. 286$ under advanced magnetic flux vector control.

The maximum droop compensation frequency is 120Hz.

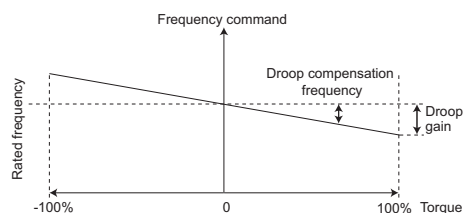

Pr. 292, 293 ➔ Refer to the section about $Pr. 61$.

Pr. 295 ➔ Refer to the section about $Pr. 161$.

Pr. 296, 297

Password function

Pr. 296 Password lock level

Pr. 297 Password lock/unlock

Registering 4-digit password can restrict parameter reading/writing.

● Level of reading/writing restriction by PU/NET mode operation command can be selected by $Pr. 296$.

Pr. 296 Setting	PU Mode Operation Command		NET Mode Operation Command			
	Read	Write	RS-485 Communication		Communication Option	
			Read	Write	Read	Write
9999	○	○	○	○	○	○
0, 100	×	×	×	×	×	×
1, 101	○	×	○	×	○	×
2, 102	○	×	○	○	○	○
3, 103	○	○	○	×	○	×
4, 104	×	×	×	×	○	×
5, 105	×	×	○	○	○	○
6, 106	○	○	×	×	○	×
99, 199	Only parameters registered in the user group can be read/written (For the parameters not registered in the user group, same restriction level as "4, 104" applies.)					

○: enabled, ×: restricted

Pr. Number	Setting Range	Description
297 *1	1000 to 9998	Register a 4-digit password
	(0 to 5) *2	Displays password unlock error count. (Reading only) (Valid when $Pr. 296 = "100"$ to "106")
	9999 (initial value)	No password lock

*1 If the password has been forgotten, perform all parameter clear to unlock the parameter restriction. In that case, other parameters are also cleared.

*2 "0 or 9999" can be entered in $Pr. 297$, but the $Pr. 297$ setting is not overwritten.

Pr. 298 ➔ Refer to the section about $Pr. 82$.

Pr. 299 ➔ Refer to the section about $Pr. 57$.

- Features
- Connection example
- Standard Specifications
- Outline Dimension Drawings
- Terminal Connection Diagram
- Terminal Specification Explanation
- Operation panel Parameter unit FR Configurator
- Parameter List
- Explanations of Parameters
- Protective Functions
- Options
- Instructions
- Motor
- Compatibility
- Warranty
- Inquiry

Pr. 338, 339, 550, 551

Start command source and frequency command source during communication operation

Pr. 338 Communication operation command source Pr. 339 Communication speed command source
Pr. 550 NET mode operation command source selection Pr. 551 PU mode operation command source selection

When the RS-485 communication with the PU connector or communication option is used, the external start command and frequency command can be made valid. Command source in the PU operation mode can be selected.

Pr. Number	Setting Range	Description
338	0 (initial value)	Start command source communication
	1	Start command source external
339	0 (initial value)	Frequency command source communication
	1	Frequency command source external
	2	Frequency command source external (\$\$When there is no external input, the frequency command via communication is valid, and the frequency command from terminal 2 is invalid.)
550*	0	The communication option is the command source in the NET operation mode.
	2	PU connector is the command source in the NET operation mode.
	9999 (initial value)	Automatic communication option recognition Normally, PU connector is valid. When a communication option is mounted, the communication option is valid.
551*	2	PU connector is the command source in the PU operation mode.
	3	USB connector is the command source in the PU operation mode.
	4	Operation panel is the command source in the PU operation mode.
	9999 (initial value)	USB automatic recognition Normally, operation panel is the command source. When the PU (FR-PU07) is connected to the PU connector, PU is the command source. When USB is connected, USB is the command source.

* This parameter allows its setting to be changed in any operation mode even if "0 (initial value) or 1" is set in Pr. 77 Parameter write selection.

Pr. 340 ➔ Refer to the section about Pr. 79.

Pr. 342, 343 ➔ Refer to the section about Pr. 117.

Pr. 450 ➔ Refer to the section about Pr. 71.

Pr. 495 to 497

Remote output function (REM signal)

Pr. 495 Remote output selection Pr. 496 Remote output data 1
Pr. 497 Remote output data 2

You can utilize the on/off of the inverter's output signals instead of the remote output terminal of the programmable controller.

Pr. Number	Setting Range	Description
495	0 (initial value)	Remote output data clear at powering off
	1	Remote output data held at powering off
	10	Remote output data clear at powering off
	11	Remote output data held at powering off
496*	0 to 4095	Remote output data is cleared during an inverter reset
497*	0 to 4095	
Refer to the following diagram.		

* The above parameters allow its setting to be changed during operation in any operation mode even if "0" (initial value) is set in Pr. 77 Parameter write selection.

<Remote output data>

Pr. 496

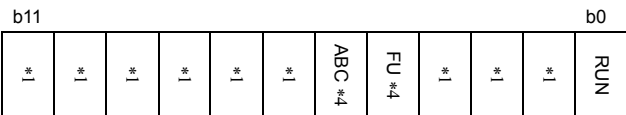

Pr. 497

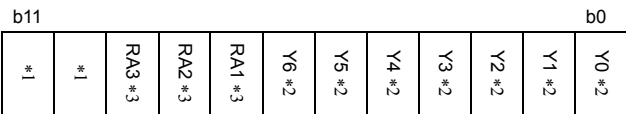

- *1 Optional (always 0 when read)
- *2 Y0 to Y6 are available only when the extension output option (FR-A7AY E kit) is fitted
- *3 RA1 to RA3 are available only when the relay output option (FR-A7AR E kit) is fitted
- *4 Optional for the CC-Link communication model (always "0" when read)

Pr. 502 ➔ Refer to the section about Pr. 117.

Pr. 503, 504

Maintenance of parts

Pr. 503 Maintenance timer Pr. 504 Maintenance timer alarm output set time

When the cumulative energization time of the inverter reaches the parameter set time, the maintenance timer output signal (Y95) is output. MT (MT) is displayed on the operation panel.

This can be used as a guideline for the maintenance time of peripheral devices.

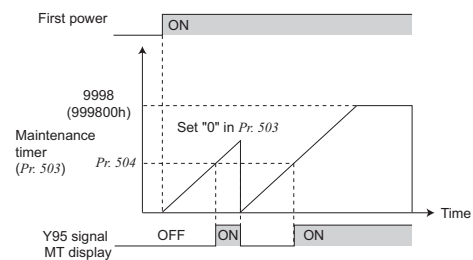

- The cumulative energization time of the inverter is stored into the EEPROM every hour and indicated in Pr. 503 Maintenance timer in 100h increments. Pr. 503 is clamped at 9998 (999800h).

Pr. 547, 548

Inverter setup using USB communication

Pr. 547 USB communication station number *Pr. 548 USB communication check time interval*

Inverter setup with setup software (FR Configurator) can be easily performed by USB communication. (FR Configurator supports the standard control circuit terminal model only.)

Pr. Number	Setting Range	Description
547	0 (initial value)	Set the station number of USB device (inverter) within the range "0 to 31".
	1 to 31	
548	0 to 999.8	Set the communication check time interval of USB communication. If data is not received within the time set in <i>Pr. 548</i> , EUSB (E.USB) is displayed.
	9999 (initial value)	Communication time interval is not checked.

Pr. 549 ➔ Refer to the section about *Pr. 117*.

Pr. 550, 551 ➔ Refer to the section about *Pr. 338*.

Pr. 555 to 557

Current average value monitor signal

Pr. 555 Current average time *Pr. 556 Data output mask time*

Pr. 557 Current average value monitor signal output reference current

The average value of the output current during constant speed operation and the maintenance timer value are output as a pulse to the current average value monitor signal (Y93).

The pulse width output to the I/O module of the programmable controller or the like can be used as a guideline due to abrasion of machines and elongation of belt and for aged deterioration of devices to know the maintenance time.

The current average value monitor signal (Y93) is output as pulse for 20s as 1 cycle and repeatedly output during constant speed operation.

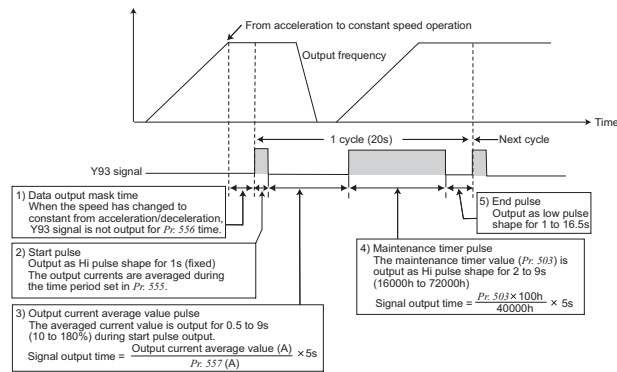

Pr. 563, 564 ➔ Refer to the section about *Pr. 52*.

Pr. 571 ➔ Refer to the section about *Pr. 13*.

Pr. 611 ➔ Refer to the section about *Pr. 57*.

Pr. 653

Reduce mechanical resonance

Pr. 653 Speed smoothing control

Mechanical vibration produced while motor is driving (resonance) can be reduced. Set 100% in *Pr. 653* and check if the vibration will be reduced. Make adjustment gradually increasing the setting, until the vibration become the smallest.

Pr. 665, 882, 883, 885, 886

Regeneration avoidance function

Pr. 665 Regeneration avoidance frequency gain *Pr. 882 Regeneration avoidance operation selection*

Pr. 883 Regeneration avoidance operation level *Pr. 885 Regeneration avoidance compensation frequency limit value*

Pr. 886 Regeneration avoidance voltage gain

This function detects a regeneration status and increases the frequency to avoid the regenerative status.

- Possible to avoid regeneration by automatically increasing the frequency and continue operation if the fan happens to rotate faster than the set speed due to the effect of another fan in the same duct.

Pr. Number	Setting Range	Description
882	0 (initial value)	Regeneration avoidance function invalid
	1	Regeneration avoidance function is always valid
	2	Regeneration avoidance function is valid only during a constant speed operation
883	300 to 800V	Set the bus voltage level at which regeneration avoidance operates. When the bus voltage level is set to low, overvoltage error will be less apt to occur. However, the actual deceleration time increases. The set value must be higher than the "power supply voltage $\times \sqrt{2}$ ".
885	0 to 10Hz	Set the limit value of frequency which rises at activation of regeneration avoidance function.
	9999	Frequency limit invalid
886	0 to 200%	Adjusts responsiveness at activation of regeneration avoidance. A larger setting will improve responsiveness to the bus voltage change. However, the output frequency could become unstable. When the load inertia of the motor is large, decrease the <i>Pr. 886</i> setting. When vibration is not suppressed by decreasing the <i>Pr. 886</i> setting, set a smaller value in <i>Pr. 665</i> .
665		

* For single-phase 100V power input model, "power input voltage $\times 2 \times \sqrt{2}$ ".

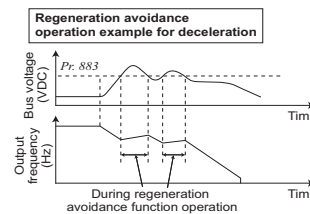

Pr. 800 ➔ Refer to the section about *Pr. 80*.

Pr. 859 ➔ Refer to the section about *Pr. 82*.

Pr. 872 ➔ Refer to the section about *Pr. 251*.

Pr. 888, 889

Free parameter

Pr. 889 Free parameter 1

Pr. 889 Free parameter 2

Parameters you can use for your own purposes.

You can input any number within the setting range 0 to 9999.

For example, the number can be used:

- As a unit number when multiple units are used.
- As a pattern number for each operation application when multiple units are used.
- As the year and month of introduction or inspection.

Pr.C0(900) Adjustment of terminal FM output (calibration)

C0 (Pr. 900) FM terminal calibration

By using the operation panel or PU (FR-PU07), you can calibrate terminal FM to full scale deflection.

FM terminal calibration (C0 (Pr. 900))

- The terminal FM is preset to output pulses. By setting the calibration parameter C0 (Pr. 900), the meter connected to the inverter can be calibrated by parameter setting without use of a calibration resistor.
- Using the pulse train output of the terminal FM, a digital display can be provided by a digital counter. The monitor value is 1440 pulses/s output at the full-scale value of Pr. 54 FM terminal function selection.

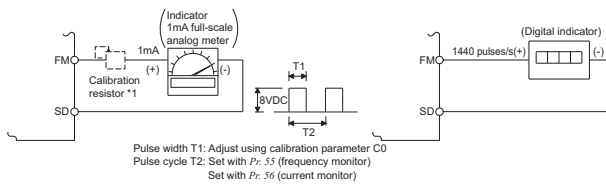

- *1 Not needed when the operation panel or PU (FR-PU07) is used for calibration. Use a calibration resistor when the indicator (frequency meter) needs to be calibrated by a neighboring device because the indicator is located far from the inverter. However, the frequency meter needle may not deflect to full-scale if the calibration resistor is connected. In this case, use this resistor and operation panel or PU (FR-PU07) together.

Pr.C2(902) to C7(905), C22(922) to C25(923) ➡ Refer to the section about Pr. 125.

Pr.990 Buzzer control of the operation panel

Pr. 990 PU buzzer control

You can make the buzzer "beep" when you press key of the operation panel and parameter unit (FR-PU04/FR-PU07)

Pr. 990 Setting	Description
0	Without buzzer
1 (initial value)	With buzzer

Pr.991 PU contrast adjustment

Pr. 991 PU contrast adjustment

Contrast adjustment of the LCD of the parameter unit (FR-PU04/FR-PU07) can be performed.

Decreasing the setting value makes contrast light.

Pr. 991 Setting	Description
0 to 63	0: Light ↓ 63: Dark

Pr.CL, ALLC, Er.CL, CH

Clear parameter, initial value change list

Pr.CL Parameter clear

ALLC All parameter clear

Er.CL Fault history clear

Pr.CH Initial value change list

- Set "1" in Pr.CL parameter clear to initialize all parameters. (Calibration parameters are not cleared.)*
- Set "1" in ALLC All parameter clear to initialize all parameters.*
- Set "1" in Er.CL Fault history clear to clear fault history.
- Using Pr.CH Initial value change list, only the parameters changed from the initial value can be displayed.

* Parameters are not cleared when "1" is set in Pr. 77 Parameter write selection.

To perform energy-saving operation for an application such as a fan or pump

To perform energy-saving operation for an application such as a fan or pump, set the parameters as follows.

(1) Load pattern selection (Pr. 14) **V/F**

Optimal output characteristics (V/F characteristics) can be selected for application or load characteristics.

- Set "1" (for variable-torque load) in Pr. 14 Load pattern selection.

- The output voltage will change in square curve against the output frequency at the base frequency or lower.

Set this parameter when driving a load with load torque change proportionally against the square of the rotation speed, such as a fan or pump.

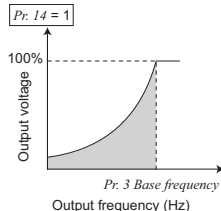

(2) Energy saving control (Pr. 60) **V/F**

Inverter will perform energy saving control automatically even when the detailed parameter settings are made.

It is appropriate for an application such as a fan or pump.

- Set Pr. 60 Energy saving control selection = "9" (Optimum excitation control mode).
- The Optimum excitation control is a control method to decide the output voltage by controlling the excitation current so the efficiency of the motor is maximized.
- The energy saving effect cannot be expected when the motor capacity is extremely smaller than the inverter capacity, or when multiple motors are connected to one inverter.

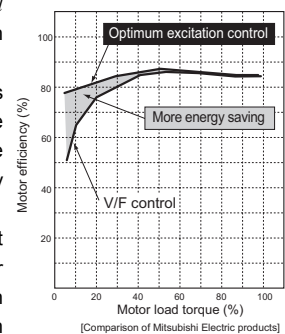

Protective Functions

When a fault occurs, the inverter output is shut off and the PU display automatically changes to any of the following fault or alarm indications.

	Function Name	Description	Display
Error message *2	Operation panel lock	Appears when operation was tried during operation panel lock.	HOLD
	Password locked	Password function is active. Display and setting of parameter is restricted.	LOCd
	Parameter write error	Appears when an error occurred during parameter writing.	Er 1 to Er 4
Warnings *3	Inverter reset	Appears when the RES signal is on.	Err.
	Stall prevention (overcurrent)	Appears during overcurrent stall prevention.	OL
	Stall prevention (overvoltage)	Appears during overvoltage stall prevention. Appears while the regeneration avoidance function is activated.	oL
	Regenerative brake pre-alarm *7	Appears if the regenerative brake duty reaches or exceeds 85% of the Pr. 70 Special regenerative brake duty value. If the regenerative brake duty reaches 100%, a regenerative overvoltage (E. OV_) occurs.	rb
	Electronic thermal relay function pre-alarm	Appears when the electronic thermal O/L relay has reached 85% of the specified value.	TH
	PU stop	Appears when  on the operation panel was pressed during external operation.	PS
	Maintenance signal output *7	Appears when the cumulative energization time has exceeded the maintenance output timer set value.	MF
	Undervoltage	Appears when the main circuit power became low voltage.	Uv
	Safety stop *10	Appears when safety stop function is activated (during output shutoff).	SR
	24V external power supply operation *11	Blinks when the main circuit power is not supplied and the 24V external power is being input.	E _v
Alarms *4	Fan alarm	Appears when the cooling fan remains stopped when operation is required or when the speed has decreased.	F _n
	Overcurrent trip during acceleration	Appears when an overcurrent occurred during acceleration.	EOC1
Fault *5	Overcurrent trip during constant speed	Appears when an overcurrent occurred during constant speed operation.	EOC2
	Overcurrent trip during deceleration or stop	Appears when an overcurrent occurred during deceleration and at a stop.	EOC3
	Regenerative overvoltage trip during acceleration	Appears when an overvoltage occurred during acceleration.	EOv1
	Regenerative overvoltage trip during constant speed	Appears when an overvoltage occurred during constant speed operation.	EOv2
	Regenerative overvoltage trip during deceleration or stop	Appears when an overvoltage occurred during deceleration and at a stop.	EOv3
	Inverter overload trip (electronic thermal O/L relay function)	Appears when the electronic thermal relay function for inverter element protection was activated.	ETHI
	Motor overload trip (electronic thermal O/L relay function) *1	Appears when the electronic thermal relay function for motor protection was activated.	ETHM
	Heatsink overheat	Appears when the heatsink overheated.	EFIN
	Input phase loss *8*9	May appear when one phase voltage is lost or differs greatly from others in three-phases power supply.	EILF
	Stall prevention stop	Appears when the output frequency drops to 1Hz as a result of deceleration due to the excess motor load.	EOLT
	Brake transistor alarm detection	This function stops the inverter output if an alarm occurs in the brake circuit, e.g. damaged brake transistors. In this case, the inverter must be powered off immediately.	E. bE
	Output side earth (ground) fault overcurrent at start *7	Appears when an earth (ground) fault occurred on the inverter's output side. (detects only at a start)	E. GF
	Output phase loss	If one of the three phases (U, V, W) on the inverter's output side (load side) is lost during inverter operation (except during DC injection brake operation and when output frequency is under 1Hz), inverter stops the output.	E. LF
	External thermal relay operation *6*7*12	Appears when the external thermal relay connected to the OH signal was activated.	EOHT
	Option fault	Appears when communication option is connected during password lock (Pr. 296 Password lock level = "0, 100").	EOPF
	Communication option fault	Appears when a communication error occurred in the communication option.	EOP1
	Option fault	Appears when a contact fault or the like of the connector between the inverter and communication option occurs.	E. 1
	Parameter storage device fault	Appears when operation of the element where parameters stored became abnormal. (control board)	E. PE
	Internal board fault	When a combination of control board and main circuit board is wrong, the inverter is tripped.	EPE2
	PU disconnection *12	Appears when a communication error between the PU and inverter occurred, the communication interval exceeded the permissible time during the RS-485 communication with the PU connector, or communication errors exceeded the number of retries during the RS-485 communication.	EPUE
	Retry count excess *7	Appears when the operation was not restarted within the set number of retries.	ErEr
	CPU fault	Appears during the CPU and peripheral circuit errors occurred.	E. 51
			E. 61
	Inrush current limit circuit fault	Appears when the resistor of the inrush current limit circuit overheated.	E. 71
			E.CPU
	Analog input fault *12	Appears if voltage (current) is input to terminal 4 when the setting in Pr.267 Terminal 4 input selection and the setting of voltage/current input switch are different.	EAI E
	Brake sequence error *7*13	The inverter output is stopped when a sequence error occurs during use of the brake sequence function (Pr. 278 to Pr. 285).	ENb4 to ENb9
	USB communication fault *14	Appears when USB communication error occurred.	EUSb
	Safety circuit fault *10	Stop the inverter output when an internal circuit fault occurred.	ESRF
	Internal circuit fault	Appears when an internal circuit error occurred.	E. 13

*1 Resetting the inverter initializes the internal thermal integrated data of the electronic thermal relay function.
 *2 The error message shows an operational error. The inverter output is not shut off.
 *3 Warnings are messages given before fault occur. The inverter output is not shut off.
 *4 Alarms warn the operator of failures with output signals. The inverter output is not shut off.
 *5 When faults occur, the protective functions are activated to inverter trip and output the fault signals.
 *6 The external thermal operates only when the OH signal is set in Pr. 178 to Pr. 184 (input terminal function selection).
 *7 This protective function does not function in the initial status.
 *8 Protective function activates when Pr. 872 Input phase loss protection selection = "1".
 *9 Available for only three-phase power input models.
 *10 This protective function does not function for the standard control circuit terminal model or the built-in Ethernet communication function model.
 *11 This protective function is available for the safety stop function model (with the FR-E7DS), FL remote communication model, and CC-Link communication model.
 *12 This protective function does not function for the FL remote communication model, the CC-Link communication model, and the dedicated EtherCAT communication model.
 *13 This protective function does not function for the FL remote communication model and the dedicated EtherCAT communication model.
 *14 This protective function does not function for the FL remote communication model.

- Features
- Connection example
- Standard Specifications
- Outline Dimension Drawings
- Terminal Connection Diagram Terminal Specification Explanation
- Operation panel Parameter unit FR Configurator
- Parameter List
- Explanations of Parameters
- Protective Functions
- Options
- Instructions
- Motor
- Compatibility
- Warranty
- Inquiry

Option and Peripheral Devices

Option list

By fitting the following options to the inverter, the inverter is provided with more functions.
One type of plug-in option can be mounted.

Name		Model	Applications, Specifications, etc.	Applicable Inverter*1	
Plug-in type	16-bit digital input	FR-A7AX E kit	<ul style="list-style-type: none"> This input interface sets the high frequency accuracy of the inverter using an external BCD or binary digital signal. BCD code 3 digits (maximum 999) Binary 12 bits (maximum FFFH) BCD code 4 digits (maximum 9999) Binary 16 bits (maximum FFFFH) 	Standard control circuit terminal model	
		FR-A7A E kit cover SC and FR-A7AX *2		Safety stop function model	
	Digital output Extension analog output	FR-A7AY E kit	<ul style="list-style-type: none"> This option provides the inverter with open collector outputs selected from among the standard output signals. This option adds two different signals that can be monitored at the terminals AM0 and AM1, such as the output frequency, output voltage and output current. 20mADC or 10VDC meter can be connected. 	Standard control circuit terminal model	
		FR-A7A E kit cover SC and FR-A7AY *2		Safety stop function model	
	Relay output	FR-A7AR E kit	<ul style="list-style-type: none"> This option provides the inverter with three different relay contact outputs selected from among the standard output signals. 	Standard control circuit terminal model	
		FR-A7A E kit cover SC and FR-A7AR *2		Safety stop function model	
	24VDC input	FR-E7DS	<ul style="list-style-type: none"> Connecting a 24V external power supply allows maintaining the I/O terminal function and the operation panel function (indication and key operation) even at power-OFF of inverter's main circuit power supply. 	Safety stop function model	
	Communication	CC-Link communication	FR-A7NC E kit	<ul style="list-style-type: none"> This option allows the inverter to be operated or monitored or the parameter setting to be changed from programmable controller, etc. 	Standard control circuit terminal model
			FR-A7NC E kit cover SC and FR-A7NC*2		Safety stop function model
		LONWORKS communication	FR-A7NL E kit		Standard control circuit terminal model
			FR-A7NL E kit cover SC and FR-A7NL*2		Safety stop function model
		DeviceNet communication	FR-A7ND E kit		Standard control circuit terminal model
			FR-A7ND E kit cover SC and FR-A7ND*2		Safety stop function model
		PROFIBUS-DP communication	FR-A7NP E kit		Standard control circuit terminal model
FR-A7NP E kit cover SC and FR-A7NP*2	Safety stop function model				
EtherCAT communication	E7NECT_2P*3	Dedicated EtherCAT communication model			
Control terminal	RS-485 2-port terminal block	FR-E7TR	Multi-drop connection is easy with the 2 port terminal block adapted for EIA-485 (RS-485) communication terminal.	Standard control circuit terminal model Ethernet communication function model	

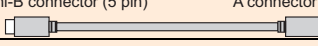
Name	Model	Applications, Specifications, etc.	Applicable Inverter*1
Parameter unit (8 languages)	FR-PU07	Interactive parameter unit with LCD display	Standard control circuit terminal model Safety stop function model Ethernet communication function model
Parameter unit with battery pack	FR-PU07BB	This parameter unit enables parameter setting without connecting the inverter to power supply.	
Enclosure surface operation panel	FR-PA07	This operation panel enables inverter operation and monitoring of frequency, etc. from the enclosure surface	
Parameter unit connection cable	FR-CB20□	Cable for connection of operation panel or parameter unit □ indicates a cable length. (1m, 3m, 5m)	
USB cable	MR-J3USBCBL3M Cable length 3m	Connector for amplifier mini-B connector (5 pin) Connector for personal computer A connector 	
Intercompatibility attachment	FR-E7AT01 to 03	For installation of a FR-E700 series inverter to the installation holes of FR-A024/A044 series inverter.	
DIN rail attachment	FR-UDA01 to 03	Attachment for installation on DIN rail	
Panel through attachment	FR-E7CN01 to 06	Using this attachment dissipates about 70% of the inverter's heat by having the inverter heatsink protrude from the back side of the enclosure.	
Totally enclosed structure specification attachment for the FR-E700 series	FR-E7CV01 to 04	Installing the attachment to the inverter changes the protective structure of the inverter to the totally enclosed structure (IP40 equivalent as specified by JEM1030).	
AC reactor	FR-HAL	For harmonic current reduction and inverter input power factor improvement	
DC reactor	FR-HEL		
EMC Directive compliant noise filter	SF, FR-E5NF, FR-S5NFSA	EMC Directive (EN61800-3 C3) compliant noise filter	All capacities. The option's model varies with the inverter's model.
EMC compliant EMC filter installation attachment	FR-A5AT03	For installation of the inverter to the EMC Directive compliant EMC filter (SF).	11K of the 200V class
	FR-AAT02		15K of the 200V class, and 11K and 15K of the 400V class
	FR-E5T(-02)		2.2K to 7.5K of the 200V class. The option's model varies with the inverter's model.
Radio noise filter	FR-BIF(H)	For radio noise reduction (connect to the input side)	All capacities.
Line noise filter	FR-BSF01, FR-BLF	For line noise reduction	
Filterpack	FR-BFP2	Combination of power factor improving DC reactor, common mode choke, and capacitive filter	0.4K or higher of the three-phase power input model. The option's model varies with the inverter's model.
Brake resistor	MRS type, MYS type	For increasing the regenerative braking capability (permissible duty 3%ED)	0.4K or higher. The option's model varies with the inverter's model.
High-duty brake resistor	FR-ABR	For increasing the regenerative braking capability (permissible duty 10%/6%ED)	
Brake unit, Resistor unit, Discharging resistor	FR-BU2, FR-BR, GZG, GRZG type	For increasing the braking capability of the inverter (for high-inertia load or negative load) Brake unit, electrical-discharge resistor and resistor unit are used in combination	
Power regeneration common converter Stand-alone reactor dedicated for the FR-CV	FR-CV FR-CVL	Unit which can return motor-generated braking energy back to the power supply in common converter system	All capacities of the standard control circuit terminal model and safety stop function model. The option's model varies with the inverter's model.
High power factor converter	FR-HC2	The high power factor converter switches the converter section on/off to reshape an input current waveform into a sine wave, greatly suppressing harmonics. (Used in combination with the standard accessory.)	
Surge voltage suppression filter	FR-ASF	Filter for suppressing surge voltage on motor	All capacities of the 400V class. The option's model varies with the inverter's model.
	FR-BMF		5.5K or higher of the 400V class. The option's model varies with the inverter's model.

Stand-alone shared

- Features
- Connection example
- Standard Specifications
- Outline Dimension Drawings
- Terminal Connection Diagram Terminal Specification Explanation
- Operation panel Parameter unit FR Configurator
- Parameter List
- Explanations of Parameters
- Protective Functions
- Options
- Instructions
- Motor
- Compatibility
- Warranty
- Inquiry

Name		Model	Applications, Specifications, etc.	Applicable Inverter*1	
FR series manual controller/speed controller	Manual controller	FR-AX	For independent operation. With frequency meter, frequency potentiometer and start switch.	All capacities.	
	DC tach. follower	FR-AL	For synchronous operation (1VA) by external signal (0 to 5V, 0 to 10V DC)*4		
	Three speed selector	FR-AT	For three speed switching, among high, middle and low speed operation (1.5VA)*4		
	Motorized speed setter	FR-FK	For remote operation. Allows operation to be controlled from several places (5VA)*4		
	Ratio setter	FR-FH	For ratio operation. The ratios of five inverters can be set (3VA)*4		
	Speed detector	FR-FP	For tracking operation by a pilot generator (PG) signal (2VA)*4		
	Master controller	FR-FG	Master controller (5VA) for parallel operation of multiple (maximum 35) inverters.*4		
	Soft starter	FR-FC	For soft start and stop. Enables acceleration/deceleration in parallel operation (3VA)*4		
	Deviation detector	FR-FD	For continuous speed control operation. Used in combination with a deviation sensor or synchro (5VA)*4		
	Preamplifier	FR-FA	Used as an A/V converter or arithmetic amplifier (3VA)*4		
Others	Pilot generator	QVAH-10	For tracking operation. 70V/35VAC 500Hz (at 2500r/min)	Standard control circuit terminal model, safety stop function model, CC-Link communication model	
	Deviation sensor	YVGC-500W-NS	For continuous speed control operation (mechanical deviation detection) Output 90VAC/90°C		
	Frequency setting potentiometer	WA2W 1kΩ	For frequency setting. Wire-wound 2W 1kΩ type B characteristic		
	Analog frequency meter (64mm × 60mm)	YM206NRI 1mA	Dedicated frequency meter (graduated to 130Hz). Moving-coil type DC ammeter		
	Calibration resistor	RV24YN 10kΩ	For frequency meter calibration. Carbon film type B characteristic		
	FR Configurator SW3 (VFD setup software)	FR-SW3-SETUP-WE	Supports an inverter startup to maintenance.		Ethernet communication function model
	FR Configurator2 (Inverter setup software)	SW1DND-FRC2	Supports an inverter startup to maintenance.		

*1 The connectable inverter models or applicable capacities differ for each option. (To check the inverter lineup, refer to page 8.)

*2 Prepare both the dedicated E kit cover and the plug-in option unit.

*3 Manufactured by HMS Industrial Networks AB

*4 Rated power consumption. The power supply specifications of the FR series manual controllers and speed controllers are 200VAC 50Hz, 220V/220VAC 60Hz, and 115VAC 60Hz.

Control terminal option

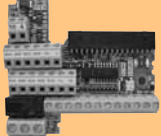
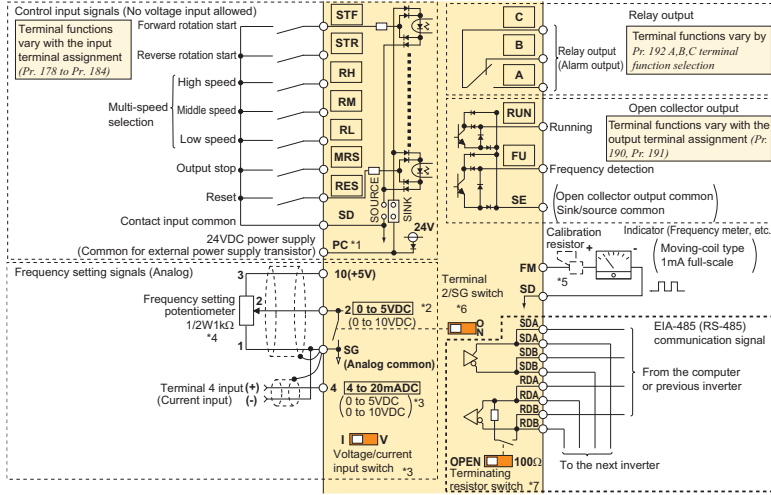
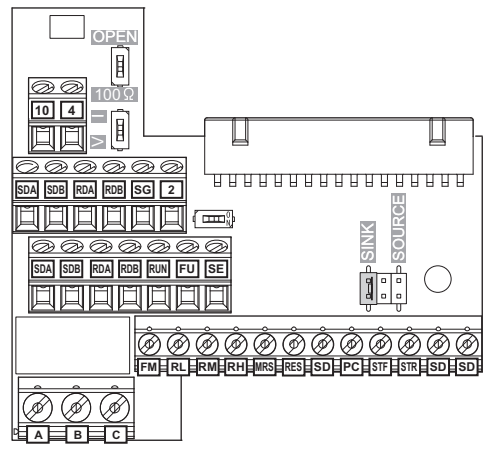
Name (Model)	Specifications, Structure, etc.																																											
<p>RS-485 2port terminal block FR-E7TR</p> 	<ul style="list-style-type: none"> Use the option in exchange with standard control circuit terminals. (This option cannot be used simultaneously with the operation panel (FR-PA07) or parameter unit (FR-PU07).) Terminal connection diagram  <p>● Communication</p> <table border="1" style="width:100%; border-collapse: collapse;"> <thead> <tr style="background-color: #fff9c4;"> <th>Item</th> <th>Description</th> </tr> </thead> <tbody> <tr> <td>Communication protocol</td> <td>Mitsubishi inverter protocol (computer link communication), MODBUS RTU protocol</td> </tr> <tr> <td>Conforming standard</td> <td>EIA-485 (RS-485)</td> </tr> <tr> <td>Number of connectable devices</td> <td>32 units maximum</td> </tr> <tr> <td>Communication speed</td> <td>4800/9600/19200/38400bps</td> </tr> <tr> <td>Communication method</td> <td>Half-duplex system</td> </tr> <tr> <td>Terminating resistor</td> <td>100Ω (valid/invalid can be changed with a terminating resistor switch)</td> </tr> </tbody> </table> <p>● Terminal layout</p>  <p>● Control terminal specifications</p> <table border="1" style="width:100%; border-collapse: collapse;"> <thead> <tr style="background-color: #fff9c4;"> <th>Terminal Symbol</th> <th>Terminal Name</th> <th>Description</th> </tr> </thead> <tbody> <tr> <td rowspan="4" style="writing-mode: vertical-rl; transform: rotate(180deg);">RS-485 communication</td> <td>SDA (2 points)</td> <td>Inverter send+</td> <td>Sending signal output terminal from the inverter.</td> </tr> <tr> <td>SDB (2 points)</td> <td>Inverter send-</td> <td>Inverse sending signal output terminal from the inverter.</td> </tr> <tr> <td>RDA (2 points)</td> <td>Inverter receive+</td> <td>Receive signal input terminal of the inverter. Changing the terminating resistor switch to "100Ω" side connects the inverter to the 100Ω terminating resistor.</td> </tr> <tr> <td>RDB (2 points)</td> <td>Inverter receive-</td> <td>Receive signal input terminal of the inverter. Changing the terminating resistor switch to "100Ω" side connects the inverter to the 100Ω terminating resistor.</td> </tr> <tr> <td rowspan="3" style="writing-mode: vertical-rl; transform: rotate(180deg);">Frequency setting</td> <td>10</td> <td>Frequency setting power supply</td> <td>Used as power supply when connecting potentiometer for frequency setting (speed setting) from outside of the inverter. (Specifications are the same as the standard control circuit terminal)</td> </tr> <tr> <td>2</td> <td>Frequency setting (voltage)/ Common terminal</td> <td>Inputting 0 to 5VDC (or 0 to 10V) provides the maximum output frequency at 5V (10V) and makes input and output proportional. (Specifications are the same as the standard control circuit terminal) Set terminal 2/SG switch to the right position (ON) to change terminal 2 to terminal SG to pass a shielded wire across terminal SG during RS-485 communication. In this case, voltage at terminal 2 is 0V input.</td> </tr> <tr> <td>4</td> <td>Frequency setting (current)</td> <td>Inputting 4 to 20mA DC (or 0 to 5V, 0 to 10V) provides the maximum output frequency at 20mA and makes input and output proportional. (Specifications are the same as the standard control circuit terminal)</td> </tr> <tr> <td>SG</td> <td>RS-485 communication common, Analog common</td> <td>Common terminal of RS-485 communication and frequency setting signal (terminal 2 or terminal 4). Do not earth (ground).</td> </tr> </tbody> </table> <p>* Specifications of contact input (STF, STR, RH, RM, RL, MRS, RES, SD, PC) and output signal (A, B, C, RUN, FU, SE, FM) are the same as the standard control circuit terminal.</p>	Item	Description	Communication protocol	Mitsubishi inverter protocol (computer link communication), MODBUS RTU protocol	Conforming standard	EIA-485 (RS-485)	Number of connectable devices	32 units maximum	Communication speed	4800/9600/19200/38400bps	Communication method	Half-duplex system	Terminating resistor	100Ω (valid/invalid can be changed with a terminating resistor switch)	Terminal Symbol	Terminal Name	Description	RS-485 communication	SDA (2 points)	Inverter send+	Sending signal output terminal from the inverter.	SDB (2 points)	Inverter send-	Inverse sending signal output terminal from the inverter.	RDA (2 points)	Inverter receive+	Receive signal input terminal of the inverter. Changing the terminating resistor switch to "100Ω" side connects the inverter to the 100Ω terminating resistor.	RDB (2 points)	Inverter receive-	Receive signal input terminal of the inverter. Changing the terminating resistor switch to "100Ω" side connects the inverter to the 100Ω terminating resistor.	Frequency setting	10	Frequency setting power supply	Used as power supply when connecting potentiometer for frequency setting (speed setting) from outside of the inverter. (Specifications are the same as the standard control circuit terminal)	2	Frequency setting (voltage)/ Common terminal	Inputting 0 to 5VDC (or 0 to 10V) provides the maximum output frequency at 5V (10V) and makes input and output proportional. (Specifications are the same as the standard control circuit terminal) Set terminal 2/SG switch to the right position (ON) to change terminal 2 to terminal SG to pass a shielded wire across terminal SG during RS-485 communication. In this case, voltage at terminal 2 is 0V input.	4	Frequency setting (current)	Inputting 4 to 20mA DC (or 0 to 5V, 0 to 10V) provides the maximum output frequency at 20mA and makes input and output proportional. (Specifications are the same as the standard control circuit terminal)	SG	RS-485 communication common, Analog common	Common terminal of RS-485 communication and frequency setting signal (terminal 2 or terminal 4). Do not earth (ground).
Item	Description																																											
Communication protocol	Mitsubishi inverter protocol (computer link communication), MODBUS RTU protocol																																											
Conforming standard	EIA-485 (RS-485)																																											
Number of connectable devices	32 units maximum																																											
Communication speed	4800/9600/19200/38400bps																																											
Communication method	Half-duplex system																																											
Terminating resistor	100Ω (valid/invalid can be changed with a terminating resistor switch)																																											
Terminal Symbol	Terminal Name	Description																																										
RS-485 communication	SDA (2 points)	Inverter send+	Sending signal output terminal from the inverter.																																									
	SDB (2 points)	Inverter send-	Inverse sending signal output terminal from the inverter.																																									
	RDA (2 points)	Inverter receive+	Receive signal input terminal of the inverter. Changing the terminating resistor switch to "100Ω" side connects the inverter to the 100Ω terminating resistor.																																									
	RDB (2 points)	Inverter receive-	Receive signal input terminal of the inverter. Changing the terminating resistor switch to "100Ω" side connects the inverter to the 100Ω terminating resistor.																																									
Frequency setting	10	Frequency setting power supply	Used as power supply when connecting potentiometer for frequency setting (speed setting) from outside of the inverter. (Specifications are the same as the standard control circuit terminal)																																									
	2	Frequency setting (voltage)/ Common terminal	Inputting 0 to 5VDC (or 0 to 10V) provides the maximum output frequency at 5V (10V) and makes input and output proportional. (Specifications are the same as the standard control circuit terminal) Set terminal 2/SG switch to the right position (ON) to change terminal 2 to terminal SG to pass a shielded wire across terminal SG during RS-485 communication. In this case, voltage at terminal 2 is 0V input.																																									
	4	Frequency setting (current)	Inputting 4 to 20mA DC (or 0 to 5V, 0 to 10V) provides the maximum output frequency at 20mA and makes input and output proportional. (Specifications are the same as the standard control circuit terminal)																																									
SG	RS-485 communication common, Analog common	Common terminal of RS-485 communication and frequency setting signal (terminal 2 or terminal 4). Do not earth (ground).																																										

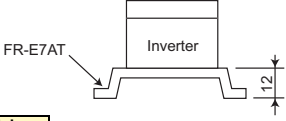
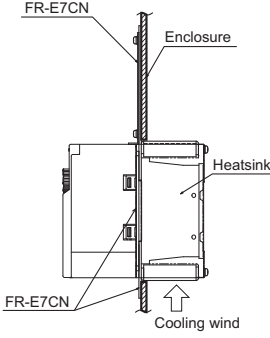

- Features
- Connection example
- Standard Specifications
- Outline Dimension Drawings
- Terminal Connection Diagram Specification Explanation
- Operation panel Parameter unit FR Configurator
- Parameter List
- Explanations of Parameters
- Protective Functions
- Options
- Instructions
- Motor
- Compatibility
- Warranty
- Inquiry

Stand-alone option

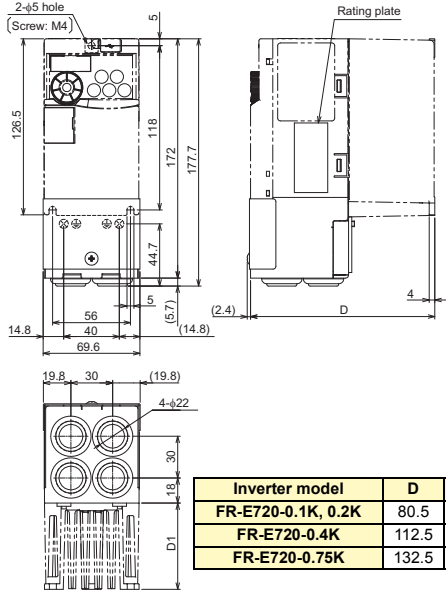
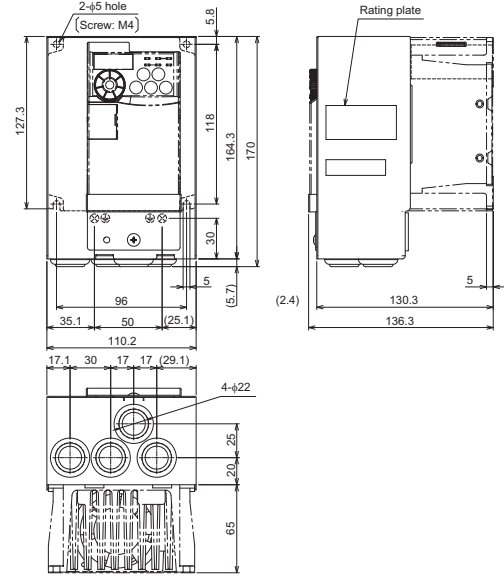
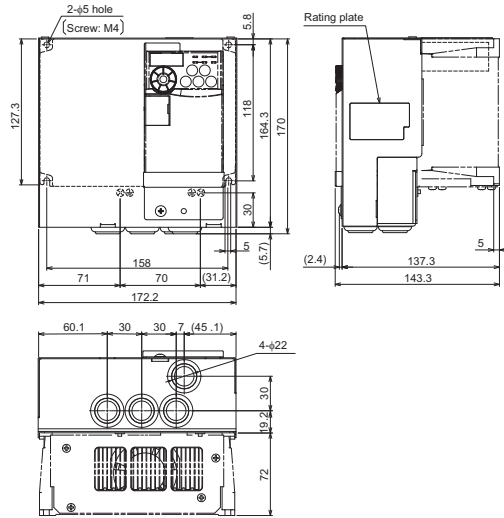
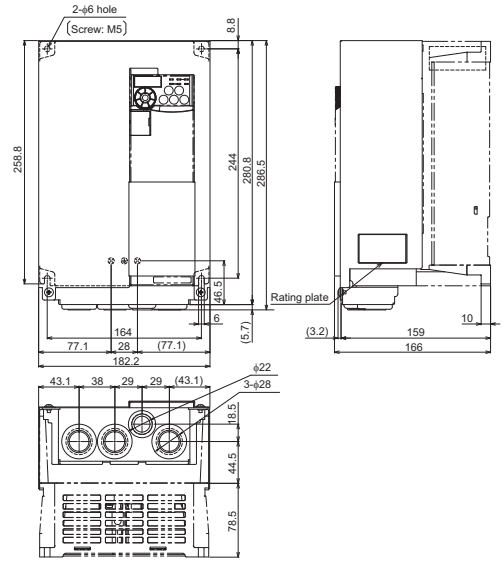
Name (Model)	Specifications, Structure, etc.																																			
<p>Intercompatibility attachment FR-E7AT□</p>	<ul style="list-style-type: none"> FR-A024/A044 series intercompatibility attachment The FR-E700 series inverter can be installed using installation holes of the conventional FR-A024/A044 series with this attachment. This attachment is useful for replacing the conventional model with the FR-E700 series. (The depth increases after installation of the inverter when the attachment is used.)  <table border="1" data-bbox="387 409 1173 600"> <thead> <tr> <th rowspan="2">Attachment Model</th> <th colspan="2">Mountable Models</th> <th colspan="2">Compatible Former Models</th> </tr> <tr> <th>E720</th> <th>E740</th> <th>A024</th> <th>A044</th> </tr> </thead> <tbody> <tr> <td rowspan="4">FR-E7AT01</td> <td>0.1K</td> <td rowspan="4">—</td> <td>0.1K</td> <td rowspan="4">—</td> </tr> <tr> <td>0.2K</td> </tr> <tr> <td>0.4K</td> </tr> <tr> <td>0.75K</td> </tr> <tr> <td>FR-E7AT02</td> <td>1.5K</td> <td>—</td> <td>1.5K</td> <td>—</td> </tr> <tr> <td rowspan="3">FR-E7AT03</td> <td>—</td> <td>1.5K</td> <td>—</td> <td>1.5K</td> </tr> <tr> <td>2.2K</td> <td>2.2K</td> <td>2.2K</td> <td>2.2K</td> </tr> <tr> <td>3.7K</td> <td>3.7K</td> <td>3.7K</td> <td>3.7K</td> </tr> </tbody> </table>	Attachment Model	Mountable Models		Compatible Former Models		E720	E740	A024	A044	FR-E7AT01	0.1K	—	0.1K	—	0.2K	0.4K	0.75K	FR-E7AT02	1.5K	—	1.5K	—	FR-E7AT03	—	1.5K	—	1.5K	2.2K	2.2K	2.2K	2.2K	3.7K	3.7K	3.7K	3.7K
Attachment Model	Mountable Models		Compatible Former Models																																	
	E720	E740	A024	A044																																
FR-E7AT01	0.1K	—	0.1K	—																																
	0.2K																																			
	0.4K																																			
	0.75K																																			
FR-E7AT02	1.5K	—	1.5K	—																																
FR-E7AT03	—	1.5K	—	1.5K																																
	2.2K	2.2K	2.2K	2.2K																																
	3.7K	3.7K	3.7K	3.7K																																
<p>DIN rail mounting attachments FR-UDA□</p>	<ul style="list-style-type: none"> Attachment to enable installation of FR-E700 series on DIN rail. Selection table <table border="1" data-bbox="387 660 1217 761"> <thead> <tr> <th rowspan="2">Attachment Model</th> <th colspan="3">Inverter Capacity</th> </tr> <tr> <th>E720</th> <th>E720S</th> <th>E710W</th> </tr> </thead> <tbody> <tr> <td>FR-UDA01</td> <td>0.1K, 0.2K, 0.4K, 0.75K</td> <td>0.1K, 0.2K, 0.4K</td> <td>0.1K, 0.2K, 0.4K</td> </tr> <tr> <td>FR-UDA02</td> <td>1.5K, 2.2K</td> <td>0.75K, 1.5K</td> <td>0.75K</td> </tr> <tr> <td>FR-UDA03</td> <td>3.7K</td> <td>—</td> <td>—</td> </tr> </tbody> </table> <ul style="list-style-type: none"> Approximate dimension <div style="display: flex; justify-content: space-around;"> <div data-bbox="371 795 646 1131"> <p><FR-UDA01></p> </div> <div data-bbox="710 795 981 1131"> <p><FR-UDA02></p> </div> <div data-bbox="1045 795 1428 1131"> <p><FR-UDA03></p> </div> </div> <p style="text-align: right;">(Unit: mm)</p>	Attachment Model	Inverter Capacity			E720	E720S	E710W	FR-UDA01	0.1K, 0.2K, 0.4K, 0.75K	0.1K, 0.2K, 0.4K	0.1K, 0.2K, 0.4K	FR-UDA02	1.5K, 2.2K	0.75K, 1.5K	0.75K	FR-UDA03	3.7K	—	—																
Attachment Model	Inverter Capacity																																			
	E720	E720S	E710W																																	
FR-UDA01	0.1K, 0.2K, 0.4K, 0.75K	0.1K, 0.2K, 0.4K	0.1K, 0.2K, 0.4K																																	
FR-UDA02	1.5K, 2.2K	0.75K, 1.5K	0.75K																																	
FR-UDA03	3.7K	—	—																																	
<p>Panel through attachment FR-E7CN□</p>	<ul style="list-style-type: none"> Using this attachment dissipates about 70% of the inverter's heat by having the inverter heatsink protrude from the back side of the enclosure. Selection table <table border="1" data-bbox="400 1205 1233 1388"> <thead> <tr> <th rowspan="2">Attachment Model</th> <th colspan="3">Inverter Capacity</th> </tr> <tr> <th>E720</th> <th>E740</th> <th>E720S</th> </tr> </thead> <tbody> <tr> <td>FR-E7CN01</td> <td>1.5K, 2.2K</td> <td>—</td> <td>0.75K, 1.5K</td> </tr> <tr> <td>FR-E7CN02</td> <td>3.7K</td> <td>—</td> <td>—</td> </tr> <tr> <td>FR-E7CN03</td> <td>5.5K, 7.5K</td> <td>—</td> <td>—</td> </tr> <tr> <td>FR-E7CN04</td> <td>—</td> <td>1.5K, 2.2K, 3.7K</td> <td>2.2K</td> </tr> <tr> <td>FR-E7CN05</td> <td>—</td> <td>5.5K, 7.5K</td> <td>—</td> </tr> <tr> <td>FR-E7CN06</td> <td>11K, 15K</td> <td>11K, 15K</td> <td>—</td> </tr> </tbody> </table> <ul style="list-style-type: none"> Installation drawing When this attachment is used, a larger installation area is required for the inverter. 	Attachment Model	Inverter Capacity			E720	E740	E720S	FR-E7CN01	1.5K, 2.2K	—	0.75K, 1.5K	FR-E7CN02	3.7K	—	—	FR-E7CN03	5.5K, 7.5K	—	—	FR-E7CN04	—	1.5K, 2.2K, 3.7K	2.2K	FR-E7CN05	—	5.5K, 7.5K	—	FR-E7CN06	11K, 15K	11K, 15K	—				
Attachment Model	Inverter Capacity																																			
	E720	E740	E720S																																	
FR-E7CN01	1.5K, 2.2K	—	0.75K, 1.5K																																	
FR-E7CN02	3.7K	—	—																																	
FR-E7CN03	5.5K, 7.5K	—	—																																	
FR-E7CN04	—	1.5K, 2.2K, 3.7K	2.2K																																	
FR-E7CN05	—	5.5K, 7.5K	—																																	
FR-E7CN06	11K, 15K	11K, 15K	—																																	

Name (Model)	Specifications, Structure, etc.												
<p>Totally enclosed structure attachment FR-E7CV□ for the FR-E700 series</p>	<ul style="list-style-type: none"> Installing the attachment to the inverter changes the protective structure of the inverter to the totally enclosed structure (IP40 equivalent as specified by JEM1030). 												
	<p>● Selection table</p> <table border="1" data-bbox="400 264 828 376"> <thead> <tr> <th>Attachment Model</th> <th>Applicable inverter model</th> </tr> </thead> <tbody> <tr> <td>FR-E7CV01</td> <td>FR-E720-0.1K to 0.75K</td> </tr> <tr> <td>FR-E7CV02</td> <td>FR-E720-1.5K, 2.2K</td> </tr> <tr> <td>FR-E7CV03</td> <td>FR-E720-3.7K</td> </tr> <tr> <td>FR-E7CV04</td> <td>FR-E720-5.5K, 7.5K</td> </tr> </tbody> </table>	Attachment Model	Applicable inverter model	FR-E7CV01	FR-E720-0.1K to 0.75K	FR-E7CV02	FR-E720-1.5K, 2.2K	FR-E7CV03	FR-E720-3.7K	FR-E7CV04	FR-E720-5.5K, 7.5K		
	Attachment Model	Applicable inverter model											
	FR-E7CV01	FR-E720-0.1K to 0.75K											
	FR-E7CV02	FR-E720-1.5K, 2.2K											
FR-E7CV03	FR-E720-3.7K												
FR-E7CV04	FR-E720-5.5K, 7.5K												
<p>*1 Plug-in options cannot be used when the attachment is installed for total enclosure.</p> <p>*2 A USB connector cannot be used when any of the FR-E7CV02 to 04 is installed.</p> <p>*3 To meet the requirement of the totally enclosed structure specification, do not use the inverter with the PU connector cover open.</p>													
<p>● Outline dimension (Unit: mm)</p>													
<p><FR-E7CV01></p>  <table border="1" data-bbox="576 969 890 1061"> <thead> <tr> <th>Inverter model</th> <th>D</th> <th>D1</th> </tr> </thead> <tbody> <tr> <td>FR-E720-0.1K, 0.2K</td> <td>80.5</td> <td>10</td> </tr> <tr> <td>FR-E720-0.4K</td> <td>112.5</td> <td>42</td> </tr> <tr> <td>FR-E720-0.75K</td> <td>132.5</td> <td>62</td> </tr> </tbody> </table>	Inverter model	D	D1	FR-E720-0.1K, 0.2K	80.5	10	FR-E720-0.4K	112.5	42	FR-E720-0.75K	132.5	62	<p><FR-E7CV02></p> 
Inverter model	D	D1											
FR-E720-0.1K, 0.2K	80.5	10											
FR-E720-0.4K	112.5	42											
FR-E720-0.75K	132.5	62											
<p><FR-E7CV03></p> 	<p><FR-E7CV04></p> 												

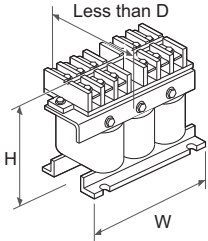
- Features
- Connection example
- Standard Specifications
- Outline Dimension Drawings
- Terminal Connection Diagram Terminal Specification Explanation
- Operation panel Parameter unit FR Configurator
- Parameter List
- Explanations of Parameters
- Protective Functions
- Options
- Instructions
- Motor
- Compatibility
- Warranty
- Inquiry

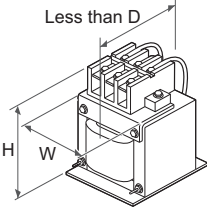
Name (Model)	Specifications, Structure, etc.																																																																																																																									
<p>AC reactor (for power coordination) FR-HAL-(H)□K</p> 	● Outline dimension																																																																																																																									
	<table border="1"> <thead> <tr> <th colspan="2"></th> <th colspan="4"></th> <th colspan="4"></th> <th>(Unit: mm)</th> </tr> <tr> <th>Inverter Model</th> <th>W</th> <th>D</th> <th>H</th> <th>Mass (kg)</th> <th>Inverter Model</th> <th>W</th> <th>D</th> <th>H</th> <th>Mass (kg)</th> </tr> </thead> <tbody> <tr> <td rowspan="10">200V</td> <td>0.4K</td> <td>104</td> <td>72</td> <td>99</td> <td>0.6</td> <td rowspan="10">400V</td> <td>H0.4K</td> <td>135</td> <td>59.6</td> <td>115</td> <td>1.5</td> </tr> <tr> <td>0.75K</td> <td>104</td> <td>74</td> <td>99</td> <td>0.8</td> <td>H0.75K</td> <td>135</td> <td>59.6</td> <td>115</td> <td>1.5</td> </tr> <tr> <td>1.5K</td> <td>104</td> <td>77</td> <td>99</td> <td>1.1</td> <td>H1.5K</td> <td>135</td> <td>59.6</td> <td>115</td> <td>1.5</td> </tr> <tr> <td>2.2K</td> <td>115</td> <td>77</td> <td>115</td> <td>1.5</td> <td>H2.2K</td> <td>135</td> <td>59.6</td> <td>115</td> <td>1.5</td> </tr> <tr> <td>3.7K</td> <td>115</td> <td>83</td> <td>115</td> <td>2.2</td> <td>H3.7K</td> <td>135</td> <td>70.6</td> <td>115</td> <td>2.5</td> </tr> <tr> <td>5.5K</td> <td>115</td> <td>83</td> <td>115</td> <td>2.3</td> <td>H5.5K</td> <td>160</td> <td>72</td> <td>142</td> <td>3.5</td> </tr> <tr> <td>7.5K</td> <td>130</td> <td>100</td> <td>135</td> <td>4.2</td> <td>H7.5K</td> <td>160</td> <td>91</td> <td>142</td> <td>5.0</td> </tr> <tr> <td>11K</td> <td>160</td> <td>111</td> <td>164</td> <td>5.2</td> <td>H11K</td> <td>160</td> <td>91</td> <td>146</td> <td>6.0</td> </tr> <tr> <td>15K</td> <td>160</td> <td>126</td> <td>167</td> <td>7.0</td> <td>H15K</td> <td>220</td> <td>105</td> <td>195</td> <td>9.0</td> </tr> </tbody> </table> 																				(Unit: mm)	Inverter Model	W	D	H	Mass (kg)	Inverter Model	W	D	H	Mass (kg)	200V	0.4K	104	72	99	0.6	400V	H0.4K	135	59.6	115	1.5	0.75K	104	74	99	0.8	H0.75K	135	59.6	115	1.5	1.5K	104	77	99	1.1	H1.5K	135	59.6	115	1.5	2.2K	115	77	115	1.5	H2.2K	135	59.6	115	1.5	3.7K	115	83	115	2.2	H3.7K	135	70.6	115	2.5	5.5K	115	83	115	2.3	H5.5K	160	72	142	3.5	7.5K	130	100	135	4.2	H7.5K	160	91	142	5.0	11K	160	111	164	5.2	H11K	160	91	146	6.0	15K	160	126	167	7.0	H15K	220	105	195
										(Unit: mm)																																																																																																																
Inverter Model	W	D	H	Mass (kg)	Inverter Model	W	D	H	Mass (kg)																																																																																																																	
200V	0.4K	104	72	99	0.6	400V	H0.4K	135	59.6	115	1.5																																																																																																															
	0.75K	104	74	99	0.8		H0.75K	135	59.6	115	1.5																																																																																																															
	1.5K	104	77	99	1.1		H1.5K	135	59.6	115	1.5																																																																																																															
	2.2K	115	77	115	1.5		H2.2K	135	59.6	115	1.5																																																																																																															
	3.7K	115	83	115	2.2		H3.7K	135	70.6	115	2.5																																																																																																															
	5.5K	115	83	115	2.3		H5.5K	160	72	142	3.5																																																																																																															
	7.5K	130	100	135	4.2		H7.5K	160	91	142	5.0																																																																																																															
	11K	160	111	164	5.2		H11K	160	91	146	6.0																																																																																																															
	15K	160	126	167	7.0		H15K	220	105	195	9.0																																																																																																															
	<p>(Note) 1. Make selection according to the applied motor capacity. (When the inverter capacity is larger than the motor capacity, make selection according to the motor capacity)</p> <p>2. Approximately 88% of the power factor improving effect can be obtained (92.3% when calculated with 1 power factor for the fundamental wave according to the Architectural Standard Specifications (Electrical Installation) (2013 revision) supervised by the Ministry of Land, Infrastructure, Transport and Tourism of Japan). (Effect of power factor may decline slightly when using a single-phase power input model.)</p> <p>3. Outline dimension drawing shown is a one of a typical model. The shape differs according to each models.</p> <p>4. Install the AC reactor (FR-HAL) horizontally or vertically.</p> <p>5. Keep enough clearance around the reactor because it heats up. (Keep a minimum clearance of 10cm each on top and bottom and minimum 5cm each on right and left regardless of the installation orientation.)</p>																																																																																																																									
<p>DC reactor (for power coordination) FR-HEL-(H)□K</p> 	● Outline dimension																																																																																																																									
	<table border="1"> <thead> <tr> <th colspan="2"></th> <th colspan="4"></th> <th colspan="4"></th> <th>(Unit: mm)</th> </tr> <tr> <th>Inverter Model</th> <th>W</th> <th>D</th> <th>H</th> <th>Mass (kg)</th> <th>Inverter Model</th> <th>W</th> <th>D</th> <th>H</th> <th>Mass (kg)</th> </tr> </thead> <tbody> <tr> <td rowspan="10">200V</td> <td>0.4K</td> <td>70</td> <td>61</td> <td>71</td> <td>0.4</td> <td rowspan="10">400V</td> <td>H0.4K</td> <td>90</td> <td>60</td> <td>78</td> <td>0.6</td> </tr> <tr> <td>0.75K</td> <td>85</td> <td>61</td> <td>81</td> <td>0.5</td> <td>H0.75K</td> <td>66</td> <td>70</td> <td>100</td> <td>0.8</td> </tr> <tr> <td>1.5K</td> <td>85</td> <td>70</td> <td>81</td> <td>0.8</td> <td>H1.5K</td> <td>66</td> <td>80</td> <td>100</td> <td>1</td> </tr> <tr> <td>2.2K</td> <td>85</td> <td>70</td> <td>81</td> <td>0.9</td> <td>H2.2K</td> <td>76</td> <td>80</td> <td>110</td> <td>1.3</td> </tr> <tr> <td>3.7K</td> <td>77</td> <td>82</td> <td>92</td> <td>1.5</td> <td>H3.7K</td> <td>86</td> <td>95</td> <td>120</td> <td>2.3</td> </tr> <tr> <td>5.5K</td> <td>77</td> <td>92</td> <td>92</td> <td>1.9</td> <td>H5.5K</td> <td>96</td> <td>100</td> <td>128</td> <td>3</td> </tr> <tr> <td>7.5K</td> <td>86</td> <td>98</td> <td>113</td> <td>2.5</td> <td>H7.5K</td> <td>96</td> <td>105</td> <td>128</td> <td>3.5</td> </tr> <tr> <td>11K</td> <td>105</td> <td>112</td> <td>133</td> <td>3.3</td> <td>H11K</td> <td>105</td> <td>110</td> <td>137</td> <td>4.5</td> </tr> <tr> <td>15K</td> <td>105</td> <td>115</td> <td>133</td> <td>4.1</td> <td>H15K</td> <td>105</td> <td>125</td> <td>152</td> <td>5</td> </tr> </tbody> </table> 																				(Unit: mm)	Inverter Model	W	D	H	Mass (kg)	Inverter Model	W	D	H	Mass (kg)	200V	0.4K	70	61	71	0.4	400V	H0.4K	90	60	78	0.6	0.75K	85	61	81	0.5	H0.75K	66	70	100	0.8	1.5K	85	70	81	0.8	H1.5K	66	80	100	1	2.2K	85	70	81	0.9	H2.2K	76	80	110	1.3	3.7K	77	82	92	1.5	H3.7K	86	95	120	2.3	5.5K	77	92	92	1.9	H5.5K	96	100	128	3	7.5K	86	98	113	2.5	H7.5K	96	105	128	3.5	11K	105	112	133	3.3	H11K	105	110	137	4.5	15K	105	115	133	4.1	H15K	105	125	152
										(Unit: mm)																																																																																																																
Inverter Model	W	D	H	Mass (kg)	Inverter Model	W	D	H	Mass (kg)																																																																																																																	
200V	0.4K	70	61	71	0.4	400V	H0.4K	90	60	78	0.6																																																																																																															
	0.75K	85	61	81	0.5		H0.75K	66	70	100	0.8																																																																																																															
	1.5K	85	70	81	0.8		H1.5K	66	80	100	1																																																																																																															
	2.2K	85	70	81	0.9		H2.2K	76	80	110	1.3																																																																																																															
	3.7K	77	82	92	1.5		H3.7K	86	95	120	2.3																																																																																																															
	5.5K	77	92	92	1.9		H5.5K	96	100	128	3																																																																																																															
	7.5K	86	98	113	2.5		H7.5K	96	105	128	3.5																																																																																																															
	11K	105	112	133	3.3		H11K	105	110	137	4.5																																																																																																															
	15K	105	115	133	4.1		H15K	105	125	152	5																																																																																																															
	<p>(Note) 1. Be sure to remove the jumper across the inverter terminals P/+–P1. (A failure to do so will produce no power factor improving effect)</p> <p>2. The wiring length between the reactor and inverter should be within 5m.</p> <p>3. The size of the cables used should be equal to or larger than that of the power supply cables (R/L1, S/L2, T/L3).</p> <p>4. Make selection according to the motor capacity. (When the inverter capacity is larger than the motor capacity, make selection according to the motor capacity)</p> <p>5. Approximately 93% of the power factor improving effect can be obtained (94.4% when calculated with 1 power factor for the fundamental wave according to the Architectural Standard Specifications (Electrical Installation) (2013 revision) supervised by the Ministry of Land, Infrastructure, Transport and Tourism of Japan). (Effect of power factor may decline slightly when using a single-phase 200V power input model.)</p> <p>6. Outline dimension drawing shown is a one of a typical model. The shape differs according to each model.</p> <p>7. Install the DC reactor (FR-HEL) horizontally or vertically.</p> <p>8. Keep enough clearance around the reactor because it heats up. (Keep a minimum clearance of 10cm each on top and bottom and minimum 5cm each on right and left regardless of the installation orientation.)</p> <p>9. Single-phase 100V power input model is not compatible with the DC reactor.</p>																																																																																																																									

Name (Model)	Specifications, Structure, etc.																																																																																																	
<p>EMC Directive compliant EMC filter SF□ FR-E5NF-H□K (400V class) FR-S5NFSA-□K (100V / 200V class)</p>	<p>● The EMC compliant EMC filter (EN61800-3 2nd Environment Category C3) is a filter compliant with the EU EMC Directive (EN61800-3 2nd Environment Category C3).</p>																																																																																																	
	<table border="1"> <thead> <tr> <th rowspan="2">EMC filter Model</th> <th rowspan="2">Applicable inverter model</th> <th rowspan="2">Intercompatibility attachment *1</th> <th colspan="3">Outline dimension (Unit: mm)</th> <th rowspan="2">Mass (kg)</th> <th rowspan="2">Leakage current (mA) *2 (reference value)</th> <th rowspan="2">Loss (W)</th> </tr> <tr> <th>W</th> <th>H</th> <th>D</th> </tr> </thead> <tbody> <tr> <td>SF1306</td> <td>FR-E720-0.1K to 1.5K</td> <td>—</td> <td>110</td> <td>200</td> <td>36.5</td> <td>0.7</td> <td>10</td> <td>7.3</td> </tr> <tr> <td rowspan="2">SF1309</td> <td>FR-E720-2.2K, 3.7K</td> <td>FR-E5T</td> <td rowspan="2">200</td> <td rowspan="2">282</td> <td rowspan="2">57</td> <td rowspan="2">2.1</td> <td rowspan="2">15</td> <td rowspan="2">15</td> </tr> <tr> <td>FR-E720S-2.2K</td> <td>FR-E7AT03</td> </tr> <tr> <td>SF1320</td> <td>FR-E720S-0.1K to 0.4K</td> <td>—</td> <td>70</td> <td>168</td> <td>30.5</td> <td>0.4</td> <td>10</td> <td>2.7</td> </tr> <tr> <td>SF1321</td> <td>FR-E720S-0.75K</td> <td>—</td> <td>110</td> <td>168</td> <td>36.5</td> <td>0.6</td> <td>10</td> <td>3.8</td> </tr> <tr> <td>FR-E5NF-H0.75K</td> <td>FR-E740-0.4K, 0.75K</td> <td>—</td> <td>140</td> <td>210</td> <td>46</td> <td>1.1</td> <td>22.6</td> <td>5.5</td> </tr> <tr> <td>FR-E5NF-H3.7K</td> <td>FR-E740-1.5K to 3.7K</td> <td>—</td> <td>140</td> <td>210</td> <td>46</td> <td>1.2</td> <td>44.5</td> <td>8</td> </tr> <tr> <td>FR-E5NF-H7.5K</td> <td>FR-E740-5.5K, 7.5K</td> <td>—</td> <td>220</td> <td>210</td> <td>47</td> <td>2</td> <td>68.4</td> <td>15</td> </tr> <tr> <td>FR-S5NFSA-0.75K</td> <td>FR-E710W-0.1K to 0.4K</td> <td>—</td> <td>70</td> <td>168</td> <td>35</td> <td>0.5</td> <td>4.5</td> <td>1.74</td> </tr> <tr> <td rowspan="2">FR-S5NFSA-1.5K</td> <td>FR-E720S-1.5K</td> <td rowspan="2">—</td> <td rowspan="2">110</td> <td rowspan="2">168</td> <td rowspan="2">35</td> <td rowspan="2">0.7</td> <td rowspan="2">9.5</td> <td rowspan="2">8.55</td> </tr> <tr> <td>FR-E710W-0.75K</td> </tr> </tbody> </table>	EMC filter Model	Applicable inverter model	Intercompatibility attachment *1	Outline dimension (Unit: mm)			Mass (kg)	Leakage current (mA) *2 (reference value)	Loss (W)	W	H	D	SF1306	FR-E720-0.1K to 1.5K	—	110	200	36.5	0.7	10	7.3	SF1309	FR-E720-2.2K, 3.7K	FR-E5T	200	282	57	2.1	15	15	FR-E720S-2.2K	FR-E7AT03	SF1320	FR-E720S-0.1K to 0.4K	—	70	168	30.5	0.4	10	2.7	SF1321	FR-E720S-0.75K	—	110	168	36.5	0.6	10	3.8	FR-E5NF-H0.75K	FR-E740-0.4K, 0.75K	—	140	210	46	1.1	22.6	5.5	FR-E5NF-H3.7K	FR-E740-1.5K to 3.7K	—	140	210	46	1.2	44.5	8	FR-E5NF-H7.5K	FR-E740-5.5K, 7.5K	—	220	210	47	2	68.4	15	FR-S5NFSA-0.75K	FR-E710W-0.1K to 0.4K	—	70	168	35	0.5	4.5	1.74	FR-S5NFSA-1.5K	FR-E720S-1.5K	—	110	168	35	0.7	9.5	8.55	FR-E710W-0.75K	
	EMC filter Model				Applicable inverter model	Intercompatibility attachment *1	Outline dimension (Unit: mm)				Mass (kg)	Leakage current (mA) *2 (reference value)	Loss (W)																																																																																					
W		H	D																																																																																															
SF1306	FR-E720-0.1K to 1.5K	—	110	200	36.5	0.7	10	7.3																																																																																										
SF1309	FR-E720-2.2K, 3.7K	FR-E5T	200	282	57	2.1	15	15																																																																																										
	FR-E720S-2.2K	FR-E7AT03																																																																																																
SF1320	FR-E720S-0.1K to 0.4K	—	70	168	30.5	0.4	10	2.7																																																																																										
SF1321	FR-E720S-0.75K	—	110	168	36.5	0.6	10	3.8																																																																																										
FR-E5NF-H0.75K	FR-E740-0.4K, 0.75K	—	140	210	46	1.1	22.6	5.5																																																																																										
FR-E5NF-H3.7K	FR-E740-1.5K to 3.7K	—	140	210	46	1.2	44.5	8																																																																																										
FR-E5NF-H7.5K	FR-E740-5.5K, 7.5K	—	220	210	47	2	68.4	15																																																																																										
FR-S5NFSA-0.75K	FR-E710W-0.1K to 0.4K	—	70	168	35	0.5	4.5	1.74																																																																																										
FR-S5NFSA-1.5K	FR-E720S-1.5K	—	110	168	35	0.7	9.5	8.55																																																																																										
	FR-E710W-0.75K																																																																																																	
<table border="1"> <thead> <tr> <th rowspan="2">EMC filter Model</th> <th rowspan="2">Applicable inverter model</th> <th rowspan="2">Intercompatibility attachment *1</th> <th colspan="4">Outline dimension (Unit: mm)</th> <th rowspan="2">Mass (kg)</th> <th rowspan="2">Leakage current (mA) *2 (reference value)</th> <th rowspan="2">Loss (W)</th> </tr> <tr> <th>W</th> <th>H</th> <th>D</th> <th>D1</th> </tr> </thead> <tbody> <tr> <td rowspan="2">SF1260</td> <td>FR-E720-5.5K, 7.5K</td> <td>FR-E5T-02</td> <td rowspan="2">222</td> <td rowspan="2">468</td> <td rowspan="2">80</td> <td rowspan="2">39</td> <td rowspan="2">5</td> <td rowspan="2">440</td> <td rowspan="2">118</td> </tr> <tr> <td>FR-E720-11K</td> <td>FR-A5AT03</td> </tr> <tr> <td>SF1261</td> <td>FR-E720-15K</td> <td>FR-AAT02</td> <td>253</td> <td>600</td> <td>86</td> <td>38</td> <td>9.3</td> <td>71</td> <td>37</td> </tr> <tr> <td>SF1175</td> <td>FR-E740-11K, 15K</td> <td>FR-AAT02</td> <td>253</td> <td>530</td> <td>60</td> <td>35</td> <td>4.7</td> <td>76</td> <td>56</td> </tr> </tbody> </table>	EMC filter Model	Applicable inverter model	Intercompatibility attachment *1	Outline dimension (Unit: mm)				Mass (kg)	Leakage current (mA) *2 (reference value)	Loss (W)	W	H	D	D1	SF1260	FR-E720-5.5K, 7.5K	FR-E5T-02	222	468	80	39	5	440	118	FR-E720-11K	FR-A5AT03	SF1261	FR-E720-15K	FR-AAT02	253	600	86	38	9.3	71	37	SF1175	FR-E740-11K, 15K	FR-AAT02	253	530	60	35	4.7	76	56																																																				
EMC filter Model				Applicable inverter model	Intercompatibility attachment *1	Outline dimension (Unit: mm)					Mass (kg)	Leakage current (mA) *2 (reference value)	Loss (W)																																																																																					
	W	H	D			D1																																																																																												
SF1260	FR-E720-5.5K, 7.5K	FR-E5T-02	222	468	80	39	5	440	118																																																																																									
	FR-E720-11K	FR-A5AT03																																																																																																
SF1261	FR-E720-15K	FR-AAT02	253	600	86	38	9.3	71	37																																																																																									
SF1175	FR-E740-11K, 15K	FR-AAT02	253	530	60	35	4.7	76	56																																																																																									
<p>*1 Depth is 12mm deeper when an intercompatibility attachment is installed. *2 Leakage current for one phase of three-phase three-wire star-connection power supply. Leakage current for all phases of three-phase three-wire delta-connection power supply is three times greater than the indicated value. (Note) This is a sample outline dimension drawing. The shape differs by the model.</p>																																																																																																		
<p>● Countermeasures for leakage current Take the following actions to prevent malfunction of peripheral devices or an electric shock caused by leakage current.</p> <ol style="list-style-type: none"> 1) Earth (ground) the EMC filter before connecting the power supply. When doing so, confirm that earthing (grounding) is securely performed through the earthing (grounding) part of the enclosure. 2) Select an appropriate earth leakage circuit breaker or an earth leakage relay by considering leakage current of the EMC filter. Note that earth leakage circuit breaker may not be used in some cases such as when leakage current of the EMC filter is too large. In that case, use an earth leakage relay with high sensitivity. When both of earth leakage circuit breaker and earth leakage relay cannot be used, securely earth (ground) as explained in 1). 																																																																																																		
<p>Radio noise filter FR-BIF (200V class) FR-BIF-H (400V class)</p>	<p>● Outline dimension</p> <p>(Note) 1. Cannot be connected to the inverter output side. 2. The wire should be cut as short as possible, and connected to the inverter terminal block. 3. To use the radio noise filter (FR-BIF) for the single-phase input model, ensure the insulation of the T-phase before connecting the filter to the input side of the inverter.</p>																																																																																																	
<p>Line noise filter FR-BSF01 (for inverters with small capacities) FR- BLF</p>	<p>● Outline dimension</p> <p>FR-BSF01</p> <p>FR-BLF</p> <p>(Note) 1. Each phase should be wound at least 3 times (4T, 4 turns) in the same direction. (The greater the number of turns, the more effective result is obtained.) When using several line noise filters to make 4T or more, wind the phases (cables) together. Do not use different line noise filters for different phases. 2. When the thickness of the wire prevents winding, use at least 4 in series and ensure that the current passes through each phase in the same direction. 3. Can be used on the output side in the same way as the input side. When using filters on the output side, do not wind the cable more than 3 times (4T) for each filter because the filter may overheat. 4. Use FR-BSF01 for the inverters with small capacities. Thick wires (38mm² or more) cannot be used. In such cases, use the FR-BLF. 5. Do not wind an earthing cable.</p>																																																																																																	

- Features
- Connection example
- Standard Specifications
- Outline Dimension Drawings
- Terminal Connection Diagram Specification Explanation
- Operation panel Parameter unit FR Configurator
- Parameter List
- Explanations of Parameters
- Protective Functions
- Options
- Instructions
- Motor
- Compatibility
- Warranty
- Inquiry

Name (Model) Specifications, Structure, etc.

- Using the option, the inverter may conform to the Japanese guideline for reduction of harmonic emission.
- The option is available for three-phase 200V/400V class inverters with 0.4K to 15K capacity.

● Specification

- Three-phase 200V power input model

Model FR-BFP2-□K	0.4	0.75	1.5	2.2	3.7	5.5	7.5	11	15
Permissible inverter output current (A) *1	2.5	4.2	7	10	16.5	23.8	31.8	45	58
Approximate mass (kg)	1.3	1.4	2.0	2.2	2.8	3.8	4.5	6.7	7.0
Power factor improving reactor	Install a DC reactor on the DC side. 93% to 95% of power supply power factor under 100% load (94.4% *3)								
Noise filter	Common mode choke	Install a ferrite core on the input side.							
	Capacitive filter	About 4mA of capacitor leakage current *2							
Protective structure (JEM1030)	Open type (IP00)								

- Three-phase 400V power input mode

Model FR-BFP2-H□K	0.4	0.75	1.5	2.2	3.7	5.5	7.5	11	15
Permissible inverter output current (A) *1	1.2	2.2	3.7	5	8.1	12	16.3	23	29.5
Approximate mass (kg)	1.6	1.7	1.9	2.3	2.6	4.5	5.0	7.0	8.2
Power factor improving reactor	Install a DC reactor on the DC side. 93% to 95% of power supply power factor under 100% load (94.4% *3)								
Noise filter	Common mode choke	Install a ferrite core on the input side.							
	Capacitive filter	About 8mA of capacitor leakage current *2							
Protective structure (JEM1030)	Open type (IP00)								

*1 Select a capacity for the load (inverter output) current to be equal to or less than the permissible inverter output current.
 *2 The indicated leakage current is for one phase of the three-phase three-wire star-connection power supply.
 *3 The values in parentheses are calculated with 1 fundamental frequency power factor according to the Year 2013 Standard specification for public constructions (electric installation works), published by the Ministry of Land, Infrastructure, Transport and Tourism in Japan.

● Outline dimension drawing

<FR-BFP2-0.4K, 0.75K, 1.5K, 2.2K, 3.7K>
 <FR-BFP2-H0.4K, H0.75K, H1.5K, H2.2K, H3.7K>

<FR-BFP2-5.5K, 7.5K, 11K, 15K>
 <FR-BFP2-H5.5K, H7.5K, H11K, H15K>

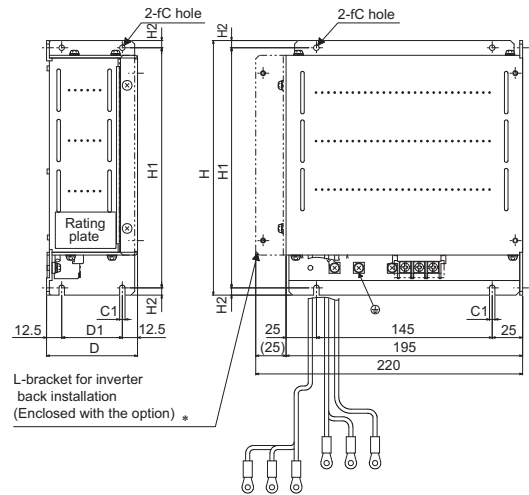
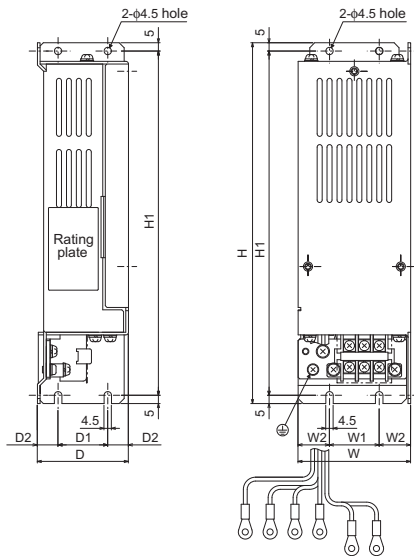

Capacity	W	W1	W2	H	H1	D	D1	D2
200V								
0.4K, 0.75K	68	30	19	218	208	60	30	15
1.5K, 2.2K	108	55	26.5	188	178	80	55	12.5
3.7K	170	120	25	188	178	65	40	12.5
400V								
H0.4K, H0.75K*	108	55	26.5	188	178	55	30	12.5
H1.5K, H2.2K, H3.7K	108	55	26.5	188	178	80	55	12.5

(Unit: mm)

Capacity	H	H1	H2	D	D1	C	C1	C2
200V								
5.5K, 7.5K	210	198	6	75	50	4.5	4.5	5.3
11K	320	305	7.5	85	60	6	6	6.4
15K	320	305	7.5	85	60	6	6	6.4
400V								
H5.5K, H7.5K	210	198	6	75	50	4.5	4.5	4.3
H11K	320	305	7.5	85	60	6	6	4.3
H15K	320	305	7.5	85	60	6	6	6.4

(Unit: mm)

* The 400V class H0.4K and H0.75K have no slit.
 (Note) 1. The option can be installed to the back or to the side. (The option cannot be installed to the back of FR-E720-5.5K/7.5K, FR-E740-0.4K to 3.7K.)
 2. Above outline dimension drawings are examples. Dimensions differ by model.

Filterpack
FR-BFP2-(H)□K



● Outline dimension

MRS type

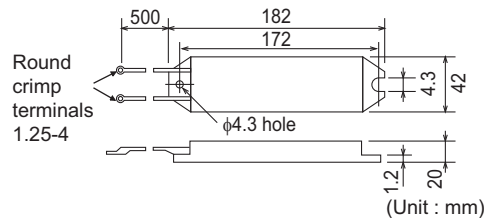

MYS type

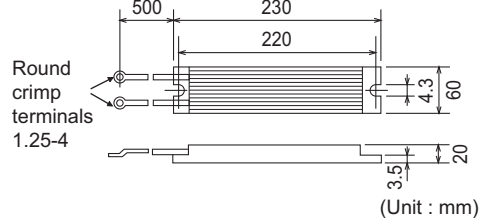



Brake resistor
MRS type, MYS type

Resistor Model	Control torque / permissible duty	Resistance Value (Ω)	Permissible Power (W)	Applicable Motor Capacity (kW)	
200V *1	MRS type	MRS120W200	200	15	0.4
		MRS120W100	100	30	0.75
		MRS120W60	60	55	1.5
	MYS type	MRS120W40	40	80	2.2
		MYS220W50 *2			50/2

(Note) 1. The temperature of the brake resistor becomes 200°C or more depending on the operation frequency, care must be taken for installation and heat dissipation.
 2. The brake resistor cannot be used with the 0.1K and 0.2K.

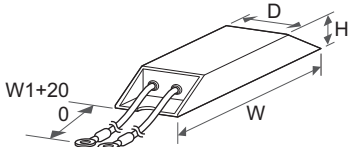
*1 The option can also be connected to a single-phase 100V class inverter.
 *2 Two unit in parallel

Name (Model)		Specifications, Structure, etc.																
High-duty brake resistor FR-ABR-(H)□K 	● Outline dimension																	
	(Unit: mm)																	
			Outline Dimension				Resistance Value (Ω)	Approx. Mass (kg)			Outline Dimension				Resistance Value (Ω)	Approx. Mass (kg)		
	Brake Resistor Model	Permissible Brake Duty	W	W1	D	H			Brake Resistor Model	Permissible Brake Duty	W	W1	D	H				
	200V ^{*1}	FR-ABR-0.4K	10%	140	500	40	21	200	0.2	400V	FR-ABR-H0.4K	10%	115	500	40	21	1200	0.2
		FR-ABR-0.75K	10%	215	500	40	21	100	0.4		FR-ABR-H0.75K	10%	140	500	40	21	700	0.2
		FR-ABR-2.2K ^{*2}	10%	240	500	50	26	60	0.5		FR-ABR-H1.5K	10%	215	500	40	21	350	0.4
		FR-ABR-3.7K	10%	215	500	61	33	40	0.8		FR-ABR-H2.2K	10%	240	500	50	26	250	0.5
		FR-ABR-5.5K	10%	335	500	61	33	25	1.3		FR-ABR-H3.7K	10%	215	500	61	33	150	0.8
		FR-ABR-7.5K	10%	400	500	80	40	20	2.2		FR-ABR-H5.5K	10%	335	500	61	33	110	1.3
FR-ABR-11K		6%	400	700	100	50	13	3.5	FR-ABR-H7.5K		10%	400	500	80	40	75	2.2	
FR-ABR-15K ^{*3}		6%	300	700	100	50	18 (x1/2)	2.4 (x2)	FR-ABR-H11K		6%	400	700	100	50	52	3.2	
								FR-ABR-H15K ^{*4}	6%	300	700	100	50	18 (x2)	2.4 (x2)			
<p>*1 The option can also be connected to a single-phase 100V class inverter.</p> <p>*2 For the 1.5K and 2.2K inverter.</p> <p>*3 For the 15K brake resistor, configure so that two 18Ω resistors are connected in parallel.</p> <p>*4 For the 15K brake resistor, configure so that two 18Ω resistors are connected in series. FR-ABR-15K is indicated on the resistor.</p> <p>(same resistor as the 200V class 15K)</p>																		
 <p>(Note) 1. The regenerative brake duty setting should be less than permissible brake duty in the table above.</p> <p>2. The temperature of the brake resistor becomes 300°C or more depending on the operation frequency, care must be taken for installation and heat dissipation.</p> <p>3. MYS type resistor can be also used. Note that the permissible brake duty.</p> <p>4. The brake resistor cannot be used with the 0.1K and 0.2K.</p> <p>5. Do not remove a jumper across terminal P/+ and P1 except when connecting a DC reactor.</p>																		
Brake unit FR-BU2-(H)□K Resistor unit FR-BR-(H)□K Discharging resistor GZG type GRZG type 	● A brake unit is an option that fully enhances the regenerative braking capability of the inverter, and should be used with an electrical-discharge resistor. Select from two discharging resistor according to the required braking torque.																	
	● Specification																	
	<Brake Unit>																	
	Model FR-BU2-□		200V ^{*1}				400V											
			1.5K	3.7K	7.5K	15K	30K	H7.5K	H15K	H30K								
	Applicable motor capacity		Capacity of the motor to be used with differs according to the braking torque and duty (%ED)															
	Connected brake resistor		GRZG type, FR-BR (refer to the table below for combinations)															
	Multiple (parallel) operation		Up to 10 units (note that torque generated is not more than the tolerable overcurrent amount of connected inverter)															
	Approximate mass (kg)		0.9	0.9	0.9	0.9	1.4	0.9	0.9	1.4								
	<p>*1 The option can also be connected to a single-phase 100V class inverter.</p>																	
<Discharging resistor>																		
Model GRZG type ^{*2}		200V				400V												
		GZG300W-50Ω (1 unit)	GRZG200-10Ω (3 units)	GRZG300-5Ω (4 units)	GRZG400-2Ω (6 units)	GRZG200-10Ω (3 units)	GRZG300-5Ω (4 units)	GRZG400-2Ω (6 units)										
Number of connectable units		1 unit	3 in series (1 set)	4 in series (1 set)	6 in series (1 set)	6 in series (2 sets)	8 in series (2 sets)	12 in series (2 sets)										
Brake resistor total resistance value (Ω)		50	30	20	12	60	40	24										
Continuous permissible power (W)		100	300	600	1200	600	1200	2400										
<p>*2 The 1 set contains the number of units in the parentheses. For the 400V class, 2 sets are required.</p>																		
<Resistor unit>																		
Model FR-BR-□		200V		400V														
		15K	30K	H15K	H30K													
Brake resistor total resistance value (Ω)		8	4	32	16													
Continuous permissible power (W)		990	1990	990	1990													
Approximate mass (kg)		15	30	15	30													
● Combinations of brake unit and resistor unit																		
Brake Unit		Discharging Resistor/Resistor Unit Model																
		GRZG type				FR-BR												
		Model ^{*3}		Number of connectable units														
200V class	FR-BU2-1.5K	GZG 300W-50Ω (1 unit)		1 unit		—												
	FR-BU2-3.7K	GRZG 200-10Ω (3 units)		3 in series (1 set)		—												
	FR-BU2-7.5K	GRZG 300-5Ω (4 units)		4 in series (1 set)		—												
	FR-BU2-15K	GRZG 400-2Ω (6 units)		6 in series (1 set)		FR-BR-15K												
	FR-BU2-30K	—		—		FR-BR-30K												
400V class	FR-BU2-H7.5K	GRZG 200-10Ω (3 units)		6 in series (2 sets)		—												
	FR-BU2-H15K	GRZG 300-5Ω (4 units)		8 in series (2 sets)		FR-BR-H15K												
	FR-BU2-H30K	GRZG 400-2Ω (6 units)		12 in series (2 sets)		FR-BR-H30K												
<p>*3 The 1 set contains the number of units in the parentheses. For the 400V class, 2 sets are required.</p>																		

- Features
- Connection example
- Standard Specifications
- Outline Dimension Drawings
- Terminal Connection Diagram Terminal Specification Explanation
- Operation panel Parameter unit FR Configurator
- Parameter List
- Explanations of Parameters
- Protective Functions
- Options
- Instructions
- Motor
- Compatibility
- Warranty
- Inquiry

Name (Model) Specifications, Structure, etc.

● Selection
 <When GRZG type is connected>
 • The maximum temperature rise of the discharging resistors is approximately 100°C. Use heat-resistant wires and wire to avoid contact with resistors.
 • Do not touch the discharging resistor while the power is ON or for about 10 minutes after the power supply turns OFF. Otherwise you may get an electric shock.

Power Supply Voltage	Motor (kW)	Motor (kW)									
		0.4	0.75	1.5	2.2	3.7	5.5	7.5	11	15	
200V class	50% 30s	FR-BU2-1.5K		FR-BU2-3.7K		FR-BU2-7.5K		FR-BU2-15K			
	100% 30s	FR-BU2-1.5K	FR-BU2-3.7K	FR-BU2-7.5K	FR-BU2-15K	2 × FR-BU2-15K*1					
400V class	50% 30s	→*2		FR-BU2-H7.5K				FR-BU2-H15K			
	100% 30s	→*2		FR-BU2-H7.5K		FR-BU2-H15K		FR-BU2-H30K			

*1 The number before the model name explains the number of connectable units in parallel.
 *2 The inverter for 400V class 1.5K or lower cannot be used in combination with a brake unit. To use in combination with a brake unit, use the inverter of 2.2K or higher.

<When FR-BR is connected>
 • The temperature rise of the resistor unit is about a maximum of 100°C. Therefore, use heat-resistant wires (such as glass wires).
 %ED at short-time rating when braking torque is 100% Braking torque (%) at short-time rating when 10%ED is 15s

Motor Capacity					Motor Capacity				
200V class	FR-BU2-15K	FR-BU2-30K	%ED		200V class	FR-BU2-15K	FR-BU2-30K	Injection brake torque (%)	
5.5kW	7.5kW	11kW	15kW		5.5kW	7.5kW	11kW	15kW	
80	40	15	10		280	200	120	100	
—	—	65	30		—	—	260	180	
400V class	FR-BU2-H15K	FR-BU2-H30K	%ED		400V class	FR-BU2-H15K	FR-BU2-H30K	Injection brake torque (%)	
80	40	15	10		280	200	120	100	
—	—	65	30		—	—	260	180	

Regeneration duty factor (operation frequency)%ED = $\frac{tb}{tc} \times 100$ $tb < 15s$ (continuous operation time)

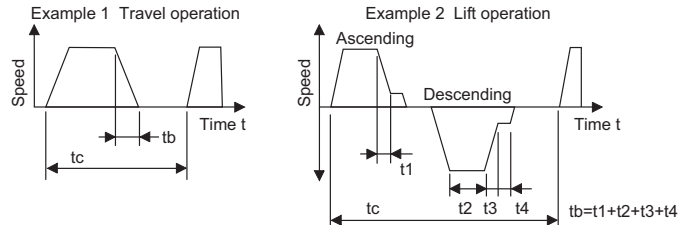

Brake unit
FR-BU2-(H)□K

Resistor unit
FR-BR-(H)□K

Discharging resistor
GZG type
GRZG type



● Connection diagram

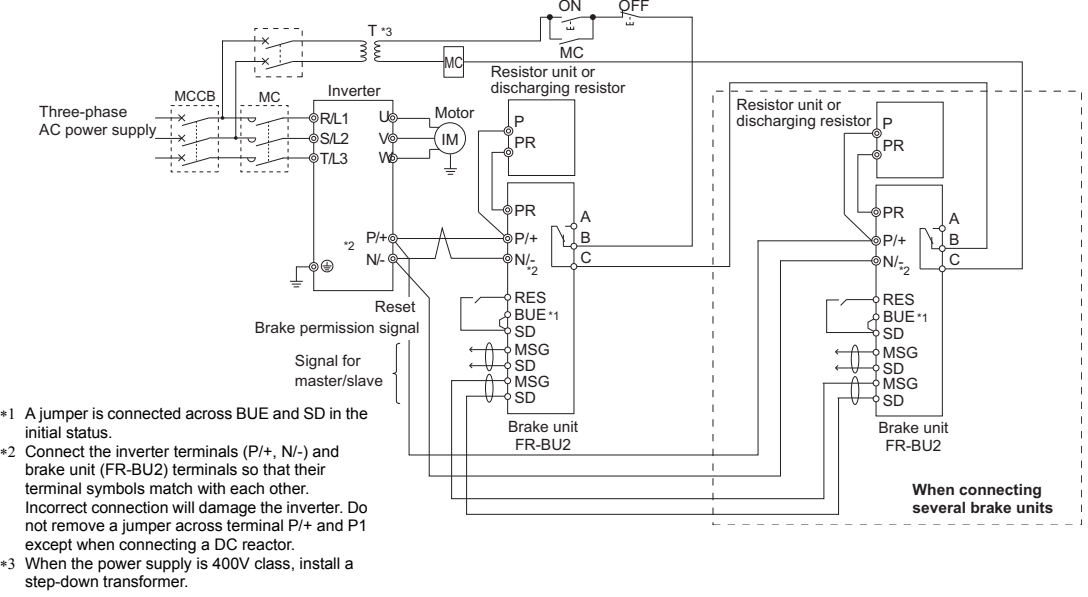

*1 A jumper is connected across BUE and SD in the initial status.
 *2 Connect the inverter terminals (P/+, N/-) and brake unit (FR-BU2) terminals so that their terminal symbols match with each other. Incorrect connection will damage the inverter. Do not remove a jumper across terminal P/+ and P1 except when connecting a DC reactor.
 *3 When the power supply is 400V class, install a step-down transformer.

● Outline dimension drawings

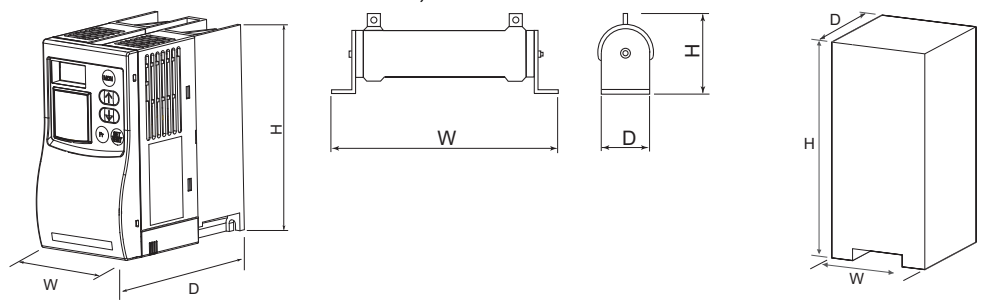

(Unit: mm)



Model	W	H	D
FR-BU2-1.5K to 15K	68	128	132.5
FR-BU2-30K	108	128	129.5
FR-BU2-H7.5K, H15K	68	128	132.5
FR-BU2-H30K	108	128	129.5

(Unit: mm)

Model	W	H	D
GZG300W	335	78	40
GRZG200	306	55	26
GRZG300	334	79	40
GRZG400	411	79	40

(Unit: mm)

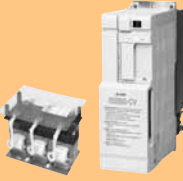
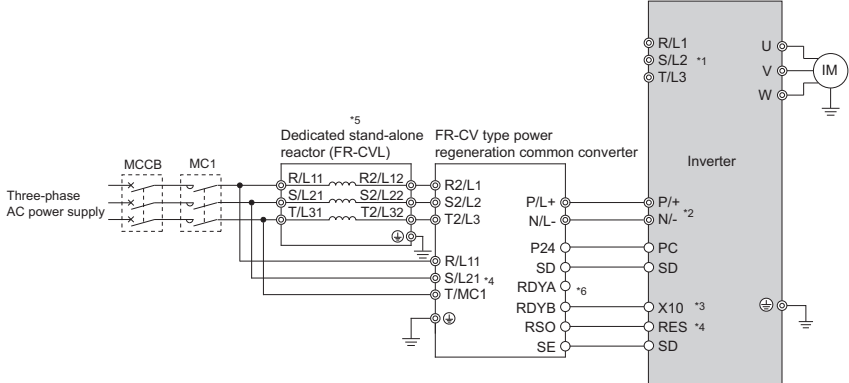
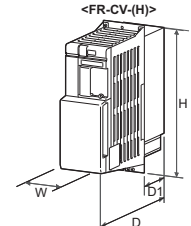
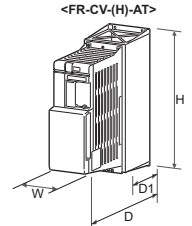
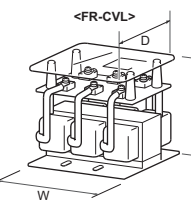
Model	W	H	D
FR-BR-15K	170	450	220
FR-BR-30K	340	600	220
FR-BR-H15K	170	450	220
FR-BR-H30K	340	600	220

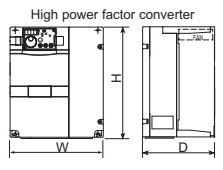
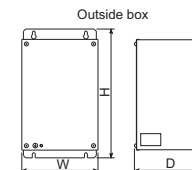
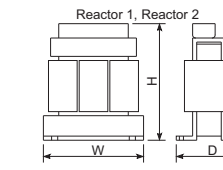
Name (Model)	Specifications, Structure, etc.																																																																																																																																																																					
<p>Power regeneration common converter FR-CV-(H)□K</p> 	<ul style="list-style-type: none"> Enables 100%-torque continuous regeneration to support continuous regenerative operation for line control, etc. (Maximum torque 150% 60s) Eliminates the need to use a brake unit with each inverter, reducing total space and total cost. Saves energy since regeneration energy is used for the other inverters and excess energy is returned to the power supply. Heatsink protrusion type has the heat generating section outside of the enclosure, and exhaust the converter generated heat to the outside of enclosure. Connection diagram  <p>*1 Keep power input terminals (R/L1, S/L2, T/L3) open. Incorrect connection will damage the inverter. Opposite polarity of terminals N/-, P/+ will damage the inverter.</p> <p>*2 Do not insert an MCCB between the terminals P/+-N/- (between P/L+-P/+, between N/L--N/-). Connect the inverter terminals (P/+, N/-) and power regeneration common converter terminals so that their terminal symbols match with each other. Incorrect connection will damage the inverter.</p> <p>*3 Assign the terminal for X10 signal using any of Pr. 178 to Pr. 184 (input terminal function selection).</p> <p>*4 Always connect the power supply and terminals R/L1, S/L21, T/MC1. If the inverter is operated without connection, the power regeneration common converter will be damaged.</p> <p>*5 Install the dedicated stand-alone reactor (FR-CVL) horizontally.</p> <p>*6 Be sure to connect terminal RDY of the FR-CV to the X10 or MRS signal assigned terminal of the inverter, and connect terminal SE of the FR-CV to terminal SD of the inverter. Without proper connecting, FR-CV will be damaged.</p> <p>● Outline dimension drawings</p> <div style="display: flex; justify-content: space-around;"> <div data-bbox="399 918 590 1142"> <p><FR-CV-(H)></p>  </div> <div data-bbox="606 918 798 1142"> <p><FR-CV-(H)-AT></p>  </div> </div> <table border="1" data-bbox="813 918 1436 1041"> <caption>FR-CV-(H) (Unit mm)</caption> <thead> <tr> <th rowspan="2">Voltage/Capacity</th> <th colspan="4">200V</th> <th colspan="4">400V</th> </tr> <tr> <th>W</th> <th>H</th> <th>D</th> <th>D1</th> <th>W</th> <th>H</th> <th>D</th> <th>D1</th> </tr> </thead> <tbody> <tr> <td>7.5K/11K</td> <td>90</td> <td>300</td> <td>303</td> <td>103</td> <td>7.5K/11K/15K</td> <td>120</td> <td>300</td> <td>305</td> <td>105</td> </tr> <tr> <td>15K</td> <td>120</td> <td>300</td> <td>305</td> <td>105</td> <td>22K/30K</td> <td>150</td> <td>380</td> <td>322</td> <td>122</td> </tr> <tr> <td>22K/30K</td> <td>150</td> <td>380</td> <td>322</td> <td>122</td> <td>37K/55K</td> <td>400</td> <td>620</td> <td>250</td> <td>135</td> </tr> <tr> <td>37K/55K</td> <td>400</td> <td>620</td> <td>250</td> <td>135</td> <td></td> <td></td> <td></td> <td></td> <td></td> </tr> </tbody> </table> <div style="display: flex; justify-content: space-around;"> <div data-bbox="399 1153 590 1355"> <p><FR-CVL></p>  </div> </div> <table border="1" data-bbox="813 1041 1436 1153"> <caption>FR-CV-(H)-AT (Unit mm)</caption> <thead> <tr> <th rowspan="2">Voltage/Capacity</th> <th colspan="4">200V</th> <th colspan="4">400V</th> </tr> <tr> <th>W</th> <th>H</th> <th>D</th> <th>D1</th> <th>W</th> <th>H</th> <th>D</th> <th>D1</th> </tr> </thead> <tbody> <tr> <td>7.5K/11K</td> <td>110</td> <td>330</td> <td>315</td> <td>115</td> <td>7.5K/11K/15K</td> <td>130</td> <td>330</td> <td>320</td> <td>120</td> </tr> <tr> <td>15K</td> <td>130</td> <td>330</td> <td>320</td> <td>120</td> <td>22K/30K</td> <td>160</td> <td>410</td> <td>350</td> <td>150</td> </tr> <tr> <td>22K/30K</td> <td>160</td> <td>410</td> <td>350</td> <td>150</td> <td></td> <td></td> <td></td> <td></td> <td></td> </tr> </tbody> </table> <table border="1" data-bbox="813 1153 1436 1332"> <caption>FR-CVL (Unit mm)</caption> <thead> <tr> <th rowspan="2">Voltage/Capacity</th> <th colspan="3">200V</th> <th colspan="3">400V</th> </tr> <tr> <th>W</th> <th>H</th> <th>D</th> <th>W</th> <th>H</th> <th>D</th> </tr> </thead> <tbody> <tr> <td>7.5K/11K/15K</td> <td>165</td> <td>155</td> <td>130</td> <td>7.5K/11K</td> <td>220</td> <td>200</td> <td>135</td> </tr> <tr> <td>22K</td> <td>165</td> <td>155</td> <td>140</td> <td>15K</td> <td>220</td> <td>205</td> <td>135</td> </tr> <tr> <td>30K</td> <td>215</td> <td>175</td> <td>160</td> <td>22K</td> <td>220</td> <td>215</td> <td>150</td> </tr> <tr> <td>37K</td> <td>220</td> <td>200</td> <td>320</td> <td>30K</td> <td>245</td> <td>220</td> <td>185</td> </tr> <tr> <td>55K</td> <td>250</td> <td>225</td> <td>335</td> <td>37K</td> <td>245</td> <td>265</td> <td>230</td> </tr> <tr> <td></td> <td></td> <td></td> <td></td> <td>55K</td> <td>290</td> <td>280</td> <td>230</td> </tr> </tbody> </table>	Voltage/Capacity	200V				400V				W	H	D	D1	W	H	D	D1	7.5K/11K	90	300	303	103	7.5K/11K/15K	120	300	305	105	15K	120	300	305	105	22K/30K	150	380	322	122	22K/30K	150	380	322	122	37K/55K	400	620	250	135	37K/55K	400	620	250	135						Voltage/Capacity	200V				400V				W	H	D	D1	W	H	D	D1	7.5K/11K	110	330	315	115	7.5K/11K/15K	130	330	320	120	15K	130	330	320	120	22K/30K	160	410	350	150	22K/30K	160	410	350	150						Voltage/Capacity	200V			400V			W	H	D	W	H	D	7.5K/11K/15K	165	155	130	7.5K/11K	220	200	135	22K	165	155	140	15K	220	205	135	30K	215	175	160	22K	220	215	150	37K	220	200	320	30K	245	220	185	55K	250	225	335	37K	245	265	230					55K	290	280	230
Voltage/Capacity	200V				400V																																																																																																																																																																	
	W	H	D	D1	W	H	D	D1																																																																																																																																																														
7.5K/11K	90	300	303	103	7.5K/11K/15K	120	300	305	105																																																																																																																																																													
15K	120	300	305	105	22K/30K	150	380	322	122																																																																																																																																																													
22K/30K	150	380	322	122	37K/55K	400	620	250	135																																																																																																																																																													
37K/55K	400	620	250	135																																																																																																																																																																		
Voltage/Capacity	200V				400V																																																																																																																																																																	
	W	H	D	D1	W	H	D	D1																																																																																																																																																														
7.5K/11K	110	330	315	115	7.5K/11K/15K	130	330	320	120																																																																																																																																																													
15K	130	330	320	120	22K/30K	160	410	350	150																																																																																																																																																													
22K/30K	160	410	350	150																																																																																																																																																																		
Voltage/Capacity	200V			400V																																																																																																																																																																		
	W	H	D	W	H	D																																																																																																																																																																
7.5K/11K/15K	165	155	130	7.5K/11K	220	200	135																																																																																																																																																															
22K	165	155	140	15K	220	205	135																																																																																																																																																															
30K	215	175	160	22K	220	215	150																																																																																																																																																															
37K	220	200	320	30K	245	220	185																																																																																																																																																															
55K	250	225	335	37K	245	265	230																																																																																																																																																															
				55K	290	280	230																																																																																																																																																															
<p>High power factor converter FR-HC2- (H)□K</p> 	<ul style="list-style-type: none"> Substantially suppresses power harmonics to realize the equivalent capacity conversion factor K5 = 0 in "the Harmonic Suppression Guidelines for Consumers Who Receive High Voltage or Special High Voltage" in Japan. The power regeneration function comes standard. The common converter driving with several inverters is possible. <p>● Specifications</p> <table border="1" data-bbox="367 1478 1029 1624"> <thead> <tr> <th rowspan="2">Model FR-HC2-□ *2</th> <th colspan="5">200V</th> <th>400V</th> </tr> <tr> <th>7.5K</th> <th>15K</th> <th>30K</th> <th>55K</th> <th>75K</th> <th>H560K</th> </tr> </thead> <tbody> <tr> <td>Applicable inverter capacity *1</td> <td>3.7K to 7.5K</td> <td>7.5K to 15K</td> <td>15K to 30K</td> <td>30K to 55K</td> <td>37K to 75K</td> <td>280K to 560K</td> </tr> <tr> <td>Rated input voltage/frequency</td> <td colspan="5">Three-phase 200V to 220V 50Hz 200V to 230V 60Hz</td> <td>Three-phase 380V to 460V 50/60Hz</td> </tr> <tr> <td>Rated input current (A)</td> <td>33</td> <td>61</td> <td>115</td> <td>215</td> <td>278</td> <td>993</td> </tr> </tbody> </table> <p>*1 The total capacity of the connected inverters.</p> <p>*2 If a high power factor converter (FR-HC2) is purchased, it comes with reactor 1 (FR-HCL21), reactor 2 (FR-HCL22), and an outside box (FR-HCB2) (If an H280K or higher is purchased, it comes with FR-HCL21, FR-HCL22, FR-HCC2, FR-HCR2, and FR-HCM2.)</p> <p>● Outline dimension</p> <table border="1" data-bbox="367 1668 1436 1859"> <thead> <tr> <th rowspan="2">Voltage</th> <th rowspan="2">Capacity</th> <th colspan="3">High Power Factor Converter FR-HC2</th> <th colspan="3">Reactor 1 FR-HCL21 *1</th> <th colspan="3">Reactor 2 FR-HCL22 *1</th> <th colspan="3">Outside Box FR-HCB2 *2</th> </tr> <tr> <th>W</th> <th>H</th> <th>D</th> <th>W</th> <th>H</th> <th>D</th> <th>W</th> <th>H</th> <th>D</th> <th>W</th> <th>H</th> <th>D</th> </tr> </thead> <tbody> <tr> <td rowspan="4">200V</td> <td>7.5K</td> <td>220</td> <td>260</td> <td>170</td> <td>132</td> <td>150</td> <td>100</td> <td>237.5</td> <td>230</td> <td>140</td> <td rowspan="4">190</td> <td rowspan="4">320</td> <td rowspan="4">165</td> </tr> <tr> <td>15K</td> <td>250</td> <td>400</td> <td>190</td> <td>162</td> <td>172</td> <td>126</td> <td>257.5</td> <td>260</td> <td>165</td> </tr> <tr> <td>30K</td> <td>325</td> <td>550</td> <td>195</td> <td>195</td> <td>210</td> <td>150</td> <td>342.5</td> <td>305</td> <td>180</td> </tr> <tr> <td>55K</td> <td>370</td> <td>620</td> <td>250</td> <td>210</td> <td>180</td> <td>200.5</td> <td>432.5</td> <td>380</td> <td>280</td> </tr> <tr> <td rowspan="2">400V</td> <td>75K</td> <td>465</td> <td>620</td> <td>300</td> <td>240</td> <td>215</td> <td>215.5</td> <td>474</td> <td>460</td> <td>280</td> <td>400</td> <td>450</td> <td>250</td> </tr> <tr> <td>H560K</td> <td>790</td> <td>1330</td> <td>440</td> <td>452</td> <td>545</td> <td>645</td> <td>632</td> <td>720</td> <td>745</td> <td>—</td> <td>—</td> <td>—</td> </tr> </tbody> </table> <div style="display: flex; justify-content: space-around;"> <div data-bbox="367 1881 590 2049"> <p>High power factor converter</p>  </div> <div data-bbox="606 1881 798 2049"> <p>Outside box</p>  </div> <div data-bbox="813 1881 1037 2049"> <p>Reactor 1, Reactor 2</p>  </div> </div> <p>*1 Install reactors (FR-HCL21 and 22) on a horizontal surface.</p> <p>*2 FR-HCB2 is not provided for H280K or higher. A filter capacitor and inrush current limit resistors are provided instead.</p>	Model FR-HC2-□ *2	200V					400V	7.5K	15K	30K	55K	75K	H560K	Applicable inverter capacity *1	3.7K to 7.5K	7.5K to 15K	15K to 30K	30K to 55K	37K to 75K	280K to 560K	Rated input voltage/frequency	Three-phase 200V to 220V 50Hz 200V to 230V 60Hz					Three-phase 380V to 460V 50/60Hz	Rated input current (A)	33	61	115	215	278	993	Voltage	Capacity	High Power Factor Converter FR-HC2			Reactor 1 FR-HCL21 *1			Reactor 2 FR-HCL22 *1			Outside Box FR-HCB2 *2			W	H	D	W	H	D	W	H	D	W	H	D	200V	7.5K	220	260	170	132	150	100	237.5	230	140	190	320	165	15K	250	400	190	162	172	126	257.5	260	165	30K	325	550	195	195	210	150	342.5	305	180	55K	370	620	250	210	180	200.5	432.5	380	280	400V	75K	465	620	300	240	215	215.5	474	460	280	400	450	250	H560K	790	1330	440	452	545	645	632	720	745	—	—	—																																		
Model FR-HC2-□ *2	200V					400V																																																																																																																																																																
	7.5K	15K	30K	55K	75K	H560K																																																																																																																																																																
Applicable inverter capacity *1	3.7K to 7.5K	7.5K to 15K	15K to 30K	30K to 55K	37K to 75K	280K to 560K																																																																																																																																																																
Rated input voltage/frequency	Three-phase 200V to 220V 50Hz 200V to 230V 60Hz					Three-phase 380V to 460V 50/60Hz																																																																																																																																																																
Rated input current (A)	33	61	115	215	278	993																																																																																																																																																																
Voltage	Capacity	High Power Factor Converter FR-HC2			Reactor 1 FR-HCL21 *1			Reactor 2 FR-HCL22 *1			Outside Box FR-HCB2 *2																																																																																																																																																											
		W	H	D	W	H	D	W	H	D	W	H	D																																																																																																																																																									
200V	7.5K	220	260	170	132	150	100	237.5	230	140	190	320	165																																																																																																																																																									
	15K	250	400	190	162	172	126	257.5	260	165																																																																																																																																																												
	30K	325	550	195	195	210	150	342.5	305	180																																																																																																																																																												
	55K	370	620	250	210	180	200.5	432.5	380	280																																																																																																																																																												
400V	75K	465	620	300	240	215	215.5	474	460	280	400	450	250																																																																																																																																																									
	H560K	790	1330	440	452	545	645	632	720	745	—	—	—																																																																																																																																																									

- Features
- Connection example
- Standard Specifications
- Outline Dimension Drawings
- Terminal Connection Diagram Terminal Specification Explanation
- Operation panel Parameter unit FR Configurator
- Parameter List
- Explanations of Parameters
- Protective Functions
- Options
- Instructions
- Motor
- Compatibility
- Warranty
- Inquiry

Name (Model)		Specifications, Structure, etc.					
<p>Surge voltage suppression filter FR-BMF-H□K</p>		<ul style="list-style-type: none"> When driving the 400V class motor by the inverter, this filter suppresses the surge voltage generates at the motor terminal. This can be applied to FR-E740-5.5K to 15K. 					
		● Specifications		● Connection diagram			
		Model FR-BMF-H□K	7.5	15		<p>* Install a step-down transformer.</p>	
		Applicable motor capacity (kW) *1	5.5	7.5	11		15
		Rated current (A)	17		31		
		Overload current rating*2	150 60s, 200% 0.5s (inverse-time characteristics)				
		Rated input AC voltage*2	Three phase 380 to 480V				
		Permissible AC voltage fluctuation*2	323 to 528V				
		Maximum frequency*2	120Hz				
		PWM carrier frequency	2kHz or less*3				
		Protective structure (JEM 1030)	Open type (IP00)				
		Cooling system	Self-cooling				
		Maximum wiring length	100m or less				
		Approximate mass (kg)	5.5	9.5			
		Environment	Surrounding air temperature	-10°C to +50°C (non-freezing)			
Ambient humidity	90%RH maximum (non-condensing)						
Atmosphere	Indoors (free from corrosive gas, flammable gas, oil mist, dust and dirt)						
Altitude/vibration	Maximum 1000m, 5.9m/s ² or less at 10 to 55Hz (directions of X, Y, Z axes) *4						
<p>*1 The applied motor capacity indicated is the maximum capacity applicable for use of the Mitsubishi Electric 4-pole standard motor.</p> <p>*2 The capacity depends on the specifications of the inverter (400V class) connected.</p> <p>*3 The setting of Pr.72 PWM frequency selection should be 2kHz or less.</p> <p>*4 When using with the filter pack installed on the rear panel, do not install this combination on moving objects or places that have vibrations (exceeding 1.96m/s²).</p>							
● Outline dimension							
<p>●FR-BMF-H7.5K</p>		<p>●FR-BMF-H15K</p>					
		(Unit: mm)					

Peripheral devices/cable size list

Voltage	Applicable Inverter	Motor Output (kW)	Molded Case Circuit Breaker (MCCB)*1 or Earth Leakage Current Breaker (ELB)*2 (NF or NV type)		Input Side Magnetic Contactor*3		Recommended Cable Gauge (mm ²)*5			Reactor	
			Power Factor Improving (AC or DC) Reactor Connection		Power Factor Improving (AC or DC) Reactor Connection		Power Factor Improving (AC or DC) Reactor Connection		U, V, W	FR-HAL	FR-HEL
			Without	With	Without	With	Without	With			
			R/L1, S/L2, T/L3*4								
Three-phase 200V	FR-E720-0.1K	0.1	5A	5A	S-T10	S-T10	2	2	2	0.4K*7	0.4K*7
	FR-E720-0.2K	0.2	5A	5A	S-T10	S-T10	2	2	2	0.4K*7	0.4K*7
	FR-E720-0.4K	0.4	5A	5A	S-T10	S-T10	2	2	2	0.4K	0.4K
	FR-E720-0.75K	0.75	10A	10A	S-T10	S-T10	2	2	2	0.75K	0.75K
	FR-E720-1.5K	1.5	15A	15A	S-T10	S-T10	2	2	2	1.5K	1.5K
	FR-E720-2.2K	2.2	20A	15A	S-T10	S-T10	2	2	2	2.2K	2.2K
	FR-E720-3.7K	3.7	30A	30A	S-T21	S-T10	3.5	3.5	3.5	3.7K	3.7K
	FR-E720-5.5K	5.5	50A	40A	S-T35	S-T21	5.5	5.5	5.5	5.5K	5.5K
	FR-E720-7.5K	7.5	60A	50A	S-T35	S-T35	14	8	8	7.5K	7.5K
	FR-E720-11K	11	75A	75A	S-T35	S-T35	14	14	14	11K	11K
	FR-E720-15K	15	125A	100A	S-T50	S-T50	22	22	22	15K	15K
Three-phase 400V	FR-E740-0.4K	0.4	5A	5A	S-T10	S-T10	2	2	2	H0.4K	H0.4K
	FR-E740-0.75K	0.75	5A	5A	S-T10	S-T10	2	2	2	H0.75K	H0.75K
	FR-E740-1.5K	1.5	10A	10A	S-T10	S-T10	2	2	2	H1.5K	H1.5K
	FR-E740-2.2K	2.2	15A	10A	S-T10	S-T10	2	2	2	H2.2K	H2.2K
	FR-E740-3.7K	3.7	20A	15A	S-T10	S-T10	2	2	2	H3.7K	H3.7K
	FR-E740-5.5K	5.5	30A	20A	S-T21	S-T12	3.5	2	2	H5.5K	H5.5K
	FR-E740-7.5K	7.5	30A	30A	S-T21	S-T21	3.5	3.5	3.5	H7.5K	H7.5K
	FR-E740-11K	11	50A	40A	S-T21	S-T21	5.5	5.5	5.5	H11K	H11K
	FR-E740-15K	15	60A	50A	S-T35	S-T21	8	5.5	5.5	H15K	H15K
Single-Phase 200V	FR-E720S-0.1K	0.1	5A	5A	S-T10	S-T10	2	2	2	0.4K*7	0.4K*7
	FR-E720S-0.2K	0.2	5A	5A	S-T10	S-T10	2	2	2	0.4K*7	0.4K*7
	FR-E720S-0.4K	0.4	10A	10A	S-T10	S-T10	2	2	2	0.75K*7	0.75K*7
	FR-E720S-0.75K	0.75	15A	10A	S-T10	S-T10	2	2	2	1.5K*7	1.5K*7
	FR-E720S-1.5K	1.5	20A	20A	S-T10	S-T10	2	2	2	2.2K*7	2.2K*7
	FR-E720S-2.2K	2.2	40A	30A	S-T21	S-T10	3.5	3.5	2	3.7K*7	3.7K*7
Single-Phase 100V	FR-E710W-0.1K	0.1	10A	5A	S-T10	S-T10	2	2	2	0.75K*6, *7	—*8
	FR-E710W-0.2K	0.2	10A	10A	S-T10	S-T10	2	2	2	1.5K*6, *7	—*8
	FR-E710W-0.4K	0.4	15A	15A	S-T10	S-T10	2	2	2	2.2K*6, *7	—*8
	FR-E710W-0.75K	0.75	30A	20A	S-T10	S-T10	3.5	3.5	2	3.7K*6, *7	—*8

*1 Select an MCCB according to the inverter power supply capacity. Install one MCCB per inverter.

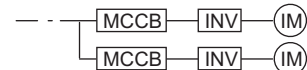

*2 For use in the United States or Canada, refer to "Instructions for UL and cUL" in the Instruction Manual (Basic), and select an appropriate fuse or molded case circuit breaker (MCCB).

*3 The magnetic contactor is selected based on the AC-1 class. The electrical durability of magnetic contactor is 500,000 times. When the magnetic contactor is used for emergency stop during motor driving, the electrical durability is 25 times. If using an MC for emergency stop during motor driving, select an MC regarding the inverter input side current as JEM1038-AC-3 class rated current. When using an MC on the inverter output side for commercial-power supply operation switching using a general purpose motor, select an MC regarding the motor rated current as JEM1038-AC-3 class rated current.

*4 When using a single-phase power input model, terminals are R/L1 and S/L2.

*5 The cable size is that of the cable (HIV cable (600V class 2 vinyl-insulated cable) etc.) with continuous maximum permissible temperature of 75°C. Assumes that the surrounding air temperature is 50°C or less and the wiring distance is 20m or less.

*6 When connecting a single-phase 100V power input inverter to a power transformer (50kVA or more), install a AC reactor (FR-HAL) so that the performance is more reliable.

*7 The power factor may be slightly lower.

*8 Single-phase 100V power input model is not compatible with DC reactor.



Note

- When the inverter capacity is larger than the motor capacity, select an MCCB and a magnetic contactor according to the inverter type and cable and reactor according to the motor output.
- When the breaker on the inverter primary side trips, check for the wiring fault (short circuit), damage to internal parts of the inverter, etc. Identify the cause of the trip, then remove the cause and power on the breaker.

Features
Connection example
Standard Specifications
Outline Dimension Drawings
Terminal Connection Diagram Terminal Specification Explanation
Operation panel Parameter unit FR Configurator
Parameter List
Explanations of Parameters
Protective Functions
Options
Instructions
Motor
Compatibility
Warranty
Inquiry

Selecting the rated sensitivity current for the earth leakage current breaker

When using the earth leakage current breaker with the inverter circuit, select its rated sensitivity current as follows, independently of the PWM carrier frequency.

- Breaker designed for harmonic and surge suppression
Rated sensitivity current $I_{\Delta n} \geq 10 \times (I_{g1} + I_{gn} + I_{gi} + I_{g2} + I_{gm})$
 - Standard breaker
Rated sensitivity current $I_{\Delta n} \geq 10 \times (I_{g1} + I_{gn} + I_{gi} + 3 \times (I_{g2} + I_{gm}))$
- I_{g1}, I_{g2} : Leakage currents in wire path during commercial power supply operation
 I_{gn} : Leakage current of inverter input side noise filter
 I_{gm} : Leakage current of motor during commercial power supply operation
 I_{gi} : Leakage current of inverter unit

Example of leakage current of cable path per 1km during the commercial power supply operation when the CV cable is routed in metal conduit (200V 60Hz)

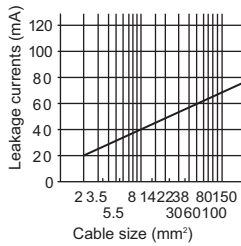

Example of leakage current per 1km during the commercial power supply operation when the CV cable is routed in metal conduit (Three-phase three-wire delta connection 400V60Hz)

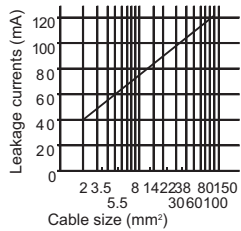

Example of leakage current of three-phase induction motor during the commercial power supply operation (200V 60Hz)

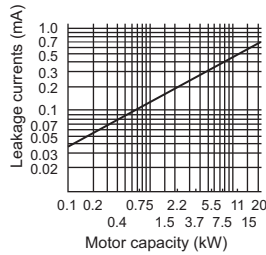

Example of leakage current of three-phase induction motor during the commercial power supply operation (Totally-enclosed fan-cooled type motor 400V60Hz)

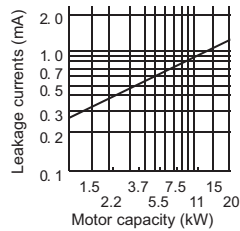

For "Δ" connection, the amount of leakage current is approx. 1/3 of the above value.

Example

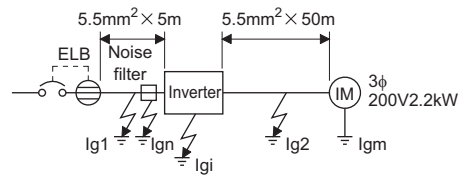

- (Note) 1 Install the earth leakage breaker (ELB) on the input side of the inverter.
 2 In the Δ connection earthed-neutral system, the sensitivity current is blunt against an earth (ground) fault in the inverter output side. Earthing (Grounding) must conform to the requirements of national and local safety regulations and electrical codes. (NEC section 250, IEC 536 class 1 and other applicable standards)

● Selection example (in the case of the above figure)

	Breaker Designed for Harmonic and Surge Suppression	Standard Breaker
Leakage current I_{g1} (mA)	$33 \times \frac{5m}{1,000m} = 0.17$	
Leakage current I_{gn} (mA)	0 (without noise filter)	
Leakage current I_{gi} (mA)	1	
Leakage current I_{g2} (mA)	$33 \times \frac{50m}{1,000m} = 1.65$	
Motor leakage current I_{gm} (mA)	0.18	
Total leakage current (mA)	3.00	6.66
Rated sensitivity current (mA) ($\geq I_g \times 10$)	30	100

Precautions for Operation/Selection

Precautions for use of the inverter

⚠ Safety Precautions

- To operate the inverter correctly and safely, be sure to read the "instruction manual" before starting operation.
- This product has not been designed or manufactured for use with any equipment or system operated under life-threatening conditions.
- Please contact our sales office when you are considering using this product in special applications such as passenger mobile, medical, aerospace, nuclear, power or undersea relay equipment or system.
- Although this product is manufactured under strict quality control, safety devices should be installed when a serious accident or loss is expected by a failure of this product.
- The load used should be a three-phase induction motor only.

Operation

- A magnetic contactor (MC) provided on the input side should not be used to make frequent starts and stops. It could cause the inverter to fail.
- However, at this time, the motor cannot be brought to a sudden stop. Hence, provide a mechanical stopping/holding mechanism for the machine/equipment which requires an emergency stop.
- It will take time for the capacitor to discharge after shutoff of the inverter power supply. When accessing the inverter for inspection, wait for at least 10 minutes after the power supply has been switched off, and check to make sure that there are no residual voltage using a tester or the like.

Wiring

- Application of power to the output terminals (U, V, W) of the inverter will damage the inverter. Therefore, fully check the wiring and sequence to ensure that wiring is correct, etc. before power-ON.
- Terminals P/+, PR, P1, and N/- are for connection to dedicated options and DC power supplies. Do not connect anything other than a dedicated option and DC power supply. Do not short the frequency setting power supply terminal 10 and common terminal 5 or the terminal PC and terminal SD.
- To remove the wire connected to the control circuit terminal on the safety stop function model, pull the wire while pressing down the open/close button firmly with a flathead screwdriver. Otherwise, the terminal block may be damaged.

Power supply

- When the inverter is connected under a large-capacity power transformer (500kVA or more transformer) or when a power capacitor is to be switched over, an excessive peak current may flow in the power input circuit, damaging the inverter.

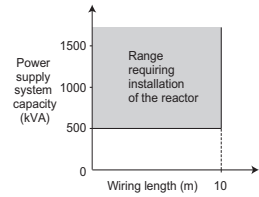

Also when connecting a single-phase 100V power input inverter to a power transformer (50kVA or more), install a AC reactor (FR-HAL) so that the performance is more reliable.

To prevent this, always install an optional AC reactor (FR-HAL).

- If a surge voltage occurs in the power supply system, this surge energy may flow into the inverter, causing the inverter to display overvoltage protection (E.OV□) and come to an inverter trip. To prevent this, always install an optional AC reactor (FR-HAL).

Installation

- Avoid hostile environment where oil mist, fluff, dust particles, etc. are suspended in the air, and install the inverter in a clean place or put it in an ingress-protected "enclosed" enclosure. When placing the inverter in an enclosure, determine the cooling system and enclosure dimensions so that the surrounding air temperature of the inverter is within the permissible value. (refer to page 12 for the specified value)
- Do not install the inverter on wood or other flammable material as it will be hot partly.
- Install the inverter in the vertical orientation.

Setting

- The inverter can be operated as fast as a maximum of 400Hz by parameter setting. Therefore, incorrect setting can cause a danger. Set the upper limit using the maximum frequency limit setting function.
- A setting higher than the initial value of DC injection brake operation voltage or operation time can cause motor overheat (electronic thermal relay error).
- Do not set Pr. 70 *Special regenerative brake duty* except for using the optional brake resistor. This function is used to protect the brake resistor from overheating. Do not set the value exceeding permissible duty of the brake resistor.

Features

Connection example

Standard Specifications

Outline Dimension Drawings

Terminal Connection Diagram Terminal Specification Explanation

Operation panel Parameter unit FR Configurator

Parameter List

Explanations of Parameters

Protective Functions

Options

Instructions

Motor

Compatibility

Warranty

Inquiry

Precautions for selection

Inverter capacity selection

- When operating a special motor or more than one motor in parallel with a single inverter, select the inverter capacity so that 1.05 times the total rated motor current is less than the rated output current of the inverter.
- Setting 2kHz or more in *Pr. 72 PWM frequency selection* to perform low acoustic noise operation with the surrounding air temperature exceeding 40°C, decrease the output current according to the rating table on *page 10*. (Also change the *Pr. 9 Electronic thermal O/L relay* setting.)

Starting torque of the motor

- The start and acceleration characteristics of the motor driven by the inverter are restricted by the overload current rating of that inverter. Generally the torque characteristic is less than when the motor is started by a commercial power supply. If torque boost adjustment, Advanced magnetic flux vector control, or General-purpose magnetic flux vector control cannot provide enough torque when a large starting torque is necessary, select the inverter of one rank higher capacity or increase the capacities of both the motor and inverter.

Acceleration/deceleration times

- The acceleration/deceleration time of the motor depends on the motor-generated torque, load torque and moment of inertia of the load (J).
- When the torque limit function or stall prevention function is activated during acceleration/deceleration, increase the acceleration/deceleration time as the actual time may become longer.
- To decrease the acceleration/deceleration time, increase the torque boost value (setting of a too large value may activate the stall prevention function at a start, longer the acceleration time), use the advanced magnetic flux vector control or general-purpose magnetic flux vector control or increase the inverter and motor capacities. To decrease the deceleration time, it is necessary to add optional brake resistor MRS type, MYS type, or FR-ABR (for the 0.4K or higher), the brake unit (FR-BU2), power regeneration common converter (FR-CV), or a similar device to absorb braking energy.

Power transfer mechanism (reduction gear, belt, chain, etc.)

- When an oil-lubricated gear box, speed change/reduction gear or similar device is used in the power transfer system, note that continuous operation at low speed only may deteriorate oil lubrication, causing seizure. When performing fast operation at higher than 60Hz, fully note that such operation will cause strength shortage due to the noise, life or centrifugal force of the power transfer mechanism.

Instructions for overload operation

- When performing operation of frequent start/stop of the inverter, rise/fall in the temperature of the transistor element of the inverter will repeat due to a repeated flow of large current, shortening the life from thermal fatigue. Since thermal fatigue is related to the amount of current, the life can be increased by reducing current at locked condition, starting current, etc. Decreasing current may increase the life. However, decreasing current will result in insufficient torque and the inverter may not start. Therefore, choose the inverter which has enough allowance for current.

Precautions for Peripheral Device Selection

Installation and selection of molded case circuit breaker

Install a molded case circuit breaker (MCCB) on the power receiving side to protect the wiring of the inverter input side. For MCCB selection, refer to *page 85* since it depends on the inverter power supply side power factor (which changes depending on the power supply voltage, output frequency and load). Especially for a completely electromagnetic MCCB, one of a slightly large capacity must be selected since its operation characteristic varies with harmonic currents. (Check it in the data of the corresponding breaker.) As an earth leakage current breaker, use the Mitsubishi Electric earth leakage current breaker designed for harmonics and surge suppression. (Refer to *page 86*)

When installing a molded case circuit breaker on the output side of the inverter, contact each manufacturer for selection of the molded case circuit breaker.

Handling of the inverter input side magnetic contactor

- For operation via external terminal (terminal STF or STR used), provide an input side MC to prevent an accident caused by a natural restart at power recovery after a power failure, such as an instantaneous power failure, and to ensure safety for maintenance work. Do not use this magnetic contactor to make frequent starts and stops. (The switching life of the inverter input circuit is about 1,000,000 times.) For parameter unit operation, an automatic restart after power failure is not made and the MC cannot be used to make a start. Note that the primary side MC may be used to make a stop but the regenerative brake specific to the inverter does not operate and the motor is coasted to a stop.
- Installation of a magnetic contactor at the input side is recommended. A magnetic contactor avoids overheat or burnout of a brake resistor when heat capacity of the resistor is insufficient or a brake regenerative transistor is damaged with short while connecting an optional brake resistor. In this case, shut-off the magnetic contactor when fault occurs and inverter trips.

Handling of the inverter output side magnetic contactor

Switch the magnetic contactor between the inverter and motor only when both the inverter and motor are at a stop. When the magnetic contactor is turned on while the inverter is operating, overcurrent protection of the inverter and such will activate. When an MC is provided for switching to the commercial power supply, for example, switch it on/off after the inverter and motor have stopped.

Thermal relay installation

The inverter has an electronic thermal relay function to protect the motor from overheating. However, when running multiple motors with one inverter or operating a multi-pole motor, provide a thermal relay (OCR) between the inverter and motor. In this case, set the electronic thermal relay function of the inverter to 0A. And for the setting of the thermal relay, add the line-to-line leakage current (refer to *page 90*) to the current value on the motor rating plate. For low-speed operation where the cooling capability of the motor reduces, it is recommended to use a thermal relay protector incorporated motor.

Measuring instrument on the output side

When the inverter-to-motor wiring length is large, especially in the 400V class small-capacity models, the meters and CTs may generate heat due to line-to-line leakage current. Therefore, choose the equipment which has enough allowance for the current rating.

Disuse of power factor improving capacitor (power capacitor)

The power factor improving capacitor and surge suppressor on the inverter output side may be overheated or damaged by the harmonic components of the inverter output. Also, since an excessive current flows in the inverter to activate overcurrent protection, do not install a capacitor or surge suppressor. For power factor improvement, use a DC reactor (refer to *page 78*).

Electrical corrosion of the bearing

- When a motor is driven by the inverter, axial voltage is generated on the motor shaft, which may cause electrical corrosion of the bearing in rare cases depending on the wiring, load, operating conditions of the motor or specific inverter settings (high carrier frequency, use of a capacitive filter*1). Contact your sales representative to take appropriate countermeasures for the motor. The following shows examples of countermeasures for the inverter.

- Decrease the carrier frequency.
- Remove the capacitive filter.
- Provide a common mode choke*2 on the output side of the inverter. (This is effective regardless of the use of the capacitive filter.)

*1 Mitsubishi Electric capacitive filter: FR-BIF, SF□, FR-E5NF-□, FR-S5NFS□, FR-BFP2-□

*2 Recommended common mode choke: FT-3KM F series FINEMET® common mode choke cores manufactured by Hitachi Metals, Ltd. FINEMET is a registered trademark of Hitachi Metals, Ltd.

Wire thickness and wiring distance

When the wiring length between the inverter and motor is long, use thick wires so that the voltage drop of the main circuit cable is 2% or less especially at low frequency output. (A selection example for the wiring distance of 20m is shown on *page 85*)

Especially at a long wiring distance, the maximum wiring length should be within the length in the table below since the overcurrent protection function may be misactivated by the influence of a charging current due to the stray capacitances of the wiring. (The overall wiring length for connection of multiple motors should be within the value in the table below.)

Pr. 72 Setting (carrier frequency)	0.1K	0.2K	0.4K	0.75K	1.5K	2.2K	3.7K or higher
1 or less	100V, 200V	200m	200m	300m	500m	500m	500m
	400V	—	—	200m	200m	300m	500m
2 to 15	100V, 200V	30m	100m	200m	300m	500m	500m
	400V	—	—	30m	100m	200m	300m

When using the automatic restart after instantaneous power failure function with wiring length exceeding 100m, select without frequency search (Pr. 162 = "1, 11").

Use the recommended connection cable when connecting the parameter unit.

For remote operation via analog signal, wire the control cable between the operation box or operation signal and inverter within 30m and away from the power circuits (main circuit and relay sequence circuit) to prevent induction from other devices.

When using the external potentiometer instead of the parameter unit to set the frequency, use a shielded or twisted cable, and do not earth (ground) the shield, but connect it to terminal 5 as shown below.

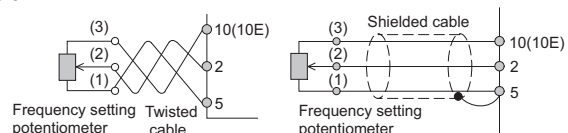

- Features
- Connection example
- Standard Specifications
- Outline Dimension Drawings
- Terminal Connection Diagram Terminal Specification Explanation
- Operation panel Parameter unit FR Configurator
- Parameter List
- Explanations of Parameters
- Protective Functions
- Options
- Instructions
- Motor
- Compatibility
- Warranty
- Inquiry

Earth (Ground)

When the inverter is run in the low acoustic noise mode, more leakage currents occur than in the non-low acoustic noise mode due to high-speed switching operation. Be sure to earth (ground) the inverter and motor before use. In addition, always use the earth (ground) terminal of the inverter to earth (ground) the inverter. (Do not use the case and chassis)

Noise

When performing low-noise operation at higher carrier frequency, electromagnetic noise tends to increase. Therefore, refer to the following measure example and consider taking the measures. Depending on the installation condition, the inverter may be affected by noise in a non-low noise (initial) status.

- The noise level can be reduced by decreasing the carrier frequency (Pr. 72).
- As measures against AM radio broadcasting noise, radio noise filter FR-BIF produces an effect.
- As measures against sensor malfunction, line noise filter FR-BSF01, FR-BLF produces an effect.
- As measures against induction noise from the power cable of the inverter, an effect is produced by putting a distance of 30cm (at least 10cm) or more and using a twisted pair shielded cable as a signal cable. Do not earth (ground) shield but connect it to signal common cable.

Noise reduction examples

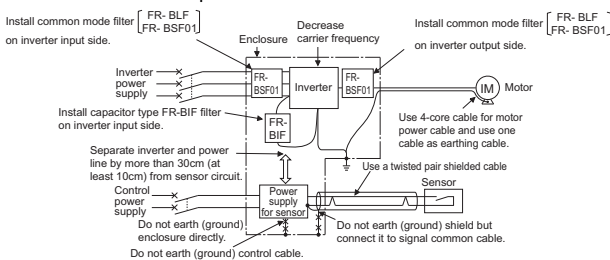

Leakage currents

Capacitances exist between the inverter I/O cables, other cables and earth and in the motor, through which a leakage current flows. Since its value depends on the static capacitances, carrier frequency, etc., low acoustic noise operation at the increased carrier frequency of the inverter will increase the leakage current. Therefore, take the following measures. Select the earth leakage current breaker according to its rated sensitivity current, independently of the carrier frequency setting. (Refer to page 86)

To-earth (ground) leakage currents

Type	Influence and Measures
Influence and measures	<ul style="list-style-type: none"> • Leakage currents may flow not only into the inverter's own line but also into the other line through the earth (ground) cable, etc. These leakage currents may operate earth (ground) leakage circuit breakers and earth leakage relays unnecessarily. • Countermeasures • If the carrier frequency setting is high, decrease the Pr. 72 PWM frequency selection setting. Note that motor noise increases. Select Pr. 240 Soft-PWM operation selection to make the sound inoffensive. • By using earth leakage circuit breakers designed for harmonic and surge suppression in the inverter's own line and other line, operation can be performed with the carrier frequency kept high (with low noise).
Undesirable current path	

Line leakage current

Type	Influence and Measures
Influence and measures	<ul style="list-style-type: none"> • This leakage current flows via a static capacitance between the inverter output cables. • The external thermal relay may be operated unnecessarily by the harmonics of the leakage current. When the wiring length is long (50m or more) for the 400V class small capacity model (7.5kW or less), the external thermal relay is likely to operate unnecessarily because the ratio of the leakage current to the rated motor current increases. • Countermeasures • Use Pr.9 Electronic thermal O/L relay. • If the carrier frequency setting is high, decrease the Pr. 72 PWM frequency selection setting. Note that motor noise increases. Select Pr. 240 Soft-PWM operation selection to make the sound inoffensive. To ensure that the motor is protected against line-to-line leakage currents, it is recommended to use a temperature sensor to directly detect motor temperature.
Undesirable current path	

•Harmonic suppression guideline

Inverters have a converter section (rectifier circuit) and generate a harmonic current.

Harmonic currents flow from the inverter to a power receiving point via a power transformer. The harmonic suppression guideline was established to protect other consumers from these outgoing harmonic currents.

The three-phase 200V input specifications 3.7kW or less (single-phase 200V power input model 2.2kW or less, single-phase 100V power input model 0.75kW) are previously covered by "Harmonic suppression guideline for household appliances and general-purpose products" and other models are covered by "Harmonic suppression guideline for consumers who receive high voltage or special high voltage". However, the transistorized inverter has been excluded from the target products covered by "Harmonic suppression guideline for household appliances and general-purpose products" in January 2004 and "Harmonic suppression guideline for household appliances and general-purpose products" was repealed on September 6, 2004.

All capacity and all models of general-purpose inverter used by specific consumers are covered by "Harmonic suppression guideline for consumers who receive high voltage or special high voltage".

- "Harmonic suppression guideline for consumers who receive high voltage or special high voltage"

This guideline sets forth the maximum values of harmonic currents outgoing from a high-voltage or especially high-voltage consumer who will install, add or renew harmonic generating equipment. If any of the maximum values are exceeded, this guideline requires the consumer to take certain suppression measures.

Users who use models other than the target models are not covered by the guideline. However, we ask to connect an AC reactor or a DC reactor as before to the users who are not covered by the guideline. For compliance to the harmonic suppression guideline for consumers who receive high voltage or special high voltage

Input Power Supply	Target Capacity	Countermeasures
Single-phase 100V Single-phase 200V Three-phase 200V Three-phase 400V	All capacities	<p>Make a judgment based on "Harmonic suppression guideline for consumers who receive high voltage or special high voltage" issued by the Japanese Ministry of Economy, Trade and Industry (formerly Ministry of International Trade and Industry) in September 1994 and take measures if necessary. For calculation method of power supply harmonics, refer to materials below.</p> <p>Reference materials</p> <ul style="list-style-type: none"> "Harmonic suppression measures of the inverter" Jan. 2004 Japan Electrical Manufacturer's Association "Calculation method of harmonic current of the general-purpose inverter used by specific consumers" JEM-TR201 (revised in Dec. 2003): Japan Electrical Manufacturer's Association Japan Electrical Manufacturer's Association

For compliance to "Harmonic suppression guideline of the transistorized inverter (input current of 20A or less) for consumers other than specific consumers" published by JEMA.

Input Power Supply	Target Capacity	Countermeasures
Single-phase 100V	0.75kW or less	Connect the AC reactor or DC reactor recommended in a catalog or an instruction manual.
Single-phase 200V	2.2kW or less	Reference materials
Three-phase 200V	3.7kW or less	<ul style="list-style-type: none"> "Harmonic suppression guideline of the general-purpose inverter (input current of 20A or less)" JEM-TR226 (revised in Dec. 2003): Japan Electrical Manufacturer's Association

● Calculation of outgoing harmonic current

Outgoing harmonic current = fundamental wave current (value converted from received power voltage) × operation ratio × harmonic content

- Operation ratio: Operation ratio = actual load factor operation time ratio during 30 minutes
- Harmonic content: Found in Table.

Table 1: Harmonic Contents (Values at the fundamental current of 100%)

	Reactor	5th	7th	11th	13th	17th	19th	23rd	25th
Three-phase bridge (Capacitor smoothing)	Not used	65	41	8.5	7.7	4.3	3.1	2.6	1.8
	Used (AC side)	38	14.5	7.4	3.4	3.2	1.9	1.7	1.3
	Used (DC side)	30	13	8.4	5.0	4.7	3.2	3.0	2.2
	Used (AC, DC sides)	28	9.1	7.2	4.1	3.2	2.4	1.6	1.4
Single-phase bridge (capacitor smoothing, double voltage rectification)	Not used	50	24	5.1	4.0	1.5	1.4	-	-
	Used (AC side)	6.0	3.9	1.6	1.2	0.6	0.1	-	-
Single-phase bridge (capacitor smoothing, full-wave rectification)	Not used	60	33.5	6.1	6.4	2.6	2.7	1.5	1.5
	Used (AC side)	31.9	8.3	3.8	3.0	1.7	1.4	1.0	0.7

Table 2: Rated Capacities and Outgoing Harmonic Currents for Three-phase Inverter Drive

Applied Motor kW	Fundamental Wave Current (A)		Fundamental Wave Current Converted from 6.6kV (mA)	Rated Capacity (kVA)	Outgoing Harmonic Current Converted from 6.6kV (mA) (No reactor, 100% operation ratio)							
	200V	400V			5th	7th	11th	13th	17th	19th	23rd	25th
0.4	1.61	0.81	49	0.57	31.85	20.09	4.165	3.773	2.107	1.519	1.274	0.882
0.75	2.74	1.37	83	0.97	53.95	34.03	7.055	6.391	3.569	2.573	2.158	1.494
1.5	5.50	2.75	167	1.95	108.6	68.47	14.20	12.86	7.181	5.177	4.342	3.006
2.2	7.93	3.96	240	2.81	156.0	98.40	20.40	18.48	10.32	7.440	6.240	4.320
3.7	13.0	6.50	394	4.61	257.1	161.5	33.49	30.34	16.94	12.21	10.24	7.092
5.5	19.1	9.55	579	6.77	376.1	237.4	49.22	44.58	24.90	17.95	15.05	10.42
7.5	25.6	12.8	776	9.07	504.4	318.2	65.96	59.75	33.37	24.06	20.18	13.97
11	36.9	18.5	1121	13.1	728.7	459.6	95.29	86.32	48.20	34.75	29.15	20.18
15	49.8	24.9	1509	17.6	980.9	618.7	128.3	116.2	64.89	46.78	39.24	27.16

Table 3: Conversion Factors

Classification	Circuit Type	Conversion Factor Ki	
3	Three-phase bridge (Capacitor smoothing)	Without reactor	K31 = 3.4
		With reactor (AC side)	K32 = 1.8
		With reactor (DC side)	K33 = 1.8
		With reactors (AC, DC sides)	K34 = 1.4
4	Single-phase bridge (capacitor smoothing, double voltage rectification)	Without reactor	K41 = 2.3
		With reactor (AC side)	K42 = 0.35
	Single-phase bridge (capacitor smoothing, full-wave rectification)	Without reactor	K43 = 2.9
		With reactor (AC side)	K44 = 1.3
5	Self-excitation three-phase bridge	When a high power factor converter is used	K5 = 0

- Features
- Connection example
- Standard Specifications
- Outline Dimension Drawings
- Terminal Connection Diagram Terminal Specification Explanation
- Operation panel Parameter unit FR Configurator
- Parameter List
- Explanations of Parameters
- Protective Functions
- Options
- Instructions
- Motor
- Compatibility
- Warranty
- Inquiry

Application to standard motors

Motor loss and temperature rise

The motor operated by the inverter has a limit on the continuous operating torque since it is slightly higher in temperature rise than the one operated by a commercial power supply. At a low speed, reduce the output torque of the motor since the cooling effect decreases. When 100% torque is needed continuously at low speed, consider using a constant-torque motor. (Refer to page 93)

Torque characteristic

The motor operated by the inverter may be less in motor torque (especially starting torque) than the one driven by the commercial power supply. It is necessary to fully check the load torque characteristic of the machine.

Vibration

The machine-installed motor operated by the inverter may be slightly greater in vibration than the one driven by the commercial power supply. The possible causes of vibration are as follows.

1. Vibration due to imbalance of the rotator itself including the machine
2. Resonance due to the natural oscillation of the mechanical system. Caution is required especially when the machine used at constant speed is operated at variable speed. The frequency jump function allows resonance points to be avoided during operation. (During acceleration/deceleration, the frequency within the set area is passed through.) An effect is also produced if Pr. 72 PWM frequency selection is changed. When a two-pole motor is operated at higher than 60Hz, caution should be taken since such operation may cause abnormal vibration.

Motor torque

When the Mitsubishi Electric standard squirrel-cage motor (SF-JR, 4-pole) and inverter of the same capacity are used, the torque characteristics are shown below.

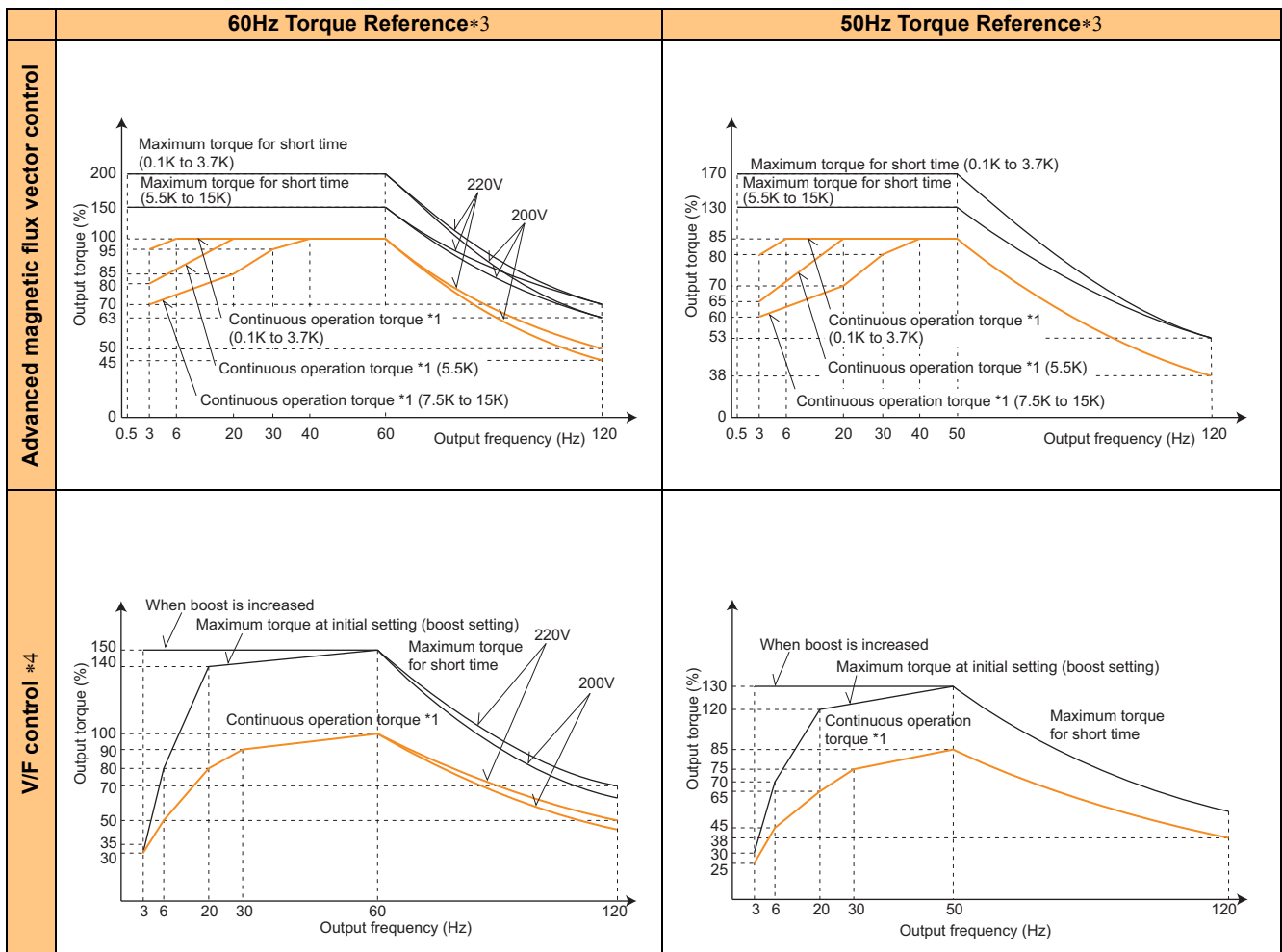

- Continuous operation torque is for checking the limit of permissible load torque when using the motor within the permissible ambient temperature, and is not the motor output torque itself. Maximum torque for short time is the amount of torque a motor can output. Continuous operation torque of a single-phase 100V power input model is 90% of the continuous operation torque indicated above.
- Depending on the motor capacity or the number of motor poles, the operation at 60Hz or more may not be performed. Make sure to check the permissible maximum operating frequency of the motor.
- A 60Hz torque reference indicates that the rated torque of the motor run at 60Hz is 100%, and a 50Hz torque reference indicates that the rated torque of the motor run at 50Hz is 100%.
- To operate continuously with the 50Hz torque reference, reduce the load torque to 85% or less.
- Under V/F control, same torque characteristic applies to the SF-JR type with 2, 4, and 6 poles.

Application to constant-torque motors

SF-HRCA type (Advanced magnetic flux vector control)

- Continuous operation with 100% torque even at low speed of 3Hz is possible
Load torque is not need to be reduced even at a low speed and constant torque (100% torque) continuous operation is possible within the range of speed ratio 1/20 (3 to 60Hz). (The characteristic of motor running at 60Hz or more is that output torque is constant.) Continuous operation torque of a single-phase 100V power input model is 90% of the indicated value.
- Installation size is the same as that of the standard motor
- ★ Note that operation characteristic in the chart below cannot be obtained if V/F control is employed.

Standard specifications (indoor type)

Output (kW)	Number of Poles	Frequency Range	Common Specifications
0.2	4	3 to 120Hz	Standard frequency 60Hz ● rotation direction (CCW) is counterclockwise when viewed from the motor end ● Lead wire 3.7kW or less 3 wires 5.5kW or more ... 6 or 12 wires ● Surrounding air temperature: 40°C maximum Protective structure is IP44
0.4			
0.75			
1.5			
2.2			
3.7			
5.5			
7.5			
11	3 to 100Hz		
15			

- Torque characteristic (during advanced magnetic flux vector control, and initial value for other parameters)

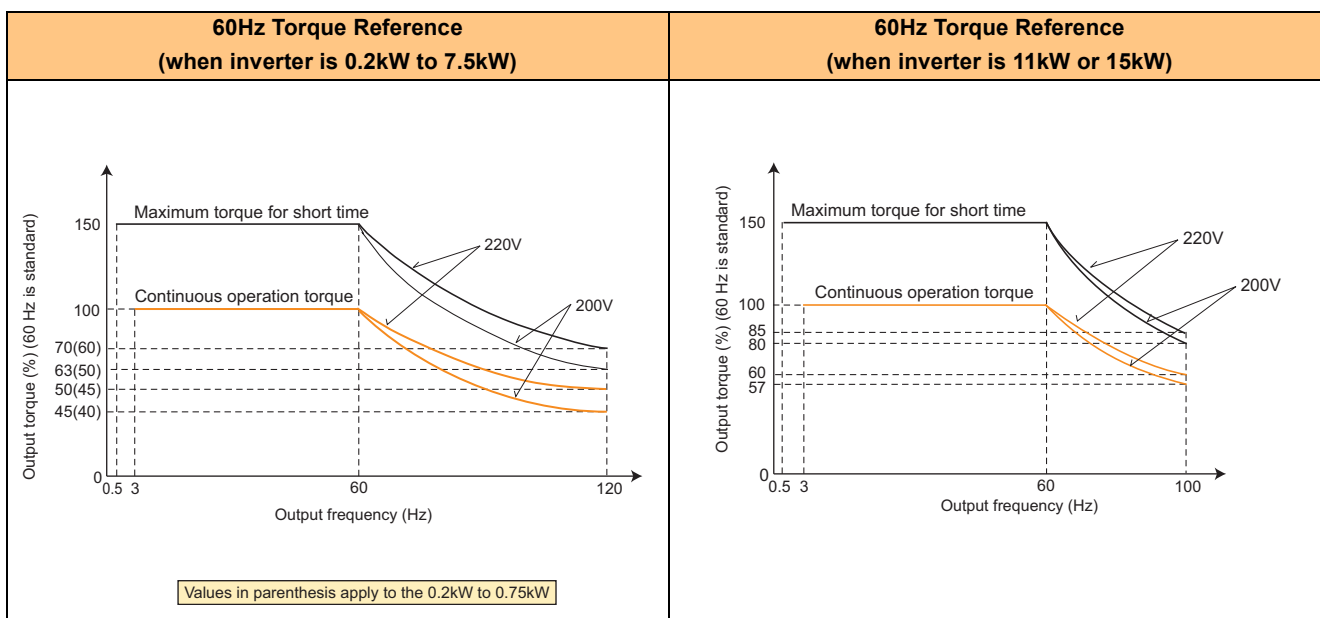

- * Please contact us separately when 150% or more of maximum torque for short time is necessary.
- When rapid acceleration/deceleration is needed, the inverter capacity may need to be one rank higher.
- When two or more motors are operated in parallel, torque imbalance is likely to occur as motor slip is smaller than that of the standard motor.

- Features
- Connection example
- Standard Specifications
- Outline Dimension Drawings
- Terminal Connection Diagram
- Terminal Specification Explanation
- Operation panel Parameter unit FR Configurator
- Parameter List
- Explanations of Parameters
- Protective Functions
- Options
- Instructions
- Motor
- Compatibility
- Warranty
- Inquiry

Application to geared motor

GM-S, GM-D, GM-SSY, GM-SHY series

- Wide constant torque range even with the standard type (when using advanced magnetic flux vector control)
Load torque is not need to be reduced even at a low speed and constant torque (100% torque) continuous operation is possible within the range of speed ratio 1/20 (3 to 60Hz). (0.1K to 0.75K)
- Wide speed control range
The motor can be used in the wide speed deviation range of 3 to 120Hz
The characteristic of motor running at 60Hz or more is that output torque is constant. (0.1K to 0.75K)
★Note that the following operating characteristics are not achieved under V/F control.

Standard specifications

Inverter Type	Output (kW)	Number of Poles	Available Frequency Range (base frequency 60Hz)		Constant Torque Range When Using Advanced Magnetic Flux Vector Control	
			Grease Lubrication	Oil Lubrication		
GM-S GM-SSY GM-SHY	0.1 to 2.2	4	3 to 120Hz		3 to 60Hz (0.1kW to 0.75kW) 6 to 60Hz (1.5kW, 2.2kW)	
GM-D	0.4 to 2.2		3 to 120Hz	25 to 120Hz		3 to 60Hz (0.4kW, 0.75kW) 6 to 60Hz (1.5kW, 7.5kW)
	3.7					
	5.5		25 to 115Hz			
	7.5					

- Torque characteristic (range during advanced magnetic flux vector control)

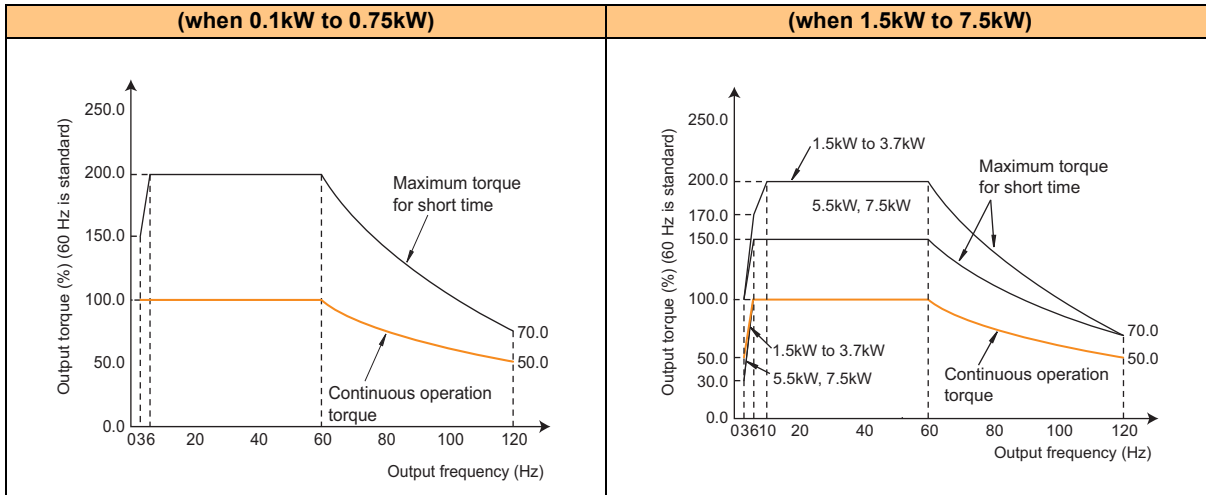

Inverter-driven 400V class motor

When driving a 400V class motor by the inverter, surge voltages attributable to the wiring constants may occur at the motor terminals, deteriorating the insulation of the motor. In such a case, consider taking the following measures.

(1) Rectifying the motor insulation

1. Use a "400V class inverter driven insulation-enhanced motor".

Note: The four poles of the Mitsubishi Electric standard motor (SF-JR, SB-JR) have the 400V class inverter driving insulation enhanced feature.

2. For the dedicated motor such as the constant-torque motor and low-vibration motor, use the "inverter-driven, dedicated motor".

(2) Suppressing the surge voltage on the inverter side

Connect a filter on the secondary side of the inverter to suppress a surge voltage so that the terminal voltage of the motor is 850V or less. When driving by the Mitsubishi Electric inverter, connect an optional surge voltage suppression filter (FR-ASF-H/FR-BMF-H) on the inverter output side.

Application to special motors

Motor with brake

Use the motor with brake having independent power supply for the brake, connect the brake power supply to the inverter input side power and make the inverter output off using the output stop terminal (MRS) when the brake is applied (motor stop). A rattle may be heard depending on the type of the brake in the low speed region but it is not a fault.

Pole changing motor

As this motor differs in rated current from the standard motor, confirm the maximum current of the motor and select the inverter. Be sure to change the number of poles after the motor has stopped. If the number of poles is changed during rotation, the regenerative overvoltage protection circuit may be activated to cause an inverter alarm, coasting the motor to a stop.

Submersible motor

Since the motor rated current is larger than that of the standard motor, make selection of the inverter capacity carefully. In addition, the wiring distance between the motor and inverter may become longer, refer to page 85 to perform wiring with a cable thick enough. Leakage current may flow more than the land motor, take care when selecting the earth leakage current breaker.

Explosion-proof motor

To drive an explosion-proof type motor in Japan, an explosion-proof test of the motor and inverter together is necessary. The test is also necessary when driving an existing explosion-proof motor. Please contact us for the FR-B, B3 series, which has passed an explosion-proof test. The inverter is a non-explosion proof structure, install it in a safe location.

Geared motor

The continuous operating rotation range of this motor changes depending on the lubrication system and maker. Especially in the case of oil lubrication, continuous operation in the low-speed range only can cause gear seizure. For fast operation at higher than 60Hz, please consult the motor maker.

Synchronous motor

This motor is not suitable for applications of large load variation or impact, where out-of-sync is likely to occur. Please contact us when using this motor because its starting current and rated current are greater than those of the standard motor and will not rotate stably at low speed.

Single phase motor

The single phase motor is not suitable for variable operation by the inverter. For the capacitor starting system, the capacitor may be damaged due to harmonic current flowing to the capacitor. For the deviation phase starting system and repulsion starting system, not only output torque is not generated at low speed but it will result in starting coil burnout due to failure of centrifugal force switch inside. Replace with a three-phase motor for use.

Features

Connection example

Standard Specifications

Outline Dimension Drawings

Terminal Connection Diagram
Terminal Specification Explanation

Operation panel Parameter unit FR Configurator

Parameter List

Explanations of Parameters

Protective Functions

Options

Instructions

Motor

Compatibility



Warranty

Inquiry

MEMO

Handwriting practice area consisting of 20 horizontal lines spaced evenly down the page.

FR-E500 Series Compatibility

Item	FR-E500	FR-E700
Control method	V/F control General-purpose magnetic flux vector control	V/F control General-purpose magnetic flux vector control Advanced magnetic flux vector control Optimum excitation control
Changed/cleared functions	Torque boost (Pr. 0) initial value FR-E520-1.5K to 7.5K: 6% FR-E540-1.5K to 3.7K: 6% FR-E540-5.5K, 7.5K: 4%	FR-E720-1.5K(SC) to 3.7K(SC): 4% FR-E720-5.5K(SC), 7.5K(SC): 3% FR-E740-1.5K(SC) to 3.7K(SC): 4% FR-E740-5.5K(SC), 7.5K(SC): 3%
	DC injection brake operation voltage (Pr. 12) initial value 0.4K to 7.5K: 6%	0.4K to 7.5K: 4%
	Frequency at 5V (10V) input (Pr. 38) Frequency at 20mA input frequency (Pr. 39) Second electronic thermal O/L relay (Pr. 48) Shortest acceleration/deceleration mode (Pr. 60)	Parameter number change (Pr. 125 Terminal 2 frequency setting gain frequency) (Pr. 126 Terminal 4 frequency setting gain frequency) (Pr. 51 Second electronic thermal O/L relay) (Pr. 60 Energy saving control selection) (Pr. 292 Automatic acceleration/deceleration)
	Reverse rotation from the inverter operation panel Press  .	After setting "1" in Pr. 40 RUN key rotation direction selection , press  .
	FM terminal function selection (Pr. 54) setting 0: Output frequency (initial value), 1: Output current, 2: Output voltage	1: Output frequency (initial value), 2: Output current, 3: Output voltage
	Second applied motor Pr. 71 = 100 to 123	Pr. 450 Second applied motor
	Terminal 2 0 to 5V, 0 to 10V selection (Pr. 73) setting 0: 0 to 5V (initial value), 1: 0 to 10V	Pr. 73 Analog input selection 0: 0 to 10V 1: 0 to 5V (initial value)
	Operation mode selection (Pr. 79) Initial value 1: PU operation mode	Initial value 0: External operation mode is selected at power ON
	Setting 8: Operation mode switching by external signal Setting General-purpose magnetic flux vector Pr. 80 ≠ 9999	Setting 8: deleted (X16 signal is used instead) Pr. 80 ≠ 9999, Pr. 81 ≠ 9999, Pr. 800 = 30
	User group 1 (16), user group 2 (16) (Pr. 160, Pr. 173 to Pr. 175)	User group (16) only, setting methods were partially changed (Pr. 160, Pr. 172, Pr. 173)
	Input terminal function selection (Pr. 180 to Pr. 183) setting 5: STOP signal (start self-holding selection) 6: MRS signal (output stop)	Pr. 178 to Pr. 184 Input terminal function selection setting 5: JOG signal (Jog operation selection) 6: None 24: MRS signal (output stop) 25: STOP signal (start self-holding selection)
	Long wiring mode (Pr. 240 setting 10, 11)	Setting is unnecessary (Pr. 240 setting 0, 11 are deleted)
	Cooling fan operation selection (Pr. 244) initial setting 0: Cooling fan operates in power-on status.	1: Cooling fan on/off control valid
	Stop selection (Pr. 250) setting increments 1s	0.1s
	RS-485 communication control source from the PU connector PU operation mode	Network operation mode (PU operation mode as FR-E500 when Pr. 551 = 2)
	Earth (ground) fault detection 400V class: Detects always	400V class: Detects only at a start
Inrush current limit circuit	Provided for the 200V class 2.2K or higher and 400V class	Provided for the all capacity
Control terminal block	Fixed terminal block (cannot be removed) Screw type terminal block (Phillips screw M2.5) The recommended blade terminal length is 7mm.	Removable terminal block Standard control circuit terminal model: Screw type terminal block (Flathead screw M2 (M3 for terminal A, B, and C) The recommended blade terminal length is 5mm (6mm for terminal A, B and C). Safety stop function model: Spring clamp terminal block (Fixes a wire with a pressure of inside spring) The recommended blade terminal length is 10mm.
Operation panel	Removable operation panel (PA02)	Integrated operation panel (cannot be removed)
Parameter unit	FR-PU04	FR-PU07
Plug-in option	Dedicated plug-in option (installation is incompatible)	
	for 400V class only FR-E5NC : CC-Link communication FR-E5ND : DeviceNet communication FR-E5NL : LonWorks communication	FR-A7NC E kit : CC-Link communication FR-A7ND E kit : DeviceNet communication FR-A7NL E kit : LonWorks communication
Installation size	FR-E720-0.1K(SC) to 7.5K(SC), FR-E740-0.4K(SC) to 7.5K(SC), FR-E720S-0.1K(SC) to 0.75K(SC), FR-E710W-0.1K to 0.75K are compatible in mounting dimensions	

- Features
- Connection example
- Standard Specifications
- Outline Dimension Drawings
- Terminal Connection Diagram Terminal Specification Explanation
- Operation panel Parameter unit FR Configurator
- Parameter List
- Explanations of Parameters
- Protective Functions
- Options
- Instructions
- Motor
- Compatibility
- Warranty
- Inquiry

Warranty

When using this product, make sure to understand the warranty described below.

1. Warranty period and coverage

We will repair any failure or defect (hereinafter referred to as "failure") in our FA equipment (hereinafter referred to as the "Product") arisen during warranty period at no charge due to causes for which we are responsible through the distributor from which you purchased the Product or our service provider. However, we will charge the actual cost of dispatching our engineer for an on-site repair work on request by customer in Japan or overseas countries. We are not responsible for any on-site readjustment and/or trial run that may be required after a defective unit are repaired or replaced.

[Term]

The term of warranty for Product is twelve months after your purchase or delivery of the Product to a place designated by you or eighteen months from the date of manufacture whichever comes first ("Warranty Period"). Warranty period for repaired Product cannot exceed beyond the original warranty period before any repair work.

[Limitations]

- (1) You are requested to conduct an initial failure diagnosis by yourself, as a general rule. It can also be carried out by us or our service company upon your request and the actual cost will be charged. However, it will not be charged if we are responsible for the cause of the failure.
- (2) This limited warranty applies only when the condition, method, environment, etc. of use are in compliance with the terms and conditions and instructions that are set forth in the instruction manual and user manual for the Product and the caution label affixed to the Product.
- (3) Even during the term of warranty, the repair cost will be charged on you in the following cases;
 - 1) a failure caused by your improper storing or handling, carelessness or negligence, etc., and a failure caused by your hardware or software problem
 - 2) a failure caused by any alteration, etc. to the Product made on your side without our approval
 - 3) a failure which may be regarded as avoidable, if your equipment in which the Product is incorporated is equipped with a safety device required by applicable laws and has any function or structure considered to be indispensable according to a common sense in the industry
 - 4) a failure which may be regarded as avoidable if consumable parts designated in the instruction manual, etc. are duly maintained and replaced
 - 5) any replacement of consumable parts (condenser, cooling fan, etc.)
 - 6) a failure caused by external factors such as inevitable accidents, including without limitation fire and abnormal fluctuation of voltage, and acts of God, including without limitation earthquake, lightning and natural disasters
 - 7) a failure generated by an unforeseeable cause with a scientific technology that was not available at the time of the shipment of the Product from our company
 - 8) any other failures which we are not responsible for or which you acknowledge we are not responsible for

2. Term of warranty after the stop of production

- (1) We may accept the repair at charge for another seven (7) years after the production of the product is discontinued. The announcement of the stop of production for each model can be seen in our Sales and Service, etc.
- (2) Please note that the Product (including its spare parts) cannot be ordered after its stop of production.

3. Service in overseas

Our regional FA Center in overseas countries will accept the repair work of the Product; however, the terms and conditions of the repair work may differ depending on each FA Center. Please ask your local FA center for details.

4. Exclusion of loss in opportunity and secondary loss from warranty liability

Regardless of the gratis warranty term, Mitsubishi Electric shall not be liable for compensation for:

- (1) Damages caused by any cause found not to be the responsibility of Mitsubishi Electric.
- (2) Loss in opportunity, lost profits incurred to the user by Failures of Mitsubishi Electric products.
- (3) Special damages and secondary damages whether foreseeable or not, compensation for accidents, and compensation for damages to products other than Mitsubishi Electric products.
- (4) Replacement by the user, maintenance of on-site equipment, start-up test run and other tasks.

5. Change of Product specifications

Specifications listed in our catalogs, manuals or technical documents may be changed without notice.

6. Application and use of the Product

- (1) For the use of our product, its applications should be those that may not result in a serious damage even if any failure or malfunction occurs in product, and a backup or fail-safe function should operate on an external system to product when any failure or malfunction occurs.
- (2) Our product is designed and manufactured as a general purpose product for use at general industries. Therefore, applications substantially influential on the public interest for such as atomic power plants and other power plants of electric power companies, and also which require a special quality assurance system, including applications for railway companies and government or public offices are not recommended, and we assume no responsibility for any failure caused by these applications when used. In addition, applications which may be substantially influential to human lives or properties for such as airlines, medical treatments, railway service, incineration and fuel systems, man-operated material handling equipment, entertainment machines, safety machines, etc. are not recommended, and we assume no responsibility for any failure caused by these applications when used. We will review the acceptability of the abovementioned applications, if you agree not to require a specific quality for a specific application. Please contact us for consultation.

- Features
- Connection example
- Standard Specifications
- Outline Dimension Drawings
- Terminal Connection Diagram Terminal Specification Explanation
- Operation panel Parameter unit FR Configurator
- Parameter List
- Explanations of Parameters
- Protective Functions
- Options
- Instructions
- Motor
- Compatibility
- Warranty
- Inquiry

Mitsubishi Electric's global FA network delivers reliable technologies and security around the world.

■ Production base
 ● Development center
 ● Global FA Center
 ▲ Mechatronics showroom
 ● Mitsubishi Electric sales office

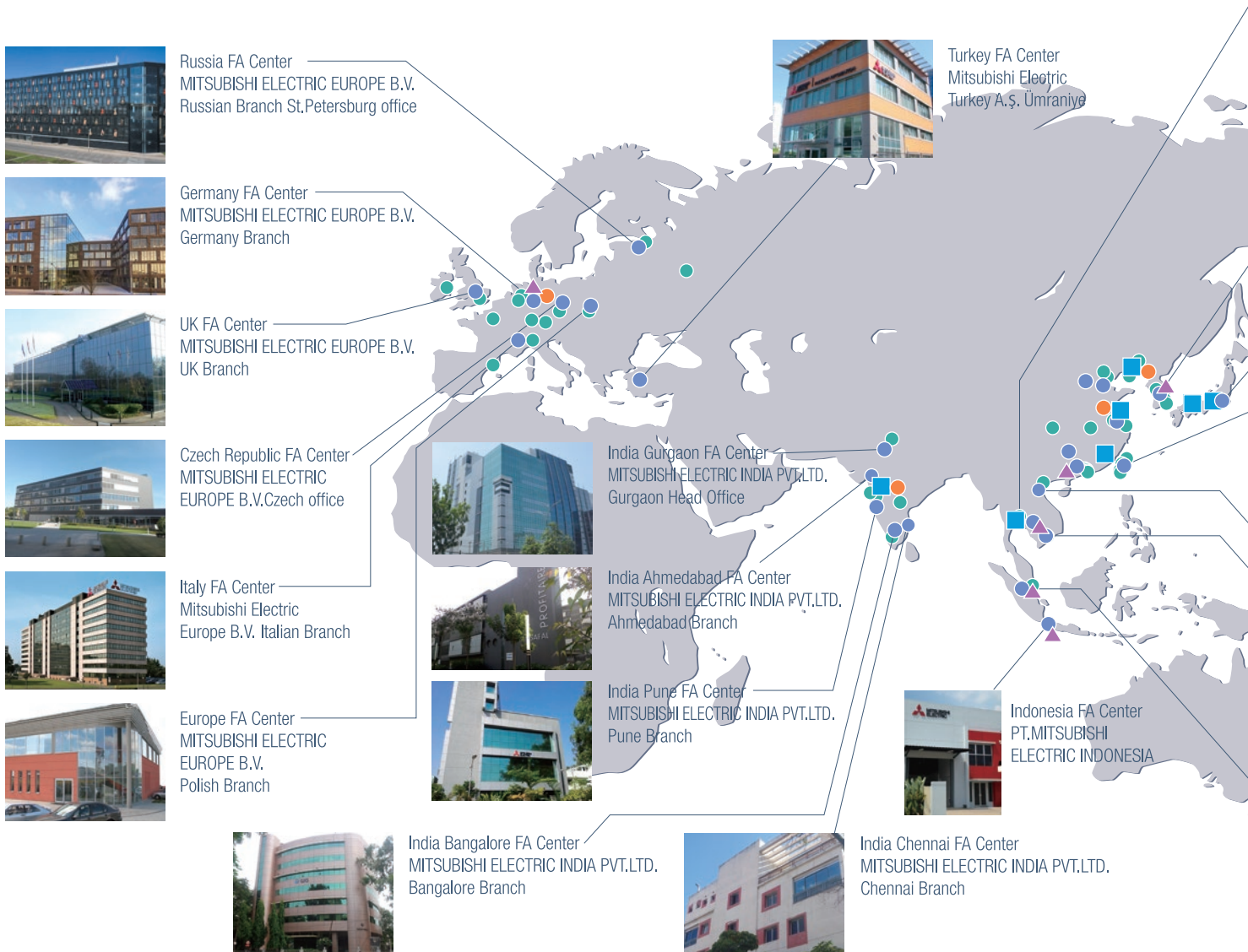

Available services



Technical consultation (engineering)

Our Japanese and/or local staff offer technical advice, and can also propose the best products and systems for a customer's specific application needs.



Showrooms

The latest automation technologies, including programmable controllers, HMI's, inverters, servo systems, and industrial automation machinery such as electrical-discharge machines, laser processing machines, CNCs, and industrial robots can be seen at Mitsubishi Electric showrooms.



Training

From basic operations to applied programming, our training schools offer regular courses that use actual machines. We also offer customized training programs and onsite training sessions.



Technical support

Our FA centers and service shops work together to provide repairs, onsite engineering support, and spare parts.



Repairs

Handle repairs of our FA products.

Thailand FA Center
 MITSUBISHI ELECTRIC FACTORY
 AUTOMATION (THAILAND) CO.,LTD

Korea FA Center
 MITSUBISHI ELECTRIC
 AUTOMATION KOREA CO.,LTD.

MITSUBISHI ELECTRIC CORPORATION
 Factory Automation Systems Group

Taichung FA Center
 MITSUBISHI ELECTRIC
 TAIWAN CO.,LTD

Taipei FA Center
 SETSUJO ENTERPRISE CO.,LTD

Ho Chi Minh FA Center
 MITSUBISHI ELECTRIC
 VIETNAM COMPANY
 LIMITED

Hanoi FA center
 Mitsubishi Electric
 Vietnam
 Company Limited
 Hanoi Branch

ASEAN FA Center
 MITSUBISHI ELECTRIC ASIA PTE.LTD.

Beijing FA Center
 MITSUBISHI ELECTRIC
 AUTOMATION (CHINA)LTD.

Tianjin FA Center
 MITSUBISHI ELECTRIC
 AUTOMATION (CHINA)LTD.

Guangzhou FA Center
 MITSUBISHI ELECTRIC
 AUTOMATION (CHINA)LTD.

Service bases are established around the world to provide the same services as in Japan globally. Overseas bases are opening one after another to support our customers' business expansion.

Area	Our overseas	FA centers
EMEA	26	7
China	17	4
Asia	31	13
Americas	15	6
Others	1	0
Total	90	30

-As of July 2017

North America FA Center
 MITSUBISHI ELECTRIC
 AUTOMATION,INC.

Mexico Monterrey FA Center
 Monterrey Office, Mitsubishi
 Electric Automation, Inc.

Mexico FA Center
 Querétaro Office, Mitsubishi
 Electric Automation, Inc.

Mexico City FA Center
 Mexico FA Center
 Mexico Branch, Mitsubishi
 Electric Automation, Inc.

Brazil FA Center
 Mitsubishi Electric do Brasil
 Comércio e Serviços Ltda.

Brazil Votorantim FA Center
 MELCO CNC do Brasil
 Comércio e Serviços S.A.

China

Shanghai FA Center
 MITSUBISHI ELECTRIC
 AUTOMATION (CHINA) LTD.

This solution solves customers' issues and concerns by enabling visualization and analysis that lead to improvements and increase availability at production sites.

Utilizing our FA and IT technologies and collaborating with e-F@ctory Alliance partners, we reduce the total cost across the entire supply chain and engineeringchain, and support the improvement initiatives and one-step-ahead manufacturing of our customers.



FA integrated solutions reduce total cost

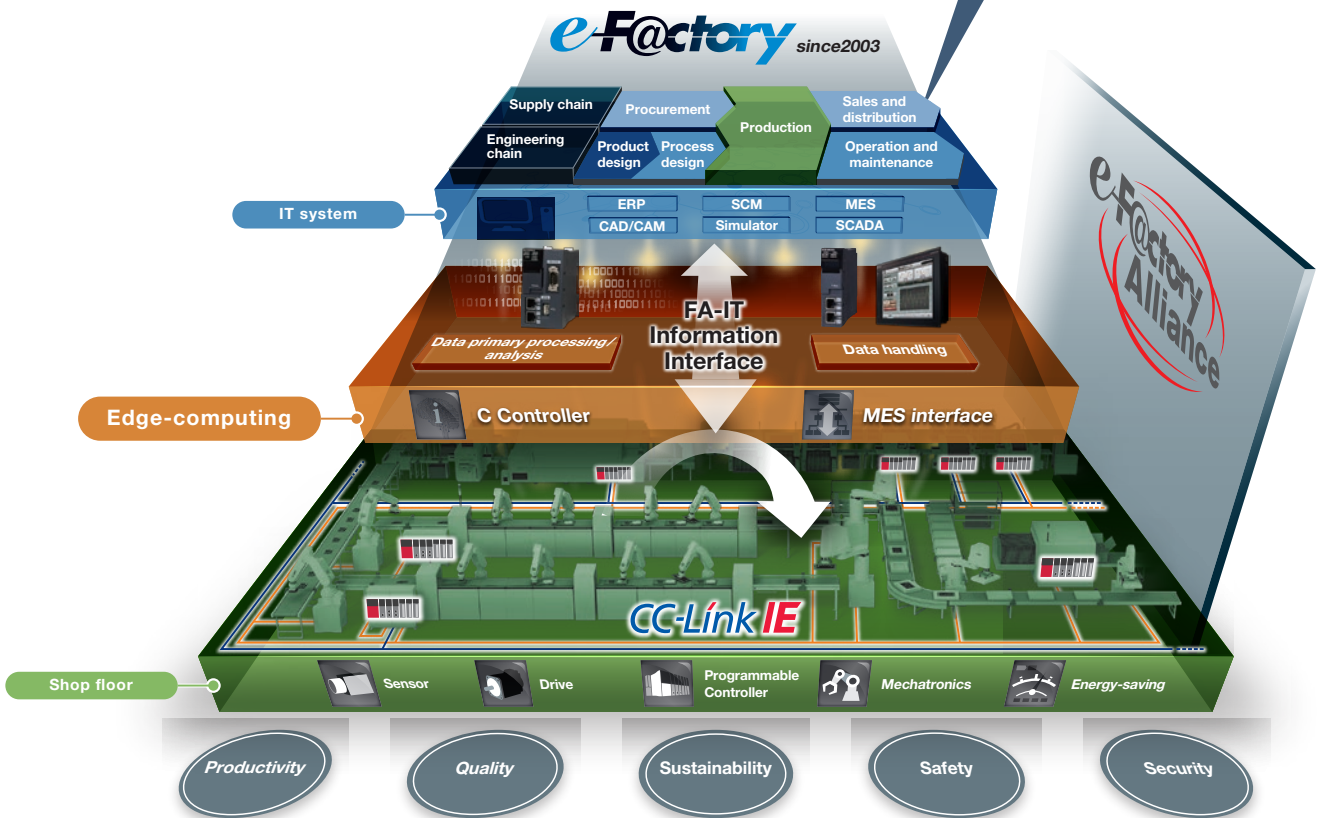
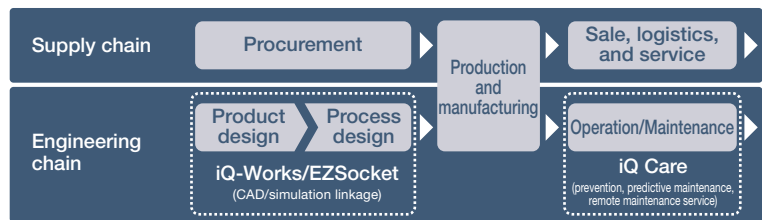

Overall production information is captured in addition to energy information, enabling the realization of efficient production and energy use (energy savings).

•Trademarks

LONWORKS is a registered trademark of Echelon Corporation, DeviceNet is a trademark of the ODVA, PROFIBUS is a trademark of the PROFIBUS User Organization, and MODBUS is a registered trademark of SCHNEIDER ELECTRIC USA, INC.
 Ethernet is a registered trademark of Fuji Xerox Corporation in Japan.
 Windows and Windows Vista are registered trademarks of Microsoft Corporation in the United States and other countries.
 EtherCAT is registered trademark and patented technology, licensed by Beckhoff Automation GmbH, Germany.
 Other company and product names herein are the trademarks and registered trademarks of their respective owners.

⚠ Safety Warning

To ensure proper use of the products listed in this catalog, please be sure to read the instruction manual prior to use.

YOUR SOLUTION PARTNER

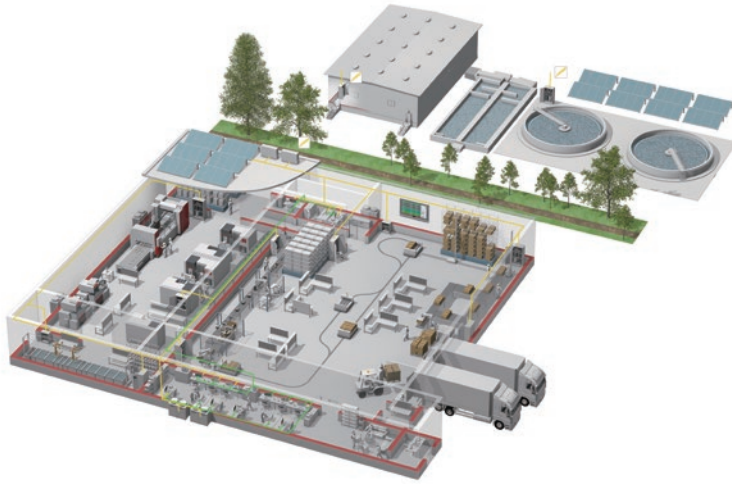

Mitsubishi Electric offers a wide range of automation equipment from PLCs and HMIs to CNC and EDM machines.

A NAME TO TRUST

Since its beginnings in 1870, some 45 companies use the Mitsubishi name, covering a spectrum of finance, commerce and industry.

The Mitsubishi brand name is recognized around the world as a symbol of premium quality.

Mitsubishi Electric Corporation is active in space development, transportation, semi-conductors, energy systems, communications and information processing, audio visual equipment and home electronics, building and energy management and automation systems, and has 237 factories and laboratories worldwide in over 121 countries.

This is why you can rely on Mitsubishi Electric automation solution - because we know first hand about the need for reliable, efficient, easy-to-use automation and control in our own factories.

As one of the world's leading companies with a global turnover of over 4 trillion Yen (over \$40 billion), employing over 100,000 people, Mitsubishi Electric has the resource and the commitment to deliver the ultimate in service and support as well as the best products.



Low voltage: MCCB, MCB, ACB



Medium voltage: VCB, VCC



Power monitoring, energy management



Compact and Modular Controllers



Inverters, Servos and Motors



Visualisation: HMIs



Numerical Control (NC)



Robots: SCARA, Articulated arm



Processing machines: EDM, Lasers, IDS



Transformers, Air conditioning, Photovoltaic systems

* Not all products are available in all countries.

Mitsubishi Electric Corporation Nagoya Works
is a factory certified for ISO 14001
(standards for environmental management
systems).



MITSUBISHI ELECTRIC CORPORATION

HEAD OFFICE: TOKYO BLDG., 2-7-3, MARUNOUCHI, CHIYODA-KU, TOKYO 100-8310, JAPAN