

Programmable Controller

Transition from MELSECNET/MINI-S3, A2C (I/O) to CC-Link Handbook



Sep. 2023 Edition

● SAFETY PRECAUTIONS ●

(Read these precautions before using this product.)

Before using this product, please read this handbook and the relevant manuals carefully and pay full attention to safety to handle the product correctly.

The precautions given in this handbook are concerned with this product only. For the safety precautions of the programmable controller system, refer to the user's manual for the CPU module used.

In this handbook, the safety precautions are classified into two levels: "⚠ WARNING" and "⚠ CAUTION".



Indicates that incorrect handling may cause hazardous conditions, resulting in death or severe injury.



Indicates that incorrect handling may cause hazardous conditions, resulting in minor or moderate injury or property damage.

Under some circumstances, failure to observe the precautions given under "⚠ CAUTION" may lead to serious consequences. Observe the precautions of both levels because they are important for personal and system safety.

Make sure that the end users read this handbook and then keep the manual in a safe place for future reference.

●When replacing with the Q series●

[Design Precautions]

WARNING

- For the operating status of each station after a communication failure in the data link, refer to the MELSEC-Q CC-Link System Master/Local Module User's Manual. Failure to do so may result in an accident due to an incorrect output or malfunction.
- When connecting a peripheral with the CPU module or connecting an external device, such as a personal computer, with an intelligent function module to modify data of a running programmable controller, configure an interlock circuit in the program to ensure that the entire system will always operate safely. For other forms of control (such as program modification or operating status change) of a running programmable controller, read the relevant manuals carefully and ensure that the operation is safe before proceeding. Especially, when a remote programmable controller is controlled by an external device, immediate action cannot be taken if a problem occurs in the programmable controller due to a communication failure. To prevent this, configure an interlock circuit in the program, and determine corrective actions to be taken between the external device and CPU module in case of a communication failure.
- Do not write any data to the "system area" of the buffer memory in the intelligent function module. Also, do not use any "use prohibited" signal as an output signal from the CPU module to the intelligent function module. Doing so may cause malfunction of the programmable controller system.
- To set a refresh device in the network parameter, select the device Y for the remote output (RY) refresh device ("Remote Output (RY)"). If a device other than Y, such as M and L, is selected, the CPU module holds the device status even after its status is changed to STOP. For how to stop data link, refer to the MELSEC-Q CC-Link System Master/Local Module User's Manual.
- If a CC-Link dedicated cable is disconnected, the network may be unstable, resulting in a communication failure of multiple stations. Configure an interlock circuit in the program to ensure that the entire system will always operate safely even if communications fail. Failure to do so may result in an accident due to an incorrect output or malfunction.

[Design Precautions]

CAUTION

- Do not install the control lines or communication cables together with the main circuit lines or power cables. Keep a distance of 100mm or more between them. Failure to do so may result in malfunction due to noise.

[Installation Precautions]

CAUTION

- Use the programmable controller in an environment that meets the general specifications in the user's manual for the CPU module used. Failure to do so may result in electric shock, fire, malfunction, or damage to or deterioration of the product.
- To mount the module, while pressing the module mounting lever located in the lower part of the module, fully insert the module fixing projection(s) into the hole(s) in the base unit and press the module until it snaps into place. Incorrect mounting may cause malfunction, failure or drop of the module. When using the programmable controller in an environment of frequent vibrations, fix the module with a screw.
Tighten the screws within the specified torque range. Undertightening can cause drop of the screw, short circuit or malfunction. Overtightening can damage the screw and/or module, resulting in drop, short circuit, or malfunction. Shut off the external power supply (all phases) used in the system before mounting or removing the module. Failure to do so may result in damage to the product.
- Shut off the external power supply (all phases) used in the system before mounting or removing the module. Failure to do so may result in damage to the product.
- Do not directly touch any conductive parts and electronic components of the module. Doing so can cause malfunction or failure of the module.

[Wiring Precautions]

WARNING

- Shut off the external power supply (all phases) used in the system before installation and wiring. Failure to do so may result in electric shock or damage to the product.
- After wiring, attach the included terminal cover to the module before turning it on for operation. Failure to do so may result in electric shock.

[Wiring Precautions]

CAUTION

- Use applicable solderless terminals and tighten them within the specified torque range. If any spade solderless terminal is used, it may be disconnected when the terminal screw comes loose, resulting in failure.
- Tighten the terminal screws within the specified torque range. Undertightening can cause short circuit, fire, or malfunction. Overtightening can damage the screw and/or module, resulting in drop, short circuit, or malfunction.
- Do not install the control lines or communication cables together with the main circuit lines or power cables. Failure to do so may result in malfunction due to noise.
- Prevent foreign matter such as dust or wire chips from entering the module. Such foreign matter can cause a fire, failure, or malfunction.
- A protective film is attached to the top of the module to prevent foreign matter, such as wire chips, from entering the module during wiring. Do not remove the film during wiring. Remove it for heat dissipation before system operation.
- Use CC-Link dedicated cables for a CC-Link system. If not, the performance of the CC-Link system is not guaranteed. For the maximum station-to-station distance and the overall cable distance, follow the specifications in Section 2.2 and the MELSEC-Q CC-Link System Master/Local Module User's Manual. If not, normal data transmission is not guaranteed.
- Place the cables in a duct or clamp them. If not, dangling cable may swing or inadvertently be pulled, resulting in damage to the module or cables or malfunction due to poor contact.
- When disconnecting the cable from the module, do not pull the cable by the cable part. For the cable with connector, hold the connector part of the cable. For the cable connected to the terminal block, loosen the terminal screw. Pulling the cable connected to the module may result in malfunction or damage to the module or cable.

[Startup and Maintenance Precautions] **WARNING**

- Do not touch any terminal while power is on. Doing so will cause electric shock or malfunction.
- Shut off the external power supply (all phases) used in the system before cleaning the module or retightening the terminal screws or module fixing screws. Failure to do so may result in electric shock or cause the module to fail or malfunction. Undertightening can cause drop of the screw, short circuit or malfunction. Overtightening can damage the screw and/or module, resulting in drop, short circuit, or malfunction.

[Startup and Maintenance Precautions] **CAUTION**

- Do not disassemble or modify the modules. Doing so may cause failure, malfunction, injury, or a fire.
- Shut off the external power supply (all phases) used in the system before mounting or removing the module. Failure to do so may cause the module to fail or malfunction.
- After the first use of the product, do not mount/remove the module to/from the base unit, and the terminal block to/from the module more than 50 times (IEC 61131-2 compliant) respectively. Exceeding the limit of 50 times may cause malfunction.
- Before handling the module, touch a grounded metal object to discharge the static electricity from the human body. Failure to do so may cause the module to fail or malfunction.

[Disposal Precautions] **CAUTION**

- When disposing of this product, treat it as industrial waste.

●When replacing with the L series●

[Design Precautions]

WARNING

- For the operating status of each station after a communication failure, refer to the MELSEC-L CC-Link System Master/Local Module User's Manual in this manual.
Incorrect output or malfunction due to a communication failure may result in an accident.
- When connecting a peripheral with the CPU module or connecting an external device, such as a personal computer, with an intelligent function module to modify data of a running programmable controller, configure an interlock circuit in the program to ensure that the entire system will always operate safely.
For other forms of control (such as program modification or operating status change) of a running programmable controller, read the relevant manuals carefully and ensure that the operation is safe before proceeding.
Especially, when a remote programmable controller is controlled by an external device, immediate action cannot be taken if a problem occurs in the programmable controller due to a communication failure.
To prevent this, configure an interlock circuit in the program, and determine corrective actions to be taken between the external device and CPU module in case of a communication failure.
- Do not write any data to the "system area" of the buffer memory in the intelligent function module. Also, do not use any "use prohibited" signals as an output signal from the CPU module to the intelligent function module.
Doing so may cause malfunction of the programmable controller system.
- To set the auto refresh parameter, select the device Y for the remote output (RY) refresh device. If a device other than Y, such as M and L, is selected, the CPU module holds the device status even after its status is changed to STOP.
For how to stop a data link, refer to the MELSEC-L CC-Link System Master/Local Module User's Manual.
- If a CC-Link dedicated cable is disconnected, the network may be unstable, resulting in a communication failure of multiple stations.
Configure an interlock circuit in the program to ensure that the entire system will always operate safely even if communications fail.
Failure to do so may result in an accident due to an incorrect output or malfunction.

[Design Precautions]

CAUTION

- Do not install the control lines or communication cables together with the main circuit lines or power cables.
Keep a distance of 100mm or more between them.
Failure to do so may result in malfunction due to noise.

[Installation Precautions]

WARNING

- Shut off the external power supply (all phases) used in the system before mounting or removing a module.
Failure to do so may result in electric shock or cause the module to fail or malfunction.

[Installation Precautions]

CAUTION

- Use the programmable controller in an environment that meets the general specifications in the Safety Guidelines provided with the CPU module or head module.
Failure to do so may result in electric shock, fire, malfunction, or damage to or deterioration of the product.
- To interconnect modules, engage the respective connectors and securely lock the module joint levers until they click.
Incorrect interconnection may cause malfunction, failure, or drop of the module.
- Do not directly touch any conductive parts and electronic components of the module.
Doing so can cause malfunction or failure of the module.

[Wiring Precautions]

WARNING

- Shut off the external power supply (all phases) used in the system before wiring.
Failure to do so may result in electric shock or cause the module to fail or malfunction.
- After installation and wiring, attach the included terminal cover to the module before turning it on for operation.
Failure to do so may result in electric shock.

[Wiring Precautions]

CAUTION

- Use applicable solderless terminals and tighten them within the specified torque range.
If any spade solderless terminal is used, it may be disconnected when a terminal block screw comes loose, resulting in failure.
- Do not install the control lines or communication cables together with the main circuit lines or power cables.
Failure to do so may result in malfunction due to noise.
- Place the cables in a duct or clamp them.
If not, dangling cable may swing or inadvertently be pulled, resulting in damage to the module or cables or malfunction due to poor contact.
- Tighten the terminal block screws within the specified torque range.
Undertightening can cause short circuit or malfunction.
Overtightening can damage the screw and/or module, resulting in drop, short circuit, fire, or malfunction.
- When disconnecting the cable from the module, do not pull the cable by the cable part.
For the cable with connector, hold the connector part of the cable.
For the cable connected to the terminal block, loosen the terminal screw.
Pulling the cable connected to the module may result in malfunction or damage to the module or cable.
- Prevent foreign matter such as dust or wire chips from entering the module.
Such foreign matter can cause a fire, failure, or malfunction.
- A protective film is attached to the top of the module to prevent foreign matter, such as wire chips, from entering the module during wiring.
Do not remove the film during wiring.
Remove it for heat dissipation before system operation.
- For the CC-Link system, use dedicated cables that are specified by the manufacturer.
If not, the performance of the CC-Link system is not guaranteed.
Also, the maximum overall cable length and the station-to-station cable length must meet those specified in Section 2.2 and the MELSEC-L CC-Link System Master/Local Module User's Manual.
If not, normal data transmission is not guaranteed.

[Startup and Maintenance Precautions]

WARNING

- Do not touch any terminal while power is on.
Doing so will cause electric shock or malfunction.
- Shut off the external power supply (all phases) used in the system before cleaning the module or retightening the terminal block screws.
Failure to do so may result in electric shock.

[Startup and Maintenance Precautions]

CAUTION

- Do not disassemble or modify the modules.
Doing so may cause failure, malfunction, injury, or a fire.
- Shut off the external power supply (all phases) used in the system before mounting or removing a module.
Failure to do so may cause the module to fail or malfunction.
- Tighten the terminal block screws within the specified torque range.
Undertightening can cause drop of the component or wire, short circuit, or malfunction.
Overtightening can damage the screw and/or module, resulting in drop, short circuit, or malfunction.
- After the first use of the product (module and terminal block), do not connect/disconnect the product more than 50 times (in accordance with IEC 61131-2).
Exceeding the limit may cause malfunction.
- Before handling the module, touch a conducting object such as a grounded metal to discharge the static electricity from the human body.
Failure to do so may cause the module to fail or malfunction.

[Disposal Precautions]

CAUTION

- When disposing of this product, treat it as industrial waste.

● CONDITIONS OF USE FOR THE PRODUCT ●

(1) Mitsubishi programmable controller ("the PRODUCT") shall be used in conditions;

i) where any problem, fault or failure occurring in the PRODUCT, if any, shall not lead to any major or serious accident; and

ii) where the backup and fail-safe function are systematically or automatically provided outside of the PRODUCT for the case of any problem, fault or failure occurring in the PRODUCT.

(2) The PRODUCT has been designed and manufactured for the purpose of being used in general industries.

MITSUBISHI SHALL HAVE NO RESPONSIBILITY OR LIABILITY (INCLUDING, BUT NOT LIMITED TO ANY AND ALL RESPONSIBILITY OR LIABILITY BASED ON CONTRACT, WARRANTY, TORT, PRODUCT LIABILITY) FOR ANY INJURY OR DEATH TO PERSONS OR LOSS OR DAMAGE TO PROPERTY CAUSED BY the PRODUCT THAT ARE OPERATED OR USED IN APPLICATION NOT INTENDED OR EXCLUDED BY INSTRUCTIONS, PRECAUTIONS, OR WARNING CONTAINED IN MITSUBISHI'S USER, INSTRUCTION AND/OR SAFETY MANUALS, TECHNICAL BULLETINS AND GUIDELINES FOR the PRODUCT.

("Prohibited Application")

Prohibited Applications include, but not limited to, the use of the PRODUCT in;

- Nuclear Power Plants and any other power plants operated by Power companies, and/or any other cases in which the public could be affected if any problem or fault occurs in the PRODUCT.
- Railway companies or Public service purposes, and/or any other cases in which establishment of a special quality assurance system is required by the Purchaser or End User.
- Aircraft or Aerospace, Medical applications, Train equipment, transport equipment such as Elevator and Escalator, Incineration and Fuel devices, Vehicles, Manned transportation, Equipment for Recreation and Amusement, and Safety devices, handling of Nuclear or Hazardous Materials or Chemicals, Mining and Drilling, and/or other applications where there is a significant risk of injury to the public or property.

Notwithstanding the above restrictions, Mitsubishi may in its sole discretion, authorize use of the PRODUCT in one or more of the Prohibited Applications, provided that the usage of the PRODUCT is limited only for the specific applications agreed to by Mitsubishi and provided further that no special quality assurance or fail-safe, redundant or other safety features which exceed the general specifications of the PRODUCTS are required. For details, please contact the Mitsubishi representative in your region.

REVISIONS

* The handbook number is given on the bottom left of the back cover.

Print Date	* Handbook Number	Revision
Dec., 2005	L(NA)08061ENG-A	First edition
Aug., 2007	L(NA)08061ENG-B	<p>Model addition</p> <p>Addition of modules to be replaced AJ65DBTB1-32D, AJ65BTB1-16D, AJ65BTB2-16D, AJ65DBTB1-32R, AJ65DBTB1-32T1, AJ65BTB1-16T, AJ65DBTB1-32DR, AJ65DBTB1-32DT1, AJ65BT-R2N, A6ADP-1MC16D, A6ADP-1MC16T, A6ADP-2MC16D</p> <p>Partial correction</p> <p>SAFETY PRECAUTIONS, Section 1.1, Section 1.2, Section 5.1, Section 5.2.1, Section 5.2.2, Section 5.2.3, Section 5.3, Chapter 8, Section 9.2, Appendix 1.3</p>
Mar., 2008	L(NA)08061ENG-C	<p>Model addition</p> <p>Renewal tool for A0J2</p> <p>Partial correction</p> <p>Section 1.1, Section 1.2 to Section 1.4 → Section 1.3 to Section 1.5, Section 1.3, Section 5.1, Section 5.2.1 to Section 5.2.3, Section 8.2, Appendix 1 → Appendix 2, Appendix 2.1, Appendix 2.4, Appendix 2.5</p>
Mar., 2013	L(NA)08061ENG-D	<p>Deletion of the AJ65BT-R2 from the alternative models</p> <p>Addition</p> <p>CONDITIONS OF USE FOR THE PRODUCT, GENERIC TERMS AND ABBREVIATIONS, Specifications comparison between AX80Y10C and AJ65DBTB1-32DR</p> <p>Partial correction</p> <p>SAFETY PRECAUTIONS, Section 1.3.2, Section 1.5, Section 2.1, Section 2.2.1, Section 2.2.2, Section 8.1, Section 8.2, Section 9.2, Appendix 2, WARRANTY</p>
Feb., 2016	L(NA)08061ENG-E	<p>Model addition</p> <p>LJ61BT11, L26CPU-(P)BT, A2CCPU</p> <p>Addition</p> <p>Section 4.1.2</p> <p>Partial addition</p> <p>Cover, Section 1.1, 1.4, 2.1, 5.1, 5.2, WARRANTY</p> <p>Change</p> <p>Chapter 9 → Appendix 1, Appendix 1 → Appendix 2, Appendix 2 → Appendix 3</p> <p>Partial correction</p> <p>SAFETY PRECAUTIONS, GENERIC TERMS AND ABBREVIATIONS, Section 4.1, 6.1, 6.2, 7.2, 8.2</p>

Print Date	* Handbook Number	Revision
Sep., 2018	L(NA)08061ENG-F	Partial correction GENERIC TERMS AND ABBREVIATIONS, Section 1.3.1, 1.4, 1.5, 2.1, 5.1, 5.3, Chapter 8
Sep., 2018	L(NA)08061ENG-G	Partial correction Front cover, back cover
Sep., 2023	L(NA)08061ENG-H	Partial correction Chapter 6

Japanese Handbook Version L-08057-J

This handbook confers no industrial property rights or any rights of any other kind, nor does it confer any patent licenses. Mitsubishi Electric Corporation cannot be held responsible for any problems involving industrial property rights which may occur as a result of using the contents noted in this handbook.

© 2005 MITSUBISHI ELECTRIC CORPORATION

CONTENTS

SAFETY PRECAUTIONS	A - 1
CONDITIONS OF USE FOR THE PRODUCT	A - 10
REVISIONS	A - 11
CONTENTS	A - 13
GENERIC TERMS AND ABBREVIATIONS	A - 16

CHAPTER 1 INTRODUCTION **1 - 1 to 1 - 8**

1.1 Replacing with MELSEC-Q/L series	1 - 1
1.2 Suggestions for Replacement with the Remote I/O Module of CC-Link System	1 - 2
1.3 Suggestions for Replacement with Renewal tool for A0J2	1 - 3
1.3.1 Advantages of using renewal tool for A0J2 (manufactured by Mitsubishi Electric System & Service Co., Ltd.)	1 - 3
1.3.2 Proposal of replacement with renewal tool for A0J2	1 - 6
1.4 Precautions for Replacement	1 - 7
1.5 Contact of the Relevant Products	1 - 8

CHAPTER 2 PERFORMANCE SPECIFICATIONS COMPARISONS **2 - 1 to 2 - 6**

2.1 Performance Specifications Comparisons between MELSECNET/MINI-S3 and CC-Link	2 - 1
2.2 Wiring in CC-Link	2 - 3
2.2.1 CC-Link Ver.1.00 cable specifications	2 - 3
2.2.2 CC-Link Ver.1.10 cable specifications	2 - 6

CHAPTER 3 FUNCTIONAL COMPARISONS **3 - 1 to 3 - 1**

3.1 Functional Comparisons between MELSECNET/MINI-S3 and CC-Link	3 - 1
--	-------

CHAPTER 4 REPLACING MASTER MODULE/REMOTE MODULE **4 - 1 to 4 - 2**

4.1 Replacing Master Module	4 - 1
4.1.1 List of alternative master module models	4 - 1
4.1.2 List of alternative models for the A2CCPU	4 - 1
4.2 Replacing Remote Module	4 - 2
4.2.1 List of alternative remote module models	4 - 2

CHAPTER 5 REPLACING I/O MODULE **5 - 1 to 5 - 127**

5.1 List of Alternative I/O Module Models	5 - 1
5.2 I/O Module Specifications Comparison	5 - 24
5.2.1 Input module specifications comparison	5 - 24
5.2.2 Output module specifications comparisons	5 - 40

5.2.3	I/O Module Specifications Comparison	5 - 65
5.3	Precautions for Replacement of I/O Module	5 - 125

CHAPTER 6 REPLACING ANALOG I/O MODULE **6 - 1 to 6 - 73**

6.1	List of Alternative Analog I/O Module Models	6 - 1
6.2	List of Alternative Master Module Models	6 - 4
6.2.1	Comparisons of analog input module	6 - 4
6.2.2	Analog output module comparison	6 - 24
6.2.3	Comparison of temperature input module	6 - 59

CHAPTER 7 REPLACING THE HIGH-SPEED COUNTER MODULE **7 - 1 to 7 - 9**

7.1	List of Alternative High-speed Counter Module Models.	7 - 1
7.2	High-speed Counter Module Comparison	7 - 2

CHAPTER 8 REPLACING THE COMMUNICATION MODULES **8 - 1 to 8 - 7**

8.1	List of Alternative Communication Module Models	8 - 1
8.2	Serial Communication Module Comparisons.	8 - 2

APPENDICES **App - 1 to App - 47**

Appendix 1	External Dimensions	App - 1
Appendix 2	Performance Specifications Comparison between MELSECNET/MINI-S3 compact type I/O module and Renewal Tool for A0J2	App - 1
Appendix 2.1	Precautions for the performance specifications comparison	App - 1
Appendix 2.2	Performance specifications comparison	App - 3
Appendix 3	Related Manuals	App - 43
Appendix 3.1	Replacement handbooks	App - 43
Appendix 3.2	MELSECNET/MINI-S3	App - 44
Appendix 3.3	CC-Link.	App - 44
Appendix 3.4	Products manufactured by Mitsubishi Electric Engineering Co., Ltd.	App - 45
Appendix 3.5	Products manufactured by Mitsubishi Electric System & Service Co., Ltd.	App - 45

- For the products shown in handbooks for transition, catalogues, and transition examples, refer to the manuals for the relevant products and check the detailed specifications, precautions for use, and restrictions before replacement.

For the products manufactured by Mitsubishi Electric Engineering Co., Ltd., Mitsubishi Electric System & Service Co., Ltd., and other companies, refer to the catalogue for each product and check the detailed specifications, precautions for use, and restrictions before use.

The manuals and catalogues for our products, products manufactured by Mitsubishi Electric Engineering Co., Ltd., and Mitsubishi Electric System & Service Co., Ltd. are shown in Appendix of each handbook for transition.

- Products shown in this handbook are subject to change without notice.

GENERIC TERMS AND ABBREVIATIONS

Unless otherwise specified, this handbook uses the following generic terms and abbreviations.

Generic term/abbreviation	Description
■Series	
A series	An abbreviation for large types of Mitsubishi Electric MELSEC-A series programmable controllers
AnS series	An abbreviation for compact types of Mitsubishi Electric MELSEC-A series programmable controllers
A/AnS series	A generic term for A series and AnS series
QnA series	An abbreviation for large types of Mitsubishi Electric MELSEC-QnA series programmable controllers
QnAS series	An abbreviation for compact types of Mitsubishi Electric MELSEC-QnA series programmable controllers
QnA/QnAS series	A generic term for QnA series and QnAS series
A/AnS/QnA/QnAS series	A generic term for A series, AnS series, QnA series, and QnAS series
Q series	An abbreviation for Mitsubishi Electric MELSEC-Q series programmable controllers
L series	An abbreviation for Mitsubishi Electric MELSEC-L series programmable controllers
■CPU module type	
CPU module	A generic term for A series, AnS series, QnA series, QnAS series, Q series, and L series CPU modules
Process CPU	A generic term for the Q02PHCPU, Q06PHCPU, Q12PHCPU, and Q25PHCPU
Redundant CPU	A generic term for the Q12PRHCPU and Q25PRHCPU
Universal model QCPU	A generic term for the Q00UJCPU, Q00UCPU, Q01UCPU, Q02UCPU, Q03UDCPU, Q03UDVCPU, Q03UDECPU, Q04UDHCPU, Q04UDVCPU, Q04UDEHCPU, Q06UDHCPU, Q06UDVCPU, Q06UDEHCPU, Q10UDHCPU, Q10UDEHCPU, Q13UDHCPU, Q13UDVCPU, Q13UDEHCPU, Q20UDHCPU, Q20UDEHCPU, Q26UDHCPU, Q26UDVCPU, and Q26UDEHCPU
LCPU	A generic term for the L02SCPU, L02SCPU-P, L02CPU, L02CPU-P, L06CPU, L06CPU-P, L26CPU, L26CPU-P, L26CPU-BT, and L26CPU-PBT
Built-in CC-Link function	The abbreviation for the L26CPU-BT/L26CPU-PBT built-in CC-Link system master/local function
■CPU module model	
ACPU	A generic term for MELSEC-A series CPU modules
AnSCPU	A generic term for MELSEC-AnS series CPU modules
AnNCP	A generic term for the A1NCP, A1NCPUP21/R21, A1NCPUP21-S3, A2NCP, A2NCP-S1, A2NCPUP21/R21, A2NCPUP21/R21-S1, A2NCPUP21-S3(S4), A3NCP, A3NCPUP21/R21, and A3NCPUP21-S3
AnACPU	A generic term for the A2ACPU, A2ACPU-S1, A3ACPU, A2ACPUP21/R21, A2ACPUP21/R21-S1, and A3ACPUP21/R21
AnUCPU	A generic term for the A2UCPU, A2UCPU-S1, A3UCPU, and A4UCPU
AnUS(H)CPU	A generic term for the A2USCPU, A2USCPU-S1, A2USHCPU-S1
A/AnSCPU	A generic term for MELSEC-A series and -AnS series CPU modules
AnN/AnACPU	A generic term for the AnNCP and AnACPU
AnN/AnA/AnSCPU	A generic term for the AnNCP, AnACPU, and AnSCPU
A2CCPU	A generic term for the A2CCPU, A2CCPU-DC24V, A2CCPUP21/R21, A2CCPUC24(-PRF), and A2CJCPU
QnACPU	A generic term for MELSEC-QnA series CPU modules
QnASCPU	A generic term for MELSEC-QnAS series CPU modules
QnA/QnASCPU	A generic term for MELSEC-QnA series and -QnAS series CPU modules
A/AnS/QnA/QnASCPU	A generic term for MELSEC-A series, -AnS series, -QnA series, and -QnAS series CPU modules
QCPU	A generic term for MELSEC-Q series CPU modules
LCPU	A generic term for MELSEC-L series CPU modules

1 INTRODUCTION

1.1 Replacing with MELSEC-Q/L series

The MELSEC-Q/L series does not have a MELSECNET/MINI-S3 master module. For this reason, it is recommended to use the CC-Link system when replacing the MELSECNET/MINI-S3 system using the MELSEC-Q/L series.

(Before replacement)

• Configuration example of MELSECNET/MINI

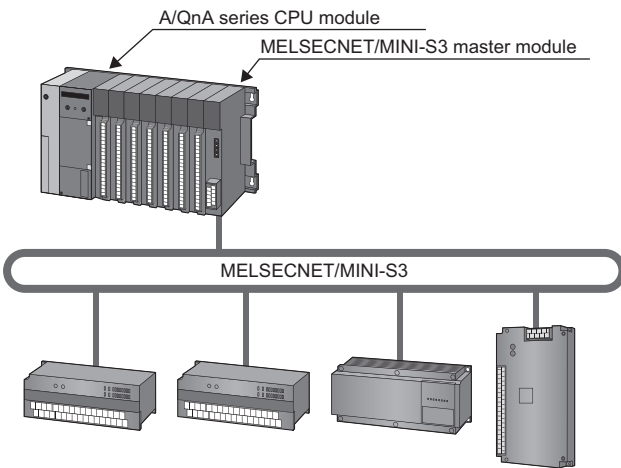

• Configuration example of A2CCPU

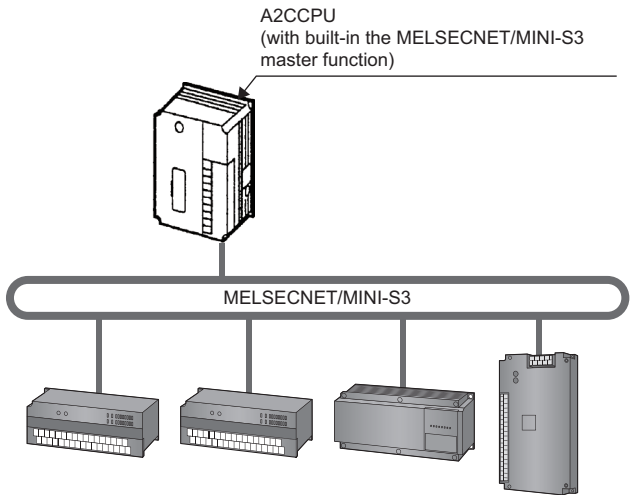

(After replacement)

• Configuration example of when the CPU module is replaced with the QCPU

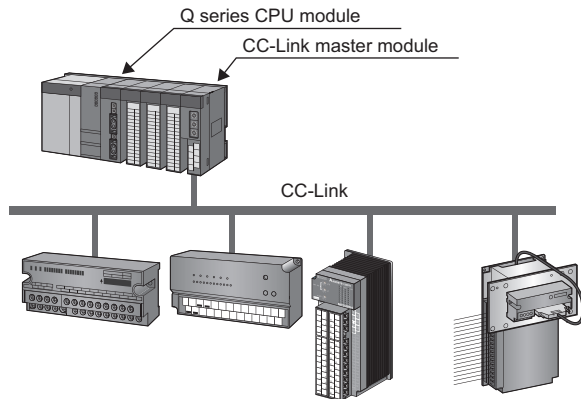

• Configuration example of when the CPU module is replaced with the LCPU

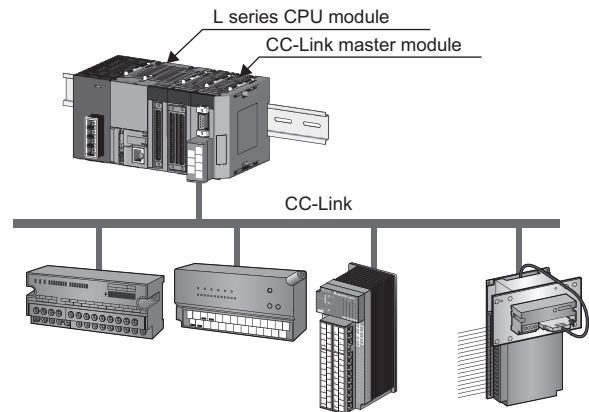

1.2 Suggestions for Replacement with the Remote I/O Module of CC-Link System

Module before replacement (current status)	Module after replacement		Corresponding module (before replacement → after replacement)
	Type	Outline	
MELSECNET/mini-S3-compatible module (AJ35□-□) A2C (I/O) module (A□C)	CC-Link system compact type remote I/O module	<ul style="list-style-type: none"> Reconfiguration of the system is easy. Selecting the best match model from the wide selection of modules for a module before replacement is possible. 	(All models)
	CC-Link system remote I/O module (A2C shape)	<ul style="list-style-type: none"> Module mounting size is the same. This A2C shape CC-Link I/O module has the same shape (same mounting dimensions) with A2C (I/O) module. No processing for mounting holes is required when replacing the module. I/O signal wiring is the same. Since the terminal block of the same shape is used, I/O signal wiring is the same.*1 Optional products are available. The A6DIN1C and A2CCOM-TB (sold separately) are available. If the A2C (I/O) is used before replacement, it can be utilized. 	AX41C/AX81C → AJ65DBTB1-32D AY51C → AJ65DBTB1-32T1 AX40Y50C → AJ65DBTB1-32DT1 AY13C → AJ65DBTB1-32R AX40Y10C/AX80Y10C → AJ65DBTB1-32DR
	CC-Link system remote I/O module	<ul style="list-style-type: none"> Change in wiring is unnecessary. By using a wiring conversion adapter, terminal block of the module before replacement can be utilized to the module after replacement*2 (regarding communication cable and power cable, wiring change is required). 	AJ35TB1-16D → AJ65BTB1-16D AJ35TB2-16D → AJ65BTB2-16D AJ35TB1-16T → AJ65BTB1-16T

*1 Man-hour taken for wiring change can be reduced since wiring to the external device can also be used by partially changing the wiring of power cable and communication cable.

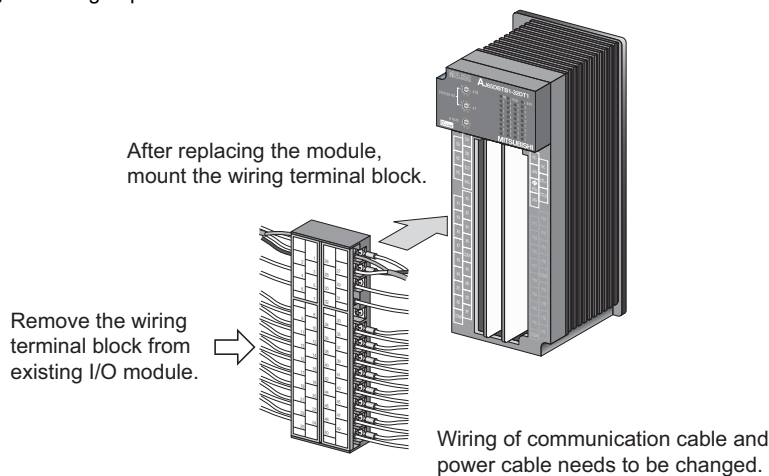

*2 Image figure of replacement using wiring conversion adapter

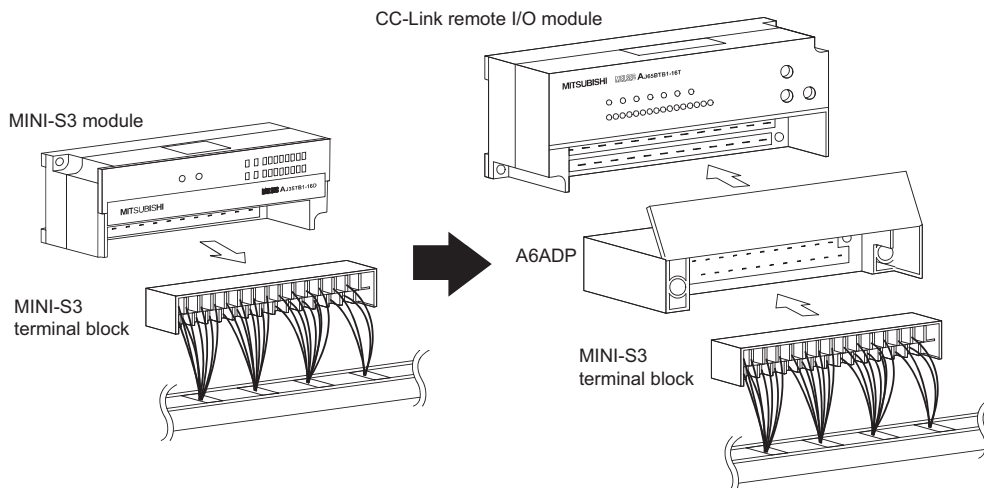

1.3 Suggestions for Replacement with Renewal tool for A0J2

1.3.1 Advantages of using renewal tool for A0J2 (manufactured by Mitsubishi Electric System & Service Co., Ltd.)

(1) Renewal tool for A0J2

This tool is for replacing the existing MELSECNET/MINI-S3 compact type I/O module with a CC-Link module. It is composed of the interface module to which wiring terminal block of existing I/O module can be attached, components for a programmable controller, and connection cable.

Also, the interface module has the conversion function that converts AC input into DC input and DC output into relay output and triac output. The interface module can be replaced with the 40-pin connector type DC I/O module.

(a) Configuration example of Renewal tool for A0J2

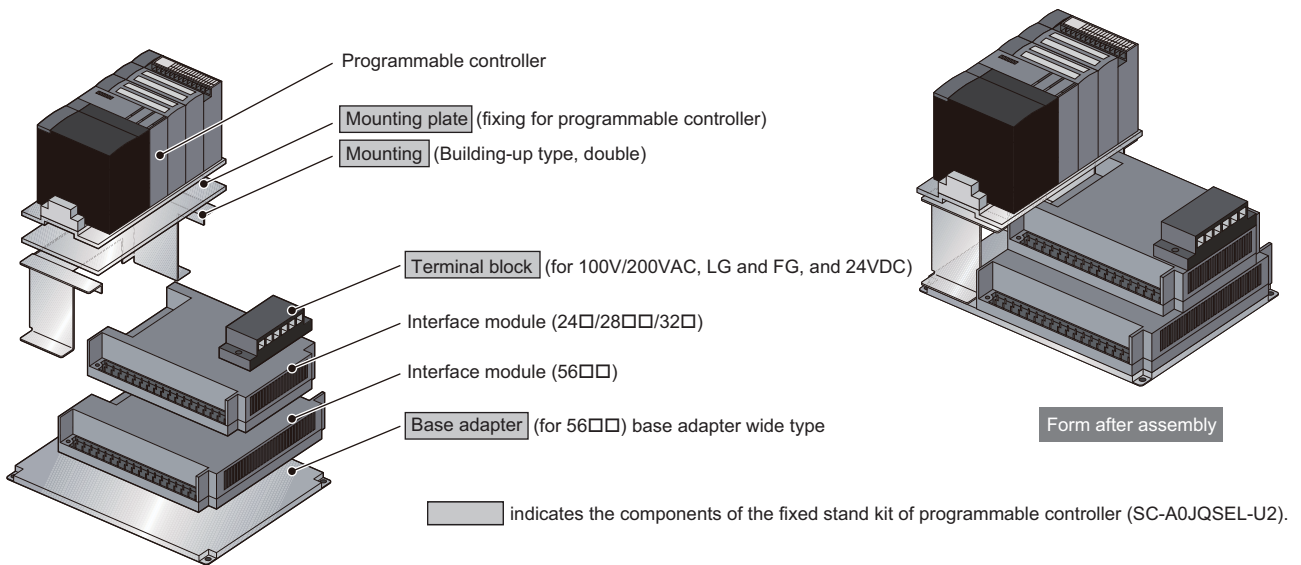

For details on the renewal tool for A0J2, interface modules, and mounting dimensions, refer to the following.

- Renewal tool for A0J2 series Transition from MELSEC-A0J2(H) series to renewal system using renewal tool
(Issued by Mitsubishi Electric System & Service Co., Ltd.)

(2) Using existing cables

Although the A/QnA series CPU module is replaced with the Q series CPU module, the external wiring terminal block attached to the existing MELSECNET/MINI-S3 compact type remote I/O module can be utilized to the interface module. It allows to replace the modules without external wiring change. (The module is replaced with 40-pin connector type DC I/O module of CC-Link.)

Also, new wiring is unnecessary since the CC-Link I/O module is connected to the interface module with dedicated cable.

(Before replacement)

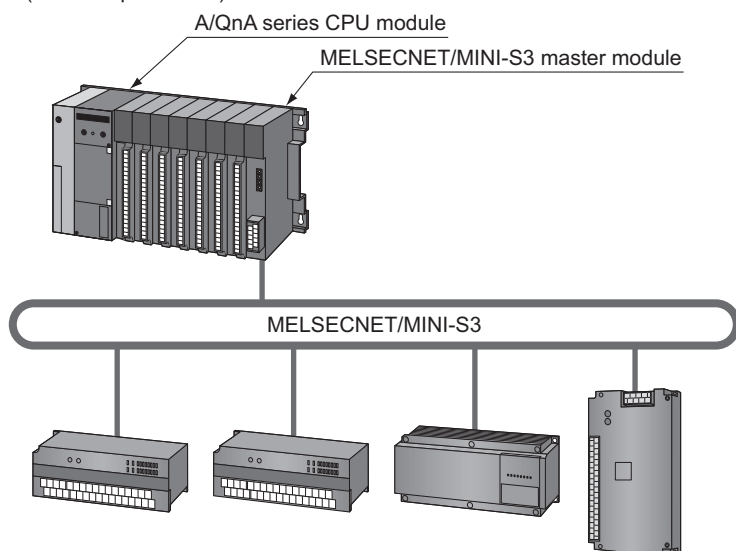

(After replacement)

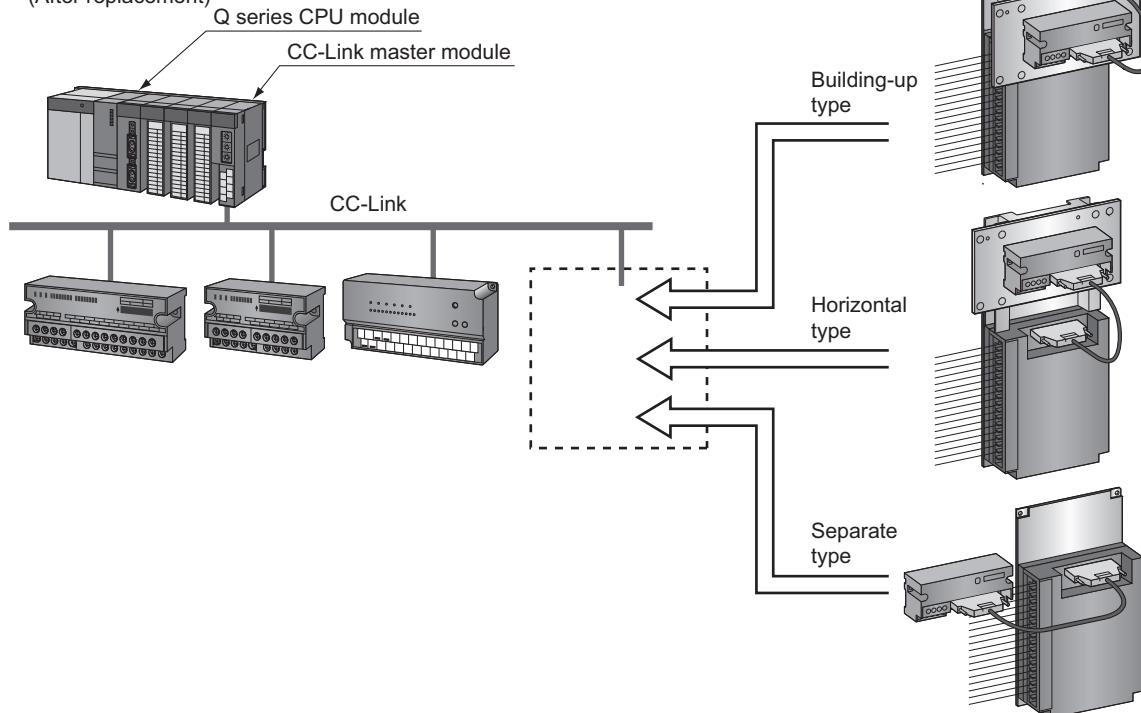

POINT

For specifications comparison and functional comparison between the existing MELSECNET/MINI-S3 compact type remote I/O module and the renewal tool for A0J2 after replacement, refer to APPENDICES.

(3) Processing the mounting holes is unnecessary.

Mounting dimensions of the base adapter included with renewal tool for A0J2 is the same with dimensions of existing A0J2 I/O module. Replacement without processing the mounting holes is possible.

(4) I/O address change is unnecessary.

By replacing the MELSECNET/MINI-S3 compact type remote I/O module with 40-pin connector type DC input/output module of CC-Link, the I/O address assignment of the MELSECNET/MINI-S3 compact type remote I/O module can be utilized.

It eliminates I/O address change and allows substantial reduction of program correction.

(5) List of alternative models

Model to be discontinued (MELSECNET/ MINI-S3)		Alternative model (CC-Link/renewal tool for A0J2)		
Product	Model	CC-Link	Renewal tool for A0J2 ^{*1}	
			Interface module	Fixed stand kit of programmable controller ^{*2*3}
Input module	AJ35PTF-32A	AJ65SBTCF1-32D	SC-A0JQIF32A	SC-A0JQSES-U1 (Building-up type, single) SC-A0JQSES-F (Horizontal type, single) SC-A0JQBSS (Separate type, single)
	AJ35PTF-32D		SC-A0JQIF32D	
Output module	AJ35PTF-24R	AJ65SBTCF1-32T	SC-A0JQIF24R	
	AJ35PTF-24S		SC-A0JQIF24S	
	AJ35PTF-24T		SC-A0JQIF24T	
I/O module	AJ35PTF-28AR	AJ65SBTCF1-32D+	SC-A0JQIF28AR	
	AJ35PTF-28AS		SC-A0JQIF28AS	
	AJ35PTF-28DR		SC-A0JQIF28DR	
	AJ35PTF-28DS		SC-A0JQIF28DS	
	AJ35PTF-28DT		SC-A0JQIF28DT	
	AJ35PTF-56AR	AJ65SBTCF1-32T	SC-A0JQIF56AR	SC-A0JQSEL-U1 (Building-up type, single) SC-A0JQSEL-U2 (Building-up type, double) SC-A0JQSEL-F (Horizontal type, single/double) SC-A0JQBSSL (Separate type, single/double)
	AJ35PTF-56AS	SC-A0JQIF56AS		
	AJ35PTF-56DR	SC-A0JQIF56DR		
	AJ35PTF-56DS	SC-A0JQIF56DS		
AJ35PTF-56DT	SC-A0JQIF56DT			

*1 The renewal tool for A0J2 series Interface module and the cable for connecting the CC-Link I/O module (SC-A0JQC□□M) are also required.

*2 The fixed stand of programmable controller is equipped with a Q33B mounting plate as standard equipment. A separately-sold mounting plate (SC-A0JQPT2) is required to use CC-Link modules.

*3 To use fixed stands of programmable controller for double stack, arrange the CC-Link module for the second stand on a location different from the installation surface of the existing panel. (Up to two CC-Link modules can be mounted on the existing space.)

For details, refer to the related catalogs and manuals issued by Mitsubishi Electric System & Service Co., Ltd.

1.3.2 Proposal of replacement with renewal tool for A0J2

(1) Building-up type

The CC-Link I/O module can be built up to the existing panel if there is room for depth in front of existing module, and can be installed on the installation surface of the existing panel.

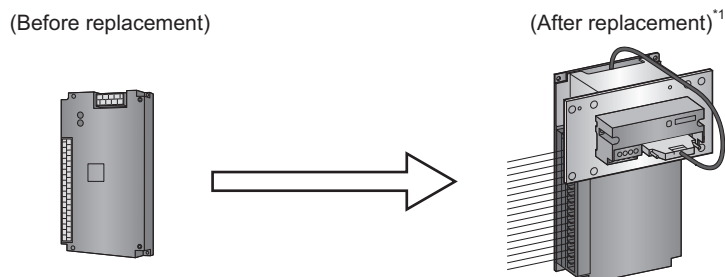

*1: Up to two CC-Link I/O modules can be used for a renewal tool for A0J2. Install the third CC-Link I/O module or later separately.

(2) Horizontal type

The CC-Link I/O module can be installed horizontally, if there is room above the existing module.

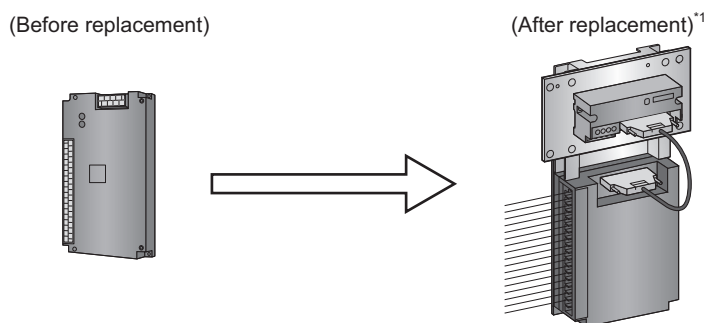

*1: Up to two CC-Link I/O modules can be used for a renewal tool for A0J2. Install the third CC-Link I/O module or later separately.

(3) Separate type

When CC-Link I/O modules cannot be stacked or installed horizontally, install them separately.

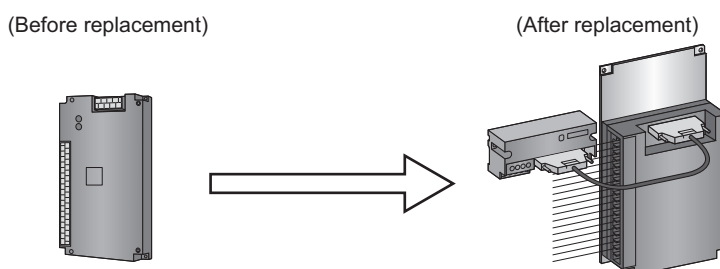

Remark

Other than CC-Link, replacement to the QCPU or AnSCPU is possible.
For details, contact your local Mitsubishi sales representative. (refer to Section 1.5).

1.4 Precautions for Replacement

- (a) Before replacing MELSECNET/MINI-S3 with CC-Link, be sure to refer to the manuals for each of the CC-Link modules, and confirm the functions, specifications, grounding method and methods of use of the modules.
- (b) For replacement using renewal tool for A0J2, always refer to the following manual. Select correct products after checking the functions, specifications, and usage. (Reference manual)
 - Renewal tool for A0J2 series transition from MELSEC-A0J2(H) series to renewal system using renewal tool (Refer to Appendix 2.5.)
- (c) When stations installing a MELSECNET/MINI-S3 - CC-Link module wiring conversion adapter to the CC-Link remote I/O module (AJ65BTB1-16D, AJ65BTB2-16D or AJ65BTB1-16T) is mixed, the maximum number of connected modules is 32 with the use of a version 1.10 compatible CC-Link dedicated cable.
(No restrictions when using cables other than a version 1.10 compatible CC-Link dedicated cable.)
- (d) After replacing MELSECNET/MINI-S3 with CC-Link, be sure to check operation of the entire system before starting actual operation.

POINT

Before replacement, make sure again that the frame ground of the programmable controller system is securely grounded.

The noise tolerance of programmable controllers is secured by diverting noise to ground via the frame ground as an EMC measure.

For this reason, the system might be affected by noise according to reconfiguring the system if grounding is insufficient.

Also, consider the following as a provisional measure when checking grounding status is difficult.

- (1) Change the ground of the system into an exclusive ground.
- (2) Add on a ferrite core between the ground wire and the module FG terminal.

1.5 Contact of the Relevant Products

Renewal tool manufactured by Mitsubishi Electric Engineering Co., Ltd.

For products manufactured by Mitsubishi Electric Engineering Co., Ltd., contact your local sales representative.

Introduction of "replacement of MELSEC-A series, system renewal service, and renewal tool for A0J2"

For replacement of MELSEC-A series and system renewal service, contact your local sales representative.

2 PERFORMANCE SPECIFICATIONS COMPARISONS

2.1 Performance Specifications Comparisons between MELSECNET/MINI-S3 and CC-Link

○ : Compatible, △ : Partial change required, × : Not compatible

Item		Specifications			Compatibility	Precautions for replacement
		MELSECNET/MINI-S3	A2CCPU	CC-Link		
Per master station	Max. number of link stations	64 stations (8 points/station)		64 stations (32 points/station)	○	
	Maximum control I/O points	1024 points *1	512 points	4096 points + 512 words	○	
Number of master modules mounted		Max. 64 modules (according to the specifications for the CPU module used.)	The CPU has specifications equivalent to those of a master module.	When setting parameters with GX Works2/GX Developer: Max. 8 modules *2*3 When setting parameters with dedicated instructions: Max. 64 modules*3 (according to the specifications for the CPU module used.)	○	
Communication speed		1.5Mbps		156k/625k/2.5M/5M/10Mbps	○	
Transmission method		Ring		Bus	×	New cable must be laid.
Overall cable distance		No restriction		1200m (at 156kbps)	×	When the transmission distance exceeds 1200m, use a CC-Link repeater module.
Max. transmission distance between stations		Optical data link: 50m (35m)*4 Twisted pair data link: 100m (50m)*5	Twisted pair data link: 100m (50m)*5	1200m (at 156kbps)	○	
Number of occupied I/O points per stations		In I/O dedicated mode: 32 points In extended mode: 48 points	---	32 points	△	For the extended mode, the number of occupied points changes.

- *1: When 16 separate refresh type remote I/O modules AJ35PTF-128DT (number of occupied stations: 4) are connected, 1024 I/O points each can be controlled.
- *2: The following CPU modules have the restriction of the number of modules mounted.
- Q00UJ/Q00U/Q01UCPU: 2
 - Q02UCPU: 4
 - L02S/L02CPU(-P): 2
 - L06/L26CPU(-P): 4
 - L26CPU(-P)BT: Built-in CC-Link function + 3
- *3: Total number of CC-Link master stations and local stations.
- *4: When a 2VTPE-1 optical combined vinyl-insulated sheath cable (manufactured by Mitsubishi Cable Industries, Ltd.) is used, the max. transmission distance between stations is 35m.
- *5: The max. transmission distance between stations varies according to the size of the twisted pair cable.
- 0.2mm² or more to less than 0.5mm² ... 50m,
 - 0.5mm² or more ... 100m

2.2 Wiring in CC-Link

New cables must be laid when replacing MELSENET/MINI-S3 with CC-Link as the two systems differ in the applicable cable types.

2.2.1 CC-Link Ver.1.00 cable specifications

(1) Connection method

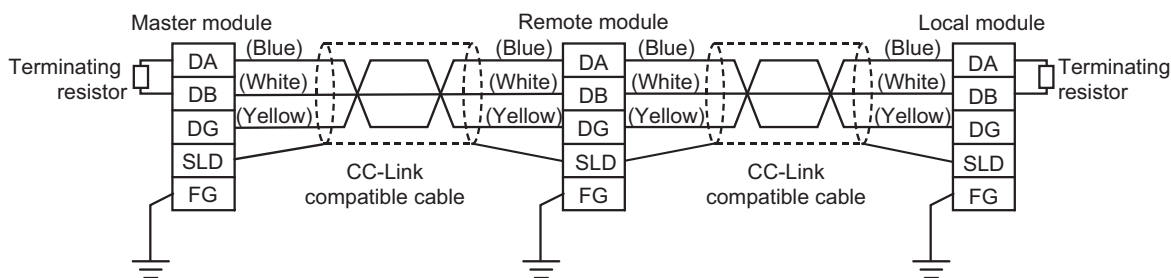

In the CC-Link system, the terminal resistor to be connected varies according to the cable to be used.

Cable type	Terminal resistor
CC-Link dedicated cable	110 Ω 1/2 W (brown/brown/brown)
CC-Link dedicated high-performance cable	130 Ω 1/2 W (brown/orange/brown)

(2) Cable length between stations, max. overall cable length

1) When the system is composed of only remote I/O stations and remote device stations

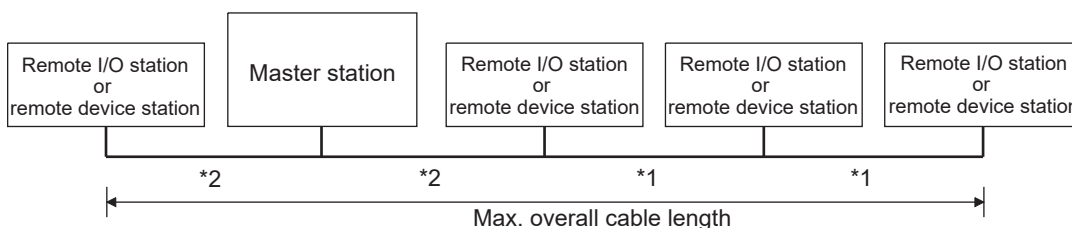

*1: Cable length between remote I/O stations or remote device stations

*2: Cable length between master station and next stations

CC-Link dedicated cable (110Ω used as terminal resistor)

Transmission speed	Cable length between stations		Max. overall cable length
	*1	*2	
156kbps	30cm or more	1m or more	1200m
625kbps			600m
2.5Mbps			200m
5Mbps	30cm to 59cm*		110m
	60cm or more		150m
10Mbps	30cm to 59cm*		50m
	60cm to 99cm*		80m
	1m or more	100m	

CC-Link dedicated high-performance cable (130Ω used as terminal resistor)

Transmission speed	Cable length between stations		Max. overall cable length	
	*1	*2		
156kbps	30cm or more	1m or more	1200m	
625kbps			900m	
2.5Mbps			400m	
5Mbps			150m	
10Mbps	Number of connected modules :1 to 32		100m	
	Number of connected modules :33 to 48		30cm to 39cm*	80m
			40cm or more	100m
	Number of connected modules :49 to 64	30cm to 39cm*	20m	
		40cm to 69cm*	30m	
	70cm or more	100m		

* When an actual cable length between remote I/O stations or remote device stations is in this range at even one location, the above max. overall cable length applies.

2) When the system is composed of remote I/O stations, remote device stations, local stations, and intelligent device stations

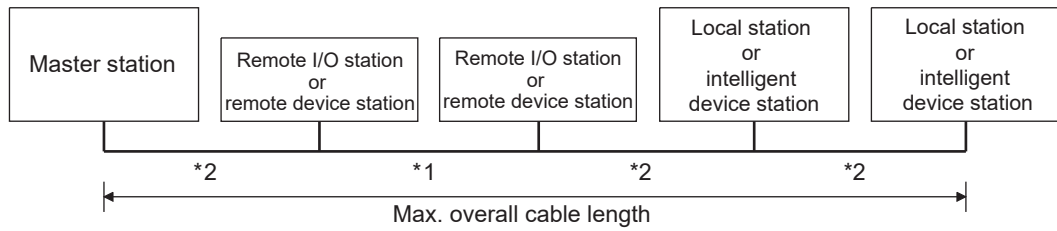

*1: Cable length between remote I/O stations or remote device stations

*2: Cable length between master/local stations or intelligent device stations and next stations

CC-Link dedicated cable (110Ω used as terminal resistor)

Transmission speed	Cable length between stations		Max. overall cable length
	*1	*2	
156kbps	30cm or more	2m or more	1200m
625kbps			600m
2.5Mbps			200m
5Mbps	30cm to 59cm*		110m
	60cm or more		150m
10Mbps	30cm to 59cm*		50m
	60cm to 99cm*		80m
	1m or more		100m

CC-Link dedicated high-performance cable (130Ω used as terminal resistor)

Transmission speed	Cable length between stations		Max. overall cable length
	*1	*2	
156kbps	30cm or more	2m or more	1200m
625kbps			600m
2.5Mbps			200m
5Mbps	30cm to 59cm*		110m
	60cm or more		150m
10Mbps	70cm to 99cm*		50m
	1m or more		80m

* When an actual cable length between remote I/O stations or remote device stations is in this range at even one location, the above max. overall cable length applies.

2.2.2 CC-Link Ver.1.10 cable specifications

(1) Connection method

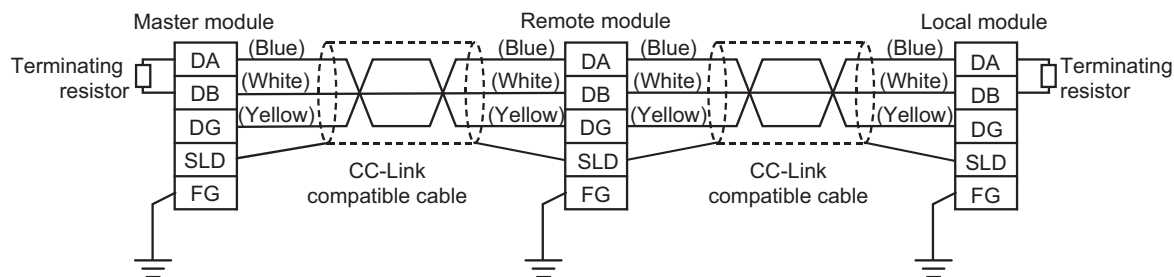

Cable type	Terminal resistor
Ver1.10-compatible CC-Link dedicated cable	110 Ω 1/2 W (brown/brown/brown)

(2) Cable length between stations, max. overall cable length

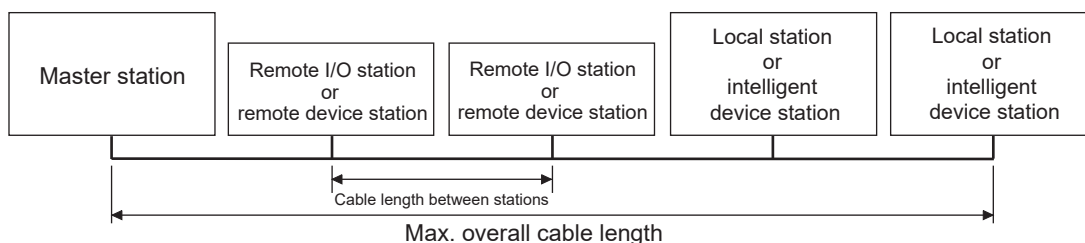

Ver.1.10-compatible CC-Link dedicated cable (110 Ω used as terminal resistor)

Transmission speed	Cable length between stations	Max. overall cable length
156kbps	20cm or more	1200m
625kbps		900m
2.5Mbps		400m
5Mbps		160m
10Mbps		100m

3

FUNCTIONAL COMPARISONS

3.1 Functional Comparisons between MELSECNET/MINI-S3 and CC-Link

○ : Compatible, △ : Partial change required, × : Not compatible

Item	Specifications		Compati- bility	Precautions for replacement	
	MELSECNET/MINI-S3	CC-Link			
Communication with remote station	Communication with batch refresh type remote I/O modules, separate refresh type remote I/O modules and remote terminal modules is possible.	Communication with remote I/O stations, remote device stations, local stations, and intelligent device stations is possible.	×	Create new programs as the two systems are not compatible in the program.	
RAS function	Communication / line error detection	Communications with all stations sometimes is discontinued when an error occurs on even one station. The faulty station is detected on the master station and is stored to buffer memory.	△	The method of confirmation is different. Review the program.	
	Line check	Breakage of the optical cables and twisted pair cables can be checked by changing the operation mode of the master station.	△		
Others	Monitor station function	The I/O status of the remote I/O module can be monitored by the LEDs on the master station.	None	×	Connect the programming tool and check by the device monitor.

4 REPLACING MASTER MODULE/REMOTE MODULE

4.1 Replacing Master Module

4.1.1 List of alternative master module models

MELSECNET/MINI-S3 models to be discontinued		Alternative model for CC-Link	
Product name	Model name	Model name	Remarks (restrictions)
Master module	AJ71PT32-S3	QJ61BT11N/LJ61BT11/ L26CPU-(P)BT (Built-in CC-Link function)	Examine replacement with CC-Link. For details, refer to the User's Manual for the respective module.
	AJ71T32-S3		
	A1SJ71PT32-S3		
	A1SJ71T32-S3		

4.1.2 List of alternative models for the A2CCPU

MELSECNET/MINI-S3 models to be discontinued		Alternative model for CC-Link	
Product name	Model name	Model name	Remarks (restrictions)
CPU module	A2CCPU	QJ61BT11N/LJ61BT11/ L26CPU-(P)BT (Built-in CC-Link function)	The A2CCPU is a CPU that has a built-in master function of the MELSECNET/MINI-S3. Examine replacement of the built-in master function with CC-Link. Separately select CPU modules and other functions depending on the existing control contents.
	A2CCPUP21		
	A2CCPUR21		
	A2CCPU-DC24		
	A2CCPUC24		
	A2CCPUC24-PRF		
	A2CJCPU		

4.2 Replacing Remote Module

CC-Link does not have a remote module that uses a building block type I/O module. When replacing a remote module, consider replacing it with each CC-Link remote module or a local station.

4.2.1 List of alternative remote module models

MELSECNET/MINI-S3 models to be discontinued		Alternative models for CC-Link	
Product name	Model name	Model name	Remarks (restrictions)
Remote module	AJ72PT35	None	Consider replacing it with each CC-Link remote module or a local station ^{*1} .
	AJ72T35	None	

*1: A program is required for a CC-Link local station as it cannot directly control I/O modules. For this reason, the following system changes are required.

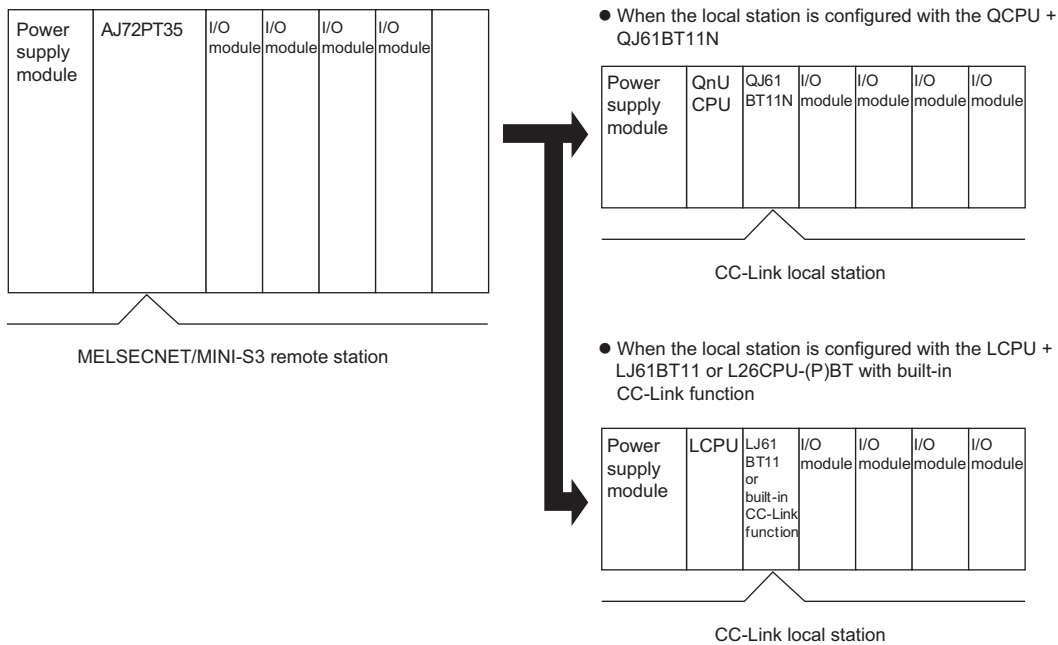

5 REPLACING I/O MODULE

5.1 List of Alternative I/O Module Models

MELSECNET/MINI-S3, A2C models to be discontinued		Alternative model for CC-Link	
Product name	Model name	Model name	Remarks (restrictions)
Input module	AX11C	AJ65SBTB2N-16A	1) Change in external wiring: Required 2) Change in number of modules (2 modules necessary) 3) Change in program Change in number of occupied I/O points: Required 4) Change in specifications Change in rated input voltage: Not required Change in rated input current: Required (Approx. 6mA → Approx. 7mA) Change in ON voltage/ON current: Not required Change in OFF voltage/OFF current: Required Change in input resistance: Required 5) Change in functions: Required (2-wire type for inputs)
	AX21C	None	No alternative model • Please consider using the FA goods FA-TH16X200A31L. (The FA goods are manufactured by Mitsubishi Electric Engineering Co., Ltd.) The 24VDC input module for CC-Link (AJ65SBTCF1-32D) is required to use the FA goods.
	AX31C	AJ65SBTB1-32D	1) Change in external wiring: Required 2) Change in number of modules: Not required 3) Change in program Change in number of occupied I/O points: Not required 4) Change in specifications Change in rated input voltage: Required (12/24VAC, 12VDC not allowed) Change in rated input current: Not required Change in ON voltage/ON current: Required Change in OFF voltage/OFF current: Required Change in input resistance: Required Change in input response time: Required (35/30ms → 1.5ms) 5) Change in functions: Required (12/24VAC, 12VDC not allowed)

MELSECNET/MINI-S3, A2C models to be discontinued		Alternative model for CC-Link	
Product name	Model name	Model name	Remarks (restrictions)
Input module	AJ35PTF-32A*1	AJ65SBTB2N-16A	1) Change in external wiring: Required 2) Change in number of modules (2 modules necessary) 3) Change in program Change in number of occupied I/O points: Required 4) Change in specifications Change in rated input voltage: Not required Change in rated input current: Required (Approx. 10mA → Approx. 7mA) Change in ON voltage/ON current: Required Change in OFF voltage/OFF current: Required Change in input resistance: Required 5) Change in functions: Required (2-wire type for inputs)
	AX41C	AJ65SBTB1-32D	1) Change in external wiring: Required 2) Change in number of modules: Not required 3) Change in program Change in number of occupied I/O points: Not required 4) Change in specifications Change in rated input voltage: Required (12VDC not allowed) Change in rated input current: Not required Change in ON voltage/ON current: Required Change in OFF voltage/OFF current: Required Change in input resistance: Not required Change in input response time: Required (10ms → 1.5ms) 5) Change in functions: Required (12VDC not allowed)

MELSECNET/mini-S3, A2C models to be discontinued		Alternative models for CC-Link	
Product name	Model name	Model name	Remarks (restrictions)
Input module	AX41C	AJ65DBTB1-32D	1) Change in external wiring: Required (Communication cable and power cable only) 2) Change in number of modules: Not required 3) Change in program Change in number of occupied I/O points: Not required 4) Change in specifications Change in rated input voltage: Required (12VDC not allowed) Change in rated input current: Required (Approx. 7mA → Approx. 5mA) Change in ON voltage/ON current: Required Change in OFF voltage/OFF current: Required Change in input resistance: Required Change in input response time: Not required 5) Change in functions: Required (12VDC not allowed)
		AJ65SBTB1-32D	1) Change in external wiring: Required 2) Change in number of modules: Not required 3) Change in program Change in number of occupied I/O points: Not required 4) Change in specifications Change in rated input voltage: Required (12VDC not allowed) Change in rated input current: Not required Change in ON voltage/ON current: Required Change in OFF voltage/OFF current: Required Change in input resistance: Not required Change in input response time: Required (10ms → 1.5ms) 5) Change in functions: Required (12VDC not allowed)
	AX81C	AJ65DBTB1-32D	1) Change in external wiring: Required (Communication cable and power cable only) 2) Change in number of modules: Not required 3) Change in program Change in number of occupied I/O points: Not required 4) Change in specifications Change in rated input voltage: Required (12VDC not allowed) Change in rated input current: Required (Approx. 7mA → Approx. 5mA) Change in ON voltage/ON current: Required Change in OFF voltage/OFF current: Required Change in input resistance: Required Change in input response time: Not required 5) Change in functions: Required (12VDC not allowed)

MELSECNET/MINI-S3, A2C models to be discontinued		Alternative models for CC-Link	
Product name	Model name	Model name	Remarks (restrictions)
Input module	AJ35PTF-32D*1	AJ65SBTB1-32D	1) Change in external wiring: Required 2) Change in number of modules: Not required 3) Change in program Change in number of occupied I/O points: Not required 4) Change in specifications Change in rated input voltage: Required (12VDC not allowed) Change in rated input current: Not required Change in ON voltage/ON current: Required Change in OFF voltage/OFF current: Required Change in input resistance: Not required Change in input response time: Required (10ms → 1.5ms) 5) Change in functions: Required (12VDC not allowed, no optics)
	AJ35TB1-16A	AJ65SBTB2N-16A	1) Change in external wiring: Required 2) Change in number of modules: Not required 3) Change in program Change in number of occupied I/O points: Required 4) Change in specifications Change in rated input voltage: Not required Change in rated input current: Required (Approx. 6mA → Approx. 7mA) Change in ON voltage/ON current: Not required Change in OFF voltage/OFF current: Required Change in input resistance: Required 5) Change in functions: Required (2-wire type for inputs)
	AJ35TB2-8D	AJ65SBTB3-8D	1) Change in external wiring: Required 2) Change in number of modules: Not required 3) Change in program Change in number of occupied I/O points: Required 4) Change in specifications Change in rated input voltage: Not required Change in rated input current: Not required Change in ON voltage/ON current: Not required Change in OFF voltage/OFF current: Not required Change in input resistance: Not required Change in input response time: Required (10ms → 1.5ms) 5) Change in functions: Required (2-wire type → 3-wire type)
	AJ35TB3-8D	AJ65SBTB3-8D	1) Change in external wiring: Required 2) Change in number of modules: Not required 3) Change in program Change in number of occupied I/O points: Required 4) Change in specifications Change in rated input voltage: Not required Change in rated input current: Not required Change in ON voltage/ON current: Not required Change in OFF voltage/OFF current: Not required Change in input resistance: Not required Change in input response time: Required (10ms → 1.5ms) 5) Change in functions: Not required

MELSECNET/MINI-S3, A2C models to be discontinued		Alternative models for CC-Link	
Product name	Model name	Model name	Remarks (restrictions)
Input module	AJ35TB1-16D	AJ65SBTB1-16D	1) Change in external wiring: Required 2) Change in number of modules: Not required 3) Change in program Change in number of occupied I/O points: Required 4) Change in specifications Change in rated input voltage: Not required Change in rated input current: Not required Change in ON voltage/ON current: Not required Change in OFF voltage/OFF current: Not required Change in input resistance: Not required Change in input response time: Required (10ms → 1.5ms) 5) Change in functions: Not required

MELSECNET/MINI-S3, A2C models to be discontinued		Alternative models for CC-Link	
Product name	Model name	Model name	Remarks (restrictions)
Input module	AJ35TB1-16D	AJ65BTB1-16D	1) Change in external wiring: Required 2) Change in number of modules: Not required 3) Change in program Change in number of occupied I/O points: Required 4) Change in specifications Change in rated input voltage: Not required Change in rated input current: Not required Change in ON voltage/ON current: Not required Change in OFF voltage/OFF current: Not required Change in input resistance: Not required Change in input response time: Not required 5) Change in functions: Not required
	AJ35TB2-16D	AJ65SBTB3-16D	1) Change in external wiring: Required 2) Change in number of modules: Not required 3) Change in program Change in number of occupied I/O points: Required 4) Change in specifications Change in rated input voltage: Not required Change in rated input current: Not required Change in ON voltage/ON current: Not required Change in OFF voltage/OFF current: Not required Change in input resistance: Not required Change in input response time: Required (10ms → 1.5ms) 5) Change in functions: Required (2-wire type → 3-wire type)
		AJ65BTB2-16D	1) Change in external wiring: Required 2) Change in number of modules: Not required 3) Change in program Change in number of occupied I/O points: Required 4) Change in specifications Change in rated input voltage: Not required Change in rated input current: Not required Change in ON voltage/ON current: Not required Change in OFF voltage/OFF current: Not required Change in input resistance: Not required Change in input response time: Not required 5) Change in functions: Not required
	AJ35TC1-32D	AJ65SBTCF1-32D	1) Change in external wiring: Required 2) Change in number of modules: Not required 3) Change in program Change in number of occupied I/O points: Not required 4) Change in specifications Change in rated input voltage: Not required Change in rated input current: Not required Change in ON voltage/ON current: Required Change in OFF voltage/OFF current: Not required Change in input resistance: Not required Change in input response time: Required (10ms → 1.5ms) 5) Change in functions: Not required

MELSECNET/MINI-S3, A2C models to be discontinued		Alternative models for CC-Link	
Product name	Model name	Model name	Remarks (restrictions)
Output module	AY13C	AJ65SBTB2N-16R	1) Change in external wiring: Required 2) Change in number of modules (2 modules necessary) 3) Change in program Change in number of occupied I/O points: Required 4) Change in specifications Change in rated output voltage: Not required Change in rated output current: Not required 5) Change in functions: Required (2-wire type for outputs)
		AJ65DBTB1-32R	1) Change in external wiring: Required (Communication cable and power cable only) 2) Change in number of modules: Not required 3) Change in program Change in number of occupied I/O points: Not required 4) Change in specifications Change in rated output voltage: Not required Change in rated output current: Not required 5) Change in functions: Not required
	AY15CEU	AJ65SBTB2N-16R	1) Change in external wiring: Required 2) Change in number of modules (2 modules necessary) 3) Change in program Change in number of occupied I/O points: Required 4) Change in specifications Change in rated output voltage: Not required Change in rated output current: Not required (Note that a connect life is half.) 5) Change in functions: Required (2-wire type for outputs)
		AJ65DBTB1-32R	1) Change in external wiring: Required 2) Change in number of modules: Not required 3) Change in program Change in number of occupied I/O points: : Not required 4) Change in specifications Change in rated output voltage: Not required Change in rated output current: Not required 5) Change in functions: Not required
	AY23C	AJ65SBTB2N-16S	1) Change in external wiring: Required 2) Change in number of modules (2 modules necessary) 3) Change in program Change in number of occupied I/O points: Required 4) Change in specifications Change in rated output voltage: Not required Change in rated output current: Required (Approx. 0.3A → Approx. 0.6A) 5) Change in functions: Required (2-wire type for outputs)

MELSECNET/MINI-S3, A2C models to be discontinued		Alternative models for CC-Link	
Product name	Model name	Model name	Remarks (restrictions)
Output module	AY51C	AJ65SBTB1-32T1	1) Change in external wiring: Required 2) Change in number of modules: Not required 3) Change in program Change in number of occupied I/O points: Not required 4) Change in specifications Change in rated output voltage: Not required Change in rated output current: Required (Approx. 0.3A → Approx. 0.5A) 5) Change in functions: Not required
		AJ65DBTB1-32T1	1) Change in external wiring: Required (Communication cable and power cable only) 2) Change in number of modules: Not required 3) Change in program Change in number of occupied I/O points: Not required 4) Change in specifications Change in rated output voltage: Not required Change in rated output current: Required (Approx. 0.3A → Approx. 0.5A) 5) Change in functions: Not required
	AY61CE	AJ65SBTB1-16TE	1) Change in external wiring: Required 2) Change in number of modules (2 modules necessary) 3) Change in program Change in number of occupied I/O points: Required 4) Change in specifications Change in rated output voltage: Required (5VDC not allowed) Change in rated output current: Required (Approx. 2A → Approx. 0.1A) 5) Change in functions: Required (5VDC not allowed)
		AJ65SBTB1-32TE1	1) Change in external wiring: Required 2) Change in number of modules: Not required 3) Change in program Change in number of occupied I/O points: Not required 4) Change in specifications Change in rated output voltage: Required (5VDC not allowed) Change in rated output current: Required (Approx. 2A → Approx. 0.5A) 5) Change in functions: Required (5VDC not allowed)

MELSECNET/MINI-S3, A2C models to be discontinued		Alternative models for CC-Link	
Product name	Model name	Model name	Remarks (restrictions)
Output module	AY81C	AJ65SBTB1-16TE	1) Change in external wiring: Required 2) Change in number of modules (2 modules necessary) 3) Change in program Change in number of occupied I/O points: Required 4) Change in specifications Change in rated output voltage: Not required Change in rated output current: Required (Approx. 0.5A → Approx. 0.1A) 5) Change in functions: Not required
		AJ65SBTB1-32TE1	1) Change in external wiring: Required 2) Change in number of modules: Not required 3) Change in program Change in number of occupied I/O points: Not required 4) Change in specifications Change in rated output voltage: Not required Change in rated output current: Not required 5) Change in functions: Not required
	AJ35PTF-24S ^{*1}	AJ65SBTB2N-16S	1) Change in external wiring: Required 2) Change in number of modules (2 modules necessary) 3) Change in program Change in number of occupied I/O points: Required 4) Change in specifications Change in rated output voltage: Not required Change in rated output current: Not required 5) Change in functions: Required (2-wire type for outputs, no high-speed type fuse, no optics)

MELSECNET/MINI-S3, A2C models to be discontinued		Alternative models for CC-Link	
Product name	Model name	Model name	Remarks (restrictions)
Output module	AJ35PTF-24T*1	AJ65SBTB1-32T1	1) Change in external wiring: Required 2) Change in number of modules: Not required 3) Change in program Change in number of occupied I/O points: Required 4) Change in specifications Change in rated output voltage: Not required Change in rated output current: Not required 5) Change in functions: Required (no optics)
	AJ35TB1A-8R	AJ65SBTB2N-8R	1) Change in external wiring: Required 2) Change in number of modules: Not required 3) Change in program Change in number of occupied I/O points: Required 4) Change in specifications Change in rated output voltage: Not required Change in rated output current: Not required 5) Change in functions: Required (Change to 16 points per common (2-wire type))
	AJ35TB2-8R	AJ65SBTB2N-8R	1) Change in external wiring: Required 2) Change in number of modules: Not required 3) Change in program Change in number of occupied I/O points: Required 4) Change in specifications Change in rated output voltage: Not required Change in rated output current: Not required 5) Change in functions: Not required
	AJ35TB1-16R	AJ65SBTB2N-16R	1) Change in external wiring: Required 2) Change in number of modules: Not required 3) Change in program Change in number of occupied I/O points: Required 4) Change in specifications Change in rated output voltage: Not required Change in rated output current: Not required 5) Change in functions: Required (2-wire type for outputs)
	AJ35TB1A-8T	AJ65SBTB1-8T1	1) Change in external wiring: Required 2) Change in number of modules: Not required 3) Change in program Change in number of occupied I/O points: Required 4) Change in specifications Change in rated output voltage: Not required Change in rated output current: Required (Approx. 0.3A → Approx. 0.5A) 5) Change in functions: Required (Change to 16 points per common (2-wire type))
	AJ35TB2-8T	AJ65SBTB2-8T1	1) Change in external wiring: Required 2) Change in number of modules: Not required 3) Change in program Change in number of occupied I/O points: Required 4) Change in specifications Change in rated input voltage: Required (5VDC not allowed) Change in rated output current: Not required 5) Change in functions: Required (5VDC not allowed)

MELSECNET/MINI-S3, A2C models to be discontinued		Alternative model for CC-Link	
Product name	Model name	Model name	Remarks (restrictions)
Output module	AJ35TB1-16T	AJ65SBTB1-16T1	1) Change in external wiring: Required 2) Change in number of modules: Not required 3) Change in program Change in number of occupied I/O points: Required 4) Change in specifications Change in rated output voltage: Not required Change in rated output current: Required (Approx. 0.1A → Approx. 0.5A) 5) Change in functions: Not required
		AJ65BTB1-16T	1) Change in external wiring: Required 2) Change in number of modules: Not required 3) Change in program Change in number of occupied I/O points: Required 4) Change in specifications Change in rated output voltage: Not required Change in rated output current: Required (Approx. 0.1A → Approx. 0.5A) 5) Change in functions: Not required
	AJ35TB2-16T	AJ65SBTB2-16T1	1) Change in external wiring: Required 2) Change in number of modules: Not required 3) Change in program Change in number of occupied I/O points: Required 4) Change in specifications Change in rated output voltage: Not required Change in rated output current: Required (Approx. 0.1A → Approx. 0.5A) 5) Change in functions: Not required
	AJ35TC1-32T	AJ65SBTCF1-32T	1) Change in external wiring: Required 2) Change in number of modules: Not required 3) Change in program Change in number of occupied I/O points: Not required 4) Change in specifications Change in rated output voltage: Not required Change in rated output current: Not required 5) Change in functions: Not required 6) Others: External wiring connectors not attached
	AJ35PTF-24R ^{*1}	AJ65SBTB2N-16R	1) Change in external wiring: Required 2) Change in number of modules: Required (2 modules necessary) 3) Change in program Change in number of occupied I/O points: Required 4) Change in specifications Change in rated output voltage: Not required Change in rated output current: Not required 5) Change in functions: Required (2-wire type for outputs, no optics)

*1: Replacement using renewal tool for A0J2 is possible (refer to Appendix 2).

MELSECNET/MINI-S3, A2C models to be discontinued		Alternative model for CC-Link	
Product name	Model name	Model name	Remarks (restrictions)
I/O module	AX10Y10C	AJ65SBTB2N-16A + AJ65SBTB2N-16R	1) Change in external wiring: Required 2) Change in number of modules (2 modules necessary) 3) Change in program Change in number of occupied I/O points: Required 4) Change in specifications Change in rated input voltage: Not required Change in rated input current: Required (Approx. 6mA → Approx. 7mA) Change in ON voltage/ON current: Not required Change in OFF voltage/OFF current: Required Change in input resistance: Required Change in rated output voltage: Not required Change in rated output current: Not required 5) Change in functions: Required (2-wire type for I/Os)
	AX10Y22C	AJ65SBTB2N-16A + AJ65SBTB2N-16S	1) Change in external wiring: Required 2) Change in number of modules (2 modules necessary) 3) Change in program Change in number of occupied I/O points: Required 4) Change in specifications Change in rated input voltage: Not required Change in rated input current: Required (Approx. 6mA → Approx. 7mA) Change in ON voltage/ON current: Not required Change in OFF voltage/OFF current: Required Change in input resistance: Required Change in rated output voltage: Not required Change in rated output current: Required (Approx. 0.3A → Approx. 0.6A) 5) Change in functions: Required (2-wire type for I/Os)

MELSECNET/MINI-S3, A2C models to be discontinued		Alternative models for CC-Link	
Product name	Model name	Model name	Remarks (restrictions)
I/O module	AX40Y10C	AJ65SBTB1-16D + AJ65SBTB2N-16R	1) Change in external wiring: Required 2) Change in number of modules (2 modules necessary) 3) Change in program Change in number of occupied I/O points: Required 4) Change in specifications Change in rated input voltage: Required (12VDC not allowed) Change in rated input current: Not required Change in ON voltage/ON current: Required Change in OFF voltage/OFF current: Required Change in input resistance: Not required Change in input response time: Required (10ms → 1.5ms) Change in rated output voltage: Not required Change in rated output current: Not required 5) Change in functions: Required (2-wire type for outputs, 12VDC not allowed)
		AJ65SBTB32-16DR	1) Change in external wiring: Required 2) Change in number of modules: Required (2 modules necessary) 3) Change in program Change in number of occupied I/O points: Required 4) Change in specifications Change in rated input voltage: Required (12VDC not allowed) Change in rated input current: Not required Change in ON voltage/ON current: Required Change in OFF voltage/OFF current: Required Change in input resistance: Not required Change in rated output voltage: Not required Change in rated output current: Not required 5) Change in functions: Required (12VDC not allowed)
	AX40Y10C	AJ65DBTB1-32DR	1) Change in external wiring: Required (Communication cable and power cable only) 2) Change in number of modules: Not required 3) Change in program Change in number of occupied I/O points: Not required 4) Change in specifications Change in rated input voltage: Required (12VDC not allowed) Change in rated input current: Required (Approx. 7mA → Approx. 5mA) Change in ON voltage/ON current: Required Change in OFF voltage/OFF current: Required Change in input resistance: Required Change in rated output voltage: Not required Change in rated output current: Not required 5) Change in functions: Required (12VDC not allowed)

MELSECNET/MINI-S3, A2C models to be discontinued		Alternative models for CC-Link	
Product name	Model name	Model name	Remarks (restrictions)
I/O module	AX40Y50C	AJ65SBTB1-32DT2	1) Change in external wiring: Required 2) Change in number of modules: Not required 3) Change in program Change in number of occupied I/O points: Not required 4) Change in specifications Change in rated input voltage: Required (12VDC not allowed) Change in rated input current: Not required Change in ON voltage/ON current: Required Change in OFF voltage/OFF current: Required Change in input resistance: Not required Change in input response time: Required (10ms → 1.5ms) Change in rated output voltage: Required (12VDC not allowed) Change in rated output current: Required (Approx. 0.3A → Approx. 0.5A) 5) Change in functions: Required (12VDC not allowed)
		AJ65DBTB1-32DT1	1) Change in external wiring: Required (Communication cable and power cable only) 2) Change in number of modules: Not required 3) Change in program Change in number of occupied I/O points: Not required 4) Change in specifications Change in rated input voltage: Required (12VDC not allowed) Change in rated input current: Required (Approx. 7mA → Approx. 5mA) Change in ON voltage/ON current: Required Change in OFF voltage/OFF current: Required Change in input resistance: Required Change in input response time: Not required Change in rated output voltage: Not required Change in rated output current: Required (Approx. 0.3A → Approx. 0.5A) 5) Change in functions: Required (12VDC not allowed)

MELSECNET/mini-S3, A2C models to be discontinued		Alternative models for CC-Link	
Product name	Model name	Model name	Remarks (restrictions)
I/O module	AX80Y10C	AJ65SBTB1-16D + AJ65SBTB2N-16R	1) Change in external wiring: Required 2) Change in number of modules (2 modules necessary) 3) Change in program Change in number of occupied I/O points: Required 4) Change in specifications Change in rated input voltage: Required (12VDC not allowed) Change in rated input current: Not required Change in ON voltage/ON current: Required Change in OFF voltage/OFF current: Required Change in input resistance: Not required Change in input response time: Required (10ms → 1.5ms) Change in rated output voltage: Not required Change in rated output current: Not required 5) Change in functions: Required (2-wire type for outputs, 12VDC not allowed)
		AJ65DBTB1-32DR	1) Change in external wiring: Required (Communication cable and power cable only) 2) Change in number of modules: Not required 3) Change in program Change in number of occupied I/O points: Not required 4) Change in specifications Change in rated input voltage: Required (12VDC not allowed) Change in rated input current: Required (Approx. 7mA → Approx. 5mA) Change in ON voltage/ON current: Required Change in OFF voltage/OFF current: Required Change in input resistance: Required Change in rated output voltage: Not required Change in rated output current: Not required 5) Change in functions: Required (12VDC not allowed)
	AX80Y14CEU	AJ65SBTB1-16D + AJ65SBTB2N-16R	1) Change in external wiring: Required 2) Change in number of modules (2 modules necessary) 3) Change in program Change in number of occupied I/O points: Required 4) Change in specifications Change in rated input voltage: Required (12VDC not allowed) Change in rated input current: Not required Change in ON voltage/ON current: Required Change in OFF voltage/OFF current: Required Change in input resistance: Not required Change in rated output voltage: Not required Change in rated output current: Not required (Note that a connect life is half.) 5) Change in functions: Required (2-wire type for outputs, 12VDC not allowed)

MELSECNET/MINI-S3, A2C models to be discontinued		Alternative models for CC-Link	
Product name	Model name	Model name	Remarks (restrictions)
I/O module	AX80Y80C	AJ65SBTB1-16D + AJ65SBTB1-16TE	1) Change in external wiring: Required 2) Change in number of modules (2 modules necessary) 3) Change in program Change in number of occupied I/O points: Required 4) Change in specifications Change in rated input voltage: Required (12VDC not allowed) Change in rated input current: Not required Change in ON voltage/ON current: Required Change in OFF voltage/OFF current: Required Change in input resistance: Not required Change in input response time: Required (10ms → 1.5ms) Change in rated output voltage: Required Change in rated output current: Required (Approx. 0.5A → Approx. 0.1A) 5) Change in functions: Required (12VDC not allowed)
	AX80Y80C	AJ65SBTB1-32DTE1	1) Change in external wiring: Required 2) Change in number of modules: Not required 3) Change in program Change in number of occupied I/O points: Not required 4) Change in specifications Change in rated input voltage: Required (12VDC not allowed) Change in rated input current: Not required Change in ON voltage/ON current: Required Change in OFF voltage/OFF current: Required Change in input resistance: Not required Change in input response time: Required (10ms → 1.5ms) Change in rated output voltage: Not required Change in rated output current: Not required 5) Change in functions: Required (12VDC not allowed)
	AJ35PTF-28AR*1	AJ65SBTB2N-16A + AJ65SBTB2N-16R	1) Change in external wiring: Required 2) Change in number of modules (2 modules necessary: AJ65SBTB2N-16A × 1 module AJ65SBTB2N-16R × 1 module) 3) Change in program Change in number of occupied I/O points: Required 4) Change in specifications Change in rated input voltage: Not required Change in rated input current: Required (Approx. 10mA → Approx. 7mA) Change in ON voltage/ON current: Required Change in OFF voltage/OFF current: Required Change in input resistance: Required Change in rated output voltage: Not required Change in rated output current: Not required (Note that a contact life is half.) 5) Change in functions: Required (2-wire type for I/Os, no optics)

MELSECNET/MINI-S3, A2C models to be discontinued		Alternative models for CC-Link	
Product name	Model name	Model name	Remarks (restrictions)
I/O module	AJ35PTF-56AR*1	AJ65SBTB2N-16A + AJ65SBTB2N-16R	1) Change in external wiring: Required 2) Change in number of modules: Required (4 modules necessary: AJ65SBTB2N-16A × 2 modules AJ65SBTB2N-16R × 2 modules) 3) Change in program Change in number of occupied I/O points: Required 4) Change in specifications Change in rated input voltage: Not required Change in rated input current: Required (Approx. 10mA → Approx. 7mA) Change in ON voltage/ON current: Required Change in OFF voltage/OFF current: Required Change in input resistance: Required Change in rated output voltage: Not required Change in rated output current: Not required (Note that a connect life is half.) 5) Change in functions: Required (2-wire type for I/Os, no optics)

*1: Replacement using renewal tool for A0J2 is possible (refer to Appendix 2).

MELSECNET/MINI-S3, A2C models to be discontinued		Alternative models for CC-Link	
Product name	Model name	Model name	Remarks (restrictions)
I/O module	AJ35PTF-28AS ^{*1}	AJ65SBTB2N-16A + AJ65SBTB2N-16S	1) Change in external wiring: Required 2) Change in number of modules (2 modules necessary: AJ65SBTB2N-16A × 1 module, AJ65SBTB2N-16S × 1 module) 3) Change in program Change in number of occupied I/O points: Required 4) Change in specifications Change in rated input voltage: Not required Change in rated input current: Required (Approx. 10mA → Approx. 7mA) Change in ON voltage/ON current: Required Change in OFF voltage/OFF current: Required Change in input resistance: Required Change in rated output voltage: Not required Change in rated output current: Not required 5) Change in functions: Required (2-wire type for I/Os, no high-speed fuse, no optics)
	AJ35PTF-56AS ^{*1}	AJ65SBTB2N-16A + AJ65SBTB2N-16S	1) Change in external wiring: Required 2) Change in number of modules: Required (4 modules necessary: AJ65SBTB2N-16A × 2 modules, AJ65SBTB2N-16S × 2 modules) 3) Change in program Change in number of occupied I/O points: Required 4) Change in specifications Change in rated input voltage: Not required Change in rated input current: Required (Approx. 10mA → Approx. 7mA) Change in ON voltage/ON current: Required Change in OFF voltage/OFF current: Required Change in input resistance: Required Change in rated output voltage: Not required Change in rated output current: Not required 5) Change in functions: Required (2-wire type for I/Os, no high-speed fuse, no optics)
	AJ35PTF-28DS ^{*1}	AJ65SBTB1-16D + AJ65SBTB2N-16S	1) Change in external wiring: Required 2) Change in number of modules (2 modules necessary) 3) Change in program Change in number of occupied I/O points: Required 4) Change in specifications Change in rated input voltage: Required (12VDC not allowed) Change in rated input current: Not required Change in ON voltage/ON current: Required Change in OFF voltage/OFF current: Required Change in input resistance: Not required Change in input response time: Required (10ms → 1.5ms) Change in rated output voltage: Not required Change in rated output current: Not required 5) Change in functions: Required (2-wire type for outputs, no optics, 12VDC not allowed)

MELSECNET/MINI-S3, A2C models to be discontinued		Alternative models for CC-Link	
Product name	Model name	Model name	Remarks (restrictions)
I/O module	AJ35PTF-56DS*1	AJ65SBTB1-32D + AJ65SBTB2N-16S	1) Change in external wiring: Required 2) Change in number of modules: Required (3 modules necessary: AJ65SBTB1-32D × 1 module AJ65SBTB2N-16S × 2 modules) 3) Change in program Change in number of occupied I/O points: Required 4) Change in specifications Change in rated input voltage: Required (12VDC not allowed) Change in rated input current: Not required Change in ON voltage/ON current: Required Change in OFF voltage/OFF current: Required Change in input resistance: Not required Change in input response time: Required (10ms → 1.5ms) Change in rated output voltage: Not required Change in rated output current: Not required 5) Change in functions: Required (2-wire type for outputs, no optics, 12VDC not allowed)

MELSECNET/MINI-S3, A2C models to be discontinued		Alternative models for CC-Link	
Product name	Model name	Model name	Remarks (restrictions)
I/O module	AJ35PTF-28DR*1	AJ65SBTB1-16D + AJ65SBTB2N-16R	1) Change in external wiring: Required 2) Change in number of modules: Required (2 modules necessary: AJ65SBTB1-16D × 1 module AJ65SBTB2N-16R × 1 modules) 3) Change in program Change in number of occupied I/O points: Required 4) Change in specifications Change in rated input voltage: Required (12VDC not allowed) Change in rated input current: Not required Change in ON voltage/ON current: Required Change in OFF voltage/OFF current: Required Change in input resistance: Not required Change in input response time: Required (10ms → 1.5ms) Change in rated output voltage: Required Change in rated output current: Not required (Note that a connect life is half.) 5) Change in functions: Required (2-wire type for outputs, no optics, 12VDC not allowed)
	AJ35PTF-56DR*1	AJ65SBTB1-32D + AJ65SBTB2N-16R	1) Change in external wiring: Required 2) Change in number of modules: Required (3 modules necessary: AJ65SBTB1-32D × 1 module AJ65SBTB2N-16R × 2 modules) 3) Change in program Change in number of occupied I/O points: Required 4) Change in specifications Change in rated input voltage: Required (12VDC not allowed) Change in rated input current: Not required Change in ON voltage/ON current: Required Change in OFF voltage/OFF current: Required Change in input resistance: Not required Change in input response time: Required (10ms → 1.5ms) Change in rated output voltage: Not required Change in rated output current: Not required (Note that a connect life is half.) 5) Change in functions: Required (2-wire type for outputs, no optics, 12VDC not allowed)

*1: Replacement using renewal tool for A0J2 is possible (refer to Appendix 2).

MELSECNET/MINI-S3, A2C models to be discontinued		Alternative models for CC-Link	
Product name	Model name	Model name	Remarks (restrictions)
I/O module	AJ35PTF-28DT*1	AJ65SBTB1-32DT2	1) Change in external wiring: Required 2) Change in number of modules: Not required 3) Change in program Change in number of occupied I/O points: Not required 4) Change in specifications Change in rated input voltage: Required (12VDC not allowed) Change in rated input current: Not required Change in ON voltage/ON current: Required Change in OFF voltage/OFF current: Required Change in input resistance: Not required Change in input response time: Required (10ms → 1.5ms) Change in rated output voltage: Required (12VDC not allowed) Change in rated output current: Not required 5) Change in functions: Required (no optics, 12VDC not allowed)
	AJ35PTF-56DT*1	AJ65SBTB1-32D + AJ65SBTB1-32T1	1) Change in external wiring: Required 2) Change in number of modules (2 modules necessary) 3) Change in program Change in number of occupied I/O points: Required 4) Change in specifications Change in rated input voltage: Required (12VDC not allowed) Change in rated input current: Not required Change in ON voltage/ON current: Required Change in OFF voltage/OFF current: Required Change in input resistance: Not required Change in input response time: Required (10ms → 1.5ms) Change in rated output voltage: Not required Change in rated output current: Not required 5) Change in functions: Required (no optics, 12VDC not allowed)
	AJ35TB1-16AR	AJ65SBTB2N-8A + AJ65SBTB2N-8R	1) Change in external wiring: Required 2) Change in number of modules (2 modules necessary) 3) Change in program Change in number of occupied I/O points: Required 4) Change in specifications Change in rated input voltage: Not required Change in rated input current: Required (Approx. 6mA → Approx. 7mA) Change in ON voltage/ON current: Required Change in OFF voltage/OFF current: Required Change in input resistance: Required Change in rated output voltage: Not required Change in rated output current: Not required (Note that a connect life is half.) 5) Change in functions: Required (2-wire type for I/Os)

*1: Replacement using renewal tool for A0J2 is possible (refer to Appendix 2).

MELSECNET/MINI-S3, A2C models to be discontinued		Alternative models for CC-Link	
Product name	Model name	Model name	Remarks (restrictions)
I/O module	AJ35TB1-16DR	AJ65SBTB1-8D + AJ65SBTB2N-8R	1) Change in external wiring: Required 2) Change in number of modules (2 modules necessary) 3) Change in program Change in number of occupied I/O points: Required 4) Change in specifications Change in rated input voltage: Not required Change in rated input current: Not required Change in ON voltage/ON current: Not required Change in OFF voltage/OFF current: Not required Change in input resistance: Not required Change in input response time: Required (10ms → 1.5ms) Change in rated output voltage: Not required Change in rated output current: Not required (Note that a connect life is half.) 5) Change in functions: Required (2-wire type for outputs)
	AJ35TB1-16DT	AJ65SBTB1-16DT2	1) Change in external wiring: Required 2) Change in number of modules: Not required 3) Change in program Change in number of occupied I/O points: Required 4) Change in specifications Change in rated input voltage: Not required Change in rated input current: Not required Change in ON voltage/ON current: Not required Change in OFF voltage/OFF current: Not required Change in input resistance: Not required Change in input response time: Required (10ms → 1.5ms) Change in rated output voltage: Not required Change in rated output current: Required (Approx. 0.3A → Approx. 0.5A) 5) Change in functions: Not required
	AJ35TC1-32DT	AJ65SBTCF1-32DT	1) Change in external wiring: Required 2) Change in number of modules: Not required 3) Change in program Change in number of occupied I/O points: Not required 4) Change in specifications Change in rated input voltage: Not required Change in rated input current: Not required Change in ON voltage/ON current: Required Change in OFF voltage/OFF current: Not required Change in input resistance: Not required Change in input response time: Required (10ms → 1.5ms) Change in rated output voltage: Not required Change in rated output current: Not required 5) Change in functions: Not required 6) Others: External wiring connectors not attached

MELSECNET/MINI-S3, A2C models to be discontinued		Alternative models for CC-Link	
Product name	Model name	Model name	Remarks (restrictions)
Stand-alone I/O module (for optical data link)	AJ35PJ-8A	None	No alternative model Consider the following mounting methods. Select a CC-Link I/O module and mount it inside a panel or prepare a dedicated mounting box.
	AJ35PJ-8D		
	AJ35PJ-8R		
	AJ35PJ-8S1		
	AJ35PJ-8T1		
	AJ35PJ-8T2		
	AJ35PJ-8T3		
Stand-alone I/O module (for twisted pair data link)	AJ35TJ-8A	None	Replace the existing module with a CC-Link water-proof module.
	AJ35TJ-8D		
	AJ35TJ-8R		
	AJ35TJ-8S1		
	AJ35TJ-8T1		
	AJ35TJ-8T2		
	AJ35TJ-8T3		
Separate refresh type remote I/O module	AJ35PTF-128DT	AJ65SBTCF1-32D + AJ65SBTCF1-32T	<ol style="list-style-type: none"> 1) Change in external wiring: Required 2) Change in number of modules (4 modules necessary: AJ65SBTCF1-32D × 2 modules AJ65SBTCF1-32T × 2 modules) 3) Change in program Change in number of occupied I/O points: Not required 4) Change in specifications Change in rated input voltage: Required (12VDC not allowed) Change in rated input current: Required (Approx. 9mA → Approx. 5mA) Change in ON voltage/ON current: Required Change in OFF voltage/OFF current: Required Change in input resistance: Required Change in input response time: Required (107ms → 1.5ms) Change in rated output voltage: Not required Change in rated output current: Not required 5) Change in functions: Required (no optics) (64 points are divided into four groups and I/O refresh is performed to each of the four groups. → Batch refresh by units)

5.2 I/O Module Specifications Comparison

5.2.1 Input module specifications comparison

(1) Specifications comparison between AX11C and AJ65SBTB2N-16A

○: Compatible, △: Partial change required, ×: Not compatible

Specifications		AX11C	AJ65SBTB2N-16A	Compatibility	Precautions for replacement
Number of input points		32 points	16 points	×	When seventeen or more points are used, use two AJ65SBTB2N-16A modules.
Insulation method		Photocoupler	Photocoupler	○	
Rated input voltage		100-120VAC, 50/60Hz	100-120VAC, 50/60Hz	○	
Rated input current		Approx. 6mA (100VAC, 60Hz)	Approx. 7mA (100VAC, 60Hz)	○	
Operating voltage range		85 to 132VAC (50/60Hz ± 5%)	85 to 132VAC (50/60Hz ± 3%, distortion rate 5% within)	○	
Maximum number of simultaneous input points		75% simultaneously ON (at 110VAC)	100% simultaneously ON (at 110VAC) 60% simultaneously ON (at 132VAC)	○	
Inrush current		Max. 200mA, within 1ms (with 132VAC)	Max. 200mA, within 1ms (with 132VAC)	○	
ON voltage/ON current		80V or more/5mA or more	80V or more/5mA or more	○	
OFF voltage/OFF current		30V or less/1mA or less	30V or less/1.7mA or less	○	
Input impedance		Approx. 18k Ω (60Hz), Approx. 21k Ω (50Hz)	Approx. 15k Ω (60Hz), Approx. 18k Ω (50Hz)	○	
Response time	OFF → ON	15ms or less (100VAC, 60Hz)	20ms or less (100VAC, 60Hz)	○	
	ON → OFF	30ms or less (100VAC, 60Hz)	20ms or less (100VAC, 60Hz)	○	
Common terminal arrangement		16 points/common	16 points/common (2-wire type)	○	
Number of occupied stations (number of occupied points)		4 stations (4 stations × 8 points)	1 station (1 station × 32 points × 2 modules)	×	The number of occupied points increases. The assignment of the entire system needs to be reconsidered.
Operation indication		ON indication (LED)	ON indication (LED)	○	
External connection method		50-point terminal block (M3.5 × 7 screws) Transmission circuit part included	Transmission/module power supply parts: 7-point terminal block (M3 × 5.2 screws) I/O part: 34-point terminal block (M3 × 5.2 screws)	×	Change in wiring is required.
Applicable wire size		0.75 to 2mm ²	0.3 to 2mm ²	○	
Applicable solderless terminal		R1.25-3.5, R2-3.5 RAV1.25-3.5, RAV2-3.5	RAV1.25-3 (Conforming to JIS C 2805) V2-MS3, RAP2-3SL, TGV2-3N	×	Change in wiring is required.
I/O module power supply	Voltage	15.6 to 31.2VDC	20.4 to 26.4VDC (ripple ratio within 5%)	△	The operating voltage range differs.
	Current	56mA (at 24V TYP.)	40mA or less (24VDC when all points are ON)	△	The current consumption increases by using two AJ65SBTB2N-16As. The current capacity needs to be reconsidered.
External dimensions		170(H) × 64(W) × 80(D) mm	54(H) × 179(W) × 40(D)mm	×	The overall size differs. Pay attention to the mounting dimensions.
Weight		0.62kg	0.25kg	△	

(2) Specifications comparison between AX31C and AJ65SBTB1-32D

○ : Compatible, △ : Partial change required, × : Not compatible

Specifications		AX31C		AJ65SBTB1-32D	Compatibility	Precautions for replacement
Number of input points		32 points		32 points	○	
Insulation method		Photocoupler		Photocoupler	○	
Rated input voltage		12/24VDC	12/24VAC 50/60Hz	24VDC	△	12/24VAC, 12VDC cannot be used.*1
Rated input current		4mA (12VAC/DC), 8.5mA (24VAC/DC)		Approx. 7mA	△	Rated input current is smaller.*2
Operating voltage range		10.2 to 26.4VDC (ripple ratio within 5%)	10.2 to 26.4VAC (50/60Hz ± 5%)	19.2 to 26.4VDC (ripple ratio within 5%)	△	12/24VAC, 12VDC cannot be used.*1
Maximum number of simultaneous input points		70% simultaneously ON (at 26.4VAC)		100% simultaneously ON	○	
ON voltage/ON current		7V or more/2mA or more		14V or more/3.5mA or more	△	12/24VAC, 12VDC cannot be used.*1
OFF voltage/OFF current		2.5V or more 0.7mA or less		6V or less/1.7mA or less	△	12/24VAC, 12VDC cannot be used.*1
Input resistance (Input impedance)		Approx 2.7k Ω		Approx. 3.3k Ω	△	Input resistance is increased.*2
Response time	OFF → ON	30ms or less (12/24VDC)	35ms or less (12/24VAC, 60Hz)	1.5ms or less (at 24VDC)	△	The response times differ.
	ON → OFF	30ms or less (12/24VDC)	35ms or less (12/24VAC, 60Hz)	1.5ms or less (at 24VDC)	△	
Common terminal arrangement		16 points/common		32 points/common	△	As common terminal arrangement changes from 16 points/common to 32 points/common, wiring with a different voltage per common is not possible.
Number of occupied stations (number of occupied points)		4 stations (4 stations × 8 points)		1 station (1 station × 32 points)	○	
Operation indication		ON indication (LED)		ON indication (LED)	○	
External connection method		50-point terminal block (M3.5 × 7 screws) Transmission circuit part included		Transmission/module power supply parts: 7-point terminal block (M3 × 5.2 screws) I/O part: 34-point terminal block (M3 × 5.2 screws)	×	Change in wiring is required.
Applicable wire size		0.75 to 2mm ²		0.3 to 2mm ²	○	
Applicable solderless terminal		R1.25-3.5, R2-3.5 RAV1.25-3.5, RAV2-3.5		RAV1.25-3 (Conforming to JIS C 2805) V2-MS3, RAP2-3SL, TGV2-3N	×	Change in wiring is required.
I/O module power supply	Voltage	15.6 to 31.2VDC		20.4 to 26.4VDC (ripple ratio within 5%)	△	The operating voltage range differs.
	Current	56mA (at 24VDC TYP.)		45mA or less (24VDC when all points are ON)	○	
External dimensions		170(H) × 64(W) × 80(D) mm		54(H) × 179(W) × 40(D) mm	×	The overall size differs. Pay attention to the mounting dimensions.
Weight		0.62kg		0.25kg	△	

*1: To use at 24VAC, convert to direct current externally before inputting.

*2: Confirm the specifications of the sensors or switches to be connected to the AJ65SBTB1-32D.

(3) Specifications comparison between AJ35PTF-32A and AJ65SBTB2N-16A

○ : Compatible, △ : Partial change required, × : Not compatible

Specifications		AJ35PTF-32A	AJ65SBTB2N-16A	Compat- ibility	Precautions for replacement
Number of input points		32 points	16 points	×	When seventeen or more points are used, use two AJ65SBTB2N-16A modules.
Insulation method		Photocoupler	Photocoupler	○	
Rated input voltage		100-120VAC, 50/60Hz	100-120VAC, 50/60Hz	○	
Rated input current		10mA (100VAC, 60Hz)	Approx. 7mA (100VAC, 60Hz)	△	Rated input current is smaller.* ¹
Maximum number of simultaneous input points		100% simultaneously ON	100% simultaneously ON (at 110VAC) 60% simultaneously ON (at 132VAC)	△	Use within specification range.
Inrush current		Max. 300mA, within 0.3ms (132VAC)	Max. 200mA, within 1ms (132VAC)	○	
ON voltage/ON current		80V or more/6mA or more	80V or more/5mA or more	○	
OFF voltage/OFF current		40V or less/4mA or less	30V or less/1.7mA or less	△	OFF current has been reduced.* ¹
Input impedance		Approx. 10k Ω (60Hz), Approx. 12k Ω (50Hz)	Approx. 15k Ω (60Hz), Approx. 18k Ω (50Hz)	△	Input impedance has increased.* ¹
Response time	OFF → ON	15ms or less (6ms TYP.)	20ms or less (100VAC, 60Hz)	○	
	ON → OFF	35ms or less (16ms TYP.)	20ms or less (100VAC, 60Hz)	○	
Common terminal arrangement		16 points/common	16 points/common (2-wire type)	○	
Number of occupied stations (number of occupied points)		4 stations (4 stations × 8 points)	1 station (1 station × 32 points × 2 modules)	×	The number of occupied points increases. The assignment of the entire system needs to be reconsidered.
Operation indication		ON indication (LED)	ON indication (LED)	○	
External connection method		Transmission/module power supply parts: 8-point terminal block I/O part: 36-point terminal block (M3 × 6 screws)	Transmission/module power supply parts: 7-point terminal block (M3 × 5.2 screws) I/O part: 34-point terminal block (M3 × 5.2 screws)	×	Change in wiring is required.
Applicable wire size		0.75 to 2mm ²	0.3 to 2mm ²	○	
Applicable solderless terminal		R1.25-3, R2-3 RAV1.25-3, RAV2-3	RAV1.25-3 (Conforming to JIS C 2805) V2-MS3, RAP2-3SL, TGV2-3N,	△	In some cases, the solderless terminal must be changed.
I/O module power supply	Voltage	15.6 to 31.2VDC	20.4 to 26.4VDC (ripple ratio within 5%)	△	The operating voltage range differs.
	Current	110mA or less	40mA or less (24VDC when all points are ON)	○	
External dimensions		254(H) × 132(W) × 41(D) mm	54(H) × 179(W) × 40(D) mm	×	The overall size differs. Pay attention to the mounting dimensions.
Weight		0.75kg	0.25kg	△	

*1 Confirm the specifications of the sensors or switches to be connected to the AJ65SBTB2N-16A.

(4) Specifications comparison between AX41C and AJ65SBTB1-32D

○ : Compatible, △ : Partial change required, × : Not compatible

Specifications		AX41C	AJ65SBTB1-32D	Compatibility	Precautions for replacement
Number of input points		32 points	32 points	○	
Insulation method		Photocoupler	Photocoupler	○	
Rated input voltage		12VDC/24VDC	24VDC	△	12VDC cannot be used.
Rated input current		Approx. 3mA/Approx. 7mA	Approx. 7mA	○	
Operating voltage range		10.2 to 31.2VDC (ripple ratio within 5%)	19.2 to 26.4VDC (ripple ratio within 5%)	△	12VDC cannot be used.
Maximum number of simultaneous input points		100% simultaneously ON (at 26.4VDC)	100% simultaneously ON	○	
ON voltage/ON current		8V or more/2mA or more	14V or more/3.5mA or more	△	12VDC cannot be used.
OFF voltage/OFF current		4V or less/1mA or less	6V or less/1.7mA or less	△	12VDC cannot be used.
Input resistance		Approx. 3.3k Ω	Approx. 3.3k Ω	○	
Input method		Positive common (sink type)	Positive/negative common shared type (sink/source shared type)	○	
Response time	OFF → ON	10ms or less (at 24VDC)	1.5ms or less (at 24VDC)	○	
	ON → OFF	10ms or less (at 24VDC)	1.5ms or less (at 24VDC)	○	
Common terminal arrangement		16 points/common	32 points/common	△	As common terminal arrangement changes from 16 points/common to 32 points/common, wiring with a different voltage per common is not possible.
Number of occupied stations (number of occupied points)		4 stations (4 stations × 8 points)	1 station (1 station × 32 points)	○	
Operation indication		ON indication (LED)	ON indication (LED)	○	
External connection method		50-point terminal block (M3.5 × 7 screws) Transmission circuit part included	Transmission/module power supply parts: 7-point terminal block (M3 × 5.2 screws) I/O part: 34-point terminal block (M3 × 5.2 screws)	×	Change in wiring is required.
Applicable wire size		0.75 to 2mm ²	0.3 to 2mm ²	○	
Applicable solderless terminal		R1.25-3.5, R2-3.5 RAV1.25-3.5, RAV2-3.5	RAV1.25-3 (Conforming to JIS C 2805) V2-MS3, RAP2-3SL, TGV2-3N	×	Change in wiring is required.
I/O module power supply	Voltage	15.6 to 31.2VDC	20.4 to 26.4VDC (ripple ratio within 5%)	△	The operating voltage range differs.
	Current	55mA (at 24VDC TYP.)	45mA or less (24VDC when all points are ON)	○	
External dimensions		170(H) × 64(W) × 80(D) mm	54(H) × 179(W) × 40(D) mm	×	The overall size differs. Pay attention to the mounting dimensions.
Weight		0.6kg	0.25kg	△	

(5) Specifications comparison between AX41C and AJ65DBTB1-32D

○ : Compatible, △ : Partial change required, × : Not compatible

Specifications		AX41C	AJ65DBTB1-32D	Compatibility	Precautions for replacement
Number of input points		32 points	32 points	○	
Insulation method		Photocoupler	Photocoupler	○	
Rated input voltage		12VDC/24VDC	24VDC	△	12VDC cannot be used.
Rated input current		Approx. 3mA/Approx. 7mA	Approx. 5mA	△	Rated input current is smaller. *1
Operating voltage range		10.2 to 31.2VDC (ripple ratio within 5%)	20.4 to 31.2VDC (ripple ratio within 5%)	△	12VDC cannot be used.
Maximum number of simultaneous input points		100% simultaneously ON (at 26.4VDC)	100% (at 26.4VDC)	○	
ON voltage/ON current		8V or more/2mA or more	15V or more/3mA or more	△	12VDC cannot be used.
OFF voltage/OFF current		4V or less/1mA or less	5V or less/1.5mA or less	△	12VDC cannot be used.
Input resistance		Approx. 3.3k Ω	Approx. 4.7k Ω	△	Input resistance becomes higher.*1
Input method		Positive common (sink type)	Positive/negative common shared type (sink/source shared type)	○	
Response time	OFF → ON	10ms or less (at 24VDC)	10ms or less (at 24VDC)	○	
	ON → OFF	10ms or less (at 24VDC)	10ms or less (at 24VDC)	○	
Common terminal arrangement		16 points/common	16 points/common (2 points) (terminal block 1-wire type)	○	
Number of occupied stations (number of occupied points)		4 stations (4 stations × 8 points)	1 station (1 station × 32 points)	○	
Operation indication		ON indication (LED)	ON indication (LED)	○	
External connection method		50-point terminal block (M3.5 × 7 screws) Transmission circuit parts included	50-point terminal block (M3.5 × 7 screws) Transmission circuit parts included	○	The number of applicable solderless terminals inserted is within two.
Applicable wire size		0.75 to 2mm ²	0.75 to 2mm ²	○	
Applicable solderless terminal		R1.25-3.5, R2-3.5 RAV1.25-3.5, RAV2-3.5	RAV1.25-3.5 (Conforming to JIS C 2805) RAV2-3.5	○	
I/O module power supply	Voltage	15.6 to 31.2VDC	20.4 to 26.4VDC (ripple ratio within 5%)	△	The operating voltage range differs.
	Current	55mA (at 24VDC TYP.)	45mA or less (24VDC, when all points are ON)	○	
External dimensions		170(H) × 64(W) × 80(D) mm	170(H) × 64(W) × 80(D) mm	○	
Weight		0.6kg	0.6kg	○	

*1: Check the specifications of the sensors or switches to be connected to the AJ65DBTB1-32D.

(6) Specifications comparison between AX81C and AJ65SBTB1-32D

○ : Compatible, △ : Partial change required, × : Not compatible

Specifications		AX81C	AJ65SBTB1-32D	Compatibility	Precautions for replacement
Number of input points		32 points	32 points	○	
Insulation method		Photocoupler	Photocoupler	○	
Rated input voltage		12VDC/24VDC	24VDC	△	12VDC cannot be used.
Rated input current		Approx. 3mA/Approx. 7mA	Approx. 7mA	○	
Operating voltage range		10.2 to 31.2VDC (ripple ratio within 5%)	19.2 to 26.4VDC (ripple ratio within 5%)	△	12VDC cannot be used.
Maximum number of simultaneous input points		100% simultaneously ON (at 26.4VDC)	100% simultaneously ON	○	
ON voltage/ON current		8V or more/2mA or more	14V or more/3.5mA or more	△	12VDC cannot be used.
OFF voltage/OFF current		4V or less/1mA or less	6V or less/1.7mA or less	△	12VDC cannot be used.
Input resistance		Approx. 3.3k Ω	Approx. 3.3k Ω	○	
Input method		Positive/negative common shared type (sink/source shared type)	Positive/negative common shared type (sink/source shared type)	○	
Response time	OFF → ON	10ms or less (at 24VDC)	1.5ms or less (at 24VDC)	○	
	ON → OFF	10ms or less (at 24VDC)	1.5ms or less (at 24VDC)	○	
Common terminal arrangement		16 points/common	32 points/common	△	As common terminal arrangement changes from 16 points/common to 32 points/common, wiring with a different voltage per common is not possible.
Number of occupied stations (number of occupied points)		4 stations (4 stations × 8 points)	1 station (1 station × 32 points)	○	
Operation indication		ON indication (LED)	ON indication (LED)	○	
External connection method		50-point terminal block (M3.5 × 7 screws) Transmission circuit part included	Transmission/module power supply parts: 7-point terminal block (M3 × 5.2 screws) I/O part: 34-point terminal block (M3 × 5.2 screws)	×	Change in wiring is required.
Applicable wire size		0.75 to 2mm ²	0.3 to 2mm ²	○	
Applicable solderless terminal		R1.25-3.5, R2-3.5 RAV1.25-3.5, RAV2-3.5	RAV1.25-3 (Conforming to JIS C 2805) V2-MS3, RAP2-3SL, TGV2-3N	×	Change in wiring is required.
I/O module power supply	Voltage	15.6 to 31.2VDC	20.4 to 26.4VDC (ripple ratio within 5%)	△	The operating voltage range differs.
	Current	55mA (at 24VDC TYP.)	45mA or less (24VDC when all points are ON)	○	
External dimensions		170(H) × 64(W) × 80(D) mm	54(H) × 179(W) × 40(D) mm	×	The overall size differs. Pay attention to the mounting dimensions.
Weight		0.6kg	0.25kg	△	

(7) Specifications comparison between AX81C and AJ65DBTB1-32D

○ : Compatible, △ : Partial change required, × : Not compatible

Specifications		AX81C	AJ65DBTB1-32D	Compatibility	Precautions for replacement
Number of input points		32 points	32 points	○	
Insulation method		Photocoupler	Photocoupler	○	
Rated input voltage		12VDC/24VDC	24VDC	△	12VDC cannot be used.
Rated input current		Approx. 3mA/Approx. 7mA	Approx. 5mA	△	Rated input current is smaller. *1
Operating voltage range		10.2 to 31.2VDC (ripple ratio within 5%)	20.4 to 31.2VDC (ripple ratio within 5%)	△	12VDC cannot be used.
Maximum number of simultaneous input points		100% simultaneously ON (at 26.4VDC)	100% (at 26.4VDC)	○	
ON voltage/ON current		8V or more/2mA or more	15V or more/3mA or more	△	12VDC cannot be used.
OFF voltage/OFF current		4V or less/1mA or less	5V or less/1.5mA or less	△	12VDC cannot be used.
Input resistance		Approx. 3.3k Ω	Approx. 4.7k Ω	△	Input resistance becomes higher. *1
Input method		Positive/negative common shared type (sink/source shared type)	Positive/negative common shared type (sink/source shared type)	○	
Response time	OFF → ON	10ms or less (at 24VDC)	10ms or less (at 24VDC)	○	
	ON → OFF	10ms or less (at 24VDC)	10ms or less (at 24VDC)	○	
Common terminal arrangement		16 points/common	16 points/common (2 points) (terminal block 1-wire type)	○	
Number of occupied stations (number of occupied points)		4 stations (4 stations × 8 points)	1 station (1 station × 32 points)	○	
Operation indication		ON indication (LED)	ON indication (LED)	○	
External connection method		50-point terminal block (M3.5 × 7 screws) Transmission circuit parts included	50-point terminal block (M3.5 × 7 screws) Transmission circuit parts included	○	The number of applicable solderless terminals inserted is within two.
Applicable wire size		0.75 to 2mm ²	0.75 to 2mm ²	○	
Applicable solderless terminal		R1.25-3.5, R2-3.5 RAV1.25-3.5, RAV2-3.5	RAV1.25-3.5 (Conforming to JIS C 2805) RAV2-3.5	○	
I/O module power supply	Voltage	15.6 to 31.2VDC	20.4 to 26.4VDC (ripple ratio within 5%)	△	The operating voltage range differs.
	Current	55mA (at 24VDC TYP.)	45mA or less (24VDC, when all points are ON)	○	
External dimensions		170(H) × 64(W) × 80(D) mm	170(H) × 64(W) × 80(D) mm	○	
Weight		0.6kg	0.6kg	○	

*1: Check the specifications of the sensors or switches to be connected to the AJ65DBTB1-32D.

(8) Specifications comparison between AJ35PTF-32D and AJ65SBTB1-32D

○ : Compatible, △ : Partial change required, × : Not compatible

Specifications		AJ35PTF-32D	AJ65SBTB1-32D	Compatibility	Precautions for replacement
Number of input points		32 points	32 points	○	
Insulation method		Photocoupler	Photocoupler	○	
Rated input voltage		12VDC/24VDC	24VDC	△	12VDC cannot be used.
Rated input current		Approx. 3mA/Approx. 7mA	Approx. 7mA	○	
Operating voltage range		10.2 to 31.2VDC (ripple ratio within 5%)	19.2 to 26.4VDC (ripple ratio within 5%)	△	12VDC cannot be used.
Maximum number of simultaneous input points		75% simultaneously ON	100% simultaneously ON	○	
ON voltage/ON current		9.5V or more/2.6mA or more	14V or more/3.5mA or more	△	12VDC cannot be used.
OFF voltage/OFF current		6.0V or less/1.0mA or less	6.0V or less/1.7mA or less	△	12VDC cannot be used.
Input resistance		Approx. 3.4k Ω	Approx. 3.3k Ω	○	
Input method		Positive common (sink type)	Positive/negative common shared type (sink/source shared type)	○	
Response time	OFF → ON	10ms or less (at 6ms TYP.)	1.5ms or less (at 24VDC)	○	
	ON → OFF	10ms or less (at 7.5ms TYP.)	1.5ms or less (at 24VDC)	○	
Common terminal arrangement		16 points/common	32 points/common	△	As common terminal arrangement changes from 16 points/common to 32 points/common, wiring with a different voltage per common is not possible.
Number of occupied stations (number of occupied points)		4 stations (4 stations × 8 points)	1 station (1 station × 32 points)	○	
Operation indication		ON indication (LED)	ON indication (LED)	○	
External connection method		Transmission/module power supply parts: 8-point terminal block (M3 screw) I/O part: 36-point terminal block (M3 × 6 screws)	Transmission/module power supply parts: 7-point terminal block (M3 × 5.2 screws) I/O part: 34-point terminal block (M3 × 5.2 screws)	×	Change in wiring is required.
Applicable wire size		0.75 to 2mm ²	0.3 to 2mm ²	○	
Applicable solderless terminal		R1.25-3, R2-3 RAV1.25-3, RAV2-3	RAV1.25-3 (Conforming to JIS C 2805) V2-MS3, RAP2-3SL, TGV2-3N	△	In some cases, the solderless terminal must be changed.
I/O module power supply	Voltage	15.6 to 31.2VDC	20.4 to 26.4VDC (ripple ratio within 5%)	△	The operating voltage range differs.
	Current	110mA	45mA or less (24VDC when all points are ON)	○	
External dimensions		254(H) × 132(W) × 41(D) mm	54(H) × 179(W) × 40(D) mm	×	The overall size differs. Pay attention to the mounting dimensions.
Weight		0.7kg	0.25kg	△	

(9) Specifications comparison between AJ35TB1-16A and AJ65SBTB2N-16A

○ : Compatible, △ : Partial change required, × : Not compatible

Specifications		AJ35TB1-16A	AJ65SBTB2N-16A	Compatibility	Precautions for replacement
Number of input points		16 points	16 points	○	
Insulation method		Photocoupler	Photocoupler	○	
Rated input voltage		100-120VAC, 50/60Hz	100-120VAC, 50/60Hz	○	
Rated input current		Approx. 6mA (100VAC, 60Hz)	Approx. 7mA (100VAC, 60Hz)	○	
Operating voltage range		85 to 132VAC (50/60Hz ± 5%)	85 to 132VAC (50/60Hz ± 3%, distortion rate 5% within)	○	
Maximum number of simultaneous input points		100% simultaneously ON	100% simultaneously ON (at 110VAC) 60% simultaneously ON (at 132VAC)	△	Use within specification range.
ON voltage/ON current		80V or more/5mA or more	80V or more/5mA or more	○	
OFF voltage/OFF current		30V or less/1mA or less	30V or less/1.7mA or less	○	
Input impedance		Approx. 18k Ω (60Hz), Approx. 21k Ω (50Hz)	Approx. 15k Ω (60Hz), Approx. 18k Ω (50Hz)	○	
Response time	OFF → ON	15ms or less (100VAC, 60Hz)	20ms or less (100VAC, 60Hz)	○	
	ON → OFF	30ms or less (100VAC, 60Hz)	20ms or less (100VAC, 60Hz)	○	
Common terminal arrangement		16 points/common	16 points/common (2-wire type)	○	
Number of occupied stations (number of occupied points)		2 stations (2 stations × 8 points)	1 station (1 station × 32 points)	×	The number of occupied points increases. The assignment of the entire system needs to be reconsidered.
Operation indication		ON indication (LED)	ON indication (LED)	○	
External connection method		34-point terminal block (M3 screw) Transmission circuit part included	Transmission/module power supply parts: 7-point terminal block (M3 × 5.2 screws) I/O part: 34-point terminal block (M3 × 5.2 screws)	×	Change in wiring is required.
Applicable wire size		0.75 to 2mm ²	0.3 to 2mm ²	○	
Applicable solderless terminal		R1.25-3, R2-3 RAV1.25-3, RAV2-3	RAV1.25-3 (Conforming to JIS C 2805) V2-MS3, RAP2-3SL, TGV2-3N	△	In some cases, the solderless terminal must be changed.
I/O module power supply	Voltage	15.6 to 31.2VDC (peak voltage 31.2VDC)	20.4 to 26.4VDC (ripple ratio within 5%)	△	The operating voltage range differs.
	Current	50mA (at 24VDC)	40mA or less (24VDC when all points are ON)	○	
External dimensions		55(H) × 166(W) × 50(D) mm	54(H) × 179(W) × 40(D) mm	×	The overall size differs. Pay attention to the mounting dimensions.
Weight		0.35kg	0.25kg	△	

(10) Specifications comparison between AJ35TB2-8D and AJ65SBTB3-8D

○ : Compatible, △ : Partial change required, × : Not compatible

Specifications		AJ35TB2-8D	AJ65SBTB3-8D	Compat- ibility	Precautions for replacement
Number of input points		8 points	8 points	○	
Insulation method		Photocoupler	Photocoupler	○	
Rated input voltage		24VDC	24VDC	○	
Rated input current		Approx. 7mA	Approx. 7mA	○	
Operating voltage range		19.2 to 26.4VDC (ripple ratio within 5%)	19.2 to 26.4VDC (ripple ratio within 5%)	○	
Maximum number of simultaneous input points		100% simultaneously ON	100% simultaneously ON	○	
ON voltage/ON current		14V or more/3.5mA or more	14V or more/3.5mA or more	○	
OFF voltage/OFF current		6.0V or less/1.7mA or less	6.0V or less/1.7mA or less	○	
Input resistance		Approx. 3.3k Ω	Approx. 3.3k Ω	○	
Input method		Positive/negative common shared type (sink/source shared type)	Positive/negative common shared type (sink/source shared type)	○	
Response time	OFF → ON	10ms or less	1.5ms or less (at 24VDC)	○	
	ON → OFF	10ms or less	1.5ms or less (at 24VDC)	○	
Common terminal arrangement		8 points/common (2-wire type)	8 points/common (3-wire type)	○	
Number of occupied stations (number of occupied points)		1 station (1 station × 8 points)	1 station (1 station × 32 points)	×	The number of occupied points increases. The assignment of the entire system needs to be reconsidered.
Operation indication		ON indication (LED)	ON indication (LED)	○	
External connection method		26-point terminal block (M3 screw) Transmission circuit part included	Transmission/module power supply parts: 7-point terminal block (M3 × 5.2 screws) I/O part: 18-point terminal block (M3 × 5.2 screws)	×	Change in wiring is required.
Applicable wire size		0.75 to 2mm ²	0.3 to 2mm ²	○	
Applicable solderless terminal		R1.25-3, R2-3 RAV1.25-3, RAV2-3	RAV1.25-3 (Conforming to JIS C 2805) V2-MS3, RAP2-3SL, TGV2-3N,	△	In some cases, the solderless terminal must be changed.
I/O module power supply	Voltage	15.6 to 31.2VDC (peak voltage 31.2VDC)	20.4 to 26.4VDC (ripple ratio within 5%)	△	The operating voltage range differs.
	Current	69mA (at 24VDC TYP.)	40mA or less (24VDC when all points are ON)	○	
External dimensions		55(H) × 135(W) × 50(D) mm	54(H) × 118(W) × 40(D) mm	×	The overall size differs. Pay attention to the mounting dimensions.
Weight		0.3kg	0.18kg	△	

(11) Specifications comparison between AJ35TB3-8D and AJ65SBTB3-8D

○ : Compatible, △ : Partial change required, × : Not compatible

Specifications		AJ35TB3-8D	AJ65SBTB3-8D	Compatibility	Precautions for replacement
Number of input points		8 points	8 points	○	
Insulation method		Photocoupler	Photocoupler	○	
Rated input voltage		24VDC	24VDC	○	
Rated input current		Approx. 7mA	Approx. 7mA	○	
Operating voltage range		19.2 to 26.4VDC (ripple ratio within 5%)	19.2 to 26.4VDC (ripple ratio within 5%)	○	
Maximum number of simultaneous input points		100% simultaneously ON	100% simultaneously ON	○	
ON voltage/ON current		14V or more/3.5mA or more	14V or more/3.5mA or more	○	
OFF voltage/OFF current		6.0V or less/1.7mA or less	6.0V or less/1.7mA or less	○	
Input resistance		Approx. 3.3k Ω	Approx. 3.3k Ω	○	
Input method		Positive common (sink type)	Positive/negative common shared type (sink/source shared type)	○	
Response time	OFF → ON	10ms or less	1.5ms or less (at 24VDC)	○	
	ON → OFF	10ms or less	1.5ms or less (at 24VDC)	○	
Common terminal arrangement		8 points/common (3-wire type)	8 points/common (3-wire type)	○	
Number of occupied stations (number of occupied points)		1 station (1 station × 8 points)	1 station (1 station × 32 points)	×	The number of occupied points increases. The assignment of the entire system needs to be reconsidered.
Operation indication		ON indication (LED)	ON indication (LED)	○	
External connection method		26-point terminal block (M3 screw) Transmission circuit part included	Transmission/module power supply parts: 7-point terminal block (M3 × 5.2 screws) I/O part: 18-point terminal block (M3 × 5.2 screws)	×	Change in wiring is required.
Applicable wire size		0.75 to 2mm ²	0.3 to 2mm ²	○	
Applicable solderless terminal		R1.25-3, R2-3 RAV1.25-3, RAV2-3	RAV1.25-3 (Conforming to JIS C 2805) V2-MS3, RAP2-3SL, TGV2-3N	△	In some cases, the solderless terminal must be changed.
I/O module power supply	Voltage	15.6 to 31.2VDC (peak voltage 31.2VDC)	20.4 to 26.4VDC (ripple ratio within 5%)	△	The operating voltage range differs.
	Current	69mA (at 24VDC)	40mA or less (24VDC when all points are ON)	○	
External dimensions		55(H) × 135(W) × 50(D) mm	54(H) × 118(W) × 40(D) mm	×	The overall size differs. Pay attention to the mounting dimensions.
Weight		0.3kg	0.18kg	△	

(12) Specifications comparison between AJ35TB1-16D and AJ65SBTB1-16D

○ : Compatible, △ : Partial change required, × : Not compatible

Specifications		AJ35TB1-16D	AJ65SBTB1-16D	Compatibility	Precautions for replacement
Number of input points		16 points	16 points	○	
Insulation method		Photocoupler	Photocoupler	○	
Rated input voltage		24VDC	24VDC	○	
Rated input current		Approx. 7mA	Approx. 7mA	○	
Operating voltage range		19.2 to 26.4VDC (ripple ratio within 5%)	19.2 to 26.4VDC (ripple ratio within 5%)	○	
Maximum number of simultaneous input points		70% simultaneously ON (at 26.4VDC)	100% simultaneously ON	○	
ON voltage/ON current		14V or more/3.5mA or more	14V or more/3.5mA or more	○	
OFF voltage/OFF current		6.0V or less/1.7mA or less	6.0V or less/1.7mA or less	○	
Input resistance		Approx. 3.3k Ω	Approx. 3.3k Ω	○	
Input method		Positive/negative common shared type (sink/source shared type)	Positive/negative common shared type (sink/source shared type)	○	
Response time	OFF → ON	10ms or less	1.5ms or less (at 24VDC)	○	
	ON → OFF	10ms or less	1.5ms or less (at 24VDC)	○	
Common terminal arrangement		16 points/common (2 terminals)	16 points/common	○	
Number of occupied stations (number of occupied points)		2 stations (2 stations × 8 points)	1 station (1 station × 32 points)	×	The number of occupied points increases. The assignment of the entire system needs to be reconsidered.
Operation indication		ON indication (LED)	ON indication (LED)	○	
External connection method		26-point terminal block (M3 screw) Transmission circuit part included	Transmission/module power supply parts: 7-point terminal block (M3 × 5.2 screws) I/O part: 18-point terminal block (M3 × 5.2 screws)	×	Change in wiring is required.
Applicable wire size		0.75 to 2mm ²	0.3 to 2mm ²	○	
Applicable solderless terminal		R1.25-3, R2-3 RAV1.25-3, RAV2-3	RAV1.25-3 (Conforming to JIS C 2805) V2-MS3, RAP2-3SL, TGV2-3N	△	In some cases, the solderless terminal must be changed.
I/O module power supply	Voltage	15.6 to 31.2VDC (peak voltage 31.2VDC)	20.4 to 26.4VDC (ripple ratio within 5%)	△	The operating voltage range differs.
	Current	45mA or less (at 24VDC)	35mA or less (24VDC when all points are ON)	○	
External dimensions		55(H) × 135(W) × 50(D) mm	54(H) × 118(W) × 40(D) mm	×	The overall size differs. Pay attention to the mounting dimensions.
Weight		0.3kg	0.18kg	△	

(13) Specifications comparison between AJ35TB1-16D and AJ65BTB1-16D

○ : Compatible, △ : Partial change required, × : Not compatible

Specifications		AJ35TB1-16D	AJ65BTB1-16D	Compatibility	Precautions for replacement
Number of input points		16 points	16 points	○	
Insulation method		Photocoupler	Photocoupler	○	
Rated input voltage		24VDC	24VDC	○	
Rated input current		Approx. 7mA	Approx. 7mA	○	
Operating voltage range		19.2 to 26.4VDC (ripple ratio within 5%)	19.2 to 28.8VDC (ripple ratio within 5%)	△	The operating voltage range differs.
Maximum number of simultaneous input points		70% simultaneously ON (at 26.4VDC)	100%	○	
ON voltage/ON current		14V or more/3.5mA or more	14V or more/3.5mA or more	○	
OFF voltage/OFF current		6.0V or less/1.7mA or less	6.0V or less/1.7mA or less	○	
Input resistance		Approx. 3.3k Ω	Approx. 3.3k Ω	○	
Input method		Positive/negative common shared type (sink/source shared type)	Positive/negative common shared type (sink/source shared type)	○	
Response time	OFF → ON	10ms or less	10ms or less	○	
	ON → OFF	10ms or less	10ms or less	○	
Common terminal arrangement		16 points/common (2 terminals)	16 points/common (terminal block 1-wire type)	○	
Number of occupied stations (number of occupied points)		2 stations (2 stations × 8 points)	1 station (1 station × 32 points)	×	The number of occupied points increases. The assignment of the entire system needs to be reconsidered.
Operation indication		ON indication (LED)	ON indication (LED)	○	
External connection method		26 point terminal block (M3 screws) Transmission circuit part included	27 point terminal block (M3.5 screws) Transmission circuit and module power supply terminal included	△	The existing terminal block of the AJ35TB1-16D can be used by using wiring conversion adapter *1.
Applicable wire size		0.75 to 2mm ²	0.75 to 2mm ²	○	
Applicable solderless terminal		R1.25-3, R2-3 RAV1.25-3, RAV2-3	RAV1.25-3.5 (Conforming to JIS C 2805) RAV2-3.5	△	The existing terminal block of the AJ35TB1-16D can be used by using wiring conversion adapter *1.
I/O module power supply	Voltage	15.6 to 31.2VDC (peak voltage 31.2VDC)	15.6 to 28.8VDC (ripple ratio within 5%)	△	The operating voltage range differs.
	Current	45mA or less (at 24VDC)	60mA or less (at 24VDC TYP.)	△	The current consumption increases. The current capacity needs to be reconsidered.
External dimensions		55(H) × 135(W) × 50(D) mm	65(H) × 151.9(W) × 46(D) mm *2	×	The overall size differs. Pay attention to the mounting dimensions.
Weight		0.3kg	0.32kg	△	

*1: The A6ADP-1MC16D, MELSECNET/MINI-S3 - CC-Link module wiring conversion adapter can be used.
For the mounting image, refer to *2 of Section 1.2.

*2: When using the A6ADP-1MC16D, MELSECNET/MINI-S3 - CC-Link module wiring conversion adapter, the external dimensions are increased by 5.1mm (height) and 28.5mm (depth).

(14) Specifications comparison between AJ35TB2-16D and AJ65SBTB3-16D

○ : Compatible, △ : Partial change required, × : Not compatible

Specifications		AJ35TB2-16D	AJ65SBTB3-16D	Compatibility	Precautions for replacement
Number of input points		16 points	16 points	○	
Insulation method		Photocoupler	Photocoupler	○	
Rated input voltage		24VDC	24VDC	○	
Rated input current		Approx. 7mA	Approx. 7mA	○	
Operating voltage range		19.2 to 26.4VDC (ripple ratio within 5%)	19.2 to 26.4VDC (ripple ratio within 5%)	○	
Maximum number of simultaneous input points		100% simultaneously ON (at 26.4VDC)	100% simultaneously ON	○	
ON voltage/ON current		14V or more/3.5mA or more	14V or more/3.5mA or more	○	
OFF voltage/OFF current		6.0V or less/1.7mA or less	6.0V or less/1.7mA or less	○	
Input resistance		Approx. 3.3kΩ	Approx. 3.3kΩ	○	
Input method		Positive/negative common shared type (sink/source shared type)	Positive/negative common shared type (sink/source shared type)	○	
Response time	OFF → ON	10ms or less	1.5ms or less (at 24VDC)	○	
	ON → OFF	10ms or less	1.5ms or less (at 24VDC)	○	
Common terminal arrangement		16 points/common (terminal block 2-wire type)	16 points/common (3-wire type)	○	
Number of occupied stations (number of occupied points)		2 stations (2 stations × 8 points)	1 station (1 station × 32 points)	×	The number of occupied points increases. The assignment of the entire system needs to be reconsidered.
Operation indication		ON indication (LED)	ON indication (LED)	○	
External connection method		34-point terminal block (M3 screw) Transmission circuit part included	Transmission/module power supply parts: 7-point terminal block (M3 × 5.2 screws) I/O part: 34-point terminal block (M3 × 5.2 screws)	×	Change in wiring is required.
Applicable wire size		0.75 to 2mm ²	0.3 to 2mm ²	○	
Applicable solderless terminal		R1.25-3, R2-3 RAV1.25-3, RAV2-3	RAV1.25-3 (Conforming to JIS C 2805) V2-MS3, RAP2-3SL, TGV2-3N	△	In some cases, the solderless terminal must be changed.
I/O module power supply	Voltage	15.6 to 31.2VDC (peak voltage 31.2VDC)	20.4 to 26.4VDC (ripple ratio within 5%)	△	The operating voltage range differs.
	Current	45mA or less (at 24VDC)	45mA or less (24VDC when all points are ON)	○	
External dimensions		55(H) × 166(W) × 50(D) mm	54(H) × 179(W) × 40(D) mm	×	The overall size differs. Pay attention to the mounting dimensions.
Weight		0.35kg	0.25kg	△	

(15) Specifications comparison between AJ35TB2-16D and AJ65BTB2-16D

○ : Compatible, △ : Partial change required, × : Not compatible

Specifications		AJ35TB2-16D	AJ65BTB2-16D	Compatibility	Precautions for replacement
Number of input points		16 points	16 points	○	
Insulation method		Photocoupler	Photocoupler	○	
Rated input voltage		24VDC	24VDC	○	
Rated input current		Approx. 7mA	Approx. 7mA	○	
Operating voltage range		19.2 to 26.4VDC (ripple ratio within 5%)	19.2 to 28.8VDC (ripple ratio within 5%)	△	The operating voltage range differs.
Maximum number of simultaneous input points		100% simultaneously ON (at 26.4VDC)	100%	○	
ON voltage/ON current		14V or more/3.5mA or more	14V or more/3.5mA or more	○	
OFF voltage/OFF current		6.0V or less/1.7mA or less	6.0V or less/1.7mA or less	○	
Input resistance		Approx. 3.3k Ω	Approx. 3.3k Ω	○	
Input method		Positive/negative common shared type (sink/source shared type)	Positive/negative common shared type (sink/source shared type)	○	
Response time	OFF → ON	10ms or less	10ms or less	○	
	ON → OFF	10ms or less	10ms or less	○	
Common terminal arrangement		16 points/common (terminal block 2-wire type)	16 points/common (terminal block 2-wire type)	○	
Number of occupied stations (number of occupied points)		2 stations (2 stations × 8 points)	1 station (1 station × 32 points)	×	The number of occupied points increases. The assignment of the entire system needs to be reconsidered.
Operation indication		ON indication (LED)	ON indication (LED)	○	
External connection method		34 point terminal block (M3 screws) Transmission circuit part included	37 point terminal block (M3.5 screws) Transmission circuit and module power supply terminal included	△	The existing terminal block of the AJ35TB2-16D can be used by using wiring conversion adapter *1.
Applicable wire size		0.75 to 2mm ²	0.75 to 2mm ²	○	
Applicable solderless terminal		R1.25-3, R2-3 RAV1.25-3, RAV2-3	RAV1.25-3.5 (Conforming to JIS C 2805) RAV2-3.5	△	The existing terminal block of the AJ35TB2-16D can be used by using wiring conversion adapter *1.
I/O module power supply	Voltage	15.6 to 31.2VDC (peak voltage 31.2VDC)	15.6 to 28.8VDC (ripple ratio within 5%)	△	The operating voltage range differs.
	Current	45mA or less (at 24VDC)	60mA or less (at 24VDC TYP.)	△	The current consumption increases. The current capacity needs to be reconsidered.
External dimensions		55(H) × 166(W) × 50(D) mm	65(H) × 197.4(W) × 46(D) mm *2	×	The overall size differs. Pay attention to the mounting dimensions.
Weight		0.35kg	0.4kg	△	

*1: The A6ADP-2MC16D, MELSECNET/MINI-S3 - CC-Link module wiring conversion adapter can be used.
For the mounting image, refer to *2 of Section 1.2.

*2: When using the A6ADP-2MC16D, MELSECNET/MINI-S3 - CC-Link module wiring conversion adapter, the external dimensions are increased by 5.1mm (height) and 28.5mm (depth).

(16) Specifications comparison between AJ35TC1-32D and AJ65SBTCF1-32D

○ : Compatible, △ : Partial change required, × : Not compatible

Specifications		AJ35TC1-32D	AJ65SBTCF1-32D	Compatibility	Precautions for replacement
Number of input points		32 points	32 points	○	
Insulation method		Photocoupler	Photocoupler	○	
Rated input voltage		24VDC	24VDC	○	
Rated input current		Approx. 5mA	Approx. 5mA	○	
Operating voltage range		19.2 to 26.4VDC (ripple ratio within 5%)	19.2 to 26.4VDC (ripple ratio within 5%)	○	
Maximum number of simultaneous input points		85% simultaneously ON (at 26.4VDC)	100% simultaneously ON	○	
ON voltage/ON current		17.5V or more/3.5mA or more	14V or more/3.5mA or more	○	
OFF voltage/OFF current		6.0V or less/1.7mA or less	6.0V or less/1.7mA or less	○	
Input resistance		Approx. 4.7k Ω	Approx. 4.7k Ω	○	
Input method		Positive/negative common shared type (sink/source shared type)	Positive/negative common shared type (sink/source shared type)	○	
Response time	OFF → ON	10ms or less	1.5ms or less (at 24VDC)	○	
	ON → OFF	10ms or less	1.5ms or less (at 24VDC)	○	
Common terminal arrangement		32 points/common	32 points/common	○	
Number of occupied stations (number of occupied points)		4 stations (4 stations × 8 points)	1 station (1 station × 32 points)	○	
Operation indication		ON indication (LED)	ON indication (LED)	○	
External connection method		Transmission circuit: 8-point terminal block (M3 screws)	Transmission/module power supply parts: 7-point terminal block (M3 × 5.2 screws)	×	Change in wiring is required.
		I/O part: 40-pin connector	I/O part: 40-pin connector	○	The existing connector can be attached without change.
Applicable wire size		Terminal block: 0.75 to 2mm ² 40-pin connector: 0.3mm ²	Terminal block: 0.3 to 2mm ² 40-pin connector: 0.3mm ² or less (for A6CON1, A6CON4) 0.2 to 0.08mm ² (for A6CON2) Twisted cable of 0.08mm ² , ϕ 0.25mm (for A6CON3)	○	
Accessory		1 external wiring connector	None	×	40-pin connectors for external wiring are sold separately.
Applicable solderless terminal		R1.25-3, R2-3 RAV1.25-3, RAV2-3	RAV1.25-3 (Conforming to JIS C 2805) V2-MS3, RAP2-3SL, TGV2-3N	△	In some cases, the solderless terminal must be changed.
I/O module power supply	Voltage	15.6 to 31.2VDC (peak voltage 31.2VDC)	20.4 to 26.4VDC (ripple ratio within 5%)	△	The operating voltage range differs.
	Current	55mA (at 24VDC)	45mA or less (24VDC when all points are ON)	○	
External dimensions		55(H) × 166(W) × 50(D) mm	54(H) × 118(W) × 40(D) mm	×	The overall size differs. Pay attention to the mounting dimensions.
Weight		0.25kg	0.15kg	△	

5.2.2 Output module specifications comparisons

(1) Specifications comparison between AY13C and AJ65SBTB2N-16R

○ : Compatible, △ : Partial change required, × : Not compatible

Specifications		AY13C	AJ65SBTB2N-16R	Compatibility	Precautions for replacement
Number of output points		32 points	16 points	×	When seventeen or more points are used, use two AJ65SBTB2N-16R modules.
Insulation method		Photocoupler	Relay isolation	△	Although the insulation methods differ, the performance of the insulation is the same.
Rated load voltage/current		24VDC 2A (resistance load)/point 240VAC 2A (COS φ =1)/point 4A/common (2A/1 terminal)	24VDC 2A (resistance load)/point 240VAC 2A (COS φ =1)/point 8A/common	○	
Minimum switching load		5VDC 1mA	5VDC 1mA	○	
Maximum switching voltage		250VAC, 110VDC	264VAC, 125VDC	○	
Response time	OFF → ON	10ms or less	10ms or less	○	
	ON → OFF	12ms or less	12ms or less	○	
Mechanical life		20 million times or more	20 million times or more	○	
Electrical life		Rated switching voltage/current load 100,000 times or more 200VAC 1.5A, 240VAC 1A (COS φ =0.7) 100,000 times or more 200VAC 1A, 240VAC 0.5A (COS φ = 0.35) 100,000 times or more 24VDC 1A, 100VDC 0.1A (L/R=7 ms) 100,000 times or more	Rated switching voltage/current load 100,000 times or more 200VAC 1.5A, 240VAC 1A (COS φ =0.7) 100,000 times or more 200VAC 1A, 240VAC 0.5A (COS φ = 0.35) 100,000 times or more 24VDC 1A, 100VDC 0.1A (L/R=7 ms) 100,000 times or more	○	
Maximum switching frequency		3,600 times/hr	3,600 times/hr	○	
External power supply	Voltage	24VDC ± 10% Ripple voltage 4Vp-p or less	None	–	
	Current	184mA (24VDC, all points ON)	None	–	
Common terminal arrangement		8 points/common	16 points/common (2-wire type)	△	As common terminal arrangement changes from 8 points/common to 16 points/common, wiring with a different voltage per common is not possible.
Number of occupied stations (number of occupied points)		4 stations (4 stations × 8 points)	1 station (1 station × 32 points × 2 modules)	×	The number of occupied points increases. The assignment of the entire system needs to be reconsidered.
Operation indication		ON indication (LED)	ON indication (LED)	○	
External connection method		50-point terminal block (M3.5 × 7 screws) Transmission circuit part included	Transmission/module power supply parts: 7-point terminal block (M3 × 5.2 screws) I/O part: 34-point terminal block (M3 × 5.2 screws)	×	Change in wiring is required.
Applicable wire size		0.75 to 2mm ²	0.3 to 2mm ²	○	
Applicable solderless terminal		R1.25-3.5, R2-3.5 RAV1.25-3.5, RAV2-3.5	RAV1.25-3 (Conforming to JIS C 2805) V2-MS3, RAP2-3SL, TGV2-3N	×	Change in wiring is required.

○ : Compatible, △ : Partial change required, × : Not compatible

Specifications		AY13C	AJ65SBTB2N-16R	Compatibility	Precautions for replacement
I/O module power supply	Voltage	15.6 to 31.2VDC	20.4 to 26.4VDC (ripple ratio within 5%)	△	The operating voltage range differs.
	Current	90mA (at 24VDC TYP.)	120mA or less (24VDC when all points are ON)	△	The current consumption increases. the current capacity needs to be reconsidered.
External dimensions		170(H) × 64(W) × 80(D) mm	54(H) × 179(W) × 40(D) mm	×	The overall size differs. Pay attention to the mounting dimensions.
Weight		0.7kg	0.35kg	△	

(2) Specifications comparison between AY13C and AJ65DBTB1-32R

○ : Compatible, △ : Partial change required, × : Not compatible

Specifications		AY13C	AJ65DBTB1-32R	Compatibility	Precautions for replacement
Number of output points		32 points	32 points	○	
Insulation method		Photocoupler	Photocoupler	○	
Rated load voltage/current		24VDC 2A (resistance load)/point 240VAC 2A (COS φ =1)/point 4A/common (2A/1 terminal)	24VDC 2A (resistance load)/point 240VAC 2A (COS φ =1)/point 4A/common (2A/1 terminal)	○	
Minimum switching load		5VDC 1mA	5VDC 1mA	○	
Maximum switching voltage		250VAC, 110VDC	264VAC, 125VDC	○	
Response time	OFF → ON	10ms or less	10ms or less	○	
	ON → OFF	12ms or less	12ms or less	○	
Mechanical life		20 million times or more	20 million times or more	○	
Electrical life		Rated switching voltage/current load 100,000 times or more 200VAC 1.5A, 240VAC 1A (COS φ =0.7) 100,000 times or more 200VAC 1A, 240VAC 0.5A (COS φ = 0.35) 100,000 times or more 24VDC 1A, 100VDC 0.1A (L/R=7 ms) 100,000 times or more	Rated switching voltage/current load 100,000 times or more 200VAC 1.5A, 240VAC 1A (COS φ =0.7) 100,000 times or more 200VAC 1A, 240VAC 0.5A (COS φ = 0.35) 100,000 times or more 24VDC 1A, 100VDC 0.1A (L/R=7 ms) 100,000 times or more	○	
Maximum switching frequency		3,600 times/hr	3,600 times/hr	○	
External power supply	Voltage	24VDC ± 10% Ripple voltage 4Vp-p or less	24VDC ± 10% Ripple ratio 4Vp-p or less	○	
	Current	184mA (24VDC, all points ON)	180mA or less (24VDC, when all points are ON)	○	
Common terminal arrangement		8 points/common	8 points/common (terminal block 1-wire type)	△	
Number of occupied stations (number of occupied points)		4 stations (4 stations × 8 points)	1 station (1 station × 32 points)	○	
Operation indication		ON indication (LED)	ON indication (LED)	○	
External connection method		50-point terminal block (M3.5 × 7 screws) Transmission circuit part included	50-point terminal block (M3.5 × 7 screws) Transmission circuit part included	○	The number of applicable solderless terminals inserted is within two.
Applicable wire size		0.75 to 2mm ²	0.75 to 2mm ²	○	
Applicable solderless terminal		R1.25-3.5, R2-3.5 RAV1.25-3.5, RAV2-3.5	RAV1.25-3.5 (Conforming to JIS C 2805) RAV2-3.5	○	
I/O module power supply	Voltage	15.6 to 31.2VDC	20.4 to 26.4VDC (ripple ratio within 5%)	△	The operating voltage range differs.
	Current	90mA (at 24VDC TYP.)	80mA or less (24VDC when all points are ON)	○	
External dimensions		170(H) × 64(W) × 80(D) mm	170(H) × 64(W) × 80(D) mm	○	
Weight		0.7kg	0.7kg	○	

(3) Specifications comparison between AY15CEU and AJ65SBTB2N-16R

○ : Compatible, △ : Partial change required, × : Not compatible

Specifications		AY15CEU	AJ65SBTB2N-16R	Compatibility	Precautions for replacement	
Number of output points		24 points	16 points	×	When seventeen or more points are used, use two AJ65SBTB2N-16R modules.	
Insulation method		Photocoupler	Relay isolation	△	Although the insulation methods differ, the performance of the insulation is the same.	
Rated load voltage/current		24VDC 2A (resistance load)/point 240VAC 2A (COS φ =1)/point 4A/common	24VDC 2A (resistance load)/point 240VAC 2A (COS φ =1)/point 8A/common	○		
Minimum switching load		5VDC 10mA	5VDC 1mA	○		
Maximum switching voltage		264VAC 125VDC	264VAC, 125VDC	○		
Response time	OFF → ON	10ms or less	10ms or less	○		
	ON → OFF	12ms or less	12ms or less	○		
Mechanical life		20 million times or more	20 million times or more	○		
Electrical life		Rated switching voltage/current load 200,000 times or more 200VAC 2A, 240VAC 1.8A (COS φ =0.7) 200,000 times or more 200VAC 1.1A, 240VAC 0.9A (COS φ =0.35) 200,000 times or more 24VDC 1.1A, 100VDC 0.1A (L/R=7ms) 200,000 times or more	Rated switching voltage/current load 100,000 times or more 200VAC 1.5A, 240VAC 1A (COS φ =0.7) 100,000 times or more 200VAC 1A, 240VAC 0.5A (COS φ = 0.35) 100,000 times or more 24VDC 1A, 100VDC 0.1A (L/R=7 ms) 100,000 times or more	△	Reduce the exchange intervals of the modules as Mechanical/Electrical Life is cut to about half.	
Maximum switching frequency		3,600 times/hr	3,600 times/hr	○		
External power supply	Voltage	24VDC ± 10% Ripple voltage 4Vp-p or less	None	-		
	Current	230mA (24VDC all points ON)	None	-		
Common terminal arrangement		8 points/common 4 points/common	16 points/common (2-wire type)	△	As common terminal arrangement changes from 8 points/common to 16 points/common, wiring with a different voltage per common is not possible.	
Dielectric withstand voltage	AC external batch-Relay drive power supply, internal 5V circuit	2,830VAC rms/3 cycle (elevation 2,000m)	Between AC external batch and ground	2,830VAC rms/3 cycle (elevation 2,000m)	○	
	Relay drive power supply-internal 5V circuit	500VDC 1 minute	Between DC external batch and ground	500VDC 1 minute	○	
Insulation resistance		10M Ω or more with the insulation resistance tester	Between AC external batch and ground 500VDC with the insulation resistance tester 10M Ω or more Between DC external batch and ground 500VDC with the insulation resistance tester 10M Ω or more	○		

○ : Compatible, △ : Partial change required, × : Not compatible

Specifications		AY15CEU	AJ65SBTB2N-16R	Compatibility	Precautions for replacement
Number of occupied stations (number of occupied points)		4 stations (4 stations × 8 points)	1 station (1 station × 32 points × 2 modules)	×	The number of occupied points increases. The assignment of the entire system needs to be reconsidered.
Operation indication		ON indication (LED)	ON indication (LED)	○	
External connection method		50-point terminal block (M3.5 × 7 screws) Transmission circuit part included	Transmission/module power supply parts: 7-point terminal block (M3 × 5.2 screws) I/O part: 34-point terminal block (M3 × 5.2 screws)	×	Change in wiring is required.
Applicable wire size		0.75 to 2mm ²	0.3 to 2mm ²	○	
Applicable solderless terminal		RAV1.25-3.5, RAV2-3.5	RAV1.25-3 (Conforming to JIS C 2805) V2-MS3, RAP2-3SL, TGV2-3N	×	Change in wiring is required.
I/O module power supply	Voltage	15.6 to 31.2VDC	20.4 to 26.4VDC (ripple ratio within 5%)	△	The operating voltage range differs.
	Current	94mA (at 24VDC TYP.)	120mA or less (24VDC when all points are ON)	△	The current consumption increases. the current capacity needs to be reconsidered.
External dimensions		170(H) × 64(W) × 80(D) mm	54(H) × 179(W) × 40(D) mm	×	The overall size differs. Pay attention to the mounting dimensions.
Weight		0.75kg	0.35kg	△	

(4) Specifications comparison between AY15CEU and AJ65DBTB1-32R

○ : Compatible, △ : Partial change required, × : Not compatible

Specifications		AY15CEU	AJ65DBTB1-32R	Compatibility	Precautions for replacement
Number of output points		24 points	32 points	○	
Insulation method		Photocoupler	Photocoupler	○	
Rated load voltage/current		24VDC 2A (resistance load)/point 240VAC 2A (COS φ =1)/point 4A/common	24VDC 2A (resistance load)/point 240VAC 2A (COS φ =1)/point 4A/common (2A/1 terminal)	○	
Minimum switching load		5VDC 10mA	5VDC 1mA	○	
Maximum switching voltage		264VAC, 110VDC	264VAC, 125VDC	○	
Response time	OFF → ON	10ms or less	10ms or less	○	
	ON → OFF	12ms or less	12ms or less	○	
Mechanical life		20 million times or more	20 million times or more	○	
Electrical life		Rated switching voltage/current load 200,000 times or more 200VAC 1.5A, 240VAC 1A (COS φ =0.7) 200,000 times or more 200VAC 1A, 240VAC 0.5A (COS φ = 0.35) 200,000 times or more 24VDC 1A, 100VDC 0.1A (L/R=7 ms) 200,000 times or more	Rated switching voltage/current load 100,000 times or more 200VAC 1.5A, 240VAC 1A (COS φ =0.7) 100,000 times or more 200VAC 1A, 240VAC 0.5A (COS φ = 0.35) 100,000 times or more 24VDC 1A, 100VDC 0.1A (L/R=7 ms) 100,000 times or more	△	The service life is reduced to almost half. Shorten the exchange intervals of the module.
Maximum switching frequency		3,600 times/hr	3,600 times/hr	○	
External power supply	Voltage	24VDC ± 10% Ripple voltage 4Vp-p or less	24VDC ± 10% Ripple ratio 4Vp-p or less	○	
	Current	230mA (24VDC, all points ON)	180mA or less (24VDC, when all points are ON)	○	
Common terminal arrangement		8 points/common 4 points/common	8 points/common (terminal block 1-wire type)	○	
Dielectric withstand voltage		AC external batch - Relay drive power supply, internal 5V circuit	Between AC external terminal batch and ground 1500VAC 1 minute Between DC external terminal batch and ground 500VAC 1 minute	△	
		Relay drive power supply - internal 5V circuit		500VDC 1 minute	○
Insulation resistance		10M Ω or more with the insulation resistance tester	Between AC external terminal batch and ground 500VDC with the insulation resistance tester 10M Ω or more Between DC external terminal batch and ground 500VDC with the insulation resistance tester 10M Ω or more	○	
Number of occupied stations (number of occupied points)		4 stations (4 stations × 8 points)	1 station (1 station × 32 points)	○	
Operation indication		ON indication (LED)	ON indication (LED)	○	
External connection method		50-point terminal block (M3.5 × 7 screws) Transmission circuit part included	50-point terminal block (M3.5 × 7 screws) Transmission circuit part included	×	Change in wiring is required.

○ : Compatible, △ : Partial change required, × : Not compatible

Specifications		AY15CEU	AJ65DBTB1-32R	Compatibility	Precautions for replacement
Applicable wire size		0.75 to 2mm ²	0.75 to 2mm ²	○	
Applicable solderless terminal		RAV1.25-3.5, RAV2-3.5	RAV1.25-3.5 (Conforming to JIS C 2805) RAV2-3.5	○	Change in wiring is required.
I/O module power supply	Voltage	15.6 to 31.2VDC	20.4 to 26.4VDC (ripple ratio within 5%)	△	The operating voltage range differs.
	Current	94mA (at 24VDC TYP.)	80mA or less (24VDC when all points are ON)	○	
External dimensions		170(H) × 64(W) × 80(D) mm	170(H) × 64(W) × 80(D) mm	○	
Weight		0.75kg	0.7kg	△	

(5) Specifications comparison between AY23C and AJ65SBTB2N-16S*1

○ : Compatible, △ : Partial change required, × : Not compatible

Specifications		AY23C	AJ65SBTB2N-16S	Compatibility	Precautions for replacement
Number of output points		32 points	16 points	×	When seventeen or more points are used, use two AJ65SBTB2N-16S modules.
Insulation method		Photocoupler	Photocoupler	○	
Rated load voltage		100-240VAC, 40 to 70Hz	100-240VAC, 50/60Hz± 5%	○	
Maximum load voltage		264VAC	264VAC	○	
Maximum load current		0.3A/point 60% simultaneously ON	0.6A/point, 4.8A/common	○	
Minimum load voltage/ current		18VAC 10mA, 100VAC 10mA, 240VAC 10mA	50VAC 100mA, 100VAC 10mA, 240VAC 10mA	○	
Maximum inrush current		20A 10ms or less	25A 10ms or less	○	
Leakage current at OFF		Approx. 1.5mA (120VAC, 60Hz) Approx. 3.0mA (240VAC, 60Hz)	1.5mA (100VAC, 60Hz) 3.0mA (200VAC, 60Hz)	○	
Maximum voltage drop at ON		1.5V or less (100 to 300mA) 1.8V or less (50 to 100mA) 2.5V or less (10 to 50mA)	1.5V or less (at 0.6A)	○	
Response time	OFF → ON	1ms or less	1ms or less	○	
	ON → OFF	0.5Hz+1ms or less	1/2 cycle + 1ms or less	○	
Surge suppressor		CR absorber (0.01 μF+68 Ω)	CR absorber (0.01 μF+47 Ω)	○	
Common terminal arrangement		8 points/common	16 points/common (2-wire type)	△	As common terminal arrangement changes from 8 points/common to 16 points/common, wiring with a different voltage per common is not possible.
Number of occupied stations (number of occupied points)		4 stations (4 stations × 8 points)	1 station (1 station × 32 points)	×	The number of points assigned per module is not changed.
Operation indication		ON indication (LED)	ON indication (LED)	○	
External connection method		50-point terminal block (M3.5 × 7 screws) Transmission circuit part included	Transmission/module power supply parts: 7-point terminal block (M3 × 5.2 screws) I/O part: 34-point terminal block (M3 × 5.2 screws)	×	Change in wiring is required.
Applicable wire size		0.75 to 2mm ²	0.3 to 2mm ²	○	
Applicable solderless terminal		R1.25-3.5, R2-3.5 RAV1.25-3.5, RAV2-3.5	RAV1.25-3 (Conforming to JIS C 2805) V2-MS3, RAP2-3SL, TGV2-3N	×	Change in wiring is required.
I/O module power supply	Voltage	15.6 to 31.2VDC	20.4 to 26.4VDC (ripple ratio within 5%)	△	The operating voltage range differs.
	Current	180mA (at 24VDC TYP.)	85mA or less (24VDC when all points are ON)	○	
External dimensions		170(H) × 64(W) × 80(D) mm	54(H) × 179(W) × 40(D) mm	×	The overall size differs. Pay attention to the mounting dimensions.
Weight		0.75kg	0.35kg	△	

*1: Consider the characteristics of the triac and observe the necessary precautions by referring to Section 5.3 (5) before replacing the modules.

(6) Specifications comparison between AY51C and AJ65SBTB1-32T1

○ : Compatible, △ : Partial change required, × : Not compatible

Specifications		AY51C	AJ65SBTB1-32T1	Compatibility	Precautions for replacement
Number of output points		32 points	32 points	○	
Insulation method		Photocoupler	Photocoupler	○	
Rated load voltage		12/24VDC	12/24VDC	○	
Operating load voltage range		10.2 to 31.2VDC	10.2 to 26.4VDC (ripple ratio within 5%)	○	
Maximum load current		0.3A/point 75% simultaneously ON (7.2A/1 common (2A/1 terminal))	0.5A/point, 4.8A/common	△	The maximum load current per common differs. Pay attention to the operating current of the entire module.
Maximum inrush current		1.2A 10ms or less	1.0A 10ms or less	△	The inrush current value differs. Pay attention to the selection of the load used.
Leakage current at OFF		0.1mA or less	0.1mA or less	○	
Maximum voltage drop at ON		0.9VDC or less (TYP.) 0.3A 1.5VDC or less (MAX.) 0.3A	0.3VDC or less (TYP.) 0.5A 0.6VDC or less (MAX.) 0.5A	○	
Output method		sink type	sink type	○	
Response time	OFF → ON	2ms or less	0.5ms or less	○	
	ON → OFF	2ms or less (resistance load)	1.5ms or less (resistance load)	○	
External power supply	Voltage	10.2 to 31.2VDC	10.2 to 26.4VDC (ripple ratio within 5%)	○	
	Current	64mA (24VDC)	50mA or less (24VDC)	○	
Surge suppressor		Zener diode	Zener diode	○	
Common terminal arrangement		32 points/common	32 points/common	○	
Number of occupied stations (number of occupied points)		4 stations (4 stations × 8 points)	1 station (1 station × 32 points × 2 modules)	○	The number of occupied points increases. The assignment of the entire system needs to be reconsidered.
Operation indication		ON indication (LED)	ON indication (LED)	○	
External connection method		50-point terminal block (M3.5 × 7 screws) Transmission circuit part included	Transmission/module power supply parts: 7-point terminal block (M3 × 5.2 screws) I/O part: 34-point terminal block (M3 × 5.2 screws)	×	Change in wiring is required.
Applicable wire size		0.75 to 2mm ²	0.3 to 2mm ²	○	
Applicable solderless terminal		R1.25-3.5, R2-3.5 RAV1.25-3.5, RAV2-3.5	RAV1.25-3 (Conforming to JIS C 2805) V2-MS3, RAP2-3SL, TGV2-3N	×	Change in wiring is required.
I/O module power supply	Voltage	15.6 to 31.2VDC	20.4 to 26.4VDC (ripple ratio within 5%)	△	The operating voltage range differs.
	Current	93mA (at 24VDC TYP.)	65mA or less (24VDC when all points are ON)	○	
External dimensions		170(H) × 64(W) × 80(D) mm	54(H) × 179(W) × 40(D) mm	×	The overall size differs. Pay attention to the mounting dimensions.
Weight		0.7kg	0.25kg	△	

(7) Specifications comparison between AY51C and AJ65DBTB1-32T1

○ : Compatible, △ : Partial change required, × : Not compatible

Specifications		AY51C	AJ65DBTB1-32T1	Compatibility	Precautions for replacement
Number of output points		32 points	32 points	○	
Insulation method		Photocoupler	Photocoupler	○	
Rated load voltage		12/24VDC	12/24VDC	○	
Operating load voltage range		10.2 to 31.2VDC	10.2 to 31.2VDC (ripple ratio within 5%)	○	
Maximum load current		0.3A/point 75% simultaneously ON (7.2A/1 common (2A/1 terminal))	0.5A/point, 8A/common (2A/1 terminal)	○	
Maximum inrush current		1.2A 10ms or less	1.2A 10ms or less	○	
Leakage current at OFF		0.1mA or less	0.1mA or less	○	
Maximum voltage drop at ON		0.9VDC or less (TYP.) 0.3A 1.5VDC or less (MAX.) 0.3A	0.3VDC or less (TYP.) 0.5A 0.6VDC or less (MAX.) 0.5A	○	
Output method		sink type	sink type	○	
Response time	OFF → ON	2ms or less	0.5ms or less	○	
	ON → OFF	2ms or less (resistance load)	1.5ms or less (resistance load)	○	
External power supply	Voltage	10.2 to 31.2VDC	10.2 to 31.2VDC (ripple ratio within 5%)	○	
	Current	64mA (24VDC)	50mA or less (24VDC, when all points are ON) External load current not included	○	
Surge suppressor		Zener diode	Zener diode	○	
Common terminal arrangement		32 points/common	32 points/common (4 points) (terminal block 1-wire type)	○	
Number of occupied stations (number of occupied points)		4 stations (4 stations × 8 points)	1 station (1 station × 32 points)	○	
Operation indication		ON indication (LED)	ON indication (LED)	○	
External connection method		50-point terminal block (M3.5 × 7 screws) Transmission circuit part included	50-point terminal block (M3.5 × 7 screws) Transmission circuit part included	○	The number of applicable solderless terminals inserted is within two.
Applicable wire size		0.75 to 2mm ²	0.75 to 2mm ²	○	
Applicable solderless terminal		R1.25-3.5, R2-3.5 RAV1.25-3.5, RAV2-3.5	RAV1.25-3.5 (Conforming to JIS C 2805) RAV2-3.5	○	
I/O module power supply	Voltage	15.6 to 31.2VDC	20.4 to 26.4VDC (ripple ratio within 5%)	△	The operating voltage range differs.
	Current	93mA (at 24VDC TYP.)	65mA or less (24VDC when all points are ON)	○	
External dimensions		170(H) × 64(W) × 80(D) mm	170(H) × 64(W) × 80(D) mm	○	
Weight		0.7kg	0.7kg	○	

(8) Specifications comparison between AY61CE and AJ65SBTB1-16TE

○ : Compatible, △ : Partial change required, × : Not compatible

Specifications		AY61CE	AJ65SBTB1-16TE	Compatibility	Precautions for replacement
Number of output points		32 points	16 points	×	When seventeen or more points are used, use two AJ65SBTB1-16TE modules.
Insulation method		Photocoupler	Photocoupler	○	
Rated load voltage		5/12/24VDC	12/24VDC	△	5VDC cannot be used.
Operating load voltage range		4.5 to 26.4VDC	10.2 to 26.4VDC (ripple ratio within 5%)	△	5VDC cannot be used.
Maximum load current		2.0A/point (Condition: $\tau = L/R \leq 2.5\text{ms}$) 5A/common	0.1A/point 1.6A/common	×	The maximum load current per point becomes lower. Pay attention to the selection of the load to be used. The maximum load current per common differs. Pay attention to the operating current of the entire module.
Maximum inrush current		8A 10ms or less	1A 10ms or less	×	The inrush current value differs. Pay attention to the selection of the load used.
Leakage current at OFF		0.1mA or less	0.1mA or less	○	
Maximum voltage drop at ON		0.25V or less (TYP.) 2.0A 0.4V or less (MAX.) 2.0A	0.1V or less (TYP.) 0.1A 0.2V or less (MAX.) 0.1A	○	
Output method		Source type	Source type	○	
Response time	OFF → ON	2ms or less	0.5ms or less	○	
	ON → OFF	10ms or less (resistance load)	1.5ms or less (resistance load)	○	
External power supply	Voltage	None	10.2 to 26.4VDC (ripple ratio within 5%)	×	Wiring of the power supply for driving the output transistor is required.
	Current	None	30mA or less (24VDC)	×	Wiring of the power supply for driving the output transistor is required.
Surge suppressor		Zener diode	Zener diode	○	
Common terminal arrangement		8 points/common	16 points/common	△	As common terminal arrangement changes from 8 points/common to 16 points/common, wiring with a different voltage per common is not possible.
Number of occupied stations (number of occupied points)		4 stations (4 stations × 8 points)	1 station (1 station × 32 points × 2 modules)	×	The number of occupied points increases. The assignment of the entire system needs to be reconsidered.
Operation indication		ON indication (LED)	ON indication (LED)	○	
External connection method		50-point terminal block (M3.5 × 7 screws) Transmission circuit part included	Transmission/module power supply parts: 7-point terminal block (M3 × 5.2 screws) I/O part: 18-point terminal block (M3 × 5.2 screws)	×	Change in wiring is required.
Applicable wire size		0.75 to 2mm ²	0.3 to 2mm ²	○	
Applicable solderless terminal		R1.25-3.5, R2-3.5 RAV1.25-3.5, RAV2-3.5	RAV1.25-3 (Conforming to JIS C 2805) V2-MS3, RAP2-3SL, TGV2-3N	×	Change in wiring is required.
I/O module power supply	Voltage	15.6 to 31.2VDC	20.4 to 26.4VDC (ripple ratio within 5%)	△	The operating voltage range differs.
	Current	150mA (at 24VDC TYP.)	50mA or less (24VDC when all points are ON)	○	
External dimensions		170(H) × 64(W) × 80(D) mm	54(H) × 118(W) × 40(D) mm	×	The overall size differs. Pay attention to the mounting dimensions.
Weight		0.7kg	0.18kg	△	

(9) Specifications comparison between AY61CE and AJ65SBTB1-32TE1

○ : Compatible, △ : Partial change required, × : Not compatible

Specifications		AY61CE	AJ65SBTB1-32TE1	Compatibility	Precautions for replacement
Number of output points		32 points	32 points	○	
Insulation method		Photocoupler	Photocoupler	○	
Rated load voltage		5/12/24VDC	12/24VDC	△	5VDC cannot be used.
Operating load voltage range		4.5 to 26.4VDC	10.2 to 26.4VDC (ripple ratio within 5%)	△	5VDC cannot be used.
Maximum load current		2.0A/point (Condition: $\tau = L/R \leq 2.5\text{ms}$) 5A/common	0.5A/point 4.8A/common	×	The maximum load current per point becomes lower. Pay attention to the selection of the load to be used. The maximum load current per common differs. Pay attention to the operating current of the entire module.
Maximum inrush current		8A 10ms or less	1A 10ms or less	×	The inrush current value differs. Pay attention to the selection of the load used.
Leakage current at OFF		0.1mA or less	0.1mA or less	○	
Maximum voltage drop at ON		0.25V or less (TYP.) 2.0A 0.4V or less (MAX.) 2.0A	0.5V or less (TYP.) 0.1A 0.8V or less (MAX.) 0.1A	×	The value of maximum voltage drop at ON becomes higher.
Output method		Source type	Source type	○	
Response time	OFF → ON	2ms or less	0.5ms or less	○	
	ON → OFF	10ms or less (resistance load)	1.5ms or less (resistance load)	○	
External power supply	Voltage	None	10.2 to 26.4VDC (ripple ratio within 5%)	×	Wiring of the power supply for driving the output transistor is required.
	Current	None	15mA or less (TYP.DC24V, per common) External load current not included	×	Wiring of the power supply for driving the output transistor is required.
Surge suppressor		Zener diode	Zener diode	○	
Common terminal arrangement		8 points/common	32 points/common (terminal block 1-wire type)	△	As common terminal arrangement changes from 8 points/common to 16 points/common, wiring with a different voltage per common is not possible.
Number of occupied stations (number of occupied points)		4 stations (4 stations × 8 points)	1 station (1 station × 32 points)	○	
Operation indication		ON indication (LED)	ON indication (LED)	○	
External connection method		50-point terminal block (M3.5 × 7 screws) Transmission circuit part included	Transmission/module power supply parts: 7-point terminal block (M3 × 5.2 screws) I/O part: 34-point terminal block (M3 × 5.2 screws)	×	Change in wiring is required. The number of applicable solderless terminals inserted is within two.
Applicable wire size		0.75 to 2mm ²	0.3 to 2mm ²	○	
Applicable solderless terminal		R1.25-3.5, R2-3.5 RAV1.25-3.5, RAV2-3.5	RAV1.25-3 (Conforming to JIS C 2805) V2-MS3, RAP2-3SL, TGV2-3N	×	Change in wiring is required.
I/O module power supply	Voltage	15.6 to 31.2VDC	20.4 to 26.4VDC (ripple ratio within 5%)	△	The operating voltage range differs.
	Current	150mA (at 24VDC TYP.)	60mA or less (24VDC when all points are ON)	○	
External dimensions		170(H) × 64(W) × 80(D) mm	54(H) × 179(W) × 40(D) mm	×	The overall size differs. Pay attention to the mounting dimensions.
Weight		0.7kg	0.26kg	△	

(10) Specifications comparison between AY81C and AJ65SBTB1-16TE

○ : Compatible, △ : Partial change required, × : Not compatible

Specifications		AY81C	AJ65SBTB1-16TE	Compatibility	Precautions for replacement
Number of output points		32 points	16 points	×	When seventeen or more points are used, use two AJ65SBTB1-16TE.
Insulation method		Photocoupler	Photocoupler	○	
Rated load voltage		24VDC	12/24VDC	○	
Operating load voltage range		21.6 to 26.4VDC	10.2 to 26.4VDC (ripple ratio within 5%)	○	
Maximum load current		0.5A/point 60% simultaneously ON	0.1A/point 1.6A/common	×	The maximum load current per point becomes lower. Pay attention to the selection of the load to be used. The maximum load current per common differs. Pay attention to the operating current of the entire module.
Maximum inrush current		2A 10ms or less	1A 10ms or less	×	The inrush current value differs. Pay attention to the selection of the load used.
Leakage current at OFF		0.1mA or less	0.1mA or less	○	
Maximum voltage drop at ON		0.9V or less (TYP.) 0.5A 1.5V or less (MAX.) 0.5A	0.1V or less (TYP.) 0.1A 0.2V or less (MAX.) 0.1A	○	
Output method		Source type	Source type	○	
Response time	OFF → ON	2ms or less	0.5ms or less	○	
	ON → OFF	2ms or less (resistance load)	1.5ms or less (resistance load)	○	
External power supply	Voltage	21.6 to 26.4VDC	10.2 to 26.4VDC (ripple ratio within 5%)	○	
	Current	17mA (24VDC)	30mA or less (24VDC)	△	The current consumption increases. the current capacity needs to be reconsidered.
Surge suppressor		Zener diode	Zener diode	○	
Common terminal arrangement		32 points/common	16 points/common	○	
Number of occupied stations (number of occupied points)		4 stations (4 stations × 8 points)	1 station (1 station × 32 points × 2 modules)	×	The number of occupied points increases. The assignment of the entire system needs to be reconsidered.
Operation indication		ON indication (LED)	ON indication (LED)	○	
External connection method		50-point terminal block (M3.5 × 7 screws) Transmission circuit part included	Transmission/module power supply parts: 7-point terminal block (M3 × 5.2 screws) I/O part: 18-point terminal block (M3 × 5.2 screws)	×	Change in wiring is required.
Applicable wire size		0.75 to 2mm ²	0.3 to 2mm ²	○	
Applicable solderless terminal		R1.25-3.5, R2-3.5 RAV1.25-3.5, RAV2-3.5	RAV1.25-3 (Conforming to JIS C 2805) V2-MS3 RAP2-3SL TGV2-3N	×	Change in wiring is required.
I/O module power supply	Voltage	15.6 to 31.2VDC	20.4 to 26.4VDC (ripple ratio within 5%)	△	The operating voltage range differs.
	Current	100mA (at 24VDC TYP.)	50mA or less (24VDC when all points are ON)	○	
External dimensions		170(H) × 64(W) × 80(D) mm	54(H) × 118(W) × 40(D) mm	×	The overall size differs. Pay attention to the mounting dimensions.
Weight		0.7kg	0.18kg	△	

(11) Specifications comparison between AY81C and AJ65SBTB1-32TE1

○ : Compatible, △ : Partial change required, × : Not compatible

Specifications		AY81C	AJ65SBTB1-32TE1	Compatibility	Precautions for replacement
Number of output points		32 points	32 points	○	
Insulation method		Photocoupler	Photocoupler	○	
Rated load voltage		24VDC	12/24VDC	○	
Operating load voltage range		21.6 to 26.4VDC	10.2 to 26.4VDC (ripple ratio within 5%)	○	
Maximum load current		0.5A/point 60% simultaneously ON	0.5A/point 4.8A/common	△	The maximum load current per common differs. Pay attention to the operating current of the entire module.
Maximum inrush current		2A 10ms or less	1A 10ms or less	×	The inrush current value differs. Pay attention to the selection of the load to be used.
Leakage current at OFF		0.1mA or less	0.1mA or less	○	
Maximum voltage drop at ON		0.9V or less (TYP.) 0.5A 1.5V or less (MAX.) 0.5A	0.5V or less (TYP.) 0.5A 0.8V or less (MAX.) 0.5A	○	
Output method		Source type	Source type	○	
Response time	OFF → ON	2ms or less	0.5ms or less	○	
	ON → OFF	2ms or less (resistance load)	1.5ms or less (resistance load)	○	
External power supply	Voltage	21.6 to 26.4VDC	10.2 to 26.4VDC (ripple ratio within 5%)	○	
	Current	17mA (24VDC)	15mA or less (TYP. 24VDC, per common) External load current not included	○	
Surge suppressor		Zener diode	Zener diode	○	
Common terminal arrangement		32 points/common	32 points/common (terminal block 1-wire type)	○	
Number of occupied stations (number of occupied points)		4 stations (4 stations × 8 points)	1 station (1 station × 32 points)	○	
Operation indication		ON indication (LED)	ON indication (LED)	○	
External connection method		50-point terminal block (M3.5 × 7 screws) Transmission circuit part included	Transmission/module power supply parts: 7-point terminal block (M3 × 5.2 screws) I/O part: 34-point terminal block (M3 × 5.2 screws)	×	Change in wiring is required. The number of applicable solderless terminals inserted is within two.
Applicable wire size		0.75 to 2mm ²	0.3 to 2mm ²	○	
Applicable solderless terminal		R1.25-3.5, R2-3.5 RAV1.25-3.5, RAV2-3.5	RAV1.25-3 (Conforming to JIS C 2805) V2-MS3 RAP2-3SL TGV2-3N	×	Change in wiring is required.
I/O module power supply	Voltage	15.6 to 31.2VDC	20.4 to 26.4VDC (ripple ratio within 5%)	△	The operating voltage range differs.
	Current	100mA (at 24VDC TYP.)	60mA or less (24VDC when all points are ON)	○	
External dimensions		170(H) × 64(W) × 80(D) mm	54(H) × 179(W) × 40(D) mm	×	The overall size differs. Pay attention to the mounting dimensions.
Weight		0.7kg	0.26kg	△	

(12) Specifications comparison between AJ35PTF-24S and AJ65SBTB2N-16S*1

○ : Compatible, △ : Partial change required, × : Not compatible

Specifications		AJ35PTF-24S	AJ65SBTB2N-16S	Compatibility	Precautions for replacement
Number of output points		24 points	16 points	×	When seventeen or more points are used, use two AJ65SBTB2N-16S modules.
Insulation method		Photocoupler	Photocoupler	○	
Rated load voltage		100-240VAC, 40 to 70Hz	100-240VAC, 50/60Hz ± 5%	○	
Maximum load voltage		264VAC	264VAC	○	
Maximum load current		0.6A/point, 2.4A/common	0.6A/point, 4.8A/common	○	
Minimum load voltage/ current		24VAC 100mA, 100VAC 10mA, 240VAC 10mA	50VAC 100mA, 100VAC 10mA, 240VAC 10mA	○	
Maximum inrush current		20A 10ms or less, 8A 100ms or less	25A 10ms or less	○	
Leakage current at OFF		1.5mA (120VAC, 60Hz) 3.0mA (240VAC, 60Hz)	1.5mA (100VAC, 60Hz) 3.0mA (200VAC, 60Hz)	○	
Maximum voltage drop at ON		1.5V or less (0.1 to 0.6A) 1.8V or less (50 to 100mA) 2.0V or less (10 to 50mA)	1.5V or less (at 0.6A)	○	
Response time	OFF → ON	1ms or less	1ms or less	○	
	ON → OFF	0.5Hz+1ms or less	1/2 cycle + 1ms or less	○	
Surge suppressor		CR absorber (0.022 μF+47 Ω)	CR absorber (0.01 μF+47 Ω)	○	
Fuse rating		High speed type fuse 3.2A (one fuse/common) HP-32	None	×	The fuse is not built in.*2
Fuse blown indication		Available	None	×	
Common terminal arrangement		8 points/common	16 points/common (2-wire type)	△	As common terminal arrangement changes from 8 points/common to 16 points/common, wiring with a different voltage per common is not possible.
Number of occupied stations (number of occupied points)		4 stations (4 stations × 8 points)	1 station (1 station × 32 points × 2 modules)	×	The number of occupied points increases. The assignment of the entire system needs to be reconsidered.
Operation indication		ON indication (LED)	ON indication (LED)	○	
External connection method		Transmission/module power supply parts: 8-point terminal block I/O part: 36-point terminal block (M3 × 6 screws)	Transmission/module power supply parts: 7-point terminal block (M3 × 5.2 screws) I/O part: 34-point terminal block (M3 × 5.2 screws)	×	Change in wiring is required.
Applicable wire size		0.75 to 2mm ²	0.3 to 2mm ²	○	
Applicable solderless terminal		R1.25-3, R2-3 RAV1.25-3, RAV2-3	RAV1.25-3 (Conforming to JIS C 2805) V2-MS3, RAP2-3SL, TGV2-3N	△	In some cases the solderless terminal must be changed.
I/O module power supply	Voltage	15.6 to 31.2VDC	20.4 to 26.4VDC (ripple ratio within 5%)	△	The operating voltage range differs.
	Current	200mA	85mA or less (24VDC when all points are ON)	○	
External dimensions		254(H) × 132(W) × 41(D) mm	54(H) × 179(W) × 40(D) mm	×	The overall size differs. Pay attention to the mounting dimensions.
Weight		0.83kg	0.35kg	△	

*1: Consider the characteristics of the triac and observe the necessary precautions by referring to Section 5.3 (5) before replacing the modules.

*2: Install a fuse for each external terminal point to prevent the burnout of the external devices and modules during load shorts. In addition, when a fuse blown indication is necessary, configure an external circuit.

(13) Specifications comparison between AJ35PTF-24T and AJ65SBTB1-32T1

○ : Compatible, △ : Partial change required, × : Not compatible

Specifications		AJ35PTF-24T	AJ65SBTB1-32T1	Compatibility	Precautions for replacement
Number of output points		24 points	32 points	○	
Insulation method		Photocoupler	Photocoupler	○	
Rated load voltage		12/24VDC	12/24VDC	○	
Operating load voltage range		10.2 to 31.2VDC	10.2 to 26.4VDC (ripple ratio within 5%)	△	Voltages exceeding 26.4VDC cannot be applied.
Maximum load current		0.5A/point, 3.2A/common	0.5A/point, 4.8A/common	△	The maximum load current per common differs. Pay attention to the operating current of the entire module.
Maximum inrush current		4A 10ms or less	1.0A 10ms or less	×	The inrush current value differs. Pay attention to the selection of the load used.
Leaking current at OFF		0.1mA or less	0.1mA or less	○	
Maximum voltage drop at ON		0.9VDC or less (TYP.) 0.5A 1.5VDC or less (MAX.) 0.5A	0.3VDC or less (TYP.) 0.5A 0.6VDC or less (MAX.) 0.5A	○	
Output method		sink type	sink type	○	
Response time	OFF → ON	2ms or less	0.5ms or less	○	
	ON → OFF	2ms or less (resistance load)	1.5ms or less (resistance load)	○	
External power supply	Voltage	10.2 to 31.2VDC	10.2 to 26.4VDC (ripple ratio within 5%)	△	Voltages exceeding 26.4VDC cannot be applied.
	Current	23mA (24VDC TYP./common)	50mA or less (24VDC)	×	The current consumption increases. The current capacity needs to be reconsidered.
Surge suppressor		Varistor (52 to 62V)	Zener diode	○	
Common terminal arrangement		8 points/common	32 points/common	△	As common terminal arrangement changes from 8 points/common to 32 points/common, wiring with a different voltage per common is not possible.
Number of occupied stations (number of occupied points)		4 stations (4 stations × 8 points)	1 station (1 station × 32 points)	○	
Operation indication		ON indication (LED)	ON indication (LED)	○	
External connection method		Transmission/module power supply parts: 8-point terminal block I/O part: 36-point terminal block (M3 × 6 screws)	Transmission/module power supply parts: 7-point terminal block (M3 × 5.2 screws) I/O part: 34-point terminal block (M3 × 5.2 screws)	×	Change in wiring is required.
Applicable wire size		0.75 to 2mm ²	0.3 to 2mm ²	○	
Applicable solderless terminal		R1.25-3, R2-3 RAV1.25-3, RAV2-3	RAV1.25-3 (Conforming to JIS C 2805) V2-MS3, RAP2-3SL, TGV2-3N	△	In some cases the solderless terminal must be changed.
I/O module Power supply	Voltage	15.6 to 31.2VDC	20.4 to 26.4VDC (ripple ratio within 5%)	△	The operating voltage range differs.
	Current	130mA	65mA or less (24VDC when all points are ON)	○	
External dimensions		254(H) × 132(W) × 41(D) mm	54(H) × 179(W) × 40(D) mm	×	The overall size differs. Pay attention to the mounting dimensions.
Weight		0.73kg	0.25kg	△	

(14) Specifications comparison between AJ35TB1A-8R and AJ65SBTB2N-8R

○ : Compatible, △ : Partial change required, × : Not compatible

Specifications		AJ35TB1A-8R	AJ65SBTB2N-8R	Compatibility	Precautions for replacement
Number of output points		8 points	8 points	○	
Insulation method		Photocoupler	Relay	△	Although the insulation methods differ, the performance of the insulation is the same.
Rated load voltage/current		24VDC 2A (resistance load)/point 240VAC 2A (COS φ =1) point	24VDC 2A (resistance load)/point 240VAC 2A (COS φ =1)/point 4A/common	△	The maximum load current per common differs. Pay attention to the operating current of the entire module.
Minimum switching load		5VDC 1mA	5VDC 1mA	○	
Maximum switching voltage		250VAC, 110VDC	264VAC, 125VDC	○	
Response time	OFF → ON	10ms or less	10ms or less	○	
	ON → OFF	12ms or less	12ms or less	○	
Mechanical life		20 million times or more	20 million times or more	○	
Electrical life		Rated switching voltage/current load 100,000 times or more 200VAC 1.5A, 240VAC 1A (COS φ =0.7) 100,000 times or more 200VAC 1A, 240VAC 0.5A (COS φ = 0.35) 100,000 times or more 24VDC 1A, 100VDC 0.1A (L/R=7 ms) 100,000 times or more	Rated switching voltage/current load 100,000 times or more 200VAC 1.5A, 240VAC 1A (COS φ =0.7) 100,000 times or more 200VAC 1A, 240VAC 0.5A (COS φ = 0.35) 100,000 times or more 24VDC 1A, 100VDC 0.1A (L/R=7 ms) 100,000 times or more	○	
Maximum switching frequency		3,600 times/hr	3,600 times/hr	○	
External power supply	Voltage	24VDC ± 10% Ripple voltage 4Vp-p or less	None	–	
	Current	45mA (24VDC, all points ON)	None	–	
Common terminal arrangement		Independent common	8 points/common (2-wire type)	×	Becomes a shared common.
Number of occupied stations (number of occupied points)		1 station (1 station × 8 points)	1 station (1 station × 32 points)	×	The number of occupied points increases. The assignment of the entire system needs to be reconsidered.
Operation indication		ON indication (LED)	ON indication (LED)	○	
External connection method		26-point terminal block (M3 screw) Transmission circuit part included	Transmission/module power supply parts: 7-point terminal block (M3 × 5.2 screws) I/O part: 18-point terminal block (M3 × 5.2 screws)	×	Change in wiring is required.
Applicable wire size		0.75 to 2mm ²	0.3 to 2mm ²	○	
Applicable solderless terminal		R1.25-3, R2-3 RAV1.25-3, RAV2-3	RAV1.25-3 (conforming to JIS C 2805) V2-MS3, RAP2-3SL, TGV2-3N	△	In some cases, the solderless terminal must be changed.
I/O module power supply	Voltage	15.6 to 31.2VDC (peak voltage 31.2VDC)	20.4 to 26.4VDC (ripple ratio within 5%)	△	The operating voltage range differs.
	Current	70mA (at 24VDC)	85mA or less (24VDC when all points are ON)	△	The current consumption increases. The current capacity needs to be reconsidered.
External dimensions		55(H) × 135(W) × 50(D) mm	54(H) × 118(W) × 40(D) mm	×	The overall size differs. Pay attention to the mounting dimensions.
Weight		0.3kg	0.25kg	△	

(15) Specifications comparison between AJ35TB2-8R and AJ65SBTB2N-8R

○ : Compatible, △ : Partial change required, × : Not compatible

Specifications		AJ35TB2-8R	AJ65SBTB2N-8R	Compatibility	Precautions for replacement
Number of output points		8 points	8 points	○	
Insulation method		Photocoupler	Relay	△	Although the insulation methods differ, the performance of the insulation is the same.
Rated load voltage/current		24VDC 2A (resistance load)/point 240VAC 2A (COS φ =1)/point 5A/common	24VDC 2A (resistance load)/point 240VAC 2A (COS φ =1)/point 4A/common	△	The maximum load current per common differs. Pay attention to the operating current of the entire module.
Minimum switching load		5VDC 1mA	5VDC 1mA	○	
Maximum switching voltage		250VAC, 110VDC	264VAC, 125VDC	○	
Response time	OFF → ON	10ms or less	10ms or less	○	
	ON → OFF	12ms or less	12ms or less	○	
Mechanical life		20 million times or more	20 million times or more	○	
Electrical life		Rated switching voltage/current load 100,000 times or more 200VAC 1.5A, 240VAC 1A (COS φ =0.7) 100,000 times or more 200VAC 1A, 240VAC 0.5A (COS φ = 0.35) 100,000 times or more 24VDC 1A, 100VDC 0.1A (L/R=7 ms) 100,000 times or more	Rated switching voltage/current load 100,000 times or more 200VAC 1.5A, 240VAC 1A (COS φ =0.7) 100,000 times or more 200VAC 1A, 240VAC 0.5A (COS φ = 0.35) 100,000 times or more 24VDC 1A, 100VDC 0.1A (L/R=7 ms) 100,000 times or more	○	
Common terminal arrangement		3,600 times/hr	3,600 times/hr	○	
External power supply	Voltage	24VDC ± 10% Ripple voltage 4Vp-p or less	None	-	
	Current	45mA (24VDC all points ON)	None	-	
Common terminal arrangement		8 points/common (2-wire type)	8 points/common (2-wire type)	○	
Number of occupied stations (number of occupied points)		1 station (1 station × 8 points)	1 station (1 station × 32 points)	×	The number of occupied points increases. The assignment of the entire system needs to be reconsidered.
Operation indication		ON indication (LED)	ON indication (LED)	○	
External connection method		26-point terminal block (M3 screw) Transmission circuit part included	Transmission/module power supply parts: 7-point terminal block (M3 × 5.2 screws) I/O part: 18-point terminal block (M3 × 5.2 screws)	×	Change in wiring is required.
Applicable wire size		0.75 to 2mm ²	0.3 to 2mm ²	○	
Applicable solderless terminal		R1.25-3, R2-3 RAV1.25-3, RAV2-3	RAV1.25-3 (conforming to JIS C 2805) V2-MS3, RAP2-3SL, TGV2-3N	△	In some cases, the solderless terminal must be changed.
I/O module power supply	Voltage	15.6 to 31.2VDC (peak voltage 31.2VDC)	20.4 to 26.4VDC (ripple ratio within 5%)	△	The operating voltage range differs.
	Current	70mA (at 24VDC)	85mA or less (24VDC when all points are ON)	△	The current consumption increases. The current capacity needs to be reconsidered.
External dimensions		55(H) × 135(W) × 50(D) mm	54(H) × 118(W) × 40(D) mm	×	The overall size differs. Pay attention to the mounting dimensions.
Weight		0.3kg	0.25kg	△	

(16) Specifications comparison between AJ35TB1-16R and AJ65SBTB2N-16R

○ : Compatible, △ : Partial change required, × : Not compatible

Specifications		AJ35TB1-16R	AJ65SBTB2N-16R	Compatibility	Precautions for replacement
Number of output points		16 points	16 points	○	
Insulation method		Photocoupler	Relay	△	Although the insulation methods differ, the performance of the insulation is the same.
Rated load voltage/current		24VDC 2A (resistance load)/point 240VAC 2A (COS φ =1)/point 5A/common	24VDC 2A (resistance load)/point 240VAC 2A (COS φ =1)/point 8A/common	△	The maximum load current per common differs. Pay attention to the operating current of the entire module.
Minimum switching load		5VDC 1mA	5VDC 1mA	○	
Maximum switching voltage		250VAC, 110VDC	264VAC, 125VDC	○	
Response time	OFF → ON	10ms or less	10ms or less	○	
	ON → OFF	12ms or less	12ms or less	○	
Mechanical life		20 million times or more	20 million times or more	○	
Electrical life		Rated switching voltage/current load 100,000 times or more 200VAC 1.5A, 240VAC 1A (COS φ =0.7) 100,000 times or more 200VAC 1A, 240VAC 0.5A (COS φ = 0.35) 100,000 times or more 24VDC 1A, 100VDC 0.1A (L/R=7 ms) 100,000 times or more	Rated switching voltage/current load 100,000 times or more 200VAC 1.5A, 240VAC 1A (COS φ =0.7) 100,000 times or more 200VAC 1A, 240VAC 0.5A (COS φ = 0.35) 100,000 times or more 24VDC 1A, 100VDC 0.1A (L/R=7 ms) 100,000 times or more	○	
Maximum switching frequency		3,600 times/hr	3,600 times/hr	○	
External power supply	Voltage	24VDC ± 10% Ripple voltage 4Vp-p or less	None	-	
	Current	90mA (24VDC all points ON)	None	-	
Common terminal arrangement		8 points/common	16 points/common (2-wire type)	△	As common terminal arrangement changes from 8 points/common to 16 points/common, wiring with a different voltage per common is not possible.
Number of occupied stations (number of occupied points)		2 stations (2 stations × 8 points)	1 station (1 station × 32 points)	×	The number of occupied points increases. The assignment of the entire system needs to be reconsidered.
Operation indication		ON indication (LED)	ON indication (LED)	○	
External connection method		34-point terminal block (M3 screw) Transmission circuit part included	Transmission/module power supply parts: 7-point terminal block (M3 × 5.2 screws) I/O part: 18-point terminal block (M3 × 5.2 screws)	×	Change in wiring is required.
Applicable wire size		0.75 to 2mm ²	0.3 to 2mm ²	○	
Applicable solderless terminal		R1.25-3, R2-3 RAV1.25-3, RAV2-3	RAV1.25-3 (conforming to JIS C 2805) V2-MS3, RAP2-3SL, TGV2-3N	△	In some cases, the solderless terminal must be changed.
I/O module power supply	Voltage	15.6 to 31.2VDC (peak voltage 31.2VDC)	20.4 to 26.4VDC (ripple ratio within 5%)	△	The operating voltage range differs.
	Current	75mA (at 24VDC)	120mA or less (24VDC when all points are ON)	△	The current consumption increases. The current capacity needs to be reconsidered.
External dimensions		55(H) × 166(W) × 50(D) mm	54(H) × 179(W) × 40(D) mm	×	The overall size differs. Pay attention to the mounting dimensions.
Weight		0.35kg	0.35kg	○	

(17) Specifications comparison between AJ35TB1A-8T and AJ65SBTB1-8T1

○ : Compatible, △ : Partial change required, × : Not compatible

Specifications		AJ35TB1A-8T	AJ65SBTB1-8T1	Compatibility	Precautions for replacement
Number of output points		8 points	8 points	○	
Insulation method		Photocoupler	Photocoupler	○	
Rated load voltage		24VDC	12/24VDC	○	
Operating load voltage range		19.2 to 26.4VDC (ripple ratio within 5%)	10.2 to 26.4VDC (ripple ratio within 5%)	○	
Maximum load current		0.3A/point	0.5A/point, 2.4A/common	○	
Maximum inrush current		1.0A 10ms or less	1.0A 10ms or less	○	
Leakage current at OFF		0.1mA or less	0.1mA or less	○	
Maximum voltage drop at ON		1.5VDC or less (MAX.) 0.3A	0.3VDC or less (TYP.) 0.5A 0.6VDC or less (MAX.) 0.5A	○	
Output method		sink type	sink type	○	
Response time	OFF → ON	2ms or less	0.5ms or less	○	
	ON → OFF	2ms or less (resistance load)	1.5ms or less (resistance load)	○	
External power supply	Voltage	None	10.2 to 26.4VDC (ripple ratio within 5%)	×	Wiring of the power supply for driving the output circuit is required.
	Current	None	15mA or less (24VDC)	×	Wiring of the power supply for driving the output circuit is required.
Surge suppressor		Zener diode	Zener diode	○	
Common terminal arrangement		Independent common	8 points/common	×	Becomes a shared common.
Number of occupied stations (number of occupied points)		1 station (1 station × 8 points)	1 station (1 station × 32 points)	×	The number of occupied points increases. The assignment of the entire system needs to be reconsidered.
Operation indication		ON indication (LED)	ON indication (LED)	○	
External connection method		26-point terminal block (M3 screw) Transmission circuit part included	Transmission/module power supply parts: 7-point terminal block (M3 × 5.2 screws) I/O part: 10-point terminal block (M3 × 5.2 screws)	×	Change in wiring is required.
Applicable wire size		0.75 to 2mm ²	0.3 to 2mm ²	○	
Applicable solderless terminal		R1.25-3, R2-3 RAV1.25-3, RAV2-3	RAV1.25-3 (conforming to JIS C 2805) V2-MS3, RAP2-3SL, TGV2-3N	△	In some cases, the solderless terminal must be changed.
I/O module power supply	Voltage	15.6 to 31.2VDC (peak voltage 31.2VDC)	20.4 to 26.4VDC (ripple ratio within 5%)	△	The operating voltage range differs.
	Current	85mA(at 24VDC)	35mA or less (24VDC when all points are ON)	○	
External dimensions		55(H) × 135(W) × 50(D) mm	54(H) × 87.3(W) × 40(D) mm	×	The overall size differs. Pay attention to the mounting dimensions.
Weight		0.3kg	0.14kg	△	

(18) Specifications comparison between AJ35TB2-8T and AJ65SBTB2-8T1

○ : Compatible, △ : Partial change required, × : Not compatible

Specifications		AJ35TB2-8T	AJ65SBTB2-8T1	Compatibility	Precautions for replacement
Number of output points		8 points	8 points	○	
Insulation method		Photocoupler	Photocoupler	○	
Rated load voltage		5/12/24VDC	12/24VDC	△	5VDC cannot be used.
Operating load voltage range		4.5 to 26.4VDC (ripple ratio within 5%)	10.2 to 26.4VDC (ripple ratio within 5%)	△	5VDC cannot be used.
Maximum load current		0.5A/point	0.5A/point, 2.4A/common	○	
Maximum inrush current		2.0A 10ms or less	1.0A 10ms or less	×	The inrush current value differs. Pay attention to the selection of the load used.
Leakage current at OFF		0.1mA or less	0.1mA or less	○	
Maximum voltage drop at ON		0.2VDC or less (MAX.) 0.5A	0.3VDC or less (TYP.) 0.5A 0.6VDC or less (MAX.) 0.5A	○	
Output method		sink type	sink type	○	
Response time	OFF → ON	2ms or less	0.5ms or less	○	
	ON → OFF	2ms or less (resistance load)	1.5ms or less (resistance load)	○	
External power supply	Voltage	4.5 to 26.4VDC (ripple ratio within 5%)	10.2 to 26.4VDC (ripple ratio within 5%)	△	5VDC cannot be used.
	Current	20mA or less (24VDC)	17.8mA or less (24VDC)	○	
Surge suppressor		Zener diode	Zener diode	○	
Common terminal arrangement		8 points/common (2-wire type)	8 points/common (2-wire type)	○	
Number of occupied stations (number of occupied points)		1 station (1 station × 8 points)	1 station (1 station × 32 points)	×	The number of occupied points increases. The assignment of the entire system needs to be reconsidered.
Operation indication		ON indication (LED)	ON indication (LED)	○	
External connection method		26-point terminal block (M3 screw) Transmission circuit part included	Transmission/module power supply parts: 7-point terminal block (M3 × 5.2 screws) I/O part: 18-point terminal block (M3 × 5.2 screws)	×	Change in wiring is required.
Applicable wire size		0.75 to 2mm ²	0.3 to 2mm ²	○	
Applicable solderless terminal		R1.25-3, R2-3 RAV1.25-3, RAV2-3	RAV1.25-3 (conforming to JIS C 2805) V2-MS3, RAP2-3SL, TGV2-3N	△	In some cases, the solderless terminal must be changed.
I/O module power supply	Voltage	15.6 to 31.2VDC (peak voltage 31.2VDC)	20.4 to 26.4VDC (ripple ratio within 5%)	△	The operating voltage range differs.
	Current	70mA (at 24VDC)	45mA or less (24VDC when all points are ON)	○	
External dimensions		55(H) × 135(W) × 50(D) mm	54(H) × 118(W) × 40(D) mm	×	The overall size differs. Pay attention to the mounting dimensions.
Weight		0.3kg	0.18kg	△	

(19) Specifications comparison between AJ35TB1-16T and AJ65SBTB1-16T1

○ : Compatible, △ : Partial change required, × : Not compatible

Specifications		AJ35TB1-16T	AJ65SBTB1-16T1	Compatibility	Precautions for replacement
Number of output points		16 points	16 points	○	
Insulation method		Photocoupler	Photocoupler	○	
Rated load voltage		24VDC	12/24VDC	○	
Operating load voltage range		19.2 to 26.4VDC (ripple ratio within 5%)	10.2 to 26.4VDC (ripple ratio within 5%)	○	
Maximum load current		0.1A/point, 1.6A/common	0.5A/point, 3.6A/common	○	
Maximum inrush current		0.4A 10ms or less	1.0A 10ms or less	○	
Leakage current at OFF		0.1mA or less	0.1mA or less	○	
Maximum voltage drop at ON		1.5VDC or less (MAX.) 0.1A	0.3VDC or less (TYP.) 0.5A 0.6VDC or less (MAX.) 0.5A	○	
Output method		sink type	sink type	○	
Response time	OFF → ON	2ms or less	0.5ms or less	○	
	ON → OFF	2ms or less (resistance load)	1.5ms or less (resistance load)	○	
External power supply	Voltage	None	10.2 to 26.4VDC (ripple ratio within 5%)	×	Wiring of the power supply for driving the output circuit is required.
	Current	None	30mA or less (24VDC)	×	Wiring of the power supply for driving the output circuit is required.
Surge suppressor		Zener diode	Zener diode	○	
Common terminal arrangement		16 points/common	16 points/common	○	
Number of occupied stations (number of occupied points)		2 stations (2 stations × 8 points)	1 station (1 station × 32 points)	×	The number of occupied points increases. The assignment of the entire system needs to be reconsidered.
Operation indication		ON indication (LED)	ON indication (LED)	○	
External connection method		26-point terminal block (M3 screw) Transmission circuit part included	Transmission/module power supply parts: 7-point terminal block (M3 × 5.2 screws) I/O part: 18-point terminal block (M3 × 5.2 screws)	×	Change in wiring is required.
Applicable wire size		0.75 to 2mm ²	0.3 to 2mm ²	○	
Applicable solderless terminal		R1.25-3, R2-3 RAV1.25-3, RAV2-3	RAV1.25-3 (conforming to JIS C 2805) V2-MS3, RAP2-3SL, TGV2-3N	△	In some cases, the solderless terminal must be changed.
I/O module power supply	Voltage	15.6 to 31.2VDC (peak voltage 31.2VDC)	20.4 to 26.4VDC (ripple ratio within 5%)	△	The operating voltage range differs.
	Current	130mA or less (at 24VDC)	50mA or less (24VDC when all points are ON)	○	
External dimensions		55(H) × 135(W) × 50(D) mm	54(H) × 118(W) × 40(D) mm	×	The overall size differs. Pay attention to the mounting dimensions.
Weight		0.3kg	0.18kg	△	

(20) Specifications comparison between AJ35TB1-16T and AJ65BTB1-16T

○ : Compatible, △ : Partial change required, × : Not compatible

Specifications		AJ35TB1-16T	AJ65BTB1-16T	Compatibility	Precautions for replacement
Number of output points		16 points	16 points	○	
Insulation method		Photocoupler	Photocoupler	○	
Rated load voltage		24VDC	12/24VDC	○	
Operating load voltage range		19.2 to 26.4VDC (ripple ratio within 5%)	10.2 to 28.8VDC (ripple ratio within 5%)	○	
Maximum load current		0.1A/point, 1.6A/common	0.5A/point 4A/1 common (Ta = 45°C) 2.8A/1 common (Ta = 55°C)	○	
Maximum inrush current		0.4A 10ms or less	4.0A 10ms or less	○	
Leakage current at OFF		0.1mA or less	0.1mA or less	○	
Maximum voltage drop at ON		1.5VDC or less (MAX.) 0.1A	0.9VDC or less (TYP.) 0.5A 1.5VDC or less (MAX.) 0.5A	○	
Output method		sink type	sink type	○	
Response time	OFF → ON	2ms or less	2ms or less	○	
	ON → OFF	2ms or less (resistance load)	2ms or less (resistance load)	○	
External power supply	Voltage	None	10.2 to 28.8VDC (ripple ratio within 5%)	×	Wiring of the power supply for driving the output circuit is required.
	Current	None	100mA or less (TYP.24VDC per common) External load current not included	×	Wiring of the power supply for driving the output circuit is required.
Surge suppressor		Zener diode	Zener diode	○	
Common terminal arrangement		16 points/common	8 points/common (terminal block 1-wire type)	△	
Number of occupied stations (number of occupied points)		2 stations (2 stations × 8 points)	1 station (1 station × 32 points)	×	The number of occupied points increases. The assignment of the entire system needs to be reconsidered.
Operation indication		ON indication (LED)	ON indication (LED)	○	
External connection method		26-point terminal block (M3 screw) Transmission circuit part included	27-point terminal block (M3.5 screw) Transmission circuit and module power supply terminal included	△	The existing terminal block of the AJ35TB1-16T can be used by using wiring conversion adapter *1. Note that wiring to the CTR+ terminal is required.
Applicable wire size		0.75 to 2mm ²	0.75 to 2mm ²	○	
Applicable solderless terminal		R1.25-3, R2-3 RAV1.25-3, RAV2-3	RAV1.25-3.5 (conforming to JIS C 2805) RAV2-3.5	△	The existing terminal block of the AJ35TB1-16T can be used by using wiring conversion adapter *1. Note that wiring to the CTR+ terminal is required.
I/O module power supply	Voltage	15.6 to 31.2VDC (peak voltage 31.2VDC)	15.6 to 28.8VDC (ripple ratio within 5%)	△	The operating voltage range differs.
	Current	130mA or less (at 24VDC)	80mA or less (at 24VDC TYP.)	○	
External dimensions		55(H) × 135(W) × 50(D) mm	65(H) × 151.9(W) × 46(D) mm *2	×	The overall size differs. Pay attention to the mounting dimensions.
Weight		0.3kg	0.34kg	△	

*1: The A6ADP-1MC16T, MELSECNET/MINI-S3 - CC-Link module wiring conversion adapter can be used.
For the mounting image, refer to Section 1.2.

*2: When using the A6ADP-1MC16T, MELSECNET/MINI-S3 - CC-Link module wiring conversion adapter, the external dimensions are increased by 5.1mm (height) and 28.5mm (depth).

(21) Specifications comparison between AJ35TB2-16T and AJ65SBTB2-16T1

○ : Compatible, △ : Partial change required, × : Not compatible

Specifications		AJ35TB2-16T	AJ65SBTB2-16T1	Compatibility	Precautions for replacement
Number of output points		16 points	16 points	○	
Insulation method		Photocoupler	Photocoupler	○	
Rated load voltage		24VDC	12/24VDC	○	
Operating load voltage range		19.2 to 26.4VDC (ripple ratio within 5%)	10.2 to 26.4VDC (ripple ratio within 5%)	○	
Maximum load current		0.1A/point, 1.6A/common	0.5A/point, 3.6A/common	○	
Maximum inrush current		0.4A 10ms or less	1.0A 10ms or less	○	
Leakage current at OFF		0.1mA or less	0.1mA or less	○	
Maximum voltage drop at ON		1.5VDC or less (MAX.) 0.1A	0.3VDC or less (TYP.) 0.5A 0.6VDC or less (MAX.) 0.5A	○	
Output method		sink type	sink type	○	
Response time	OFF → ON	2ms or less	0.5ms or less	○	
	ON → OFF	2ms or less (resistance load)	1.5ms or less (resistance load)	○	
External power supply	Voltage	None	10.2 to 26.4VDC (ripple ratio within 5%)	×	Wiring of the power supply for driving the output circuit is required.
	Current	None	24.2mA or less (24VDC)	×	Wiring of the power supply for driving the output circuit is required.
Surge suppressor		Zener diode	Zener diode	○	
Common terminal arrangement		16 points/common (2-wire type)	16 points/common (2-wire type)	○	
Number of occupied stations (number of occupied points)		2 stations (2 stations × 8 points)	1 station (1 station × 32 points)	×	The number of occupied points increases. The assignment of the entire system needs to be reconsidered.
Operation indication		ON indication (LED)	ON indication (LED)	○	
External connection method		34-point terminal block (M3 screw) Transmission circuit part included	Transmission/module power supply parts: 7-point terminal block (M3 × 5.2 screws) I/O part: 34-point terminal block (M3 × 5.2 screws)	×	Change in wiring is required.
Applicable wire size		0.75 to 2mm ²	0.3 to 2mm ²	○	
Applicable solderless terminal		R1.25-3, R2-3 RAV1.25-3, RAV2-3	RAV1.25-3 (conforming to JIS C 2805) V2-MS3, RAP2-3SL, TGV2-3N	△	In some cases, the solderless terminal must be changed.
I/O module power supply	Voltage	15.6 to 31.2VDC (peak voltage 31.2VDC)	20.4 to 26.4VDC (ripple ratio within 5%)	△	The operating voltage range differs.
	Current	130mA (at 24VDC)	55mA or less (24VDC when all points are ON)	○	
External dimensions		55(H) × 166(W) × 50(D) mm	54(H) × 179(W) × 40(D) mm	×	The overall size differs. Pay attention to the mounting dimensions.
Weight		0.35kg	0.25kg	△	

(22) Specifications comparison between AJ35TC1-32T and AJ65SBTCF1-32T

○ : Compatible, △ : Partial change required, × : Not compatible

Specifications		AJ35TC1-32T	AJ65SBTCF1-32T	Compatibility	Precautions for replacement
Number of output points		32 points	32 points	○	
Insulation method		Photocoupler	Photocoupler	○	
Rated load voltage		24VDC	12/24VDC	○	
Operating load voltage range		19.2 to 26.4VDC (ripple ratio within 5%)	10.2 to 26.4VDC (ripple ratio within 5%)	○	
Maximum load current		0.1A/point, 2A/common	0.1A/point, 3.2A/common	○	
Maximum inrush current		0.4A 10ms or less	1.0A 10ms or less	○	
Leakage current at OFF		0.1mA or less	0.1mA or less	○	
Maximum voltage drop at ON		1.5VDC or less (MAX.) 0.1A	0.085VDC or less (TYP.) 0.1A 0.2VDC or less (MAX.) 0.1A	○	
Output method		sink type	sink type	○	
Response time	OFF → ON	2ms or less	0.5ms or less	○	
	ON → OFF	2ms or less (resistance load)	1.5ms or less (resistance load)	○	
External power supply	Voltage	None	10.2 to 26.4VDC (ripple ratio within 5%)	×	Wiring of the power supply for driving the output circuit is required.
	Current	None	50mA or less (24VDC)	×	Wiring of the power supply for driving the output circuit is required.
Surge suppressor		Zener diode	Zener diode	○	
Common terminal arrangement		32 points/common	32 points/common	○	
Number of occupied stations (number of occupied points)		4 stations (4 stations × 8 points)	1 station (1 station × 32 points)	○	
Operation indication		ON indication (LED)	ON indication (LED)	○	
External connection method		Transmission circuit: 8-point terminal block (M3 screws)	Transmission/module power supply parts: 7-point terminal block (M3 × 5.2 screws)	×	Change in wiring is required.
		I/O part: 40-pin connector	I/O part: 40-pin connector	○	The existing connector can be attached without change.
Applicable wire size		Terminal block: 0.75 to 2mm ² 40-pin connector: 0.3mm ²	Terminal block: 0.3 to 2mm ² 40 pin connector: 0.3mm ² or less (A6CON1, A6CON4) 0.2 to 0.08mm ² (for A6CON2) From 0.08mm ² twisted line, φ 0.25mm (for A6CON3)	○	
Accessory		1 external wiring connector	None	×	40-pin connectors for external wiring are sold separately.
Applicable solderless terminal		R1.25-3, R2-3 RAV1.25-3, RAV2-3	RAV1.25-3 (conforming to JIS C 2805) V2-MS3, RAP2-3SL, TGV2-3N	△	In some cases, the solderless terminal must be changed.
I/O module power supply	Voltage	15.6 to 31.2VDC (peak voltage 31.2VDC)	20.4 to 26.4VDC (ripple ratio within 5%)	△	The operating voltage range differs.
	Current	55mA(at 24V)	60mA or less (24VDC when all points are ON)	△	The current consumption increases. The current capacity needs to be reconsidered.
External dimensions		55(H) × 166(W) × 50(D) mm	54(H) × 118(W) × 40(D) mm	×	The overall size differs. Pay attention to the mounting dimensions.
Weight		0.25kg	0.15kg	△	

5.2.3 I/O Module Specifications Comparison

(1) Specifications comparison between AX10Y10C and AJ65SBTB2N-16A+ AJ65SBTB2N-16R

○ : Compatible, △ : Partial change required, × : Not compatible

Specifications		AX10Y10C input specifications	AJ65SBTB2N-16A	Compatibility	Precautions for replacement
Number of input points		16 points	16 points	○	
Insulation method		Photocoupler	Photocoupler	○	
Rated input voltage		100-120VAC, 50/60Hz	100-120VAC, 50/60Hz	○	
Rated input current		Approx. 6mA (100VAC, 60Hz)	Approx. 7mA (100VAC, 60Hz)	○	
Operating voltage range		85 to 132VAC (50/60Hz ± 5%)	85 to 132VAC (50/60Hz ± 3%, distortion rate 5% within)	○	
Maximum number of simultaneous input points		100% simultaneously ON (at 110VAC)	100% simultaneously ON (at 110VAC) 60% simultaneously ON (at 132VAC)	○	
Inrush current		Max. 200mA, within 1ms (at 132VAC)	Max. 200mA, within 1ms (at 132VAC)	○	
ON voltage/ON current		80V or more/5mA or more	80V or more/5mA or more	○	
OFF voltage/OFF current		30V or less/1mA or less	30V or less/1.7mA or less	○	
Input impedance		Approx. 18k Ω (60Hz), Approx. 21k Ω (50Hz)	Approx. 15k Ω (60Hz), Approx. 18k Ω (50Hz)	○	
Response time	OFF → ON	15ms or less (100VAC, 60Hz)	20ms or less (100VAC, 60Hz)	○	
	ON → OFF	30ms or less (100VAC, 60Hz)	20ms or less (100VAC, 60Hz)	○	
Common terminal arrangement		16 points/common	16 points/common (2-wire type)	○	
Specifications		AX10Y10C output specifications	AJ65SBTB2N-16R	Compatibility	Precautions for replacement
Number of output points		16 points	16 points	○	
Insulation method		Photocoupler	Relay	△	Although the insulation methods differ, the performance of the insulation is the same.
Rated load voltage/current		24VDC 2A (resistance load)/point 240VAC 2A (COS φ = 1)/point 4A/common	24VDC 2A (resistance load)/point 240VAC 2A (COS φ = 1)/point 8A/common	○	
Minimum switching load		5VDC 1mA	5VDC 1mA	○	
Maximum switching voltage		250VAC, 110VDC	264VAC, 125VDC	○	
Response time	OFF → ON	10ms or less	10ms or less	○	
	ON → OFF	12ms or less	12ms or less	○	
Mechanical life		20 million times or more	20 million times or more	○	
Electrical life		Rated switching voltage/current load 100,000 times or more 200VAC 1.5A, 240VAC 1A (COS φ = 0.7) 100,000 times or more 200VAC 1A, 240VAC 0.5A (COS φ = 0.35) 100,000 times or more 24VDC 1A, 100VDC 0.1A (L/R=7 ms) 100,000 times or more	Rated switching voltage/current load 100,000 times or more 200VAC 1.5A, 240VAC 1A (COS φ = 0.7) 100,000 times or more 200VAC 1A, 240VAC 0.5A (COS φ = 0.35) 100,000 times or more 24VDC 1A, 100VDC 0.1A (L/R=7 ms) 100,000 times or more	○	
Maximum switching frequency		3,600 times/hr	3,600 times/hr	○	

○: Compatible, △: Partial change required, ×: Not compatible

Specifications		AX10Y10C output specifications	AJ65SBTB2N-16A		Compatibility	Precautions for replacement
External power supply	Voltage	24VDC ± 10% Ripple voltage 4Vp-p or less	None		–	
	Current	92mA (24VDC, all points ON)	None		–	
Common terminal arrangement		8 points/common	16 points/common (2-wire type)		△	As common terminal arrangement changes from 8 points/common to 16 points/common, wiring with a different voltage per common is not possible.
Specifications		AX10Y10C	AJ65SBTB 2N-16A	AJ65SBTB 2N-16R	Compatibility	Precautions for replacement
Number of occupied stations (number of occupied points)		4 stations (4 stations × 8 points)	1 station (1 station × 32 points × 2 modules)		×	The number of occupied points increases. The assignment of the entire system needs to be reconsidered.
Operation indication		ON indication (LED)	ON indication (LED)		○	
External connection method		50-point terminal block (M3.5 × 7 screws) Transmission circuit part included	Transmission/module power supply parts: 7-point terminal block (M3 × 5.2 screws) I/O part: 34-point terminal block (M3 × 5.2 screws)		×	Change in wiring is required.
Applicable wire size		0.75 to 2mm ²	0.3 to 2mm ²		○	
Applicable solderless terminal		R1.25-3.5, R2-3.5 RAV1.25-3.5, RAV2-3.5	RAV1.25-3 (conforming to JIS C 2805) V2-MS3, RAP2-3SL, TGV2-3N		×	Change in wiring is required.
I/O module power supply	Voltage	15.6 to 31.2VDC	20.4 to 26.4VDC (ripple ratio within 5%)		△	The operating voltage range differs.
	Current	74mA (at 24VDC TYP.)	40mA or less (24VDC when all points are ON)	120mA or less (24VDC when all points are ON)	△	The current consumption increases. The current capacity needs to be reconsidered.
External dimensions		170(H) × 64(W) × 80(D) mm	54(H) × 179(W) × 40(D) mm		×	The overall size differs. Pay attention to the mounting dimensions.
Weight		0.66kg	0.25kg	0.35kg	△	

(2) Specifications comparison between AX10Y22C and AJ65SBTB2N-16A+ AJ65SBTB2N-16S*1

○ : Compatible, △ : Partial change required, × : Not compatible

Specifications		AX10Y22C input specifications	AJ65SBTB2N-16A	Compatibility	Precautions for replacement
Number of input points		16 points	16 points	○	
Insulation method		Photocoupler	Photocoupler	○	
Rated input voltage		100-120VAC, 50/60Hz	100-120VAC, 50/60Hz	○	
Rated input current		Approx. 6mA (100VAC, 60Hz)	Approx. 7mA (100VAC, 60Hz)	○	
Operating voltage range		85 to 132VAC (50/60Hz ± 5%)	85 to 132VAC (50/60Hz ± 3%, distortion rate 5% within)	○	
Maximum number of simultaneous input points		60% simultaneously ON (at 110VAC)	100% simultaneously ON (at 110VAC) 60% simultaneously ON (at 132VAC)	○	
Inrush current		Max. 200mA, within 1ms (at 132VAC)	Max. 200mA, within 1ms (at 132VAC)	○	
ON voltage/ON current		80V or more/5mA or more	80V or more/5mA or more	○	
OFF voltage/OFF current		30V or less/1mA or less	30V or less/1.7mA or less	○	
Input impedance		Approx. 18k Ω (60Hz), Approx. 21k Ω (50Hz)	Approx. 15k Ω (60Hz), Approx. 18k Ω (50Hz)	○	
Response time	OFF → ON	15ms or less (100VAC, 60Hz)	20ms or less (100VAC, 60Hz)	○	
	ON → OFF	30ms or less (100VAC, 60Hz)	20ms or less (100VAC, 60Hz)	○	
Common terminal arrangement		16 points/common	16 points/common (2-wire type)	○	
Specifications		AX10Y22C output specifications	AJ65SBTB2N-16S	Compatibility	Precautions for replacement
Number of output points		16 points	16 points	○	
Insulation method		Photocoupler	Photocoupler	○	
Rated load voltage		100-240VAC, 40 to 70Hz	100-240VAC, 50/60Hz ± 5%	○	
Maximum load voltage		264VAC	264VAC	○	
Maximum load current		0.3A/point 75% simultaneously ON	0.6A/point 4.8A/common	○	
Minimum load voltage/current		18VAC 10mA, 100VAC 10mA, 240VAC 10mA	50VAC 100mA, 100VAC 10mA, 240VAC 10mA	○	
Maximum inrush current		20A 10ms or less	25A, 10ms or less	○	
Leakage current at OFF		Approx. 1.5mA (120VAC, 60Hz) Approx. 3.0mA (240VAC, 60Hz)	1.5mA (100VAC, 60Hz) 3.0mA (200VAC, 60Hz)	○	
Maximum voltage drop at ON		1.5V or less (100 to 300mA) 1.8V or less (50 to 100mA) 2.5V or less (10 to 50mA)	1.5V or less (at 0.6A)	○	
Response time	OFF → ON	1ms or less	1ms or less	○	
	ON → OFF	0.5Hz+1ms or less	1/2 cycle + 1ms or less	○	
Surge suppressor		CR absorber (0.01 μF+68 Ω)	CR absorber (0.01 μF+47 Ω)	○	
Common terminal arrangement		8 points/common	16 points/common (2-wire type)	△	As common terminal arrangement changes from 8 points/common to 16 points/common, wiring with a different voltage per common is not possible.

○ : Compatible, △ : Partial change required, × : Not compatible

Specifications		AX10Y22C	AJ65SBTB 2N-16A	AJ65SBTB 2N-16S	Compatibility	Precautions for replacement
Number of occupied stations (number of occupied points)		4 stations (4 stations × 8 points)	1 station (1 station × 32 points × 2 modules)		×	The number of occupied points increases. The assignment of the entire system needs to be reconsidered.
Operation indication		ON indication (LED)	ON indication (LED)		○	
External connection method		50-point terminal block (M3.5 × 7 screws) Transmission circuit part included	Transmission/module power supply parts: 7-point terminal block (M3 × 5.2 screws) I/O part: 34-point terminal block (M3 × 5.2 screws)		×	Change in wiring is required.
Applicable wire size		0.75 to 2mm ²	0.3 to 2mm ²		○	
Applicable solderless terminal		R1.25-3.5, R2-3.5 RAV1.25-3.5, RAV2-3.5	RAV1.25-3 (conforming to JIS C 2805) V2-MS3, RAP2-3SL, TGV2-3N		×	Change in wiring is required.
I/O module power supply	Voltage	15.6 to 31.2VDC	20.4 to 26.4VDC (ripple ratio within 5%)		△	The operating voltage range differs.
	Current	116mA (at 24V TYP.)	40mA or less (24VDC when all points are ON)	85mA or less (24VDC with all points ON)	△	The current consumption increases. The current capacity needs to be reconsidered.
External dimensions		170(H) × 64(W) × 80(D) mm	54(H) × 179(W) × 40(D) mm		×	The overall size differs. Pay attention to the mounting dimensions.
Weight		0.68kg	0.25kg	0.35kg	△	

*1: Consider the characteristics of the triac and observe the necessary precautions by referring to Section 5.3 (5) before replacing the modules.

(3) Specifications comparison between AX40Y10C and AJ65SBTB1-16D+ AJ65SBTB2N-16R

○ : Compatible, △ : Partial change required, × : Not compatible

Specifications		AX40Y10C input specifications	AJ65SBTB1-16D	Compatibility	Precautions for replacement
Number of input points		16 points	16 points	○	
Insulation method		Photocoupler	Photocoupler	○	
Rated input voltage		12VDC/24VDC	24VDC	△	12VDC cannot be used.
Rated input current		Approx. 3mA/Approx. 7mA	Approx. 7mA	○	
Operating voltage range		10.2 to 31.2VDC (ripple ratio within 5%)	19.2 to 26.4VDC (ripple ratio within 5%)	△	12VDC cannot be used.
Maximum number of simultaneous input points		100% simultaneously ON (at 26.4VDC)	100% simultaneously ON	○	
ON voltage/ON current		8V or more/2mA or more	14V or more/3.5mA or more	△	12VDC cannot be used.
OFF voltage/OFF current		4V or less/1mA or less	6V or less/1.7mA or less	△	12VDC cannot be used.
Input resistance		Approx. 3.3k Ω	Approx. 3.3k Ω	○	
Input method		Positive common (sink type)	Positive/negative common shared type (sink/source shared type)	○	
Response time	OFF → ON	10ms or less (at 24VDC)	1.5ms or less (at 24VDC)	△	The response times differ.
	ON → OFF	10ms or less (at 24VDC)	1.5ms or less (at 24VDC)	△	
Common terminal arrangement		16 points/common	16 points/common	○	
Specifications		AX40Y10C output specifications	AJ65SBTB2N-16R	Compatibility	Precautions for replacement
Number of output points		16 points	16 points	○	
Insulation method		Photocoupler	Relay	△	Although the insulation methods differ, the performance of the insulation is the same.
Rated load voltage/current		24VDC 2A (resistance load)/point 240VAC 2A(COS φ = 1)/point 4A/common	24VDC 2A (resistance load)/point 240VAC 2A (COS φ = 1)/point 8A/common	○	
Minimum switching load		5VDC 1mA	5VDC 1mA	○	
Maximum switching voltage		250VAC, 110VDC	264VAC, 125VDC	○	
Response time	OFF → ON	10ms or less	10ms or less	○	
	ON → OFF	12ms or less	12ms or less	○	
Mechanical life		20 million times or more	20 million times or more	○	
Electrical life		Rated switching voltage/current load 100,000 times or more 200VAC 1.5A, 240VAC 1 A (COS φ = 0.7) 100,000 times or more 200VAC 1A, 240VAC 0.5A (COS φ = 0.35) 100,000 times or more 24VDC 1A, 100VDC 0.1A (L/R=7 ms) 100,000 times or more	Rated switching voltage/current load 100,000 times or more 200VAC 1.5A, 240VAC 1 A (COS φ = 0.7) 100,000 times or more 200VAC 1A, 240VAC 0.5A (COS φ = 0.35) 100,000 times or more 24VDC 1A, 100VDC 0.1A (L/R=7 ms) 100,000 times or more	○	
Maximum switching frequency		3,600 times/hr	3,600 times/hr	○	
External power supply	Voltage	24VDC ± 10% Ripple voltage 4Vp-p or less	None	-	
	Current	92mA (24VDC all points ON)	None	-	
Surge suppressor		None	None	○	
Common terminal arrangement		8 points/common	16 points/common (2-wire type)	△	As common terminal arrangement changes from 8 points/common to 16 points/common, wiring with a different voltage per common is not possible.

○ : Compatible, △ : Partial change required, × : Not compatible

Specifications		AX40Y10C	AJ65SBTB1-16D	AJ65SBTB2N-16R	Compatibility	Precautions for replacement
Number of occupied stations (number of occupied points)		4 stations (4 stations × 8 points)	1 station (1 station × 32 points × 2 modules)		×	The number of occupied points increases. The assignment of the entire system needs to be reconsidered.
Operation indication		ON indication (LED)	ON indication (LED)		○	
External connection method		50-point terminal block (M3.5 × 7 screws) Transmission circuit part included	Transmission/ module power supply parts 7-point terminal block (M3 × 5.2 screws) I/O part: 18-point terminal block (M3 × 5.2 screws)	Transmission/ module power supply parts 7-point terminal block (M3 × 5.2 screws) I/O part: 34-point terminal block (M3 × 5.2 screws)	×	Change in wiring is required.
Applicable wire size		0.75 to 2mm ²	0.3 to 2mm ²		○	
Applicable solderless terminal		R1.25-3.5, R2-3.5 RAV1.25-3.5, RAV2-3.5	RAV1.25-3 (conforming to JIS C 2805) V2-MS3, RAP2-3SL, TGV2-3N		×	Change in wiring is required.
I/O module power supply	Voltage	15.6 to 31.2VDC	20.4 to 26.4VDC (ripple ratio within 5%)		△	The operating voltage range differs.
	Current	72mA (at 24V TYP.)	35mA or less (24VDC) when all points are ON)	120mA or less (24VDC) when all points are ON)	△	The current consumption increases. The current capacity needs to be reconsidered.
External dimensions		170(H) × 64(W) × 80(D) mm	54(H) × 118(W) × 40(D) mm	54(H) × 179(W) × 40(D) mm	×	The overall size differs. Pay attention to the mounting dimensions.
Weight		0.65kg	0.18kg	0.35kg	△	

(4) Specifications comparison between AX40Y10C and AJ65DBTB1-32DR

○ : Compatible, △ : Partial change required, × : Not compatible

Specifications		AX40Y10C input specifications	AJ65DBTB1-32DR input specifications	Compatibility	Precautions for replacement
Number of input points		16 points	16 points	○	
Insulation method		Photocoupler	Photocoupler	○	
Rated input voltage		12VDC/24VDC	24VDC	△	12VDC cannot be used.
Rated input current		Approx. 3mA/Approx. 7mA	Approx. 5mA	△	Rated input current is smaller. *1
Operating voltage range		10.2 to 31.2VDC (ripple ratio within 5%)	20.4 to 31.2VDC (ripple ratio within 5%)	△	12VDC cannot be used.
Maximum number of simultaneous input points		100% simultaneously ON (at 26.4VDC)	100% (at 26.4VDC)	○	
ON voltage/ON current		8V or more/2mA or more	15V or more/3mA or more	△	12VDC cannot be used.
OFF voltage/OFF current		4V or less/1mA or less	5V or less/1.5mA or less	△	12VDC cannot be used.
Input resistance		Approx. 3.3k Ω	Approx. 4.7k Ω	△	Input resistance becomes higher. *1
Input method		Positive common (sink type)	Positive/negative common shared type (sink/source shared type)	○	
Response time	OFF → ON	10ms or less (at 24VDC)	10ms or less (at 24VDC)	○	
	ON → OFF	10ms or less (at 24VDC)	10ms or less (at 24VDC)	○	
Common terminal arrangement		16 points/common	16 points/common (2 points) (terminal block 1-wire type)	○	
Specifications		AX40Y10C output specifications	AJ65DBTB1-32DR output specifications	Compatibility	Precautions for replacement
Number of output points		16 points	16 points	○	
Insulation method		Photocoupler	Photocoupler	○	
Rated load voltage/current		24VDC 2A (resistance load)/point 240VAC 2A(COS φ = 1)/point 4A/common (2A/terminal)	24VDC 2A (resistance load)/point 240VAC 2A (COS φ = 1)/point 4A/common (2A/terminal)	○	
Minimum switching load		5VDC 1mA	5VDC 1mA	○	
Maximum switching voltage		250VAC, 110VDC	264VAC, 125VDC	○	
Response time	OFF → ON	10ms or less	10ms or less	○	
	ON → OFF	12ms or less	12ms or less	○	
Mechanical life		20 million times or more	20 million times or more	○	
Electrical life		Rated switching voltage/current load 100,000 times or more 200VAC 1.5A, 240VAC 1 A (COS φ = 0.7) 100,000 times or more 200VAC 1A, 240VAC 0.5A (COS φ = 0.35) 100,000 times or more 24VDC 1A, 100VDC 0.1A (L/R=7 ms) 100,000 times or more	Rated switching voltage/current load 100,000 times or more 200VAC 1.5A, 240VAC 1 A (COS φ = 0.7) 100,000 times or more 200VAC 1A, 240VAC 0.5A (COS φ = 0.35) 100,000 times or more 24VDC 1A, 100VDC 0.1A (L/R=7 ms) 100,000 times or more	○	
Maximum switching frequency		3,600 times/hr	3,600 times/hr	○	
External power supply	Voltage	24VDC ± 10% Ripple voltage 4Vp-p or less	24VDC ± 10% Ripple voltage 4Vp-p or less	○	
	Current	92mA (24VDC all points ON)	90mA (24VDC all points ON)	○	
Surge suppressor		None	None	○	
Common terminal arrangement		8 points/common	8 points/common (terminal block 1-wire type)	○	

○ : Compatible, △ : Partial change required, × : Not compatible

Specifications		AX40Y10C	AJ65DBTB1-32DR	Compatibility	Precautions for replacement
Number of occupied stations (number of occupied points)		4 stations (4 stations × 8 points)	1 station (1 station × 32 points)	○	
Operation indication		ON indication (LED)	ON indication (LED)	○	
External connection method		50-point terminal block (M3.5 × 7 screws) Transmission circuit part included	50-point terminal block (M3.5 × 7 screws) Transmission circuit part included	○	The number of applicable solderless terminals inserted is within two.
Applicable wire size		0.75 to 2mm ²	0.75 to 2mm ²	○	
Applicable solderless terminal		R1.25-3.5, R2-3.5 RAV1.25-3.5, RAV2-3.5	RAV1.25-3 (conforming to JIS C 2805) RAV2-3.5	○	
I/O module power supply	Voltage	15.6 to 31.2VDC	20.4 to 26.4VDC (ripple ratio within 5%)	△	The operating voltage range differs.
	Current	72mA (at 24V TYP.)	60mA or less (24VDC, when all points are ON)	○	
External dimensions		170(H) × 64(W) × 80(D) mm	170(H) × 64(W) × 80(D) mm	○	
Weight		0.65kg	0.65kg	△	

(5) Specifications comparison between AX40Y10C and AJ65SBTB32-16DR

○ : Compatible, △ : Partial change required, × : Not compatible

Specifications		AX40Y10C input specifications	AJ65SBTB32-16DR input specifications	Compatibility	Precautions for replacement
Number of input points		16 points	8 points	×	When nine or more points are used, use two AJ65SBTB32-16DR modules.
Insulation method		Photocoupler	Photocoupler	○	
Rated input voltage		12VDC/24VDC	24VDC	△	12VDC cannot be used.
Rated input current		Approx. 3mA/Approx. 7mA	Approx. 7mA	○	
Operating voltage range		10.2 to 31.2VDC (ripple ratio within 5%)	19.2 to 26.4VDC (ripple ratio within 5%)	△	12VDC cannot be used.
Maximum number of simultaneous input points		100% simultaneously ON (at 26.4VDC)	100%	○	
ON voltage/ON current		8V or more/2mA or more	14V or more/3.5mA or more	△	12VDC cannot be used.
OFF voltage/OFF current		4V or less/1mA or less	6V or less/1.7mA or less	△	12VDC cannot be used.
Input resistance		Approx. 3.3k Ω	Approx. 3.3k Ω	○	
Input method		Positive common (sink type)	Positive/negative common shared type (sink/source shared type)	○	
Response time	OFF → ON	10ms or less (at 24VDC)	10ms or less (at 24VDC)	○	
	ON → OFF	10ms or less (at 24VDC)	10ms or less (at 24VDC)	○	
Common terminal arrangement		16 points/common	8 points/common (terminal block 3-wire type)	○	
Specifications		AX40Y10C output specifications	AJ65SBTB32-16DR output specifications	Compatibility	Precautions for replacement
Number of output points		16 points	8 points	×	When nine or more points are used, use two AJ65SBTB32-16DR modules.
Insulation method		Photocoupler	Relay	△	Although the insulation method differs, the insulation performance is the same.
Rated load voltage/current		24VDC 2A (resistance load)/point 240VAC 2A(COS φ = 1)/point 4A/common (2A/terminal)	24VDC 2A (resistance load)/point 240VAC 2A (COS φ = 1)/point 4A/common	○	
Minimum switching load		5VDC 1mA	5VDC 1mA	○	
Maximum switching voltage		250VAC, 110VDC	264VAC, 125VDC	○	
Response time	OFF → ON	10ms or less	10ms or less	○	
	ON → OFF	12ms or less	12ms or less	○	
Mechanical life		20 million times or more	20 million times or more	○	
Electrical life		Rated switching voltage/current load 100,000 times or more 200VAC 1.5A, 240VAC 1 A (COS φ = 0.7) 100,000 times or more 200VAC 1A, 240VAC 0.5A (COS φ = 0.35) 100,000 times or more 24VDC 1A, 100VDC 0.1A (L/R=7 ms) 100,000 times or more	Rated switching voltage/current load 100,000 times or more 200VAC 1.5A, 240VAC 1 A (COS φ = 0.7) 100,000 times or more 200VAC 1A, 240VAC 0.5A (COS φ = 0.35) 100,000 times or more 24VDC 1A, 100VDC 0.1A (L/R=7 ms) 100,000 times or more	○	
Maximum switching frequency		3,600 times/hr	3,600 times/hr	○	
External power supply	Voltage	24VDC ± 10% Ripple voltage 4Vp-p or less	None	-	
	Current	92mA (24VDC all points ON)	None	-	
Surge suppressor		None	None	○	
Common terminal arrangement		8 points/common	4 points/common (terminal block 2-wire type)	○	

○ : Compatible, △ : Partial change required, × : Not compatible

Specifications		AX40Y10C	AJ65SBTB32-16DR	Compatibility	Precautions for replacement
Number of occupied stations (number of occupied points)		4 stations (4 stations × 8 points)	1 station (1 station × 32 points × 4 modules)	×	The number of occupied points increases. The assignment of the entire system needs to be reconsidered.
Operation indication		ON indication (LED)	ON indication (LED)	○	
External connection method		50-point terminal block (M3.5 × 7 screws) Transmission circuit part included	Transmission/module power supply parts 7-point terminal block (M3 × 5.2 screws) I/O part: 34-point terminal block (M3 × 5.2 screws)	×	Change in wiring is required. The number of applicable solderless terminals inserted is within two.
Applicable wire size		0.75 to 2mm ²	0.3 to 2mm ²	○	
Applicable solderless terminal		R1.25-3.5, R2-3.5 RAV1.25-3.5, RAV2-3.5	RAV1.25-3 (conforming to JIS C 2805) V2-MS3, RAP2-3SL, TGV2-3N	×	Change in wiring is required.
I/O module power supply	Voltage	15.6 to 31.2VDC	20.4 to 26.4VDC (ripple ratio within 5%)	△	The operating voltage range differs.
	Current	72mA (at 24V TYP.)	85mA or less (24VDC, when all points are ON)	△	The current consumption increases. The current capacity needs to be reconsidered.
External dimensions		170(H) × 64(W) × 80(D) mm	54(H) × 179(W) × 40(D) mm	×	The overall size differs. Pay attention to the mounting dimensions.
Weight		0.65kg	0.28kg	△	

(6) Specifications comparison between AX40Y50C and AJ65SBTB1-32DT2

○ : Compatible, △ : Partial change required, × : Not compatible

Specifications		AX40Y50C input specifications	AJ65SBTB1-32DT2 input specifications	Compatibility	Precautions for replacement
Number of input points		16 points	16 points	○	
Insulation method		Photocoupler	Photocoupler	○	
Rated input voltage		12VDC/24VDC	24VDC	△	12VDC cannot be used.
Rated input current		Approx.3mA/Approx.7mA	Approx. 7mA	○	
Operating voltage range		10.2 to 31.2VDC (ripple ratio within 5%)	19.2 to 26.4VDC (ripple ratio within 5%)	△	12VDC cannot be used.
Maximum number of simultaneous input points		60% simultaneously ON (at 26.4VDC)	100% simultaneously ON	○	
ON voltage/ON current		8V or more/2mA or more	14V or more/3.5mA or more	△	12VDC cannot be used.
OFF voltage/OFF current		4V or less/1mA or less	6V or less/1.7mA or less	△	12VDC cannot be used.
Input resistance		Approx. 3.3k Ω	Approx. 3.3k Ω	○	
Input method		Positive common (sink type)	Positive common (sink type)	○	
Response time	OFF → ON	10ms or less (at 24VDC)	1.5ms or less (at 24VDC)	○	
	ON → OFF	10ms or less (at 24VDC)	1.5ms or less (at 24VDC)	○	
Common terminal arrangement		16 points/common	32 points/common (Common shared by I/O)	△	As input common and output common are shared, wiring a different voltage for each common is not possible.
Specifications		AX40Y50C output specifications	AJ65SBTB1-32DT2 output specifications	Compatibility	Precautions for replacement
Number of output points		16 points	16 points	○	
Insulation method		Photocoupler	Photocoupler	○	
Rated load voltage		12VDC/24VDC	24VDC	△	12VDC cannot be used.
Operating load voltage range		10.2 to 31.2VDC	19.2 to 26.4VDC (ripple ratio within 5%)	△	12VDC cannot be used.
Maximum load current		0.3A/point 75% simultaneously ON	0.5A/point, 3.6A/common	○	
Maximum inrush current		1.2A 10ms or less	1.0A, 10ms or less	○	
Leakage current at OFF		0.1mA or less	0.1mA or less	○	
Maximum voltage drop at ON		0.9VDC or less (TYP.) 0.3A 1.5VDC or less (MAX.) 0.3A	0.3VDC or less (TYP.) 0.5A 0.6VDC or less (MAX.) 0.5A	○	
Output method		sink type	sink type	○	
Response time	OFF → ON	2ms or less	0.5ms or less	○	
	ON → OFF	2ms or less (resistance load)	1.5ms or less (resistance load)	○	
External power supply	Voltage	10.2 to 31.2VDC	19.2 to 26.4VDC (ripple ratio within 5%)	△	12VDC cannot be used.
	Current	64mA (24VDC)	30mA or less (24VDC)	○	
Surge suppressor		Zener diode	Zener diode	○	
Common terminal arrangement		16 points/common	32 points/common (I/O shared)	△	As input common and output common are shared, wiring a different voltage for each common is not possible.

○ : Compatible, △ : Partial change required, × : Not compatible

Specifications		AX40Y50C	AJ65SBTB1-32DT2	Compatibility	Precautions for replacement
Number of occupied stations (number of occupied points)		4 stations (4 stations × 8 points)	1 station (1 station × 32 points)	○	
Operation indication		ON indication (LED)	ON indication (LED)	○	
External connection method		50-point terminal block (M3.5 × 7 screws) Transmission circuit part included	Transmission/module power supply parts: 7-point terminal block (M3 × 5.2 screws) I/O part: 34-point terminal block (M3 × 5.2 screws)	×	Change in wiring is required.
Applicable wire size		0.75 to 2mm ²	0.3 to 2mm ²	○	
Applicable solderless terminal		R1.25-3.5, R2-3.5 RAV1.25-3.5, RAV2-3.5	RAV1.25-3 (conforming to JIS C 2805) V2-MS3, RAP2-3SL, TGV2-3N	×	Change in wiring is required.
I/O module power supply	Voltage	15.6 to 31.2VDC	20.4 to 26.4VDC (ripple ratio within 5%)	△	The operating voltage range differs.
	Current	74mA (at 24V TYP.)	60mA or less (24VDC when all points are ON)	○	
External dimensions		170(H) × 64(W) × 80(D) mm	54(H) × 179(W) × 40(D) mm	×	The overall size differs. Pay attention to the mounting dimensions.
Weight		0.65kg	0.25kg	△	

(7) Specifications comparison between AX40Y50C and AJ65DBTB1-32DT1

○ : Compatible, △ : Partial change required, × : Not compatible

Specifications		AX40Y50C input specifications	AJ65DBTB1-32DT1 input specifications	Compatibility	Precautions for replacement
Number of input points		16 points	16 points	○	
Insulation method		Photocoupler	Photocoupler	○	
Rated input voltage		12VDC/24VDC	24VDC	△	12VDC cannot be used.
Rated input current		Approx.3mA/Approx.7mA	Approx. 5mA	△	Rated input current is smaller.*1
Operating voltage range		10.2 to 31.2VDC (ripple ratio within 5%)	20.4 to 31.2VDC (ripple ratio within 5%)	△	12VDC cannot be used.
Maximum number of simultaneous input points		60% simultaneously ON (at 26.4VDC)	100% (at 26.4VDC)	○	
ON voltage/ON current		8V or more/2mA or more	15V or more/3mA or more	△	12VDC cannot be used.
OFF voltage/OFF current		4V or less/1mA or less	5V or less/1.5mA or less	△	12VDC cannot be used.
Input resistance		Approx. 3.3k Ω	Approx. 4.7k Ω	○	Input resistance becomes higher.*1
Input method		Positive common (sink type)	Positive common (sink type)	○	
Response time	OFF→ON	10ms or less (at 24VDC)	10ms or less (at 24VDC)	○	
	ON→OFF	10ms or less (at 24VDC)	10ms or less (at 24VDC)	○	
Common terminal arrangement		16 points/common	16 points/common (2 points) (terminal block 1-wire type)	○	
Specifications		AX40Y50C output specifications	AJ65DBTB1-32DT1 output specifications	Compatibility	Precautions for replacement
Number of output points		16 points	16 points	○	
Insulation method		Photocoupler	Photocoupler	○	
Rated load voltage		12VDC/24VDC	12VDC/24VDC	○	
Operating load voltage range		10.2 to 31.2VDC	10.2 to 31.2VDC (ripple ratio within 5%)	○	
Maximum load current		0.3A/point 75% simultaneously ON	0.5A/point, 4A/common (2A/terminal)	○	
Maximum inrush current		1.2A 10ms or less	1.2A, 10ms or less	○	
Leakage current at OFF		0.1mA or less	0.1mA or less	○	
Maximum voltage drop at ON		0.9VDC or less (TYP.) 0.3A 1.5VDC or less (MAX.) 0.3A	0.3VDC or less (TYP.) 0.5A 0.6VDC or less (MAX.) 0.5A	○	
Output method		sink type	sink type	○	
Response time	OFF→ON	2ms or less	0.5ms or less	○	
	ON→OFF	2ms or less (resistance load)	1.5ms or less (resistance load)	○	
External power supply	Voltage	10.2 to 31.2VDC	10.2 to 31.2VDC (ripple ratio within 5%)	○	
	Current	64mA (24VDC)	30mA or less (24VDC, when all points are ON) External load current not included	○	
Surge suppressor		Zener diode	Zener diode	○	
Common terminal arrangement		16 points/common	16 points/common (2 points) (terminal block 1-wire type)	○	

○ : Compatible, △ : Partial change required, × : Not compatible

Specifications		AX40Y50C	AJ65DBTB1-32DT1	Compatibility	Precautions for replacement
Number of occupied stations (number of occupied points)		4 stations (4 stations × 8 points)	1 station (1 station × 32 points)	○	
Operation indication		ON indication (LED)	ON indication (LED)	○	
External connection method		50-point terminal block (M3.5 × 7 screws) Transmission circuit part included	50-point terminal block (M3.5 × 7 screws) Transmission circuit part included	○	The number of applicable solderless terminals inserted is within two.
Applicable wire size		0.75 to 2mm ²	0.75 to 2mm ²	○	
Applicable solderless terminal		R1.25-3.5, R2-3.5 RAV1.25-3.5, RAV2-3.5	R1.25-3.5 (conforming to JIS C 2805) RAV2-3.5	○	
I/O module power supply	Voltage	15.6 to 31.2VDC	20.4 to 26.4VDC (ripple ratio within 5%)	△	The operating voltage range differs.
	Current	74mA (at 24V TYP.)	55mA or less (24VDC when all points are ON)	○	
External dimensions		170(H) × 64(W) × 80(D) mm	170(H) × 64(W) × 80(D) mm	○	
Weight		0.65kg	0.65kg	○	

*1: Check the specifications of the sensors or switches to be connected to the AJ65DBTB1-32DT1.

(8) Specifications comparison between AX80Y10C and AJ65SBTB1-16D+ AJ65SBTB2N-16R

○ : Compatible, △ : Partial change required, × : Not compatible

Specifications		AX80Y10C input specifications	AJ65SBTB1-16D	Compatibility	Precautions for replacement
Number of input points		16 points	16 points	○	
Insulation method		Photocoupler	Photocoupler	○	
Rated input voltage		12VDC/24VDC	24VDC	△	12VDC cannot be used.
Rated input current		Approx. 3mA/Approx. 7mA	Approx. 7mA	○	
Operating voltage range		10.2 to 31.2VDC (ripple ratio within 5%)	19.2 to 26.4VDC (ripple ratio within 5%)	△	12VDC cannot be used.
Maximum number of simultaneous input points		100% simultaneously ON (at 26.4VDC)	100% simultaneously ON	○	
ON voltage/ON current		8V or more/2mA or more	14V or more/3.5mA or more	△	12VDC cannot be used.
OFF voltage/OFF current		4V or less/1mA or less	6V or less/1.7mA or less	△	12VDC cannot be used.
Input resistance		Approx. 3.3kΩ	Approx. 3.3kΩ	○	
Input method		Positive/negative common shared type (sink/source shared type)	Positive/negative common shared type (sink/source shared type)	○	
Response time	OFF → ON	10ms or less (at 24VDC)	1.5ms or less (at 24VDC)	○	
	ON → OFF	10ms or less (at 24VDC)	1.5ms or less (at 24VDC)	○	
Common terminal arrangement		16 points/common	16 points/common	○	
Specifications		AX80Y10C output specifications	AJ65SBTB2N-16R	Compatibility	Precautions for replacement
Number of output points		16 points	16 points	○	
Insulation method		Photocoupler	Relay	△	Although the insulation methods differ, the performance of the insulation is the same.
Rated load voltage/current		24VDC 2A (resistance load)/point 240VAC 2A (COS φ =1)/point 4A/common	24VDC 2A (resistance load)/point 240VAC 2A (COS φ =1)/point 8A/common	○	
Minimum switching load		5VDC 1mA	5VDC 1mA	○	
Maximum switching voltage		250VAC, 110VDC	264VAC, 125VDC	○	
Response time	OFF → ON	10ms or less	10ms or less	○	
	ON → OFF	12ms or less	12ms or less	○	
Mechanical life		20 million times or more	20 million times or more	○	
Electrical life		Rated switching voltage/current load 100,000 times or more 200VAC 1.5A, 240VAC 1A (COS φ = 0.7) 100,000 times or more 200VAC 1A, 240VAC 0.5A (COS φ = 0.35) 100,000 times or more 24VDC 1A, 100VDC 0.1A (L/R = 7ms) 100,000 times or more	Rated switching voltage/current load 100,000 times or more 200VAC 1.5A, 240VAC 1A (COS φ = 0.7) 100,000 times or more 200VAC 1A, 240VAC 0.5A (COS φ = 0.35) 100,000 times or more 24VDC 1A, 100VDC 0.1A (L/R = 7ms) 100,000 times or more	○	
Maximum switching frequency		3,600 times/hr	3,600 times/hr	○	
External power supply	Voltage	24VDC ± 10% Ripple voltage 4Vp-p or less	None	-	
	Current	92mA (24VDC all points ON)	None	-	
Surge suppressor		None	None	○	
Common terminal arrangement		8 points/common	16 points/common (2-wire type)	△	As common terminal arrangement changes from 8 points/common to 16 points/common, wiring with a different voltage per common is not possible.

○ : Compatible, △ : Partial change required, × : Not compatible

Specifications		AX80Y10C	AJ65SBTB1-16D	AJ65SBTB2N-16R	Compatibility	Precautions for replacement
Number of occupied stations (number of occupied points)		4 stations (4 stations × 8 points)	1 station (1 station × 32 points × 2 modules)		×	The number of occupied points increases. The assignment of the entire system needs to be reconsidered.
Operation indication		ON indication (LED)	ON indication (LED)		○	
External connection method		50-point terminal block (M3.5 × 7 screws) Transmission circuit part included	Transmission/ module power supply parts 7-point terminal block (M3 × 5.2 screws) I/O part: 18-point terminal block (M3 × 5.2 screws)	Transmission/ module power supply parts 7 points terminal block (M3 × 5.2 screws) I/O part: 34-point terminal block (M3 × 5.2 screws)	×	Change in wiring is required.
Applicable wire size		0.75 to 2mm ²	0.3 to 2mm ²		○	
Applicable solderless terminal		R1.25-3.5, R2-3.5 RAV1.25-3.5, RAV2-3.5	RAV1.25-3 (conforming to JIS C 2805) V2-MS3, RAP2-3SL, TGV2-3N		×	Change in wiring is required.
I/O module power supply	Voltage	15.6 to 31.2VDC	20.4 to 26.4VDC (ripple ratio within 5%)		△	The operating voltage range differs.
	Current	72mA (at 24V TYP.)	35mA or less (24VDC when all points are ON)	120mA or less (24VDC when all points are ON)	△	The current consumption increases. The current capacity needs to be reconsidered.
External dimensions		170(H) × 64(W) × 80(D) mm	54(H) × 118(W) × 40(D) mm	54(H) × 179(W) × 40(D) mm	×	The overall size differs. Pay attention to the mounting dimensions.
Weight		0.65kg	0.18kg	0.35kg	△	

(9) Specifications comparison between AX80Y10C and AJ65DBTB1-32DR

○ : Compatible, △ : Partial change required, × : Not compatible

Specifications		AX80Y10C input specifications	AJ65DBTB1-32DR input specifications	Compatibility	Precautions for replacement
Number of input points		16 points	16 points	○	
Insulation method		Photocoupler	Photocoupler	○	
Rated input voltage		12VDC/24VDC	24VDC	△	12VDC cannot be used.
Rated input current		Approx.3mA/Approx.7mA	Approx. 5mA	△	Rated input current is smaller. *1
Operating voltage range		10.2 to 31.2VDC (ripple ratio within 5%)	20.4 to 31.2VDC (ripple ratio within 5%)	△	12VDC cannot be used.
Maximum number of simultaneous input points		100% simultaneously ON (at 26.4VDC)	100% (at 26.4VDC)	○	
ON voltage/ON current		8V or more/2mA or more	15V or more/3mA or more	△	12VDC cannot be used.
OFF voltage/OFF current		4V or less/1mA or less	5V or less/1.5mA or less	△	12VDC cannot be used.
Input resistance		Approx. 3.3k Ω	Approx. 4.7k Ω	△	Input resistance becomes higher.*1
Input method		Positive/negative common shared type (sink/source shared type)	Positive/negative common shared type (sink/source shared type)	○	
Response time	OFF → ON	10ms or less (at 24VDC)	10ms or less (at 24VDC)	○	
	ON → OFF	10ms or less (at 24VDC)	10ms or less (at 24VDC)	○	
Common terminal arrangement		16 points/common	16 points/common (2 points) (terminal block 1-wire type)	○	
Specifications		AX80Y10C output specifications	AJ65DBTB1-32DR output specifications	Compatibility	Precautions for replacement
Number of output points		16 points	16 points	○	
Insulation method		Photocoupler	Photocoupler	○	
Rated load voltage/current		24VDC 2A (resistance load)/point 240VAC 2A (COS φ =1)/point 4A/common	24VDC 2A (resistance load)/point 240VAC 2A (COS φ =1)/point 4A/common (2A/terminal)	○	
Minimum switching load		5VDC 1mA	5VDC 1mA	○	
Maximum switching voltage		250VAC, 110VDC	264VAC, 125VDC	○	
Response time	OFF → ON	10ms or less	10ms or less	○	
	ON → OFF	12ms or less	12ms or less	○	
Electrical life		Rated switching voltage/current load 100,000 times or more 200VAC 1.5A, 240VAC 1 A (COS φ = 0.7) 100,000 times or more 200VAC 1A, 240VAC 0.5A (COS φ = 0.35) 100,000 times or more 24VDC 1A, 100VDC 0.1A (L/R=7 ms) 100,000 times or more	Rated switching voltage/current load 100,000 times or more 200VAC 1.5A, 240VAC 1 A (COS φ = 0.7) 100,000 times or more 200VAC 1A, 240VAC 0.5A (COS φ = 0.35) 100,000 times or more 24VDC 1A, 100VDC 0.1A (L/R=7 ms) 100,000 times or more	○	
Maximum switching frequency		3,600 times/hr	3,600 times/hr	○	
External power supply	Voltage	24VDC ± 10% Ripple voltage 4Vp-p or less	24VDC ± 10% Ripple voltage 4Vp-p or less	○	
	Current	92mA (24VDC all points ON)	90mA or less (24VDC all points ON)	○	
Surge suppressor		None	None	○	
Common terminal arrangement		8 points/common	8 points/common (terminal block 1-wire type)	○	

○ : Compatible, △ : Partial change required, × : Not compatible

Specifications		AX80Y10C	AJ65DBTB1-32DR	Compatibility	Precautions for replacement
Number of occupied stations (number of occupied points)		4 stations (4 stations × 8 points)	1 station (1 station × 32 points)	○	
Operation indication		ON indication (LED)	ON indication (LED)	○	
External connection method		50-point terminal block (M3.5 × 7 screws) Transmission circuit part included	50-point terminal block (M3.5 × 7 screws) Transmission circuit part included	○	The number of applicable solderless terminals inserted is within two.
Applicable wire size		0.75 to 2mm ²	0.75 to 2mm ²	○	
Applicable solderless terminal		R1.25-3.5, R2-3.5 RAV1.25-3.5, RAV2-3.5	R1.25-3.5 (conforming to JIS C 2805) RAV2-3.5	○	
I/O module power supply	Voltage	15.6 to 31.2VDC	20.4 to 26.4VDC (ripple ratio within 5%)	△	The operating voltage range differs.
	Current	72mA (at 24V TYP.)	60mA or less (24VDC when all points are ON)	○	
External dimensions		170(H) × 64(W) × 80(D) mm	170(H) × 64(W) × 80(D) mm	○	
Weight		0.65kg	0.65kg	○	

*1: Check the specifications of the sensors or switches to be connected to the AJ65DBTB1-32DR.

(10) Specifications comparison between AX80Y14CEU and AJ65SBTB1-16D +AJ65SBTB2N-16R

○ : Compatible, △ : Partial change required, × : Not compatible

Specifications		AX80Y14CEU input specifications	AJ65SBTB1-16D	Compatibility	Precautions for replacement
Number of input points		16 points	16 points	○	
Insulation method		Photocoupler	Photocoupler	○	
Rated input voltage		12VDC/24VDC	24VDC	△	12VDC cannot be used.
Rated input current		Approx. 3mA/Approx. 7mA	Approx. 7mA	○	
Operating voltage range		10.2 to 31.2VDC (ripple ratio within 5%)	19.2 to 26.4VDC (ripple ratio within 5%)	△	12VDC cannot be used.
Maximum number of simultaneous input points		60% simultaneously ON (at 26.4VDC)	100% simultaneously ON	○	
ON voltage/ON current		8V or more/2mA or more	14V or more/3.5mA or more	△	12VDC cannot be used.
OFF voltage/OFF current		4V or less/1mA or less	6V or less/1.7mA or less	△	12VDC cannot be used.
Input resistance		Approx. 3.3k Ω	Approx. 3.3k Ω	○	
Input method		Positive/negative common shared type (sink/source shared type)	Positive/negative common shared type (sink/source shared type)	○	
Response time	OFF → ON	10ms or less (at 24VDC)	1.5ms or less (at 24VDC)	○	
	ON → OFF	10ms or less (at 24VDC)	1.5ms or less (at 24VDC)	○	
Common terminal arrangement		16 points/common	16 points/common	○	
Specifications		AX80Y14CEU output specifications	AJ65SBTB2N-16R	Compatibility	Precautions for replacement
Number of output points		12 points	16 points	○	
Insulation method		Photocoupler	Relay	△	Although the insulation methods differ, the performance of the insulation is the same.
Rated load voltage/current		24VDC 2A (resistance load)/point 240VAC 2A (COS φ =1)/point 5A/common	24VDC 2A (resistance load)/point 240VAC 2A (COS φ =1)/point 8A/common	○	
Minimum switching load		5VDC 10mA	5VDC 1mA	○	
Maximum switching voltage		264VAC 125VDC	264VAC, 125VDC	○	
Response time	OFF → ON	10ms or less	10ms or less	○	
	ON → OFF	12ms or less	12ms or less	○	
Mechanical life		20 million times or more	20 million times or more	○	
Electrical life		Rated switching voltage/current load 200,000 times or more 200VAC 2A, 240VAC 1.8A (COS φ = 0.7)200,000 times or more 200VAC 1.1A, 240VAC 0.9A (COS φ = 0.35)200,000 times or more 24VDC 1.1A, 100VDC 0.1A (L/R=7ms) 200,000 times or more	Rated switching voltage/current load 100,000 times or more 200VAC 1.5A, 240VAC 1A (COS φ = 0.7) 100000 times or more 200VAC 1A, 240VAC 0.5A (COS φ = 0.35) 100,000 times or more 24VDC 1A, 100VDC 0.1A (L/R=7 ms) 100,000 times or more	△	Reduce the exchange intervals of the modules as Mechanical/ Electrical Life is cut to about half.
Maximum switching frequency		3,600 times/hr	3,600 times/hr	○	
External power supply	Voltage	24VDC ± 10% Ripple voltage 4Vp-p or less	None	-	
	Current	118mA (24VDC all points ON)	None	-	
Surge suppressor		None	None	○	

○ : Compatible, △ : Partial change required, × : Not compatible

Specifications		AX80Y14CEU output specifications		AJ65SBTB2N-16R		Compatibility	Precautions for replacement
Common terminal arrangement		8 points/common 4 points/common		16 points/common (2-wire type)		△	As common terminal arrangement changes from 8 points/common to 16 points/common, wiring with a different voltage per common is not possible.
Dielectric withstand voltage		AC external batch-Relay drive power supply-internal 5V circuit	AC2,830Vrms/ 3 cycle (elevation 2,000m)	Between AC external terminal batch and ground	AC2,830Vrms/ 3 cycle (elevation 2,000m)	○	
		Relay drive power supply, internal 5V circuit	500VDC/ minute	Between DC external batch and ground	500VDC/ minute	○	
Insulation resistance		10M Ω or more with the insulation resistance tester		Between AC external batch and ground 500VDC with the insulation resistance tester 10M Ω or more Between DC external batch and ground 500VDC with the insulation resistance tester 10M Ω or more		○	
Specifications		AX80Y14CEU		AJ65SBTB1-16D	AJ65SBTB2N-16R	Compatibility	Precautions for replacement
Number of occupied stations (number of occupied points)		4 stations (4 stations × 8 points)		1 station (1 station × 32 points × 2 modules)		×	The number of occupied points increases. The assignment of the entire system needs to be reconsidered.
Operation indication		ON indication (LED)		ON indication (LED)		○	
External connection method		50-point terminal block (M3.5 × 7 screws) Transmission circuit part included		Transmission/ module power supply parts 7-point terminal block (M3 × 5.2 screws) I/O part: 18-point terminal block (M3 × 5.2 screws)	Transmission/ module power supply parts 7-point terminal block (M3 × 5.2 screws) I/O part: 34-point terminal block (M3 × 5.2 screws)	×	Change in wiring is required.
Applicable wire size		0.75 to 2mm ²		0.3 to 2mm ²		○	
Applicable solderless terminal		R1.25-3.5, R2-3.5 RAV1.25-3.5, RAV2-3.5		RAV1.25-3 (conforming to JIS C 2805) V2-MS3, RAP2-3SL, TGV2-3N		×	Change in wiring is required.
I/O module power supply	Voltage	15.6 to 31.2VDC		20.4 to 26.4VDC (ripple ratio within 5%)		△	The operating voltage range differs.
	Current	73mA (at 24V TYP.)		35mA or less (24VDC when all points are ON)	120mA or less (24VDC when all points are ON)	△	The current consumption increases. The current capacity needs to be reconsidered.
External dimensions		170(H) × 64(W) × 80(D) mm		54(H) × 118(W) × 40(D) mm	54(H) × 179(W) × 40(D) mm	×	The overall size differs. Pay attention to the mounting dimensions.
Weight		0.65kg		0.18kg	0.35kg	△	

(11) Specifications comparison between AX80Y80C and AJ65SBTB1-16D+ AJ65SBTB1-16TE

○ : Compatible, △ : Partial change required, × : Not compatible

Specifications		AX80Y80C input specifications	AJ65SBTB1-16D	Compatibility	Precautions for replacement
Number of input points		16 points	16 points	○	
Insulation method		Photocoupler	Photocoupler	○	
Rated input voltage		12/24VDC	24VDC	△	12VDC cannot be used.
Rated input current		Approx. 3mA/Approx. 7mA	Approx. 7mA	○	
Operating voltage range		10.2 to 31.2VDC (ripple ratio within 5%)	19.2 to 26.4VDC (ripple ratio within 5%)	△	12VDC cannot be used.
Maximum number of simultaneous input points		60% simultaneously ON (at 26.4VDC)	100% simultaneously ON	○	
ON voltage/ON current		8V or more/2mA or more	14V or more/3.5mA or more	△	12VDC cannot be used.
OFF voltage/OFF current		4V or less/1mA or less	6V or less/1.7mA or less	△	12VDC cannot be used.
Input resistance		Approx. 3.3k Ω	Approx. 3.3k Ω	○	
Input method		Positive/negative common shared type (sink/source shared type)	Positive/negative common shared type (sink/source shared type)	○	
Response time	OFF → ON	10ms or less (at 24VDC)	1.5ms or less (at 24VDC)	△	The response times differ.
	ON → OFF	10ms or less (at 24VDC)	1.5ms or less (at 24VDC)	△	
Common terminal arrangement		16 points/common	16 points/common	○	
Specifications		AX80Y80C output specifications	AJ65SBTB1-16TE	Compatibility	Precautions for replacement
Number of output points		16 points	16 points	○	
Insulation method		Photocoupler	Photocoupler	○	
Rated load voltage		24VDC	12/24VDC	○	
Operating load voltage range		21.6 to 26.4VDC	10.2 to 26.4VDC	○	
Maximum load current		0.5A/point, 60% simultaneously ON	0.1A/point 1.6A/common	×	The maximum load current per point becomes lower. Pay attention to the selection of the load to be used.
Maximum inrush current		2A 10ms or less	1A 10ms or less	×	The inrush current value differs. Pay attention to the selection of the load used.
Leakage current at OFF		0.1mA or less	0.1mA or less	○	
Maximum voltage drop at ON		0.9VDC or less (TYP.) 0.5A 1.5VDC or less (MAX.) 0.5A	0.1VDC or less (TYP.) 0.1A 0.2VDC or less (MAX.) 0.1A	○	
Output method		Source type	Source type	○	
Response time	OFF → ON	2ms or less	0.5ms or less	○	
	ON → OFF	2ms or less (resistance load)	1.5ms or less (resistance load)	○	
External power supply	Voltage	21.6 to 26.4VDC	10.2 to 26.4VDC (ripple ratio within 5%)	○	
	Current	10mA (24VDC)	30mA or less (24VDC)	△	The current consumption increases. The current capacity needs to be reconsidered.
Surge suppressor		Zener diode	Zener diode	○	
Common terminal arrangement		16 points/common	16 points/common	○	

○ : Compatible, △ : Partial change required, × : Not compatible

Specifications		AX80Y80C	AJ65SBTB1-16D	AJ65SBTB1-16TE	Compatibility	Precautions for replacement
Number of occupied stations (number of occupied points)		4 stations (4 stations × 8 points)	1 station (1 station × 32 points × 2 modules)		×	The number of occupied points increases. The assignment of the entire system needs to be reconsidered.
Operation indication		ON indication (LED)	ON indication (LED)		○	
External connection method		50-point terminal block (M3.5 × 7 screws) Transmission circuit part included	Transmission/module power supply parts: 7-point terminal block (M3 × 5.2 screws) I/O part: 34-point terminal block (M3 × 5.2 screws)		×	Change in wiring is required.
Applicable wire size		0.75 to 2mm ²	0.3 to 2mm ²		○	
Applicable solderless terminal		R1.25-3.5, R2-3.5 RAV1.25-3.5, RAV2-3.5	RAV1.25-3 (conforming to JIS C 2805) V2-MS3, RAP2-3SL, TGV2-3N		×	Change in wiring is required.
I/O module power supply	Voltage	15.6 to 31.2VDC	20.4 to 26.4VDC (ripple ratio within 5%)		△	The operating voltage range differs.
	Current	82mA (at 24V TYP.)	35mA or less (24VDC when all points are ON)	50mA or less (24VDC when all points are ON)	△	The current consumption increases. The current capacity needs to be reconsidered.
External dimensions		170(H) × 64(W) × 80(D) mm	54(H) × 118(W) × 40(D) mm		×	The overall size differs. Pay attention to the mounting dimensions.
Weight		0.65kg	0.18kg		△	

(12) Specifications comparison between AX80Y80C and AJ65SBTB1-32DTE1

○ : Compatible, △ : Partial change required, × : Not compatible

Specifications		AX80Y80C input specifications	AJ65SBTB1-32DTE1 input specifications	Compatibility	Precautions for replacement
Number of input points		16 points	16 points	○	
Insulation method		Photocoupler	Photocoupler	○	
Rated input voltage		12VDC/24VDC	24VDC	△	12VDC cannot be used.
Rated input current		Approx. 3mA/Approx. 7mA	Approx. 7mA	○	
Operating voltage range		10.2 to 31.2VDC (ripple ratio within 5%)	19.2 to 26.4VDC (ripple ratio within 5%)	△	12VDC cannot be used.
Maximum number of simultaneous input points		60% simultaneously ON (at 26.4VDC)	100%	○	
ON voltage/ON current		8V or more/2mA or more	14V or more/3.5mA or more	△	12VDC cannot be used.
OFF voltage/OFF current		4V or less/1mA or less	6V or less/1.7mA or less	△	12VDC cannot be used.
Input resistance		Approx. 3.3k Ω	Approx. 3.3k Ω	○	
Input method		Positive/negative common shared type (sink/source shared type)	Negative common (Source type)	△	A positive common input method is not supported.
Response time	OFF → ON	10ms or less (at 24VDC)	1.5ms or less (at 24VDC)	○	
	ON → OFF	10ms or less (at 24VDC)	1.5ms or less (at 24VDC)	○	
Common terminal arrangement		16 points/common	32 points/common (terminal block 1-wire type)	△	Input and output shares common.
Specifications		AX80Y80C output specifications	AJ65SBTB1-32DTE1 output specifications	Compatibility	Precautions for replacement
Number of output points		16 points	16 points	○	
Insulation method		Photocoupler	Photocoupler	○	
Rated load voltage		24VDC	24VDC	○	
Operating load voltage range		21.6 to 26.4VDC	19.2 to 26.4VDC (ripple ratio within 5%)	○	
Maximum load current		0.5A/point, 60% simultaneously ON	0.5A/point 3.6A/common	△	The maximum load current per common differs. Pay attention to the operating current of the entire module.
Maximum inrush current		2A 10ms or less	1A 10ms or less	×	The inrush current value differs. Pay attention to the selection of the load used.
Leakage current at OFF		0.1mA or less	0.1mA or less	○	
Maximum voltage drop at ON		0.9VDC or less (TYP.) 0.5A 1.5VDC or less (MAX.) 0.5A	0.5VDC or less (TYP.) 0.5A 0.8VDC or less (MAX.) 0.5A	○	
Output method		Source type	Source type	○	
Response time	OFF → ON	2ms or less	0.5ms or less	○	
	ON → OFF	2ms or less (resistance load)	1.5ms or less (resistance load)	○	
External power supply	Voltage	21.6 to 26.4VDC	19.2 to 26.4VDC (ripple ratio within 5%)	○	
	Current	10mA (24VDC)	10mA or less (TYP.24VDC, per common) External load current not included	○	
Surge suppressor		Zener diode	Zener diode	○	
Common terminal arrangement		16 points/common	32 points/common (terminal block 1-wire type)	△	Input and output shares common.

○ : Compatible, △ : Partial change required, × : Not compatible

Specifications		AX80Y80C	AJ65SBTB1-32DTE1	Compatibility	Precautions for replacement
Number of occupied stations (number of occupied points)		4 stations (4 stations × 8 points)	1 station (1 station × 32 points)	○	
Operation indication		ON indication (LED)	ON indication (LED)	○	
External connection method		50-point terminal block (M3.5 × 7 screws) Transmission circuit part included	Transmission/module power supply parts: 7-point terminal block (M3 × 5.2 screws) I/O part: 34-point terminal block (M3 × 5.2 screws)	×	Change in wiring is required. The number of applicable solderless terminals inserted is within two.
Applicable wire size		0.75 to 2mm ²	0.3 to 2mm ²	○	
Applicable solderless terminal		R1.25-3.5, R2-3.5 RAV1.25-3.5, RAV2-3.5	RAV1.25-3 (conforming to JIS C 2805) V2-MS3, RAP2-3SL, TGV2-3N	×	Change in wiring is required.
I/O module power supply	Voltage	15.6 to 31.2VDC	20.4 to 26.4VDC (ripple ratio within 5%)	△	The operating voltage range differs.
	Current	82mA (at 24V TYP.)	50mA or less (24VDC when all points are ON)	○	
External dimensions		170(H) × 64(W) × 80(D) mm	54(H) × 179(W) × 40(D) mm	×	The overall size differs. Pay attention to the mounting dimensions.
Weight		0.65kg	0.26kg	△	

(13) Specifications comparison between AJ35PTF-28AR and AJ65SBTB2N-16A + AJ65SBTB2N-16R

○ : Compatible, △ : Partial change required, × : Not compatible

Specifications		AJ35PTF-28AR input specifications	AJ65SBTB2N-16A	Compatibility	Precautions for replacement
Number of input points		16 points	16 points	○	
Insulation method		Photocoupler	Photocoupler	○	
Rated input voltage		100-120VAC, 50/60Hz	100-120VAC, 50/60Hz	○	
Rated input current		10mA (100VAC, 60Hz)	Approx. 7mA (100VAC, 60Hz)	△	Rated input current is smaller.*1
Operating voltage range		85 to 132VAC (50/60Hz ± 5%)	85 to 132VAC (50/60Hz ± 3%, distortion rate within 5%)	○	
Maximum number of simultaneous input points		100% simultaneously ON	100% simultaneously ON (at 110VAC) 60% simultaneously ON (at 132VAC)	△	Use within specification range.
Inrush current		Max. 300mA, within 0.3ms (132VAC)	Max. 200mA, within 1ms (132VAC)	○	
ON voltage/ON current		80V or more/6mA or more	80V or more/5mA or more	○	
OFF voltage/OFF current		40V or less/4mA or less	30V or less/1.7mA or less	△	OFF current has been reduced.*1
Input impedance		Approx. 10k Ω (60Hz), Approx. 12k Ω (50Hz)	Approx. 15k Ω (60Hz), Approx. 18k Ω (50Hz)	△	Input impedance has increased.*1
Response time	OFF → ON	15ms or less (6ms TYP.)	20ms or less (100VAC, 60Hz)	○	
	ON → OFF	25ms or less (16ms TYP.)	20ms or less (100VAC, 60Hz)	○	
Common terminal arrangement		16 points/common	16 points/common (2-wire type)	○	

○ : Compatible, △ : Partial change required, × : Not compatible

Specifications		AJ35PTF-28AR output specifications	AJ65SBTB2N-16R	Compatibility	Precautions for replacement
Number of output points		12 points	16 points	○	
Insulation method		Photocoupler	Relay isolation	△	Although the insulation methods differ, the performance of the insulation is the same.
Rated load voltage/current		24VDC 2A (resistance load)/point 240VAC 2A (COS φ = 1)/point 5A/common	24VDC 2A (resistance load)/point 240VAC 2A (COS φ = 1)/point 8A/common	△	Use caution on the common current.
Minimum switching load		5VDC 1mA	5VDC 1mA	○	
Maximum switching voltage		264VAC, 125VDC	264VAC, 125VDC	○	
Response time	OFF → ON	10ms or less	10ms or less	○	
	ON → OFF	12ms or less	12ms or less	○	
Mechanical life		20 million times or more	20 million times or more	○	
Electrical life		Rated switching voltage/current load 200000 times or more 200VAC 1.5A, 240VAC 1A (COS φ = 0.7) 200000 times or more 200VAC 1A, 240VAC 0.5A (COS φ = 0.35) 200000 times or more 24VDC 1A, 100VDC 0.1A (L/R = 7 ms) 200000 times or more	Rated switching voltage/current load 100000 times or more 200VAC 1.5A, 240VAC 1A (COS φ = 0.7) 100000 times or more 200VAC 1A, 240VAC 0.5A (COS φ = 0.35) 100000 times or more 24VDC 1A, 100VDC 0.1A (L/R = 7 ms) 100000 times or more	△	Reduce the exchange intervals of the modules as Mechanical/Electrical Life is cut to about half.
Maximum switching frequency		3600 times/hr	3600 times/hr	○	
External power supply	Voltage	24VDC ± 10% Ripple voltage 4Vp-p or less	None	-	
	Current	110mA (24VDC, all points ON)	None	-	
Surge suppressor		None	None	○	
Common terminal arrangement		8 points/common, 3 points/common, 1-point independent contact	16 points/common (2-wire type)	△	As common terminal arrangement changes from 3 commons to 16 points/common, wiring with a different voltage per common is not possible.

○ : Compatible, △ : Partial change required, × : Not compatible

Specifications		AJ35PTF-28AR	AJ65SBTB2N-16A	AJ65SBTB2N-16R	Compatibility	Precautions for replacement
Number of occupied stations (number of occupied points)		4 stations (4 stations × 8 points)	1 station (1 station × 32 points × 2 modules)		×	The number of occupied points increases. The assignment of the entire system needs to be reconsidered.
Operation indication		ON indication (LED)	ON indication (LED)		○	
External connection method		Transmission/module power supply parts: 8-point terminal block I/O part: 36-point terminal block (M3 × 6 screws)	Transmission/module power supply parts: 7-point terminal block (M3 × 5.2 screws) I/O part: 34-point terminal block (M3 × 5.2 screws)		×	Change in wiring is required.
Applicable wire size		0.75 to 2mm ²	0.3 to 2mm ²		○	
Applicable solderless terminal		R1.25-3, R2-3 RAV1.25-3, RAV2-3	RAV1.25-3 (conforming to JIS C 2805) V2-MS3, RAP2-3SL, TGV2-3N,		△	In some cases, the solderless terminal must be changed.
I/O module power supply	Voltage	15.6 to 31.2VDC	20.4 to 26.4VDC (ripple ratio within 5%)		△	The operating voltage range differs.
	Current	120mA	40mA or less (24VDC when all points are ON)	120mA or less (24VDC when all points are ON)	△	The current consumption increases. The current capacity needs to be reconsidered.
External dimensions		254(H) × 132(W) × 41(D) mm	54(H) × 179(W) × 40(D) mm		×	The overall size differs. Pay attention to the mounting dimensions.
Weight		0.78kg	0.25kg	0.35kg	△	

*1: Confirm the specifications of the sensors or switches to be connected to the AJ65SBTB2N-16A.

(14) Specifications comparison between AJ35PTF-56AR and AJ65SBTB2N-16A+ AJ65SBTB2N-16R

○ : Compatible, △ : Partial change required, × : Not compatible

Specifications	AJ35PTF-56AR input specifications	AJ65SBTB2N-16A	Compatibility	Precautions for replacement
Number of input points	32 points	16 points	×	When seventeen or more points are used, use two AJ65SBTB2N-16A modules.
Insulation method	Photocoupler	Photocoupler	○	
Rated input voltage	100-120VAC, 50/60Hz	100-120VAC, 50/60Hz	○	
Rated input current	10mA (100VAC, 60Hz)	Approx. 7mA (100VAC, 60Hz)	△	Rated input current has been reduced. *1
Operating voltage range	85 to 132VAC (50/60Hz ± 5%)	85 to 132VAC (50/60Hz ± 3%, distortion rate 5% within)	○	
Maximum number of simultaneous input points	100% simultaneously ON	100% simultaneously ON (at 110VAC) 60% simultaneously ON (at 132VAC)	△	Use within specification range.
Inrush current	Max. 300mA, within 0.3ms (132VAC)	Max. 200mA, within 1ms (132VAC)	○	
ON voltage/ON current	80V or more/6mA or more	80V or more/5mA or more	○	
OFF voltage/OFF current	40V or less/4mA or less	30V or less/1.7mA or less	△	OFF current has been reduced. *1
Input impedance	Approx. 10k Ω (60Hz), Approx. 12k Ω (50Hz)	Approx. 15k Ω (60Hz), Approx. 18k Ω (50Hz)	△	Input impedance has increased. *1
Response time	OFF → ON	15ms or less (6ms TYP.)	○	
	ON → OFF	25ms or less (16ms TYP.)	○	
Common terminal arrangement	16 points/common	16 points/common (2-wire type)	○	

○ : Compatible, △ : Partial change required, × : Not compatible

Specifications		AJ35PTF-56AR output specifications	AJ65SBTB2N-16R	Compatibility	Precautions for replacement
Number of output points		24 points	16 points	×	When seventeen or more points are used, use two AJ65SBTB2N-16R modules.
Insulation method		Photocoupler	Relay	△	Although the insulation methods differ, the performance of the insulation is the same.
Rated load voltage/current		24VDC 2A (resistance load)/point 240VAC 2A (COS φ =1)/point 5A/common	24VDC 2A (resistance load)/point 240VAC 2A (COS φ =1)/point 8A/common	△	Use caution on the common current.
Minimum switching load		5VDC 1mA	5VDC 1mA	○	
Maximum switching voltage		264VAC, 125VDC	264VAC, 125VDC	○	
Response time	OFF → ON	10ms or less	10ms or less	○	
	ON → OFF	12ms or less	12ms or less	○	
Mechanical life		20 million times or more	20 million times or more	○	
Electrical life		Rated switching voltage/current load 200,000 times or more 200VAC 1.5A, 240VAC 1A (COS φ =0.7) 200,000 times or more 200VAC 1A, 240VAC 0.5A (COS φ =0.35) 200,000 times or more 24VDC 1A, 100VDC 0.1A (L/R=7ms) 200,000 times or more	Rated switching voltage/current load 100,000 times or more 200VAC 1.5A, 240VAC 1A (COS φ =0.7) 100,000 times or more 200VAC 1A, 240VAC 0.5A (COS φ = 0.35) 100,000 times or more 24VDC 1A, 100VDC 0.1A (L/R=7 ms) 100,000 times or more	△	Reduce the exchange intervals of the modules as Mechanical/ Electrical Life is cut to about half.
Maximum switching frequency		3,600 times/hr	3,600 times/hr	○	
External power supply	Voltage	24VDC ± 10% Ripple voltage 4Vp-p or less	None	-	
	Current	220mA (24VDC, all points ON)	None	-	
Surge suppressor		None	None	○	
Common terminal arrangement		8 points/common	16 points/common (2-wire type)	△	As common terminal arrangement changes from 8 points/common to 16 points/common, wiring with a different voltage per common is not possible.

○ : Compatible, △ : Partial change required, × : Not compatible

Specifications		AJ35PTF-56AR	AJ65SBTB2N-16A	AJ65SBTB2N-16R	Compatibility	Precautions for replacement
Number of occupied stations (number of occupied points)		8 stations (8 stations × 8 points)	1 station (1 station × 32 points × 4 modules)		×	The number of occupied points increases. The assignment of the entire system needs to be reconsidered.
Operation indication		ON indication (LED)	ON indication (LED)		○	
External connection method		Transmission/module power supply parts: 8-point terminal block I/O part: 36-point terminal block (M3 × 6 screws) 2 pieces	Transmission/module power supply parts: 7-point terminal block (M3 × 5.2 screws) I/O part: 34-point terminal block (M3 × 5.2 screws)		×	Change in wiring is required.
Applicable wire size		0.75 to 2mm ²	0.3 to 2mm ²		○	
Applicable solderless terminal		R1.25-3, R2-3 RAV1.25-3, RAV2-3	RAV1.25-3 (conforming to JIS C 2805) V2-MS3, RAP2-3SL, TGV2-3N		△	In some cases, the solderless terminal must be changed.
I/O module power supply	Voltage	15.6 to 31.2VDC	20.4 to 26.4VDC (ripple ratio within 5%)		△	The operating voltage range differs.
	Current	150mA	40mA or less (24VDC when all points are ON)	120mA or less (24VDC when all points are ON)	△	The current consumption increases. The current capacity needs to be reconsidered.
External dimensions		254(H) × 190(W) × 41(D) mm	54(H) × 179(W) × 40(D) mm		×	The overall size differs. Pay attention to the mounting dimensions.
Weight		1.2kg	0.25kg	0.35kg	△	

*1: Confirm the specifications of the sensors or switches to be connected to the AJ65SBTB2N-16A.

(15) Specifications comparison between AJ35PTF-28AS and AJ65SBTB2N-16A + AJ65SBTB2N-16S*1

○ : Compatible, △ : Partial change required, × : Not compatible

Specifications		AJ35PTF-28AS input specifications	AJ65SBTB2N-16A	Compatibility	Precautions for replacement
Number of input points		16 points	16 points	○	
Insulation method		Photocoupler	Photocoupler	○	
Rated input voltage		100-120VAC, 50/60Hz	100-120VAC, 50/60Hz	○	
Rated input current		10mA (100VAC, 60Hz)	Approx. 7mA (100VAC, 60Hz)	△	Rated input current is smaller.*2
Operating voltage range		85 to 132VAC (50/60Hz ± 5%)	85 to 132VAC (50/60Hz ± 3%, distortion rate within 5%)	○	
Maximum number of simultaneous input points		100% simultaneously ON	100% simultaneously ON (at 110VAC) 60% simultaneously ON (at 132VAC)	△	Use within specification range.
Inrush current		Max. 300mA, within 0.3ms (132VAC)	Max. 200mA, within 1ms (132VAC)	○	
ON voltage/ON current		80V or more/6mA or more	80V or more/5mA or more	○	
OFF voltage/OFF current		40V or less/4mA or less	30V or less/1.7mA or less	△	OFF current has been reduced.*2
Input impedance		Approx. 10k Ω (60Hz), Approx. 12k Ω (50Hz)	Approx. 15k Ω (60Hz), Approx. 18k Ω (50Hz)	△	Input impedance has increased.*2
Response time	OFF → ON	15ms or less (6ms TYP.)	20ms or less (100VAC, 60Hz)	○	
	ON → OFF	25ms or less (16ms TYP.)	20ms or less (100VAC, 60Hz)	○	
Common terminal arrangement		16 points/common	16 points/common (2-wire type)	○	

○ : Compatible, △ : Partial change required, × : Not compatible

Specifications		AJ35PTF-28AS output specifications	AJ65SBTB2N-16S	Compatibility	Precautions for replacement
Number of output points		12 points	16 points	○	
Insulation method		Photocoupler	Photocoupler	○	
Rated load voltage		100-240VAC, 40 to 70Hz	100-240VAC, 50/60Hz ± 5%	○	
Maximum load voltage		264VAC	264VAC	○	
Maximum load current		0.6A/point, 2.4A/common	0.6A/point, 4.8A/common	○	
Minimum load voltage/ current		24VAC 100mA, 100VAC 10mA, 240VAC 10mA	50VAC 100mA, 100VAC 10mA, 240VAC 10mA	○	
Maximum inrush current		20A 10ms or less, 8A 100ms or less	25A 10ms or less	○	
Leakage current at OFF		1.5mA (132VAC, 60Hz) 3.0mA (264VAC, 60Hz)	1.5mA (100VAC, 60Hz) 3.0mA (200VAC, 60Hz)	○	
Maximum voltage drop at ON		1.5V or less (0.1 to 0.6A) 1.8V or less (50 to 100mA) 2.0V or less (10 to 50mA)	1.5V or less (at 0.6A)	○	
Response time	OFF → ON	1ms or less	1ms or less	○	
	ON → OFF	0.5Hz + 1ms or less	1/2 cycle + 1ms or less	○	
Surge suppressor		CR absorber (0.022 μ F + 47 Ω)	CR absorber (0.01 μ F + 47 Ω)	○	
Fuse rating		High speed type fuse 3.2A (one fuse /common) HP-32	None	×	The fuse is not built in.*3
Fuse blown indication		Available	None	×	
Common terminal arrangement		8 points/common 4 points/common	16 points/common (2-wire type)	△	As common terminal arrangement changes from 2 commons to 16 points/ common, wiring with a different voltage per common is not possible.

○: Compatible, △: Partial change required, ×: Not compatible

Specifications		AJ35PTF-28AS	AJ65SBTB2N-16A	AJ65SBTB2N-16S	Compatibility	Precautions for replacement
Number of occupied stations (number of occupied points)		4 stations (4 stations × 8 points)	1 station (1 station × 32 points × 2 modules)		×	The number of occupied points increases. The assignment of the entire system needs to be reconsidered.
Operation indication		ON indication (LED)	ON indication (LED)		○	
External connection method		Transmission/module power supply parts: 8-point terminal block I/O part: 36-point terminal block (M3 × 6 screws)	Transmission/module power supply parts: 7-point terminal block (M3 × 5.2 screws) I/O part: 34-point terminal block (M3 × 5.2 screws)		×	Change in wiring is required.
Applicable wire size		0.75 to 2mm ²	0.3 to 2mm ²		○	
Applicable solderless terminal		R1.25-3, R2-3 RAV1.25-3, RAV2-3	RAV1.25-3 (conforming to JIS C 2805) V2-MS3, RAP2-3SL, TGV2-3N,		△	In some cases, the solderless terminal must be changed.
I/O module power supply	Voltage	15.6 to 31.2VDC	20.4 to 26.4VDC (ripple ratio within 5%)		△	The operating voltage range differs.
	Current	140mA	40mA or less (24VDC when all points are ON)	85mA or less (24VDC when all points are ON)	○	
External dimensions		254(H) × 132(W) × 41(D) mm	54(H) × 179(W) × 40(D) mm		×	The overall size differs. Pay attention to the mounting dimensions.
Weight		0.65kg	0.25kg	0.35kg	△	

- *1: Consider the characteristics of the triac and observe the necessary precautions by referring to Section 5.3 (5) before replacing the modules.
- *2: Confirm the specifications of the sensors or switches to be connected to the AJ65SBTB2N-16A.
- *3: Install a fuse for each external terminal point to prevent the burnout of the external devices and modules during load shorts. In addition, when a fuse blown indication is necessary, configure an external circuit.

(16) Specifications comparison between AJ35PTF-56AS and AJ65SBTB2N-16A+ AJ65SBTB2N-16S*1

○ : Compatible, △ : Partial change required, × : Not compatible

Specifications		AJ35PTF-56AS input specifications	AJ65SBTB2N-16A	Compatibility	Precautions for replacement
Number of input points		32 points	16 points	×	When seventeen or more points are used, use two AJ65SBTB2N-16A modules.
Insulation method		Photocoupler	Photocoupler	○	
Rated input voltage		100-120VAC, 50/60Hz	100-120VAC, 50/60Hz	○	
Rated input current		10mA (100VAC, 60Hz)	Approx. 7mA (100VAC, 60Hz)	△	Rated input current has been reduced.*2
Operating voltage range		85 to 132VAC (50/60Hz ± 5%)	85 to 132VAC (50/60Hz ± 3%, distortion rate 5% within)	○	
Maximum number of simultaneous input points		60% simultaneously ON	100% simultaneously ON (at 110VAC) 60% simultaneously ON (at 132VAC)	△	Use within specification range.
Inrush current		Max. 300mA, within 0.3ms (132VAC)	Max. 200mA, within 1ms (132VAC)	○	
ON voltage/ON current		80V or more/6mA or more	80V or more/5mA or more	○	
OFF voltage/OFF current		40V or less/4mA or less	30V or less/1.7mA or less	△	OFF current has been reduced.*2
Input impedance		Approx. 10k Ω (60Hz), Approx. 12k Ω (50Hz)	Approx. 15k Ω (60Hz), Approx. 18k Ω (50Hz)	△	Input impedance has increased.*2
Response time	OFF → ON	15ms or less (6ms TYP.)	20ms or less (100VAC, 60Hz)	○	
	ON → OFF	35ms or less (16ms TYP.)	20ms or less (100VAC, 60Hz)	○	
Common terminal arrangement		16 points/common	16 points/common (2-wire type)	○	
Specifications		AJ35PTF-56AS output specifications	AJ65SBTB2N-16S	Compatibility	Precautions for replacement
Number of output points		24 points	16 points	×	When seventeen or more points are used, use two AJ65SBTB2N-16S modules.
Insulation method		Photocoupler	Photocoupler	○	
Rated load voltage		100 to 240VAC, 40 to 70Hz	100-240VAC, 50/60Hz ± 5%	○	
Maximum load voltage		264VAC	264VAC	○	
Maximum load current		0.6A/point, 2.4A/common	0.6A/point, 4.8A/common	○	
Minimum load voltage/current		24VAC 100mA, 100VAC 10mA, 240VAC 10mA	50VAC 100mA/100VAC 10mA, 240VAC 10mA	○	
Maximum inrush current		20A 10ms or less 8A 100ms or less	25A 10ms or less	○	
Leakage current at OFF		1.5mA (132VAC, 60Hz) 3.0mA (264VAC, 60Hz)	1.5mA (100VAC, 60Hz) 3.0mA (200VAC, 60Hz)	○	
Maximum voltage drop at ON		1.5V or less (0.1 to 0.6A) 1.8V or less (50 to 100mA) 2.0V or less (10 to 50mA)	1.5V or less (at 0.6A)	○	
Response time	OFF → ON	1ms or less	1ms or less	○	
	ON → OFF	0.5Hz+1ms or less	1/2 cycle + 1ms or less	○	
Surge suppressor		CR absorber (0.022 μF+47 Ω)	CR absorber (0.01 μF+47 Ω)	○	
Fuse rating		High speed type fuse 3.2A (one fuse /common) HP-32	None	×	The fuse is not built in.*3
Fuse blown indication		Available	None	×	
Common terminal arrangement		8 points/common	16 points/common (2-wire type)	△	As common terminal arrangement changes from 8 points/common to 16 points/common, wiring with a different voltage per common is not possible.

○ : Compatible, △ : Partial change required, × : Not compatible

Specifications		AJ35PTF-56AS	AJ65SBTB2N-16A	AJ65SBTB2N-16S	Compatibility	Precautions for replacement
Number of occupied stations (number of occupied points)		8 stations (8 stations × 8 points)	1 station (1 station × 32 points × 4 modules)		×	The number of occupied points increases. The assignment of the entire system needs to be reconsidered.
Operation indication		ON indication (LED)	ON indication (LED)		○	
External connection method		Transmission/module power supply parts: 8-point terminal block I/O part: 36-point terminal block (M3 × 6 screws) 2 pieces	Transmission/module power supply parts: 7-point terminal block (M3 × 5.2 screws) I/O part: 34-point terminal block (M3 × 5.2 screws)		×	Change in wiring is required.
Applicable wire size		0.75 to 2mm ²	0.3 to 2mm ²		○	
Applicable solderless terminal		R1.25-3, R2-3 RAV1.25-3, RAV2-3	RAV1.25-3 (conforming to JIS C 2805) V2-MS3, RAP2-3SL, TGV2-3N		△	In some cases, the solderless terminal must be changed.
I/O module power supply	Voltage	15.6 to 31.2VDC	20.4 to 26.4VDC (ripple ratio within 5%)		△	The operating voltage range differs.
	Current	230mA	40mA or less (24VDC when all points are ON)	85mA or less (24VDC when all points are ON)	△	The current consumption increases. The current capacity needs to be reconsidered.
External dimensions		254(H) × 190(W) × 41(D) mm	54(H) × 179(W) × 40(D) mm		×	The overall size differs. Pay attention to the mounting dimensions.
Weight		1.1kg	0.25kg	0.35kg	△	

- *1: Consider the characteristics of the triac and observe the necessary precautions by referring to Section 5.3 (5) before replacing the modules.
- *2: Confirm the specifications of the sensors or switches to be connected to the AJ65SBTB2N-16A.
- *3: Install a fuse for each external terminal point to prevent the burnout of the external devices and modules during load shorts. In addition, when a fuse blown indication is necessary, configure an external circuit.

(17) Specifications comparison between AJ35PTF-28DS and AJ65SBTB1-16D+ AJ65SBTB2N-16S*1

○ : Compatible, △ : Partial change required, × : Not compatible

Specifications		AJ35PTF-28DS input specifications	AJ65SBTB1-16D	Compatibility	Precautions for replacement
Number of input points		16 points	16 points	○	
Insulation method		Photocoupler	Photocoupler	○	
Rated input voltage		12/24VDC	24VDC	△	12VDC cannot be used.
Rated input current		Approx. 3mA/Approx. 7mA	Approx. 7mA	○	
Operating voltage range		10.2 to 31.2VDC (ripple ratio within 5%)	19.2 to 26.4VDC (ripple ratio within 5%)	△	12VDC cannot be used.
Maximum number of simultaneous input points		100% simultaneously ON	100% simultaneously ON	○	
ON voltage/ON current		9.5V or more/2.6mA or more	14V or more/3.5mA or more	△	12VDC cannot be used.
OFF voltage/OFF current		6V or less/1.0mA or less	6V or less/1.7mA or less	△	12VDC cannot be used.
Input resistance		Approx. 3.4k Ω	Approx. 3.3k Ω	○	
Input method		Positive common (sink type)	Positive/negative common shared type (sink/source shared type)	○	
Response time	OFF → ON	10ms or less (6ms TYP.)	1.5ms or less (at 24VDC)	○	
	ON → OFF	10ms or less (7.5ms TYP.)	1.5ms or less (at 24VDC)	○	
Common terminal arrangement		16 points/common	16 points/common	○	
Specifications		AJ35PTF-28DS output specifications	AJ65SBTB2N-16S	Compatibility	Precautions for replacement
Number of output points		12 points	16 points	○	
Insulation method		Photocoupler	Photocoupler	○	
Rated load voltage		100-240VAC, 40 to 70Hz	100-240VAC, 50/60Hz ± 5%	○	
Maximum load voltage		264VAC	264VAC	○	
Maximum load current		0.6A/point, 2.4A/common	0.6A/point, 4.8A/common	○	
Minimum load voltage/current		24VAC 100mA, 100VAC 10mA, 240VAC 10mA	50VAC 100mA, 100VAC 10mA, 240VAC 10mA	○	
Maximum inrush current		20A 10ms or less 8A 100ms or less	25A 10ms or less	○	
Leakage current at OFF		1.5mA (132VAC, 60Hz) 3.0mA (264VAC, 60Hz)	1.5mA (100VAC, 60Hz) 3.0mA (200VAC, 60Hz)	○	
Maximum voltage drop at ON		1.5V or less (0.1 to 0.6A) 1.8V or less (50 to 100mA) 2.0V or less (10 to 50mA)	1.5V or less (at 0.6A)	○	
Response time	OFF → ON	1ms or less	1ms or less	○	
	ON → OFF	0.5Hz+1ms or less	1/2 cycle + 1ms or less	○	
Surge suppressor		CR absorber (0.022 μF+47 Ω)	CR absorber (0.01 μF+47 Ω)	○	
Fuse rating		High speed type fuse 3.2A (one fuse /common) HP-32	None	×	The fuse is not built in.*2
Fuse blown indication		Available	None	×	
Common terminal arrangement		8 points/common 4 points/common	16 points/common (2-wire type)	△	As common terminal arrangement changes from 2 commons to 16 points/ common, wiring with a different voltage per common is not possible.

○ : Compatible, △ : Partial change required, × : Not compatible

Specifications		AJ35PTF-28DS	AJ65SBTB1-16D	AJ65SBTB2N-16S	Compatibility	Precautions for replacement
Number of occupied stations (number of occupied points)		4 stations (4 stations × 8 points)	1 station (1 station × 32 points × 2 modules)		×	The number of occupied points increases. The assignment of the entire system needs to be reconsidered.
Operation indication		ON indication (LED)	ON indication (LED)		○	
External connection method		Transmission/module power supply parts: 8-point terminal block I/O part: 36-point terminal block (M3 × 6 screws)	Transmission/module power supply parts 7-point terminal block (M3 × 5.2 screws) I/O part: 18-point terminal block (M3 × 5.2 screws)	Transmission/module power supply parts 7-point terminal block (M3 × 5.2 screws) I/O part: 34-point terminal block (M3 × 5.2 screws)	×	Change in wiring is required.
Applicable wire size		0.75 to 2mm ²	0.3 to 2mm ²		○	
Applicable solderless terminal		R1.25-3, R2-3 RAV1.25-3, RAV2-3	RAV1.25-3 (conforming to JIS C 2805) V2-MS3, RAP2-3SL, TGV2-3N		△	In some cases, the solderless terminal must be changed.
I/O module power supply]	Voltage	15.6 to 31.2VDC	20.4 to 26.4VDC (ripple ratio within 5%)		△	The operating voltage range differs.
	Current	150mA	35mA or less (24VDC when all points are ON)	85mA or less (24VDC when all points are ON)	○	
External dimensions		254(H) × 132(W) × 41(D) mm	54(H) × 118(W) × 40(D) mm	54(H) × 179(W) × 40(D) mm	×	The overall size differs. Pay attention to the mounting dimensions.
Weight		0.76kg	0.18kg	0.35kg	△	

- *1 Consider the characteristics of the triac and observe the necessary precautions by referring to Section 5.3 (5) before replacing the modules.
- *2 Install a fuse for each external terminal point to prevent the burnout of the external devices and modules during load shorts. In addition, when a fuse blown indication is necessary, configure an external circuit.

(18) Specifications comparison between AJ35PTF-56DS and AJ65SBTB1-32D+ AJ65SBTB2N-16S*1

○ : Compatible, △ : Partial change required, × : Not compatible

Specifications		AJ35PTF-56DS input specifications	AJ65SBTB1-32D	Compatibility	Precautions for replacement
Number of input points		32 points	32 points	○	
Insulation method		Photocoupler	Photocoupler	○	
Rated input voltage		12VDC/24VDC	24VDC	△	12VDC cannot be used.
Rated input current		Approx. 3mA/Approx. 7mA	Approx. 7mA	○	
Operating voltage range		10.2 to 31.2VDC (ripple ratio within 5%)	19.2 to 26.4VDC (ripple ratio within 5%)	△	12VDC cannot be used.
Maximum number of simultaneous input points		60% simultaneously ON	100% simultaneously ON	○	
ON voltage/ON current		9.5V or more/2.6mA or more	14V or more/3.5mA or more	△	12VDC cannot be used.
OFF voltage/OFF current		6V or less/1.0mA or less	6V or less/1.7mA or less	△	12VDC cannot be used.
Input resistance		Approx. 3.4k Ω	Approx. 3.3k Ω	○	
Input method		Positive common (sink type)	Positive/negative common shared type (sink/source shared type)	○	
Response time	OFF → ON	10ms or less (6ms TYP.)	1.5ms or less (at 24VDC)	○	
	ON → OFF	10ms or less (7.5ms TYP.)	1.5ms or less (at 24VDC)	○	
Common terminal arrangement		16 points/common	32 points/common	○	
Specifications		AJ35PTF-56DS output specifications	AJ65SBTB2N-16S	Compatibility	Precautions for replacement
Number of output points		24 points	16 points	×	When seventeen or more points are used, use two AJ65SBTB2N-16S modules.
Insulation method		Photocoupler	Photocoupler	○	
Rated load voltage		100-240VAC, 40 to 70Hz	100-240VAC, 50/60Hz ± 5%	○	
Maximum load voltage		264VAC	264VAC	○	
Maximum load current		0.6A/point, 2.4A/common	0.6A/point, 4.8A/common	○	
Minimum load voltage/ current		24VAC 100mA, 100VAC 10mA, 240VAC 10mA	50VAC 100mA, 100VAC 10mA, 240VAC 10mA	○	
Maximum inrush current		20A 10ms or less, 8A 100ms or less	25A 10ms or less	○	
Leakage current at OFF		1.5mA (132VAC, 60Hz) 3.0mA (264VAC, 60Hz)	1.5mA (100VAC, 60Hz) 3.0mA (200VAC, 60Hz)	○	
Maximum voltage drop at ON		1.5V or less (0.1 to 0.6A) 1.8V or less (50 to 100mA) 2.0V or less (10 to 50mA)	1.5V or less (at 0.6A)	○	
Response time	OFF → ON	1ms or less	1ms or less	○	
	ON → OFF	0.5Hz+1ms or less	1/2 cycle + 1ms or less	○	
Surge suppressor		CR absorber (0.022 μF+47 Ω)	CR absorber (0.01 μF+47 Ω)	○	
Fuse rating		High speed type fuse 3.2A (one fuse /common) HP-32	None	×	The fuse is not built in.*2
Fuse blown indication		Available	None	×	
Common terminal arrangement		8 points/common	16 points/common (2-wire type)	△	As common terminal arrangement changes from 8 points/common to 16 points/common, wiring with a different voltage per common is not possible.

○ : Compatible, △ : Partial change required, × : Not compatible

Specifications		AJ35PTF-56DS	AJ65SBTB1-32D	AJ65SBTB2N-16S	Compatibility	Precautions for replacement
Number of occupied stations (number of occupied points)		8 stations (8 stations × 8 points)	1 station (1 station × 32 points × 3 modules)		×	The number of occupied points increases. The assignment of the entire system needs to be reconsidered.
Operation indication		ON indication (LED)	ON indication (LED)		○	
External connection method		Transmission/module power supply parts: 8-point terminal block I/O part: 36-point terminal block (M3 × 6 screws) 2 pieces	Transmission/module power supply parts: 7-point terminal block (M3 × 5.2 screws) I/O part: 34-point terminal block (M3 × 5.2 screws)		×	Change in wiring is required.
Applicable wire size		0.75 to 2mm ²	0.3 to 2mm ²		○	
Applicable solderless terminal		R1.25-3, R2-3 RAV1.25-3, RAV2-3	RAV1.25-3 (conforming to JIS C 2805) V2-MS3, RAP2-3SL, TGV2-3N		△	In some cases, the solderless terminal must be changed.
I/O module power supply	Voltage	15.6 to 31.2VDC	20.4 to 26.4VDC (ripple ratio within 5%)		△	The operating voltage range differs.
	Current	230mA	45mA or less (24VDC when all points are ON)	85mA or less (24VDC when all points are ON)	△	The current consumption increases. The current capacity needs to be reconsidered.
External dimensions		254(H) × 190(W) × 41(D) mm	54(H) × 179(W) × 40(D) mm		×	The overall size differs. Pay attention to the mounting dimensions.
Weight		1.16kg	0.25kg	0.35kg	△	

- *1 Consider the characteristics of the triac and observe the necessary precautions by referring to Section 5.3 (5) before replacing the modules.
- *2 Install a fuse for each external terminal point to prevent the burnout of the external devices and modules during load shorts. In addition, when a fuse blown indication is necessary, configure an external circuit.

(19) Specifications comparison between AJ35PTF-28DR and AJ65SBTB1-16D + AJ65SBTB2N-16R

○ : Compatible, △ : Partial change required, × : Not compatible

Specifications		AJ35PTF-28DR input specifications	AJ65SBTB1-16D	Compatibility	Precautions for replacement
Number of input points		16 points	16 points	○	
Insulation method		Photocoupler	Photocoupler	○	
Rated input voltage		12/24VDC	24VDC	△	12VDC cannot be used.
Rated input current		Approx. 3mA/Approx. 7mA	Approx. 7mA	○	
Operating voltage range		10.2 to 31.2VDC (ripple ratio within 5%)	19.2 to 26.4VDC (ripple ratio within 5%)	△	12VDC cannot be used.
Maximum number of simultaneous input points		100% simultaneously ON	100% simultaneously ON	○	
ON voltage/ON current		9.5V or more/2.6mA or more	14V or more/3.5mA or more	△	12VDC cannot be used.
OFF voltage/OFF current		6V or less/1.0mA or less	6V or less/1.7mA or less	△	12VDC cannot be used.
Input resistance		Approx. 3.4k Ω	Approx. 3.3k Ω	○	
Input method		Positive common (sink type)	Positive/negative common shared type (sink/source shared type)	○	
Response time	OFF → ON	10ms or less (6ms TYP.)	1.5ms or less (at 24VDC)	○	
	ON → OFF	10ms or less (7.5ms TYP.)	1.5ms or less (at 24VDC)	○	
Common terminal arrangement		16 points/common	16 points/common	○	

○ : Compatible, △ : Partial change required, × : Not compatible

Specifications		AJ35PTF-28DR output specifications	AJ65SBTB2N-16R	Compatibility	Precautions for replacement
Number of output points		12 points	16 points	○	
Insulation method		Photocoupler	Relay isolation	△	Although the insulation methods differ, the performance of the insulation is the same.
Rated load voltage/current		24VDC 2A (resistance load)/point 240VAC 2A (COS φ = 1)/point 5A/common	24VDC 2A (resistance load)/point 240VAC 2A (COS φ = 1)/point 8A/common	△	The maximum load current per common differs. Pay attention to the operating current of the entire module.
Minimum switching load		5VDC 1mA	5VDC 1mA	○	
Maximum switching voltage		264VAC, 125VDC	264VAC, 125VDC	○	
Response time	OFF → ON	10ms or less	10ms or less	○	
	ON → OFF	12ms or less	12ms or less	○	
Mechanical life		20 million times or more	20 million times or more	○	
Electrical life		Rated switching voltage/current load 200000 times or more 200VAC 1.5A, 240VAC 1A (COS φ = 0.7) 200000 times or more 200VAC 1A, 240VAC 0.5A (COS φ = 0.35) 200000 times or more 24VDC 1A, 100VDC 0.1A (L/R = 7 ms) 200000 times or more	Rated switching voltage/current load 100000 times or more 200VAC 1.5A, 240VAC 1A (COS φ = 0.7) 100000 times or more 200VAC 1A, 240VAC 0.5A (COS φ = 0.35) 100000 times or more 24VDC 1A, 100VDC 0.1A (L/R = 7 ms) 100000 times or more	△	Reduce the exchange intervals of the modules as Mechanical/Electrical Life is cut to about half.
Maximum switching frequency		3600 times/hr	3600 times/hr	○	
External power supply	Voltage	24VDC ± 10% Ripple voltage 4Vp-p or less	None	-	
	Current	110mA (24VDC, all points ON)	None	-	
Surge suppressor		None	None	○	
Common terminal arrangement		8 points/common, 3 points/common, 1-point independent contact	16 points/common (2-wire type)	△	As common terminal arrangement changes from 3 commons to 16 points/common, wiring with a different voltage per common is not possible.

○ : Compatible, △ : Partial change required, × : Not compatible

Specifications		AJ35PTF-28DR	AJ65SBTB1-16D	AJ65SBTB2N-16R	Compatibility	Precautions for replacement
Number of occupied stations (number of occupied points)		4 stations (4 stations × 8 points)	1 station (1 station × 32 points × 2 modules)		×	The number of occupied points increases. The assignment of the entire system needs to be reconsidered.
Operation indication		ON indication (LED)	ON indication (LED)		○	
External connection method		Transmission/module power supply parts: 8-point terminal block I/O part: 36-point terminal block (M3 × 6 screws)	Transmission/module power supply parts: 7-point terminal block (M3 × 5.2 screws) I/O part: 34-point terminal block (M3 × 5.2 screws)		×	Change in wiring is required.
Applicable wire size		0.75 to 2mm ²	0.3 to 2mm ²		○	
Applicable solderless terminal		R1.25-3, R2-3 RAV1.25-3, RAV2-3	RAV1.25-3 (conforming to JIS C 2805) V2-MS3, RAP2-3SL, TGV2-3N,		△	In some cases, the solderless terminal must be changed.
I/O module power supply	Voltage	15.6 to 31.2VDC	20.4 to 26.4VDC (ripple ratio within 5%)		△	The operating voltage range differs.
	Current	120mA	35mA or less (24VDC when all points are ON)	120mA or less (24VDC when all points are ON)	△	The current consumption increases. The current capacity needs to be reconsidered.
External dimensions		254(H) × 132(W) × 41(D) mm	54(H) × 118(W) × 40(D) mm	54(H) × 179(W) × 40(D) mm	×	The overall size differs. Pay attention to the mounting dimensions.
Weight		0.76kg	0.18kg	0.35kg	△	

(20) Specifications comparison between AJ35PTF-56DR and AJ65SBTB1-32D+ AJ65SBTB2N-16R

○ : Compatible, △ : Partial change required, × : Not compatible

Specifications		AJ35PTF-56DR input specifications	AJ65SBTB1-32D	Compatibility	Precautions for replacement
Number of input points		32 points	32 points	○	
Insulation method		Photocoupler	Photocoupler	○	
Rated input voltage		12/24VDC	24VDC	△	12VDC cannot be used.
Rated input current		Approx. 3mA/Approx. 7mA	Approx. 7mA	○	
Operating voltage range		10.2 to 31.2VDC (ripple ratio within 5%)	19.2 to 26.4VDC (ripple ratio within 5%)	△	12VDC cannot be used.
Maximum number of simultaneous input points		60% simultaneously ON	100% simultaneously ON	○	
ON voltage/ON current		9.5V or more/2.6mA or more	14V or more/3.5mA or more	△	12VDC cannot be used.
OFF voltage/OFF current		6V or less/1.0mA or less	6V or less/1.7mA or less	△	12VDC cannot be used.
Input resistance		Approx. 3.4k Ω	Approx. 3.3k Ω	○	
Input method		Positive common (sink type)	Positive/negative common shared type (sink/source shared type)	○	
Response time	OFF → ON	10ms or less (6ms TYP.)	1.5ms or less (at 24VDC)	○	
	ON → OFF	10ms or less (7.5ms TYP.)	1.5ms or less (at 24VDC)	○	
Common terminal arrangement		16 points/common	32 points/common	△	As common terminal arrangement changes from 16 points/common to 32 points/common, wiring with a different voltage per common is not possible.

○ : Compatible, △ : Partial change required, × : Not compatible

Specifications		AJ35PTF-56DR output specifications	AJ65SBTB2N-16R	Compatibility	Precautions for replacement
Number of output points		24 points	16 points	×	When seventeen or more points are used, use two AJ65SBTB2N-16R modules.
Insulation method		Photocoupler	Relay	△	Although the insulation methods differ, the performance of the insulation is the same.
Rated load voltage/current		24VDC 2A (resistance load)/point 240VAC 2A (COS ϕ =1)/point 5A/common	24VDC 2A (resistance load)/point 240VAC 2A (COS ϕ =1)/point 8A/common	△	The maximum load current per common differs. Pay attention to the operating current of the entire module.
Minimum switching load		5VDC 1mA	5VDC 1mA	○	
Maximum switching voltage		264VAC, 125VDC	264VAC, 125VDC	○	
Response time	OFF → ON	10ms or less	10ms or less	○	
	ON → OFF	12ms or less	12ms or less	○	
Mechanical life		20 million times or more	20 million times or more	○	
Electrical life		Rated switching voltage/current load 200,000 times or more 200VAC 1.5A, 240VAC 1A (COS ϕ =0.7) 200,000 times or more 200VAC 1A, 240VAC 0.5A (COS ϕ =0.35) 200,000 times or more 24VDC 1A, 100VDC 0.1A (L/R=7ms) 200,000 times or more	Rated switching voltage/current load 100,000 times or more 200VAC 1.5A, 240VAC 1A (COS ϕ =0.7) 100,000 times or more 200VAC 1A, 240VAC 0.5A (COS ϕ = 0.35) 100,000 times or more 24VDC 1A, 100VDC 0.1A (L/R=7 ms) 100,000 times or more	△	Reduce the exchange intervals of the modules as Mechanical/ Electrical Life is cut to about half.
Maximum switching frequency		3,600 times/hr	3,600 times/hr	○	
External power supply	Voltage	24VDC \pm 10% Ripple voltage 4Vp-p or less	None	-	
	Current	220mA (24VDC, all points ON)	None	-	
Surge suppressor		None	None	○	
Common terminal arrangement		8 points/common	16 points/common (2-wire type)	△	As common terminal arrangement changes from 8 points/common to 16 points/common, wiring with a different voltage per common is not possible.

○ : Compatible, △ : Partial change required, × : Not compatible

Specifications		AJ35PTF-56DR	AJ65SBTB1-32D	AJ65SBTB2N-16R	Compatibility	Precautions for replacement
Number of occupied stations (number of occupied points)		8 stations (8 stations × 8 points)	1 station (1 station × 32 points × 3 modules)		×	The number of occupied points increases. The assignment of the entire system needs to be reconsidered.
Operation indication		ON indication (LED)	ON indication (LED)		○	
External connection method		Transmission/module power supply parts: 8-point terminal block I/O part: 36-point terminal block (M3 × 6 screws) 2 pieces	Transmission/module power supply parts: 7-point terminal block (M3 × 5.2 screws) I/O part: 34-point terminal block (M3 × 5.2 screws)		×	Change in wiring is required.
Applicable wire size		0.75 to 2mm ²	0.3 to 2mm ²		○	
Applicable solderless terminal		R1.25-3, R2-3 RAV1.25-3, RAV2-3	RAV1.25-3 (conforming to JIS C 2805) V2-MS3, RAP2-3SL, TGV2-3N		△	In some cases, the solderless terminal must be changed.
I/O module power supply	Voltage	15.6 to 31.2VDC	20.4 to 26.4VDC (ripple ratio within 5%)		△	The operating voltage range differs.
	Current	150mA	45mA or less (24VDC when all points are ON)	120mA or less (24VDC when all points are ON)	△	The current consumption increases. The current capacity needs to be reconsidered.
External dimensions		254(H) × 190(W) × 41(D) mm	54(H) × 179(W) × 40(D) mm		×	The overall size differs. Pay attention to the mounting dimensions.
Weight		1.16kg	0.25kg	0.35kg	△	

(21) Specifications comparison between AJ35PTF-28DT and AJ65SBTB1-32DT2

○ : Compatible, △ : Partial change required, × : Not compatible

Specifications		AJ35PTF-28DT input specifications	AJ65SBTB1-32DT2 input specifications	Compatibility	Precautions for replacement
Number of input points		16 points	16 points	○	
Insulation method		Photocoupler	Photocoupler	○	
Rated input voltage		12/24VDC	24VDC	△	12VDC cannot be used.
Rated input current		3mA/7mA	Approx. 7mA	○	
Operating voltage range		10.2 to 31.2VDC (ripple ratio within 5%)	19.2 to 26.4VDC (ripple ratio within 5%)	△	12VDC cannot be used.
Maximum number of simultaneous input points		100% simultaneously ON	100% simultaneously ON	○	
ON voltage/ON current		9.5V or more/2.6mA or more	14VDC or more/ 3.5mA or more	△	12VDC cannot be used.
OFF voltage/OFF current		6V or less/1.0mA or less	6VDC or less/1.7mA or less	△	12VDC cannot be used.
Input resistance		Approx. 3.4k Ω	Approx. 3.3k Ω	○	
Input method		Positive common (sink type)	Positive common (sink type)	○	
Response time	OFF → ON	10ms or less (6ms TYP.)	1.5ms or less (at 24VDC)	○	
	ON → OFF	10ms or less (7.5ms TYP.)	1.5ms or less (at 24VDC)	○	
Common terminal arrangement		16 points/common	32 points/common (Common to input/output)	△	Use the same power supply for the input and output sides.
Specifications		AJ35PTF-28DT output specifications	AJ65SBTB1-32DT2 output specifications	Compatibility	Precautions for replacement
Number of output points		12 points	16 points	○	
Insulation method		Photocoupler	Photocoupler	○	
Rated load voltage		12/24VDC	24VDC	△	12VDC cannot be used.
Operating load voltage range		10.2 to 31.2VDC	19.2 to 26.4VDC (ripple ratio within 5%)	△	12VDC cannot be used.
Maximum load current		0.5A/point, 3.2A/common	0.5A/point, 3.6A/common	○	
Maximum inrush current		4.0A 10ms or less	1.0A 10ms or less	△	The inrush current value differs. Pay attention to the selection of the load used.
Leakage current at OFF		0.1mA or less	0.1mA or less	○	
Maximum voltage drop at ON		0.9VDC or less (TYP.) 0.5A 1.5VDC or less (MAX.) 0.5A	0.3VDC or less (TYP.) 0.5A, 0.6VDC or less (MAX.) 0.5A	○	
Output method		Sink type	Sink type	○	
Response time	OFF → ON	2ms or less	0.5ms or less	○	
	ON → OFF	2ms or less (resistance load)	1.5ms or less (resistance load)	○	
External power supply	Voltage	10.2 to 31.2VDC (ripple ratio within 5%)	19.2 to 26.4VDC (ripple ratio within 5%)	△	The operating voltage range differs.
	Current	23mA (24VDC TYP./common)	30mA or less (24VDC, when all points are ON) External load current not included	△	The current consumption increases. The current capacity needs to be reconsidered.
Surge suppressor		Varistor (52 to 62V)	Zener diode	○	
Common terminal arrangement		8 points/common, 4 points/common	32 points/common (Common to input/output)	△	Use the same power supply for the input and output sides.

○: Compatible, △: Partial change required, ×: Not compatible

Specifications		AJ35PTF-28DT	AJ65SBTB1-32DT2	Compatibility	Precautions for replacement
Number of occupied stations (number of occupied points)		4 stations (4 stations × 8 points)	1 station (1 station × 32 points)	○	
Operation indication		ON indication (LED)	ON indication (LED)	○	
External connection method		Transmission/module power supply parts: 8-point terminal block I/O part: 36-point terminal block (M3 × 6 screws)	Transmission/module power supply parts: 7-point terminal block (M3 × 5.2 screws) I/O part: 34-point terminal block (M3 × 5.2 screws)	×	Change in wiring is required.
Applicable wire size		0.75 to 2mm ²	0.3 to 2mm ²	○	
Applicable solderless terminal		R1.25-3, R2-3 RAV1.25-3, RAV2-3	RAV1.25-3 (conforming to JIS C 2805) V2-MS3, RAP2-3SL, TGV2-3N,	△	In some cases, the solderless terminal must be changed.
I/O module power supply	Voltage	15.6 to 31.2VDC	20.4 to 26.4VDC (ripple ratio within 5%)	△	The operating voltage range differs.
	Current	110mA or less	60mA or less (24VDC when all points are ON)	○	
External dimensions		254(H) × 132(W) × 41(D) mm	54(H) × 179(W) × 40(D) mm	×	The overall size differs. Pay attention to the mounting dimensions.
Weight		0.65kg	0.25kg	△	

*1: Confirm the specifications of the sensors or switches to be connected to the AJ65SBTB1-32DT2.

(22) Specifications comparison between AJ35PTF-56DT and AJ65SBTB1-32D+ AJ65SBTB1-32T1

○ : Compatible, △ : Partial change required, × : Not compatible

Specifications		AJ35PTF-56DT input specifications	AJ65SBTB1-32D	Compatibility	Precautions for replacement
Number of input points		32 points	32 points	○	
Insulation method		Photocoupler	Photocoupler	○	
Rated input voltage		12/24VDC	24VDC	△	12VDC cannot be used.
Rated input current		Approx. 3mA/Approx. 7mA	Approx. 7mA	○	
Operating voltage range		10.2 to 31.2VDC (ripple ratio within 5%)	19.2 to 26.4VDC (ripple ratio within 5%)	△	12VDC cannot be used.
Maximum number of simultaneous input points		60% simultaneously ON	100% simultaneously ON	○	
ON voltage/ON current		9.5V or more/2.6mA or more	14V or more/3.5mA or more	△	12VDC cannot be used.
OFF voltage/OFF current		6V or less/1.0mA or less	6V or less/1.7mA or less	△	12VDC cannot be used.
Input resistance		Approx. 3.4k Ω	Approx. 3.3k Ω	○	
Input method		Positive common (sink type)	Positive/negative common shared type (sink/source shared type)	○	
Response time	OFF → ON	10ms or less (6ms TYP.)	1.5ms or less (at 24VDC)	○	
	ON → OFF	10ms or less (7.5ms TYP.)	1.5ms or less (at 24VDC)	○	
Common terminal arrangement		16 points/common	32 points/common	△	As common terminal arrangement changes from 16 points/common to 32 points/common, wiring with a different voltage per common is not possible.
Specifications		AJ35PTF-56DT output specifications	AJ65SBTB1-32T1	Compatibility	Precautions for replacement
Number of output points		24 points	32 points	○	
Insulation method		Photocoupler	Photocoupler	○	
Rated load voltage		12VDC/24VDC	12VDC/24VDC	○	
Operating load voltage range		10.2 to 31.2VDC	10.2 to 26.4VDC (ripple ratio within 5%)	△	Voltages exceeding 26.4VDC cannot be applied.
Maximum load current		0.5A/point, 3.2A/common	0.5A/point, 4.8A/common	△	The maximum load current per common differs. Pay attention to the operating current of the entire module.
Maximum inrush current		4.0A 10ms or less	1.0A 10ms or less	△	The inrush current value differs. Pay attention to the selection of the load used.
Leakage current at OFF		0.1mA or less	0.1mA or less	○	
Maximum voltage drop at ON		0.9VDC or less (TYP.) 0.5A 1.5VDC or less (MAX.) 0.5A	0.3VDC or less (TYP.) 0.5A 0.6VDC or less (MAX.) 0.5A	○	
Output method		sink type	sink type	○	
Response time	OFF → ON	2.0ms or less	0.5ms or less	○	
	ON → OFF	2.0ms or less (resistance load)	1.5ms or less (resistance load)	○	
External power supply	Voltage	10.2 to 31.2VDC (ripple ratio within 5%)	10.2 to 26.4VDC (ripple ratio within 5%)	△	Voltages exceeding 26.4VDC cannot be applied.
	Current	23mA (24VDC TYP./common)	50mA or less (24VDC)	△	The current consumption increases. The current capacity needs to be reconsidered.
Surge suppressor		Varistor (52 to 62V)	Zener diode	○	
Common terminal arrangement		8 points/common	32 points/common	△	As common terminal arrangement changes from 16 points/common to 32 points/common, wiring with a different voltage per common is not possible.

○ : Compatible, △ : Partial change required, × : Not compatible

Specifications		AJ35PTF-56DT	AJ65SBTB1-32D	AJ65SBTB1-32T1	Compatibility	Precautions for replacement
Number of occupied stations (number of occupied points)		8 stations (8 stations × 8 points)	1 station (1 station × 32 points × 2 modules)		×	The number of occupied points increases. The assignment of the entire system needs to be reconsidered.
Operation indication		ON indication (LED)	ON indication (LED)		○	
External connection method		Transmission/module power supply parts: 8-point terminal block I/O part: 36-point terminal block (M3 × 6 screws) 2 pieces	Transmission/module power supply parts: 7-point terminal block (M3 × 5.2 screws) I/O part: 34-point terminal block (M3 × 5.2 screws)		×	Change in wiring is required.
Applicable wire size		0.75 to 2mm ²	0.3 to 2mm ²		○	
Applicable solderless terminal		R1.25-3, R2-3 RAV1.25-3, RAV2-3	RAV1.25-3 (conforming to JIS C 2805) V2-MS3, RAP2-3SL, TGV2-3N		△	In some cases, the solderless terminal must be changed.
I/O module power supply	Voltage	15.6 to 31.2VDC	20.4 to 26.4VDC (ripple ratio within 5%)		△	The operating voltage range differs.
	Current	160mA	45mA or less (24VDC when all points are ON)	65mA or less (24VDC when all points are ON)	○	
External dimensions		254(H) × 190(W) × 41(D) mm	54(H) × 179(W) × 40(D) mm		×	The overall size differs. Pay attention to the mounting dimensions.
Weight		1.09kg	0.25kg	0.25kg	△	

(23) Specifications comparison between AJ35TB1-16AR and AJ65SBTB2N-8A+ AJ65SBTB2N-8R

○ : Compatible, △ : Partial change required, × : Not compatible

Specifications		AJ35TB1-16AR input specifications	AJ65SBTB2N-8A	Compatibility	Precautions for replacement
Number of input points		8 points	8 points	○	
Insulation method		Photocoupler	Photocoupler	○	
Rated input voltage		100-120VAC, 50/60Hz	100-120VAC, 50/60Hz	○	
Rated input current		Approx. 6mA (100VAC, 60Hz)	Approx. 7mA (100VAC, 60Hz)	○	
Operating voltage range		85 to 132VAC (50/60Hz ± 5%)	85 to 132VAC (50/60Hz ± 3%, distortion rate 5% within)	○	
Maximum number of simultaneous input points		100% simultaneously ON	100% simultaneously ON (at 110VAC), 60% simultaneously ON (at 132VAC)	△	Use within specification range.
Inrush current		—	Max. 200mA, within 1ms (132VAC)	○	
ON voltage/ON current		80V or more/5mA or more	80V or more/5mA or more	○	
OFF voltage/OFF current		30V or less/1mA or less	30V or less/1.7mA or less	○	
Input impedance		Approx. 18k Ω (60Hz), Approx. 21k Ω (50Hz)	Approx. 15k Ω (60Hz), Approx. 18k Ω (50Hz)	○	
Response time	OFF → ON	15ms or less (100VAC, 60Hz)	20ms or less (100VAC, 60Hz)	○	
	ON → OFF	30ms or less (100VAC, 60Hz)	20ms or less (100VAC, 60Hz)	○	
Common terminal arrangement		8 points/common	8 points/common (2-wire type)	○	
Specifications		AJ35TB1-16AR output specifications	AJ65SBTB2N-8R	Compatibility	Precautions for replacement
Number of output points		8 points	8 points	○	
Insulation method		Photocoupler	Relay isolation	△	Although the insulation methods differ, the performance of the insulation is the same.
Rated load voltage/current		24VDC 2A (resistance load)/point 240VAC 2A (COS φ = 1)/point 5A/common	24VDC 2A (resistance load)/point 240VAC 2A (COS φ = 1)/point 4A/common	△	The maximum load current per common differs. Pay attention to the operating current of the entire module.
Minimum switching load		5VDC 1mA	5VDC 1mA	○	
Maximum switching voltage		250VAC, 110VDC	264VAC, 125VDC	○	
Response time	OFF → ON	10ms or less	10ms or less	○	
	ON → OFF	12ms or less	12ms or less	○	
Mechanical life		20 million times or more	20 million times or more	○	
Electrical life		Rated switching voltage/current load 100,000 times or more 200VAC 1.5A, 240VAC 1A (COS φ = 0.7) 100,000 times or more 200VAC 1A, 240VAC 0.5A (COS φ = 0.35) 100,000 times or more 24VDC 1A, 100VDC 0.1A (L/R=7 ms) 100,000 times or more	Rated switching voltage/current load 100,000 times or more 200VAC 1.5A, 240VAC 1A (COS φ = 0.7) 100,000 times or more 200VAC 1A, 240VAC 0.5A (COS φ = 0.35) 100,000 times or more 24VDC 1A, 100VDC 0.1A (L/R=7 ms) 100,000 times or more	○	
Maximum switching frequency		3,600 times/hr	3,600 times/hr	○	
External power supply	Voltage	24VDC ± 10% Ripple voltage 4Vp-p or less	None	—	
	Current	45mA (24VDC, all points ON)	None	—	
Surge suppressor		None	None	○	
Common terminal arrangement		8 points/common	8 points/common (2-wire type)	○	

○ : Compatible, △ : Partial change required, × : Not compatible

Specifications		AJ35TB1-16AR	AJ65SBTB2N-8A	AJ65SBTB2N-8R	Compatibility	Precautions for replacement
Number of occupied stations (number of occupied points)		2 stations (2 stations × 8 points)	1 station (1 station × 32 points × 2 modules)		×	The number of occupied points increases. The assignment of the entire system needs to be reconsidered.
Operation indication		ON indication (LED)	ON indication (LED)		○	
External connection method		34-point terminal block (M3 screw) Transmission circuit part included	Transmission/module power supply parts: 7-point terminal block (M3 × 5.2 screws) I/O part: 18-point terminal block (M3 × 5.2 screws)		×	Change in wiring is required.
Applicable wire size		0.75 to 2mm ²	0.3 to 2mm ²		○	
Applicable solderless terminal		R1.25-3, R2-3 RAV1.25-3, RAV2-3	RAV1.25-3 (conforming to JIS C 2805) V2-MS3, RAP2-3SL, TGV2-3N		△	In some cases, the solderless terminal must be changed.
I/O module power supply	Voltage	15.6 to 31.2VDC (peak voltage 31.2VDC)	20.4 to 26.4VDC (ripple ratio within 5%)		△	The operating voltage range differs.
	Current	62mA (at 24V)	35mA or less (24VDC when all points are ON)	85mA or less (24VDC when all points are ON)	△	The current consumption increases. The current capacity needs to be reconsidered.
External dimensions		55(H) × 166(W) × 50(D) mm	54(H) × 118(W) × 40(D) mm		×	The overall size differs. Pay attention to the mounting dimensions.
Weight		0.35kg	0.20kg	0.25kg	△	

(24) Specifications comparison between AJ35TB1-16DR and AJ65SBTB1-8D+ AJ65SBTB2N-8R

○ : Compatible, △ : Partial change required, × : Not compatible

Specifications		AJ35TB1-16DR input specifications	AJ65SBTB1-8D	Compatibility	Precautions for replacement
Number of input points		8 points	8 points	○	
Insulation method		Photocoupler	Photocoupler	○	
Rated input voltage		24VDC	24VDC	○	
Rated input current		Approx. 7mA	Approx. 7mA	○	
Operating voltage range		19.2 to 26.4VDC (ripple ratio within 5%)	19.2 to 26.4VDC (ripple ratio within 5%)	○	
Maximum number of simultaneous input points		100% simultaneously ON	100% simultaneously ON	○	
ON voltage/ON current		14V or more/3.5mA or more	14V or more/3.5mA or more	○	
OFF voltage/OFF current		6V or less/1.7mA or less	6V or less/1.7mA or less	○	
Input resistance		Approx. 3.3k Ω	Approx. 3.3k Ω	○	
Input method		Positive/negative common shared type (sink/source shared type)	Positive/negative common shared type (sink/source shared type)	○	
Response time	OFF → ON	10ms or less (at 24VDC)	1.5ms or less (at 24VDC)	○	
	ON → OFF	10ms or less (at 24VDC)	1.5ms or less (at 24VDC)	○	
Common terminal arrangement		8 points/common	8 points/common	○	
Specifications		AJ35TB1-16DR output specifications	AJ65SBTB2N-8R	Compatibility	Precautions for replacement
Number of output points		8 points	8 points	○	
Insulation method		Photocoupler	Relay	△	Although the insulation methods differ, the performance of the insulation is the same.
Rated load voltage/current		24VDC 2A (resistance load)/point 240VAC 2A (COS φ =1)/point 5A/common	24VDC 2A (resistance load)/point 240VAC 2A (COS φ =1)/point 4A/common	△	The maximum load current per common differs. Pay attention to the operating current of the entire module.
Minimum switching load		5VDC 1mA	5VDC 1mA	○	
Maximum switching voltage		250VAC, 110VDC	264VAC, 125VDC	○	
Response time	OFF → ON	10ms or less	10ms or less	○	
	ON → OFF	12ms or less	12ms or less	○	
Mechanical life		20 million times or more	20 million times or more	○	
Electrical life		Rated switching voltage/current load 100,000 times or more 200VAC 1.5A, 240VAC 1A (COS φ =0.7) 100,000 times or more 200VAC 1A, 240VAC 0.5A (COS φ = 0.35) 100,000 times or more 24VDC 1A, 100VDC 0.1A (L/R=7 ms) 100,000 times or more	Rated switching voltage/current load 100,000 times or more 200VAC 1.5A, 240VAC 1A (COS φ =0.7) 100,000 times or more 200VAC 1A, 240VAC 0.5A (COS φ = 0.35) 100,000 times or more 24VDC 1A, 100VDC 0.1A (L/R=7 ms) 100,000 times or more	○	
Maximum switching frequency		3,600 times/hr	3,600 times/hr	○	
External power supply	Voltage	24VDC ± 10% Ripple voltage 4Vp-p or less	None	-	
	Current	45mA (24VDC, all points ON)	None	-	
Surge suppressor		None	None	○	
Common terminal arrangement		8 points/common	8 points/common (2-wire type)	○	

○: Compatible, △: Partial change required, ×: Not compatible

Specifications		AJ35TB1-16DR	AJ65SBTB1-8D	AJ65SBTB 2N-8R	Compatibility	Precautions for replacement
Number of occupied stations (number of occupied points)		2 stations (2 stations × 8 points)	1 station (1 station × 32 points × 2 modules)		×	The number of occupied points increases. The assignment of the entire system needs to be reconsidered.
Operation indication		ON indication (LED)	ON indication (LED)		○	
External connection method		34-point terminal block (M3 screw) Transmission circuit part included	Transmission/ module power supply parts 7-point terminal block (M3 × 5.2 screws) I/O part: 10-point terminal block (M3 × 5.2 screws)	Transmission/ module power supply parts 7-point terminal block (M3 × 5.2 screws) I/O part: 18-point terminal block (M3 × 5.2 screws)	×	Change in wiring is required.
Applicable wire size		0.75 to 2mm ²	0.3 to 2mm ²		○	
Applicable solderless terminal		R1.25-3, R2-3 RAV1.25-3, RAV2-3	RAV1.25-3 (conforming to JIS C 2805) V2-MS3, RAP2-3SL, TGV2-3N		△	In some cases, the solderless terminal must be changed.
I/O module power supply	Voltage	15.6 to 31.2VDC (peak voltage 31.2VDC)	20.4 to 26.4VDC (ripple ratio within 5%)		△	The operating voltage range differs.
	Current	62mA (at 24VDC)	30mA or less (24VDC when all points are ON)	85mA or less (24VDC when all points are ON)	△	The current consumption increases. The current capacity needs to be reconsidered.
External dimensions		55(H) × 166(W) × 50(D) mm	54(H) × 87.3(W) × 40(D) mm	54(H) × 118(W) × 40(D) mm	×	The overall size differs. Pay attention to the mounting dimensions.
Weight		0.35kg	0.14kg	0.25kg	△	

(25) Specifications comparison between AJ35TB1-16DT and AJ65SBTB1-16DT2

○ : Compatible, △ : Partial change required, × : Not compatible

Specifications		AJ35TB1-16DT input specifications	AJ65SBTB1-16DT2 input specifications	Compatibility	Precautions for replacement
Number of input points		8 points	8 points	○	
Insulation method		Photocoupler	Photocoupler	○	
Rated input voltage		24VDC	24VDC	○	
Rated input current		Approx. 7mA	Approx. 7mA	○	
Operating voltage range		19.2 to 26.4VDC (ripple ratio within 5%)	19.2 to 26.4VDC (ripple ratio within 5%)	○	
Maximum number of simultaneous input points		100% simultaneously ON	100% simultaneously ON	○	
ON voltage/ON current		14V or more/3.5mA or more	14V or more/3.5mA or more	○	
OFF voltage/OFF current		6.0V or less/1.7mA or less	6.0V or less/1.7mA or less	○	
Input resistance		Approx. 3.3k Ω	Approx. 3.3k Ω	○	
Input method		Positive/negative common shared type (sink/source shared type)	Positive common (sink type)	△	A negative common current cannot be used.
Response time	OFF → ON	10ms or less (at 24VDC)	1.5ms or less (at 24VDC)	○	
	ON → OFF	10ms or less (at 24VDC)	1.5ms or less (at 24VDC)	○	
Common terminal arrangement		8 points/common	8 points/common	○	
Specifications		AJ35TB1-16DT output specifications	AJ65SBTB1-16DT2 output specifications	Compatibility	Precautions for replacement
Number of output points		8 points	8 points	○	
Insulation method		Photocoupler	Photocoupler	○	
Rated load voltage		24VDC	24VDC	○	
Operating load voltage range		19.2 to 26.4VDC (ripple ratio within 5%)	19.2 to 26.4VDC (ripple ratio within 5%)	○	
Maximum load current		0.3A/point, 2.4A/common	0.5A/point, 2.4A/common	○	
Maximum inrush current		3.0A 10ms or less	1.0A 10ms or less	×	The inrush current value differs. Pay attention to the selection of the load used.
Leakage current at OFF		0.1mA or less	0.1mA or less	○	
Maximum voltage drop at ON		1.5VDC or less (MAX.) 0.3A	0.3VDC or less (TYP.) 0.5A 0.6VDC or less (MAX.) 0.5A	○	
Output method		sink type	sink type	○	
Response time	OFF → ON	2.0ms or less	0.5ms or less	○	
	ON → OFF	2.0ms or less (resistance load)	1.5ms or less (resistance load)	○	
External power supply	Voltage	19.2 to 26.4VDC (ripple ratio within 5%)	19.2 to 26.4VDC (ripple ratio within 5%)	○	
	Current	60mA or less (24VDC)	17.8mA or less (24VDC)	○	
Surge suppressor		Zener diode	Zener diode	○	
Common terminal arrangement		8 points/common	8 points/common	○	

○ : Compatible, △ : Partial change required, × : Not compatible

Specifications		AJ35TB1-16DT	AJ65SBTB1-16DT2	Compatibility	Precautions for replacement
Number of occupied stations (number of occupied points)		2 stations (2 stations × 8 points)	1 station (1 station × 32 points)	×	The number of occupied points increases. The assignment of the entire system needs to be reconsidered.
Operation indication		ON indication (LED)	ON indication (LED)	○	
External connection method		34-point terminal block (M3 screw) Transmission circuit part included	Transmission/module power supply parts: 7-point terminal block (M3 × 5.2 screws) I/O part: 18-point terminal block (M3 × 5.2 screws)	×	Change in wiring is required.
Applicable wire size		0.75 to 2mm ²	0.3 to 2mm ²	○	
Applicable solderless terminal		R1.25-3, R2-3 RAV1.25-3, RAV2-3	RAV1.25-3 (conforming to JIS C 2805) V2-MS3, RAP2-3SL, TGV2-3N	△	In some cases, the solderless terminal must be changed.
I/O module power supply	Voltage	15.6 to 31.2VDC (peak voltage 31.2VDC)	20.4 to 26.4VDC (ripple ratio within 5%)	△	The operating voltage range differs.
	Current	61mA (at 24VDC)	50mA or less (24VDC when all points are ON)	○	
External dimensions		55(H) × 166(W) × 50(D) mm	54(H) × 118(W) × 40(D) mm	×	The overall size differs. Pay attention to the mounting dimensions.
Weight		0.35kg	0.18kg	△	

(26) Specifications comparison between AJ35TC1-32DT and AJ65SBTCF1-32DT

○ : Compatible, △ : Partial change required, × : Not compatible

Specifications		AJ35TC1-32DT input specifications	AJ65SBTCF1-32DT input specifications	Compatibility	Precautions for replacement
Number of input points		16 points	16 points	○	
Insulation method		Photocoupler	Photocoupler	○	
Rated input voltage		24VDC	24VDC	○	
Rated input current		Approx. 5mA	Approx. 5mA	○	
Operating voltage range		19.2 to 26.4VDC (ripple ratio within 5%)	19.2 to 26.4VDC (ripple ratio within 5%)	○	
Maximum number of simultaneous input points		100% simultaneously ON	100% simultaneously ON	○	
ON voltage/ON current		17.5V or more/3.5mA or more	14V or more/3.5mA or more	○	
OFF voltage/OFF current		6V or less/1.7mA or less	6V or less/1.7mA or less	○	
Input resistance		Approx. 4.7k Ω	Approx. 4.7k Ω	○	
Input method		Positive/negative common shared type (sink/source shared type)	Positive/negative common shared type (sink/source shared type)	○	
Response time	OFF → ON	10ms or less (at 24VDC)	1.5ms or less (at 24VDC)	○	
	ON → OFF	10ms or less (at 24VDC)	1.5ms or less (at 24VDC)	○	
Common terminal arrangement		16 points/common	16 points/common	○	
Specifications		AJ35TC1-32DT output specifications	AJ65SBTCF1-32DT output specifications	Compatibility	Precautions for replacement
Number of output points		16 points	16 points	○	
Insulation method		Photocoupler	Photocoupler	○	
Rated load voltage		24VDC	12VDC/24VDC	○	
Operating load voltage range		19.2 to 26.4VDC (ripple ratio within 5%)	10.2 to 26.4VDC (ripple ratio within 5%)	○	
Maximum load current		0.1A/point, 1.6A/common	0.1A/point, 1.6A/common	○	
Maximum inrush current		0.4A 10ms or less	1.0A 10ms or less	○	
Leakage current at OFF		0.1mA or less	0.1mA or less	○	
Maximum voltage drop at ON		1.5VDC or less (MAX.) 0.1A	0.085VDC or less (TYP.) 0.1A 0.2VDC or less (MAX.) 0.1A	○	
Output method		sink type	sink type	○	
Response time	OFF → ON	2.0ms or less	0.5ms or less	○	
	ON → OFF	2.0ms or less (resistance load)	1.5ms or less (resistance load)	○	
External power supply	Voltage	None	10.2 to 26.4VDC (ripple ratio within 5%)	×	Wiring of the power supply for driving the output circuit is required.
	Current	None	30mA or less (24VDC)	×	Wiring of the power supply for driving the output circuit is required.
Surge suppressor		Zener diode	Zener diode	○	
Common terminal arrangement		16 points/common	16 points/common	○	

○ : Compatible, △ : Partial change required, × : Not compatible

Specifications		AJ35TC1-32DT	AJ65SBTCF1-32DT	Compatibility	Precautions for replacement
Number of occupied stations (number of occupied points)		4 stations (4 stations × 8 points)	1 station (1 station × 32 points)	○	
Operation indication		ON indication (LED)	ON indication (LED)	○	
External connection method		Transmission circuit: 8-point terminal block (M3 screw)	Transmission/module power supply parts: 7-point terminal block (M3 × 5.2 screws)	×	Change in wiring is required.
		I/O part: 40-pin connector	I/O part: 40-pin connector	○	The existing connector can be attached without change.
Applicable wire size		Terminal block: 0.75 to 2mm ² 40-pin connector: 0.3mm ²	Terminal block: 0.3 to 2mm ² 40-pin connector: 0.3mm ² or less (for A6CON1, A6CON4) 0.2 to 0.08mm ² (for A6CON2) Twisted wire of 0.08mm ² , φ 0.25mm (for A6CON3)	○	
Accessory		1 external wiring connector	None	×	40-pin connectors for external wiring are sold separately.
Applicable solderless terminal		R1.25-3, R2-3 RAV1.25-3, RAV2-3	RAV1.25-3 (conforming to JIS C 2805) V2-MS3, RAP2-3SL, TGV2-3N	△	In some cases, the solderless terminal must be changed.
I/O module power supply	Voltage	15.6 to 31.2VDC (peak voltage 31.2VDC)	20.4 to 26.4VDC (ripple ratio within 5%)	△	The operating voltage range differs.
	Current	137mA (at 24VDC)	50mA or less (24VDC when all points are ON)	○	
External dimensions		55(H) × 166(W) × 50(D) mm	54(H) × 118(W) × 40(D) mm	×	The overall size differs. Pay attention to the mounting dimensions.
Weight		0.25kg	0.15kg	△	

(27) Specifications comparison between AJ35PTF-128DT and AJ65SBTCF1-32D + AJ65SBTCF1-32T

○ : Compatible, △ : Partial change required, × : Not compatible

Specifications		AJ35PTF-128DT input specifications	AJ65SBTCF1-32D input specifications	Compatibility	Precautions for replacement
Number of input points		64 points	32 points	×	When 33 or more points are used, use two AJ65SBTCF1-32D modules.
Insulation method		Photocoupler	Photocoupler	○	
Rated input voltage		12/24VDC	24VDC	△	12VDC cannot be used.
Rated input current		4mA/Approx. 9mA	Approx. 5mA	△	Rated input current is smaller.*1
Operating voltage range		10.2 to 26.4VDC (ripple ratio within 5%)	19.2 to 26.4VDC (ripple ratio within 5%)	△	12VDC cannot be used.
Maximum number of simultaneous input points		100% simultaneously ON (64 points are divided into four groups and I/O refresh is performed to each of the four groups.)	100% simultaneously ON	○	
ON voltage/ON current		8V or more/2.3mA or more	14VDC or more/ 3.5mA or more	△	12VDC cannot be used.
OFF voltage/OFF current		4V or less/0.5mA or less	6VDC or less/1.7mA or less	△	12VDC cannot be used.
Input resistance		Approx. 2.4k Ω	Approx. 4.7k Ω	△	Input impedance has increased.*1
Input method		Positive common (sink type) Dynamic scan method (64 points are divided into four groups and I/O refresh is performed to each of the four groups.)	Positive/negative shared type (sink/source shared type)	△	The I/O refresh method is changed.
Response time	OFF → ON	107ms or less*2	1.5ms or less (at 24VDC)	△	The I/O refresh method is changed, and the response time changes.
	ON → OFF	107ms or less*2	1.5ms or less (at 24VDC)	△	
Common terminal arrangement		16 points/common (common pin: 1A17, 1B17, 2A17, 2B17)	32 points/common (40-pin connector 1-wire type)	△	As common terminal arrangement changes from 16 points/common to 32 points/common, wiring with a different voltage per common is not possible.

○ : Compatible, △ : Partial change required, × : Not compatible

Specifications		AJ35PTF-128DT output specifications	AJ65SBTCF1-32T output specifications	Compatibility	Precautions for replacement
Number of output points		64 points	32 points	×	When 33 or more points are used, use two AJ65SBTCF1-32T modules.
Insulation method		Photocoupler	Photocoupler	○	
Rated load voltage		12/24VDC	12/24VDC	○	
Operating load voltage range		10.2 to 31.2VDC	10.2 to 26.4VDC (ripple ratio within 5%)	△	Voltages exceeding 26.4VDC cannot be applied.
Maximum load current		0.1A/point, 2A/common	0.1A/point, 32A/common	○	
Maximum inrush current		0.4A, 100ms or less	1.0A, 10ms or less	○	
Leakage current at OFF		0.1mA or less	0.1mA or less	○	
Maximum voltage drop at ON		2.5VDC 100mA 1.75VDC 5mA 1.7VDC 1mA	0.1VDC or less (TYP.) 0.1A, 0.2VDC or less (MAX.) 0.1A	○	
Output method		Static method of sink type	Sink type	△	The I/O refresh method is changed.
Response time	OFF → ON	(2 + I/O refresh time × 5) ms or less*2	0.5ms or less	△	The I/O refresh method is changed, and the response time changes.
	ON → OFF	(2 + I/O refresh time × 5) ms or less*2	1.5ms or less (resistance load)	△	
External power supply	Voltage	10.2 to 31.2VDC	10.2 to 26.4VDC (ripple ratio within 5%)	△	Voltages exceeding 26.4VDC cannot be applied.
	Current	40mA or less (TYP.24VDC, 1 common ON)	50mA or less (TYP.24VDC, per common) External load current not included	○	
Surge suppressor		Clamp diode	Zener diode	○	
Common terminal arrangement		32 points/common (common pin: TB5, TB7)	32 points/common (40-pin connector 1-wire type)	○	

○: Compatible, △: Partial change required, ×: Not compatible

Specifications		AJ35PTF-128DT	AJ65SBTCF1 -32D	AJ65SBTCF1 -32T1	Compatibility	Precautions for replacement
Number of occupied stations (number of occupied points)		4 stations (number of required I/O points: 128 points)	1 station (1 station × 32 points × 4 modules)		○	The number of modules is changed, and the number of occupied points does not change.
Operation indication		ON indication (LED) 32-point switching display with switches	ON indication (LED)		○	
External connection method		Transmission/module power supply parts: 8-point terminal block I/O part: Four 40-pin connectors (soldering)	Communication part, module power supply part: 7-point two-piece terminal block M3 × 5.2 screws I/O power supply part, I/O part: 40-pin connector		×	Change in wiring is required.
Applicable wire size		Terminal block: 0.75 to 2mm ² 40-pin connector: 0.3mm ²	Terminal block: 0.3 to 2mm ² 40-pin connector: 0.3mm ² or less (for A6CON1, A6CON4) 0.2 to 0.08mm ² (for A6CON2) Stranded wire of 0.08mm ² , φ 0.25mm (for A6CON3)		○	
Transmission/ communication part, module power supply part Applicable solderless terminal		R1.25-3, R2-3 RAV1.25-3, RAV2-3	RAV1.25-3 (conforming to JIS C 2805) V2-MS3, RAP2-3SL TGV2-3N		△	In some cases, the solderless terminal must be changed.
I/O module power supply	Voltage	15.6 to 31.2VDC	20.4 to 26.4VDC (ripple ratio within 5%)		△	The operating voltage range differs.
	Current	200mA	45mA or less (24VDC when all points are ON)	60mA or less (24VDC when all points are ON)	△	The current consumption increases. The current capacity needs to be reconsidered.
External dimensions		250(H) × 190(W) × 41(D) mm	54(H) × 118(W) × 40(D) mm		×	The shape and the number of modules differ. Pay attention to the mounting dimensions.
Weight		1.05kg	0.15kg		△	

*1: Confirm the specifications of the sensors or switches to be connected to the AJ65SBTCF1-32D.

*2: For details on the response time, refer to the MELSECNET/MINI-S3 Master Module Type AJ71PT32-S3, AJ71T32-S3, A1SJ71PT32-S3, A1SJ71T32-S3 User's Manual.

5.3 Precautions for Replacement of I/O Module

(1) Wiring

(a) Wire gauge and size of solderless terminals

As CC-Link supports compact modules and terminal blocks, the wire gauge and size of the solderless terminals applicable to terminal blocks differ from those that can be used on the MELSECNET/MINI-S3, A2C(I/O).

For this reason, when replacing the existing system with CC-Link, use wires and solderless terminals that meet the CC-Link specifications.

(b) Input method

Contents of the "Input method" item in the "Specifications" column for input modules and I/O modules in Section 5.2 are described below.

Positive common (Sink type) : means that DC power + is connected to the common terminal.

Negative common (Source type) : means that DC power - is connected to the common terminal.

Positive/negative common shared type (Sink/source shared type):

means that either DC power + or DC power - is connected to the common terminal.

(c) Using wiring conversion adapter

When installing a MELSECNET/MINI-S3 - CC-Link module wiring conversion adapter to the CC-Link remote I/O module (AJ65BTB1-16D, AJ65BTB2-16D or AJ65BTB1-16T), the external dimensions are increased by 5.1mm (height) and 28.5mm (depth).

If the connected cable is not long enough, wiring to the CC-Link remote I/O module cannot be made.

(2) External wiring connector

(a) Purchasing external wiring connectors

At the CC-Link 32-point connector type I/O module, the external wiring connector is not included in the package. The external wiring connector (A6CON□) must be purchased separately.

(3) Tightening module mounting screws and terminal block screws

Tighten module mounting screws and terminal block screws within the range described below. Tightening screws too much may cause damage to the module case. For details, refer to each product manual.

(a) CC-Link system compact type remote I/O module

For terminal block type, one-touch connector type, and 40-pin connector type remote I/O module

Screw	Tightening torque range
Module mounting screw (M4 screw with plain washer finished round)	78 to 108N•cm
Terminal block screw (M3 screw)	59 to 88N•cm
Terminal block mounting screw (M3.5 screw)	68 to 98N•cm

(b) CC-Link system remote I/O module (A2C shape)

Screw	Tightening torque range
Module mounting screw (M4 screw with plain washer finished round)	78 to 108N•cm
Terminal block screw (M3.5 screw)	68 to 92N•cm
Terminal block mounting screw (M4 screw)	102 to 138N•cm

(c) CC-Link system remote I/O module

Screw	Tightening torque range
Module mounting screw (M4 screw)	78 to 118N•cm
Terminal block screw (M3.5 screw)	59 to 88N•cm
Terminal block mounting screw (M4 screw)	78 to 118N•cm

(d) Wiring conversion adapter

Screw	Tightening torque range
Adapter, Terminal block mounting screw (M4 screw)	78 to 118N•cm
CTL + terminal screw (M3 screw)	49 to 78.4N•cm

(4) Precautions for input module (specifications change)

(a) The rated input current

Some CC-Link modules support a smaller rated input current than MELSECNET/MINI-S3,A2C(I/O) modules do. Confirm the specifications of the sensors or switches to be connected before use.

(b) The rated voltage value

CC-Link's DC input module is dedicated for use at 24VDC. Confirm the specifications of the sensors or switches to be connected before use.

(c) The common terminal arrangement

Use caution when using voltages that differ depending on each common as the common terminal arrangement may differ between the CC-Link and the MELSECNET/MINI-S3, A2C(I/O).

(5) Precautions for output module (specifications change)

(a) The output current values

Some CC-Link modules support a smaller output current than MELSECNET/MINI-S3,A2C(I/O) modules do. Before using an output module having a smaller output current on CC-Link, confirm the specifications on the load side.

(b) The common terminal arrangement

Use caution when using voltages that differ depending on each common as the common terminal arrangement may differ between the CC-Link and the MELSECNET/MINI-S3, A2C(I/O).

(c) The common maximum load current

Sometimes the maximum load current per common differs between CC-Link and MELSECNET/MINI-S3,A2C(I/O). Check the maximum load current per common before use.

(d) Precautions when using the triac output module

Operation of the triac that is used on the triac output module may be unstable when a sudden change occurs in the voltage and current due to component characteristics.

Problems due to voltage and current fluctuation might become obvious depending on individual differences between components. For this reason, refer to the following manual and check for any corresponding items in the precautions.

- I/O Module Type Building Block User's Manual

6

REPLACING ANALOG I/O MODULE

6.1 List of Alternative Analog I/O Module Models

MELSECNET/MINI-S3, A2C models to be discontinued		Replacement to CC-Link	
Product name	Model name	Model name	Remarks (restrictions)
Analog input module	A68ADC	AJ65BT-64AD	1) Change in external wiring: Wiring change due to differences in terminal blocks, communication cable change to CC-Link dedicated cable, applicable wire size of signal lead change 2) Change in number of modules: Required (2 modules necessary) 3) Change in program: Change to programs for CC-Link 4) Change in performance specifications: 4CH/module 5) Change in functional specifications: Not required 6) Change in dimensions for mounting the panel: Required
		AJ65SBT2B-64AD AJ65SBT-64AD	1) Change in external wiring: Wiring change due to differences in terminal blocks, communication cable change to CC-Link dedicated cable, applicable wire size of signal lead change 2) Change in number of modules: Required (2 modules necessary) 3) Change in program: Change to programs for CC-Link 4) Change in performance specifications: 4CH/module, negative current conversion not possible 5) Change in functional specifications: An averaging processing function of the AJ65SBT-64AD can handle only a moving averaging processing. 6) Change in dimensions for mounting the panel: Required
		AJ65VBTCU-68ADVN	1) Change in external wiring: Wiring change due to differences in terminal blocks, communication cable change to CC-Link dedicated cable, applicable wire size of signal lead change 2) Change in number of modules: Not required 3) Change in program: Change to programs for CC-Link 4) Change in performance specifications: Voltage input only 5) Change in functional specifications: Not required 6) Change in dimensions for mounting the panel: Required

MELSECNET/MINI-S3, A2C models to be discontinued		Replacement to CC-Link	
Product name	Model name	Model name	Remarks (restrictions)
Analog input module	A68ADC	AJ65VBTCU-68ADIN	1) Change in external wiring: Wiring change due to differences in terminal blocks, communication cable change to CC-Link dedicated cable, applicable wire size of signal lead change 2) Change in number of modules: Not required 3) Change in program: Change to programs for CC-Link 4) Change in performance specifications: Current input only 5) Change in functional specifications: Not required 6) Change in dimensions for mounting the panel: Required
Analog output module	A64DAVC	AJ65SBT2B-64DA AJ65BT-64DAV	1) Change in external wiring: Wiring change due to differences in terminal blocks, communication cable change to CC-Link dedicated cable, applicable wire size of signal lead change 2) Change in number of modules: Not required 3) Change in program: Change to programs for CC-Link 4) Change in performance specifications: Change in resolution 5) Change in functional specifications: Not required 6) Change in dimensions for mounting the panel: Required
		AJ65SBT-62DA	1) Change in external wiring: Wiring change due to differences in terminal blocks, communication cable change to CC-Link dedicated cable, applicable wire size of signal lead change 2) Change in number of modules: Required (2 modules necessary) 3) Change in program: Change to programs for CC-Link 4) Change in performance specifications: Change in resolution 5) Change in functional specifications: 2CH/module 6) Change in dimensions for mounting the panel: Required
		AJ65VBTCU-68DAVN	1) Change in external wiring: Wiring change due to differences in terminal blocks, communication cable change to CC-Link dedicated cable, applicable wire size of signal lead change 2) Change in number of modules: Not required 3) Change in program: Change to programs for CC-Link 4) Change in performance specifications: 8CH/module 5) Change in functional specifications: Not required 6) Change in dimensions for mounting the panel: Required

MELSECNET/MINI-S3, A2C models to be discontinued		Replacement to CC-Link	
Product name	Model name	Model name	Remarks (restrictions)
Analog output module	A64DAIC	AJ65SBT2B-64DA AJ65BT-64DAI	1) Change in external wiring: Wiring change due to differences in terminal blocks, communication cable change to CC-Link dedicated cable, applicable wire size of signal lead change 2) Change in number of modules: Not required 3) Change in program: Change to programs for CC-Link 4) Change in performance specifications: Upward compatible 5) Change in functional specifications: Not required 6) Change in dimensions for mounting the panel: Required
		AJ65SBT-62DA	1) Change in external wiring: Wiring change due to differences in terminal blocks, communication cable change to CC-Link dedicated cable, applicable wire size of signal lead change 2) Change in number of modules: Required (2 modules necessary) 3) Change in program: Change to programs for CC-Link 4) Change in performance specifications: Change in resolution 5) Change in functional specifications: 2CH/module 6) Change in dimensions for mounting the panel: Required
Temperature input module	A64RD3C	AJ65SBT2B-64RD3 AJ65BT-64RD3	1) Change in external wiring: Wiring change due to differences in terminal blocks, communication cable change to CC-Link dedicated cable, applicable wire size of signal lead change 2) Change in number of modules: Not required 3) Change in program: Change to programs for CC-Link 4) Change in performance specifications: Change in temperature detecting output current, change in resistive values of allowable conductor 5) Change in functional specifications: Not required 6) Change in dimensions for mounting the panel: Required
		AJ65BT-64RD4	1) Change in external wiring: Wiring change due to differences in terminal blocks, communication cable change to CC-Link dedicated cable, applicable wire size of signal lead change 2) Change in number of modules: Not required 3) Change in program: Change to programs for CC-Link 4) Change in performance specifications: Change in temperature detecting output current, change in resistive values of allowable conductor 5) Changes in functional specifications: Change in the specifications of the line breakage detection function 6) Change in dimensions for mounting the panel: Required

6.2 List of Alternative Master Module Models

6.2.1 Comparisons of analog input module

(1) Comparisons between A68ADC and AJ65BT-64AD

(a) Performance specifications comparisons

○ : Compatible, △ : Partial change required, × : Not compatible

Item	A68ADC	AJ65BT-64AD		Compati- bility	Precautions for replacement												
Analog input	Voltage: -10 to 0 to +10VDC (input resistance 30K Ω) Current: +4 to +20mA (input resistance 250 Ω) Select via input terminal * Current input can also be used as -20 to 0 to +20mA.	Voltage: -10 to 0 to +10VDC (input resistance 1M Ω) Current: -20 to 0 to +20mA (input resistance 250 Ω) (select via input terminal)		○													
Digital output	16bits signed binary (data part 11bits) -2048 to 2047	16bits signed binary (data part 12bits)		○													
I/O characteristics	<table border="1"> <thead> <tr> <th>Analog input</th> <th>Digital output</th> </tr> </thead> <tbody> <tr> <td>+10V</td> <td>+2000</td> </tr> <tr> <td>+5V or +20mA</td> <td>+1000</td> </tr> <tr> <td>0V or +4mA</td> <td>± 0</td> </tr> <tr> <td>-5V or -12mA</td> <td>-1000</td> </tr> <tr> <td>-10V</td> <td>-2000</td> </tr> </tbody> </table>	Analog input	Digital output	+10V	+2000	+5V or +20mA	+1000	0V or +4mA	± 0	-5V or -12mA	-1000	-10V	-2000	Analog input value -10 to 10V or -20 to 20mA	Digital output value 0 to 4000 or -2000 to 2000	△	Precautions are needed as gain values are different.
		Analog input	Digital output														
		+10V	+2000														
		+5V or +20mA	+1000														
		0V or +4mA	± 0														
-5V or -12mA	-1000																
-10V	-2000																
0 to 10V or 0 to 20mA	0 to 4000 or -2000 to 2000																
0 to 5V or 0 to 20mA	0 to 4000 or -2000 to 2000																
1 to 5V or 4 to 20mA	0 to 4000 or -2000 to 2000																
0 to 5V or 0 to 20mA	0 to 4000 or -2000 to 2000																
Maximum resolution	Voltage 5mV (1/2000) Current 20 μA (1/1000)	Analog input value -10 to 10V or -20 to 20mA	Resolution 5mV or 20 μA	○													
		0 to 10V or 0 to 20mA	2.5mV or 10 μA														
		0 to 5V or 0 to 20mA	1.25mV or 5 μA														
		1 to 5V or 4 to 20mA	1mV or 4 μA														
Overall accuracy	Within ± 1% (± 20) (accuracy relative to maximum value)	± 1%(± 40)		○													
Maximum conversion speed	Max. 2.5ms/channel	1ms/channel		○													
Absolute maximum input	Voltage ± 15V, current ± 30mA			○													
Analog input	8 channels/module	4 channels/module		×	Please consider replacing by using two or more AJ65BT-64AD modules.												
Insulation method	Photocoupler isolation between input terminal and programmable controller power supply (non-isolated between channels)	Photocoupler isolation between power supply/communication system and analog input (non-isolated between channels)		○													

○ : Compatible, △ : Partial change required, × : Not compatible

Item	A68ADC	AJ65BT-64AD	Compati- bility	Precautions for replacement
Number of occupied I/O stations (number of points)	4 stations (4 stations × 8 points)	2 stations (2 stations × 32 points) (RX/RV 32 points each, RWr/RVw 8 points each)	×	The number of occupied points increases. The assignment of the entire system needs to be reconsidered.
Connected terminal	47-point terminal block	27-point terminal block	×	Change in wiring is required.
Applicable wire size	0.75 to 2mm ² (applicable tightening torque 7kg · cm)		○	
Applicable solderless terminal	V1.25-3, V1.25-YS3A, V2-S3, V2-YS3A	RAV1.25-3.5, RAV2-3.5	×	
24VDC internal current consumption	0.3A	0.12A	○	
Weight	1.01kg	0.35kg	△	
External dimensions	170(H) × 100(W) × 80(D)mm	65(H) × 151.9(W) × 63(D)mm	×	The overall size differs. Pay attention to the mounting dimensions.

(b) Functional comparisons

○ : Compatible, △ : Partial change required, × : Not compatible

Item	A68ADC	AJ65BT-64AD	Compati- bility	Precautions for replacement
Averaging processing A/D conversion system	A/D conversion is performed according to set times or set processing time on a channel, which is specified for the averaging processing to be performed on by the programmable controller CPU. After the conversion, the maximum and minimum values are removed, and the remaining total is averaged and the results are stored in the buffer memory.	A/D conversion is performed according to the preset number of times or preset time on each channel, the A/D conversion data obtained during that time is averaged, and the average value is stored to the remote register as a digital output value.	○	
Specification of channel to use	The A68ADC has an 8 channels of the A/D conversion circuit. Execution/non-execution of the A/D conversion can be specified on each of those channels. With the programmable controller CPU, the channel to execute A/D conversion on is specified to address 0 (specification of channel to use) of the buffer memory.	Enable (execute)/disable (do not execute) A/D conversion is specified on each channel. (default: execution on all channels disabled) By making unused channels conversion prohibited, sampling time can be shortened.	○	
Offset/gain setting	Changes the I/O conversion characteristics.	Changes the I/O conversion characteristics. For that, offset/gain settings can be configured for each channel without a aid of a various register.	○	

(c) Programmable controller CPU I/O signal comparisons

I/O signal is different, so the sequence program must be changed.

For details on I/O signals and sequence programs, refer to the User's Manual.

A68ADC				AJ65BT-64AD			
Device No.	Description	Device No.	Description	Device No.	Description	Device No.	Description
X(n+0) to X(n+3)	Use prohibited	Y(n+0) to Y(n+3)	Use prohibited	RXn0	CH1 A/D Conversion completed flag	RYn0	Offset/gain value selection
X(n+4)	Communication error detection flag indicating that execution of the FROM and TO instructions resulted in a communication error	Y(n+4)	Error detection reset signal *1	RXn1	CH2 A/D Conversion completed flag	RYn1	Voltage/current selection
X(n+5)	A68ADC reset switch ON detection flag	Y(n+5)	Reset signal for reset switch ON detection flag	RXn2	CH3 A/D Conversion completed flag	RYn2 to RY(n+1)7	Use prohibited
X(n+6)	Use prohibited	Y(n+6)	Use prohibited	RXn3	CH4 A/D Conversion completed flag		
X(n+7)	Communication completion response signal wait flag	Y(n+7)	Communication reset signal *1	RXn4 to RX(n+1)7	Use prohibited		
X(n+8) to X(n+17)	Use prohibited	Y(n+8) to Y(n+1F)	Use prohibited	RX(n+1)8	Initial data processing request flag	RY(n+1)8	Initial data processing complete flag
X(n+18)	A/D conversion READY			RX(n+1)9	Initial data setting complete flag	RY(n+1)9	Initial data setting request flag
X(n+19) to X(n+1F)	Use prohibited			RX(n+1)A	Error status flag	RY(n+1)A	Error reset request flag
				RX(n+1)B to RX(n+1)F	Remote READY Use prohibited	RY(n+1)B to RY(n+1)F	Use prohibited

*1: The signal contents differ when a version B A68ADC is combined with a version B A2CCPU.

(d) Buffer memory addresses comparisons

Buffer memory allocation is different, so the sequence program must be changed.

For details on buffer memories and sequence programs, refer to the User's Manual.

A68ADC			AJ65BT-64AD		
Address	Name	Read/write	Address	Name	Read/write
0	Specification of channel to use	R/W	RWwm	Averaging processing specification	W
1	Averaging processing specification		RWwm+1	CH1 Averaging time, count	
2	CH1 Averaging time, count		RWwm+2	CH2 Averaging time, count	
3	CH2 Averaging time, count		RWwm+3	CH3 Averaging time, count	
4	CH3 Averaging time, count		RWwm+4	CH4 Averaging time, count	
5	CH4 Averaging time, count		RWwm+5	Data format	
6	CH5 Averaging time, count		RWwm+6	A/D conversion enable/disable specification	
7	CH6 Averaging time, count		RWwm+7	Use prohibited	-
8	CH7 Averaging time, count		RWrn	CH1 Digital output value	R
9	CH8 Averaging time, count	RWrn+1	CH2 Digital output value		
10	CH1 Digital output value	RWrn+2	CH3 Digital output value		
11	CH2 Digital output value	RWrn+3	CH4 Digital output value		
12	CH3 Digital output value	RWrn+4	Error code	-	
13	CH4 Digital output value	RWrn+5	Use prohibited		
14	CH5 Digital output value	RWrn+6			
15	CH6 Digital output value	RWrn+7			
16	CH7 Digital output value				
17	CH8 Digital output value				
18	Write data error code	R/W			
19	A/D conversion completed flag	R			

(2) Comparisons between A68ADC and AJ65SBT-64AD

(a) Performance specifications comparisons

○ : Compatible, △ : Partial change required, × : Not compatible

Item	A68ADC	AJ65SBT-64AD	Compati- bility	Precautions for replacement																																																		
Analog input	Voltage: -10 to 0 to +10VDC (input resistance 30K Ω) Current: +4 to +20mA (input resistance 250 Ω) Select via input terminal * Current input can also be used as -20 to 0 to +20mA.	Voltage: -10 to 0 to +10VDC (input resistance 1M Ω) Current: 0 to +20mA (input resistance 250 Ω)	△	Negative current cannot be converted.																																																		
Digital output	16bits signed binary (data part 11bits) -2048 to 2047	16bits signed binary (-4096 to +4095)	○																																																			
I/O characteristics	<table border="1"> <thead> <tr> <th>Analog input</th> <th>Digital output</th> </tr> </thead> <tbody> <tr> <td>+10V</td> <td>+2000</td> </tr> <tr> <td>+5V or +20mA</td> <td>+1000</td> </tr> <tr> <td>0V or +4mA</td> <td>± 0</td> </tr> <tr> <td>-5V or -12mA</td> <td>-1000</td> </tr> <tr> <td>-10V</td> <td>-2000</td> </tr> </tbody> </table>	Analog input	Digital output	+10V	+2000	+5V or +20mA	+1000	0V or +4mA	± 0	-5V or -12mA	-1000	-10V	-2000	<table border="1"> <thead> <tr> <th rowspan="2">Analog input range</th> <th rowspan="2">Digital output</th> <th colspan="2">Accuracy</th> <th rowspan="2">Maximum resolution</th> </tr> <tr> <th>Ambient Temperature 0 to 55 °C</th> <th>Ambient Temperature 25 ± 5 °C</th> </tr> </thead> <tbody> <tr> <td>-10 to +10V</td> <td rowspan="2">-4000 to +4000</td> <td rowspan="2">± 0.4% (± 16 digits*)</td> <td rowspan="2">± 0.2% (± 8 digits*)</td> <td>2.5mV</td> </tr> <tr> <td>User range setting 1 (-10 to +10V)</td> <td>1.25mV</td> </tr> <tr> <td>0 to 5V</td> <td rowspan="2">0 to 4000</td> <td rowspan="2">± 0.4% (± 16 digits*)</td> <td rowspan="2">± 0.2% (± 8 digits*)</td> <td>1.0mV</td> </tr> <tr> <td>1 to 5V</td> <td>5 μ A</td> </tr> <tr> <td>User range setting 2 (0 to 5V)</td> <td rowspan="2">0 to 4000</td> <td rowspan="2">± 0.4% (± 16 digits*)</td> <td rowspan="2">± 0.2% (± 8 digits*)</td> <td>4 μ A</td> </tr> <tr> <td>0 to 20mA</td> <td></td> </tr> <tr> <td>4 to 20mA</td> <td></td> <td></td> <td></td> <td></td> </tr> <tr> <td>User range setting 3 (0 to 20mA)</td> <td></td> <td></td> <td></td> <td></td> </tr> </tbody> </table> <p>*: Digit is the digital value. Factory-set: -10 to +10V.</p>	Analog input range	Digital output	Accuracy		Maximum resolution	Ambient Temperature 0 to 55 °C	Ambient Temperature 25 ± 5 °C	-10 to +10V	-4000 to +4000	± 0.4% (± 16 digits*)	± 0.2% (± 8 digits*)	2.5mV	User range setting 1 (-10 to +10V)	1.25mV	0 to 5V	0 to 4000	± 0.4% (± 16 digits*)	± 0.2% (± 8 digits*)	1.0mV	1 to 5V	5 μ A	User range setting 2 (0 to 5V)	0 to 4000	± 0.4% (± 16 digits*)	± 0.2% (± 8 digits*)	4 μ A	0 to 20mA		4 to 20mA					User range setting 3 (0 to 20mA)					△	Precautions are needed as gain values are different.
Analog input	Digital output																																																					
+10V	+2000																																																					
+5V or +20mA	+1000																																																					
0V or +4mA	± 0																																																					
-5V or -12mA	-1000																																																					
-10V	-2000																																																					
Analog input range	Digital output	Accuracy		Maximum resolution																																																		
		Ambient Temperature 0 to 55 °C	Ambient Temperature 25 ± 5 °C																																																			
-10 to +10V	-4000 to +4000	± 0.4% (± 16 digits*)	± 0.2% (± 8 digits*)	2.5mV																																																		
User range setting 1 (-10 to +10V)				1.25mV																																																		
0 to 5V	0 to 4000	± 0.4% (± 16 digits*)	± 0.2% (± 8 digits*)	1.0mV																																																		
1 to 5V				5 μ A																																																		
User range setting 2 (0 to 5V)	0 to 4000	± 0.4% (± 16 digits*)	± 0.2% (± 8 digits*)	4 μ A																																																		
0 to 20mA																																																						
4 to 20mA																																																						
User range setting 3 (0 to 20mA)																																																						
Maximum resolution	Voltage 5mV (1/2000) Current 20 μ A (1/1000)		○																																																			
Overall accuracy	Within ± 1% (± 20) (accuracy relative to maximum value)		○																																																			
Max. conversion speed	Maximum 2.5ms/channel	1ms/channel	○																																																			
Absolute maximum input	Voltage ± 15V, current ± 30mA		○																																																			
Number of analog input points	8 channels/module	4 channels/module	×	Consider replacing by using two or more AJ65SBT-64AD modules.																																																		
Insulation method	Photocoupler isolation between input terminal and programmable controller power supply (non-isolated between channels)	Between communication line and all analog inputs: Photocoupler isolation between power line and all analog inputs: Photocoupler isolation (non-isolated between channels)	○																																																			
Number of occupied I/O stations (number of points)	4 stations (4 stations × 8 points)	1 station (1 station × 32 points) (RX/RV 32 points each, RWr/RWw 4 points each)	×	The number of occupied stations has been changed.																																																		
Connected terminal	47-point terminal block	Communication part, module communication part: 7-point two-piece terminal block (M3 screw) I/O part: 18-point direct-mount terminal block (M3 screw)	×	Change in wiring is required.																																																		
Applicable wire size	0.75 to 2mm ² (applicable tightening torque 7kg · cm)	0.3 to 0.75mm ²	×																																																			
Applicable solderless terminal	V1.25-3, V1.25-YS3A, V2-S3, V2-YS3A	<ul style="list-style-type: none"> RAV1.25-3 (conforming to JIS C 2805) [Applicable wire size: 0.3 to 1.25mm²] V2-MS3, RAP2-3SL, TGV2-3N [Applicable wire size: 1.25 to 2.0mm²] 	×																																																			
24VDC internal current consumption	0.3A	0.09A	○																																																			
Weight	1.01kg	0.20kg	△																																																			
External dimensions	170(H) × 100(W) × 80(D)mm	50(H) × 118(W) × 40(D)mm	×	The overall size differs. Pay attention to the mounting dimensions.																																																		

(b) Functional comparisons

○ : Compatible, △ : Partial change required, × : Not compatible

Item	A68ADC	AJ65SBT-64AD	Compati- bility	Precautions for replacement																		
Averaging processing A/D conversion system	A/D conversion is performed according to set times or set processing time on a channel, which is specified for the averaging processing to be performed on by the programmable controller CPU. After the conversion, the maximum and minimum values are removed, and the remaining total is averaged and the results are stored in the buffer memory.	Digital output values for the specified number of times, which have been obtained by measuring at each sampling period, are averaged.	△	Averaging processing performed on the AJ65SBT-64AD is movement averaging processing.																		
Specification of channel to use	The A68ADC has 8 channels of an A/D conversion circuit. Execution/non-execution of the A/D conversion can be specified on each of those channels. With the programmable controller CPU, the channel to execute A/D conversion on is specified to address 0 (specification of channel to use) of the buffer memory.	Enable (execute)/disable (do not execute) A/D conversion is specified on each channel. By making unused channels conversion prohibited, sampling period can be shortened.	○																			
Switching function of input range	—	Sets the analog input range on each channel and changes the I/O conversion characteristics. The following eight input ranges can be selected: <table border="1" style="margin-left: auto; margin-right: auto;"> <thead> <tr> <th>Input range</th> <th>Set value</th> </tr> </thead> <tbody> <tr> <td>-10 to +10V</td> <td>0_H</td> </tr> <tr> <td>0 to 5V</td> <td>1_H</td> </tr> <tr> <td>1 to 5V</td> <td>2_H</td> </tr> <tr> <td>0 to 20mA</td> <td>3_H</td> </tr> <tr> <td>4 to 20mA</td> <td>4_H</td> </tr> <tr> <td>User range setting 1 (-10 to +10V)</td> <td>5_H</td> </tr> <tr> <td>User range setting 2 (0 to 5V)</td> <td>6_H</td> </tr> <tr> <td>User range setting 3 (0 to 20mA)</td> <td>7_H</td> </tr> </tbody> </table>	Input range	Set value	-10 to +10V	0 _H	0 to 5V	1 _H	1 to 5V	2 _H	0 to 20mA	3 _H	4 to 20mA	4 _H	User range setting 1 (-10 to +10V)	5 _H	User range setting 2 (0 to 5V)	6 _H	User range setting 3 (0 to 20mA)	7 _H	—	
Input range	Set value																					
-10 to +10V	0 _H																					
0 to 5V	1 _H																					
1 to 5V	2 _H																					
0 to 20mA	3 _H																					
4 to 20mA	4 _H																					
User range setting 1 (-10 to +10V)	5 _H																					
User range setting 2 (0 to 5V)	6 _H																					
User range setting 3 (0 to 20mA)	7 _H																					
Offset/gain setting	Changes the I/O conversion characteristics.	Changes the I/O conversion characteristics. For that, offset/gain settings can be configured for each channel without a aid of a various register.	○																			

(c) Programmable controller CPU I/O signal comparisons

I/O signal is different, so the sequence program must be changed.

For details on I/O signals and sequence programs, refer to the User's Manual.

A68ADC				AJ65SBT-64AD			
Device No.	Description	Device No.	Description	Device No.	Description	Device No.	Description
X(n+0) to X(n+3)	Use prohibited	Y(n+0) to Y(n+3)	Use prohibited	RXn0	CH1 A/D Conversion complete flag	RYn0	CH1 Specified flag of movement averaging processing
X(n+4)	Communication error detection flag indicating that execution of the FROM and TO instructions resulted in a communication error	Y(n+4)	Error detection reset signal *1	RXn1	CH2 A/D Conversion complete flag	RYn1	CH2 Specified flag of movement averaging processing
X(n+5)	A68ADC reset switch ON detection flag	Y(n+5)	Reset signal of reset switch ON detection flag	RXn2	CH3 A/D Conversion complete flag	RYn2	CH3 Specified flag of movement averaging processing
X(n+6)	Use prohibited	Y(n+6)	Use prohibited	RXn3	CH4 A/D Conversion completed flag	RYn3	CH4 Specified flag of movement averaging processing
				RXn4	CH1 Range error flag	RYn4 to RY(n+1)7	Use prohibited
				RXn5	CH2 Range error flag		
				RXn6	CH3 Range error flag		
				RXn7	CH4 Range error flag		
X(n+7)	Communication completion response signal wait flag	Y(n+7)	Communication reset signal *1	RXn8 to RXnB	Use prohibited		
X(n+8) to X(n+17)	Use prohibited	Y(n+8) to Y(n+1F)	Use prohibited	RXnC	E ² PROM write error flag		
X(n+18)	A/D conversion READY			RXnD	Use prohibited		
				RxnE	Use prohibited		
X(n+19) to X(n+1F)	Use prohibited			RXnF	Test mode flag		
				RX(n+1)0 to RX(n+1)7	Use prohibited		
		RX(n+1)8	Initial data processing request flag	RY(n+1)8	Initial data setting complete flag		
		RX(n+1)9	Initial data setting complete flag	RY(n+1)9	Initial data setting request flag		
		RX(n+1)A	Error status flag	RY(n+1)A	Error reset request flag		
		RX(n+1)B	Remote READY	RY(n+1)B to RY(n+1)F	Use prohibited		
		RX(n+1)C to RX(n+1)F	Use prohibited				

*1: The signal contents differ when a version B A68ADC is combined with a version B A2CCPU.

(d) Buffer memory addresses comparisons

Buffer memory allocation is different, so the sequence program must be changed.
 For details on buffer memory and sequence programs, refer to the User's Manual.

A68ADC			AJ65SBT-64AD			
Address	Name	Read/write	Address	Name	Read/write	
0	Specification of channel to use	R/W	RWwm	A/D conversion enable/disable specification	W	
1	Averaging processing specification		RWwm+1	Input range setting		
2	CH1 Averaging time, count		RWwm+2	Number of movement averaging processing setting		
3	CH2 Averaging time, count		RWwm+3	Use prohibited	-	
4	CH3 Averaging time, count		RWrn	CH1 Digital output value	R	
5	CH4 Averaging time, count		RWrn+1	CH2 Digital output value		
6	CH5 Averaging time, count		RWrn+2	CH3 Digital output value		
7	CH6 Averaging time, count		RWrn+3	CH4 Digital output value		
8	CH7 Averaging time, count		R			
9	CH8 Averaging time, count					
10	CH1 Digital output value					
11	CH2 Digital output value					
12	CH3 Digital output value					
13	CH4 Digital output value					
14	CH5 Digital output value					
15	CH6 Digital output value					
16	CH7 Digital output value					
17	CH8 Digital output value					
18	Write data error code	R/W				
19	A/D conversion completed flag	R				

(3) Comparisons between A68ADC and AJ65SBT2B-64AD

(a) Performance specifications comparisons

○ : Compatible, △ : Partial change required, × : Not compatible

Item	A68ADC	AJ65SBT2B-64AD	Compati- bility	Precautions for replacement																																										
Analog input	Voltage: -10 to 0 to +10VDC (input resistance 30K Ω) Current: +4 to +20mA (input resistance 250 Ω) Select via input terminal * Current input can also be used as -20 to 0 to +20mA.	Voltage: -10 to 0 to +10VDC (input resistance 1M Ω) Current: 0 to +20mA (input resistance 250 Ω)	△	Negative current cannot be converted.																																										
Digital output	16bits signed binary (data part 11 bits) -2048 to +2047	16bits signed binary (-16384 to 16383)	○																																											
I/O characteristics	<table border="1"> <thead> <tr> <th>Analog input</th> <th>Digital output</th> </tr> </thead> <tbody> <tr> <td>+10V</td> <td>+2000</td> </tr> <tr> <td>+5V or +20mA</td> <td>+1000</td> </tr> <tr> <td>0V or +4mA</td> <td>± 0</td> </tr> <tr> <td>-5V or -12mA</td> <td>-1000</td> </tr> <tr> <td>-10V</td> <td>-2000</td> </tr> </tbody> </table>	Analog input	Digital output	+10V	+2000	+5V or +20mA	+1000	0V or +4mA	± 0	-5V or -12mA	-1000	-10V	-2000	<table border="1"> <thead> <tr> <th rowspan="2">Analog input range</th> <th rowspan="2">Digital output</th> <th colspan="2">Accuracy</th> </tr> <tr> <th>Ambient temperature 0 to 55 °C</th> <th>Maximum resolution</th> </tr> </thead> <tbody> <tr> <td>-10 to +10V</td> <td rowspan="3">-16000 to +16000</td> <td rowspan="3">± 0.2% (± 32 digits)</td> <td>0.625mV</td> </tr> <tr> <td>User range setting 1 (-10 to +10V)</td> <td>0.5mV</td> </tr> <tr> <td>User range setting 2 (-5 to 5V)</td> <td>0.25mV</td> </tr> <tr> <td>0 to 5V</td> <td>0 to 16000</td> <td rowspan="3">± 0.2% (± 32 digits)</td> <td>0.3125mV</td> </tr> <tr> <td>1 to 5V</td> <td>0 to 16000</td> <td>0.25mV</td> </tr> <tr> <td>0 to 20mA</td> <td>0 to 16000</td> <td>1.25 μA</td> </tr> <tr> <td>4 to 20mA</td> <td rowspan="2">-16000 to +16000</td> <td rowspan="2">± 0.2% (± 32 digits)</td> <td>1 μA</td> </tr> <tr> <td>User range setting 2</td> <td></td> </tr> </tbody> </table>	Analog input range	Digital output	Accuracy		Ambient temperature 0 to 55 °C	Maximum resolution	-10 to +10V	-16000 to +16000	± 0.2% (± 32 digits)	0.625mV	User range setting 1 (-10 to +10V)	0.5mV	User range setting 2 (-5 to 5V)	0.25mV	0 to 5V	0 to 16000	± 0.2% (± 32 digits)	0.3125mV	1 to 5V	0 to 16000	0.25mV	0 to 20mA	0 to 16000	1.25 μA	4 to 20mA	-16000 to +16000	± 0.2% (± 32 digits)	1 μA	User range setting 2		△	Precautions are needed as gain values are different.
Analog input	Digital output																																													
+10V	+2000																																													
+5V or +20mA	+1000																																													
0V or +4mA	± 0																																													
-5V or -12mA	-1000																																													
-10V	-2000																																													
Analog input range	Digital output	Accuracy																																												
		Ambient temperature 0 to 55 °C	Maximum resolution																																											
-10 to +10V	-16000 to +16000	± 0.2% (± 32 digits)	0.625mV																																											
User range setting 1 (-10 to +10V)			0.5mV																																											
User range setting 2 (-5 to 5V)			0.25mV																																											
0 to 5V	0 to 16000	± 0.2% (± 32 digits)	0.3125mV																																											
1 to 5V	0 to 16000		0.25mV																																											
0 to 20mA	0 to 16000		1.25 μA																																											
4 to 20mA	-16000 to +16000	± 0.2% (± 32 digits)	1 μA																																											
User range setting 2																																														
Maximum resolution	Voltage 5mV (1/2000) Current 20 μA (1/1000)		○																																											
Overall accuracy	Within ± 1% (± 20) (accuracy relative to maximum value)		○																																											
Max. conversion speed	Maximum 2.5ms/channel	200 μs/channel	○																																											
Absolute maximum input	Voltage ± 15V, current ± 30mA		○																																											
Number of analog input points	8 channels/module	4 channels/module	×	Consider replacing by using two or more AJ65SBT2B-64AD modules.																																										
Insulation method	Photocoupler isolation between input terminal and programmable controller power supply (non-isolated between channels)	Between communication line and all analog inputs: Photocoupler isolation between power line and all analog inputs: Photocoupler isolation (non-isolated between channels)	○																																											
Number of occupied I/O stations (number of points)	4 stations (4 stations × 8 points)	1 station (1 station × 32 points) (RX/RX 32 points each, RWw/RWw 4 points each)	○																																											
Connected terminal	47-point terminal block	Communication part, module communication part: 7-point two-piece terminal block (M3 screw) I/O part: 18-point two-piece terminal block (M3 screw)	×	Change in wiring is required.																																										
Applicable wire size	0.75 to 2mm ² (applicable tightening torque 7kg · cm)	0.3 to 2.0mm ²	○																																											
Applicable solderless terminal	V1.25-3, V1.25-YS3A, V2-S3, V2-YS3A	<ul style="list-style-type: none"> RAV1.25-3 (conforming to JIS C 2805) [Applicable wire size: 0.3 to 1.25mm²] V2-MS3, RAP2-3SL, TGV2-3N [Applicable wire size: 1.25 to 2.0mm²] 	○																																											
24VDC internal current consumption	0.3A	0.12A	○																																											
Weight	1.01kg	0.25kg	△																																											

○ : Compatible, △ : Partial change required, × : Not compatible

Item	A68ADC	AJ65SBT2B-64AD	Compati- bility	Precautions for replacement
External dimensions	170(H) × 100(W) × 80(D) mm	50(H) × 122(W) × 54(D) mm	×	The overall size differs. Pay attention to the mounting dimensions.

(b) Functional comparisons

○ : Compatible, △ : Partial change required, × : Not compatible

Item	A68ADC	AJ65SBT2B-64AD	Compati- bility	Precautions for replacement
Averaging processing A/D conversion system	A/D conversion is performed according to set times or set processing time on a channel, which is specified for the averaging processing to be performed on by the programmable controller CPU. After the conversion, the maximum and minimum values are removed, and the remaining total is averaged and the results are stored in the buffer memory.	Selects whether to perform the sampling processing or averaging processing (count average/time average/moving average) on each channel.	○	
Specification of channel to use	The A68ADC has the A/D conversion circuits of 8 channels. Execution/non-execution of the A/D conversion can be specified on each of those channels. With the programmable controller CPU, the channel to execute A/D conversion on is specified to address 0 (specification of channel to use) of the buffer memory.	Selects whether to enable or disable A/D conversion on each channel. By making unused channels A/D conversion prohibited, conversion cycle can be shortened.	○	
Input range setting function	—	Selects the analog input range to be used from the factory default ranges (4 to 20mA, 0 to 20mA, 1 to 5V, 0 to 5V, -10 to 10V) and the user range (user range setting) and changes the I/O conversion characteristics.	—	
Offset/gain setting	Changes the I/O conversion characteristics.	Corrects an error of a digital output value.	○	
Transmission speed auto-tracking function	—	Automatically sets the transmission speed according to the settings of the master module when the AJ65SBT2B-64AD is powered on.	—	

(c) Programmable controller CPU I/O signal comparisons

I/O signals are different, so the sequence program must be changed.

For details on I/O signals and sequence programs, refer to the User's Manual.

A68ADC				AJ65SBT2B-64AD			
Device No.	Description	Device No.	Description	Device No.	Description	Device No.	Description
X(n+0) to X(n+3)	Use prohibited	Y(n+0) to Y(n+3)	Use prohibited	RXn0	CH1 A/D Conversion complete flag	RYn0	CH1 A/D conversion enable/disable setting
X(n+4)	Communication error detection flag indicating that execution of the FROM and TO instructions resulted in a communication error	Y(n+4)	Error detection reset signal ^{*1}	RXn1	CH2 A/D Conversion complete flag	RYn1	CH2 A/D conversion enable/disable setting
X(n+5)	A68ADC reset switch ON detection flag	Y(n+5)	Reset signal of reset switch ON detection flag	RXn2	CH3 A/D Conversion complete flag	RYn2	CH3 A/D conversion enable/disable setting
X(n+6)	Use prohibited	Y(n+6)	Use prohibited	RXn3	CH4 A/D Conversion complete flag	RYn3	CH4 A/D conversion enable/disable setting
				RXn4 to RXn9	Use prohibited	RYn4	CH1 Input range setting (0th bit)
						RYn5	CH1 Input range setting (1st bit)
						RYn6	CH1 Input range setting (2nd bit)
						RYn7	CH2 Input range setting (0th bit)
						RYn8	CH2 Input range setting (1st bit)
				RXnA	Hardware error flag	RYn9	CH2 Input range setting (2nd bit)
RYnA	CH3 Input range setting (0th bit)						
X(n+7)	Communication completion response signal wait flag	Y(n+7)	Communication reset signal ^{*1}	RXnB	User range read error flag	RYnB	CH3 Input range setting (1st bit)

A68ADC				AJ65SBT2B-64AD			
Device No.	Description	Device No.	Description	Device No.	Description	Device No.	Description
X(n+8) to X(n+17)	Use prohibited	Y(n+8) to Y(n+1F)	Use prohibited	RXnC	Flash memory write error flag	RYnC	CH3 Input range setting (2nd bit)
				RXnD	Number of offset/gain settings excess flag	RYnD	CH4 Input range setting (0th bit)
X(n+18)	A/D conversion READY			RxnE	Use prohibited	RYnE	CH4 Input range setting (1st bit)
				RXnF	Test mode flag	RYnF	CH4 Input range setting (2nd bit)
				RX(n+1)0 to RX(n+1)7	Use prohibited	RY(n+1)0 to RY(n+1)7	Use prohibited
				RX(n+1)8	Initial data processing request flag	RY(n+1)8	Initial data setting complete flag
				RX(n+1)9	Initial data setting complete flag	RY(n+1)9	Initial data setting request flag
				RX(n+1)A	Error status flag	RY(n+1)A	Error reset request flag
				RX(n+1)B	Remote READY	RY(n+1)B to RY(n+1)F	Use prohibited
X(n+19) to X(n+1F)	Use prohibited			RX(n+1)C to RX(n+1)F	Use prohibited		

*1 The signal contents differ when a version B A68ADC is combined with a version B A2CCPU.

(d) Buffer memory addresses comparisons

Buffer memory allocation is different, so the sequence program must be changed.
 For details on buffer memory and sequence programs, refer to the User's Manual.

A68ADC			AJ65SBT2B-64AD		
Address	Name	Read/write	Address	Name	Read/write
0	Specification of channel to use	R/W	RWwm	CH1 Average processing setting	W
1	Averaging processing specification		RWwm+1	CH2 Average processing setting	
2	CH1 Averaging time, count		RWwm+2	CH3 Average processing setting	
3	CH2 Averaging time, count		RWwm+3	CH4 Average processing setting	
4	CH3 Averaging time, count		RWrn	CH1 Digital output value	R
5	CH4 Averaging time, count		RWrn+1	CH2 Digital output value	
6	CH5 Averaging time, count		RWrn+2	CH3 Digital output value	
7	CH6 Averaging time, count		RWrn+3	CH4 Digital output value	
8	CH7 Averaging time, count		R	m, n: The address assigned to the master station by a station number setting	
9	CH8 Averaging time, count				
10	CH1 Digital output value				
11	CH2 Digital output value				
12	CH3 Digital output value				
13	CH4 Digital output value				
14	CH5 Digital output value				
15	CH6 Digital output value				
16	CH7 Digital output value				
17	CH8 Digital output value	R/W			
18	Write data error code	R			
19	A/D conversion completed flag				

(4) Comparisons between A68ADC and AJ65VBTCU-68ADVN/AJ65VBTCU-68ADIN

(a) Performance specifications comparisons

○ : Compatible, △ : Partial change required, × : Not compatible

Item	A68ADC	AJ65VBTCU-68ADVN	AJ65VBTCU-68ADIN	Compati-bility	Precautions for replacement																																												
Analog input	Voltage: -10 to 0 to +10VDC (input resistance 30K Ω) Current: +4 to +20mA (input resistance 250 Ω) Select via input terminal * Current input can also be used as -20 to 0 to +20mA.	Voltage: -10 to +10VDC (input resistance 1M Ω)	Current: 0 to +20mA (input resistance 250 Ω)	△	Voltage and current cannot be mixed, and negative current cannot be converted.																																												
Digital output	16bits signed binary (data part 11bits) -2048 to 2047	16bits signed binary (-4096 to +4095)	16bits signed binary (-96 to +4095)	○																																													
I/O characteristics	<table border="1"> <thead> <tr> <th>Analog input</th> <th>Digital output</th> </tr> </thead> <tbody> <tr> <td>+10V</td> <td>+2000</td> </tr> <tr> <td>+5V or +20mA</td> <td>+1000</td> </tr> <tr> <td>0V or +4mA</td> <td>± 0</td> </tr> <tr> <td>-5V or -12mA</td> <td>-1000</td> </tr> <tr> <td>-10V</td> <td>-2000</td> </tr> </tbody> </table>	Analog input	Digital output	+10V	+2000	+5V or +20mA	+1000	0V or +4mA	± 0	-5V or -12mA	-1000	-10V	-2000	<table border="1"> <thead> <tr> <th rowspan="2">Analog input range</th> <th rowspan="2">Digital output</th> <th colspan="2">Accuracy</th> <th rowspan="2">Maximum resolution</th> </tr> <tr> <th>Ambient temperature 0 to 55 °C</th> <th>Ambient temperature 25 ± 5 °C</th> </tr> </thead> <tbody> <tr> <td>-10 to +10V</td> <td>-4000 to +4000</td> <td rowspan="6">± 0.3% (± 12 digits*)</td> <td rowspan="6">± 0.2% (± 8 digits*)</td> <td>2.5mV</td> </tr> <tr> <td>User range setting 1 (-10 to +10V)</td> <td></td> <td>1.25mV</td> </tr> <tr> <td>0 to 5V</td> <td>0 to 4000</td> <td>1.0mV</td> </tr> <tr> <td>1 to 5V</td> <td></td> <td></td> </tr> <tr> <td>User range setting 2 (0 to 5V)</td> <td></td> <td></td> </tr> <tr> <td>0 to 20mA</td> <td>0 to 4000</td> <td>5 μ A</td> </tr> <tr> <td>4 to 20mA</td> <td></td> <td>4 μ A</td> </tr> <tr> <td>User range setting 3 (0 to 20mA)</td> <td></td> <td></td> </tr> </tbody> </table>	Analog input range	Digital output	Accuracy		Maximum resolution	Ambient temperature 0 to 55 °C	Ambient temperature 25 ± 5 °C	-10 to +10V	-4000 to +4000	± 0.3% (± 12 digits*)	± 0.2% (± 8 digits*)	2.5mV	User range setting 1 (-10 to +10V)		1.25mV	0 to 5V	0 to 4000	1.0mV	1 to 5V			User range setting 2 (0 to 5V)			0 to 20mA	0 to 4000	5 μ A	4 to 20mA		4 μ A	User range setting 3 (0 to 20mA)			△	Precautions are needed as gain values are different.
Analog input	Digital output																																																
+10V	+2000																																																
+5V or +20mA	+1000																																																
0V or +4mA	± 0																																																
-5V or -12mA	-1000																																																
-10V	-2000																																																
Analog input range	Digital output	Accuracy		Maximum resolution																																													
		Ambient temperature 0 to 55 °C	Ambient temperature 25 ± 5 °C																																														
-10 to +10V	-4000 to +4000	± 0.3% (± 12 digits*)	± 0.2% (± 8 digits*)	2.5mV																																													
User range setting 1 (-10 to +10V)				1.25mV																																													
0 to 5V	0 to 4000			1.0mV																																													
1 to 5V																																																	
User range setting 2 (0 to 5V)																																																	
0 to 20mA	0 to 4000			5 μ A																																													
4 to 20mA		4 μ A																																															
User range setting 3 (0 to 20mA)																																																	
Maximum resolution	Voltage 5mV (1/2000) Current 20 μ A (1/1000)			○																																													
Overall accuracy	Within ± 1% (± 20) (accuracy relative to maximum value)			○																																													
Maximum conversion speed	Maximum 2.5ms/channel	1ms/channel		○																																													
Absolute maximum input	Voltage ± 15V, current ± 30mA			○																																													
Number of analog input points	8 channels/module			○																																													
Insulation method	Photocoupler isolation between input terminal and programmable controller power supply (non-isolated between channels)	<table border="1"> <thead> <tr> <th>Isolated locations</th> <th>Isolation method</th> <th>Dielectric withstand voltage</th> <th>Isolation resistance</th> </tr> </thead> <tbody> <tr> <td>Between communication line and all analog inputs:</td> <td>Photocoupler isolation</td> <td rowspan="2">500VAC for 1 min</td> <td rowspan="2">5M Ω or more by 500VDC insulation resistance tester</td> </tr> <tr> <td>Between power supply line and all analog inputs:</td> <td>Transformer</td> </tr> <tr> <td>Between channels</td> <td>Non-isolated</td> <td>-</td> <td>-</td> </tr> </tbody> </table>	Isolated locations	Isolation method	Dielectric withstand voltage	Isolation resistance	Between communication line and all analog inputs:	Photocoupler isolation	500VAC for 1 min	5M Ω or more by 500VDC insulation resistance tester	Between power supply line and all analog inputs:	Transformer	Between channels	Non-isolated	-	-	○																																
Isolated locations	Isolation method	Dielectric withstand voltage	Isolation resistance																																														
Between communication line and all analog inputs:	Photocoupler isolation	500VAC for 1 min	5M Ω or more by 500VDC insulation resistance tester																																														
Between power supply line and all analog inputs:	Transformer																																																
Between channels	Non-isolated	-	-																																														
Number of occupied I/O stations (number of points)	4 stations (4 stations × 8 points)	When set to Ver.1 remote device station (Ver.1 compatible local station): 3 stations (3 stations × 32 points) (RX/RV 32 points each, RWr/RWw 12 points each) When set to Ver.2 remote device station (Ver.2 compatible local station): 1 station (1 station × 32 points) (Expanded cyclic setting: 4X) (RX/RV 32 points each, RWr/RWw 16 points each)		×	When Ver.1 remote device station is set, the number of occupied points increases. The assignment of the entire system needs to be reconsidered.																																												

○: Compatible, △: Partial change required, ×: Not compatible

Item	A68ADC	AJ65VBTCU-68ADV	AJ65VBTCU-68ADIN	Compati- bility	Precautions for replacement
Connected terminal	47-point terminal block				
Applicable wire size	0.75 to 2mm ² (applicable tightening torque 7kg · cm)	One-touch connector for communication	Communication line: Ver.1.10 compatible CC-Link dedicated cable 0.5mm ² (AWG#20) [φ 2.2 to 3.0] Shield wire 0.5mm ² (AWG#20)		
Applicable solderless terminal	V1.25-3, V1.25-YS3A, V2-S3, V2-YS3A	One-touch connector for power supply/FG	0.66 to 0.98mm ² (AWG#18) [φ 2.2 to 3.0] Wire diameter 0.16mm or more	×	Change in wiring is required.
		One-touch connector for analog I/O	<ul style="list-style-type: none"> ▪ φ 1.0 to 1.4 (A6CON-P214), φ 1.4 to 2.0 (A6CON-P220) [Applicable wire size: 0.14 to 0.2mm²] ▪ φ 1.0 to 1.4 (A6CON-P514), φ 1.4 to 2.0 (A6CON-P520) [Applicable wire size: 0.3 to 0.5mm²] 		
24VDC internal current consumption	0.3A		0.1A	○	
Weight	1.01kg		0.17kg	△	
External dimensions	170(H) × 100(W) × 80(D)mm		115(H) × 41(W) × 67(D)mm	×	The overall size differs. Pay attention to the mounting dimensions.

(b) Functional comparisons

○ : Compatible, △ : Partial change required, × : Not compatible

Item	A68ADC	AJ65VBTCU-68ADVN/ AJ65VBTCU-68ADIN	Compati- bility	Precautions for replacement
Averaging processing A/D conversion system	A/D conversion is performed according to set times or set processing time on a channel, which is specified for the averaging processing to be performed on by the programmable controller CPU. After the conversion, the maximum and minimum values are removed, and the remaining total is averaged and the results are stored in the buffer memory.	A/D conversion is performed according to set times or set processing time on a channel, which is specified for the averaging processing to be performed on. After the conversion, the results are stored in the remote register.	○	
Specification of channel to use	The A68ADC has 8 channels of an A/D conversion circuit. Execution/non-execution of A/D conversion can be specified on each of those channels. With the programmable controller CPU, the channel to execute A/D conversion on is specified to address 0 (specification of channel to use) of the buffer memory.	Enable (execute)/disable (do not execute) A/D conversion is specified on each channel. By making unused channels conversion prohibited, sampling period can be shortened.	○	
Offset/gain setting	Changes the I/O conversion characteristics.		○	

(c) Programmable controller CPU I/O signal comparisons

I/O signal is different, so the sequence program must be changed.

For details on I/O signals and sequence programs, refer to the User's Manual.

A68ADC				AJ65VBTCU-68ADV/AJ65VBTCU-68ADIN			
Device No.	Description	Device No.	Description	Device No.	Description	Device No.	Description
X(n+0) to X(n+3)	Use prohibited	Y(n+0) to Y(n+3)	Use prohibited	RXn0	CH1 A/D Conversion complete flag	RYn0 to RY(n+1)7	Use prohibited
X(n+4)	Communication error detection flag indicating that execution of the FROM and TO instructions resulted in a communication error	Y(n+4)	Error detection reset signal *1	RXn1	CH2 A/D Conversion completed flag		
				RXn2	CH3 A/D Conversion completed flag		
				RXn3	CH4 A/D Conversion completed flag		
X(n+5)	A68ADC reset switch ON detection flag	Y(n+5)	Reset switch ON detection flag reset signal	RXn4	CH5 A/D Conversion completed flag		
				RXn5	CH6 A/D Conversion completed flag		
X(n+6)	Use prohibited	Y(n+6)	Use prohibited	RXn6	CH7 A/D Conversion completed flag		
X(n+7)	Communication completion response signal wait flag	Y(n+7)	Communication reset signal *1	RXn7	CH8 A/D Conversion completed flag		
X(n+8) to X(n+17)	Use prohibited	Y(n+8) to Y(n+1F)	Use prohibited	RXn8 to RXnB	Use prohibited		
				RXnC	E ² PROM write error flag		
X(n+18)	A/D conversion READY			RXnD to RX(n+1)7	Use prohibited		
				RX(n+1)8	Initial data processing request flag	RY(n+1)8	Initial data processing complete flag
				RX(n+1)9	Initial data setting complete flag	RY(n+1)9	Initial data setting request flag
X(n+19) to X(n+1F)	Use prohibited			RX(n+1)A	Error status flag	RY(n+1)A	Error reset request flag
				RX(n+1)B	Remote READY	RY(n+1)B to RY(n+5)F	Use prohibited
				RX(n+1)C to RX(n+5)F	Use prohibited		

*1: The signal contents differ when a version B A68ADC is combined with a version B A2CCPU.

(d) Buffer memory addresses comparisons

Buffer memory allocation is different, so the sequence program must be changed.

For details on buffer memory and sequence programs, refer to the User's Manual.

A68ADC			AJ65VBTCU-68ADV/AJ65VBTCU-68ADIN		
Address	Name	Read/write	Address	Name	Read/write
0	Specification of channel to use	R/W	RWwm+0	A/D conversion enable/disable specification	W
1	Averaging processing specification		RWwm+1	CH1 to 4 input range setting	
2	CH1 Averaging time, count		RWwm+2	CH5 to 8 input range setting	
3	CH2 Averaging time, count		RWwm+3	Averaging processing specification	
4	CH3 Averaging time, count		RWwm+4	CH1 Averaging time, count	
5	CH4 Averaging time, count		RWwm+5	CH2 Averaging time, count	
6	CH5 Averaging time, count		RWwm+6	CH3 Averaging time, count	
7	CH6 Averaging time, count		RWwm+7	CH4 Averaging time, count	
8	CH7 Averaging time, count		RWwm+8	CH5 Averaging time, count	
9	CH8 Averaging time, count		RWwm+9	CH6 Averaging time, count	
10	CH1 Digital output value	R	RWwm+A	CH7 Averaging time, count	R
11	CH2 Digital output value		RWwm+B	CH8 Averaging time, count	
12	CH3 Digital output value		RWrn+0	CH1 Digital output value	
13	CH4 Digital output value		RWrn+1	CH2 Digital output value	
14	CH5 Digital output value		RWrn+2	CH3 Digital output value	
15	CH6 Digital output value		RWrn+3	CH4 Digital output value	
16	CH7 Digital output value		RWrn+4	CH5 Digital output value	
17	CH8 Digital output value		RWrn+5	CH6 Digital output value	
18	Write data error code	R/W	RWrn+6	CH7 Digital output value	-
19	A/D conversion completed flag	R	RWrn+7	CH8 Digital output value	
			RWrn+8	Error code	
			RWrn+9 to RWrn+B	Use prohibited	-

6.2.2 Analog output module comparison

(1) Comparisons between A64DAVC and AJ65BT-64DAV

(a) Performance specifications comparisons

○ : Compatible, △ : Partial change required, × : Not compatible

Item	A64DAVC	AJ65BT-64DAV	Compati- bility	Precautions for replacement																																								
Digital input	(1) 16-bit signed binary value (2) Setting range: <table border="1"> <thead> <tr> <th>Set resolution</th> <th>Setting range</th> </tr> </thead> <tbody> <tr> <td>1/4000</td> <td>-4000 to 4000</td> </tr> <tr> <td>1/8000</td> <td>-8000 to 8000</td> </tr> <tr> <td>1/12000</td> <td>-12000 to 12000</td> </tr> </tbody> </table>	Set resolution	Setting range	1/4000	-4000 to 4000	1/8000	-8000 to 8000	1/12000	-12000 to 12000	16bits signed binary (valid bits: 12 bits) -2048 to +2047	×	The setting range has been changed.																																
Set resolution	Setting range																																											
1/4000	-4000 to 4000																																											
1/8000	-8000 to 8000																																											
1/12000	-12000 to 12000																																											
Analog output	-10 to 0 to 10VDC (external load resistance: 2kΩ to 1MΩ)	Voltage: -10 to +10VDC (external load resistance: 2kΩ to 1MΩ)	○																																									
I/O characteristics	<table border="1"> <thead> <tr> <th rowspan="2">Digital input value</th> <th colspan="3">Digital value resolution</th> <th rowspan="2">Analog output value*</th> </tr> <tr> <th>1/4000</th> <th>1/8000</th> <th>1/12000</th> </tr> </thead> <tbody> <tr> <td>4000</td> <td>8000</td> <td>12000</td> <td>+10V</td> </tr> <tr> <td>2000</td> <td>4000</td> <td>6000</td> <td>+5V</td> </tr> <tr> <td>0</td> <td>0</td> <td>0</td> <td>0V</td> </tr> <tr> <td>-2000</td> <td>-4000</td> <td>-6000</td> <td>-5V</td> </tr> <tr> <td>-4000</td> <td>-8000</td> <td>-12000</td> <td>-10V</td> </tr> </tbody> </table> <p>* When the offset value is set to 0V and the gain value is set to 10V</p>	Digital input value	Digital value resolution			Analog output value*	1/4000	1/8000	1/12000	4000	8000	12000	+10V	2000	4000	6000	+5V	0	0	0	0V	-2000	-4000	-6000	-5V	-4000	-8000	-12000	-10V	<table border="1"> <thead> <tr> <th>Digital input value</th> <th>Analog conversion value</th> </tr> </thead> <tbody> <tr> <td>+2000</td> <td>+10V</td> </tr> <tr> <td>+1000</td> <td>+5V</td> </tr> <tr> <td>0</td> <td>± 0V</td> </tr> <tr> <td>-1000</td> <td>-5V</td> </tr> <tr> <td>-2000</td> <td>-10V</td> </tr> </tbody> </table>	Digital input value	Analog conversion value	+2000	+10V	+1000	+5V	0	± 0V	-1000	-5V	-2000	-10V	△	The digital input range is different.
Digital input value	Digital value resolution			Analog output value*																																								
	1/4000	1/8000	1/12000																																									
4000	8000	12000	+10V																																									
2000	4000	6000	+5V																																									
0	0	0	0V																																									
-2000	-4000	-6000	-5V																																									
-4000	-8000	-12000	-10V																																									
Digital input value	Analog conversion value																																											
+2000	+10V																																											
+1000	+5V																																											
0	± 0V																																											
-1000	-5V																																											
-2000	-10V																																											
Maximum resolution of digital value	0.83mV (1/12000)	5mV (1/2000)	×	The maximum resolution is different.																																								
Overall accuracy (accuracy of maximum value)	± 1.0% (± 100mV)		○																																									
Maximum conversion speed	Within 25ms/4 channels (1 channel is same period of time)	Max. 1ms/channel (4ms/4 channels)	○																																									
Number of analog output points	4 channels/module		○																																									
Insulation method	Between the output terminal and programmable controller power supply: Photocoupler isolation (non-isolated between channels)	Between output channels: Non-isolated Between external power supply and analog output: Transformer insulation	○																																									
Number of occupied I/O stations (number of points)	4 stations (4 stations × 8 points)	2 stations (2 stations × 32 points) (RX/RV 32 points each, RWr/RWw 8 points each)	×	The number of occupied points increases. The assignment of the entire system needs to be reconsidered.																																								
Connected terminal	47-point terminal block	27-point terminal block	×	Change in wiring is required.																																								
Applicable wire size	0.75 to 2mm ² (applicable tightening torque 39 to 59N · cm)		○																																									
Applicable solderless terminal	V1.25-3, V1.25-YS3A, V2-S3, V2-YS3A	RAV1.25-3.5 (comforting to JIS C 2805), RAV2-3.5	×																																									
24VDC internal current consumption	0.12A	0.18A	△	The current consumption increases. The current capacity needs to be reconsidered.																																								
Weight	1.01kg	0.4kg	△																																									
External dimensions	170(H) × 100(W) × 80(D) mm	65(H) × 151.9(W) × 63(D) mm	×	The overall size differs. Pay attention to the mounting dimensions.																																								

(b) Functional comparisons

○ : Compatible, △ : Partial change required, × : Not compatible

Item	A64DAVC	AJ65BT-64DAV	Compati- bility	Precautions for replacement
Analog output enable signal	With the analog output enable signals (Yn+18 to Yn+1B), it is possible to select the type of output values at each channel from D/A converted analog values and output offset values.	By turning the analog output enable signal ON or OFF with the sequence program, it is possible to select the type of output values at each channel from D/A converted analog values and output offset values. Note, however, that the D/A conversion time (conversion speed) is fixed regardless of the setting of the analog output enable signal.	○	
Analog output enable/disable setting	Stores the channel to disable analog output from (0V/0mA) in the buffer memory of the A64DAVC.	By writing "0" or "1" to the address of the remote register using the sequence program, it is possible to select on each channel whether to enable or disable outputs of analog values.	○	
HOLD/CLEAR setting	In preparation for the event that the programmable controller CPU enters a stop status or an error status, select HOLD or CLEAR (offset values or 0V/0mA) analog values that are stored before a stop or an error occurrence using the HOLD/CLEAR terminal.	In preparation for the event that the programmable controller CPU enters a stop status or the AJ65BT-64DAV stops D/A conversion due to an error, the HLD/CLR terminal can be used to select whether to hold or clear analog values (output offset values) that are being output from each channel right before those stops. The HLD/CLR terminal is provided on the front of the module and this selection can be made on all channels at once. (Including the case of the disconnections of link communication)	○	
Offset/gain setting	Changes the I/O conversion characteristics.	I/O conversion characteristics can be changed as desired when the detailed ones are required. To do this, short the test mode terminal to enter a test mode, and configure the offset/gain settings for each channel without a aid of a various register. Also, if detailed I/O conversion characteristics are not required, the default offset/gain values can be used by turning on the I/O signal RYn4 (offset/gain selection) to the master station.	○	

(c) Programmable controller CPU I/O signal comparisons

I/O signal is different, so the sequence program must be changed.

For details on I/O signals and sequence programs, refer to the User's Manual.

A64DAVC				AJ65BT-64DAV			
Device No.	Description	Device No.	Description	Device No.	Description	Device No.	Description
X(n+0) to X(n+3)	Use prohibited	Y(n+0) to Y(n+3)	Use prohibited	RXn0 to RXnF	Use prohibited	RYn0	CH1 Enable signal flag for analog output
						RYn1	CH2 Enable signal flag for analog output
RYn2	CH3 Enable signal flag for analog output						
RYn3	CH4 Enable signal flag for analog output						
RYn4	Offset/gain value selection						
X(n+4)	Communication error detection flag indicating that execution of the FROM and TO instructions resulted in a communication error	Y(n+4)	Error detection reset signal	RX(n+1)0 to RX(n+1)7		RYn5 to RYnF	Use prohibited
X(n+5)	A64DAVC reset switch ON detection flag	Y(n+5)	Reset signal for reset switch ON detection flag	RX(n+1)8	Initial data processing request flag	RY(n+1)8	Initial data processing complete flag
X(n+6)	Use prohibited	Y(n+6)	Use prohibited	RX(n+1)9	Initial data setting complete flag	RY(n+1)9	Initial data setting request flag
X(n+7)	Communication completion response signal wait flag	Y(n+7)	Communication reset signal	RX(n+1)A	Error status flag	RY(n+1)A	Error reset request flag
X(n+8) to X(n+17)	Use prohibited	Y(n+8) to Y(n+17)	Use prohibited	RX(n+1)B	Remote READY	RY(n+1)B	
X(n+18)	D/A conversion READY	Y(n+18)	CH1 Analog output enable signal	RX(n+1)C	Use prohibited	RY(n+1)C	Use prohibited
		Y(n+19)	CH2 Analog output enable signal	RX(n+1)D		RY(n+1)D	
		Y(n+1A)	CH3 Analog output enable signal	RX(n+1)E		RY(n+1)E	
		Y(n+1B)	CH4 Analog output enable signal	RX(n+1)F		RY(n+1)F	
X(n+19) to X(n+1F)	Use prohibited	Y(n+1C) to Y(n+1F)	Use prohibited				

(d) Buffer memory addresses comparisons

Buffer memory allocation is different, so the sequence program must be changed.

For details on buffer memory and sequence programs, refer to the User's Manual.

A64DAVC			AJ65BT-64DAV		
Address	Name	Read/write	Address	Name	Read/write
0	CH1 Digital value setting area	R/W	RWwm	CH1 Digital value setting area	W
1	CH2 Digital value setting area		RWwm+1	CH2 Digital value setting area	
2	CH3 Digital value setting area		RWwm+2	CH3 Digital value setting area	
3	CH4 Digital value setting area		RWwm+3	CH4 Digital value setting area	
4	CH1 Analog output disable/enable setting area		RWwm+4	Analog output enable/disable area	-
5	CH2 Analog output disable/enable setting area		RWwm+5	Use prohibited	
6	CH3 Analog output disable/enable setting area		RWwm+6		
7	CH4 Analog output disable/enable setting area		RWwm+7		
8	Resolution of digital value setting area		RWrn	CH1 Set value check code	R
9	Error code storage area	RWm+1	CH2 Set value check code		
		RWm+2	CH3 Set value check code		
		RWm+3	CH4 Set value check code		
		RWm+4	Error code	-	
		RWm+5	Use prohibited		
		RWm+6			
		RWm+7			

(2) Comparisons between A64DAVC and AJ65SBT2B-64DA (voltage output)

(a) Performance specifications comparisons

○ : Compatible, △ : Partial change required, × : Not compatible

Item	A64DAVC	AJ65SBT2B-64DA	Compati- bility	Precautions for replacement																																																																						
Digital input	(1) 16-bit signed binary value (2) Setting range: <table border="1"> <thead> <tr> <th>Set resolution</th> <th>Setting range</th> </tr> </thead> <tbody> <tr> <td>1/4000</td> <td>-4000 to 4000</td> </tr> <tr> <td>1/8000</td> <td>-8000 to 8000</td> </tr> <tr> <td>1/12000</td> <td>-12000 to 12000</td> </tr> </tbody> </table>	Set resolution	Setting range	1/4000	-4000 to 4000	1/8000	-8000 to 8000	1/12000	-12000 to 12000	Voltage: 16bits signed binary (-12288 to 12287, -16384 to 16383, -288 to 12287) Current: 16bits signed binary (-288 to 12287)	×	The setting range has been changed.																																																														
Set resolution	Setting range																																																																									
1/4000	-4000 to 4000																																																																									
1/8000	-8000 to 8000																																																																									
1/12000	-12000 to 12000																																																																									
Analog output	Voltage: -10 to +10VDC (external load resistance: 2k Ω to 1M Ω)	Voltage: -10 to +10VDC (external load resistance: 1k Ω to 1M Ω) Current: 0 to 20mA (external load resistance: 0 to 600 Ω)	○																																																																							
I/O characteristics	<table border="1"> <thead> <tr> <th rowspan="3">Digital input value</th> <th colspan="3">Digital value resolution</th> <th rowspan="3">Analog output value*</th> </tr> <tr> <th>1/4000</th> <th>1/8000</th> <th>1/12000</th> </tr> </thead> <tbody> <tr> <td>4000</td> <td>8000</td> <td>12000</td> <td>+10V</td> </tr> <tr> <td>2000</td> <td>4000</td> <td>6000</td> <td>+5V</td> </tr> <tr> <td>0</td> <td>0</td> <td>0</td> <td>0V</td> </tr> <tr> <td>-2000</td> <td>-4000</td> <td>-6000</td> <td>-5V</td> </tr> <tr> <td>-4000</td> <td>-8000</td> <td>-12000</td> <td>-10V</td> </tr> </tbody> </table> <p>* When the offset value is set to 0V and the gain value is set to 10V</p>	Digital input value	Digital value resolution			Analog output value*	1/4000	1/8000	1/12000	4000	8000	12000	+10V	2000	4000	6000	+5V	0	0	0	0V	-2000	-4000	-6000	-5V	-4000	-8000	-12000	-10V	<table border="1"> <thead> <tr> <th rowspan="2">Digital input value</th> <th rowspan="2">Analog output range</th> <th colspan="2">Accuracy</th> <th rowspan="2">Maximum resolution</th> </tr> <tr> <th>Ambient temperature 0 to 3°C</th> <th>Ambient temperature 25 ± 5°C</th> </tr> </thead> <tbody> <tr> <td rowspan="2">-16000 to 16000</td> <td rowspan="2">-10 to 10V</td> <td>± 0.3% (± 30mV)</td> <td>± 0.2% (± 20mV)</td> <td>0.625mV</td> </tr> <tr> <td>± 0.3% (± 15mV)</td> <td>± 0.2% (± 10mV)</td> <td>0.416mV</td> </tr> <tr> <td rowspan="2">0 to 12000</td> <td>0 to 5V</td> <td>± 0.3% (± 30mV)</td> <td>± 0.2% (± 20mV)</td> <td>0.333mV</td> </tr> <tr> <td>1 to 5V</td> <td>± 0.3% (± 30mV)</td> <td>± 0.2% (± 20mV)</td> <td>0.333mV</td> </tr> <tr> <td rowspan="2">-12000 to 12000</td> <td>User range setting 2 (-10 to 10V)</td> <td>± 0.3% (± 30mV)</td> <td>± 0.2% (± 20mV)</td> <td>0.333mV</td> </tr> <tr> <td>0 to 20mA</td> <td></td> <td></td> <td>1.66 μ A</td> </tr> <tr> <td rowspan="3">0 to 12000</td> <td>4 to 20mA</td> <td></td> <td></td> <td>1.33 μ A</td> </tr> <tr> <td>User range setting 1 (0 to 20mA)</td> <td>± 0.3% (± 60 μ A)</td> <td>± 0.2% (± 40 μ A)</td> <td>0.95 μ A</td> </tr> </tbody> </table> <p>Factory-set: -10 to +10V.</p>	Digital input value	Analog output range	Accuracy		Maximum resolution	Ambient temperature 0 to 3°C	Ambient temperature 25 ± 5°C	-16000 to 16000	-10 to 10V	± 0.3% (± 30mV)	± 0.2% (± 20mV)	0.625mV	± 0.3% (± 15mV)	± 0.2% (± 10mV)	0.416mV	0 to 12000	0 to 5V	± 0.3% (± 30mV)	± 0.2% (± 20mV)	0.333mV	1 to 5V	± 0.3% (± 30mV)	± 0.2% (± 20mV)	0.333mV	-12000 to 12000	User range setting 2 (-10 to 10V)	± 0.3% (± 30mV)	± 0.2% (± 20mV)	0.333mV	0 to 20mA			1.66 μ A	0 to 12000	4 to 20mA			1.33 μ A	User range setting 1 (0 to 20mA)	± 0.3% (± 60 μ A)	± 0.2% (± 40 μ A)	0.95 μ A	△	The digital input range is different.
Digital input value	Digital value resolution			Analog output value*																																																																						
	1/4000		1/8000		1/12000																																																																					
	4000	8000	12000		+10V																																																																					
2000	4000	6000	+5V																																																																							
0	0	0	0V																																																																							
-2000	-4000	-6000	-5V																																																																							
-4000	-8000	-12000	-10V																																																																							
Digital input value	Analog output range	Accuracy		Maximum resolution																																																																						
		Ambient temperature 0 to 3°C	Ambient temperature 25 ± 5°C																																																																							
-16000 to 16000	-10 to 10V	± 0.3% (± 30mV)	± 0.2% (± 20mV)	0.625mV																																																																						
		± 0.3% (± 15mV)	± 0.2% (± 10mV)	0.416mV																																																																						
0 to 12000	0 to 5V	± 0.3% (± 30mV)	± 0.2% (± 20mV)	0.333mV																																																																						
	1 to 5V	± 0.3% (± 30mV)	± 0.2% (± 20mV)	0.333mV																																																																						
-12000 to 12000	User range setting 2 (-10 to 10V)	± 0.3% (± 30mV)	± 0.2% (± 20mV)	0.333mV																																																																						
	0 to 20mA			1.66 μ A																																																																						
0 to 12000	4 to 20mA			1.33 μ A																																																																						
	User range setting 1 (0 to 20mA)	± 0.3% (± 60 μ A)	± 0.2% (± 40 μ A)	0.95 μ A																																																																						
	Maximum resolution of digital value	0.83mV (1/12000)		×	The maximum resolution is different.																																																																					
Overall accuracy (accuracy of maximum value)	± 1.0% (± 100mV)		○																																																																							
Max. conversion speed	Within 25ms/4 channels (1 channel is same period of time)	200 μs/channel	○																																																																							
Output protection function	-	Available	○																																																																							
Number of analog output points	4 channels/module		○																																																																							
Insulation method	Between the output terminal and programmable controller power supply: Photocoupler isolation (non-isolated between channels)	Between communication line and all analog outputs: Photocoupler isolation between power supply line and all analog outputs: Transformer isolation between channels: Non-isolated	○																																																																							
Number of occupied I/O stations (number of points)	4 stations (4 stations × 8 points)	1 station (1 station × 32 points) (RX/RV 32 points each, RWr/RVw 4 points each)	○																																																																							
Connected terminal	47-point terminal block	Communication part, module communication part: 7-point two-piece terminal block (M3 screw) I/O part: 18-point two-piece terminal block (M3 screw)	×	Change in wiring is required.																																																																						
Applicable wire size	0.75 to 2mm ² (Applicable tightening torque 39 to 59N · cm)	0.3 to 2mm ²	○																																																																							
Applicable solderless terminal	V1.25-3, V1.25-YS3A, V2-S3, V2-YS3A	RAV1.25-3 (conforming to JIS C 2805) [Applicable wire size: 0.3 to 1.25mm ²] V2-MS3, RAP2-3SL, TGV2-3N [Applicable wire size: 1.25 to 2.0mm ²]	○																																																																							

○ : Compatible, △ : Partial change required, × : Not compatible

Item	A64DAVC	AJ65SBT2B-64DA	Compati- bility	Precautions for replacement
External power supply	24VDC (20.4 to 28.8VDC) Current consumption: 0.12A	24VDC (20.4 to 28.8VDC) Current consumption: 0.24A (at 24VDC) Inrush current: 2.6A 3.2ms or less	△	The current consumption increases. The current capacity needs to be reconsidered.
Weight	1.01kg	0.25kg	△	
External dimensions	170(H) × 100(W) × 80(D) mm	50(H) × 122(W) × 54(D) mm	×	The overall size differs. Pay attention to the mounting dimensions.

(b) Functional comparisons

○ : Compatible, △ : Partial change required, × : Not compatible

Item	A64DAVC	AJ65SBT2B-64DA	Compati- bility	Precautions for replacement
Analog output enable/disable setting	Selects whether to output D/A conversion values or offset values on each channel. Note, however, that the conversion speed is fixed regardless of the output enable/disable setting.	Selects whether to output D/A conversion values or offset values on each channel. Note, however, that the conversion speed is fixed regardless of the output enable/disable setting.	○	
Analog conversion enable/disable function	–	Selects whether to enable or disable D/A conversion on each channel. By making unused channels D/A conversion prohibited, conversion speed can be increased.	–	
Output range switching function	–	Sets the analog output range on each channel and changes the I/O conversion characteristics.	–	
HOLD/CLEAR setting	As the analog output status of the programmable controller CPU that is in RUN, at STOP, or in an error status, switching the type of output values as desired between D/A conversion values, offset values and 0V/0mA is possible.	In preparation for the event that the programmable controller CPU enters a stop status or the AJ65SBT2B-64DA stops D/A conversion due to an error, this settings can be configured to select whether to hold or clear analog values (output offset values) that are being output from each channel right before those stops.	○	
Offset/gain setting	Changes the I/O conversion characteristics.	Changes the I/O conversion characteristics as desired. For that, offset/gain settings can be configured for each channel without an aid of a various register.	○	
Transmission speed auto-tracking function	–	Automatically sets the transmission speed according to the settings of the master module when the AJ65SBT2B-64DA is powered on.	–	

(c) Programmable controller CPU I/O signal comparisons

I/O signals are different, so the sequence program must be changed.

For details on I/O signals and sequence programs, refer to the User's Manual.

A64DAVC				AJ65SBT2B-64DA			
Device No.	Description	Device No.	Description	Device No.	Description	Device No.	Description
X(n+0) to X(n+3)	Use prohibited	Y(n+0) to Y(n+3)	Use prohibited	RXn0 to RXn9	Use prohibited	RYn0	CH1 Analog output enable/disable flag
X(n+4)	Communication error detection flag indicating that execution of the FROM and TO instructions resulted in a communication error	Y(n+4)	Error detection reset signal			RYn1	CH2 Analog output enable/disable flag
						RYn2	CH3 Analog output enable/disable flag
						RYn3	CH4 Analog output enable/disable flag
X(n+5)	A64DAVC reset switch ON detection flag	Y(n+5)	Reset signal of reset switch ON detection flag			RYn4	CH1 Range setting (0th bit)
X(n+6)	Use prohibited	Y(n+6)	Use prohibited			RYn5	CH1 Range setting (1st bit)
X(n+7)	Communication completion response signal wait flag	Y(n+7)	Communication reset signal			RYn6	CH1 Range setting (2nd bit)
						RYn7	CH2 Range setting (0th bit)
X(n+8) to X(n+17)	Use prohibited	Y(n+8) to Y(n+17)	Use prohibited	RYn8	CH2 Range setting (1st bit)		
				RYn9	CH2 Range setting (2nd bit)		
				RXnA	Flash memory read error flag	RYnA	CH3 Range setting (0th bit)
				RXnB	User range read error flag	RYnB	CH3 Range setting (1st bit)
				RXnC	Flash memory write error flag	RYnC	CH3 Range setting (2nd bit)
				RXnD, RXnE	Use prohibited	RYnD	CH4 Range setting (0th bit)
				RXnF	Test mode flag	RYnE	CH4 Range setting (1st bit)
						RYnF	CH4 Range setting (2nd bit)
RY(n+1)0	CH1 HOLD/CLEAR setting						
RY(n+1)1	CH2 HOLD/CLEAR setting						
RY(n+1)2	CH3 HOLD/CLEAR setting						
RY(n+1)3	CH4 HOLD/CLEAR setting						
RY(n+1)4	CH1 Conversion enable/disable setting						
RY(n+1)5	CH2 Conversion enable/disable setting						
RY(n+1)6	CH3 Conversion enable/disable setting						
RY(n+1)7	CH4 Conversion enable/disable setting						

A64DAVC				AJ65SBT2B-64DA			
Device No.	Description	Device No.	Description	Device No.	Description	Device No.	Description
X(n+18)	D/A conversion READY	Y(n+18)	CH1 Analog output enable signal	RX(n+1)8	Initial data processing request flag	RY(n+1)8	Initial data setting complete flag
X(n+19) to X(n+1F)	Use prohibited	Y(n+19)	CH2 Analog output enable signal	RX(n+1)9	Initial data setting complete flag	RY(n+1)9	Initial data setting request flag
		Y(n+1A)	CH3 Analog output enable signal	RX(n+1)A	Error status flag	RY(n+1)A	Error reset request flag
		Y(n+1B)	CH4 Analog output enable signal	RX(n+1)B	Remote READY	RY(n+1)B to RY(n+1)F	Use prohibited
		Y(n+1C) to Y(n+1F)	Use prohibited	RX(n+1)C to RX(n+1)F	Use prohibited		

(d) Buffer memory addresses comparisons

Buffer memory allocation is different, so the sequence program must be changed.

For details on buffer memory and sequence programs, refer to the User's Manual.

A64DAVC			AJ65SBT2B-64DA		
Address	Name	Read/write	Address	Name	Read/write
0	CH1 Digital value setting area	R/W	RWwm	CH1 Digital input value setting	W
1	CH2 Digital value setting area		RWwm+1	CH2 Digital input value setting	
2	CH3 Digital value setting area		RWwm+2	CH3 Digital input value setting	
3	CH4 Digital value setting area		RWwm+3	CH4 Digital input value setting	
4	CH1 Analog output disable/enable setting area		RWrn	CH1/CH2 Check code	R
5	CH2 Analog output disable/enable setting area		RWm+1	CH3/CH4 Check code	
6	CH3 Analog output disable/enable setting area		RWm+2	Error code	
7	CH4 Analog output disable/enable setting area		RWm+3	Use prohibited	
8	Resolution of digital value setting area			m, n: The address assigned to the master station by a station number setting	
9	Error code storage area				

(3) Comparisons between A64DAVC and AJ65SBT-62DA

(a) Performance specifications comparisons

○ : Compatible, △ : Partial change required, × : Not compatible

Item	A64DAVC	AJ65SBT-62DA	Compati- bility	Precautions for replacement																																																								
Digital input	(1) 16-bit signed binary value (2) Setting range: <table border="1"> <thead> <tr> <th>Set resolution</th> <th>Setting range</th> </tr> </thead> <tbody> <tr> <td>1/4000</td> <td>-4000 to 4000</td> </tr> <tr> <td>1/8000</td> <td>-8000 to 8000</td> </tr> <tr> <td>1/12000</td> <td>-12000 to 12000</td> </tr> </tbody> </table>	Set resolution	Setting range	1/4000	-4000 to 4000	1/8000	-8000 to 8000	1/12000	-12000 to 12000	Voltage: 16bits signed binary (-4096 to +4095) Current: 16bits signed binary (0 to 4095)	×	The setting range has been changed.																																																
Set resolution	Setting range																																																											
1/4000	-4000 to 4000																																																											
1/8000	-8000 to 8000																																																											
1/12000	-12000 to 12000																																																											
Analog output	-10 to 0 to 10VDC (external load resistance: 2kΩ to 1MΩ)	Voltage: -10 to +10VDC (external load resistance: 2kΩ to 1MΩ) Current: 0 to 20mA (external load resistance: 0 to 600Ω)	○																																																									
I/O characteristics	<table border="1"> <thead> <tr> <th rowspan="2">Digital input value</th> <th colspan="3">Digital value resolution</th> <th rowspan="2">Analog output value*</th> </tr> <tr> <th>1/4000</th> <th>1/8000</th> <th>1/12000</th> </tr> </thead> <tbody> <tr> <td>4000</td> <td>8000</td> <td>12000</td> <td>+10V</td> </tr> <tr> <td>2000</td> <td>4000</td> <td>6000</td> <td>+5V</td> </tr> <tr> <td>0</td> <td>0</td> <td>0</td> <td>0V</td> </tr> <tr> <td>-2000</td> <td>-4000</td> <td>-6000</td> <td>-5V</td> </tr> <tr> <td>-4000</td> <td>-8000</td> <td>-12000</td> <td>-10V</td> </tr> </tbody> </table> <p>* When the offset value is set to 0V and the gain value is set to 10V</p>	Digital input value	Digital value resolution			Analog output value*	1/4000	1/8000	1/12000	4000	8000	12000	+10V	2000	4000	6000	+5V	0	0	0	0V	-2000	-4000	-6000	-5V	-4000	-8000	-12000	-10V	<table border="1"> <thead> <tr> <th rowspan="2">Digital input value</th> <th rowspan="2">Analog output</th> <th colspan="2">Accuracy</th> <th rowspan="2">Maximum resolution</th> </tr> <tr> <th>Ambient temperature 0 to 55℃</th> <th>Ambient temperature 25±5℃</th> </tr> </thead> <tbody> <tr> <td rowspan="2">-4000 to +4000</td> <td>-10 to +10V</td> <td rowspan="2">±0.4% (±40mV)</td> <td rowspan="2">±0.2% (±20mV)</td> <td rowspan="2">2.5mV</td> </tr> <tr> <td>User range setting 1 (-10 to +10V)</td> </tr> <tr> <td rowspan="2">0 to 4000</td> <td>0 to 5V</td> <td rowspan="2">±0.4% (±20mV)</td> <td rowspan="2">±0.2% (±10mV)</td> <td>1.25mV</td> </tr> <tr> <td>1 to 5V</td> <td>1.0mV</td> </tr> <tr> <td rowspan="3">0 to 4000</td> <td>0 to 20mA</td> <td rowspan="3">±0.4% (±80μA)</td> <td rowspan="3">±0.2% (±40μA)</td> <td>5μA</td> </tr> <tr> <td>4 to 20mA</td> <td rowspan="2">4μA</td> </tr> <tr> <td>User range setting 3 (0 to 20mA)</td> </tr> </tbody> </table> <p>Factory-set: -10 to +10V.</p>	Digital input value	Analog output	Accuracy		Maximum resolution	Ambient temperature 0 to 55℃	Ambient temperature 25±5℃	-4000 to +4000	-10 to +10V	±0.4% (±40mV)	±0.2% (±20mV)	2.5mV	User range setting 1 (-10 to +10V)	0 to 4000	0 to 5V	±0.4% (±20mV)	±0.2% (±10mV)	1.25mV	1 to 5V	1.0mV	0 to 4000	0 to 20mA	±0.4% (±80μA)	±0.2% (±40μA)	5μA	4 to 20mA	4μA	User range setting 3 (0 to 20mA)	△	The digital input range is different.
Digital input value	Digital value resolution			Analog output value*																																																								
	1/4000	1/8000	1/12000																																																									
4000	8000	12000	+10V																																																									
2000	4000	6000	+5V																																																									
0	0	0	0V																																																									
-2000	-4000	-6000	-5V																																																									
-4000	-8000	-12000	-10V																																																									
Digital input value	Analog output	Accuracy		Maximum resolution																																																								
		Ambient temperature 0 to 55℃	Ambient temperature 25±5℃																																																									
-4000 to +4000	-10 to +10V	±0.4% (±40mV)	±0.2% (±20mV)	2.5mV																																																								
	User range setting 1 (-10 to +10V)																																																											
0 to 4000	0 to 5V	±0.4% (±20mV)	±0.2% (±10mV)	1.25mV																																																								
	1 to 5V			1.0mV																																																								
0 to 4000	0 to 20mA	±0.4% (±80μA)	±0.2% (±40μA)	5μA																																																								
	4 to 20mA			4μA																																																								
	User range setting 3 (0 to 20mA)																																																											
Maximum resolution of digital value	0.83mV(1/12000)		×	The maximum resolution is different.																																																								
Overall accuracy (accuracy of maximum value)	± 1.0% (± 100mV)		○																																																									
Maximum conversion speed	Within 25ms/4 channels (1 channel is same period of time)	1ms/channel	○																																																									
Absolute maximum output	—	Voltage: ± 12V, current: +21mA	○																																																									
Number of analog output points	4 channels/module	2 channels/module	×	Please consider replacing by using two or more AJ65SBT-62DA modules.																																																								
Insulation method	Between the output terminal and programmable controller power supply: Photocoupler isolation (non-isolation between channels)	Between communication line and all analog outputs: Photocoupler isolation between power supply line and all analog outputs: Photocoupler isolation (non-isolated between channels)	○																																																									
Number of occupied I/O stations (number of points)	4 stations (4 stations × 8 points)	1 station (1 station × 32 points) (RX/R Y 32 points each, RWr/RWw 4 points each)	○																																																									

○ : Compatible, △ : Partial change required, × : Not compatible

Item	A64DAVC	AJ65SBT-62DA	Compati- bility	Precautions for replacement
Connected terminal	47-point terminal block	Communication part, module communication part: 7-point two-piece terminal block (M3 screw) I/O part: 18-point direct-mount terminal block (M3 screw)	×	Change in wiring is required.
Applicable wire size	0.75 to 2mm ² (Applicable tightening torque 39 to 59 N · cm)	0.75 to 2mm ²	○	
Applicable solderless terminal	V1.25-3, V1.25-YS3A, V2-S3, V2-YS3A	<ul style="list-style-type: none"> RAV1.25-3 (conforming to JIS C 2805) [Applicable wire size: 0.3 to 1.25mm²] V2-MS3, RAV2-3SL, TGV2-3N [Applicable wire size: 1.25 to 2.0mm²] 	○	
24VDC internal current consumption	0.12A	0.16A	△	The current consumption increases. The current capacity needs to be reconsidered.
Weight	1.01kg	0.20kg	△	
External dimensions	170(H) × 100(W) × 80(D)mm	50(H) × 118(W) × 40(D)mm	×	The overall size differs. Pay attention to the mounting dimensions.

(b) Functional comparisons

○ : Compatible, △ : Partial change required, × : Not compatible

Item	A64DAVC	AJ65SBT-62DA	Compati- bility	Precautions for replacement																		
D/A output enable/disable function	Selects on each channel whether to output D/A conversion values or offset values. Note, however, that the conversion speed is fixed regardless of the output enable/disable setting.	Selects on each channel whether to output D/A conversion values or offset values. Note, however, that the conversion speed is fixed regardless of the output enable/disable setting.	○																			
D/A conversion enable/disable function	-	Selects whether to enable or disable D/A conversion on each channel. By making unused channels D/A conversion prohibited, sampling period can be shortened.	-																			
Output range switching function	-	<p>Sets the analog output range on each channel and changes the I/O conversion characteristics. The following eight input ranges can be selected:</p> <table border="1"> <thead> <tr> <th>Output range</th> <th>Set value</th> </tr> </thead> <tbody> <tr> <td>-10 to +10V</td> <td>0_H</td> </tr> <tr> <td>0 to 5V</td> <td>1_H</td> </tr> <tr> <td>1 to 5V</td> <td>2_H</td> </tr> <tr> <td>0 to 20mA</td> <td>3_H</td> </tr> <tr> <td>4 to 20mA</td> <td>4_H</td> </tr> <tr> <td>User range setting 1 (-10 to +10V)</td> <td>5_H</td> </tr> <tr> <td>User range setting 2 (0 to 5V)</td> <td>6_H</td> </tr> <tr> <td>User range setting 3 (0 to 20mA)</td> <td>7_H</td> </tr> </tbody> </table>	Output range	Set value	-10 to +10V	0 _H	0 to 5V	1 _H	1 to 5V	2 _H	0 to 20mA	3 _H	4 to 20mA	4 _H	User range setting 1 (-10 to +10V)	5 _H	User range setting 2 (0 to 5V)	6 _H	User range setting 3 (0 to 20mA)	7 _H	-	
Output range	Set value																					
-10 to +10V	0 _H																					
0 to 5V	1 _H																					
1 to 5V	2 _H																					
0 to 20mA	3 _H																					
4 to 20mA	4 _H																					
User range setting 1 (-10 to +10V)	5 _H																					
User range setting 2 (0 to 5V)	6 _H																					
User range setting 3 (0 to 20mA)	7 _H																					
HOLD/CLEAR setting	As the analog output status of the programmable controller CPU that is in RUN, at STOP, or in an error status, switching the type of output values as desired between D/A conversion values, offset values and 0V/0mA is possible.	In preparation for the event that the programmable controller CPU enters a stop status or the AJ65SBT-62DA stops D/A conversion due to an error, this settings can be configured to select whether to hold or clear analog values (output offset values) that are being output from each channel right before those stops.	○																			
Offset/gain value selection	Changes the I/O conversion characteristics.	Changes the I/O conversion characteristics as desired. For that, offset/gain settings can be configured for each channel without a aid of a various register.	○																			

(c) Programmable controller CPU I/O signal comparisons

I/O signal is different, so the sequence program must be changed.

For details on I/O signals and sequence programs, refer to the User's Manual.

A64DAVC				AJ65SBT-62DA			
Device No.	Description	Device No.	Description	Device No.	Description	Device No.	Description
X(n+0) to X(n+3)	Use prohibited	Y(n+0) to Y(n+3)	Use prohibited	RXn0 to RXnB	Use prohibited	RYn0	CH1 Analog output enable/disable flag
				RXnC	E ² PROM write error flag	RYn1	CH2 Analog output enable/disable flag
				RXnD	Use prohibited		
				RxnE			
				RXnF	Test mode flag		
X(n+4)	Communication error detection flag indicating that execution of the FROM and TO instructions resulted in a communication error	Y(n+4)	Error detection reset signal	RX(n+1)0 to RX(n+1)7	Use prohibited	RYn2 to RY(n+1)7	Use prohibited
X(n+5)	A64DAVC reset switch ON detection flag	Y(n+5)	Reset signal for reset switch ON detection flag	RX(n+1)8	Initial data processing request flag	RY(n+1)8	Initial data processing complete flag
X(n+6)	Use prohibited	Y(n+6)	Use prohibited	RX(n+1)9	Initial data setting complete flag	RY(n+1)9	Initial data setting request flag
X(n+7)	Communication completion response signal wait flag	Y(n+7)	Communication reset signal	RX(n+1)A	Error status flag	RY(n+1)A	Error reset request flag
X(n+8) to X(n+17)	Use prohibited	Y(n+8) to Y(n+17)	Use prohibited	RX(n+1)B	Remote READY	RY(n+1)B to RY(n+1)F	Use prohibited
X(n+18)	D/A conversion READY	Y(n+18)	CH1 Analog output enable signal	RX(n+1)C to RX(n+1)F	Use prohibited		
		Y(n+19)	CH2 Analog output enable signal				
		Y(n+1A)	CH3 Analog output enable signal				
		Y(n+1B)	CH4 Analog output enable signal				
X(n+19) to X(n+1F)	Use prohibited	Y(n+1C) to Y(n+1F)	Use prohibited				

(d) Buffer memory addresses comparisons

Buffer memory allocation is different, so the sequence program must be changed.
 For details on buffer memory and sequence programs, refer to the User's Manual.

A64DAVC			AJ65SBT-62DA		
Address	Name	Read/write	Address	Name	Read/write
0	CH1 Digital value setting area	R/W	RWwm	CH1 Digital value setting	W
1	CH2 Digital value setting area		RWwm+1	CH2 Digital value setting	
2	CH3 Digital value setting area		RWwm+2	Analog output enable/disable setting	
3	CH4 Digital value setting area		RWwm+3	Output range HOLD/CLEAR setting	R
4	CH1 Analog output disable/enable setting area		RWrn	CH1 Check code	
5	CH2 Analog output disable/enable setting area		RWrn+1	CH2 Check code	
6	CH3 Analog output disable/enable setting area		RWrn+2	Error code	
7	CH4 Analog output disable/enable setting area		RWrn+3	Use prohibited	
8	Resolution of digital value setting area				
9	Error code storage area				

(4) Comparisons between A64DAVC and AJ65VBTCU-68DAVN

(a) Performance specifications comparisons

○ : Compatible, △ : Partial change required, × : Not compatible

Item	A64DAVC	AJ65VBTCU-68DAVN	Compati-bility	Precautions for replacement																																																	
Digital input	(1) 16-bit signed binary value (2) Setting range: <table border="1"> <tr> <th>Set resolution</th> <th>Setting range</th> </tr> <tr> <td>1/4000</td> <td>-4000 to 4000</td> </tr> <tr> <td>1/8000</td> <td>-8000 to 8000</td> </tr> <tr> <td>1/12000</td> <td>-12000 to 12000</td> </tr> </table>	Set resolution	Setting range	1/4000	-4000 to 4000	1/8000	-8000 to 8000	1/12000	-12000 to 12000	16bits signed binary (-4096 to +4095)	×	The setting range has been changed.																																									
Set resolution	Setting range																																																				
1/4000	-4000 to 4000																																																				
1/8000	-8000 to 8000																																																				
1/12000	-12000 to 12000																																																				
Analog output	-10 to 0 to 10VDC (external load resistance: 2kΩ to 1MΩ)	-10 to +10V DC (external load resistance: 2kΩ to 1MΩ)	○																																																		
I/O characteristics	<table border="1"> <tr> <td rowspan="6">Digital input value</td> <td colspan="3">Digital value resolution</td> <td rowspan="2">Analog output value*</td> </tr> <tr> <td>1/4000</td> <td>1/8000</td> <td>1/12000</td> </tr> <tr> <td>4000</td> <td>8000</td> <td>12000</td> <td>+10V</td> </tr> <tr> <td>2000</td> <td>4000</td> <td>6000</td> <td>+5V</td> </tr> <tr> <td>0</td> <td>0</td> <td>0</td> <td>0V</td> </tr> <tr> <td>-2000</td> <td>-4000</td> <td>-6000</td> <td>-5V</td> </tr> <tr> <td>-4000</td> <td>-8000</td> <td>-12000</td> <td>-10V</td> </tr> </table> <p>* When the offset value is set to 0V and the gain value is set to 10V</p>	Digital input value	Digital value resolution			Analog output value*	1/4000	1/8000	1/12000	4000	8000	12000	+10V	2000	4000	6000	+5V	0	0	0	0V	-2000	-4000	-6000	-5V	-4000	-8000	-12000	-10V	<table border="1"> <tr> <td rowspan="4">Digital input value</td> <td rowspan="4">Analog output range</td> <td colspan="2">Accuracy</td> <td rowspan="4">Maximum resolution</td> </tr> <tr> <td>Ambient temperature 0 to 55℃</td> <td>Ambient temperature 25±5℃</td> </tr> <tr> <td>±0.3% (±30mV)</td> <td>±0.2% (±20mV)</td> </tr> <tr> <td>2.5mV</td> </tr> <tr> <td rowspan="4">Voltage</td> <td rowspan="4">-4000 to +4000</td> <td>-10 to +10V</td> <td rowspan="2">User range setting 1 (-10 to +10V)</td> <td rowspan="4">1.25mV</td> </tr> <tr> <td>0 to 5V</td> </tr> <tr> <td>0 to 5V</td> <td rowspan="2">User range setting 2 (0 to 5V)</td> <td rowspan="4">1.0mV</td> </tr> <tr> <td>±0.3% (±15mV)</td> <td>±0.2% (±10mV)</td> </tr> </table>	Digital input value	Analog output range	Accuracy		Maximum resolution	Ambient temperature 0 to 55℃	Ambient temperature 25±5℃	±0.3% (±30mV)	±0.2% (±20mV)	2.5mV	Voltage	-4000 to +4000	-10 to +10V	User range setting 1 (-10 to +10V)	1.25mV	0 to 5V	0 to 5V	User range setting 2 (0 to 5V)	1.0mV	±0.3% (±15mV)	±0.2% (±10mV)	△	The digital input range is different.
Digital input value	Digital value resolution			Analog output value*																																																	
	1/4000		1/8000		1/12000																																																
	4000		8000	12000	+10V																																																
	2000		4000	6000	+5V																																																
	0		0	0	0V																																																
	-2000	-4000	-6000	-5V																																																	
-4000	-8000	-12000	-10V																																																		
Digital input value	Analog output range	Accuracy		Maximum resolution																																																	
		Ambient temperature 0 to 55℃	Ambient temperature 25±5℃																																																		
		±0.3% (±30mV)	±0.2% (±20mV)																																																		
		2.5mV																																																			
Voltage	-4000 to +4000	-10 to +10V	User range setting 1 (-10 to +10V)	1.25mV																																																	
		0 to 5V																																																			
		0 to 5V	User range setting 2 (0 to 5V)		1.0mV																																																
		±0.3% (±15mV)				±0.2% (±10mV)																																															
Maximum resolution of digital value	0.83mV(1/12000)		×	The maximum resolution is different.																																																	
Overall accuracy (accuracy relative to maximum value)	± 1.0% (± 100mV)		○																																																		
Maximum conversion speed	Within 25ms/4 channels (1 channel is same period of time)	1ms/channel	○																																																		
Absolute maximum output	-	± 12V	○																																																		
Analog output points	4 channels/module	8 channels/module	△	The number of channels has increased.																																																	
Insulation method	Between the output terminal and programmable controller power supply: Photocoupler isolation (non-isolated between channels)	<table border="1"> <tr> <th>Isolated locations</th> <th>Isolation method</th> <th>Dielectric withstand voltage</th> <th>Isolation resistance</th> </tr> <tr> <td>Between communication line and all analog outputs:</td> <td>Photocoupler</td> <td rowspan="2">500VAC for 1 minute</td> <td rowspan="2">500VDC 5MΩ or more by isolation resistance tester</td> </tr> <tr> <td>Between power supply line and all analog outputs:</td> <td>Transformer</td> </tr> <tr> <td>Between channels</td> <td>Non-isolated</td> <td>-</td> <td>-</td> </tr> </table>	Isolated locations	Isolation method	Dielectric withstand voltage	Isolation resistance	Between communication line and all analog outputs:	Photocoupler	500VAC for 1 minute	500VDC 5MΩ or more by isolation resistance tester	Between power supply line and all analog outputs:	Transformer	Between channels	Non-isolated	-	-	○																																				
Isolated locations	Isolation method	Dielectric withstand voltage	Isolation resistance																																																		
Between communication line and all analog outputs:	Photocoupler	500VAC for 1 minute	500VDC 5MΩ or more by isolation resistance tester																																																		
Between power supply line and all analog outputs:	Transformer																																																				
Between channels	Non-isolated	-	-																																																		
Number of occupied I/O stations (number of points)	4 stations (4 stations × 8 points)	When set to Ver.1 remote device station (Ver.1 compatible local station): 3 stations (3 stations × 32 points) (RX/Ry 32 points each, RWr/RWw 12 points each) When set to Ver.2 remote device station (Ver.2 compatible local station): 1 station (1 station × 32 points) (Expanded cyclic setting: 4X) (RX/Ry 32 points each, RWr/RWw 16 points each)	×	When Ver.1 remote device station is set, the number of occupied points increases. The assignment of the entire system needs to be reconsidered.																																																	

○ : Compatible, △ : Partial change required, × : Not compatible

Item	A64DAVC	AJ65VBTCU-68DAVN	Compati- bility	Precautions for replacement
Connected terminal	47-point terminal block			
Applicable wire size	0.75 to 2mm ² (Applicable tightening torque 39 to 59 N · cm)	One-touch connector for communication	×	Change in wiring is required.
		One-touch connector for power supply/FG		
Applicable solderless terminal	V1.25-3, V1.25-YS3A, V2-S3, V2-YS3A	One-touch connector for analog I/O	×	Change in wiring is required.
24VDC internal current consumption	0.12A	0.15A	△	The current consumption increases. The current capacity needs to be reconsidered.
Weight	1.01kg	0.16kg	△	
External dimensions	170(H) × 100(W) × 80(D) mm	115(H) × 41(W) × 67(D) mm	×	The overall size differs. Pay attention to the mounting dimensions.

(b) Functional comparisons

○ : Compatible, △ : Partial change required, × : Not compatible

Item	A64DAVC	AJ65VBTCU-68DAVN	Compati- bility	Precautions for replacement												
D/A output enable/disable function	Selects on each channel whether to output D/A conversion values or offset values. Note, however, that the conversion speed is fixed regardless of the output enable/disable setting.	Selects on each channel whether to output D/A conversion values or offset values. Note, however, that the conversion speed is fixed regardless of the output enable/disable setting.	○													
D/A conversion enable/disable function	—	Selects whether to enable or disable D/A conversion on each channel. By making unused channels D/A conversion prohibited, sampling period can be shortened.	—													
Output range switching function	—	<p>Sets the analog output range on each channel and changes the I/O conversion characteristics. The following five output ranges can be selected:</p> <table border="1"> <thead> <tr> <th>Output range</th> <th>Set value</th> </tr> </thead> <tbody> <tr> <td>-10 to +10V</td> <td>0_H</td> </tr> <tr> <td>0 to 5V</td> <td>1_H</td> </tr> <tr> <td>1 to 5V</td> <td>2_H</td> </tr> <tr> <td>User range setting 1 (-10 to +10V)</td> <td>3_H</td> </tr> <tr> <td>User range setting 2 (0 to 5V)</td> <td>4_H</td> </tr> </tbody> </table>	Output range	Set value	-10 to +10V	0 _H	0 to 5V	1 _H	1 to 5V	2 _H	User range setting 1 (-10 to +10V)	3 _H	User range setting 2 (0 to 5V)	4 _H	—	
Output range	Set value															
-10 to +10V	0 _H															
0 to 5V	1 _H															
1 to 5V	2 _H															
User range setting 1 (-10 to +10V)	3 _H															
User range setting 2 (0 to 5V)	4 _H															
HOLD/CLEAR setting	As the analog output status of the programmable controller CPU that is in RUN, at STOP, or in an error status, switching the type of output values as desired between D/A conversion values, offset values and 0V/0mA is possible. D/A conversion value outputs, offset value outputs and 0V/0mA outputs can be revised arbitrarily.	In preparation for the event that the programmable controller CPU enters a stop status or the AJ65VBTCU-68DAVN stops D/A conversion due to an error, this settings can be configured to select whether to hold or clear analog values (output offset values) that are being output from each channel right before those stops.	○													
Offset/gain value selection	Changes the I/O conversion characteristics.	Changes the I/O conversion characteristics as desired. For that, offset/gain settings can be configured for each channel without a aid of a various register.	○													

(c) Programmable controller CPU I/O signal comparisons

I/O signal is different, so the sequence program must be changed.

For details on I/O signals and sequence programs, refer to the User's Manual.

A64DAVC				AJ65VBTCU-68DAVN			
Device No.	Description	Device No.	Description	Device No.	Description	Device No.	Description
X(n+0) to X(n+3)	Use prohibited	Y(n+0) to Y(n+3)	Use prohibited	RXn0 to RXnB	Use prohibited	RYn0	CH1 Analog output enable/disable flag
						RYn1	CH2 Analog output enable/disable flag
X(n+4)	Communication error detection flag indicating that execution of the FROM and TO instructions resulted in a communication error	Y(n+4)	Error detection reset signal	RXnC	E ² PROM write error flag	RYn2	CH3 Analog output enable/disable flag
						RYn3	CH4 Analog output enable/disable flag
X(n+5)	A64DAVC reset switch ON detection flag	Y(n+5)	Reset switch ON detection flag	RXnD to RX(n+1)7	Use prohibited	RYn4	CH5 Analog output enable/disable flag
						RYn5	CH6 Analog output enable/disable flag
						RYn6	CH7 Analog output enable/disable flag
X(n+6)	Use prohibited	Y(n+6)	Use prohibited			RYn7	CH8 Analog output enable/disable flag
X(n+7)	Communication completion response signal wait flag	Y(n+7)	Communication reset signal			RYn8 to RY(n+1)7	Use prohibited
X(n+8) to X(n+17)	Use prohibited	Y(n+8) to Y(n+17)	Use prohibited	RX(n+1)8	Initial data processing request flag	RY(n+1)8	Initial data processing complete flag
X(n+18)	A/D conversion READY	Y(n+18)	CH1 Analog output enable signal	RX(n+1)9	Initial data setting complete flag	RY(n+1)9	Initial data setting request flag
		Y(n+19)	CH2 Analog output enable signal	RX(n+1)A	Error status flag	RY(n+1)A	Error reset
		Y(n+1A)	CH3 Analog output enable signal	RX(n+1)B	Remote READY	RY(n+1)B to RY(n+5)F	Use prohibited
		Y(n+1B)	CH4 Analog output enable signal	RX(n+1)C to RX(n+5)F	Use prohibited		
X(n+19) to X(n+1F)	Use prohibited	Y(n+1C) to Y(n+1F)	Use prohibited				

(d) Buffer memory addresses comparisons

Buffer memory allocation is different, so the sequence program must be changed.

For details on buffer memory and sequence programs, refer to the User's Manual.

A64DAVC			AJ65VBTCU-68DAVN		
Address	Name	Read/write	Address	Name	Read/write
0	CH1 Digital value setting area	R/W	RWwm+0	CH1 Digital value setting	W
1	CH2 Digital value setting area		RWwm+1	CH2 Digital value setting	
2	CH3 Digital value setting area		RWwm+2	CH3 Digital value setting	
3	CH4 Digital value setting area		RWwm+3	CH4 Digital value setting	
4	CH1 Analog output disable/enable setting area		RWwm+4	CH5 Digital value setting	
5	CH2 Analog output disable/enable setting area		RWwm+5	CH6 Digital value setting	
6	CH3 Analog output disable/enable setting area		RWwm+6	CH7 Digital value setting	
7	CH4 Analog output disable/enable setting area		RWwm+7	CH8 Digital value setting	
8	Resolution of digital value setting area		RWwm+8	Analog output enable/disable setting	
9	Error code storage area		RWwm+9	CH1 to CH4 Output range setting	
			RWwm+A	CH5 to CH8 Output range setting	
			RWwm+B	HOLD/CLEAR setting	
			RWrn+0	CH1 Check code	R
			RWrn+1	CH2 Check code	
			RWrn+2	CH3 Check code	
			RWrn+3	CH4 Check code	
			RWrn+4	CH5 Check code	
			RWrn+5	CH6 Check code	
			RWrn+6	CH7 Check code	
			RWrn+7	CH8 Check code	
			RWrn+8	Error code	
			RWrn+9 to RWrn+B	Use prohibited	-

(5) Comparisons between A64DAIC and AJ65BT-64DAI

(a) Performance specifications comparisons

○ : Compatible, △ : Partial change required, × : Not compatible

Item	A64DAIC	AJ65BT-64DAI	Compati- bility	Precautions for replacement																												
Digital input	(1) 16-bit signed binary value (2) Setting range: <table border="1"> <thead> <tr> <th>Set resolution</th> <th>Setting range</th> </tr> </thead> <tbody> <tr> <td>1/4000</td> <td>0 to 4000</td> </tr> <tr> <td>1/8000</td> <td>0 to 8000</td> </tr> <tr> <td>1/12000</td> <td>0 to 12000</td> </tr> </tbody> </table>	Set resolution	Setting range	1/4000	0 to 4000	1/8000	0 to 8000	1/12000	0 to 12000	16bits signed binary (valid bits: 12 bits) 0 to 4095	×	The setting range has been changed.																				
Set resolution	Setting range																															
1/4000	0 to 4000																															
1/8000	0 to 8000																															
1/12000	0 to 12000																															
Analog output	0 to 20mA (external load resistance: 0 to 600 Ω)	Current: +4 to 20mA (external load resistance: 0 to 600 Ω)	○																													
I/O characteristics	<table border="1"> <thead> <tr> <th rowspan="2">Digital input value</th> <th colspan="3">Digital value resolution</th> <th rowspan="2">Analog output value*</th> </tr> <tr> <th>1/4000</th> <th>1/8000</th> <th>1/12000</th> </tr> </thead> <tbody> <tr> <td>4000</td> <td>8000</td> <td>12000</td> <td>+20mA</td> </tr> <tr> <td>2000</td> <td>4000</td> <td>6000</td> <td>+12mA</td> </tr> <tr> <td>0</td> <td>0</td> <td>0</td> <td>+4mA</td> </tr> </tbody> </table> <p>* When the offset value is set to 4mA and the gain value is set to 20mA</p>	Digital input value	Digital value resolution			Analog output value*	1/4000	1/8000	1/12000	4000	8000	12000	+20mA	2000	4000	6000	+12mA	0	0	0	+4mA	<table border="1"> <thead> <tr> <th>Digital input value</th> <th>Analog conversion value</th> </tr> </thead> <tbody> <tr> <td>4000</td> <td>+20mA</td> </tr> <tr> <td>2000</td> <td>+12mA</td> </tr> <tr> <td>0</td> <td>+4mA</td> </tr> </tbody> </table>	Digital input value	Analog conversion value	4000	+20mA	2000	+12mA	0	+4mA	△	The digital input range is different.
Digital input value	Digital value resolution			Analog output value*																												
	1/4000	1/8000	1/12000																													
4000	8000	12000	+20mA																													
2000	4000	6000	+12mA																													
0	0	0	+4mA																													
Digital input value	Analog conversion value																															
4000	+20mA																															
2000	+12mA																															
0	+4mA																															
Maximum resolution of digital value	1.3 μA(1/2000)	4 μA(1/4000)	×	The maximum resolution is different.																												
Overall accuracy (accuracy relative to maximum value)	± 1.0%(± 200 μA)		○																													
Maximum conversion speed	Within 25ms/4 channels (1 channel is same period of time)	Max. 1ms/channel (4ms/4 channels)	○																													
Analog output	4 channels/module		○																													
Insulation method	Between the output terminal and programmable controller power supply: Photocoupler isolation (non-isolated between channels)	Between output channels: Non-isolated (Between external power supply and analog output: Transformer isolation)	○																													
Number of occupied I/O stations (number of points)	4 stations (4 stations × 8 points)	2 stations (2 stations × 32 points) (RX/Ry 32 points each, RWr/RWw 8 points each)	×	The number of occupied points increases. The assignment of the entire system needs to be reconsidered.																												
Connected terminal	47-point terminal block	27-point terminal block	×	Change in wiring is required.																												
Applicable wire size	0.75 to 2mm ² (applicable tightening torque 39 to 59N · cm)		○																													
Applicable solderless terminal	V1.25-3, V1.25-YS3A, V2-S3, V2-YS3A	RAV1.25-3.5 (conforming to JIS C 2805), RAV2-3.5	×																													
24VDC internal current consumption	0.15A	0.27A	△	The current consumption increases. The current capacity needs to be reconsidered.																												
Weight	1.01kg	0.4kg	△																													
External dimensions	170(H) × 100(W) × 80(D) mm	65(H) × 151.9(W) × 63(D) mm	×	The overall size differs. Pay attention to the mounting dimensions.																												

(b) Functional comparisons

○ : Compatible, △ : Partial change required, × : Not compatible

Item	A64DAIC	AJ65BT-64DAI	Compati- bility	Precautions for replacement
Analog output enable signal	With the analog output enable signals (Yn+18 to Yn+1B), it is possible to select the type of output values at each channel from D/A converted analog values and output offset values.	By turning the analog output enable signal ON or OFF with the sequence program, it is possible to select the type of output values at each channel from D/A converted analog values and output offset values. Note, however, that the D/A conversion time (conversion speed) is fixed regardless of the setting of the analog output enable signal.	○	
Analog output enable/disable setting	Stores the channel to disable analog output from (0V/0mA) in the buffer memory of the A64DAIC.	By writing "0" or "1" to the address of the remote register using the sequence program, it is possible to select on each channel whether to enable or disable outputs of analog values.	○	
HOLD/CLEAR setting	In preparation for the event that the programmable controller CPU enters a stop status or an error status, the HOLD/CLEAR terminal can be used to select HOLD or CLEAR (offset values or 0V/0mA) analog values that are stored before a stop or an error occurrence.	In preparation for the event that the programmable controller CPU enters a stop status or the AJ65BT-64DAI stops D/A conversion due to an error, the HLD/CLR terminal can be used to select whether to hold or clear analog values (output offset values) that are being output from each channel right before those stops. The HLD/CLR terminal is provided on the front of the module and this selection can be made on all channels at once. (Including the case of the disconnections of link communication)	○	
Offset/gain setting	Changes the I/O conversion characteristics.	I/O conversion characteristics can be changed as desired when the detailed ones are required. To do this, short the test mode terminal to enter a test mode, and configure the offset/gain settings for each channel without a aid of a various register. Also, if detailed I/O conversion characteristics are not required, the default offset/gain values can be used by turning on the I/O signal RYn4 (offset/gain selection) to the master station.	○	

(c) Programmable controller CPU I/O signal comparisons

I/O signal is different, so the sequence program must be changed.

For details on I/O signals and sequence programs, refer to the User's Manual.

A64DAIC				AJ65BT-64DAI			
Device No.	Description	Device No.	Description	Device No.	Description	Device No.	Description
X(n+0) to X(n+3)	Use prohibited	Y(n+0) to Y(n+3)	Use prohibited	RXn0 to RXnF	Use prohibited	RYn0	CH1 Analog output enable flag
X(n+4)	Communication error detection flag indicating that execution of the FROM and TO instructions resulted in a communication error	Y(n+4)	Error detection reset signal			RYn1	CH2 Analog output enable flag
						RYn2	CH3 Analog output enable flag
						RYn3	CH4 Analog output enable flag
						RYn4	Offset/gain value selection
						RYn5 to RYnF	Use prohibited
RY(n+1)0 to RY(n+1)7							
X(n+5)	A64DAIC reset switch ON detection flag	Y(n+5)	Reset switch ON detection flag reset signal	RX(n+1)0 to RX(n+1)7			
X(n+6)	Use prohibited	Y(n+6)	Use prohibited	RX(n+1)8	Initial data processing request flag	RY(n+1)8	Initial data processing complete flag
X(n+7)	Communication completion response signal wait flag	Y(n+7)	Communication reset signal	RX(n+1)9	Initial data setting complete flag	RY(n+1)9	Initial data setting request flag
X(n+8) to X(n+17)	Use prohibited	Y(n+8) to Y(n+17)	Use prohibited	RX(n+1)A	Error status flag	RY(n+1)A	Error reset request flag
X(n+18)	D/A conversion READY	Y(n+18)	CH1 Analog output enable signal	RX(n+1)B	Remote READY	RY(n+1)B	Use prohibited
X(n+19) to X(n+1F)	Use prohibited	Y(n+19)	CH2 Analog output enable signal	RX(n+1)C	Use prohibited	RY(n+1)C	
		Y(n+1A)	CH3 Analog output enable signal	RX(n+1)D		RY(n+1)D	
		Y(n+1B)	CH4 Analog output enable signal	RX(n+1)E		RY(n+1)E	
		Y(n+1C) to Y(n+1F)	Use prohibited	RX(n+1)F		RY(n+1)F	

(d) Buffer memory addresses comparisons

Buffer memory allocation is different, so the sequence program must be changed.

For details on buffer memory and sequence programs, refer to the User's Manual.

A64DAIC			AJ65BT-64DAI		
Address	Name	Read/write	Address	Name	Read/write
0	CH1 Digital value setting area	R/W	RWwm	CH1 Digital value setting area	W
1	CH2 Digital value setting area		RWwm+1	CH2 Digital value setting area	
2	CH3 Digital value setting area		RWwm+2	CH3 Digital value setting area	
3	CH4 Digital value setting area		RWwm+3	CH4 Digital value setting area	
4	CH1 Analog output disable setting area		RWwm+4	Analog output enable/disable area	
5	CH2 Analog output disable setting area		RWwm+5	Use prohibited	-
6	CH3 Analog output disable setting area		RWwm+6		
7	CH4 Analog output disable setting area		RWwm+7		
8	Resolution of digital value setting area		RWrn	CH1 Set value check code	R
9	Error code storage area	RWrn+1	CH2 Set value check code		
		RWrn+2	CH3 Set value check code		
		RWrn+3	CH4 Set value check code		
		RWrn+4	Error code		
		RWrn+5	Use prohibited	-	
		RWrn+6			
		RWrn+7			

(6) Comparisons between A64DAIC and AJ65SBT2B-64DA (current output)

(a) Performance specifications comparisons

○ : Compatible, △ : Partial change required, × : Not compatible

Item	A64DAIC	AJ65SBT2B-64DA	Compati- bility	Precautions for replacement																																												
Digital input	(1) 16-bit signed binary value (2) Setting range: <table border="1"> <thead> <tr> <th>Set resolution</th> <th>Setting range</th> </tr> </thead> <tbody> <tr> <td>1/4000</td> <td>0 to 4000</td> </tr> <tr> <td>1/8000</td> <td>0 to 8000</td> </tr> <tr> <td>1/12000</td> <td>0 to 12000</td> </tr> </tbody> </table>	Set resolution	Setting range	1/4000	0 to 4000	1/8000	0 to 8000	1/12000	0 to 12000	Voltage: 16bits signed binary (-12288 to 12287, -16384 to 16383, -288 to 12287) Current: 16bits signed binary (-288 to 12287)	×	The setting range has been changed.																																				
Set resolution	Setting range																																															
1/4000	0 to 4000																																															
1/8000	0 to 8000																																															
1/12000	0 to 12000																																															
Analog output	0 to 20mA (external load resistance: 0 to 600 Ω)	Voltage: -10 to +10VDC (external load resistance: 1k Ω to 1M Ω) Current: 0 to 20mA (external load resistance: 0 to 600 Ω)	○																																													
I/O characteristics	<table border="1"> <thead> <tr> <th rowspan="2">Digital input value</th> <th colspan="3">Digital value resolution</th> <th rowspan="2">Analog output value*</th> </tr> <tr> <th>1/4000</th> <th>1/8000</th> <th>1/12000</th> </tr> </thead> <tbody> <tr> <td>4000</td> <td>8000</td> <td>12000</td> <td>+20mA</td> </tr> <tr> <td>2000</td> <td>4000</td> <td>6000</td> <td>+12mA</td> </tr> <tr> <td>0</td> <td>0</td> <td>0</td> <td>+4mA</td> </tr> </tbody> </table> <p>* When the offset value is set to 4mA and the gain value is set to 20mA</p>	Digital input value	Digital value resolution			Analog output value*	1/4000	1/8000	1/12000	4000	8000	12000	+20mA	2000	4000	6000	+12mA	0	0	0	+4mA	<table border="1"> <thead> <tr> <th rowspan="2">Digital input value</th> <th rowspan="2">Analog output range</th> <th colspan="2">Accuracy</th> <th rowspan="2">Maximum resolution</th> </tr> <tr> <th>Ambient temperature 0 to 55℃</th> <th>Ambient temperature 25 ± 5℃</th> </tr> </thead> <tbody> <tr> <td>-16000 to 16000</td> <td>-10 to 10V</td> <td>± 0.3% (± 30mV)</td> <td>± 0.2% (± 20mV)</td> <td>0.625mV</td> </tr> <tr> <td rowspan="2">0 to 12000</td> <td>0 to 5V</td> <td rowspan="2">± 0.3% (± 15mV)</td> <td rowspan="2">± 0.2% (± 10mV)</td> <td>0.416mV</td> </tr> <tr> <td>1 to 5V</td> <td>0.333mV</td> </tr> <tr> <td>-12000 to 12000</td> <td>User range setting 2 (-10 to 10V)</td> <td>± 0.3% (± 30mV)</td> <td>± 0.2% (± 20mV)</td> <td>0.333mV</td> </tr> </tbody> </table>	Digital input value	Analog output range	Accuracy		Maximum resolution	Ambient temperature 0 to 55℃	Ambient temperature 25 ± 5℃	-16000 to 16000	-10 to 10V	± 0.3% (± 30mV)	± 0.2% (± 20mV)	0.625mV	0 to 12000	0 to 5V	± 0.3% (± 15mV)	± 0.2% (± 10mV)	0.416mV	1 to 5V	0.333mV	-12000 to 12000	User range setting 2 (-10 to 10V)	± 0.3% (± 30mV)	± 0.2% (± 20mV)	0.333mV	△	The digital input range is different.
Digital input value	Digital value resolution			Analog output value*																																												
	1/4000	1/8000	1/12000																																													
4000	8000	12000	+20mA																																													
2000	4000	6000	+12mA																																													
0	0	0	+4mA																																													
Digital input value	Analog output range	Accuracy		Maximum resolution																																												
		Ambient temperature 0 to 55℃	Ambient temperature 25 ± 5℃																																													
-16000 to 16000	-10 to 10V	± 0.3% (± 30mV)	± 0.2% (± 20mV)	0.625mV																																												
0 to 12000	0 to 5V	± 0.3% (± 15mV)	± 0.2% (± 10mV)	0.416mV																																												
	1 to 5V			0.333mV																																												
-12000 to 12000	User range setting 2 (-10 to 10V)	± 0.3% (± 30mV)	± 0.2% (± 20mV)	0.333mV																																												
Maximum resolution of digital value	1.3 μ A (1/12000)	<table border="1"> <thead> <tr> <th rowspan="2">Digital input value</th> <th rowspan="2">Analog output range</th> <th rowspan="2">Accuracy</th> <th rowspan="2">Maximum resolution</th> </tr> </thead> <tbody> <tr> <td>0 to 20mA</td> <td>1.66 μ A</td> </tr> <tr> <td rowspan="2">0 to 12000</td> <td>4 to 20mA</td> <td rowspan="2">± 0.3% (± 60 μ A)</td> <td rowspan="2">± 0.2% (± 40 μ A)</td> <td>1.33 μ A</td> </tr> <tr> <td>User range setting 1 (0 to 20mA)</td> <td>0.95 μ A</td> </tr> </tbody> </table> <p>Factory-set: -10 to +10V.</p>	Digital input value	Analog output range	Accuracy	Maximum resolution	0 to 20mA	1.66 μ A	0 to 12000	4 to 20mA	± 0.3% (± 60 μ A)	± 0.2% (± 40 μ A)	1.33 μ A	User range setting 1 (0 to 20mA)	0.95 μ A	×	The maximum resolution is different.																															
Digital input value	Analog output range	Accuracy					Maximum resolution																																									
			0 to 20mA	1.66 μ A																																												
0 to 12000	4 to 20mA	± 0.3% (± 60 μ A)	± 0.2% (± 40 μ A)	1.33 μ A																																												
	User range setting 1 (0 to 20mA)			0.95 μ A																																												
Overall accuracy (accuracy relative to maximum value)	± 1.0% (± 200 μ A)		○																																													
Max. conversion speed	Within 25ms/4 channels (1 channel is same period of time)	200 μ s/channel	○																																													
Output protection function	-	Available	○																																													
Number of analog output points	4 channels/module		○																																													
Insulation method	Between the output terminal and programmable controller power supply: Photocoupler isolation (non-isolated between channels)	Between communication line and all analog outputs: Photocoupler isolation between power supply line and all analog outputs: Transformer isolation between channels: Non-isolated	○																																													
Number of occupied I/O stations (number of points)	4 stations (4 stations × 8 points)	1 station (1 station × 32 points) (RX/R Y 32 points each, RWr/RWw 4 points each)	○																																													

Item	A64DAIC	AJ65SBT2B-64DA	Compati- bility	Precautions for replacement
Connected terminal	47-point terminal block	Communication part, module communication part: 7-point two-piece terminal block (M3 screw) I/O part: 18-point two-piece terminal block (M3 screw)	×	Change in wiring is required.
Applicable wire size	0.75 to 2mm ² (Applicable tightening torque 39 to 59N · cm)	0.3 to 2mm ²	○	
Applicable solderless terminal	V1.25-3, V1.25-YS3A, V2-S3, V2-YS3A	RAV1.25-3 (conforming to JIS C 2805) [Applicable wire size: 0.3 to 1.25mm ²] V2-MS3, RAP2-3SL, TGV2-3N [Applicable wire size: 1.25 to 2.0mm ²]	○	
External power supply	24VDC (20.4 to 28.8VDC) Current consumption: 0.15A	24VDC (20.4 to 28.8VDC) Current consumption: 0.24A (at 24VDC) Inrush current: 2.6A 3.2ms or less	△	The current consumption increases. The current capacity needs to be reconsidered.
Weight	1.01kg	0.25kg	△	
External dimensions	170(H) × 100(W) × 80(D) mm	50(H) × 122(W) × 54(D) mm	×	The overall size differs. Pay attention to the mounting dimensions.

(b) Functional comparisons

○ : Compatible, △ : Partial change required, × : Not compatible

Item	A64DAIC	AJ65SBT2B-64DA	Compati- bility	Precautions for replacement
Analog output enable/disable setting	Selects whether to output D/A conversion values or offset values on each channel. Note, however, that the conversion speed is fixed regardless of the output enable/disable setting.	Selects whether to output D/A conversion values or offset values on each channel. Note, however, that the conversion speed is fixed regardless of the output enable/disable setting.	○	
Analog conversion enable/disable function	–	Selects whether to enable or disable D/A conversion on each channel. By making unused channels D/A conversion prohibited, conversion speed can be increased.	–	
Output range switching function	–	Sets the analog output range on each channel and changes the I/O conversion characteristics.	–	
HOLD/CLEAR setting	As the analog output status of the programmable controller CPU that is in RUN, at STOP, or in an error status, switching the type of output values as desired between D/A conversion values, offset values and 0V/0mA is possible.	In preparation for the event that the programmable controller CPU enters a stop status or the AJ65SBT2B-64DA stops D/A conversion due to an error, this settings can be configured to select whether to hold or clear analog values (output offset values) that are being output from each channel right before those stops.	○	
Offset/gain setting	Changes the I/O conversion characteristics.	Changes the I/O conversion characteristics as desired. For that, offset/gain settings can be configured for each channel without an aid of a various register.	○	
Transmission speed auto-tracking function	–	Automatically sets the transmission speed according to the settings of the master module when the AJ65SBT2B-64DA is powered on.	–	

(c) Programmable controller CPU I/O signal comparisons

I/O signals are different, so the sequence program must be changed.

For details on I/O signals and sequence programs, refer to the User's Manual.

A64DAIC				AJ65SBT2B-64DA			
Device No.	Description	Device No.	Description	Device No.	Description	Device No.	Description
X(n+0) to X(n+3)	Use prohibited	Y(n+0) to Y(n+3)	Use prohibited	RXn0 to RXn9	Use prohibited	RYn0	CH1 Analog output enable/disable flag
X(n+4)	Communication error detection flag indicating that execution of the FROM and TO instructions resulted in a communication error	Y(n+4)	Error detection reset signal			RYn1	CH2 Analog output enable/disable flag
						RYn2	CH3 Analog output enable/disable flag
X(n+5)	A64DAIC reset switch ON detection flag	Y(n+5)	Reset signal of reset switch ON detection flag			RYn3	CH4 Analog output enable/disable flag
X(n+6)	Use prohibited	Y(n+6)	Use prohibited			RYn4	CH1 Range setting (0th bit)
X(n+7)	Communication completion response signal wait flag	Y(n+7)	Communication reset signal			RYn5	CH1 Range setting (1st bit)
				RYn6	CH1 Range setting (2nd bit)		
X(n+8) to X(n+17)	Use prohibited	Y(n+8) to Y(n+17)	Use prohibited	RYn7	CH2 Range setting (0th bit)		
				RYn8	CH2 Range setting (1st bit)		
				RYn9	CH2 Range setting (2nd bit)		
				RXnA	Flash memory read error flag	RYnA	CH3 Range setting (0th bit)
				RXnB	User range read error flag	RYnB	CH3 Range setting (1st bit)
				RXnC	Flash memory write error flag	RYnC	CH3 Range setting (2nd bit)
				RXnD, RXnE	Use prohibited	RYnD	CH4 Range setting (0th bit)
						RYnE	CH4 Range setting (1st bit)
				RXnF	Test mode flag	RYnF	CH4 Range setting (2nd bit)
				RY(n+1)0	CH1 HOLD/CLEAR setting		
RY(n+1)1	CH2 HOLD/CLEAR setting						
RY(n+1)2	CH3 HOLD/CLEAR setting						
RY(n+1)3	CH4 HOLD/CLEAR setting						
RY(n+1)4	CH1 Conversion enable/disable setting						
RY(n+1)5	CH2 Conversion enable/disable setting						
RY(n+1)6	CH3 Conversion enable/disable setting						
RY(n+1)7	CH4 Conversion enable/disable setting						

A64DAIC				AJ65SBT2B-64DA			
Device No.	Description	Device No.	Description	Device No.	Description	Device No.	Description
X(n+18)	D/A conversion READY	Y(n+18)	CH1 Analog output enable signal	RX(n+1)8	Initial data processing request flag	RY(n+1)8	Initial data setting complete flag
X(n+19) to X(n+1F)	Use prohibited	Y(n+19)	CH2 Analog output enable signal	RX(n+1)9	Initial data setting complete flag	RY(n+1)9	Initial data setting request flag
		Y(n+1A)	CH3 Analog output enable signal	RX(n+1)A	Error status flag	RY(n+1)A	Error reset request flag
		Y(n+1B)	CH4 Analog output enable signal	RX(n+1)B	Remote READY	RY(n+1)B to RY(n+1)F	Use prohibited
		Y(n+1C) to Y(n+1F)	Use prohibited	RX(n+1)C to RX(n+1)F	Use prohibited		

(d) Buffer memory addresses comparisons

Buffer memory allocation is different, so the sequence program must be changed.

For details on buffer memory and sequence programs, refer to the User's Manual.

A64DAIC			AJ65SBT2B-64DA		
Address	Name	Read/write	Address	Name	Read/write
0	CH1 Digital value setting area	R/W	RWwm	CH1 Digital input value setting	W
1	CH2 Digital value setting area		RWwm+1	CH2 Digital input value setting	
2	CH3 Digital value setting area		RWwm+2	CH3 Digital input value setting	
3	CH4 Digital value setting area		RWwm+3	CH4 Digital input value setting	
4	CH1 Analog output disable/enable setting area		RWrn	CH1/CH2 Check code	R
5	CH2 Analog output disable/enable setting area		RWm+1	CH3/CH4 Check code	
6	CH3 Analog output disable/enable setting area		RWm+2	Error code	
7	CH4 Analog output disable/enable setting area		RWm+3	Use prohibited	
8	Resolution of digital value setting area			m, n: The address assigned to the master station by a station number setting	
9	Error code storage area				

(7) Comparisons between A64DAIC and AJ65SBT-62DA

(a) Performance specifications comparisons

○ : Compatible, △ : Partial change required, × : Not compatible

Item	A64DAIC	AJ65SBT-62DA	Compati- bility	Precautions for replacement																																																							
Digital input	(1) 16-bit signed binary value (2) Setting range: <table border="1"> <thead> <tr> <th>Set resolution</th> <th>Setting range</th> </tr> </thead> <tbody> <tr> <td>1/4000</td> <td>0 to 4000</td> </tr> <tr> <td>1/8000</td> <td>0 to 8000</td> </tr> <tr> <td>1/12000</td> <td>0 to 12000</td> </tr> </tbody> </table>	Set resolution	Setting range	1/4000	0 to 4000	1/8000	0 to 8000	1/12000	0 to 12000	Voltage: 16-bit signed binary (-4096 to +4095) Current: 16bits signed binary (0 to 4095)	×	The setting range has been changed.																																															
Set resolution	Setting range																																																										
1/4000	0 to 4000																																																										
1/8000	0 to 8000																																																										
1/12000	0 to 12000																																																										
Analog output	0 to 20mA (external load resistance: 0 to 600 Ω)	Voltage: -10 to +10V DC (external load resistance: 2k Ω to 1M Ω) 0 to 20mA (external load resistance: 0 to 600 Ω)	○																																																								
I/O characteristics	<table border="1"> <thead> <tr> <th rowspan="2"></th> <th colspan="3">Digital value resolution</th> <th rowspan="2">Analog output value*</th> </tr> <tr> <th>1/4000</th> <th>1/8000</th> <th>1/12000</th> </tr> </thead> <tbody> <tr> <td>Digital input value</td> <td>4000</td> <td>8000</td> <td>12000</td> <td>+20mA</td> </tr> <tr> <td></td> <td>2000</td> <td>4000</td> <td>6000</td> <td>+10mA</td> </tr> <tr> <td></td> <td>0</td> <td>0</td> <td>0</td> <td>+4mA</td> </tr> </tbody> </table> <p>* When the offset value is set to 4mA and the gain value is set to 20mA</p>		Digital value resolution			Analog output value*	1/4000	1/8000	1/12000	Digital input value	4000	8000	12000	+20mA		2000	4000	6000	+10mA		0	0	0	+4mA	<table border="1"> <thead> <tr> <th rowspan="2"></th> <th rowspan="2">Digital input value</th> <th rowspan="2">Analog output range</th> <th colspan="2">Accuracy</th> <th rowspan="2">Maximum resolution</th> </tr> <tr> <th>Ambient temperature 0 to 55℃</th> <th>Ambient temperature 25±5℃</th> </tr> </thead> <tbody> <tr> <td rowspan="3">Voltage</td> <td rowspan="2">-4000 to +4000</td> <td>-10 to +10V</td> <td rowspan="2">± 0.4% (± 40mV)</td> <td rowspan="2">± 0.2% (± 20mV)</td> <td rowspan="2">2.5mV</td> </tr> <tr> <td>User range setting1 (-10 to +10V)</td> </tr> <tr> <td>0 to 4000</td> <td>0 to 5V</td> <td rowspan="2">± 0.4% (± 20mV)</td> <td rowspan="2">± 0.2% (± 10mV)</td> <td>1.25mV</td> </tr> <tr> <td></td> <td>1 to 5V</td> <td>1.0mV</td> </tr> <tr> <td rowspan="3">Current</td> <td rowspan="3">0 to 4000</td> <td>0 to 20mA</td> <td rowspan="3">± 0.4% (± 80 μ A)</td> <td rowspan="3">± 0.2% (± 40 μ A)</td> <td>5 μ A</td> </tr> <tr> <td>4 to 20mA</td> <td>4 μ A</td> </tr> <tr> <td>User range setting3 (0 to 20mA)</td> </tr> </tbody> </table> <p>Factory-set: -10 to +10V.</p>		Digital input value	Analog output range	Accuracy		Maximum resolution	Ambient temperature 0 to 55℃	Ambient temperature 25±5℃	Voltage	-4000 to +4000	-10 to +10V	± 0.4% (± 40mV)	± 0.2% (± 20mV)	2.5mV	User range setting1 (-10 to +10V)	0 to 4000	0 to 5V	± 0.4% (± 20mV)	± 0.2% (± 10mV)	1.25mV		1 to 5V	1.0mV	Current	0 to 4000	0 to 20mA	± 0.4% (± 80 μ A)	± 0.2% (± 40 μ A)	5 μ A	4 to 20mA	4 μ A	User range setting3 (0 to 20mA)	△	The digital input range is different.
	Digital value resolution			Analog output value*																																																							
	1/4000	1/8000	1/12000																																																								
Digital input value	4000	8000	12000	+20mA																																																							
	2000	4000	6000	+10mA																																																							
	0	0	0	+4mA																																																							
	Digital input value	Analog output range	Accuracy		Maximum resolution																																																						
			Ambient temperature 0 to 55℃	Ambient temperature 25±5℃																																																							
Voltage	-4000 to +4000	-10 to +10V	± 0.4% (± 40mV)	± 0.2% (± 20mV)	2.5mV																																																						
		User range setting1 (-10 to +10V)																																																									
	0 to 4000	0 to 5V	± 0.4% (± 20mV)	± 0.2% (± 10mV)	1.25mV																																																						
	1 to 5V	1.0mV																																																									
Current	0 to 4000	0 to 20mA	± 0.4% (± 80 μ A)	± 0.2% (± 40 μ A)	5 μ A																																																						
		4 to 20mA			4 μ A																																																						
		User range setting3 (0 to 20mA)																																																									
Maximum resolution of digital value	1.3 μA(1/12000)		×	The maximum resolution is different.																																																							
Overall accuracy (accuracy relative to maximum value)	± 1.0%(± 200 μA)		○																																																								
Maximum conversion speed	Within 25ms/4 channels (1 channel is same period of time)	1ms/channel	○																																																								
Number of analog output points	4 channels/module	2 channels/module	×	Please consider replacing by using two or more AJ65SBT-62DA modules.																																																							
Insulation method	Between the output terminal and programmable controller power supply: Photocoupler isolation (non-isolated between channels)	Between communication line and all analog outputs: Photocoupler isolation between power supply line and all analog outputs: Photocoupler isolation (non-isolated between channels)	○																																																								
Number of occupied I/O stations (number of points)	4 stations (4 stations × 8 points)	1 station (1 station × 32 points) (RX/RV 32 points each, RWr/RWw 4 points each)	○	The number of occupied stations has been changed.																																																							

○ : Compatible, △ : Partial change required, × : Not compatible

Item	A64DAIC	AJ65SBT-62DA	Compati- bility	Precautions for replacement
Connected terminal	47-point terminal block	Communication part, module communication part: 7-point two-piece terminal block (M3 screw) I/O part: 18-point direct-mount terminal block (M3 screw)	×	Change in wiring is required.
Applicable wire size	0.75 to 2mm ² (Applicable tightening torque 39 to 59 N · cm)	0.3 to 0.75mm ²	×	
Applicable solderless terminal	V1.25-3, V1.25-YS3A, V2-S3, V2-YS3A	<ul style="list-style-type: none"> ▪ RAV1.25-3 (conforming to JIS C 2805) [Applicable wire size: 0.3 to 1.25mm²] ▪ V2-MS3, RAP2-3SL, TGV2-3N [Applicable wire size: 1.25 to 2.0mm²] 	×	
24VDC internal current consumption	0.15A	0.16A	△	The current consumption increases. The current capacity needs to be reconsidered.
Weight	1.01kg	0.20kg	△	
External dimensions	170(H) × 100(W) × 80(D) mm	50(H) × 118(W) × 40(D) mm	×	The overall size differs. Pay attention to the mounting dimensions.

(b) Functional comparisons

○ : Compatible, △ : Partial change required, × : Not compatible

Item	A64DAIC	AJ65SBT-62DA	Compati- bility	Precautions for replacement																		
D/A output enable/disable function	Selects on each channel whether to output D/A conversion values or offset values. Note, however, that the conversion speed is fixed regardless of the output enable/disable setting.	Selects on each channel whether to output D/A conversion values or offset values. Note, however, that the conversion speed is fixed regardless of the output enable/disable setting.	○																			
D/A conversion enable/disable function	-	Selects whether to enable or disable D/A conversion on each channel. By making unused channels D/A conversion prohibited, sampling period can be shortened.	-																			
Output range switching function	-	Sets the analog output range on each channel and changes the I/O conversion characteristics. The following eight output ranges can be selected: <table border="1" style="margin-left: 20px;"> <thead> <tr> <th>Output range</th> <th>set value</th> </tr> </thead> <tbody> <tr> <td>-10 to +10V</td> <td>0_H</td> </tr> <tr> <td>0 to 5V</td> <td>1_H</td> </tr> <tr> <td>1 to 5V</td> <td>2_H</td> </tr> <tr> <td>0 to 20mA</td> <td>3_H</td> </tr> <tr> <td>4 to 20mA</td> <td>4_H</td> </tr> <tr> <td>User range setting 1 (-10 to +10V)</td> <td>5_H</td> </tr> <tr> <td>User range setting 2 (0 to 5V)</td> <td>6_H</td> </tr> <tr> <td>User range setting 3 (0 to 20mA)</td> <td>7_H</td> </tr> </tbody> </table>	Output range	set value	-10 to +10V	0 _H	0 to 5V	1 _H	1 to 5V	2 _H	0 to 20mA	3 _H	4 to 20mA	4 _H	User range setting 1 (-10 to +10V)	5 _H	User range setting 2 (0 to 5V)	6 _H	User range setting 3 (0 to 20mA)	7 _H	-	
Output range	set value																					
-10 to +10V	0 _H																					
0 to 5V	1 _H																					
1 to 5V	2 _H																					
0 to 20mA	3 _H																					
4 to 20mA	4 _H																					
User range setting 1 (-10 to +10V)	5 _H																					
User range setting 2 (0 to 5V)	6 _H																					
User range setting 3 (0 to 20mA)	7 _H																					
HOLD/CLEAR setting	As the analog output status of the programmable controller CPU that is in RUN, at STOP, or in an error status, switching the type of output values as desired between D/A conversion values, offset values and 0V/0mA is possible. D/A conversion value outputs, offset value outputs and 0V/0mA outputs can be revised arbitrarily.	In preparation for the event that the programmable controller CPU enters a stop state or the AJ65SBT-62DA stops D/A conversion due to an error, this settings can be configured to select whether to hold or clear analog values (output offset values) that are being output from each channel right before those stops.	○																			
Offset/gain setting	Changes the I/O conversion characteristics.	Changes the I/O conversion characteristics as desired. For that, offset/gain settings can be configured for each channel without a aid of a various register.	○																			

(c) Programmable controller CPU I/O signal comparisons

The sequence program must be changed as the I/O signals differ.

For details on I/O signals and sequence programs, refer to the User's Manual.

A64DAIC				AJ65SBT-62DA			
Device No.	Description	Device No.	Description	Device No.	Description	Device No.	Description
X(n+0) to X(n+3)	Use prohibited	Y(n+0) to Y(n+3)	Use prohibited	RXn0 to RXnB	Use prohibited	RYn0	CH1 Analog output enable/disable flag
				RXnC	E ² PROM write error flag	RYn1	CH2 Analog output enable/disable flag
X(n+4)	Communication error detection flag indicating that execution of the FROM and TO instructions resulted in a communication error	Y(n+4)	Error detection reset signal	RXnD	Use prohibited	RYn2 to RY(n+1)7	Use prohibited
				RXnE			
				RXnF	Test mode flag		
				RX(n+1)0 to RX(n+1)7	Use prohibited		
X(n+5)	A64DAIC reset switch ON detection flag	Y(n+5)	Reset switch ON detection flag reset signal	RX(n+1)8	Initial data processing request flag	RY(n+1)8	Initial data processing complete flag
X(n+6)	Use prohibited	Y(n+6)	Use prohibited	RX(n+1)9	Initial data setting complete flag	RY(n+1)9	Initial data setting request flag
X(n+7)	Communication completion response signal wait flag	Y(n+7)	Communication reset signal	RX(n+1)A	Error status flag	RY(n+1)A	Error reset request flag
X(n+8) to X(n+17)	Use prohibited	Y(n+8) to Y(n+17)	Use prohibited	RX(n+1)B	Remote READY	RY(n+1)B to RY(n+1)F	Use prohibited
X(n+18)	D/A conversion READY	Y(n+18)	CH1 Analog output enable signal	RX(n+1)C	Use prohibited		
		Y(n+19)	CH2 Analog output enable signal	RX(n+1)D			
		Y(n+1A)	CH3 Analog output enable signal	RX(n+1)E			
		Y(n+1B)	CH4 Analog output enable signal	RX(n+1)F			
X(n+19) to X(n+1F)	Use prohibited	Y(n+1C) to Y(n+1F)	Use prohibited				

(d) Buffer memory addresses comparisons

The sequence program must be changed as the buffer memory assignments differ.

For details on buffer memory and sequence programs, refer to the User's Manual.

A64DAIC			AJ65SBT-62DA		
Address	Name	Read/write	Address	Name	Read/write
0	CH1 Digital value setting area	R/W	RWwm	CH1 Digital value setting	W
1	CH2 Digital value setting area		RWwm+1	CH2 Digital value setting	
2	CH3 Digital value setting area		RWwm+2	Analog output enable/disable setting	
3	CH4 Digital value setting area		RWwm+3	Output range HOLD/CLEAR setting	
4	CH1 Analog output disable/enable setting area		RWrn	CH1 Check code	R
5	CH2 Analog output disable/enable setting area		RWrn+1	CH2 Check code	
6	CH3 Analog output disable/enable setting area		RWrn+2	Error code	
7	CH4 Analog output disable/enable setting area		RWrn+3	Use prohibited	-
8	Resolution of digital value setting area				
9	Error code storage area				

6.2.3 Comparison of temperature input module

(1) Comparisons between A64RD3C and AJ65BT-64RD3

(a) Performance specifications comparisons

○ : Compatible, △ : Partial change required, × : Not compatible

Item	A64RD3C	AJ65BT-64RD3	Compati- bility	Precautions for replacement
Measurement method	3-wire type		○	
Connectable platinum resistance thermometer	Pt100 (JIS C 1604-1989, DIN43760-1980)	Pt100, JPt100	○	
	JPt100 (JIS C 1604-1981)		○	
Temperature input range	Pt100: -180[°C] to +600[°C] (27.08 Ω to 313.59 Ω)	-180[°C] to 600[°C]	○	
	Pt100: -180[°C] to +600[°C] (25.8 Ω to 317.28 Ω)		○	
Detected temperature value	16bits signed binary -1800 to +6000 (down to 1 decimal place × 10)		○	
	32bits signed binary -180000 to +600000 (down to 3 decimal places × 1000)		○	
Resolution	0.025°C		○	
Overall accuracy	± 1% (accuracy relative to full-scale)	Ambient temperature (25 ± 5°C): ± 0.1% (accuracy relative to maximum value) Ambient temperature (20°C or less, 30°C or more): ± 0.25% (accuracy relative to maximum value)	○	
Conversion speed	40ms/channel		○	
Number of temperature input points	4 channels/module		○	
Output current for temperature detection	4.2mA (MIN.), 4.7mA (MAX.)	1mA	×	The temperature detecting output current has been changed.
Insulation method	Between input terminal and programmable controller: Photocoupler isolation (non-isolated between channels)	Between platinum resistance thermometer input and CC-Link transmission line: Photocoupler isolation (non-isolated between channels)	○	
Number of occupied stations (number of occupied points)	4 stations (4 stations × 8 points)	4 stations (4 stations × 32 points) (RX/Ry 128 points each, RWw/RWr 16 points each)	×	The number of occupied points increases. The assignment of the entire system needs to be reconsidered.
Connected terminal block	47-point terminal block	27-point terminal block	×	Change in wiring is required.
Applicable wire size	0.75 to 2.00mm ²		○	
Applicable solderless terminal	V1.25-3, V1.25-YS3A, V2-S3, V2-YS3A	RAV 1.25-3.5, RAV 2-3.5 (conforming to JIS C 2805)	×	Change in wiring is required.

○ : Compatible, △ : Partial change required, × : Not compatible

Item	A64RD3C	AJ65BT-64RD3	Compati- bility	Precautions for replacement
24VDC internal current consumption	0.2A	0.17A	○	
Weight	0.81kg	0.38kg	△	
External dimensions	170(H) × 100(W) × 80(D)mm	65(H) × 151.9(W) × 63(D) mm	×	The overall size differs. Pay attention to the mounting dimensions.

(b) Functional comparisons

○ : Compatible, △ : Partial change required, × : Not compatible

Item	A64RD3C	AJ65BT-64RD3	Compati- bility	Precautions for replacement
Conversion enable/disable specification for each channel	Selects on each channel whether to enable or disable temperature detection.		○	
Sampling/averaging processing specification	<p>Performs processing on a detected temperature in the specified processing method, and stores the processed data to the buffer memory.</p> <p>The following three processing methods are available:</p> <ul style="list-style-type: none"> • Sampling processing • Time averaging processing • Count averaging processing 	Selects on each channel whether to perform the sampling processing or movement averaging processing. (default... sampling processing)	△	The AJ65BT-64RD4 has been provided the movement averaging processing instead of the averaging processing on A64RD3C.
Storage of detected temperature value	<p>The value down to the 1st decimal place and the value down to the 3rd decimal place are stored to the buffer memory.</p> <ul style="list-style-type: none"> • Value down to 1st decimal place (16-bit signed binary) Example) 53.8(°C) → 538 • Value down to 3rd decimal place (32-bit signed binary) Example) 216.025(°C) → 216025 	The value down to the 1st decimal place and the value down to the 3rd decimal place are stored to the remote register.	○	
Wire break detection	<p>Detects wire breaks on the connected Pt100 or cable.</p> <p>Wire breaks on each channel are detected, and the wire break detection flag (X19 to X1A) corresponding to each channel is turned ON.</p>	Detects wires breaks on the connected platinum resistance thermometer for each channel.	○	
Specification of platinum temperature measuring resistor type	<p>Specifies platinum temperature measuring resistor type to be used.</p> <p>The following two types of platinum temperature measuring resistors can be used:</p> <ul style="list-style-type: none"> • Pt100... new JIS - DIN type (JIS C 1604-1989, DIN43760-1980) • JPt100... conventional JIS type (JIS C 1604-1981) 	<p>Specifies platinum temperature measuring resistor type to be used.</p> <p>The following two types of platinum temperature measuring resistors can be used:</p> <ul style="list-style-type: none"> • Pt100... new JIS, IEC type (JIS C 1604-1997, IEC 751 1983) • JPt100... conventional JIS type (JIS C 1604-1981) 	○	

(c) Programmable controller CPU I/O signal comparisons

The sequence program must be changed as the I/O signals differ.

For details on I/O signals and sequence programs, refer to the User's Manual.

A64RD3C				AJ65BT-64RD3			
Device No.	Description	Device No.	Description	Device No.	Description	Device No.	Description
X(n+0) to X(n+3)	Use prohibited	Y(n+0) to Y(n+3)	Use prohibited	RXn0	CH1 Conversion completed flag	RYn0	CH1 Conversion enable flag
				RXn1	CH2 Conversion completed flag	RYn1	CH2 Conversion enable flag
X(n+4)	FROM/TO instruction error detection flag	Y(n+4)	Error detection reset signal	RXn2	CH3 Conversion completed flag	RYn2	CH3 Conversion enable flag
				RXn3	CH4 Conversion completed flag	RYn3	CH4 Conversion enable flag
				RXn4	CH1 Wire break detection flag	RYn4	CH1 Sampling processing/movement averaging processing specification flag
X(n+5)	A64RD3C reset switch ON detection flag	Y(n+5)	Reset switch ON detection flag reset signal	RXn5	CH2 Wire break detection flag	RYn5	CH2 Sampling processing/movement averaging processing specification flag
				RXn6	CH3 Wire break detection flag	RYn6	CH3 Sampling processing/movement averaging processing specification flag
X(n+6)	Use prohibited	Y(n+6)	Use prohibited	RXn7	CH4 Wire break detection flag	RYn7	CH4 Sampling processing/movement averaging processing specification flag
X(n+7)	Communication completion response signal wait flag	Y(n+7)	Communication reset signal	RXn8	E ² PROM error flag	RYn8 to RY(n+7)6	Use prohibited
X(n+8) to X(n+17)	Use prohibited	Y(n+8) to Y(n+1F)	Use prohibited	RXn9	Test mode flag		
X(n+18)	READY flag			RXnA to RX(n+7)7	Use prohibited	RY(n+7)7	Offset/gain value selection flag
X(n+19)	CH1 Wire break detection flag			RX(n+7)8	Initial data processing request flag	RY(n+7)8	Initial data processing complete flag
X(n+1A)	CH2 Wire break detection flag			RX(n+7)9	Initial data setting complete flag	RY(n+7)9	Initial data setting request flag
X(n+1B)	CH3 Wire break detection flag			RX(n+7)A	Error status flag	RY(n+7)A	Error reset
X(n+1C)	CH4 Wire break detection flag			RX(n+7)B	Remote READY	RY(n+7)B to RY(n+7)F	Use prohibited
X(n+1D) to X(n+1F)	Use prohibited			RX(n+7)C to RX(n+7)F	Use prohibited		

(d) Buffer memory addresses comparisons

The sequence program must be changed as the buffer memory assignments differ.

For details on buffer memory and sequence programs, refer to the User's Manual.

A64RD3C			AJ65BT-64RD3		
Address	Name	Read/write	Address	Name	Read/write
0	Conversion enable/disable specification	R/W	RWwm to RWwm+15	Use prohibited	-
1	Averaging processing specification				
2	CH1 Averaging time, count				
3	CH2 Averaging time, count				
4	CH3 Averaging time, count				
5	CH4 Averaging time, count				
6	CH1 Detected temperature value	R	RWrn	CH1 Detected temperature value (16 bits)	R
7	CH2 Detected temperature value		RWrn+1	CH2 Detected temperature value (16 bits)	
8	CH3 Detected temperature value		RWrn+2	CH3 Detected temperature value (16 bits)	
9	CH4 Detected temperature value		RWrn+3	CH4 Detected temperature value (16 bits)	
10	CH1 Detected temperature value (L)		RWrn+4	CH1 Detected temperature value	
11	(32 bits) (H)		RWrn+5	(32 bits)	
12	CH2 Detected temperature value (L)		RWrn+6	CH2 Detected temperature value	
13	(32 bits) (H)		RWrn+7	(32 bits)	
14	CH3 Detected temperature value (L)		RWrn+8	CH3 Detected temperature value	
15	(32 bits) (H)		RWrn+9	(32 bits)	
16	CH4 Detected temperature value (L)		RWrn+10	CH4 Detected temperature value	
17	(32 bits) (H)		RWrn+11	(32 bits)	
18	Write data error code	R/W	RWrn+12 to RWrn+15	Use prohibited	-
19	Conversion completed flag	R			
20	Specification of platinum temperature measuring resistor type	R/W			

(2) Comparisons between A64RD3C and AJ65SBT2B-64RD3

(a) Performance specifications comparisons

○ : Compatible, △ : Partial change required, × : Not compatible

Item	A64RD3C	AJ65SBT2B-64RD3	Compati- bility	Precautions for replacement
Measuring method	3-wire type		○	
Connectable temperature measuring resistor	Pt100 (JIS C 1604-1989, DIN43760-1980) JPt100 (JIS C 1604-1981)	Pt100 (JIS C 1604-1997), JPt100 (JIS C 1604-1981), Ni100 (DIN 43760 1987)	○	
Temperature input range	Pt100: -180[°C] to +600[°C] (27.08 Ω to 313.59 Ω) JPt100: -180[°C] to +600[°C] (25.8 Ω to 317.28 Ω)	Pt100: -200 to 850°C JPt100: -180 to 600°C Ni100: -60 to 180°C	○	
Detected temperature value	16bits signed binary -1800 to +6000 (down to 1 decimal place × 10)	16bits signed binary -2000 to 8500 (down to 1 decimal place × 10)	○	
	32bits signed binary -180000 to +600000 (down to 3 decimal places × 1000)	—	×	32-bit output is not available.
Resolution	0.025°C	0.1°C	△	The maximum resolution is different.
Overall accuracy	± 1% (accuracy relative to full-scale)	*1	○	
Conversion speed	40ms/channel		○	
Number of temperature input points	4 channels/module		○	
Output current for temperature detection	4.2mA (MIN.), 4.7mA (MAX.)	1mA	×	The temperature detecting output current has been changed.
Insulation method	Between input terminal and programmable controller: Photocoupler isolation (non-isolated between channels)	Between communication line and all temperature measuring resistor inputs: Photocoupler isolation between power supply line and all temperature measuring resistor inputs: Transformer isolation between channels: Non-isolated	○	
Number of occupied stations (number of occupied points)	4 stations (4 stations × 8 points)	1 station (1 station × 32 points) (RX/R Y 32 points each, RWr/RWw 4 points each)	○	
Connected terminal block	47-point terminal block	Communication part, module communication part: 7-point two-piece terminal block (M3 screw) I/O part: 18-point two-piece terminal block (M3 screw)	×	Change in wiring is required.
Applicable wire size	0.75 to 2.0mm ²	0.3 to 2.0mm ²	○	
Applicable solderless terminal	V1.25-3, V1.25-YS3A, V2-S3, V2-YS3A	RAV1.25-3 (conforming to JIS C 2805) [Applicable wire size: 0.3 to 1.25mm ²] V2-MS3, RAP2-3SL, TGV2-3N [Applicable wire size: 1.25 to 2.0mm ²]	○	
24VDC internal current consumption	0.2A	0.14A	○	
Weight	0.81kg	0.25kg	△	

○ : Compatible, △ : Partial change required, × : Not compatible

Item	A64RD3C	AJ65SBT2B-64RD3	Compati- bility	Precautions for replacement
External dimensions	170(H) × 100(W) × 80(D) mm	50(H) × 122(W) × 54(D) mm	×	The overall size differs. Pay attention to the mounting dimensions.

*1 The accuracy of the AJ65SBT2B-64RD3 varies depending on the temperature measuring resistor as shown below.

	Conversion accuracy	Specifications
Pt100	-200 to 850°C	± 0.5°C (ambient temperature: 25 ± 5°C), ± 1.4°C (ambient temperature: 0 ± 55°C)
	-20 to 120°C	± 0.2°C (ambient temperature: 25 ± 5°C), ± 0.6°C (ambient temperature: 0 ± 55°C)
	0 to 200°C	± 0.2°C (ambient temperature: 25 ± 5°C), ± 0.6°C (ambient temperature: 0 ± 55°C)
JPt100	-18 to 600°C	± 0.4°C (ambient temperature: 25 ± 5°C), ± 1.0°C (ambient temperature: 0 ± 55°C)
	-20 to 120°C	± 0.2°C (ambient temperature: 25 ± 5°C), ± 0.6°C (ambient temperature: 0 ± 55°C)
	0 to 200°C	± 0.2°C (ambient temperature: 25 ± 5°C), ± 0.6°C (ambient temperature: 0 ± 55°C)
Ni100	-60 to 180°C	± 0.2°C (ambient temperature: 25 ± 5°C), ± 0.5°C (ambient temperature: 0 ± 55°C)

(b) Functional comparisons

○ : Compatible, △ : Partial change required, × : Not compatible

Item	A64RD3C	AJ65SBT2B-64RD3	Compati- bility	Precautions for replacement
Conversion enable/disable specification for each channel	Selects whether to enable or disable temperature detection on each channel.		○	
Sampling/averaging processing specification	Performs processing on a detected temperature in the specified processing method, and stores the processed data to the buffer memory. The following three processing methods are available: Sampling processing Time averaging processing Count averaging processing	Selects whether to perform the sampling processing or averaging processing (count average/time average/moving average) on each channel.	○	
Storage of detected temperature value	The value down to the 1st decimal place and the value down to the 3rd decimal place are stored to the buffer memory. Value down to 1st decimal place (16-bit signed binary) Example) 53.8(°C) → 538 Value down to 3rd decimal place (32-bit signed binary) Example) 216.025(°C) → 216025	The value down to the 1st decimal place and the value down to the 3rd decimal place are stored to the remote register.	△	Only the value down to the 1st decimal place (16-bit signed binary) is stored.
Wire break detection	Detects wire breaks on the connected Pt100 or cable. Wire breaks on each channel are detected, and the wire break detection flag (X19 to X1A) corresponding to each channel is turned ON.	Detects wires breaks on the connected temperature measuring resistor for each channel.	○	
Selection of temperature measuring resistor type	Specifies the platinum temperature measuring resistor type to be used. The following two types of platinum temperature measuring resistor can be used: Pt100: new JIS - DIN type (JIS C 1604-1989, DIN43760-1980) JPt100: conventional JIS type (JIS C 1604-1981)	Specifies the temperature measuring resistor type to be used for each channel. The following three types of temperature measuring resistor can be used: Pt100 (JIS C 1604-1997) JPt100 (JIS C 1604-1981) Ni100 (DIN 43760 1987)	○	
Error correction with offset/gain setting	–	Corrects an error by using the set offset and gain values.	–	
Transmission speed auto-tracking function	–	Automatically sets the transmission speed according to the settings of the master module.	–	

(c) Programmable controller CPU I/O signal comparisons

I/O signals are different, so the sequence program must be changed.

For details on I/O signals and sequence programs, refer to the User's Manual.

A64RD3C				AJ65SBT2B-64RD3			
Device No.	Description	Device No.	Description	Device No.	Description	Device No.	Description
X(n+0) to X(n+3)	Use prohibited	Y(n+0) to Y(n+3)	Use prohibited	RXn0	CH1 Conversion completed flag	RYn0	CH1 Conversion enable flag
X(n+4)	FROM/TO instruction error detection flag	Y(n+4)	Error detection reset signal	RXn1	CH2 Conversion completed flag	RYn1	CH2 Conversion enable flag
				RXn2	CH3 Conversion completed flag	RYn2	CH3 Conversion enable flag
				RXn3	CH4 Conversion completed flag	RYn3	CH4 Conversion enable flag
X(n+5)	A64RD3C reset switch ON detection flag	Y(n+5)	Reset signal of reset switch ON detection flag	RXn4	CH1 Wire break detection flag	RYn4 to RYn7	Use prohibited
						RYn8	CH1 Measurement range (0th bit)
						RYn9	CH1 Measurement range (1st bit)
						RYnA	CH1 Measurement range (2nd bit)
X(n+6)	Use prohibited	Y(n+6)	Use prohibited	RXn5	CH2 Wire break detection flag	RYnB	CH2 Measurement range (0th bit)
						RYnC	CH2 Measurement range (1st bit)
X(n+7)	Communication completion response signal wait flag	Y(n+7)	Communication reset signal	RXn6	CH3 Wire break detection flag	RYnD	CH2 Measurement range (2nd bit)
						RYnE	CH3 Measurement range (0th bit)
X(n+8) to X(n+17)	Use prohibited	Y(n+8) to Y(n+1F)	Use prohibited	RXn7	CH4 Wire break detection flag	RYnF	CH3 Measurement range (1st bit)
				RXn8	Use prohibited	RY(n+1)0	CH3 Measurement range (2nd bit)
				RXn9		RY(n+1)1	CH4 Measurement range (0th bit)
				RXnA	Flash memory read error flag	RY(n+1)2	CH4 Measurement range (1st bit)
				RXnB		RY(n+1)3	CH4 Measurement range (2nd bit)
				RXnC	User range read error flag	RY(n+1)4	Wire break detection upper/lower limit flag (all channels)
				RXnD	Flash memory write error flag		RY(n+1)5
				RXnE		Use prohibited	
RXnF	Test mode flag						
X(n+18)	READY flag			RX(n+1)0 to RX(n+1)7	Use prohibited	RY(n+1)7	Offset/gain value selection flag
X(n+19)	CH1 Wire break detection flag			RX(n+1)8	Initial data processing request flag	RY(n+1)8	Initial data setting complete flag
X(n+1A)	CH2 Wire break detection flag			RX(n+1)9	Initial data setting complete flag	RY(n+1)9	Initial data setting request flag
X(n+1B)	CH3 Wire break detection flag			RX(n+1)A	Error status flag	RY(n+1)A	Error reset request flag
X(n+1C)	CH4 Wire break detection flag			RX(n+1)B	Remote READY	RY(n+1)B to RY(n+1)F	Use prohibited
X(n+1D) to X(n+1F)	Use prohibited			RX(n+1)C to RX(n+1)F	Use prohibited		

(d) Buffer memory addresses comparisons

Buffer memory allocation is different, so the sequence program must be changed.
 For details on buffer memory and sequence programs, refer to the User's Manual.

A64RD3C			AJ65SBT2B-64RD3		
Address	Name	Read/write	Address	Name	Read/write
0	Conversion enable/disable specification	R/W	RWwm	CH1 Average processing setting	R/W
1	Averaging processing specification		RWwm+1	CH2 Average processing setting	
2	CH1 Averaging time, count		RWwm+2	CH3 Average processing setting	
3	CH2 Averaging time, count		RWwm+3	CH4 Average processing setting	
4	CH3 Averaging time, count		R	RWm	CH1 Detected temperature value (16 bits)
5	CH4 Averaging time, count	RWrn+1		CH2 Detected temperature value (16 bits)	
6	CH1 Detected temperature value	RWrn+2		CH3 Detected temperature value (16 bits)	
7	CH2 Detected temperature value	RWrn+3		CH4 Detected temperature value (16 bits)	
8	CH3 Detected temperature value	m, n: The address assigned to the master station by a station number setting			
9	CH4 Detected temperature value				
10	CH1 Detected temperature value (L)				
11	(32 bits) (H)				
12	CH2 Detected temperature value (L)				
13	(32 bits) (H)				
14	CH3 Detected temperature value (L)				
15	(32 bits) (H)				
16	CH4 Detected temperature value (L)				
17	(32 bits) (H)				
18	Write data error code	R/W			
19	Conversion-completed flag	R			
20	Type specification of a platinum temperature-measuring resistor	R/W			

(3) Comparisons between A64RD4C and AJ65BT-64RD4

(a) Performance specifications comparisons

○ : Compatible, △ : Partial change required, × : Not compatible

Item	A64RD4C	AJ65BT-64RD4	Compati- bility	Precautions for replacement
Measuring method	4-wire type		○	
Connectable platinum temperature measuring resistor	Pt100 (JIS C 1604-1989, DIN43760-1980)	Pt100, JPt100	○	
	JPt100 (JIS C 1604-1981)		○	
Temperature input range	Pt100: -180[°C] to +600[°C] (27.08 Ω to 313.59 Ω)	-180[°C] to 600[°C]	○	
	JPt100: -180[°C] to +600[°C] (25.8 Ω to 317.28 Ω)		○	
Detected temperature value	16bits signed binary -1800 to +6000 (down to 1 decimal place × 10)		○	
	32bits signed binary -180000 to +600000 (down to 3 decimal places × 1000)		○	
Resolution	0.025°C		○	
Overall accuracy	± 1% (accuracy relative to full-scale)	Ambient temperature: (25 ± 5°C) ± 0.1% (accuracy relative to maximum value) Ambient temperature (20°C or less, 30°C or more): ± 0.25% (accuracy relative to maximum value)	○	
Conversion speed	40ms/channel		○	
Number of temperature input points	4 channels/module		○	
Output current for temperature detection	4.2mA (MIN.), 4.7mA (MAX.)	1mA	×	The temperature detecting output current has been changed.
Insulation method	Between input terminal and programmable controller: Photocoupler isolation (non-isolated between channels)	Between platinum temperature measuring resistor input and CC-Link transmission line: Photocoupler isolation (non-isolated between channels)	○	
Number of occupied stations (number of occupied points)	4 stations (4 stations × 8 points)	4 stations (4 stations × 32 points) (RX/Ry 128 points each, RWw/RWr 16 points each)	×	The number of occupied points increases. The assignment of the entire system needs to be reconsidered.
Connected terminal block	47-point terminal block	27-point terminal block	×	Change in wiring is required.
Applicable wire size	0.75 to 2.00mm ²		○	
Applicable solderless terminal	V1.25-3, V1.25-YS3A, V2-S3, V2-YS3A	RAV 1.25-3.5, RAV 2-3.5 (conforming to JIS C 2805)	×	

○ : Compatible, △ : Partial change required, × : Not compatible

Item	A64RD4C	AJ65BT-64RD4	Compati- bility	Precautions for replacement
24VDC internal current consumption	0.15A	0.17A	△	The current consumption increases. The current capacity needs to be reconsidered.
Weight	0.81kg	0.38kg	△	
External dimensions	170(H) × 100(W) × 80(D) mm	65(H) × 151.9(W) × 63(D) mm	×	The overall size differs. Pay attention to the mounting dimensions.

(b) Functional comparisons

○ : Compatible, △ : Partial change required, × : Not compatible

Item	A64RD4C	AJ65BT-64RD4	Compati- bility	Precautions for replacement
Conversion enable/disable specification for each channel	Selects on each channel whether to enable or disable temperature detection.		○	
Sampling/averaging processing specification	<p>Performs processing on a detected temperature in the specified processing method, and stores the processed data to the buffer memory.</p> <p>The following three processing methods are available:</p> <ul style="list-style-type: none"> • Sampling processing • Time averaging processing • Count averaging processing 	<p>Selects on each channel whether to perform the sampling processing or movement averaging processing. (default... sampling processing)</p>	△	The AJ65BT-64RD4 has been provided the movement averaging processing instead of the averaging processing on A64RD3C.
Storage of detected temperature value	<p>The value down to the 1st decimal place and the value down to the 3rd decimal place are stored to the buffer memory.</p> <ul style="list-style-type: none"> • Value down to 1st decimal place (16-bit signed binary) Example) 53.8(°C) → 538 • Value down to 3rd decimal place (32-bit signed binary) Example) 216.025(°C) → 216025 	<p>The value down to the 1st decimal place and the value down to the 3rd decimal place are stored to the remote register.</p>	○	
Wire break detection	<p>Detects wire breaks on the connected Pt100 or cable.</p> <p>A wire break on a wire on a channel is detected, turning the Σ wire break detection flag (X19) ON.</p>	<p>Detects wires breaks on the connected platinum temperature measuring resistor for each channel.</p>	○	
Specification of platinum temperature measuring resistor type	<p>Specifies the platinum temperature measuring resistor type to be used.</p> <p>The following two types of platinum temperature measuring resistor can be used:</p> <ul style="list-style-type: none"> • Pt100... new JIS - DIN type (JIS C 1604-1989, DIN43760-1980) • JPt100... conventional JIS type (JIS C 1604-1981) 	<p>Specifies the platinum temperature measuring resistor type to be used.</p> <p>The following two types of platinum temperature measuring resistor can be used:</p> <ul style="list-style-type: none"> • Pt100... new JIS, IEC type (JIS C 1604-1997, IEC 751 1983) • JPt100... conventional JIS type (JIS C 1604-1981) 	○	

(c) Programmable controller CPU I/O signal comparisons

The sequence program must be changed as the I/O signals differ.

For details on I/O signals and sequence programs, refer to the User's Manual.

A64RD4C				AJ65BT-64RD4			
Device No.	Description	Device No.	Description	Device No.	Description	Device No.	Description
X(n+0) to X(n+3)	Use prohibited	Y(n+0) to Y(n+3)	Use prohibited	RXn0	CH1 Conversion completed flag	RYn0	CH1 Conversion enable flag
				RXn1	CH2 Conversion completed flag	RYn1	CH2 Conversion enable flag
X(n+4)	FROM/TO instruction error detection flag	Y(n+4)	Error detection reset signal	RXn2	CH3 Conversion completed flag	RYn2	CH3 Conversion enable flag
				RXn3	CH4 Conversion completed flag	RYn3	CH4 Conversion enable flag
				RXn4	CH1 Wire break detection flag	RYn4	CH1 Sampling processing/movement averaging processing specification flag
X(n+5)	A64RD4C reset switch ON detection flag	Y(n+5)	Reset switch ON detection flag reset signal	RXn5	CH2 Wire break detection flag	RYn5	CH2 Sampling processing/movement averaging processing specification flag
				RXn6	CH3 Wire break detection flag	RYn6	CH3 Sampling processing/movement averaging processing specification flag
X(n+6)	Use prohibited	Y(n+6)	Use prohibited	RXn7	CH4 Wire break detection flag	RYn7	CH4 Sampling processing/movement averaging processing specification flag
X(n+7)	Communication completion response signal wait flag	Y(n+7)	Communication reset signal	RXn8	E ² PROM error flag	RYn8 to RY(n+7)6	Use prohibited
X(n+8) to X(n+17)	Use prohibited	Y(n+8) to Y(n+1F)	Use prohibited	RXn9	Test mode flag		
X(n+18)	READY flag			RXnA to RX(n+7)7	Use prohibited	RY(n+7)7	Offset/gain value selection flag
X(n+19)	Σ wire break detection flag			RX(n+7)8	Initial data processing request flag	RY(n+7)8	Initial data processing complete flag
X(n+1A) to X(n+1F)	Use prohibited			RX(n+7)9	Initial data setting complete flag	RY(n+7)9	Initial data setting request flag
				RX(n+7)A	Error status flag	RY(n+7)A	Error reset request flag
		RX(n+7)B	Remote READY	RY(n+7)B to RY(n+7)F	Use prohibited		
RX(n+7)C to RX(n+7)F							

(d) Buffer memory addresses comparisons

The sequence program must be changed as the buffer memory assignments differ.

For details on buffer memory and sequence programs, refer to the User's Manual.

A64RD4C			AJ65BT-64RD4		
Address	Name	Read/write	Address	Name	Read/write
0	Conversion enable/disable specification	R/W	RWwm to RWwm+15	Use prohibited	-
1	Averaging processing specification				
2	CH1 Averaging time, count				
3	CH2 Averaging time, count				
4	CH3 Averaging time, count				
5	CH4 Averaging time, count				
6	CH1 Detected temperature value	R	RWrn	CH1 Detected temperature value (16 bits)	R
7	CH2 Detected temperature value		RWrn+1	CH2 Detected temperature value (16 bits)	
8	CH3 Detected temperature value		RWrn+2	CH3 Detected temperature value (16 bits)	
9	CH4 Detected temperature value		RWrn+3	CH4 Detected temperature value (16 bits)	
10	CH1 Detected temperature value (L)		RWrn+4	CH1 Detected temperature value	
11	(32 bits) (H)		RWrn+5	(32 bits)	
12	CH2 Detected temperature value (L)		RWrn+6	CH2 Detected temperature value	
13	(32 bits) (H)		RWrn+7	(32 bits)	
14	CH3 Detected temperature value (L)		RWrn+8	CH3 Detected temperature value	
15	(32 bits) (H)		RWrn+9	(32 bits)	
16	CH4 Detected temperature value (L)		RWrn+10	CH4 Detected temperature value	
17	(32 bits) (H)		RWrn+11	(32 bits)	
18	Write data error code	R/W	RWrn+12 to RWrn+15	Use prohibited	-
19	Conversion completed flag	R			
20	Specification of platinum temperature measuring resistor type	R/W			

7 REPLACING THE HIGH-SPEED COUNTER MODULE

7.1 List of Alternative High-speed Counter Module Models

MELSECNET/MINI-S3, A2C models to be discontinued		Alternative model for CC-Link	
Product name	Model name	Model name	Remarks (restrictions)
High-speed counter module	AD61C	AJ65BT-D62	1) Change in external wiring: Wiring change due to differences in terminal blocks, communication cable change to CC-Link dedicated cable, applicable wire size change of signal wire 2) Change in number of modules: Not required 3) Change in program: Change to programs for CC-Link 4) Change in performance specifications: Change in interface specifications of coincidence output 5) Change in functional specifications: Not required 6) Change in dimensions for mounting to the panel: Required
	AD62C		1) Change in external wiring: Wiring change due to differences in terminal blocks, communication cable change to CC-Link dedicated cable, applicable wire size of signal lead change 2) Change in number of modules: Not required 3) Change in program: Change to programs for CC-Link 4) Change in performance specifications: Counting range change, external output specifications change 5) Change in functional specifications: Limit switch output function not provided 6) Change in dimensions for mounting to the panel: Required

7.2 High-speed Counter Module Comparison

(1) Comparison between AD61C and AJ65BT-D62

(a) Performance specifications comparisons

○ : Compatible, △ : Partial change required, × : Not compatible

Item	AD61C	AJ65BT-D62		Compati- bility	Precautions for replacement			
		Counting speed switch settings switch						
		HIGH side	LOW side					
Number of occupied stations (occupied points)	4 stations (4 stations × 8 points)	4 stations (4 stations × points) (RX/Ry 128 points each, RWw/RWw 16 points each)		×	The number of occupied points increases. The assignment of the entire system needs to be reconsidered.			
Number of channels	2 channels			○				
Performance specifications of one channel	Count input signal	Phase	1-phase input, 2-phase input		○			
		Signal level (φ A, φ B)	5VDC 12VDC } 2 to 5mA 24VDC }		○			
	Counter	Counting speed (max.)	1-phase input	50KPPS	200KPPS	10KPPS	○	
			2-phase input	50KPPS	200KPPS	7KPPS	○	
		Counting range	0 to 16,777,215 (decimal notation): Binary format 24bits			○		
	System	Addition/subtraction preset counter + ring counter function		UP/DOWN preset counter + ring counter function		○		
	Min. count pulse width (1-, 2-phase input)						○	
		Set input rise and fall times to 5 µs or less. Duty ratio 50%		Set input rise and fall times to 2 µs or less. Duty ratio 50%		○		
	Maximum/minimum comparison	Comparison range	Binary format 24bits			○		
		Comparison result	Setting value < Count value Set value = Count value Setting value > Count value	Setting value < Count value Set value = Count value Setting value > Count value		○		
External input	Preset	12/24VDC 3/6mA 5VDC 5mA	5/12/24VDC 2 to 5mA		△	At AJ65BT-D62, external input/output specifications are different, so confirm the external device specifications.		
	Count disable	12/24VDC 3/6mA 5VDC 5mA	-					
	Function start	-	5/12/24VDC 2 to 5mA					
External output	Coincidence output	Transistor (open collector) output 12/24VDC 0.3A	12/24VDC 2A per common		△			
24VDC internal current consumption	0.15A	0.07A		○				
Weight	1.0kg	0.41kg		△				
External dimensions	170(H) × 100(W) × 80(D) mm	65(H) × 151.9(W) × 63(D) mm		×	The overall size differs. Pay attention to the mounting dimensions.			

(b) Functional comparisons

○ : Compatible, △ : Partial change required, × : Not compatible

Item	AD61C	AJ65BT-D62	Compatibility	Precautions for replacement
Count function at 1-phase/2-phase pulse input	<ul style="list-style-type: none"> Captures 1-phase or 2-phase pulses from a pulse generator, and counts each of these pulses at its rise and fall. 1-phase input . . . Two counts are performed on a single pulse. 2-phase input . . . Four counts are performed on a single pulse at each of the A and B phases. Specifies the addition and subtraction counts in buffer memory during 1-phase input. During 2-phase input, it is automatically judged to perform addition when the A phase pulse comes before the B phase pulse, and perform subtraction when the B phase pulse comes before the A phase pulse. 	<ul style="list-style-type: none"> Captures 1-phase or 2-phase pulses from a pulse generator, and counts each of these pulses at its rise and fall. 1-phase input . . . Two counts are performed on a single pulse. 2-phase input . . . Four counts are performed on a single pulse at each of the A and B phases. Specifies the addition and subtraction counts to RY during 1-phase input. During 2-phase input, it is automatically judged to perform addition when the A phase pulse comes before the B phase pulse, and perform subtraction when the B phase pulse comes before the A phase pulse. 	○	
Comparison signal output function for counter value	<ul style="list-style-type: none"> Compares the counter value with the set value, and outputs result signals of small, large (>, <), or coincidence (=) to the programmable controller CPU. Performs external outputs of the coincidence signal to the external (EQU) terminal when the set value coincides with the count value. Note, however, that to do this the coincidence signal output enable flag must be turned ON beforehand by the sequence program. 	Sets the output status of any channel in advance, and compares it with the current value to output ON/OFF signals.	○	
Preset function	<ul style="list-style-type: none"> Changes the current counter value to the specified value. Execution of a preset is performed by the sequence program or input of an external preset. 		○	
Ring counter function	<ul style="list-style-type: none"> Outputs the coincidence signal when the set value matches the counter value, and set the current value as the preset value. Note, however, that to do this the ring counter switch must be turned ON. 	Counts repeatedly between the ring counter value and the preset value by the ring counter command.	○	
Count start/stop function by external input	<ul style="list-style-type: none"> Starts or stops counting by the external disable (DIS) terminal turning ON/OFF. 	–	△	This is performed on the function start terminal.
Hardware reset function	<ul style="list-style-type: none"> Initializes (clears data and sets default value) AD61C I/O signals and buffer memory by the reset switch on the front of the AD61C. 	–	×	This function is not available.
Error detection function	<ul style="list-style-type: none"> Stores the first error to buffer memory if any errors are found in communication (FROM/TO instructions) from the programmable controller CPU to buffer memory on AD61C. 	–	×	This function is not available.

(c) Programmable controller CPU I/O signal comparisons

The sequence program must be changed as the I/O signals differ.

For details on I/O signals and sequence programs, refer to the User's Manual.

AD61C					AJ65BT-D62						
Device No.		Description	Device No.		Description	Device No.		Description	Device No.		Description
CH1	CH2		CH1	CH2		CH1	CH2		CH1	CH2	
X00 to X03		Use prohibited	Y00 to Y03		Use prohibited	RXn0	RXn4	Counter value large (Point No. 1)	RYn0 to RYnF		Use prohibited
X04 *1		Communication error detection	Y04 *1		Communication error detection reset	RXn1	RXn5	Counter value coincidence (Point No. 1)	RY (n+1)0	RY (n+1)7	Point No.1 coincidence signal reset command
X05		Detection of reset status	Y05		Reset status detection reset	RXn2	RXn6	Counter value small (Point No.1)	RY (n+1)1	RY (n+1)8	Preset command
X06		Use prohibited	Y06		Use prohibited	RXn3	RXn7	External preset command detection	RY (n+1)2	RY (n+1)9	Coincidence signal enable
X07 *2		Communication completion wait flag	Y07 *2		Communication completion wait flag reset	RXn8	RXnB	Counter value large (Point No. 2)	RY (n+1)3	RY (n+1)A	Down count command
X08 to X17		Use prohibited	Y08 to Y17		Use prohibited	RXn9	RXnC	Counter value coincidence (Point No. 2)	RY (n+1)4	RY (n+1)B	Count enable command
X18	X1C	CH1/CH2 counter value small/large	Y18	Y1C	CH1/CH2 coincidence signal reset command	RXnA	RXnD	Counter value small (Point No. 2)	RY (n+1)5	RY (n+1)C	Use prohibited
X19	X1D	CH1/CH2 counter value coincidence	Y19	Y1D	CH1/CH2 preset command	RXnE	RXnF	Use prohibited	RY (n+1)6	RY (n+1)D	Counter function selection start command
X1A	X1E	CH1/CH2 external preset request detection	Y1A	Y1E	CH1/CH2 count enable command	RX (n+1)0	RX (n+1)2	Preset completion	RY(n+1)E to RY(n+1)F		Use prohibited
X1B	X1F	CH1/CH2 preset completion	Y1B	Y1F	CH1/CH2 external preset request detection	RX (n+1)1	RX (n+1)3	Counter function detection	RY (n+2)0	RY (n+2)2	External preset detection reset command
						RX(n+1)4 to RX(n+7)7		Use prohibited	RY (n+2)1	RY (n+2)3	Point No.2 coincidence signal reset command
									RY(n+2)4 to RY(n+7)7		Use prohibited
						RX(n+7)8		Initial data processing request flag	RY(n+7)8		Initial data processing complete flag
						RX(n+7)9 to RX(n+7)A		Use prohibited	RY(n+7)9 to RY(n+7)F		Use prohibited
						RX(n+7)B		Remote READY			
						RX(n+7)C to RX(n+7)F		Use prohibited			

*1, *2: These input signals are used on the A2CCPU side.

(d) Buffer memory addresses comparisons

The sequence program must be changed as the buffer memory assignments differ.

For details on buffer memory and sequence programs, refer to the User's Manual.

AD61C			AJ65BT-D62				
Address	Name	Read/write	Address		Name	Read/write	
			CH1	CH2			
0	CH1 mode register	R/W	RWwm	RWwm+8	Preset value setting area (L) (H)	W	
1	CH1 subtraction count specification		RWwm+1	RWwm+9			
2	CH1 coincidence signal output enable flag	W	RWwm+2	RWwm+A	Pulse input mode/ Function selection register/ External output hold/ clear setting area		
3	CH1 set value	R/W	RWwm+3	RWwm+B	Coincidence output point (L)		
4			RWwm+4	RWwm+C	No.1 setting area (H)		
5	CH1 preset value	W	RWwm+5	RWwm+D	Sampling/periodic setting area		
6			RWwm+6	RWwm+E	Coincidence output point (L)		
7	CH2 mode register	R/W	RWwm+7	RWwm+F	No.2 setting area (H)		
8	CH2 down count specification	W	RWrn	RWrn+8	(L)		R
9	CH2 coincidence signal output enable flag		RWrn+1	RWrn+9	Current value storage area (H)		
10	CH2 set value		R/W	RWrn+2	RWrn+A	Latch count value/ Sampling count value	
11		RWrn+3		RWrn+B	Periodic pulse count previous value storage area (H)		
12	CH2 preset value	W	RWrn+4	RWrn+C	Periodic pulse count (L)		
13			RWrn+5	RWrn+D	present value storage area (H)		
14	CH1 current value	R	RWrn+6		Sampling/periodic counter flag storage area (common for CH1, CH2)		
15	CH2 current value		RWrn+7		Use prohibited		
16			RWrn+E				
17			RWrn+F				
18	Error code					-	

(2) Comparisons between AD62C and AJ65BT-D62

(a) Performance specifications comparisons

○ : Compatible, △ : Partial change required, × : Not compatible

Item		AD62C		AJ65BT-D62		Compati- bility	Precautions for replacement	
Counting speed switch settings		50k pulse/s (on silk-screen diagram: 50kPPS)	10k pulse/s (on silk-screen diagram: 10kPPS)	Counting speed switch settings switch HIGH side LOW side		○		
Number of occupied stations (number of occupied points)		4 stations (4 stations × 8 points)		4 stations (4 stations × 32 points) (RX/Ry 128 points each, Rww/RWr 16 points each)		×	The number of occupied points increases. The assignment of the entire system needs to be reconsidered.	
Number of channels		1 channel		2 channels		○		
Count input signal	Phase	1-phase input, 2-phase input				○		
	Signal level (φ A, φ B)	5VDC } 12VDC } 2 to 5mA 24VDC }				○		
Counter	Counting speed* (max.)	1-phase input	50k pulse/s	10k pulse/s	200kPPS	10kPPS	○	
		2-phase input	50k pulse/s	7k pulse/s	200kPPS	7kPPS	○	
	Counting range	32bits signed binary -2147483648 to 2147483647		0 to 16,777,215 (decimal notation) Binary format 24bits		×	The counting range varies.	
	Type	UP/DOWN Preset counter + Ring counter function				○		
Minimum count pulse width							○	
	<p>Limit the input rise and fall times to 5 μs or less. Duty ratio 50%</p>		<p>Limit the input rise and fall times to 2 μs or less. Duty ratio 50%</p>		<p>Limit the input rise and fall times to 2 μs or less. Duty ratio 50%</p>		○	
Limit switch output	Comparison range	32bits signed binary		-		×	Limit switch output is not available.	
	Comparison result	N/O contact action: Dog ON address ≤ Count value ≤ Dog OFF address N/C contact action: Dog OFF address ≤ Count value ≤ Dog ON address		-		×		
External input	Preset	12/24VDC 3/6mA, 5VDC 5mA		5/12/24VDC 2 to 5mA		△	As the external input/output specifications are different on AJ65BT-D62, confirm the specifications of external device.	
	Function start							
External output	Comparison output	Transistor (open collector) output 12/24VDC, 0.1A per point, 0.8A per common		12/24VDC 2A per common		△		
24VDC internal current consumption		0.15A		0.07A		○		
Weight		0.86kg		0.41kg		△		
External dimensions		170(H) × 100(W) × 80(D) mm		65(H) × 151.9(W) × 63(D) mm		×	The overall size differs. Pay attention to the mounting dimensions.	

(b) Functional comparisons

○: Compatible, △: Partial change required, ×: Not compatible

Item	AD62C	AJ65BT-D62	Compatibility	Precautions for replacement
Preset function	Any value can be overwritten to the counter's present values. Preset is performed by the sequence program or an external preset input.		○	
Ring counter function	Counts repeatedly between the ring counter value and the preset value by the ring counter command.		○	
Limit switch output function	Sets the output status of any channel in advance, and compares it with the current value of the limit switch output command counter to output ON/OFF signals.	–	×	The limit switch output function is not available.
Counter function selection*	Latch counter function	Stores the current value of the counter to buffer memory when the counter function selection start command signal is input.	○	
	Sampling counter function	Stores the number of input pulses to the buffer memory for the preset sampling period after a signal carrying the counter function selection start command is input.	○	
	Periodic pulse counter function	Stores the number of input pulses to the buffer memory at each preset cycle time for the duration that a signal carrying the counter function selection start command is being input.	○	
	Count disable function	Stops counting of the pulse while the count enable command is ON.		○

*: With counter function selection, only one of the four functions can be selected and used.

(c) Programmable controller CPU I/O signal comparisons

The sequence program must be changed as the I/O signals differ.

For details on I/O signals and sequence programs, refer to the User's Manual.

AD62C				AJ65BT-D62					
Device No.	Description	Device No.	Description	Device No.		Description	Device No.		Description
				CH1	CH2		CH1	CH2	
X00 to X03	Use prohibited	Y00 to Y03	Use prohibited	RXn0	RXn4	Counter value large (Point No. 1)	RYn0 to RYnF		–
X04 *1	Communication error detection	Y04 *1	Communication error detection reset	RXn1	RXn5	Counter value coincidence (Point No. 1)	RY (n+1)0	RY (n+1)7	Point No.1 coincidence signal reset command
X05	Detection of reset status	Y05	Reset status detection reset	RXn2	RXn6	Counter value small (Point No.1)	RY (n+1)1	RY (n+1)8	Preset command
X06	Use prohibited	Y06	Use prohibited	RXn3	RXn7	External preset command detection	RY (n+1)2	RY (n+1)9	Coincidence signal enable
X07 *2	Communication completion wait flag	Y07 *2	Communication completion flag reset	RXn8	RXnB	Counter value large (Point No. 2)	RY (n+1)3	RY (n+1)A	Down count command
X08 to X1A	Use prohibited	Y08 to Y17	Use prohibited	RXn9	RXnC	Counter value coincidence (Point No. 2)	RY (n+1)4	RY (n+1)B	Count enable
		Y18	Count enable command	RXnA	RXnD	Counter value small (Point No. 2)	RY (n+1)5	RY (n+1)C	–
		Y19	Down count command	RXnE	RXnF	–	RY (n+1)6	RY (n+1)D	Counter function selection start command
		Y1A	Preset command				RY(n+1)E to RY(n+1)F		–
X1B	Fuse blown detection	Y1B	Ring counter command	RX (n+1)0	RX (n+1)2	Preset completion	RY (n+2)0	RY (n+2)2	External preset detection reset command
X1C	Sampling/periodic counter ON/OFF flag	Y1C	Counter function selection start command	RX (n+1)1	RX (n+1)3	Counter function detection	RY (n+2)1	RY (n+2)3	Point No.2 coincidence signal reset command
				RX(n+1)4 to RX(n+7)7		–	RY(n+2)4 to RY(n+7)7		–
X1D	Limit switch output READY flag	Y1D	Limit switch output command	RX(n+7)8		Initial data processing request flag	RY(n+7)8		Initial data processing complete flag
X1E	External preset request detection	Y1E	External preset request detection reset command	RX(n+7)9 to RX(n+7)A		–	RY(n+7)9 to RY(n+7)F		–
X1F	Multiple-dog setting error detection	Y1F	Multiple-dog setting error detection reset	RX(n+7)B		Remote READY			
				RX(n+7)C to RX(n+7)F		–			

*1, *2: These input signals are used on the A2CCPU side.

(d) Buffer memory addresses comparisons

The sequence program must be changed as the buffer memory assignments differ.
For details on buffer memory and sequence programs, refer to the User's Manual.

AD62C			AJ65BT-D62			
Address	Name	Read/write	Address		Name	Read/write
			CH1	CH2		
0	Present value (L) (H)	R	RWwm	RWwm+8	Preset value setting area (L) (H)	W
1			RWwm+1	RWwm+9		
2	Counter function selection count value (L) (H)		RWwm+2	RWwm+A	Pulse input mode/Function selection register/External output hold and clear setting area (L)	
3			RWwm+3	RWwm+B		
4	Limit switch output status flag (CH1 to CH8)		RWwm+4	RWwm+C	Coincidence output point No.1 setting area (H)	
5			RWwm+5	RWwm+D		
6	Counter function selection setting		RWwm+6	RWwm+E	Coincidence output point No.2 setting area (L) (H)	
7	Preset value setting (L) (H)		RWwm+7	RWwm+F		
8			Ring counter value setting (L) (H)	RWrn	RWrn+8	
9	RWrn+1			RWrn+9		
10	Sampling/periodic setting	RWrn+2		RWrn+A	Latch count value/Sampling count value/Periodic pulse count previous value storage area (H)	
11		RWrn+3		RWrn+B		
12	Communication error code	RWrn+4	RWrn+C	Periodic pulse count (L) present value storage area (H)		
13	Multiple-dog setting error code	RWrn+5	RWrn+D			
14 to 30	CH1 limit switch output data setting	R/W	RWrn+6		Sampling/periodic counter flag storage area (common for CH1, CH2)	
31 to 47	CH2 limit switch output data setting		RWrn+7		Use prohibited	
48 to 64	CH3 limit switch output data setting		RWrn+E			
65 to 81	CH4 limit switch output data setting		RWrn+F			
82 to 98	CH5 limit switch output data setting					
99 to 115	CH6 limit switch output data setting					
116 to 132	CH7 limit switch output data setting					
133 to 149	CH8 limit switch output data setting					

8

REPLACING THE COMMUNICATION MODULES

8.1 List of Alternative Communication Module Models

MELSECNET/MINI-S3, A2C models to be discontinued		Alternative models for CC-Link	
Product name	Model name	Model name	Remarks (restrictions)
RS-232 interface module	AJ35PTF-R2	AJ65BT-R2N	1) Change in RS-232C cable (25-pin → 9-pin) 2) Change in general-purpose I/O specifications (power voltage range, number of points) 3) Change is required as the program is not compatible.
Portable type operating box	AJ35T-OPB-P1-S3	None	Transition to GOT is recommended.
	AJ35PT-OPB-M1-S3	None	
Connection cable for operating box	AC30MINI	None	
Relay type joint box	AJ35T-JB-S3	None	
Transmission converter	AJ35PTC-CNV	AJ65SBT-RPS	

8.2 Serial Communication Module Comparisons

(1) Comparisons between AJ35PTF-R2 and AJ65BT-R2N

(a) Performance specifications comparisons

○ : Compatible, △ : Partial change required, × : Not compatible

Item	Specifications		Compatibility	Precautions for replacement
	AJ35PTF-R2	AJ65BT-R2N		
Interface specifications	RS-232C-compliant (25-pin) × 1 channel	RS-232C-compliant (9-pin) × 1 channel	△	For differences in the RS-232C interface specifications, refer to 1).
Communication method	Full-duplex communication system (nonprocedural)	Full-duplex communication system (nonprocedural)	○	
Synchronization method	Asynchronous method	Asynchronous method	○	
Transmission speed	300, 600, 1200, 2400, 4800, 9600, 19200 bps	300, 600, 1200, 2400, 4800, 9600, 19200, 38400, 57600, 115200 bps*1	○	
Data type	Start bit	1	○	
	Data bit	7 or 8	○	
	Parity bit	1 or 0 (none)	○	
	Stop bit	1 or 2	○	
Error detection	Parity check (Odd or Even)	Parity check (Odd or Even)	○	
Communication control	DTR/DSR (ER/DR) control	DTR/DSR (ER/DR) control	○	
	XON/XOFF (DC1/DC3) control	DC1/DC3 control	○	
Transmission distance	15m	Up to 15m	○	
OS receive buffer	2048 bytes	5120 bytes	○	
General-purpose I/O	Input	12/24VDC (sink type) × 4 points	△	For differences in the general-purpose I/O specifications, refer to 2) and 3).
	Output	Transistor output (sink type) 12/24VDC × 4 points		
Number of occupied stations	4 stations (4 stations × 8 points)	1 station (1 station × 32 points)	×	
Power supply voltage	15.6 to 31.2VDC	24VDC	○	
Current consumption	130mA (24V)	110mA (24V)	○	
Weight	0.71kg	0.40kg	△	
Max. size of send/receive buffer	1000 bytes each for send/receive (1000 bytes for total of send and receive)	(1536 words for total of send and receive)	○	
External dimensions	250(H) × 132(W) × 41(D)mm	80(H) × 170(W) × 47(D)mm	×	The overall size differs. Pay attention to the mounting dimensions.

1) RS-232 interface specifications comparisons

The RS-232C cable must be changed as the RS-232C interface specifications are different between the AJ35PTF-R2 and AJ65BT-R2N.

[AJ35PTF-R2]

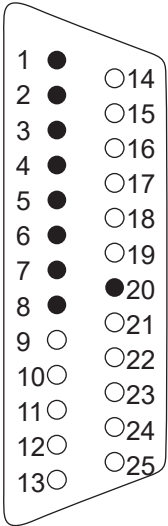

Pin No.	Name	Signal code	Signal direction AJ35PTF-R2 ↔ External device
1	Frame ground	FG	←→
2	Send data	SD(TXD)	→
3	Receive data	RD(RXD)	←
4	Request to send	RS(RTS)	→
5	Clear to send	CS(CTS)	←
6	Data set ready	DSR(DR)	←
7	Signal ground	SG	←
8	Carrier detect	CD	←
20	Data terminal ready	DTR(ER)	→

25-pin D-sub (female) screw type
17LE-13250-22-D2AC (DDK Ltd.) or equivalent

[AJ65BT-R2N]

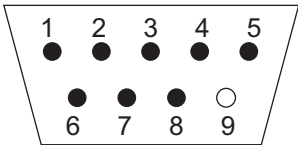

Use the following model as a connector of the AJ65BT-R2N side connection cable.
· DDK Ltd.
Plug, shell: 17JE-23090-02 (D8A) (-CG)

Pin No.	Name	Signal code	Signal direction AJ65BT-R2N ↔ External device
1	Data carrier detect	CD(DCD)	←
2	Received data	RD(RXD)	←
3	Transmitted data	SD(TXD)	→
4	Data terminal ready	ER(DTR)	→
5	Signal ground	SG	←
6	Data set ready	DR(DSR)	←
7	Request to send	RS(RTS)	→
8	Clear to send	CS(CTS)	←
9	—	—	—

2) General-purpose input specifications comparisons

[AJ35PTF-R2]

Item	DC input (sink type)	
	AJ35PTF-R2	Terminal layout
Number of input points	4 points	
Insulation method	Photocoupler	
Rated input voltage	12VDC	24VDC
Rated input current	3mA	7mA
Operating voltage range	10.2 to 31.2VDC (ripple ratio within 5%)	
Maximum number of simultaneous input points	100% (4 points) simultaneously ON	
ON voltage/ON current	9.5V or more / 2.6mA or more	
OFF voltage/OFF current	6V or less / 1.0mA or less	
Input resistance	Approx. 3.4kΩ	
Response time	OFF→ON	10ms or less
	ON→OFF	10ms or less
Wiring method for common	4 points per common (common terminal: TB5)	
Operation indication	ON indication (LED)	
External connection	8-point terminal block connector (M3 × 6 screws)	
Applicable wire size	0.75 to 2mm ² (applicable tightening torque 7kg · cm)	
Applicable solderless terminal	1.25-3, 1.25-YS3A, 2-S3, 2-YS3A, V1.25-3, V1.25-YS3A, V2-S3, V2-YS3A, 1.25-3, 1.25-YS3A, 2-S3, 2-YS3A, V1.25-3, V1.25-YS3A, V2-S3, V2-YS3A	

[AJ65BT-R2N]

Item	DC input (positive/negative common shared type)	
	AJ65BT-R2N	External connection
Number of input points	2 points	
Isolation method	Photocoupler	
Rated input voltage	24VDC	
Rated input current	Approx. 7mA	
Operating voltage range	19.2 to 28.8VDC (ripple ratio within 5%)	
Maximum number of simultaneous input points	100%	
ON voltage/ON current	14V or more / 3.5mA or more	
OFF voltage/OFF current	6V or less / 1.7mA or less	
Input resistance	Approx. 3.3kΩ	
Response time	OFF→ON	10ms or less
	ON→OFF	10ms or less
Wiring method for common	2 points/common (COM1) Positive/negative common shared type	
External connection system	7-point terminal block (M3.5 screw)	
Applicable wire size	0.75 to 2mm ²	
Applicable solderless terminal	RAV1.25-3.5, RAV2-3.5 (JIS C 2805-compliant)	

Terminal number	Signal	Terminal number	Signal
TB1	XC	TB3	XD
TB2	COM1	-	-

3) General-purpose output specifications comparisons

[AJ35PTF-R2]

Item		Transistor output (sink type)	
		AJ35PTF-R2	Terminal layout
Number of output points		4 points	
Insulation method		Photocoupler	
Rated load voltage		12/24VDC	
Operating load voltage range		10.2 to 31.2VDC	
Maximum load current		0.1A/point, 0.4A/common	
Maximum inrush current		0.4A 100ms or less	
Leakage current at OFF		0.1mA or less	
Maximum voltage drop at ON		2.5V (0.1A), 1.75V (5mA), 1.7V (1mA)	
Response time	OFF→ON	2ms or less	
	ON→OFF	2ms or less (resistance load)	
Surge suppressor		Clamp diode	
Wiring method for common		4 points per common (common terminal: TB14)	
Operation indication		ON indication (LED)	
External connection		8-point terminal block connector (M3 × 6 screws)	
Applicable wire size		0.75 to 2mm ² (applicable tightening torque 7kg · cm)	
Applicable solderless terminal		1.25-3 1.25-YS3A 2-S3 2-YS3A V1.25-3 V1.25-YS3A V2-S3 V2-YS3A	
External power supply for output	Voltage	10.2 to 31.2VDC	
	Current	15mA (TYP.24VDC)	

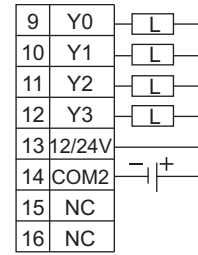

[AJ65BT-R2N]

Item		Transistor output (Sink type)			
		AJ65BT-R2N		External connection	
No. of output points		2 points			
Insulation method		Photocoupler			
Rated load voltage		12 to 24VDC (+20/-15%)			
Operating load voltage range		10.2 to 28.8VDC (Ripple ratio is 5% or less)			
Max. load current		0.1A/point 0.2A/common			
Max. inrush current		0.7A, 10ms or less			
Leakage current at OFF		0.1mA or lower			
Max. voltage drop at ON		0.1VDC(TYP.)0.1A, 0.2VDC(MAX.)0.1A			
Output method		sink type			
Response time	OFF → ON	1ms or less			
	ON → OFF	1ms or less (Resistance load)			
External power supply of output section	Voltage	10.2 to 28.8VDC (Ripple ratio is 5% or less)			
	Current	10mA (at 24VDC) (MAX all points ON)			
Surge suppressor		Zener diode			
Wiring method for common		2 points/common (COM2)			
External connection method		7-point terminal block (M3.5 screw)			
Applicable wire size		0.75 to 2mm ²			
Applicable solderless terminal		RAV1.25-3.5, RAV2-3.5 (JIS C 2805-Compliant)			
Protective function		Provided			
		<ul style="list-style-type: none"> Overheat protective function operates in unit of 1 point. Overload protective function operates in unit of 1 point. 			
		(Detection disabled)			
		Terminal number	Signal	Terminal number	Signal
		TB4	+24V	TB6	COM2
		TB5	YC	TB7	YD

(b) Functional comparisons

The following table shows RS-232 interface module comparisons between MELSECNET/MINI-S3 and CC-Link.

○: Compatible, △: Partial change required, ×: Not compatible

Item	Functions		Compati- bility	Precautions for replacement
	AJ35PTF-R2	AJ65BT-R2N		
Barcode reading	Actually required data only can be read to the programmable controller CPU regardless of the data communication protocol of the compatible barcode reader.	None	×	Utilize nonprocedural communication.
ID card reading/writing	Data can be read from and written to a programmable controller CPU by setting the MINI standard protocol for communication with the compatible ID card controller.	None	×	Utilize nonprocedural communication.
Nonprocedural communication	Nonprocedural communication with external devices is available.	Nonprocedural communication with external devices is available. There are two methods for nonprocedural communications: the automatic buffer memory update function and the RIWT (RISEND) and RIRD (RIRCV) instructions.	△	Create new programs as there is no compatibility in programs.

(c) Switch comparisons

The switch settings are not compatible as MELSECNET/MINI-S3 and CC-Link are different networks.

For details, refer to the User's Manual for each module.

(d) Parameter comparisons

The parameter settings are not compatible as MELSECNET/MINI-S3 and CC-Link are different networks.

For details, refer to the User's Manual for each module.

(e) Program Comparisons

The I/O signals and buffer memory are not compatible as MELSECNET/MINI-S3 and CC-Link are different networks.

For details, refer to the User's Manual for each module.

APPENDICES

Appendix 1 External Dimensions

For external dimensions of modules described in this handbook, refer to the user's manual for each module.

Appendix 2 Performance Specifications Comparison between MELSECNET/MINI-S3 compact type I/O module and Renewal Tool for A0J2

Appendix 2.1 Precautions for the performance specifications comparison

This section describes the precautions when comparing the performance specifications between a MELSECNET/MINI-S3 compact type I/O module and a renewal tool for A0J2.

(1) External supply power (24VDC)

The renewal tool for A0J2 requires an external supply power (24VDC). Reuse the I/O module terminal block of the existing MELSECNET/MINI-S3 compact type I/O module and connect the external supply power (24VDC) to the renewal tool.

For precautions or details when connecting the external supply power, refer to the following.

- Renewal tool for A0J2 series Transition from MELSEC-A0J2(H) series to renewal system using renewal tool
(Issued by Mitsubishi Electric System & Service Co., Ltd.)

When the I/O module on the CC-Link side is connected to the renewal tool for A0J2 with the dedicated cable, the external supply power (24VDC) supplies the driving power for external devices of the I/O module on the CC-Link side.

(2) Selection of I/O modules on the CC-Link

The renewal tool for A0J2 has functions that convert AC input into DC input, and convert transistor output into relay output or triac output.

Therefore, select a DC input module and a transistor output module for the I/O modules on the CC-Link side, regardless of the type of the renewal tool for A0J2.

When the I/O module on the CC-Link side is connected to the renewal tool for A0J2 with the dedicated cable, select the AJ65SBTCF1-32D or AJ65SBTCF1-32T that can be wired using a connector for the I/O module on the CC-Link side.

The mounting plate SC-A0JQPT2 can be used to mount the AJ65SBTCF1-32D or AJ65SBTCF1-32T. In this case, drilling of mounting holes is not required.

(3) Derating chart for the maximum number of simultaneous input points

(a) Input module on the programmable controller side

Check the number of simultaneous input points by referring to the derating chart of the selected CC-Link input module.

When the AJ65SBTCF1-32D is used, the maximum number of simultaneous input points is 100% (all points turn on simultaneously).

(b) Renewal tool for A0J2

The maximum number of simultaneous input points of the renewal tool for A0J2 (input module) has the limitation depending on the external supply power (24VDC) that supplies the power to the module. Use the module within the range shown in the derating chart in the performance specifications comparison.

(4) Temperature derating for the triac output module

The output load current of the renewal tool for A0J2 (triac output module) has the limitation depending on the ambient temperature in the environment where the module is used.

Use the module within the range shown in the temperature derating chart in the performance specifications comparison.

Appendix 2.2 Performance specifications comparison

This section shows the performance specifications comparison between MELSECNET/MINI-S3 compact type remote I/O module and interface module of renewal tool for A0J2 described in Section 1.2.

(1) Specifications comparison between AJ35PTF-32A and interface module (SC-A0JQIF32A)

○: Compatible, △: Partially changed, ×: Incompatible

Specifications		AJ35PTF-32A input specifications	SC-A0JQIF32A input specifications	Compatibility	Precautions for replacement
Number of input points		32 points	32 points	○	
Insulation method		Photocoupler	Photocoupler	○	
Rated input voltage		100 to 120VAC, 50/60Hz	100 to 120VAC, 50/60Hz	○	
Rated input current		10mA (100VAC 60Hz)	10mA (100VAC 60Hz)	○	
Operating voltage range		85 to 132VAC (50/60Hz ± 5%)	85 to 132VAC (50/60Hz ± 5%)	○	
Maximum number of simultaneous input points		100% (16 points/common) simultaneously ON	Refer to the derating chart. *1	△	Use the module within the range in the derating chart. When the voltage of the external power supply (module power supply) is high, the AC input simultaneous ON ratio is low.
ON voltage/ON current		80VAC or more/6mA or more	80VAC or more/6mA or more	○	
OFF voltage/OFF current		40VAC or less/4mA or less	26VAC or less/1.7mA or less	△	The OFF voltage/OFF current have been reduced. *2
Inrush current		Max. 300mA, within 0.3ms (132VAC)	Max. 300mA, within 0.3ms (132VAC)	○	
Input resistance		Approx. 10kΩ (60Hz), Approx. 12k (50Hz)	Approx. 10kΩ (60Hz), Approx. 12k (50Hz)	○	
Response time	OFF → ON	15ms or less (6ms TYP.)	14ms or less (11ms TYP.)	△	In combination with CC-Link input module: 15.5ms or less (12ms TYP.) *3
	ON → OFF	35ms or less (16ms TYP.)	19ms or less (13ms TYP.)	△	In combination with CC-Link input module: 21.5ms or less (14ms TYP.) *3
Common terminal arrangement		16 points/common (Common terminal: TB17, TB34)	16 points/common (Common terminal: TB17, TB34)	○	
Operation indication		Available (Turning ON the input turns LED ON)	None	△	Operation indication can be checked with the CC-Link input module.
External power supply (Module power supply)	Voltage	15.6 to 31.2VDC	24VDC ± 10% Ripple voltage 4Vp-p or less	△	To deliver a power for programmable controller operation, connecting a module power supply to TB35 and TB36 of the interface module is required.
	Current	110mA	210mA	△	The current consumption increases. The current capacity needs to be reconsidered.
External connection method		36-point terminal block connector (M3 × 6 screws)	36-point terminal block connector (M3 × 6 screws)	○	
Applicable wire size		0.75 to 2mm ² (Applicable tightening torque 69N·cm)	0.75 to 2mm ² (Applicable tightening torque 69N·cm)	○	

○: Compatible, △: Partially changed, ×: Incompatible

Specifications	AJ35PTF-32A input specifications	SC-A0JQIF32A input specifications	Compatibility	Precautions for replacement
Applicable solderless terminal	R1.25-3, R2-3 RAV1.25-3, RAV2-3	1.25-3, 1.25-YS3A, 2-S3, 2-YS3A, V1.25-3, V1.25-YS3A, V2-S3, V2-YS3A	○	
Number of occupied stations	4 stations (4 stations × 8 points)	-	-	When the AJ65SBTCF1-32D is used, the number of occupied stations is 1 station (When using CC-Link, it is 1 station × 32 points).
Weight	0.75kg	0.40kg	△	Also consider the weight of the fixed stand of programmable controller.*4
External dimensions	250(H) × 132(W) × 41(D) mm	182(H) × 132(W) × 41(D) mm*5	×	Check the dimensions since they depend on the installation type (building-up/horizontal/separate type).

*1 The following figure shows the derating.

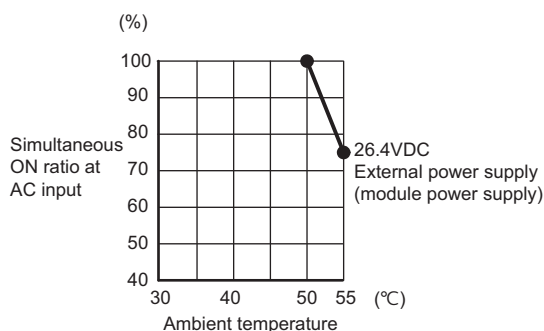

*2 Check that the specifications of leakage current of the used sensor and switches are equal to or less than the OFF current value.

If leakage current is equal to or more than the OFF current specifications, take measures against it with referring to "Input Module Troubleshooting" in the following handbook.

(Handbook for replacement)

Renewal tool for A0J2 series transition from MELSEC-A0J2(H) series to renewal system using renewal tool (Refer to Appendix 2.6.)

*3 A value when the AJ65SBTCF1-32D is used.

*4 The weight of the fixed stand of programmable controller depends on replacement type of renewal tool for A0J2.

*5 The external dimensions of the SC-A0JQIF32A do not include those of its projection.

(2) Specifications comparison between AJ35PTF-32D and interface module (SC-A0JQIF32D)

○: Compatible, △: Partially changed, ×: Incompatible

Specifications		AJ35PTF-32D input specifications	SC-A0JQIF32D input specifications	Compatibility	Precautions for replacement
Number of input points		32 points	32 points	○	
Insulation method		Photocoupler	Photocoupler	○	
Rated input voltage		12/24VDC	12/24VDC	○	
Rated input current		Approx. 3mA/Approx. 7mA	Approx. 3mA/Approx. 7mA	○	
Operating voltage range		10.2 to 31.2VDC (ripple ratio within 5%)	10.2 to 26.4VDC (ripple ratio within 5%)	△	The operating voltage range differs.
Maximum number of simultaneous input points		100% (16 points/common) simultaneously ON	Refer to the derating chart.*1	△	Use the module within the range in the derating chart.
ON voltage/ON current		9.5VDC or more/2.6mA or more	9.5VDC or more/2.6mA or more	○	
OFF voltage/OFF current		6VDC or less/1.0mA or less	6VDC or less/1.0mA or less	○	
Input resistance		Approx. 3.4kΩ	Approx. 3.3kΩ	○	
Input form		Sink input (Input current flows off.)	Sink input (Input current flows off.)	○	
Response time	OFF → ON	10ms or less (6ms TYP.)	5ms or less (1ms TYP.)	△	In combination with CC-Link input module: 6.5ms or less (2.5ms TYP.)*2
	ON → OFF	10ms or less (7.5ms TYP.)	5ms or less (1ms TYP.)	△	In combination with CC-Link input module: 6.5ms or less (2.5ms TYP.)*2
Common terminal arrangement		16 points/common (Common terminal: TB17, TB34)	16 points/common (Common terminal: TB17, TB34)	○	
Operation indication		Available (Turning ON the input turns LED ON)	None	△	Operation indication can be checked with the CC-Link input module.

○: Compatible, △: Partially changed, ×: Incompatible

Specifications		AJ35PTF-32D	SC-A0JQIF32D	Compatibility	Precautions for replacement
External power supply (Module power supply)	Voltage	15.6 to 31.2VDC	24VDC ± 10% Ripple voltage 4Vp-p or less	△	To deliver a power for CC-Link input module operation, connecting a module power supply to TB35 and TB36 of the interface module is required.
	Current	110mA	200mA	△	The current consumption increases. The current capacity needs to be reconsidered.
External connection method		36-point terminal block connector (M3 × 6 screws)	36-point terminal block connector (M3 × 6 screws)	○	
Applicable wire size		0.75 to 2mm ² (Applicable tightening torque 69N·cm)	0.75 to 2mm ² (Applicable tightening torque 69N·cm)	○	
Applicable solderless terminal		R1.25-3, R2-3 RAV1.25-3, RAV2-3	1.25-3, 1.25-YS3A, 2-S3, 2-YS3A, V1.25-3, V1.25-YS3A, V2-S3, V2-YS3A	○	
Number of occupied stations		4 stations (4 stations × 8 points)	—	—	When using the AJ65SBTCF1-32D, the number of occupied stations is 1 station (When using CC-Link, it is 1 station × 32 points). (When using CC-Link, it is 1 station × 32 points).
Weight		0.70kg	0.36kg	△	Also consider the weight of the fixed stand of programmable controller.* ³
External dimensions		250(H) × 132(W) × 41(D) mm	182(H) × 132(W) × 41(D) mm* ⁴	×	Check the dimensions since they depend on the installation type (building-up/horizontal/separate type).

*1 The following figure shows the derating.

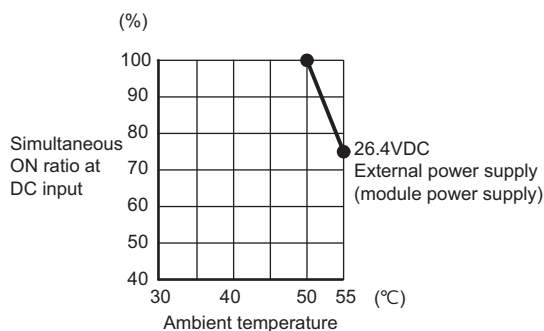

*2 A value when the AJ65SBTCF1-32D is used.

*3 The weight of the fixed stand of programmable controller depends on replacement type of renewal tool for A0J2.

*4 The external dimensions of the SC-A0JQIF32D do not include those of its projection.

(3) Specifications comparison between AJ35PTF-24R and interface module (SC-A0JQIF24R)

○: Compatible, △: Partially changed, ×: Incompatible

Specifications		AJ35PTF-24R output specifications	SC-A0JQIF24R output specifications	Compatibility	Precautions for replacement
Number of output points		24 points	24 points	○	
Insulation method		Photocoupler	Relay isolation	△	Although the insulation methods differ, the performance of the insulation is the same.
Rated switching voltage/current		24VDC 2A (Resistance load)/point 240VAC 2A (COS ϕ =1)/point 5A/common	24VDC 2A (Resistance load)/point 240VAC 2A (COS ϕ =1)/point 5A/common	○	
Minimum switching load		5VDC 1mA	5VDC 1mA	○	
Maximum switching voltage		264VAC 125VDC	264VAC 125VDC	○	
Maximum switching frequency		3600 times/hr	3600 times/hr	○	
Mechanical life		20 million times or more	20 million times or more	○	
Electrical life		Rated switching voltage/current load 200,000 times or more	Rated switching voltage/current load 200,000 times or more	○	
		200VAC 1.5A, 240VAC 1A (COS ϕ =0.7) 200,000 times or more	200VAC 1.5A, 240VAC 1A (COS ϕ =0.7) 200,000 times or more	○	
		200VAC 1A, 240VAC 0.5A (COS ϕ =0.35) 200,000 times or more	200VAC 0.75A, 240VAC 0.5A (COS ϕ =0.35) 200,000 times or more		
		24VDC 1A, 100VDC 0.1A (L/R=7ms) 200,000 times or more	24VDC 1A, 100VDC 0.1A (L/R=7ms) 200,000 times or more		
Response time	OFF→ON	10ms or less	9ms or less	△	In combination with CC-Link output module: 9.5ms or less *1
	ON→OFF	12ms or less	11ms or less	△	In combination with CC-Link output module: 12.5ms or less *1
External supply power (Relay coil driving power)	Voltage	24VDC \pm 10% Ripple voltage 4Vp-p or less	24VDC \pm 10% Ripple voltage 4Vp-p or less	○	
	Current	220mA (24VDC All points are ON.)	230mA (24VDC All points are ON.)	○	Review current capacity since current consumption is increased.
Surge suppressor		None	None	○	
Fuse rating		None	None	○	
Fuse blown indication		-	-	○	
Relay socket		None	None	○	
Common terminal arrangement		8 points/common (Common terminal: TB9, TB19, TB29)	8 points/common (Common terminal: TB9, TB19, TB29)	○	
Operation indication		Available (Turning ON the output turns LED ON)	None	△	Operation indication can be checked with CC-Link output module.

○: Compatible, △: Partially changed, ×: Incompatible

Specifications		AJ35PTF-24R	SC-A0JQIF24R	Compatibility	Precautions for replacement
External supply power (Module power supply)	Voltage	15.6 to 31.2VDC	—	○	No external power supply (module power supply) is required.
	Current	120mA	—	○	
External connection method		36-point terminal block connector (M3 × 6 screws)	36-point terminal block connector (M3 × 6 screws)	○	
Applicable wire size		0.75 to 2mm ² (Applicable tightening torque 69N·cm)	0.75 to 2mm ² (Applicable tightening torque 69N·cm)	○	
Applicable solderless terminal		R1.25-3, R2-3, RAV1.25-3, RAV2-3	1.25-3, 1.25-YS3A, 2-S3, 2-YS3A, V1.25-3, V1.25-YS3A, V2-S3, V2-YS3A	○	
Number of occupied stations (number of occupied points)		4 stations (4 stations × 8 points)	—	—	When using the AJ65SBTCF1-32T, the number of occupied stations is 1 station (When using CC-Link, it is 1 station × 32 points).
Weight		0.80kg	0.47kg	△	Also consider the weight of fixed stand of programmable controller.*2
External dimensions		250(H) × 132(W) × 41(D) mm*3	182(H) × 132(W) × 41(D)mm*4	×	Check the dimensions since they depend on the installation type (building-up/horizontal/separate type).

*1: A value when using the AJ65SBTCF1-32T.

*2: The weight of fixed stand of programmable controller depends on replacement type of renewal tool for A0J2.

*3: External dimensions of the AJ35PTF-24R does not include dimensions of the optical fiber cable connector.

*4: The external dimensions of the SC-A0JQIF24R do not include those of its projection.

(4) Specifications comparison between AJ35PTF-24S and interface module (SC-A0JQIF24S)

○: Compatible, △: Partially changed, ×: Incompatible

Specifications		AJ35PTF-24S output specifications	SC-A0JQIF24S output specifications	Compatibility	Precautions for replacement
Number of input points		24 points	24 points	○	
Insulation method		Photocoupler	Photocoupler	○	
Rated load voltage		100 to 240VAC, 40 to 70Hz	100 to 240VAC, 47 to 63Hz	△	The available frequency range is small.
Maximum load voltage		264VAC	264VAC	○	
Maximum load current		0.6A/point, 2.4A/common	0.6A/point, 2.4A/common	○	
Minimum load voltage/ current		24VAC 100mA, 100V/240VAC 10mA	24VAC 100mA, 100V/240VAC 10mA	○	
Maximum inrush current		20A 10ms or less 8A 100ms or less	20A 10ms or less 8A 100ms or less	○	
Leakage current at OFF		1.5mA (120VAC, 60Hz) 3mA (240VAC, 60Hz)	1.5mA (120VAC, 60Hz) 3mA (240VAC, 60Hz)	○	
Maximum voltage drop at ON		1.5V or less (0.1 to 0.6A) 1.8V or less (0.1A or less) 2.0V or less (10 to 50mA)	1.5V or less (0.1 to 0.6A) 1.8V or less (0.1A or less) 2.0V or less (10 to 50mA)	○	
Temperature derating		None	Refer to the derating chart. *1	△	Use the module within the range in the derating chart.
Response time	OFF → ON	1ms or less	1ms or less	△	In combination with CC-Link output module: 2ms or less *2
	ON → OFF	0.5 cycle + 1ms or less	0.5 cycle + 1ms or less	△	In combination with CC-Link output module: 0.5 cycle + 2ms or less *2
Fuse		High speed type fuse 3.2A (one fuse/common) HP-32	None	×	Install a fuse externally from the module (one fuse/common). (A fuse and fuse holder are included.)
Fuse blown indication		Available (When a fuse is blown, the LED turns on and a signal is output to the CPU.)	-	-	
Surge suppressor	CR absorber	0.022 μ F + 47 Ω	0.015 μ F + 22 Ω	○	
	Varistor	None	Varistor voltage (400 to 540V)	○	
Common terminal arrangement		8 points/common (Common terminal: TB9, TB19, TB29)	8 points/common (Common terminal: TB9, TB19, TB29)	○	
Operation indication		Available (Turning ON the input turns LED ON)	None	△	Operation indication can be checked with the CC-Link output module.

○: Compatible, △: Partially changed, ×: Incompatible

Specifications		AJ35PTF-24S	SC-A0JQIF24S	Compatibility	Precautions for replacement
External power supply (Module power supply)	Voltage	15.6 to 31.2VDC	24VDC ± 10% Ripple voltage 4Vp-p or less	△	To deliver a power for CC-Link output module operation, connecting a module power supply to TB35 and TB36 of the interface module is required.
	Current	200mA	370mA	△	The current consumption increases. The current capacity needs to be reconsidered.
External connection method		36-point terminal block connector (M3 × 6 screws)	36-point terminal block connector (M3 × 6 screws)	○	
Applicable wire size		0.75 to 2mm ² (Applicable tightening torque 69N·cm)	0.75 to 2mm ² (Applicable tightening torque 69N·cm)	○	
Applicable solderless terminal		R1.25-3, R2-3 RAV1.25-3, RAV2-3	1.25-3, 1.25-YS3A, 2-S3, 2-YS3A, V1.25-3, V1.25-YS3A, V2-S3, V2-YS3A	○	
Number of occupied stations		4 stations (4 stations × 8 points)	—	—	When using the AJ65SBTCF1-32T, the number of occupied stations is 1 station (When using CC-Link, it is 1 station × 32 points). (When using CC-Link, it is 1 station × 32 points).
Weight		0.70kg	0.46kg	△	Also consider the weight of the fixed stand of programmable controller.*3
External dimensions		250(H) × 132(W) × 41(D) mm	182(H) × 132(W) × 41(D) mm*4	×	Check the dimensions since they depend on the installation type (building-up/horizontal/separate type).

*1 Temperature derating chart

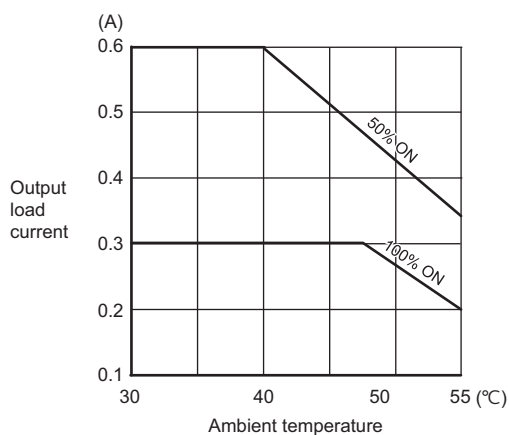

*2 A value when the AJ65SBTCF1-32T is used.

*3 The weight of the fixed stand of programmable controller depends on replacement type of renewal tool for A0J2.

*4 The external dimensions of the SC-A0JQIF24S do not include those of its projection.

(5) Specifications comparison between AJ35PTF-24T and interface module (SC-A0JQIF24T)

○: Compatible, △: Partially changed, ×: Incompatible

Specifications		AJ35PTF-24T output specifications	SC-A0JQIF24T output specifications	Compatibility	Precautions for replacement
Number of input points		24 points	24 points	○	
Insulation method		Photocoupler	Photocoupler	○	
Rated load voltage		12/24VDC	12/24VDC	○	
Operating load voltage range		10.2 to 31.2VDC	10.2 to 30VDC	○	The operating voltage range differs.
Maximum load current		0.5A/point, 4A/common	0.5A/point, 4A/common	○	
Maximum inrush current		4A 10ms or less	4A 10ms or less	○	
Leakage current at OFF		0.1mA or less	0.1mA or less	○	
Maximum voltage drop at ON		0.9VDC (TYP.) 0.5A 1.5VDC (MAX.) 0.5A	0.9VDC (TYP.) 0.5A 0.8VDC (MAX.) 0.5A	○	
Response time	OFF → ON	2ms or less	1ms or less	△	In combination with CC-Link output module: 2ms or less* ¹
	ON → OFF	2ms or less (resistance load)	1ms or less (resistance load)	△	In combination with CC-Link output module: 2ms or less (resistance load)* ¹
External power supply	Voltage	12/24VDC (10.2 to 31.2VDC)	12/24VDC (10.2 to 30VDC)	○	
	Current	23mA (TYP. 24VDC 8 points/ common ON)	5mA (TYP. 24VDC 8 points/ common ON)	○	
Surge suppressor		Varistor (52 to 62V)	Varistor (50.4 to 61.6V)	○	
Common terminal arrangement		8 points/common (Common terminal: TB9, TB19, TB29)	8 points/common (Common terminal: TB9, TB19, TB29)	○	
Operation indication		Available (Turning ON the output turns LED ON)	None	△	Operation indication can be checked with the CC-Link output module.
Fuse		None	6.7A (Replacement is not available.) (Fuse breaking capacity: 50A)	○	
Fuse blown indication		None	None	○	

○ : Compatible, △ : Partially changed, × : Incompatible

Specifications		AJ35PTF-24T	SC-A0JQIF24T	Compatibility	Precautions for replacement
External power supply (Module power supply)	Voltage	15.6 to 31.2VDC	24VDC \pm 10% Ripple voltage 4Vp-p or less	△	To deliver a power for CC-Link output module operation, connecting a module power supply to TB35 and TB36 of the interface module is required.
	Current	130mA	70mA	○	
External connection method		36-point terminal block connector (M3 \times 6 screws)	36-point terminal block connector (M3 \times 6 screws)	○	
Applicable wire size		0.75 to 2mm ² (Applicable tightening torque 69N \cdot cm)	0.75 to 2mm ² (Applicable tightening torque 69N \cdot cm)	○	
Applicable solderless terminal		1.25-S3, 1.25-YS3A, 2-S3, 2-YS3A, V1.25-S3, V1.25-YS3A, V2-S3, V2-YS3A	1.25-S3, 1.25-YS3A, 2-S3, 2-YS3A, V1.25-S3, V1.25-YS3A, V2-S3, V2-YS3A	○	
Number of occupied stations		4 stations (4 stations \times 8 points)	–	–	When using the AJ65SBTCF1-32T, the number of occupied stations is 1 station (When using CC-Link, it is 1 station \times 32 points).
Weight		0.73kg	0.36kg	△	Also consider the weight of the fixed stand of programmable controller. *2
External dimensions		250(H) \times 132(W) \times 41(D) mm	182(H) \times 132(W) \times 41(D) mm*3	×	Check the dimensions since they depend on the installation type (building-up/horizontal/separate type).

*1 A value when the AJ65SBTCF1-32T is used.

*2 The weight of the fixed stand of programmable controller depends on replacement type of renewal tool for A0J2.

*3 The external dimensions of the SC-A0JQIF24T do not include those of its projection.

(6) Specifications comparison between AJ35PTF-28AR and interface module (SC-A0JQIF28AR)

○: Compatible, △: Partially changed, ×: Incompatible

Specifications		AJ35PTF-28AR input specifications	SC-A0JQIF28AR input specifications	Compatibility	Precautions for replacement
Number of input points		16 points	16 points	○	
Insulation method		Photocoupler	Photocoupler	○	
Rated input voltage		100 to 120VAC, 50/60Hz	100 to 120VAC, 50/60Hz	○	
Rated input current		10mA (100VAC 60Hz)	10mA (100VAC 60Hz)	○	
Operating voltage range		85 to 132VAC (50/60Hz ± 5%)	85 to 132VAC (50/60Hz ± 5%)	○	
Maximum number of simultaneous input points		100% (16 points/common) simultaneously ON	Refer to the derating chart.* ¹	△	Use the module within the range in the derating chart. When the voltage of the external power supply (module power supply) is high, the AC input simultaneous ON ratio is low.
ON voltage/ON current		80VAC or more/6mA or more	80VAC or more/6mA or more	○	
OFF voltage/OFF current		40VAC or less/4mA or less	26VAC or less/1.7mA or less	△	The OFF voltage/OFF current have been reduced.* ²
Inrush current		Max. 300mA, within 0.3ms (132VAC)	Max. 300mA, within 0.3ms (132VAC)	○	
Input resistance		Approx. 10kΩ (60Hz), Approx. 12kΩ (50Hz)	Approx. 10kΩ (60Hz), Approx. 12kΩ (50Hz)	○	
Response time	OFF → ON	15ms or less (6ms TYP.)	14ms or less (11ms TYP.)	△	In combination with CC-Link input module: 15ms or less (12ms TYP.)* ³
	ON → OFF	25ms or less (16ms TYP.)	19ms or less (13ms TYP.)	△	In combination with CC-Link input module: 21.5ms or less (14ms TYP.)* ³
Common terminal arrangement		16 points/common (Common terminal: TB17)	16 points/common (Common terminal: TB17)	○	
Operation indication		Available (Turning ON the input turns LED ON)	None	△	Operation indication can be checked with the CC-Link input module.

○ : Compatible, △ : Partially changed, × : Incompatible

Specifications		AJ35PTF-28AR output specifications	SC-A0JQIF28AR output specifications	Compatibility	Precautions for replacement
Number of input points		12 points	12 points	○	
Insulation method		Photocoupler	Relay isolation	△	Although the insulation methods differ, the performance of the insulation is the same.
Rated load voltage/current		24VDC 2A (resistance load)/point 240VAC 2A (COS ϕ = 1)/point 5A/common	24VDC 2A (resistance load)/point 240VAC 2A (COS ϕ = 1)/point 5A/common	○	
Minimum switching load		5VDC 1mA	5VDC 1mA	○	
Maximum switching voltage		264VAC, 125VDC	264VAC, 125VDC	○	
Maximum switching frequency		3600 times/hr	3600 times/hr	○	
Mechanical life		20 million times or more	20 million times or more	○	
Electrical life		Rated switching voltage/current load 200000 times or more	Rated switching voltage/current load 200000 times or more	○	
		200VAC 1.5A, 240VAC 1A (COS ϕ = 0.7) 200000 times or more 200VAC 0.75A, 240VAC 0.5A (COS ϕ = 0.35) 200000 times or more 24VDC 1A, 100VDC 0.1A (L/R = 7 ms) 200000 times or more	200VAC 1.5A, 240VAC 1A (COS ϕ = 0.7) 200000 times or more 200VAC 0.75A, 240VAC 0.5A (COS ϕ = 0.35) 200000 times or more 24VDC 1A, 100VDC 0.1A (L/R = 7 ms) 200000 times or more	○	
Response time	OFF → ON	10ms or less	9ms or less	△	In combination with CC-Link input module: 10ms or less*4
	ON → OFF	12ms or less	11ms or less	△	In combination with CC-Link input module: 12ms or less*4
External power supply	Voltage	24VDC \pm 10% Ripple voltage 4Vp-p or less	24VDC \pm 10% Ripple voltage 4Vp-p or less	○	
	Current	110mA (24VDC, all points ON)	125mA (24VDC, all points ON)	△	The current consumption increases. The current capacity needs to be reconsidered.
Surge suppressor		None	None	○	
Common terminal arrangement		8 points/common (Common terminal: B26) 3 points/common (Common terminal: B31) Independent contact (Common terminal: TB33)	8 points/common (Common terminal: B26) 3 points/common (Common terminal: B31) Independent contact (Common terminal: TB33)	○	
Operation indication		Available (Turning ON the input turns LED ON)	None	△	Operation indication can be checked with the CC-Link output module.
Fuse		None	None	○	
Fuse blown indication		–	–	–	
Relay socket		None	None	–	

○ : Compatible, △ : Partially changed, × : Incompatible

Specifications		AJ35PTF-28AR	SC-A0JQIF28AR	Compatibility	Precautions for replacement
External power supply (Module power supply)	Voltage	15.6 to 31.2VDC	24VDC ± 10% Ripple voltage 4Vp-p or less	△	To deliver a power for CC-Link I/O module operation, connecting a module power supply to TB35 and TB36 of the interface module is required.
	Current	120mA	105mA	○	
External connection method		36-point terminal block connector (M3 × 6 screws)	36-point terminal block connector (M3 × 6 screws)	○	
Applicable wire size		0.75 to 2mm ² (Applicable tightening torque 69N·cm)	0.75 to 2mm ² (Applicable tightening torque 69N·cm)	○	
Applicable solderless terminal		1.25-3, 1.25-YS3A, 2-S3, 2-YS3A, V1.25-3, V1.25-YS3A, V2-S3, V2-YS3A	1.25-3, 1.25-YS3A, 2-S3, 2-YS3A, V1.25-3, V1.25-YS3A, V2-S3, V2-YS3A	○	
Number of occupied stations		4 stations (4 stations × 8 points)	–	–	When using the AJ65SBTCF1-32D and AJ65SBTCF1-32T, the number of occupied stations is 2 stations (When using CC-Link, it is 1 station × 32 points).
Weight		0.68kg	0.43kg	△	Also consider the weight of the fixed stand of programmable controller.*5
External dimensions		250(H) × 132(W) × 41(D) mm	182(H) × 132(W) × 41(D) mm*6	×	Check the dimensions since they depend on the installation type (building-up/horizontal/separate type).

*1 The following figure shows the derating.
When the voltage of the external power supply (module power supply) is high, the AC input simultaneous ON ratio is low.

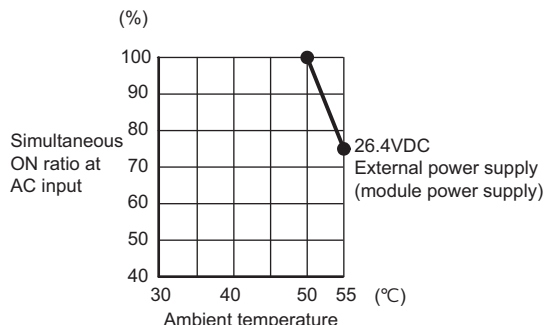

*2 Check that the specifications of leakage current of the used sensor and switches are equal to or less than the OFF current value.

If leakage current is equal to or more than the OFF current specifications, take measures against it with referring to "Input Module Troubleshooting" in the following handbook.

(Handbook for replacement)

Renewal tool for A0J2 series transition from MELSEC-A0J2(H) series to renewal system using renewal tool (Refer to Appendix 2.5.)

*3 A value when the AJ65SBTCF1-32D is used.

*4 A value when the AJ65SBTCF1-32T is used.

*5 The weight of the fixed stand of programmable controller depends on replacement type of renewal tool for A0J2.

*6 The external dimensions of the SC-A0JQIF28AR do not include those of its projection.

(7) Specifications comparison between AJ35PTF-28AS and interface module (SC-A0JQIF28AS)

○: Compatible, △: Partially changed, ×: Incompatible

Specifications		AJ35PTF-28AS input specifications	SC-A0JQIF28AS input specifications	Compatibility	Precautions for replacement
Number of input points		16 points	16 points	○	
Insulation method		Photocoupler	Photocoupler	○	
Rated input voltage		100 to 120VAC, 50/60Hz	100 to 120VAC, 50/60Hz	○	
Rated input current		10mA (100VAC 60Hz)	10mA (100VAC 60Hz)	○	
Operating voltage range		85 to 132VAC (50/60Hz ±5%)	85 to 132VAC (50/60Hz ±5%)	○	
Maximum number of simultaneous input points		100% (16 points/common) simultaneously ON	100% (16 points/common) simultaneously ON	○	
ON voltage/ON current		80VAC or more/6mA or more	80VAC or more/6mA or more	○	
OFF voltage/OFF current		40VAC or less/4mA or less	26VAC or less/1.7mA or less	△	The OFF voltage/OFF current have been reduced.*1
Inrush current		Max. 300mA, within 0.3ms (132VAC)	Max. 300mA, within 0.3ms (132VAC)	○	
Input resistance		Approx. 10k Ω (60Hz), Approx. 12k Ω (50Hz)	Approx. 10k Ω (60Hz), Approx. 12k Ω (50Hz)	○	
Response time	OFF → ON	15ms or less (6ms TYP.)	14ms or less (11ms TYP.)	△	In combination with CC-Link input module: 15ms or less (12ms TYP.)*2
	ON → OFF	25ms or less (16ms TYP.)	19ms or less (13ms TYP.)	△	In combination with CC-Link input module: 21.5ms or less (14ms TYP.)*2
Common terminal arrangement		16 points/common (Common terminal: TB17)	16 points/common (Common terminal: TB17)	○	
Operation indication		Available (Turning ON the input turns LED ON)	None	△	Operation indication can be checked with the CC-Link input module.

○ : Compatible, △ : Partially changed, × : Incompatible

Specifications		AJ35PTF-28AS output specifications	SC-A0JQIF28AS output specifications	Compatibility	Precautions for replacement
Number of input points		12 points	12 points	○	
Insulation method		Photocoupler	Photocoupler	○	
Rated load voltage		100 to 240VAC, 40 to 70Hz	100 to 240VAC, 47 to 63Hz	△	The available frequency range is small.
Maximum load voltage		264VAC	264VAC	○	
Maximum load current		0.6A/point, 2.4A/common	0.6A/point, 2.4A/common	○	
Minimum load voltage/ current		24VAC 100mA, 100V/240VAC 10mA,	24VAC 100mA, 100V/240VAC 10mA,	○	
Maximum inrush current		20A 10ms or less, 8A 100ms or less	20A 10ms or less, 8A 100ms or less	○	
Leakage current at OFF		1.5mA (120VAC, 60Hz) 3mA (240VAC, 60Hz)	1.5mA (120VAC, 60Hz) 3mA (240VAC, 60Hz)	○	
Maximum voltage drop at ON		1.5V or less (0.1 to 0.6A) 1.8V or less (0.1A or less) 2.0V or less (10 to 50mA)	1.5V or less (0.1 to 0.6A) 1.8V or less (0.1A or less) 2.0V or less (10 to 50mA)	○	
Temperature derating		None	Refer to the derating chart.*3	△	Use the module within the range in the derating chart.
Response time	OFF → ON	1ms or less	1ms or less	△	In combination with CC-Link output module: 2ms or less*4
	ON → OFF	0.5 cycle + 1ms or less	0.5 cycle + 1ms or less	△	In combination with CC-Link output module: 0.5 cycle + 2ms or less*4
Fuse		High speed type fuse 3.2A (one fuse/common) HP-32	None	×	Install a fuse externally from the module (one fuse/common). (A fuse and fuse holder are included.)
Fuse blown indication		Available (When a fuse is blown, the LED turns on and a signal is output to the CPU.)	-	-	
Surge suppressor	CR absorber	0.022 μ F + 47 Ω	0.015 μ F + 22 Ω	○	
	Varistor	None	Varistor voltage (400 to 540V)	○	
Common terminal arrangement		8 points/common (Common terminal: TB26) 4 points/common (Common terminal: TB33)	8 points/common (Common terminal: TB26) 4 points/common (Common terminal: TB33)	○	
Operation indication		Available (Turning ON the input turns LED ON)	None	△	Operation indication can be checked with the CC-Link output module.

○ : Compatible, △ : Partially changed, × : Incompatible

Specifications		AJ35PTF-28AS	SC-A0JQIF28AS	Compatibility	Precautions for replacement
External power supply (Module power supply)	Voltage	15.6 to 31.2VDC	24VDC ± 10% Ripple voltage 4Vp-p or less	△	To deliver a power for CC-Link I/O module operation, connecting a module power supply to TB35 and TB36 of the interface module is required.
	Current	140mA	290mA	△	The current consumption increases. The current capacity needs to be reconsidered.
External connection method		36-point terminal block connector (M3 × 6 screws)	36-point terminal block connector (M3 × 6 screws)	○	
Applicable wire size		0.75 to 2mm ² (Applicable tightening torque 69N·cm)	0.75 to 2mm ² (Applicable tightening torque 69N·cm)	○	
Applicable solderless terminal		1.25-3, 1.25-YS3A, 2-S3, 2-YS3A, V1.25-3, V1.25-YS3A, V2-S3, V2-YS3A	1.25-3, 1.25-YS3A, 2-S3, 2-YS3A, V1.25-3, V1.25-YS3A, V2-S3, V2-YS3A	○	
Number of occupied stations		4 stations (4 stations × 8 points)	—	—	When using the AJ65SBTCF1-32D and AJ65SBTCF1-32T, the number of occupied stations is 2 stations (When using CC-Link, it is 1 station × 32 points).
Weight		0.65kg	0.43kg	△	Also consider the weight of the fixed stand of programmable controller.*5
External dimensions		250(H) × 132(W) × 41(D) mm	182(H) × 132(W) × 41(D) mm*6	×	Check the dimensions since they depend on the installation type (building-up/horizontal/separate type).

*1 Check that the specifications of leakage current of the used sensor and switches are equal to or less than the OFF current value.

If leakage current is equal to or more than the OFF current specifications, take measures against it with referring to "Input Module Troubleshooting" in the following handbook.

(Handbook for replacement)

Renewal tool for A0J2 series transition from MELSEC-A0J2(H) series to renewal system using renewal tool (Refer to Appendix 2.6.)

*2 A value when the AJ65SBTCF1-32D is used.

*3 Temperature derating chart

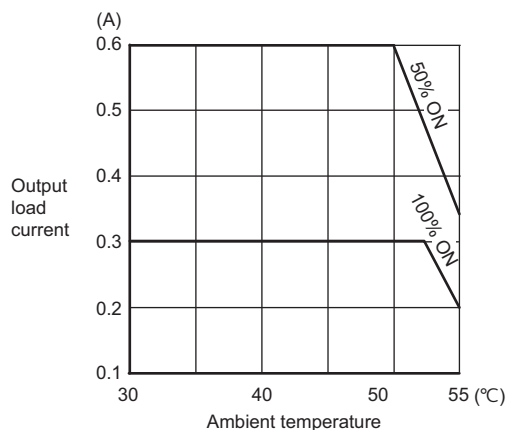

*4 A value when the AJ65SBTCF1-32T is used.

*5 The weight of the fixed stand of programmable controller depends on replacement type of renewal tool for A0J2.

*6 The external dimensions of the SC-A0JQIF28AS do not include those of its projection.

(8) Specifications comparison between AJ35PTF-28DR and interface module (SC-A0JQIF28DR)

○: Compatible, △: Partially changed, x: Incompatible

Specifications		AJ35PTF-28DR input specifications	SC-A0JQIF28DR input specifications	Compatibility	Precautions for replacement
Number of input points		16 points	16 points	○	
Insulation method		Photocoupler	Photocoupler	○	
Rated input voltage		12VDC/24VDC	12VDC/24VDC	○	
Rated input current		Approx. 3mA/Approx. 7mA	Approx. 3mA/Approx. 7mA	○	
Operating voltage range		10.2 to 31.2VDC (Ripple ratio within 5%)	10.2 to 26.4VDC (Ripple ratio within 5%)	△	The operating voltage range differs.
Maximum number of simultaneous input points		100% (16 points/common) simultaneously ON	100% (16 points/common) simultaneously ON	○	
ON voltage/ON current		9.5VDC or more/2.6mA or more	9.5VDC or more/2.6mA or more	○	
OFF voltage/OFF current		6VDC or less/1.0mA or less	6VDC or less/1.0mA or less	○	
Input resistance		Approx. 3.4k Ω	Approx. 3.3k Ω	○	
Input form		Sink input (Input current flows off.)	Sink input (Input current flows off.)	○	
Response time	OFF→ON	10ms or less (6ms TYP.)	5ms or less (1ms TYP.)	△	In combination with CC-Link input module: 6.5ms or less (2.5ms TYP.) ^{*1}
	ON→OFF	10ms or less (7.5ms TYP.)	5ms or less (1ms TYP.)	△	In combination with CC-Link input module: 6.5ms or less (2.5ms TYP.) ^{*1}
Common terminal arrangement		16 points/common (Common terminal: TB17)	16 points/common (Common terminal: TB17)	○	
Operation indication		Available (Turning ON the input turns LED ON)	None	△	Operation indication can be checked with CC-Link input module.

○: Compatible, △: Partially changed, ×: Incompatible

Specifications		AJ35PTF-28DR output specifications	SC-A0JQIF28DR output specifications	Compatibility	Precautions for replacement
Number of output points		12 points	12 points	○	
Insulation method		Photocoupler	Relay isolation	△	Although the insulation methods differ, the performance of the insulation is the same.
Rated switching voltage/current		24VDC 2A (Resistance load)/point 240VAC 2A (COSφ =1)/point 5A/common	24VDC 2A (Resistance load)/point 240VAC 2A (COSφ =1)/point 5A/common	○	
Minimum switching load		5VDC 1mA	5VDC 1mA	○	
Maximum switching voltage		264VAC 125VDC	264VAC 125VDC	○	
Maximum switching frequency		3600 times/hr	3600 times/hr	○	
Mechanical life		20 million times or more	20 million times or more	○	
Electrical life		Rated switching voltage/current load 200,000 times or more	Rated switching voltage/current load 200,000 times or more	○	
		200VAC 1.5A, 240VAC 1A (COSφ =0.7) 200,000 times or more 200VAC 1A, 240VAC 0.5A (COSφ =0.35) 200,000 times or more 24VDC 1A, 100VDC 0.1A (L/R=7ms) 200,000 times or more	200VAC 1.5A, 240VAC 1A (COSφ =0.7) 200,000 times or more 200VAC 0.75A, 240VAC 0.5A (COSφ =0.35) 200,000 times or more 24VDC 1A, 100VDC 0.1A (L/R=7ms) 200,000 times or more	○	
Response time	OFF→ON	10ms or less	9ms or less	△	In combination with CC-Link output module: 9.5ms or less ^{*2}
	ON→OFF	12ms or less	11ms or less	△	In combination with CC-Link output module: 12.5ms or less ^{*2}
External supply power (Relay coil driving power)	Voltage	24VDC ± 10% Ripple voltage 4Vp-p or less	24VDC ± 10% Ripple voltage 4Vp-p or less	○	
	Current	110mA (24VDC All points are ON.)	125mA (24VDC All points are ON.)	△	Review current capacity since current consumption is increased.
Surge suppressor		None	None	○	
Fuse rating		None	None	○	
Fuse blown indication		-	-	○	
Relay socket		None	None	○	
Common terminal arrangement		8 points/common (Common terminal: TB26) 3 points/common (Common terminal: TB31) Independent contact (Common terminal: TB33)	8 points/common (Common terminal: TB26) 3 points/common (Common terminal: TB31) Independent contact (Common terminal: TB33)	○	
Operation indication		Available (Turning ON the output turns LED ON)	None	△	Operation indication can be checked with CC-Link output module.

○: Compatible, △: Partially changed, ×: Incompatible

Specifications		AJ35PTF-28DR	SC-A0JQIF28DR	Compatibility	Precautions for replacement
External supply power (Module power supply)	Voltage	15.6 to 31.2VDC	24VDC ± 10% Ripple voltage 4Vp-p or less	△	To deliver a power for programmable controller operation, connecting a module power supply to the interface module, TB27 or TB36 is required.
	Current	120mA	100mA	○	
External connection method		36-point terminal block connector (M3 × 6 screws)	36-point terminal block connector (M3 × 6 screws)	○	
Applicable wire size		0.75 to 2mm ² (Applicable tightening torque 69N·cm)	0.75 to 2mm ² (Applicable tightening torque 69N·cm)	○	
Applicable solderless terminal		R1.25-3, R2-3, RAV1.25-3, RAV2-3	1.25-3, 1.25-YS3A, 2-S3, 2-YS3A, V1.25-3, V1.25-YS3A, V2-S3, V2-YS3A	○	
Number of occupied stations (number of occupied points)		4 stations (4 stations × 8 points)	—	—	When using the AJ65SBTCF1-32D and AJ65SBTCF1-32T, the number of occupied stations is 2 stations (When using CC-Link, it is 1 station × 32 points).
Weight		0.76kg	0.42kg	△	Also consider the weight of fixed stand of programmable controller.*3
External dimensions		250(H) × 132(W) × 41(D) mm*4	182(H) × 132(W) × 41(D) mm*5	×	Check the dimensions since they depend on the installation type (building-up/horizontal/separate type).

*1: A value when using the AJ65SBTCF1-32D.

*2: A value when using the AJ65SBTCF1-32T.

*3: The weight of fixed stand of programmable controller depends on replacement type of renewal tool for A0J2.

*4: External dimensions of the AJ35PTF-28DR does not include dimensions of the optical fiber cable connector.

*5: The external dimensions of the SC-A0JQIF28DR do not include those of its projection.

(9) Specifications comparison between AJ35PTF-28DS and interface module (SC-A0JQIF28DS)

○: Compatible, △: Partially changed, ×: Incompatible

Specifications		AJ35PTF-28DS input specifications	SC-A0JQIF28DS input specifications	Compatibility	Precautions for replacement
Number of input points		16 points	16 points	○	
Insulation method		Photocoupler	Photocoupler	○	
Rated input voltage		12/24VDC	12/24VDC	○	
Rated input current		Approx. 3mA/Approx. 7mA	Approx. 3mA/Approx. 7mA	○	
Operating voltage range		10.2 to 26.4VDC (ripple ratio within 5%)	10.2 to 26.4VDC (ripple ratio within 5%)	○	
Maximum number of simultaneous input points		100% (16 points/common) simultaneously ON	100% (16 points/common) simultaneously ON	○	
ON voltage/ON current		9.5VDC or more/2.6mA or more	9.5VDC or more/2.6mA or more	○	
OFF voltage/OFF current		6VDC or less/1.0mA or less	6VDC or less/1.0mA or less	○	
Input resistance		Approx. 3.4kΩ	Approx. 3.3kΩ	○	
Input form		Sink input (Input current flows off.)	Sink input (Input current flows off.)	○	
Response time	OFF → ON	10ms or less (6ms TYP.)	5ms or less (1ms TYP.)	△	In combination with CC-Link input module: 6ms or less (2ms TYP.) ^{*1}
	ON → OFF	10ms or less (7.5ms TYP.)	5ms or less (1ms TYP.)	△	In combination with CC-Link input module: 6ms or less (2ms TYP.) ^{*1}
Common terminal arrangement		16 points/common (Common terminal: TB17)	16 points/common (Common terminal: TB17)	○	
Operation indication		Available (Turning ON the input turns LED ON)	None	△	Operation indication can be checked with the CC-Link input module.

○: Compatible, △: Partially changed, ×: Incompatible

Specifications		AJ35PTF-28DS output specifications	SC-A0JQIF28DS output specifications	Compatibility	Precautions for replacement
Number of input points		12 points	12 points	○	
Insulation method		Photocoupler	Photocoupler	○	
Rated load voltage		100 to 240VAC, 40 to 70Hz	100 to 240VAC, 47 to 63Hz	○	
Maximum load voltage		264VAC	264VAC	○	
Maximum load current		0.6A/point, 2.4A/common	0.6A/point, 2.4A/common	○	
Minimum load voltage/ current		24VAC 100mA, 100V/240VAC 10mA,	24VAC 100mA, 100V/240VAC 10mA,	○	
Maximum inrush current		20A 10ms or less, 8A 100ms or less	20A 10ms or less, 8A 100ms or less	○	
Leakage current at OFF		1.5mA (120VAC, 60Hz) 3mA (240VAC, 60Hz)	1.5mA (120VAC, 60Hz) 3mA (240VAC, 60Hz)	○	
Maximum voltage drop at ON		1.5V or less (0.1 to 0.6A) 1.8V or less (0.1A or less) 2.0V or less (10 to 50mA)	1.5V or less (0.1 to 0.6A) 1.8V or less (0.1A or less) 2.0V or less (10 to 50mA)	○	
Temperature derating		None	None	—	
Response time	OFF → ON	1ms or less	1ms or less	△	In combination with CC-Link output module: 2ms or less* ²
	ON → OFF	0.5 cycle + 1ms or less	0.5 cycle + 1ms or less	△	In combination with CC-Link output module: 0.5 cycle + 2ms or less* ²
Fuse		High speed type fuse 3.2A (one fuse/common) HP-32	None	×	Install a fuse externally from the module (one fuse/common). (A fuse and fuse holder are included.)
Fuse blown indication		Available (When a fuse is blown, the LED turns on and a signal is output to the CPU.)	—	—	
Surge suppressor	CR absorber	0.022 μF + +47 Ω	0.015 μF + +22 Ω	○	
	Varistor	None	Varistor voltage (400 to 540V)	○	
Common terminal arrangement		8 points/common (Common terminal: TB26) 4 points/common (Common terminal: TB33)	8 points/common (Common terminal: TB26) 4 points/common (Common terminal: TB33)	○	
Operation indication		Available (Turning ON the input turns LED ON)	None	△	Operation indication can be checked with the CC-Link output module.

○: Compatible, △: Partially changed, ×: Incompatible

Specifications		AJ35PTF-28DS	SC-A0JQIF28DS	Compatibility	Precautions for replacement
External power supply (Module power supply)	Voltage	15.6 to 31.2VDC	24VDC ± 10% Ripple voltage 4Vp-p or less	△	To deliver a power for CC-Link I/O module operation, connecting a module power supply to TB35 and TB36 of the interface module is required.
	Current	150mA	285mA	△	The current consumption increases. The current capacity needs to be reconsidered.
External connection method		36-point terminal block connector (M3 × 6 screws)	36-point terminal block connector (M3 × 6 screws)	○	
Applicable wire size		0.75 to 2mm ² (Applicable tightening torque 69N·cm)	0.75 to 2mm ² (Applicable tightening torque 69N·cm)	○	
Applicable solderless terminal		1.25-3, 1.25-YS3A, 2-S3, 2-YS3A, V1.25-3, V1.25-YS3A, V2-S3, V2-YS3A	1.25-3, 1.25-YS3A, 2-S3, 2-YS3A, V1.25-3, V1.25-YS3A, V2-S3, V2-YS3A	○	
Number of occupied stations		4 stations (4 stations × 8 points)	–	–	When using the AJ65SBTCF1-32D and AJ65SBTCF1-32T, the number of occupied stations is 2 stations (When using CC-Link, it is 1 station × 32 points).
Weight		0.76kg	0.41kg	△	Also consider the weight of the fixed stand of programmable controller.*3
External dimensions		250(H) × 132(W) × 41(D) mm	182(H) × 132(W) × 41(D) mm*4	×	Check the dimensions since they depend on the installation type (building-up/horizontal/separate type).

*1 A value when the AJ65SBTCF1-32D is used.

*2 A value when the AJ65SBTCF1-32T is used.

*3 The weight of the fixed stand of programmable controller depends on replacement type of renewal tool for A0J2.

*4 The external dimensions of the SC-A0JQIF28DS do not include those of its projection.

(10) Specifications comparison between AJ35PTF-28DT and interface module (SC-A0JQIF28DT)

○: Compatible, △: Partially changed, ×: Incompatible

Specifications		AJ35PTF-28DT input specifications	SC-A0JQIF28DT input specifications	Compatibility	Precautions for replacement
Number of input points		16 points	16 points	○	
Insulation method		Photocoupler	Photocoupler	○	
Rated input voltage		12VDC/24VDC	12VDC/24VDC	○	
Rated input current		Approx. 3mA/Approx. 7mA	Approx. 3mA/Approx. 7mA	○	
Operating voltage range		10.2 to 31.2VDC (Ripple ratio within 5%)	10.2 to 26.4VDC (Ripple ratio within 5%)	△	The operating voltage range differs.
Maximum number of simultaneous input points		100% (16 points/common) simultaneously ON	100% (16 points/common) simultaneously ON	○	
ON voltage/ON current		9.5VDC or more/2.6mA or more	9.5VDC or more/2.6mA or more	○	
OFF voltage/OFF current		6VDC or less/1.0mA or less	6VDC or less/1.0mA or less	○	
Input resistance		Approx. 3.4k Ω	Approx. 3.3k Ω	○	
Input form		Sink input (Input current flows off.)	Sink input (Input current flows off.)	○	
Response time	OFF→ON	10ms or less (6ms TYP.)	5ms or less (1ms TYP.)	△	In combination with CC-Link input module: 6.5ms or less (2.5ms TYP.) ^{*1}
	ON→OFF	10ms or less (7.5ms TYP.)	5ms or less (1ms TYP.)	△	In combination with CC-Link input module: 6.5ms or less (2.5ms TYP.) ^{*1}
Common terminal arrangement		16 points/common (Common terminal: TB17)	16 points/common (Common terminal: TB17)	○	
Operation indication		Available (Turning ON the input turns LED ON)	None	△	Operation indication can be checked with CC-Link input module.

○: Compatible, △: Partially changed, ×: Incompatible

Specifications		AJ35PTF-28DT output specifications	SC-A0JQIF28DT output specifications	Compatibility	Precautions for replacement
Number of output points		12 points	12 points	○	
Insulation method		Photocoupler	Photocoupler	○	
Rated load voltage		12VDC/24VDC	12VDC/24VDC	○	
Operating load voltage range		10.2 to 31.2VDC	10.2 to 30VDC	△	The operating load voltage range differs.
Maximum load current		0.5A/point, 3.2A/common	0.5A/point, 4A/common	○	
Maximum inrush current		4A 10ms or less	4A 10ms or less	○	
Leakage current at OFF		0.1mA or less	0.1mA or less	○	
Maximum voltage drop at ON		0.9VDC (TYP.) 0.5A 1.5VDC (MAX.) 0.5A	0.5VDC (TYP.) 0.5A 0.8VDC (MAX.) 0.5A	○	
Output method		Sink type	Sink type	○	
Response time	OFF→ON	2ms or less	1ms or less	△	In combination with CC-Link output module: 1.5ms or less ^{*2}
	ON→OFF	2ms or less (Resistance load)	1ms or less (Resistance load)	△	In combination with CC-Link output module: 2.5ms or less (Resistance load) ^{*2}
External supply power	Voltage	12VDC/24VDC (10.2 to 31.2VDC)	12VDC/24VDC (10.2 to 30VDC)	△	The operating voltage range differs.
	Current	23mA (TYP. 24VDC 8 points/common ON)	5mA (TYP. 24VDC 8 points/common ON)	○	
Surge suppressor		Varistor (52 to 62V)	Varistor (50.4 to 61.6V)	○	
Common terminal arrangement		8 points/common (Common terminal: TB26) 4 points/common (Common terminal: TB33)	8 points/common (Common terminal: TB26) 4 points/common (Common terminal: TB33)	○	
Operation indication		Available (Turning ON the output turns LED ON)	None	△	Operation indication can be checked with CC-Link output module.
Fuse		None	None	○	
Fuse blown indication		None	None	○	

○: Compatible, △: Partially changed, ×: Incompatible

Specifications		AJ35PTF-28DT	SC-A0JQIF28DT	Compatibility	Precautions for replacement
External supply power (Module power supply)	Voltage	15.6 to 31.2VDC	24VDC ± 10% Ripple voltage 4Vp-p or less	△	To deliver a power for programmable controller operation, connecting a module power supply to the interface module, TB35 or TB36 is required.
	Current	110mA	130mA	△	The current consumption increases. The current capacity needs to be reconsidered.
External connection method		36-point terminal block connector (M3 × 6 screws)	36-point terminal block connector (M3 × 6 screws)	○	
Applicable wire size		0.75 to 2mm ² (Applicable tightening torque 69N·cm)	0.75 to 2mm ² (Applicable tightening torque 69N·cm)	○	
Applicable solderless terminal		R1.25-3, R2-3, RAV1.25-3, RAV2-3	1.25-3, 1.25-YS3A, 2-S3, 2-YS3A, V1.25-3, V1.25-YS3A, V2-S3, V2-YS3A	○	
Number of occupied stations (number of occupied points)		4 stations (4 stations × 8 points)	—	—	When using the AJ65SBTCF1-32D and AJ65SBTCF1-32T, the number of occupied stations is 2 stations (When using CC-Link, it is 1 station × 32 points).
Weight		0.65kg	0.36kg	△	Also consider the weight of fixed stand of programmable controller.*3
External dimensions		250(H) × 132(W) × 41(D)mm*4	182(H) × 132(W) × 41(D)mm*5	×	Check the dimensions since they depend on the installation type (building-up/horizontal/separate type).

*1: A value when using the AJ65SBTCF1-32D.

*2: A value when using the AJ65SBTCF1-32T.

*3: The weight of fixed stand of programmable controller depends on replacement type of renewal tool for A0J2.

*4: External dimensions of the AJ35PTF-28DT does not include dimensions of the optical fiber cable connector.

*5: The external dimensions of the SC-A0JQIF28DT do not include those of its projection.

(11) Specifications comparison between AJ35PTF-56AR and interface module (SC-A0JQIF56AR)

○: Compatible, △: Partially changed, ×: Incompatible

Specifications		AJ35PTF-56AR input specifications	SC-A0JQIF56AR input specifications	Compatibility	Precautions for replacement
Number of input points		32 points	32 points	○	
Insulation method		Photocoupler	Photocoupler	○	
Rated input voltage		100 to 120VAC 50/60Hz	100 to 120VAC 50/60Hz	○	
Rated input current		10mA (100VAC 60Hz)	10mA (100VAC 60Hz)	○	
Operating voltage range		85 to 132VAC (50/60Hz±5%)	85 to 132VAC (50/60Hz±5%)	○	
Maximum number of simultaneous input points		100% (16 points/common) simultaneously ON	60% (10 points/common) simultaneously ON	△	The maximum number of simultaneous input points differs.
ON voltage/ON current		80VAC or more/6mA or more	80VAC or more/6mA or more	○	
OFF voltage/OFF current		40VAC or less/4mA or less	26VAC or less/1.7mA or less	△	OFF voltage/OFF current is smaller.*1
Inrush current		Maximum 300mA, Within 0.3ms (132VAC)	Maximum 300mA, Within 0.3ms (132VAC)	○	
Input impedance		Approx. 10k Ω (60Hz), Approx. 12k Ω (50Hz)	Approx. 10k Ω (60Hz), Approx. 12k Ω (50Hz)	○	
Response time	OFF→ON	15ms or less (6ms TYP.)	14ms or less (11ms TYP.)	△	In combination with CC-Link input module: 15.5ms or less (12ms TYP.)*2
	ON→OFF	25ms or less (16ms TYP.)	19ms or less (13ms TYP.)	△	In combination with CC-Link input module: 21.5ms or less (14ms TYP.)*2
Common terminal arrangement		16 points/common (Common terminal: TB17, TB34)	16 points/common (Common terminal: TB17, TB34)	○	
Operation indication		Available (Turning ON the input turns LED ON)	None	△	Operation indication can be checked with CC-Link input module.

○: Compatible, △: Partially changed, ×: Incompatible

Specifications		AJ35PTF-56AR output specifications	SC-A0JQIF56AR output specifications	Compatibility	Precautions for replacement
Number of output points		24 points	24 points	○	
Insulation method		Photocoupler	Relay isolation	△	Although the insulation methods differ, the performance of the insulation is the same.
Rated switching voltage/current		24VDC 2A (Resistance load)/point 240VAC 2A (COS φ =1)/point 5A/common	24VDC 2A (Resistance load)/point 240VAC 2A (COS φ =1)/point 5A/common	○	
Minimum switching load		5VDC 1mA	5VDC 1mA	○	
Maximum switching voltage		264VAC 125VDC	264VAC 125VDC	○	
Maximum switching frequency		3600 times/hr	3600 times/hr	○	
Mechanical life		20 million times or more	20 million times or more	○	
Electrical life		Rated switching voltage/current load 200,000 times or more	Rated switching voltage/current load 200,000 times or more	○	
		200VAC 1.5A, 240VAC 1A (COS φ =0.7) 200,000 times or more	200VAC 1.5A, 240VAC 1A (COS φ =0.7) 200,000 times or more	○	
		200VAC 1A, 240VAC 0.5A (COS φ =0.35) 200,000 times or more	200VAC 0.75A, 240VAC 0.5A (COS φ =0.35) 200,000 times or more		
		24VDC 1A, 100VDC 0.1A (L/R=7ms) 200,000 times or more	24VDC 1A, 100VDC 0.1A (L/R=7ms) 200,000 times or more		
Response time	OFF→ON	10ms or less	9ms or less	△	In combination with CC-Link output module: 9.5ms or less *3
	ON→OFF	12ms or less	11ms or less	△	In combination with CC-Link output module: 12.5ms or less *3
External supply power (Relay coil driving power)	Voltage	24VDC ± 10% Ripple voltage 4Vp-p or less	24VDC ± 10% Ripple voltage 4Vp-p or less	○	
	Current	220mA (24VDC All points are ON.)	230mA (24VDC All points are ON.)	△	Review current capacity since current consumption is increased.
Surge suppressor		None	None	○	
Fuse rating		None	None	○	
Fuse blown indication		-	-	○	
Relay socket		None	None	○	
Common terminal arrangement		8 points/common (Common terminal: TB9, TB19, TB29)	8 points/common (Common terminal: TB9, TB19, TB29)	○	
Operation indication		Available (Turning ON the output turns LED ON)	None	△	Operation indication can be checked with CC-Link output module.

○: Compatible, △: Partially changed, ×: Incompatible

Specifications		AJ35PTF-56AR	SC-A0JQIF56AR	Compatibility	Precautions for replacement
External supply power (Module power supply)	Voltage	15.6 to 31.2VDC	24VDC ± 10% Ripple voltage 4Vp-p or less	△	To deliver a power for programmable controller operation, connecting a module power supply to the interface module, TB35 or TB36 is required.
	Current	150mA	210mA	△	The current consumption increases. The current capacity needs to be reconsidered.
External connection method		36-point terminal block connector (M3 × 6 screws) 2 pieces	36-point terminal block connector (M3 × 6 screws) 2 pieces	○	
Applicable wire size		0.75 to 2mm ² (Applicable tightening torque 69N·cm)	0.75 to 2mm ² (Applicable tightening torque 69N·cm)	○	
Applicable solderless terminal		R1.25-3, R2-3, RAV1.25-3, RAV2-3	1.25-3, 1.25-YS3A, 2-S3, 2-YS3A, V1.25-3, V1.25-YS3A, V2-S3, V2-YS3A	○	
Number of occupied stations (number of occupied points)		8 stations (8 stations × 8 points)	–	–	When using the AJ65SBTCF1-32D and AJ65SBTCF1-32T, the number of occupied stations is 2 stations (When using CC-Link, it is 1 station × 32 points).
Weight		1.20kg	0.66kg	△	Also consider the weight of fixed stand of programmable controller.*4
External dimensions		250(H) × 190(W) × 41(D)mm*5	182(H) × 190(W) × 41(D)mm*6	×	Check the dimensions since they depend on the installation type (building-up/horizontal/separate type).

- *1: Check that the specifications of leakage current of the used sensor and switches are equal to or less than the OFF current value.
If leakage current is equal to or more than the OFF current specifications, take measures against it with referring to "Input Module Troubleshooting" in the following handbook.
(Handbook for replacement)
Renewal tool for A0J2 series Transition from MELSEC-A0J2(H) series to renewal system using renewal tool (refer to Appendix 2.5.)
- *2: A value when using the AJ65SBTCF1-32D.
- *3: A value when using the AJ65SBTCF1-32T.
- *4: The weight of fixed stand of programmable controller depends on replacement type of renewal tool for A0J2.
- *5: External dimensions of the AJ35PTF-56AR does not include dimensions of the optical fiber cable connector.
- *6: The external dimensions of the SC-A0JQIF56AR do not include those of its projection.

(12) Specifications comparison between AJ35PTF-56AS and interface module (SC-A0JQIF56AS)

○: Compatible, △: Partially changed, ×: Incompatible

Specifications		AJ35PTF-56AS input specifications	SC-A0JQIF56AS input specifications	Compatibility	Precautions for replacement
Number of input points		32 points	32 points	○	
Insulation method		Photocoupler	Photocoupler	○	
Rated input voltage		100 to 120VAC, 50/60Hz	100 to 120VAC, 50/60Hz	○	
Rated input current		10mA (100VAC 60Hz)	10mA (100VAC 60Hz)	○	
Operating voltage range		85 to 132VAC (50/60Hz ± 5%)	85 to 132VAC (50/60Hz ± 5%)	○	
Maximum number of simultaneous input points		60% (10 points/common) simultaneously ON	60% (10 points/common) simultaneously ON	○	
ON voltage/ON current		80VAC or more/6mA or more	80VAC or more/6mA or more	○	
OFF voltage/OFF current		40VAC or less/4mA or less	26VAC or less/1.7mA or less	△	The OFF voltage/OFF current have been reduced.*1
Inrush current		Max. 300mA, within 0.3ms (132VAC)	Max. 300mA, within 0.3ms (132VAC)	○	
Input resistance		Approx. 10k Ω (60Hz), Approx. 12k Ω (50Hz)	Approx. 10k Ω (60Hz), Approx. 12k Ω (50Hz)	○	
Response time	OFF → ON	15ms or less (6ms TYP.)	14ms or less (11ms TYP.)	△	In combination with CC-Link input module: 15ms or less (12ms TYP.)*2
	ON → OFF	35ms or less (16ms TYP.)	19ms or less (13ms TYP.)	△	In combination with CC-Link input module: 10ms or less (6ms TYP.)*2
Common terminal arrangement		16 points/common (Common terminal: TB17, TB34)	16 points/common (Common terminal: TB17, TB34)	○	
Operation indication		Available (Turning ON the input turns LED ON)	None	△	Operation indication can be checked with the CC-Link input module.

○: Compatible, △: Partially changed, ×: Incompatible

Specifications		AJ35PTF-56AS output specifications	SC-A0JQIF56AS output specifications	Compatibility	Precautions for replacement
Number of input points		24 points	24 points	○	
Insulation method		Photocoupler	Photocoupler	○	
Rated load voltage		100 to 240VAC, 40 to 70Hz	100 to 240VAC, 47 to 63Hz	△	The available frequency range is small.
Maximum load voltage		264VAC	264VAC	○	
Maximum load current		0.6A/point, 2.4A/common	0.6A/point, 2.4A/common	○	
Minimum load voltage/current		24VAC 100mA, 100V/240VAC 10mA,	24VAC 100mA, 100V/240VAC 10mA,	○	
Maximum inrush current		20A 10ms or less, 8A 100ms or less	20A 10ms or less, 8A 100ms or less	○	
Leakage current at OFF		1.5mA (120VAC, 60Hz) 3mA (240VAC, 60Hz)	1.5mA (120VAC, 60Hz) 3mA (240VAC, 60Hz)	○	
Maximum voltage drop at ON		1.5V or less (0.1 to 0.6A) 1.8V or less (0.1A or less) 2.0V or less (10 to 50mA)	1.5V or less (0.1 to 0.6A) 1.8V or less (0.1A or less) 2.0V or less (10 to 50mA)	○	
Temperature derating		None	Refer to the derating chart.*3	△	Use the module within the range in the derating chart.
Response time	OFF → ON	1ms or less	1ms or less	△	In combination with CC-Link output module: 2ms or less*4
	ON → OFF	0.5 cycle + 1ms or less	0.5 cycle + 1ms or less	△	In combination with CC-Link output module: 0.5 cycle + 2ms or less*4
Fuse		High speed type fuse 3.2A (one fuse/common) HP-32	None	×	Install a fuse externally from the module (one fuse/common). (A fuse and fuse holder are included.)
Fuse blown indication		Available (When a fuse is blown, the LED turns on and a signal is output to the CPU.)	—	—	
Surge suppressor	CR absorber	0.022 μF + +47 Ω	0.015 μF + +22 Ω	○	
	Varistor	None	Varistor voltage (400 to 540V)	○	
Common terminal arrangement		8 points/common (Common terminal: TB9, TB19, TB29)	8 points/common (Common terminal: TB9, TB19, TB29)	○	
Operation indication		Available (Turning ON the input turns LED ON)	None	△	Operation indication can be checked with the CC-Link output module.

○: Compatible, △: Partially changed, ×: Incompatible

Specifications		AJ35PTF-56AS	SC-A0JQIF56AS	Compatibility	Precautions for replacement
External power supply (Module power supply)	Voltage	15.6 to 31.2VDC	24VDC ± 10% Ripple voltage 4Vp-p or less	△	To deliver a power for CC-Link I/O module operation, connecting a module power supply to TB35 and TB36 of the interface module is required.
	Current	230mA	580mA	△	The current consumption increases. The current capacity needs to be reconsidered.
External connection method		Two 36-point terminal block connectors (M3 × 6 screws)	Two 36-point terminal block connectors (M3 × 6 screws)	○	
Applicable wire size		0.75 to 2mm ² (Applicable tightening torque 69N·cm)	0.75 to 2mm ² (Applicable tightening torque 69N·cm)	○	
Applicable solderless terminal		1.25-3, 1.25-YS3A, 2-S3, 2-YS3A, V1.25-3, V1.25-YS3A, V2-S3, V2-YS3A	1.25-3, 1.25-YS3A, 2-S3, 2-YS3A, V1.25-3, V1.25-YS3A, V2-S3, V2-YS3A	○	
Number of occupied stations		8 stations (8 stations × 8 points)	—	—	When using the AJ65SBTCF1-32D and AJ65SBTCF1-32T, the number of occupied stations is 2 stations (When using CC-Link, it is 1 station × 32 points).
Weight		1.10kg	0.66kg	△	Also consider the weight of the fixed stand of programmable controller.*5
External dimensions		250(H) × 190(W) × 41(D) mm	182(H) × 190(W) × 41(D) mm*6	×	Check the dimensions since they depend on the installation type (building-up/horizontal/separate type).

*1 Check that the specifications of leakage current of the used sensor and switches are equal to or less than the OFF current value.

If leakage current is equal to or more than the OFF current specifications, take measures against it with referring to "Input Module Troubleshooting" in the following handbook.

(Handbook for replacement)

Renewal tool for A0J2 series transition from MELSEC-A0J2(H) series to renewal system using renewal tool (Refer to Appendix 2.6.)

*2 A value when the AJ65SBTCF1-32D is used.

*3 Temperature derating chart

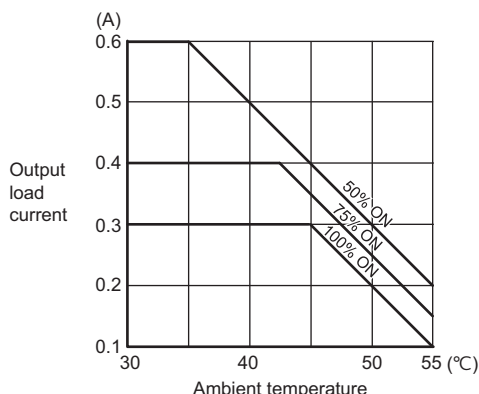

*4 A value when the AJ65SBTCF1-32T is used.

*5 The weight of the fixed stand of programmable controller depends on replacement type of renewal tool for A0J2.

*6 The external dimensions of the SC-A0JQIF56AS do not include those of its projection.

(13) Specifications comparison between AJ35PTF-56DR and interface module (SC-A0JQIF56DR)

○: Compatible, △: Partially changed, ×: Incompatible

Specifications		AJ35PTF-56DR input specifications	SC-A0JQIF56DR input specifications	Compatibility	Precautions for replacement
Number of input points		32 points	32 points	○	
Insulation method		Photocoupler	Photocoupler	○	
Rated input voltage		12VDC/24VDC	12VDC/24VDC	○	
Rated input current		Approx. 3mA/Approx. 7mA	Approx. 3mA/Approx. 7mA	○	
Operating voltage range		10.2 to 31.2VDC (Ripple ratio within 5%)	10.2 to 26.4VDC (Ripple ratio within 5%)	△	The operating voltage range differs.
Maximum number of simultaneous input points		60% (10 points/common) simultaneously ON	60% (10 points/common) simultaneously ON	○	
ON voltage/ON current		9.5VDC or more/2.6mA or more	9.5VDC or more/2.6mA or more	○	
OFF voltage/OFF current		6VDC or less/1.0mA or less	6VDC or less/1.0mA or less	○	
Input resistance		Approx. 3.4k Ω	Approx. 3.3k Ω	○	
Input form		Sink input (Input current flows off.)	Sink input (Input current flows off.)	○	
Response time	OFF→ON	10ms or less (6ms TYP.)	5ms or less (1ms TYP.)	△	In combination with CC-Link input module: 6.5ms or less (2.5ms TYP.) ^{*1}
	ON→OFF	10ms or less (7.5ms TYP.)	5ms or less (1ms TYP.)	△	In combination with CC-Link input module: 6.5ms or less (2.5ms TYP.) ^{*1}
Common terminal arrangement		16 points/common (Common terminal: TB17, TB34)	16 points/common (Common terminal: TB17, TB34)	○	
Operation indication		Available (Turning ON the input turns LED ON)	None	△	Operation indication can be checked with CC-Link input module.

○: Compatible, △: Partially changed, ×: Incompatible

Specifications		AJ35PTF-56DR output specifications	SC-A0JQIF56DR output specifications	Compatibility	Precautions for replacement
Number of output points		24 points	24 points	○	
Insulation method		Photocoupler	Relay isolation	△	Although the insulation methods differ, the performance of the insulation is the same.
Rated switching voltage/current		24VDC 2A (Resistance load)/point 240VAC 2A (COS ϕ =1)/point 5A/common	24VDC 2A (Resistance load)/point 240VAC 2A (COS ϕ =1)/point 5A/common	○	
Minimum switching load		5VDC 1mA	5VDC 1mA	○	
Maximum switching voltage		264VAC 125VDC	264VAC 125VDC	○	
Maximum switching frequency		3600 times/hr	3600 times/hr	○	
Mechanical life		20 million times or more	20 million times or more	○	
Electrical life		Rated switching voltage/current load 200,000 times or more	Rated switching voltage/current load 200,000 times or more	○	
		200VAC 1.5A, 240VAC 1A (COS ϕ =0.7) 200,000 times or more	200VAC 1.5A, 240VAC 1A (COS ϕ =0.7) 200,000 times or more		
		200VAC 1A, 240VAC 0.5A (COS ϕ =0.35) 200,000 times or more	200VAC 0.75A, 240VAC 0.5A (COS ϕ =0.35) 200,000 times or more	○	
		24VDC 1A, 100VDC 0.1A (L/R=7ms) 200,000 times or more	24VDC 1A, 100VDC 0.1A (L/R=7ms) 200,000 times or more		
Response time	OFF→ON	10ms or less	9ms or less	△	In combination with CC-Link output module: 9.5ms or less*2
	ON→OFF	12ms or less	11ms or less	△	In combination with CC-Link output module: 12.5ms or less*2
External supply power (Relay coil driving power)	Voltage	24VDC \pm 10% Ripple voltage 4Vp-p or less	24VDC \pm 10% Ripple voltage 4Vp-p or less	○	
	Current	220mA (24VDC All points are ON.)	230mA (24VDC All points are ON.)	△	Review current capacity since current consumption is increased.
Surge suppressor		None	None	○	
Fuse rating		None	None	○	
Fuse blown indication		-	-	○	
Relay socket		None	None	○	
Common terminal arrangement		8 points/common (Common terminal: TB9, TB19, TB29)	8 points/common (Common terminal: TB9, TB19, TB29)	○	
Operation indication		Available (Turning ON the output turns LED ON)	None	△	Operation indication can be checked with CC-Link output module.

○: Compatible, △: Partially changed, ×: Incompatible

Specifications		AJ35PTF-56DR	SC-A0JQIF56DR	Compatibility	Precautions for replacement
External supply power (Module power supply)	Voltage	15.6 to 31.2VDC	24VDC ± 10% Ripple voltage 4Vp-p or less	△	To deliver a power for programmable controller operation, connecting a module power supply to the interface module, TB35 or TB36 is required.
	Current	150mA	200mA	△	The current consumption increases. The current capacity needs to be reconsidered.
External connection method		36-point terminal block connector (M3 × 6 screws) 2 pieces	36-point terminal block connector (M3 × 6 screws) 2 pieces	○	
Applicable wire size		0.75 to 2mm ² (Applicable tightening torque 69N·cm)	0.75 to 2mm ² (Applicable tightening torque 69N·cm)	○	
Applicable solderless terminal		R1.25-3, R2-3, RAV1.25-3, RAV2-3	1.25-3, 1.25-YS3A, 2-S3, 2-YS3A, V1.25-3, V1.25-YS3A, V2-S3, V2-YS3A	○	
Number of occupied stations (number of occupied points)		8 stations (8 stations × 8 points)	–	–	When using the AJ65SBTCF1-32D and AJ65SBTCF1-32T, the number of occupied stations is 2 stations (When using CC-Link, it is 1 station × 32 points).
Weight		1.16kg	0.62kg	△	Also consider the weight of fixed stand of programmable controller.*3
External dimensions		250(H) × 190(W) × 41(D)mm*4	182(H) × 190(W) × 41(D)mm*5	×	Check the dimensions since they depend on the installation type (building-up/horizontal/separate type).

*1: A value when using the AJ65SBTCF1-32D.

*2: A value when using the AJ65SBTCF1-32T.

*3: The weight of fixed stand of programmable controller depends on replacement type of renewal tool for A0J2.

*4: External dimensions of the AJ35PTF-56DR does not include dimensions of the optical fiber cable connector.

*5: The external dimensions of the SC-A0JQIF56DR do not include those of its projection.

(14) Specifications comparison between AJ35PTF-56DS and interface module (SC-A0JQIF56DS)

○: Compatible, △: Partially changed, ×: Incompatible

Specifications		AJ35PTF-56DS input specifications	SC-A0JQIF56DS input specifications	Compatibility	Precautions for replacement
Number of input points		32 points	32 points	○	
Insulation method		Photocoupler	Photocoupler	○	
Rated input voltage		12/24VDC	12/24VDC	○	
Rated input current		Approx. 3mA/Approx. 7mA	Approx. 3mA/Approx. 7mA	○	
Operating voltage range		10.2 to 26.4VDC (ripple ratio within 5%)	10.2 to 26.4VDC (ripple ratio within 5%)	○	
Maximum number of simultaneous input points		60% (10 points/common) simultaneously ON	60% (10 points/common) simultaneously ON	○	
ON voltage/ON current		9.5VDC or more/2.6mA or more	9.5VDC or more/2.6mA or more	○	
OFF voltage/OFF current		6VDC or less/1.0mA or less	6VDC or less/1.0mA or less	○	
Input resistance		Approx. 3.4k Ω	Approx. 3.3k Ω	○	
Input form		Sink input (Input current flows off.)	Sink input (Input current flows off.)	○	
Response time	OFF → ON	10ms or less (6ms TYP.)	5ms or less (1ms TYP.)	△	In combination with CC-Link input module: 6.5ms or less (2ms TYP.) ^{*1}
	ON → OFF	10ms or less (7.5ms TYP.)	5ms or less (1ms TYP.)	△	In combination with CC-Link input module: 6.5ms or less (2ms TYP.) ^{*1}
Common terminal arrangement		16 points/common (Common terminal: TB17, TB34)	16 points/common (Common terminal: TB17, TB34)	○	
Operation indication		Available (Turning ON the input turns LED ON)	None	△	Operation indication can be checked with the CC-Link input module.

○: Compatible, △: Partially changed, ×: Incompatible

Specifications		AJ35PTF-56DS output specifications	SC-A0JQIF56DS output specifications	Compatibility	Precautions for replacement
Number of input points		24 points	24 points	○	
Insulation method		Photocoupler	Photocoupler	○	
Rated load voltage		100 to 240VAC, 40 to 70Hz	100 to 240VAC, 47 to 63Hz	△	The available frequency range is small.
Maximum load voltage		264VAC	264VAC	○	
Maximum load current		0.6A/point, 2.4A/common	0.6A/point, 2.4A/common	○	
Minimum load voltage/current		24VAC 100mA, 100V/240VAC 10mA,	24VAC 100mA, 100V/240VAC 10mA,	○	
Maximum inrush current		20A 10ms or less, 8A 100ms or less	20A 10ms or less, 8A 100ms or less	○	
Leakage current at OFF		1.5mA (120VAC, 60Hz) 3mA (240VAC, 60Hz)	1.5mA (120VAC, 60Hz) 3mA (240VAC, 60Hz)	○	
Maximum voltage drop at ON		1.5V or less (0.1 to 0.6A) 1.8V or less (0.1A or less) 2.0V or less (10 to 50mA)	1.5V or less (0.1 to 0.6A) 1.8V or less (0.1A or less) 2.0V or less (10 to 50mA)	○	
Temperature derating		None	Refer to the derating chart.*2	△	Use the module within the range in the derating chart.
Response time	OFF → ON	1ms or less	1ms or less	△	In combination with CC-Link output module: 2ms or less*3
	ON → OFF	0.5 cycle + 1ms or less	0.5 cycle + 1ms or less	△	In combination with CC-Link output module: 0.5 cycle + 2ms or less*3
Fuse		High speed type fuse 3.2A (one fuse/common) HP-32	None	×	Install a fuse externally from the module (one fuse/common). (A fuse and fuse holder are included.)
Fuse blown indication		Available (When a fuse is blown, the LED turns on and a signal is output to the CPU.)	—	—	
Surge suppressor	CR absorber	0.022 μF + +47 Ω	0.015 μF + +22 Ω	○	
	Varistor	None	Varistor voltage (400 to 540V)	○	
Common terminal arrangement		8 points/common (Common terminal: TB9, TB19, TB29)	8 points/common (Common terminal: TB9, TB19, TB29)	○	
Operation indication		Available (Turning ON the input turns LED ON)	None	△	Operation indication can be checked with the CC-Link output module.

○: Compatible, △: Partially changed, ×: Incompatible

Specifications		AJ35PTF-56DS	SC-A0JQIF56DS	Compatibility	Precautions for replacement
External power supply (Module power supply)	Voltage	15.6 to 31.2VDC	24VDC ± 10% Ripple voltage 4Vp-p or less	△	To deliver a power for CC-Link I/O module operation, connecting a module power supply to TB35 and TB36 of the interface module is required.
	Current	230mA	570mA	△	The current consumption increases. The current capacity needs to be reconsidered.
External connection method		36-point terminal block connector (M3 × 6 screws)	36-point terminal block connector (M3 × 6 screws)	○	
Applicable wire size		0.75 to 2mm ² (Applicable tightening torque 69N·cm)	0.75 to 2mm ² (Applicable tightening torque 69N·cm)	○	
Applicable solderless terminal		1.25-3, 1.25-YS3A, 2-S3, 2-YS3A, V1.25-3, V1.25-YS3A, V2-S3, V2-YS3A	1.25-3, 1.25-YS3A, 2-S3, 2-YS3A, V1.25-3, V1.25-YS3A, V2-S3, V2-YS3A	○	
Number of occupied stations		8 stations (8 stations × 8 points)	—	—	When using the AJ65SBTCF1-32D and AJ65SBTCF1-32T, the number of occupied stations is 2 stations (When using CC-Link, it is 1 station × 32 points).
Weight		1.06kg	0.61kg	△	Also consider the weight of the fixed stand of programmable controller.*4
External dimensions		250(H) × 190(W) × 41(D) mm	182(H) × 190(W) × 41(D) mm ^{*5}	×	Check the dimensions since they depend on the installation type (building-up/horizontal/separate type).

*1 A value when the AJ65SBTCF1-32D is used.

*2 Temperature derating chart

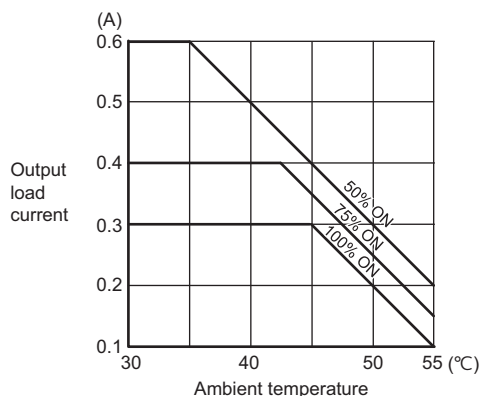

*3 A value when the AJ65SBTCF1-32T is used.

*4 The weight of the fixed stand of programmable controller depends on replacement type of renewal tool for A0J2.

*5 The external dimensions of the SC-A0JQIF56DS do not include those of its projection.

(15) Specifications comparison between AJ35PTF-56DT and interface module (SC-A0JQIF56DT)

○: Compatible, △: Partially changed, ×: Incompatible

Specifications		AJ35PTF-56DT input specifications	SC-A0JQIF56DT input specifications	Compatibility	Precautions for replacement
Number of input points		32 points	32 points	○	
Insulation method		Photocoupler	Photocoupler	○	
Rated input voltage		12VDC/24VDC	12VDC/24VDC	○	
Rated input current		Approx. 3mA/Approx. 7mA	Approx. 3mA/Approx. 7mA	○	
Operating voltage range		10.2 to 31.2VDC (Ripple ratio within 5%)	10.2 to 26.4VDC (Ripple ratio within 5%)	△	The operating voltage range differs.
Maximum number of simultaneous input points		60% (10 points/common) simultaneously ON	60% (10 points/common) simultaneously ON	○	
ON voltage/ON current		9.5VDC or more/2.6mA or more	9.5VDC or more/2.6mA or more	○	
OFF voltage/OFF current		6VDC or less/1.0mA or less	6VDC or less/1.0mA or less	○	
Input resistance		Approx. 3.4kΩ	Approx. 3.3kΩ	○	
Input form		Sink input (Input current flows off.)	Sink input (Input current flows off.)	○	
Response time	OFF→ON	10ms or less (6ms TYP.)	5ms or less (1ms TYP.)	△	In combination with CC-Link input module: 6.5ms or less (2.5ms TYP.) ^{*1}
	ON→OFF	10ms or less (7.5ms TYP.)	5ms or less (1ms TYP.)	△	In combination with CC-Link input module: 6.5ms or less (2.5ms TYP.) ^{*1}
Common terminal arrangement		16 points/common (Common terminal: TB17, TB34)	16 points/common (Common terminal: TB17, TB34)	○	
Operation indication		Available (Turning ON the input turns LED ON)	None	△	Operation indication can be checked with CC-Link input module.

○: Compatible, △: Partially changed, ×: Incompatible

Specifications		AJ35PTF-56DT output specifications	SC-A0JQIF56DT output specifications	Compatibility	Precautions for replacement
Number of output points		24 points	24 points	○	
Insulation method		Photocoupler	Photocoupler	○	
Rated load voltage		12VDC/24VDC	12VDC/24VDC	○	
Operating load voltage range		10.2 to 31.2VDC	10.2 to 30VDC	△	The operating load voltage range differs.
Maximum load current		0.5A/point, 3.2A/common	0.5A/point, 4A/common	○	
Maximum inrush current		4A 10ms or less	4A 10ms or less	○	
Leakage current at OFF		0.1mA or less	0.1mA or less	○	
Maximum voltage drop at ON		0.9VDC (TYP.) 0.5A 1.5VDC (MAX.) 0.5A	0.5VDC (TYP.) 0.5A 0.8VDC (MAX.) 0.5A	○	
Output method		Sink type	Sink type	○	
Response time	OFF→ON	2ms or less	1ms or less	△	In combination with CC-Link output module: 1.5ms or less ^{*2}
	ON→OFF	2ms or less (Resistance load)	1ms or less (Resistance load)	△	In combination with CC-Link output module: 2.5ms or less (Resistance load) ^{*2}
External supply power	Voltage	12VDC/24VDC (10.2 to 31.2VDC)	12VDC/24VDC (10.2 to 30VDC)	△	The operating voltage range differs.
	Current	23mA (TYP. 24VDC 8 points/common ON)	5mA (TYP. 24VDC 8 points/common ON)	○	
Surge suppressor		Varistor (52 to 62V)	Varistor (50.4 to 61.6V)	○	
Common terminal arrangement		8 points/common (Common terminal: TB9, TB19, TB29)	8 points/common (Common terminal: TB9, TB19, TB29)	○	
Operation indication		Available (Turning ON the output turns LED ON)	None	△	Operation indication can be checked with CC-Link output module.
Fuse		None	None	○	
Fuse blown indication		None	None	○	

○: Compatible, △: Partially changed, ×: Incompatible

Specifications		AJ35PTF-56DT	SC-A0JQIF56DT	Compatibility	Precautions for replacement
External supply power (Module power supply)	Voltage	15.6 to 31.2VDC	24VDC ± 10% Ripple voltage 4Vp-p or less	△	To deliver a power for programmable controller operation, connecting a module power supply to the interface module, TB35 or TB36 is required.
	Current	160mA	260mA	△	The current consumption increases. The current capacity needs to be reconsidered.
External connection method		36-point terminal block connector (M3 × 6 screws) 2 pieces	36-point terminal block connector (M3 × 6 screws) 2 pieces	○	
Applicable wire size		0.75 to 2mm ² (Applicable tightening torque 69N·cm)	0.75 to 2mm ² (Applicable tightening torque 69N·cm)	○	
Applicable solderless terminal		R1.25-3, R2-3, RAV1.25-3, RAV2-3	1.25-3, 1.25-YS3A, 2-S3, 2-YS3A, V1.25-3, V1.25-YS3A, V2-S3, V2-YS3A	○	
Number of occupied stations (number of occupied points)		8 stations (8 stations × 8 points)	–	–	When using the AJ65SBTCF1-32D and AJ65SBTCF1-32T, the number of occupied stations is 2 stations (When using CC-Link, it is 1 station × 32 points).
Weight		1.09kg	0.49kg	△	Also consider the weight of fixed stand of programmable controller.*3
External dimensions		250(H) × 190(W) × 41(D)mm*4	182(H) × 190(W) × 41(D)mm*5	×	Check the dimensions since they depend on the installation type (building-up/horizontal/separate type).

*1: A value when using the AJ65SBTCF1-32D.

*2: A value when using the AJ65SBTCF1-32T.

*3: The weight of fixed stand of programmable controller depends on replacement type of renewal tool for A0J2.

*4: External dimensions of the AJ35PTF-56DT does not include dimensions of the optical fiber cable connector.

*5: The external dimensions of the SC-A0JQIF56DT do not include those of its projection.

Appendix 3 Related Manuals

Appendix 3.1 Replacement handbooks

(1) Renewal catalogue

No.	Manual Name	Manual Number	Model Code
1	MELSEC-A/QnA Series Transition Guide	L08077E	–
2	MELSEC-AnS/QnAS (Small Type) Series Transition Guide	L08236E	–

(2) Handbook for transition

No.	Manual Name	Manual Number	Model Code
1	Transition from MELSEC-A/QnA (Large Type) Series to Q Series Handbook (Fundamentals)	L08043ENG	–
	Transition from MELSEC-AnS/QnAS (Small Type) Series to Q Series Handbook (Fundamentals)	L08219ENG	–
	Transition from MELSEC-AnS/QnAS (Small Type) Series to L Series Handbook (Fundamentals)	L08258ENG	–
2	Transition from MELSEC-A/QnA (Large Type) Series to Q Series Handbook (Intelligent Function Modules)	L08046ENG	–
	Transition from MELSEC-AnS/QnAS (Small Type) Series to Q Series Handbook (Intelligent Function Modules)	L08220ENG	–
	Transition from MELSEC-AnS/QnAS (Small Type) Series to L Series Handbook (Intelligent Function Modules)	L08259ENG	–
3	Transition from MELSEC-A/QnA (Large Type), AnS/QnAS (Small Type) Series to Q Series Handbook (Network Modules)	L08048ENG	–
	Transition from MELSEC-AnS/QnAS (Small Type) Series to L Series Handbook (Network Modules)	L08260ENG	–
4	Transition from MELSEC-A/QnA (Large Type), AnS/QnAS (Small Type) Series to Q Series Handbook (Communications)	L08050ENG	–
	Transition from MELSEC-AnS/QnAS (Small Type) Series to L Series Handbook (Communications)	L08261ENG	–
5	Transition from MELSEC-A0J2H Series to Q Series Handbook	L08060ENG	–
6	Transition from MELSECNET/MINI-S3, A2C(I/O) to CC-Link Handbook	L08061ENG	–
7	Transition from MELSEC-I/OLINK to CC-Link/LT Handbook	L08062ENG	–
8	Transition from MELSEC-I/OLINK to AnyWire DB A20 Handbook	L08263ENG	–
9	Transition of CPUs in MELSEC Redundant System Handbook (Transition from Q4ARCPU to QnPRHCPU)	L08117ENG	–

(3) Renewal examples

No.	Manual Name	Manual Number	Model Code
1	MELSEC-A/QnA (Large), AnS/QnAS (Small) Transition Examples	L08121E	–

Appendix 3.2 MELSECNET/MINI-S3

No.	Manual Name	Manual Number	Model Code
1	MELSECNET/MINI-S3 Master Module Type AJ71PT32-S3, AJ71T32-S3, A1SJ71PT32-S3, A1SJ71T32-S3 User's Manual	IB-66565	13JE64
2	Type A2CCPU(P21/R21), A2CCPU-DC24V, A2CCPUC24(-PRF), A2CJCPU User's Manual	IB-66545	13JE85
3	A2C, MELSECNET/MINI-S3 I/O MODULE User's Manual	SH-3546	13JL00
4	Analog-Digital Converter Module type A68ADC User's Manual	IB-66247	13J782
5	Digital-Analog Converter Module type A64DAVC/A64DAIC User's Manual	IB-66248	13J783
6	Pt100 input module type A64RD3C/4C User's Manual	IB-66312	13J671
7	High Speed Counting Module type AD61C User's Manual	IB-66246	13J779
8	High speed counter unit type AD62C User's Manual	IB-66400	13JE17
9	RS-232C interface unit type AJ35PTF-R2 User's Manual	IB-66219	13J771
10	Operating boxes type AJ35PT-OPB-M1/AJ35T-OPB-P1 User's Manual	IB-66218	13J770
11	Transmission converter unit type AJ35PTC(PP)-CNV-(SI/GI) User's Manual	IB-66349	13J669

Appendix 3.3 CC-Link

No.	Manual Name	Manual Number	Model Code
1	Open Field Network CC-Link, CC-Link/LT Catalog	L-08038E	-
2	CC-Link and CC-Link/LT Compatible Product databook	L-08039E	-
3	MELSEC-Q CC-Link System Master/Local Module User's Manual	SH-080394E	13JR64
4	MELSEC-L CC-Link System Master/Local Module User's Manual	SH-080895ENG	13JZ41
5	CC-Link System Compact Type Remote I/O Module User's Manual	SH-4007	13JL72
6	CC-Link System Remote I/O Module User's Manual	IB-66728	13J878
7	MELSECNET/MINI-S3 - CC-Link Module Wiring Conversion Adapter User's Manual A6ADP-1MC16D/A6ADP-1MC16T/A6ADP-2MC16D	IB-0800373	13JY20
8	AJ65BT-64AD Analog-Digital Converter Module User's Manual	SH-3614	13J893
9	Analog-Digital Converter Module type AJ65BT-64AD User's Manual	SH-080106	13JR18
10	Analog-Digital Converter Module Type AJ65SBT2B-64AD User's Manual	SH-080979ENG	13JZ57
11	Analog-Digital Converter Module type AJ65VBTCU-68ADV/N/ADIN User's Manual	SH-080401E	13JR65
12	Digital-Analog Conversion Module type AJ65BT-64DAV/DAI User's Manual	SH-3615	13J895
13	Digital-Analog Converter Module type AJ65SBT-62DA User's Manual	SH-080107	13JR19
14	Digital-Analog Converter Module Type AJ65SBT2B-64DA User's Manual	SH-080768ENG	13JZ19
15	Digital-Analog Converter Module type AJ65VBTCU-68DAVN User's Manual	SH-080402E	13JR66
16	Pt 100 Temperature Input Module Type AJ65BT-64RD3/AJ65BT-64RD4 User's Manual	SH-4001	13JL54
17	RTD Input Module Type AJ65SBT2B-64RD3 User's Manual	SH-080770ENG	13JZ21
18	High-Speed Counter Module type AJ65BT-D62/AJ65BT-D62D/AJ65BT-D62D-S1 User's Manual	IB-66823	13JL45
19	CC-Link System RS-232 Interface Module User's Manual (Nonprocedural Protocol Mode) (AJ65BT-R2N)	SH-080685ENG	13JZ00
20	CC-Link System RS-232 Interface Module User's Manual (MELSOFT Connection Mode) (AJ65BT-R2N)	SH-080687ENG	13JZ01
21	CC-Link System Repeater Optical Repeater Module User's Manual AJ65SBT-RPS/AJ65SBT-RPG	IB-0800089	13JQ85

Appendix 3.4 Products manufactured by Mitsubishi Electric Engineering Co., Ltd.

No.	Catalog name	Catalog Number
1	Programmable Controller Upgrade Tool General Catalog	SAN C044-068R

Appendix 3.5 Products manufactured by Mitsubishi Electric System & Service Co., Ltd.

No.	Data/catalog	Number
1	Renewal tool for A0J2 series Transition from MELSEC-A0J2(H) series to renewal system using renewal tool	X903071003
2	Replace A0J2(H) system with Q series using existing wiring!	X900707-115

Memo

WARRANTY

Please confirm the following product warranty details before using this product.

1. Gratis Warranty Term and Gratis Warranty Range

If any faults or defects (hereinafter "Failure") found to be the responsibility of Mitsubishi occurs during use of the product within the gratis warranty term, the product shall be repaired at no cost via the sales representative or Mitsubishi Service Company.

However, if repairs are required onsite at domestic or overseas location, expenses to send an engineer will be solely at the customer's discretion. Mitsubishi shall not be held responsible for any re-commissioning, maintenance, or testing on-site that involves replacement of the failed module.

[Gratis Warranty Term]

The gratis warranty term of the product shall be for one year after the date of purchase or delivery to a designated place. Note that after manufacture and shipment from Mitsubishi, the maximum distribution period shall be six (6) months, and the longest gratis warranty term after manufacturing shall be eighteen (18) months. The gratis warranty term of repair parts shall not exceed the gratis warranty term before repairs.

[Gratis Warranty Range]

- (1) The range shall be limited to normal use within the usage state, usage methods and usage environment, etc., which follow the conditions and precautions, etc., given in the instruction manual, user's manual and caution labels on the product.
- (2) Even within the gratis warranty term, repairs shall be charged for in the following cases.
 1. Failure occurring from inappropriate storage or handling, carelessness or negligence by the user. Failure caused by the user's hardware or software design.
 2. Failure caused by unapproved modifications, etc., to the product by the user.
 3. When the Mitsubishi product is assembled into a user's device, Failure that could have been avoided if functions or structures, judged as necessary in the legal safety measures the user's device is subject to or as necessary by industry standards, had been provided.
 4. Failure that could have been avoided if consumable parts (battery, backlight, fuse, etc.) designated in the instruction manual had been correctly serviced or replaced.
 5. Failure caused by external irresistible forces such as fires or abnormal voltages, and Failure caused by force majeure such as earthquakes, lightning, wind and water damage.
 6. Failure caused by reasons unpredictable by scientific technology standards at time of shipment from Mitsubishi.
 7. Any other failure found not to be the responsibility of Mitsubishi or that admitted not to be so by the user.

2. Onerous repair term after discontinuation of production

- (1) Mitsubishi shall accept onerous product repairs for seven (7) years after production of the product is discontinued. Discontinuation of production shall be notified with Mitsubishi Technical Bulletins, etc.
- (2) Product supply (including repair parts) is not available after production is discontinued.

3. Overseas service

Overseas, repairs shall be accepted by Mitsubishi's local overseas FA Center. Note that the repair conditions at each FA Center may differ.

4. Exclusion of loss in opportunity and secondary loss from warranty liability

Regardless of the gratis warranty term, Mitsubishi shall not be liable for compensation to:

- (1) Damages caused by any cause found not to be the responsibility of Mitsubishi.
- (2) Loss in opportunity, lost profits incurred to the user by Failures of Mitsubishi products.
- (3) Special damages and secondary damages whether foreseeable or not, compensation for accidents, and compensation for damages to products other than Mitsubishi products.
- (4) Replacement by the user, maintenance of on-site equipment, start-up test run and other tasks.

5. Changes in product specifications

The specifications given in the catalogs, manuals or technical documents are subject to change without prior notice.

The company names, system names and product names mentioned in this manual are either registered trademarks or trademarks of their respective companies.

Programmable Controller

Country/Region	Sales office	Tel/Fax
USA	MITSUBISHI ELECTRIC AUTOMATION, INC. 500 Corporate Woods Parkway, Vernon Hills, IL 60061, U.S.A.	Tel : +1-847-478-2100 Fax : +1-847-478-2253
Mexico	MITSUBISHI ELECTRIC AUTOMATION, INC. Mexico Branch Mariano Escobedo #69, Col. Zona Industrial, Tlalnepantla Edo. Mexico, C.P.54030	Tel : +52-55-3067-7500
Brazil	MITSUBISHI ELECTRIC DO BRASIL COMÉRCIO E SERVIÇOS LTDA. Avenida Adelino Cardana, 293, 21 andar, Bethaville, Barueri SP, Brazil	Tel : +55-11-4689-3000 Fax : +55-11-4689-3016
Germany	MITSUBISHI ELECTRIC EUROPE B.V. German Branch Mitsubishi-Electric-Platz 1, 40882 Ratingen, Germany	Tel : +49-2102-486-0 Fax : +49-2102-486-1120
UK	MITSUBISHI ELECTRIC EUROPE B.V. UK Branch Travellers Lane, Hatfield, Hertfordshire, AL10 8XB, U.K.	Tel : +44-1707-28-8780 Fax : +44-1707-27-8695
Ireland	MITSUBISHI ELECTRIC EUROPE B.V. Irish Branch Westgate Business Park, Ballymount, Dublin 24, Ireland	Tel : +353-1-4198800 Fax : +353-1-4198890
Italy	MITSUBISHI ELECTRIC EUROPE B.V. Italian Branch Centro Direzionale Colleoni-Palazzo Sirio Viale Colleoni 7, 20864 Agrate Brianza(Milano) Italy	Tel : +39-039-60531 Fax : +39-039-6053-312
Spain	MITSUBISHI ELECTRIC EUROPE, B.V. Spanish Branch Carretera de Rubí, 76-80-Apdo. 420, 08190 Sant Cugat del Vallés (Barcelona), Spain	Tel : +34-935-65-3131 Fax : +34-935-89-1579
France	MITSUBISHI ELECTRIC EUROPE B.V. French Branch 25, Boulevard des Bouvets, 92741 Nanterre Cedex, France	Tel : +33-1-55-68-55-68 Fax : +33-1-55-68-57-57
Czech Republic	MITSUBISHI ELECTRIC EUROPE B.V. Czech Branch Avenir Business Park, Radlicka 751/113e, 158 00 Praha5, Czech Republic	Tel : +420-251-551-470 Fax : +420-251-551-471
Poland	MITSUBISHI ELECTRIC EUROPE B.V. Polish Branch ul. Krakowska 50, 32-083 Balice, Poland	Tel : +48-12-347-65-00 Fax : +48-12-630-47-01
Sweden	MITSUBISHI ELECTRIC EUROPE B.V. (Scandinavia) Fjellievägen 8, SE-22736 Lund, Sweden	Tel : +46-8-625-10-00 Fax : +46-46-39-70-18
Russia	MITSUBISHI ELECTRIC (RUSSIA) LLC St. Petersburg Branch Piskarevsky pr. 2, bld 2, lit "Sch", BC "Benuea", office 720; 195027 St. Petersburg, Russia	Tel : +7-812-633-3497 Fax : +7-812-633-3499
Turkey	MITSUBISHI ELECTRIC TURKEY A.Ş Ümraniye Branch Serifali Mah. Kale Sok. No:41 34775 Umraniye - Istanbul, Turkey	Tel : +90-216-969-2500 Fax : +90-216-526-3995
UAE	MITSUBISHI ELECTRIC EUROPE B.V. Dubai Branch Dubai Silicon Oasis, P.O.BOX 341241, Dubai, U.A.E.	Tel : +971-4-3724716 Fax : +971-4-3724721
South Africa	ADROIT TECHNOLOGIES 20 Waterford Office Park, 189 Witkoppen Road, Fourways, South Africa	Tel : +27-11-658-8100 Fax : +27-11-658-8101
China	MITSUBISHI ELECTRIC AUTOMATION (CHINA) LTD. No.1386 Hongqiao Road, Mitsubishi Electric Automation Center, Shanghai, China	Tel : +86-21-2322-3030 Fax : +86-21-2322-3000
Korea	MITSUBISHI ELECTRIC AUTOMATION KOREA CO., LTD. 7F-9F, Gangseo Hangang Xi-tower A, 401, Yangcheon-ro, Gangseo-Gu, Seoul 07528, Korea	Tel : +82-2-3660-9530 Fax : +82-2-3664-8372
Singapore	MITSUBISHI ELECTRIC ASIA PTE. LTD. 307, Alexandra Road, Mitsubishi Electric Building, Singapore 159943	Tel : +65-6473-2308 Fax : +65-6476-7439
Thailand	MITSUBISHI ELECTRIC FACTORY AUTOMATION (THAILAND) CO., LTD. 12th Floor, SV.City Building, Office Tower 1, No. 896/19 and 20 Rama 3 Road, Kwaeng Bangpongpan, Khet Yannawa, Bangkok 10120, Thailand	Tel : +66-2682-6522 Fax : +66-2682-6020
Vietnam	MITSUBISHI ELECTRIC VIETNAM COMPANY LIMITED Hanoi Branch 6th Floor, Detech Tower, 8 Ton That Thuyet Street, My Dinh 2 Ward, Nam Tu Liem District, Hanoi, Vietnam	Tel : +84-4-3937-8075 Fax : +84-4-3937-8076
Malaysia	MITSUBISHI ELECTRIC SALES MALAYSIA SDN. BHD. Lot 11, Jalan 219, 46100 Petaling Jaya, Selangor Darul Ehsan, Malaysia	Tel : +60-3-7626-5000 Fax : +60-3-7658-3544
Indonesia	PT. MITSUBISHI ELECTRIC INDONESIA Gedung Jaya 11th Floor, JL. MH. Thamrin No.12, Jakarta Pusat 10340, Indonesia	Tel : +62-21-3192-6461 Fax : +62-21-3192-3942
India	MITSUBISHI ELECTRIC INDIA PVT. LTD. Pune Branch Emerald House, EL-3, J Block, M.I.D.C., Bhosari, Pune-411026, Maharashtra, India	Tel : +91-20-2710-2000 Fax : +91-20-2710-2100
Australia	MITSUBISHI ELECTRIC AUSTRALIA PTY. LTD. 348 Victoria Road, P.O. Box 11, Rydalmere, N.S.W 2116, Australia	Tel : +61-2-9684-7777 Fax : +61-2-9684-7245

MITSUBISHI ELECTRIC CORPORATION

HEAD OFFICE: TOKYO BLDG., 2-7-3, MARUNOUCHI, CHIYODA-KU, TOKYO 100-8310, JAPAN
NAGOYA WORKS: 1-14, YADA-MINAMI 5-CHOME, HIGASHI-KU, NAGOYA 461-8670, JAPAN