



22 mm Push Button Specifications

Bulletin Numbers 598, 800B, 800F, 800FC, 800FD, 800MB, 800MR

Topic	Page
Bulletin 800F 22.5 mm Push Buttons	3
Specifications	3
Momentary Push Button Operators	7
Alternate Action Operators	10
Pilot Light Operators	11
Selector Switch Operators	12
Key-operated Selector Switches	17
Push-pull Operators	20
Momentary Mushroom Push Buttons	25
Momentary Multi-operator	27
Reset Operators	31
Threaded Reset Rod Reset Operators	31
Single-turn Potentiometer Assembly	32
Key-operated Selector Switch – SensEject	33
Selector Push Button Operators	34
Toggle Switch Operators	35
Back-of-panel Components	36
Plastic and Metal Enclosures	41
Assembled Stations	42
Pendant Stations	45
Accessories	48
Legend Plates/Caps	55
Assembled Station Pin Out Chart	64
Bulletin 598 General-purpose Push Button Enclosures	65
Bulletin 800FC 22.5 mm Configured Pendant Stations	68
Operator Mounting and Sequence	68
Enclosures	68
1-, 2-, and 3-speed Operators	69
800F Selector Switch Operators – Maintained and Non-illuminated	70
800F Multi Operators and Caps – Extended	71
800F Pilot Lights – Monolithic	72
1-, 2-, and 3-speed Contact Block Assemblies	72
800F Potentiometer Operators	72
800F Hole Plug	72
Configured Pendant Stations	73
Accessories	75
Specifications	77
Approximate Dimensions	80
Custom Text Fax/Scan Sheet	81

Topic	Page
Bulletin 800FD 22.5 mm Monolithic Push Buttons	82
Momentary Push Button Operators, Non-illuminated	82
Pilot Light Devices	83
Selector Switch Operators	84
Push-pull/Twist-to-release Mushroom Operators	85
Plastic Enclosures – 1-hole Only	85
Assembled Stations	86
Replacement Parts	86
Specifications	87
Approximate Dimensions	88
Instruction Sheet	89
Bulletin 800B 16 mm Push Buttons	90
Push Button and Pilot Light Operators	90
Lens Cap with Diffuser	90
Selector Switch Operators	91
Emergency Stop Operators	91
Contact Block/Latch Module	92
Replacement Parts and Accessories	92
Specifications	94
Operator Assembly Sequence	95
Approximate Dimensions	96
Bulletin 800MR/MB Oiltight Operators	98
Momentary Contact Push Buttons – 800MR	98
Push-pull and Push-pull/Twist-to-release Units – 800MR	100
Selector Switch Units – 800MR	102
Potentiometer Operator Only – 800MR	107
Pilot Light Units – 800MR	107
Wobble Stick Units – 800MR	108
Momentary Contact Push Button Units – 800MB	108
Dual Operator, Non-illuminated – 800MB	110
Pilot Light Units – 800MB	111
Accessories – Bulletin 800MB/MR	112
Legend Plates – 800MB/MR	116
Specifications	118
Approximate Dimensions – 800MB/MR	119

Summary of Changes

This publication contains the following new or updated information. This list includes substantive updates only and is not intended to reflect all changes.

Topic	Page
Corrected cap colors	7
Updated voltage range for 24V AC/DC selection and added blue and amber operator colors for white LED choice.	36, 37

Bulletin 800F 22.5 mm Push Buttons

Our Bulletin 800F 22 mm round operator family meets demanding performance specifications. We use state-of-the-art solid modeling techniques and finite element analysis to optimize the durability and performance of our push buttons.

800FP Plastic Operators

- IP69K
- IP65/66, Type 4/4X/13
- Engineering grade thermoplastics
- Chemical-resistant for harsh environments



800FM Metal Operators

- IP65/66, Type 4/13
- Die-cast metal construction
- Chrome-plated



3-across x 2-deep Back-of-panel (6 Circuits Max)

- Rugged snap-fit design for plastic or metal latch
- Stackable contact blocks
- Rotating collar for easy one-hand latch removal
- Color-coded contact block plungers for contact identification



Plastic Latch with Contact Block



Metal Latch with Contact Block

Assembly Overview

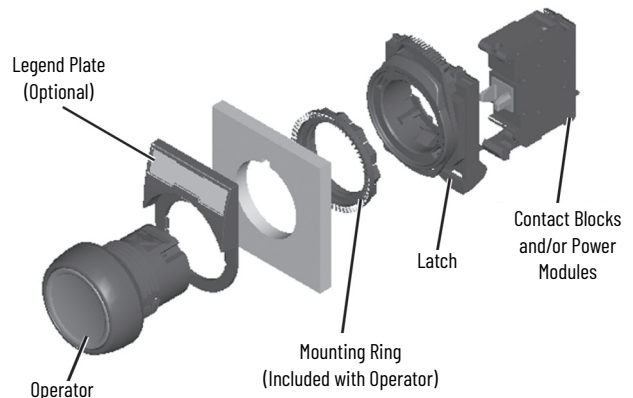

Specifications

Product Certifications

Attribute	Plastic (Bulletin 800FP) and Metal (Bulletin 800FM)
Certifications	UR/UL, CSA, CCC, CE
Standards Compliance – CE Marked	NEMA ICS-5; UL 508, EN ISO 13850, EN 60947-1, EN 60947-5-1, EN 60947-5-5
Terminal Identification	EN/IEC 60947-1
Shipping Approvals	ABS
RoHS	Yes

Front-of-Panel (Operators)

IMPORTANT Performance Data – Performance data that is given in this publication is provided only as a guide for you to determine suitability and does not constitute a performance warranty of any kind. Such data can represent the results of accelerated testing at elevated stress levels, and you are responsible for correlating the data to actual application requirements. ALL WARRANTIES AS TO ACTUAL PERFORMANCE, WHETHER EXPRESS OR IMPLIED, ARE EXPRESSLY DISCLAIMED.

Table 1 - Mechanical Ratings – Operators

Attribute		Plastic (Bulletin 800FP)	Metal (Bulletin 800FM)
Vibration (assembled to panel)		Tested at 10...2000 Hz, 1.52 mm (0.06 in.) displacement (peak-to-peak) max./10 G max. for 3 hr duration, no damage	
Shock		Tested at 1/2 cycle sine wave for 11 ms; no damage at 100 G	
Degree of protection ⁽¹⁾ ⁽²⁾		IP69K ⁽³⁾ and IP65/66 (Type 3/3R/4/4X/12/13)	IP65/66 (Type 3/3R/4/12/13)
Mechanical durability per EN 60947-5-1 (Annex C)	10,000,000 Cycles	Momentary push buttons, momentary mushroom	
	1,000,000 Cycles	Multi-function, selector switch, key selector switch, selector jog, SensEject™ key selector switch	
	500,000 Cycles	Non-illuminated push-pull E-stop ⁽⁴⁾	
	300,000 Cycles	Twist-to-release E-stop, illuminated push-pull E-stop ⁽⁴⁾ , alternate action push buttons	
	100,000 Cycles	Potentiometer, toggle switch	
Operating forces (typical with one contact block)		Flush/extended = 5 N, E-stop = 36 N Mushroom = 9 N	
Operating torque (typical application with one contact block)		Selector switch = 0.25 N•m (2.2 lb•in)	
Mounting torque	Plastic	1.7 N•m (15 lb•in)	
	Metal	4.4 N•m (40 lb•in)	

(1) Momentary mushroom operators are IP65. Plastic keyed operators are IP66, Type 4/13; not Type 4X.

(2) IP65/66 products are compliant to IEC 60529.

(3) IP69K products listed in [Table 2](#) are compliant to ISO 20653 (replaces DIN 40050 Part 9) for IP69K and IEC 60529 for all other IP ratings.

(4) Limit of four contact blocks max for these devices.

Table 2 - IP69K Operators and Assembled Stations

IP69K Rated Operators		IP69K Rated Assembled Stations
<ul style="list-style-type: none"> • 800FD-MT44* • 800FP-F* • 800FP-F* and 800F-AB7 • 800FP-LF* • 800FP-E* • 800FP-E* and 800F-ABE7 • 800FP-LE* • 800FP-FA* • 800FP-LFA* • 800FP-G* • 800FP-P* • 800FP-MT3* • 800FP-MT4* • 800FP-LMT4* • 800FP-MT6* 	<ul style="list-style-type: none"> • 800FP-LMT6* • 800FP-LMP3* • 800FP-MP4* • 800FP-LMP4* • 800FP-MM4* • 800FP-LMM4* • 800FP-MM6* • 800FP-LMP6* • 800FP-MP9* • 800FP-LMP9* • 800FP-U2* • 800FP-LU2* • 800FP-U3* • 800FP-MM9* • 800FP-POT* 	<ul style="list-style-type: none"> • 800F-1YP1 • 800F-1YP2 • 800F-1YP3 • 800F-1YP7 • 800F-1YP8 • 800F-1YM1 • 800F-1YM2 • 800F-1YM3 • 800F-1YM7 • 800F-1YM8 • 800F-1YML1 • 800F-1YML2 • 800F-1YML3 • 800F-1YMD51 • 800F-1YMD52 • 800F-1YMD81
<ul style="list-style-type: none"> • 800F-1YMD and 800F-ALC2 (1 pc) and IP69K rated operators • 800F-2PM and 800F-ALC2 (2 pcs) and IP69K rated operators • 800F-3PM and 800F-ALC2 (3 pcs) and IP69K rated operators • 800F-4PM and 800F-ALC2 (4 pcs) and IP69K rated operators • 800F-6PM and 800F-ALC2 (6 pcs) and IP69K rated operators • 800F-AHA1 • 800F-1YMD51, 800F-1YMD52, and 800F-1YMD81 		

Table 3 - Environmental – Operators

Attribute		Plastic (Bulletin 800FP)	Metal (Bulletin 800FM)
Temperature Range	Operating	-25...+70 °C (-13...+158 °F) ⁽¹⁾	
	Short-term Storage	-40...+85 °C (-40...+185 °F)	
Humidity		≤95% RH from 25...60 °C (77...140 °F)	

(1) Operating temperatures below 0 °C (32 °F) are based on the absence of freezing moisture and liquids, UL Recognized to 55 °C (131 °F) - Incandescent module max. 40 °C (104 °F).

Back-of-panel Components

IMPORTANT Performance Data — Performance data that is given in this publication is provided only as a guide for you to determine suitability and does not constitute a performance warranty of any kind. Such data can represent the results of accelerated testing at elevated stress levels, and you are responsible for correlating the data to actual application requirements. ALL WARRANTIES AS TO ACTUAL PERFORMANCE, WHETHER EXPRESS OR IMPLIED, ARE EXPRESSLY DISCLAIMED.

Table 4 - Electrical Ratings – Back-of-panel Components

Attribute	Screw Termination	Spring Clamp Termination			
Standard Contact Block Ratings	A600, Q600 600V AC	A300, Q300 300V AC			
	AC 15, DC 13 to IEC/EN 60947-5-1 and UL 508, 17V, 5 mA min.				
Low-voltage Contact Block Ratings ⁽¹⁾	5V, 1 mA DC min. C300, R150, AC 15, DC 13 to EN 60947-5-1 and UL 508				
	Lamp Voltage	Voltage Range	Current, Typical	Leakage Current	Frequency
Light-emitting diode (LED) Module Ratings	Universal	24...120V AC/DC	15 mA (AC), 12 mA (DC)	3 mA	50/60 Hz, DC
	24V AC	10...29V AC	31 mA	3 mA	50/60 Hz
	24V DC	10...30V DC	24 mA	3 mA	DC
	120V AC	102...132V DC	6 mA	3 mA	50/60 Hz
	240V AC	204...264V AC	6 mA	3 mA	50/60 Hz
Thermal Current	10 A max. enclosed (40 °C [104 °F] ambient) to UL508, EN 60947-5-1 @ A600				
Insulation Voltage (U _i)	Screw terminal = 690V, spring-clamp = 300V				
Wire Capacity	Screw Terminal ⁽²⁾	#18...12 AWG (0.75...2.5 mm ²); Max. (2) #14 AWG or (1) #12 AWG			
	Spring-clamp terminal	#18...14 AWG (0.75...1.5 mm ²) One per spring clamp, two spring clamps per terminal			
Recommended Tightening Torque on Screw Terminals	0.7...0.9 N•m (6...8 lb•in)				
Dielectric Strength (Minimum)	2500V for 1 minute				
External Short Circuit Protection	Standard blocks	10 A type gL/gG cartridge fuse to EN 60269-2-1 or gN (Class J to UL 248-8 or Class C to UL 248-4)			
	Low-voltage contact blocks	6 A type gL/gG cartridge fuse to EN 60269-2-1 or gN (Class J to UL 248-8 or Class C to UL 248-4)			
Electrical shock protection	Fingersafe conforming to IP2X				

(1) Low-voltage contacts are recommended for applications below 17V, 5 mA.

(2) Wires less than #18 AWG (0.75 mm²) may not hold in terminal securely.

Table 5 - Mechanical Ratings – Back-of-panel Components

Attribute	Value	
Vibration (assembled to panel)	Tested at 10...2000 Hz, 1.52 mm displacement (peak-to-peak) max./10 G max. 6 hr	
Shock	Tested at 1/2 cycle sine wave for 11 ms and no damage at 100 G max.	
Contact durability per EN 60947-5-1 (Annex C)	10,000,000 cycles	
Contact operation	N.O.	Slow double make and break
	N.C. & S.M.C.B.	Slow double make and break – positive opening ⊙
	N.O.E.M.	Double break / double make, early make
	N.C.L.B.	Double break / double make, late break – positive opening ⊙
	N.C.E.B.	Double break / double make, early break – positive opening ⊙
Push button travel to change electrical state	N.C. and N.O.E.M.	1.5 mm (0.060 in.)
	N.O. and N.C.L.B.	2.5 mm (0.1 in.)
Operating forces (typical)	Single-circuit contact block	3.4 N
	Dual-circuit contact block	5...6.5 N

Table 6 - Illumination – Back-of-panel Components

Attribute	Green	Red	White
LED Dominant Wavelength	525 nm	629 nm	–
LED Luminous Intensity	780 mcd	780 mcd	360 mcd
Incandescent maximum wattage	2.6 W		

Table 7 - Materials – Back-of-panel Components

Attribute	Value	
Springs	Stainless steel and zinc coated music wire	
Electrical contacts	Standard	Silver-nickel
	Low-voltage	Gold-plated over silver
Terminals	Screw	Brass
	Spring-clamp	Silver-plated brass

Material Listing

Component	For Use with	Material Used
Panel gasket	All operators	Nitrile, TPE
Diaphragm seal	Illuminated push button, non-illuminated push button	Automotive industry acceptable silicone
K-seal	Selector switch, key selector switch, push/twist-to-release E-stop, key E-stop, push/pull mushroom	Nitrile
Diaphragm retainer, return spring I	Illuminated push button, non-illuminated push button, momentary mushroom	Stainless steel
Return spring II	Reset, selector switch, key selector switch, alternate action, push/twist-to-release E-stop, key E-stop, push/pull mushroom	Zinc-coated music wire
Button cap/mushroom head	Non-illuminated push button, momentary mushroom, reset, push/twist-to-release E-stop, key E-stop, push/pull mushroom, multi-function	PBT/polycarbonate blend
2-color molded button cap	Non-illuminated push button	PBT/polycarbonate blend
Lens	Multi-function	Acetal
Lens, knob	Illuminated push button, illuminated momentary mushroom, illuminated selector switch	Polyamide
Knob	Non-illuminated selector switch	Glass-filled polyamide
Plastic bezel/bushing I	Non-illuminated push button, illuminated push button, momentary mushroom, selector switch, key selector switch, push/twist-to-release E-stop, key E-stop, push/pull mushroom, multi-function, reset	Glass-filled polyamide
Plastic bezel/bushing II, jam nut	Pilot light, reset jam nut, reset pushers	Glass-filled PBT
Metal bezel/bushing	All metal operators	Zinc
Diffuser	Illuminated push button, pilot light	Polycarbonate
Legend frames	–	Glass-filled polyamide
Plastic mounting ring	All plastic operators	Glass-filled polyamide
Metal mounting ring	All metal operators	Chromated zinc
Plastic latch	–	Glass-filled polyamide
Metal latch	–	Chromated zinc + stainless steel
Plastic enclosure	–	PBT/polycarbonate blend
Metal enclosure	–	Aluminum
Terminal screws	LED module, incandescent module, contact blocks	Zinc-plated steel with chromate
Terminals	LED module, incandescent module, contact blocks	Brass with silver-nickel contacts
Spring clamps	LED module, incandescent module, contact blocks	Stainless steel
Lamp socket	Incandescent module	Brass
Housing	Incandescent module, LED module	Glass-filled polyamide
Low-voltage terminals	Contact blocks	Gold-plated silver-nickel contacts
Low-voltage spanner	Contact blocks	Gold-plated silver-nickel contacts
Spanner	Contact blocks	Brass with silver-nickel contacts
Boot	Toggle Switch, illuminated push button, non-illuminated push button, multi-function illuminated and non-illuminated	Automotive industry acceptable silicone

Momentary Push Button Operators

Non-illuminated – Flush, Extended, Guarded



Flush Operator
Cat. No. 800FP-F3



Extended Operator
Cat. No. 800FM-E4



Guarded Operator
Cat. No. 800FP-G6

Color	Package Quantity	Flush		Extended	
		Plastic	Metal	Plastic	Metal
		Cat. No.	Cat. No.	Cat. No.	Cat. No.
Black	1	800FP-F2	800FM-F2	800FP-E2	800FM-E2
Green		800FP-F3	800FM-F3	800FP-E3	800FM-E3
Red		800FP-F4	800FM-F4	800FP-E4	800FM-E4

800F $\frac{P}{a}$ - $\frac{F}{b}$ $\frac{3}{c}$ - $\frac{d}{d}$

a	
Operator Construction	
Code	Description
P	Round plastic operator (IP69K; IP66, Type 4/4X/13)
M	Round metal operator (IP66, Type 4/13)

b	
Operator Type	
Code	Description
F	Flush
E	Extended
G	Guarded

c	
Color Cap	
Code	Description
0	Orange
1	White
2	Black
3	Green
4	Red
5	Yellow
6	Blue
8	Gray ⁽¹⁾
9	No cap
X	Assortment pack ⁽²⁾

d	
Packaging	
Code	Description
Blank	1 per package
BP	10 per package ⁽³⁾

- (1) Available in flush only.
- (2) Assortment pack contains one cap of each color, not available in BP packaging.
- (3) Only available with no color cap (option 9 from Table c).

Non-illuminated – with Two-color Molded Legend Caps



Flush Operator
Cat. No. 800FP-F301

Button Color	Text Color	Legend Text	Package Quantity	Flush		Extended	
				Plastic	Metal	Plastic	Metal
				Cat. No.	Cat. No.	Cat. No.	Cat. No.
Green	White	START	1	800FP-F301	800FM-F301	–	–
		I		800FP-F306	800FM-F306	–	–
Red	White	STOP		800FP-F402	800FM-F402	800FP-E402	800FM-E402
		O		–	–	800FP-E405	800FM-E405
Black	White	→		800FP-F208	800FM-F208	800FP-E208	800FM-E208

800F P - F 3 01
 a b c d

a	
Operator Construction	
Code	Description
P	Round plastic operator (IP69K; IP66, Type 4/4X/13)
M	Round metal operator (IP66, Type 4/13)

b	
Operator Type	
Code	Description
F	Flush
E	Extended
G	Guarded

c	
Color Cap	
Code	Description
0	Orange
1	White
2	Black
3	Green
4	Red
5	Yellow
6	Blue

d	
Legend Text (1) (2) (3) (4)	
Code	Description
Blank	No Text
01	START
02	STOP
05	O
06	I
08	→
09	Forward ⁽⁵⁾
10	Reverse ⁽⁵⁾
11	R

- (1) For custom laser-engraved legend cap, consult your local Rockwell Automation sales office or Allen-Bradley distributor.
 (2) White and yellow caps have black text. All other color caps have white text.
 (3) Legend button cap supplied loose for customer installation.
 (4) For valid combinations, see [Table 8](#).
 (5) Available for flush only.

Table 8 - Valid Color Cap/Legend Text Codes

Color	Text	
	Flush Caps	Extended Caps
White	FORWARD, REVERSE, START, I, →, R	→, R
Black	FORWARD, REVERSE, →, R	STOP, O, →, R
Green	FORWARD, REVERSE, START, I, →	→
Red	FORWARD, REVERSE, STOP, O, →	STOP, O, →
Yellow	FORWARD, REVERSE, →	→
Blue	FORWARD, REVERSE, →, R	→, R

Illuminated – Flush, Extended, Guarded



Flush Operator
Cat. No. 800FM-LF4



Extended Operator
Cat. No. 800FP-LE3



Guarded Operator
Cat. No. 800FP-LG3

Color	Package Quantity	Flush		Extended	
		Plastic	Metal	Plastic	Metal
		Cat. No.	Cat. No.	Cat. No.	Cat. No.
Green	1	800FP-LF3	800FM-LF3	800FP-LE3	800FM-LE3
Red		800FP-LF4	800FM-LF4	800FP-LE4	800FM-LE4
Yellow		800FP-LF5	800FM-LF5	800FP-LE5	800FM-LE5
Clear		800FP-LF7	800FM-LF7	800FP-LE7	800FM-LE7

800F $\frac{P}{a}$ - $\frac{LE}{b}$ $\frac{3}{c}$ - $\frac{\quad}{d}$

a Operator Construction	
Code	Description
P	Round plastic operator (IP69K; IP66, Type 4/4X/13)
M	Round metal operator (IP66, Type 4/13)

b Operator Type	
Code	Description
F	Flush
E	Extended
G	Guarded

c Color Cap ⁽¹⁾	
Code	Description
0	Amber ⁽²⁾
3	Green
4	Red
5	Yellow ⁽²⁾
6	Blue ⁽²⁾
7	Clear
9	No cap

d Packaging	
Code	Description
Blank	1 per package
BP	10 per package ⁽³⁾

- (1) For custom laser-engraved operator, consult your local Rockwell Automation sales office or Allen-Bradley distributor.
- (2) When using LED for illumination, a white LED is recommended.
- (3) Only available with no color cap (9 from Table c).

Push-to-test Push Button Device Schematic

Illuminated push buttons can be wired as a push-to-test device by using the following schematic and a catalog number 800F-XD7 diode module (see [page 52](#)).

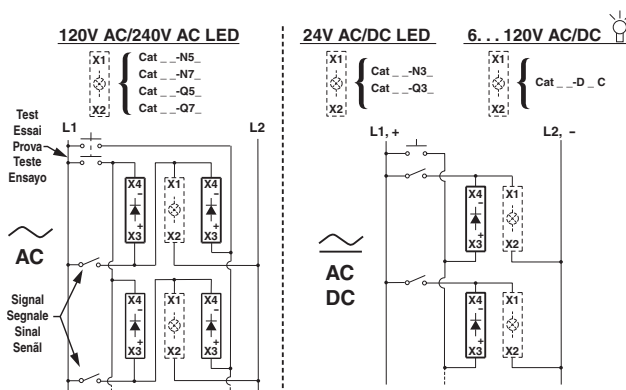

Approximate Dimensions – Momentary Operators

Dimensions in millimeters (inches). Dimensions are not intended to be used for manufacturing purposes.

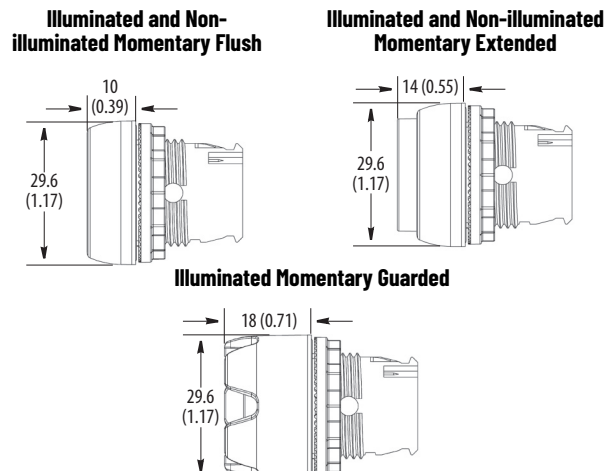

Alternate Action Operators

Non-illuminated

800F M - FA 3
 a b c



Cat. No. 800FM-FA3

a	
Operator Construction	
Code	Description
P	Round plastic operator (IP69K; IP66, Type 4/4X/13)
M	Round metal operator (IP66, Type 4/13)

b	
Operator Type ⁽¹⁾	
Code	Description
FA	Non-illuminated, flush, alternate action

c	
Lens Cap Color ⁽²⁾	
Code	Description
0	Orange
1	White
2	Black
3	Green
4	Red
5	Yellow
6	Blue
9	No cap
X	Assortment pack ⁽³⁾

- (1) Must use N.O.E.M. or N.C. contacts.
- (2) For custom laser-engraved legend cap, consult your local Rockwell Automation sales office or Allen-Bradley distributor.
- (3) Assortment pack contains one each of cap colors white, black, green, red, yellow, and blue.

Illuminated

800F P - LFA 3
 a b c



Cat. No. 800FP-LFA3

a	
Operator Construction	
Code	Description
P	Round plastic operator (IP69K; IP66, Type 4/4X/13)
M	Round metal operator (IP66, Type 4/13)

b	
Operator Type ^{(1) (2)}	
Code	Description
LFA	Illuminated, flush, alternate action

c	
Color Cap ⁽³⁾	
Code	Description
0	Amber ⁽⁴⁾
3	Green
4	Red
5	Yellow ⁽⁴⁾
6	Blue ⁽⁴⁾
7	Clear
9	No cap

- (1) Must use N.O.E.M. or N.C. contacts.
- (2) LED module is required for illumination, cannot use incandescent module.
- (3) For custom laser-engraved legend cap, consult your local Rockwell Automation sales office or Allen-Bradley distributor.
- (4) Use of a white LED is recommended.

Approximate Dimensions

Dimensions in millimeters (inches). Dimensions are not intended to be used for manufacturing purposes.

Non-illuminated Guarded, Illuminated, and Non-illuminated Alternate Action Push Button Operators

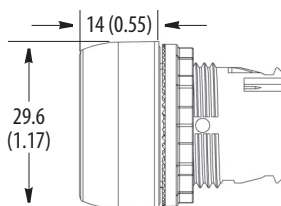

Pilot Light Operators



Plastic Pilot Light
Cat. No. 800FP-P7



Metal Pilot Light
Cat. No. 800FM-P4

Color	Package Quantity	Plastic	Metal
		Cat. No.	Cat. No.
Green	1	800FP-P3	800FM-P3
Red		800FP-P4	800FM-P4
Yellow		800FP-P5	800FM-P5

800F P - P 3 -
 a b c d

a	
Operator Construction	
Code	Description
P	Round plastic operator (IP69K; IP66, Type 4/4X/13)
M	Round metal operator (IP66, Type 4/13)

b	
Operator Type	
Code	Description
P	Diffuser

c	
Lens Color ⁽¹⁾	
Code	Description
0	Amber ⁽²⁾
3	Green
4	Red
5	Yellow ⁽²⁾
6	Blue ⁽²⁾
7	Clear
9	No cap

d	
Packaging	
Code	Description
Blank	1 per package
BP	10 per package ⁽³⁾

- (1) For custom laser-engraved operator, consult your local Rockwell Automation sales office or Allen-Bradley distributor.
- (2) When using LED for illumination, a white LED is recommended.
- (3) Only available with no color cap (Code 9 from Table c).

Approximate Dimensions

Dimensions in millimeters (inches). Dimensions are not intended to be used for manufacturing purposes.

Pilot Light Operators

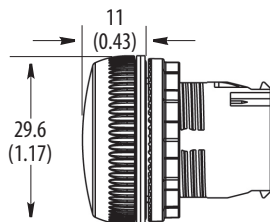

Selector Switch Operators

2-position, Non-illuminated





Standard Knob
Cat. No. 800FP-SM22



Knob Lever
Cat. No. 800FP-HM22

Switching Angle





Table 9 - Target Table and Operator Position ⁽¹⁾

Contact Type ⁽²⁾			
N.O.	0	X	
N.C.	X	0	

(1) Target table for spring return from left is reversed from what is shown in the table.

(2) Contact selection is limited to the following options, consult your local Rockwell Automation sales office or Allen-Bradley distributor for other options.



Note: X = Closed / 0 = Open

Color	Operator Type		Package Quantity	Standard Knob	
				Plastic	Metal
				Cat. No.	Cat. No.
Black with White Insert	Maintained (60° switching angle) 		1	800FP-SM22	800FM-SM22

800F P - S M2 2 - -
 a b c d e f

a	
Operator Construction	
Code	Description
P	Round plastic operator (IP66, Type 4/4X/13)
M	Round metal operator (IP66, Type 4/13)

b	
Operator Type	
Code	Description
S	Standard knob
H	Knob lever ⁽¹⁾

c	
Operator Function	
Code	Type
M2	Maintained (60° switching angle) 
L2	Spring return from left (60° switching angle) 
R2	Spring return from right (60° switching angle) 

d		
Knob/Insert Color		
Code	Knob Color	Insert Color
2	Black	White

e	
Orientation	
Code	Description
Blank	Standard
N	90° offset ⁽²⁾

f	
Packaging	
Code	Description
Blank	1 per package
BP	10 per package ⁽³⁾

(1) 30 mm hole spacing does not work if knob lever is used. See [page 47](#) for recommended operator panel spacing.

(2) For use in vertical mount Bulletin 800F enclosures.

(3) Not available with 90° offset orientation.

2-position, Illuminated



IMPORTANT Crevices can exist on product that make it unsuitable for certain applications. Consult your local Rockwell Automation sales office or Allen-Bradley distributor.



Standard Knob
Cat. No. 800FP-LSM26

Switching Angle

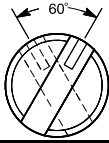

Table 10 - Target Table and Operator Position ⁽¹⁾

Contact Type ⁽²⁾			
N.O.	0	X	
N.C.	X	0	

(1) Target table for spring return from left is reversed from what is shown in the table.

(2) Contact selection is limited to the following options, consult your local Rockwell Automation sales office or Allen-Bradley distributor for other options.



Note: X = Closed / 0 = Open

Color	Operator Type		Package Quantity	Standard Knob	
				Plastic	Metal
	Maintained (60° switching angle) 			Cat. No.	Cat. No.
Green			1	800FP-LSM23	800FM-LSM23
Red				800FP-LSM24	800FM-LSM24
Yellow				800FP-LSM25	800FM-LSM25

800F P - LS M2 3 _____
 a b c d e

a	
Operator Construction	
Code	Description ⁽¹⁾
P	Round plastic operator (IP66, Type 4/4X/13)
M	Round metal operator (IP66, Type 4/13)

b	
Operator Type	
Code	Description
LS	Standard knob
LH	Knob lever ⁽³⁾

c	
Operator Function	
Code	Type
M2	Maintained (60° switching angle) 
L2	Spring return from left (60° switching angle) 
R2	Spring return from right (60° switching angle) 

d		
Knob/Insert Color		
Code	Knob Color	Insert Color
0	Amber ⁽²⁾	White
3	Green	White
4	Red	White
5	Yellow ⁽²⁾	Black
6	Blue ⁽²⁾	White
7	Clear	Black

e	
Orientation	
Code	Description
Blank	Standard
N	90° offset ⁽⁴⁾

(1) LED module is required for illumination.

(2) Use of a white LED is recommended.

(3) Only available in clear.

(4) For use in vertical mount enclosures.

3-position, Non-illuminated



Standard Knob
Cat. No. 800FP-SM32



Knob Lever
Cat. No. 800FM-HM32

Switching Angle

Table 11 - Target Table and Operator Position (60° Switching Angle)

Contact Type ⁽¹⁾	Position on Mounting Latch			
N.O.	Left	X	0	0
	Right	0	0	X
	Center	X	0	X
	Center CL ⁽²⁾	X	0	0
	Center CR ⁽²⁾	0	0	X
N.C.	Left	0	X	X
	Right	X	X	0
	Center	0	X	0
	Center CL ⁽²⁾	0	X	X
	Center CR ⁽²⁾	X	X	0

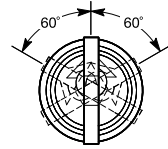

- (1) Contact selection is limited to the following options, consult your local Rockwell Automation sales office or Allen-Bradley distributor for other options.
 (2) The center contact block can have the same target output as the left or right contact block, by specifying center left (CL) or center right (CR) option.
Note: X = Closed / 0 = Open

Color	Operator Type			Package Quantity	Standard Knob		Knob Lever	
					Plastic	Metal	Plastic	Metal
	Cat. No.	Cat. No.	Cat. No.		Cat. No.	Cat. No.	Cat. No.	Cat. No.
Black with White Insert	Maintained			1	800FP-SM32	800FM-SM32	800FP-HM32	800FM-HM32
	Spring return from left and right				800FP-SB32	800FM-SB32	800FP-HB32	800FM-HB32

800F P - S M3 2 _____
 a b c d e f

a	
Operator Construction	
Code	Description
P	Round plastic operator (IP66, Type 4/4X/13)
M	Round metal operator (IP66, Type 4/13)

b	
Operator Type	
Code	Description
S	Standard knob
H	Knob lever ⁽¹⁾

c	
Operator Function	
Code	Type
M3	Maintained
L3	Spring return from left
R3	Spring return from right
B3	Spring return from left and right

d		
Knob/Insert Color		
Code	Knob Color	Insert Color
2	Black	White

e	
Orientation	
Code	Description
Blank	Standard
N	90° offset ⁽²⁾

f	
Operation	
Code	Description
Blank	Standard
CL	Center left ⁽³⁾
CR	Center right ⁽³⁾

- (1) 30 mm hole spacing does not work if knob lever is used. See [page 47](#) for recommended operator panel spacing.
 (2) For use in vertical mount Bulletin 800F enclosures.
 (3) The center contact block can have the same target output as the left or right contact block, by specifying center left (CL) or center right (CR) option.

3-position, Illuminated

IMPORTANT Crevices can exist on product that make it unsuitable for certain applications. Consult your local Rockwell Automation sales office or Allen-Bradley distributor.



Standard Knob
Cat. No. 800FP-LSM37

Switching Angle

Table 12 - Target Table and Operator Position (60° Switching Angle)

Contact Type (1)	Position on Mounting Latch			
N.O.	Left	X	0	0
	Right	0	0	X
N.C.	Left	0	X	X
	Right	X	X	0

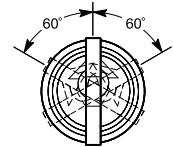

(1) Contact selection is limited to the following options, consult your local Rockwell Automation sales office or Allen-Bradley distributor for other options.

Note: X = Closed / 0 = Open

Operator Type			Package Quantity	Green		Red		Yellow	
				Plastic	Metal	Plastic	Metal	Plastic	Metal
				Cat. No.	Cat. No.	Cat. No.	Cat. No.	Cat. No.	Cat. No.
Maintained			1	800FP-LSM33	800FM-LSM33	800FP-LSM34	800FM-LSM34	800FP-LSM35	800FM-LSM35
Spring return from right				800FP-LSR33	800FM-LSR33	800FP-LSR34	800FM-LSR34	800FP-LSR35	800FM-LSR35
Spring return from left				800FP-LSL33	800FM-LSL33	800FP-LSL34	800FM-LSL34	800FP-LSL35	800FM-LSL35
Spring return from left and right				800FP-LSB33	800FM-LSB33	800FP-LSB34	800FM-LSB34	800FP-LSB35	800FM-LSB35

800F P - LS M3 3
 a b c d e

a	
Operator Construction	
Code	Description (1)
P	Round plastic operator (IP66, Type 4/4X/13)
M	Round metal operator (IP66, Type 4/13)

b	
Operator Type	
Code	Description
LS	Standard knob
LH	Knob lever (3)

c	
Operator Function	
Code	Type
M3	Maintained
L3	Spring return from left
R3	Spring return from right
B3	Spring return from left and right

d		
Knob/Insert Color		
Code	Knob Color	Insert Color
0	Amber (2)	White
3	Green	White
4	Red	White
5	Yellow (2)	Black
6	Blue (2)	White
7	Clear	Black

e	
Orientation	
Code	Description
Blank	Standard
N	90° offset (4)

- (1) LED module is required for illumination, cannot use incandescent module.
 (2) Use of a white LED is recommended.
 (3) Only available in clear.
 (4) For use in vertical mount Bulletin 800F enclosures.

4-position, Non-illuminated



Standard Knob
Cat. No. 800FP-SM42

Table 13 - Target Table and Operator Position (45° Switching Angle) ⁽¹⁾

Contact Type ⁽²⁾	Position on Mounting Latch				
N.O.	Left	0	0	X	0
	Right	X	0	0	0
	Center	X	0	X	0
	Center CL	0	0	X	0
	Center CR	X	0	0	0
N.C.E.B.	Left	0	0	0	X
	Right	0	X	0	0
	Center CL	0	0	0	X
	Center CR	0	X	0	0
N.C.L.B.	Left	X	X	0	X
	Right	0	X	X	X
	Center	0	X	0	X
	Center CL	X	X	0	X
	Center CR	0	X	X	X

(1) Must use N.O., N.C.E.B., or N.C.L.B. contact blocks only. Cannot use N.C. or N.O.E.M. contact blocks with 4-position selector switch.

(2) Contact selection is limited to the following options, consult your local Rockwell Automation sales office or Allen-Bradley distributor for other options.

Note: X = Closed / 0 = Open

Color	Pkg. Quantity	Standard Knob – Maintained	
		Plastic	Metal
		Cat. No.	Cat. No.
Black with White Insert	1	800FP-SM42	800FM-SM42

800F P - S M4 2
 a b c d e f

a		b		c	
Operator Construction		Operator Type		Operator Function	
Code	Description		Description	Code	Type
P	Round plastic operator (IP66, Type 4/4X/13)		Standard knob	M4	Maintained (45° switching angle)
M	Round metal operator (IP66, Type 4/13)		Knob lever		

d			e		f	
Knob/Insert Color			Orientation		Operation	
Code	Knob Color	Insert Color	Code	Description	Code	Description
2	Black	White	Blank	Standard	Blank	Standard
			N	90° offset ⁽¹⁾	CL	Center left ⁽²⁾
					CR	Center right ⁽²⁾

(1) For use in vertical mount enclosures.

(2) The center contact block can have the same target output as the left or right contact block, by specifying center left (CL) or center right (CR) option.

Approximate Dimensions – Selector Switch Operators

Illuminated and Non-illuminated Knob Selector Switch Operators

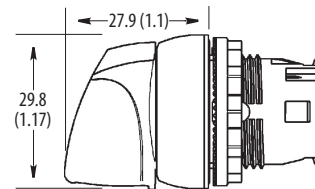

Non-illuminated Knob Lever Selector Switch Operators

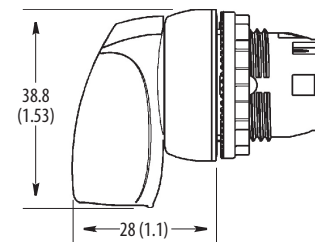

Key-operated Selector Switches

2-position, Non-illuminated



Switching Angle

Table 14 - Target Table and Operator Position (1)

Contact Type (2)		
N.O.	0	X
N.C.	X	0



(1) Target table for spring return from left is reversed from what is shown in the table.

(2) Contact selection is limited to the following options, consult your local Rockwell Automation sales office or Allen-Bradley distributor for other options.

Note: X = Closed / 0 = Open

Key Removal Position	Operator Type		Package Quantity	Standard Knob	
				Plastic	Metal
				Cat. No.	Cat. No.
Left			1	800FP-KM21	800FM-KM21
Both				800FP-KM23	800FM-KM23

800F M - KM2 1
 a b c d

a	
Operator Construction	
Code	Description
P	Round plastic operator (IP66, Type 4/13)
M	Round metal operator (IP66, Type 4/13)

b		
Operator Type		
Code	Type	
KM2	Maintained (60° switching angle)	
KL2	Spring return from left (60° switching angle)	
KR2	Spring return from right (60° switching angle)	

c		
Key Removal Position (4)		
Code	Position	
1	Left	
2	Right	
3	Both	

d			
Ronis Key Lock (1) (2) (3)			
Code	Key No.	Code	Key No.
Blank	3825 (Standard)	27R	4001
R	455	28R	4002
01R	3801	29R	4003
02R	3802	30R	4004
03R	3803	31R	4005
04R	3804	32R	4006
05R	3805	33R	4007
06R	3806		

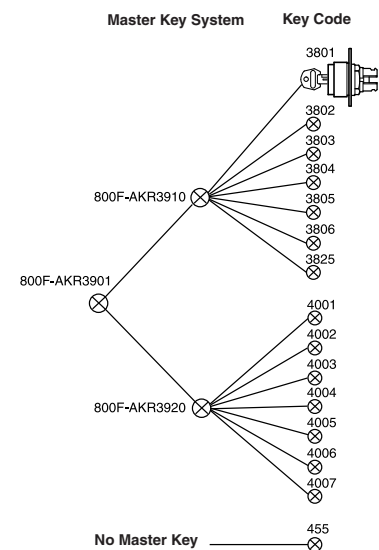

(1) Keyed operators are IP66, Type 4/13.

(2) Not intended for high security applications. Interoperability is possible with certain key/cylinder lock combinations. Consult your local Rockwell Automation sales office or Allen-Bradley distributor for interoperability information.

(3) For replacement Ronis keys, consult your local Rockwell Automation sales office or Allen-Bradley distributor.

(4) Key removal in maintained positions only.

3-position, Non-illuminated





Key-operated Selector Switch
Cat. No. 800FP-KM31R



Key-operated Selector Switch
Cat. No. 800FM-KM31R

Switching Angle





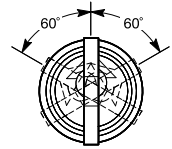

Table 15 - Target Table and Operator Position (60° Switching Angle)

Contact Type (1)	Position on Mounting Latch			
N.O.	Left	X	O	O
	Right	O	O	X
	Center	X	O	X
N.C.	Left	O	X	X
	Right	X	X	O
	Center	O	X	O



(1) Contact selection is limited to the following options, consult your local Rockwell Automation sales office or Allen-Bradley distributor for other options.

Note: X = Closed / O = Open





Key Removal Position	Operator Type			Package Quantity	Standard Knob	
					Plastic	Metal
					Cat. No.	Cat. No.
Left				1	800FP-KM31	800FM-KM31
All					800FP-KM33	800FM-KM33
Center					800FP-KM34	800FM-KM34
Center					800FP-KB34	800FM-KB34







800F M - KM3 3
 a b c d

a	
Operator Construction	
Code	Description
P	Round plastic operator (IP66, Type 4/13)
M	Round metal operator (IP66, Type 4/13)

d

See [page 17](#) for optional key codes (2) (3) (4)

b		
Operator Type		
Code	Description	
KM3	Maintained	
KR3	Spring return from right	
KL3	Spring return from left	
KB3	Spring return from both	

c		
Key Removal Position (1)		
Code	Type	
1	Left	
3	All	
4	Center	
5	Left/center	
7	Center/right (5)	

- (1) Key removal in maintained positions only.
- (2) Keyed operators are IP66, Type 4/13.
- (3) Not intended for high security applications. Interoperability is possible with certain key/cylinder lock combinations. Consult your local Rockwell Automation sales office or Allen-Bradley distributor for interoperability information.
- (4) For replacement Ronis keys, consult your local Rockwell Automation sales office or Allen-Bradley distributor.
- (5) Key removal position only valid with operator types 800F_-KM3 and 800F_-KL3.

Approximate Dimensions – Key-operated Selector Switches

Key Selector Switch Operators

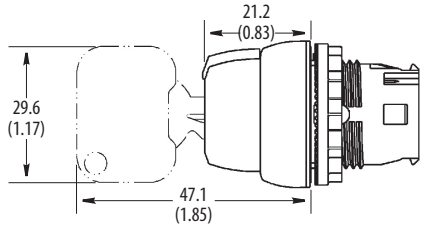

Push-pull Operators

2-position, Non-illuminated – Twist-to-release/Push-pull (Trigger Action)

IMPORTANT

- All emergency stop operators are EN ISO 13850 compliant with standard N.C., N.C.L.B., or self-monitoring contact blocks.
- E-stop operators, latch, and contact block combinations have been third-party tested for B10d values. B10d values can be found in publication [SAFETY-SR001](#).



40 mm Trigger Action
Twist-to-Release Mushroom
Cat. No. 800FP-MT44



40 mm Trigger Action
Push-Pull Mushroom
Cat. No. 800FP-MP44

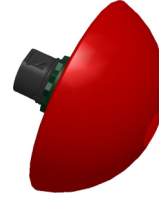

90 mm Half-dome
Cat. No. 800FP-MP94

Color	Package Quantity	40 mm Mushroom (Trigger Action) Twist-to-release		40 mm Mushroom (Trigger Action) Push-Pull	
		Plastic	Metal	Plastic	Metal
		Cat. No.	Cat. No.	Cat. No.	Cat. No.
Red	1	800FP-MT44	800FM-MT44	800FP-MP44	800FM-MP44

800F P - MT4 4
a b c d

a	
Operator Construction	
Code	Description
P	Round plastic operator (IP69K; IP66, Type 4/4X/13)
M	Round metal operator (IP66, Type 4/13)

b	
Operator Type	
Push, Twist-to-release ⁽¹⁾	
Code	Type
MT3	30 mm color cap
MT4	40 mm color cap
MT6	60 mm color cap
Push-pull ⁽²⁾	
MP4	40 mm color cap
Half-dome Push-pull ⁽²⁾	
MP9	90 mm color cap ⁽³⁾

c	
Color Cap	
Code	Color
2	Black
3	Green
4	Red
5	Yellow
6	Blue

d ⁽⁴⁾ ⁽⁵⁾ ⁽⁶⁾	
Engraving	
Code	Description
Blank	No engraving on cap
LE	EMO laser engraved
E	EMO printed

- (1) Only available with red color cap.
- (2) Limit of four contact blocks max. for these devices.
- (3) Half-dome operators only available with black, red, and yellow color caps
- (4) For EMO guards, consult your local Rockwell Automation sales office or Allen-Bradley distributor.
- (5) Only available on 40 mm color cap.
- (6) Only available on red, 40 mm push, twist-to-release operator type (MT44).

2-position, Illuminated – Twist-to-release / Push-pull (Trigger Action)

- IMPORTANT**
- LED module is required for illumination.
 - All emergency stop operators are EN ISO 13850 compliant with standard N.C., N.C.L.B., or self-monitoring contact blocks.
 - E-stop operators, latch, and contact block combinations have been third-party tested for B10d values. B10d values can be found in publication [SAFETY-SR001](#).



40 mm Illuminated
Twist-to-release
Cat. No. 800FP-LMT44



40 mm Mushroom Push-pull
Cat. No. 800FM-LMP44

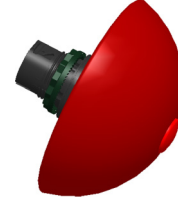

90 mm Half-dome
Cat. No. 800FP-LMP94

Color	Package Quantity	40 mm Mushroom (Trigger Action) Twist-to-release		40 mm Mushroom (Trigger Action) Push-Pull	
		Plastic	Metal	Plastic	Metal
		Cat. No.	Cat. No.	Cat. No.	Cat. No.
Red	1	800FP-LMT44	800FM-LMT44	800FP-LMP44	800FM-LMP44

800F P - LMP4 3
 a b c

a	
Operator Construction	
Code	Description
P	Round plastic operator (IP69K; IP66, Type 4/4X/13)
M	Round metal operator (IP66, Type 4/13)

b	
Operator Type	
Push, Twist-to-release ⁽¹⁾ ⁽²⁾	
Code	Type
LMT4	40 mm color cap
LMT6	60 mm color cap
Push-pull ⁽³⁾	
LMP3	30 mm color cap
LMP4	40 mm color cap
LMP6	60 mm color cap
Half-dome Push-pull ⁽³⁾	
LMP9	90 mm color cap ⁽⁴⁾

c	
Lens Cap Color	
Code	Color
3	Green
4	Red
5	Yellow ⁽⁵⁾
6	Blue ⁽⁵⁾ ⁽⁶⁾

- (1) Only available with red color cap.
 (2) 60 mm version has black arrows; 30 and 40 mm versions have white arrows.
 (3) Limit of four contact blocks max. for these devices.
 (4) Half-dome operators only available with red and yellow lens cap colors.
 (5) Use of a white LED is recommended.
 (6) Only available with 40 mm Push-Pull color cap (Code LMP4 from Table [b](#)).

2-position, Non-illuminated – Mushroom, Key Release (Trigger Action)

- IMPORTANT**
- All emergency stop operators are EN ISO 13850 compliant with standard N.C., N.C.L.B., or self-monitoring contact blocks.
 - E-stop operators, latch, and contact block combinations have been third-party tested for B10d values. B10d values can be found in publication [SAFETY-SR001](#).



40 mm Key Release Mushroom
Cat. No. 800FP-MK44

Color	Package Quantity	2-Position (Trigger Action) 40 mm Mushroom Key Release	
		Plastic	Metal
		Cat. No.	Cat. No.
Red	1	800FP-MK44	800FM-MK44

800F P - MK4 4

a b c d

a	
Operator Construction	
Code	Description
P	Round plastic operator (IP66, Type 4/13)
M	Round metal operator (IP66, Type 4/13)

b	
Operator Type	
Key Release Mushroom	
Code	Type
MK4	40 mm

c	
Lens Cap Color	
Code	Color
4	Red

d	
Ronis Key Lock (1) (2) (3)	
Code	Key No.
Blank	3825 (Standard)
R	455
01R	3801
02R	3802
03R	3803
04R	3804
05R	3805
06R	3806
27R	4001
28R	4002
29R	4003
30R	4004
31R	4005
32R	4006
33R	4007

- (1) Keyed operators are IP66, Type 4/13.
 (2) Not intended for high security applications. Interoperability is possible with certain key/cylinder lock combinations. Consult your local Rockwell Automation sales office or Allen-Bradley distributor for interoperability information.
 (3) For replacement Ronis keys, consult your local Rockwell Automation sales office or Allen-Bradley distributor.

3-position, Illuminated and Non-illuminated – Mushroom



Illuminated 3-position Push-pull
Cat. No. 800FM-LMP44E3

IMPORTANT Sold as standalone operator only. Not available as a composite catalog number.

Table 16 - Target Table and Operator Position ⁽¹⁾

Contact Type ⁽²⁾			
	Out	Center	In
N.O.	0	0	X
N.C.E.B	X	0	0
N.C.L.B	X	X	0

(1) Must use N.O., N.C.E.B., or N.C.L.B. contact blocks only. Cannot use N.C. or N.O.E.M. contact blocks with 3-position push-pull operators.

(2) Contact selection is limited to the following options, consult your local Rockwell Automation sales office or Allen-Bradley distributor for other options.

Note: X = Closed / 0 = Open

Operator Function	Operator Type	Color	Package Quantity	Cat. No.			
Momentary Out, Maintained Center, Momentary In	Non-illuminated	Black ⁽¹⁾	1	800FM-MM42E3			
		Green		800FM-MM43E3			
		Red ⁽²⁾		800FM-MM44E3			
	Illuminated	Amber ⁽³⁾		800FM-LMM40E3			
		Green		800FM-LMM43E3			
		Red		800FM-LMM44E3			
		Blue ⁽³⁾		800FM-LMM46E3			
		Clear ⁽³⁾		800FM-LMM47E3			
		Momentary Out, Maintained Center, Maintained In		Non-illuminated	Black ⁽¹⁾	1	800FM-MP42E3
					Green		800FM-MP43E3
Red ⁽²⁾	800FM-MP44E3						
Illuminated	Amber ⁽³⁾		800FM-LMP40E3				
	Green		800FM-LMP43E3				
	Red		800FM-LMP44E3				
	Blue ⁽³⁾		800FM-LMP46E3				
	Clear ⁽³⁾		800FM-LMP47E3				

(1) Available in non-illuminated only.

(2) Replacement caps are available for this device. Order Cat. No. 800F-AMP4.

(3) Available in illuminated only.

800F **M** - **L** **MM** **4** **4** **E3**
 a b c d e f

a		b		c		d		e		f	
Operator Construction		Operator Type		Operator Function		Cap Size		Cap Color		Positions	
Code	Description	Code	Description	Code	Description	Code	Description	Code	Description	Code	Description
M	Round metal operator (IP66, Type 4/13)	Blank	Non-illuminated	MM	Momentary out, Maintained center, Momentary in	4	40 mm plastic	0	Amber ⁽²⁾ ⁽³⁾	E3	3-position
		L	Illuminated ⁽¹⁾	MP	Momentary out, Maintained center, Maintained in			2	Black ⁽⁴⁾		
								3	Green		
								4	Red		
								6	Blue ⁽²⁾ ⁽³⁾		
								7	Clear ⁽²⁾ ⁽³⁾		

(1) LED module is required for illumination. Cannot use incandescent module.

(2) Available in illuminated only.

(3) Use of white LED is recommended.

(4) Available in non-illuminated only.

Approximate Dimensions – Push-pull Operators

Dimensions in millimeters (inches). Dimensions are not intended to be used for manufacturing purposes.

90 mm Half Dome

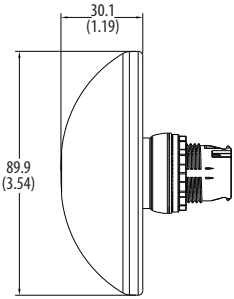

90 mm Mushroom

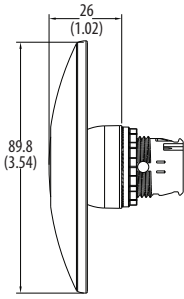

Illuminated and Non-illuminated Momentary Mushroom Operators (40 mm and 60 mm)

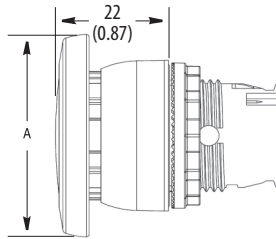

Operator	A
40 mm	39.8 (1.57)
60 mm	59.8 (2.35)

Illuminated and Non-illuminated Twist-to-release Operators (30 mm, 40 mm, and 60 mm)

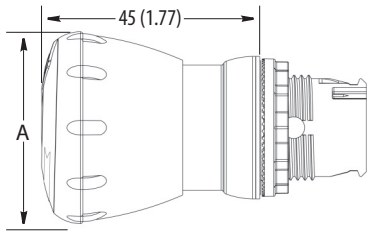

Illuminated and Non-illuminated Push-pull Mushroom Operators (30 mm, 40 mm, and 60 mm)

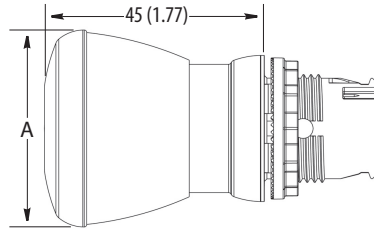

Operator	A
30 mm	30 (1.18)
40 mm	40 (1.57)
60 mm	60 (2.36)

Mushroom Key Release Operator (40 mm)

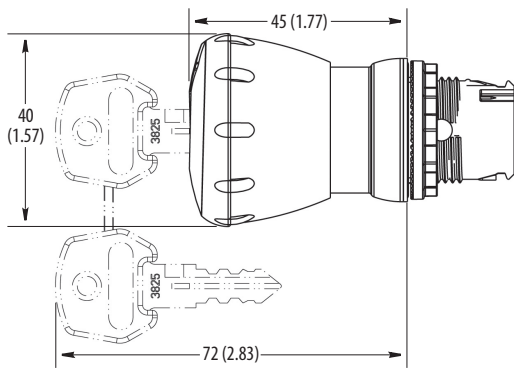

Momentary Mushroom Push Buttons

Non-illuminated



40 mm Mushroom
Cat. No. 800FM-MM42



60 mm Mushroom
Cat. No. 800FP-MM63



90 mm Mushroom
Cat. No. 800FP-MM94

Color	Package Quantity	40 mm Mushroom		60 mm Mushroom		90 mm Mushroom	
		Plastic	Metal	Plastic	Metal	Plastic	Metal
		Cat. No.	Cat. No.	Cat. No.	Cat. No.	Cat. No.	Cat. No.
Black	1	800FP-MM42	800FM-MM42	800FP-MM62	800FM-MM62	800FP-MM92	800FM-MM92
Green		800FP-MM43	800FM-MM43	800FP-MM63	800FM-MM63	—	—
Red		800FP-MM44	800FM-MM44	800FP-MM64	800FM-MM64	800FP-MM94	800FM-MM94
Yellow		800FP-MM45	800FM-MM45	800FP-MM65	800FM-MM65	800FP-MM95	800FM-MM95
Blue		800FP-MM46	800FM-MM46	800FP-MM66	800FM-MM66	—	—

800F P - MM4 3
 a b c

a	
Operator Construction	
Code	Description
P	Round plastic operator (IP69K; IP65, Type 4/4X/13)
M	Round metal operator (IP65, Type 4/13)

b	
Size and Operator Type	
Code	Type
MM4	40 mm momentary
MM6	60 mm momentary
MM9	90 mm momentary ⁽¹⁾

c	
Color Cap	
Code	Color
2	Black
3	Green
4	Red
5	Yellow
6	Blue

(1) Only available with black, red, and yellow cap colors.

Illuminated



40 mm Mushroom
Cat. No. 800FP-LMM43

Color	Package Quantity	40 mm Mushroom	
		Plastic	Metal
		Cat. No.	Cat. No.
Green	1	800FP-LMM43	800FM-LMM43
Red		800FP-LMM44	800FM-LMM44
Yellow		800FP-LMM45	800FM-LMM45
Blue		800FP-LMM46	800FM-LMM46
Clear		800FP-LMM47	800FM-LMM47

800F P - LMM4 3
 a b c

a	
Operator Construction	
Code	Description
P	Round plastic operator (IP69K; IP65, Type 4/4X/13)
M	Round metal operator (IP65, Type 4/13)

b	
Size and Operator Type	
Code	Type
LMM4	40 mm momentary

c	
Color Cap	
Code	Color
3	Green
4	Red
5	Yellow ⁽¹⁾
6	Blue ⁽¹⁾
7	Clear ⁽¹⁾

(1) When using LED for illumination, a white LED is recommended.

Approximate Dimensions – Momentary Mushroom Push Buttons

Dimensions in millimeters (inches). Dimensions are not intended to be used for manufacturing purposes.

Illuminated and Non-illuminated Momentary Mushroom Operators (40 mm and 60 mm)

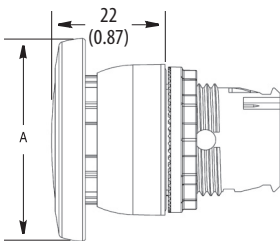

Operator	A
40 mm	39.8 (1.57)
60 mm	59.8 (2.35)

90 mm Mushroom

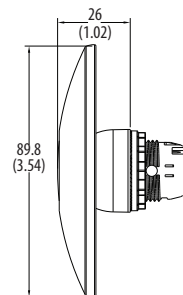

Momentary Multi-operator

2-function, Non-illuminated



2-function Momentary Multi-operator Non-illuminated
Cat. No. 800FP-U2E4F3

Position A			Position C			Package Quantity	Plastic
Color	Type	Text	Color	Type	Text		Cat. No.
Red	Extended	Blank	Green	Flush	Blank	1	800FP-U2E4F3
		0			I		800FP-U2E4FE
		STOP			START		800FP-U2E4FA

800F P - U2 E 4 F 3 (with button caps)
 a b c d e f

800F P - U2 X (with button caps)
 a b c

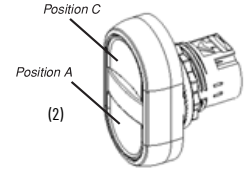

a	
Operator Construction	
Code	Description
P	Round plastic operator (IP69K; IP66, Type 4/4X)
M	Round metal operator (IP66, Type 4)

b	
Operator Type	
Code	Description
U2	Two-function

c	
Operator Type – Position A ⁽²⁾	
Code	Description
F	Flush
E	Extended
X	No caps (all positions) ⁽³⁾

d	
Operator Color Cap/Text – Position A ⁽¹⁾	
Code	Description
1	White
2	Black
3	Green
4	Red
5	Yellow
6	Blue
A	Green with "Start" text
B	Red with "Stop" text
C	White with "Start" text
D	Black with "Stop" text
E	Green with "I" text
F	Red with "O" text
G	White with "I" text
H	Black with "O" text

e	
Operator Type – Position C ⁽²⁾	
Code	Description
F	Flush
E	Extended

f	
Operator Color Cap/Text – Position C ⁽¹⁾	
Code	Description
1	White
2	Black
3	Green
4	Red
5	Yellow
6	Blue
A	Green with "Start" text
B	Red with "Stop" text
C	White with "Start" text
D	Black with "Stop" text
E	Green with "I" text
F	Red with "O" text
G	White with "I" text
H	Black with "O" text

- (1) Valid color cap/legend text codes shown in [Table 17](#).
- (2) Position 1 of the latch (left position when viewed from the back) corresponds to position A of the operator. Position 2 of the latch (right position when viewed from the back) corresponds to position C of the operator.
- (3) For custom-engraved caps, consult your local Rockwell Automation sales office or Allen-Bradley distributor.

Table 17 - Cap/Legend Text

Color	Text	
	Flush Caps	Extended Caps
White	START, I	–
Black	–	STOP, O
Green	START, I	–
Red	–	STOP, O

3-function, Non-illuminated



3-function Momentary Multi-operator Non-illuminated
Cat. No. 800FP-U3E4F34

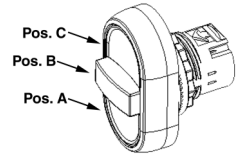

Position A			Position B			Position C			Pkg. Qty.	Plastic
Color	Type	Text	Color	Type	Text	Color	Type	Text		Cat. No.
Green	Flush	Blank	Red	Extended	Blank	Green	Flush	Blank	1	800FP-U3F3F34

800F P - U3 E 4 F 3 4 (with button caps)
 a b c d e f g

800F P - U3 X (with button caps)
 a b c

a	
Operator Construction	
Code	Description
P	Round plastic operator (IP69K; IP66, Type 4/4X)
M	Round metal operator (IP66, Type 4)

b	
Operator Type	
Code	Description
U3	Three-function

c	
Operator Type – Position A ⁽²⁾	
Code	Description
F	Flush
E	Extended
X	No caps (all positions) ⁽³⁾⁽⁴⁾

d	
Operator Color Cap/Text – Position A ⁽¹⁾	
Code	Description
1	White
2	Black
3	Green
4	Red
5	Yellow
6	Blue
A	Green with "Start" text
B	Red with "Stop" text
C	White with "Start" text
D	Black with "Stop" text
E	Green with "I" text
F	Red with "O" text
G	White with "I" text
H	Black with "O" text

e	
Operator Type – Position C ⁽²⁾	
Code	Description
F	Flush
E	Extended

f	
Operator Color Cap/Text – Position C ⁽¹⁾	
Code	Description
1	White
2	Black
3	Green
4	Red
5	Yellow
6	Blue
A	Green with "Start" text
B	Red with "Stop" text
C	White with "Start" text
D	Black with "Stop" text
E	Green with "I" text
F	Red with "O" text
G	White with "I" text
H	Black with "O" text

g	
Operator Color Cap/Text – Position B ⁽²⁾⁽⁴⁾	
Code	Description
4	Red
B	Red with "Stop" text
F	Red with "O" text

- (1) Valid color cap/legend text codes shown in [Table 19](#).
- (2) Position 1 of the latch (left position when viewed from the back) corresponds to position A of the operator. Position 2 of the latch (right position when viewed from the back) corresponds to position C of the operator. Position 3 of the latch (center position) corresponds to position B of the operator.
- (3) For custom-engraved caps, consult your local Rockwell Automation sales office or Allen-Bradley distributor.
- (4) For "no caps" option, (position B) center cap available as red, no text only.

Table 19 – Cap/Legend Text

Color	Text	
	Flush Caps	Extended Caps
White	START, I	–
Black	–	STOP, O
Green	START, I	–
Red	–	STOP, O

Approximate Dimensions – Momentary Multi-operator

Dimensions in millimeters (inches). Dimensions are not intended to be used for manufacturing purposes.

Illuminated and Non-illuminated 2-position Multi-function Operators

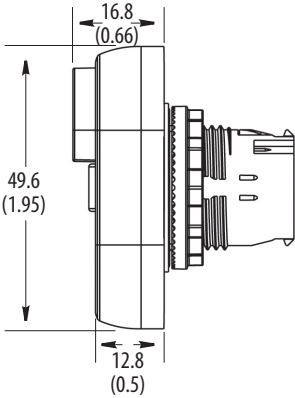

Non-illuminated 3-position Multi-function Operators

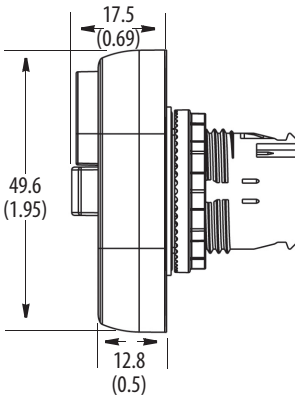

Reset Operators



Reset Operator
Cat. No. 800FP-R611

Mechanical and/or Electrical Reset

Button Color	Legend Text	Pkg. Quantity	Flush – Round	
			Plastic	Metal
			Cat. No.	Cat. No.
Blue	R	1	800FP-R611	800FM-R611
	No legend		800FP-R6	800FM-R6

800F **M** - **R** **6** **11**
 a b c d

a	
Operator Construction	
Code	Description
P	Round plastic operator (IP66, Type 4/4X/13)
M	Round metal operator (IP66, Type 4/13)

b	
Operator Type	
Code	Type
R	Reset ⁽¹⁾ ⁽²⁾

c	
Color Cap	
Code	Color
1	White
2	Black
6	Blue

d	
Legend Text	
Code	Text
Blank	No text
11	R

- (1) Accepts latch and up to four single-circuit contact blocks or two dual-circuit contact blocks; no contacts are allowed in center position.
 (2) 11 mm (0.4 in.) reset stroke length.

Threaded Reset Rod Reset Operators



Threaded Reset Rod with 35 mm Pusher
Cat. No. 800F-ATR19L

Rod Length [mm (in.)] ⁽¹⁾	Rod Length Adjustability [mm (in.)]	Pkg. Quantity	Threaded Reset Rod	
			10 mm Pusher	35 mm Pusher
			Cat. No.	Cat. No.
40 (1.6)	34...52 (1.3...2.1)	1	800F-ATR01	800F-ATR01L
55 (2.2)	50...67 (2.0...2.6)		800F-ATR02	800F-ATR02L
85 (3.4)	80...98		800F-ATR04	800F-ATR04L
115 (4.5)	110...128		800F-ATR06	800F-ATR06L
145 (5.7)	141...159		800F-ATR08	800F-ATR08L
315 (12.4)	34...326		800F-ATR19 ⁽²⁾	800F-ATR19L ⁽²⁾

- (1) If contact blocks are used, they must have a minimum rod length of 55 mm for one level of contact blocks and 85 mm for two levels of contact blocks.
 (2) Rod is threaded along its entire length for ease of cutting to desired length.

Approximate Dimensions

Dimensions in millimeters (inches). Dimensions are not intended to be used for manufacturing purposes.

Reset Operators with Reset Rod

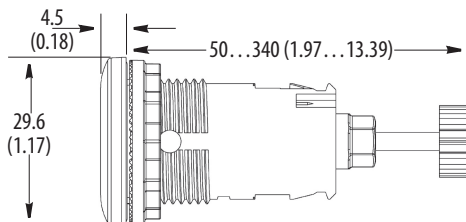

Single-turn Potentiometer Assembly

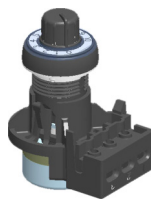

Resistive Element ⁽¹⁾ ⁽²⁾ ⁽³⁾	Series B Cat. No.	Series A Cat. No. ⁽⁴⁾
None (Operator Only) ⁽⁵⁾	800FP-POT	800FP-POTA
150 Ω	800FP-POT1	800FP-POT1A
500 Ω	800FP-POT2	800FP-POT2A
1000 Ω	800FP-POT3	800FP-POT3A
2500 Ω	800FP-POT4	800FP-POT4A
5000 Ω	800FP-POT5	800FP-POT5A
10,000 Ω	800FP-POT6	800FP-POT6A

(1) Rated 300V AC/DC, 2 W max.

(2) A latch is not needed.

(3) Additional hole spacing required for potentiometers. See [Instruction Sheet on page 47](#) for panel hole spacing requirements.

(4) Not stocked. Longer leadtime.

(5) The catalog number 800FP-POT is a complete operator assembly supplied without the resistive element, used with potentiometers having a shaft diameter of 6.0 mm (0.23 in.) and a shaft length of 50.0 mm (1.97 in.), or a shaft diameter of 6.4 mm (0.25 in.) and a shaft length of 22.5 mm (0.88 in.). This operator is used with Type J potentiometers only.

Approximate Dimensions

Dimensions in millimeters (inches). Dimensions are not intended to be used for manufacturing purposes.

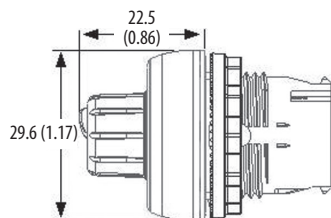

Key-operated Selector Switch – SensEject

SensEject™ – patented spring-loaded key ejection system

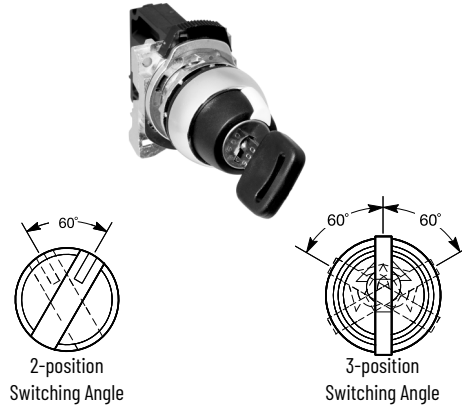

Operator Construction	Operator Type	Key Eject Position	Key Option ⁽¹⁾	Spare Key Cat. No.	Contact Blocks	Cat. No. ⁽²⁾
Round metal operator – SensEject is IP6X (dust-tight) Type 1	2-position spring return from right		Ronis key	800F-AKE006	None	800FM-KEM2106R
					1 N.O., 1 N.C.	800FM-KEM2106ZMX11
	3-position spring return from both		Ronis key	800F-AKE001	None	800FM-KEB3401R
					2 N.O., 3 N.C.	800FM-KEB3401RMX23

(1) Not intended for high security applications. Interoperability is possible with certain key/cylinder lock combinations. Consult your local Rockwell Automation sales office or Allen-Bradley distributor for interoperability information.
 (2) Includes latch and spacer block.

Approximate Dimensions

Dimensions in millimeters (inches). Dimensions are not intended to be used for manufacturing purposes.

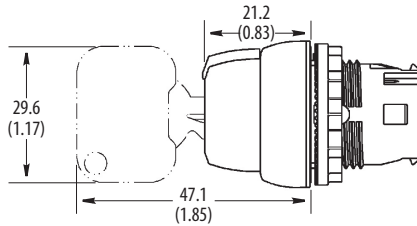

Selector Push Button Operators



Selector Jog Operator
Cat. No. 800FM-SJ23

Table 20 - Target Table and Operator Position (2-position)





Contact Type ⁽¹⁾	Position on Mounting Latch				
		Selector Left Free	Selector Left Depressed	Selector Right Free	Selector Right Depressed
N.O.	Left	0	X	0	0
	Right	0	0	0	X
	Center	0	X	0	X
N.C.	Left	X	0	X	X
	Right	X	X	X	0
	Center	X	0	X	0

Table 21 - Target Table and Operator Position (3-position)

Contact Type ⁽¹⁾	Position on Mounting Latch						
		Selector Left Free	Selector Left Depressed	Selector Center Free	Selector Center Depressed	Selector Right Free	Selector Right Depressed
N.O.	Left	0	X	0	X	0	0
	Right	0	0	0	X	0	X
	Center	0	X	0	X	0	X
N.C.	Left	X	0	X	0	X	X
	Right	X	X	X	0	X	0
	Center	X	0	X	0	X	0

⁽¹⁾ Contact selection is limited to the following options, consult your local Rockwell Automation sales office or Allen-Bradley distributor for other options.
Note: X = Closed / 0 = Open

800F P - SJ 2 2
 a b c d

a	
Operator Construction	
Code	Description
P	Round plastic operator (IP66, Type 4/4X/13)
M	Round metal operator (IP66, Type 4/13)

b	
Operator Type	
Code	Description
SJ	Selector jog

c	
Operator Function	
Code	Description
2	2-position
3	3-position

d	
Color Cap ⁽¹⁾	
Code	Description
2	Black
3	Green

⁽¹⁾ Buttons cannot be engraved.

Approximate Dimensions

Dimensions in millimeters (inches). Dimensions are not intended to be used for manufacturing purposes.

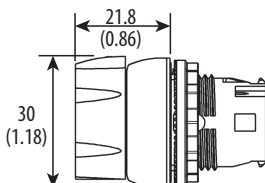

Toggle Switch Operators



Toggle Switch Operator
Cat. No. 800FM-JM2

Table 22 - Target Table and Operator Position (2-position)

Contact Type ⁽²⁾	Position on Mounting Latch			
		Toggle Left	Center	Toggle Right
N.O.	Left	0	0	X
	Right	X	0	0
	Center	X	0	X
N.C.	Left	X	X	0
	Right	0	X	X
	Center	0	X	0

Table 23 - Target Table and Operator Position (4-position) ⁽¹⁾

Contact Type ⁽²⁾	Position on Mounting Latch					
		Toggle Up	Toggle Left	Center	Toggle Right	Toggle Down
N.O.	Left	X	0	0	0	0
	Right	0	X	0	0	0
	Center	X	X	0	0	0
N.C.L.B.	Left	0	X	X	X	X
	Right	X	0	X	X	X
	Center	0	0	X	X	X
N.C.E.B.	Left	0	0	0	0	X
	Right	0	0	0	X	0

(1) Must use N.O., N.C.E.B., or N.C.L.B. contact blocks only. Cannot use N.C. or N.O.E.M. contact blocks with 4-position toggle switch.

(2) Contact selection is limited to the following options, consult your local Rockwell Automation sales office or Allen-Bradley distributor for other options.

Note: X = Closed / 0 = Open

800F M - J M2
 a b c

a	
Operator Construction	
Code	Description
M	Round metal operator (IP66, Type 4/13)

b	
Operator Type	
Code	Description
J	Toggle switch ⁽¹⁾⁽²⁾

c	
Operator Function	
Code	Description
M2	2-position, maintained
R2	2-position, momentary
M4	4-position, maintained
R4	4-position, momentary

(1) Use legend plates 800F-34_ and 800F-35_.

(2) Silicone boot comes standard with toggle switch, consult your local Rockwell Automation sales office or Allen-Bradley distributor for replacement boots.

Approximate Dimensions

Dimensions in millimeters (inches). Dimensions are not intended to be used for manufacturing purposes.

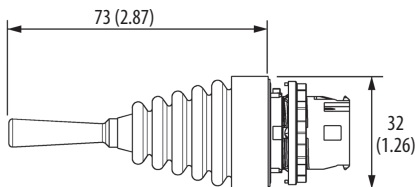

Back-of-panel Components

Contact Blocks with Latch – Composite



800F - P X 0 1 E
a b c d e

a	
Style	
Code	Description
P	Plastic latch
M	Metal latch

b	
Contact Block Termination Style ⁽¹⁾	
Code	Description
X	Screw termination
Q	Spring-clamp termination

c	
N.O. (Normally Open) Circuits	
Code	Description
0	No contact
1	1 N.O.
2	2 N.O.
3	3 N.O.
4	4 N.O.
5	5 N.O.
6	6 N.O.

d	
N.C. (Normally Closed) Circuits	
Code	Description
0	No contact
1	1 N.C.
2	2 N.C.
3	3 N.C.
4	4 N.C.
5	5 N.C.
6	6 N.C.

e	
Specialty Contact Block	
Code	Description
Blank	Standard blocks
V	Low-voltage – QuadConnect™
E	N.O. early make
L	N.C. late break
B	N.C. early break
S	N.C. self-monitoring

(1) Six circuits maximum allowable.

Power Modules with Latch – Composite



800F - M N 3 G
a b c d

a	
Style	
Code	Description
P	Plastic latch
M	Metal latch

b	
Power Module Type ⁽¹⁾ ⁽²⁾	
Code	Description
D	Incandescent module, screw termination
N	Integrated LED module, screw termination
Q	Integrated LED module, spring-clamp termination

c	
Voltage	
Code	Description
0	No bulb ⁽³⁾
1	6V AC/DC ⁽³⁾
2	12V AC/DC ⁽³⁾
3	10...29V AC 10...30V DC
4	48V AC/DC ⁽³⁾
5	120V AC
7	240V AC ⁽⁴⁾

d	
Lamp Color ⁽⁵⁾	
Code	Description
C	Incandescent
R	Red LED
G	Green LED
W	White LED

- (1) LED modules for use with all illuminated operators. Incandescent module for use with pilot lights, momentary push buttons, and momentary mushroom operators only.
- (2) Four circuits maximum allowable when power module is used. Contact blocks cannot be stacked on power module.
- (3) Only available for incandescent module.
- (4) Only available for integrated LED module.
- (5) For best illumination results, LED color should match lens color. For yellow, blue, or amber operator, select a white LED.

Power Modules with Contact Blocks and Latch – Composite

800F - P N 5 R X 1 0 E
a b c d e f g h

a	
Style	
Code	Description
P	Plastic latch
M	Metal latch

b	
Power Module Type ^{(1) (2)}	
Code	Description
D	Incandescent module, screw termination
N	Integrated LED module, screw termination
Q	Integrated LED module, spring-clamp termination

c	
Voltage	
Code	Description
0	No bulb ⁽³⁾
1	6V AC/DC ⁽³⁾
2	12V AC/DC ⁽³⁾
3	10...29V AC 10...30V DC
4	48V AC/DC ⁽³⁾
5	120V AC
7	240V AC ⁽⁴⁾

d	
Lamp Color ⁽⁵⁾	
Code	Description
C	Incandescent
R	Red LED
G	Green LED
W	White LED

e	
Contact Block Termination Style	
Code	Description
X	Screw termination
Q	Spring-clamp termination

f	
N.O. (Normally Open) Circuits	
Code	Description
0	No contact
1	1 N.O.
2	2 N.O.
3	3 N.O.
4	4 N.O.

g	
N.C. (Normally Closed) Circuits	
Code	Description
0	No contact
1	1 N.C.
2	2 N.C.
3	3 N.C.
4	4 N.C.

h	
Specialty Contact Block	
Code	Description
Blank	Standard blocks
V	Low-voltage – QuadConnect™
E	N.O. early make
L	N.C. late break
B	N.C. early break
S	N.C. self-monitoring

- (1) Four circuits maximum allowable when power module is used. Contact blocks cannot be stacked on power module.
(2) LED modules for use with all illuminated operators. Incandescent module for use with pilot lights, push buttons, and momentary mushroom operators only.
(3) Only available for incandescent module.
(4) Only available for integrated LED module.
(5) For best illuminated results, LED should match lens color. For yellow, blue, or amber operator, select a white LED.

Other Back-of-panel Components

Table 24 - Latches





	Description	Pkg. Qty.	Cat. No.
 Cat. No. 800F-ALM	Metal Mounting Latch Zinc-plated, metal die cast mounting latches. Sold only in multiples of 10. Order (quantity of) 10 to receive one package of 10 pieces.	10	800F-ALM
	Note: Sold only in multiples of 100. Order (quantity of) 100 to receive one package of 100 pieces.	100	800F-ALM-BP
 Cat. No. 800F-ALP	Plastic Mounting Latch Note: Sold only in multiples of 10. Order (quantity of) 10 to receive one package of 10 pieces.	10	800F-ALP
	Note: Sold only in multiples of 100. Order (quantity of) 100 to receive one package of 100 pieces.	100	800F-ALP-BP

Table 25 - Contact Blocks

	Description	Contact Type	Pkg. Qty.	Cat. No.
 <p>Cat. No. 800F-X10</p>	<p>Contact Block Note: Sold only in multiples of 10. Order (quantity of) 10 to receive one package of 10 pieces. Latch not included.</p>	N.O.	10	800F-X10
		N.C.		800F-X01
		N.O. low-voltage — QuadConnect		800F-X10V
		N.C. low-voltage — QuadConnect		800F-X01V
		N.O.L.M.		800F-X10N ⁽¹⁾
		N.O.E.M.		800F-X10E
		N.O.E.E.M.		800F-X10M ⁽²⁾
		N.C.L.B.		800F-X01L
		N.C.E.B.		800F-X01B ⁽³⁾
		Self-Monitoring		800F-X01S ⁽⁴⁾
		Dual-circuit of 2 N.O.		800F-X20D ⁽⁴⁾
		Dual-circuit of 2 N.C.		800F-X02D ⁽⁴⁾
		Dual-circuit of 1 N.O.-1 N.C.		800F-X11D ⁽⁴⁾
		N.O. spring-clamp		800F-Q10
		N.C. spring-clamp		800F-Q01
		Ring lug N.O.		800F-R10 ^{(5) (6)}
Ring lug N.C.	800F-R01 ^{(5) (6)}			
<p>Note: Sold only in multiples of 100. Order (quantity of) 100 to receive one package of 100 pieces. Latch not included.</p>	N.O.	100	800F-X10-BP	
	N.C.		800F-X01-BP	
 <p>Cat. No. 800F-BX01</p>	<p>Base-mounted Contact Block Base-mounted contact blocks can be used in plastic or metal enclosures. Note: Sold only in multiples of 10. Order (quantity of) 10 to receive one package of 10 pieces. Latch not included.</p>	N.O.	10	800F-BX10
		N.C.		800F-BX01

- (1) For use with Cat. No. 800FP-CB_ and Cat. No. 800FP-CC_ operators.
- (2) For use with Cat. No. 800FP-CC_ operators.
- (3) Only for use with 4-position selector switch, 4-position toggle switch, or 3-position push-pull operator.
- (4) Cannot stack.
- (5) Cannot be used in a composite catalog number.
- (6) Replacement screws are available (Cat. No. 800F-ARS1)

Table 26 - Power Modules



	Description	Voltage	Pkg. Qty.	Cat. No.
 <p>Cat. No. 800F-D3C</p>	<p>Incandescent Module For use with pilot lights, push buttons, and momentary mushroom operators. Note: Sold in multiples of 10. Order (quantity of) 10 to receive one package of 10 pieces. Latch not included.</p>	No bulb	10	800F-D0C
		6V AC/DC		800F-D1C
		12V AC/DC		800F-D2C
		24V AC/DC		800F-D3C
		48V AC/DC		800F-D4C
		120V AC/DC		800F-D5C

Table 26 - Power Modules (Continued)

	Description	Voltage	Pkg. Qty.	Cat. No.
 Cat. No. 800F-N3G	Integrated LED Module For use with all illuminated devices. For best results, LED should match lens color. For amber, yellow, and blue operators use white LED. Note: Sold in multiples of 10. Order (quantity of) 10 to receive one package of 10 pieces. Latch not included.	24...120V AC/DC	10	800F-NU _x ^{(1) (2)}
		24V AC/DC		800F-N3 _x ⁽¹⁾
		120V AC		800F-N5 _x ⁽¹⁾
		240V AC		800F-N7 _x ⁽¹⁾
		24V AC/DC spring-clamp		800F-Q3 _x ⁽¹⁾
		120V AC spring-clamp		800F-Q5 _x ⁽¹⁾
		240V AC spring-clamp		800F-Q7 _x ⁽¹⁾
		24V AC/DC ring lug		800F-R3 _x ^{(1) (2) (3)}
 Cat. No. 800F-BN3R	Base-mounted Integrated LED Module Base-mounted modules can be used in plastic or metal enclosures. For best illumination results, LED should match lens color. Note: Sold in multiples of 10. Order (quantity of) 10 to receive one package of 10 pieces. Latch not included.	24V AC/DC	10	800F-BN3 _x ⁽¹⁾
		120V AC		800F-BN5 _x ⁽¹⁾
		240V AC		800F-BN7 _x ⁽¹⁾

- (1) To complete the cat. no., replace the x with one of the following letters for the desired color: R = Red, G = Green, W = White.
- (2) Cannot be used in a composite catalog number.
- (3) Replacement screws are available (Cat. No. 800F-ARS1)

Approximate Dimensions – Back-of-panel Components

Dimensions in millimeters (inches). Dimensions are not intended to be used for manufacturing purposes.

Incandescent Module with Latch

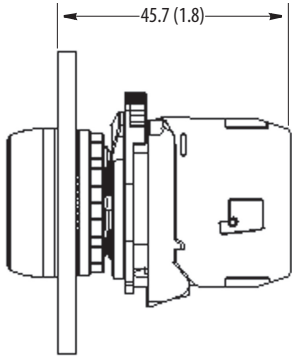

LED Module with Latch

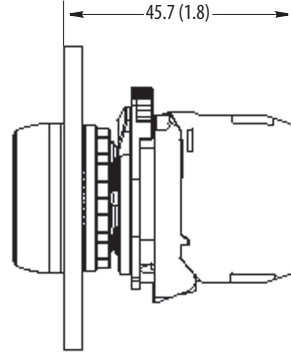

Contact Cartridges with Latch

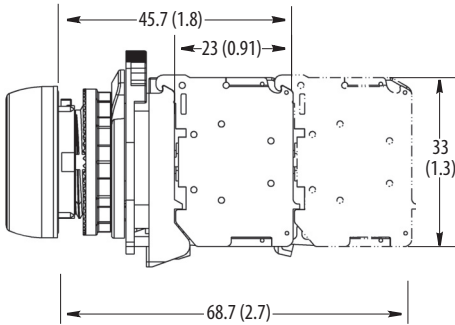

Dual-circuit Contact Block or Self-monitoring Contact Block (1 Deep, Max)

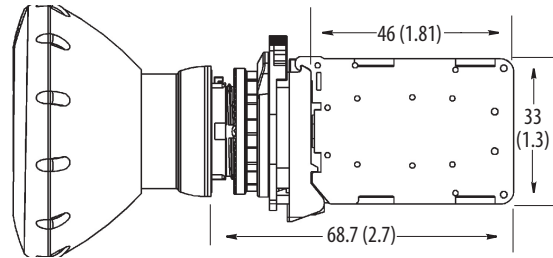

Potentiometer with Resistive Element

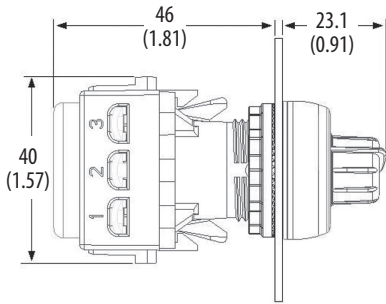

Customer Supplied Resistive Element

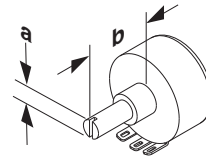

	Max.		Min.
a (Dia.)	6.4 (0.252)	5.9 (0.232)	5.7 (0.224)
b (Length)	24 (0.945)	32 (1.26)	14 (0.551)

Plastic and Metal Enclosures

Plastic Enclosure (Latch/Base Mount)

- Accepts two-piece snap-in legends
- One-hole enclosure accepts 60 mm E-stop legends
- UL Listed and CSA Certified



Cat. No. 800F-3PM

Metal Enclosure (Latch/Base Mount)

- Feed-through design
- Accepts two-piece snap-in legends
- Includes base mount adapter



Cat. No. 800F-5MM

Type	Pkg. Qty.	Enclosures			
		Plastic (IP69K ⁽¹⁾ ; IP66, 4/4X)		Metal – Die Cast (IP66, 4/13)	
		PG Conduit Knockouts	Metric Conduit Knockouts	PG Conduit Openings	Metric Conduit Openings
		Cat. No.	Cat. No.	Cat. No.	Cat. No.
1-hole	1	800F-1PP ^{(2) (3)}	800F-1PM ^{(2) (3)}	800F-1MP ⁽⁴⁾	800F-1MM ⁽⁴⁾
2-hole		800F-2PP ^{(2) (3)}	800F-2PM ^{(2) (3)}	800F-2MP ⁽⁴⁾	800F-2MM ⁽⁴⁾
3-hole		800F-3PP ^{(2) (3)}	800F-3PM ^{(2) (3)}	800F-3MP ⁽⁴⁾	800F-3MM ⁽⁴⁾
4-hole		800F-4PP ^{(2) (3)}	800F-4PM ^{(2) (3)}	–	–
5-hole		–	–	800F-5MP ⁽⁵⁾	800F-5MM ⁽⁵⁾
6-hole		800F-6PP ^{(2) (6)}	800F-6PM ^{(2) (6)}	–	–
1-hole (yellow)		800F-1YP ⁽²⁾	800F-1YM ⁽²⁾	800F-1MYP ⁽⁴⁾	800F-1MYM ⁽⁴⁾
1-hole (yellow) latch only		–	–	800F-1LYP ⁽⁴⁾	800F-1LYM ⁽⁴⁾
1-hole (yellow) dual-circuit		800F-1YPD ⁽⁷⁾	800F-1YMD ⁽⁷⁾	–	–

(1) Select enclosures; see [Table 2 on page 4](#).

(2) Can only use single deep contact block.

(3) Knockouts: PG (PG11/16), Metric (M16/20)

(4) Openings: PG (PG16), Metric (M20)

(5) Openings: PG (PG16), Metric (M32)

(6) Knockouts: PG (PG16), Metric (M25)

(7) Can stack contact blocks two deep or one dual-circuit contact block.

Assembled Stations

Enclosure Material	Operator Type	Illumination Voltage	Contact Configuration	PG Knockouts	Metric Knockouts	
				Cat. No.	Cat. No.	
1-hole, Yellow Plastic	Red 90 mm momentary	Non-illuminated	1 N.C.	800F-1YP1M94	800F-1YM1M94	
			1 N.O./1 N.C.	800F-1YP2M94	800F-1YM2M94	
			2 N.C.	800F-1YP3M94	800F-1YM3M94	
1-hole, Gray Plastic	Black 90 mm momentary		1 N.O./1 N.C.	800F-1PP2M92	800F-1PM2M92	
	Black Push Button		1 N.O.	800F-1PP1	800F-1PM1	
	"0-1" 2-Position Selector Switch		1 N.O.	800F-1PP2	800F-1PM2	
	"OFF-ON" 2-position Selector Switch		1 N.O. / 1 N.C.	800F-1PP3	800F-1PM3	
2-hole, Gray Plastic	Start and Stop Push Buttons		↔ (Flush Black)	1 N.O.	800F-1PP4	—
			1 N.O./1 N.C.	800F-2PP1	—	
3-hole, Gray Plastic	↑ (Flush Black) 0 (Extended Red) ↓ (Flush Black)		4 N.O./1 N.C.	800F-3PP1	—	

1-Hole Enclosure E-Stop Station



Cat. No. 800F-1YP4

Table 27 - Yellow Plastic Enclosure

Quick Connect	Operator Type	Illumination Voltage	Contact Configuration	PG Knockouts	Metric Knockouts	
				Cat. No.	Cat. No.	
N/A	Twist-to-release 40 mm	Non-illuminated	1 N.C.	800F-1YP1	800F-1YM1	
			1 N.O./1 N.C.	800F-1YP2	800F-1YM2	
			2 N.C.	800F-1YP3	800F-1YM3	
	Key Release 40 mm		1 N.C.	800F-1YP4	800F-1YM4	
			1 N.O. / 1 N.C.	800F-1YP5	800F-1YM5	
			2 N.C.	800F-1YP6	800F-1YM6	
	Twist-to-release 60 mm		2 N.C.	800F-1YP7	—	
			1 N.O. / 2 N.C.	800F-1YP8	—	
	Twist-to-release 40 mm		24V AC/DC	1 N.C.	—	800F-1YML1
			120V AC		—	800F-1YML2
		240V AC	—		800F-1YML3	
	Red half dome	Non-illuminated	1 N.C.	800F-1YP1HD	800F-1YM1HD	
			1 N.O./1 N.C.	800F-1YP2HD	800F-1YM2HD	
			2 N.C.	800F-1YP3HD	800F-1YM3HD	
		24V AC/DC	1 N.C.	—	800F-1YML1HD	
120V AC				—	800F-1YML2HD	
240V AC				—	800F-1YML3HD	

Table 27 - Yellow Plastic Enclosure

Quick Connect		Operator Type	Illumination Voltage	Contact Configuration	PG Knockouts	Metric Knockouts
					Cat. No.	Cat. No.
AC Micro	5-pin	Twist-to-release 40 mm	Non-illuminated	2 N.C. – Low-voltage	–	800F-1YM053V
	6-pin			1 N.O. / 2 N.C.	–	800F-1YM0A
DC Micro	4-pin		Non-illuminated/EMO/ Guard	1 N.C.	–	800F-NX1
			Non-illuminated	1 N.C.	–	800F-1YM01
				1 N.O. / 1 N.C.	–	800F-1YM02
				2 N.C.	–	800F-1YM03
			5-pin	Non-illuminated/EMO/ Guard	2 N.C.	–
Mini Receptacle	4-pin		Non-illuminated	1 N.C.	–	800F-1YM041
			24V AC/DC	1 N.O. / 1 N.C.	–	800F-1YM044
			24V AC/DC	1 N.O./1 N.C.	–	800F-1YM04
	6-pin		120V AC	1 N.O. / 1 N.C.	–	800F-1YM05
			240V AC	1 N.O. / 1 N.C.	–	800F-1YM06

Table 28 - Gray Metal Enclosure

Quick Connect		Operator Type	Illumination Voltage	Contact Configuration	PG Knockouts	Metric Knockouts
					Cat. No.	Cat. No.
N/A	Twist-to-release 40 mm	Non-Illuminated	1 N.C.	–	800F-1MM1	
			1 N.O. / 1 N.C.	–	800F-1MM2	
			2 N.C.	–	800F-1MM3	
	Key Release 40 mm	Non-Illuminated	1 N.C.	–	800F-1MM4	
			1 N.O. / 1 N.C.	–	800F-1MM5	
			2 N.C.	–	800F-1MM6	

Table 29 - Yellow Metal Enclosure

Quick Connect		Operator Type	Illumination Voltage	Contact Configuration	PG Knockouts	Metric Knockouts
					Cat. No.	Cat. No.
Mini Receptacle ⁽¹⁾	6-pin	Twist-to-release 40 mm	24V AC/DC	1 N.O./1 N.C.	–	800F-1MYM04
			120V AC	1 N.O./1 N.C.	–	800F-1MYM05
			240V AC	1 N.O./1 N.C.	–	800F-1MYM06

(1) See [Assembled Station Pin Out Chart on page 64](#).

Assembled Stations with DeviceNet

2-hole

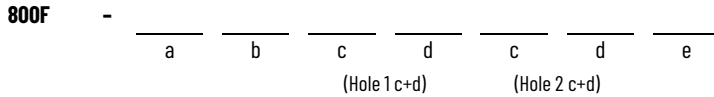

3-hole

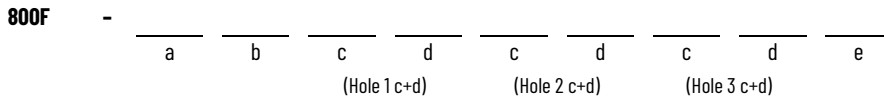

4-hole

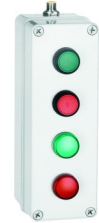
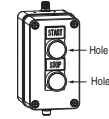
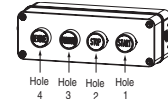
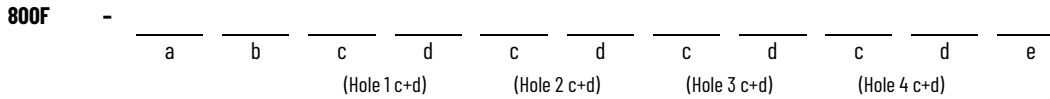

4-hole Assembled Station
Cat. No. 800F-VHA3A4J3J4J

a	
Mounting Orientation	
Code	Description
V	Vertical ⁽¹⁾
H	Horizontal

b	
Enclosure Style/Legends	
Code	Description
A	2-hole/legend frames
B	3-hole/legend frames
C	4-hole/legend frames
D	2-hole/no legend frames
E	3-hole/no legend frames
F	4-hole/no legend frames
H	2-hole/E-stop only no legend frames ⁽²⁾

c	
Operator Types	
Code	Description
A	Non-illuminated flush button
B	Non-illuminated extended button
C	Non-illuminated guarded button
D	Illuminated flush button ⁽³⁾
E	Illuminated extended button ⁽³⁾
F	Illuminated guarded button ⁽³⁾
G	Non-illuminated 2-position selector switch
H	Non-illuminated 3-position selector switch
J	Pilot light (diffused)
K	Hole plug ⁽⁴⁾
L	Non-illuminated TTR E-stop ^{(4) (5)}
M	Non-illuminated push-pull ^{(4) (5)}
N	2-position key selector switch
P	3-position key selector switch
R	Non-illuminated 40 mm mushroom
T	E-stop key release ^{(4) (5)}
U	Potentiometer ^{(5) (6)}
W	Illuminated push-pull
X	Illuminated 2-position maintained selector switch
Y	Illuminated 3-position maintained selector switch
Z	Illuminated 40 mm mushroom

d	
Color/Text	
Code	Description
1	White
2	Black
3	Green
4	Red
5	Yellow
6	Blue
7	Clear
8	Gray ⁽⁷⁾
9	No cap
0	Amber
A	Green with "Start" text
B	Red with "Stop" text
C	Black with "→" symbol
D	Black with "←" symbol
E	Black with "↑" symbol
F	Black with "↓" symbol
G	Green with "I" symbol
H	Red with "O" symbol
L	Blue with "R" text
M	Red with yellow metal guard ⁽⁸⁾
N	Yellow with yellow metal guard ⁽⁸⁾

e	
External I/O Version ⁽⁹⁾	
Code	Description
Blank	No external I/O
A	1 input/1 output (sinking)
B	1 input/1 output (sourcing)
C	2 input
E	2 output (sourcing)
F	1 E-stop block ⁽¹⁰⁾
G	2 E-stop block ⁽¹⁰⁾
H	2 input/2 output
K	2 input/2 output (sourcing)
L	1 input/1 output (sinking) + 1 E-stop block ⁽¹⁰⁾
M	1 input/1 output (sourcing) + 1 E-stop block ⁽¹⁰⁾
N	1 input/1 output (sinking) + 2 E-stop block ⁽¹⁰⁾
P	1 input/1 output (sourcing) + 2 E-stop block ⁽¹⁰⁾
Q	2 input + 1 E-stop block ⁽¹⁰⁾
R	2 input + 2 E-stop block ⁽¹⁰⁾
U	2 output (sourcing) + 1 E-stop block ⁽¹⁰⁾
W	2 output (sourcing) + 2 E-stop block ⁽¹⁰⁾
X	2 input + 1 input/1 output (sinking)

- (1) Selector Switches in a vertical mount enclosure are mounted with a horizontal orientation.
- (2) Enclosure Style/Legend option H from Table **b** can only select one operator from Table **c**. Valid options are L, M, and T. Also see footnote **5**.
- (3) Cannot be ordered with "No Cap" (Code 9 from Table **d** - Color/Text).
- (4) Operator Types K, L, M, T, and U from Table **c** are not available with legend frames.
- (5) Operator Types L, M, and T from Table **c** can be used as emergency stops. To be valid as an E-stop, operators must use color/text code 4 from Table **d** and it must be placed in the last hole position in the enclosure, where a yellow round E-stop legend plate is provided. An E-stop connector must also be chosen from Table **e**. Also see footnote **10**.
- (6) A potentiometer is allowed in first hole position only.
- (7) Available in flush only.
- (8) Only available with non-illuminated push-pull operator (Code M from Table **c**).
- (9) This is an 8-in/4-out device. 2-in and 1-out are assigned to each hole position in the enclosure. If a 2-hole enclosure is selected, 4-in and 2-out are assigned internally and up to 4 unassigned I/O points can be assigned to external connectors. This device contains up to two physical external I/O connectors. The "+" symbol in the Description field of table **e** indicates that two external connectors exist. If an E-stop connector is used, 2 unassigned I/O points can be assigned to the other connector.
- (10) External I/O Versions F, L, M, Q, and U receive only one contact block for the external E-stop string. These connectors are rated 3 A. If more than 3 A of current is needed or if there are two E-stop strings, use External I/O Versions G, N, P, R, and W. These versions receive two contact blocks. This configuration allows for 6 A of switching or for two E-stop strings.

Pendant Stations

Latch Mounting

- Blank legend cap marking
- Connector not included. See [Miscellaneous on page 48](#) for ordering information.



Pendant Station
Cat. No. 800F-P25

Type	Pkg. Quantity	Yellow Plastic (IP66, 4/4X/13)
		Cat. No. ⁽¹⁾
1 hole in face	1	800F-P15
2 holes in face		800F-P25
1 hole in bottom		800F-P35
1 hole in face / 1 hole in bottom		800F-P45

(1) Only use with single-deep contact block.

Assembled Two-Hole Pendant Stations

Table 30 - Prewired Pendant Station with Mini Quick Disconnect Connector ⁽¹⁾

Push Button and Contact Selection	Cat. No. ⁽²⁾
Green flush (no text) in face with 1 N.O. contact; Red pilot light in bottom with 1 N.O. contact; 24V AC/DC	800F-PN2
White flush (with up arrow – ↑) with 1 N.O./1 N.C. contact; Black flush (with down arrow – ↓) with 1 N.O./1 N.C. contact	800F-P251
Black flush (with “Forward” text) with 1 N.O./1 N.C. contact; Black flush (with “Reverse” text) with 1 N.O./1 N.C. contact	800F-P252
Black flush (with “On” text) with 1 N.O. contact; Black flush (with “Off” text) with 1 N.C. contact	800F-P253
Green flush (with “Start” text) with 1 N.O. contact; Red flush (with “Stop” text) with 1 N.C. contact	800F-P254
2 flush black push buttons (no text), each with 1 N.O. contact	800F-P255

(1) Connector is a 4-pin mini male.

(2) Only use with single-deep contact block.



Pendant Station
Cat. No. 800F-PN2

Approximate Dimensions – Enclosures

Dimensions in millimeters (inches). Dimensions are not intended to be used for manufacturing purposes.

Plastic Enclosures (1)

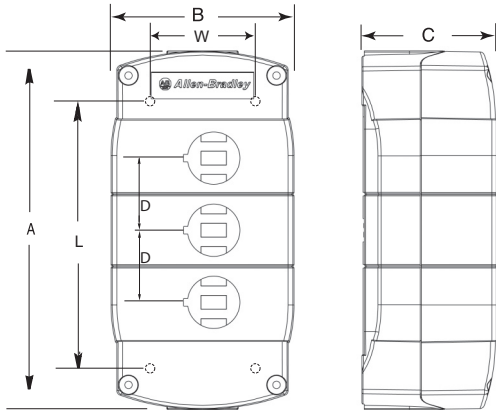

Pendant Stations

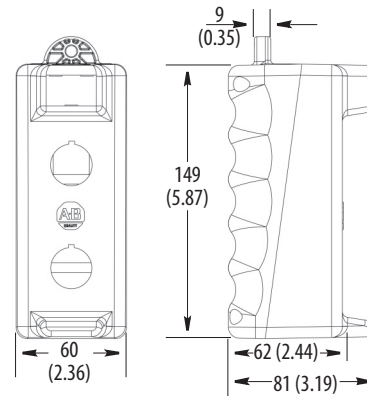

Note: Cable opening = 21.2 mm (0.83 in.) diameter

Cat. No.	Holes	A	B	C	D	Mounting Holes	
						W	L
800F-1P ⁽²⁾ 800F-1Y ⁽²⁾	1	85 (3.35)	89 (3.5)	58 (2.28)	—	58 (2.28)	59 (2.32)
800F-1Y ⁽²⁾ D	1	85 (3.35)	89 (3.5)	74 (2.91)	—	58 (2.28)	65 (2.56)
800F-2P ⁽²⁾	2	124 (4.88)	79 (3.11)	58 (2.28)	31 (1.22)	48 (1.89)	102.5 (4.04)
800F-3P ⁽²⁾	3	155 (6.1)	79 (3.11)	58 (2.28)	31 (1.22)	48 (1.89)	133 (5.24)
800F-4P ⁽²⁾	4	186 (7.32)	79 (3.11)	58 (2.28)	31 (1.22)	48 (1.89)	164.5 (6.48)
800F-6P ⁽²⁾	6	248 (9.76)	87 (3.43)	64 (2.52)	31 (1.22)	55 (2.17)	224 (8.82)

- (1) Mounting screw – pan head with diameter ≤ 7 mm (0.28 in.).
 (2) P = PG conduit holes or M = Metric conduit holes

Metal Enclosures

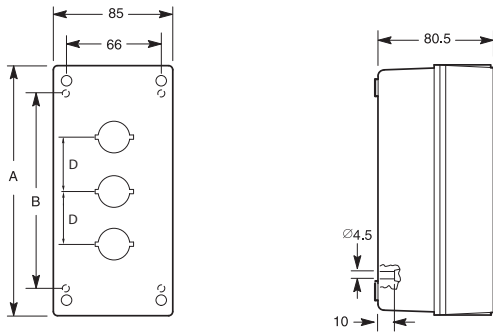

Cat. No.	Holes	A	D	Mounting Holes
				L
800F-1M ⁽¹⁾	1	99 (3.9)	—	62 (2.44)
800F-2M ⁽¹⁾	2	137 (5.39)	37.5 (1.48)	100 (3.94)
800F-3M ⁽¹⁾	3	147 (5.79)	37.5 (1.48)	137 (5.39)
800F-5M ⁽¹⁾	5	249 (9.8)	37.5 (1.48)	212 (8.35)

- (1) P = PG conduit holes or M = Metric conduit holes

Instruction Sheet

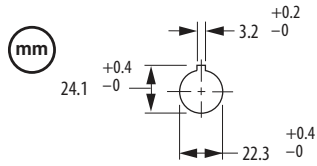

OPTIONAL
EN OPTION
OPTIONAL
OPCIONAL
OPZIONALE

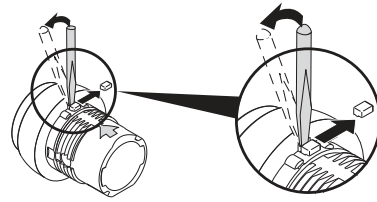



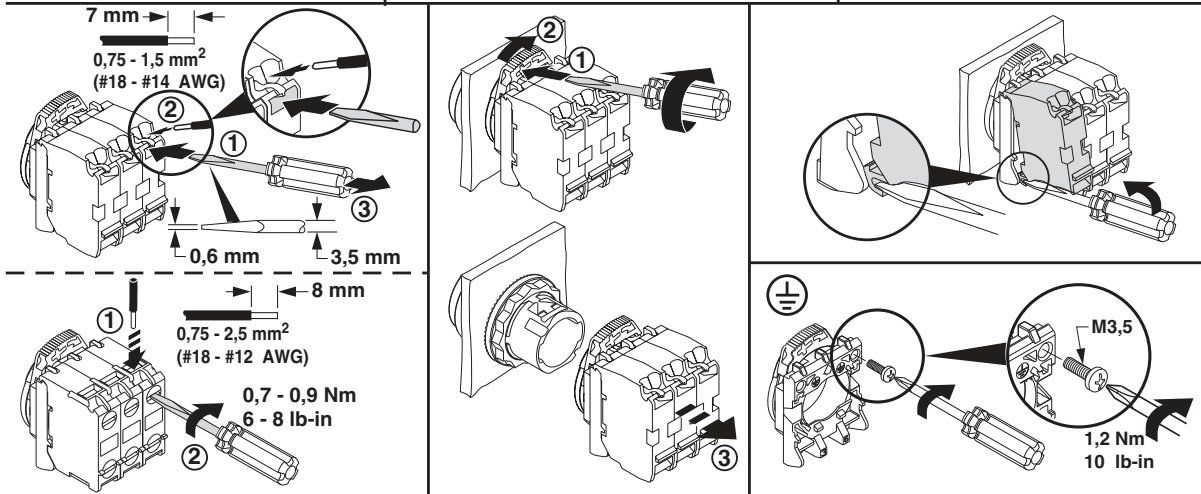
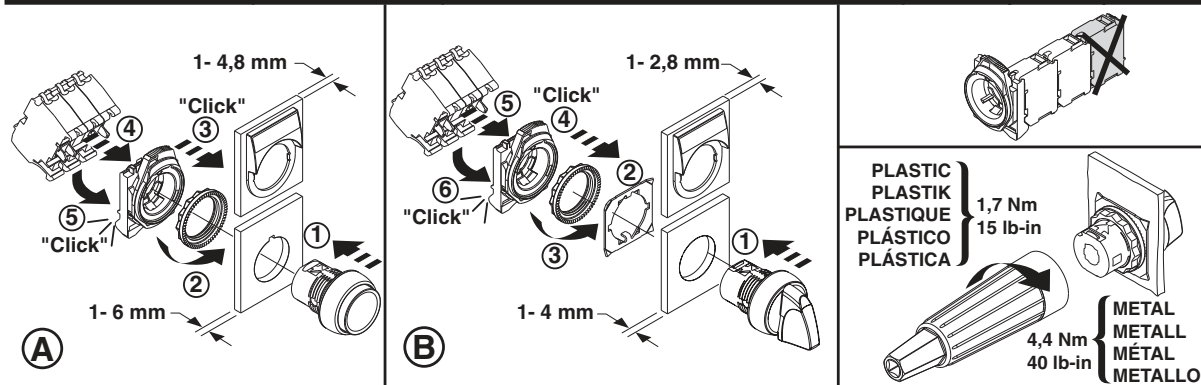





A									
A									
B									
	40	50	40	50	40/60	50/60		70	50
	30		48		40/60		60/90	30	50

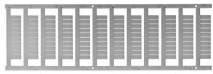

Accessories

The following accessories are available for use with Bulletin 800F operators.

Miscellaneous







	Description	Type	Pkg. Quantity	Cat. No.
 Cat. No. 800F-AHA1	30.5 mm to 22.5 mm Hole Size Adapter This adapter allows a 22.5 mm push button operator to be installed in a panel with existing 30.5 mm mounting holes.	Metal	1	800F-AHA1 ⁽¹⁾
 Cat. No. 888N-M4AF1-1F	Quick Disconnect Male receptacle for pendant stations.	4-pin		888N-M4AF1-1F
		5-pin		888N-M5AF1-1F
	Description	Material	Pkg. Quantity	Cat. No.
 Cat. No. 800F-ARP	Replacement Mounting Rings	Plastic	10 ⁽²⁾	800F-ARP
		Metal		800F-ARM
	Description		Pkg. Quantity	Cat. No.
 Cat. No. 800F-AW2	Mounting Ring Wrench This mounting ring wrench is used to tighten plastic or metal mounting rings quickly and securely.		1	800F-AW2
 Cat. No. 800F-ALR1	Bulb Removal Tool For quick and easy removal of lamps from incandescent modules.			800F-ALR1
 Cat. No. 1492-MS5X9	Snap-In Marker This item can be used for circuit identification on all back-of-panel components.			(3)
 Cat. No. 800F-ATK2	Stab Terminals Can be used with all single-circuit contact blocks. Minimum spacing requirements apply. See instruction sheet for details.		100 ⁽⁴⁾	800F-ATK2
 Cat. No. 800F-AGS1	Ground Screws These are self-tapping #6-32 (M3.5) ground screws for metal latches.		10 ⁽²⁾	800F-AGS1
 Cat. No. 800F-AGS2	Ground Screws This accessory is used for grounding on Bulletin 800F plastic enclosures only.			800F-AGS2

(1) Comes with anti-rotation washer (800F-ALC1).

(2) Sold only in multiples of 10. Order (quantity of) 10 to receive one package of 10 pieces.

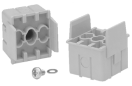



(3) See <https://ab.rockwellautomation.com/Terminal-Blocks> for ordering information.

(4) Sold only in multiples of 100. Order (quantity of) 100 to receive one package of 100 pieces.

	Description	Panel Thickness with Legend Plates	Pkg. Qty.	Cat. No.
 Cat. No. 800F-ALC1	Locking Washer (Anti-rotation Washer) This item provides an extra anti-rotation feature for rotary operators such as selector switches.	1...4 mm	10 ⁽¹⁾	800F-ALC1
		1...5 mm		800F-ALC2
	Description		Pkg. Qty.	Cat. No.
 Cat. No. 800F-ATW1	Replacement Trim Washer This accessory comes standard with all enclosures. It must be used if using base-mounted contact blocks/power modules without legend plates.		10 ⁽¹⁾	800F-ATW1
 Cat. No. 800F-A3BA	Replacement Base Mount Adapter This accessory comes standard with all metal enclosures. It is required when using metal enclosures with base-mounted contact blocks or base-mounted power modules.			800F-A3BA
 Cat. No. 800F-ABZ1	Square Bezel Gives round operator a square appearance. This item is made of plastic. Not for use with toggle switch operators.			800F-ABZ1
	Description	Material	Pkg. Qty.	Cat. No.
 Cat. No. 800F-ABJS	Replacement Boot for Toggle Switch	Silicone	1	800F-ABJS
		Nitrile		800F-ABJN
 Cat. No. 800F-N2	Hole Plug for 22.5 mm holes.	Black plastic		800F-N2
		Gray plastic		800F-N8
 Cat. No. 800F-ACP	Selector Switch Tabs Changes functionality of selector switch from normal to CenterLeft or CenterRight.		10 ⁽¹⁾	800F-ACP







(1) Sold only in multiples of 10. Order (quantity of) 10 to receive one package of 10 pieces.

Guards

	Description	Type	Pkg. Qty.	Cat. No.
 Cat. No. 800F-AMRG	Protective Ring for use with illuminated/non-illuminated 2-position maintained and illuminated/non-illuminated 3-position mushroom operators (30 mm and 40 mm only)	Shiny metal	1	800F-AMRG
		Black		800F-AMRGB
		Yellow metal		800F-AMRGY
 Cat. No. 800F-A6PR5	Plastic Guard for use with the following operators: <ul style="list-style-type: none"> • 40 mm E-stop (SEMI Standards Compliant) • 40 mm illuminated/non-illuminated alternate action and momentary operators • 60 mm illuminated/non-illuminated momentary operators • Selector switches (standard knob and key operated) • Potentiometers 	Yellow, round	1	800F-A6PR5
 Cat. No. 800F-AMEGY	Narrow Plastic Guard for use with the following operators: <ul style="list-style-type: none"> • Bul. 800FD monolithic E-stops (SEMI standards compliant) • Flush/extended/guarded push buttons • Alternate action operators • Selector switches (standard knob and key operated) • Potentiometers 	Yellow	1	800F-AMEGY
 Cat. No. 800F-AMMG	40 mm Protective Guard that is used with illuminated and non-illuminated momentary mushroom operators (40 mm) only.	Shiny metal	1	800F-AMMG
 Protective Boots	Clear silicone Protective Boot used on illuminated and non-illuminated, flush and extended operators.	Flush push button	10 ⁽¹⁾	800F-AB7
		Extended push button		800F-ABE7
		3-position multi-function		800F-AUB1
		2-position multi-function		800F-AUB2

(1) Sold in multiples of 10. Order (quantity of) 10 to receive one package of 10 pieces.

Locking Attachments

	Description	Type	Pkg. Qty.	Cat. No.
 Cat. No. 800F-AFL1	Locking Attachments are used to lock push button in the depressed position. <ul style="list-style-type: none"> • N.C. contacts are open • N.O. contacts may or may not be open • N.C.L.B. contacts may or may not be closed • N.O.E.M contacts are closed 	Flush momentary, non-illuminated	1	800F-AFL1
 Cat. No. 800F-AEL1		Extended momentary, non-illuminated		800F-AEL1
 Cat. No. 800F-AML1		Momentary mushroom		800F-AML1
 Cat. No. 800F-AML2		Maintained mushroom		800F-AML2
	Description	Lock Position	Pkg. Qty.	Cat. No.
 Cat. No. 800F-ASL2L	Selector Switch Locking Attachment Locks standard knob selector switch in specified position	2-position selector switches, left lock	1	800F-ASL2L
		3-position selector switches, center lock		800F-ASL3C
 Cat. No. 800F-ASL23A	Selector Switch Locking Attachment Ability to put two locks on standard knob selector switch.	2- or 3-position selector switches, all positions		800F-ASL23A
 Cat. No. 800F-AL01	Locking Cover Used on flush, extended and guarded momentary and alternate action operators, and standard knob selector switch operators.			800F-AL01





Replacement Keys

	Description	Pkg. Qty.	Key No. (Std)	Cat. No.	Key No. (Std)	Cat. No.
 Cat. No. 800F-AKR3825	Replacement Ronis Key Standard replacement key is Cat. No. 800F-AKR3825.	1 ⁽¹⁾	3825	800F-AKR3825	3910 ⁽²⁾	800F-AKR3910
			455	800F-AKR455	3920 ⁽²⁾	800F-AKR3920
			3801	800F-AKR3801	4001	800F-AKR4001
			3802	800F-AKR3802	4002	800F-AKR4002
			3803	800F-AKR3803	4003	800F-AKR4003
			3804	800F-AKR3804	4004	800F-AKR4004
			3805	800F-AKR3805	4005	800F-AKR4005
			3806	800F-AKR3806	4006	800F-AKR4006
			3901 ⁽²⁾	800F-AKR3901	4007	800F-AKR4007

(1) Standard package quantity is one set with two keys.



(2) Master key. See [page 17](#) for details.

Other Accessories

	Description	Volts	Pkg. Qty.	Cat. No.
 Cat. No. 800F-XD7	Diode Module For lamp checking circuits. Latch not included.	≤600V AC	10 ⁽¹⁾	800F-XD7
	Null Block For wire terminations only.			800F-NX70
 Cat. No. 800F-30WN	Potentiometer Legend Plate Scale 0...9		10	800F-30WN
 Cat. No. 800F-30WG	Potentiometer Legend Plate Graphical scale			800F-30WG
	Description	Resistance	Pkg. Qty.	Cat. No.
 Cat. No. 800F-AC1	Replacement resistive elements for the 800FP potentiometer operator.	150 Ω	1	800F-AC1
		500 Ω		800F-AC2
		1000 Ω		800F-AC3
		2500 Ω		800F-AC4
		5000 Ω		800F-AC5
		10,000 Ω		800F-AC6

(1) Sold only in multiples of 10. Order (quantity of) 10 to receive one package of 10 pieces.

Replacement Lamps for Incandescent Modules

Lamp	Type	Typical Current	Voltage	ANSI No.	Pkg. Quantity	Cat. No.
 Cat. No. 800F-N130	Full-voltage Incandescent	150 mA	6V AC/DC	755	10 ⁽¹⁾	800F-N65
		80 mA	12V AC/DC	756		800F-N141
		70 mA	24V AC/DC	757		800F-N157
		50 mA	48V AC/DC	1835		800F-N48
		22 mA	130V AC/DC	949		800F-N130
 Cat. No. 800F-N240	Neon	2 mA	240V AC	—	10 ⁽¹⁾	800F-N240
	LED	50 mA	6V AC/DC	—	10 ⁽¹⁾	800T-N318x ⁽²⁾
		12 mA/17 mA	32V AC/DC	—		800T-N363x ⁽²⁾
		9 mA/14 mA	48V AC/DC	—		800T-N364x ⁽²⁾
		4.5 mA/6.2 mA	130V AC/DC	—		800T-N321x ⁽²⁾

(1) Sold in multiples of 10. Order (quantity of) 10 to receive one package of 10 pieces.

(2) To complete the cat. no., replace the x with one of the following letters for the desired color: A = Amber; B = Blue; G = Green; R = Red; W = White. White LEDs only available in 6V and 130V.

Caps, Diffusers, Lenses

Color caps listed below are for completion of devices that are ordered with color caps omitted.

Table 31 - Non-illuminated Color Caps (without Text)

	Color	Pkg. Qty.	Momentary Extended	Momentary Flush/Guarded	Alternate Action Flush
			Cat. No.	Cat. No.	Cat. No.
	Orange	10 ⁽¹⁾	800F-AE0	800F-AF0	800F-AFA0
	White		800F-AE1	800F-AF1	800F-AFA1
	Black		800F-AE2	800F-AF2	800F-AFA2
	Green		800F-AE3	800F-AF3	800F-AFA3
	Red		800F-AE4	800F-AF4	800F-AFA4
	Yellow		800F-AE5	800F-AF5	800F-AFA5
	Blue		800F-AE6	800F-AF6	800F-AFA6
	Gray		—	800F-AF8	—

(1) Sold only in multiples of 10. Order (quantity of) 10 to receive one package of 10 pieces.

Table 32 - Non-illuminated Color Caps – Multi-Function Operators (without Text)

	Color	Pkg. Qty.	Flush	Extended
			Cat. No.	Cat. No.
	White	10 ⁽¹⁾	800F-AFU1	800F-AEU1
	Black		800F-AFU2	800F-AEU2
	Green		800F-AFU3	800F-AEU3
	Red		800F-AFU4	800F-AEU4
	Yellow		800F-AFU5	800F-AEU5
	Blue		800F-AFU6	800F-AEU6

(1) Sold only in multiples of 10. Order (quantity of) 10 to receive one package of 10 pieces.

Table 33 - Illuminated Color Lens Caps and Pilot Light Lenses (without Text)

	Color	Pkg. Qty.	Color Lens Caps – Flush, Alternate Action	Color Lens Caps – Extended, Guarded	Pilot Light Lenses – Standard Lens
			Cat. No. ⁽¹⁾	Cat. No. ⁽¹⁾	Cat. No. ⁽¹⁾
	Amber	10 ⁽²⁾	800F-ALF0	800F-ALE0	800F-AP0
	Green		800F-ALF3	800F-ALE3	800F-AP3
	Red		800F-ALF4	800F-ALE4	800F-AP4
	Yellow		800F-ALF5	800F-ALE5	800F-AP5
	Blue		800F-ALF6	800F-ALE6	800F-AP6
	Clear		800F-ALF7	800F-ALE7	800F-AP7

(1) Includes diffuser.

(2) Sold only in multiples of 10. Order (quantity of) 10 to receive one package of 10 pieces.

Table 34 - Operator Diffusers (without Text)

	Description	Pkg. Qty.	Cat. No.
	Illuminated push buttons – flush	10 ⁽¹⁾	800F-AD2
	Pilot lights		800F-AD3
	Illuminated push buttons – extended, guarded		800F-AD4

(1) Sold only in multiples of 10. Order (quantity of) 10 to receive one package of 10 pieces.

Approximate Dimensions – Accessories

Dimensions in millimeters (inches). Dimensions are not intended to be used for manufacturing purposes.

Locking Cover

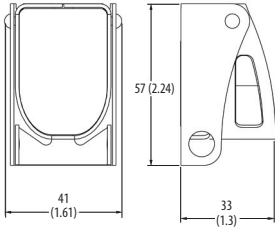

Maintained Mushroom Locking Attachment

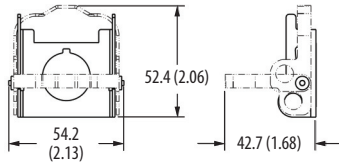

Momentary Mushroom Locking Attachment

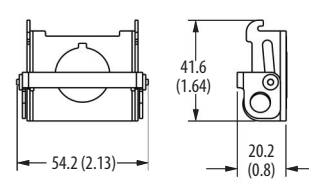

Extended Non-illuminated Locking Attachment

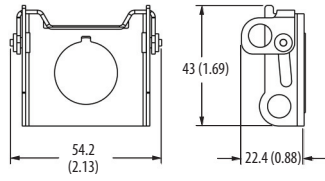

Flush Non-illuminated Locking Attachment

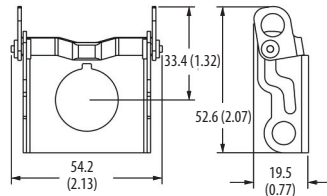

Selector Switch Locking Cover (Same for All Lock Positions)

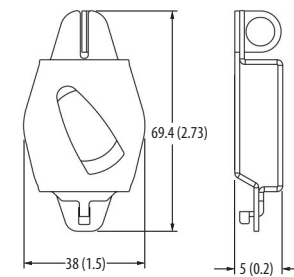

Narrow Guard

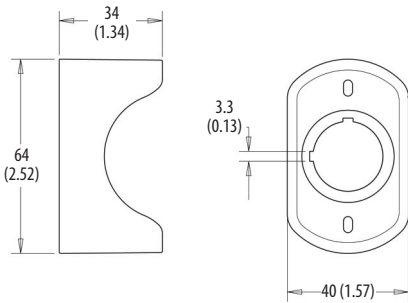

Protective Ring

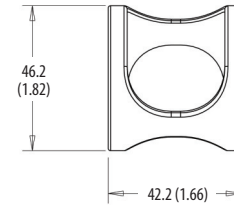

Plastic Guard

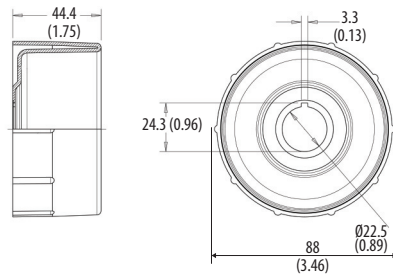

Legend Plates/Caps

Two-color Molded Legend Caps – Non-illuminated Push Buttons

800F - AF 3 01
a b c



Cat. No. 800F-15YSE112

a	
Button Cap Type	
Code	Description
AF	Flush
AE	Extended

b	
Color Cap	
Code	Description
1	White
2	Black
3	Green
4	Red
5	Yellow
6	Blue

c	
Legend Text (English) ^{(1) (2)}	
Code	Description
01	START
02	STOP
05	0
06	I
08	→
09	FORWARD ⁽³⁾
10	REVERSE ⁽³⁾
11	R

- (1) White and yellow caps have black text. All other color caps have white text.
- (2) See [Table 35](#) for valid color cap text codes.
- (3) Available in flush only.

Table 35 - Valid Color Cap Text Codes

Color	Text	
	Flush Caps	Extended Caps
White	FORWARD, REVERSE, START, I, →, R	→, R
Black	FORWARD, REVERSE, →, R	STOP, 0, →, R
Green	FORWARD, REVERSE, START, I, →	→
Red	FORWARD, REVERSE, STOP, 0, →	STOP, 0, →
Yellow	FORWARD, REVERSE, →	→
Blue	FORWARD, REVERSE, →, R	→, R

Emergency Stop Legend Plates ⁽⁵⁾

800F - 15YS
a b

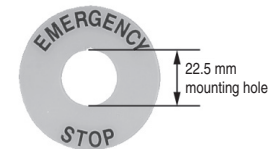

a	
Size/Color (Yellow)	
Code	Description
15Y	60 mm round (30.5 mm mounting hole)
15YS	60 mm round (22.5 mm mounting hole) ⁽¹⁾
16Y	90 mm round (22.5 mm mounting hole) ⁽¹⁾

b	
Text	
Code	Description
Blank	No text
E112	EMERGENCY STOP
F112	ARRÊT D'URGENCE ⁽²⁾
S112	PARO DE EMERGENCIA
G112	NOT HALT
T112	ARRESTO EMERGENZA
N112	NÖDSTOPP, EMERGENCY STOP ⁽²⁾
P112	PARADA DE EMERGENCIA

b (continued)	
Text	
Code	Description
W112	NÖDSTOPP, EMERGENCY STOP ⁽²⁾
A112	NÖDSTOP
B112	EMERGENCY STOP, ARRÊT D'URGENCE, PARADA DE EMERGENCIA ⁽²⁾
D112	NOODSTOP ⁽²⁾
M112	OT HALT, ARRESTO EMERGENZA, ARRÊT D'URGENCE ⁽³⁾
	EMERGENCY STOP, ARRÊT D'URGENCE, NOT HALT ⁽⁴⁾
L112	NEYÐARSTOPP, NEYÐARSTOPP ⁽²⁾
H112	NÖD-STOP, HÄTÄ-SEIS, NÖD-STOP ⁽²⁾

- (1) Not for use with base-mounted contact blocks.
- (2) Not available on 15YS version.
- (3) Text is printed on the 15Y version only.
- (4) Text is printed on the 15YS & 16Y versions only.
- (5) Sold only multiples of 10. Order (quantity of) 10 to receive one package of 10 pieces.

Legend Plate Ordering Information (a) (b) (c)

Standard Text/Symbols

1. Select the catalog number for the appropriate legend size and color from the selection tables on this page.
2. Complete the catalog number by adding the appropriate suffix number selected from [page 59](#). Font size is automatically determined by the number of characters, as shown in the following table. Do not add the font code to the catalog number.

Font Size	Number of Characters		
	One-Piece Legend Plate	Two-Piece Legend Plate	Special Multi-Function Legend Plate
K (small)	>14	>13	>6
S (standard)	≤14	≤13	≤ 6

Example: Catalog number 800F-11WE101 identifies a white, 30 x 40 mm snap-in legend plate and frame with AUTO engraved on it.



Custom Text (d)

1. Select the catalog number for the appropriate legend size and color from the Selection Tables on this page.
2. Add E100 followed by the font code (K, S, L) from the following table.

Font Size	Type of Legend Plate							
	One-Piece			Two-Piece			Special Multi-Function	
	Char. per Line, Max	No. of Lines, Max		Char. per Line, Max	No. of Lines, Max		Char. per Line, Max	No. of Lines, Max
		30 x 40 mm	30 x 50 mm		30 x 40 mm	30 x 50 mm or 30 x 60 mm		
K (small)	16	2	5	15	2	5	7	3
S (standard)	14	2	3	13	1	3	6	3
L (large)	10	1	3	9	1	3	4	2

3. Complete the catalog number by adding custom text to the order memo text or notes field.

Example: Catalog number 800F-12WE100K, with STARTER text entered into memo text on order, identifies a white, 30 x 50 mm snap-in legend plate and frame with custom text STARTER engraved in small font.



- (a) Blank legend frames sold only in multiples of 10. Order (quantity of) 10 to receive one package of 10 pieces. Legends with standard text/symbols or custom text are packaged in quantities of 1.
- (b) Font code K = 0.08 in; font code S = 0.10 in; font code L = 0.14 in.
- (c) For configuration assistance, see the product configurator at configurator.rockwellautomation.com.
- (d) Text found on [page 61](#).

Selection Tables

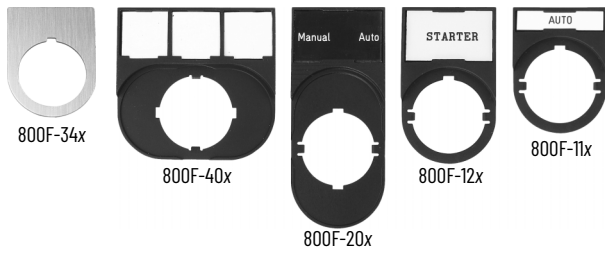

Type ⁽¹⁾	Description	Cat. No. (Blank)	Cat. No. (with Text Symbols)
30 x 40 mm 2-piece snap-in plate and frame	Red with white text	800F-11RE100	800F-11Rxxxx
	White with black text	800F-11WE100	800F-11Wxxxx
	Black with white text	800F-11BE100	800F-11Bxxxx
	Aluminum with black text	800F-11AE100	800F-11Axxxx
30 x 50 mm 2-piece snap-in plate and frame	White with black text	800F-12WE100	800F-12Wxxxx
	Black with white text	800F-12BE100	800F-12Bxxxx
	Aluminum with black text	800F-12AE100	800F-12Axxxx
30 x 60 mm 2-piece snap-in plate and frame	White with black text	800F-20WE100	800F-20Wxxxx
	Black with white text	800F-20BE100	800F-20Bxxxx
	Aluminum with black text	800F-20AE100	800F-20Axxxx
Special multi- function 4-piece snap- in plates and frame	White with black text	800F-40WE100	—
	Black with white text	800F-40BE100	—
	Aluminum with black text	800F-40AE100	—
30 x 40 mm 1-piece	Red with white text	800F-34RE100	800F-34Rxxxx
	White with black text	800F-34WE100	800F-34Wxxxx
	Black with white text	800F-34BE100	800F-34Bxxxx
	Aluminum with black text	800F-34AE100	800F-34Axxxx
30 x 50 mm 1-piece	Red with white text	800F-35RE100	800F-35Rxxxx
	White with black text	800F-35WE100	800F-35Wxxxx
	Black with white text	800F-35BE100	800F-35Bxxxx
	Aluminum with black text	800F-35AE100	800F-35Axxxx
30 x 40 mm snap-in plate only	Red with white text	800F-17RE100	800F-17Rxxxx
	White with black text	800F-17WE100	800F-17Wxxxx
	Black with white text	800F-17BE100	800F-17Bxxxx
	Aluminum with black text	800F-17AE100	800F-17Axxxx
30 x 50 mm snap-in plate only	White with black text	800F-18WE100	800F-18Wxxxx
	Black with white text	800F-18BE100	800F-18Bxxxx
	Aluminum with black text	800F-18AE100	800F-18Axxxx
Special multi- function snap-in plate only ⁽²⁾	White with black text	800F-42WE100	800F-42Wxxxx
	Black with white text	800F-42BE100	800F-42Bxxxx
	Aluminum with black text	800F-42AE100	800F-42Axxxx
30 x 66 mm 1-piece	Yellow with black text	800F-37YE100	800F-37Yxxxx

(1) Plate dimensions found on [page 62](#).

(2) Three snap-in plates are required for each legend frame.

Legend Plate Frame – 2-Piece Snap-In ⁽¹⁾			
Type	Cat. No.	Type	Cat. No.
30 x 40 mm	800F-110	30 x 60 mm	800F-200
30 x 50 mm	800F-120	Special multifunction ⁽²⁾	800F-400

(1) Blank legend frames sold only in multiples of 10. Order (quantity of) 10 to receive one package of 10 pieces. Legends with standard text/symbols or custom text are packaged in quantities of 1.

(2) Three snap-in plates are required for each legend frame.

Legend Texts

Standard Symbols

Marking ⁽¹⁾	Description	Std.	Suffix No.
(Blank)	Blank	—	U100
	—	—	U112
	START ⁽²⁾⁽³⁾⁽⁴⁾⁽⁵⁾	ISO 71	U219
	_ ⁽²⁾⁽³⁾⁽⁴⁾⁽⁵⁾	ISO 72	U220
	START ⁽²⁾⁽³⁾⁽⁴⁾⁽⁵⁾	ISO 5232	U221
	CONTINUOUS MOTION LEFT, RIGHT ⁽⁶⁾	—	U226
	CONTINUOUS MOTION UP, DOWN ⁽⁶⁾	—	U227
0	STOP	—	U228
I	STEP 1	—	U229
II	STEP 2	—	U230
0-I	STOP-START ⁽⁶⁾	—	U231
I-0	START-STOP ⁽⁶⁾	—	U232
I-II	_ ⁽⁶⁾	—	U233
I-0-II	_ ⁽⁶⁾	—	U234
	_ ⁽⁶⁾	—	U236
	_ ⁽⁶⁾	—	U237
I-II-III	_ ⁽⁶⁾	—	U240
	CONTINUOUS MOTION	—	U241
	CONTINUOUS MOTION	—	U242
	CONTINUOUS MOTION	—	U243
III	STEP 3	—	U249
	_ ⁽⁶⁾	—	U256
I-0-I	START-STOP-START ⁽⁶⁾	—	U282
0-I-2	_ ⁽⁶⁾	—	U285
IV	STEP 4	—	U604
V	STEP 5	—	U605
	CONTINUOUS MOTION	ISO 1	U700
	LINEAR MOTION TWO DIRECTIONS	ISO 2	U701
	VERTICAL MOTION	—	U702
	INTERRUPTED MOTION ⁽²⁾⁽⁴⁾	—	U703
	LIMITED MOTION ⁽²⁾⁽⁴⁾	ISO 4	U704
	LIMITED MOTION AND RETURN ⁽²⁾⁽⁴⁾	ISO 5	U705
	OSCILLATING MOTION, CONTINUOUS CYCLE ⁽²⁾⁽⁴⁾	—	U706
	CONTINUOUS ROTATION TO RIGHT ⁽²⁾⁽⁴⁾	DIN 100, ISO 7A	U707
	CONTINUOUS ROTATION TO LEFT ⁽²⁾⁽⁴⁾	ISO 7B	U708

Marking ⁽¹⁾	Description	Std.	Suffix No.
	INTERRUPTED ROTATION TO LEFT ⁽²⁾⁽⁴⁾	—	U710
	INTERRUPTED ROTATION TO RIGHT ⁽²⁾⁽⁴⁾	—	U711
	DIRECTION OF SPINDLE SPEED ⁽²⁾⁽⁴⁾	—	U717
	FEED ⁽²⁾⁽⁴⁾	ISO 16	U720
	REDUCED SPEED ⁽²⁾⁽⁴⁾	—	U723
	RAPID FEED ⁽²⁾⁽⁴⁾	—	U724
	NORMAL FEED ⁽²⁾⁽⁴⁾	—	U725
	LONGITUDINAL FEED ⁽²⁾⁽⁴⁾	—	U726
	TRANSVERSE FEED ⁽²⁾⁽⁴⁾	—	U727
	RAPID TRANSVERSE ⁽²⁾⁽⁴⁾	ISO 26	U728
	THREADING ⁽²⁾⁽⁴⁾	—	U729
+	INCREASE ⁽²⁾⁽⁴⁾	ISO 28	U730
-	DECREASE ⁽²⁾⁽⁴⁾	ISO 29	U731
	CONVENTIONAL MILLING ⁽²⁾⁽⁴⁾	—	U736
	CLIMB MILLING ⁽²⁾⁽⁴⁾	—	U737

- (1) Items in gray shaded table cells only available on legend plates. Not available as laser-engraved text on button caps, illuminated push button diffusers, or pilot light diffusers.
- (2) Not available on -11 or -17 legend plates.
- (3) Not available on -12, -18, or -20 legend plates.
- (4) Not available on -34 legend plates.
- (5) Not available on -35 legend plates.
- (6) Not available on -42 legend plates.

Standard Symbols, Continued

Marking	Description	Std.	Suffix No. (1) (2)
	ELECTRIC MOTOR (2) (4)	ISO 41	U800
	TURNING SPINDLE (2) (4)	—	U803
	DRILLING SPINDLE (2) (4)	—	U804
	MILLING SPINDLE (2) (4)	—	U805
	GRINDING SPINDLE (2) (4)	—	U806
	PUMP (2) (4)	ISO 48	U807
	COOLANT PUMP (2) (4)	—	U808
	LUBRICATION PUMP (2) (4)	—	U809
	HYDRAULIC SYSTEMS PUMP (2) (4)	—	U810
	HYDRAULIC MOTOR (2) (4)	—	U811
	TRACER (2) (4)	—	U812
	SHEAR PIN CONSTRUCTION (2) (4)	ISO 91	U850
	ATTENTION/DANGER (2) (4)	DIN 131, ISO 92	U851
	CAUTION (2) (4)	ISO 93	U852
	MAIN SWITCH (2) (4)	ISO 94	U853
	ACOUSTIC WARNING EQUIPMENT (2) (4)	DIN 155	U854
	SETUP	DIN 986	U855
	COOLANT FLUID	ISO 101	U875
	LIGHT	ISO 139, 102	U876
	WEIGHT	—	U877
	REFILLING	DIN 256, ISO 104	U878
	FULL LEVEL	—	U879
	DRAIN	DIN 257, ISO 106	U880
	OVERFLOW	DIN 258, ISO 105	U881
	OIL LUBRICATION	DIN 175, ISO 107	U882
	BLOWING UNIT	DIN 263, ISO 108	U883
	SUCTION UNIT	DIN 264, ISO 109	U884
	STEPLESS OPERATION	ISO 61	U900
	CLAMP OR TIGHTEN	ISO 63A	U901
	CLAMP OR TIGHTEN	—	U902
	LOOSEN	ISO 64A	U903
	LOOSEN	—	U904
	BRAKE ON	ISO 65	U905

Marking	Description	Std.	Suffix No. (1) (2)
	BRAKE RELEASE	ISO 66	U906
	AUTO CYCLE	—	U907
	MANUAL	DIN 35	U908
	START	ISO 69	U909
	STOP	ISO 70	U910
	TAKE ACTION WHEN CONTROL IS OPERATING	—	U912
	ENGAGE	DIN 46, ISO 74	U913
	DISENGAGE	DIN 45, ISO 75	U914
	ENGAGE TRACE	—	U917
	DISENGAGE TRACE	—	U918
	CHANGE SPEED ONLY IN STOPPED POSITION	—	U919
	CHANGE SPEED ONLY WHEN IN MOTION	—	U920
	CONTINUOUS ADJUSTMENT	ISO 62	U921
	AUTOMATIC OR SEMIAUTOMATIC CYCLE	DIN 267	U922
R RESET	R RESET	—	U924

- (1) Not available on -11 or -17 legend plates.
(2) Not available on -34 legend plates.

Standard Text

IMPORTANT For legend plates in French, Spanish, German, Italian, or Swedish contact your local Allen-Bradley distributor or Rockwell Automation sales office.

Marking (1)	Suffix No.	Marking (1)	Suffix No.	Marking (1)	Suffix No.	Marking (1)	Suffix No.	Marking (1)	Suffix No.
(Blank)	E100	FOR-AUTO-REV ⁽⁴⁾	E252	JOG-STOP-RUN ⁽⁴⁾	E144	POWER ON	E178	SOFT STOP	E292
I-O-AUTO ⁽²⁾⁽³⁾⁽⁴⁾	E235	FOR-OFF-REV ⁽⁴⁾	E261	LAST STOP	E278	PULL TO START	E180	SPEED	E293
ACCU-STOP ⁽⁴⁾	E284	FOR-REV ⁽⁴⁾	E253	LEFT	E145	PULL TO RESET	E176	START	E208
AT SPEED	E285	FOR-STOP-REV ⁽⁴⁾	E254	LEFT-RIGHT ⁽⁴⁾	E146	PUMP STOP	E290	START CYCLE	E209
AUTO	E101	FORWARD	E120	LOCAL-REMOTE ⁽⁴⁾	E147	PURGE	E271	START-JOG ⁽⁴⁾	E210
AUTO-O-HAND ⁽²⁾⁽³⁾⁽⁴⁾	E250	FORWARD-AUTO-REVERSE ⁽⁴⁾	E121	LOW	E148	PUSH TO STOP	E179	START-STOP ⁽⁴⁾	E211
AUTO-HAND ⁽⁴⁾	E102			LOW-HIGH ⁽⁴⁾	E149	PUSH TO STOP-TWIST OR PULL, RELEASE ⁽²⁾⁽⁴⁾⁽⁵⁾	E262	STOP	E212
AUTO-MAN-OFF ⁽⁴⁾	E103	FORWARD-OFF-REVERSE ⁽⁴⁾	E122	LOW-OFF-HIGH ⁽⁴⁾	E150			STOP-CYCLE ⁽⁴⁾	E213
AUTO-MANUAL ⁽⁴⁾	E286			LOW SPEED	E151	PUSH-TO-TEST	E181	STOP-RESET ⁽⁴⁾	E214
AUTO-OFF-HAND ⁽⁴⁾	E104	FORWARD-STOP-REVERSE ⁽⁴⁾	E123	LOWER	E152	RAISE	E182	STOP-START ⁽⁴⁾	E215
BLOWER	E268			LOW-OFF-RAISE ⁽⁴⁾	E153	RAISE-LOWER ⁽⁴⁾	E183	SUMMER-OFF-WINTER ⁽⁴⁾	E216
BRAKE	E105	FORWARD-REVERSE ⁽⁴⁾	E124	LOWER-RAISE ⁽⁴⁾	E154	RAISE-OFF-LOWER ⁽⁴⁾	E184		
BYPASS-OFF-DRIVE ⁽²⁾⁽³⁾⁽⁴⁾	E297	FULL SPEED	E125	MANUAL	E155	READY	E185	SUMMER-WINTER ⁽⁴⁾	E217
BYPASS ON ⁽²⁾⁽³⁾⁽⁴⁾	E295	HAND	E126	MAN-O-AUTO ⁽²⁾⁽³⁾⁽⁴⁾	E238	RESET	E186	SUPPLY ON	E218
BYPASS START ⁽²⁾⁽³⁾⁽⁴⁾	E299	HAND-I-AUTO ⁽²⁾⁽³⁾⁽⁴⁾	E239	MAN-AUTO ⁽⁴⁾	E258	RETURN	E187	TEST	E219
BYPASS STOP ⁽²⁾⁽³⁾⁽⁴⁾	E298	HAND-O-AUTO ⁽⁴⁾	E283	MANUAL-AUTO ⁽⁴⁾	E156	REV-FOR ⁽⁴⁾	E260	TRANSFER ⁽⁴⁾	E220
CLAMP	E106	HAND-AUTO ⁽⁴⁾	E127	MAN-OFF-AUTO ⁽⁴⁾	E259	REVERSE	E188	TRIP	E221
CLOSE	E107	HAND-OFF-AUTO ⁽⁴⁾	E128	MANUAL-OFF-AUTO ⁽⁴⁾	E157	REVERSE-FORWARD ⁽⁴⁾	E189	UNCLAMP	E222
CYCLE START	E108	HAND OFF	E264	MOTOR RUN	E158	REVERSE-OFF-FORWARD ⁽⁴⁾	E190	UP	E223
DECREASE ⁽⁴⁾	E109	HAND ON	E263	MOTOR RUNNING	E159			UP-DOWN ⁽⁴⁾	E224
DRIVE-START ⁽⁴⁾	E287	HAND START	E265	MOTOR START	E160	RIGHT	E191	UP-OFF-DOWN ⁽⁴⁾	E225
DRIVE-STOP ⁽⁴⁾	E288	HAND STOP	E266	MOTOR STOP	E161	RIGHT-LEFT ⁽⁴⁾	E192		
DOWN	E110	HEAT	E270	MOTOR STOPPED	E162	ROTATE CW	E246		
DOWN-OFF-UP ⁽⁴⁾	E111	HIGH	E129	NO FLIP	E275	ROTATE CCW	E247		
DRIVE ON ⁽²⁾⁽³⁾⁽⁴⁾	E296	HIGH-LOW ⁽⁴⁾	E130	OFF	E163	RUN	E193		
EMERG STOP	E251	HIGH-OFF-LOW ⁽⁴⁾	E131	OFF CIRCUIT	E244	RUN-JOG ⁽⁴⁾	E194		
EMERGENCY ⁽⁴⁾	E248	IN	E132	OFF-COOLANT-ON ⁽⁴⁾	E164	RUN-SAFE-JOG ⁽⁴⁾	E195		
EMERGENCY OFF ⁽⁴⁾	E294	IN-OUT ⁽⁴⁾	E133	OFF-LIGHT-ON ⁽⁴⁾	E272	RUNNING	E243		
EMERGENCY STOP ⁽⁴⁾	E112	INCH	E134	OFF-ON ⁽⁴⁾	E165	SAFE	E196		
ENABLE	E279	INCH-REV ⁽⁴⁾	E257	ON	E166	SAFE-RUN ⁽⁴⁾	E197		
ENTER	E277	INCH-REVERSE ⁽⁴⁾	E135	ON CIRCUIT	E245	SETUP	E198		
ERROR	E273	INCH-RUN ⁽⁴⁾	E136	ON-OFF ⁽⁴⁾	E167	SETUP-RUN ⁽⁴⁾	E302		
EXHAUSTER ⁽⁴⁾	E269	INCREASE ⁽⁴⁾	E137	ON-OFF-AUTO ⁽⁴⁾	E168	SETUP-SERVICE ⁽⁴⁾	E199		
FAULT	E113	INSPECT	E274	ON-STOP-SAFE ⁽⁴⁾	E169	SEQUENCE-TEST ⁽⁴⁾	E200		
FAST	E114	JOG	E138	OPEN	E170	SLOW	E201		
FAST-OFF-SLOW ⁽⁴⁾	E289	JOG-FOR ⁽⁴⁾	E255	OPEN-CLOSE ⁽⁴⁾	E171	SLOWER	E202		
FASTER	E115	JOG-FORWARD ⁽⁴⁾	E139	OPEN-OFF-CLOSE ⁽⁴⁾	E172	SLOWEST	E203		
FEED START	E116	JOG-OFF-RUN ⁽⁴⁾	E140	OUT	E173	SLOW-FAST ⁽⁴⁾	E204		
FEED STOP	E117	JOG-REV ⁽⁴⁾	E256	OVERLOAD ⁽⁴⁾	E267	SLOW-OFF-FAST ⁽⁴⁾	E205		
FEEDER OFF	E118	JOG-REVERSE ⁽⁴⁾	E141	OVERLOAD TRIP ⁽⁴⁾	E174	SLOW-STOP-FAST ⁽⁴⁾	E206		
FEEDER ON	E119	JOG-RUN ⁽⁴⁾	E142	OVERLOAD RESET ⁽⁴⁾	E175	SLOW-OFF-START ⁽⁴⁾	E207		
FIFO	E276	JOG-SAFE-RUN ⁽⁴⁾	E143	POWER OFF	E177	SLOW SPEED	E291		

(1) Items in gray shaded table cells only available on legend plates. Not available as laser-engraved text on button caps, illuminated push button diffusers, or pilot light diffusers.

(2) Not available on -34 legend plates.

(3) Not available on -35 legend plates.

(4) Not available on -42 legend plates.

(5) Not available on -11 or -17 legend plates.

Approximate Dimensions – Legend Plates

Dimensions in millimeters (inches). Dimensions are not intended to be used for manufacturing purposes.

30 x 40 mm Snap-in Legend Plate

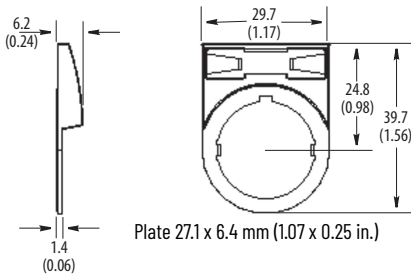

30 x 50 mm Snap-in Legend Plate

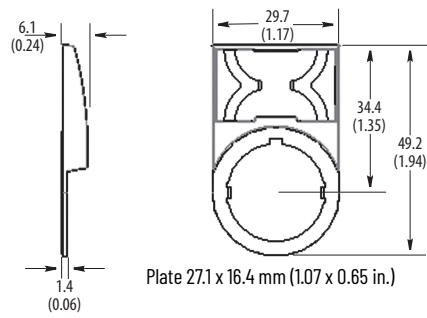

60 mm Round Legend – 15Y

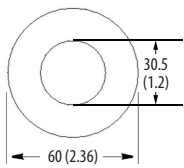

60 mm Round Legend – 15YS

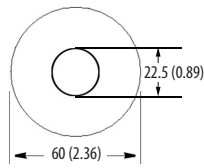

30 x 60 mm Snap-in Legend Plate

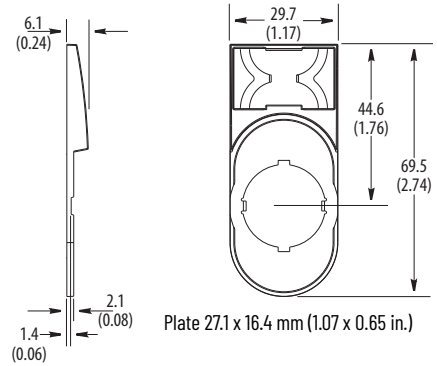

90 mm Round Legend

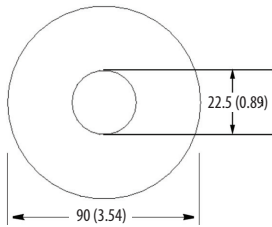

Potentiometer Legend Plate (Series A)

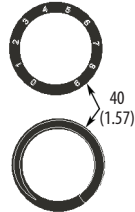

Trim Washer

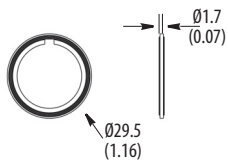

Anti-rotation Washer

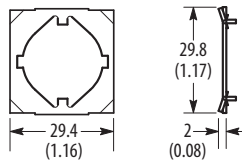

Special Multi-function Snap-in Legend Plate

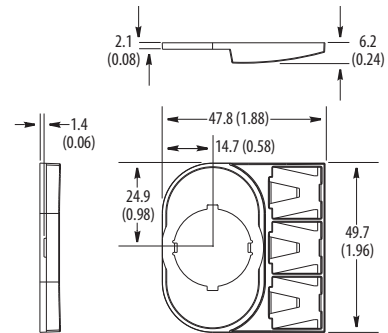

30 x 40 mm One-piece Legend Plate

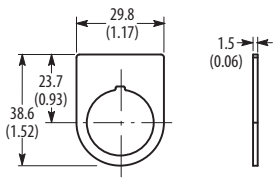

30 x 50 mm One-piece Legend Plate

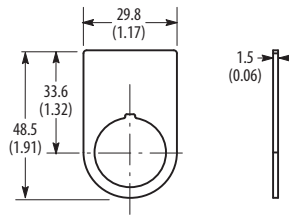

30 mm to 22.5 mm Hole Adapter

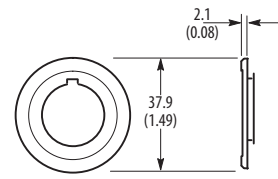

30 x 66 mm One-piece Legend Plate

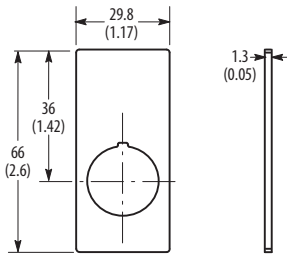

Hole Plug

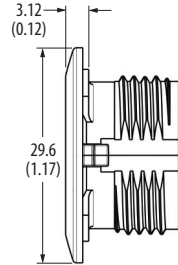

Base Mount Adapter

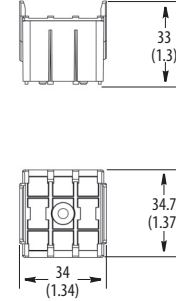

Panel thickness range is 1.0...6.0 mm (0.04...0.24 in.) maximum.

Panel thickness is reduced to 4 mm (0.16 in. [standard anti-rotation washer]) or 5 mm (0.2 in. [thin anti-rotation washer]) when optional legend plates are used.

Assembled Station Pin Out Chart

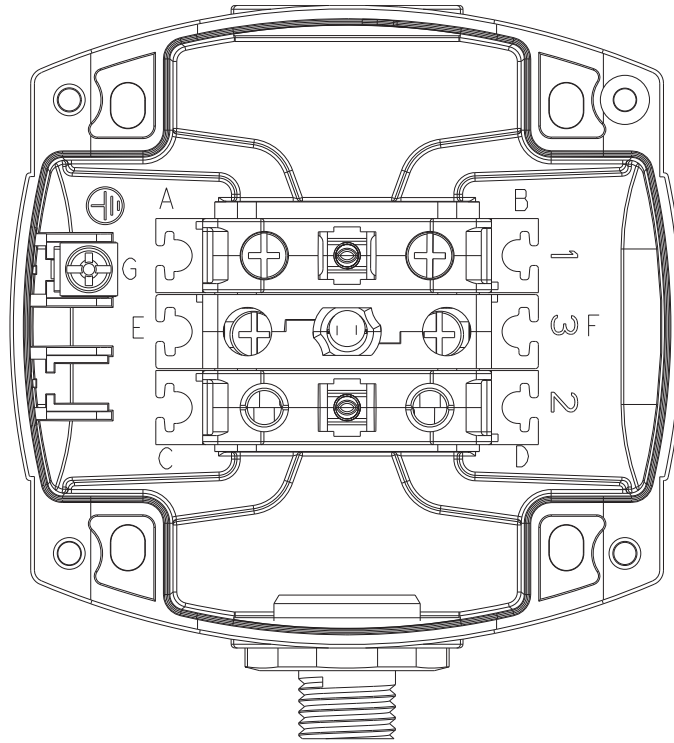

Cat. No.	Connector Style / Number of Pins	Location 1	A to Pin #	B to Pin #	Location 2	C to Pin #	D to Pin #	Location 3	E to Pin #	F to Pin #	G to Pin #
800F-1YM053V	AC Micro / 5-pin	BX01	1	2	BX01	4	5	—	—	—	3
800F-1YM0A	AC Micro / 6-pin	BX01	1	5	BX01	2	6	BX10	3	4	—
800F-NX1	DC Micro / 4-pin	BX01	1/4	2/3	—	—	—	—	—	—	—
800F-1YM01		BX01	1/4	2/3	—	—	—	—	—	—	—
800F-1YM02		BX10	2	4	BX01	1	3	—	—	—	—
800F-1YM03		BX01	1	3	BX01	2	4	—	—	—	—
800F-1YM03VEG		BX01	1	3	BX01	2	4	—	—	—	—
800F-1YM03V		DC Micro / 5-pin	BX01	1	2	BX01	4	5	—	—	—
800F-1YM041	Mini Receptacle / 4-pin	BX01	2	4	—	—	—	—	—	—	—
800F-1YM044		BX10	1	J	BX01	2	4	BN3R	3	J	J
800F-1YM04	Mini Receptacle / 6-pin	BX10	1	J	BX01	6	5	BN3R	2	J	J
800F-1YM05		BX10	1	J	BX01	6	5	BN5R	2	J	J
800F-1YM06		BX10	1	J	BX01	6	5	BN7R	2	J	J
800F-1MYM04		BX10	1	J	BX01	6	5	BN3R	2	J	J
800F-1MYM05		BX10	1	J	BX01	6	5	BN5R	2	J	J
800F-1MYM06		BX10	1	J	BX01	6	5	BN7R	2	J	J

J = Jumper

Bulletin 598 General-purpose Push Button Enclosures

Our enclosures are designed to house 22.5 mm push buttons. These enclosures are available in both gray and yellow.

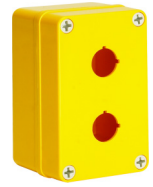
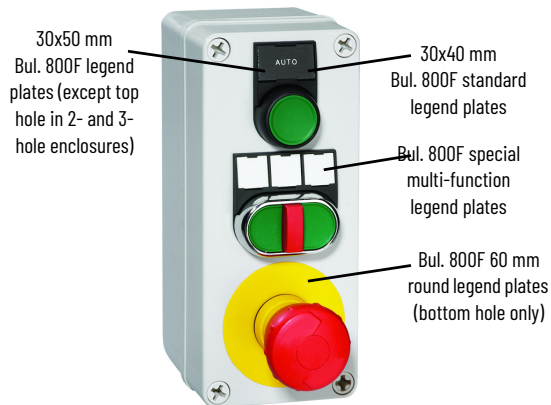

Table 36 - Product Selection

Enclosure ⁽¹⁾	Pkg. Qty.	Cat. No. (1-hole)	Cat. No. (2-hole)	Cat. No. (3-hole)	Cat. No. (4-hole)
Gray Enclosure	1	598-1PB22G	598-2PB22G	598-3PB22G	598-4PB22G
Yellow Enclosure	1	598-1PB22Y	598-2PB22Y	598-3PB22Y	598-4PB22Y
Outside Dimensions (H x W x D) ⁽²⁾ [mm (in.)]		110 x 80 x 85 (4.33 x 3.15 x 3.35)	130 x 80 x 85 (5.12 x 3.15 x 3.35)	180 x 80 x 85 (7.09 x 3.15 x 3.35)	250 x 80 x 85 (9.84 x 3.15 x 3.35)
Base Depth [mm (in.)]	50 (1.97)				
Cover Depth [mm (in.)]	35 (1.38)				
Cover Screw Material	Glass-reinforced nylon				
Recommended Tightening Torque [N·m (lb·in)]	1.0...1.2 (9...11)				
Approx. Shipping Weight [g (lb)]	232 (0.51)	271 (0.60)	357 (0.79)	435 (0.96)	

- (1) Holes are premolded to fit 22.5 mm push buttons, such as 800F push buttons.
 (2) Dimensions are not intended to be used for manufacturing purposes.

Legend Plate Compatibility/Options



Contact Block Compatibility/Options

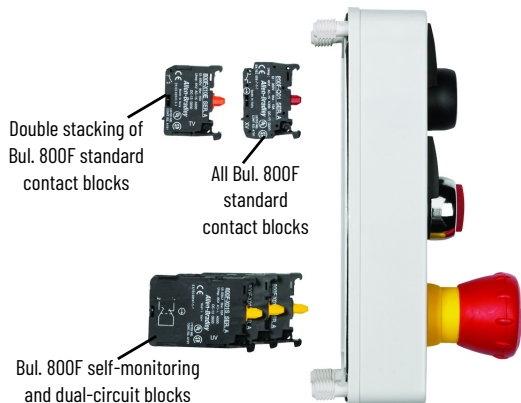

Specifications

Product Certification	
Approvals/Certifications	c-UL-us Listed (File No. E54866; Guide No. NITW, NITW7), CE Marked
Standards Compliance	UL 508A and CSA C22.2, No. 14
Degree of Protection	Type 4, 4X, 12, and 13, IP66 (indoor/outdoor)
Environmental	
Storage Temperature Range	-40...+75 °C (-40...+158 °F)
Operating Temperature Range	-40...+55 °C (-40...+131 °F)
Material	
Enclosure	Thermoplastic polyester blend, UL94; 5VA
Gasket	Foam-in-place polyurethane

Approximate Dimensions

Dimensions in millimeters (inches). Dimensions are not intended to be used for manufacturing purposes.

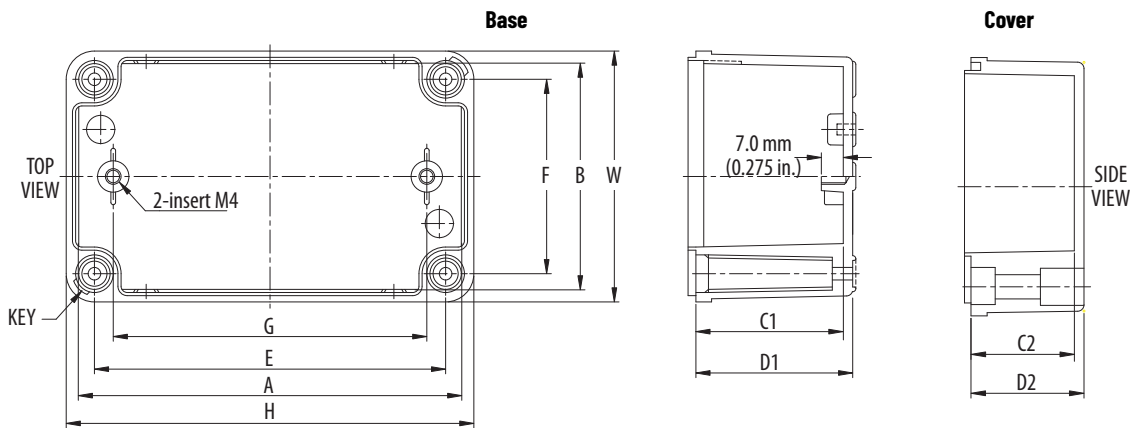

Cat. No.	Overall Dimension				Inside Dimension				Enclosure Mounting Dimension		Mounting Plate Mounting Dim.
	H	W	D1	D2	A	B	C1	C2	E	F	G
598-1PB22__	110 (4.33)	80 (3.15)	50 (1.97)	35 (1.38)	104 (4.09)	74 (2.91)	46.5 (1.83)	31.5 (1.24)	92 (3.62)	62 (2.44)	80 (3.15)
598-2PB22__	130 (5.12)	80 (3.15)	50 (1.97)	35 (1.38)	120 (4.72)	70 (2.76)	46.5 (1.83)	31.5 (1.24)	112 (4.41)	62 (2.44)	100 (3.94)
598-3PB22__	180 (7.09)	80 (3.15)	50 (1.97)	35 (1.38)	170 (6.69)	70 (2.76)	46.5 (1.83)	31.5 (1.24)	162 (6.38)	62 (2.44)	50 (5.91)
598-4PB22__	250 (9.84)	80 (3.15)	50 (1.97)	35 (1.38)	240 (9.45)	70 (2.76)	46.5 (1.83)	31.5 (1.24)	232 (9.13)	62 (2.44)	220 (8.66)

Push Button Hole

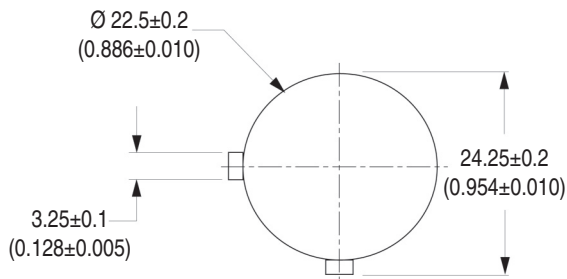

Push Button Hole Spacing

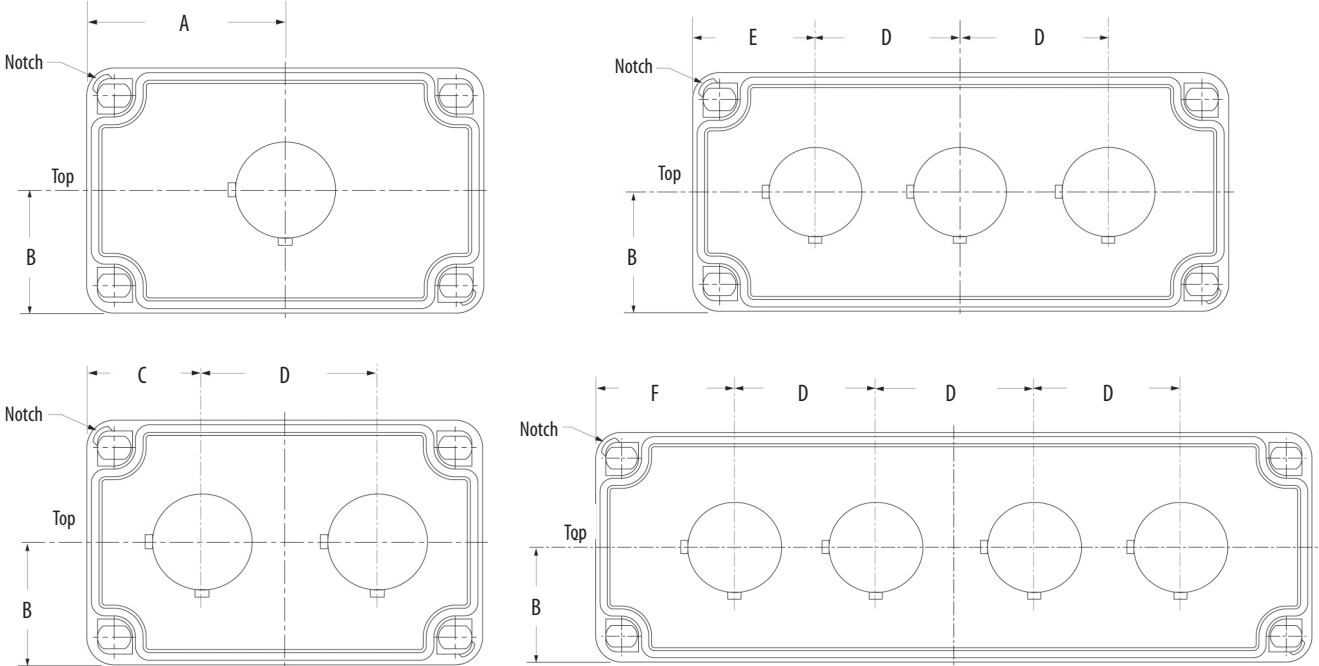

Cat. No.	Type	A	B	C	D	E	F
598-1PB22G	1-hole	55 ± 0.216 (2.165 ± 0.0085)	40 ± 0.5 (1.57 ± 0.020)	-	50.0 ± 0.191 (1.968 ± 0.0075)	-	-
598-2PB22G	2-hole	-		40 ± 0.175 (1.57 ± 0.0069)		-	-
598-3PB22G	3-hole	-		-		$40 + 0.32 / - 0.18$ ($1.57 + 0.0126 / - 0.0071$)	-
598-4PB22G	4-hole	-		-		-	50 ± 0.216 (1.968 ± 0.0085)

Bulletin 800FC 22.5 mm Configured Pendant Stations

Our pendant stations use the time-saving line of Bulletin 800F 22.5 mm push buttons for minimum inventory and maximum efficiency. We also offer multiple options and customization options to fit your unique needs.

Operator Mounting and Sequence

Operator Mounting - Vertical vs. Horizontal Definition

Because of the design of the enclosures, operators can be mounted in both a vertical and horizontal orientation. The easiest way to visualize the operator orientation is by observing the contact block direction that is attached to the operators. If the contact blocks are mounted vertically, the operator is mounted vertically in the enclosure.

Vertical mounted operators are only found in position 2 and 3 of the 3-hole enclosure. If the contact blocks are mounted horizontally, the operator is mounted horizontally in the enclosure. Horizontal mounted operators are found in position 1 of the 3-hole enclosure and all positions of the 5-...9-hole enclosures. It is necessary to have this knowledge when ordering individual operators for populating at the customer location.

Operator Sequence When Using a Mechanical Interlock

The 1-, 2-, and 3-speed operators can be mounted with either our standard catalog number 800F-ALP latch or a mechanical interlocking latch (catalog number 800FC-ALP).

For the 3-hole enclosure, the mechanical interlock can only be located in positions 2 and 3, with the black operator being located in position 2 and the white operator being located in position 3.

For the 5-...9-hole enclosures, the mechanical interlock can be located in any two adjacent positions. For the 5-...9-hole enclosures, the white operator is located in position X of the mechanical interlock and the black operator is located in position X+1 of the mechanical interlock.

Operator Assembly Sequence and Mounting Orientation

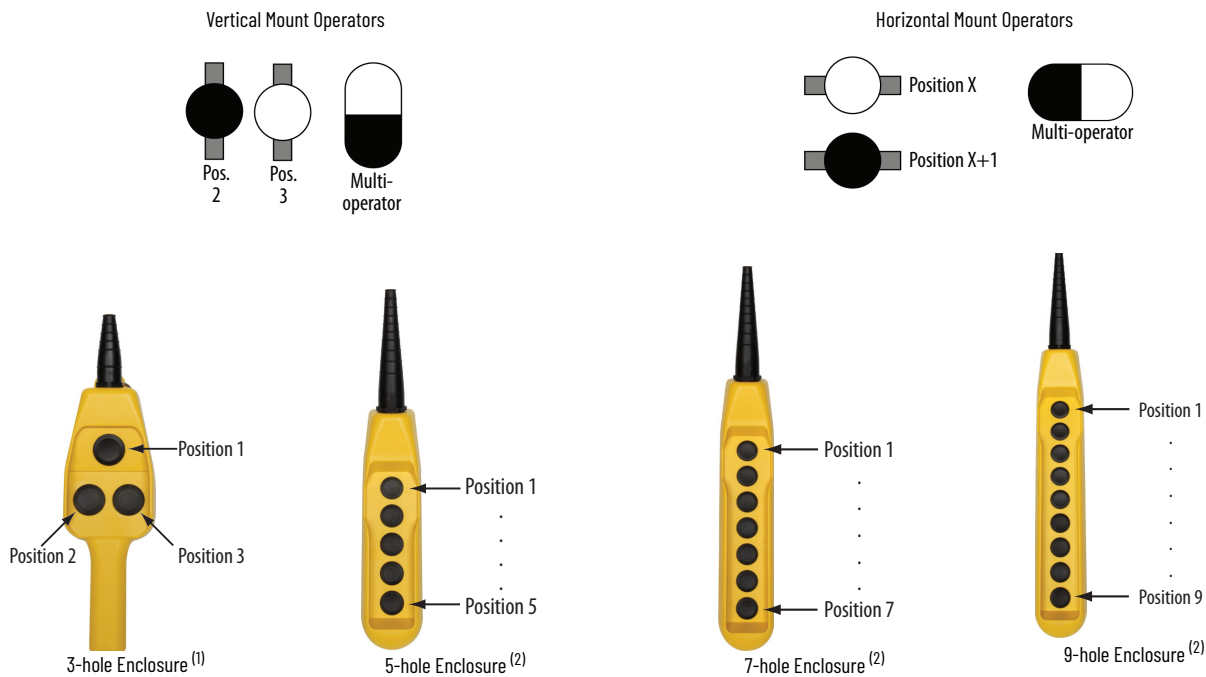

- (1) Operator in Position 1 is mounted horizontally, contact blocks are horizontal. Operators in Positions 2 and 3 are mounted vertically, contact blocks are vertical.
- (2) Operators in all positions are mounted horizontally, contact blocks are horizontal.

Enclosures

Enclosure Color/Material	Enclosure Type	Degree of Protection	Pkg. Quantity	Cat. No. ⁽¹⁾
Yellow plastic	3-hole	IP66	1	800FC-3Z
	5-hole			800FC-5Z
	7-hole			800FC-7Z
	9-hole			800FC-9Z

(1) Housings supplied with cable sleeve, hanger ring, cable clamp, wire guides, and gasket.

1-, 2-, and 3-speed Operators



800FP - C A 1 U243
a b c

a	
Operator Type ^{(1) (2)}	
Code	Description
A	1-speed single arrow
D	1-speed double arrow
B	2-speed
C	3-speed ⁽³⁾

b	
Cap Color	
Code	Description
1	White
2	Black

- (1) Catalog number 800F-ALP (standard latch) and catalog number 800FC-ALP (mechanical interlock latch) can be used with these operators.
 (2) Booted style of operators for pendant stations.
 (3) Proper contact block assembly of these devices is required.

c						
Symbol						
	Code	Valid with Table a Code:	Description ⁽¹⁾			
			Vertical Mounting		Horizontal Mounting	
			Black with White Arrow	White with Black Arrow	Black with White Arrow	White with Black Arrow
	U100	A, B, C	Blank	Blank	Blank	Blank
One-speed Operators						
	U241	A	DOWN	UP	—	—
	U243		—	—	LEFT	RIGHT
	U244		REVERSE	FORWARD	—	—
	U246		—	—	REVERSE	FORWARD
	U700		LEFT	RIGHT	DOWN	UP
	U261	D	DOWN FAST	UP FAST	—	—
	U263		—	—	LEFT FAST	RIGHT FAST
	U264		REVERSE FAST	FORWARD FAST	—	—
	U266		—	—	REVERSE FAST	FORWARD FAST
	U260		LEFT FAST	RIGHT FAST	DOWN FAST	UP FAST
Two-speed Operators						
	U271	B	2-speed DOWN	2-speed UP	—	—
	U273		—	—	2-speed LEFT	2-speed RIGHT
	U274		2-speed REVERSE	2-speed FORWARD	—	—
	U276		—	—	2-speed REVERSE	2-speed FORWARD
	U270		2-speed LEFT	2-speed RIGHT	2-speed DOWN	2-speed UP
Three-speed Operators						
	U291	C	3-speed DOWN	3-speed UP	—	—
	U293		—	—	3-speed LEFT	3-speed RIGHT
	U294		3-speed REVERSE	3-speed FORWARD	—	—
	U296		—	—	3-speed REVERSE	3-speed FORWARD
	U290		3-speed LEFT	3-speed RIGHT	3-speed DOWN	3-speed UP

- (1) Text (DOWN, UP, LEFT, and so on) indicates arrow direction. Text is not printed on operators.
 For proper latch and contact block configurations, consult your local Rockwell Automation sales office or Allen-Bradley distributor.

Figure 1 - Arrow Direction Chart

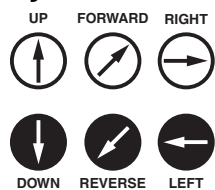

800F Two-position Twist-to-release and Twist-to-release/Push-pull Operators



Description	Operator Cat. No.	Guard Cat. No.
Twist-to-release – Red	800FP-MT44PX01	–
Twist-to-release – Red, illuminated	800FP-LMT44PNxRX01 ⁽¹⁾	–
Keyed twist-to-release – Red	800FP-MK44PX01	–
Twist-to-release or push-pull – Red, monolithic	800FD-MT44X01	–
Twist-to-release or push-pull – Red, monolithic with guard, monolithic	800FD-MT44X01	800F-AMEGY

(1) Replace the x with a 3 for 24V AC/DC or 5 for 120V AC.

800F Push Button Operators and Caps – Extended and Non-illuminated



IMPORTANT Mechanical interlock is not allowed.

Cap Color	Description	Symbol Definition	Operator Cat. No.	Cap Cat. No.	Complete Operator Cat. No.	Composite Cat. No./ No Electrical Interlock ⁽¹⁾	Composite Cat. No./ Electrical Interlock ⁽¹⁾
Black	Blank	–	800FP-E2	–	–	800FP-E2PX10	800FP-E2PX11
	LEFT or DOWN	Single arrow 0°	800FP-E9	800F-AE208	800FP-E208	800FP-E208PX10	800FP-E208PX11
	REVERSE	Single arrow 45°		800F-AE2CU244	800FP-E2U244	800FP-E2U244PX10	800FP-E2U244PX11
	LEFT FAST or DOWN FAST	Double arrow 0°		800F-AE2CU261	800FP-E2U261	800FP-E2U261PX10	800FP-E2U261PX11
	REVERSE FAST	Double arrow 45°		800F-AE2CU264	800FP-E2U264	800FP-E2U264PX10	800FP-E2U264PX11
White	Blank	–	800FP-E1	–	–	800FP-E1PX10	800FP-E1PX11
	UP or RIGHT	Single arrow 0°	800FP-E9	800F-AE108	800FP-E108	800FP-E108PX10	800FP-E108PX11
	FORWARD	Single arrow 45°		800F-AE1CU244	800FP-E1U244	800FP-E1U244PX10	800FP-E1U244PX11
	UP FAST or RIGHT FAST	Double arrow 0°		800F-AE1CU261	800FP-E1U261	800FP-E1U261PX10	800FP-E1U261PX11
	FORWARD FAST	Double arrow 45°		800F-AE1CU264	800FP-E1U264	800FP-E1U264PX10	800FP-E1U264PX11
Green	Blank	–	800FP-E3	–	–	800FP-E3PX10	–
	START/ALARM	Start/Alarm	800FP-E9	800F-AE3CU222	800FP-E3U222	800FP-E3U222PX10	–
	START	Start symbol	–	800F-AE3CU909	800FP-E3U909	800FP-E3U909PX10	–
Red	Blank	–	800FP-E4	–	–	800FP-E4PX10	–
	STOP	Stop symbol	800FP-E9	800F-AE405	800FP-E405	800FP-E405PX10	–
Yellow	Blank	–	800FP-E5	–	–	800FP-E5PX10	–
	ALARM	Alarm	800FP-E9	800F-AE5CU223	800FP-E5U223	800FP-E5U223PX10	–
Blue	Blank	–	800FP-E6	–	–	800FP-E6PX10	–
	R	Reset symbol	800FP-E9	800F-AE611	800FP-E611	800FP-E611PX10	–

(1) For 24V AC/DC units, add V for low-voltage contact blocks. Example: Cat. No. 800FP-E5PX10 becomes Cat. No. 800FP-E5PX10V.

800F Push Button Operators – Extended and Illuminated



IMPORTANT Mechanical interlock is not allowed.

Lens Color	Operator Cat. No.	Composite Cat. No. ⁽¹⁾
Green	800FP-LE3	800FP-LE3PNxGX10
Red	800FP-LE4	800FP-LE4PNxRX10
Yellow	800FP-LE5	800FP-LE5PNxWX10
Blue	800FP-LE6	800FP-LE6PNxBX10
Clear	800FP-LE7	800FP-LE7PNxWX10

(1) Replace the x with a 3 for 24V AC/DC or 5 for 120V AC.

800F Selector Switch Operators – Maintained and Non-illuminated



Positions	Keyed	Operator Cat. No.	Composite Cat. No. ⁽¹⁾
2	No	800FP-SM22	800FP-SM22PX11
	Yes	800FP-KM21	800FP-KM21PX11
3	No	800FP-SM32	800FP-SM32PX20
	Yes	800FP-KM34	800FP-KM34PX20

(1) For 24V AC/DC units, add V for low-voltage contact blocks. Example: Cat. No. 800FP-E5PX10 becomes Cat. No. 800FP-E5PX10V.

800F Multi Operators and Caps – Extended

- IMPORTANT**
- Mechanical interlock is not allowed.
 - Electrical interlock cannot be performed within the pendant enclosure.



Description	Symbol Definition	Illumination	Operator Cat. No.	Position A Cap Cat. No.	Position C Cap Cat. No.	Back of Panel Cat. No. ⁽¹⁾
Blank (black and white cap)	—	Non-Illuminated	800FP-U2X	800F-AEU2	800F-AEU1	800F-PX20
		Illuminated	800FP-LU2X			800F-PNxWX20 ⁽²⁾
Vertical Mounting						
UP (white)/DOWN (black)	Single arrow 0°	Non-Illuminated	800FP-U2X	800F-AECU2CU241	800F-AECU1CU241	800F-PX20
		Illuminated	800FP-LU2X			800F-PNxWX20 ⁽²⁾
RIGHT (white)/LEFT (black)	Single arrow 90°	Non-Illuminated	800FP-U2X	800F-AECU2CU700	800F-AECU1CU700	800F-PX20
		Illuminated	800FP-LU2X			800F-PNxWX20
FORWARD (white)/REVERSE (black)	Single arrow 45°	Non-Illuminated	800FP-U2X	800F-AECU2CU244	800F-AECU1CU244	800F-PX20
		Illuminated	800FP-LU2X			800F-PNxWX20 ⁽²⁾
UP FAST (white)/DOWN FAST (black)	Double arrow 0°	Non-Illuminated	800FP-U2X	800F-AECU2CU261	800F-AECU1CU261	800F-PX20
		Illuminated	800FP-LU2X			800F-PNxWX20 ⁽²⁾
RIGHT FAST (white)/LEFT FAST (black)	Double arrow 90°	Non-Illuminated	800FP-U2X	800F-AECU2CU260	800F-AECU1CU260	800F-PX20
		Illuminated	800FP-LU2X			800F-PNxWX20 ⁽²⁾
FORWARD FAST (white)/REVERSE FAST (black)	Double arrow 45°	Non-Illuminated	800FP-U2X	800F-AECU2CU264	800F-AECU1CU264	800F-PX20
		Illuminated	800FP-LU2X			800F-PNxWX20 ⁽²⁾
Horizontal Mounting						
LEFT (black)/RIGHT (white)	Single arrow 90°	Non-Illuminated	800FP-U2X	800F-AECU1CU241	800F-AECU2CU241	800F-PX20
		Illuminated	800FP-LU2X			800F-PNxWX20 ⁽²⁾
DOWN (black)/UP (white)	Single arrow 0°	Non-Illuminated	800FP-U2X	800F-AECU1CU242	800F-AECU2CU242	800F-PX20
		Illuminated	800FP-LU2X			800F-PNxWX20 ⁽²⁾
REVERSE (black)/FORWARD (white)	Single arrow 45°	Non-Illuminated	800FP-U2X	800F-AECU1CU245	800F-AECU2CU245	800F-PX20
		Illuminated	800FP-LU2X			800F-PNxWX20 ⁽²⁾
LEFT FAST (black)/UP FAST (white)	Double arrow 90°	Non-Illuminated	800FP-U2X	800F-AECU1CU261	800F-AECU2CU261	800F-PX20
		Illuminated	800FP-LU2X			800F-PNxWX20 ⁽²⁾
DOWN FAST (black)/UP FAST (white)	Double arrow 0°	Non-Illuminated	800FP-U2X	800F-AECU1CU262	800F-AECU2CU262	800F-PX20
		Illuminated	800FP-LU2X			800F-PNxWX20 ⁽²⁾
REVERSE FAST (black)/FORWARD FAST (white)	Double arrow 45°	Non-Illuminated	800FP-U2X	800F-AECU1CU265	800F-AECU2CU265	800F-PX20
		Illuminated	800FP-LU2X			800F-PNxWX20 ⁽²⁾

(1) For 24V AC/DC units, add V for low-voltage contact blocks. Example: Cat. No. 800F-PX20 becomes Cat. No. 800F-PX20V.

(2) Replace the x with 3 for 24V AC/DC or 5 for 120V AC.

800F Pilot Lights – Monolithic



Lens Color	Lamp Voltage	Cat. No.
Green	24V AC/DC	800FD-P3N3
	120V AC	800FD-P3N5
Red	24V AC/DC	800FD-P4N3
	120V AC	800FD-P4N5
Yellow	24V AC/DC	800FD-P5N3
	120V AC	800FD-P5N5
Blue	24V AC/DC	800FD-P6N3
	120V AC	800FD-P6N5
Clear	24V AC/DC	800FD-P7N3
	120V AC	800FD-P7N5

800F Potentiometer Operators

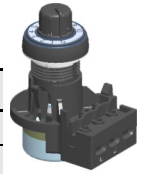

Resistive Element (Ω)	Cat. No. ⁽¹⁾
150	800FP-POT1
500	800FP-POT2
1000	800FP-POT3
2500	800FP-POT4
5000	800FP-POT5
10,000	800FP-POT6

(1) Only available in Position 1 for a 3-hole enclosure, Positions 1 and/or 5 for a 5-hole enclosure, Positions 1 and/or 7 for a 7-hole enclosure, and positions 1 and/or 9 for a 9-hole enclosure. No latches are required.

800F Hole Plug



Color	Cat. No.
Black plastic	800F-N2

1-, 2-, and 3-speed Contact Block Assemblies

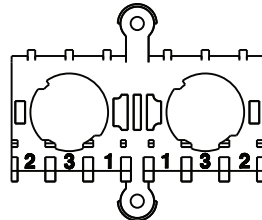

Cat. No. 800FC-ALP

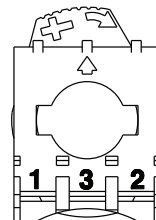

Cat. No. 800F-ALP

Operator Type	Interlock Type	Composite Cat. No.	Separate Catalog Numbers			
			Latch Cat. No.	Contact Block Location 1 Cat. No.	Contact Block Location 2 Cat. No.	Contact Block Location 3 Cat. No.
1-speed	No interlock	800F-PX10E	800F-ALP	—	—	800F-X10E
	Electrical interlock	800F-PX11C	800F-ALP	800F-X01B		
	Mechanical interlock ⁽¹⁾	800F-LX20C	800FC-ALP	—		
	Electrical and mechanical interlock ⁽¹⁾	800F-LX22C	800FC-ALP	800F-X01B		
2-speed	No interlock	800F-PX20C	800F-ALP	—	800F-X10N (Speed 2)	800F-X10E (Speed 1)
	Electrical interlock	800F-PX21C	800F-ALP	800F-X01B		
	Mechanical interlock ⁽¹⁾	800F-LX40C	800FC-ALP	—		
	Electrical and mechanical interlock ⁽¹⁾	800F-LX42C	800FC-ALP	800F-X01B		
3-speed	No interlock	800F-PX30C ⁽²⁾	800F-ALP	800F-X10N	800F-X10E (Speed 2)	800F-X10M (Speed 1) ⁽³⁾
	Mechanical interlock ⁽¹⁾	800F-LX60C	800FC-ALP	800F-X10N (Speed 3)		

(1) When ordering separate components, two pieces of each contact block must be ordered, one for each operator.

(2) Contact blocks come preassembled onto latch.

(3) For proper operation, Cat. No. 800F-X10M must be mounted in position 3 of either the mechanical or standard latch.

Configured Pendant Stations

800FC -

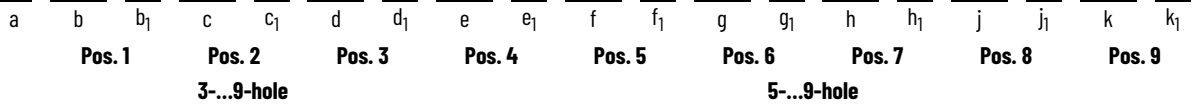

Note: A code from Tables [b...k](#) and [b1...k1](#) must be specified for each operator to create a valid cat. no.

a					
Enclosure Code					
Voltage ⁽¹⁾	Legend Plate	3-hole	5-hole	7-hole	9-hole
		Code	Code	Code	Code
24V AC/DC	No	2	4	6	8
120V AC		3	5	7	9
24V AC/DC	Yes	A	C	E	G
120V AC		B	D	F	H

b ₁ ...k ₁	
Interlock and/or Rubber Boot	
Code	Description
N	No interlock, no additional boots
E	Electrical interlock, no additional boots
M	Mechanical interlock, boots standard ⁽²⁾
B	Electrical and mechanical interlock, boots standard ⁽²⁾
R	No interlock, additional rubber boot
S	Electrical interlock, additional rubber boot

b...k		
Operator Type		
Single Speed Operators for Use with Mechanical Interlock ^{(2) (3) (4) (5)}		
Code	Description	Legend Plate Text (When Selected)
A2	Black operator (no text or symbol)	Blank
AB	Black operator with arrow (reverse – down/left)	O/H CRANE, REVERSE
AD	Black operator with arrow (down)	LIFT, DOWN
AL	Black operator with arrow (left)	HOIST, LEFT
A1	White operator (no text or symbol)	Blank
AF	White operator with arrow (forward – up/right)	O/H CRANE, FORWARD
AR	White operator with arrow (right)	HOIST, RIGHT
AU	White operator with arrow (up)	LIFT, UP
Fast Single Speed Operators for use with Mechanical Interlock ^{(2) (3) (4) (5)}		
Code	Description	Legend Plate Text (When Selected)
DB	Black operator w/ double arrow (reverse fast – down/left)	O/H CRANE, REVERSE, FAST
DD	Black operator with double arrow (down fast)	LIFT, DOWN FAST
DL	Black operator with double arrow (left fast)	O/H CRANE, LEFT FAST
DF	White operator w/ double arrow (forward fast – up/right)	O/H CRANE, FORWARD, FAST
DR	White operator with double arrow (right fast)	O/H CRANE, RIGHT FAST
DU	White operator with double arrow (up fast)	LIFT, UP FAST
Two-speed Operators for Use with Mechanical Interlock ^{(2) (3) (4) (5)}		
Code	Description	Legend Plate Text (When Selected)
B2	Black operator (no text or symbol)	Blank
BB	Black operator with arrow (reverse – down/left)	1-2 SPEED, O/H CRANE, REVERSE
BD	Black operator with arrow (down)	1-2 SPEED, LIFT, DOWN
BL	Black operator with arrow (left)	1-2 SPEED, HOIST, LEFT
B1	White operator (no text or symbol)	Blank
BF	White operator with arrow (forward – up/right)	1-2 SPEED, O/H CRANE, FORWARD
BR	White operator with arrow (right)	1-2 SPEED, HOIST, RIGHT
BU	White operator with arrow (up)	1-2 SPEED, LIFT, UP
Three-speed Operators for Use with Mechanical Interlock ^{(2) (3) (4) (5) (6) (7)}		
Code	Description	Legend Plate Text (When Selected)
C2	Black operator (no text or symbol)	Blank
CB	Black operator with arrow (reverse – down/left)	1-2-3 SPEED, O/H CRANE, REVERSE
CD	Black operator with arrow (down)	1-2-3 SPEED, LIFT, DOWN
CL	Black operator with arrow (left)	1-2-3 SPEED, HOIST, LEFT
C1	White operator (no text or symbol)	Blank
CF	White operator with arrow (forward – up/right)	1-2-3 SPEED, O/H CRANE, FORWARD
CR	White operator with arrow (right)	1-2-3 SPEED, HOIST, RIGHT
CU	White operator with arrow (up)	1-2-3 SPEED, LIFT, UP

- (1) Enclosure code is always required. Voltage is used to select LEDs for illuminated operators. Standard contact blocks are used for both 24V and 120V enclosures.
- (2) For a 3-hole enclosure, when a mechanical interlock (c1 & d1 = M or B) is selected with a 1-...3-speed operator, the black operator is located in position 2 of the enclosure and the opposite white operator is placed in position 3 of the enclosure (Example: ABMAFM or BDMBUM). For a 5-...9-hole enclosure, when a mechanical interlock (b1...k1 = M or B) is selected with a 1-...3-speed operator, the white operator is located in position X of the mechanical interlock and the opposite black operator is placed in position X+1 of the mechanical interlock (Example: AFMABM or BUMBDM).
- (3) Interlock and/or rubber boot selection = **R** (no interlock, additional rubber boot) is **not** allowed.
- (4) Interlock and/or rubber boot selection = **S** (electrical interlock, additional rubber boot) is **not** allowed.
- (5) For proper installation, a trim washer or Cat. No. 800F-36 legend plate must be installed with this operator.
- (6) Interlock and/or rubber boot selection = **N** (no interlock, no additional boots) is **not** allowed.
- (7) Interlock and/or rubber boot selection = **E** (electrical interlock, no additional boots) is **not** allowed.

b...k, Continued			
Operator Type			
Emergency Stop Operators ^{(1) (2) (3) (4) (5) (6)}			
Code	Description	Legend Plate Text (When Selected)	
MT	Red operator – twist-to-release	Not provided	
ME	Illuminated red operator – twist-to-release		
MK	Red operator – keyed twist-to-release		
MM	Red operator – twist-to-release/push-pull ⁽⁷⁾		
MG	Red operator with guard – twist-to-release/push-pull ⁽⁷⁾		
Standard Extended Push Buttons – Non-illuminated ^{(3) (4)}			
E2	Black operator (no text or symbol)	Blank	
ED	Black operator with arrow (down)	LIFT, DOWN	
EL	Black operator with arrow (left)	HOIST, LEFT	
EB	Black operator with arrow (reverse – down/left)	O/H CRANE, REVERSE	
FD	Black operator with double arrow (down fast)	LIFT, DOWN FAST	
FL	Black operator with double arrow (left fast)	O/H CRANE, LEFT FAST	
FB	Black operator with double arrow (reverse fast – down/left)	O/H CRANE, REVERSE, FAST	
E1	White operator (no text or symbol)	Blank	
EU	White operator with arrow (up)	LIFT, UP	
ER	White operator with arrow (right)	HOIST, RIGHT	
EF	White operator with arrow (forward – up/right)	O/H CRANE, FORWARD	
FU	White operator with double arrow (up fast)	LIFT, UP FAST	
FR	White operator with double arrow (right fast)	O/H CRANE, RIGHT FAST	
FF	White operator with double arrow (forward fast – up/right)	O/H CRANE, FORWARD, FAST	
E3	Green operator (no text or symbol) ^{(2) (6)}	Blank	
EQ	Green operator with Start/Alarm symbol ^{(2) (6)}	START, ALARM	
EN	Green operator with Start symbol ^{(2) (6)}	START	
E4	Red operator (no text or symbol) ^{(2) (6)}	Blank	
ES	Red operator with Stop symbol ^{(2) (6)}	STOP	
E5	Yellow operator (no text or symbol) ^{(2) (6)}	Blank	
EA	Yellow operator with Alarm symbol ^{(2) (6)}	ALARM	
E6	Blue operator (no text or symbol) ^{(2) (6)}	Blank	
R6	Blue operator with R	RESET	
Standard Extended Push Buttons – Illuminated ^{(3) (4) (6)}			
L3	Green operator (no text or symbol)	Blank	
L4	Red operator (no text or symbol)	Blank	
L5	Yellow operator (no text or symbol)	Blank	
L6	Blue operator (no text or symbol)	Blank	
L7	Clear operator (no text or symbol)	Blank	
Selector Switches ^{(2) (3) (4) (5) (6)}			
SH	2-position	Standard-maintained	0-I
KH		Keyed-maintained	
SJ	3-position	Standard-maintained	I-0-II
KJ		Keyed-maintained	

b...k, Continued			
Operator Type			
2-function Multi-operator Push Buttons ^{(2) (3) (4) (6)}			
Code	Description	Legend Plate Text (When Selected)	
VV	Black/white operator with arrow (down and up)	Not provided	
VW	Black/white operator with arrow (left and right)		
VX	Black/white operator with arrow (reverse and forward)		
WV	Black/white operator, illuminated, with arrow (down and up)		
WW	Black/white operator, illuminated, with arrow (left and right)		
WX	Black/white operator, illuminated, with arrow (reverse and forward)		
XV	Black/white operator with double arrows (down fast and up fast)		
XW	Black/white operator with double arrows (left fast and right fast)		
XX	Black/white operator with double arrows (reverse fast and forward fast)		
YV	Black/white operator, illuminated, with double arrows (down fast and up fast)		
YW	Black/white operator, illuminated, with double arrows (left fast and right fast)		
YX	Black/white operator, illuminated, with double arrows (reverse fast and forward fast)		
Pilot Lights ^{(2) (3) (4) (5) (6) (7)}			
P0	Amber light-emitting diode (LED)		Blank
P3	Green LED		Blank
P4	Red LED	Blank	
P5	Yellow LED	Blank	
P6	Blue LED	Blank	
P7	Clear LED	Blank	
Potentiometers ^{(2) (3) (4) (6) (8)}			
1P	Black operator – 150 Ω	Blank	
2P	Black operator – 500 Ω	Blank	
3P	Black operator – 1000 Ω	Blank	
4P	Black operator – 2500 Ω	Blank	
5P	Black operator – 5000 Ω	Blank	
6P	Black operator – 10,000 Ω	Blank	
Hole Plug ^{(2) (3) (4) (5) (6)}			
N2	Black hole plug	Blank	

- (1) Only available in position 1 of a 3-hole enclosure and in positions 1 & 2 of a 5-...9-hole enclosure.
(2) Interlock and/or rubber boot selection = **E** (electrical interlock, no additional boots) is **not** allowed.
(3) Interlock and/or rubber boot selection = **M** (mechanical interlock) is **not** allowed.
(4) Interlock and/or rubber boot selection = **B** (electrical and mechanical interlock) is **not** allowed.
(5) Interlock and/or rubber boot selection = **N** (no interlock, no additional boots) is **not** allowed.
(6) Interlock and/or rubber boot selection = **R** (no interlock, additional rubber boot) is **not** allowed.
(7) Monolithic style device provided.
(8) Only available in position 1 for a 3-hole enclosure, positions 1 and/or 5 for a 5-hole enclosure, positions 1 and/or 7 for a 7-hole enclosure, and positions 1 and/or 9 for a 9-hole enclosure.

Accessories

Figure 2 - Engraved Legend Plates

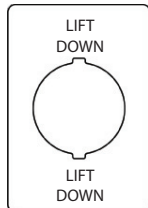

Cat. No. 800F-36VE416

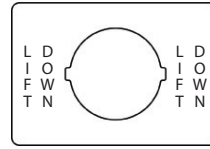

Cat. No. 800F-36HE416

Description	Cat. No. ⁽¹⁾
Blank	800F-36BE100
0-I	800F-36xU231
I-0-II	800F-36xU234
RESET	800F-36xE186
START	800F-36xE208
STOP	800F-36xE212
1-2 SPEED, HOIST, LEFT	800F-36xE401
1-2 SPEED, HOIST, RIGHT	800F-36xE402
1-2 SPEED, LIFT, DOWN	800F-36xE403
1-2 SPEED, LIFT, UP	800F-36xE404
1-2 SPEED, O/H CRANE, FORWARD	800F-36xE405
1-2 SPEED, O/H CRANE, REVERSE	800F-36xE406
1-2-3 SPEED, HOIST, LEFT	800F-36xE407
1-2-3 SPEED, HOIST, RIGHT	800F-36xE408
1-2-3 SPEED, LIFT, DOWN	800F-36xE409
1-2-3 SPEED, LIFT, UP	800F-36xE410

Description	Cat. No. ⁽¹⁾
1-2-3 SPEED, O/H CRANE, FORWARD	800F-36xE411
1-2-3 SPEED, O/H CRANE, REVERSE	800F-36xE412
ALARM	800F-36xE413
HOIST, LEFT	800F-36xE414
HOIST, RIGHT	800F-36xE415
LIFT, DOWN	800F-36xE416
LIFT, DOWN FAST	800F-36xE417
LIFT, UP	800F-36xE418
LIFT, UP FAST	800F-36xE419
O/H CRANE, FORWARD	800F-36xE420
O/H CRANE, FORWARD, FAST	800F-36xE421
O/H CRANE, LEFT FAST	800F-36xE422
O/H CRANE, REVERSE	800F-36xE423
O/H CRANE, REVERSE, FAST	800F-36xE424
O/H CRANE, RIGHT FAST	800F-36xE425
START, ALARM	800F-36xE426
Custom text	800F-36xE100 ⁽²⁾ ⁽³⁾

- (1) For vertically mounted operators, replace the x with a V. Example: Cat. No. 800F-36xE186 becomes Cat. No. 800F-36VE186.
For horizontally mounted operators, replace the x with an H. Example: Cat. No. 800F-36xE186 becomes Cat. No. 800F-36HE186.
- (2) Font code (K, S, L) must be selected from the table following [Figure 3](#).
- (3) Please complete the [Custom Text Fax/Scan Sheet on page 81](#) to verify accuracy of legend plate engraving.

Figure 3 - Font Code

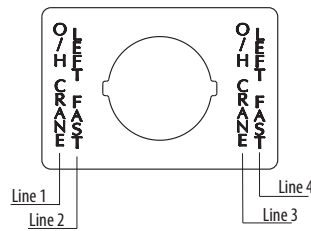
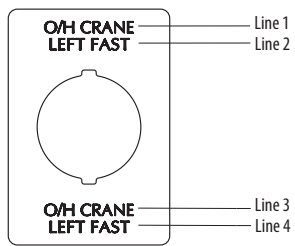

Font Size	Vertical Mounting (V)		Horizontal Mounting (H)	
	Characters Per Line, Max	No. of Lines, Max	Characters Per Line, Max	No. of Lines, Max
K (small)	16	4	9	4
S (standard)	14	4	8	4
L (large)	10	2	7	2

Table 37 - Miscellaneous Accessories

	Description		Pkg. Quantity	Cat. No.	
	Plastic mounting latch		10	800F-ALP	
	Mechanical interlock latch		1	800FC-ALP ⁽¹⁾	
	Replacement wire guide ⁽²⁾		10	800FC-AWG	
	Replacement trim washer		10	800F-ATW1	
	Insulated side jumper		50	1492-SJ5A-24	
				1492-SJ5A-10	
	Hole plug		1	800F-N2	
	Description	Type	Pkg. Quantity	Cat. No.	
	Contact block		N.O.	10	800F-X10
			N.C.		800F-X01
			N.O. low-voltage – QuadConnect™		800F-X10V
			N.C. low-voltage – QuadConnect		800F-X01V
			N.C.E.B.		800F-X01B
			N.O.E.M. ⁽³⁾		800F-X10E
			N.O.L.M. ⁽⁴⁾		800F-X10N
		N.O.E.E.M. ⁽⁵⁾	800F-X10M ⁽⁶⁾		
	Cable sleeve	3-hole (M20 x 1.5)	1	800FC-AS3	
		9-hole (M32 x 1.5)		800FC-AS5	
	Protective boot	Extended push button	10	800F-ABE7 ⁽⁷⁾	
		2-position multi-operator		800F-AUB2 ⁽⁷⁾	
	Narrow plastic guard	Yellow	1	800F-AMEGY	
	Integrated LED module	24V AC/DC	10	800F-N3x ⁽⁸⁾	
		120V AC		800F-N5x ⁽⁸⁾	

- (1) Only for use with 1-, 2-, and 3-speed operators.
- (2) Wire guides are provided with enclosures.
- (3) First contact closure of 1- and 2-speed operators.
- (4) Second contact closure of 2-speed operators and third contact closure of 3-speed operators.
- (5) First contact closure of 3-speed operators.
- (6) For proper operation, Cat. No. 800F-X10M must be mounted in position 3 of the mechanical or standard latch.
- (7) Not for use with 1-, 2-, and 3-speed operators.
- (8) To complete the cat. no., replace the x with one of the following letters for the desired color: Y = Amber, R = Red, G = Green, B = Blue, W = White.

Specifications

Table 38 - Front-of-panel (Operators) ⁽¹⁾

Description		Mechanical Ratings
		Plastic (Bulletin 800FP)
Vibration (assembled to panel)		Tested at 10...2000 Hz, 1.52 mm displacement (peak-to-peak) max/10 G max for 3 hr duration, no damage
Shock		Tested at 1/2 cycle sine wave for 11 ms; no damage at 100 G
Degree of protection ⁽²⁾		IP66 (Type 4/4X/13)
Mechanical durability per EN 60947-5-1 (Annex C)	10,000,000 Cycles	Momentary push buttons
	1,000,000 Cycles	Multi-function, selector switch, key selector switch
	300,000 Cycles	Twist-to-release E-stop, illuminated push-pull E-stop, alternate action push buttons
	100,000 Cycles	Potentiometer, toggle switch
Operating forces (typical with one contact block)		Flush/extended = 5 N, E-stop = 36 N
Operating torque (typical application with one contact block)		Selector switch = 0.25 N•m (2.2 lb•in)
Mounting torque		1.7 N•m (15 lb•in)
		Environmental
Temperature range (operating)		-25...+70 °C (-13...+158 °F) ⁽³⁾
Temperature range (short-term storage)		-40...+85 °C (-40...+185 °F)
Humidity		≤95% RH from 25...60 °C (77...140 °F)

(1) Performance Data – see Important table on [page 4](#).

(2) Plastic-keyed operators are IP66, Type 4/13; not Type 4X.

(3) Operating temperatures below 0 °C (32 °F) are based on the absence of freezing moisture and liquids, UL Recognized to 55 °C (131 °F) - Incandescent module max 40 °C (104 °F) - fully populated 9-hole pendant enclosure 45 °C (113 °F) with 75 °C wire.

Note: Use UL Listed type S or SJ cords, with a smooth outer jacket rated for wet locations use (marked W) and oil-resistant outer covering (marked O) such as SOW or SJOW with copper wire, rated 75 °C min, 18...12 AWG, with an overall OD of 7.5...15 mm for the small cable sleeve (catalog number 800FC-AS3) and 9...22.5 mm for the large cable sleeve (catalog number 800FC-AS5).

Table 39 - Product Certifications

Certifications	UR/UL, CSA, CCC, CE
Standards Compliance	NEMA ICS-5, UL 508, CSA C22.2 No. 14, EN ISO 13850, EN 60947-1, EN 60947-5-1, EN 60947-5-5
Terminal Identification	EN/IEC 60947-1
RoHS	Yes

Table 40 - Material Listing

Component	For Use with	Material Used
Panel gasket	All operators	Nitrile, TPE
Diaphragm seal	Illuminated push button, non-illuminated push button	Automotive industry acceptable silicone
K-seal	Selector switch, key selector switch, push/twist-to-release E-stop, key E-stop	Nitrile
Diaphragm retainer, return spring I	Illuminated push button, non-illuminated push button	Stainless steel
Return spring II	Selector switch, key selector switch, alternate action, push/twist-to-release E-stop, key E-stop	Zinc-coated music wire
Button cap	Non-illuminated push button, push/twist-to-release, E-stop, key E-stop, multi-function	PBT/polycarbonate blend
2-color molded button cap	Non-illuminated push button	PBT/polycarbonate blend
Lens	Multi-function	Acetal
Lens, knob	Illuminated push button	Polyamide
Knob	Non-illuminated selector switch	Glass-filled polyamide
Plastic bezel/bushing I	Non-illuminated push button, illuminated push button, selector switch, key selector switch, push/twist-to-release E-stop, key E-stop, multi-function	Glass-filled polyamide
Plastic bezel/bushing II	Pilot light	Glass-filled PBT
Diffuser	Illuminated push button, pilot light	Polycarbonate
Plastic mounting ring	All plastic operators	Glass-filled polyamide
Plastic latch	–	Glass-filled polyamide
Mechanical interlock latch	–	Glass-filled polyamide
Plastic enclosure	–	PBT/polycarbonate blend
Terminal screws	LED module, contact blocks	Zinc-plated steel with chromate
Terminals	LED module, contact blocks	Brass with silver-nickel contacts
Housing	LED module	Glass-filled polyamide
Low-voltage terminals	Contact blocks	Gold-plated silver-nickel contacts
Low-voltage spanner	Contact blocks	Gold-plated silver-nickel contacts
Spanner	Contact blocks	Brass with silver-nickel contacts
Boot	Illuminated/non-illuminated push button, illuminated/non-illuminated multi-function	Automotive industry acceptable silicone

Table 41 - Back-of-Panel Components ⁽¹⁾

Electrical Ratings				
Standard contact block ratings	A600, 0600 600V AC AC 15, DC 13 to IEC/EN 60947-5-1 and UL 508, 17V, 5 mA min			
Low-voltage contact block ratings ⁽²⁾	5V, 1 mA DC min C300, R150, AC 15, DC 13 to EN 60947-5-1 and UL 508			
	Nominal Voltage	Range	Current Draw	Frequency
LED Module Ratings	24V AC 24V DC 120V AC 240V AC	10...29V AC 10...30V DC 70...132V AC 180...264V AC	31 mA 24 mA 25 mA 22 mA	50/60 Hz DC 50/60 Hz 50/60 Hz
Thermal current	10 A max enclosed (40 °C [104 °F] ambient) to UL508, EN 60947-5-1			
Insulation voltage (U _i)	Screw terminal = 690V, spring-clamp = 300V			
Wire capacity (screw terminal) ⁽³⁾	#18...12 AWG (0.75...2.5 mm ²) / max (2) #14 AWG or (1) #12 AWG			
Wire capacity (spring-clamp terminal)	#18...14 AWG (0.75...1.5 mm ²) One per spring clamp, two spring clamps per terminal			
Recommended tightening torque on screw terminals	0.7...0.9 N•m (6...8 lb•in)			
Dielectric strength (minimum)	2500V for 1 minute			
External short circuit protection	Standard blocks	10 A type gL/gG cartridge fuse to EN 60269-2-1 or gN (Class J to UL 248-8 or Class C to UL 248-4)		
	Low-voltage contact blocks	6 A type gL/gG cartridge fuse to EN 60269-2-1 or gN (Class J to UL 248-8 or Class C to UL 248-4)		
Electrical shock protection	Fingersafe conforming to IP2X			
Mechanical Ratings				
Vibration (assembled to panel)	Tested at 10...2000 Hz, 1.52 mm displacement (peak-to-peak) max/10 G max 6 hr			
Shock	Tested at 1/2 cycle sine wave for 11 ms and no damage at 100 G max			
Contact durability per EN 60947-5-1 (Annex C)	10,000,000 cycles			
Contact operation	N.O.	Slow double make and break		
	N.C.	Slow double make and break – positive opening →		
	N.O.E.M.	Double break / double make, early make		
	N.C.L.B.	Double break / double make, late break – positive opening →		
	N.C.E.B.	Double break / double make, early break – positive opening →		
	N.O.E.E.M.	Double break / double make, early early make		
	N.O.L.M.	Double break / double make, late make		
Standard push button travel to change electrical state	N.C. and N.O.E.M.	1.5 mm (0.060 in.)		
	N.O. and N.C.L.B.	2.5 mm (0.1 in.)		
Multi-speed push button travel to change electrical state	N.O.E.E.M.	3 mm (0.12 in.)		
	N.C.E.B.	4 mm (0.16 in.)		
	N.O.L.M.	7 mm (0.28 in.)		
Operating forces (typical)	Single-circuit contact block	3.4 N		
	Dual-circuit contact block	5...6.5 N		
Materials				
Springs	Stainless steel and zinc-coated music wire			
Electrical contacts	Standard	Silver-nickel		
	Low-voltage	Gold-plated over silver		
Terminals	Screw	Brass		
	Spring-clamp	Silver-plated brass		

(1) Performance Data – see Important table on [page 5](#).

(2) Low-voltage contacts are recommended for applications below 17V, 5 mA.

(3) Wires less than #18 AWG (0.75 mm²) cannot hold in terminal securely.

	Illumination				
	Green	Red	Yellow	Blue	White
LED dominant wavelength	525 nm	629 nm	590 nm	470 nm	–
LED luminous intensity	780 mcd	780 mcd	600 mcd	168 mcd	360 mcd

Approximate Dimensions

Dimensions in millimeters (inches). Dimensions are not intended to be used for manufacturing purposes.

Bulletin 800FC 1-, 2-, and 3-speed Operator

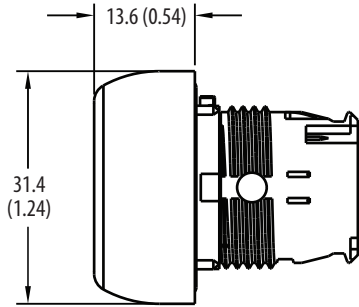

Bulletin 800FC Legend Plate

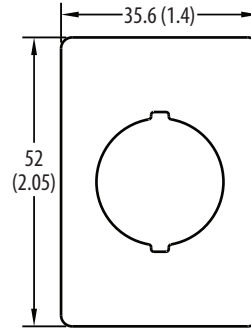

Bulletin 800FC Pendant Station (3-hole)

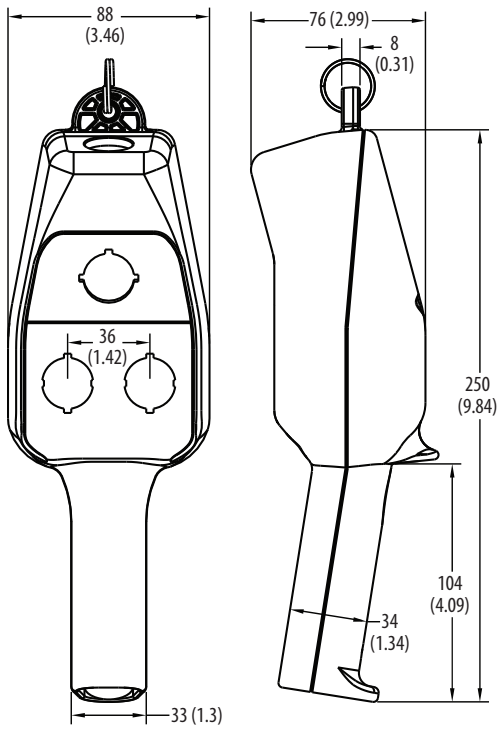

Bulletin 800FC Pendant Station (5-, 7-, and 9-hole)

Cat. No.	Holes	A	B
800FC-4/5/C/D	5	309 (12.17)	36 (1.42)
800FC-6/7/E/F	7	381 (15)	36 (1.42)
800FC-8/9/G/H	9	453 (17.83)	36 (1.42)

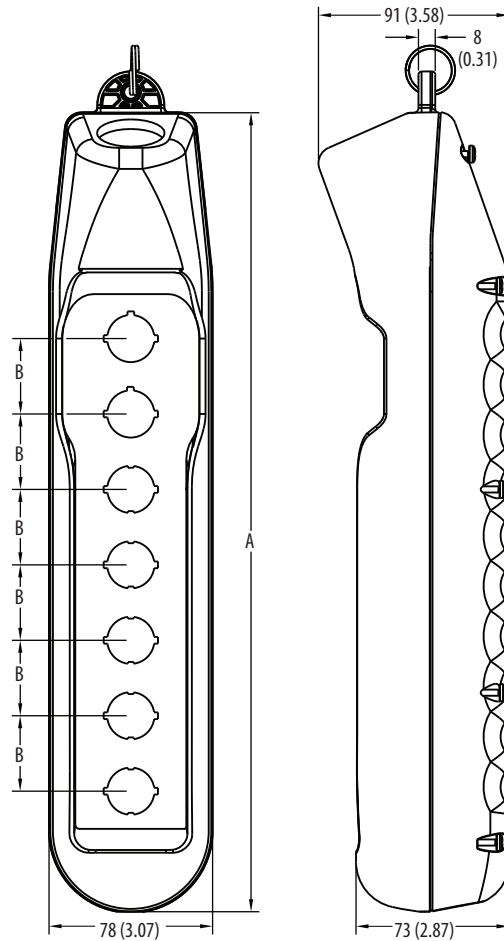

Table 42 - Bulletin 800F Operator Dimensions

Operator	Page
Momentary push button	9
Alternate action	10
Pilot light	11
Selector switch	16 and 19
Push-pull	24
Mushroom	26
Multi-operator	30
Reset	31
Potentiometer	32
Key-operated selector switch	33
Selector push button	34

Custom Text Fax/Scan Sheet

Order/Item _____

Vertical Mounting

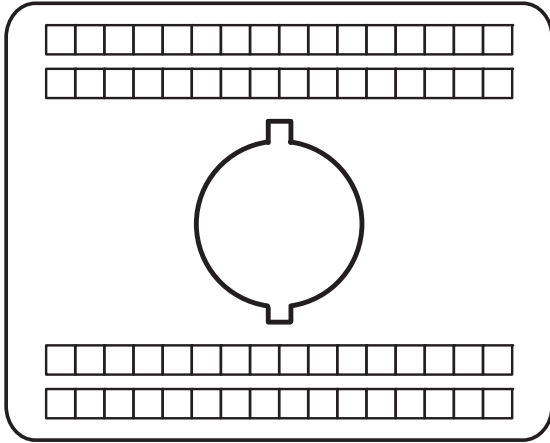

Cat. No. 800F-36VE100K

Horizontal Mounting

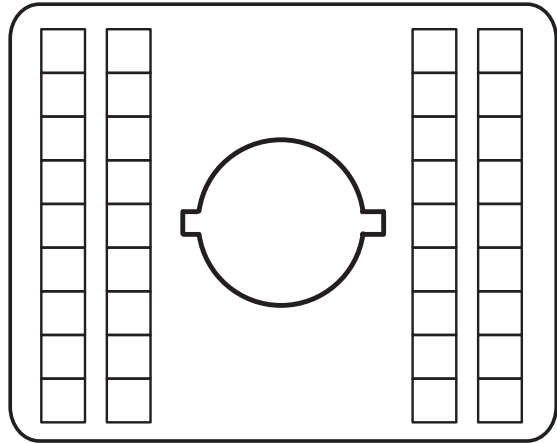

Cat. No. 800F-36HE100K

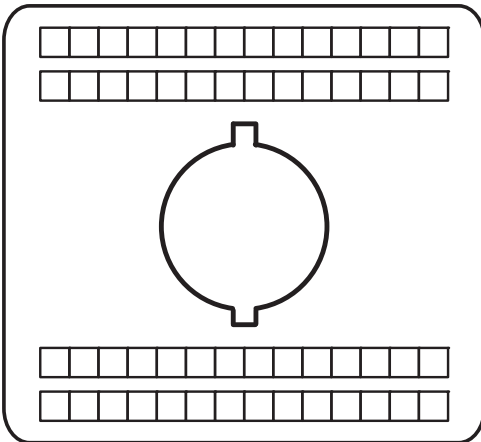

Cat. No. 800F-36VE100S

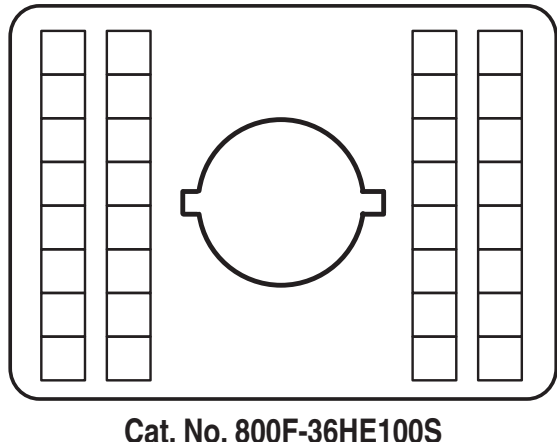

Cat. No. 800F-36HE100S

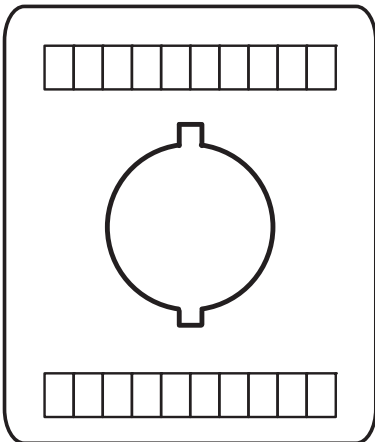

Cat. No. 800F-36VE100L

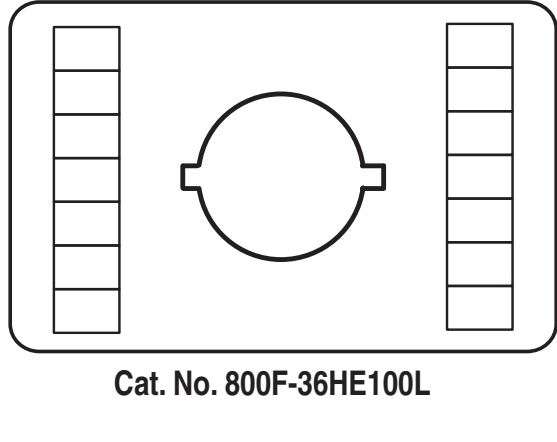

Cat. No. 800F-36HE100L

Bulletin 800FD 22.5 mm Monolithic Push Buttons

Our monolithic operators are designed to meet worldwide standards. These operators include E-stops and pilot lights with either light indicators or incandescent illumination options. With one catalog number, you can now order a fully assembled product for easy stocking and installation.

Momentary Push Button Operators, Non-illuminated



800FD - F 3 01 X 11
a b c d e

a	
Operator Type	
Code	Description
F	Flush
E	Extended

b	
Color Cap	
Code	Color
1	White
2	Black
3	Green
4	Red
5	Yellow
6	Blue

c (1) (2)	
Legend Text	
Code	Text
—	No text (blank)
01	START
02	STOP
05	0
06	I
08	→
09	FORWARD
10	REVERSE
11	R

d	
Termination Style	
Code	Description
X	Standard screw
R	Ring lug

e		
Contact Module		
Code	Number of N.O.	Number of N.C.
01	0	1
10	1	0
11	1	1
02	0	2
20	2	0

- (1) White and yellow caps have black text. All other color caps have white text.
(2) Valid color cap/legend text combinations are as follows:

Color	Text	
	Flush Caps	Extended Caps
White	START, I, →, FORWARD, REVERSE, R	→, R
Black	→, FORWARD, REVERSE, R	STOP, 0, →, R ⁽¹⁾
Green	START, I, →, FORWARD, REVERSE	→
Red	→, FORWARD, REVERSE	STOP, 0, → ⁽¹⁾
Yellow	→, FORWARD, REVERSE	→
Blue	→, FORWARD, REVERSE, R	→, R

(1) "STOP" or "0" color cap/legend text are not available for "10" or "20" contact modules.

Pilot Light Devices

Light-emitting Diode (LED)



Lens and LED Color	Pkg. Quantity	Voltage		
		24V AC/DC	120V AC	240V AC
		Cat. No.	Cat. No.	Cat. No.
Green	1	800FD-P3N3	800FD-P3N5	800FD-P3N7
Red		800FD-P4N3	800FD-P4N5	800FD-P4N7
Yellow		800FD-P5N3	800FD-P5N5	800FD-P5N7

800FD - P 3 N 7 _____
a b c

a	
Lens Cap	
Code	Color
0	Amber
3	Green
4	Red
5	Yellow
6	Blue
7	Clear

b	
Voltage	
Code	Type
3	24V AC/DC
5	120V AC
7	240V AC

c	
Termination Style	
Code	Description
Blank	Standard screw
R	Ring lug

Incandescent

Lens and LED Color	Pkg. Quantity	Voltage	
		24V AC/DC	120V AC
		Cat. No.	Cat. No.
Green	1	800FD-P3D3	800FD-P3D5
Red		800FD-P4D3	800FD-P4D5
Yellow		800FD-P5D3	800FD-P5D5

800FD - P 3 D 5 _____
a b c

a	
Lens Cap	
Code	Color
0	Amber
3	Green
4	Red
5	Yellow
6	Blue
7	Clear
9	No lens ⁽¹⁾

b	
Voltage	
Code	Type
0	No bulb ⁽²⁾
1	6V AC/DC
2	12V AC/DC
3	24V AC/DC
4	48V AC/DC
5	120V AC/DC

c	
Termination Style	
Code	Description
Blank	Standard screw
R	Ring lug

(1) Only valid with "no bulb" option.
 (2) Only valid with "no lens" option.

Selector Switch Operators



Non-illuminated

Operator Type	Contact Configuration	Pkg. Quantity	2-position	3-position
			Cat. No.	Cat. No.
Maintained	1 N.O.	1	800FD-SM22X10	—
	1 N.C.		800FD-SM22X01	—
	2 N.O.		800FD-SM22X20	800FD-SM32X20
	2 N.C.		800FD-SM22X02	800FD-SM32X02
	1 N.O.,1 N.C.		800FD-SM22X11	800FD-SM32X11
Spring Return From Both	2 N.O.		—	800FD-SB32X20
	2 N.C.	—	800FD-SB32X02	
	1 N.O.,1 N.C.	—	800FD-SB32X11	

800FD - S L3 2 X 11
a b c

a	
Operator Function	
Code	Description
M2	Maintained, 2-position
L2	Return from left, 2-position
R2	Return from right, 2-position
M3	Maintained, 3-position
L3	Return from left, 3-position
R3	Return from right, 3-position
B3	Return from both, 3-position

b	
Termination Style	
Code	Description
X	Standard screw
R	Ring lug

c		
Contact Module		
Code	Number of N.O.	Number of N.C.
01 ⁽¹⁾	0	1
10 ⁽¹⁾	1	0
11	1	1
02	0	2
20	2	0

(1) Only available for 2-position selector switch.

Table 43 - Selector Switch

Knob Position	2-Position			
	Left	Right	Left	Right
01	X	—	0	—
10	—	0	—	X
11	X	0	0	X
02	X	X	0	0
20	0	0	X	X

Knob Position	3-Position					
	Left	Right	Left	Right	Left	Right
11	0	0	X	0	X	X
02	0	X	X	X	X	0
20	X	0	0	0	0	X

Note: X = Closed/0 = Open

Push-pull/Twist-to-release Mushroom Operators



2-position, Non-illuminated

- IMPORTANT**
- All emergency stop operators are EN ISO 13850 compliant with standard NC, NCLB, or self-monitoring contact blocks.
 - E-stop operators, latch, and contact block combinations have been third-party tested for B10d values. B10d values can be found in publication [SAFETY-SR001](#).

Color	Contacts	Pkg. Quantity	Cat. No.
Red	1 N.C.	1	800FD-MT44X01
	2 N.C.		800FD-MT44X02

800FD - MT4 $\frac{4}{a}$ $\frac{X}{b}$ $\frac{11}{c}$

a	
Color Cap	
Code	Description
2	Black
3	Green
4	Red
4E	Red - EMO
5	Yellow
6	Blue

b	
Termination Style	
Code	Description
X	Standard screw
R	Ring lug

c		
Contact Module ⁽¹⁾		
Code	Number of N.O.	Number of N.C.
01	0	1
11	1	1
02	0	2

(1) E-stops must contain at least one N.C. circuit.

Plastic Enclosures – 1-hole Only

- Feed-through design
- Knockout sizes: PG 11/16
- Not UL Listed or CSA Certified
- Monolithic or latch-mounted contact blocks
- Double insulated



Type	Pkg. Quantity	Plastic Enclosures (IP66, NEMA 4/4X/13) ⁽¹⁾	
		Gray	Yellow
		Cat. No.	Cat. No.
1-hole	1	800FD-1P	800FD-1PY

(1) Can only use single deep contact block.

Assembled Stations

Enclosure Color	Quick Connect	Operator Type	Contact Configuration	Cat. No.
Gray	—	2-position selector switch	1 N.O.	800FD-1SP5
	DC Micro 4-pin		1 N.O./1 N.C.	800FD-1SP6 800FD-1SP6Q
Yellow	—	Red 40 mm push-pull/twist-to-release	1 N.O./1 N.C.	800FD-1SP2
	DC Micro 4-pin			800FD-1SP2Q

Replacement Parts

Table 44 - Replacement Lamps



Lamp	Type	Typical Current	Voltage	ANSI No.	Pkg. Quantity	Cat. No.
 Cat. No. 800F-N130	Full-voltage Incandescent	150 mA	6V AC/DC	755	10	800F-N65
		80 mA	12V AC/DC	756		800F-N141
		70 mA	24V AC/DC	757		800F-N157
		50 mA	48V AC/DC	1835		800F-N48
		22 mA	130V AC/DC	949		800F-N130
 Cat. No. 800F-N240	Neon	2 mA	240V AC	—		800F-N240

Table 45 - Replacement Lenses

Lens Color	Pkg. Quantity	Cat. No.
Amber	10 ⁽¹⁾	800FD-AP0
Green		800FD-AP3
Red		800FD-AP4
Yellow		800FD-AP5
Blue		800FD-AP6
Clear		800FD-AP7

(1) Sold in multiples of 10. Order (quantity of) 10 to receive one package of 10 pieces.

Specifications

IMPORTANT Performance Data – Performance data that is given in this publication is provided only as a guide for you to determine suitability and does not constitute a performance warranty of any kind. Such data can represent the results of accelerated testing at elevated stress levels, and you are responsible for correlating the data to actual application requirements. ALL WARRANTIES AS TO ACTUAL PERFORMANCE, WHETHER EXPRESS OR IMPLIED, ARE EXPRESSLY DISCLAIMED.

Mechanical Ratings				
Vibration (assembled to panel)	Tested at 10...2000 Hz, 1.52 mm displacement (peak-to-peak) max/10 G max for 3 hr duration, no damage			
Shock	Shock Tested at 1/2 cycle sine wave for 11 ms; no damage at 100 G			
Degree of protection	IP66 (Type 3/3R/4/4X/12/13)			
Mechanical durability per EN 60947-5-1 (Annex C)	300,000 cycles	Selector switch		
	2,000,000 cycles	Push-pull/twist-to-release E-stop		
		Momentary push buttons		
Operating forces	E-stop = 36 N			
Operating torque (typical application with one contact block)	Selector switch = 0.25 N•m			
Contact operation	N.O.	Slow double make and break		
	N.C.	Slow double make and break – positive opening \Rightarrow		
Push button travel to change electrical state	N.O.	2.5 mm (0.1 in.)		
	N.C.	1.5 mm (0.060 in.)		
Environmental				
Temperature range (operating)	-25...+60 °C (-13...+140 °F) ⁽¹⁾			
Temperature range (short-term storage)	-40...+85 °C (-40...+185 °F)			
Humidity	≤95% RH from 25...60 °C (77...140 °F)			
Electrical Ratings				
Standard contact block ratings	B300, R300 AC 15, DC 13 300VAC EN/IEC 60947-5-1 and UL 508, 17V, 5 mA min			
Low-voltage contact block ratings	5V, 1 mA DC min C300, R150, AC 15, DC 13 to EN 60947-5-1 and UL 508			
	Nominal Voltage	Range	Current Draw	Frequency
LED Module Ratings	24V AC	20...26V AC	32 mA	50/60 Hz
	24V DC	18...30V DC	24 mA	DC
	120V AC	102...132V AC	22 mA	50/60 Hz
	240V AC	204...264V AC	22 mA	50/60 Hz
Thermal current	5 A max enclosed (40 °C [104 °F] ambient) to UL 508, EN/IEC 60947-5-1			
Insulation voltage (U_i)	300V			
Wire capacity (screw terminal)	#18...14 AWG (0.75...2.5 mm ²) Max (2) #14 AWG, uses same size wire only			
Recommendations for ring lug termination option ⁽²⁾	6.35 mm (0.250 in.) max outer diameter with 3.8 mm (0.148 in.) hole diameter			
Recommended tightening torque on screw terminals	0.7...0.9 N•m (6...8 lb•in)			
Dielectric strength (min)	2500V for 1 minute			
External short circuit protection	5 A Type gL/gG cartridge fuse to EN 60269-2-1 or gN (Class J to UL 248-8 or Class CC to UL 248-4)			
Electrical shock protection	Fingersafe conforming to IP2X			

(1) Operating temperatures below 0 °C (32 °F) are based on the absence of freezing moisture and liquids.

(2) 3M MV018-R/S (#22...18 AWG) or 3M MVU14-6R/S (#16...14 AWG)

	Illumination				
	Green	Red	Yellow	Blue	White
LED dominant wavelength	525 nm	629 nm	590 nm	470 nm	–
LED luminous intensity	780 mcd	780 mcd	600 mcd	168 mcd	360 mcd
Incandescent wattage, max	2.6 W				

Materials			
Springs	Stainless steel and zinc-coated music wire	Lens (pilot light)	Acrylic
Electrical contacts	Brass with silver-nickel contacts	Bezel/bushing, housing	Glass-filled polyester
Terminals	Brass and phosphor bronze	Legend frames	Glass-filled polyamide
Panel gasket	Nitrile and polyester-based TPE	Mounting ring	Glass-filled polyamide
Seal	Nitrile	Terminal screws	Zinc-plated steel with chromate
Button cap/mushroom head	Polyester/polycarbonate blend	Lamp socket	Brass and Phosphor bronze

Table 46 - Standards Compliance and Certifications

Certifications	UL, CSA, CCC, CE
Conformity to standards – CE Marked	UL 508, EN/ISO 13850, EN 60947-1, EN 60947-5-1, EN 60947-5-5
Terminal identification	EN/IEC 60947-1

Approximate Dimensions

Dimensions in millimeters (inches). Dimensions are not intended to be used for manufacturing purposes.

Momentary Push Button Operators – Flush

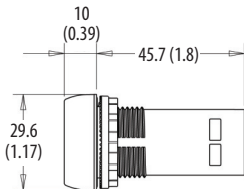

Momentary Push Button Operators – Extended

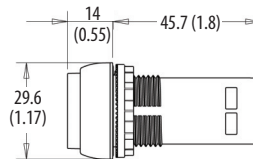

Pilot Light Devices

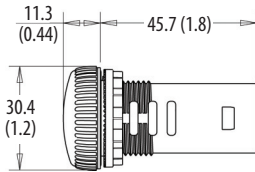

2-Position Push-pull/Twist-to-release Mushroom Operators

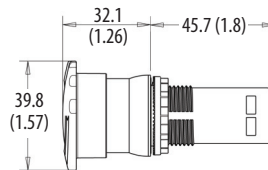

Plastic Enclosures

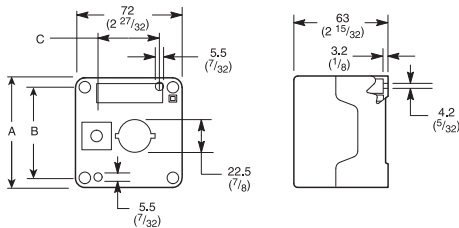

Selector Switch Operators

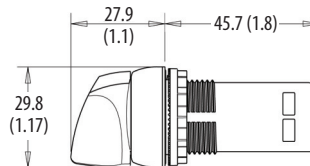

Plastic Enclosures [mm (in.)]

Cat. No.	No. of Units (Holes)	A	B	C	Weight
800FD-1P	1	72	59	41	95 g
800FD-1PY		(2-27/32)	(2-5/16)	(1-5/8)	(3.5 oz)

Instruction Sheet

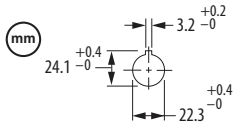

OPTION
WAHL
OPZIONE
OPÇÃO
OPCIÓN

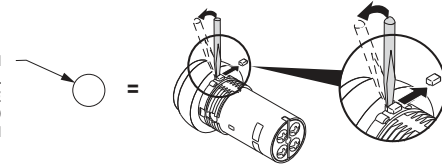



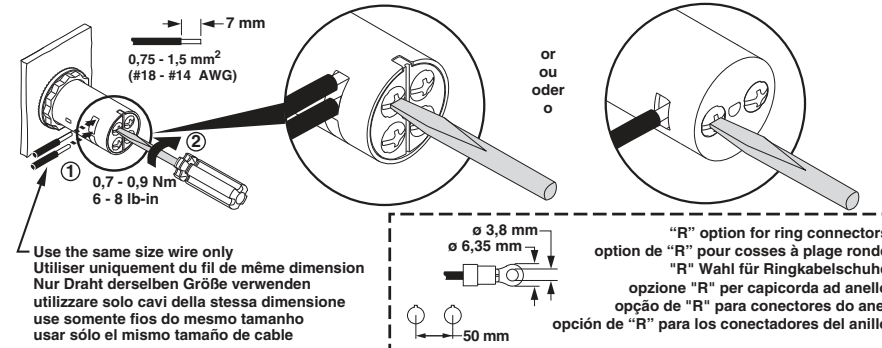
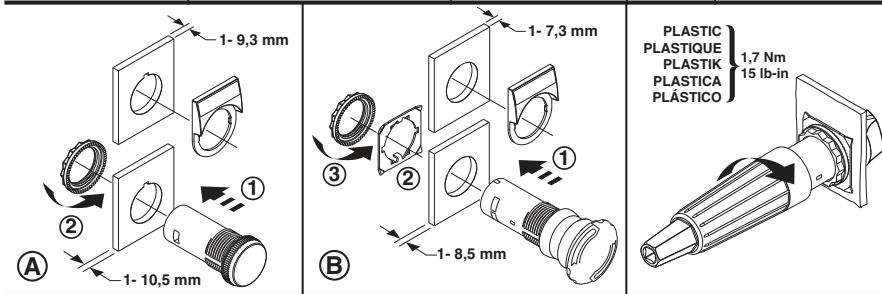

(A)						
(A)						
(B)						
	30	40	50	40	50	ø60, ø90
	30		40			60 / 90
	30		40			







Our 16 mm operators can meet your light industrial and instrumentation application needs with their highly configurable and flexible design. These operators are excellent for applications with limited panel space or a small footprint. They are made of corrosion-proof plastic to deliver long push button life.

Push Button and Pilot Light Operators

Operator Type ⁽¹⁾	Pkg. Quantity				
		Round Cat. No.	Square Cat. No.	Rectangle Cat. No.	Large Square Cat. No.
Momentary, push button/pilot light	1	800B-EPA	800B-EPB	800B-EPC	800B-EPD
Maintained, push button		800B-EAA	800B-EAB	800B-EAC	800B-EAD









(1) All operators are sold without a lens cap and diffuser.

Lens Cap with Diffuser

Lens Color ⁽¹⁾	Pkg. Quantity				
		Round Cat. No.	Square Cat. No.	Rectangle Cat. No.	Large Square Cat. No.
Green	1	800B-ALA3	800B-ALB3	800B-ALC3	800B-ALD3
Red		800B-ALA4	800B-ALB4	800B-ALC4	800B-ALD4
Yellow		800B-ALA5	800B-ALB5	800B-ALC5	800B-ALD5
Blue		800B-ALA6	800B-ALB6	800B-ALC6	800B-ALD6
White		800B-ALA7	800B-ALB7	800B-ALC7	800B-ALD7





(1) For illuminated devices, LED bulbs are color specific. (Green LED bulb with green lens caps, red LED bulbs with red lens cap, white LED bulbs with yellow, blue, and white lens cap.) Incandescent bulbs can be used with any lens cap color.

Selector Switch Operators

Operator Type ⁽¹⁾	Pkg. Quantity	2-position Selector Switches		3-Position Selector Switches	
					
Cat. No.	1	Maintained	Return from Right	Maintained	Return from Both
		800B-SM2A	800B-SR2A	800B-SM3A	800B-SB3A
Operator Type ⁽¹⁾	Pkg. Quantity				
		Keyed, Maintained	Keyed, Return from Right	Keyed, Maintained	Keyed, Return from Both
Cat. No.	1	800B-KM2A	800B-KR2A	800B-KM3A	800B-KB3A

(1) To illuminate a selector switch, add either an LED or incandescent bulb. All selector switches have a clear lens. Green and red LED bulbs can be used to change the selector switch color.

Table 47 - Target Table and Operator Position

Contact Block Cat. No.	Contact Block Location	Contact Type	2-position Target Table ⁽¹⁾		3-position Target Table ⁽¹⁾		
							
800B-PS11	Top	—	—	—	—	—	—
	Bottom	N.C.	X	0	0	X	X
N.O.		0	X	X	0	0	
800B-PS22	Top	N.C.	X	0	X	X	0
		N.O.	0	X	0	0	X
	Bottom	N.C.	X	0	0	X	X
		N.O.	0	X	X	0	0
800B-PT01	Top	—	—	—	—	—	
	Bottom	N.C.	X	0	0	X	X
800B-PT02	Top	N.C.	X	0	X	X	0
	Bottom		X	0	0	X	X
800B-PT11	Top	N.O.	0	X	0	0	X
	Bottom	N.C.	X	0	0	X	X

(1) X = Closed, 0 = Open

Emergency Stop Operators

Table 48 - Non-illuminated, Twist-to-release (Trigger Action)

	Description	Pkg. Quantity	Cat. No. ⁽¹⁾
	Emergency stop operator	1	800B-MT

(1) Operator is EN ISO 13850 compliant with standard slow make/break, direct drive N.C. contact blocks (Cat. Nos. 800B-PT01, 800B-PT02, and 800B-PT11).



Contact Block/Latch Module

	Description	Pkg. Quantity	Cat. No.
Push Button/Selector Switch			
	1 N.O./1 N.C. snap action	1	800B-PS11
	2 N.O./2 N.C. snap action	1	800B-PS22
Pilot Light			
	Dummy block	1	800B-PL
Emergency Stop ⁽¹⁾/Push Button/Selector Switch			
	1 N.C. slow make/break	1	800B-PT01
	2 N.C. slow make/break	1	800B-PT02
	1 N.O./1 N.C. slow make/break	1	800B-PT11

(1) 800B-PT contact blocks must be used with an emergency stop operator to have a UL E-stop device.

Replacement Parts and Accessories

Table 49 - Replacement Bulbs

	Description	Lamp Color	Lamp Voltage	Pkg. Quantity	Cat. No.
	Light-emitting diode (LED) bulb ⁽¹⁾	Green	12...24V AC/DC	1	800B-N3G
			120V AC		800B-N5G
		Red	12...24V AC/DC		800B-N3R
			120V AC		800B-N5R
		White	12...24V AC/DC		800B-N3W
			120V AC		800B-N5W
	Incandescent bulb ⁽²⁾	Clear	6V AC/DC	800B-N1C	
			12V AC/DC	800B-N2C	
			24V AC/DC	800B-N3C	

(1) Not available in 6V AC/DC.

(2) Not available in 120V AC.

Table 50 - Accessories

	Description	Pkg. Quantity	Cat. No.
	Replacement mounting ring	10	800B-ARP
	Mounting ring wrench	1	800B-AW2
	Bulb removal tool	1	800B-ALR1
	Lens removal tool	1	800B-ALR2
	Locking washer (anti-rotation)	10	800B-ALW1
	Stab connector (insulated)	10	800B-ATK
	Hole plug	10	800B-N2
	Replacement key	1	800B-AK1
	Printed circuit board pin socket	10	800B-APCB
	Emergency stop legend plate	1	800B-15YE112
	Square bezel	10	800B-ABZB
	Rectangle bezel	10	800B-ABZC
	Large square bezel	10	800B-ABZD

Specifications

Mechanical Ratings			
Vibration (assembled to panel)	Tested at 10...2000 Hz, 1.52 mm displacement (peak-to-peak) max/10 G max for 6 hr duration, no damage		
Shock	Tested at 1/2 cycle sine wave for 11 ms; no damage at 100 G		
Degree of protection ⁽¹⁾	IP66, Type 4/4X/13		
Mechanical durability per EN 60947-5-1 (Annex C)	2,000,000 Cycles	Push buttons - momentary	
	1,000,000 Cycles	Push buttons - maintained	
	250,000 Cycles	Selector switch	
	200,000 Cycles	Key selector switch	
	200,000 Cycles	Twist-to-release E-stop	
Operating forces (typical with one contact block)	Extended = 5...8 N / E-stop = 14...16 N		
Operating torque (typical application with one contact block)	Selector switch = 0.06 N•m (0.5 lb•in)		
Mounting torque	1.1 N•m (10 lb•in)		
Environmental			
Temperature range (operating)	-25...+55 °C (-13...+131 °F)		
Temperature range (short-term storage)	-40...+70 °C (-40...+158 °F)		
Humidity	≤95% RH from 25...60 °C (77...140 °F)		
Mechanical Ratings – Contact Blocks ⁽²⁾			
Vibration (assembled to panel)	Tested at 10...2000 Hz, 1.52 mm displacement (peak-to-peak) max/10 G max 6 hr		
Shock	Tested at 1/2 cycle sine-wave for 11 ms and no damage at 100 G max		
Contact durability	200,000 cycles (Cat. No. 800B-PS...)		
Contact operation	N.O. / N.C.	Snap action	
	N.C.	Slow make/break – positive opening \rightarrow	
	N.O.	Slow make/break	
Push button travel to change electrical state	1.4 mm (0.06 in.)		
Operating forces (typical)	1 contact block = 3 N 2 contact blocks = 6 N		
Electrical Ratings			
Standard contact block ratings	AC 15, B300, 1.5 A/240V AC, 3 A/120V AC / DC 13, R300, 0.1 A/250V DC, 0.22 A/125V DC		
LED Module ratings	Nominal Voltage	Current	Frequency
	12...24V AC	12 mA	50/60 Hz
	12...24V DC	12 mA	DC
	120V AC	9 mA	50/60 Hz
Thermal current	$I_{th} = 5 \text{ A (AC)}, I_{th} = 1 \text{ A (DC)}$		
Insulation voltage (U_i)	300V		
Stab termination	2.8 x 0.5 mm		
Dielectric strength, min	1500V 1 min.		
External short circuit protection - standard blocks	6 A type gL/gG cartridge fuse to EN 60269-2-1 or gN (Class J to UL 248-8 or Class C to UL 248-4)		
Electrical shock protection	Fingersafe conforming to IP2X		

(1) Keyed selector switches do not meet 4X rating.

(2) 800B-PT contact blocks must be used with an emergency stop operator to have a UL E-stop device.

Illumination		
LED Dominant wavelength	Green	525 nm
	Red	624 nm
	White	—
LED Luminous intensity	Green	500 mcd
	Red	400 mcd
	White	1000 mcd
Incandescent wattage, max	1.2 W	
Materials		
Springs	Stainless steel and gold-plated, high-carbon steel	
Electrical contacts	Gold-plated silver	
Stab terminals	Phosphor bronze with gold or nickel plating	
Lenses	Polycarbonate	

Standards Compliance and Certifications	
Certifications	UR, CSA, CCC, CE
Standards Compliance	UL 508, EN ISO 13850, EN 60947-1, EN 60947-5-1, EN 60947-5-5
Terminal Identification	EN/IEC 60947-1
RoHS Compliant	Yes

Operator Assembly Sequence

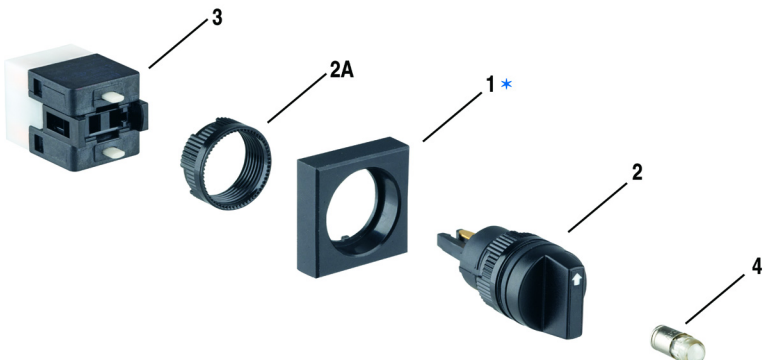
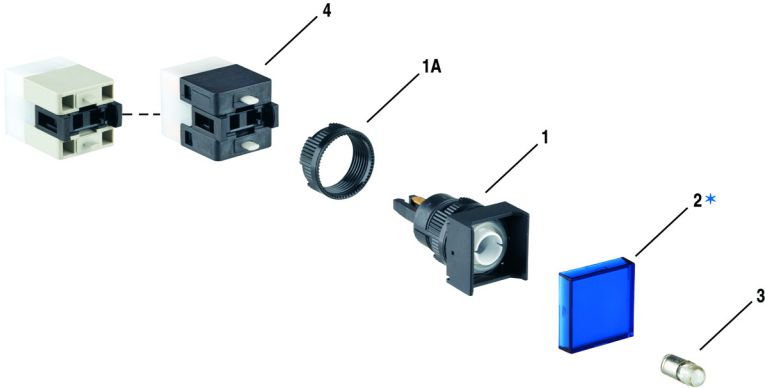

* Optional

Approximate Dimensions

Dimensions in millimeters (inches). Dimensions are not intended to be used for manufacturing purposes.

Round

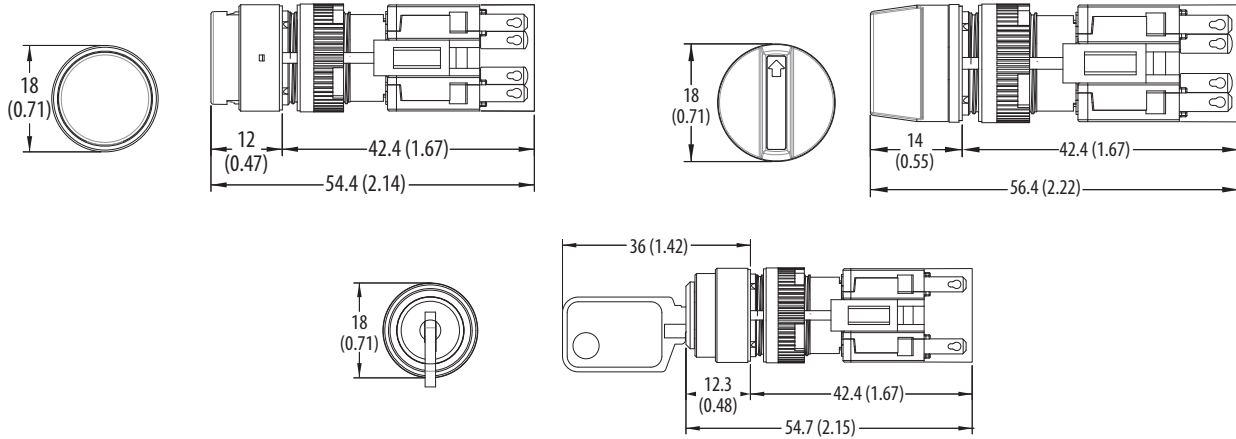

Square

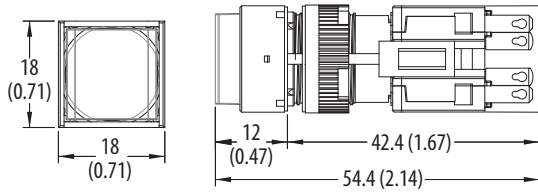

Rectangle

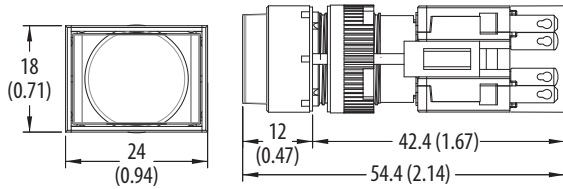

Large Square

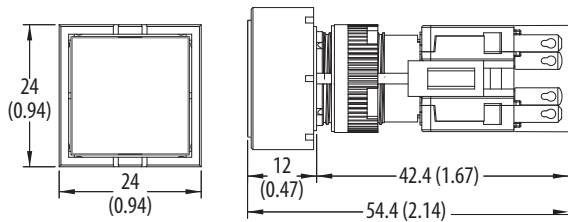

Emergency Stop

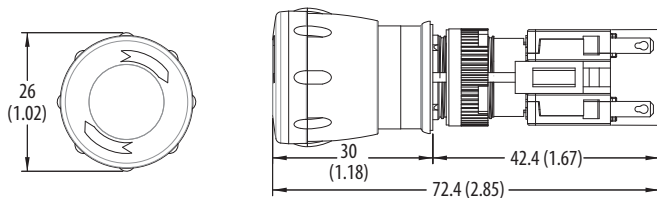

Hole Patterns

Round and Square

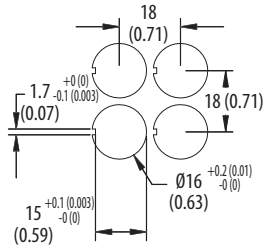

Rectangle

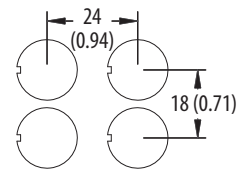

Large Square

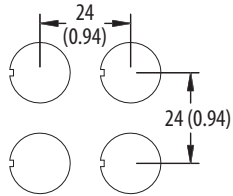

Emergency Stop

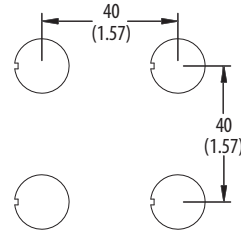

Printed Circuit Board Pin Socket

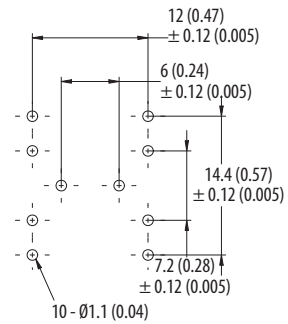
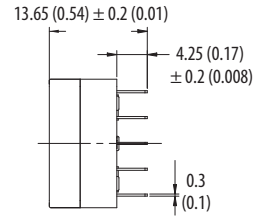
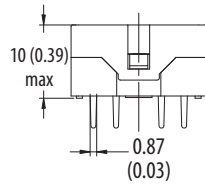
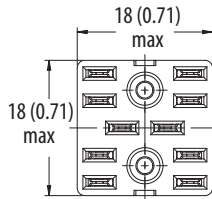

Bulletin 800MR/MB Oiltight Operators

Our oiltight operators are tough and rugged for your heavy-duty applications. Our push buttons are Type 13 oiltight, and are built for durability and harsh environments.

Bulletin 800MR

- 22.5 mm mounting hole
- Type 13 oiltight
- Round operators

Bulletin 800MB

- 22.5 mm mounting hole
- Type 13 oiltight
- Square backlit operators

Momentary Contact Push Buttons – 800MR

Non-illuminated



Flush Head Unit
Cat. No. 800MR-A1B



Extended Head Unit
Cat. No. 800MR-B2A



Mushroom Head Unit
Cat. No. 800MR-D2B

800MR - A 1 A
 a b c d

a	
Operator Type ⁽¹⁾	
Code	Description
A	Flush head
B	Extended head
D	Mushroom head

b	
Button Color	
Code	Description
1	Green
2	Black
3	Orange
4	Gray
5	White
6	Red
7	Blue
9	Yellow

c	
Standard Contact Cartridges	
Code	Description
Blank	No contacts
A	1 N.O. - 1 N.C.
A2	2 N.O.
A3	1 N.O.E.M. - 1 N.C.L.B.
A4	2 N.C.
A7	1 N.C.L.B. - 1 N.C.
B	2 N.O. - 2 N.C.
D1	1 N.O.
D2	1 N.C.

d	
Contact Block Termination Type ⁽²⁾	
Code	Description
Blank	Stab terminals
K	Large screw

(1) Guards must be ordered separately.

(2) Logic Reed and small screw blocks can be ordered separately.

Illuminated



Flush Head Unit
Cat. No. 800MR-QA24GA



Extended Head Unit
Cat. No. 800MR-PB16RA



Mushroom Head Unit
Cat. No. 800MR-QMB24RA

800MR - PA L 24 R
a b c d e f

a	
Operator	
Transformer	
Code	Description
PA	Flush ⁽¹⁾
PB	Extended
PMB	Mushroom
Full Voltage	
Code	Description
QA	Flush ⁽¹⁾
QB	Extended
QMB	Mushroom

b	
Illumination Options	
Code	Description
Blank	Standard illumination as determined by power module type
L	LED ⁽⁴⁾

c	
Input Voltage	
Full Voltage	
Code	Description
12	12 24V AC/DC
24	24 24V AC/DC
10	120V AC ⁽⁵⁾
Transformer	
Code	Description
16	120V AC 50/60 Hz
26	240V AC 50/60 Hz

d	
Lens Color	
Code	Color
A	Amber
B	Blue
C	Clear
G	Green
R	Red
W	White
X	No lens with contact blocks
Blank	No lens without contact blocks

e	
Standard Contact Cartridges	
Code	Description
Blank	No contacts
A	1 N.O. - 1 N.C.
A2	2 N.O.
A3	1 N.O.E.M. - 1 N.C.L.B.
A4	2 N.C.
A7	1 N.C.L.B. - 1 N.C.
B	2 N.O. - 2 N.C. ⁽²⁾
D1	1 N.O.
D2	1 N.C.

f	
Contact Block Termination Type ⁽³⁾	
Code	Description
Blank	Stab terminals
K	Large screw

- (1) Guards must be ordered separately.
- (2) Only available with full-voltage power module option and standard stab terminations.
- (3) Logic Reed and small screw blocks must be ordered separately.
- (4) LEDs available in red, green, amber, blue, and white. LED color must match lens color, except clear lens supplied with white LED and white lens supplied with amber LED.
- (5) Only available with LED illumination option.

Push-pull and Push-pull/Twist-to-release Units – 800MR

2-position Push-pull and Push-pull/Twist-to-release and 3-position Push-pull Units, Non-illuminated



2-position Push-pull
Cat. No. 800MR-FX6A



2-position Push-pull/Twist
Cat. No. 800MR-FXT6A4



3-position Push-pull
Cat. No. 800MR-FXN6A7

800MR - FX T 6 A (2-position)
a b c d e f

800MR - FX N 6 A (3-position)
a b₁ c d e f

a	
Operator Type	
Code	Description
FX	Push-pull unit

b	
Operator Function, 2-position	
Code	Description
Blank	Maintained – push-pull
T	Twist-release

b ₁			
Operator Function, 3-position ⁽¹⁾			
Code	Operator Position		
	Out	Center	In
N	Momentary	Maintained	Momentary

c	
Operator	
Code	Color
Blank	Non-illuminated

d	
Button Color	
Code	Color
1	Green
2	Black
3	Orange
4	Gray
5	White
6	Red
7	Blue
9	Yellow
Blank	No cap

e	
Contact Cartridges	
Code	Description
Blank	No contacts
A	1 N.O. - 1 N.C.
A2	2 N.O.
A4	2 N.C.
A7	1 N.C.L.B. - 1 N.C.
B	2 N.O. - 2 N.C.
D1	1 N.O.
D2	1 N.C.





Note: See [Table 51](#) for target description.

f	
Contact Block Termination Type ⁽²⁾	
Code	Description
Blank	Stab terminals
K	Large screw

(1) Not available in twist release.

(2) Logic Reed and small screw blocks must be ordered separately.

Table 51 - Target Selection

Code	2-Position		Contact Description	3-Position			Code
							
	Out	In		Out	Center	In	
Blank	—	—	No contacts	—	—	—	Blank
D1	0	X	N.O.	—	—	—	—
D2	X	0	N.C.	—	—	—	—
A	0 X	X 0	N.O. - N.C.	0 X	0 0	X 0	A
A2	0 0	X X	N.O. - N.O.	0 0	0 0	X X	A2
A4	X X	0 0	N.C. - N.C.	X X	0 0	0 0	A4
—	—	—	N.C. - N.C.L.B.	X X	0 X	0 0	A7
B	0 X 0 X	X 0 X 0	N.O. - N.C. N.O. - N.C.	0 X 0 X	0 0 0 0	X 0 X 0	B

Note:
X = Closed/0 = Open

2-position Push-pull and Push-pull/Twist-to-release and 3-position Push-pull Units, Illuminated



Illuminated 2-position Push-pull
Cat. No. 800MR-FXQ24RA



Illuminated 2-position Push-pull/Twist
Cat. No. 800MR-FXTP16RA





Illuminated 3-position Push-pull
Cat. No. 800MR-FXNQ24RA7

800MR	-	FX	T	P		16	R	A		(2-position)
		a	b	c	d	e	f	g	h	
800MR	-	FX	N	P		16	R	A		(3-position)
		a	b ₁	c	d	e	f	g	h	

a	
Operator Type	
Code	Description
FX	Push-pull unit

b	
Operator Function, 2-position	
Code	Description
Blank	Maintained
T	Twist-release

b ₁			
Operator Function, 3-position			
Code	Operator Position		
			
	Out	Center	In
N	Momentary	Maintained	Momentary

c	
Operator Type	
Code	Description
P	Transformer
Q	Full voltage

d	
Illumination Options	
Code	Description
Blank	Incandescent lamp
L	LED ⁽¹⁾

e	
Voltage	
Full Voltage	
Code	Description
12	12V AC/DC
24	24V AC/DC
10	120V AC ⁽²⁾
Transformer	
Code	Description
16	120V AC 50/60 Hz
26	240V AC 50/60 Hz





f	
Button Color	
Code	Color
A	Amber
B	Blue
C	Clear
G	Green
R	Red
W	White ⁽⁴⁾
X	No cap

g	
Contact Cartridges	
Code	Description
Blank	No contacts
A	1 N.O. - 1 N.C.
A2	2 N.O.
A4	2 N.C.
A7	1 N.C.L.B. - 1 N.C.
B	2 N.O. - 2 N.C. ⁽⁵⁾
D1	1 N.O.
D2	1 N.C.

Note: See [Table 52](#) for target description.

- (1) LEDs available in red, green, amber, blue, and white. LED color must match lens color, except clear lens supplied with white LED and white lens supplied with amber LED.
- (2) Only available with LED Illumination option.
- (3) Logic Reed and small screw blocks must be ordered separately.
- (4) Not available in twist release.
- (5) Only available with full-voltage power module option and standard stab terminations.

Table 52 - Target Selection

Code	2-Position		Contact Description	3-Position			Code
							
	Out	In		Out	Center	In	
Blank	—	—	No contacts	—	—	—	Blank
D1	0	X	N.O.	—	—	—	—
D2	X	0	N.C.	—	—	—	—
A	0 X	X 0	N.O. - N.C.	0 X	0 0	X 0	A
A2	0 0	X X	N.O. - N.O.	0 0	0 0	X X	A2
A4	X X	0 0	N.C. - N.C.	X X	0 0	0 0	A4
—	—	—	N.C. - N.C.L.B.	X X	0 X	0 0	A7
B	0 X 0 X	X 0 X 0	N.O. - N.C. N.O. - N.C.	0 X 0 X	0 0 0 0	X 0 X 0	B

Note:
X = Closed/0 = Open

Selector Switch Units – 800MR

2-position Selector Switch Units, Non-illuminated



Standard Knob Operator
Cat. No. 800MR-HH2BLA



Knob Lever Operator
Cat. No. 800MR-HK2BLA



Cylinder Lock Operator
Cat. No. 800MR-H31BB

800MR - **H** **H** **2** **B** **L** **A** (Selector Switch)
a b c d e e₁ f

800MR - **H** **31** **B** **L** **A** (Cylinder Lock)
a b c₁ c₂ d e e₁ f

a	
Operator Positions	
Code	Description
H	2-position selector switch
H	2-position cylinder lock

b	
Operator Color and Type ⁽¹⁾	
Standard Knob	
Code	Description
X	No knob
H	Black
Knob Lever	
X	No knob lever
K	Black
Cylinder Lock	
Blank	Key

c	
Operator Function	
Standard Knob	
Code	Description
2	Maintained
4	Spring return from left
5	Spring return from right

c ₁	
Operator Function/Locking Position ⁽²⁾	
Maintained	
Code	Description
31	Lock in left
32	Lock in right
33	Lock in both
Spring Return from Left	
42	Lock in right
Spring Return from Right	
48	Lock in left

c ₂		
Key Codes ⁽³⁾		
Code	Key No.	Master Key
Blank	T100 (standard)	1T
02	T101	1T
03	T102	1T
04	T106	1T
05	T107	1T
07	T109	2T
08	T134	2T
09	T135	2T
10	T136	2T

d	
Cam Type	
Code	Description
B	B cam

e	
Contact Cartridge Position	
Code	Description
Blank	Both left and right
L	Left

e ₁	
Contact Cartridges	
Code	Description
Blank	No contacts
A	1 N.O. - 1 N.C. ⁽⁴⁾
A2	2 N.O. ⁽⁴⁾
A4	2 N.C. ⁽⁴⁾
B	2 N.O. - 2 N.C. ⁽⁵⁾
D1	1 N.O. ⁽⁴⁾
D2	1 N.C. ⁽⁴⁾
P1	3 N.O. ⁽⁵⁾
P2	3 N.C. ⁽⁵⁾

14	T147	2T
----	------	----

f	
Contact Block Termination Type ⁽⁶⁾	
Code	Description
Blank	Stab terminals
K	Large screw

- (1) Red, green, blue, yellow, orange, gray, and white non-illuminated selector switch knobs and lever knobs must be ordered separately.
- (2) Key removable in locked position only.
- (3) If no optional key code is specified, the standard key (T100) is supplied.
- (4) Contact cartridge position code (Table e) must be L.
- (5) Contact cartridge position code (Table e) must be Blank.
- (6) Logic Reed and small screw contact blocks must be ordered separately.

Table 53 - Selector Switch Cam Targets

Cam Description (2-position)			
Target		Operator Function	
		Maintained and spring return from right	Spring return from left
X	0	N.C.	N.O.
0	X	N.O.	N.C.

Note:
X = Closed/O = Open

3-position Selector Switch Units, Non-Illuminated



Standard Knob Operator
Cat. No. 800MR-JH2BB



Knob Lever Operator
Cat. No. 800MR-JK2BB



Cylinder Lock Operator
Cat. No. 800MR-J44BB

800MR	-	J	H	2	B	L	A	(Selector Switch)	
		a	b	c	d	e	e ₁	f	
800MR	-	J		41		B	L	A	(Cylinder Lock)
		a	b	c ₁	c ₂	d	e	e ₁	f

Operator Positions	
Code	Description
J	3-position selector switch
J	3-position cylinder lock

b	
Operator Color and Type ⁽¹⁾	
Standard Knob	
Code	Description
X	No knob
H	Black
Knob Lever	
X	No knob
K	Black
Cylinder Lock	
Blank	Key

c	
Operator Function	
Code	Description
2	Maintained
4	Spring return from left
5	Spring return from right
9	Spring return from both

c ₁	
Operator Function/Locking Position ⁽²⁾	
Maintained	
Code	Description
41	Lock in left
42	Lock in center
43	Lock in right
44	Lock in all positions
45	Lock in left and center
46	Lock in right and left
47	Lock in right and center
Spring Return from Left	
50	Lock in center
52	Lock in right
51	Lock in right and center
Spring Return from Right	
69	Lock in left
38	Lock in center
73	Lock in left and center
Spring Return from Left and Right	
631	Lock in center ⁽²⁾

c ₂	
Key Codes ⁽³⁾	
1T Master Series	
Code	Key No.
Blank	T100 (standard)
02	T101
03	T102
04	T106
05	T107
2T Master Series	
07	T109
08	T134
09	T135

d	
Cam Type	
Code	Description
B	B cam
K	K cam
P	P cam
U	U cam

e	
Contact Cartridge Position	
Code	Description
Blank	Both left and right

e ₁		
Contact Cartridges		
Standard	Description	
Code	Left Side	Right Side
Blank	No contacts	
A ⁽⁴⁾	1 N.O. - 1 N.C.	
A3 ⁽⁴⁾	1 N.O.E.M. - 1 N.C.L.B.	
B ⁽⁵⁾	1 N.O. - 1 N.C.	
P1 ⁽⁵⁾	2 N.O.	1 N.O.
P2 ⁽⁵⁾	2 N.C.	1 N.C.
P3 ⁽⁵⁾	2 N.O.	1 N.C.
P4 ⁽⁵⁾	2 N.C.	1 N.O.
P5 ⁽⁵⁾	2 N.O.	2 N.O.

P3	2 N.O. - 1 N.C. ⁽⁵⁾
P4	2 N.C. - 1 N.O. ⁽⁵⁾
P5	4 N.O. ⁽⁵⁾
P6	4 N.C. ⁽⁵⁾
P7	3 N.O. - 1 N.C. ⁽⁵⁾
P8	1 N.O. - 3 N.C. ⁽⁵⁾

Note: See [Table 53](#) for target description.

10	T136
14	T147

L	Left
R	Right

P6 ⁽⁵⁾	2 N.C.	2 N.C.
P7 ⁽⁵⁾	2 N.O.	1 N.O. - 1 N.C.
P8 ⁽⁵⁾	2 N.C.	1 N.O. - 1 N.C.
P9 ⁽⁵⁾	1 N.O.	1 N.C.
T1 ⁽⁵⁾	1 N.O. - 1 N.C.	1 N.C.

f	
Contact Block Termination Type ⁽⁶⁾	
Code	Description
Blank	Stab terminals
K	Large screw

Note: See Table 54 for cam and contact block selection.

- (1) Red, green, blue, yellow, orange, gray, and white non-illuminated selector switch knobs and lever knobs must be ordered separately.
- (2) Key removable in locked position only.
- (3) If no optional key code is specified, the standard key (T100) is supplied.
- (4) Contact cartridge position code (Table e) must be L or R.
- (5) Contact cartridge position code (Table e) must be --.
- (6) Logic Reed and small screw contact blocks must be ordered separately.

Table 54 - Selector Switch Cam Targets

Note: X = Closed/O = Open			Cam Description							
Target			B		K		P		U	
			Left Side	Right Side	Left Side	Right Side	Left Side	Right Side	Left Side	Right Side
0	0	X	N.O.	N.O.	N.O.	—	N.O.	—	—	N.O.
X	0	0	N.C.	N.C.	—	N.O.	N.C.	N.O.	N.O.	—
0	X	X	N.O.E.M.	N.O.E.M.	—	N.C.L.B.	N.O.E.M.	N.C.L.B.	N.C.	—
X	X	0	N.C.L.B.	N.C.L.B.	N.C.L.B.	—	N.C.L.B.	—	—	N.C.
0	X	0	—	—	N.C.	N.C.	—	N.C.	—	—

4-position Selector Switch Units, Non-illuminated



Standard Knob Operator
Cat. No. 800MR-NH2QB



Knob Lever Operator
Cat. No. 800MR-NK2QB



Cylinder Lock Operator
Cat. No. 800MR-N31QB

800MR - N H 2 Q B _____ (Selector Switch)
 a b c d e f

800MR - N _____ 31 _____ Q B _____ (Cylinder Lock)
 a b c₁ c₂ d e f

a	
Operator Positions	
Code	Description
N	4-position selector switch
N	4-position cylinder lock

b	
Operator Color and Type ⁽¹⁾	
Standard Knob	
Code	Description
X	No knob
H	Black
Knob Lever	
X	No knob
K	Black
Cylinder Lock	
Blank	Key

c	
Operator Function ⁽²⁾	
Code	Description
2	Maintained

c ₁	
Operator Function/Locking Position ⁽³⁾	
Standard Key	
Code	Description
31	Lock in position 1
32	Lock in position 2
33	Lock in position 3
34	Lock in position 4
41	Lock in position 1-2
42	Lock in position 1-3
43	Lock in position 1-4
44	Lock in position 2-3
45	Lock in position 2-4
46	Lock in position 3-4
51	Lock in position 1-2-3
52	Lock in position 1-2-4
53	Lock in position 1-3-4
54	Lock in position 2-3-4
61	Lock in all positions

c ₂		
Key Codes ⁽⁴⁾		
Code	Key No.	Master Key
Blank	T100 (standard)	T1
02	T101	T1
03	T102	T1
04	T106	T1
05	T107	T1
07	T109	T2
08	T134	T2
09	T135	T2
10	T136	T2
14	T147	T2

d					
Cam Type and Target Table					
0					
Target				Contact Type (Rear View)	
				Left	Right
0	0	0	X	1 N.O.	—
0	0	X	0	1 N.C.	—
0	X	0	0	—	1 N.O.
X	0	0	0	—	1 N.C.

Note: X = Closed/O = Open

e	
Contact Cartridges	
Standard Block/ Stab Terminations	
Code	Description
Blank	No contacts
B	2 N.O. - 2 N.C.

f	
Contact Block Termination Type ⁽⁵⁾	
Code	Description
Blank	Stab terminals
K	Large screw

- (1) Red, green, blue, yellow, orange, gray, and white non-illuminated selector switch knobs and knob levers must be ordered separately.
- (2) Operators are maintained in all positions.
- (3) Key removable in locked position only.
- (4) If no optional key code is specified, the standard key (T100) is supplied.
- (5) Logic Reed and small screw contact blocks must be ordered separately.

2-position and 3-position Knob/Lever Type Selector Switch Units, Illuminated



Standard Knob Operator
Cat. No. 800MR-24HA2BRA



Knob Lever Operator
Cat. No. 800MR-24HL2BRA

800MR - 24 H A L 2 B R A h
a b c d e f g₁ g₂ h

a	
Input Voltage	
Full Voltage	
Code	Description
12	12V AC/DC
24	24V AC/DC
10	120V AC ⁽²⁾
Transformer	
16	120V AC 50/60 Hz
26	240V AC 50/60 Hz

b	
Operator Positions	
Code	Description
H	2-position
J	3-position

d	
Illumination Options	
Code	Description
Blank	Incandescent
L	LED ⁽⁶⁾

c	
Operator Color and Type	
Standard Knob	
Code	Description
X	No knob
A	Red
B	Green
D	Amber
Y	Clear
Knob Lever	
X	No knob
L	Red
M	Green
P	Amber
Z	Clear

e	
Operator Function	
Code	Description
2	Maintained
4	Spring return from left
5	Spring return from right
9	Spring return from both

f	
Cam Type (2-position)	
Code	Description
B	B cam

Note: For Target arrangements, see [Table 55](#).

f ₁	
Cam Type (3-position)	
Code	Description
B	B cam
K	K cam
P	P cam
U	U cam

Note: For Target arrangements, see [Table 56](#).

g ₁	
Contact Cartridge Position	
Code	Description
R	Right

h	
Contact Block Termination Type ⁽⁷⁾	
Code	Description
Blank	Stab terminals
K	Large screw

g ₂		
Contact Cartridges		
Description		
Code	Left Side	Right Side
Blank	No contacts	
A ⁽¹⁾	—	1 N.O. - 1 N.C.
A2 ⁽¹⁾⁽³⁾	—	2 N.O.
A3 ⁽¹⁾	—	1 N.O.E.M.- 1 N.C.L.B.
A4 ⁽¹⁾⁽³⁾	—	2 N.C.
B ⁽⁴⁾⁽⁵⁾	1 N.O. - 1 N.C.	1 N.O. - 1 N.C.
D1 ⁽¹⁾⁽³⁾	—	1 N.O.
D2 ⁽¹⁾⁽³⁾	—	1 N.C.
P1 ⁽⁴⁾⁽⁵⁾	2 N.O.	1 N.O.
P2 ⁽⁴⁾⁽⁵⁾	2 N.C.	1 N.C.
P3 ⁽⁴⁾⁽⁵⁾	2 N.O.	1 N.C.
P4 ⁽⁴⁾⁽⁵⁾	2 N.C.	1 N.O.
P5 ⁽⁴⁾⁽⁵⁾	2 N.O.	2 N.O.
P6 ⁽⁴⁾⁽⁵⁾	2 N.C.	2 N.C.
P7 ⁽⁴⁾⁽⁵⁾	2 N.O.	1 N.O. - 1 N.C.
P8 ⁽⁴⁾⁽⁵⁾	2 N.C.	1 N.O. - 1 N.C.
P9 ⁽⁴⁾⁽⁵⁾	1 N.O.	1 N.C.
T1 ⁽⁴⁾⁽⁵⁾	1 N.O. - 1 N.C.	1 N.C.

Note: See [Table 55](#) for 2-pos. contact block selection.
See [Table 56](#) for 3-pos. contact block selection.

- (1) Contact cartridge position code (Table g₁) must be R.
- (2) Only available with LED illumination option.

- (3) Logic Reed and small screw contact blocks must be ordered separately.
- (4) Only available with full voltage power module and standard stab terminations.
- (5) Contact cartridge position code (Table g₁) must be –.
- (6) LEDs only available in red, green, amber, and white. Knob color must match LED color, except clear knob supplied with white LED.
- (7) Only available for 2-position selector switches

Table 55 - Selector Switch Cam Targets

Cam Description (2-position)			
Target		B	
↙	↘	Maintained and Spring Return from Right	Spring Return from Left
X	0	N.C.	N.O.
0	X	N.O.	N.C.

Note:
X = Closed/O = Open

Table 56 - Selector Switch Cam Targets

Cam Description (3-position)										
Target			B		K		P		U	
↙	↕	↘	Left Side	Right Side	Left Side	Right Side	Left Side	Right Side	Left Side	Right Side
0	0	X	N.O.	N.O.	N.O.	–	N.O.	–	–	N.O.
X	0	0	N.C.	N.C.	–	N.O.	N.C.	N.O.	N.O.	–
0	X	X	N.O.E.M.	N.O.E.M.	–	N.C.L.B.	N.O.E.M.	N.C.L.B.	N.C.	–
X	X	0	N.C.L.B.	N.C.L.B.	N.C.L.B.	–	N.C.L.B.	–	–	N.C.
0	X	0	–	–	N.C.	N.C.	–	N.C.	–	–

4-position Knob/Lever Type Selector Switch Units, Illuminated



Standard Knob Operator
Cat. No. 800MR-24NA2QB



Knob Lever Operator
Cat. No. 800MR-24NL2QB

800MR - 24 N A L 2 Q B
a b c d e f g h

a	
Input Voltage	
Full Voltage	
Code	Description
12	12V AC/DC
24	24V AC/DC
10	120V AC ⁽³⁾

b	
Operator Positions	
Code	Description
N	4-position ⁽¹⁾

c	
Operator Color and Type	
Standard Knob	
Code	Description
X	No knob
A	Red
B	Green
D	Amber
Y	Clear
Knob Lever	
X	No knob
L	Red
M	Green
P	Amber
Z	Clear

d	
Illumination Options	
Code	Description
Blank	Incandescent
L	LED ⁽²⁾

e	
Operator Function	
Code	Description
2	Maintained

f					
Cam Type and Target Table					
Q					
Target				Contact Type (Rear View)	
↙	↘	↕	↗	Left	Right
0	0	0	X	1 N.O.	–

g	
Contact Cartridge	
Standard Block	
Code	Description
B	2 N.O. - 2 N.C.
Note: X = Closed/O = Open	

h	
Contact Block Termination Type ⁽⁴⁾	
Code	Description
Blank	Stab terminals

0	0	X	0	1 N.C.	—
0	X	0	0	—	1 N.O.
X	0	0	0	—	1 N.C.

Note: X = Closed/0 = Open

- (1) Operator is maintained in all positions.
- (2) LEDs only available in red, green, amber, and white. Knob color must match LED color, except clear knob supplied with white LED.
- (3) Only available with LED Illumination option.
- (4) Logic Reed contact blocks must be ordered separately.

Potentiometer Operator Only – 800MR

Type	Cat. No.
Operator only (without resistive element)	800MR-N37



Pilot Light Units – 800MR



Pilot Light
Cat. No. 800MR-Q24R



Push-to-test Pilot Light
Cat. No. 800MR-QT24R

800MR - P L 24 R
 a b c d e

a	
Operator	
Transformer	
Code	Description
P	Pilot light
PDT ⁽²⁾⁽³⁾	Pilot light – dual-input transformer
PT	Pilot light – push-to-test
Full Voltage	
Q	Pilot light
QT	Pilot light – push-to-test

b	
Illumination Options	
Code	Description
Blank	Incandescent
L	LED ⁽¹⁾

c	
Input Voltage	
Full Voltage	
Code	Description
12	12V AC/DC
24	24V AC/DC
10	120V AC ⁽⁴⁾
Transformer	
16	120V AC 50/60 Hz
26	240V AC 50/60 Hz

d	
Lens Color	
Code	Color
Blank	No lens
A	Amber
B	Blue
C	Clear
G	Green
R	Red
W	White

e	
Contact Block Termination Type ⁽⁵⁾	
Pilot Lights	
Code	Description
Blank	Stab terminals
K	Large screw ⁽⁶⁾

Note: If large screw terminations are desired with a dual-input transformer (Cat. No. 800MR-PDT...), configurator space e must be left blank.

- (1) LEDs available in red, green, amber, blue, and white. LED color must match lens color, except clear lens supplied with white LED and white lens supplied with amber LED.
- (2) Dual-input transformer is transformer-relay type.
- (3) Comes standard with screw terminations.
- (4) Only available with LED illumination option.
- (5) Small screw contact blocks must be ordered separately.
- (6) Only available with Push-to-test units.

Wobble Stick Units – 800MR



Wobble Stick Unit
Cat. No. 800MR-M1B

800MR - $\frac{M1}{a}$ $\frac{A}{b}$ $\frac{\quad}{c}$

a	
Operator Type	
Code	Description
M1	Wobble stick

b	
Contact Cartridges	
Code	Description
Blank	No contacts
A	1 N.O. - 1 N.C.
B	2 N.O. - 2 N.C.

c	
Contact Block Termination Type ⁽¹⁾	
Code	Description
Blank	Stab terminals
K	Large screw

(1) Logic Reed and small screw contact blocks must be ordered separately.

Momentary Contact Push Button Units – 800MB

Non-illuminated



Flush Head Unit
Cat. No. 800MB-CA1B



Extended Head Unit
Cat. No. 800MB-CB1B

800 $\frac{MB}{a}$ - $\frac{CA}{b}$ $\frac{1}{c}$ $\frac{A}{d}$ $\frac{\quad}{e}$

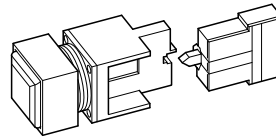

a	
Bezel Color ⁽¹⁾	
Code	Color
MB	Black

b	
Operator Type	
Code	Description
CA	Flush head
CB	Extended head

c	
Color Insert	
Code	Color
X	No color insert
1	Green
3	Orange
4	Gray
5	White
6	Red ⁽³⁾
7	Blue
9	Yellow

d	
Contact Blocks	
Standard	
Code	Description
Blank	No contacts
D1	1 N.O.
D2	1 N.C.
A	1 N.O. - 1 N.C.
A2	2 N.O.
A4	2 N.C.
A7	1 N.C.L.B. - 1 N.C.
B	2 N.O. - 2 N.C.

e	
Contact Block Termination Type ⁽²⁾	
Code	Description
Blank	Stab terminals
K	Large screw

(1) Gray bezel can be ordered separately.

(2) Logic Reed and small screw contact blocks must be ordered separately.

(3) Red flush head must be ordered separately.

Illuminated



Flush Head Unit
Cat. No. 800MB-CPA16GA



Extended Head Unit
Cat. No. 800MB-CQB24RA

800 MB - CQ A L O6 R A
a b c d e f g h

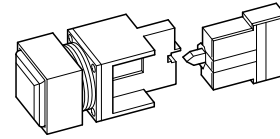

a	
Bezel Color ⁽¹⁾	
Code	Color
MB	Black

b	
Power Module Type	
Code	Description
CQ	Full voltage
CP	Transformer

c	
Operator Type	
Code	Description
A	Flush
B	Extended

d	
Illumination Options	
Code	Description
Blank	Incandescent
L	LED ^{(2) (3)}

e	
Voltage	
Full Voltage	
Code	Description
12	12V AC/DC
24	24V AC/DC
10	120V AC ⁽⁶⁾
Transformer	
16	120V AC
26	240V AC

f	
Color Insert	
Code	Color
Blank	No contacts
X	Packet of colored inserts ⁽⁵⁾
A	Amber
B	Blue
C	Clear
G	Green
R	Red ⁽⁷⁾

g	
Contact Blocks	
Standard	
Code	Description
Blank	No contacts
D1	1 N.O.
D2	1 N.C.
A	1 N.O. - 1 N.C.
A2	2 N.O.
A4	2 N.C.
A7	1 N.C.L.B. - 1 N.C.
B	2 N.O. - 2 N.C. ⁽⁸⁾

h	
Contact Block Termination Type ⁽⁴⁾	
Code	Description
Blank	Stab terminals
K	Large screw

- (1) Gray bezels can be ordered separately.
- (2) LEDs are only available in red, green, amber, and white; lens color must match LED color.
- (3) White LED available in 24V AC/DC only.
- (4) LED only.
- (5) Packet of colored inserts, one of each color. Not available with LED option for illuminated devices.
- (6) Logic Reed and small screw contact blocks must be ordered separately.
- (7) Red flush-head push buttons are not suitable for applications that require extended head or other unguarded buttons capable of being operated quickly in emergencies, and they do not comply with applicable codes or standards.
- (8) Only available with full voltage illumination option and standard stab terminations.

Dual Operator, Non-illuminated – 800MB



Dual Operator Black Bezel
Cat. No. 800MB-DB16B

800 MB - DB16 B _____
 a b c d e

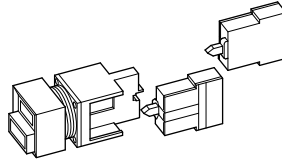

a	
Bezel Color ⁽¹⁾ ⁽²⁾	
Code	Color
MB	Black

b	
Operator Type	
Code	Description
DB16	Dual push button unit: Upper – Flush green Lower – Extended red

c	
Contact Blocks	
Standard	
Code	Description
Blank	No contacts
B	2 N.O. - 2 N.C.

d	
Contact Block Termination Type ⁽³⁾	
Code	Description
Blank	Stab terminals
K	Large screw

e	
Legend Options	
Code	Description
Blank	Upper – Blank Lower – Blank
50	Upper – ON Lower – OFF
64	Upper – START Lower – STOP

- (1) Gray bezels must be ordered separately.
- (2) Must use Bulletin 800MS color inserts and legend plates. Type 13 oiltight, square traditional.
- (3) Logic Reed and small screw contact blocks must be ordered separately.

Pilot Light Units – 800MB



Pilot Light
Cat. No. 800MB-CQ24RS



Push-to-test Pilot Light
Cat. No. 800MB-CPT16G

800 MB - CP L 24 R

a b c d e f

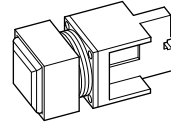

a	
Bezel Color ⁽¹⁾	
Code	Color
MB	Black

b	
Power Module Type	
Code	Description
CP	Transformer
CQ	Full voltage

c	
Illumination Options	
Code	Description
Blank	Incandescent
L	LED ⁽²⁾
T	Push-to-test
TL	Push-to-test with LED

d	
Voltage	
Full Voltage	
Code	Description
12	12V AC/DC
24	24V AC/DC
10	120V AC ⁽³⁾
Transformer	
16	120V AC
26	240V AC

e	
Lens Color	
Code	Color
X	Packet of colored inserts ⁽⁵⁾
A	Amber
B	Blue
C	Clear/white
G	Green
R	Red

f	
Termination Type ⁽⁴⁾	
Pilot Lights	
Code	Description
Blank	Stab terminals
Push-to-test Pilot Lights	
Blank	Stab terminals
K	Large screw ⁽⁶⁾

- (1) Gray bezel can be ordered separately.
- (2) LEDs are only available in red, green, amber, and white; lens color must match LED color.
- (3) LED only.
- (4) Small screw contact blocks must be ordered separately.
- (5) Packet of colored inserts, one of each color. Not available with LED illumination option.
- (6) Only available with full voltage power module and standard stab terminations.

Accessories – Bulletin 800MB/MR

Contact Blocks



Cat. No. 800M-XA



Cat. No. 800M-XAS



Cat. No. 800M-XAK



Cat. No. 800M-XAR

Contact Arrangement	Standard Blocks			Logic Reed Blocks ⁽¹⁾
	Quick Connect Terminals	Small Screw Terminals with Pressure Plates	Large Screw Terminals with Pressure Plates	Quick Connect Terminals
	Cat. No.	Cat. No.	Cat. No.	Cat. No.
1 N.O.	800M-XD1	800M-XD1S	800M-XD1K	800M-XD1R
1 N.C.	800M-XD2	800M-XD2S	800M-XD2K	800M-XD2R
1 N.O. - 1 N.C.	800M-XA	800M-XAS	800M-XAK	800M-XAR
2 N.O.	800M-XA2	800M-XA2S	800M-XA2K	800M-XA2R
2 N.C.	800M-XA4	800M-XA4S	800M-XA4K	800M-XA4R
1 N.O.E.M. - 1 N.C.L.B.	800M-XA3	800M-XA3S	800M-XA3K	–
1 N.C.L.B. - 1 N.C.	800M-XA7	800M-XA7S	800M-XA7K	–

(1) Screw terminals with pressure plates are not available.

IMPORTANT For contact block rating information, see [Standard Contact Ratings on page 118](#).

Color Caps

Table 57 - Non-illuminated Devices



Color	Flush Head Push Buttons	Extended Head Push Buttons	Mushroom Buttons	Push-Pull Units	Twist or Pull Release Caps
	Cat. No.	Cat. No.	Cat. No.	Cat. No.	Cat. No.
Green	800MR-N41	800MR-N21	800MR-N56G	800MR-N160B	800MR-N30B
Black	800MR-N42	800MR-N22	800MR-N56B	800MR-N160H	800MR-N30H
Orange	800MR-N43	800MR-N23	800MR-N56O	800MR-N160F	800MR-N30F
Gray	800MR-N44	800MR-N24	800MR-N56GR	800MR-N160G	–
White	800MR-N45	800MR-N25	800MR-N56W	800MR-N160J	–
Red	800MR-N46	800MR-N26	800MR-N56R	800MR-N160A	800MR-N30A
Blue	800MR-N47	800MR-N27	800MR-N56BL	800MR-N160C	800MR-N30C
Yellow	800MR-N49	800MR-N29	800MR-N56Y	800MR-N160E	800MR-N30E

Table 58 - Illuminated Devices



Color	Pilot Lights	Push-to-test Pilots and Illuminated Push Buttons	Illuminated Push-Pull Units	Illuminated Mushroom Buttons	Illuminated Twist or Pull Release Caps
	Cat. No.	Cat. No.	Cat. No.	Cat. No.	Cat. No.
Red	800MR-N1R	800MR-N2R	800MR-N159R	800MR-N156R	800MR-N20R
Green	800MR-N1G	800MR-N2G	800MR-N159G	—	800MR-N20G
Amber	800MR-N1A	800MR-N2A	800MR-N159A	800MR-N156A	800MR-N20A
Blue	800MR-N1B	800MR-N2B	800MR-N159B	800MR-N156B	800MR-N20B
White	800MR-N1W	800MR-N2W	800MR-N159W	800MR-N156W	—
Clear	800MR-N1C	800MR-N2C	800MR-N159C	800MR-N156C	800MR-N20C

Replacement Selector Switch Knobs





Color	Selector Switch Knobs, Non-Illuminated		Color	Selector Switch Knobs, Illuminated	
	Standard Knob	Knob Lever		Standard Knob	Knob Lever
	Cat. No.	Cat. No.		Cat. No.	Cat. No.
Gray	800M-NG	800M-NT	Red	800M-LA	800M-LL
Red	800M-NA	800M-NL	Amber	800M-LD	800M-LP
Green	800M-NB	800M-NM	Clear	800M-LY	800M-LZ
Blue	800M-NC	800M-NN	Green	800M-LB	800M-LM
Yellow	800M-NE	800M-NR			
Orange	800M-NF	800M-NS			
Black	800M-NH	800M-NK			
White	800M-NJ	800M-NV			

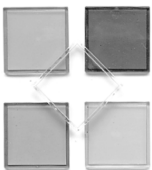









Color Chip Kits – Bulletin 800MB

	Description	Type of Unit	Color	Cat. No.
 <p>Cat. No. 800MS-N10</p>	<p>Color Chip Kits These kits are available for replacement on backlit style devices. A packet of color chips that contains one of each color is included in each kit.</p>	Full-face illuminated	Amber	800MS-N10A
			Blue	800MS-N10B
			Clear	800MS-N10C
			Green	800MS-N10G
			Red	800MS-N10R
		Non-illuminated	Blue	800MS-N12B
			Gray	800MS-N12GR
			Green	800MS-N12G
			Orange	800MS-N12O
			Red	800MS-N12R
			White	800MS-N12W
			Yellow	800MS-N12Y

Boots

	Description	Cat. No.	
	<p>Insulation Boot When properly combined with a Bulletin 800MR unit, this device meets CSA grounding requirements.</p>	800M-N18	
	Description	Cat. No.	
 <p>Cat. No. 800MR-N9</p>	<p>Rubber Boot These accessories are used as dust covers. They can be added to flush and extended head push button units (illuminated and non-illuminated) to help protect against foreign materials reaching the opening between the button and the mounting ring.</p>	Black	800MR-N8
		Red	800MR-N9
		Green	800MR-N10
		Blue	800MR-N11
		Yellow	800MR-N12
		Clear	800MR-N14

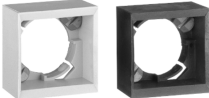

Miscellaneous

	Description			Cat. No.
	Extended Mounting Ring This mounting ring helps protect against accidental push button operation.			800MR-N4
	Padlocking Cover ⁽¹⁾ Stainless steel mounting bracket with clear plastic cover. Guards against unauthorized operation. Used with round design push buttons and selector switches (not for use with wing lever). Also available for 2-position push-pull units (button must be in the depressed position when the cover is closed).			800MR-N6
	Locking Ring Wrench This device is used to tighten and loosen mounting rings properly in the 800MR family.			800MR-N3
	Hole Closing Plug Wherever an enclosure or flush plate with more than the required number of openings is used, this neat-appearing plug can be supplied to close the unused openings.			800M-N1
	Lamp Remover This tool can be used to remove and install wedge-based lamps in illuminated selector switches.			800M-N5
	Connectors Used with wire sizes AWG 18...22. The connectors come in packages of 100 pieces.			800M-NT2 ⁽²⁾
	Guard for Illuminated Push Buttons This device is used to help prevent accidental operation of illuminated push buttons.			800MR-N93
	Mounting Ring This device is a retaining ring that is used to keep an operator in the panel when removing the guard ring to service the light bulb.			40167-287-02
	Lens Remover This device makes it easier to remove the lens.			800MS-N9
 Cat. No. 800MS-N16 (Gray) Cat. No. 800MB-N16 (Black)	Additional Bezels These bezels fit square traditional and backlit styles.	Style	Color	Cat. No.
			Gray	800MS-N16
 Cat. No. 800MS-N17		Flush button backlit	Black	800MB-N16
			Gray	800MS-N17
		Extended button backlit	Black	800MB-N17
			Gray	800MS-N18
	Legend Insert Do-It-Yourself Kits These kits contain material necessary to create transparent backlit legend inserts	Type	Color	Cat. No.
			Legend marking start package	800MS-N13

(1) Padlock not included.

(2) Must be ordered in multiples of 100.

Replacement Lamps

Lamp	Type	Lamp Voltage	ANSI Number	Cat. No.
Incandescent 	Full Voltage and Transformer	6.3V AC	86	800M-N15
	Full Voltage	12V AC/DC	73	800M-N16
		24V AC/DC	85	800M-N17
	Dual-input Transformer	6.3V AC	755/1866	800T-N65
Standard LED 	Full Voltage	6.3V AC/DC	—	800T-N60x ⁽¹⁾
		14V AC/DC	—	800T-N61x ⁽¹⁾
		28V AC/DC	—	800T-N62x ⁽²⁾
		120V AC	—	800T-N64x ⁽¹⁾

(1) To complete the cat. no. replace the x with the first letter of the desired color: A (amber), G (green), R (red), W (white), or B (blue).

(2) To complete the cat. no. replace the x with the first letter of the desired color: A (amber), G (green), R (red), or W (white).

IMPORTANT All illuminated devices, except dual-input transformer units, use T 1-3/4 wedge base units. Existing Bulletin 800M devices can have incandescent lamps replaced with shock and vibration resistant LEDs. Existing ANSI number 86, 73, or 85 lamps can be replaced by LEDs.

Legend Plates – 800MB/MR

Bulletin 800MR Legend Plates



Standard Size Blank Legend Plate
 Gray (Cat. No. 800MR-W00)
 Red (Cat. No. 800MR-W600)



Standard Size Blank Legend Plate
 Gray (Cat. No. 800MR-W00)
 Red (Cat. No. 800MR-W600)

Table 59 - Push Buttons/Pilot Lights

Marking	Cat. No.
CLOSE	800MR-W01
DOWN	800MR-W02
EMERG. STOP (Red)	800MR-W624
FAST	800MR-W03
FORWARD	800MR-W23
HIGH	800MR-W04
IN	800MR-W06
INCH	800MR-W07
JOG	800MR-W08
LOW	800MR-W05

Marking	Cat. No.
LOWER	800MR-W11
OFF	800MR-W09
ON	800MR-W10
OPEN	800MR-W13
OUT	800MR-W12
PUSH-TO-TEST	800MR-W29
RAISE	800MR-W14
RESET	800MR-W15
REV	800MR-W16
RUN	800MR-W17

Marking	Cat. No.
SLOW	800MR-W18
START	800MR-W19
STOP (Red)	800MR-W620
TEST	800MR-W21
UP	800MR-W22
1ST SPEED	800MR-W25
2ND SPEED	800MR-W26
3RD SPEED	800MR-W27
4TH SPEED	800MR-W28
—	—

Table 60 - Selector Switches

Marking	Cat. No.
OPEN-CLOSE	800MR-W57
RAISE-LOWER	800MR-W58
RUN-JOG	800MR-W59
SAFE-RUN	800MR-W60
SLOW-FAST	800MR-W61
SLOW-OFF-START	800MR-W75
START-JOG	800MR-W62
START-STOP	800MR-W63

Marking	Cat. No.
STOP-START	800MR-W64
SUM-WINT	800MR-W65
UP-DOWN	800MR-W66
1-2-3-4	800MR-W80
AUTO-OFF-HAND	800MR-W79
FOR-OFF-REV	800MR-W77
FOR-REV	800MR-W51
HAND-AUTO	800MR-W52

Marking	Cat. No.
HAND-OFF-AUTO	800MR-W78
HIGH-LOW	800MR-W53
JOG-REV	800MR-W54
JOG-RUN	800MR-W55
JOG-STOP-RUN	800MR-W76
LEFT-RIGHT	800MR-W56
OFF-ON	800MR-W50
—	—

Table 61 - Blank Legend Plates

Size – Color	Cat. No.
Standard – gray	800MR-W00
Large – gray	800MR-W100
Standard – red	800MR-W600
Large – red	800MR-W6100

Table 62 - Custom Legend Plates

Number of Lines and Characters	Cat. No.
1 line, 12 characters	800MR-W00E plus custom text
2 lines, 12 characters	800MR-W100E plus custom text
1 line, 12 characters	800MR-W600E plus custom text
2 lines, 12 characters	800MR-W6100E plus custom text

Extra Large Legend Plates

IMPORTANT An adapter ring is available for Bulletin 800MR push buttons when used with Bulletin 800T legend plates. Order Cat. No. 800MR-N50. See [Legend Plates on page 122](#) for dimension requirements.

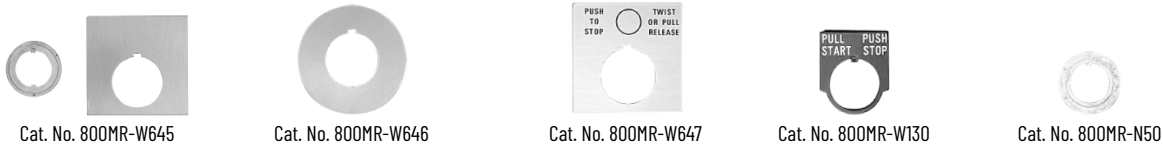

Format	Cat. No.
Large size with adapter ring (blank)	800MR-W645
Round with adapter ring (blank)	800MR-W646
Pre-printed includes adapter ring (Cat. No. 800MR-N50) Push to stop Twist or pull release	800MR-W647

Format	Cat. No.
For Push-Pull only Push stop Pull start	800MR-W130
Adapter Ring ⁽¹⁾ Used with Bulletin 800T legend plates	800MR-N50
–	–

(1) To use the Bulletin 800T legend plates with Bulletin 800MR devices, use adapter ring (Cat. No. 800MR-N50).

Bulletin 800MB Special Legend Inserts

Special legend inserts are available. To order, specify catalog number 800MS-WC00E and marking required. A maximum of nine characters per line:

- One or two lines 0.140 in. high characters
- Three or four lines 0.110 in. high characters

Bulletin 800MB Backlit Legends

[Table 63](#) lists standard legend markings that are available. To order legend insert only, add the suffix of the legend to catalog number 800MS-WC. Example: catalog number 800MS-WC03 would be a FAST legend insert only.

Table 63 - Standard Legend Markings

Marking	Suffix	Marking	Suffix	Marking	Suffix	Marking	Suffix
CLOSE	01	LOW	05	RESET	15	UP	22
DOWN	02	LOWER	11	REV	16	1ST SPEED	25
FAST	03	OFF	09	RUN	17	2ND SPEED	26
FORWARD	23	ON	10	SLOW	18	3RD SPEED	27
HIGH	04	OPEN	13	START	19	4TH SPEED	28
IN	06	OUT	12	STOP	20	0	40
INCH	07	PUSH-TO-TEST	29	EMERG STOP	24	1	41
JOG	08	RAISE	14	TEST	21	–	–

Specifications

Table 64 - 800MB/MR ⁽¹⁾

Electrical Ratings		
Contact Ratings	See Standard Contact Ratings and Logic Reed Contact Ratings on page 118	
Dielectric Strength	1600V for 1 minute 1300V for 1 minute (Logic Reed)	
Electrical Design Lifecycles	750,000 at maximum rated load 200,000 at maximum rated load (Logic Reed)	
Mechanical Ratings		
Vibration	10...2000 Hz 1.52 mm displacement (peak-to-peak) max/10 G max (except Logic Reed)	
Shock	1/2 cycle sine-wave for 11 milliseconds \geq 25 G (contact fragility) and no damage at 100 G	
Degree of Protection	Type 13; IEC I44 IP65 oiltight	
Mechanical Design Lifecycles, Min	Push Buttons	1,000,000
	Potentiometers	100,000
	All other devices	200,000
Contact Operation	Contact blocks with Bifurcated spanner: Slow make and break, simple break. Logic Reed Contact Blocks: Snap action	
Typical Operating Forces	Operators without contact blocks	10.8 N (2.45 lb)
	Push-Pull Units	35.3 N (8 lb) push to in position 17.7 N (4 lb) maximum pull to out position
	Contact Blocks	Standard – 6.7 N (1.5 lb) Logic Reed – 2.6 N (0.616 lb)
Environment		
Temperature Range	Operating	0...55 °C (32...131 °F)
	Storage	-40...+85 °C (-40...+185 °F)
Note: Operating temperatures at 0 °C (32 °F) are based on the absence of freezing moisture and liquids.		
Humidity	50% at 40 °C (104 °F)	
Panel Thickness Requirements	1.6...6.4 mm (1/16...1/4 in.)	

(1) Performance Data – see Important table on [page 4](#).

Certifications

- UL Listed – File: E14840, E10314
- CSA Certified: LR1234, LR11924
- Guide: NKCR, NOIV
- IEC Compliance, IEC 529

Standard Contact Ratings

(IEC 337-1) (NEMA ICS 2-125) Max continuous current I_{th} 10 A. 800M units have control circuit ratings with 800M contact blocks as follows:

Maximum Operational Volts U_e	Utilization Category		Rated Operational Currents		
	IEC	NEMA	Volts U_e	Make	Break
AC 300	AC-II	A300	120...300	7200VA	720VA
			72...120	60VA	720VA
			24...72 ⁽¹⁾	60 A	10 A

(1) For applications below 24V and 24 mA, Logic Reed contacts are recommended.

Logic Reed Contact Ratings

Max: 150V AC, 0.15 A, 8VA and 30V DC, 0.06 A, 1.8VA. Should only be used with resistive loads.

Wire Capacity

Contact Block	Wire Size
Stab termination contact blocks	Accepts two 2.79 x 0.81 mm (0.110 x 0.032 in.) push-on connectors or one 6.35 x 0.81 mm (0.250 x 0.032 in.) push-on connector.
Small screw contact blocks	Accepts one #14 or two #16 AWG solid or stranded wires.
Large screw-termination contact blocks	Accepts two #12 AWG solid or stranded wires.

Approximate Dimensions – 800MB/MR

Dimensions in inches (millimeters). Dimensions are not intended to be used for manufacturing purposes.

Bulletin 800MR Extension in Front of Panel

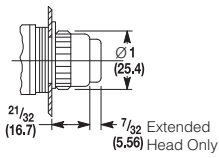

Round Push Button
Flush, Extended, and
Illuminated Extended

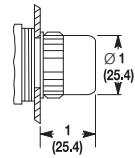

Round Push Button
Illuminated Flush

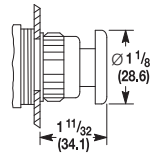

Round Push Button
Mushroom

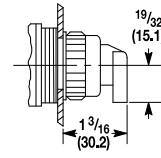

Round Selector Switch
and Potentiometer
and Standard Knob

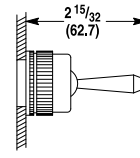

Panel Wobble
Stick Unit

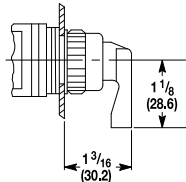

Round Selector Switch
and Potentiometer
and Wing Lever

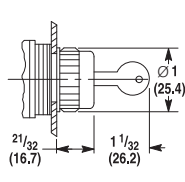

Round Cylinder Lock
Selector Switch

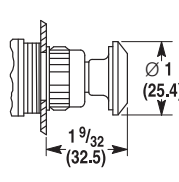

Round Push-pull

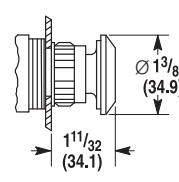

Twist or Pull
Release Units

Bulletin 800MB Front View of Square Units

Dimensions in inches (millimeters). Dimensions are not intended to be used for manufacturing purposes.



ATTENTION: To avoid possible excessive heat, clusters of nine or more continuously illuminated units that are mounted in a small enclosure should be spaced at 1.5 in. (38.1 mm) minimum centers in one direction.

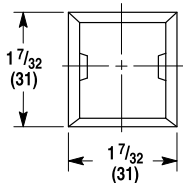

Unit without Insert
and Backlit Unit

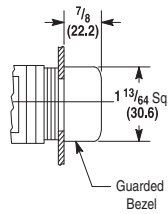

Square Backlit
with Guarded Bezel

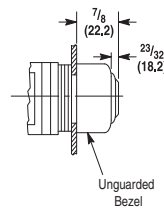

Square Backlit
with Unguarded Bezel

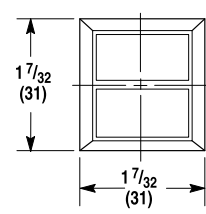

Dual Operator Unit

Bulletin 800MB Extension in Front of Panel

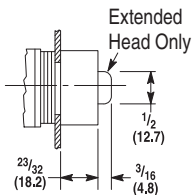

Square Push Button
Flush and Extended

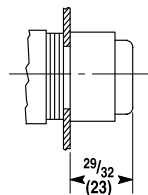

Square Push Button
Large Extended

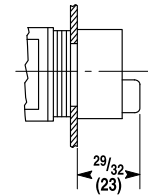

Square Push Button
Dual Operator

Extension Behind Panel

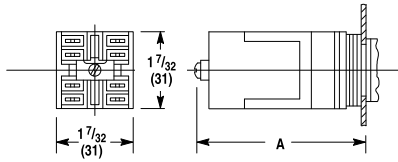

Quick Connect Terminal Contact Block
(Typical View)⁽¹⁾

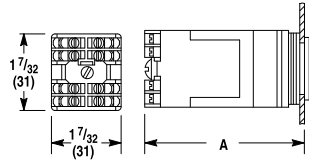

Screw Terminals with Pressure Plate Contact Block
(Typical View)⁽¹⁾

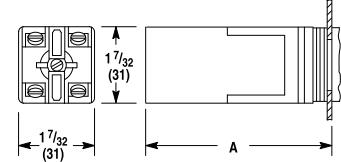

Large Screw Terminals with Pressure Plate Contact Block
(Typical View)⁽¹⁾

Units with Transformer

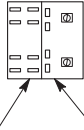

Contact Block Terminals Transformer Terminals

(1) For A dimension, see [Table 65 on page 120](#).

Panel Depth Requirements

1/16...1/4 in. (1.6...6.4 mm)

Table 65 - Dimension A [in. (mm)]

Description	Push Button	Pilot Light	Selector Switch	Cylinder Lock	Potentiometer	Push-Pull or Twist Release
Quick Connect Terminal						
Non-illuminated	2-1/4 (57.2)	— —	2-15/32 (62.7)	3-1/2 (88.9)	2-1/32 (51.6)	2-3/4 (69.8)
Illuminated	Full Voltage	2-1/4 (57.2)	2-15/32 (62.7)	— —	— —	2-3/4 (69.8)
	Transformer	2-23/32 (69.1)	2-23/32 (69.1)	2-29/32 (73.8)	— —	3-3/32 (78.6)
Small Screw Terminals with Pressure Plates						
Non-illuminated	2-5/16 (59)	— —	2-17/32 (64.3)	3-9/16 (90.5)	2-1/32 (51.6)	2-13/16 (71.4)
Illuminated	Full Voltage	2-25/32 (70.6)	2-25/32 (70.6)	2-17/32 (64.3)	— —	2-13/16 (71.4)
	Transformer	2-25/32 (70.6)	2-25/32 (70.6)	2-31/32 (75.4)	— —	3-5/32 (80.1)
Large Screw Terminals with Pressure Plates						
Non-illuminated	2-45/64 (68.6)	— —	2-59/64 (74.2)	3-15/16 (100)	— —	3-13/64 (81.4)
Illuminated	Full Voltage	3-11/64 (80.6)	3-11/64 (80.6)	3-23/64 (85.3)	— —	3-13/64 (81.4)
	Transformer	3-11/64 (80.6)	3-11/64 (80.6)	3-23/64 (85.3)	— —	3-35/64 (90.1)

Approximate Mounting Dimensions



ATTENTION: To avoid possible excessive heat, clusters of nine or more continuously illuminated units that are mounted in a small enclosure should be spaced at 1.5 in. (38.1 mm) minimum centers in one direction.

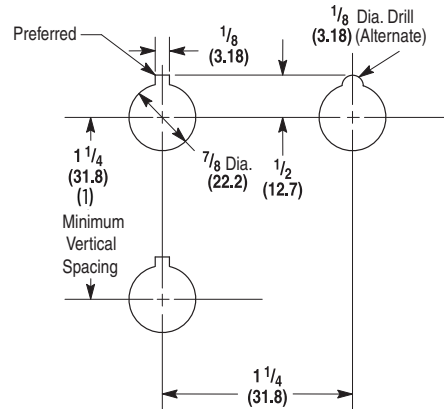

- (1) Large screw-terminal contact blocks require a minimum vertical spacing of 1-37/64 in. (40 mm); selector switches with wing lever knobs require 2-1/4 in. (57.1 mm) vertical and horizontal minimum spacing and large round legend plates require 1-1/2 in. (38.1 mm) minimum spacing.

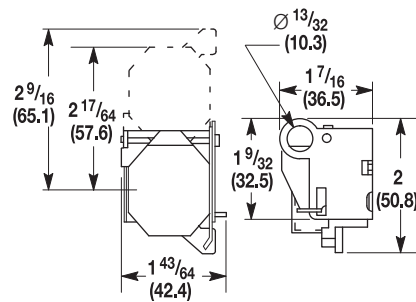

Padlocking Cover ⁽¹⁾
Cat. No. 800MR-N6

- (1) When using a padlocking cover and depending upon the types of adjacent units that are involved, the minimum vertical or horizontal spacing may have to be increased for operating clearance.

Shipping Weights [oz (kg)]

Type of Unit		Weight	
Push Buttons	Non-Illuminated	3.25 (0.09)	
	Illuminated	Full Voltage	3.5 (0.10)
		Transformer	5 (0.14)
Pilot Lights	Pilot Light	2.25 (0.06)	
	Push-to-test	3 (0.09)	
	Pilot Light	4.5 (0.13)	
	Push-to-test	5 (0.14)	
Cylinder Lock		6 (0.17)	

Type of Unit		Weight	
Selector Switches	Non-Illuminated	4 (0.11)	
	Illuminated	Full Voltage	4 (0.11)
		Transformer	5.5 (0.16)
Push-Pull Units	Non-Illuminated	4.5 (0.13)	
	Illuminated	Full Voltage	4.5 (0.13)
		Transformer	5.5 (0.16)
Potentiometer Units		4 (0.11)	

Dimensions in inches (millimeters). Dimensions are not intended to be used for manufacturing purposes.

Legend Plates

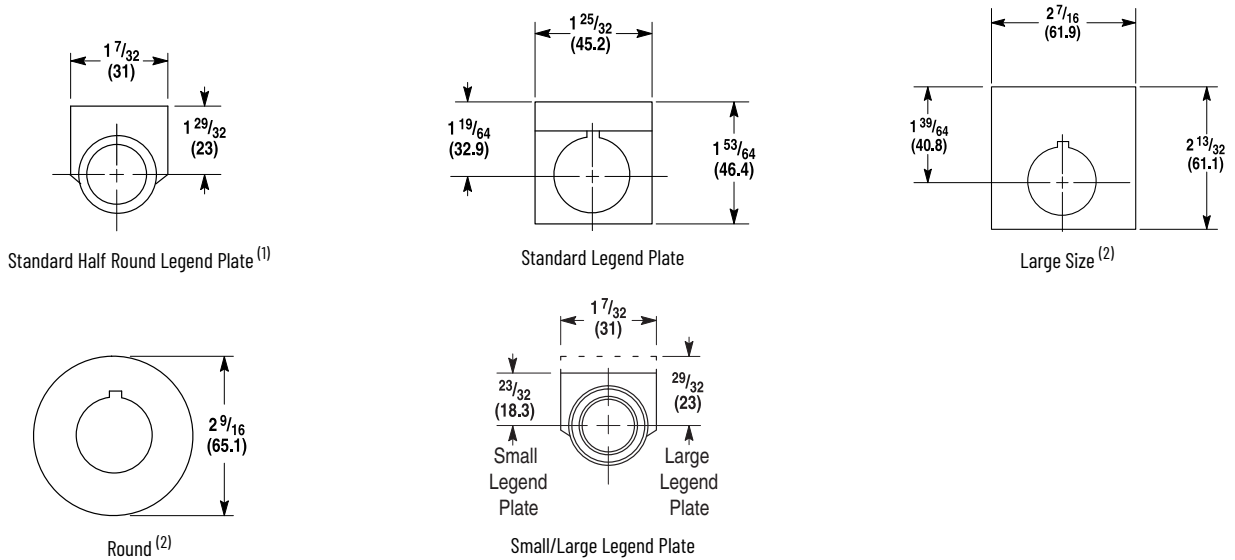

- (1) 800MR large half round legend plates are not recommended for use with the twist-release units because of the operator knob size. The legend plate is virtually unreadable. Push-pull units can be mounted in a 1-1/4 in. minimum horizontal spacing when no legend plate is used. Vertical spacing is 1-1/2 in. when the 800MR large half round legend plate is used.
- (2) These 800MR legend plates consist of 800T legend plates with Cat. No. 800MR-N50 adapter rings.

Additional Resources

These documents contain additional information concerning related products from Rockwell Automation.

Resource	Description
800F 22 mm Push Button Brochure, publication 800F-BR001	Provides an overview of the Bulletin 800F product family.
Don't Let Contact Build-up Cause Machine Downtime, publication 800-AT002	Provides solutions to help prevent downtime due to contact build-up.
Bulletin 800FC 22.5 mm Push Button Pendant Station Brochure, publication 800FC-BR001	Provides an overview of the 800FC product family.
Bulletin 800B 16 mm Push Button Brochure, publication 800B-BR001	Provides an overview of the 800B product family.
UL Standards Listing for Industrial Control Products, publication CMPNTS-SR002	Assists original equipment manufacturers (OEMs) with construction of panels, to help ensure that they conform to the requirements of Underwriters Laboratories.
American Standards, Configurations, and Ratings: Introduction to Motor Circuit Design, publication IC-AT001	Provides an overview of American motor circuit design based on methods that are outlined in the NEC.
Industrial Components Preventive Maintenance, Enclosures, and Contact Ratings Specifications, publication IC-TD002	Provides a quick reference tool for Allen-Bradley industrial automation controls and assemblies.
Safety Guidelines for the Application, Installation, and Maintenance of Solid-state Control, publication SGI-1.1	Designed to harmonize with NEMA Standards Publication No. ICS 1.1-1987 and provides general guidelines for the application, installation, and maintenance of solid-state control in the form of individual devices or packaged assemblies incorporating solid-state components.
Industrial Automation Wiring and Grounding Guidelines, publication 1770-4.1	Provides general guidelines for installing a Rockwell Automation industrial system.
Product Certifications website, rok.auto/certifications .	Provides declarations of conformity, certificates, and other certification details.

You can view or download publications at rok.auto/literature.

Rockwell Automation Support

Use these resources to access support information.

Technical Support Center	Find help with how-to videos, FAQs, chat, user forums, and product notification updates.	rok.auto/support
Knowledgebase	Access Knowledgebase articles.	rok.auto/knowledgebase
Local Technical Support Phone Numbers	Locate the telephone number for your country.	rok.auto/phonesupport
Literature Library	Find installation instructions, manuals, brochures, and technical data publications.	rok.auto/literature
Product Compatibility and Download Center (PCDC)	Download firmware, associated files (such as AOP, EDS, and DTM), and access product release notes.	rok.auto/pcdc

Documentation Feedback

Your comments help us serve your documentation needs better. If you have any suggestions on how to improve our content, complete the form at rok.auto/docfeedback.





Allen-Bradley, expanding human possibility, FactoryTalk, SensEject, and Rockwell Automation are trademarks of Rockwell Automation, Inc.

DeviceNet and EtherNet/IP are trademarks of ODVA, Inc.

Trademarks not belonging to Rockwell Automation are property of their respective companies.

Rockwell Automation maintains current product environmental compliance information on its website at rok.auto/pec.

Rockwell Otomasyon Ticaret A.Ş. Kar Plaza İş Merkezi E Blok Kat:6 34752, İçerenköy, İstanbul, Tel: +90 (216) 5698400 EEE Yönetmeliğine Uygundur

Connect with us.    

rockwellautomation.com ————— expanding **human possibility**[™]

AMERICAS: Rockwell Automation, 1201 South Second Street, Milwaukee, WI 53204-2496 USA, Tel: (1) 414.382.2000, Fax: (1) 414.382.4444

EUROPE/MIDDLE EAST/AFRICA: Rockwell Automation NV, Pegasus Park, De Kleetlaan 12a, 1831 Diegem, Belgium, Tel: (32) 2 663 0600, Fax: (32) 2 663 0640

ASIA PACIFIC: Rockwell Automation, Level 14, Core F, Cyberport 3, 100 Cyberport Road, Hong Kong, Tel: (852) 2887 4788, Fax: (852) 2508 1846

Publication 800-TD008E-EN-P - September 2021

Supersedes Publication 800-TD008D-EN-P - May 2021

Copyright © 2021 Rockwell Automation, Inc. All rights reserved. Printed in the U.S.A.