

Load Centers & Circuit Breakers

SPEEDFAX™

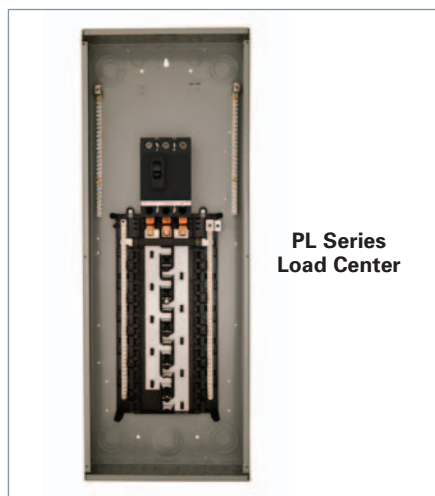
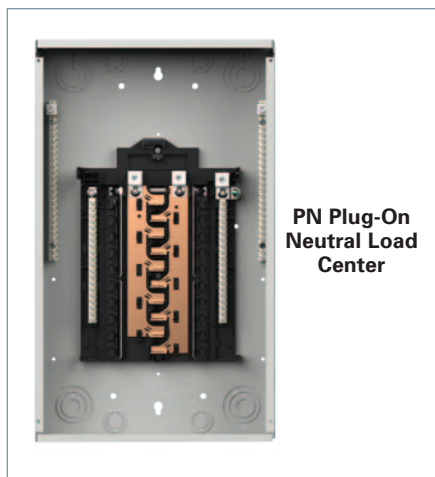

Contents

Load Centers

Catalog Numbering System	1-2
Plug-On Neutral Load Centers	1-3
Electronic Breakers and Surge Protection	1-4
PN Series 1-Phase Plug-On Neutral Load Centers	
Features	1-5
1-phase, 3-wire, 120/240 Volts AC Main Breaker/Convertible	1-6
1-phase, 3-wire, 120/240 Volts AC Main Lug/Convertible	1-7
SN Series 1-Phase Plug-On Neutral Load Centers	
Features	1-8
1-phase, 3-wire, 120/240 Volts AC Main Breaker	1-9
1-phase, 3-wire, 120/240 Volts AC Main Lug	1-10
1-phase, 3-wire, 120/240 Volts AC Specialty Main Lug and Breakers	1-11
PL and ES Series 3-Phase Load Centers	
Features	1-12
PL Series Main Lug and Main Breakers	1-13
PL Series Unassembled Load Centers	1-14
ES Series Main Lug and Main Breakers	1-15
EQ® Load Centers, 300-400 Amp	1-16
Generator Ready Load Centers	1-17
Riser Panel Load Centers	1-18
EQ® Load Centers, Small Circuit and Circuit Breaker Enclosures	1-19 – 1-20
Renovation Interiors	1-21
Load Center Accessories	1-22 – 1-25
Knockout Diagrams	1-26 – 1-30
Load Center Cross Reference	1-31 – 1-39

Circuit Breakers

Arc-Fault and Ground-Fault Breakers	1-40
Type QP, 1" Breakers	1-41
Duplex, Triplex and Quadplex Plug-In Breakers	1-42
Special Application Breakers	1-43
Type QD, 3/4" Breakers	1-44
Main and Branch Circuit Breakers	1-45
Circuit Breaker Dimension Drawings and Lug Data	1-46 – 1-47
Circuit Breaker Accessories	1-48 – 1-49

Surge Protection Products

AC Disconnects, 1-Phase, NEMA 3R Rated	1-50 – 1-52
--	-------------

Scan to connect online to the most up-to-date version of this Section of SPEEDFAX.



Load Centers

Catalog Numbering System

Catalog Numbering System

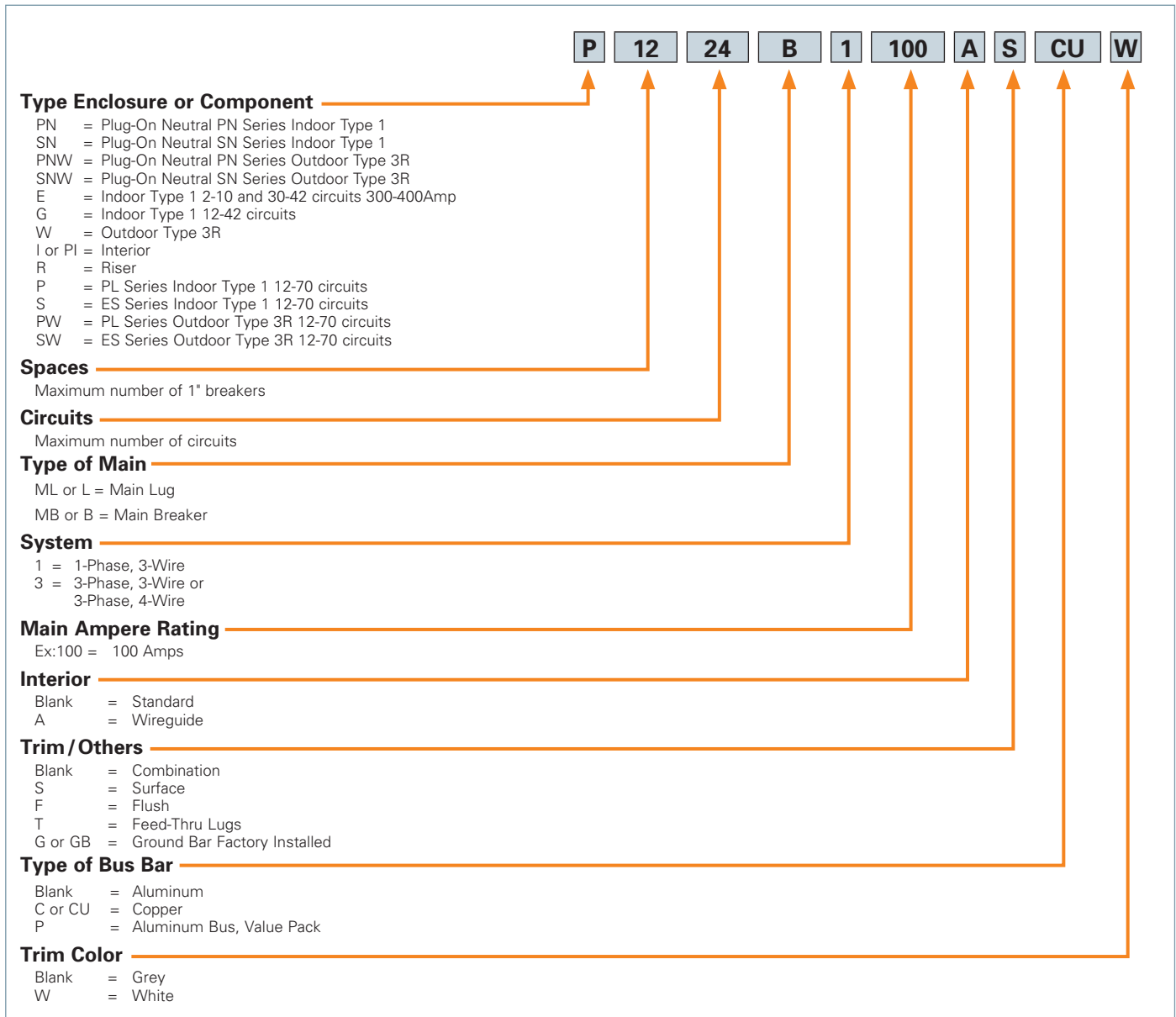

Products Shown In Sections 1 of this Speedfax Meet or Exceed the Following Standards.

- UL50 — Electric Cabinets and Boxes
- UL67 — Electric Panelboards
- UL486 — Wire Connectors
- UL489 — Molded-Case Circuit Breakers
- UL869 — Service Equipment
- UL943 — Ground Fault Interrupters (Class A — Personnel Protection)
- Federal Specification W-P-115b — Panel Power Distribution
- Federal Specification W-C-375B — Circuit Breakers
- NEC
- NEMA 250

Underwriters' Laboratories, Inc. Reference File Numbers:

- Series Connected Circuit Breaker Information is recognized by UL under file #E10848(N)
- Load Centers Listed by UL under file #E10703
- Load Centers UL recognized components found under file #E10703, Volume 6 and 7. (Also referenced under the recognized components directory — section QEUY2)
- EQ Circuit Breakers are Listed by UL under file #E82615

Plug-On Neutral Load Centers

Overview

Plug-On Neutral Load Centers

You have come to know Siemens solutions for their durability, innovation, and safety attributes. This continues with the plug-on neutral load center with electronic breakers to provide a more secure connection resulting in a more confident installation.

With an overall smaller electronic breaker footprint, the plug-on neutral load center still gives you over 4" of wire bending space, which allows for a simpler, cleaner, and faster path to a finished project.



Simple Spacious Secure

- Quicker breaker installation
- Wiring made easier with the neutral lug removed on CAFCI breakers
- Same great features as PL and ES load centers

- Small electronic breaker footprint
- Design allows for neutral terminal accessibility
- Over 4 inches of wire bending space

- Same reliable installation method
- Neutral clip is the same as line side
- Durable hook-rail

A Siemens Advantage

The plug-on neutral load center has the same great features of the PL and ES line, plus an integrated neutral bus.^①

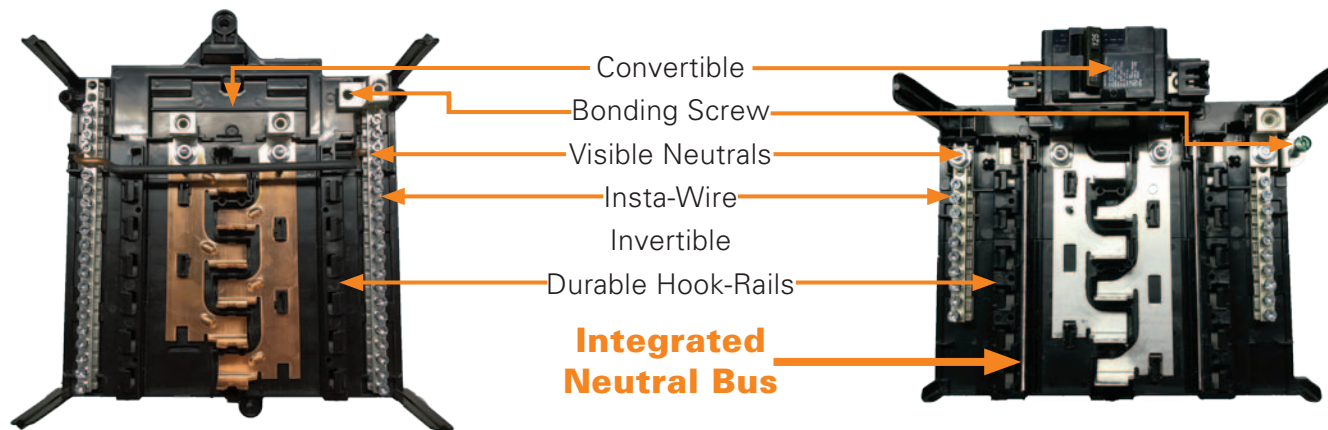

^① PN panels are convertible and come with two ground bars. SN panels come with one ground bar.

Electronic Breakers and Surge Protection

Complete Offering

Electronic Breakers and Surge Protection

The new plug-on neutral load center is compatible with existing surge solutions including the QSA breaker and FirstSurge™ stand-alone units. Additionally, there are four panels offered with a factory-installed FirstSurge unit.

For more information on the Surge Protection product line, see Section 10 and Section 7 Page 7-28 of the Speedfax at usa.siemens.com/speedfax.



FirstSurge™
Surge Protection Device



QSA Circuit Breaker and
Surge Protection Device



1-Pole
Combination Type AFCI



2-Pole
Combination Type AFCI



1-Pole
Dual Function



1-Pole
GFCI

Plug-on neutral breaker offering:

- 1 and 2-pole CAFCI
- 1-pole Dual Function (CAFCI/GFCI)
- 1-pole GFCI

Features:

- Load Lug(s) only on the CAFCI breakers
- LED indicators for troubleshooting
- Insta-Wire connectors

Technical Data:

- 10,000 AIC
- 120V
- UL Listed
- HACR and SWD rated

	Breaker Type	Ampere Rating	10,000 A IR Catalog No.
AFCI	QAF2N Plug-on Neutral 1-Pole 120V AC	15	QA115AFCN
		20	QA120AFCN
	QAF2N Plug-on Neutral 2-Pole 120/240V AC	15	Q215AFCN
		20	Q220AFCN
Dual Function	QFGA2N Plug-on Neutral 1-Pole 120V AC	15	Q115DFN
		20	Q120DFN
GFCI (5mA)	QPF2N Plug-on Neutral 1-Pole 120V AC	15	QF115AN
		20	QF120AN
		30	QF130AN

Note: Both plug-on neutral and existing pigtail breakers are listed for use in plug-on neutral load centers. For information on the complete product line, go to page 25.

PN Series 1-Phase Plug-On Neutral Load Centers

Features

- Convertible
 - Invertible
 - Bonding Screw
 - Visible Neutrals
 - Insta-Wire
 - Durable Hook-Rails
 - Integrated Neutral Bus
 - Extended Lifetime Warranty
- Sku's with C suffix that are 150A and above are tin plated copper bus
 - Tin plated copper bus stamped with CU to indicate copper
 - 100% Neutral & Ground positions based on number of circuits
- Can use twin AFI breakers in all PN & SN Series load centers
 - Easy to install neutral kits. Click here for the [PN & SN Accessory and Replacement Parts Guide](#).
 - Click here for [Siemens Warranty Information](#).

Invertible for bottom feed application.®

All devices convertible from main lug to main breaker and vice versa.

Mounting tabs on the trim hold it in place on the load center, freeing up both hands to drive the trim screws.

The pre-positioned bond screw eliminates bond strap/screw assemblies, and reduces the risk of losing components in the field.

The patented INSTA-WIRE™ neutral/ground system allows for faster installation because screws are backed out, ready for wire insertion. The visible neutral and grounds system aids in the insertion of conductors.

Combination head screw on the neutrals, ground, trim, upper pan, and bond screw provide installation flexibility.

A rigid, sturdy base pan provides the ruggedness required for the most harsh applications.

Copper Bus®

All devices come with an integrated neutral bus.

1-Phase PN Series Plug-On Neutral Load Centers ship with trims packaged separately.

The outdoor enclosure has a slide hinge door for the easiest installation and can be removed by backing out only one screw.

© Applies only to NEMA 1 PN and SN plug-on neutral load centers.
 © PN SKUs that have a C suffix have copper bus.

PN Series 1-Phase Plug-On Neutral Load Centers

1-phase, 3-wire, 120/240 Volts AC Main Breaker/Convertible

Main Breaker/Convertible Load Centers^① 100-225 Amperes

Copper Bus
60/75°C Rated

Amp Rating	No. of Spaces	No. of Circuits	Indoor Enclosure - NEMA Type 1		Outdoor Enclosure - NEMA Type 3R	
			Catalog Number ^⑥	Enclosure Height (inches) ^②	Catalog Number	Enclosure Height (inches) ^③
100	12	24	PN1224B1100C	18	PNW1224B1100C	21
100	16	32	PN1632B1100C	21	PNW1632B1100C	23
100	20	20	PN2020B1100C	21	PNW2020B1100C	27
100	20	40	PN2040B1100C	21	—	—
100	24	24	PN2424B1100C	24	—	—
100	30	30	PN3030B1100C	26	—	—
100	30	48	—	—	PNW3048B1100C	29
125	30	30	PN3030B1125C	26	—	—
125	30	48	—	—	PNW3048B1125C	29
150	8	16	—	—	PNW0816B1150TC ^⑤	23
150	20	40	PN2040B1150C	24	PNW2040B1150C	27
150	30	30	PN3030B1150C	30	—	—
150	30	48	—	—	PNW3048B1150C	35
200	8	16	—	—	PNW0816B1200TC ^⑤	23
200	20	40	PN2040B1200C	26	PNW2040B1200C	27
200	30	48	PN3048B1200 ^④	30	—	—
200	30	48	PN3048B1200C	30	PNW3048B1200C	35
200	40	40	PN4040B1200 ^④	36	—	—
200	40	40	PN4040B1200C	36	PNW4040B1200C	38
200	40	60	PN4060B1200 ^④	36	—	—
200	40	60	PN4060B1200C	36	—	—
200	54	82	PN5482B1200C	42	—	—
225	42	64	PN4264B1225C	39	PNW4264B1225C	38
225	54	82	PN5482B1225C	43	—	—

① Factory installed 22KAIC main breaker. Suitable for use as service equipment.

② Indoor enclosures are 14 1/4" wide by 3 7/8" deep.

③ Outdoor enclosures are 14 1/2" wide by 4 1/4" deep.

④ Includes all PN series features with aluminum bus.

⑤ Feed-thru lugs.

⑥ Available (made to order) in white by adding "W" to the end of the catalog number.

PN Series 1-Phase Plug-On Neutral Load Centers

1-phase, 3-wire, 120/240 Volts AC Main Lug/Convertible

Main Lug/Convertible Load Centers^③ 125-225 Amperes

Copper Bus
60/75°C Rated

Amp Rating	No. of Spaces	No. of Circuits	Indoor Enclosure - NEMA Type 1		Outdoor Enclosure - NEMA Type 3R	
			Catalog Number ^④	Enclosure Height (inches) ^①	Catalog Number	Enclosure Height (inches) ^②
125	12	12	PN1212L1125C	18	PNW1212L1125C	21
125	12	24	PN1224L1125C	18	PNW1224L1125C	21
125	16	32	PN1632L1125C	21	PNW1632L1125C	23
125	20	20	PN2020L1125C	21	—	—
125	20	40	PN2040L1125C	21	—	—
125	24	48	PN2448L1125C	24	—	—
125	30	48	PN3048L1125C	26	PNW3048L1125C	29
125	40	40	PN4040L1125C	36	—	—
150	20	40	PN2040L1150C	24	PNW2040L1150C	27
200	8	16	—	—	PNW0816L1200TC ^⑤	23
200	12	24	PN1224L1200C	21	PNW1224L1200C	23
200	20	40	PN2040L1200C	26	PNW2040L1200C	27
200	24	48	PN2448L1200C	30	—	—
200	30	30	PN3030L1200C	30	—	—
200	30	48	PN3048L1200 ^④	30	—	—
200	30	48	PN3048L1200C	30	PNW3048L1200C	35
200	40	40	PN4040L1200 ^④	36	—	—
200	40	40	PN4040L1200C	36	PNW4040L1200C	38
200	40	60	PN4060L1200C	36	—	—
225	12	24	—	—	PNW1224L1225C	27
225	42	64	PN4264L1225C	39	PNW4264L1225C	38
225	54	82	PN5482L1225C	43	—	—

① Indoor enclosures are 14 1/4" wide by 3 7/8" deep.
② Outdoor enclosures are 14 1/2" wide by 4 1/4" deep.

③ 125A load centers will accept MBK100A and MBK125A. 150A load centers will accept MBK150A. 200A load centers will accept MBK200A and MBK150A. 225A load centers will accept MBK225A, MBK200A, MBK150A.

④ Includes all PN series features with aluminum bus.
⑤ Feed-thru lugs.
⑥ Available (made to order) in white by adding "W" to the end of the catalog number.

SN Series 1-Phase Plug-On Neutral Load Centers

Features

LOAD CENTERS & CIRCUIT BREAKERS

- Invertible
- Bonding Screw
- Visible Neutrals
- Insta-Wire
- Durable Hook-Rails
- Integrated Neutral Bus
- Extended 10-Year Warranty
- 75% Neutral & 50% Ground positions based on number of circuits
- Can use twin AFCI breakers in all PN & SN Series load centers
- Easy to install neutral kits. Click here for the [PN & SN Accessory and Replacement Parts Guide](#).
- Click here for [Siemens Warranty Information](#).

Invertible for bottom feed application.Ⓞ

All devices come with an integrated neutral bus

SN Series Plug-On Neutral Load Centers come with one factory installed ground bar

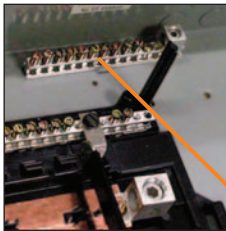

Combination head screw on the neutrals, ground, trim, upper pan, and bond screw provide installation flexibility.



A rigid, sturdy base pan provides the ruggedness required for the most harsh applications.



Aluminum Bus

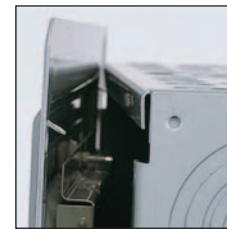

Mounting tabs on the trim hold it in place on the load center, freeing up both hands to drive the trim screws.

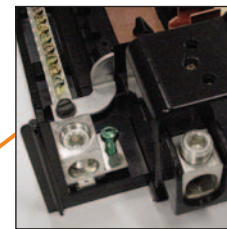

The pre-positioned bond screw eliminates bond strap/screw assemblies, and reduces the risk of losing components in the field.

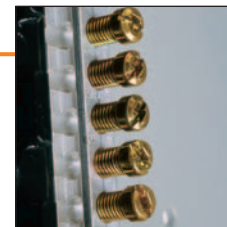

The patented INSTA-WIRE™ neutral/ground system allows for faster installation because screws are backed out, ready for wire insertion. The visible neutral and grounds system aids in the insertion of conductors.

The outdoor enclosure has a slide hinge door for the easiest installation and can be removed by backing out only one screw.

Ⓞ Applies only to NEMA 1 PN and SN plug-on neutral load centers

SN Series 1-Phase Plug-On Neutral Load Centers

1-phase, 3-wire, 120/240 Volts AC Main Breaker

Main Breaker Load Centers^① 100-225 Amperes

Aluminum Bus
60/75°C Rated

Amp Rating	No. of Spaces	No. of Circuits	Indoor Enclosure - NEMA Type 1		Outdoor Enclosure - NEMA Type 3R	
			Catalog Number ^⑤	Enclosure Height (inches) ^②	Catalog Number	Enclosure Height (inches) ^③
100	12	24	SN1224B1100	18	SNW1224B1100	21
100	16	32	SN1632B1100	21	SNW1632B1100	23
100	20	20	SN2020B1100	21	SNW2020B1100	27
100	20	40	SN2040B1100	21	—	—
100	24	48	SN2448B1100	24	—	—
100	30	30	SN3030B1100	26	—	—
100	30	48	SN3048B1100	26	—	—
125	12	24	—	—	SNW1224B1125	21
125	16	32	SN1632B1125	21	—	—
125	20	40	—	—	SNW2040B1125	27
125	24	24	SN2424B1125	24	SNW2424B1125	27
125	30	30	SN3030B1125	26	—	—
125	30	48	SN3048B1125	26	SNW3048B1125	29
150	16	32	SN1632B1150	24	—	—
150	20	40	SN2040B1150	24	SNW2040B1150	27
150	24	48	SN2448B1150	26	—	—
150	30	30	SN3030B1150	30	—	—
150	30	48	SN3048B1150	30	SNW3048B1150	35
200	40	40	—	—	SNW4040B1150	38
200	8	16	—	—	SNW0816B1200T ^④	23
200	12	24	—	—	SNW1224B1200	23
200	16	32	SN1632B1200	24	—	—
200	20	40	SN2040B1200	26	SNW2040B1200	27
200	24	48	SN2448B1200	30	—	—
200	30	48	SN3048B1200	30	SNW3048B1200	35
200	40	40	SN4040B1200	36	SNW4040B1200	38
200	40	60	SN4060B1200	36	—	—
200	42	64	SN4264B1200	39	—	—
200	54	82	SN5482B1200	42	—	—
225	42	64	SN4264B1225	39	SNW4264B1225	38
225	54	82	SN5482B1225	43	—	—

① Factory installed 22KAIC main breaker. Suitable for use as service equipment.
② Indoor enclosures are 14 1/4" wide by 3 7/8" deep.

③ Outdoor enclosures are 14 1/2" wide by 4 1/4" deep.
④ Feed-thru lugs.

⑤ Available (made to order) in white by adding "W" to the end of the catalog number.

SN Series 1-Phase Plug-On Neutral Load Centers

1-phase, 3-wire, 120/240 Volts AC Main Lug

Main Lug Load Centers 100-225 Amperes

Aluminum Bus
60/75°C Rated

Amp Rating	No. of Spaces	No. of Circuits	Indoor Enclosure - NEMA Type 1		Outdoor Enclosure - NEMA Type 3R	
			Catalog Number ^①	Enclosure Height (inches) ^①	Catalog Number	Enclosure Height (inches) ^②
125	12	12	SN1212L1125	18	SNW1212L1125	21
125	12	24	SN1224L1125	18	SNW1224L1125	21
125	16	32	SN1632L1125	21	SNW1632L1125	21
125	20	20	SN2020L1125	21	—	—
125	20	40	SN2040L1125	21	SNW2040L1125	23
125	24	24	SN2424L1125	24	SNW2424L1125	27
125	24	48	SN2448L1125	24	—	—
125	30	48	SN3048L1125	26	SNW3048L1125	29
125	40	40	SN4040L1125	30	—	—
150	16	32	SN1632L1150	21	—	—
150	20	40	SN2040L1150	24	SNW2040L1150	27
150	24	48	SN2448L1150	26	—	—
200	8	16	—	—	SNW0816L1200T ^③	23
200	12	24	SN1224L1200	21	SNW1224L1200	21
200	20	40	SN2040L1200	26	SNW2040L1200	27
200	24	48	SN2448L1200	26	—	—
200	30	30	SN3030L1200	30	—	—
200	30	48	SN3048L1200	30	SNW3048L1200	29
200	40	40	SN4040L1200	36	SNW4040L1200	35
225	12	24	—	—	SNW1224L1225	21
225	40	60	SN4060L1225	36	—	—
225	42	64	SN4264L1225	36	SNW4264L1225	38
225	54	82	SN5482L1225	42	—	—

① Indoor enclosures are 14 1/4" wide by 3 7/8" deep.
② Outdoor enclosures are 14 1/2" wide by 4 1/4" deep.

③ Feed-thru lugs.

④ Available (made to order) in white by adding "W" to the end of the catalog number.

Specialty Main Lug and Main Breaker Plug-On Neutral Load Centers

1-phase, 3-wire, 120/240 Volts AC

Factory Installed FirstSurge™ Load Centers^{①⑤④}

Amp Rating	No. of Spaces	No. of Circuits	Indoor Enclosure – NEMA Type 1		Surge Protection
			Catalog Number	Enclosure Height ^② (inches)	
200	30	48	PN3048B1200S14	36	140kA
200	40	60	PN4060B1200S14	42	140kA
200	30	48	SN3048B1200S06	36	60kA
200	40	60	SN4060B1200S06	42	60kA

500 Kcmil Lug Load Center^{①⑥}

Amp Rating	No. of Spaces	No. of Circuits	Indoor Enclosure – NEMA Type 1	
			Catalog Number	Enclosure Height ^② (inches)
200	30	48	SN3048L1200L50	36

Selectable Main Load Centers^{④⑥}

Amp Rating	No. of Spaces	No. of Circuits	Indoor Enclosure – NEMA Type 1		Outdoor Enclosure – NEMA Type 3R	
			Catalog Number	Enclosure Height ^② (inches)	Catalog Number	Enclosure Height ^③ (inches)
125	24	24	SN2424C1125	24	SNW2424C1125	27
200	20	40	SN2040C1200	26	SNW2040C1200	27
200	30	48	SN3048C1200	30	SNW3048C1200	35
200	40	40	SN4040C1200	36	SNW4040C1200	38

① Factory installed 22KAIC main breaker. Suitable for use as service equipment.

② Indoor enclosures are 14 1/4" wide by 3 7/8" deep.

③ Outdoor enclosures are 14 1/2" wide by 4 1/4" deep.

④ Selectable main load centers do not come with main lugs or main breakers. Those kits are sold separately.

⑤ PN has Copper bus

⑥ SN has Aluminum Bus

PL and ES Series 3-Phase Load Centers

Features

PL Series:

- Convertible
- Invertible
- Flush or Surface Mount Combination Cover
- Insta-wire neutrals & grounds
- Ground bars included
- Copper busbars
- Dual neutrals on all configurations
- Carton-in-carton packaging
- Lifetime warranty

ES Series:

- Invertible
- Flush or Surface Mount Combination Cover
- Insta-wire neutrals & grounds
- Aluminum busbars
- Single sided neutral on 24 circuits and below
- Single piece carton packaging
- 10 year warranty

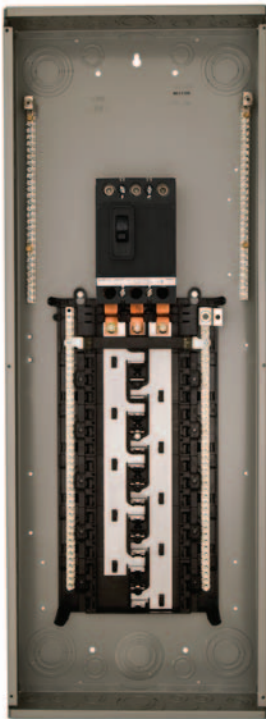

PL Series 3-phase

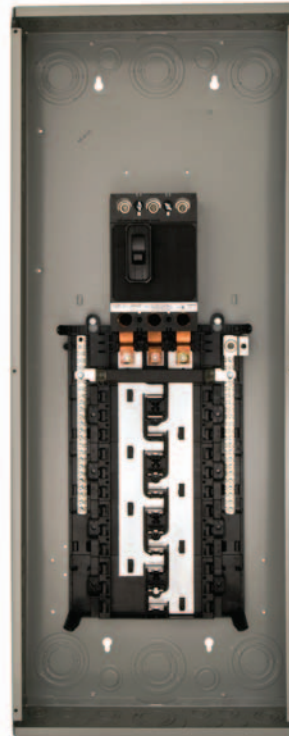

ES Series 3-phase

PL Series 3-Phase Main Lug & Main Breaker Load Centers

3-phase, 3-wire, 240 Volt AC or 3-phase, 4-wire, 120/240 or 120/208 Volts AC

Main Breaker/Convertible Load Centers 30-70 Circuits / 100-225 Amperes

Copper Bus^⑦
60/75°C Rated 22,000A IR^①

Branch Circuits			Indoor Enclosure – NEMA Type 1		Outdoor Enclosure – NEMA Type 3R	
Amp Rating	No. of Spaces	No. of Circuits	Catalog Number	Enclosure Height (inches) ^③	Catalog Number	Enclosure Height (inches) ^④
100	12	24	P1224B3100CU ^②	24	—	—
100	30	42	P3042B3100CU ^②	30	—	—
125	30	30	P3030B3125CU	39	—	—
150	24	42	P2442B3150CU	36	—	—
150	42	42	P4242B3150CU	42	—	—
200	30	54	P3054B3200CU	39	PW3054B3200CU	38
200	42	60	P4260B3200CU ^⑤	42	PW4260B3200CU	42
225	42	60	P4260B3225CU	42	—	—
225	42	60	P4260B3225TCU ^⑤	49	—	—
225	54	70	P5470B3225CU	49	—	—

Main Lug/Convertible Load Centers 12-70 Circuits / 125-225 Amperes

Copper Bus^⑦
60/75° Rated 100,000A IR^⑧

Branch Circuits			Indoor Enclosure – NEMA Type 1		Outdoor Enclosure – NEMA Type 3R	
Amp Rating	No. of Spaces	No. of Circuits	Catalog Number	Enclosure Height (inches) ^③	Catalog Number	Enclosure Height (inches) ^④
125	12	24	P1224L3125CU ^⑥	21	PW1224L3125CU ^⑥	21
200	24	42	P2442L3200CU	36	PW2442L3200CU	35
200	30	54	P3054L3200CU	39	PW3054L3200CU	38
225	42	60	P4260L3225CU	42	PW4260L3225CU	42
225	54	70	P5470L3225CU	49	—	—

① May be installed on higher rated systems when protected by a circuit breaker with a higher AIR rating.

② Back fed main breaker.

③ Indoor enclosures are 14 1/4" wide by 3 7/8" deep.

④ Outdoor enclosures are 14 1/2" wide by 4 1/4" deep.

⑤ Includes factory installed feed through lugs and is also non-convertible.

⑥ Non-convertible to main breaker.

⑦ All load centers are provided with tin plated copper bus bars.

⑧ Rated 100,000A IR in series with breakers listed on wiring diagram.

⑨ Available (made to order) in white by adding "W" to the end of the part number

PL Series 3-Phase Unassembled Load Centers

3-phase, 3-wire, 240 Volt AC or 3-phase, 4-wire, 120/240 or 120/208 Volts AC

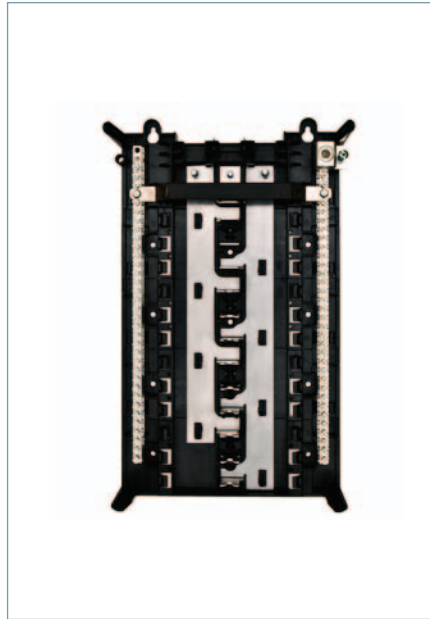

Main Breaker Convertible Unassembled Load Centers 24-70 Circuits / 100-225 Amperes

Copper Bus^⑤
60/75°C Rated 22,000A IR^①

Interiors				Enclosure		Trim Kit	
Amp Rating	No. of Spaces	No. of Circuits	Interior Catalog Number	Enclosure Height (inches) ^③	Enclosure Catalog Number	No. Breaker Spaces	Trim Catalog Number ^④
100	30	42	PI3042B3100CU ^②	30	3PE30	30	PT3042B3100
150	24	42	PI2442B3150CU	36	3PE36	24	PT2442X3150
200	30	54	PI3054B3200CU	39	3PE39	30	PT3054X3200
200	42	60	PI4260B3200CU	42	3PE42	42	PT4260X3200
225	54	70	PI5470B3225CU	49	3PE49	54	PT5470X3225

Main Lug Convertible Unassembled Load Centers 12-70 Circuits / 125-225 Amperes

Copper Bus^⑤
60/75° Rated 100,000A IR^⑥

Interiors				Enclosure		Trim Kit	
Amp Rating	No. of Spaces	No. of Circuits	Interior Catalog Number	Enclosure Height (inches) ^③	Enclosure Catalog Number	No. Breaker Spaces	Trim Catalog Number ^④
125	12	24	PI1224L3125CU	21	3PE21	12	PT1224L3125
200	24	42	PI2442L3200CU	36	3PE36	24	PT2442X3200
200	30	54	PI3054L3200CU	39	3PE39	30	PT3054X3200
225	42	60	PI4260L3225CU	42	3PE42	42	PT4260X3225
225	54	70	PI5470L3225CU	49	3PE49	54	PT5470X3225

① May be installed on higher rated systems when protected by a circuit breaker with a higher AIR rating.

② Back fed main breaker.

③ Indoor enclosures are 14 1/4" wide by 3 7/8" deep.

④ Trim catalog numbers with a "B" indicate for use with main breaker and is not convertible. "L" indicates for use with main lug and is not convertible. "X" indicates can be used with convertible interior.

⑤ All load center interiors are provided with tin plated copper bus bars.

⑥ Rated 100,000A IR in series with breakers listed on wiring diagram.

ES Series 3-Phase Main Lug & Main Breaker Load Centers

3-Phase, 3-Wire, 240 Volt AC or 3-Phase, 4-Wire, 120/240 or 120/208 Volts AC

Main Breaker

30-60 Circuits / 100-225 Amperes

Aluminum Bus

60/75°C Rated 10,000A IR^①

Branch Circuits			Indoor Enclosure – NEMA Type 1		Outdoor Enclosure – NEMA Type 3R	
Amp Rating	No. of Spaces	No. of Circuits	Catalog Number	Enclosure Height (inches) ^③	Catalog Number	Enclosure Height (inches) ^④
100	12	24	S1224B3100 ^②	24	SW1224B3100	23
100	30	30	S3030B3100 ^②	30	—	—
100	30	42	S3042B3100 ^②	30	—	—
125	30	42	S3042B3125	35	—	—
150	24	42	S2442B3150	36	SW2442B3150	35
150	42	42	S4242B3150	42	—	—
150	30	54	S3054B3150	35	—	—
200	30	54	S3054B3200	39	SW3054B3200	38
200	42	60	S4260B3200	42	SW4260B3200	42
225	42	42	S4242B3225	42	SW4242B3225	42

Main Lug

12-70 Circuits / 125-225 Amperes

Aluminum Bus

60/75° Rated 100,000A IR^⑤

Branch Circuits			Indoor Enclosure – NEMA Type 1		Outdoor Enclosure – NEMA Type 3R	
Amp Rating	No. of Spaces	No. of Circuits	Catalog Number	Enclosure Height (inches) ^③	Catalog Number	Enclosure Height (inches) ^④
125	12	24	S1224L3125	21	SW1224L3125	21
150	18	36	S1836L3150	24	SW1836L3150	23
150	24	42	S2442L3150	30	SW2442L3150	27
200	12	24	S1224L3200	21	SW1224L3200	21
200	24	42	S2442L3200	30	SW2442L3200	27
200	30	54	S3054L3200 ^⑥	30	SW3054L3200	35
225	42	60	S4260L3225 ^⑥	36	SW4260L3225	38
225	54	70	S5470L3225 ^⑥	42	—	—

① May be installed on higher rated systems when protected by a circuit breaker with a higher AIR rating.
 ② Back fed main breaker.

③ Indoor enclosures are 14 1/4" wide by 3 7/8" deep.
 ④ Outdoor enclosures are 14 1/2" wide by 4 1/4" deep.
 ⑤ Rated 100,000A IR in series with breakers listed on wiring diagram.

⑥ Available (made to order) in white by adding "W" to the end of the part number.

EQ® Load Centers—300-400 Amp

1-Phase, 3-Wire/3-Phase, 3-Wire, 4-Wire

Features

- UL listed for 60/75°C conductors. See equipment markings for applications.
- Copper bus standard.
- Factory installed lock on indoor enclosures.
- Main breaker units have a factory installed JXD2 type breaker.

E3030MB1400SCU

Main Breaker 300-400 Ampere^②
1Ø, 3-Wire120/240 Volts AC
65,000A IR

Branch Circuits			Indoor Enclosure – NEMA Type 1			Outdoor Enclosure – NEMA Type 3R	
Amp Rating	No. of Spaces	No. of Circuits	Catalog Number	Enclosure Height ^①	Trim Style	Catalog Number	Enclosure Height ^①
300	42	42	E4242MB1300FCU	58	Flush	—	—
	42	42	E4242MB1300SCU	58	Surface	—	—
400	30	30	—	47	Surface	—	—
	30	30	E3030MB1400SCU	52	Surface	W3030MB1400CU	52
	42	42	E4242MB1400FCU	58	Flush	—	—
	42	42	E4242MB1400SCU	58	Surface	W4242MB1400CU	58

3Ø, 3-Wire, 4-Wire

240 Volts AC
65,000A IR

Branch Circuits			Indoor Enclosure – NEMA Type 1			Outdoor Enclosure – NEMA Type 3R	
Amp Rating	No. of Spaces	No. of Circuits	Catalog Number	Enclosure Height ^①	Trim Style	Catalog Number	Enclosure Height ^①
300	42	42	E4242MB3300SCU	58	Surface	—	—
400	30	30	E3030MB3400SCU	52	Surface	—	—
	42	42	E4242MB3400FCU	58	Flush	—	—
	42	42	E4242MB3400SCU	58	Surface	W4242MB3400CU	58

Main Lug 400 Ampere
1Ø, 3-Wire120/240 Volts AC
65,000A IR

Branch Circuits			Indoor Enclosure – NEMA Type 1			Outdoor Enclosure – NEMA Type 3R	
Amp Rating	No. of Spaces	No. of Circuits	Catalog Number	Enclosure Height ^①	Trim Style	Catalog Number	Enclosure Height ^①
400	12	6	—	—	—	W0606ML1400CU ^{③④}	43
	30	30	E3030ML1400SCU	41	Surface	W3030ML1400CU	43
	42	42	E4242ML1400FCU	47	Flush	—	—
	42	42	E4242ML1400SCU	47	Surface	W4242ML1400CU	47

3Ø, 3-Wire, 4-Wire

240 Volts AC
22,000A IR

Branch Circuits			Indoor Enclosure - NEMA Type 1			Outdoor Enclosure - NEMA Type 3R	
Amp Rating	No. of Spaces	No. of Circuits	Catalog Number	Enclosure Height ^①	Trim Style	Catalog Number	Enclosure Height ^①
400	30	30	E3030ML3400SCU	41	Surface	—	—
	42	42	E4242ML3400FCU	47	Flush	—	—
	42	42	E4242ML3400SCU	47	Surface	W4242ML3400CU	47

^① Indoor and outdoor enclosures are 20" wide by 6" deep.
^② UL listed as suitable for use as service equipment.

^③ Accepts up to six QN style breakers
^④ 22,000A IR

Generator Ready Load Centers

1-Phase, 3-Wire SN, 120/240 Volts AC

Generator Ready Load Centers

The Siemens generator ready load center can save thousands of dollars in future generator installation expenses while keeping initial expenses to a minimum. Works with an automatic standby generator or a portable generator.

Load center features:

- UL Listed
- Indoor Type 1 and outdoor Type 3R
- 225A max rated
- Flush or surface mounting
- Fits between standard stud centers
- Tin plated copper bus bars
- 22 kAIC rated
- 120/240V ~
- Main lug – convertible to main breaker with addition of MBK150A, MBK200A, or MBK225A
- Installation of transfer mechanism can be performed at time of generator installation

Automatic transfer switch features:

- UL Listed
- Operates automatically when connected to generator
- Transfers load from utility to generator and back to utility
- Transfer switch (sold separately) catalog number: GENTFRSWTCH^{①③}

Indoor Enclosure – NEMA Type 1

Amp Rating	No. of Spaces ^②	No. of Circuits ^②	Catalog Number	Main	Enclosure Height ^④
200	30	42	G3042B1200GEN	Main Breaker	42
225	30	42	G3042L1225GEN	Main Lug	42
200	42	54	G4254B1200GEN	Main Breaker	44
225	42	54	G4254L1225GEN	Main Lug	44

Outdoor Enclosure – NEMA Type 3R

Amp Rating	No. of Spaces ^②	No. of Circuits ^②	Catalog Number	Main	Enclosure Height ^⑤
200	30	42	W3042B1200GEN	Main Breaker	42
225	30	42	W3042L1225GEN	Main Lug	42

① Q2125S provided with GENTFRSWTCH for use with automatic transfer mechanism.

② 2 spaces and 2 circuits are reserved for standby generator installation.

③ Field install breaker for voltage sensing required.

④ Indoor enclosures are 14 1/4" wide by 3 7/8" deep.

⑤ Outdoor enclosures are 14 1/2" wide by 4 1/4" deep.



NEMA 1

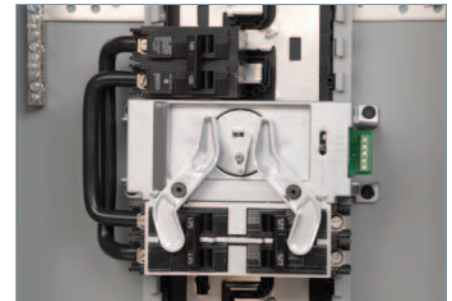

GENTFRSWTCH



NEMA 3R

Riser Panel Load Centers

1-Phase, 3-Wire SN, 120/240 Volts AC

Riser Panel Load Centers^①

Riser panel load centers are ideal for high rise applications. The shifted interior provides room for conductors to pass through the load center. The tap kits allow the installer to tap off from those conductors to power the panel.

Features

- UL Listed for use in 1Ø and 3Ø riser gutter applications.
- Copper bus standard.
- Main lug factory standard - convertible to main breaker.
- Neutrals aligned on left side- keeps way clear for riser cables.
- Available in 125 and 200 amp models.
- Invertible for left and right hand applications.

Riser Gutter Tap Kit^②

The riser gutter tap kit (ECRLK250) allows the installer to tap off the main conductors, eliminating the need to cut completely through the conductor. The tap kit accepts 250 -1/0 on the main conductor side and 250-#6 on the tap side.

Riser Gutter

The riser gutter (RAG24) is used to convert any load center 24" or larger into a riser panel.

Features

- Single and 3-phase applications
- Compatible with any single or 3-phase Siemens load center 24" or higher
- Flush trim included
- Load center mounting hardware and pass through brush included (Catalog no. RAG24)



R1632L1125CU



ECRLK250



Any Load Center
24" or larger



RAG24

1-phase, 3-wire SN, 120/240 Volts AC

Amp Rating	No. of Spaces	No. of Circuits	Catalog Number				Dimensions (inches)			Acceptable Main Breaker Kits
			Aluminum Bus	Aluminum Bus White Coating	Copper Bus	Copper Bus White Coating	Height	Width	Depth	
125	16	32	R1632L1125	R1632L1125W	R1632L1125CU	—	24	14.25	3.88	MBK100A, MBK125A
125	24	24	R2424L1125	R2424L1125W	R2424L1125CU	—	30	14.25	3.88	MBK100A, MBK125A
125	24	42	R2442L1125	R2442L1125W	R2442L1125CU	R2442L1125CUW	30	14.25	3.88	MBK100A, MBK125A
200	30	42	R3042L1200	R3042L1200W	R3042L1200CU	R3042L1200CUW	36	14.25	3.88	MBK150A, MBK200A

① The riser panels are single phase only, but can be fed from 1-phase or 3-phase systems running through the gutter trough area.

② ECRLK250 is sold separately.

EQ® Load Centers, Small Circuit and Circuit Breaker Enclosures

1-Phase, 3-Wire SN, 120/240 Volts AC

Features/Applications

- Indoor and Outdoor Applications
- UL Listed
- 2 to 12 Space Options
- SPA panels offer a 50A or 60A factory installed GFCI breaker
- Service Entrance or Subfeed Applications



Small Circuit Load Centers

Ideal for subfeed applications

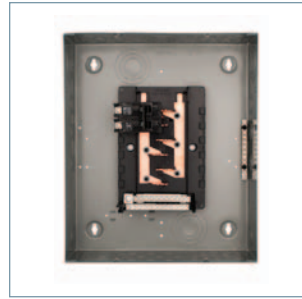

Renovation Panel

Ideal for older home renovation projects where the distance between the studs is narrower than current construction practices. The narrower panel eliminates the need to 'notch' out the existing studs.



Spa Panels

Spa Panels are ideal for outdoor applications requiring the use of ground fault protection, such as hot tubs. A factory installed 2-Pole GFCI breaker is provided, along with 2 extra circuits.

LOAD CENTERS & CIRCUIT BREAKERS

Amp Rating	No. of Spaces	No. of Circuits	Indoor Enclosure - NEMA Type 1					Ground Bar	Dimensions (inches)		
			Catalog Number	Max Short Circuit Rating	Bus Material	Mounting	Phase Lug Wire Size		H	W	D
100	10	20	E1020MB1100FCGP ^{①②③}	22,000	Copper	Flush	CU or AL #4 - 2/0 AWG	ECGB10 Installed	14.6	12.3	3.7
	12	24	E1224ML1100FG ^{④⑤}	100,000	Aluminum	Flush			14.6	12.3	3.7
			E1224ML1100FCU ^{④⑤}	100,000	Copper	Flush			14.6	12.3	3.7
125	4	8	E0408ML1125F ^{⑥⑦⑧⑨⑩}	100,000	Aluminum	Flush ^⑩	AL #12 - 2/0 AWG or CU #14 - 2/0 AWG	Use ECGB or ECLX kits	12.8	6.5	3.3
			E0408ML1125S ^{⑥⑦⑧⑨⑩}	100,000	Aluminum	Surface ^⑩			12.8	6.5	3.3
	8	16	E0816ML1125F ^{⑦⑨}	100,000	Aluminum	Flush	CU or AL #4 - 2/0 AWG	ECGB10 or ECLX071M Installed	14.6	12.3	3.7
			E0816ML1125S ^{⑦⑨}	100,000	Aluminum	Surface			14.6	12.3	3.7
			E0816ML1125FGB ^⑦	100,000	Aluminum	Flush			14.6	12.3	3.7
			—	100,000	Aluminum	Surface			14.6	12.3	3.7
			E0816ML1125FCU ^⑦	100,000	Copper	Flush			14.6	12.3	3.7
			E0816ML1125SCU ^⑦	100,000	Copper	Surface			14.6	12.3	3.7

Amp Rating	No. of Spaces	No. of Circuits	Outdoor Enclosure - NEMA Type 3R					Ground Bar	Dimensions (inches)			
			Catalog Number	Max Short Circuit Rating	Bus Material	Hub Provision	Phase Lug Wire Size		H	W	D	
100	2	4	W0204MB1100 ^{③⑦}	100,000	Aluminum	1.25" HS Hub	AL #12 - 2/0 AWG or CU #14 - 2/0 AWG	Use ECGB or ECLX kits	12.1	6.2	4.4	
125	4	8	W0408ML1125 ^{⑥⑧⑨⑩}	100,000	Aluminum	HS Cover Plate			ECGB5 Installed	12.1	6.2	4.4
			W0408L1125SPA50 ^{②③}	100,000	Aluminum			Use ECGB or ECLX kits		12.1	6.2	4.4
			W0408L1125SPA60 ^{②③}	100,000	Aluminum				14.7	12.1	4.1	
150	4	4	W0404MB1150CTS ^{③⑩}	22,000	Copper	2" HS Hub	CU or AL #4 - 2/0 AWG	ECLX384M Installed	20.0	11.1	4.7	
200	4	8	—	100,000	Aluminum				HS Cover Plate	20.0	11.1	4.7
			—	100,000	Aluminum					20.0	11.1	4.7
		W0404MB1200CT ^{⑩⑭}	22,000	Copper	20.0				11.1	4.7		
W0404MB1200CTS ^{⑩⑭}	22,000	Copper	20.0	11.1	4.7							

① Suitable for use as service equipment when a main breaker (100A maximum) is used with retainer clip (Cat. No. ECMBR1).
 ② Two Q115 and one Q130 included
 ③ 22KAIC Main Breaker factory installed
 ④ 70 amp maximum breaker.
 ⑤ Suitable for use as service entrance equipment when a main breaker (70A maximum) is used with retainer clip (Cat. No. ECMBR1).

⑥ Will not accommodate a 2-pole circuit breaker with shunt trip.
 ⑦ Suitable for use as service equipment when not more than six main disconnecting means are provided. Check local codes and restrictions.
 ⑧ Packaged in quantities of 5.
 ⑨ CSA Listed
 ⑩ No Door

⑪ 10KAIC Main Breaker factory installed
 ⑫ I2-pole 60A GFCI, a restriction of #6 wire applies due to wire bend space of the enclosure.
 ⑬ Suffix SPA50 indicates a factory installed 50A 2-pole GFCI and suffix SPA60 indicates a factory installed 60A 2-pole GFCI.
 ⑭ Suitable only for use as service equipment.

EQ® Load Centers, Small Circuit and Circuit Breaker Enclosures

1-Phase and 3-Phase, 240V AC Max.

Features

- Circuit breaker enclosures range from 60A to 250A, indoor and outdoor models
- UL listed
- Suitable for use as service entrance equipment
- UL listed for 60/75°C Conductors (See equipment markings for applications)
- Outdoor type 3R devices use HS type hubs except for the W0204ML1060 which uses HA type hubs



Amp Rating	No. of Poles	Indoor Enclosure - NEMA Type 1						Outdoor Enclosure - NEMA Type 3R							
		Catalog Number	Breaker Used ^①	Max Short Circuit Rating	Std. Pkg.	Dimensions (inches)			Catalog Number	Breaker Used ^①	Max Short Circuit Rating	Std. Pkg.	Dimensions (inches)		
						H	W	D					H	W	D

1-Phase, 3-Wire SN - 120/240 Volts AC - Breaker Factory Installed

100	2	E0202MB1100	Q2100	22,000	1	17.3	7.3	4.3	W0202MB1100CU	Q2100	22,000	1	17.2	7.3	4.3
150	2	—	—	—	—	—	—	—	W0202MB1150CU	QN2150H	65,000	1	19.8	8.7	5
200	2	E0202MB1200	QN2200	22,000	1	20	8.7	4	W0202MB1200CU	QN2200H					
150	2	—	—	—	—	—	—	—	WB2150BQR	QR22B150L	10,000	1	26.9	7.1	4.4
200	2	—	—	—	—	—	—	—	WB2200BQR	QR22B200L					
225	2	—	—	—	—	—	—	—	WB2225BQR	QR22B225L					

1-Phase, 3-Wire SN - 120/240 Volts AC - Enclosure Only

60	2	E0204ML1060S ^{②④}	QP, QPH, or HQP	100,000 ^⑥	5	9.9	5.2	2.7	W0204ML1060 ^{②④}	QP, QPH, or HQP	100,000 ^⑥	5	8.1	5.5	3.5
		E0204ML1060F ^{②④}							—						
125	2	E0204ML1125SCU ^③	QP or QPH	22,000	1	17.3	7.3	4.3	W0204ML1125CU ^③	QP or QPH	22,000	1	17.2	7.3	4.3
		E0204ML1125FCU ^③							—						
200	2	—	—	—	—	—	—	—	W0202ML1200CU	QN, QNH, or HQN	65,000	1	19.8	8.7	5
225	1-4	—	—	—	—	—	—	—	W0406ML1225CU	QPP or QP	10,000	1	23.2	10.4	4.5
	2	—	—	—	—	—	—	—	QR2N3R2	QR2, QRH2, or HQR2	65,000	1	26.9	7.1	4.4
250	2	QR2N1S	QR2, QRH2, HQR2, or HQR2H	100,000	1	31.4	9.6	5.6	—	—	—	—	—	—	—
		QR2N1F							—	—	—	—	—	—	

3-Phase, 3-Wire 240 Volts AC or 3-Phase, 4-Wire SN — 120/208 Volts AC, 120/240, 240 Volts AC - Enclosure Only

100	2-3	E0303ML3100S ^⑤	QP or QPH	22,000	1	17.3	7.3	4.3	W0303ML3100 ^⑤	QP or QPH	22,000	1	17.2	7.3	4.3
		EB3100S ^⑤	BQ or BQH						WB3100 ^⑤	BQ or BQH					
250	2-3	QR2N1S	QR2, QRH2, HQR2, or HQR2H	100,000	1	31.4	9.6	5.6	QR2N3R3	QR2, QRH2, HQR2, or HQR2H	100,000	1	31.4	9.6	5.6
		QR2N1F	—						—	—					

① Additional breaker types may be listed on the wiring diagram.

② Will not accommodate 2-pole GFCI or Circuit breaker with shunt trip.
③ Can accommodate 2-pole GFCI breaker up to 60A.

④ CSA Listed
⑤ Will not accommodate circuit breaker with shunt trip.
⑥ Series rating

Renovation Interiors

1 Phase, 3 WIRE, 120/240V

Features

- For use in home renovations with existing load centers[Ⓞ]
- Suitable for use in indoor Type 1 Enclosure
- Interior, Flush Cover, and Hardware included
- Adjustable depth
- Incoming lugs: 2/0 - #4 AWG
- UL listed



Amp Rating	No. of Spaces	No. of Circuits	Catalog Numbers	Min. Enclosure Size (inches)			Max. Enclosure Size (inches)			Cover Dimensions (inches)	
				L	W	D [Ⓞ]	L	W	D [Ⓞ]	L	W
100	8	16	RE0816ML1100J	13.00	10.50	3.75	19.00	14.25	6.00	22.00	18.00
100	8	16	RE0816ML1100K	20.00	10.50	3.75	26.00	14.25	6.00	29.00	18.00
125	12	24	RE1224ML1125J	17.00	12.25	3.75	21.00	14.25	6.00	23.00	18.00
125	12	24	RE1224ML1125K	22.00	12.25	3.75	26.00	14.25	6.00	29.00	18.00

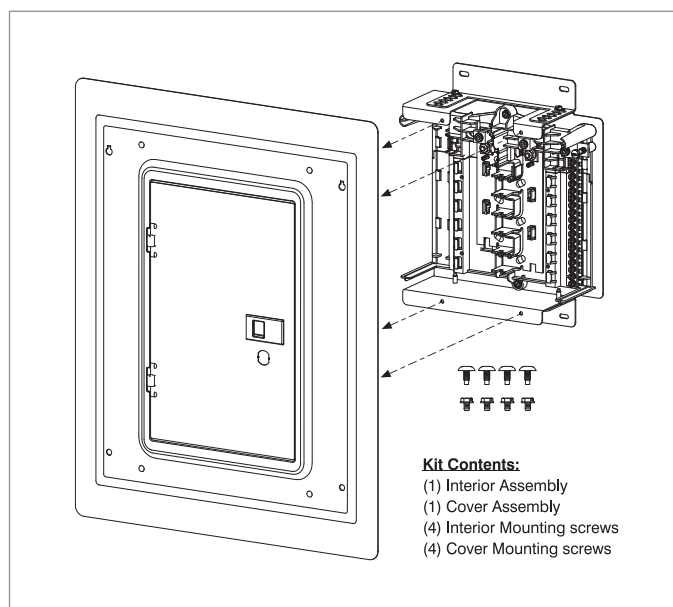

[Ⓞ] Existing enclosure must measure within listed dimensions for the use of the kit.

[Ⓞ] Depth of enclosure is measured from finished wall surface.

Load Center Accessories^①

Ground bar kits, hubs, lugs, and conversion kits

Catalog Number	Description	Pack Qty
----------------	-------------	----------

Ground Bar Kits

EC1GB8	GROUND BAR KIT-8 POS	1
EC1GB82	GROUND BAR KIT-8 POS, 2/0 LUG	1
EC2GB12	GROUND BAR KIT-12 POS	1
EC2GB122	GROUND BAR KIT-12 POS, 2/0 LUG	1
EC2GB15	GROUND BAR KIT-15 POS	1
EC2GB152	GROUND BAR KIT-15 POS, 2/0 LUG	1
EC3GB21	GROUND BAR KIT-21 POS	1
EC3GB212	GROUND BAR KIT-21 POS, 2/0 LUG	1
EC3GB27	GROUND BAR KIT-27 POS	1
EC3GB272	GROUND BAR KIT-27 POS, 2/0 LUG	1
EC3GB30	GROUND BAR KIT-30 POS	1
EC3GB302	GROUND BAR KIT-30 POS, 2/0 LUG	1
EC3GB352	GROUND BAR KIT-35 POS, 2/0 LUG	1
EC3GB352G	GROUND BAR KIT-35 POS, 2/0 LUG ^②	1

Ground Bar Kits (For Legacy Load Centers)

ECGB5	GROUND BAR KIT-5 POS	1
ECGB10	GROUND BAR KIT-10 POS	1
ECGB101	GROUND BAR KIT-10 POS, 1/0 LUG	1
ECGB14	GROUND BAR KIT-14 POS	1
ECGB141	GROUND BAR KIT-14 POS, 1/0 LUG	1
ECGB142	GROUND BAR KIT-14 POS, 2/0 LUG	1
ECGB20	GROUND BAR KIT-20 POS	1
ECGB201	GROUND BAR KIT-20 POS, 1/0 LUG	1
ECGB202	GROUND BAR KIT-20 POS, 2/0 LUG	1
ECINSGB5	INSULATED GROUND BAR KIT-5 POS	1
ECINSGB14	INSULATED GROUND BAR KIT-14 POS	1
ECINSGB20	INSULATED GROUND BAR KIT-20 POS	1

Hubs

ECHA000	HA Type W0204ML1060	CLOSURE PLATE	1
ECHA075		HUB - 3/4"	1
ECHA100		HUB - 1"	1
ECHA125		HUB - 1 1/4"	1
ECHA150		HUB - 1 1/2"	1
ECHS000	HS Type PL & ES and Small Circuit Loadcenters	CLOSURE PLATE	1
ECHS075		HUB - 3/4"	1
ECHS100		HUB - 1"	1
ECHS125		HUB - 1 1/4"	1
ECHS150		HUB - 1 1/2"	1
ECHS200		HUB - 2"	1
ECHS250		HUB - 2 1/2"	1
ECHV000	HV Type 300-400A Loadcenters	CLOSURE PLATE	1
ECHV200		HUB - 2"	1
ECHV250		HUB - 2.5"	1
ECHV300		HUB 3"	1
ECHV350		HUB - 3.5"	1
ECHV400	HUB - 4"	1	

Lock Kits

ECQFL2	FLUSH LOCK KIT FOR ULT., PL, ES, 3PH 100A-225A	1
ECQFL1	FLUSH LOCK KIT-REPLACEMENT FOR EQ LC	1
ECQFL3	ADD-A-LOCK (FLUSH LOCK) FOR 300-400A LC	1

① The pack quantity is the number that is sold in a pack. Items listed on this page must be ordered in multiples of pack quantities but items are priced per each. For example, ECRLK250 come 3 to a pack so must be ordered in multiples of 3 but pricing would be individual unit price times 3.

Catalog Number	Description	Pack Qty
----------------	-------------	----------

Load Center Conversion Kits^{③④}

MBK100A	MAIN BREAKER KIT 100A 1PH 22K	1
MBK125A	MAIN BREAKER KIT 125A 1PH 22K	1
MBK150A	MAIN BREAKER KIT 150A 1PH 22K	1
MBK200A	MAIN BREAKER KIT 200A 1PH 22K	1
MBK225A	MAIN BREAKER KIT 225A 1PH 22K	1
MBK3100	MAIN BREAKER KIT 100A 3PH QP 240V 10K	1
MBK3125R	MAIN BREAKER KIT 125A 3PH 240V 10K, QR	1
MBK3150R	MAIN BREAKER KIT 150A 3PH 240V 10K, QR	1
MBK3175R	MAIN BREAKER KIT 175A 3PH 240V 10K, QR	1
MBK3200R	MAIN BREAKER KIT 200A 3PH 240V 10K, QR	1
MBK3225R	MAIN BREAKER KIT 225A 3PH 240V 10K, QR	1
MBK3125HR	MAIN BREAKER KIT 125A 3PH 240V 22K, QR	1
MBK3150HR	MAIN BREAKER KIT 150A 3PH 240V 22K, QR	1
MBK3175HR	MAIN BREAKER KIT 175A 3PH 240V 22K, QR	1
MBK3200HR	MAIN BREAKER KIT 200A 3PH 240V 22K, QR	1
MBK3225HR	MAIN BREAKER KIT 225A 3PH 240V 22K, QR	1
MBK3125HHR	MAIN BREAKER KIT 125A 3PH 240V 65K, QR	1
MBK3150HHR	MAIN BREAKER KIT 150A 3PH 240V 65K, QR	1
MBK3175HHR	MAIN BREAKER KIT 175A 3PH 240V 65K, QR	1
MBK3200HHR	MAIN BREAKER KIT 200A 3PH 240V 65K, QR	1
MBK3225HHR	MAIN BREAKER KIT 225A 3PH 240V 65K, QR	1
HMBK3125HR	MAIN BREAKER KIT 125A 3PH 240V 100K, QR	1
HMBK3150HR	MAIN BREAKER KIT 150A 3PH 240V 100K, QR	1
HMBK3175HR	MAIN BREAKER KIT 175A 3PH 240V 100K, QR	1
HMBK3200HR	MAIN BREAKER KIT 200A 3PH 240V 100K, QR	1
HMBK3225HR	MAIN BREAKER KIT 225A 3PH 240V 100K, QR	1
ECMLK125	1 PH MAIN LUG CONVERSION KIT 100-125A	1
ECMLK225	1 PH MAIN LUG CONVERSION KIT 150-225A	1
ECMLK3125	3 PH MAIN LUG CONVERSION KIT 100-125A	1
ECMLK3225	3 PH MAIN LUG CONVERSION KIT 150-225A	1

Lug Kits

ECCS1	COLLAR STRAP FOR GRD BARS #14-1/0	1
ECCS2	COLLAR STRAP FOR GRD BARS #6-250	1
ECLKB1	NEUTRAL LUG KIT WITH BOND TAB	1
ECLK3	NEUTRAL LUG KIT #1-300	1
ECLK1-2	NEUTRAL LUG KIT #2 TO 1/0	1
ECLK2N	NEUTRAL LUG KIT #4-2/0	1
ECLK3N	NEUTRAL LUG KIT #1-300	1
ECLK2	NEUTRAL LUG KIT #4-2/0	1
ECLK2SC	2/0 LUG FOR 125AMP NEUTRAL FEEDER	1
ECLK2125	125A SUB FEED LUGS-USES 2 SPACES	1
ECLK2225	150A-225A SUB FEED LUGS-USES 4 SPACES	1
ECLK3225	3P SUB FEED LUGS-USES 6 SPACES	1
ECRLK250	RISER LUG KIT 250 KCMIL	3

Miscellaneous Load Center Accessories

ECCP1	PKG OF 100 CIRCUIT DIRECTORY	100
ECQF3	QP/BQ/ED2 FILLER PLATE	5
ECMBF125	1 PH 100&125A MAIN BREAKER FILLER PLATE	1
EC3PMFP1	3 POLE MAIN FILLER PLATE, QJ	1
EC3PMFPR	3 POLE MAIN FILLER PLATE, QR	1
ECSMK1	SURFACE MOUNT 1/4" SPACE KIT FOR LC'S	4
ECTS2	LC TRIM SCREWS	6
ECTS2W	LC TRIM SCREWS WHITE	6
ECLCHINGE	GREY LC HINGES	100
ECADHLCDIRLBL	ADHESIVE LC DIRECTORY LABELS	100
ECSIELATCH	SIEMENS LC LATCHES	25
ECBONDSCRW	LC BOND SCREW	10
ECSN1	SCREWS & NUTS FOR HC HUB-BOTTOM USE	4
RAG24	RISER AUX GUTTER 24"	1
ECAFL	ARC FLASH LABEL	10

② Bar has green-colored screws.

③ QR Main Breaker Kits include a QR filler plate.

④ Main Breaker Kits include line terminal barriers.

Load Centers Accessories

Miscellaneous Load Center Accessories



Lug Kit, 3-Pole, Subfeed or Feed thru Applications
ECLK3225



2 PH Main Lug Conversion Kit
150A-225A
ECMLK225



Main Breaker Kit
200A - 225A, 1PH 22K
MBK200A

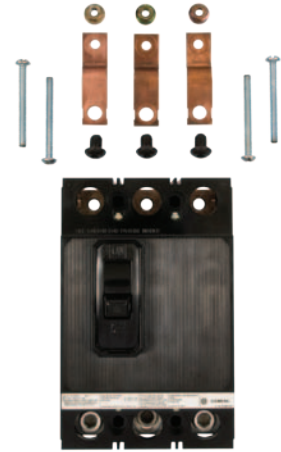

3-Pole Main Breaker Kit
MBK3200



Main Breaker Retainer Kit for EQ Load Centers
ECMBR1



Main Breaker Retainer kit for PN, SN, PL, ES, & Ultimate Load Centers
ECMBR2



Ground Bar Kit
20 POS. 2/0 Lug
ECGB202



Ground Bar Kit, **ECGB14**

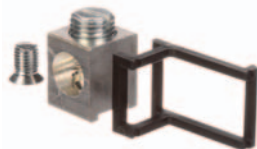

Neutral Lug Kit, **ECLK1-2**
wire range — #2-1 AWG
Cu or Al



Neutral Lug Kit, **ECLK3**
wire range — #1-300 MCM
Neutral Lug Kit, **ECLK2**
wire range — #4-#2/0 AWG
Cu or Al



For use on Ground Bar only
Collar Strap, Wire Range;
ECCS1; ECCS2



Add-A-Lock (Flush Lock) **ECQFL1**
For EQ load centers



Filler Plate, **ECQF3**



Add-A-Lock (Flush Lock), **ECQFL2**
PN, SN, PL, ES, Ultimate Load Centers and EQ III up to 225A



Add-A-Lock (Flush Lock), **ECQFL3**
300-400A Load Centers

Load Centers Accessories





Load Center and Meter Combos Accessories

Load centers and meter combos

Touchsafe barriers are required for any single main service entrance application for a panel covered under UL 67. Line Terminal Barriers will be included in Main Breaker Load Centers and Single Main Meter Combos manufactured after January 1, 2017.

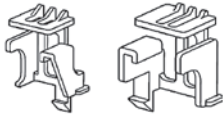
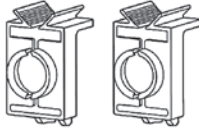
Single phase and 3-phase main breaker kits will include a barrier. Field installable kits are being created for replacements if needed and line terminal barriers are being added to hold down kits that can be used in back-fed applications. The barriers are designed to have minimal interference during load center installation, and can be removed and reattached as necessary.

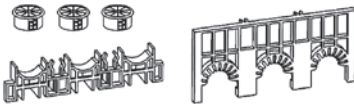
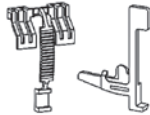
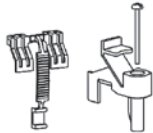
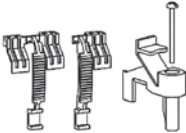

	Catalog number	Description
	ECLTB1	For EQ Main Breakers/MBK kits 100A-125A
	ECLTB2	For EQ Main Breakers/MBK kits 150A-225A
	ECLTB3	For QN / QNR type breakers
	ECLTB4	For QR 3 phase breakers
	ECMBR1 ^①	For 2 Pole QP / MP-T type breakers for EQIII (extruded basepan) and Line 5
	ECMBR2 ^①	For 2 Pole QP / MP-T type breakers to be used with PN, SN, ES, PL, Ultimate, and legacy Murray or Rock Solid load centers
	ECMBR3	For 3 Pole QP / MP-T type breakers to be used with PL, ES 3 phase load centers
	ECLX387HD	For 2 Pole MP-T type breakers in legacy Murray load centers











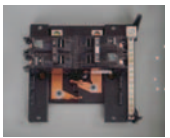



① Barrier fits with 2-pole QP 70A and above and all amperages of QPH and HQP.

Load Centers Accessories

Manual Transfer Interlock Kits for Load Centers and Meter Combinations

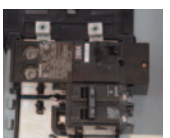
Prevents dangerous feedback between two sources of power

Manual Transfer Interlock Kits[®]

Catalog number	Usage Information	Utility main breaker types	Standby main breaker types	Interlock Number
 ECSBPK01	For use on load centers or meter combinations that will accept 2-pole circuit breakers opposite one another as shown.	QP, QPH, HQPH	QP, QPH, HQPH	1 
 ECSBPK02	For use on load centers or meter combinations that will accept 2- or 4-pole next to a 2-pole circuit breaker side by side as shown.	QP, QPH, HQPH	QP, QPH, HQPH	2 
 ECSBPK03	For use on Ultimate™ and Rock Solid load centers, 150 amp and higher, to connect the main breaker to a 2-pole circuit breaker.	MBK150A, MBK200A, OR MBK225A	QP, QPH, HQPH	3 
 ECSBPK10	For use on PN and SN plug-on neutral load centers, 150 amp and higher, to connect the main breaker to a 2-pole circuit breaker.			
 ECSBPK04	For use on Ultimate™ and Rock Solid load centers, 125 amp and lower, to connect the main breaker to a 2-pole circuit breaker.	MBK100A or MBK125A	QP, QPH, HQPH	4 
 ECSBPK11	For use on PN and SN plug-on neutral load centers, 125 amp and lower, to connect the main breaker to a 2-pole circuit breaker.			
 ECSBPK05	For use on load centers or meter combinations that will accept a QNR (MD-TR) frame circuit breaker next to a 2-pole circuit breaker as shown.	QNR, QNRH, HQNR	QP, QPH, HQPH	5 
 ECSBPK06	For use on load centers or meter combinations that will accept a QN (MD-T) frame circuit breaker next to a 2-pole circuit breaker as shown.	QN, QNH, HQN	QP, QPH, HQPH	6 
 ECSBPK07	For use on load centers or meter combinations that will accept two QNR (MD-TR) circuit breakers side by side as shown OR will accept two QN (MD-T) circuit breakers side by side as shown.	QNR, QNRH, HQNR, QN, QNH, HQN	QNR, QNRH, HQNR QN, QNH, HQN	7 

[®] Manual breaker interlock kits are attached to the breakers not the trim of the load center.

Load Centers

1-Phase Indoor and 1-Phase & 3-Phase Outdoor Enclosures—Knockout Diagrams

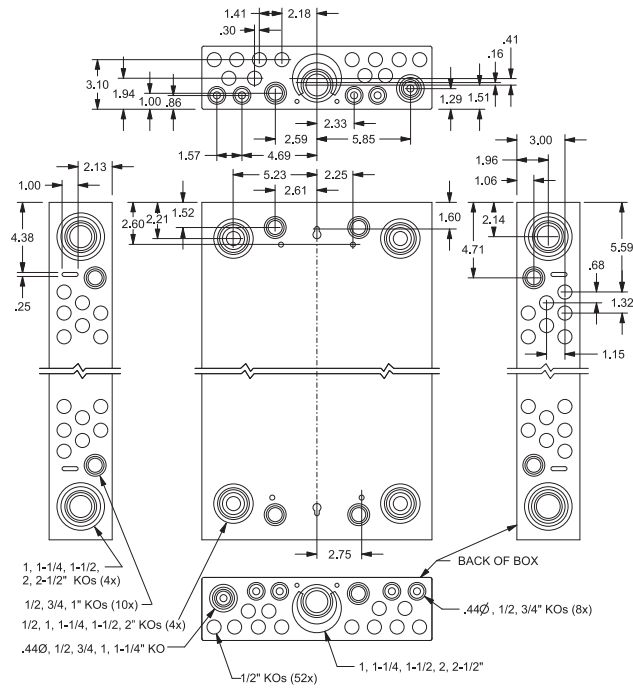

**SN and PN
 1 Phase Load Centers
 Indoor**

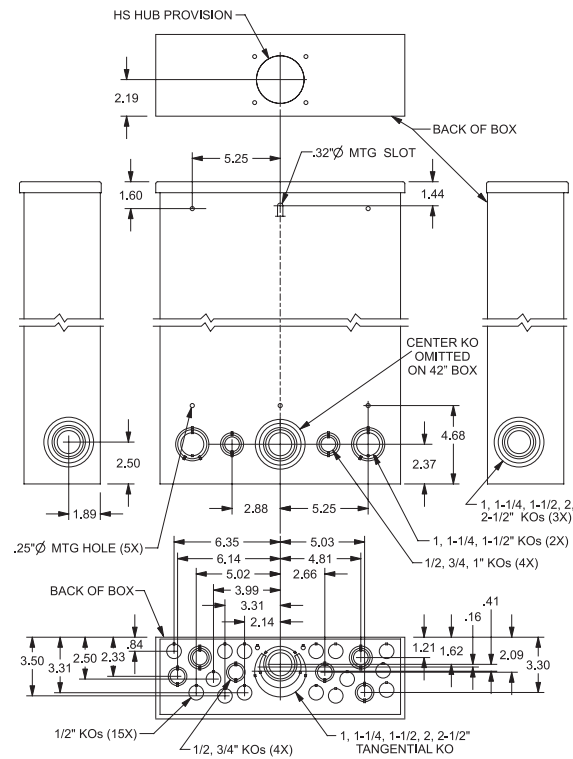

**ES, PL, and Generator Ready
 1 and 3 Phase Load Centers
 Outdoor**

Load Centers

Outdoor Enclosures—Knockout Diagrams

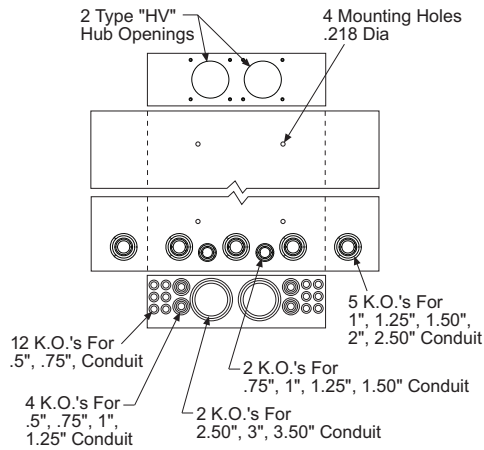

Outdoor 400A Load Center

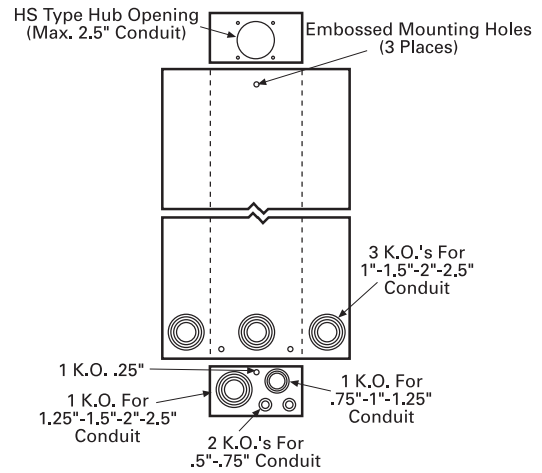

W0406ML1125CU

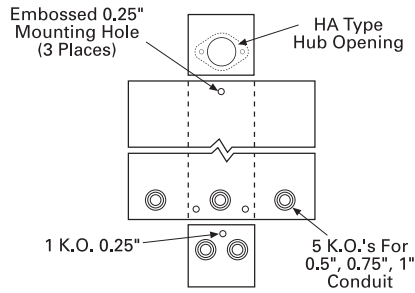

W0204ML1060

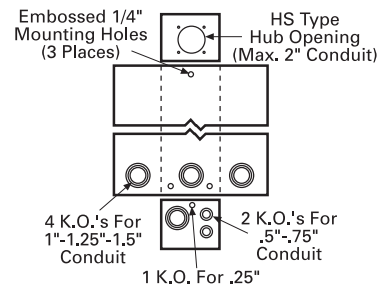

W0408ML1125

Load Centers

Outdoor Enclosures—Knockout Diagrams

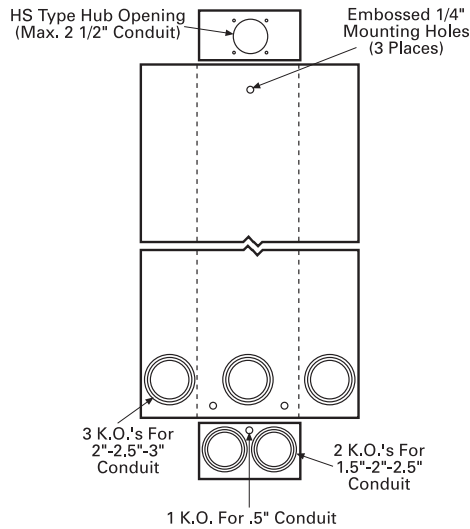

WB2225 and WB32225

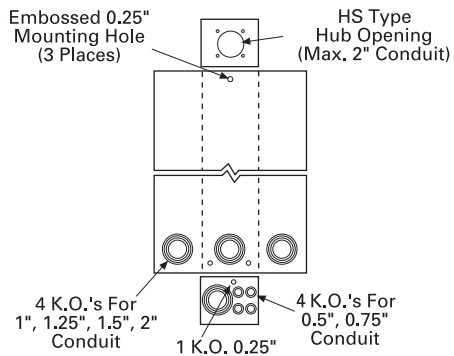

W0204ML1125

W0303ML3100

WB3100

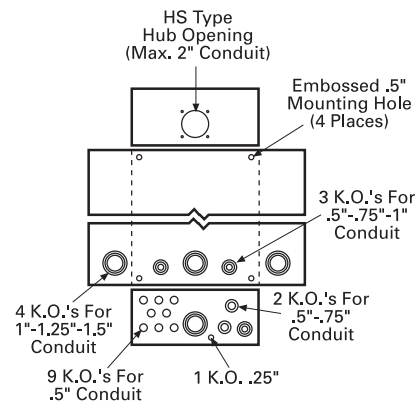

W0612ML1125

W0816ML1125

Load Centers

Indoor Enclosures—Knockout Diagrams

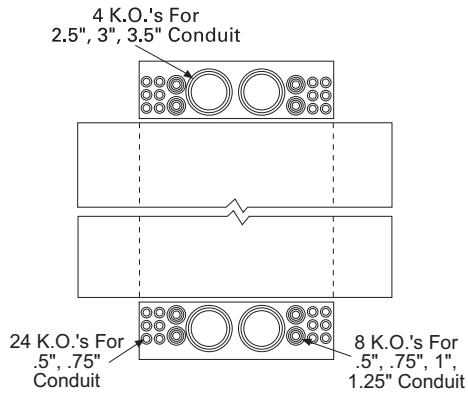

Indoor 300-400A Load Center

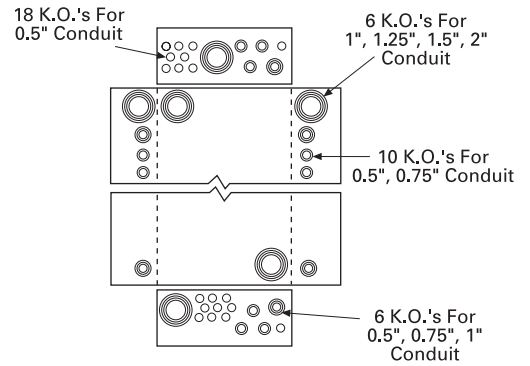

E0612ML1125

E0816ML1125

E1224ML1100F

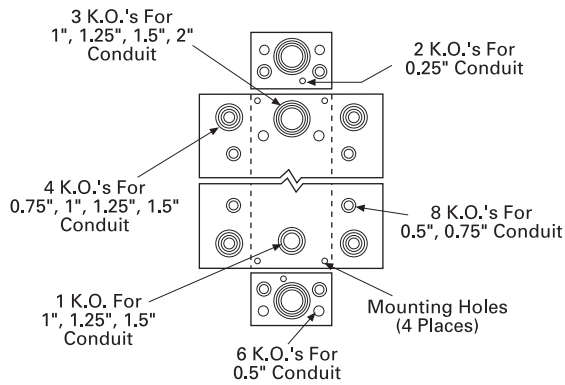

E0408ML1125

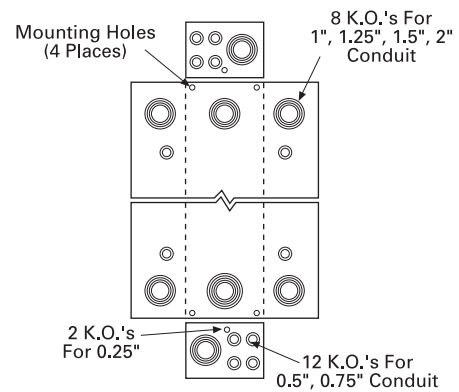

E0303ML3100SCU

EB3100

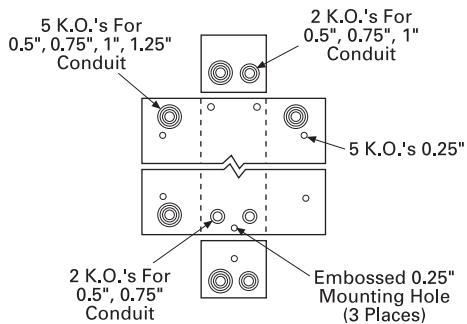

E0204ML1060

Load Centers

Cross Reference

Phase	Enclosure	Legacy Catalog Number	New Catalog Number	Main	Amperage	Bus
1	Indoor	LC1224B1100	SN1224B1100	Main Breaker	100	Aluminum
1	Indoor	LC1224L1125	SN1224L1125	Main Lug	125	Aluminum
1	Indoor	LC1224L1125P	SN2020B1100P1	Main Lug	125	Aluminum
1	Indoor	LC1224L1125W	SN1224L1125W	Main Lug	125	Aluminum
1	Indoor	LC1632B1150	SN1632B1150	Main Breaker	150	Aluminum
1	Indoor	LC1632B1200	SN1632B1200	Main Breaker	200	Aluminum
1	Indoor	LC1632L1125	SN1632L1125	Main Lug	125	Aluminum
1	Indoor	LC1632L1125W	SN1632L1125W	Main Lug	125	Aluminum
1	Indoor	LC1632L1150	SN1632L1150	Main Lug	150	Aluminum
1	Indoor	LC2040B1100	SN2040B1100	Main Breaker	100	Aluminum
1	Indoor	LC2040B1100CU	PN2040B1100C	Main Breaker	100	Copper
1	Indoor	LC2040B1100P	SN2020B1100P1	Main Breaker	100	Aluminum
1	Indoor	LC2040B1150	SN2040B1150	Main Breaker	150	Aluminum
1	Indoor	LC2040B1200	SN2040B1200	Main Breaker	200	Aluminum
1	Indoor	LC2040B1200CU	PN2040B1200C	Main Breaker	200	Copper
1	Indoor	LC2040B1200P	SN3048B1200P1	Main Breaker	200	Aluminum
1	Indoor	LC2040L1125	SN2040L1125	Main Lug	125	Aluminum
1	Indoor	LC2040L1125CU	PN2040L1125C	Main Lug	125	Copper
1	Indoor	LC2040L1200	SN2040L1200	Main Lug	200	Aluminum
1	Indoor	LC2040L1200CU	PN2040L1200C	Main Lug	200	Copper
1	Indoor	LC2440B1100	SN2448B1100	Main Breaker	100	Aluminum
1	Indoor	LC2440B1150	SN2448B1150	Main Breaker	150	Aluminum
1	Indoor	LC2440B1200	SN2448B1200	Main Breaker	200	Aluminum
1	Indoor	LC2440L1150	SN2448L1150	Main Lug	150	Aluminum
1	Indoor	LC2440L1200	SN2448L1200	Main Lug	200	Aluminum
1	Indoor	LC2448B1100	SN2448B1100	Main Breaker	100	Aluminum
1	Indoor	LC2448B1100P	SN2020B1100P1	Main Breaker	100	Aluminum
1	Indoor	LC3040B1100	SN3048B1100	Main Breaker	100	Aluminum
1	Indoor	LC3040B1100W	SN3048B1100W	Main Breaker	100	Aluminum
1	Indoor	LC3040B1150	SN3048B1150	Main Breaker	150	Aluminum
1	Indoor	LC3040B1200	SN3048B1200	Main Breaker	200	Aluminum
1	Indoor	LC3040B1200CU	PN3048B1200C	Main Breaker	200	Copper
1	Indoor	LC3040B1200P	SN3048B1200P1	Main Breaker	200	Aluminum
1	Indoor	LC3040L1125	SN3048L1125	Main Lug	125	Aluminum
1	Indoor	LC3040L1200	SN3048L1200	Main Lug	200	Aluminum
1	Indoor	LC3040L1200CU	PN3048L1200C	Main Lug	200	Copper
1	Indoor	LC3054B1200	SN3048B1200	Main Breaker	200	Aluminum
1	Indoor	LC3060B1200P	SN3048B1200P1	Main Breaker	200	Aluminum
1	Indoor	LC4040B1200	SN4040B1200	Main Breaker	200	Aluminum
1	Indoor	LC4040B1200CU	PN4040B1200C	Main Breaker	200	Copper
1	Indoor	LC4040B1200P	SN4040B1200P1	Main Breaker	200	Aluminum
1	Indoor	LC4040L1200	SN4040L1200	Main Lug	200	Aluminum

Load Centers

Cross Reference

Phase	Enclosure	Legacy Catalog Number	New Catalog Number	Main	Amperage	Bus
1	Indoor	LC4040L1200CU	PN4040L1200C	Main Lug	200	Copper
1	Indoor	LC4040L1200W	SN4040L1200W	Main Lug	200	Aluminum
1	Indoor	LC4060B1200	SN4060B1200	Main Breaker	200	Aluminum
1	Indoor	LC4060L1225	SN4060L1225	Main Lug	225	Aluminum
1	Indoor	LC4242L1225CU	PN4264L1225C	Main Lug	225	Copper
1	Indoor	LC4260B1200	SN4264B1200	Main Breaker	200	Aluminum
1	Indoor	LC4260B1200P	SN4040B1200P1	Main Breaker	200	Aluminum
1	Outdoor	LW0816L1200TR	SNW0816L1200T	Main Lug	200	Aluminum
1	Outdoor	LW1224B1100	SNW1224B1100	Main Breaker	100	Aluminum
1	Outdoor	LW1224B1200	SNW1224B1200	Main Breaker	200	Aluminum
1	Outdoor	LW1224L1125	SNW1224L1125	Main Lug	125	Aluminum
1	Outdoor	LW1224L1200	SNW1224L1200	Main Lug	200	Aluminum
1	Outdoor	LW1224L1225CU	PNW1224L1225C	Main Lug	225	Copper
1	Outdoor	LW1632B1100	SNW1632B1100	Main Breaker	100	Aluminum
1	Outdoor	LW1632L1125	SNW1632L1125	Main Lug	125	Aluminum
1	Outdoor	LW2040B1150	SNW2040B1150	Main Breaker	150	Aluminum
1	Outdoor	LW2040B1200	SNW2040B1200	Main Breaker	200	Aluminum
1	Outdoor	LW2040L1125	SNW2040L1125	Main Lug	125	Aluminum
1	Outdoor	LW2040L1200	SNW2040L1200	Main Lug	200	Aluminum
1	Outdoor	LW3040B1200	SNW3048B1200	Main Breaker	200	Aluminum
1	Outdoor	LW3040L1200	SNW3048L1200	Main Lug	200	Aluminum
1	Outdoor	LW4040B1200	SNW4040B1200	Main Breaker	200	Aluminum
1	Outdoor	LW4242L1225CU	PNW4264L1225C	Main Lug	225	Copper
1	Indoor	P1212L1125CU	PN1212L1125C	Main Lug	125	Copper
1	Indoor	P1224B1100CU	PN1224B1100C	Main Breaker	100	Copper
1	Indoor	P1224L1125CU	PN1224L1125C	Main Lug	125	Copper
1	Indoor	P1224L1125CUSG	PN1224L1125C	Main Lug	125	Copper
1	Indoor	P1224L1200CU	PN1224L1200C	Main Lug	200	Copper
1	Indoor	P1624B1100CU	PN1632B1100C	Main Breaker	100	Copper
1	Indoor	P1624B1100CUW	PN1632B1100CW	Main Breaker	100	Copper
1	Indoor	P1624L1125CU	PN1632L1125C	Main Lug	125	Copper
1	Indoor	P1624L1125CUSG	PN1632L1125C	Main Lug	125	Copper
1	Indoor	P2020B1100CU	PN2020B1100C	Main Breaker	100	Copper
1	Indoor	P2020L1125CU	PN2020L1125C	Main Lug	125	Copper
1	Indoor	P2020L1125CUW	PN2020L1125CW	Main Lug	125	Copper
1	Indoor	P2024B1100CU	PN2040B1100C	Main Breaker	100	Copper
1	Indoor	P2024L1125CU	PN2040L1125C	Main Lug	125	Copper
1	Indoor	P2030B1150CU	PN2040B1150C	Main Breaker	150	Copper
1	Indoor	P2030L1125CUSG	PN2040L1125C	Main Lug	125	Copper
1	Indoor	P2030L1150CU	PN2040L1150C	Main Lug	150	Copper
1	Indoor	P2030L1150CUSG	PN2040L1150C	Main Lug	150	Copper
1	Indoor	P2040B1100ACU	PN2040B1100C	Main Breaker	100	Copper

Load Centers

Cross Reference

Phase	Enclosure	Legacy Catalog Number	New Catalog Number	Main	Amperage	Bus
1	Indoor	P2040B1100ACUW	PN2040B1100CW	Main Breaker	100	Copper
1	Indoor	P2040B1150ACU	PN2040B1150C	Main Breaker	150	Copper
1	Indoor	P2040B1150ACUW	PN2040B1150CW	Main Breaker	150	Copper
1	Indoor	P2040B1200ACU	PN2040B1200C	Main Breaker	200	Copper
1	Indoor	P2040B1200ACUW	PN2040B1200CW	Main Breaker	200	Copper
1	Indoor	P2040B1200CU	PN2040B1200C	Main Breaker	200	Copper
1	Indoor	P2040L1125ACU	PN2040L1125C	Main Lug	125	Copper
1	Indoor	P2040L1125ACUW	PN2040L1125CW	Main Lug	125	Copper
1	Indoor	P2040L1150ACU	PN2040L1150C	Main Lug	150	Copper
1	Indoor	P2040L1150ACUW	PN2040L1150CW	Main Lug	150	Copper
1	Indoor	P2040L1200ACU	PN2040L1200C	Main Lug	200	Copper
1	Indoor	P2040L1200ACUW	PN2040L1200CW	Main Lug	200	Copper
1	Indoor	P2040L1200CU	PN2040L1200C	Main Lug	200	Copper
1	Indoor	P2424B1100CU	PN2424B1100C	Main Breaker	100	Copper
1	Indoor	P2430L1125CUSG	PN2448L1125C	Main Lug	125	Copper
1	Indoor	P2440L1125CU	PN2448L1125C	Main Lug	125	Copper
1	Indoor	P2440L1125CUW	PN2448L1125CW	Main Lug	125	Copper
1	Indoor	P2440L1200CU	PN2448L1200C	Main Lug	200	Copper
1	Indoor	P2448B1100ACU	PN2424B1100C	Main Breaker	100	Copper
1	Indoor	P2448B1100ACUW	PN2424B1100CW	Main Breaker	100	Copper
1	Indoor	P2448L1125ACU	PN2448L1125C	Main Lug	125	Copper
1	Indoor	P2448L1125ACUW	PN2448L1125CW	Main Lug	125	Copper
1	Indoor	P2448L1200ACU	PN2448L1200C	Main Lug	200	Copper
1	Indoor	P2448L1200ACUW	PN2448L1200CW	Main Lug	200	Copper
1	Indoor	P3030B1100CU	PN3030B1100C	Main Breaker	100	Copper
1	Indoor	P3030B1125CU	PN3030B1125C	Main Breaker	125	Copper
1	Indoor	P3030B1125CUW	PN3030B1125CW	Main Breaker	125	Copper
1	Indoor	P3030B1150CU	PN3030B1150C	Main Breaker	150	Copper
1	Indoor	P3030L1200CU	PN3030L1200C	Main Lug	200	Copper
1	Indoor	P3040B1200	PN3048B1200	Main Breaker	200	Aluminum
1	Indoor	P3040B1200CU	PN3048B1200C	Main Breaker	200	Copper
1	Indoor	P3040B1200W	PN3048B1200W	Main Breaker	200	Aluminum
1	Indoor	P3040L1125CU	PN3048L1125C	Main Lug	125	Copper
1	Indoor	P3040L1125CUW	PN3048L1125CW	Main Lug	125	Copper
1	Indoor	P3040L1200	PN3048L1200	Main Lug	200	Aluminum
1	Indoor	P3040L1200CU	PN3048L1200C	Main Lug	200	Copper
1	Indoor	P3040L1200CUSG	PN3048L1200C	Main Lug	200	Copper
1	Indoor	P3040L1200CUW	PN3048L1200CW	Main Lug	200	Copper
1	Indoor	P3040L1200SG	PN3048L1200	Main Lug	200	Aluminum
1	Indoor	P3040L1200W	PN3048L1200W	Main Lug	200	Aluminum
1	Indoor	P3042B1125CUSP	PN3030B1125C	Main Breaker	125	Copper
1	Indoor	P3054B1200S140	PN3048B1200S14	Main Breaker	200	Copper

Load Centers

Cross Reference

Phase	Enclosure	Legacy Catalog Number	New Catalog Number	Main	Amperage	Bus
1	Indoor	P3054L1200CU	PN3048L1200C	Main Lug	200	Copper
1	Indoor	P3060B1100ACU	PN3030B1100C	Main Breaker	100	Copper
1	Indoor	P3060B1100ACUW	PN3030B1100CW	Main Breaker	100	Copper
1	Indoor	P3060B1125ACU	PN3030B1125C	Main Breaker	125	Copper
1	Indoor	P3060B1125ACUW	PN3030B1125CW	Main Breaker	125	Copper
1	Indoor	P3060B1150ACU	PN3030B1150C	Main Breaker	150	Copper
1	Indoor	P3060B1150ACUW	PN3030B1150CW	Main Breaker	150	Copper
1	Indoor	P3060B1200A	PN3048B1200	Main Breaker	200	Aluminum
1	Indoor	P3060B1200ACU	PN3048B1200C	Main Breaker	200	Copper
1	Indoor	P3060B1200ACUW	PN3048B1200CW	Main Breaker	200	Copper
1	Indoor	P3060B1200AW	PN3048B1200W	Main Breaker	200	Aluminum
1	Indoor	P3060L1125ACU	PN3048L1125C	Main Lug	125	Copper
1	Indoor	P3060L1125ACUW	PN3048L1125CW	Main Lug	125	Copper
1	Indoor	P3060L1200A	PN3048L1200	Main Lug	200	Aluminum
1	Indoor	P3060L1200ACU	PN3048L1200C	Main Lug	200	Copper
1	Indoor	P3060L1200ACUW	PN3048L1200CW	Main Lug	200	Copper
1	Indoor	P3060L1200AW	PN3048L1200W	Main Lug	200	Aluminum
1	Indoor	P4040B1200	PN4040B1200	Main Breaker	200	Aluminum
1	Indoor	P4040B1200CU	PN4040B1200C	Main Breaker	200	Copper
1	Indoor	P4040B1200CUSG	PN4040B1200C	Main Breaker	200	Copper
1	Indoor	P4040B1200CUW	PN4040B1200CW	Main Breaker	200	Copper
1	Indoor	P4040B1200W	PN4040B1200W	Main Breaker	200	Aluminum
1	Indoor	P4040L1125CU	PN4040L1125C	Main Lug	125	Copper
1	Indoor	P4040L1125CUW	PN4040L1125CW	Main Lug	125	Copper
1	Indoor	P4040L1200	PN4040L1200	Main Lug	200	Aluminum
1	Indoor	P4040L1200CU	PN4040L1200C	Main Lug	200	Copper
1	Indoor	P4040L1200CUSG	PN4040L1200C	Main Lug	200	Copper
1	Indoor	P4040L1200CUW	PN4040L1200CW	Main Lug	200	Copper
1	Indoor	P4040L1200SG	PN4040L1200	Main Lug	200	Aluminum
1	Indoor	P4060B1200S140	PN4060B1200S14	Main Breaker	200	Copper
1	Indoor	P4080B1200A	PN4060B1200	Main Breaker	200	Aluminum
1	Indoor	P4080B1200ACU	PN4060B1200C	Main Breaker	200	Copper
1	Indoor	P4080B1200ACUW	PN4060B1200CW	Main Breaker	200	Copper
1	Indoor	P4080B1200AW	PN4060B1200W	Main Breaker	200	Aluminum
1	Indoor	P4080L1125ACU	PN4040L1125C	Main Lug	125	Copper
1	Indoor	P4080L1125ACUW	PN4040L1125CW	Main Lug	125	Copper
1	Indoor	P4080L1200A	PN4040L1200	Main Lug	200	Aluminum
1	Indoor	P4080L1200ACU	PN4060L1200C	Main Lug	200	Copper
1	Indoor	P4080L1200ACUW	PN4060L1200CW	Main Lug	200	Copper
1	Indoor	P4080L1200AW	PN4040L1200W	Main Lug	200	Aluminum
1	Indoor	P4260B1225CU	PN4264B1225C	Main Breaker	225	Copper
1	Indoor	P4260B1225CUW	PN4264B1225CW	Main Breaker	225	Copper

Load Centers

Cross Reference

Phase	Enclosure	Legacy Catalog Number	New Catalog Number	Main	Amperage	Bus
1	Indoor	P4260L1225CU	PN4264L1225C	Main Lug	225	Copper
1	Indoor	P4260L1225CUSG	PN4264L1225C	Main Lug	225	Copper
1	Indoor	P4260L1225CUW	PN4264L1225CW	Main Lug	225	Copper
1	Indoor	P4280B1225ACU	PN4264B1225C	Main Breaker	225	Copper
1	Indoor	P4280B1225ACUW	PN4264B1225CW	Main Breaker	225	Copper
1	Indoor	P4280L1225ACU	PN4264L1225C	Main Lug	225	Copper
1	Indoor	P4280L1225ACUW	PN4264L1225CW	Main Lug	225	Copper
1	Indoor	P5470B1200CU	PN5482B1200C	Main Breaker	200	Copper
1	Indoor	P5470B1200CUW	PN5482B1200CW	Main Breaker	200	Copper
1	Indoor	P5470B1225CU	PN5482B1225C	Main Breaker	225	Copper
1	Indoor	P5470L1225CU	PN5482L1225C	Main Lug	225	Copper
1	Indoor	P5480B1200ACU	PN5482B1200C	Main Breaker	200	Copper
1	Indoor	P5480B1200ACUW	PN5482B1200CW	Main Breaker	200	Copper
1	Indoor	P5480B1225ACU	PN5482B1225C	Main Breaker	225	Copper
1	Indoor	P5480B1225ACUW	PN5482B1225CW	Main Breaker	225	Copper
1	Indoor	P5480L1225ACU	PN5482L1225C	Main Lug	225	Copper
1	Indoor	P5480L1225ACUW	PN5482L1225CW	Main Lug	225	Copper
1	Outdoor	PW0816B1150TC	PNW0816B1150TC	Main Breaker	150	Copper
1	Outdoor	PW0816B1200TC	PNW0816B1200TC	Main Breaker	200	Copper
1	Outdoor	PW0816L1200TC	PNW0816L1200TC	Main Lug	200	Copper
1	Outdoor	PW1212L1125CU	PNW1212L1125C	Main Lug	125	Copper
1	Outdoor	PW1224B1100CU	PNW1224B1100C	Main Breaker	100	Copper
1	Outdoor	PW1224L1125CU	PNW1224L1125C	Main Lug	125	Copper
1	Outdoor	PW1224L1200CU	PNW1224L1200C	Main Lug	200	Copper
1	Outdoor	PW1224L1225CU	PNW1224L1225C	Main Lug	225	Copper
1	Outdoor	PW1624B1100CU	PNW1632B1100C	Main Breaker	100	Copper
1	Outdoor	PW1624L1125CU	PNW1632L1125C	Main Lug	125	Copper
1	Outdoor	PW2020B1100CU	PNW2020B1100C	Main Breaker	100	Copper
1	Outdoor	PW2030B1150CU	PNW2040B1150C	Main Breaker	150	Copper
1	Outdoor	PW2030L1150CU	PNW2040L1150C	Main Lug	150	Copper
1	Outdoor	PW2040B1200CU	PNW2040B1200C	Main Breaker	200	Copper
1	Outdoor	PW2040L1200CU	PNW2040L1200C	Main Lug	200	Copper
1	Outdoor	PW3040B1100CU	PNW3048B1100C	Main Breaker	100	Copper
1	Outdoor	PW3040B1125CU	PNW3048B1125C	Main Breaker	125	Copper
1	Outdoor	PW3040B1150CU	PNW3048B1150C	Main Breaker	150	Copper
1	Outdoor	PW3040B1200CU	PNW3048B1200C	Main Breaker	200	Copper
1	Outdoor	PW3040L1125CU	PNW3048L1125C	Main Lug	125	Copper
1	Outdoor	PW3040L1200CU	PNW3048L1200C	Main Lug	200	Copper
1	Outdoor	PW3054L1200CU	PNW3048L1200C	Main Lug	200	Copper
1	Outdoor	PW4040B1200CU	PNW4040B1200C	Main Breaker	200	Copper
1	Outdoor	PW4040L1200CU	PNW4040L1200C	Main Lug	200	Copper

Load Centers

Cross Reference

Phase	Enclosure	Legacy Catalog Number	New Catalog Number	Main	Amperage	Bus
1	Outdoor	PW4260B1225CU	PNW4264B1225C	Main Breaker	225	Copper
1	Outdoor	PW4260L1225CU	PNW4264L1225C	Main Lug	225	Copper
1	Indoor	S1020B1100	SN1224B1100	Main Breaker	100	Aluminum
1	Indoor	S1212L1125	SN1212L1125	Main Lug	125	Aluminum
1	Indoor	S1224B1100	SN1224B1100	Main Breaker	100	Aluminum
1	Indoor	S1224L1125	SN1224L1125	Main Lug	125	Aluminum
1	Indoor	S1224L1200	SN1224L1200	Main Lug	200	Aluminum
1	Indoor	S1624B1100	SN1632B1100	Main Breaker	100	Aluminum
1	Indoor	S1624B1100W	SN1632B1100W	Main Breaker	100	Aluminum
1	Indoor	S1624B1125	SN1632B1125	Main Breaker	125	Aluminum
1	Indoor	S1624L1125	SN1632L1125	Main Lug	125	Aluminum
1	Indoor	S1630B1150	SN1632B1150	Main Breaker	150	Aluminum
1	Indoor	S1632B1200	SN1632B1200	Main Breaker	200	Aluminum
1	Indoor	S2020B1100	SN2020B1100	Main Breaker	100	Aluminum
1	Indoor	S2020B1100P	SN2020B1100P1	Main Breaker	100	Aluminum
1	Indoor	S2020L1125	SN2020L1125	Main Lug	125	Aluminum
1	Indoor	S2020L1125G	SN2020L1125	Main Lug	125	Aluminum
1	Indoor	S2020L1125GW	SN2020L1125W	Main Lug	125	Aluminum
1	Indoor	S2020L1125W	SN2020L1125W	Main Lug	125	Aluminum
1	Indoor	S2024B1100	SN2040B1100	Main Breaker	100	Aluminum
1	Indoor	S2024L1125	SN2040L1125	Main Lug	125	Aluminum
1	Indoor	S2024L1125G	SN2040L1125	Main Lug	125	Aluminum
1	Indoor	S2030B1150	SN2040B1150	Main Breaker	150	Aluminum
1	Indoor	S2030L1125SG	SN2040L1125	Main Lug	125	Aluminum
1	Indoor	S2030L1150	SN2040L1150	Main Lug	150	Aluminum
1	Indoor	S2030L1150W	SN2040L1150W	Main Lug	150	Aluminum
1	Indoor	S2040B1100A	SN2040B1100	Main Breaker	100	Aluminum
1	Indoor	S2040B1100AW	SN2040B1100W	Main Breaker	100	Aluminum
1	Indoor	S2040B1150A	SN2040B1150	Main Breaker	150	Aluminum
1	Indoor	S2040B1150AW	SN2040B1150W	Main Breaker	150	Aluminum
1	Indoor	S2040B1200	SN2040B1200	Main Breaker	200	Aluminum
1	Indoor	S2040B1200A	SN2040B1200	Main Breaker	200	Aluminum
1	Indoor	S2040B1200AW	SN2040B1200W	Main Breaker	200	Aluminum
1	Indoor	S2040C1200	SN2040C1200	Main Convertible	200	Aluminum
1	Indoor	S2040L1125AG	SN2040L1125	Main Lug	125	Aluminum
1	Indoor	S2040L1125AGW	SN2040L1125W	Main Lug	125	Aluminum
1	Indoor	S2040L1150AG	SN2040L1150	Main Lug	150	Aluminum
1	Indoor	S2040L1150AGW	SN2040L1150W	Main Lug	150	Aluminum
1	Indoor	S2040L1200	SN2040L1200	Main Lug	200	Aluminum
1	Indoor	S2040L1200AG	SN2040L1200	Main Lug	200	Aluminum
1	Indoor	S2040L1200AGW	SN2040L1200W	Main Lug	200	Aluminum

Load Centers

Cross Reference

Phase	Enclosure	Legacy Catalog Number	New Catalog Number	Main	Amperage	Bus
1	Indoor	S2424B1125	SN2424B1125	Main Breaker	125	Aluminum
1	Indoor	S2424B1125W	SN2424B1125W	Main Breaker	125	Aluminum
1	Indoor	S2424C1125	SN2424C1125	Main Convertible	125	Aluminum
1	Indoor	S2424L1125	SN2424L1125	Main Lug	125	Aluminum
1	Indoor	S2424L1125G	SN2424L1125	Main Lug	125	Aluminum
1	Indoor	S2424L1125GW	SN2424L1125W	Main Lug	125	Aluminum
1	Indoor	S2424L1125W	SN2424L1125W	Main Lug	125	Aluminum
1	Indoor	S2430B1150	SN2448B1150	Main Breaker	150	Aluminum
1	Indoor	S2440B1200	SN2448B1200	Main Breaker	200	Aluminum
1	Indoor	S2440L1125	SN2448L1125	Main Lug	125	Aluminum
1	Indoor	S2440L1125G	SN2448L1125	Main Lug	125	Aluminum
1	Indoor	S2440L1200	SN2448L1200	Main Lug	200	Aluminum
1	Indoor	S2440L1200W	SN2448L1200W	Main Lug	200	Aluminum
1	Indoor	S2448B1125A	SN2424B1125	Main Breaker	125	Aluminum
1	Indoor	S2448B1125AW	SN2424B1125W	Main Breaker	125	Aluminum
1	Indoor	S2448B1150A	SN2448B1150	Main Breaker	150	Aluminum
1	Indoor	S2448B1150AW	SN2448B1150W	Main Breaker	150	Aluminum
1	Indoor	S2448B1200A	SN2448B1200	Main Breaker	200	Aluminum
1	Indoor	S2448B1200AW	SN2448B1200W	Main Breaker	200	Aluminum
1	Indoor	S2448L1125AG	SN2448L1125	Main Lug	125	Aluminum
1	Indoor	S2448L1125AGW	SN2448L1125W	Main Lug	125	Aluminum
1	Indoor	S2448L1200AG	SN2448L1200	Main Lug	200	Aluminum
1	Indoor	S2448L1200AGW	SN2448L1200W	Main Lug	200	Aluminum
1	Indoor	S3030B1100	SN3030B1100	Main Breaker	100	Aluminum
1	Indoor	S3030B1100W	SN3030B1100W	Main Breaker	100	Aluminum
1	Indoor	S3030B1125	SN3030B1125	Main Breaker	125	Aluminum
1	Indoor	S3030B1125W	SN3030B1125W	Main Breaker	125	Aluminum
1	Indoor	S3030B1150	SN3030B1150	Main Breaker	150	Aluminum
1	Indoor	S3030B1150SG	SN3030B1150	Main Breaker	150	Aluminum
1	Indoor	S3030B1150W	SN3030B1150W	Main Breaker	150	Aluminum
1	Indoor	S3030L1200	SN3030L1200	Main Lug	200	Aluminum
1	Indoor	S3030L1200W	SN3030L1200W	Main Lug	200	Aluminum
1	Indoor	S3040B1125	SN3048B1125	Main Breaker	125	Aluminum
1	Indoor	S3040B1150	SN3048B1150	Main Breaker	150	Aluminum
1	Indoor	S3040B1200	SN3048B1200	Main Breaker	200	Aluminum
1	Indoor	S3040B1200P	SN3048B1200P1	Main Breaker	200	Aluminum
1	Indoor	S3040B1200W	SN3048B1200W	Main Breaker	200	Aluminum
1	Indoor	S3040C1200	SN3048C1200	Main Convertible	200	Aluminum
1	Indoor	S3040L1125	SN3048L1125	Main Lug	125	Aluminum
1	Indoor	S3040L1125G	SN3048L1125	Main Lug	125	Aluminum
1	Indoor	S3040L1125GW	SN3048L1125W	Main Lug	125	Aluminum
1	Indoor	S3040L1125W	SN3048L1125W	Main Lug	125	Aluminum

Load Centers

Cross Reference

Phase	Enclosure	Legacy Catalog Number	New Catalog Number	Main	Amperage	Bus
1	Indoor	S3040L1200	SN3048L1200	Main Lug	200	Aluminum
1	Indoor	S3040L1200L50	SN3048L1200L50	Main Lug	200	Aluminum
1	Indoor	S3040L1200L50W	SN3048L1200L5W	Main Lug	200	Aluminum
1	Indoor	S3040L1200P	SN3048B1200P1	Main Lug	200	Aluminum
1	Indoor	S3040L1200W	SN3048L1200W	Main Lug	200	Aluminum
1	Indoor	S3054B1200P	SN3048B1200P1	Main Breaker	200	Aluminum
1	Indoor	S3054B1200S060	SN3048B1200S06	Main Breaker	200	Aluminum
1	Indoor	S3054L1200	SN3048L1200	Main Lug	200	Aluminum
1	Indoor	S3060B1100A	SN3048B1100	Main Breaker	100	Aluminum
1	Indoor	S3060B1100AW	SN3048B1100W	Main Breaker	100	Aluminum
1	Indoor	S3060B1125A	SN3048B1125	Main Breaker	125	Aluminum
1	Indoor	S3060B1125AW	SN3048B1125W	Main Breaker	125	Aluminum
1	Indoor	S3060B1150A	SN3048B1150	Main Breaker	150	Aluminum
1	Indoor	S3060B1150AW	SN3048B1150W	Main Breaker	150	Aluminum
1	Indoor	S3060B1200A	SN3048B1200	Main Breaker	200	Aluminum
1	Indoor	S3060B1200AW	SN3048B1200W	Main Breaker	200	Aluminum
1	Indoor	S3060L1125AG	SN3048L1125	Main Lug	125	Aluminum
1	Indoor	S3060L1125AGW	SN3048L1125W	Main Lug	125	Aluminum
1	Indoor	S3060L1200AG	SN3048L1200	Main Lug	200	Aluminum
1	Indoor	S3060L1200AGW	SN3048L1200W	Main Lug	200	Aluminum
1	Indoor	S4040B1200	SN4040B1200	Main Breaker	200	Aluminum
1	Indoor	S4040B1200P	SN4040B1200P1	Main Breaker	200	Aluminum
1	Indoor	S4040B1200SG	SN4040B1200	Main Breaker	200	Aluminum
1	Indoor	S4040B1200W	SN4040B1200W	Main Breaker	200	Aluminum
1	Indoor	S4040C1200	SN4040C1200	Main Convertible	200	Aluminum
1	Indoor	S4040L1125	SN4040L1125	Main Lug	125	Aluminum
1	Indoor	S4040L1200	SN4040L1200	Main Lug	200	Aluminum
1	Indoor	S4040L1200W	SN4040L1200W	Main Lug	200	Aluminum
1	Indoor	S4060B1200S060	SN4060B1200S06	Main Breaker	200	Aluminum
1	Indoor	S4080B1200A	SN4060B1200	Main Breaker	200	Aluminum
1	Indoor	S4080B1200AW	SN4060B1200W	Main Breaker	200	Aluminum
1	Indoor	S4080L1125AG	SN4040L1125	Main Lug	125	Aluminum
1	Indoor	S4080L1125AGW	SN4040L1125W	Main Lug	125	Aluminum
1	Indoor	S4080L1200AG	SN4040L1200	Main Lug	200	Aluminum
1	Indoor	S4080L1200AGW	SN4040L1200W	Main Lug	200	Aluminum
1	Indoor	S4260B1200	SN4264B1200	Main Breaker	200	Aluminum
1	Indoor	S4260B1225	SN4264B1225	Main Breaker	225	Aluminum
1	Indoor	S4260L1225	SN4264L1225	Main Lug	225	Aluminum
1	Indoor	S4280B1225A	SN4264B1225	Main Breaker	225	Aluminum
1	Indoor	S4280B1225AW	SN4264B1225W	Main Breaker	225	Aluminum
1	Indoor	S4280L1225AG	SN4264L1225	Main Lug	225	Aluminum
1	Indoor	S4280L1225AGW	SN4264L1225W	Main Lug	225	Aluminum

Load Centers

Cross Reference

Phase	Enclosure	Legacy Catalog Number	New Catalog Number	Main	Amperage	Bus
1	Indoor	S5470B1200	SN5482B1200	Main Breaker	200	Aluminum
1	Indoor	S5470B1225	SN5482B1225	Main Breaker	225	Aluminum
1	Indoor	S5470L1225	SN5482L1225	Main Lug	225	Aluminum
1	Indoor	S5480B1200A	SN5482B1200	Main Breaker	200	Aluminum
1	Indoor	S5480B1200AW	SN5482B1200W	Main Breaker	200	Aluminum
1	Indoor	S5480B1225A	SN5482B1225	Main Breaker	225	Aluminum
1	Indoor	S5480B1225AW	SN5482B1225W	Main Breaker	225	Aluminum
1	Indoor	S5480L1225AG	SN5482L1225	Main Lug	225	Aluminum
1	Indoor	S5480L1225AGW	SN5482L1225W	Main Lug	225	Aluminum
1	Outdoor	SW0816B1200T	SNW0816B1200T	Main Breaker	200	Aluminum
1	Outdoor	SW0816L1200T	SNW0816L1200T	Main Lug	200	Aluminum
1	Outdoor	SW1212L1125	SNW1212L1125	Main Lug	125	Aluminum
1	Outdoor	SW1224B1100	SNW1224B1100	Main Breaker	100	Aluminum
1	Outdoor	SW1224B1125	SNW1224B1125	Main Breaker	125	Aluminum
1	Outdoor	SW1224L1125	SNW1224L1125	Main Lug	125	Aluminum
1	Outdoor	SW1224L1200	SNW1224L1200	Main Lug	200	Aluminum
1	Outdoor	SW1224L1225	SNW1224L1225	Main Lug	225	Aluminum
1	Outdoor	SW1624B1100	SNW1632B1100	Main Breaker	100	Aluminum
1	Outdoor	SW1624L1125	SNW1632L1125	Main Lug	125	Aluminum
1	Outdoor	SW2020B1100	SNW2020B1100	Main Breaker	100	Aluminum
1	Outdoor	SW2024B1125	SNW2040B1125	Main Breaker	125	Aluminum
1	Outdoor	SW2030L1150	SNW2040L1150	Main Lug	150	Aluminum
1	Outdoor	SW2040B1200	SNW2040B1200	Main Breaker	200	Aluminum
1	Outdoor	SW2040C1200	SNW2040C1200	Main Convertible	200	Aluminum
1	Outdoor	SW2040L1200	SNW2040L1200	Main Lug	200	Aluminum
1	Outdoor	SW2424B1125	SNW2424B1125	Main Breaker	125	Aluminum
1	Outdoor	SW2424C1125	SNW2424C1125	Main Convertible	125	Aluminum
1	Outdoor	SW2424L1125	SNW2424L1125	Main Lug	125	Aluminum
1	Outdoor	SW3040B1125	SNW3048B1125	Main Breaker	125	Aluminum
1	Outdoor	SW3040B1150	SNW3048B1150	Main Breaker	150	Aluminum
1	Outdoor	SW3040B1200	SNW3048B1200	Main Breaker	200	Aluminum
1	Outdoor	SW3040C1200	SNW3048C1200	Main Convertible	200	Aluminum
1	Outdoor	SW3040L1125	SNW3048L1125	Main Lug	125	Aluminum
1	Outdoor	SW3040L1200	SNW3048L1200	Main Lug	200	Aluminum
1	Outdoor	SW3054L1200	SNW3048L1200	Main Lug	200	Aluminum
1	Outdoor	SW4040B1150	SNW4040B1150	Main Breaker	150	Aluminum
1	Outdoor	SW4040B1200	SNW4040B1200	Main Breaker	200	Aluminum
1	Outdoor	SW4040C1200	SNW4040C1200	Main Convertible	200	Aluminum
1	Outdoor	SW4040L1200	SNW4040L1200	Main Lug	200	Aluminum
1	Outdoor	SW4260B1225	SNW4264B1225	Main Breaker	225	Aluminum
1	Outdoor	SW4260L1225	SNW4264L1225	Main Lug	225	Aluminum

Circuit Breakers

Arc-Fault and Ground-Fault Breakers

Selection

LOAD CENTERS & CIRCUIT BREAKERS

Arc-Fault Circuit Interrupters (AFCI)

AFCI's are designed to detect arcing faults (an unintentional arcing condition in a circuit) and mitigate the effects by functioning to de-energize the circuit when an arc-fault is detected.

Combination Type AFCI

Detects all three possible types of arc faults: line-to-ground, line-to-neutral and series arcs.

Breaker Type	Amp Rating	10,000 A IR Catalog No.	22,000 A IR Catalog No.	65,000 A IR Catalog No.
QAF2/QAFH2/HQAF2 1-Pole 120V AC	15	QA115AFC	QA115AFCH	QA115AFCHH
	20	QA120AFC	QA120AFCH	QA120AFCHH
QAF/QAFH 2-Pole 120/240V AC	15	Q215AFC	Q215AFCH	—
	20	Q220AFC	Q220AFCH	—
QTA NEW Tandem 120V AC	15/15	Q1515AFC	—	—
	20/20	Q2020AFC	—	—
QAF2N Plug-on Neutral / 1-Pole 120V AC	15	QA115AFCN	—	—
	20	QA120AFCN	—	—
QAFN Plug-on Neutral / 2-Pole 120/240V AC	15	Q215AFCN	—	—
	20	Q220AFCN	—	—
QTAN NEW Plug-on Neutral / Tandem 120V AC	15/15	Q1515AFCN	—	—
	20/20	Q2020AFCN	—	—

Dual Function (AFCI/GFCI)

The Dual Function Circuit Breaker combines Combination Type AFCI and 5mA Class A GFCI protection in one device.

Breaker Type	Amp Rating	10,000 A IR Catalog No.	22,000 A IR Catalog No.	65,000 A IR Catalog No.
QFGA2/QFGAH2/HQFGA2 1-Pole 120V AC	15	Q115DF	Q115DFH	Q115DFHH
	20	Q120DF	Q120DFH	Q120DFHH
QFGA2N Plug-on Neutral / 1-Pole 120V AC	15	Q115DFN	—	—
	20	Q120DFN	—	—

Ground-Fault Circuit Interrupters (GFCI)

Class A (5mA) Ground Fault Protection Intended for personnel protection.

Breaker Type	Amp Rating	10,000 A IR Catalog No.	22,000 A IR Catalog No.	65,000 A IR Catalog No.
QPF2 / QPHF2 / HQPF2 1-Pole 120V AC	15	QF115A	QF115AH	QF115AHH
	20	QF120A	QF120AH	QF120AHH
	30	QF130A	QF130AH	QF130AHH
QPF/QPHF 2-Pole 120/240V AC	15	QF215A	QF215AH	—
	20	QF220A	QF220AH	—
	25	QF225A	—	—
	30	QF230A	QF230AH	—
	35	QF235A	—	—
	40	QF240A	QF240AH	—
	45	QF245A	—	—
	50	QF250A	QF250AH	—
QPF2N Plug-on Neutral / 1-Pole 120V AC	15	QF115AN	—	—
	20	QF120AN	—	—
	30	QF130AN	—	—

Ground-Fault Equipment Protection (30mA)

QE2/QEH2 1-Pole 120V AC	15	QE115	QE115H
	20	QE120	QE120H
	30	QE130	QE130H
QE/QEH 2-Pole 120/240V AC	15	QE215	QE215H
	20	QE220	QE220H
	30	QE230	QE230H
	40	QE240	QE240H
	50	QE250	QE250H
	60	QE260	QE260H

Accessories

Description	Catalog Number ^①
Padlocking Device 1-Pole	ECPLD1
Padlocking Device 2-Pole	ECPLD2
Handle Block	ECBX231M

■ Built to order. Allow 8 -10 weeks for delivery.



1-Pole Combination Type AFCI



2-Pole Combination Type AFCI



1-Pole Dual Function AFCI/GFC



1-pole Tandem Type AFCI



1-Pole AFCI Plug-on Neutral



1-Pole Dual Function Plug-on Neutral



1-Pole GFCI



2-Pole GFCI

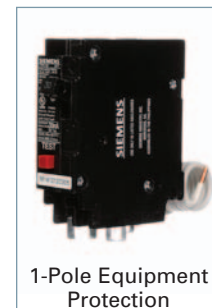

1-Pole Equipment Protection



2-Pole Equipment Protection

Circuit Breakers

Type QP with INSTA-WIRE

Continuous Current Rating @ 40° C	Type QP ^①	Type QPH	Type HQP
	10,000A IR	22,000A IR	65,000A IR
	Catalog Number	Catalog Number	Catalog Number

1-Pole Plug-In (120/240V AC)^⑤

Rating	Type QP	Type QPH	Type HQP
10	Q110 ^②	—	—
15	Q115 ^③	Q115H ^④	Q115HH ^③
20	Q120 ^③	Q120H ^③	Q120HH ^③
25	Q125	Q125H■	Q125HH■
30	Q130	Q130H	Q130HH■
35	Q135■	Q135H■	Q135HH■
40	Q140	Q140H	Q140HH■
45	Q145■	Q145H■	Q145HH■
50	Q150	Q150H	Q150HH■
60	Q160	Q160H■	Q160HH■
70	Q170	Q170H■	Q170HH■



2-Pole Plug-In (Common-Trip 120/240V AC)^⑥

Rating	Type QP	Type QPH	Type HQP
10	Q210 ^②	—	—
15	Q215	Q215H	Q215HH
20	Q220	Q220H	Q220HH
25	Q225	Q225H■	Q225HH■
30	Q230	Q230H	Q230HH
35	Q235	Q235H■	Q235HH■
40	Q240	Q240H	Q240HH■
45	Q245	Q245H■	Q245HH■
50	Q250	Q250H	Q250HH
60	Q260	Q260H	Q260HH
70	Q270	Q270H	Q270HH
80	Q280	Q280H■	Q280HH■
90	Q290	Q290H	Q290HH■
100	Q2100	Q2100H	Q2100HH
110	Q2110	Q2110H	Q2110HH■
125	Q2125	Q2125H	Q2125HH



2-Pole Plug-In (Common-Trip 240V AC)^{④⑥}

Rating	Type QP	Type QPH	Type HQP
15	Q215R	—	—
20	Q220R	—	—
30	Q230R	—	—
40	Q240R	—	—
50	Q250R	—	—

3-Pole Plug-In (Common-Trip 240V AC)^⑦

Rating	Type QP	Type QPH	Type HQP
15	Q315	Q315H	Q315HH■
20	Q320	Q320H	Q320HH
25	Q325	Q325H■	Q325HH■
30	Q330	Q330H	Q330HH
35	Q335	Q335H■	Q335HH■
40	Q340	Q340H	Q340HH
45	Q345	Q345H■	Q345HH■
50	Q350	Q350H	Q350HH
60	Q360	Q360H	Q360HH
70	Q370	Q370H	Q370HH■
80	Q380	Q380H	Q380HH■
90	Q390	Q390H	Q390HH■
100	Q3100	Q3100H	Q3100HH



QP / QPH / HQP Internal Accessories

Control Voltage AC	Catalog Number	Field/Factory Installed
120V Shunt Trip	add suffix ...00S01■	Factory
24V Shunt Trip	add suffix ...00S07■	Factory
120V Auxiliary Switch	add suffix ...01■ ^②	Factory

Modifications

Description	Catalog Number
400 Hz Calibration	add suffix ...Y ^⑧
Marine 50°C Ambient Calibration	add suffix ...M
Fungus Proofing	add suffix ...F

For external accessories please refer to page 1-48.

■ Built to order. Allow 2-3 weeks for delivery.

① UL Listed for use with 60/75° wire through 40 amps, UL listed for use with 75° wire only for 50 amps and above, HACR rated.

② 1A and 1B contacts.

③ UL Listed for frequent switching applications (SWD). 120V AC Fluorescent Lighting.

④ UL Listed for use on 3-phase grounded "B" systems — 10,000 for this application.

⑤ Shipped 12 per sleeve.

⑥ Shipped 6 per sleeve.

⑦ Shipped 4 per sleeve.

⑧ UL Listed 5 KA IR.

⑨ Type QP1, UL listed for 16 AWG conductors and multiple wires.

Circuit Breakers

Duplex, Triplex and Quadplex Plug-In Breakers

Duplex Circuit Breakers

Breaker Type	Ampere Rating	Catalog Number	Catalog Number
QT 1-Pole 10K AIC 120V AC	15-15	Q1515	Q1515NC ^①
	15-20	Q1520	Q1520NC ^①
	20-20	Q2020	Q2020NC ^①
	20-30	Q2030	—
	30-15■	Q3015	—
	30-20	Q3020	—
	30-30	Q3030	Q3030NC ^①
SHIPPING: 12 per carton, (Wt. 4.8 lbs.)			

Triplex Circuit Breakers

Breaker Type	Ampere Rating		Catalog Number	
	Single Pole	Common-Trip 2-Pole		
QT 2-Pole 10K AIC 120/240V AC Inner Poles Common Trip	15	15	Q21515CT	
	15	20	Q21520CT	
	15	25	Q21525CT ■	
	15	30	Q21530CT	
	15	35	Q21535CT ■	
	15	40	Q21540CT	
	15	45	Q21545CT ■	
	15	50	Q21550CT	
	20	20	Q22020CT	
	20	25	Q22025CT ■	
	20	30	Q22030CT	
	20	35	Q22035CT ■	
	20	40	Q22040CT	
	20	45	Q22045CT ■	
	20	50	Q22050CT	
	30	30	Q23030CT	
	SHIPPING: 6 per carton, (Wt. 4.9 lbs.)			

Quadplex Circuit Breakers

Breaker Type	Ampere Rating		Catalog Number
	Common-Trip 2-Pole Outside	Common-Trip 2-Pole Inside	
QT 2-Pole 10K AIC 120/240V AC Inner and Outer 2 Poles Common Trip	15	15	Q21515CT2
	15	30	Q21530CT2
	20	20	Q22020CT2
	20	50	Q22050CT2
	30	20	Q23020CT2
	30	25	Q23025CT2
	30	30	Q23030CT2
	30	50	Q23050CT2
	40	20	Q24020CT2
	40	30	Q24030CT2
	40	40	Q24040CT2
	SHIPPING: 6 per carton, (Wt. 4.8 lbs.)		

QT Duplex

These space saver duplex breakers combine two independent 1/2" breaker poles in a common unit. This unit plugs into one load center stab and requires one panel space. HACR rated.

QT Triplex

These space saver triplex breakers provide a 2-pole common trip breaker for 120/240V AC circuits and two single poles for 120V AC circuits. Triplex require two panel spaces. HACR rated.

QT Quadplex

These space saver quadplex breakers provide two sets of common trip, two-pole breakers for 120/240V AC circuits, and require two panel spaces. HACR rated.

For external accessories, please refer to page 1-48.

Circuit Breakers

Special Application Breakers

HID Lighting

For high-intensity discharge lamp loads having in-rush currents above the instantaneous trip setting of a standard breaker.

Breaker Type	Wiring Diagram	Complete Breaker UL Unenclosed	
		Ampere Rating	Catalog Number
QP 1-Pole 120V AC	Figure 1	15	Q115HID ^① ■
		20	Q120HID ^①
		30	Q130HID
QP 2-Pole 120/240V AC	Figure 2	15	Q215HID
		20	Q220HID ■
		30	Q230HID ■

Molded Case Switch

For applications that do not require overcurrent protection.

QP 1-Pole 120V AC	Figure 1	100	Q1100S
QP 2-Pole 120/240V AC	Figure 2	30	Q230S
		50	Q250S
		60	Q260S
		125	Q2125S

No-Noise

For applications that require a reduction in the 60-cycle hum of a standard breaker.

QP 2-Pole 120/240V AC	Figure 2	50 60	Q250NN ■ Q260NN
------------------------------------	----------	----------	--------------------

Switching Neutrals

Used where all conductors are required to be disconnected. Neutral pole of the circuit breaker does not connect to load center bus. One side is wired to neutral and the other side to the device.

QG 2-Wire Common Trip 120V AC	Figure 3	15 20	QG215 QG220
QG 3-Wire Common Trip 120/240V AC	Figure 4	20	QG320



Switching Neutral

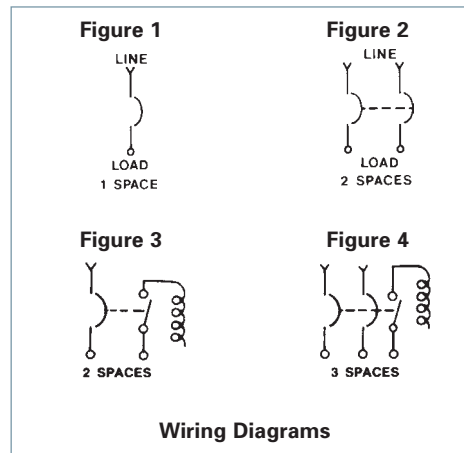

Wiring Diagrams

■ Built to order. Allow 2–3 weeks for delivery.
Note: All circuit breakers on this page are 10K AIC

① UL Listed as SWD (Switching Duty) Rated, suitable for 120V AC Fluorescent Lighting.

Circuit Breakers

3/4 Inch Plug-In Breakers

Features

- 3/4" format
- HACR Rated
- UL Classified for use in certain Square D load centers

Type QD Circuit Breakers

The Type QD circuit breaker line is available in 1-pole and 2-pole common trip versions listed on this page.

The circuit breakers are UL Classified and UL Listed.

All QD breakers are supplied with load side connectors suitable for 60/75°C wire and are calibrated for 40°C maximum ambient applications.

UL Classified

Siemens Type QD circuit breakers are UL Classified for use in specific Square D load centers in place of Square D Type QO® circuit breakers. A Panelboard Compatibility List packaged with each QD breaker shows which type QD circuit breakers are acceptable for use in Square D load centers.

The interrupting rating on these circuit breakers is 10,000A IR maximum and they are **not** series rated with Square D circuit breakers or equipment. This UL Classification allows a Siemens Type QD circuit breaker to be used in place of a Square D Type QO circuit breaker in those load centers that are specifically shown on the Panelboard Compatibility list. For additional information, contact your local Siemens sales engineer.



D120



D220

Continuous Current Rating @ 40°C	1-Pole	2-Pole
	120V	120/240V Common Trip
	Catalog Number	Catalog Number
15	D115 ^①	D215
20	D120 ^①	D220
30	D130	D230
40	D140	D240
50	D150	D250
60	D160	D260

Shipping Weights

Number of Poles	Number Per Carton	Shipping Weight (lbs.)
1	16	3.8
2	8	4.2

Panelboard Compatibility List

Listed Panelboards—Square D—Catalog Numbers

QO2L30F/S	QO12M100/RB	QO120-30M150/RB	QO130-40M200
QO2-4L70F/S	QO16-20M100/RB	QO124L150G	QO130M200/RB
QO2-4L70TS	QO16M100/RB	QO124M150	QO130-40L200G/RB
QO2-4L70RB	QO20M100/RB	QO130L150G/RB	QO140M200/RB
QO6-12L100F/S	QO112L125G/RB	QO130M150/RB	QO16L200/RB
QO6-12L100DF/S	QO112-24L125G/RB	QO16L150/RB	QO16M200/RB
QO6-12L100TF/S	QO112-24L125GWGC	QO16M150/RB	QO18-16M200FTRB
QO6-12L100DTF/S	QO116L125G	QO16-30L150/RB	QO20-40L200/RB
QO6-12L100RB	QO116-24L125G/RB	QO18-16M150FTRB	QO20-40M200TF/S
QO8-16L100F/S	QO12-24L125/RB	QO20-30M150/RB	QO20-40M200/RB
QO8-16L100DF/S	QO120-24L125G	QO20-30M150TF/S	QO24L200/RB
QO8-16L100TF/S	QO120-24L125GWGC	QO20-30L150	QO24M200/RB
QO8-16L100DTF/S	QO120L125G	QO24L150/RB	QO30L200/RB
QO8-16L100RB	QO124L125G/RB	QO24M150/RB	QO30M200/RB
QO112M100/RB	QO124M125/RB	QO30L150/RB	QO30-40L200/RB
QO116M100/RB	QO16L125/RB	QO30M150/RB	QO30-40M200/RB
QO120M100/RB	QO16-12M125FTRB	QO8-16M200FT/RB	QO40M200/RB
QO124M100	QO16-24L125/RB	QO112L200G/RB	QO140M225
QO12L100DF/S	QO20L125/RB	QO120-40M200/RB	QO142L225G/RB
QO12L100RB	QO20-24L125/RB	QO120-40M200TC	
QO12-20M100/RB	QO24L125/RB	QO124M200	
QO12-20M100TF/S	QO120-30L150G	QO130L200G/RB	

For inches / millimeters conversion, see Application Data section.

① UL Listed for frequent switching applications (SWD). 120V AC Fluorescent Lighting. One or two load conductors.

Circuit Breakers

Main and Branch Circuit Breakers^①

Breaker Type	Ampere Rating	Catalog Number	Catalog Number	UL Interrupting Ratings (kA)
QN 2-Pole 120/240V AC	150	QN2150	QN2150R ^②	10
	175	QN2175■	QN2175R ^② ■	10
	200	QN2200	QN2200R ^②	10
QNH 2-Pole 120/240V AC	150	QN2150H	QN2150RH ^②	22
	175	QN2175H■	QN2175RH ^② ■	22
	200	QN2200H	QN2200RH ^②	22
HQN 2-Pole 120/240V AC	150	HQN2150	HQN2150R ^②	65
	175	HQN2175■	—	65
	200	HQN2200	HQN2200R ^②	65

Requires 4 panel spaces, 2 adjacent and 2 opposite. **SHIPPING:** 1 per carton (Wt. 3 lbs.)

Main Breaker Kits

For use in PL, ES, and Ult Load Centers ^④			For use in EQIII Load Centers			
UL Type	Ampere Rating	Catalog Number	UL Type	Ampere Rating	Catalog Number	UL Interrupting Ratings (kA)
EQ8681	100	MBK100A	EQ9675	100	MBK100	22
EQ8682	125	MBK125A	EQ9677	125	MBK125	22
EQ8693	150	MBK150A	EQ9683	150	MBK150	22
—	—	—	EQ9684	175	MBK175■	22
EQ8695	200	MBK200A	EQ9685	200	MBK200	22
EQ8696	225	MBK225A	EQ9686	225	MBK225	22

Breaker Type	Ampere Rating	Catalog Number	UL Interrupting Ratings (kA)
QPJ ^⑤ 3-Pole 240V AC	125	QPJ3125	10
	150	QPJ3150	10
	200	QPJ3200	10

Requires 6 spaces due to cross over design. Fits only EQIII 125-400A 3-phase load centers

SHIPPING: 5 per carton (Wt. 17 lbs.)

Breaker Type	Ampere Rating	Catalog Number	UL Interrupting Breaker Ratings (kA) Volts AC 120/240
QPP 2-Pole 120/240V AC	125	Q2125B	10
	150	Q2150B	10
	175	Q2175B■	10
	200	Q2200B	10
	225	Q2225B	10
QPPH 2-Pole 120/240V AC	125	Q2125BH	22
	150	Q2150BH	22
	175	Q2175BH■	22
	200	Q2200BH	22
HQPH 2-Pole, 120/240V AC	100	HQ2100H	100
	125	HQ2125H	100
HQPP 2-Pole 120/240V AC	125	Obsolete	
	150		
	175		
	200		
HQPPH 2-Pole 120/240V AC	225	Obsolete	
	100		
	125		
	150		
	175		

For inches / millimeters conversion, see Application Data section.
■ Built to order. Allow 2-3 weeks for delivery.

- ① All circuit breakers on this page are common trip.
- ② Reverse handle.
- ③ CSA Listed.
- ④ MBK100A for use in 100 and 125A load centers.
MBK125A for use in 125A load centers.
MBK150A for use in 150, 200 and 225A load centers.
MBK200A for use in 200 and 225A load centers.
MBK225A for use in 225A load centers.
MBK175A for use in 200 and 225A load centers.

- ⑤ QNR required for horizontal applications or vertical applications where the lugs are facing up. The QN breaker is required for vertical applications where the lugs are facing down as shown.



QNR^⑤ QN^⑤



EQ9675

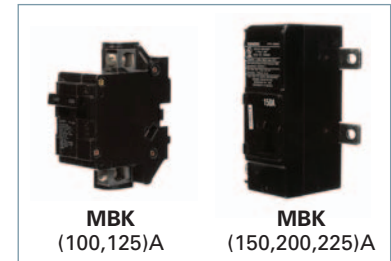

MBK (100,125)A MBK (150,200,225)A



QPJ



2-Pole QPP

Circuit Breakers

Lug Data

Circuit Breaker Type	Circuit Breaker Ampere Rating	Cables Per Connector	Connector Wire Range
	LOAD SIDE		
QP, QPH, HQP, Plug-in	10	1 or 2	#14-#16 AWG Cu
	15-35	1 1	#14-#6 AWG Cu #14-#6 AWG Al
	40-50	1 1	#8-#6 AWG Cu #8-#4 AWG Al
	55-125	1 1	#8-#2/0 AWG Cu #8-#2/0 AWG Al
QP 1 & 2-Pole Only	55-60	1	#6-#4 AWG Cu-Al (#3 AWG compatible with QPH & HQP)
QT	15-35	1 1	#14-#6 AWG Cu #14-#6 AWG Al
	40	1	#8 AWG CU-AL
	40-50 Exception: 1 & 2-pole QP at 55-60	1 1	#8-#6 AWG Cu #8-#4 AWG Al
QPF, QPHF	15-30	1 1	#14-#10 AWG Cu #12-#8 AWG Al
	40-60	1 1	#8-#6 AWG Cu #8-#4 AWG Al
QAF2, QAFH2, QFGA2, QFGAH2	15-20	1 1	#14-#12 AWG Cu #12-#10 AWG Al
QD	15-20	2	#14-#10 AWG Cu Only
	15-20	1 1	#14-#12 AWG Cu #12-#10 AWG Al
	25-35	1 1	#10-#8 AWG Cu #10-#6 AWG Al
	40-60	1 1	#8-#6 AWG Cu #8-#4 AWG Al
QN, QNH, HQN	150-200	1	#1-300kcmil Cu-Al
QS, QSH, QSHH, HQS, HQSH	100-225	1	#3-300kcmil Cu-Al
EQ8681-Ultimate, PL, ES, PN, SN	100	1	#4-3/0 AWG Cu-Al
EQ8682-Ultimate, PL, ES, PN, SN	125	1	#4-3/0 AWG Cu-Al
EQ8693-Ultimate, PL, ES, PN, SN	150	1	#1-300kcmil Cu-Al
EQ8695-Ultimate, PL, ES, PN, SN	200	1	#1-300kcmil Cu-Al
EQ8696-Ultimate, PL, ES, PN, SN	225	1	#1-300kcmil Cu-Al
QPP, QPPH, HQPP, HQPPH	125	1 1	#1 AWG Cu #2/0 AWG Al
	150	1 1	#1/0 AWG Cu #3/0 AWG Al
	175	1 1	#2/0 AWG Cu #4/0 AWG Al
	200	1 1	#3/0 AWG Cu 250kcmil AWG Al
	225	1 1	#4/0 AWG Cu 300kcmil AWG Al
EQ9675-EQIII	100	1 1	#8-#2/0 AWG Cu #8-#2/0 AWG Al
EQ9677-EQIII	125	1 1	#8-#2/0 AWG Cu #8-#2/0 AWG Al
EQ9683-EQIII	150	1 1	#1/0 AWG Cu #3/0 AWG Al
EQ9684	175	1 1	#3/0 AWG Cu 250kcmil AWG Al
EQ9685-EQIII	200	1 1	#2/0 AWG Cu #4/0 AWG Al
EQ9686-EQIII	225	1 1	#4/0 AWG Cu 300kcmil AWG Al
QPJ	125-200	1	#2-300kcmil Cu-Al

Circuit Breakers

Circuit Breaker Accessories

Circuit Breaker Accessories ④⑤⑥⑦⑧⑨

Catalog Number	For Use With Breaker Type	Number of Poles	Standard Package
Padlocking Device			
For locking breaker in "OFF" position. Note "ON" position does not affect breaker functionally			
ECPLD1	Type QP, BL, QAF2, QPF2, QE, QT-Duplex, BQ, BQXD	1P	3 Pieces
ECPLD1R	Type QP, BL, QAF2, QPF, QE, QT-Duplex, BQ, BQXD (Red Color)	1P	3 Pieces
ECPLD2	Type QP, BL, QAF2, QPF, QE, QT-Triplex & Quadplex, BQ, BQXD	2P	3 Pieces
ECPLD2R	Type QP, BL, QAF2, QPF, QE, QT-Triplex & Quadplex, BQ, BQXD (Red Color)	2P	3 Pieces
ECPLD3	Type QP, BL, QAF2, QPF, QE, BQ	3P	1 Piece
US2:ECPLD3R	Type QP, BL, QAF2, QPF, QE, BQ (Red Color)	3P	1 Piece
ECQLD3	Type QP, BL, BQ, BQXD	1P	10 Pieces
ECQLD4	Type QT-Duplex	QT-Duplex Breakers	10 Pieces
ECQLN3 ^②	150-225 MBKA, QN, QNR	n/a	1 Piece
ECQTH4	Type QP, BL, BQH	Designed for (3) 1P Breakers	1 Piece
Handle Tie			
Provide simultaneous swiching of 2 adjacent handles.			
ECQTH2	Type QT Duplex	Designed for (2) QT Duplex Breakers	25 Pieces
ECQTH3	Type QP, BL	2P	50 Pieces
Mechanical Interlock^①			
ECQML12	Type QP, BL, BQ Interlock Bracket	Designed for 1" Breaker	10 Pieces
Handle Blocking Device			
For holding breaker in "ON" or "OFF" position. Not a lockout/tagout device			
ECQL1	Type QP, BL, BQ, BQXD	1P	10 Pieces
ECBX231M	Type QT-Duplex	1/2" Breakers	10 Pieces
Main Breaker Retainer			
ECMBR1 ^③	EQ Load Centers		1 Piece
ECMBR2	PL, ES, and Ultimate Load Centers: 2-pole QP		1 Piece
ECMBR3	PL, ES, and Ultimate Load Centers: 3-pole QP		1 Piece
Mounting Accessories			
MB120	Type BQ, BQH Mounting Clips	1P	20 Pieces
FP9508	Type BQ, BQH FACE MOUNT PLATE	1P	10 Pieces
FP9555	Type BQ, BQH FACE MOUNT PLATE	2P	10 Pieces
FP9556	Type BQ, BQH FACE MOUNT PLATE	3P	10 Pieces
SMB6R	Type BQ MOUNTING BRACKET	1P, 2P, 3P	6 Pieces
TCH65K	Type BQ MOUNTING ADAPTER		500 Pieces
BR2	Type BQ, BQH, BQXD Back Mounting Plates	2P	10 Pieces
BR3	Type BQ, BQH, BQXD Back Mounting Plates	3P	10 Pieces
BR4	Type BQ, BQH, BQXD Back Mounting Plates	4P	10 Pieces
I0204ML1125CU	Type QP Back Mounting Plates	1P, 2P	10 Pieces
I0303ML3100CU	Type QP Back Mounting Plates	3P	10 Pieces
Replacement Lugs			
TA1Q1	Type BQ, NGG 100A Al Cu LGS	n/a	6 Pieces
TC1Q1	Type BQ, NGG 40A Al Cu LUGS	n/a	6 Pieces
Finger Shield			
BQFS1K	Type BQXD Finger Shield (Bulk Pack)	n/a	1000 Pieces
BQFS2	Type BQXD Finger Shield	n/a	2 Pieces
Filler Plate			
ECQF3	1" Filler Plate	n/a	5 Pieces

① For a complete list of standby power mechanical interlock kits, see page 1-25

③ For use with Ultimate Load Center Main Breakers

② Not suitable for use on 15-50A, 10 AIC Type QP Circuit Breakers

④ QP Type includes QPH, HQP

⑤ BL Type includes BLH, HBL

⑥ BQ Type includes BQH, HBO

⑦ QAF2 Type includes QAFH2, BAF2, BAFH2, QFGA2, QFGAH2, BFGA2, BFGAH2

⑧ QPF Type includes QPHF, BLF, BLHF

⑨ QE Type includes QEH, BLE, BLEH

Circuit Breakers

Circuit Breaker Accessories

Padlocking Device



ECPLD1

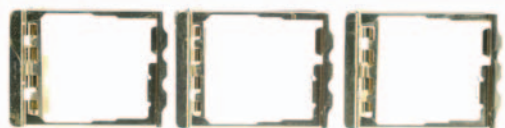

ECPLD2



ECPLD1R/2R/3R (Single pole pictured. 2-/3-pole available)



ECQLD3

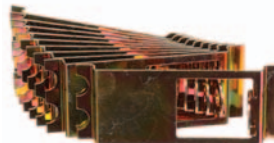

ECQLD4



ECQTH4

Handle Tie



ECQTH2



ECQTH3

Handle Blocking Device

ECQL1

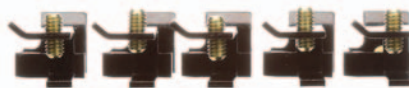

ECBX231M



Main Breaker Retainer



ECMBR1



ECMBR2

Mechanical Interlock

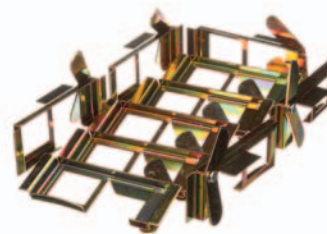

ECQML12

Mounting Accessories



MB120



SMB6R



I0204ML1125



FP9508



FP9555



FP9556

Surge Protection

Circuit Breaker and Surge Protective Device (SPD)

1 Features

- 2 inch wide plug-on design
 - Includes (2) 1 Pole circuit breakers
 - No loss of load center spaces
- Easy to install and perfect for retrofit
- LEDs provide protection status

Benefits

By installing a Siemens Circuit Breaker and Surge Protective Device (SPD) in the load center of the residence, surge protection is provided for all branch circuits®.

Two green LED indicator lights are provided to show that surge protection is provided for all circuits connected to the load center. These breakers should be used for circuit protection of frequently used household or facility circuits because the lights and devices connected to these circuits provide an effective indication that surge protection is being provided.

The circuit breaker and SPD utilize Siemens-built 150V AC, 40mm, metal oxide varistors (MOVs). The maximum impulse rating for the SPD module is 40kA. The standard interrupting rating for the circuit breakers is 10k AIC. All Type QP circuit breakers and SPD are plug-on style, with load terminals provided. The devices are rated for 120/240V AC and are calibrated for 40 degrees C maximum ambient applications.

Breaker Type	Ampere Rating	Catalog Number	Surge Type
QP 1- Pole 120/240V AC 10K AIC	(2) 15	QSA1515SPD	SPD
	(2) 20	QSA2020SPD	SPD

Catalog Number	QSA1515SPD QSA2020SPD
Amperage	15 or 20 Amp
Number of Poles	(2) 1-Pole Circuit Breakers
Initial Clamping Level	240 Volts
Transient Energy Rating	360 Joules line-to-neutral 720 Joules line-to-line
Transient Suppression	500 volts peak, line-to-neutral
Voltage Rating	1000 volts peak, line-to-line
Peak Current Rating (impulse)	40,000 amperes
Discharge Voltage Characteristic	@ 1,500A, 600 volts @ 5,000A, 800 volts (both line-to-neutral)
Discharge Current Withstand Rating	10,000 amperes line-to-neutral
Circuit Breaker Interrupting Rating	10,000A, 120/240V AC
Listings/Certifications	UL, CSA Meets UL 1449 4th Edition



© For warranty information please refer to the surge website www.usa.siemens.com/surge

Surge Protection

Power Service Entrance Surge Protection

FirstSurge™ - Power, Plus, or Pro

- 4th Listed, Type 2, Surge Protective Device (SPD)
 - Surge Current Capacities:
 - 60,000 A, FirstSurge Power (FS060)
 - 100,000 A, FirstSurge Plus (FS100)
 - 140,000 A, FirstSurge Pro (FS140)
 - 3 Stage Commercial Grade Notification:
 - Protection Status LEDs
 - Audible Alarm
 - Flashing Red Service LED
 - Ground Reference Monitoring (GRM)
 - 10 year product & connected equipment warranty*
- * See www.usa.siemens.com/surge for warranty terms and conditions.

Surge Type	Catalog Number
FirstSurge Power	FS060
FirstSurge Plus	FS100
FirstSurge Pro	FS140

AC Surge Protection	
UL and CSA Listings	1449 4th Edition & CSA 22.2 No. 269.2
Surge Spike Capacity	60kA, 100kA, or 140kA
Line Voltage	120/240 1 Phase 50/60 Hz
UL 1449 4th Edition VPR	L-N, L-G, N-G: 600 V; L-L: 900V
Rated Voltage (MCOV)	L-N, L-G, and N-G: 150V; L-L: 300V
Short Circuit Current Rating (SCCR)	100kA
Inominal (I _n) Rating	20kA
Response Time	<1 nanosecond
Enclosure	NEMA 4X Indoor and Outdoor Rated
Product Warranty	10 years

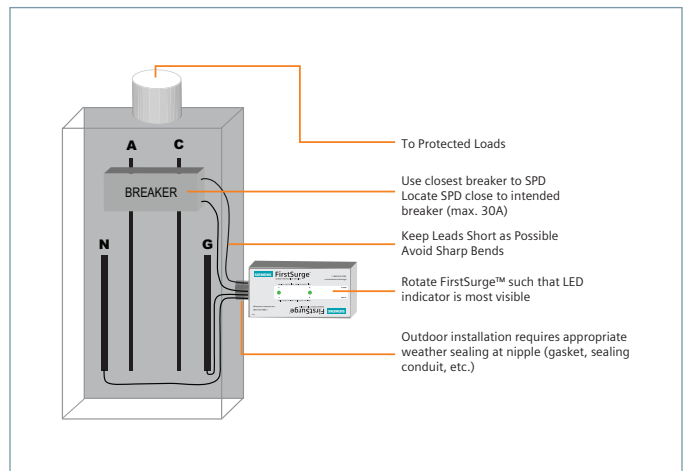

Type 1 SPD / Surge Arrestor Replacement

TPS3 03

TPS3 03 is a UL 1449 4th Edition 50 kA Type 1 compact surge protective device that can be used as a replacement secondary surge or lightning arrestors. Having a Type 1 designation allows for flexible electrical system connection location (line or load side) as well as UL 96A compliance (@ 20 kA I_n).

TPS3 03 Key Features

- UL 1449 4th Edition Listed Type 1
- Type 1 Rated SPD
- 50 kA Per Phase Surge Current
- 20 kA I_n (Most models)
- 200 kA SCCR (Most models)
- UL 96A Lightning Protection Master Labeling compliant (@ 20 kA)
- Every MOV is monitored
- Mounts external to electrical distribution equipment
 - Recommend for Line Side or Load Side Applications
- Standard compact NEMA 4X polycarbonate enclosure
- Modes of Protection: L-N or L-G and L-L
- Standard Monitoring: LED Indicator
- Dimensions: 3.25" x 3.25" x 3.3"
(82.6 mm x 82.6 mm x 83.8 mm)
- Weight: 2 lb. (0.9 kg)
- 2 Year Product Warranty

Available Options:

- Dry contacts & Audible Alarm (option "D")



Ordering Information

Catalog # **TPS3** **03**

<p>Voltage Code</p> <p>A = 120/240 V, 1Ø, 3W B = 120/240 V, 3Ø, 4W C = 120/208 V, 3Ø, 4W D = 240 V, 3Ø, 3W E = 277/480 V, 3Ø, 4W F = 480 V, 3Ø, 3W G = 600 V, 3Ø, 3W K = 380/220 V, 3Ø, 4W L = 600/347 V, 3Ø, 4W</p>	<p>Surge Current (kA)</p> <p>05 = 50 kA per phase</p>	<p>Options</p> <p>D = Dry contact & audible alarm</p> <p>N = Adds N-G Protection</p>
--	---	---

Example: **TPS3C0305D0** = Type 1 SPD for a 208/120V application with a surge current capacity of 50 kA per phase, in a standard NEMA 4X enclosure with dry contacts and audible alarm option.

When an option is not selected, include a **zero (0)** in the field.

Available Accessories: Ordered Separately

RMSIE = Remote monitor

SPD - Surge Protective Device

Telephone Service Entrance Surge Protection

FSPHONE & FSPHONE4X

- UL/cUL listed
- Hardwired Telephone/Modem/Fax/DSL protection
- Exceptionally fast response time
- Low insertion loss
- Available with or without enclosure
- 5 Year product warranty*

* See www.usa.siemens.com/surge for warranty terms and conditions.

The Siemens FSPHONE & FSPHONE4X is a 2 pair, hardwired surge protector designed to stop surges from entering through the main telephone incoming service connection. It is equipped with a failshort device to permanently ground the telephone line in the event of a power cross. The FSPHONE is designed for indoor applications where the FSPHONE4X is used for outdoor mounting is required.

The FSPHONE4X includes the FSPHONE plus a weatherproof enclosure to facilitate indoor or outdoor applications. The enclosure is molded of temperature and humidity resistant thermoplas-tic to resist cracking and discoloration. The cover can be secured with a tie wrap or similar locking device.



FSPHONE



FSPHONE4X

AC Surge Protection	
Catastrophic Surge Circuit	Yes
Spike Capacity	200 Amps
Let Through Voltage	<270V
Overcurrent Protection	Yes
Response Time	<1 nanosecond
Environmentally Sealed	Yes
UL/cUL Listings	497A
Meets Telcordia (formally Bellcore) GR-974-CORE Requirements for Telecommunications Line Protectors	Yes
Product Warranty	5 years

Surge Type	Catalog Number
Telco	FSPHONE
Telco	FSPHONE4X

Coaxial Service Entrance Surge Protection

FSCATV

- UL/cUL listed surge protection
- Rated for CATV, DSS, TV, VCR, and Cable Modem
- Easy to install
- Standard Female to Female F connector
- Low insertion loss
- Automatic recovery
- 5 Year product warranty*

* See www.usa.siemens.com/surge for warranty terms and conditions.

Siemens FSCATV shields coaxial connected electronics in residential and light commercial applications against electrical transient damage, including lightning, from entering through the main cable connection.

FSCATV includes a section of coaxial cable with female to female splice for line side application. The Siemens warranty covers product defects for 5 years. To have complete protection for your equipment, home, or business, it is important to protect AC power lines and all data lines the equipment is connected through.

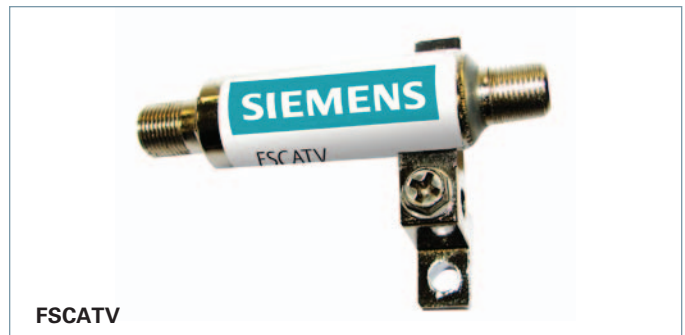

FSCATV

AC Surge Protection	
Frequency Range	DC thru 1.5 GHz
Catastrophic Surge Circuit	Yes
Spike Capacity	5000 Amps, 8/20 μSec
Impedance	75 Ohms
Overcurrent Protection	Yes
Return Loss	30dB @ 1 GHz
Insertion Loss	<0.1dB
UL/cUL Listings	497B
Meets IEEE C62.41.1 Requirements	Yes
Product Warranty	5 Years

Surge Type	Catalog Number
Coaxial	FSCATV

AC Disconnects

1-Phase, NEMA 3R Rated



Steel AC Disconnects^①

Ampere Rating	Disconnect Type	Catalog Number	Horse Power Rating	Dimensions			Pallet Qty.
				Height	Width	Depth	
30	Fused Pullout	WF2030	3	7¼	5	2½	360
60	Fused Pullout	WF2060	10	9	5	2½	360
60	Non-fused Pullout	WN2060	10	7¼	5	2½	360
60	Non-automatic Switch	WNAS2060	10	7¼	5	2½	360

Plastic AC Disconnects^①

Ampere Rating	Disconnect Type	Catalog Number	Horse Power Rating	Dimensions			Pallet Qty.
				Height	Width	Depth	
30	Fused Pullout	WF2030PL	3	7¼	5	2½	216
60	Fused Pullout	WF2060PL	10	7¼	5	2½	216
60	Non-fused Pullout	WN2060PL	10	7¼	5	2½	360
60	Non-Fused Pullout	WN2060PLX	10	8	5¼	3½	288
60	Non-automatic switch	WNAS2060PL	10	7¼	5	2½	360

Steel AC Disconnects with 15 Amp GFCI Receptacle^①

Ampere Rating	Disconnect Type	Catalog Number	Horse Power Rating	Dimensions			Pallet Qty.
				Height	Width	Depth	
30	Fused Pullout	WF2030GFCI	3	9	6⅝	5⅝	112
60	Fused Pullout	WF2060GFCI	10	9	6⅝	5⅝	112
60	Non-fused Pullout	WN2060GFCI	10	7⅞	5¼	5⅝	144
60	Non-automatic Switch	WNAS2060GFCI	10	7⅞	5¼	5⅝	144

Wire Range Table

Connector	Copper		Aluminum	
	Solid	Stranded	Solid	Stranded
Line	#14-8	#14-3	#12-8	#12-3
Load	#14-8	#14-3	#12-8	#12-3
Neutral	#12-8	#12-2	#12-8	#12-2
Equip. Grnd	#12-8	#12-2	#12-8	#12-2

① Accepts Class H Fuse

Load Centers and Circuit Breakers

Notes

1

LOAD CENTERS &
CIRCUIT BREAKERS