

SIEMENS

Ingenuity for life



G-frame Circuit Breakers

Product Guide

usa.siemens.com/circuitbreakers

Advantages to reduce your installed cost

- Compact size saves space and helps reduce overall panel size.
- Interchangeable lugs and nut keepers for customer-supplied connections allow for last minute changes on site.
- UL listed field installable accessories allow for last minute changes on site. Also, inventory can be minimized as these accessories cover two families of Siemens breakers.
- Integral DIN rail or base mounting capability simplifies mounting the breaker without having to add plates or adapters.
- CE/CSA/NOM marked UL breakers let you serve all major markets with one design.

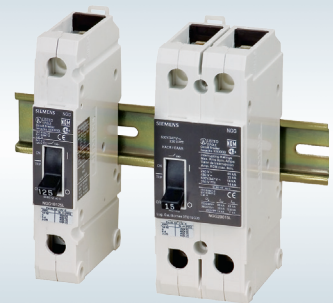
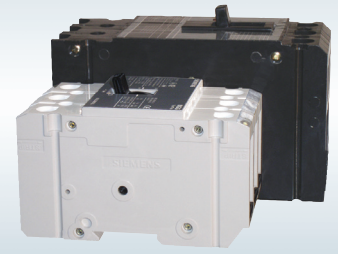

General information

The Siemens GG circuit breaker is a compact, industrial design thermal magnetic breaker with valuable features for the global markets. These features include a design that meets multi-national standards, is suitable for DIN rail or base mounting without the need for adapters, and includes UL listed field installable accessories. The GG also has an overcenter toggle mechanism that is trip free and uses repulsion contact arm construction. Therefore, should a short circuit or tripping condition occur, the contacts are forced apart and the breaker cannot be held closed by means of the handle.

The GB and GB2 circuit breakers include the same design features as the GG except the line end of the breaker is configured for panelboard mounting applications and it is without some of the global markings.

125A frame Type GG / GB / GB2

- Global rated (UL/CSA/ IEC /NOM)
UL489
CSA-C22.2 No. 5-02
IEC 60947-2 (GG) (PENDING)
NOM-003
- HACR, SWD, and HID marked (at applicable ratings)
- Integral DIN rail or base mount without adapters (GG)
- UL Listed field installable accessories
- Removable lugs
- 25 kA, 35 kA, 65 kA @ 480V AC (GG/GB2) 25 kA, 35 kA, 65 kA @ 480Y/277V AC (GB)
- Compact Size
3.0"W x 5.4"H x 2.8"D (1.0" wide per pole)
- 1, 2, 3 pole units
- Overcenter toggle and trip free mechanism
- Suitable for reverse feed applications
- Common trip
- Voltage ratings of 120V, 240V, 277V, 480V (GG / GB2)
480Y/277V AC, 600Y/347V AC
DC rated at 125V, 250V DC
- Meets or exceeds federal specifications W-C-375c
Classes 10b, 11a, 11b, 12b, 12c, 13a, 13b, 15b

Applications:

- With their compact size, the G-frame circuit breakers are well suited for OEM designed equipment in both light commercial and industrial applications.
- The GG can be independently mounted on DIN rail or held in place by mounting screws.
- The GB and GB2 breakers are for panelboard mounted applications.
- These circuit breakers may be used as incoming main and branch breakers in distribution systems.

Operating conditions:

- The GG circuit breakers are designed for use in enclosed rooms, in which there are no adverse operating conditions (e.g. dust, corrosive vapors, destructive gases).
- For installation in dusty and damp rooms or outdoors, suitable enclosures must be used.
- The G-Frame is factory calibrated for 40° C ambient.



General information

Ratings and markings

Type	Current range (A)	HACR rated	SWD marked	HID marked
1 pole	15 - 125	15 - 125	15 - 20	15 - 50
2 pole	15 - 125	15 - 125	—	15 - 50
3-pole	15 - 125	15 - 125	—	15 - 50

Shipping weight

Frame	1 pole	2 poles	3 poles
xGB	0.9 lbs. / 0.4 kgs.	1.9 lbs. / 0.9 kgs.	2.9 lbs. / 1.2 kgs.
GG/xGB2	0.75 lbs. / 0.34 kgs.	1.3 lbs. / 0.59 kgs.	2.0 lbs / 0.98 kgs.

Interrupting ratings (max. RMS symmetrical amperes kA)

Type	Poles	UL489						IEC 60947-2 (Ics = 50% Icu)					
		Volts AC						Volts DC		Volts AC			Volts DC
		120	240	277	347	480	600Y/347	125	125/250	240	415	125/250	
NGG	1	65	—	25	14	—	—	14	—	25	—	—	
	2, 3	—	65	—	—	25	14	—	14 ¹⁾	65	25	14 ¹⁾	
HGG	1	65	—	35	14	—	—	14	—	—	—	—	
	2, 3	—	65	—	—	35	14	—	14 ¹⁾	—	—	—	
LGG	1	65	—	65	14	—	—	14	—	—	—	—	
	2, 3	—	65	—	—	65	14	—	14 ¹⁾	—	—	—	

Type	Poles	UL489						Volts DC	
		Volts AC						125	125/250
		120	240	277	347	480Y/277	600Y/347	125	125/250
NGB	1	100	—	25	14	—	—	14	—
	2, 3	—	100	—	—	25	14	—	14 ¹⁾
HGB	1	100	—	35	14	—	—	14	—
	2, 3	—	100	—	—	35	14	—	14 ¹⁾
LGB	1	100	—	65	14	—	—	14	—
	2, 3	—	100	—	—	65	14	—	14 ¹⁾

Type	Poles	UL489						Volts DC	
		Volts AC						125	125/250
		120	240	277	347	480	600Y/347	125	125/250
NGB2	1	100	—	25	14	—	—	14	—
	2, 3	—	100	—	—	25	14	—	14 ¹⁾
HGB2	1	100	—	35	22	—	—	14	—
	2, 3	—	100	—	—	35	22	—	14 ¹⁾
LGB2	1	100	—	65	25	—	—	14	—
	2, 3	—	100	—	—	65	25	—	14 ¹⁾

1) 2-pole only or two outer poles of 3-pole breaker.

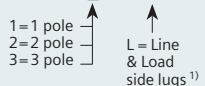
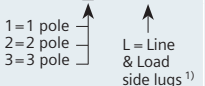
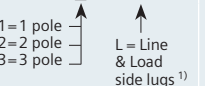
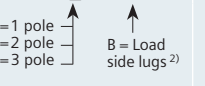
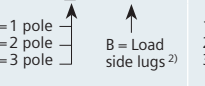
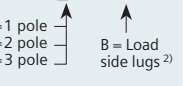

G-Frame 1, 2 and 3 poles

Ampere rating	NGG catalog number	HGG catalog number	LGG catalog number	NGB catalog number	HGB catalog number	LGB catalog number
In	(Cable in - Cable out)	(Cable in - Cable out)	(Cable in - Cable out)	(Low Tab Panelboard Mount)	(Low Tab Panelboard Mount)	(Low Tab Panelboard Mount)
15	NGG_B015L	HGG_B015L	LGG_B015L	NGB_B015B	HGB_B015B	LGB_B015B
20	NGG_B020L	HGG_B020L	LGG_B020L	NGB_B020B	HGB_B020B	LGB_B020B
25	NGG_B025L	HGG_B025L	LGG_B025L	NGB_B025B	HGB_B025B	LGB_B025B
30	NGG_B030L	HGG_B030L	LGG_B030L	NGB_B030B	HGB_B030B	LGB_B030B
35	NGG_B035L	HGG_B035L	LGG_B035L	NGB_B035B	HGB_B035B	LGB_B035B
40	NGG_B040L	HGG_B040L	LGG_B040L	NGB_B040B	HGB_B040B	LGB_B040B
45	NGG_B045L	HGG_B045L	LGG_B045L	NGB_B045B	HGB_B045B	LGB_B045B
50	NGG_B050L	HGG_B050L	LGG_B050L	NGB_B050B	HGB_B050B	LGB_B050B
60	NGG_B060L	HGG_B060L	LGG_B060L	NGB_B060B	HGB_B060B	LGB_B060B
70	NGG_B070L	HGG_B070L	LGG_B070L	NGB_B070B	HGB_B070B	LGB_B070B
80	NGG_B080L	HGG_B080L	LGG_B080L	NGB_B080B	HGB_B080B	LGB_B080B
90	NGG_B090L	HGG_B090L	LGG_B090L	NGB_B090B	HGB_B090B	LGB_B090B
100	NGG_B100L	HGG_B100L	LGG_B100L	NGB_B100B	HGB_B100B	LGB_B100B
110	NGG_B110L	HGG_B110L	LGG_B110L	NGB_B110B	HGB_B110B	LGB_B110B
125	NGG_B125L	HGG_B125L	LGG_B125L	NGB_B125B	HGB_B125B	LGB_B125B
						

1) This "L" indicates Line Side and Load Side lugs are supplied as standard. To order a GG without lugs, remove the L suffix.

2) This "B" indicates Load Side lugs are supplied as standard. To order a GB without lugs, remove the B suffix.

G-Frame 1, 2 and 3 poles (Panelboard mount)

Ampere rating	NGB2 catalog number	HGB2 catalog number	LGB2 catalog number
In	(Low Tab Panelboard Mount)	(Low Tab Panelboard Mount)	(Low Tab Panelboard Mount)
15	NGB_K015B	HGB_K015B	LGB_K015B
20	NGB_K020B	HGB_K020B	LGB_K020B
25	NGB_K025B	HGB_K025B	LGB_K025B
30	NGB_K030B	HGB_K030B	LGB_K030B
35	NGB_K035B	HGB_K035B	LGB_K035B
40	NGB_K040B	HGB_K040B	LGB_K040B
45	NGB_K045B	HGB_K045B	LGB_K045B
50	NGB_K050B	HGB_K050B	LGB_K050B
60	NGB_K060B	HGB_K060B	LGB_K060B
70	NGB_K070B	HGB_K070B	LGB_K070B
80	NGB_K080B	HGB_K080B	LGB_K080B
90	NGB_K090B	HGB_K090B	LGB_K090B
100	NGB_K100B	HGB_K100B	LGB_K100B
110	NGB_K110B	HGB_K110B	LGB_K110B
125	NGB_K125B	HGB_K125B	LGB_K125B
			

Note: Load Lugs are included as standard. HACR rated.

Internal accessories

Shunt trip, auxiliary switches, and alarm switches are operational devices that are contained within an add-on module for the G-frame circuit breakers. One module can be attached to the left side only of the circuit breaker. Each module can be installed in the field.

Shunt trip – A shunt trip is used to trip the breaker remotely. It is operated by providing voltage to the shunt trip coil. The coil in this device is designed to be energized only momentarily, so included is a built-in limit switch which opens the coil circuit after the breaker trips. With the circuit breaker in the tripped position, voltage cannot be applied through the coil circuit due to the open contacts in the limit switch. The operational range of this device is (70 to 110%) of the marked voltage rating.

Auxiliary switches – Auxiliary switches are used for remote indication of breaker contact position (ON or OFF). Each switch consists of "A" (normally open) and "B" (normally closed) contact with a common connection. These devices are typically used for signaling purposes.

Alarm switch – The alarm switch provides indication of breaker tripping. Alarm contacts operate off of the tripping mechanism of the circuit breaker and only change state when the breaker is tripped. Each alarm switch consists of 1 "A" (normally open) and 1 "B" (normally closed) contact, with a common connection. Sometimes these are also called Bell Alarms.

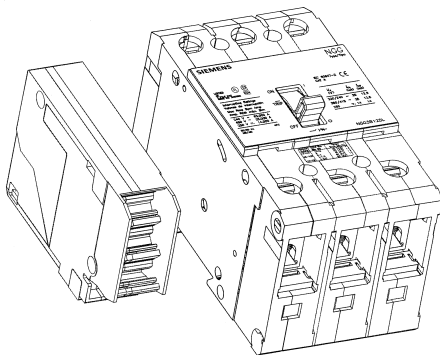

Mounted left side only, not available on single pole breakers.

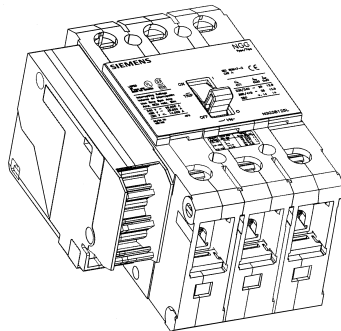

Available accessory combinations

Shunt trip	Auxiliary switch	Alarm contact
1	0	0
0	1	0
0	2	0
1	1	0
0	0	1
0	1	1

Accessories

Shunt trip – Contains (1) shunt trip device. A combination includes a shunt trip device and an auxiliary switch with 1A-1B contacts.

Control Voltage			Shunt trip	Shunt trip and auxiliary switch combination
AC	DC	Current draw	Catalog number	Catalog number
120	—	0.09A	CQDST120	CQDST120AAS
240	—	0.50A	CQDST240	CQDST240AAS
277	—	0.55A	CQDST277	CQDST277AAS
480	—	0.45A	CQDST480	CQDST480AAS
600	—	0.50A	CQDST600	CQDST600AAS
—	12	1.20A	CQDST12	CQDST12DAS
—	24	0.80A	CQDST24	CQDST24DAS
—	48	0.80A	CQDST48	CQDST48DAS
—	125	0.35A	CQDST125	CQDST125DAS

Auxiliary switch – Contains (1) or (2) sets of “A” contacts and “B” contacts.

Maximum control supply voltage U _s		Single auxiliary switch 1A-1B contact		Double auxiliary 2A-2B switch contacts	
AC	DC	Catalog number	Maximum operational current	Catalog number	Maximum operational current
240	125	CQDA1	@240V AC – 15A @125V DC – 0.5A	CQDA2	@240V AC – 15A @125V DC – 0.5A

Alarm switch – Contains (1) set of “A” and “B” contacts.

Maximum control supply voltage U _s		Single alarm switch	Auxiliary and alarm switch	Maximum operational current
AC	DC	Catalog number	Catalog number	
240	125	CQDBA	CQDA1BA	@240V AC – 15A @125V DC – 0.5A

Position of the toggle handle

Position of the auxiliary switch contacts

Position of the alarm switch contacts

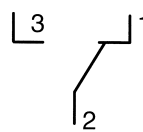
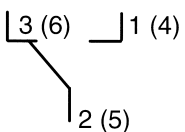
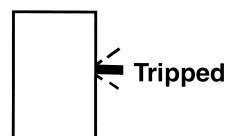
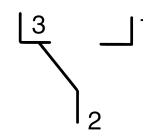
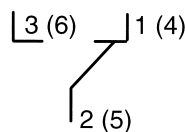
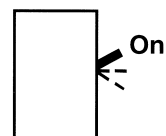
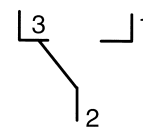
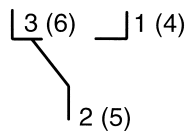
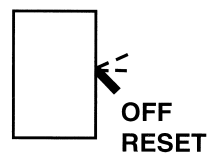

External accessories

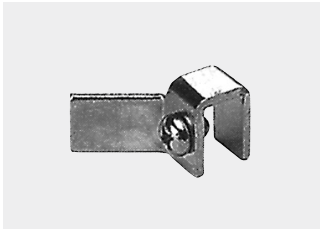

Handle blocking device
BQDHBD



Handle padlock device
HPLG
(use BQDPLD in panelboards)



Mounting screw kit
MSKG4



Handle tie
BQDHT2 and BQDHT3
(with padlock)

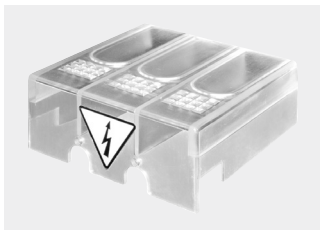

Terminal Shield (3 pole)
TSSG3A
(Line or Load Side)

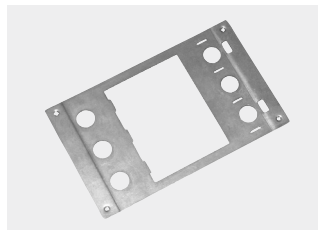

Face mounting plate
FMPG1 1-pole
FMPG2 2-pole
FMPG3 3-pole



Nut keeper plate
TNKG3 (kit of 3)

Terminal connectors

Lug information

Breaker amp rating (A)	Wire size (AWG)	Torque Inch-lb (NM)	Lug Catalog number	
15 – 30	#14-#10 Al or Cu #8 Al or Cu	35 (4.0) 40 (4.5)	3TC1Q1 (pkg. of 3)	TC1Q1 (pkg. of 1)
35 – 125	#8 Al or Cu #6 - #4 Al or Cu #3 - 1/0 Al or Cu	40 (4.5) 45 (5.1) 55 (6.2)	3TC1GG20 (pkg. of 3)	

Distribution Lugs

For circuit breaker types	Ampere rating	Poles	Lugs per kit	Wires per lug	Lug wire size	Catalog number
GG	15-125	1,2,3	1	6	#6-#4 AL #14-#4 Cu	TA6GG04

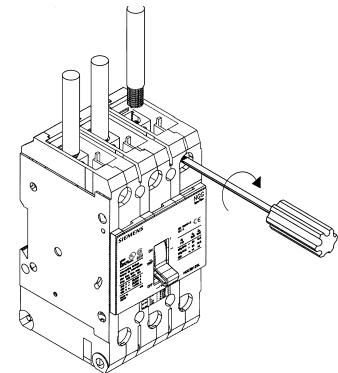

It is possible to remove factory installed lugs to allow customer-supplied connections.

Nut Keeper Plates are available instead of lugs for use with customer-supplied connections.

Accessories

Enclosures

Enclosure type	Mounting	Ampere rating	Catalog number
NEMA 1 – Indoor (general duty)	Surface	15 - 125	GG0121SN
NEMA 1 – Indoor (general duty)	Flush	15 - 125	GG0121FN
NEMA 3R – Outdoor (rain, snow)	Surface	15 - 125	GG0123RN
NEMA 4X – Outdoor (Corrosion Resistant; non-metallic)	Surface	15 - 125	GG0124XN

Strap Kits

Catalog number	Description	Panelboard type
MBKNB1	Main/Subfeed strap kit for _GB breakers – 1-phase	P1
MBKNB3	Main/Subfeed strap kit for _GB breakers – 3-phase	P1
BBKNB32 ³⁾	_GB 6-pole 3" branch breaker kit – P2/P3	P2, P3
SNB	Twin Mounting Panel Branch Kit – 1 and 3 Phase	P4
SNBD	Twin Mounting Panel Branch Kit – 1 and 3 Phase	P5

³⁾ Kit contains top barrier, (3) A/C connectors, (1) B connector, hardware.

Accessories

Handle Operators

Catalog number	Type	Description	NEMA enclosure
RHVM12H	Manual Rotary Door Mount Handle Operator - D/M-FR	Standard Handle	1, 12, 12K
RHVM3RH	Manual Rotary Door Mount Handle Operator - D-M	Metal Handle	1, 2, 3, 3R, 12, 12K, 13
RHVMEMH	Manual Rotary Door Mount Handle Operator - DG-MG	Red & Yellow Handle	1, 2, 3, 3R, 12, 12K, 13
RHVM4XH	Manual Rotary Door Mount Handle Operator - D-M	Metal Chrome Handle	1, 2, 3, 3R, 4, 4X, 12, 12K, 13
RHVG79H	NFPA-79 Intermediate Handle	NFPA 79 Handle	ANY
RHVGBM	Door Mounted Breaker Operating Mechanism (RHO)	Breaker Operator	ANY
RHVGSxx 1)	Breaker Shaft with Bracket	Shaft	ANY
RHVG1212	Rotary Handle Kit 3)	RHVM12H + RHVGBM + RHVGS12	1, 2, 3, 3R, 12, 12K, 13
RHVG123R	Rotary Handle Kit 3)	RHVM3RH + RHVGBM + RHVGS12	1, 2, 3, 3R, 12, 12K, 13
RHVG124X	Rotary Handle Kit 3)	RHVM4XH + RHVGBM + RHVGS12	1, 2, 3, 3R, 4, 4X, 12, 12K, 13
RHVG1612	Rotary Handle Kit 3)	RHVM12H + RHVGBM + RHVGS16	1, 2, 3, 3R, 12, 12K, 13
RHVG163R	Rotary Handle Kit 3)	RHVM3RH + RHVGBM + RHVGS16	1, 2, 3, 3R, 12, 12K, 13
RHVG164X	Rotary Handle Kit 3)	RHVM4XH + RHVGBM + RHVGS16	1, 2, 3, 3R, 4, 4X, 12, 12K, 13
RHVGEM123R	Rotary Handle Kit 3)	RHVMEMH + RHVGBM + RHVGS12	1, 2, 3, 3R, 12, 12K, 13
RHVGEM163R	Rotary Handle Kit 3)	RHVMEMH + RHVGBM + RHVGS16	1, 2, 3, 3R, 12, 12K, 13
MFHG3R	MaxFlex Handle - 3R	Handle/Frame	1, 3, 3R, 4, 12, 12K
MFHG4X	MaxFlex Handle - 4X	Handle/Frame	1, 2, 3, 3R, 4, 4X, 12, 12K, 13
MFMG	MaxFlex Breaker Operating Mechanism	Breaker Operator	ANY
MFCFxxx 2)	MaxFlex Cable - xx" D/F-FR	Breaker Operator	ANY
MFKG3R3	MaxFlex Kit 4)	MFHG3R + MFMG + MFCF036	1, 2, 3, 3R, 12, 12K, 13
MFKG3R4	MaxFlex Kit 4)	MFHG3R + MFMG + MFCF048	1, 2, 3, 3R, 12, 12K, 13
MFKG3R5	MaxFlex Kit 4)	MFHG3R + MFMG + MFCF060	1, 2, 3, 3R, 12, 12K, 13
MFKG3R6	MaxFlex Kit 4)	MFHG3R + MFMG + MFCF072	1, 2, 3, 3R, 12, 12K, 13
MFKG3R7	MaxFlex Kit 4)	MFHG3R + MFMG + MFCF084	1, 2, 3, 3R, 12, 12K, 13
MFKG3R8	MaxFlex Kit 4)	MFHG3R + MFMG + MFCF096	1, 2, 3, 3R, 12, 12K, 13
MFKG3R9	MaxFlex Kit 4)	MFHG3R + MFMG + MFCF108	1, 2, 3, 3R, 12, 12K, 13
MFKG3R10	MaxFlex Kit 4)	MFHG3R + MFMG + MFCF120	1, 2, 3, 3R, 12, 12K, 13
MFKG3R12	MaxFlex Kit 4)	MFHG3R + MFMG + MFCF144	1, 2, 3, 3R, 12, 12K, 13
MFKG4X3	MaxFlex Kit 4)	MFHG4X + MFMG + MFCF036	1, 2, 3, 3R, 4, 4X, 12, 12K, 13
MFKG4X4	MaxFlex Kit 4)	MFHG4X + MFMG + MFCF048	1, 2, 3, 3R, 4, 4X, 12, 12K, 13
MFKG4X5	MaxFlex Kit 4)	MFHG4X + MFMG + MFCF060	1, 2, 3, 3R, 4, 4X, 12, 12K, 13
MFKG4X6	MaxFlex Kit 4)	MFHG4X + MFMG + MFCF072	1, 2, 3, 3R, 4, 4X, 12, 12K, 13
MFKG4X7	MaxFlex Kit 4)	MFHG4X + MFMG + MFCF084	1, 2, 3, 3R, 4, 4X, 12, 12K, 13
MFKG4X8	MaxFlex Kit 4)	MFHG4X + MFMG + MFCF096	1, 2, 3, 3R, 4, 4X, 12, 12K, 13
MFKG4X9	MaxFlex Kit 4)	MFHG4X + MFMG + MFCF108	1, 2, 3, 3R, 4, 4X, 12, 12K, 13
MFKG4X10	MaxFlex Kit 4)	MFHG4X + MFMG + MFCF120	1, 2, 3, 3R, 4, 4X, 12, 12K, 13
MFKG4X12	MaxFlex Kit 4)	MFHG4X + MFMG + MFCF144	1, 2, 3, 3R, 4, 4X, 12, 12K, 13

1) xx = Represents length of shaft, up to 24 inches.

2) xxx = Represents length of cable; 036, 048, 060, 072, 084, 096, 120, or 144.

3) Rotary Handle Kit includes: Handle, breaker operating mechanism, breaker shaft

4) MaxFlex Kit includes: 3R/4X handle, breaker operating mechanism, cable

Mounting

Replacement neutral kit for all GG breaker enclosures is catalog number N125GG.

The GG series of Siemens circuit breakers can be mounted in several manners.

- 1) Mounted on 35x7.5mm or 35x15mm DIN rail
- 2) Mounted to customer supplied surface using Mounting Screw Kit – MSKG4

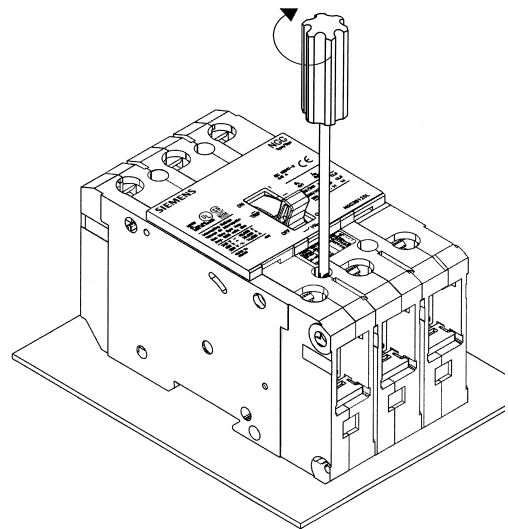
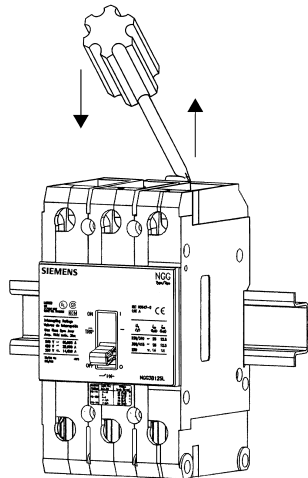
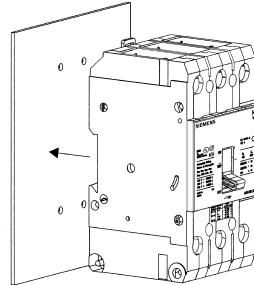
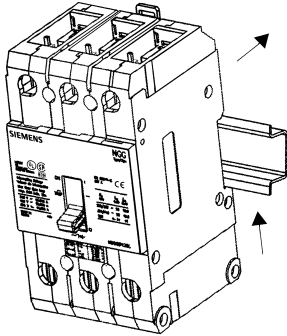

Dimensions

GG/GB2 Frame Outline Drawing – 1, 2, 3 Pole

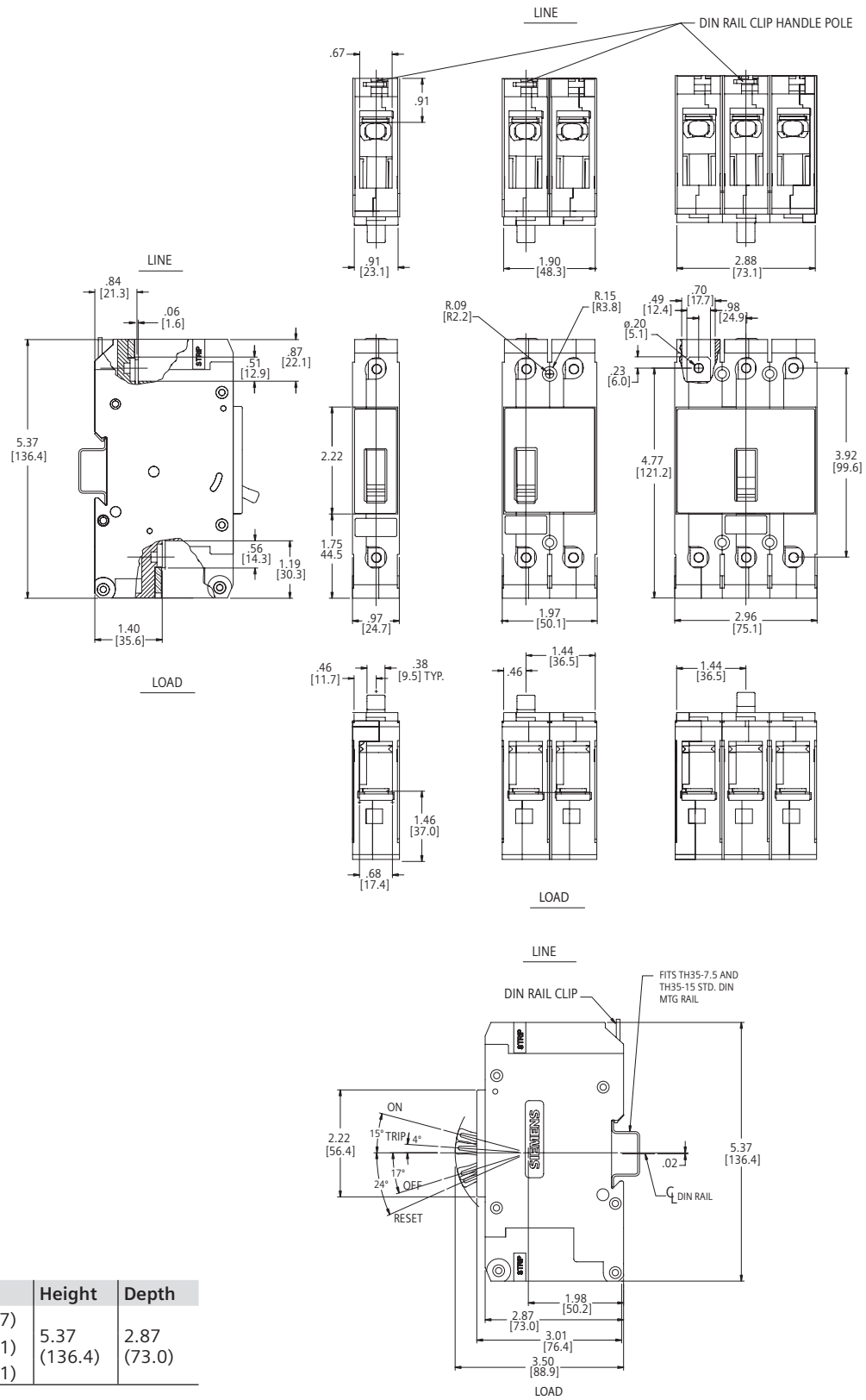

Dimensions

GB Frame Outline Drawing – 1, 2, 3 Pole

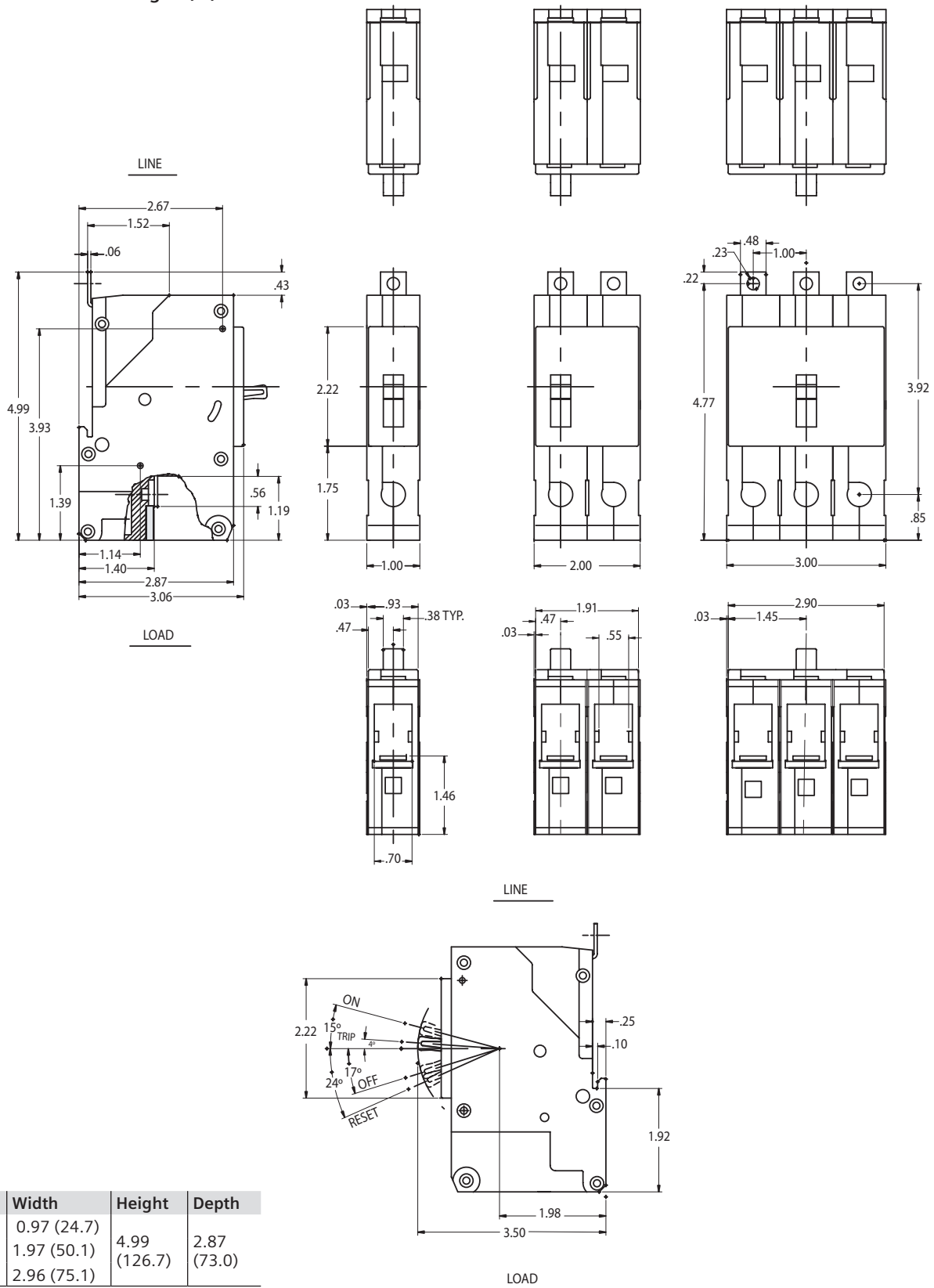

GG/GB time current curve – example

(Contact Siemens for specific curves)

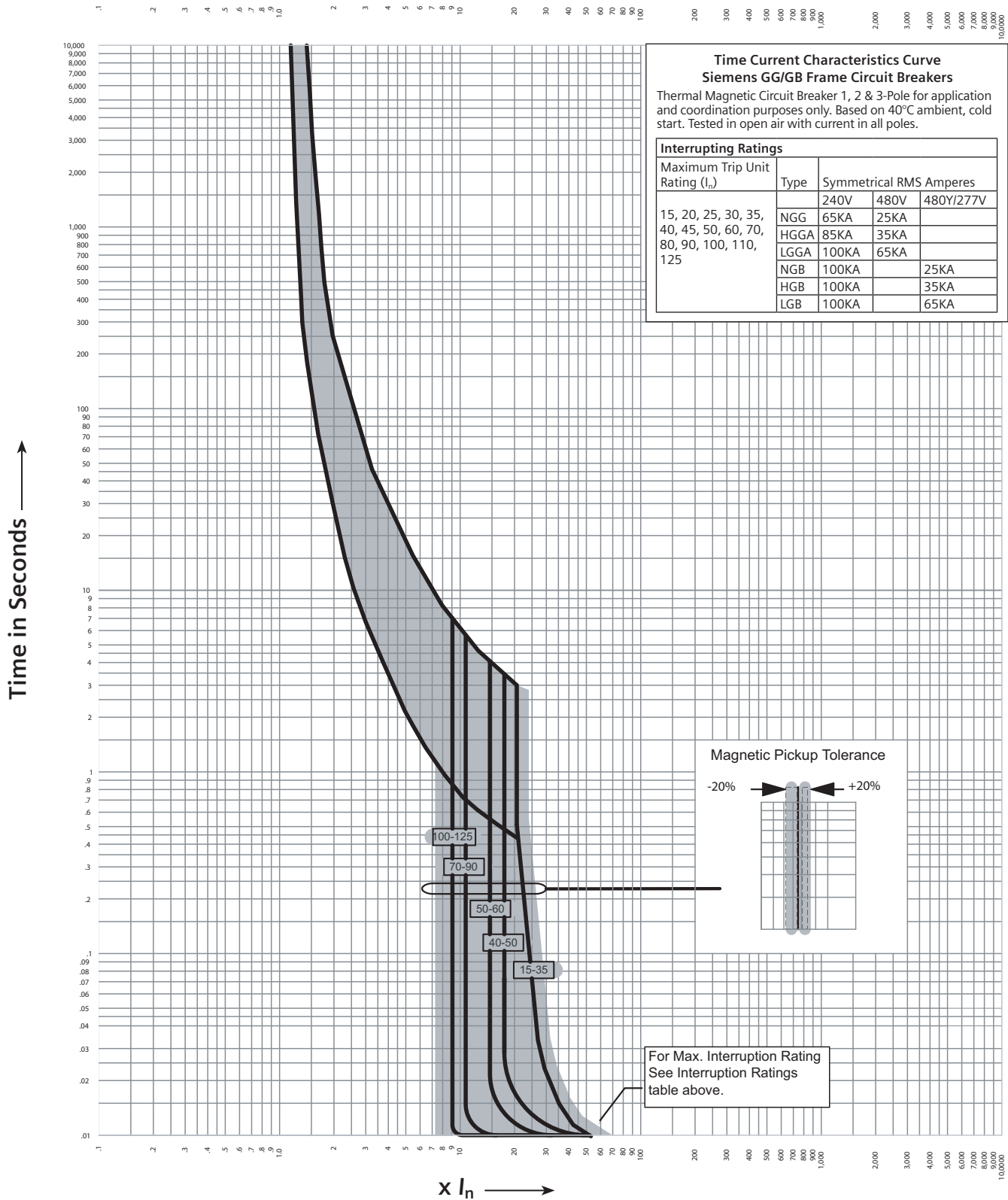

Application data

General

In the application of circuit breakers, consideration should be given to the following factors:

1. Voltage of circuit.
2. Ampacity of circuit.
3. Frequency of power source.
4. Operating conditions.
5. Fault current available.

Voltage of circuit – The system voltage should not exceed the listed voltage rating of the circuit breaker, fuse or switch.

Ampacity of circuit – The listed continuous current rating of the circuit breaker should not exceed the allowable ampacity of the conductors. Where the allowable ampacity of the conductor does not correspond to listed current ratings for fuses or circuit breakers, the next larger rating of fuses or circuit breakers is permitted providing it does not exceed the conductor ampacity by more than 25%. An exception to this rule is permitted for motor circuits or other circuits where high inrush currents may persist for an appreciable time.

Frequency of power source – Circuit breakers are calibrated for use on direct current or 48-60-Hertz alternating current. For frequencies above 62-Hertz, some fuses, switches and circuit breakers must be derated. The derating varies with each type and size of protective device. Consult your local representative for specific information.

Operating conditions – Molded case circuit breakers and fuses are calibrated without any enclosure as specified by the Underwriters' Laboratories, Inc. Sound engineering practice dictates that continuous loads should not exceed 80% of the breaker or fuse current rating for most applications.

Electrical connections – Molded Case Circuit Breakers are to be connected with 60 or 75°C wire for breakers having a rated ampacity of 125 amperes or less. For circuit breakers having a rated ampacity greater than 125 amperes, only 75°C cable shall be used unless otherwise indicated on the circuit breaker label.

Note: Exceptions to this rule are outlined in Article 110-14-C(1) and C(2) of the 2005 National Electric Code.

Conductors should be derated in accordance with the National Electrical Code for both ambient temperature and continuous loading. Conductors which are loaded continuously should be derated to 80% of their allowable current-carrying capacity except when supplied by an assembly including its overcurrent device that is listed for continuous operation at 100% of its rating.

When the type of load is unusual, intermittent, or one which involves momentary peak currents such as motor loads, consideration should be given to the heating effect on the protective device over a period of time. The duty cycle of a motor which is started and stopped frequently may require a circuit breaker or fuses with a higher rating than an infrequently started motor.

The presence of excessive dust, moisture, corrosive fumes, or explosive atmosphere requires the use of enclosures suitable for such atmospheres. For application in regions where fungus growth may occur, some circuit breakers should be treated with a fungus and moisture resistant material.

Fault current available – The interrupting rating of the circuit breaker should be greater than the available short circuit current at the point of application. The short circuit current from some power sources, such as engine driven generators, is limited, and the protective device characteristics should be selected to clear such faults without delay.

Some systems require a study of protective device characteristics to assure proper protection and coordination for any possible value of fault current. Your representative is available to assist in making coordination studies.

**Published by
Siemens Industry, Inc. 2018.**

Siemens Industry, Inc.
5400 Triangle Parkway
Norcross, GA 30092

For more information, please contact
our Customer Support Center.

Phone: 1-800-241-4453

E-mail: info.us@siemens.com

usa.siemens.com/switchgear

Order No.: CBBR-NGGPG-0518 BA

Printed in U.S.A.

© 2018 Siemens Industry, Inc.

The technical data presented in this document is based on an actual case or on as-designed parameters, and therefore should not be relied upon for any specific application and does not constitute a performance guarantee for any projects. Actual results are dependent on variable conditions. Accordingly, Siemens does not make representations, warranties, or assurances as to the accuracy, currency or completeness of the content contained herein. If requested, we will provide specific technical data or specifications with respect to any customer's particular applications. Our company is constantly involved in engineering and development. For that reason, we reserve the right to modify, at any time, the technology and product specifications contained herein.