

SIEMENS

SIMATIC



S7-1500/ET 200MP
CM PtP RS232 HF
(6ES7541-1AD00-0AB0)
communication module
Manual

Preface	
Documentation guide	1
Product overview	2
Connecting	3
Parameters/address space	4
Programming	5
Error and system messages	6
Technical specifications	7
Dimensional drawing	A

Legal information

Warning notice system

This manual contains notices you have to observe in order to ensure your personal safety, as well as to prevent damage to property. The notices referring to your personal safety are highlighted in the manual by a safety alert symbol, notices referring only to property damage have no safety alert symbol. These notices shown below are graded according to the degree of danger.

 DANGER
indicates that death or severe personal injury will result if proper precautions are not taken.
 WARNING
indicates that death or severe personal injury may result if proper precautions are not taken.
 CAUTION
indicates that minor personal injury can result if proper precautions are not taken.
NOTICE
indicates that property damage can result if proper precautions are not taken.

If more than one degree of danger is present, the warning notice representing the highest degree of danger will be used. A notice warning of injury to persons with a safety alert symbol may also include a warning relating to property damage.

Qualified Personnel

The product/system described in this documentation may be operated only by **personnel qualified** for the specific task in accordance with the relevant documentation, in particular its warning notices and safety instructions. Qualified personnel are those who, based on their training and experience, are capable of identifying risks and avoiding potential hazards when working with these products/systems.

Proper use of Siemens products

Note the following:

 WARNING
Siemens products may only be used for the applications described in the catalog and in the relevant technical documentation. If products and components from other manufacturers are used, these must be recommended or approved by Siemens. Proper transport, storage, installation, assembly, commissioning, operation and maintenance are required to ensure that the products operate safely and without any problems. The permissible ambient conditions must be complied with. The information in the relevant documentation must be observed.

Trademarks

All names identified by ® are registered trademarks of Siemens AG. The remaining trademarks in this publication may be trademarks whose use by third parties for their own purposes could violate the rights of the owner.

Disclaimer of Liability

We have reviewed the contents of this publication to ensure consistency with the hardware and software described. Since variance cannot be precluded entirely, we cannot guarantee full consistency. However, the information in this publication is reviewed regularly and any necessary corrections are included in subsequent editions.

Preface

Purpose of the documentation

This device manual complements the system manual S7 1500 Automation System (<http://support.automation.siemens.com/WW/view/en/59191792>). General functions of the S7-1500 are described in the S7-1500 Automation System System Manual.

Conventions

This documentation contains figures of the described device. The figures may differ slightly from the devices supplied.

Please also observe notes marked as follows:

Note

A note contain important information on the product described in the documentation, on the handling of the product and on the section of the documentation to which particular attention should be paid.

Note on IT security

Siemens offers IT security mechanisms for its automation and drive product portfolio in order to support the safe operation of the plant/machine. We recommend that you inform yourself regularly on the IT security developments regarding your products. You can find information on this on the Internet (<http://support.automation.siemens.com>).

You can register for a product-specific newsletter here.

For the safe operation of a plant/machine, however, it is also necessary to integrate the automation components into an overall IT security concept for the entire plant/machine, which corresponds to the state-of-the-art IT technology. You can find information on this on the Internet (<http://www.siemens.com/industrialsecurity>).

Products used from other manufacturers should also be taken into account here.

Copyright notice for the open-source software used

Open-source software is used in the firmware of the product described. The open-source software is provided free of charge. We are liable for the product described, including the open-source software contained in it, pursuant to the conditions applicable to the product. Siemens accepts no liability for the use of the open source software over and above the intended program sequence, or for any faults caused by modifications to the software.

For legal reasons, we are obliged to publish the original text of the following copyright notices.

© Copyright William E. Kempf 2001

Permission to use, copy, modify, distribute and sell this software and its documentation for any purpose is hereby granted without fee, provided that the above copyright notice appear in all copies and that both that copyright notice and this permission notice appear in supporting documentation. William E. Kempf makes no representations about the suitability of this software for any purpose. It is provided "as is" without express or implied warranty.

Copyright © 1994 Hewlett-Packard Company

Permission to use, copy, modify, distribute and sell this software and its documentation for any purpose is hereby granted without fee, provided that the above copyright notice appear in all copies and that both that copyright notice and this permission notice appear in supporting documentation. Hewlett-Packard Company makes no representations about the suitability of this software for any purpose. It is provided ``as is" without express or implied warranty.

Table of contents

	Preface	3
1	Documentation guide	7
2	Product overview	9
	2.1 Properties	9
	2.2 Accessories	11
	2.3 Functions	12
	2.4 Properties of the RS232 interface	14
3	Connecting	15
	3.1 RS232 interface of the communications module	15
	3.2 Installation guidelines	16
4	Parameters/address space	17
	4.1 Parameter assignment	17
	4.2 Reaction to CPU STOP	17
	4.3 Address space	18
5	Programming	19
6	Error and system messages	21
7	Technical specifications	23
A	Dimensional drawing	27

Documentation guide

Introduction

This modular documentation of the SIMATIC products covers diverse topics concerning your automation system.

The complete documentation for the S7-1500 and ET 200MP automation systems consists of system manuals, function manuals and manuals.

The STEP 7 information system (Online Help) also helps you configure and program your automation system.

Overview of the documentation provided for the CM PtP RS232 HF communication module

The following table lists additional references that you will need when using the CM PtP RS232 HF communication module.

Table 1- 1 Documentation for the CM PtP RS232 HF communication module

Topic	Documentation	Key content
System description	System manual S7 -1500 Automation System (http://support.automation.siemens.com/WW/view/en/59191792)	<ul style="list-style-type: none"> • Application planning • Installation • Connecting • Addressing • Commissioning • Maintenance
	System manual ET 200MP distributed I/O system (http://support.automation.siemens.com/WW/view/en/59193214)	
	System manual ET 200SP distributed I/O system (http://support.automation.siemens.com/WW/view/en/58649293)	
	Power supply manuals (http://support.automation.siemens.com/WW/view/en/59173914)	<ul style="list-style-type: none"> • Connecting • Interrupt, error and system messages
CPU manuals (http://support.automation.siemens.com/WW/view/en/56926947)	<ul style="list-style-type: none"> • Technical specifications • Dimensional drawing 	
Function manual EMC/EMI compatible installation of control systems (http://support.automation.siemens.com/WW/view/en/59193566)	<ul style="list-style-type: none"> • Basics • Electromagnetic compatibility • Lightning protection 	

Topic	Documentation	Key content
Point-to-point communication	Function manual CM PtP - Configurations for point-to-point connections (http://support.automation.siemens.com/WW/view/en/59057093)	<ul style="list-style-type: none">• Basic information• Data transmission functions• Diagnostics functions

SIMATIC manuals

All current manuals for the SIMATIC products are available for download free of charge on the Internet (<http://www.siemens.com/automation/service&support>).

Product overview

2.1 Properties

Order number

6ES7541-1AD00-0AB0

View of the module

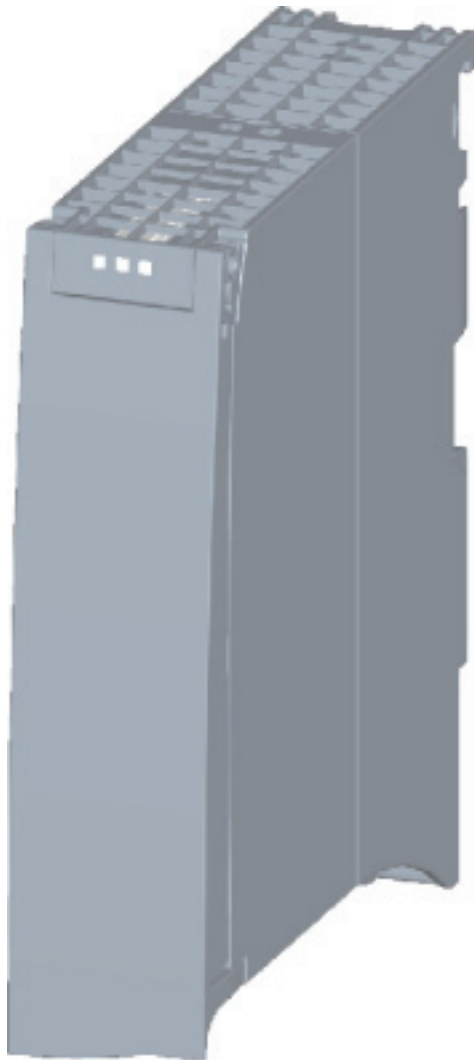

Figure 2-1 CM PtP RS232 HF view

Properties

The communication module has the following properties:

- Technical properties
 - RS232 interface
 - short-circuit proof
 - electrically disconnected
 - Protocols: 3964(R), Modbus master (RTU), Modbus slave (RTU), Freeport and USS with instructions
- Supported system functions
 - Firmware update
 - Identification data I&M0
 - Parameter re-assignment in CPU RUN mode (using instructions)
 - Diagnostic interrupts

Additional information

Additional information on the properties of the CM PtP RS232 HF can be found in the function manual CM PtP - Configurations for point-to-point connections (<http://support.automation.siemens.com/WW/view/en/59057093>).

Information on the properties of the S7-1500 and associated modules can be found in the system manual S7 -1500 Automation System (<http://support.automation.siemens.com/WW/view/en/59191792>).

2.2 Accessories

Scope of delivery

The scope of delivery of the communication module includes a U connector for connection to the backplane bus.

Connecting cables

The following connecting cables can be ordered separately in the standard lengths: 5 m, 10 m and 15 m (each with a 9-pin sub D female connector).

Table 2- 1 Order numbers of connecting cables

Connecting cables for CM PtP RS232 BA CM PtP RS232 HF	Type	Order number
RS232 interface	RS232, 5 m	6ES7902-1AB00-0AA0
	RS232, 10 m	6ES7902-1AC00-0AA0
	RS232, 15 m	6ES7902-1AD00-0AA0

Online catalog

Additional order numbers for S7-1500 can be found on the Internet (<http://www.siemens.com/industrymall>) in the online catalog and online ordering system.

2.3 Functions

Introduction

The communication module allows you to exchange data between your own and other programmable controllers or computers by means of a point-to-point connection, and to connect various devices from a variety of manufacturers.

Functionality of the CM PtP RS232 HF

The CM PtP RS232 HF communication module offers the following functionality:

- RS232 interface
- Data transmission rate: 300 to 115200 bps
- Maximum frame length: 4 kbyte
- Transmission protocols: Freeport, 3964(R) and Modbus

Note

The USS protocol can be implemented with instructions included in STEP 7 (TIA Portal).

Hardware components of a point-to-point connection

You require certain hardware components for a point-to-point connection with the CM PtP RS232 HF.

Components	Function
CPU module Accessories: Memory card	... executes the user program.
CM PtP RS232 HF communication module	... communicates with a communication partner (point-to-point) by means of the interface.
Connecting cable	... connects the CM PtP RS232 HF communication module with the communication partner. 
U connector	... provides the mechanical and electrical connection between the modules.
Optional: Power supply module (PS)	... converts the line voltage (120/230V AC or 24V DC) into the operating voltage required to supply the S7-1500.

System environment

The communication module can be used in the following system environments:

Applications	Components required	Configuration
Central operation in an S7-1500 system	<ul style="list-style-type: none"> • CPU 151x • CM PtP RS232 HF • Power supply (optional) 	STEP 7 (TIA Portal)
Distributed operation in an S7-1500 system	<ul style="list-style-type: none"> • CPU 151x • IM 155-5 • CM PtP RS232 HF • Power supply (optional) 	STEP 7 (TIA Portal)
Distributed operation in an S7-300/400 system	<ul style="list-style-type: none"> • CPU 31x / CPU 41x • IM 155-5 • CM PtP RS232 HF 	STEP 7 (TIA Portal) STEP 7 with integration of a GSD file
Distributed operation in a third-party system	<ul style="list-style-type: none"> • Third-party programmable controller • IM 155-5 • CM PtP RS232 HF 	GSD file imported to/installed in the engineering system ¹⁾

1) Information on using the communication module in a third-party system is available in the programming and operating manual CM PtP operation with PROFINET controller (<http://support.automation.siemens.com/WW/view/en/59062563>).

Additional information

Information on configuring and programming the CM PtP RS232 HF communication module is available in the function manual CM PtP - Configurations for point-to-point connections (<http://support.automation.siemens.com/WW/view/en/59057093>).

2.4 Properties of the RS232 interface

Definition

The RS232 interface is a voltage interface used for serial data transmission.

Properties

The RS232 interface has the following properties and meets the following requirements:

Type	Voltage interface
Front connector	9-pin sub-D male connector with screw lock
RS232 signals	TXD, RXD, RTS, CTS, DTR, DSR, RI, DCD, GND; all signals isolated against the backplane bus and load voltage
Max. data transmission rate	115.2 kbps
max. cable length	15 m, cable type LIYCY 9 x 0.14
Standard	DIN 66020, DIN 66259, EIA-RS 232C, CCITT V.24/V.28

RS232 signals

The table below shows the meaning of the individual RS232 accompanying signals.

Table 2- 2 Signals of the RS232 interface

Signal	Designation	Meaning
TXD	Transmit Data	Transmit data; transmit cable logically held to "1" by communication module in idle state.
RXD	Receive Data	Receive data; receive cable logically held to "1" by communication partner in idle state.
RTS	Request To Send	Request to send RTS set to "ON": Communication module ready to send; signals to the communication partner that there is data ready to send RTS set to "OFF": Communication module not ready to send
CTS	Clear To Send	Clear to send CTS set to "ON": Signals "clear to send" to the communication partner CTS set to "OFF": Signals "Not clear to send" to the communication partner
DTR	Data Terminal Ready	DTR set to "ON": Communications module switched on, ready for operation DTR set to "OFF": Communications module not switched on, not ready for operation
DSR	Data Set Ready	DSR set to "ON": Communication partner signals "ready for operation" DSR set to "OFF": Communication partner not switched on, not ready for operation
RI	Ring Indicator	Incoming call when connecting a modem
DCD	Data Carrier Detect	Carrier signal when connecting a modem. The communication partner signals with a high level that it detects incoming data on the cable.

Connecting

3.1 RS232 interface of the communications module

Terminal assignment

The table below shows the terminal assignment for the 9-pin sub D male connector in the front panel of the communications module.

Table 3- 1 Terminal assignment for the sub D male connector of the integrated interface of the communications module

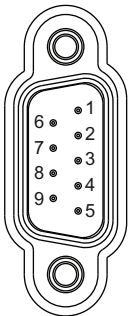
Male connector of the communications module	Pin	Designation	Input/output	Meaning
	1	DCD Data Carrier Detect	Input	Received signal level
	2	RXD Receive Data	Input	Receive data
	3	TXD Transmit Data	Output	Transmit data
	4	DTR Data Terminal Ready	Output	Data terminal ready
	5	GND Ground	-	Functional ground (isolated)
	6	DSR Data Set Ready	Input	Data set ready
	7	RTS Request To Send	Output	Request to send
	8	CTS Clear To Send	Input	Clear to send
	9	RI Ring Indicator	Input	Incoming call

* View from the front

Connecting cables

Standard connecting cables of various lengths (see chapter Accessories (Page 11)) are available for connection with a communication partner which also has a 9-pin sub-D male connector.

Please note that you must only use shielded connector casings and cables. A large surface area of the cable shield must be in contact with the connector casing on both sides.

NOTICE

Never connect the cable shield with the GND, as this could destroy the interfaces. GND must always be connected on both sides (pin 5), otherwise the modules could be destroyed.

3.2 Installation guidelines

To take into consideration

The general installation guidelines must be taken into consideration (see function manual EMC/EMI compatible installation of control systems (<http://support.automation.siemens.com/WW/view/en/59193566>)).

The cable shield must be installed on a grounding rail to maintain the EMC values (electromagnetic compatibility).

Parameters/address space

4.1 Parameter assignment

Introduction

You configure and assign the parameters of the communication module with STEP 7 (TIA Portal V12 or later) or with STEP 7 with integration of a GSD file.

Additional information

The device manual of the communication module is supplemented by the function manual CM PtP - Configurations for point-to-point connections (<http://support.automation.siemens.com/WW/view/en/59057093>) and the TIA Portal information system.

There you will find information on the following topics:

- Operating modes
- Receive buffer
- Data flow control
- Transmission integrity
- Data transmission - protocol specific
- Programming/configuring in STEP 7 (TIA Portal)
- Module-specific instructions
- Diagnostics

4.2 Reaction to CPU STOP

Ongoing transmissions are aborted when the higher-level control (CPU) goes to STOP.

Frames in the receive buffer are retained. With a corresponding configuration in the properties dialog of the communication module, you can automatically clear the receive buffer on the communication module during CPU startup.

4.3 Address space

Address space of the communication module

The input addresses of the communications module total 8 bytes. The input addresses are automatically assigned for each communications module when you specify the device configuration in STEP 7 (TIA Portal). Output addresses are not required.

Hardware identification (not freely configurable)

The hardware identification (HW ID) is automatically assigned for each communications module when you specify the device configuration in STEP 7 (TIA Portal).

The hardware ID is issued along with the diagnostic messages to localize the module. In addition, the HW identification is required for S7-1500 at the communication instructions in order to identify the communication module. For S7-300/400, the communication module is identified by the start address of the input data.

Overview of the instructions

Communication between the CPU, the communication module and a communication partner takes place by means of special instructions and protocols that support the corresponding communication modules. The instructions process the exchange of data between the CPU and the communication module. They must be called cyclically from the user program. Data transmission takes place asynchronously across several cycles.

The transmission protocols are implemented on the communication module. The protocol is used to adapt the interface of the communication module to the interface of the communication partner.

Instruction	Meaning
Port_Config	You use the Port_Config instruction to dynamically assign basic interface parameters.
Send_Config	You use the Send_Config (send configuration) instruction to dynamically assign serial send parameters of a port.
Receive_Config	You use the Receive_Config (receive configuration) instruction to dynamically assign serial receive parameters of a port.
P3964_Config	You use the P3964_Config (protocol configuration) instruction to dynamically assign the parameters of the 3964(R) procedure.
Send_P2P	You use the Send_P2P instruction to send data to a communication partner.
Receive_P2P	You use the Receive_P2P instruction to receive data from a communication partner.
Receive_Reset	You use the Receive_Reset instruction to delete the receive buffer of the communication module.
Signal_Get	You use the Signal_Get instruction to read the RS232 accompanying signals.
Signal_Set	You use the Signal_Set instruction to set the RS232 accompanying signals.
Get_Features	You use the Get_Features instruction to read expanded functions supported by the communication module.
Set_Features	You use the Set_Features instruction to set expanded functions supported by the communication module.
USS_Port_Scan	You use the USS_Port_Scan instruction to communicate via the USS network.
USS_Drive_Control	You use the USS_Drive_Control instruction to exchange data with a drive.
USS_Read_Param	You use the USS_Read_Param instruction to read parameters from the drive.
USS_Write_Param	You use the USS_Write_Param instruction to change parameters in the drive.
Modbus_Comm_Load	The instruction Modbus_Comm_Load allows you to configure the port of the communication module for Modbus RTU.

Instruction	Meaning
Modbus_Master	The instruction Modbus_Master allows you to communicate as Modbus master by means of the PtP port.
Modbus_Slave	The instruction Modbus_Slave allows you to communicate as Modbus slave by means of the PtP port.

The instructions are part of STEP 7 (TIA Portal). The instructions are available in the "Instructions" task card under Communication > Communication processor.

Additional information

Additional information on programming the communication modules is available in the function manual CM PtP - Configurations for point-to-point connections (<http://support.automation.siemens.com/WW/view/en/59057093>) and in the TIA Portal information system.

Error and system messages

LED displays of the communication module



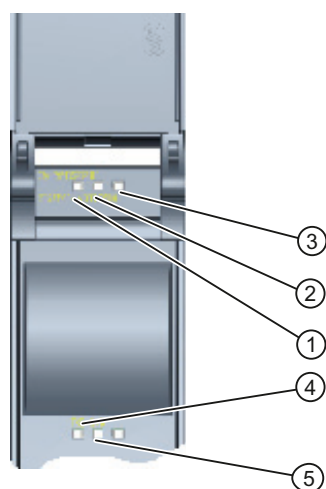









The figure below shows the LED displays of the CM PtP RS232 HF communication module with open front panel.



- ① LED display RUN
- ② LED display ERROR
- ③ LED display MAINT
- ④ LED display TXD
- ⑤ LED display RXD





Figure 6-1 CM PtP RS232 HF view

Meaning of the LED displays for RUN/ERROR/(MAINT)

LED			Meaning	Solution
RUN	ERROR	MAINT		
 Off	 Off	 Off	Supply voltage not present or too low at communication module	Check the power supply of the station.
 Flashes	 Off	 Off	CM in startup, parameters not assigned yet	---
 On	 Off	 Off	CM configured and ready for operation	---
 Off	 Flashes	 Off	Group error (at least one error pending)	Evaluate the diagnostics data and eliminate the error. ¹⁾

1) Information on startup and diagnostics of the communication module is available in the function manual CM PtP - Configurations for point-to-point connections (<http://support.automation.siemens.com/WW/view/en/59057093>).

Meaning of LED displays for TXD/RXD (under the front panel)

LED		Meaning	Solution
TXD	RXD		
 Flashes	 Off	Interface is transmitting	---
 Off	 Flashes	Interface is receiving	---

Technical specifications

6ES7541-1AD00-0AB0	
Product type designation	CM PtP RS232 HF
General information	
<ul style="list-style-type: none"> I&M data 	Yes; I&M 0
Engineering with	
STEP 7 TIA Portal can be configured/integrated as of version	V12.0 / V12.0
STEP 7 can be configured/integrated as of version	V5.5 SP2 or higher with a GSD file
PROFIBUS as of GSD version/GSD revision	- / -
PROFINET as of GSD version/GSD revision	V2.3
Installation type/mounting	
<ul style="list-style-type: none"> Rail mounting possible 	Yes; S7-1500 mounting rail
Supply voltage	
Voltage type of supply voltage	System power supply
Input current	
<ul style="list-style-type: none"> Current consumption (rated value) 	35 mA; from backplane bus
Power	
<ul style="list-style-type: none"> Power from the backplane bus 	0.65 W
Power loss	
<ul style="list-style-type: none"> Power loss, typ. 	0.6 W
Address area	
Occupied address area	
<ul style="list-style-type: none"> Inputs 	8 bytes
Interfaces	
1. Interface	
Interface hardware	
<ul style="list-style-type: none"> RS 232 	Yes
Interface hardware	
RS 232	
<ul style="list-style-type: none"> Transmission rate, max. 	115.2 kbps
<ul style="list-style-type: none"> Max. cable length 	15 m
RS-232 accompanying signals	RTS, CTS, DTR, DSR, RI, DCD
Protocols	
Integrated protocols	
Freeport	

6ES7541-1AD00-0AB0	
<ul style="list-style-type: none"> • Frame length, max. 	4 kbyte
<ul style="list-style-type: none"> • Bits per character 	7 or 8
<ul style="list-style-type: none"> • Number of stop bits 	1 or 2 bits
<ul style="list-style-type: none"> • Parity 	None, even, odd, always 1, always 0, any
3964 (R)	
<ul style="list-style-type: none"> • Frame length, max. 	4 kbyte
<ul style="list-style-type: none"> • Bits per character 	7 or 8
<ul style="list-style-type: none"> • Number of stop bits 	1 or 2 bits
<ul style="list-style-type: none"> • Parity 	None, even, odd, always 1, always 0, any
Modbus RTU master	
Address area	1 to 247, extended 1 to 65,535
<ul style="list-style-type: none"> • Max. number of slaves 	1
Modbus RTU slave	
Address area	1 to 247, extended 1 to 65,535
Frame buffer	
<ul style="list-style-type: none"> • Buffer memory for frames 	8 kbyte
<ul style="list-style-type: none"> • Number of frames which can be buffered 	255
Interrupts/diagnostics/status information	
Interrupts	
<ul style="list-style-type: none"> • Diagnostic interrupt 	Yes
<ul style="list-style-type: none"> • Hardware interrupt 	No
Diagnostic messages	
Diagnostics	Yes
<ul style="list-style-type: none"> • Wire break 	Yes
Diagnostics display LED	
<ul style="list-style-type: none"> • RUN LED 	Yes; green LED
<ul style="list-style-type: none"> • ERROR LED 	Yes; red LED
<ul style="list-style-type: none"> • Receive RxD 	Yes; yellow LED
<ul style="list-style-type: none"> • Send TxD 	Yes; yellow LED
Electrical isolation	
<ul style="list-style-type: none"> • between backplane bus and interface 	Yes
Insulation	
Insulation tested with	707 V DC (Type Test)
Ambient conditions	
Operating temperature	
<ul style="list-style-type: none"> • Horizontal installation, min. 	0 °C
<ul style="list-style-type: none"> • Horizontal installation, max. 	60 °C

6ES7541-1AD00-0AB0	
<ul style="list-style-type: none"> • Vertical installation, min. • Vertical installation, max. 	<p>0 °C</p> <p>40 °C</p>
Distributed operation	
<ul style="list-style-type: none"> • At SIMATIC S7-300 • At SIMATIC S7-400 • At SIMATIC S7-1500 • At Standard Profinet Controller • Supports Fast Startup 	<p>Yes</p> <p>Yes</p> <p>Yes</p> <p>Yes</p> <p>Yes</p>
Dimensions	
<ul style="list-style-type: none"> • Width • Height • Depth 	<p>35 mm</p> <p>147 mm</p> <p>127 mm</p>
Weights	
<ul style="list-style-type: none"> • Weight, approx. 	<p>0.22 kg</p>

Additional general technical specifications for SIMATIC S7-1500 are available in the system manual S7 -1500 Automation System (<http://support.automation.siemens.com/WW/view/en/59191792>).

A

Dimensional drawing

This appendix contains the dimensional drawing of the communication module installed on a mounting rail and with a shield bracket. Always observe the specified dimensions for installation in cabinets, control rooms, etc.

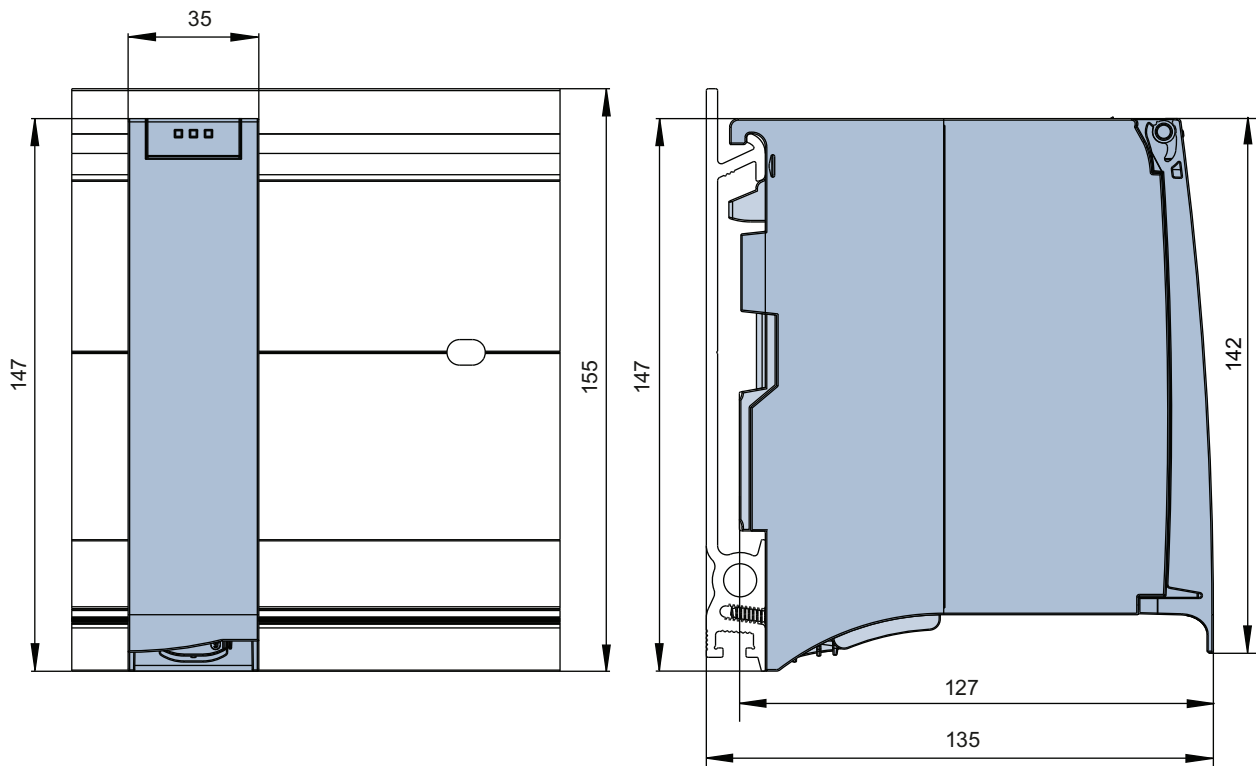

Figure A-1 Dimensional drawing of the CM PtP RS232 HF communication module

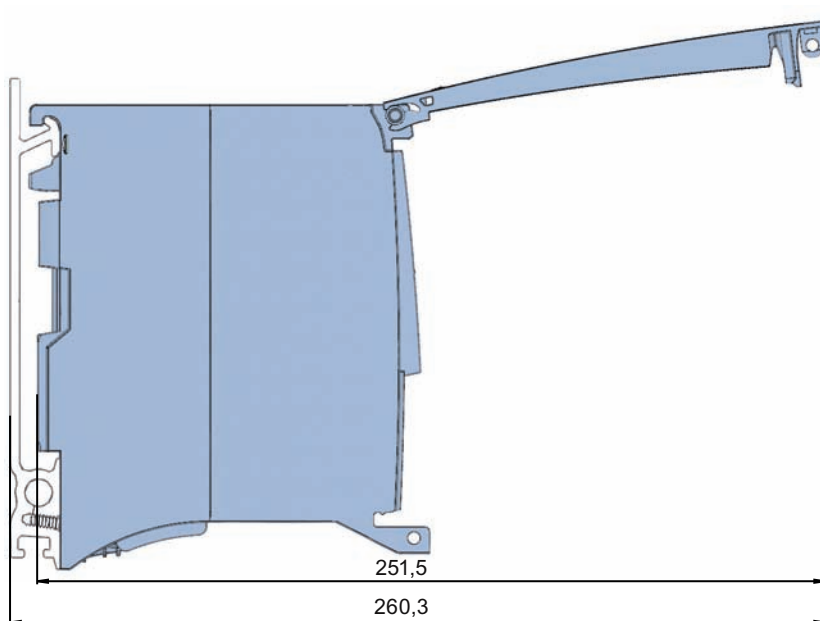

Figure A-2 Dimensional drawing of the CM PtP RS232 HF communication module with open front panel