

Radar Transmitters

SITRANS LR560 (mA/HART)

Operating Instructions · 3/2011



SITRANS

SIEMENS

Safety Guidelines: Warning notices must be observed to ensure personal safety as well as that of others, and to protect the product and the connected equipment. These warning notices are accompanied by a clarification of the level of caution to be observed.

Qualified Personnel: This device/system may only be set up and operated in conjunction with this manual. Qualified personnel are only authorized to install and operate this equipment in accordance with established safety practices and standards.

Unit Repair and Excluded Liability:

- The user is responsible for all changes and repairs made to the device by the user or the user's agent.
- All new components are to be provided by Siemens Milltronics Process Instruments.
- Restrict repair to faulty components only.
- Do not reuse faulty components.

Warning: Cardboard shipping package provides limited humidity and moisture protection. This product can only function properly and safely if it is correctly transported, stored, installed, set up, operated, and maintained.

This product is intended for use in industrial areas. Operation of this equipment in a residential area may cause interference to several frequency based communications.

Note: Always use product in accordance with specifications.

Copyright Siemens AG 2011. All Rights Reserved

Disclaimer of Liability

This document is available in bound version and in electronic version. We encourage users to purchase authorized bound manuals, or to view electronic versions as designed and authored by Siemens Milltronics Process Instruments. Siemens Milltronics Process Instruments will not be responsible for the contents of partial or whole reproductions of either bound or electronic versions.

While we have verified the contents of this manual for agreement with the instrumentation described, variations remain possible. Thus we cannot guarantee full agreement. The contents of this manual are regularly reviewed and corrections are included in subsequent editions. We welcome all suggestions for improvement.

Technical data subject to change.

MILLTRONICS® is a registered trademark of Siemens Milltronics Process Instruments.

Contact SMPI Technical Publications

at the following address:

Technical Publications
Siemens AG
Siemens Milltronics Process Instruments
1954 Technology Drive, P.O. Box 4225
Peterborough, Ontario, Canada, K9J 7B1
Email: techpubs.smpi@siemens.com

European Authorized Representative

Siemens AG
Industry Sector
76181 Karlsruhe
Deutschland

- For a selection of Siemens Milltronics level measurement manuals, go to: **www.siemens.com/processautomation**. Under Process Instrumentation, select *Level Measurement* and then go to the manual archive listed under the product family.
- For a selection of Siemens Milltronics weighing manuals, go to: **www.siemens.com/processautomation**. Under Weighing Technology, select *Continuous Weighing Systems* and then go to the manual archive listed under the product family.

Table of Contents

Safety Notes	1
Safety marking symbols	1
FCC Conformity	1
CE Electromagnetic Compatibility (EMC) Conformity	2
R&TTE Compliance (Europe)	2
Industry Canada	3
The Manual	4
Technical Support	4
SITRANS LR560 Overview	6
Programming	6
Local Display Interface (LDI)	7
Versions	7
Applications	7
Approvals and Certificates	7
Specifications	8
Power	8
Performance	8
Interface	9
Mechanical	9
Environmental	10
Process	10
Approvals	11
Programmer (infrared keypad)	11
Dimensions	12
Universal Slotted Flange	16
Installation	18
Mounting location	19
Nozzle location	19
Aimer Adjustment	21
Air Purging System	22
Purge Connection	22
Wiring	24
Power	24
Connecting SITRANS LR560	24
Connecting HART	25
Wiring setups for hazardous area installations	26
Non-incendive and Dust Ignition Proof wiring (US/Canada)	26
Instructions specific to hazardous area installations	27
Local operation	28
Activating SITRANS LR560	28
The LCD Display	29
Handheld Programmer	30
Programming SITRANS LR560	31
Quick Start Wizard via the LDI push buttons	34

Quick Start Wizard via the handheld programmer	34
Requesting an Echo Profile	37
Level application example	38
Operating via SIMATIC PDM	39
Functions in SIMATIC PDM	39
SIMATIC PDM Version	39
Electronic Device Description (EDD)	39
Configuring a new device	40
Quick Start Wizard via SIMATIC PDM	40
Changing parameter settings using SIMATIC PDM	43
Parameters accessed via pull-down menus	44
Diagnostics	52
Security	54
Operating via FDT (Field Device Tool)	55
Device Type Manager (DTM)	55
SITRANS DTM	55
The Instrument EDD	55
Configuring a new device via FDT	55
Operating via AMS Device Manager	56
Functions in AMS Device Manager	56
Features of AMS Device Manager	56
Device Description (DD)	56
Configuring a new device	57
Startup	57
Pull-down menu access	58
Device configuration	58
Quick Start Wizard via AMS Device Manager	59
Maintenance and Diagnostics	66
Communication	68
Security	68
Device Diagnostics	69
Password Protection	70
User Manager Utility	70
AMS Menu Structure	71
Parameter Reference	78
Quick Start	78
Quick Start Wizard	78
AFES (Auto False Echo Suppression) Wizard	79
Copy Parameters to Display	80
Copy Parameters from Display	80
Copy Firmware to Display	80
Copy Firmware from Display	81
Setup	81
Device	81
Sensor	82
Calibration	83
Rate	84
Fail-safe	86
Analog Output Scaling	87

Signal Processing.....	90
TVT setup.....	95
TVT shaper.....	96
Measured Values.....	97
Diagnostics.....	98
Fault Reset.....	98
Echo Profile.....	98
Trend.....	99
Peak Values.....	99
Electronics Temperature.....	99
Remaining Device Lifetime.....	100
Remaining Sensor Lifetime.....	102
Service.....	105
Demo Mode.....	105
Master Reset.....	105
Powered Hours.....	105
Power-on Resets.....	105
LCD Backlight.....	105
LCD Contrast.....	106
Service Schedule.....	106
Calibration Schedule.....	109
Communication.....	111
Device Address.....	111
Remote Lockout.....	112
Security.....	112
Write Protection.....	112
Language.....	112
Appendix A: Alphabetical Parameter List	113
Appendix B: Troubleshooting	116
Communication Troubleshooting.....	116
Device Status Icons.....	117
General Fault Codes.....	118
Operation Troubleshooting.....	121
Appendix C: Maintenance	123
Unit Repair and Excluded Liability.....	123
Appendix D: Technical Reference	124
Principles of Operation.....	124
Process Variables.....	124
Echo Processing.....	125
Process Intelligence.....	125
Echo Selection.....	125
Measurement Range.....	129
Measurement Response.....	130
Analog Output.....	130
Sensor Mode (2.2.2.).....	131
Current Output Function (2.6.1.).....	131
Loss of Echo (LOE).....	132
Temperature derating curve.....	133
Loop power.....	134

Typical Connection Drawing	134
Allowable operating area of SITRANS LR560	135
Startup Behavior	135
Appendix E: HART Communications	136
SIMATIC PDM	136
HART Electronic Device Description (EDD)	136
HART Communicator 375 Menu Structure	137
HART Version	141
Burst Mode	141
HART Multidrop Mode	141
Appendix F: Firmware Revision History	142
Glossary	143
Index	146
LCD menu structure	149

Safety Notes

Special attention must be paid to warnings and notes highlighted from the rest of the text by grey boxes.



WARNING symbol relates to a caution symbol on the product, and means that failure to observe the necessary precautions can result in death, serious injury, and/or considerable material damage.



WARNING symbol, used when there is no corresponding caution symbol on the product, means that failure to observe the necessary precautions can result in death, serious injury, and/or considerable material damage.

Note: means important information about the product or that part of the operating manual.

Safety marking symbols

In manual	On product	Description
		Earth (ground) Terminal
		Protective Conductor Terminal
		(Label on product: yellow background.) WARNING: refer to accompanying documents (manual) for details.

FCC Conformity

US Installations only: Federal Communications Commission (FCC) rules

! WARNING: Changes or modifications not expressly approved by Siemens Milltronics could void the user's authority to operate the equipment.

Notes:

- This equipment has been tested and found to comply with the limits for a Class A digital device, pursuant to Part 15 of the FCC Rules. These limits are designed to provide reasonable protection against harmful interference when the equipment is operated in a commercial environment.
- This equipment generates, uses, and can radiate radio frequency energy and, if not installed and used in accordance with the instruction manual, may cause harmful interference to radio communications. Operation of this equipment in a residential area is likely to cause harmful interference to radio communications, in which case the user will be required to correct the interference at his own expense.

CE Electromagnetic Compatibility (EMC) Conformity

This equipment has been tested and found to comply with the following EMC Standards:

EMC Standard	Title
CISPR 11:2004/EN 55011:1998+A1:1999&A2:2002, CLASS B	Limits and methods of measurements of radio disturbance characteristics of industrial, scientific, and medical (ISM) radio-frequency equipment.
EN 61326:1997+A1:1998+A2:2001+A3:2003 (IEC 61326:2002)	Electrical Equipment for Measurement, Control and Laboratory Use – Electromagnetic Compatibility.
EN61000-4-2:2001	Electromagnetic Compatibility (EMC) Part 4-2: Testing and measurement techniques – Electrostatic discharge immunity test.
EN61000-4-3:2002	Electromagnetic Compatibility (EMC) Part 4-3: Testing and measurement techniques – Radiated, radio-frequency, electromagnetic field immunity test.
EN61000-4-4:2004	Electromagnetic Compatibility (EMC) Part 4-4: Testing and measurement techniques – Electrical fast transient/burst immunity test.
EN61000-4-5:2001	Electromagnetic Compatibility (EMC) Part 4-5: Testing and measurement techniques – Surge immunity test.
EN61000-4-6:2004	Electromagnetic Compatibility (EMC) Part 4-6: Testing and measurement techniques – Immunity to conducted disturbances, induced by radio-frequency fields.
EN61000-4-8:2001	Electromagnetic Compatibility (EMC) Part 4-8: Testing and measurement techniques – Power frequency magnetic field immunity test.

R&TTE Compliance (Europe)

Hereby, Siemens Milltronics Process Instruments, declares that the SITRANS LR560 is in compliance with the essential requirements and other relevant provisions of Directive 1999/5/EC.

The LR560 complies with EN 302 372 for use in closed storage vessels, when installed according to the installation requirements of EN 302 372, and may be used in all EU countries.

The LR560 complies with Draft ETSI EN 302 729 for use outside of closed tanks in most EU countries. (For a list of exceptions, see the LR560 Declaration to EN 302 729, which can be accessed online at www.siemens.com/LR560.) For open air installations, the following conditions must be observed:

Installation and maintenance is performed by suitably qualified and trained personnel.

The LR560 shall be installed only in a permanent fixed position pointing downwards. Its location shall comply with the following two restrictions:

- 1) It shall be installed with a minimum separation distance of 4 km from Radio Astronomy sites listed below unless special authorization has been provided by the responsible national regulatory authority.
- 2) If it is installed at a location between 4 and 40 km from any Radio Astronomy site listed below, the LR560 shall be installed at a height not exceeding 15m from the ground.

Country	Name of Station	Geographic Latitude	Geographic Longitude
France	Plateau de Bure	44°38'01" N	05°54'26" E
	Bordeaux	44°84'00" N	0°52'00" W
Germany	Effelsberg	50°31'32" N	06°53'00" E
Italy	Sardinia	39°29'50" N	09°14'40" E
Spain	Yebeas	40°31'27" N	03°05'22" W
	Pico Veleta	37°03'58.3" N	03°23'33.7" W
Sweden	Onsala	57°23'45" N	11°55'35" E

The LR560 Declaration of Conformity may be accessed online at www.siemens.com/LR560.

Industry Canada

- a) Operation is subject to the following two conditions: (1) this device may not cause interference, and (2) this device must accept any interference, including interference that may cause undesired operation of the device.
- b) This device shall be installed and operated in a completely enclosed container to prevent RF emission which otherwise can interfere with aeronautical navigation. Installation shall be done by trained installers, in strict compliance with the manufacturer's instructions.
- c) The use of this device is on a "no-interference, no-protection" basis. That is, the user shall accept operations of high-powered radar in the same frequency band which may interfere with or damage this device. On the other hand, level probing devices found to interfere with primary licensing operations will be required to be removed at the user's expense.

- d) This level probing device is only permitted for installation inside enclosed containers. The installer/user of this device shall ensure that it is at least 10 km from the Penticton radio astronomy station (British Columbia latitude: 49° 19' 12" N, longitude: 119° 37' 12" W). For devices not meeting this 10 km separation (e.g. the Okanagan Valley, British Columbia) the installer/ user must coordinate with and obtain the written concurrence of the Director of the Penticton radio astronomy station before the equipment can be installed or operated. The Penticton contact is Tel: 250-493-2277/ fax: 250-493-7767. (In case of difficulty, the Manager, Radio Equipment Standards, Industry Canada, may also be contacted.)

The Manual

Notes:

- This product is intended for use in industrial areas. Operation of this equipment in a residential area may cause interference to several frequency based communications.
- Please follow the installation and operating procedures for a quick, trouble-free installation and to ensure the maximum accuracy and reliability of your SITRANS LR560.
- This manual applies to the SITRANS LR560 (mA/HART) only.

This manual will help you set up your SITRANS LR560 for optimum performance. We always welcome suggestions and comments about manual content, design, and accessibility. Please direct your comments to techpubs.smpi@siemens.com.

For other Siemens Milltronics level measurement manuals, go to: www.siemens.com/level and look under **Level Measurement**.

Application Example

The application example used in this manual illustrates a typical installation using SITRANS LR560. (See *Level application example* on page 38.) Because there is often a range of ways to approach an application, other configurations may also apply.

In all examples, substitute your own application details. If the example does not apply to your application, check the applicable parameter reference for the available options.

Technical Support

Support is available 24 hours a day.

To find your local Siemens Automation Office address, phone number and fax number go to: www.siemens.com/automation/partner

- Click on the tab **Contact**, select **Service**, then click **Service** again to find your product group (**+Automation Technology > +Sensor Systems >+Process Instrumentation > +Level Measurement > +Continuous**). Select **Radar**.
- Select the country followed by the City/Region.
- Select **Technical Support** under **Service**.

For on-line technical support go to: www.siemens.com/automation/support-request

- Enter the device name (SITRANS LR560) or order number, then click on **Search**, and select the appropriate product type. Click on **Next**.
- You will be prompted to enter a keyword describing your issue. Then either browse the relevant documentation, or click on **Next** to email a detailed description of your issue to Siemens Technical Support staff.

Siemens IA/DT Technical Support Center: phone +49 (0)911 895 7222

Abbreviations and Identifications

Short form	Long Form	Description	Units
CE / FM / CSA	Conformité Européene / Factory Mutual / Canadian Standards Association	safety approval	
DCS	Distributed Control System	control room apparatus	
dK	dielectric constant		
EDD	Electronic Device Description		
ESD	Electrostatic Discharge		
FMCW	Frequency Modulated Continuous Wave	radar principle	
I_i	Input current		mA
I_o	Output current		mA
LCD	Liquid Crystal Display		
LDI	Local Display Interface	removable display with push buttons	
LUI	Local User Interface	view outputs via LCD display; make modifications via push buttons or handheld programmer	
μ s	microsecond	10^{-6}	Second
PA	Process Automation (PROFIBUS)		
PED	Pressure Equipment Directive	safety approval	
ppm	parts per million		
PV	Primary Value	measured value	
SELV	Safety extra low voltage		
SV	Secondary Value	equivalent value	
TB	Transducer Block		
TVT	Time Varying Threshold	sensitivity threshold	
U_i	Input voltage		V
U_o	Output voltage		V

SITRANS LR560 Overview

SITRANS LR560 is a 2-wire, 78 GHz FMCW radar level transmitter for continuous monitoring of solids in vessels to a range of 100 m (329 ft). The plug and play performance is ideal for all solids applications, including those with extreme dust and high temperatures to +200 °C (+392 °F). The device is an electronic circuit coupled to a lens antenna and flange for quick and easy positioning.

The main benefits of using 78 GHz over devices using lower frequency are:

- very narrow beam, so device is insensitive to mounting nozzle interference and vessel obstructions.
- short wavelength yields very good reflection properties on sloped solids, so aiming towards material angle of repose is usually not necessary.

The technology is very tolerant to buildup on the lens antenna, however an air purge inlet is provided for periodic cleaning if required.

SITRANS LR560 supports HART communication protocol, and SIMATIC PDM software. Signals are processed using Process Intelligence which has been field-proven in over 1,000,000 applications worldwide (ultrasonic and radar).

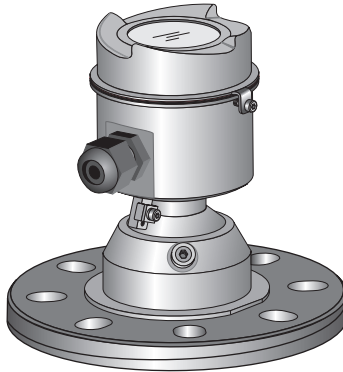

Programming

SITRANS LR560 is very easy to install and configure via an optional graphical local display interface. You can modify the built-in parameters either locally via the push buttons or using the infra-red handheld programmer, or from a remote location using one of the following options:

- HART (using 375 handheld Field Communicator, SIMATIC PDM, AMS, Pactware FDT/DTM)
- PROFIBUS PA (using SIMATIC PDM, FDT [such as PACTware or Fieldcare]) (See SITRANS LR560 (PROFIBUS PA) Instruction Manual for more information.)
- Foundation Fieldbus FF (using handheld 375 Field Communicator, FF host system or AMS Device Manager) [See SITRANS LR560 (Foundation Fieldbus) Instruction Manual for more information.]

Once programmed, the graphic Local Display Interface (LDI) can be removed if desired and used to transfer parameters to multiple SITRANS LR560s.

Local Display Interface (LDI)

- LDI may be ordered installed or added later as an option
- can be mounted in 1 of 4 positions at 90 degree intervals, for easy viewing after installation
- displays level and diagnostic information including echo profile and trend over time
- backlit for easy viewing in dimly lit areas
- allows you to copy parameters from one device to another
- provides high speed firmware transfer capabilities for future upgrades



Versions

Two different versions of the LR560 are available:

- 40 m range, +100 °C maximum process temperature
- 100 m range, +200 °C maximum process temperature

Applications

- solids bulk storage vessels
- cement powder, plastic powder/pellets, grain, flour, coal, and other applications

Approvals and Certificates

SITRANS LR560 is available with General Purpose approval, or for Hazardous areas. For details, see *Approvals* on page 11.

Application Type	LR560 Version	Approval Rating	Valid for:
Non-hazardous	General Purpose	CSA _{US/C} , FM, CE, C-TICK	N. America, Europe
Hazardous	Non-Sparking/ Energy Limited	ATEX II 3G Ex nA/nL IIC T4 Gc	Europe
	Dust Ignition Proof	ATEX II 1D, 1/2D, 2D IECEx Cert. SIR 09.0149X Ex ta IIIC T139 °C Da	Europe and International
		FM/CSA: Class II, Div. 1, Groups E, F, G Class III T4	US/Canada
	Non-incendive	FM/CSA: Class I, Div. 2, Groups A, B, C, D T4	US/Canada

Specifications

Note: Siemens Milltronics makes every attempt to ensure the accuracy of these specifications but reserves the right to change them at any time.

Power



Nominal 24 V DC with
max. 550 Ohm loop resis-
tance:

For other configurations, see the chart under *Loop power* on page 134

- Maximum 30 V DC
- 4 to 20 mA loop power

Performance

Reference operating conditions according to IEC 60770-1

- ambient temperature +15 to +25 °C (+59 to +77 °F)
- humidity 45% to 75% relative humidity
- ambient pressure 860 to 1060 mbar g (86 000 to 106 000 N/m² g)

Measurement Accuracy¹⁾ (measured in accordance with IEC 60770-1)

- Maximum measured error - Greater of 25 mm (1") or 0.25 % of range from minimum detectable distance to full range

Frequency 78 to 79 GHz FMCW

Max. measurement range²⁾

- 40 m version 40 m (131 ft)
- 100 m version 100 m (328 ft)

Min. detectable distance 400 mm (15.7") from sensor reference point³⁾

Update time⁴⁾ maximum 10 seconds, depending on setting for **Response Rate (2.4.1.)**

Influence of ambient temperature < 0.003%/K (average over full temperature range, referenced to maximum range)

Dielectric constant of material measured

- for ranges up to 20 m (65.6 ft) minimum dK = 1.6
- for ranges up to 100 m (328 ft) minimum dK = 2.5

¹⁾ Reference conditions: **Position Detect (2.7.3.3.)** set to **Center** and **Algorithm (2.7.3.1.)** set to **True First Echo**.

²⁾ From sensor reference point.

³⁾ See *Dimensions* on page 12.

⁴⁾ Reference conditions: **Response Rate (2.4.1.)** set to **FAST**

Memory:

- non-volatile EEPROM
- no battery required

Interface

Analog output

- signal range 4 to 20 mA (± 0.02 mA accuracy)
upper limit 20 to 22.6 mA adjustable
lower limit 3.56 to 4 mA adjustable
- fail signal 3.56 mA to 22.6 mA; or last value
- load Max. 550 Ω @ 24 V DC

Communication: HART

- Load 230 to 550 Ω , 230 to 500 Ω when connecting a coupling module
- Max. Line Length¹⁾ multi-wire: ≤ 1500 m (4921 ft)
- Protocol HART²⁾, Version 6.0

Configuration

- remote Siemens SIMATIC PDM or AMS Device Manager (PC) or FDT such as PACTWARE
- local Siemens infrared handheld programmer, local control buttons, or HART handheld communicator

Optional removeable

local display interface (LDI)³⁾ graphic LCD, with bar graph representing level

Mechanical

Process Connections:

- universal flat-faced flanges⁴⁾
3"/80 mm, 4"/100 mm, 6"/150 mm
materials stainless steel 316L (1.4404 or 1.4435), or 304
- Aimer flanges⁴⁾
3"/80 mm, 4"/100 mm, 6"/150 mm
material polyurethane powder-coated cast aluminum

¹⁾ Max. length depends on wire type. See www.hartcomm.org for more details.

²⁾ HART[®] is a registered trademark of HART Communication Foundation.

³⁾ Display quality will be degraded in temperatures below -20 °C (-4 °F) and above +65 °C (+149 °F).

⁴⁾ Universal flange mates with EN 1092-1 (PN16)/ASME B16.5 (150 lb)/JIS 2220 (10K) bolt hole pattern.

- Enclosure
- construction 316L/1.4404 stainless steel
 - conduit entry M20x1.5, or ½" NPT
 - conduit entry connector optional M12 connector (shipped with M20 to M12 adaptor) or 7/8" connector (shipped with 1/2" NPT to 7/8" adaptor)
 - ingress protection Type 4X/NEMA 4X, Type 6/NEMA 6, IP68
 - lid with window polycarbonate (window material)
- Lens antenna material
- construction 40 m version PEI
100 m version PEEK
- Air Purge Connection
- equipped with female 1/8" NPT fitting
- Weight
- 3" stainless steel flange model 3.15 kg (6.94 lb)

Environmental

Note: Use appropriate conduit seals to maintain IP or NEMA rating.

- location indoor/ outdoor
- altitude 5000 m (16 404 ft) max.
- ambient temperature -40 to +80 °C (-40 to +176 °F)
- relative humidity suitable for outdoor
Type 4, 4X/NEMA 4, 4X, Type 6/NEMA 6, IP68 enclosure (see note above)
- installation category I
- pollution degree 4

Process

- temperature and pressure¹⁾

Versions	stainless steel flange	Aimer flange 0.5 bar max.	Aimer flange 3.0 bar max
40 m	-40 to +100 °C (-40 to +212 °F)	-40 to +100 °C (-40 to +212 °F)	-40 to +100 °C (-40 to +212 °F)
100 m	-40 to +200 °C (-40 to +392 °F)	-40 to +200 °C (-40 to +392 °F)	-40 to +120 °C (-40 to +248 °F)

¹⁾ Maximum and minimum temperatures are dependent on the process connection, antenna and O-ring materials. Use of the Easy Aimer limits maximum temperature.

Approvals

Note: The device label lists the approvals that apply to your device.

- General CSA_{US/C}, FM, CE, C-TICK
- Radio R&TTE (Europe), FCC, Industry Canada,
- Hazardous
 - Non-sparking/
Energy Limited¹⁾ (Europe) ATEX II 3G Ex nA/nL IIC T4 Gc
 - Dust Ignition Proof²⁾(Europe/International) ATEX II 1D, 1/2D, 2D
IECEx SIR 09.0149X
Ex ta IIC T139 °C Da
 - Dust Ignition Proof³⁾ (US/Canada) FM/CSA:
Class II, Div. 1, Groups E, F, G
Class III T4
 - Non-incendive²⁾ (US/Canada) FM/CSA Class I, Div. 2,
Groups A, B, C, D, T4

Programmer (infrared keypad)

Notes:

- Battery is non-replaceable with a lifetime expectancy of 10 years in normal use.
- To estimate the lifetime expectancy, check the nameplate on the back for the serial number. The first six numbers show the production date (mmddy), for example, serial number 032608101V.

Siemens Milltronics Infrared IS (Intrinsically Safe) Hand Programmer for hazardous and all other locations (battery is non-replaceable)

- approval FM/CSA Class I, II, III, Div. 1, Gr. A to G T6
ATEX II 1GD Ex ia IIC T4 Ga
Ex iaD 20 T135 °C
CE
IECEx SIR 09.0073 Ex ia IIC T4 Ga
Ex iaD 20 T135 °C
INMETRO Br-Ex ia IIC T4
- ambient temperature -20 to +50 °C (-5 to +122 °F)
- interface proprietary infrared pulse signal
- power 3 V lithium battery
- weight 150 g (0.3 lb)
- color black
- Part Number 7ML1930-1BK

¹⁾ See *Non-Sparking/Energy Limited wiring (Europe) and Dust Ignition Proof wiring (Europe/International)* on page 26 for more details.

²⁾ See *Non-Sparking/Energy Limited wiring (Europe) and Dust Ignition Proof wiring (Europe/International)* on page 26 for more details.

³⁾ See *Non-incendive and Dust Ignition Proof wiring (US/Canada)* on page 26.

Dimensions

SITRANS LR560 with stainless steel Universal Flat-faced Flange

Note: Refer to *Universal Slotted Flange* on page 16 for bolt hole patterns and dimensions.

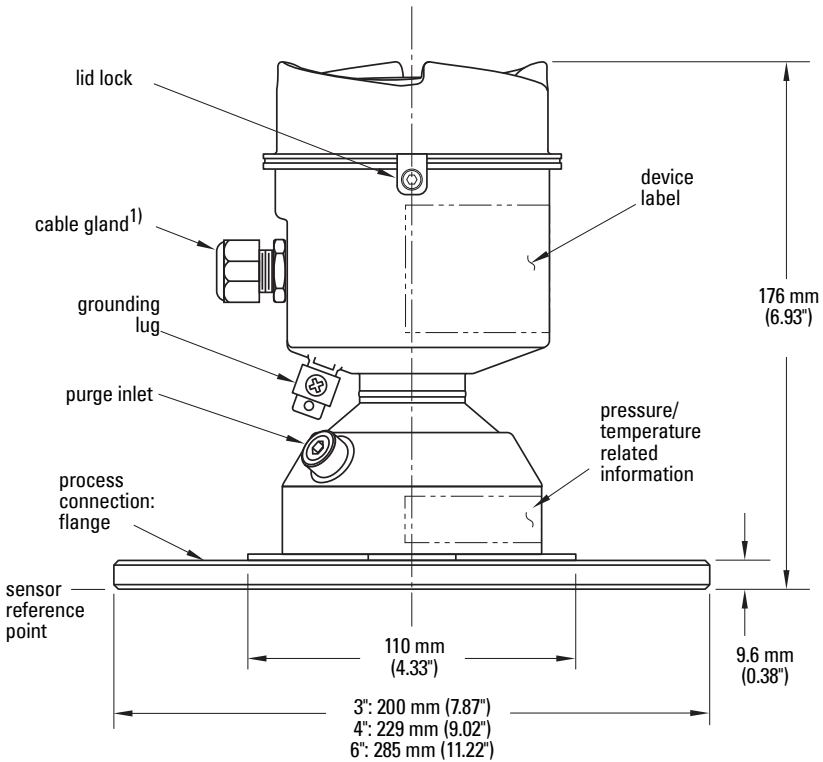

¹⁾ Shipped with product, packed in a separate bag.

SITRANS LR560 with 3" Aimer Flange

Note: Refer to *Universal Slotted Flange* on page 16 for bolt hole patterns and dimensions.

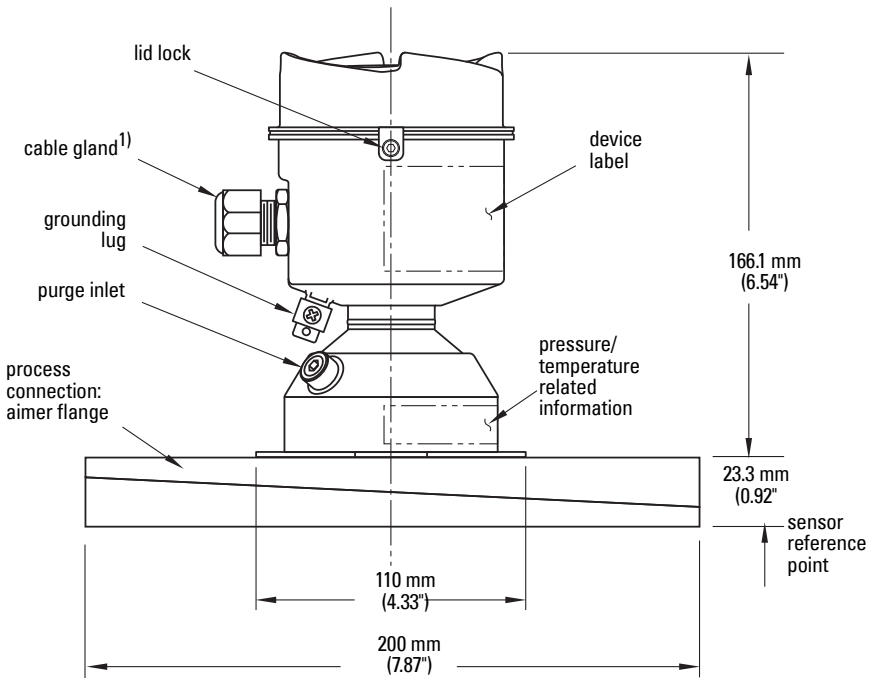

¹⁾ Shipped with product, packed in a separate bag.

SITRANS LR560 with 4 and 6" Aimer Flange

Note: Refer to *Universal Slotted Flange* on page 16 for bolt hole patterns and dimensions.

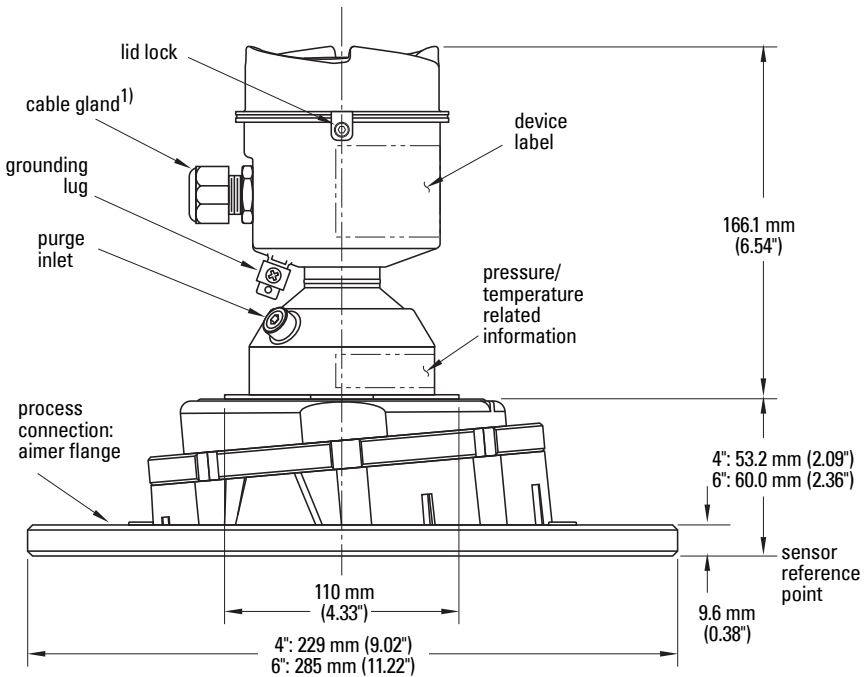

C Spanner

A C spanner, used to loosen the aimer locking ring, is shipped with the device, packed separately.

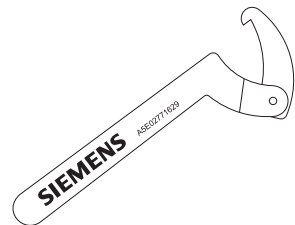

¹⁾ Shipped with product, packed in a separate bag.

Process Connection Label (Pressure Rated Versions)

For pressure-rated versions only, the process connection label lists the following information:

Item	Sample Text	Comments/Explanation
CONNECTION SERIES	ASME B16.5 / EN 1092-1 / JIS B 2220	Flange Series: dimensional pattern based on ASME B16.5/EN 1092-1/JIS B 2220 flange standards
NOM. PIPE SIZE (DN)	4 INCH / 100mm	Nominal Pipe Size: based on 150#/PN16/10K flange pressure classes
MAWP (PS)	3 BAR	Maximum Allowable Working Pressure at Design Temperature
DESIGN TEMP. (TS)	100 °C	Maximum Allowable Working Temperature
MIN. PROCESS	3 BAR AT -40 °C	Minimum Wetted Process Conditions
0F13589.5		Canadian Registration Number (CRN)
TEST PRESSURE (PT)	5.2 BAR	Production Test Pressure
TEST DATE	10/01/04	Date of Pressure Test (Year/Month/Day)
PROCESS SERIES	25785	Pressure Tag Family Series
WETTED NON-METALLIC	PEI	Sensor Lens Material
WETTED METALLICS	304L	Process Connection Material(s)
WETTED SEALS	FKM / VQM	Seal Material(s)

Universal Slotted Flange

! WARNING: The user is responsible for the selection of bolting and gasket materials which will fall within the limits of the flange and its intended use and which are suitable for the service conditions.

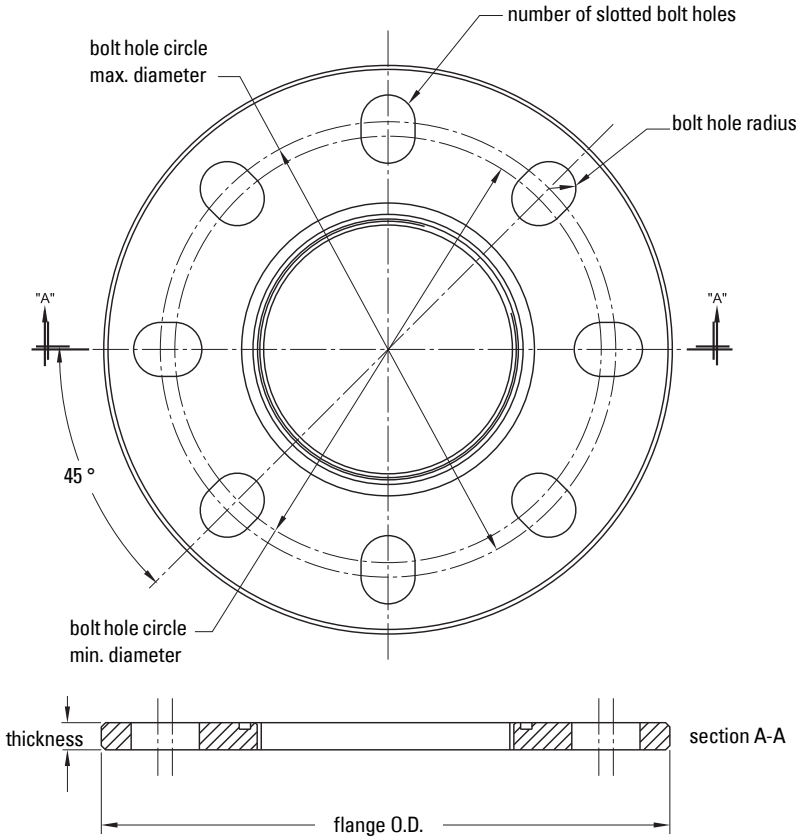

Slotted Flange Dimensions and Aimer¹⁾

Pipe Size	Flange O.D.	Thick-ness (s)	Bolt Hole Circle Max Ø	Bolt Hole Circle Min Ø	Bolt Hole radius	No. of Slotted Holes
3" or 80 mm	7.87" (200 mm)	0.38" (9.65 mm)	6.30" (160 mm)	5.91" (150 mm)	0.38" (9.65 mm)	8
4" or 100 mm	9.00" (229 mm)	0.38" (9.65 mm)	7.52" (191 mm)	6.89" (175 mm)	0.38" (9.65 mm)	8
6" or 150 mm	11.22" (285 mm)	0.38" (9.65 mm)	9.53" (242 mm)	9.45" (240 mm)	0.45" (11.5 mm)	8

¹⁾ Universal flange mates with EN 1092-1 (PN16)/ASME B16.5 (150 lb)/JIS 2220 (10K) bolt hole pattern.

Installation



WARNINGS:

- **Installation shall only be performed by qualified personnel and in accordance with local governing regulations.**
- **SITRANS LR560 is to be used only in the manner outlined in this manual, otherwise protection provided by the device may be impaired.**
- **Never attempt to loosen, remove, or disassemble process connection or instrument housing while vessel contents are under pressure.**
- **The user is responsible for the selection of bolting and gasket materials which will fall within the limits of the flange and its intended use and which are suitable for the service conditions.**
- **Improper installation may result in loss of process pressure.**

Notes:

- Refer to the device label for approval information.
- SITRANS LR560 units are pressure tested, meeting or exceeding the requirements of the ASME Boiler and Pressure Vessel Code and the European Pressure Equipment Directive.
- The serial numbers stamped in each process connection body provide a unique identification number indicating date of manufacture.
Example: MMDDYY – XXX (where MM = month, DD = day, YY = year, and XXX= sequential unit produced)
Further markings (space permitting) indicate flange configuration, size, pressure class, material, and material heat code.

Pressure Equipment Directive, PED, 97/23/EC

Note: Pertains to pressure-rated version only.

SITRANS LR560 Radar Level Measurement instrument falls below the limits of Article 3, sections 1&2 of the Pressure Equipment directive (PED, 97/23/EC), as a category I pressure accessory. However, in accordance with PED, 97/23/EC, Article 3, section 3, this equipment has been designated and manufactured in accordance with Sound Engineering Practice (SEP) (see EU Commission Guideline 1/5).

Mounting location

Notes:

- Correct location is key to a successful application.
- Avoid reflective interference from vessel walls and obstructions by following the guidelines below.

Nozzle location

Notes:

- For details on avoiding false echoes, see *Shaper Mode (2.8.4.)* on page 128.

Beam angle

- Beam angle is the width of the cone where the energy density is half of the peak energy density.
- The peak energy density is directly in front of and in line with the antenna.
- There is a signal transmitted outside the beam angle, therefore false targets may be detected.

Emission cone

- Keep emission cone free of interference from ladders, pipes, I-beams or filling streams.
- Avoid central locations on tall, narrow vessels.

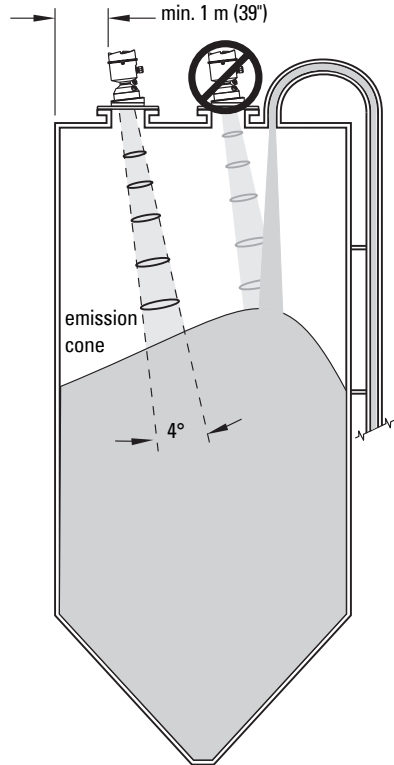

Environment

- Provide easy access for viewing the display and programming via the hand programmer.
- Provide an environment suitable to the housing rating and materials of construction.

ambient temperature
-40 °C to +80 °C
(-40 °F to +176 °F)

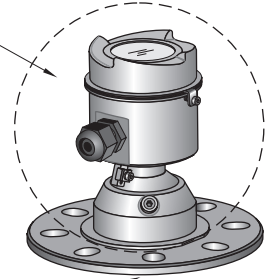

process temperature
-40 to +100 °C (-40 to +212 °F) or
-40 to +200 °C (-40 to +392 °F) depending on the version

Sunshield

The LR560 display can be protected by an optional sunshield if the instrument will be mounted in direct sunlight.

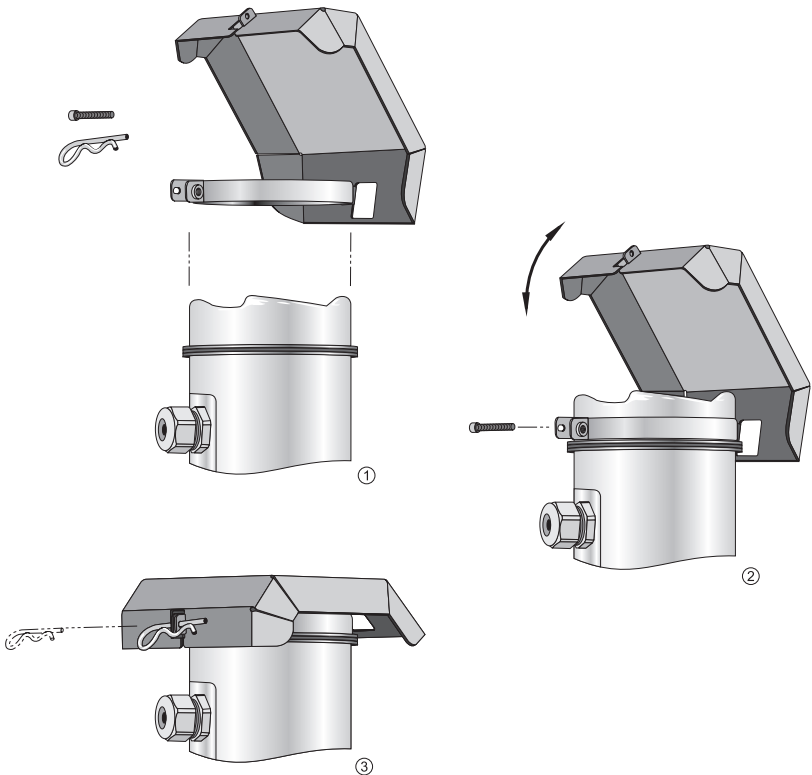

Aimer Adjustment

Note: Aiming will assist in measuring material in the cone.

3" flange

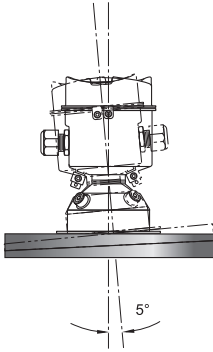

4 and 6" flange

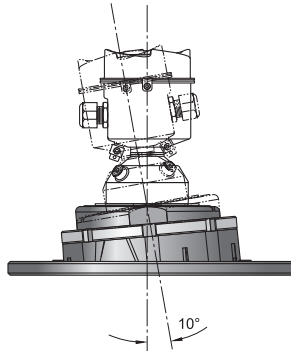

Aiming is not required for signal optimization with 78 GHz frequency.

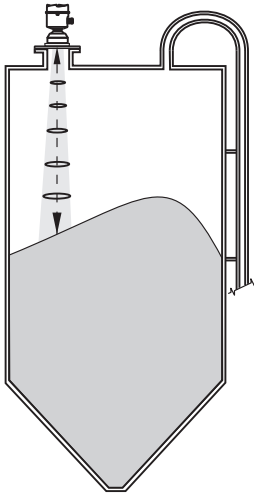

Aiming will assist in measuring material in the cone.

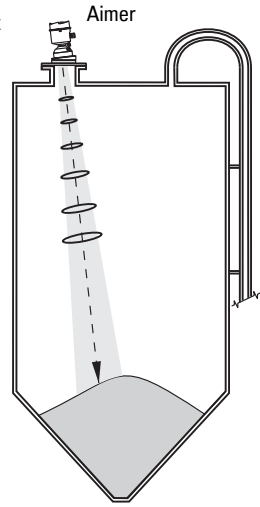

1. For 4" and 6" Aimer: Loosen the set screws in the locking ring. Holding the electronics enclosure firmly, loosen the Aimer locking ring using the supplied C spanner, until the LR560 drops down slightly. The enclosure can then be turned freely.
2. Direct SITRANS LR560 so the antenna is pointed at an angle perpendicular to the material surface, if possible.
3. When the desired position is reached, re-tighten the locking ring using the C spanner, and tighten set screws.
4. For the 3" Aimer flange, tapered split washers with pressure rated versions are provided to keep nuts and bolts perpendicular to the flange surface.

Air Purging System

For convenient cleaning, a purging inlet is provided above the antenna. The system provides an 1/8" inlet (female thread) above the antenna where clean, dry air passes to the face of the antenna lens to clean it. The customer will supply the purging air by a manual or automatic valve system.

Notes:

- Purge duration, pressure, and interval, will vary with each application. It is the user's responsibility to determine the requirements depending on the application and cleaning required.
- Short duration bursts of high pressure provide more effective cleaning than continuous low pressure air.
- It is the customer's responsibility to ensure that any vacuum or pressure in the measured vessel is maintained, considering the hole that passes through the process connection and SITRANS LR560 antenna system.

Air Consumption (Flow rate versus applied pressure)

Air Pressure (psi)	Approx. inlet volume flow rate (SCFM)
20	5
40	10
50	15
80	20
100	25
110	30

Recommended 90 to 110 psi for effective cleaning¹⁾

Purge Connection

- The purge connection is closed by the manufacturer, using a 1/8" plug.
- When the plug is removed to connect a purging system, the operator is responsible for ensuring that the purging circuit conforms to "Ex" requirements: for example, by fitting an NRV valve.¹⁾

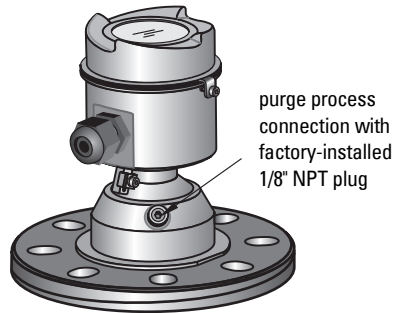

Purge airflow

- The purge airflow is designed to create a strong vortex of air that rapidly cleans the face of the lens.
- The air purge system can clean both dust and moisture off the lens.

¹⁾ Air pressure in vessel can affect purge operation.

- It can be used for periodic cleaning.

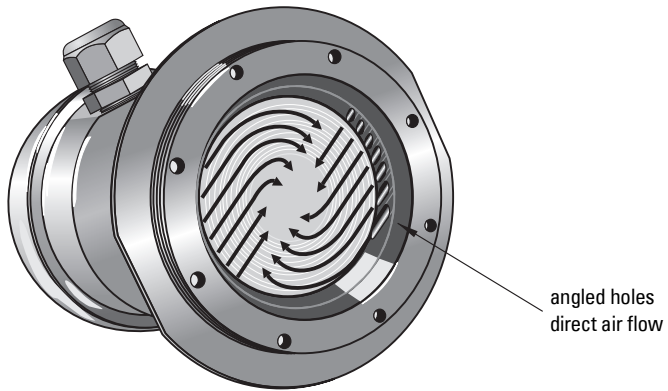

Removable Display

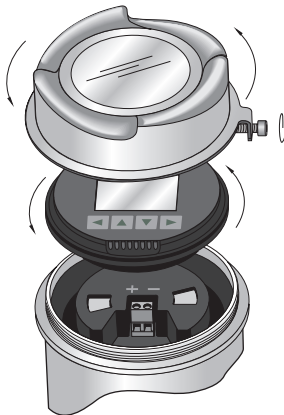

The optional display can be rotated as required, to one of 4 positions, 90 degrees apart. (See *Connecting SITRANS LR560* on page 24.)

It can also be used to transfer parameters from one device to another. (See *Copy Parameters to Display* on page 80.)

Wiring

Power

WARNINGS:



The DC input terminals shall be supplied from a source providing electrical isolation between the input and output, in order to meet the applicable safety requirements of IEC 61010-1.



All field wiring must have insulation suitable for rated voltages.

Connecting SITRANS LR560



WARNINGS:

- Check the device label on your instrument, to verify the approval rating.
- Use appropriate conduit seals to maintain IP or NEMA rating.
- Read *Instructions specific to hazardous area installations* on page 27.

Notes:

- Use twisted pair cable: AWG 22 to 14 (0.34 mm² to 2.5 mm²).
- Separate cables and conduits may be required to conform to standard instrumentation wiring practices or electrical codes.

1. Loosen locking screw.
2. Remove LR560 lid.
3. Remove optional display by gently turning the display a quarter turn counter-clockwise until it is free.
4. Strip the cable jacket for approximately 70 mm (2.75") from the end of the cable, and thread the wires through the gland¹⁾.

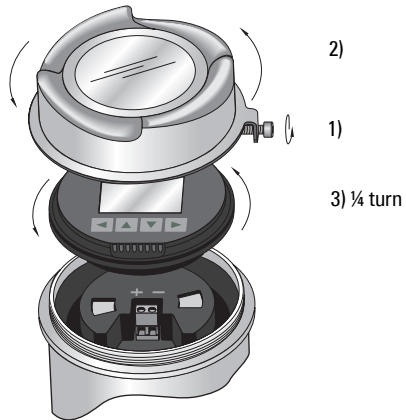

¹⁾ If cable is routed through conduit, use only approved suitable-size hubs for waterproof applications.

- Connect the wires to the terminals as shown: the polarity is identified on the terminal block.

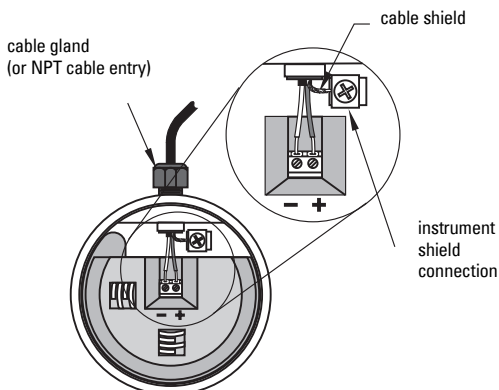

- Ground the instrument according to local regulations.
- Tighten the gland to form a good seal.
- Replace optional display and device lid.
- Tighten locking screw.

Connecting HART

Typical PLC/mA configuration with HART

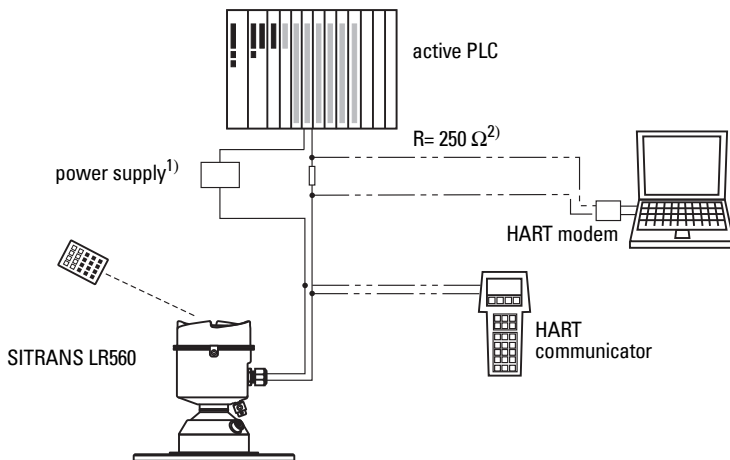

- Depending on the system design, the power supply may be separate from the PLC, or integral to it.
- HART resistance (total loop resistance, that is, cable resistance plus 250 Ohm [resistor]) must be less than 550 Ohm for the device to function properly.

Wiring setups for hazardous area installations

The following wiring options are available for hazardous area installations:

- *Non-Sparking/Energy Limited wiring (Europe) and Dust Ignition Proof wiring (Europe/International)* on page 26
- *Non-incendive and Dust Ignition Proof wiring (US/Canada)* on page 26

In all cases, check the device label on your instrument, and confirm the approval rating.

1. Non-Sparking/Energy Limited wiring (Europe) and Dust Ignition Proof wiring (Europe/International)

<p>Segurança</p>  <p>ATEN 0 - RISCO POTENCIAL DE CARGA ELETROSTÁTICA - VEJA INSTRUÇÕES</p> <p>ATEN 0 - N O ABRA QUANDO ENERGICADO</p> <p>ATEN 0 - UTILIZAR CABOS ADEQUADOS</p>	<p>SIEMENS</p> <p>SITRANS LR560</p> <p>7ML19985KBB01-0000-0000</p> <p>SERIAL NO. 01034567</p> <p>ENCLOSURE: NEMA / TYPE 4X, 6, IP68</p> <p>AMB. TEMP. - 40°C to 80°C</p> <p>INPUT: 24 V \approx NOM., 30 V \approx MAX., 4 - 20 mA</p> <p>OUTPUT: HART</p> <p>0899 0518</p> <p>Siemens XRT Process Instruments, Pittsburgh Assembly Plant, 10000 North Dome Rd, Waukegan, IL 60087-1000</p>	<p>Sira 09ATEX4357X</p> <p>Ex nA II T4 Gc</p> <p>U₀ = 32 V</p> <p>Ex nA IIC T4 Gc</p> <p>U₁ = 32 V</p> <p>I₁ = 22,63 mA</p> <p>C₂ = 5 nF</p> <p>L₂ = 20 µH</p> <p>POTENTIAL ELECTROSTATIC CHARGING HAZARD DO NOT CLEAN WITH DRY CLOTH DO NOT INSTALL WHERE BUILD-UP OF CHARGE IS LIKELY USE SUITABLY RATED CABLE DE-ENERGIZE BEFORE REMOVING COVER</p>
--	--	---

The ATEX certificate listed on the device label can be downloaded from the product page of our website at: www.siemens.com/sitransLR560.

The IECEx certificate listed on the device label can be viewed on the IECEx website. Go to: <http://iecex.iec.ch> and click on **Ex Equipment Certificates of Conformity** then enter the certificate numbers IECEx Sira 09ATEX9356X and Sira 09ATEX4357X.

- For power demands, see *Loop power* on page 134.
- For wiring requirements follow local regulations.
- See also *Instructions specific to hazardous area installations* on page 27 and the ATEX certificate listed above.

2. Non-incendive and Dust Ignition Proof wiring (US/Canada)

<p>FM APPROVED</p> <p>CSA</p> <p>159194</p> <p>CLASS II, DIV 1, GR. E, F G</p> <p>CLASS III, T4</p> <p>CLASS I, DIV 2</p> <p>GR. A, B, C, D</p> <p>TEMP. CODE: T4</p> <p>REFER TO INSTALLATION DWG. A5E02795836</p>	<p>SIEMENS</p> <p>SITRANS LR560</p> <p>7ML19985KBB01-0000-0000</p> <p>SERIAL NO. 01034567</p> <p>ENCLOSURE: NEMA / TYPE 4X, 6, IP68</p> <p>AMB. TEMP. - 40°C to 80°C</p> <p>INPUT: 24 V \approx NOM., 30 V \approx MAX., 4 - 20 mA</p> <p>OUTPUT: HART</p> <p>0899 0518</p> <p>Siemens XRT Process Instruments, Pittsburgh Assembly Plant, 10000 North Dome Rd, Waukegan, IL 60087-1000</p>	<p>THIS DEVICE COMPLIES WITH PART 15 OF THE FCC RULES, OPERATIONS SUBJECT TO THE FOLLOWING TWO CONDITIONS:</p> <p>1) THIS DEVICE MAY NOT CAUSE HARMFUL INTERFERENCE AND</p> <p>2) THIS DEVICE MUST ACCEPT ANY INTERFERENCE RECEIVED, INCLUDING INTERFERENCE THAT MAY CAUSE UNDESIRABLE OPERATION</p> <p>IC: 267P-LR560</p> <p>FCC ID: NJA-LR560</p>
---	--	---

FM/CSA Class 1, Div 2 connection drawing number A5E02795836 can be downloaded from the product page of our website at: www.siemens.com/sitransLR560.

For power demands, see *Temperature derating curve* on page 133.

Instructions specific to hazardous area installations

(Reference European ATEX Directive 94/9/EC, Annex II, 1.0.6)

Note: Installation shall be performed only by qualified personnel and in accordance with local governing regulations.

The following instructions apply to equipment covered by certificate numbers Sira 09ATEX9356X and Sira 09ATEX4357X:

1. For use and assembly and details of marking/coding, refer to the main instructions.
2. The equipment is certified for use as Category 1D, 1/2D and 2D equipment per certificate Sira 09ATEX9356X and may be used in hazardous zones 20, 21 and 22. The equipment is also certified for use as Category 3G equipment per certificate Sira 09ATEX4357X and may be used in hazardous zone 2.
3. This equipment has a maximum surface temperature of 139 °C (in an 80 °C ambient). Refer to the applicable code of practice for selection of this equipment with respect to specific dust ignition temperatures.
4. The equipment is certified for use in an ambient temperature range of -40 °C to 80 °C.
5. The equipment has not been assessed as a safety related device (as referred to by Directive 94/9/EC Annex II, clause 1.5).
6. Installation and inspection of this equipment shall be carried out by suitably trained and authorized personnel in accordance with the applicable code of practice.
7. The equipment shall be installed such that the supply cable is protected from mechanical damage. The cable shall not be subjected to tension or torque. The equipment manufacturer is not responsible for providing the supply cable.
8. Repair of this equipment shall be carried out by suitably trained and authorized personnel in accordance with the applicable code of practice.

SPECIAL CONDITIONS FOR SAFE USE

The 'X' suffix to the certificate number relates to the following special condition(s) for safe use:

- Parts of the enclosure may be non-conducting and may generate an ignition-capable level of electrostatic charge under certain extreme conditions. The user should ensure that the equipment is not installed in a location where it may be subjected to external conditions (such as high-pressure steam), which might cause a build-up of electrostatic charge on non-conducting surfaces.
- The end user must ensure that an ingress protection of at least IP65 is maintained at each entry to the enclosure by use of a blanking element or cable entry device that meets the requirements of the protection concepts type 'n' or increased safety 'e' or flameproof 'd'.
- The supply to the equipment shall be rated for a prospective short-circuit current of not more than 10 kA and shall be protected by a suitably-rated fuse.

Local operation

SITRANS LR560 carries out its level measurement tasks according to settings made via parameters. The settings can be modified locally via the optional Local Display Interface (LDI) which consists of an LCD display with buttons. You can use either the push buttons or an infrared handheld programmer to make changes.

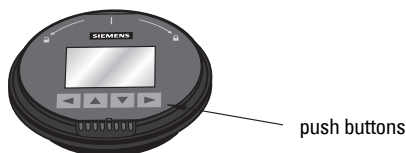

A Quick Start Wizard provides an easy step-by-step procedure to help you configure the device for a simple application. There are two ways to access the wizard:

- locally (see *Quick Start Wizard via the LDI push buttons* on page 34 or *Quick Start Wizard via the handheld programmer* on page 34)
- from a remote location (see *Quick Start Wizard via SIMATIC PDM* on page 40 or *Operating via AMS Device Manager* on page 56.)

See *Level application example* on page 38 for an illustration, and for the complete range of parameters, see *Parameter Reference* on page 78

Activating SITRANS LR560

Notes:

- To enter Program mode using the device buttons, press ►. Press ◀ to return to Measurement mode.
- To toggle between Measurement and Program Mode using the handheld programmer, press **Mode** .

Power up the device. A transition screen showing first the Siemens logo and then the current firmware revision is displayed while the first measurement is being processed. SITRANS LR560 automatically starts up in Measurement mode. The first time the device is configured, you will be prompted to select a language (English, German, French, Spanish or Chinese). To change the language again, see **Language (7.)** on page 112.

The LCD Display

Measurement mode display: Normal operation

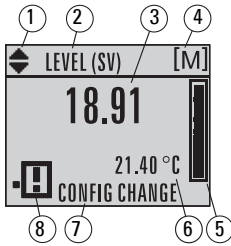

- 1 – toggle indicator¹⁾ for PV or SV (primary or secondary values)
- 2 – selected operation: level, space, or distance
- 3 – measured value (level, space, or distance)
- 4 – units
- 5 – bar graph indicates level
- 6 – secondary region indicates on request²⁾ electronics temperature, echo confidence, loop current, or distance
- 7 – text area displays status messages
- 8 – device status indicator

Fault present



S: 0 LOE

- 7 – text area displays a fault code and an error message
- 8 – service required icon appears

PROGRAM mode display

Navigation view

- A visible menu bar indicates the menu list is too long to display all items.
- The depth of the item band on the menu bar indicates the length of the menu list: a deeper band indicates fewer items.
- The position of the item band indicates the approximate position of the current item in the list. A band halfway down the menu bar indicates the current item is halfway down the list.

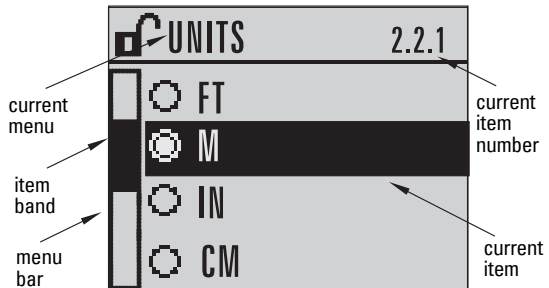

Parameter view

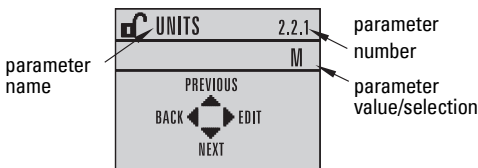

Edit view

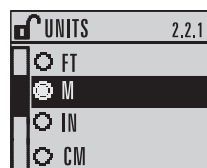

¹⁾ Press UP or DOWN arrow to switch

²⁾ In response to a key press request. For details, see *Key functions in Measurement mode* on page 30.

Handheld Programmer

(Part No. 7ML1930-1BK)

The programmer is ordered separately.



Key functions in Measurement mode

Key	Function	Result
	Displays the loop current.	New value is displayed in LCD secondary region.
	Displays internal enclosure temperature reading.	
	Displays echo confidence value.	
	Displays distance measurement.	
	Mode opens PROGRAM mode.	Opens the menu level last displayed in this power cycle, unless power has been cycled since exiting PROGRAM mode or more than 10 minutes have elapsed since PROGRAM mode was used. Then top level menu will be displayed.
	Home toggles LCD	LCD toggles between % or linear units
	RIGHT arrow opens PROGRAM mode.	Opens the top level menu.
	UP or DOWN arrow toggles between PV and SV.	LCD displays primary or secondary value.

Programming SITRANS LR560

Notes:

- While the device is in PROGRAM mode, the output remains active and continues to respond to changes in the device.
- SITRANS LR560 automatically returns to Measurement mode after a period of inactivity in PROGRAM mode (*Menu Timeout 2.1.9.* on page 82).

Change parameter settings and set operating conditions to suit your specific application. (For remote operation, see *Operating via SIMATIC PDM* on page 39 or *Operating via AMS Device Manager* on page 56.)

Parameter menus

Note: For the complete list of parameters with instructions, see *Parameter Reference* on page 78.

Parameters are identified by name and organized into function groups, then arranged in a 5-level menu structure (see *LCD menu structure* on page 149).

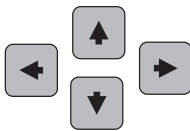



1. QUICK START
2. SETUP
 - 2.1 DEVICE
 - 2.2 SENSOR
 - 2.2.1 UNITS
 - 2.2.3 DAMPING FILTER

1. Enter PROGRAM mode

Using LDI buttons:

- Press  to enter Program Mode

Using handheld programmer:



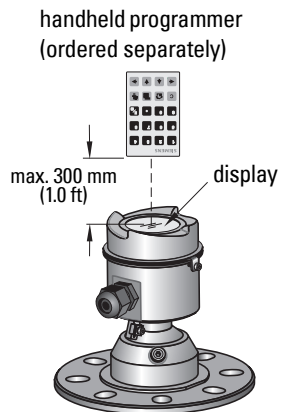



- Point the programmer at the display from a maximum distance of 300 mm (1 ft).
- **RIGHT arrow**  activates PROGRAM mode and opens menu level 1.
- **Mode**  opens the menu level last displayed in PROGRAM mode within the last 10 minutes, or menu level 1 if power has been cycled since then.



2. Navigating: key functions in Navigation mode



Notes:

- In Navigation mode, **ARROW keys** move to the next menu item in the direction of the arrow.
- For Quick Access to parameters via the handheld programmer, press Home , and then enter the menu number, for example: **3.2. Echo Profile**.

Key	Name	Menu level	Function
 	UP or DOWN arrow	menu or parameter	Scroll to previous or next menu or parameter.
	RIGHT arrow	menu	Go to first parameter in the selected menu, or open next menu.
		parameter	Open Edit mode.
	LEFT arrow	menu or parameter	Open parent menu.
	Mode	menu or parameter	Change to MEASUREMENT mode.
	Home	menu or parameter	Open top level menu: menu 1.

3. Editing in PROGRAM mode



Selecting a listed option

- Navigate to the desired parameter.
- Press **RIGHT arrow**  to open parameter view.
- Press **RIGHT arrow**  again to open **Edit** mode. The current selection is highlighted. Scroll to a new selection.
- Press **RIGHT arrow**  to accept it. The LCD returns to parameter view and displays the new selection.

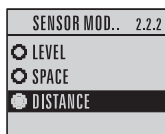
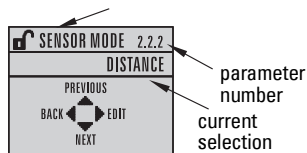
parameter name







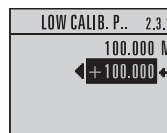
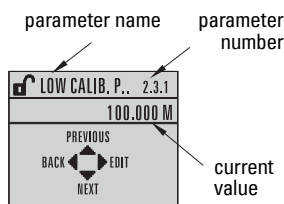



Changing a numeric value

- Navigate to the desired parameter.
- Press **RIGHT arrow**  to open parameter view. The current value is displayed.
- Press **RIGHT arrow**  again to open **Edit** mode. The current value is highlighted.
- Key in a new value.
- Press **RIGHT arrow**  to accept it. The LCD returns to parameter view and displays the new selection.



Key functions in Edit mode

Key	Name		Function
 	UP or DOWN arrow	Selecting options	Scrolls to item.
		Alpha-numeric editing	<ul style="list-style-type: none"> - Increments or decrements digits - Toggles plus and minus sign
	RIGHT arrow	Selecting options	<ul style="list-style-type: none"> - Accepts the data (writes the parameter) - Changes from Edit to Navigation mode
		Numeric editing	<ul style="list-style-type: none"> - Moves cursor one space to the right - or with cursor on Enter sign, accepts the data and changes from Edit to Navigation mode
	LEFT arrow:	Selecting options	<ul style="list-style-type: none"> - Cancels Edit mode without changing the parameter
		Numeric editing	<ul style="list-style-type: none"> - Moves cursor to plus/minus sign if this is the first key pressed - or moves cursor one space to the left. - or with cursor on Enter sign, cancels the entry
	Clear	Numeric editing	Erases the display.
	Decimal point	Numeric editing	<ul style="list-style-type: none"> - In Edit mode, enters a decimal point. - In Parameter View, press  to store menu path to that parameter, and create custom Secondary Value to be displayed in secondary region of LCD.
	Plus or minus sign	Numeric editing	Changes the sign of the entered value.
	Numeral	Numeric editing	Enters the corresponding character.

Quick Start Wizard via the LDI push buttons

- 1) Press **▶** to enter Program mode.
- 2) Choose **Quick Start (1.)**, and then **Quick Start Wizard (11.)**.
- 3) Follow the steps then choose **Finish** to save Quick Start parameter changes and return to Program menu, or press **◀** to return to Measurement mode.

To add or delete digits using the push buttons:

Note: When the Enter icon  is highlighted, press **▲** to insert a digit on the right, **▼** to delete the right-most digit, **▶** to accept the value, or **◀** to cancel.

- 1) Navigate to the parameter you wish to modify and press **▶** to edit it. The value will be highlighted.
- 2) Press **▲** or **▼** to delete the highlighted value, or **◀** to modify the value from the left-most digit, starting with the plus/minus sign.
- 3) With the plus or minus sign highlighted, press **▲** or **▼** to change it. Press **▶** to highlight the next digit to the right.
- 4) Use **▲** or **▼** to modify the highlighted digit. Scroll past 9 to reach the decimal point.
- 5) When the value is complete, press **▶** until the Enter icon , then press **▶** to accept the value.

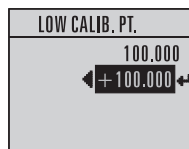

To modify a text string:

- 1) Navigate to the parameter you wish to modify and press **▶** to edit it. The string will be highlighted.
- 2) Follow the same steps as above, to add, delete, or modify characters.

Quick Start Wizard via the handheld programmer







Notes:

- The Quick Start wizard settings are inter-related and changes apply only after you choose Finish in the Wizard Complete step.
- Do not use the Quick Start wizard to modify individual parameters: see instead *Parameter Reference* on page 78. (Perform customization for your application only after the Quick Start has been completed.).
- Default settings in the parameter tables are indicated with an asterisk (*).

1. Quick Start

1.1. Quick Start Wizard

- a. Point the programmer at the display from a maximum distance of 300 mm (1 ft), then press **RIGHT arrow**  to activate PROGRAM mode and open menu level 1.

- b. Press **RIGHT arrow**  twice to navigate to menu item 1.1 and open the Quick Start Wizard.
- c. At each step, press **DOWN arrow**  to accept default values and move directly to the next item, or **RIGHT arrow**  to open Edit mode: the current selection is highlighted.
- d. Scroll to desired item and press **RIGHT arrow**  to store the change, then press **DOWN arrow**  to continue.
- e. At any time, you can press **UP arrow**  to go back, or **LEFT arrow**  to cancel and return to Measurement mode.



Vessel

Select vessel construction material.

- Selecting either STEEL or CONCRETE does a functional reset (see **Master Reset (4.2)** on page 105).
- Selecting STEEL changes the setting for **Position Detect (2.7.3.3)** to Rising Edge and for **Algorithm (2.7.3.1)** to F.
- Selecting CONCRETE changes the setting for **Position Detect (2.7.3.3)** to Rising Edge and for **Algorithm (2.7.3.1)** to ALF.

Parameter View

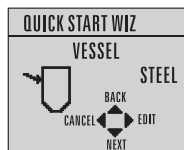

Edit mode

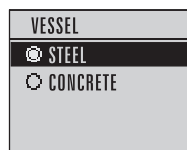

Options	*	STEEL
		CONCRETE

Response Rate

Sets the reaction speed of the device to measurement changes in the target range. Selecting SLOW changes setting for Average Amount (2.7.5.3) to 0.9.

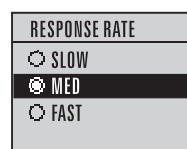
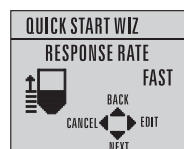

Response Rate		Vessel Fill Rate/Min or Empty Rate/Min
SLOW		0.1 m/min (0.32 ft/min)
MED	*	1.0 m/min (3.28 ft/min)
FAST		10.0 m/min (32.8 ft/min)

Use a setting just faster than the maximum vessel filling or vessel emptying rate (whichever is greater).

Units

Sensor measurement units.

Values	m, cm, mm, ft, in. Default: m
---------------	----------------------------------

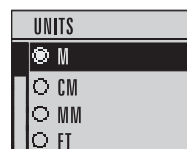

Operation

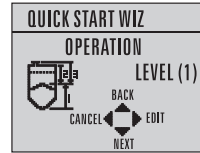

Operation		Description
LEVEL (1)	*	Distance from Low Calibration Point to material surface
SPACE (2)		Distance from High Calibration Point to material surface
DISTANCE(3)		Distance from Sensor Reference Point to material surface

sensor reference point
(flange face: see
Dimensions on page
12)

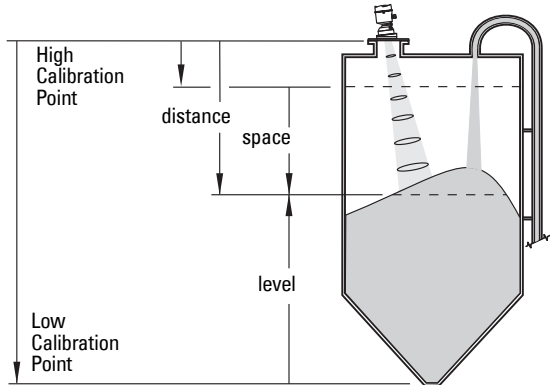

Low Calibration Point

Distance from Sensor Reference Point to Low Calibration Point: usually process empty level.

Values	Range: 0.0000 to 100.000 m
---------------	----------------------------

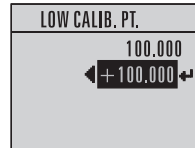
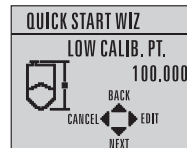

High Calibration Point

Distance from Sensor Reference Point to High Calibration Point: usually process full level.

Values	Range: 0.0000 to 100.000 m
---------------	----------------------------

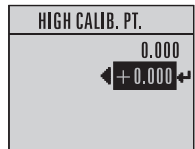

Wizard Complete

Options	BACK, CANCEL, FINISH (Display returns to 1.1 Quick Start Wizard menu when Quick Start is successfully completed.)
----------------	---

To transfer Quick Start values to the device and return to Program menu, press

DOWN arrow ▼ (**Finish**). Then press **LEFT arrow** ◀ to return to Measurement mode.

Requesting an Echo Profile

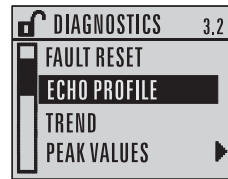

- In PROGRAM mode, navigate to: **Level Meter > Diagnostics (3.) > Echo Profile (3.2).**
- Press **RIGHT arrow** to request a profile.

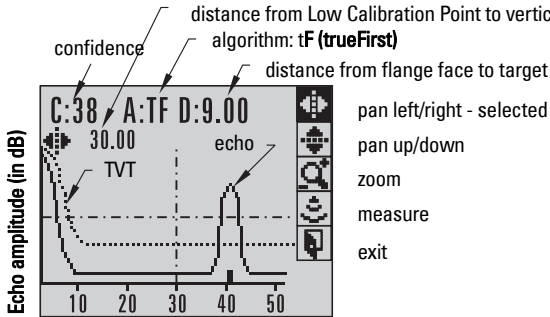

- Use **UP** or **DOWN arrow** to scroll to an icon. When an icon is highlighted, that feature becomes active.
- To move a cross-hair, press **RIGHT arrow** to increase the value, **LEFT arrow** to decrease.
- To Zoom into an area, position the intersection of the cross-hairs at the center of that area, select **Zoom**, and press **RIGHT arrow** . Press **LEFT arrow** to Zoom out.
- To update the profile, select **Measure** and press **RIGHT arrow** .
- To return to the previous menu, select **Exit** then press **RIGHT arrow** .

Level application example

The application is a vessel that takes an average 3 hours (180 minutes) to fill and 3 weeks to empty.

$$\begin{aligned}\text{Fill rate} &= 0.08 \text{ m/minute} \text{ [(Low Cal Pt. minus High Cal Pt.) / fastest of fill or empty time]} \\ &= (15.5 \text{ m} - 1 \text{ m}) / 180 \text{ min.} \\ &= 14.5 \text{ m} / 180 \text{ min.} = 0.08 \text{ m/min.}\end{aligned}$$

Therefore SLOW response rate (0.1 m/minute) can be selected.

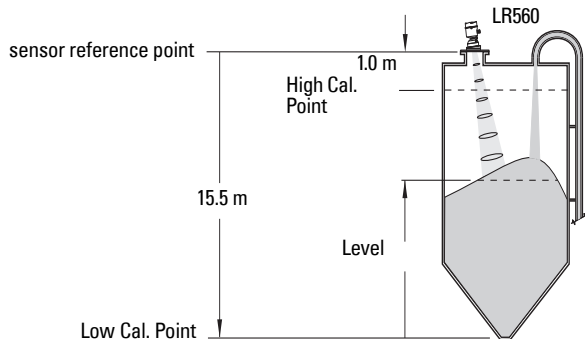

Quick Start Parameter	Setting	Description
Vessel	STEEL	Selects vessel construction material.
Response Rate	SLOW	Resets Fill Rate/ Empty Rate to 0.1 m/minute.
Units	M	Sensor measurement units.
Operation	LEVEL (1)	Material level referenced from Low Cal. Point.
Low Calibration Point	15.5	Process empty level.
High Calibration Point	1.0	Process full level.

Operating via SIMATIC PDM

SIMATIC PDM is a software package used to commission and maintain SITRANS LR560 and other process devices. Please consult the operating instructions or online help for details on using SIMATIC PDM. (You can find more information at www.siemens.com/simatic-pdm.)

Functions in SIMATIC PDM

Notes:

- For a complete list of parameters, see *Parameter Reference* on page 78.
- While the device is in PROGRAM MODE, the output remains active and continues to respond to changes in the device.

SIMATIC PDM monitors the process values, alarms and status signals of the device. It allows you to display, compare, adjust, verify, and simulate process device data; also to set schedules for calibration and maintenance.

Parameters are identified by name and organized into function groups. See *LCD menu structure* on page 149 for a chart¹⁾ and *Changing parameter settings using SIMATIC PDM* on page 43 for more details.

See Parameters accessed via pull-down menus on page 48 for parameters that do not appear in the menu structure in SIMATIC PDM.

SIMATIC PDM Version

Check the support page of our website to make sure you have the latest version of SIMATIC PDM, the most recent Service Pack (SP) and the most recent hot fix (HF). Go to:

<https://support.automation.siemens.com/WWW/llisapi.dll?func=cslib.csinfo&lang=en&siteid=csius&aktprim=0&extranet=standard&viewreg=WWW&objid=10806857&treeLang=en>

Electronic Device Description (EDD)

You can locate the EDD in Device Catalog, under **Sensors/Level/Echo/Siemens AG/SITRANS LR560**. The EDD revision must match the Firmware revision in the device.

To check it in PDM, go to **Level Meter > Identification > Device**.

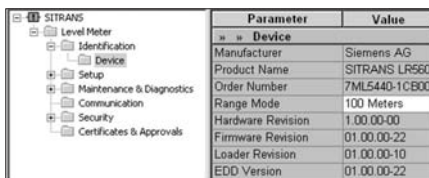

Parameter	Value
Device	
Manufacturer	Siemens AG
Product Name	SITRANS LR560
Order Number	7ML5440-1CB00
Range Mode	100 Meters
Hardware Revision	1.00.00-00
Firmware Revision	01.00.00-22
Loader Revision	01.00.00-10
EDD Version	01.00.00-22

matching
Firmware
and EDD
revisions

See *To install a new EDD* on page 40.

¹⁾ The menu structure for SIMATIC PDM is almost identical to that for the LCD.

To install a new EDD

- Go to www.siemens.com/LR560 > **Support** > **Software Downloads** to download the most up-to-date EDD from the product page of our website.
- Save the files to your computer and extract the zipped file to an easily accessed location.
- Launch **SIMATIC PDM – Manage Device Catalog**, browse to the unzipped EDD file and select it.

Configuring a new device

Notes:

- Clicking on **Cancel** during an upload from device to SIMATIC PDM will result in some parameters being updated.
- Application Guides for setting up HART devices with SIMATIC PDM can be downloaded from the product page of our website at: www.siemens.com/sitransLR560.

- 1) Check that you have the most recent EDD, and if necessary update it (see *To install a new EDD* above).
- 2) Launch SIMATIC Manager and create a new project for LR560.
- 3) Open the menu **Device – Master Reset** and click **OK**.
- 4) After the reset is complete, upload parameters to the PC/PG.
- 5) Configure the device via the Quick Start wizard.

Quick Start Wizard via SIMATIC PDM

The graphic Quick Start Wizard provides an easy step-by-step procedure that configures the device for a simple application.

Please consult the operating instructions or online help for details on using SIMATIC PDM.

- 1) If you have not already done so, check that you have the most up-to-date Electronic Device Description (EDD) for your instrument. (See *Configuring a new device* above.)
- 2) Launch SIMATIC Manager and create a new project for LR560. (Application Guides for setting up HART devices with SIMATIC PDM can be downloaded from the product page of our website at: www.siemens.com/sitransLR560.)

Quick Start

Notes:

- The Quick Start wizard settings are inter-related and changes apply only after you click on **FINISH AND DOWNLOAD** at the end of the last step to save settings offline and transfer them to the device.
- Do not use the Quick Start Wizard to modify individual parameters: for quick access to echo profile parameters, see *Echo profile* on page 46, or see *Parameter Reference* on page 78 for a complete list. (Perform customization only after the Quick Start has been completed.)
- Click on **BACK** to return and revise setting or **Cancel** to exit the Quick Start.
- For a vessel with obstructions, see *Auto False Echo Suppression* on page 48.

Launch SIMATIC PDM, open the menu **Device – Wizard – Quick Start**, and follow steps 1 to 4.

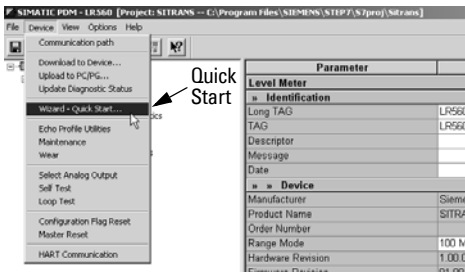

Step 1 – Identification

Note: The layout of the dialog boxes shown may vary according to the resolution setting for your computer monitor.

- 1) Click on **Read Data from Device** to upload Quick Start parameter settings from the device to the PC/PG and ensure PDM is synchronized with the device.
- 2) Click on **NEXT** to accept the default values. (Description, Message, and Installation Date fields can be left blank.)



Step 2 – Application Type

Note:

- Selecting STEEL changes the setting for **Position Detect (2.7.3.3.)** to Rising Edge. and for **Algorithm (2.7.3.1.)** to F.
- Selecting CONCRETE changes the setting for **Position Detect (2.7.3.3.)** to Rising Edge and for **Algorithm (2.7.3.1.)** to ALF.

Select the application type (steel or concrete silo construction), operation type (level, space, or distance) and then click on **NEXT**.



Step 3 – Ranges

Note: Selecting SLOW Response Rate changes setting for **Average Amount (2.7.5.3.)** to 0.9.

Set the parameters, and click on **NEXT**.

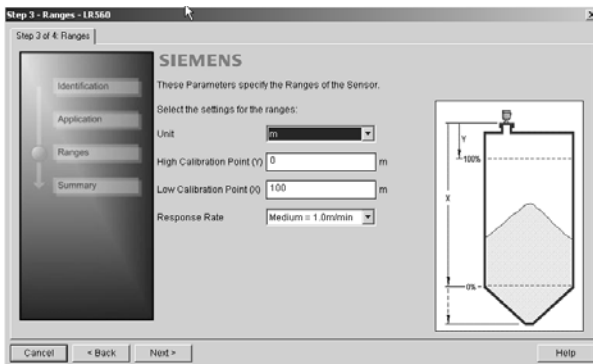

Step 4 – Summary

Check parameter settings, and click on **BACK** to return and revise values, **FINISH** to save settings offline, or **FINISH AND DOWNLOAD** to save settings offline and transfer them to the device.

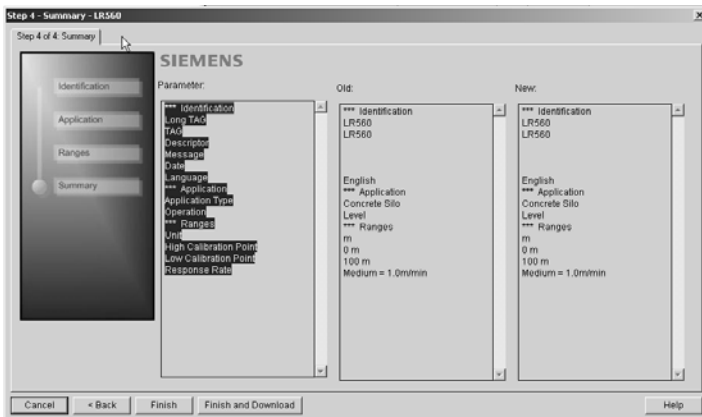

The message **Quick Start was successful** will appear. Click on **OK**.

Changing parameter settings using SIMATIC PDM

Notes:

- For a complete list of parameters, see *Parameter Reference* on page 78.
- Clicking on **Cancel** during an upload from device to SIMATIC PDM will result in some parameters being updated.

Many parameters are accessed via the 4-level menu in PDM. See *Parameters accessed via pull-down menus* below for the others.

- 1) Launch SIMATIC PDM, connect to SITRANS LR560, and upload data from the device.
- 2) Adjust parameter values in the parameter value field and then press **Enter**. The status fields read **Changed**.

- 3) Open the Device menu, click on **Download to device**, then use **File – Save**, to save parameter settings. The status fields are cleared.

Parameter	Value	Unit	Status
Level Meter			
» Identification			
Long TAG	LR560		Loaded
TAG	LR560		Loaded
Descriptor			Loaded
Message			Loaded
Date			Loaded
» Device			
Manufacturer	Siemens AG		Loaded
Product Name	SITRANS LR560		Loaded
Order Number			Loaded
Range Mode	100 Meters		Loaded
Hardware Revision	1.00.00.00		Loaded
Firmware Revision	01.00.00-10		Loaded
Loader Revision	00.00.08-12		Loaded
EDD Version	01.00.00-10		Loaded
Date of Manufacturing			Loaded
» Setup			
» Sensor			
Units	m		Loaded

Parameters accessed via pull-down menus

You have access to a number of functions via pull-down menus from the menu bar under Device or View.

For a complete list, see Pull-down menus below

Parameter	Value	Unit	Status
Level Meter			
» Identification			
Long TAG	LR560		Lo
TAG	LR560		Lo
Descriptor			Lo
Message			Lo
Date			Lo
» Device			
Manufacturer	Siemens AG		Lo
Product Name	SITRANS LR560		Lo
Order Number			Lo
Range Mode	100 Meters		Lo
Hardware Revision	1.00.00.00		Lo
Firmware Revision	01.00.00-10		Lo
Loader Revision	00.00.08-12		Lo
EDD Version	01.00.00-10		Lo
Date of Manufacturing			Lo

Pull-down menus

Device menus	page	View menus	page
Communication path		Process Variables	52
Download to device		Device Status	54
Upload to PC/PG		Toolbar	
Update Diagnostic Status		Status bar	
Wizard - Quick Start	41	Update	
Echo Profile Utilities	45		
Maintenance	50		
Wear	52		
Select Analog Output	51		
Self Test	51		
Loop Test	51		
Configuration Flag Reset	51		
Master Reset	52		
HART Communication	52		

Echo Profile Utilities

Open the menu **Device – Echo Profile Utilities** and click on the appropriate tab for easy access to:

- *Echo profile* on page 46
- *View Saved Echo Profiles* on page 46
- *Echo Setup* on page 50
- *TVT Shaper* on page 47
- *Auto False Echo Suppression* on page 48

Echo profile

Notes:

- Double click on each axis to see the Xscale and Data Scale values. Right-click or Left-click on the axis and drag to reposition the scale.
- After saving a profile click on **Close**, not the **x** button, to close the Echo Profile Utilities window: otherwise the profile will not be saved.
- In the **Echo Profile Utilities** window, click on the tab **Echo Profile**.
- Click on the **Measure** button to update the profile. Select Standard Resolution to update the profile faster. Detailed Resolution uploads all data points.
- Click on the **Save** button and in the new window enter a name (maximum 50 characters) and click on **OK**.
- Click on **Close** to exit.

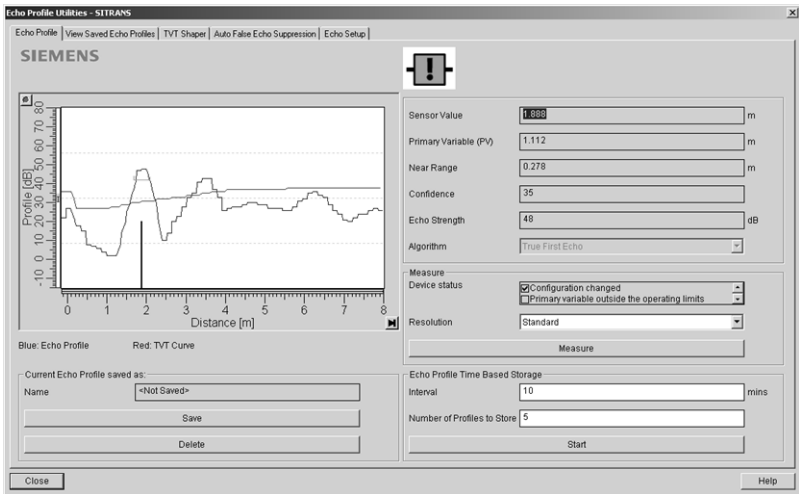

Echo profile data logging

You can store up to 60 profiles at a selected interval (maximum 60 minutes).

Inside Echo Profile Utilities, in the **Echo Profile Time Based Storage** window:

- Enter the desired interval between stored profiles.
- Enter the desired number of profiles to be stored (maximum 60).
- Click on **Start**. A message appears warning of the time delay and warning that all previous saved profiles will be overwritten. Click on **OK** to proceed. The new profiles will be saved with their date and time.
- Click on the tab **View Saved Echo Profiles** to view the stored profiles

View Saved Echo Profiles

To view a saved profile, click on the tab **View Saved Echo Profiles**.

TVT Shaper

Note: Double click on each axis to see the Xscale and Data Scale values. Right-click or Left-click on the axis and drag to reposition the scale.

This feature allows you to manually adjust the TVT to avoid false echoes caused by obstructions. (For an explanation see *Shaper Mode* on page 96.)

Open the menu **Device – Echo Profile Utilities** and click on the tab **TVT Shaper**

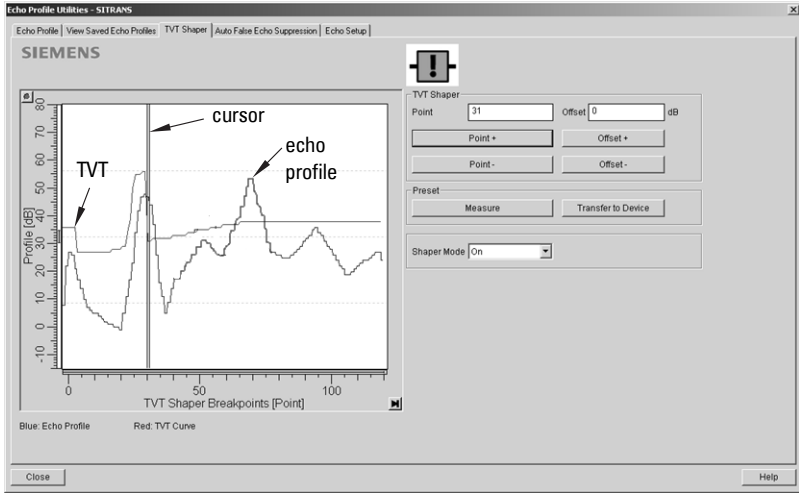

- Turn Shaper Mode **On**.
- Click on **Measure** to refresh the echo profile and load the current TVT from the device.
- Change the position of the cursor on the TVT using the **Point+** and **Point-** buttons: raise and lower the TVT using **Offset+** and **Offset-**.
- Alternatively, enter values for **Point** and **Offset** directly into the dialog boxes.
- Click on **Transfer to Device**.

Auto False Echo Suppression

Notes:

- Make sure material level is below all known obstructions at the moment Auto False Echo Suppression is used to learn a custom TVT (Time Varying Threshold). We recommend an empty or almost empty vessel.
- Note the distance to material level when the environment is learned, and set Auto False Echo Suppression Range to a shorter distance to avoid the material echo being screened out.

If you have a vessel with known obstructions, we recommend using Auto False Echo Suppression to prevent false echo detection. This feature can also be used if the device displays a false high level, or the reading is fluctuating between the correct level and a false high level.

The device learns the echo profile over the whole measurement range and the TVT is shaped around all echoes present at that moment. (See *Shaper Mode* on page 96 for a more detailed explanation.)

The learned TVT will be applied over a specified range. The default TVT is applied over the remainder of the measurement range.

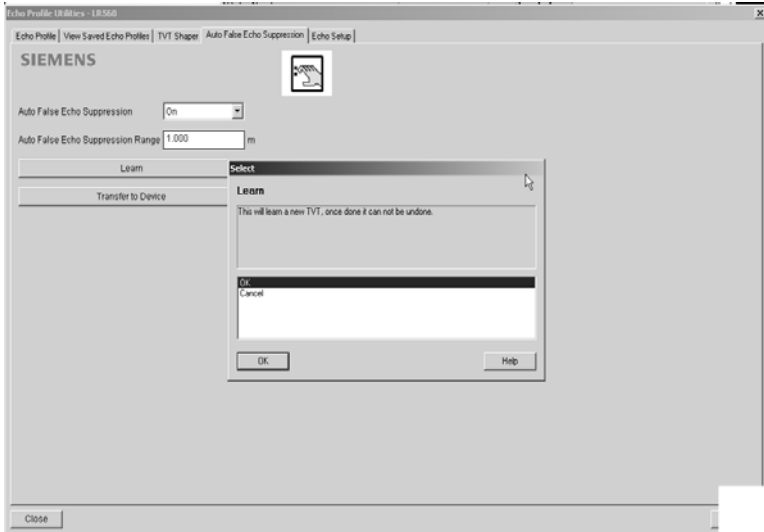

- 1) Make sure the material level is below all known obstructions.
- 2) Determine **Auto False Echo Suppression Range**. Measure the actual distance from the sensor reference point to the material surface using a rope or tape measure. Subtract 0.5 m (20") from this distance, and use the resulting value.

- 3) Open the menu **Device – Echo Profile Utilities** and click on the tab **Auto False Echo Suppression**.
- 4) Make sure **Auto False Echo Suppression** is **On**.
- 5) Enter the value for **Auto False Echo Suppression Range**.
- 6) Click on **Learn**. The message appears: **'This will learn a new TVT. Once done it cannot be undone'**. Click on **OK**.
- 7) Once Auto TVT is complete, click on **Transfer to Device**. To exit, click on **Close**. Auto TVT is enabled and the learned TVT will be used.
- 8) To turn Auto False Echo Suppression off or on, reopen the **Auto False Echo Suppression** window, change the Auto False Echo Suppression to **On** or **Off**, and click on **Transfer to Device**.

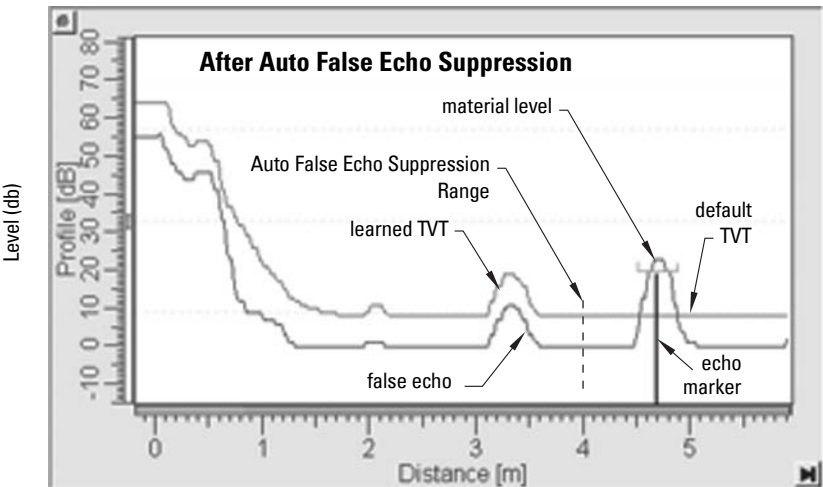
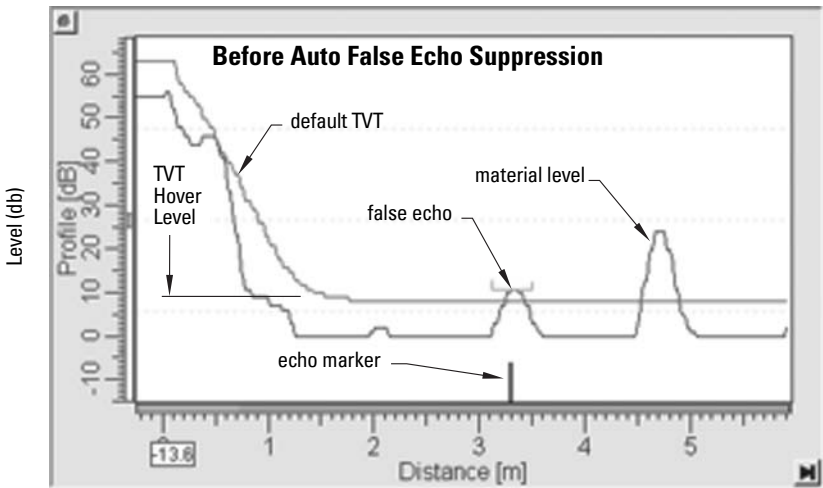

Echo Setup

Provides quick access to echo selection, filtering, and response rate parameters.

Algorithm
Position Detect
Echo Threshold
Damping Filter
CLEF Range
Response Rate
Fill Rate/min.
Empty Rate/min.

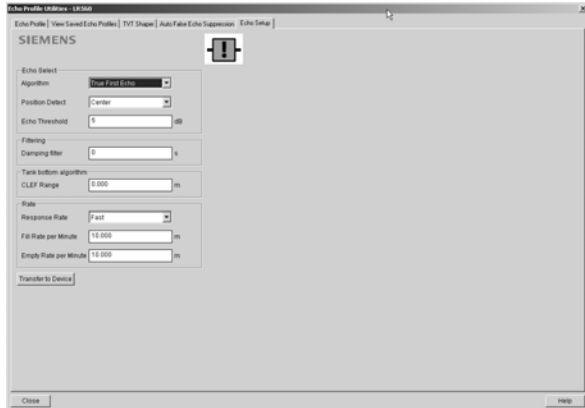

Open the menu **Device – Echo Profile Utilities** and click on **Echo Setup**.

Maintenance

You can set schedules for:

- maintenance of the device based on its projected lifetime
- maintenance of the sensor based on its projected lifetime
- service
- calibration

To set Device/Sensor Maintenance schedules:

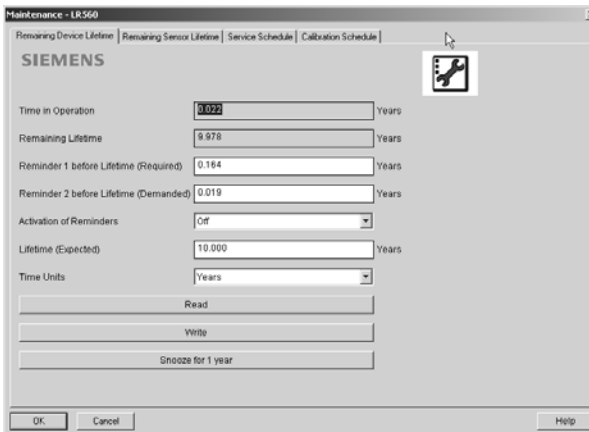

- 1) Open the menu **Device – Maintenance**, and click on the **Remaining Device/Sensor Lifetime** tab.
- 2) Modify desired values, and if desired, set reminders for either or both of **Reminder 1 (Required)/Reminder 2 (Demanded)**

- 3) Click on **Write**.
- 4) Click on **Read**, to see the effects of your modification.
- 5) Click on **Snooze** to add a year to the Total Expected Device Life.

To set Service/Calibration schedules:

- 1) Open the menu **Device – Maintenance**, and click on the **Service/Calibration Schedule** tab.
- 2) Modify desired values, and if desired, set reminders for either or both of **Reminder 1 (Required)/Reminder 2 (Demanded)**.
- 3) Click on **Write**.
- 4) Click on **Read**, to see the effects of your modification.
- 5) Click on **Service/Calibration Performed** to reset the schedule.

Select Analog Output

Allows you to set the mA Output to report Level, Distance, or Space.

- 1) Open the menu **Device – Select Analog Output**.
- 2) The **Select Analog Output** window displays the current setting: click on **OK**.
- 3) Select a different setting and click on **OK**.
- 4) The **Select Analog Output** window displays the new setting: click on **OK**.

Self Test

Checks memory (RAM and Flash). If there are no errors, returns the message 'Self Test OK.' If errors are found, returns the message 'Self Test Fails.'

Open the menu **Device – Self Test**, select the option **Yes** and click on **OK**.

Loop Test

Note: The simulated AO (Analog Output) value influences output to the control system.

*Allows you to input a simulated value (4 mA, 20 mA, or a user-defined value) in order to test the functioning of the mA connections during commissioning or maintenance of the device. (The range is 3.56 mA to 22.6 mA: see **Signal Processing (2.7.)** on page 90.)*

To simulate a user-defined mA value:

- 1) Open the menu **Device – Loop Test**.
- 2) Select **Other**, enter the new value, and click on **OK**. The message 'Field Device fixed at [new value]' appears. Click on **OK**. The Loop Test window remains open.
- 3) When you are ready to end simulation, select **End** and click on **OK** to return the device to the actual output value.

Configuration Flag Reset

To reset the configuration flag to zero, open the menu **Device – Configuration Flag Reset** and perform a reset.

Master Reset

Factory Defaults

Factory Defaults resets all parameters to the default settings with the following exceptions:

- Device Address
 - Write Protection
 - Learned TVT curve
 - Auto False Echo Suppression Range
- 1) Open the menu **Device – Master Reset**, select **OK** to perform a reset to Factory Defaults.
 - 2) After the reset is complete, upload parameters to the PC/PG. (If you are performing a reset after replacing the device with a different instrument, do not upload parameters to the PC/PG).

Wear

Reports the number of days the device has been operating, and the number of times it has been powered up.

Open the menu **Device – Wear** to view:

- Powered Days
- Power-on Resets

HART Communication

Sets the number of request/response preambles (default 5).

We recommend you do not change this value.

Diagnostics

You can monitor level trends, electronics temperature, and device status.

Process Variables

To compare outputs in real time open the menu **View – Process Variables** and click on **Overview** to see reading (level, space, distance); analog output; device status; and current electronics temperature.

To see highest and lowest electronics temperatures, navigate to **Level Meter > Maintenance and Diagnostics > Electronics Temperature**.

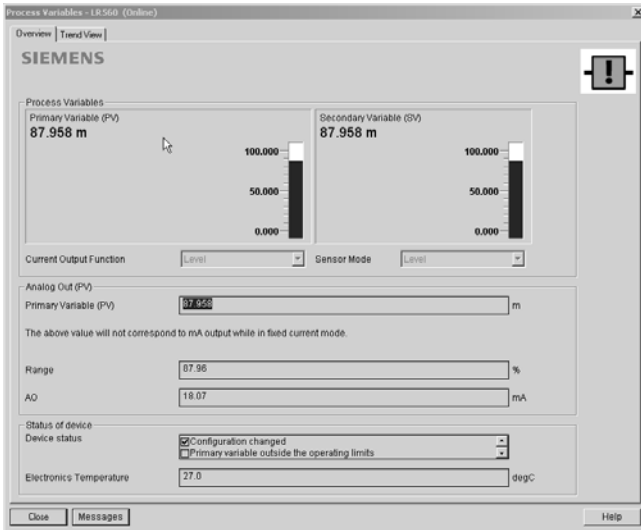

Trend

Open the menu **View – Process Variables** and click on **Trend View**.

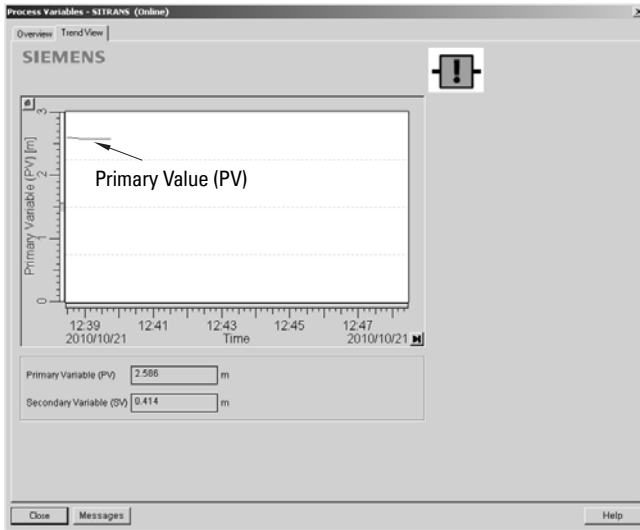

PV trend can be monitored.

The mA Output follows Primary Value (PV), and can be set to either Level, Space, or Distance. See *Select Analog Output* on page 51.

Device Status

Open the menu **View – Device Status** to view Diagnostics, Device Status, Hardware/ Firmware (HW/FW) Status, and Maintenance status.

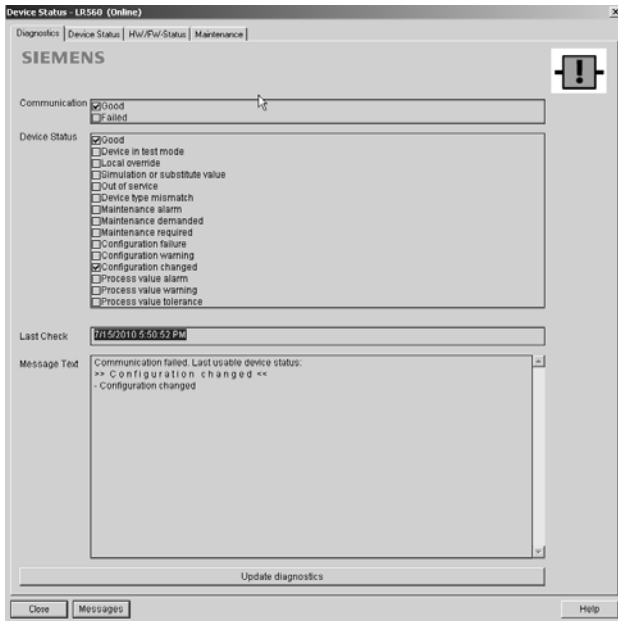

In the Diagnostics window, click on **Update diagnostics** to update diagnostic information and refresh linked icons.

Update

Open the menu **View – Update** to refresh the screen.

Security

A password option protects security and communication control parameters from modification by a maintenance user.

When you open a project the **User** dialog window provides two options: maintenance or specialist. If a password has been set, it will not be possible to open the project as a specialist without it. A maintenance user will be able to open the project without a password but will not have access to security and communication control parameters.

- 1) Open a project, double-click on the device icon, and in the **User** window select **Specialist**.
- 2) Open the menu **Options – Settings** and click on the **Password** tab.
- 3) Enter a new password and re-enter it in the **Confirmation** window. Click on **OK**.

Operating via FDT (Field Device Tool)

FDT is a standard used in several software packages designed to commission and maintain field devices such as SITRANS LR560. Two commercially available FDTs are PACTware and Fieldcare.

Functionally FDT is very similar to PDM (see *Operating via SIMATIC PDM* on page 39 for more detail).

- To configure a field device via FDT, you need the DTM (Device Type Manager) for the device.
- To configure a field device via SIMATIC PDM, you need the EDD (Electronic Data Description) for the device.

Device Type Manager (DTM)

A DTM is a type of software that 'plugs into' FDT. It contains the same information as an EDD but an EDD is independent of the operating system.

SITRANS DTM

- SITRANS DTM is an EDDL interpreter developed by Siemens to interpret the EDD for that device.
- To use SITRANS DTM to connect to an instrument, you must first install SITRANS DTM on your system and then install the instrument EDD written for SITRANS DTM.
- You can download SITRANS DTM from the Siemens service and support website at: <http://support.automation.siemens.com>. Click on **Product Support** then go to **Product Information/Automation Technology/Sensor systems/Process Instrumentation/Software & Communications**.

The Instrument EDD

The SITRANS LR560 HART EDD for SITRANS DTM can be downloaded from the product page of our website.

Go to www.siemens.com/sitransLR560 under **Support** and click on **Software Downloads**.

Configuring a new device via FDT

The full process to configure a field device via FDT is outlined in an application guide which can be downloaded from the product page of our website. Go to:

www.siemens.com/sitransLR560 under **More Info** and click on **Application Guides**.

Operating via AMS Device Manager

AMS Device Manager is a software package used to commission and maintain SITRANS LR560 and other process devices. Please consult the operating instructions or online help for details on using AMS Device Manager. (You can find more information at <http://www.emersonprocess.com/AMS/>.)

Functions in AMS Device Manager

AMS Device Manager monitors the process values, alarms and status signals of the device. It allows you to display, compare, adjust, verify, and simulate process device data

Parameters organized into three main function groups allow you to configure and monitor the device:

- Configure/Setup
- Device Diagnostics (read only)
- Process Variables (read only)

See *AMS Menu Structure* on page 71 for a chart¹⁾ and *Changing parameter settings using AMS Device Manager* on page 62 for more details.

Features of AMS Device Manager

The graphic interface in SITRANS LR560 makes monitoring and adjustments easy.

Feature	page	Function
Quick Start	59	Device configuration for simple applications
Echo Profile	66	Echo profile viewing
TVT	65	Screen out false echoes
Process Variables	69	Monitor process variables and level trend
Security	68	Protect security and communication parameters from modification by the maintenance user

Device Description (DD)

SITRANS LR560 requires the EDD for AMS Device Manager version 9.0.

You can locate the EDD in Device Catalog, under **Sensors/Level/Echo/Siemens Milltronics/SITRANS LR560**. Check the product page of our website at: www.siemens.com/sitransLR560, under **Support->Software Downloads**, to make sure you have the latest version of the EDD for AMS Device Manager. If you need to install a new EDD, see *Configuring a new device* below.

¹⁾ The menu structure for AMS Device Manager is almost identical to that for the LCD.

Configuring a new device

- 1) Check that you have the most recent EDD, and if necessary download it from the product page listed above. Save the files to your computer, and extract the zipped file to an easily accessed location.
- 2) Launch **AMS Device Manager– Add Device Type**, browse to the unzipped DD file, and select it.

Startup

- 1) **Launch AMS Device Manager.** (Application Guides for setting up HART devices with AMS Device Manager can be downloaded from the product page of our website at www.siemens.com/sitransLR560.)
- 2) In **Device Connection View**, right-click on the device icon and select **Scan Device** to upload parameters from the device.
- 3) Double click the device icon to open the startup screen. The startup screen shows device identification details, and a navigation window on the left-hand side of the screen.

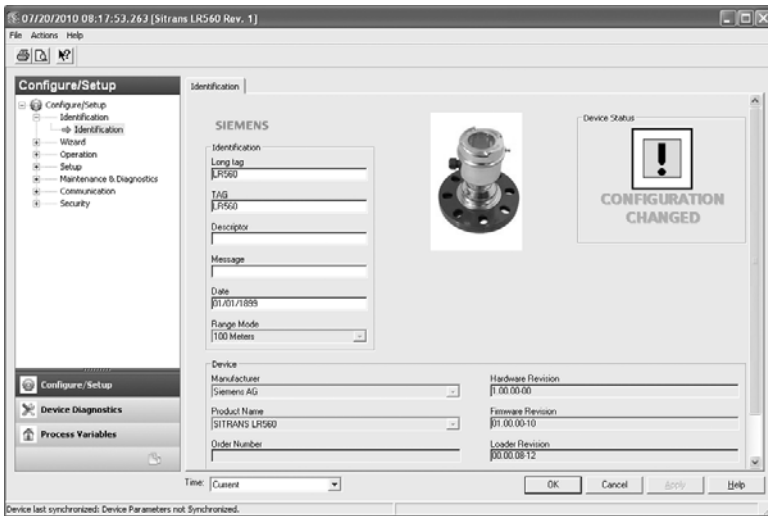

Master Reset

- Navigate to **Configure/Setup > Operation**
- In the **General** field, click on **Master Reset** and accept the option **Factory Defaults**.

Pull-down menu access

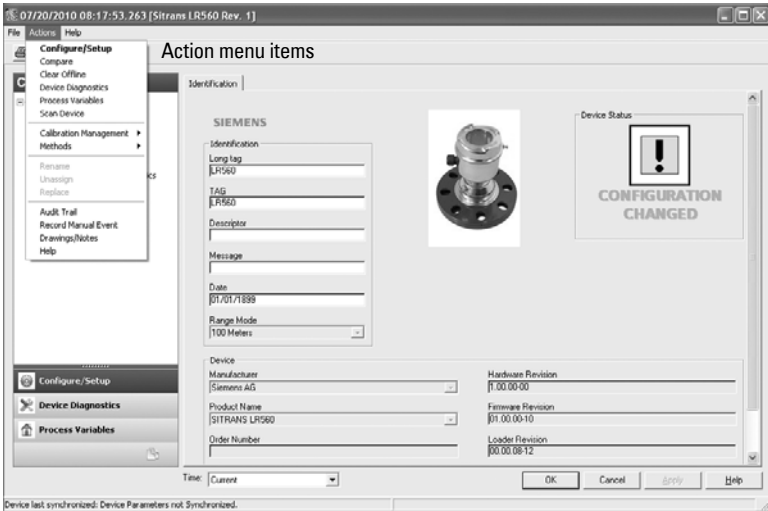

A pull-down menu under **Actions** gives alternative access to several features.

Scan Device

- Open the menu **Actions – Scan Device**.
- **Scan Device** uploads parameters from the device (synchronizes parameters).

Device configuration

- 1) Navigate to **Configure/Setup > Operation** and click to open the dialog window.

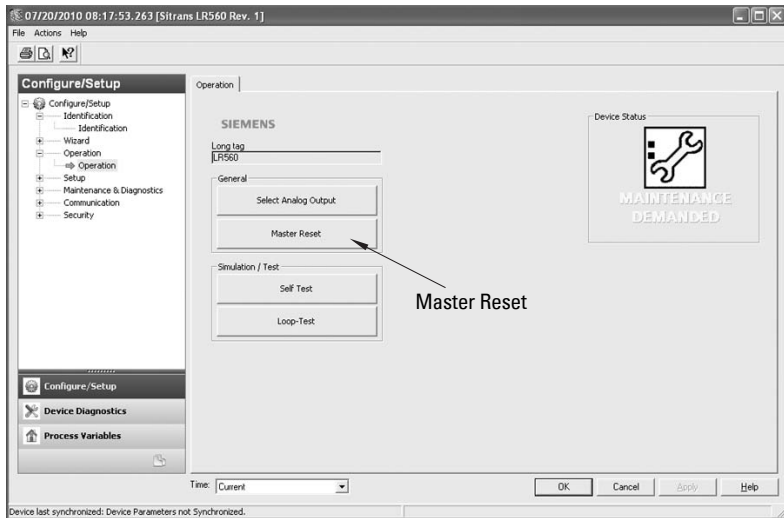

- 2) In the **General** field, click on **Master Reset** and perform a reset to Factory Defaults.
- 3) Open the pull-down menu **Actions – Scan Device** to synchronize parameters (upload parameters from the device to AMS).
- 4) Configure the device via the Quick Start wizard.

Quick Start Wizard via AMS Device Manager

Notes:

- The layout of the dialog boxes shown may vary according to the resolution setting for your computer monitor
- At each step, you can accept the default values without modification and click on the next step to proceed.
- After modifying parameters click on **Apply** inside the Quick Start window to write the new values to the device.
- Click on **OK** only if you wish to update all parameters to the device and close AMS.

A Wizard provides an easy step-by-step Quick Start procedure that configures the device for a simple application.

Quick Start

Step 1 – Identification

- 1) Navigate to **Configure/Setup > Wizard > Quick Start**.
- 2) Click on **Step 1**.
- 3) You can accept the default values without modification. (Descriptor, Message, and Date fields can be left blank.) If desired, make changes then click on **Apply**.

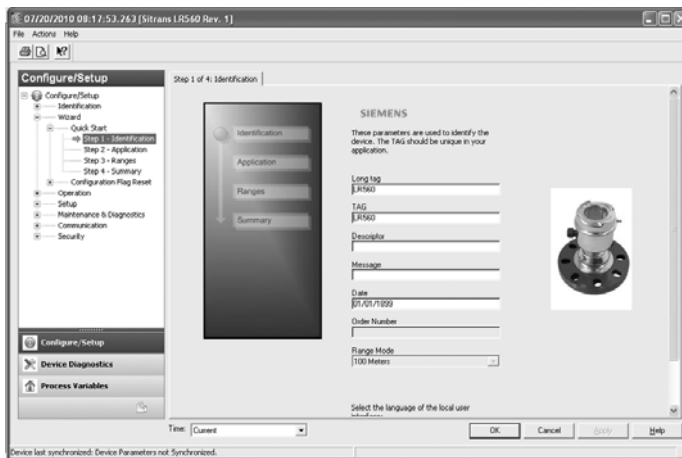

Step 2 – Application Type

Notes:

- Selecting **STEEL** changes the setting for **Position Detect (2.7.3.3.)** to Rising Edge. and for **Algorithm (2.7.3.1.)** to F.
- Selecting **CONCRETE** changes the setting for **Position Detect (2.7.3.3.)** to Rising Edge and for **Algorithm (2.7.3.1.)** to ALF.

- 1) Click on **Step 2**.
- 2) Select the application type (Steel or Concrete) and the operation (Level, Space, or Distance¹⁾).

¹⁾ For details see *Sensor Mode (2.2.2.)* on page 131.

3) Click on **Apply**.

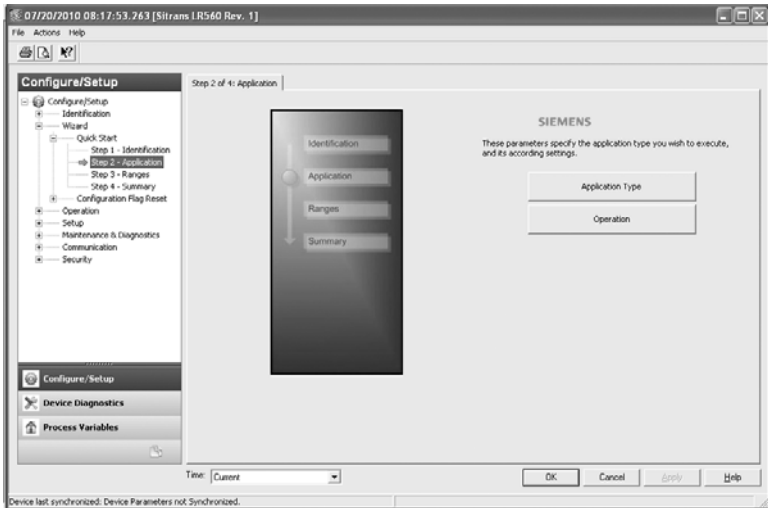

Step 3 – Ranges

Note: Selecting SLOW Response Rate changes setting for **Average Amount (2.75.3.)** to 0.9.

- 1) Click on **Step 3**.
- 2) Change units if desired (in meters by default).
- 3) Set High and Low Calibration points.
- 4) Set Response Rate.
- 5) Click on **Apply**.

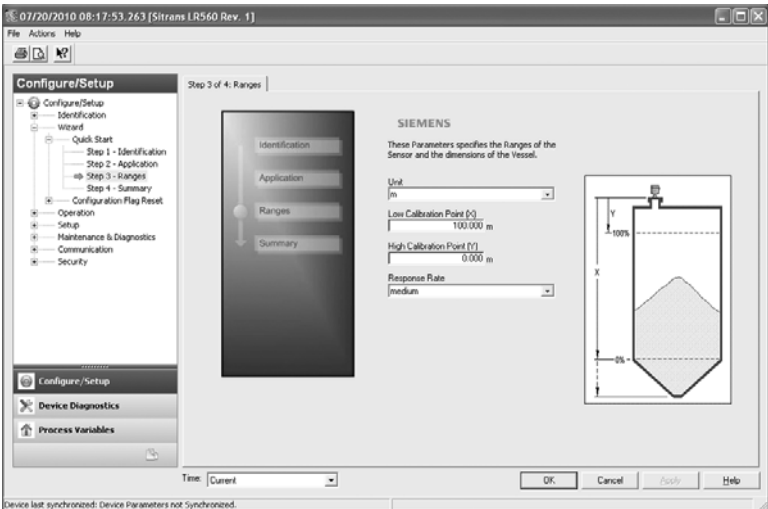

Step 4 – Summary

Check parameter settings, and click on **Cancel** to abort, or **Apply** to transfer values to the device.

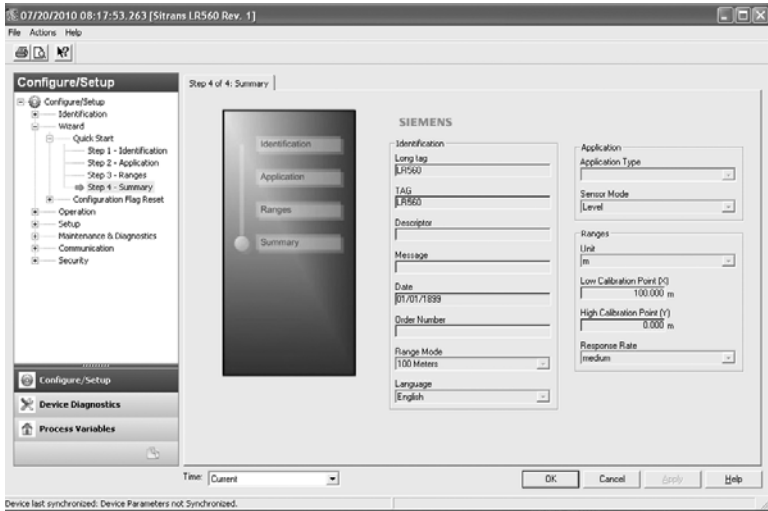

Changing parameter settings using AMS Device Manager

Notes:

- For a complete list of parameters, see *Parameter Reference* on page 78.
- For more detailed explanations of the parameters listed below see the pages referenced.

- 1) Adjust parameter values in the parameter value field in Configure/Setup view, then click on **Apply** to write the new values to the device. The parameter field will display in yellow until the value has been written to the device.
- 2) Click on **OK** only if you wish to update all parameters and exit AMS.

Operation

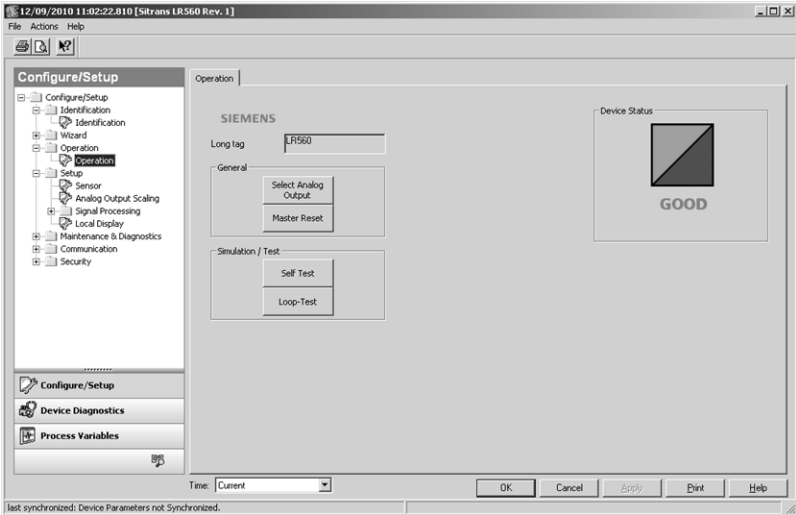

Navigate to **Configure/Setup > Operation** and click on **Operation** to open the dialog window for access to:

General:

- Select Analog Output (see *Select Analog Output* on page 51)
- Master Reset (see *Master Reset* on page 52)

Simulation/Test

- Self Test (see *Self Test* on page 51)
- Loop Test (see *Loop Test* on page 51)

Setup

Note: For more detailed explanations of the Rate parameters listed below, see the pages referenced.

Sensor

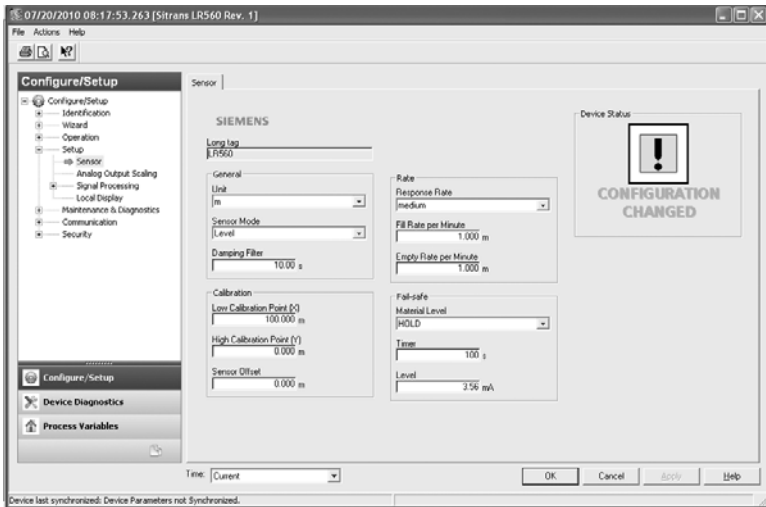

Navigate to **Configure/Setup > Setup** and click on **Sensor** for access to:

General [see Sensor (2.2.) on page 82]

- Unit
- Sensor Mode
- Damping Filter

Calibration [see Calibration (2.3.) on page 83]

- Low Calibration Point
- High Calibration Point
- Sensor Offset

Rate [see Rate (2.4.) on page 84]

- Response Rate
- Fill rate/minute
- Empty rate/minute

Fail-safe [see Fail-safe (2.5.) on page 86]

- Material level
- Timer
- Level

Analog Output Scaling

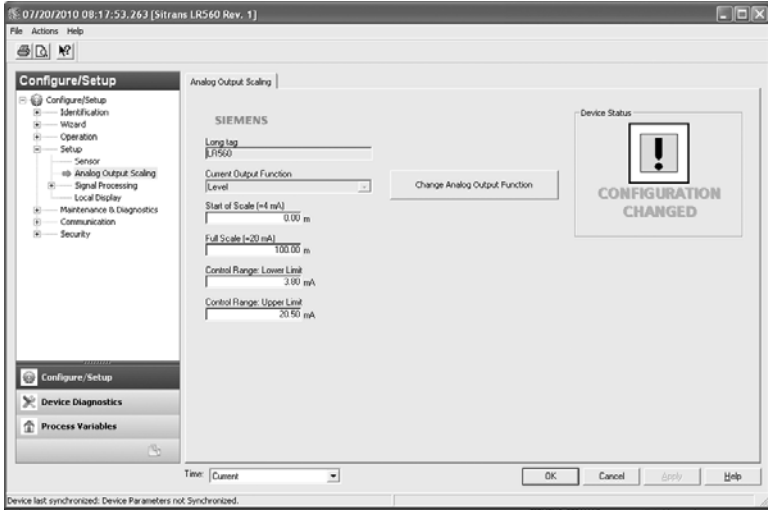

Navigate to **Configure/Setup > Setup** and click on **Analog Output Scaling** for access to:

Analog Output Scaling [see Analog Output Scaling (2.6.) on page 87]

- Current Output Function
- Start of scale (=4mA)
- Full Scale (=20mA)
- Control Range (lower limit)
- Control Range (upper limit)

Signal Processing

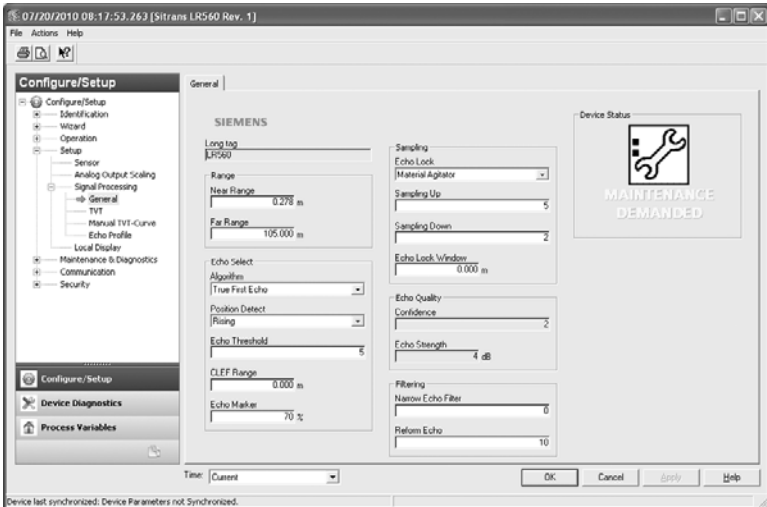

Signal Processing (continued)

General

Navigate to **Configure/Setup > Setup > Signal Processing** and click on **General** for access to:

Range [see Signal Processing (2.7.) on page 90]

- Near Range
- Far Range

Echo Select [see Echo select (2.7.3.) on page 90]

- Algorithm
- Position Detect
- Echo Threshold
- CLEF Range
- Echo Marker

Sampling [see Sampling (2.7.4.) on page 93]

- Echo Lock
- Sampling Up
- Sampling Down
- Echo Lock Window

Echo Quality

- Confidence
- Echo Strength

Filtering

- Narrow Echo Filter
- Reform Echo

TVT

Modify the TVT to screen out false echoes [see *Shaper Mode* on page 96].

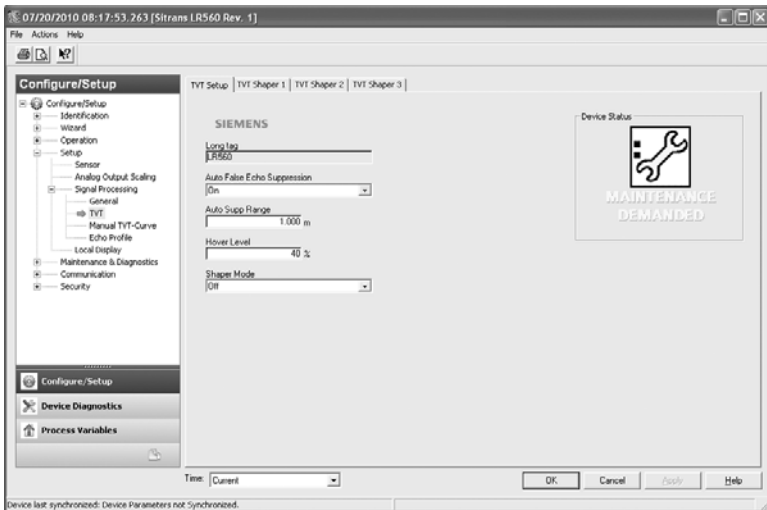

Navigate to **Configure/Setup > Setup > Signal Processing** and click on **TVT**. Click on one of the two tabs to access the parameters listed:

TVT Setup [see TVT setup (2.8.) on page 95]

- Auto False Echo Suppression
- Auto False Echo Suppression Range
- Hover Level
- Shaper Mode

TVT Shaper

- Shaper breakpoints 1 to 120. (Turn TVT Setup/Shaper Mode on to activate.)

Manual TVT Curve

Displays the effects of the TVT shaper modifications. Navigate to **Configure/Setup > Setup > Signal Processing** and click on **Manual TVT Curve**.

Echo Profile

- Navigate to **Configure/Setup > Setup > Signal Processing** and click on **Echo Profile**.
- To view a previous profile, click the drop-down arrow on the **Time** field and select the desired profile (note: available only using AMS version 10.1 or later).

Local Display

Navigate to **Configure/Setup > Setup > Local Display** for access to:

- Language
- LCD Contrast [see **LCD Contrast (4.6.)** on page 106]
- LCD Backlight [see **LCD Backlight (4.5.)** on page 105]

Maintenance and Diagnostics

Navigate to **Maintenance and Diagnostics** for access to:

Remaining Device Lifetime [see Remaining Device Lifetime (3.6.) on page 100]

- Lifetime expected
- Remaining Lifetime
- Time in Operation
- Activation of Reminders
- Reminder 1 before Lifetime (Required)
- Reminder 2 before Lifetime (Demanded)

- a) Open the window **Remaining Device Lifetime**.
- b) After modifying values/units as required, click on **Apply** to accept the change.

c) Click on **Snooze for 1 Year** to add a year to the Total Expected Device Life.

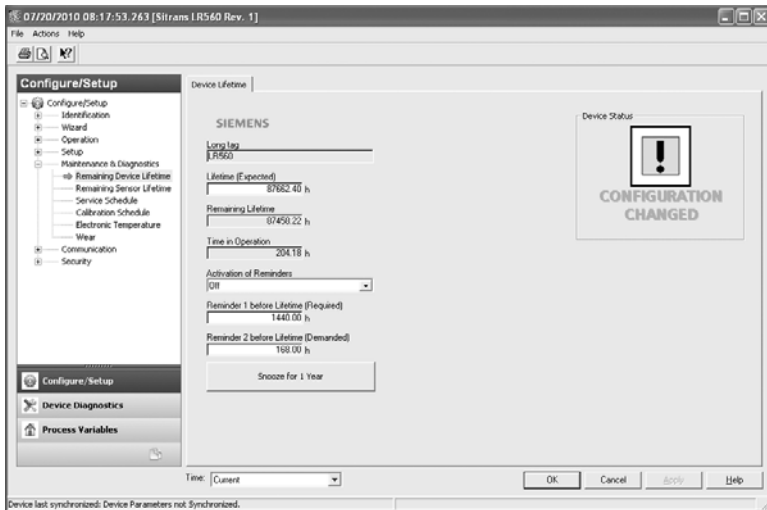

Remaining Sensor Lifetime [see Remaining Sensor Lifetime (3.7.) on page 102]

- Lifetime expected
- Time in Operation
- Remaining Lifetime
- Activation of Reminders
- Reminder 1 before Lifetime (Required)
- Reminder 2 before Lifetime (Demanded)

- a) Open the window **Remaining Device Lifetime**.
- b) After modifying values/units as required, click on **Apply** to accept the change.
- c) Click on **Sensor Replaced** to reset Remaining Lifetime to 0 hours.
- d) Click on **Snooze for 1 Year** to add a year to the Total Expected Sensor Life.

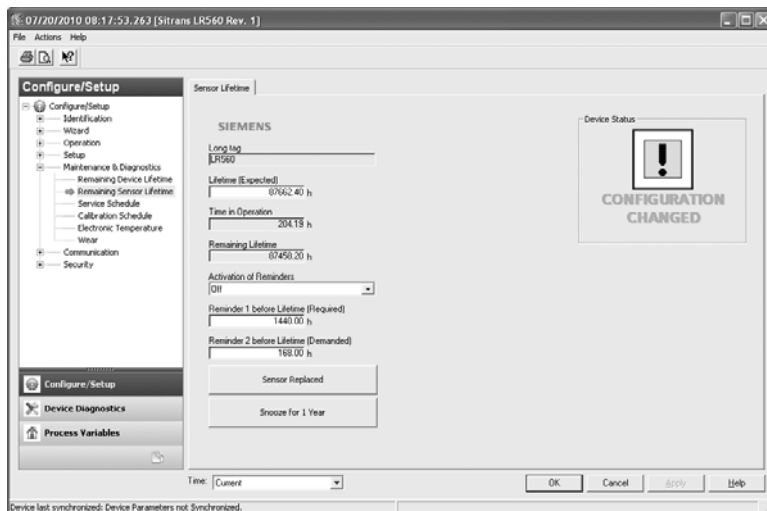

Service Schedule [see Service Schedule (4.7.) on page 106]

- Service Interval
- Time since last Service
- Time until next Service
- Activation of Reminders
- Reminder 1 before Service (Required)
- Reminder 2 before Service (Demanded)
- Click on **Service Performed** to reset Time Until Next Service to the full service interval.

Calibration Schedule [see Calibration Schedule (4.8.) on page 109]

- Calibration Interval
- Time since last Calibration
- Time Until Next Calibration
- Activation of Reminders
- Reminder 1 before Calibration (Required)
- Reminder 2 before Calibration (Demanded)
- Click on **Calibration Performed** to reset Time Until Next Calibration to the full calibration interval.

Electronic Temperature

- Electronic Temperature
- Lowest Value
- Highest Value

Wear (see Powered Hours (4.3.) on page 105)

- Time in Operation (Reset to 0 after clicking Sensor Replaced)
- Poweron Resets

Communication

Navigate to **Communication** to read the following:

Long Tag; Manufacturer's ID; Device ID; Product ID; Device Revision; EDD Revision; Universal Command

Security

Navigate to **Configure/Setup > Security** to access:

Remote Access [see Remote Lockout (5.2.) on page 112]

Note: If access control is changed via the handheld programmer to limit remote access, it can only be reset via the handheld programmer. See **Remote Lockout (5.2.)** on page 112.

- Write Protection

Local Access

- Local Operation Enable

See also *Password Protection* on page 70.

Device Diagnostics

Click on the **Device Diagnostics** bar at the bottom of the navigation window, for access to:

Device Status

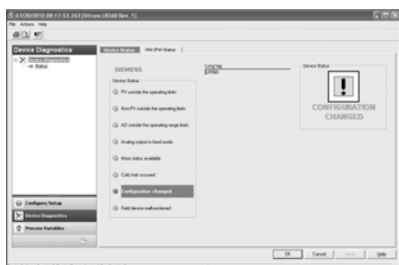

Hardware/Firmware Status

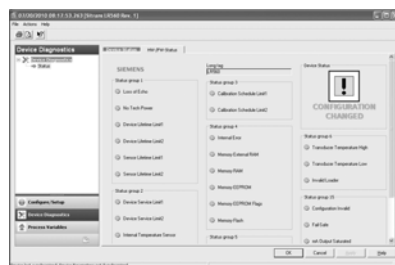

Process Variables

To compare outputs in real time, click on **Process Variables** at the bottom of the navigation window, for access to:

Process Variables

- Values (level, space, distance)
- Analog Output
- Trend View

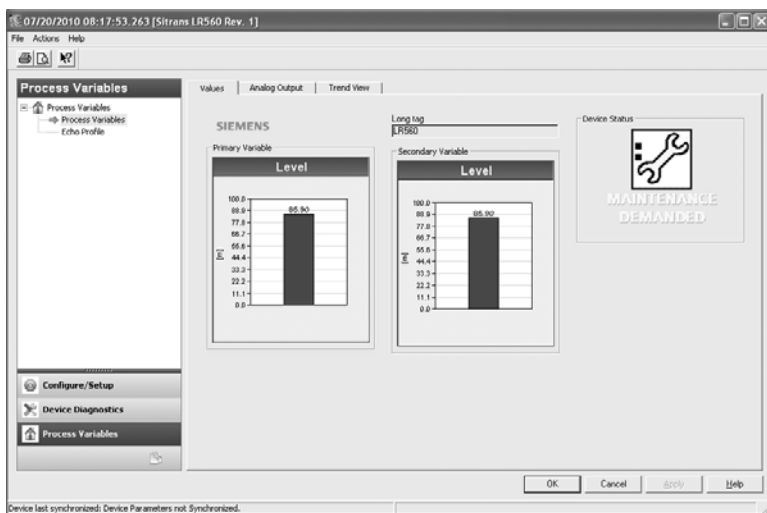

Echo Profile

- Navigate to **Process Variables>Echo Profile**.
 - To view a previous profile, click the drop-down arrow on the **Time** field and select the desired profile (note: available only using AMS version 10.1 or later).

Password Protection

An AMS Device Manager administrator can configure the user to require a password. The use of passwords is recommended. A password should be assigned to the 'admin' username immediately after installing AMS Device Manager.

Each user is given an AMS Device Manager username and password and required to enter them when they start AMS Device Manager. Access to functions depends on the level of permissions granted.

Login types

- standard, local, or domain

A standard user can change their password in AMS Device Manager. A Local or Domain Windows user cannot change their password using AMS Device Manager and must request their network administrator to do so.

User Manager Utility

Username, passwords, and permissions are assigned to users by an AMS Device Manager administrator, using the User Manager utility on the Server Plus Station. Only a user with AMS Device Manager System Administration rights can log in to User Manager.

To configure a new user/edit existing user:

- 1) From the Windows taskbar select: **Start > AMS Device Manager > User Manager.**
- 2) In the User Manager window click on **Add User.**

The Add User Wizard dialog allows you to:

- select a user type, standard (AMS Device Manager) or Window user.
- enter the username and password, and set permissions
- edit existing users

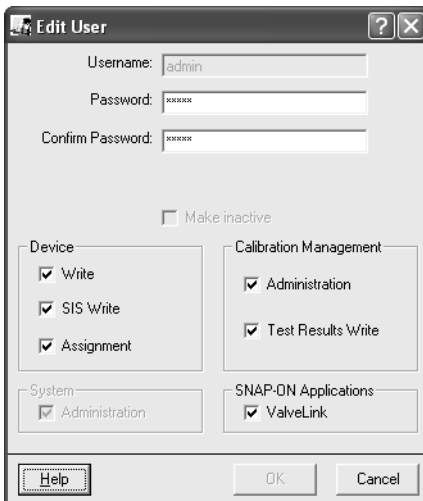

AMS Menu Structure

Note: Where a parameter number is listed, more information is available for that parameter in *Parameter Reference* on page 78.

Configure/Setup Function Group				parameter number
		IDENTIFICATION		
		Identification		
		<i>Identification (tab)</i>		
			Long tag	2.1.1
			TAG	2.1.2
			Descriptor	2.1.3
			Message	2.1.4
			Date	
			Range Mode	
			Manufacturer	
			Product Name	
			Order Number	
			Final Assembly Number	
			Hardware Revision	
			Firmware Revision	
			Loader Revision	
			EDD Version	
		Wizard		
		Quick Start		
		<i>Step 1 of 4: Identification (tab)</i>		
			Long tag	2.1.1
			TAG	2.1.2
			Descriptor	2.1.3
			Message	2.1.4
			Date	
			Order Number	
			Range Mode	
			Language	
		<i>Step 2 of 4: Application (tab)</i>		
			Application Type	
			Operation	
		<i>Step 3 of 4: Ranges (tab)</i>		
			Unit	
			Low Calibration Point (X)	
			High Calibration Point (Y)	
			Response Rate	
		<i>Step 4 of 4: Summary (tab)</i>		
			Long tag	

Configure/Setup Function Group (cont'd)						parameter number
					Tag	
					Descriptor	
					Message	
					Date	
					Order Number	
					Range Mode	
					Language	
					Application Type	
					Operating Mode	
					Unit	
					Low Calibration Point (X)	
					High Calibration Point (Y)	
					Response Rate	
					Configuration Flag Reset	
					<i>Configuration Flag Reset (tab)</i>	
					Long tag	
					Configuration Flag Reset	
					OPERATION	
					Operation	
					<i>Operation (tab)</i>	
					Long tag	
					Select Analog Output	
					Master Reset	4.2
					Self Test	
					Loop Test	
					SENSOR	
					Sensor	
					<i>Sensor (tab)</i>	
					Long tag	
					Unit	
					Operating Mode	
					Damping Filter	
					Low Calibration Point (X)	
					High Calibration Point (Y)	
					Sensor Offset	
					Response Rate	
					Fill Rate per Minute	
					Empty Rate per Minute	
					Material Level	
					Timer	
					Level	
					Analog Output Scaling	

Configure/Setup Function Group (cont'd)						parameter number
				<i>Analog Output Scaling (tab)</i>		
				Long tag		
				Current Output Function		
				Start of Scale (=4 mA)		
				Full Scale (=20 mA)		
				Control Range: Lower Limit		
				Control Range: Upper Limit		
				Signal Processing		
				General		
				<i>General (tab)</i>		
				Long tag		
				Near Range		2.71
				Far Range		2.72
				Algorithm		2.73.1
				Position Detect		2.73.3
				Echo Threshold		2.73.2
				Clef Range		2.73.4
				Echo Marker		2.73.5
				Echo Lock		2.74.1
				Sampling Up		2.74.2
				Sampling Down		2.74.3
				Echo Lock Window		2.74.4
				Confidence		2.76.1
				Echo Strength		2.76.2
				Narrow Echo Filter		2.75.1
				Reform Echo		2.75.2
				TVT		
				<i>TVT Setup (tab)</i>		
				Long tag		
				Auto False Echo Suppression		2.84
				Auto False Echo Suppression Range		2.84
				Hover Level		2.82
				Shaper Mode		2.84
				<i>TVT Shaper 1 (tab)</i>		
				Long tag		
				Breakpoints		2.92
				<i>TVT Shaper 2 (tab)</i>		
				Long tag		
				Breakpoints		2.95
				<i>TVT Shaper 3 (tab)</i>		
				Long tag		

Configure/Setup Function Group (cont'd)							parameter number
						Breakpoints	2.9.8
				Manual TVT Curve			
				<i>Manual TVT Diagram (tab)</i>			
						Long tag	
						Shaper Mode	2.8.4
				Echo Profile			
				<i>Echo Profile (tab)</i>			
						Long tag	
						Distance Measurement	
						Confidence	2.7.6.1
						Near Range	2.7.1
				Local Display			
				<i>Local Display (tab)</i>			
						Long tag	
						Language	7
						LCD Contrast	4.6
						LCD Backlight	4.5
				MAINTENANCE AND DIAGNOSTICS			
				Remaining Device Lifetime			
				<i>Device Lifetime (tab)</i>			
						Long tag	
						Lifetime (Expected)	3.6.6
						Remaining Lifetime	3.6.2
						Time in Operation	3.6.1
						Activation of Reminders	3.6.5
						Reminder 1 before Lifetime (Required)	3.6.3
						Reminder 2 before Lifetime (Demanded)	3.6.5
						Snooze for 1 Year	
				Remaining Sensor Lifetime			
				<i>Device Sensor (tab)</i>			
						Long tag	
						Lifetime (Expected)	3.7.6
						Time In Operation	3.7.1
						Remaining Lifetime	3.7.2
						Activation of Reminders	3.7.5
						Reminder 1 before Lifetime (Required)	3.7.3
						Reminder 2 before Lifetime (Demanded)	3.7.4
						Sensor Replaced	
						Snooze for 1 Year	
				Service Schedule			
				<i>Service Schedule (tab)</i>			
						Long tag	

Configure/Setup Function Group (cont'd)						parameter number
					Service Interval	4.76
					Time Since Last Service	4.71
					Time Until Next Service	4.72
					Activation of Reminders	4.75
					Reminder 1 before Service (Required)	4.73
					Reminder 2 before Service (Demanded)	4.74
					Service Performed	
				Calibration Schedule		
				<i>Calibration Schedule (tab)</i>		
					Long tag	
					Calibration Interval	4.86
					Time Since Last Calibration	4.81
					Time Until Next Calibration	4.82
					Activation of Reminders	4.85
					Reminder 1 before Calibration (Required)	4.83
					Reminder 2 before Calibration (Demanded)	4.84
					Calibration Performed	
				Electronic Temperature		
				<i>Electronics Temperature (tab)</i>		
					Long tag	
					Electronic Temperature	3.5
					Lowest Value	
					Highest Value	
				Wear		
				<i>Wear (tab)</i>		
					Long tag	
					Time in Operation	
					Poweron Resets	4.4
				COMMUNICATION		
				Communication		
				<i>Communication (tab)</i>		
					Long tag	
					Manufacturer's ID	
					Device ID	
					Product ID	
					Device Revision	
					EDD Revision	
					Universal Command	
				SECURITY		
				Security		
				<i>Security (tab)</i>		

Configure/Setup Function Group (cont'd)						parameter number
					Long tag	
					Write Protection	6.1
					Local Operation Enable	





Device Diagnostics Function Group						parameter number
					DEVICE DIAGNOSTICS	
					Status	
					<i>Device Status (tab)</i>	
					Long tag	
					Status listing	
					<i>HW-/FW Status (tab)</i>	
					Long tag	
					Status listing	

Process Variables Function Group						parameter number
					PROCESS VARIABLES	
					Process Variables	
					<i>Values (tab)</i>	
					Long tag	
					Primary Variable	
					Secondary Variable	
					<i>Analog Output (tab)</i>	
					Long tag	
					Distance Range (%)	
					Analog Output (PV) =	
					<i>Trend View (tab)</i>	
					Long tag	
					Primary Variable	
					Secondary Variable	
					Echo Profile	
					<i>Echo Profile (tab)</i>	
					Long tag	
					Echo Profile/TVT Curve	
					Distance Measurement	
					Confidence	
					Near Range	

Compare Function Group				parameter number
		COMPARE		
		Compare		
		<i>Identification (tab)</i>		
			TAG	
			Descriptor	
			Message	
			Date	
			Manufacturer	
			Product Name	
			Universal Command Revision	
			Device Revision	
			Device ID	
			Final Assembly Number	
			Hardware Revision	
			Software rev	
			Distributor	
			Order Number	
		<i>Setup (tab)</i>		
			Long tag	
			Status listing	

Parameter Reference

Notes:

- Parameter names and menu structure are almost identical for SIMATIC PDM and the local display interface (LDI).
- Default settings in the parameter tables are indicated with an asterisk (*) unless explicitly stated.
- To enter Program mode using the device buttons, press . Press  to return to Measurement mode.
- To enter PROGRAM mode/return to Measurement mode via the handheld programmer, press .
- For Quick Access to parameters via the handheld programmer, press **Home** , then enter the menu number, for example: **2.2.1**.
 - In Navigation mode, **ARROWS** navigate the menu in the direction of the arrow.
 - Press **RIGHT arrow** to open **Edit Mode**, or to save a modification.

Parameters are identified by name and organized into function groups. See *LCD menu structure* on page 149 for a chart.

Parameters accessible via the local push buttons or handheld programmer are preceded by a number. Parameters not preceded by a number are accessible only via remote operation.

For more details see:

- *Operating via SIMATIC PDM* on page 39
- *Operating via AMS Device Manager* on page 56

1. Quick Start

Wizards provide step-by-step procedures to configure the device, filter out false echoes, and upload and download parameters and firmware to the optional display for easy configuration of multiple LR560s.

1.1. Quick Start Wizard

The Quick Start wizard provides an easy step-by-step procedure to configure the device for a simple application.

Press **RIGHT arrow** twice to open the Wizards menu. Select a wizard, press **RIGHT arrow** to open the first step, and follow the instructions.

Notes: Do not use the Quick Start wizard to modify individual parameters. (Perform customization only after the Quick Start has been completed.)

- See *Quick Start Wizard via the LDI push buttons* on page 34.
- See *Quick Start Wizard via the handheld programmer* on page 34.
- See *Quick Start Wizard via SIMATIC PDM* on page 40.

1.2. AFES (Auto False Echo Suppression) Wizard

Note: Before using AFES, configure the device via the Quick Start wizard.

If you have a vessel with known obstructions, we recommend using AFES to prevent false echo detection.

This feature can also be used if SITRANS LR560 displays a false high level, or the reading is fluctuating between the correct level and a false high level.

a) Make sure the material level is below all known obstructions.

b) Navigate to **Level Meter** >

Diagnostics (3.) > Echo Profile (3.2.)

and press **RIGHT arrow**  to request a profile.

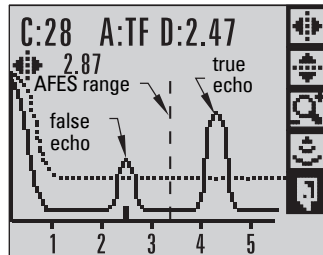

c) Determine a range that includes the false echo but not the true echo: in the example, 3.3 m.

d) Open the AFES wizard and press **DOWN arrow**  to continue.

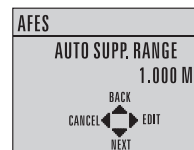



e) Press **RIGHT arrow**  to edit Auto False Echo Suppression Range.

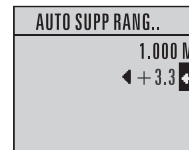

f) Enter the new range value and press **RIGHT arrow**  to transfer it.

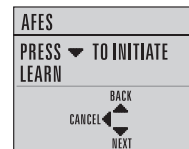

g) Press **DOWN arrow**  to initiate learn. A transition screen appears, followed by the message **Wizard Complete**.



h) Press **DOWN arrow (Finish)**  to save AFES parameter changes and return to Program menu.

- i) Navigate to **Echo Profile (3.2)** and press **RIGHT arrow**  to request a profile. The false echo is now screened out and the true echo selected.
- j) Press **LEFT arrow**  to return to Measurement mode.

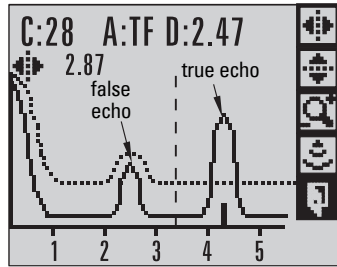



1.3. Copy Parameters to Display



See *Connecting SITRANS LR560* on page 24 for instructions on removing the local display interface.

Transfers parameter settings from a device to the local display interface.



- Press **RIGHT arrow**  to Edit.
- Press **DOWN arrow**  to select **Start** and **RIGHT arrow**  to begin the transfer.



PARAM UPLOAD is displayed, then the device returns to Measurement mode.

1.4. Copy Parameters from Display

Transfers parameter settings from the local display interface to a device.

- Press **RIGHT arrow**  to Edit.
- Press **DOWN arrow**  to select **Start** and **RIGHT arrow**  to begin the transfer.

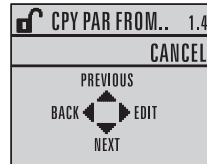

PARAM DOWNLOAD is displayed, then the device returns to Measurement mode.

1.5. Copy Firmware to Display

Transfers firmware from a device to the local display interface.

- Press **RIGHT arrow**  to Edit.
- Press **DOWN arrow**  to select **Start** and **RIGHT arrow**  to begin the transfer.

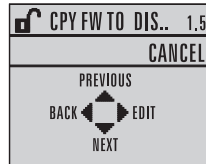



SW UPLOAD is displayed, then the device returns to Measurement mode.

1.6. Copy Firmware from Display

Notes

- Do not interrupt power supply during transfer.

Transfers firmware from the local display interface to a device.

- Press **RIGHT arrow**  to Edit.
- Press **DOWN arrow**  to select
- Start and RIGHT arrow**  to begin the transfer.

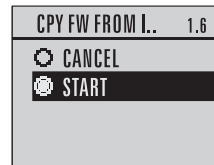
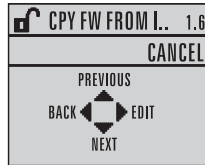

SW DOWNLOAD is displayed, then the device returns to Measurement mode.

2. Setup

Notes:

- Default settings in the parameter tables are indicated with an asterisk (*) unless explicitly stated.
- Values shown in the following tables can be entered via the handheld programmer.

2.1. Device

2.1.1. Long Tag

Text that can be used in any way. A recommended use is as a unique label for a field device in a plant. Limited to 32 ASCII characters. Read only on device, Read/Write using SIMATIC PDM and AMS.

2.1.2. Tag

Text that can be used in any way. A recommended use is as a unique label for a field device in a plant. Limited to 8 ASCII characters. Read only on device, Read/Write using SIMATIC PDM and AMS.

2.1.3. Descriptor

Text that can be used in any way. Limited to 16 ASCII characters. No specific recommended use. Read only on device, Read/Write using SIMATIC PDM and AMS.

2.1.4. Message

Text that can be used in any way. Limited to 32 ASCII characters. No specific recommended use. Read only on device, Read/Write using SIMATIC PDM and AMS.

2.1.5. Installation Date

Date the device was first commissioned. Read only locally. Can be written via HART (dd mm yyyy).

2.1.6. Hardware Revision

Read only. Corresponds to the electronics hardware of the SITRANS LR560.

2.1.7. Firmware Revision

Read only. Corresponds to the firmware that is embedded in the SITRANS LR560.

2.1.8. Loader Revision

Read only. Corresponds to the software used to update the SITRANS LR560.

2.1.9. Menu Timeout

Time menu stays visible before switching back to Measurement view if no key is pressed.

Values	Range: 15 to 65535 s Default: 120 s
---------------	-------------------------------------

2.1.10. Date of Manufacture

The date of manufacture of the SITRANS LR560 (dd mm yyyy).

2.2. Sensor

2.2.1. Units

PV (Primary Value) and SV (Secondary Value) units. Used in setting High/Low Calibration Point, and displayed on LCD and in PDM.

Values	m, cm, mm, ft, in, %
	Default: m

Changing units to % will update the mA setpoints.

2.2.2. Sensor Mode

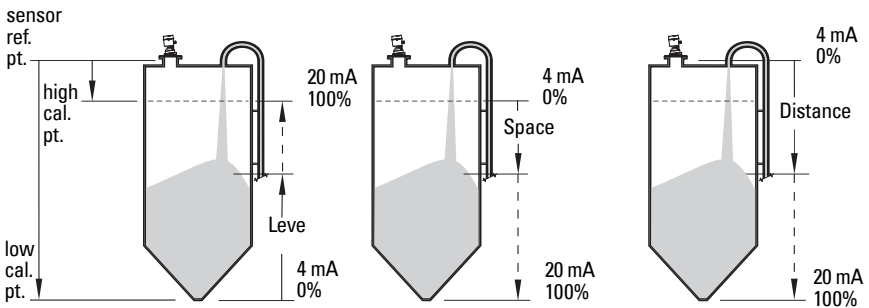

Mode	Description
LEVEL	Distance to material surface from Low Calibration Point (process empty level).
SPACE	Distance to material surface from High Calibration Point (process full level).
DISTANCE	* Distance to material surface from Sensor Reference Point.

2.2.3. Damping Filter

The time constant for the damping filter. The damping filter smooths out the response to a sudden change in level. This is an exponential filter and the engineering unit is always in seconds (see *Damping* on page 130 for more detail).

Values	Range: 0 to 1500 s
	Default: 10 s

2.2.4. Temperature Units

Selects the engineering unit to be displayed with the value representing temperature.

Options	Degrees C, F, R, or K. Default: Degrees C
----------------	---

2.2.5. Unit

Sensor measurement units.

2.3. Calibration

Note: We recommend using the Quick Start wizard to configure the device.

2.3.1. Low Calibration Pt.

Distance from sensor reference point¹⁾ to Low Calibration Point. Units are defined in **Units (2.2.1.)** and displayed on the LCD and in PDM

Values	Range: 0 to 100.00 m. Default 100.00 m
Related parameters	Units (2.2.1.) Far Range (2.7.2.)

Any change to Low Calibration Point will cause the mA setpoints to be updated.

2.3.2. High Calibration Pt.

Distance from sensor reference point¹⁾ to High Calibration Point. Units are defined in **Units (2.2.1.)** and displayed on the LCD and in PDM.

Values	Range: 0 to 100.00 m. Default 0.00 m
Related parameters	Units (2.2.1.) Near Range (2.7.1.)

When setting the High Calibration Point value, note that echoes are ignored within Near Range (2.7.1.).

Any change to High Calibration Point will cause the mA setpoints to be updated.

¹⁾ The point from which level measurement is referenced (see **Sensor Mode (2.2.2.)** on page 82 for an illustration).

2.3.3. Sensor Offset

A constant offset (negative or positive) that can be added to sensor value¹⁾ to compensate if the sensor reference point has shifted. (For example, this could result from adding a thicker gasket or reducing the standoff/nozzle height.) The units are defined in Units (2.2.1.)

Values	Range: -100 to 100 m. Default: 0.00 m
Related parameters	Units (2.2.1.)

2.4. Rate

Note: Default settings in the parameter tables are indicated with an asterisk (*) unless explicitly stated.

2.4.1. Response Rate

Note: Changing Response Rate resets Fill Rate/Min (2.4.2.), Empty Rate/Min (2.4.3.), and Damping Filter (2.2.3.).

Sets the reaction speed of the device to measurement changes.

Response Rate (2.4.1.)	Fill Rate/Min (2.4.2.)	Empty Rate/Min (2.4.3.)	Damping Filter (2.2.3.)
Slow	0.1 m/min (0.32 ft/min)		10 s
* Medium	1.0 m/min (3.28 ft/min)		10 s
Fast	10.0 m/min (32.8 ft/min)		0 s

Use a setting just faster than the maximum filling or emptying rate (whichever is faster).

¹⁾ The value produced by the echo processing which represents the distance from sensor reference point to the target. (see **Sensor Mode (2.2.2.)** on page 82 for an illustration).

2.4.2. Fill Rate/Min

Defines the maximum rate at which the reported sensor value¹⁾ is allowed to increase. Allows you to adjust the SITRANS LR560 response to increases in the actual material level. Fill Rate is automatically updated whenever Response Rate is altered.

Options	Range: 0 to 999 999 m / min. (when using AMS, max. value is 99 999 m/min.)		
	Response Rate (2.4.1.)		Fill Rate
		Slow	0.1 m/min (0.32 ft/min)
	*	Medium	1.0 m/min (3.28 ft/min)
	Fast	10.0 m/min (32.8 ft/min)	
Altered by:	Response Rate (2.4.1.)		
Related parameters	Units (2.2.1.)		

Enter a value slightly greater than the maximum vessel-filling rate, in units per minute.

2.4.3. Empty Rate/Min

Defines the maximum rate at which the reported sensor value¹⁾ is allowed to decrease. Adjusts the SITRANS LR560 response to decreases in the actual material level. Empty Rate is automatically updated whenever Response Rate (2.4.1.) is altered.

Options	Range: 0 to 999 999 m / min. (when using AMS, max. value is 99 999 m/min.)		
	Response Rate (2.4.1.)		Empty Rate
		Slow	0.1 m/min (0.32 ft/min)
	*	Medium	1.0 m/min (3.28 ft/min)
	Fast	10.0 m/min (32.8 ft/min)	
Altered by:	Response Rate (2.4.1.)		
Related parameters	Units (2.2.1.)		

Enter a value slightly greater than the vessel's maximum emptying rate, in units per minute.

¹⁾ The value produced by the echo processing which represents the distance from sensor reference point to the target.

2.5. Fail-safe

Notes:

- Default settings in the parameter tables are indicated with an asterisk (*) unless explicitly stated.
- The default setting depends whether your device is a standard or NAMUR NE 43-compliant device.^{a)}

a) NE43 device part number ends with -Z N07.

2.5.1. Material Level

Defines the mA output to use when the Fail-safe Timer expires.

Options		HI	20.5 mA (max. mA Limit)
		LO	3.8 mA (min. mA Limit)
	*	HOLD	Last valid reading (default 22.6 mA)
		VALUE	User-selected value [defined in Level (2.5.3)]; default 3.58 mA]

NAMUR NE 43-COMPLIANT DEVICE			
Options		HI	20.5 mA (max. mA Limit)
		LO	3.8 mA (min. mA Limit)
		HOLD	Last valid reading
	*	VALUE	User-selected value [defined in Level (2.5.3)]; default 3.58 mA]

2.5.2. Timer

Note: When a Loss of Echo occurs **Material Level (2.5.1)** determines the material level to be reported when the Fail-safe timer expires.

Sets the time to elapse since the last valid reading, before the Fail-safe Level is reported.

Values	Range: 0.00 to 720 seconds
	Default: 100 s

2.5.3. Level

Notes:

- **Material Level (2.5.1)** must be set to **VALUE** to enable the Level value to be reported.

Allows the user to define the mA value to be reported when the Fail-safe timer expires.

Values	Range	3.56 mA to 22.6 mA
	Default	3.56 mA

2.6. Analog Output Scaling

2.6.1. Current Output Function

Notes:

- **Level, space, and distance** have different reference points.
- Use caution when changing Current Output Function while the device is connected to a HART network. Current Output Function controls the primary value. Changes to Current Output Function will update the mA Setpoints.
- Current Output Function also affects the secondary, tertiary and quaternary variables in a HART network.

*Can be set to either **Level, Space, or Distance.***

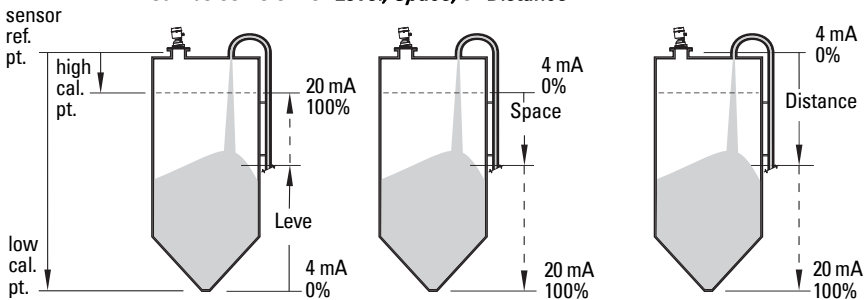

Options	Reference point	Description
Level	Low Calibration Point	measured as a percentage of the difference between High Calibration Point and Low Calibration Point
Space	High Calibration Point	
* Distance	sensor reference point	measured as a percentage of Low Calibration Point
Related Parameters	Units (2.2.1.) 4 mA Setpoint (2.6.2.)/20 mA Setpoint (2.6.3.) Low Calibration Pt. (2.3.1.)/High Calibration Pt. (2.3.2.)	

To view the mA reading in the secondary region of the LCD, press **5** on the handheld programmer.

To modify Current Output Function via SIMATIC PDM:

- Open the menu **Device – Select Analog Output.**

2.6.2. 4 mA Setpoint

*Sets the process level corresponding to the 4 mA value. 4 mA always defaults to 0, and **Current Output Function (2.6.1.)** determines whether this is a Level, Space, or Distance measurement. (See **Current Output Function (2.6.1.)** for an illustration.)*

Values	Range: -999999 to +999999
	Default: 0.00 m (set to value corresponding to 0% as defined by Current Output Function)
Related Parameters	Units (2.2.1.) Low Calibration Pt. (2.3.1.)/High Calibration Pt. (2.3.2.) Current Output Function (2.6.1.)

- Enter the reading that is to correspond to a 4 mA output.
- Units are defined in **Units (2.2.1.)** for Level, Space, or Distance.

2.6.3. 20 mA Setpoint

*Sets the process level corresponding to the 20 mA value. 20 mA always defaults to 100%, and **Current Output Function (2.6.1.)** determines whether this is a Level, Space, or Distance measurement. (See **Current Output Function (2.6.1.)** for an illustration.)*

Values	Range: -999999 to +999999
	Default: 40.00 m or 100.0 m (set to value corresponding to 100% as defined by Current Output Function)
Related Parameters	Units (2.2.1.) Low Calibration Pt. (2.3.1.)/High Calibration Pt. (2.3.2.) Current Output Function (2.6.1.)

- Enter the reading that is to correspond to a 20 mA output.
- Units are defined in **Units (2.2.1.)** for Level, Space, or Distance.

2.6.4. Min. mA limit

Prevents the mA output from dropping below this minimum level for a measurement value. This does not restrict the Fail-safe or Manual settings.

Values	Range: 3.56 to 22.6 (mA)
	Default: 3.80 (mA)

2.6.5. Max. mA limit

Prevents the mA output from rising above this maximum level for a measurement value. This does not restrict the Fail-safe or Manual settings.

Values	Range: 3.56 to 22.6 (mA)
	Default: 20.50 (mA)

2.6.6. mA Output Mode

Can be set to Manual, or Auto.

Options		Description
	Manual	User can enter mA value for loop current.
*	Auto	Loop current will follow measurement value.
	Fixed^{a)}	Read only. Loop current is set to the multidrop level of 4 mA

- a) Fixed mode can be selected or cancelled only via HART command 6. It cannot be changed using PDM, AMS, or the HART 375 Communicator.

2.6.7. Manual Value

Allows you to use a simulated value to test the functioning of the loop. You can enter 4 mA, 20 mA, or any other user-defined value within the range.

Values	Range: 3.56 mA to 22.6 mA
Related parameter	mA Output Mode (2.6.6.)

- First set **mA Output Mode (2.6.6.)** to **Manual**.
- Enter the desired mA value in mA Output Value.
- After completing the test, remember to reset **mA Output Mode (2.6.6.)** to the previous setting.

Via SIMATIC PDM:

Open the menu **Device – Loop Test**.

2.6.8. mA Output Value

Allows you to view the simulated value entered to test the functioning of the loop.

Values	Range: 3.56 mA to 22.6 mA
	Read Only.
Related parameter	Manual Value (2.6.7.)

2.7. Signal Processing

Note: Default settings in the parameter tables are indicated with an asterisk (*) unless explicitly stated.

2.7.1. Near Range

The range in front of the device (measured from the sensor reference point) within which any echoes will be ignored. This is sometimes referred to as blanking or a dead zone.

Values	Range: 0 to 105 m (0 to 344.5 ft) Default: 0.278 m (0.91 ft)
Related parameters	Units (2.2.1)

2.7.2. Far Range

Note: Far Range can extend beyond the bottom of the vessel.

*Allows the material level to drop below Low Calibration Point without generating a Loss of Echo (LOE) state. See **Sensor Mode (2.2.2)** on page 82 for an illustration.*

Values	Range: Min. = Low Calibration Pt. Max. = 105 m (344.5 ft) Default: Value for Low Calibration Pt. + 5 m (16.4 ft)
Related parameters	Units (2.2.1) CLEF Range (2.7.3.4.)

Use this feature if the measured surface can drop below the Low Cal. Point in normal operation.

2.7.3. Echo select

2.7.3.1. Algorithm

Selects the algorithm to be applied to the echo profile to extract the true echo.

Options	ALF	Area Largest First
	A	Echo Area
	L	Largest Echo
	* F	First Echo
	AL	Echo Area Largest
	AF	Echo Area First
	LF	Echo Largest First
	BLF	Best of First and Largest echo
	BL	Best Largest Echo
	BF	Best First Echo
		LAST
		TF

2.7.3.2. Echo Threshold

Sets the minimum echo confidence that the echo must meet in order to prevent a Loss of Echo condition and the expiration of the Fail-safe (LOE) timer. When **Confidence (2.7.6.1.)** exceeds **Echo Threshold (2.7.3.2.)**, the echo is accepted as a valid echo and is evaluated.

Values	Range: 0 to 99
	Default: 5
Related Parameters	Timer (2.5.2.)

Use this feature when an incorrect material level is reported.

2.7.3.3. Position Detect

Note: Selecting Steel or Concrete vessel type in the Quick Start wizard changes the setting for **Position Detect (2.7.3.3.)** to Rising Edge.

Defines where on the echo the distance measurement is determined. See *Shaper Mode (2.8.4.)* on page 128 for more details.

Options	*	RISING (yields highest stability on sloped targets)
		CENTER (yields higher accuracy on flat, non-sloped targets)
		HYBRID (CENTER and CLEF)
		CLEF (Constrained Leading Edge Fit)
Related Parameters		CLEF Range (2.7.3.4.)

If the vessel bottom is being reported as the level instead of the actual material level (at low conditions), we recommend setting Position to Hybrid and using it in combination with **CLEF Range (2.7.3.4.)**.

2.7.3.4. CLEF Range

Notes:

- CLEF Range is referenced from Far Range.
- The value for CLEF Range must include the difference between Far Range and Low Calibration Point, plus any level above the Low Calibration Point to be managed by the CLEF algorithm.

The CLEF algorithm is used mainly to allow correct level reporting for low dK materials which may otherwise cause an incorrect reading in an empty or almost empty vessel.

It is used from Far Range up to the level defined by CLEF Range (see illustration below). Above that point, the Center algorithm is used. For more detail, see CLEF Range (2.7.3.4.) on page 127.

Values	Range: 0 to 45 m (40 m device) 0 to 105 m (100 m device)
	Default: 0.0 m
Related parameters	Position Detect (2.7.3.3.) Far Range (2.7.2.)

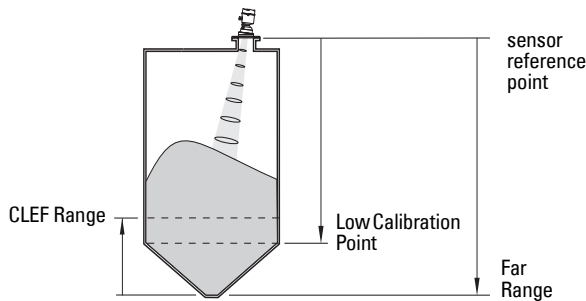

2.7.3.5. Echo Marker

The point on the selected echo from which the measured value is taken.

Values	Range: 5 to 95%
	Default: 70%

Use this feature if the reported material level fluctates slightly due to a variable rise in the leading edge of the true echo on the Echo Profile.

Enter the value (in percent of echo height) to ensure the Echo Lock window intersects the Echo Profile at the sharpest rising portion of the Echo Profile representing the true echo. This value is preset to 70%.

2.7.4. Sampling

Provides a method of checking the reliability of a new echo before accepting it as the valid reading, based on numbers of samples above or below the currently selected echo.

2.7.4.1. Echo Lock

Selects the measurement verification process.

Options	Lock Off
	Maximum Verification (not recommended for radar)
	* Material Agitator
	Total Lock (not recommended for radar)
Related parameters	Fill Rate/Min (2.4.2.) Empty Rate/Min (2.4.3.) Up Sampling (2.7.4.2.) Down Sampling (2.7.4.3.)

For radar applications, Material Agitator is the most often-used setting, to avoid agitator blade detection.

2.7.4.2. Up Sampling

Specifies the number of consecutive echoes that must appear above the echo currently selected, before the measurement is accepted as valid.

Values	Range: 1 to 50
	Default: 5

2.7.4.3. Down Sampling

Specifies the number of consecutive echoes that must appear below the echo currently selected, before the measurement is accepted as valid.

Values	Range: 1 to 50
	Default: 2

2.7.4.4. Echo Lock Window

A “distance window” centered on the echo is used to derive the reading. When a new measurement is in the window, the window is re-centered and the reading is calculated.

Values	Range: 0 to 45 m (or 105 m, depending on model)
	Default: 0 m

When the value is 0, the window is automatically calculated after each measurement.

- For slower Measurement Response values, the window grows at a slower rate.
- For faster Measurement Response values, the window grows at a faster rate.

Note: The Echo Lock window is stored as a standard sample, but displayed in sensor units. Any value entered for the Echo Lock window will be rounded to the nearest sample.

2.7.5. Filtering

2.7.5.1. Narrow Echo Filter

Filters out echoes of a specific width.

Values	Range: 0 to 255
	0 = OFF
	greater = wider

To remove a false echo from the Echo Profile, take its width in mm and multiply it by 0.006. Enter the result.

For example, to filter out a spike with 500 mm width, enter 6 or 7 (the closest integer product of 500 x 0.006).

When a value is keyed in, the nearest acceptable value is entered.

2.7.5.2. Reform Echo

Smooths jagged peaks in the echo profile. Reforms fragmented echoes into one echo.

Values	0 = OFF
	greater = wider
	Range: 0 to 255 samples
	Recommended: 10 samples

2.7.5.3. Average Amount

The fraction of the old shot data that is kept for averaging purposes. A higher value will give a smoother profile at the expense of a slower echo profile response.

Values	0.0 to 1.0
	Default: 0.75

2.7.6. Echo Quality

2.7.6.1. Confidence

Indicates echo reliability: higher values represent better echo quality. The display shows the echo confidence of the last measurement. **Echo Threshold (2.7.3.2.)** defines the minimum criterion for echo confidence.

Values (view only)	0 to 99	
	----	Shot not used
Related Parameters	Echo Threshold (2.7.3.2.)	

Open the menu **Device – Echo Profile Utilities** and click on the tab **Echo Profile**.

2.7.6.2. Echo Strength

Displays the absolute strength (in dB above 1 μ V rms) of the echo selected as the measurement echo.

Values (view only)	–20 to 99
---------------------------	-----------

Open the menu **Device – Echo Profile Utilities** and click on the tab **Echo Profile**.

2.8. TVT setup

Note: Default settings in the parameter tables are indicated with an asterisk (*) unless explicitly stated.

2.8.1. Auto False Echo Suppression

Note: We recommend setting Auto False Echo Suppression either via SIMATIC PDM or via local operation using the Auto False Echo Suppression wizard.

Used together with **Shaper Mode (2.8.4.)** to screen out false echoes in a vessel with known obstructions. A 'learned TVT' (time varying threshold) replaces the default TVT over a specified range.

- See *Shaper Mode (2.8.4.)* on page 128 for a more detailed explanation.
- To set via SIMATIC PDM, see *Auto False Echo Suppression* on page 48.
- To set via local operation, see *AFES (Auto False Echo Suppression) Wizard* on page 79.

2.8.2. Auto False Echo Suppression Range

Defines the endpoint of the Learned TVT distance. Units are defined in Units (2.2.1.). Used in combination with Auto False Echo Suppression (see above).

Values	Range: 0.00 to 45.00 m (or 105.00 m depending on model)
	Default: 1.00 m
Related parameters	Units (2.2.1.)

2.8.3. Hover Level

Defines how high the TVT (Time Varying Threshold) is placed above the noise floor of the echo profile, as a percentage of the difference between the peak of the largest echo in the profile and the noise floor. (See **Before Auto False Echo Suppression** on page 49 for an illustration.)

Values	Range: 0 to 100%
	Default: 40%

When the device is located in the center of the vessel, the TVT hover level may be lowered to increase the confidence level of the largest echo.

2.8.4. Shaper Mode

Enables/disables the TVT shaper.

Options		ON
	*	OFF

2.9. TVT shaper

Note:

- **Shaper Mode (2.8.4.)** must be turned ON in order for TVT breakpoints to be transferred.
- We recommend using SIMATIC PDM to access this feature

Adjusts the TVT (Time Varying Threshold) at a specified range (breakpoint on the TVT). This allows you to reshape the TVT to avoid unwanted echoes. There are 120 breakpoints.

Values	Range: -50 to 50 dB
	Default: 0 dB

To use TVT shaper via SIMATIC PDM:

- Go to **Level Meter > Setup > Signal Processing > TVT setup > Shaper Mode** and select **On**.
- Open the menu **Device – Echo Profile Utilities** and click on **TVT Shaper**.

To use TVT shaper via LDI (local display interface):

- a) Go to Shaper Mode (2.8.4.) and select **On**.
- b) Go to Breakpoint 1-9 (2.9.1.).
- c) Open Shaper 1 and enter the TVT Offset value (between –50 and 50).
- d) Go to the next Shaper point and repeat steps c) and d) till all desired breakpoint values have been entered.

2.9.1. Breakpoint 1-9

2.9.2. Breakpoint 10-18

2.9.3. Breakpoint 19-27

2.9.4. Breakpoint 28-36

2.9.5. Breakpoint 37-45

2.9.6. Breakpoint 46-54

2.9.7. Breakpoint 55-63

2.9.8. Breakpoint 64-72

2.9.9. Breakpoint 73-81

2.9.10. Breakpoint 82-90

2.9.11. Breakpoint 91-99

2.9.12. Breakpoint 100-108

2.9.13. Breakpoint 109-117

2.9.14. Breakpoint 118-120

2.10. Measured Values

Read only. Allows you to view measured values for diagnostic purposes.

To access measured values via SIMATIC PDM:

Open the menu **View – Process Variables**.

2.10.1. Main Output

The value for Level/Volume, always displayed here in percent.

2.10.2. Output No Linearization

The value for Level, always displayed here in percent.

2.10.3. Output No Offsets

The value for distance, displayed in sensor units.

3. Diagnostics

3.1. Fault Reset

*Clears the following fault (known as **Acknowledge Fault** in PDM.)*

To clear a fault using the handheld programmer:

- Enter the fault code number then press **RIGHT Arrow**.

Fault Code	Description
S12	Internal Temperature High

To clear a fault via SIMATIC PDM:

- Open the menu **View – Device Status** and click on **Maintenance** tab. Click on **Acknowledge Warnings** in the applicable box to clear the fault.

Description
Device Lifetime Limit 1 (Maintenance Required)
Device Lifetime Limit 2 (Maintenance Demanded)
Sensor Lifetime Limit 1 (Maintenance Required)
Sensor Lifetime Limit 2 (Maintenance Demanded)
Device Service Limit 1 (Maintenance Required)
Device Service Limit 2 (Maintenance Demanded)
Calibration Schedule Limit 1 (Maintenance Required)
Calibration Schedule Limit 2 (Maintenance Demanded)
Internal Error (Maintenance Demanded)

Clearing a fault in one parameter of a "maintenance pair" automatically clears a fault in the second parameter of the pair. For example, entering S3 or S4 will clear a fault on Device (Maintenance Required), and on Device (Maintenance Demanded). This applies when clearing faults via the handheld programmer or 375 Field Communicator.

3.2. Echo Profile

Allows you to request the current echo profile either locally via the handheld programmer, or remotely via SIMATIC PDM, or AMS Device Manager. (For more detail see Echo Processing on page 125.)

To request a profile via SIMATIC PDM open the menu **Device – Echo Profile Utilities**.

To request a profile via the handheld programmer:

- a) In PROGRAM mode, navigate to **LEVEL METER > DIAGNOSTICS (3) > ECHO PROFILE (3.2)**
- b) Press **RIGHT arrow** to request a profile.
(For more detail see *Requesting an Echo Profile* on page 37.)

3.3. Trend

Shows current trend.

3.4. Peak Values

To view via SIMATIC PDM:

Open the menu **View – Status**, and click on the tab **Device Status**. For more details see *Diagnostics* on page 52.

3.4.1. Min. Measured Value

*The minimum recorded Sensor value, reported in units defined in **Units (2.2.1.)**.*

3.4.2. Max. Measured Value

*The maximum recorded Sensor value, reported in units defined in **Units (2.2.1.)**.*

3.4.3. Minimum PV

The minimum recorded Primary Value from the Analog Input Function Block 1.

3.4.4. Maximum PV

The maximum recorded Primary Value from the Analog Input Function Block 1.

3.4.5. Minimum SV

The minimum recorded Secondary Value from the Analog Input Function Block 1.

3.4.6. Maximum SV

The maximum recorded Secondary Value from the Analog Input Function Block 1.

3.5. Electronics Temperature

3.5.1. Min value

Note: Read only in PDM or AMS. Can be written via the handheld programmer.

Displays (in degrees C) the minimum temperature recorded by the internal electronics. The high and low values are maintained over a power cycle.

Via SIMATIC PDM navigate to Maintenance and Diagnostics > Electronics Temperature.

3.5.2. Max value

Note: Read only in PDM or AMS. Can be written via the handheld programmer.

Displays (in degrees C) the maximum temperature recorded by the internal electronics. The high and low values are maintained over a power cycle.

Via SIMATIC PDM navigate to Maintenance and Diagnostics > Electronics Temperature.

3.5.3. Internal Temperature

Read only. Displays (in degrees C) the current temperature on the circuit board recorded by the internal electronics.

For access via SIMATIC PDM open the menu View – Process Variables and check the field Electronics Temperature.

3.6. Remaining Device Lifetime

Notes:

- Default settings in the parameter tables are indicated with an asterisk (*) unless explicitly stated.
- Four sets of parameters allow you to monitor the Device/Sensor Lifetimes and set up Maintenance/Service schedules, based on operating hours instead of a calendar-based schedule. See also **Remaining Sensor Lifetime (3.7.)**, **Service Schedule (4.7.)**, and **Calibration Schedule (4.8.)**.
- Performing a reset to **Factory Defaults** will reset all the Maintenance Schedule parameters to their factory defaults.
- The device operates in years. To view Remaining Device Lifetime parameters in hours or days (via SIMATIC PDM only) see **Lifetime Expected (3.6.6.)**.

The device tracks itself based on operating hours and monitors its predicted lifetime. You can modify the expected device lifetime, set up schedules for maintenance reminders, and acknowledge them.

The maintenance warnings and reminders are available through HART communications. This information can be integrated into an Asset Management system. For optimal use, we recommend that you use SIMATIC PCS7 Asset Management Software in conjunction with SIMATIC PDM.

To access these parameters via SIMATIC PDM:

- Open the menu **Device – Maintenance** and select the **Remaining Device Lifetime** tab.
- After modifying values/units as required, click on **Write** to accept the change, and **Read** to view the effect of the change.
- Click on **Snooze** to add a year to the Total Expected Device Life.

Time Units

Options ^{a)}	Hours; days; years
	Default: years

a) Selectable only via SIMATIC PDM.

3.6.1. Time in Operation

Read only. The amount of time the device has been operating.

3.6.2. Remaining Lifetime

Read only. Lifetime Expected (3.6.6.) less Time in Operation (3.6.1.).

3.6.3. Reminder 1 (Required)

If **Remaining Lifetime (3.6.2.)** is equal to or less than this value, the device generates a **Maintenance Required** reminder.

Values	Range: 0 to 20 years
	Default: 0.164 years

- a) Modify values as required.
- b) Set **Reminder Activation (3.6.5.)** to the desired option.

3.6.4. Reminder 2 (Demanded)

If **Remaining Lifetime (3.6.2.)** is equal to or less than this value, the device generates a **Maintenance Demanded** reminder.

Values	Range: 0 to 20 years
	Default: 0.019 years

- a) Modify values as required.
- b) Set **Reminder Activation (3.6.5.)** to the desired option.

3.6.5. Reminder Activation

Note: To modify this parameter via SIMATIC PDM it must be accessed via the pull-down menu **Device – Maintenance**.

Allows you to enable a maintenance reminder.

Options	Reminder 1 (Maintenance Required)
	Reminder 2 (Maintenance Demanded)
	Reminders 1 and 2
	* OFF

3.6.6. Lifetime Expected

Note: The device always operates in years. Changing the units affects only the parameter view of the Remaining Device Lifetime parameters in SIMATIC PDM.

Allows you to override the factory default.

Values	Units ^{a)} : hours, days, years
	Range: 0 to 20 years
	Default: 10.00 years

- a) Units are selectable only via SIMATIC PDM.

3.6.7. Maintenance Status

Indicates which level of maintenance reminder is active.

In SIMATIC PDM, open the menu **View – Device Status**, click on the **Maintenance** tab, and check the **Device Lifetime Status** window.

3.6.8. Acknowledge Status

Indicates which level of maintenance reminder has been acknowledged.

In SIMATIC PDM, open the menu **View – Device Status**, click on the **Maintenance** tab, and check the **Device Lifetime Status** window.

3.6.9. Acknowledge

Acknowledges the current maintenance reminder.

To acknowledge a reminder via SIMATIC PDM:

- a) Open the menu **View – Device Status** and click on the tab **Maintenance**.
- b) In the **Device Lifetime** section, click on **Acknowledge Warnings**.

To acknowledge a reminder via the local control buttons or handheld programmer:

- a) Press **RIGHT arrow** twice to open parameter view and activate **Edit Mode**.
- b) Press **RIGHT arrow** to acknowledge the reminder.

3.7. Remaining Sensor Lifetime

Notes:

- Default settings in the parameter tables are indicated with an asterisk (*) unless explicitly stated.
- Four sets of parameters allow you to monitor the Device/Sensor Lifetimes and set up Maintenance/Service schedules, based on operating hours instead of a calendar-based schedule. See also **Remaining Device Lifetime (3.6.)**, **Service Schedule (4.7.)**, and **Calibration Schedule (4.8.)**.
- Performing a reset to **Factory Defaults** will reset all the Maintenance Schedule parameters to their factory defaults.
- The device operates in years. To view Remaining Sensor Lifetime parameters in hours or days (via SIMATIC PDM only), see **Lifetime Expected (3.7.6.)**.

The device monitors the predicted lifetime of the sensor (the components exposed to the vessel environment). You can modify the expected sensor lifetime, set up schedules for maintenance reminders, and acknowledge them.

To access these parameters via SIMATIC PDM:

- Open the menu **Device – Maintenance** and select the **Remaining Sensor Lifetime** tab.
- After modifying values/units as required, click on **Write** to accept the change, and **Read** to view the effect of the change.
- Click on **Snooze** to add a year to the Total Expected Sensor Life.
- Click on **Sensor Replaced** to restart the timer and clear any fault messages.

Time Units

Options ^{a)}	Hours; days; years
	Default: years

a) Selectable only via SIMATIC PDM.

3.7.1. Time in Operation

Read only. The amount of time the sensor has been operating.

3.7.2. Remaining Lifetime

Read only. Lifetime Expected (3.7.6.) less Time in Operation (3.7.1.).

3.7.3. Reminder 1 (Required)

*If Remaining Lifetime (3.7.2.) is equal to or less than this value, the device generates a **Maintenance Required** reminder.*

Values	Range: 0 to 20 years
	Default: 0.164 years

- Modify values as required.
- Set **Reminder Activation (3.7.5.)** to the desired option.

3.7.4. Reminder 2 (Demanded)

*If Remaining Lifetime (3.7.2.) is equal to or less than this value, the device generates a **Maintenance Demanded** reminder.*

Values	Range: 0 to 20 years
	Default: 0.019 years

- Modify values as required.
- Set **Reminder Activation (3.7.5.)** to the desired option.

3.7.5. Reminder Activation

Note: To modify this parameter via SIMATIC PDM it must be accessed via the pull-down menu **Device – Maintenance**.

Allows you to enable a maintenance reminder.

Options		Reminder 1 (Maintenance Required)
		Reminder 2 (Maintenance Demanded)
		Reminders 1 and 2
	*	OFF

- First set the values in **Reminder 1 (Required) (3.7.3.)**/**Reminder 2 (Demanded) (3.7.4.)**.
- Select the desired **Reminder Activation** option.

3.7.6. Lifetime Expected

Note: The device always operates in years. Changing the units affects only the parameter view of Remaining Sensor Life parameters in SIMATIC PDM.

Allows you to override the factory default.

Values	Units ^{a)} : hours, days, years
	Range: 0 to 20 years
	Default: 10.00 years

- Units are selectable only via SIMATIC PDM.

3.7.7. Maintenance Status

Indicates which level of maintenance reminder is active.

In SIMATIC PDM, open the menu **View – Device Status**, click on the **Maintenance** tab, and check the **Sensor Lifetime Status** window.

3.7.8. Acknowledge Status

Indicates which level of maintenance reminder has been acknowledged.

In SIMATIC PDM, open the menu **View – Device Status**, click on the **Maintenance** tab and check the **Sensor Lifetime Status** window.

3.7.9. Acknowledge

Acknowledges the current maintenance reminder.

To acknowledge a reminder via SIMATIC PDM:

- Open the menu **View – Device Status** and click on the **Maintenance** tab.
- In the **Sensor Lifetime** section click on **Acknowledge Warnings**.

To acknowledge a reminder via the local control buttons or handheld programmer:

- Press **RIGHT arrow** twice to open parameter view and activate **Edit Mode**.
- Press **RIGHT arrow** to acknowledge the reminder.

4. Service

4.1. Demo Mode

Used to set up for demonstrations: reduces the time between measurements and the accuracy for demonstration purposes.

Values	ON or OFF
	Default: OFF

4.2. Master Reset

Note:

- Following a reset to **Factory Defaults**, the LCD displays the Quick Start wizard.
- Following a reset to **Factory Defaults**, complete reprogramming is required.

Resets all parameter to factory defaults, with certain exceptions. The list of exceptions includes, but is not limited to:

- Language
- Identification parameters (such as Tag, Installation Date)
- Device Address
- Write Protection
- Auto False Echo Suppression
- Auto False Echo Suppression Range

Options	*	Factory Defaults
		Warm Start

To perform a reset to factory defaults via SIMATIC PDM, open the menu **Device – Master Reset** and click on **OK**.

4.3. Powered Hours

Read only unless **Write Protection (6.1)** is set to **Unlock (2457)**. Displays the number of hours the unit has been powered up since manufacture.

In SIMATIC PDM, open the menu **Device – Wear**.

4.4. Power-on Resets

Read only unless **Write Protection (6.1)** is set to **Unlock (2457)**. The number of power cycles that have occurred since manufacture.

In SIMATIC PDM, open the menu **Device – Wear**.

4.5. LCD Backlight

Time the backlight remains on.

Options	Range: 0 (backlight off) to 128 seconds (>120 means backlight always on) Default: 128 seconds
---------	--

4.6. LCD Contrast

The factory setting is for optimum visibility at room temperature and in average light conditions. Extremes of temperature will lessen the contrast.

Values	Range: 0 to 20. Default: 8	Contrast setting will depend on ambient temperature.
---------------	--------------------------------------	--

Adjust the value to improve visibility in different temperatures and light conditions.
Change the value in small steps to ensure you can continue to read the display.

4.7. Service Schedule

Notes:

- Four sets of parameters allow you to monitor the Device/Sensor Lifetimes and set up Maintenance/Service schedules, based on operating hours instead of a calendar-based schedule. See also **Remaining Device Lifetime (3.6.)**, **Remaining Sensor Lifetime (3.7.)**, and **Calibration Schedule (4.8.)**.
- Performing a reset to **Factory Defaults** will reset all the Maintenance Schedule parameters to their factory defaults.
- The device operates in years. To view Service Interval parameters in hours or days (via SIMATIC PDM only) see **Service interval (4.7.6.)**.

The device tracks service intervals based on operating hours and monitors the predicted lifetime to the next service. You can modify the Total Service Interval, set schedules for maintenance reminders, and acknowledge them.

The maintenance warnings and reminders are communicated to the end user through status information. This information can be integrated into any Asset Management system. For optimal use, we recommend that you use SIMATIC PCS7 Asset Management Software in conjunction with SIMATIC PDM.

To access these parameters via SIMATIC PDM:

- Open the menu **Device – Maintenance** and select the **Service Schedule** tab.
- After modifying values/units as required, click on **Write** to accept the change, and **Read** to view the effect of the change.
- Click on **Service Performed** to restart the timer and clear any fault messages.

Time Units

Options^{a)}	Hours; days; years
	Default: years

a) Selectable only via SIMATIC PDM.

4.7.1. Time since Last Service

Time elapsed since last service. Can be reset to zero after performing a service. Can be reset locally by entering 0 in this parameter.

To reset to zero:

- In SIMATIC PDM, open the menu **Device – Maintenance**, click on the **Service Schedule** tab, and click on **Service Performed** to restart the timer and clear any fault messages.
- Via the handheld programmer, manually reset **Time since Last Service (4.7.1.)** to zero.

4.7.2. Time until Next Service

Read only. Service interval (4.7.6.) less Time since Last Service (4.7.1.).

4.7.3. Reminder 1 (Required)

If Time until Next Service (4.7.2.) is equal to or less than this value, the device generates a Maintenance Required reminder.

Values	Range: 0 to 20 years
	Default: 0.164 years

- Modify values as required.
- Set **Reminder Activation (4.7.5.)** to the desired option.

4.7.4. Reminder 2 (Demanded)

If Time until Next Service (4.7.2.) is equal to or less than this value, the device generates a Maintenance Demanded reminder.

Values	Range: 0 to 20 years
	Default: 0.019 years

- Modify values as required.
- Set **Reminder Activation (4.7.5.)** to the desired option.

4.7.5. Reminder Activation

Note: To modify this parameter via SIMATIC PDM it must be accessed via the pull-down menu **Device – Maintenance**.

Allows you to enable a maintenance reminder.

Values	*	Timer OFF
		ON NO LIMITS
		ON REMinder 1 (Maintenance Required) checked
		ON REMinders 1 and 2 checked
		ON REMinder 2 (Maintenance Demanded) checked

- First set the values in **Reminder 1 (Required) (4.7.3.)**/**Reminder 2 (Demanded) (4.7.4.)**.
- Select the desired **Reminder Activation** option.

4.7.6. Service interval

Note: The device always operates in years. Changing the units affects only the parameter view of the Service Interval parameters in SIMATIC PDM.

User-configurable recommended time between product inspections.

Values	Units ^{a)} : hours, days, years
	Range: 0 to 20 years
	Default: 1.0 year

a) Units are selectable only via SIMATIC PDM.

4.7.7. Maintenance Status

Indicates which level of maintenance reminder is active.

Open the menu **View – Device Status**, click on the **Maintenance** tab and check the **Service Schedule Status** window.

4.7.8. Acknowledge Status

Indicates which level of maintenance reminder has been acknowledged.

Open the menu **View – Device Status**, click on the **Maintenance** tab and check the **Service Schedule Status** window.

4.7.9. Acknowledge

Acknowledges the current maintenance reminder.

To acknowledge a reminder via SIMATIC PDM:

- Open the menu **View – Device Status** and click on the **Maintenance** tab.
- In the **Service Schedule Status** section click on **Acknowledge Warnings**.

To acknowledge a reminder via the local control buttons or handheld programmer:

- Press **RIGHT arrow** twice to open parameter view and activate **Edit Mode**.
- Press **RIGHT arrow** to acknowledge the reminder.

4.8. Calibration Schedule

Notes:

- Default settings in the parameter tables are indicated with an asterisk (*) unless explicitly stated.
- Four sets of parameters allow you to monitor the Device/Sensor Lifetimes and set up Maintenance/Service schedules, based on operating hours instead of a calendar-based schedule. See also **Remaining Device Lifetime (3.6.)**, **Remaining Sensor Lifetime (3.7.)**, and **Service Schedule (4.7.)**.
- Performing a reset to **Factory Defaults** will reset all the Maintenance Schedule parameters to their factory defaults.
- The device operates in years. To view Calibration Interval parameters in hours or days (via SIMATIC PDM only) see **Calibration Interval (4.8.6.)**.

The device tracks calibration intervals based on operating hours and monitors the predicted lifetime to the next calibration. You can modify the Total Calibration Interval, set schedules for maintenance reminders, and acknowledge them.

To access these parameters via SIMATIC PDM:

- Open the menu **Device – Maintenance** and select the **Calibration Schedule** tab.
- After modifying values/units as required, click on **Write** to accept the change, and **Read** to view the effect of the change.
- Click on **Calibration Performed** to restart the timer and clear any fault messages.

Time Units

Options ^{a)}	Hours; days; years
	Default: years

^{a)} Selectable only via SIMATIC PDM.

4.8.1. Time since Last Calibration

Time elapsed since last calibration. Can be reset to zero after performing a calibration. Can be reset locally by entering 0 in this parameter.

To reset to zero:

- In SIMATIC PDM, open the menu **Device – Maintenance**, click on the **Calibration Schedule** tab, and click on **Calibration Performed** to restart the timer and clear any fault messages.
- Via the handheld programmer, manually reset Time since Last Calibration (4.8.1.) to zero.

4.8.2. Time until Next Calibration

Read only. Calibration Interval (4.8.6.) less Time since Last Calibration (4.8.1.).

4.8.3. Reminder 1 (Required)

If *Time until Next Calibration (4.8.2.)* is equal to or less than this value, the device generates a **Maintenance Required** reminder.

Values	Range: 0 to 20 years
	Default: 0.164 years

- a) Modify values as required.
- b) Set **Reminder Activation (4.8.5.)** to the desired option.

4.8.4. Reminder 2 (Demanded)

If *Time until Next Calibration (4.8.2.)* is equal to or less than this value, the device generates a **Maintenance Demanded** reminder.

Values	Range: 0 to 20 years
	Default: 0.019 years

- a) Modify values as required.
- b) Set **Reminder Activation (4.8.5.)** to the desired option.

4.8.5. Reminder Activation

Note: To modify this parameter via SIMATIC PDM it must be accessed via the pull-down menu **Device – Maintenance**.

Allows you to enable a maintenance reminder.

Values	*	Timer OFF
		ON NO LIMITS
		ON REMinder 1 (Maintenance Required) checked
		ON REMinders 1 and 2 checked
		ON REMinder 2 (Maintenance Demanded) checked

- a) First set the values in **Reminder 1 (Required) (4.8.3.)/Reminder 2 (Demanded) (4.8.4.)**.
- b) Select the desired **Reminder Activation** option.

4.8.6. Calibration Interval

Note: The device always operates in years. Changing the units affects only the parameter view of the Calibration Interval parameters in SIMATIC PDM.

User-configurable recommended time between product calibrations.

Values	Units ^{a)} : hours, days, years
	Range: 0 to 20 years
	Default: 1.0 year

- a) Units are selectable only via SIMATIC PDM.

4.8.7. Maintenance Status

Indicates which level of maintenance reminder is active.

In SIMATIC PDM, open the menu **View – Device Status**, click on the **Maintenance** tab and check the **Calibration Schedule Status** window.

4.8.8. Acknowledge Status

Indicates which level of maintenance reminder has been acknowledged.

In SIMATIC PDM, open the menu **View – Device Status**, click on the **Maintenance** tab and check the **Calibration Schedule Status** window.

4.8.9. Acknowledge

Acknowledges the current maintenance reminder.

To acknowledge a reminder via SIMATIC PDM:

- a) Open the menu **View – Device Status** and click on the **Maintenance** tab.
- b) In the **Calibration Schedule Status** section click on **Acknowledge Warnings**.

To acknowledge a reminder via the the local control buttons or handheld programmer:

- a) Press **RIGHT arrow** twice to open parameter view and activate **Edit Mode**.
- b) Press **RIGHT arrow** to acknowledge the reminder.

5. Communication

Note: Default settings in the parameter tables are indicated with an asterisk (*) unless explicitly stated.

5.1. Device Address

*Sets the device address or poll ID on a HART network. Any address other than 0 will cause the output current to be a fixed value, and the current will not indicate the reading. Range should be limited to **0 to 15** for a HART 5 master.*

Values	Range: 0 to 63
	Default: 0

To reset Device Address via SIMATIC PDM:

- Open the project in **Process Device Network View** then right-click on the device.
- Go to **Object Properties > Connection** to access the field **Short Address**.

Note: SIMATIC PDM only allows addresses 0-15.

5.2. Remote Lockout

Enables/disables the read/write access to parameters via remote communications. If locked via the handheld programmer, it can be unlocked only via the handheld programmer. If locked via AMS, it can be reset via AMS or via the handheld programmer.

Options		ON	No changes are permitted via remote communications.
	*	OFF	Changes are permitted.

6. Security

Note: Default settings in the parameter tables are indicated with an asterisk (*) unless explicitly stated.

6.1. Write Protection

Prevents any changes to parameters.

Options		Range: 0 to 9999	
	*	Unlock value (2457)	Lock Off
		Any other value	Lock On

- To turn Lock On, key in any value other than the Unlock Value 2457.
- To turn Lock Off, key in the Unlock Value 2457.

7. Language

Selects the language to be used on the LCD.

Options	*	ENGLISH
		DEUTSCH
		FRANÇAIS
		ESPAÑOL
		简体中文

Appendix A: Alphabetical Parameter List

Note: Maintenance Parameters are not listed below. See *Remaining Device Lifetime (3.6.) on page 100*, *Remaining Sensor Lifetime (3.7.) on page 102*, *Service Schedule (4.7.) on page 106*, and *Calibration Schedule (4.8.) on page 109* for those parameters.

Parameter Name (Parameter Number)	Page Number
20 mA Setpoint (2.6.3.)	88
4 mA Setpoint (2.6.2.)	88
AFES (Auto False Echo Suppression) Wizard (1.2.)	79
Algorithm (2.7.3.1.)	90
Analog Output Scaling (2.6.)	87
Shaper Mode (2.8.4.)	96
Shaper Mode (2.8.4.)	96
Breakpoint 100-108 (2.9.12.)	97
Breakpoint 10-18 (2.9.2.)	97
Breakpoint 109-117 (2.9.13.)	97
Breakpoint 118-120 (2.9.14.)	97
Breakpoint 1-9 (2.9.1.)	97
Breakpoint 19-27 (2.9.3.)	97
Breakpoint 28-36 (2.9.4.)	97
Breakpoint 37-45 (2.9.5.)	97
Breakpoint 46-54 (2.9.6.)	97
Breakpoint 55-63 (2.9.7.)	97
Breakpoint 64-72 (2.9.8.)	97
Breakpoint 73-81 (2.9.9.)	97
Breakpoint 82-90 (2.9.10.)	97
Breakpoint 91-99 (2.9.11.)	97
Calibration (2.3.)	83
CLEF Range (2.7.3.4.)	92
Communication (5.)	111
Confidence (2.7.6.1.)	95
Copy Firmware from Display (1.6.)	81
Copy Firmware to Display (1.5.)	80
Copy Parameters from Display (1.4.)	80
Copy Parameters to Display (1.3.)	80
Current Output Function (2.6.1.)	87
Damping Filter (2.2.3.)	83
Demo Mode (4.1.)	105
Descriptor (2.1.3.)	81

Parameter Name (Parameter Number)	Page Number
Device (2.1.)	81
Device Address (5.1.)	111
Diagnostics (3.)	98
Down Sampling (2.7.4.3.)	93
Echo Lock (2.7.4.1.)	93
Echo Lock Window (2.7.4.4.)	94
Echo Marker (2.7.3.5.)	92
Echo Profile (3.2.)	98
Echo Quality (2.7.6.)	95
Echo select (2.7.3.)	90
Echo Strength (2.7.6.2.)	95
Echo Threshold (2.7.3.2.)	91
Electronics Temperature (3.5.)	99
Empty Rate/Min (2.4.3.)	85
Fail-safe (2.5.)	86
Material Level (2.5.1.)	86
Level (2.5.3.)	86
Far Range (2.7.2.)	90
Fault Reset (3.1.)	98
Fill Rate/Min (2.4.2.)	85
Filtering (2.7.5.)	94
Firmware Revision (2.1.7.)	82
Hardware Revision (2.1.6.)	81
High Calibration Pt. (2.3.2.)	83
Auto False Echo Suppression Range (2.8.2.)	96
Internal Temperature (3.5.3.)	100
Language (7.)	112
LCD Backlight (4.5.)	105
LCD Contrast (4.6.)	106
Loader Revision (2.1.8.)	82
Timer (2.5.2.)	86
Long Tag (2.1.1.)	81
Low Calibration Pt. (2.3.1.)	83
mA Output Mode (2.6.6.)	89
mA Output Value (2.6.8.)	89
Main Output (2.10.1.)	97
Manual Value (2.6.7.)	89
Master Reset (4.2.)	105
Max. mA limit (2.6.5.)	88
Measured Values (2.10.)	97
Menu Timeout (2.1.9.)	82

Parameter Name (Parameter Number)	Page Number
Message (2.1.4.)	81
Min. mA limit (2.6.4.)	88
Narrow Echo Filter (2.7.5.1.)	94
Near Range (2.7.1.)	90
Output No Linearization (2.10.2.)	97
Output No Offsets (2.10.3.)	97
Peak Values (3.4.)	99
Position Detect (2.7.3.3.)	91
Powered Hours (4.3.)	105
Power-on Resets (4.4.)	105
Quick Start (1.)	78
Quick Start Wizard (1.1.)	78
Rate (2.4.)	84
Remote Lockout (5.2.)	112
Response Rate (2.4.1.)	84
Sampling (2.7.4.)	93
Security (6.)	112
Sensor (2.2.)	82
Sensor Mode (2.2.2.)	82
Sensor Offset (2.3.3.)	84
Service (4.)	105
Setup (2.)	81
Shaper Mode (2.8.4.)	96
Signal Processing (2.7.)	90
Tag (2.1.2.)	81
Trend (3.3.)	99
TVT setup (2.8.)	95
TVT shaper (2.9.)	96
Units (2.2.1.)	82
Up Sampling (2.7.4.2.)	93
Write Protection (6.1.)	112

Appendix B: Troubleshooting





Communication Troubleshooting





- 1) Check the following:
 - There is power at the instrument.
 - The LCD shows the relevant data.
 - The device can be programmed using the handheld programmer.
 - If any fault codes are being displayed, see “General Fault Codes” on page 118 for a detailed list.
- 2) Verify that the wiring connections are correct.
- 3) See the table below for specific symptoms.

Symptom	Corrective action
The device cannot be programmed via the handheld programmer.	<ul style="list-style-type: none">• Ensure Write Protection (6.1.) on page 112 is set to the unlock value.
You try to set a SITRANS LR560 parameter via remote communications but the parameter remains unchanged.	<ul style="list-style-type: none">• Ensure Write Protection (6.1.) on page 112 is set to the unlock value, then try setting the parameter via the handheld programmer.• Some parameters can be changed only when the device is not scanning. Try pressing Mode  to put the device into PROGRAM mode.

If you continue to experience problems, go to our website at: www.siemens.com/sitransLR560, and check the FAQs for SITRANS LR560, or contact your Siemens Milltronics representative.

Device Status Icons

Icon	Priority Level	Meaning
	1	<ul style="list-style-type: none"> • Maintenance alarm • Measurement values are not valid
	2	<ul style="list-style-type: none"> • Maintenance warning: maintenance demanded immediately • Measured signal still valid
	3	<ul style="list-style-type: none"> • Maintenance required • Measured signal still valid
	1	<ul style="list-style-type: none"> • Process value has reached an alarm limit
	2	<ul style="list-style-type: none"> • Process value has reached a warning limit
	3	<ul style="list-style-type: none"> • Process value has reached a tolerance limit
	1	<ul style="list-style-type: none"> • Configuration error • Device will not work because one or more parameters/components is incorrectly configured
	2	<ul style="list-style-type: none"> • Configuration warning • Device can work but one or more parameters/components is incorrectly configured
	3	<ul style="list-style-type: none"> • Configuration changed • Device parameterization not consistent with parameterization in project. Look for info text.
	1	<ul style="list-style-type: none"> • Manual operation (local override) • Communication is good; device is in manual mode.
	2	<ul style="list-style-type: none"> • Simulation or substitute value • Communication is good; device is in simulation mode or works with substitute values.
	3	<ul style="list-style-type: none"> • Out of operation • Communication is good; device is out of action.



Icon	Priority Level	Meaning (Continued)
		<ul style="list-style-type: none"> Data exchanged
		<ul style="list-style-type: none"> No data exchange
		<ul style="list-style-type: none"> Write access enabled
		<ul style="list-style-type: none"> Write access disabled

General Fault Codes

Notes:









- If more than one fault is present, the device status indicator and text for each fault alternate at 2 second intervals.
- Some faults cause the device to go to Fail-safe mode (Fault 52). These are indicated with an asterisk (*).

General Fault Codes





Code / Icon	Meaning	Corrective Action
S: 0 	* The device was unable to get a measurement within the Fail-safe LOE Timer period. Possible causes: faulty installation, antenna material buildup, foaming/other adverse process conditions, invalid calibration range.	<ul style="list-style-type: none"> Ensure installation details are correct. Ensure no antenna material buildup. Clean if necessary. Adjust process conditions to minimize adverse conditions. Correct range calibration. If fault persists, contact your local Siemens representative.
S: 2 	* Unable to collect profile because of a power condition that is outside the operating range of the device.	Repair required: contact your local Siemens representative.
S: 3 	Device is nearing its lifetime limit according to the value set in Maintenance Required Limit.	Replacement is recommended.

General Fault Codes (Continued)		
Code / Icon	Meaning	Corrective Action
S: 4 	Device is nearing its lifetime limit according to the value set in Maintenance Demanded Limit.	Replacement is recommended.
S: 6 	Sensor is nearing its lifetime limit according to the value set in Maintenance Required Limit.	Replacement is recommended.
S: 7 	Sensor is nearing its lifetime limit according to the value set in Maintenance Demanded Limit.	Replacement is recommended.
S: 8 	Service interval as defined in Maintenance Required Limit has expired.	Perform service.
S: 9 	Service interval as defined in Maintenance Demanded Limit has expired.	Perform service.
S: 11 	Internal temperature sensor failure.	Repair required: contact your local Siemens representative.
S: 12 	Internal temperature of device has exceeded specifications: it is operating outside its temperature range.	<ul style="list-style-type: none"> Relocate device and/or lower process temperature enough to cool device. Inspect for heat-related damage and contact your local Siemens representative if repair is required. Fault code will persist until a manual reset is performed using SIMATIC PDM or the LCD interface.
S: 17 	Calibration interval as defined in Maintenance Required Limit has expired.	Perform calibration.
S: 18 	Calibration interval as defined in Maintenance Demanded Limit has expired.	Perform calibration.
S:25 	Internal error.	Reset power. If fault persists, contact your local Siemens representative.
S:27 	Internal device failure caused by an External RAM memory error.	Repair required: contact your local Siemens representative.
S: 28 	* Internal device failure caused by a RAM memory error.	Repair required: contact your local Siemens representative.

General Fault Codes (Continued)



Code / Icon	Meaning	Corrective Action
S: 29 	* EEPROM damaged.	Repair required: contact your local Siemens representative.
S: 30 	EEPROM corrupt.	Reset power. If fault persists, contact your local Siemens representative.
S: 31 	* Flash error.	Repair required: contact your local Siemens representative.
S: 33 	* Factory calibration for the internal temperature sensor has been lost.	Repair required: contact your local Siemens representative.
S: 34 	* Factory calibration for the device has been lost.	Repair required: contact your local Siemens representative.
S:39 	* Temperature sensor failure.	Repair required: contact your local Siemens representative.
S:40 	Temperature too high.	Relocate device and/or lower process temperature enough to cool device. Inspect for heat-related damage and contact your local Siemens representative if repair is required.
S:41 	Temperature too low.	Relocate device and/or raise process temperature enough to warm device. Inspect for temperature-related damage and contact your local Siemens representative if repair is required.
S: 48 	* User configuration is invalid. One or more of parameters: Low Calibration Point, High Calibration Point, Volume breakpoints, and/or Auto False-Echo Suppression, are set to invalid values.	<ul style="list-style-type: none"> • Reconfigure the unit. • Ensure the difference between High Calibration Point and Low Calibration Point is not less than or equal to zero; do a Master Reset.



General Fault Codes (Continued)

Code / Icon	Meaning	Corrective Action
S: 52 	Fail-safe is activated. Possible causes: 1) hardware failure 2) memory failure 3) Fail-safe LOE timer expired– possible causes: faulty installation, antenna material buildup, foaming/other adverse process conditions, invalid calibration range.	For 3): <ul style="list-style-type: none"> • Correct configuration; ensure installation is correct; • no antenna buildup; • adjust process conditions to minimize adverse conditions; • correct calibration range. If fault persists, or for 1) and 2), contact your local Siemens representative.
S: 54 	*	Adjust process to fall within limits of min./max. mA values or adjust limits of mA if possible.
S:66 to S:83 	Device error. NOTE: Fault text and icons appear only on LCD.	Repair required. Contact your local Siemens representative.
S:94 to S:97 	Device error. NOTE: Fault text and icons appear only on LCD.	Repair required. Contact your local Siemens representative.
S:98 to S:108 	Device error. NOTE: Fault text and icons appear only on LCD.	Repair required. Contact your local Siemens representative.

Operation Troubleshooting

Operating symptoms, probable causes, and resolutions.

Operation Troubleshooting		
Symptom	Cause	Action
Display shows  S: 0 LOE	level or target is out of range	<ul style="list-style-type: none"> • check specifications • check Low Calibration Pt. (2.3.1) • increase Confidence (2.7.6.1)
Display shows  S: 0 LOE	material build-up on antenna	<ul style="list-style-type: none"> • Use the air purge feature to clean the antenna. • re-locate SITRANS LR560

Operation Troubleshooting (Continued)		
Symptom	Cause	Action
Display shows  S: 0 LOE	location or aiming: <ul style="list-style-type: none"> poor installation Auto False Echo Suppression may be incorrectly applied 	<ul style="list-style-type: none"> ensure antenna has clear view of material to be measured review "Shaper Mode (2.8.4.)" on page 128 ensure Auto False Echo Suppression Range is set correctly
Display shows  S: 0 LOE	antenna malfunction: <ul style="list-style-type: none"> temperature too high physical damage 	<ul style="list-style-type: none"> Check for physical damage and replace sensor if required.
Reading does not change, but the level does	SITRANS LR560 processing wrong echo, for example, vessel wall, or structural member	<ul style="list-style-type: none"> re-locate SITRANS LR560 check nozzle for internal burrs or welds use Shaper Mode (2.8.4.) if necessary: see "Shaper Mode (2.8.4.)" on page 128
Measurement is consistently off by a constant amount	<ul style="list-style-type: none"> setting for Low Calibration Pt. (2.3.1.) not correct setting for Sensor Offset (2.3.3.) not correct 	<ul style="list-style-type: none"> check distance from sensor reference point to Low Calibration Pt. (2.3.1.) check Sensor Offset (2.3.3.)
Screen blank	power error	<ul style="list-style-type: none"> check device label rating against voltage supply check power wiring or source
	too much load resistance	<ul style="list-style-type: none"> remove something from the loop, or increase supply voltage
Reading erratic	echo confidence weak	<ul style="list-style-type: none"> refer to Confidence (2.7.6.1.) use Shaper Mode (2.8.4.) and Shaper Mode (2.8.4.)
	material filling	<ul style="list-style-type: none"> re-locate SITRANS LR560
Reading response slow	Fill Rate/Min (2.4.2.) setting incorrect	<ul style="list-style-type: none"> increase measurement response if possible
Reads correctly but occasionally reads high when vessel is not full	<ul style="list-style-type: none"> detecting close range echo build up near top of vessel or nozzle nozzle problem 	<ul style="list-style-type: none"> Use the air purge feature to clean the antenna use Shaper Mode (2.8.4.) and Shaper Mode (2.8.4.)
Level reading lower than actual material level	<ul style="list-style-type: none"> material is within Near Range zone multiple echoes processed 	<ul style="list-style-type: none"> decrease Near Range (2.7.1.) (minimum value depends on antenna type) raise SITRANS LR560 ensure Algorithm (2.7.3.1.) is set to F (First echo)
	<ul style="list-style-type: none"> vessel near empty and low dK material 	<ul style="list-style-type: none"> set CLEF Range (2.7.3.4.) to 0.5 m

Appendix C: Maintenance

SITRANS LR560 requires no maintenance or cleaning under normal operating conditions.

Under severe operating conditions, the antenna may require periodic cleaning. If cleaning becomes necessary:

- Note the antenna material and the process medium, and select a cleaning solution that will not react adversely with either.
- Remove the instrument from service and wipe the antenna clean using a cloth and suitable cleaning solution.

Unit Repair and Excluded Liability

All changes and repairs must be done by qualified personnel, and applicable safety regulations must be followed. Please note the following:

- The user is responsible for all changes and repairs made to the device.
- All new components must be provided by Siemens Milltronics Process Instruments Inc.
- Restrict repair to faulty components only.
- Do not re-use faulty components.

Appendix D: Technical Reference

Note: Where a number follows the parameter name (for example, Device (2.1)) this is the parameter access number via the local push buttons or handheld programmer. See *Parameter Reference* on page 78 for a complete list of parameters.

Principles of Operation

SITRANS LR560 is a 2-wire, 78 GHz FMCW (Frequency Modulated Continuous Wave) radar level transmitter for continuous monitoring of solids in vessels to a range of 100 m (329 ft)¹⁾. Radar level measurement uses the time of flight principle to determine distance to a material surface.

FMCW radar transmits a continuous wave. The frequency of the wave is constantly increasing: this is known as the sweep. By the time the first part of the wave has been reflected off the target and returned to the device, the part of the wave that is just being emitted is at a higher frequency. The difference in frequency between the transmitted and received signals is proportional to time of flight.

Electromagnetic wave propagation is virtually unaffected by temperature or pressure changes, or by changes in the vapor levels inside a vessel. Electromagnetic waves are not attenuated by dust.

SITRANS LR560 consists of an enclosed electronic circuit coupled to an antenna and process connection. The electronic circuit generates a radar signal (78 GHz) that is directed to the lens antenna.

The signal is emitted from the lens antenna, and the reflected echoes are digitally converted to an echo profile. The profile is analyzed to determine the distance from the sensor reference point²⁾ to the material surface. This value (sensor value) is used as a basis for calculating the display of material level and mA output.

Process Variables

The Process Variables are sensor value and measured value. Sensor value is the distance from the sensor reference point (flange face) to the material surface. The measured value can be either Level (distance from low calibration point to material surface), Distance (distance from sensor reference point to the material surface), or Space (distance from high calibration point to the material surface).

¹⁾ The microwave output level is significantly less than that emitted from cellular phones.

²⁾ See *Dimensions* on page 12.

Echo Processing

Process Intelligence

The signal processing technology embedded in Siemens radar level devices is known as **Process Intelligence**.

Process intelligence provides high measurement reliability regardless of the dynamically changing conditions within the vessel being monitored. The embedded Process Intelligence dynamically adjusts to the constantly changing material surfaces within these vessels.

Process Intelligence is able to differentiate between the true microwave reflections from the surface of the material and unwanted reflections being returned from obstructions such as seam welds or supports within a vessel. The result is repeatable, fast and reliable measurement. This technology was developed as result of field data gained over some twenty years from more than 1,000,000 installations in many industries around the world.

Higher order mathematical techniques and algorithms are used to provide intelligent processing of microwave reflection profiles. This “knowledge based” technique produces superior performance and reliability.

Echo Selection

Time Varying Threshold (TVT)

A Time Varying Threshold (TVT) hovers above the echo profile to screen out unwanted reflections (false echoes).

In most cases the material echo is the only one which rises above the default TVT.

In a vessel with obstructions, a false echo may occur. See *Shaper Mode (2.8.4.)* on page 128 for more details.

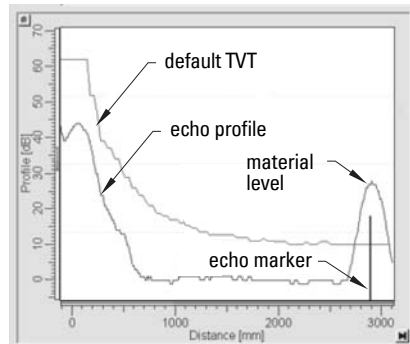

The device characterizes all echoes that rise above the TVT as potential good echoes. Each peak is assigned a rating based on its strength, area, height above the TVT, and reliability, amongst other characteristics.

Algorithm (2.7.3.1.)

The true echo is selected based on the setting for the Echo selection algorithm. For a list of options see **Algorithm (2.7.3.1.)** on page 90.

Position Detect (2.7.3.3.)

The echo position detection algorithm determines which point on the echo will be used to calculate the precise time of flight, and calculates the range using the calibrated propagation velocity. The following options are available:

- **Rising**
- **Center**
- **Hybrid**
- **CLEF (Constrained Leading Edge Fit)**

Rising

Uses rising edge of the echo.

Center

Uses center of the echo.

Hybrid

Uses the Center algorithm for the top part of the vessel, and the CLEF algorithm for the part nearest the vessel bottom, according to the settings for **CLEF range**.

CLEF (Constrained Leading Edge Fit)

- Uses the leading edge of the echo.
- Is used mainly to process the echo from materials with a low dK value.

In an almost empty flat-bottomed vessel, a low dK material may reflect an echo weaker than the echo from the vessel bottom. The echo profile shows these echoes merging. The device may then report a material level equal to or lower than empty

The CLEF algorithm enables the device to report the level correctly.

Example: CLEF off: Position set to Hybrid

Vessel height: 1.5 m; CLEF range set to 0 (Center algorithm gives the same result.)

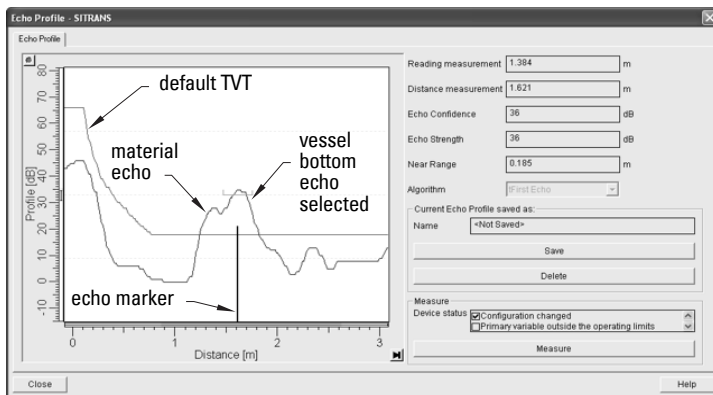

Example: CLEF enabled

Vessel height: 1.5 m; CLEF range set to 0.5 m

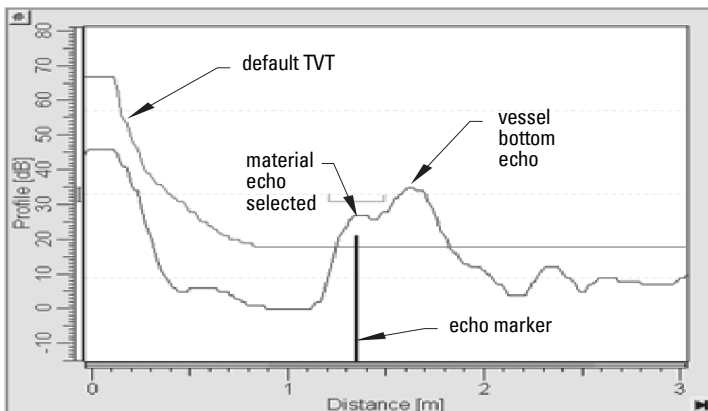

CLEF Range (2.7.3.4.)

Determines the level below which the CLEF algorithm will be used. Above this level, the Center algorithm is used when Hybrid is selected in **Position Detect (2.7.3.3.)**.

CLEF Range is referenced from Far Range.

Echo Threshold (2.7.3.2.)

Confidence (2.7.6.1.) describes the quality of an echo. Higher values represent higher quality. **Echo Threshold** defines the minimum confidence value required for an echo to be accepted as valid and evaluated.

Echo Lock (2.7.4.1.)

If the echo selected by **Algorithm** is within the Echo Lock window, the window is centered about the echo, which is used to derive the measurement. In radar applications, two measurement verification options are used:

Lock Off

SITRANS LR560 responds immediately to a new selected echo (within the restrictions set by the Maximum Fill / Empty Rate), but measurement reliability is affected.

Material Agitator

A new measurement outside the Echo Lock Window must meet the sampling criteria before the window will move to include it.

The other available options, **Maximum Verification** and **Total Lock** are not recommended for radar.

Shaper Mode (2.8.4.)

Notes:

- For detailed instructions on using this feature via PDM, see *Auto False Echo Suppression* on page 48.
- For detailed instructions on using this feature via the handheld programmer, see **Shaper Mode (2.8.4.)** on page 96.

Auto False Echo Suppression is designed to learn a specific environment (for example, a particular vessel with known obstructions), and in conjunction with Auto False Echo Suppression Range to remove false echoes appearing in front of the material echo.

The material level should be below all known obstructions at the moment when Auto False Echo Suppression learns the echo profile. Ideally the vessel should be empty or almost empty, and if an agitator is present, it should be running.

The device learns the echo profile over the whole measurement range and the TVT is shaped around all echoes present at that moment.

Shaper Mode (2.8.4.)

Auto False Echo Suppression Range specifies the range within which the learned TVT is applied. Default TVT is applied over the remainder of the range.

The learned TVT screens out the false echoes caused by obstructions. The default TVT allows the material echo to rise above it.

Auto False Echo Suppression Range must be set to a distance shorter than the distance to the material level when the environment was learned, to avoid the material echo being screened out.

Example before Auto False Echo Suppression

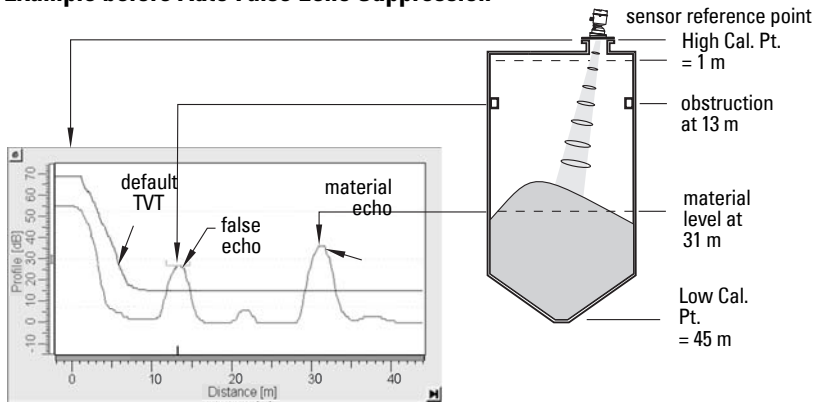

Example after Auto False Echo Suppression

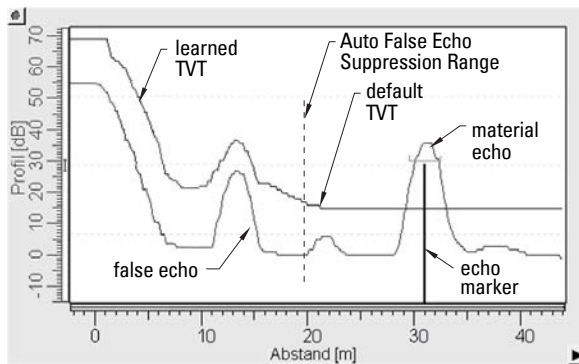

Auto False Echo Suppression Range set to 20 m

Measurement Range

Near Range (2.7.1.)

Near Range programs SITRANS LR560 to ignore the zone in front of the antenna. The default blanking distance is 27.8 cm (0.91 ft) from the sensor reference point.

Near Range allows you to increase the blanking value from its factory default. But Shaper Mode (2.8.4.) is generally recommended in preference to extending the blanking distance from factory values.

Far Range (2.7.2.)

Far Range can be used in applications where the base of the vessel is conical or parabolic. A reliable echo may be available below the vessel empty distance, due to an indirect reflection path.

Increasing Far Range to 30% or 40% can provide stable empty vessel readings.

Measurement Response

Note: Units are defined in **Quick Start Wizard (11.)** and are in meters by default.

Response Rate (2.4.1.) limits the maximum rate at which the display and output respond to changes in the measurement. There are three preset options: slow, medium, and fast.

Once the real process fill/empty rate (m/s by default) is established, a response rate can be selected that is slightly higher than the application rate. Response Rate automatically adjusts the filters that affect the output response rate.

Response Rate (2.4.1.)		/	Damping Filter (2.2.3.)
	Slow	0.1 m/min (0.32 ft/min)	10 s
*	Medium	1.0 m/min (3.28 ft/min)	10 s
	Fast	10.0 m/min (32.8 ft/min)	0 s

Damping

Damping Filter (2.2.3.) smooths out the response to a sudden change in level. This is an exponential filter and the engineering unit is always in seconds.

In 5 time constants, the output rises exponentially: from 63.2% of the change in the first time constant, to almost 100% of the change by the end of the 5th time constant.

Damping example

time constant = 2 seconds
input (level) change = 2 m

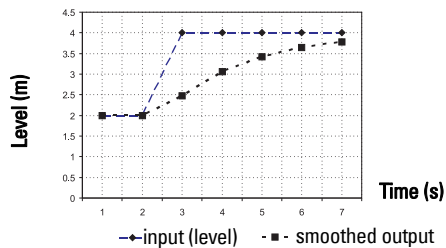

Analog Output

The mA Output (current output) is proportional to material level in the range 4 to 20 mA. 0% and 100% are percentages of the full-scale reading (m, cm, mm, ft, in). Typically mA output is set so that 4 mA equals 0% and 20 mA equals 100%.

While the device is in **PROGRAM** mode, the output remains active and continues to respond to changes in the device.

SITRANS LR560 automatically returns to **Measurement** mode after a period of inactivity in PROGRAM mode.

Sensor Mode (2.2.2.)

This parameter controls the input. Depending on the reference point used, the measurement reports either Level, Space, or Distance. By default Sensor Mode is set to **Distance**.

Operation	Description	Reference point
LEVEL	Measurement from reference point to material surface	Low Calibration Point (process empty level)
SPACE	Measurement from reference point to material surface	High Calibration Point (process full level)
DISTANCE	Measurement from reference point to material surface	Sensor Reference Point

You also have the option to put the device out of service, in which case the device defaults to Fail-safe mode, and the reported level depends on the device type. A standard device reports the last valid reading, and a NAMUR NE 43-compliant device reports the user-defined value for Material Level (3.58 mA by default).

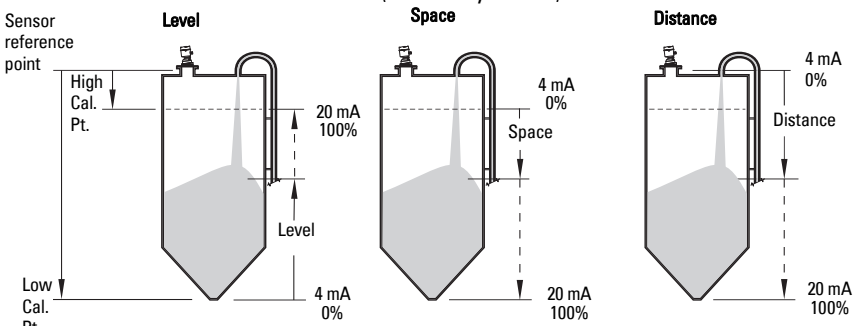

Current Output Function (2.6.1.)

Current Output Function (2.6.1.) controls the mA output and applies any relevant scaling. By default it is set to **Distance**. Other options are Space and Level.

To view the mA reading in the secondary region of the LCD, press **5** on the handheld programmer.

Loss of Echo (LOE)

A loss of echo (LOE) occurs when the calculated measurement is judged to be unreliable because the echo confidence value has dropped below the echo confidence threshold.

Confidence (2.7.6.1.) describes the quality of an echo. Higher values represent higher quality.

Echo Threshold (2.7.3.2.) defines the minimum confidence value required for an echo to be accepted as valid and evaluated.

If the LOE condition persists beyond the time limit set in **Timer (2.5.2.)**, the LCD displays the Service Required icon, and the text region displays the fault code **S: 0** and the text LOE.

If two faults are present at the same time, the fault code, error text, and error icon for each fault are displayed alternately. For example, Loss of Echo and Fail-safe.



S: 0 LOE



S: 52 Fail-safe

Fail-safe Mode

The purpose of the Fail-safe setting is to put the process into a safe mode of operation in the event of a fault or failure. The value to be reported in the event of a fault is selected so that a loss of power or loss of signal triggers the same response as an unsafe level.

Timer (2.5.2.) determines the length of time a Loss of Echo (LOE) condition will persist before a Fail-safe state is activated. The default setting is 100 seconds.

Material Level (2.5.1.) determines the material level to be reported when **Timer (2.5.2.)** expires.

STANDARD DEVICE			
Options		HI	20.5 mA (max. mA Limit)
		LO	3.8 mA (min. mA Limit)
	*	HOLD	Last valid reading
		VALUE	User-selected value defined in Level (2.5.3.)

Upon receiving a reliable echo, the loss of echo condition is aborted, the Service Required icon and error message are cleared, and the reading and mA output return to the current material level.

Temperature derating curve

! WARNINGS:

- **Never attempt to loosen, remove or disassemble process connection or instrument housing while vessel contents are under pressure.**
- **This product is NOT intended for use as a safety device for Directive 97/23/EC.**
- **The user is responsible for the selection of bolting and gasket materials which will fall within the limits of the flange and its intended use and which are suitable for the service conditions.**
- **Improper installation may result in loss of process pressure and/or release of process fluids and/or gases.**

ambient temperature
-40 °C to +80 °C
(-40 °F to +176 °F)

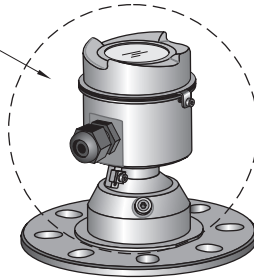

process temperature
-40 to +100 °C (-40 to +212 °F) or
-40 to +200 °C (-40 to +392 °F) depending on the version

¹⁾ The process pressure boundary assembly comprises the components that act as a barrier against pressure loss from the process vessel: that is, the combination of process connection body and lens.

Temperature De-Rating

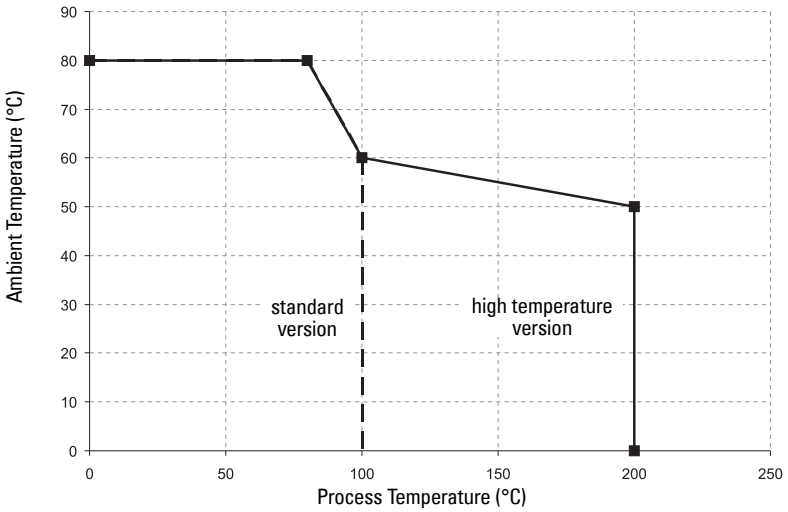

! WARNING: Never attempt to loosen, remove or disassemble process connection or instrument housing while vessel contents are under pressure.

Loop resistance R_L

Loop power

Typical Connection Drawing

Note: Loop voltage is the voltage at the terminals of the power supply (not the voltage at the terminals of the device).

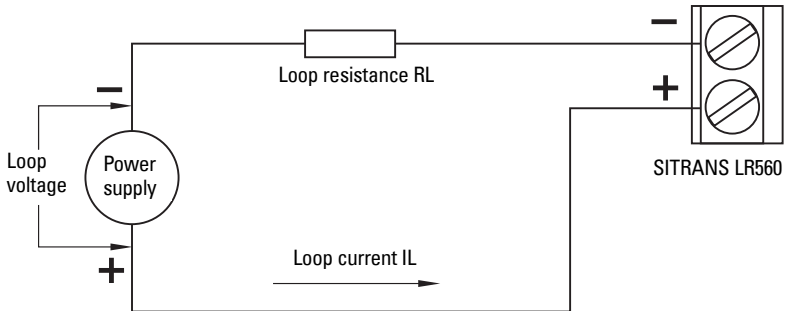

Allowable operating area of SITRANS LR560

Loop Voltage versus Loop Resistance

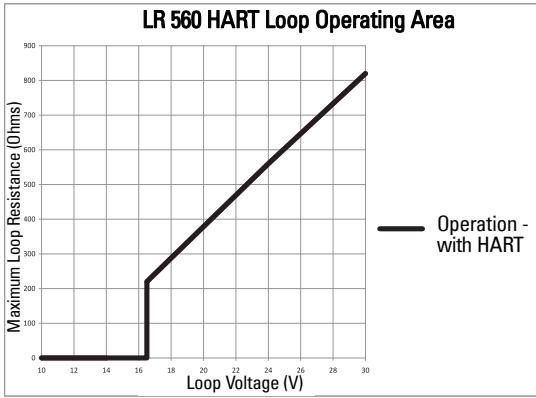

Startup Behavior

- The device draws less than 3.6 mA at startup.
- Time to first measurement is 60 seconds nominal.

Appendix E: HART Communications

Highway Addressable Remote Transducer, HART, is an industrial protocol that is superimposed on the 4-20 mA signal. It is an open standard, and full details about HART can be obtained from the HART Communication Foundation at www.hartcomm.org

SITRANS LR560 can be configured over the HART network using either the HART Communicator 375 by Emerson, or a software package. The recommended software package is the SIMATIC Process Device Manager (PDM) by Siemens.

SIMATIC PDM

This software package is designed to permit easy configuration, monitoring, and troubleshooting of HART devices. The HART EDD for SITRANS LR560 was written with SIMATIC PDM in mind and has been extensively tested with this software.

For more information, see *Operating via SIMATIC PDM* on page 39.

HART Electronic Device Description (EDD)

In order to configure a HART device, the configuration software requires the HART Electronic Device Description for the instrument in question.

You can download the HART EDD for SITRANS LR560 from the product page of our website. Go to: www.siemens.com/sitransLR560 and click on **Support > Software Downloads**.

Older versions of the library will have to be updated in order to use all the features of SITRANS LR560.

HART Communicator 375 Menu Structure

Note: HART Communicator 375 is supported by SITRANS LR560 HART. The menu structure is aligned with the menu structure of SIMATIC PDM.

SITRANS LR560

1 Configure/Setup

1 Identification

1 Identification

- 1 Long Tag
- 2 Tag
- 3 Descriptor
- 4 Message
- 5 Date
- 6 Range Mode

2 Device

- 1 Manufacturer
- 2 Product Name
- 3 Order Number
- 4 Final Assembly num
- 5 Hardware Revision
- 6 Firmware Revision
- 7 Loader Revision
- 8 EDD Version: xx.xx.xx-xx

3 Device Status Icon

2 Wizard

1 Quick Start

1 Step 1 - Identification

- 1 Long tag
- 2 Tag
- 3 Descriptor
- 4 Message
- 5 Installation Date
- 6 Order Number
- 7 Range Mode
- 8 Language

English
German
French
Spanish
Chinese

9 Device Image

2 Step 2 - Application

1 Application Type

Steel Silo
Concrete Silo

2 Operation

Level
Space
Distance

3 Step 3 - Ranges

- 1 Unit
- 2 Low Calibration Point (X)

		3 High Calibration Point (Y)
		4 Response Rate
		5 Tank Image
	4 Step 4 - Summary	
		1 Identification
		1 Long Tag
		2 Tag
		3 Descriptor
		4 Message
		5 Installation Date
		6 Order Number
		7 Range Mode
		8 Language
		2 Application
		1 Application Type
		2 Operation
		3 Ranges
		1 Unit
		2 Low Calibration Po...
		3 High Calibration P...
		4 Response Rate
	2 Configuration Flag Reset	
		1 Configuration Flag Reset
		2 Device Status Icon
	3 Operation	
	1 General	
		1 Select Analog Output
		2 Master Reset
	2 Simulation / Test	
		1 Self Test
		2 Loop Test
	3 Device Status Icon	
	4 Setup	
	1 Sensor	
		1 General
		1 Unit
		2 Sensor Mode
		3 Damping filter
		2 Calibration
		1 Low Calibration Point (X)
		2 High Calibration Point (Y)
		3 Sensor Offset
		3 Rate
		1 Response Rate
		2 Fill Rate per Minute
		3 Empty Rate per Minute
		4 Fail-safe
		1 Material Level
		2 Timer
		3 Level
		5 Device Status Icon
	2 Analog Output Scaling	
		1 Current Output Function
		2 Start of Scale (=4 mA)

- 3 Full Scale (=20 mA)
- 4 Control Range: Lower Limit
- 5 Control Range: Upper Limit
- 6 Device Status Icon
- 3 Signal Processing
 - 1 General
 - 1 Range
 - 1 Near Range
 - 2 Far Range
 - 2 Echo Select
 - 1 Algorithm
 - 2 Position Detect
 - 3 Echo Threshold
 - 4 CLEF Range
 - 5 Echo Marker
 - 3 Sampling
 - 1 Echo Lock
 - 2 Sampling Up
 - 3 Sampling Down
 - 4. Echo Lock Window
 - 4 Echo Quality
 - 1 Confidence
 - 2 Echo Strength
 - 5 Filtering
 - 1 Narrow Echo Filter
 - 2 Reform Echo
 - 6 Device Status Icon
 - 2 TVT
 - 1 TVT Setup
 - 1 Auto False Echo Suppression
 - 2 Auto False Echo Suppression Range
 - 3 Hover Level
 - 4 Shaper Mode
 - 5 Device Status Icon
- 4 Local Display
 - 1 Language
 - 2 LCD Contrast
 - 3 LCD Backlight
 - 4 Device Status Icon

5 Maintenance & Diagnostics

- 1 Remaining Device Lifetime
 - 1 Lifetime (Expected)
 - 2 Remaining Lifetime
 - 3 Time in Operation
 - 4 Activation of Reminders
 - 5 Reminder 1 before Lifetime (Required)
 - 6 Reminder 2 before Lifetime (Demanded)
 - 7 Snooze for 1 Year
 - 8 Device Status Icon
- 2 Remaining Sensor Lifetime
 - 1 Lifetime (Expected)
 - 2 Time in Operation
 - 3 Remaining Lifetime

- 4 Activation of Reminders
- 5 Reminder 1 before Lifetime (Required)
- 6 Reminder 2 before Lifetime (Demanded)
- 7 Sensor Replaced
- 8 Snooze for 1 Year
- 9 Device Status Icon
- 3 Service Schedule
 - 1 Service Interval
 - 2 Time Since Last Service
 - 3 Time Until Next Service
 - 4 Activation of Reminders
 - 5 Reminder 1 before Service (Required)
 - 6 Reminder 2 before Service (Demanded)
 - 7 Service Performed
 - 8 Device Status Icon
- 4 Calibration Schedule
 - 1 Calibration Interval
 - 2 Time Since Last Calibration
 - 3 Time Until Next Calibration
 - 4 Activation of Reminders
 - 5 Reminder 1 before Calibration (Required)
 - 6 Reminder 2 before Calibration (Demanded)
 - 7 Calibration Performed
 - 8 Device Status Icon
- 5 Electronic Temperature
 - 1 Electronics Temperature
 - 2 Lowest Value
 - 3 Highest Value
 - 4 Device Status Icon
- 6 Wear
 - 1 Time in Operation
 - 2 Poweron Resets
 - 3 Device Status Icon

6 Communication

- 1 Manufacturer
- 2 Dev ID
- 3 Product Name
- 4 Fld dev rev
- 5 EDD Revision 1
- 6 Universal Command Revision
- 7 Device Status Icon

7 Security

- 1 Remote Access
 - 1 Write Protection
- 2 Local Access
 - 1 Local Operation Enable
- 3 Device Status Icon

2 Device Diagnostics

- 1 Device Status
 - 1 Device status
 - 2 Device Status Icon
- 2 HW/FW-Status
 - 1 Status group 0
 - 2 Status group 1

- 3 Status group 2
- 4 Status group 3
- 5 Status group 4
- 6 Status group 5
- 7 Status group 14
- 8 Device Status Icon

3 Process Variables

- 1 Values
 - 1 Primary
 - 2 PV: Distance
 - 3 Secondary
 - 4 SV: Distance
 - 5 Device Status Icon
- 2 Analog Output
 - 1 Distance Range [%]
 - 2 Analog Output [mA]
 - 3 Device Status Icon
- 3 Trend View
 - 1 Trend Values
 - 1 Primary
 - 2 Secondary
 - 2 Trend View
 - 3 Device Status Icon

HART Version

SITRANS LR560 conforms to HART rev. 6.

Burst Mode

SITRANS LR560 does not support burst mode.

HART Multidrop Mode

We do not recommend the use of HART Multidrop Mode.

Appendix F: Firmware Revision History

Firmware Rev.	EDD Rev.	Date	Changes
1.00.00	1.00.00	19 Oct.. 2010	<ul style="list-style-type: none">Initial release

Glossary

accuracy: degree of conformity of a measure to a standard or true value.

algorithm: a prescribed set of well-defined rules or processes for the solution of a problem in a finite number of steps.

ambient temperature: the temperature of the surrounding air that comes in contact with the enclosure of the device.

antenna: an aerial which sends out and receives a signal in a specific direction. There are four basic types of antenna in radar level measurement, horn, parabolic, rod, and waveguide.

attenuation: a term used to denote a decrease in signal magnitude in transmission from one point to another. Attenuation may be expressed as a scalar ratio of the input magnitude to the output magnitude, or in decibels.

Auto False-Echo Suppression: a technique used to adjust the level of a TVT curve to avoid the reading of false echoes. (See TVT.)

Auto False-Echo Suppression Distance: defines the endpoint of the learned TVT distance. (See TVT.) This is used in conjunction with Auto False-Echo Suppression.

beam width: the angle diametrically subtended by the one-half power limits (-3 dB) of the microwave beam.

beam spreading: the divergence of a beam as it travels through a medium.

blanking: a blind zone extending away from the reference point plus any additional shield length. The instrument is programmed to ignore this zone.

capacitance: the property of a system of conductors and dielectrics that permits the storage of electricity when potential differences exist between the conductors. Its value is expressed as the ratio of a quantity of electricity to a potential difference, and the unit is a Farad.

confidence: see Echo Confidence: describes the quality of an echo. Higher values represent higher quality. Confidence threshold defines the minimum value.

damping: term applied to the performance of an instrument to denote the manner in which the measurement settles to its steady indication after a change in the level.

dB (decibel): a unit used to measure the amplitude of signals.

derating: to decrease a rating suitable for normal conditions according to guidelines specified for different conditions.

dielectric: a nonconductor of direct electric current.

dielectric constant (DK): the ability of a dielectric to store electrical potential energy under the influence of an electric field. Also known as Relative Permittivity. An increase in the

dielectric constant is directly proportional to an increase in signal amplitude. The value is usually given relative to a vacuum /dry air: the dielectric constant of air is 1.

echo: a signal reflected with sufficient magnitude and delay to be perceived as a signal distinct from that are directly transmitted. Echoes are frequently measured in decibels relative to the directly transmitted signal.

Echo confidence: describes the quality of an echo. Higher values represent higher quality. Echo threshold defines the minimum value required for an echo to be accepted as valid and evaluated.

Echo Lock Window: a window centered on an echo in order to locate and display the echo's position and true reading. Echoes outside the window are not immediately processed.

Echo Marker: a marker that points to the processed echo.

Echo Processing: the process by which the radar unit determines echoes.

Echo Strength: describes the strength of the selected echo in dB referred to 1 mV rms.

Echo Profile: a graphical display of a processed echo.

false echo: any echo which is not the echo from the desired target. Generally, false echoes are created by vessel obstructions.

FMCW: FMCW (Frequency Modulated Continuous Wave) radar transmits a continuous wave. The frequency of the wave is constantly increasing: this is known as the sweep. By the time the first part of the wave has been reflected off the target and returned to the device, the part of the wave that is just being emitted is at a higher frequency. The difference in frequency between the transmitted and received signals is proportional to time of flight.

frequency: the number of periods occurring per unit time. Frequency may be stated in cycles per second.

Hertz (Hz): unit of frequency, one cycle per second. 1 Gigahertz (GHz) is equal to 10^9 Hz.

HART: Highway Addressable Remote Transducer. An open communication protocol used to address field instruments.

inductance: the property of an electric circuit by virtue of which a varying current induces an electromotive force in that circuit or in a neighboring circuit. The unit is a Henry.

lens antenna: an antenna consisting of a radiator and a microwave lens to enhance the antenna gain. It is similar to an optical lens used to straighten spherical wave fronts.

microwaves: the term for the electromagnetic frequencies occupying the portion of the radio frequency spectrum from 1 GHz to 300 GHz.

multiple echoes: secondary echoes that appear as double, triple, or quadruple echoes in the distance from the target echo.

Near Blanking: see Blanking

nozzle: a length of pipe mounted onto a vessel that supports the flange.

parameters: in programming, variables that are given constant values for specific purposes or processes.

polarization: the property of a radiated electromagnetic wave describing the time-varying direction and amplitude of the electric field vector.

polarization error: the error arising from the transmission or reception of an electromagnetic wave having a polarization other than that intended for the system.

propagation factor (pf): where the maximum velocity is 1.0, pf is a value that represents a reduction in propagation velocity as a result of the wave travelling through a pipe or medium.

pulse radar: a radar type that directly measures distance using short microwave pulses. Distance is determined by the return transit time.

radar: radar is an acronym for RAdio Detection And Ranging. A device that radiates electromagnetic waves and utilizes the reflection of such waves from distant objects to determine their existence or position.

range: distance between a transmitter and a target.

range extension: the distance below the zero percent or empty point in a vessel.

relative humidity: the ratio of the actual amount of moisture in the atmosphere to the maximum amount of moisture the atmosphere could hold (which varies depending on the air temperature).

relative permittivity: see dielectric constant.

repeatability: the closeness of agreement among repeated measurements of the same variable under the same conditions.

shot: one transmit pulse or measurement.

speed of light: the speed of electromagnetic waves (including microwave and light) in free space. Light speed is a constant 299, 792, 458 meters per second.

stillpipe: a pipe that is mounted inside a vessel, parallel to the vessel wall, and open to the vessel at the bottom.

stilling-well: see stillpipe.

two wire radar: a low-energy radar. Can be loop powered, analog, intrinsically safe 4 to 20 mA, or a digital (BUS) transmitter.

TVT (time varying threshold): a time-varying curve that determines the threshold level above which echoes are determined to be valid.

waveguide antenna: a hollow, metallic tube that transmits a microwave signal to the product target.

Index

A

Abbreviations and Identifications

list 5

access control

remote access 112

activating LR560 28

agitator blade detection

avoiding 93

AMS Device Manager

features 56

analog output

explanation 130

fail signal 9

load 9

select 51

signal range 9

simulate via PDM 51

approvals 11

Auto False Echo Suppression 128

explanation 128

setup 96

setup via PDM 48

B

blanking (see Near Range) 129

C

cables

requirements 24

Calibration Interval 109

cleaning

instructions 123

communication

load 9

max. line length 9

conduits

requirements 24

configuration

new device via AMS 57

configuration flag reset 52

D

Damping

explanation 130

Damping Filter

setup 83

data logging

time-based echo profile storage 46

Device Address 111

device description

HART 136

Device Reset 105

device reset

see Master Reset 105

device status

view via PDM 54

Diagnostics 98

E

echo confidence

parameter setup 95

echo processing

Process Intelligence 125

process intelligence 125

Echo Profile

view via LUI 37

echo profile

data logging 46

view via PDM 54

Echo Profile Utilities 45

echo profile viewing

via LUI 34

echo selection

Algorithm 126

Position algorithm 126

time varying threshold (TVT) 125

EDD

updating 39

edit mode

handheld programmer 32

key functions 33

Electronic Device Description (EDD)

updating 39

F

factory defaults

Master Reset 105

Fail-safe

settings 86

Fail-safe Mode

explanation 132

Fail-safe Timer

explanation 132

false echo

see Auto False Echo Suppression 128

Far Range

explanation 129

setup 90

- function keys
 - measurement mode 30
 - navigation mode 32
- H**
- handheld programmer
 - edit mode 32
 - measurement mode 30
 - navigation 32
- HART
 - device description 136
 - multidrop mode 141
- HART communication
 - set preambles 52
- HART Communications
 - details 136
- HART version 9
- hazardous area installations
 - wiring requirements 26
- I**
- Identifications and Abbreviations
 - list 5
- installation
 - hazardous area requirements 26
- K**
- key functions
 - edit mode 33
- L**
- Language 112
- LCD display
 - contrast adjustment 106
 - echo profile viewing 34, 37
 - fast mode 105
 - measurement mode 29
 - PROGRAM mode 29
- level application example
 - via LUI 38
- LOE
 - Fail-safe Mode 132
- loop test
 - simulate analog output 51
- Loss of Echo (LOE)
 - explanation 132
- M**
- mA output
 - select analog output 51
- maintenance
 - calibration schedules via PDM 50
 - cleaning 123
 - service schedules via PDM 50
- maintenance settings 98
- see Calibration Interval 109
- see Remaining Sensor Lifetime 103
- see Service Interval 106
- Master Reset
 - factory defaults 105
 - factory defaults via AMS 57
- measurement range
 - blinking via Near Range 129
 - extension via Far Range 129
- Measurement Response
 - explanation 130
- mounting
 - handheld programmer access 20
 - housing construction 20
 - nozzle design 19
 - nozzle location 19
 - sunshield recommended 20
- multidrop mode 141
- N**
- Near Range
 - explanation 129
 - setup 90
- P**
- password protection
 - via AMS 70
 - via PDM 54
- performance
 - specifications 8
- power 8
- power source
 - requirements 24
- Process Intelligence 125
- programmer
 - handheld 30
- Q**
- Quick Start
 - launching via PDM 41
- Quick Start Wizard
 - via LUI 34
 - via SIMATIC PDM 40
- Quick Start wizard
 - via LUI 34
- R**
- reading erratic
 - troubleshooting 122
- reading incorrect
 - troubleshooting 122
- repair 123
- reset
 - see Master Reset 105

Response Rate
 explanation 130
 settings 84

S

Scan Device
 synchronize parameters via AMS 58

security
 password protection via AMS 70
 password protection via PDM 54
 remote access control 112
 remote access control via AMS 68

self-test
 device self-test via PDM 51

settings
 adjust parameters via LUI 32

SIMATIC PDM
 Quick Start 41

simulate analog output
 loop test 51

specifications 8
 ambient temperature 10
 antenna 9
 enclosure 9
 environmental 10
 performance 8
 power 8
 pressure 10
 process connections 9
 process temperature 10
 weight 9

synchronize parameters
 scan device via AMS 58

T

technical support
 contact information 4

temperature de-Rating
 curves 133

test
 loop test 51

trend
 view trend line 53

troubleshooting
 communication 116
 operation 121

TVT (time varying threshold)
 explanation 125

TVT Shaper
 manual adjustment via PDM 47

U

uploads/downloads

accelerated 96

W

wear
 view via PDM 54

wiring
 cables 24
 connecting HART 25
 hazardous areas 26

LCD menu structure

LCD menu structure

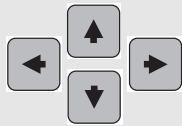

Notes:

- In Navigation mode **ARROW keys** navigate the menu in the direction of the arrow..
- See *See Parameter Reference* on page 78. for detailed information and instructions.

1. WIZARDS

- 1.1 QUICK START WIZ
 - VESSEL
 - RESPONSE RATE
 - UNITS
 - OPERATION
 - LOW CALIB. PT.
 - HIGH CALIB. PT.
- 1.2 AFES WIZ
- 1.3 COPY PARAMETERS TO DISPLAY
- 1.4 COPY PARAMETERS FROM DISPLAY
- 1.5 COPY FIRMWARE TO DISPLAY
- 1.6 COPY FIRMWARE FROM DISPLAY

2. SETUP

- 2.1 DEVICE
 - 2.1.1 LONG TAG
 - 2.1.2 TAG
 - 2.1.3 DESCRIPTOR
 - 2.1.4 MESSAGE
 - 2.1.5 INSTAL DATE
 - 2.1.6 HARDWARE REV
 - 2.1.7 FIRMWARE REV
 - 2.1.8 LOADER REV
 - 2.1.9 MENU TIMEOUT
 - 2.1.10 MANUF. DATE
- 2.2 SENSOR
 - 2.2.1 UNITS
 - 2.2.2 SENSOR MODE
 - 2.2.3 DAMPING FILTER
 - 2.2.4 TEMP. UNITS
 - 2.2.5 UNIT
- 2.3 CALIBRATION
 - 2.3.1 LOW CALIB. PT.
 - 2.3.2 HIGH CALIB. PT.
 - 2.3.3 SENSOR OFFSET
- 2.4 RATE
 - 2.4.1 RESPONSE RATE
 - 2.4.2 FILL RATE/MIN
 - 2.4.3 EMPTY RATE/MIN
- 2.5 FAIL-SAFE
 - 2.5.1 MAT. LEV
 - 2.5.2 TIMER
 - 2.5.3 LEVEL

- 2.6 ANALOG OUTPUT SCALE
 - 2.6.1 CURRENT OUTPUT FUNCTION
 - 2.6.24 MA SETPOINT
 - 2.6.320 MA SETPOINT
 - 2.6.4 MIN MA LIMIT
 - 2.6.5 MAX MA LIMIT
 - 2.6.6 MA OUTPUT MODE
 - 2.6.7 MANUAL VALUE
 - 2.6.8 MA OUTPUT VALUE
- 2.7 SIGNAL PROCESSING
 - 2.7.1 NEAR RANGE
 - 2.7.2 FAR RANGE
 - 2.7.3 ECHO SELECT
 - 2.7.3.1 ALGORITHM
 - 2.7.3.2 ECHO THRESHOLD
 - 2.7.3.3 POSITION DETECT
 - 2.7.3.4 CLEF RANGE
 - 2.7.3.5 ECHO MARKER
 - 2.7.4 SAMPLING
 - 2.7.4.1 ECHO LOCK
 - 2.7.4.2 UP SAMP.
 - 2.7.4.3 DOWN SAMP.
 - 2.7.4.4 ECHO LOCK WINDOW
 - 2.7.5 FILTERING
 - 2.7.5.1 NARROW ECHO FILTER
 - 2.7.5.2 REFORM ECHO
 - 2.7.5.3 AVG AMOUNT
 - 2.7.6 ECHO QUALITY
 - 2.7.6.1 CONFIDENCE
 - 2.7.6.2 ECHO STRENGTH
- 2.8 TVT SETUP
 - 2.8.1 AUTO ECHO SUPP
 - 2.8.2 AUTO SUPP RANGE
 - 2.8.3 HOVER LEVEL
 - 2.8.4 SHAPER MODE
- 2.9 TVT SHAPER
 - 2.9.1 BREAKPOINT 1-9
 - 2.9.2 BREAKPOINT 10-18
 - 2.9.3 BREAKPOINT 19-27
 - 2.9.4 BREAKPOINT 28-36
 - 2.9.5 BREAKPOINT 37-45
 - 2.9.6 BREAKPOINT 46-54
 - 2.9.7 BREAKPOINT 55-63
 - 2.9.8 BREAKPOINT 64-72
 - 2.9.9 BREAKPOINT 73-81
 - 2.9.10 BREAKPOINT 82-90
 - 2.9.11 BREAKPOINT 91-99
 - 2.9.12 BREAKPOINT 100-108
 - 2.9.13 BREAKPOINT 109-117
 - 2.9.14 BREAKPOINT 118-120
- 2.10 MEASURED VALUES
 - 2.10.1 MAIN OUTPUT
 - 2.10.2 O/P NO LINEAR
 - 2.10.3 O/P NO OFFSETS

3. DIAGNOSTICS

- 3.1 FAULT RESET
- 3.2 ECHO PROFILE
- 3.3 TREND
- 3.4 PEAK VALUES
 - 3.4.1 MIN MEAS. VALUE
 - 3.4.2 MAX. MEAS. VALUE
 - 3.4.3 MINIMUM PV
 - 3.4.4 MAXIMUM PV
 - 3.4.5 MINIMUM SV
 - 3.4.6 MAXIMUM SV
- 3.5 ELECT TEMP
 - 3.5.1 MIN. VALUE
 - 3.5.2 MAX. VALUE
 - 3.5.3 INTERN. TEMP
- 3.6 REMAIN. DEV. LIFE
 - 3.6.1 TIME IN OPER
 - 3.6.2 REMAIN LIFETIME
 - 3.6.3 REMIND. 1 (REQ.)
 - 3.6.4 REMIND. 2 (DEM.)
 - 3.6.5 REMINDER ACTIVATION
 - 3.6.6 LIFETIME EXPECTED
 - 3.6.7 MAINT STAT
 - 3.6.8 ACK STATUS
 - 3.6.9 ACK
- 3.7 REMAIN. SENS LIFE
 - 3.7.1 TIME IN OPER
 - 3.7.2 REMAIN LIFETIME
 - 3.7.3 REMIND. 1 (REQ.)
 - 3.7.4 REMIND. 2 (DEM.)
 - 3.7.5 REMINDER ACTIVATION
 - 3.7.6 LIFETIME EXPECTED
 - 3.7.7 MAINT STAT
 - 3.7.8 ACK STATUS
 - 3.7.9 ACK

4. SERVICE

- 4.1 DEMO MODE
- 4.2 MASTER RESET
- 4.3 POWERED HOURS
- 4.4 POWERON RESETS
- 4.5 LCD BACKLIGHT
- 4.6 LCD CONTRAST
- 4.7 SERVICE SCHEDULE
 - 4.7.1 TIME LAST SERV
 - 4.7.2 TIME NEXT SERV
 - 4.7.3 REMINDER 1 (REQ)
 - 4.7.4 REMINDER 2 (DEM)
 - 4.7.5 REMINDER ACTIVATION
 - 4.7.6 SERVICE INTERVAL
 - 4.7.7 MAINT STAT
 - 4.7.8 ACK STATUS
 - 4.7.9 ACK
- 4.8 CALIB. SCHEDULE
 - 4.8.1 TIME LAST CALIB
 - 4.8.2 TIME NEXT CALIB
 - 4.8.3 REMINDER 1 (REQ)
 - 4.8.4 REMINDER 2 (DEM)
 - 4.8.5 REMINDER ACTIVATION

- 4.8.6 CALIB INTERVAL
- 4.8.7 MAINT STATUS
- 4.8.8 ACK STATUS
- 4.8.9 ACK

5. COMMUNICATION

- 5.1 DEVICE ADDRESS
- 5.2 REMOTE LOCKOUT

6. SECURITY

- 6.1 WRITE PROTECTION

7. LANGUAGE

For more information

www.siemens.com/level

www.siemens.com/continuous-weighing

Siemens Milltronics Process Instruments Inc.
Industry Automation (IA)
1954 Technology Drive
P.O. Box 4225
Peterborough, ON
Canada K9J 7B1

email: techpubs.smpi@siemens.com

www.siemens.com/processautomation

Subject to change without prior notice
7ML19985KB01 Rev. 1.1

© Siemens Milltronics Process Instruments Inc. 2011



7 M L 1 9 9 8 5 K B 0 1
Printed in Canada