

### Multimeter

251428.41.06c 800268-002

### Bedienungsanleitung



Multimeter, 3-phasig, 24 Anzeigen, 96x96 Fronteinbau

Wandleranschluß 7KT1 302

	7KT1 302
24 elektrische Größe Anzeige	■
für 3-Phasen, 4-Leiteranschluß	■
für 3-Phasen, 3-Leiteranschluß	■
für 1-Phase, 2-Leiteranschluß	■
für Wandleranschluß von 10 bis 5000/1 A oder /5 A	■



### WARNUNG

Die Installation muß von einer Elektrofachkraft oder unter deren Leitung und Aufsicht durchgeführt und geprüft werden. Bei Arbeiten am Meßgerät, Netzspannung abschalten!

### Anzeigen und Betätigungstasten

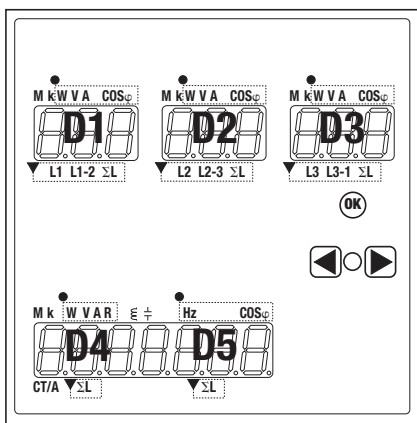

- Größe
  - ▼ Phasen
- D1**  
**D2**  
**D3**  
**D4**  
**D5**
- Displays für Anzeigewerte und Einstellungen

► **Einstellung:** das blinkende Display oder das Digit werden durch die Taste betätigt  
**Textänderung:** Der Wert wird durch die Taste erhöht

◄ **Einstellung:** das blinkende Display oder das Digit werden durch die Taste betätigt  
**Textänderung:** Der Wert wird durch die Taste vermindert

- ◀ ▶ Anwahltaste
  - ⊗ Bestätigungstaste
  - ε induktive Blindenergie- und leistung
  - ± kapazitive Blindenergie- und leistung
- Die Anzeige wechselt automatisch von k nach M
- k** = kilo =  $10^3$
- M** = Mega =  $10^6$

### Grundeinstellung

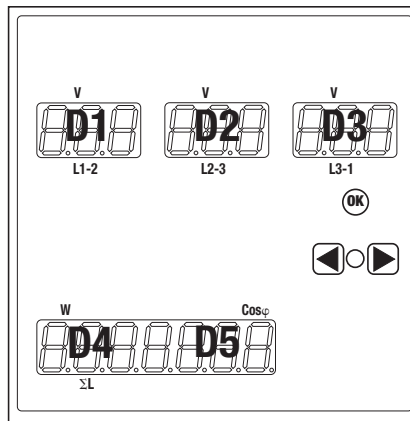

Passwort: 000000  
D1: V (L1-2)  
D2: V (L2-3)  
D3: V (L3-1)  
D4: W (ΣL)  
D5: cosφ (ΣL)

Netzarteinstellung = 3L/N  
Wandler Primärstrom = 5000 A  
Wandler Sekundärstrom = 5 A

### Anzeigen

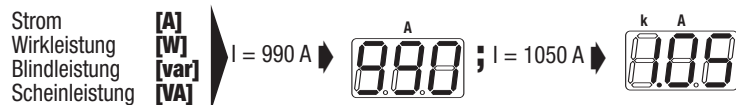

### Ablauf Diagramm

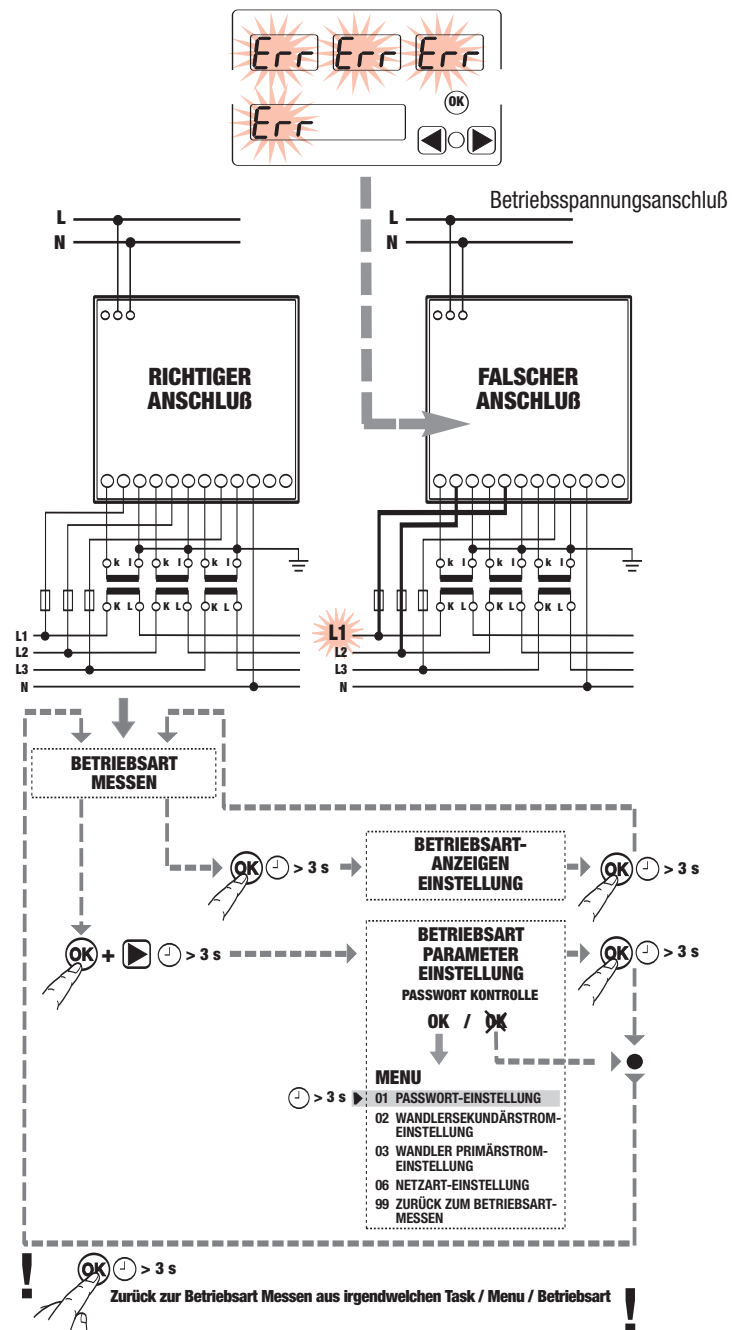

**Multimeter**

**Operating instructions**



Multimeter, three phase,  
24 readouts, 96x96 panel mounting

CT connection **7KT1 302**

7KT1 302	
24 electrical quantities display	■
For 3-phase, 4 wire	■
For 3-phase, 3 wire	■
For 1-phase, 2 wires	■
Current transformer connection, 10 to 5000/1 or /5 A	■

**⚠ WARNING**

**Installation must be carried out and inspected by a specialist or under his supervision.**

**When working on the instrument, switch off the mains voltage!**

**Display interfaces and control keys**

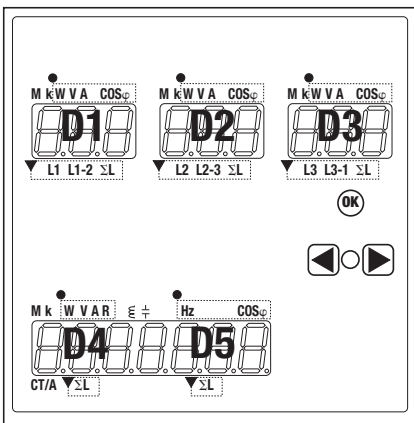

- Quantity Icons
  - ▼ Phase Icons
- D1**  
**D2**  
**D3**  
**D4**  
**D5**
- Display for readouts and settings**

- ▶ **Set:** blinking display or digit is operated with the key
- Edit:** increases value
- ◀ **Set:** blinking display or digit is operated with the key
- Edit:** decreases value
- ◀ ▶ Selection Switch
- ⊙ Confirmation Key
- ε Inductive Reactive Energy and Power symbol
- ± Capacitive Reactive Energy and Power symbol
- Automatic prefixes associated with quantities displayed:
- k** = kilo = 10<sup>3</sup>
- M** = Mega = 10<sup>6</sup>

**Factory presetting**

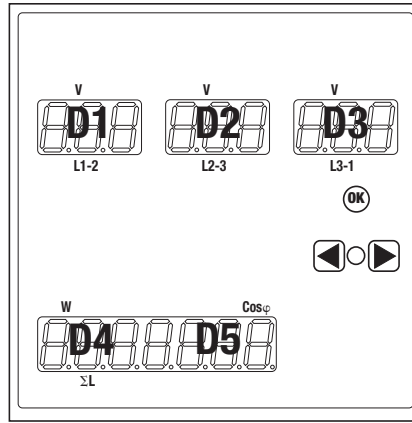

Password: **000000**  
 D1: **V (L1-2)**  
 D2: **V (L2-3)**  
 D3: **V (L3-1)**  
 D4: **W (ΣL)**  
 D5: **cos φ (ΣL)**

**Electrical connection = 3L/N**  
**CT primary current = 5000 A**  
**CT secondary current = 5 A**

**Displays**

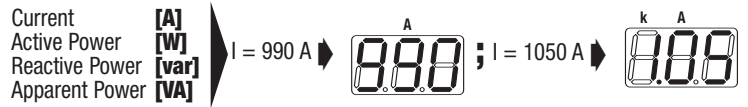

**Operation flow diagram**

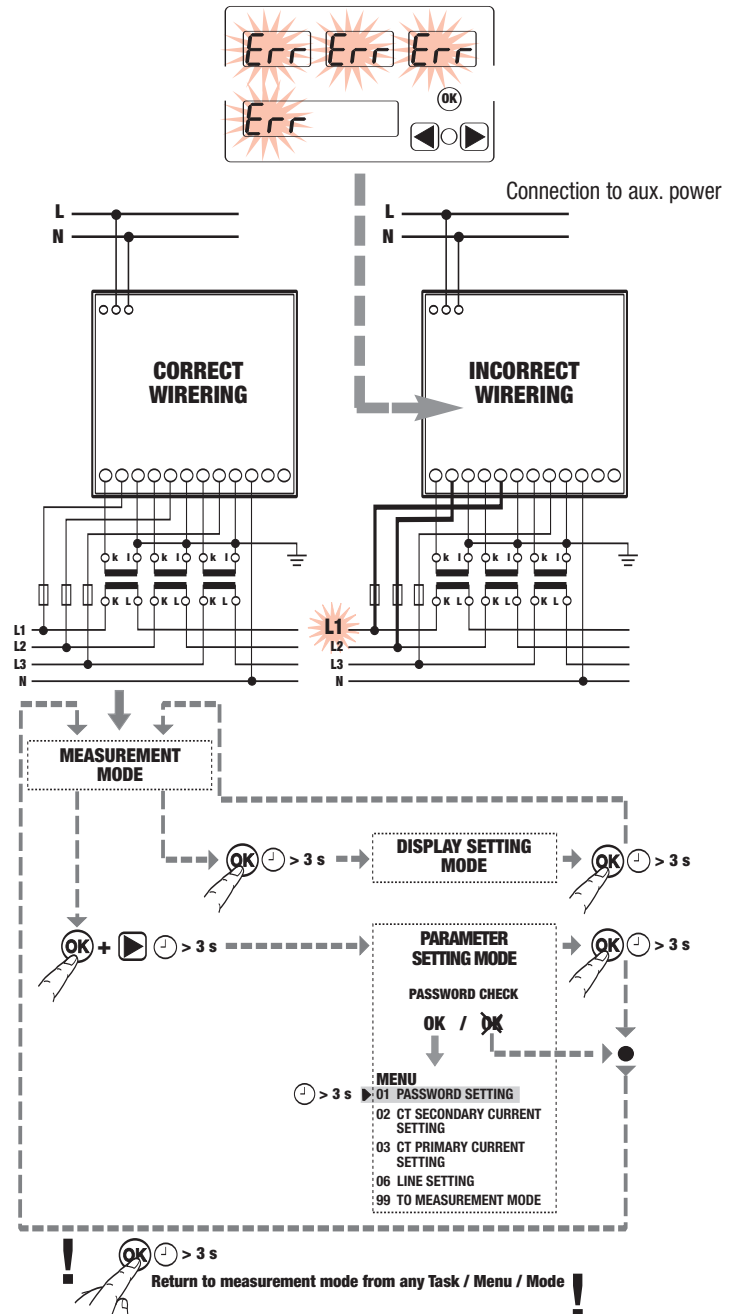

**Multimetro**

**Istruzioni di servizio**



Multimetro, trifase 24 grandezze  
montaggio frontequadro 96x96 mm

Inserzione TA **7KT1 302**

<b>7KT1 302</b>	
Visualizzazione di 24 grandezze elettriche	■
Collegamento trifase a 4 fili	■
Collegamento trifase a 3 fili	■
Collegamento monofase a 2 fili	■
Collegamento con TA di corrente da 10 a 5000/1 o /5 A	■

**ATTENZIONE**

L'installazione deve essere effettuata e verificata da uno specialista o sotto la sua supervisione.  
Togliere tensione prima di intervenire sull'apparecchio.

**Display e tasti di controllo**

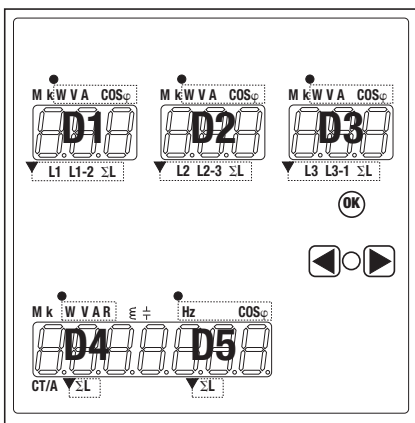

● **Icone relative alla grandezza**

▼ **Icone relative alle fasi**

**D1**  
**D2**  
**D3**  
**D4**  
**D5** **Display di lettura e di selezione**

► **Impostazione:** seleziona il display o la cifra  
**Modifica:** selezione della grandezza / fase

◄ **Impostazione:** seleziona il display o la cifra  
**Modifica:** selezione della grandezza / fase

◄ ◃ **Selettore di comando**

⊗ **Tasto di conferma**

ε **Energia e potenza reattiva induttiva**

⊕ **Energia e potenza reattiva capacitiva**

**Prefissi automatici associati ai valori visualizzati:**

**k** = kilo = 10<sup>3</sup>

**M** = Mega = 10<sup>6</sup>

**Impostazione di fabbrica**

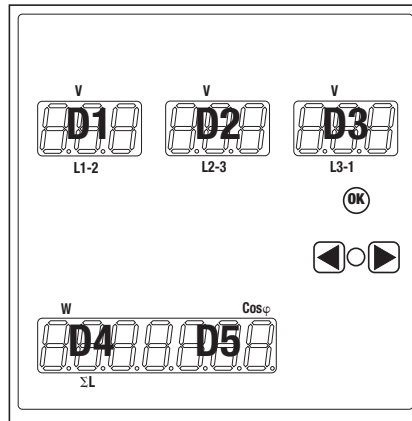

Password: **000000**  
D1: **V (L1-2)**  
D2: **V (L2-3)**  
D3: **V (L3-1)**  
D4: **W (ΣL)**  
D5: **cosφ (ΣL)**

**Connessione elettrica = 3L/N**  
**Corrente primaria TA = 5000 A**  
**Corrente secondaria TA = 5 A**

**Display**

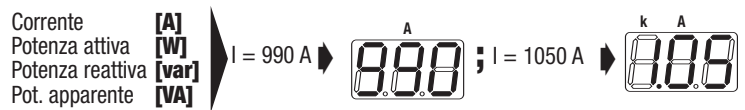

**Schema di collegamento**

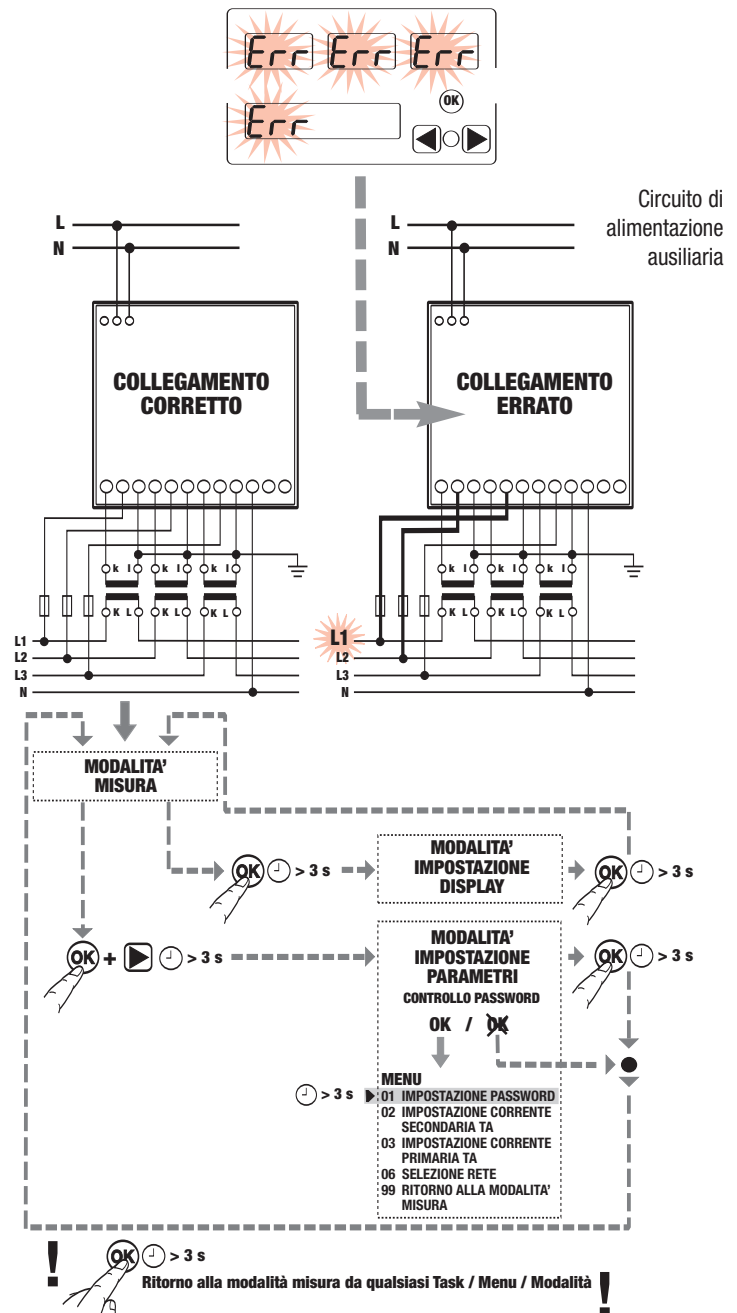

# Multimètre

## Mode d'emploi



Multimètre, triphasé 24 grandeurs installation sur panneau arrière 96x96 mm

Connexion à CT 7KT1 302

7KT1 302	
Affichage de 24 grandeurs électriques	■
Branchement triphasé à 4 fils	■
Branchement triphasé à 3 fils	■
Branchement monophasé à 2 fils	■
Branchement avec CT de courant de 10 à 5000/1 ou /5 A	■

### ATTENTION

L'installation doit être effectuée et contrôlée par un spécialiste ou bien sous sa supervision. Débrancher les différents branchements au secteur avant d'intervenir sur l'appareil!

## Afficheur et touches de contrôle

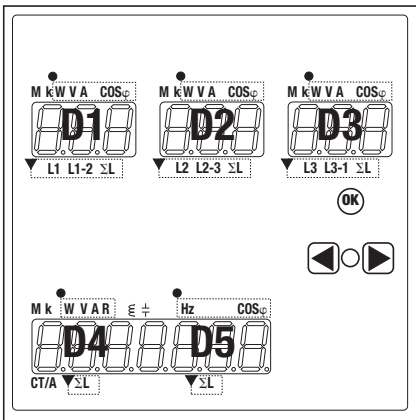

- Icônes pour la grandeur
- ▼ Icônes pour les phases

D1  
D2  
D3  
D4  
D5

**Afficheur de lecture et de sélection**

- **Configurer:** l'afficheur clignotant ou le chiffre est commandé par la touche
- Modifier:** incrémentation des valeurs
- ◄ **Configurer:** l'afficheur clignotant ou le chiffre est commandé par la touche
- Modifier:** décrémentation des valeurs

- ◁ ▷ Sélection de commande
- ⊗ Touche de confirmation
- ⊕ Énergie et puissance réactive inductive
- ⊖ Énergie et puissance réactive capacitive
- Sigles automatiques associés aux valeurs affichées:
- k** = kilo =  $10^3$
- M** = Méga =  $10^6$

## Valeur d'usine

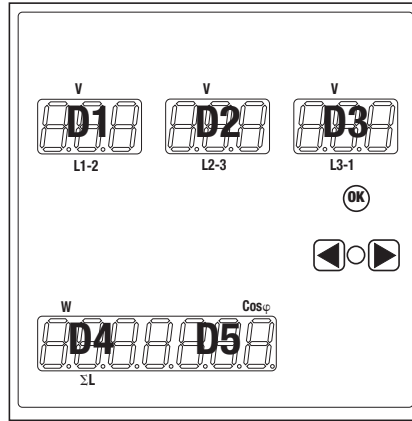

Mot de passe: 000000  
 D1: V (L1-2)  
 D2: V (L2-3)  
 D3: V (L3-1)  
 D4: W (ΣL)  
 D5: cos φ (ΣL)

Connexion électrique = 3L/N  
 Courant primaire CT = 5000 A  
 Courant secondaire CT = 5 A

## Afficheur

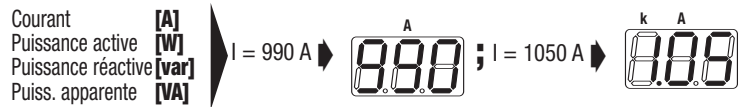

## Schéma de fonctionnement

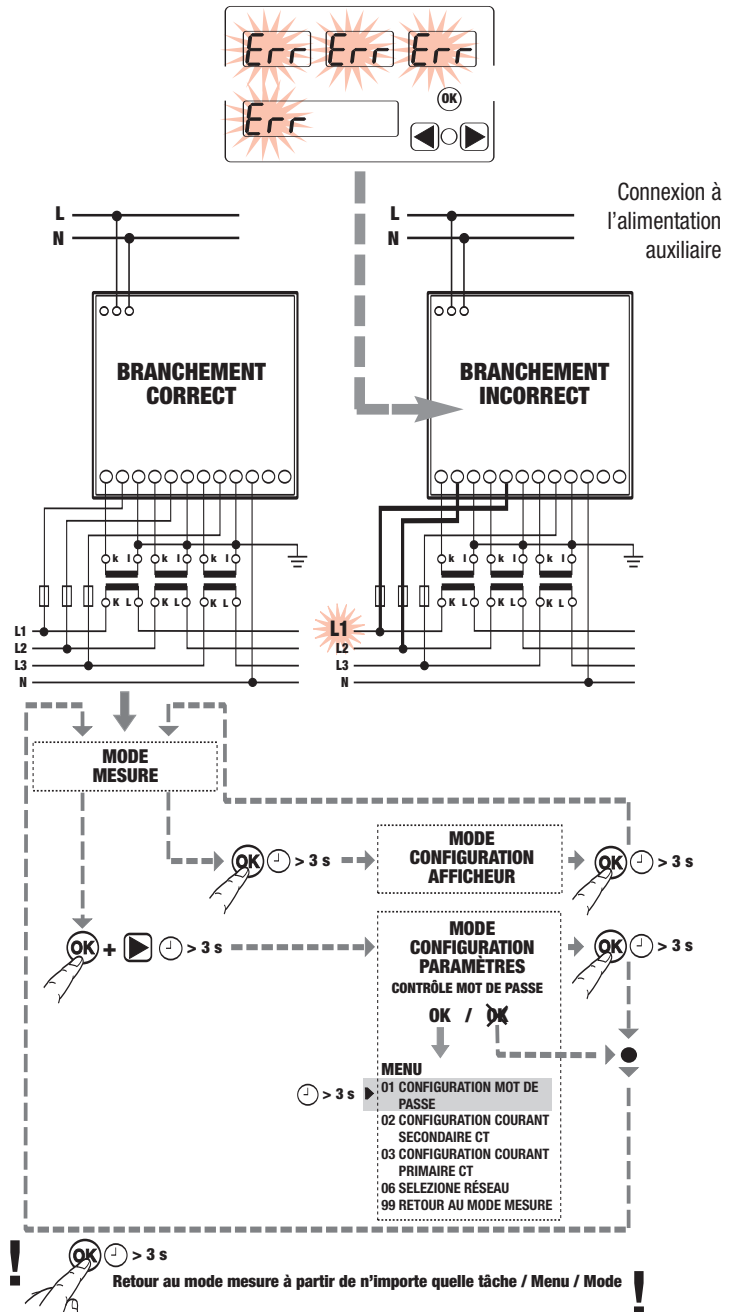

**BETRIEBSART MESSEN / MEASUREMENT MODE  
MODALITA' MISURA / MODE MESURE**

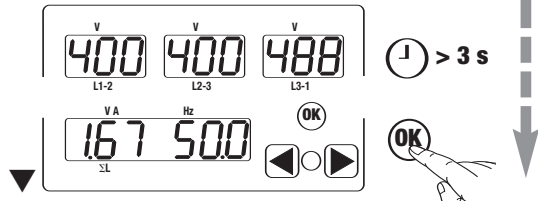

**BETRIEBSART-ANZEIGE-EINSTELLUNG / DISPLAY SETTING MODE  
MODALITA' IMPOSTAZIONE DISPLAY / MODE CONFIGURATION AFFICHEUR**

**D1 =  $\cos\varphi \Sigma L$**

Display D1 bis D5 auswählen

Selection of Displays D1 to D5

Selezione del Display D1÷D5

Sélection de l'afficheur D1÷D5

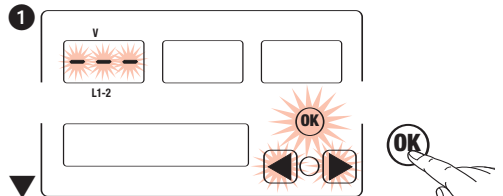
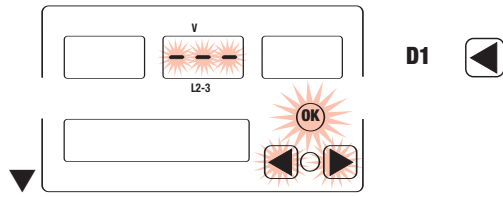
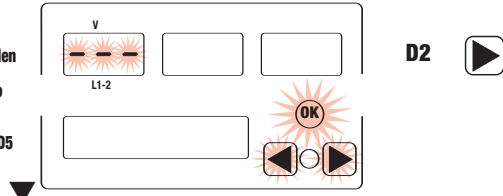

Messgröße auswählen

Quantity selection

Selezione delle grandezze

Sélection des grandeurs

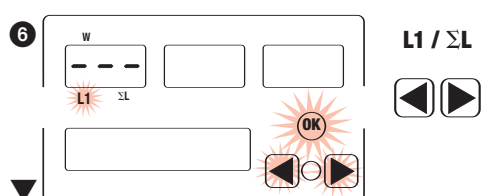
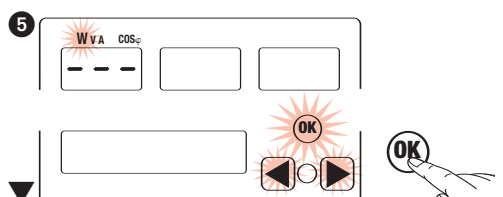
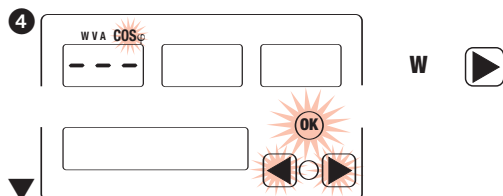
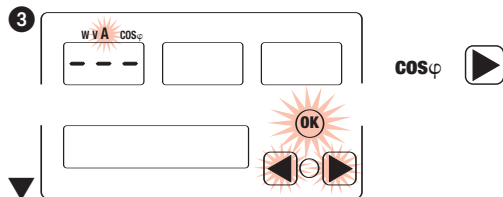
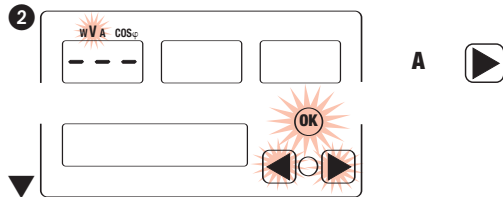

**D1 =  $W \Sigma L$**

**OK!**

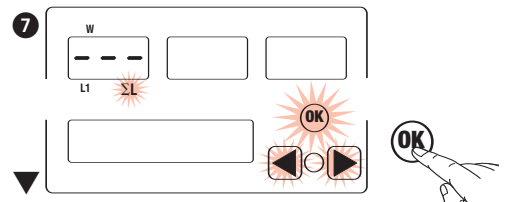

**D2 = V L2**

**D3 = V L3**

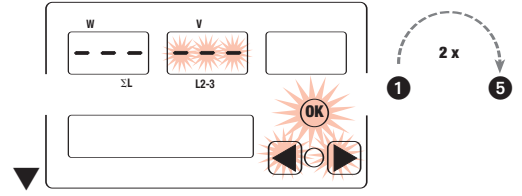
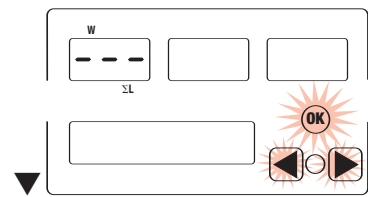

**D2 = V L2**

**D3 = V L3**

**OK!**

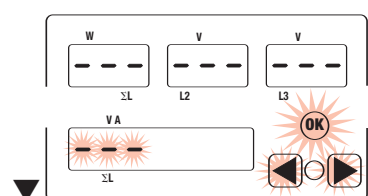

**D4 = var ΣL**

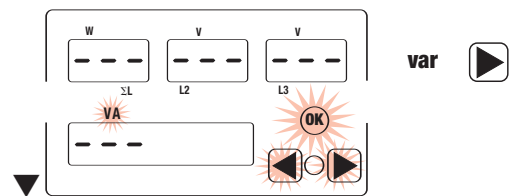
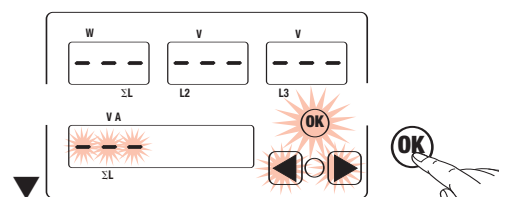

**D4 = var ΣL**

**OK!**

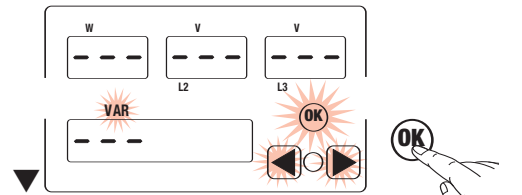

**D5 = Hz**

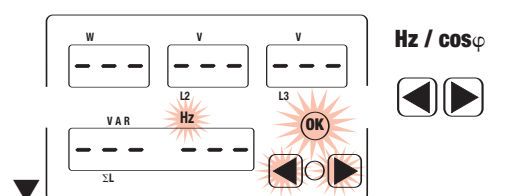
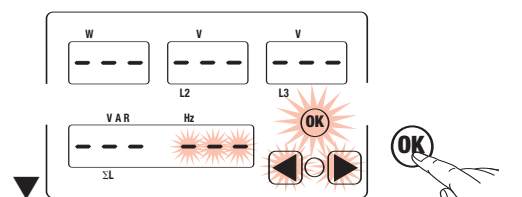

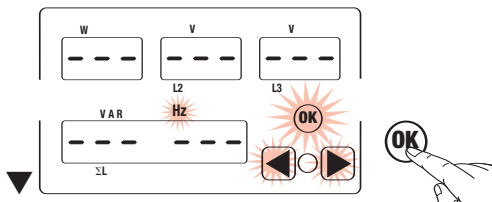

D5 = Hz

OK!

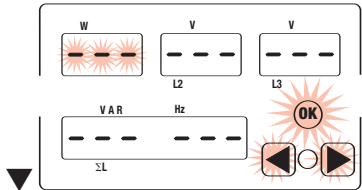

D1 = W ΣL

D2 = V L2

D3 = V L3

D4 = var ΣL

D5 = Hz

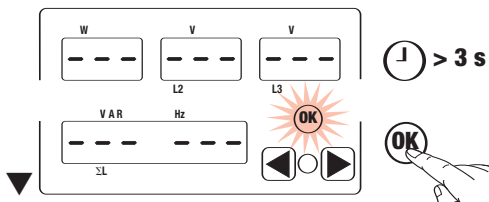

**BETRIEBSART MESSEN / MEASUREMENT MODE  
MODALITA' MISURA / MODE MESURE**

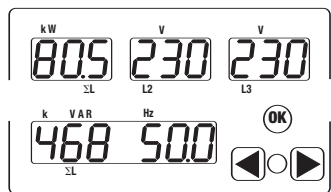

**BETRIEBSART MESSEN / MEASUREMENT MODE  
MODALITA' MISURA / MODE MESURE**

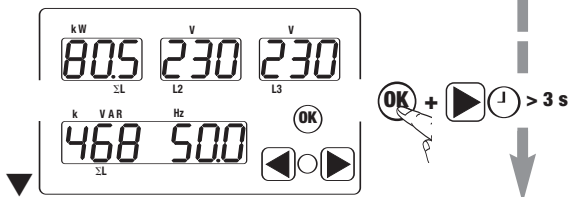

**BETRIEBSART PARAMETEREINSTELLUNG / PARAMETER SETTING MODE  
MODALITA' IMPOSTAZIONE PARAMETRI / MODE CONFIGURATION PARAMÈTRES**

PASSWORT KONTROLLE  
PASSWORD CHECK  
CONTROLLO PASSWORD  
CONTRÔLE MOT DE PASSE

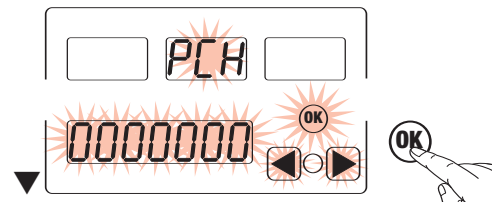
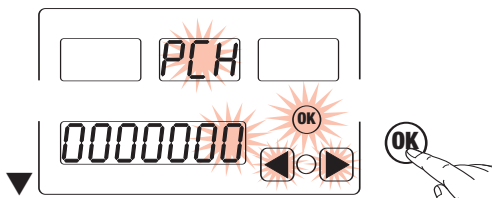
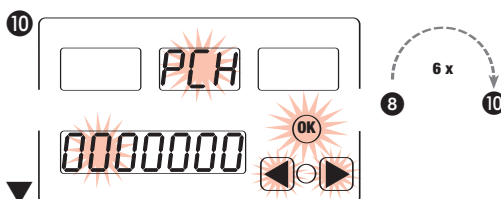
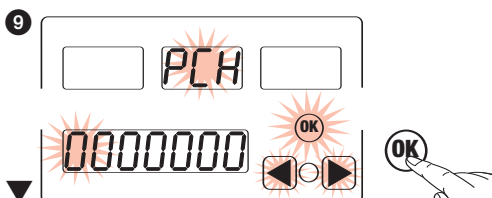
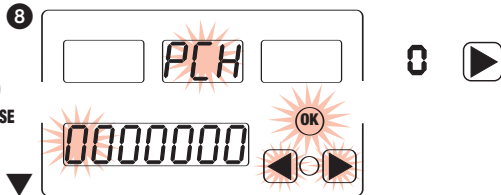

PASSWORT =  
PASSWORD =  
PASSWORD =  
MOT DE PASSE =  
0000000

OK!

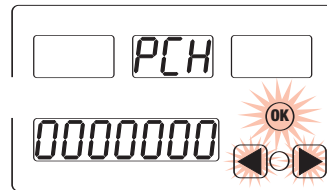

**MENÜ-FOLGE / MENU SEQUENCE  
SEQUENZA MENU / SÉQUENCE MENU**

BETRIEBSART MESSEN  
MEASUREMENT MODE  
MODALITA' MISURA  
MODE MESURE



BETRIEBSART PARAMETEREINSTELLUNG  
PARAMETER SETTING MODE  
MODALITA' IMPOSTAZIONE PARAMETRI  
MODE CONFIGURATION PARAMÈTRES

PASSWORT KONTROLLE  
PASSWORD CHECK  
CONTROLLO PASSWORD  
CONTRÔLE MOT DE PASSE

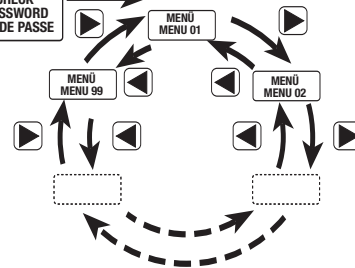

**MENÜ / MENU 01**

PASSWORT-EINSTELLUNG  
=  
SETTING PASSWORD =  
IMPOSTAZIONE PASS-  
WORD =  
CONFIGURATION  
MOT DE PASSE =  
9456789

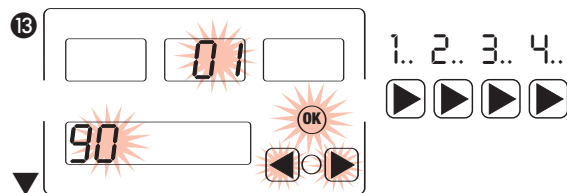
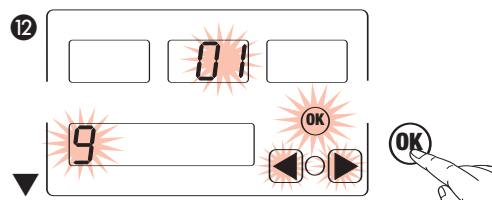
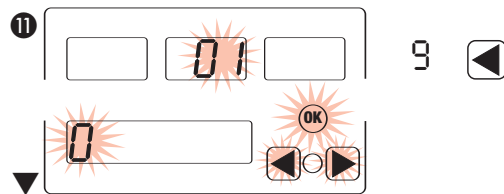
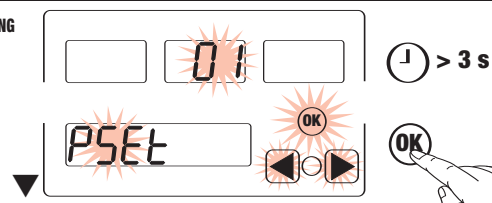

**14**

01

94

**OK**

**15**

01

940

**OK**

5 x

11 15

01

9456759

**OK**

01

9456759

**OK**

01

PSEt

**OK**

**MENÜ MENU 02**

PASSWORT =  
PASSWORD =  
PASSWORD =  
MOT DE PASSE =  
9456789

**OK!**

**MENÜ / MENU 02**

WANDLER SEKUNDÄR-  
STROM EINSTELLUNG  
CT SECONDARY  
CURRENT SETTING  
! IMPOSTAZIONE CORRENTE  
SECONDARIA TA  
CONFIGURATION COURANT  
SECONDAIRE CT  
CT I<sub>2</sub> = ... / 5 A

02

CT/A

75

02

CT/A

75

02

CT/A

75

02

CT/A

75

**OK!**

**MENÜ MENU 03**

CT I<sub>2</sub> = ... / 5 A

**OK!**

**MENÜ / MENU 03**

WANDLER PRIMÄR-  
STROM EINSTELLUNG  
CT PRIMARY  
CURRENT SETTING  
! IMPOSTAZIONE CORRENTE  
PRIMARIA TA  
CONFIGURATION COURANT  
PRIMAIRE CT  
CT I<sub>1</sub> = 750 A

03

CT/A

-5000/5

03

CT/A

-0000/5

03

CT/A

--000/5

03

CT/A

--700/5

03

CT/A

--700/5

03

CT/A

--750/5

03

CT/A

750/5

03

CT/A

750/5

**OK!**

**MENÜ MENU 06**

CT I<sub>1</sub> = 750 A

**OK!**

**MENÜ / MENU 06**

NETZART-EINSTELLUNG  
LINE SETTING  
! SELEZIONE RETE  
SELEZIONE RÉSEAU

06

LinESeT

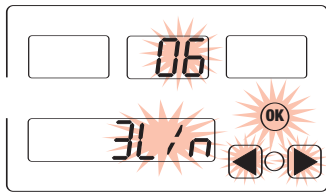

**3L/N** (Grundeinstellung  
-Default-Défaut)

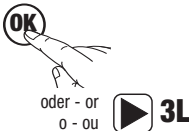

ES WERDEN FOLGENDE  
GRÖSSEN NICHT ANGEZEIGT:

THE SIZES WILL NOT BE  
VISUALIZED:

NON VERRANNO  
VISUALIZZATE LE  
GRANDEZZE:

ELLES NE SERONT  
PAS VISUALISÉES LES  
GRANDEURS:

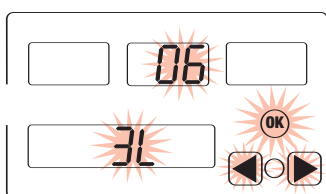

**3L**



Spannung-Stern  
Voltage-star  
Tensione-stella  
Tension-étoile

L1/N  
L2/N  
L3/N

Wirkleistung  
Active power  
Potenza attiva  
Puissance active

L1  
L2  
L3

Scheinleistung  
Apparent power  
Potenza apparente  
Puissance apparente

L1  
L2  
L3

Cosφ  
L2  
L3

DIE WERTE DER PHASEN  
2 UND 3 SOWIE DIE  
SPANNUNG L1-L2 WERDEN  
NICHT ABGEBILDET

THE VALUES FOR PHASES  
2 AND 3 AND THE L1-L2  
VOLTAGE WILL NOT BE  
DISPLAYED

NON VERRANNO  
VISUALIZZATE LE  
GRANDEZZE DELLE FASE  
2 E 3 E LA TENSIONE  
L1-L2

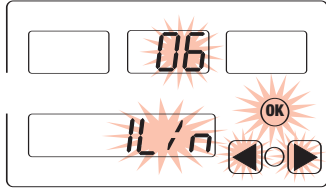

**1L/N**



LES GRANDEURS DES PHASES 2 ET 3 ET LA TENSION L1-L2  
NE SERONT PAS AFFICHÉES

NETZART-EINSTELLUNG

LINE SETTING

SELEZIONE RETE

SELEZIONE RÉSEAU

**OK!**

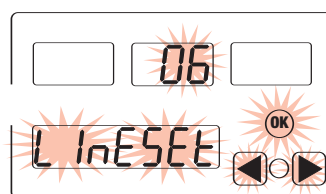

**MENÜ  
MENU  
99**



**MENÜ / MENU 99**

ZURÜCK ZUM  
BETRIEBSART MESSEN

TO MEASUREMENT MODE

RITORNO MODALITA'  
MISURA

RETOUR AU MODE MESURE

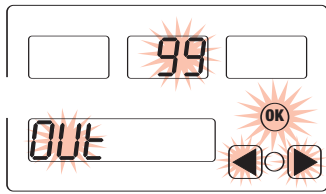

**> 3 s**



**BETRIEBSART MESSEN / MEASUREMENT MODE  
MODALITA' MISURA / MODE MESURE**

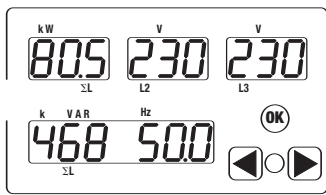

**Maße / Dimension / Dimensioni / Dimensions**

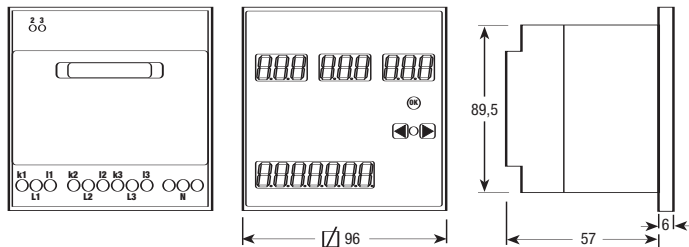

**Einbau / Mounting / Montaggio / Installation**

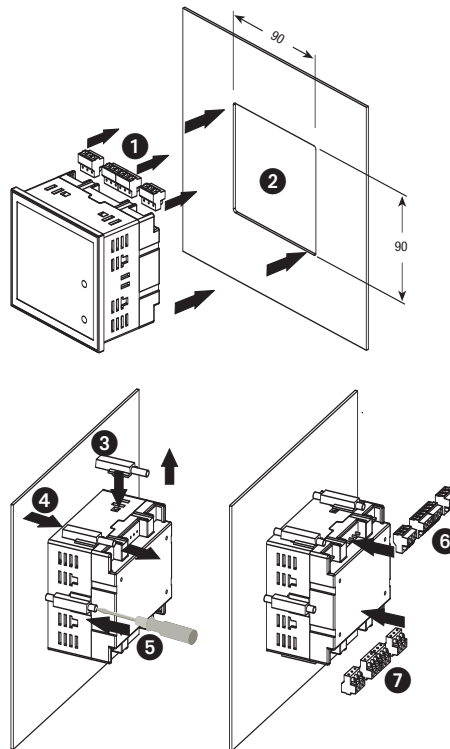

**Abisolierlänge und Max Drehmoment  
Cable stripping length and max terminal screw torque  
Lunghezza di spelatura dei fili e coppia massima di serraggio  
Longueur de dénudage des fils et couple de serrage maximum**

5 A Wandleranschluss Hauptklemmen  
5 A CT connection main terminals  
5 A connessione TA morsetti principali  
5 A connexion CT bornes principales

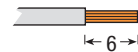

Betriebsspannungs-Tarif- und Datenübertragungsklemmen  
Auxiliary supply, tariff and communication terminals  
Morsetti alimentazione ausiliaria, tariffe e comunicazioni  
Bornes alimentation auxiliaire, tarifs et communications



**Schaltbild / Wiring diagram / Schema di cablaggio / Schéma de câblage**

**3P+N**

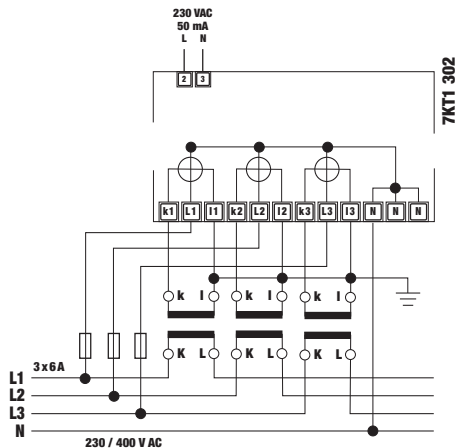

**3P**

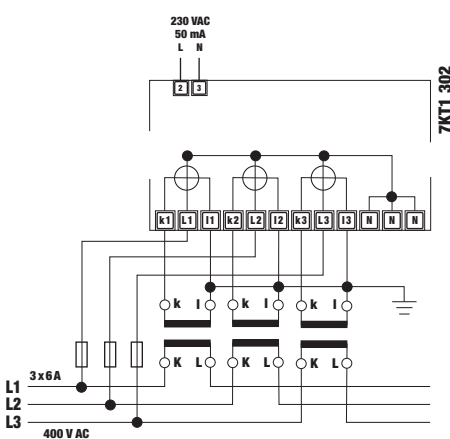

**1P+N**

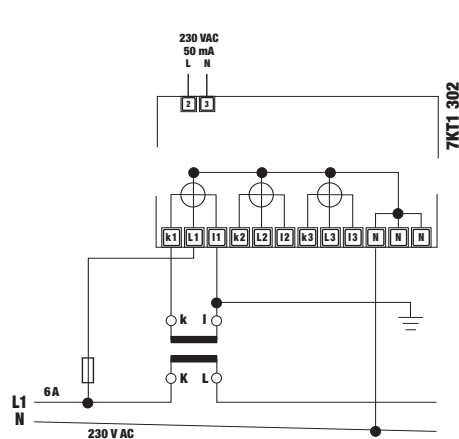



# Technische Daten

# DEUTSCH

Daten nach EN 61010-1, EN 61326

## 7KT1 302 Wandleranschluß

### Allgemeine Daten

• Gehäuse		mm	96x96
• Befestigung		-	mit 6 Schrauben
• Bauhöhe (Einbautiefe)		mm	57
• Daten nach Norm	DIN 43751-1-2	-	-

### Funktion

• Betriebsart	Einphasige / Dreiphasige Netze	n° Leiter	2-3-4
• Speicherung der Einstellung / Daten		-	EEPROM

### Versorgung

• Bemessungssteuerspeisespannung $U_n$		V	230
• Arbeitsbereich		x $U_n$	0.8 ... 1.2
• Bemessungsfrequenz		Hz	50
• Frequenzbereich		Hz	45 ... 65
• Bemessungsverlustleistung		VA	≤5

### Überlastbarkeit

• Spannung $U_n$	dauernd: Phase/Phase	V	480
	1 Sekunde: Phase/Phase	V	800
	dauernd: Phase/N	V	276
	1 Sekunde: Phase/N	V	460
• Strom $I_b/I_n$	dauernd	A	6
	0,5 s	A	110

### Messeingang

• Anschlußart	darüber	-	Wandler .../1 A oder .../5 A
• Spannung $U_n$	Phase/Phase	V	400
	Phase/N	V	230
• Arbeitsbereich Spannung	Phase/Phase	V	87 ... 480
	Phase/N	V	50 ... 276
• Strom $I_b/I_n$		A	1 oder 5
• Arbeitsbereich Strom		A	0.010 ... 6
• Wandlerstrom	Primärstrom des Wandlers	A	5 ... 5000
	kleinster Eingabeschritt	A	5
• Frequenz		Hz	50
• Frequenzbereich		Hz	45 ... 65
• Eingangswelligkeitsform		-	symmetrische sinusoid.
• Betriebsanlaufstrom		mA	10

### Anzeige

• Anschlußfehler	vertauschte Phase		Err
• Spannung: 3 Anzeigen, 3 stellig	Dreieck L1-L2, L2-L3, L3-L1	V	87 ... 480
	Stern L1/N-L2/N-L3/N	V	50 ... 276
	Spannung >480/276 V	-	H H H
	Spannung <87/50 V	-	- - -
• Strom: 3 Anzeigen, 3 stellig	L1-L2-L3	A oder kA	0.01 (1.2 oder 6)
	für Strom >1.2 oder 6 A x Wandlerübersetzung	-	H H H
	für Strom <0.010 A x Wandlerübersetzung	-	0 0 0
• Frequenz: 1 Anzeige, 3 stellig	$\Sigma L$	Hz	45.0 ... 65.0
• Wirkleistung: 3 Anzeigen, 3 stellig	L1-L2-L3; $\Sigma L$	W, kW oder	0 ... 999
oder 1 Anzeige, 3 von 7 stellig	Anzeige mit Fliessskomma	MW	
• Blindleistung: 1 Anzeige, 3 stellig	$\Sigma L$ , Anzeige mit Fliessskomma	var, kvar	0 ... 999
	Anzeige: für Wandlerübersetzung	oder Mvar	
• Wirkleistung: 3 Anzeige, 3 stellig	L1-L2-L3; $\Sigma L$	VA, kVA	0 ... 999
oder 1 Anzeige, 3 stellig	Anzeige mit Fliessskomma	oder MVA	
• $\cos\phi$ : 3 Anzeigen, 3 stellig	L1-L2-L3; $\Sigma L$	-	0 ... 1.00
oder 1 Anzeige, 3 stellig	Anzeige mit Fliessskomma		
• Wandler Primärstrom	nur bei Einstellung	A	5 ... 5000
• Wandler Sekundärstrom	nur bei Einstellung	A	1 oder 5
• Anzeigezyklus		/s	2

### Messgenauigkeit (von Nominalwerten $I_n$ - $I_b$ - $U_n$ )

• Spannung		%	±2 ±1 Digit
• Strom		%	±2 ±1 Digit
• Leistung		%	±2 ... ±4 ±1 Digit
• $\cos\phi$		%	±2 ... ±10 ± 1 Digit
• Frequenz		%	±1 ±1 Digit

### Sicherheit nach EN 61010-1

• Verschmutzungsgrad		-	2
• Überspannungskategorie		-	II
• Betriebsspannung		V	600
• Prüfstoßspannung	1,2/50 $\mu$ s	kV	4
• Flammenwiderstand	UL 94	Klasse	V0

### Klemmen

• Liftklemmen der Hauptstrombahnen	Schraubenkopf Z +/-	POZIDRIV	PZ0
• Liftklemmen für Betriebs- und Datenbahnen	Klinge für Schlitzschraube	POZIDRIV	PZ0
• Klemmenkapazität Hauptbahnen	starr min. (max)	mm <sup>2</sup>	0.14 (2.5)
	flexibel, mit Hülse min. (max)	mm <sup>2</sup>	0.14 (1.5)
• Klemmenkapazität Betriebs- und Datenbahnen	starr min. (max)	mm <sup>2</sup>	0.14 (2.5)
	flexibel, mit Hülse min. (max)	mm <sup>2</sup>	0.14 (1.5)

### Umweltbedingungen

• Temperatur		°C	0 ... +55
• Relative Feuchte		%	≤ 80
• Schwingen	Sinus-Amplitude bei 50 Hz	mm	± 0.25
• Schutzklasse	nach EN 61010-1	-	II
• Schutzart	Eingebautes Gerät Front (Klemmen)	-	IP56 (IP20)

## Technical data

## ENGLISH

Data in compliance with EN 61010-1, EN 61326		7KT1 302 CT connection
<b>General characteristics</b>		
• Housing	mm	96x96
• Mounting	-	panel
• Depth	mm	57
• Reference standard	DIN 43751-1-2	-
<b>Operating features</b>		
• Connectivity	to single / three-phase network	n° wires
• Storage of setting		-
<b>Auxiliary supply</b>		
• Rated control supply voltage $U_n$		V
• Operating range		x $U_n$
• Rated frequency		Hz
• Frequency range		Hz
• Rated power dissipation		VA
<b>Overload capability</b>		
• Voltage $U_n$	continuous: phase/phase	V
	1 second: phase/phase	V
	continuous: phase/N	V
	1 second: phase/N	V
• Current $I_b/I_n$	continuous	A
	0,5 s	A
<b>Measuring input</b>		
• Connectivity		-
• Voltage $U_n$	phase/phase	V
	phase/N	V
• Operating range voltage	phase/phase	V
	phase/N	V
• Current $I_b/I_n$		A
• Operating range current		A
• Transformer current	primary current of the transformer	A
	smallest input step	A
• Frequency		Hz
• Operating range frequency		Hz
• Input waveform		-
• Starting current for power measurement		mA
<b>Display (readouts)</b>		
• Connection errors	inverted phases	-
• Voltage: 3 displays, 3-digit	delta L1-L2, L2-L3, L3-L1	V
	star L1/N-L2/N-L3/N	V
	voltage >480/276 V	-
	voltage <87/50 V	-
• Current: 3 displays, 3-digit	L1-L2-L3	A or kA
	for current >1.2 or 6 A x transformer conversion ratio	-
	for current <0.010 A x transformer conversion ratio	-
• Frequency: 1 display, 3-digit	$\Sigma L$	Hz
• Active power: 3 displays, 3-digit or 1 display 3 or 7 digits	L1-L2-L3; $\Sigma L$	W, kW or MW
• Reactive power: 1 display, 3-digit	$\Sigma L$ , with capacitive or inductive indication: transformer conversion ratio	var, kvar or Mvar
• Apparent power: 3 displays, 3-digit or 1 display, 3-digit	L1-L2-L3; $\Sigma L$	VA, kVA or MVA
• $\cos\phi$ : 3 displays, 3-digit or 1 display, 3-digit	L1-L2-L3; $\Sigma L$	-
• Transformer primary current	only if set	A
• Transformer secondary current	only if set	A
• Display refresh period		/s
<b>Measuring accuracy (of nominal values <math>I_n - I_b - U_n</math>)</b>		
• Voltage		%
• Current		%
• Power output		%
• $\cos\phi$		%
• Frequency		%
<b>Safety acc. to EN 61010-1</b>		
• Degree of pollution		-
• Overvoltage category		-
• Operational voltage		V
• Test pulse voltage	1,2/50 $\mu$ s	kV
• Housing material flame resist.	UL 94	class
<b>Connection terminals</b>		
• Type cage main current paths	screw head Z +/-	POZIDRIV
• Type cage power supply and auxiliary	screw head Z +/-	POZIDRIV
• Terminal capacity main current paths	solid wire min. (max)	mm <sup>2</sup>
	stranded wire with sleeve min. (max)	mm <sup>2</sup>
• Terminal capacity power supply and auxiliary cable section	solid wire min. (max)	mm <sup>2</sup>
	stranded wire with sleeve min. (max)	mm <sup>2</sup>
<b>Environmental conditions</b>		
• Operating temperature		°C
• Relative humidity		%
• Vibrations	sinus-amplitude at 50 Hz	mm
• Protection class	acc. to EN 61010-1	-
• Degree of protection	housing when mounted (terminal)	-

## Dati tecnici

ITALIANO

Secondo Norme EN 61010-1, EN 61326

**7KT1 302  
inserzione TA**

### Caratteristiche generali

• Custodia		mm	96x96
• Fissaggio		-	pannello
• Profondità		mm	57
• Norme di riferimento	DIN 43751-1-2	-	-

### Caratteristiche di funzionamento

• Connessione	a rete monofase / trifase	n° fili	2-3-4
• Mantenimento dati			EEPROM

### Alimentazione

• Tensione nominale di alimentazione $U_n$		V	230
• Campo di variazione		x $U_n$	0.8 ... 1.2
• Frequenza nominale		Hz	50
• Campo di variazione	frequenza	Hz	45 ... 65
• Potenza assorbita		VA	≤5

### Sovraccaricabilità

• Tensione $U_n$	permanente: fase/fase	V	480
	1 secondo: fase/fase	V	800
• Corrente $I_b/I_n$	permanente: fase/N	V	276
	1 secondo: fase/N	V	460
	permanente	A	6
	0,5 s	A	110

### Ingressi di misura

• Inserzione		-	a mezzo TA .../1 A o .../5 A
• Tensione $U_n$	fase/fase	V	400
	fase/N	V	230
	fase/fase	V	87 ... 480
	fase/N	V	50 ... 276
• Corrente $I_b/I_n$		A	1 o 5
		A	0.010 ... 6
• Campo di corrente		A	5 ... 5000
		A	5
• Frequenza		Hz	50
		Hz	45 ... 65
• Campo di frequenza		-	sinusoidale simmetrico
• Forma d'onda in ingresso		-	10
• Corrente minima per inizio conteggio		mA	

### Visualizzazione (lettura)

• Errore di collegamento	fase invertita	-	Err
• Tensione: 1 indicatore, 3 cifre	triangolo L1-L2, L2-L3, L3-L1	V	87 ... 480
	stella L1/N-L2/N-L3/N	V	50 ... 276
	tensione >480/276 V	-	H H H
	tensione <87/50 V	-	- - -
• Corrente: 1 indicatore, 3 cifre	L1-L2-L3	A o kA	0.01 (1.2 o 6)
	per corrente >1.2 or 6 A x rapporto TA	-	H H H
	per corrente <0.010 A x rapporto TA	-	0 0 0
• Frequenza: 1 indicatore, 3 cifre	$\Sigma L$	Hz	45.0 ... 65.0
	L1-L2-L3; $\Sigma L$	W, kW o MW	0 ... 999
• Potenza attiva: 3 indicatori, 3 cifre o 1 cifra, 3 o 7 cifre	indicatore con virgola mobile	var, kvar	0 ... 999
	$\Sigma L$ , indicazione assorbita o erogata	o Mvar	
• Potenza reattiva: 1 indicatore, 3 cifre	indicazione: rapporto di conversione del TA	VA, kVA	0 ... 999
	L1-L2-L3; $\Sigma L$	o MVA	
• Potenza attiva: 3 indicatori, 3 cifre o 1 indicatore, 3 cifre	indicatore con virgola mobile	-	0 ... 1.00
• $\cos\phi$ : 3 indicatori, 3 cifre o 1 indicatore, 3 cifre	indicatore con virgola mobile	-	
• Trasformatore primario	solo dopo impostazione	A	5 ... 5000
• Trasformatore secondario	solo dopo impostazione	A	1 o 5
• Ciclo di visualizzazione		/s	2

### Precisione (dei valori nominali $I_n - I_b - U_n$ )

• Tensione		%	±2 ±1 digit
• Corrente		%	±2 ±1 digit
• Potenza		%	±2 ... ±4 ±1 digit
• $\cos\phi$		%	±2 ... ±10 ±1 digit
• Frequenza		%	±1 ±1 digit

### Sicurezza secondo EN 61010-1

• Grado di inquinamento		-	2
• Categoria di sovratensione		-	II
• Tensione di funzionamento		V	600
• Tenuta all'impulso	valore di picco dell'impulso 1,2/50 $\mu$ s	kV	4
• Resistenza della custodia alla fiamma	UL 94	classe	V0

### Morsetti

• Tipo di gabbia morsetto tensione principale	testa della vite Z +/-	POZIDRIV	PZ0
• Tipo di gabbia morsetto alimentazione e ausiliario	testa della vite a taglio	POZIDRIV	PZ0
• Capacità morsetto amperometriche	filo compatto min. (max)	mm <sup>2</sup>	0.14 (2.5)
	filo flessibile con capocorda min. (max)	mm <sup>2</sup>	0.14 (1.5)
	filo compatto min. (max)	mm <sup>2</sup>	0.14 (2.5)
	filo flessibile con capocorda min. (max)	mm <sup>2</sup>	0.14 (1.5)
• Capacità morsetto alimentazione e ausiliario			

### Condizioni ambientali

• Temperatura d'impiego		°C	0 ... +55
• Umidità relativa		%	≤ 80
• Vibrazioni	ampiezza vibrazioni sinusoidali 50 Hz	mm	± 0.25
• Classe di protezione	secondo EN 61010-1	-	II
• Grado di protezione	apparecchio montato (morsetti)	-	IP56 (IP20)

# Caractéristiques techniques

# FRANÇAIS

Conforme aux normes EN 61010-1, EN 61326

**7KT1 302**  
**connexion à CT**

## Caractéristiques générales

• Boîtier	mm	96x96
• Fixation	-	sur panneau
• Profondeur	mm	57
• Normes de référence	DIN 43751-1-2	-

## Caractéristiques de fonctionnement

• Connexion	à réseau monophasé/triphasé	n° fils	2-3-4
• Maintien des données		-	EEPROM

## Alimentation

• Tension nominale d'alimentation $U_n$		V	230
• Champ de variation		x $U_n$	0.8 ... 1.2
• Fréquence nominale		Hz	50
• Champ de variation	fréquence	Hz	45 ... 65
• Puissance absorbée		VA	≤5

## Surchargeabilité

• Tension $U_n$	permanent: phase/phase	V	480
	1 seconde: phase/phase	V	800
• Courant $I_b/I_n$	permanent: phase/N	V	276
	1 seconde: phase/N	V	460
	permanent	A	6
	0,5 s	A	110

## Entrées de mesure

• Insertion		-	à l'aide de CT .../5 A
• Tension $U_n$	phase/phase	V	400
	phase/N	V	230
• Champ de tension	phase/phase	V	87 ... 480
	phase/N	V	50 ... 276
• Courant $I_b/I_n$		A	1 ou 5
• Champ de courant		A	0.010 ... 6
• Réducteur de courant	primaire	A	5 ... 5000
	minimum imp.	A	5
• Fréquence		Hz	50
• Champ de fréquence		Hz	45 ... 65
• Forme d'onde en entrée		-	sinusoïd. sym.
• Courant minimum pour début de calcul		mA	10

## Visualisation (lecture)

• Erreur de branchement	phase inversée	-	Err
	triangle L1-L2, L2-L3, L3-L1	V	87 ... 480
• Tension: 3 chiffres, 3 digits	étoile L1/N-L2/N-L3/N	V	50 ... 276
	tension >480/276 V	-	H H H
	tension <87/50 V	-	- - -
• Courant: 3 chiffres, 3 digits	L1-L2-L3	A ou kA	0.01 (1.2 ou 6)
	pour courant >1.2 ou 6 A x rapport CT	-	H H H
	pour courant <0.010 A x rapport CT	-	0 0 0
	ΣL	Hz	45.0 ... 65.0
• Fréquence: 1 indicateur, 3 chiffres	L1-L2-L3; ΣL	W, kW ou MW	0 ... 999
• Puissance active: 3 indicateurs, 3 chiffres ou 1 chiffre, 3 de 7 chiffres	indicateur avec virgule flottante	var, kvar ou Mvar	0 ... 999
• Puissance réactive: 1 indicateur, 3 chiffres	ΣL, indication: puissance absorbée ou distribuée	VA, kVA ou MVA	0 ... 999
• Puissance apparente: 3 indicateurs, 3 chiffres ou 1 indicateur, 3 chiffres	L1-L2-L3; ΣL	indicateur avec virgule flottante	0 ... 1.00
• $\cos\varphi$ : 3 indicateurs, 3 chiffres ou 1 indic., 3 chiffres	L1-L2-L3; ΣL	indicateur avec virgule flottante	
• Primaire réducteur	seulement après configuration	A	5 ... 5000
• Secondaire réducteur	seulement après configuration	A	1 ou 5
• Cycle d'affichage		/s	2

## Précision (des valeurs nominales $I_n - I_b - U_n$ )

• Tension		%	±2 ±1 digit
• Courant		%	±2 ±1 digit
• Puissance		%	±2 ... ±4 ±1 digit
• $\cos\varphi$		%	±2 ... ±10 ±1 digit
• Fréquence		%	±1 ±1 digit

## Sécurité selon EN 61010-1

• Indice de pollution		-	2
• Catégorie de surtension		-	II
• Tension de fonctionnement		V	600
• Étanchéité à l'impulsion	valeur de crête de l'impulsion 1,2/50 μs	kV	4
• Résistance du boîtier à la flamme	UL 94	classe	V0

## Bornes

• Type de cage borne tension principale	tête de la vis +/-	POZIDRIV	PZ0
• Type de cage borne alimentation et auxiliaires	tête de la vis à fente	POZIDRIV	PZ0
• Type de cage borne tension principale	fil compact min. (max)	mm <sup>2</sup>	0.14 (2.5)
	fil flexible avec cosse min. (max)	mm <sup>2</sup>	0.14 (1.5)
• Type de cage borne alimentation et auxiliaires	fil compact min. (max)	mm <sup>2</sup>	0.14 (2.5)
	fil flexible avec cosse min. (max)	mm <sup>2</sup>	0.14 (1.5)

## Conditions ambiantes

• Température d'utilisation		°C	0 ... +55
• Humidité relative		%	≤ 80
• Vibrations	amplitude vibration sinusoïdale à 50 Hz	mm	± 0.25
• Classe de protection	selon les normes EN 61010-1	-	II
• Indice de protection	appareil installé (bornes)	-	IP56 (IP20)