

SIEMENS

# SINUMERIK 810M

## Basic Version 3, Software Version 3

### Operating and Programming

User's Guide

01.93 Edition

User Documentation

SINUMERIK 810M  
Basic Version 3, Software Version 3  
Operating and Programming

User's Guide

01.93 Edition

User Documentation

# **SINUMERIK 810M Basic Version 3, Software Version 3 Operating and Programming**

**User's Guide**

**User Documentation**

**Valid for:**

*Control*

SINUMERIK 810M, GA3

*Software Version*

3 and higher

**January 1993 Edition**

## Printing history

Brief details of this edition and previous editions are listed below.

The status of each edition is shown by the code in the "Remarks" column.

*Status code in "Remarks" column:*

**A** . . . New documentation

**B** . . . Unrevised reprint with new Order No.

**C** . . . Revised edition with new status

If factual changes have been made on the page since the last edition, this is indicated by a new edition coding in the header on that page.

<b>Edition</b>	<b>Order No.</b>	<b>Remarks</b>
11.90	6ZB5 410-0EQ02-0BA0	<b>A</b>
09.91	6ZB5 410-0EQ02-0BA1	<b>C</b>
01.93	6ZB5 410-0EQ02-0BA2	<b>C</b>

Other functions not described in this documentation might be executable in the control. This does not, however, represent an obligation to supply such functions with a new control or when servicing.

This publication was produced on the Siemens 5800 Office System.  
Subject to change without prior notice.

The reproduction, transmission or use of this document or its contents is not permitted without express written authority. Offenders will be liable for damages. All rights, including rights created by patent grant or registration of a utility model or design, are reserved.

# Preliminary Remarks

## Notes for the reader

The SINUMERIK documentation is organized in three parts:

- User documentation
- Manufacturer documentation and
- Service documentation

This documentation/User's Guide has been written for **machine tool users**.

This publication provides detailed information required by the user for *operating* and *programming* the SINUMERIK 810M Basic Version 3 control.

This User's Guide comprises two distinct parts:

- Part 1 : **Operating**
- Part 2 : **Programming**

## Operating

Part 1 of the User's Guide explains:

- The configuration of the control
- The operating elements:
  - CRT display with softkeys
  - Keyboard and display panel of the control  
(The machine tool manufacturer can alter the ASCII code of the keys; see information supplied by the machine tool manufacturer).
  - Keys and switches on the external machine control panel
- Operating sequences
- Data interfaces and interfacing to the machine
- Diagnostics and maintenance

It is **not** possible to include in this User's Guide any details relating to an additional operator panel provided by the machine tool manufacturer.

## Programming

Part 2 of the User's Guide describes the programming possibilities which are currently available for the SINUMERIK 810M Basic Version 3.

The information required in order to execute the designed operations, such as:

- Workpiece dimensions
- Choice of tool
- Traverse path of tool and axis slides
- Sequence of machining operations
- Rotational speeds
- Feedrates

is put in the required sequence by the programming which also translates them into a language understood by the SINUMERIK 810M Basic Version 3.

More information on other SINUMERIK 810M publications (or SINUMERIK 810 in general) and on publications which are available for all SINUMERIK controls ("Universal Interface", "Measuring Cycles", . . .) are obtainable from your **Siemens local branch office**.

**Technical comments**

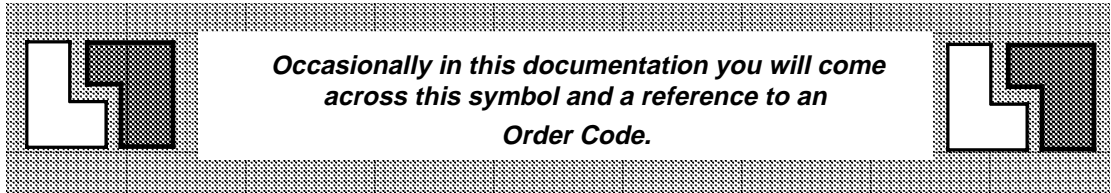

*Occasionally in this documentation you will come across this symbol and a reference to an Order Code.*

This is intended to indicate that the function described is only capable of operating if the control includes the option shown. An overview of the possible Order Codes is provided in:

**Part 1: Operating/Section 7.2.**

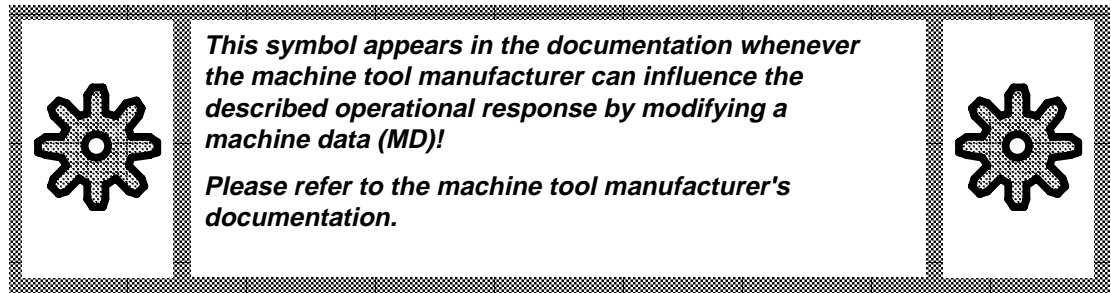

*This symbol appears in the documentation whenever the machine tool manufacturer can influence the described operational response by modifying a machine data (MD)!*

*Please refer to the machine tool manufacturer's documentation.*

Functions over and above those described in this documentation may be executable in the control.

However, this does not represent an obligation to provide such functions when the system is supplied or on servicing.

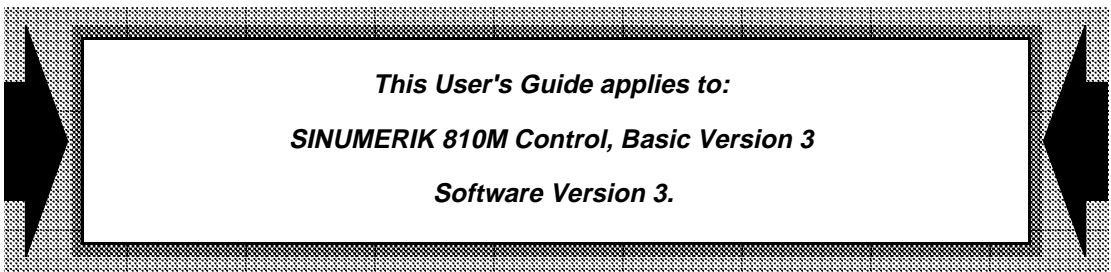

*This User's Guide applies to:*

**SINUMERIK 810M Control, Basic Version 3**

*Software Version 3.*

## Terms/Abbreviations

AP 1.0	– Siemens Automation Protocol Version 1.0
CL	– Computer Link
COM Area	– Communications Area
CNC	– Computer Numerical Control
CP	– Communications Processor Module
DB/DX	– Data block class DB or DX
DPR	– Dual Port Ram (interface between communications processor module and COM area)
DW	– Data Word
FB/FX	– Function block class FB or FX
Fct. no.	– Function number
FMS	– Flexible Manufacturing System
Frame	– A data block exchanged between two partners written according to defined rules
ID	– Identification
I/O buffer	– Input/Output buffer
MD	– Machine Data
MPR	– Multiport RAM
NC	– Numerical Control (or CNC)
PLC	– Programmable controller
STEP 5	– The program language STEP 5 is used to write the various automation tasks on the SIMATIC S5 programmable controllers. The program can be written as a control system flowchart (CSF), a ladder diagram (LAD), a statement list (STL) or in GRAPH 5.
SW	– Software
UI	– User Interface
UII	– User Interface Input
UIQ	– User Interface Output

# **SINUMERIK 810M Basic Version 3, Software Version 3**

## **Part 1: Operating**

**User Documentation**



General Notes

---

1

Operation

---

2

Operating Sequences

---

3

Monitoring Functions

---

4

Maintenance

---

5

Data Interfaces

---

6

Interfacing to the Machine

---

7

Appendix

---

8

# Contents

	Page
<b>1</b>	<b>General Notes</b> ..... 1-1
1.1	Product ..... 1-1
1.2	Configuration ..... 1-2
1.2.1	SINUMERIK 810M with integrated machine control panel ..... 1-2
1.2.2	SINUMERIK 810M with external machine control panel ..... 1-3
<b>2</b>	<b>Operation</b> ..... 2-1
2.1	Operating elements ..... 2-1
2.1.1	SINUMERIK 810M operator interface with integrated machine control panel ..... 2-1
2.1.1.1	CRT display with softkeys ..... 2-2
2.1.1.2	Display panel ..... 2-4
2.1.1.3	Address / numerical keys ..... 2-7
2.1.1.4	Editing and input keys ..... 2-10
2.1.1.5	Control keys ..... 2-11
2.1.1.6	Integrated machine control panel ..... 2-16
2.1.2	SINUMERIK 810M operator interface with external machine control panel ..... 2-24
2.1.2.1	External machine control panel ..... 2-25
2.2	Switching on / off ..... 2-34
2.2.1	Switching on the control ..... 2-34
2.2.2	Switching off the control ..... 2-34
2.2.3	Darkening the screen ..... 2-34
2.3	Operating modes ..... 2-35
2.3.1	General ..... 2-35
2.3.2	Operating modes - overview ..... 2-35
2.3.3	Selection of operating modes ..... 2-38
2.3.3.1	Selection of operating modes with internal machine control panel ..... 2-38
2.3.3.2	Selection of operating modes with external machine control panel ..... 2-41
2.3.4	"Reset" with change of operating mode ..... 2-42
2.3.5	Branching to operating functions within an operating mode ..... 2-43
2.3.5.1	Example for the selection of operating functions and branching to other menus ..... 2-44
2.3.5.2	Example for the selection of further operating functions within the same menu ..... 2-45
2.3.5.3	Menu display from the NC program or from the PLC ..... 2-45
2.3.6	Jumping back to operating functions in higher-level menus within an operating mode ..... 2-46
2.4	Operating mode menu trees ..... 2-47
2.4.1	"AUTOMATIC" mode ..... 2-48
2.4.2	"JOG" mode ..... 2-50
2.4.3	"JOG" mode (after "TEACH IN/PLAYBACK" in "AUTOMATIC" mode) ..... 2-52
2.4.4	"MDI-AUTOMATIC" mode ..... 2-53
2.4.5	"REFPOINT" mode ..... 2-54
2.4.6	"INC FEED 1 ... INC FEED 10 000" mode ..... 2-56
2.4.7	"PRESET" mode ..... 2-58
2.4.8	"REPOS" mode ..... 2-60

2.4.9	"GUIDING" (operator prompting) function .....	2-61
2.5	Glossary of softkey functions .....	2-64
<b>3</b>	<b>Operating Sequences .....</b>	<b>3-1</b>
3.0	Preliminary remarks .....	3-1
3.1	Preparation .....	3-2
3.1.1	Switching on .....	3-2
3.1.2	Traverse to reference point .....	3-2
3.1.3	Tools .....	3-4
3.1.4	Tool offset .....	3-4
3.1.4.1	Input of tool offset .....	3-4
3.1.4.2	Deleting/modifying an individual offset value .....	3-10
3.1.4.3	Deleting all offset values in an offset number D... .....	3-11
3.1.4.4	Integrated tool administration .....	3-12
3.1.4.5	Input of tool data .....	3-12
3.1.4.6	Display of tool data .....	3-14
3.1.5	Zero offset .....	3-16
3.1.5.1	Settable zero offset .....	3-17
3.1.5.2	Programmable zero offset - external zero offset .....	3-19
3.1.6	Setting data : " R PARAMETERS", "SPINDLE", "AXIAL", "ANGLE OF ROTATION", "SCALE MODIFICATION" .....	3-21
3.1.7	Flexible plane selection .....	3-31
3.1.8	Axis synchronization .....	3-33
3.1.8.1	Function of the modes with "axis synchronization" .....	3-33
3.1.9	TRANSMIT coordinate transformation .....	3-35
3.1.9.1	Behaviour of the transformation in the modes .....	3-35
3.1.9.2	TRANSMIT function in the various modes .....	3-37
3.1.9.3	Monitoring the software limit switch for fictitious axes with the TRANSMIT function .....	3-39
3.1.10	Program input .....	3-40
3.1.10.1	Program input with the keyboard .....	3-40
3.1.10.2	Program input with operator prompting (GUIDING) .....	3-43
3.1.11	Contour .....	3-48
3.1.12	Program correction ("EDIT"): Insert/modify/delete word, insert/delete block .....	3-53
3.1.12.1	Correction display ("CORRECTION BLOCK") .....	3-56
3.1.13	Program management .....	3-57
3.1.13.1	Displaying the stored programs ("DIRECTORY") .....	3-57
3.1.13.2	Protection of subroutines (cycle lock) .....	3-58
3.1.13.3	Cycle lock release ("ENABLE") .....	3-59
3.1.13.4	Copying a program ("COPY") .....	3-60
3.1.13.5	Moving a program ("MOVE") .....	3-61
3.1.13.6	Renaming a program ("RENAME") .....	3-62
3.1.13.7	Deleting a program ("DELETE") .....	3-63
3.1.13.8	Reorganizing the program memory ("REORG") .....	3-64
3.1.13.9	"Selecting a program" .....	3-65
3.1.13.10	Operator guidance macros (OGM) and back translation .....	3-66
3.1.14	"SIMULATION" .....	3-71
3.1.14.1	Simulation "AREA OF THE WORKPIECE" .....	3-71
3.1.14.2	Influencing simulation .....	3-75
3.1.15	Data input/data output .....	3-79
3.1.15.1	Setting data bits .....	3-79
3.1.15.2	Data input .....	3-82

3.1.15.3	Data output .....	3-84
3.1.15.4	Part program - block transfer .....	3-88
3.1.16	Selecting the second language .....	3-91
3.2	Machining .....	3-92
3.2.1	Starting a part program .....	3-92
3.2.2	"AUTOMATIC" operating mode	
	- Selection of the "ACTUAL VALUES" or "ACTUAL BLOCK" display ..	3-93
3.2.3	Influencing "AUTOMATIC" operation .....	3-96
3.2.3.1	Influencing the program .....	3-97
3.2.3.2	"OVERSTORE" .....	3-102
3.2.3.3	"BLOCK SEARCH" .....	3-104
3.2.3.4	Interrupting the program .....	3-107
3.2.3.5	Program sequencing (OPS) .....	3-108
3.2.4	"Manual data input - automatic" (MDI AUTOMATIC) mode .....	3-117
3.2.5	"TEACH IN" .....	3-119
3.2.6	"PLAYBACK" .....	3-120
3.2.7	"JOG" mode .....	3-124
3.2.8	"Incremental" mode ("INC FEED 1 ... INC FEED 10000") .....	3-126
3.2.9	"HANDWHEEL" .....	3-128
3.2.10	"DRF" .....	3-130
3.2.11	"Actual value setting" mode ("PRESET") .....	3-132
3.2.12	"Repositioning" mode ("REPOS") .....	3-135
3.2.13	"Scratching" .....	3-138
<b>4</b>	<b>Monitoring Functions</b> .....	<b>4-1</b>
4.1	General .....	4-1
4.2	Diagnostics display on the CRT .....	4-1
4.3	Display representation .....	4-2
4.4	Alarm numbers and groups/delete alarms .....	4-4
4.5	DIAGNOSTICS/Selection of further alarms .....	4-5
4.6	Listing of the alarms/alarm description .....	4-5
<b>5</b>	<b>Maintenance</b> .....	<b>5-1</b>
5.1	Operating data .....	5-1
5.2	Handling modules .....	5-1
5.3	Changing the battery in the battery receptacle .....	5-2
5.4	CRT display .....	5-4
5.5	Cleaning .....	5-4
<b>6</b>	<b>Data Interfaces</b> .....	<b>6-1</b>
6.1	General .....	6-1
6.2	Setting data for description of the interfaces .....	6-1
6.3	Assignment of the setting data for the connection of peripheral devices ..	6-3
6.4	Device connection data .....	6-5

<b>7</b>	<b>Interfacing to the Machine</b> .....	7-1
7.1	General notes .....	7-1
7.2	Ordering data - Options .....	7-1
7.3	SINUMERIK 810M machine data .....	7-4
7.3.1	General machine data .....	7-4
7.3.2	Definition of R parameters as cycle machine data, cycle setting data ...	7-6
7.3.3	Machine data bits .....	7-7
7.3.4	Definition of the initial setting of the G groups .....	7-9
7.4	Setting data .....	7-11
7.4.1	General SD bits .....	7-11
7.4.2	Axis-specific bits .....	7-11
7.4.3	Spindle-specific setting data .....	7-12
<b>8</b>	<b>Appendix</b> .....	8-1
8.1	List of abbreviations .....	8-1
8.2	Lists of terms used .....	8-3
8.3	SINUMERIK 810M operator interface - Layout .....	8-10

# 1 General Notes

## 1.1 Product

The SINUMERIK 810M is a microprocessor-controlled CNC continuous-path control system for compact machine tools.

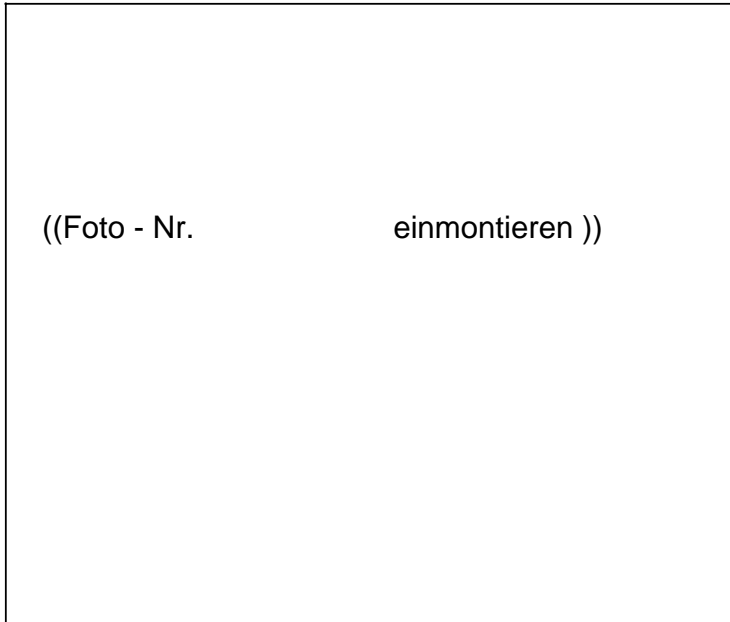

*SINUMERIK 810M without integrated machine control panel*

- The SINUMERIK 810M is used primarily to control boring and milling machines
- Programming can be either computer-aided or manual
- Operation:
  - Softkeys for selecting different softkey functions
  - 9" graphics screen
  - Address/numerical keyboard and function keys
- Screen displays provide information in plain text, e. g. covering:
  - current NC operating modes
  - setpoint / actual values
  - NC and PLC alarms
- Graphics displays aid the programmer when entering programs at the machine.
- "Blueprint programming" is available for higher-speed programming of complex contour elements.
- Entered programs may be simulated graphically.
- The SINUMERIK 810M can process 9999 main programs and 9999 subroutines. 200 main programs and subroutines can be stored simultaneously in the memory.
- Lengthy part programs can be executed using the optional "BLOCK TRANSFER" function.

## 1.2 Configuration

### 1.2.1 SINUMERIK 810M with integrated machine control panel

SINUMERIK 810M with **integrated** machine control panel incorporates in a single unit:

- Display panel
- Key panel
- 9" Graphics CRT display with integrated function keys (softkeys)
- Integrated machine control panel, with 22 fixed-function operating elements.

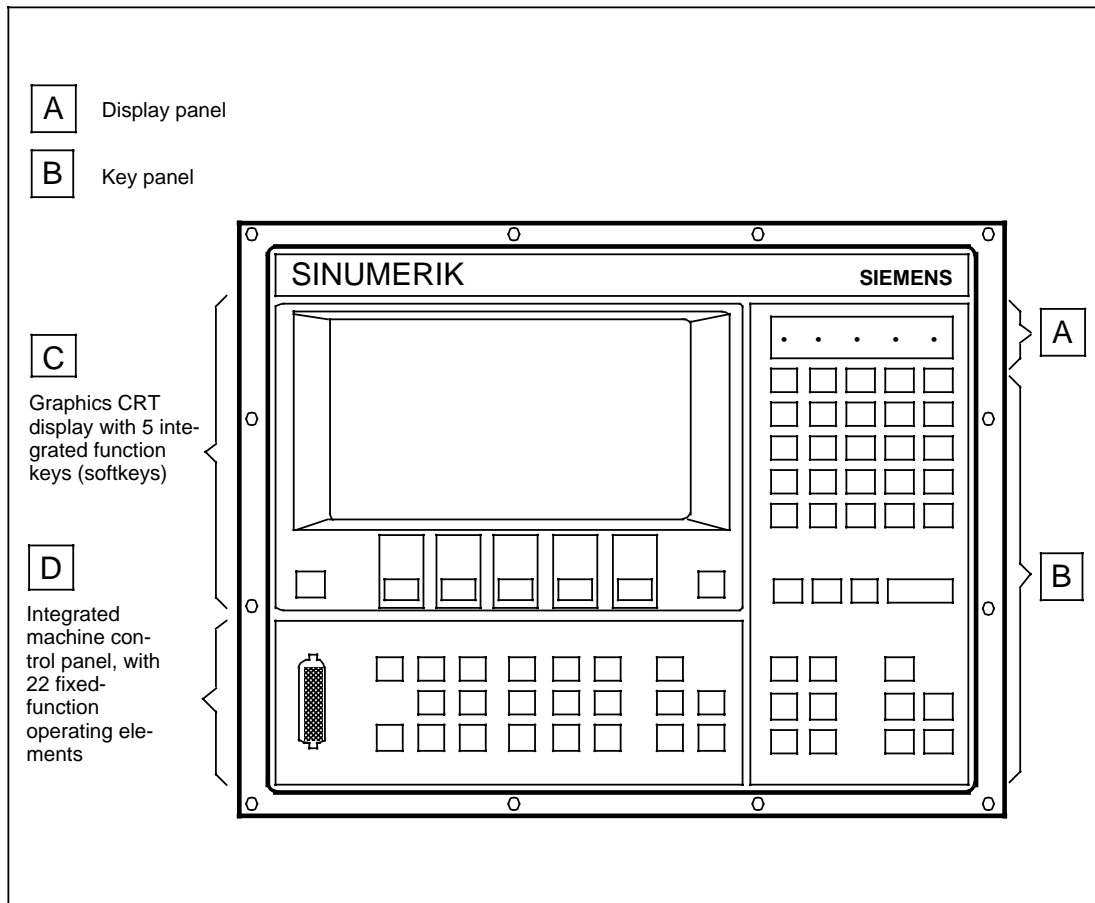

*SINUMERIK 810M with integrated machine control panel*

## 1.2.2 SINUMERIK 810M with external machine control panel

SINUMERIK 810M with **external** machine control panel incorporates in a single unit:

- Display panel, key panel, graphics CRT display as described in Section 1.2.1.
- Blank panel ...
- ... or integrated customer operator panel with 22 freely assignable operating elements,
- External machine control panel with fixed-function operating elements.

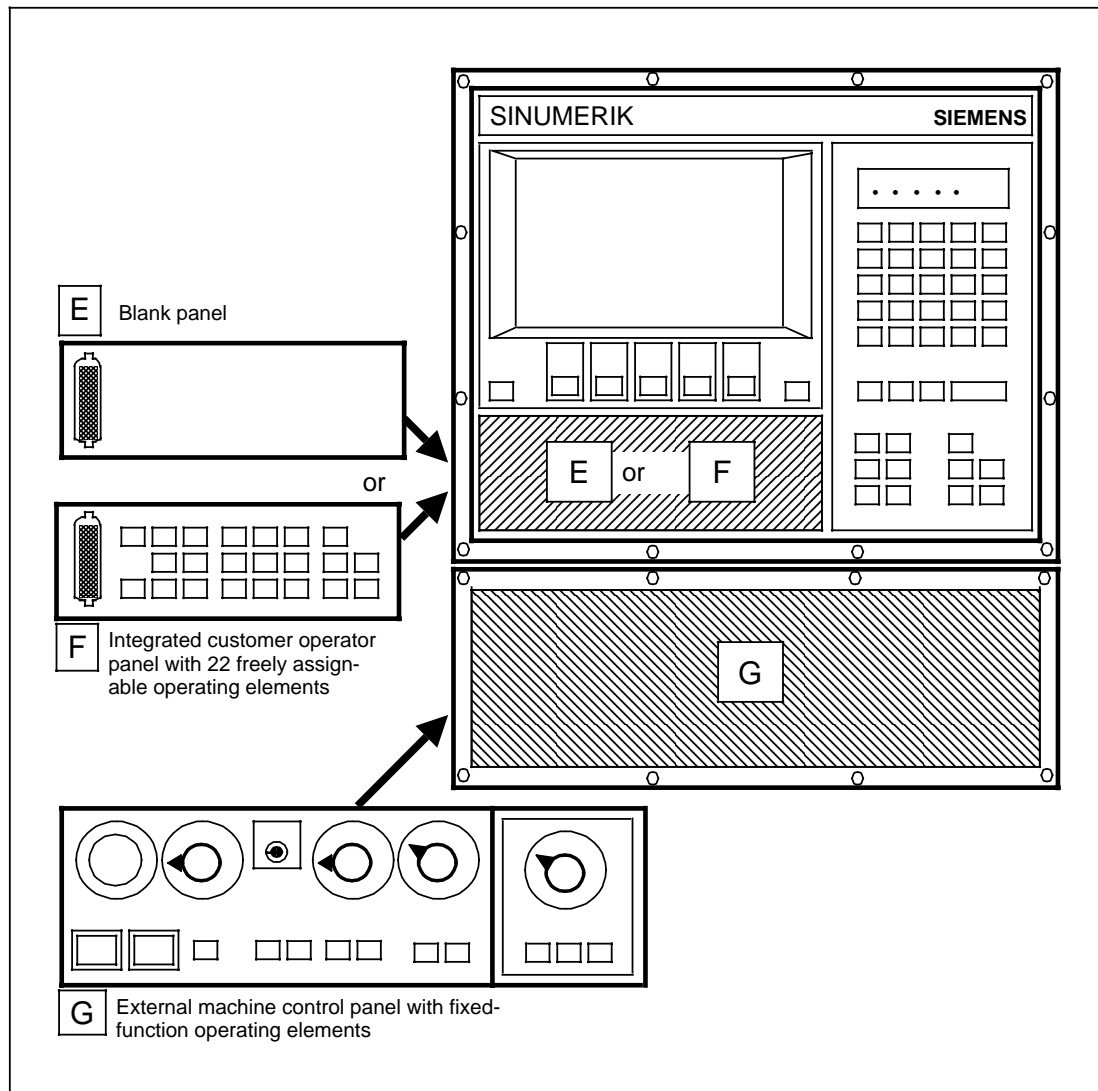

*SINUMERIK 810M with external machine control panel*



## 2 Operation

### 2.1 Operating elements

#### 2.1.1 SINUMERIK 810M operator interface with integrated machine control panel

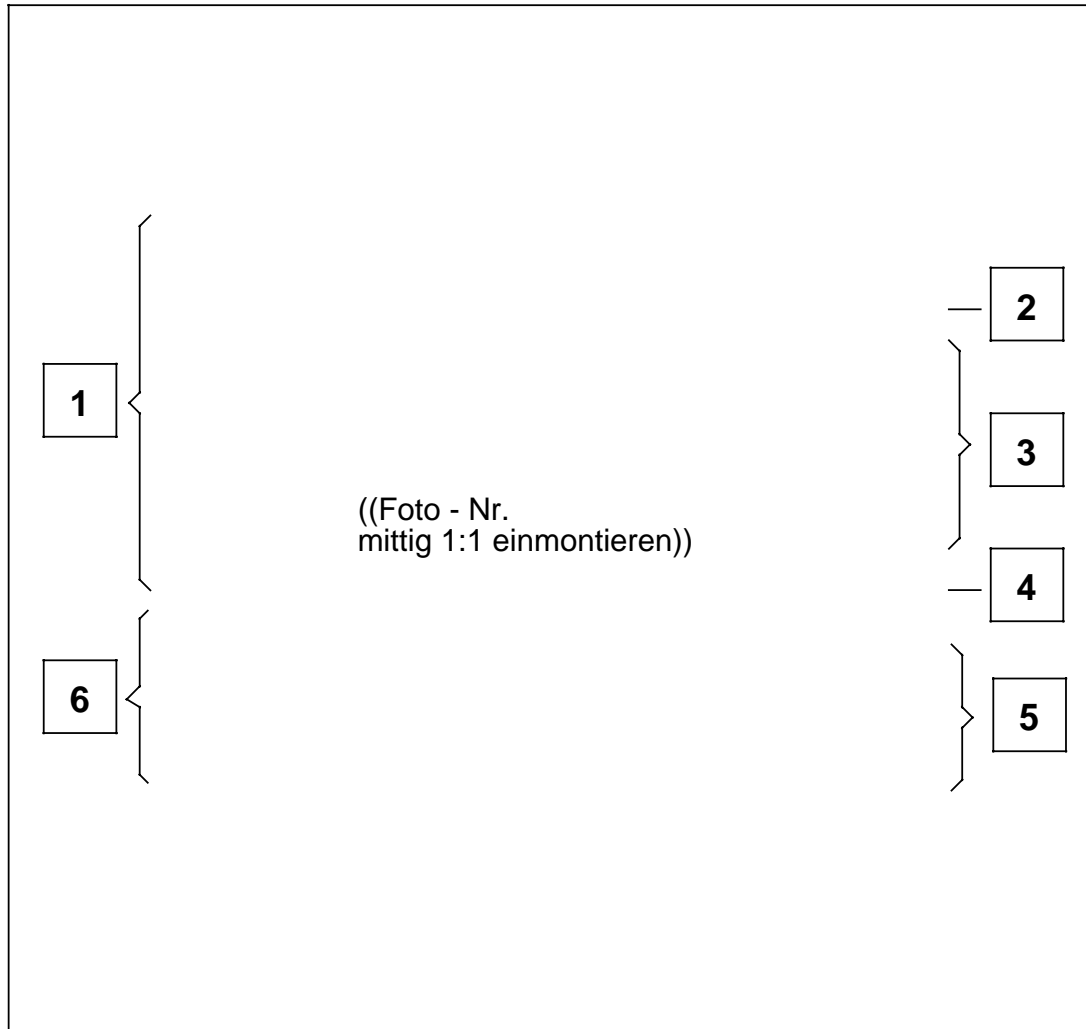

View of the SINUMERIK 810M operator interface with integrated machine control panel

- |   |  |
|---|--|
| <p><b>1</b> CRT display with softkeys<br/>(see Section 2.1.1.1)</p> | <p><b>4</b> Editing and input keys<br/>(see Section 2.1.1.4)</p>           |
| <p><b>2</b> Display panel<br/>(see Section 2.1.1.2)</p>             | <p><b>5</b> Control keys<br/>(see Section 2.1.1.5)</p>                     |
| <p><b>3</b> Address/numerical keys<br/>(see Section 2.1.1.3)</p>    | <p><b>6</b> Integrated machine control panel<br/>(see Section 2.1.1.6)</p> |

### 2.1.1.1 CRT display with softkeys

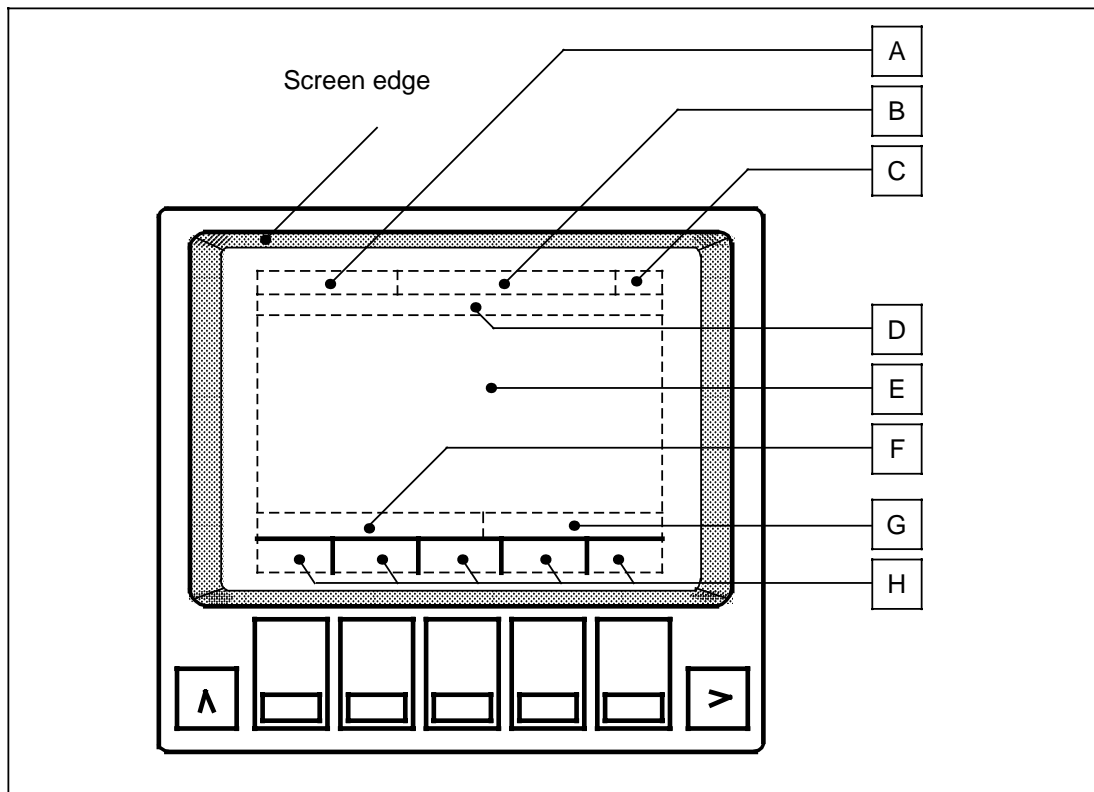

CRT display division, text / graphics only within the area of the dotted lines

The CRT display is divided into **17 lines**, each of **41 characters**. The following table shows the display function of the individual line / line area:

Note	CRT line	Display area for .....	Max. number of characters
A	1	Operating modes	14
B		Operating status	24
C		Channel number	3
D	2	Alarm No., text (comments)	41
E	3 to 14	NC displays, texts, graphics	41 x 12
F	15	Notes for the operator	24
G		Inputs from keyboard	17
H	16 and 17	Softkey menu with up to 5 softkey functions	5 x 7 x 2

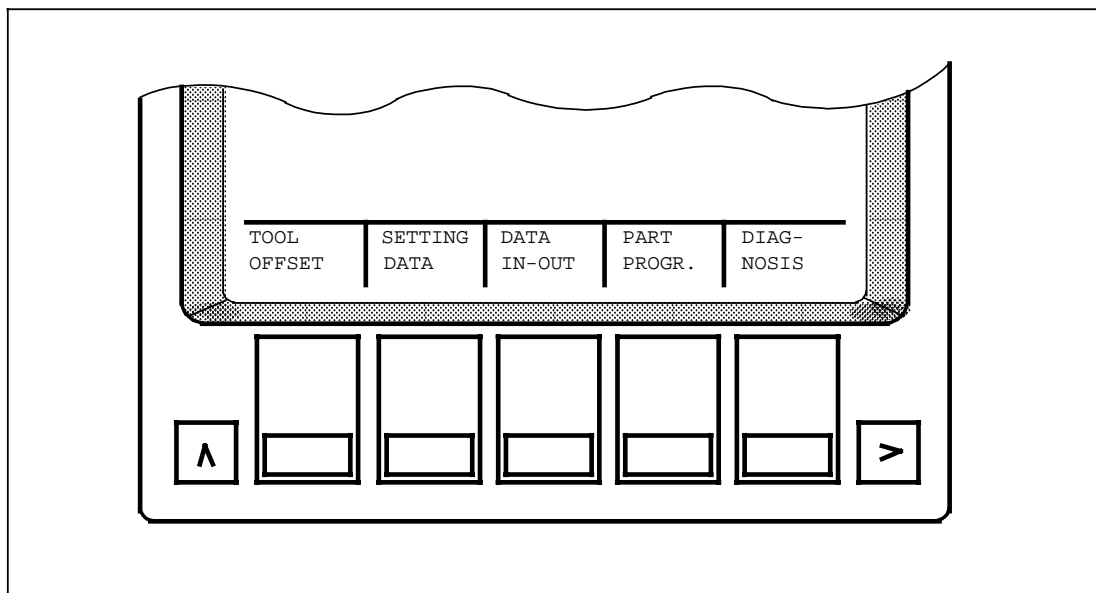

Keys below the CRT display

**“RECALL” key for jump back to a higher-level menu in the text display**



By pressing the RECALL key, you change the softkey functions displayed and return to a **higher-level menu**.

**Softkeys**

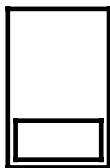

With the operation of any one of the 5 softkeys (a softkey is defined as a key that does not have a fixed function), you select the required softkey functions, shown in the menu directly above the softkey.

**“ETC” key for extension of the same menu**



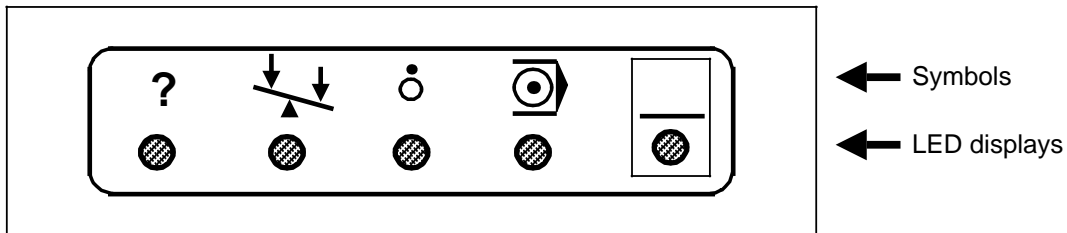

By pressing the ETC key, you change the displayed softkey function in the text display.  
Further functions for **the same menu** are shown.

### 2.1.1.2 Display panel



View of the display panel

#### "Alarm" display

- 
  - The red LED lights up whenever there is a signal from the diagnostics monitor. The CRT display indicates the relevant message no., and the message text (2nd line of display).
- 
  - The message numbers are explained in the Alarm list in Section 4 of this Operator's Guide.
- 
  - The LED is extinguished when the message has been acknowledged:

with key  (Section 2.1.1.5)

with key  (Section 2.1.1.6 or 2.1.2.1)

With certain messages, the display is only extinguished when the cause of the fault has been cleared (Section 4).

#### "Out of position" display

- 
  - The green LED is bright, when at least one axis is moving.
- The LED is extinguished, when all axes have reached their command positions.

If the  display does not clear after a traversing movement, the drift has exceeded the permitted value. Drift compensation **must** then be performed.

#### DIAGNOSIS

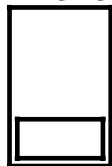

Press the "DIAGNOSIS" softkey.

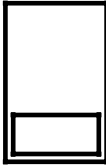

Extend the softkey menu with the ETC key, on the right below the screen.

**NC-MD**

Press the "NC-MD" softkey.

272\*



Use this key to call up MD 272\*. Position the cursor at the desired axis.

- \*=0 1st axis
- \*=1 2nd axis
- \*=2 3rd axis
- \*=3 4th axis
- \*=4 5th axis
- \*=6 6th axis
- \*=7 7th axis.



Press the "Modify word" key.

The new compensation value is displayed in the MD.

#### "Feed hold" display



The red LED is bright when feed is interrupted.  
The program is stopped.



#### "Program running" display



- The green LED is bright when a program is being processed, even if the machine is not moving any axes!



- The LED is extinguished when program processing is completed:
  - with programmed stop M00, M01
  - at the end of single block
  - at the end of program.

<b>"Key assignment" display</b>
---------------------------------

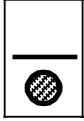

- The yellow LED is bright:  
When the **lower** symbols of all the double-function keys on the Address/numerical keyboard (Section 2.1.1.3) are active:  
The **lower** character of the operated double-function key is shown in the input line (Section 2.1.1.1).

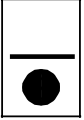

- The yellow LED is extinguished:  
When the **upper** symbols of all the double-function keys on the Address/numerical keyboard are active:  
The **upper** character of the operated double-function key is shown in the input line.

- Both display states:



yellow LED extinguished



yellow LED bright

are automatically switched over by the NC control.

- Using the key



on the Address/numerical keyboard (see Section 2.1.1.3) you can also switch over "manually".

### 2.1.1.3 Address / numerical keys

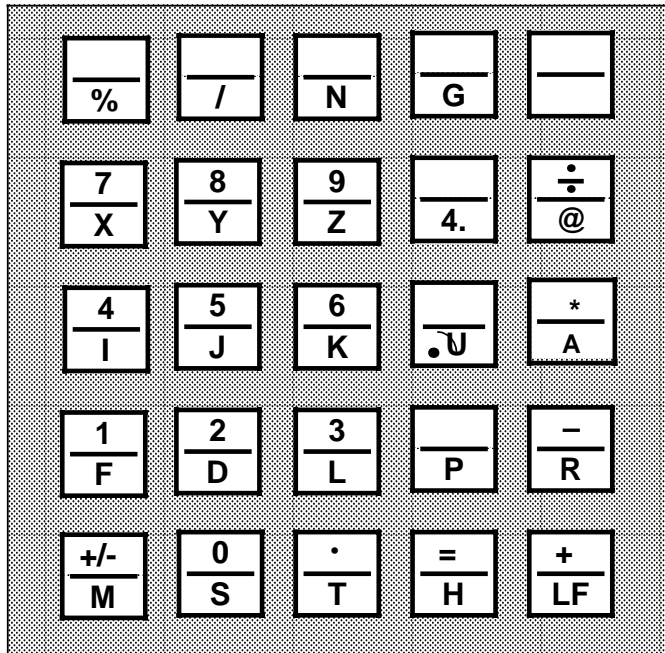





View of the address / numerical keys

#### Note:

The address/numerical keyboard can be assigned differently by the machine tool manufacturer. The description below shows the standard assignment.

#### Description of the double function keys

	Letter: <b>a</b> 1)
	Symbol for: " <b>Program start</b> "
	Letter: <b>b</b> 1)
	Symbol for: " <b>Skip block</b> "
	Letter: <b>c</b> 1)
	Address for: " <b>Block No.</b> " <b>N</b> ----
	Letter: <b>d</b> 1)
	Address for: " <b>Preparatory function</b> " <b>G</b> --

1) Note: These letters are not permissible for normal programming. They are used for input of, or changes to, commands in "CL800" Machine Code (@ . . .).



Key assignment changeover:

With successive operations of this key you make either the upper or lower symbols of the double function keys active

- yellow LED (Section 2.1.1.2) lit: lower symbols are active
- yellow LED not lit: upper symbols are active



Numeral: **7**

Address for: "**Position information**" X axis .....



Numeral: **8**

Address for: "**Position information**" Y axis .....



Numeral: **9**

Address for: "**Position information**" Z axis .....



Letter **e**<sup>1)</sup>

Address for: "**Position information**" 4th axis .....



Symbol for: "**Division**"

Address for: "**Program control function**" @ .....



Numeral: **4**

Address for: "**Interpolation parameter**" I .....



Numeral: **5**

Address for: "**Interpolations parameter**" J .....



Numeral: **6**

Address for: "**Interpolations parameter**" K .....



Letter **f** <sup>1)</sup>

Address for: "**Radius**" U .....

1) Note: These letters are not permissible for normal programming. They are used for input of, or changes to, commands in "CL800" Machine Code (@ . . .).

2) Note: The 5th axis must be programmed by the extended address writing method. There is no separate key available for the 5th axis.



$\frac{*}{A}$	Symbol for: <b>"Multiplication"</b> Address for: <b>"Angle" A .....</b>
$\frac{1}{F}$	Numeral: <b>1</b> Address for: <b>"Feed" F .....</b>
$\frac{2}{D}$	Numeral: <b>2</b> Address for: <b>"Tool offset number" D ...</b>
$\frac{3}{L}$	Numeral: <b>3</b> Address for: <b>"Subroutine number" L ...</b>
$\frac{\sim}{P}$	Symbol for: <b>(Tilde character)</b> Address for: <b>"Subroutine pass" P ..</b>
$\frac{-}{R}$	Symbol for: <b>"Subtraction"</b> Address for: <b>"Parameter " R ...</b>
$\frac{+/-}{M}$	Sign changeover for <b>+ - oder - +</b> Address for: <b>"Auxiliary function" M ..</b>
$\frac{0}{S}$	Numeral: <b>0</b> Address for: <b>"Spindle speed" S .....</b>
$\frac{\cdot}{T}$	Symbol for: <b>"Decimal point"</b> Address for: <b>"Tool number" T ....</b>
$\frac{=}{H}$	Symbol for: <b>"Equals"</b> Address for: <b>"Auxiliary function" H ....</b>
$\frac{+}{LF}$	Symbol for: <b>"Addition"</b> Symbol for: <b>"End of block" (Line Feed)</b>

### 2.1.1.4 Editing and input keys

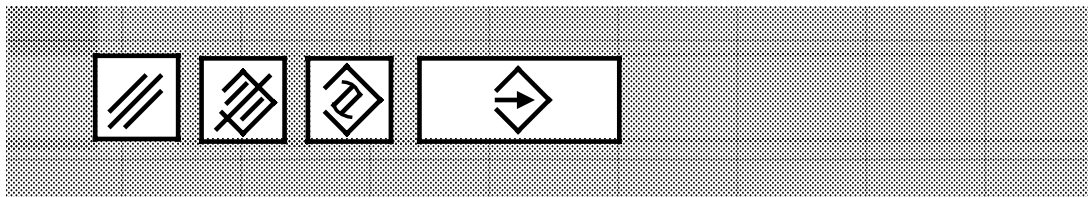

View of editing and input keys

#### Delete input / operator message



With this key you delete:

- Characters on the input line (Section 2.1.1.1)
  - with single operation: always the last / most extreme right character
  - with continuous operation: all characters consecutively, from right to left, until the input line is clear.
- Characters on the operator message line (Section 2.1.1.1)
  - with single operation: all characters simultaneously

#### Delete word / block



With this key you delete from the part program memory

- The **word** on the CRT display to the **right** of the cursor (Section 2.1.1.5), when the **same address** is shown on the input line (Section 2.1.1.1).
- The **block** on the CRT display to the **right** of the cursor; when the **same block number** is shown on the input line.

#### Modify word



With this key you modify the **word** on the CRT display to the **right** of the cursor in the part program memory (Section 2.1.1.5):

The word marked with the cursor is modified to the word with the **same address** that is shown on the input line (Section 2.1.1.1).

#### Input character / word



You conclude your inputs with this key:

- The **characters** shown on the input line (Section 2.1.1.1) are transferred into the **screen list**, i.e. the **input field** where the cursor (Section 2.1.1.5) is positioned is transferred.
- A **word** shown on the input line is transferred into the **part program memory**.

### 2.1.1.5 Control keys

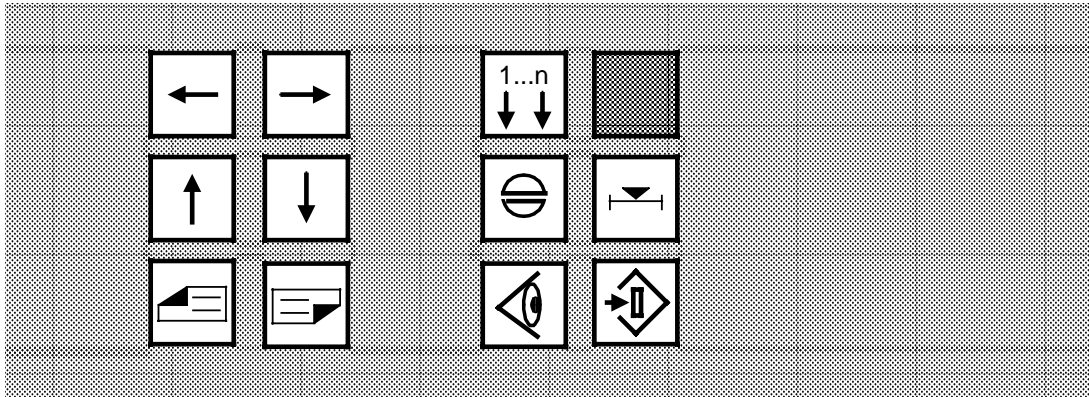

View of the control keys

#### Cursor left / right movement Cursor up/down movement

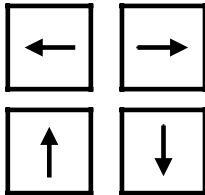

With these keys you move the cursor on the CRT  
SINUMERIK 810M differentiates between:

- Cursor for marking a word / block within displayed **part programs**  
Cursor appearance / format: ■
- Cursor for marking an input field within displayed **input forms / dimensioned graphics**  
Cursor appearance / format: ■■■■ or ■■

(Cursor length depends on the max. permitted number of characters of the marked field).

#### Cursor movement in a part program



With this key you move the cursor :

- from word to word, to the left
- to the end of the previous block (after the last word / in front of LF), when the cursor is positioned before the start of the block.



With this key you move the cursor :

- from word to word, to the right
- before the start of the following block, when the cursor is positioned at the end of block (after the last word / in front of LF).



With this key you move the cursor

- from the start of block to the start of the previous block
- to the start of the block in which the cursor is positioned
- to the start of program by continuously operating the key



With this key you move the cursor

- from the start of block to the start of the following block
- to the start of the following block if the cursor is positioned within a block
- to the end of program by continuously operating the key

### Cursor movement in an input screen form / dimension graphic display



With one of these keys, you move the cursor

- **Backwards** in an **input form** \* from field to field: from right to left in the line and then to the line above from right to left etc.



- Backwards in a **dimensioned graphic display** to the previous point; if the key is operated continuously, the cursor jumps to the input field for the first dimension to be input.



With one or the other of these keys, you move the cursor

- **Forwards** in an **input form** \* from field to field: from left to right in the line, and then to the line below from left to right



- **Forwards** in a **dimensioned graphic display**, after the previously entered sequence of measurement; If the key is operated continuously, the cursor jumps to the input field for the last dimension to be input.

- \* Input forms are available for:  
Tool offset, setting data, machine data, operator prompting (guiding), ect.

### Paging up / down



By operating either of these keys you can change the current CRT display when further displays of a similar format are available..



You page one display **up**.



You page one display **down**.

## Channel changeover



The control has **3 channels** :

- By pressing this key once, you switch to the next higher channel no. than the one displayed
- Pressing the key again switches to the next higher channel.

### Explanation of channel structure:

The three channels have the following significance:

Channel 1: **Main channel** for processing part programs and spindle programming.

Channel 2: **Auxiliary channel** for processing programs for auxiliary axes or calculation functions in the background.

Channel 3: **Graphic simulation** for program display on the CRT.  
(Note : Graphic simulation is an Option).

*In addition to structural operations such as program editing and interface operation parallel to program processing, the channels also permit the simultaneous processing of two different programs.*

*All three channels can be operated simultaneously. However with a few functions, collision problems can occur.*

Function set of the channels ( • ... function not implemented):

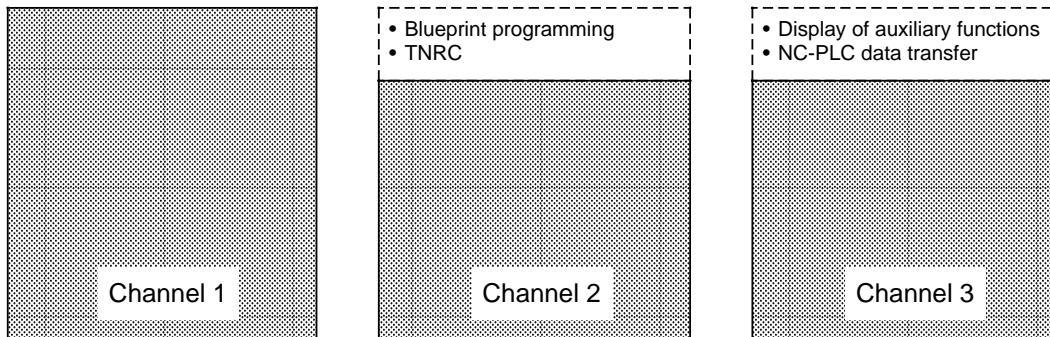

*Channel 2 (except for the functions not implemented) is a fully operative channel. Its main function is the execution of auxiliary movements (e.g. tool change) or calculations in the background.*

*The same axis can be traversed in both Channel 1 and Channel 2 if it can be ensured that a traversing command is not output by Channel 1 and Channel 2 **simultaneously** (...Alarm 180\*: "Axis programmed in both channels")*

*The main function of the auxiliary channel is the operation of loader axes under PLC control simultaneous with the main channel.*

*If the above-mentioned conditions are observed, other concepts can be implemented with the auxiliary channel, opening up a whole range of possible applications.*

*However, as only M functions can be transferred to the PLC from channel 2, the exchange of data with the PLC is restricted.*

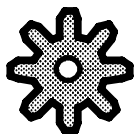

**Please refer to the machine tool manufacturer's documentation:**

- **Is channel changeover used?**
- **Which axes are allocated to which channel?**

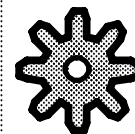

### Acknowledge alarm



With the operation of this key:

- you **acknowledge** the information from the NC diagnostics, displayed on the second line of the CRT display (see Section 2.1.1.1)
  - Fault message text
  - Fault message number

for message nos. 3000 .... 3094  
and nos. 6000 .... 6163

Program operation is not interrupted!

- you **clear** the red fault LED  on the display panel (see Section 2.1.1.2)



### Actual position in double height characters



When you operate this key, the CRT display of "Actual position" for the " X, Y, Z", 4th and 5th axes (e.g. C1, C2 axes) is shown in double-height characters. Axes 3-7 can be displayed with the "page down" function.

(( Bild 810M/1 einmontieren))

The "Distance to go" display remains in normal character size.  
The CRT. information previously displayed is faded out.  
Further operation of the key will take you back to the previous display (with normal character size).

***If you set setting data 5001, bit 0, the actual value display refers to the workpiece zero and not to the reference point, i.e. the zero offset and the tool offsets are not displayed.***

### Diagnostics and start up



This switch is intended for:

- Start up
- Service

Please see the Installation Guide for further information.

### Search for address / block no. / word / calling up data



You operate this key when you want to search in a **part program** for:

- an address
- a block number
- a word

or when you want to **display on the screen**:

- a tool offset number (with the appropriate data)
- a machine datum (MD) or setting datum (SD) .

**Before** operating the Search key you need to write the data to be searched for into the input line (see Section 2.1.1.1).

Upon operation of the key, the cursor (appearance / format: **█** ) jumps directly to the data searched for.

Please note when searching in a part program:

- Addresses (other than the N... address) and words are only searched for from the current cursor position in the direction of end of program.
- If the data sought is between the start of the program and the current cursor position, it will not be found; the "CHARACTER NOT FOUND" message is shown in the operator prompt line (see Section 2.1.1.1).
- Block numbers (e.g. "N85") are searched for and marked in both directions of program end and program start.

***If, before entering a block number, you move the cursor to the next line with the "+" key and the enter key, the block numbers are not displayed.***

### 2.1.1.6 Integrated machine control panel

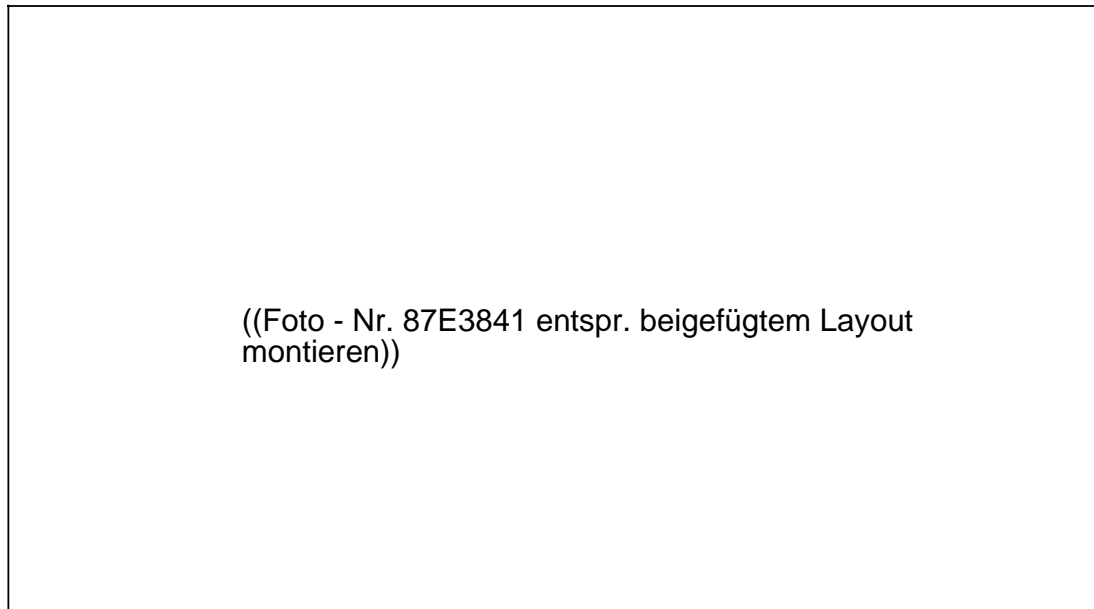

View of the integrated machine control panel / SINUMERIK 810 M

#### Description of the keys

##### Reset



When you operate the "Reset" key:

- Operation of the current part program is interrupted.
- Diagnostics messages are cleared (Alarm nos.100 to 2999).
- The control is switched to the "RESET" state:
  - the NC remains synchronized with the machine
  - all buffer and working memories are cleared (the part program memory remains unchanged)
  - the control is in the reset condition and ready for a new program start



### Single block



This key enables you to run a part program on a block-by-block basis in the "AUTOMATIC" operating mode.

When you operate this key, the "SBL" (Single block) message is displayed on the first line of the CRT (Section 2.1.1.1).

The current part program block is processed when

you press the "Program start" key:



When the block has been processed, the message "HOLD SINGLE BLOCK" is displayed on the CRT.

When you operate the "Program start" key again, the next block is called and processed etc.

When you terminate single block operation by pressing the

key again: 

### Program stop / Program start (NC stop / NC start)



When you press the "Program stop" key:



The operation of the program is interrupted.

You can continue the operation by pressing "Program start".

When you press the "Program start" key:



The active part program is re-started at the current block. In Automatic operation, the overstored functions are transferred to the PLC.

### Spindle stop / Spindle start

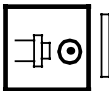
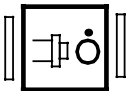

When you operate the "Spindle stop" key:

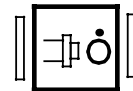

- the spindle is reduced to standstill.



**Example for the use of "Spindle stop":**

- during operation in "MDI AUTOMATIC" mode, a block with a fault is discovered
- in "JOG", "INC..", "REPOS" modes e.g. during repositioning to the contour
- to change a tool
- to input S, T, H, M functions during setting up (overstore)

When you operate the "Spindle start" key:

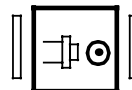

- the spindle runs at the speed specified in the part program.

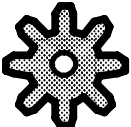

*The following values are specified in machine data:*

- *the max. spindle speed*
- *the values for the spindle speed override switch positions.*

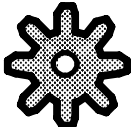

**Feed hold/Feed start**

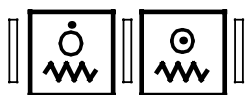

When you operate the "Feed hold" key:

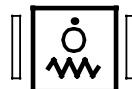

- the feed drives are brought to a defined standstill
- the red "Feed hold" LED  lights up.

**Example of the use of "Feed hold":**

- during operation in "MDI AUTOMATIC" mode, a block with a fault is discovered
- in "JOG", "INC..", "REPOS" modes , e.g. during repositioning to the contour
- to change a tool
- to input S, T, H, M functions during setting up (overstore).

When you operate the "Feed start" key:

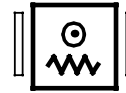

- the feedrate reaches the value specified in the part program.

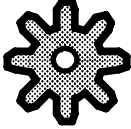

**The following values are specified in machine data:**

- the feed and rapid traverse rates
- the values for the feedrate override switch positions
- whether the feedrate override switch is also active for rapid traverse.

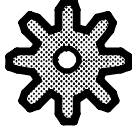

#### Direction keys/Jogging axes



This key pad enables you to jog the axes in the "JOG", "REPOS" or "INC..." modes.



- The "Feed stop" LED must not be bright.



- The CRT shows you the **specified** feedrate value "F" at which the axes will travel when you operate the direction keys. The value is displayed as an absolute value, and as a "%" of the **programmed** feedrate "F" (see: "Feedrate decrease / increase" in this Section).
- You can traverse up to 2 axes simultaneously.
- In "JOG" the feed motion is arbitrary. The traverse path is only limited by the end limit switch.
- In "REPOS" the feed motion is arbitrary (see "JOG").  
If, however, the point of interruption (in a part program that has been partially run) is reached first, the direction keys become **inactive**.
- The direction keys can traverse the axes:
  - in **continuous mode**
  - in **jog mode**.

**For the 5th axis there are no keys available on the integrated control panel.**

**Continuous mode:**

When the direction key is pressed (whether you press for a short or long time), the axis only traverses one increment (1/ 10/ 100/ 1000/ 10000  $\mu\text{m}$ , depending on the setting).

**Jog mode:**

The axis traverses as long as you press the direction key. Traversing stops when you release the key. This also happens if the set increment has not been reached.

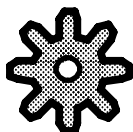

*It is defined in machine data whether the axes are traversed using the direction keys in either:*

- continuous mode
- jog mode .

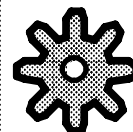

## Function of the direction keys

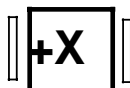

With this key you traverse the "X" axis.



With this key you traverse the "X" axis in the opposite direction.



With this key you traverse the "Y" axis.



With this key you traverse the "Y" axis in the opposite direction.



With this key you traverse the "Z" axis.

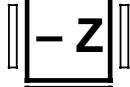

With this key you traverse the "Z" axis in the opposite direction.



With this key you traverse the "4th" axis (auxiliary axis).



With this key you traverse the "4th" axis (auxiliary axis) in the opposite direction.

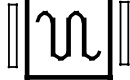

Rapid traverse override:

When you operate this key at the **same time** as any of the keys above, the axis is traversed at **rapid**.

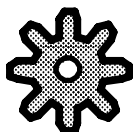

*The rapid traverse speed is defined in a machine data.*

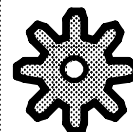

### Key for the selection of operating modes



You use this key when you want to select operating modes or further softkey functions.

The menu selected is shown on the bottom two lines of the CRT display (menu for softkey functions Section 2.1.1.1) .

Operate the  key

until you see the menu for the following operating modes displayed:

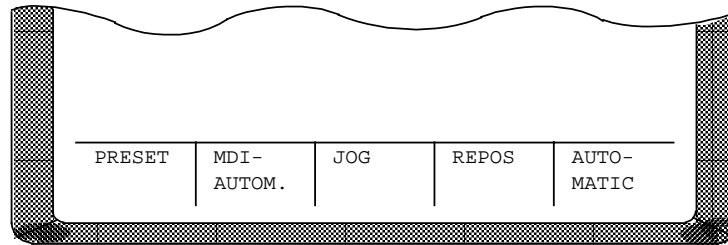

Section of the CRT display with menu of the operating modes

Operate the  key a second time.

A menu of further softkey functions is displayed.

The menu displayed depends on the current operating mode, which is shown on the first line of the display (see Section 2.1.1.1).

For detailed information see Sections 2.3.3 to 2.3.6 and 2.4 !

You can extend the displayed operating mode menu:

Operate the ETC key  below the CRT.

The extension of the operating mode menu is shown:

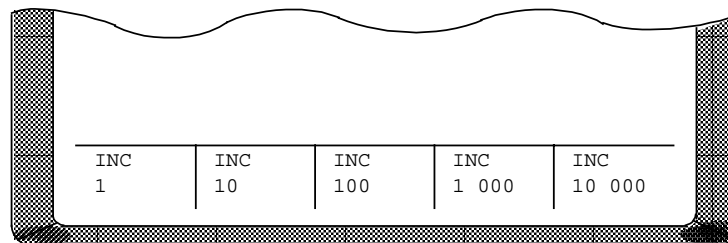

Section of the CRT display:  
1st extension of the operating mode menu

Operate the ETC  key a second time.

A 2nd extension of the operating mode menu is shown.

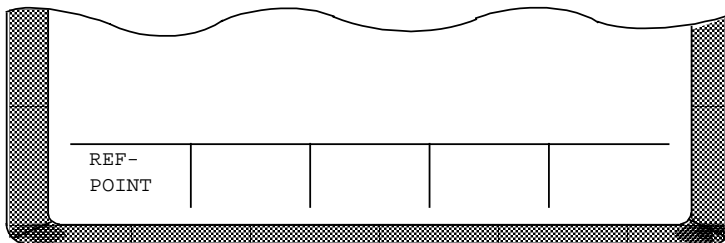

Section of the CRT display:  
2nd extension of the operating mode menu

Operate the ETC  key a third time.

The text display returns to the operating mode menu first selected, ect.

### Spindle speed override decrease / increase

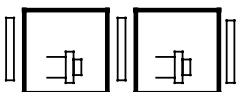

The two keys make it possible for you to decrease or increase the **programmed** spindle speed value "S" (with reference to 100% value).

The set spindle speed value "S" set with these keys is displayed as an **absolute** value, and as a percentage.

Operate the  key quickly.

The spindle speed is **reduced by 5%**.

**Continuous operation** causes the spindle speed to be **reduced** in steps of 5% until the end value **0%** (zero speed) is reached.

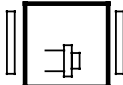
Operate the  key quickly.

The spindle speed is **increased** by 5%.

**Continuous operation** causes the spindle speed to be **increased** in steps of 5% until the end value **120%** is reached.

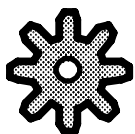

*The increments specified apply to standard machine data.*

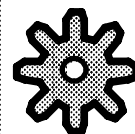

### Feed or rapid traverse override decrease / increase

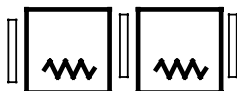

The two keys make it possible for you to decrease or increase the **programmed** feedrate value "F" (with reference to 100% value). The value set with these keys is displayed as an absolute value and as a percentage.

Operate the  key quickly.

The feedrate is **decreased** in the following steps:

- by 5%, in the feed range 120 % to 70 %
- by 10%, in the feed range 70 % to 10 %
- by 2%, in the feed range 10 % to 2 %
- by 1%, in the feed range 2 % to 0 %

**Continuous operation** causes the feedrate to be **decremented** in steps until the end value 0% (standstill) is reached.

Operate the  key quickly.

The feedrate is **increased** in the following step:

- by 1%, in the feed range 0 % to 2 %
- by 2%, in the feed range 2 % to 10 %
- by 10%, in the feed range 10 % to 70 %
- by 5%, in the feed range 70 % to 120 %

**Continuous operation** causes the feedrate to be **incremented** in steps until the end value 120% is reached.

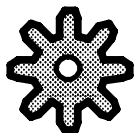

*The increments specified apply to standard machine data.*

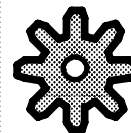

### Socket connector for universal interface

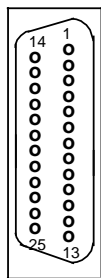

Beneath the cover hinged on the left, you will find a 25-pole socket for D-type sub-miniature connectors.

Via this V.24 (RS232) / 20 mA interface, you can transfer serial data to or from peripheral devices.

For details of transmission data see Section 6.3 (Setting data), and for device connection see Section 6.4 (Device connection data).

For details of the correct connecting cables see : "SINUMERIK System 800", Configuring Instructions / Universal Interface.





## 2.1.2 SINUMERIK 810M operator interface with external machine control panel

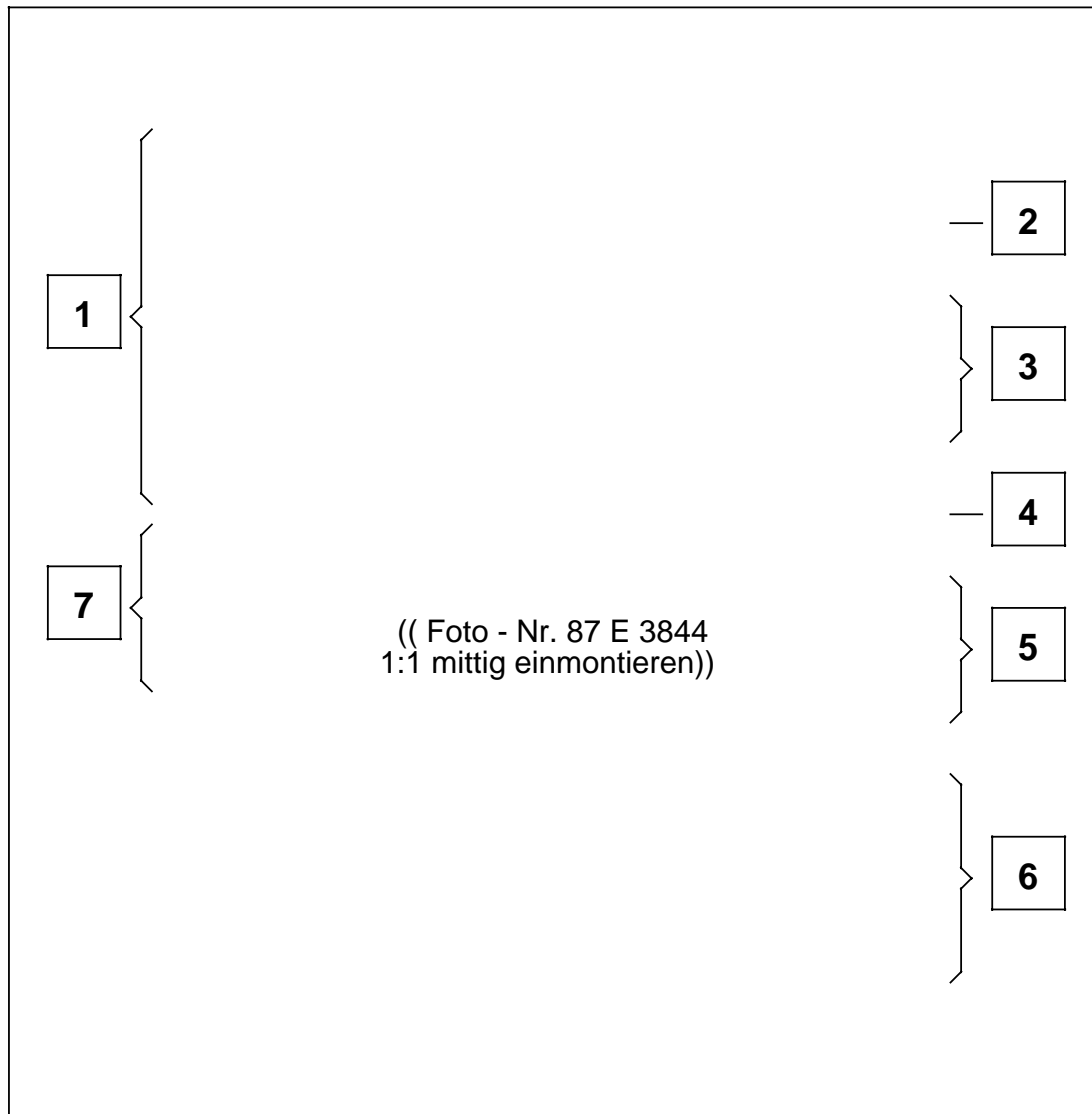

View of the SINUMERIK 810M operator interface with external machine control panel

- |   |   |
|---|---|
| <p><b>1</b> CRT display with softkeys<br/>(see Section 2.1.1.1)</p> | <p><b>4</b> Editing and input keys<br/>(see Section 2.1.1.4)</p>  |
| <p><b>2</b> Display panel<br/>(see Section 2.1.1.2)</p>             | <p><b>5</b> Control keys<br/>(see Section 2.1.1.5)</p>  |
| <p><b>3</b> Address / numerical keys<br/>(see Section 2.1.1.3)</p>  | <p><b>6</b> External machine control panel<br/>(see Section 2.1.2.1)</p>                                |
|   | <p><b>7</b> Operator panel with 22 freely assignable unlabelled keys, or blank panel with connector</p> |

### 2.1.2.1 External machine control panel



*View of the external machine control panel*

#### Explanation of the operating elements

##### Emergency stop switch

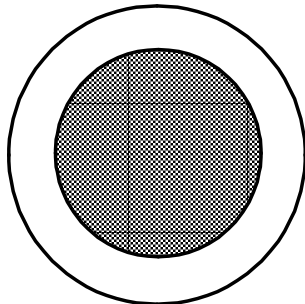

You operate the red switch in **emergency situations**:

- when there is a danger to life
- when there is a danger that the machine or workpiece could be damaged.

Operation of the Emergency stop switch generally brakes all drives with maximum braking power to a defined state and causes a RESET.

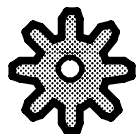

*Further or other reactions to "Emergency stop" are possible.*

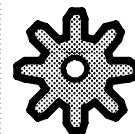

**Operating mode selector switch**

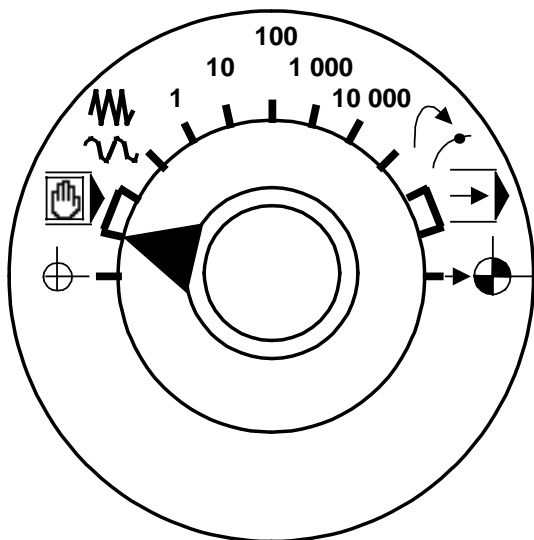

This rotary switch with 13 latched positions enables you to select the following operating modes:

Symbol on the selector switch	Function	Designation of the operating mode
	<b>ACTUAL VALUE SETTING</b>	<b>PRESET</b> <u>Preset</u> <u>Setpoint</u> (1st position)
	<b>MANUAL DATA INPUT/ AUTOMATIC</b>	<b>MDI - AUTOMATIC</b> <u>Manual</u> <u>Data</u> <u>Input</u> - <u>Automatic</u> (2nd and 3rd position)
	<b>FEED/ JOG</b>	<b>JOG</b> <u>Jogging</u> (4th position)
1, 10, 100, 1 000, 10 000	<b>INCREMENTAL TRAVERSE</b>	<b>INC FEED...</b> <u>Incremental</u> <u>Feed</u> (5th to 9th position)
	<b>REPOSITIONING</b> Reapproach contour	<b>REPOS</b> <u>Reposition</u> (10th position)
	<b>AUTOMATIC OPERATION</b> Processing of stored programs	<b>AUTOMATIC</b> (11th and 12th position)
	<b>TRAVERSE TO REFERENCE POINT</b>	<b>REFPOINT</b> <u>Reference</u> <u>Point</u> (13th position)

### Single block switch

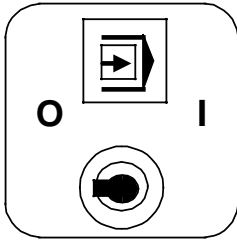

This key enables you to run a program on a block-by-block basis in the "AUTOMATIC" operating mode.

When the switch is in position "0": Single block operation is not active!

When the switch is in position "I": Single block operation is active!

When single block operation is active :

- the "SBL" (Single block) message is shown on the first line of the CRT (2.1.1.1)
- the current part program block is processed when you press the "Program start" key 
- when the block has been processed, the "HOLD SINGLE BLOCK" message is displayed on the CRT
- when you operate the "Program start" key again, the next block is transferred and processed etc...

**For certain functions (e.g. "coordinate rotation", "soft approach to contour"), the control inserts further blocks. Depending on the number of blocks inserted the "program start" key must be pressed several times.**

### Spindle speed override switch

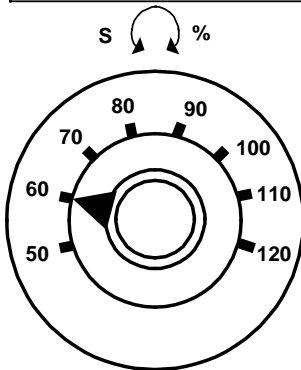

- The rotary switch, with 16 latched positions, enables you to decrease or increase the programmed spindle speed "S" (relative to 100%).
- The actual function of the switch depends on machine data.
- The set spindle speed value "S" is displayed on the CRT as an absolute value and as a percentage.

Control range: 50% ..... 120% of the programmed spindle speed

Step increment: 5% from position to position

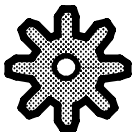

**The step increment and control range specified apply to standard machine data.**

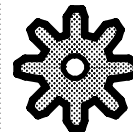



**Feed / rapid override switch**

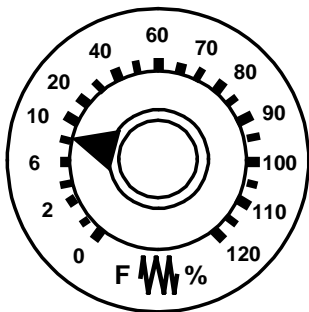

The rotary switch, with 23 latched positions, enables you to decrease or increase the **programmed** feedrate value "F" (relative to 100%).

The set feedrate value "F" is displayed on the CRT in %.

Control range: 0% . . . . . 120% of the programmed feed rate.  
In **rapid**, the maximum is 100%.

Step value: 0%, 1%, 2%, 4%, 6%, 8%, 10%, 20%, 30%, 40%, 50%, 60%, 70%, 75%, 80%, 85%, 90%, 95%, 100%, 105%, 110%, 115%, 120%.

*The step increment and control range specified apply to standard machine data.*

**Switch for switching on the NC control**



By operating this key, you switch the NC control on.

**Key-operated switch for input inhibit / operation inhibit**

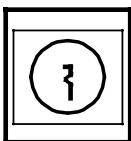

You can inhibit data input with the key-operated switch. Then associated operating functions are no longer possible. (e.g. COPY, DELETE, REORG, RENAME, MOVE).



The key can be withdrawn.



The key **cannot** be withdrawn.

*The step increment and control range specified apply to standard machine data.*

## Reset



When you operate the "Reset" key:

- The current part program is interrupted.
- Diagnostics messages are cleared (Alarm nos.100 to 2999)
- The control is switched to the "Reset" state:
  - the NC remains synchronized with the machine
  - all buffer and working memories are cleared (the part program memory remains unchanged)
  - the control is in the reset condition and ready for a new program start

## Program stop / program start (NC stop / NC start)

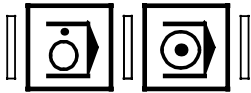

When you press the "Program stop" key:

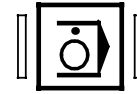

The program being processed is interrupted. You can continue the operation by pressing "Program start".

When you press the "Program start" key:



The part program called is re-started at the current block. In automatic operation the overstored functions are transferred to the PLC.

## Spindle stop / Spindle start

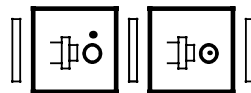

When you operate the "Spindle stop" key:

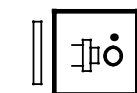

- the spindle is brought to a standstill

### Example of the use of "Spindle stop"

- during operation in "MDI AUTOMATIC" mode, a block with a fault is discovered
- in "JOG", "INC.", "REPOS" modes, e.g. during repositioning to the contour
- to change a tool
- to input S, T, H, M functions during setting up (overstore)



When you operate the "Spindle start" key:

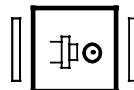

- the spindle speed accelerates to the value specified in the part program

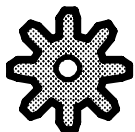

**The following values are specified in machine data:**

- the max. spindle speed
- the values for the spindle speed override switch positions.

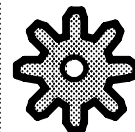

### Feed hold/ Feed start



When you operate the "Feed hold" key:



- the feed drives are brought to a standstill
- the red "Feed hold" LED  lights up



#### Examples of the use of "Feed hold"

- during operation in "MDI AUTOMATIC" mode, a block with a fault is discovered
- in "JOG", "INC..", "REPOS" modes, e.g. during repositioning to the contour
- to change a tool
- to input S, T, H, M functions during setting up (overstore)

When you operate the "Feed start" key:



- the feedrate is accelerated to the value given in the part program

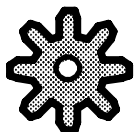

**The following values are specified in machine data:**

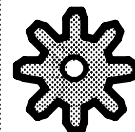

- the feed and rapid traverse rates
- the values for the feedrate override switch positions
- whether the feedrate override switch is also active for rapid traverse.

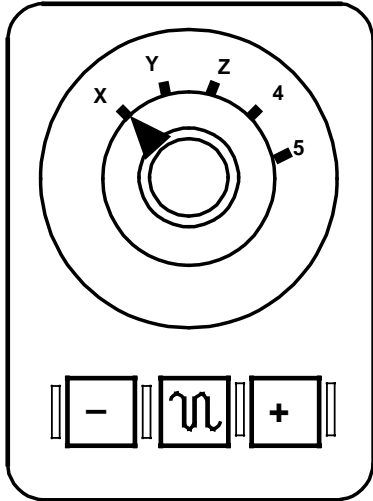

### Axis selector switch with direction keys / Jogging axes



This key pad enables you to jog the axes in the "JOG", "REPOS" or "INC..." modes.

- The "Feed hold" LED must not be bright
  - 
  - 
- The CRT shows the **specified** feedrate value "F" at which the axes will travel when you operate the direction keys. The value is displayed as an absolute value and as a "%" of the **programmed** feedrate (see Section 2.1.1.6: "Feedrate decrease / increase", in this section)
- In "JOG" the feed motion is arbitrary. The traverse path is only limited by the end limit switch.
- In "REPOS" the feed motion is arbitrary (see "JOG").  
If, however, the point of interruption (in a part program that has been partially run) is reached first, the direction keys become **inactive**.
- The direction keys can traverse the axes:
  - in **continuous mode**
  - in **jog mode**

#### **Continuous mode:**

When the direction key is pressed (whether you press for a short or long time), the axis only traverses one increment (1/10/100/1000/10000  $\mu\text{m}$ , depending on the setting).

#### **Jog mode:**

The axis will traverse as long as you press the direction key. Traversing stops when you release the key. This also happens if the set increment has not been reached.

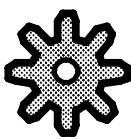

**It is defined in machine data whether the axes are traversed using the direction keys in either:**

- **continuous mode**
- **jog mode.**

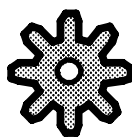

### Function of the axis selector switch with direction keys

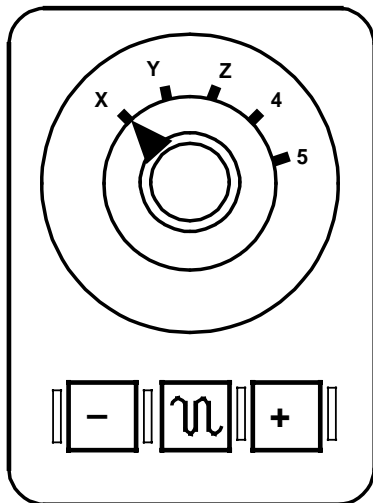

Select the axis to be traversed with the axis selector switch (X axis in the example).



Traverse the axis selected.



Traverse the axis selected in the opposite direction.



Rapid traverse:  
When you operate this key **together** with one of the above keys, the axis is traversed **at rapid**.

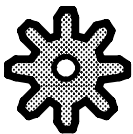

*The "rapid traverse rate" is defined in machine data.*

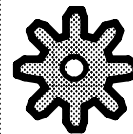

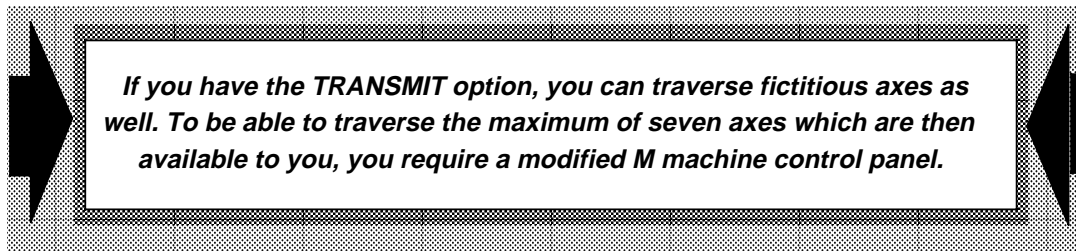

On this control panel you can select the X, Z, C, 4, 5, 6 and 7 axes with the axis selection switch.

But you can also connect

- any M machine control panel to a SINUMERIK 810/820/T.
- any T machine control panel to a SINUMERIK 810/820/M.

In any case you must define which machine control panel is connected in machine data 5009.1.

- 5009.1 = "0": T machine control panel
- 5009.1 = "1": M machine control panel.

## 2.2 Switching on / off

### 2.2.1 Switching on the control

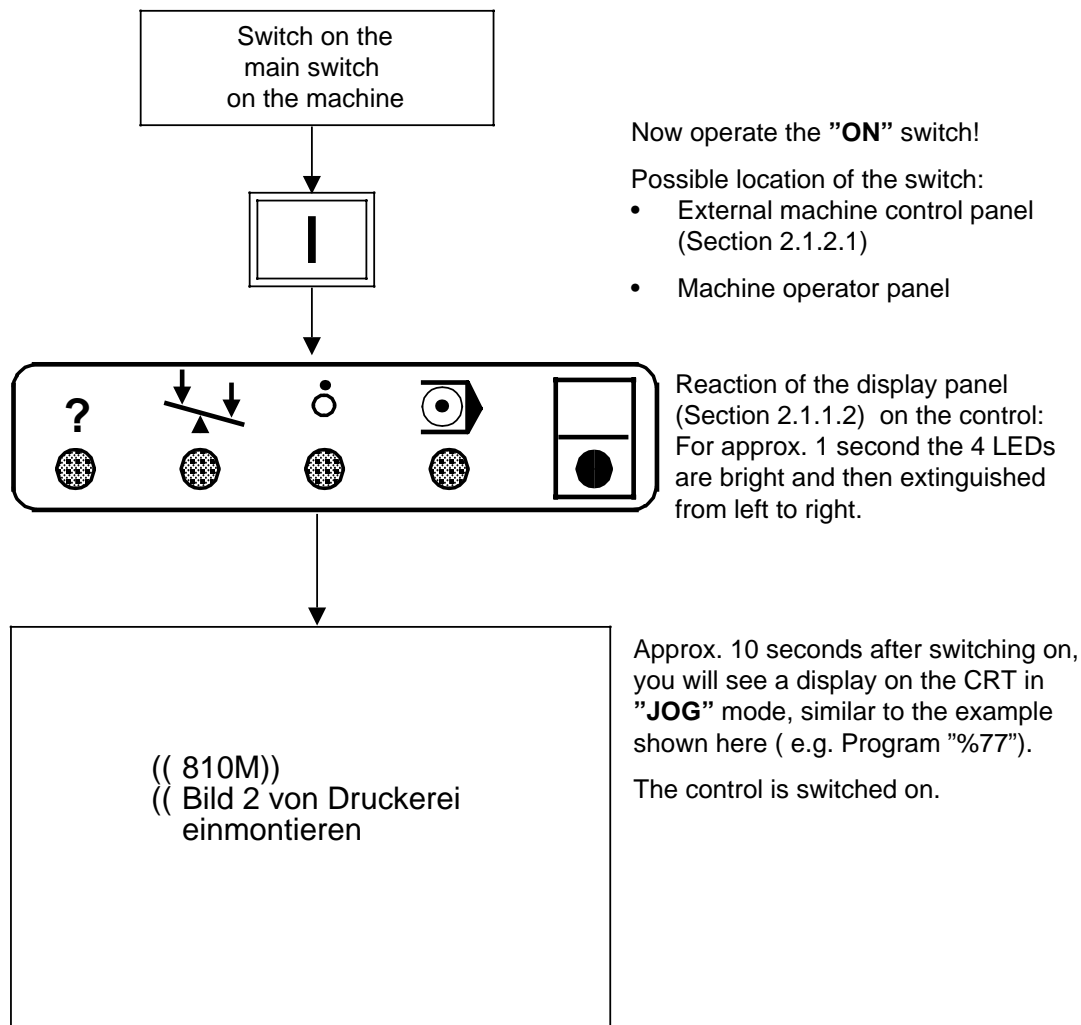

### 2.2.2 Switching off the control

You switch the control off with the main switch on the machine.

### 2.2.3 Darkening the screen

The machine tool manufacturer can define in a PLC program whether the screen is to be darkened. This is intended to prevent the luminescent layer on the screen from wearing out unnecessarily quickly.

If you select a new display during the dark phase of the screen, e.g. by changing mode, the screen is displayed again.

## 2.3 Operating modes

### 2.3.1 General

On a machine tool an NC controls

- the motion of the tool
- the motion of the workpiece

by means of the **part program**.

Beyond this, further preparations are required with numerically controlled machine tool before the actual machining process can be started.

For these preparations, the control has to be set to certain **operating states** to prepare it for certain operations.

These include:

- Traversing the tool or the workpiece to the start position required in the setting up plan
- Loading the part programs into the part program memory of the control
- Checking and entering the zero offsets
- Checking and entering the tool offsets

The SINUMERIK 810M has **7 operating modes** for bringing the control into the desired operating states.

### 2.3.2 Operating modes - overview

A differentiation is made between the following operating modes:

- **Automatic operation** (CRT Display: **AUTOMATIC**)

To process a part program in this operating mode, the control calls the blocks in sequence and evaluates them. The evaluation takes all offsets into account. The blocks prepared in this way are processed in sequence.

The part program can be entered into the control via the universal interface (e.g. via punched tape) or via the key-board. While one part program is being processed, another part program can be entered simultaneously.

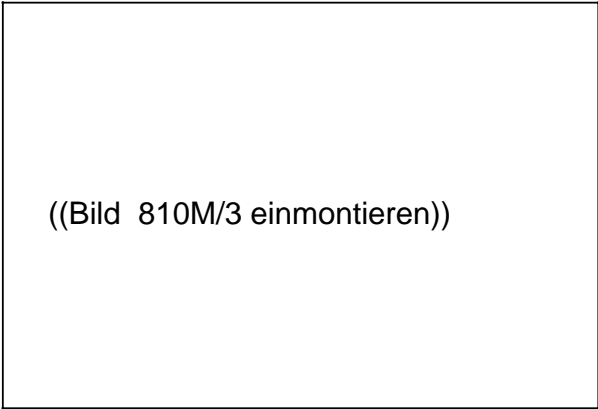

((Bild 810M/3 einmontieren))

"AUTOMATIC" basic display

- **Feed / Jog** (CRT display: **JOG**)

With the direction keys and the preset feedrate value "F", you can traverse the tool at random.

After a program interruption, you can see the distance to the point of interruption displayed in the "REPOS offset".

You traverse to the point of interruption until the REPOS offset shows zero.



*"JOG" basic display*

- **Manual Data Input / Automatic** (CRT display: **MDI AUTOMATIC**)

In this operating mode, you can input part program blocks into the buffer memory of the control.

The control processes the input block, and then clears the buffer memory ready for new data.

Used, for example, in connection with operations in "JOG" or "INC FEED" modes.



*"MDI-AUTOMATIC" basic display*

- **Traverse to reference point** (CRT display: **REFPOINT**)

When the direction keys are used, the machine moves in either jog or continuous operation, depending on the machine data set.

The reference point must be approached in each axis individually.

When the reference point has been reached, the position register is set to the value of the reference point coordinates.

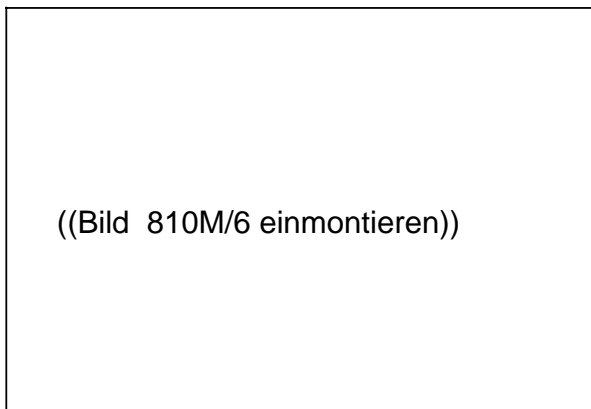

*"REFPOINT" basic display*

- **Incremental 1 . . . 10 000 jog** (CRT display: **INC FEED 1 . . . 10 000**)

In this operating mode, defined paraxial positioning is possible using the direction keys. The feedrate is fixed with a machine data. Feedrate override (in the range 0% ... 120%) is only possible when the appropriate interface signal is transferred from the PLC to the NC. MD define whether the set increment (in example shown: 100  $\mu\text{m}$ ) will be traversed in continuous mode or jog operation.



*"INC FEED 1 . . . 10 000" basic display*

- **Actual value setting** (CRT display: **PRESET**)

The directions of movement of a NC machine are based on a right-angled system of coordinates assigned to the individual machine axes.

In the absolute machine coordinate system, control zero can be shifted in comparison to the machine zero point. In "PRESET" mode, the control zero point can be placed anywhere within the machine coordinate system.

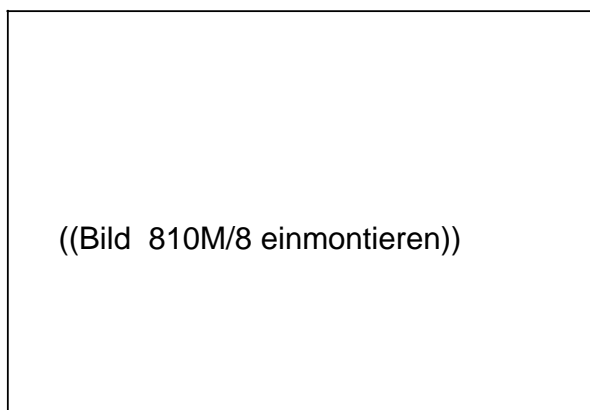

*"PRESET" basic display*

- **Repositioning** (CRT display: **REPOS**)

In "REPOS" mode, the tool can be returned to the point of interruption using the direction keys and the set feedrate value "F".

The "REPOS offset" display shows the distance from the actual position to the point of interruption, with the correct sign to show the direction of traverse.

When the point of interruption is reached, the "REPOS offset" display is zero; at the same time the direction keys are no longer active.

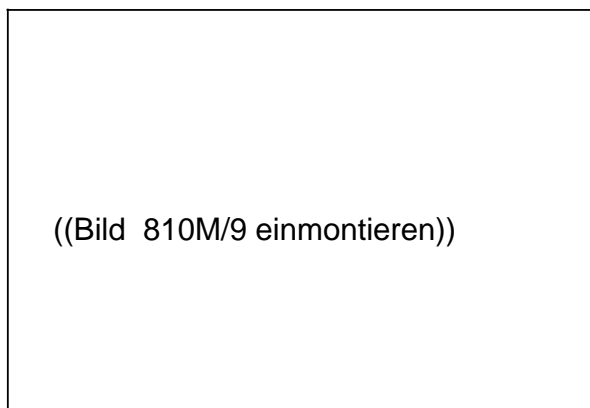

*"REPOS" basic display*





## 2.3.3 Selection of operating modes

### 2.3.3.1 Selection of operating modes with internal machine control panel

You call up the following named operating modes:

- PRESET (Actual Value Setting)
- MDI - AUTOMATIC (Manual Data Input / Automatic)
- JOG (Feed / Jog)
- REPOS (Repositioning)
- AUTOMATIC (Automatic operation).



by operating this key on the machine control panel.

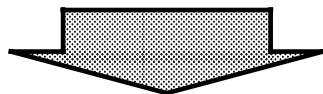
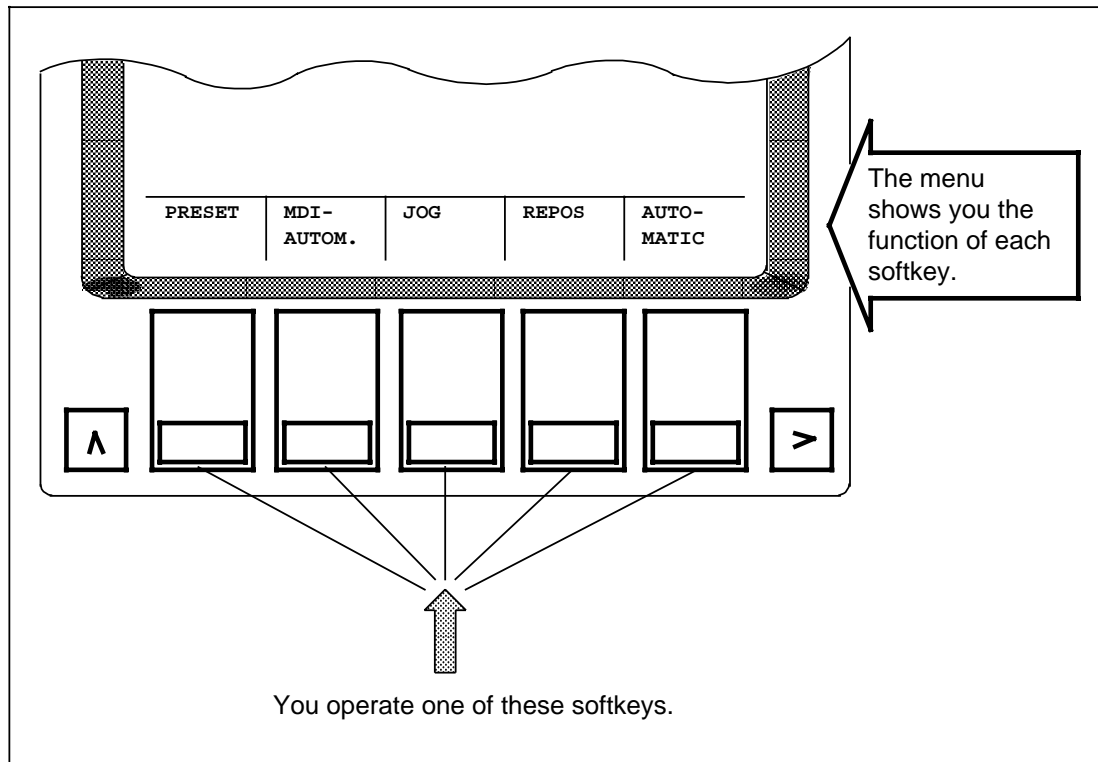
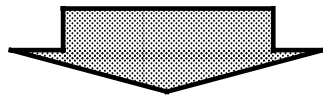

The basic display of the operating mode you selected is shown on the CRT.

Further selection: Operating Mode **INC FEED 1 . . . . INC FEED 10 000 (Incremental jog)**

Operate the key  on the machine control panel.



Operate the ETC key  under the CRT display once.

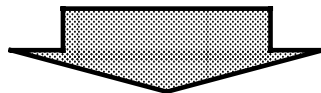
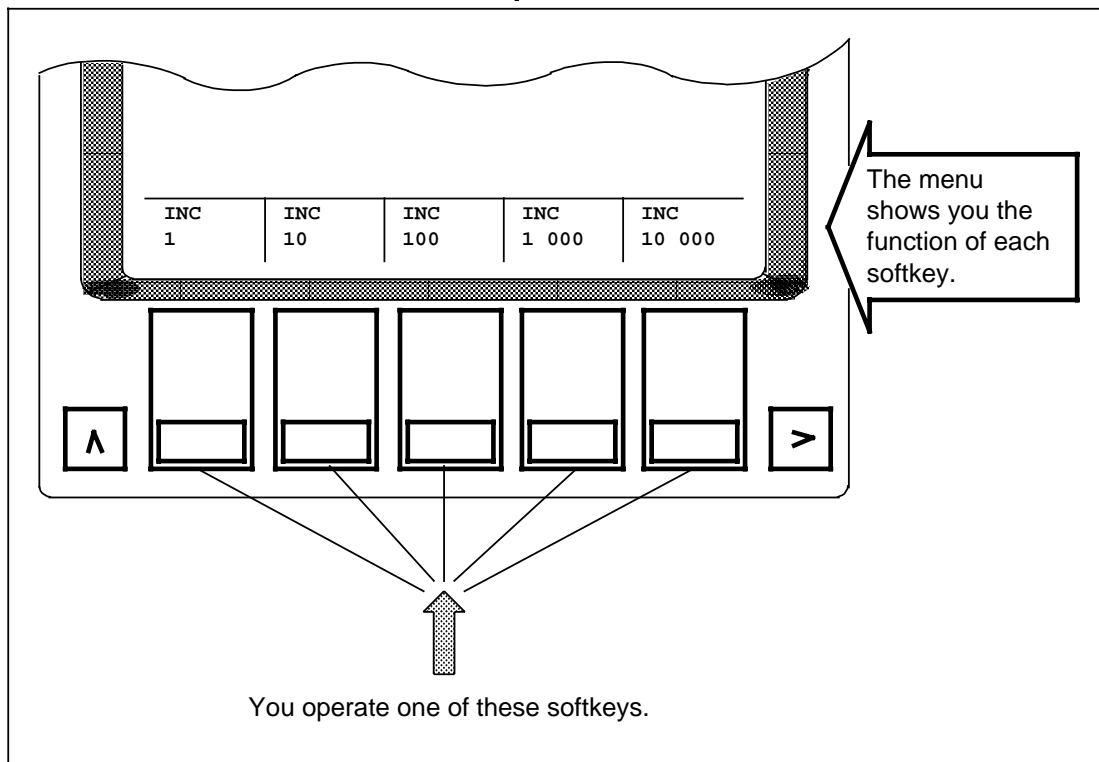
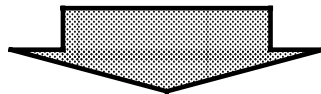

The basic display for "INC 1.. INC 10000" mode is shown on the CRT display.

Further selection: **REFPOINT mode (traverse to reference point)**

Operate the key  on the machine control panel.



Operate the ETC key  under the CRT display twice.

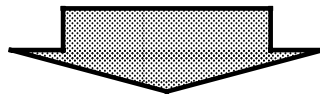
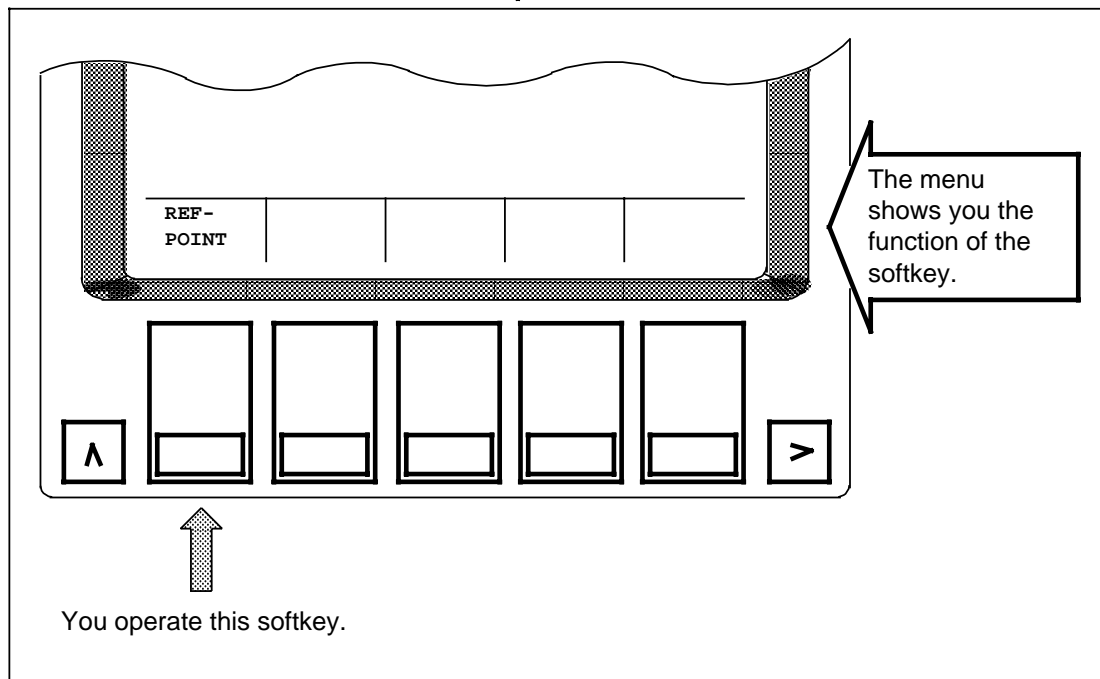
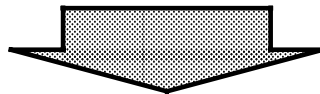



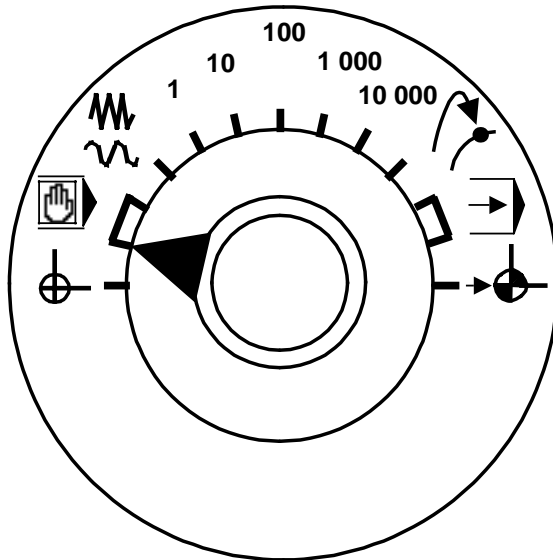

The basic display for "REFPOINT" mode is shown on the CRT display.

### 2.3.3.2 Selection of operating modes with external machine control panel

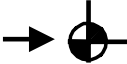

Rotate the mode selector switch to the desired position.

Symbol on the selector switch	Function	Designation of the operating mode
	<b>ACTUAL VALUE SETTING</b>	<b>PRESET</b> <u>P</u> reset <u>S</u> etpoint (1st position)
	<b>MANUAL DATA INPUT/ AUTOMATIC</b>	<b>MDI-AUTOMATIC</b> <u>M</u> anual <u>D</u> ata <u>I</u> ntput - <u>A</u> utomatic (2nd and 3rd position)
	<b>FEED/ JOG</b>	<b>JOG</b> <u>J</u> ogging (4th position)
1, 10, 100, 1 000, 10 000	<b>INCREMENTAL FEED</b>	<b>INC FEED...</b> <u>I</u> ncremental <u>F</u> eed (5th to 9th position)
	<b>REPOSITIONING</b> Reapproach contour	<b>REPOS</b> <u>R</u> e <u>P</u> osition (10th position)
	<b>AUTOMATIC OPERATION</b> Execute stored programs	<b>AUTOMATIC</b> (11th and 12th position)
	<b>TRAVERSE TO REFERENCE POINT</b>	<b>REFPOINT</b> <u>R</u> e <u>F</u> erence <u>P</u> oint (13th position)

### 2.3.4 "Reset" with change of operating mode

- When changing from one selected operating mode to another (Handling see 2.3.3.1 and / or 2.3.3.2), a "RESET" can be generated by the control.
- The "RESET" generated by the control when changing has the same effect as if the "RESET" key has been operated (see Sections 2.1.1.6 or 2.1.2.1).
- The generation of a "RESET" depends on the modes switched.

	PRESET	MDI AUTO-MATIC	JOG	REPOS	AUTO-MATIC	INC ...	REF-POINT
PRESET		+	+	+	+	+	+
MDI AUTO-MATIC	+		+	+	+	+	+
JOG	+	+		O	O	O	+
REPOS	+	+	O		O	O	+
AUTO-MATIC	+	+	O	O		O	+
INC ...	+	+	O	O	O		+
REF-POINT	+	+	+	+	+	+	

Generation of "RESET" with change of operating mode

(+... Reset, O... no reset)

#### Examples:

- 1) When changing from "AUTOMATIC" to "JOG" mode, **no** "RESET" is generated by the control!
- 2) When changing from "JOG" to "REFPOINT" mode, a "RESET" is generated by the control!

## 2.3.5 Branching to operating functions within an operating mode

Depending on the mode you have selected, you will be offered a "Basic softkey menu" of operating functions in the **menu display** (See Section 2.1.1.1) on the CRT.

After you select a function using the softkeys, the control will display other/new menus, and Menu Trees with several branchings.

Menu Trees for each operating mode are stored in the control:

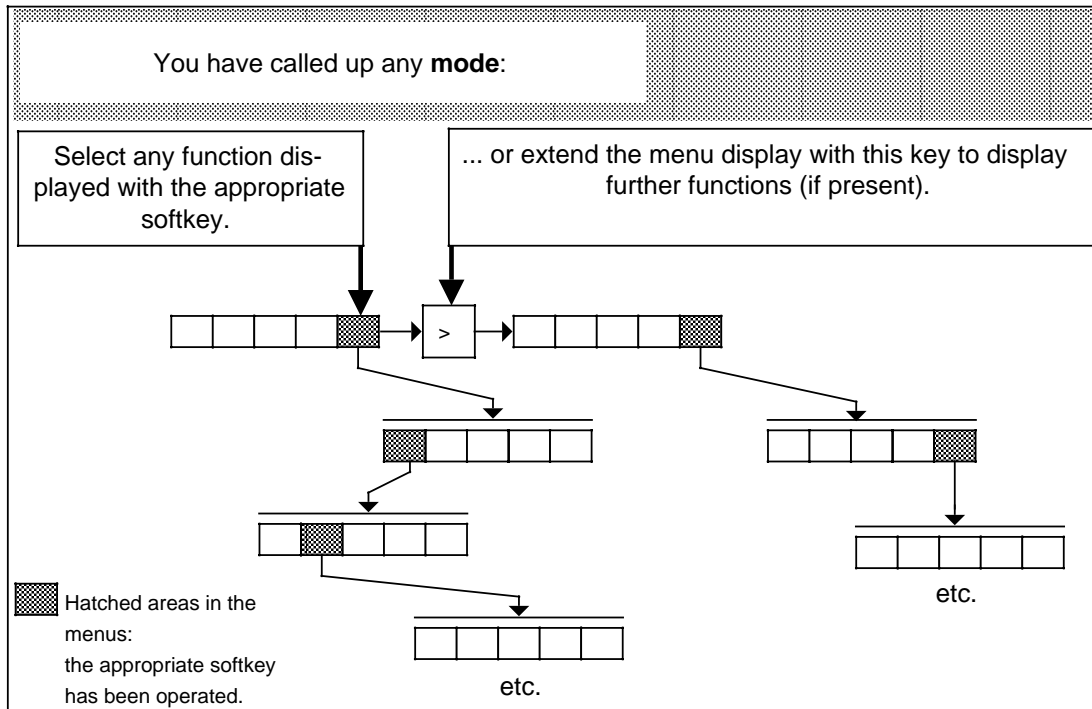

*Branching of the operating functions ("Menu tree") with stylized representation of the menus.*

### Note:

The detailed branching structure is explained **separately for each operating mode** in Sections 2.4.1 to 2.4.9.

### 2.3.5.1 Example for the selection of operating functions and branching to other menus

To select and branch to **other** menus, you simply use the 5 softkeys (see Section 2.1.1.1) under the CRT.

**Example:**

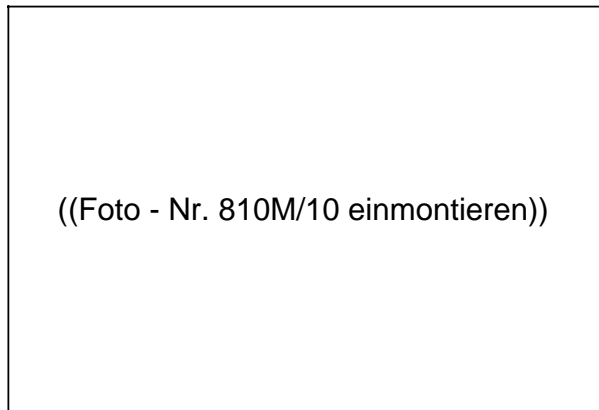

Basic CRT display with the selected operating mode, e.g. "AUTOMATIC". A menu of 5 selectable operating functions is shown.

You wish, for example, to select the "PART PROGRAM" function: Operate the appropriate softkey !

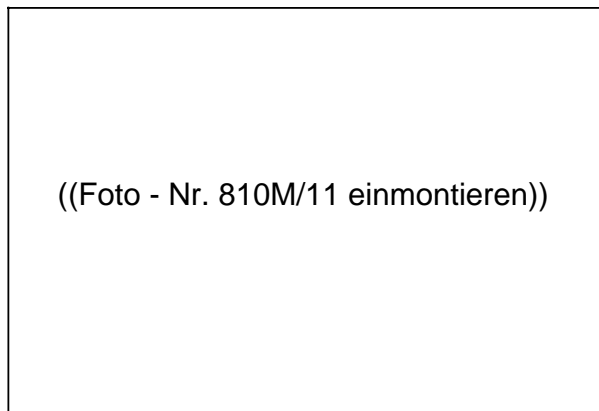

The "PART PROGRAM" function in "AUTOMATIC" mode is shown on the CRT display. A menu of 5 more selectable functions is shown.

You wish, for example, to select the "EDIT" function: Operate the appropriate softkey!

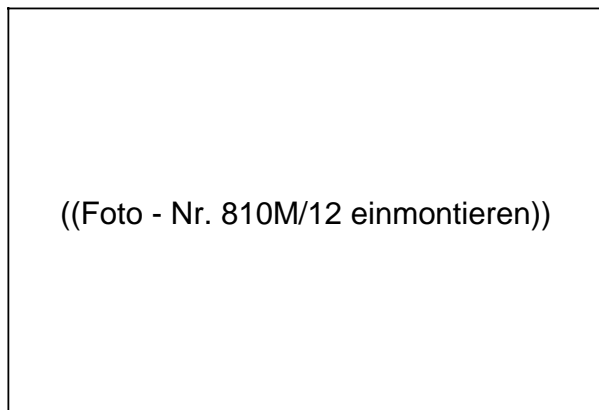

The function selected ("EDIT") in the "PART PROGRAM" menu in "AUTOMATIC" mode is shown on the CRT display. The menu shows a branch to 3 new functions.

etc.



### 2.3.5.2 Example for the selection of further operating functions within the same menu

The menu on the CRT can display max. 5 functions.

To call further operating functions in the control in the **same menu**,

you use the ETC key:



**Example:**

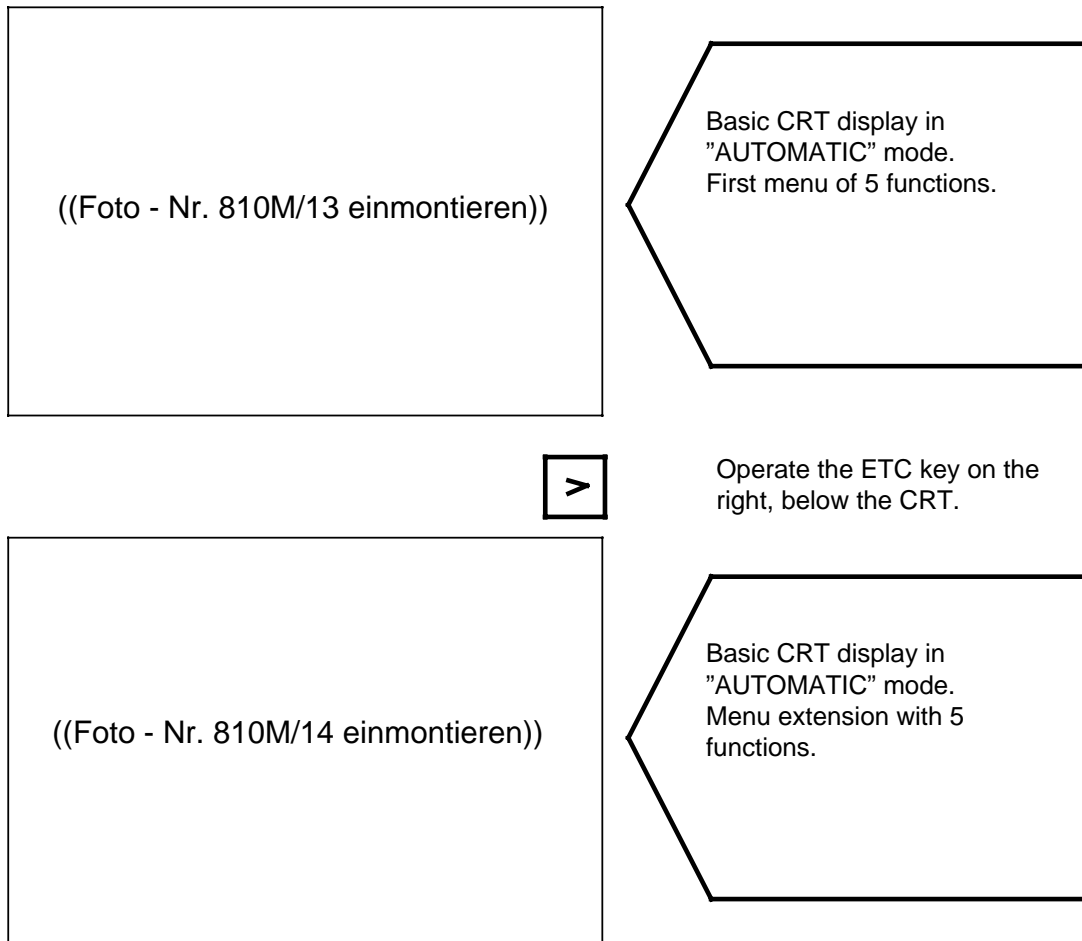

### 2.3.5.3 Menu display from the NC program or from the PLC

The control allows you to display any menu from the system or user area at any time. This is done either via a new interface (DB 40) in the PLC program or a new softkey function (SK 56). The machine tool manufacturer defines which menus can be displayed when. For further details see the relevant User's Guide of the machine tool manufacturer.

2.3.6 Jumping back to operating functions in higher-level menus within an operating mode



## 2.4 Operating mode menu trees

In this section you will find graphical overviews for **all** the SINUMERIK 810M **operating modes**. For each operating mode all the appropriate branches to further functions are represented for:

- **"AUTOMATIC"** mode
- **"JOG"** mode
- **"JOG"** mode  
(to **"TEACH IN/PLAYBACK"** function in AUTOMATIC mode)
- **"MDI-AUTOMATIC"** mode
- **"REFPOINT"** mode
- **"INC FEED 1 ... INC FEED 10000"** mode
- **"PRESET"** mode
- **"REPOS"** mode
- **"GUIDING"** (operator prompting) function.

## 2.4.1 "AUTOMATIC" mode

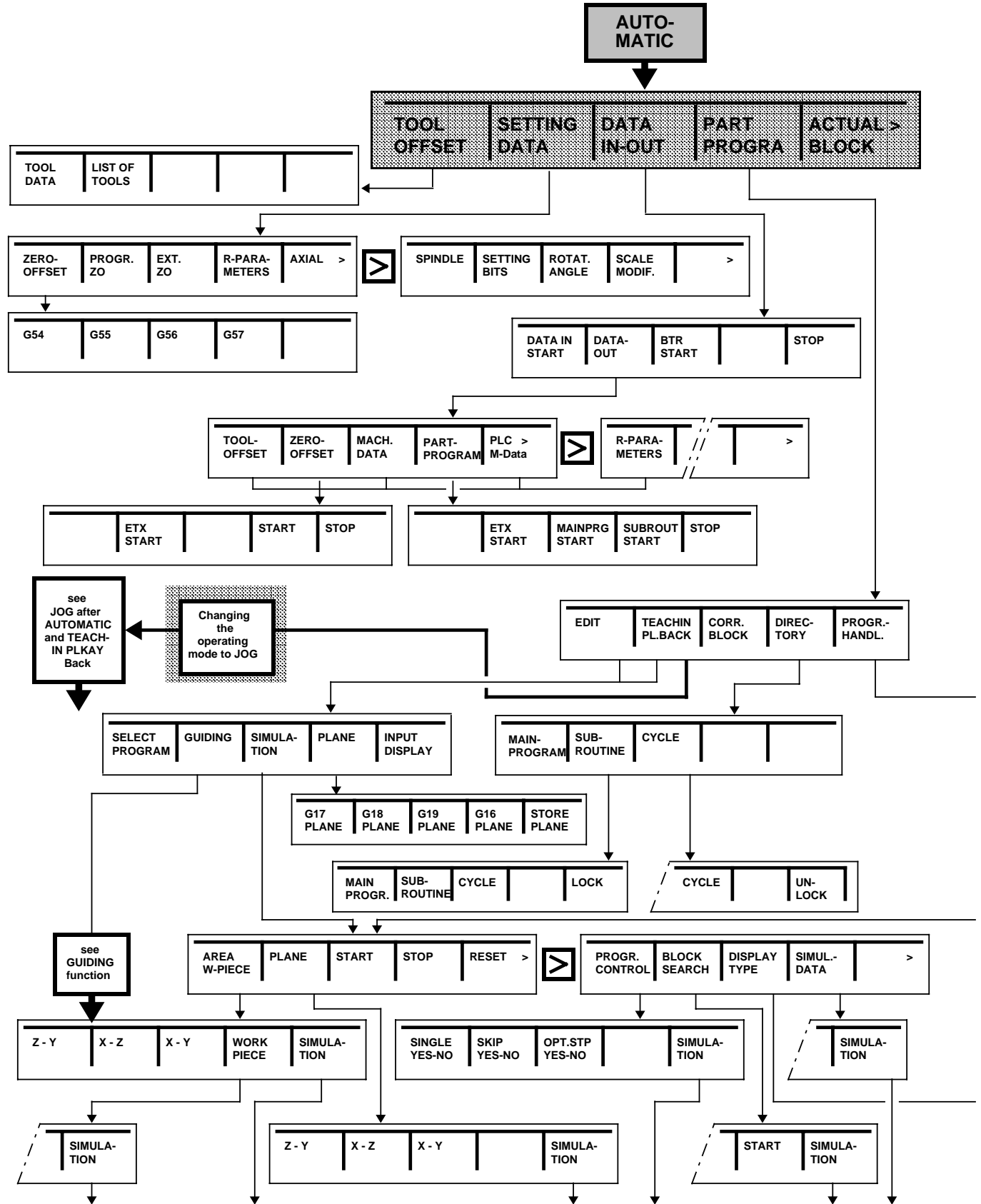

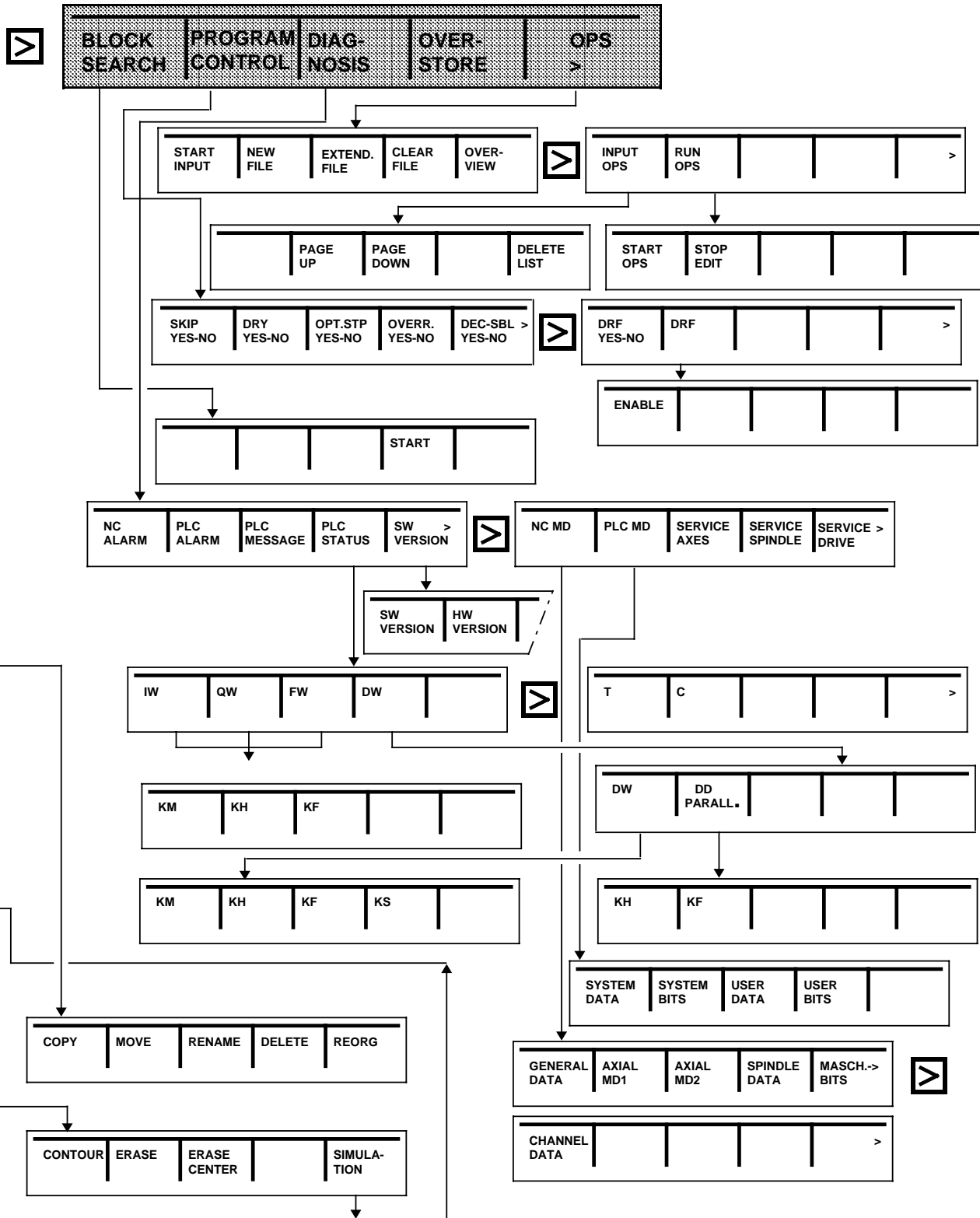

## 2.4.2 "JOG" mode

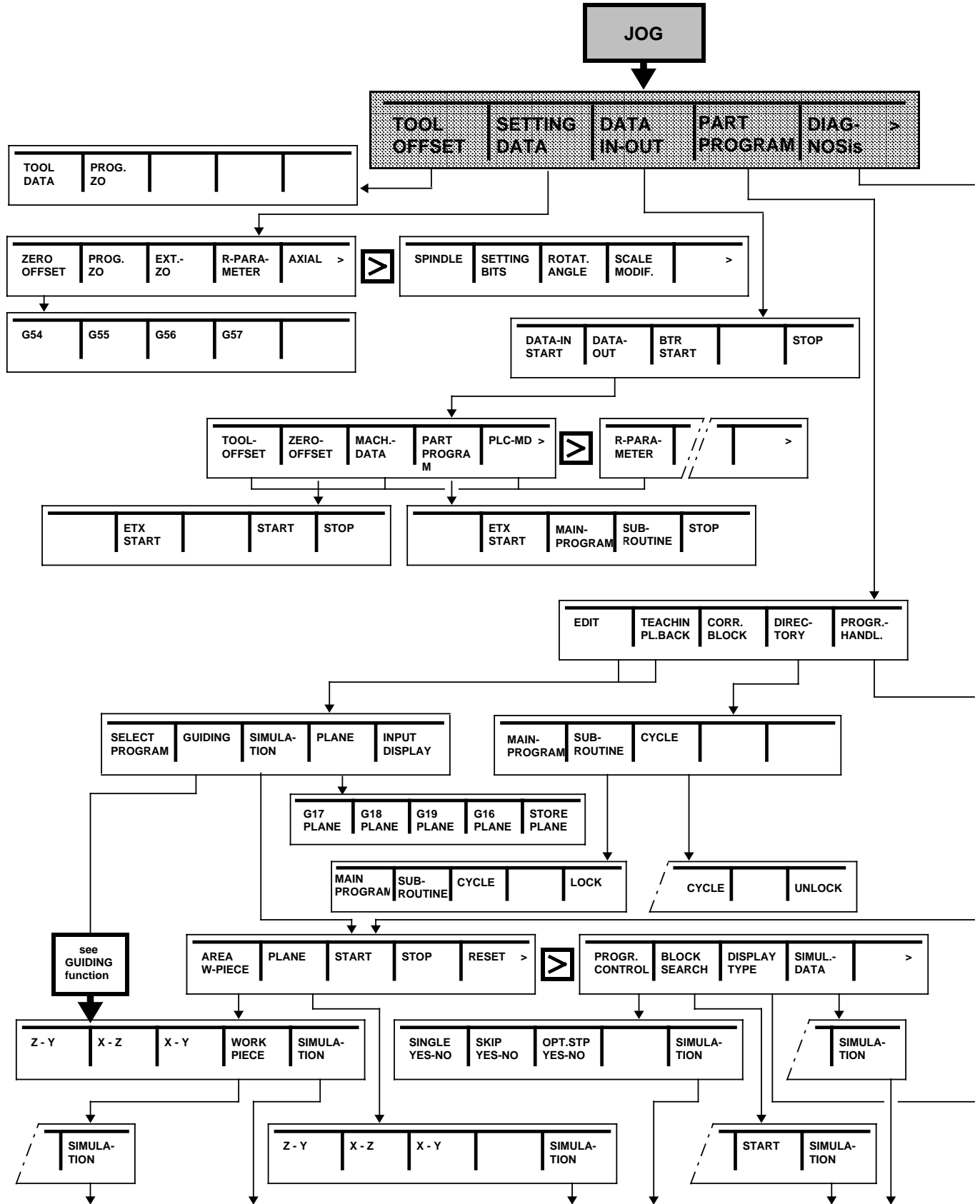

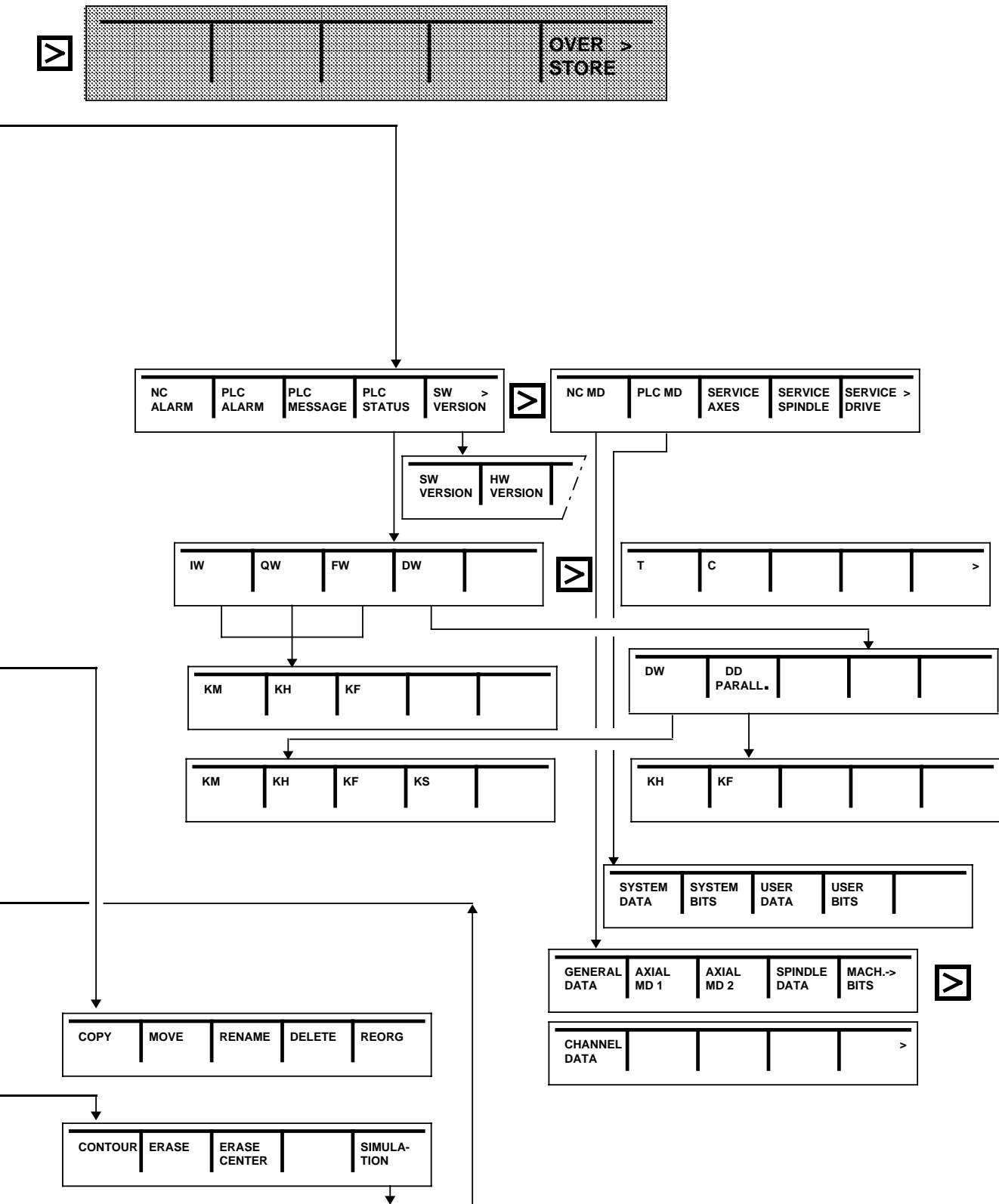



### 2.4.3 "JOG" mode (after "TEACH IN/PLAYBACK" in "AUTOMATIC" mode)

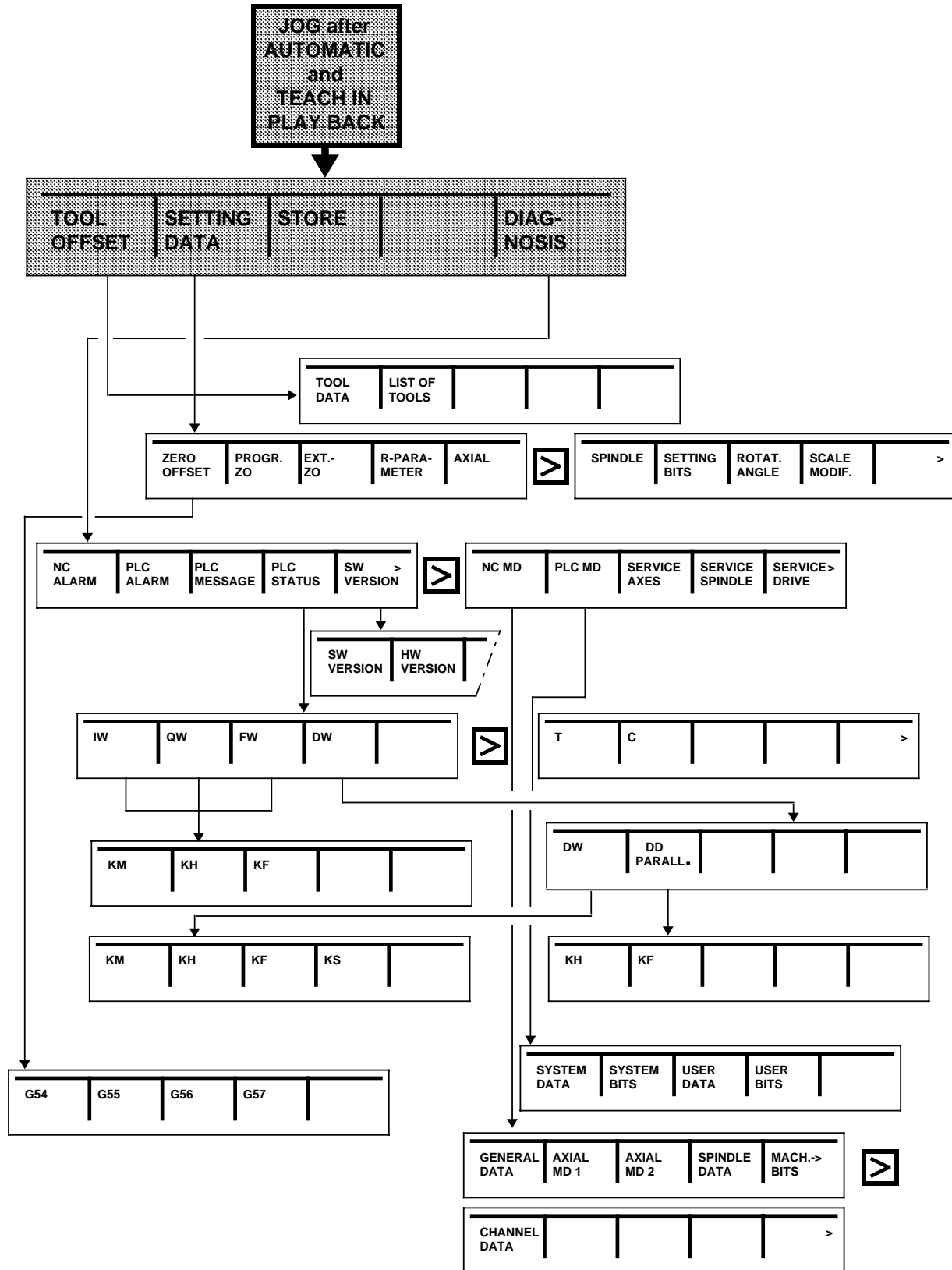



## 2.4.5 "REFPOINT" mode

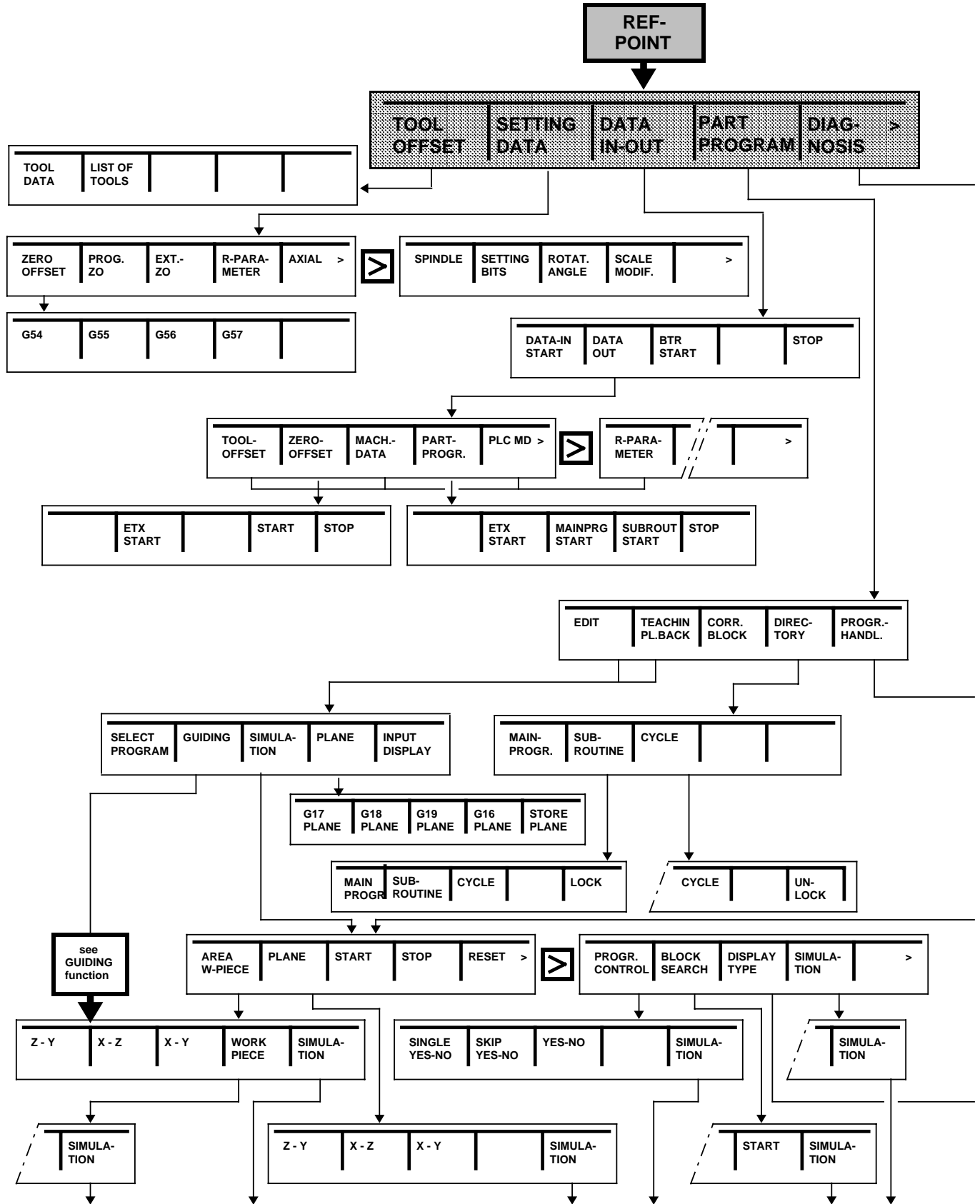

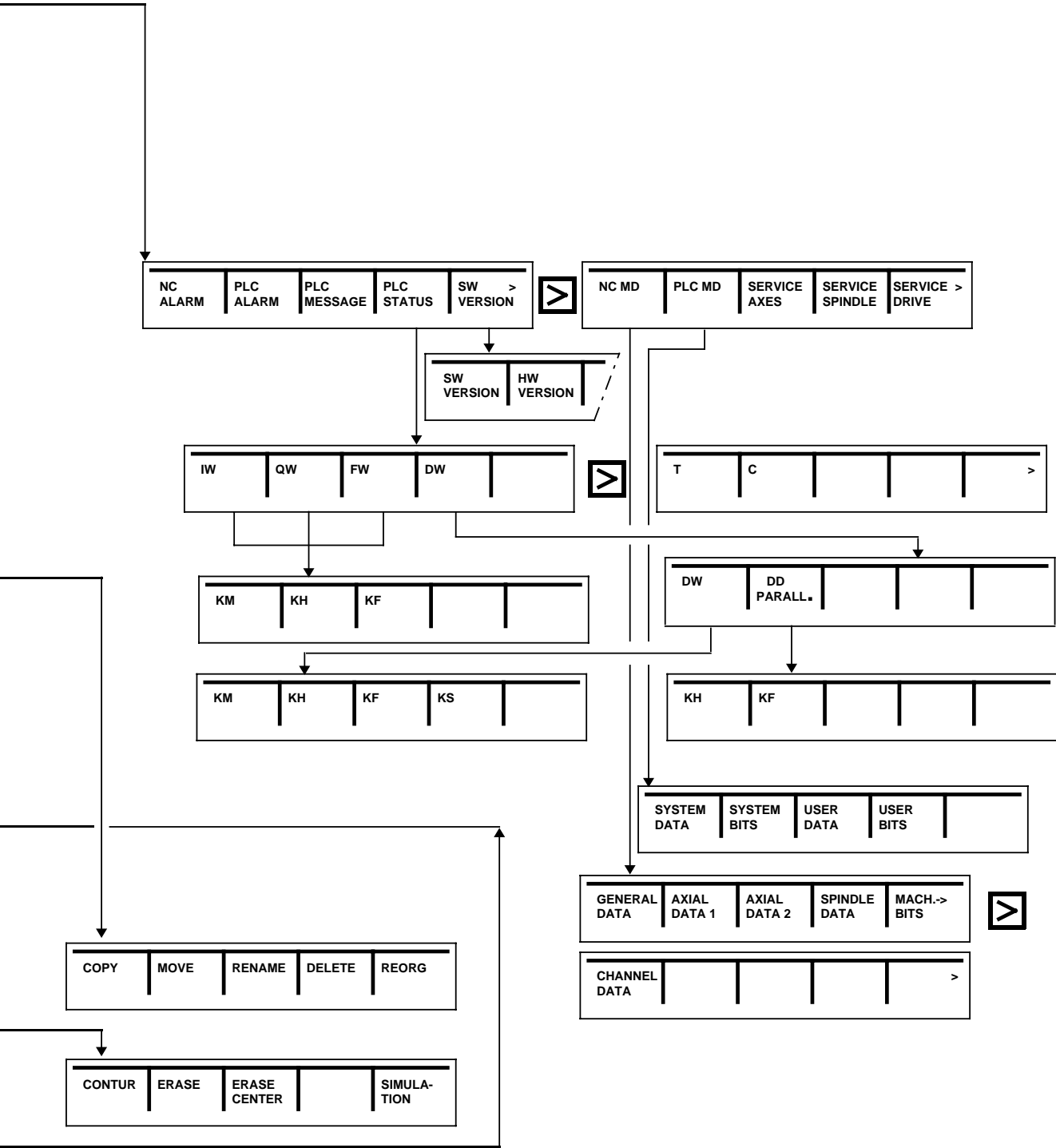



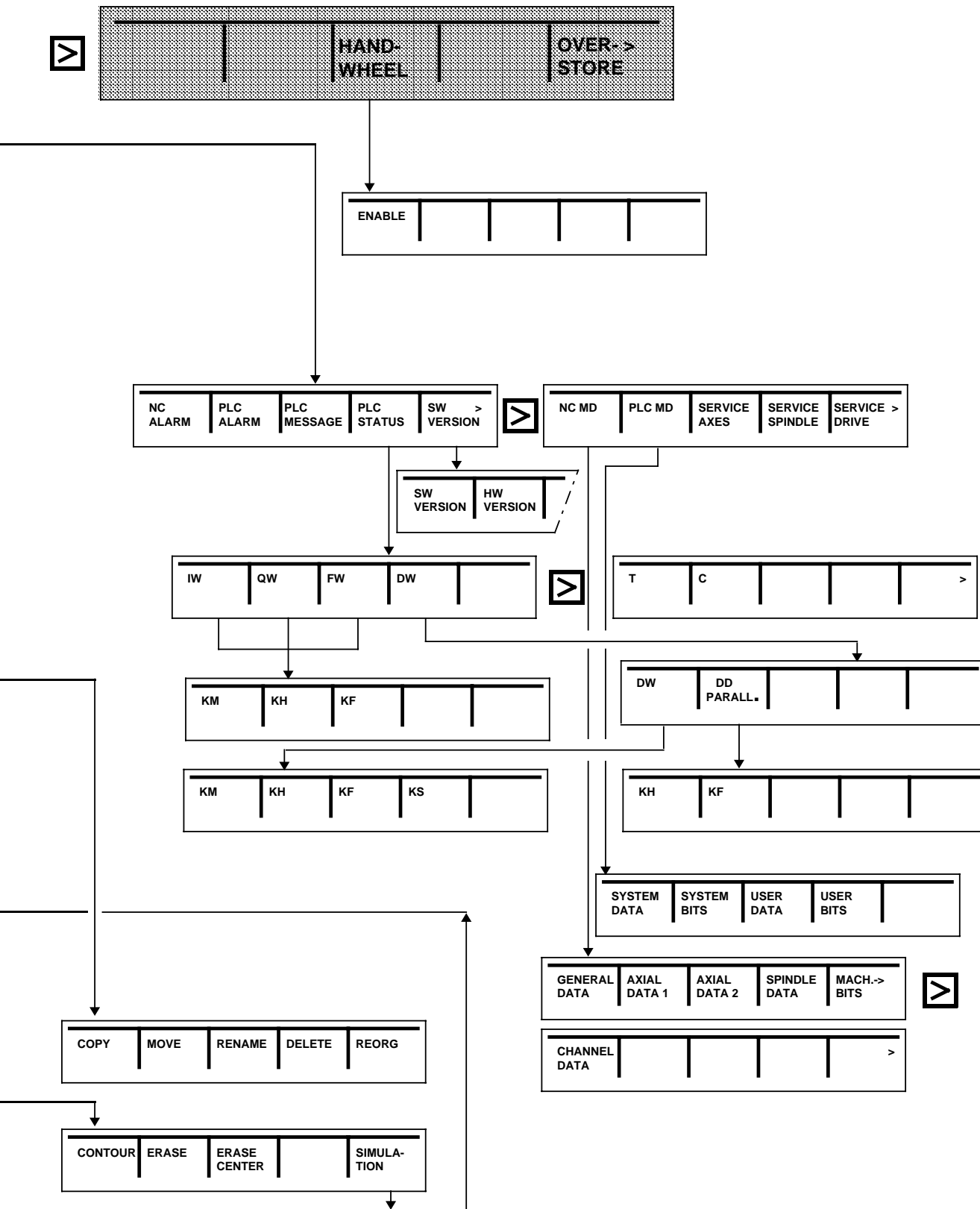

## 2.4.7 "PRESET" mode

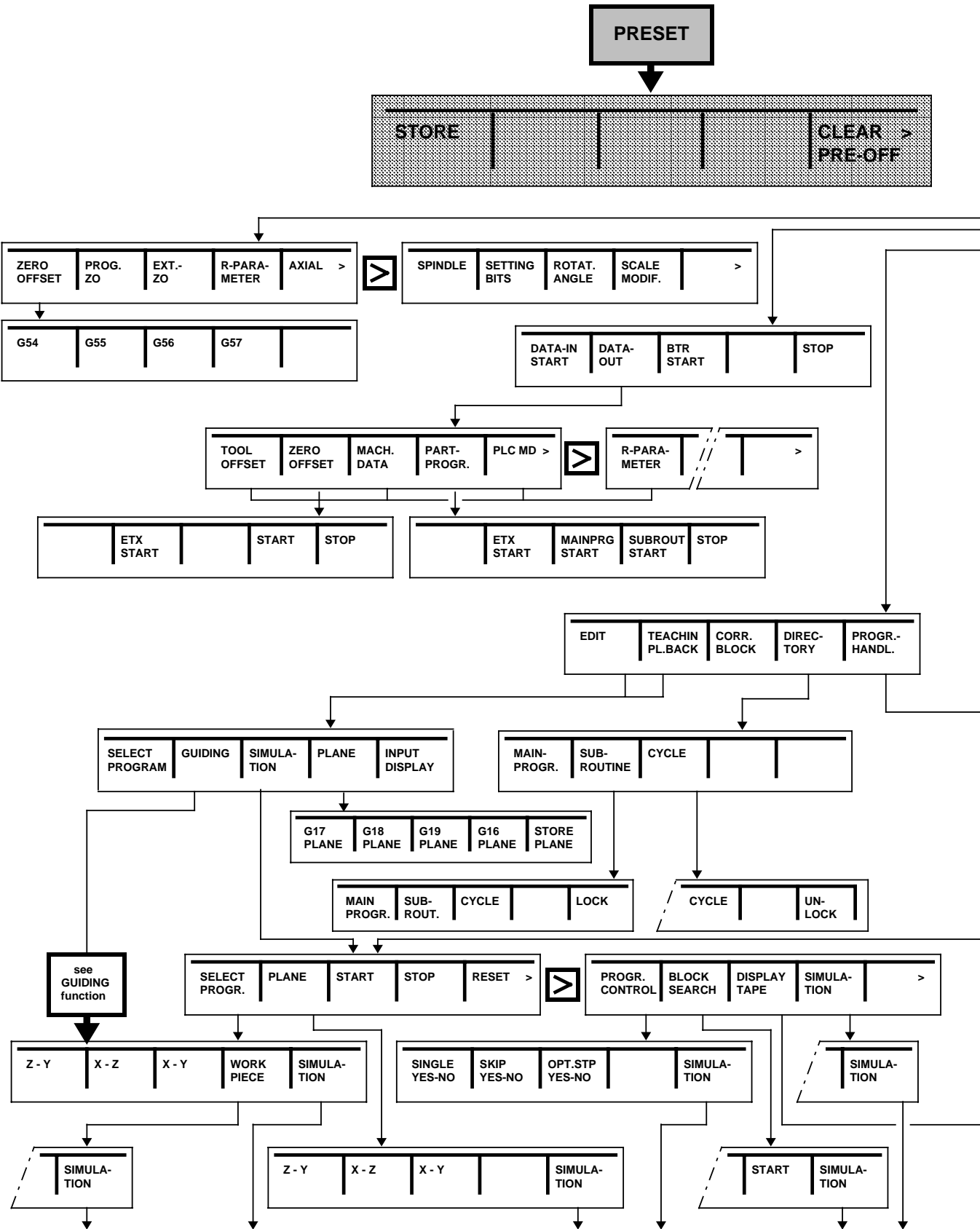





### 2.4.8 "REPOS" mode

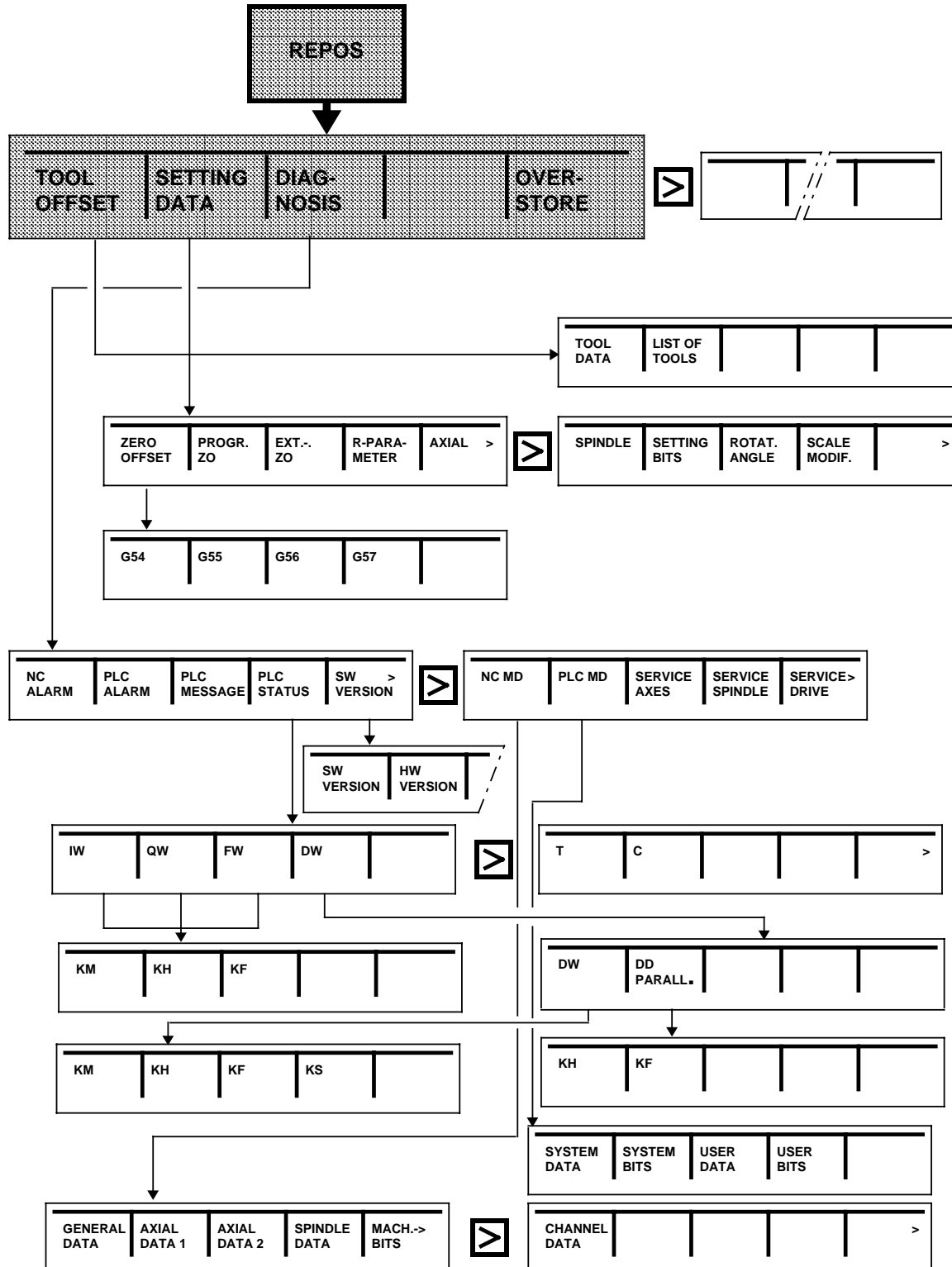

### 2.4.9 "GUIDING" (operator prompting) function

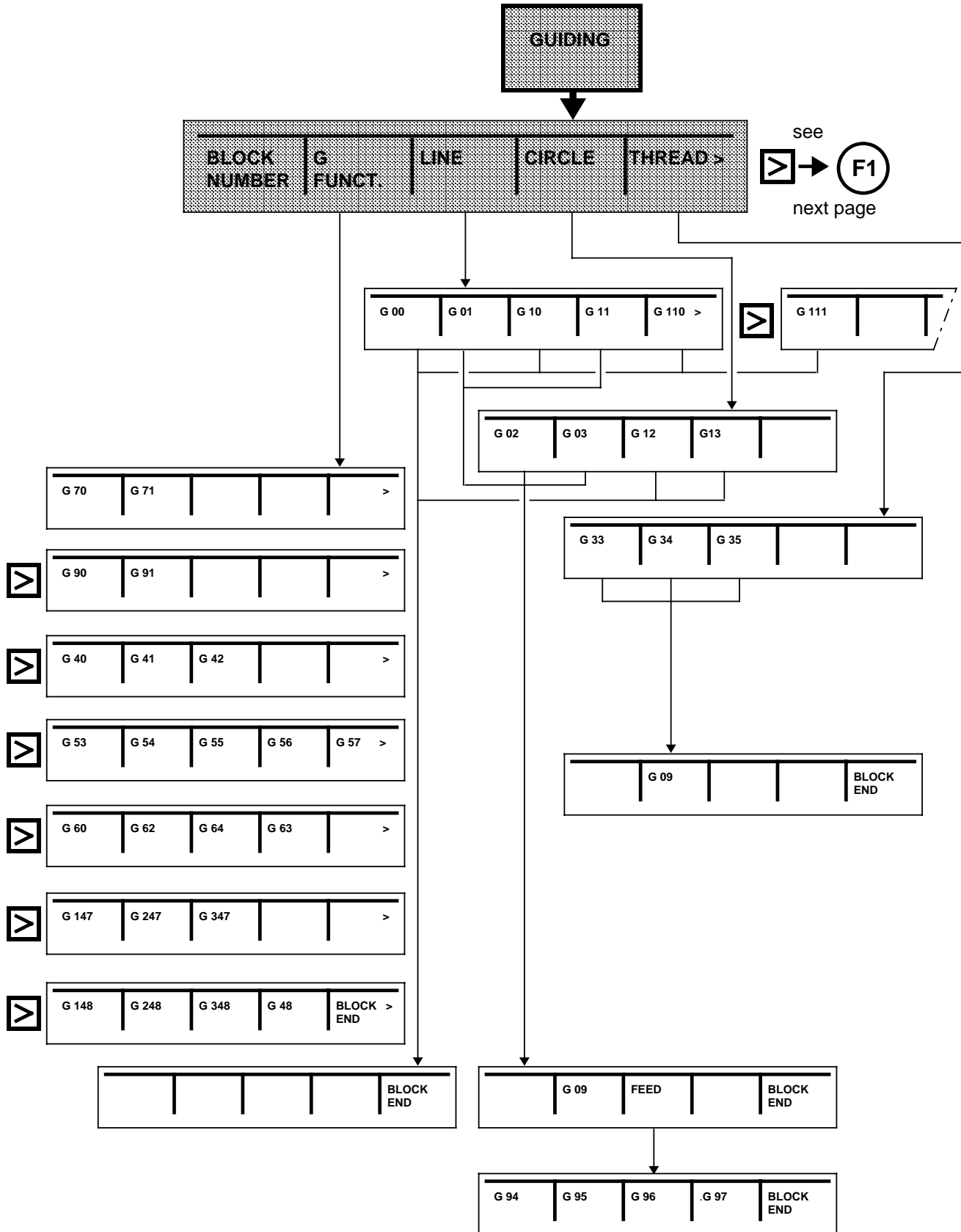

"GUIDING" (operator prompting) function, continued

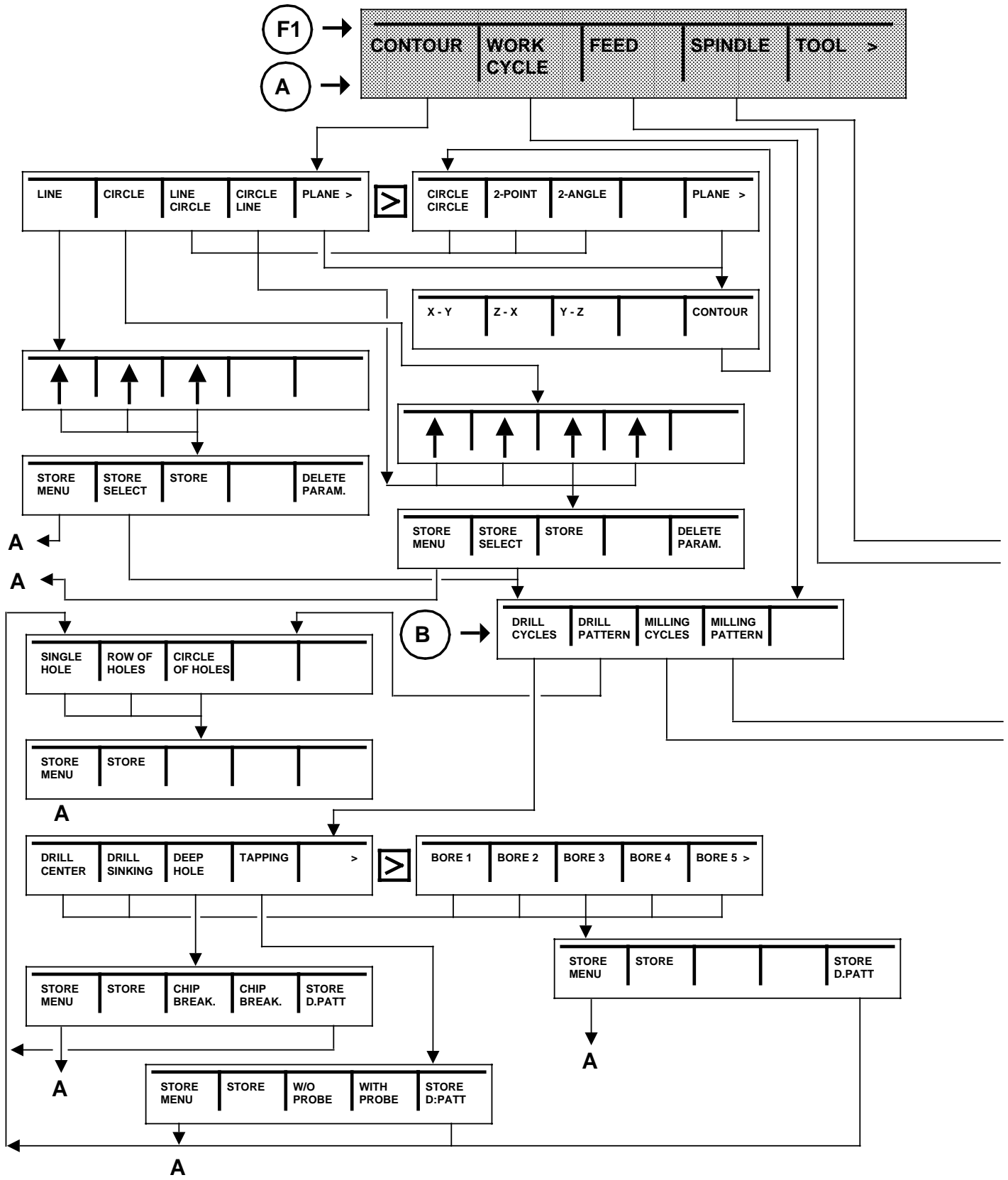

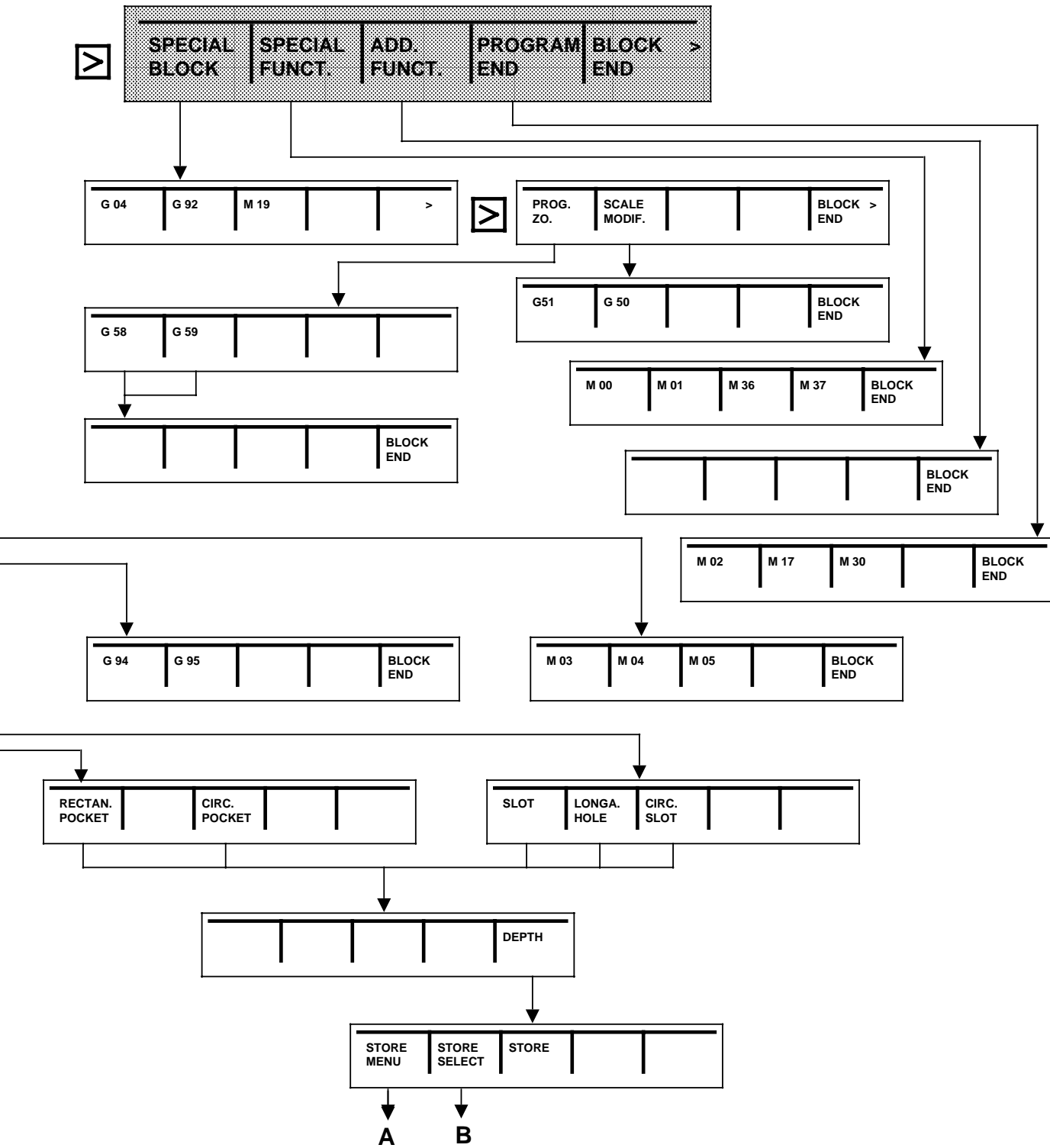

((Bitte wegwerfen))

## 2.5 Glossary of softkey functions

The softkey glossary explains in brief the functions that are activated when the softkeys are operated. The softkey functions are listed in alphabetical order.

### ACTUAL BLOCK

(CURRENT BLOCK)

The current block is the block currently being processed. The display shows:  
The block before the current block, the current block and the block after the current block.

### ACTUAL VALUES

(CURRENT VALUES)

The display shows the values valid for the current operating sequence.

### ADD. FUNCTION

(ADDITIONAL FUNCTION)

The additional functions (5th M Group) fixed by the machine tool manufacturer are grouped together in this function. Preselect: softkey "GUIDING".

### AREA W-PIECE

(WORK PIECE AREA)

You enter the simulation area and the workpiece dimensions.

### BLOCK END

You select the character for "Block End (LF)" via softkey.  
Preselect: "GUIDING" softkey.

### BLOCK NUMBER

The block number is automatically generated by the control in steps of five.

### BLOCK SEARCH

Block search makes it possible to start the operation at any point in the program. During block search, the same calculations are carried out as in normal program operation, however there is no axis movement.

### BTR START

(BLOCK TRANSFER)

Part programs are loaded into the NC from external storage in sections and executed.

### CLEAR PRE-OFF

(CLEAR PRESET-OFFSET)

You clear the PRESET offset.

**CIRCLE**

You select the G functions for circular interpolation with this softkey.  
Preselect: "GUIDING" softkey (operator prompting).

**CONTOUR**

This function simplifies programming of workpiece contours with the transfer of values directly from the drawing and graphic displays.

You can select the following elements and combinations:

- Line
- Line - circle
- Circle
- Circle - line
- Circle - circle
- 2 - point definition
- 2 - angle definition

**COPY**

You copy a part program and re-enter it into memory under another program number.

**CORR. BLOCK**

(CORRECTION BLOCK)

An error in the program is marked with the cursor (correction pointer).

**CYCLES**

The following are displayed:

- The stored cycle numbers
- The number of characters used
- The free memory space

Cycles are protected subroutines which can be called for frequently used technologies or for machine-specific operations (stock removal cycles, drilling cycles, tool change cycles).

The values required are defined as parameter assignments before the cycles are called (cycle parameter assignment).

**DATA-IN START**

(START DATA INPUT)

You start data input via the universal interface.

## DATA IN-OUT

The data (part program, settable zero offsets, machine data, R parameters, tool offsets, PLC program, PLC operator messages, PLC machine data, user programs) are read in from an external device (e.g. punched tape reader) or output to an external device (e.g. printer). Data input and output is handled via interface 1 or 2. Interface 1 is variable, interface 2 is normally assigned to a particular device. The interface data can be defined separately using setting data.

## DATA OUT

You select data output via the universal interface. You decide the data type with the subsequent softkeys. Using "START" (in "PART PROGRAM" with "MAINPRG. START" or "SUBROUT. START") you activate data output.

## DEC-SBL YES-NO

(DECODING SINGLE BLOCK ON-OFF)

With "YES", the blocks are processed singly. The function is active at the end of the block in which decoding takes place with the signal present (program control).

## DELETE

Using "DELETE" you clear one or more part programs in the program memory.

## DIAGNOSIS

All current alarms are displayed separately as NC alarms, PLC alarms and PLC messages. Other displays are for service purposes.

## DIRECTORY

The following is displayed:

- The stored part program numbers
- The number of characters used
- The free memory space

## DRF

The differential resolver function produces an additional incremental zero offset via a handwheel connected to the NC control.

## DRF ASSIGNM

(DRF ASSIGNMENT)

With this function you can select the handwheel assignment. You can assign a handwheel to each defined axis by entering the axis number.

## DRF YES-NO

When "YES", the differential resolver function is activated.



**DRY RUN YES-NO**

With "YES", the axes are traversed at the dry run feedrate, not the programmed feedrate. The dry run feedrate is set via setting data.

**EDIT**

EDIT leads to "SELECT PROGRAM", "GUIDING" and "SIMULATION".

Editing means:

Input of a program into the memory or changing or altering a program already in the memory.

**ENABLE**

You can enable the handwheel for the selected axis with this softkey.

**ETX START**

Output of the end of block character (end of text)

**FEED**

You select the G functions for the type of feed via softkey. Preselect: softkey "GUIDING".

**G FUNCT.**

You select the G functions from groups G 0 to G 12 via softkeys (see Programming Guide).

Preselect: "GUIDING" softkey.

**GUIDING**

The operator guiding (operator prompting) function speeds up and simplifies the input of part programs.

Apart from geometric functions (G-function, contour definition) you can also input machining cycles and technological functions (feedrate, spindle speed) via softkeys.

**HANDWHEEL**

In the INC 1...INC 10000 operating mode you activate an electronic handwheel via softkeys. The electronic handwheel enables operation which is equivalent to jog handwheel operation.

**HW VERSION**

You can display the hardware data by operating this softkey.

Preselect: DIAGNOSIS and SW VERSION softkeys.

**INPUT DISPLAY**

To call up the input displays with corresponding operator guidance macros configured by the machine tool manufacturer from the user memory submodule. Please refer to the information supplied by the machine tool manufacturer for the actual menus, display descriptions and operating sequence.

**LINE**

You select the G functions for linear interpolation by means of a softkey.

## LIST OF TOOLS

The location number and tool number of worn tools is displayed.

## MACH. DATA

(MACHINE DATA)

Using machine data (MD) the control is interfaced to the machine. Certain functions are defined with machine data (e.g. "Dry run feedrate locked with keyswitch"). A differentiation is made between NC MD and PLC MD. NC MD are divided into general data, axial data and spindle data; the PLC MD are divided into system data and user data. Machine data are fixed at the time of installation and should not be changed by the user. You select the output of machine data with the "MACH. DATA" softkey after "DATA OUT".

## MAINPRG. START

(MAIN PROGRAM START)

You activate the output of part programs via the universal interface.

## MAIN PROGRAM

The following is shown in the display which appears if you press this softkey:

- the numbers of the main programs stored
- the number of characters taken up in memory
- the free memory capacity.

## MOVE

You shift the selected part program to the end of memory. Only the program at the end of memory can be edited at the same time as another program is being processed.

## NC ALARM

All current NC alarms are displayed (see Section 4).

## NC MD

(NC MACHINE DATA)

The NC machine data are displayed.

## OPS

(PROGRAM SEQUENCING)

With this function you can load programs from a disk drive unit into the NC and execute them.

## OPT. STOP YES-NO

(PROGRAMMED STOP ON-OFF)

With "YES", the processing of the program is stopped at the point at which the "M01" command is programmed.

**OVERR. YES-NO**

(FEED / RAPID OVERRIDE ON-OFF)

When "YES", the set override is valid for the rapid traverse override/feedrate override switch.

**OVERSTORE**

You can change the value of the T, D, S, H, M words in the buffer memory.

**PART PROGRAM**

The "PART PROGRAM" softkey leads to:

- EDIT
- TEACH IN / PLAYBACK
- CORRECT BLOCK
- DIRECTORY
- PROGRAM HANDLING

This key is not used to select a program for processing.

After "DATA OUT", you can select program output with the softkey "PART PROGRAM"

**PLANE**

Select the machining plane in simulation and contour definition.

**PLAYBACK**

With this function, the positions are transferred and a program is built up.

**PLC ALARM**

All current PLC alarms are displayed (see Section 4).

**PLC MESSAGE**

All current PLC messages are displayed (see Section 4).

**PLC - MD**

(PLC MACHINE DATA)

The PLC machine data are displayed. After "DATA OUT" you select the output of PLC machine data via "PLC MD" softkey.

## PLC STATUS

The PLC status shows the current state of all inputs, outputs, flags, timers, counters and data words on the CRT :

- IW = Input word
- QW = Output word
- FW = Flag word
- T = Timer
- C = Counter
- DB = Data block
- DD PARALL. = Display of two data words
- DW = Data word
- KH = Hex constant
- KM = Binary constant
- KF = Fixed-point number constant
- KS = Symbol constant (up to two characters)

## PROGRAM CONTROL

(INFLUENCING THE PROGRAM)

The key leads to the following functions:

- SKIP BLOCK
- DRY RUN FEEDRATE
- PROGRAMMED STOP
- RAPID OVERRIDE
- DECODING SINGLE BLOCK
- DRF HANDWHEEL ENABLE
- DRF

## PROGRAM END

You select the functions of the "M02" (end of program) group via softkeys.

## PROG. HANDL.

(PROGRAM HANDLING)

You can copy, move, rename and delete the program in the program memory. You can reorganize the program memory (after deleting programs) (see "REORG").

## RENAME

You can change the program number.  
The program itself remains unchanged.

## REORG

(REORGANIZE)

You can reorganize the program memory.  
The space that has been made available by the deletion of programs can be used again for entering further programs.

## R PARAMETER

You input the R parameters as setting data.  
After "DATA OUT", you can select the output of R parameters with the "R PARAMETER" softkey.

## RESET

Simulation is interrupted and returned to the reset state.

## ROTAT. ANGLE

(ANGLE OF ROTATION)

Input of setting data for coordinate system rotation.

## SCALE MODIF.

(SCALE MODIFICATION)

Input of setting data for scale modification.

## SERVICE AXES

In this display, all the axis service data are displayed.  
With the "Page" key you can switch to the desired axis.

## SERVICE DRIVE

All data required for servicing the integrated drive control (IAR) are shown in the display obtained by pressing this softkey. However the hardware for the IAR is not implemented on the GA3, SW2.

## SERVICE SPINDLE

All data required for servicing the spindles are shown in the display obtained by pressing this softkey. You can switch to the spindle required with the "page down" key.

## SETTING DATA

Using setting data, the operator (user) fixes certain operating states. Setting data are adjustable for:

- Programmable and settable zero offsets
- External zero offsets
- R parameters
- Spindle data
- Axial data
- Angle of rotation
- Scale modification
- Data transfer
- General data (setting data bits).

## SIMULATION

To test the program the programmed movements are shown on the CRT display. Programming errors are displayed as alarms.

**SINGLE BLOCK**

After "Program start" only one block is processed. The next block is only processed after another operation of "Program Start".

**SKIP YES-NO**

With "YES" selected, the blocks marked with an oblique (/) are skipped during program processing (Program control).

**SPECIAL BLOCK**

You select G04, G92, M19, G58, G59, G50 and G51 with this softkey.

**SPECIAL FUNCT.**

The special functions M00, M01. (1st M Group) and M 36, M37 (4th M Group) are grouped together in this function.

**SPINDLE**

You select the M function for the spindle motion with this softkey.  
Preselect: "GUIDING" softkey.

**START**

You activate the selected softkey function.

**STOP**

You stop the activated softkey function.

**STORE**

In "PLAYBACK" mode you store the position traversed to.

**STORE**

Store the PRESET values entered axis-specifically.

**STORE PLANE**

Planes defined via machine data (G17, G18, G19) or by manual input (G16) are stored as the basic plane with this softkey and used for further program execution ("flexible plane selection")

**STORE SELECT**

Store the values entered and jump back to the selection

**STORE MENU**

Store the values entered and jump back to the main menu.

**SUBROUT.**

(SUBROUTINE)

This softkey is used to display:

- The stored subroutine numbers
- The number of characters used
- The free memory space

**SUBROUT START**

(SUBROUTINE START)

Activation of output of subroutines via the universal interface.

**SW VERSION**

This softkey is used to display:

- Type of control
- Hardware data
- Software versions of CPU and UMS.

**TEACH IN**

With "TEACH IN" you generate a part program block by block. By doing this, you can test the program immediately.

**THREAD**

Select the G functions for thread cutting with this softkey.

**TO AUTOM**

(AUTOMATIC TOOL OFFSET)

By traversing to the desired reference plane, the tool offset can be measured and stored.

**TOOL**

You input the tool number T... and the tool offset number D...

**TOOL DATA**

You can enter data, such as tool number, tool life, workpiece count, etc. in a screen form for up to four tools.

**TOOL OFFSET**

The tool offset takes into account the tool dimensions and wear. The tool offset is stored under a tool offset number, D1 to D99, in the tool offset memory. If the "axis duplication" function is active, the tool offset memory is divided into two halves automatically (D1 to D49 for tool system 1 and D50 to D99 for tool system 2).

Via the "TOOL OFFSET" softkey after "DATA OUT", you select the output of tool offsets via the universal interface.

## **WORK CYCLE**

(MACHINING CYCLE)

Using a softkey you can select cycles for frequently occurring machining sequences.

Preselect: "GUIDING" softkey.

## **WORKING AREA LIM.**

(WORKING AREA LIMITATION)

The minimum and maximum working area limits of the defined axes appear in the display. You can modify the values displayed.

## **ZO AUTOM**

(AUTOMATIC ZERO OFFSET)

By traversing to the desired reference plane, the zero offset can be measured and stored.

## **ZERO OFFSET**

The settable zero offsets are input as setting data. Programmable and external zero offsets are displayed on the CRT (see Section 3.1.5).



## 3 Operating Sequences

### 3.0 Preliminary remarks

In the previous Section, the functions of the individual operating elements were described in detail.

This Section shows how to use the operating elements in frequently occurring operating sequences.

It explains:

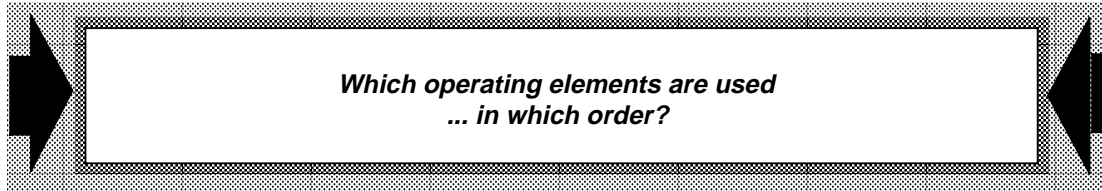

The Section is divided into two parts:

- In the first part (preparation) operating methods are explained that you use before, during or after **program input** or that you use only once before you start the control operation.
- In the second part (operating) the operating methods are explained that occur during **processing**.
- In the following subsections, the part of the illustrations **shaded grey** show the function of the **dual function keys** required!
- In screen forms without an extension (>), the S value for the leading spindle is displayed under S.

### 3.1 Preparation

#### 3.1.1 Switching on

When you switch the control and machine on:

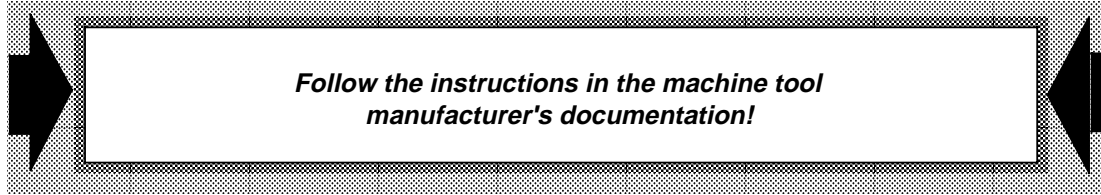

#### 3.1.2 Traverse to reference point

After switching on you traverse the individual axes to the reference points. This synchronizes the control with the machine.

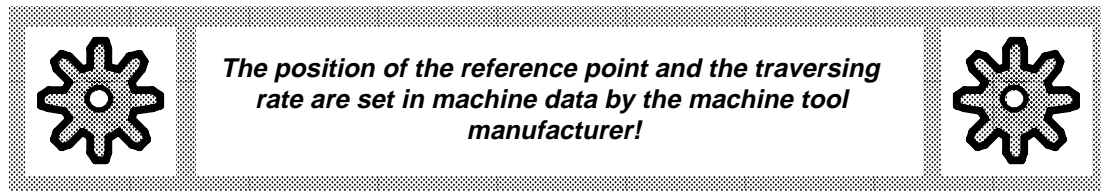

REF-  
POINT

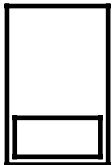

You select the "REFPOINT" operating mode via softkey

or



You set the operating mode selector switch on the external machine control panel to this symbol (REFPOINT).

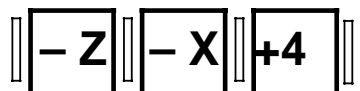

Operate the direction keys on the integrated machine control panel ...

or

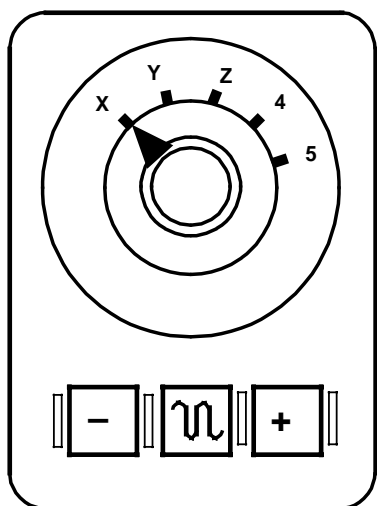



or

Select the axis you wish to traverse with the axis selector switch on the external machine control panel and then press the direction key. You can now traverse the individual axes one after the other to the reference point.

Note:

The selected traverse direction is checked by the control before starting.

→ If you have operated the incorrect direction key (e.g.  instead of  ), no traverse motion will result as the operation is rejected).



With the "Feed Hold" key you can stop the selected axis before the reference point is reached.

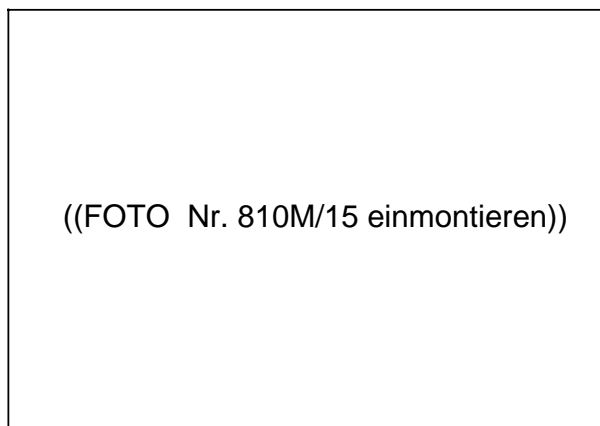

After reaching the reference point the position value referring to the machine zero point is displayed as "ACTUAL POSITION" on the CRT. The control is now synchronised with the machine.

### 3.1.3 Tools

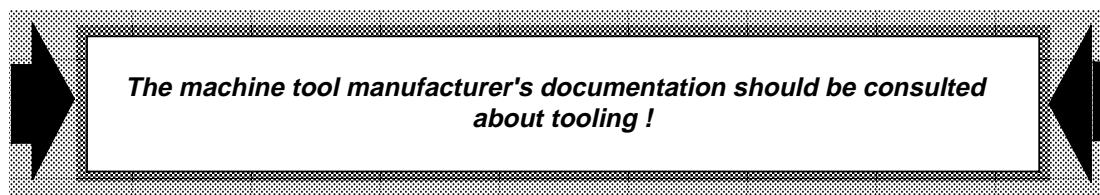

### 3.1.4 Tool offset

#### 3.1.4.1 Input of tool offset

The input display will help you to input "Tool offset".

You can call up this display with the softkey in **all** operating modes.

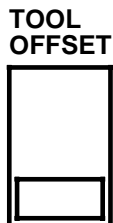

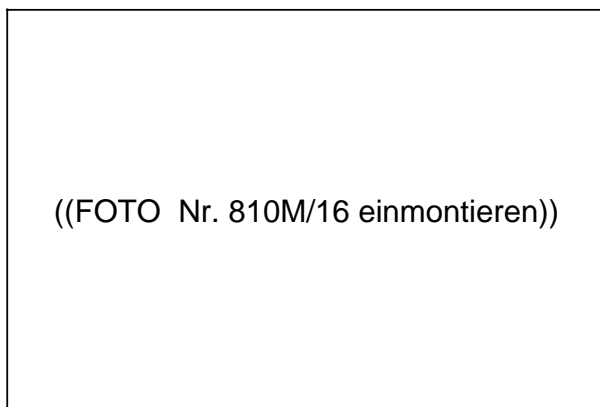

This input screen form appears.

### Explanation of the input screen

#### D 5

Name of the tool offset memory ("D5" in this example).  
The SINUMERIK 810M has 99 offset memories.  
Therefore you can address the tool offset numbers  
D1 ... D99, and store compensation data under each one.

#### 0 Tool number

The input field marked P= "0" is intended for the input of  
a max. 8 digit "tool number".  
Normally entries are not required except when using  
flexible tool management!

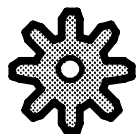

*Whether tool numbers are used or not is  
fixed in machine data (MD).*

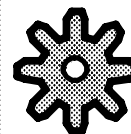

# 1 Tool type

The input field marked P= "1" is reserved for the input of "Tool type P1".

## Explanation of tool type:

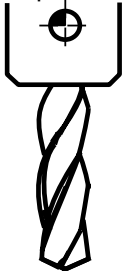
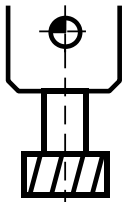
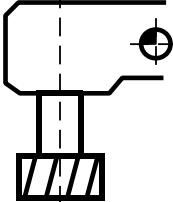
Tool	Tool type P1 = . . .
<p>1. Tools with length compensation only</p>  <p>Example: <b>Drill</b></p>	<p>10 (... 19)</p>
<p>2. Tools with radius compensation and one length compensation</p>  <p>Example: <b>End mill</b></p>	<p>20 (... 29)</p>
<p>3. Tools with radius compensation and two length compensations</p>  <p>Example: <b>Angular milling cutter</b></p>	<p>30 (... 39)</p>

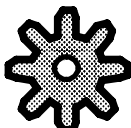

*In machine data the machine manufacturer can specify that tool type 0 have the same effect as tool type 20. Radius and length compensation are then assigned as with type 20. The display type 0 remains unchanged.*

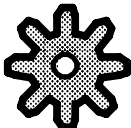

- 2 L1 Geometry
- 3 L2 Geometry
- 4 Diameter/radius

Under points P= "2" and P= "3", you enter the geometry values of the tool into the input field  
Under point P= "4" you enter the value of the cutter radius.

Geometry values of the available tool types:

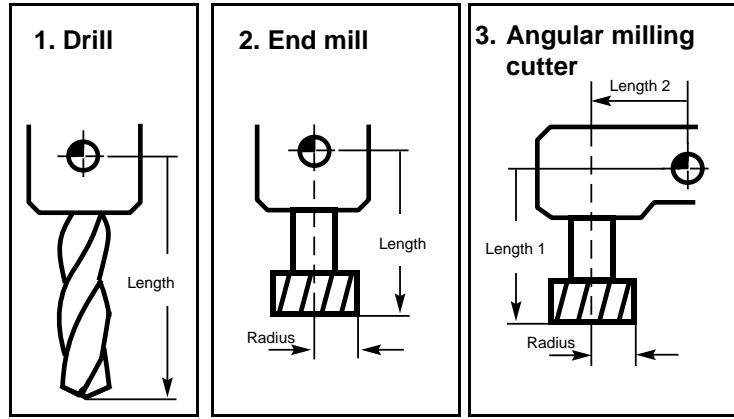

*Input of the tool geometry values can be prevented by keyswitch.*

- 5 L1 Wear
- 6 L2 Wear
- 7 Diameter/radius

Under points P= "5" to P="7", you can enter the wear data of the tools into the input form if you wish (not obligatory).  
The machine tool manufacturer can set the maximum wear input to  $\pm 0.999$  mm.

*Input of the wear data can be inhibited by means of a key switch.*

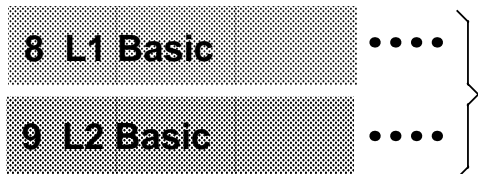

Identifiers P= "8" and P= "9" are reserved for special uses. The "Basic dimension" permits an additional tool length compensation.

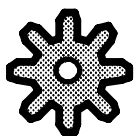

*The standard list of identifiers 0 to 9 can be raised to a maximum of 16 via MD.*

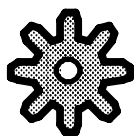

Sequence of operation

TOOL  
OFFSET

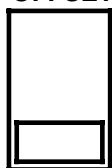

Operate the "Tool offset" softkey.  
(It is possible in all operating modes).

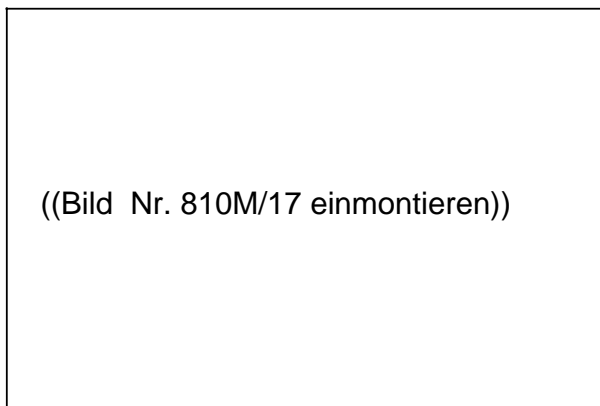

This input screen form appears. The current input field (=the field into which your input will be transferred) is displayed in inverse video.



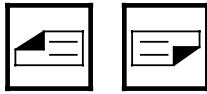

or

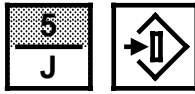

You select the desired tool offset number, in the range D1, ... D99, by operating either the "Page forward" or "Page backwards" key.

or

you call the desired tool offset number D ... ("5", in this example). The letter D need not be entered.  
Now press the Search key.

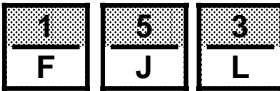

Now operate any of the cursor keys to position the cursor at the desired input field (Identifiers 1 ... 9).

Then enter your desired offset value ("153" in this example) with the numeric keys.  
You can see the entered value on the **input line** of the display.



Now operate the yellow input key, and store the offset value in the offset memory.  
The value you input is now displayed in the selected **input field**.

- The inverse video marking of the input field now automatically jumps to the next position (next identifier P ..) of the selected offset number D ...
- After storing **all** the compensation values of the selected offset number D..., the inverse video marking of the input field now jumps to the **first** offset value of the **following** offset number.

### 3.1.4.2 Deleting/modifying an individual offset value

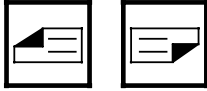

You select the desired tool offset number under which you intend to delete/modify a offset value with the "Page up/down" keys.

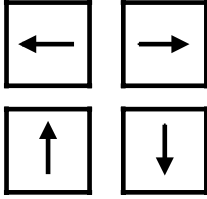

With these keys you position the cursor at the input field to be deleted/modified.



Using the numerical keys you enter the value "zero" (**delete**)

or

or

Using the numerical keys you enter a new value (**modification**).

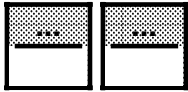

With this key you transfer the deletion or modification into the offset memory.

### 3.1.4.3 Deleting all offset values in an offset number D...

- a) You would like, for example, to delete all stored values under tool offset number "D5":

#### Sequence of operation



Using the key you enter "5".



You operate the "Delete word/block" key.

When you now select the tool offset number "D5", using either the "Page up/down"

keys

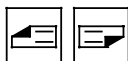

, or by entering the number "5"



and operating the search key, you can check that all the values

in this offset number have been set to zero!

- b) You would like, for example, to delete all stored values under tool offset numbers "D4" to "D9":

#### Sequence of operation



Using the keys you enter "4 = 9".



You operate the "Delete word/block" key.

When you now call the tool offset numbers "D4" to "D9", as described in a) above, you can check that all offset values have been set to zero!

### 3.1.4.4 Integrated tool management



### 3.1.4.5 Input of tool data

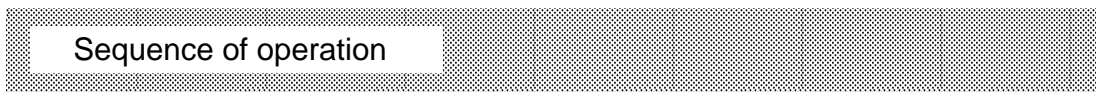
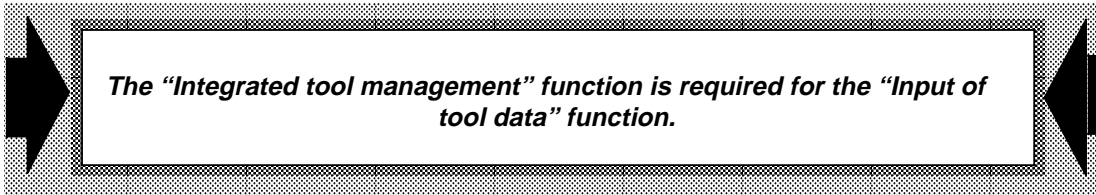

**TOOL  
OFFSET**

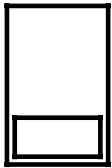

Press the "TOOL OFFSET" softkey.

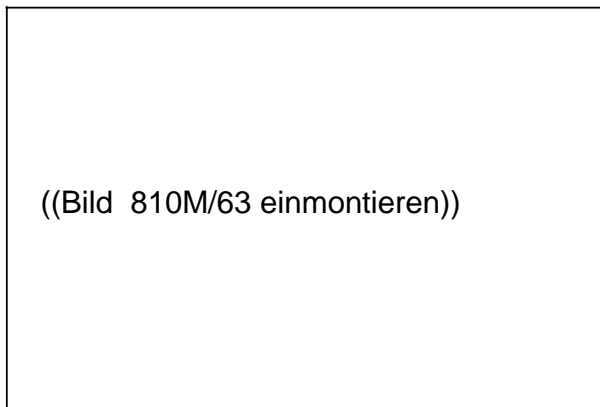

This display then appears on the screen.

**TOOL  
DATA**

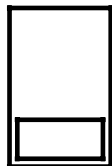

Press the "TOOL DATA" softkey.

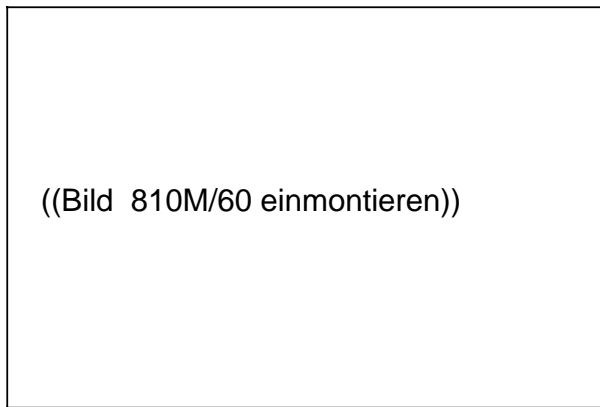

This display then appears on the screen.

Enter data for up to four tools in this input screen form.

**ENTER**

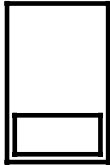

Now press the "ENTER" softkey.

The data input is transferred to the PLC and stored in the magazine table (visible on the screen).

**PAGE  
UP**

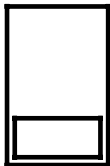

Press the "PAGE UP" or "PAGE DOWN" softkeys to page through the magazine table.

**PAGE  
DOWN**

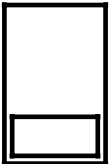

**GEOM.  
DATA**

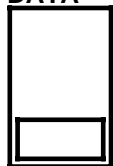

Press the "GEOMETRY DATA" softkey.

The input form for tool offset data is displayed again.

Enter the geometry data in this screen form. Note that the location number in the magazine table (e. g. 3) is the same as the D No. of the tool offset memory (e. g. D3). Press the "GEOMETRY DATA" softkey to return to the "TOOL OFFSET" menu. You can return to the standard menu by pressing the "RECALL" key twice.

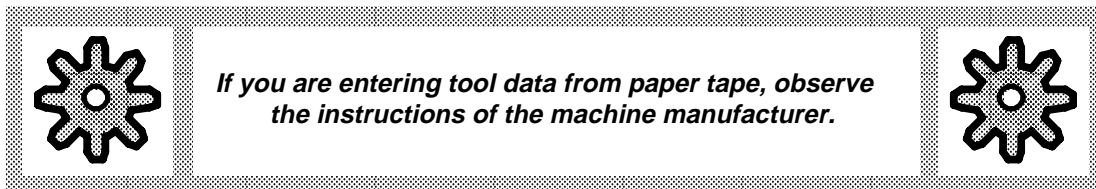

### 3.1.4.6 Display of tool data

TOOL  
OFFSET

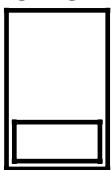

GEOM.  
DATA

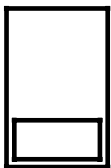

or

D...



Press either "TOOL OFFSET" softkey or the "GEOMETRY DATA" softkey.

Press the appropriate keys to page through the display and select a certain D No. input is then displayed.

or

Select a D No. and press the search key. The tool data under the D No. input is then displayed.

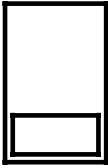
**TOOL  
DATA**

Press the "TOOL DATA" softkey.

The data stored in the magazine table (PLC) is displayed (the location No. is the same as the D No. of the tool offset table). Press the "RECALL" key to return to the "TOOL OFFSET" menu.

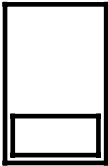
**LIST OF  
TOOLS**

Press the "LIST OF TOOLS" softkey.

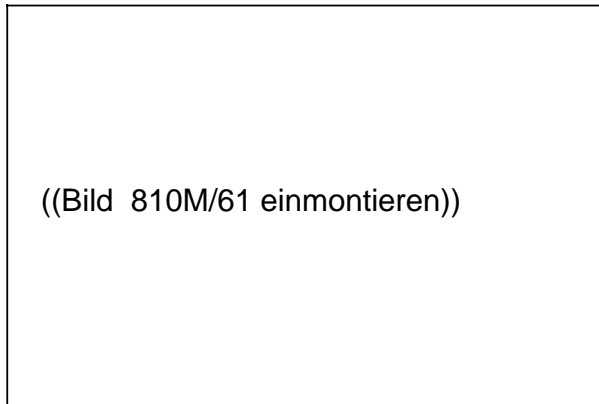

This display then appears on the screen.

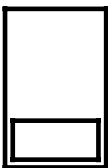
**NEXT**

When you have pressed the "NEXT" softkey further stored tool numbers are displayed. You cannot "PAGE UP" in the tool table.

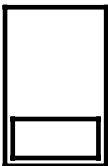
**DISPLAY DATA**

Press the "DISPLAY DATA" softkey.  
The first six tool numbers stored (T number) in ascending order of location numbers.

Press the "GEOMETRY DATA" softkey to move to the "TOOL OFFSET" menu. You can return to the standard menu by pressing the "RECALL" key twice.

### 3.1.5 Zero offset

The actual position memory, and therefore the actual position display, are referred to the machine zero point "M" after traversing to the reference point.

The machining program for the workpiece is referred to the workpiece zero point "W".

Machine zero point "M" and workpiece zero point "W" are **not** identical. The dimensions between the machine zero point "M" and the workpiece zero point "W" can vary, depending upon the type and fixing of the workpiece. The **zero offset** will allow for this during program operation.

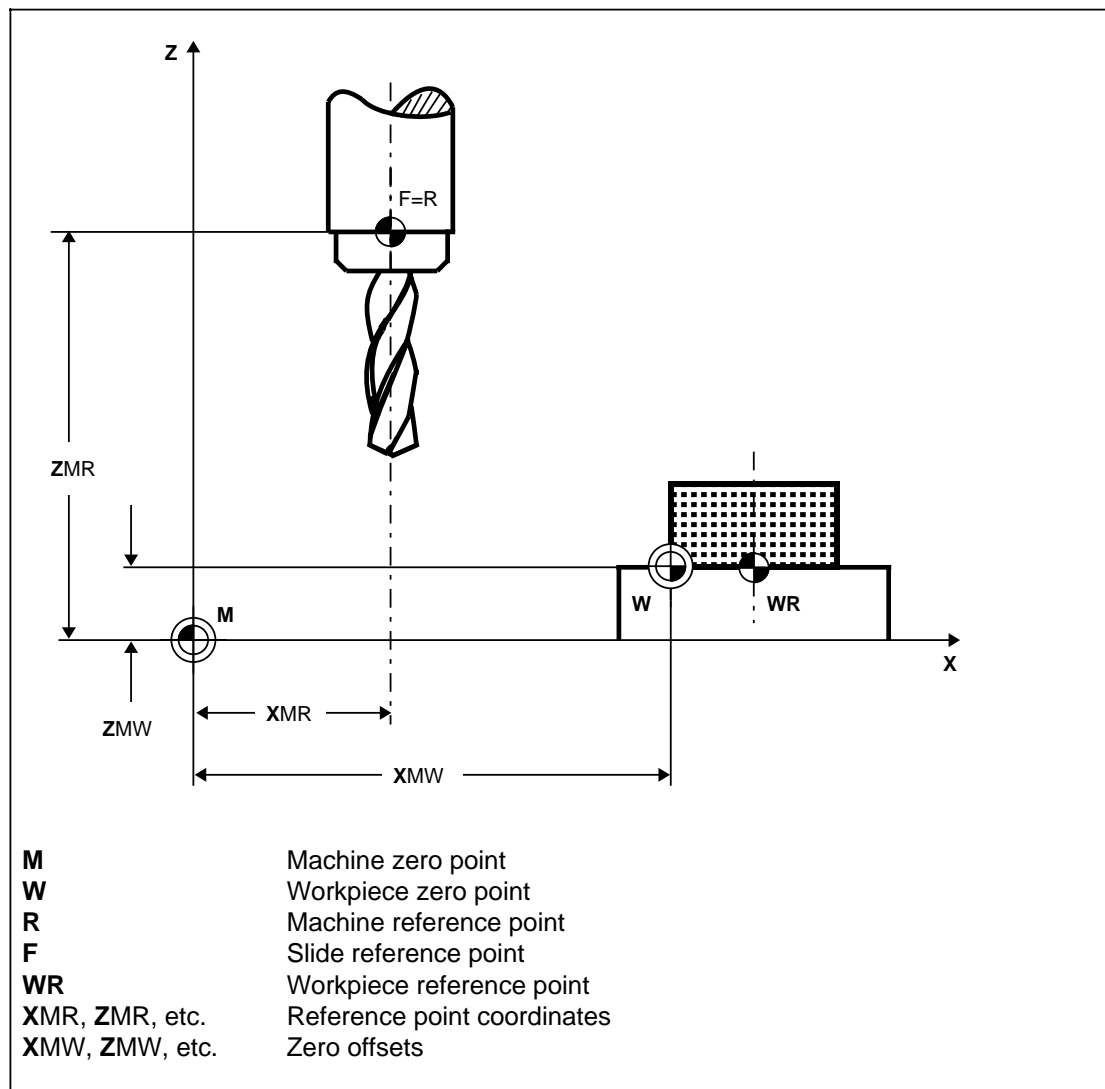



### 3.1.5.1 Settable zero offset

For each axis you can select 4 variable zero offsets using "G54" to "G57".

For "G54" to "G57" there are 2 settings respectively :

- a "coarse offset" (**ZO**) and
- a "fine offset" of the zero points ( **ADD. ZO**)

Input the value for the variable zero offset into the control, as "SETTING DATA".  
The entered zero point offsets are activated in the part program called.

Sequence of operation

**SETTING DATA**

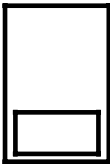

In any operating mode, operate the "SETTING DATA" softkey...

**ZERO-OFFSET**

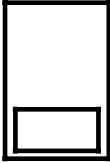

... and subsequently the "ZERO OFFSET" softkey.

(( 810M))  
(( Bild 19 von Druckerei einmontieren

This input screen form appears for the input of values for the "coarse offset" (ZO) and "fine offset" (ADD.ZO) of the zero points for G54 to G57.

Press the softkey for the desired G function. The preselected G function is indicated in the display (e.g. G 54).



Now enter the value for the coarse offset "G54" for the **X axis** into the input line, using the numerical keys; then transfer the value into the input field with the input key.

The inverse marking now jumps to the next input field (coarse offset for the **Y axis**).

Now enter the value for the coarse offset for the **Y axis** using the numerical keys; then transfer the value into the input field with the input key.

The inverse marking now jumps to the next input field (coarse offset for the Z or third axis).

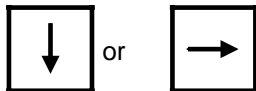

Operate this cursor key until the inverse marking has jumped into the right-hand input field (ZERO OFFSET ADD).



Now enter the value for the fine offset "G54" for the **X axis** into the input line, using the numerical keys; then transfer the value into the input field with the input key.

The inverse marking now jumps to the next input field ("fine offset" for Y axis).

Now continue - as described for the preceding input - until you have entered all values for the "Fine offset" for G54 as well.

Select the other settable zero offset G55 to G57 using the appropriate softkeys in the menu and proceed as for G54.

### 3.1.5.2 Programmable zero offset - external zero offset

#### a) Programmable zero offsets

The values for the G58 and G59 offsets can be written in the program.

You will find information on the programming of these zero offsets in Part 2, "Programming", Section 2.5.

The programmed zero offset for the current part program % ... can be displayed.

#### Sequence of operation

##### Precondition:

You have selected the "AUTOMATIC" operating mode,  
with the operating mode selector switch, symbol



and have called a program %:

##### SETTING DATA

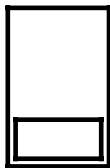

Now operate the "SETTING DATA" softkey...

##### PROG.- ZO

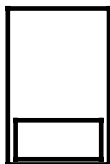

... and then the "PROGRAMMABLE ZERO OFFSET" softkey.

((Bild 810M/19 einmontieren))

This display appears.  
You can now read the values  
for "G58" and "G59" for the X, Y, Z  
axes (4th and 5th axes if present), but  
you cannot change them.

b) **External zero offset**

The "External zero offset" values for the X, Y and Z (4th and 5th axes if present) are transferred from the PLC.

These values can also be displayed on the screen.

Sequence of operation

**SETTING  
DATA**

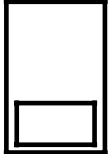

Press the "SETTING DATA" softkey  
in any mode...

**EXT.  
ZO**

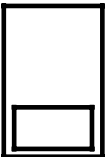

... and then the "EXT. ZO" softkey.

((Bild 810M/20 einmontieren))

This display appears on screen.  
You can now read the value for the  
external zero offset for the X, Y and Z  
axes (4th and 5th axes, if present), but  
you cannot change them.

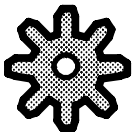

*The "External zero offset" is defined via machine data.*

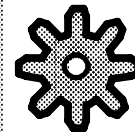

### 3.1.6 Setting data : " R PARAMETERS", "SPINDLE", "AXIAL", "ANGLE OF ROTATION", "SCALE MODIFICATION"

Using the **setting data**, you determine certain operating states.

You can **input**, **modify** or **delete** setting data using screen forms.

#### Setting data "R PARAMETERS"

The 810M control recognises parameters **R 0** to **R 699** and **R 700** to **R 999**.

- Parameters R0 to R699 are channel-specific, i.e. they exist for both channels, "CH1" and "CH3", separately.
- Parameters R700 to R999 are jointly valid for all channels (central parameters).

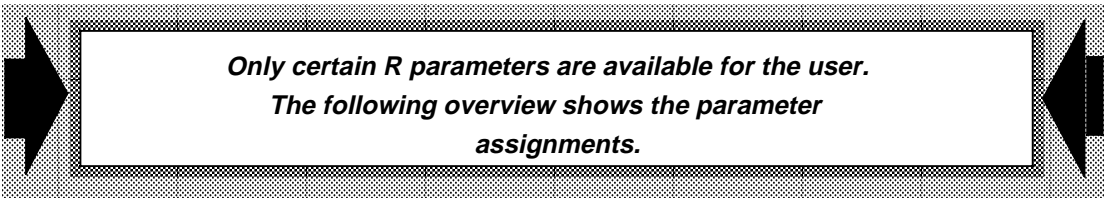

*Only certain R parameters are available for the user.  
The following overview shows the parameter  
assignments.*

## 3.1.6 Setting data: "R PARAMETERS", "SPINDLE", "AXIAL", "ANGLE OF ROTAT.", "SCALE MODIFICATION"



## 3.1.6 Setting data: "R PARAMETERS", "SPINDLE", "AXIAL", "ANGLE OF ROTAT.", "SCALE MODIFICATION"

Channel-specific and central R parameters:

Channel-specific R parameters (0-699)/ Central R parameters (700-999)			
No.	Used in cycle	Permanently assigned?	Function
R 0 : R 49	In all Siemens cycles	As long as cycles are being processed	Transfer parameters, see Descriptions: Standard cycles, Measuring cycles, Mould making cycles.
R 50 : R 99	In all Siemens cycles	As long as cycles are being processed	Local R parameters Cycle calculations are carried out with these R parameters
R 110 : R 199	L 898 : L 979	Yes	Global R parameters Measuring cycles -machine data
R 200 : R 219	In all Siemens cycles	As long as cycles are being processed	Converter (PG 675 or WS 800) SINUMERIK 3/8: 800 converted cycles
R 220 : R 239	All cycles generated with WS 800	As long as cycles are being processed	WS 800 compiler
R 240 : R 299			Reserved for SIEMENS
R 300 : R 499	All cycles generated with WS 800	As long as cycles are being processed	WS 800 compiler (STACK for the local R parameters R 50-R 99)
R 500 : R 699	Additional channel-specific parameters 810T/M		Free for user
R 700 : R 799	Central parameters 810T/M		Free for user
R 800 : R 959			Free for user
R 960 : R 999			Reserved for SIEMENS
R 9n : R9n+9	L 968 : L 969	As long as cycles are being processed	Transfer program n=00... 90 (Working channel R 11-R 199 <-> Store channel) 10 R parameters required: No. is freely selectable.



## Sequence of operation for "R PARAMETER" setting data

### SETTING DATA

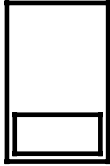

Operate the "SETTING DATA" softkey in any of the operating modes.

### R PARAMETERS

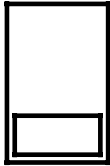

Operate the "R PARAMETERS" softkey.

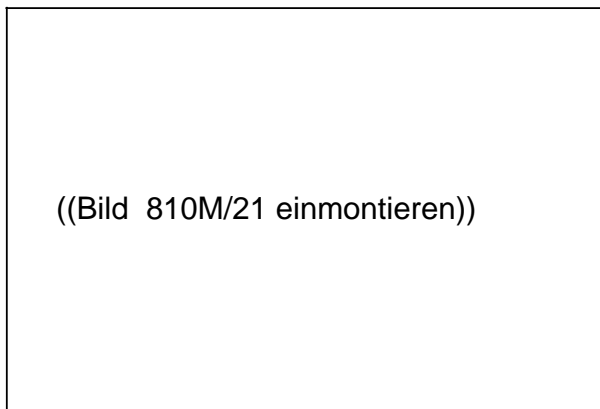

This input screen form appears with the input field marked in inverse video.



Using the "channel switchover" key, select either channel "CH1" or "CH3" (marked in inverse video in the upper right hand corner of the display).

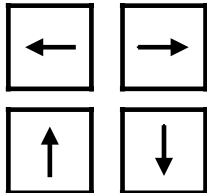

Now operate any of the cursor keys to position the cursor to the desired input field of the displayed R parameters.

## 3.1.6 Setting data: "R PARAMETERS", "SPINDLE", "AXIAL", "ANGLE OF ROTAT.", "SCALE MODIFICATION"

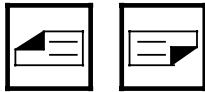

You can call up further screen forms with input fields for other R parameters with the page up/down keys.

or



You can call up an input screen form or a particular R parameter using the alphanumeric keys and the search key ("63" in example, "R" need not be entered).



Enter the value for the selected R parameter with the numeric keys. Subsequently, you can transfer the value into the input field with the input key.

### "SPINDLE" setting data

Using an input screen form, you can enter/modify the following spindle data via "SETTING DATA":

Designation	Standard setting data (delivery state)	Maximum input value	Input unit
Smoothing constant with threading	0	5	-
Programmed spindle speed limitation	0	16000	rev/min
Oriented spindle stop	0	359.9	1/10 degree
Spindle speed limitation (absolute)	0	16000	rev/min

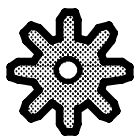

- 1) The "Max input value" is fixed in MD !
- 2) The "Input unit" is fixed in MD: you can also use 0.1 rev/min instead of rev/min !

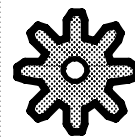

# Sequence of operation for "SPINDLE" setting data

## SETTING DATA

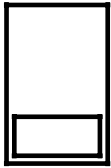

Operate the "SETTING DATA" softkey in any operating mode.



Extend the softkey menu displayed using the ETC key to the right below the display.

## SPINDLE

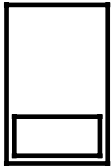

Operate the "SPINDLE" softkey.

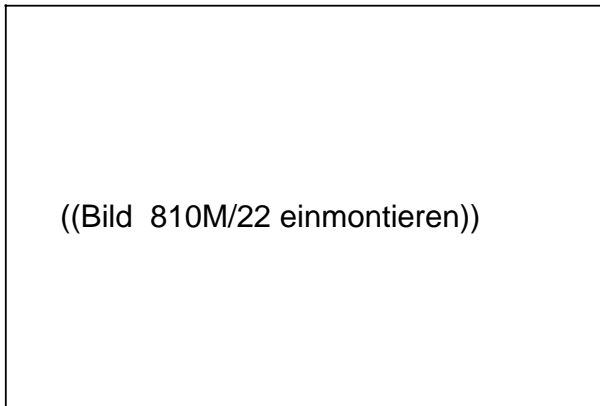

This input screen form appears with the input field marked in inverse video.

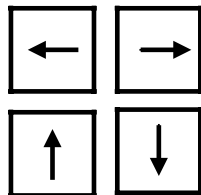

With the cursor keys, position the cursor at the desired input field.



Enter the value for the selected input field with the numeric keys. Subsequently, you can transfer the value into the input field with the input key.

**"AXIAL" setting data**

Using an input screen form, you can enter/modify the following data via "SETTING DATA":

Designation	Standard-setting data (delivery state)	Maximum input value	Input unit
Dry run feed rate	0	e.g. 24000	1000 units/min (Reference syst.: IS)
Min. working area limit	0	+/-99999999	units (Reference syst.: IS)
Max. working area limit	0	+/-99999999	units (Reference syst.: IS)

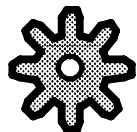

*Please consult the machine tool manufacturer for the "Maximum input value"!*

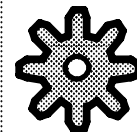

### Sequence of operation for "AXIAL" setting data

#### SETTING DATA

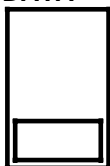

Operate the "SETTING DATA" softkey in any operating mode.



Extend the softkey menu displayed using the ETC key to the right below the display.

#### AXIAL

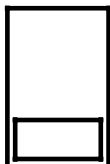

Operate the "AXIAL" softkey.

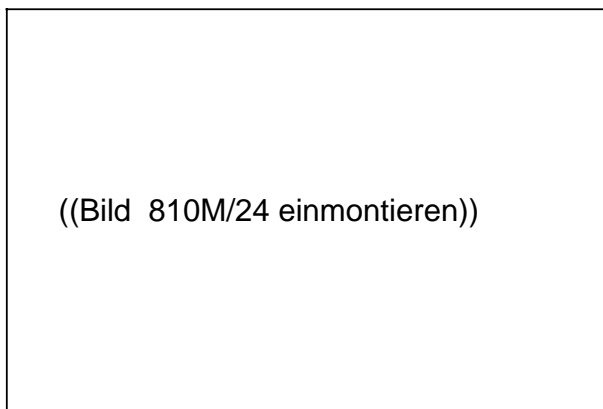

This input screen form appears with the input field marked in inverse video.

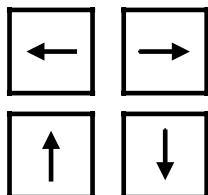

Use the cursor keys to position the inverse marking on the required input field and change the minimum and maximum working area limitation for the defined axes (for the fictitious axes of the TRANSMIT function, too).



Enter the value for the selected input field with the numeric keys. Subsequently, you can transfer the value into the input field with the input key.

**DRF  
ASSIGNM**

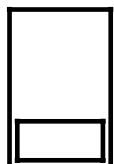

Operate the "DRF ASSIGNM" softkey.

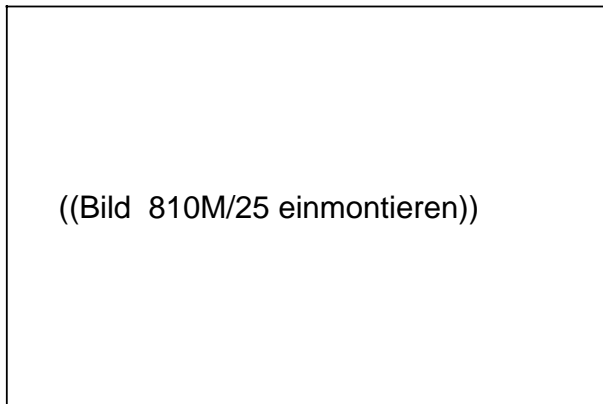

This input screen form appears with the input field marked in inverse video.

You can assign each of up to seven axes (for the TRANSMIT function) to a handwheel.

## 3.1.6 Setting data : "R PARAMETERS", "SPINDLE", "AXIAL", "ANGLE OF ROTAT.", "SCALE MODIFICATION"



To do this enter the axis name, e.g. "X", and assign the number of the handwheel, e.g. "1", to it.

You can also assign several axes to a handwheel, but you can only ever enable one axis for this handwheel (for further details, see "HANDWHEEL" in Section 3.2.9 for "DRF" in Section 3.2.10).

Press the softkey "WORKING AREA LIM" to return to the display for the minimum and maximum working area limitation.

### "ANGLE OF ROTATION" setting

#### Sequence of operation for "ANGLE OF ROTATION" setting data

##### SETTING DATA

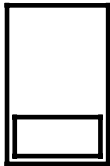

Operate the "SETTING DATA" softkey in any operating mode.



Extend the softkey menu displayed using the ETC key to the right below the display.

##### ROTAT. ANGLE

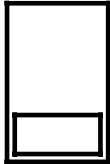

Operate the "ROTAT. ANGLE" softkey .

The "SETTING DATA COORDINATE ROTATION" input screen form appears in "AUTOMATIC" mode.

Enter the desired angle of rotation A... for G54 to G57 in the input screen form (the angles of rotation A... for G58 and G59 are defaulted by the program and only displayed in the screen form).

Then proceed as follows:

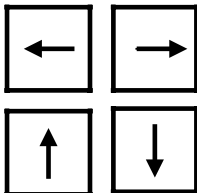

With the cursor keys, position the cursor at the desired field (G54 ... G57).

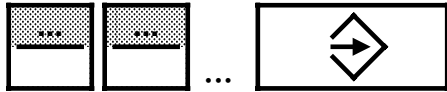

Input a value for the angle of rotation "A" selected with the numeric keys.  
Subsequently, you can transfer the value into the input field with the input key.

### "SCALE MODIFICATION" setting data

#### Sequence of operation for "SCALE MODIFICATION" setting data

##### SETTING DATA

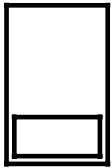

Operate the "SETTING DATA" softkey in any operating mode.



Extend the softkey menu displayed using the ETC key to the right below the display.

##### SCALE MODIF.

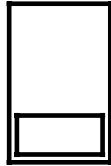

Operate the "SCALE MODIFICATION" softkey.

The "SETTING DATA SCALE MODIFICATION" input screen form appears in "AUTOMATIC" mode.

The following values defaulted by the program are displayed:

- The "scale factor" (magnification or reduction) for
  - Channel 1: P ... (e.g. "2" signifies double size;  
"0.5" signifies half size)
  - Channel 3: P ...
- The "scale centre" (reference point) for
  - Axis 1: X ...
  - Axis 2: Y ...
  - Axis 3: Z ...
  - Axis 4: C1 ...
  - Axis 5: C2 ...

### 3.1.7 Flexible plane selection

#### Sequence of operation

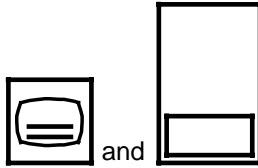

Call one of the following modes:

- PRESET
- JOG
- AUTOMATIC
- INC 1 ... INC 10 000
- REFPOINT.

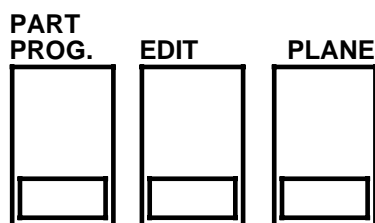

Now press the softkeys "PART PROGRAM", "EDIT" and "Plane" one after the other.

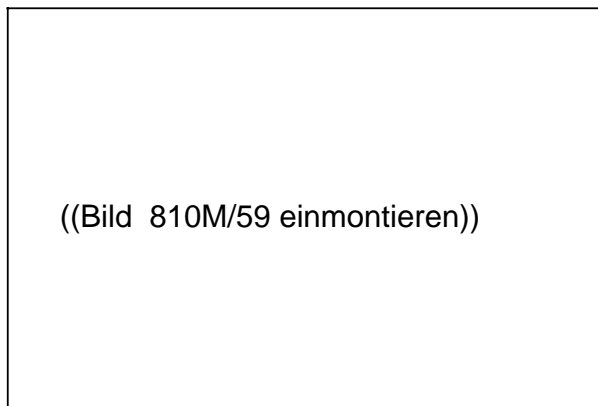

This screen form appears on the screen with the input field marked inverse.

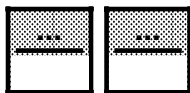

Using the numeric keypad enter the channel No. of the channel via which the part program is to be executed (Channel 1 to 3).

If you wish to select one of the predefined planes G17, G18 or G19, press the appropriate softkey.

The control then automatically enters the designations for the abscissa, ordinate and applicate and the two interpolation parameters. All designations must have been defined by the machine manufacturer in the appropriate NC MD 548\*, 550\*, 552\* and 304\*.



**STORE  
PLANE**

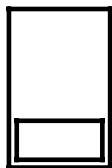

Press the “STORE PLANE”.  
The selected plane is transferred into the part program. In the subsequent operator guidance (e.g. “CONTOUR” or “MACHINING CYCLES”) the axis are automatically displayed in the parameter input forms.

However you can define a new plane as well.

**G16  
PLANE**

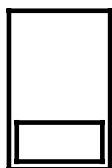

Press softkey “G16”.  
The axis names for the abscissa, ordinate and applicate must now be entered manually, so that they are defined for further operator guidance.

**STORE  
PLANE**

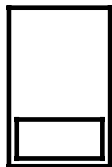

Press the “STORE PLANE” softkey.  
The previously defined axis names behind the G16 function are transferred into the part program.

**Caution:**

The functions “SIMULATION” and “CONTOUR” only work on the axes defined to DIN. On the M version these are the 1st to the 3rd axis, on the T version they are the 1st to the 2nd axes. If you have used other axes than these via the flexible plane selection, it could cause errors in simulation and machining (“CONTOUR”).

Modifications of the planes for the “CONTOUR” function also affect the definition of the selectable plane G16, i.e. the corresponding axis names of the selected plane are transferred for G16.

The plane definition for the “CONTOUR” function via G16 (G17 to G19) also applies to the “CONTOUR” function.

The axis names themselves are defined in machine data and apply to every plane selection.

**Note:**

A fixed channel-specific initial setting can be defined in the 2nd G group for the machining plane via MD 110\* (see Section 7.3.4).

Example: standard plane G18 for turning or G17 for drilling.

How this basic setting is defined is described in Section 7.3.4 “Definition of the initial setting of the G groups”.

### 3.1.8 Axis synchronization

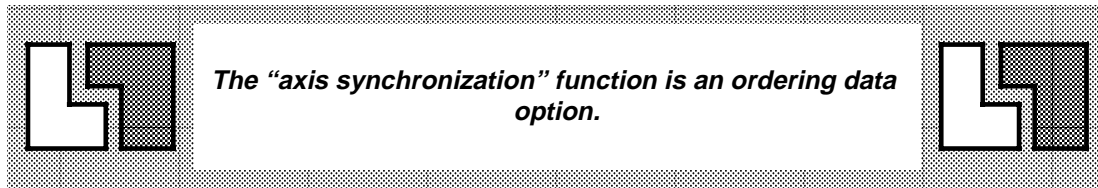

The “axis synchronization” function duplicates the programmable main axis as long as the maximum permissible number of axes is not exceeded (for 810T/M and 820T/M, five axes). With this function two identical workpieces can be produced by one machine tool with two tool systems by a part program running in a channel of the NC.

The function “axis synchronization” is only available in “AUTOMATIC” and “MDI-AUTOMATIC” modes and in “AUTOMATIC interrupted”. For axis synchronization a measuring circuit is available for every axes including the following axis. Therefore, two pairs of axes can be synchronized. The fifth axis remains for use as an independent axis.

The “axis synchronization” function is modal, i.e. it remains active, until a RESET is performed using the RESET key or until a mode change with an implicit RESET is initiated (for further details see Section 2.3.4 “RESET with change of operating mode”).

#### Example:

If the part program is interrupted in “AUTOMATIC mode”, an axis pair can still be traversed simultaneously after a change to “JOG” or “INC” (**leading and following axis**).

Reason: This mode change does not cause a “RESET”. The “axis synchronization” function remains active.

#### 3.1.8.1 Function of the modes with “axis synchronization”

##### “PRESET” AND “REFPOINT” modes:

The axes of tool system 1 and tool system 2 must be selected separately using the traverse keys as in the modes without “axis synchronization”.

##### “JOG”, “REPOS”, “INC” without “AUTOMATIC interrupted” or “Block search”:

The axes of the two tool systems can only be moved separately.

##### “JOG”, “REPOS”, “INC” after “AUTOMATIC interrupted” or “Block search”:

In these modes the offsets which have arisen between the leading and the following axis after “Block search” or “AUTOMATIC interrupted” etc. can be eliminated in various ways:

- Case 1: The tool system 1 axis and the tool system 2 axis have the same offset. **Both** axes are traversed synchronously after you have pressed the traverse key for the leading axis (tool system 1).
- Case 2: The tool system 1 axis and the tool system 2 axis have different offsets. You can only eliminate offsets by traversing the axes separately. Press the appropriate traverse keys on the machine control panel (see the note in the box on this page!).
- Case 3: Press "NC start" and the offsets are eliminated simultaneously on all axes.

By offsets we mean all additional differences in axial position between the machine zero and the workpiece zero, which are not contained in the position instructions of the part program. The following four offsets exist separately for the leading and the following axes:

- settable ZO G54-G57
- external ZO
- DRF offset
- PRESET offset.

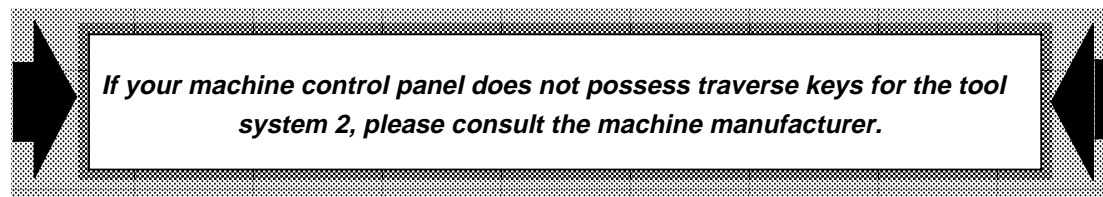

**Note:**

If "axis synchronization" is selected, the following axis is always traversed together with the leading axis (tool system 1), as long as the movements are ***programmed!***

### 3.1.9 TRANSMIT coordinate transformation

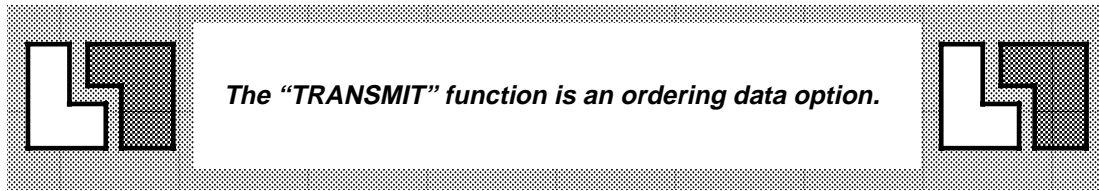

Definition: TRANSMIT = **TRANS**formation **M**illing Into **T**urning,

The TRANSMIT coordinate transformation permits face milling of turning parts on a turning machine. You program the milling operation in a **fictitious** (Cartesian) coordinate system. Machine movements are executed in the **real** machine coordinate system. The machine manufacturer defines the axes for the fictitious coordinate system via machine data.

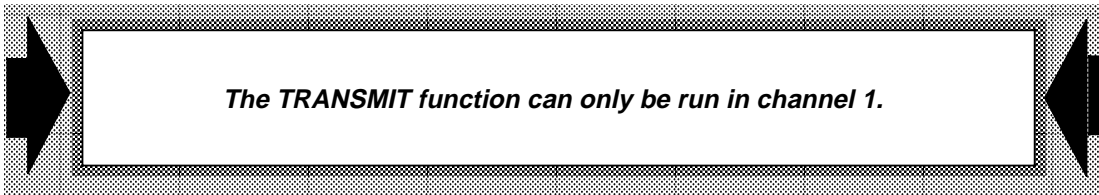

#### 3.1.9.1 Behaviour of the transformation in the modes

The transformation either be deselected on a RESET or still be active after a RESET. This facilitates operation of a grinding machine, for example, where the transformation generally remains active permanently.

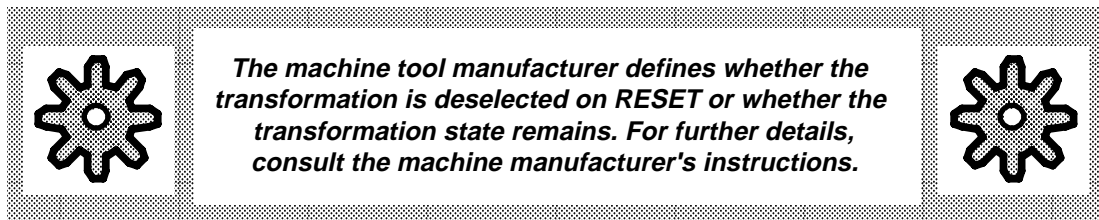

**Exception:** The TRANSMIT function is **always** deselected by the change to the "REFPOINT" mode (reference point approach).

**State / event matrix for transformation selection and deselection:**

State / Event	Automatic passive	Automatic active	JOG	JOG (Automatic interrupted)	Automatic interrupted
NC Start	Automatic active				Automatik active
NC Stop		Automatic interrupted			
Change to JOG	JOG	JOG (Automatic interrupted)			JOG (Automatic interrupted)
Change to AUTOMATIC			Automatic passive	Automatic interrupted	
RESET	Automatic passive <i><sup>1)</sup>Deselection of transform.</i>	Automatic passive <i><sup>1)</sup>Deselection of transform.</i>	JOG <i><sup>1)</sup>Deselection of transform.</i>	JOG <i><sup>1)</sup>Deselection of transform.</i>	Automatic passive <i><sup>1)</sup>Deselection of transform.</i>
Change to REFPOINT	<i>Deselection of transform.</i>	<i>Deselection of transform.</i>	<i>Deselection of transform.</i>	<i>Deselection of transform.</i>	<i>Deselection of transform.</i>

Note <sup>1)</sup>

Case 1: Transformation deselection on RESET: RESET is caused by pressing the RESET key, part programm (PP) end and mode change except REFPOINT.

Case 2: No transformation deselection on RESET: generally transformation modal except for REFPOINT.

Explanations of the state/event matrix:

The fields within the matrix contain the state subsequent to the event and information on the transformation state.

- **“AUTOMATIC passive” state:**  
No program is being executed (Reset).
- **“AUTOMATIC active” state:**  
The program is being executed (program running).
- **“JOG” state:**  
You can traverse manually in the mode “JOG”, “INC” or “REPOS”.
- **“JOG” (AUTOMATIC interrupted) state:**  
The program was interrupted and the “JOG” state selected.
- **“AUTOMATIC interrupted” state:**  
The programm was interrupted, without leaving the “AUTOMATIC” mode (NC Stop).

### 3.1.9.2 TRANSMIT function in the various modes

#### “AUTOMATIC” and “MDI AUTOMATIC” mode:

In this mode the TRANSMIT function is selected and deselected via G functions in the program.

Selection of TRANSMIT:           G131  
Deselection of TRANSMIT:       G130.

On selection of TRANSMIT control initializes the fictitious axes. The NC interpolates only in the fictitious coordinate system where the axes affected by TRANSMIT are concerned. The contour between the block final values is defined. Please consult the instructions of the machine manufacturer to see which axes are involved in TRANSMIT.

#### “JOG”, “INC” mode:

Definition:           Transformation grouping =   real and fictitious axes involved in the transformation

In JOG mode the axes of the transformation grouping can be traversed both in the real and in the fictitious coordinate system. To be able to traverse a fictitious you must first select the TRANSMIT transformation with G131 in the program. The machine manufacturer must also have defined that TRANSMIT remain after a RESET (key or mode change), this does not apply to “AUTOMATIC interrupted.”

Real axes **cannot** be traversed, if they belong to the transformation grouping. Traverse commands coming from outside for such axes are ignored, without an error message appearing. If the control recognizes a traverse command for a fictitious axis, it generates the distance-to-go to the software limit switch of the fictitious axis. If the software limit switch is outside the permissible working area of the machine tool, the limit switches of the real axes of the grouping restrict the fictitious position. If **only** the real axes are to be traversed, the channel 1 reserved by the transformation must be enabled again (deselection of the transformation via G130). If a real axis of the transformation grouping is reserved by “feed halt”, this applies to all axes of the grouping.

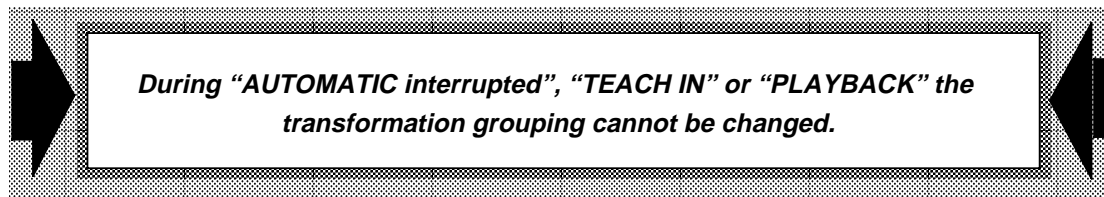

#### “REFPOINT” mode:

On a change to “REFPOINT” mode the TRANSMIT function is automatically deselected. Reference points therefore **only** exist for real axes and not for fictitious axes.

#### “REPOS” mode:

After “block search” or “AUTOMATIC interrupted” the contour can only be approached in the previously selected coordinate system.

### “PRESET” mode:

The actual value for a fictitious axis can only be set while the transformation (G131) is selected. It only makes sense to use the function if the transformation remain active after a RESET. A PRESET offset with @435 is possible for fictitious axes, independent of those for real axes (see Part 2, “Programming”, Section 11.7).

The actual value memory and therefore also the actual value display refer to the machine zero “M” after reference point approach. The offset entered in “PRESET” mode is calculated into the actual value and displayed.

Independent of the value for the 1st real axis during TRANSMIT (radius axis) the origin of the fictitious coordinate system coincides with the machine zero when the transformation is selected (PRESET offset is not taken into account).

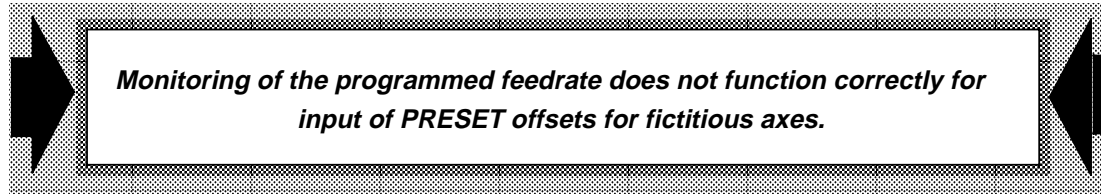

### “TEACH IN”/“PLAYBACK” mode:

“TEACH IN” is a block program mode and is therefore also possible in the TRANSMIT function.

There are two applications of the “PLAYBACK” mode:

- If the transformation is deselected (G130), **only real** axis positions are transferred into the part program.
- If the transformation is selected (G131), axis positions of the **real** (not belonging to the grouping) **or of the fictitious** axes can be transferred into the part program.

### Special cases:

#### – “DRF/handwheel” active

The transformation must be selected before “DRF/handwheel” can be activated for the fictitious system. Otherwise no handwheels must be enabled for the real axes of the transformation grouping.

#### – Follow-up mode

During follow-up mode for real axes, the values for the fictitious axes are not prepared. Data preparation in the NC begins with the changeover of the axes from follow-up mode to closed-loop control.

**Display of the TRANSMIT function:**

In addition to the maximum of five real axes of the NC control, there are also two fictitious axes for the TRANSMIT function, i.e. a total of up to seven axes. In the displays of the sub-menus "Zero offsets (G54 to G59)", "Scale modification", "External zero offset", "Setting data axial" etc. this has been taken into account (input and display fields for the sixth and seventh axes).

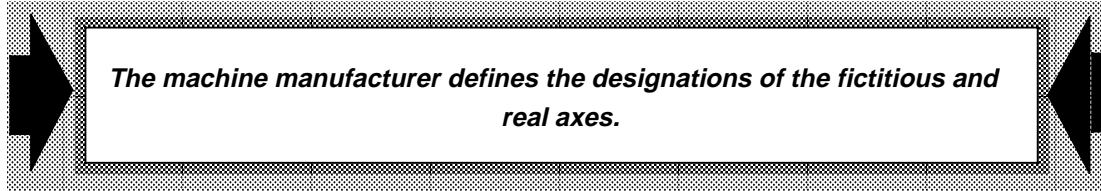
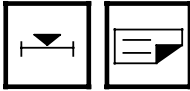
**Sequence of operation**

If, in any display, only the actual or other values for the first five axes be shown, you can display the remaining two axes after the keying sequence "Actual value with double character height", "page forwards".

**3.1.9.3 Monitoring the software limit switch for fictitious axes with the TRANSMIT function**

As in the case for real axes, fictitious axes, too, are checked for their position relative to the software limit switches. During traversing in JOG mode the distance from the software limit switch is loaded as the maximum axial distance-to-go. In "AUTOMATIC" mode the block final points are checked for software limit switches and working area limitation only for the fictitious axes of the transformation grouping. The real axes of the grouping are checked constantly for software limit switch and working area limitation during axis motion.

The software limit switches set by the reduction area are not active for the fictitious axes. If the radius axis is located outside the limits of the working area or the software limit switches, you can move back in with transformation selected but you cannot move further out. You must acknowledge the pending alarm message with a RESET. Acknowledgement of the alarm message only functions, if the working area limitation and the software limit switches are no longer active (i.e. you have moved the axes back into the normal working area in JOG or INC mode).



### 3.1.10 Program input

You can input a program

- using the keyboard
- using operator guiding (prompting)

While entering a program using one of the above methods, it is possible to change over to the other method; you can **alternate** between working with operator prompting and the keyboard.

#### 3.1.10.1 Program input with the keyboard

You enter an opened program % ... with the individual blocks N ... LF to N ...LF character by character only with the keyboard.

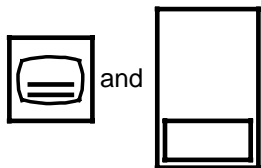
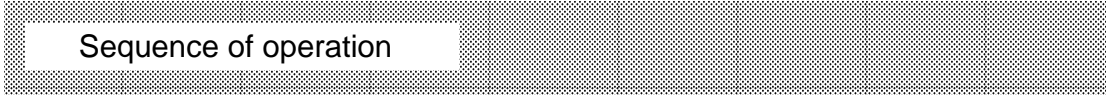

Call any of the following operating modes:

- PRESET ( Actual value setting )
- JOG ( Feed / Jog )
- AUTOMATIC ( Automatic operation )
- INC 1 ... INC 10000 ( incremental jog )
- REFPOINT ( Traverse to reference point ).

For this purpose, use the operating mode selection key, and subsequently the relevant softkey (see below) or the operating mode selector switch (external machine control panel).

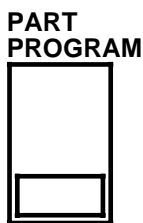

Now operate the "PART PROGRAM" softkey.

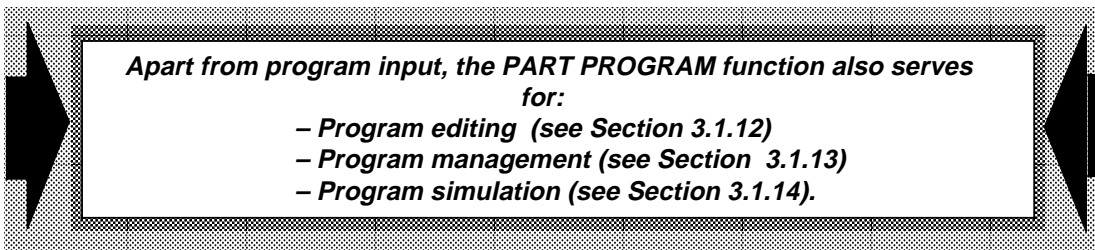

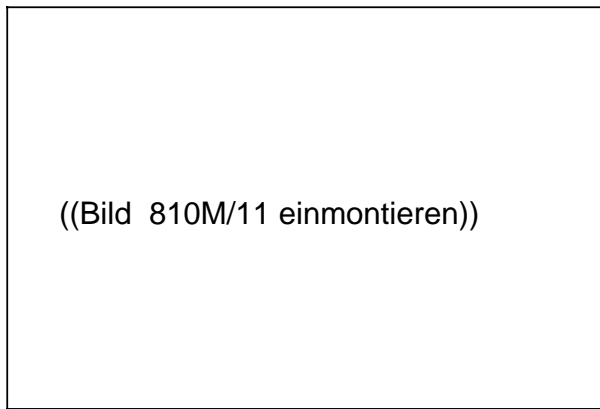

The display appears on the screen.  
The control shows the **last** part program called, in the example program no. " % 77".

### EDIT

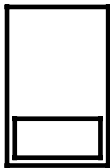

Operate the "EDIT" softkey.

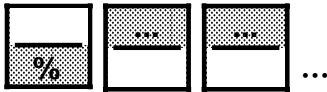

Enter the desired program no. % ... via the keyboard.

### SELECT PROGRAM

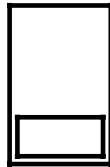

Operate the "SELECT PROGRAM" softkey.

You can now either input a new program or modify a part program already in the control using the input screen form displayed.

**Example:** Entering an individual block.



Enter the block number "N ..." using the numerical keys, and conclude with the input key.



Enter the first word - in the example "G 01"- and conclude with the input key.



Enter the second word - in the example "G 90" for "Absolute" - and conclude with the input key.

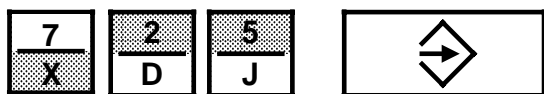

Enter a target coordinate - in the example "X 25" - and conclude with the input key.

⋮  
etc.

⋮  
etc.



You end the block with "LF" ( block end) and conclude with the input key.

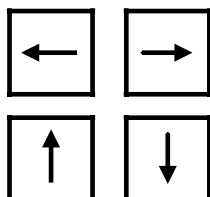

With these keys you can **position** the, cursor at any point in a stored part program; at the start of any block, or before any word within a block.



With this key you can **delete** either the complete or a single word before which the cursor is positioned.



With this key you can **modify** either the complete block or a single word before which the cursor is positioned.

### 3.1.10.2 Program input with operator prompting (GUIDING)

Program input **with** operator prompting (guiding) means:

You enter new program blocks into an opened program % ... **with the aid of a menu:** frequently occurring input functions (e.g. G functions, M functions, complete contour paths etc.) are offered as menus. You can select and enter the desired function in this menu with the appropriate softkey.

Menu-supported input will save you time and operating work; and reduces input errors.

After operating the "GUIDING" softkey, the following softkey functions (displayed in the softkey menu) are available:

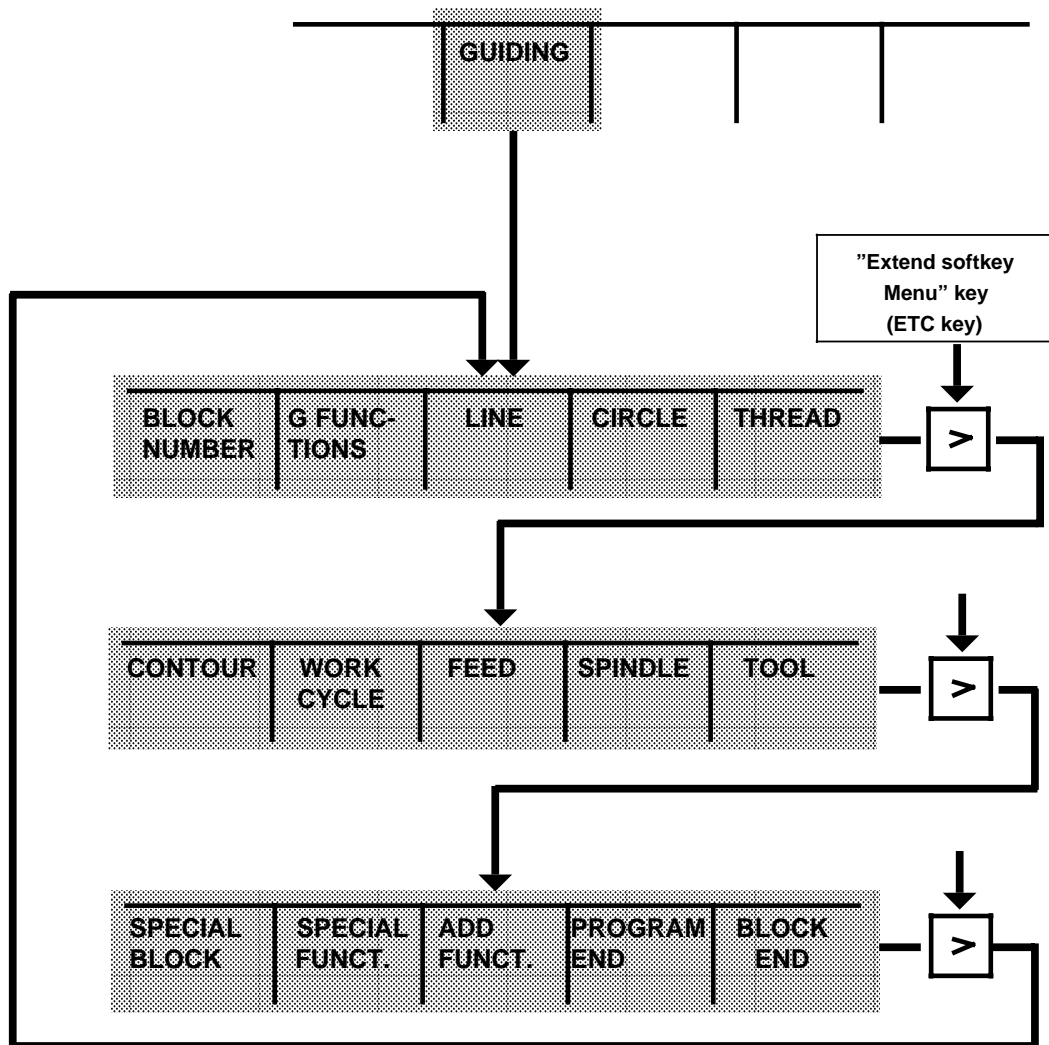

## Sequence of operation

You wish for example, to enter block "N5 G90 G00 X25 LF", into program no. "%12":

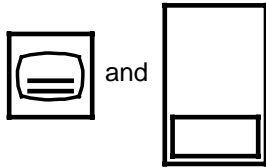

Select one of the following operating modes:

- PRESET (Actual value setting)
- JOG (Feed/jog)
- AUTOMATIC (Automatic operation)
- INC 1 ... INC 10000 ( Incremental jog)
- REFPOINT (Approach reference point)

To do that you use the operating mode selection key, and then the corresponding softkey (see above) or the operating mode selector switch (external machine control panel).

**PART  
PROGRAM**

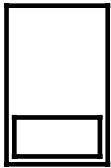

Operate the "PART PROGRAM" softkey.

***Apart from program input, the PART PROGRAM function  
also serves for***

- Program editing (see Section 3.1.12)***
- Program management (see Section 3.1.13)***
- Program simulation (see Section 3.1.14).***

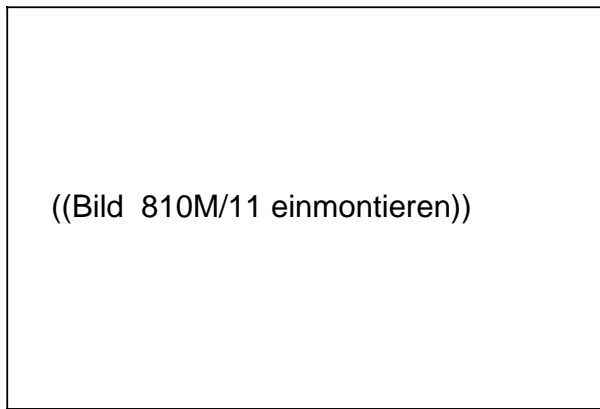

This display appears on the CRT.  
The control shows you the **last** part  
program called, in the example  
program no. "%77".

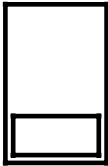
**EDIT**

Operate the "EDIT" softkey.

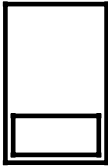

Enter the desired program no. "%12".

**SELECT  
PROGRAM**

Using the "SELECT PROGRAM" softkey call the desired  
program.

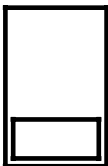
**GUIDING**

Operate the "GUIDING" softkey.

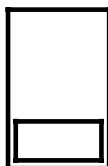
**BLOCK  
NUMBER**

Operate the "BLOCK NUMBER" softkey. The  
block number "**N0005**" is displayed.

**Note:**

The block numbers are generated by the control in steps  
of 5, i.e. after each LF (end of block) the block number is  
incremented by "5".

### G-FUNCTIONS

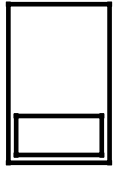

Operate the "G FUNCTIONS" softkey.



Extend the softkey menu.

### G90

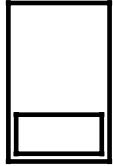

By operating the "G90" softkey, select the first G-Function required. It is **not necessary** to press the input key. "**G90**" is displayed.



Operate this key to return to a higher level softkey menu.

### LINE

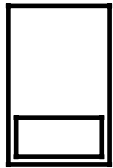

With the "LINE" softkey, select "linear interpolation".

### G00

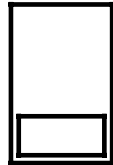

By operating the "G00" softkey, select the "Rapid traverse" function. "**G00**" is displayed.



Using the numerical keys, you enter the desired "X" coordinate, with the value "25", and store it with the input key. "X25" is displayed.

#### BLOCK END

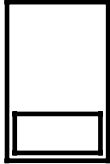

Complete the block by operating the "BLOCK END" softkey. "LF" is displayed. The complete block is transferred into the program memory.

#### BLOCK NUMBER

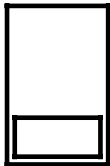

Operate the "BLOCK NUMBER" softkey. The control generates the next number, "5" higher. "N0010" is displayed and created in the program.

⋮

etc.

⋮

etc.

Continue with input until you have completed the part program.





### 3.1.11 Contour

The "CONTOUR" softkey function is an extension of "Program input with operator guiding" (Section 3.1.10.2).

With "CONTOUR" you can select contour elements. Graphics displays support the programming of specific geometric contour values.



As described in 3.1.10.1 or 3.1.10.2 - select any of the operating modes:

- PRESET
- JOG
- AUTOMATIC
- INC 1 ... INC 10000
- REFPOINT.

#### PART PROGRAM

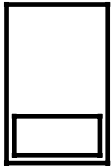

Now operate the "PART PROGRAM" softkey.

#### EDIT

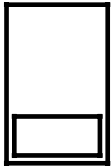

Operate the "EDIT" softkey.

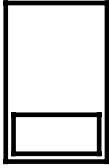

Use the numeric keys to enter the desired program no. %...

**SELECT PROGRAM**

Call desired program using  
"SELECT PROGRAM".

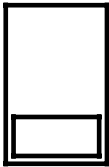
**GUIDING**

Operate the "GUIDING" softkey.

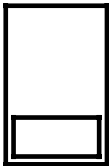
**BLOCK NUMBER**

Operate the "BLOCK NUMBER" softkey. The control generates the lowest available block number N..

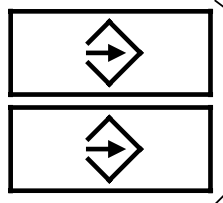
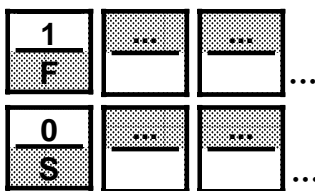

Enter the functions for feed **F...** and spindle **S...** using the numeric keys and store them using the input key.

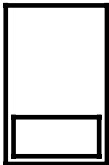

Extend the softkey menu.

**CONTOUR**

Select the "CONTOUR" softkey.

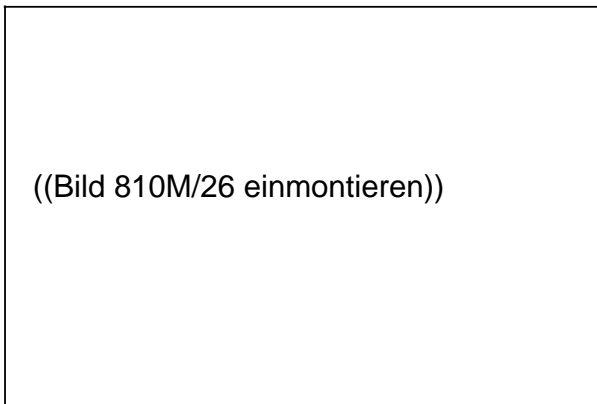

This display appears.  
The available softkey functions are displayed in the menu.



When you operate the ETC key...

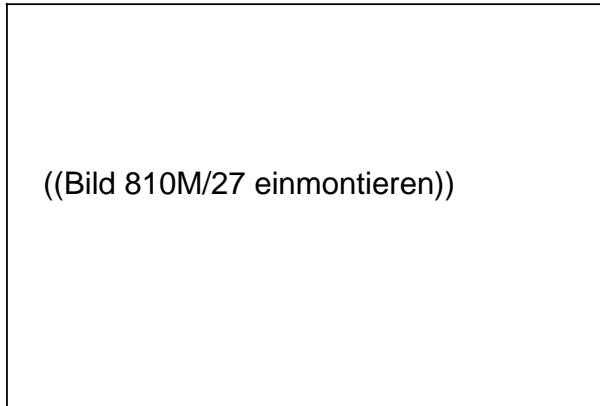

... this display appears with further softkey functions.



When you operate the ETC key, the previous display reappears.

Before programming the contour, select the plane:

**PLANE**

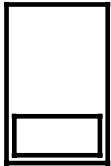

Press the "PLANE" softkey.

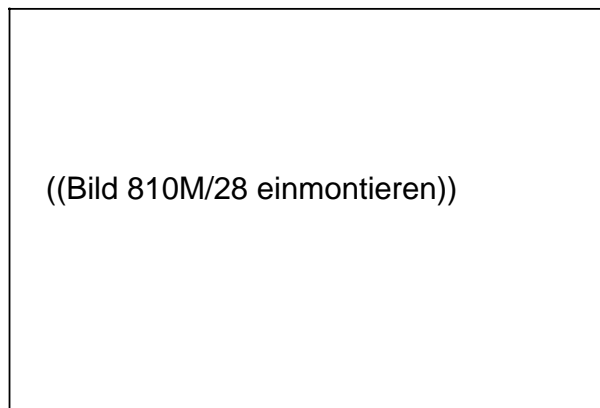

This display appears on the screen. The axis names can be modified from those specified by the machine manufacturer.

**X - Y**

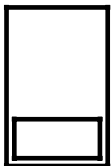

or

**Z - X**

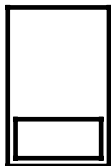

or

**Y - Z**

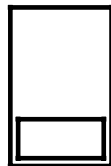

Select the plane you require with one of the softkeys.

The appropriate axis names of the plane selected are also transferred into the display for the selectable plane G16 in flexible plane selection (see Section 3.1.7).

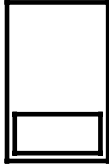
**CONTOUR**

Then press the "CONTOUR" softkey in the same menu.

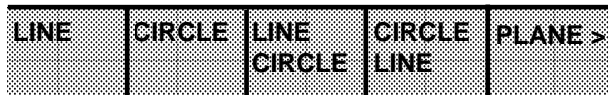

The menu which then appears offers you these contour elements ...



... or you extend the menu with the ETC key ...

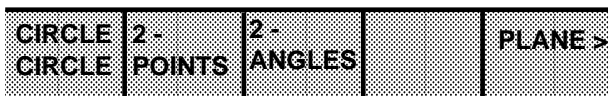

... and select one of the contour elements from this menu.

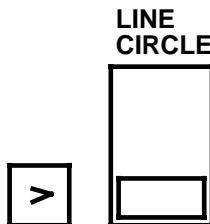

When you operate the "Extend menu" key, the previous display reappears. You now select, for example, the "LINE-CIRCLE" function using a softkey.

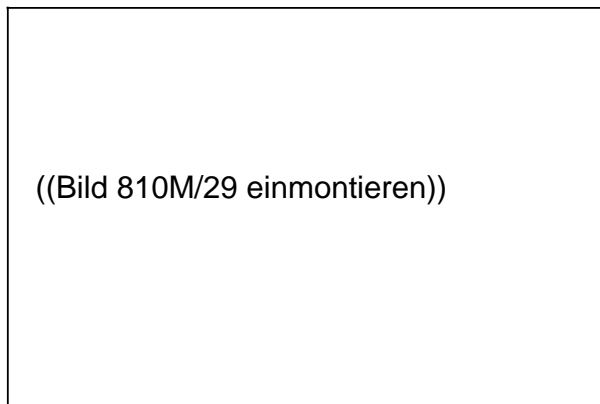

This input screen form appears with the input field marked in inverse video. The contour element selected is displayed graphically.



Now enter the first value using the numeric keys; then store it using the input key. The inverse video marking now jumps to the next input field for the contour: the control now waits for your next input etc.



Now enter, one after the other, into all of the input fields of the contour marked in inverse video - the rest of the geometry values - as described above.

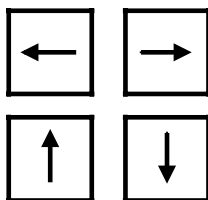

Using the cursor keys, you can position the inverse video marking to any input field, if, for example, you wish to modify the geometry values for the selected contour.

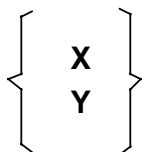

**Note:**

Note the input fields marked in inverse video on the CRT display, in curly brackets, in which there are several values ("X" and "Y" in example).

In this case you are only allowed to enter one value (i.e. only the X value or the Y value, in the example).

**DELETE PARAM.**

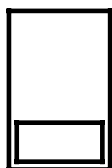

If you have inadvertently entered two values, operate the "DELETE PARAMETER" softkey.

**STORE**

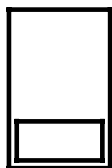

When you have entered all the values required for the contour, operate the "STORE" softkey.

The contour is now stored in the part program with all the entered values. The control generates the "Block End" (LF) character itself, and shows you the complete block entered.

### 3.1.12 Program correction ("EDIT"): Insert/modify/delete word, insert/delete block

You can edit any part program stored in the program memory.

Program correction can also be used while another part program is being processed.

The following corrections are possible:

- Input word
- Modify word
- Delete word
- Input block
- Delete block.

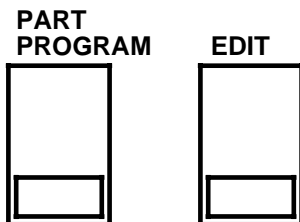

Operate the "PART PROGRAM" and then the "EDIT" softkeys in any of the operating modes : PRESET / JOG / AUTOMATIC / INC1 ... INC10000 / REFPOINT.



Using the keyboard, enter the %... (or "L...") number of the program you wish to edit.

**PROGRAM  
SELECT**

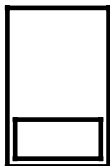

Call the desired program using "PROGRAM SELECT".

You can now either modify a stored part program or enter a new program in the displayed screen form.

3.1.12 Program correction ("EDIT"): Insert/modify/delete word, insert/delete block

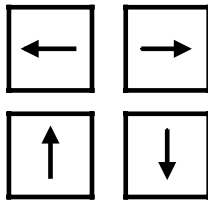

Using the cursor keys, set the cursor, marked in inverse video, in front of the point to be edited.

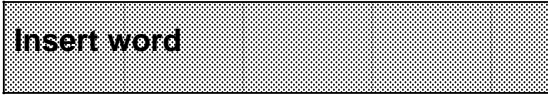

Enter the address **and** the new value ("X15" in example) and store it using the input key.

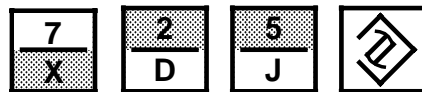
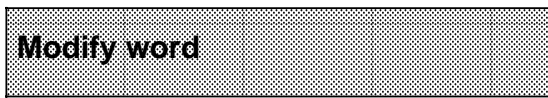

Enter the address of word **and** the new value ("X25" in example) and press the "Modify word" key.

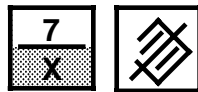

Enter the address of word to be deleted ("X" in example) **and** press the "Delete word/block" key.



N5 .....LF

Position the cursor **in front** of the block which will **follow** the inserted block, (in the example a new block will be inserted in front of block "N5").





Enter the block number to be input ("N4" in example) and store it with the input key.

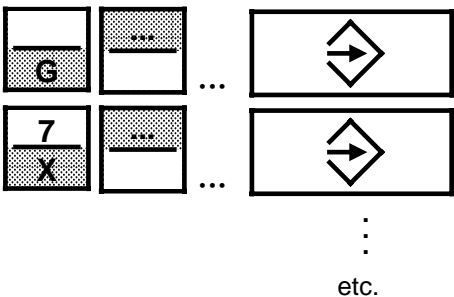

Using the keyboard now enter the block information word for word, and store each time with the input key.



End the new block with "LF" (end of block), and also complete this input with the input key.

**Delete block**

N10 .....LF

Position the cursor **in front of** the block to be deleted ("N10" in the example).



Using the keyboard, enter "N10" and operate the "Delete word/block" key.

For blocks without a block no. N... proceed as follows:

G .....F.....X.....LF

Position the cursor **in front of** the first word in the block to be deleted, (in the example, preparatory function "G....").



Using the numerical keys enter "N0" (0=zero) and then operate the "Delete word/block" key.

### 3.1.12.1 Correction display ("CORRECTION BLOCK")

When processing or simulating (Section 3.1.14) a program, the program processing is stopped and the relevant alarm displayed when the control recognizes a programming error. Using the "CORRECTION BLOCK" function the block or the word to be corrected will be marked.

#### Sequence of operation

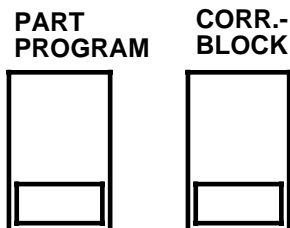

Operate the "PART PROGRAM" softkey, and then subsequently the "CORRECTION BLOCK" softkey, in any of the operating modes: PRESET / JOG / AUTOMATIC / INC 1 .... INC 10000 / REFPOINT.

The cursor is now positioned in front of the block/word recognized as containing an error.



Using the keyboard, now correct the relevant address (address "X" in the example) and enter the appropriate value:  
Subsequently operate the "Modify word" key.



After the correction operate the "Program start" key to continue program processing.

### 3.1.13 Program management

#### 3.1.13.1 Displaying the stored programs ("DIRECTORY")

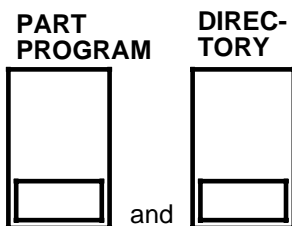
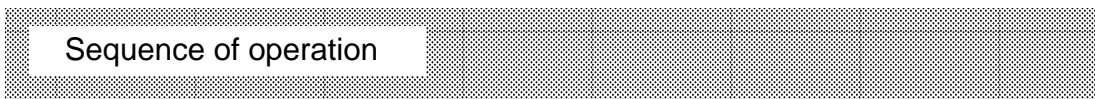

Operate the "PART PROGRAM", and "DIRECTORY" softkeys, one after the other in any of the operating modes: PRESET / JOG / AUTOMATIC / INC 1 .... INC 10000 / REFPOINT.

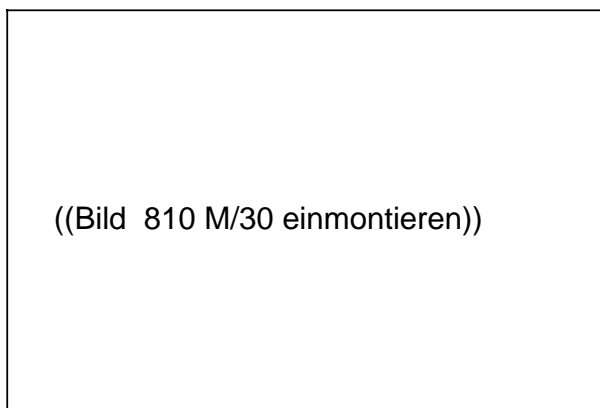

The relevant directory is displayed.  
All main programs are listed.



#### When the display is full :

By operating the "Page up/down" keys, you obtain displays of directories of further stored main programs.

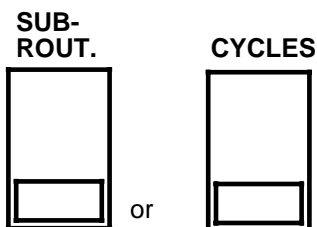

The displays of the directories for: "SUBROUTINE" or "CYCLES" are selected using the softkey menu on the CRT.

"Page up/down" is possible as described previously.

### 3.1.13.2 Protection of subroutines (cycle lock)

You can protect subroutines from unauthorised output or inadvertent deletion by locking them:

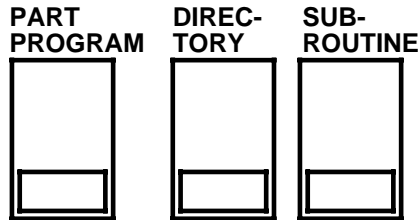

Operate the "PART PROGRAM", "DIRECTORY" and "SUBROUTINE", softkeys one after the other, in any of the operating modes: PRESET / JOG / AUTOMATIC / INC1... INC10000 / REFPOINT.

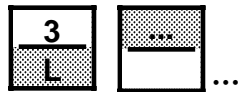

Using the keyboard enter "L" for the subroutine, and the number of the disired subroutine.

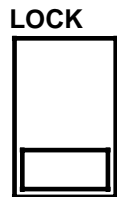

Now operate the "LOCK" softkey.

The protected subroutine is entered in the cycles list.  
Cycles are protected subroutines.

### 3.1.13.3 Cycle lock release ("ENABLE")

#### Sequence of operation

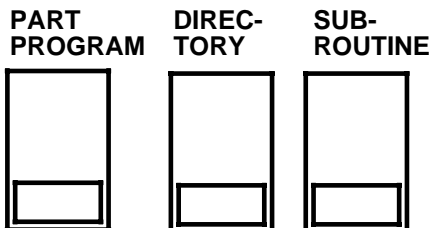

Operate the "PART PROGRAM", "DIRECTORY" and "SUBROUTINE" softkeys, one after the other, in any of the operating modes:  
PRESET / JOG / AUTOMATIC /  
INC 1 .... INC 10000 / REFPOINT.



Using the keyboard enter "L" for the subroutine, and the number of the desired subroutine.

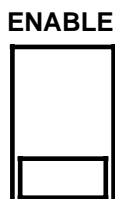

Now operate the "ENABLE" softkey.

The cycle is entered in the list of (unprotected) subroutines.

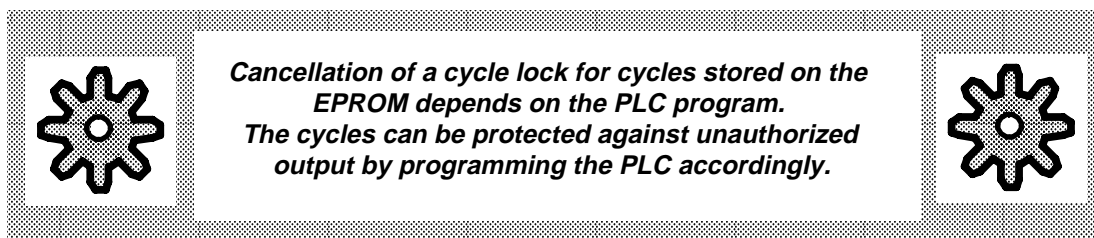

This effectively protects the machine tool manufacturer's or user's knowhow. It is then no longer possible for the operator to enable and disable programs!

### 3.1.13.4 Copying a program ("COPY")

Using the "COPY" function, you can store the same program under a different program number in the program memory. This enables you to keep one program with the contents unchanged and make changes to the copy.

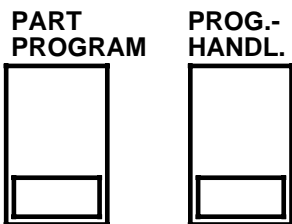

Operate the "PART PROGRAM" and "PROGRAM HANDLING" softkeys one after the other, in any of the operating modes  
 PRESET / JOG / AUTOMATIC /  
 INC 1 ... INC 10000 / REFPOINT

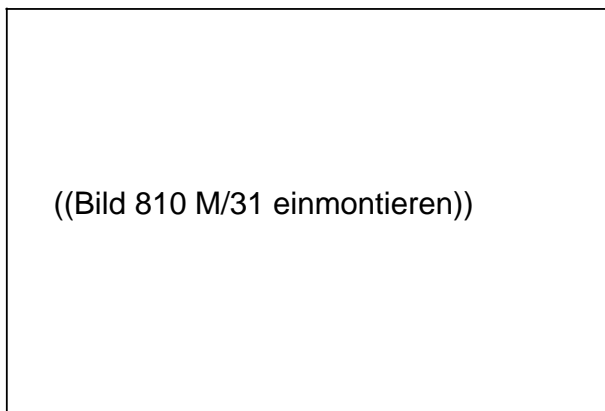

The relevant CRT display is shown, - program no. "%77" in the example, that was the **last** program to be called.

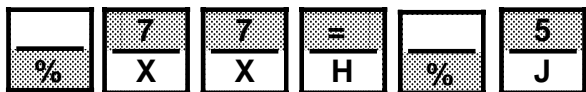

Using the keyboard, enter:  
 "% 77 = % 5".

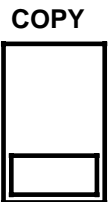

Now operate the "COPY" softkey.

The control now copies program "%77" and stores a copy it under program number "%5". Program "%77" remains unchanged!

### 3.1.13.5 Moving a program ("MOVE")

Using the "MOVE" function, you move the selected program to the end of the memory.

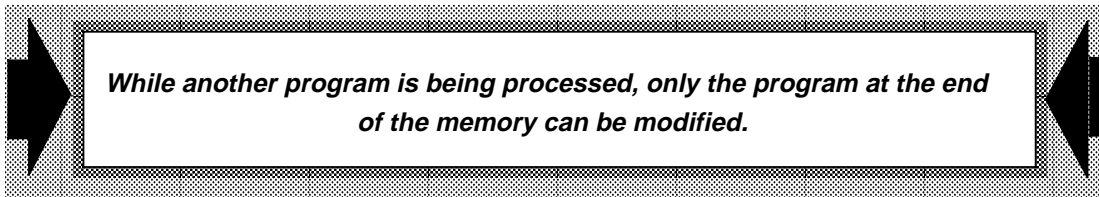

#### Sequence of operation

**PART  
PROGRAM**

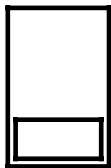

**PROG.-  
HANDL.**

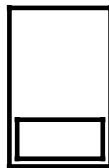

Operate the "PART PROGRAM" and "PROGRAM HANDLING" softkeys, one after the other, in any of the operating modes:  
PRESET / JOG / AUTOMATIC /  
INC1... INC 10000 / REFPOINT

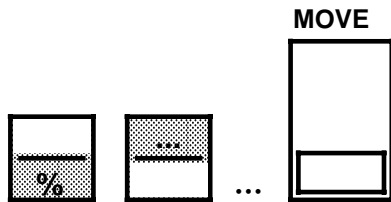

Using the keyboard, enter the desired program no., "%..." (or "L..."), and operate the "MOVE" softkey.

The program selected is moved to the end of the memory.

#### Note:

If the cycle lock has been cancelled by the PLC, you can copy a cycle from the EPROM to the end of the program memory with the "MOVE" function. You can then edit the cycle like a normal part program.

As the cycle now exists twice under the identical no. L... (in the EPROM and the program memory) the cycle in the EPROM is marked in the directory with an (\*). The cycle in the program memory has priority on selection.

The cycle in the EPROM can only be called again using the "SELECT PROGRAM" softkey when the respective cycle has been deleted from the program memory.

### 3.1.13.6 Renaming a program ("RENAME")

The program number can be corrected by "RENAME" function.  
The contents of the renamed part program remain unchanged.

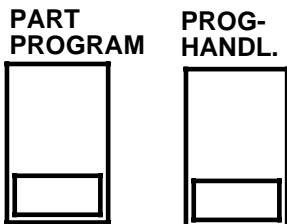

Operate the "PART PROGRAM" and "PROGRAM HANDLING" softkeys, one after the other in any of the operating modes:  
PRESET / JOG / AUTOMATIC /  
INC 1 .... INC 10000 / REFPOINT.

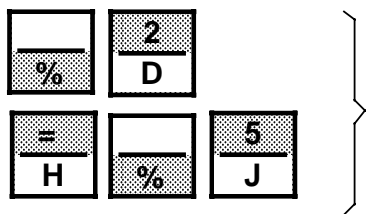

Using the keyboard, enter the old program number ("2" in example), operate the "=" key, and enter the new program number ("5" in example).

#### RENAME

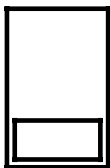

Operate the "RENAME" softkey.

The (former) program "%2" now has the number "%5".

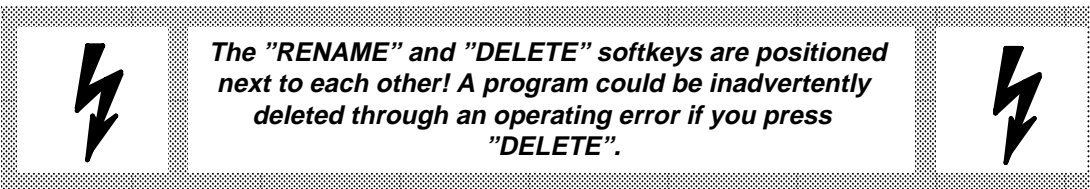



### 3.1.13.7 Deleting a program ("DELETE")

Using the "DELETE" function you can either delete each program singly, or in sequence.

#### Sequence of operation

**PART  
PROGRAM**

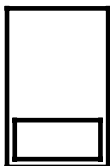

**PROG.-  
HANDL.**

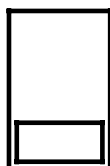

Operate the "PART PROGRAM" and "PROGRAM HANDLING" softkeys, one after the other, in any of the operating modes: PRESET / JOG / AUTOMATIC / INC 1...INC 10000 / REFPOINT.

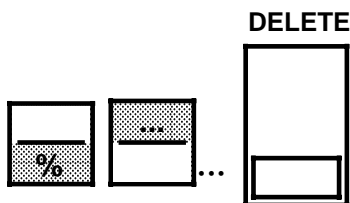

#### Deleting an individual program

Using the keyboard, enter the desired program number "%..." (or "L..."), and operate the "DELETE" softkey.

The program entered is deleted by the control.

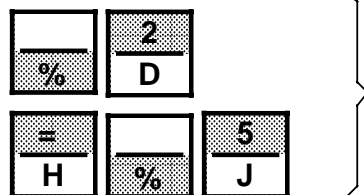

#### Deleting a sequence of programs

Using the keyboard, enter for example, "% 2", operate the "=" key, and enter for example "% 5".

**DELETE**

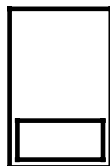

Operate the "DELETE" softkey.

All programs from "% 2" to "% 5" inclusive, are now deleted by the control!

**Note:** The memory space that has been cleared by deleting the programs, will only be available again after a "REORG" (see Section 3.1.13.8).

### 3.1.13.8 Reorganizing the program memory ("REORG")

Using the "REORG" function, the contents of the program memory can be reorganised. The space that has been cleared by deleting the programs, can be used again for the input of programs.

#### Sequence of operation

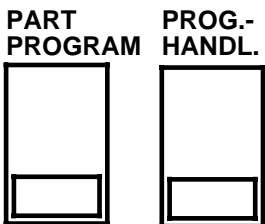

In any of the operating modes, PRESET / JOG / AUTOMATIC / INC 1 .... INC 10 000 / REFPOINT, operate the "PART PROGRAM" and "PROGRAM HANDLING" softkeys one after the other.

#### REORG

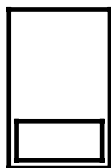

Operate the "REORG" softkey.

The program memory is reorganised by the control.

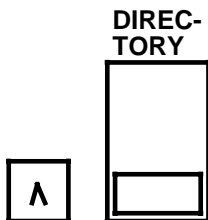

Switch back to the higher-level menu for softkey functions, and subsequently operate the "DIRECTORY" softkey.

The available memory space is displayed on the CRT.

#### Attention:

The available (displayed) memory cannot be used to its full capacity !

The following must be deducted from the displayed capacity:

- 10 % are reserved blank (blanks are provided for subsequent editing)
- plus: 11 characters multiplied by the number of possible programs (max. 200) in the part program memory.

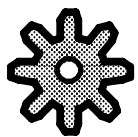

***The number of possible programs is fixed in a machine data.***

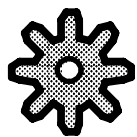

### 3.1.13.9 “Selecting a program”

Using "SELECT PROGRAM", you can either start a new program, or call a program already stored in the program memory, e.g. for editing (3.1.12) or simulation (3.1.14) .

#### Sequence of operation

##### PART PROGRAM

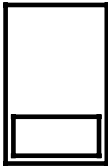

Operate the "PART PROGRAM" softkey in any of the operating modes:  
PRESET / JOG / AUTOMATIC /  
INC 1 .... INC 10000 / REFPOINT.

##### EDIT

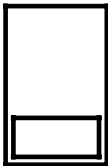

Operate the "EDIT" softkey.



Using the keyboard, enter the desired program number "%..." (or "L..."), "% 5" in this example.

##### SELECT PROGRAM

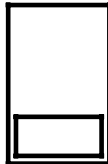

Operate the "SELECT PROGRAM" softkey.

The program number called is shown on the CRT and, if there is a program with this number already in the memory, the start of the program and blocks N0005 to N .... !

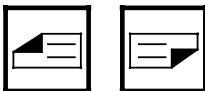

Using the "Page up/down" keys, you can call up the parts of the program not yet displayed (if already in memory) onto the CRT.

### 3.1.13.10 Operator guidance macros (OGM) and back translation

**Precondition:**

Input displays and the associated operator guidance macros developed by the machine manufacturer on the WS800A NC workstation are stored on the UMS of the system and can be activated. The displays shown in this section are only examples. See the machine manufacturer's instructions for current menus, display descriptions and operating sequences.

Assignment of parameters to part programs can be supported graphically using these configured input displays. If the operator inputs values into a display of this type, they are stored in the configured input buffer (MIB) when the INPUT key is pressed. These values can be inserted into the program section preconfigured by the operator guidance macro (OGM) and placed in the part program in the program memory using the softkey function "Store".

Parts and data blocks of this kind can be present in a part program several times with the same structure but variable values.

The function "Back translation" permits you to display a part program section generated using OGMs in its input display again, then to display the data and update the program with the softkey function "store".

Operator guidance macros and configured input displays are developed using WS 800A. The result of such a configuration might be:

```
%BFM 7  
(OGM: recessing)  
R1= ~101 R12= ~112 ...
```

The OGM number is between 1 and 998.  
%BFM 999 contains a cross-reference list of all OGMs.

e. g.

```
%BFM 999  
Plunge-cut = 7,34 <name> = <OGM No.>, <MB No.>  
Dressing = 8,35 MB=menu block
```

Example of a data block

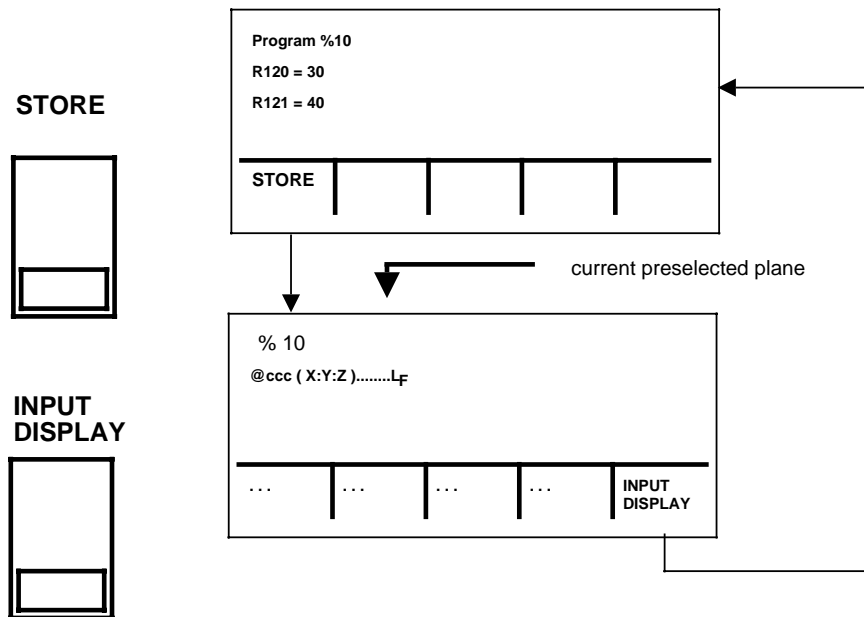

Meaning of the parenthesized expression (X:Y:Z):

The content of the parenthesized expression represents the current plane selection as follows:

X : Y : Z    abscissa : ordinate : applicate .

The plane selection must be compatible with the following contour definition. I.e. if the plane selection has been changed using the function EDIT, back translation of the data block might not be possible.

### Back translation

Move the cursor into the required data block in the basic display part program under EDIT and press the softkey INPUT DISPLAY.

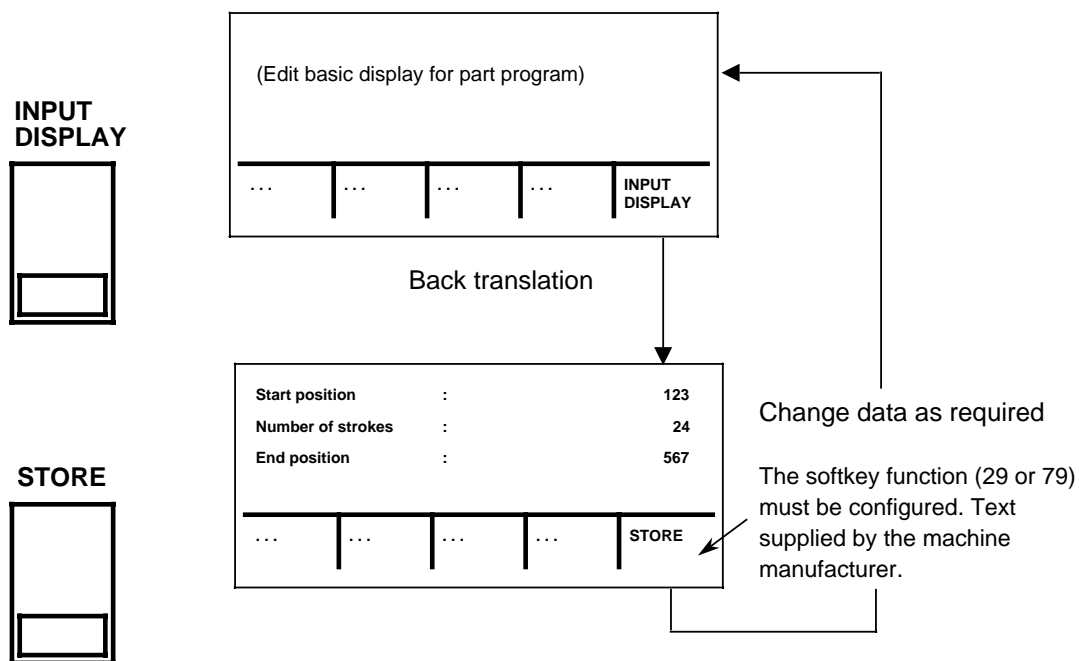

With "STORE", the changed values are transferred to the appropriate data block in the part program. The basic display part program is displayed again.

***DIN instructions can be inserted between the data blocks generated by OGMs. Insertions within a data block make back translation of that data block impossible.***

Example of the result of a part program

```

%1234                                if                                BFM:
:                                     %BFM 7
@ccc (X:Z:Y) N10 L_F                 (OGM: recessing) N 100
R11=123 R12=24 . . . (OGM: recessing) L_F  R11= 101 R12= 112

OF
%1234                                if                                %BFM 7
:                                     (OGM: recessing) N 100
@ccc (X:Y:Z) N10 L_F                 R11 = 101
R11 = 123 L_F                         R12 = 112
R12 = 24 L_F                           :
:                                       :
(OGM: recessing) L_F                  :
    
```

### Function FIND BLOCK using block number

**Precondition:**

The configured input display must be prepared.

e.g. in the OGM	in the program block
%BFM7	%1234
(OGM: APPROACH) N~100	: @ccc (X:Y:Z) N15
:	:
:	:

Operating sequence

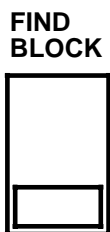
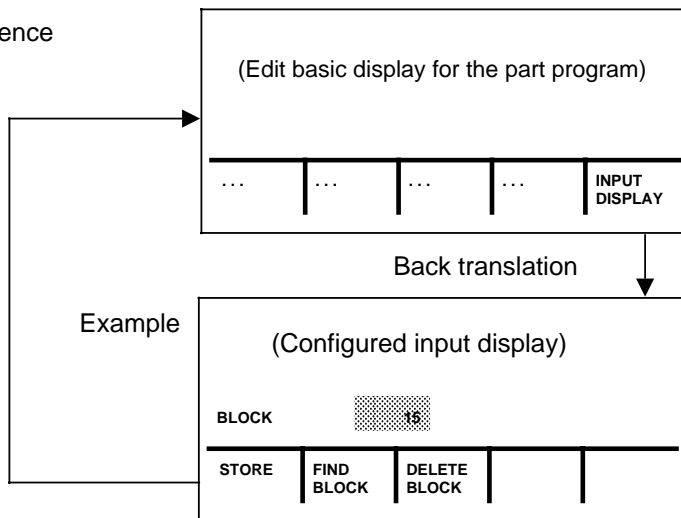

Current values are transferred into the specified input fields. The data block is selected via the block number field (BLOCK in the example).

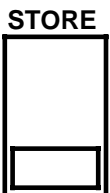

Data transfer into the program block

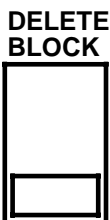

With this key, you can delete the data block with the preselected number.

### Function PROGRAM PRESELECTION via a configured display

**Precondition;**

The configured display must be selected for this function.



Configured display

**Example**

The program number entered is preselected in the display for part program editing (EDIT).



### 3.1.14 "SIMULATION"

With the "SIMULATION" function, it is possible to test a program. The traversing movements of the tools are simulated graphically on the CRT.

#### 3.1.14.1 Simulation "AREA OF THE WORKPIECE"

- A graphic display with input fields simplifies the input of the values for the simulation area and the dimensions of the workpiece.
- Select the simulation area so that the programmed traversing range is covered.
- The values entered need not be in proportion to the display; the simulation area is not cut off, because the control evaluates the larger value for the display.

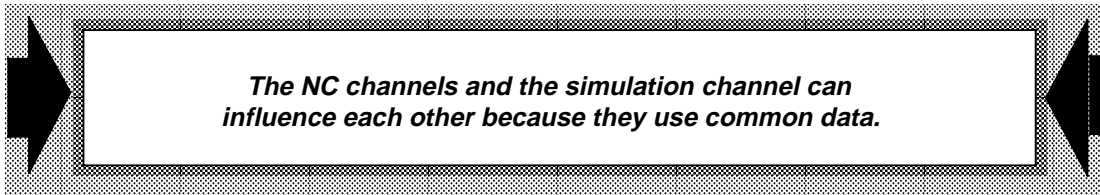

Common data are, for example:

- Settable zero offsets
- Programmable zero offsets
- Tool offset
- Global R parameters
- Machine data
- Setting data.

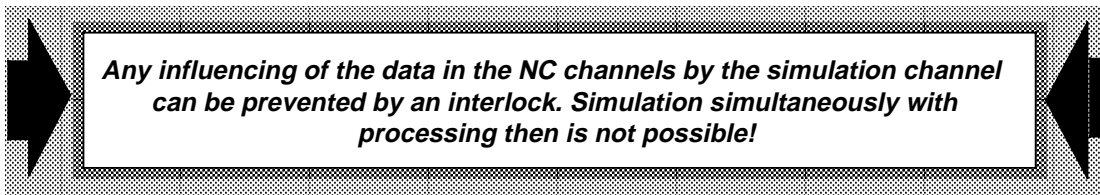

Sequence of operation

**PART  
PROGRAM EDIT**

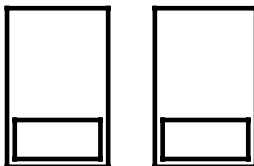

In any of the operating modes:  
PRESET / JOG / AUTOMATIC /  
INC 1 .... INC 10000 / REFPOINT,  
operate the "PART PROGRAM" and "EDIT" softkeys one  
after the other.



Using the keyboard, enter the desired program number "%..." (or "L..."), "%16" in this example.

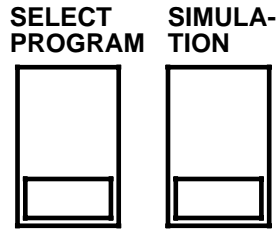

Operate the "SELECT PROGRAM" softkey, and then "SIMULATION".

PLANE

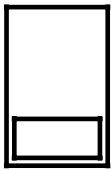

Z - Y

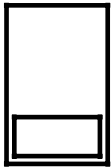

or

X - Z

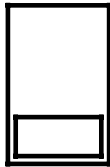

or

X - Y

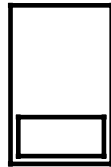

Select the required plane with the softkey.

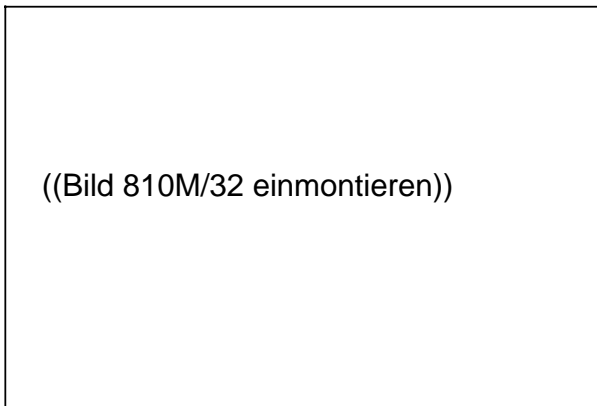

The simulation plane you have selected is marked in the display in inverse video.

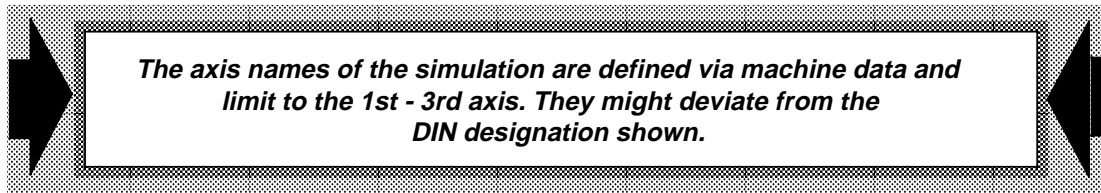

**SIMULA-  
TION**

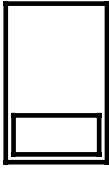

Operate the "SIMULATION" softkey.

**AREA  
W-PIECE**

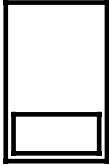

Now select "AREA W-PIECE" in the newly displayed softkey menu.

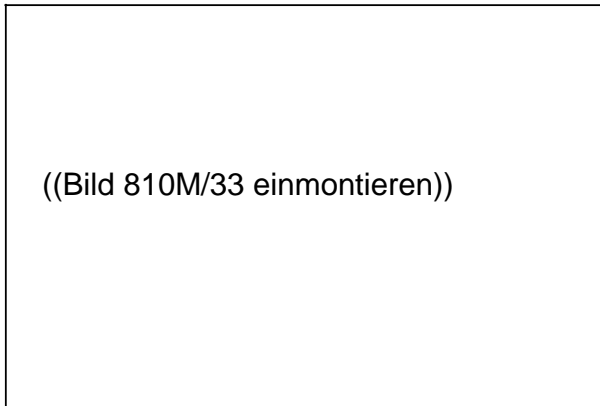

This input form with the input fields for "Simulation area" appears.

The current input field, into which you can input values, is identified in inverse video.

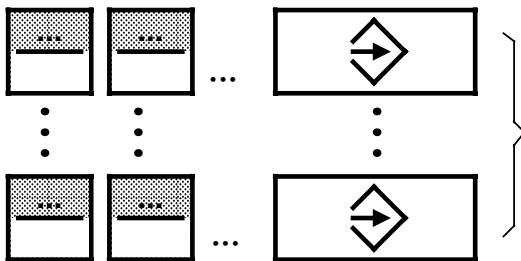

Using the keyboard, now enter the appropriate **values** for the "Simulation Area". Terminate each input with the input key. After each input, the inverse video marking jumps to the next input field.

**WORK-PIECE**

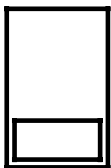

Select the "WORKPIECE" function with the appropriate softkey.

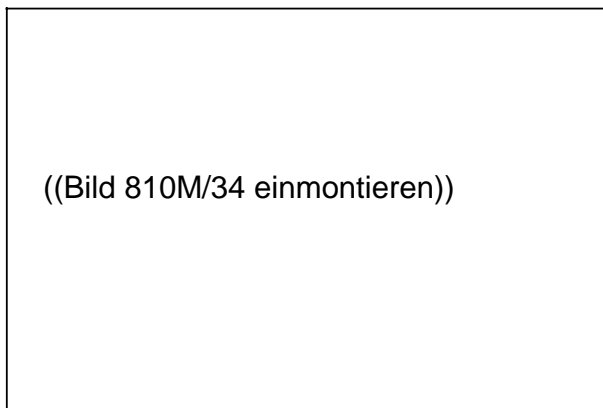

This input screen form appears with the input fields for the workpiece dimensions.

The current input field, into which you can input values, is identified in inverse video.

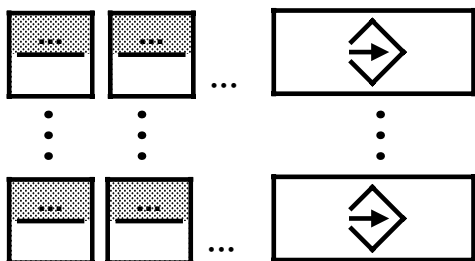

Using the keyboard, enter the appropriate dimension for "workpiece" into the input form. Terminate each input with the input key. After each input, the inverse video marking jumps to the next input field.

**SIMULATION**

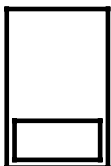

**START**

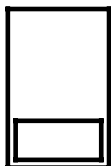

Now operate the "SIMULATION" and "START" softkeys, one after the other.

The control now simulates the motions programmed on the CRT.

**STOP**

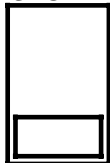

or

**RESET**

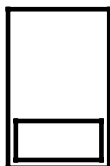

You can interrupt simulation at any time simply by pressing the "STOP" softkey.

If you press the "RESET" softkey, simulation is aborted.

### 3.1.14.2 Influencing simulation

The simulation can be influenced so that it is adapted to the program sequence in the "AUTOMATIC" mode.

Sequence of operation

**PART  
PROGRAM EDIT**

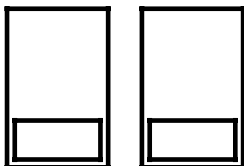

Operate the "PART PROGRAM" and "EDIT" softkey, one after the other in any of the operating modes: PRESET / JOG / AUTOMATIC / INC FEED 1 .... INC FEED 10000 / REFPOINT.



Using the numerical keyboard, enter the desired program number "% ..." (or "L..."), "% 16" in the example.

**SELECT  
PROGRAM SIMULA-  
TION**

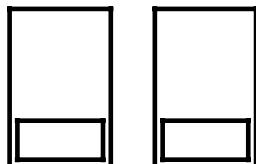

Operate the "SELECT PROGRAM" and "SIMULATION" softkeys one after the other.



Using the ETC key, extend the displayed softkey menu.

The new softkey menu shows four possible selections:

PROGRAM CONTROL	BLOCK SEARCH	DISPLAY TYPE	SIMUL- DATA
--------------------	-----------------	-----------------	----------------

a)

b)

c)

d)

These four possible selections are described in more detail in the following paragraphs a) to d).

**a) "PROGRAM CONTROL"**

**PROGRAM  
CONTROL**

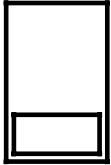

When you operate the "PROGRAM CONTROL" softkey...

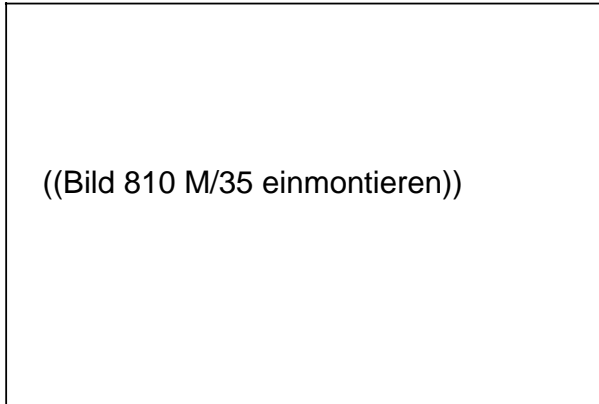

... the relevant CRT display is shown. You can alter the simulation "Status" using a softkey, by selecting the desired function and setting to "YES".

**SIMULA-  
TION**

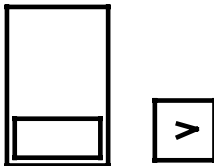

Now operate the "SIMULATION" softkey again, and then operate the ETC key to extend the displayed softkey menu. This brings you back to the softkey menu for influencing simulation.

**b) "BLOCK SEARCH"**

**BLOCK  
SEARCH**

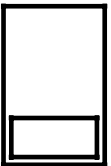

Using the softkey, select the "BLOCK SEARCH" function.

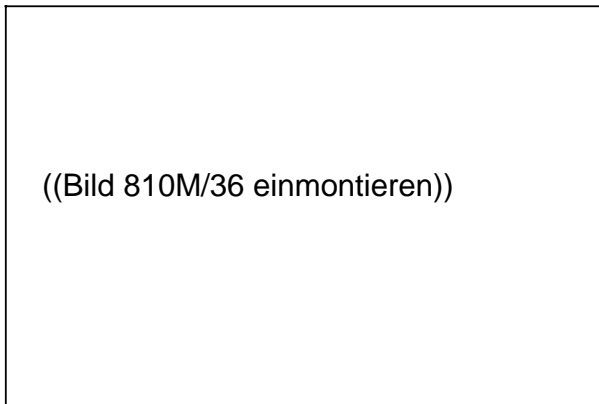

The relevant display is shown on the CRT.

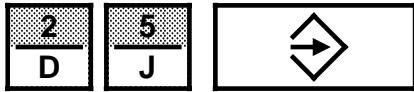

Using the keyboard, enter the desired block number "N..." ("25" in the example; "N" need not be entered) and store it with the input key.

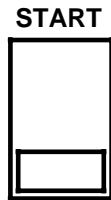

Operate the "START" softkey.

Now the simulation does not start at the beginning of the program, but at the point set by the selected block ("N 25" in the example).

### c) "DISPLAY TYPE"

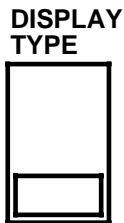

Press the "DISPLAY TYPE" softkey.

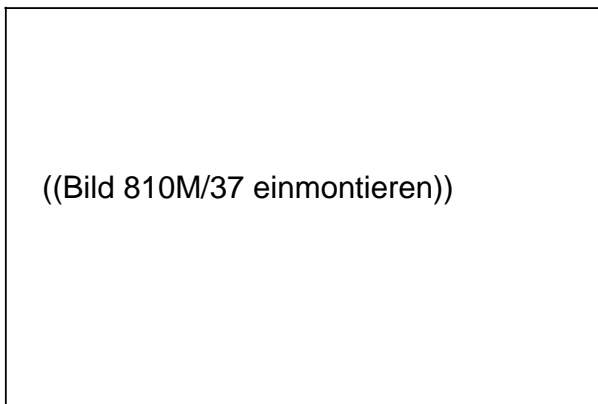

Two types of display are offered on the display:  
"CONTOUR" or "ERASE"

Select the one you require with the respective softkey.

**Note:** "ERASE CENTER" is an option, which is only active when the option bit has been set.

Significance of "ERASE CENTER": Erase and display cutter centre path (CENTER).

#### **Note:**

For the simulation you can enter the length  $l_3$  for three tool offset numbers D ... (this is not taken into account in the tool data (Section 3.1.4).

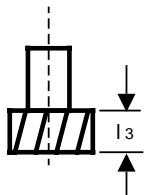

The cutter length  $l_3$  is visible in the respective plane when "ERASE" is selected.

d) "SIMULATION DATA"

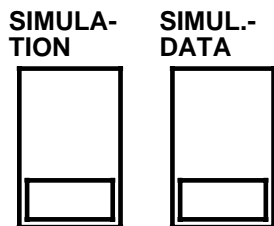

If, after you have chosen the type of display, you press the "SIMULATION" and "SIMULATION DATA" softkeys ...

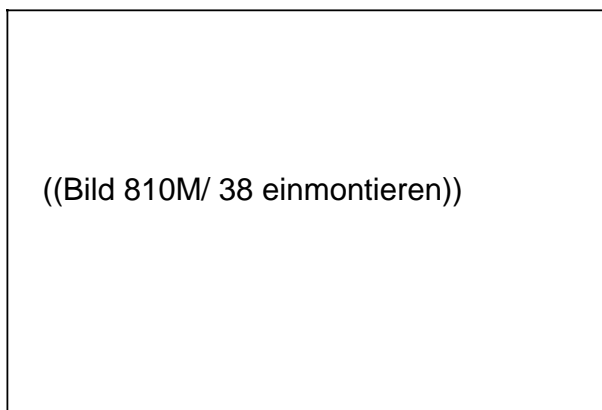

... this input screen form appears for "Simulation data".

The current input field in which you can enter/modify values is marked in inverse video.

Now you can enter/modify up to three correction numbers D ... and the respective values for cutter length (l<sub>3</sub>) using the keys. After each input and pressing the input key the cursor jumps to the next input field.

**Example of the simulation of a part program ( " %16 " ) :**

```
% 16
N05 G1 Z50 F100 LF
N10 X20 Y10 D3 LF
N15 Z10 LF
N20 L1 P5 LF
N25 M30 LF
```

Subroutine L1

```
N05 G1 G91 Y50 F500 LF
N10 X10 LF
N15 Y-50 LF
N20 X10 LF
N25 M17 LF
```

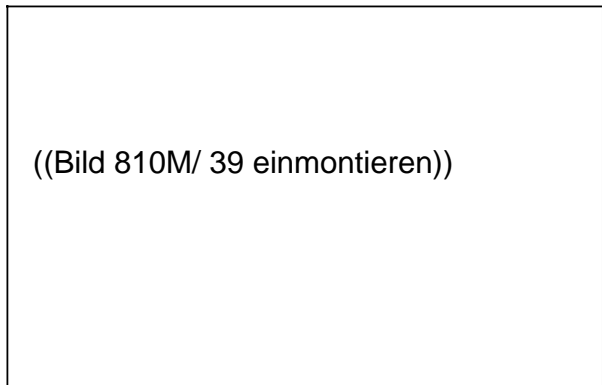

**The following display appears:**

- %16** Part program no.
- N ..** Block number
- L ..** Subroutine no.
- P ..** Subroutine passes
- X . ., Y. .,** Current axis values
- Z . .,**
- X124.60** Simulation area for "X"
- Y70.000** Simulation area for "Y"
- F ..** Current feedrate

T-, D-, H-, M-, S- functions are not displayed. Any subroutine nesting is simulated, but not displayed!



### 3.1.15 Data input/data output

For the input and output of data you will find a RS232C (V.24)/20 mA interface (=Interface 1, with variable device connections possible) on the front of the operating panel.  
A further RS 232 C (V.24) interface (=Interface 2, with fixed assignment for the connection of a particular device) is located at the back of the control.

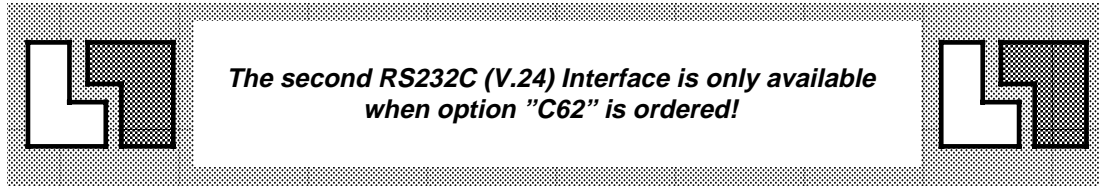

Fixed interface data are defined for the interfaces. These data can be modified by calling the "SETTING DATA" function.

Modification of the interface data - especially for interface no. 1 - is necessary for example, when a different device is interfaced to the SINUMERIK 810M (printer, tape reader, programmer, etc.)

You will find the necessary information for setting/modifying the setting data bits in Section 3.1.15.1 (Setting data bits) and Section 6.3 (Assignment of the setting data for the connection of peripheral devices).

#### 3.1.15.1 Setting data bits

The setting data - from byte No. 5000 (to 5029) - each consist of 8 bits: No. 0 to No. 7.  
These setting data serve for the matching of Interfaces 1 and 2, for the connection of different devices.

##### Explanation of setting data - structure:

(e. g. for setting data (SD) 5011)

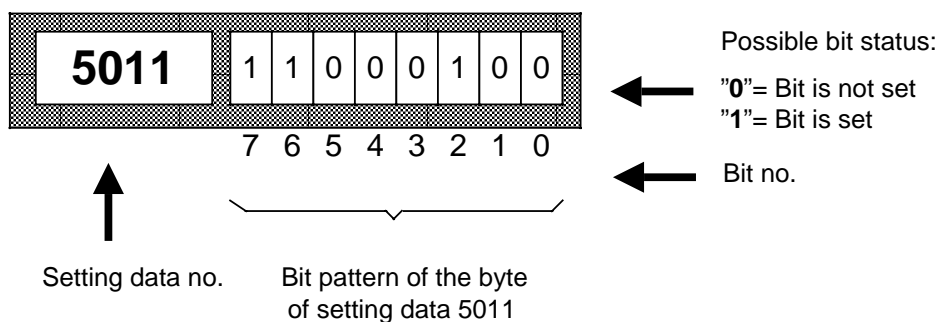

Using an input form on the CRT you can enter/modify the desired bit pattern for any byte in the range **5000** . . . to **5029**.

## Sequence of operation

### SETTING DATA

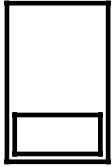

Operate the "SETTING DATA" softkey in any of the operating modes.



Using the ETC key, extend the displayed softkey menu.

### SETTING BITS

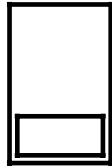

Using the softkey, select the "SETTING BITS" function.

((Bild 810M/40 einmontieren))

The relevant input form appears.  
The setting data on the top line is  
marked in inverse video.

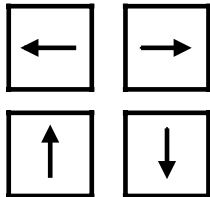

Using the cursor keys, you can position the  
cursor to any other setting data or ...

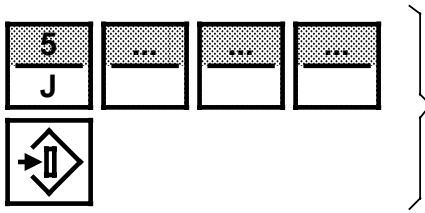

... using the keyboard enter the no. of the required setting data, and operate the search key.

The input field marked in inverse video is now positioned on the 8 bit pattern of setting data no. 5 . . . called.



Using the "0" or "1" numerical keys, enter the desired 8-bit pattern, and store the entire sequence of characters using the input key. Leading zeros in the bit combination can be omitted.

Carry on in this way until all the required setting data have been set.

### 3.1.15.2 Data input



#### DATA IN-OUT

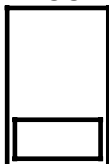

Operate the "DATA IN-OUT" softkey in any of the operating modes:  
PRESET / JOG / AUTOMATIC /  
INC 1 .... INC 10000 / REFPOINT.

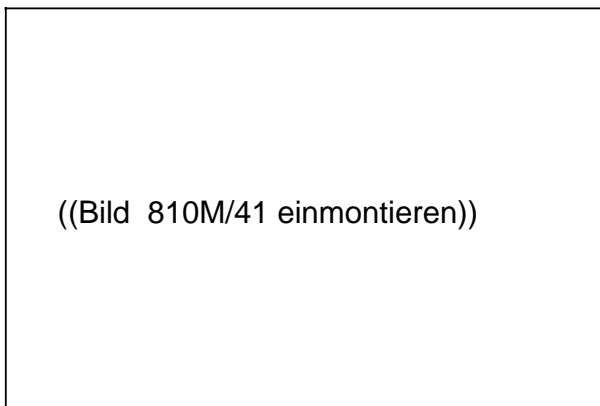

This input form is shown, with the input field for "Interface no. for data in" marked in inverse video.



or



Now enter:

"1" ( for input into interface 1 ) or  
"2" ( for input into interface 2 )  
and store it with the input key.

#### DAT. IN START

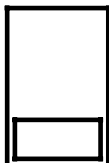

Select the softkey function "DATA IN START"  
By doing this you enable the control's receive function.

On the upper right-hand side of the CRT the message **DIO** (Data input/output) is displayed.

On the **Data type:** line the data coming from the transmission device (tape reader, programmer ...) is identified.

The following table explains the types of data that can be loaded into the SINUMERIK **810M**:

Data type	Meaning
MPF	Part program ( <b>M</b> ain <b>P</b> rogram <b>F</b> ile)
SPF	Subroutine ( <b>S</b> ub <b>P</b> rogram <b>F</b> ile)
TOA	Tool offset ( <b>T</b> ool <b>O</b> ffset <b>A</b> ctive)
ZOA	Zero offset ( <b>Z</b> ero <b>O</b> ffset <b>A</b> ctive)
TEA 1	NC machine data ( <b>T</b> esting <b>D</b> ata <b>A</b> ctive 1)
TEA 2	PLC machine data ( <b>T</b> esting <b>D</b> ata <b>A</b> ctive 2)
PCA	PLC alarm text ( <b>P</b> rogrammable <b>C</b> ontrol <b>A</b> larms)
PCP	PLC program ( <b>P</b> rogrammable <b>C</b> ontrol <b>P</b> rogram)
RPA	R parameters with assigned values ( <b>R</b> Parameter <b>A</b> ctive)
SEA	Addresses with assigned values ( <b>S</b> etting <b>D</b> ata <b>A</b> ctive)
CLF	Clear instruction ( <b>C</b> lear <b>F</b> ile)
UMS	<b>U</b> ser <b>M</b> emory <b>S</b> ubmodule

Under **Interface Assignment**, the control indicates the **identifier** of the connected **device type** for Interface 1 and Interface 2. (For identification of various device types see Section 6.3).

#### STOP

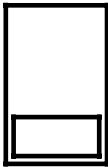

Using the "STOP" softkey, you can interrupt data input at any time.

#### DATA IN START

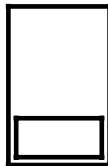

You continue data input again.

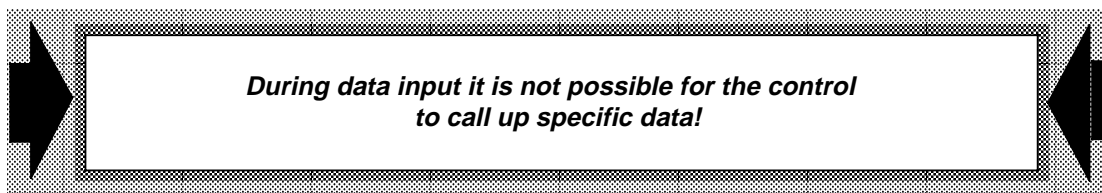

Notes:

When inputting from punched tape, the input data are checked for simple errors.

All characters in punched tape code have a common identification character:

- in ISO code there is always an even hole count
- in EIA code there is always an odd hole count

The control automatically identifies the correct code when reading the first "%" (ISO) or "EOR" (EIA)!

The criterion "Odd hole count" or "Even hole count" is used for character parity checking from the second character in the program onwards.

As a further check, if a program already in the program memory is read in again, a complete program comparison is carried out.

When an error is recognized, reading in is stopped and the error displayed on the CRT.

### 3.1.15.3 Data output

#### Sequence of operation

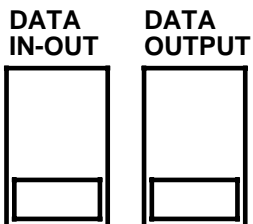

In any of the operation modes:  
PRESET / JOG / AUTOMATIC /  
INC 1 .... INC 10000 / REFPOINT,  
operate the "DATA IN-OUT" softkey and subsequently  
"DATA OUTPUT".

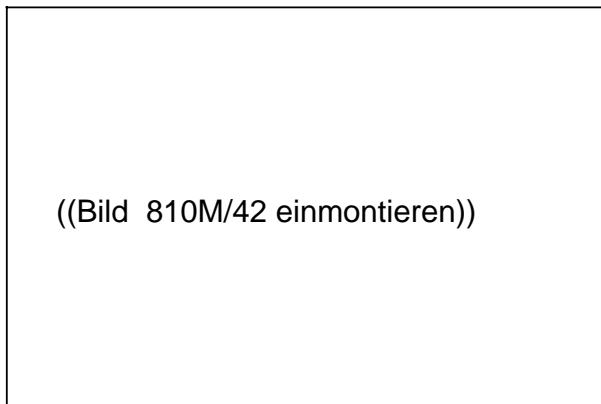

This input form, with the input field identified in inverse video, appears.



or

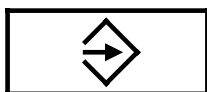

Now enter:  
"1" ( for output via Interface 1 ) or  
"2" ( for output via Interface 2 )  
and store it using the input key.

**PART  
PROGRAM**

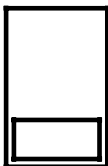

Using the softkey, now select, for example, the "PART PROGRAM" function.

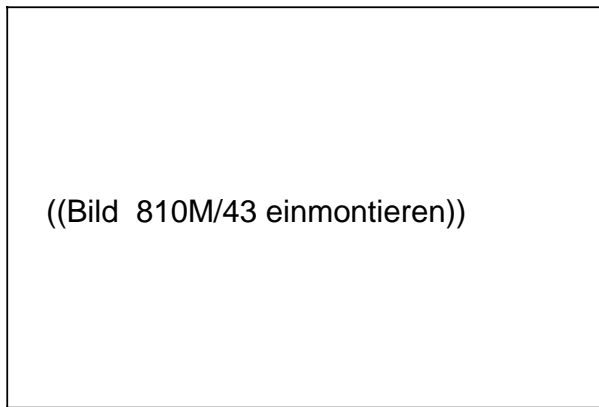

This input form appears.

((Bild 810M/43 einmontieren))

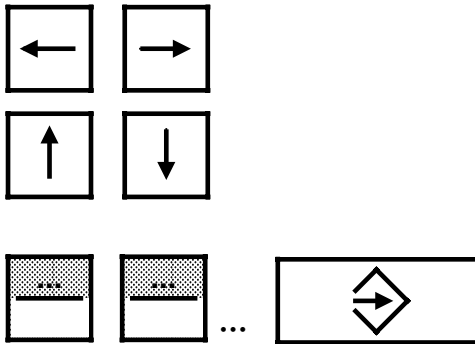

Using the cursor keys, now select the **upper** of the two main program "%..." or, to the right of it, subroutine "L..." lines.

Using the numerical keyboard, enter the **number** of the main program, or the subroutine with which you want the output to **begin**.  
Now store your input with the input key.

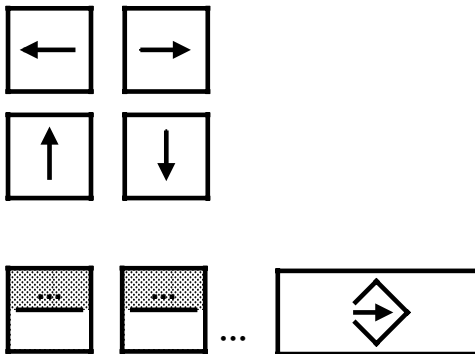

Again using the cursor keys, select the **lower** of the two main program "%..." or, to the right of it, subroutine "L..." lines.

Using the numerical keyboard, enter the **number** of the main program, or the subroutine with which you want the output to **end**. Now store your input with the input key.

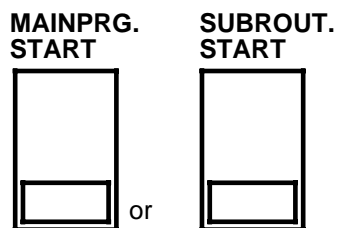

Operate the "MAIN PROGRAM START" or "SUBROUTINE START" softkey.

By doing this, you start the control's transmit function (**output of data**).

**STOP**

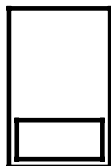

Using the "STOP" softkey, you can interrupt data output at any time.

**MAINPRG.  
START**

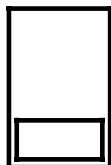

or

**SUBROUT.  
START**

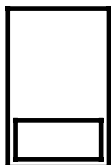

Start data output again.



After the transfer (data output) is complete, return to a higher level softkey menu using the RECALL key.

TOOL OFFSET	ZERO OFFSET	MACH. DATA	PART PROGRAM	PLC-M- DATA
----------------	----------------	---------------	-----------------	----------------

You can now call any of these functions for data input (PART PROGRAM known - see above).



Using the ETC key you can extend the displayed softkey menu.

R- PARAM.		
--------------	--	--

The displayed function gives you the possibility to output all the "R parameters".

**R-  
PARAM.**

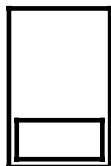

Operate the "R parameter" softkey.





Using the keyboard, enter the channel no.:  into the input field marked in inverse video:

- "1" for output of local R parameters, channel 1
- "2" for output of local R parameters, channel 2
- "0" for output of the global R parameters

#### START

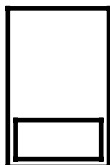

Start the output of the R parameters by operating the "START" softkey.

#### STOP

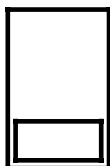

Using this softkey, you can stop data output at any time... and continue it again with "START".

In the same way, you can select and start the output of data for the following:

- "TOOL OFFSET"
- "ZERO OFFSET"
- "MACHINE DATA"
- "PLC MACHINE DATA"

which have not been detailed here.

#### ETX START

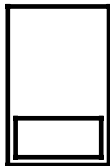

You can use the "ETX START" softkey to output the end of transmission character stored in setting data.

This is always output irrespective of whether RTS-line or X on/off protocol is set.

#### Note:

- A selection of the data, ie. the output of a section as with "PART PROGRAM", is not possible!
- The input of a channel no, is only required by the control for "R PARAMETERS".
- Data output with or without leader or trailer can be set via setting data (SD 5016, bit 1).

### 3.1.15.4 Part program - block transfer

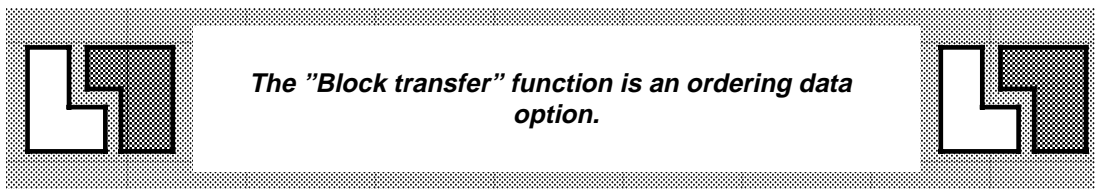

#### Sequence of operation

##### DATA IN-OUT

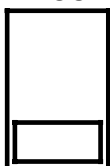

Press the "DATA IN-OUT" softkey in one of the following modes:  
PRESET / JOG / AUTOMATIC / INC 1 ... INC 10 000 / REFPOINT.

##### BTR START

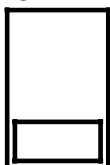

You activate the "Block transfer" function by operating the "BTR START" softkey.

This function enables you to run part programs which are too extensive for the part program memory of the control system (max. 128 kByte).

In this way a part program can be entered and executed from an external storage (punched tape, diskette, computer) via a standard interface. You enter the program number for processing in the AUTOMATIC basic display.

After NC-Start of the relevant channel the interface is started for reading in. The "BTR" display appears on the screen. You define the interface by entering it into the appropriate screen display.

All functions such as DEC-SBL, SBL, ... may be used as in normal operation.

Block search is also possible without restrictions. The interface is then started with the "Block search start" softkey. "NC Start" resumes normal operation after block search.

The current block is indicated in the AUTOMATIC basic display as well as during normal operation.

When data are being transmitted, the program number selected from the AUTOMATIC basic display is compared with the program number received from the external storage. It is only possible to select a main program. If the program numbers are not identical, an error message will appear. Otherwise the program is executed.

If you have entered 0 as program number in the AUTOMATIC basic display, the incoming program number will not be checked. This enables you to read in a program of which you do not know the program number.

## Circular buffer

The circular buffer is located in the part program memory and stores program sections loaded via the interface.

The use of this circular buffer reduces the amount of memory available for part programs to be edited. The size of the circular buffer is defined on installation in an NC machine data. Then the part program memory has to be newly formatted. The circular buffer contains up to two programs, which can be processed in two ways:

- If only one part program or parts therefore are in the circular buffer, normal block transfer mode is used.
- If the circular buffer contains two part programs, they can be processed one after another with "NC start". While the first program is being executed the second program can be loaded into the buffer. If the first program has terminated, the second program can be started and third program loaded into the buffer. You determine when which program can be read into the buffer and executed. Unlike in the part program memory, in the circular buffer a program once executed is discarded to make room for the next program to be loaded. A reorganization of the buffer like that of the part program memory is therefore obviated.

Data can be transferred between the peripheral device and the NC in two ways.

- **Unprotected transmission**

Unprotected transmission of data for the "BLOCK TRANSFER" function is controlled by the NC using the XON/XOFF interface signals. The NC initiates data transfer from the storage device by sending an XON. The external storage medium then sends data to the NC until the circular buffer is full (free are < 120 bytes) and the NC interrupts the data flow with the XOFF signal. If the circular buffer becomes empty again, the NC sends the XON signal and transmission is continued.

- **Protected transmission**

Via NC machine data 5016.0 you can define whether the data is to be transferred **protected** or **unprotected** from the peripheral devices. If you have selected secured transmission of data (bit set to "1"), the 3964R procedure is activated when data transfer is initiated. After NC start, the control sends a command block (initialization block) to the peripheral device. The command block contains the required program number so that after receiving this command block the peripheral device begins with the transmission of the data. Should you require more detailed information on data transmission, please refer to the "Installation Instructions".

**Note:**

When programming part programs which are to be loaded block-serially into the NC the following has to be observed:

- @-commands with return jumps are not allowed in main programs. (Alarm 3012 "Block not in memory").
- Forward jumps in the program are possible, even when the jump address does not yet exist in the circular buffer. The circular buffer is refilled until the target block has been found.
- Subroutine calls are only possible if these subroutines exist in the part program memory of the NC or in the UMS.
- @-commands with jumps are possible in the subroutine.
- Part programs stored in the circular buffer cannot be edited.  
If you discover a programming error you cannot remedy it with the "Corr. Block" function. If you try, the alarm "No correction block" appears.
- If you call the "Block transfer" function when an interface is still active, the error message "Interface busy" appears and the program is not started.
- If the "Block transfer" function is already active and if the second interface is activated from the PLC, the alarm "RS232C (V.24) abort" appears. However, the program running via the first interface is still processed.
- If the size of the circular buffer is set to zero and the part program memory is newly formatted, the alarm "Program memory wrongly formatted" appears.

### 3.1.16 Selecting the second language

The standard operator interface texts are available in two languages. The selected language is marked in the display "Software version display" with an arrow (>). You can select the "Software version display" via the softkeys DIAGNOSIS and SW VERSION. The language selection is made in the machine data.



## 3.2 Machining

### 3.2.1 Starting a part program

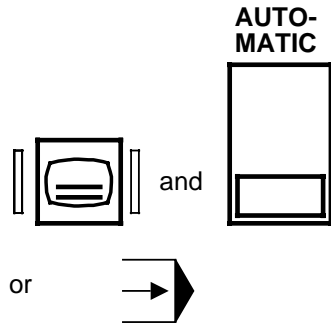
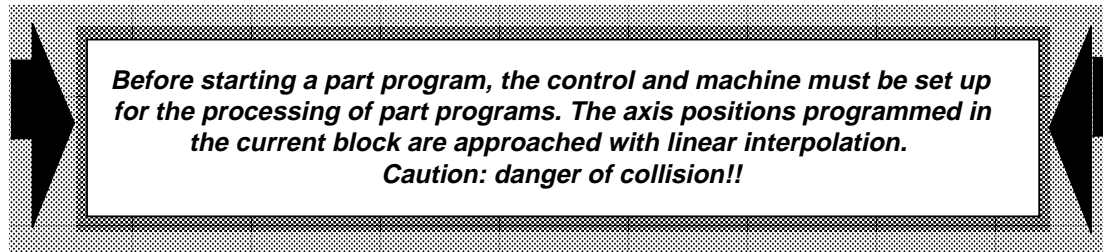

Operate the operating mode selector key on the integrated machine control panel, and select the "AUTOMATIC" softkey, or...

... set the operating mode selector switch on the external machine control panel to this symbol.

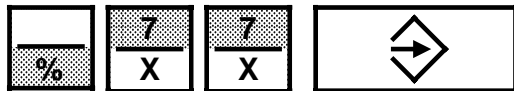

Enter the desired part program number, - "%77" in the example - and store it with the input key.



Operate the "Program start" key on the machine control panel.



The green "Program running" LED display lights up.

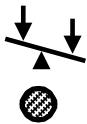

The green "Position not yet reached" LED display is bright until all axes have reached their set positions.



When the red "Feed Hold" LED display is bright, program processing is stopped!

There is no feed enable from the PLC. Remove the feed inhibit following the instructions of the machine tool manufacturer. The red "Feed stop" LED display will then go out.

After the program start, either "ACTUAL VALUES" or "ACTUAL BLOCK" appear on the CRT display.

### 3.2.2 "AUTOMATIC" operating mode

#### - Selection of the "CURRENT VALUES" or "CURRENT BLOCK" display

##### Precondition:

An active program is being processed in "AUTOMATIC" mode.

#### Sequence of operation

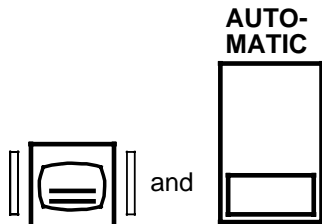

Operate the operating mode selector key in the integrated machine control panel, and then the "AUTOMATIC" softkey, or...

... set the operating mode selector switch on the external machine control panel to this symbol.

((Bild 810M/44 einmontieren))

The "CURRENT VALUES" basic display for the active program is shown on the CRT - in the example, for the program "%77".





You can extend the displayed softkey menu with this key.

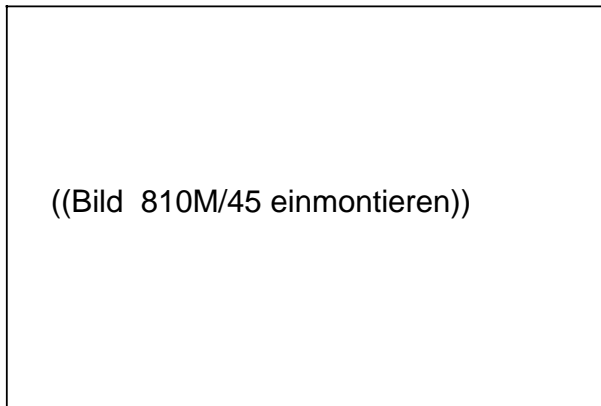

It is not possible to modify the **data** displayed on the CRT.  
 The 5 relevant new softkey functions however are displayed.  
 The auxiliary functions are no longer displayed.  
 The speed values for the second spindle (if used) are now also displayed along with the extension of the position display to 7 axes.



You can return to the previous display.

**Explanation of the "ACTUAL VALUES" display (basic display)**

% 77

Display of the selected program (Program pointer)

N20 L0 P0 N0  
 .....

} Operating pointer, with information on the block number ("N20") and the subroutine number L..., pass count P... and the block number within the subroutine with up to four levels of nesting.

Set value	Actual value
S1.....	S1.....
F.....M	F.....

} Programmed and actual values of spindle speed (leading spindle) and feedrate (the characters after the feedrate value:  
 "R"= feed per revolution, "M"= linear feedrate),  
 "U" = revolutional feedrate

S...100%  
 F... 0%

} Spindle speed override and feedrate override in %.

AUX. Functions  
 M =3 M = M =  
 D2 T 1 H

} M = 3 (direction of spindle rotation clockwise).  
 Tool compensation number ("D2"), tool number ("T1") and further miscellaneous/additional functions.

Actual pos.	Dist. to go
X.....	X.....
Y.....	Y.....
Z.....	Z.....
C1.....	C1.....
C2.....	C2.....

} Actual position and distance to go value of the axes

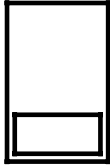
**CURRENT  
BLOCK**

Operate the "CURRENT BLOCK" softkey.

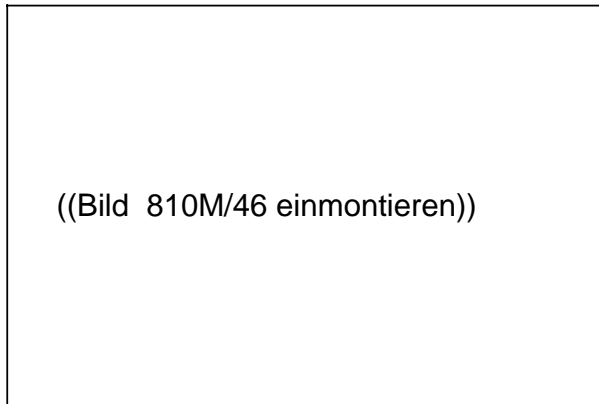

The "CURRENT BLOCK" display for the active program appears - program "% 77 " in this example.

### Explanation of the "CURRENT BLOCK" display

In addition to the displays already mentioned ("CURRENT VALUES"), the following are displayed:

- The block **before** the "current block", here block "**N5**"
- The "current block", here block "**N10**"
- The block **after** the "current block", here block "**N15**".

Instead of the actual positions of the individual axes as shown in the "CURRENT VALUES" display, the current G functions are listed here.

#### Note:

If the "current block" consists of more than 41 characters, the **following** block is **not** displayed!

Likewise, a block **before** or **after** the "current block" with more than 41 characters is not displayed.

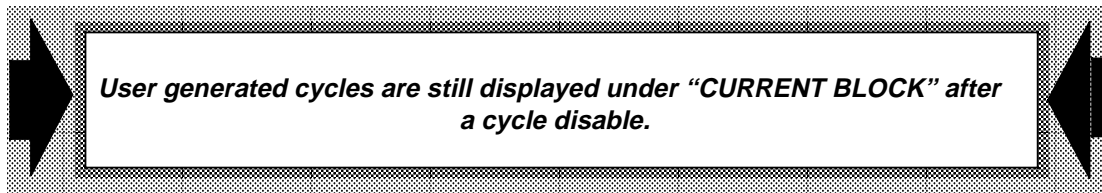

### 3.2.3 Influencing "AUTOMATIC" operation

#### General:

Influencing "AUTOMATIC" operation (e.g. through programmed functions), is displayed in the first line of the CRT display.

Display:

**STOP: AUTO interrupted**

Interruption of "AUTOMATIC" operation (program hold),  
see 3.2.3.4 "Program Interruption"

Display:

**STOP: Single block**

The single block has been processed  
(with switch position "Single block - ON")

Display:

**STOP: Pr. stop M00, M01**

Programmed interruption of the program process

with "Program start"



the processing of the program  
is continued

Display:

**STOP: Read enable**

Read enable is a PLC output signal. When the read enable signal is removed, the processing of the current NC block is finished. The next program block is not transferred for processing.

Display:

**STOP Dwell time**

Processing of the program is interrupted for the duration of the programmed dwell time.

#### Note:

"Feed hold" is **not** displayed on the CRT !

### 3.2.3.1 Influencing the program

With the operation of the softkeys described here, the active program is influenced.

#### Sequence of operation

##### PROGRAM CONTROL

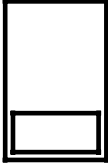

Operate the "PROGRAM CONTROL" softkey in the "AUTOMATIC" or "MDI-AUTOMATIC" operating mode.

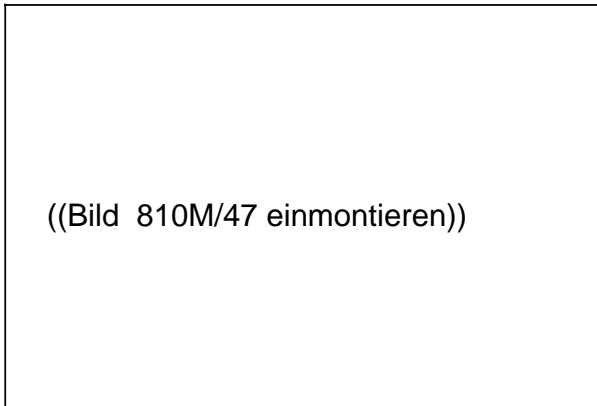

This CRT display with a menu of 5 functions appears.

By operating any of the 5 softkeys, you can now change over the preset "NO" to "YES". A function marked with "YES" is **active!**

##### SKIP YES-NO

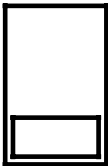

You select, for example, the "SKIP BLOCK" softkey function.

Display:

Skip Block

YES

Blocks in the program which are marked with an **oblique** before the block number ("I N ...") are skipped.

**DRY  
YES-NO**

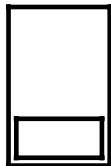

You select, for example, the "DRY RUN FEEDRATE" softkey.

Display:



All blocks in which a feedrate is programmed (G01, G02, G03, G33, G34, G35), will now be traversed at the feedrate value entered into the "Dry run feedrate" setting data, instead of the programmed feedrate!

The dry run feedrate then applies to "Feed per revolution" G95, and the feedrates for threading (G33, G34, G35).

**OPT. STOP  
YES-NO**

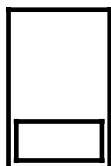

You select, for example, the "OPTIONAL STOP" softkey function

Display:



When an "M01" is present in the part program, the program is stopped!  
When the softkey function is marked with "**NO**", "M01" is ignored.

**OVERR.  
YES-NO**

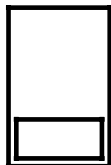

You select, for example, the "RAPID OVERRIDE" softkey function.

Display:



This signal presupposes that there is only **one** common feedrate/rapid override switch. If the softkey function is set to "**NO**", this override switch is only active with "feedrate".  
If the softkey function is set to "**YES**", the override set with this override switch is also effective for "rapid traverse".

User notes on "RAPID OVERRIDE" :

During processing of a new NC program the feedrate override switch can be enabled with the keyswitch.

The following rapid override values can be set with the feedrate override selector switch on the customer operator panel.

Setting	Override value in %
1	1
2	10
3	50
4	100

This table is only applicable when the "Rapid override switch present" machine data is set. When this is not the case, the setting for the "Feedrate override switch" applies for rapid override, with a limitation of 100%!

DEC-SBL  
YES-NO

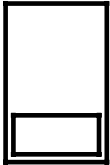

You select, for example, the "DECODING SINGLE BLOCK" softkey function.

Display:

**Decoding Single Block**      **YES**

When the function is activated with "**YES**", the control generates the "Decoding single block active" signal.

The signal is active at the **end of the block** in the running part program, which is running through **with the decoding** signal present.



Now operate the "Program start" key. The decoding single block is now processed.



Operate the "Program start" key **once more**. The next decoding single block is processed ... etc.

**Note:**

The "Single block" (Section 2.1.1.6) function works in a similar way.



Operating this key activates the "Single block" function. The generated signal is active at the **end** of the (current) block being processed.  
 The "SBL" (Single block) display appears in the first line of the CRT display.



Operating the "Program start" key, causes the single block to be processed.

The following table indicates in which blocks the "Decoding single block active" signal, or the "Single block active" signal must be present if a program is to be **processed on a block-by-block basis**.

Block	Single block	Decoding single block
Traversing blocks		
Blocks without path information		
Calculation blocks		
Switching and auxiliary function blocks		
Internally generated control blocks (CRC ...)		
Threading blocks without dry run feedrate		
Threading blocks with dry run feedrate		

= "Single block" or "Decoding single block" signal is required.

- Blocks which have been "pre-processed" without the "Decoding single block" signal present in the buffer memory - that have not yet been processed - cannot be stopped!
- A "Decoding single block" can be influenced using "OVERSTORE" (Section 3.2.3.2).



You extend the softkey menu called under "PROGRAM CONTROL" ...

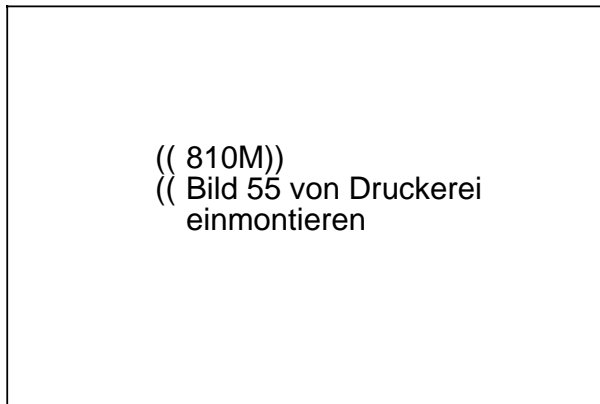

... and subsequently operate the "DRF-HANDWHEEL-ENABLE" softkey.

Display:

**DRF handwheel enable** **YES**

You have activated DRF (Differential Resolver Function). It is now possible to activate the handwheel for the selected axis.

The handwheel-to-axis assignment is defined in axial setting data (see Section 3.2.10).

It is always only possible to activate one axis with one handwheel. If a second axis is selected, the previously selected axis is automatically deactivated (see Section 3.2.9 "HANDWHEEL" and Section 3.2.10 "DRF" for further details).





### 3.2.3.2 "OVERSTORE"

Using the "OVERSTORE" function, you can modify one or more values in the buffer memory.

To "OVERSTORE", the program must be stopped.



**Precondition:**

A program is being processed in the "AUTOMATIC" operating mode:



Operate the "PROGRAM STOP" key.

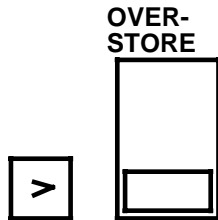

Extend the displayed softkey menu and operate the "OVERSTORE" softkey .

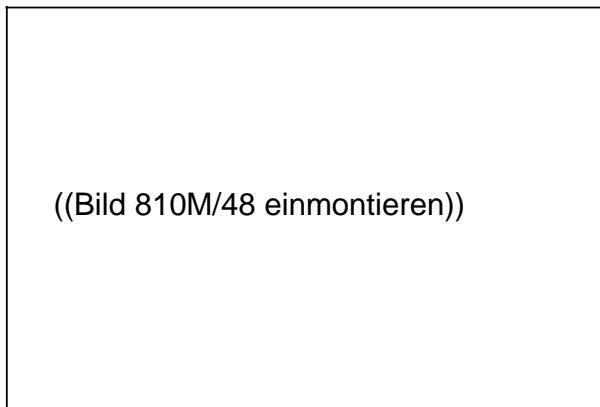

This input form appears with input field marked in inverse video.

You can now modify the following data:

- Tool number T ...
- Tool offset number D
- Spindle speed S ... or S1= ..., S2= ...
- Auxiliary function H ...
- Additional function M ... or M n = ...

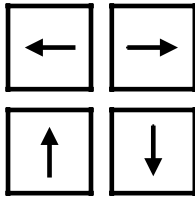

Using the cursor keys, now set the inverse marking to the desired input field.



Using the keyboard, enter the first correction value and store it with the input key.

⋮  
etc.

⋮  
etc.

⋮  
etc.



Press the "Program start" key when all corrections have been completed.

The program now operates with these new values until a new value in the program supersedes the overstored function, or until you enter a new value using "OVERSTORE".

### 3.2.3.3 "BLOCK SEARCH"

The "BLOCK SEARCH" function allows entry into a program at any desired point. In the "Block search" display, you enter the program and the block number.

A block search is also possible in nested subroutines. Enter in the main program the number of the block in which the subroutine call is programmed. After this, enter the subroutine number, the pass count, and the block number of the subroutine.

During the block search operation, the same calculations are carried out as in normal program operation although the axes are not traversed!

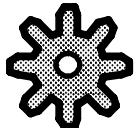
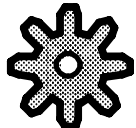
	<p><i>Output of the auxiliary functions during "block search" can be defined in machine data.</i></p>	
---	---	---

Depending upon the setting made at the time of installation, the H-, M-, S-, and T- functions are output either completely or in part or they are fully suppressed.

#### Sequence of operation



Operate the "RESET" key on the machine control panel.

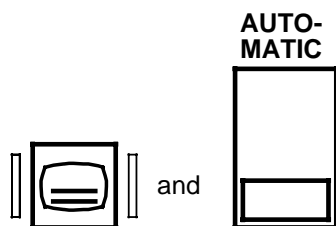

Operate the operating mode selection key on the integrated machine control panel, and then the "AUTOMATIC" softkey, or ...

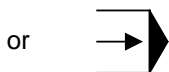

... set the operating mode selector switch on the external machine control panel to this symbol.

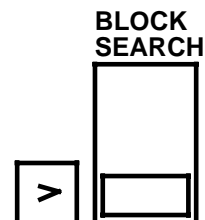

Extend the displayed softkey menu, and subsequently select the "BLOCK SEARCH" softkey function.

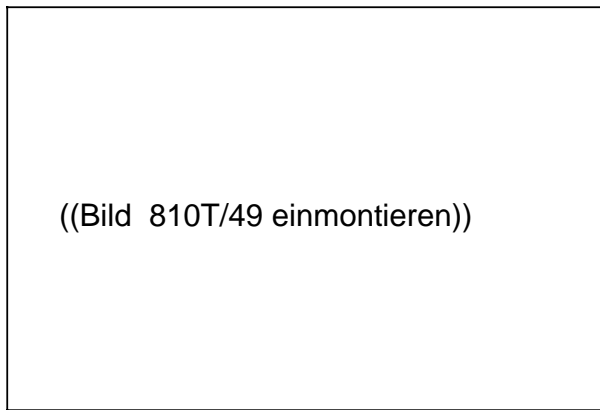

This screen form appears with the input field marked in inverse video.

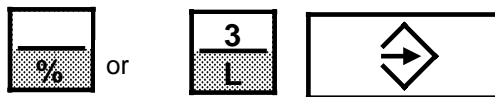

Input "%" for the main program or "L" for the subroutine and then press the input key. The inverse marking jumps to the next field for the program number.



Using the numerical keyboard enter the program number "...", and store it with the input key.



Using the numerical keyboard enter the block number "...", and store it with the input key.

START

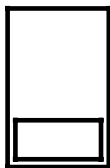

Operate the "START" softkey.

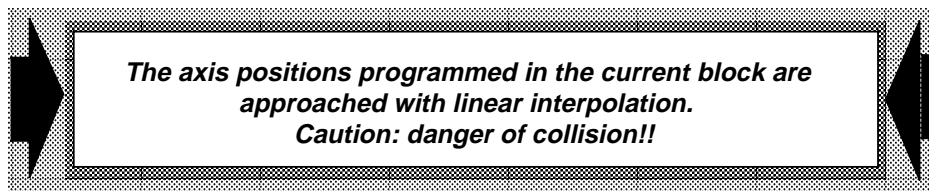

Using the "Program start" key, activate program processing.

After "BLOCK SEARCH", you can traverse the difference between the actual position and the calculated command position, by selecting the axis and using the jog keys, in "REPOS" operating mode.

## Sequence of operation

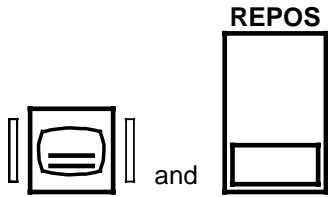

Operate the operating mode selection key on the integrated machine control panel, and then the "REPOS" softkey or...



... set the operating mode selector switch on the external machine control panel to this symbol.

The "REPOS offset" with reference to the endpoint of the preceding block appears on the display.

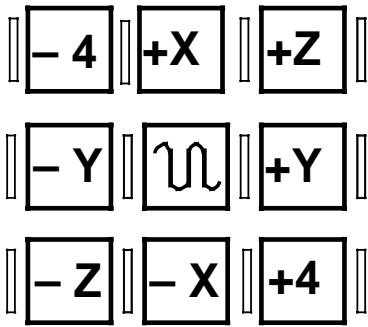

Operate the relevant direction keys. The control guides the tool using linear interpolation to the endpoint of the preceding block.

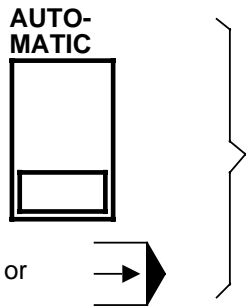

Now switch again to "AUTOMATIC" mode using the softkey or the mode selection switch.

Program processing continues after you have pressed the "NC start" key.

### 3.2.3.4 Interrupting the program

#### Sequence of operation

You can interrupt a running program in one of the following ways:

- 1) Perform one of the operating mode changes which causes a **RESET** (see Section 2.3.4). The drives are brought to a controlled standstill.
- 2) By **NC STOP**:



Operate the "NC STOP" key.  
The drives are brought to a controlled standstill  
without leaving the programmed path.

The STOP: "AUTO INTERRUPTED" display appears.



Now operate the keys "NC Start" and "Feed On".  
The feed is enabled.

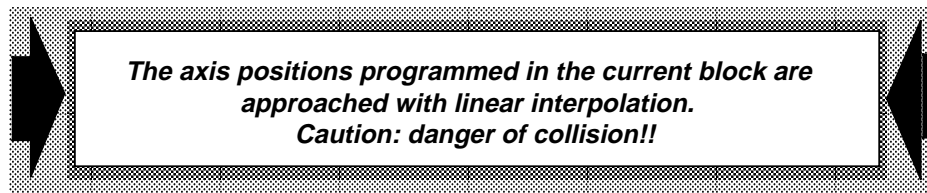

### 3.2.3.5 Program sequencing (OPS)

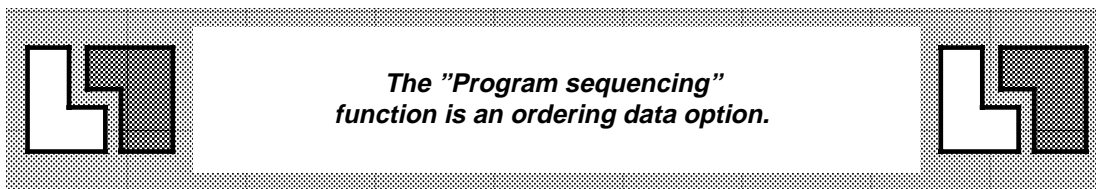

This function enables you to automatically reload and execute programs from a diskette following a predefined list. To do this you need the PLC function block FB120 and DSG-2S disk drive. Each must be ordered separately!  
You can monitor the execution of the program sequencing in a separate screen display and - if desired - interrupt it.  
After the interruption you can restart the program at any point within the list.



You are in the AUTOMATIC mode.

AUTOMATIC



OPS

Having expanded the softkey menu you operate the "OPS" softkey.

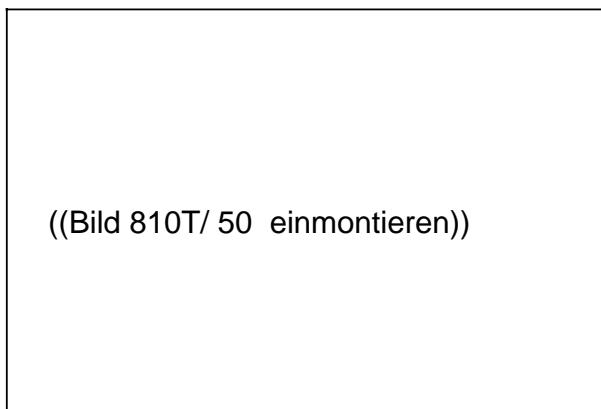
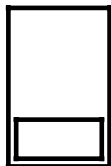

This display appears on the screen.



Using the softkey functions in this display, you can load files from the diskette into the NC as well as create, extend or delete them on the diskette (remote operation functions). Besides that you can call for the directory of the diskette ("DIRECTORY").

The "Data type" field indicates the program currently being transmitted via the RS232C (V.24) interface.

### Remote operation functions:

The remote operation functions are used for program saving and program management on diskettes and they support the preparations for program sequencing (OPS). They are designed in such a way that the ordering principle required for OPS "1 file = 1 main program + an unlimited number of subroutines" and "file name = main program name" must inevitably be adhered to.

### This means:

When a main program is transferred a new file with the same name is opened on the diskette and when subroutines are transferred they are appended to an existing file.

### The same general rule applies to all remote operation functions:

First fill in the input fields required, then press the softkey for the desired function.

## Sequence of operation

### NEW FILE

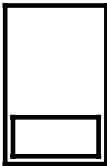

### Creating a new file:

Using the "NEW FILE" softkey, you open the NC-xxxx file (xxxx=4-digit number) on diskette.

The main program "%xxxx" is transferred from the NC part program memory into this file on diskette.

You can only enter the file number, the main program number is automatically set to the same value. Entering subroutine numbers is not affected by this.

### Note:

If there already exists a file with the same name on the diskette an error message is given by the disk drive unit and the command is not executed (see also Section 4.6, Alarm 33 "Different programs same No. RS 232C (V.24)").

**Example:** File=10    The file NC-0010 is opened on diskette, the %10 main program is transferred from the NC part program memory into this file.



## Sequence of operation

### EXTEND FILE

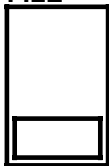

#### Extending an existing file:

You can add one or more subroutines to a file which already exists by using "EXTEND FILE". The number of the file you wish to extend has to be entered in the "FILE" entry field, the first and the last subroutine to be transferred are entered in the "Subroutine" entry field. It is not possible to add a main program to a file!

#### Attention:

If a subroutine is added to a file several times it is also stored several times in this file (existing programs with the same name are not overwritten!)

**Example:** File=10, Begin=100, End=200.

All subroutines from the NC part program memory the numbers of which are 100 and 200 are added to the NC-0010 file on diskette.

If "End" "Begin" is selected only the one number entered under "Begin" is taken into account.

If a file is intended to consist of subroutines only, e. g. frequently required standard subroutines, a main program has to be created for formal reasons.

### CLEAR FILE

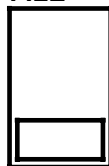

#### Deleting a file:

Using the "CLEAR FILE" softkey you can delete any file on diskette which has been created in the remote operation mode (or has been stored on diskette with a name "NC-xxxx"). The file number desired is entered in the entry field "File". The main program of this file and all subroutines that may have been added to this file are deleted.

### START INPUT

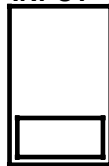

#### Reading a file:

Using the "START INPUT" softkey you can transfer a file existing on diskette into the NC memory. You only have to enter the file number. The main program of this file and all subroutines that may have been added to this file are transferred.

## Sequence of operation

### DIRECTORY

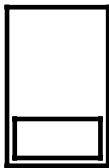

### Directory of diskette:

Using the "DIRECTORY" softkey you demand from the disk drive unit a directory of all files stored on the diskette inserted. The disk drive unit sends this directory as a part program %9999.

The program number %9999 has to be reserved for this purpose! As any other part program, the directory can be displayed using the "PART-PROGRAM", "EDIT", "SELECT PROGRAM" softkeys.

### Creating the program sequence list:



You extend the softkey menu and operate the "INPUT OPS" softkey.

### INPUT OPS

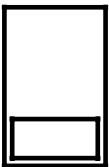

The program sequence list appears on the screen.

((Bild 810M/ 51 einmontieren))

You enter the number of main programs which are to be processed in OPS into the screen form, together with their respective number of units (= number of runs).

You use the cursor keys to move the cursor.

## Sequence of operation

### PAGE DOWN

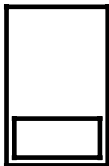

If more than 20 programs have to be entered you use "PAGE DOWN" to switch over to the second page of the screen form. "PAGE UP" is used to switch back to the first page.

The list can comprise up to 40 main program numbers (= file numbers). The "CURRENT NO" (= current number) column on the left signifies the sequence of processing in OPS. OPS always begins with the program at the current number 1.

OPS uses the program number 0000 as end criterion. As soon as this number is reached during processing the program sequence list, OPS ends automatically.

When the program number ffff is entered, this line in the list is skipped in OPS.

**Application:** Creating space lines in order to subsequently enter a program or subsequently delete a program number entered already.

### DELETE LIST

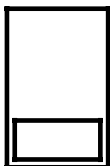

You use the "DELETE LIST" softkey to delete all 40 program numbers (not the actual programs!) and unit numbers entered by overwriting with zeros.

## Program sequencing (= OPS)

OPS requires:

- 1) The files on the diskette which are used for the OPS must be given (e. g. by using the remote operation functions) the following structure:
  - One file contains exactly one main program at the beginning of the file
  - The numbers of the main program and the file, each consisting of four digits, are equal.
  - The main program at the beginning of the file may be followed by an unlimited number of subroutines.

**Important:** A file should contain all subroutines which are called in the main program of this file.

**Exception:** Subroutines required by a great number of main programs, which would consequently have to be stored in a great number of files.

**Suggestion:** Store these programs in a protected range of numbers of the part program memory which is not deleted during OPS.

**Explanation:** If during OPS the next program file is reloaded after the end of a program, the NC memory is prior to this cleared except for a reserved range of program numbers (the limits of this range can be set at the disk drive unit).

If the deletion range is defined as MP=0-8999 or  
SR=100-799  
then the main programs with the numbers 9000  
and the subroutines 99 or 800  
are not deleted prior to retroloading. They remain in memory throughout OPS!

- 2) The program list must have been completed.
- 3) All files which are to be processed according to the numbers in the program sequence list must exist on the diskette inserted.

### Sequence of operation

**RUN  
OPS**

You operate the "RUN OPS" softkey.

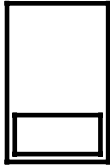

The display below appears on the screen. You may now start, monitor and interrupt program sequencing.

((Foto - Nr. 810T/ 52 einmontieren))

## Sequence of operation

### START OPS

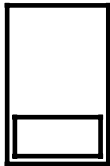

#### Start:

Every time the "START OPS" softkey is pressed the next program to be processed according to the list is loaded into the NC memory. The first program is demanded immediately, all following ones after processing of the previous program has ended.

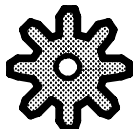

*Whether the NC has to be restarted manually after the new program has been loaded or whether it is restarted automatically, is set by the machine tool manufacturer.*

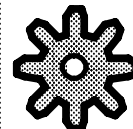

#### Display:

The 2nd line in the screen form (marked by >...< ) is the "actual line", which is being processed.

The "REM" column indicates the number of program runs remaining until the set quantity (= "RQD" column) has been reached. It is updated after each change of program.

After each change of program the list moves up one line in the screen form, so that the following program appears in the "actual line" (scroll function).

After the last run of the last program the initial display is shown again, i. e. consecutive number 1 is in the "actual line".

## Sequence of operation

### STOP EDIT

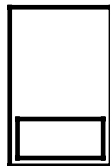

#### Interruption:

If OPS is to be interrupted (not ended!), e. g. in case of tool breakage, the "STOP EDIT" softkey must be pressed; automatic reloading is then interrupted (it depends on the user PLC program if this triggers "NC RESET" at the same time). The cursor appears in the "actual line" of the screen form.

### START OPS

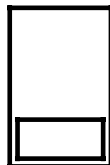

#### Continuation:

Pressing "START OPS" you resume program sequencing directly at the interruption point of the program sequence.

If you wish to proceed with a different part program, i. e. restart from a different line of the program sequence list, you can change the consecutive number in the screen form before starting.

#### Note:

If the same part program is to be executed with a quantity other than the remaining amount, you may change this number before the start.

If the consecutive number and the remaining quantity are **both** changed **at the same time** only the new consecutive number will be taken into account!

## Sequence of operation

### STOP EDIT

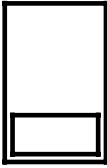

You stop program sequencing manually by operating the "STOP EDIT" softkey.

#### End:

Program sequencing comes to a regular end as soon as the program number 0000 is reached the first time during processing the program sequence list.

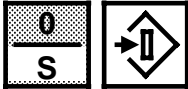

Enter consecutive number 0, if No. 0 exists in the list and press the search key.

### START OPS

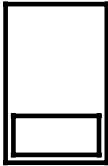

Operate the "START OPS" softkey.

OPS operation is terminated (program number 0000 is reached).

As opposed to "Interruption", "End" results in the internal OPS management being reset to its defined starting state. In the case of an interruption, internal flags and pointers are preserved as they were at the moment of interruption.

#### Note:

If "STOP EDIT" is pressed while programs are being transferred (indicated by the "DIO" screen display), it may happen that the last program loaded is incomplete in the NC memory! Unless the "OPS mode" display is left, this has no consequences at all.

In the case of a return jump to the "Note: "OPS mode" display this can result in an error message ("Different programs same No. RS 232C (V.24)") if the incompletely transferred file is once again called from there.

For further details, please refer to the documents on the DSG-2S disk drive.



### Data backup / manual operation:

In manual operation - i.e. operator input required on the NC as well as on the disk drive unit - other types of data (e. g. machine data, PLC program etc.), besides main programs and subroutines, may be transferred.

#### Transfer from the NC to the disk drive unit:

On the NC the type of data to be transferred is selected in the standard way ("DATA IN-OUT", "DATA OUT" ... softkeys).

On the keyboard of the disk drive unit "Receive on channel 1" then has to be set. When "?" appears on the LCD display, the disk drive unit is ready. Data transfer can now be started and stopped on the NC. The disk drive unit closes its channel by itself and returns to its initial state as soon as no more data is being transferred and the set "Time Out" waiting period has elapsed (no further "?" on the display).

#### Transfer from the disk drive unit to the NC:

The "DATA-IN-OUT" and "DATA-IN START" softkeys are used to switch the NC to receive mode. On the disk drive unit the desired file must be selected by means of the directory function and subsequently be sent ("!" on the LCD display). When the disk drive unit is sending no more data (no further "!" on the display) the NC interface may then also be closed by means of the "STOP" softkey.

The following data can be transferred manually between the NC and the disk drive unit:

<b>Types of data:</b>	<b>Header line (or the first 8 characters):</b>
Tool offset	" T O A  xx"
Zero offset	" Z O A  "
NC machine data	" T E A  1"
PLC machine data	" T E A  2"
R parameters (channel 1)	" R P A  1"
UMS data	" A S M  xx"
PLC program	" P C P  xx"

(xx are any two characters which no longer belong to the header)

### 3.2.4 "Manual data input - automatic" (MDI AUTOMATIC) mode

In this operating mode, you can process individual operations block-by-block under NC control. After the blocks entered have been processed, they are deleted.

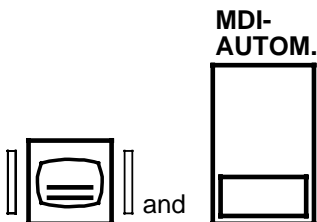

Operate the operating mode selection key on the integrated machine control panel, and then the "MDI-AUTOMATIC" softkey or ...



... set the operating mode selector switch on the external machine control panel to this symbol.

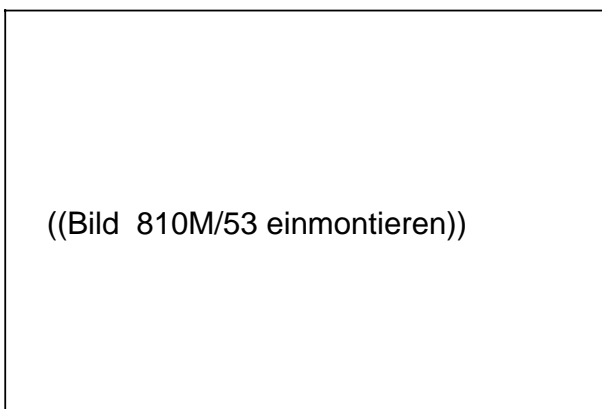

This screen form appears with the input field marked in inverse video.

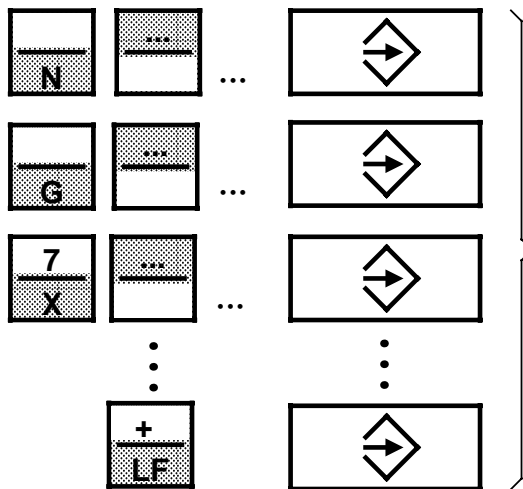

Using the numerical keyboard enter a block following the guidelines in the Programming Instructions, and terminate each input including "LF" (end of block) - using the input key.



Operate the "Program start" key

**Important:**

"Feed hold" display must not be present.

The entered block is now processed by the control and subsequently deleted.

Note:

Before "Program start" is operated, you can enter several blocks (max. 256 characters).

The "retentive (modal) input data" (e. g. feedrate) remain.

They are deleted or reset.

- by changing the operating mode
- by "RESET".

### 3.2.5 "TEACH IN"

Using the "TEACH IN" function in the "AUTOMATIC" operating mode you can generate a part program on a block by block basis. You can test the program immediately.

#### Sequence of operation

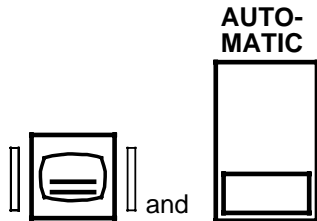

Operate the operating mode selection key on the integrated machine control panel, and then the "AUTOMATIC" softkey or...

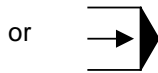

... set the operating mode selector switch on the external machine control panel to this symbol.



Enter the desired program number "% ..." (or subroutine no. "L ...") in the "AUTOMATIC" basic display.

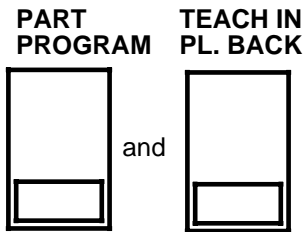

Operate the "PART PROGRAM" and "TEACH IN/PLAYBACK" softkeys, one after the other.

The selected part program no. with the input pointer below it are displayed.

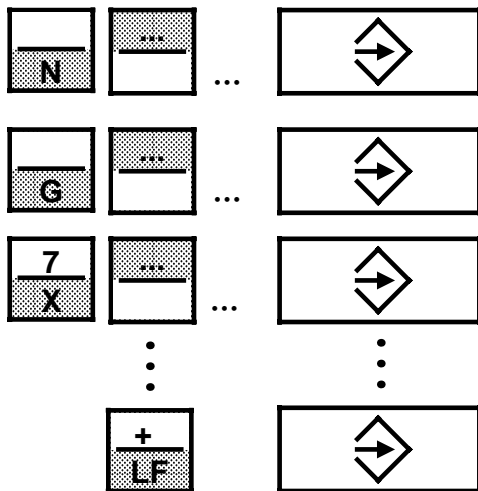

Using the numerical keyboard, enter a block (or more than one block) following the guidelines in the Programming Instructions, and terminate each input - including "LF" (end of block) - with the input key.

**Note :**  
You can also work with operator - "GUIDING" (Section 3.1.10.2).  
The part program is entered directly into the part program memory.





The blocks entered can be traversed using the "Program start" key.



You can delete the blocks not required, by entering the block no. "N ...", and operating the delete key.  
Blocks traversed correctly remain - as entered - in the memory. They do not have to be acknowledged.

### 3.2.6 "PLAYBACK"

Using the "PLAYBACK" function after "TEACH IN", you can program **linear movements**.

The position values are approached at jog traverse rate. Positions traversed to are transferred into the program memory.

The blocks entered are transferred into the program selected in the "AUTOMATIC" basic display.

"TEACH IN" und "PLAYBACK" can be used alternately for generating a part program.

The "TEACH IN" and the "PLAY BACK" functions are retained when changing from "AUTOMATIC" to the "JOG" or "INC ..." modes.

When changing from the "JOG" or "INC ..." modes to "AUTOMATIC" you must reselect "TEACH IN / PLAYBACK".

Sequence of operation

*At least one complete part program block must be entered and traversed.*

Set the operating mode selector switch on the external machine control panel to one of the following symbols.



JOG



INC...

1, 10, 100,  
1 000, 10 000



Traverse to the desired position using the direction keys.

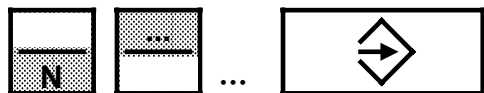

Using the keyboard, enter a block No. "N ...", and store it with the input key.

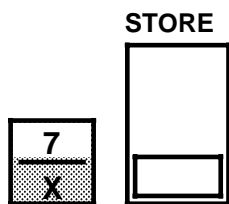

Enter the axis assignment "X" using the keyboard, and then operate the "STORE" softkey.

The control transfers the X axis value under "Actual position" into the selected block "N...".

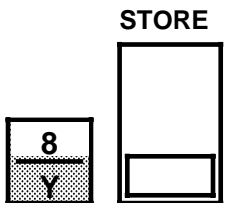

Enter the axis assignment "Y" using the keyboard, and then operate the "STORE" softkey.

The control transfers the Y axis value under "Actual position" into the selected block "N...".

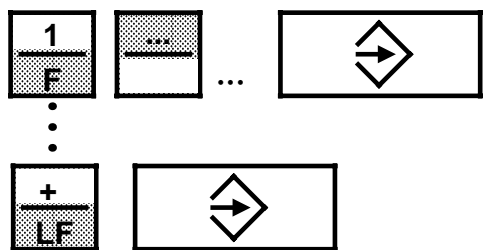

Using the numerical keyboard, enter the required technology values, e.g. feedrate "F..." etc., and terminate each input including "LF" (block end) - with the inout key.

**Note :**  
You cannot work with operator "GUIDING".

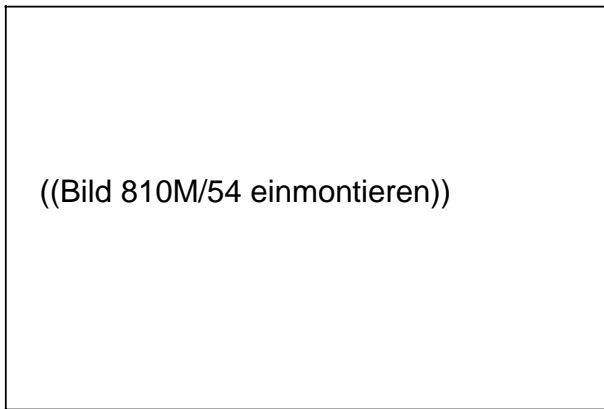

This display shows an example of a block "N1", entered using "PLAYBACK".



Operate the "Program start" key after **each** block is entered. This transfers the block to the program memory.

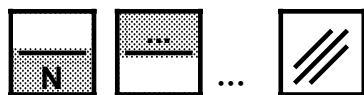

Blocks not required can be deleted by entering the block no. " N...", and operating the delete key. Blocks traversed correctly remain - as entered - in the memory.



After each "RESET" using this key, the processing of the program can be repeated

**Continuing TEACH IN / PLAYBACK after RESET**



Set the mode selector switch to the symbol for "AUTOMATIC".



Enter the desired part program number "%..." in the "AUTOMATIC" basic display and store it with the input key.

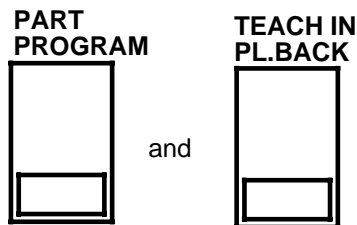

Then operate the "PART PROGRAM" softkey followed by the "TEACHIN / PLAYBACK" softkey.





Press the RECALL key **twice** to return to the "AUTOMATIC" basic display.

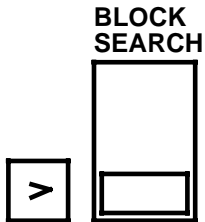

Extend the softkey menu displayed and then select the "BLOCK SEARCH" softkey function.

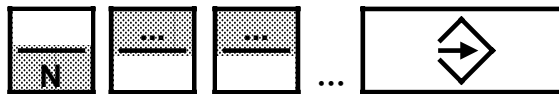

Then enter block no. "N..." of the last block in the part program and store it with the input key.

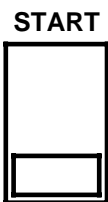

Operate the "START" softkey and ...



... activate the program with the "PROGRAM START" key.



Call up the "AUTOMATIC" basic display using the RECALL and ETC keys.

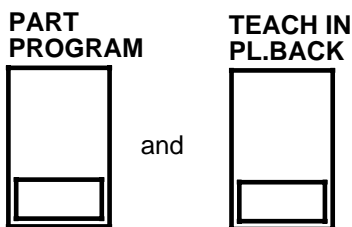

Then operate the "PART PROGRAM" and "TEACH IN / PLAYBACK" softkeys one after the other.

Continue as described above under "Sequence of operation".

**Note:**

When you have set up the desired program, terminate it with M02 L<sub>F</sub> or M30 L<sub>F</sub>.

### 3.2.7 "JOG" mode

In this mode, machining is performed in the NC in JOG/manual mode, but it is not programmed.

You **traverse** the axes with the **direction keys!**

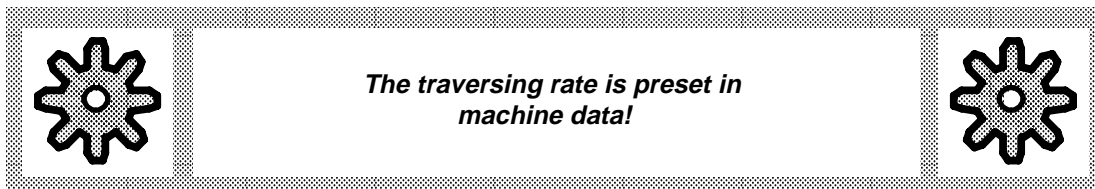

#### Sequence of operation

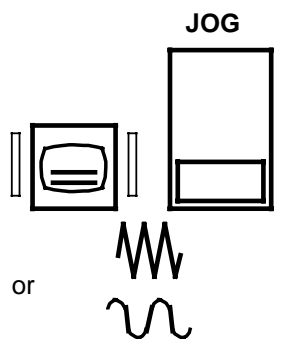

Operate the operating mode selection key in the integrated machine control panel, and then the "JOG" softkey or ...

... set the operating mode selector switch in the external machine control panel to this symbol.

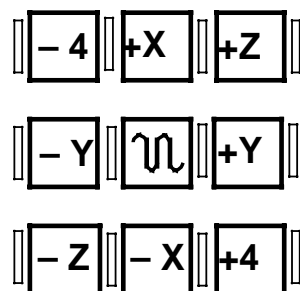

#### Integrated machine control panel:

By operating the direction keys, you cause the axes to traverse in "jog" mode!  
 You can traverse a maximum of 2 axes at the same time ...

or

or

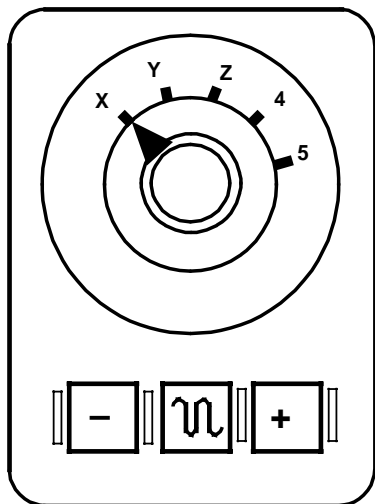

#### On the external machine control panel:

Select the axis to be traversed with the axis selector switch on the external machine control panel ...

... and then press one of the direction keys.

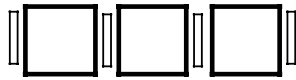
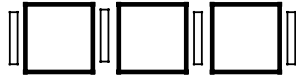

or

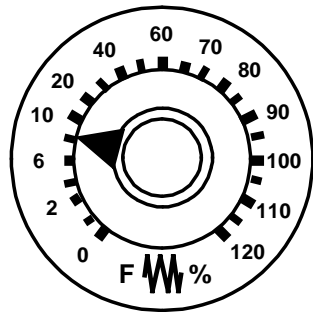
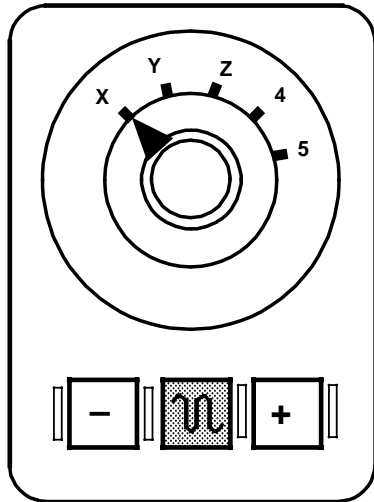

**Note:**

The red "Feed hold" LED display, must **not** be bright!

**On the integrated machine control panel:**

You can select "Rapid traverse" by operating the "Rapid overlay" key, simultaneously with the direction keys ...

or

**On the external machine control panel:**

You can press the rapid override key situated below the axis selector switch between the direction keys.

You can modify the rapid traverse rate, using the feedrate override switch. The "0%" setting generally causes feed and rapid traverse to stop.

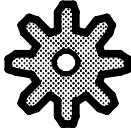
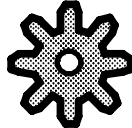
	<p><i>The traversing rate is preset in machine data.</i></p> <p><i>The feedrate can also be active for rapid traverse in the 0% to 100% range !</i></p>	
---	---	---

The spindle speed, and T, H, and M functions can be changed using "OVERSTORE" (see Section 3.2.3.2).

### 3.2.8 "Incremental" mode ("INC FEED 1 ... INC FEED 10000")

In this mode, operation is NC-controlled in "JOG/manual" mode, not in a program; with each operation of the direction key, you traverse the axis concerned in the selected direction by the set increment.

The increment values are settable as follows:

**1, 10, 100, 1000, 10000** increments. The weighting of the increments depends on the display resolution. However, the smallest possible traversing distance is defined by the input resolution.

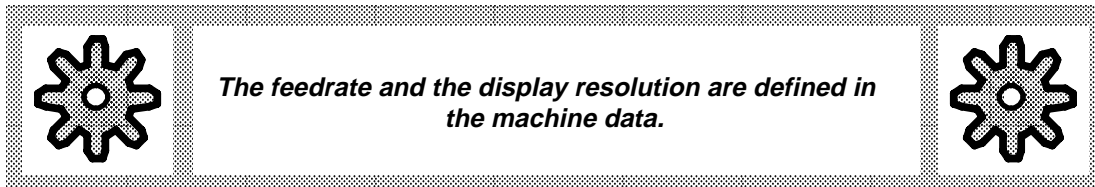

#### Sequence of operation

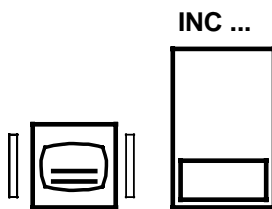

Operate the operating mode selection key on the integrated machine control panel and then any of the "INC 1" to "INC 10000" softkeys or...

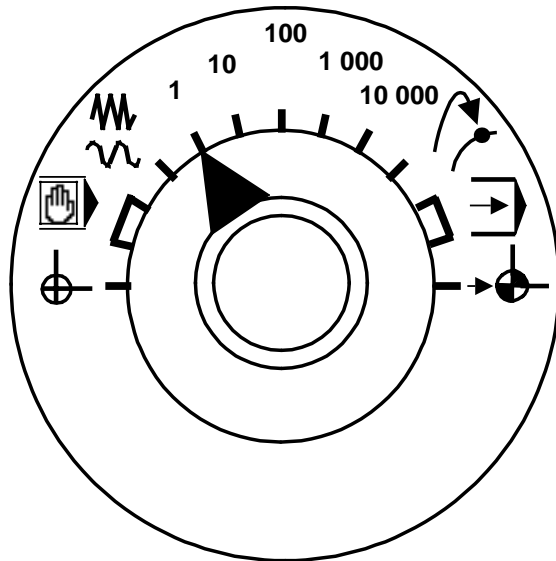

... set the operating mode selector switch, on the external machine control panel, to the setting "1", "10", "100", "1000" or "10000" ("1" in the example) .



By operating the appropriate direction key on the integrated machine control panel you traverse the axis selected ...

or

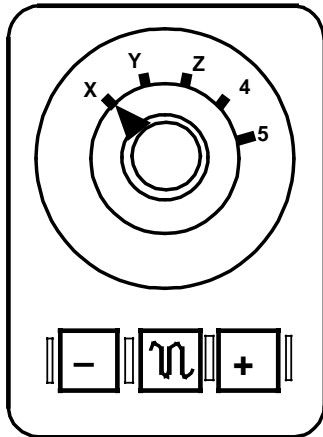

or

... select the axis to be traversed with the axis selector switch on the external machine control panel ...

... and then press one of the direction keys.

**Note:**

The red "Feed hold" LED display must **not** be bright during the sequence of operation.

**Note:**

The direction keys can perform in two different ways:

- "Modal"
- "Jog Operation"

When "Modal" the axis is always traversed by one increment, in accordance with the setting (1, 10, 100, 1000, 10000 increments), when the key is pressed (irrespective of whether the key is pressed for a short or long time).

In "Jog operation" the axis is traversed for as long as the key remains pressed. When the key is no longer being pressed, the traversing movement is stopped - even if the set increment has not been reached.

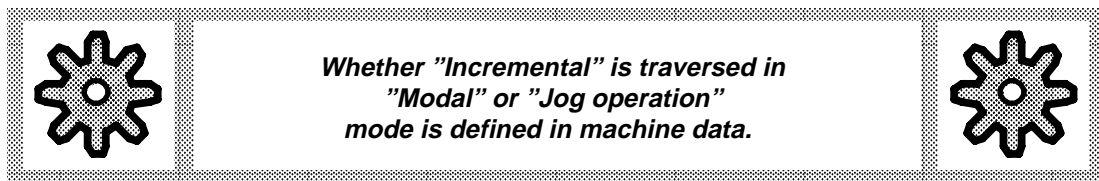

The spindle speed, and T, H and M functions can be changed using "OVERSTORE" (see Section 3.2.3.2).

### 3.2.9 "HANDWHEEL"

Using the "HANDWHEEL" softkey function, a command pulse from a digital-incremental encoder, connected to a handwheel, can be activated.

The increment per encoder pulse, is set as for "Incremental" (INC ...), however, the "1000" and "10000" values are **inhibited** !

For these softkey functions, and selector switch settings, the selection is limited to "100".

**Caution!** The smallest possible traversing distance is defined by the input resolution.

#### Sequence of operation

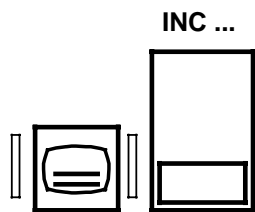

Operate the operating mode selection key on the integrated machine control panel, and then any of the "INC 1" to "INC 10000" softkeys or...

or

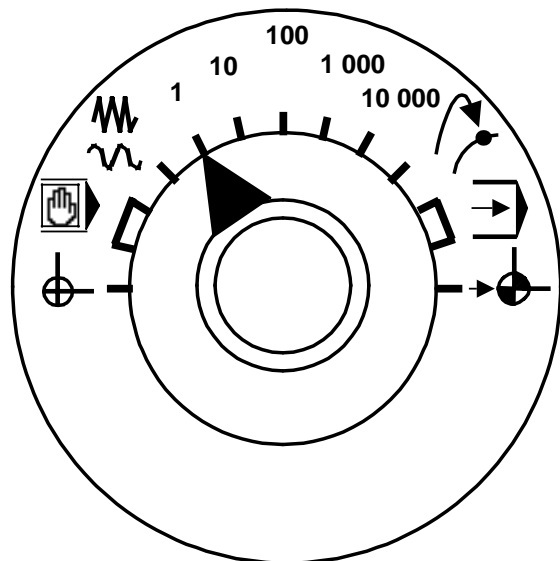

... set the operating mode selector switch on the external machine control panel to the "1", "10", "100", "1000" or "10000" setting.



Extend the displayed softkey menu using the ETC key.

**HANDWHEEL**

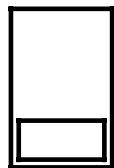

Select the "HANDWHEEL" softkey function.

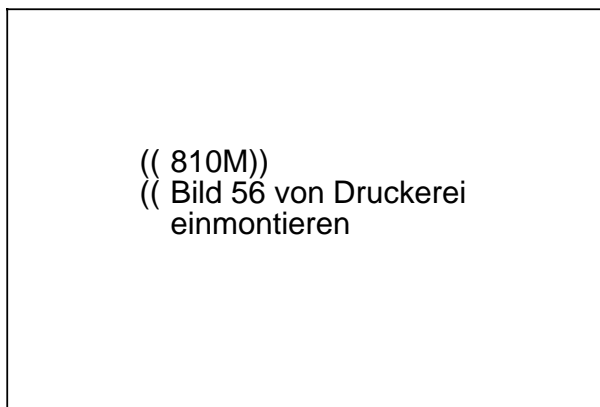

This display appears on the screen.

The screen display shows you the axis-handwheel assignment which you have set via the axial setting data (see Section 3.1.6).

#### Enable of the handwheels connected:

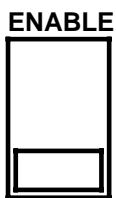

Enter the axis name (e.g. "X") and press the "ENABLE" softkey. The "ENABLE" display changes from "NO" to "YES". Now handwheel No. 1 applies to axis "X". Proceed in an analogous manner for the other axes (see also Section 3.2.10 "DRF").

If one handwheel is assigned to several axes by the axis setting data, the enable always applies to the last axis to have been input. On the display, the enable for the other axes automatically changes to "NO", i.e. the axis is blocked for the handwheel.





### 3.2.10 "DRF"

The "DRF" (differential resolver function) softkey function makes it possible to generate an additional, incremental zero offset using the "HANDWHEEL".

This zero offset is **not** taken into account for the actual position display.

#### Sequence of operation

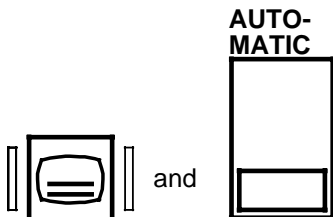

Operate the operating mode selection key in the integrated machine control panel, and then the "AUTOMATIC" softkey  
or ...

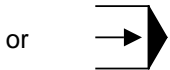

... set the operating mode selector switch in the external machine control panel to this symbol.



Extend the displayed softkey menu with the ETC key.

#### PROGRAM CONTROL

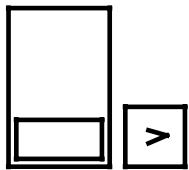

Operate the "PROGRAM CONTROL" softkey, and then extend the displayed softkey menu.

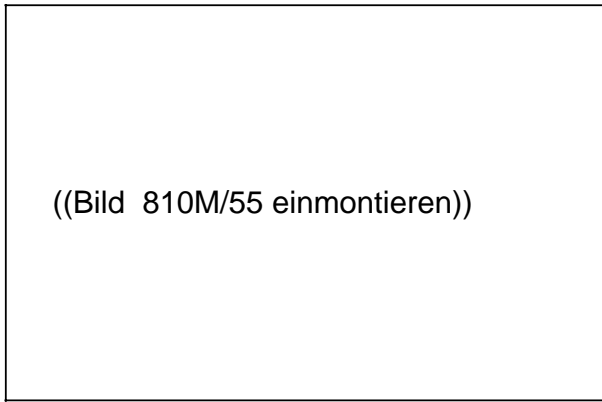

This CRT display appears.

((Bild 810M/55 einmontieren))

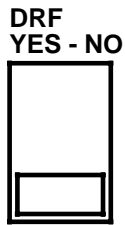

Operate the "DRF YES - NO" softkey:  
You activate the DRF offset by switching from "NO" to "YES"

The "DRF-handwheel" enable ("YES") is displayed on the CRT.

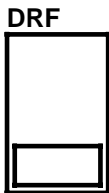

Select the "DRF" softkey function.

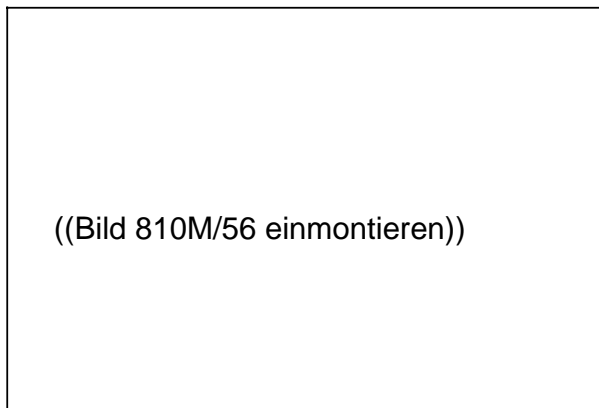

This display appears on the CRT.

The screen display shows you the axis-handwheel assignment which you have set via the axial setting data (see also Section 3.2.9 "HANDWHEEL").

#### **DRF offset with connected handwheels:**

Enter the axis name (e.g. "X") and press the "ENABLE" softkey. The "ENABLE" display changes from "NO" to "YES". Now handwheel No. 1 applies to axis "X". When you operate the handwheel, you can effect a DRF offset, for the "X" axis in the example. The value of the DRF offset is displayed on the screen. Proceed in an analogous manner for the other axes.

If one handwheel is assigned to several axes by the axial setting data, the enable always applies to the last axis to have been input. On the display, the enable for the other axes automatically changes to "NO", i.e. the axis is blocked for the handwheel.

### 3.2.11 "Actual value setting" mode ("PRESET")

- In the "PRESET" operating mode, you can offset the control zero point to any point within the machine coordinate system. You enter the value for the offset into the actual value memory (preset). This preset results in a "PRESET offset", which is displayed on the CRT.
- When required, a tool offset can be calculated into the "PRESET offset". You enter the tool offset data **before** "actual value setting" (offset number, offset direction and type). The value then entered is transferred into the actual value memory taking the tool offset into account.
- **No movement** of the axes takes place with "actual value setting".
- The "PRESET offset" **remains stored**:
  - after "End of Program"
  - after "RESET"

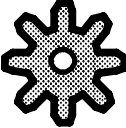
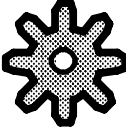

	<p><i>Machine data defines whether the PRESET offset is automatically deleted;</i></p> <ul style="list-style-type: none"><li>- <i>by switching on the control</i></li><li>- <i>by traversing to reference point</i></li></ul>	
--	---	--

## Sequence of operation

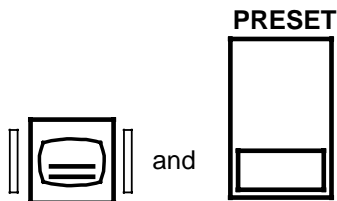

Operate the operating mode selection key in the integrated machine control panel, and then the "PRESET" softkey or...



... set the operating mode selector switch on the external machine control panel to this symbol.

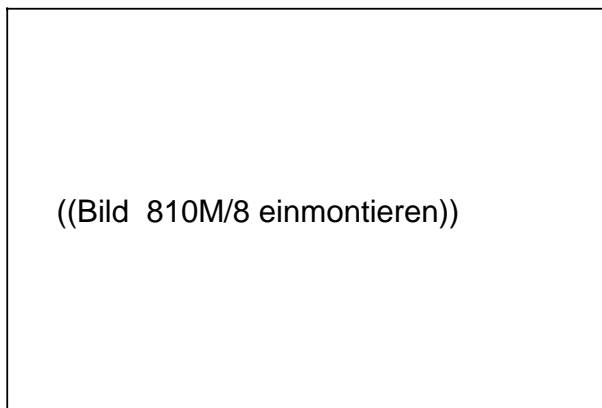

This input form with the input field marked in inverse video appears.

1. "PRESET offset" **without** inclusive calculation of the tool offset



Using the keyboard, enter numeric "0" into the "Offset number" input field, and store it using the input key.

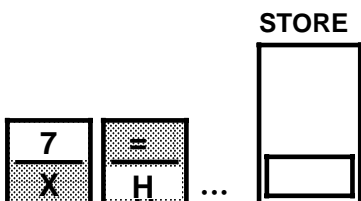

First enter the desired axis designation - "X" for the X axis in this example.

Assign this axis the appropriate **value** of the "PRESET offset" (enter by numerical keys) and finally operate the "STORE" softkey.

The new "actual position" and the "PRESET offset" for the X axis are displayed.

In the same way you enter the values for the other axes, and subsequently operate the "STORE ... AXIS" softkey after input for each.

2. "PRESET offset" **with** inclusive calculation of the tool offset.



Using the keyboard, enter the number of the desired tool offset number D ... , into the "offset number" input field, and store it using the input key.

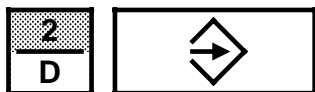

Using the keyboard, enter the identification "Ident. No." (see Section 3.1.3) for the X axis, into the "Ident no." input field - "2" in the example. Store it using the input key.

Use the same method to enter the ident no. for the other axes.

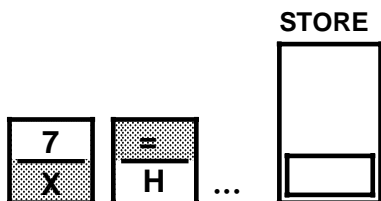

First enter the desired axis designation - "X" for the X axis in this example. Assign this axis the appropriate **value** of the "PRESET offset" (enter by numerical keys) and finally operate the "STORE" softkey.

The new "actual position" and the "PRESET offset" for the X axis are displayed.

The displayed value "PRESET offset" comprises:

- the entered value
- plus: the calculated tool offset.

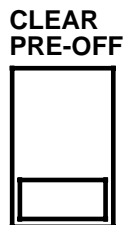

You can clear all the "PRESET offset" at once by operating the "CLEAR PRESET-OFFSET" softkey.

### 3.2.12 "Repositioning" mode ("REPOS")

After a program interruption - e.g. after switching from "AUTOMATIC operation" to "JOG" (JOG) or "Incremental" (INC...) - you can traverse away from the contour.

"AUTOMATIC" operation is **not** aborted, i.e. the control is **not** brought to the reset state by a self-generated "RESET".

As described in Section 2.3.4, no "RESET" is generated by switching from "AUTOMATIC" mode to:

- "JOG" or
- "INC ..." or
- REPOS".

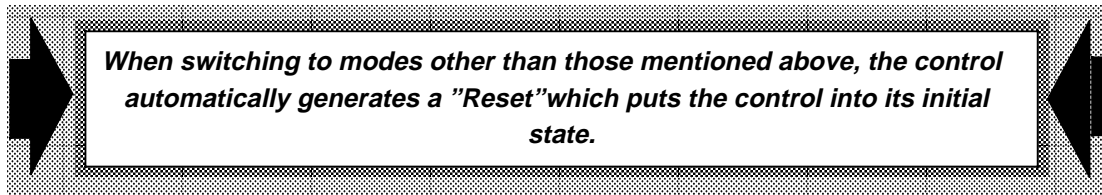

When traversing away from the contour, the distance moved is registered by the control. The distance to the interruption point is stored and displayed as the "**Repos offset**".

In "Repositioning" (REPOS) mode, you can now traverse to the interruption point using the direction keys.

The direction key for the opposite direction is inhibited, and overtravel past the start position is not possible.

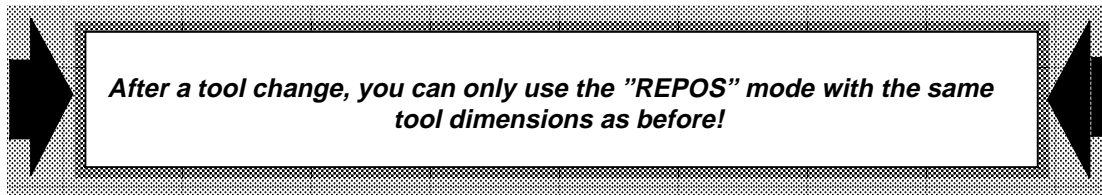

Otherwise you use:

- the "Block search" method (see Section 3.2.3.3)
- the "Scratching" method (see Section 3.2.13) .

# Sequence of operation

## Preconditions:

You have generated a program interruption - e.g. by switching to "JOG" mode - and subsequently traverse away from the contour (see Section 3.2.7 for sequence of operation).

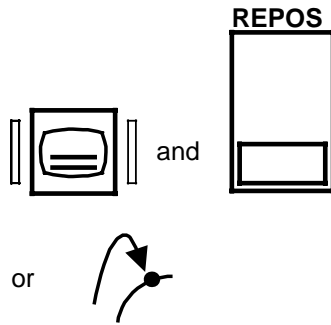

Operate the operating mode selection key on the integrated machine control panel and then the "REPOS" softkey or ...

... set the operating mode selector switch on the external machine control panel to this symbol.

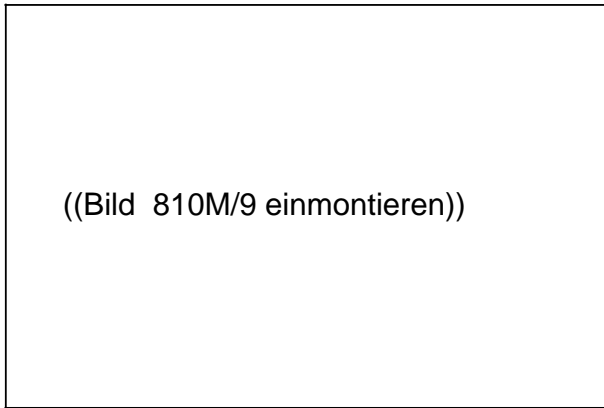

This display appears on the CRT.



The red "Feed hold" LED display extinguishes.

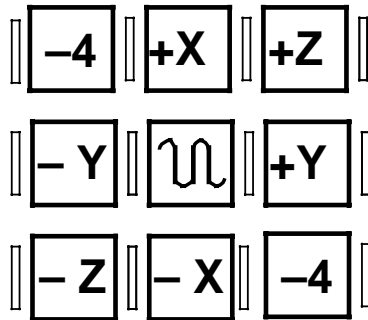

Using the direction keys, you traverse to the point of interruption.

### Note:

A maximum of 2 axes can be traversed at anyone time!

The feedrate override switch is active, the rapid override key is **not** active!

**Note:**

The direction keys can perform in two ways:

- "Modal"
- "Jog operation"

When "Modal" the axis is always traversed by one increment, in accordance with the setting (1, 10, 100, 1000, 10000  $\mu\text{m}$ ), when the key is pressed (regardless of whether the key is pressed for a short or long time).

In "Jog operation" the axis is traversed for as long as the key remains pressed. When the key is no longer being pressed, the traverse movement is stopped - even when the set increment has not been reached.

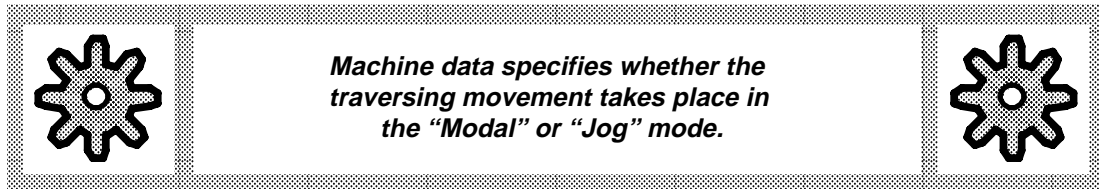

You can interrupt the retraction of the axes with "Feed hold".

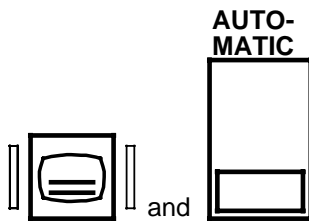

or



Using the operating mode selection key (integrated machine control panel), and softkey...

or

...the operating mode selector switch (external machine control panel), select "AUTOMATIC" mode if the contour is to be approached again.



Resume program process with "Program start".



### 3.2.13 Scratching

If there is a breakdown during the program process, e.g. a tool breakage, you must leave the contour by changing to the "JOG" or "INC1...1000" operating mode, in order to change the tool.

After entry of the new tool length compensation (the cutter radius remains unchanged) you traverse the tool to return to any point on the contour - within the interrupted block - ("Scratching").

#### Sequence of operation

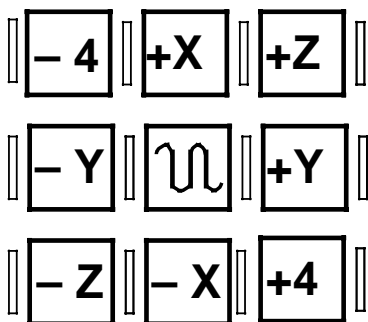

**Prerequisite:**

A tool change has been carried out;  
 The control is in "JOG" mode;

Using the direction keys, now traverse to any point that lies **within the interrupted** block.

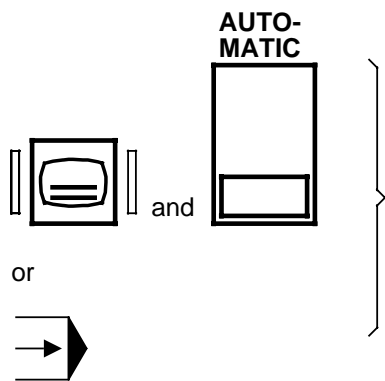

Using the operating mode selection key (integrated machine control panel) and softkey ...

or

... with this symbol on the operating mode selector switch (external machine control panel) select "AUTOMATIC" mode.



Resume the program process with "Program start".

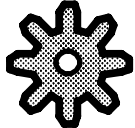

*In a block with circular interpolation (G02, G03) the scratching must take place within a very narrow range.  
 This range is defined with machine data.*

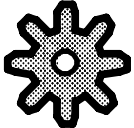

Standard definition via MD "9".

If the range is exceeded: alarm **3018**: "Distance from contour too great (NC MD9)".

## 4 Monitoring Functions

### 4.1 General

The control contains permanently active monitoring functions, which can detect faults in the NC, the interface control and the machine at such an early stage that extensive damage to the workpiece, tool or machine are practically eliminated. If a fault occurs, first of all machining is interrupted and the drives brought to a standstill, and then the reason for the fault is stored and displayed as an alarm. At the same time the PLC is informed that an NC alarm is present.

Monitoring functions exist for the following areas:

- Reading in
- Format
- Measuring circuit cables
- Encoders and drives
- Contour
- Spindle speed
- Enable signals
- Voltage
- Microprocessors
- Serial interfaces
- Transfer between NC and PLC
- Voltage level of the back-up battery
- System program memory
- User program memory.

### 4.2 Diagnostics display on the CRT

Messages from the monitoring system are displayed in the "Alarm line" of the CRT display. The "Alarm line" is the second display line from the top.

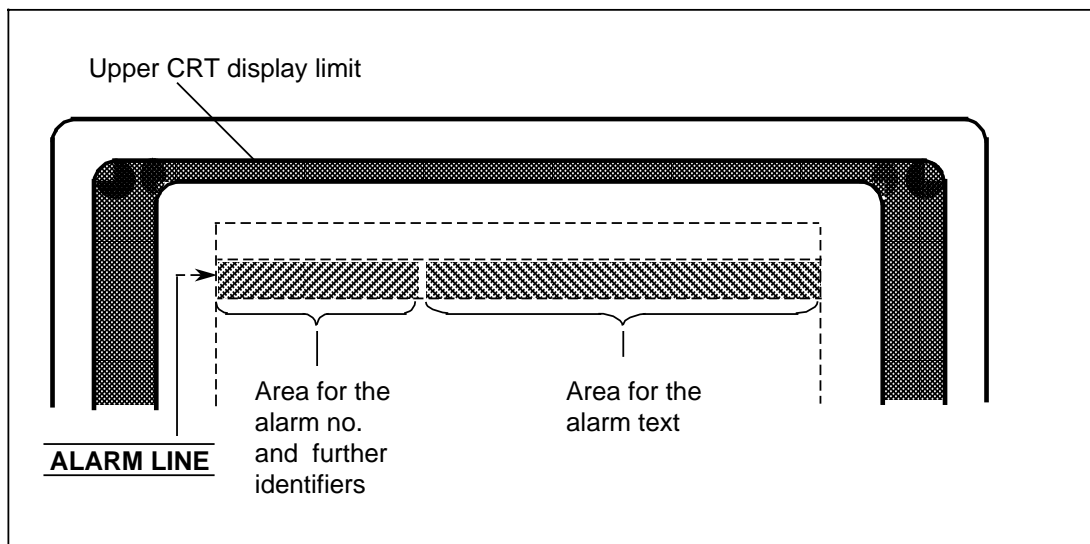

### 4.3 Display representation

There are 4 types of display representation:

- **Example of display representation type A**  
Valid for alarm numbers 0 .... 39 und 2000 ..... 2999 (partly)

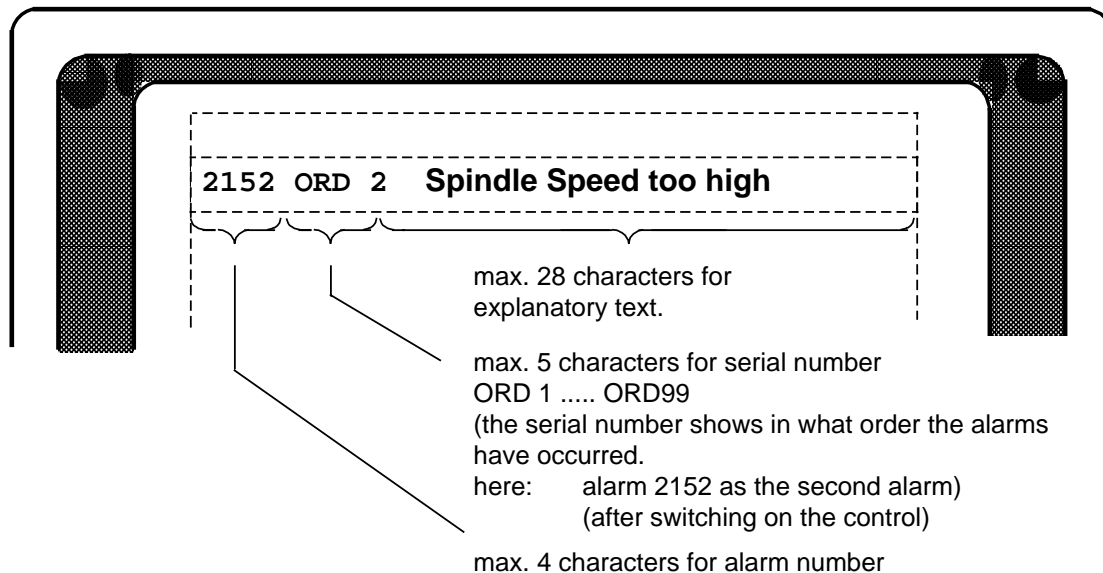

- **Example of display representation type B**  
Valid for alarm numbers 1000 ..... 1963

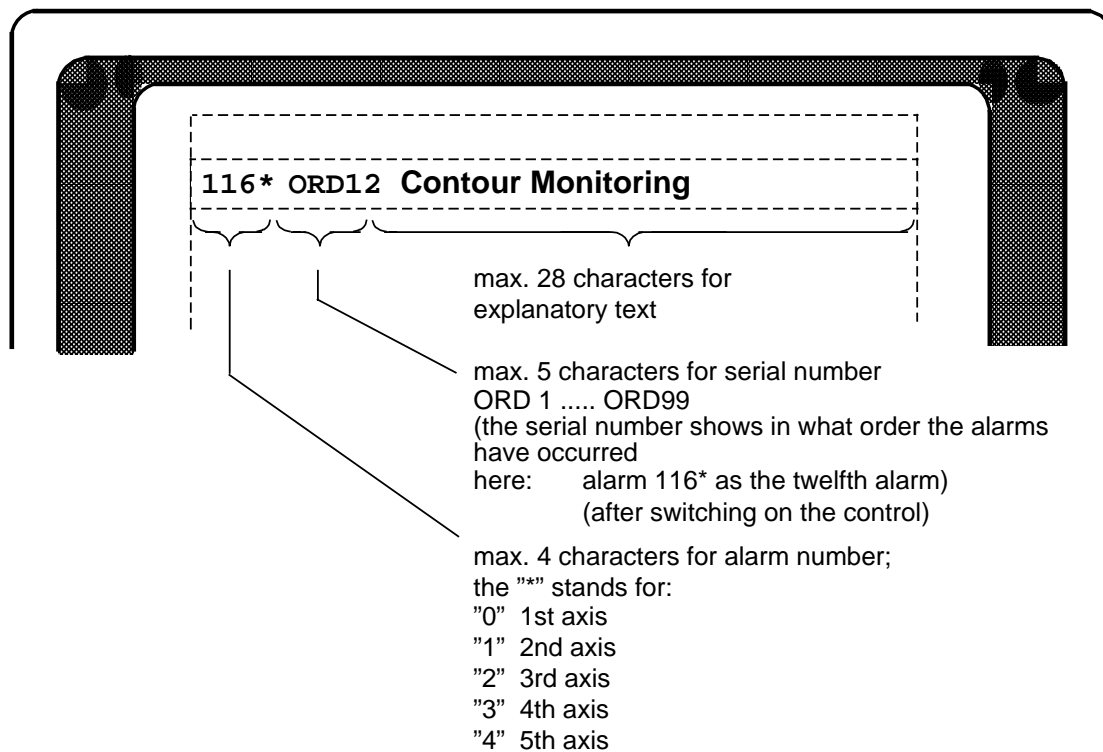

- **Example of display representation type C**

Valid for alarm numbers 2000 .... 2999 (partly) and 3000 .... 3094 (partly)

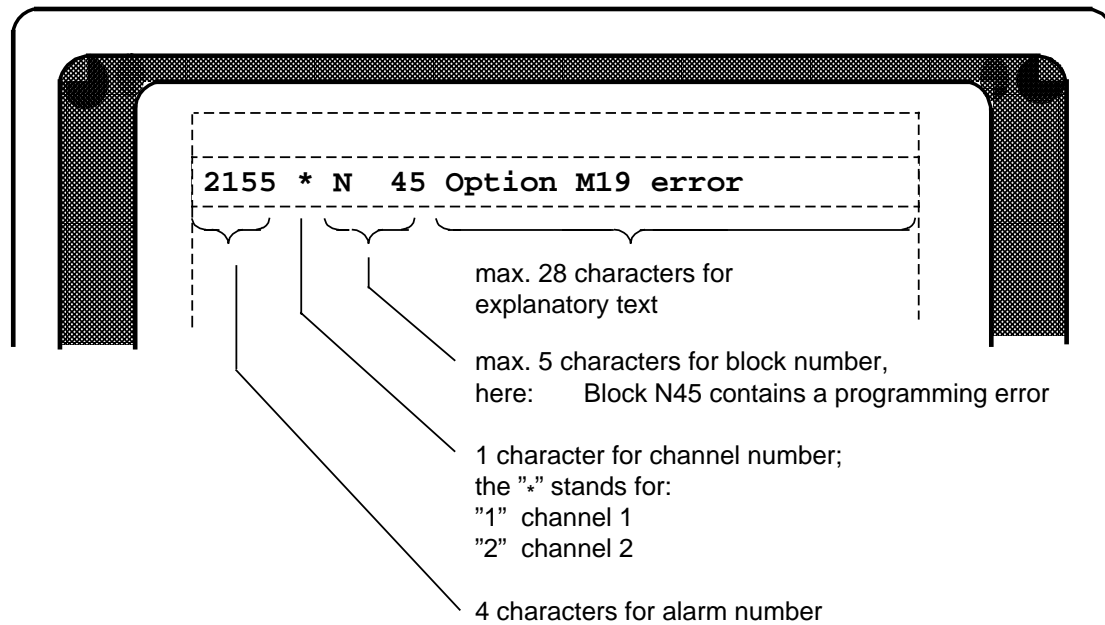

- **Example of display representation type D**

Valid for alarm numbers 6000 .... 6163 (PLC error messages) and for alarm numbers 7000 .... 7023 (PLC operational messages)

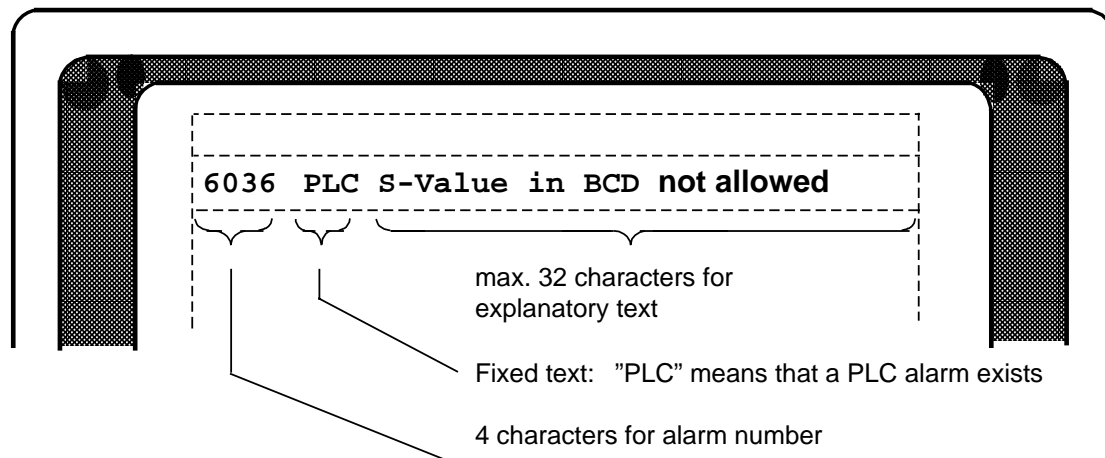







## 4.4 Alarm numbers and groups/delete alarms

The alarms are divided into 7 alarm groups (5 NC and 2 PLC alarm groups)

- NC alarms:**
- POWER ON alarms
  - RS232C (V.24) alarms
  - RESET alarms/axis-specific
  - RESET alarms/general
  - ERASE alarms

- PLC alarms:**
- PLC error messages
  - PLC operational messages

Alarm number	Alarm group	Alarm cleared by ...
1 .... 15 40 ....99, 132 * 2)	POWER ON alarms	Switching on the control 
16 ... 39	RS232C (V.24) alarms	1. Calling the softkey menu including the "DATA IN-OUT function"1) 2. Operating "DATA IN-OUT softkey" 3. Operating "STOP softkey"
100* ....196* 2)	RESET alarms/axis-specific	Operating the RESET key 
1320, 1321, 1322, 1323, 1324	RESET alarms/axis-specific	Switching on the control 
2000 .... 2999	RESET alarms/general	Operating the RESET key 
3000 .... 3201	ERASE alarms	Operating the acknowledge key 
6000 .... 6163	PLC error messages	Operating the acknowledge key 
7000 .... 7023	PLC operational messages	The messages are reset automatically by the PLC

*Tabular overview with assignment of alarm no. and clear function*

1) The "DATA-IN-OUT" function can be called in the following operating modes:

**AUTOMATIC / JOG / REFPOINT / INC1 ..... INC10000 / PRESET**

2) The asterisk " \* " stands for : "0" = axis 1, "1" = axis 2, "2" = axis 3, "3" = axis 4, "4" = axis 5.

## 4.5 DIAGNOSTICS/Selection of further alarms

When the diagnostics react, the reason could be **several different faults occurring at the same time**.

Only the alarm with the **lowest alarm number** is displayed in the alarm line.

If you need an overview of any other current alarm/messages, proceed as follows:

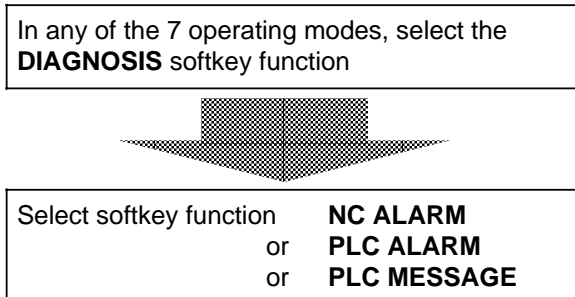

## 4.6 Listing of the alarms/alarm description

Preliminary: In the following listing, it is presumed that servicing will not be carried out by the user himself.

Alarms which requires a service visit, are described in detail in the Installation Guide.

Alarm No.	1
Alarm Text:	"Battery alarm power supply"
Reason:	Backup battery voltage has dropped
Effect:	Backup of user memory no longer guaranteed
Remedy:	Replace battery (See Instruction Manual)
Remarks:	Do <b>not</b> switch off control, data may be lost
Alarm No.	3
Alarm Text:	"PLC stop"
Reason:	PLC not operational
Effect:	– NC START is inhibited
	– Operation is brought to a defined standstill
Remedy:	Report the problem to Service.



## 4.6 Listing of the alarms/alarm description

Alarm No.	<b>4</b>
Alarm Text:	"Incorrect unit system"
Remarks:	Alarm only on commissioning
Alarm No.	<b>5</b>
Alarm Text:	"Too many input buffer parameters"
Remarks:	Alarm only on commissioning
Alarm No.	<b>7</b>
Alarm Text:	"EPROM CHECK error"
Remarks:	Alarm only on commissioning
Alarm No.	<b>8</b>
Alarm Text:	"Wrong axis/spindle assignment"
Remarks:	Alarm only on commissioning
Alarm No.	<b>9</b>
Alarm Text:	"Memory too small for UMS"
Remarks:	Alarm only on commissioning
Alarm No.	<b>10</b>
Alarm Text:	"UMS error"
Remarks:	Alarm only on commissioning
Alarm No.	<b>11</b>
Alarm Text:	"Wrong UMS identifier"
Remarks:	Alarm only on commissioning
Alarm No.	<b>12</b>
Alarm Text:	"PP memory wrongly formatted"
Remarks:	Alarm only on commissioning
Alarm No.	<b>13</b>
Alarm Text:	"RAM error CPU"
Remarks:	Alarm on commissioning



Alarm No.	<b>14</b>
Alarm Text:	"RAM error memory module"
Remarks:	Alarm on commissioning
Alarm No.	<b>16</b>
Alarm Text:	"Parity error RS232C (V.24)"
Reason:	The last character transferred has incorrect parity.
Effect:	RS232C (V.24) transfer is interrupted; the last block is not stored
Remedy:	<ul style="list-style-type: none"> <li>– Check setting data 5011/5013/5019/5021</li> <li>– Test external device</li> </ul>
Explanation:	The alarm only appears when the setting data "with parity bit" is set.
Alarm No.	<b>17</b>
Alarm Text:	"Overflow error RS232C (V.24)"
Reason:	Transfer speed is not correct
Effect:	<ul style="list-style-type: none"> <li>– Data transfer is interrupted</li> <li>– The last block is not stored</li> </ul>
Remedy:	<ul style="list-style-type: none"> <li>– Check setting data 5011/5013/5019/5021</li> <li>– Check transfer speed (Baudrate)</li> </ul>
Alarm No.	<b>18</b>
Alarm Text:	"Frame error RS232C (V.24)"
Reason:	<ul style="list-style-type: none"> <li>– Number of stop bits is incorrect</li> <li>– Baudrate is incorrect</li> </ul>
Effect:	<ul style="list-style-type: none"> <li>– Number of data bits is incorrect</li> <li>– Data transfer is interrupted</li> <li>– The last block is not stored</li> </ul>
Remedy:	<ul style="list-style-type: none"> <li>– Check setting data 5011/5013/5019/5021</li> <li>– Test external device</li> </ul>
Alarm No.	<b>19</b>
Alarm Text:	"I/O device not ready RS232C (V.24)"
Reason:	DSR (data set ready) signal has low level
Effect:	Data are not read in
Remedy:	<ul style="list-style-type: none"> <li>– Start external device</li> <li>– Do not use DSR (disconnect cable)</li> </ul>
Alarm No.	<b>20</b>
Alarm Text:	"PLC alarm memory not formatted"
Remarks:	Alarm only on commissioning

4.6 Listing of the alarms/alarm description

Alarm No.	<b>22</b>
Alarm Text:	"Time monitoring RS232C (V.24)"
Reason: Remedy:	Delay of 60 sec. for data transfer exceeded – Check external device – Check cable – Check setting data 5017 and 5025 – Set bit 0 to "1".
Alarm No.	<b>23</b>
Alarm Text:	"Char. parity error RS232C (V.24)"
Reason: Effect:  Remedy:  Explanation:	Punched tape dirty or damaged – RS232C (V.24) transfer is interrupted – The last block is not stored Block transfer: Faulted cable RS232C (V.24) transfer is stopped Check punched tape Block transfer: Check connections Depending upon the definition of the start of program "%" or "EOR", the NC automatically establishes the ISO or EIA, code upon receipt of this character, and establishes the character parity. Block transfer: Each character of a data block is checked for character parity and the block itself is checked for BCC. When checking the characters or the block, it was established that one character did <b>not</b> have the set parity.
Note:	Do not switch off control, data may be lost
Alarm No.	<b>24</b>
Alarm Text:	"Invalid EIA character RS232C (V.24)"
Reason: Effect: Remedy:  Explanation:	An EIA character with the correct parity was read in, but the character was <b>not</b> defined in EIA code – Data transfer is interrupted – The last block is invalid check punched tape: Setting data 5026 (EIA code for "@") and Setting data 5027 (EIA code for ":",") The "=" character in EIA code is not defined, and the following data cannot be read in: %TEA1 (NC machine data) %TEA2 (PLC machine data) %TEA5 (Drive machine data for SERCOS interface) %TEA6 (Drive machine data for parallel interface) %PRA (R parameters) %ZOA (Zero offsets) %TOA (Tool offsets) %PCA (PLC alarm text) Main programs and subroutines with R parameter calculations

Alarm No.	<b>26</b>
Alarm Text:	"Block > 120 characters RS232C (V.24)"
Reason:	The part program block that has been read-in contains more than 120 characters. Only the actual stored characters are counted (no spaces, no CR, ...)
Effect:	– Data transfer is interrupted – The last block is not stored
Abhilfe:	The block must be divided into 2 or more blocks
Alarm No.	<b>27</b>
Alarm Text:	"Data input disabled RS232C (V.24)"
Reason:	Interface signal "Cycle Inhibit" is on: NC, PLC Machine Data Text, PLC Alarm Text or PLC Program
Effect:	No data will be stored
Remedy:	Via Service
Alarm No.	<b>28</b>
Alarm Text:	"Circ. buffer overflow RS232C (V.24)"
Reason:	Data transfer speed too high
Effect:	RS232C (V.24) transfer is interrupted, several blocks are invalid (depends on the block length)
Remedy:	Report the problem to Service
Alarm No.	<b>29</b>
Alarm Text:	"Block > 254 char. RS232C (V.24)"
Reason:	The block that has been read in has more than 254 characters. All characters (e.g. spaces) read in are counted.
Effect:	– RS232 transfer is interrupted – The last block is not stored
Remedy:	The block must be divided into 2 or more blocks
Alarm No.	<b>30</b>
Alarm Text:	"PP memory overflow RS232C (V.24)"
Reason:	The maximum part program memory space is full
Effect:	– Data transfer is interrupted – The last block is not stored
Remedy:	Delete programs that are no longer required, and reorganise memory
Alarm No.	<b>31</b>
Alarm Text:	"No free PP number RS232C (V.24)"
Reason:	The maximum number of programs defined in machine data has been reached
Remedy:	Erase programs no longer needed and reorganize memory or change machine data (Service)

## 4.6 Listing of the alarms/alarm description

Alarm No.	<b>32</b>
Alarm Text:	"Data format error RS232C (V.24)"
Reason:	<ul style="list-style-type: none"> <li>– The permissible number of decades after an address is not correct</li> <li>– The decimal point occurs in the wrong place</li> <li>– The part programs or subroutines are not defined or completed correctly (check heading!)</li> <li>– The NC is waiting for an "=" character, which is not defined in EIA code.</li> </ul>
Effect:	-Data transfer is interrupted
Remedy:	-The last block is not stored Check the data to be read in.
Alarm No.	<b>33</b>
Alarm Text:	"Different programs same no. RS232C (V.24)"
Reason:	The stored program and the program being read-in, have the same program number, but are not identical.
Effect:	Block transfer: Program read in is unequal to selected program No data are stored
Remedy:	Either delete or "RENAME" the old program Block transfer: Enter correct program number in Automatic basic display
Explanation:	If a new program is read-in which has the same program number as one already stored. Both programs are compared, and because they are different alarm 33 is displayed. Block transfer: The program number received is compared with the program number entered in the Automatic basic display. If they differ alarm 33 is displayed.
Alarm No.	<b>34</b>
Alarm Text:	"Operator error RS232C (V.24)"
Reason:	Data transfer was started on the NC, but the PLC gave a second Start signal.
Effect:	No data are read in
Remedy:	Stop data input, and restart
Alarm No.	<b>35</b>
Alarm Text:	"Reader error RS232C (V.24)"
Reason:	Error message from Siemens Tape Reader
Effect:	-Data transfer is interrupted -The last block is not stored
Remedy:	– Restart data transfer – If the fault reoccurs call Service
Alarm No.	<b>36</b>
Alarm Text:	"BTR aborted by the computer"
Reason:	Part program received from BTR partner with error.
Remedy:	Restart

Alarm No.	<b>40</b>
Alarm Text:	"Wrong data in MD 576**"
Remarks:	Alarm only on commissioning
Alarm No.	<b>41</b>
Alarm Text:	"Error in absolute submodule"
Reason: Explanation:	Error when using a SIPOS absolute endcoder module. The precise type of error is shown in the "status of absolute module" line in the "axis service data" display. The error number is displayed. You can look up the meaning of the error number in the documentation for the SIPOS absolute endcoder module.
Alarm No.	<b>44</b>
Alarm Text:	"Part program memory not available"
Remarks:	Alarm only on commissioning
Alarm No.	<b>48</b>
Alarm Text:	"PLC alarm texts from UMS illegal"
Remarks:	Alarm only on commissioning
Alarm No.	<b>87</b>
Alarm Text:	"Illegal software limit switch"
Remarks:	Alarm only on commissioning
Alarm No.	<b>104 *</b>
Alarm Text:	"DAC limit"
Remarks:	Alarm only on commissioning
Alarm No.	<b>108*</b>
Alarm Text:	"Overflow of actual value"
Remarks:	Alarm only on commissioning
Alarm No.	<b>112*</b>
Alarm Text:	"Clamping monitoring"
Reason:	During positioning, the following error could not be eliminated faster than the time given in machine data 156.
Effect:	<ul style="list-style-type: none"> <li>– NC START inhibited</li> <li>– Operation will be brought to a controlled standstill</li> <li>– Follow-up operation</li> </ul>
Remedy:	Report the problem to Service

\*\* stands for: "0" = axis 1, "1" = axis 2, "2" = axis 3, "3" = axis 4, "4" = axis 5.

Alarm No.	<b>116*</b>
Alarm Text:	"Contour monitoring"
Reason:	During acceleration or deceleration, the axis did not reach the new traverse rate inside the time fixed by the servo gain factor.
Effect:	– NC START inhibited – Operation will be brought to a controlled standstill
Remedy:	Report the problem to Service
Alarm No.	<b>132*</b>
Alarm Text:	"Control loop hardware"
Reason:	The measuring circuit differential signals: – Are not in phase – Have a short-circuit to earth
Effect:	– Are missing – Inhibiting of NC START – Operation is brought to a defined stop – Follow-up operation
Remedy:	Report the problem to Service
Alarm No.	<b>136*</b>
Alarm Text:	"Meas. system dirty" (POWER ON necessary)
Reason:	In measuring systems with contamination signal, the measuring system signals a fault to the NC.
Effect:	Inhibiting of NC START The program operation is continued to the end
Remedy:	Report the problem to Service
Alarm No.	<b>148*/152*</b>
Alarm Text:	"+*/-* SW overtravel switch"
Reason:	Depending upon the PLC Interface Signal "2nd Software Limit Switch Active", the 1st or 2nd software limit switch has been approached
Effect:	Inhibiting of NC START
Remedy:	Traverse away from the limit switch in the opposite direction
Explanation:	The alarm is only active after reference point approach.
Alarm No.	<b>156*</b>
Alarm Text:	"Set speed too high"
Reason:	Within the control, a higher set speed was output than the value set in machine data 264*.
Effect:	The motor cannot follow the speed command value – Inhibiting of NC START – Operation is brought to a defined stop – Follow-up operation
Remedy:	Report the problem to Service

\*" stands for: "0" = axis 1, "1" = axis 2, "2" = axis 3, "3" = axis 4, "4" = axis 5.

Alarm No.	<b>160*</b>
Alarm Text:	"Drift too high"
Reason:	The drift to be corrected by the NC is too high
Effect:	– Inhibiting of NC START
	– The green "Position not yet reached" LED lights up
Remedy:	– No traverse movement possible Execute drift compensation (Service)
Alarm No.	<b>168*</b>
Alarm Text:	"Servo enable, trav. axis"
Reason:	The axis-specific servo enable signal was removed by the PLC user program during traversing.
Effect:	Inhibiting of NC START Operation is brought to a definer stop
Remedy:	Follow-up operation Report the problem to Service
Alarm No.	<b>172*/176*</b>
Alarm Text:	"+* / -* Working area limit"
Reason:	The set working area limits have been reached
Effect:	Inhibiting of NC START
Remedy:	– Check the program – Check the working area limits in setting data.
Explanation:	Working area limits in "JOG" mode are set in a machine data
Alarm No.	<b>180*</b>
Alarm Text:	"Axis in several channels"
Reason:	With two program running simultaneously in different channels, one axis was programmed in both programs (channels), causing a traversing movement for the related axis to be output for both programs.
Effect:	Inhibiting of NC START
Remedy:	Check both programs
Alarm No.	<b>184*</b>
Alarm Text:	"Stop behind ref. point"
Reason:	When traversing to reference point, the axis was stopped between the reference cam and the zero mark of the measuring system
Effect:	– Inhibiting of NC START
Remedy:	– Reference point not reached Approach reference point again

"\*" stands for: "0" = axis 1, "1" = axis 2, "2" = axis 3, "3" = axis 4, "4" = axis 5.

## 4.6 Listing of the alarms/alarm description

Alarm No.	<b>196</b>
Alarm Text:	"Follow-up /park for axis"
Reason:	Spindle is not active as rotary axis.
Remedy:	Switch spindle to axis mode.
Alarm No.	<b>2000</b>
Alarm Text:	"Emergency Stop"
Reason:	The EMERGENCY STOP signal is output from the PLC to the NC
Effect:	Inhibiting of NC START <ul style="list-style-type: none"> <li>– Operation is brought to a defined stop</li> <li>– Servo enable is removed</li> <li>– Follow up operation</li> </ul>
Remedy:	Check to see if the EMERGENCY STOP cam was traversed to, or if the EMERGENCY STOP switch was operated
Alarm No.	<b>2030</b>
Alarm Text:	"Wrong path increment"
Effect:	<ul style="list-style-type: none"> <li>– Inhibiting of NC start</li> <li>– Inhibiting of NC ready</li> <li>– Machining stopped.</li> </ul>
Remedy:	Check the G06 block, recalculate and correct if necessary.
Explanation:	Distance-to-go contains an uncorrect value which does not match the programmed contour.
Alarm No.	<b>2031</b>
Alarm Text:	"Eval. (weighting) factor too high (MD 388*)"
Note:	Alarm only on commissioning
Alarm No.	<b>2032</b>
Alarm Text:	"Stop during threading"
Reason:	During thread cutting, the feed per revolution was stopped, and the thread destroyed
Effect:	Inhibiting of NC START
Alarm No.	<b>2034</b>
Alarm Text:	"Speed reduction area"
Reason:	The software pre-limit was overshoot, and the axis decelerated to the reduced traverse rate.
Remedy:	Check the program
Alarm No.	<b>2035</b>
Alarm Text:	"Feed Limitation"
Reason:	The programmed feedrate is higher than the contouring feedrate, based on the maximum feedrate of the axes.
Remedy:	Program a lower contouring feedrate



Alarm No.	<b>2036</b>
Alarm Text:	"G35 thread lead decr. error"
Reason:	The pitch decrease in threading, is so high that at the end of the thread, a diameter of less than, or equal to zero would result.
Remedy:	Program either a smaller pitch decrease or a shorter thread
Alarm No.	<b>2037</b>
Alarm Text:	"Programmed S value too high"
Reason:	The programmed spindle speed "S" is higher than "16 000"
Remedy:	Program a smaller spindle speed (the S value is limited to "16 000" within the control).
Alarm No.	<b>2038</b>
Alarm Text:	"Path feed too large"
Reason:	Axis velocity too great because of the programmed path velocity.
Effect:	NC START disabled and setpoint relay drops out.
Remedy:	Observe permissible value range.
Alarm No.	<b>2039</b>
Alarm Text:	"Reference point not reached"
Reason:	The reference point has not been traversed to in all defined axes.
Effect:	Inhibiting of NC START.
Remedy:	Traverse the related axes to reference point.
Explanation:	The need to traverse to reference point can be suppressed for one or more special axes with axis-specific machine data.
<b>Attention:</b>	Software limits are not active for these axes.
Alarm No.	<b>2040</b>
Alarm Text:	"Block not in memory"
Reason:	– During block search, the required block number was not found
Effect:	– During a jump in the program, the required block number could not be found in the given direction Inhibiting of NC START
Alarm No.	<b>2041</b>
Alarm Text:	"Program not in memory"
Reason:	– The pre-selected program is not in the memory
Effect:	– The subroutine called is not in the memory Inhibiting of NC START

## 4.6 Listing of the alarms/alarm description

Alarm No.	<b>2042</b>
Alarm Text:	"Parity error in memory"
Reason:	One or more characters in the memory have been deleted and cannot longer be identified (these characters are output as "?").
Effect:	Inhibiting of NC START
Remedy:	<ul style="list-style-type: none"> <li>– Correct the program in EDITOR or delete the complete block and re-enter it</li> <li>– When a lot of "?" are shown, it is possible that the entire memory has been deleted; in this case, check the battery.</li> </ul>
Alarm No.	<b>2043</b>
Alarm Text:	"Programming error on transformation"
Reason:	<ul style="list-style-type: none"> <li>– Programming of real axes of the transformation grouping whole transformation is selected.</li> <li>– Programming of fictitious axes while transformation is not selected.</li> <li>– Repeated selection of transformation without having deselected the current transformation.</li> <li>– Programming of traverse movements in the selection block.</li> </ul>
Effect:	NC START inhibited.
Remedy:	Press the "RESET" key.
Alarm No.	<b>2046</b>
Alarm Text:	"Block greater than 120 characters"
Reason:	There is an incorrect "LF" in the memory so that a block containing more than 120 characters exists
Effect:	Inhibiting of NC START
Remedy:	Either insert "LF", or delete the complete block
Alarm No.	<b>2047</b>
Alarm Text:	"Option not available"
Reason:	A function was programmed that is not included in the function set of the control
Effect:	Inhibiting of NC START
Remedy:	Correct program
Alarm No.	<b>2048</b>
Alarm Text:	"Circle endpoint error"
Reason:	The programmed circle endpoint does not lie on the circle The tolerance band set in machine data is exceeded.
Effect:	Inhibiting of NC START
Remedy:	Correct program

Alarm No.	<b>2056</b>
Alarm Text:	"Travel through transf. center"
Explanation:	– On the programmed contour, the radius axis (linear axis) wants to traverse into the zero of the fictitious coordinate system.
Remedy:	– Change cutter radius. – Program a different contour.
Alarm No.	<b>2057</b>
Alarm Text:	"Thread/rev. feedrate"
Reason:	– A thread has been programmed with G33, G34, G35, although this function has <b>not</b> been implemented in the control. – G95 thread rev. feedrate has been programmed
Remedy:	Correct program
Explanation:	Alarm only for SINUMERIK 810M
Alarm No.	<b>2058</b>
Alarm Text:	"3D option not avail."
Reason:	In the program, 3 axes were programmed simultaneously
Remedy:	Correct program
Explanation:	Alarm only for SINUMERIK 810 M
Alarm No.	<b>2059</b>
Alarm Text:	"G92 program error"
Reason:	– Use of an invalid address character – Error on cylindrical interpolation
Remedy:	G92 is only allowed with address "S" (programmed spindle speed limitation) or "P" (cylindrical interpolation)
Alarm No.	<b>2060</b>
Alarm Text:	"TO, ZO program error"
Reason:	– A non-existent tool offset number was selected – The value in the selected zero offset or tool offset is too large
Alarm No.	<b>2061</b>
Alarm Text:	"General programming error"
Effect:	Inhibiting of NC START
Reason:	– Contour calculation not possible – Machine data for "axis duplication" function incorrect.

## 4.6 Listing of the alarms/alarm description

Alarm No.	<b>2062</b>
Alarm Text:	"Feed missing/not prog."
Reason:	<ul style="list-style-type: none"> <li>– No F value programmed</li> <li>– F value too small (machine data)</li> <li>– Feed per rev., G95 greater than 50mm/min per revolution</li> <li>– No feed per rev. programmed</li> </ul>
Remedy:	<ul style="list-style-type: none"> <li>– The axial distance to go for the rotary axis with G98 or G36 is 0 or no G98 feed has been programmed.</li> </ul> Program correct feed
Alarm No.	<b>2063</b>
Alarm Text:	"Thread lead too high"
Reason:	A thread pitch of more than 400mm/rev. (16 inch/rev.) has been programmed.
Effect:	Inhibiting of Cycle Start
Remedy:	Program a smaller thread pitch
Alarm No.	<b>2064</b>
Alarm Text:	"Program error round (rotary) axis"
Reason:	If you round to either a half or full degree on a rotary axis, the control will monitor whether the programmed positions correlate with the rounding.
Effect:	<ul style="list-style-type: none"> <li>– Inhibiting of NC START</li> <li>– The programmed move in the block is not executed.</li> </ul>
Remedy:	Program the correct rotary axis position
Explanation:	In the JOG, INC modes, the control automatically rounds to valid values. In the AUTOMATIC or MDI AUTOMATIC modes, the control only monitors the programmed positions, without rounding itself.
Alarm No.	<b>2065</b>
Alarm Text:	"Position behind SW overtravel"
Reason:	The programmed block end-point lies behind the software limit switch.
Effect:	<ul style="list-style-type: none"> <li>– Inhibiting of NC START</li> <li>– The programmed move is <b>not</b> executed</li> </ul>
Remedy:	Correct program
Alarm-No.	<b>2066</b>
Alarm Text:	"Thread lead increase / decrease"
Reason:	A thread lead increase or decrease of more than 16 mm / rev (0.6 inch/rev) has been programmed.
Effect:	Inhibiting of NC START
Remedy:	Program a smaller thread lead increase / decrease

Alarm No.	<b>2067</b>
Alarm Text:	"Max. speed=0"
Remarks:	Alarm only on commissioning
Alarm-No. Alarm Text:	<b>2068</b> "Pos. behind working area"
Reason:	The programmed block end-point lies, in one or more axes, outside the working area limits.
Effect:	– Inhibiting of NC START
Remedy:	– The programmed move is <b>not</b> executed – Check working area limits (plus and minus) – Alter working area limits in program with G25/G26
Alarm No. Alarm Text:	<b>2072</b> "Incorrect input value"
Reason:	Input for contour definition calculation cannot be calculated.
Effect:	The incorrectly programmed block is not simulated or executed.
Remedy:	Enter correct values for contour definition.
Alarm No. Alarm Text:	<b>2073</b> "No intersection point"
Reason:	Calculation of the contour path gives no intersection point with the values programmed.
Effect:	As for alarm 2072
Remedy:	As for alarm 2072
Alarm No. Alarm Text:	<b>2074</b> "Incorrect angle value"
Reason:	– An angle greater than or equal to 360 degrees was programmed – The angle value has no meaning for the described contour
Effect:	As for alarm 2072
Remedy:	As for alarm 2072
Alarm No. Alarm Text:	<b>2075</b> "Incorrect radius value"
Reason:	– Radius value too large – Radius value not allowed for the described contour
Effect:	As for alarm 2072
Remedy:	As for alarm 2072



## 4.6 Listing of the alarms/alarm description

Alarm No.	<b>2076</b>
Alarm Text:	"Incorrect G02/G03"
Reason:	Direction of circle for the described contour is <b>not</b> possible
Effect:	As for alarm 2072
Remedy:	As for alarm 2072
Alarm No.	<b>2077</b>
Alarm Text:	"Incorrect block sequence"
Reason:	Several blocks are needed for the calculation of the contour path: – Block sequence not correct – Insufficient information (underdefined)
Effect:	As for alarm 2072
Remedy:	As for alarm 2072
Alarm No.	<b>2078</b>
Alarm Text:	"Incorrect input parameter"
Reason:	– Programmed parameter sequence not allowed – Parameter sequence not complete for the described contour
Effect:	As for alarm 2072
Remedy:	As for alarm 2072
Alarm No.	<b>2081</b>
Alarm Text:	"CRC not allowed"
Reason:	With selected TNRC/CRC (G41/G42), the following functions cannot be programmed: G33, G34, G35, G58, G59, G92, M19 S ...
Remedy:	First program cancellation of TNRC/CRC with G40 or D0
Alarm No.	<b>2082</b>
Alarm Text:	"CRC plane not determinable"
Reason:	The axes for the selected CRC/TNRC plane do not exist
Remedy:	Select correct plane with G16
Alarm No.	<b>2087</b>
Alarm Text:	"Coordinate rotation not permitted"
Remedy:	Check NC program.
Alarm No.	<b>2088</b>
Alarm Text	"Battery alarm abs. submod. 1"
Reason:	Battery voltage is too low. Battery test is performed every 10 min.
Remedy:	Replace battery module on absolute encoder module 1 while the control is switched on.

Alarm No.	<b>2089</b>
Alarm Text	"Battery alarm abs. submod. 2"
Reason: Remedy:	Battery voltage is too low. Battery test is performed every 10 min. Replace battery module on absolute encoder module 2 while the control is switched on.
Alarm No.	<b>2152</b>
Alarm Text:	"Spindle speed too high"
Reason: Remedy:	The actual spindle speed is higher than that set in machine data. – Program a smaller S value – G92 S ... with v-constant – Search for a block number in the "EDIT" mode ("AUTOMATIC"mode) – Check or inform Service
Alarm No.	<b>2153</b>
Alarm Text:	"Control loop spindle HW"
Reason: Effect: Remedy:	As for alarm 132* – Inhibiting of NC START – Operation is brought to a defined standstill As for alarm 132*
Alarm No.	<b>2154</b>
Alarm Text:	"Spindle measuring system dirty"
Reason: Effect: Remedy:	On measuring systems with a contamination signal, the measuring system has signalled a fault to the NC Inhibiting of NC START Check the measuring system
Alarm No.	<b>2155</b>
Alarm Text:	"Option M19 not available"
Reason: Effect: Remedy:	"M19 S ..." has been programmed, although this function is not present Inhibiting of NC START – Correct program – Retrofit option "M19"
Alarm No.	<b>2160</b>
Alarm Text:	"Scale factor not allowed"
Remedy:	Modify scale factor
Alarm No.	<b>2161</b>
Alarm Text:	"Scale change not allowed"
Remedy:	Correct scale factor modification
Alarm No.	<b>2171</b>
Alarm Text:	"Approach not possible"
Remedy:	Correct approach block



## 4.6 Listing of the alarms/alarm description

Alarm No.	<b>2172</b>
Alarm Text:	"Retract not possible"
Remedy:	Correct retraction block
Alarm No.	<b>2173</b>
Alarm Text:	"Wrong approach/retract plane"
Remedy:	Correct approach/retraction plane
Alarm No.	<b>2183</b>
Alarm Text:	"Axis is not a rotary axis"
Reason:	The axis must be declared a rotary axis in MD 564*, bit 5.
Effect:	NC Start and NC Ready 2 disabled.
Remedy:	Set MD 564, bit 5 = 1.
Alarm No.	<b>2184</b>
Alarm Text:	"M fnct. for C axis invalid"
Alarm No.	<b>2189</b>
Alarm Text:	"Transformation undefined"
Reason:	<ul style="list-style-type: none"> <li>– Type of transformation not defined.</li> <li>– Option bit for the transformation not set.</li> <li>– Transformation axes defined multiply or incorrectly.</li> </ul>
Remedy:	Press the "RESET" key.
Alarm No.	<b>2190</b>
Alarm Text:	"Transformation axes assigned"
Explanation:	When transformation is selected, one of the real axes of the transformation grouping is programmed in another channel (except channel 1).
Alarm No.	<b>2191</b>
Alarm Text:	"Transformation in zero"
Reason:	A real axis (usually the X axis) is in the zero on selection of transformation (G131).
Remedy:	Press the "RESET" key.

Alarm No.	<b>2192</b>
Alarm Text:	"Axis doubling (duplication) active"
Reason:	<ul style="list-style-type: none"> <li>– PLC signals QB 81.2 or QB 81.3 have changed outside the "Reset state".</li> <li>– Traverse key pressed in "JOG mode" in "AUTOMATIC active" state, while PLC signal QB 81.2 or QB 81.3 was active and MD 5019.0 set.</li> <li>– While axis duplication is active, the axial PLC signals (servo enable, feedrate enable, mirror, follow-up, axis disable) are not the same for both axes.</li> <li>– PLC signals QB 81.2 and QB 81.3 at "Zero" while option bits is set.</li> </ul>
Effect:	NC START inhibited.
Remedy:	Set PLC signals correctly.
Alarm No.	<b>2193</b>
Alarm Text:	"No additional axes possible"
Reason:	<p>Only appears when a block search with calculation is initiated in the target block and MD "Additional axis after block search with calculation" is set, if</p> <ol style="list-style-type: none"> <li>1. additional axes are to be programmed in G36 blocks,</li> <li>2. additional axes are to be programmed in G98 blocks which have no axes.</li> </ol>
Remedy:	<p>For 1. Block search with calculation to program block without G36 function.</p> <p>For 2. Block search with calculation to program block without G98 function.</p>
Alarm No.	<b>2194</b>
Alarm Text:	"G36 position rotary axis missing"
Reason:	<p>The alarm only appears with modulo programming. The alarm is triggered when a G98 is to be generated for the rotary axis in a G36 block (not with MD 572*, bit 4):</p> <ol style="list-style-type: none"> <li>1. when the rotary axis is programmed for the first time after RESET or after a C axis switchover using an M function,</li> <li>2. when the rotary axis is programmed for the first time as from the target block of a block search with calculation.</li> </ol>
Remedy:	<p>For 1: First program the C axis once with G0 or G01 (e.g. G0 G91 C = 0 LF).</p> <p>For 2: Choose a target block with no G36 and where the C axis is programmed until the G36 block (additional axes in target block is also sufficient).</p>

Alarm No.	<b>225*</b>
Alarm Text:	"Spindle speed to high"
Scan:	Only when NC MD 520* bit 2 (encoder available) is set.
Explanation:	The actual spindle speed is higher than set in machine data or setting data.
Remedy:	<ul style="list-style-type: none"> <li>• Program lower S value</li> <li>• NC MD 403* to 410* (max. spindle speed for 1st to 8th gear ratio)</li> <li>• NC MD 445* (tolerance band of maximum spindle speed)</li> <li>• NC MD 451* (max. spindle speed)</li> <li>• Check gear stage via PLC</li> <li>• Check G92 S... at "v constant"</li> <li>• Check setting data for spindle speed limitation</li> <li>• Program G26 S...</li> </ul>
Alarm No.	<b>226*</b>
Alarm Text:	"Control loop spindle hardware"
Scan:	Cyclic
Effect:	<ul style="list-style-type: none"> <li>• NC START disabled</li> <li>• Set value relay drops, set value 0</li> <li>• Mode group ready 2 signal cancelled</li> <li>• Servo enable of the spindle is removed after the time set in MD447* has elapsed</li> </ul>
Explanation:	<ul style="list-style-type: none"> <li>• As for Alarm 132*</li> </ul>
Remedy:	<ul style="list-style-type: none"> <li>• As for Alarm 132*</li> </ul>
Alarm No.	<b>227*</b>
Alarm Text:	"Measuring system dirty (spindle)"
Scan:	Cyclic
Effect:	NC START disabled
Explanation:	A measuring system with a contamination signal signals a fault to the NC.
Remedy:	Check the measuring system
Alarm No.	<b>228*</b>
Alarm Text:	"Option M19 missing"
Explanation:	M19 S... was programmed in the part program although this function is <b>not</b> implemented in the control.
Remedy:	<ul style="list-style-type: none"> <li>• Check program</li> <li>• Check NC MD</li> <li>• Upgrade with option E42</li> </ul>

Alarm No.	<b>3000</b>
Alarm Text:	"General program error"
Reason:	<ul style="list-style-type: none"> <li>– In one block of the program, a general, not precisely definable, programming error was made.</li> </ul>
Remedy:	<p>Example:</p> <ul style="list-style-type: none"> <li>– An axis was programmed that is not present on the machine</li> <li>– An incorrect interpolation parameter was programmed</li> </ul> <ul style="list-style-type: none"> <li>– "Axis duplication" option is active and D number in the part program &gt; 49.</li> </ul> <p>– Check the faulty block in "Correction block". If possible, the cursor is positioned in front of the word containing the error.</p> <p>The number of the block containing the error is displayed in the alarm line after the alarm No.</p>
Alarm No.	<b>3001</b>
Alarm Text:	"Geometry parameters > 5"
Reason:	More than 5 geometry parameters, such as axes, interpolation parameters, radii, angles have been programmed in a block.
Remedy:	As for alarm 3000
Alarm No.	<b>3002</b>
Alarm Text:	"Polar / radius error"
Reason:	In a block with polar/radius programming: <ul style="list-style-type: none"> <li>– no angle</li> <li>– no radius</li> <li>– no coordinates for the centre point have been programmed</li> </ul>
Remedy:	As for alarm 3000
Alarm No.	<b>3003</b>
Alarm Text:	"Invalid address"
Reason:	<ul style="list-style-type: none"> <li>– Axis duplication active and axes of tool system 2 programmed in the part program.</li> <li>– An address has been programmed that is not defined in machine data.</li> </ul>
Effect:	NC START inhibited.
Remedy:	Change part program.

## 4.6 Listing of the alarms/alarm description

Alarm No.	<b>3004</b>
Alarm Text:	"CL800 error"
Reason:	<ul style="list-style-type: none"> <li>– @ Function not implemented</li> <li>– Incorrect address after the @</li> <li>– Incorrect number of addresses after the @</li> <li>– Value in K, R or P not permissible</li> <li>– Number of decades too large</li> <li>– No decimal point permissible</li> <li>– Jump destination incorrectly defined</li> <li>– System line (NC MD, PLC MD, TO ...) does not exist</li> <li>– Bit number too large</li> <li>– Incorrect angle data for sine or cosine</li> </ul>
Remedy:	<ul style="list-style-type: none"> <li>– Program as @ list</li> <li>– Only K, R and P are valid addresses</li> <li>– Define jump destination forward with "+"back with "-"</li> <li>– Check validity of data in given addresses</li> <li>– Select decoded single block (DEC-SBL) and check program again</li> </ul>
Alarm No.	<b>3005</b>
Alarm Text:	"Contour definition error"
Reason:	The coordinates in the contour description have been defined so that no intersection point is given.
Remedy:	As for alarm 3000
Alarm No.	<b>3006</b>
Alarm Text:	"Wrong block structure"
Reason:	<ul style="list-style-type: none"> <li>– More than 3 M functions have been programmed in one block</li> <li>– More than 1 S function has been programmed in one block</li> <li>– More than 1 T function has been programmed in one block</li> <li>– More than 1 H function has been programmed in one block</li> <li>– More than 4 auxiliary functions have been programmed in one block</li> <li>– More than 3 axes with G00/G01 have been program. in one block</li> <li>– More than 2 axes with G02/G03 have been program. in one block</li> <li>– G04 has been programmed with addresses other than "X" or "F"</li> <li>– M19 has been programmed with addresses other than "S"</li> <li>– Invalid, or no interpolation parameters with G02/G03</li> <li>– G92 P.. not in a block of its own</li> <li>– G74 not in a block of its own.</li> <li>– At least one axis and no rotary axes or more than 2 rotary axes are programmed in a block with active G98 or G36.</li> <li>– Radius, angle or L or P are programmed in a block with active G36.</li> <li>– Because of the thread lead and the distance to go of the infeed axis, the distance to go with G36 for the rotary axis is too large.</li> <li>– G98 is active, but neither G0, G1 or G36 of G group 0 is active.</li> <li>– The function TRANSMIT is active for the same rotary axis in a block with G98 or G36.</li> <li>– The rotary axis in a block with active G98 or G36 is also selected as a rotary axis for cylindrical interpolation.</li> <li>– Contour definition is traversed with G98 feed.</li> <li>– In a block with active G36 the thread lead is either missing or is not assigned to the programmed infeed axis.</li> </ul>
Remedy:	As for alarm 3000

Alarm No.	<b>3007</b>
Alarm Text:	"Wrong setting data program"
Reason:	<ul style="list-style-type: none"> <li>– G25/G26 has been programmed</li> <li>– G92 has been programmed with an address other than "S" or "P"</li> <li>– M19 has been programmed with an address other than "S"</li> </ul>
Remedy:	As for alarm 3000
Alarm No.	<b>3008</b>
Alarm Text:	"Subroutine error"
Reason:	<ul style="list-style-type: none"> <li>– Subroutine call without pass count "P"</li> <li>– M30 has been programmed as end of program</li> <li>– M17 missing at end of program</li> <li>– 5 levels of nesting have been called</li> <li>– M17 has been programmed in a main program</li> </ul>
Remedy:	As for alarm 3000
Alarm No.	<b>3009</b>
Alarm Text:	"Program disabled"
Explanation:	<ul style="list-style-type: none"> <li>– L0 preselected in the AUTOMATIC display (not permitted).</li> <li>– Missing program called by PLC.</li> </ul>
Alarm No.	<b>3010</b>
Alarm Text:	"Intersection error"
Reason:	<p>This error can appear in conjunction with the L95 stock removal cycle, when:</p> <ul style="list-style-type: none"> <li>– A contouring program has been programmed without G00, G01, G02, G03</li> <li>– @ 714 has been programmed in a contouring program</li> <li>– An incorrect plane has been selected in a contouring program</li> <li>– No intersection point has been found</li> <li>– More than a quarter circle has been programmed in a contouring program</li> </ul>
Remedy:	As for alarm 3000
Alarm No.	<b>3011</b>
Alarm Text:	"Too many axes/axes twice"
Reason:	<ul style="list-style-type: none"> <li>– More axes have been programmed than present on the machine</li> <li>– An axis has been programmed twice in the same block</li> </ul>
Remedy:	As for alarm 3000
Alarm No.	<b>3012</b>
Alarm Text:	"Block not in memory"
Reason:	<ul style="list-style-type: none"> <li>– The program has not been terminated with M02/M30/M17</li> <li>– In a jump instruction (@ 100, 11y, 12y, 13y) the given block number was not found in the given direction</li> <li>– A @ instruction was programmed in the function "block transfer".</li> </ul>
Remedy:	As for alarm 3000

## 4.6 Listing of the alarms/alarm description

Alarm No.	<b>3013</b>
Alarm Text:	"Simulation disabled"
Reason: Remedy:	When the appropriate machine data is set, graphic simulation (for testing part programs) is only possible when a program is not being simultaneously run on the machine.
Alarm No.	<b>3016</b>
Alarm Text:	"External data input error"
Reason: Effect: Remedy:	During external data input from PLC to NC: <ul style="list-style-type: none"> <li>– the code is incorrect</li> <li>– the value is too large</li> <li>– the dimension identifier is invalid</li> <li>– the option is not fitted</li> </ul> Data transfer is interrupted – Check PLC program or call Service
Alarm No.	<b>3017</b>
Alarm Text:	"Part prog. no. occurs twice"
Reason: Effect: Remedy:	There is a program present on the Cycles EPROM submodule, which is also present in the part program (RAM) memory. Inhibiting of NC START Delete the program in RAM
Alarm No.	<b>3018</b>
Alarm Text:	"Distance from contour too great (NC MD9)"
Reason: Effect: Remedy:	After re-positioning to a circular contour, the distance between the axes and the contour is too great. The NC inhibits "Program Start". Re-traverse to the contour to reduce the distance.
Alarm No.	<b>3019</b>
Alarm Text:	"Option RS232 not available"
Reason: Effect: Remedy:	The 2nd RS232C (V.24) interface has been started, either from the PLC or with the softkey, but the option is not fitted. Transfer data via the 1st RS232C (V.24) interface. Retrofit option C62 (2nd RS232C (V.24) interface)
Alarm No.	<b>3020</b>
Alarm Text:	"Option not available"
Reason: Remedy:	A function has been programmed which is not implemented in the system. <ul style="list-style-type: none"> <li>– As for alarm 3000</li> <li>– Retrofit option</li> </ul>

Alarm No.	<b>3021</b>
Alarm Text:	"CRC/TNRC contour error"
Reason:	The compensation calculation results in a traversing movement which is in the opposite direction to the movement programmed.
Remedy:	Check the program.
Alarm No.	<b>3024</b>
Alarm Text:	"Display description not available"
Reason:	A jump has been made with a programmed softkey to a display which is not present in the UMS memory.
Remedy:	<ul style="list-style-type: none"> <li>– check graphic display number</li> <li>– check softkey function</li> </ul>
Explanation:	Only with additional programming developed in WS800.
Alarm No.	<b>3025</b>
Alarm Text:	"Display description error"
Reason:	<ul style="list-style-type: none"> <li>– A display with graphic elements has been programmed, without the graphic option fitted in the control</li> <li>– The selected display has too many variables or fields</li> <li>– A type of display has been programmed that is not valid for the control</li> </ul>
Remedy:	<ul style="list-style-type: none"> <li>– Check the display using the workstation</li> <li>– Retrofit graphics option</li> </ul>
Explanation:	Only with additional programming developed in WS800
Alarm No.	<b>3026</b>
Alarm Text:	"Graphics / text too voluminous"
Reason:	<ul style="list-style-type: none"> <li>– Projecting error in selected display</li> <li>– Sum of the display and text elements too large</li> </ul>
Remedy:	<ul style="list-style-type: none"> <li>– Check the display using the workstation</li> <li>– Distribute the contents over two displays</li> </ul>
Explanation:	Only with additional programming developed in WS800
Alarm No.	<b>3027</b>
Alarm Text:	"Too many graphics commands"
Reason:	The total of graphics commands in the display selected is too great
Remedy:	As for alarm 3026
Explanation:	<ul style="list-style-type: none"> <li>– This alarm triggers alarm 3026</li> <li>– Only with additional programming via WS800</li> </ul>
Alarm No.	<b>3028</b>
Alarm Text:	"Too many field/variables"
Remarks:	Alarm only on commissioning



## 4.6 Listing of the alarms/alarm description

Alarm No.	<b>3029</b>
Alarm Text:	"Graphics option not available"
Reason:	Graphic elements have been projected into the selected display, but the "Graphics" option is not fitted in the control
Remedy:	– Retrofit "Graphics" option
Explanation:	– Configure displays without graphic elements Only with additional programming developed in WS800
Alarm No.	<b>3030</b>
Alarm Text:	"Cursor memory not available"
Reason:	The cursor memory programmed for the display selected is not correct (number not allowed or too large).
Remedy:	Use the workstation to redefine the cursor memory
Explanation:	– The function of the cursor memory is to position the cursor where it was previously when the display is called again. – Only with additional programming via WS 800
Alarm No.	<b>3032</b>
Alarm Text:	"Too many fields / variables"
Remarks:	Alarm only on commissioning
Alarm No.	<b>3033</b>
Alarm Text:	"Display text not available"
Reason:	An error has occurred while linking with the workstation.
Remedy:	Check link list, and re-link with the workstation (to clear link error).
Explanation:	– Only with additional programming via WS 800 – Alarm only on commissioning
Alarm No.	<b>3034</b>
Alarm Text:	"Text not available"
Explanation:	– Only with additional programming via WS 800 – Alarm only on commissioning
Alarm No.	<b>3040</b>
Alarm Text:	"Fields / var. not displayable"
Explanation:	– Only with additional programming via WS 800 – Alarm only on commissioning
Alarm No.	<b>3041</b>
Alarm Text:	"Too many fields / variables"
Remarks:	Alarm only on commissioning

Alarm No.	<b>3042</b>
Alarm Text:	"Display description error" {serious error}
Reason:	An error has been found in the display description which cannot be exactly defined; eg. a non-existent field has been programmed
Remedy:	Check the display with the workstation
Explanation:	Only with additional programming via WS 800
Alarm No.	<b>3043</b>
Alarm Text:	"Display description error" {non serious error}
Reason:	As for alarm 3042
Remedy:	As for alarm 3042
Explanation:	As for alarm 3042
Alarm No.	<b>3046</b>
Alarm Text:	"Variable error"
Reason:	A variable has been selected that cannot be displayed in the control
Remedy:	Check display with workstation, reenter variable if necessary
Explanation:	Only with additional programming via WS800
Alarm No.	<b>3048</b>
Alarm Text:	"Wrong workpiece definition"
Reason:	Minimum and maximum workpiece definition values have been interchanged
Remedy:	Check the workpiece definition for valid values
Alarm No.	<b>3049</b>
Alarm Text:	"Wrong simulation area!"
Reason:	Incorrect or no values given for the definition of the simulation area
Remedy:	<ul style="list-style-type: none"> <li>– check the values for the simulation area (all planes)</li> <li>– A new start of simulation is possible only after RESET and operation of the "ACKNOWLEDGE ALARM" key</li> </ul>
Alarm No.	<b>3050</b>
Alarm Text:	"Incorrect input"
Reason:	Incorrect/undefined simulation data
Alarm No.	<b>3063</b>
Alarm Text:	"Data block not available"
Explanation:	A DB No. was selected in PLC STATUS which is not available.
Remedy:	Select or create the correct data block.

Alarm No.	<b>3081</b>
Alarm Text:	"CRC not selected for approach"
Remedy:	CRC must be selected before approach
Alarm No.	<b>3082</b>
Alarm Text:	"Feed missing/not prog."
Explanation:	During simulation of a part program <ul style="list-style-type: none"> <li>– No feed F programmed</li> <li>– F value too small (MD).</li> </ul> A feed type other than G98 has been programmed in a program section with G36.
Remedy:	Program feed correctly.
Alarm No.	<b>3083</b>
Alarm Text:	"Feed limit fictitious axis"
Explanation:	So that the rotary axis does not travel faster in the TRANSMIT function that defined in MD 280*, the feed is reduced for individual blocks, if necessary. The alarm does not occur during rapid traverse in the part program (G00, G10).
Remedy:	Use feed override.
Alarm No.	<b>3084</b>
Alarm Text:	"Wrong data in DB 39"
Explanation:	<ul style="list-style-type: none"> <li>– R parameter No. not in the permissible area</li> <li>– Assignment of axis to cam parameter wrong.</li> </ul>
Remedy:	Correct DB 39 values and perform value transfer.
Alarm No.	<b>3087</b>
Alarm Text:	"Transformation data error"
Explanation:	Incorrect content in the transformation MD. The alarm applies to an individual block. The number of the incorrect machine data (MD) is specified in the block number.
Alarm No.	<b>3200</b>
Alarm Text:	"Illegal working area limitation"
Reason:	Values were entered in the setting data (300*, 304*) which lie outside the traverse range.
Remarks:	The control enters the permissible maximum or minimum value in the setting data.

Alarm No.	<b>3201</b>
Alarm Text:	"Spindle not synchronous"
Reason:	• Rotary axis operation has been initiated even though the spindle is not synchronous.
Remarks:	Turn spindle again until it is synchronous.
Alarm No.	<b>4100</b>
Alarm Text:	"No D number active"
Note:	Cycles alarm
Alarm No.	<b>4101</b>
Alarm Text:	"Cutter radius=0"
Note:	Cycles alarm
Alarm No.	<b>4102</b>
Alarm Text:	"Cutter radius too large"
Note:	Cycles alarm
Alarm No.	<b>4103</b>
Alarm Text:	"Tool too wide"
Note:	Cycles alarm
Alarm No.	<b>4104</b>
Alarm Text:	"Illegal ZO data block number"
Note:	Cycles alarm
Alarm No.	<b>4105</b>
Alarm Text:	"No direction of spindle rotation programmed"
Note:	Cycles alarm

Alarm No.	<b>6000 to 6063</b>
Alarm Text:	see explanation
Explanation:	These PLC error messages are set by the machine tool manufacturer (see machine tool manufacturer's documentation)
Alarm No.	<b>6100 to 6163</b>
Explanation:	Alarm only on commissioning

## 5 Maintenance

### 5.1 Operating data

Humidity content to DIN 40040	F
Air pressure	860 to 1080 hPa
Shockproof, dustproof and waterproof to DIN 40050:	
– Operator panel	IP 54
– External machine control panel	IP 54

### 5.2 Handling modules



Modules/components carrying this warning symbol (yellow hand on a black triangle, with stripe through) are susceptible to electrostatic discharge.

Therefore, please pay attention to the following guidelines:

- Electronics modules should not be touched unless it is absolutely vital for work to be done.
- Before touching a module, any static in the body must be discharged. The easiest way to do this is by touching a conductive, earthed part of the structure (e.g. bare metal parts of the cubicle, socket earth contact).
- Modules should not be brought into contact with materials that are good insulators (e.g. plastic foil, insulated desk tops, clothing made from synthetic fibres).
- Modules should only be laid on conductive surfaces.
- Modules should only be removed or replaced with the power off.

- The power supply should be switched on before any signal voltages are applied.
- Modules and components should always be stored and carried in conductive packing (e.g. metallised plastic boxes, metal containers).
- If the packing is not conductive, the modules should be wrapped in conductive material. For example, conductive foam rubber or aluminium foil can be used.

### 5.3 Replacing the battery in the battery receptacle

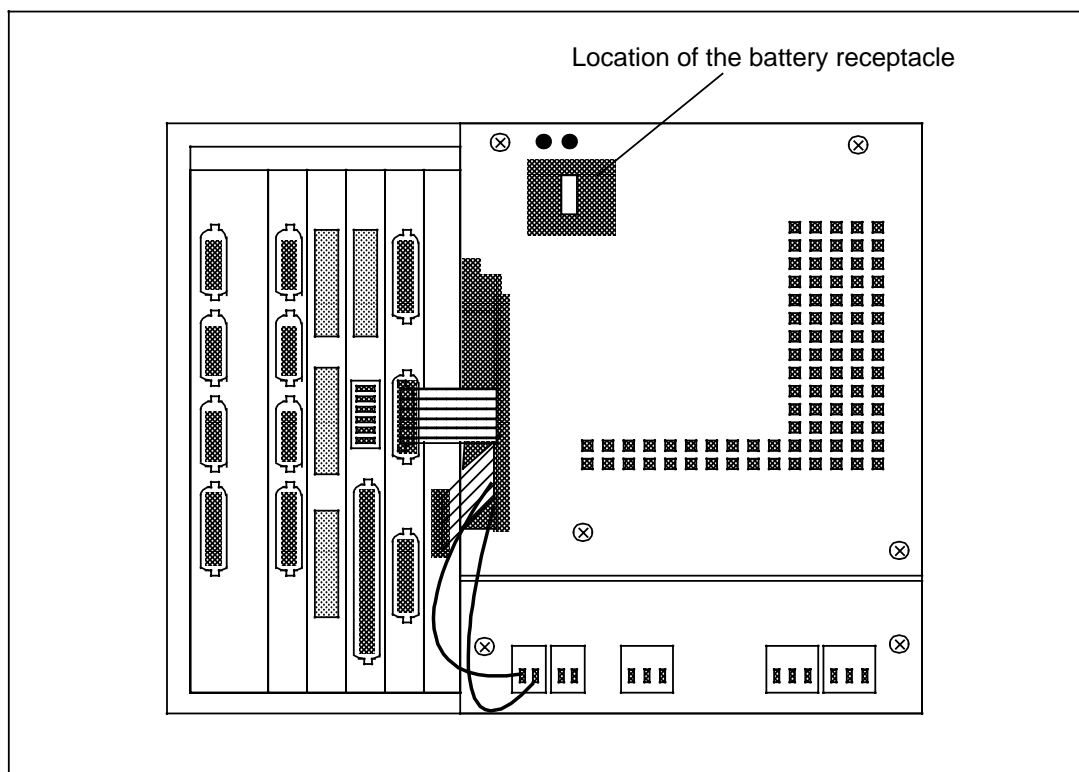

Schematic of the back of the SINUMERIK 810M

### Replacing the battery in the battery receptacle

- The battery backs up:
  - The part program RAM memory
  - The working memory
  - The PLC user memory
  - The MD memory.

The back-up time of the battery is 1 year.

- When alarm number "1" is displayed, the battery should be replaced.
- The battery should be exchanged **within one week** of the alarm appearing!

**For the battery type, see the Instruction Manual.** To order: Please contact your local Siemens Service Centre.

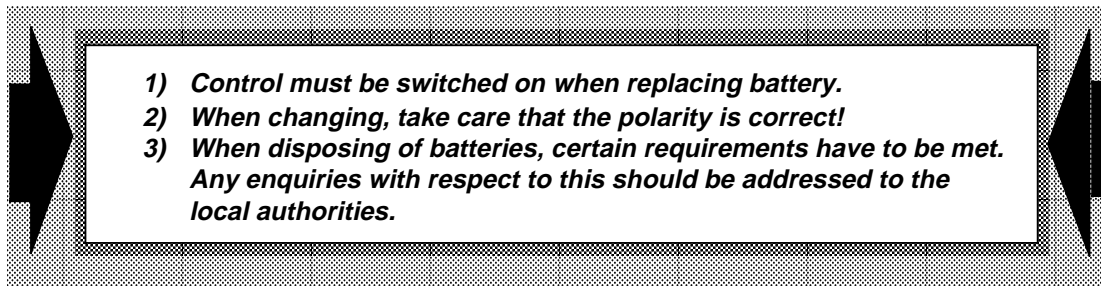

## 5.4 CRT display

The picture on the CRT display can oscillate when the monitor is exposed to electromagnetic fields. Devices which generate electro-magnetic fields, such as transformers, fans, electro-magnetic switches, a.c. cables under power, etc. must be more than 300 mm away from the CRT display unit.

## 5.5 Cleaning

The front of the monitor, and the surface of the operating panel can be cleaned. For dirt that is relatively easy to remove, standard household washing-up liquid, or the industrial cleaner "Special Swipe" can be used. These cleaners will also remove dirt containing graphite.

Cleaning agents which contain one or more of the following ingredients can be used for short periods of time:

- diluted mineral acids
- bases
- alcohol
- organic hydrocarbons
- detergent solutions
- greases and oils.



## 6 Data Interfaces

### 6.1 General

There are 2 universal Interfaces (RS232C (V.24) / 20 mA) available for data transfer:

- **Interface 1**, on the front of the control, is variable with regard to the connection possibilities of different devices.
- **Interface 2**, on the back of the control, is normally used for the connection of a particular device with fixed assignment.

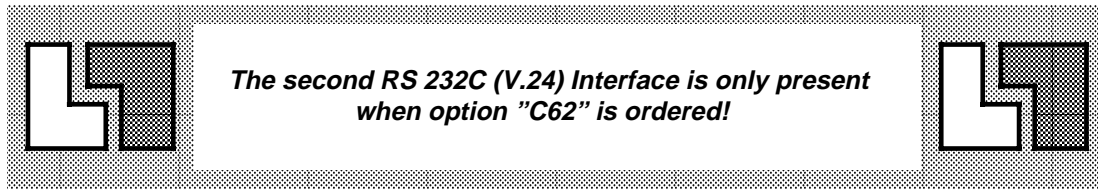

The interface data (Interface "characteristics") are separately adjustable via "Setting data" (SD).

### 6.2 Setting data for description of the interfaces

On the SINUMERIK 810M, the interfaces are described using setting data (SD).

Both the interfaces "1" and "2" can be defined singly:

- Interface 1 : SD No. 5010 to 5017 **and** 5026 to 5029
- Interface 2 : SD No. 5018 to 5029.

The EIA Code for special characters is the same for both interfaces (SD Numbers 5026 to 5029).

## 6.2 Setting data for description of the interfaces

SD No.		Setting data function							
Inter- face 1	Inter- face 2	Bit no.							
		7	6	5	4	3	2	1	0
5010	5018	Device coding - input							
5011	5019	Transfer format - input							
		Stop bit	Stop bit	Parity bits	Parity bits	Baud rate	Baud rate	Baud rate	Baud rate
5012	5020	Device coding - output							
5013	5021	Transfer format - output							
		Stop bit	Stop bit	Parity bits	Parity bits	Baud rate	Baud rate	Baud rate	Baud rate
5014	5022	X <sub>ON</sub> -Characters (DC-start-characters)							
5015	5023	X <sub>OFF</sub> -Characters (DC-stop-characters)							
5016	5024	Output without first X <sub>ON</sub> character	Progr. Start with LF	Block end CR LF	Output in EIA code	Stop at "End of Transmission" character	Data Set Ready (DSR) is evaluated	Output without leading and trailing tape	Input of SINUMERIK System 3 and 8 programs
5017	5025	Special Functions:							
		Not Allocated (without function)							
5026	5026	EIA code for "@" character							
5027	5027	EIA code for ":" character							
5028	5028	EIA code for "End of transmission" character							
5029	5029	EIA code for "=" character							

Table 6.1: Description of the Interfaces

### 6.3 Assignment of the setting data for the connection of peripheral devices

Before you connect a particular device to Interface 1 (or Interface 2), you must change the setting data bits according to the SD No.

To do this, you call up the relevant Setting Data number (SD No.) - as described in Section 3.1.15.1.

Only those setting data numbers (SD Nos.) applicable to the relevant devices on Interface 1 (or 2) are shown in the table.

Peripheral device	Ident. of the device type (CRT display)	SD No.		Required setting data bits (binary code)
		Interface 1	Interface 2	
SINUMERIK - Reader:T40,T50,T60, RS232C (V.24), 9600 baud	RTS - LINE	5010 5011	5018 5019	0000 0000 1100 0111
SINUMERIK WS800, RS232C (V.24), 20 mA 9600 baud	RTS - LINE	5010 5011 5012 5013	5018 5019 5020 5021	0000 0000 1100 0111 0000 0000 1100 0111
Siemens-Programmer PG 685/675/670/730/750 20 mA, 9600 baud PLC S5 interface	PLC - PROG.	5010 5011	5018 5019	0000 0100 0000 0111
Siemens-Programmer PG 675, RS232C (V.24), 1200 baud Interface printer	RTS - LINE	5010 5011 5012 5013 5016 5028	5018 5019 5020 5021 5024 5028	0000 0000 1100 0100 0000 0000 1100 0100 0010 1000 0000 0011
Siemens-Programmer PG 615 U 20 mA, 9600 baud	PLC - PROG.	5010 5011	5018 5019	0000 0100 0000 0111
Siemens-Page Printer PT 80 20 mA, RS232C (V.24), 300 baud	RTS - LINE	5010 5011 5012 5013	5018 5019 5020 5021	0000 0000 1100 0010 0000 0000 1100 0010

Setting data number (SD no.) and setting data bits, dependent on type of peripheral device

## 6.3 Assignment of the setting data for the connection of peripheral devices

Peripheral device	Ident. of the device type (CRT display)	SD No.		Required setting data bits (binary code)
		Interface 1	Interface 2	
Siemens-Printer PT 88 RS232C (V.24), 9600 baud	RTS - LINE	5012 5013	5020 5021	0000 0000 1100 0111
SINUMERIK System 800 NC-NC link RS232C (V.24), 9600 baud	RTS - LINE	5010 5011 5012 5013	5018 5019 5020 5021	0000 0000 1100 0111 0000 0000 1100 0111
Siemens-Programming workstation PD..., PG... RS232C (V.24), 4800 baud	PD / PF	5010 5011 5012 5013 5014 5015	5018 5019 5020 5021 5022 5023	0000 0011 1100 0110 0000 0011 1100 0110 0001 0001 1001 0011
Sanyo cassette M2502U-ZE601 RS232C (V.24), 1200 baud	RTS - LINE	5010 5011 5012 5013	5018 5019 5020 5021	0000 0000 1100 0100 0000 0000 1100 0100
Teletype, ASR33 Full duplex 20 mA, 110 baud	RTS - LINE	5010 5011 5012 5013	5018 5019 5020 5021	0000 0000 1100 0000 0000 0000 1100 0000
Facit 4040, 4042 Reader/punch RS232C (V.24), 1200 baud	RTS - LINE	5010 5011 5012 5013	5018 5019 5020 5021	0000 0000 1100 0011
Facit reader 4030 RS232C (V.24), 1200 baud	RTS - LINE	5010 5011	5018 5019	0000 0000 1100 0100
Sommer terminal MDC-3 SNC Cassette unit RS232C (V.24), 9600 baud	RTS - LINE	5010 5011 5012 5013	5018 5019 5020 5021	0000 0000 1100 0111 0000 0000 1100 0111

Setting data number (SD no.) and setting data bits, dependent on type of peripheral device

## 6.4 Device connection data

SINUMERIK reader T40 and T50	SINUMERIK reader T60 (hand-held unit) Type GNT 2910
Cable Order No.: 6FC9 340-8S.	Cable Order No.: 6FC9 344-2C.
<b>Device data</b>	<b>Device data</b>
Transfer rate 9600 baud	Transfer rate 9600 baud
Character format 1 Start bit	Character format 1 Start bit
8 Data bits	8 Data bits
2 Stop bits	2 Stop bits
<b>Settings on T40 reader</b>	<b>Settings</b>
Switch block A:	DIP switch in unit
1 2 3 4 5 6 7 8	1 2 3 4 5 6 7 8
ON ON - OFF OFF OFF OFF OFF	OFF OFF OFF OFF OFF OFF ON OFF
Switch block B:	
1 2 3 4 5 6 7 8	
ON OFF OFF OFF OFF OFF OFF OFF	
<b>Settings on T50 reader</b>	<b>Operating notes</b>
Jumper assignment at 27 P01: not allocated	Before switching the device on, ensure that the paper tape has been inserted. If there is a fault, the green LED flashes. Acknowledge by switching the device off and on. Read-in start is controlled by the SINUMERIK 810M.
Jumper assignment at 27 P02: Jumpers 2 and 5 closed	<b>Further operating conditions</b> The device stops on a precise character.
Jumper assignment at 27 S02: Jumpers 1, 2, 3, 4 open	
<b>Operating notes</b>	<b>SINUMERIK WS 800</b>
To automatically start from the SINUMERIK 810M, the reader must be ready to start, the "Reader Start" LED must be lit. An exact character stop is not possible.	Cable Order No.: 6FC9 344-1B. (RS232C (V. 24)) 6FC9 344-1Q. (20 mA)
If programs are produced externally, and several programs punched onto one tape, at least 20 blanks must be left between programs.	<b>Device data</b>
When punching programs from the SINUMERIK 810M, these blank characters are automatically generated, providing that the "Output without leader and trainer" setting data bit is not set, (SD no. 5016, bit 1 for interface 1 or SD no. 5024, bit 1 for interface 2).	Interface: RS232C (V. 24) or 20 mA current loop (TTY)
	Transfer rate 9600 baud
	Character format 1 Start bit 8 Data bits 2 Stop bits
	<b>Setting of the interface module DF 20</b>
	Interface SS2
	RS232C
	(V. 24) : no hardware setting
	TTY : passive
	Socket X9
	Jumpers 2 - 14 Receive 3 - 13
	6 - 10 Transmit 7 - 9

**Siemens Programmer  
PG 685/675/670/730/750**

**Interface S5 PLC**

Cable Order No.: 6FC9 340-8G  
6FC9 344-4R  
(PG 730/750 only)

**Device data**

Interface: 20 mA current  
loop  
Transfer rate: 9600 baud  
Character format: 1 Start bit,  
7 Data bits,  
1 Parity bit (even  
parity),  
2 Stop bits

**Operating conditions**

For PLC programming the PG685/675/670/750 Programmer should be connected directly to Interface 1 (20 mA current loop interface) on the SINUMERIK 810M.  
(If cable 6FC9340-8G is used with the PG 750, the supplied adaptor must be used)

**Siemens Programmer PG 675/685**

**Interface printer**

Cable Order No.: 6FC9 344-1A.

**Device data**

Interface RS232C (V.24)  
Transfer rate 1200 baud  
Character format 1 Start bit  
8 Data bits  
2 Stop bits

**Operating conditions**

Archiving of NC cycles and programs on disk, and the transfer to and from the NC and the creation of programs is possible with the PG 675/685. For data transfer, the PG 675/685 should be connected from the **printer** interface to an RS232C (V.24) interface on the SINUMERIK 810M.

**Siemens Programmer PG 615 U with  
PG 615 adapter and power pack**

**Interface PLC**

Cable Order No.: 6FC9 340-8H.

**Device data**

Interface 20 mA current  
loop  
Transfer rate 9600 baud  
Character format 1 Start bit  
7 Data bits  
1 Parity bit  
(even parity)  
2 Stop bits

**Operating conditions**

For PLC programming the PG615 Programmer is connected via the adapter and a cable to Interface 1 (20 mA current loop) on the SINUMERIK 810M.

Siemens page printer PT 80	Siemens printer PT88
Cable Order No.: 6FC9 340-8C RS232C ( V.24 ) 6FC9 340-8T (20mA)	Cable Order No.: 6FC9 340-8D.
<b>Device data</b>	<b>Device data</b>
Transfer rate: 300 baud	Interface adaptation SAP-S2 (RS232C (V.24))
Character format 1 Start bit 8 Data bits 2 Stop bits	<b>Setting of the operating mode switches</b>
Order No. for PT80 to SINUMERIK specification:	Switch S1
Type. RS232C (V.24) : L22751-A80-D442 (Interface module STT104)	1 2 3 4 5 6 ON ON ON OFF OFF OFF
Type. 20 mA : L22751-A80-D441 (Interface module STT104 + LAT101)	(with this setting, the printer has a transfer rate of 9600 baud )
Additional cable for terminal connection: 6FC9340-4KA	Switch S2
An NC-controlled read operation (start /stop) is possible on the device with a 20 mA interface.	1 2 3 4 5 6 OFF ON OFF ON OFF ON
	(this setting denotes: BUSY (X2.10) line is switched to BUSY (X1.25) line, with negative potential)

# 7 Interfacing to the Machine

## 7.1 General notes

The operating of the SINUMERIK 810M depends on the setting of the machine data, and the Options.

In the basic version of the SINUMERIK 810M (Order No.: 6FC3 551-1AC), the **standard machine data** are set in the works.

It can be modified when interfacing to the machine and when the control is equipped with Options!

Sections 7.2 and 7.3 contain tables showing:

- possible Order **Options** which **influence the operation**.
- all of the standard **machine data** which can be modified by machine tool manufacturer, and **influence the operation**.

The tables have extra columns for entering the configuration of the control as delivered.

## 7.2 Ordering data - Options

The Order No. for the basic version of the SINUMERIK 810M control is **6FC3 551-1AC**

If the control is equipped with options, the Order No. is **extended**.

It then has the following format:

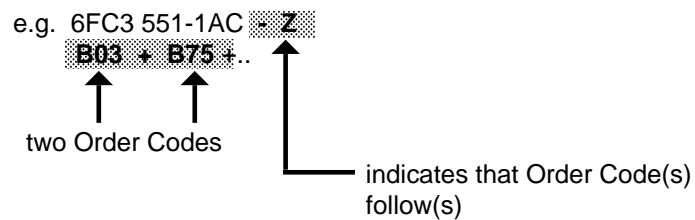

Tick the boxes in the **"Option supplied with control?"** column for the following table if the Order No. 6FC3 551-1AC-Z is followed by the order code listed.



Identification No. of the NC control:  
 (Serial No., Ident., Inventory No. etc.)

Function of the Option	Order code	Option supplied with control?	Comments
4th axis	A04	<input type="checkbox"/>	
5th axis	A05	<input type="checkbox"/>	
Tape reader type T40	B02	<input type="checkbox"/>	
Tape reader type T50	B03	<input type="checkbox"/>	
Program sequencing	B25	<input type="checkbox"/>	
Interpolatory thread cutting	B52	<input type="checkbox"/>	
3-D Interpolation, Helical interpolation 1)	B61	<input type="checkbox"/>	
Transmit	B65	<input type="checkbox"/>	
Boring/drilling and milling patterns polar coordinate programm	B70	<input type="checkbox"/>	
Cylindrical interpolation	B73	<input type="checkbox"/>	
Blueprint programming	B75	<input type="checkbox"/>	
Memory expansion			
- 64 000 bytes	C47	<input type="checkbox"/>	
- 96 000 bytes	C48	<input type="checkbox"/>	
- 128 000 bytes	C49	<input type="checkbox"/>	Precludes the PLC memory expansion
2nd RS232C (V.24) interface	C62	<input type="checkbox"/>	
		<input type="checkbox"/>	
Block transfer	C69	<input type="checkbox"/>	
Thread, rev. feedrate	E31	<input type="checkbox"/>	
Oriented spindle stop	E42	<input type="checkbox"/>	

1) not for 810ME

Identification No. of the NC control:  
(serial No., Ident., Inventory No. etc)

Function of the Option	Order Code	Option supplied with control?	Comments
Axis synchronization	E88	<input type="checkbox"/>	
Analog spindle speed	F05	<input type="checkbox"/>	
2nd spindle	F06	<input type="checkbox"/>	
Graphics	J16	<input type="checkbox"/>	
Display texts in:			
– English/German	-	<input type="checkbox"/>	
– French/German	J23	<input type="checkbox"/>	
– Italian/German	J24	<input type="checkbox"/>	
– Spanish/German	J25	<input type="checkbox"/>	
Integrated machine control panel	J81	<input type="checkbox"/>	
Integrated customer machine control panel	J82	<input type="checkbox"/>	
External machine control panel for 5 axes	J85	<input type="checkbox"/>	
External machine control panel for 7 axes	J96	<input type="checkbox"/>	
Interface submodule for electronic handwheels			
without mounting plate	M10	<input type="checkbox"/>	
with mounting plate	M11	<input type="checkbox"/>	
Integrated tool management	N05	<input type="checkbox"/>	
Integrated PLC auxiliary axes	N06	<input type="checkbox"/>	
Configurability with EPROM-UMS			
– 128 000 bytes	N31	<input type="checkbox"/>	
– 256 000 bytes	N32	<input type="checkbox"/>	



## 7.3 SINUMERIK 810M machine data

### 7.3.1 General machine data

In this section you will find tables of machine data, whose values can be changed from the standard values by the machine tool manufacturer at any time.

In the 

Set value
-----------

 column you can enter the value displayed on the CRT of the control delivered.

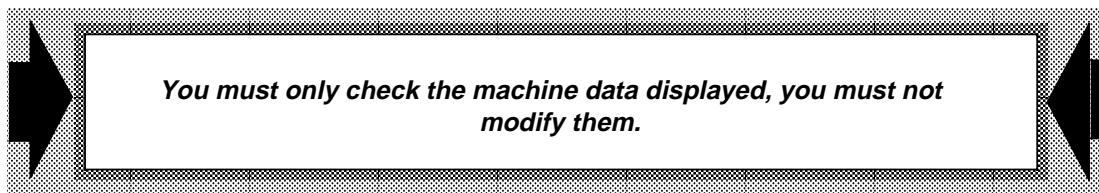

To call up the CRT display, proceed as follows ...

#### Sequence of operation: Calling general machine data

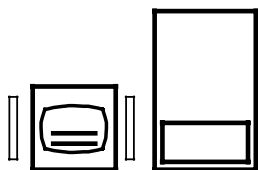

Operate the mode selection key on the integrated machine control panel, and then **any operating mode** softkey.

or select **any operating mode** using the mode selector switch (external machine control panel).

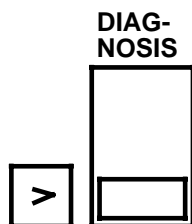

Operate the ETC key to extend the softkey menu, and then the "DIAGNOSIS" softkey.

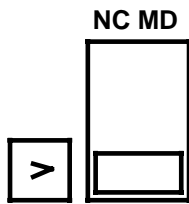

Operate the ETC key to extend the softkey menu again , and then the "NC machine data" softkey.

The "General machine data" display appears.



Using the keyboard, now enter the number of the desired machine data ... and operate the search key.

The machine data searched for, and the value stored in the control are displayed marked in inverse video.

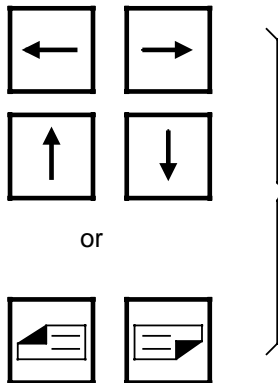

You can also use the cursor keys ...

or

... the "Page up/down" keys to call further machine data.

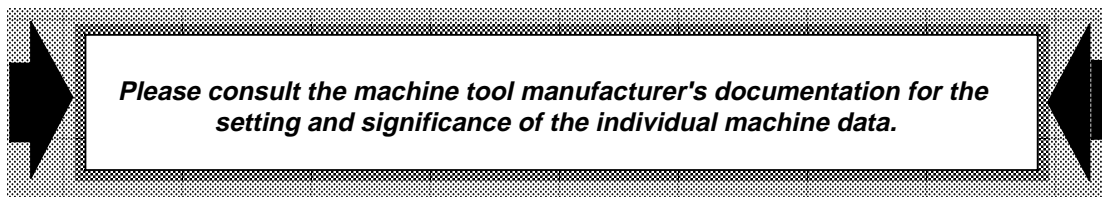



### 7.3.2 Definition of R parameters as cycle machine data, cycle setting data

To protect parameters (R110 to R199) used for measuring cycles against unauthorized modification, parameters can be defined as:

- Cycle machine data (CMD) or
- Cycle setting data (CSD)

They are defined with general NC MD 14 to 17.

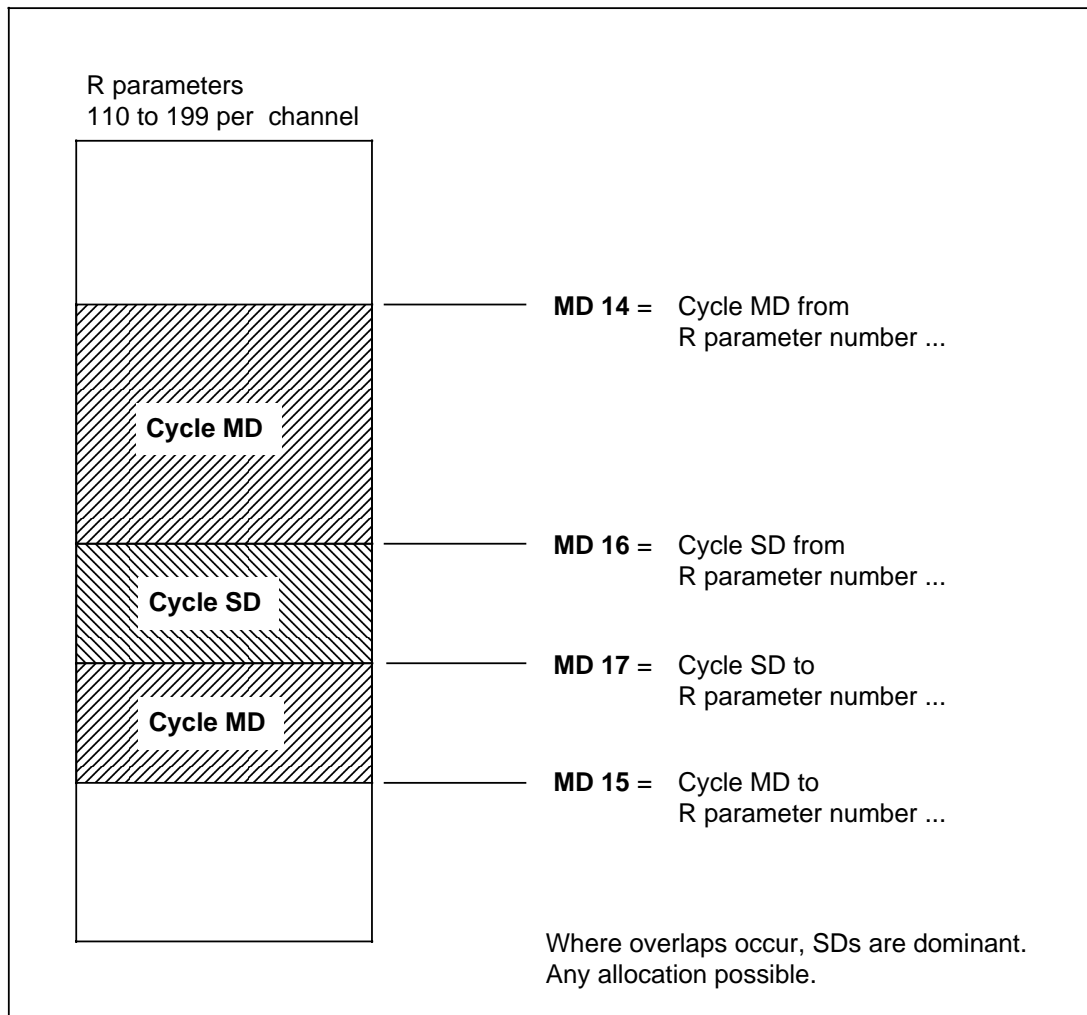

Definitions of area limits with general NC MD 14 to 17

### 7.3.3 Machine data bits

In this Section you will find tables of machine data, in the range from "5000" to "5684". Their 8 bit "Bit patterns" are preset by the machine tool manufacturer.

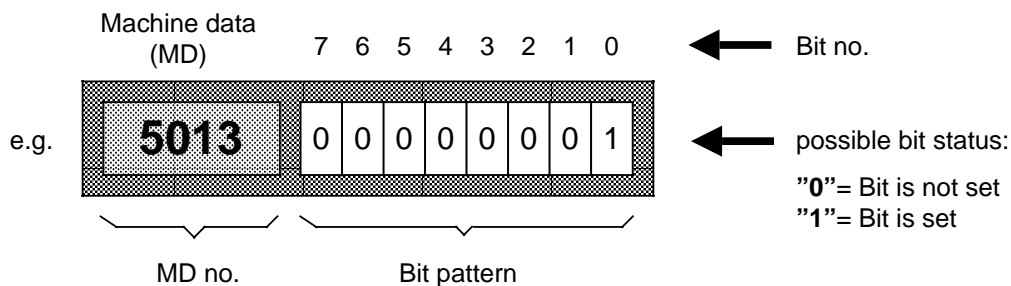

The following table shows:

- which bit ...
- in which machine data MD ...
- has which function ...

when the appropriate **bit is set to "1"** .

In the **Bit status as delivered** column, you can enter the status of bits

"1" - "7" as displayed on the screen.

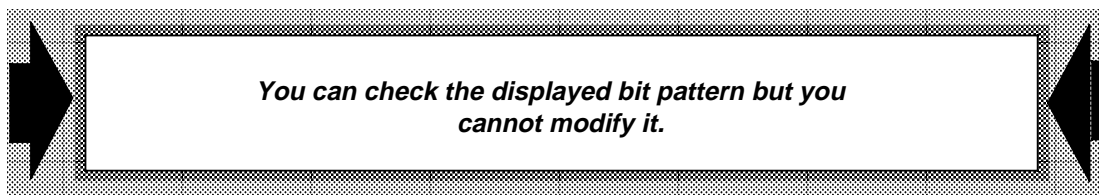

To call the CRT display, proceed as follows ...



## Sequence of operation: calling machine data bits

Sequence of operation as in Section 7.3.1 for: "General machine data", in connection with operating the "NC MACHINE DATA" softkey, and then ...

### MACHINE BITS

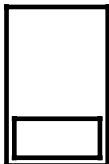

... operate the "MACHINE DATA BITS" softkey.

The "Machine data bits" display appears.



Using the keyboard, now enter the number of the desired machine data ... and operate the search key.

The machine data searched for and the bit pattern stored in the control are displayed marked in inverse video.

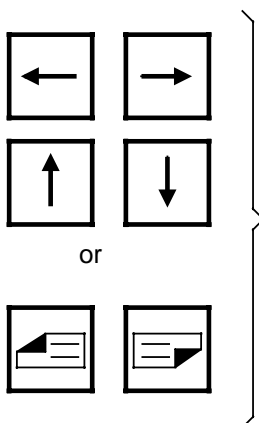

You can also use the cursor keys ...

or

... the "Page up/down" keys to call further machine data.

***Please consult the machine tool manufacturer's documentation for the setting and significance of the individual machine data bits.***

### 7.3.4 Definition of the initial setting of the G groups

Previously the initial settings for the G groups 0/2/3/5/7/9/10/11 and 13 were defined **permanently** (For G group allocation see Section 12).  
Now you can define the initial setting of

G groups 0/2/5/7 and 11

**channel-specifically.** Simply enter the number of the G function you want to be the initial setting in the channel data.

Exception:

The initial setting G70/G71 is still entered in machine data 5002, bit 4.

#### Sequence of operation

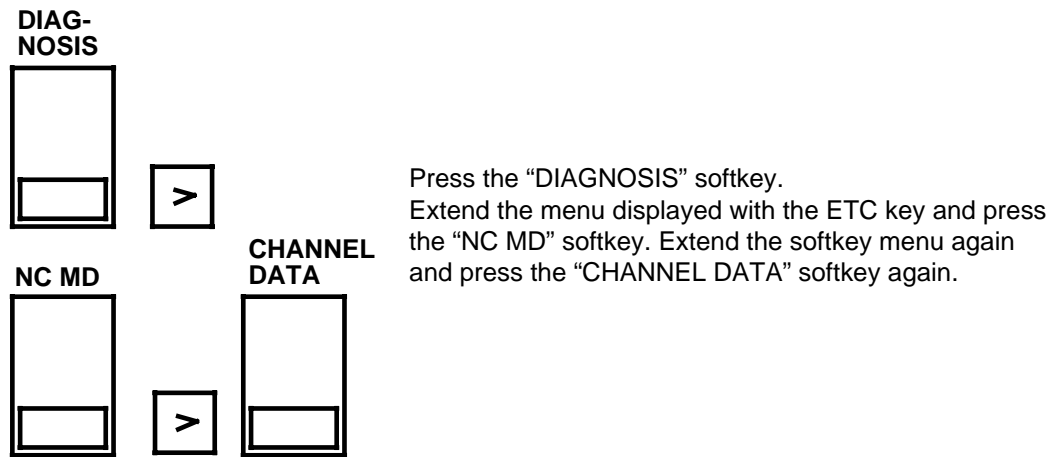

A display with the channel-specific machine data MD 1000 to 1016 appears. Use the "page down" key to page through the display until the machine data up to 1199 appear. Now you can enter the initial settings of the above G groups directly into MD 108\* to 118\* (2nd steps). Four input fields are available to you. In the first two (from left to right) of each you define the channel-specific (1st and 2nd channel) initial setting of the G group assigned to the machine data. Inputs in other input fields cause the alarm message "General data error". The allocation of NC MDs to G groups or G functions are to be found in the overview on the next page.

## 7.3.4 Definition of the initial setting of the G groups

**NC MD for the initial settings of the G groups (CHANNEL DATA):**

NC MD	G group																
		15	14	13	12	11	10	9	8	7	6	5	4	3	2	1	
108*	0			G36	G13	G12	G06	T	T	G33	G03	G02	G11	G10	M/T	G00	
	1															1) G09	
110*	2												G16	G19	T	M	
	3													G42	G41	M/T	
	4															1) G53	
112*	5												G57	G56	G55	M/T	
	6									G74	G92	G59	1) G53	1) G26	1) G25	1) G04	
114*	7												G62	T	G63	M	
	8														G71	G70	
	9							G89	G88	G87	G86	G85	G84	G83	G82	G81	M/T
	10													G68	G91	M/T	
118*	11												G98	G97	G96	T	M
	12									G48	G	G	G	G	G	G	
	13															G51	M/T
																G50	

1) Active in individual blocks

M/T : basic setting on M or T version

## 7.4 Setting data

### 7.4.1 General SD bits

**SD 5000 Bit 0,1,2:** As from standard UMS 03 the user interface and the cycles have been completely revised. The cycles have new and expanded functions. For these functions, new or modified cycle parameter assignments (R parameters) are required.

To guarantee part program compatibility the new functions are activated with set SD bits.

The SD bits must be zero (compatibility mode) on programs which were developed with older software versions (e.g. 810 A1 SW06).

On programs developed with the user interface from UMS03 the SD bits must be set accordingly.

		Turning cycles L95/L93/L98	Drilling patterns Milling patterns L903/L930	Drilling cycles L81 - L89
SD 5000	Bit	2	1	0
	M	0	1	1
	T	1	0	1

Bit = 1 cycle function expansion from UMS from version 03 can be used  
 Bit = 0 cycle function as UMS version less than or equal to 02 (compatible mode).

### 7.4.2 Axis-specific bits

SD No.	Bit No.							
	7	6	5	4	3	2	1	0
560*						Enable scale modification		

In SD 560\*, bit 2 the axis in question is enabled for scale modification.

### 7.4.3 Spindle-specific setting data

SD No.	Significance
401*	Spindle speed limitation for G96
402*	Position for oriented spindle stop (M19)
403*	Spindle speed limitation
404*	Smoothing constant for thread

Significance of "\*\*":

0 = Spindle 1

1 = Spindle 2

## 8 Appendix

### 8.1 List of abbreviations

Abbreviations	Meaning
BCD	Binary coded decimal
CH1	Channel 1, main channel
CH2	Channel 2, auxiliary channel
CLF	Clear file
CPU	Central processing unit
CRC	Cutter radius compensation
DAC	Digital/analog convertor
DIO	Data input/output
DRF	Differential resolver function
EIA code	Special tape code, number of holes per character is always odd
EOB	Label for end of block for data in EIA code
EOR	Label for the program number (when EIA code is used)
EPROM	Program memory with fixed program ( <b>e</b> rasable <b>p</b> rogrammable <b>r</b> ead <b>o</b> nly <b>m</b> emory)
INC	"Incremental" mode
ISO code	Special tape code, number of holes per character is always even
LED	Light emitting diode
LF	Label for end of block for data in ISO code ( <b>l</b> ine <b>f</b> eed)
MD	Machine data
MDI	Manual data input
MIB	Machine input buffer
MPF	NC part program ( <b>m</b> ain <b>p</b> rogram <b>f</b> ile)
NC	Numerical control
OGM	Operator Guidance Macro
PCA	PLC alarm text
PCP	PLC program in machine code ( <b>p</b> rogrammable <b>c</b> ontrol <b>p</b> rogram)
PLC	Programmable logic control
Pr Stop	Display of a programmed interruption of the program sequence

## 8.1 List of abbreviations

<b>Abbreviations</b>	<b>Meaning</b>
RAM	Program memory which can be written into and read from ( <b>r</b> andom <b>a</b> ccess <b>m</b> emory)
RPA	R parameter numbers with value assignment ( <b>R</b> parameter <b>a</b> ctive)
SEA	Addresses with value assignment ( <b>s</b> etting <b>d</b> ata <b>a</b> ctive)
SPF	<b>S</b> ub <b>p</b> rogram (subroutine) file
SW-Limit switch	Software - Limit switch
TEA1	NC machine data ( <b>t</b> esting <b>d</b> ata <b>a</b> ctive <b>1</b> )
TEA2	PLC machine data ( <b>t</b> esting <b>d</b> ata <b>a</b> ctive <b>2</b> )
TNRC	Tool nose radius compensation
TOA	Tool offset ( <b>t</b> ool <b>o</b> ffset <b>a</b> ctive)
TO	Tool offset
UMS	User memory submodule
WS	Tool system
ZO	Zero offset
ZOA	Zero offset ( <b>z</b> ero <b>o</b> ffset <b>a</b> ctive)

**8.2 Lists of terms used**

<b>Term</b>	<b>Section</b>
Acknowledge alarm	2.1.1.5
Actual position	2.1.1.5
Actual value setting	2.3.2
Actual value setting (Preset)	3.2.11
ADD.FUNCT.	2.5
Address keys	2.1.1.3
Alarm acknowledge	2.1.1.5
Alarm Messages	4.6
AUTOMATIC	2.3.2
Automatic tool compensation	3.1.4.2
Automatic zero offset	3.1.5.3
AUTOM. TO	2.5
AUTOM. ZO	2.5
AUTOM. ZERO POINT	2.5
Axis synchronization	3.1.8
Basic dimension	3.1.4
BLOCK end	2.5
BLOCK number	2.5
BLOCK search	2.5
Block search	3.2.3.3
Block transfer	3.1.15.4
BTR START	2.5
Buffer batteries	5.2
Channel switchover	2.1.1.5
CIRCLE	2.5
Cleaning	5.3
CLEAR PRE-OFF	2.5
CONTOUR	2.5
Contour	3.1.11
Control keys	2.1.1.5
COPY	2.5



<b>Term</b>	<b>Section</b>
CORR. BLOCK	2.5
CRT display	21.1.1
CURRENT BLOCK	2.5
CURRENT VALUES	2.5
Cursor	2.1.1.5
CYCLES	2.5
DATA IN - OUT	2.5
Data input/output	3.1.15
DATA IN START	2.5
DATA OUTPUT	2.5
DEC-SBL YES-NO	2.5
DELETE	2.5
Delete input	2.1.1.4
Delete word/block	2.1.1.4
Device interface data	6.4
Device setting data	6.3
DIAGNOSTICS	2.5
Diagnostics	4
Differential resolver function (DRF)	3.2.10
Direction keys	2.1.1.6/2.1.2.1
DIRECTORY	2.5
Display field	2.1.1.2
DRF	2.5
DRF ASSIGNM	2.5
DRF assignment	3.1.6
DRF YES-NO	2.5
DRY RUN YES-NO	2.5
EDIT	2.5
Edit and input keys	2.1.1.4
EM.STOP	2.5

<b>Term</b>	<b>Section</b>
ENABLE	2.5
Enable	3.2.9/3.2.10
ERASE	2.5
Erase	3.1.14
EXT START	2.5
External machine control panel	2.1.2/2.1.2.1
FEED	2.5
Feed	2.1.1.6
"Feed hold" display	2.1.1.2
Feed/Jog	2.3.2
Feed/Rapid override	2.1.2.1
Feed stop/feed start	2.1.1.6/2.1.2.1
Flexible plane selection	3.1.7
G FUNCTIONS	2.5
GUIDING	2.5
HANDWHEEL	2.5
Handwheel	3.2.9
"Incremental" (INC...) mode.	3.2.8
Incremental Jog 1... 10 000	2.3.2
Input character/word	2.1.1.4
Input with operator guiding	3.1.10.2
Installation	2.1.1.5
Interfaces	6
Integrated machine control panel	2.1.1.6
Integrated tool management	3.1.4.4
"Jog" (JOG) mode	3.2.7
Key assignment (LED) display	2.1.1.2
Keypad	2.1.2.1
Line	2.5
LIST OF TOOLS	2.5
Machine data	7.3

<b>Term</b>	<b>Section</b>
MACHINING CYCLE	2.5
MACH. DATA	2.5
MAINPRG START	2.5
MAIN PROGRAM	2.5
Maintenance	5
Manual data input automatic	2.3.2
MDI automatic	3.2.4
Menu tree	2.3.5
Menu trees for the operating modes	2.4
Modify, word	2.1.1.4
Monitoring active (LED) display	2.1.1.2
MOVE	2.5
NC ALARM	2.5
NC MD	2.5
Operating data	5.1
Operating modes	2.3
Operating modes - Overview	2.3.2
Operating mode selection	2.3.3.1/2.3.3.2
Operating sequence	3
Operating sequences, machining	3.2
Operating sequences, preparation	3.1
Operator guidance macro	3.1.13.10
Operator interface	2.1.1
OPS	2.5
Options	2.1/7.2
OVERR. ON/OFF	2.5
OVERSTORE	2.5
Overstore	3.2.3.2
Paging	2.1.1.5
Parameter number	3.1.4
PART PROGRAM	2.5

<b>Term</b>	<b>Section</b>
PLANE	2.5
PLAYBACK	2.5
Playback	3.2.6
PLC ALARM	2.5
PLC/MD	2.5
PLC MESSAGE	2.5
PLC STATUS	2.5
"Position not yet reached" display	2.1.1.2
PROGRAM CONTROL	2.5
PROGRAM CONTROL	3.2.3.1
Program edit	3.1.12
PROGRAM END	2.5
PROG. HANDL.	2.5
Program input	3.1.10
Program interruption	3.2.3.4
Program management	3.1.13
Program memory	3.1.13.8
"Program running" display	2.1.1.2
Program sequencing (OPS)	3.2.3.5
PRG. STP. ON-OFF	2.5
Program stop/Program start	2.1.1.6/2.1.2.1
RS232 (V.24) interface	6.1
Rapid	2.1.1.6
Reference point approach	2.3.2/3.1.2
RENAME	2.5
REORG	2.5
Repositioning	2.3.2
Repositioning (Repos)	3.2.12
RESET	2.5
Reset	2.1.1.6/2.1.2.1
Reset with change of mode	2.3.4

<b>Term</b>	<b>Section</b>
ROTAT. ANGLE	2.5
R PARAMETER	2.5
R Parameter	3.1.6
R Parameter setting data	3.1.6
SCALE MODIF.	2.5
Scratching	3.2.13
Search address, block no, word or data	2.1.1.5
Selecting the second language	3.1.16
Semi-automatic tool compensation offset	3.1.4.4
Semi-automatic zero offset	3.1.5.3
SERVICE AXIS	2.5
SERVICE DRIVE	2.5
SERVICE SPINDLE	2.5
Settable zero offset	3.1.5.1
SETTING DATA	2.5
Setting data	3.1.5/3.1.6/6.4/6.3
Setting data zero offset	3.1.6
Setting offset setting data	3.1.5
SIMUL. DATA	2.5
SIMULATION	2.5
Simulation	3.1.14
Simulation data	3.1.14
Single block	2.1.1.6/2.1.2.1
SINGLE BLOCK	2.5
SKIP BLOCK ON/OFF	2.5
Softkey functions	2.5
Softkeys	2.1.1.1
SPECIAL BLOCK	2.5
SPECIAL FUNCT.	2.5
SPINDLE	2.5
Spindle setting data	3.1.6

<b>Term</b>	<b>Section</b>
Spindle speed	2.1.1.6
Spindle speed override	2.1.2.1
Spindle stop/spindle start	2.1.1.6/2.1.2.1
START	2.5
STOP	2.5
STORE	2.5
STORE AXES	2.5
STORE MENU	2.5
STORE SELECT	2.5
SUBROUTINE	2.5
SW VERSION	2.5
Switching off	2.2.2
Switching on	2.1.2.1/2.2.1
SUBROUTINE START	2.5
Teach in	3.2.4
TEACH IN	2.5
TOOL	2.5
Tool	3.1.3
Tool offset	3.1.4
TOOL DATA	2.5
Tool data	3.1.4.6/3.1.4.7
Tool number	3.1.4
TOOL OFFSET	2.5
Transmit	3.1.9
Universal interface	2.1.1.6
UNLOCK	2.5
WORKING AREA LIM	2.5
Working area limitation	3.1.6
WORKPIECE	2.5
WORKPIECE AREA	2.5
ZERO OFFSET	2.5
Zero offset	3.1.5

### 8.3 SINUMERIK 810M operator interface - Layout

#### SINUMERIK 810M with integrated machine control panel

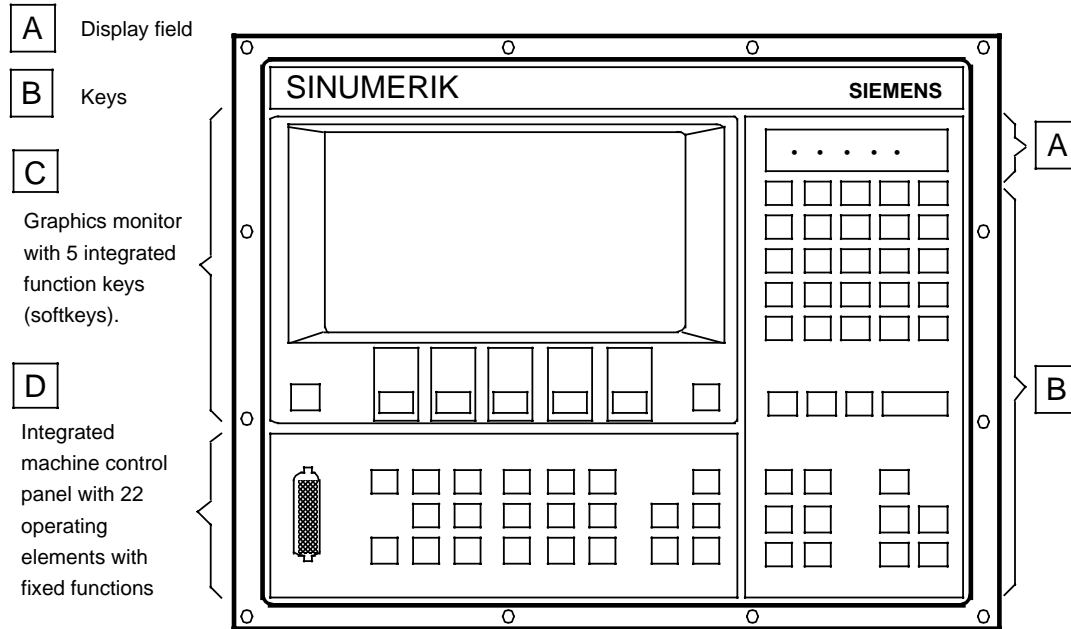

### SINUMERIK 810M with external machine control panel

