

MULTIRANGER PLUS

PROGRAMMABLE LEVEL SYSTEM

Instruction Manual

PL-313

June 1994



Table of Contents

General Information

Important	1 - 1
MultiRanger Plus	1 - 1

Specifications

MultiRanger Plus	2 - 1
Programmer	2 - 2
Transducer	2 - 2
Temperature Sensor	2 - 2
Current Output Isolator	2 - 2
Cabling	2 - 2

Installation

Multiranger Plus	3 - 1
Outline and Mounting	3 - 1
Circuit Board Layout	3 - 2
Interconnection	3 - 3
Installing the Transducer	3 - 3
Current Output	3 - 4
Current Output Isolator	3 - 5
Synchronization	3 - 6
Power Connections	3 - 7
Programmer	3 - 8

Start Up

General	4 - 1	
Programmer Keypad	Run Mode	4 - 2
	Program Mode	4 - 3
Legend	4 - 4	
Parameter Entry	4 - 4	
Common Display Messages	4 - 6	

Functional

Transceiver		5 - 1
Damping and Process Rate		5 - 1
Temperature Compensation		5 - 2
Sound Velocity		5 - 2
Blanking		5 - 3
Agitator Discrimination		5 - 4
Relays	General	5 - 4
	Function	
	Alarm	5 - 5
	Pump	5 - 6
	Miscellaneous	5 - 7
Analog Output		5 - 10

Applications

		6 - 1
Simple Level Application		6 - 2
Pump Control Applications		6 - 4
	Pump Run-On	6 - 8
	Pump Totalizer Application	6 - 10
	Volume Application	6 - 14
	Common Tank Shapes	6 - 15
	Custom Design Tanks	6 - 16
	Compensation	6 - 19
Differential Level Application		6 - 22
OCM Applications		6 - 26
	Single Exponential	6 - 33
	Palmer-Bowlus	6 - 37
	H Flumes	6 - 38
	Other	6 - 39
Applications with Standpipes		6 - 42

Parameter Description

Parameters 7 - 1

Troubleshooting

General 8 - 1

Oscilloscope 8 - 1

Troubleshooting Guide 8 - 3

Maintenance

Maintenance 9 - 1

Appendices

Sound Velocities 10 - 1

Glossary 10 - 2

Alphabetical Parameter Listing 10 - 4



GENERAL INFORMATION

IMPORTANT

First and foremost it is essential that this manual be read and understood before installation and start up of the MultiRanger Plus.

"Applications" provides a general description of the common applications found in industry and illustrates them with examples. It is suggested that you refer to the sub-section which most suits your application. The programming of the MultiRanger Plus can be optimized by referring to Parameter Description or Appendices \ Alphabetical Parameter Listing.

THE MultiRanger Plus

The MultiRanger Plus is a multi-purpose level monitoring system consisting of a MultiRanger Plus in a CSA type 4 enclosure, a programmer and a ultrasonic transducer.

The MultiRanger Plus emits an ultrasonic pulse via the transducer. The echo is reflected from the material and received by the transducer. The echo is processed by the MultiRanger Plus and the time at which the ultrasonic pulse hits the level or target is extracted and compared to the time at which it was sent. The time differential is then converted into distance, material level, volume, flow or differential level as a basis for display, relay control, analog output and totalling.

As well as simple level measurement, the MultiRanger Plus was designed to handle specific applications such as: pumped volume totalling, differential level and open channel flow measurement.



SPECIFICATIONS

MULTIRANGER PLUS

Power:	» 100/115/200/230 V \pm 15%, stab selective » 50/60 Hz, 15 VA » optional: » 12 V dc model, 10 to 18 V dc » 24 V dc model, 18 to 36 V dc
Fuse:	» 1/4 amp MDL Slo-Blo or equivalent
Range:	» 0.3 to 15 m (1 to 50 ft)
Accuracy:	» 0.25% of range or 6 mm (0.24"), whichever is greater
Resolution:	» 0.1% of range or 2 mm (0.08"), whichever is greater
Memory:	» EEPROM (non-volatile) no back-up battery required
Display:	» Liquid Crystal Display of 4 digits, 18mm (0.7") high
Operating Temperature:	» - 20 to 60 °C (- 5 to 140 °F)
Outputs: transducer drive:	» 41 KHz, 400 V peak pulses of 1 msec max duration at a max repetition rate of 300 msec
analog:	» 0 - 20 or 4 - 20 mA » max loading: » 350 ohms, return to ground » 750 ohms, return to -12 V » resolution: 0.1% of range » optional mA isolator
relays:	» 5 multipurpose relays (for alarms, pump control,...) » 1 Form "C" SPDT contact per relay, rated 5 A at 220 V ac non-inductive » adjustable deadband

All relays are certified for use in equipment where the short circuit capacity of the circuits in which they are connected is limited by fuses having ratings not exceeding the rating of the relays.

Enclosure	» CSA enclosure type 4 (similar to NEMA 4) » 160 mm W x 250 mm H x 82 mm D (6.3" W x 9.5"H x 3.2"D) » polycarbonate
Weight	» 1.8 kg (4lb)

PROGRAMMER

- Enclosure:
- » general purpose
 - » 67 mm W x 100 mm H x 25mm D (2.6" W x 4" H x 1" D)
 - » ABS plastic
- Operating Temperature:
- » – 20 to 50 °C (– 5 to 122 °F)
- Power:
- » 9 V battery (style - ANSI/NEDA 1604)

TRANSDUCER

Refer to associated Transducer manual.

TEMPERATURE SENSOR

Refer to associated Temperature Sensor manual

CURRENT OUTPUT ISOLATOR (Optional Refer to PL-293)

- Model:
- » LIs-1 loop isolator
- Input:
- » 4 - 20 mA dc (from MultiRanger Plus)
- Output:
- » 4 - 20 mA dc into 600 ohm max
- Isolation:
- » 300 V ac continuous
- Common Mode Rejection
- » 100 dB at 60Hz

CABLING

- Optional:
- » RG-62A/U coax
 - » max distance to electronics: 365 m (1200 ft)
 - » must be run in grounded metal conduit
- Temperature Sensor
- » Belden 8760, 2 wire shielded
 - » max distance to electronics: 365 m (1200 ft)
 - » can be run with transducer cable



INSTALLATION

MULTIRANGER PLUS

The MultiRanger Plus should be mounted in an area that is within the unit's ambient temperature range, and is suitable for CSA type 4 enclosures and polycarbonate material. The front cover should be accessible for programming and viewing.

It is advisable to keep the MultiRanger Plus away from high voltage or current runs, contactors and SCR control drives.

**Do not mount the multiranger plus in direct sunlight
without the use of a sun shield.**

OUTLINE AND MOUNTING

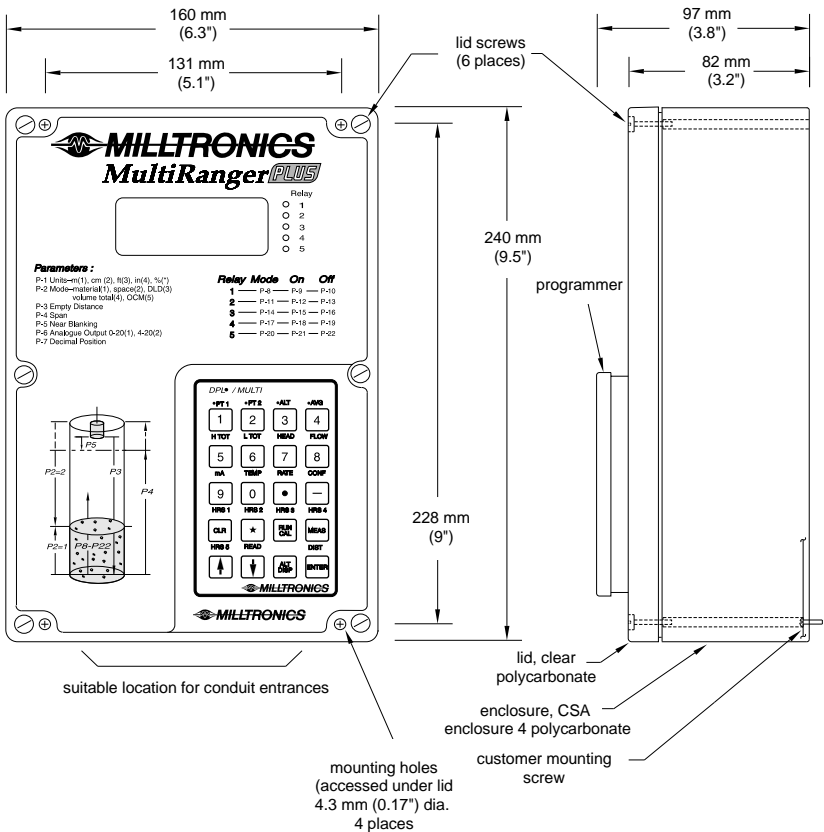

Milltronics recommends using a punch for making holes in enclosure.

CIRCUIT BOARD LAYOUT

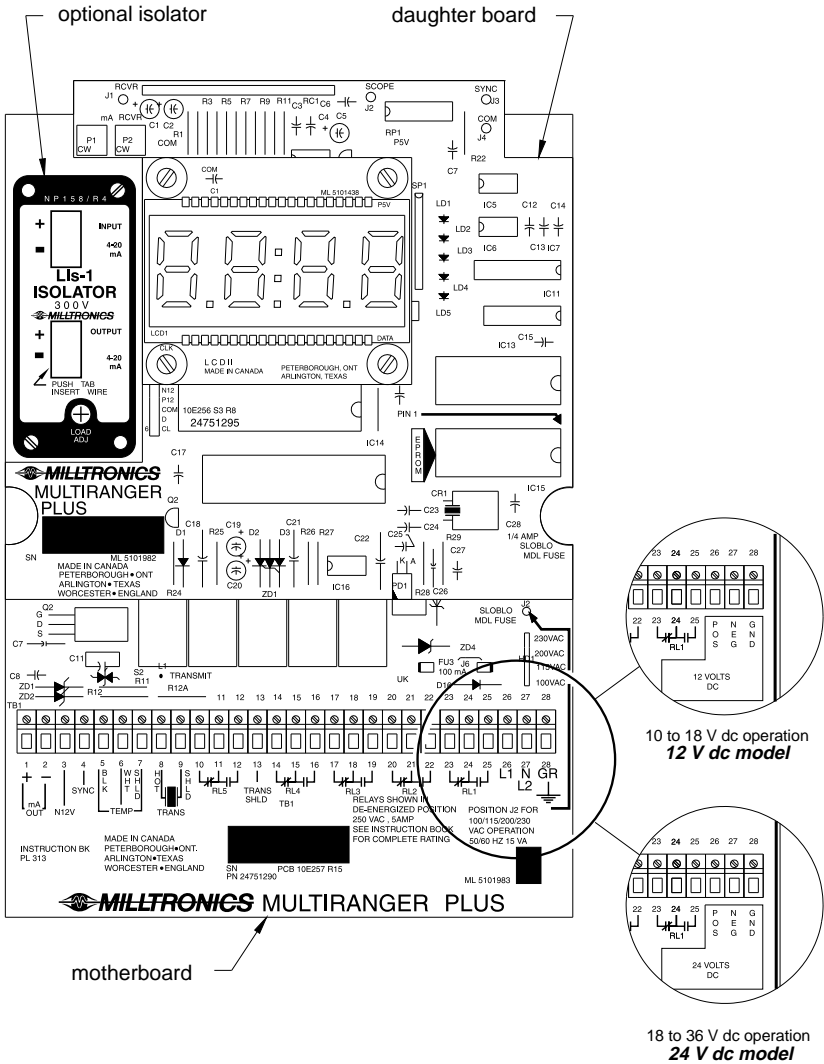

INTERCONNECTION

All wiring must be done in conjunction with approved conduit, boxes and fittings and to procedures in accordance with all governing regulations.

Note : — — — — indicates customer wiring in all diagrams.

INSTALLING THE TRANSDUCER

Basic Wiring

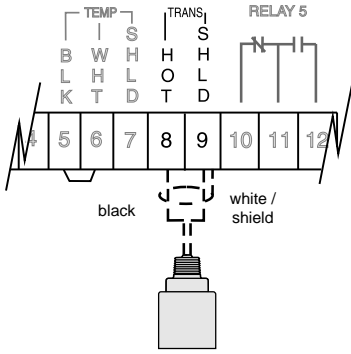

Differential Level - Basic Wiring

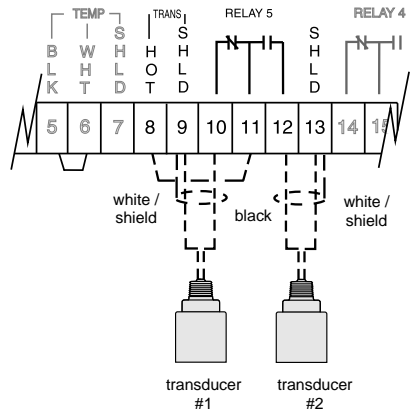

refer to transducer manual for wiring details

INSTALLING THE TEMPERATURE SENSOR

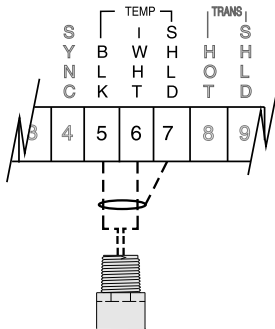

CURRENT OUTPUT

mA Output - GROUNDED (additional to basic wiring)

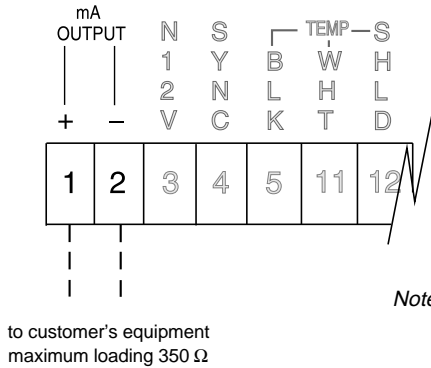

mA Output - FLOATING (additional to basic wiring)

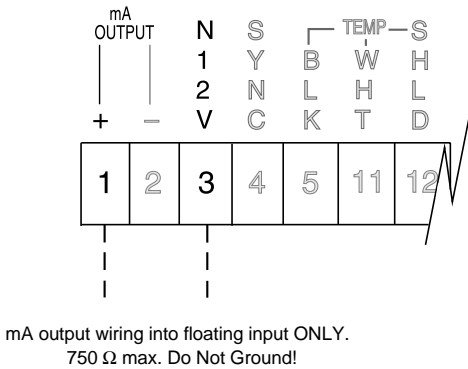

CURRENT OUTPUT ISOLATOR

If the isolator has not been factory installed, mount it on the upper left hand corner of the motherboard using the two long machine screws provided. The input terminals of the isolator are then connected to the motherboard output terminals, TB-1, using twisted pair maximum 16 gauge wire.

Proper shielding and grounding are required in order to minimize noise levels that could otherwise affect weak receiver signals by introducing false echoes.

The isolator enclosure is grounded by the mounting bolts to the motherboard. This can be checked with an ohmmeter if a poor connection is suspected.

The isolator output wiring must be a shielded twisted pair. The shield must be intact up to the isolator and the shield grounded at the isolator mounting screw only. Do not ground shield at any other point as this will void isolation.

mA Output - Optional Isolation (additional to basic wiring)

Customer Wired

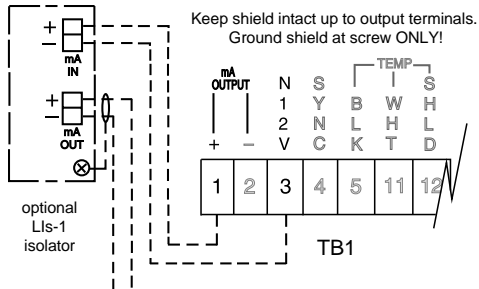

Route output wiring cable in separate conduit, entering enclosure as near as possible to isolator. Keep wiring as short as possible. Do not route cable along terminal board.

isolated 4 - 20 mA output wiring into 600 Ω max

Factory Wired

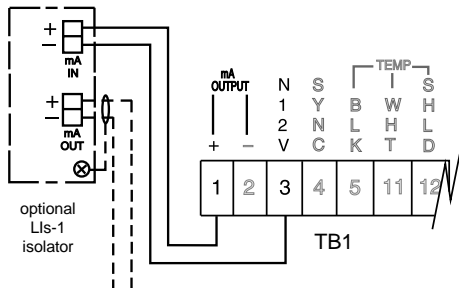

isolated 4 - 20 mA output wiring into 600 Ω max

SYNCHRONIZATION

In applications where more than one MultiRanger Plus, up to a maximum of 8, are going to be used or where their transducers will be sharing a common conduit, synchronization is required. When synchronized, no MultiRanger Plus(s) will transmit within 180 msec of the prior one(s).

To synchronize MultiRanger Plus's, interconnect the SYNC terminals TB1-4 of all motherboards and ensure that there is a common hydro ground interconnecting all units.

To synchronize MultiRanger Plus's and MultiRangers, interconnect the SYNC terminal TB1-4 of the MultiRanger Plus to the SYNC terminal TB1-9 of the MultiRanger.

To synchronize more than 8 MultiRangers or MultiRangers with other Milltronics ultrasonic level detection models (e.g. MicroRanger, AirRanger, etc...) consult Milltronics or your distributor.

Synchronization of 2 to 8 MultiRanger Plus's (additional to basic wiring)

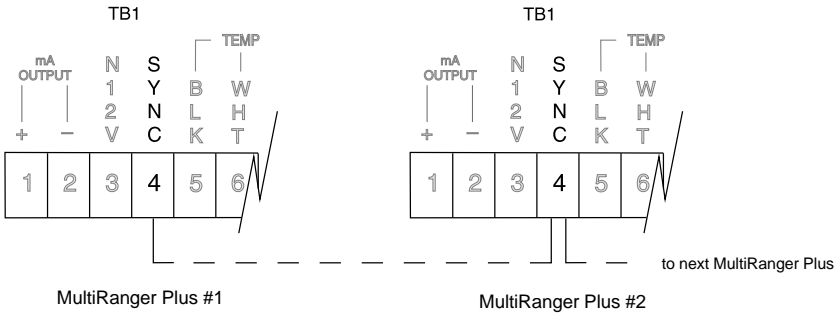

Synchronization of 2 to 8 MultiRanger / MultiRanger Plus's (additional to basic wiring)

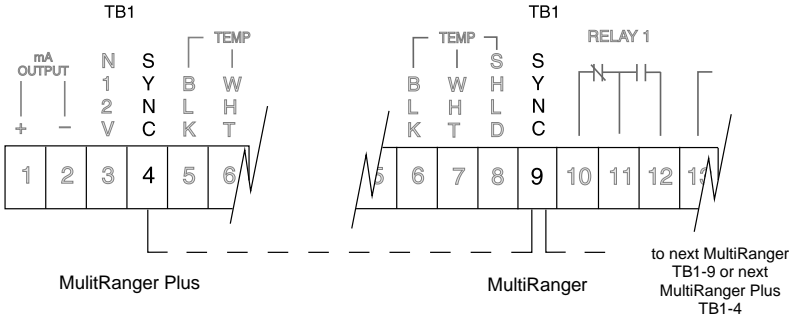

All units to be synchronized must be interconnected by a common hydro ground.

POWER CONNECTIONS

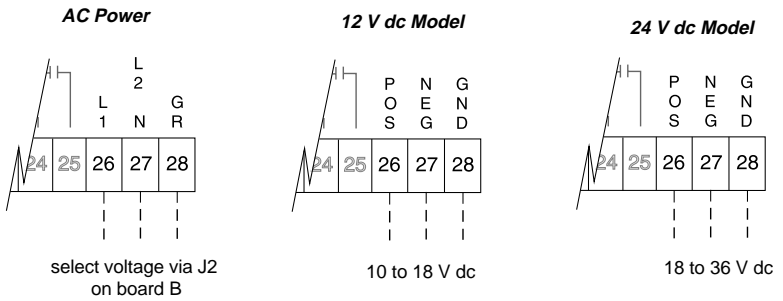

CHECKS

- If a temperature sensor is not used, a jumper must be installed across TB1-5 / 6.
- Make sure that voltage stab connector, J2, is properly set for either 100, 115, 200, or 230 V ac operation.
- One 1/4 Amp fuse must be installed.
- Make power connection. Be sure that wires are securely fastened to the proper terminals.

Do not operate with grounding (earthing) wire disconnected.

PROGRAMMER

In order to program the MultiRanger Plus, a programmer (which has a magnetic back plate) must be placed into the front cover recess on the MultiRanger Plus. Be sure to keep it away from objects such as floppy disks that are susceptible to damage from magnetic fields.

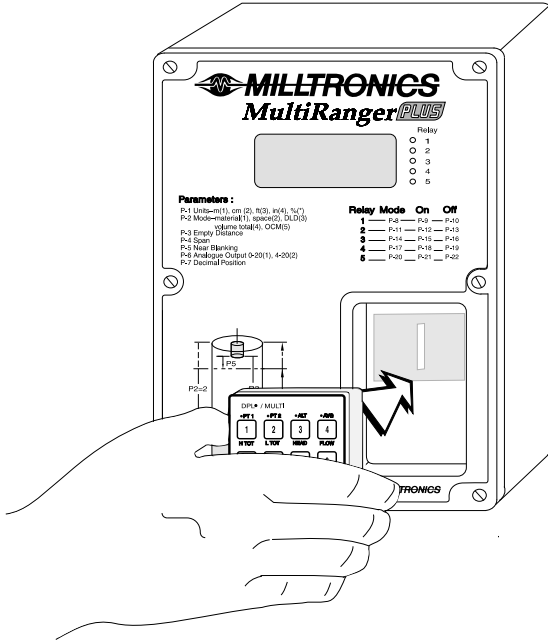

**A programmer need not be ordered with each unit.
Check your order if you think that the programmer is missing.**

START UP

GENERAL

The MultiRanger Plus has two modes of operation: Run and Program (Cal). When the unit is powered up, after installation procedures have been completed, it is factory set to start up in the run mode, to detect the distance from the transducer face to the target in meters. This is the normal mode of operation, which can be programmed to display level, volume, totals or flow readings and yield corresponding mA output and relay closures for alarms, pump controls, etc.

The program mode is selected by pressing the *Run/Cal* key. This mode will enable the user to program the MultiRanger Plus to suit his preference and to the particular application to which the MultiRanger Plus is being applied.

The first step when programming is to reset all parameters to their factory setting by using the master reset P-99

After having entered all required parameters, the MultiRanger Plus can be made to simulate its operation within the particular application giving display, relay operation and analog output. Refer to parameters P-76 through P-78.

When programming has been completed, the MultiRanger Plus can be put into normal operation by pressing the *Run/Cal* key.

PROGRAMMER KEYPAD

All entries are made via the programmer keypad.

Run Mode

Press the associated key to view.

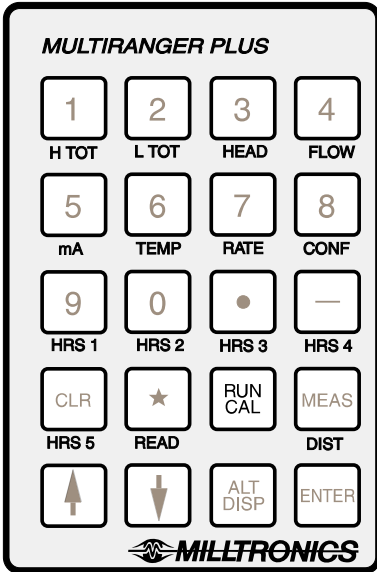

H TOT • high total; P-2 = 4 or 5 (P-55)
 • PT 1; press to view level at DLD transducer #1 P-2 = 3

L TOT • low total; P-2 = 4 or 5 (P-54)
 • PT 2; press to view level at DLD transducer #2, P-2 = 3

HEAD head reading, P-2 = 5

FLOW flow rate, P-2 = 5

mA mA output

TEMP temperature (P-65)

RATE rate of level change (P-70)

CONF echo confidence (P-80)

HRS 1 pump 1 service hours (P-24)

HRS 2 pump 2 service hours (P-25)

HRS 3 pump 3 service hours (P-26)

HRS 4 pump 4 service hours (P-27)

HRS 5 pump 5 service hours (P-28)









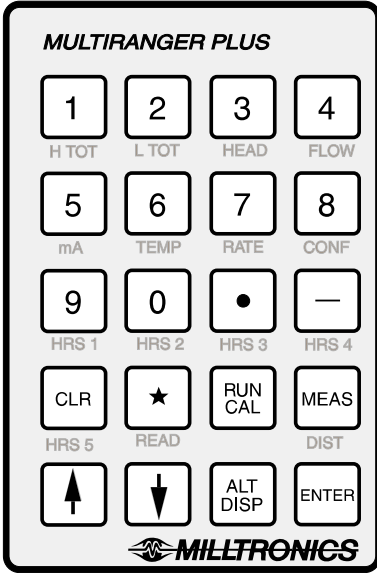



READ reading (P-76)

RUN CAL initiates access into program mode

DIST press to view distance (P-78)

Program Mode



-  to  numeric entry
-  decimal point entry
-  negative entry
-  clear display
-  completes access into program mode
-  enter run mode
-  press to make a measurement
-  increments display to show the next parameter
-  decrements display to show the preceding parameter
-  alternates display to show either the parameter number or parameter value
-  enters display as contents of selected parameter

LEGEND

Press the associated key on programmer:



Display shown on MultiRanger Plus:



Display appears for a short time:

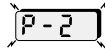



Programmer key:







PARAMETER ENTRY

Initial start up

All entries are made via the programmer keypad. All programmers are interchangeable, thus any programmer can be used in conjunction with any MultiRanger Plus.

Apply power to the MultiRanger Plus and place the programmer in its front cover recess.  will be momentarily displayed and then a distance reading e.g.  will appear. This is a space or distance reading of up to approximately 12 m.

If   is alternately displayed, an open or short circuited transducer connection is being indicated.

If  is displayed rather than a continuous numeric reading the actual material distance may be beyond 12 m. Proceed with the programming and if  persists, consult Troubleshooting guide.

To enter Program mode



The user may now program the MultiRanger Plus starting at parameter P-1.

To direct access a parameter:

The display should have a 'P-' and the number of the currently selected parameter.

Current parameter selection









Select desired parameter.









e.g. select parameter P-20

To set a parameter:







			access desired parameter	e.g. P-20
			display parameter value	e.g. 0
			select new option	e.g. 5
			new value is entered and displayed	e.g. 5

To reset a parameter to its factory value:



			e.g. reset P-20
			display parameter value
			display will go blank
			factory setting of parameter is entered and displayed

After a minute and a half, the content display will revert to the parameter number if the keypad is not used further. Press  again if it is desired to return to a display of the content.











To access the next parameter:

	parameter number displayed	parameter content displayed	
			e.g. value of P-20
			scroll ahead to P-21
			value of P-21

To access the previous parameter:

			e.g. value of P-21
			scroll back to P-20
			value of P-20

COMMON DISPLAY MESSAGES

		cable loss of echo	» messages CABL and LOE will alternately flash, indicating open or short circuited transducer connection
		have entered program mode	» appears after pressing "RUN/CAL" key
		clear all parameters - return factory setting	» P-99
		overflow	» reading is larger than display capabilities
		loss of echo	» displayed in run mode to indicate loss of echo
		percent	» appears when programming units of measurement in percent
		parameter number	» indicates which parameter is being displayed
		have entered run mode	» appears after pressing "RUN/CAL" key
		no value	» contents of parameter empty or no reading display
		invalid request	» application does not yield requested reading option or spare parameter



FUNCTIONAL

TRANSCIVER

The MultiRanger Plus transceiver will transmit via the transducer, a set of long and/or short pulses per measurement. The number and duration of the pulses is dependent upon P-88.

A short pulse has a maximum measurement range of 2 m (6.6 ft) from the transducer face and the CAbl LOE message does not work.

A long pulse has a measurement range of 2 m (6.6 ft) from the transducer face out to its maximum setting (P-3, empty distance to transducer plus P-87, range extension). Submergence detection (P-23) does not work with a long pulse.

DAMPING AND PROCESS RATE

The MultiRanger Plus provides damping to control the maximum rate of change of the displayed material level, volume or flow rate and of the mA output signal. As most relay functions respond to the dampened level reading, they indirectly fall under the control of the damping function. Damping may be set within the range of 0.001 to 9999 in units selected per minute (eg. if P-1 = 3 and P-68 = 15, then the fill damping rate is 15 ft/min). P-68 is set to provide damping specifically for filling conditions while P-69 is set to provide damping specifically for emptying conditions.

The required damping may be estimated by filling and emptying the vessel at its normal rate. The rate of material level change can be viewed via the process rate display parameter, P-70 or by pressing "7" while in the run mode. The value of P-68 and P-69 should be equal to or greater than the rates of level change encountered in P-70. The process rate averaging parameter P-71 selects the method of averaging used to determine the process rate display, however it has no bearing on the damping function.

Damping is often used to slow down the rate of response of the display especially where liquid surfaces are in agitation or material falls into the sound path during filling.

When in the program mode, the damping is automatically overridden to give fast response when "MEAS" is pressed. In the run mode, the response can be further increased by turning the fuzz filter (P-72) and agitator discriminator (P-73) off - ONLY if they are not required.

If the transducer aiming is being adjusted while in the run mode, it is suggested that damping be at its factory setting of 10 to start. The damping can later be changed to suit prevailing conditions.

Upon a loss of echo condition and after the fail-safe timer (P-75) expires, the display will go to fail-safe high at the fill damping rate if P-74 = 1 or to fail-safe low at the empty damping rate if P-74 = 2.

TEMPERATURE COMPENSATION

The MultiRanger Plus comes factory set with a jumper across terminals TB1-5/6, to simulate the temperature programmed into P-65 (factory set for 20 °C). By removing the jumper and installing a temperature sensor, automatic temperature compensation is provided). Refer to associated Temperature Sensor manual.

In order to compensate for uniform temperature changes of the sound medium, temperature sensing should be used. This will allow the MultiRanger Plus to more accurately measure the physical distance when the medium is subjected to temperatures other than 20 °C.

The expected error due to temperature change will decrease from 0.17% of the transducer to material distance per Celsius degree over the operating range to 0.09% of the measurement.

If the transducer's ambient temperature is to remain constant, compensation may be programmed into the MultiRanger Plus by one of the two following methods.

**If a temperature sensor is not used, leave
jumper across terminals TB1 - 5/6.**

- 1 - select P-65
 - enter temperature in °C
- 2 - select P-61
 - perform an empty calibration

The following temperature functions (in °C) can be viewed:

- | | |
|--------------------|--|
| P-65 air temp. | - present temperature at sensor |
| | or |
| | - programmed temperature, if sensor not used |
| P-66 max. air temp | - highest temperature encountered during operation |
| P-67 min. air temp | - lowest temperature encountered during operation |

SOUND VELOCITY

The MultiRanger Plus can be calibrated for transducer operation in homogeneous vapours with sound velocities other than that of air.

The basis is to physically measure the level (measuring tape or sight glass) and enter this value via P-61. The MultiRanger Plus then calculates the sound velocity by comparing the entered physical measurement to its own ultrasonic measurement (empty calibration, P-61)

P-63, velocity at 20 °C can be used to enter the known velocity at 20 °C of sound in a particular gas or vapour to view the resultant velocity of a sound velocity compensation, normalized to 20 °C.

P-64, velocity at P-65, can be used to enter the known velocity of sound in a particular gas or vapour, or to view the resultant velocity of a sound velocity compensation, at the temperature of P-65.

Refer to Appendices/Sound Velocities, for typical sound velocities in various gases and vapours.

BLANKING

Near blanking (P-5) is used to ignore the zone in front of the transducer where ringing or other false echo is at a level with the processing of the true echo.

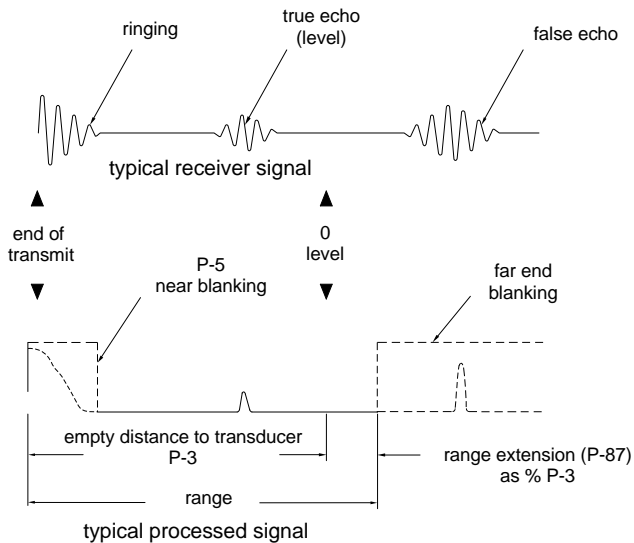

Ringing is the inherent nature of the transducer mass to continue vibrating after the transmit pulse has ceased. The amount of ringing varies with the type of transducer used and decays to acceptable levels in the order of milliseconds. Excessive cold and overtightening of the transducer mounting will increase the ring time such that it may appear as an echo during the receive cycle. This is usually indicated by an incorrect high level reading. This condition may be verified with the use of an oscilloscope and may be overcome by increasing the near blanking (refer to Troubleshooting).

Far end blanking is a design function that ignores the zone below the zero or empty level where false echoes may appear at levels that interfere with the processing of true echo.

In applications where the zero level is above the bottom of the vessel and it is desired to monitor the zone below the normal zero, range extension (P-87) may be used to extend the range into the far end blanking. Range extension is entered as a percent of P-3. As range extension reduces the protection afforded by the far end blanking, it should be used judiciously. Avoid excessive range extension as this may reduce the

measurement's reliability and accuracy. If it is found that false echoes are appearing ahead of the blanking zone, P-87 should be reduced accordingly.

Blanking is automatically corrected for sound velocity change where temperature and velocity compensation is used, keeping the blanking at the distance at which it was entered.

AGITATOR DISCRIMINATION

In applications where there is an agitator operating in the vessel, the blades may interfere with level readings when the material level is lower than the blades. In such a case, the agitator discriminator (P-73) can be turned on (factory setting).

With the agitator turned on, the reading will not change unless the echo is closer for at least 5 consecutive measurements nor will it change unless the echo is farther for at least 2 consecutive measurements.

This feature allows the MultiRanger Plus to remain locked on the true echo, even if there are occasional false echoes due to the agitator blades, electrical noise or crosstalk from other ultrasonic units.

Agitator discrimination, however, slows down the MultiRanger Plus's speed of response. Therefore, if fast response is required, especially when aiming the transducer while in the run mode, and there is no agitator involved, the discriminator should be turned off.

Agitator discrimination will not work if the blades are stationary and in the transducer's beam path.

RELAYS

General

Five onboard multi-purpose relays are provided on the MultiRanger Plus. Each relay may be independently assigned to one function and has a corresponding status LED, visible through the front cover.

The relay functions fall under three modes of operation :

- » alarm : alarm ON = LED ON = relay coil de-energized
- » pump : pump ON = LED ON = relay coil energized
- » miscellaneous : contact closed = LED ON = relay coil energized

Complete programming of each relay requires two steps. Refer to the Relay Programming Chart Relays.

1 - select a relay function

2 - enter relay ON/OFF setpoints for function options 1-6 and 8-10.

OR

- set control parameters for function options 7,11,12,13 and 14.

Function

Alarm

- level :
 - in high alarm, the function goes on when the level rises to the ON setpoint and goes off when the level lowers to the OFF setpoint. In low alarm, the function goes on when the level lowers to the ON setpoint and goes off when the level rises to the OFF setpoint.

- in bounds :
 - the relay will be in alarm if the level is inside the zone between the setpoints.

- out of bounds :
 - the relay will be in alarm if the level is outside the zone between the setpoints.

- differential :
 - the high alarm function goes on when differential level increases to the ON setpoint and goes off when the differential level decreases to OFF setpoint. The low alarm function goes on when the differential level decreases to the ON setpoint and goes off when the differential level increases to the OFF setpoint.

- rate of change :
 - in filling alarm, the function goes on when the rate of filling increases to the ON setpoint and goes off when the rate of filling drops to the OFF setpoint. In emptying alarm, the function goes on when the rate of emptying increases to the ON setpoint and goes OFF when the rate of emptying drops to the OFF setpoint. For emptying alarm, the setpoints must be entered as negative values.

- temperature :
 - in high alarm, the function goes on when the temperature rises to the ON setpoint and goes off when the temperature lowers to the OFF setpoint. In low alarm, the function goes on when the temperature lowers to the ON setpoint and goes off when the temperature rises to the OFF setpoint.

- loss of echo :
 - the function goes on when the fail-safe timer expires. The function goes OFF when a valid echo is received (fail-safe timer is reset).

Pump

- level : - in pump down, the function goes on when the level rises to the ON setpoint and goes off when the level lowers to the OFF setpoint. In pump up, the function goes on when the level lowers to the ON setpoint and goes off when the level rises to the OFF setpoint.

- sequential : - refer to Applications\Pump Control. Select function option 8, 9 or 10 and press "*" to scroll through the loss of echo defaults. For option 9, pressing "*" will also scroll through the cumulative, ratio or duty/back-up mode of pump up operation.

- differential : - the pump down function goes on when differential level increases to the ON setpoint and goes off when the differential level decreases to OFF setpoint. The pump up function goes on when the differential level decreases to the ON setpoint and goes off when the differential level increases to the OFF setpoint.

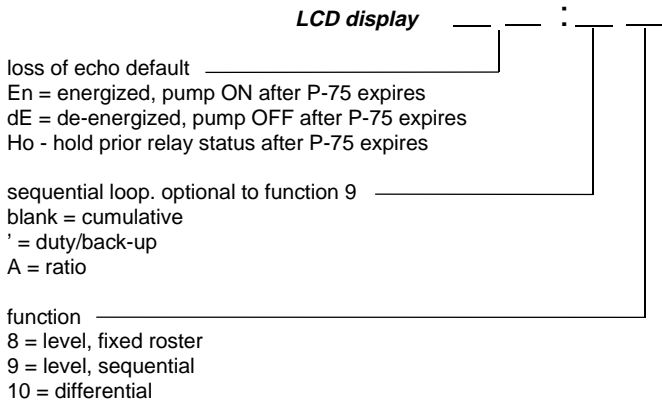

e.g. dE : '9 = duty/back up sequential pumping
 de-energize under loss of echo

Miscellaneous

totalizer and samplers : - refer to Application Pump Totalizer and OCM . Relays are normally de-energized, contact closure is approximately 200 mSec duration.

scanner : - this function is specific to relay 5 and the DLD mode of operation. The transducer hot is wired to the common terminal of the relay so that when switched, the transceiver may alternately access transducer #1 and #2.

Refer to Applications \ Differential Level Application.

Setpoint - ON / OFF

If the ON setpoint is higher than the OFF setpoint, the relay operates as :

- » high alarm
- » pump down control
- » high differential alarm

If the ON setpoint is lower than the OFF setpoint, the relay operates as :

- » low alarm
- » pump up control
- » low differential alarm

The ON and OFF setpoints can not be the same on an individual relay but may be common to other relays. The dead band or hysteresis is the difference between the ON and OFF setpoints. For in and out of bounds level alarms, the hysteresis is set $\pm 2\%$ of span from either boundary.

The setpoints for alarm functions 1 - 4 and pump functions 8 - 10 are always entered in the P-1 units of measurement selected (but not %). The setpoints are measured from the bottom up, referenced to zero or empty except for the differential functions, 4 and 10. There the setpoints represent the absolute differential between levels, regardless of the level with respect to zero.

Relay status - non run modes

When the fail-safe timer expires, pump control relays respond as previously described. However, alarm relays will respond in the following manner.

FAIL-SAFE MODE	RELAY STATUS	
	high alarm	low alarm
P-74		
fail-safe high	on	off
fail-safe low	off	on
fail-safe hold	hold	hold

Upon entering the program mode, all pump control relays will be turned OFF. Alarm relays will hold their prior status, but will respond to measurements take when "MEAS" is pressed.

Simulation

Parameters P-76 through P-78 can be used to simulate relay operation in the program mode. Pump relays will be held OFF during simulation, however their corresponding LED's will respond. Remote totalizer and flow sampler relay operation do not apply to simulation. Refer to Parameter Description.

**If the relay status can affect plant operation or personnel safety,
it is advisable to override the relay functions or disconnect the relay
wiring during calibration or simulation**

**Keep power disconnected at main breaker
when MultiRanger Plus cover is opened.**

Relay Function Vs Mode of Operation

It should be noted that some relay functions can not be used in certain modes of operation. The following table shows the valid functions for the five modes of operation.

Function	Mode of Operation				
	Mat'l (P2 = 1)	Space (P2 = 2)	DLD (P2 = 3)	Pump Vol. (P2 = 4)	OCM (P2 = 5)
0	off	off	off	off	off
1	level	level	level	level	level
2	in bounds	in bounds	off	in bounds	in bounds
3	out of bounds	out of bounds	off	out of bounds	out of bounds
4	off	off	differential level	off	off
5	rate	rate	off	rate	rate
6	temp.	temp.	temp.	temp.	temp.
7	L.O.E.	L.O.E.	L.O.E.	L.O.E.	L.O.E.
8	pump	pump	pump	pump	pump
9	sequential	sequential	off	sequential	sequential
10	off	off	pump on differential	off	off
11	off	off	off	totalizer	totalizer
12	off	off	off	flow sampler	flow sampler
13	time sampler	time sampler	time sampler	time sampler	time sampler
14	off	off	scanner	off	off

RELAY PROGRAM CHART

Relay Function	Relay 1			Relay 2			Relay 3			Relay 4			Relay 5			Units
	Fctn P-8	Setpoints ON	OFF	Fctn P-11	Setpoints ON	OFF	Fctn P-14	Setpoints ON	OFF	Fctn P-17	Setpoints ON	OFF	Fctn P-20	Setpoints ON	OFF	
Alarm : Level	1	P-9	P-10	1	P-12	P-13	1	P-15	P-16	1	P-18	P-19	1	P-20	P-21	P-1
In bounds	2	"	"	2	"	"	2	"	"	2	"	"	2	"	"	"
Out of bounds	3	"	"	3	"	"	3	"	"	3	"	"	3	"	"	"
Differential	4	"	"	4	"	"	4	"	"	4	"	"	4	"	"	"
Rate of Change	5	"	"	5	"	"	5	"	"	5	"	"	5	"	"	P-1/min
Temperature	6	"	"	6	"	"	6	"	"	6	"	"	6	"	"	°C
Loss of Echo	7	set	P-75	7	set	P-75	7	set	P-75	7	set	P-75	7	set	P-75	n/a
Pump : Level En:	8*	P-9	P-10	8*	P-12	P-13	8*	P-15	P-16	8*	P-18	P-19	8*	P-21	P-22	P-1
dE:	8*	"	"	8*	"	"	8*	"	"	8*	"	"	8*	"	"	"
Ho:	8*	"	"	8*	"	"	8*	"	"	8*	"	"	8*	"	"	"
Sequential	9*	"	"	9*	"	"	9*	"	"	9*	"	"	9*	"	"	"
cumulative	dE:	"	"	9*	"	"	9*	"	"	9*	"	"	9*	"	"	"
Ho:	9*	"	"	9*	"	"	9*	"	"	9*	"	"	9*	"	"	"
duty / backup	En:¹	"	"	9*	"	"	9*	"	"	9*	"	"	9*	"	"	"
dE:¹	9*	"	"	9*	"	"	9*	"	"	9*	"	"	9*	"	"	"
Ho:¹	9*	"	"	9*	"	"	9*	"	"	9*	"	"	9*	"	"	"
ratio	En:A	"	"	9*	"	"	9*	"	"	9*	"	"	9*	"	"	"
dE:A	9*	"	"	9*	"	"	9*	"	"	9*	"	"	9*	"	"	"
Ho:A	9*	"	"	9*	"	"	9*	"	"	9*	"	"	9*	"	"	"
Differential En:	10*	"	"	10*	"	"	10*	"	"	10*	"	"	10*	"	"	"
dE:	10*	"	"	10*	"	"	10*	"	"	10*	"	"	10*	"	"	"
Ho:	10*	"	"	10*	"	"	10*	"	"	10*	"	"	10*	"	"	"
Miscellaneous :																
Totalizer	11	set	P-56	11	set	P-56	11	set	P-56	11	set	P-56	11	set	P-56	vol.P-43
Flow Sampler	12	set	P-57 & P-58	12	set	P-57 & P-58	12	set	P-57 & P-58	12	set	P-57 & P-58	12	set	P-57 & P-58	volume
Time Sampler	13	set	P-59	13	set	P-59	13	set	P-59	13	set	P-59	13	set	P-59	hr
Scanner	n/a	n/a		n/a	n/a		n/a	n/a		n/a	n/a		14	set	P-2	n/a

* = Press to select LOE default (En, dE & Ho) and sequential option (cumulative, duty / backup or ratio).

ANALOG OUTPUT

The MultiRanger Plus can be programmed to provide analog output (P-6) of 0 or 4 - 20 mA, proportional or inverse span.

The 4 and 20 mA levels can be trimmed slightly via P-97 and P-98 respectively to compensate for any offset between the MultiRanger Plus and the customer's equipment.

The analog output feature can be turned OFF by setting P-6=0. The output and alternate displays(5 &P-92) will immediately drop to 0 mA after a new measurement is processed. The output will remain disabled during simulation (P-76,77, & 78)

However, the test routine of P- 92 and the trim parameters will remain active.

If P-60 = 0, then the analog output will return to its programmed output after a new measurement is processed.

If the analog output must be isolated, the optional LIs-1 mA isolator must be mounted on the motherboard and wired. When using the isolator, the load adjust can be done via P-97 and 98 rather than via the load adjust potentiometer.

The analog output responds in the following manner :

		MODES					
		P2 = 1 LEVEL	P2 = 2 SPACE	P2 = 3 DLD	P2 =1 VOLUME	P2 = 4 PUMP TOTAL	P2 = 5 OCM
A N A L O G O U T P U	responds to	material level	material distance	<ul style="list-style-type: none"> • differential (if P-32 = 1) • level on xdcr 1 (if P-32 = 2) 	volume	<ul style="list-style-type: none"> • level (if P-34 = 0) • volume (if P-34 ≠ 0) 	<ul style="list-style-type: none"> • head 1 (if P-50 = 1) • flow (if P-50 = 2)
	if P-6 = 1 or 2, reads 20 mA when	full	empty	maximum differential or level	full	full	at max. head or flow
	if P-6 = 3 or 4, reads 20 mA when	empty	full	0 differential or level	empty	empty	at 0 head or flow



APPLICATIONS

This section highlights the most common applications for which the MultiRanger Plus can be applied. Other applications not listed here may be similar to those listed or a combination thereof.

(e.g. monitoring piston position on a wood pulverizer is in essence a level application)

When programming, refer to the application which is most similar to yours. A practical example has been given to further expand on the programming features. As the example may not cover all facets of the particular application, the user should become familiar with the parameters available. Refer to Parameter Description or Appendices \ Alphabetical Parameters Listing.

For ease of reference and programming, parameters have been organized into groups relating to their function or application.

P-0	security
P-1 to P-7	general
P-8 to P-22	relays
P-23 to P-33	pump control
P-34 to P-39	volume and display conversion
P-40 to P-50	OCM
P-51 to P-59	OCM and pump totalizer
P-60 to P-67	custom calibration
P-68 to P-75	filters
P-76 to P-78	measurement and display
P-79 to P-88	echo processing and analysis
P-89 to P-98	testing
P-99	master reset

The minimum distance from the transducer face to the target is limited by the minimum near blanking value, P-5, of 30 cm (1 ft).

SIMPLE LEVEL APPLICATION PARAMETERS

General	Relays	Pump Control	Vol. & Disp. Conversion	OCM	Totalizer	Custom	Filter
P-1 units	P-8 1 function	P-23 submers.	P-34 tank	P-40 primary	P-51 OCM sim.	P-60 full	P-68 fill damp
P-2 mode	P-9 1 on	P-24 1 hrs.	P-35 dim. A	P-41 time	P-52 factor	P-61 empty	P-69 empty damp
P-3 empty dist.	P-10 1 off	P-25 2 hrs.	P-36 dim. L	P-42 expon.	P-53 decimal	P-62 offset	P-70 rate disp.
P-4 span	P-11 2 function	P-26 3 hrs.	P-37 convert	P-43 flume dim.	P-54 low tot.	P-63 vel. 20 °C	P-71 rate avg.
P-5 near blank	P-12 2 on	P-27 4 hrs.	P-38 disp. offset	P-44 spare	P-55 high tot.	P-64 vel. P-65	P-72 fuzz filter
P-6 mA out	P-13 2 off	P-28 5 hrs.	P-39 disp. opt'n	P-45 max. head	P-56 remote tot.	P-65 temp.	P-73 agitator
P-7 decimal	P-14 3 function	P-29 run-on		P-46 max. flow	P-57 flow samp.	P-66 max. temp	P-74 f-s mode
	P-15 3 on	P-30 run-on		P-47 auto zero	P-58 flow samp.	P-67 min. temp	P-75 f-s timer
	P-16 3 off	P-31 spare		P-48 cutoff	P-59 time samp.		
	P-17 4 function	P-32 DLD mA out		P-49 decimal			
	P-18 4 on	P-33 totaling		P-50 mA out			
	P-19 4 off						
	P-20 5 function						
	P-21 5 on						
	P-22 5 off						

P-# required parameters

P-# optional parameters

P-# parameters not required

SIMPLE LEVEL APPLICATION

The most common application of a Milltronics ultrasonic level measuring system is for simple level monitoring, whereby the material level or space measurement is displayed. This may or may not include alarms and mA output.

When in the program mode, alarm relays hold their contact state. However, they will respond to measurements taken when "MEAS" is pressed.

Simple Level Example

The application is to obtain a level measurement and corresponding 4-20 mA output of a 30 ft high vessel. The transducer face is level to the top of the vessel, the empty level will be at 0 ft (bottom) and the full level will be at 28 ft from the bottom (span). A high alarm is required at 4 ft from the top (26 ft from the bottom) and a low alarm is required at 5 ft from the bottom. The maximum emptying rate is 1 ft / min, a rate greater than this should set an alarm. In the event of a loss of echo, the MultiRanger Plus is to go into fail-safe hold after 2 minutes.

select:

P-1 enter option "3", units in feet

advance to:

P-2 enter option "1", material level
P-3 enter "30", empty distance to transducer
P-4 enter "28", span
P-5 enter ".984", blanking distance , (use factory setting)
P-6 enter option "2", 4 – 20 mA output
P-7 enter "2", display max 2 digits after decimal
P-8 enter option "1", relay 1 - alarm function
P-9 enter "26", relay 1 - alarm ON (30' – 4' = 26')
P-10 enter "25.5", relay 1 - alarm OFF deadband = 0.5', arbitrary setting
P-11 enter option "1", relay 2 - alarm function
P-12 enter "5", relay 2 - alarm ON
P-13 enter "5.5", relay 2 - alarm OFF
P-14 enter option "5", relay 3 - rate of change function
P-15 enter "-1", relay 3 - alarm ON 9 '–' denotes emptying
P-16 enter "- 0.9", relay 3 - alarm OFF
P-37 enter "1", convert display (x1)
P-68 enter "1", maximum fill damping 1 ft / min
P-69 enter "1", maximum empty damping 1 ft / min
P-74 enter option "3", fail-safe hold
P-75 enter "2", fail-safe timer - 2 min.



to re-enter run mode

PUMP CONTROL APPLICATION PARAMETERS

General		Relays		Pump Control		Vol. & Disp. Conversion		OCM		Totalizer		Custom		Filter	
P-1	units	P-8	1 function	P-23	submers.	P-34	tank	P-40	primary	P-51	OCM sim.	P-60	full	P-68	fill damp
P-2	mode	P-9	1 on	P-24	1 hrs.	P-35	dim. A	P-41	time	P-52	factor	P-61	empty	P-69	empty damp
P-3	empty dist.	P-10	1 off	P-25	2 hrs.	P-36	dim. L	P-42	expon.	P-53	decimal	P-62	offset	P-70	rate disp.
P-4	span	P-11	2 function	P-26	3 hrs.	P-37	convert	P-43	flume dim.	P-54	low tot.	P-63	vel. 20 °C	P-71	rate avg.
P-5	near blank	P-12	2 on	P-27	4 hrs.	P-38	disp. offset	P-44	spare	P-55	high tot.	P-64	vel. P-65	P-72	fuzz filter
P-6	mA out	P-13	2 off	P-28	5 hrs.	P-39	disp. opt'n	P-45	max. head	P-56	remote tot.	P-65	temp.	P-73	agitator
P-7	decimal	P-14	3 function	P-29	run-on			P-46	max. flow	P-57	flow samp.	P-66	max. temp	P-74	f-s mode
		P-15	3 on	P-30	run-on			P-47	auto zero	P-58	flow samp.	P-67	min. temp	P-75	f-s timer
		P-16	3 off	P-31	spare			P-48	cutoff	P-59	time samp.				
		P-17	4 function	P-32	DLD mA out			P-49	decimal						
		P-18	4 on	P-33	totaling			P-50	mA out						
		P-19	4 off												
		P-20	5 function												
		P-21	5 on												
		P-22	5 off												

P-# required parameters

P-# optional parameters

P-# parameters not required

PUMP CONTROL APPLICATIONS

The basic difference between a simple level application and a pump control application is that the relays assigned to pump functions are normally in a de-energized state and are energized when pumping is required.

The MultiRanger Plus can be programmed to control up to 5 pumps. Each may be configured in one of the following ways.

1. Fixed roster: (P-8,11,14,17& 20 = 8)

selected pump relays 1-5 always operate in conjunction with their respective relay setpoints. i.e. relay 1's operation is always subject to relay 1's setpoints (P-9 & P-10). Any combination of the selected pumps can be operating at a time.

2. Sequential loop: (P-8,11,14,17& 20 = 9)

cumulative selected pump relays 1 - 5 sequentially rotate through the associated relay setpoints changing pump / setpoint assignment each time the lead pump is turned off. The lead pump is defined as the pump responding to the first ON setpoint.

duty / back-up similar to the cumulative sequential loop except that only one of the pumps designated as duty/back-up can be on at a time. This feature is useful in older installations where the discharge main cannot tolerate excessive pressure. If the lead pump, through wear or blockage, cannot keep up with the inflow, the next pump in sequence will come on and the lead pump will be turned off. The ON setpoints are generally in close proximity, but the OFF setpoints must be common for all pumps on the loop.

Sequential operation can be programmed as either cumulative or duty/back-up, but not both. The MultiRanger Plus will take the last mode entered as the common choice for all sequenced relays.

3. Assignment of a pump / relay contact to a setpoint parameter is done by ratio of the logged service hours. When the service of a pump is required, the pump with the least amount of service hours (P/C-24 to 28) with respect to the set ratio (P/A - 24 to 28) is started. When a pump is to be taken out of service, the pump with the least amount of service hours is stopped.

e.g. relays 1, 2 and 3 control three pumps by service ratio. It is required that pump 1 operate 60% of the time, pump 2 operate 10% of the time and pump 3 operate 30% of the time.

- » set the relay function : P-8, 11, 14 = dE : A9
- » set the relay setpoints : P-9/10, 12/13, 15/16
- » set the P-24, 25, 26 ratios : A-24 = 60
A-25 = 10
A-26 = 30

Relays assigned to pump control operation are software set that no two pumps can start up within 10 seconds of each other, a power failure or return to the run mode.

When in the program mode, pump relays will be held de-energized (OFF). In the event of a loss of echo condition, the pump relays can be individually programmed to be:

- » de-energized (dE)
- » energized (En)
- » hold (Ho)

when the fail-safe timer P-75 expires. Refer to Applications/Relays.

In applications where flooding is possible, a submersible transducer should be used. The submersible transducer's air cavity insures that a high level reading will be maintained rather than a loss of echo condition when the liquid level reaches the transducer. **When using a submersible transducer, set P-23.**

When relays are assigned a pump function, parameters P-24 through P-28 are used to log the respective service hours and number of pump starts for pump relays 1 - 5. These parameters may also be viewed while in the run mode by pressing the appropriate programmer keys. The initial pressing of the key causes the display to show the service hours. Holding the key in for at least five seconds causes the number of starts to be displayed. Each register may be reset to 0 by pressing "CLR" and then "ENTER" or preset by entering a particular value.

The preset value is immediately stored in memory, however subsequent values are only stored every 4 hours. Thus, after a power failure, the registers will display the last value stored. The registers will automatically reset to 0.000 after reaching a value of 9,999.

Pump Control Example

The application is to control the level in a wet well 3 meters deep. It is required that :

- » the level is displayed in meters
- » to start/stop two constant speed pumps: start pump 1 at 1 m level
 start pump 2 at 2 m level
 stop both pumps at 0.5 m level
- » the two pumps operate on a cumulative sequential loop, de-energized under loss of echo
- » low alarm is set at 0.4 m to protect the two pumps from cavitating
- » the transducer is mounted 3.4 meters from the bottom of the wet well
- » the span of level in the well is 3 m
- » maximum fill rate is 1 m / min, maximum draw rate is 0.2 m / min
- » in the event of loss of echo, go into fail-safe low after 30 seconds to protect pumps
- » the transducer is the submersible type as there is a possibility of flooding

select :

P-1 enter option "1", units in meters

advance to:

P-2 enter option "1", material level
P-3 enter "3.3", empty distance to transducer
P-4 enter "3", span
P-5 enter ".300", blanking distance, (use factory setting)
P-7 enter "2", display max 2 digits after decimal
P-8 enter option "dE 9" relay 1 - pump function
 (press "9" and
 then "." until "dE 9"
 is displayed)
P-9 enter "1", relay 1 - pump ON
P-10 enter ".5", relay 1 - pump OFF
P-11 enter option "dE 9" relay 2 - pump function
 (press "9" and
 then "." until "dE 9"
 is displayed)

P-12	enter "2",	relay 2 - pump ON
P-13	enter ".5",	relay 2 - pump OFF
P-14	enter option "1",	relay 3 - alarm function
P-15	enter ".4",	relay 3 - alarm ON
P-16	enter ".45",	relay 3 - alarm OFF deadband = 0.05 m, arbitrary setting
P-23	enter option "1",	using submersible transducer
P-37	enter "1",	convert display (x1)
P-68	enter "1",	fill damping 1 m / min
P-69	enter ".2",	empty damping 0.2 m / min
P-74	enter option "2",	fail-safe low to protect pumps
P-75	enter ".5",	fail-safe timer at a maximum draw rate of 0.2 m / min, this would protect pumps. If a loss of echo occurred at 0.5 m, after 30 sec the level would equal that of acceptable low level alarm and the pump would shut off.



to re-enter run mode

Pump Run-On

Pump run-on is a special feature designed to allow the pump assigned, temporarily (sequential loop) or permanently (fixed roster), to the lowest OFF setpoint to continue pumping after it has reached that OFF setpoint. The duration of run-on is set by P-30. Only one run-on duration is allowed per interval. The interval is the time period set by P-29 which begins upon return to the run mode or resumption of power. No run-on is allowed during the first interval.

Caution: extended pump run-on can lead to cavitation, causing air lock or pump damage

- Conditions of use :
- » Do not use run-on feature during pump-up operation as an overflow condition may occur. Set P-29 and 30 to 0.
 - » Select the loss of echo default "dE" to protect pumps from cavitating in the event of loss of echo
 - » The run-on interval must be greater than the run-on duration.

e.g. P-29 = 24 and P-30 = 15

After 24 hours from going into the run mode, the MultiRanger Plus enters the second run-on interval allowing only one pump run-on cycle of 15 seconds, at the first time the lead pump turns off. If the lead pump turns off a second time during that 24 hour interval, no run-on will occur. After the 24 hour interval has elapsed, whether a pump run-on has occurred or not, the next run-on interval will begin, allowing one run-on cycle.

PUMP TOTALIZER APPLICATION PARAMETERS

General		Relays		Pump Control		Vol. & Disp. Conversion		OCM		Totalizer		Custom		Filter	
P-1	units	P-8	1 function	P-23	submers.	P-34	tank	P-40	primary	P-51	OCM sim.	P-60	full	P-68	fill damp
P-2	mode	P-9	1 on	P-24	1 hrs.	P-35	dim. A	P-41	time	P-52	factor	P-61	empty	P-69	empty damp
P-3	empty dist.	P-10	1 off	P-25	2 hrs.	P-36	dim. L	P-42	expon.	P-53	decimal	P-62	offset	P-70	rate disp.
P-4	span	P-11	2 function	P-26	3 hrs.	P-37	convert	P-43	flume dim.	P-54	low tot.	P-63	vel. 20 °C	P-71	rate avg.
P-5	near blank	P-12	2 on	P-27	4 hrs.	P-38	disp. offset	P-44	spare	P-55	high tot.	P-64	vel. P-65	P-72	fuzz filter
P-6	mA out	P-13	2 off	P-28	5 hrs.	P-39	disp. opt'n	P-45	max. head	P-56	remote tot.	P-65	temp.	P-73	agitator
P-7	decimal	P-14	3 function	P-29	run-on			P-46	max. flow	P-57	flow samp.	P-66	max. temp	P-74	f-s mode
		P-15	3 on	P-30	run-on			P-47	auto zero	P-58	flow samp.	P-67	min. temp	P-75	f-s timer
		P-16	3 off	P-31	spare			P-48	cutoff	P-59	time samp.				
		P-17	4 function	P-32	DLD mA out			P-49	decimal						
		P-18	4 on	P-33	totaling			P-50	mA out						
		P-19	4 off												
		P-20	5 function												
		P-21	5 on												
		P-22	5 off												

P-# required parameters

P-# optional parameters

P-# parameters not required

PUMP TOTALIZER APPLICATION

This type of application is an extension of the pump control application, accessed by setting P- 2 = 4. Unlike a pump application in which the mode of the measurement (P-2) can be of material or space, the pump volume totalizer mode is a measurement of the liquid volume pumped with reference to the material level.

The material level must be converted to volume using volume conversion parameters P-34, 35 and 36 and / or convert display P-37. The MultiRanger Plus in pump-down, will record the volume being pumped out. Alternately, the MultiRanger Plus will record the volume pumped in if the pump setpoints are set for pump-up.

When the pump(s) is OFF, the MultiRanger Plus estimates the volume of the inflow or discharge by recording the rate at which the liquid level changes. When the pump(s) is operating, the estimated inflow or discharge volume may be added (P-33 = 1) to the pumped volume total, as in batch processing.

When the pump(s) stops, the pumped volume of the previous pump cycle is added to the total volume pumped in the 8 digit totalizer.

The totalizer contents are stored in RAM and will be lost in the event of a power failure. However, after every 1 hour of continuous operation, the totalizer contents are stored in the EEPROM. Thus, after a power failure, the totalizer will be loaded with the last value stored.

In the event of a loss of echo, the totalizer will continue being incremented by the flowrate established from the last valid echo. The totalizer will stop being incremented and hold its last updated value when in the program mode or if the fail-safe timer expires ("LOE" is displayed). Once the totalizer has been filled (99999999), it will automatically reset itself to zero and resume totalling.

The MultiRanger Plus can be programmed (P-39) to normally display one of the following readings :

- » enter option "0", hold last reading selected in run mode
- » enter option "1", high total: 4 highest digits of the 8 digit totalizer
- » enter option "2", low total: 4 lowest digits of the 8 digit totalizer
- » enter option "5", level

It must be noted that only half of the totalizer digits can be accessed or viewed at one time.

e.g.	high total	low total
	P-54	P-55
	8 digit total	
	1325	4679

If it is wished to momentarily view an alternate reading while in the run mode and P-39 $\neq 0$, press the desired programmer key ('HEAD' and 'FLOW' are not applicable to the pumped volume totalling)

e.g.

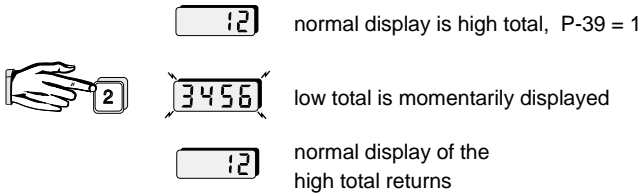

If P-39 = 0, alternate reading cannot be momentarily displayed. Pressing the desired key will change the display and hold it there until the next alternate reading is selected.

In the program mode, the high and low totals can be viewed or preset to any value by P-54 and P-55 respectively.

The pumped volume readings (high and low total) may be scaled down by factors of 10 (P-52) to slow down the totalizer's rate of fill, and its decimal point (P-53) positioned for the resolution required. If it is desired to change the scaling factor or decimal point location after totalling has begun, record the high and low totals and reset the totalizer to zero.

Further to alarm and pump functions, relays may be programmed to act as a momentary contact closure for a remote totalizer, flow sampler or time sampler (refer to Applications \ Relays). The duration of a momentary contact closure is 200 msec for which the corresponding relay status LED will flash. As a remote totalizer relay, the contact is closed each time the displayed total is increased by the amount entered into P-56. As a flow sampler relay, the contact is closed each time the volume of liquid, as set by P-57 and P-58, is pumped. As a time sampler relay, the contact is closed at the rate of the time period entered into P-59.

The mA output responds to the liquid reading only (level, if P-34 = 0 or volume if P-34 $\neq 0$). In the event of fail-safe due to loss of echo, the mA output will respond as programmed by P-6 and P-74, but the totalized volume will hold its last reading.

Pump Totalizer Example

Further to the Pump Control Example it is required that the volume pumped be totalized. A daily flow total of 1,200 cubic meters is expected and a contact closure is required every 10 cu. m. The full level of the well is equal to 42 cu.m. The following parameters should be set.

select:

P-2	enter option "4",	volume totalizer
P-17	enter option "11",	relay 4-remote totalizer contact
P-33	enter option "1",	estimated inflow volume is added to pumped volume
P-37	enter "14",	convert display, $x14$ ($42 / 3 = 14$)
P-39	enter option "2",	display low total
P-52	enter "1",	totalizer convert display, totalized volume will read as tens of cubic meters or 1 count per 10 cubic metres.
P-53	enter option "0",	totalizer decimal point no decimal digits or resolution equals 100% of a count
P-54	press "CLR" enter "0",	totalizer preset value, arbitrarily chosen
P-55	press "CLR" enter "0",	totalizer preset value, arbitrarily chosen
P-56	enter "1",	totalizer contact control-closure every 10 cu. m



to re-enter run mode.

VOLUME APPLICATION PARAMETERS

General	Relays	Pump Control	Vol. & Disp. Conversion	OCM	Totalizer	Custom	Filter
P-1 units	P-8 1 function	P-23 submers.	P-34 tank	P-40 primary	P-51 OCM sim.	P-60 full	P-68 fill damp
P-2 mode	P-9 1 on	P-24 1 hrs.	P-35 dim. A	P-41 time	P-52 factor	P-61 empty	P-69 empty damp
P-3 empty dist.	P-10 1 off	P-25 2 hrs.	P-36 dim. L	P-42 expon.	P-53 decimal	P-62 offset	P-70 rate disp.
P-4 span	P-11 2 function	P-26 3 hrs.	P-37 convert	P-43 flume dim.	P-54 low tot.	P-63 vel. 20 °C	P-71 rate avg.
P-5 near blank	P-12 2 on	P-27 4 hrs.	P-38 disp. offset	P-44 spare	P-55 high tot.	P-64 vel. P-65	P-72 fuzz filter
P-6 mA out	P-13 2 off	P-28 5 hrs.	P-39 disp. opt'n	P-45 max. head	P-56 remote tot.	P-65 temp.	P-73 agitator
P-7 decimal	P-14 3 function	P-29 run-on		P-46 max. flow	P-57 flow samp.	P-66 max. temp	P-74 f-s mode
	P-15 3 on	P-30 run-on		P-47 auto zero	P-58 flow samp.	P-67 min. temp	P-75 f-s timer
	P-16 3 off	P-31 spare		P-48 cutoff	P-59 time samp.		
	P-17 4 function	P-32 DLD mA out		P-49 decimal			
	P-18 4 on	P-33 totaling		P-50 mA out			
	P-19 4 off						
	P-20 5 function						
	P-21 5 on						
	P-22 5 off						

P-# required parameters

P-# optional parameters

P-# parameters not required

VOLUME APPLICATION

In addition to simple liquid level and pump applications, volume conversions can be included in the programming.

Common Tank Shapes

Volume conversion is provided for 8 common tank shapes, (P-34). Dimensions are entered using P-4 and 36. Volume is displayed as 0-100% and may be converted to volume units using P-37.

P-4, span, must be equal to the 100% (full) level of tank.

Volume Example

The application is to measure the volume of glue in a horizontal tank with parabolic ends. The tank manufacturer's specifications state that the volume is 40.6 cubic metres.

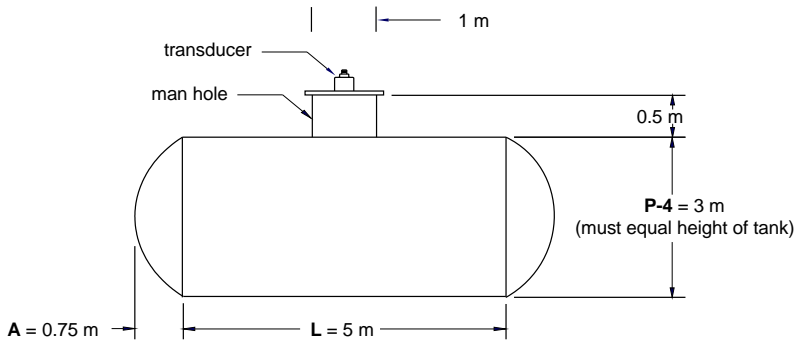

The maximum fill / draw rate is 0.35 cu. m / min. In the event of a loss of echo, the MultiRanger Plus is to go into fail-safe high after 30 sec.

select:

P-1 enter option "1", units in meters

advance to:

P-2 enter option "1", material level

P-3 enter "3.5", empty distance to transducer

P-4 enter "3", span (inside diameter of tank)

P-5 enter ".300", near blanking distance, (use factory setting)

P-7 enter "1", display maximum 1 digit after decimal

P-34 enter option "7", tank shape for volumetric conversion

P-35	enter ".75",	tank dimension A
P-36	enter "5",	tank dimension L
P-37	enter ".406",	convert display, x.406 (automatically shows the levels in %). As 100% full = 40.6 cubic metres, a conversion factor of .406 must be entered. $\frac{\text{actual volume}}{\text{percentage}} = \text{conversion factor}$
P-68	enter "10",	fill damping 10 m/min $\frac{40.6 \text{ cu. m}}{0.35 \text{ cu. m / min}} = 116 \text{ min total fill time}$ $\frac{3 \text{ m}}{116 \text{ min}} = 0.025 \text{ m / min average fill rate}$ <p>However, because of the tank's shape, the top and bottom levels will fill faster than the middle section. Therefore the actual P-68 value should be greater than the average value. Typically, the factory set damping of "10" can be used.</p>
P-69	enter "10",	empty damping-same as fill damping rate
P-74	enter "1",	fail-safe high
P-75	enter ".5",	fail-safe timer, 30 sec.



to re-enter run mode

Custom Design Tanks

Where the tank design does not match one of the eight common tank shapes, P-34 may be programmed for level versus volume characterization.

Characterization is achieved by entering the level (H parameters) and corresponding volume (F parameters) for the elevations where there is a change in the tank profile. Where curves are involved, the more breakpoints that are defined, the more accurate will be the volume of measurement. A maximum of eleven breakpoints can be defined.

Level data is entered in the linear units selected (P-1) and volume data is entered in the tank desired volumetric units. Both of these are referenced to the bottom of the tank.

Custom Design Tanks Example 'A'

The application is to measure the level of liquid in a custom designed tank. The tank manufacturer specifies the following level versus volume data.

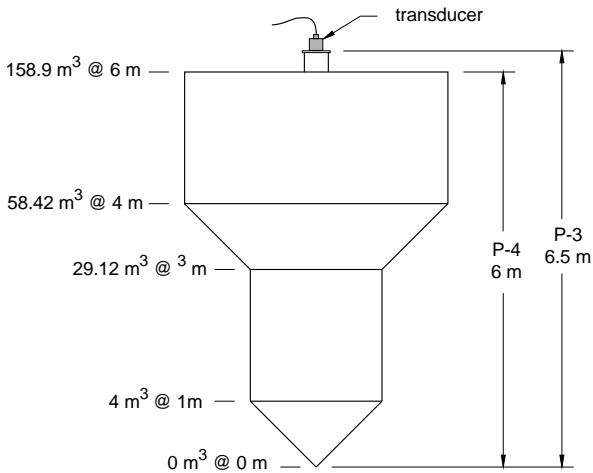

select :

P-1 enter option "1", units in metres

advance to :

- P-2 enter option "1", material level
- P-3 enter "6.5", empty distance to transducer
- P-4 enter "6", span
- P-5 enter ".5", near blanking distance
- P-34 enter option "9" universal level vs volume

press

display will show

	H - 1

	0.0 0 0
	H - 2 (then) ----
	1.0 0 0

press



display will show

H - 3 (then) ----
3.000



H - 4 (then) ----
4.000



H - 5 (then) ----
6.000

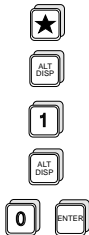

F - 5 (then) ----
F - 5
F - 1

0.000



F - 2 (then) ----
4.000



F - 3 (then) ----
29.12



F - 4 (then) ----
58.42



F - 5 (then) ----
158.9



F - 5
P - 34



to re-enter run mode

Compensation

In many volume applications, the ambient atmosphere is other than air or at a temperature other than 20 °C. Refer to Functional \ Temperature or \ Sound Velocity, for details on compensating for such circumstances.

If it is noted that the MultiRanger Plus reading is consistently off by a constant amount as compared to the physical reading, this may be compensated for by P-62. This tank measurement offset might occur when P-3 or P-4 does not exactly match the tank dimensions referenced for volume conversion. If the cause of the offset appears below the relay setpoints, the setpoint parameters may need to be reset as these will have shifted accordingly.

Custom Design Tanks Example 'B'

Further to the Volume Example or the Custom Design Tank Example 'A', the liquid is a glue giving off formaldehyde vapour. Velocity compensation will be required.

As the next two steps involve physical measurements, for convenience sake, P-60 can be done before P-61.

select:

- | | | |
|------|--------------------|---|
| P-62 | (optional to P-60) | record present offset for reference |
| P-60 | (optional) | with the tank as full as permissible, without going into the blanking zone, press "MEAS". The MultiRanger Plus will take a measurement and display the level. Press "meas" at least 5 times and insure that a stable reading is being obtained.

Enter the "physical measurement".

The MultiRanger Plus will now calculate the measurement offset to be used in future level measurements. The offset reading will be automatically entered into P-62 and can now be viewed. |
| P-63 | | record present sound velocity for reference |

P-61 with the tank as empty as permissible and filled with its normal vapour and at its normal temperature press "MEAS".
The MultiRanger Plus will take a measurement and display the level in the units selected, regardless that percent, volume or convert display are used. Press "MEAS" at least 5 times and insure that a stable reading is being obtained.

Enter the "physical measurement". The MultiRanger Plus will now calculate the correct sound velocity to be used in future level measurements. The new sound velocity will automatically be entered into P-63 and P-64, and can now be viewed.



to re-enter run mode.

DIFFERENTIAL LEVEL APPLICATION PARAMETERS

General	Relays	Pump Control	Vol. & Disp. Conversion	OCM	Totalizer	Custom	Filter
P-1 units	P-8 1 function	P-23 submers.	P-34 tank	P-40 primary	P-51 OCM sim.	P-60 full	P-68 fill damp
P-2 mode	P-9 1 on	P-24 1 hrs.	P-35 dim. A	P-41 time	P-52 factor	P-61 empty	P-69 empty damp
P-3 empty dist.	P-10 1 off	P-25 2 hrs.	P-36 dim. L	P-42 expon.	P-53 decimal	P-62 offset	P-70 rate disp.
P-4 span	P-11 2 function	P-26 3 hrs.	P-37 convert	P-43 flume dim.	P-54 low tot.	P-63 vel. 20 °C	P-71 rate avg.
P-5 near blank	P-12 2 on	P-27 4 hrs.	P-38 disp. offset	P-44 spare	P-55 high tot.	P-64 vel. P-65	P-72 fuzz filter
P-6 mA out	P-13 2 off	P-28 5 hrs.	P-39 disp. opt'n	P-45 max. head	P-56 remote tot.	P-65 temp.	P-73 agitator
P-7 decimal	P-14 3 function	P-29 run-on		P-46 max. flow	P-57 flow samp.	P-66 max. temp	P-74 f-s mode
	P-15 3 on	P-30 run-on		P-47 auto zero	P-58 flow samp.	P-67 min. temp	P-75 f-s timer
	P-16 3 off	P-31 spare		P-48 cutoff	P-59 time samp.		
	P-17 4 function	P-32 DLD mA out		P-49 decimal			
	P-18 4 on	P-33 totaling		P-50 mA out			
	P-19 4 off						
	P-20 5 function						
	P-21 5 on						
	P-22 5 off						

P-# required parameters

P-# optional parameters

P-# parameters not required

DIFFERENTIAL LEVEL APPLICATION

This type of application monitors the difference between two liquid levels, hence two transducers are required. The MultiRanger Plus monitors the two levels, calculates the difference and displays the differential as the reading. The following parameters should be left at their factory setting:

- » volume conversion (P-34)
- » display conversion (p-37)
- » offset (P-62)
- » velocity compensation (P-63)
- » temperature compensation (P-65)

In the run mode, the reading display will show the absolute difference between the levels, hence there are no negative readings. The level at transducer 1 or 2 may be viewed individually by pressing "PT1" or "PT2" respectively.

When programming as a differential level detector

- » P-2, mode: option 3 must be selected for DLD operation
- » P-3, empty distance to transducer: represents the lowest or common level
- » P-4, span: represents differential level corresponding to the 20 mA value
- » P-6, ma output: select range
- » P-20, function: option 14 must be selected for relay 5 to operate as scanner
- » P-32, mA output: may be dedicated to correspond to differential or level under transducer #1

On alarm and pump relay functions with setpoints referenced to zero, the setpoints are common to both levels. The in bounds, out of bounds, rate of change and sequential relay functions are not allowed.

In the event that the echo on either transducer is lost:

- » If set for fail-safe high: the differential reading will display the maximum differential level(P- 4)
- » if set for fail-safe low: the differential reading will display zero
- » If set for fail-safe hold: the display will hold its present reading after the fail-safe timer has expired

In order to use the MultiRanger Plus as a differential level detector TB-1 must be wired as in Installation \ Installing the Transducer and both transducers must be installed at the same level.

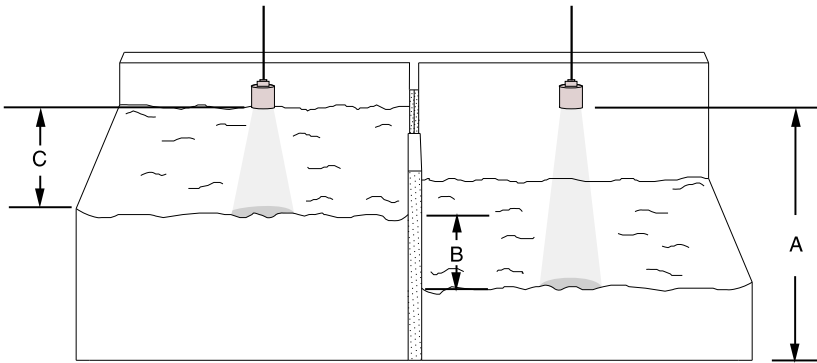

A = transducers must be at the same elevation (P-3).

B = maximum differential (Span, P-4)

C = transducer should be mounted at least 0.3 m above the highest liquid level and 0.3 m away from the wall for every 3 m / ST-25 or 6 m / ST-50 of measurement.

Differential Level Example

The application is to monitor the differential level across a sewage bar screen. When a differential level of greater than 12" is obtained, it is required that a rake be started. If the water level on either side rises above 20", a high level alarm is required.

The height from the common (low) level to the transducer face is 4 ft . A 4 - 20 mA output corresponding to the differential is required, and the 20 mA has been arbitrarily set to correspond to a 24" differential (span). In the event of a loss of echo, the MultiRanger Plus should go into a fail-safe high after 5 minutes.

select:

- | | | |
|-----|--------------------|--|
| P-1 | enter option "4", | units in inches |
| P-2 | enter option "3", | differential level |
| P-3 | enter "48", | empty distance to transducer |
| P-4 | enter "24", | span |
| P-5 | enter "11.81", | blanking distance, (use factory setting) |
| P-6 | enter option "24", | 4 - 20 mA output |
| P-7 | enter "1", | display max 1 digit after decimal |
| P-8 | enter option "4", | relay 1 - differential alarm |
| P-9 | enter "12", | relay 1 - rake on |
- This would be used only to initiate the rake control circuitry.

P-10	enter "6",	relay 1 - reset this value can be arbitrarily set
P-11	enter option "1",	relay 2 - alarm function
P-12	enter "20",	relay 2 - alarm ON
P-13	enter "19",	relay 2 - alarm OFF
P-20	enter option "14",	relay 5 - scanner
P-32	enter option "1",	mA output on differential
P-68	enter "393.7",	fill damping 393.7 in / min. Normally this level would rise over a period of days or weeks, therefore damping requirements would be fairly slow. Typically, the factory set damping of 32.81 can be used.
P-69	enter "393.7",	empty damping - same as fill damping
P-74	enter option "1",	fail-safe high
P-75	enter "5",	fail-safe timer



to re-enter run mode

OPEN CHANNEL MEASUREMENT APPLICATION PARAMETERS

General	Relays	Pump Control	Vol. & Disp. Conversion	OCM	Totalizer	Custom	Filter
P-1 units	P-8 1 function	P-23 submers.	P-34 tank	P-40 primary	P-51 OCM sim.	P-60 full	P-68 fill damp
P-2 mode	P-9 1 on	P-24 1 hrs.	P-35 dim. A	P-41 time	P-52 factor	P-61 empty	P-69 empty damp
P-3 empty dist.	P-10 1 off	P-25 2 hrs.	P-36 dim. L	* P-42 expon.	P-53 decimal	P-62 offset	P-70 rate disp.
◇ P-4 span	P-11 2 function	P-26 3 hrs.	P-37 convert	* P-43 flume dim.	P-54 low tot.	P-63 vel. 20 °C	P-71 rate avg.
P-5 near blank	P-12 2 on	P-27 4 hrs.	P-38 disp. offset	P-44 spare	P-55 high tot.	P-64 vel. P-65	P-72 fuzz filter
P-6 mA out	P-13 2 off	P-28 5 hrs.	P-39 disp. opt'n	◇ P-45 max. head	P-56 remote tot.	P-65 temp.	P-73 agitator
P-7 decimal	P-14 3 function	P-29 run-on		P-46 max. flow	P-57 flow samp.	P-66 max. temp	P-74 f-s mode
	P-15 3 on	P-30 run-on		P-47 auto zero	P-58 flow samp.	P-67 min. temp	P-75 f-s timer
	P-16 3 off	P-31 spare		P-48 cutoff	P-59 time samp.		
	P-17 4 function	P-32 DLD mA out		P-49 decimal			
	P-18 4 on	P-33 totaling		P-50 mA out			
	P-19 4 off						
	P-20 5 function						
	P-21 5 on						
	P-22 5 off						

P-# required parameters

P-# optional parameters

P-# parameters not required

* either parameter, depending on P-40

◇ same

OCM APPLICATION

This application is specific to monitoring the flowrate in one of the four following categories of primary measuring devices. Refer to the respective drawings at the end of this section for weir and flume outlines and transducer location.

Single Exponential, these are flumes and weirs that can be characterized by a single exponential term (P-40 = 1) i.e. $Q = K H^X$.

where : Q = flow

K = constant

H = head

x = exponent, characteristic to the primary measuring device (flume or weir)

Examples :

<i>Primary measuring device</i>	<i>exponent</i>
Suppressed rectangular, Cipolletti weir, or Venturi flume	1.50
Parshall Flume, or Leopold Lagco	1.55
V-notch weir	2.50
etc	

**Refer to manufacturer's specifications for the exact exponent.
The exponents listed above are for reference only.**

Palmer-Bowlus flumes : typically those manufactured by Plasti-Fab or Warminster Fiberglass (P-40 = 2)

H-flumes : excluding HS and HL sizes, as developed by the U.S. Department of Agriculture, Soil Conservation (P-40=3)

Other : these are primary measuring devices that do not fit the first three categories (P-40 = 4)

As most OCM applications are outdoors, the use of a temperature sensor is strongly recommended for optimum accuracy. Refer to Functional \ Temperature.

Flow readings are calculated by the MultiRanger Plus as a function of the head under the transducer, installed upstream from the primary measuring device (P-40). The flows are then accumulated in the arbitrary volume units chosen per the time units of P-41 in an 8 digit totalizer. In the event of a loss of echo, the totalizer will continue being incremented by the flowrate established from the last valid echo. The totalizer will stop being incremented and hold its last updated value when in the program mode or if the fail-safe timer expires ("LOE" is displayed).

The totalizer contents are stored in RAM and will be lost in the event of a power failure. However, after every 1 hour of continuous operation, the totalizer contents are stored in the EEPROM. Thus, after a power failure, the totalizer will be loaded with the last value stored. Once the totalizer has been filled (99999999) it will automatically reset itself to zero and resume totalling.

The MultiRanger Plus can be programmed (P-39) to normally display one of the following readings :





- » enter option "0", hold last reading selected in run mode
- » enter option "1", high total: 4 highest digits of the 8 digit totalizer
- » enter option "2", low total: 4 lowest digits of the 8 digit totalizer
- » enter option "3", head
- » enter option "4", flow

It must be noted that only half of the totalizer digits can be accessed or viewed at one time.

e.g.	<i>high total</i>	<i>low total</i>
	P-54	P-55
	8 digit total	
	1325	4769

To momentarily view an alternate reading while in run mode and P-39 ≠ 0, press the desired programmer key ("READ" is not applicable to OCM).

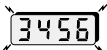
e.g.

		normal display is high total, P-39 = 1
		low total is momentarily displayed
		normal display of the high total returns

If P-39 = 0, alternate readings cannot be momentarily displayed. Pressing the desired key will change the display and hold it there until the next alternate reading is selected.

In the program mode, the high and low totals can be viewed or preset to any value by P-54 and P-55 respectively.

The flow readings (high and low total) may be scaled down by factors of 10 (P-52) to slow down the totalizer's rate of fill and its decimal point (P-53) positioned for the resolution required. To change the scaling factor or decimal point location after totaling has begun, record the high and low totals and reset the totalizer to zero.

The MultiRanger Plus can be programmed to ignore low head, i.e. flows for heads less than that set in P-48 will not be accumulated in the totalizer. The low head cutoff is measured in % of maximum head (P-45).

Further to alarm and pump functions, relays may be programmed to act as a momentary contact closure for a remote totalizer, flow sampler or time sampler (refer to Application \ Relays). The duration of a momentary contact closure is 200 msec for which the corresponding relay status LED will flash. As a remote totalizer relay, the contact is closed each time the displayed total is increased by the amount entered into P-56. As a flow sampler relay, the contact is closed each time the volume of liquid as set by P-57 and P-58 is pumped. As a time sampler relay, the contact is closed at the rate of the time period.

The mA output responds to the head or flow (P-50). In the event of fail-safe due to loss of echo, the mA output will respond as programmed by P-6 and P-74.

When programming the MultiRanger Plus for the OCM function, the empty distance to transducer (P-3) may be considered and entered as the distance from the transducer face to the 0 head or no flow reference level. If this measurement is not easily obtained, P-3 can be estimated and corrected via P-47. This is referred to as the Auto Zero calibration and requires the MultiRanger Plus to compare a physical measurement (from wall gauge, dipstick or stilling well) to the ultrasonic measurement via P-47. Refer to OCM Auto Zero Example.

It should also be noted that when operating in the OCM function: percent display, volume conversion (P-34) and convert display (P-37) are inoperative. Empty calibration (P-61) must be clear, i.e. 4 hyphens in the display.

An important consideration in OCM applications is that many primary measuring devices have the potential of running dry. In such cases, it must be insured that the range extension (P-87) is sufficient so that the floor of the channel or of the converging section of the flume can be read. Otherwise, false readings may be obtained indicating flow.

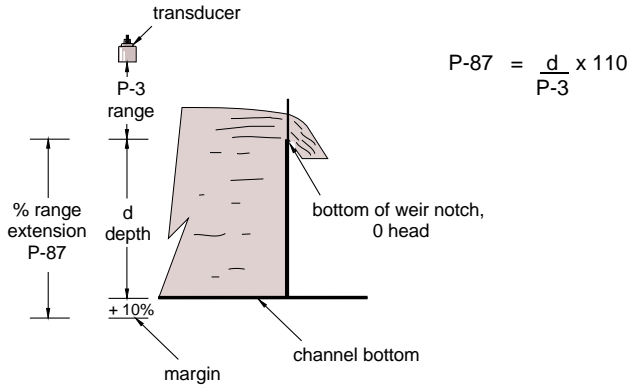

OCM Example

9" Parshall Flume

$$Q = 1.98 H^{1.53}$$

where Q = flow rate, MGD (million gallons per day),

H = head, feet

- » max flow rate - Q max = 4.112 MGD
= 4,112,000 gal. / day
- » max head - H max = 1.61
- » transducer is mounted 3 ft above the zero flow level
- » max flow rate display = 4,112
i.e. one count = 1000 gal.

select:

P-1	enter option "3",	units in feet
P-2	enter option "5",	OCM
P-3	enter "3",	zero level distance to transducer
P-4	enter "1.61",	max head
P-5	enter "1",	near blanking distance, minimum allowable
P-39	enter option "4",	display flowrate in units per day
P-40	enter option "1",	primary measuring device - exponential
P-41	enter option "4",	flowrate time units - per day
P-42	enter "1.53"	exponent from manufacturer's specs. for 9" Parshall Flume
P-46	enter "4112",	max flow in thousand gal / day
P-49	enter option "3",	flowrate decimal point display max 3 digits after decimal
P-52	enter option "0",	totalizer convert display total is divided by 1 before being displayed or 1 count per thousand gallons.
P-53	enter option "2",	totalizer decimal point display 2 digits after decimal or resolution equals 1/100th of a count.
P-68	enter "32.81",	fill damping 32.81 ft / min. As the head would fluctuate over a period of hours, damping requirements would be fairly low. Typically, the factory set damping of 32.81 can be used.
P-69	enter "32.81",	empty damping - same as fill damping



to re-enter run mode

OCM Auto Zero Example

Further to OCM Example, the following is required :

- » alarm at 10% overflow (approx. = 1.8 ft) and 0 head
- » in the event of loss of echo, the MultiRanger Plus is to go into low alarm after 45 sec.
- » head to read to 1 decimal place
- » sampler contact every day
- » head under "1" (40 thousand gal / day) not be totalized
- » 4 - 20 mA output to respond to flow

Single Exponential, P-40 = 1

Weirs

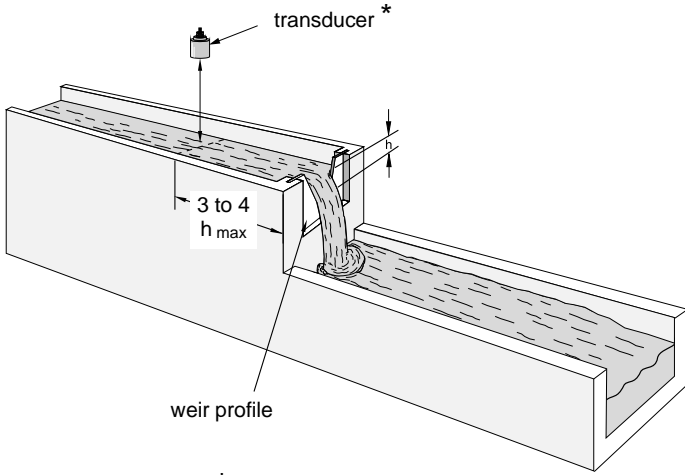

* The transducer must be above the maximum head by at least the blanking value, P-5.

Applicable Weir Profiles

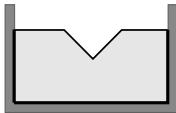

V - notch or triangular

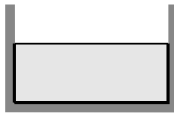

suppressed rectangular

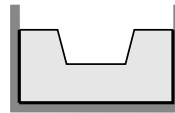

Cipolletti or trapezoidal

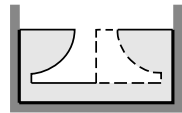

Sutro or proportional

Non-Applicable Weir Profiles

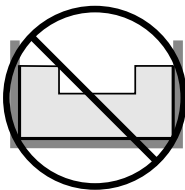

contracted rectangular

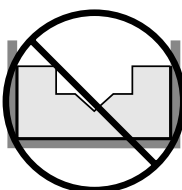

compound

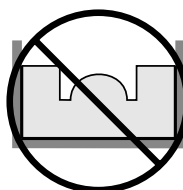

Poebing

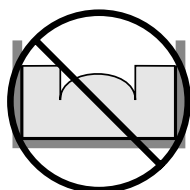

approximate exponential

Flows through these weirs may be measured using the universal head vs flow characterization, P-40 = 4.

**Single Exponential P-40 = 1 (cont'd)
FLUMES**

Parshall Flume

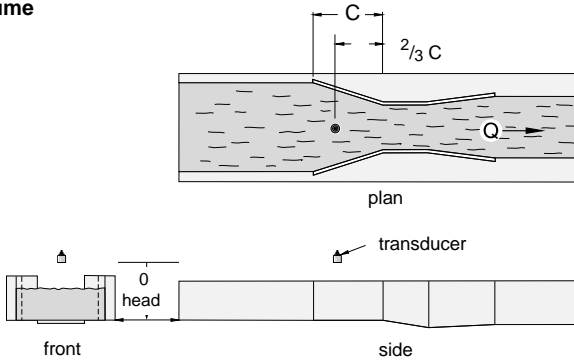

- » sized by throat width
- » set on solid foundation
- » general free flow equation is $Q = K H^x$ where: Q = flow rate
 K = constant
 H = head
 x = exponent
- » For rated flows under free flow conditions, the head is measured at $2/3$ the length of the converging section from the beginning of the throat section.
- » Position the transducer such that it is centered over the flow at a minimum head.

Khafagi Venturi

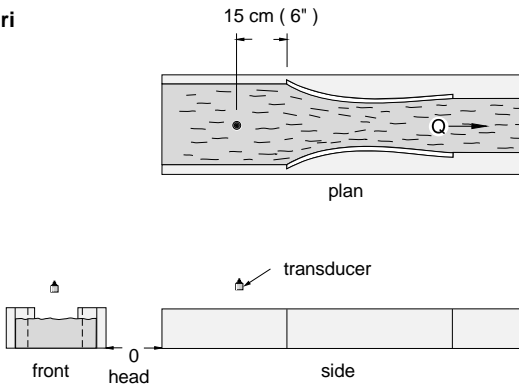

- » for rated flows under free flow conditions, the head is measured 15 cm (6") upstream from the beginning of the converging section.
- » position the transducer such that it is centered over the flow at a minimum height of 30 cm (12") above the maximum head.

Single Exponential, P- 40 = 1 (cont'd)
FLUMES (cont'd)

Leopold Lagco (as manufactured by Leopold Co., Inc.)

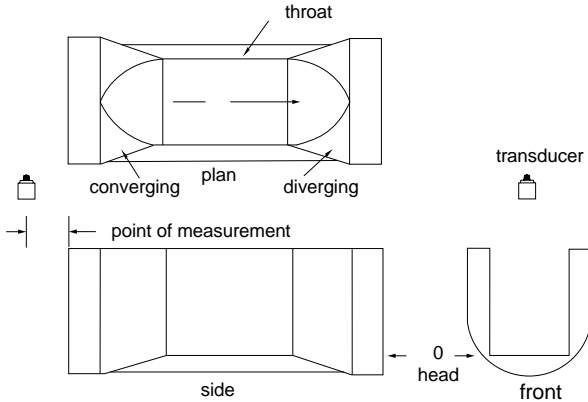

- » designed to be installed directly into pipelines and manholes
- » Leopold Lagco may be classed as a rectangle Palmer-Bowlus flume
- » sized by pipe (sewer) diameter
- » for rated flows under free flow conditions, the head is measured at a point upstream referenced to the beginning of the converging section. Refer to the following table:

Flume Size (pipe dia. in inches)	Point of Measurement	
	cm	inches
4 - 12	2.5	1
15	3.2	1 1/4
18	4.4	1 3/4
21	5.1	2
24	6.4	2 1/2
30	7.6	3
42	8.9	3 1/2
48	10.2	4
54	11.4	4 1/2
60	12.7	5
66	14.0	5 1/2
72	15.2	6

- » general free flow equation is $Q = K H^x$, where:
 - Q = flow rate
 - K = constant
 - H = head
 - x = exponent
- » position the transducer such that it is centered over the flow at a minimum height of 30 cm (12") above the maximum head.

**Single Exponential, P-40 = 1 (cont'd)
FLUMES (cont'd)**

Cutthroat Flume

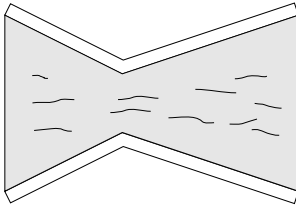

plan

- » similar to Parshall flume except that the floor is flat bottomed and throat has no virtual length
- » refer to manufacturer's specifications for flow equation and point of head measurement.

Flow through the following flumes may be measured using the universal head vs flow characterization, P-40 = 4.

Trapezoidal Flume

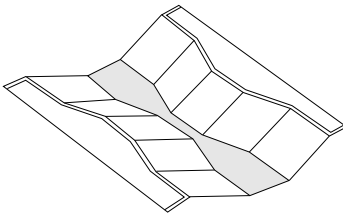

isometric

- » similar to Parshall flume except that the floor is flat bottomed and walls are sloped.

Dual Range (nested) Parshall Flume

- » two flumes, a larger on top of the smaller, in order to handle a larger range of flows.

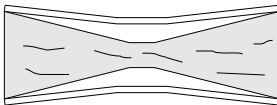

plan

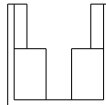

front

Palmer-Bowlus Flume, P-40 = 2

(typically those manufactured by Warminster Fiberglass or Plasti-Fab)

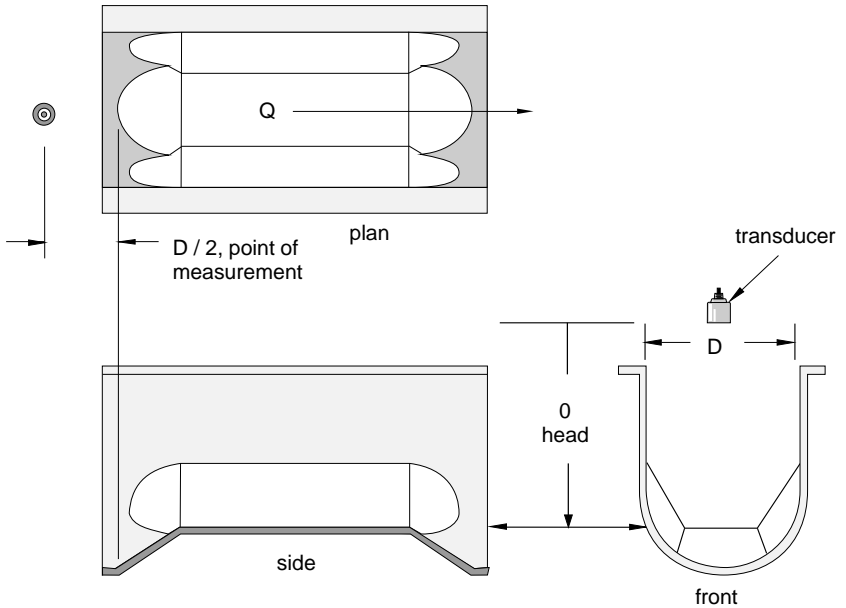

- » sized by pipe diameter, D. Enter value (in units of P-1) into P-43.
- » flume relief is trapezoidal
- » designed to install directly into pipelines and manholes
- » head is referenced to bottom of the throat not to bottom of pipes
- » for rated flows under free flow conditions, the head is measured at a distance of $D / 2$ upstream from the beginning of the converging section
- » position the transducer such that it is centered over the flow at a minimum height 30 cm (12") above the maximum head

H Flumes, P-40 = 3

(as developed by the U.S.Department of Agriculture, Soil Conservation Service)

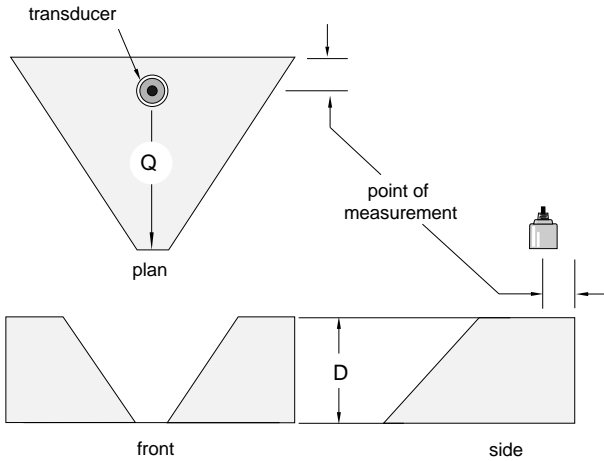

- » sized by max depth of flume, D. Enter value (in units of P-1) into P-43.
- » approach is preferably rectangular, matching width and depth for distance 3 to 5 times the depth of the flume
- » flow range 100 : 1
- » may be installed in channels under partial submergence (ratio of downstream level to head).

Typically: » 1% error @ 30% submergence
 » 3% error @ 50% submergence

- » for rated flows under free flow conditions, the head is measured at a point downstream for the flume entrance.

Flume Size (D ft)	Point of Measurement	
	cm	inches
0.5	5	1 ³ / ₄
0.75	7	2 ³ / ₄
1.0	9	3 ³ / ₄
1.5	14	5 ¹ / ₂
2.0	18	7 ¹ / ₄
2.5	23	9
3.0	28	10 ³ / ₄
4.5	41	16 ¹ / ₄

- » H flumes come with a flat or sloping floor.
 The same flow table can be used as error is less than 1%.
- » position the transducer such that it is centered over the flow at a minimum height of 30 cm (12") above the maximum head.

Other, P- 40 = 4

Where the primary measuring device does not fit one of the three other categories, P-40 may be programmed for one or two head versus flow characterizations:

- » P-40 = 4 : curved
- » P-40 = 5 : linear

Select the characterization which most closely fits the flow characteristics of the primary measuring element.

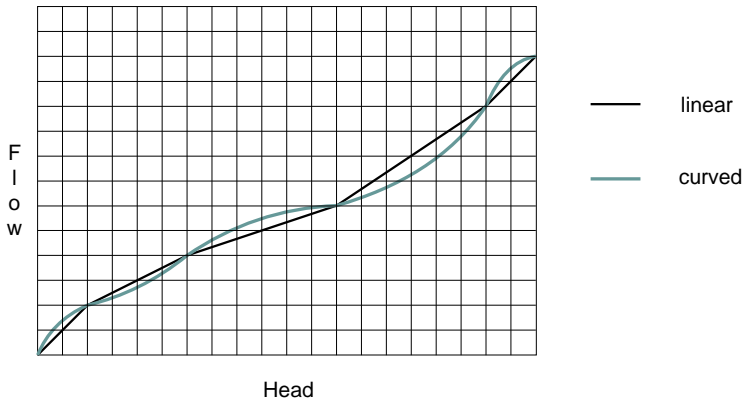

Characterization is achieved by entering the head (H parameter) and corresponding flow (F parameter) either from empirical measurement or from the manufacturer's specification. The more breakpoints that are defined, the more accurate will be the flow measurement. Breakpoints should be concentrated in areas exhibiting the higher degrees of non linear flow. A maximum of eleven breakpoints can be defined.

Head data is entered in the linear units selected (P-1) and flow data is entered in the desired units of flowrate.

Other Flumes Example

The application is to measure the flow across a 4 ft rectangular weir with end contractions. The flow is characterized by the following formula:

$$\text{cfs} = 3.33 (L - 0.2H) H^{1.5}$$

where: cfs = flow in cu ft / sec
L = length of crest
H = head

select :

























P-1 enter option "3", units in feet

advance to:

- P-2 enter option "5", OCM
- P-3 enter "4", empty distance to transducer
- P-4 enter "3", span
- P-5 enter "1", near blanking distance
- P-39 enter option "4", display flowrate
- P-40 enter option "4", universal head vs flow

press

display will show

	H - 1
	-----
 	0.0 0 0
	H - 2 (then) ----
  	0.3 0 0
	H - 3 (then) ----
  	0.6 0 0
≍ ≍ ≍	
	H - 10 (then) ----
   	2.7 0 0
	H - 11 (then) ----
 	3.0 0 0
	F - 11 (then) ----
	F - 11
	F - 1
	-----

press

display will show



0.0 0 0



F - 2 (then) ----



2.1 5 6



F - 3 (then) ----



6.0 0 5



F - 10 (then) ----



5 1.1 2



F - 11 (then) ----



5 8.8 3



F - 11



P - 4 0

- P-41 enter option "1", flowrate time units per sec
- P-46 enter "58.83", maximum flowrate in cu ft / sec
- P-49 enter option "3", flowrate decimal point display max
3 digits after decimal
- P-52 enter option "0", totalizer convert display is divided by 1 before
being displayed or 1 count per thousand cu ft
- P-53 enter option "2", totalizer decimal point display 2 digits after
decimal or resolution equals 1/100th of a count



to re-enter run mode

APPLICATIONS WITH STANDPIPES

In many solids and liquid applications, access to the vessel must be made via a standpipe. In such cases, Milltronics can provide flange mounted transducers that will readily mate to the standpipe.

The maximum standpipe length that can be used without additional near blanking (P-5 not greater than 0.3 m) is 200 mm (8"). For greater standpipe lengths, up to 30" long, near blanking must be extended to 150 mm (6") beyond the end of the pipe.

The preferred dimension when selecting a standpipe arrangement is a 100 mm (4") diameter pipe, 300 mm (12") long. Near blanking would be set at 460 mm (18").

Standpipe Example

Referring to Volume Application \ Volume Example, if the transducer were mounted to a 150 mm diameter flanged standpipe 0.5 m long, instead of a 1 m diameter manhole, the following will be required :

select :

P-5	enter ".65",	near blanking
		0.50 m (standpipe length)
		<u>+0.15 m (blanking past pipe)</u>
		0.65 total blanking distance



to re-enter run mode.



PARAMETER DESCRIPTION

**(F) indicates the parameter's factory setting, where applicable.
For reference only, factory set values
may change with software revisions.**

(V) indicates that parameter can be viewed only, not entered.

P-0 security

This parameter can be used to lock out the programmer such that the content of parameters P-1 through P-99 can not be changed. This however does not prevent the parameters from being selected and viewed. The programmer is locked out if the content of P-0 is of any value other than 1954. P-0 can only be direct accessed.

content = 1954, programmer functional (F)
≠ 1954, programmer locked out
= -1, pumps active during simulation

P-1 units of calibration and display

enter: 1 = meters (F) 1* = calibrate in meters, display in %
2 = centimeters 2* = calibrate in centimeters, display in %
3 = feet 3* = calibrate in feet, display in %
4 = inches 4* = calibrate in inches, display in %

**For % display, entry must be made as # *
and will be displayed as " # P "**

e.g. Press  and then  , the display will show " 3 P ".

P-2 mode of measurement

enter: 1 = material level
2 = space (F)
3 = differential level
4 = volume totalizer (pump totalizer)
5 = OCM (open channel measurement)

P-3 empty distance to transducer

enter desired amount (F = 10.00 m)

P-4 span

- » distance between full (high) and empty (low) levels
- » maximum level differential if DLD (P-2 = 3) is selected
- » maximum head if OCM (P-2 = 5) is selected

enter desired amount (F = 10.00 m)

P-5 near blanking

normally leave at factory setting. However for blanking extension, entry must be slightly larger than distance to end of standpipe or far side of obstruction. Blanking should not extend all the way into span level. Some margin of material span should be allowed to avoid loss of echo.

enter distance required, in units as set in P-1 (F = 0.300 m)

P-6 milliamp output

- enter:
- 0 = off
 - 1 = 0 to 20 mA
 - 2 = 4 to 20 mA
 - 3 = 20 to 0 mA
 - 4 = 20 to 4 mA

P-7 decimal point location

Sets the maximum number of digits after the decimal. The number of digits after the decimal will automatically reduce to avoid display overflow.

- enter:
- 0 = no digits after decimal
 - 1 = one digit after decimal
 - 2 = two digits after decimal (F)
 - 3 = three digits after decimal

P-8 relay 1 function

Refer to Functional \ Relays.

enter desired option (F = 0)

P-9 / 10 relay 1- ON / OFF setpoints

enter level in units as selected in P-1 or °C (F = - - - -)

- P-11 relay 2 function
Refer to Functional \ Relays.
enter desired option (F = 0)
- P-12 / 13 relay 2 - ON / OFF setpoints
enter level in units as selected in P-1 or °C (F = - - - -)
- P-14 relay 3 function
Refer to Functional \ Relays.
enter desired option (F = 0)
- P-15 / 16 relay 3 - ON / OFF setpoints
enter level in units as selected in P-1 or °C (F = - - - -)
- P-17 relay 4 function
Refer to Function \ Relays.
enter desired option (F = 0)
- P-18 / 19 relay 4 - ON / OFF setpoints
enter level in units as selected in P-1 or °C (F = - - - -)
- P-20 relay 5 function
Refer to Functional \ Relays.
enter desired option (F = 0)
- P-21 / 22 relay 5 - ON / OFF setpoints
enter level in units as selected in P-1 or °C (F = - - - -)

**Parameters P-23 through P-33 are used specifically for pump applications.
Refer to Applications \ Pump Control Applications.**

P-23 submersible transducer
 enter: 0 = normal ST- series transducer (F)
 1 = submersible transducer

P-24 relay 1 pump log *

P-25 relay 2 pump log *

P-26 relay 3 pump log *

P-27 relay 4 pump log *

P-28 relay 5 pump log *

*** These parameters are divided into three levels of subparameters:**

- » " service hours " log
- » " pump starts " log
- » " ratio " setpoint

Access is made by scrolling through the levels.

press

display will show



P-24

initial access (service hours)

[- 24]

" pump starts "



R-24

" ratio " setpoints





P-24

" service hours "



press

display will show

To view the service hours

 at the 'P' parameter
  e.g. 1,234 hours of service
(F = 0.000)







To view the number of starts

 at the 'C' parameter
  e.g. 321 pump starts (F = 0)









To view the ratio setpoint

 at the 'A' parameter
  factory setting

To reset or preset the " service hours " or " pump starts " log

 e.g. " service hours " selected
  e.g. 1,234 hours
  e.g. reset to zero
  e.g. 0 " service hours "

To set the service " ratio "

 " ratio " setpoint
  e.g. 20
   e.g. 15
  " ratio " setpoint is now 15

P-29 pump run-on interval

the cyclical period in hours, in which a pump run-on duration may occur. The initial interval begins upon return to the run mode or resumption of power to the MultiRanger Plus. Subsequent intervals begin at the end of the previous interval. Intervals end after the time entered has expired or when the power or run mode is interrupted.

enter interval in hours (F = - - - -)

P-30 pump run-on duration

the amount of time which the lead pump will continue pumping after it has reached its OFF setpoint.

enter duration in seconds (F = 0)

P-31 spare

P-32 DLD milliamp output

when operating on the DLD mode, the milliamp output can be set to correspond either to the differential or to the level under transducer #1

enter: 1 = differential (F)
2 = level

P-33 inflow / discharge totaling

refer to Applications \ Pump Totalizer Application

enter: 1 = estimated inflow or discharge volume as added to the pumped volume total (F)
2 = estimated inflow or discharge volume is omitted from the pumped volume total.

Parameters P-34 through P-39 are used for volume and display conversion.

P-34 tank shape for volumetric conversion

enter: 0 = non volume - linear level measurement (F)

1 = flat bottom

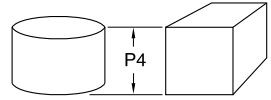

2 = conic or pyramidic bottom

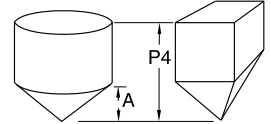

3 = parabolic bottom
or

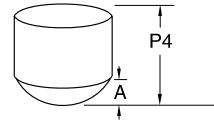

4 = half sphere bottom

5 = flat slope bottom

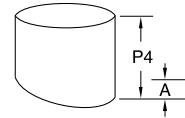

6 = horizontal cylinder, flat ends



7 = horizontal cylinder, parabolic ends

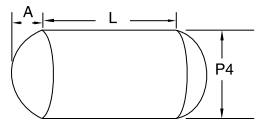

8 = sphere

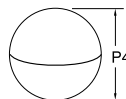

(cont'd)

9 = custom tank design *
(refer to Applications \ Volume Application)

* This option is divided into two levels of subparameters:

H - # where: H = level coordinate
F - # F = volume coordinate
= breakpoint 1 to 11

Access is made by scrolling through the levels.

press **display will show**

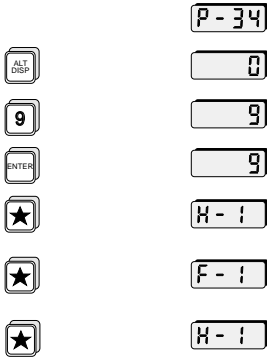

Setting of the subparameters is done in the same way as with the 'P' parameters.

To exit the " H " and " F " subparameters:

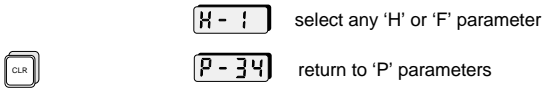

If P-34 ≠ 0, reading will be in percent of full volume. For volumetric reading, set conversion factoring by using P-37.

P-35 tank dimension 'A'

the height of the bottom section of tank shapes 2, 3, 4, 5 or the length of one end section in tank shape 7.
(not required for other tank shapes)

enter " dimension A ", in units selected per P-1 (F = 0000)

P-36 tank dimension 'L'

horizontal length of tank shape excluding parabolic ends
(not required for other tank shapes).

enter " dimension L ", in units selected per P-1 (F = 0.0 0 0)

P-37 convert display

parameter value is the factor by which the measurement is to be
multiplied by before being displayed. Range is 0.001 to 9999.

enter desired factor (F = 1)

P-38 display offset

this value is added to material space, volume or ullage measurement
before being displayed (P-39, P-76 or " * " key). The mA output and
alarms are not affected by the offset. The display offset is entered in
the units programmed, subject to P-1, P-34 and P-37.

enter offset required (F = 0.000)

P-39 display reading options

enter : 0 = hold last alternate reading selected (F)

0

1 = high total: 4 highest digits of the 8 digit totalizer
(pumped volume and OCM only)

1

= point 1: DLD level / transducer #1

2 = low total: 4 lowest digits of the 8 digit totalizer
(pumped volume and OCM only)

2

= point 2: DLD level / transducer #2

3 = head (OCM only)

3

4 = flow rate (OCM only)

4

5 = reading level, space, differential, volume or ullage

★

In the run mode, the programmer keys illustrated can be pressed
to view alternate readings. The display will return to the reading
option selected (except option 0) after momentarily displaying
alternate reading.

**Parameters P-40 through P-50 used specifically for
OCM applications. Refer to Applications.**

P-40 primary measuring device

enter option: 1 = exponential (F)
 2 = Palmer-Bowlus
 3 = H-flume
 4 = universal head vs flow - curve *
 5 = universal head vs flow - linear *

* these options are divided into 2 levels of subparameters:

H - # where: H = level coordinate
 F - # F = flow coordinate
 # = breakpoint 1 to 11

Access is made by scrolling through the levels.

<i>press</i>	<i>display will show</i>

Setting of the subparameters is done in the same way as with the ' P ' parameters.

To exit the ' H ' and ' F ' subparameters

		select any ' H ' or ' F ' parameter
		return to ' P ' parameters

P-41 flow rate time units

enter option: 1 = per second
2 = per minute
3 = per hour
4 = per day (F)

P-42 OCM exponent

exponent for primary measuring devices, P-40 = 1 where $Q = K H^x$
Obtain from manufacturer's specifications.

enter " exponent " (F = 1.550)

P-43 flume dimension (P-40 = 2 or 3)

enter ' D ', flume size in units of P-1 (F = 1.000)

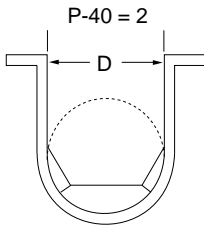

Palmer Bowlus

D = pipe or sewer dia.

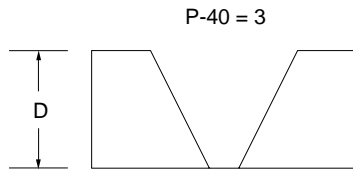

H Flume

P-44 spare

P-45 maximum head

this is the head corresponding to the max flow rate. This parameter is identical to P-4, span. A change to either parameter will simultaneously change the other. (F = 10.00)

P-46 maximum flow rate

this is the flow rate which occurs at maximum head and determines the mA output span (refer to Functions \ Analog Output).
Obtain from manufacturer's specifications.

enter " maximum flow rate ", volume units are arbitrary (F = 1000)

P-47 Auto zero

this parameter allows automatic zero calibration for the empty distance to transducer parameter (P-3) when the physical measurement is not obtainable.

P-3 is the estimated empty distance to the transducer face with the transducer aimed at the proper portion of the crest in the open channel and at a height of at least 1 ft above maximum head.

Press  at least five times and until a stable reading is obtained on the display. The reading, regardless of the height of the transducer, will be the apparent head with respect to the estimated empty distance, P-3. Enter the actual physical measurement of head at a point beneath the transducer.

Press , the MultiRanger Plus will then calculate the correct zero reference level. The offset will be automatically entered into P-62.

P-48 OCM low head cutoff

flows for head below this level will not be totalled. Unit of cutoff is percent of maximum head (P-45)

enter "percentage required" (F=5.000)

P-49 OCM decimal point

sets the maximum number of digits after the decimal for display of flow rate (P-39 = 4). The number of digits after the decimal will automatically reduce to avoid display overflow.

enter: 0 = no digits after decimal
 1 = one digit after decimal
 2 = two digits after decimal (F)
 3 = three digits after decimal

P-50 OCM mA output

refer to Functional \ Analog Output

enter: 1 = mA responds to head (F)
 2 = mA responds to flow

P-51 OCM simulation

press  , display will show previous flow

enter head in units programmed, display will show head

press  , display will show corresponding flow

Parameters P-52 through P-59 are used specifically for OCM and pump totalizer applications. Refer to Applications.

P-52 totalizer display factor

totalizer display of flow or volume pumped is factored by a power of 10 to determine the count per flow. The factor is selected as follows:

enter: - 3 = multiply by 1000

- 2 = 100

- 1 = 10

0 = divide by 1 (F)

1 = 10

2 = 100

3 = 1,000

4 = 10,000

5 = 100,000

6 = 1,000,000

7 = 10,000,000

e.g. present flow rate is 450 gal / sec

if P-52 = 0, totalizer is incremented at a rate of 1 count per gallon

if P-52 = 3, totalizer is incremented at a rate of 1 count per thousand gallons

P-53 totalizer decimal point location

sets the number of digits after the decimal point for the low total only. The decimal point will not float.

enter: 0 = no digit after decimal

1 = one digit after decimal

2 = two digits after decimal (F)

3 = three digits after decimal

P-54 low total

this parameter will display the 4 lowest digits of the 8 digit totalizer used in pump totalizer or OCM application. The parameter will also allow the display to be reset to any value. (F = 00.00)

P-55 high total

the parameter will display the 4 highest digits of the 8 digit totalizer used in pump totalizer or OCM applications. The parameter will also allow the display to be reset to any value. (F = 0000)

P-56 remote totalizer contact control.

a momentary closure of the remote totalizer contact occurs once each time the entered flow or pumped volume has passed.

enter option: - 3 = 0.001
- 2 = 0.01
- 1 = 0.1
0 = 1 (F)
1 = 10
2 = 100
3 = 1,000
4 = 10,000
5 = 100,000
6 = 1,000,000
7 = 10,000,000

P-57
&
P-58 flow sampler control

a momentary closure of the flow sampler contact occurs once each time a volume of $y \times 10^x$, as defined by P-57 (x) and P-58 (y), flows or is pumped.

enter P-57 (x) = base 10 exponent, - 3 to 7 (F = 0)

enter P-58 (y) = mantissa, 0.001 to 9999 (F = 1.000)

e.g. if P-57 = 3 and P-58 = 5, then a sampler contact closure will occur each time $5 \times 10^3 = 5000$ units of volume has passed

P-59 time sampler control



a momentary closure of the time sampler contact occurs each time the entered amount of time in hours has elapsed (F = - - - -)

Parameters P-60 through P-67 are used to achieve specialized or custom calibration.

P-60 full calibration

this provides a measurement offset compensation on a full tank. A measurement offset might occur when parameters 3 and 4 do not exactly match the tank dimensions referenced for volume conversion. (F = - - - -)

Fill tank as much as permissible, but without going into the blanking zone.

Press , the MultiRanger Plus will take a measurement and display the space or level (P-2) in the linear units chosen (P-1) regardless if percent, volume or convert display is used. Press  at least 5 times and insure that a stable reading is being obtained.



Enter the actual space or level (P-2).

Press , the MultiRanger Plus will now calculate the correct measurement offset to be used in future measurements and automatically enter it into P-62.

P-61 empty calibration

this provides sound velocity compensation on an empty tank. This is required on a volume application where the atmosphere in the tank is other than air or the atmospheric temperature is constant but other than 20 °C and no temperature sensor is being used. (F = - - - -)

Empty tank is much as permissible. Leave filled with normal vapour and at normal operating temperature.

Press , the MultiRanger Plus will take a measurement and display the space or level (P-2) in the linear units chosen (P-1) regardless if percent, volume or convert display is used. Press  at least 5 times and insure that a stable reading is being obtained.

Enter the actual space or level (P-2).

Press , the MultiRanger Plus will now calculate in correct sound velocity to be used in future measurements and automatically enters it into P-63 and P-64.

P-62 measurement offset

this displays the measurement offset: used in conjunction with a full tank calibration, P-60, or an offset value may be entered directly. The offset is added to the ultrasonic measurement such that its effect will be carried through the reading (P-39, P-76 or ), mA output and relay setpoints. (F = 0.000)

P-63 sound velocity at 20 °C

can be used to enter the known velocity, at 20 °C, of sound in a particular gas or vapour or to view the resultant velocity of an empty calibration (P-61), normalized to 20 °C. (F = 344.1)

the units of velocity are assumed to be:

meter / sec	if P-1 = 1 (meters), 2 (centimeters)
feet / sec	if P-1 = 3 (feet), 4 (inches)

P-64 velocity at P-65

can be used to enter the known velocity, at the temperature of P- 65, of sound in a particular gas or vapour or to view the resultant velocity of an empty calibration, at the temperature of P- 65. (F = 344.1)

the units of velocity are assumed to be:

meters / sec	if P-1 = 1 (meters), 2 (centimeters)
feet / sec	if P-1 = 3 (feet), 4 (inches)

P-65 air temperature in °C, as measured by temperature sensor or programmed transducer operating temperature, if sensor is not used, enter temperature required in °C (F = 20 °C)

P-66 maximum air temperature in °C

records maximum air temperature measured by temperature sensor.

Press  then  to reset (F = - 99 °C)

P-67 minimum air temperature in °C

records the minimum air temperature measured by temperature sensor.

Press  then  to reset (F = 150 °C)

Parameters in P-68 through P-75 are used to stabilize the reading. These are general purpose parameters, suitable for all applications.

P-68 fill damping

is the maximum rate at which the display reading and analog output will change under filling conditions. The damping rate is measured in P-1 units per minute and has a range of 0.001 to 9999. Thus the smaller the number entered, the greater the damping.

enter desired amount (F = 10.00 m / min).

In pump up applications, for safe operation it is suggested that the damping value allow for level changes at the pumps maximum operating capacity, rather than the process design value.

P-69 empty damping

is the maximum rate at which the display reading and analog output will change under emptying conditions. The damping rate is measured in P-1 units per minute and has a range of 0.001 to 9999. Thus the smaller the number entered, the greater the damping.

enter desired amount (F = 10.00 m / min).

In pump down applications, for safe operation it is suggested that the damping value allow for level changes at the pumps maximum operating capacity, rather than the process design value.

P-70 process rate display (V)

display the rate of filling (+) or emptying (-) in P-1 units / minute

P-71 process rate filter

controls the response of the rate display

enter option: 0 = continually averaged rate

1 = update rate every minute or 50 mm (F)

2 = update rate every 5 minutes or 100 mm

3 = update rate every 10 minutes or 300 mm

99 = programmable *

* this option is divided into two levels of subparameters:

» S-71: time in seconds

» D-71: distance in linear units as set in P-1

Access is made by scrolling through the levels.

<i>press</i>	<i>display will show</i>
	P-71
ALT DISP	!
9 9	99
ENTER	99
★	5-71
★	d-71
★	P-71

Setting the subparameters is done the same way as with the ' P ' parameters.

P-72 fuzz filter

the fuzz filter is designed to keep the display constant when minor changes on the surface of the liquid (ripples), electrical noise or air movements in the vessel occur.

enter:

0 = off

1 = on (F)

P-73 agitator discrimination

enter:

0 = off

1 = on (F)

P-74 fail-safe mode

in the event of a loss of echo, the MultiRanger Plus will flash " LOE " and go into one of the following fail-safe modes after the timer (P-75) expires

enter: 1 = high
2 = low
3 = hold last entry (F)

P-75 fail-safe timer

the amount of time delay before going into fail-safe mode enter " desired amount of time ", in minutes (F = 15.00)

e.g. for 30 sec. time delay, enter " 0.5 "

Parameter P-76 through P-78 are used for measurement and simulation.

DISPLAY:

select desired parameter

P-76, 77 or 78 press  , the display will show the reading of the last ultrasonic measurement





press  to update ultrasonic measurement

SIMULATION:

select desired parameter

P-76, 77 or 78 press  , the display will show the simulated rise and fall of the material level

The simulation will raise and lower the material level through the calibrated span, P-4, at a rate of 1% of the span per second. On the DLD application, one side (relay / LED 5 ON) is kept at a constant level, while the other side (relay / LED 5 OFF) is varied. The DLD simulation will alternate every 6 seconds.

Pressing  during simulation causes the apparent level to rise. Holding in , increases the rate of filling. Pressing  causes the level to fall. Holding in , increases the rate of emptying. During simulation, relay LED's, alarm relays and mA output are all enabled to allow full response of the MultiRanger Plus. Pump relays are maintained in a de-energized state throughout simulation (unless P-0 = - 1), however the corresponding relay LED's will respond. Relay LED's for pumps will not be illuminated within 1 second, simulating the 10 second start delay under actual operation. As damping, fuzz filtering and agitator discrimination are not required, they are turned off.

To end simulation program, press  twice.

P-76 reading

this is one of the optional displays selected in the display options parameter, P-39. It can also be obtained by pressing . This reading incorporates both the measurement and display offsets.

MODE (P-2)	READING (linear, %, volume)
material	material
space	space
DLD	differential
volume total	material
OCM	head

P-77 material level

this is the actual material level referenced to zero or empty level in m, cm, ft or in.

P-78 space or distance

this is the actual distance from the transducer face to the material level in m, cm, ft. or in.

Parameters P-79 through P-88 are used for echo processing and analysis.

P-79 scope displays

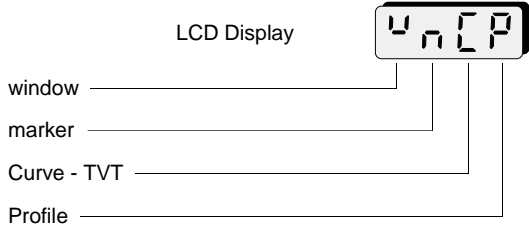

select any combination of scope displays

0 = scope display off (display ' _ ') (F = _ _ _ _)

1 = scope display on (display ' **u** , **n**, **C** or **P**')

press

e.g. to display the curve and the profile on the oscilloscope:

press , enter " 0110 "

press , display will show

P-80 echo confidence (V)

a measure of echo reliability. Press to make an ultrasonic measurement and the updated echo confidence will be displayed. This feature is useful when aiming the transducer.

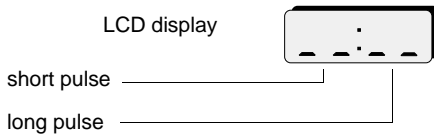

display:

e.g. short pulse confidence of '11' / long pulse confidence of '2' (dB)

e.g. short pulse confidence of '19' / no long pulses transmitted

pulses transmitted, but no echo
(check for faulty transducer or wiring)

submersible transducer submerged (P-23 = 1)

P-81 confidence threshold for short measurement

minimum echo confidence for echoes within 1 meter of transducer. If echoes are beyond 1 meter or have a confidence under the threshold level, the short measurement will be ignored and the long measurements will become valid.

Enter threshold. (F = 10)

Typical usage; if transducer were picking up small unwanted echoes from close in, increase threshold to a value above that of the echo confidence (P-80) so that close in echoes are no longer detected.

P-82 confidence threshold for long measurement

minimum echo confidence for long measurements. If no echo confidences meet this threshold, a loss of echo condition will prevail.

Enter threshold. (F = 5)

Typical usage; during filling of vessel, material intersects beam path. Instead of displaying wrong level, increasing threshold to a value above that of the echo confidence (P-80) will force the MultiRanger Plus into fail-safe.

P-83 echo strength (v)

displays the absolute strength of the selected echo in dB above 1 uV rms

P-84 noise

average and peak ambient noise, in dB above 1 uV rms

Ambient noise includes acoustical and electrical noise being picked up by the transducer / receiver circuit when the transmit / receive cycles have been disabled during the program mode.

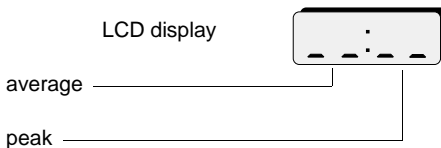

P-85 echo processing algorithms for long pulses
(for short pulses, a fixed algorithm is automatically selected)

enter: 1 = best echo of first and largest (F)
2 = first echo
3 = largest echo

P-86 TVT curve

enter: 1 = standard (F)
2 = flat

typical usage; solids applications where low confidence is obtained,
using flat echo extraction may yield higher confidence.

P-87 range extension

used to extend the measurement range into the far end blanking.

In applications where the zero level does not correspond to the bottom of the vessel and it is desired to monitor this zone, the far end blanking may need to be reduced. This is accomplished by entering a range extension value as the percentage of P-3 which equals the extra distance required. If it found that false echoes are appearing ahead of the far end blanking zone, the range extension should be decreased by reducing the factory set value of 20%.

enter, as percent of P-3, distance below 0 not blanked (F = 20)

P-88 number of transmit pulses

this parameter is used to select the number and duration of the pulses to be transmitted per measurement.

enter: 1 = one short pulse only
2 = one long pulse only
3 = two long pulses and one short pulse
4 = one short pulse if target is within 1 m, or
one short pulse and two long pulses if target
is beyond 1 m (F)

Parameters P-89 through P-98 are used for testing.

P-89 software revision number (V)

P-90 memory test (V)

press  the display will show

' PASS ' » memory test passed

' 1 ' » RAM failure

' 2 ' » EPROM failure

' 3 ' » EEPROM failure

P-91 LCD, LED and relay test (V)

**This test will cause the relays to change state.
Be sure to lock out all applicable alarms,
pumps and machinery before pressing " Enter "**

press  » LCD characters should flash sequentially
» all relays should turn on and off sequentially
» all LED's should flash sequentially
» press any key to stop

P-92 mA output test

used to display the last mA output (in the RUN mode, press 5)

A test value may be entered with the keypad or obtained by pressing  . The value displayed is transmitted via TB1. Upon returning to the RUN mode, the parameter value will assume the actual mA output level. (F = 0.000)









































P-93 temperature sensor resistance in K ohms (V)

P-94 transmitter test (V)

press  , the transmitter will fire at a regular rate and the transmit neon LI will flash correspondingly.
Press any other key to stop. (F = - - - -)

P-95 programmer test (V)

press , then press each key from left to right starting with the top row. The display will acknowledge each key pressed:



Key	Display	Key	Display
			
			
			
			
			
			
			
			
			
			

if any key is pushed out of sequence or malfunctions, the display will show ' FAIL '. Press  to return to the parameter mode.

P-96 watchdog reset test (V)

press , hyphens will flash for 5 seconds or less and then the MultiRanger Plus goes into the run mode. Should the test fail, the MultiRanger Plus will not go back into the run mode.

P-97 trim for 4 mA

when this parameter is selected, the mA output goes to 4 mA. This display however, will show a typical value of 200. The value can be increased or decreased by pressing  or  respectively, or by entering a value. This will proportionally change the mA output value so that remote equipment will read 4 mA. This parameter is not reset by P-99.

e.g. select P-97

<i>press</i>	<i>display will show</i>	<i>meter will show</i>

P-98 trim for 20 mA

When this parameter is selected, the mA output goes to 20 mA. The display however, will show a typical value of 3490. The value can be increased or decreased by pressing or respectively or by entering a value. This will proportionally change the mA output value so that remote equipment will read 20 mA. This parameter is not reset by P-99.

e.g. select P-98

<i>press</i>	<i>display will show</i>	<i>meter will show</i>

P-99 master reset

used to reset ALL parameters to their factory setting.

<i>press</i>	<i>display will show</i>



All parameters have now been returned to their factory settings. ■

TROUBLESHOOTING

GENERAL

There are a few adjustments for echo processing and they should be used judiciously.

Transducer location and aiming are the most important factors affecting the reliability of the MultiRanger Plus. Location and aiming of the transducer may be

optimized by pressing  to view the confidence level while in the RUN mode. In the PROGRAM mode, the same can be achieved by observing the echo confidence, P-80 and pressing .

OSCILLOSCOPE

An oscilloscope can be used to view the transmit, receive and processed echo signals.

Connect as follows:

<i>oscilloscope</i>	<i>location</i>	<i>description</i>
probe	J1,RCVR,board A	amplified receiver signal
	J2,SCOPE,board A	processed echo
	TB1-8,board B	raw transmit/receive signal
external trigger	J3,SYNC,board A	oscilloscope synchronization
ground	J4,COM,board A	ground

The transmit and receive signals are best viewed while in the run mode or with P-94, transmitter test, set to fire automatically in the program mode. This may be useful when aiming the transducer to obtain the best echo.

To view the processed echo, P-79 must be set for the desired display. If the PROGRAM mode is exited for more than 10 minutes, P-79 will have to be reset to view the displays on the oscilloscope.

The processed echo can be viewed and updated by pressing . This must be done while in the program mode, but can be done while viewing any parameter. For example, echo analysis parameters 79 - 84 or echo processing parameters 85 - 87 can be viewed or changed while monitoring results on both the MultiRanger Plus display and on the oscilloscope.

The processed echo display (P-79) can be made to show not only the processed echo profile, but also the:

- echo marker
- window
- TVT curve or auxiliary window

Typical scope settings for viewing the processed echo are:

- gain - 1 v / d
- sweep - 1 msec / div

The following are restricted to transmission in air at 20 °C.

- to obtain a time measurement of the processed echo, the sweep time must be multiplied by a factor of 10
- to obtain a time measurement of the transmit or receive signal, use the actual sweep setting
- to obtain a distance measurement of either of the above types of echoes, divide the respective time measurement by 1.8 msec / ft or 5.9 msec / m

Typical Scope Display

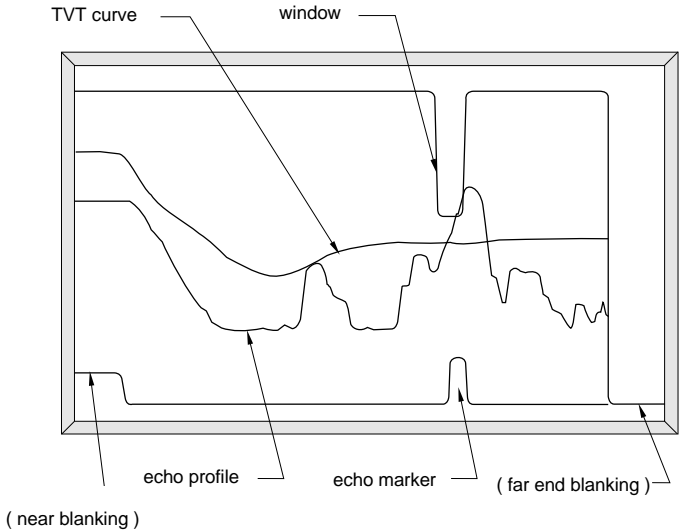

Scope Display

Window
 Marker
 Curve - TVT
 Profile

LCD display (P-79)

u
 n
 c
 P

TROUBLESHOOTING GUIDE

The following is a list of operating symptoms, their probable causes and the actions to resolve them.

SYMPTOM	CAUSE	ACTION
Loss of Echo (LOE) display will flash CAbL / LOE, neon L1 will flash but no pulsing is felt on the transducer face	open circuit	check transducer wiring *
	defective transducer	check maximum temperature P-66 against transducer rating * try a substitute
display will flash CAbL / LOE, neon L1 remains off and no pulsing is felt on the transducer face	short circuit	check transducer wiring *
	defective transducer or circuit board	check maximum temp. P-66 against transducer rating * try a substitute
display will flash LOE, neon L1 will flash, pulsing is felt on transducer face	level or target is out of range. Under optimum conditions maximum range is 15 m plus 20% of P-3	check transducer specifications * check calibration parameters
	application too dusty or steamy. Under these conditions range may be adversely affected	re-aim transducer * use polyethylene foam faced transducer for dusty applications *. DO NOT USE ON WET APPLICATIONS
	if condition occurs only during filling, the transducer face may be covered. Shipping cardboard or material build-up on transducer face	if using ST25, try ST50 for longer range increase fail-safe timer, P-75 clean move transducer to better location * mount in standpipe *

* refer to associated transducer manual

SYMPTOM	CAUSE	ACTION
. . . continued	transducer location or aiming : - poor installation - moved by material or vibration - flanging not level transducer malfunction - temperature too high or low - physical damage - excessive foam on liquid face	re-locate or re-aim transducer for maximum echo confidence, P-80 * check P-65, 66 & 67 inspect use foam deflector or stilling well
Reading does not change, but the level does	MultiRanger Plus processing wrong echo, i.e. vessel wall, structural member, stationary agitator, material hang-up or rat-tailing transducer ringing, reading high level	re-aim transducer * check echoes with oscilloscope transducer must not be in contact with metal * mounting need only be hand tight * increase blanking, P-5 check echoes with oscilloscope raise short measurement confidence threshold, P-81
Measurement is consistently off by a constant amount	measurement offset	refer to P-60 & 62 and the volume application example
Reading error progressively worsens with distance	temperature compensation sound velocity compensation	install temperature sensor [▲] P-61 & 63, and the volume application example
Screen blank, neon L1 not flashing	loss of power	check power wiring, jumpers and fuse.

* refer to associated transducer manual

▲ refer to associated temperature sensor manual

SYMPTOM	CAUSE	ACTION
MultiRanger Plus will not respond to programmer	programmer improperly positioned	refer to installation
	infrared window obstructed	clean
	programmer battery low	test programmer P-95
Reading erratic	echo confidence weak	refer to P-85, 86 87 & 88
	liquid surface agitated	increase damping, P-68 & 69, turn on fuzz filter P-72
	material filling	relocate transducer * increase damping, P-68 & 69
	electrical noise	check P-84 under quiescent conditions, noise should be under 15 dB transducer cable must be in grounded metal conduit and cable grounded only at TB-1 * increase damping, P-68 & 69
	agitator blades	set P-73 to 1
Reading 'EEEE'	reading too large	re-calibrate, i.e. P-3, 4, 37, 52 & 53
Reading response slow	damping too high	increase P-68 & 69
	agitator on	turn off P-73
	fuzz filter on	turn off P-72
Reads correctly but occasionally reads high when vessel is not full	detecting close range echo or ringing	increase blanking increase short measurement threshold, P-81
		transducer mounting *
High level reading lower than material level	material is within near blanking zone (P-5).	decrease blanking limit material high
	Echo multiple being level processed	

* refer to associated transducer manual



MAINTENANCE

The MultiRanger Plus requires no maintenance, however a program of periodic checks would be beneficial.

The enclosure and circuit boards should be cleaned if necessary, but only when the power is disconnected at the main breaker and using a vacuum cleaner and a clean, dry paint brush. Check all electrical contacts for corrosion and arcing.

If the MultiRanger Plus is mounted in a dusty or oily environment, make sure that the programmer and front cover are kept clean, otherwise it may impede the infrared signal transmission required for programming.

It is also a good idea to periodically check the face of the transducer. It should be free of material build-up, corrosion or deformation.



SOUND VELOCITIES

GASES (0 °C)	m/sec	ft/sec
air, dry	331	1086
ammonia	415	1362
argon	308	1010
carbon dioxide	259	850
carbon monoxide	338	1109
chlorine	206	676
deuterium	890	2920
ethane (10 °C)	308	1010
ethylene	317	1040
helium	965	3166
hydrogen	1284	4213
hydrogen bromide	200	656
hydrogen chloride	206	676
hydrogen iodide	157	515
hydrogen sulfide	289	948
illuminating (coal gas)	453	1486
methane	430	1411
neon	435	1427
nitric oxide (10 °C)	324	1063
nitrogen	334	1096
nitrous oxide	263	863
oxygen	316	1037
sulfur dioxide	213	699
 VAPOURS (97 °C)		
acetone	230	755
benzene	202	663
carbon tetrachloride	145	476
chloroform	171	561
ethanol	269	883
ethyl ether	206	676
methanol	335	1099
water vapour (134 °C)	494	1621

GLOSSARY

Aeration:	air gap between nappe and weir.
Beam angle:	angle between the opposing one-half power limits (-3 dB) of the sound beam
Blanking:	zone in which received echoes are ignored.
Crest:	the edge (sharp-crested weir) or surface (broad crested weir) over which the flow passes.
EEPROM:	electrically erasable programmable read only memory.
EPROM:	erasable programmable read only memory.
Flume:	a 3 part hydraulic structure, consisting of converging, throat and diverging sections, to constrict the flow through the throat, thereby increasing the head in the converging section. The change in head is proportional to the change in flow.
Free flow:	downstream liquid level is low enough or the discharge flow is fast enough, so as not to impede flow through the flume or weir.
Gauge well:	same as stilling well.
Head:	liquid level above zero (static) reference level.
LCD:	liquid crystal display.
Max head:	head at maximum flow rate.
Measurement:	each time a transmit pulse or set number of pulses is sent to the transducer.
Nappe:	the jet of liquid leaving the weir crest.
OCM:	open channel measurement
Primary measuring device:	hydraulic structure of an open channel for measuring liquid flow. e.g. weirs and flumes.
Ringling:	the inherent nature of the transducer to continue vibrating after the transmit pulse has ceased.
Secondary measuring device:	any instrument for measuring the head or flow related to the primary measuring device.

Stilling well:	a well separate from but adjacent to the primary measuring device and interconnected by a small duct to provide an ideal point of head measurement.
Subcritical flow:	same as submerged flow.
Submerged flow:	when the downstream level rises or the discharge flow is so slow that it impedes the free flow of liquid through the primary measuring device.
Ullage:	the remaining spatial volume of a vessel or the volume required to fill a vessel.
Weir:	a dam with or without flow notch across an open channel to produce a crest in the liquid upstream. The head of the crest is proportional to the flow.

ALPHABETICAL PARAMETER LISTING

PARAMETER	#	PARAMETER	#
agitator discrimination	P-73	pump 5, hours	P-28
air temperature	P-65	pump, run-on, duration	P-30
air temperature, maximum	P-66	pump, run-on, interval	P-29
air temperature, minimum	P-67	range extension	P-87
algorithms	P-85	rate display	P-70
analog output	P-6	rate filter	P-71
analog output, DLD	P-32	relay 1, function	P-8
analog output, OCM	P-50	relay 2, function	P-11
analog output, trim, 4 mA	P-97	relay 3, function	P-14
analog output, trim, 20 mA	P-98	relay 4, function	P-17
auto zero (OCM)	P-47	relay 5, function	P-20
blanking	P-5	relay 1, setpoint, off	P-10
confidence	P-80	relay 2, setpoint, off	P-13
confidence threshold, short	P-81	relay 3, setpoint, off	P-16
confidence threshold, long	P-82	relay 4, setpoint, off	P-19
convert display	P-37	relay 5, setpoint, off	P-22
convert display, totalizer	P-52	relay 1, setpoint, on	P-9
damping, empty	P-69	relay 2, setpoint, on	P-12
damping, fill	P-68	relay 3, setpoint, on	P-15
decimal point	P-7	relay 4, setpoint, on	P-18
decimal point, OCM	P-49	relay 5, setpoint, on	P-21
decimal point, totalizer	P-53	relay, flow sampler, exponent	P-57
display reading options	P-39	relay, flow sampler, mantissa	P-58
echo strength	P-83	relay, time sampler	P-59
empty calibration	P-61	remote totalizer	P-56
empty distance	P-3	reset	P-99
exponent (OCM)	P-42	scope displays	P-79
fail-safe	P-74	security	P-0
fail-safe timer	P-75	simulation, distance	P-78
flume dimension	P-43	simulation, material level	P-77
full calibration	P-60	simulation, OCM	P-51
fuzz filter	P-72	simulation, reading	P-76
high total	P-55	software version	P-89
inflow/discharge totalling (pump)	P-33	sound velocity at 20 °C	P-63
low head cutoff (OCM)	P-48	sound velocity at air temperature	P-64
low total	P-54	span	P-4
maximum flow rate	P-46	tank dimension A	P-35
maximum head	P-45	tank dimension L	P-36
measurement, distance	P-78	tank shape	P-34
measurement, material level	P-77	test, analog output	P-92
measurement, reading	P-76	test, programmer	P-95
mode of measurement	P-2	test, memory	P-90
noise	P-84	test, temperature sensor	P-93
number of transmit pulses	P-88	test, transmitter	P-94
offset, display	P-38	test, watchdog reset	P-96
offset, measurement	P-62	test, LCD, LED and relay	P-91
primary measuring device	P-40	transducer, submersible	P-23
pump 1, hours	P-24	TVT curve	P-86
pump 2, hours	P-25	units	P-1
pump 3, hours	P-26	units, flow rate time	P-41
pump 4, hours	P-27		