

SIEMENS

Configuration Manual

SIMOTICS

SIMOTICS S-1FT7 synchronous motors

For SINAMICS S120

Edition

09/2018

www.siemens.com

SIEMENS

SIMOTICS

Drive technology S-1FT7 synchronous motors

Configuration Manual

Introduction

Fundamental safety
instructions

1

Description of the motors

2

Mechanical properties

3

Motor components and
options

4

Configuration

5

Technical data and
characteristic curves

6

Preparation for use

7

Electrical connection

8

Assembly
drawings/dimension sheets

9



Appendix

A

Legal information

Warning notice system

This manual contains notices you have to observe in order to ensure your personal safety, as well as to prevent damage to property. The notices referring to your personal safety are highlighted in the manual by a safety alert symbol, notices referring only to property damage have no safety alert symbol. These notices shown below are graded according to the degree of danger.

 DANGER
indicates that death or severe personal injury will result if proper precautions are not taken.
 WARNING
indicates that death or severe personal injury may result if proper precautions are not taken.
 CAUTION
indicates that minor personal injury can result if proper precautions are not taken.
NOTICE
indicates that property damage can result if proper precautions are not taken.

If more than one degree of danger is present, the warning notice representing the highest degree of danger will be used. A notice warning of injury to persons with a safety alert symbol may also include a warning relating to property damage.

Qualified Personnel

The product/system described in this documentation may be operated only by **personnel qualified** for the specific task in accordance with the relevant documentation, in particular its warning notices and safety instructions. Qualified personnel are those who, based on their training and experience, are capable of identifying risks and avoiding potential hazards when working with these products/systems.

Proper use of Siemens products

Note the following:

 WARNING
Siemens products may only be used for the applications described in the catalog and in the relevant technical documentation. If products and components from other manufacturers are used, these must be recommended or approved by Siemens. Proper transport, storage, installation, assembly, commissioning, operation and maintenance are required to ensure that the products operate safely and without any problems. The permissible ambient conditions must be complied with. The information in the relevant documentation must be observed.

Trademarks

All names identified by ® are registered trademarks of Siemens AG. The remaining trademarks in this publication may be trademarks whose use by third parties for their own purposes could violate the rights of the owner.

Disclaimer of Liability

We have reviewed the contents of this publication to ensure consistency with the hardware and software described. Since variance cannot be precluded entirely, we cannot guarantee full consistency. However, the information in this publication is reviewed regularly and any necessary corrections are included in subsequent editions.

Introduction

Additional documents

For configuring, you require Catalog D 21.4 (<https://support.industry.siemens.com/cs/document/109747019/>) as print version or online.

More information

Information on the following topics is available at:

- Ordering documentation / overview of documentation
- Additional links to download documents
- Using documentation online (find and search in manuals / information)

More information (<https://support.industry.siemens.com/cs/de/en/view/108998034>)

If you have any questions regarding the technical documentation (e.g. suggestions, corrections), please send an e-mail to the following address E-mail (<mailto:docu.motioncontrol@siemens.com>).

Target group

This documentation addresses project planners and project engineers as well as machine manufacturers and commissioning engineers.

Benefits

The Configuration Manual enables the target group to apply the rules and guidelines to be observed when configuring products and systems.

The Configuration Manual supports you with selecting motors, calculating the drive components, and selecting the required accessories. The Configuration Manual helps the target group to create a system or plant configuration.

Utilization phase

Planning and configuration phase

My support

The following link provides information on how to create your own individual documentation based on Siemens content, and adapt it for your own machine documentation:

My support (<https://support.industry.siemens.com/My/de/en/documentation>)

Note

If you want to use this function, you must first register.

Later, you can log on with your login data.

Training

The following link provides information on SITRAIN - training from Siemens for products, systems and automation engineering solutions:

SITRAIN (<http://siemens.com/sitrain>)

Technical Support

Country-specific telephone numbers for technical support are provided on the Internet under Contact:

Technical Support (<https://support.industry.siemens.com>)

Internet address for products

Products (<http://www.siemens.com/motioncontrol>)

Websites of third parties

This publication contains hyperlinks to websites of third parties. Siemens does not take any responsibility for the contents of these websites or adopt any of these websites or their contents as their own, because Siemens does not control the information on these websites and is also not responsible for the contents and information provided there. Use of these websites is at the risk of the person doing so.

Information regarding third-party products

Note

Recommendation relating to third-party products

This document contains recommendations relating to third-party products. Siemens accepts the fundamental suitability of these third-party products.

You can use equivalent products from other manufacturers.

Siemens does not accept any warranty for the properties of third-party products.

Table of contents

	Introduction	3
1	Fundamental safety instructions	11
1.1	General safety instructions	11
1.2	Equipment damage due to electric fields or electrostatic discharge	16
1.3	Industrial security	17
1.4	Residual risks of power drive systems.....	19
2	Description of the motors	21
2.1	Highlights and benefits.....	21
2.2	Intended use	23
2.3	Technical features and environmental conditions	24
2.3.1	Standards and guidelines	24
2.3.2	Technical features.....	26
2.3.3	Torque overview	28
2.3.4	Environmental conditions.....	30
2.4	Derating factors.....	32
2.5	Selection based on the article number	33
2.6	Rating plate data (type plate).....	36
3	Mechanical properties	37
3.1	Cooling.....	37
3.1.1	Natural cooling	37
3.1.2	Forced ventilation.....	39
3.1.3	Water cooling	40
3.1.3.1	Cooling circuit	41
3.1.3.2	Pressure conditions in the cooling circuit.....	44
3.1.3.3	Specification of the cooling water	46
3.1.3.4	Coolant connection	48
3.2	Degree of protection	50
3.3	Types of construction.....	52
3.4	Bearing versions	52
3.5	Flange forms	53
3.6	Shaft extension	54
3.7	Radial and axial forces.....	54
3.7.1	Sample calculation of the belt pre-tension.....	54
3.7.2	Radial force loading	55
3.7.3	Radial force diagrams	56
3.7.4	Axial force loading.....	60

3.8	Radial eccentricity, concentricity and axial eccentricity	61
3.9	Balancing	62
3.10	Vibration response	62
3.11	Noise emission	64
3.12	Bearing change interval	64
3.13	Service and inspection intervals	65
4	Motor components and options	67
4.1	Motor components	67
4.1.1	Thermal motor protection	67
4.1.2	Encoders	69
4.1.2.1	Encoders for 1FT7 motors	69
4.1.2.2	Technical specifications of the incremental encoders	71
4.1.2.3	Technical specifications of the absolute encoders	72
4.2	Options	74
4.2.1	Holding brake	74
4.2.1.1	Type of the holding brake	74
4.2.1.2	Properties	74
4.2.1.3	Technical specifications	76
4.2.2	Output coupling	77
4.2.3	Motors with planetary gearboxes	78
4.2.3.1	Properties	78
4.2.3.2	Selection and ordering data for the planetary gearboxes	78
4.2.4	Special options	80
4.2.4.1	Introduction	80
4.2.4.2	Option B02 - Manufacturer's test certificate	82
4.2.4.3	Option K20 - Reinforced bearing	83
4.2.4.4	Option L03 - Increased resistance to vibration	89
4.2.4.5	Option L06 - increased shock loads	91
4.2.4.6	Option N05 - Alternative shaft geometry	92
4.2.4.7	Option N16 - Increased chemical resistance	94
4.2.4.8	Option N27 - Brake with low moment of inertia	96
4.2.4.9	Option N40 - Increased resistance to industrial cleaning	97
4.2.4.10	Option Q12 - Sealing air connection	100
4.2.4.11	Option Q13 - Encoder sealing	102
4.2.4.12	Option Q41-Q44 - Connector outlet directions for fixed fan connectors at 1FT7117 force-ventilated	102
4.2.4.13	Options X., K23, K24, and N16 - Paint finish	103
4.2.4.14	Option Y84 - Customer data on the rating plate	106
5	Configuration	107
5.1	Configuring software	107
5.1.1	SIZER configuration tool	107
5.1.2	STARTER drive/commissioning software	107
5.2	Procedure when engineering	108
5.2.1	1. Clarification of the drive type	109
5.2.2	2. Specification of the supplementary conditions and integration into the automation system	109

5.2.3	3. Definition of the load, calculation of the maximum load torque and determination of the motor	110
5.3	Dimensioning the gearbox	117
5.4	Brake resistances (armature short-circuit braking)	120
5.4.1	Description of function braking resistor	120
5.4.2	Dimensioning of braking resistors	124
6	Technical data and characteristic curves	131
6.1	Explanations	131
6.2	Motor overview / assignment of Motor Modules / power cables	142
6.3	Data sheets and characteristics	150
6.3.1	1FT7 Compact - natural cooling	150
6.3.1.1	1FT7034- _A	150
6.3.1.2	1FT7036- _A	152
6.3.1.3	1FT7042- _A	154
6.3.1.4	1FT7044- _A	158
6.3.1.5	1FT7046- _A	162
6.3.1.6	1FT7062- _A	166
6.3.1.7	1FT7064- _A	170
6.3.1.8	1FT7066- _A	174
6.3.1.9	1FT7068- _A	178
6.3.1.10	1FT7082- _A	180
6.3.1.11	1FT7084- _A	186
6.3.1.12	1FT7086- _A	192
6.3.1.13	1FT7102- _A	198
6.3.1.14	1FT7105- _A	204
6.3.1.15	1FT7108- _A	210
6.3.1.16	1FT7132- _A	216
6.3.1.17	1FT7134- _A	222
6.3.1.18	1FT7136- _A	226
6.3.1.19	1FT7138- _A	230
6.3.2	1FT7 Compact - forced ventilation	232
6.3.2.1	1FT7084- _S	232
6.3.2.2	1FT7086- _S	238
6.3.2.3	1FT7105- _S	244
6.3.2.4	1FT7108- _S	248
6.3.2.5	1FT7132- _S	252
6.3.2.6	1FT7134- _S	258
6.3.2.7	1FT7136- _S	262
6.3.2.8	1FT7138- _S	266
6.3.3	1FT7 Compact - water cooling	268
6.3.3.1	1FT7062- _W	268
6.3.3.2	1FT7064- _W	272
6.3.3.3	1FT7066- _W	276
6.3.3.4	1FT7068- _W	280
6.3.3.5	1FT7082- _W	282
6.3.3.6	1FT7084- _W	288
6.3.3.7	1FT7086- _W	294
6.3.3.8	1FT7102- _W	300
6.3.3.9	1FT7105- _W	306

6.3.3.10	1FT7108-_W	312
6.3.4	1FT7 High Dynamic - natural cooling.....	318
6.3.4.1	1FT7087-_A	318
6.3.4.2	1FT7117-_A	320
6.3.5	1FT7 High Dynamic - forced ventilation.....	324
6.3.5.1	1FT7065-_S	324
6.3.5.2	1FT7067-_S	328
6.3.5.3	1FT7085-_S	332
6.3.5.4	1FT7087-_S	336
6.3.5.5	1FT7117-_S	340
6.3.6	1FT7 High Dynamic - water cooling.....	344
6.3.6.1	1FT7065-_W	344
6.3.6.2	1FT7067-_W	348
6.3.6.3	1FT7085-_W	352
6.3.6.4	1FT7087-_W	356
7	Preparation for use	361
7.1	Transporting.....	361
7.2	Storage.....	365
8	Electrical connection	367
8.1	Permissible line system types.....	367
8.2	Circuit diagram of the motor.....	367
8.3	System integration	368
8.3.1	Connection notes	368
8.3.1.1	Rotating a connector on the motor	370
8.3.1.2	Routing cables in a damp environment	374
8.3.1.3	Handling the SPEED-CONNECT connection	374
8.3.2	Connecting to a converter.....	376
8.3.3	Connecting a separately driven fan	384
8.3.4	Connecting the holding brake	387
8.3.5	Signal connection / motor protection	389
8.3.5.1	Motors with DRIVE-CLiQ interface	389
8.3.5.2	Motors without DRIVE-CLiQ interface	392
8.3.5.3	PIN assignment of the signal connectors	393
8.3.5.4	Signal cables.....	394
8.3.5.5	Connecting the signal cable on a force-ventilated motor.....	394
9	Assembly drawings/dimension sheets.....	397
A	Appendix	399
A.1	Glossary.....	399
	Index	403

Fundamental safety instructions

1.1 General safety instructions



! WARNING

Electric shock and danger to life due to other energy sources

Touching live components can result in death or severe injury.

- Only work on electrical devices when you are qualified for this job.
- Always observe the country-specific safety rules.

Generally, the following six steps apply when establishing safety:

1. Prepare for disconnection. Notify all those who will be affected by the procedure.
2. Isolate the drive system from the power supply and take measures to prevent it being switched back on again.
3. Wait until the discharge time specified on the warning labels has elapsed.
4. Check that there is no voltage between any of the power connections, and between any of the power connections and the protective conductor connection.
5. Check whether the existing auxiliary supply circuits are de-energized.
6. Ensure that the motors cannot move.
7. Identify all other dangerous energy sources, e.g. compressed air, hydraulic systems, or water. Switch the energy sources to a safe state.
8. Check that the correct drive system is completely locked.

After you have completed the work, restore the operational readiness in the inverse sequence.



! WARNING

Electric shock due to connection to an unsuitable power supply

When equipment is connected to an unsuitable power supply, exposed components may carry a hazardous voltage that might result in serious injury or death.

- Only use power supplies that provide SELV (Safety Extra Low Voltage) or PELV- (Protective Extra Low Voltage) output voltages for all connections and terminals of the electronics modules.



⚠ WARNING

Electric shock due to damaged motors or devices

Improper handling of motors or devices can damage them.

Hazardous voltages can be present at the enclosure or at exposed components on damaged motors or devices.

- Ensure compliance with the limit values specified in the technical data during transport, storage and operation.
- Do not use any damaged motors or devices.



⚠ WARNING

Electric shock due to unconnected cable shield

Hazardous touch voltages can occur through capacitive cross-coupling due to unconnected cable shields.

- As a minimum, connect cable shields and the conductors of power cables that are not used (e.g. brake cores) at one end at the grounded housing potential.



⚠ WARNING

Electric shock if there is no ground connection

For missing or incorrectly implemented protective conductor connection for devices with protection class I, high voltages can be present at open, exposed parts, which when touched, can result in death or severe injury.

- Ground the device in compliance with the applicable regulations.



⚠ WARNING

Arcing when a plug connection is opened during operation

Opening a plug connection when a system is operation can result in arcing that may cause serious injury or death.

- Only open plug connections when the equipment is in a voltage-free state, unless it has been explicitly stated that they can be opened in operation.

NOTICE**Property damage due to loose power connections**

Insufficient tightening torques or vibration can result in loose power connections. This can result in damage due to fire, device defects or malfunctions.

- Tighten all power connections to the prescribed torque.
- Check all power connections at regular intervals, particularly after equipment has been transported.

 **WARNING****Unexpected movement of machines caused by radio devices or mobile phones**

When radio devices or mobile phones with a transmission power > 1 W are used in the immediate vicinity of components, they may cause the equipment to malfunction.

Malfunctions may impair the functional safety of machines and can therefore put people in danger or lead to property damage.

- If you come closer than around 2 m to such components, switch off any radios or mobile phones.
- Use the "SIEMENS Industry Online Support app" only on equipment that has already been switched off.

 **WARNING****Unrecognized dangers due to missing or illegible warning labels**

Dangers might not be recognized if warning labels are missing or illegible. Unrecognized dangers may cause accidents resulting in serious injury or death.

- Check that the warning labels are complete based on the documentation.
- Attach any missing warning labels to the components, where necessary in the national language.
- Replace illegible warning labels.

 **WARNING**

Unexpected movement of machines caused by inactive safety functions

Inactive or non-adapted safety functions can trigger unexpected machine movements that may result in serious injury or death.

- Observe the information in the appropriate product documentation before commissioning.
- Carry out a safety inspection for functions relevant to safety on the entire system, including all safety-related components.
- Ensure that the safety functions used in your drives and automation tasks are adjusted and activated through appropriate parameterizing.
- Perform a function test.
- Only put your plant into live operation once you have guaranteed that the functions relevant to safety are running correctly.

Note

Important safety notices for Safety Integrated functions

If you want to use Safety Integrated functions, you must observe the safety notices in the Safety Integrated manuals.

 **WARNING**

Active implant malfunctions due to electromagnetic fields

Electromagnetic fields (EMF) are generated by the operation of electrical power equipment, such as transformers, converters, or motors. People with pacemakers or implants are at particular risk in the immediate vicinity of this equipment.

- If you have a heart pacemaker or implant, maintain the minimum distance specified in chapter "Correct usage" from such motors.

 **WARNING**

Active implant malfunctions due to permanent-magnet fields

Even when switched off, electric motors with permanent magnets represent a potential risk for persons with heart pacemakers or implants if they are close to converters/motors.

- If you have a heart pacemaker or implant, maintain the minimum distance specified in chapter "Correct usage".
- When transporting or storing permanent-magnet motors always use the original packing materials with the warning labels attached.
- Clearly mark the storage locations with the appropriate warning labels.
- IATA regulations must be observed when transported by air.

! WARNING**Injury caused by moving or ejected parts**

Contact with moving motor parts or drive output elements and the ejection of loose motor parts (e.g. feather keys) out of the motor enclosure can result in severe injury or death.

- Remove any loose parts or secure them so that they cannot be flung out.
- Do not touch any moving parts.
- Safeguard all moving parts using the appropriate safety guards.

! WARNING**Fire due to inadequate cooling**

Inadequate cooling can cause the motor to overheat, resulting in death or severe injury as a result of smoke and fire. This can also result in increased failures and reduced service lives of motors.

- Comply with the specified cooling requirements for the motor.

! WARNING**Fire due to incorrect operation of the motor**

When incorrectly operated and in the case of a fault, the motor can overheat resulting in fire and smoke. This can result in severe injury or death. Further, excessively high temperatures destroy motor components and result in increased failures as well as shorter service lives of motors.

- Operate the motor according to the relevant specifications.
- Only operate the motors in conjunction with effective temperature monitoring.
- Immediately switch off the motor if excessively high temperatures occur.

**! CAUTION****Burn injuries caused by hot surfaces**

In operation, the motor can reach high temperatures, which can cause burns if touched.

- Mount the motor so that it is not accessible in operation.

Measures when maintenance is required:

- Allow the motor to cool down before starting any work.
- Use the appropriate personnel protection equipment, e.g. gloves.

1.2 Equipment damage due to electric fields or electrostatic discharge

Electrostatic sensitive devices (ESD) are individual components, integrated circuits, modules or devices that may be damaged by either electric fields or electrostatic discharge.



NOTICE

Equipment damage due to electric fields or electrostatic discharge

Electric fields or electrostatic discharge can cause malfunctions through damaged individual components, integrated circuits, modules or devices.

- Only pack, store, transport and send electronic components, modules or devices in their original packaging or in other suitable materials, e.g. conductive foam rubber or aluminum foil.
- Only touch components, modules and devices when you are grounded by one of the following methods:
 - Wearing an ESD wrist strap
 - Wearing ESD shoes or ESD grounding straps in ESD areas with conductive flooring
- Only place electronic components, modules or devices on conductive surfaces (table with ESD surface, conductive ESD foam, ESD packaging, ESD transport container).

1.3 Industrial security

Note

Industrial security

Siemens provides products and solutions with industrial security functions that support the secure operation of plants, systems, machines and networks.

In order to protect plants, systems, machines and networks against cyber threats, it is necessary to implement – and continuously maintain – a holistic, state-of-the-art industrial security concept. Siemens' products and solutions constitute one element of such a concept.

Customers are responsible for preventing unauthorized access to their plants, systems, machines and networks. Such systems, machines and components should only be connected to an enterprise network or the Internet if and to the extent such a connection is necessary and only when appropriate security measures (e.g. firewalls and/or network segmentation) are in place.

For additional information on industrial security measures that may be implemented, please visit:

Industrial security (<http://www.siemens.com/industrialsecurity>)

Siemens' products and solutions undergo continuous development to make them more secure. Siemens strongly recommends that product updates are applied as soon as they are available and that the latest product versions are used. Use of product versions that are no longer supported, and failure to apply the latest updates may increase customer's exposure to cyber threats.

To stay informed about product updates, subscribe to the Siemens Industrial Security RSS Feed at:

Industrial security (<http://www.siemens.com/industrialsecurity>)

Further information is provided on the Internet:

Industrial Security Configuration Manual
(<https://support.industry.siemens.com/cs/ww/en/view/108862708>)

 **WARNING**

Unsafe operating states resulting from software manipulation

Software manipulations (e.g. viruses, trojans, malware or worms) can cause unsafe operating states in your system that may lead to death, serious injury, and property damage.

- Keep the software up to date.
- Incorporate the automation and drive components into a holistic, state-of-the-art industrial security concept for the installation or machine.
- Make sure that you include all installed products into the holistic industrial security concept.
- Protect files stored on exchangeable storage media from malicious software by with suitable protection measures, e.g. virus scanners.
- Protect the drive against unauthorized changes by activating the "know-how protection" drive function.

1.4 Residual risks of power drive systems

When assessing the machine- or system-related risk in accordance with the respective local regulations (e.g., EC Machinery Directive), the machine manufacturer or system installer must take into account the following residual risks emanating from the control and drive components of a drive system:

1. Unintentional movements of driven machine or system components during commissioning, operation, maintenance, and repairs caused by, for example,
 - Hardware and/or software errors in the sensors, control system, actuators, and cables and connections
 - Response times of the control system and of the drive
 - Operation and/or environmental conditions outside the specification
 - Condensation/conductive contamination
 - Parameterization, programming, cabling, and installation errors
 - Use of wireless devices/mobile phones in the immediate vicinity of electronic components
 - External influences/damage
 - X-ray, ionizing radiation and cosmic radiation
2. Unusually high temperatures, including open flames, as well as emissions of light, noise, particles, gases, etc., can occur inside and outside the components under fault conditions caused by, for example:
 - Component failure
 - Software errors
 - Operation and/or environmental conditions outside the specification
 - External influences/damage
3. Hazardous shock voltages caused by, for example:
 - Component failure
 - Influence during electrostatic charging
 - Induction of voltages in moving motors
 - Operation and/or environmental conditions outside the specification
 - Condensation/conductive contamination
 - External influences/damage
4. Electrical, magnetic and electromagnetic fields generated in operation that can pose a risk to people with a pacemaker, implants or metal replacement joints, etc., if they are too close
5. Release of environmental pollutants or emissions as a result of improper operation of the system and/or failure to dispose of components safely and correctly
6. Influence of network-connected communication systems, e.g. ripple-control transmitters or data communication via the network

For more information about the residual risks of the drive system components, see the relevant sections in the technical user documentation.

Description of the motors

2.1 Highlights and benefits

Overview

1FT7 synchronous motors are permanent-magnet motors with very compact dimensions.

The motors can be quickly and easily mounted due to the well-proven cross-profile for shaft heights 36 to 100.

The 1FT7 motors meet the highest demands for dynamic response and speed setting range, including field weakening, radial eccentricity, and positioning accuracy. They are equipped with state-of-the-art encoder technology and are optimized for operation on our completely digital drive and control systems.

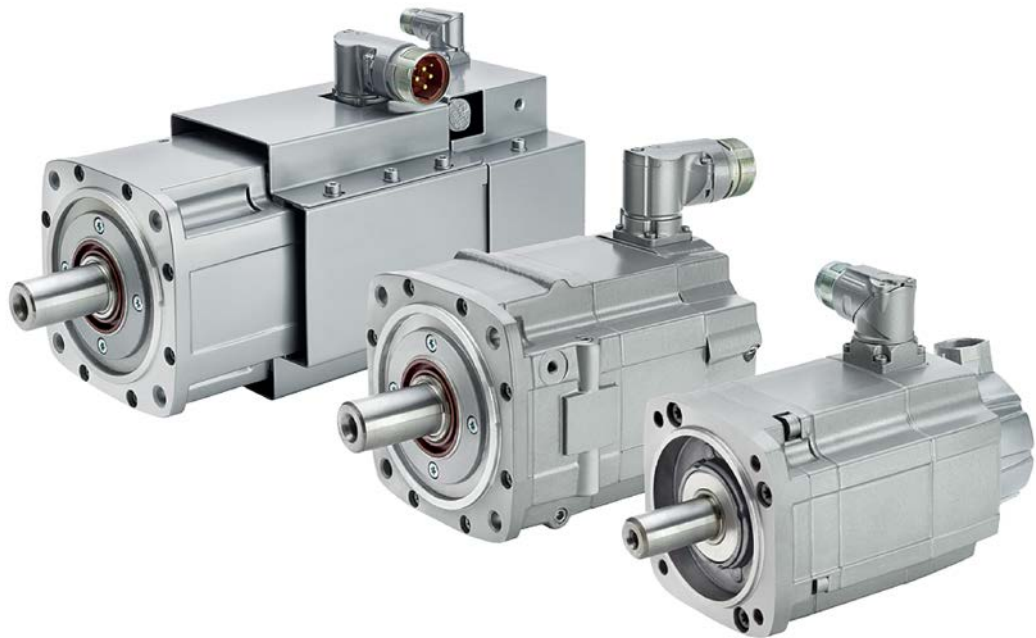



Figure 2-1 1FT7 overview

The cooling methods natural cooling, forced ventilation, or water cooling are available. Whereas in natural cooling the thermal losses are dissipated through the surface into the ambient air, in forced ventilation a mounted fan provides a constant air flow, which forcibly dissipates the thermal losses. Maximum cooling and, therefore, maximum power can be achieved using water cooling.

Benefits

- High degree of protection – allows operation even in difficult ambient conditions
- High ruggedness against vibration and shock loads as the encoder is mounted with effective vibration damping
- Quick and easy mounting due to cross-profile (for shaft heights 36 to 100) and rotatable connectors with quick-release locks
- Very high efficiency
- 1FT7 Compact motors have a low torque ripple and are therefore especially suitable for use in machine tools that require maximum surface quality and optimum machining quality. Their compact dimensions allow the motors to be mounted even where space is restricted.
- 1FT7 High Dynamic motors achieve extremely good dynamic performance and very short cycle times due to their very low rotor inertia. The 1FT7 High Dynamic motors are available in the cooling modes natural cooling, forced ventilation and water cooling. This makes these motors highly suitable for use in continuous operation.

2.2 Intended use

 WARNING
Motors not used for the intended purpose If you do not use the motors correctly, there is a risk of death, severe injury and/or material damage. <ul style="list-style-type: none">• Only use the motors for their intended purpose.• Make sure that the conditions at the location of use comply with all the rating plate data.• Make sure that the conditions at the location of use comply with the conditions specified in this documentation. When necessary, take into account deviations regarding approvals or country-specific regulations.

 WARNING
Malfunctions of active implants due to magnetic and electrical fields Electric motors endanger people with active implants, for example heart pacemakers, who come close to the motors. <ul style="list-style-type: none">• If you are affected, stay a minimum distance of 300 mm from the motors (tripping threshold for static magnetic fields of 0.5 mT according to Directive 2013/35/EU).

If you wish to use special versions and design variants whose specifications vary from the motors described in this document, then contact your local Siemens office.

If you have any questions regarding the intended usage, please contact your local Siemens office.

The 1FT7 motor is intended for industrial or commercial plants.

The motor is designed for operation in sheltered areas under normal climatic conditions, such as those found on shop floors.

The motor is only approved for operation through a converter.

More detailed information is provided in Chapter "Environmental conditions (Page 30)".

Any other application of the motor is considered to be incorrect usage.

Compliance with all of the specifications in the Operating Instructions is part of correct usage.

Observe the data on the rating plate (type plate).

Applications

- High-performance machine tools
- Machines with high requirements in terms of dynamic response and precision

2.3 Technical features and environmental conditions

2.3.1 Standards and guidelines

Standards that are complied with

The motors of the type series SIMOTICS S, SIMOTICS M, SIMOTICS L, SIMOTICS T, SIMOTICS A, called "SIMOTICS motor series" below, fulfill the requirements of the following directives and standards:

- EN 60034-1 - Rotating electrical machines – Dimensioning and operating behavior
- EN 60204-1 - Safety of machinery – Electrical equipment of machines; general requirements

Where applicable, the SIMOTICS motor series are in conformance with the following parts of IEC / EN 60034:

Feature	Standard
Degree of protection	IEC / EN 60034-5
Cooling ¹⁾	IEC / EN 60034-6
Type of construction	IEC / EN 60034-7
Connection designations	IEC / EN 60034-8
Noise levels ¹⁾	IEC / EN 60034-9
Temperature monitoring	IEC / EN 60034-11
Vibration severity grades ¹⁾	IEC / EN 60034-14

¹⁾ Standard component, e.g. cannot be applied to built-in motors

Relevant directives

The following directives are relevant for SIMOTICS motors.

European Low-Voltage Directive

SIMOTICS motors comply with the Low-Voltage Directive 2014/35/EU.

European Machinery Directive

SIMOTICS motors do not fall within the scope covered by the Machinery Directive.

However, the use of the products in a typical machine application has been fully assessed for compliance with the main regulations in this directive concerning health and safety.

European EMC Directive

SIMOTICS motors do not fall within the scope covered by the EMC Directive. The products are not considered as devices in the sense of the directive. Installed and operated with a converter, the motor - together with the Power Drive System - must comply with the requirements laid down in the applicable EMC Directive.





Eurasian conformity

SIMOTICS motors comply with the requirements of the Russia/Belarus/Kazakhstan (EAC) customs union.



China Compulsory Certification

SIMOTICS motors do not fall within the scope covered by the China Compulsory Certification (CCC).

CCC negative certification:

CCC product certification

(<https://support.industry.siemens.com/cs/products?search=CCC&ctp=Certificate&o=DefaultRankingDesc&pnid=13347&lc=de-WW // XmlEditor.InternalXmlClipboard:65c36f4c-2e8c-d8c9-ae3f-9d6074d36b88>)



Underwriters Laboratories

SIMOTICS motors are generally in compliance with UL and cUL as components of motor applications, and are appropriately listed.

Specifically developed motors and functions are the exceptions in this case. Here, it is important that you carefully observe the contents of the quotation and that there is a cUL mark on the rating plate!

Quality systems

Siemens AG employs a quality management system that meets the requirements of ISO 9001 and ISO 14001.

Certificates for SIMOTICS motors can be downloaded from the Internet at the following link:

Certificates for SIMOTICS motors

(<https://support.industry.siemens.com/cs/products?ctp=Certificate&pnid=13347&lc=de-WW // XmlEditor.InternalXmlClipboard:8c9b08a9-3f1f-5513-8cf9-8dce082595ac>)

European RoHS Directive

The SIMOTICS motor series complies with the Directive 2011/65/EU regarding limiting the use of certain hazardous substances.

European Directive on Waste Electrical and Electronic Equipment (WEEE)

The SIMOTICS motor series complies with the 2012/19/EU directive on taking back and recycling waste electrical and electronic equipment.

2.3.2 Technical features

Table 2- 1 Technical features

Motor type	Permanent-magnet synchronous motor
Magnet material	Rare-earth magnetic material
Cooling	<ul style="list-style-type: none"> • Natural cooling • Forced ventilation • Water cooling
Insulation of the stator winding according to EN 60034-1 (IEC 60034-1)	Temperature class 155 °C (F) for a winding overtemperature of $\Delta T = 100$ K at an ambient temperature of +40 °C (naturally cooled, force-ventilated) or a coolant temperature of +30 °C (water-cooled)
Impulse voltage insulation class according to EN 60034-18-41 (IEC 60034-18-41)	IVIC: C
Operating range	-15° to +40° C, derating at higher temperatures
Installation altitude for naturally-cooled and force-ventilated motors according to EN 60034-1 (IEC 60034-1)	<p>≤ 1000 m above sea level, otherwise power derating</p> <p>For installation altitudes of more than 2000 m above sea level, additional reduction of the voltage load of the motors (see ambient conditions).</p>
Type of construction according to EN 60034-7 (IEC 60034-7)	IM B5 (IM V1, IM V3)
Degree of protection according to EN60034-5 (IEC 60034-5)	IP64, optionally IP65 and IP67, motors with forced ventilation IP54
Flange form	Flange, classic (compatible 1FT6/1FK7), optional flange, compact (recessed)
Temperature monitoring according to EN 60034-11 (IEC 60034-11)	Temperature sensor in the stator winding
Paint finish	Pearl dark gray (similar to RAL 9023)
Drive shaft extension according to DIN 748-3 (IEC 60072-1)	Plain shaft, shaft with feather key
Radial eccentricity, concentricity, and axial eccentricity according to DIN 42955 (IEC 60072-1)	Tolerance N (normal) or R
Vibration severity grade according to EN 60034-14 (IEC 60034-14)	Grade A is observed up to rated speed, optional grade R
Sound pressure level according to DIN EN ISO 1680 Tolerance + 3 dB(A)	<p>Natural cooling:</p> <p>1FT703□ to 1FT706□: 65 dB(A)</p> <p>1FT708□ to 1FT713□: 70 dB(A)</p> <p>1FT7117: ≤ 80 dB(A)</p> <p>Forced ventilation:</p> <p>1FT706□ to 1FT713□: 73 dB(A)</p> <p>1FT7117: ≤ 80 dB(A)</p> <p>Water cooling:</p> <p>1FT706□: 65 dB(A)</p> <p>1FT708□ to 1FT710□: 70 dB(A)</p>

2.3 Technical features and environmental conditions

Integrated encoder system for motors without DRIVE-CLiQ interface	<ul style="list-style-type: none"> • IC2048S/R ¹⁾ incremental encoder sin/cos 1 Vpp, 2048 S/R ¹⁾ with C and D tracks • AM2048S/R ¹⁾ absolute encoder sin/cos 1 Vpp, 4096 revolutions multiturn with EnDat interface
Integrated encoder system for motors with DRIVE-CLiQ interface	<ul style="list-style-type: none"> • IC22DQ incremental encoder 22-bit (resolution 4194304, in the encoder 2048 S/R ¹⁾) + commutation position 11-bit • AM22DQ absolute encoder 22-bit singleturn (resolution 4194304, in the encoder 2048 S/R ¹⁾) + 12-bit multiturn (traversing range 4096 revolutions) • AS24DQI absolute encoder 24-bit singleturn (resolution 16777220, in the encoder 2048 S/R ¹⁾) • AM24DQI absolute encoder 24-bit singleturn (resolution 16777220, in the encoder 2048 S/R ¹⁾) + 12-bit multiturn (traversing range 4096 revolutions)
Connection	Signal and power connectors (sizes 1, 1.5 and 3; alternative for connector size 3 terminal box possible) Connector for a separately driven fan
Holding brake	Optional integrated holding brake (free of backlash, 24 V)

¹⁾ S/R = Signals/revolution

2.3.3 Torque overview

1FT7 Compact

Static torques for the 1FT7 Compact, natural cooling

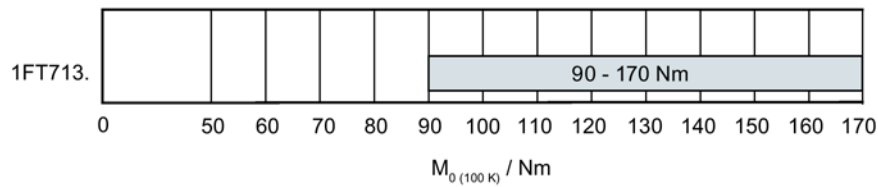
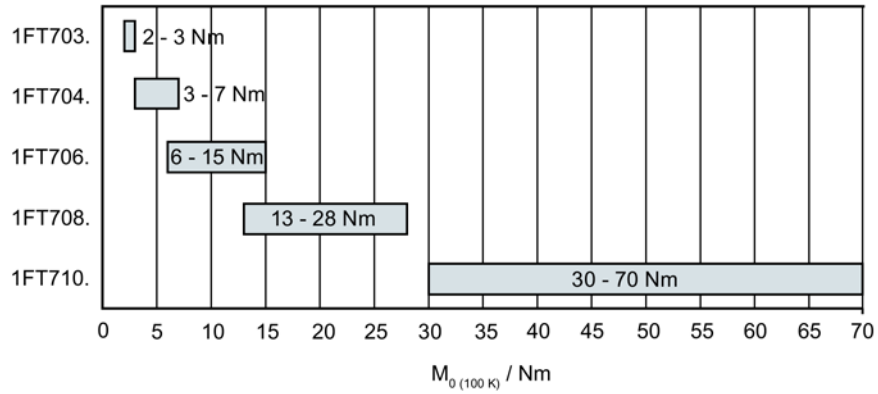

Static torques for the 1FT7 Compact, forced ventilation

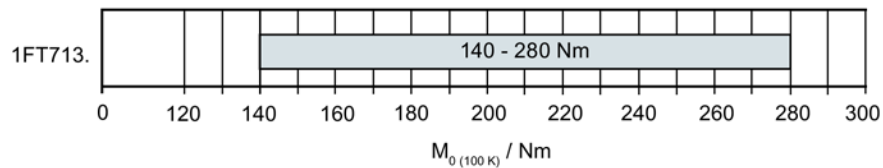
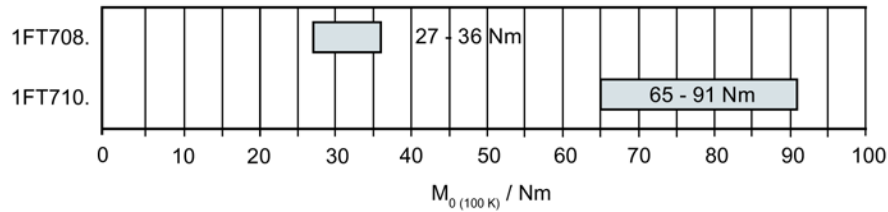

Static torques for the 1FT7 Compact, water cooling

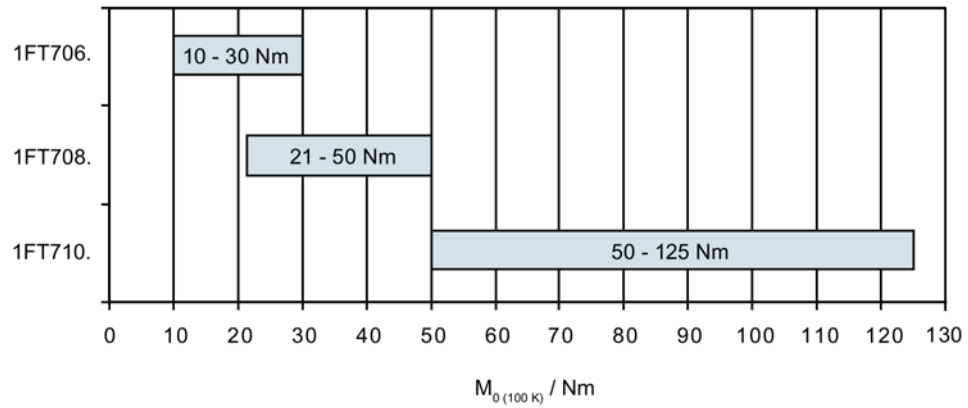

1FT7 High Dynamic

Static torques for the 1FT7 High Dynamic, natural cooling

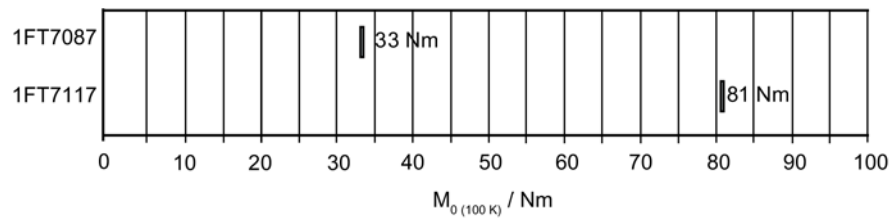
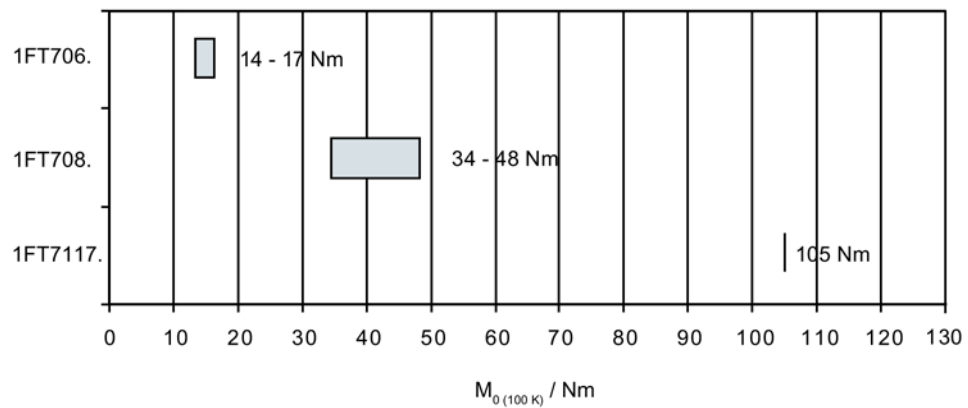
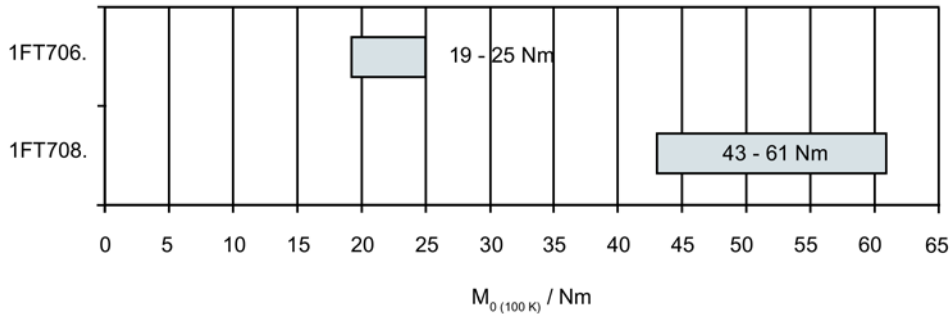

Figure 2-2 Static torque High Dyn natural cooling

Static torques for the 1FT7 High Dynamic, forced ventilation



Static torques for the 1FT7 High Dynamic, water cooling



2.3.4 Environmental conditions

You can classify the environmental conditions for stationary use at weather-protected locations according to the standard DIN IEC 60721-3-3. The environmental effects and their limit values are defined in various classes in this standard.

With the exception of environmental influences "Low air temperature", "Condensation" and "Low air pressure", you can assign SIMOTICS S-1FT7 servomotors to climate class 3K4.

The following temperature ranges apply for naturally-cooled and forced-ventilation motors.

Table 2- 2 **Environmental conditions based on climate class 3K4**

Environmental parameter	Unit	Value
a) Low air temperature	°C	- 15
b) High air temperature	°C	+ 40
c) Low relative humidity	%	5
d) High relative humidity	%	95
e) Low absolute humidity	g/m ³	1
f) High absolute humidity	g/m ³	29
g) Rate of temperature change ¹⁾	°C/min	0.5
h) Low air pressure ⁴⁾	kPa	89
i) High air pressure ²⁾	kPa	106
j) Solar radiation (insolation)	W/m ²	700
k) Thermal radiation	-	-
l) Air movement ³⁾	m/s	1.0
m) Condensation	-	Not permissible
n) Wind-driven precipitation (rain, snow, hail, etc.)	-	-

Environmental parameter		Unit	Value
o)	Water (other than rain)	-	See degree of protection
p)	Formation of ice	-	-

- 1) Averaged over a period of 5 min
- 2) Conditions in mines are not considered.
- 3) A cooling system based on natural convection can be disturbed by unforeseen air movements.
- 4) The limit value of 89 kPa covers applications at altitudes up to 1000 m.

Note

Installation instructions

SIMOTICS S motors are not suitable for operation

- In salt-laden or aggressive atmospheres
 - Outdoors
-

You can find additional data on the environmental conditions, such as ambient temperatures or conditions for transport and storage of the motors, in the relevant chapters of this documentation.

2.4 Derating factors

For deviating conditions (ambient temperature > 40 °C or installation altitude > 1000 m above sea level), you can determine the thermally permissible torques and powers from the table below. Ambient temperatures and installation altitudes are rounded up to 5°C and 500 m respectively.

Table 2- 3 Derating of the thermally permissible power as a function of the installation altitude and ambient temperature

Installation altitude above sea level [m]	Ambient temperature in °C				
	< 30	30 - 40	45	50	55
1000	1.07	1.00	0.96	0.92	0.87
1500	1.04	0.97	0.93	0.89	0.84
2000	1.00	0.94	0.90	0.86	0.82
2500	0.96	0.90	0.86	0.83	0.78
3000	0.92	0.86	0.82	0.79	0.75
3500	0.88	0.82	0.79	0.75	0.71
4000	0.82	0.77	0.74	0.71	0.67

Reduce the torque and the speed by the derating factor.

At installation altitudes of 2000 m above mean sea level or higher, the voltage load of the motors must be reduced accordingly based on the table below (reciprocal values from EN 60664-1 Table A. 2).

Table 2- 4 Factors for reducing the maximum DC-link voltage

Installation altitude up to [m] above mean sea level	Factor
2000	1
3000	0.877
4000	0.775
5000	0.656
6000	0.588
7000	0.513
8000	0.444

As the DC-link voltage is reduced, the converter output voltage also decreases. This reduces the operating range in the M-n diagram.

Consider the reduced operating range during configuration.

Operation in a vacuum is not permissible because of the low dielectric strength and poor heat dissipation.

2.5 Selection based on the article number

The article number comprises a combination of digits and letters. It is divided into three hyphenated blocks.

Possible combinations are contained in Catalog D 21.4

(<https://support.industry.siemens.com/cs/document/109747019/>).

Note that not every theoretical combination is available.

Description		Position of the article number																						
		1	2	3	4	5	6	7	-	8	9	10	11	12	-	13	14	15	16	-	Z			
SIMOTICS S-1FT7 synchronous built-in motors		1	F	D	7																			
Frame size / shaft height		SH 36			0	3																		
		SH 48			0	4																		
		SH 63			0	6																		
		SH 80			0	8																		
		SH 100			1	0																		
		SH 132			1	3																		
Overall length							2																	
							4																	
							5																	
							6																	
							7																	
							8																	
Feature	Core type								1															
	Compact								5															
	High Dynamic								7															
	Special version								9															
Cooling	Natural cooling									A														
	Water cooling									W														
	Forced ventilation									S														
Rated speeds	(380 V ... 480 V 3 AC)				1500 rpm					B														
					2000 rpm					C														
					3000 rpm					F														
					4500 rpm					H														
					6000 rpm					K														
					Special version					Z														
DC-link voltage (600 V ... 720 V)											7													
Flange-mounted version	compact (recessed)				With DRIVE-CLiQ interface					0														
					Without DRIVE-CLiQ interface					5														
	classic (compatible with 1FT6/1FK7) ¹⁾				With DRIVE-CLiQ interface					1														
					Without DRIVE-CLiQ interface					4														

2.5 Selection based on the article number

Description		Position of the article number																													
		1	2	3	4	5	6	7	-	8	9	10	11	12	-	13	14	15	16	-	Z										
Connector outlet direction		Connector size M23 and M40		Rotatable connector												1															
		Connector size M58 ²⁾		Transverse right												1															
				Transverse left												2															
				Axial NDE												3															
				Axial DE												4															
Terminal box / cable entry		Top		Transverse from the right												5															
				Transverse from the left												6															
				Axial from the NDE												7															
				Axial from the DE												8															
Encoder	With DRIVE-CLiQ	IC22DQ		RJ45 signal connection												D															
		AM22DQ		RJ45 signal connection												F															
		AS24DQI		RJ45 signal connection												B															
				M17 signal connection												K															
		AM24DQI		RJ45 signal connection												C															
				M17 signal connection												L															
	Without DRIVE-CLiQ	IC2048S/R		M23 signal connection												N															
		AM2048S/R		M23 signal connection												M															
Shaft extension	Feather key and keyway		Shaft and flange accuracy				Tolerance N		Holding brake		None	A																			
							Tolerance R				With	B																			
							Tolerance N				None	D																			
							Tolerance R				With	E																			
	Plain shaft						Tolerance N				None	G																			
							Tolerance R				With	H																			
							Tolerance N				None	K																			
							Tolerance R				With	L																			
Vibration severity grade		Grade A		Degree of protection ³⁾				IP64						0																	
								IP65						1																	
								IP67						2																	
		Grade R						IP64						3																	
								IP65						4																	
								IP67						5																	
Options ⁴⁾		Planetary gearbox mounting																		J□□											
		Reinforced bearing																		K20											
		Version for increased vibration loads																		L03											
		Version for increased shock loads ⁵⁾																		L06											
		Alternative shaft geometry																		N05											
		Increased chemical resistance																		N16											
		Brake with low moment of inertia																		N27											
		Stainless steel shaft and coating for increased chemical resistance																		N40											
		Factory certificate																		B02											

Description	Position of the article number																			
	1	2	3	4	5	6	7	-	8	9	10	11	12	-	13	14	15	16	-	Z
Sealing air connection																			Q12	
Encoder sealing																			Q13	
Connector outlet directions for fixed ventilation connectors with 1FT7117 force-ventilated																		Q41...Q44		
Customer data on the rating plate																			Y84	
Special paint finish for environmental conditions according to climate group 3K4, primer and paint finish in anthracite gray, RAL 7016																			K23	
Special paint finish for environmental conditions according to climate group 3K4, primer and additional paint finish																			K23+X..	
Primed (unpainted)																			K24	
Paint finish ⁶⁾	jet black, matt										RAL 9005					X01				
	cream										RAL 9001					X02				
	reseda green										RAL 6011					X03				
	pebble grey										RAL 7032					X04				
	sky blue										RAL 5015					X05				
	light ivory										RAL 1015					X06				
	white aluminum										RAL 9006					X08				
	anthracite gray										RAL 7016					X09				

- 1) Only up to shaft height 100
- 2) Connector size M58, cannot be rotated. A terminal box can only be selected as an alternative up to connector size M58.
- 3) For motors with forced ventilation IP54 or IP55
- 4) More detailed information is provided in Chapter "Special options (Page 80)" and in the associated Chapter "SIMOTICS Servomotors" in Catalog D 21.4 (<https://support.industry.siemens.com/cs/document/109747019/>)
- 5) Only for 1FT7117 motors
- 6) Additional colors can be found in Chapter "Special options (Page 80)" and in the associated Chapter "SIMOTICS Servomotors" in Catalog D 21.4 (<https://support.industry.siemens.com/cs/document/109747019/>)

2.6 Rating plate data (type plate)

The rating plate contains the technical specifications applicable to the motor. A second rating plate is provided loose with the motor when it is delivered.

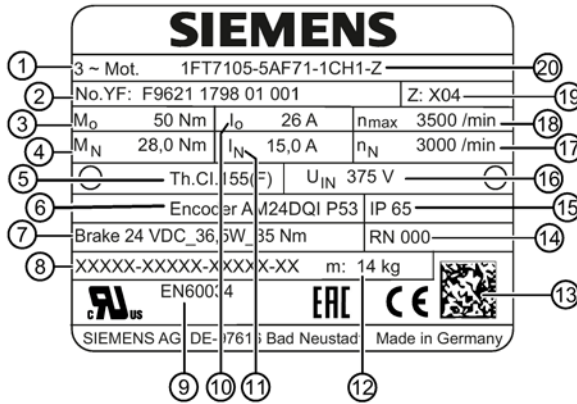

Figure 2-3 Rating plate 1FT7

Table 2- 5 Description of the rating plate data

Position	Description / Technical specifications
1	Motor type: Synchronous motors
2	ID No., serial number
3	Static torque M_0
4	Rated torque M_N
5	Temperature class
6	Code, encoder type
7	Holding brake data: Typical, voltage, power consumption
8	Field for customer data for the option Y84 (max. 20 characters, any distribution)
9	Standard according to which the motor is constructed
10	Stall current I_0
11	Rated current I_N
12	Motor weight m
13	2D code
14	Motor version
15	Degree of protection
16	Induced voltage at rated speed U_{IN}
17	Rated speed n_N
18	Maximum speed n_{max}
19	Options of the motor (up to 2 options can be represented, no marking for further options)
20	Motor type/order number

Mechanical properties

3.1 Cooling

3.1.1 Natural cooling

On naturally cooled motors, the heat loss is dissipated through thermal conduction, radiation and natural convection.

Some of the heat loss is dissipated through the mounting surface of the motor. With large motors, heat is dissipated via the base frame (steel plate).

Note the specifications on thermally non-insulated mounting and on thermally insulated mounting.

Note

To ensure enough heat is dissipated, a minimum clearance to adjacent components of 100 mm must be kept free on three side surfaces.

- Mount the motor so that there is enough clearance around it for the power loss to be thermally radiated.

The motor ratings apply at an ambient temperature of 40 °C (104 °F). If the ambient temperature exceeds 40 °C (104 °F), you must adjust the torque and power of the motor accordingly.

- Adjust the torque or the power of the motor at the converter based on the table in Chapter "Derating factors (Page 32)."
Follow the operating instructions of the converter.

Fasten the base frame to the mounting surface thermally conductively.

Non-thermally insulated mounting

For the specified motor data, the following mounting conditions apply:

Table 3- 1 Non-thermally insulated mounting conditions

Shaft height	Steel plate, width x height x thickness in mm	Mounting surface in m ²	Base plate Width x depth in mm	Surface of the base plate in m ²
36 and 48	120 x 100 x 40	0.012	150 x 350	0.053
63 to 100	450 x 370 x 30	0.17	500 x 1500	0.75
132	550 x 380 x 35	0.21	550 x 2500	1.38

For larger mounting surfaces, the heat dissipation conditions improve.

Thermally insulated mounting without additionally mounted components

For non-ventilated and force-ventilated motors, the static motor torque must be reduced by between 5% and 15%. We recommend configuring the static torque of the motor using the $M_{0(60K)}$ values. As the speed increases, the reduction factor rises, see figure "Effect of the mounting conditions on the S1 characteristic curve".

Thermally insulated mounting with additionally mounted components

- Holding brake (integrated in the motor): No additional torque reduction required
- Gearbox: Torque reduction is required, see figure "Effect of the mounting conditions on the S1 characteristic curve".

Effect of thermally insulated/non-insulated mounting without and with gearbox

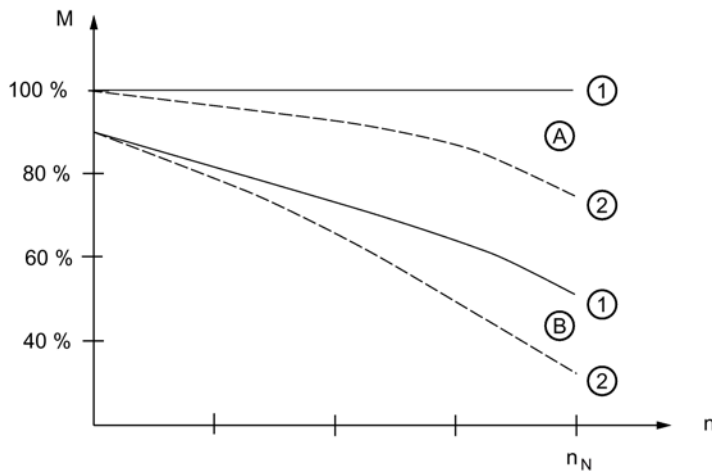

- A Non-insulated mounting
 - 1 Characteristic without mounted gearbox
 - 2 Characteristic with mounted gearbox
- B Insulated mounting
 - 1 Characteristic without mounted gearbox
 - 2 Characteristic with mounted gearbox

Figure 3-1 Effect of the mounting conditions on the S1 characteristic curve

3.1.2 Forced ventilation

This cooling method is achieved using a separate ventilation unit with a fan that is driven independently of the motor. This fan has degree of protection IP54.

WARNING

Risk of explosion when operated in hazardous environments

Operating the fan in an environment with inflammable, chemically corrosive, electrically conductive, or explosive dust or gases can cause explosions and result in death or serious injury.

- Operate the motor with forced ventilation only in an environment that is free of inflammable, chemically corrosive, electrically conductive, or explosive dust or gases.

WARNING

Hair, clothing and other objects can be drawn in

For example, hair, neckties, loose objects can be sucked into the air intake and cause death or serious injury.

- Take measures to prevent objects from being sucked in, e.g.
 - Wear a head covering or hair net,
 - Remove any neckties or similar,
 - Keep the air intake area free.

Note

Ensure that the motor is only operated when the separately driven fan is running.

Operate the fan only with normal ambient air.

Table 3- 2 Air flow direction of the forced ventilation

Motor	Air flow direction
For 1FT706□ to 1FT7117	NDE --> DE
For 1FT713□	DE --> NDE

Deposits of contaminated air can impair the heat dissipation of the motor or block the cooling duct and overheat the motor.

- Position the motor so that the cooling air can freely flow in and out.
- Make sure that no heated discharged air is drawn in.
- Maintain the minimum clearance between the air intake and discharge openings and adjacent components (see the "Minimum clearance" diagram).
- To remove the fan cover and connect the signal connector when the motor is installed, maintain a minimum clearance of 125 mm.

3.1 Cooling

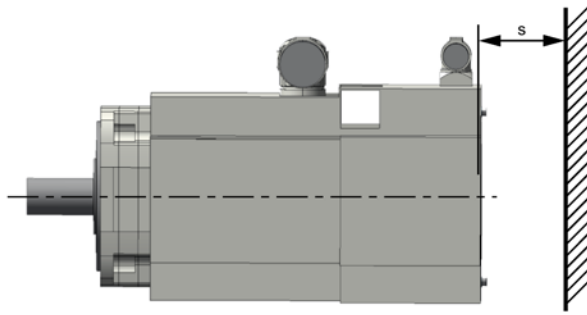

- s A minimum clearance of 30 mm applies for SH 63 and SH 80.
- A minimum clearance of 50 mm applies for SH 100.
- A minimum clearance of 60 mm applies for SH 132

Figure 3-2 Minimum clearance s

3.1.3 Water cooling

The cooling circuit has to dissipate the following cooling powers.

Cooling power to be dissipated

The specified values refer to operation at the rated speed with rated torque. The cooling water temperature must be < 30 °C.

Table 3- 3 Cooling power to be dissipated 1FT7 Compact

Motor type	Cooling power to be dissipated in kW
1FT7062-5WF7	450
1FT7062-5WK7	600
1FT7064-5WF7	650
1FT7064-5WK7	950
1FT7066-5WF7	700
1FT7066-5WH7	1000
1FT7068-5WF7	750
1FT7082-5WC7	500
1FT7082-5WF7	600
1FT7082-5WH7	800
1FT7084-5WC7	800
1FT7084-5WF7	1000
1FT7084-5WH7	1300
1FT7086-5WC7	1000
1FT7086-5WF7	1400
1FT7086-5WH7	1600
1FT7102-5WB7	1000
1FT7102-5WC7	1200

Motor type	Cooling power to be dissipated in kW
1FT7102-5WF7	1400
1FT7105-5WB7	1200
1FT7105-5WC7	1600
1FT7105-5WF7	1900
1FT7108-5WB7	1500
1FT7108-5WC7	1800
1FT7108-5WF7	1900

Table 3- 4 Cooling power to be dissipated 1FT7 High Dynamic

Motor type	Cooling power to be dissipated in kW
1FT7065-7WF7	700
1FT7065-7WH7	750
1FT7067-7WF7	800
1FT7067-7WH7	900
1FT7085-7WF7	1100
1FT7085-7WH7	1200
1FT7087-7WF7	1300
1FT7087-7WH7	1500

3.1.3.1 Cooling circuit

The motor can only be operated in a closed cooling-water circuit with a cooling unit.

Materials used in the motor cooling circuit

The materials used in the cooling circuit must be coordinated with the materials in the motor.

Table 3- 5 Materials used in the motor cooling circuit

Shaft height	Bearing shield	Pipes in the stator
1FT706x	Cast iron (EN-GJL-200)	Stainless steel
1FT708x	Cast iron (EN-GJL-200)	Stainless steel
1FT710x	Cast iron (EN-GJL-200)	Stainless steel

Materials and components in the cooling circuit

Note

Minimizing electrochemical processes in the cooling circuit

The electrochemical processes that take place in a cooling system must be minimized by choosing the right materials.

Avoid combinations of different materials, such as copper, brass, iron, or halogenated plastic (PVC hoses and seals).

The following table lists a wide variety of materials and components that may or must not be used in a cooling circuit.

Table 3- 6 Materials and components of a cooling circuit

Material	Used as	Description
Zinc	Pipes, valves and fittings	Use is not permitted.
Brass	Pipes, valves and fittings	Can be used in closed circuits with inhibitor.
Copper	Pipes, valves and fittings	Can be used only in closed circuits with inhibitors in which the heat sink and copper component are separated (e.g. connection hose on units).
Common steel (e.g. St37)	Pipes	Permissible in closed circuits and semi-open circuits with inhibitors or Antifrogen N, check for oxide formation, inspection window recommended.
Cast steel, cast iron	Pipes, motors	Closed circuit and use of strainers and flushback filters. Fe separator for stainless heat sink.
High-alloy steel, Group 1 (V2A)	Pipes, valves and fittings	Can be used for drinking or tap water with a chloride content up to < 250 ppm, suitable according to definition in Chapter "Cooling water."
High-alloy steel, Group 2 (V4A)	Pipes, valves and fittings	Can be used for drinking or tap water with a chloride content up to < 500 ppm, suitable according to definition in Chapter "Cooling water."
ABS (AcrylnitrileButadieneStyrene)	Pipes, valves and fittings	Suitable according to definition in Chapter "Cooling water." Suitable for mixing with inhibitor and/or biocide as well as Antifrogen N.
Installation comprising different materials (mixed installation)	Pipes, valves and fittings	Use is not permitted.
PVC	Pipes, valves, fittings and hoses	Use is not permitted.
Hoses		Reduce the use of hoses to a minimum (device connection). Must not be used as the main pipe for the whole system. Recommendation: EPDM hoses with an electrical resistance > 10 ⁹ Ω (e.g. Semperflex FKD supplied by Semperit or DEMITTEL; from PE/EPD, supplied by Telle).
Gaskets	Pipes, valves and fittings	Use of FPM (Viton), AFM34, EPDM is recommended.
Hose connections	Transition Hose - pipe	Secure with clips conforming to DIN EN 14420, available, e.g. from Telle.

The following recommendation applies in order to achieve an optimum motor heatsink (enclosure) service life:

- Use a closed cooling circuit with stainless steel cooling unit. The heat is dissipated via a water-water heat exchanger.
- Use ABS, stainless steel, or general construction steel for all other components, such as pipes and fittings.

Cooling system manufacturers

ait-deutschland GmbH	www.kkt-chillers.com
BKW Kälte-Wärme-Versorgungstechnik GmbH	www.bkw-kuema.de
DELTATHERM Hirmer GmbH	www.deltatherm.de
Glen Dimplex Deutschland GmbH	www.riedel-cooling.com
Helmut Schimpke und Team Industriekühlanlagen GmbH + Co. KG	www.schimpke.org
Hydac System GmbH	www.hydac.com
Hyfra Industriekühlanlagen GmbH	www.hyfra.de
Pfannenberg GmbH	www.pfannenberg.com

Note

Other manufacturers

You can also use equivalent products from other manufacturers.

Responsibility for the properties of third-party products resides with the plant manufacturer.

3.1.3.2 Pressure conditions in the cooling circuit

Consider the following pressure conditions when designing the cooling circuit.

Permissible pressure

- Define the working pressure based on the flow conditions in the supply and return pipes of the cooling circuit.

The maximum permitted pressure in the cooling circuit is 0.6 MPa (6 bar).

Note

If you use a pump that reaches a higher pressure, maintain a maximum pressure of 0.6 MPa by taking appropriate measures (pressure relief valve, pressure control, etc.).

- Design the cooling circuit to have the smallest possible pressure difference between the supply and return pipes so that pumps with a shallow characteristic curve can be used.
- Design the cooling circuit with a self-cleaning filter to avoid blockage and corrosion.

Pressure drop in the motor

NOTICE
Motor damage caused by cavitation and abrasion
An excessive pressure drop causes cavitation or abrasion damage.
<ul style="list-style-type: none">• Do not exceed the maximum permissible pressure drop.

During continuous operation, the maximum permissible pressure drop across a motor can be 0.2 MPa (2 bar).

The pressure drops for 1FT7 motors are shown in the diagram below.

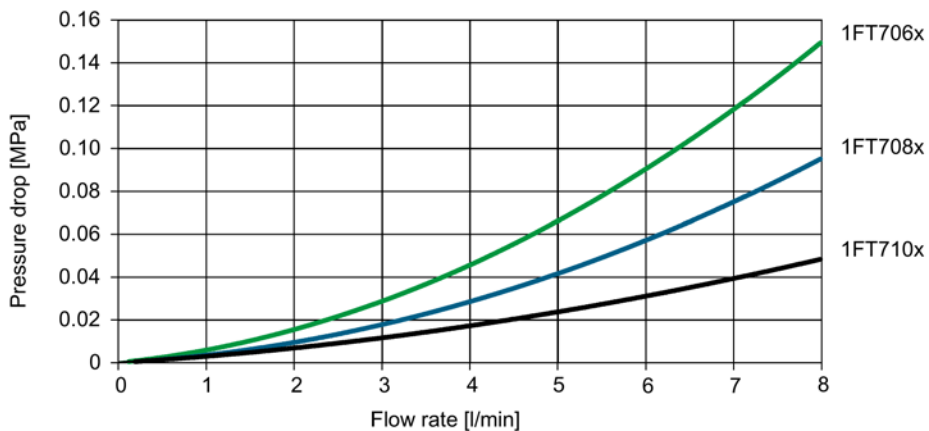

Figure 3-3 Pressure drop 1FT7

Table 3- 7 Pressure drop at the nominal coolant flow

Shaft height	Flow rate	Pressure drop
1FT706x	3 l/min	0.03 MPa
1FT708x	4 l/min	0.03 MPa
1FT710x	5 l/min	0.025 MPa

Ensure the nominal coolant flows in the above table for sufficient heat dissipation.

Pressure adjustment

If various components are connected up in the cooling circuit, it may be necessary to measure the inlet and outlet pressure and adjust accordingly.

Note

Mount flow restrictors on the cooling water outlet of the motor or the relevant component!

- Adjust the pressure, if necessary.

Cooling water inlet temperature

The motors are designed for operation with a cooling water inlet temperature of ≤ 30 °C.

Note

Cooling water temperatures that are lower than the ambient temperature tend to result in increased water condensation.

- Use the formula below to determine the permissible cooling water inlet temperature to prevent condensation from forming on the motor surface:

$$T_{\text{cooling water}} > T_{\text{ambient}} - 5 \text{ K}$$

The determined temperature $T_{\text{cooling water}}$ is valid for a relative humidity up to approximately 75%.

The cooling water inlet temperature must be higher if the relative humidity is $> 75\%$.

The cooling water inlet temperature can be lowered if the relative humidity is $< 75\%$.

If necessary, a Mollier diagram can be used to determine more precise details.

The permissible rated torque M_N of the motor changes at a cooling water inlet temperature of ≥ 30 °C.

- Reduce the static torque M_0 according to the derating factor k in the following table.

Table 3- 8 Derating factors

Cooling water inlet temperature	≤ 30 °C	35 °C	40 °C	45 °C
Derating factor k	1.00	0.97	0.95	0.92

Reduce the torque and the speed by the derating factor.

You can calculate the reduced rated torque $M_{N \text{ red}}$ with the following formula: $M_{N \text{ red}} = M_N - (M_0 - M_0 * k)$

3.1 Cooling

Connecting motors in series

We can only recommend series connection of motors if:

- The required flow rates of the motors are approximately the same (< factor of 2)
- The maximum cooling water inlet temperature is maintained in the second or third motor.

Note

Derating of series-connected motors

The heat dissipation of the cooling water in the second and third motor may require derating (see Table Derating factors).

3.1.3.3 Specification of the cooling water

Cooling water

Table 3- 9 Water specification as coolant

	Quality of the water used as coolant for motors with aluminum, stainless steel tubes + cast iron or steel jacket
Chloride ions	< 40 ppm, can be achieved by adding deionized water.
Sulfate ions	< 50 ppm
Nitrate ions	< 50 ppm
pH value	6 ... 9 (with aluminum 6 ... 8)
Electrical conductivity	< 500 µS/cm
Total hardness	< 170 ppm
Dissolved solids	< 340 ppm
Size of entrained particles	< 100 µm
Corrosion protection	0.2 ... 0.25% inhibitor Nalco TRAC100 (previously 0GE056)
Anti-freeze protection	If necessary 20 ... 30% Antifrogen N (manufacturer Clariant)

Other coolants (not water-based)

If you use different cooling media (e.g. oil, cooling lubricant), derating may be necessary in order to comply with the thermal motor limit.

Note

Derating when using other cooling lubricants

Derating is required for water-oil mixtures with more than 10% oil.

To determine the derating, you need the following values of the coolant at a temperature of 30 °C:

Density	ρ / kg/m ³
Specific thermal capacitance	c_p / J/(kg•K)
Thermal conductivity	λ / W/(K•m)
Kinematic viscosity	ν / m ² /s
Flow rate	V / l/min

The required derating can be obtained from Technical support.

Please send your enquiry to Technical support (<https://support.industry.siemens.com>).

Biocide

The risk of corrosion caused by microbes is virtually non-existent in chlorinated drinking water systems.

Closed cooling circuits with soft water are susceptible to microbes.

The following types of microbes are encountered in practice:

- Slime-forming bacteria
- Corrosive bacteria
- Iron-depositing bacteria

The suitability of a biocide depends on the type of microbe.

- Analyze the cooling water for microbes at least once a year.

Necessary biocides can be obtained from the manufacturer, e.g. Nalco. Ask the manufacturer for compatibility with an inhibitor used in your system.

- Dose the biocide as recommended by the manufacturer.

Antifrogen N already acts like a biocide at the minimum concentration of > 20%.

Note

Compatibility of coolant additives

Biocides and Antifrogen N must not be mixed.

There are other manufacturers of chemical additives in the market. You can use equivalent products from other manufacturers. Have the suitability of the third-party products determined.

Manufacturers of chemical additives

Tyforop Chemie GmbH	http://www.tyfo.de
Clariant Produkte Deutschland GmbH (Anti-frogen)	https://www.clariant.com
Cimcool Industrial Products Inc	http://www.cimcool.net
FUCHS PETROLUB SE	http://www.fuchs.com
Hebro Chemie GmbH	http://www.hebro-chemie.de
HOUGHTON Deutschland GmbH	http://www.houghton.com
Nalco Water in Germany (Ecolab)	http://www.nalco.com
Schweitzer-Chemie GmbH	http://www.schweitzer-chemie.de

3.1.3.4 Coolant connection

Connection to the cooling circuit

The motor is connected to the cooling circuit by means of two female threads on the rear of the motor. Which one is the inlet and which one is the outlet can be freely connected.

Cooling water connection for 1FT7: G 1/4 "

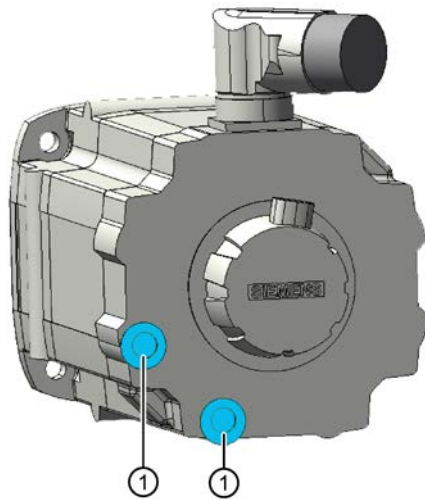

1 Ports (internal thread) for the water cooling

Figure 3-4 1FT7 water cooling connection

To ensure mechanical decoupling, the devices should be connected by means of hoses. See Table "Materials and components of a cooling circuit"

Equipotential bonding

Provide all components in the cooling system (motor, heat exchanger, piping system, pump, pressure equalization tank, etc.) with equipotential bonding. Implement the equipotential bonding using a copper rail or finely stranded copper cable with the appropriate conductor cross-sections.

Note

Installation of the cooling water pipes

Electrically conductive cooling water pipes must not come into contact with live components.

- Ensure adequate insulation.
 - Securely fasten the pipe.
-

3.2 Degree of protection

The degree of protection designation in accordance with EN 60034-5 (IEC 60034-5) is described using the letters IP and two digits, e.g. IP64.

IP = International Protection

1st digit = protection against the ingress of foreign bodies

2nd digit = protection against water

The validity of DIN 60034-5 refers to water as a medium that can potentially enter, and not oil. Since machine tools, for example, use oil-containing, creep-capable and/or aggressive cooling lubricants, protection only against water is not sufficient.

Configure the motor in the environment of creep-capable oils with the appropriate degree of protection.

Effect / environment	General workshop environment	Water, general cooling lubricant (95% water, 5% oil), oil	Creep oil, kerosene, aggressive cooling lubricants
Dry	IP64	-	-
Environment with liquids	-	IP64	IP67
Mist	-	IP65	IP67
Spray	-	IP65	IP67 + additional measures
Jet	-	IP67	IP67 + additional measures
Splash, brief submersion	-	IP67	IP67 + additional measures

Specified degrees of protection as a function of the ambient conditions

Available degrees of protection

1FT7 motors can be supplied with degree of protection IP64, IP65, or IP67 according to EN 60034-5 (IEC 60034-5).

1FT7 motors with forced ventilation are available with degree of protection IP54 according to EN 60034-5 (IEC 60034-5).

The motor shafts are sealed according to the degree of protection that is ordered.

Table 3- 10 Sealing of the motor shaft

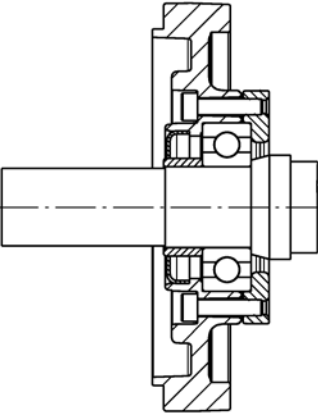
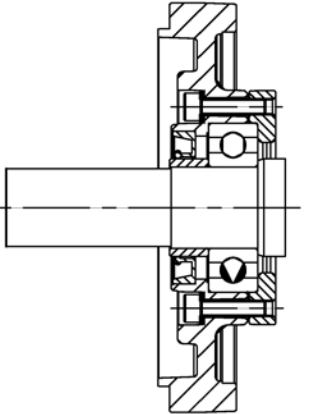
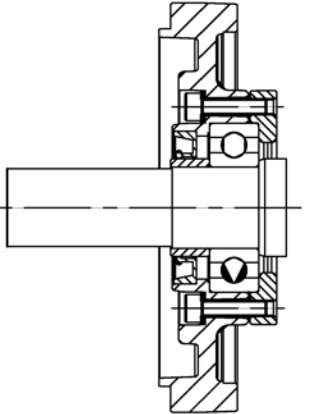
IP64	IP65	IP67
		
<p>Labyrinth seal It is not permissible that there is any moisture in the area around the shaft and the flange. Note: For IP 64 degree of protection it is not permissible for liquid to collect in the flange.</p>	<p>Radial shaft sealing ring without annular spring Sealing of the shaft exit against splashwater or coolant. It is permissible that the radial shaft sealing ring runs dry. Lifetime approx. 25000 hours (nominal value). With degree of protection IP65, it is not permissible for liquid to collect in the flange.</p>	<p>Radial shaft sealing ring For gearbox mounting (for gearboxes that are not sealed) to seal against oil. The sealing lip must be adequately cooled and lubricated by the gearbox oil in order to guarantee reliable function. Lifetime approx. 10000 hours (nominal value). If a radial shaft sealing ring runs dry, then this has a significant negative impact on the functionality and the lifetime.</p>

Sealed through the motor flange

You can additionally seal motors at the flange

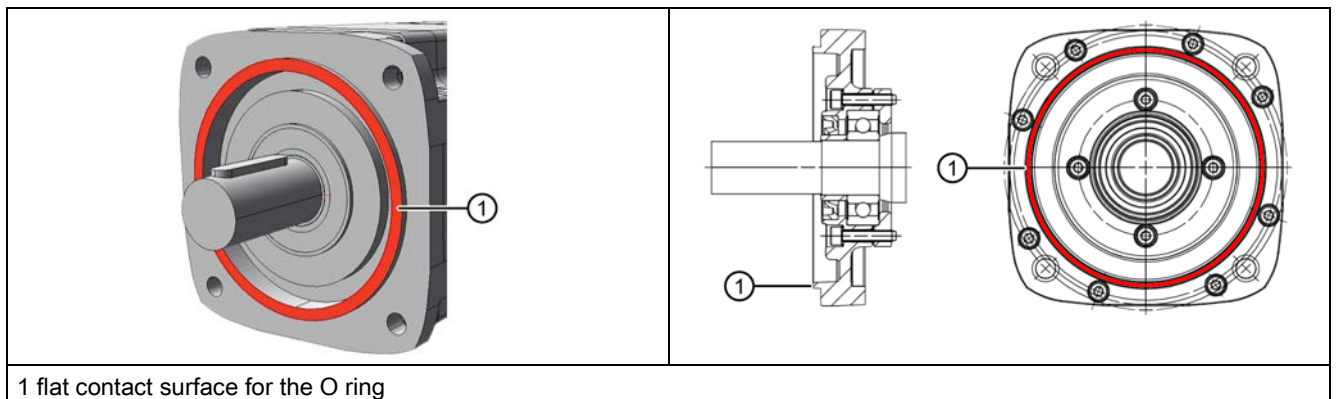

The motor is sealed using an O ring on a flat machined contact surface of the centering edge at the DE flange. The whole circumference is sealed.

The flange surface of the motor is not used to establish the seal.

Additional measures to increase tightness when using creep-capable oils

- DRIVE-CLiQ encoder with round connector M17, additional information in Chapter "Motors with DRIVE-CLiQ interface (Page 389)".
- Z option Q13: Encoder sealing (Page 102)
- Z option Q12: Sealing air (Page 100)

Further additional measures to increase tightness

- Protect the motor against media, e.g. with covers.
- Secure the cables in the vicinity of the motor so that no tensile or bending forces act on the connectors.
- Avoid moving the connectors.
- Avoid pinching the cables due to inadequate bending radii.

3.3 Types of construction

Table 3- 11 Designation of types of construction (acc. to IEC 60034-7)

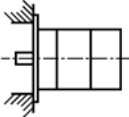
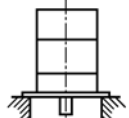
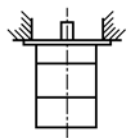
Designation	Representation	Description
IM B5		Standard
IM V1		The motors can be used in types of construction IM V1 and IM V3 without having to order anything special. Note: When configuring the IM V3 type of construction, attention must be paid to the permissible axial forces (force due to the weight of the drive elements) and especially to the necessary degree of protection.
IM V3		

3.4 Bearing versions

The motors have rolling bearings with permanent grease lubrication (greased for a lifetime). The bearing arrangement is a typical fixed-floating design with the fixed bearing at the DE. The bearing arrangement is for the load case "Circumferential load at the inner ring, point-type load at the outer ring".

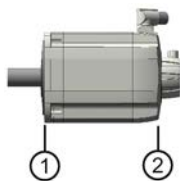

- 1 DE
- 2 NDE

3.5 Flange forms

Table 3- 12 Flange forms

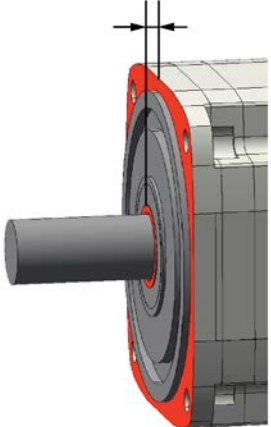
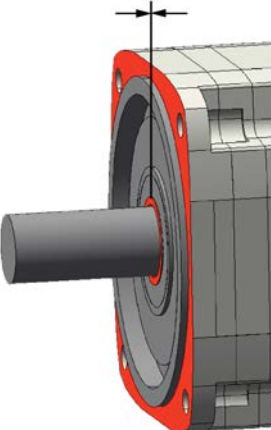
Designation	Representation	Description
Flange "compact"		Flange recessed In the article number: 1FT7□□□-□□□□ 0 -□□□□ or 1FT7□□□-□□□□ 5 -□□□□
Flange "classic"		Flange compatible with 1FT6/1FK7 motors In the article number: 1FT7□□□-□□□□ 1 -□□□□ or 1FT7□□□-□□□□ 4 -□□□□

3.6 Shaft extension

The shaft extension at the DE is cylindrical according to DIN 748 Part 3, IEC 60072-1.

Standard: Plain shaft (without keyway)

Option: Keyway and feather key (half key balancing)

For fast acceleration levels and reversing operation, we recommend that you use friction-locked shaft-hub coupling.

3.7 Radial and axial forces

As a result of the bearing arrangement, as described in Chapter "Bearing versions (Page 52)" the motor is designed for vectored forces. Forces such as these occur, e.g. for a belt drive.

All radial forces always involve vectored forces.

NOTICE
Motor damage caused by rotating forces
Rotating forces can result in bearing motion and in turn damage the motor.
<ul style="list-style-type: none"> Rotating forces are not permissible.

3.7.1 Sample calculation of the belt pre-tension

Note

Carefully comply with the guidelines provided by the belt manufacturer

- Carefully comply with the guidelines provided by the belt manufacture when configuring the motor for radial forces at the shaft extension.
- Adjust the belt tension using the appropriate measuring instruments.

$$F_v = 2 \cdot M_0 \cdot c / d_k$$

$$F_v \leq F_{R, perm}$$

Table 3- 13 Explanation of the formula abbreviations

Formula abbreviations	Unit	Description
F _v	N	Belt pretension
M ₀	Nm	Motor static torque

Formula abbrevia- tions	Unit	Description
c	—	Pre-tensioning factor; this factor is an empirical value provided by the belt manufacturer. It can be assumed as follows: for toothed belts: $c = 1.5$ to 2.2 for flat belts $c = 2.2$ to 3.0
d_R	m	Effective diameter of the belt pulley
$F_{R, perm}$	N	Permissible radial force

When using other configurations, you must take into account the actual forces generated from the torque being transferred.

3.7.2 Radial force loading

Point of application of radial forces F_R at the shaft extension

- for average operating speeds
- at nominal bearing lifetime of 25000 hours

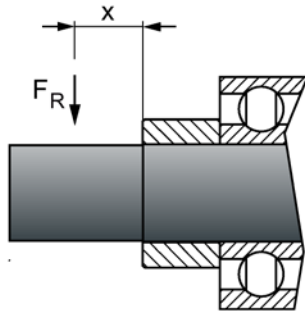

F_R Radial force

x Distance between the point of application of the force F_R and the shaft shoulder in mm.

Figure 3-5 Force application point at DE

3.7.3 Radial force diagrams

Radial force 1FT703□

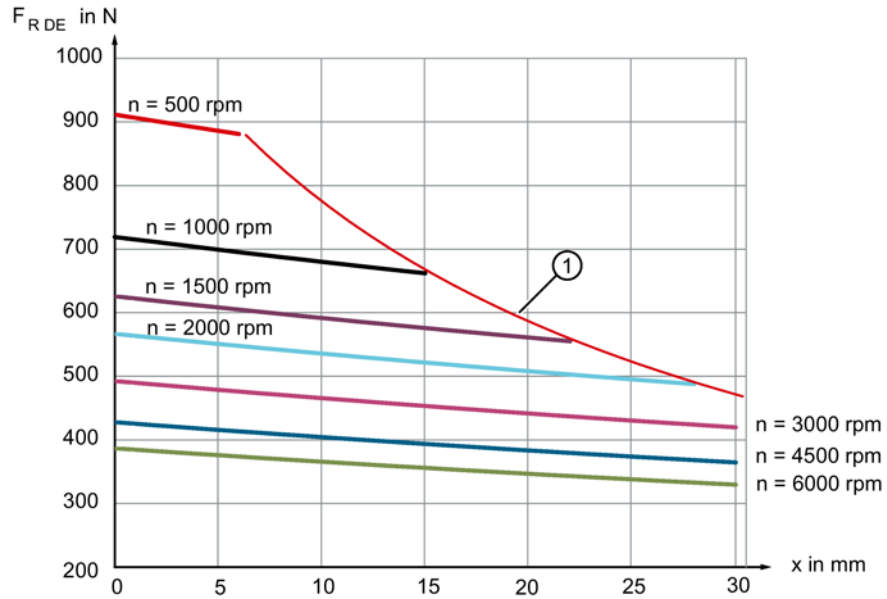

1 Permissible radial force on the shaft

Figure 3-6 Radial force F_R at a distance x from the shaft shoulder for a statistical bearing lifetime of 25000 hours

Radial force 1FT704□

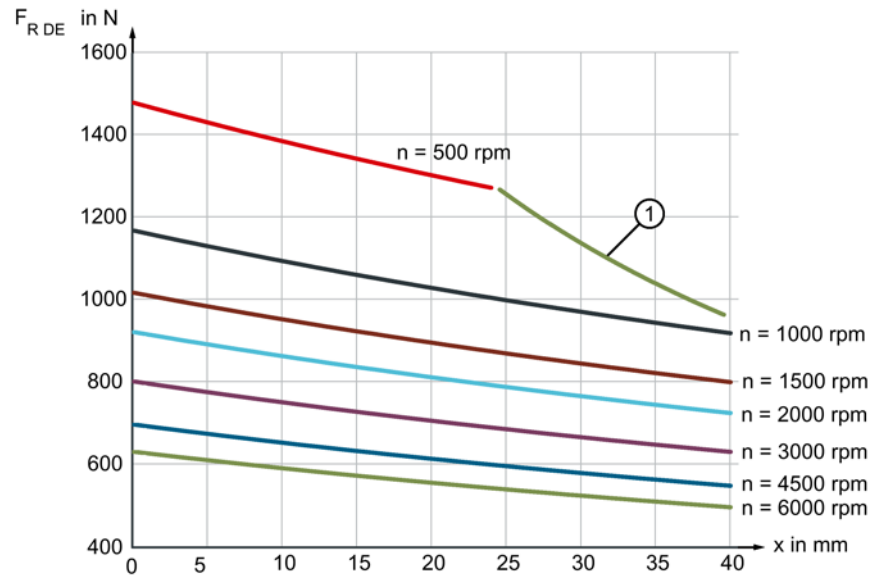

1 Permissible radial force on the shaft

Figure 3-7 Radial force F_R at a distance x from the shaft shoulder for a statistical bearing lifetime of 25000 hours

Radial force, 1FT706□

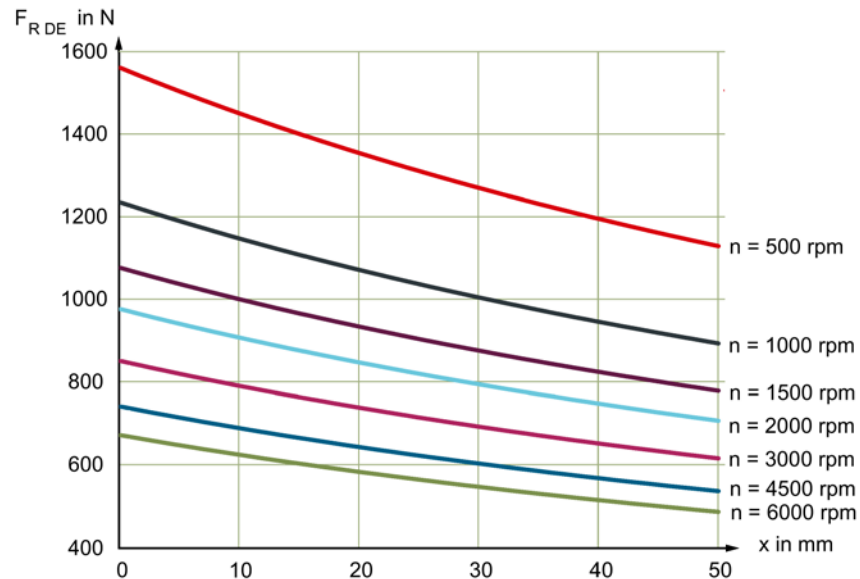

Figure 3-8 Radial force F_R at a distance x from the shaft shoulder for a statistical bearing lifetime of 25000 hours

Radial force 1FT708□

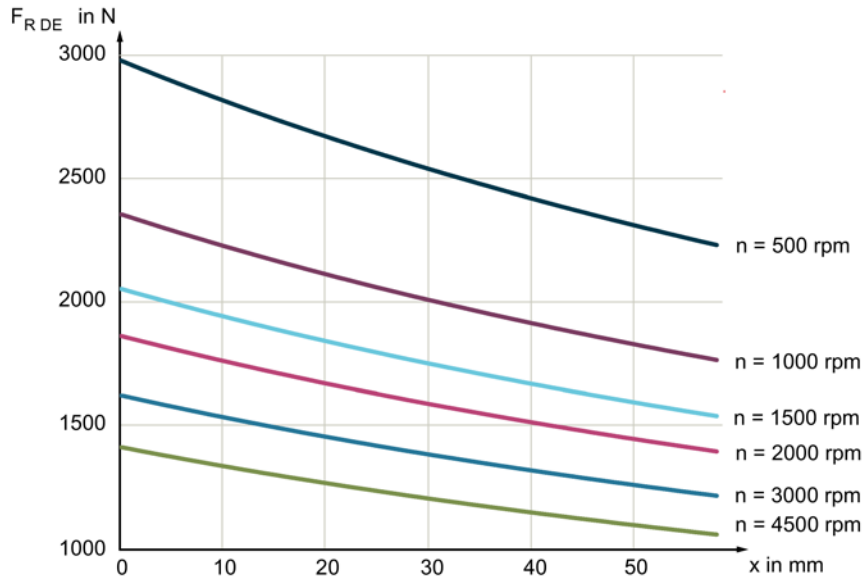

Figure 3-9 Radial force F_R at a distance x from the shaft shoulder for a statistical bearing lifetime of 25000 hours

Radial force 1FT710□

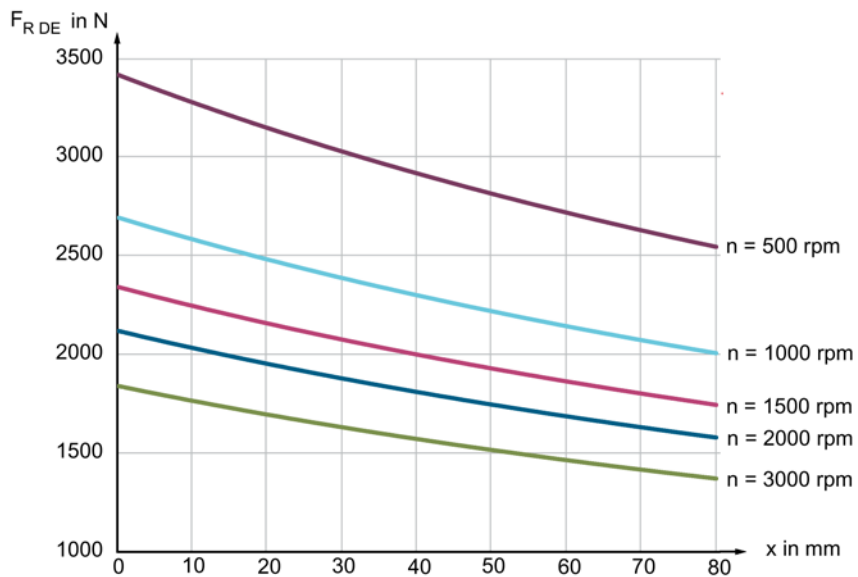

Figure 3-10 Radial force F_R at a distance x from the shaft shoulder for a statistical bearing lifetime of 25000 hours

Radial force 1FT7, only SH117

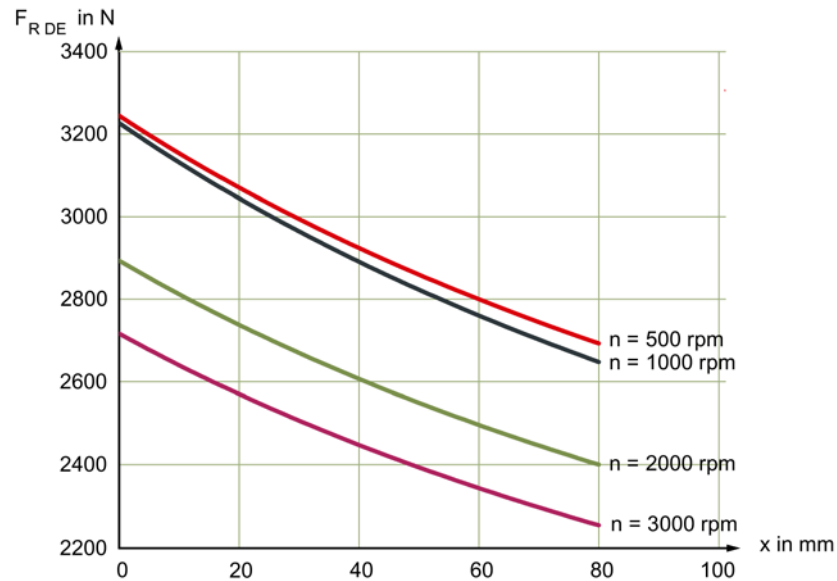

Figure 3-11 Radial force F_R at a distance x from the shaft shoulder for a statistical bearing lifetime of 25000 hours

Radial force 1FT713□

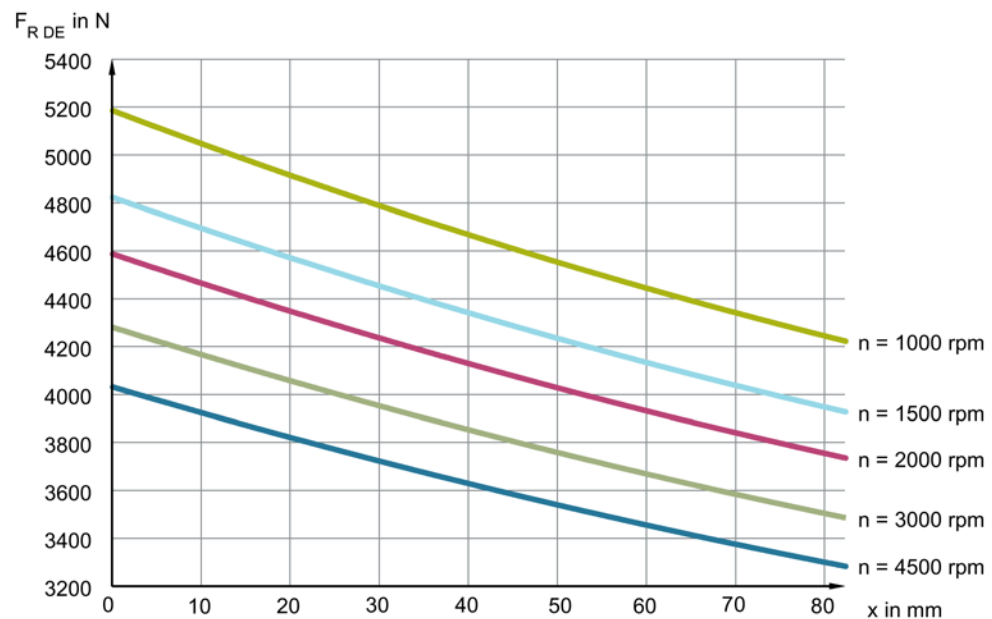

Figure 3-12 Radial force F_R at a distance x from the shaft shoulder for a statistical bearing lifetime of 25000 hours

3.7.4 Axial force loading

When using, for example, helical toothed wheels as drive element, in addition to the radial force, there is also an axial force on the motor bearings.

The axial forces can overcome the spring loading of the bearings so that the rotor is shifted corresponding to the bearing axial play that exists.

Table 3- 14 Permissible axial rotor shift

Shaft height	Displacement
36 and 48	approx. 0.2 mm
63 to 132	approx. 0.35 mm

NOTICE

Motor damage as a result of bearings that are not pretensioned

Bearings that are not pretensioned can result in premature failure of the motor. An axial force as large as the spring-loading is not permitted (100 ... 500 N).

- Comply with the permissible axial force.

Calculating the permissible axial force: $F_{A\text{ perm}} = F_R \bullet 0.35$

NOTICE

Motor damage caused by axial force for motors with integrated holding brake

It is not permissible for motors with integrated holding brake to be subject to axial forces.

- For motors with integrated holding brake ensure that no axial forces are applied to the shaft extension.

3.8 Radial eccentricity, concentricity and axial eccentricity

The shaft and flange accuracies are checked according to DIN 42955, IEC 60072-1. Any specifications deviating from these values are stated on the dimension drawings.

Table 3- 15 Radial eccentricity tolerance of the shaft to the frame axis (referred to cylindrical shaft extensions)

Shaft height	Standard N	Option R
36	0.035 mm	0.018 mm
48, 63	0.04 mm	0.021 mm
80, 100, 132	0.05 mm	0.025 mm

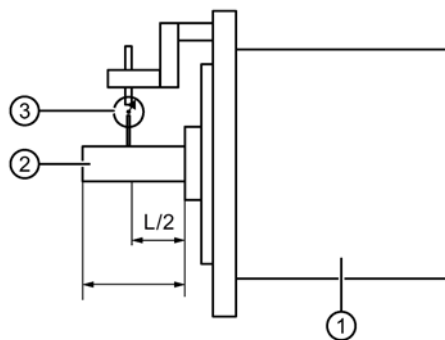

- ① Motor
- ② Motor shaft
- ③ Dial gauge

Figure 3-13 Checking the radial eccentricity

Table 3- 16 Concentricity and axial eccentricity tolerance of the flange surface to the shaft axis (referred to the centering diameter of the mounting flange)

Shaft height	Standard N	Option R
36, 48	0.08 mm	0.04 mm
63, 80, 100	0.1 mm	0.05 mm
132	0.125 mm	0.063 mm

3.9 Balancing

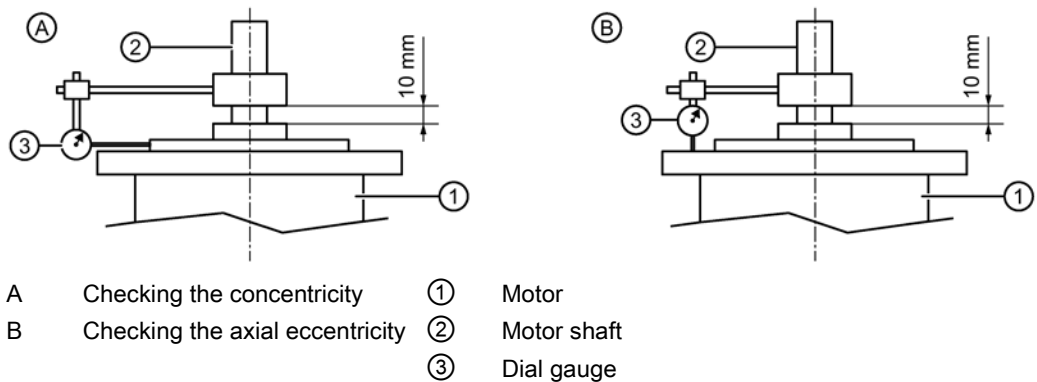

Figure 3-14 Checking the concentricity and axial eccentricity

3.9 Balancing

The motors are balanced according to DIN ISO 8821.

Motors with featherkey in the shaft are half-key balanced.

A mass equalization for the protruding half key must be taken into account for the output elements.

3.10 Vibration response

Vibration severity grade

Motors with a keyway are balanced with a half feather key by the manufacturer. The vibration response of the system at the location of use is influenced by output elements, mounting conditions, alignment, installation, and external vibrations. As a result, the vibration values of the motor may change.

The motors conform to vibration severity grade A according to EN 60034-14 (IEC 60034-14).

The values indicated refer only to the motor. These values may increase on the motor due to the overall vibration characteristics of the complete drive installation.

The vibration severity grade is maintained up to the rated speed (n_N).

Standard: Vibration severity grade A

Option: Vibration severity grade R (compliance with vibration severity grades A and R up to n_N)

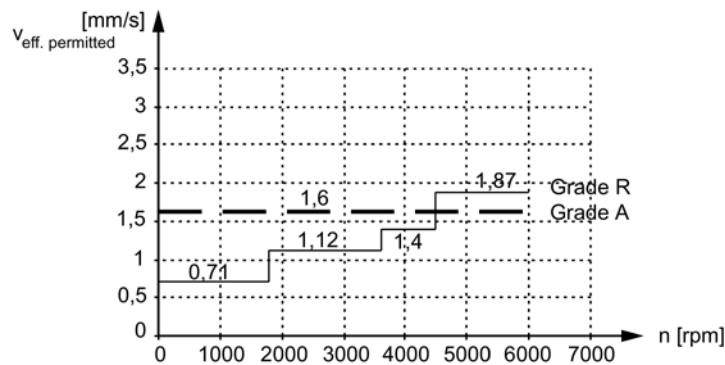

Figure 3-15 Vibration severity grades

Vibration response

To ensure proper functioning and to comply with the motor specification (in particular the bearing lifetime), observe the vibration values specified in the following table.

Table 3- 17 Vibration values

Vibration velocity V_{rms} to ISO 10816	max. 4.5 mm/s
Vibration acceleration a_{peak} axial ¹⁾	25 m/s ²
Vibration acceleration a_{peak} radial ¹⁾	50 m/s ²

1) For motors with separately driven fan, the limit value for axial and radial vibration acceleration is limited to 10 m/s².

Select the measuring locations according to ISO 10816-1 para. 3.2. The vibration values must not exceed the specified limits at any measuring location.

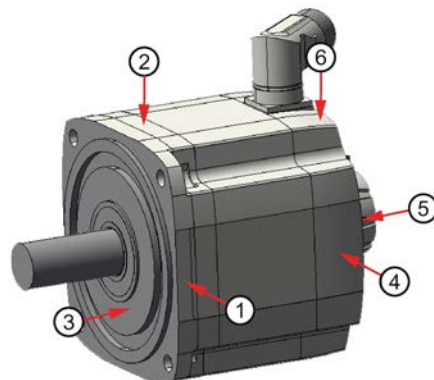

- | | | | |
|---|--------------------------|---|---------------------------|
| 1 | Bearing shield DE radial | 4 | Bearing shield NDE radial |
| 2 | Bearing shield DE radial | 5 | Bearing shield NDE axial |
| 3 | Bearing shield DE axial | 6 | Bearing shield NDE radial |

Figure 3-16 Measuring locations for vibration values

The vibration acceleration is evaluated in the frequency band from 10 to 2000 Hz. The maximum peak value in the time range is considered here.

To evaluate the vibration velocity, the measuring equipment shall meet the requirements of ISO 2954.

3.11 Noise emission

When operated in the speed range 0 to rated speed, 1FT7 motors can reach the following measuring-surface sound pressure level $L_p(A)$:

Table 3- 18 Sound pressure level

Cooling method	Shaft height	Measuring-surface sound pressure level $L_p(A)$
Naturally cooled	1FT703 to 1FT706 1FT708 to 1FT713 1FT7117	65 dB(A) + 3 dB tolerance 70 dB(A) + 3 dB tolerance ≤ 80 dB(A)
Force-ventilated	1FT706 to 1FT713 1FT7117	73 dB(A) + 3 dB tolerance ≤ 80 dB(A)
Water-cooled	1FT706 1FT708 to 1FT710	65 dB(A) + 3 dB tolerance 70 dB(A) + 3 dB tolerance

Take into account that the installation and operating conditions, such as rigid or vibration-isolated foundation structure, influence the noise emission.

3.12 Bearing change interval

The bearings are subject to wear and must be replaced after a defined number of operating hours.

For average load levels, the bearings must be replaced after approx. 25,000 hours.

Bearing replacement intervals can be extended if the motor is operated under favorable conditions, e.g. low average speeds, low radial forces (cantilever forces), vibration load.

Note

Harsh operating conditions

If the motor is subject to harsh operating conditions (e.g. continuous operation at n_{max} , high vibration/shock loads, frequent reversing duty etc.), the bearing replacement intervals t_{LW} can decrease by up to 50%.

3.13 Service and inspection intervals

General

Carry out maintenance work, inspections and revisions at regular intervals in order to be able to identify faults at an early stage and remove them.

Note

Inspection if there are faults or unusual conditions

Unusual conditions or faults that place undue stress on a three-phase motor - e.g. overload, short-circuit - can cause consequential damage to the machine.

Immediately perform an inspection when faults or exceptional conditions occur.

Maintenance measures, inspection/maintenance times intervals

The maintenance intervals depend on the operating conditions.

- Adapt the maintenance intervals to match the local conditions, such as pollution/dirt, switching frequency, load, etc.

NOTICE
Improper maintenance
Service and maintenance must only be performed by properly authorized qualified personnel.
Only use original SIEMENS parts.

Siemens Service Centers distributed around the globe can maintain and repair the motor. To do this, contact your local Siemens representative.

- Perform the following maintenance measures as listed in the table.

Table 3- 19 Maintenance measures after operating times or intervals

Operating times and intervals	Measure
Operation	
Daily; if possible, more frequently during operation.	Monitor and check the motor for unusual noise, vibrations, and changes.
After approx. 10,000 operating hours, at the latest after two years	If oil-lubricated, replace the radial shaft seal rings
as required - or after 25 000 operating hours	Replace the motor bearings

Motor components and options

4.1 Motor components

4.1.1 Thermal motor protection

A temperature-dependent resistor is integrated as temperature sensor to monitor the motor temperature.

- 1FT7 motors with integrated DRIVE-CLiQ interface were switched over to Pt1000. The marking is made with the revision number of the motors. The order number does not need to be changed.
- Motors without integrated DRIVE-CLiQ interface were switched over to the new Pt1000 temperature sensor with changed order number. In connection with the following encoders without DRIVE-CLiQ, the 12th digit of the order number must be changed accordingly.
- For new plants and systems always configure a motor with Pt1000 temperature sensor.

Note

Ensure that the converter used supports the evaluation of the Pt1000.

1FT7 motors without DRIVE-CLiQ interface:	Order number with Pt1000
with flange "compact" (recessed) and encoder IC2048S/R	1FT7□□□-□□□□5-□N□□
with flange "compact" (recessed) and encoder AM2048S/R	1FT7□□□-□□□□5-□M□□
with flange "classic", compatible with 1FT6/1FK7 and encoder IC2048S/R	1FT7□□□-□□□□4-□N□□
with flange "classic", compatible with 1FT6/1FK7 and encoder AM2048S/R	1FT7□□□-□□□□4-□M□□

with flange "classic", compatible with 1FT6/1FK7 and encoder IC2048S/R	-	1FT713□-□□□□4-□N□□
with flange "classic", compatible with 1FT6/1FK7 and encoder AM2048S/R	-	1FT713□-□□□□4-□M□□

Table 4- 1 Features and technical specifications

Type	Pt1000
	Not an ESD component
Resistance when cold (20 °C)	Approx. 1090 Ω
Resistance when hot (100 °C)	Approx. 1390 Ω
Connection	Via signal cable
Response temperature	Prewarning < 135 °C Alarm / shutdown at max. 145 °C

The following figure shows the resistance curve as a function of the temperature for the Pt1000 temperature sensor.

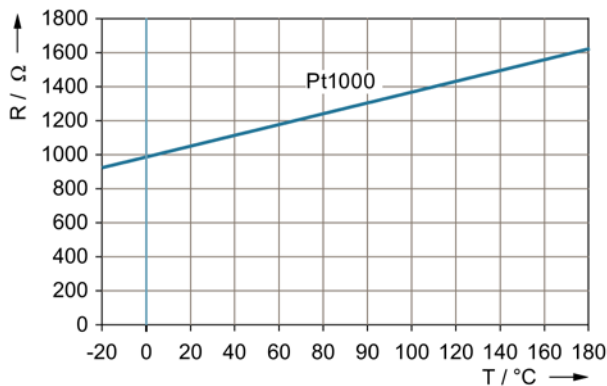

Figure 4-1 Characteristic Pt1000

The winding temperature is evaluated in the converter. When a fault occurs, an appropriate message is output at the converter. When the motor temperature increases, a message "Alarm motor overtemperature" is output. The message can be evaluated externally.

If this message is ignored, the converter shuts down with the appropriate fault message after a preset time period or when the motor limiting temperature or the shutdown temperature is exceeded.

The integrated temperature sensor protects the synchronous motors only to a certain extent against overloads:

Shaft heights 36 and 48: up to $2 \cdot I_{0(60K)}$ and speed $\neq 0$
 from SH 63: up to $3 \cdot I_{0(60K)}$ and speed $\neq 0$

<p>NOTICE</p> <p>Destruction of the motor for a thermal critical load</p> <p>For load applications that are critical from a thermal perspective, e.g. overload when the motor is stationary or an overload of M_{max} longer than 4 s, adequate protection is no longer available.</p> <ul style="list-style-type: none"> • Activate the "Thermal motor model i²t monitoring" function in the converter.
--

The temperature sensor is part of an SELV circuit, which can be destroyed if a high voltage is applied. The temperature sensor is designed so that the DIN/EN requirement for "protective separation" is fulfilled.

Due to the thermal coupling time of the temperature sensor, high short-term overloads require additional protective measures.

NOTICE
Destruction of the motor for a thermal critical load
A thermal critical load, e.g. high overload at motor standstill, can destroy the motor.
<ul style="list-style-type: none"> • Use an overcurrent relay, for example, as an additional protective measure.

4.1.2 Encoders

4.1.2.1 Encoders for 1FT7 motors

NOTICE
Destruction of the encoder when incorrectly handling ESD parts and components
Encoders are ESD components.
<ul style="list-style-type: none"> • Comply with the regulations for handling parts and components that can be destroyed by electrostatic discharge, see Equipment damage due to electric fields or electrostatic discharge (Page 16).

The following encoders can be used with the 1FT7.

Encoders with DRIVE-CLiQ interface: For SINAMICS drive systems		
	Incremental encoders or singleturn encoders	Multiturn absolute encoders
High resolution, suitable for Safety Integrated Extended Functions		
Encoder designation	AS24DQI	AM24DQI
Identification in the article number	B, K ²⁾ ³⁾	C, L ²⁾
Resolution	16,777,216 = 24 bits	16,777,216 = 24 bits
Absolute position	Yes, one revolution	Yes, 4096 revolutions (12 bits)
Max. angular error	± 40"	± 40"
Average resolution, suitable for Safety Integrated Extended Functions		
Encoder designation	IC22DQ ¹⁾	AM22DQ ¹⁾
Identification in the article number	D ³⁾ ⁴⁾	F ³⁾ ⁴⁾

4.1 Motor components

	Encoders with DRIVE-CLiQ interface: For SINAMICS drive systems	
Resolution	4,194,304 = 22 bit	4,194,304 = 22 bit
Absolute position	No	Yes, 4096 revolutions (12 bits)
Max. angular error	± 40"	± 40"

	Encoder without DRIVE-CLiQ interface: EnDat 2.1 or Sin/Cos 1Vpp	
	Incremental encoder	Multiturn absolute encoders
Suitable for Safety Integrated Extended Functions		
Encoder designation	IC2048S/R	AM2048S/R
Identification in the article number	N ³⁾	M ³⁾
Resolution	2048 Sin/Cos 1Vpp	2048 Sin/Cos 1Vpp
Absolute position	No	Yes, 4096 revolutions
Max. angular error	± 40"	± 40"

- 1) Use the DQI encoder generation for new applications. The AM22DQ is superseded by the AM24DQI and the IC22DQ by the AS24DQI.
- 2) Code letters for the round connector M17
- 3) Not approved for 1FT7117
- 4) Not approved for 1FT713□

Encoder systems with DRIVE-CLiQ interface

Motors with DRIVE-CLiQ encoder interface are designed to operate with the SINAMICS S110 / S120 converter system. Signal transmission to the converter is performed digitally. They have an electronic rating plate that simplifies commissioning and diagnostics. The motor and encoder system are automatically identified and all motor parameters are automatically set, see SINAMICS Equipment Manual.

Encoder systems without a DRIVE-CLiQ interface

For motors without an integrated DRIVE-CLiQ interface, the analog encoder signal is first converted to a digital signal in the drive system. For these motors, the encoder signals for SINAMICS S110 / S120 must be transferred via Sensor Modules.

4.1.2.2 Technical specifications of the incremental encoders

Description

This encoder senses relative movements and does not supply absolute position information. In combination with evaluation logic, a zero point can be determined via the integrated reference mark, which can be used in turn to calculate the absolute position.

The encoder outputs sine and cosine signals. These signals can be interpolated using evaluation logic (usually 2048x) and the direction of rotation can be determined. In the version with a DRIVE-CLiQ interface, this evaluation logic is already integrated in the encoder.

Function and technical specifications

- Angular measuring system for the commutation
- Speed actual value sensing
- Indirect incremental measuring system for the position control loop
- One zero pulse (reference mark) per revolution

Table 4- 2 Technical specifications for incremental encoders

Encoders	Code	Operating voltage	Max. current consumption	A-B track: Resolution incremental (sin/cos periods per revolution)	Angular error
Without DRIVE-CLiQ interface					
Incremental encoder sin/cos 1 Vpp, 2048 S/R with C and D tracks	IC2048S/R	5 V \pm 5%	140 mA	2048 S/R (1 Vpp)	\pm 40 "
with DRIVE-CLiQ interface¹⁾					
Incremental encoder 22 bits (resolution 4,194,304, internal 2048 S/R) + commutation position 11 bits	IC22DQ	24 V	180 mA	4,194,304 (=22 bits)	\pm 40 "

Mech. speed limit for all incremental encoders: 12000 rpm

1) The "singleturn absolute encoders" are other encoders which can be used as incremental encoders in the SINAMICS drive system. Use the new DQI encoder generation for new applications. The IC22DQ is superseded by the AS24DQI.

4.1 Motor components

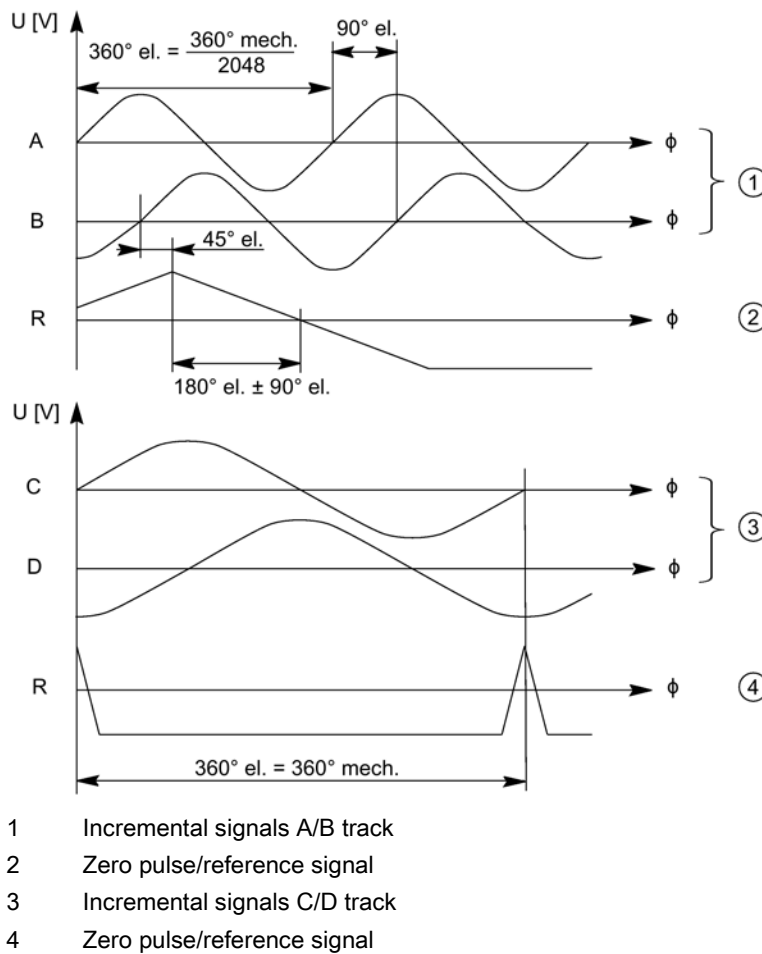

Figure 4-2 Signal sequence and assignment for encoder IC2048S/R without a DRIVE-CLiQ interface, for a positive direction of rotation

For encoder connection, pin assignment, and cables, refer to Chapter "Connection system".

4.1.2.3 Technical specifications of the absolute encoders

Description of multiturn absolute encoders

This encoder outputs an absolute angular position between 0° and 360° in the specified resolution. In addition, the encoder can distinguish 4096 revolutions. With a ball screw, for example, the encoder can determine the absolute position of the slide over a long distance.

Description: Singleturn absolute encoder

This encoder outputs an absolute angular position between 0° and 360° in the specified resolution. Contrary to a multiturn absolute encoder, the singleturn absolute encoder can only supply the position value within just one revolution. The singleturn absolute encoder does not have a traversing range.

Function and technical specifications

- Angular measuring system for the commutation
- Speed actual value acquisition
- For singleturn encoder: Indirect measuring system for absolute position determination within a revolution
- For multiturn encoder: Indirect measuring system for determining the absolute position within a traversing range of 4096 revolutions

Table 4- 3 Technical specifications, absolute encoder without DRIVE-CLiQ interface

Designation	Code	Operating voltage	Maximum power consumption	Absolute resolution (singleturn)	Traversing range (multiturn)	A-B track: Incremental resolution (sin/cos periods per revolution)	Angular error
Serial absolute position interface: EnDat 2.1							
Absolute encoder 2048 S/R, (4096 revolutions, multiturn, with EnDat interface)	AM2048S/R	5 V \pm 5 %	200 mA	8192 (= 13 bits)	4096 (= 12 bits)	2048 S/R (1 Vpp)	\pm 40 "

Table 4- 4 Technical specifications, absolute encoder with DRIVE-CLiQ interface

Designation	Code	Operating voltage	Maximum power consumption	Absolute resolution (singleturn)	Traversing range (multiturn)	Angular error
Serial absolute position interface: DRIVE-CLiQ						
Absolute encoder, singleturn, 24-bit	AS24DQI	24 V	110 mA	16,777,216 (=24 bits)	-	\pm 40 "
Absolute encoder 24-bit + 12-bit multiturn	AM24DQI	24 V	110 mA	16,777,216 (=24 bits)	4096 (= 12 bits)	\pm 40 "
Absolute encoder 22 bits + 12 bits multiturn	AM22DQ ¹⁾	24 V	200 mA	4,194,304 (= 22 bits)	4096 (= 12 bits)	\pm 40 "

Mech. speed limit for all absolute encoders: 12000 rpm

1) Use the new DQI encoder generation for new applications. The AM22DQ is superseded by the AM24DQI absolute encoder.

The signal sequence and assignment A/B track is provided in Chapter "Technical specifications of the incremental encoders (Page 71)" figure "Signal sequence and assignment for encoder IC2048S/R without DRIVE-CLiQ interface for a positive direction of rotation".

Information on encoder connection, pin assignment and cables is provided in Chapter "Signal connection / motor protection (Page 389)".

4.2 Options

4.2.1 Holding brake

4.2.1.1 Type of the holding brake

The holding brake is implemented as a permanent-magnet brake.

The magnetic field of the permanent magnets exerts a pulling force on the brake armature disk. This means that in the no-current condition, the brake is closed and the motor shaft is held.

When a 24 V DC rated voltage is applied to the brake, the current-carrying coil produces an opposing field. This neutralizes the force of the permanent magnets and the brake opens without any residual torque.

The permanent magnet brake has zero backlash.

NOTICE

Damage to the motor due to axial forces on the shaft extension

Axial forces on the shaft extension can damage motors with an integrated permanent-magnet holding brake.

- Avoid axial forces on the shaft extension.

4.2.1.2 Properties

The holding brake is used to lock the motor shaft when the motor is at a standstill. The holding brake is not a working brake to brake a spinning motor.

The holding brake is designed for 5 million switching cycles when the motor is at a standstill.

A limited number of EMERGENCY STOP operations is permissible. The holding brake can perform up to 2000 EMERGENCY STOP braking operations with the specified highest braking energy. In so doing, the holding brake is subject to permissible wear.

- Comply with the specified highest braking energy for each emergency braking operation.

Formula to calculate the braking energy for each braking operation

$$W_{BR} = (J_{Mot Br} + J_{Last}) \cdot n_{Mot}^2 / 182.4$$

W_{Br} / J Braking energy for each braking operation

n_{Mot} / rpm Speed at which the brake is closed

$J_{Mot Br} / kgm^2$ Motor rotor moment of inertia with brake → see Chapter "Data sheets and characteristics (Page 150)"

J_{Load} / kgm² Load moment of inertia of the mounted part at the motor with brake is assumed 3 x motor rotor moment of inertia with brake (kgm²) → see Chapter "Data sheets and characteristics (Page 150)"

182.4 Constant to calculate the angular frequency and SI units

Example for calculating the highest braking energy for braking the 1FT7062-5AF7□-□□□□ from 3000 rpm with three times the rotor moment of inertia as load moment of inertia:

$$W_{\text{BR}} = (J_{\text{Mot Br}} + J_{\text{Last}}) \cdot n_{\text{Mot}}^2 / 182.4$$

$$W_{\text{BR}} = (1.02 \cdot 10^{-3} + 3 \cdot 1.02 \cdot 10^{-3}) \cdot 9 \cdot 10^6 \text{ s}^{-2} \cdot \text{kgm}^2 / 182.4$$

$$W_{\text{BR}} = 4.08 \text{ kgm}^2 \cdot 9000 \text{ s}^{-2} / 184.2$$

$$W_{\text{BR}} = 201.13 \text{ J}$$

$$W_{\text{BR}} = 201.13 \text{ J} < 880 \text{ J} \rightarrow W_{\text{Br}} = \text{ok}$$

880 J is the highest braking energy for this brake. See "Technical specifications (Page 76)"

- The holding brake opens so that it has no residual torque.
- The rated voltage of the holding brake is 24 V DC, with a permissible tolerance range of $\pm 10\%$, measured at the motor connector. Take into account the voltage drop along the supply cable, see Chapter "Connecting the holding brake (Page 387)".

WARNING

Inadvertent motion as a result of reduced braking effect

If you use the holding brake incorrectly, e.g. as safety brake, or you do not comply with the number of permissible brake closing operations, then the effect of the holding brake can be irreversibly reduced. This can result in inadvertent motion of your machine or system - and in turn can cause death or severe injury.

- Comply with the permissible number of EMERGENCY STOP braking operations with the specified highest braking energy.
- Avoid that the motor repeatedly and briefly accelerates with the brake still closed.
- Take into account the brake switching times and relay switching times for the brake control and/or release.
- Only operate the motor with an intact brake that is operating perfectly.

Note

Motors with or without holding brake cannot be subsequently retrofitted.

Motors with holding brake are longer by the installation space required (see the dimension drawings).

Note

It is not permissible that motors with integrated permanent magnet excited holding brake are subject to axial forces.

4.2.1.3 Technical specifications

Table 4- 5 Technical specifications of the holding brakes

Motor type	Holding torque at 120 °C M_h / Nm	Dyn. Braking torque M_m / Nm	DC current at 20 °C // A	Opening time with varistor ¹⁾ t_o / ms	Closing time with varistor ¹⁾ t_{c1} / ms	Highest braking energy W / J
Permanent magnet brakes for 1FT7						
1FT703□	3	1.5	0.3	60	25	30
1FT704□	8	5	0.6	90	30	270
1FT706□	18	11	0.8	150	50	880
1FT708□	48	25	1.0	220	65	1900
1FT710□	85	35	1.6	250	70	5300
1FT713□	140	60	1.8	350	70	9800

1) Measured at 24.0 V

Note

Option N27 - holding brake with low moment of inertia

Information on option N27 can be found at Option N27 - Brake with low moment of inertia (Page 96)

Note

If the brake is switched in two stages ("click" twice), then when opening, the first switching point is decisive, and when closing, the second switching point is decisive.

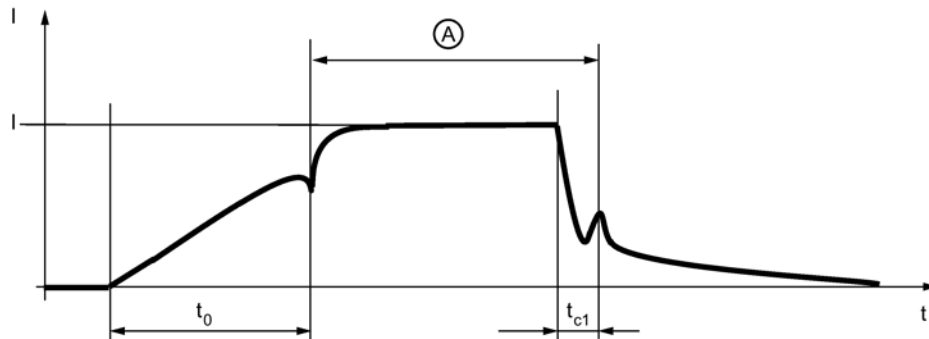

- I Current magnitude
- t Time
- t_o Opening time with varistor (measured at 24.0 V)
- t_{c1} Closing time with varistor (measured at 24.0 V)
- A Brake open

Figure 4-3 Terminology (time) for holding operation

Holding torque M_4

The holding torque M_4 is the highest possible torque that can be applied to the closed brake in steady-state operation without slip (holding function in a no-current state).

Dynamic braking torque M_{1m}

The dynamic braking torque M_{1m} is the smallest mean dynamic braking torque that can occur for an Emergency Stop.

4.2.2 Output coupling

NOTICE
Motor damage caused by rotating forces
Output couplings, especially stiff metal bellows-type couplings can exercise rotating forces on the shaft. These forces can result in bearing motion and in turn damage the motor.
<ul style="list-style-type: none">• Rotating forces are not permissible.

To achieve optimum output characteristics, we recommend ROTEX® GS couplings from the KTR company.

The advantages of ROTEX® GS couplings are as follows:

- 2 to 4x torsional stiffness of a belt gearbox
- No teeth meshing (when compared to a belt gearbox)
- Low moment of inertia
- Good closed-loop control response

KTR can provide support when selecting the coupling, see <http://www.ktr.com>

4.2.3 Motors with planetary gearboxes

4.2.3.1 Properties

Overview

1FT703□ to 1FT713□ motors can be supplied complete with a planetary gearbox from the factory (Siemens AG).

The gearboxes are flanged directly onto the drive end of the motors.

Benefits

- High efficiency; 1-stage: > 97 %, 2-stage: > 94 %
- Minimum torsional play; 1-stage: ≤ 4 arcmin, 2-stage: ≤ 6 arcmin
- Power transmission from the central sun wheel via planet wheels
- No shaft deflections in the planet wheel set due to symmetrical force distribution
- Very low moment of inertia and thus short acceleration times of the motors
- The gearboxes are connected to the motor shaft via an integrated clamping hub. This requires a plain motor shaft extension. Shaft and flange accuracy tolerance N according to DIN 42955 and vibration severity grade A according to EN 60034-14 are sufficient for the connection. The motor flange is adapted by means of adapter plates.
- Output shaft of gearbox exactly coaxial with the motor
- The gearboxes are enclosed (seal between gearbox and motor) and filled with oil at the factory. They are lubricated and sealed for their service life. The gearboxes are suitable for all mounting positions.
- Degree of protection of gearbox: IP65
- Small dimensions
- Low weight

4.2.3.2 Selection and ordering data for the planetary gearboxes

The selection and ordering data for the gearboxes is provided in Chapter "SIMOTICS Servomotors" in Catalog D 21.4

(<https://support.industry.siemens.com/cs/document/109747019/>) in the print version - or online.

Note

When selecting the motor-gearbox combination, ensure that the maximum permissible gearbox input speed is not exceeded. It must be greater than or equal to the maximum motor speed.

At high switching frequencies, you must take into account the additional factor f_2 .

The motor-gearbox combinations listed in the selection tables are predominantly for cyclic duty S3-60 % (ON duration \leq 60 % and \leq 20 min) .

For use in continuous duty S1 (ON duration $>$ 60 % or $>$ 20 min) reduced maximum motor speeds and output torques apply.

The maximum gearbox temperature is 90 °C.

- For mounting the gearbox, select the following motor options:
 - Flange, classic
 - Plain motor shaft extension
 - Shaft and flange accuracy tolerance N
 - Vibration severity grade A
 - Degree of protection IP65

Additional information for configuring the motor-gearbox combination is provided in Chapter Dimensioning the gearbox (Page 117).

4.2.4 Special options

4.2.4.1 Introduction

The following options are available for the 1FT7.

- Option B02 - factory certificate
- Option J□□ - planetary gearbox mounting
- Option K20 - Reinforced bearing
- Option L03 - increased vibration stress
- Option L06 - increased shock loads
- Option N05 - Alternative shaft geometry
- Option N16 - Increased chemical resistance
- Option N27 - Brake with low moment of inertia
- Option N40 - Increased resistance to industrial cleaning
- Option Q12 - sealing air connection (only in conjunction with IP67)
- Option Q13 - Encoder sealing
- Option Q41...Q44 - fan connector, fixed,
 - transverse right or left
 - axial DE or NDE
- Option X., K23, K24 - painting
- Option Y84 - customer data on the rating plate

You can recognize the selected options on the rating plate by the following digits.

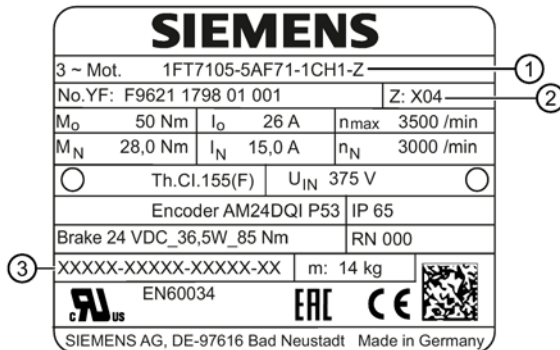

- 1 "-Z" is the code for an option in the article number
- 2 "X04" as example for identification of the options. Up to 2 options, separated by slashes, are shown on the rating plate.
- 3 Field for customer data for the option Y84 (max. 20 characters, any distribution)

Figure 4-4 Rating plate 1FT7 code options

Note

If more than 2 options are ordered, no options will appear on line 2.

In this case, specify the motor ID (No.YF) when ordering more motors of the same type.

The following options can also be ordered. They are a part of the article number.

- Flange "compact", recessed flange
- Shaft extension on DE with feather key and keyway (half-key balancing)
- Integrated holding brake
- Degree of protection IP65 or IP67
- Vibration severity grade R
- Radial eccentricity, concentricity and axial eccentricity: Tolerance R
- A terminal box version is alternatively possible for motors with connector size 3

Additional information is provided in Chapter "Selection based on the article number (Page 33)".

4.2.4.2 Option B02 - Manufacturer's test certificate

Option B02 provides a manufacturer's test certificate according to DIN 55 350 Part 18 for motors according to DIN EN 10204:2004 (DIN 50049).

You will find the 1FT7 motors that are available with option B02 in Section "Limited validity."

The manufacturer's test certificate states and certifies the values of the motor for

- the induced voltage at 1000 rpm
- the winding resistance values (ohm)
- confirmation that the high-voltage test has been passed.

SIEMENS		accordin to: DIN EN 10 204 : 2004						
acceptance test certificate 3.1		according to: DIN 55 350 T 18						
manufacturer: SIEMENS AG Digital Factory Motion Control EWN address: Industriestraße 1 D-97616 Bad Neustadt a. d. Saale		purchaser: SIEMENS SPA Siemens Ital consumer:						
motor-number: F8619922501		order number:	XXXXXXXXXX					
3~ Motor 1FT7108-5AC71-1CH1-Z								
Test report [1]								
Mot-Nr [2]	induced voltage at 1000 rpm			stator resistance			high-voltage test	
	Voltage [3] [V]			U-V [4] [Ohm]	V-W [4] [Ohm]	W-U [4] [Ohm]	[5]	
1	172,4			0,222	0,222	0,222	passed	

Figure 4-5 Manufacturer's test certificate (example)

Limited validity for 1FT7 motors

Option B02 can be ordered for all 1FT7 motors with the exception of the

- core types
- 1FT7117
- 1FT713□

4.2.4.3 Option K20 - Reinforced bearing

The 1FT7 motors are available with reinforced bearings by selecting option K20.

You will find the 1FT7 motors that are available with option K20 in Section "Limited validity."

The following diagrams show the maximum permissible radial forces of the corresponding motor sizes for option K20. It depends on the points of application of the force, and the average speed for the nominal bearing lifetime of 25000 hours.

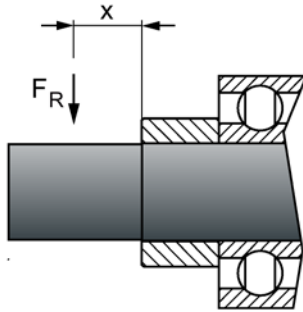

F_R Point of application of the radial force

x Distance between where the radial force is applied and the shaft shoulder in mm

Figure 4-6 Force application point at DE

Motor 1FT7062

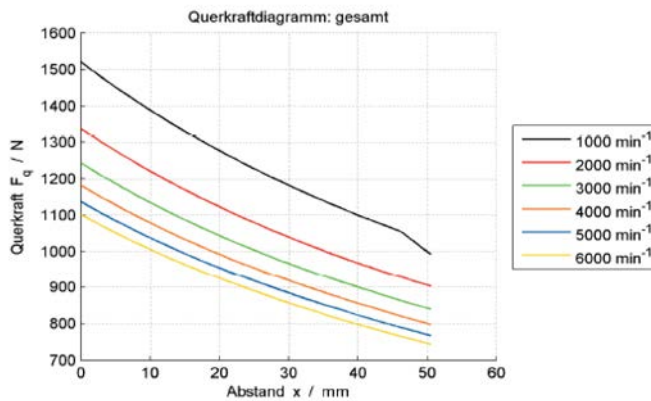

Figure 4-7 Radial force diagram 1FT7062

Motor 1FT7064

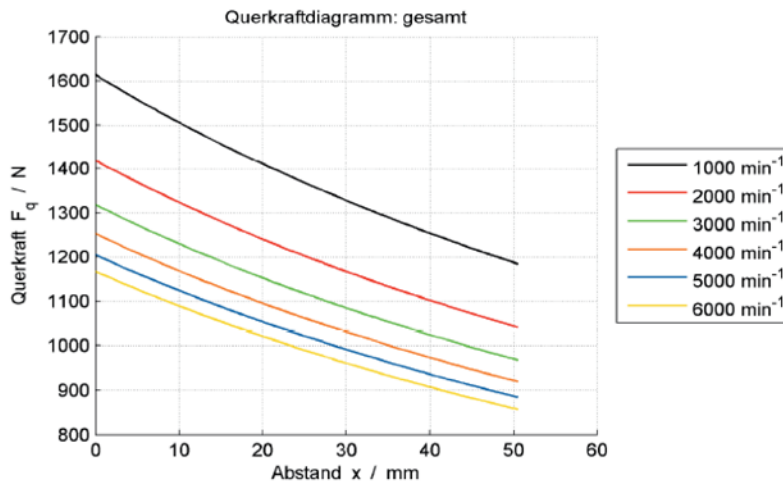

Figure 4-8 Radial force diagram 1FT7064

Motor 1FT7066

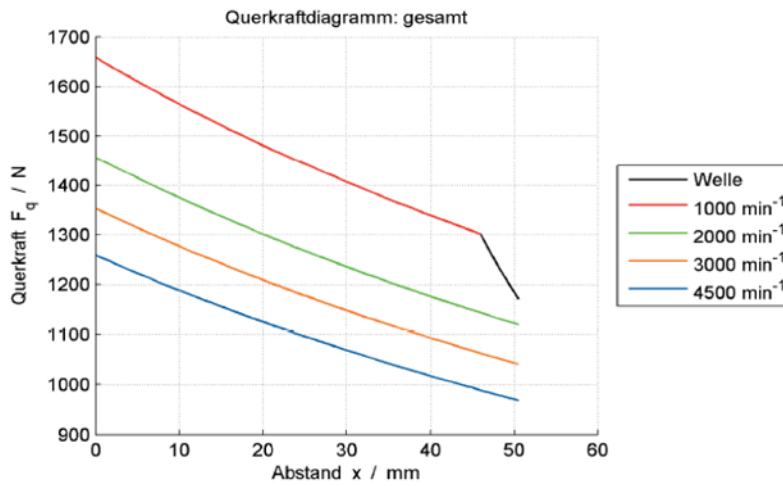

Figure 4-9 Radial force diagram 1FT7066

Motor 1FT7068

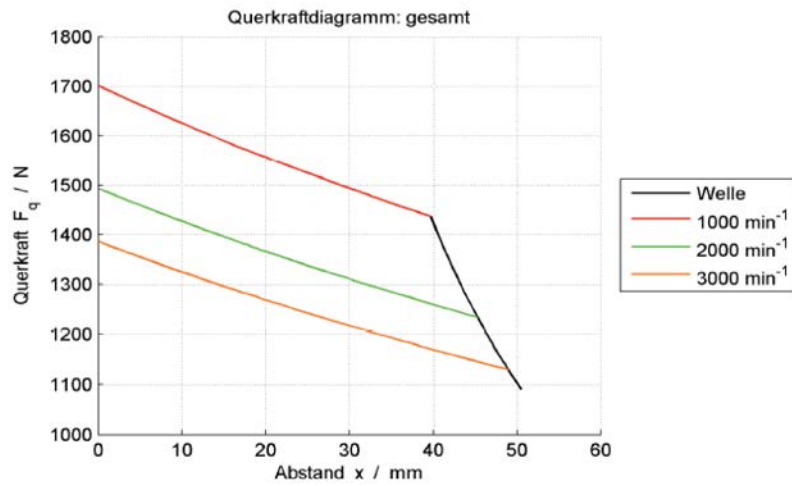

Figure 4-10 Radial force diagram 1FT7068

Motor 1FT7082

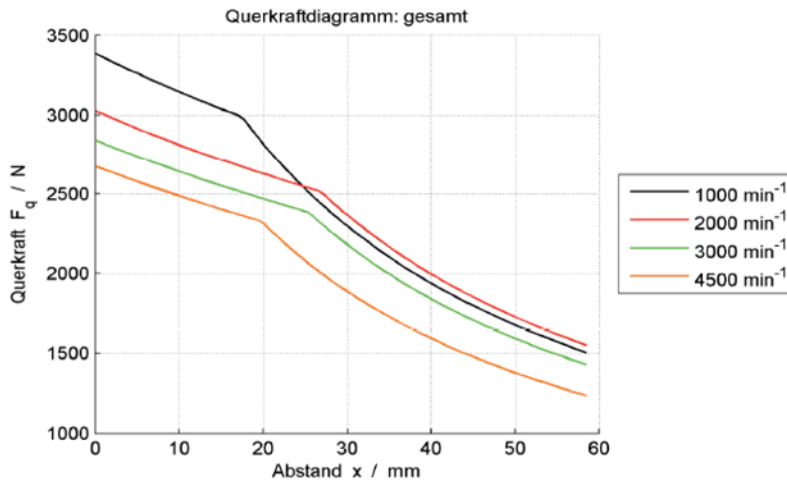

Figure 4-11 Radial force diagram 1FT7082

Motor 1FT7084

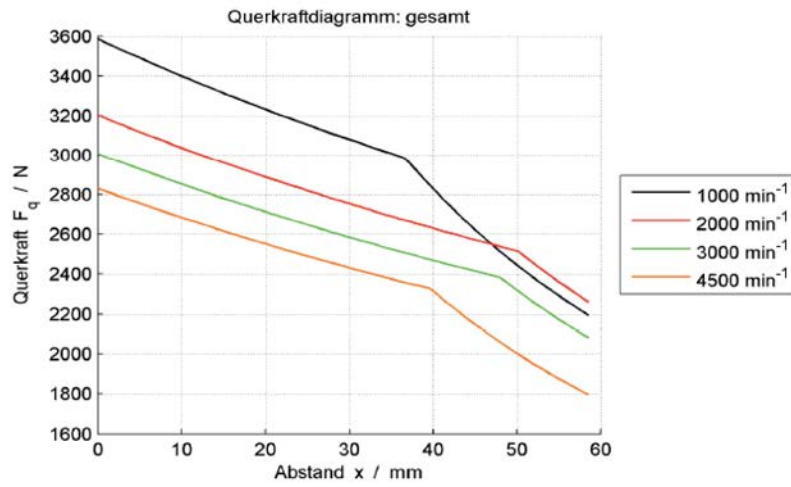

Figure 4-12 Radial force diagram 1FT7084

Motor 1FT7086

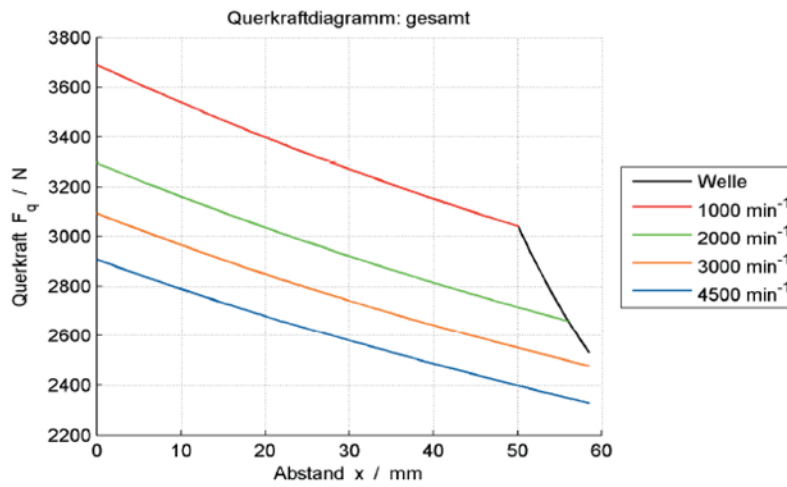

Figure 4-13 Radial force diagram 1FT7086

Motor 1FT7102

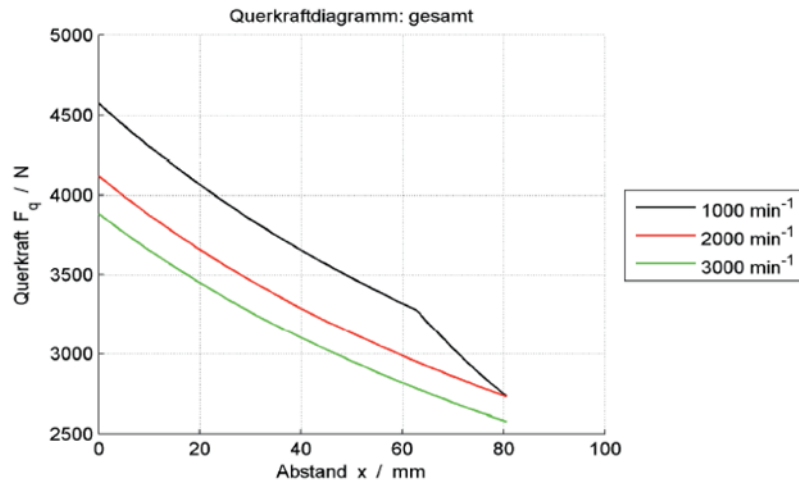

Figure 4-14 Radial force diagram 1FT7102

Motor 1FT7105

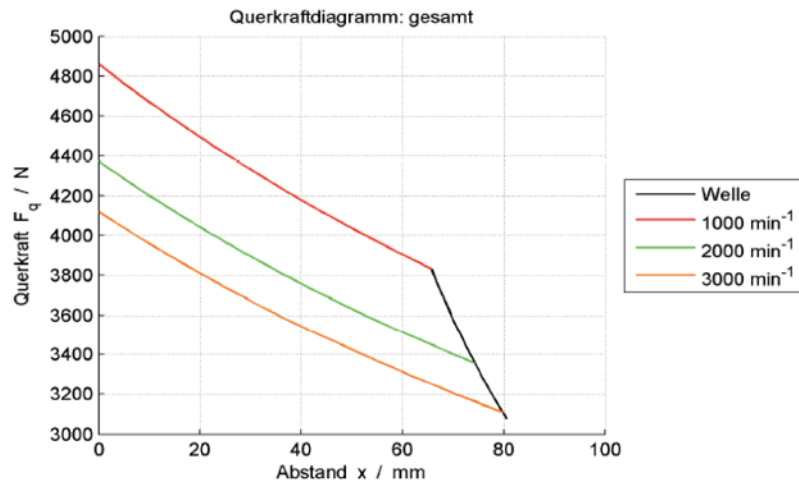

Figure 4-15 Radial force diagram 1FT7105

Motor 1FT7108

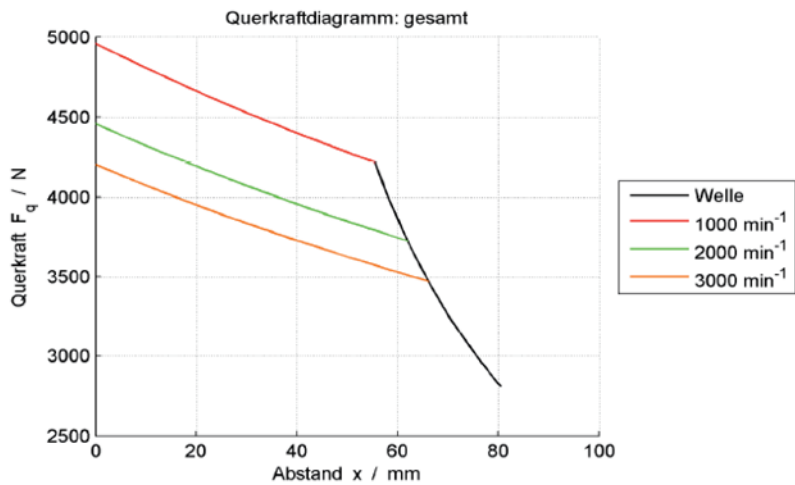

Figure 4-16 Radial force diagram 1FT7108

Limited validity for 1FT7 motors

Option K20 is only available for the standard type. The motors of the core type are not supplied with option K20.

Motors with option K20 are only delivered with flange form "Classic".

Option K20 is available for the following 1FT7 order numbers:

- 1FT706□-5□□71-□□□□
- 1FT708□-5□□71-□□□□
- 1FT710□-5□□71-□□□□
- 1FT706□-5□□74-□□□□
- 1FT708□-5□□74-□□□□
- 1FT710□-5□□74-□□□□

4.2.4.4 Option L03 - Increased resistance to vibration

The 1FT7 motors are available with the option L03 "Increased resistance to vibration".

Area of application

Applications of motors with option L03 include:

- Servo presses
- Punching machines

Specification

Maximum permissible vibration acceleration

Note

The vibration acceleration rates (0 peak) measured in the frequency range from 0 Hz to 1 kHz at the bearings (position of the measuring points according to DIN ISO 10816-1) must not exceed the values stated in the table.

Vibration acceleration	1FT7 Standard	1FT7 Compact with option L03
Horizontal/vertical	5 g*	10 g*
axial	2.5 g*	2.5 g*

* 1 g corresponds to 9.81 m/s²

Availability of option L03

Option L03 "Increased resistance to vibration" is available for the following 1FT7 order numbers:

1FT7□□□-5□□□□-0B□□-Z	1FT7□□□-5□□□□-0L□□-Z
1FT7□□□-5□□□□-1B□□-Z	1FT7□□□-5□□□□-1L□□-Z
1FT7□□□-5□□□□-2B□□-Z	1FT7□□□-5□□□□-2L□□-Z
1FT7□□□-5□□□□-3B□□-Z	1FT7□□□-5□□□□-3L□□-Z
1FT7□□□-5□□□□-4B□□-Z	1FT7□□□-5□□□□-4L□□-Z
1FT7□□□-5□□□□-0C□□-Z	1FT7□□□-5□□□□-0M□□-Z
1FT7□□□-5□□□□-1C□□-Z	1FT7□□□-5□□□□-1M□□-Z
1FT7□□□-5□□□□-2C□□-Z	1FT7□□□-5□□□□-2M□□-Z
1FT7□□□-5□□□□-3C□□-Z	1FT7□□□-5□□□□-3M□□-Z
1FT7□□□-5□□□□-4C□□-Z	1FT7□□□-5□□□□-4M□□-Z
1FT7□□□-5□□□□-0K□□-Z	1FT7□□□-5□□□□-0N□□-Z
1FT7□□□-5□□□□-1K□□-Z	1FT7□□□-5□□□□-1N□□-Z
1FT7□□□-5□□□□-2K□□-Z	1FT7□□□-5□□□□-2N□□-Z
1FT7□□□-5□□□□-3K□□-Z	1FT7□□□-5□□□□-3N□□-Z
1FT7□□□-5□□□□-4K□□-Z	1FT7□□□-5□□□□-4N□□-Z

Limited validity

Option L03 can be ordered for the above motors in the following version:

- 1FT7 Compact only
- with natural cooling or water cooling
- encoder types used
 - with DRIVE-CLiQ AS24DQI and AM24DQI
 - without DRIVE-CLiQ: IC2048S/R and AM2048S/R

Option L03 is only available for motors with

- Shaft height 132
- Power connector, size 3
- Power connector with sealing air connection (option Q12)
- Terminal box
- Option "Increased resistance to chemicals" (N16 and N40)

Configuration note

The modified selection and ordering data now apply to all motors with a fixed connector with sizes 1 and 1.5.

Selection and ordering data:

- 1FT7□□□-5□□□□-0□□□-Z L03: Fixed connector transverse right
- 1FT7□□□-5□□□□-1□□□-Z L03: Rotatable connector (for sizes 1 and 1.5 only)
- 1FT7□□□-5□□□□-2□□□-Z L03: Fixed connector transverse left
- 1FT7□□□-5□□□□-3□□□-Z L03: Fixed connector axial NDE (from shaft height 100 only)
- 1FT7□□□-5□□□□-4□□□-Z L03: Fixed connector axial DE

Note

For greater ruggedness when subjected to vibration, we recommend using fixed connectors.

4.2.4.5 Option L06 - increased shock loads

Option L06 - increased shock loads

Option L06 can be ordered for motors 1FT7117. The motors are designed for operation under high shock loads in accordance with DIN ISO 10816-1.

Option L06 cannot be combined with option L03 "increased vibration stress".

The following motors are available with option L06:

- 1FT7117-7SC71-□L□0-Z L06 (force-ventilated 2000 rpm)
- 1FT7117-7SF71-□L□0-Z L06 (force-ventilated 3000 rpm)
- 1FT7117-7AC71-□L□0-Z L06 (naturally cooled 2000 rpm)
- 1FT7117-7AF71-□L□0-Z L06 (naturally cooled 3000 rpm)

Technical specifications

Version	M_0	M_N	M_{max}
1FT7117-7SC71-□L□0-Z L06 Q4□ ¹⁾	105 Nm	82 Nm (2000 rpm)	290 Nm
1FT7117-7SF71-□L□0-Z L06 Q4□ ¹⁾	105 Nm	54 Nm (3000 rpm)	290 Nm
1FT7117-7AC71-□L□0-Z L06	81 Nm	55 Nm (2000 rpm)	290 Nm
1FT7117-7AF71-□L□0-Z L06	81 Nm	30 Nm (3000 rpm)	290 Nm

1) Selectable outlet direction of the fan connector:

Table 4- 6 Outlet directions of the fixed fan connector

Q41	Transverse right	Q43	Axial NDE
Q42	Transverse left	Q44	Axial DE

Shock loads in operation acc. to DIN ISO 10816-1

Radial acceleration of 250 m/s² during a period of 10⁷ shocks radial.

Noise emission

Measuring-surface sound pressure level $L_p(A) < 80$ dB (A) (speed range from 0 to rated speed)

See also

Sales and delivery release SIMOTICS S-1FT7117

[https://support.industry.siemens.com/cs/document/109742370/release-for-sales-and-delivery-simotics-s-1ft7117-\(shaft-height-100-high-dynamic\)?dti=0&lc=en-WW](https://support.industry.siemens.com/cs/document/109742370/release-for-sales-and-delivery-simotics-s-1ft7117-(shaft-height-100-high-dynamic)?dti=0&lc=en-WW)

4.2.4.6 Option N05 - Alternative shaft geometry

The 1FT7 motors are available with alternative shaft geometry by selecting option N05.

You will find the 1FT7 motors that are available with option N05 in Section "Limited validity."

The 1FT7 motors with option N05 ensure interchangeability with motors of the 1FT5 type series.

Type of construction

Option N05 is available in type of construction IM B5 with classic flange (article number: 1FT7□□□-□□□□1-□□□□), compatible with 1FT5.

Limited validity for 1FT7 motors

Note

Option N05 is only possible with 1FT7 motors with natural cooling, except 1FT7117-□□□□□-□□□□..

Option N05 is not available for force-ventilated and water-cooled 1FT7 motors.

Option N05 is available for the following 1FT7 order numbers:

- 1FT7034-5A□7□-□□□□
- 1FT7042-5A□7□-□□□□
- 1FT7062-5A□7□-□□□□
- 1FT7064-5A□7□-□□□□
- 1FT7082-5A□7□-□□□□
- 1FT7084-5A□7□-□□□□
- 1FT7086-5A□7□-□□□□
- 1FT7102-5A□7□-□□□□
- 1FT7105-5A□7□-□□□□
- 1FT7108-5A□7□-□□□□

Shaft dimensions (diameter x length) according to shaft height (SH) with Option N05

- SH 36: 11 × 23 mm
- SH 48: 14 × 30 mm
- SH 63: 19 × 40 mm (not compatible with flange)
- SH 80: 24 × 50 mm
- SH 100: 32 × 58 mm

Table of compatibility of 1FT7 N05 with 1FT5

1FT7	Shaft extension	compatible with 1FT5	Flange-compatible**	Shaft-compatible*
1FT7034-5A□7□-□□□□-Z; Z=N05	Diam. 11x23 mm	1FT503...	compatible	compatible
1FT7042-5A□7□-□□□□-Z; Z=N05	Diam. 14x30 mm	1FT504...	compatible	compatible
1FT7062-5A□7□-□□□□-Z; Z=N05 1FT7064-5A□7□-□□□□-Z; Z=N05	Diam. 19x40 mm	1FT506...	not compatible	compatible
1FT7082-5A□7□-□□□□-Z; Z=N05 1FT7084-5A□7□-□□□□-Z; Z=N05 1FT7086-5A□7□-□□□□-Z; Z=N05	Diam. 24x50 mm	1FT507...	compatible	compatible
1FT7102-5A□7□-□□□□-Z; Z=N05 1FT7105-5A□7□-□□□□-Z; Z=N05 1FT7108-5A□7□-□□□□-Z; Z=N05	Diam. 32x58 mm	1FT510...	compatible	compatible

* The shafts are not compatible with the following motors: 1FT5070-..., 1FT5071-..., 1FT5073-..., 1FT5100-..., 1FT5101-..., 1FT5103-...

** Flange compatibility means the same centering and the same diameter of the hole circle. However, the edge dimension can be different.

Table for comparison of the flange dimensions of the 1FT7 N05 with 1FT5

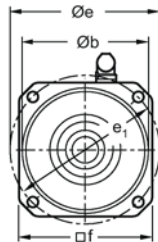

- e Diameter of the hole circle
- b Diameter of the centering edge
- f Edge dimensions

Order number		Flange dimensions on the motor					
		Edge dimensions in mm		Hole circle Ø in mm		Centering edge Ø in mm	
1FT7 N05	1FT5	1FT7 N05	1FT5	1FT7 N05	1FT5	1FT7 N05	1FT5
1FT703...	1FT503...	72	70	Ø 75		Ø 60	
1FT704...	1FT504...	96	92	Ø 100		Ø 80	
1FT706...	1FT506...	126	105	Ø 130	Ø 115	Ø 110	Ø 95
1FT708...	1FT507...	155	142	Ø 165		Ø 130	
1FT710...	1FT510...	196	190	Ø 215		Ø 180	

You can find additional information in the "DT Configurator (<http://siemens.de/dt-konfigurator>)".

Configuring

The cantilever force diagrams provided in the Configuration Manual are also valid for 1FT7 servomotors with option N05.

4.2.4.7 Option N16 - Increased chemical resistance

The 1FT7 motors are available with the option N16, protective properties for increased resistance to chemicals.

You will find the 1FT7 motors that are available with option N16 in Product notification SIMOTICS S with option N16

(<https://support.industry.siemens.com/cs/document/58657336>).

Additional characteristics of the motor with option N16

- 4-coat paintwork
- Nickel-plated connectors
- Encoder with round connector M17

Application environments of the motor

Typical applications for these versions are for plants and systems in the foodstuff industry - as well as machine tools, for example.

The paint system for these motors is resistant to a wide range of common cleaning and disinfecting agents.

Note

The ECOLAB Deutschland GmbH company verified the resistance to cleaning and disinfecting agents based on a material resistance test. The certificate is available at Product notification SIMOTICS S with option N16

(<https://support.industry.siemens.com/cs/document/58657336>).

- Check the resistance of your complete system comprising motor, connections and cables before use.
-

Connection system

For motors with DRIVE-CLiQ interface, the signal connector deviates from the standard version of the motor.

DQI encoders with option N16 are only supplied with a rotatable angled connector.

The rotatable angled connector is a round connector M17.

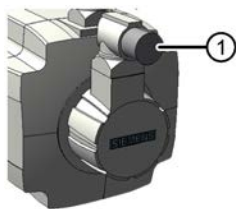

1 Round connector M17

Table 4- 7 Rotation range of the round connector M17

Motor	Round connector M17		Drawing
	Angle α'	Angle β'	
1FT703 1FT704	125°	130°	
1FT706	115°	110°	
1FT708	105°	100°	
1FT710 1FT713	95°	95°	

- The motor is 5 mm longer and has the same overall length as the motor without a DRIVE-CLiQ interface.
- The height of the obstructing contour from the center of the motor is 82 mm.
- Connection requires a signal cable that deviates from the standard.

Additional information is provided at Product notification SIMOTICS S with option N16 (<https://support.industry.siemens.com/cs/document/58657336>).

Additional information on DRIVE-CLiQ signal cables with round connector M17 at the motor end is available at DRIVE-CLiQ cables for motors equipped with option N16 (<https://support.industry.siemens.com/cs/document/109478937>).

Limited availability

Option N16 is only available for the following naturally cooled and water-cooled 1FT7 motors.

- 1FT7□□□-5A□□□-1B□□-Z
- 1FT7□□□-5A□□□-1C□□-Z
- 1FT7□□□-5A□□□-1K□□-Z
- 1FT7□□□-5A□□□-1L□□-Z
- 1FT7□□□-5A□□□-1M□□-Z
- 1FT7□□□-5W□□□-1B□□-Z
- 1FT7□□□-5W□□□-1C□□-Z
- 1FT7□□□-5W□□□-1K□□-Z
- 1FT7□□□-5W□□□-1L□□-Z
- 1FT7□□□-5W□□□-1M□□-Z

Option N16 is only available in combination with the following encoders:

- Encoder AS24DQI (DRIVE-CLiQ absolute encoder 24 bit singleturn)
- Encoder AM24DQI (DRIVE-CLiQ absolute encoder 24 bit + 12 bit multiturn)
- Encoder AM2048S/R (absolute encoder 2048 S/R, 4096 revolutions multiturn, with EnDat interface)

Option N16 is only available for motors with rotatable connector (connector size 1 and 1.5).

Option N16 is not available for 1FT7 motors SH132.

Cleaning recommendation

Cleaning recommendations for motors equipped with option N16 are provided in Product notification SIMOTICS S with option N16 (<https://support.industry.siemens.com/cs/document/58657336>).

4.2.4.8 Option N27 - Brake with low moment of inertia

The option "Brake with low moment of inertia" is available for all 1FT7 motors except 1FT713□. The brake has a lower moment of inertia than the standard brake.

For the brake with low moment of inertia, the description and characteristics of the holding brake according to chapter "Holding brake (Page 74)" apply, with the exception of the technical specifications.

The following technical specifications apply to the brake with low moment of inertia, deviating from the standard version.

Table 4- 8 Technical specifications of the holding brake with low moment of inertia

Motor type	Holding torque M_h at 120 °C / Nm	Dyn. Braking torque M_m / Nm	DC current / at 20 °C / A	Opening time with varistor ¹⁾ t_o / ms	Closing time with varistor ¹⁾ t_{c1} / ms	Highest braking energy W/ J	Moment of inertia J_{Br} / kgm ² • 10 ⁻⁴
1FT703□	1.9	1	0.3	50	30	40	0.11
1FT704□	4	3	0.5	70	30	150	0.36
1FT706□	13	8.5	0.8	100	50	380	1.1
1FT708□	22	11	0.9	200	60	1400	3.9
1FT710□ 1FT7117	43	25	1.0	300	70	3380	8.6

1) Measured at 24.0 V.

Calculating the motor moment of inertia with brake

Use the following formula to calculate the motor moment of inertia with brake $J_{Mot Br}$:

$$J_{Mot Br} = J_{Mot} + J_{Br}$$

Electrical connection of the brake with low moment of inertia

The brake with low moment of inertia is connected like a standard holding brake.

Information on the electrical connection of the holding brake is provided in Chapter "Connecting the holding brake (Page 387)".

4.2.4.9 Option N40 - Increased resistance to industrial cleaning

The 1FT7 motors are available with the option N40 for increased resistance to industrial cleaning.

You will find the 1FT7 motors that are available with option N40 in Section "Limited validity."

Option N40 improves the resistance of motors to the effects of industrial cleaning agents in wet areas of a production environment.

Option N40 also applies to the shaft extension of the servomotors.

Additional characteristics of the motor with option N40 as compared with option N16

- Stainless steel shaft
- Sleeve made of stainless steel at the shaft sealing ring
- Lubricating grease in the shaft sealing ring that is compatible with food
- Screws on the outer surface have been surface treated
- Nickel-plated power connector
- Nickel-plated signal connector
- In conjunction with encoder "C," you automatically receive the round connector M17.
- Multi-layer paint finish PS Premium (certified by ECOLAB)

Application environments of the motor

Motors with option N40 are suitable for areas where there are increased demands placed on the protection properties of the painting system – as well as other exposed motor components.

The paint system "PS Premium" has been tested with a broad spectrum of industrial cleaning products with pH values ranging from 1.5 – 13.

The PS Premium paint system is resistant to:

- Acids (e.g. phosphoric acid),
- Alkalis (e.g. active chlorine),
- Disinfectants (e.g. hydrogen peroxide and peracetic acid),
- Salt water,
- Acidic and alkali cleaning agents with the pH value range 1.5. to 13.

Note

The resistance of the paint system "PS Premium" was verified in a material resistance test by ECOLAB Deutschland GmbH. See Product notification SIMOTICS S with option N40 (<https://support.industry.siemens.com/cs/ww/de/view/85195226>)

Connection system

The power/brake and signal connections of motors with option N40 are nickel-plated.

For motors with DRIVE-CLiQ interface, the signal connector deviates from the standard version of the motor.

DQI encoders with option N40 are only supplied with a rotatable angled connector.

The rotatable angled connector is a round connector M17.

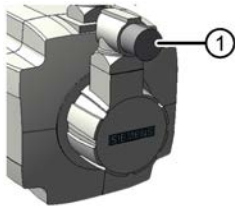

1 Round connector M17

- The motor is 5 mm longer and has the same overall length as the motor without a DRIVE-CLiQ interface.
- The connector is implemented as a rotatable angled connector.
- The height of the obstructing contour from the center of the motor is 82 mm.
- Connection requires a signal cable that deviates from the standard.

DRIVE-CLiQ signal cables with M17 round connector at the motor end for option N40 are identical to the DRIVE-CLiQ signal cables for option N16.

Further information on these DRIVE-CLiQ signal cables can be found at DRIVE-CLiQ cables for motors equipped with option N16

(<https://support.industry.siemens.com/cs/document/109478937>).

Further information on option N40 can be found at Product notification SIMOTICS S with option N40 (<https://support.industry.siemens.com/cs/ww/de/view/85195226>)

Cleaning recommendation

Cleaning recommendations for motors equipped with option N40 are provided in Product notification SIMOTICS S with option N40

(<https://support.industry.siemens.com/cs/ww/de/view/85195226>).

Limited validity for 1FT7 motors

Option N40 is only available for motors encoders

- AM24DQI (absolute encoder 24 bit + 12 bit multiturn)
- AM2048 S/R (absolute encoder 2048 S/R, 4096 revolutions multiturn)
- Degree of protection IP67
- Connector sizes 1 and 1.5

A sealing air connection at the connector (option Q12) is not available.

Option N40 is only available for the following naturally cooled 1FT7 motors up to shaft height 100.

- 1FT703-5A□711C□2 - Z N40 / 1FT703□5A□711C□5 - Z N40
- 1FT704-5A□711C□2 - Z N40 / 1FT704□5A□711C□5 - Z N40
- 1FT706-5A□711C□2 - Z N40 / 1FT706□5A□711C□5 - Z N40
- 1FT708-5A□711C□2 - Z N40 / 1FT708□5A□711C□5 - Z N40
- 1FT710-5A□711C□2 - Z N40 / 1FT710□5A□711C□2 - Z N40
- 1FT703-5A□741L□2 - Z N40 / 1FT703□5A□741L□5 - Z N40
- 1FT704-5A□741L□2 - Z N40 / 1FT704□5A□741L□5 - Z N40
- 1FT706-5A□741L□2 - Z N40 / 1FT706□5A□741L□5 - Z N40
- 1FT708-5A□741L□2 - Z N40 / 1FT708□5A□741L□5 - Z N40
- 1FT710-5A□741L□2 - Z N40 / 1FT710□5A□741L□2 - Z N40
- 1FT703-5A□741M□2 - Z N40 / 1FT703□5A□741M□5 - Z N40
- 1FT704-5A□741M□2 - Z N40 / 1FT704□5A□741M□5 - Z N40
- 1FT706-5A□741M□2 - Z N40 / 1FT706□5A□741M□5 - Z N40
- 1FT708-5A□741M□2 - Z N40 / 1FT708□5A□741M□5 - Z N40
- 1FT710-5A□741M□2 - Z N40 / 1FT710□5A□741M□2 - Z N40

4.2.4.10 Option Q12 - Sealing air connection

The 1FT7 motors can be protected from the ingress of very creep-capable media with sealing air.

The sealing air connection is ordered with option Q12.

You will find the 1FT7 motors that are available with option Q12 in Section "Limited validity."

Note

Option Q12 can only be ordered in conjunction with degree of protection IP67.

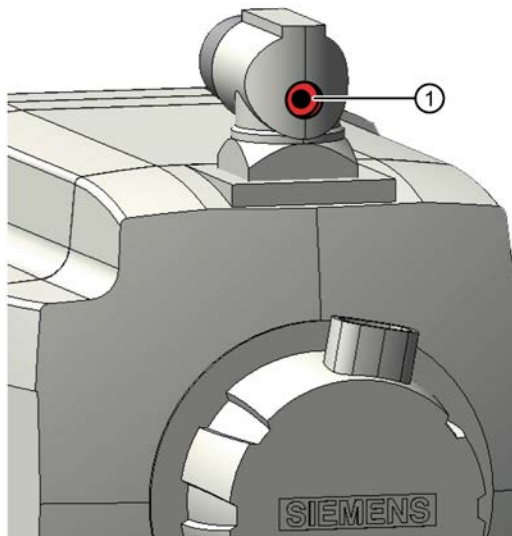

1 Sealing air connection (if not closed with a plug)

Figure 4-17 1FT7 sealing air connection

The sealing air connection is located in the power connector.

Technical specifications of the sealing air connection

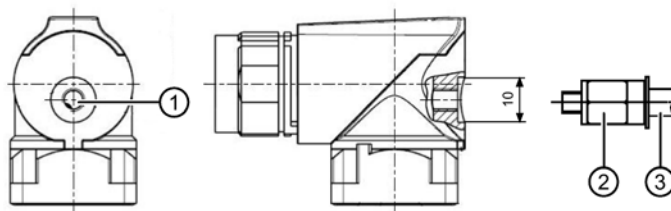

1 Sealing air connection M5

2 Connector nipple, e.g. Festo QSM-B-M5-4-20

3 Tube, outside diameter 4 mm, inside diameter 2.5 mm.

Tightening torque of the sealing air connection: 3.5 Nm to 5 Nm

When supplied, the M5 thread is sealed with an Allen screw with flat head, sealed with FluidD. The FluidD remains pasty and does not harden.

Requirements of the sealing air supply

Conditioning the sealing air	
Minimum supply air temperature in °C	Ambient temperature
Maximum supply air temperature in °C	40
Maximum residual water content in g/m ³	0.12
Maximum residual oil content in g/m ³	0.01
Maximum residual dust in mg/m ³	0.1
Minimum connection pressure in Pa	0.05 x 10 ⁵
Maximum connection pressure in Pa	0.1 x 10 ⁵
Particle size with hollow shaft encoder in µm	< 8
Particle size with optical encoder in µm	< 3
Volume	
Volume in Nm ³ /h (Nm ³ = standard cubic meter)	1 - 1.5

Limited validity for 1FT7 motors

Option Q12 is available for the following 1FT7 motors:

1FT7□□□-5□□□□-□□□2

1FT7□□□-7□□□□-□□□2

1FT7□□□-5□□□□-□□□5

1FT7□□□-7□□□□-□□□5

Option Q12 is only available in conjunction with a shaft sealing ring.

Option Q12 is not available in conjunction with option N16 and N40.

Available for connector size:

- 1 (SPEED TEC connector)
- 1.5 (SPEED TEC connector)
- 3

4.2.4.11 Option Q13 - Encoder sealing

Z option Q13 improves sealing at the flange sealing surfaces of the encoder and power connector on the motor with wetting sealant adhesive.

Encoder replacement is only possible in a specialist workshop or at the manufacturer's.

Option Q13 is only available for motors with DQI encoders that have the following letters at the 14th position of the article number:

Article number	Encoder type
1FT7□□□□-□□□□□□-□B□□	AS24DQI
1FT7□□□□-□□□□□□-□K□□	
1FT7□□□□-□□□□□□-□C□□	AM24DQI
1FT7□□□□-□□□□□□-□L□□	

4.2.4.12 Option Q41-Q44 - Connector outlet directions for fixed fan connectors at 1FT7117 force-ventilated

With option Q41 ... Q44 you can select the outlet direction of the fixed fan connector, e. g. 1FT7117-7SC71-1LH0-Z Q4□¹⁾.

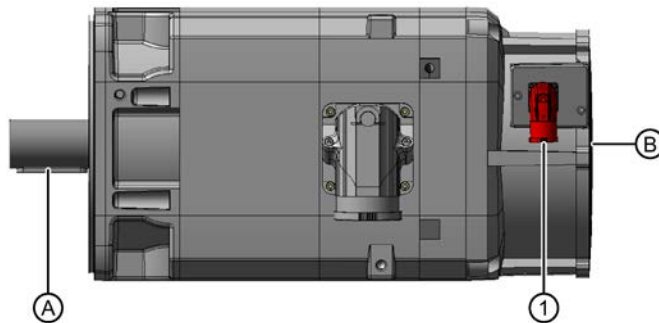

- 1 Fan connector, outlet direction Q41 - transverse right
- A DE - Drive end
- B NDE - Non drive end

Figure 4-18 Outlet direction of the fixed fan connector

1) Selectable connector outlet direction of the fan connector in the following table

Table 4-9 Outlet directions of the fixed fan connector

Q41	Transverse to the right	Q43	Axial to NDE
Q42	Transverse to the left	Q44	Axial to DE

4.2.4.13 Options X., K23, K24, and N16 - Paint finish

Paint finish

If no special color is selected, 1FT7 type series motors are painted in the standard color pearl dark gray (RAL 9023).



Figure 4-19 1FT7 standard color

The 1FT7 servomotor can be supplied in various colors.

You can select between optional colors and special colors.

All finishes meet the requirements for environmental conditions of climate class 3K4 according to IEC 60721-3-3 with the exception of the environmental influencing variables "low air temperature", "condensation" and "low air pressure".







Note

Additional information is provided in Chapter "Environmental conditions (Page 30)". Additional data relating to environmental conditions for "Transporting (Page 361)" and "Storage (Page 365)" of the motors is provided in the appropriate chapters in this documentation.



























The optional colors are available in the standard delivery time.



Special colors may increase the delivery time.

Optional colors

Designation	Order code	Color schemes
RAL 9005, jet black	X01	
RAL 9001, cream white	X02	
RAL 6011, reseda green	X03	
RAL 7032, pebble gray	X04	
RAL 5015, sky blue	X05	
RAL 1015, light ivory	X06	
RAL 7016, anthracite gray	X09	

Special colors (option X..)



Designation	Order code	Color schemes
RAL 6019, pastel green	X11	
RAL 5010, gentian blue	X12	
RAL 5024, pastel blue	X13	
RAL 5017, traffic blue	X14	
RAL 9010, pure white	X15	
RAL 6018, yellow green	X16	
RAL 5014, pigeon blue	X17	
RAL 9018, papyrus white	X18	
RAL 2004, pure orange	X19	
RAL 9003, signal white	X21	
RAL 9002, gray white	X22	
RAL 5005, signal blue	X23	
RAL 7001, silver gray	X24	
RAL 1000, green beige	X25	
RAL 6017, May green	X26	
RAL 5009, azure blue	X28	
RAL 7005, mouse gray	X29	
RAL 1014, ivory	X30	
RAL 5007, brilliant blue	X31	
RAL 3004, purple red	X50	
RAL 2003, pastel orange	X51	
RAL 3000, fire red	X52	
RAL 7035, light gray	X53	
RAL 7004, signal gray	X54	
RAL 7038, agate gray	X55	
RAL 1013, oyster white	X56	
RAL 5012, light blue	X57	

Designation	Order code	Color schemes
RAL 2001, red orange	X58	
RAL 7030, stone gray	X59	

Primer (option K23, K24)

1FT7 motors can be supplied with primer finish.

The following versions are possible.

Description	Order code	Color schemes
Primed in RAL 6021, pale green, without additional coat of paint	K24	
Special paint finish corresponding to the environmental conditions for the standard paint finish and for condensation on the outer motor surfaces. Primer and paint finish in RAL 9023, dark pearl gray	K23	
Special paint finish corresponding to the environmental conditions for the standard paint finish and for condensation on the outer motor surfaces. Primer and paint finish according to color table	K23 + X...	

4.2.4.14 Option Y84 - Customer data on the rating plate

Option Y84 permits customer data on the rating plate of the motor. If you are ordering electronically, you can enter the text for the rating plate when you select option Y84.

Note

The text can be up to 20 characters long. Excess characters will be cut off. Option Y84 does not have any effect on the delivery time.

Option identifier Y84 is not shown as Z option on the rating plate.

The customer data are printed on the rating plate and on the type labels for the product packaging.

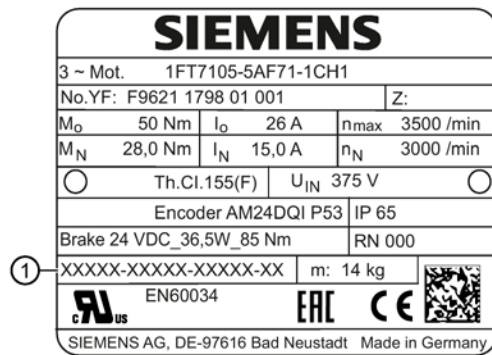

1 C-line: Field for customer data (max. 20 characters, any distribution)

Limited validity for 1FT7 motors

Option Y84 is available for all 1FT7 motors with the exception of the core types.

Ordering example:

- 1FT7□□□-5□□□□-□□□□
- 1FT7□□□-7□□□□-□□□□

Configuration

5.1 Configuring software

5.1.1 SIZER configuration tool

Overview

The SIZER calculation tool supports you in the technical dimensioning of the hardware and firmware components required for a drive task.

SIZER supports the following configuration steps:

- Configuring the power supply
- Designing the motor and gearbox, including calculation of mechanical transmission elements
- Configuring the drive components
- Compiling the required accessories
- Selection of the line-side and motor-side power options

The configuration process produces the following results:

- A parts list of components required (Export to Excel)
- Technical specifications of the system
- Characteristic curves
- Comments on system reactions
- Installation information of the drive and control components
- Energy considerations of the configured drive systems

You can find additional information that you can download in the Internet at SIZER (<https://support.industry.siemens.com/cs/document/54992004/sizer-for-siemens-drives?dti=0&pnid=13434&lc=en-WW>).

5.1.2 STARTER drive/commissioning software

The STARTER commissioning tool offers

- Commissioning
- Optimization
- Diagnostics

Table 5- 1 Article number for STARTER

Commissioning tool	Article no. of the DVD
STARTER German, English, French, Italian, Spanish	6SL3072-0AA00-0AG0

5.2 Procedure when engineering

Motion control

Drives are optimized for motion control applications. They execute linear or rotary movements within a defined movement cycle. All movements should be optimized in terms of time.

As a result, drives must meet the following requirements:

- High dynamic response, i.e. short rise times
- Capable of overload, i.e. a high reserve for accelerating
- Wide control range, i.e. high resolution for precise positioning.

The following table "Configuring procedure" is valid for synchronous and induction motors.

General configuring procedure

The function description of the machine provides the basis when configuring the drive application. The definition of the components is based on physical interdependencies and is usually carried out as follows:

Table 5-2 Configuring procedure

step	Description of the configuring activity	
1.	Clarification of the type of drive	Refer to the next chapter
2.	Definition of supplementary conditions and integration into an automation system	
3.	Definition of the load, calculation of the maximum load torque and selection of the motor	
4.	Selection of the SINAMICS Motor Module	Refer to catalog
5.	Steps 3 and 4 are repeated for additional axes	
6.	Calculation of the required DC link power and selection of the SINAMICS Line Module	
7.	Selection of the line-side options (main switch, fuses, line filters, etc.)	
8.	Specification of the required control performance and selection of the Control Unit, definition of component cabling	
9.	Definition of other system components (e.g. braking resistors)	
10.	Calculation of the current demand of the 24 V DC supply for the components and specification of the power supplies (SITOP devices, Control Supply Modules)	
11.	Selection of the components for the connection system	
12.	Configuration of the drive line-up components	
13.	Calculation of the required cable cross sections for power supply and motor connections	
14.	Inclusion of mandatory installation clearances	

5.2.1 1. Clarification of the drive type

Select the motor on the basis of the required torque (load torque), which is defined by the application, e.g. traveling drives, hoisting drives, test stands, centrifuges, paper and rolling mill drives, feed drives or main spindle drives.

Gearboxes to convert motion or to adapt the motor speed and motor torque to the load conditions must also be taken into account when selecting the motor.

You must know the following mechanical data in order to determine the torque to be supplied by the motor:

- The load torque specified by the application
- Masses to be moved
- Diameter of the drive wheel
- Leadscrew pitch, gear ratios
- Frictional resistance data
- Mechanical efficiency
- Traversing distances
- Maximum velocity
- Maximum acceleration and maximum deceleration
- Cycle time

5.2.2 2. Specification of the supplementary conditions and integration into the automation system

Take the following into account during the configuration:

- The line system configuration when using specific motor types and/or line filters
- The utilization of the motor rated values for winding overtemperatures of 60 K or 100 K (for synchronous motors)
- The ambient temperatures and the installation altitude of the motors and drive components
- The heat dissipation from the motors through natural ventilation, forced ventilation or water cooling

Other conditions apply when integrating the drives into an automation environment such as SINUMERIK or SIMOTION.

For motion control and technology functions (e.g. positioning), as well as for synchronous operation functions, the corresponding automation system, e.g. SIMATIC S7-1500 or SIMOTION D is used.

5.2.3 3. Definition of the load, calculation of the maximum load torque and determination of the motor

The motors are defined bases on the motor type-specific limiting characteristic curves.

The limiting characteristic curves describe the torque or power curve over the speed.

The limiting characteristic curves take the limits of the motor into account on the basis of the DC-link voltage. The DC-link voltage is dependent on the line voltage.

In the case of torque drive the DC-link voltage is dependent on the type of Line Module and the type of infeed module or infeed/regenerative feedback module.

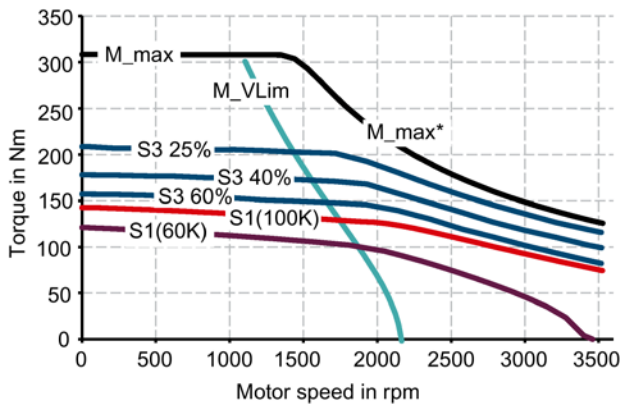

M_max	Curve of the maximum torque	S3 25%	S3 characteristic curve for 25%
M_max*	Curve of the maximum torque with field weakening	S3 40%	S3 characteristic curve for 40%
S1 (100 K)	S1 characteristic curve at 100 K	S3 60%	S3 characteristic curve for 60%
S1 (60K)	S1 characteristic curve for 60 K	M_VLim	Voltage limit characteristic without field weakening

Figure 5-1 Limiting characteristic curve for synchronous motors

Procedure

1. Determine the load which is specified by the application.
 - Use different characteristics for the different loads.
 - The following operating scenarios have been defined:
 - Duty cycle with constant ON duration
 - Duty cycle with varying ON duration
 - Free duty cycle
2. Determine the characteristic torque and speed operating points of the motor for the defined load.

3. Calculate the acceleration torque of the motor.
Add the load torque and the acceleration torque to obtain the maximum required torque.
4. Verify the maximum motor torque with the limiting characteristic curves of the motors.

The following criteria must be taken into account when selecting the motor:

- Compliance with the dynamic limits.
All speed-torque points of the load must be below the relevant limiting characteristic curve.
- Compliance with the thermal limits.
At average speed, the effective motor torque must be below the S1 characteristic curve (continuous operation) during the load.

You have defined a motor.



Duty cycles with constant ON duration

For duty cycles with constant ON duration, there are specific requirements for the torque characteristic curve as a function of the speed, for example:

$M = \text{constant}$, $M \sim n^2$, $M \sim n$ or $P = \text{constant}$.

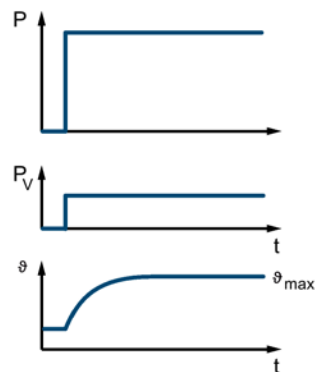

Figure 5-2 S1 duty (continuous operation)

These drives typically operate at a specific operating point.

Procedure

1. Configure a base load for the stationary operating point. The base load torque must lie below the S1 characteristic curve.
2. In the event of transient overloads (e.g. during acceleration), configure an overload. Calculate the overload current in relation to the required overload torque. The overload torque must lie below the voltage limiting characteristic curve.

In summary, the motor is configured as follows:

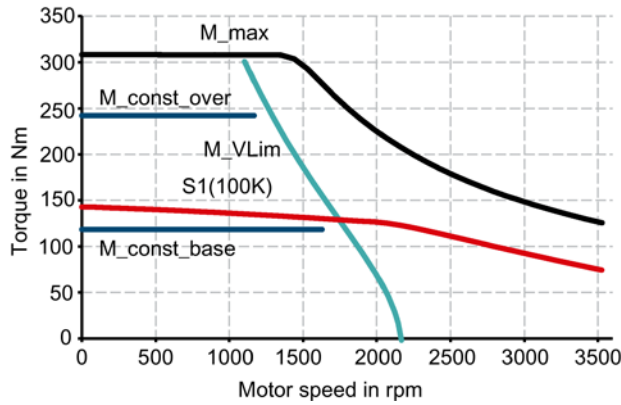

- M_max Curve of the maximum torque
- M_const_ov Curve of the overload torque
- M_VLim Voltage limiting characteristic curve
- M_const_ba Curve of the base load torque
- S1 (100K) S1 characteristic curve

Figure 5-3 Motor selection for duty cycle with constant ON duration (example)

3. Select a motor that satisfies the requirements of duty type S1.
 -

Duty cycles with varying ON duration

Standardized intermittent duties (S3) are specified for duty cycles with varying ON durations. Each intermittent duty (S3) is made up of a sequence of duty cycles of the same type. Each duty cycle encompasses a time with constant load and a pause.

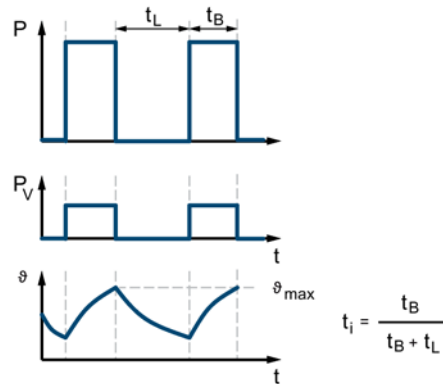

Figure 5-4 S3 duty (intermittent operation without influencing starting)

Fixed variables are generally used for the relative ON duration:

- S3 – 60%
- S3 – 40%
- S3 – 25%

The corresponding motor characteristics are provided for these specifications.

The load torque must lie below the corresponding thermal limiting characteristic curve of the motor. An overload is taken into account for duty cycles with varying ON duration.

Free duty cycle

A free duty cycle defines the curve of the motor speed and the torque over time.

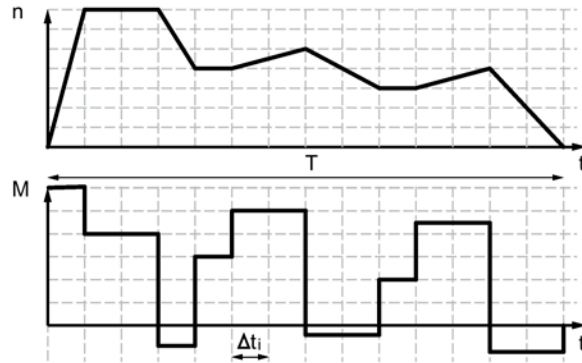

n	Speed	T	Cycle time
M	Torque	Δt_i	Time interval
t	Time		

Figure 5-5 Example of free duty cycle

Procedure

Determine the required motor torque as follows:

- Define a load torque for each time slice. Also take the average load moment of inertia and motor moment of inertia into account for acceleration operations. If required, take a frictional torque into account that opposes the direction of motion.
- With mounted gearbox:
Determine the load torque and the acceleration torque that must be supplied by the motor. Take the gear ratio and gear efficiency into account.

Note

A higher gear ratio increases positioning accuracy in terms of encoder resolution. For any given motor encoder resolution, as the gear ratio increases, so does the resolution of the machine position to be detected.

The following formulas can be used for duty cycles outside the field weakening range. For duty cycles in the field weakening range, the drive system must be configured using the SIZER configuration tool.

For the motor torque in a time slice Δt_i the following applies:

$$M_{\text{Mot}, i} = (J_M + J_G) \cdot \frac{2\pi}{60} \cdot \frac{\Delta n_{\text{Last}, i}}{\Delta t_i} \cdot i + \left(J_{\text{Last}} \cdot \frac{2\pi}{60} \cdot \frac{\Delta n_{\text{Last}, i}}{\Delta t_i} + M_{\text{Last}, i} + M_R \right) \cdot \frac{1}{i \cdot \eta_G}$$

The motor speed is:

$$n_{\text{Mot}, i} = n_{\text{Last}, i} \cdot i$$

The effective torque is obtained as follows:

$$M_{\text{Mot}, \text{eff}} = \sqrt{\frac{\sum M_{\text{Mot}, i}^2 \cdot \Delta t_i}{T}}$$

The average motor speed is calculated as follows:

$$n_{\text{Mot}, \text{mittel}} = \frac{\sum n_{\text{Mot}, i, A} + n_{\text{Mot}, i, E} \cdot \Delta t_i}{T}$$

J_M	Motor moment of inertia
J_G	Gearbox moment of inertia
J_{load}	Load moment of inertia
n_{load}	Load speed
i	Gear ratio
η_G	Gearbox efficiency
M_{load}	Load torque
M_R	Frictional torque
T	Cycle time
A; E	Initial value, final value in time slice Δt_i
t_e	ON duration
Δt	Time interval

The effective torque M_{eff} must lie below the S1 characteristic curve.

The maximum torque M_{max} is produced during the acceleration operation. M_{max} must lie below the voltage limiting characteristic curve. In summary, the motor is configured as follows:

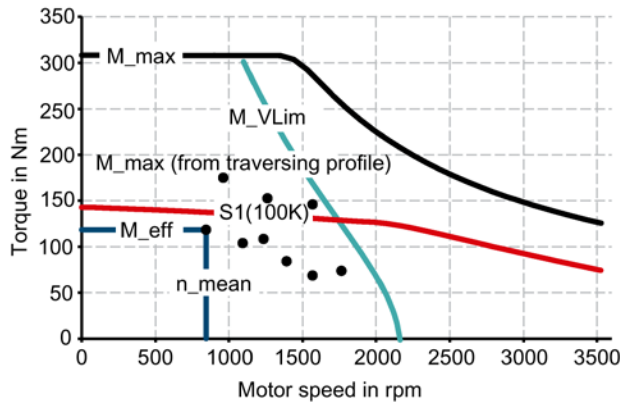

M_max	Curve of the maximum torque	S1 (100K)	S1 characteristic curve for 100 K = M ₀ (100K)
M_eff	Effective torque	•	Points from the traversing profile
n_mean	Mean speed	M_VLim	Voltage limiting characteristic curve

Figure 5-6 Motor selection for duty cycle (example)

You have defined the characteristic motor values corresponding to the duty cycle.



Specification of the motor

By varying, you can find the motor that satisfies the conditions of the operating mode (duty cycle).

- Determine the motor current at base load. The calculation depends on the type of motor (synchronous motor or induction motor) and the operating mode (duty cycle) used.

Note

When configuring according to duty cycle with constant ON duration with overload, the overload current is calculated in relation to the required overload torque.

- Comply with the thermal limits of the motor.
- Configure the other properties of the motor through the available motor options.

5.3 Dimensioning the gearbox

Overview

- Take into account the following influencing variables when configuring the gearbox:
 - Accelerating torque
 - Continuous torque
 - Number of cycles
 - Cycle type
 - Permissible input speed
 - Mounting position
 - Torsional play
 - Torsional stiffness
 - Radial and axial forces

Note

For reversing operation for servo applications, worm gearboxes are only conditionally suitable.

- Refer to the catalogs from the gearbox manufacturer for technical data.
- Suitable shaft and flange seals must be selected if gearbox oil is in contact with the motor flange.

Dimensioning for S3 duty

When engineering geared drive systems you can use the motor characteristic without reduction. In so doing, take into account the permissible maximum torque and the permissible input speed of the gearbox.

$$M_{\text{Mot}} = M_{\text{out}} / (i \cdot \eta_G)$$

Motor and gearbox are assigned as follows: $M_{\text{max, gear}} \geq M_{0(100\text{K})} \cdot i \cdot f$

$M_{\text{max, gear}}$ Max. permissible drive torque

$M_{0(100\text{K})}$ Motor static torque

i Gear ratio

f Additional factor $f = f_1 \cdot f_2$

$f_1 = 2$ for motor accelerating torque

$f_2 = 1$ for ≤ 1000 gearbox switching cycles / h

$f_2 > 1$ for > 1000 switching cycles / h (see the gearbox catalog)

e. g. $f_2 = 1.5$ for 3000 switching cycles / h

$f_2 = 1.8$ for 5000 switching cycles / h

$f_2 = 2.0$ for 8000 switching cycles / h

NOTICE

Gearbox failures as a result of superimposed oscillations

Switching cycles can also be superimposed oscillations. The safety factor (f_2) is then not adequately dimensioned. This can result in gearbox failures.

- Optimize the overall system so that the superimposed oscillations are minimized.

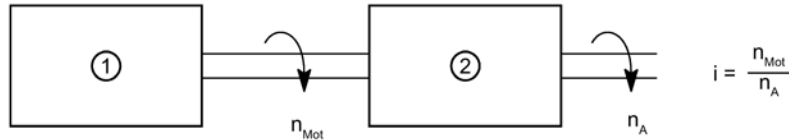

- 1 Motor
- 2 Gearbox

Figure 5-7 Configuring the gearbox

The load torque and required starting speed define the gearbox output torque and the output speed - and in turn, the output power.

The required drive power is calculated from this:

$$P_{Out} / W = P_{Mot} / W \cdot \eta_G = (\pi/30) \cdot M_{Mot} / Nm \cdot n_{Mot} / rpm \cdot \eta_G$$

Dimensioning for S1 duty

The gearbox itself generates heat due to friction and acts as a thermal barrier preventing heat from being dissipated through the motor flange. This is the reason that you must reduce the torque for S1 duty.

The required motor torque is calculated as follows:

$$M_{Mot} = \sqrt{\left(\frac{M_{ab}}{i \cdot \eta_G} + M_V \right)^2 - M_V^2} \quad \text{mit} \quad M_V = a \cdot b \cdot \frac{n_{Mot}}{60} (1 - \eta_G) \cdot \frac{k_T^2}{R_{Strw}}$$

- M_{Mot} / Nm Motor torque
- M_V / Nm Theoretical "Torque loss"
- a $\pi/3$ for 1FT7/1FK7 motors supplied with sinusoidal current
- b Weighting factor for gearbox losses (without dimensions); $b = 0.5$
- η_G Gearbox efficiency
- i Gearbox ratio ($i > 1$)
- $k_T / Nm/A$ Torque constant
- M_{Out} / Nm Gearbox output torque
- n_{Out} / rpm Gearbox output speed
- n_{Mot} / rpm Motor speed
- R_{Phw} / Ω Motor phase resistance when warm; $R_{Phw} = 1.4 \cdot R_{Ph}$ (see Chapter "Technical data and characteristics")
- P_{Out} / W Gearbox output power
- P_{Mot} / W Motor power
- π $\pi = 3.1416$

Change in characteristic due to mounted gearbox

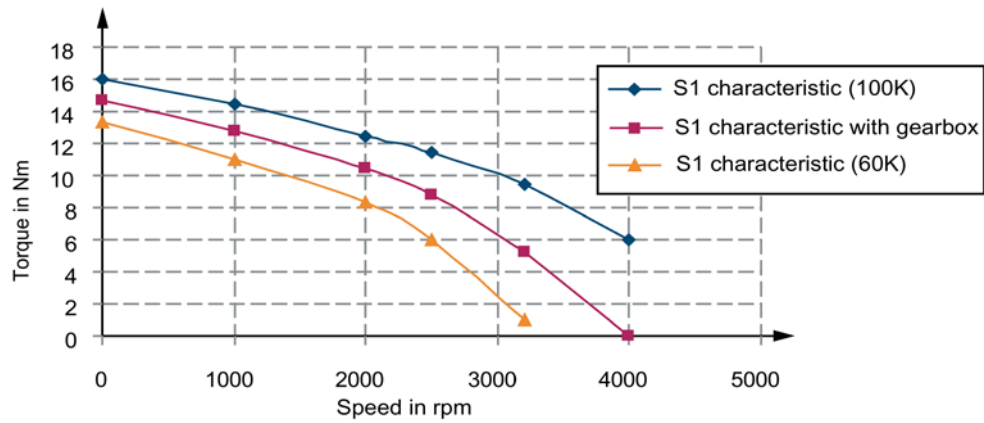

Figure 5-8 S1 characteristic (example)

Note relating to additional characteristics: $S1_{\text{gearbox}} = S1_{100\text{K}} - (S1_{100\text{K}} - S1_{60\text{K}}) / 2$

Starting response of a motor with mounted gearbox

Note

When commissioning, increased currents can be drawn as a result of the lubricating characteristics (inadequate distribution of oil or grease) - and the running-in behavior of the shaft sealing rings.

5.4 Brake resistances (armature short-circuit braking)

5.4.1 Description of function braking resistor

The motor cannot be electrically braked if, for converters

- The permissible DC link voltage values are exceeded
- The electronics fails

Then, the motor that is coasting down can only be braked using an armature short circuit.

You can switch the armature short-circuit braking internally via the Motor Module or externally using a contactor circuit with braking resistors.

Armature short-circuit braking must be initiated at the latest by the limit switch in the traversing range of the feed axis.

NOTICE
Damage to the drive at the end of the traversing range
To avoid mechanical damage, mount mechanical stops at the end of the absolute traversing range.

NOTICE
Destruction of the converter as the armature short-circuit contactor incorrectly switches
Incorrect switching of the armature short-circuiting contactor can erode the contactor contacts and destroy the converter.
<ul style="list-style-type: none">• Program the converter so that pulses are first canceled and this is actually implemented before an armature short-circuit contactor is closed or opened.

In servo motors with an integrated holding brake, you can produce additional braking torque with the holding brake.

Note

The holding brake is not a working brake to brake a spinning motor. A limited number of EMERGENCY STOP operations is permissible.

Additional information is provided in Chapter "Holding brake (Page 74)".

Note

Braking under normal operating conditions must always be performed via the setpoint input.

For further information, see the configuration manual of the converter.

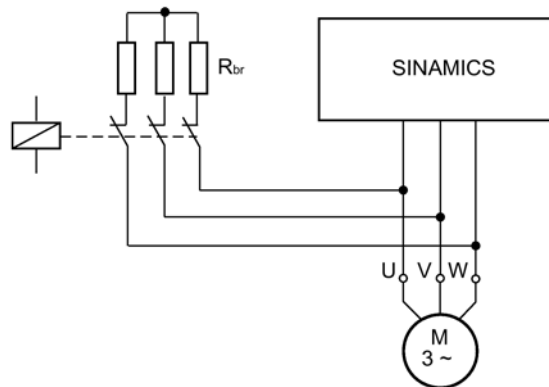

Figure 5-9 Circuit (schematic) with brake resistors

Rating

NOTICE

Destruction of the braking resistors

Braking from the rated speed is not permitted any more frequently than every 2 minutes; otherwise the resistors will be destroyed.

- Maintain a time interval of at least 2 minutes or longer between braking operations.
- When required, specify other braking cycles when ordering.

You can dimension the braking resistor so that a surface temperature of 300 °C can occur briefly (max. 500 ms).

The external moment of inertia and the intrinsic motor moment of inertia are decisive when dimensioning the braking resistors.

When ordering the braking resistors, determine the kinetic energy involved.

Kinetic energy	$W = (\omega^2 \cdot J) / 2$	$W / W_s = \text{kinetic energy}$
		$J / \text{kgm}^2 = \text{moment of inertia}$
Angular velocity	$\omega = (2 \cdot \pi / 60) \cdot n$	$\omega / 1/\text{s} = \text{angular velocity}$
		$n / \text{rpm} = \text{speed}$

Coordinate the braking resistor ratings to the I²t load capability.

Calculating the braking time

The values for calculation are provided in Chapter "Data sheets and characteristics (Page 150)".

Braking time $t_B = J_{Tot} \cdot n / 9.55 \cdot M_{Br}$

t_B / s = braking time

n / rpm = operating speed

M_{Br} / Nm = average braking torque

Moment of inertia $J_{Tot} = J_{Mot} + J_{Ext}$

J_{Tot} / kgm^2 = moment of inertia

J_{Mot} / kgm^2 = motor moment of inertia

J_{Ext} / kgm^2 = external moment of inertia

Note

In determining the run-on distance, consider the friction of the mechanical transmission elements (included in the calculation as an allowance in M_B) and the switching delay times of the contactors.

To avoid mechanical damage to the drive, mount mechanical stops at the end of the absolute traversing range of the machine axes.

Armature short-circuit braking

with external braking resistor

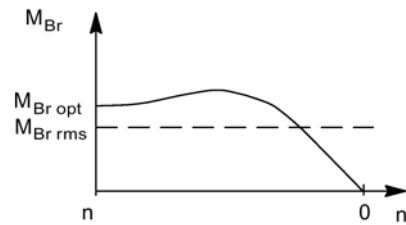

without external braking resistor

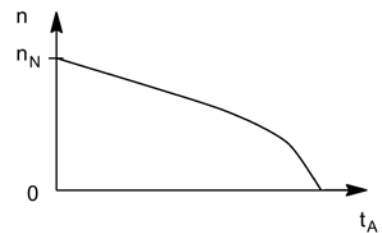
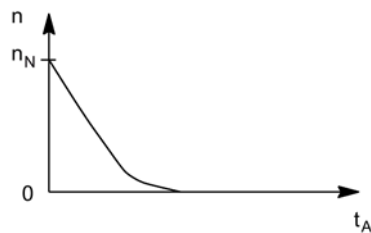
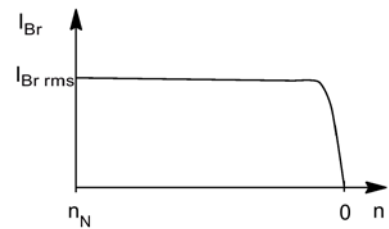
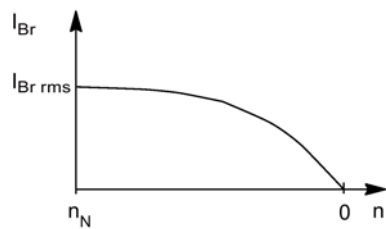
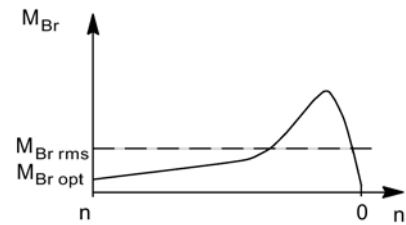

M_{Br} = braking torque
 $M_{Br\ rms}$ = average braking torque
 $M_{Br\ opt}$ = optimum braking torque
 I_{Br} = braking current

$I_{Br\ rms}$ = rms braking current
 t_R = run-out time
 n = speed
 n_N = rated speed

5.4.2 Dimensioning of braking resistors

Correct dimensioning of the braking resistors determines the optimum braking time.

The braking torques that are obtained are listed in the tables. The data applies for braking from the rated speed and moment of inertia $J_{external} = J_{Mot}$.

If you brake the drive from another speed, the braking time cannot simply be reduced proportionally.

In this case, calculate the braking time using the formula provided in Chapter "Description of function braking resistor (Page 120)".

If the speed at the start of braking is less than the rated speed, the braking times will be shorter or remain the same.

The data in the following table is calculated for rated values according to the data sheet. The variance during production as well as iron saturation have not been considered. Due to saturation, currents and torques can be higher than calculated.

1FT7 Compact, natural cooling

Table 5- 3 Armature short-circuit braking with/without external braking resistors

Motor type	External braking resistor R_{opt} / Ω	Average braking torque $M_{Br rms} / Nm$		Max. braking torque $M_{Br max} / Nm$	rms braking current $I_{br rms} [A]$	
		Without external braking resistor	With external braking resistor		Without external braking resistor	With external braking resistor
1FT7034-□AK7	6.7	2	3	4	9	8
1FT7036-□AF7	4.2	3	5	6	15	14
1FT7042-□AF7	6.6	3	4	5	7	7
1FT7042-□AK7	5.0	2	4	6	14	12
1FT7044-□AF7	4.8	7	10	12	13	12
1FT7044-□AK7	3.3	5	10	12	25	22
1FT7046-□AF7	3.6	10	14	17	18	17
1FT7046-□AH7	1.6	8	14	17	36	32
1FT7062-□AF7	10.4	2	4	5	7	6
1FT7062-□AK7	5.0	1	4	5	15	13
1FT7064-□AF7	7.0	3	7	9	11	10
1FT7064-□AK7	6.1	2	7	9	17	15
1FT7066-□AF7	3.8	4	11	13	18	16
1FT7066-□AH7	2.5	3	10	13	27	24
1FT7068-□AF7	4.5	6	15	18	20	18
1FT7082-□AC7	9.6	4	9	11	8	8
1FT7082-□AF7	6.7	3	9	11	13	11
1FT7082-□AH7	3.9	2	9	11	21	19
1FT7084-□AC7	3.9	7	16	20	18	16
1FT7084-□AF7	4.4	5	16	20	21	19

Motor type	External braking resistor R_{opt} / Ω	Average braking torque $M_{Br\ rms} / Nm$		Max. braking torque $M_{Br\ max} / Nm$	rms braking current $I_{br\ rms} [A]$	
		Without external braking resistor	With external braking resistor		Without external braking resistor	With external braking resistor
1FT7084-□AH7	3.2	4	16	20	30	27
1FT7086-□AC7	4.0	9	24	30	21	19
1FT7086-□AF7	2.9	7	24	30	31	28
1FT7086-□AH7	2.2	5	24	29	44	39
1FT7102-□AB7	4.3	12	27	34	19	17
1FT7102-□AC7	2.9	10	27	34	27	24
1FT7102-□AF7	2.3	7	28	34	38	34
1FT7105-□AB7	2.4	18	51	63	35	32
1FT7105-□AC7	2.1	14	5	64	44	40
1FT7105-□AF7	1.7	10	50	62	60	54
1FT7108-□AB7	2.2	24	72	89	44	40
1FT7108-□AC7	1.5	21	72	90	62	56
1FT7108-□AF7	1.3	16	71	88	83	74
1FT7132-5AB7	2.1	34	89	111	50	45
1FT7132-5AC7	1.6	28	89	111	66	59
1FT7132-5AF7	1.2	21	88	110	97	87
1FT7134-5AB7	1.5	38	115	142	66	59
1FT7134-5AC7	1.5	32	115	142	80	72
1FT7136-5AB7	1.2	49	149	185	88	79
1FT7136-5AC7	1.1	39	149	185	104	93
1FT7138-5AB7	1.0	57	185	230	107	96

NOTICE**Damage to motors caused by incorrect connection**

Short-circuiting 1FT713x motors that make full use of thermal class 155 without a series resistor can cause damage to the motor.

Do not short-circuit the motors without a series resistor.

1FT7 Compact, forced ventilation

Table 5- 4 Armature short-circuit braking with/without external braking resistors

Motor type	External braking resistor R_{opt} / Ω	Average braking torque $M_{Br rms} / Nm$		Max. braking torque $M_{Br max} / Nm$	rms braking current $I_{br rms} [A]$	
		Without external braking resistor	With external braking resistor		Without external braking resistor	With external braking resistor
1FT7084-5SC7	2.5	7	18	22	23	21
1FT7084-5SF7	2.0	6	18	22	33	29
1FT7084-5SH7	1.6	4	17	20	44	39
1FT7086-5SC7	2.1	9	24	29	30	27
1FT7086-5SF7	2.2	5	24	29	44	39
1FT7086-5SH7	1.6	5	24	29	53	47
1FT7105-5SC7	1.3	15	50	62	56	50
1FT7105-5SF7	0.9	12	50	62	81	73
1FT7108-5SC7	1.1	19	69	86	70	63
1FT7108-5SF7	0.8	15	71	88	103	92
1FT7132-5SB7	1.2	36	94	117	68	61
1FT7132-5SC7	1	30	94	118	86	77
1FT7132-5SF7	0.8	22	94	118	122	109
1FT7134-5SC7	0.7	35	125	156	122	109
1FT7134-5SF7	0.5	26	125	155	170	154
1FT7136-5SB7	0.9	51	157	196	101	91
1FT7136-5SC7	0.6	41	156	194	142	128
1FT7138-5SB7	0.6	57	185	231	132	120

1FT7 Compact, liquid cooling

Table 5- 5 Armature short-circuit braking with/without external braking resistors

Motor type	External braking resistor R_{opt} / Ω	Average braking torque $M_{Br rms} / Nm$		Max. braking torque $M_{Br max} / Nm$	rms braking current $I_{br rms} [A]$	
		Without external braking resistor	With external braking resistor		Without external braking resistor	With external braking resistor
1FT7062-5WF7	5.5	3	7	8	12	10
1FT7062-5WK7	4.2	2	7	8	19	17
1FT7064-5WF7	3.3	5	11	14	19	17
1FT7064-5WK7	2.4	3	11	14	33	30
1FT7066-5WF7	2.7	7	15	19	26	23
1FT7066-5WH7	2.1	5	16	19	36	33
1FT7068-5WF7	2.1	11	24	30	36	32
1FT7082-5WC7	3.0	8	16	20	19	17
1FT7082-5WF7	2.2	7	16	20	29	26
1FT7082-5WH7	1.5	5	16	20	44	40
1FT7084-5WC7	2.2	12	27	34	30	27
1FT7084-5WF7	1.8	9	27	33	42	38
1FT7084-5WH7	1.2	7	27	33	62	56
1FT7086-5WC7	1.6	16	38	47	42	37
1FT7086-5WF7	1.2	13	38	47	62	56
1FT7086-5WH7	1.3	10	38	47	74	66
1FT7102-5WB7	1.8	21	44	55	37	33
1FT7102-5WC7	1.2	18	44	55	53	48
1FT7102-5WF7	0.7	14	44	55	85	76
1FT7105-5WB7	1.1	39	90	111	68	61
1FT7105-5WC7	0.8	32	89	111	94	84
1FT7105-5WF7	0.7	26	89	111	127	114
1FT7108-5WB7	0.8	54	127	158	95	85
1FT7108-5WC7	0.8	45	128	159	112	100
1FT7108-5WF7	0.6	36	128	159	163	145

1FT7 High Dynamic, natural cooling

Table 5- 6 Armature short-circuit braking with/without external braking resistors

Motor type	External braking resistor R_{opt} / Ω	Average braking torque $M_{Br rms} / Nm$		Max. braking torque $M_{Br max} / Nm$	rms braking current $I_{br rms} [A]$	
		Without external braking resistor	With external braking resistor		Without external braking resistor	With external braking resistor
1FT7087-7AF7	1.2	7	26	32	51	45
1FT7117-7AC7	1.4	27	86	107	69	62
1FT7117-7AF7	1.0	21	88	110	104	93

1FT7 High Dynamic, forced ventilation

Table 5- 7 Armature short-circuit braking with/without external braking resistors

Motor type	External braking resistor R_{opt} / Ω	Average braking torque $M_{Br rms} / Nm$		Max. braking torque $M_{Br max} / Nm$	rms braking current $I_{br rms} [A]$	
		Without external braking resistor	With external braking resistor		Without external braking resistor	With external braking resistor
1FT7065-7SF7	3.4	4	8	10	17	15
1FT7065-7SH7	2.9	2	8	10	23	21
1FT7067-7SF7	2.4	5	11	14	24	21
1FT7067-7SH7	2.3	4	11	14	30	27
1FT7085-7SF7	1.8	4	18	22	34	31
1FT7085-7SH7	1.5	4	17	22	47	42
1FT7087-7SF7	1.2	7	26	32	51	45
1FT7087-7SH7	1.5	5	25	31	55	49
1FT7117-7SC7	1.4	27	86	107	69	62
1FT7117-7SF7	1.0	21	88	110	104	93

1FT7 High Dynamic, liquid cooling

Table 5- 8 Armature short-circuit braking with/without external braking resistors

Motor type	External braking resistor R_{opt} / Ω	Average braking torque $M_{Br\ rms} / Nm$		Max. braking torque $M_{Br\ max} / Nm$	rms braking current $I_{br\ rms} [A]$	
		Without external braking resistor	With external braking resistor		Without external braking resistor	With external braking resistor
1FT7065-7WF7	3.4	4	8	10	17	15
1FT7065-7WH7	2.9	2	8	10	23	21
1FT7067-7WF7	2.4	4	11	14	24	21
1FT7067-7WH7	2.3	4	11	14	30	27
1FT7085-7WF7	1.8	4	18	22	34	31
1FT7085-7WH7	1.1	4	17	21	55	49
1FT7087-7WF7	1.2	7	26	32	51	45
1FT7087-7WH7	1.1	5	26	32	67	60

Technical data and characteristic curves

6.1 Explanations

Permissible operating range

The permissible operating range is limited by thermal, mechanical, and electromagnetic boundaries. The data in this documentation apply to the following temperatures:

- For naturally cooled motors: up to 40 °C ambient temperature
- For water-cooled motors: up to 30 °C coolant inlet temperature

The motor heats up due to the losses generated in the motor (current-dependent losses, no-load losses, friction losses).

The utilization of the motor depends on the cooling method (naturally cooled, forced ventilation, liquid-cooled).

To maintain the temperature limits, the permissible torque – starting from static torque M_0 – decreases as the speed increases.

The characteristics below show the limits of the permissible temperature range.

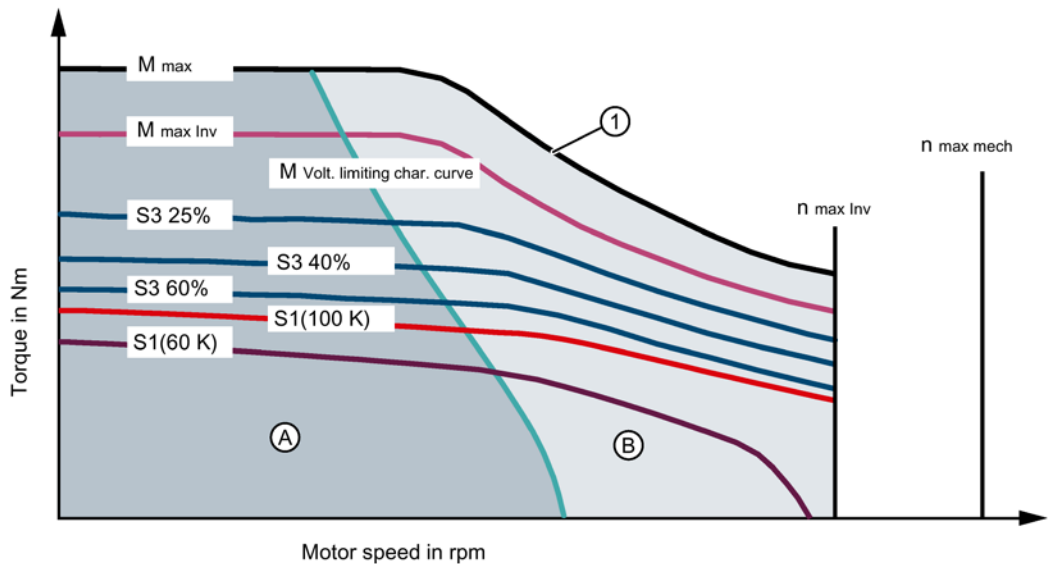

- | | |
|-----------------------|--|
| $M_{\text{Volt lim}}$ | Voltage limit characteristic without field weakening |
| 1 | Voltage limit characteristic with field weakening |
| A | Without field weakening |
| B | Field weakening range |

Figure 6-1 Torque characteristics of synchronous motors

Permissible temperature range, characteristics S1_(100 K) and S1_(60 K)

1FT7 motors can be operated up to an average winding temperature of 145 °C.

The S1_(100 K) characteristic in the diagram "Torque characteristics of synchronous motors" indicates the limits of the permissible temperature range for continuous operation. This corresponds to a utilization according to thermal class F (155 °C).

A lower thermal class can be necessary if, for example,

- the enclosure temperature must be below 90 °C for safety reasons
- the motor temperature rise has a negative impact on the machine

In this case, choose the S1_(60 K) characteristic. The motor now corresponds to thermal class B (130 °C).

NOTICE

Motor damage caused by overheating

Continuous operation outside the permissible temperature range can result in the motor overheating and cause damage to the motor.

- Operate the motor continuously only within the S1(100 K) characteristic.

Periodic intermittent duty, characteristics S3 25 %, S3 40 %, S3 60 % and M_{max}

In periodic intermittent duty, you can apply a higher load to the motor, depending on the ON duration, see also Chapter "Procedure when engineering (Page 108)".

Review the S3 characteristics with the 25 %, 40 % and 60 % ON durations.

The cycle time is always 10 minutes. The overtemperature is 100 K.

The exception are small motors, for which a cycle time of one minute is specified and noted in the characteristic curves.

A transient, high overload capacity up to characteristic M_{max} is available over the complete speed range.

Recommended Motor Module

A Motor Module is recommended in Chapter "Motor overview / assignment of Motor Modules / power cables (Page 142)" for each motor in accordance with its stall current. The maximum achievable torque is shown in the characteristic M_{max conv.}

- When configuring intermittent or overload operation, check whether a larger Motor Module is required to provide the necessary peak current.

Speed limits $n_{\max \text{ mech}}$ and $n_{\max \text{ conv}}$

The speed range is limited by the following variables:

- The mechanical speed limit $n_{\max \text{ mech}}$ (rotor centrifugal forces, bearing lifetime)
- The electrical speed limit $n_{\max \text{ conv}}$ (voltage strength of the converter and/or max. frequency of the converter)

It is not permissible that the maximum permissible speed n_{\max} exceeds the mechanical speed limit $n_{\max \text{ mech}}$ nor the electrical speed limit $n_{\max \text{ conv}}$.

NOTICE**Damage to the converter due to excessively high speeds**

A motor speed greater than $n_{\max \text{ conv}}$ can induce a voltage in the winding, which is higher than the permissible voltage at the converter. This induced voltage can destroy the converter.

- Run the motor at speeds $n_{\max \text{ conv}}$.

Torque limit when operating on a SINAMICS S120 drive system with field weakening

The field weakening function is active as standard on the SINAMICS S120 drive system.

A field-weakening current is injected in such a way as to enable operation to the right of or above the voltage limiting characteristic.

In the diagram "Torque characteristics of synchronous motors" below, the area with field weakening is marked with "B".

The shape of the voltage limiting characteristic for field weakening is determined by the winding version (armature circuit) and the magnitude of the converter output voltage.

The voltage limiting characteristic is calculated for a motor at operating temperature.

6.1 Explanations

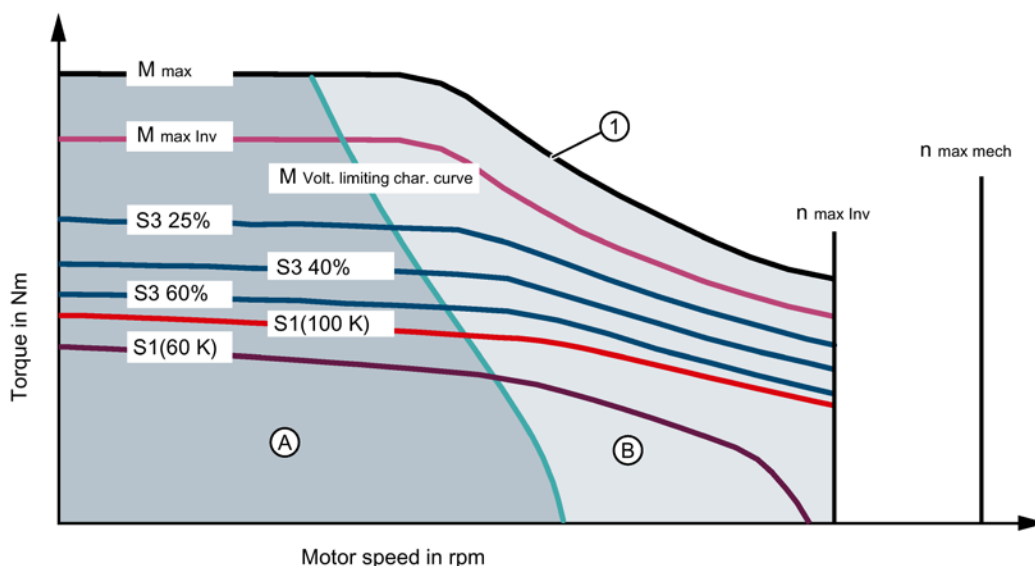

- M Volt lim Voltage limit characteristic without field weakening
- 1 Voltage limit characteristic with field weakening
- A Without field weakening
- B Field weakening range

Figure 6-2 Shape of the voltage limiting characteristic with/without field weakening

The characteristics for each winding version are shown in a separate data sheet.

The torque-speed diagrams for different converter output voltages are assigned to each data sheet:

Table 6-1 Converter output voltages

Diagram	Converter output voltage V_{mot}	Infeed module	Line supply voltage
Upper diagram	380 V	SINAMICS SLM	400 V
	425 V	SINAMICS ALM	400 V
Lower diagram	460 V	SINAMICS SLM	480 V
	510 V	SINAMICS ALM	480 V

For different converter output voltages, the voltage limiting characteristic curve must be offset accordingly. See "Explanations (Page 131)"

Torque limit when operating on a SINAMICS S120 drive system without field weakening

It is possible to deactivate the field weakening function with the SINAMICS S120 drive system. This therefore reduces the operating range that is available.

In the diagram "Torque characteristics of synchronous motors" below, the area without field weakening is marked with "A".

The voltage induced in the motor winding increases as the speed increases.

The difference between the DC link voltage of the converter and the induced motor voltage can be used to impress the current. This difference limits the applicable current level. This causes the torque to drop off quickly at high speeds.

All operating points that can be achieved with the motor lie to the left of the voltage limiting characteristic line in area "A".

The characteristics for each winding version are shown in a separate data sheet. The torque-speed diagrams for different converter output voltages are assigned to each data sheet:

Table 6- 2 Converter output voltages

Diagram	Converter output voltage V_{mot}	Infeed module	Line supply voltage
Upper diagram	380 V	SINAMICS SLM	400 V
	425 V	SINAMICS ALM	400 V
Lower diagram	460 V	SINAMICS SLM	480 V
	510 V	SINAMICS ALM	480 V

For different converter output voltages, the voltage limiting characteristic curve must be offset accordingly. See "Explanations (Page 131)."

Winding types

Several winding types (armature circuits) for different rated speeds n_N are possible within one motor frame size.

Table 6- 3 Code letter, winding type

Rated speed n_N / rpm	Winding type (10th digit of the order no.)
1500	B
2000	C
3000	F
4500	H
6000	K

6.1 Explanations

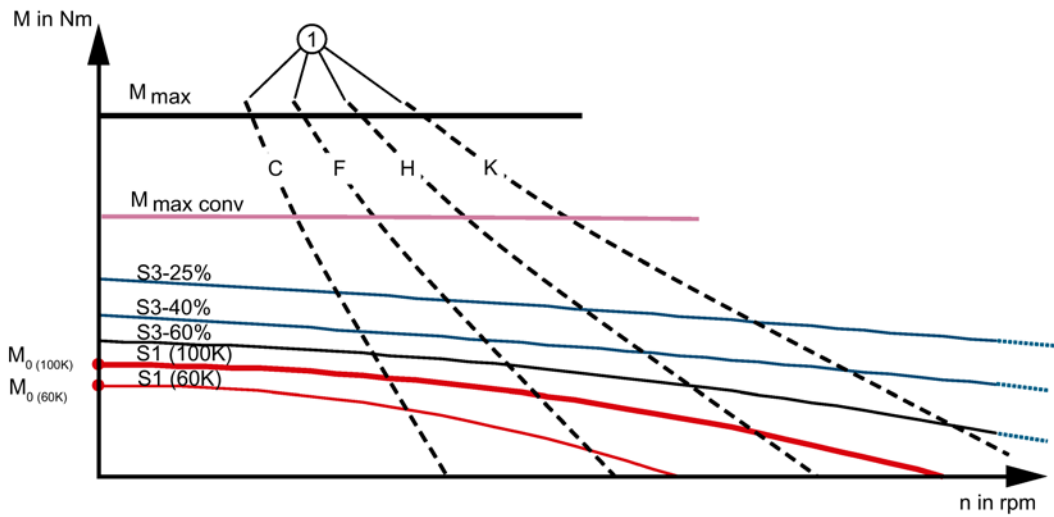

① Voltage limiting characteristic curve = torque limit without field weakening, e.g. with winding types C, F, H, K

Figure 6-3 Speed-torque diagram

Note

The voltage limit characteristic of a motor with 6000 rpm rated speed is far above that of the same motor type with 2000 rpm. The motor with the rated speed 6000 rpm requires a much higher current for the same torque.

Therefore select a rated speed for the requirement that is slightly higher than the required maximum speed.

In this way, the size of the converter module (output current) can be minimized.

Shift of the voltage limiting characteristic (only relevant when field weakening is deactivated)

The voltage limiting characteristic can only be shifted:

- For approximately linear limiting characteristics
- For $U_{Mot\ new} > U_{IN}$

Determining the induced voltage U_{IN}

You can read-off the induced voltage U_{IN} from the motor rating plate - or you can calculate it using the following formula.

$$U_{IN} = k_E \cdot n_N / 1000$$

Rated speed n_N / rpm

Voltage constant k_E / V/1000 rpm

U_{IN} / V

Shifting the voltage limiting characteristic by a factor x

If the converter output voltage (U_{Mot}) is not equal to 380 V, 425 V, 460 V or 510 V, then you must shift the voltage limiting characteristic involved for the new output voltage ($U_{Mot, new}$).

$$x = U_{Mot, new} / U_{Mot} \quad U_{Mot, new} = \text{new converter output voltage} / V$$

$$U_{Mot} = \text{converter output voltage from the characteristic for 380 V, 425 V, 460 V or 510 V, see Chapter "Data sheets and characteristics (Page 150)"}$$

- Shift the voltage limiting characteristic for an output voltage of $U_{Mot, new}$ on the x axis (speed) by factor x.

Calculating the new torque limit with the new limiting characteristic

Procedure

The variables are graphically shown in the following diagram.

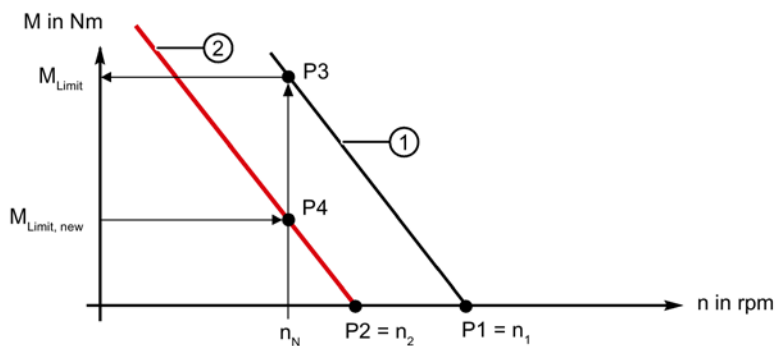

- 1 Voltage limiting line U_{Mot}
- 2 New voltage limiting line $U_{Mot, new}$

Figure 6-4 Shifting the voltage limiting line

Take the values for the variables from the "Technical specifications" tables for the individual motors, or determine these as described below.

1. Determine P1, the point of intersection of the voltage limiting characteristic on the x axis. P1 corresponds to n_1 .
 n_1 - calculate this as follows:

$n_1 = U_{Mot} \cdot 1000 / k_E \cdot 0.95$	n_1 / rpm;
	Voltage constant k_E / V/1000 rpm
	Converter output voltage U_{Mot} / V

6.1 Explanations

2. Determine P2, the new point of intersection of the voltage limiting characteristic on the x axis.
P2 corresponds to n_2 .
 n_2 - calculate this as follows:

$n_2 = n_1 \cdot U_{Mot\ new} / U_{Mot}$	n_2 / rpm;
Converter output voltage $U_{Mot\ new}$ / V	

3. Determine P3.
At rated speed n_N , draw a vertical line upwards to the voltage limiting characteristic.
P3 is the point of intersection.
4. From point P3, draw a horizontal line to the vertical torque axis.
At the point of intersection with the vertical torque axis, read-off the torque limit M_{Limit} .
5. Calculate $M_{Limit, new}$.

$M_{Limit, new} = ((U_{Mot\ new} - U_N) / (U_{Mot} - U_N)) \cdot M_{Limit}$	$M_{Limit, new}$ / Nm
---	-----------------------

Enter $M_{Limit, new}$ on the vertical torque axis.

6. Determine P4.
Draw a horizontal line from $M_{Limit, new}$ to the vertical line from n_N .
The point of intersection of $M_{Limit, new}$ and n_N is P4.
7. You obtain a new voltage limiting characteristic by drawing a straight line through points P2 and P4.

You have determined the values to calculate the limit torque.



Example for calculating the shift of the voltage limiting characteristic without field weakening

Procedure

e.g. motor 1FT7042-2AF71

$$n_N = 3000 \text{ rpm} \qquad U_{Mot\ new} = 290 \text{ V}$$

$$k_E = 87 \text{ V/1000 rpm} \qquad U_{Mot} = 380 \text{ V}$$

Determining the condition

$$U_{IN} = k_E \cdot n_N / 1000$$

$$V_{IN} = 87 \cdot 3000 / 1000$$

$$V_{IN} = 261 \text{ V}$$

$$V_{IN} = 261 \text{ V} < U_{Mot\ new} = 290 \text{ V}$$

The condition to shift the voltage limiting characteristic is fulfilled.

Calculating and determining points P1, P2, P3 and P4

- P1 $n_1 = 380 \text{ V} \cdot 1000 / 87 \cdot 0.95$ $n_1 = 4597 \text{ rpm}$
- P2 $n_2 = 4597 \text{ rpm} \cdot 290 \text{ V} / 380 \text{ V}$ $n_2 = 3508 \text{ rpm}$
- P3 M_{limit} at $n_N = 3000 \text{ rpm}$ and $V_{\text{Mot}} = 380 \text{ V}$ read: $M_{\text{limit}} = \text{approx. } 8.8 \text{ Nm}$
- P4 $M_{\text{limit new}} = ((290 \text{ V} - 261 \text{ V}) / (380 \text{ V} - 261 \text{ V})) \cdot 8.8 \text{ Nm}$ $M_{\text{limit new}} = 2.14 \text{ Nm}$

P4 is the point of intersection of $M_{\text{Limit, new}}$ and n_N . The new voltage limiting characteristic is obtained by connecting P2 and P4.

Enter and connect points P2 and P4.

This line is the new voltage limiting characteristic for $V_{\text{Mot, new}} = 290 \text{ V}$.



Typical M/I characteristic

Because of saturation effects, the achievable torque cannot be calculated linearly from the current (particularly at high currents).

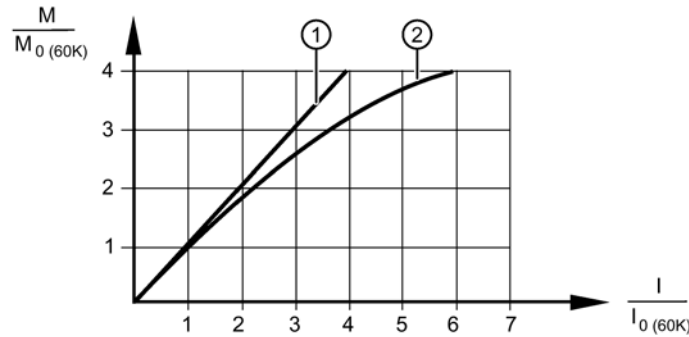

- 1 Best case
- 2 Worst case

Figure 6-5 Torque-current characteristic curve for self-cooled motors

From M_0 (or I_0), you can calculate the torque or the torque constant as a function of the current using the following formulas:

$$k_T(I) = M / I$$

Torque constant $k_T(I)$ / Nm/A
Torque M / Nm
Current I / A

$$k_T(I) = (M_0 / I_0) + ((I - I_0) / (I_{\text{max}} - I_0)) \cdot ((M_{\text{max}} / I_{\text{max}}) - (M_0 / I_0))$$

Static torque M_0 / Nm
Stall current I_0 / A
Maximum torque M_{max} / Nm
Maximum current I_{max} / A

6.1 Explanations

Tolerance data

The data shown in the data sheets are nominal values that are subject to natural variation. The following tolerances apply:

Table 6- 4 Tolerance data in the motor list data

Motor list data		Typ. value	Guaranteed value
Stall current	I_0	$\pm 3 \%$	$\pm 7.5\%$
Electrical time constant	T_{el}	$\pm 5 \%$	$\pm 10 \%$
Torque constant	k_T	$\pm 3 \%$	$\pm 7.5\%$
Voltage constant	k_E	$\pm 3 \%$	$\pm 7.5\%$
Winding resistance	R_{Str}	$\pm 5 \%$	$\pm 10 \%$
Moment of inertia	J_{mot}	$\pm 2 \%$	$\pm 10 \%$

Effects of temperature and parameter spread on the characteristic

The torque-speed characteristics specified in the following chapter apply to motors with nominal/rated values.

For cold motors, characteristic 2 results, and characteristic 3 for motors at operating temperature, provided that the voltage constant corresponds to the data sheet value.

With field weakening (=characteristic B), much larger torque / speed ranges are possible. Without field weakening (=characteristic A), the torque / speed range is significantly limited.

Characteristics 1 and 4 result from the theoretically permissible tolerances of the voltage constant k_e of $\pm 7.5 \%$.

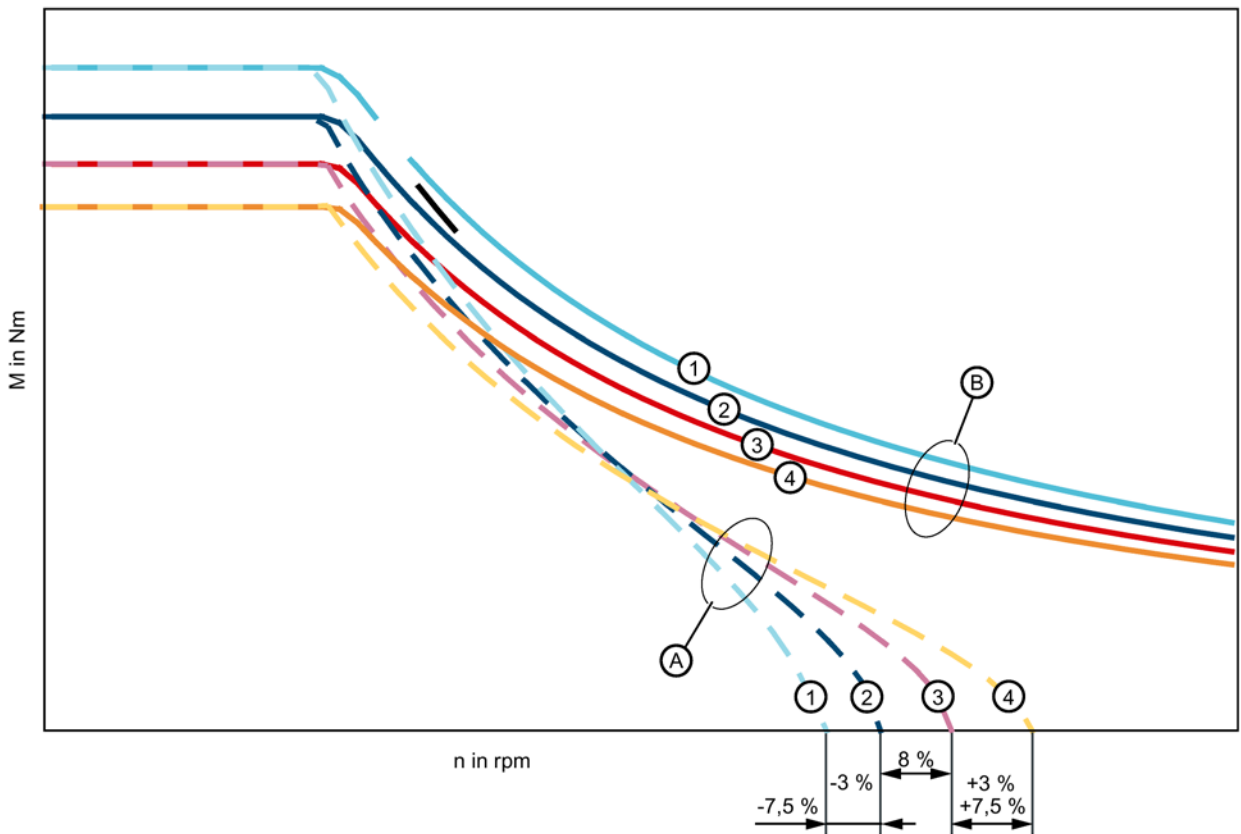

Figure 6-6 Effect of the parameter spread

Note

The motor temperature results in a clear displacement of the voltage limiting characteristic in the upper speed range.

Consider this when configuring applications with converter systems without field weakening, in which the cold motor has to produce maximum speeds.

6.2 Motor overview / assignment of Motor Modules / power cables

You can find the matching SINAMICS Motor Modules and MOTION-CONNECT power cables for the 1FT7 on the following pages.

You can find additional information in the catalog "Chapter, "MOTION-CONNECT connection systems" in Catalog D 21.4 (<https://intranet.for.siemens.com/org/i-dt-mc/de/motion-control/support/infomaterial/kataloge/d-21-4-sinamics-s120-simotics/Seiten/d-21-4.aspx>)".

1FT7 for SINAMICS S120 Booksize, DC link voltages 510 V to 720 V DC, (line voltages, 380 V to 480 V 3 AC)

Example of an article number (order number) for a SINAMICS Motor Module

The following table describes the options that can be selected for the SINAMICS Motor Module.

Description	Position of the article number																	
	1	2	3	4	5	6	7	-	8	9	10	11	12	-	13	14	15	16
SINAMICS Motor Module S120 Booksize (example)	6	S	L	3	1	2	0	-										
	Single Motor Module								1									
	Double Motor Module								2									
										T	E	2	1	-	0	A	D	
	Version release <input type="checkbox"/>																	

Example of an article number (order number) for a MOTION-CONNECT power cable

The following table describes the options that can be selected for a MOTION-CONNECT power cable between the motor and the converter.

Description	Position of the article number																		
	1	2	3	4	5	6	7	-	8	9	10	11	12	-	13	14	15	16	
MOTION-CONNECT power cable (example)	6	F	X																
MOTION-CONNECT 500				5															
MOTION-CONNECT 800 PLUS				8															
					0	0	2	-	5										
	Without brake cables									C									
	With brake cables									D									
	Connector size, connector type (SPEED-CONNECT / full thread), conductor cross-section										N	0	6	-					
	Length codes												<input type="checkbox"/>	<input type="checkbox"/>	<input type="checkbox"/>	<input type="checkbox"/>			

You can find additional information on the length codes in Chapter, "MOTION-CONNECT connection systems" in Catalog D 21.4 (<https://intranet.for.siemens.com/org/i-dt-mc/de/motion-control/support/infomaterial/kataloge/d-21-4-sinamics-s120-simotics/Seiten/d-21-4.aspx>).

SINAMICS S120 Booksize, DC link voltages 510 V to 720 V DC, (line voltages, 3 AC 380 V to 480 V)

You can find the matching SINAMICS Motor Modules and MOTION-CONNECT power cables in the following tables.

Table 6- 5 1FT7 Compact core type natural cooling

Motor			Converter: SINAMICS S120 Booksize			Power cable
Order number	M_0 (100K) / Nm	Connector size ⁵⁾ / Cable cross-section ⁴⁾	Order number ²⁾	Base load current I_H / A	M_{max} (100K Inv ¹⁾ / Nm	Order number ³⁾
1FT7034-1AK7	2	1 / 4 x 1.5	6SL3120-1TE13-0AD□	3	6.3	6FX□002-5□N06-□□□□
1FT7044-1AF7	5	1 / 4 x 1.5	6SL3120-1TE13-0AD□	3	14.8	6FX□002-5□N06-□□□□
1FT7062-1AF7	6	1 / 4 x 1.5	6SL3120-1TE15-0AD□	5	18.7	6FX□002-5□N06-□□□□
1FT7062-1AK7	6	1 / 4 x 1.5	6SL3120-1TE21-0AD□	9	16.4	6FX□002-5□N06-□□□□
1FT7064-1AF7	9	1 / 4 x 1.5	6SL3120-1TE21-0AD□	9	34.7	6FX□002-5□N06-□□□□
1FT7064-1AK7	9	1 / 4 x 1.5	6SL3120-1TE21-0AD□	9	25.3	6FX□002-5□N06-□□□□
1FT7082-1AF7	13	1 / 4 x 1.5	6SL3120-1TE21-0AD□	9	39.8	6FX□002-5□N06-□□□□
1FT7084-1AF7	20	1 / 4 x 1.5	6SL3120-1TE21-8AD□	18	79.5	6FX□002-5□N06-□□□□
1FT7084-1AH7	20	1.5 / 4 x 2.5	6SL3120-1TE21-8AD□	18	60.0	6FX□002-5□N36-□□□□
1FT7086-1AF7	28	1.5 / 4 x 2.5	6SL3120-1TE21-8AD□	18	86.0	6FX□002-5□N36-□□□□
1FT7086-1AH7	28	1.5 / 4 x 4	6SL3120-1TE23-0AD□	30	100	6FX□002-5□N46-□□□□
1FT7102-1AC7	30	1.5 / 4 x 1.5	6SL3120-1TE21-8AD□	18	106.0	6FX□002-5□N26-□□□□
1FT7105-1AC7	50	1.5 / 4 x 2.5	6SL3120-1TE21-8AD□	18	135.0	6FX□002-5□N36-□□□□

Table 6- 6 1FT7 Compact natural cooling

Motor			Converter: SINAMICS S120 Booksize			Power cable
Order number	M_0 (100K) / Nm	Connector size ⁵⁾ / Cable cross-section ⁴⁾	Order number ²⁾	Base load current I_H / A	M_{max} (100K Inv ¹⁾ / Nm	Order number ³⁾
1FT7034-5AK7	2	1 / 4 x 1.5	6SL3120-1TE13-0AD□	3	6.3	6FX□002-5□N06-□□□□
1FT7036-5AK7	3	1 / 4 x 1.5	6SL3120-1TE15-0AD□	5	10.8	6FX□002-5□N06-□□□□
1FT7042-5AF7	3	1 / 4 x 1.5	6SL3120-1TE13-0AD□	3	10.9	6FX□002-5□N06-□□□□
1FT7042-5AK7	3	1 / 4 x 1.5	6SL3120-1TE15-0AD□	5	10.4	6FX□002-5□N06-□□□□
1FT7044-5AF7	5	1 / 4 x 1.5	6SL3120-1TE13-0AD□	3	14.8	6FX□002-5□N06-□□□□
1FT7044-5AK7	5	1 / 4 x 1.5	6SL3120-1TE21-0AD□	9	21.9	6FX□002-5□N06-□□□□
1FT7046-5AF7	7	1 / 4 x 1.5	6SL3120-1TE15-0AD□	5	24.5	6FX□002-5□N06-□□□□
1FT7046-5AH7	7	1 / 4 x 1.5	6SL3120-1TE21-0AD□	9	22.4	6FX□002-5□N06-□□□□
1FT7062-5AF7	6	1 / 4 x 1.5	6SL3120-1TE15-0AD□	5	18.7	6FX□002-5□N06-□□□□
1FT7062-5AK7	6	1 / 4 x 1.5	6SL3120-1TE21-0AD□	9	16.4	6FX□002-5□N06-□□□□
1FT7064-5AF7	9	1 / 4 x 1.5	6SL3120-1TE21-0AD□	9	34.7	6FX□002-5□N06-□□□□
1FT7064-5AK7	9	1 / 4 x 1.5	6SL3120-1TE21-0AD□	9	25.3	6FX□002-5□N06-□□□□
1FT7066-5AF7	12	1 / 4 x 1.5	6SL3120-1TE21-0AD□	9	35.2	6FX□002-5□N06-□□□□
1FT7066-5AH7	12	1 / 4 x 1.5	6SL3120-1TE21-8AD□	18	42.8	6FX□002-5□N06-□□□□
1FT7068-5AF7	15	1 / 4 x 1.5	6SL3120-1TE21-0AD□	9	46.0	6FX□002-5□N06-□□□□
1FT7082-5AC7	13	1 / 4 x 1.5	6SL3120-1TE15-0AD□	5	35.0	6FX□002-5□N06-□□□□
1FT7082-5AF7	13	1 / 4 x 1.5	6SL3120-1TE21-8AD□	9	39.8	6FX□002-5□N06-□□□□
1FT7082-5AH7	13	1 / 4 x 1.5	6SL3120-1TE21-0AD□	18	48.0	6FX□002-5□N06-□□□□
1FT7084-5AC7	20	1 / 4 x 1.5	6SL3120-1TE21-8AD□	9	51.0	6FX□002-5□N06-□□□□
1FT7084-5AF7	20	1 / 4 x 1.5	6SL3120-1TE21-0AD□	18	79.5	6FX□002-5□N06-□□□□
1FT7084-5AH7	20	1.5 / 4 x 2.5	6SL3120-1TE21-8AD□	18	60.0	6FX□002-5□N36-□□□□
1FT7086-5AC7	28	1 / 4 x 1.5	6SL3120-1TE21-8AD□	18	120.0	6FX□002-5□N06-□□□□
1FT7086-5AF7	28	1.5 / 4 x 2.5	6SL3120-1TE21-8AD□	18	86.0	6FX□002-5□N36-□□□□
1FT7086-5AH7	28	1.5 / 4 x 4	6SL3120-1TE23-0AD□	30	100	6FX□002-5□N46-□□□□

6.2 Motor overview / assignment of Motor Modules / power cables

Motor			Converter: SINAMICS S120 Booksize			Power cable
Order number	M_0 (100K) / Nm	Connector size ⁵⁾ / Cable cross-section ⁴⁾	Order number ²⁾	Base load current I_H / A	M_{max} (100K Inv ¹⁾ / Nm	Order number ³⁾
1FT7102-5AB7	30	1.5 / 4 x 1.5	6SL3120-1TE21-0AD□	9	84.0	6FX□002-5□N26-□□□□
1FT7102-5AC7	30	1.5 / 4 x 1.5	6SL3120-1TE21-8AD□	18	106.0	6FX□002-5□N26-□□□□
1FT7102-5AF7	30	1.5 / 4 x 2.5	6SL3120-1TE21-8AD□	18	79.0	6FX□002-5□N36-□□□□
1FT7105-5AB7	50	11.5 / 4 x 1.5	6SL3120-1TE21-8AD□	18	165.0	6FX□002-5□N26-□□□□
1FT7105-5AC7	50	1.5 / 4 x 2.5	6SL3120-1TE21-8AD□	18	135.0	6FX□002-5□N36-□□□□
1FT7105-5AF7	50	1.5 / 4 x 6	6SL3120-1TE23-0AD□	30	157.0	6FX□002-5□N46-□□□□
1FT7108-5AB7	70	1.5 / 4 x 2.5	6SL3120-1TE21-8AD□	18	190.0	6FX□002-5□N36-□□□□
1FT7108-5AC7	70	1.5 / 4 x 4	6SL3120-1TE23-0AD□	30	215.0	6FX□002-5□N46-□□□□
1FT7108-5AF7	70	1.5 / 4 x 6	6SL3120-1TE24-5AA□	45	150.0	6FX□002-5□N54-□□□□
1FT7132-5AB7	90	1.5 / 4 x 4	6SL3120-1TE23-0AD□	30	290.0	6FX□002-5□N46-□□□□
1FT7132-5AC7	90	1.5 / 4 x 6	6SL3120-1TE23-0AD□	30	235.0	6FX□002-5□N56-□□□□
1FT7132-5AF7	90	3 / 4 x 10	6SL3120-1TE24-5AA□	45	168.0	6FX□002-5□S14-□□□□
1FT7134-5AB7	118	1.5 / 4 x 6	6SL3120-1TE23-0AD□	30	305.0	6FX□002-5□N56-□□□□
1FT7134-5AC7	118	1.5 / 4 x 6	6SL3120-1TE24-5AA□	45	260.0	6FX□002-5□N54-□□□□
1FT7136-5AB7	140	1.5 / 4 x 6	6SL3120-1TE24-5AA□	45	305.0	6FX□002-5□N54-□□□□
1FT7136-5AC7	140	3 / 4 x 10	6SL3120-1TE24-5AA□	45	265.0	6FX□002-5□S14-□□□□
1FT7138-5AB7	170	3 / 4 x 10	6SL3120-1TE24-5AA□	45	320.0	6FX□002-5□S14-□□□□

Table 6-7 1FT7 Compact forced ventilation

Motor			Converter: SINAMICS S120 Booksize			Power cable
Order number	M_0 (100K) / Nm	Connector size ⁵⁾ / Cable cross-section ⁴⁾	Order number ²⁾	Base load current I_H / A	M_{max} (100K Inv ¹⁾ / Nm	Order number ³⁾
1FT7084-5SC7	27	1.5 / 4 x 1.5	6SL3120-1TE21-8AD□	18	80	6FX□002-5□N26-□□□□
1FT7084-5SF7	27	1.5 / 4 x 2.5	6SL3120-1TE23-0AD□	30	81	6FX□002-5□N36-□□□□
1FT7084-5SH7	27	1.5 / 4 x 6	6SL3120-1TE24-5AA□	30	67	6FX□002-5□N54-□□□□
1FT7086-5SC7	36	1.5 / 4 x 2.5	6SL3120-1TE23-0AD□	30	120	6FX□002-5□N36-□□□□
1FT7086-5SF7	36	1.5 / 4 x 6	6SL3120-1TE23-0AD□	30	101	6FX□002-5□N56-□□□□
1FT7086-5SH7	36	1.5 / 4 x 6	6SL3120-1TE24-5AA□	45	85	6FX□002-5□N54-□□□□
1FT7105-5SC7	65	1.5 / 4 x 6	6SL3120-1TE24-5AA□	45	168	6FX□002-5□N54-□□□□
1FT7105-5SF7	65	1.5 / 4 x 10	6SL3120-1TE24-5AA□	45	120	6FX□002-5□N64-□□□□
1FT7108-5SC7	91	1.5 / 4 x 10	6SL3120-1TE24-5AA□	45	190	6FX□002-5□N64-□□□□
1FT7108-5SF7	91	3 / 4 x 16	6SL3120-1TE26-0AA□	60	177	6FX□002-5□S23-□□□□
1FT7132-5SB7	140	3 / 4 x 10	6SL3120-1TE26-0AA□	60	235	6FX□002-5□S14-□□□□
1FT7132-5SC7	140	3 / 4 x 16	6SL3120-1TE26-0AA□	60	245	6FX□002-5□S23-□□□□
1FT7132-5SF7	140	3 / 4 x 35	6SL3120-1TE28-5AA□	85	220	6FX□002-5□G53-□□□□
1FT7134-5SC7	190	3 / 4 x 35	6SL3120-1TE28-5AA□	85	300	6FX□002-5□G53-□□□□
1FT7134-5SF7	190	open wire ends / 4 x 50	6SL3120-1TE31-3AA□	132	315	6FX□002-5□CR83-□□□□
1FT7136-5SB7	235	3 / 4 x 25	6SL3120-1TE28-5AA□	85	440	6FX□002-5□G33-□□□□
1FT7136-5SC7	235	open wire ends / 4 x 35	6SL3120-1TE31-3AA□	132	455	6FX□002-5□CR73-□□□□
1FT7138-5SB7	280	3 / 4 x 35	6SL3120-1TE28-5AA□	85	415	6FX□002-5□G53-□□□□

Table 6- 8 1FT7 Compact water cooling

Motor			Converter: SINAMICS S120 Booksize			Power cable
Order number	M_0 (100K) / Nm	Connector size ⁵⁾ / Cable cross-section ⁴⁾	Order number ²⁾	Base load current I_H / A	M_{max} (100K Inv ¹⁾ / Nm	Order number ³⁾
1FT7062-5WF7	10	1 / 4 x 1.5	6SL3120-1TE21-0AD□	9	26.0	6FX□002-5□N06-□□□□
1FT7062-5WK7	10	1 / 4 x 1.5	6SL3120-1TE21-8AD□	18	26.0	6FX□002-5□N06-□□□□
1FT7064-5WF7	16	1 / 4 x 1.5	6SL3120-1TE21-8AD□	18	40.0	6FX□002-5□N06-□□□□
1FT7064-5WK7	16	1 / 4 x 2.5	6SL3120-1TE23-0AD□	30	40.0	6FX□002-5□N16-□□□□
1FT7066-5WF7	20	1 / 4 x 1.5	6SL3120-1TE21-8AD□	18	55.0	6FX□002-5□N06-□□□□
1FT7066-5WH7	20	1 / 4 x 2.5	6SL3120-1TE23-0AD□	30	55.0	6FX□002-5□N16-□□□□
1FT7068-5WF7	30	1 / 4 x 2.5	6SL3120-1TE23-0AD□	18	68.5	6FX□002-5□N16-□□□□
1FT7082-5WC7	21	1.5 / 4 x 1.5	6SL3120-1TE23-0AD□	18	55.0	6FX□002-5□N26-□□□□
1FT7082-5WF7	21	1.5 / 4 x 2.5	6SL3120-1TE23-0AD□	18	55.0	6FX□002-5□N36-□□□□
1FT7082-5WH7	21	1.5 / 4 x 4	6SL3120-1TE23-0AD□	30	55.0	6FX□002-5□N46-□□□□
1FT7084-5WC7	35	1.5 / 4 x 2.5	6SL3120-1TE24-5AA□	18	87.0	6FX□002-5□N36-□□□□
1FT7084-5WF7	35	1.5 / 4 x 4	6SL3120-1TE24-5AA□	30	90.0	6FX□002-5□N46-□□□□
1FT7084-5WH7	35	1.5 / 4 x 6	6SL3120-1TE24-5AA□	45	71.0	6FX□002-5□N54-□□□□
1FT7086-5WC7	50	1.5 / 4 x 4	6SL3120-1TE26-0AA□	30	125.0	6FX□002-5□N46-□□□□
1FT7086-5WF7	50	1.5 / 4 x 6	6SL3120-1TE26-0AA□	45	102.0	6FX□002-5□N54-□□□□
1FT7086-5WH7	50	1.5 / 4 x 10	6SL3120-1TE26-0AA□	45	88.0	6FX□002-5□N64-□□□□
1FT7102-5WB7	50	1.5 / 4 x 2.5	6SL3120-1TE21-8AD□	18	125.0	6FX□002-5□N36-□□□□
1FT7102-5WC7	50	1.5 / 4 x 4	6SL3120-1TE23-0AD□	30	130.0	6FX□002-5□N46-□□□□
1FT7102-5WF7	50	1.5 / 4 x 10	6SL3120-1TE24-5AA□	45	89.5	6FX□002-5□N64-□□□□
1FT7105-5WB7	90	1.5 / 4 x 6	6SL3120-1TE23-0AD□	30	230.0	6FX□002-5□N56-□□□□
1FT7105-5WC7	90	1.5 / 4 x 10	6SL3120-1TE24-5AA□	45	167.5	6FX□002-5□N64-□□□□
1FT7105-5WF7	90	3 / 4 x 16	6SL3120-1TE26-0AA□	60	161.0	6FX□002-5□S23-□□□□
1FT7108-5WB7	125	1.5 / 4 x 10	6SL3120-1TE24-5AA□	45	249.5	6FX□002-5□N64-□□□□

Motor			Converter: SINAMICS S120 Booksize			Power cable
Order number	M_0 (100K) / Nm	Connector size ⁵⁾ / Cable cross-section ⁴⁾	Order number ²⁾	Base load current I_H / A	M_{max} (100K) Inv ¹⁾ / Nm	Order number ³⁾
1FT7108-5WC7	125	3 / 4 x 10	6SL3120-1TE26-0AA□	45	214.0	6FX□002-5□S14-□□□□
1FT7108-5WF7	125	3 / 4 x 16	6SL3120-1TE28-5AA□	85	238.5	6FX□002-5□S23-□□□□

Table 6- 9 1FK7 High Dynamic, natural cooling

Motor			Converter: SINAMICS S120 Booksize			Power cable
Order number	M_0 (100K) / Nm	Connector size ⁵⁾ / Cable cross-section ⁴⁾	Order number ²⁾	Base load current I_H / A	M_{max} (100K) Inv ¹⁾ / Nm	Order number ³⁾
1FT7087-7AF7	33	1.5 / 4 x 4	6SL3120-1TE23-0AD□	30	96.0	6FX□002-5□N46-□□□□
1FT7117-7AC7	81	3 / 4 x 4	6SL3120-1TE23-0AD□	30	260.0	6FX□002-5□S14-□□□□
1FT7117-7AF7	81	3 / 4 x 10	6SL3120-1TE24-0AD□	45	290.0	6FX□002-5□S14-□□□□

Table 6- 10 1FT7 High Dynamic forced ventilation

Motor			Converter: SINAMICS S120 Booksize			Power cable
Order number	M_0 (100K) / Nm	Connector size ⁵⁾ / Cable cross-section ⁴⁾	Order number ²⁾	Base load current I_H / A	M_{max} (100K) Inv ¹⁾ / Nm	Order number ³⁾
1FT7065-7SF7	14	1.5 / 4 x 1.5	6SL3120-1TE21-8AD□	18	45.0	6FX□002-5□N26-□□□□
1FT7065-7SH7	14	1.5 / 4 x 2.5	6SL3120-1TE21-8AD□	18	39.0	6FX□002-5□N36-□□□□
1FT7067-7SF7	17	1.5 / 4 x 1.5	6SL3120-1TE21-8AA□	18	54.0	6FX□002-5□N26-□□□□
1FT7067-7SH7	17	1.5 / 4 x 2.5	6SL3120-1TE23-0AD□	30	60.0	6FX□002-5□N36-□□□□
1FT7085-7SF7	34	1.5 / 4 x 4	6SL3120-1TE23-0AD□	30	89.0	6FX□002-5□N46-□□□□
1FT7085-7SH7	34	1.5 / 4 x 10	6SL3120-1TE24-5AA□	45	68.00	6FX□002-5□N64-□□□□
1FT7087-7SF7	48	1.5 / 4 x 10	6SL3120-1TE24-5AA□	45	96.00	6FX□002-5□N64-□□□□
1FT7087-7SH7	48	3 / 4 x 10	6SL3120-1TE24-5AA□	45	85.00	6FX□002-5□S14-□□□□
1FT7117-7SC7	105	3 / 4 x 6	6SL3120-1TE24-5AA□	45	260.0	6FX□002-5□S14-□□□□
1FT7117-7SF7	105	3 / 4 x 16	6SL3120-1TE26-0AA□	60	290.0	6FX□002-5□S23-□□□□

Table 6- 11 1FT7 High Dynamic water cooling

Motor			Converter: SINAMICS S120 Booksize			Power cable
Order number	M_0 (100K) / Nm	Connector size ⁵⁾ / Cable cross-section ⁴⁾	Order number ²⁾	Base load current I_H / A	M_{max} (100K Inv ¹⁾ / Nm	Order number ³⁾
1FT7065-7WF7	19	1.5 / 4 x 2.5	6SL3120-1TE21-8AD□	18	18	6FX□002-5□N36-□□□□
1FT7065-7WH7	19	1.5 / 4 x 4	6SL3120-1TE23-0AD□	30	30	6FX□002-5□N46-□□□□
1FT7067-7WF7	25	1.5 / 4 x 4	6SL3120-1TE23-0AD□	30	30	6FX□002-5□N46-□□□□
1FT7067-7WH7	25	1.5 / 4 x 4	6SL3120-1TE23-0AD□	30	30	6FX□002-5□N46-□□□□
1FT7085-7WF7	43	1.5 / 4 x 6	6SL3120-1TE24-5AA□	45	45	6FX□002-5□N54-□□□□
1FT7085-7WH7	43	3 / 4 x 16	6SL3120-1TE26-5AA□	60	60	6FX□002-5□S23-□□□□
1FT7087-7WF7	61	3 / 4 x 16	6SL3120-1TE26-0AA□	60	60	6FX□002-5□S23-□□□□
1FT7087-7WH7	61	3 / 4 x 25	6SL3120-1TE28-0AA□	85	85	6FX□002-5□G33-□□□□

- 1) The maximum torques of servomotors up to and including stall currents of 30 A are shown with 3-fold overload capacity. Beyond that with 2-fold.
- 2) The Motor Modules are shown as Single Motor Module (6SL3120-1□□□□-□□□□). Up to and including 18 A stall current you can also choose Double Motor Modules (6SL3120-2□□□□-□□□□). The last digit of the order number shows the version.
- 3) The 4th digit of the order number of pre-assembled power cables defines the type (5: for Motion Connect 500 and 8: for Motion Connect 800 Plus). Via the 9th digit of the order number the brake connection can be set (C: Without brake cores, and D: with brake cores). The cable cross-section for the brake connection is 2 x 1.5 mm². Power cables in connector sizes 1 and 1.5 are shown as SPEED-CONNECT. For assigned Motor Modules for IN > 30 A, the cables on the module side are equipped with ring cable lugs. From connector size 3 onwards, the power connector has a full thread.
- 4) The current carrying capacity of the power cables corresponds to EN 60204-1 for routing type C under continuous operation conditions at an ambient air temperature of 40 °C.
- 5) Open wire ends

6.3 Data sheets and characteristics

6.3.1 1FT7 Compact - natural cooling

6.3.1.1 1FT7034- A

Three-phase servomotor 1FT7034-5AK7			
Technical specifications	Symbol	Unit	Value
Configuration data:			
Rated speed	n_N	rpm	6000
Rated torque (100K)	$M_{N(100K)}$	Nm	1.4
Rated current (100K)	$I_{N(100K)}$	A	2.1
Static torque (100K)	$M_{0(100K)}$	Nm	2.0
Stall current (100K)	$I_{0(100K)}$	A	2.7
Static torque (60K)	$M_{0(60K)}$	Nm	1.6
Stall current (60K)	$I_{0(60K)}$	A	2.1
Optimum operating point:			
Optimum speed	n_{opt}	rpm	6000
Optimum power	P_{opt}	kW	0.88
Limiting data:			
Max. permissible speed (mech.)	$n_{max\ mech}$	rpm	10000
Maximum torque	M_{max}	Nm	8.0
Maximum current	I_{max}	A	12.0
Motor data:			
No. of poles	2p		6
Torque constant (100K)	k_T	Nm/A	0.76
Voltage constant (at 20 °C)	k_E	V/1000 rpm	48.5
Winding resistance (at 20 °C)	R_{Str}	W	2.4
Rotating field inductance	L_D	mH	9.7
Electrical time constant	T_{el}	ms	4.0
Mechanical time constant	T_{mech}	ms	1.1
Thermal time constant	T_{th}	min	25
Moment of inertia	J_{mot}	$kgm^2 \cdot 10^{-4}$	0.85
Shaft torsional stiffness	C_t	Nm/rad	5100
Weight	m_{mot}	kg	3.8
Motor data with integrated brake:			
Moment of inertia (with brake)	J_{mot}	$kgm^2 \cdot 10^{-4}$	0.98
Shaft torsional stiffness (with brake)	C_t	Nm/rad	3650
Weight (with brake)	m_{mot}	kg	4.2
Data with SINAMICS S120 Booksize / S120 Booksize Compact			
Rated converter current	$I_{N\ Inv}$	A	3
Maximum converter current	$I_{max\ Inv}$	A	9
Max. torque (converter operation)	$M_{max\ Inv}$	Nm	6.3
Max. permissible speed (converter operation)	$n_{max\ Inv}$	rpm	10000
The rated data are valid for a 600 V DC-link voltage			

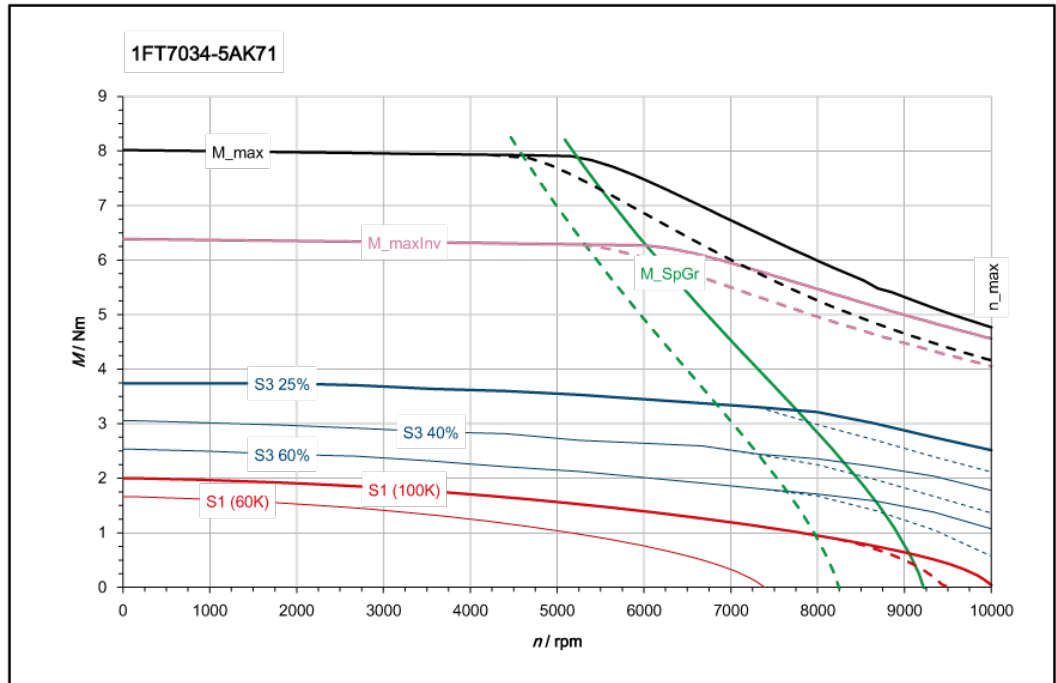

[———] SINAMICS ALM 400 V (600 V DC)
 [- - - -] SINAMICS BLM/SLM 400 V (540 V DC)

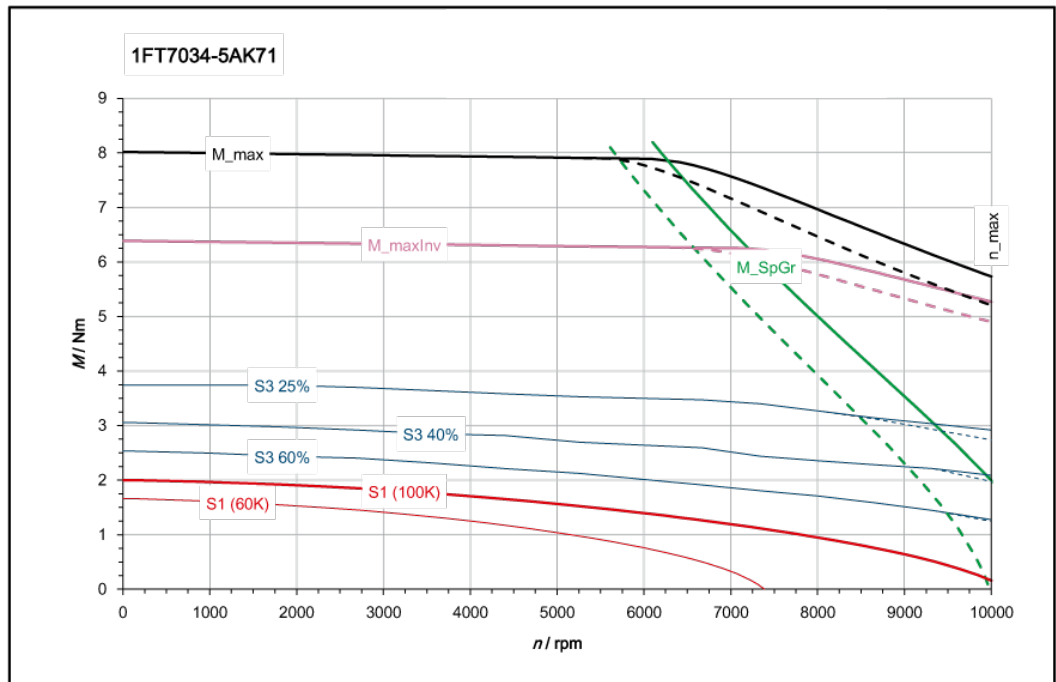

[———] SINAMICS ALM 480 V (720 V DC)
 [- - - -] SINAMICS BLM/SLM 480 V (650 V DC)

6.3.1.2 1FT7036_A

Three-phase servomotor 1FT7036-5AK7			
Technical specifications	Symbol	Unit	Value
Configuration data:			
Rated speed	n_N	rpm	6000
Rated torque (100K)	$M_{N(100K)}$	Nm	1.7
Rated current (100K)	$I_{N(100K)}$	A	2.4
Static torque (100K)	$M_{0(100K)}$	Nm	3.0
Stall current (100K)	$I_{0(100K)}$	A	4.0
Static torque (60K)	$M_{0(60K)}$	Nm	2.4
Stall current (60K)	$I_{0(60K)}$	A	3.1
Optimum operating point:			
Optimum speed	n_{opt}	rpm	6000
Optimum power	P_{opt}	kW	1.07
Limiting data:			
Max. permissible speed (mech.)	$n_{max\ mech}$	rpm	10000
Maximum torque	M_{max}	Nm	12.0
Maximum current	I_{max}	A	17.0
Motor data:			
No. of poles	2p		6
Torque constant (100K)	k_T	Nm/A	0.76
Voltage constant (at 20 °C)	k_E	V/1000 rpm	48.5
Winding resistance (at 20 °C)	R_{Str}	W	1.37
Rotating field inductance	L_D	mH	5.9
Electrical time constant	T_{el}	ms	4.3
Mechanical time constant	T_{mech}	ms	1
Thermal time constant	T_{th}	min	30
Moment of inertia	J_{mot}	$kgm^2 \cdot 10^{-4}$	1.33
Shaft torsional stiffness	C_t	Nm/rad	4100
Weight	m_{mot}	kg	5.0
Motor data with integrated brake:			
Moment of inertia (with brake)	J_{mot}	$kgm^2 \cdot 10^{-4}$	1.45
Shaft torsional stiffness (with brake)	C_t	Nm/rad	3150
Weight (with brake)	m_{Mot}	kg	5.4
Data with SINAMICS S120 Booksize / S120 Booksize Compact:			
Rated converter current	$I_{N\ Inv}$	A	5
Maximum converter current	$I_{max\ Inv}$	A	15
Max. torque (converter operation)	$M_{max\ Inv}$	Nm	10.8
Max. permissible speed (converter operation)	$n_{max\ Inv}$	rpm	10000
The rated data are valid for a 600 V DC-link voltage			

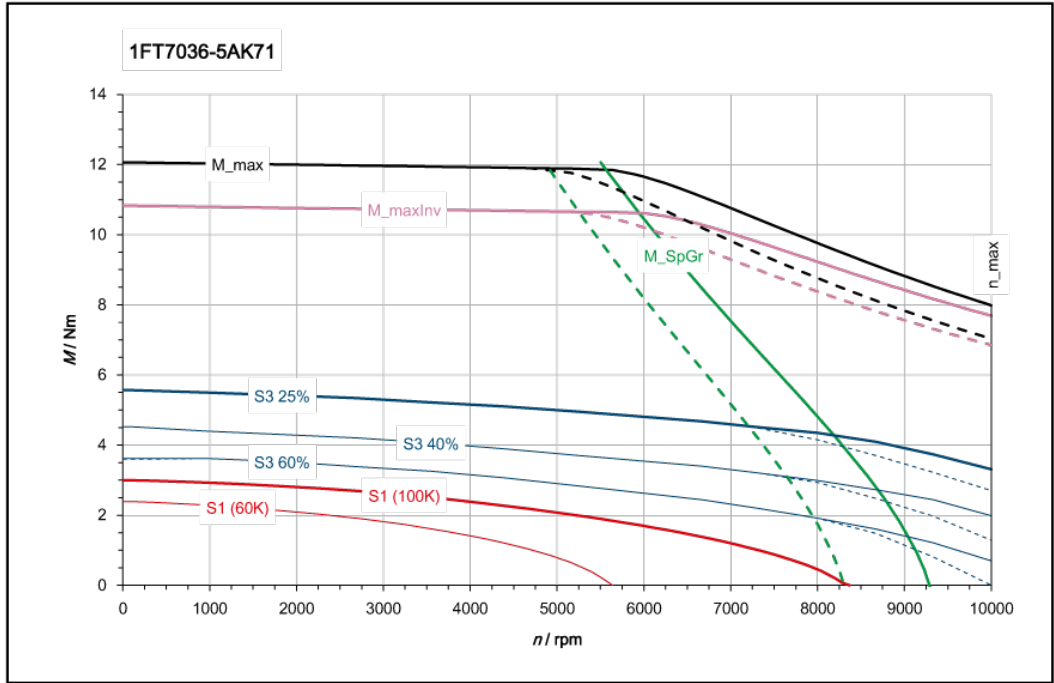

[———] SINAMICS ALM 400 V (600 V DC)
[- - - -] SINAMICS BLM/SLM 400 V (540 V DC)

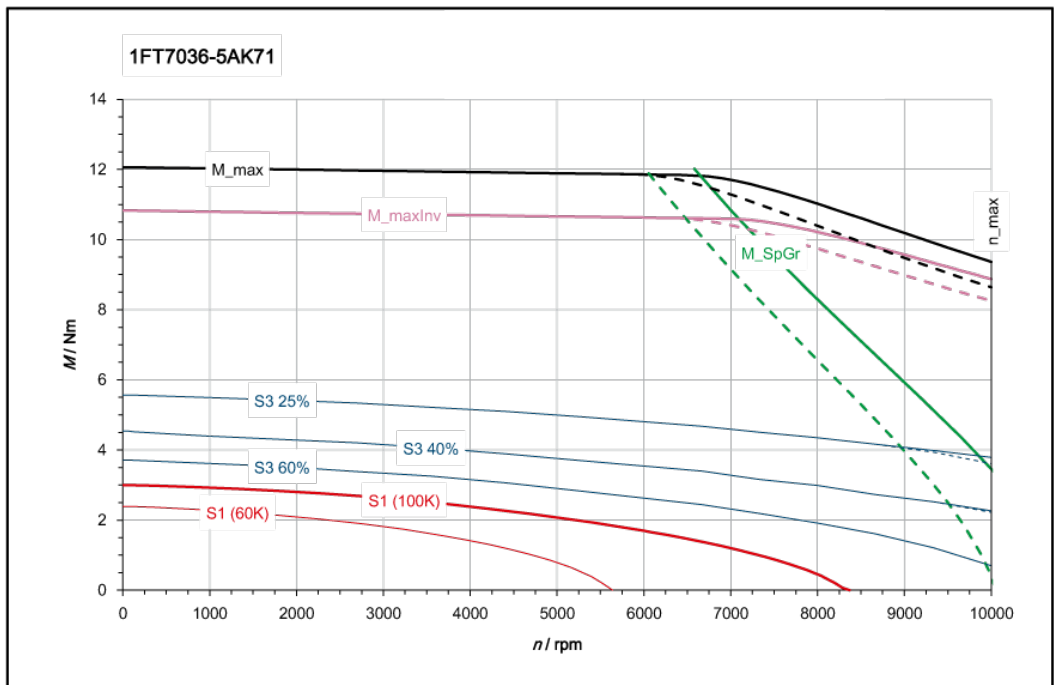

[———] SINAMICS ALM 480 V (720 V DC)
[- - - -] SINAMICS BLM/SLM 480 V (650 V DC)

6.3.1.3 1FT7042-_A

Three-phase servomotor 1FT7042-5AF7			
Technical specifications	Symbol	Unit	Value
Configuration data:			
Rated speed	n_N	rpm	3000
Rated torque (100K)	$M_{N(100K)}$	Nm	2.7
Rated current (100K)	$I_{N(100K)}$	A	2.1
Static torque (100K)	$M_{0(100K)}$	Nm	3.0
Stall current (100K)	$I_{0(100K)}$	A	2.1
Static torque (60K)	$M_{0(60K)}$	Nm	2.5
Stall current (60K)	$I_{0(60K)}$	A	1.8
Optimum operating point:			
Optimum speed	n_{opt}	rpm	3000
Optimum power	P_{opt}	kW	0.85
Limiting data:			
Max. permissible speed (mech.)	$n_{max\ mech}$	rpm	9000
Maximum torque	M_{max}	Nm	13.0
Maximum current	I_{max}	A	11.0
Motor data:			
No. of poles	2p		6
Torque constant (100K)	k_T	Nm/A	1.375
Voltage constant (at 20 °C)	k_E	V/1000 rpm	87.5
Winding resistance (at 20 °C)	R_{Str}	W	3.6
Rotating field inductance	L_D	mH	21.4
Electrical time constant	T_{el}	ms	5.9
Mechanical time constant	T_{mech}	ms	1.6
Thermal time constant	T_{th}	min	20
Moment of inertia	J_{mot}	$kgm^2 \cdot 10^{-4}$	2.81
Shaft torsional stiffness	C_t	Nm/rad	16200
Weight	m_{mot}	kg	4.6
Motor data with integrated brake:			
Moment of inertia (with brake)	J_{mot}	$kgm^2 \cdot 10^{-4}$	3.68
Shaft torsional stiffness (with brake)	C_t	Nm/rad	11700
Weight (with brake)	m_{mot}	kg	5.5
Data with SINAMICS S120 Booksize / S120 Booksize Compact			
Rated converter current	$I_{N\ Inv}$	A	3
Maximum converter current	$I_{max\ Inv}$	A	9
Max. torque (converter operation)	$M_{max\ Inv}$	Nm	10.9
Max. permissible speed (converter operation)	$n_{max\ Inv}$	rpm	6600
The rated data are valid for a 600 V DC-link voltage			

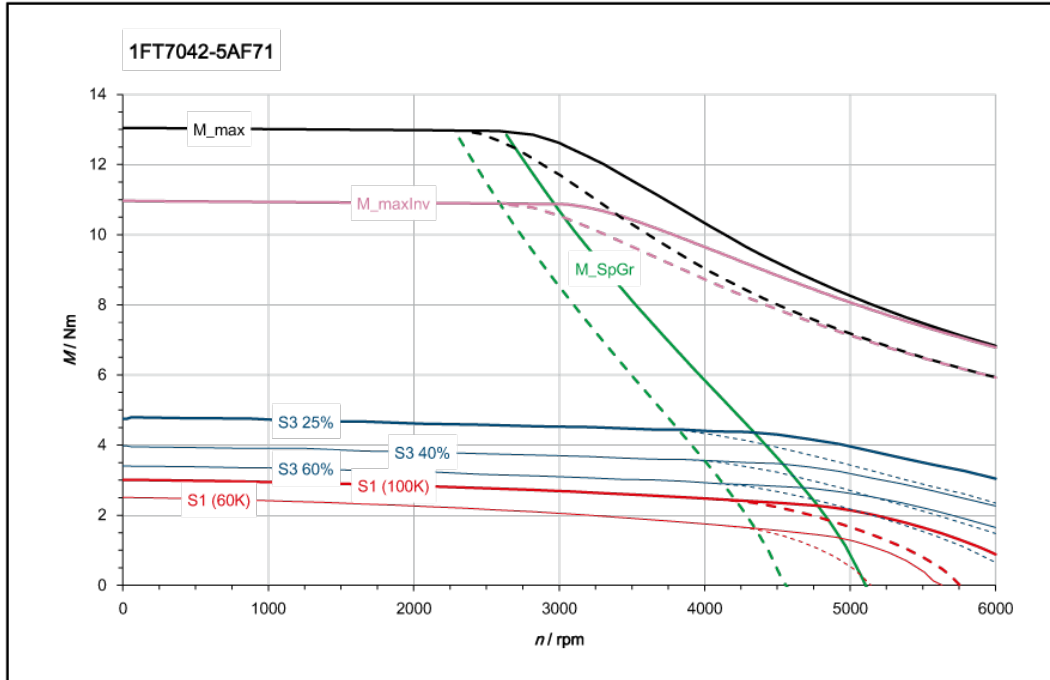

[———] SINAMICS ALM 400 V (600 V DC)
 [- - - -] SINAMICS BLM/SLM 400 V (540 V DC)

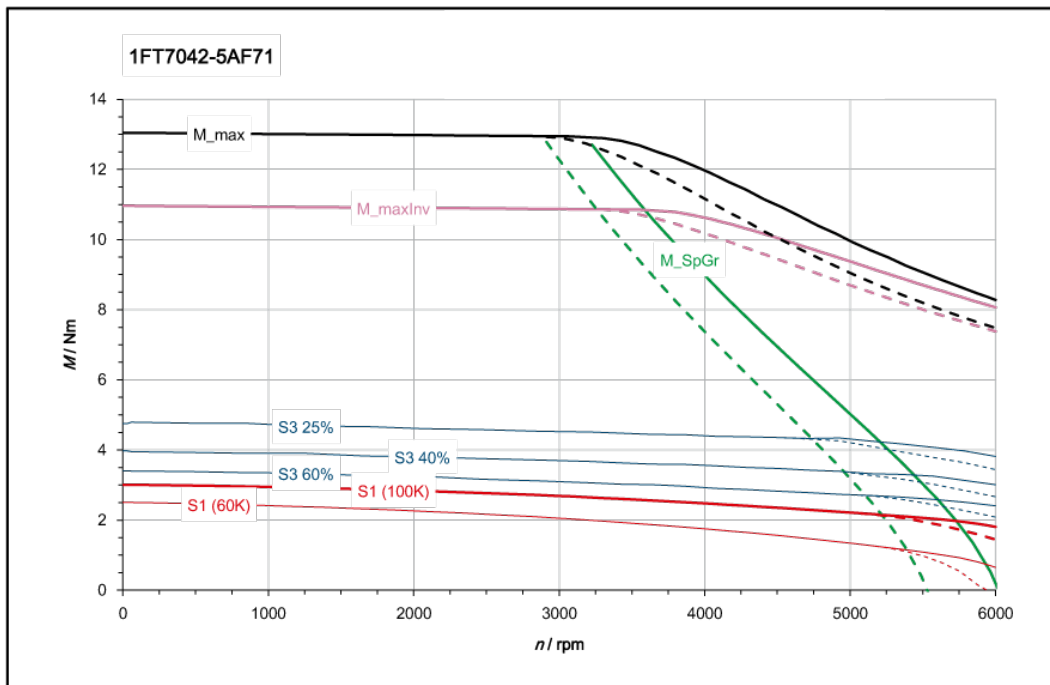

[———] SINAMICS ALM 480 V (720 V DC)
 [- - - -] SINAMICS BLM/SLM 480 V (650 V DC)

Three-phase servomotor 1FT7042-5AK7			
Technical specifications	Symbol	Unit	Value
Configuration data:			
Rated speed	n_N	rpm	6000
Rated torque (100K)	$M_{N(100K)}$	Nm	2.0
Rated current (100K)	$I_{N(100K)}$	A	3.0
Static torque (100K)	$M_{0(100K)}$	Nm	3.0
Stall current (100K)	$I_{0(100K)}$	A	3.9
Static torque (60K)	$M_{0(60K)}$	Nm	2.4
Stall current (60K)	$I_{0(60K)}$	A	3.1
Optimum operating point:			
Optimum speed	n_{opt}	rpm	6000
Optimum power	P_{opt}	kW	1.26
Limiting data:			
Max. permissible speed (mech.)	$n_{max\ mech}$	rpm	9000
Maximum torque	M_{max}	Nm	13.0
Maximum current	I_{max}	A	21.0
Motor data:			
No. of poles	$2p$		6
Torque constant (100K)	k_T	Nm/A	0.765
Voltage constant (at 20 °C)	k_E	V/1000 rpm	48.6
Winding resistance (at 20 °C)	R_{Str}	W	1.11
Rotating field inductance	L_D	mH	6.5
Electrical time constant	T_{el}	ms	6
Mechanical time constant	T_{mech}	ms	1.6
Thermal time constant	T_{th}	min	20
Moment of inertia	J_{mot}	$kgm^2 \cdot 10^{-4}$	2.81
Shaft torsional stiffness	C_t	Nm/rad	16200
Weight	m_{mot}	kg	4.6
Motor data with integrated brake:			
Moment of inertia (with brake)	J_{mot}	$kgm^2 \cdot 10^{-4}$	3.68
Shaft torsional stiffness (with brake)	C_t	Nm/rad	11700
Weight (with brake)	m_{mot}	kg	5.5
Data with SINAMICS S120 Booksize / S120 Booksize Compact			
Rated converter current	$I_{N\ Inv}$	A	5
Maximum converter current	$I_{max\ Inv}$	A	15
Max. torque (converter operation)	$M_{max\ Inv}$	Nm	10.4
Max. permissible speed (converter operation)	$n_{max\ Inv}$	rpm	9000
The rated data are valid for a 600 V DC-link voltage			

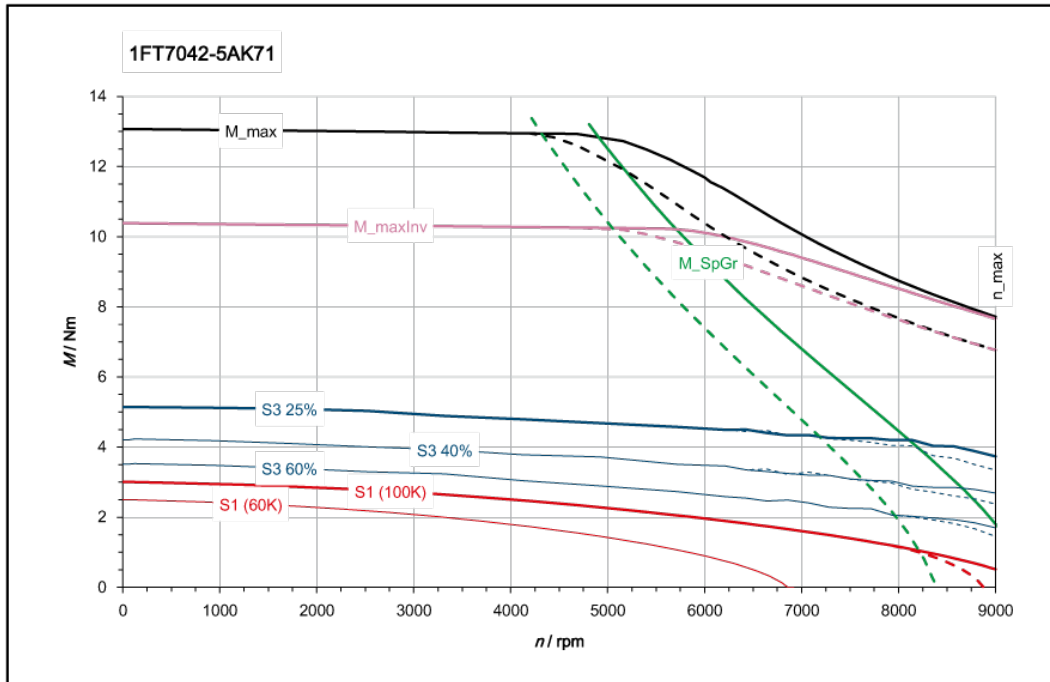

[———] SINAMICS ALM 400 V (600 V DC)
 [- - - -] SINAMICS BLM/SLM 400 V (540 V DC)

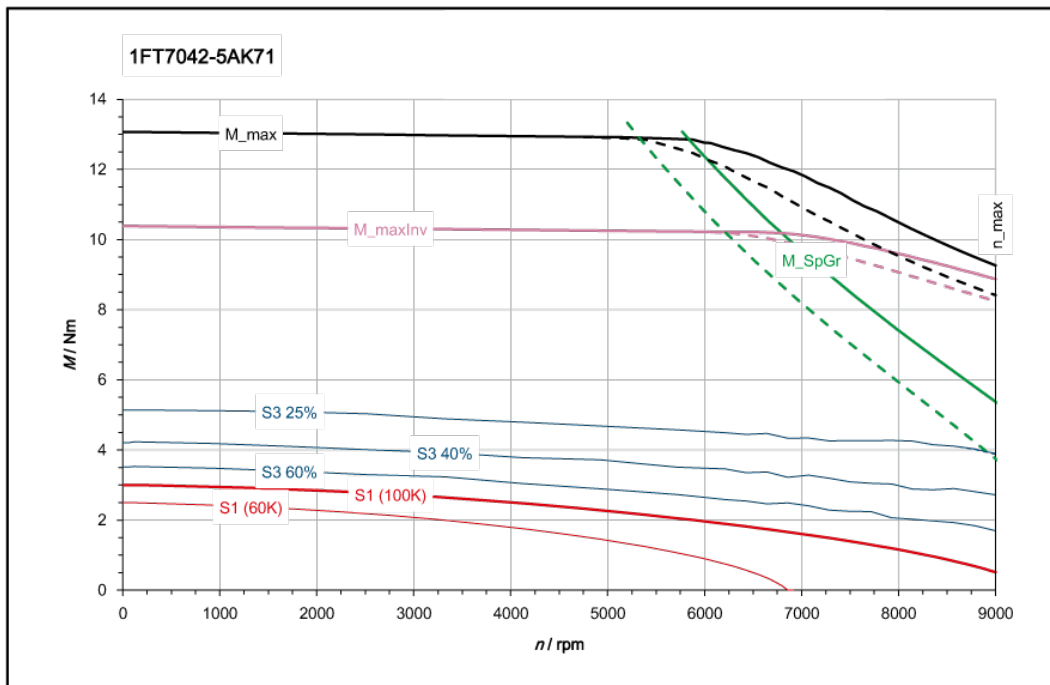

[———] SINAMICS ALM 480 V (720 V DC)
 [- - - -] SINAMICS BLM/SLM 480 V (650 V DC)

6.3.1.4 1FT7044-_A

Three-phase servomotor 1FT7044-5AF7			
Technical specifications	Symbol	Unit	Value
Configuration data:			
Rated speed	n_N	rpm	3000
Rated torque (100K)	$M_{N(100K)}$	Nm	4.3
Rated current (100K)	$I_{N(100K)}$	A	2.6
Static torque (100K)	$M_{0(100K)}$	Nm	5.0
Stall current (100K)	$I_{0(100K)}$	A	2.8
Static torque (60K)	$M_{0(60K)}$	Nm	4.4
Stall current (60K)	$I_{0(60K)}$	A	2.5
Optimum operating point:			
Optimum speed	n_{opt}	rpm	3000
Optimum power	P_{opt}	kW	1.35
Limiting data:			
Max. permissible speed (mech.)	$n_{max\ mech}$	rpm	9000
Maximum torque	M_{max}	Nm	23.0
Maximum current	I_{max}	A	16.0
Motor data:			
No. of poles	2p		6
Torque constant (100K)	k_T	Nm/A	1.735
Voltage constant (at 20 °C)	k_E	V/1000 rpm	110.5
Winding resistance (at 20 °C)	R_{Str}	W	2.35
Rotating field inductance	L_D	mH	15.0
Electrical time constant	T_{el}	ms	6.4
Mechanical time constant	T_{mech}	ms	1.3
Thermal time constant	T_{th}	min	35
Moment of inertia	J_{mot}	$kgm^2 \cdot 10^{-4}$	5.43
Shaft torsional stiffness	C_t	Nm/rad	12300
Weight	m_{mot}	kg	7.2
Motor data with integrated brake:			
Moment of inertia (with brake)	J_{mot}	$kgm^2 \cdot 10^{-4}$	6.3
Shaft torsional stiffness (with brake)	C_t	Nm/rad	9500
Weight (with brake)	m_{Mot}	kg	8.1
Data with SINAMICS S120 Booksize / S120 Booksize Compact			
Rated converter current	$I_{N\ Inv}$	A	3
Maximum converter current	$I_{max\ Inv}$	A	9
Max. torque (converter operation)	$M_{max\ Inv}$	Nm	14.8
Max. permissible speed (converter operation)	$n_{max\ Inv}$	rpm	5200
The rated data are valid for a 600 V DC-link voltage			

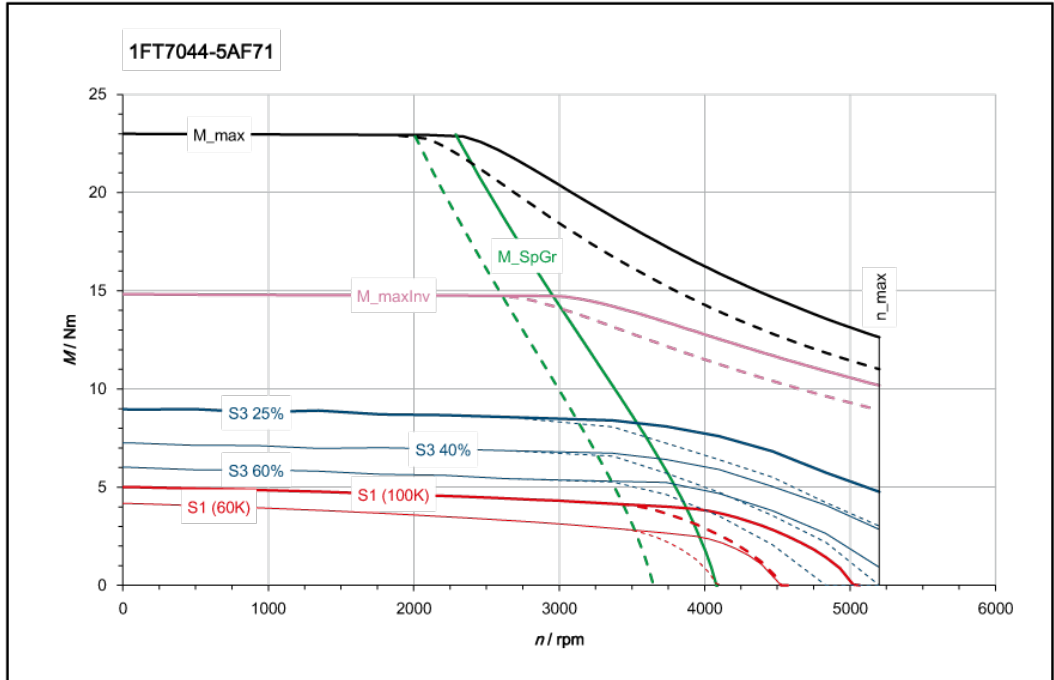

[———] SINAMICS ALM 400 V (600 V DC)
 [- - - -] SINAMICS BLM/SLM 400 V (540 V DC)

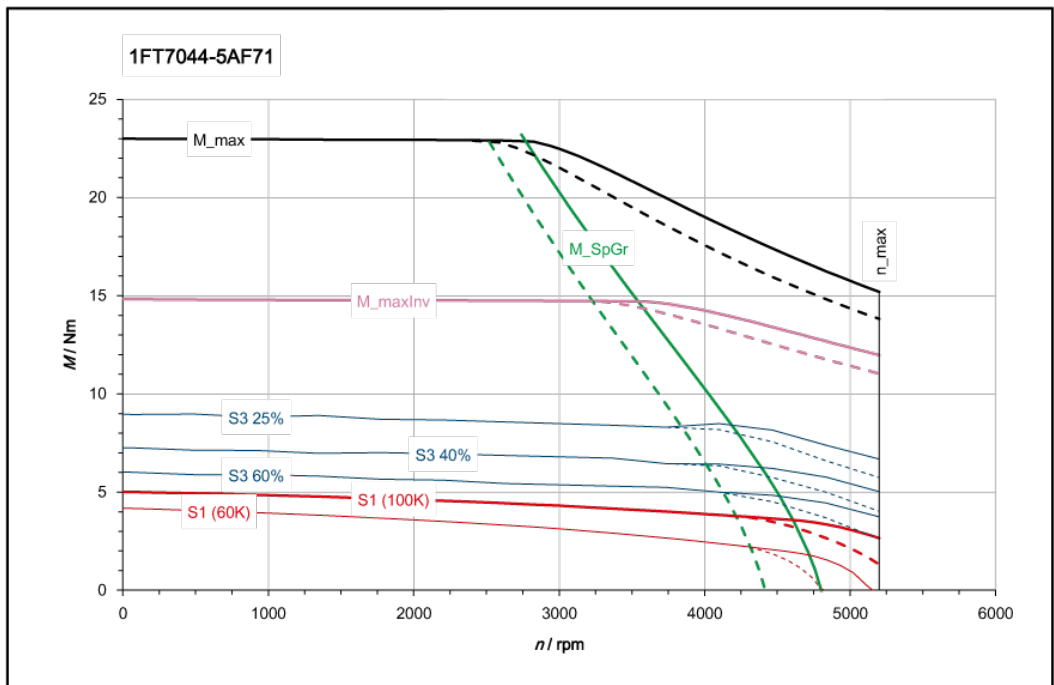

[———] SINAMICS ALM 480 V (720 V DC)
 [- - - -] SINAMICS BLM/SLM 480 V (650 V DC)

Three-phase servomotor 1FT7044-5AK7			
Technical specifications	Symbol	Unit	Value
Configuration data:			
Rated speed	n_N	rpm	6000
Rated torque (100K)	$M_{N(100K)}$	Nm	2.0
Rated current (100K)	$I_{N(100K)}$	A	2.5
Static torque (100K)	$M_{0(100K)}$	Nm	5.0
Stall current (100K)	$I_{0(100K)}$	A	5.7
Static torque (60K)	$M_{0(60K)}$	Nm	4.4
Stall current (60K)	$I_{0(60K)}$	A	4.9
Optimum operating point:			
Optimum speed	n_{opt}	rpm	4500
Optimum power	P_{opt}	kW	1.41
Limiting data:			
Max. permissible speed (mech.)	$n_{max\ mech}$	rpm	9000
Maximum torque	M_{max}	Nm	23.0
Maximum current	I_{max}	A	30.0
Motor data:			
No. of poles	$2p$		6
Torque constant (100K)	k_T	Nm/A	0.885
Voltage constant (at 20 °C)	k_E	V/1000 rpm	56.5
Winding resistance (at 20 °C)	R_{Str}	W	0.61
Rotating field inductance	L_D	mH	4.2
Electrical time constant	T_{el}	ms	7
Mechanical time constant	T_{mech}	ms	1.3
Thermal time constant	T_{th}	min	35
Moment of inertia	J_{mot}	$kgm^2 \cdot 10^{-4}$	5.43
Shaft torsional stiffness	C_t	Nm/rad	12300
Weight	m_{mot}	kg	7.2
Motor data with integrated brake:			
Moment of inertia (with brake)	J_{mot}	$kgm^2 \cdot 10^{-4}$	6.3
Shaft torsional stiffness (with brake)	C_t	Nm/rad	9500
Weight (with brake)	m_{Mot}	kg	8.1
Data with SINAMICS S120 Booksize / S120 Booksize Compact			
Rated converter current	$I_{N\ Inv}$	A	9
Maximum converter current	$I_{max\ Inv}$	A	27
Max. torque (converter operation)	$M_{max\ Inv}$	Nm	21.9
Max. permissible speed (converter operation)	$n_{max\ Inv}$	rpm	9000
The rated data are valid for a 600 V DC-link voltage			

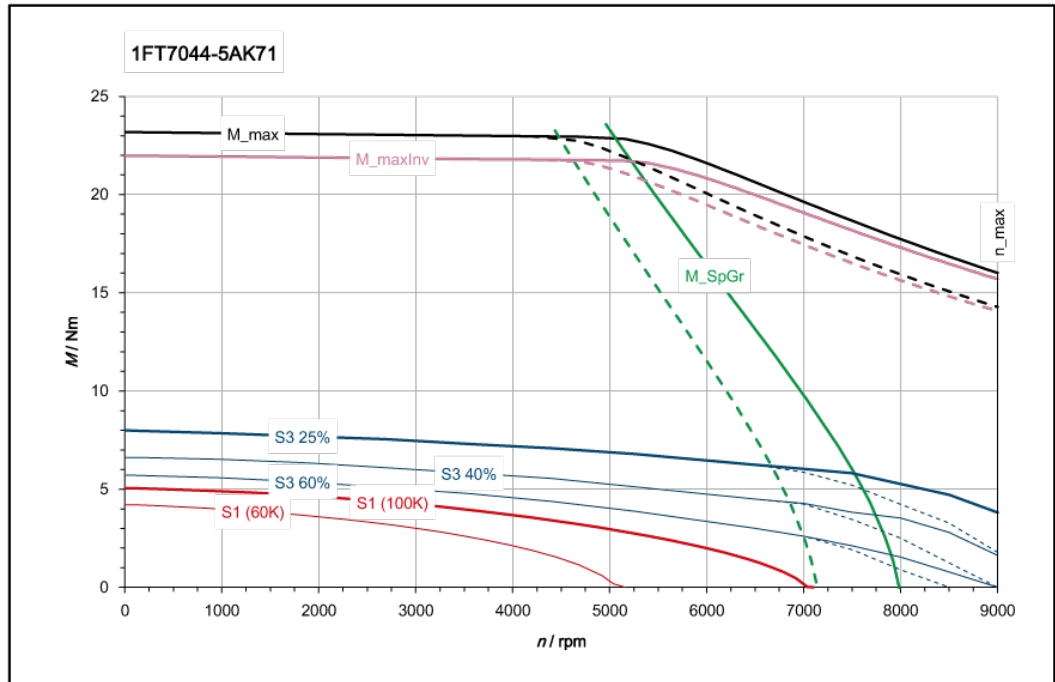

[———] SINAMICS ALM 400 V (600 V DC)
 [- - - -] SINAMICS BLM/SLM 400 V (540 V DC)

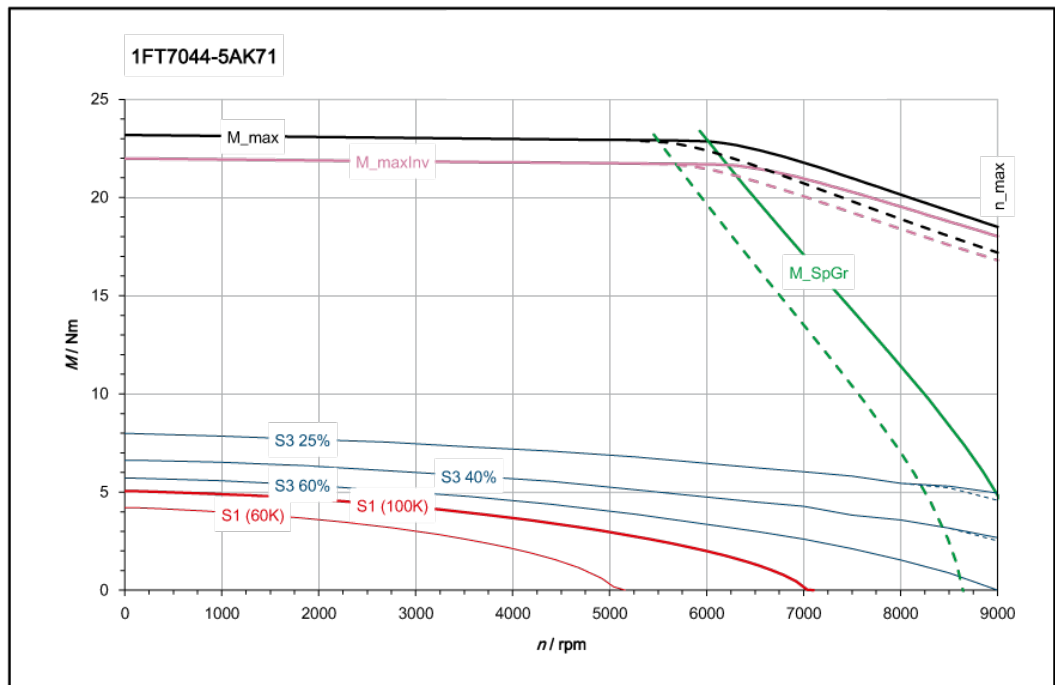

[———] SINAMICS ALM 480 V (720 V DC)
 [- - - -] SINAMICS BLM/SLM 480 V (650 V DC)

6.3.1.5 1FT7046-_A

Three-phase servomotor 1FT7046-5AF7			
Technical specifications	Symbol	Unit	Value
Configuration data:			
Rated speed	n_N	rpm	3000
Rated torque (100K)	$M_{N(100K)}$	Nm	5.6
Rated current (100K)	$I_{N(100K)}$	A	3.5
Static torque (100K)	$M_{0(100K)}$	Nm	7.0
Stall current (100K)	$I_{0(100K)}$	A	4.0
Static torque (60K)	$M_{0(60K)}$	Nm	6.0
Stall current (60K)	$I_{0(60K)}$	A	3.4
Optimum operating point:			
Optimum speed	n_{opt}	rpm	3000
Optimum power	P_{opt}	kW	1.76
Limiting data:			
Max. permissible speed (mech.)	$n_{max\ mech}$	rpm	9000
Maximum torque	M_{max}	Nm	31
Maximum current	I_{max}	A	19.0
Motor data:			
No. of poles	2p		6
Torque constant (100K)	k_T	Nm/A	1.745
Voltage constant (at 20 °C)	k_E	V/1000 rpm	111
Winding resistance (at 20 °C)	R_{Str}	W	1.55
Rotating field inductance	L_D	mH	11.0
Electrical time constant	T_{el}	ms	7
Mechanical time constant	T_{mech}	ms	1.1
Thermal time constant	T_{th}	min	35
Moment of inertia	J_{mot}	$kgm^2 \cdot 10^{-4}$	7.52
Shaft torsional stiffness	C_t	Nm/rad	10300
Weight	m_{mot}	kg	9.3
Motor data with integrated brake:			
Moment of inertia (with brake)	J_{mot}	$kgm^2 \cdot 10^{-4}$	8.39
Shaft torsional stiffness (with brake)	C_t	Nm/rad	8300
Weight (with brake)	m_{Mot}	kg	10.2
Data with SINAMICS S120 Booksize / S120 Booksize Compact:			
Rated converter current	$I_{N\ Inv}$	A	5
Maximum converter current	$I_{max\ Inv}$	A	15
Max. torque (converter operation)	$M_{max\ Inv}$	Nm	24.5
Max. permissible speed (converter operation)	$n_{max\ Inv}$	rpm	5200
The rated data are valid for a 600 V DC-link voltage			

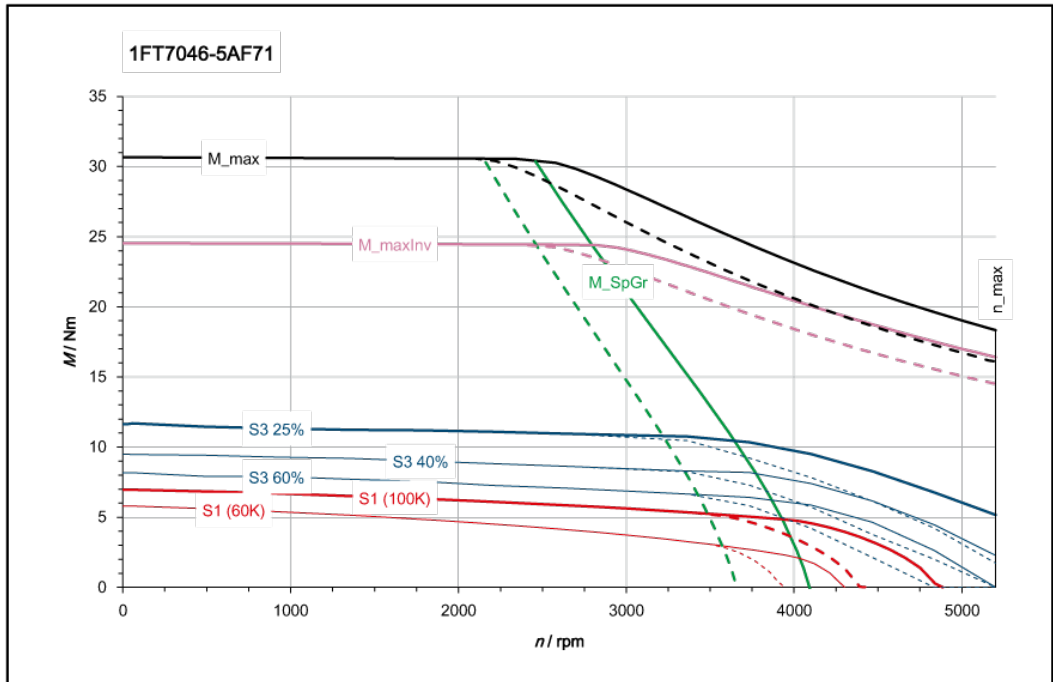

[———] SINAMICS ALM 400 V (600 V DC)
 [- - - -] SINAMICS BLM/SLM 400 V (540 V DC)

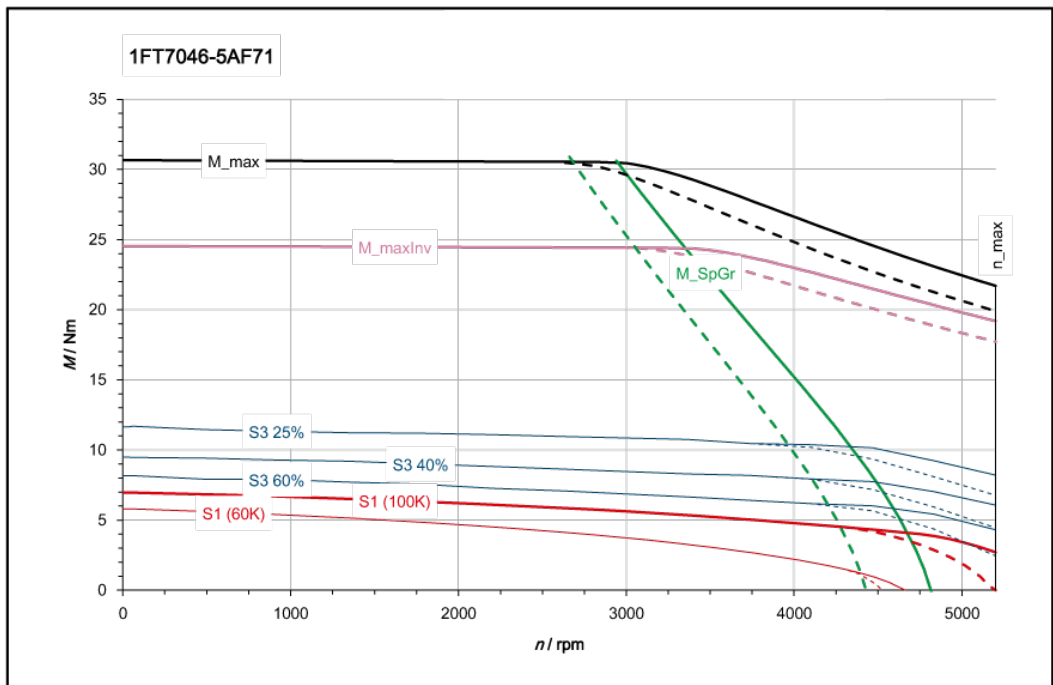

[———] SINAMICS ALM 480 V (720 V DC)
 [- - - -] SINAMICS BLM/SLM 480 V (650 V DC)

Three-phase servomotor 1FT7046-5AH7			
Technical specifications	Symbol	Unit	Value
Configuration data:			
Rated speed	n_N	rpm	4500
Rated torque (100K)	$M_{N(100K)}$	Nm	2.4
Rated current (100K)	$I_{N(100K)}$	A	3.2
Static torque (100K)	$M_{0(100K)}$	Nm	7.0
Stall current (100K)	$I_{0(100K)}$	A	8.1
Static torque (60K)	$M_{0(60K)}$	Nm	6.0
Stall current (60K)	$I_{0(60K)}$	A	6.9
Optimum operating point:			
Optimum speed	n_{opt}	rpm	3500
Optimum power	P_{opt}	kW	1.32
Limiting data:			
Max. permissible speed (mech.)	$n_{max\ mech}$	rpm	9000
Maximum torque	M_{max}	Nm	31.0
Maximum current	I_{max}	A	38.0
Motor data:			
No. of poles	2p		6
Torque constant (100K)	k_T	Nm/A	0.87
Voltage constant (at 20 °C)	k_E	V/1000 rpm	55.5
Winding resistance (at 20 °C)	R_{Str}	W	0.415
Rotating field inductance	L_D	mH	2.9
Electrical time constant	T_{el}	ms	7.0
Mechanical time constant	T_{mech}	ms	1.2
Thermal time constant	T_{th}	min	35
Moment of inertia	J_{mot}	kgm ² * 10 ⁻⁴	7.52
Shaft torsional stiffness	C_t	Nm/rad	10300
Weight	m_{mot}	kg	9.3
Motor data with integrated brake:			
Moment of inertia (with brake)	J_{mot}	kgm ² * 10 ⁻⁴	8.39
Shaft torsional stiffness (with brake)	C_t	Nm/rad	8300
Weight (with brake)	m_{Mot}	kg	10.2
Data with SINAMICS S120 Booksize / S120 Booksize Compact:			
Rated converter current	$I_{N\ Inv}$	A	9
Maximum converter current	$I_{max\ Inv}$	A	27
Max. torque (converter operation)	$M_{max\ Inv}$	Nm	22.4
Max. permissible speed (converter operation)	$n_{max\ Inv}$	rpm	9000
The rated data are valid for a 600 V DC-link voltage			

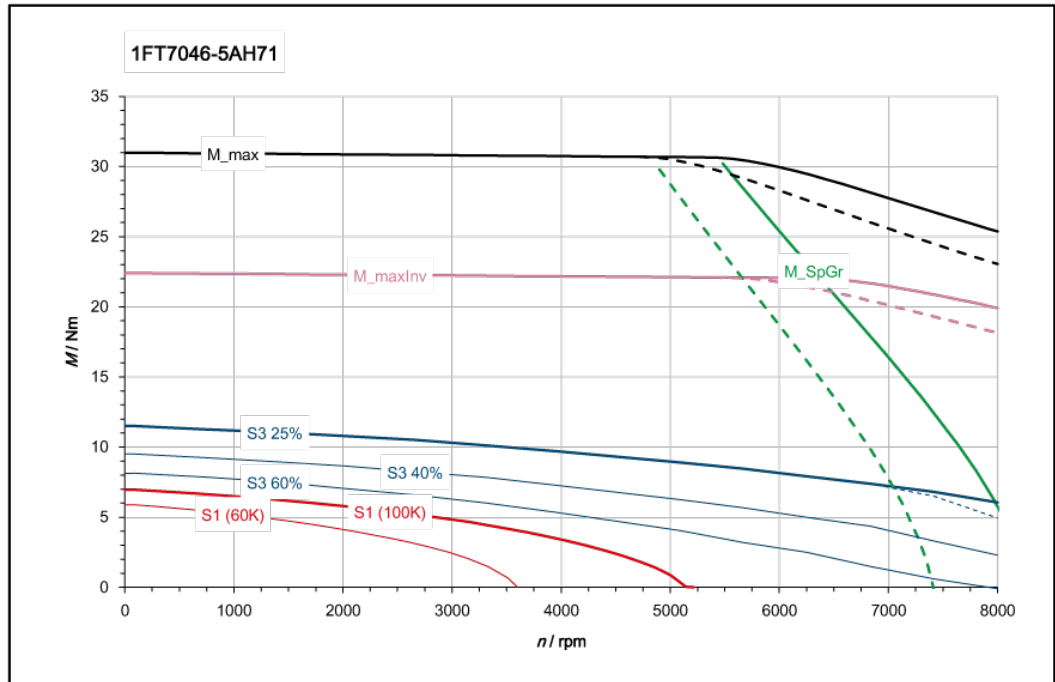

[———] SINAMICS ALM 400 V (600 V DC)
 [- - - -] SINAMICS BLM/SLM 400 V (540 V DC)

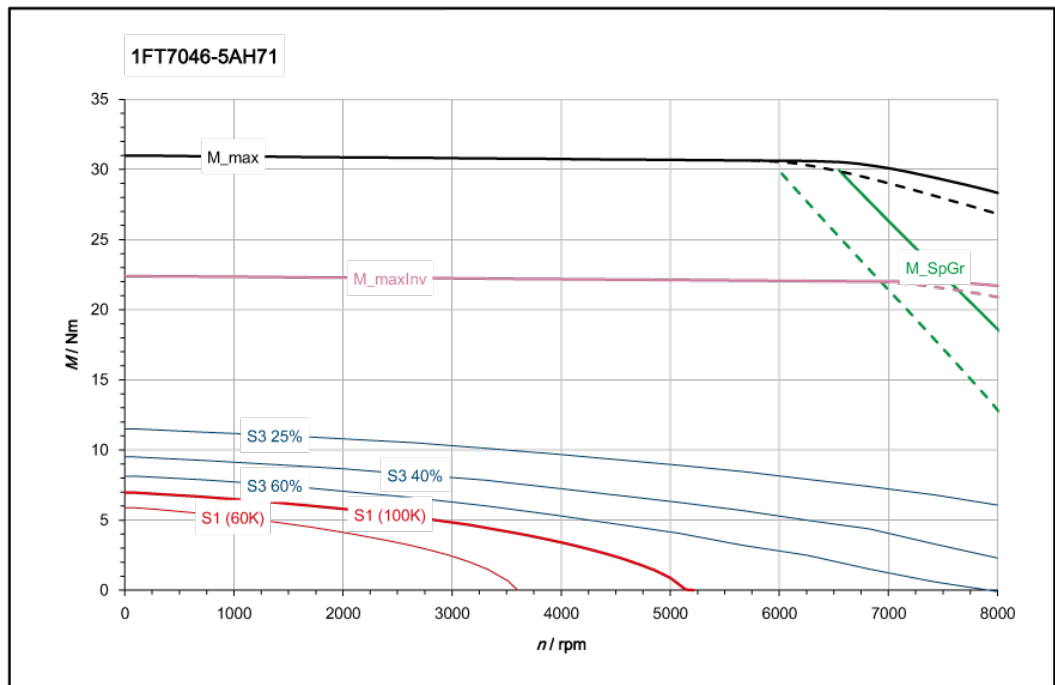

[———] SINAMICS ALM 480 V (720 V DC)
 [- - - -] SINAMICS BLM/SLM 480 V (650 V DC)

6.3.1.6 1FT7062-_A

Three-phase servomotor 1FT7062-5AF7			
Technical specifications	Symbol	Unit	Value
Configuration data:			
Rated speed	n_N	rpm	3000
Rated torque (100K)	$M_{N(100K)}$	Nm	5.4
Rated current (100K)	$I_{N(100K)}$	A	3.9
Static torque (100K)	$M_{0(100K)}$	Nm	6.0
Stall current (100K)	$I_{0(100K)}$	A	3.9
Static torque (60K)	$M_{0(60K)}$	Nm	5.0
Stall current (60K)	$I_{0(60K)}$	A	3.4
Optimum operating point:			
Optimum speed	n_{opt}	rpm	3000
Optimum power	P_{opt}	kW	1.7
Limiting data:			
Max. permissible speed (mech.)	$n_{max\ mech}$	rpm	9000
Maximum torque	M_{max}	Nm	24.0
Maximum current	I_{max}	A	22.0
Motor data:			
No. of poles	2p		10
Torque constant (100K)	k_T	Nm/A	1.485
Voltage constant (at 20 °C)	k_E	V/1000 rpm	94.5
Winding resistance (at 20 °C)	R_{Str}	W	1.57
Rotating field inductance	L_D	mH	15.2
Electrical time constant	T_{el}	ms	10
Mechanical time constant	T_{mech}	ms	1.6
Thermal time constant	T_{th}	min	25
Moment of inertia	J_{mot}	$kgm^2 \cdot 10^{-4}$	7.36
Shaft torsional stiffness	C_t	Nm/rad	39500
Weight	m_{mot}	kg	7.1
Motor data with integrated brake:			
Moment of inertia (with brake)	J_{mot}	$kgm^2 \cdot 10^{-4}$	10.2
Shaft torsional stiffness (with brake)	C_t	Nm/rad	28500
Weight (with brake)	m_{Mot}	kg	8.8
Data with SINAMICS S120 Booksize / S120 Booksize Compact			
Rated converter current	$I_{N\ Inv}$	A	5
Maximum converter current	$I_{max\ Inv}$	A	15
Max. torque (converter operation)	$M_{max\ Inv}$	Nm	18.7
Max. permissible speed (converter operation)	$n_{max\ Inv}$	rpm	6100
The rated data are valid for a 600 V DC-link voltage			

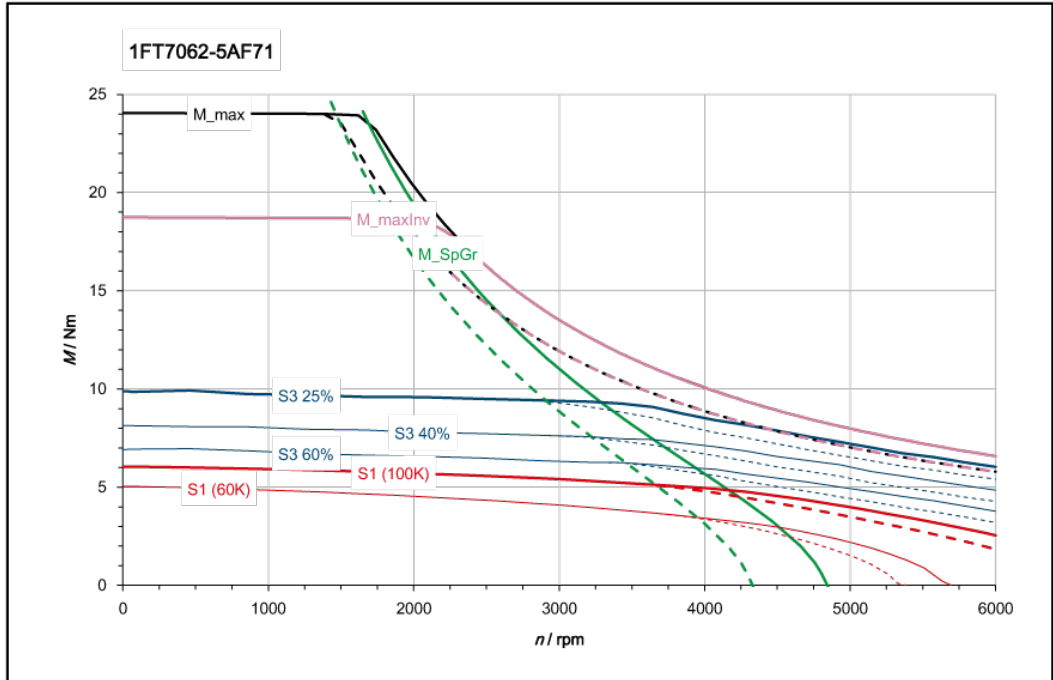

[———] SINAMICS ALM 400 V (600 V DC)
 [- - - -] SINAMICS BLM/SLM 400 V (540 V DC)

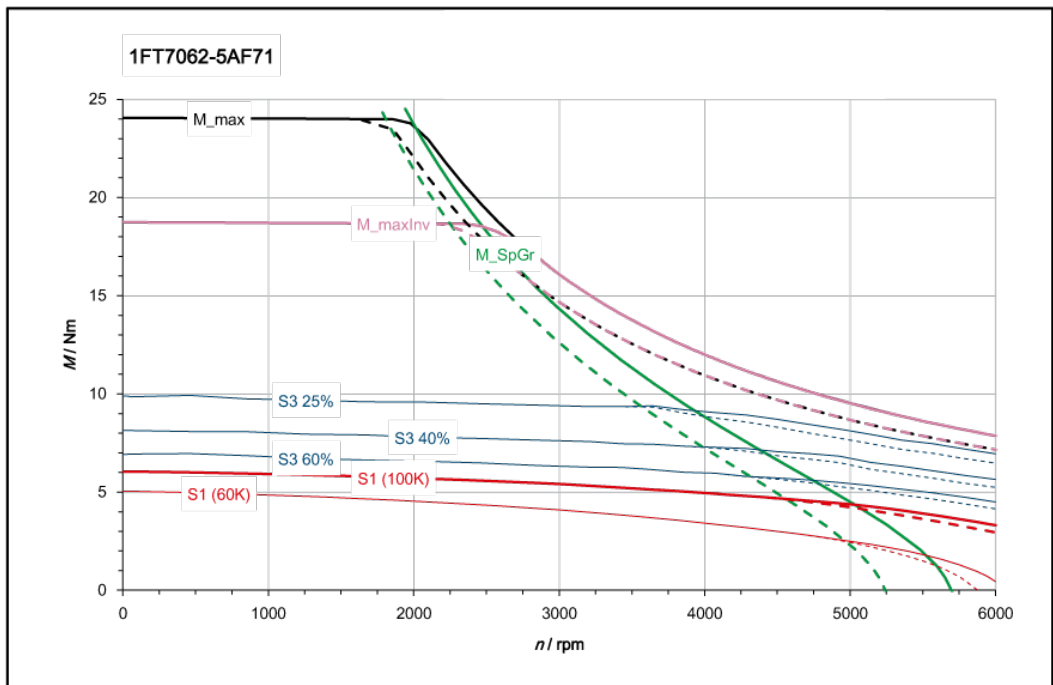

[———] SINAMICS ALM 480 V (720 V DC)
 [- - - -] SINAMICS BLM/SLM 480 V (650 V DC)

Three-phase servomotor 1FT7062-5AK7			
Technical specifications	Symbol	Unit	Value
Configuration data:			
Rated speed	n_N	rpm	6000
Rated torque (100K)	$M_{N(100K)}$	Nm	3.3
Rated current (100K)	$I_{N(100K)}$	A	5.4
Static torque (100K)	$M_{0(100K)}$	Nm	6.0
Stall current (100K)	$I_{0(100K)}$	A	8.4
Static torque (60K)	$M_{0(60K)}$	Nm	5.0
Stall current (60K)	$I_{0(60K)}$	A	7.1
Optimum operating point:			
Optimum speed	n_{opt}	rpm	5500
Optimum power	P_{opt}	kW	2.13
Limiting data:			
Max. permissible speed (mech.)	$n_{max\ mech}$	rpm	9000
Maximum torque	M_{max}	Nm	24.0
Maximum current	I_{max}	A	47.0
Motor data:			
No. of poles	$2p$		10
Torque constant (100K)	k_T	Nm/A	0.7
Voltage constant (at 20 °C)	k_E	V/1000 rpm	44.6
Winding resistance (at 20 °C)	R_{Str}	W	0.355
Rotating field inductance	L_D	mH	3.4
Electrical time constant	T_{el}	ms	10
Mechanical time constant	T_{mech}	ms	1.6
Thermal time constant	T_{th}	min	25
Moment of inertia	J_{mot}	$kgm^2 \cdot 10^{-4}$	7.36
Shaft torsional stiffness	C_t	Nm/rad	39500
Weight	m_{mot}	kg	7.1
Motor data with integrated brake:			
Moment of inertia (with brake)	J_{mot}	$kgm^2 \cdot 10^{-4}$	10.2
Shaft torsional stiffness (with brake)	C_t	Nm/rad	28500
Weight (with brake)	m_{Mot}	kg	8.8
Data with SINAMICS S120 Booksize / S120 Booksize Compact			
Rated converter current	$I_{N\ Inv}$	A	9
Maximum converter current	$I_{max\ Inv}$	A	27
Max. torque (converter operation)	$M_{max\ Inv}$	Nm	16.4
Max. permissible speed (converter operation)	$n_{max\ Inv}$	rpm	8000
The rated data are valid for a 600 V DC-link voltage			

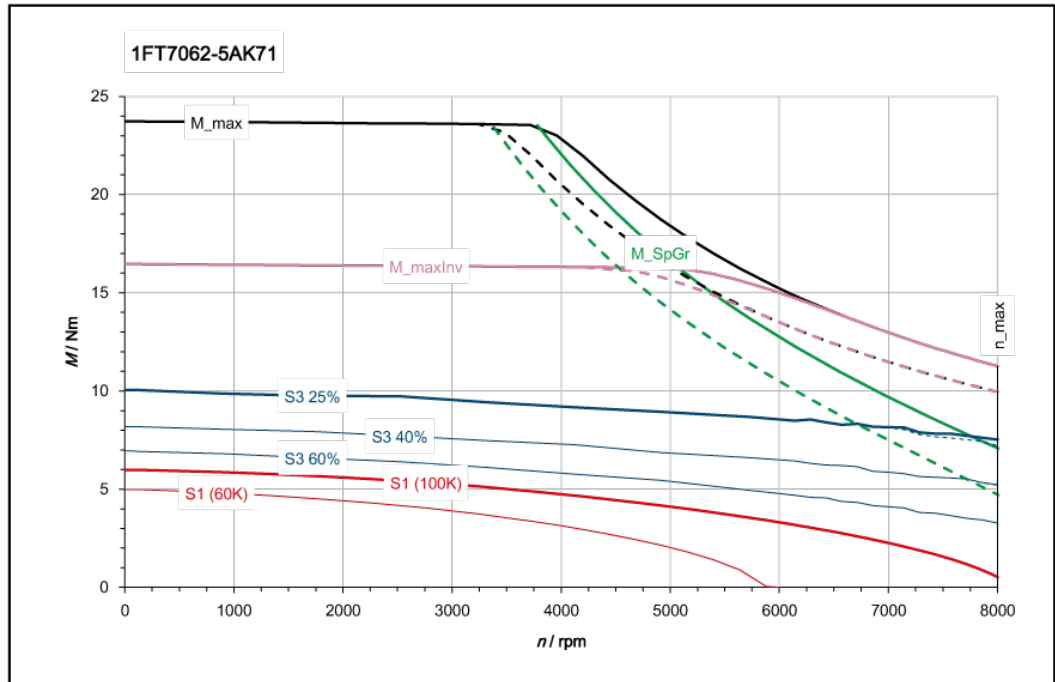

[———] SINAMICS ALM 400 V (600 V DC)
 [- - - -] SINAMICS BLM/SLM 400 V (540 V DC)

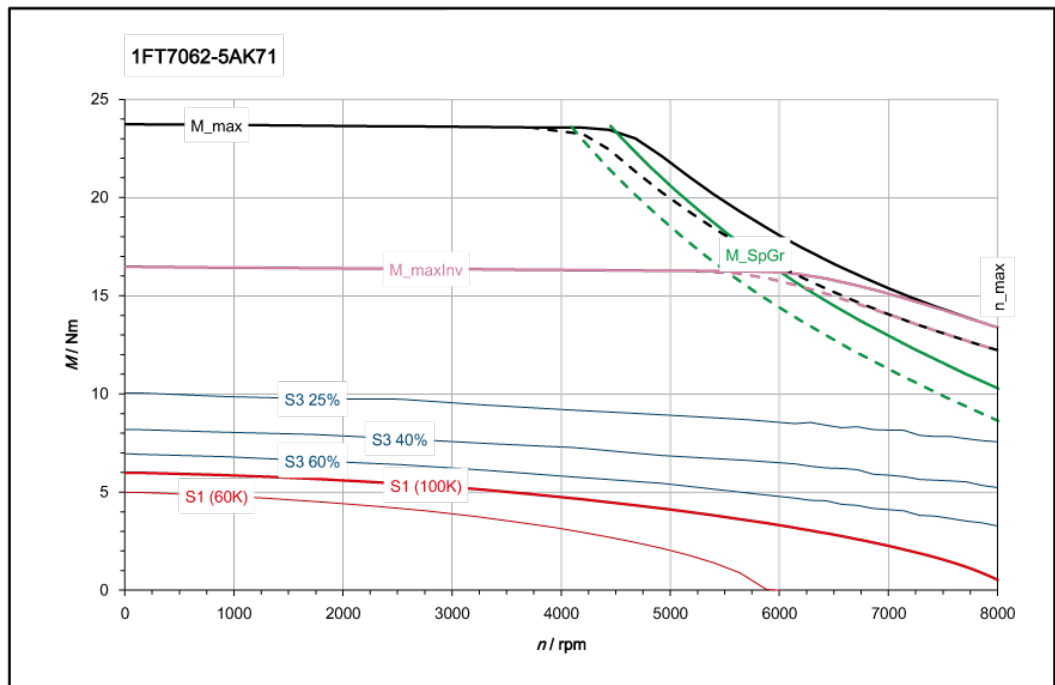

[———] SINAMICS ALM 480 V (720 V DC)
 [- - - -] SINAMICS BLM/SLM 480 V (650 V DC)

6.3.1.7 1FT7064-_A

Three-phase servomotor 1FT7064-5AF7			
Technical specifications	Symbol	Unit	Value
Configuration data:			
Rated speed	n_N	rpm	3000
Rated torque (100K)	$M_{N(100K)}$	Nm	7.6
Rated current (100K)	$I_{N(100K)}$	A	5.2
Static torque (100K)	$M_{0(100K)}$	Nm	9.0
Stall current (100K)	$I_{0(100K)}$	A	5.7
Static torque (60K)	$M_{0(60K)}$	Nm	7.7
Stall current (60K)	$I_{0(60K)}$	A	4.9
Optimum operating point:			
Optimum speed	n_{opt}	rpm	3000
Optimum power	P_{opt}	kW	2.39
Limiting data:			
Max. permissible speed (mech.)	$n_{max\ mech}$	rpm	9000
Maximum torque	M_{max}	Nm	36.0
Maximum current	I_{max}	A	29.0
Motor data:			
No. of poles	2p		10
Torque constant (100K)	k_T	Nm/A	1.57
Voltage constant (at 20 °C)	k_E	V/1000 rpm	100.0
Winding resistance (at 20 °C)	R_{Str}	W	0.92
Rotating field inductance	L_D	mH	10.0
Electrical time constant	T_{el}	ms	11
Mechanical time constant	T_{mech}	ms	1.3
Thermal time constant	T_{th}	min	30
Moment of inertia	J_{mot}	$kgm^2 \cdot 10^{-4}$	11.9
Shaft torsional stiffness	C_t	Nm/rad	35000
Weight	m_{mot}	kg	9.7
Motor data with integrated brake:			
Moment of inertia (with brake)	J_{mot}	$kgm^2 \cdot 10^{-4}$	14.7
Shaft torsional stiffness (with brake)	C_t	Nm/rad	26000
Weight (with brake)	m_{Mot}	kg	11.4
Data with SINAMICS S120 Booksize / S120 Booksize Compact			
Rated converter current	$I_{N\ Inv}$	A	9
Maximum converter current	$I_{max\ Inv}$	A	27
Max. torque (converter operation)	$M_{max\ Inv}$	Nm	34.7
Max. permissible speed (converter operation)	$n_{max\ Inv}$	rpm	5700
The rated data are valid for a 600 V DC-link voltage			

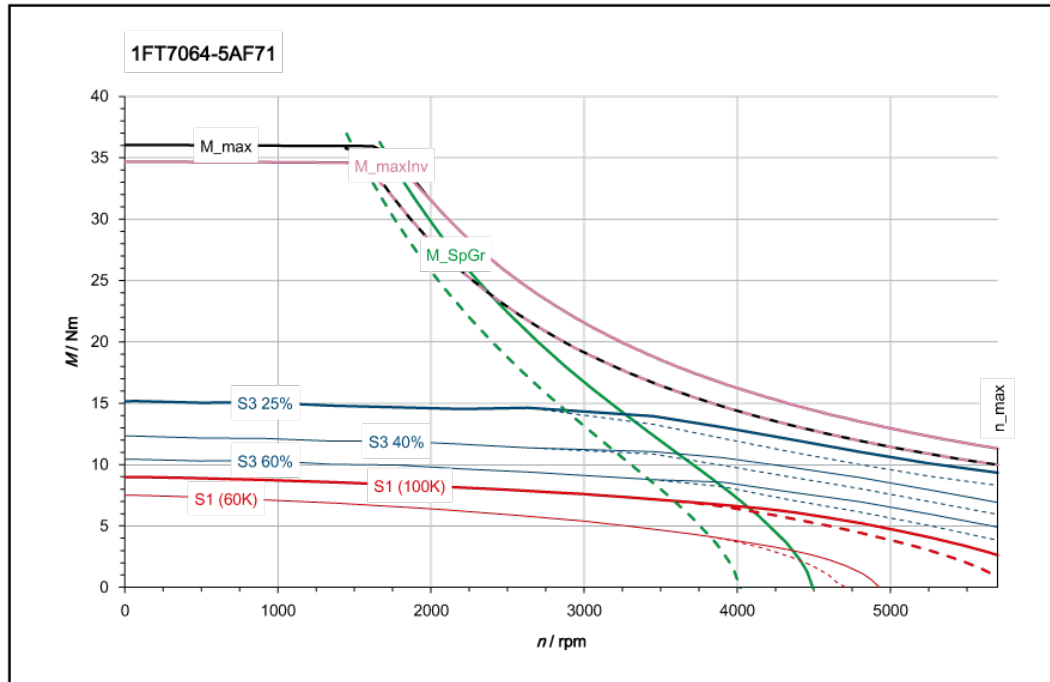

[———] SINAMICS ALM 400 V (600 V DC)
 [- - - -] SINAMICS BLM/SLM 400 V (540 V DC)

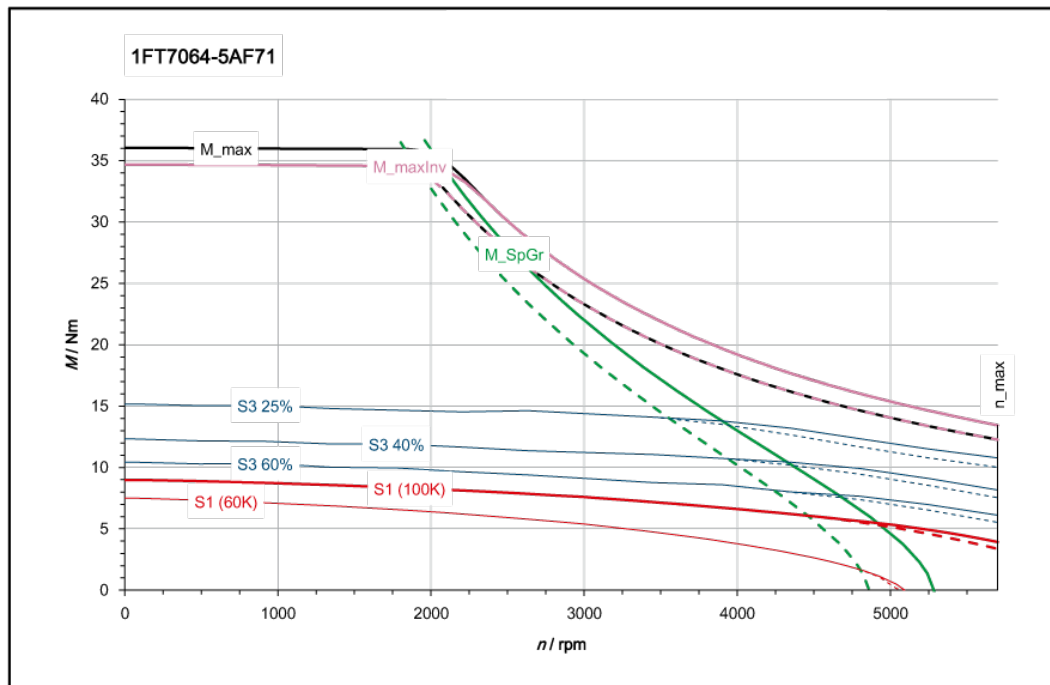

[———] SINAMICS ALM 480 V (720 V DC)
 [- - - -] SINAMICS BLM/SLM 480 V (650 V DC)

Three-phase servomotor 1FT7064-5AK7			
Technical specifications	Symbol	Unit	Value
Configuration data:			
Rated speed	n_N	rpm	6000
Rated torque (100K)	$M_{N(100K)}$	Nm	2.9
Rated current (100K)	$I_{N(100K)}$	A	3.4
Static torque (100K)	$M_{0(100K)}$	Nm	9.0
Stall current (100K)	$I_{0(100K)}$	A	9.0
Static torque (60K)	$M_{0(60K)}$	Nm	7.7
Stall current (60K)	$I_{0(60K)}$	A	7.7
Optimum operating point			
Optimum speed	n_{opt}	rpm	4500
Optimum power	P_{opt}	kW	2.59
Limiting data:			
Max. permissible speed (mech.)	$n_{max\ mech}$	rpm	9000
Maximum torque	M_{max}	Nm	36.0
Maximum current	I_{max}	A	45.0
Motor data:			
No. of poles	$2p$		10
Torque constant (100K)	k_T	Nm/A	1
Voltage constant (at 20 °C)	k_E	V/1000 rpm	64.0
Winding resistance (at 20 °C)	R_{Str}	W	0.385
Rotating field inductance	L_D	mH	4.1
Electrical time constant	T_{el}	ms	11
Mechanical time constant	T_{mech}	ms	1.4
Thermal time constant	T_{th}	min	30
Moment of inertia	J_{mot}	$kgm^2 \cdot 10^{-4}$	11.9
Shaft torsional stiffness	C_t	Nm/rad	35000
Weight	m_{mot}	kg	9.7
Motor data with integrated brake:			
Moment of inertia (with brake)	J_{mot}	$kgm^2 \cdot 10^{-4}$	14.7
Shaft torsional stiffness (with brake)	C_t	Nm/rad	26000
Weight (with brake)	m_{Mot}	kg	11.4
Data with SINAMICS S120 Booksize / S120 Booksize Compact			
Rated converter current	$I_{N\ Inv}$	A	9
Maximum converter current	$I_{max\ Inv}$	A	27
Max. torque (converter operation)	$M_{max\ Inv}$	Nm	25.3
Max. permissible speed (converter operation)	$n_{max\ Inv}$	rpm	8000
The rated data are valid for a 600 V DC-link voltage			

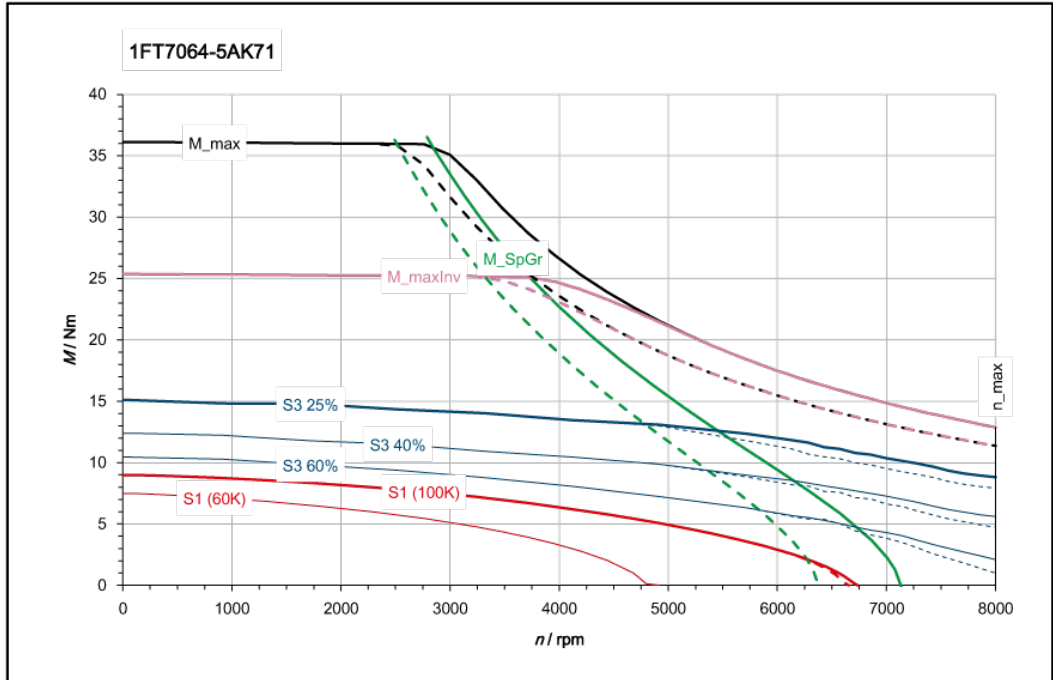

[———] SINAMICS ALM 400 V (600 V DC)
 [- - - -] SINAMICS BLM/SLM 400 V (540 V DC)

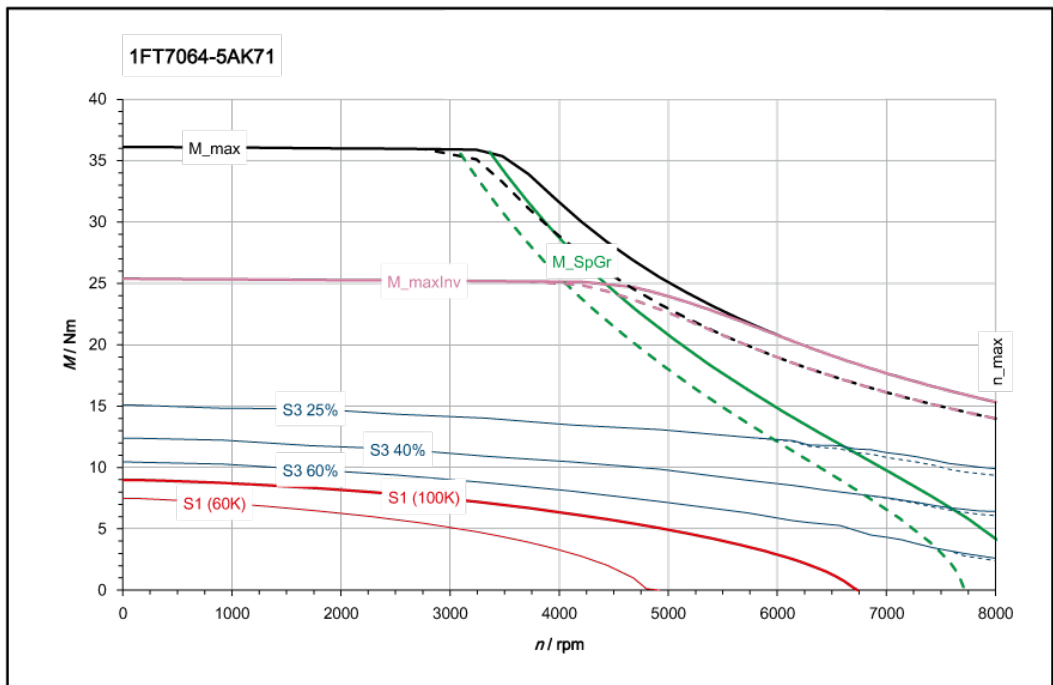

[———] SINAMICS ALM 480 V (720 V DC)
 [- - - -] SINAMICS BLM/SLM 480 V (650 V DC)

6.3.1.8 1FT7066-_A

Three-phase servomotor 1FT7066-5AF7			
Technical specifications	Symbol	Unit	Value
Configuration data:			
Rated speed	n_N	rpm	3000
Rated torque (100K)	$M_{N(100K)}$	Nm	9.3
Rated current (100K)	$I_{N(100K)}$	A	7.2
Static torque (100K)	$M_{0(100K)}$	Nm	12.0
Stall current (100K)	$I_{0(100K)}$	A	8.4
Static torque (60K)	$M_{0(60K)}$	Nm	10.0
Stall current (60K)	$I_{0(60K)}$	A	7.1
Optimum operating point:			
Optimum speed	n_{opt}	rpm	3000
Optimum power	P_{opt}	kW	2.92
Limiting data:			
Max. permissible speed (mech.)	$n_{max\ mech}$	rpm	9000
Maximum torque	M_{max}	Nm	49.0
Maximum current	I_{max}	A	44.0
Motor data:			
No. of poles	2p		10
Torque constant (100K)	k_T	Nm/A	1.405
Voltage constant (at 20 °C)	k_E	V/1000 rpm	89.5
Winding resistance (at 20 °C)	R_{Str}	W	0.5
Rotating field inductance	L_D	mH	5.5
Electrical time constant	T_{el}	ms	11
Mechanical time constant	T_{mech}	ms	1.2
Thermal time constant	T_{th}	min	40
Moment of inertia	J_{mot}	$kgm^2 \cdot 10^{-4}$	16.4
Shaft torsional stiffness	C_t	Nm/rad	31500
Weight	m_{mot}	kg	12.3
Motor data with integrated brake:			
Moment of inertia (with brake)	J_{mot}	$kgm^2 \cdot 10^{-4}$	19.3
Shaft torsional stiffness (with brake)	C_t	Nm/rad	24000
Weight (with brake)	m_{Mot}	kg	14.1
Data with SINAMICS S120 Booksize / S120 Booksize Compact			
Rated converter current	$I_{N\ Inv}$	A	9
Maximum converter current	$I_{max\ Inv}$	A	27
Max. torque (converter operation)	$M_{max\ Inv}$	Nm	35.2
Max. permissible speed (converter operation)	$n_{max\ Inv}$	rpm	6500
The rated data are valid for a 600 V DC-link voltage			

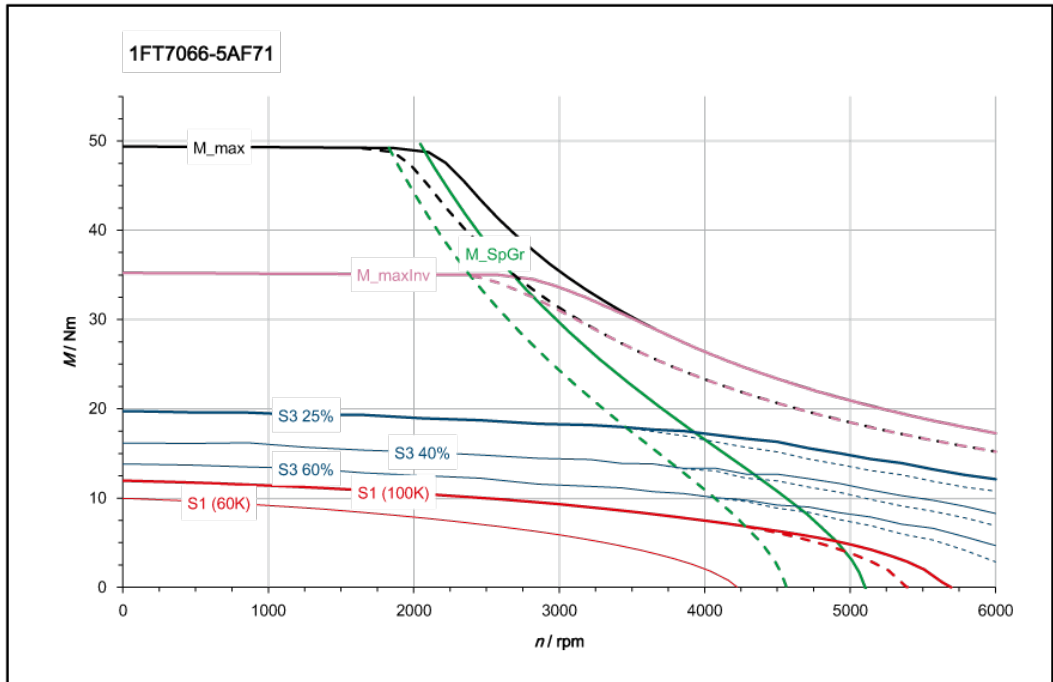

[———] SINAMICS ALM 400 V (600 V DC)
 [- - - -] SINAMICS BLM/SLM 400 V (540 V DC)

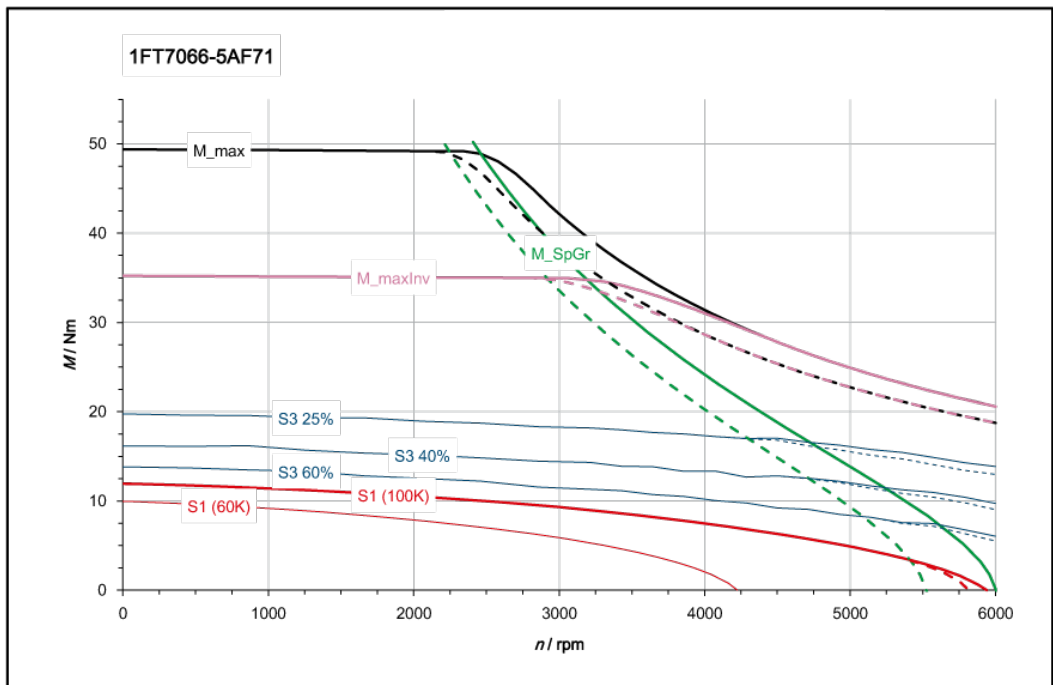

[———] SINAMICS ALM 480 V (720 V DC)
 [- - - -] SINAMICS BLM/SLM 480 V (650 V DC)

Three-phase servomotor 1FT7066-5AH7			
Technical specifications	Symbol	Unit	Value
Configuration data:			
Rated speed	n_N	rpm	4500
Rated torque (100K)	$M_{N(100K)}$	Nm	5.0
Rated current (100K)	$I_{N(100K)}$	A	6.3
Static torque (100K)	$M_{0(100K)}$	Nm	12.0
Stall current (100K)	$I_{0(100K)}$	A	13.6
Static torque (60K)	$M_{0(60K)}$	Nm	10.0
Stall current (60K)	$I_{0(60K)}$	A	11.3
Optimum operating point:			
Optimum speed	n_{opt}	rpm	4000
Optimum power	P_{opt}	kW	2.55
Limiting data:			
Max. permissible speed (mech.)	$n_{max\ mech}$	rpm	9000
Maximum torque	M_{max}	Nm	49.0
Maximum current	I_{max}	A	70
Motor data:			
No. of poles	$2p$		10
Torque constant (100K)	k_T	Nm/A	0.88
Voltage constant (at 20 °C)	k_E	V/1000 rpm	56.0
Winding resistance (at 20 °C)	R_{Str}	W	0.196
Rotating field inductance	L_D	mH	2.3
Electrical time constant	T_{el}	ms	12
Mechanical time constant	T_{mech}	ms	1.2
Thermal time constant	T_{th}	min	40
Moment of inertia	J_{mot}	$kgm^2 \cdot 10^{-4}$	16.4
Shaft torsional stiffness	C_t	Nm/rad	31500
Weight	m_{mot}	kg	12.3
Motor data with integrated brake:			
Moment of inertia (with brake)	J_{mot}	$kgm^2 \cdot 10^{-4}$	19.3
Shaft torsional stiffness (with brake)	C_t	Nm/rad	24000
Weight (with brake)	m_{Mot}	kg	14.1
Data with SINAMICS S120 Booksize / S120 Booksize Compact			
Rated converter current	$I_{N\ Inv}$	A	18
Maximum converter current	$I_{max\ Inv}$	A	54
Max. torque (converter operation)	$M_{max\ Inv}$	Nm	42.8
Max. permissible speed (converter operation)	$n_{max\ Inv}$	rpm	8000
The rated data are valid for a 600 V DC-link voltage			

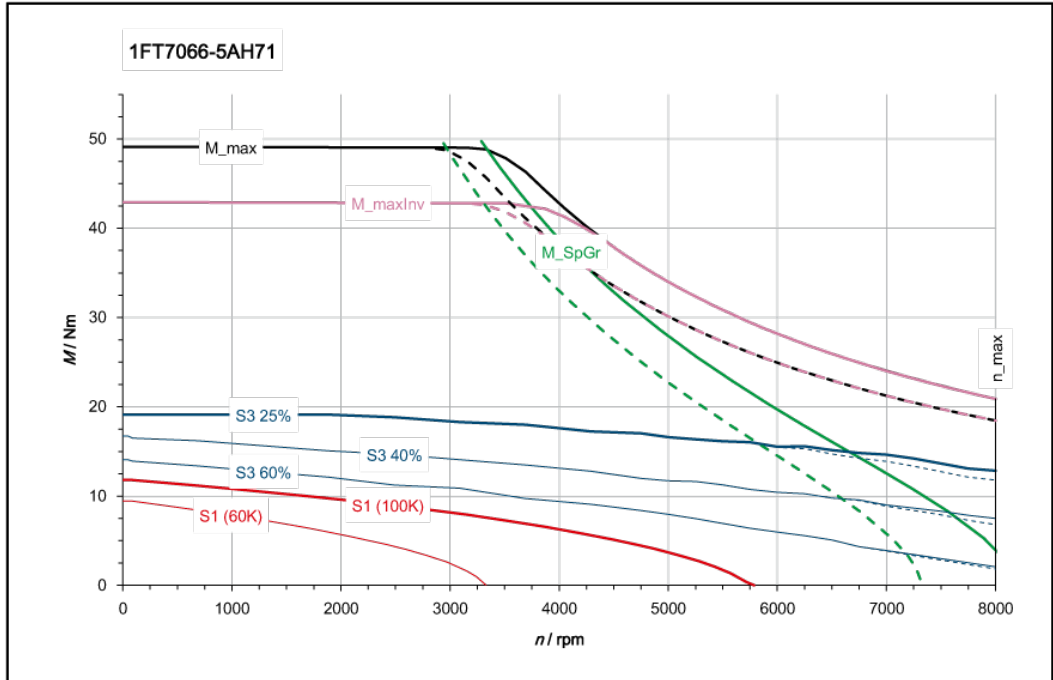

[———] SINAMICS ALM 400 V (600 V DC)
 [- - - -] SINAMICS BLM/SLM 400 V (540 V DC)

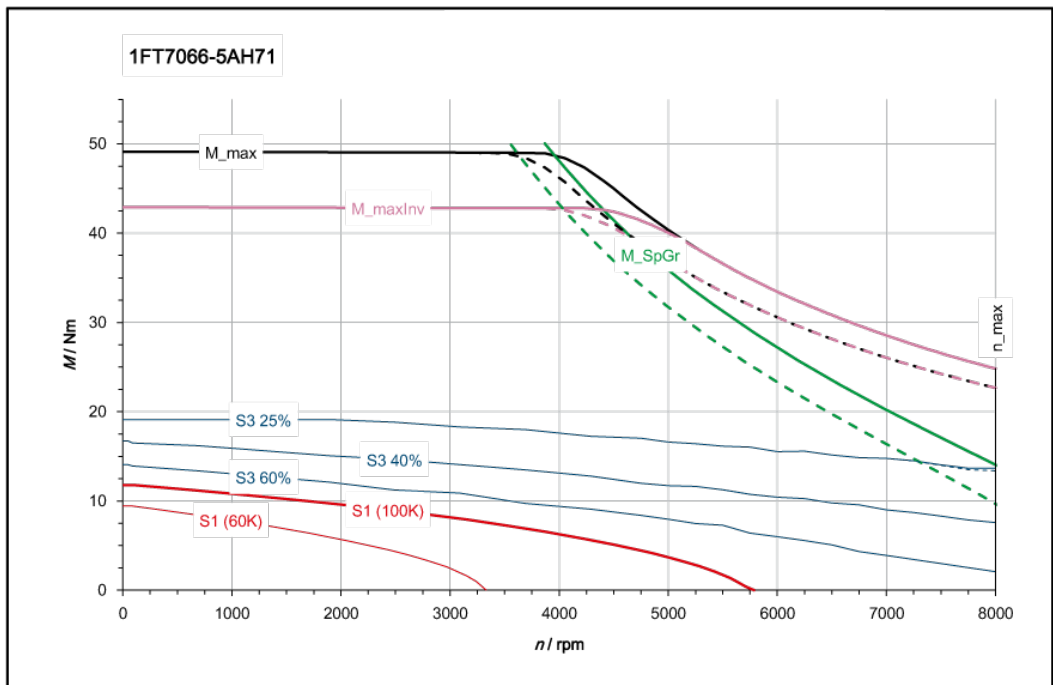

[———] SINAMICS ALM 480 V (720 V DC)
 [- - - -] SINAMICS BLM/SLM 480 V (650 V DC)

6.3.1.9 1FT7068-_A

Three-phase servomotor 1FT7068-5AF7			
Technical specifications	Symbol	Unit	Value
Configuration data:			
Rated speed	n_N	rpm	3000
Rated torque (100K)	$M_{N(100K)}$	Nm	10.9
Rated current (100K)	$I_{N(100K)}$	A	6.7
Static torque (100K)	$M_{0(100K)}$	Nm	15.0
Stall current (100K)	$I_{0(100K)}$	A	8.3
Static torque (60K)	$M_{0(60K)}$	Nm	13.0
Stall current (60K)	$I_{0(60K)}$	A	7.3
Optimum operating point:			
Optimum speed	n_{opt}	rpm	3000
Optimum power	P_{opt}	kW	3.42
Limiting data:			
Max. permissible speed (mech.)	$n_{max\ mech}$	rpm	9000
Maximum torque	M_{max}	Nm	63
Maximum current	I_{max}	A	43.0
Motor data:			
No. of poles	2p		10
Torque constant (100K)	k_T	Nm/A	1.775
Voltage constant (at 20 °C)	k_E	V/1000 rpm	113
Winding resistance (at 20 °C)	R_{Str}	W	0.54
Rotating field inductance	L_D	mH	6.4
Electrical time constant	T_{el}	ms	12
Mechanical time constant	T_{mech}	ms	1.2
Thermal time constant	T_{th}	min	45
Moment of inertia	J_{mot}	$kgm^2 \cdot 10^{-4}$	23.2
Shaft torsional stiffness	C_t	Nm/rad	27500
Weight	m_{mot}	kg	16.3
Motor data with integrated brake:			
Moment of inertia (with brake)	J_{mot}	$kgm^2 \cdot 10^{-4}$	26.1
Shaft torsional stiffness (with brake)	C_t	Nm/rad	21500
Weight (with brake)	m_{Mot}	kg	18.0
Data with SINAMICS S120 Booksize / S120 Booksize Compact			
Rated converter current	$I_{N\ Inv}$	A	9
Maximum converter current	$I_{max\ Inv}$	A	27
Max. torque (converter operation)	$M_{max\ Inv}$	Nm	46.0
Max. permissible speed (converter operation)	$n_{max\ Inv}$	rpm	5100
The rated data are valid for a 600 V DC-link voltage			

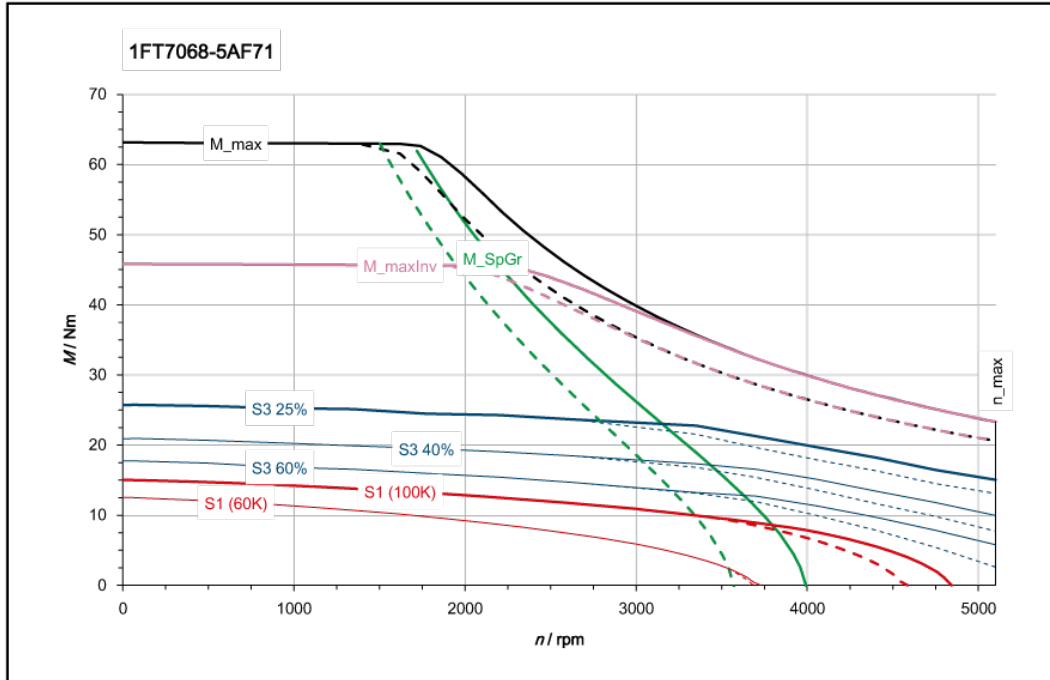

[———] SINAMICS ALM 400 V (600 V DC)
 [- - - -] SINAMICS BLM/SLM 400 V (540 V DC)

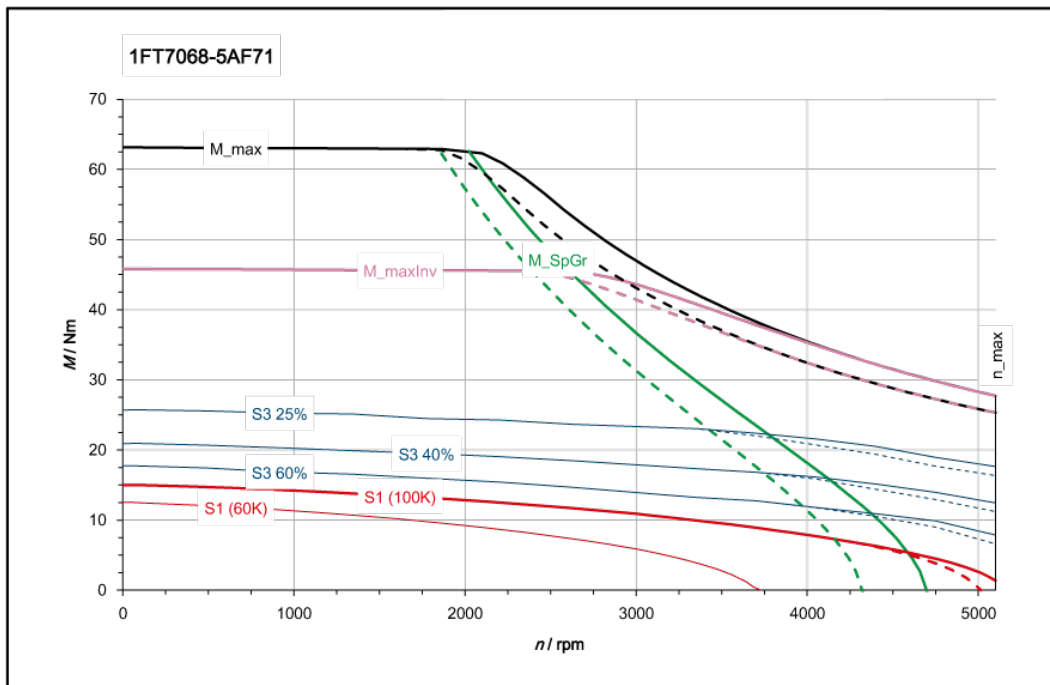

[———] SINAMICS ALM 480 V (720 V DC)
 [- - - -] SINAMICS BLM/SLM 480 V (650 V DC)

6.3.1.10 1FT7082-_A

Three-phase servomotor 1FT7082-5AC7			
Technical specifications	Symbol	Unit	Value
Configuration data			
Rated speed	n_N	rpm	2000
Rated torque (100K)	$M_{N(100K)}$	Nm	11.4
Rated current (100K)	$I_{N(100K)}$	A	4.9
Static torque (100K)	$M_{0(100K)}$	Nm	13.0
Stall current (100K)	$I_{0(100K)}$	A	5.0
Static torque (60K)	$M_{0(60K)}$	Nm	10.6
Stall current (60K)	$I_{0(60K)}$	A	4.2
Optimum operating point			
Optimum speed	n_{opt}	rpm	2000
Optimum power	P_{opt}	kW	2.39
Limiting data:			
Max. permissible speed (mech.)	$n_{max\ mech}$	rpm	8000
Maximum torque	M_{max}	Nm	52
Maximum current	I_{max}	A	26.0
Motor data:			
No. of poles	2p		10
Torque constant (100K)	k_T	Nm/A	2.5
Voltage constant (at 20 °C)	k_E	V/1000 rpm	159.5
Winding resistance (at 20 °C)	R_{Str}	W	1.38
Rotating field inductance	L_D	mH	21
Electrical time constant	T_{el}	ms	15
Mechanical time constant	T_{mech}	ms	1.8
Thermal time constant	T_{th}	min	40
Moment of inertia	J_{mot}	$kgm^2 \cdot 10^{-4}$	26.5
Shaft torsional stiffness	C_t	Nm/rad	108000
Weight	m_{mot}	kg	14.0
Motor data with integrated brake:			
Moment of inertia (with brake)	J_{mot}	$kgm^2 \cdot 10^{-4}$	41.9
Shaft torsional stiffness (with brake)	C_t	Nm/rad	76000
Weight (with brake)	m_{Mot}	kg	18.3
Data with SINAMICS S120 Booksize / S120 Booksize Compact			
Rated converter current	$I_{N\ Inv}$	A	5
Maximum converter current	$I_{max\ Inv}$	A	15
Max. torque (converter operation)	$M_{max\ Inv}$	Nm	35.0
Max. permissible speed (converter operation)	$n_{max\ Inv}$	rpm	3500
The rated data are valid for a 600 V DC-link voltage			

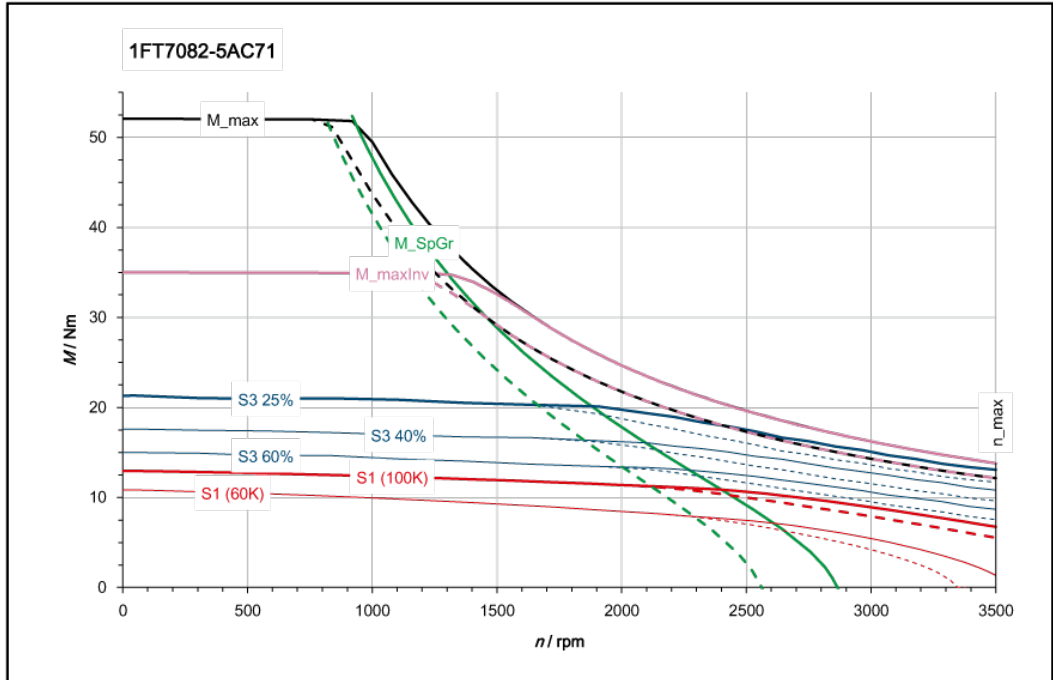

[———] SINAMICS ALM 400 V (600 V DC)
 [- - - -] SINAMICS BLM/SLM 400 V (540 V DC)

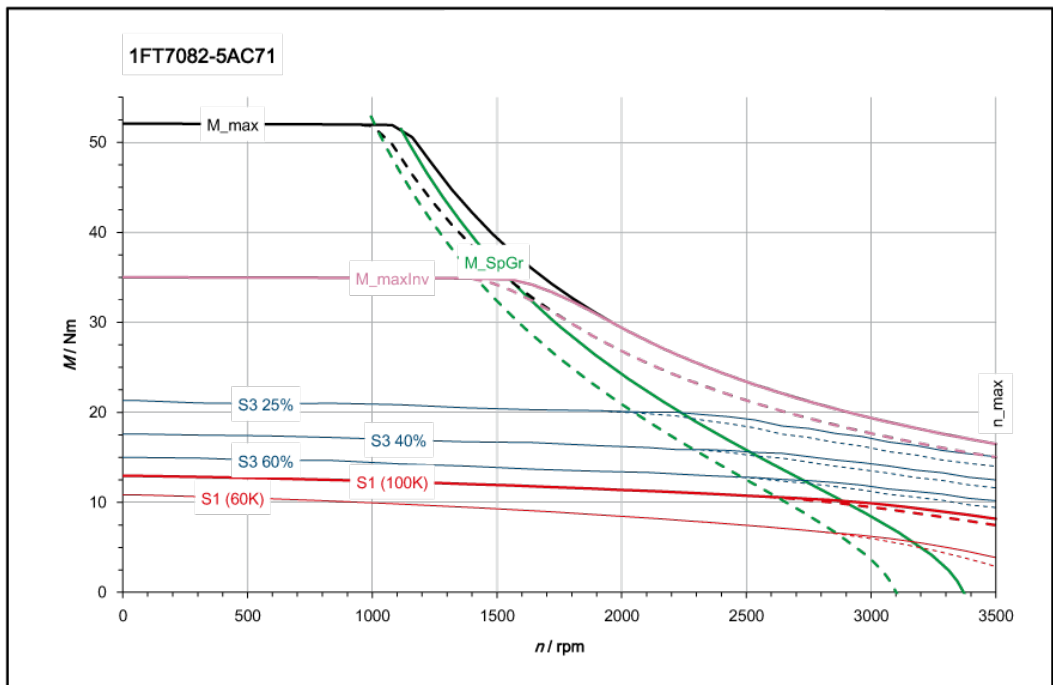

[———] SINAMICS ALM 480 V (720 V DC)
 [- - - -] SINAMICS BLM/SLM 480 V (650 V DC)

Three-phase servomotor 1FT7082-5AF7			
Technical specifications	Symbol	Unit	Value
Configuration data:			
Rated speed	n_N	rpm	3000
Rated torque (100K)	$M_{N(100K)}$	Nm	10.3
Rated current (100K)	$I_{N(100K)}$	A	6.6
Static torque (100K)	$M_{0(100K)}$	Nm	13.0
Stall current (100K)	$I_{0(100K)}$	A	7.6
Static torque (60K)	$M_{0(60K)}$	Nm	10.6
Stall current (60K)	$I_{0(60K)}$	A	6.3
Optimum operating point:			
Optimum speed	n_{opt}	rpm	3000
Optimum power	P_{opt}	kW	3.24
Limiting data:			
Max. permissible speed (mech.)	$n_{max\ mech}$	rpm	8000
Maximum torque	M_{max}	Nm	52
Maximum current	I_{max}	A	39.0
Motor data:			
No. of poles	$2p$		10
Torque constant (100K)	k_T	Nm/A	1.67
Voltage constant (at 20 °C)	k_E	V/1000 rpm	106.5
Winding resistance (at 20 °C)	R_{Str}	W	0.61
Rotating field inductance	L_D	mH	9.3
Electrical time constant	T_{el}	ms	15
Mechanical time constant	T_{mech}	ms	1.7
Thermal time constant	T_{th}	min	40
Moment of inertia	J_{mot}	$kgm^2 \cdot 10^{-4}$	26.5
Shaft torsional stiffness	C_t	Nm/rad	108000
Weight	m_{mot}	kg	14.0
Motor data with integrated brake:			
Moment of inertia (with brake)	J_{mot}	$kgm^2 \cdot 10^{-4}$	41.9
Shaft torsional stiffness (with brake)	C_t	Nm/rad	76000
Weight (with brake)	m_{Mot}	kg	18.3
Data with SINAMICS S120 Booksize / S120 Booksize Compact			
Rated converter current	$I_{N\ Inv}$	A	9
Maximum converter current	$I_{max\ Inv}$	A	27
Max. torque (converter operation)	$M_{max\ Inv}$	Nm	39.8
Max. permissible speed (converter operation)	$n_{max\ Inv}$	rpm	5400
The rated data are valid for a 600 V DC-link voltage			

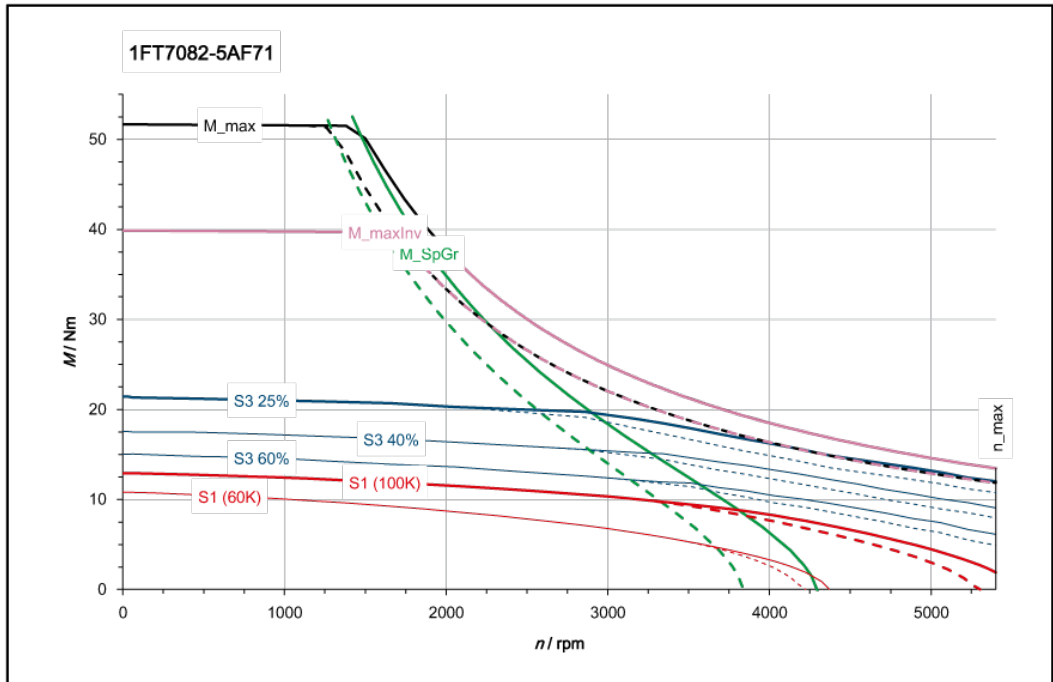

[———] SINAMICS ALM 400 V (600 V DC)
 [- - - -] SINAMICS BLM/SLM 400 V (540 V DC)

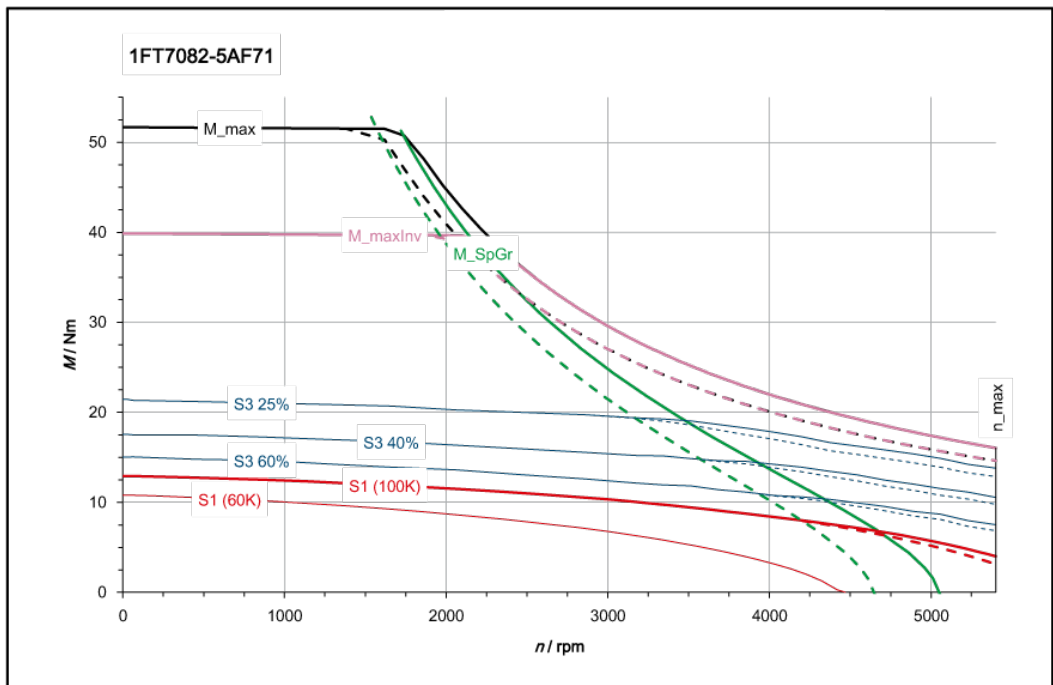

[———] SINAMICS ALM 480 V (720 V DC)
 [- - - -] SINAMICS BLM/SLM 480 V (650 V DC)

Three-phase servomotor 1FT7082-5AH7			
Technical specifications	Symbol	Unit	Value
Configuration data			
Rated speed	n_N	rpm	4500
Rated torque (100K)	$M_{N(100K)}$	Nm	8.0
Rated current (100K)	$I_{N(100K)}$	A	7.8
Static torque (100K)	$M_{0(100K)}$	Nm	13.0
Stall current (100K)	$I_{0(100K)}$	A	12.3
Static torque (60K)	$M_{0(60K)}$	Nm	10.6
Stall current (60K)	$I_{0(60K)}$	A	10.3
Optimum operating point:			
Optimum speed	n_{opt}	rpm	4500
Optimum power	P_{opt}	kW	3.77
Limiting data:			
Max. permissible speed (mech.)	$n_{max\ mech}$	rpm	8000
Maximum torque	M_{max}	Nm	52
Maximum current	I_{max}	A	63
Motor data:			
No. of poles	$2p$		10
Torque constant (100K)	k_T	Nm/A	1.03
Voltage constant (at 20 °C)	k_E	V/1000 rpm	65.5
Winding resistance (at 20 °C)	R_{Str}	W	0.23
Rotating field inductance	L_D	mH	3.5
Electrical time constant	T_{el}	ms	15
Mechanical time constant	T_{mech}	ms	1.7
Thermal time constant	T_{th}	min	40
Moment of inertia	J_{mot}	$kgm^2 \cdot 10^{-4}$	26.5
Shaft torsional stiffness	C_t	Nm/rad	108000
Weight	m_{mot}	kg	14.0
Motor data with integrated brake:			
Moment of inertia (with brake)	J_{mot}	$kgm^2 \cdot 10^{-4}$	41.9
Shaft torsional stiffness (with brake)	C_t	Nm/rad	76000
Weight (with brake)	m_{Mot}	kg	18.3
Data with SINAMICS S120 Booksize / S120 Booksize Compact			
Rated converter current	$I_{N\ Inv}$	A	18
Maximum converter current	$I_{max\ Inv}$	A	54
Max. torque (converter operation)	$M_{max\ Inv}$	Nm	48.0
Max. permissible speed (converter operation)	$n_{max\ Inv}$	rpm	8000
The rated data are valid for a 600 V DC-link voltage			

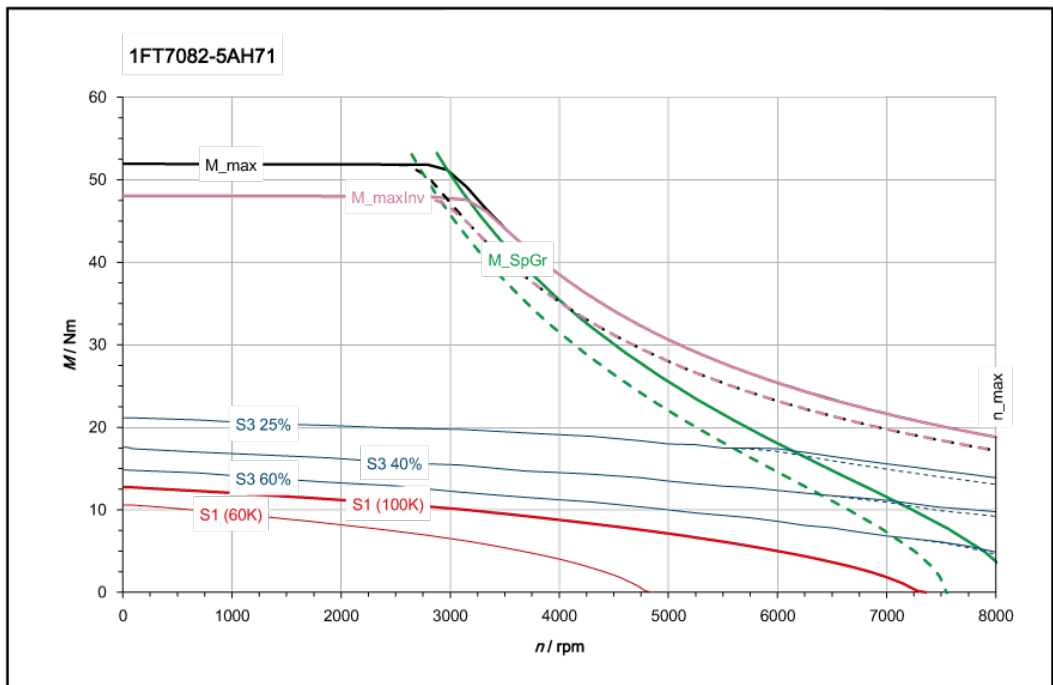
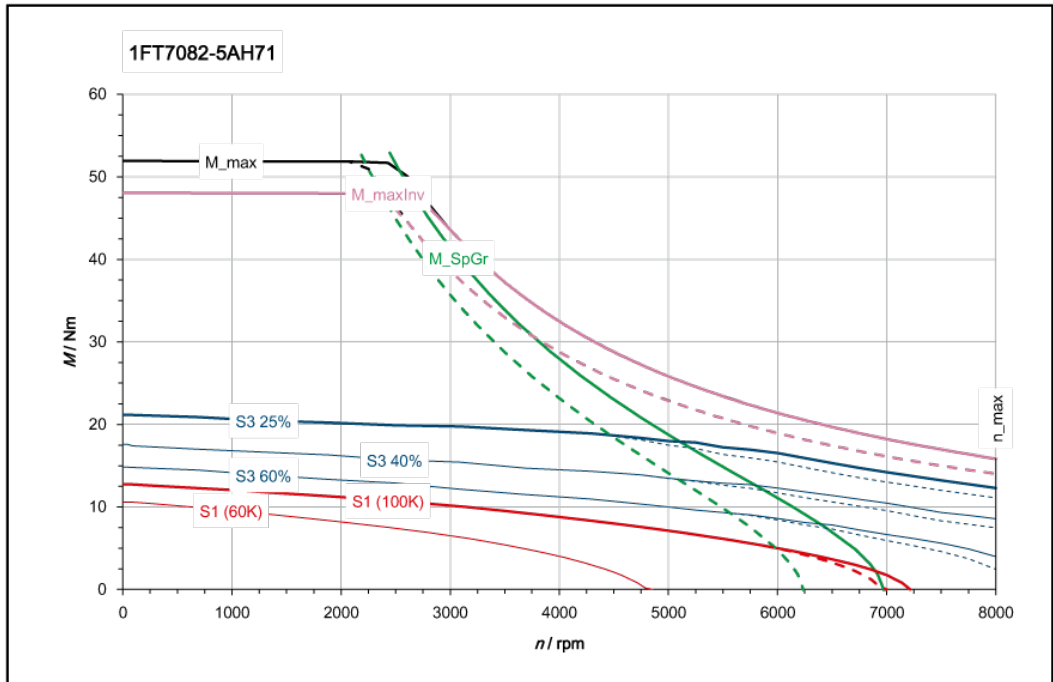

6.3.1.11 1FT7084-_A

Three-phase servomotor 1FT7084-5AC7			
Technical specifications	Symbol	Unit	Value
Configuration data:			
Rated speed	n_N	rpm	2000
Rated torque (100K)	$M_{N(100K)}$	Nm	16.9
Rated current (100K)	$I_{N(100K)}$	A	8.4
Static torque (100K)	$M_{0(100K)}$	Nm	20.0
Stall current (100K)	$I_{0(100K)}$	A	9.0
Static torque (60K)	$M_{0(60K)}$	Nm	16.8
Stall current (60K)	$I_{0(60K)}$	A	7.6
Optimum operating point:			
Optimum speed	n_{opt}	rpm	2000
Optimum power	P_{opt}	kW	3.54
Limiting data:			
Max. permissible speed (mech.)	$n_{max\ mech}$	rpm	8000
Maximum torque	M_{max}	Nm	81
Maximum current	I_{max}	A	46.0
Motor data:			
No. of poles	2p		10
Torque constant (100K)	k_T	Nm/A	2.21
Voltage constant (at 20 °C)	k_E	V/1000 rpm	141.0
Winding resistance (at 20 °C)	R_{Str}	W	0.53
Rotating field inductance	L_D	mH	8.5
Electrical time constant	T_{el}	ms	16
Mechanical time constant	T_{mech}	ms	1.5
Thermal time constant	T_{th}	min	55
Moment of inertia	J_{mot}	$kgm^2 \cdot 10^{-4}$	45.1
Shaft torsional stiffness	C_t	Nm/rad	88000
Weight	m_{mot}	kg	20.8
Motor data with integrated brake:			
Moment of inertia (with brake)	J_{mot}	$kgm^2 \cdot 10^{-4}$	60.4
Shaft torsional stiffness (with brake)	C_t	Nm/rad	65000
Weight (with brake)	m_{Mot}	kg	25.1
Data with SINAMICS S120 Booksize / S120 Booksize Compact			
Rated converter current	$I_{N\ Inv}$	A	9
Maximum converter current	$I_{max\ Inv}$	A	27
Max. torque (converter operation)	$M_{max\ Inv}$	Nm	51
Max. permissible speed (converter operation)	$n_{max\ Inv}$	rpm	4000
The rated data are valid for a 600 V DC-link voltage			

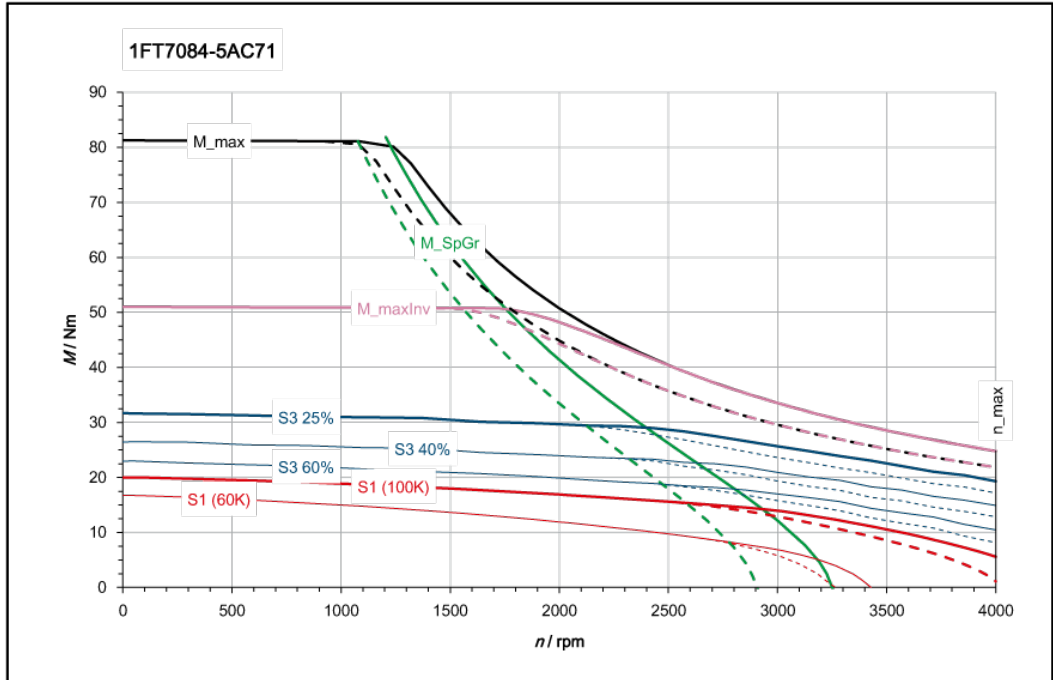

[———] SINAMICS ALM 400 V (600 V DC)
 [- - - -] SINAMICS BLM/SLM 400 V (540 V DC)

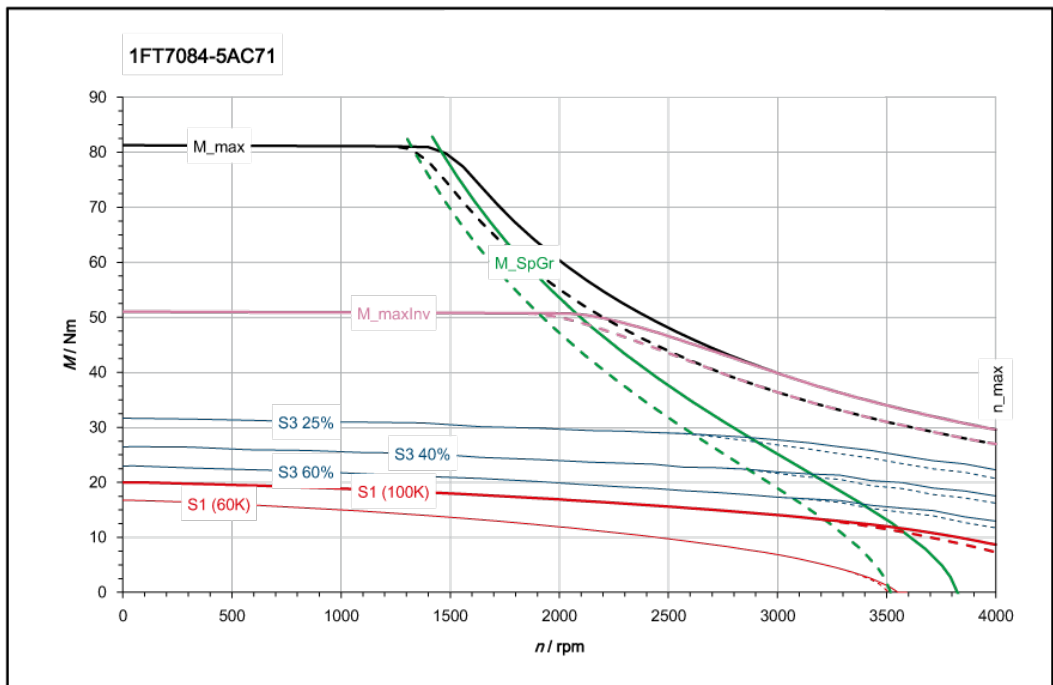

[———] SINAMICS ALM 480 V (720 V DC)
 [- - - -] SINAMICS BLM/SLM 480 V (650 V DC)

Three-phase servomotor 1FT7084-5AF7			
Technical specifications	Symbol	Unit	Value
Configuration data:			
Rated speed	n_N	rpm	3000
Rated torque (100K)	$M_{N(100K)}$	Nm	14.5
Rated current (100K)	$I_{N(100K)}$	A	8.5
Static torque (100K)	$M_{0(100K)}$	Nm	20.0
Stall current (100K)	$I_{0(100K)}$	A	11
Static torque (60K)	$M_{0(60K)}$	Nm	16.8
Stall current (60K)	$I_{0(60K)}$	A	9.2
Optimum operating point:			
Optimum speed	n_{opt}	rpm	3000
Optimum power	P_{opt}	kW	4.55
Limiting data:			
Max. permissible speed (mech.)	$n_{max\ mech}$	rpm	8000
Maximum torque	M_{max}	Nm	81
Maximum current	I_{max}	A	55
Motor data:			
No. of poles	$2p$		10
Torque constant (100K)	k_T	Nm/A	1.815
Voltage constant (at 20 °C)	k_E	V/1000 rpm	115.5
Winding resistance (at 20 °C)	R_{Str}	W	0.35
Rotating field inductance	L_D	mH	6.0
Electrical time constant	T_{el}	ms	17
Mechanical time constant	T_{mech}	ms	1.4
Thermal time constant	T_{th}	min	55
Moment of inertia	J_{mot}	$kgm^2 \cdot 10^{-4}$	45.1
Shaft torsional stiffness	C_t	Nm/rad	88000
Weight	m_{mot}	kg	20.8
Motor data with integrated brake:			
Moment of inertia (with brake)	J_{mot}	$kgm^2 \cdot 10^{-4}$	60.4
Shaft torsional stiffness (with brake)	C_t	Nm/rad	65000
Weight (with brake)	m_{Mot}	kg	25.1
Data with SINAMICS S120 Booksize / S120 Booksize Compact			
Rated converter current	$I_{N\ Inv}$	A	18
Maximum converter current	$I_{max\ Inv}$	A	54
Max. torque (converter operation)	$M_{max\ Inv}$	Nm	79.5
Max. permissible speed (converter operation)	$n_{max\ Inv}$	rpm	5000
The rated data are valid for a 600 V DC-link voltage			

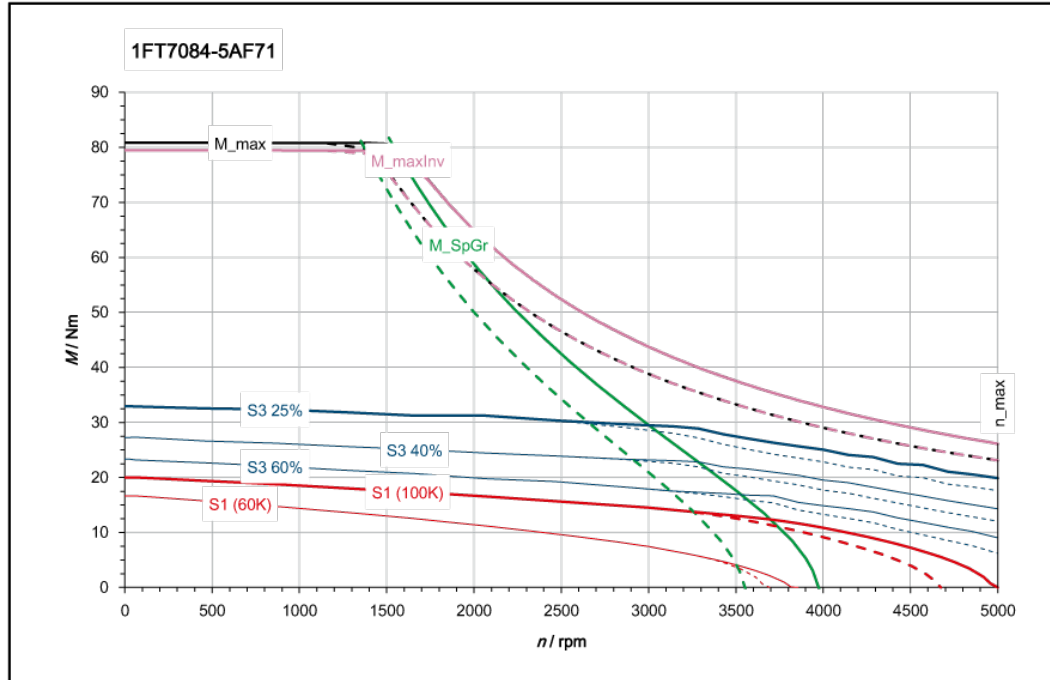

[———] SINAMICS ALM 400 V (600 V DC)
 [- - - -] SINAMICS BLM/SLM 400 V (540 V DC)

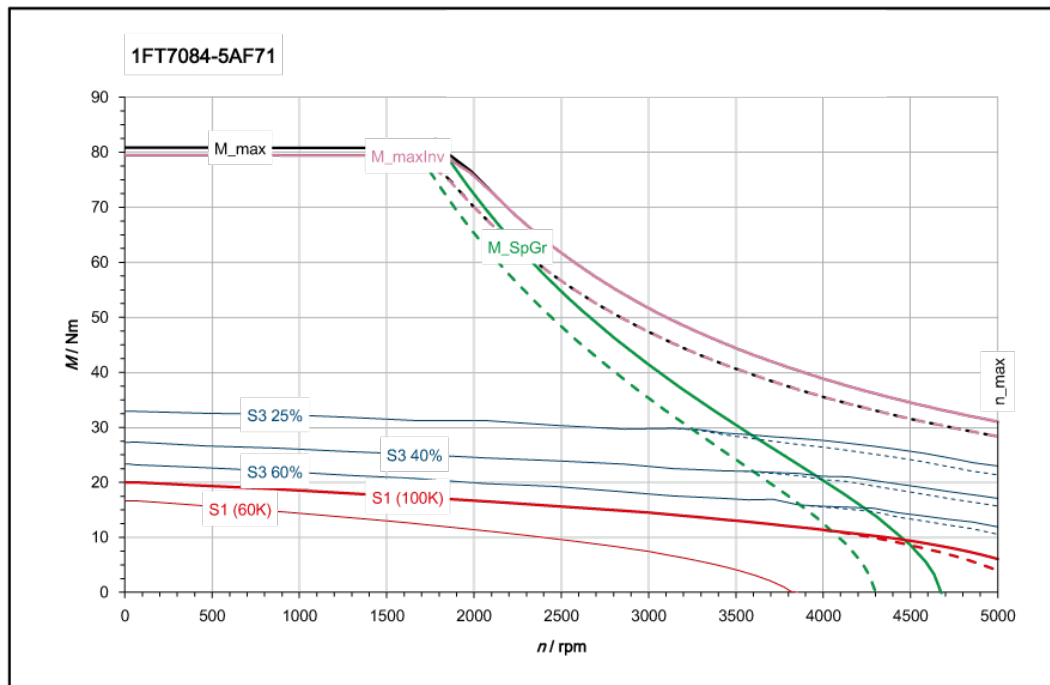

[———] SINAMICS ALM 480 V (720 V DC)
 [- - - -] SINAMICS BLM/SLM 480 V (650 V DC)

Three-phase servomotor 1FT7084-5AH7			
Technical specifications	Symbol	Unit	Value
Configuration data:			
Rated speed	n_N	rpm	4500
Rated torque (100K)	$M_{N(100K)}$	Nm	9.5
Rated current (100K)	$I_{N(100K)}$	A	7.8
Static torque (100K)	$M_{0(100K)}$	Nm	20
Stall current (100K)	$I_{0(100K)}$	A	15.6
Static torque (60K)	$M_{0(60K)}$	Nm	16.8
Stall current (60K)	$I_{0(60K)}$	A	13.4
Optimum operating point:			
Optimum speed	n_{opt}	rpm	4000
Optimum power	P_{opt}	kW	4.82
Limiting data:			
Max. permissible speed (mech.)	$n_{max\ mech}$	rpm	8000
Maximum torque	M_{max}	Nm	81
Maximum current	I_{max}	A	80
Motor data:			
No. of poles	$2p$		10
Torque constant (100K)	k_T	Nm/A	1.25
Voltage constant (at 20 °C)	k_E	V/1000 rpm	79.5
Winding resistance (at 20 °C)	R_{Str}	W	0.172
Rotating field inductance	L_D	mH	2.9
Electrical time constant	T_{el}	ms	17
Mechanical time constant	T_{mech}	ms	1.5
Thermal time constant	T_{th}	min	55
Moment of inertia	J_{mot}	$kgm^2 \cdot 10^{-4}$	45.1
Shaft torsional stiffness	C_t	Nm/rad	88000
Weight	m_{mot}	kg	20.8
Motor data with integrated brake:			
Moment of inertia (with brake)	J_{mot}	$kgm^2 \cdot 10^{-4}$	60.4
Shaft torsional stiffness (with brake)	C_t	Nm/rad	65000
Weight (with brake)	m_{Mot}	kg	25.1
Data with SINAMICS S120 Booksize / S120 Booksize Compact			
Rated converter current	$I_{N\ Inv}$	A	18
Maximum converter current	$I_{max\ Inv}$	A	54
Max. torque (converter operation)	$M_{max\ Inv}$	Nm	60
Max. permissible speed (converter operation)	$n_{max\ Inv}$	rpm	7200
The rated data are valid for a 600 V DC-link voltage			

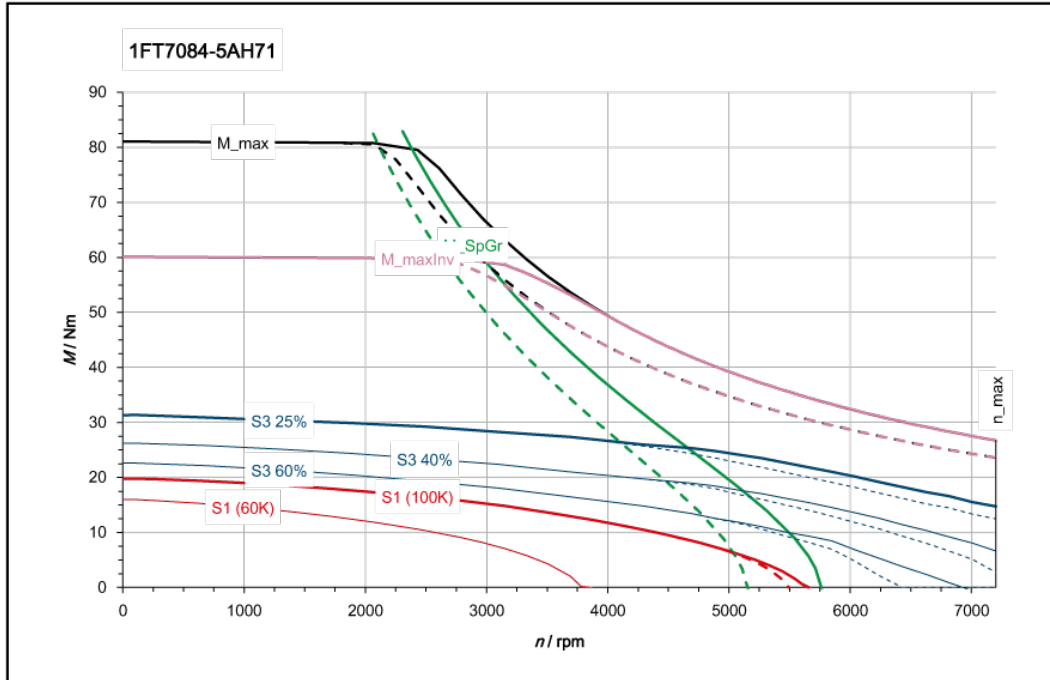

[———] SINAMICS ALM 400 V (600 V DC)
 [- - - -] SINAMICS BLM/SLM 400 V (540 V DC)

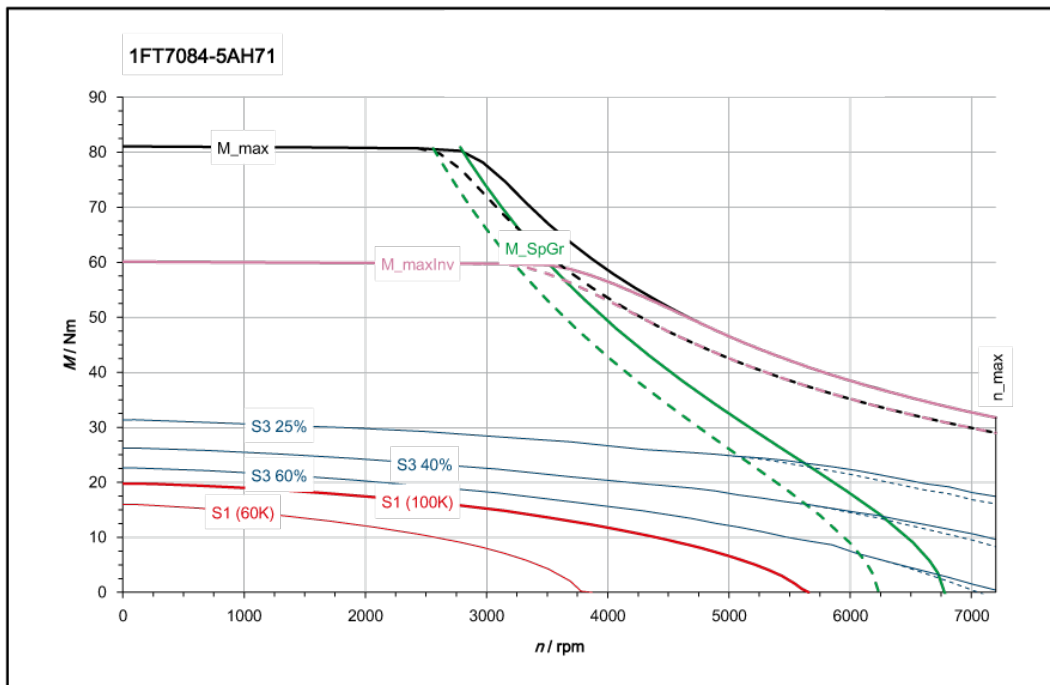

[———] SINAMICS ALM 480 V (720 V DC)
 [- - - -] SINAMICS BLM/SLM 480 V (650 V DC)

6.3.1.12 1FT7086-_A

Three-phase servomotor 1FT7086-5AC7			
Technical specifications	Symbol	Unit	Value
Configuration data:			
Rated speed	n_N	rpm	2000
Rated torque (100K)	$M_{N(100K)}$	Nm	22.5
Rated current (100K)	$I_{N(100K)}$	A	9.2
Static torque (100K)	$M_{0(100K)}$	Nm	28.0
Stall current (100K)	$I_{0(100K)}$	A	10.6
Static torque (60K)	$M_{0(60K)}$	Nm	23.0
Stall current (60K)	$I_{0(60K)}$	A	8.9
Optimum operating point:			
Optimum speed	n_{opt}	rpm	2000
Optimum power	P_{opt}	kW	4.71
Limiting data:			
Max. permissible speed (mech.)	$n_{max\ mech}$	rpm	8000
Maximum torque	M_{max}	Nm	120
Maximum current	I_{max}	A	54
Motor data:			
No. of poles	2p		10
Torque constant (100K)	k_T	Nm/A	2.59
Voltage constant (at 20 °C)	k_E	V/1000 rpm	165.0
Winding resistance (at 20 °C)	R_{Str}	W	0.465
Rotating field inductance	L_D	mH	8.5
Electrical time constant	T_{el}	ms	18
Mechanical time constant	T_{mech}	ms	1.3
Thermal time constant	T_{th}	min	60
Moment of inertia	J_{mot}	$kgm^2 \cdot 10^{-4}$	63.6
Shaft torsional stiffness	C_t	Nm/rad	74000
Weight	m_{mot}	kg	27.5
Motor data with integrated brake:			
Moment of inertia (with brake)	J_{mot}	$kgm^2 \cdot 10^{-4}$	79
Shaft torsional stiffness (with brake)	C_t	Nm/rad	57000
Weight (with brake)	m_{Mot}	kg	31.8
Data with SINAMICS S120 Booksize / S120 Booksize Compact			
Rated converter current	$I_{N\ Inv}$	A	18
Maximum converter current	$I_{max\ Inv}$	A	54
Max. torque (converter operation)	$M_{max\ Inv}$	Nm	120
Max. permissible speed (converter operation)	$n_{max\ Inv}$	rpm	3500
The rated data are valid for a 600 V DC-link voltage			

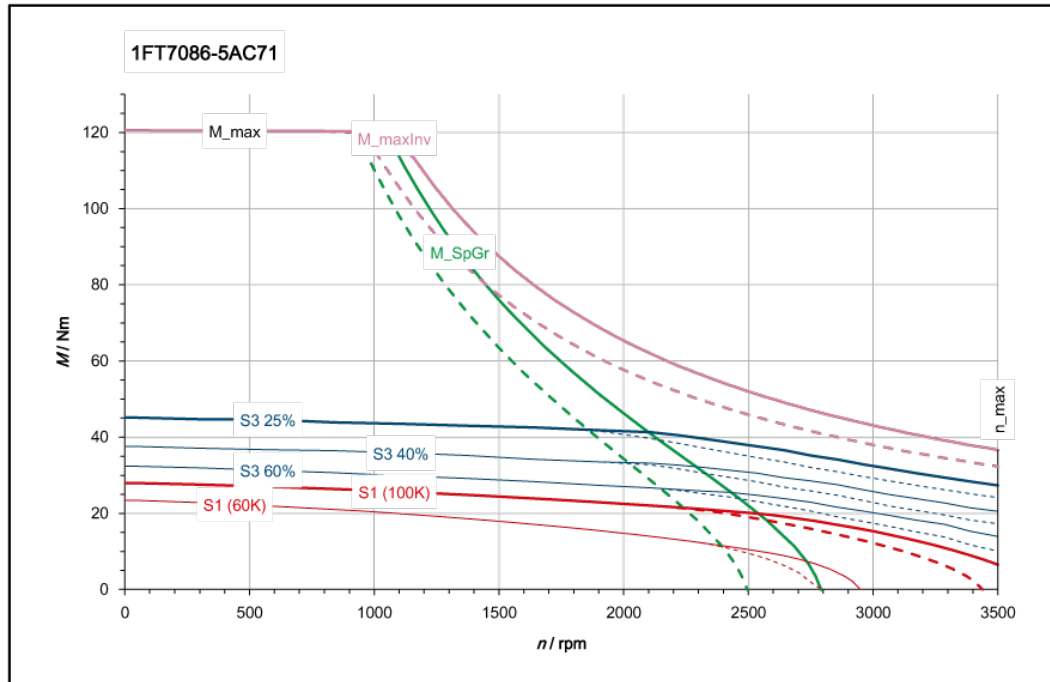

[———] SINAMICS ALM 400 V (600 V DC)
 [- - - -] SINAMICS BLM/SLM 400 V (540 V DC)

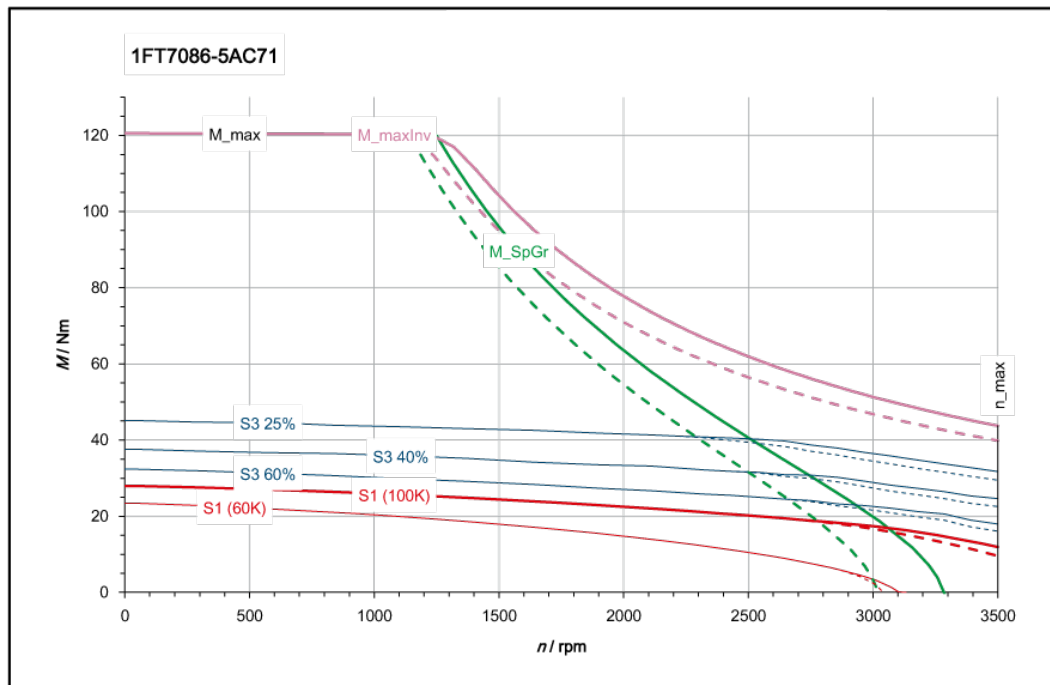

[———] SINAMICS ALM 480 V (720 V DC)
 [- - - -] SINAMICS BLM/SLM 480 V (650 V DC)

Three-phase servomotor 1FT7086-5AF7			
Technical specifications	Symbol	Unit	Value
Configuration data:			
Rated speed	n_N	rpm	3000
Rated torque (100K)	$M_{N(100K)}$	Nm	18.0
Rated current (100K)	$I_{N(100K)}$	A	11.0
Static torque (100K)	$M_{0(100K)}$	Nm	28
Stall current (100K)	$I_{0(100K)}$	A	15.5
Static torque (60K)	$M_{0(60K)}$	Nm	23.0
Stall current (60K)	$I_{0(60K)}$	A	12.9
Optimum operating point:			
Optimum speed	n_{opt}	rpm	3000
Optimum power	P_{opt}	kW	5.65
Limiting data			
Max. permissible speed (mech.)	$n_{max\ mech}$	rpm	8000
Maximum torque	M_{max}	Nm	120
Maximum current	I_{max}	A	78
Motor data:			
No. of poles	$2p$		10
Torque constant (100K)	k_T	Nm/A	1.78
Voltage constant (at 20 °C)	k_E	V/1000 rpm	113.5
Winding resistance (at 20 °C)	R_{Str}	W	0.235
Rotating field inductance	L_D	mH	4
Electrical time constant	T_{el}	ms	17
Mechanical time constant	T_{mech}	ms	1.4
Thermal time constant	T_{th}	min	60
Moment of inertia	J_{mot}	$kgm^2 \cdot 10^{-4}$	63.6
Shaft torsional stiffness	C_t	Nm/rad	74000
Weight	m_{mot}	kg	27.5
Motor data with integrated brake:			
Moment of inertia (with brake)	J_{mot}	$kgm^2 \cdot 10^{-4}$	79
Shaft torsional stiffness (with brake)	C_t	Nm/rad	57000
Weight (with brake)	m_{Mot}	kg	31.8
Data with SINAMICS S120 Booksize / S120 Booksize Compact			
Rated converter current	$I_{N\ Inv}$	A	18
Maximum converter current	$I_{max\ Inv}$	A	54
Max. torque (converter operation)	$M_{max\ Inv}$	Nm	86.0
Max. permissible speed (converter operation)	$n_{max\ Inv}$	rpm	5100
The rated data are valid for a 600 V DC-link voltage			

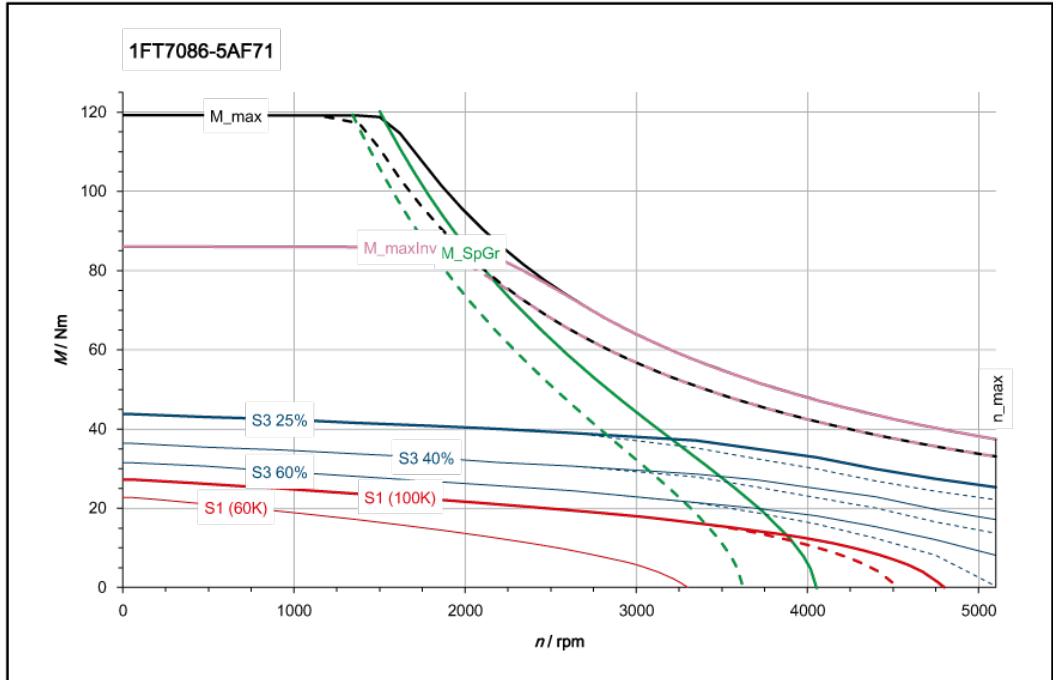

[———] SINAMICS ALM 400 V (600 V DC)
 [- - - -] SINAMICS BLM/SLM 400 V (540 V DC)

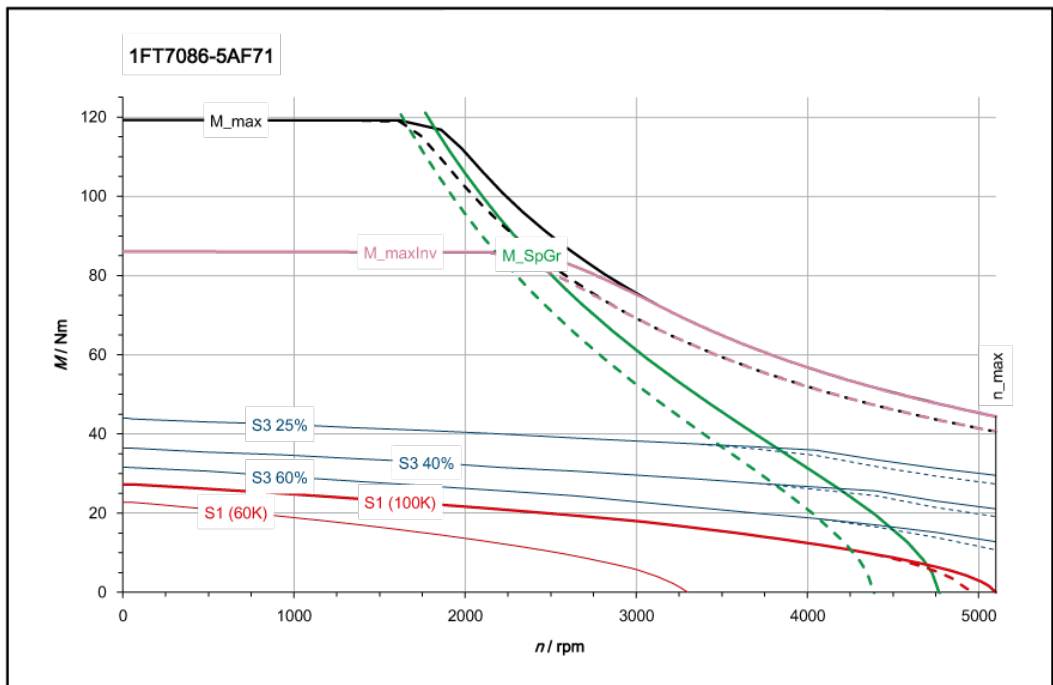

[———] SINAMICS ALM 480 V (720 V DC)
 [- - - -] SINAMICS BLM/SLM 480 V (650 V DC)

Three-phase servomotor 1FT7086-5AH7			
Technical specifications	Symbol	Unit	Value
Configuration data:			
Rated speed	n_N	rpm	4500
Rated torque (100K)	$M_{N(100K)}$	Nm	10.0
Rated current (100K)	$I_{N(100K)}$	A	10
Static torque (100K)	$M_{0(100K)}$	Nm	28
Stall current (100K)	$I_{0(100K)}$	A	22.4
Static torque (60K)	$M_{0(60K)}$	Nm	23
Stall current (60K)	$I_{0(60K)}$	A	18.4
Optimum operating point:			
Optimum speed	n_{opt}	rpm	4500
Optimum power	P_{opt}	kW	4.71
Limiting data			
Max. permissible speed (mech.)	$n_{max\ mech}$	rpm	8000
Maximum torque	M_{max}	Nm	120
Maximum current	I_{max}	A	110
Motor data:			
No. of poles	$2p$		10
Torque constant (100K)	k_T	Nm/A	1.25
Voltage constant (at 20 °C)	k_E	V/1000 rpm	80.0
Winding resistance (at 20 °C)	R_{Str}	W	0.113
Rotating field inductance	L_D	mH	2.0
Electrical time constant	T_{el}	ms	18
Mechanical time constant	T_{mech}	ms	1.4
Thermal time constant	T_{th}	min	60
Moment of inertia	J_{mot}	$kgm^2 \cdot 10^{-4}$	63.6
Shaft torsional stiffness	C_t	Nm/rad	74000
Weight	m_{mot}	kg	27.5
Motor data with integrated brake:			
Moment of inertia (with brake)	J_{mot}	$kgm^2 \cdot 10^{-4}$	79
Shaft torsional stiffness (with brake)	C_t	Nm/rad	57000
Weight (with brake)	m_{Mot}	kg	31.8
Data with SINAMICS S120 Booksize			
Rated converter current	$I_{N\ Inv}$	A	24
Maximum converter current	$I_{max\ Inv}$	A	72
Max. torque (converter operation)	$M_{max\ Inv}$	Nm	82.7
Max. permissible speed (converter operation)	$n_{max\ Inv}$	rpm	7200
The rated data are valid for a 600 V DC-link voltage			

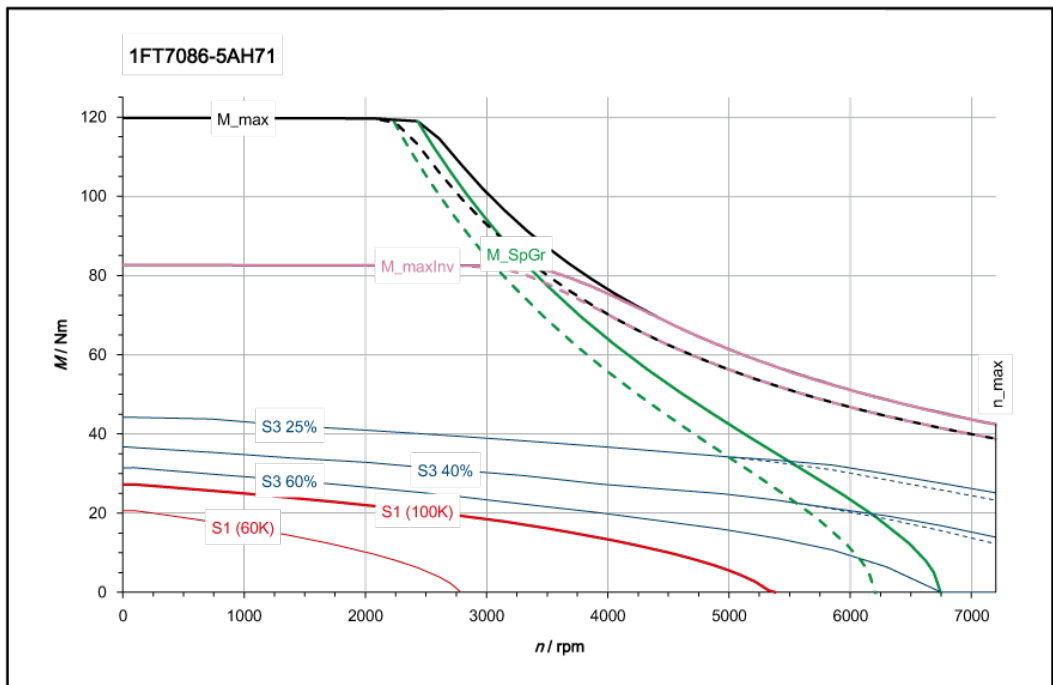
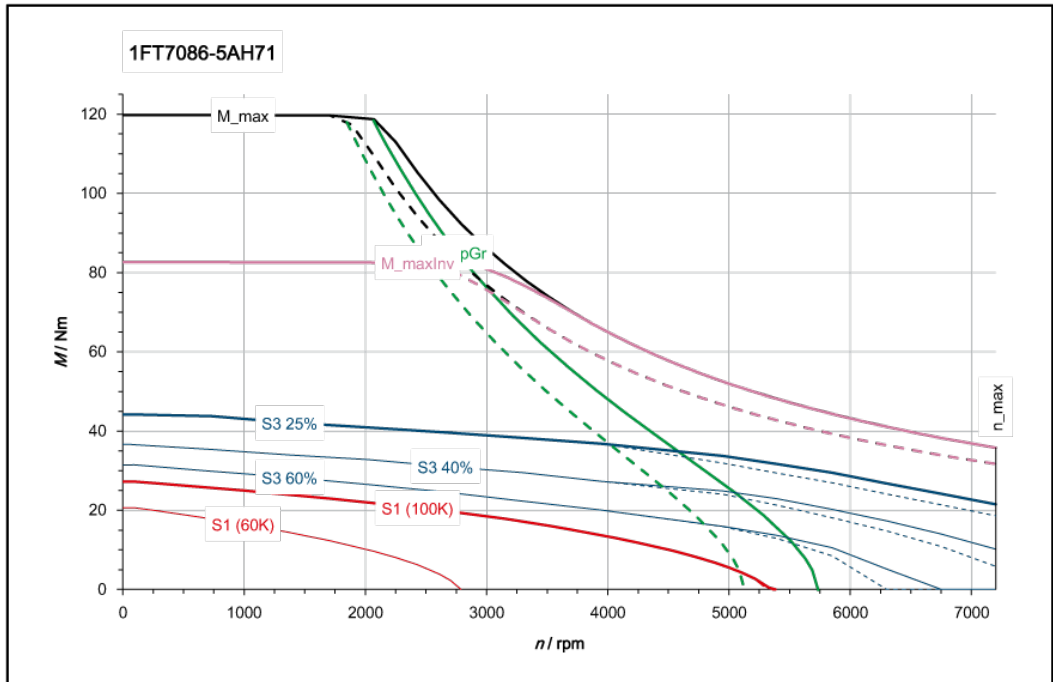

6.3.1.13 1FT7102-_A

Three-phase servomotor 1FT7102-5AB7			
Technical specifications	Symbol	Unit	Value
Configuration data:			
Rated speed	n_N	rpm	1500
Rated torque (100K)	$M_{N(100K)}$	Nm	26.0
Rated current (100K)	$I_{N(100K)}$	A	8.0
Static torque (100K)	$M_{0(100K)}$	Nm	30.0
Stall current (100K)	$I_{0(100K)}$	A	9.0
Static torque (60K)	$M_{0(60K)}$	Nm	25.0
Stall current (60K)	$I_{0(60K)}$	A	8.0
Optimum operating point:			
Optimum speed	n_{opt}	rpm	1500
Optimum power	P_{opt}	kW	4.08
Limiting data:			
Max. permissible speed (mech.)	$n_{max\ mech}$	rpm	6000
Maximum torque	M_{max}	Nm	120
Maximum current	I_{max}	A	45
Motor data:			
No. of poles	2p		10
Torque constant (100K)	k_T	Nm/A	3.33
Voltage constant (at 20 °C)	k_E	V/1000 rpm	212.3
Winding resistance (at 20 °C)	R_{Str}	W	0.6
Rotating field inductance	L_D	mH	12.5
Electrical time constant	T_{el}	ms	21
Mechanical time constant	T_{mech}	ms	1.5
Thermal time constant	T_{th}	min	70
Moment of inertia	J_{mot}	kgm ² * 10 ⁻⁴	91.4
Shaft torsional stiffness	C_t	Nm/rad	181000
Weight	m_{mot}	kg	26.1
Motor data with integrated brake:			
Moment of inertia (with brake)	J_{mot}	kgm ² * 10 ⁻⁴	119
Shaft torsional stiffness (with brake)	C_t	Nm/rad	124000
Weight (with brake)	m_{Mot}	kg	32.3
Data with SINAMICS S120 Booksize / S120 Booksize Compact:			
Rated converter current	$I_{N\ Inv}$	A	9
Maximum converter current	$I_{max\ Inv}$	A	27
Max. torque (converter operation)	$M_{max\ Inv}$	Nm	84
Max. permissible speed (converter operation)	$n_{max\ Inv}$	rpm	2680
The rated data are valid for a 600 V DC-link voltage			

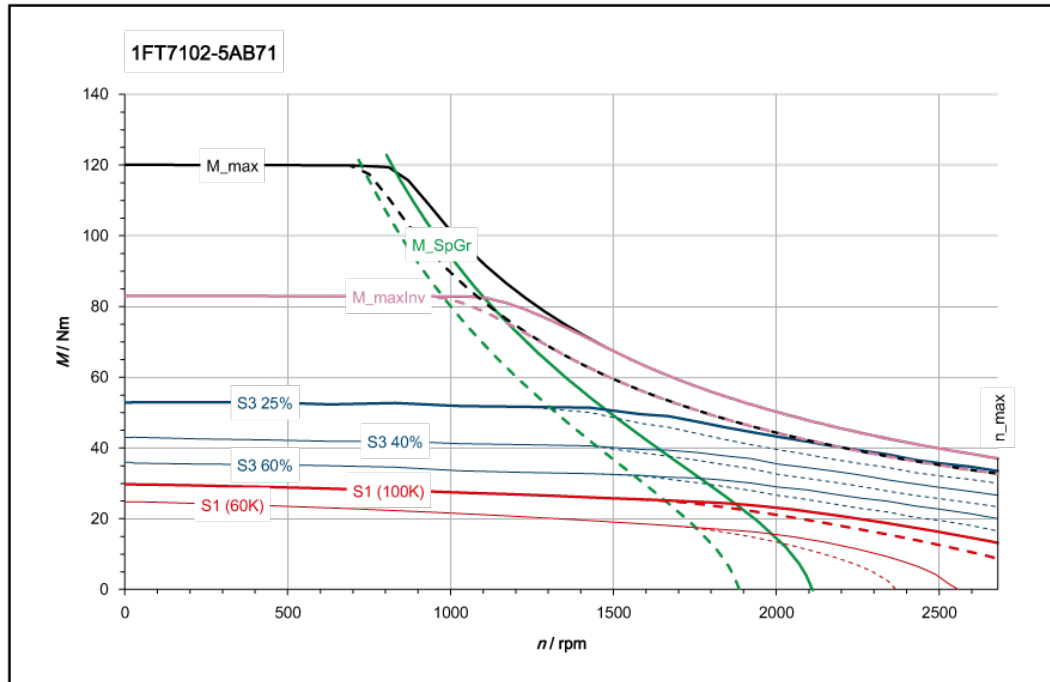

[———] SINAMICS ALM 400 V (600 V DC)
 [- - - -] SINAMICS BLM/SLM 400 V (540 V DC)

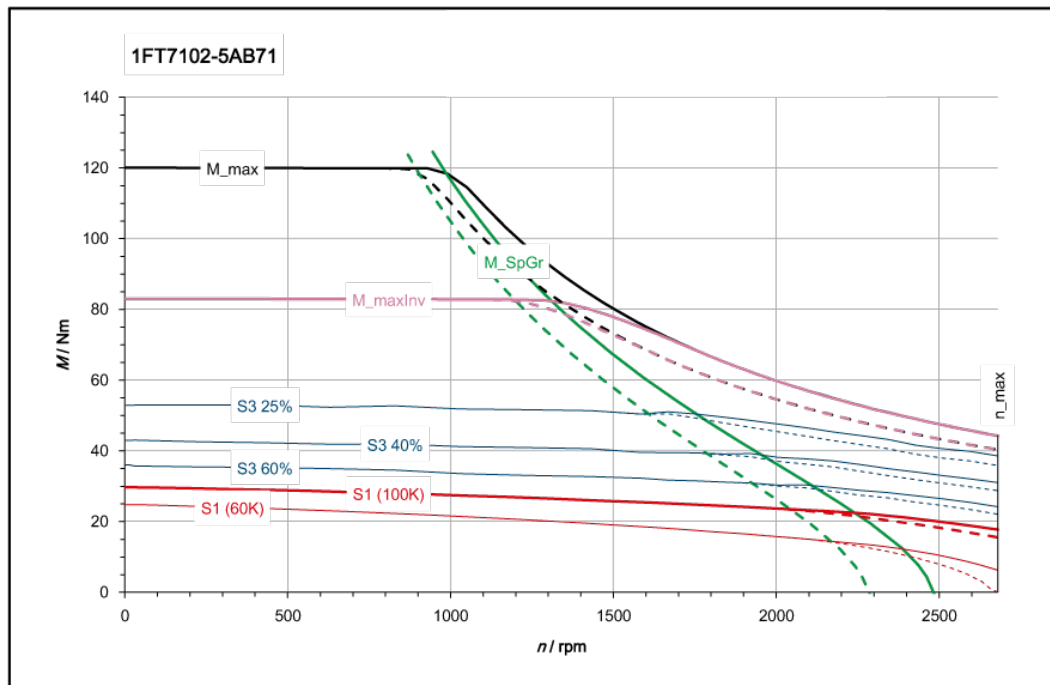

[———] SINAMICS ALM 480 V (720 V DC)
 [- - - -] SINAMICS BLM/SLM 480 V (650 V DC)

Three-phase servomotor 1FT7102-5AC7			
Technical specifications	Symbol	Unit	Value
Configuration data			
Rated speed	n_N	rpm	2000
Rated torque (100K)	$M_{N(100K)}$	Nm	24
Rated current (100K)	$I_{N(100K)}$	A	10
Static torque (100K)	$M_{0(100K)}$	Nm	30
Stall current (100K)	$I_{0(100K)}$	A	12.5
Static torque (60K)	$M_{0(60K)}$	Nm	25
Stall current (60K)	$I_{0(60K)}$	A	10.5
Optimum operating point:			
Optimum speed	n_{opt}	rpm	2000
Optimum power	P_{opt}	kW	5.03
Limiting data:			
Max. permissible speed (mech.)	$n_{max\ mech}$	rpm	6000
Maximum torque	M_{max}	Nm	120
Maximum current	I_{max}	A	64
Motor data:			
No. of poles	$2p$		10
Torque constant (100K)	k_T	Nm/A	2.35
Voltage constant (at 20 °C)	k_E	V/1000 rpm	149.5
Winding resistance (at 20 °C)	R_{Str}	W	0.3
Rotating field inductance	L_D	mH	6.2
Electrical time constant	T_{el}	ms	21
Mechanical time constant	T_{mech}	ms	1.4
Thermal time constant	T_{th}	min	70
Moment of inertia	J_{mot}	kgm ² * 10 ⁻⁴	91.4
Shaft torsional stiffness	C_t	Nm/rad	181000
Weight	m_{mot}	kg	26.1
Motor data with integrated brake:			
Moment of inertia (with brake)	J_{mot}	kgm ² * 10 ⁻⁴	119
Shaft torsional stiffness (with brake)	C_t	Nm/rad	124000
Weight (with brake)	m_{Mot}	kg	32.3
Data with SINAMICS S120 Booksize / S120 Booksize Compact:			
Rated converter current	$I_{N\ Inv}$	A	18
Maximum converter current	$I_{max\ Inv}$	A	54
Max. torque (converter operation)	$M_{max\ Inv}$	Nm	106
Max. permissible speed (converter operation)	$n_{max\ Inv}$	rpm	3800
The rated data are valid for a 600 V DC-link voltage			

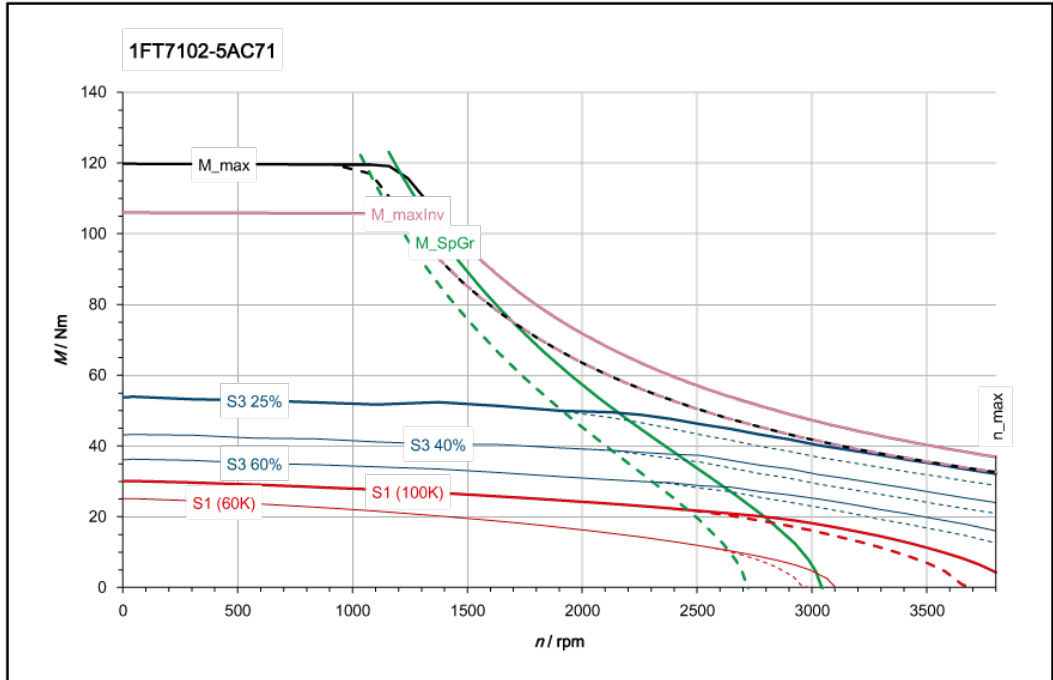

[———] SINAMICS ALM 400 V (600 V DC)
 [- - - -] SINAMICS BLM/SLM 400 V (540 V DC)

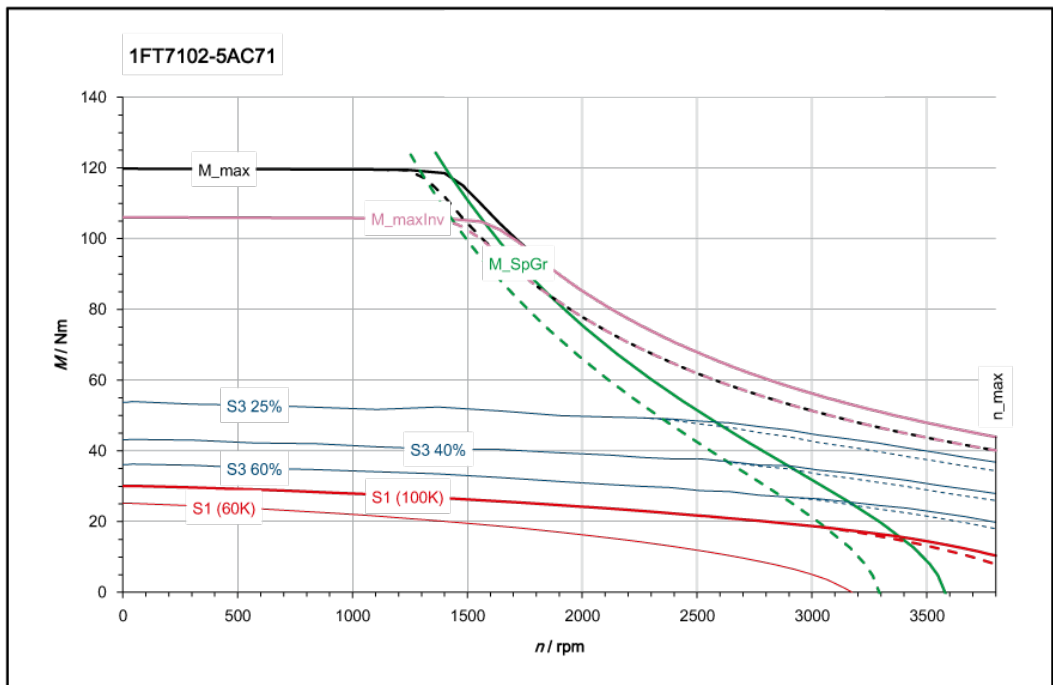

[———] SINAMICS ALM 480 V (720 V DC)
 [- - - -] SINAMICS BLM/SLM 480 V (650 V DC)

Three-phase servomotor 1FT7102-5AF7			
Technical specifications	Symbol	Unit	Value
Configuration data:			
Rated speed	n_N	rpm	3000
Rated torque (100K)	$M_{N(100K)}$	Nm	20.0
Rated current (100K)	$I_{N(100K)}$	A	12.0
Static torque (100K)	$M_{0(100K)}$	Nm	30.0
Stall current (100K)	$I_{0(100K)}$	A	18.0
Static torque (60K)	$M_{0(60K)}$	Nm	25.0
Stall current (60K)	$I_{0(60K)}$	A	15.0
Optimum operating point:			
Optimum speed	n_{opt}	rpm	3000
Optimum power	P_{opt}	kW	6.28
Limiting data:			
Max. permissible speed (mech.)	$n_{max\ mech}$	rpm	6000
Maximum torque	M_{max}	Nm	120
Maximum current	I_{max}	A	90
Motor data:			
No. of poles	$2p$		10
Torque constant (100K)	k_T	Nm/A	1.67
Voltage constant (at 20 °C)	k_E	V/1000 rpm	106.0
Winding resistance (at 20 °C)	R_{Str}	W	0.151
Rotating field inductance	L_D	mH	3.1
Electrical time constant	T_{el}	ms	21
Mechanical time constant	T_{mech}	ms	1.5
Thermal time constant	T_{th}	min	70
Moment of inertia	J_{mot}	kgm ² * 10 ⁻⁴	91.4
Shaft torsional stiffness	C_t	Nm/rad	181000
Weight	m_{mot}	kg	26.1
Motor data with integrated brake:			
Moment of inertia (with brake)	J_{mot}	kgm ² * 10 ⁻⁴	119
Shaft torsional stiffness (with brake)	C_t	Nm/rad	124000
Weight (with brake)	m_{Mot}	kg	32.3
Data with SINAMICS S120 Booksize / S120 Booksize Compact:			
Rated converter current	$I_{N\ Inv}$	A	18
Maximum converter current	$I_{max\ Inv}$	A	54
Max. torque (converter operation)	$M_{max\ Inv}$	Nm	79
Max. permissible speed (converter operation)	$n_{max\ Inv}$	rpm	5360
The rated data are valid for a 600 V DC-link voltage			

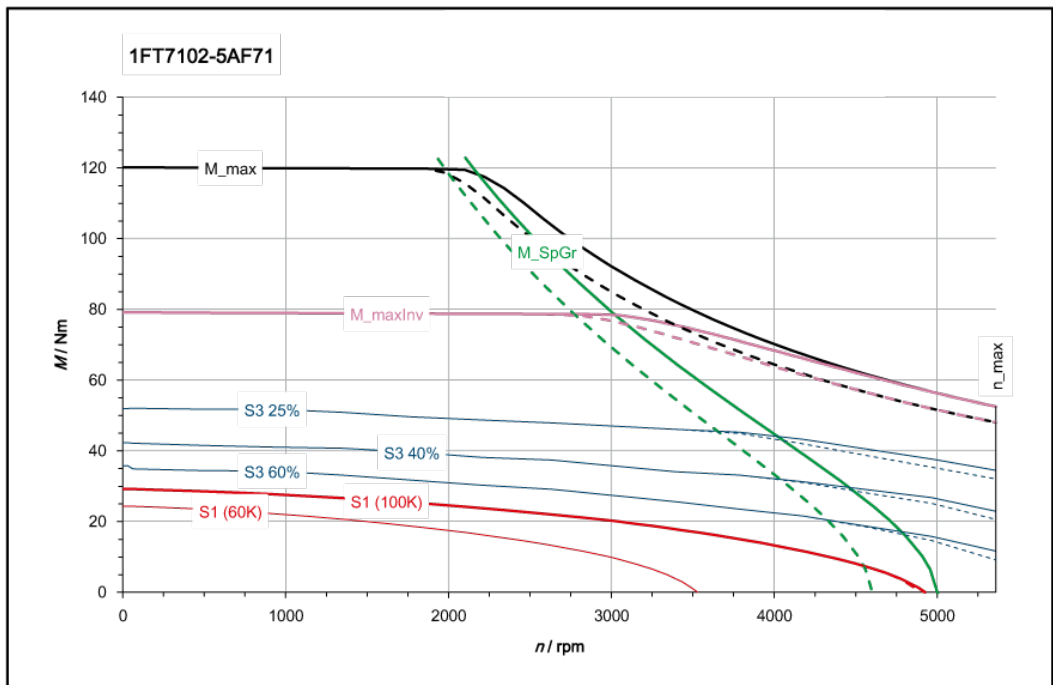
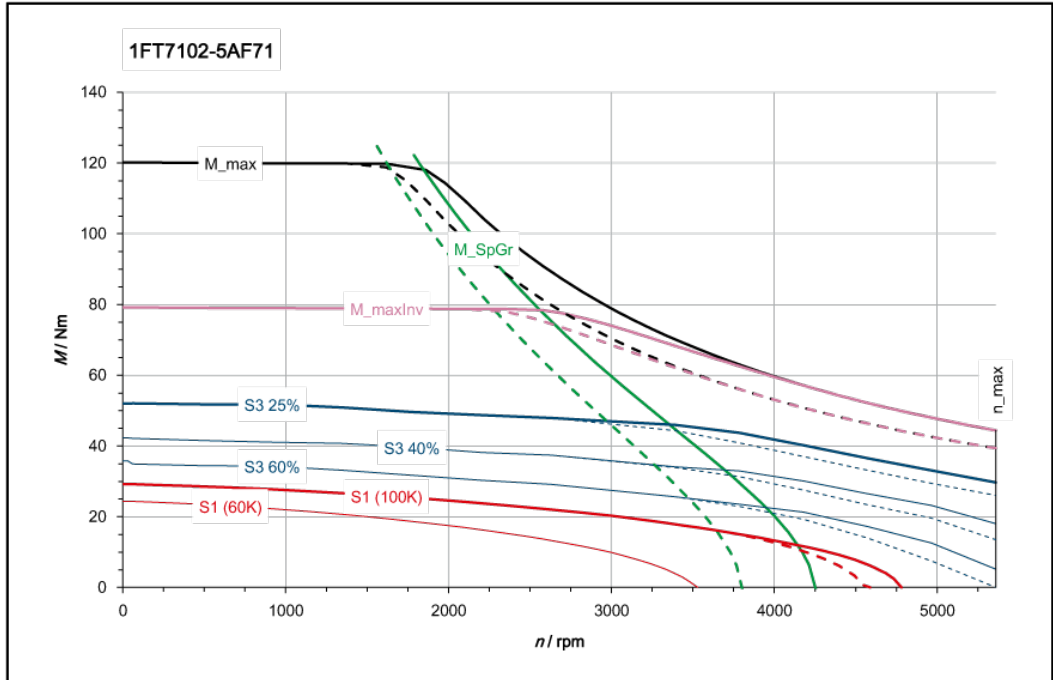

6.3.1.14 1FT7105-_A

Three-phase servomotor 1FT7105-5AB7			
Technical specifications	Symbol	Unit	Value
Configuration data:			
Rated speed	n_N	rpm	1500
Rated torque (100K)	$M_{N(100K)}$	Nm	42.0
Rated current (100K)	$I_{N(100K)}$	A	13.0
Static torque (100K)	$M_{0(100K)}$	Nm	50.0
Stall current (100K)	$I_{0(100K)}$	A	15.0
Static torque (60K)	$M_{0(60K)}$	Nm	41.0
Stall current (60K)	$I_{0(60K)}$	A	12.0
Optimum operating point:			
Optimum speed	n_{opt}	rpm	1500
Optimum power	P_{opt}	kW	6.6
Limiting data:			
Max. permissible speed (mech.)	$n_{max\ mech}$	rpm	6000
Maximum torque	M_{max}	Nm	200
Maximum current	I_{max}	A	67
Motor data:			
No. of poles	2p		10
Torque constant (100K)	k_T	Nm/A	3.33
Voltage constant (at 20 °C)	k_E	V/1000 rpm	214
Winding resistance (at 20 °C)	R_{Str}	W	0.255
Rotating field inductance	L_D	mH	6.8
Electrical time constant	T_{el}	ms	27
Mechanical time constant	T_{mech}	ms	1.2
Thermal time constant	T_{th}	min	80
Moment of inertia	J_{mot}	kgm ² * 10 ⁻⁴	178
Shaft torsional stiffness	C_t	Nm/rad	146000
Weight	m_{mot}	kg	44.2
Motor data with integrated brake			
Moment of inertia (with brake)	J_{mot}	kgm ² * 10 ⁻⁴	206
Shaft torsional stiffness (with brake)	C_t	Nm/rad	107000
Weight (with brake)	m_{Mot}	kg	50.4
Data with SINAMICS S120 Booksize / S120 Booksize Compact:			
Rated converter current	$I_{N\ Inv}$	A	18
Maximum converter current	$I_{max\ Inv}$	A	54
Max. torque (converter operation)	$M_{max\ Inv}$	Nm	165
Max. permissible speed (converter operation)	$n_{max\ Inv}$	rpm	2670
The rated data are valid for a 600 V DC-link voltage			

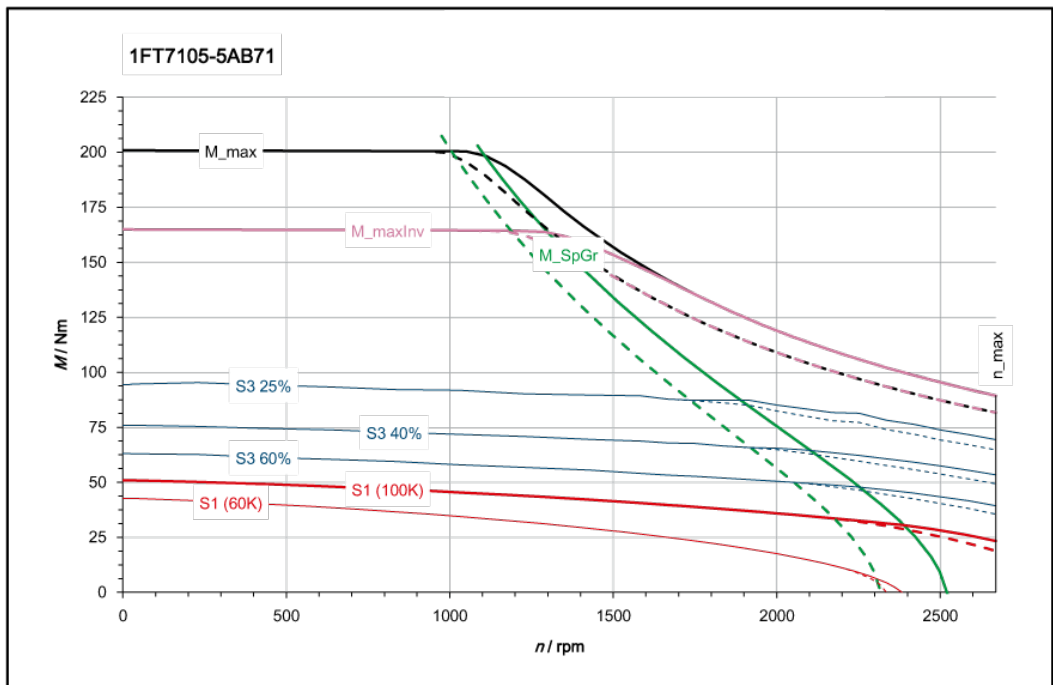
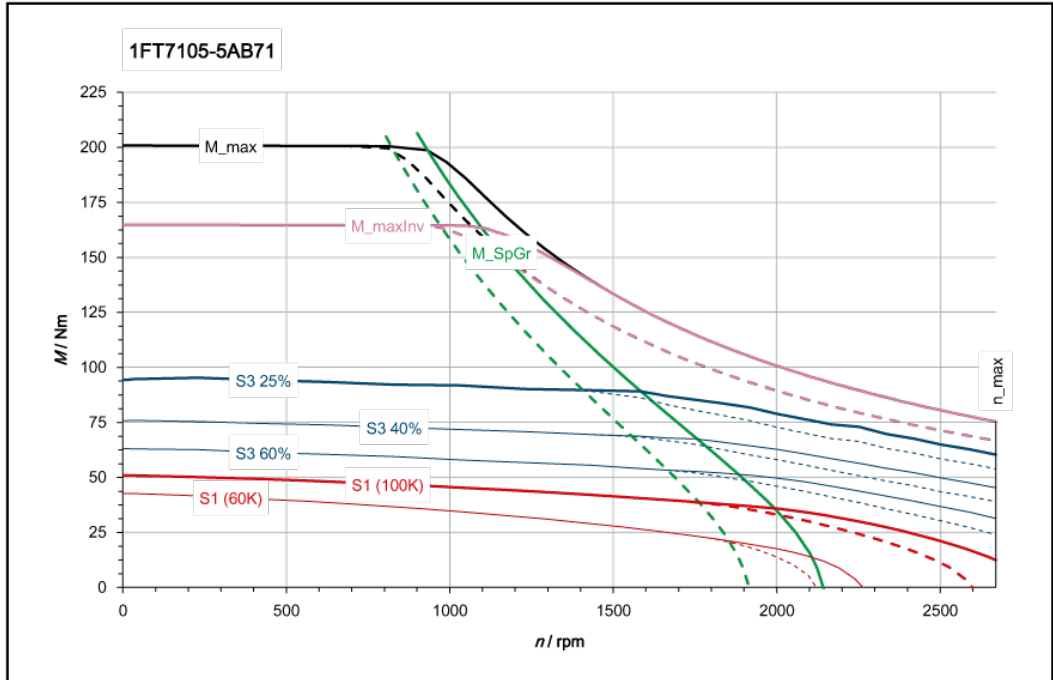

Three-phase servomotor 1FT7105-5AC7			
Technical specifications	Symbol	Unit	Value
Configuration data:			
Rated speed	n_N	rpm	2000
Rated torque (100K)	$M_{N(100K)}$	Nm	38.0
Rated current (100K)	$I_{N(100K)}$	A	15.0
Static torque (100K)	$M_{0(100K)}$	Nm	50.0
Stall current (100K)	$I_{0(100K)}$	A	18.0
Static torque (60K)	$M_{0(60K)}$	Nm	41.0
Stall current (60K)	$I_{0(60K)}$	A	15.0
Optimum operating point:			
Optimum speed	n_{opt}	rpm	2000
Optimum power	P_{opt}	kW	7.95
Limiting data:			
Max. permissible speed (mech.)	$n_{max\ mech}$	rpm	6000
Maximum torque	M_{max}	Nm	200
Maximum current	I_{max}	A	84
Motor data:			
No. of poles	$2p$		10
Torque constant (100K)	k_T	Nm/A	2.68
Voltage constant (at 20 °C)	k_E	V/1000 rpm	170.5
Winding resistance (at 20 °C)	R_{Str}	W	0.157
Rotating field inductance	L_D	mH	4.3
Electrical time constant	T_{el}	ms	27
Mechanical time constant	T_{mech}	ms	1.0
Thermal time constant	T_{th}	min	80
Moment of inertia	J_{mot}	kgm ² * 10 ⁻⁴	178
Shaft torsional stiffness	C_t	Nm/rad	146000
Weight	m_{mot}	kg	44.2
Motor data with integrated brake:			
Moment of inertia (with brake)	J_{mot}	kgm ² * 10 ⁻⁴	206
Shaft torsional stiffness (with brake)	C_t	Nm/rad	107000
Weight (with brake)	m_{Mot}	kg	50.4
Data with SINAMICS S120 Booksize / S120 Booksize Compact:			
Rated converter current	$I_{N\ Inv}$	A	18
Maximum converter current	$I_{max\ Inv}$	A	54
Max. torque (converter operation)	$M_{max\ Inv}$	Nm	135
Max. permissible speed (converter operation)	$n_{max\ Inv}$	rpm	3350
The rated data are valid for a 600 V DC-link voltage			

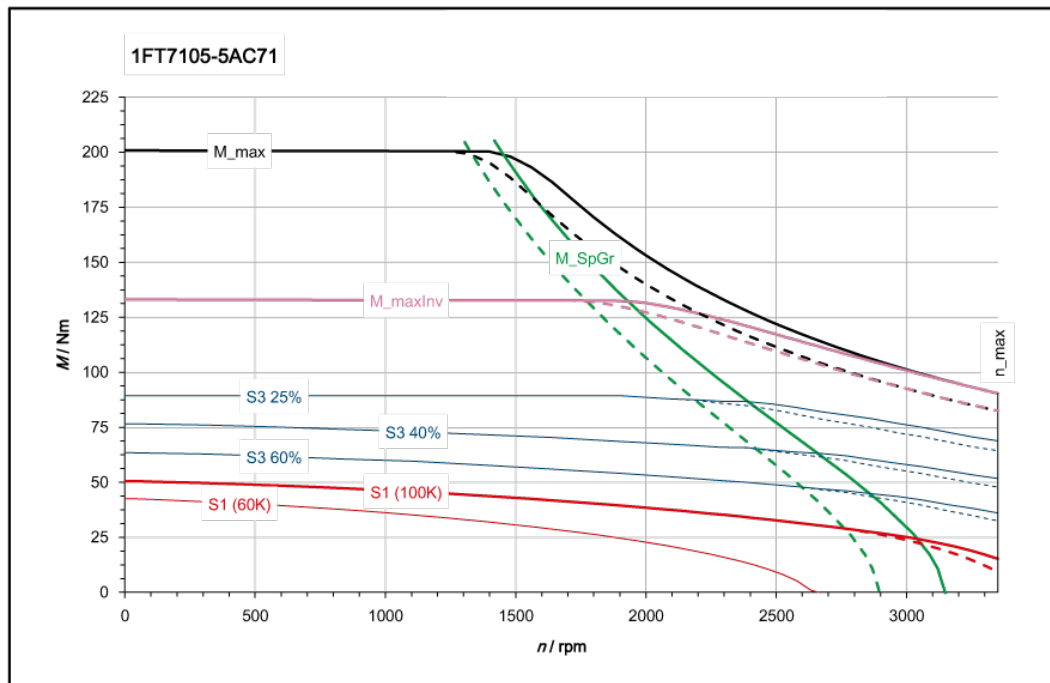
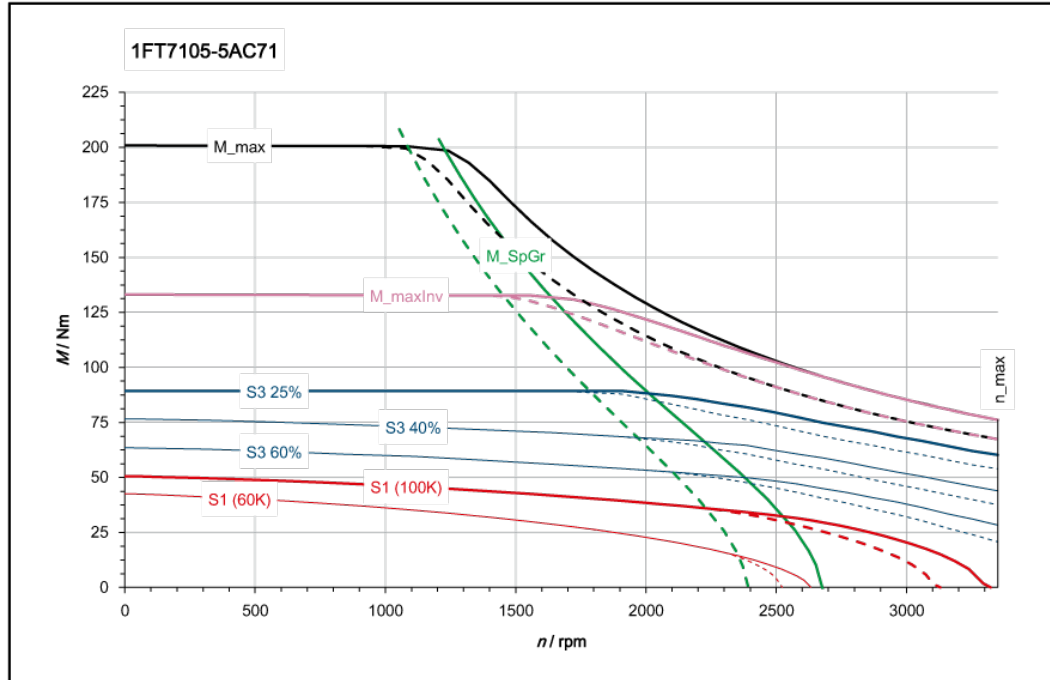

Three-phase servomotor 1FT7105-5AF7			
Technical specifications	Symbol	Unit	Value
Configuration data:			
Rated speed	n_N	rpm	3000
Rated torque (100K)	$M_{N(100K)}$	Nm	28.0
Rated current (100K)	$I_{N(100K)}$	A	15.0
Static torque (100K)	$M_{0(100K)}$	Nm	50.0
Stall current (100K)	$I_{0(100K)}$	A	26.0
Static torque (60K)	$M_{0(60K)}$	Nm	41.0
Stall current (60K)	$I_{0(60K)}$	A	21.0
Optimum operating point:			
Optimum speed	n_{opt}	rpm	3000
Optimum power	P_{opt}	kW	8.8
Limiting data:			
Max. permissible speed (mech.)	$n_{max\ mech}$	rpm	6000
Maximum torque	M_{max}	Nm	200
Maximum current	I_{max}	A	116
Motor data:			
No. of poles	$2p$		10
Torque constant (100K)	k_T	Nm/A	1.92
Voltage constant (at 20 °C)	k_E	V/1000 rpm	123.5
Winding resistance (at 20 °C)	R_{Str}	W	0.084
Rotating field inductance	L_D	mH	2.3
Electrical time constant	T_{el}	ms	27
Mechanical time constant	T_{mech}	ms	1.2
Thermal time constant	T_{th}	min	80
Moment of inertia	J_{mot}	kgm ² * 10 ⁻⁴	178
Shaft torsional stiffness	C_t	Nm/rad	146000
Weight	m_{mot}	kg	44.2
Motor data with integrated brake:			
Moment of inertia (with brake)	J_{mot}	kgm ² * 10 ⁻⁴	206
Shaft torsional stiffness (with brake)	C_t	Nm/rad	107000
Weight (with brake)	m_{Mot}	kg	50.4
Data with SINAMICS S120 Booksize:			
Rated converter current	$I_{N\ Inv}$	A	30
Maximum converter current	$I_{max\ Inv}$	A	90
Max. torque (converter operation)	$M_{max\ Inv}$	Nm	157
Max. permissible speed (converter operation)	$n_{max\ Inv}$	rpm	4630
The rated data are valid for a 600 V DC-link voltage			

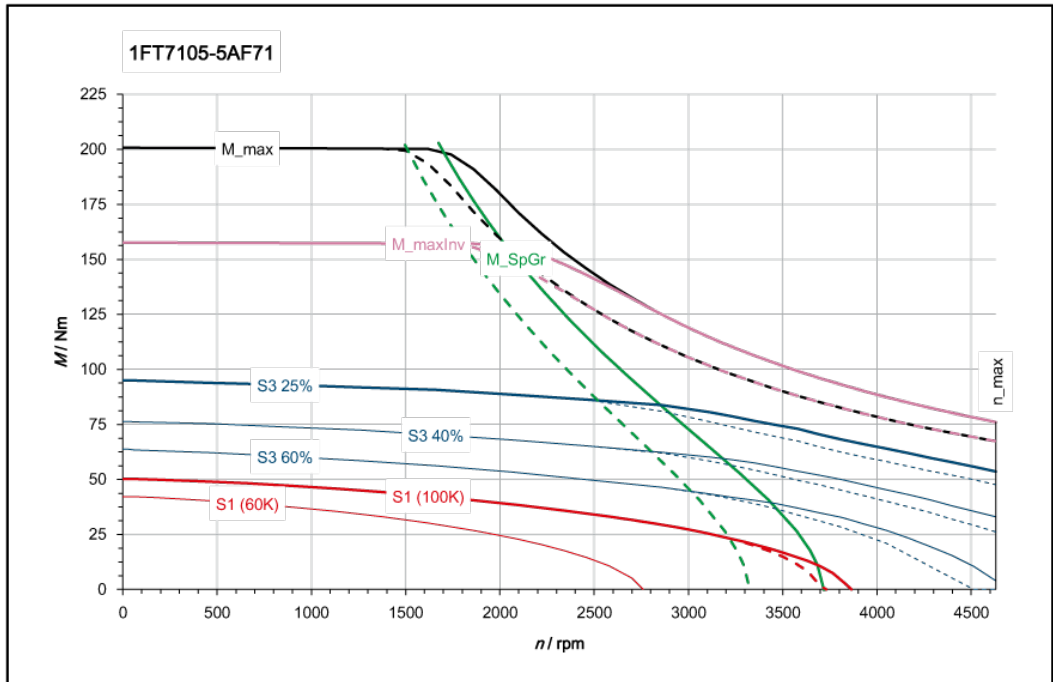

[———] SINAMICS ALM 400 V (600 V DC)
 [- - - -] SINAMICS BLM/SLM 400 V (540 V DC)

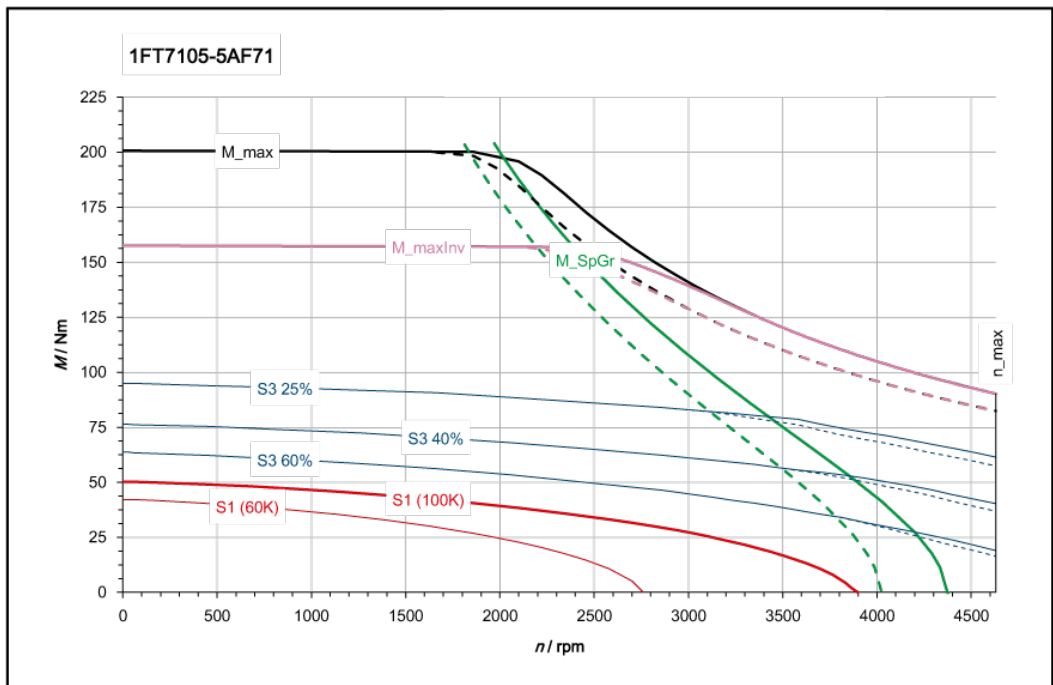

[———] SINAMICS ALM 480 V (720 V DC)
 [- - - -] SINAMICS BLM/SLM 480 V (650 V DC)

6.3.1.15 1FT7108-_A

Three-phase servomotor 1FT7108-5AB7			
Technical specifications	Symbol	Unit	Value
Configuration data:			
Rated speed	n_N	rpm	1500
Rated torque (100K)	$M_{N(100K)}$	Nm	61
Rated current (100K)	$I_{N(100K)}$	A	16
Static torque (100K)	$M_{0(100K)}$	Nm	70
Stall current (100K)	$I_{0(100K)}$	A	18
Static torque (60K)	$M_{0(60K)}$	Nm	58
Stall current (60K)	$I_{0(60K)}$	A	15
Optimum operating point:			
Optimum speed	n_{opt}	rpm	1500
Optimum power	P_{opt}	kW	9.58
Limiting data:			
Max. permissible speed (mech.)	$n_{max\ mech}$	rpm	6000
Maximum torque	M_{max}	Nm	280
Maximum current	I_{max}	A	87
Motor data:			
No. of poles	2p		10
Torque constant (100K)	k_T	Nm/A	3.75
Voltage constant (at 20 °C)	k_E	V/1000 rpm	239
Winding resistance (at 20 °C)	R_{Str}	W	0.21
Rotating field inductance	L_D	mH	6
Electrical time constant	T_{el}	ms	29
Mechanical time constant	T_{mech}	ms	1
Thermal time constant	T_{th}	min	95
Moment of inertia	J_{mot}	kgm ² * 10 ⁻⁴	248
Shaft torsional stiffness	C_t	Nm/rad	126000
Weight	m_{mot}	kg	59.0
Motor data with integrated brake:			
Moment of inertia (with brake)	J_{mot}	kgm ² * 10 ⁻⁴	276
Shaft torsional stiffness (with brake)	C_t	Nm/rad	96000
Weight (with brake)	m_{Mot}	kg	65.1
Data with SINAMICS S120 Booksize / S120 Booksize Compact:			
Rated converter current	$I_{N\ Inv}$	A	18
Maximum converter current	$I_{max\ Inv}$	A	54
Max. torque (converter operation)	$M_{max\ Inv}$	Nm	190
Max. permissible speed (converter operation)	$n_{max\ Inv}$	rpm	2390
The rated data are valid for a 600 V DC-link voltage			

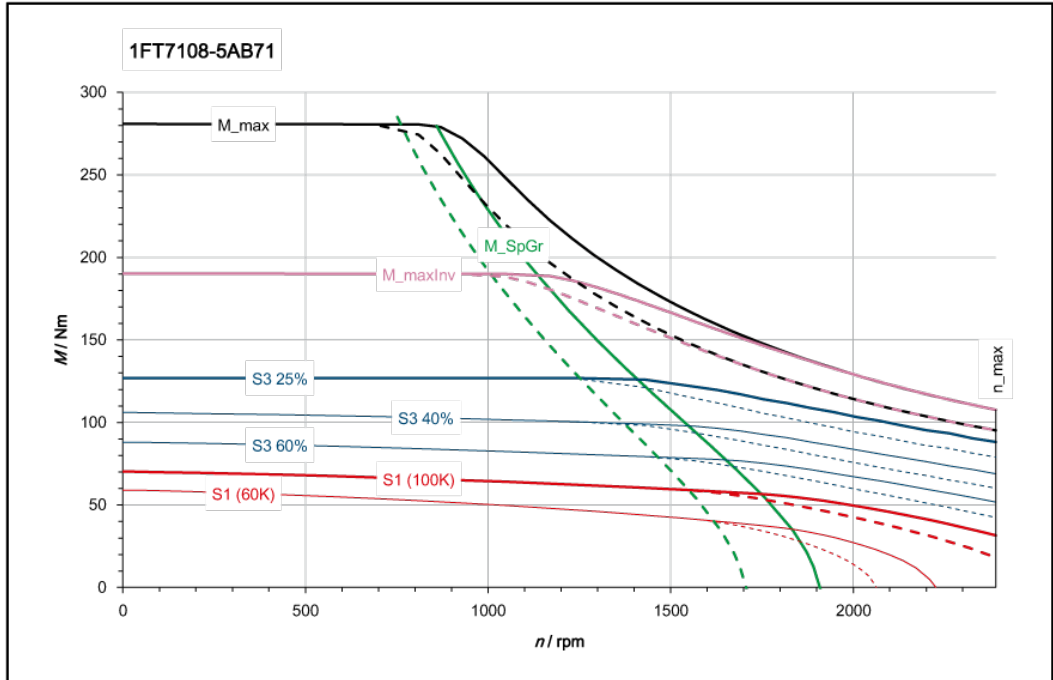

[—] SINAMICS ALM 400 V (600 V DC)
 [- - -] SINAMICS BLM/SLM 400 V (540 V DC)

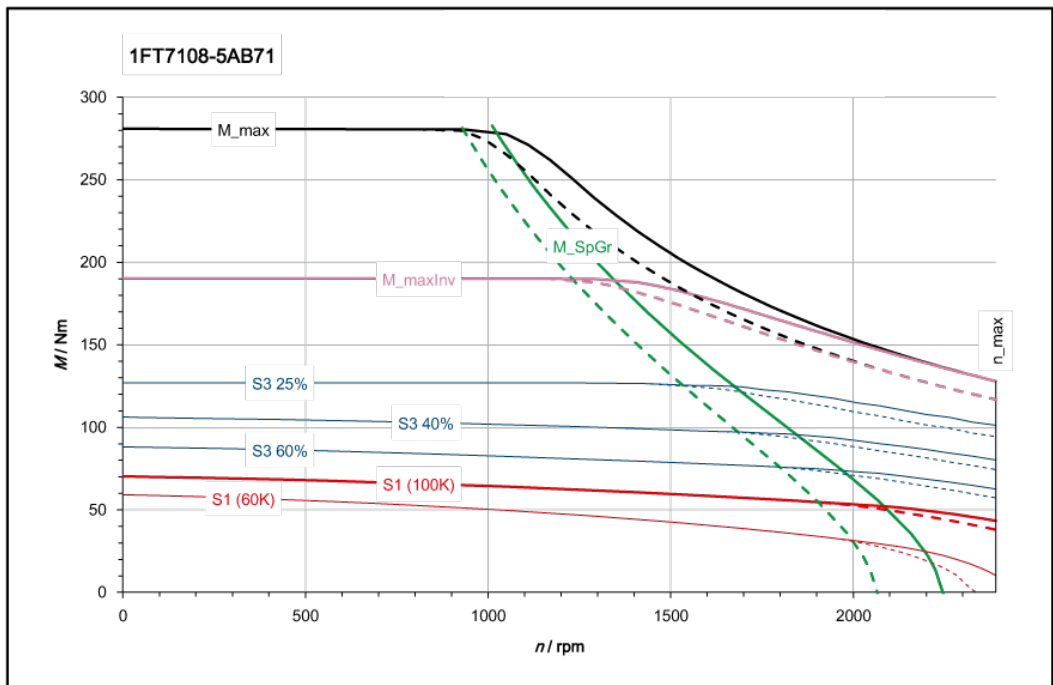

[—] SINAMICS ALM 480 V (720 V DC)
 [- - -] SINAMICS BLM/SLM 480 V (650 V DC)

Three-phase servomotor 1FT7108-5AC7			
Technical specifications	Symbol	Unit	Value
Configuration data:			
Rated speed	n_N	rpm	2000
Rated torque (100K)	$M_{N(100K)}$	Nm	50
Rated current (100K)	$I_{N(100K)}$	A	18
Static torque (100K)	$M_{0(100K)}$	Nm	70
Stall current (100K)	$I_{0(100K)}$	A	25
Static torque (60K)	$M_{0(60K)}$	Nm	58
Stall current (60K)	$I_{0(60K)}$	A	21
Optimum operating point:			
Optimum speed	n_{opt}	rpm	2000
Optimum power	P_{opt}	kW	10.5
Limiting data:			
Max. permissible speed (mech.)	$n_{max\ mech}$	rpm	6000
Maximum torque	M_{max}	Nm	280
Maximum current	I_{max}	A	120
Motor data:			
No. of poles	2p		10
Torque constant (100K)	k_T	Nm/A	2.72
Voltage constant (at 20 °C)	k_E	V/1000 rpm	173.5
Winding resistance (at 20 °C)	R_{Str}	W	0.111
Rotating field inductance	L_D	mH	3.1
Electrical time constant	T_{el}	ms	28
Mechanical time constant	T_{mech}	ms	1.0
Thermal time constant	T_{th}	min	95
Moment of inertia	J_{mot}	kgm ² * 10 ⁻⁴	248
Shaft torsional stiffness	C_t	Nm/rad	126000
Weight	m_{mot}	kg	59.0
Motor data with integrated brake:			
Moment of inertia (with brake)	J_{mot}	kgm ² * 10 ⁻⁴	276
Shaft torsional stiffness (with brake)	C_t	Nm/rad	96000
Weight (with brake)	m_{Mot}	kg	65.1
Data with SINAMICS S120 Booksize / S120 Booksize Compact:			
Rated converter current	$I_{N\ Inv}$	A	30
Maximum converter current	$I_{max\ Inv}$	A	90
Max. torque (converter operation)	$M_{max\ Inv}$	Nm	215
Max. permissible speed (converter operation)	$n_{max\ Inv}$	rpm	3310
The rated data are valid for a 600 V DC-link voltage			

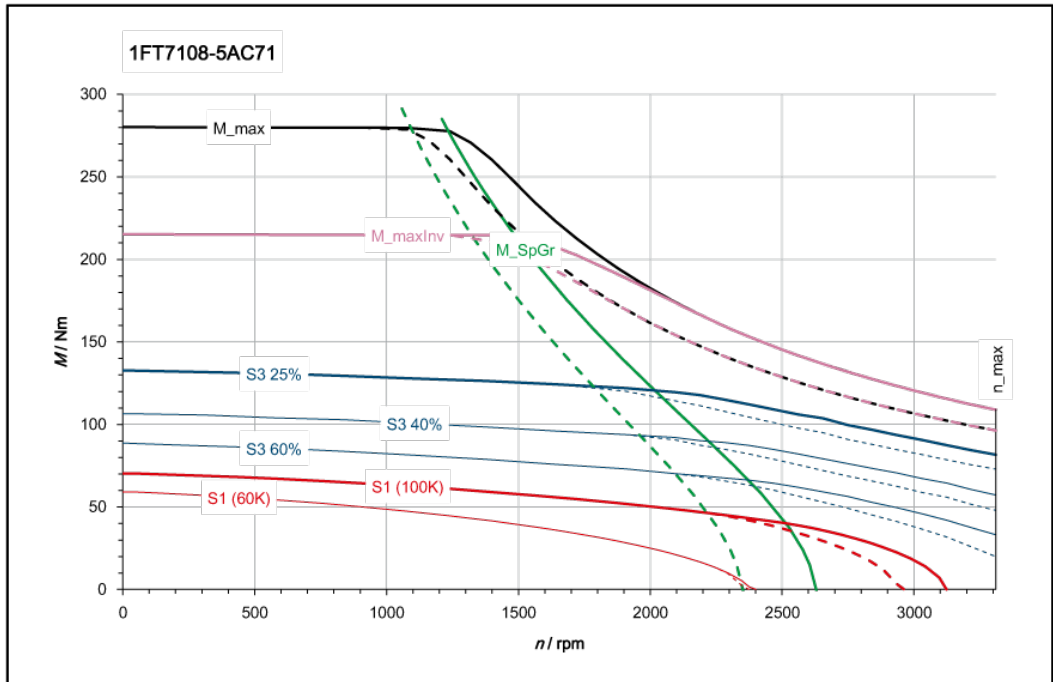

[—] SINAMICS ALM 400 V (600 V DC)
 [- - -] SINAMICS BLM/SLM 400 V (540 V DC)

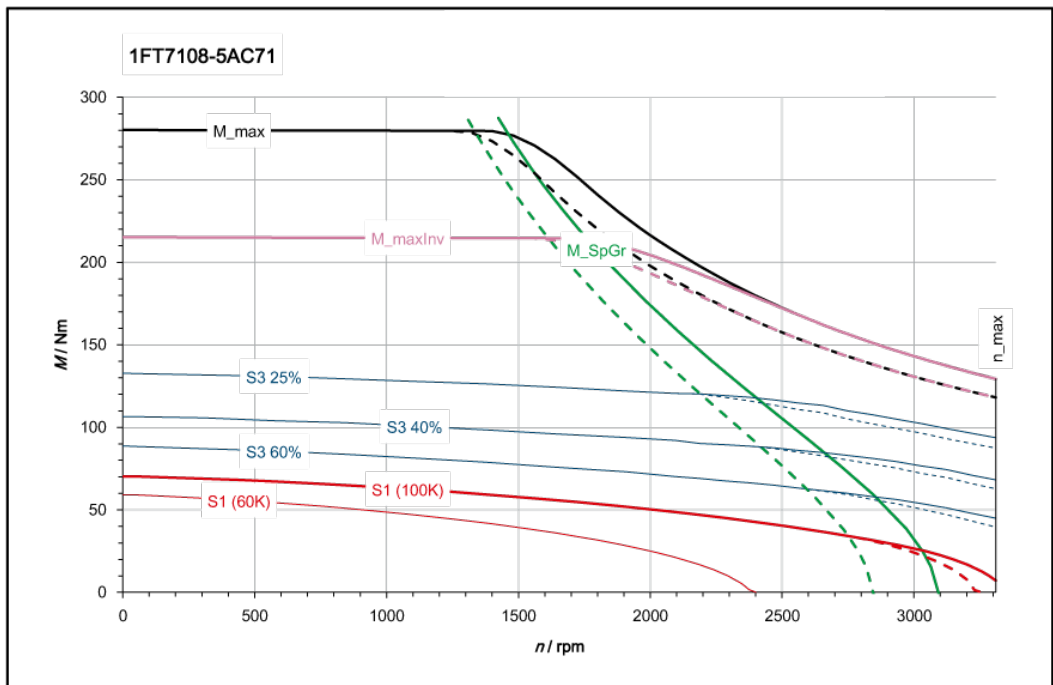

[—] SINAMICS ALM 480 V (720 V DC)
 [- - -] SINAMICS BLM/SLM 480 V (650 V DC)

Three-phase servomotor 1FT7108-5AF7			
Technical specifications	Symbol	Unit	Value
Configuration data:			
Rated speed	n_N	rpm	3000
Rated torque (100K)	$M_{N(100K)}$	Nm	20.0
Rated current (100K)	$I_{N(100K)}$	A	12.0
Static torque (100K)	$M_{0(100K)}$	Nm	70.0
Stall current (100K)	$I_{0(100K)}$	A	36.0
Static torque (60K)	$M_{0(60K)}$	Nm	58.0
Stall current (60K)	$I_{0(60K)}$	A	28.0
Optimum operating point:			
Optimum speed	n_{opt}	rpm	2000
Optimum power	P_{opt}	kW	8.17
Limiting data:			
Max. permissible speed (mech.)	$n_{max\ mech}$	rpm	6000
Maximum torque	M_{max}	Nm	280
Maximum current	I_{max}	A	165
Motor data:			
No. of poles	$2p$		10
Torque constant (100K)	k_T	Nm/A	1.94
Voltage constant (at 20 °C)	k_E	V/1000 rpm	127.0
Winding resistance (at 20 °C)	R_{Str}	W	0.065
Rotating field inductance	L_D	mH	1.7
Electrical time constant	T_{el}	ms	26
Mechanical time constant	T_{mech}	ms	1.3
Thermal time constant	T_{th}	min	95
Moment of inertia	J_{mot}	kgm ² * 10 ⁻⁴	248
Shaft torsional stiffness	C_t	Nm/rad	126000
Weight	m_{mot}	kg	59.0
Motor data with integrated brake:			
Moment of inertia (with brake)	J_{mot}	kgm ² * 10 ⁻⁴	276
Shaft torsional stiffness (with brake)	C_t	Nm/rad	96000
Weight (with brake)	m_{Mot}	kg	65.1
Data with SINAMICS S120 Booksize / S120 Booksize Compact:			
Rated converter current	$I_{N\ Inv}$	A	45
Maximum converter current	$I_{max\ Inv}$	A	90
Max. torque (converter operation)	$M_{max\ Inv}$	Nm	158
Max. permissible speed (converter operation)	$n_{max\ Inv}$	rpm	4500
The rated data are valid for a 600 V DC-link voltage			

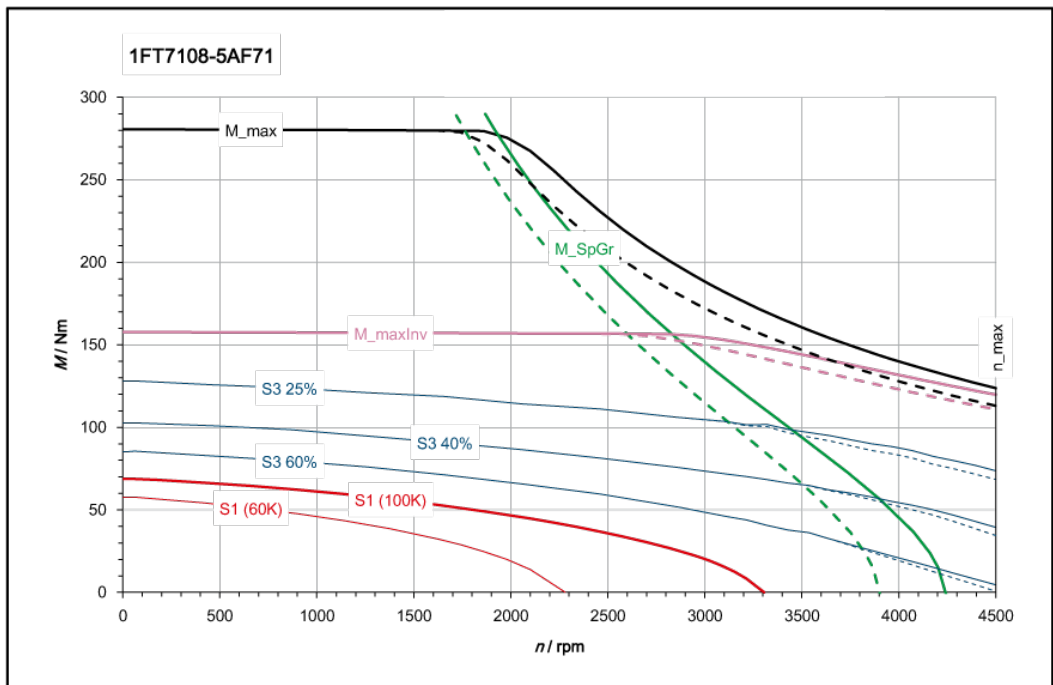
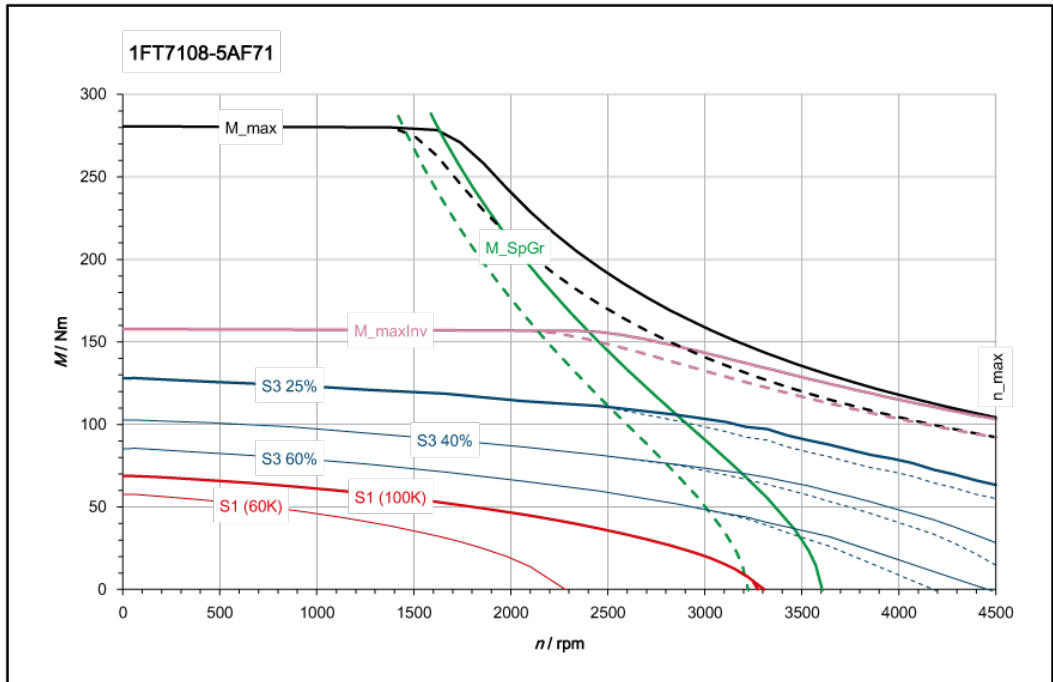

6.3.1.16 1FT7132-_A

Three-phase servomotor 1FT7132-5AB71			
Technical specifications	Symbol	Unit	Value
Configuration data:			
Rated speed	n_N	rpm	1500
Rated torque (100K)	$M_{N(100K)}$	Nm	67
Rated current (100K)	$I_{N(100K)}$	A	17.4
Static torque (100K)	$M_{0(100K)}$	Nm	90
Stall current (100K)	$I_{0(100K)}$	A	22.5
Static torque (60K)	$M_{0(60K)}$	Nm	75
Stall current (60K)	$I_{0(60K)}$	A	18.6
Optimum operating point:			
Optimum speed	n_{opt}	rpm	1500
Optimum power	P_{opt}	kW	10.5
Limiting data:			
Max. permissible speed (mech.)	$n_{max\ mech}$	rpm	3600
Maximum torque	M_{max}	Nm	290
Maximum current	I_{max}	A	89
Motor data:			
No. of poles	2p		8
Torque constant (100K)	k_T	Nm/A	4.04
Voltage constant (at 20 °C)	k_E	V/1000 rpm	266
Winding resistance (at 20 °C)	R_{Str}	W	0.238
Rotating field inductance	L_D	mH	7.5
Electrical time constant	T_{el}	ms	32
Mechanical time constant	T_{mech}	ms	2.0
Thermal time constant	T_{th}	min	75
Moment of inertia	J_{mot}	$kgm^2 \cdot 10^{-4}$	459
Shaft torsional stiffness	C_t	Nm/rad	347000
Weight	m_{mot}	kg	76
Motor data with integrated brake:			
Moment of inertia (with brake)	J_{mot}	$kgm^2 \cdot 10^{-4}$	512
Shaft torsional stiffness (with brake)	C_t	Nm/rad	231000
Weight (with brake)	m_{Mot}	kg	85
Data with SINAMICS S120 Booksize / S120 Booksize Compact			
Rated converter current	$I_{N\ Inv}$	A	24
Maximum converter current	$I_{max\ Inv}$	A	72
Max. torque converter	$M_{max\ Inv}$	Nm	246
Max. permissible speed converter	$n_{max\ Inv}$	rpm	2150
The rated data are valid for a 600 V DC-link voltage			

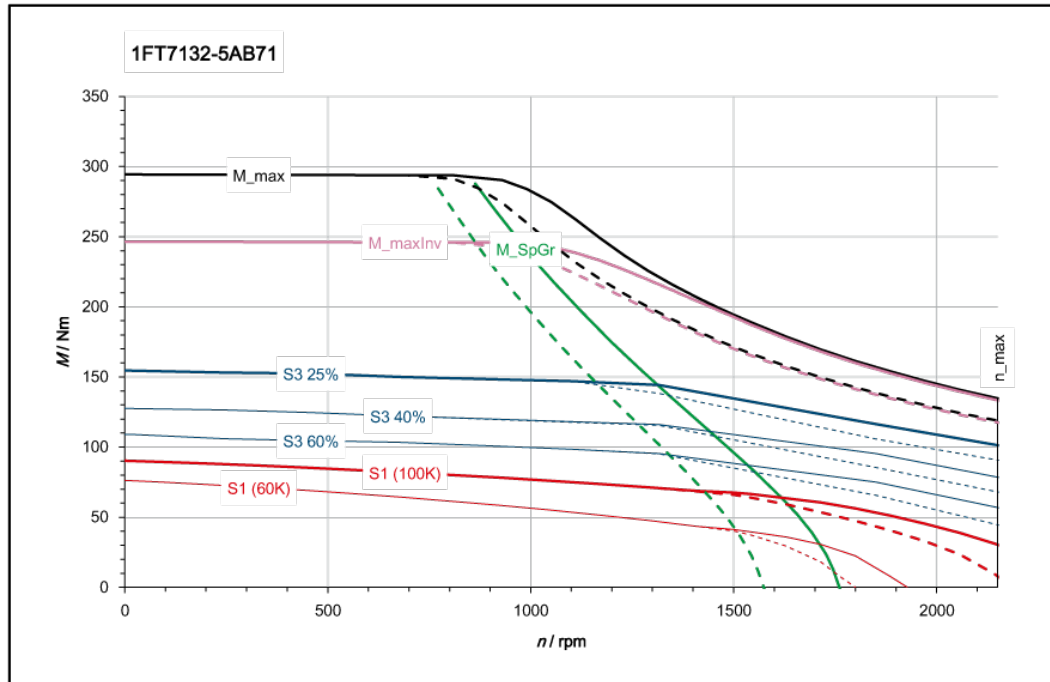

[———] SINAMICS ALM 400 V (600 V DC)
 [- - - -] SINAMICS BLM/SLM 400 V (540 V DC)

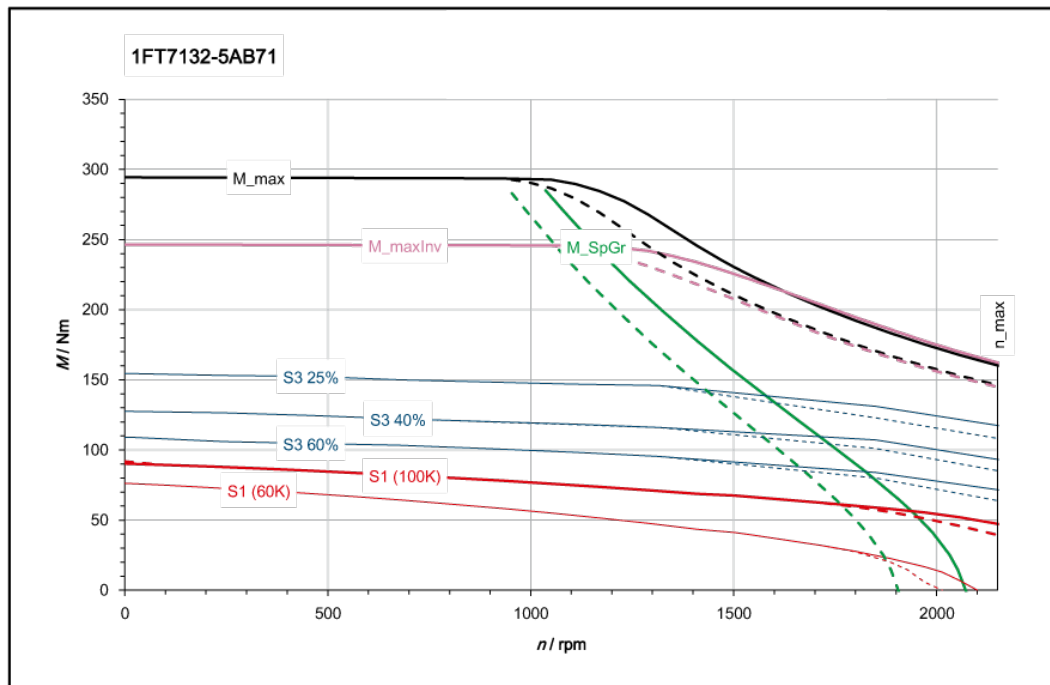

[———] SINAMICS ALM 480 V (720 V DC)
 [- - - -] SINAMICS BLM/SLM 480 V (650 V DC)

Three-phase servomotor 1FT7132-5AC71			
Technical specifications	Symbol	Unit	Value
Configuration data:			
Rated speed	n_N	rpm	2000
Rated torque (100K)	$M_{N(100K)}$	Nm	55
Rated current (100K)	$I_{N(100K)}$	A	18.7
Static torque (100K)	$M_{0(100K)}$	Nm	90
Stall current (100K)	$I_{0(100K)}$	A	29.5
Static torque (60K)	$M_{0(60K)}$	Nm	75
Stall current (60K)	$I_{0(60K)}$	A	24.5
Optimum operating point:			
Optimum speed	n_{opt}	rpm	2000
Optimum power	P_{opt}	kW	11.5
Limiting data:			
Max. permissible speed (mech.)	$n_{max\ mech}$	rpm	3600
Maximum torque	M_{max}	Nm	290
Maximum current	I_{max}	A	117
Motor data:			
No. of poles	$2p$		8
Torque constant (100K)	k_T	Nm/A	3.07
Voltage constant (at 20 °C)	k_E	V/1000 rpm	202
Winding resistance (at 20 °C)	R_{Str}	W	0.136
Rotating field inductance	L_D	mH	4.3
Electrical time constant	T_{el}	ms	32
Mechanical time constant	T_{mech}	ms	2.0
Thermal time constant	T_{th}	min	75
Moment of inertia	J_{mot}	$kgm^2 \cdot 10^{-4}$	459
Shaft torsional stiffness	C_t	Nm/rad	347000
Weight	m_{mot}	kg	76
Motor data with integrated brake:			
Moment of inertia (with brake)	J_{mot}	$kgm^2 \cdot 10^{-4}$	512
Shaft torsional stiffness (with brake)	C_t	Nm/rad	231000
Weight (with brake)	m_{Mot}	kg	87
Data with SINAMICS S120 Booksize / S120 Booksize Compact			
Rated converter current	$I_{N\ Inv}$	A	30
Maximum converter current	$I_{max\ Inv}$	A	90
Max. torque converter	$M_{max\ Inv}$	Nm	235
Max. permissible speed converter	$n_{max\ Inv}$	rpm	2850
The rated data are valid for a 600 V DC-link voltage			

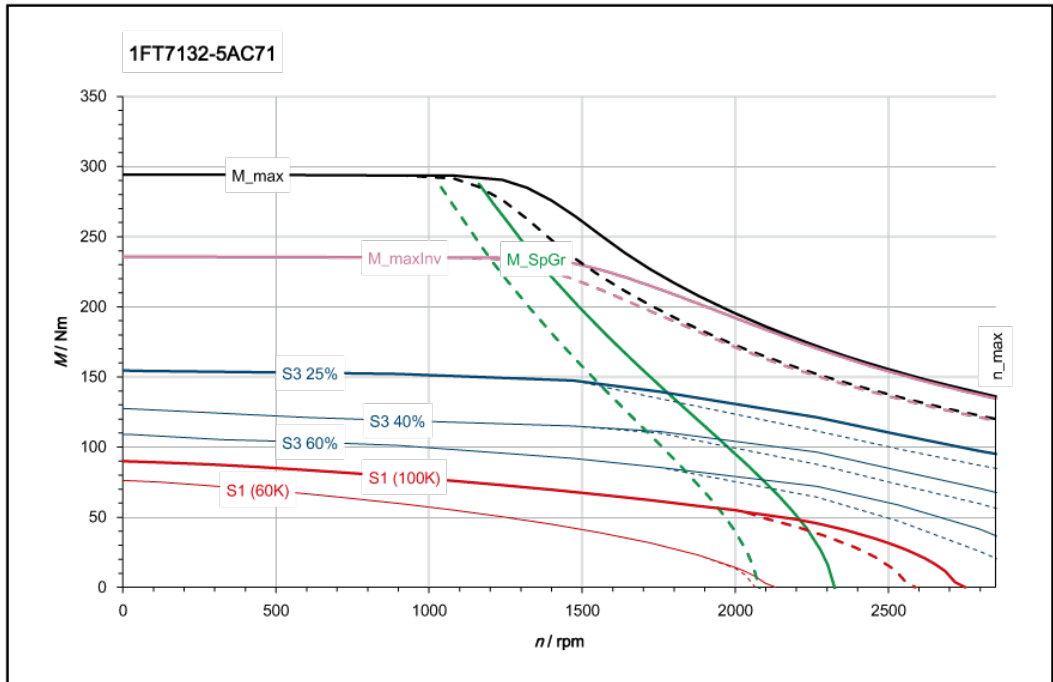

[———] SINAMICS ALM 400 V (600 V DC)
 [- - - -] SINAMICS BLM/SLM 400 V (540 V DC)

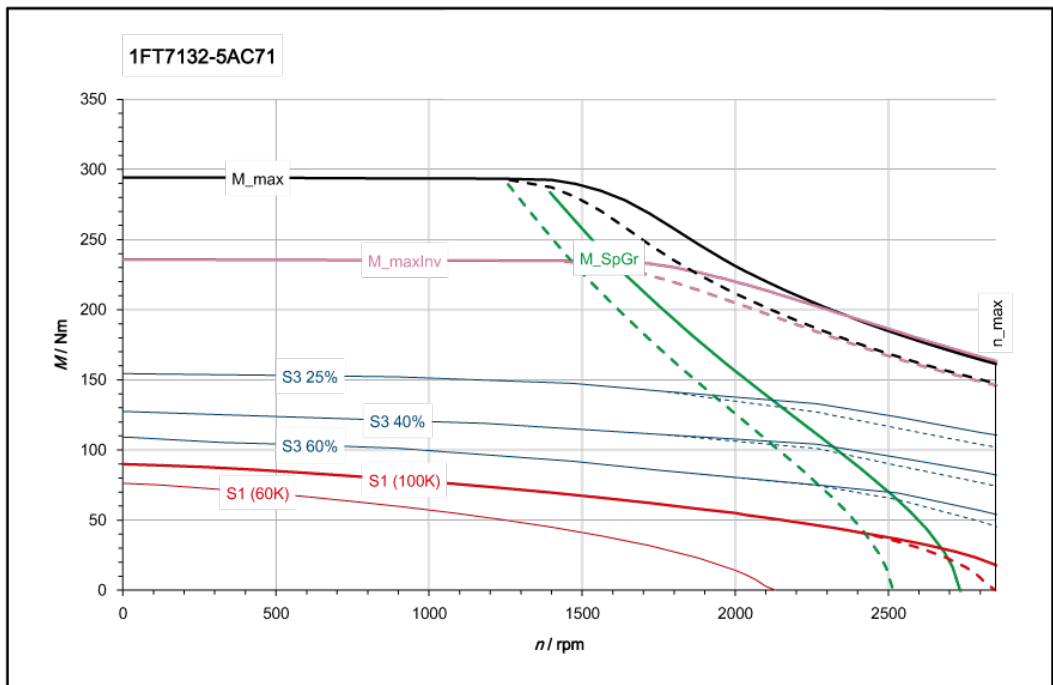

[———] SINAMICS ALM 480 V (720 V DC)
 [- - - -] SINAMICS BLM/SLM 480 V (650 V DC)

Three-phase servomotor 1FT7132-5AF71			
Technical specifications	Symbol	Unit	Value
Configuration data:			
Rated speed	n_N	rpm	3000
Rated torque (100K)	$M_{N(100K)}$	Nm	27.0
Rated current (100K)	$I_{N(100K)}$	A	14.0
Static torque (100K)	$M_{0(100K)}$	Nm	90
Stall current (100K)	$I_{0(100K)}$	A	43.5
Static torque (60K)	$M_{0(60K)}$	Nm	75
Stall current (60K)	$I_{0(60K)}$	A	36.0
Optimum operating point:			
Optimum speed	n_{opt}	rpm	2150
Optimum power	P_{opt}	kW	12.0
Limiting data:			
Max. permissible speed (mech.)	$n_{max\ mech}$	rpm	3600
Maximum torque	M_{max}	Nm	290
Maximum current	I_{max}	A	172
Motor data:			
No. of poles	2p		8
Torque constant (100K)	k_T	Nm/A	2.08
Voltage constant (at 20 °C)	k_E	V/1000 rpm	137.0
Winding resistance (at 20 °C)	R_{Str}	W	0.0625
Rotating field inductance	L_D	mH	2.0
Electrical time constant	T_{el}	ms	32
Mechanical time constant	T_{mech}	ms	2.0
Thermal time constant	T_{th}	min	75
Moment of inertia	J_{mot}	$kgm^2 \cdot 10^{-4}$	459
Shaft torsional stiffness	C_t	Nm/rad	347000
Weight	m_{mot}	kg	77
Motor data with integrated brake:			
Moment of inertia (with brake)	J_{mot}	$kgm^2 \cdot 10^{-4}$	512
Shaft torsional stiffness (with brake)	C_t	Nm/rad	231000
Weight (with brake)	m_{Mot}	kg	88
Data with SINAMICS S120 Booksize / S120 Booksize Compact			
Rated converter current	$I_{N\ Inv}$	A	45
Maximum converter current	$I_{max\ Inv}$	A	90
Max. torque converter	$M_{max\ Inv}$	Nm	176.5
Max. permissible speed converter	$n_{max\ Inv}$	rpm	3600
The rated data are valid for a 600 V DC-link voltage			

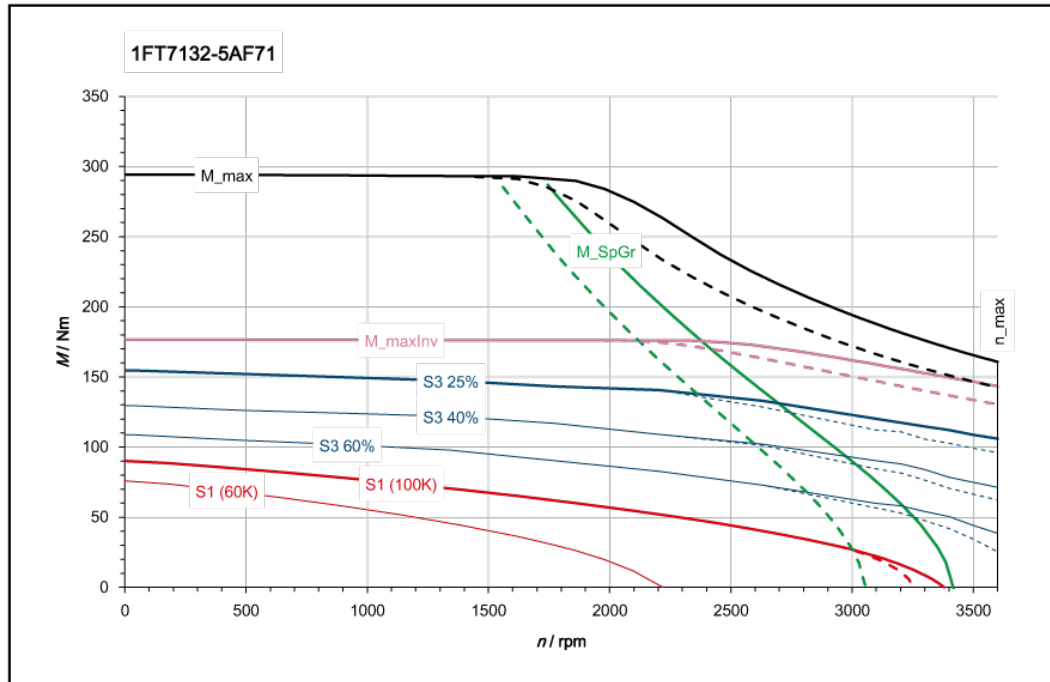

[———] SINAMICS ALM 400 V (600 V DC)
 [- - - -] SINAMICS BLM/SLM 400 V (540 V DC)

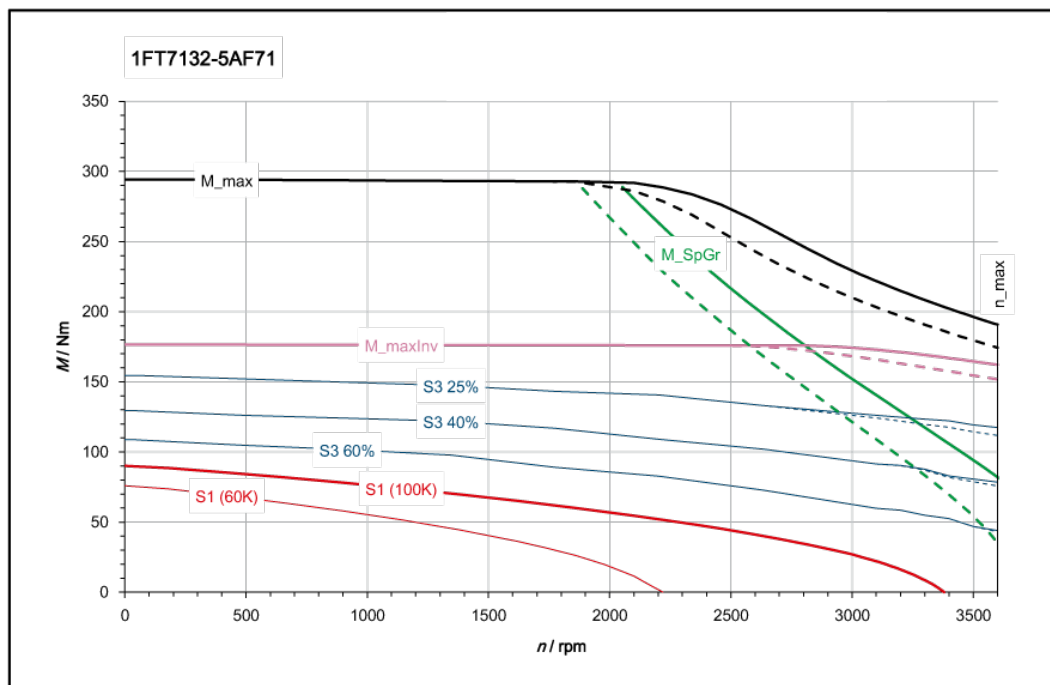

[———] SINAMICS ALM 480 V (720 V DC)
 [- - - -] SINAMICS BLM/SLM 480 V (650 V DC)

6.3.1.17 1FT7134-_A

Three-phase servomotor 1FT7134-5AB71			
Technical specifications	Symbol	Unit	Value
Configuration data:			
Rated speed	n_N	rpm	1500
Rated torque (100K)	$M_{N(100K)}$	Nm	82
Rated current (100K)	$I_{N(100K)}$	A	22.0
Static torque (100K)	$M_{0(100K)}$	Nm	118
Stall current (100K)	$I_{0(100K)}$	A	30.0
Static torque (60K)	$M_{0(60K)}$	Nm	100
Stall current (60K)	$I_{0(60K)}$	A	25.5
Optimum operating point:			
Optimum speed	n_{opt}	rpm	1500
Optimum power	P_{opt}	kW	12.9
Limiting data:			
Max. permissible speed (mech.)	$n_{max\ mech}$	rpm	3600
Maximum torque	M_{max}	Nm	390
Maximum current	I_{max}	A	122
Motor data:			
No. of poles	2p		8
Torque constant (100K)	k_T	Nm/A	3.92
Voltage constant (at 20 °C)	k_E	V/1000 rpm	258
Winding resistance (at 20 °C)	R_{Str}	W	0.144
Rotating field inductance	L_D	mH	5.2
Electrical time constant	T_{el}	ms	36
Mechanical time constant	T_{mech}	ms	1.7
Thermal time constant	T_{th}	min	80
Moment of inertia	J_{mot}	$kgm^2 \cdot 10^{-4}$	604
Shaft torsional stiffness	C_t	Nm/rad	323000
Weight	m_{mot}	kg	92
Motor data with integrated brake:			
Moment of inertia (with brake)	J_{mot}	$kgm^2 \cdot 10^{-4}$	657
Shaft torsional stiffness (with brake)	C_t	Nm/rad	220000
Weight (with brake)	m_{Mot}	kg	103
Data with SINAMICS S120 Booksize / S120 Booksize Compact			
Rated converter current	$I_{N\ Inv}$	A	30
Maximum converter current	$I_{max\ Inv}$	A	90
Max. torque (converter operation)	$M_{max\ Inv}$	Nm	305
Max. permissible speed (converter operation)	$n_{max\ Inv}$	rpm	2200
The rated data are valid for a 600 V DC-link voltage			

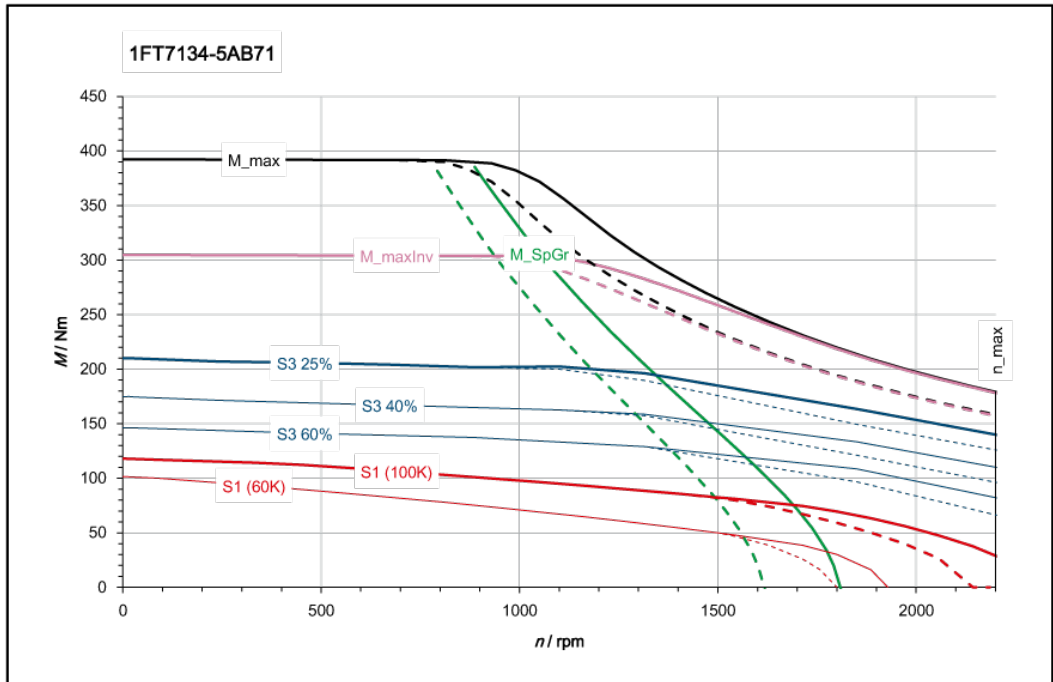

[———] SINAMICS ALM 400 V (600 V DC)
 [- - - -] SINAMICS BLM/SLM 400 V (540 V DC)

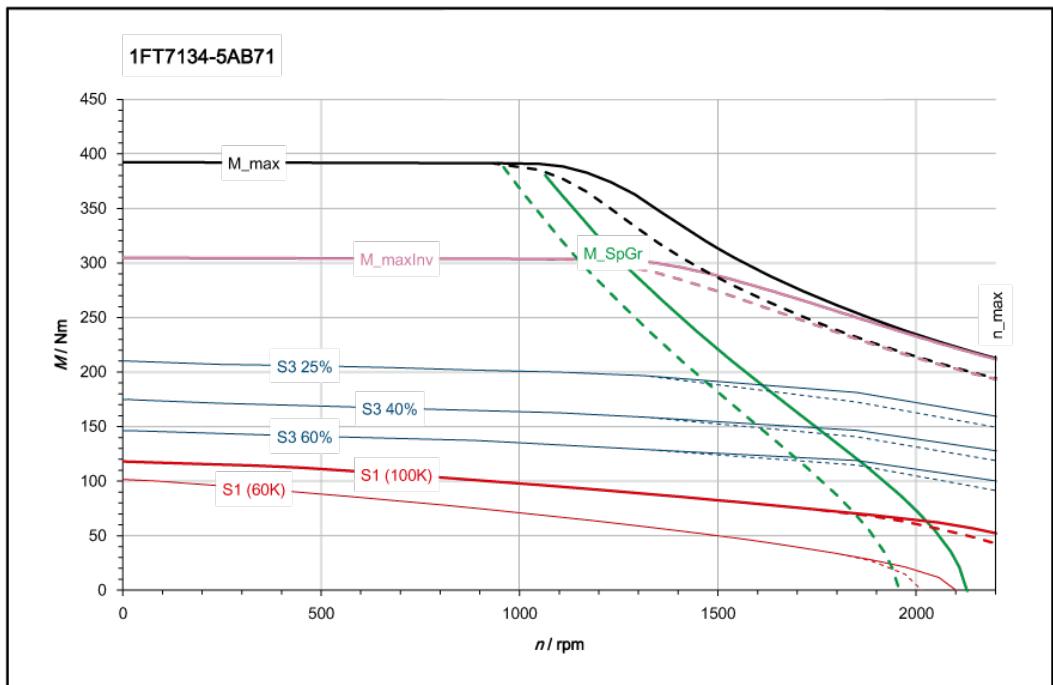

[———] SINAMICS ALM 480 V (720 V DC)
 [- - - -] SINAMICS BLM/SLM 480 V (650 V DC)

Three-phase servomotor 1FT7134-5AC71			
Technical specifications	Symbol	Unit	Value
Configuration data:			
Rated speed	n_N	rpm	2000
Rated torque (100K)	$M_{N(100K)}$	Nm	66
Rated current (100K)	$I_{N(100K)}$	A	21
Static torque (100K)	$M_{0(100K)}$	Nm	118
Stall current (100K)	$I_{0(100K)}$	A	36.0
Static torque (60K)	$M_{0(60K)}$	Nm	100
Stall current (60K)	$I_{0(60K)}$	A	30.5
Optimum operating point:			
Optimum speed	n_{opt}	rpm	1880
Optimum power	P_{opt}	kW	14.0
Limiting data:			
Max. permissible speed (mech.)	$n_{max\ mech}$	rpm	3600
Maximum torque	M_{max}	Nm	390
Maximum current	I_{max}	A	146
Motor data:			
No. of poles	2p		8
Torque constant (100K)	k_T	Nm/A	3.27
Voltage constant (at 20 °C)	k_E	V/1000 rpm	215
Winding resistance (at 20 °C)	R_{Str}	W	0.1
Rotating field inductance	L_D	mH	3.6
Electrical time constant	T_{el}	ms	36
Mechanical time constant	T_{mech}	ms	1.69
Thermal time constant	T_{th}	min	80
Moment of inertia	J_{mot}	$kgm^2 \cdot 10^{-4}$	604
Shaft torsional stiffness	C_t	Nm/rad	323000
Weight	m_{mot}	kg	92
Motor data with integrated brake:			
Moment of inertia (with brake)	J_{mot}	$kgm^2 \cdot 10^{-4}$	657
Shaft torsional stiffness (with brake)	C_t	Nm/rad	220000
Weight (with brake)	m_{Mot}	kg	103
Data with SINAMICS S120 Booksize / S120 Booksize Compact			
Rated converter current	$I_{N\ Inv}$	A	45
Maximum converter current	$I_{max\ Inv}$	A	90
Max. torque (converter operation)	$M_{max\ Inv}$	Nm	271.5
Max. permissible speed (converter operation)	$n_{max\ Inv}$	rpm	2650
The rated data are valid for a 600 V DC-link voltage			

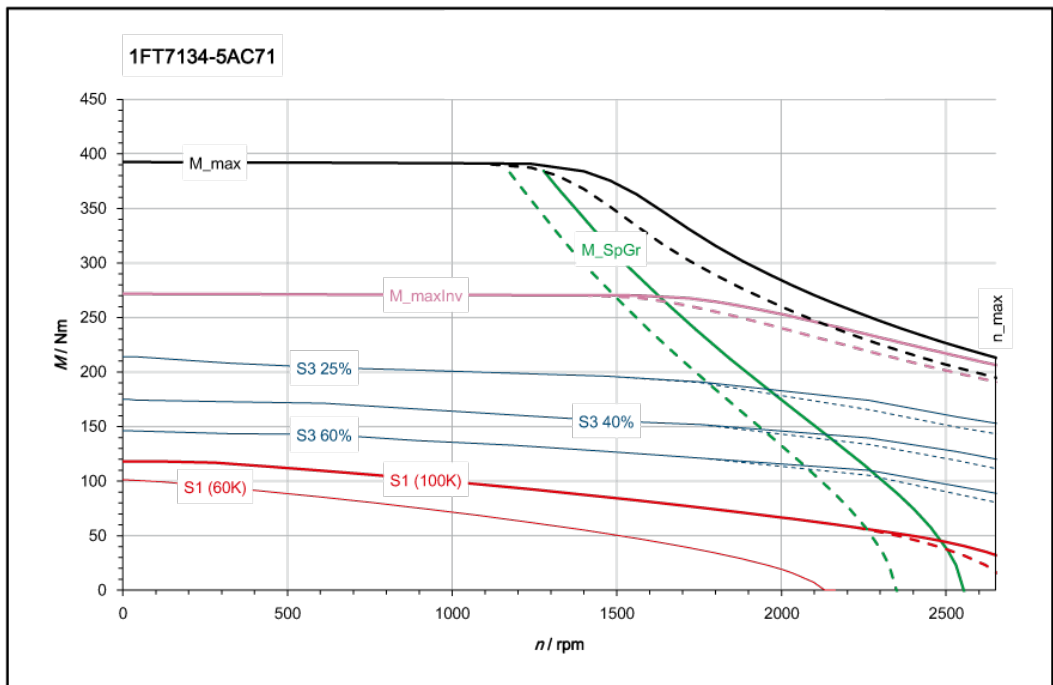
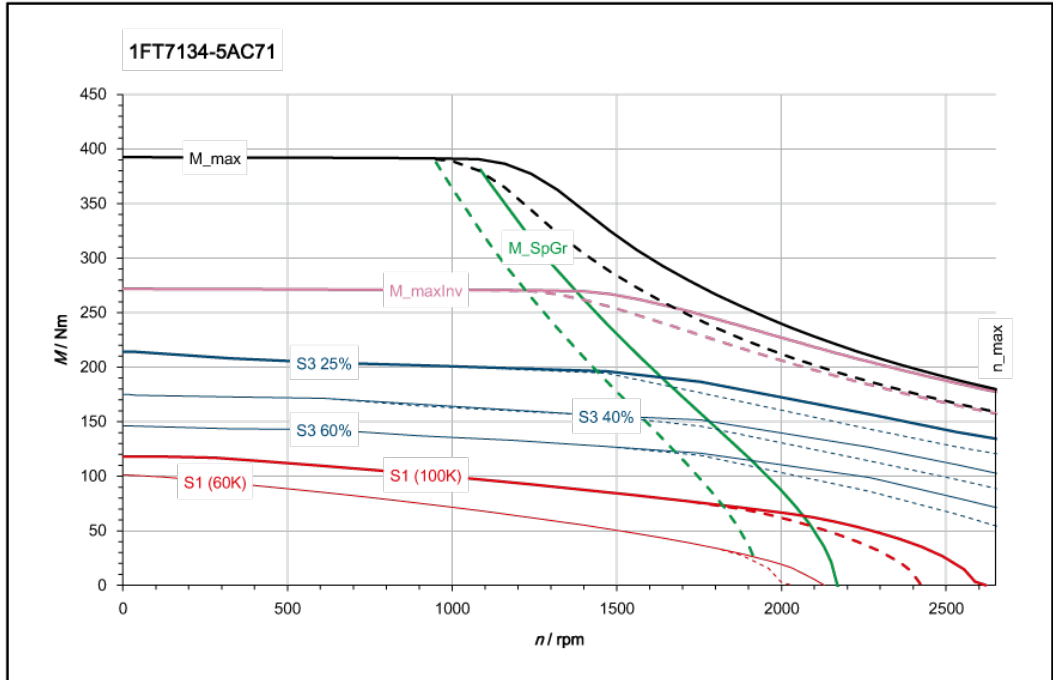

6.3.1.18 1FT7136_A

Three-phase servomotor 1FT7136-5AB71			
Technical specifications	Symbol	Unit	Value
Configuration data:			
Rated speed	n_N	rpm	1500
Rated torque (100K)	$M_{N(100K)}$	Nm	92
Rated current (100K)	$I_{N(100K)}$	A	25.0
Static torque (100K)	$M_{0(100K)}$	Nm	140
Stall current (100K)	$I_{0(100K)}$	A	36.0
Static torque (60K)	$M_{0(60K)}$	Nm	115
Stall current (60K)	$I_{0(60K)}$	A	29.5
Optimum operating point:			
Optimum speed	n_{opt}	rpm	1500
Optimum power	P_{opt}	kW	14.5
Limiting data:			
Max. permissible speed (mech.)	$n_{max\ mech}$	rpm	3600
Maximum torque	M_{max}	Nm	490
Maximum current	I_{max}	A	154
Motor data:			
No. of poles	2p		8
Torque constant (100K)	k_T	Nm/A	3.88
Voltage constant (at 20 °C)	k_E	V/1000 rpm	255
Winding resistance (at 20 °C)	R_{Str}	W	0.103
Rotating field inductance	L_D	mH	3.9
Electrical time constant	T_{el}	ms	38
Mechanical time constant	T_{mech}	ms	1.5
Thermal time constant	T_{th}	min	90
Moment of inertia	J_{mot}	$kgm^2 \cdot 10^{-4}$	748
Shaft torsional stiffness	C_t	Nm/rad	301000
Weight	m_{mot}	kg	108
Motor data with integrated brake:			
Moment of inertia (with brake)	J_{mot}	$kgm^2 \cdot 10^{-4}$	801
Shaft torsional stiffness (with brake)	C_t	Nm/rad	210000
Weight (with brake)	m_{Mot}	kg	119
Data with SINAMICS S120 Booksize / S120 Booksize Compact			
Rated converter current	$I_{N\ Inv}$	A	45
Maximum converter current	$I_{max\ Inv}$	A	90
Max. torque (converter operation)	$M_{max\ Inv}$	Nm	323
Max. permissible speed (converter operation)	$n_{max\ Inv}$	rpm	2250
The rated data are valid for a 600 V DC-link voltage			

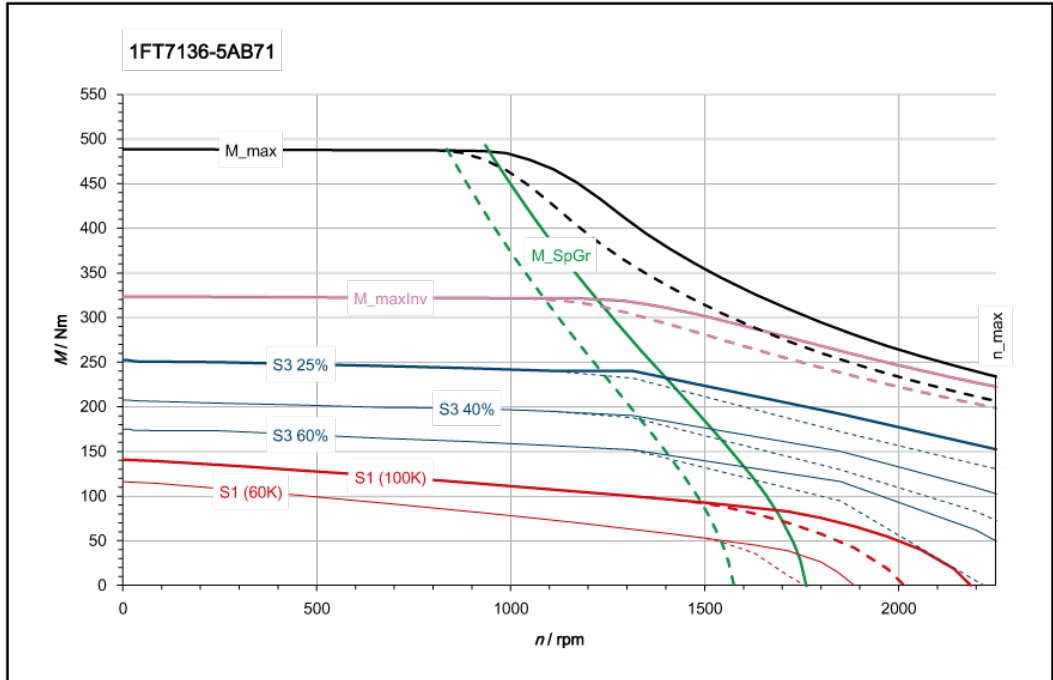

[———] SINAMICS ALM 400 V (600 V DC)
 [- - - -] SINAMICS BLM/SLM 400 V (540 V DC)

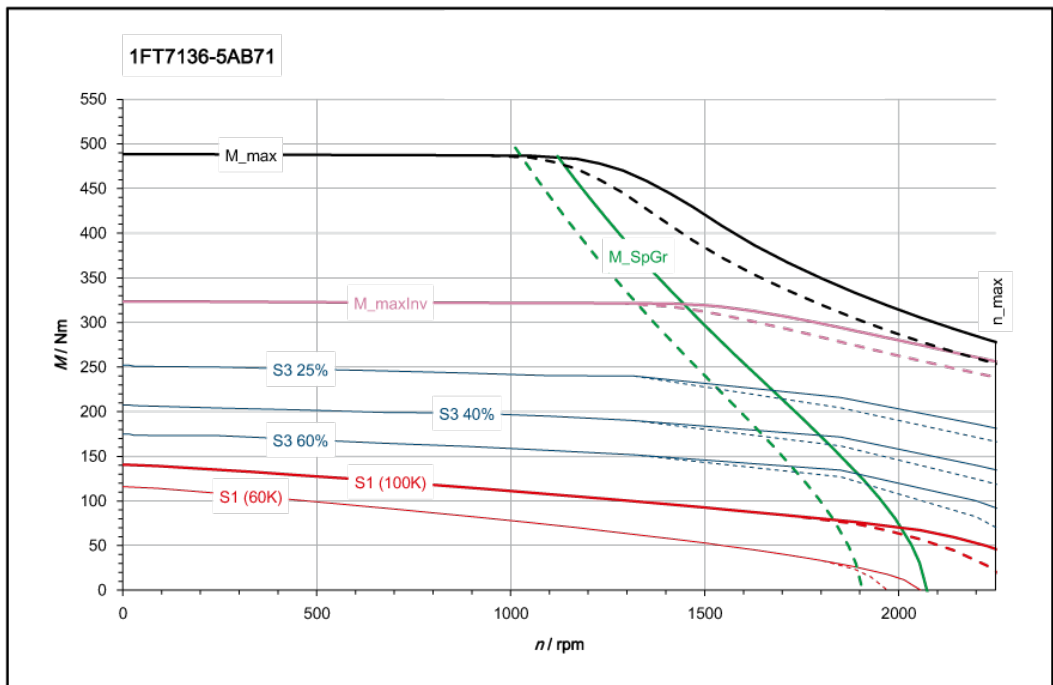

[———] SINAMICS ALM 480 V (720 V DC)
 [- - - -] SINAMICS BLM/SLM 480 V (650 V DC)

Three-phase servomotor 1FT7136-5AC71			
Technical specifications	Symbol	Unit	Value
Configuration data:			
Rated speed	n_N	rpm	2000
Rated torque (100K)	$M_{N(100K)}$	Nm	71
Rated current (100K)	$I_{N(100K)}$	A	23.0
Static torque (100K)	$M_{0(100K)}$	Nm	140
Stall current (100K)	$I_{0(100K)}$	A	43.0
Static torque (60K)	$M_{0(60K)}$	Nm	115
Stall current (60K)	$I_{0(60K)}$	A	35.0
Optimum operating point:			
Optimum speed	n_{opt}	rpm	1840
Optimum power	P_{opt}	kW	15.2
Limiting data:			
Max. permissible speed (mech.)	$n_{max\ mech}$	rpm	3600
Maximum torque	M_{max}	Nm	490
Maximum current	I_{max}	A	183
Motor data:			
No. of poles	2p		8
Torque constant (100K)	k_T	Nm/A	3.27
Voltage constant (at 20 °C)	k_E	V/1000 rpm	215
Winding resistance (at 20 °C)	R_{Str}	W	0.072
Rotating field inductance	L_D	mH	2.8
Electrical time constant	T_{el}	ms	39
Mechanical time constant	T_{mech}	ms	1.5
Thermal time constant	T_{th}	min	90
Moment of inertia	J_{mot}	$kgm^2 \cdot 10^{-4}$	748
Shaft torsional stiffness	C_t	Nm/rad	301000
Weight	m_{mot}	kg	109
Motor data with integrated brake:			
Moment of inertia (with brake)	J_{mot}	$kgm^2 \cdot 10^{-4}$	801
Shaft torsional stiffness (with brake)	C_t	Nm/rad	210000
Weight (with brake)	m_{Mot}	kg	120
Data with SINAMICS S120 Booksize / S120 Booksize Compact			
Rated converter current	$I_{N\ Inv}$	A	45
Maximum converter current	$I_{max\ Inv}$	A	90
Max. torque (converter operation)	$M_{max\ Inv}$	Nm	277.5
Max. permissible speed (converter operation)	$n_{max\ Inv}$	rpm	2650
The rated data are valid for a 600 V DC-link voltage			

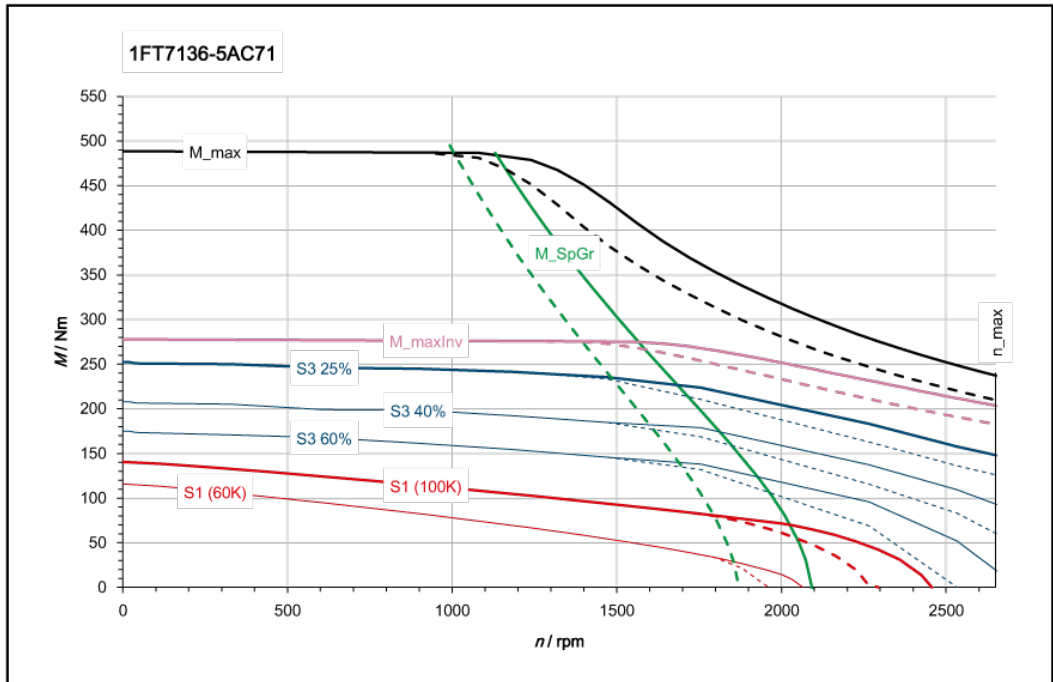

[———] SINAMICS ALM 400 V (600 V DC)
 [- - - -] SINAMICS BLM/SLM 400 V (540 V DC)

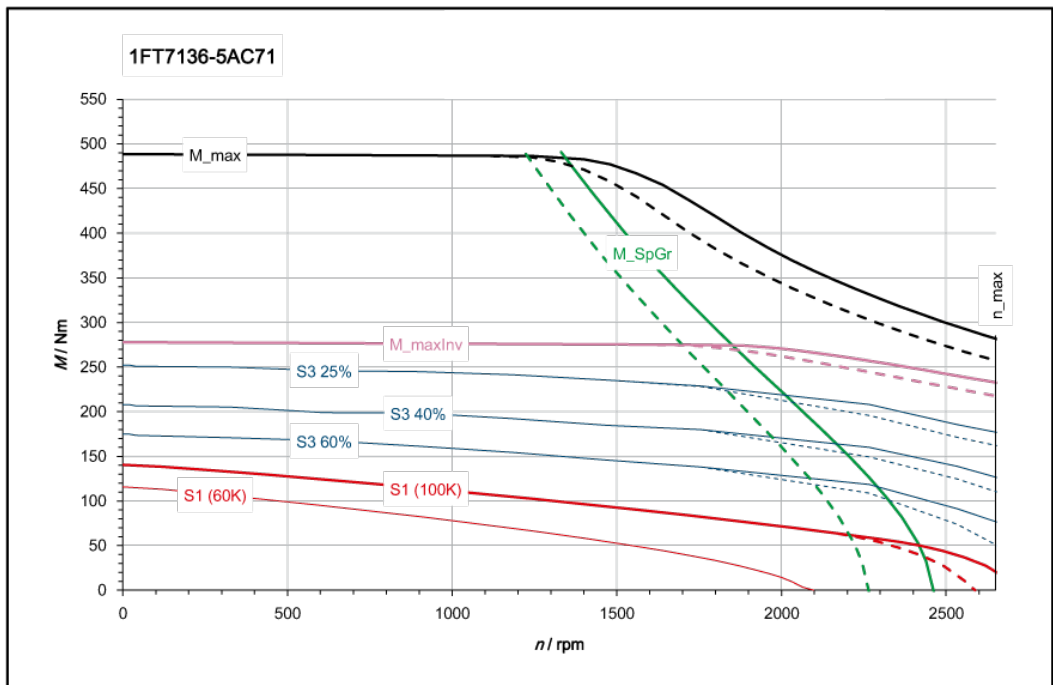

[———] SINAMICS ALM 480 V (720 V DC)
 [- - - -] SINAMICS BLM/SLM 480 V (650 V DC)

6.3.1.19 1FT7138-_A

Three-phase servomotor 1FT7138-5AB71			
Technical specifications	Symbol	Unit	Value
Configuration data:			
Rated speed	n_N	rpm	1500
Rated torque (100K)	$M_{N(100K)}$	Nm	108
Rated current (100K)	$I_{N(100K)}$	A	28.5
Static torque (100K)	$M_{0(100K)}$	Nm	170
Stall current (100K)	$I_{0(100K)}$	A	43.0
Static torque (60K)	$M_{0(60K)}$	Nm	140
Stall current (60K)	$I_{0(60K)}$	A	35.5
Optimum operating point:			
Optimum speed	n_{opt}	rpm	1500
Optimum power	P_{opt}	kW	17.0
Limiting data:			
Max. permissible speed (mech.)	$n_{max\ mech}$	rpm	3600
Maximum torque	M_{max}	Nm	590
Maximum current	I_{max}	A	183
Motor data:			
No. of poles	2p		8
Torque constant (100K)	k_T	Nm/A	3.95
Voltage constant (at 20 °C)	k_E	V/1000 rpm	260
Winding resistance (at 20 °C)	R_{Str}	W	0.0805
Rotating field inductance	L_D	mH	3.1
Electrical time constant	T_{el}	ms	39
Mechanical time constant	T_{mech}	ms	1.4
Thermal time constant	T_{th}	min	100
Moment of inertia	J_{mot}	$kgm^2 \cdot 10^{-4}$	896
Shaft torsional stiffness	C_t	Nm/rad	283000
Weight	m_{mot}	kg	124
Motor data with integrated brake:			
Moment of inertia (with brake)	J_{mot}	$kgm^2 \cdot 10^{-4}$	949
Shaft torsional stiffness (with brake)	C_t	Nm/rad	201000
Weight (with brake)	m_{Mot}	kg	135
Data with SINAMICS S120 Booksize / S120 Booksize Compact			
Rated converter current	$I_{N\ Inv}$	A	45
Maximum converter current	$I_{max\ Inv}$	A	90
Max. torque (converter operation)	$M_{max\ Inv}$	Nm	336
Max. permissible speed (converter operation)	$n_{max\ Inv}$	rpm	2200
The rated data are valid for a 600 V DC-link voltage			

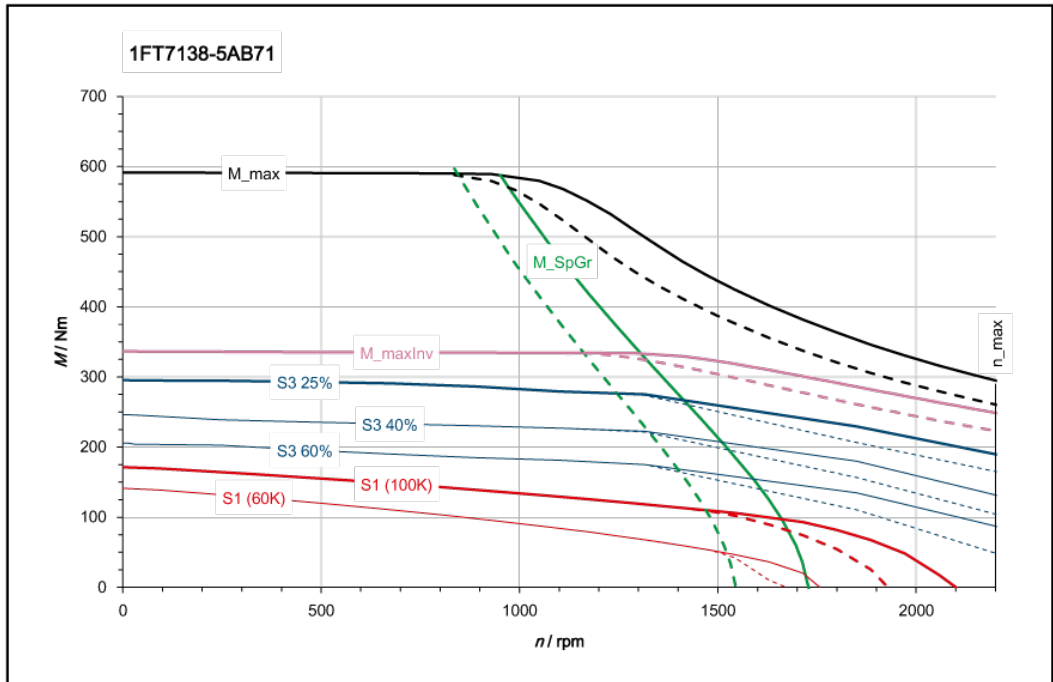

[———] SINAMICS ALM 400 V (600 V DC)
 [- - - -] SINAMICS BLM/SLM 400 V (540 V DC)

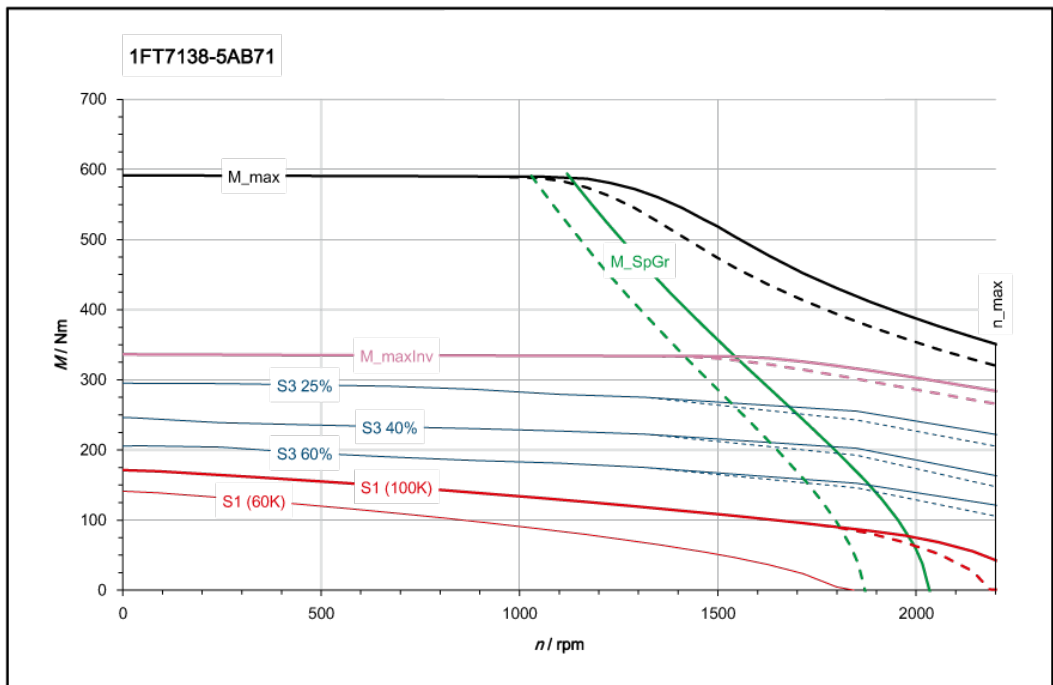

[———] SINAMICS ALM 480 V (720 V DC)
 [- - - -] SINAMICS BLM/SLM 480 V (650 V DC)

6.3.2 1FT7 Compact - forced ventilation

6.3.2.1 1FT7084_S

Three-phase servomotor 1FT7084 - 5SC7			
Technical specifications	Symbol	Unit	Value
Configuration data:			
Rated speed	n_N	rpm	2000
Rated torque (100K)	$M_{N(100K)}$	Nm	24
Rated current (100K)	$I_{N(100K)}$	A	13.5
Static torque (100K)	$M_{0(100K)}$	Nm	27
Stall current (100K)	$I_{0(100K)}$	A	15
Static torque (60K)	$M_{0(60K)}$	Nm	21.5
Stall current (60K)	$I_{0(60K)}$	A	12
Optimum operating point			
Optimum speed	n_{opt}	rpm	2000
Optimum power	P_{opt}	kW	5.0
Limiting data:			
Max. permissible speed (mech.)	$n_{max\ mech}$	rpm	8000
Maximum torque	M_{max}	Nm	81
Maximum current	I_{max}	A	55
Motor data:			
No. of poles	2p		10
Torque constant (100K)	k_T	Nm/A	1.8
Voltage constant (at 20 °C)	k_E	V/1000 rpm	115
Winding resistance (at 20 °C)	R_{Str}	W	0.345
Rotating field inductance	L_D	mH	5.4
Electrical time constant	T_{el}	ms	16
Mechanical time constant	T_{mech}	ms	1.4
Thermal time constant	T_{th}	min	35
Moment of inertia	J_{mot}	$kgm^2 \cdot 10^{-4}$	45
Shaft torsional stiffness	c_t	Nm/rad	88000
Weight	m_{mot}	kg	25
Motor data with integrated brake:			
Moment of inertia (with brake)	J_{mot}	$kgm^2 \cdot 10^{-4}$	60
Shaft torsional stiffness (with brake)	c_t	Nm/rad	65000
Weight (with brake)	m_{Mot}	kg	29
Data with SINAMICS S120 Booksize / S120 Booksize Compact			
Rated converter current	$I_{N\ Inv}$	A	18
Maximum converter current	$I_{max\ Inv}$	A	54
Max. torque (converter operation)	$M_{max\ Inv}$	Nm	80
Max. permissible speed (converter operation)	$n_{max\ Inv}$	rpm	5000
The rated data are valid for a 600 V DC-link voltage			

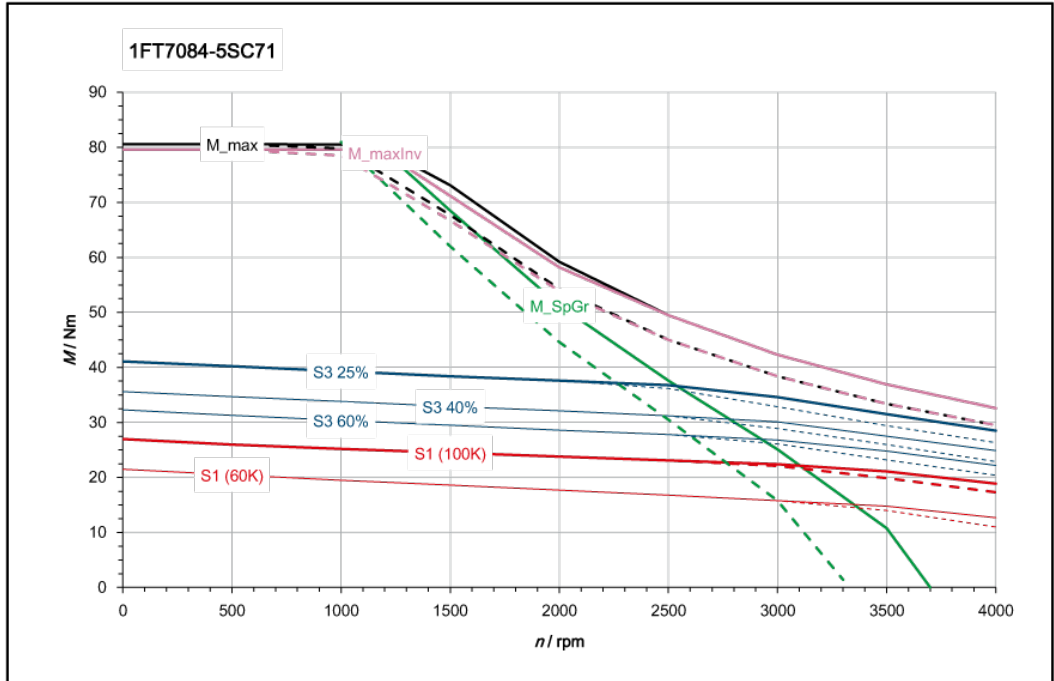

[———] SINAMICS ALM 400 V (600 V DC)
 [- - - -] SINAMICS BLM/SLM 400 V (540 V DC)

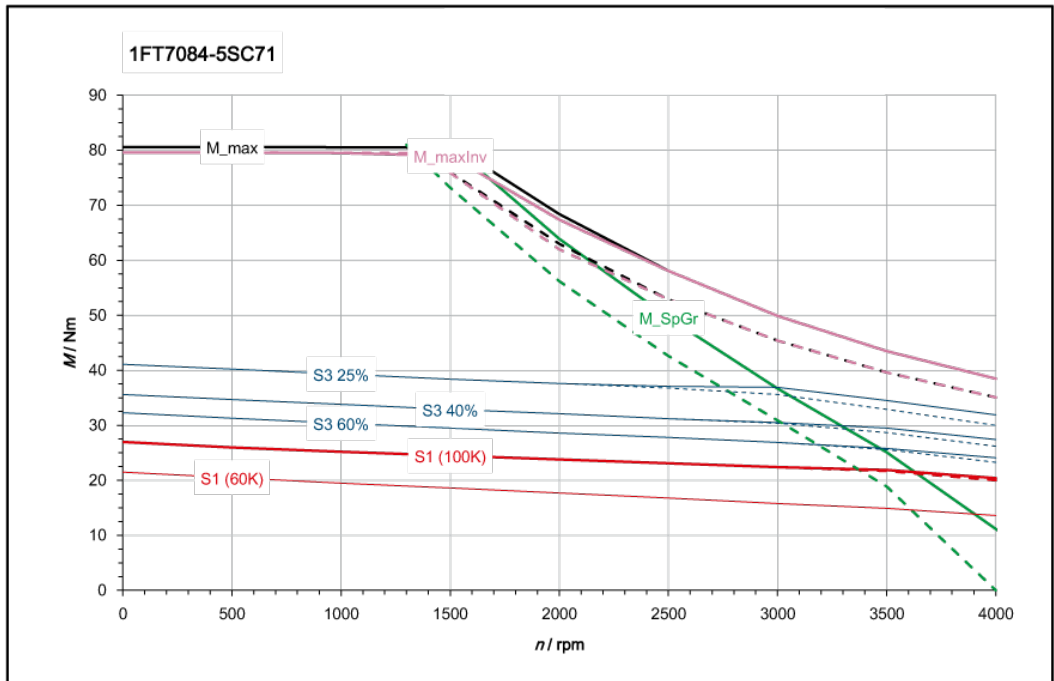

[———] SINAMICS ALM 480 V (720 V DC)
 [- - - -] SINAMICS BLM/SLM 480 V (650 V DC)

Three-phase servomotor 1FT7084 - 5SF7			
Technical specifications	Symbol	Unit	Value
Configuration data:			
Rated speed	n_N	rpm	3000
Rated torque (100K)	$M_{N(100K)}$	Nm	23
Rated current (100K)	$I_{N(100K)}$	A	18.5
Static torque (100K)	$M_{0(100K)}$	Nm	27
Stall current (100K)	$I_{0(100K)}$	A	21
Static torque (60K)	$M_{0(60K)}$	Nm	21.5
Stall current (60K)	$I_{0(60K)}$	A	16.5
Optimum operating point			
Optimum speed	n_{opt}	rpm	3000
Optimum power	P_{opt}	kW	7.2
Limiting data			
Max. permissible speed (mech.)	$n_{max\ mech}$	rpm	8000
Maximum torque	M_{max}	Nm	81
Maximum current	I_{max}	A	77
Motor data:			
No. of poles	2p		10
Torque constant (100K)	k_T	Nm/A	1.30
Voltage constant (at 20 °C)	k_E	V/1000 rpm	83
Winding resistance (at 20 °C)	R_{Str}	W	0.18
Rotating field inductance	L_D	mH	2.8
Electrical time constant	T_{el}	ms	16
Mechanical time constant	T_{mech}	ms	1.4
Thermal time constant	T_{th}	min	35
Moment of inertia	J_{mot}	$kgm^2 \cdot 10^{-4}$	45
Shaft torsional stiffness	C_t	Nm/rad	88000
Weight	m_{mot}	kg	25
Motor data with integrated brake:			
Moment of inertia (with brake)	J_{mot}	$kgm^2 \cdot 10^{-4}$	60
Shaft torsional stiffness (with brake)	C_t	Nm/rad	65000
Weight (with brake)	m_{Mot}	kg	29
Data with SINAMICS S120 Booksize			
Rated converter current	$I_{N\ Inv}$	A	24
Maximum converter current	$I_{max\ Inv}$	A	72
Max. torque (converter operation)	$M_{max\ Inv}$	Nm	77
Max. permissible speed (converter operation)	$n_{max\ Inv}$	rpm	7000
The rated data are valid for a 600 V DC-link voltage			

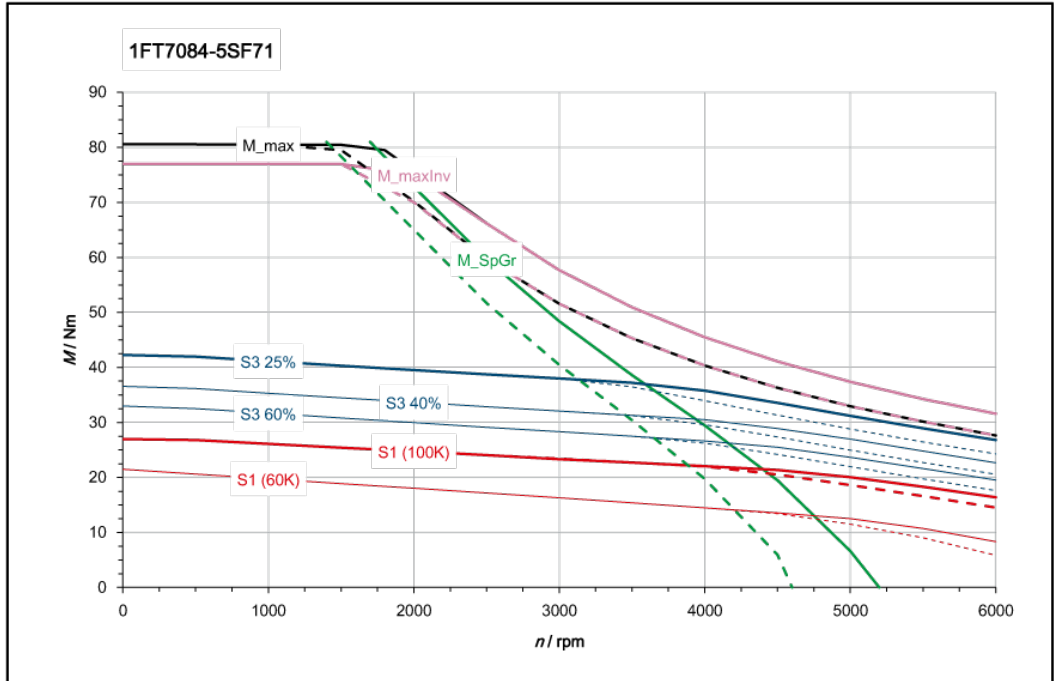

[———] SINAMICS ALM 400 V (600 V DC)
[- - - -] SINAMICS BLM/SLM 400 V (540 V DC)

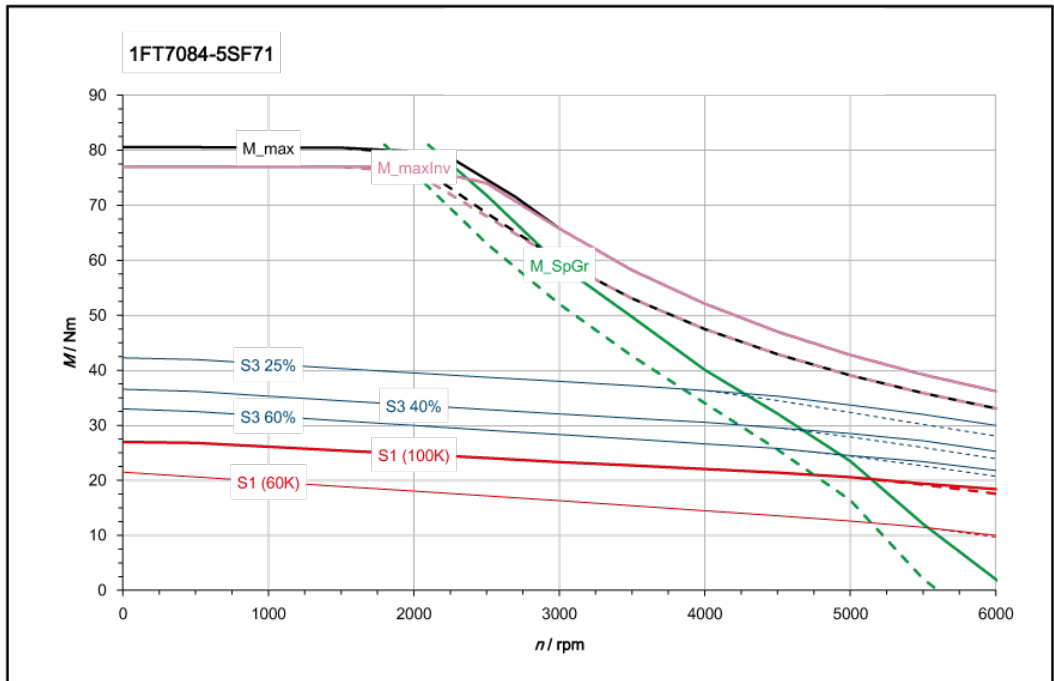

[———] SINAMICS ALM 480 V (720 V DC)
[- - - -] SINAMICS BLM/SLM 480 V (650 V DC)

Three-phase servomotor 1FT7084 - 5SH7			
Technical specifications	Symbol	Unit	Value
Configuration data:			
Rated speed	n_N	rpm	4500
Rated torque (100K)	$M_{N(100K)}$	Nm	21
Rated current (100K)	$I_{N(100K)}$	A	24.5
Static torque (100K)	$M_{0(100K)}$	Nm	27
Stall current (100K)	$I_{0(100K)}$	A	30.5
Static torque (60K)	$M_{0(60K)}$	Nm	21.5
Stall current (60K)	$I_{0(60K)}$	A	24.0
Optimum operating point:			
Optimum speed	n_{opt}	rpm	4500
Optimum power	P_{opt}	kW	9.9
Limiting data:			
Max. permissible speed (mech.)	$n_{max\ mech}$	rpm	8000
Maximum torque	M_{max}	Nm	81
Maximum current	I_{max}	A	114
Motor data:			
No. of poles	2p		10
Torque constant (100K)	k_T	Nm/A	0.88
Voltage constant (at 20 °C)	k_E	V/1000 rpm	56
Winding resistance (at 20 °C)	R_{Str}	W	0.08
Rotating field inductance	L_D	mH	1.4
Electrical time constant	T_{el}	ms	18
Mechanical time constant	T_{mech}	ms	1.4
Thermal time constant	T_{th}	min	35
Moment of inertia	J_{mot}	$kgm^2 \cdot 10^{-4}$	45
Shaft torsional stiffness	C_t	Nm/rad	88000
Weight	m_{mot}	kg	25
Motor data with integrated brake:			
Moment of inertia (with brake)	J_{mot}	$kgm^2 \cdot 10^{-4}$	60
Shaft torsional stiffness (with brake)	C_t	Nm/rad	65000
Weight (with brake)	m_{Mot}	kg	29
Data with SINAMICS S120 Booksize			
Rated converter current	$I_{N\ Inv}$	A	30
Maximum converter current	$I_{max\ Inv}$	A	90
Max. torque (converter operation)	$M_{max\ Inv}$	Nm	67
Max. permissible speed (converter operation)	$n_{max\ Inv}$	rpm	8000
The rated data are valid for a 600 V DC-link voltage			

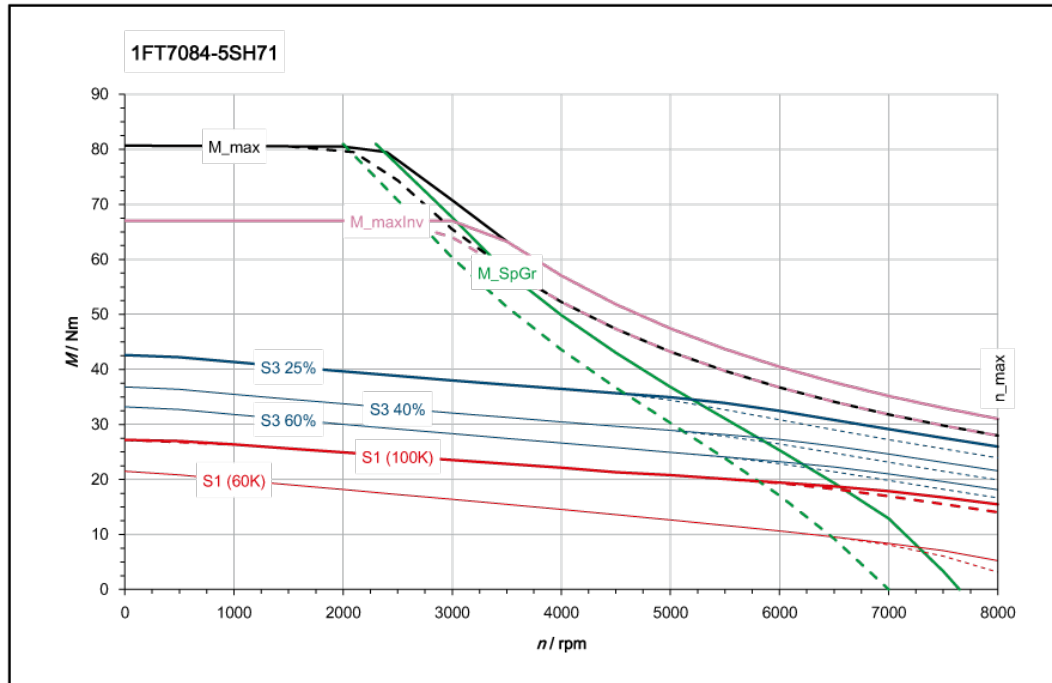

[———] SINAMICS ALM 400 V (600 V DC)
 [- - - -] SINAMICS BLM/SLM 400 V (540 V DC)

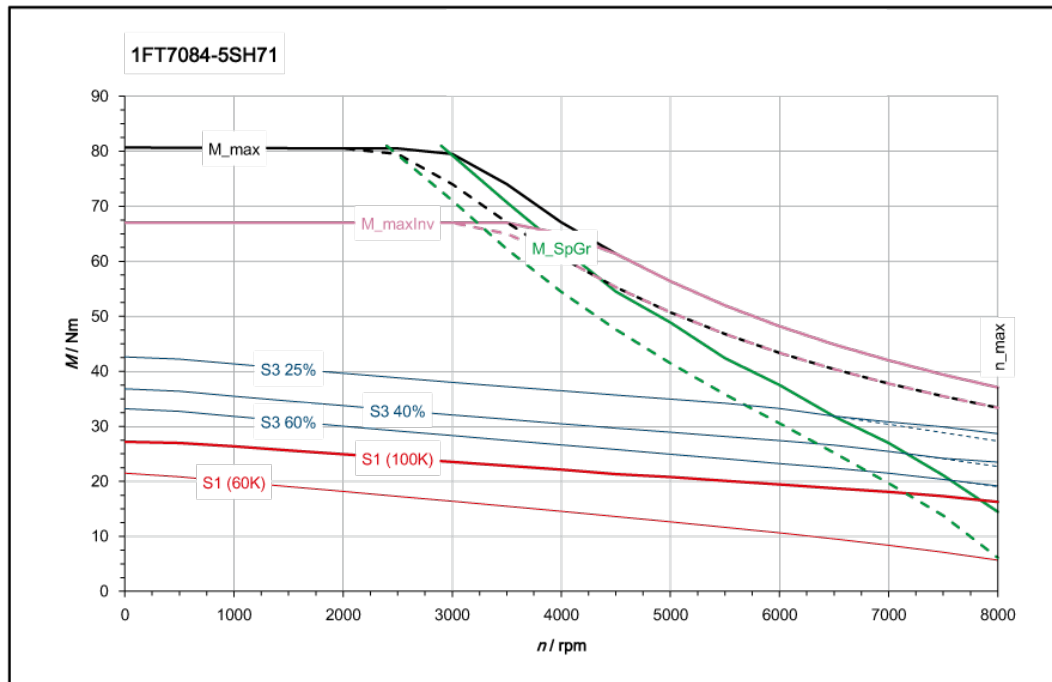

[———] SINAMICS ALM 480 V (720 V DC)
 [- - - -] SINAMICS BLM/SLM 480 V (650 V DC)

6.3.2.2 1FT7086_S

Three-phase servomotor 1FT7086 - 5SC7			
Technical specifications	Symbol	Unit	Value
Configuration data:			
Rated speed	n_N	rpm	2000
Rated torque (100K)	$M_{N(100K)}$	Nm	32
Rated current (100K)	$I_{N(100K)}$	A	17
Static torque (100K)	$M_{0(100K)}$	Nm	36
Stall current (100K)	$I_{0(100K)}$	A	19.5
Static torque (60K)	$M_{0(60K)}$	Nm	30
Stall current (60K)	$I_{0(60K)}$	A	16
Optimum operating point:			
Optimum speed	n_{opt}	rpm	2000
Optimum power	P_{opt}	kW	6.7
Limiting data:			
Max. permissible speed (mech.)	$n_{max\ mech}$	rpm	8000
Maximum torque	M_{max}	Nm	120
Maximum current	I_{max}	A	74
Motor data:			
No. of poles	2p		10
Torque constant (100K)	k_T	Nm/A	1.86
Voltage constant (at 20 °C)	k_E	V/1000 rpm	119
Winding resistance (at 20 °C)	R_{Str}	W	0.245
Rotating field inductance	L_D	mH	4.4
Electrical time constant	T_{el}	ms	18
Mechanical time constant	T_{mech}	ms	1.3
Thermal time constant	T_{th}	min	40
Moment of inertia	J_{mot}	$kgm^2 \cdot 10^{-4}$	64
Shaft torsional stiffness	C_t	Nm/rad	74000
Weight	m_{mot}	kg	32
Motor data with integrated brake:			
Moment of inertia (with brake)	J_{mot}	$kgm^2 \cdot 10^{-4}$	79
Shaft torsional stiffness (with brake)	C_t	Nm/rad	57000
Weight (with brake)	m_{Mot}	kg	36
Data with SINAMICS S120 Booksize			
Rated converter current	$I_{N\ Inv}$	A	24
Maximum converter current	$I_{max\ Inv}$	A	72
Max. torque (converter operation)	$M_{max\ Inv}$	Nm	117
Max. permissible speed (converter operation)	$n_{max\ Inv}$	rpm	4900
The rated data are valid for a 600 V DC-link voltage			

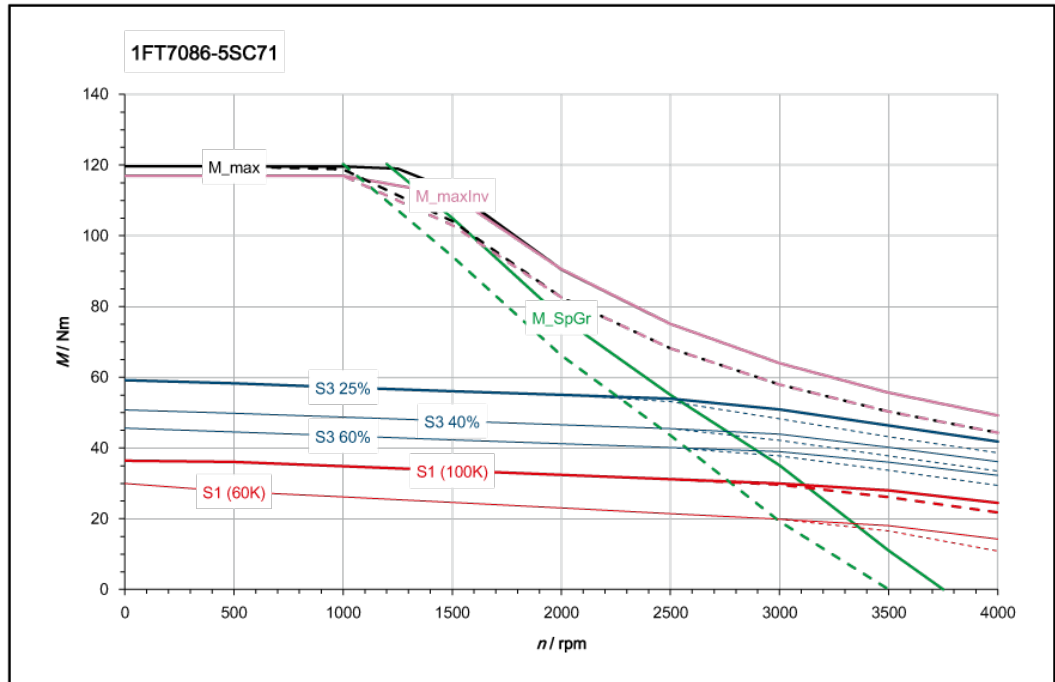

[———] SINAMICS ALM 400 V (600 V DC)
 [- - - -] SINAMICS BLM/SLM 400 V (540 V DC)

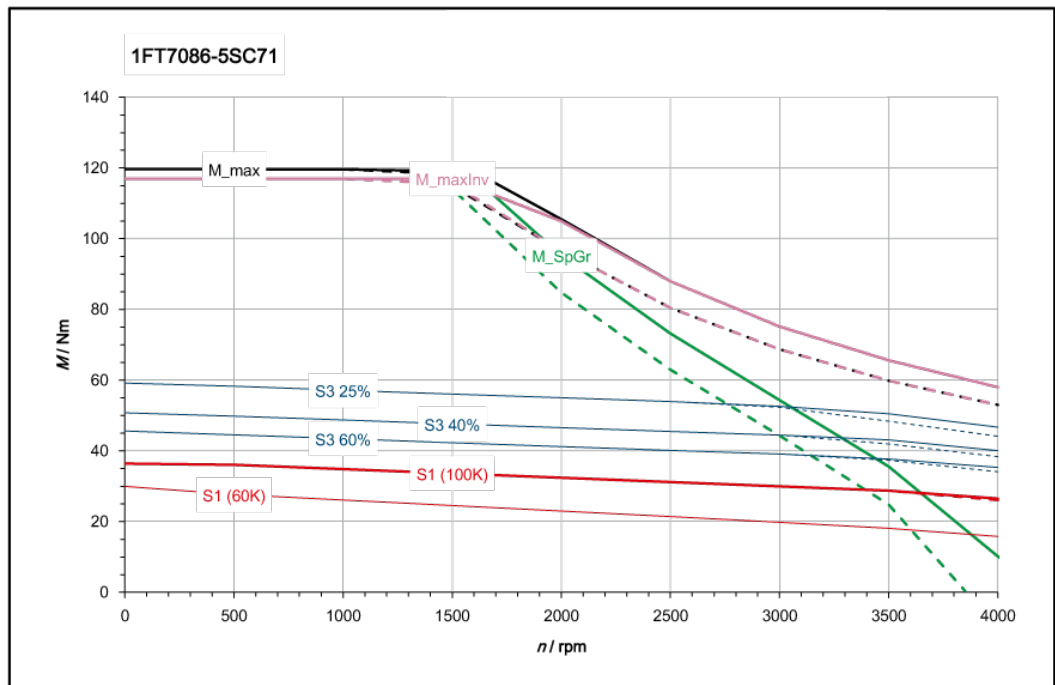

[———] SINAMICS ALM 480 V (720 V DC)
 [- - - -] SINAMICS BLM/SLM 480 V (650 V DC)

Three-phase servomotor 1FT7086 - 5SF7			
Technical specifications	Symbol	Unit	Value
Configuration data:			
Rated speed	n_N	rpm	3000
Rated torque (100K)	$M_{N(100K)}$	Nm	29
Rated current (100K)	$I_{N(100K)}$	A	24
Static torque (100K)	$M_{0(100K)}$	Nm	36
Stall current (100K)	$I_{0(100K)}$	A	29
Static torque (60K)	$M_{0(60K)}$	Nm	30
Stall current (60K)	$I_{0(60K)}$	A	24
Optimum operating point:			
Optimum speed	n_{opt}	rpm	3000
Optimum power	P_{opt}	kW	9.1
Limiting data:			
Max. permissible speed (mech.)	$n_{max\ mech}$	rpm	8000
Maximum torque	M_{max}	Nm	120
Maximum current	I_{max}	A	110
Motor data:			
No. of poles	$2p$		10
Torque constant (100K)	k_T	Nm/A	1.25
Voltage constant (at 20 °C)	k_E	V/1000 rpm	80
Winding resistance (at 20 °C)	R_{Str}	W	0.113
Rotating field inductance	L_D	mH	2
Electrical time constant	T_{el}	ms	18
Mechanical time constant	T_{mech}	ms	1.4
Thermal time constant	T_{th}	min	40
Moment of inertia	J_{mot}	$kgm^2 \cdot 10^{-4}$	64
Shaft torsional stiffness	C_t	Nm/rad	74000
Weight	m_{mot}	kg	32
Motor data with integrated brake:			
Moment of inertia (with brake)	J_{mot}	$kgm^2 \cdot 10^{-4}$	79
Shaft torsional stiffness (with brake)	C_t	Nm/rad	57000
Weight (with brake)	m_{Mot}	kg	36
Data with SINAMICS S120 Booksize			
Rated converter current	$I_{N\ Inv}$	A	30
Maximum converter current	$I_{max\ Inv}$	A	90
Max. torque (converter operation)	$M_{max\ Inv}$	Nm	101
Max. permissible speed (converter operation)	$n_{max\ Inv}$	rpm	7200
The rated data are valid for a 600 V DC-link voltage			

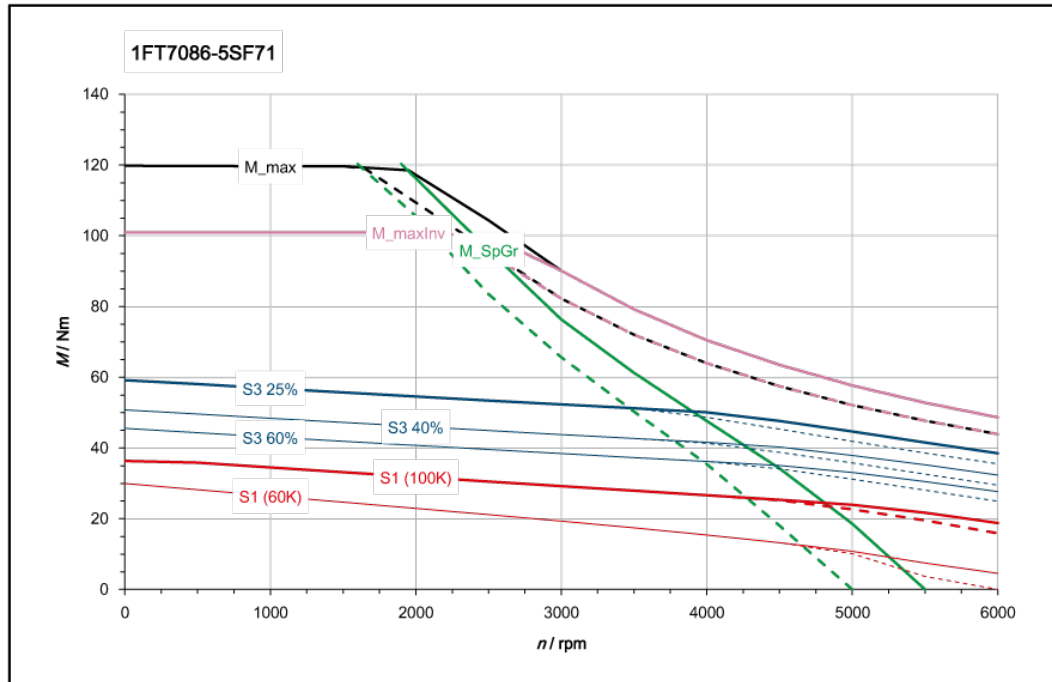

[———] SINAMICS ALM 400 V (600 V DC)
 [- - - -] SINAMICS BLM/SLM 400 V (540 V DC)

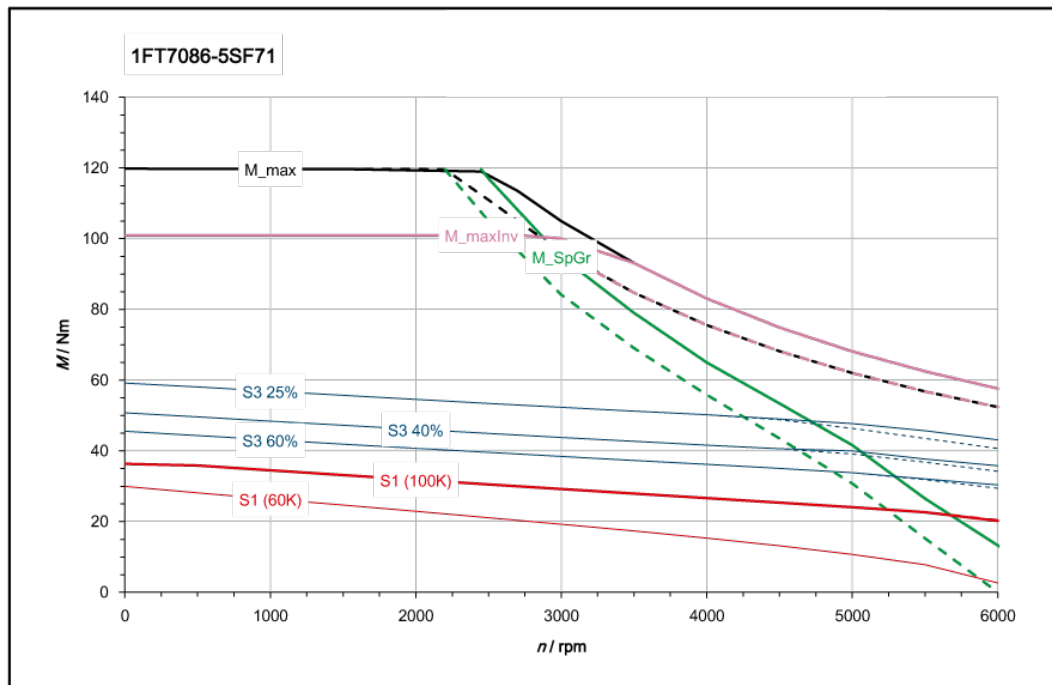

[———] SINAMICS ALM 480 V (720 V DC)
 [- - - -] SINAMICS BLM/SLM 480 V (650 V DC)

Three-phase servomotor 1FT7086 - 5SH7			
Technical specifications	Symbol	Unit	Value
Configuration data			
Rated speed	n_N	rpm	4500
Rated torque (100K)	$M_{N(100K)}$	Nm	25
Rated current (100K)	$I_{N(100K)}$	A	25
Static torque (100K)	$M_{0(100K)}$	Nm	36
Stall current (100K)	$I_{0(100K)}$	A	34
Static torque (60K)	$M_{0(60K)}$	Nm	30
Stall current (60K)	$I_{0(60K)}$	A	28
Optimum operating point:			
Optimum speed	n_{opt}	rpm	4500
Optimum power	P_{opt}	kW	11.8
Limiting data:			
Max. permissible speed (mech.)	$n_{max\ mech}$	rpm	8000
Maximum torque	M_{max}	Nm	120
Maximum current	I_{max}	A	131
Motor data:			
No. of poles	$2p$		10
Torque constant (100K)	k_T	Nm/A	1.05
Voltage constant (at 20 °C)	k_E	V/1000 rpm	67
Winding resistance (at 20 °C)	R_{Str}	W	0.085
Rotating field inductance	L_D	mH	1.4
Electrical time constant	T_{el}	ms	16
Mechanical time constant	T_{mech}	ms	1.5
Thermal time constant	T_{th}	min	40
Moment of inertia	J_{mot}	$kgm^2 \cdot 10^{-4}$	64
Shaft torsional stiffness	C_t	Nm/rad	74000
Weight	m_{mot}	kg	32
Motor data with integrated brake:			
Moment of inertia (with brake)	J_{mot}	$kgm^2 \cdot 10^{-4}$	79
Shaft torsional stiffness (with brake)	C_t	Nm/rad	57000
Weight (with brake)	m_{Mot}	kg	36
Data with SINAMICS S120 Booksize			
Rated converter current	$I_{N\ Inv}$	A	45
Maximum converter current	$I_{max\ Inv}$	A	90
Max. torque (converter operation)	$M_{max\ Inv}$	Nm	88.5
Max. permissible speed (converter operation)	$n_{max\ Inv}$	rpm	8000
The rated data are valid for a 600 V DC-link voltage			

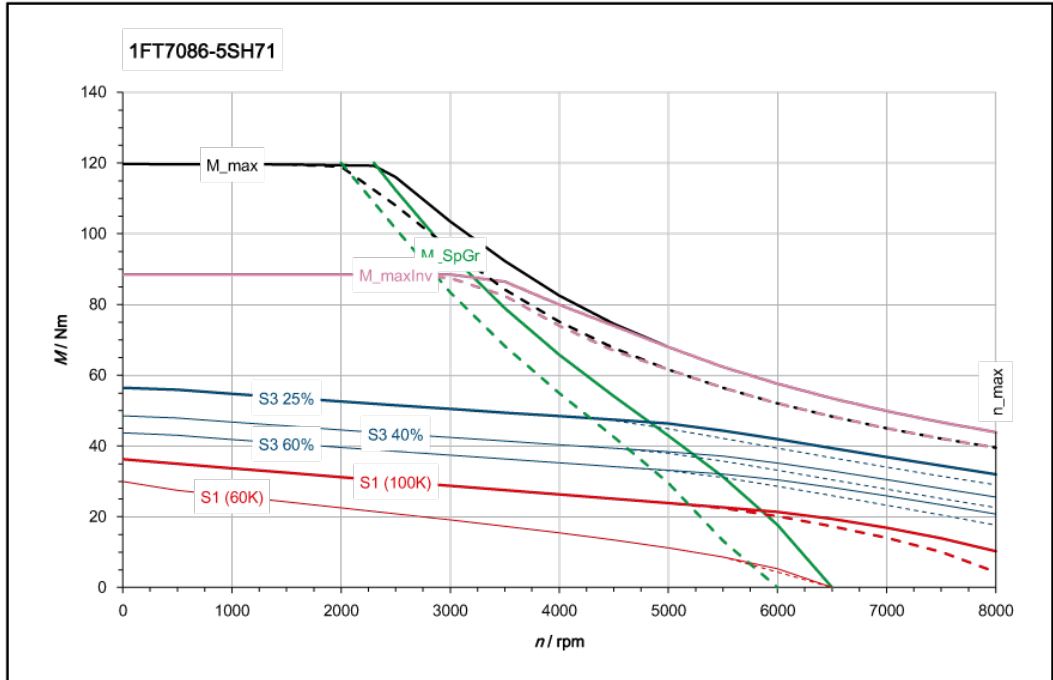

[———] SINAMICS ALM 400 V (600 V DC)
 [- - - -] SINAMICS BLM/SLM 400 V (540 V DC)

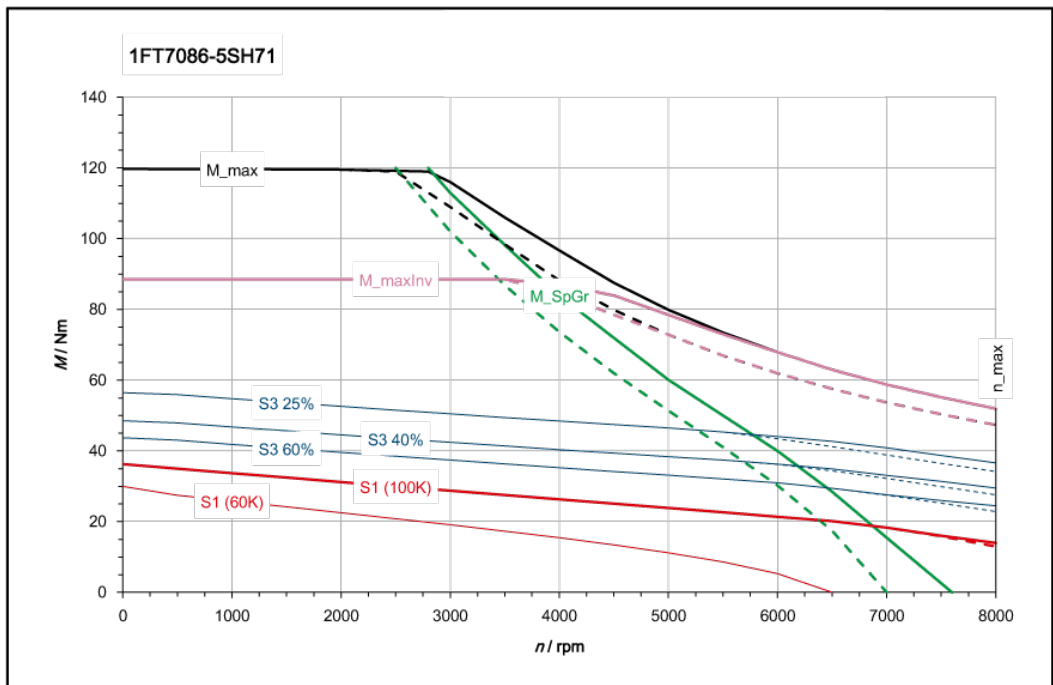

[———] SINAMICS ALM 480 V (720 V DC)
 [- - - -] SINAMICS BLM/SLM 480 V (650 V DC)

6.3.2.3 1FT7105_S

Three-phase servomotor 1FT7105 - 5SC7			
Technical specifications	Symbol	Unit	Value
Configuration data:			
Rated speed	n_N	rpm	2000
Rated torque (100K)	$M_{N(100K)}$	Nm	56
Rated current (100K)	$I_{N(100K)}$	A	29
Static torque (100K)	$M_{0(100K)}$	Nm	65
Stall current (100K)	$I_{0(100K)}$	A	31
Static torque (60K)	$M_{0(60K)}$	Nm	51
Stall current (60K)	$I_{0(60K)}$	A	24
Optimum operating point:			
Optimum speed	n_{opt}	rpm	2000
Optimum power	P_{opt}	kW	11.7
Limiting data:			
Max. permissible speed (mech.)	$n_{max\ mech}$	rpm	6000
Maximum torque	M_{max}	Nm	200
Maximum current	I_{max}	A	107
Motor data:			
No. of poles	2p		10
Torque constant (100K)	k_T	Nm/A	2.11
Voltage constant (at 20 °C)	k_E	V/1000 rpm	134.5
Winding resistance (at 20 °C)	R_{Str}	W	0.102
Rotating field inductance	L_D	mH	2.7
Electrical time constant	T_{el}	ms	26
Mechanical time constant	T_{mech}	ms	1.2
Thermal time constant	T_{th}	min	50
Moment of inertia	J_{mot}	$kgm^2 \cdot 10^{-4}$	178
Shaft torsional stiffness	C_t	Nm/rad	146000
Weight	m_{mot}	kg	50
Motor data with integrated brake:			
Moment of inertia (with brake)	J_{mot}	$kgm^2 \cdot 10^{-4}$	206
Shaft torsional stiffness (with brake)	C_t	Nm/rad	107000
Weight (with brake)	m_{Mot}	kg	56
Data with SINAMICS S120 Booksize:			
Rated converter current	$I_{N\ Inv}$	A	45
Maximum converter current	$I_{max\ Inv}$	A	90
Max. torque (converter operation)	$M_{max\ Inv}$	Nm	175
Max. permissible speed (converter operation)	$n_{max\ Inv}$	rpm	4250
The rated data are valid for a 600 V DC-link voltage			

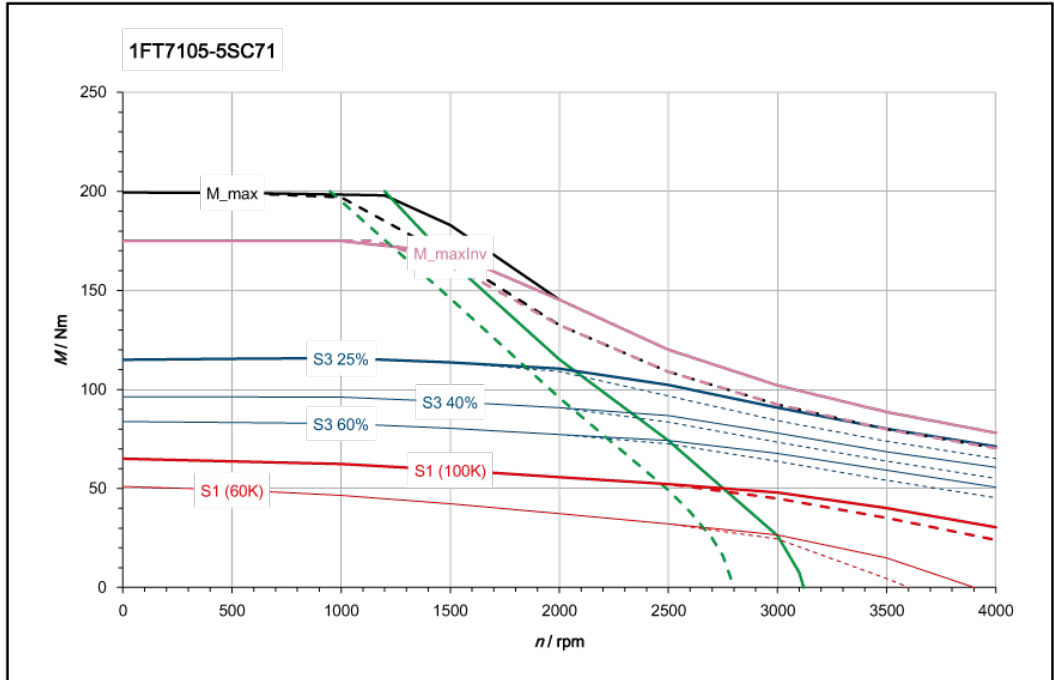

[———] SINAMICS ALM 400 V (600 V DC)
 [- - - -] SINAMICS BLM/SLM 400 V (540 V DC)

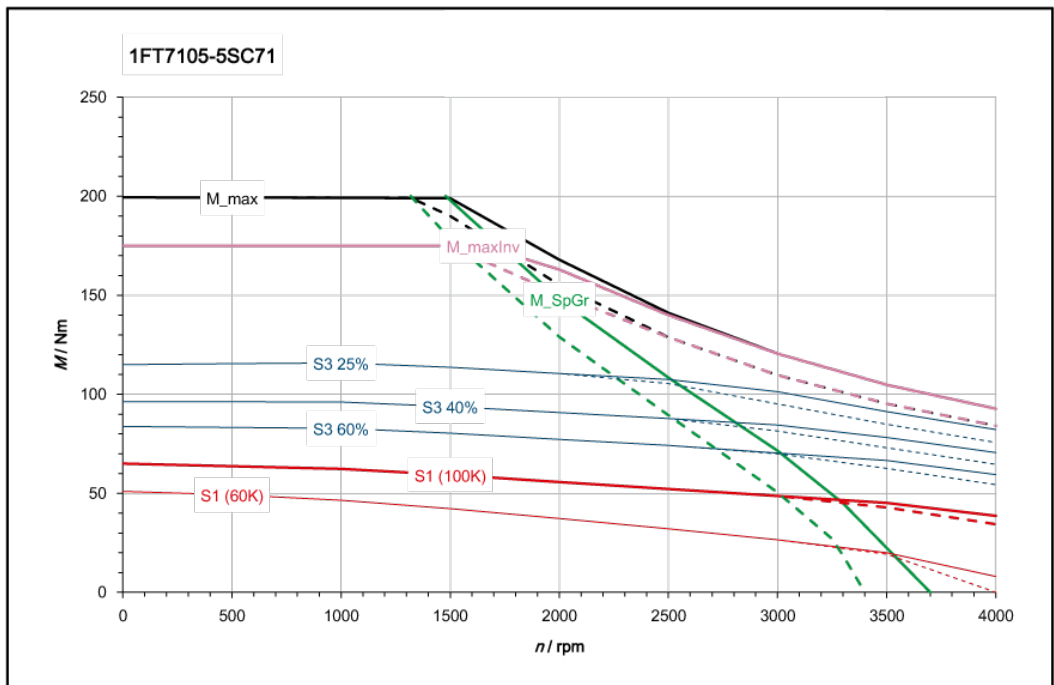

[———] SINAMICS ALM 480 V (720 V DC)
 [- - - -] SINAMICS BLM/SLM 480 V (650 V DC)

Three-phase servomotor 1FT7105 - 5SF7			
Technical specifications	Symbol	Unit	Value
Configuration data:			
Rated speed	n_N	rpm	3000
Rated torque (100K)	$M_{N(100K)}$	Nm	48
Rated current (100K)	$I_{N(100K)}$	A	35
Static torque (100K)	$M_{0(100K)}$	Nm	65
Stall current (100K)	$I_{0(100K)}$	A	45
Static torque (60K)	$M_{0(60K)}$	Nm	51
Stall current (60K)	$I_{0(60K)}$	A	36
Optimum operating point:			
Optimum speed	n_{opt}	rpm	3000
Optimum power	P_{opt}	kW	15.1
Limiting data:			
Max. permissible speed (mech.)	$n_{max\ mech}$	rpm	6000
Maximum torque	M_{max}	Nm	200
Maximum current	I_{max}	A	158
Motor data:			
No. of poles	$2p$		10
Torque constant (100K)	k_T	Nm/A	1.43
Voltage constant (at 20 °C)	k_E	V/1000 rpm	91
Winding resistance (at 20 °C)	R_{Str}	W	0.05
Rotating field inductance	L_D	mH	1.25
Electrical time constant	T_{el}	ms	25
Mechanical time constant	T_{mech}	ms	1.3
Thermal time constant	T_{th}	min	50
Moment of inertia	J_{mot}	$kgm^2 \cdot 10^{-4}$	178
Shaft torsional stiffness	C_t	Nm/rad	146000
Weight	m_{mot}	kg	50
Motor data with integrated brake:			
Moment of inertia (with brake)	J_{mot}	$kgm^2 \cdot 10^{-4}$	206
Shaft torsional stiffness (with brake)	C_t	Nm/rad	107000
Weight (with brake)	m_{Mot}	kg	56
Data with SINAMICS S120 Booksize			
Rated converter current	$I_{N\ Inv}$	A	45
Maximum converter current	$I_{max\ Inv}$	A	90
Max. torque (converter operation)	$M_{max\ Inv}$	Nm	125
Max. permissible speed (converter operation)	$n_{max\ Inv}$	rpm	6000
The rated data are valid for a 600 V DC-link voltage			

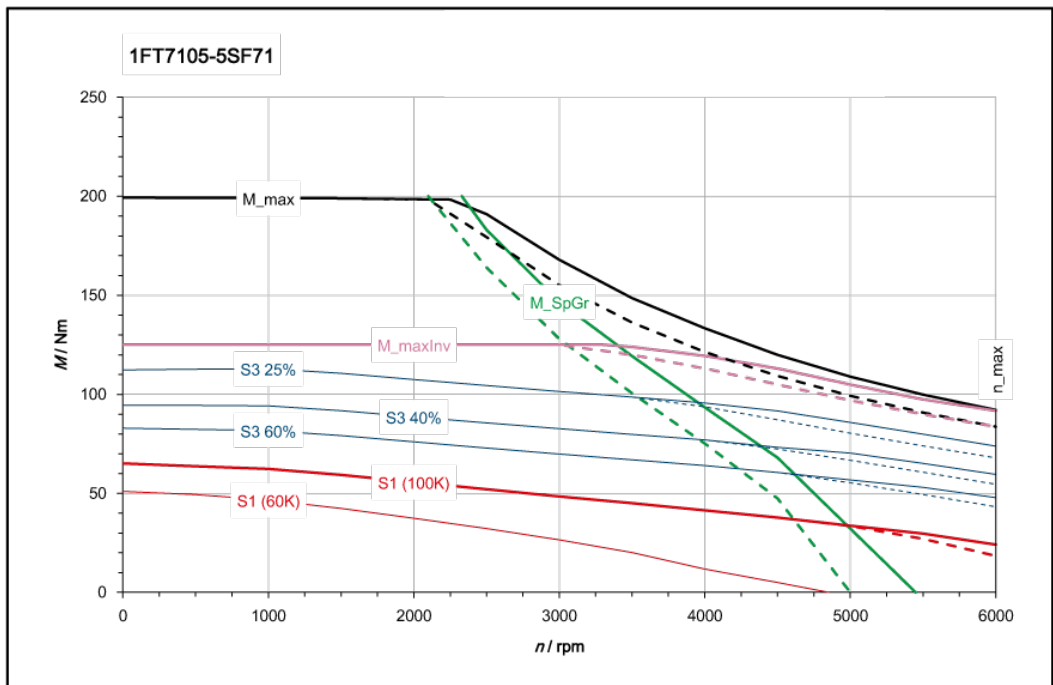
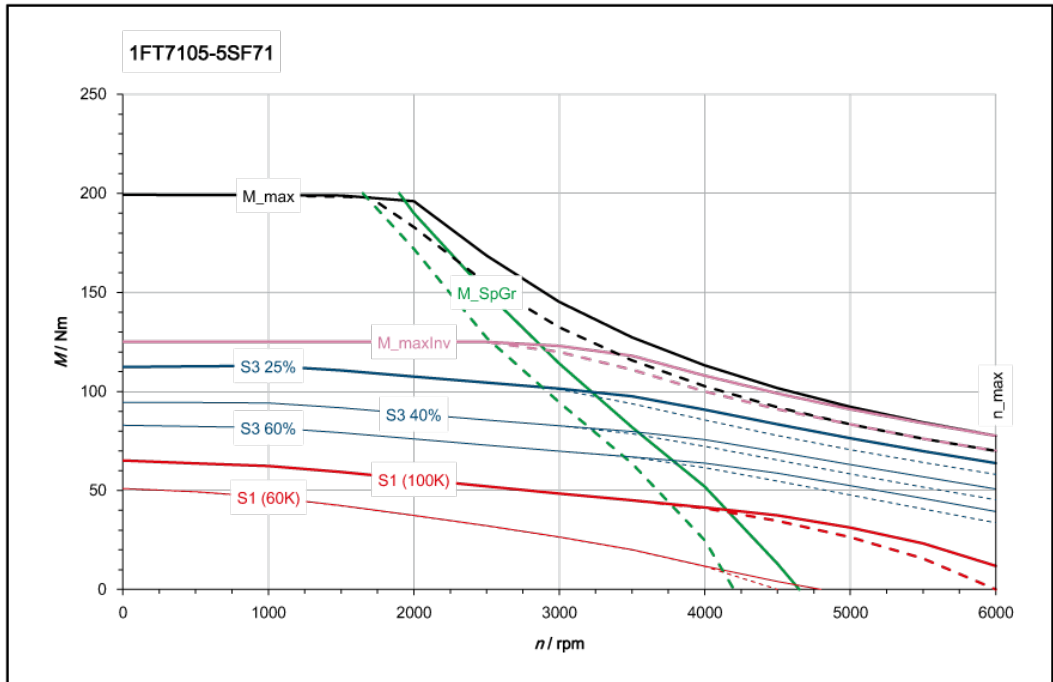

6.3.2.4 1FT7108_S

Three-phase servomotor 1FT7108 - 5SC7			
Technical specifications	Symbol	Unit	Value
Configuration data:			
Rated speed	n_N	rpm	2000
Rated torque (100K)	$M_{N(100K)}$	Nm	73
Rated current (100K)	$I_{N(100K)}$	A	33
Static torque (100K)	$M_{0(100K)}$	Nm	91
Stall current (100K)	$I_{0(100K)}$	A	39
Static torque (60K)	$M_{0(60K)}$	Nm	74
Stall current (60K)	$I_{0(60K)}$	A	32
Optimum operating point:			
Optimum speed	n_{opt}	rpm	2000
Optimum power	P_{opt}	kW	15.3
Limiting data:			
Max. permissible speed (mech.)	$n_{max\ mech}$	rpm	6000
Maximum torque	M_{max}	Nm	280
Maximum current	I_{max}	A	142
Motor data:			
No. of poles	2p		10
Torque constant (100K)	k_T	Nm/A	2.32
Voltage constant (at 20 °C)	k_E	V/1000 rpm	148
Winding resistance (at 20 °C)	R_{Str}	W	0.085
Rotating field inductance	L_D	mH	2.35
Electrical time constant	T_{el}	ms	28
Mechanical time constant	T_{mech}	ms	1.2
Thermal time constant	T_{th}	min	60
Moment of inertia	J_{mot}	$kgm^2 \cdot 10^{-4}$	248
Shaft torsional stiffness	C_t	Nm/rad	126000
Weight	m_{mot}	kg	64
Motor data with integrated brake:			
Moment of inertia (with brake)	J_{mot}	$kgm^2 \cdot 10^{-4}$	276
Shaft torsional stiffness (with brake)	C_t	Nm/rad	96000
Weight (with brake)	m_{Mot}	kg	70
Data with SINAMICS S120 Booksize:			
Rated converter current	$I_{N\ Inv}$	A	45
Maximum converter current	$I_{max\ Inv}$	A	90
Max. torque (converter operation)	$M_{max\ Inv}$	Nm	197.5
Max. permissible speed (converter operation)	$n_{max\ Inv}$	rpm	3900
The rated data are valid for a 600 V DC-link voltage			

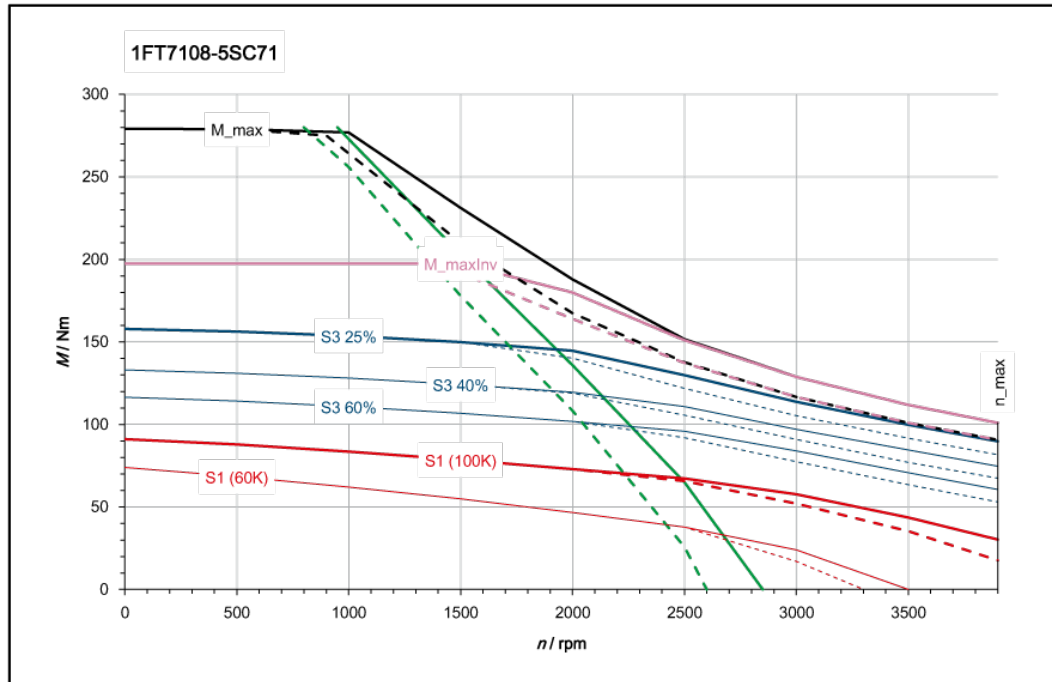

[———] SINAMICS ALM 400 V (600 V DC)
 [- - - -] SINAMICS BLM/SLM 400 V (540 V DC)

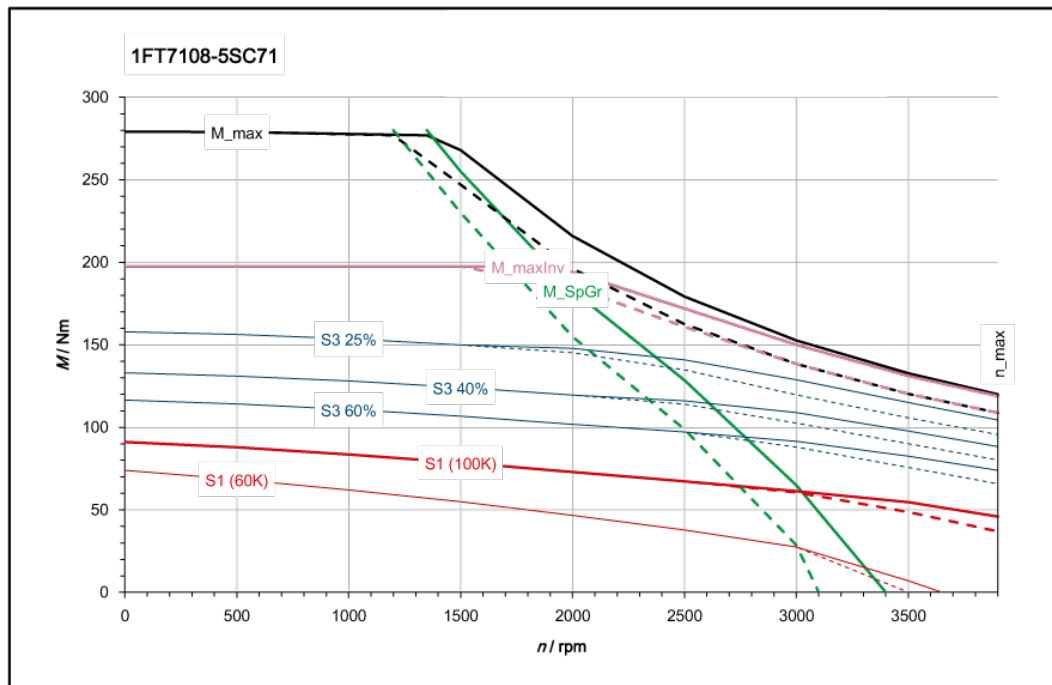

[———] SINAMICS ALM 480 V (720 V DC)
 [- - - -] SINAMICS BLM/SLM 480 V (650 V DC)

Three-phase servomotor 1FT7108 - 5SF7			
Technical specifications	Symbol	Unit	Value
Configuration data:			
Rated speed	n_N	rpm	3000
Rated torque (100K)	$M_{N(100K)}$	Nm	60
Rated current (100K)	$I_{N(100K)}$	A	38
Static torque (100K)	$M_{0(100K)}$	Nm	91
Stall current (100K)	$I_{0(100K)}$	A	57
Static torque (60K)	$M_{0(60K)}$	Nm	74
Stall current (60K)	$I_{0(60K)}$	A	46
Optimum operating point:			
Optimum speed	n_{opt}	rpm	3000
Optimum power	P_{opt}	kW	18.8
Limiting data:			
Max. permissible speed (mech.)	$n_{max\ mech}$	rpm	6000
Maximum torque	M_{max}	Nm	280
Maximum current	I_{max}	A	205
Motor data:			
No. of poles	$2p$		10
Torque constant (100K)	k_T	Nm/A	1.595
Voltage constant (at 20 °C)	k_E	V/1000 rpm	101.5
Winding resistance (at 20 °C)	R_{Str}	W	0.043
Rotating field inductance	L_D	mH	1.1
Electrical time constant	T_{el}	ms	26
Mechanical time constant	T_{mech}	ms	1.3
Thermal time constant	T_{th}	min	60
Moment of inertia	J_{mot}	$kgm^2 \cdot 10^{-4}$	248
Shaft torsional stiffness	C_t	Nm/rad	126000
Weight	m_{mot}	kg	64
Motor data with integrated brake:			
Moment of inertia (with brake)	J_{mot}	$kgm^2 \cdot 10^{-4}$	276
Shaft torsional stiffness (with brake)	C_t	Nm/rad	96000
Weight (with brake)	m_{Mot}	kg	70
Data with SINAMICS S120 Booksize:			
Rated converter current	$I_{N\ Inv}$	A	60
Maximum converter current	$I_{max\ Inv}$	A	120
Max. torque (converter operation)	$M_{max\ Inv}$	Nm	184.5
Max. permissible speed (converter operation)	$n_{max\ Inv}$	rpm	5600
The rated data are valid for a 600 V DC-link voltage			

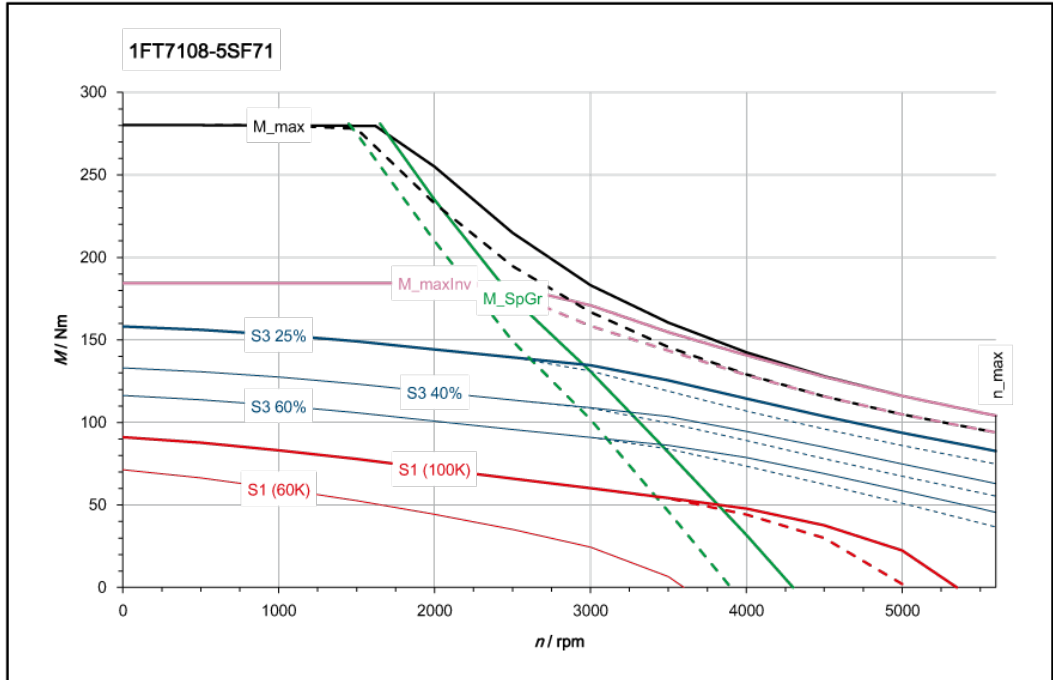

[———] SINAMICS ALM 400 V (600 V DC)
 [- - - - -] SINAMICS BLM/SLM 400 V (540 V DC)

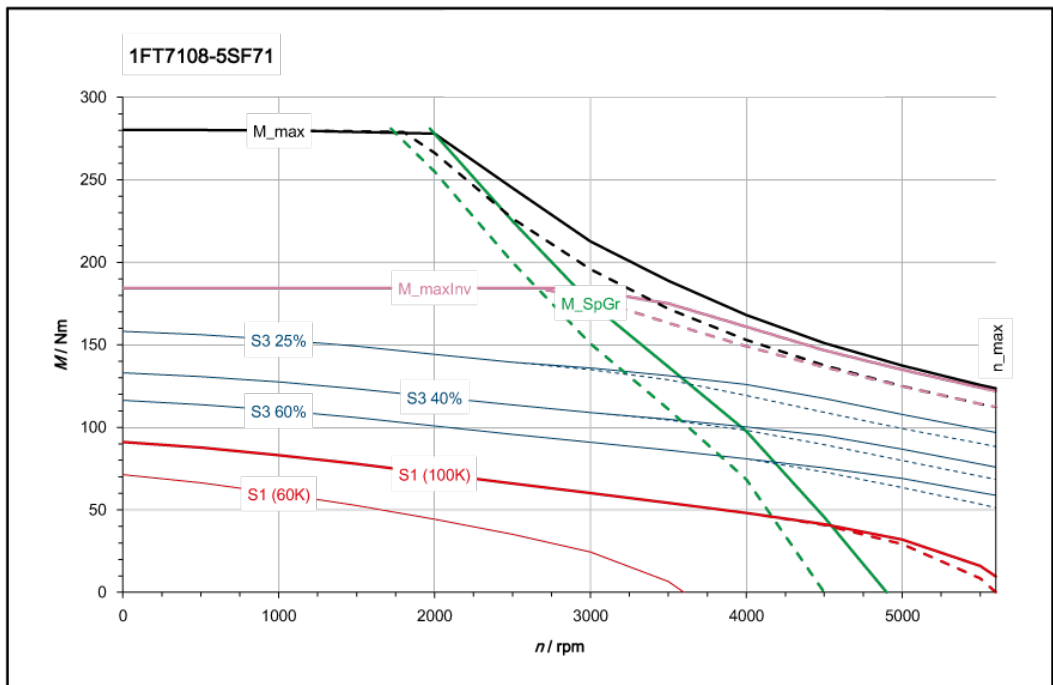

[———] SINAMICS ALM 480 V (720 V DC)
 [- - - - -] SINAMICS BLM/SLM 480 V (650 V DC)

6.3.2.5 1FT7132-S

Three-phase servomotor 1FT7132 - 5SB7			
Technical specifications	Symbol	Unit	Value
Configuration data:			
Rated speed	n_N	rpm	1500
Rated torque (100K)	$M_{N(100K)}$	Nm	132
Rated current (100K)	$I_{N(100K)}$	A	45
Static torque (100K)	$M_{0(100K)}$	Nm	140
Stall current (100K)	$I_{0(100K)}$	A	48
Static torque (60K)	$M_{0(60K)}$	Nm	120
Stall current (60K)	$I_{0(60K)}$	A	40
Optimum operating point:			
Optimum speed	n_{opt}	rpm	1500
Optimum power	P_{opt}	kW	20.5
Limiting data:			
Max. permissible speed (mech.)	$n_{max\ mech}$	rpm	3600
Maximum torque	M_{max}	Nm	305
Maximum current	I_{max}	A	118
Motor data:			
No. of poles	2p		8
Torque constant (100K)	k_T	Nm/A	3.02
Voltage constant (at 20 °C)	k_E	V/1000 rpm	206
Winding resistance (at 20 °C)	R_{Str}	W	0.136
Rotating field inductance	L_D	mH	3.8
Electrical time constant	T_{el}	ms	28
Mechanical time constant	T_{mech}	ms	2.1
Thermal time constant	T_{th}	min	20
Moment of inertia	J_{mot}	$kgm^2 \cdot 10^{-4}$	459
Shaft torsional stiffness	C_t	Nm/rad	347000
Weight	m_{mot}	kg	81
Motor data with integrated brake:			
Moment of inertia (with brake)	J_{mot}	$kgm^2 \cdot 10^{-4}$	512
Shaft torsional stiffness (with brake)	C_t	Nm/rad	231000
Weight (with brake)	m_{Mot}	kg	93
Data with SINAMICS S120 Booksize:			
Rated converter current	$I_{N\ Inv}$	A	45
Maximum converter current	$I_{max\ Inv}$	A	90
Max. torque (converter operation)	$M_{max\ Inv}$	Nm	250
Max. permissible speed (converter operation)	$n_{max\ Inv}$	rpm	2800
The rated data are valid for a 600 V DC-link voltage			

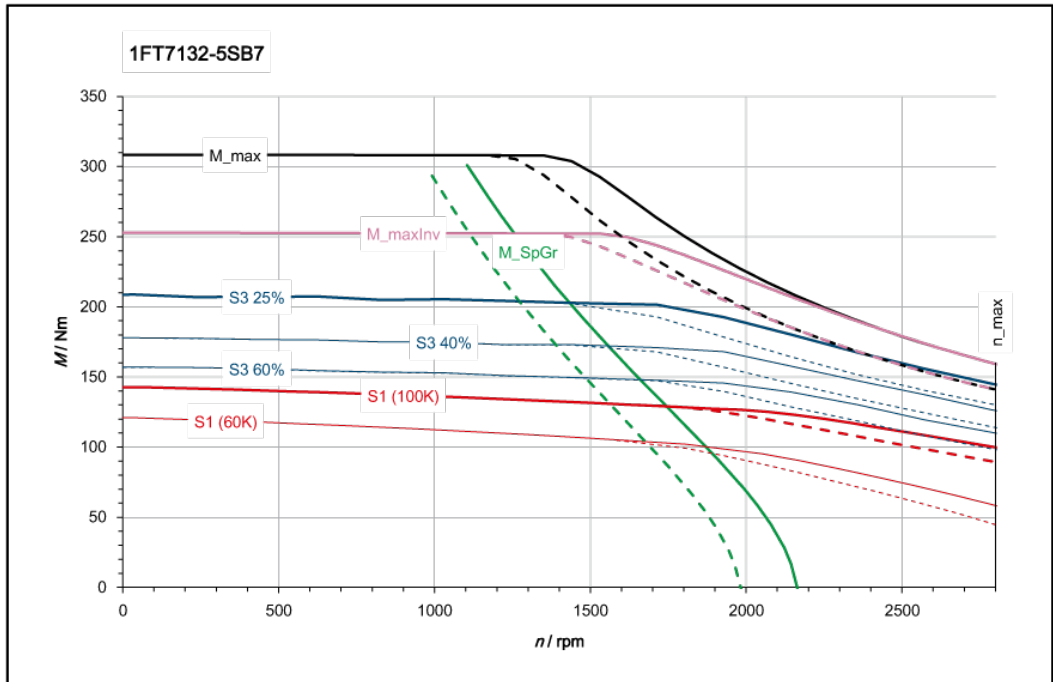

[———] SINAMICS ALM 400 V (600 V DC)
 [- - - -] SINAMICS BLM/SLM 400 V (540 V DC)

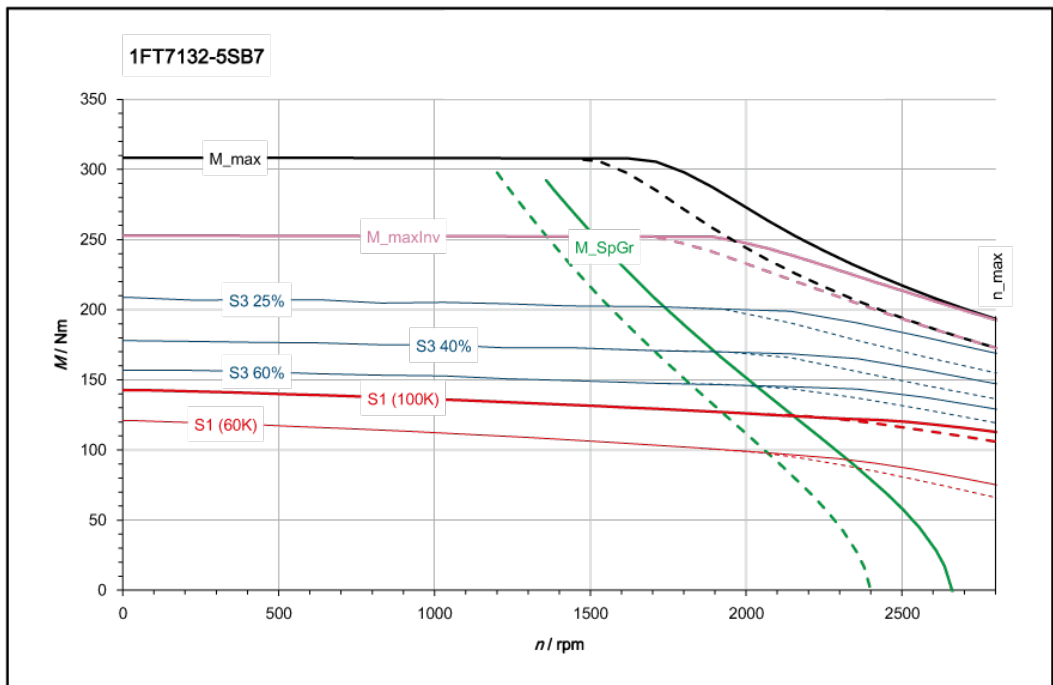

[———] SINAMICS ALM 480 V (720 V DC)
 [- - - -] SINAMICS BLM/SLM 480 V (650 V DC)

Three-phase servomotor 1FT7132 - 5SC7			
Technical specifications	Symbol	Unit	Value
Configuration data:			
Rated speed	n_N	rpm	2000
Rated torque (100K)	$M_{N(100K)}$	Nm	126
Rated current (100K)	$I_{N(100K)}$	A	55
Static torque (100K)	$M_{0(100K)}$	Nm	140
Stall current (100K)	$I_{0(100K)}$	A	60
Static torque (60K)	$M_{0(60K)}$	Nm	120
Stall current (60K)	$I_{0(60K)}$	A	50
Optimum operating point:			
Optimum speed	n_{opt}	rpm	2000
Optimum power	P_{opt}	kW	26.5
Limiting data:			
Max. permissible speed (mech.)	$n_{max\ mech}$	rpm	3600
Maximum torque	M_{max}	Nm	305
Maximum current	I_{max}	A	147
Motor data:			
No. of poles	$2p$		8
Torque constant (100K)	k_T	Nm/A	2.42
Voltage constant (at 20 °C)	k_E	V/1000 rpm	165
Winding resistance (at 20 °C)	R_{Str}	W	0.087
Rotating field inductance	L_D	mH	2.43
Electrical time constant	T_{el}	ms	28
Mechanical time constant	T_{mech}	ms	2.0
Thermal time constant	T_{th}	min	20
Moment of inertia	J_{mot}	$kgm^2 \cdot 10^{-4}$	459
Shaft torsional stiffness	C_t	Nm/rad	347000
Weight	m_{mot}	kg	81
Motor data with integrated brake:			
Moment of inertia (with brake)	J_{mot}	$kgm^2 \cdot 10^{-4}$	512
Shaft torsional stiffness (with brake)	C_t	Nm/rad	231000
Weight (with brake)	m_{Mot}	kg	93
Data with SINAMICS S120 Booksize:			
Rated converter current	$I_{N\ Inv}$	A	60
Maximum converter current	$I_{max\ Inv}$	A	120
Max. torque (converter operation)	$M_{max\ Inv}$	Nm	265
Max. permissible speed (converter operation)	$n_{max\ Inv}$	rpm	3500
The rated data are valid for a 600 V DC-link voltage			

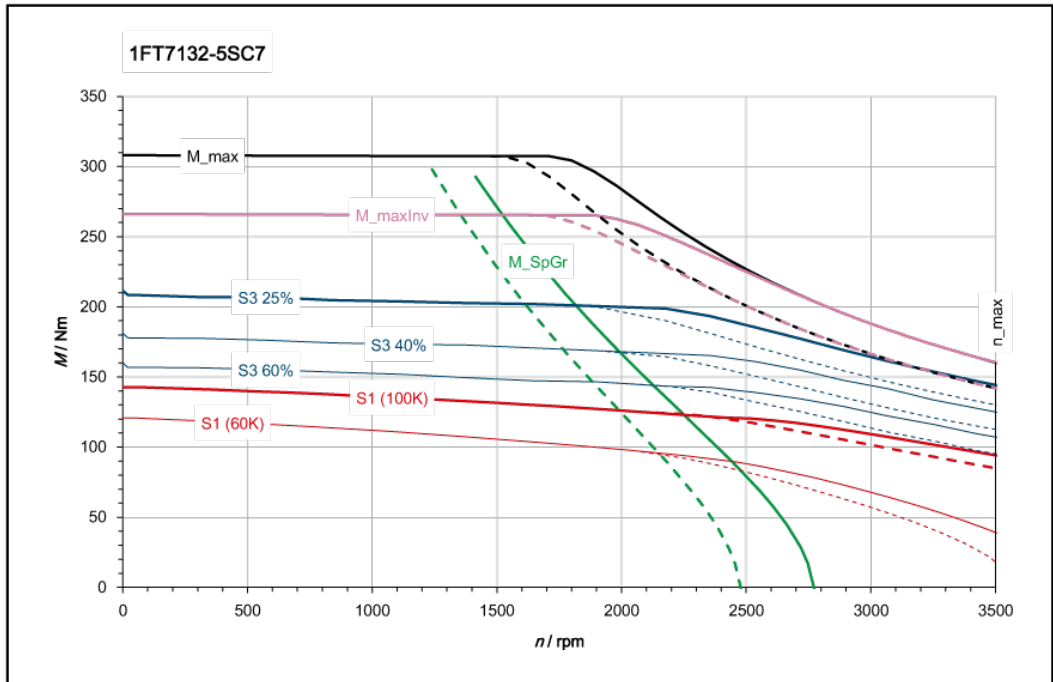

[—] SINAMICS ALM 400 V (600 V DC)
 [- - -] SINAMICS BLM/SLM 400 V (540 V DC)

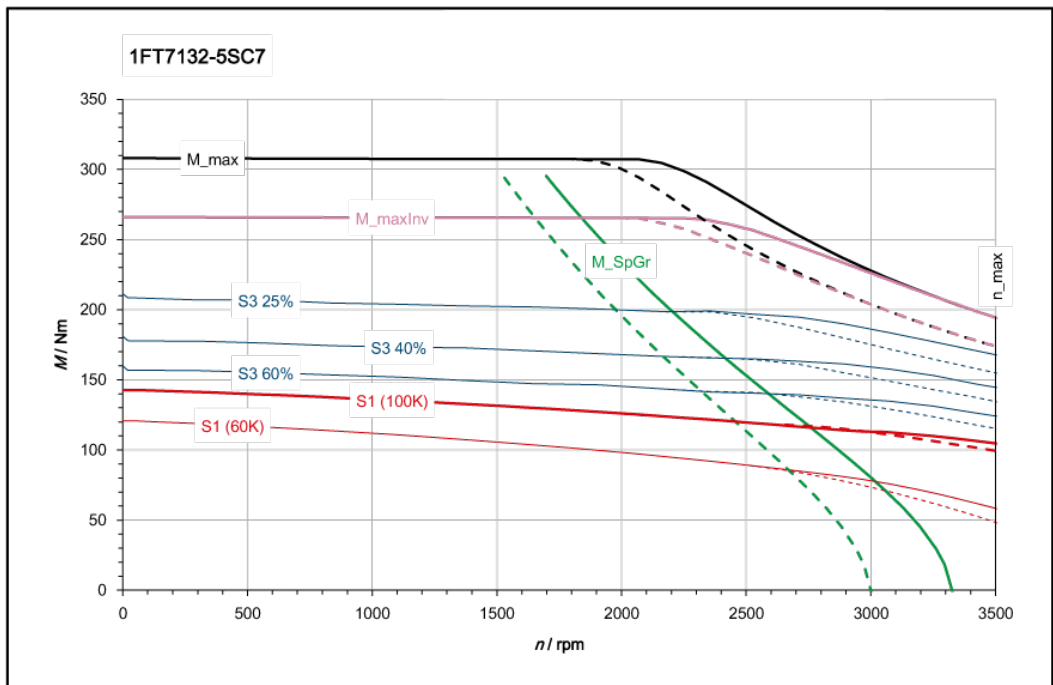

[—] SINAMICS ALM 480 V (720 V DC)
 [- - -] SINAMICS BLM/SLM 480 V (650 V DC)

Three-phase servomotor 1FT7132 - 5SF7			
Technical specifications	Symbol	Unit	Value
Configuration data:			
Rated speed	n_N	rpm	3000
Rated torque (100K)	$M_{N(100K)}$	Nm	113
Rated current (100K)	$I_{N(100K)}$	A	69
Static torque (100K)	$M_{0(100K)}$	Nm	140
Stall current (100K)	$I_{0(100K)}$	A	85
Static torque (60K)	$M_{0(60K)}$	Nm	120
Stall current (60K)	$I_{0(60K)}$	A	72
Optimum operating point:			
Optimum speed	n_{opt}	rpm	3000
Optimum power	P_{opt}	kW	35.5
Limiting data:			
Max. permissible speed (mech.)	$n_{max\ mech}$	rpm	3600
Maximum torque	M_{max}	Nm	305
Maximum current	I_{max}	A	210
Motor data:			
No. of poles	$2p$		8
Torque constant (100K)	k_T	Nm/A	1.69
Voltage constant (at 20 °C)	k_E	V/1000 rpm	116
Winding resistance (at 20 °C)	R_{Str}	W	0.043
Rotating field inductance	L_D	mH	1.19
Electrical time constant	T_{el}	ms	28
Mechanical time constant	T_{mech}	ms	2.1
Thermal time constant	T_{th}	min	20
Moment of inertia	J_{mot}	$kgm^2 \cdot 10^{-4}$	459
Shaft torsional stiffness	C_t	Nm/rad	347000
Weight	m_{mot}	kg	81
Motor data with integrated brake:			
Moment of inertia (with brake)	J_{mot}	$kgm^2 \cdot 10^{-4}$	512
Shaft torsional stiffness (with brake)	C_t	Nm/rad	231000
Weight (with brake)	m_{Mot}	kg	93
Data with SINAMICS S120 Booksize:			
Rated converter current	$I_{N\ Inv}$	A	85
Maximum converter current	$I_{max\ Inv}$	A	141
Max. torque (converter operation)	$M_{max\ Inv}$	Nm	220
Max. permissible speed (converter operation)	$n_{max\ Inv}$	rpm	3600
The rated data are valid for a 600 V DC-link voltage			

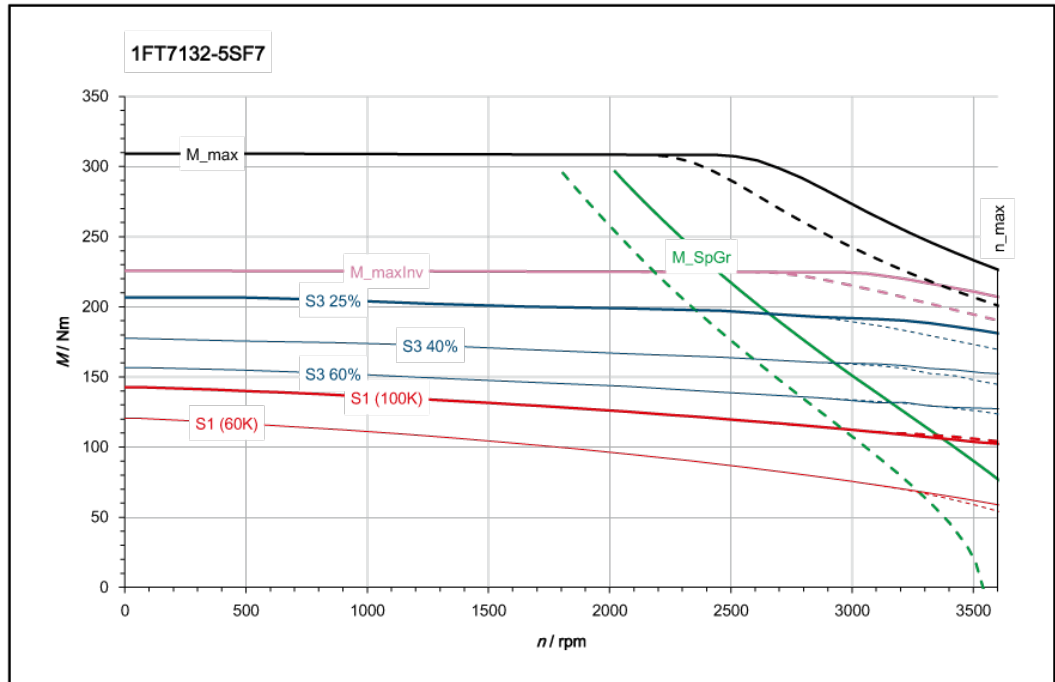

[———] SINAMICS ALM 400 V (600 V DC)
 [- - - -] SINAMICS BLM/SLM 400 V (540 V DC)

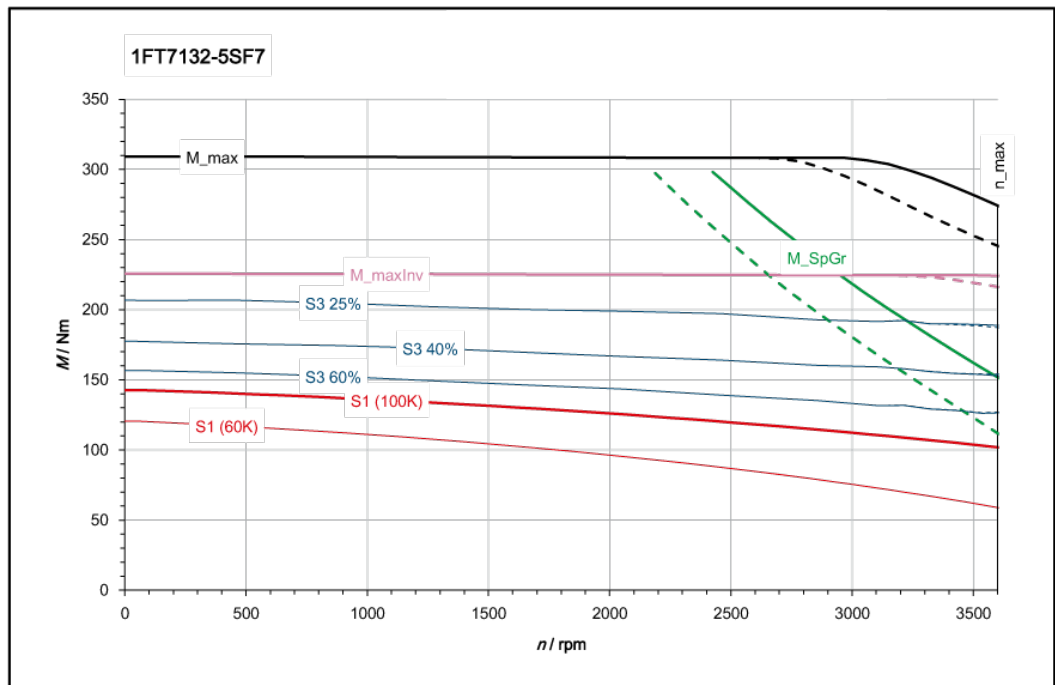

[———] SINAMICS ALM 480 V (720 V DC)
 [- - - -] SINAMICS BLM/SLM 480 V (650 V DC)

6.3.2.6 1FT7134-S

Three-phase servomotor 1FT7134 - 5SC7			
Technical specifications	Symbol	Unit	Value
Configuration data:			
Rated speed	n_N	rpm	2000
Rated torque (100K)	$M_{N(100K)}$	Nm	160
Rated current (100K)	$I_{N(100K)}$	A	73
Static torque (100K)	$M_{0(100K)}$	Nm	190
Stall current (100K)	$I_{0(100K)}$	A	85
Static torque (60K)	$M_{0(60K)}$	Nm	160
Stall current (60K)	$I_{0(60K)}$	A	70
Optimum operating point:			
Optimum speed	n_{opt}	rpm	2000
Optimum power	P_{opt}	kW	33.5
Limiting data:			
Max. permissible speed (mech.)	$n_{max\ mech}$	rpm	3600
Maximum torque	M_{max}	Nm	410
Maximum current	I_{max}	A	210
Motor data:			
No. of poles	2p		8
Torque constant (100K)	k_T	Nm/A	2.25
Voltage constant (at 20 °C)	k_E	V/1000 rpm	154
Winding resistance (at 20 °C)	R_{Str}	W	0.049
Rotating field inductance	L_D	mH	1.59
Electrical time constant	T_{el}	ms	32
Mechanical time constant	T_{mech}	ms	1.8
Thermal time constant	T_{th}	min	22
Moment of inertia	J_{mot}	$kgm^2 \cdot 10^{-4}$	604
Shaft torsional stiffness	C_t	Nm/rad	323000
Weight	m_{mot}	kg	97
Motor data with integrated brake:			
Moment of inertia (with brake)	J_{mot}	$kgm^2 \cdot 10^{-4}$	657
Shaft torsional stiffness (with brake)	C_t	Nm/rad	220000
Weight (with brake)	m_{Mot}	kg	108
Data with SINAMICS S120 Booksize:			
Rated converter current	$I_{N\ Inv}$	A	85
Maximum converter current	$I_{max\ Inv}$	A	141
Max. torque (converter operation)	$M_{max\ Inv}$	Nm	300
Max. permissible speed (converter operation)	$n_{max\ Inv}$	rpm	3600
The rated data are valid for a 600 V DC-link voltage			

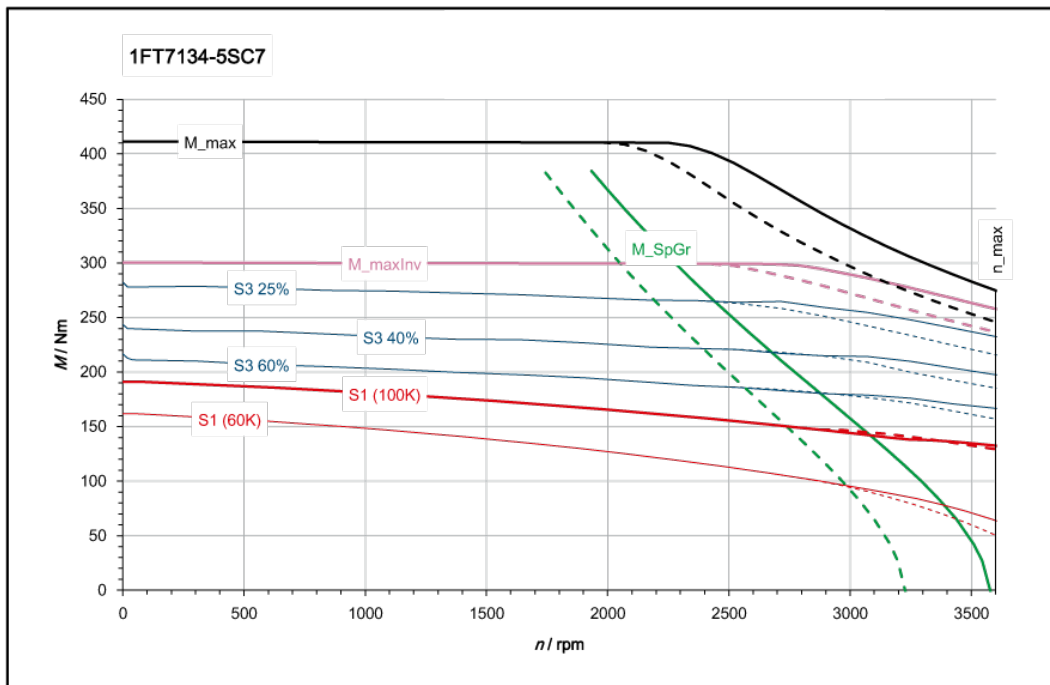
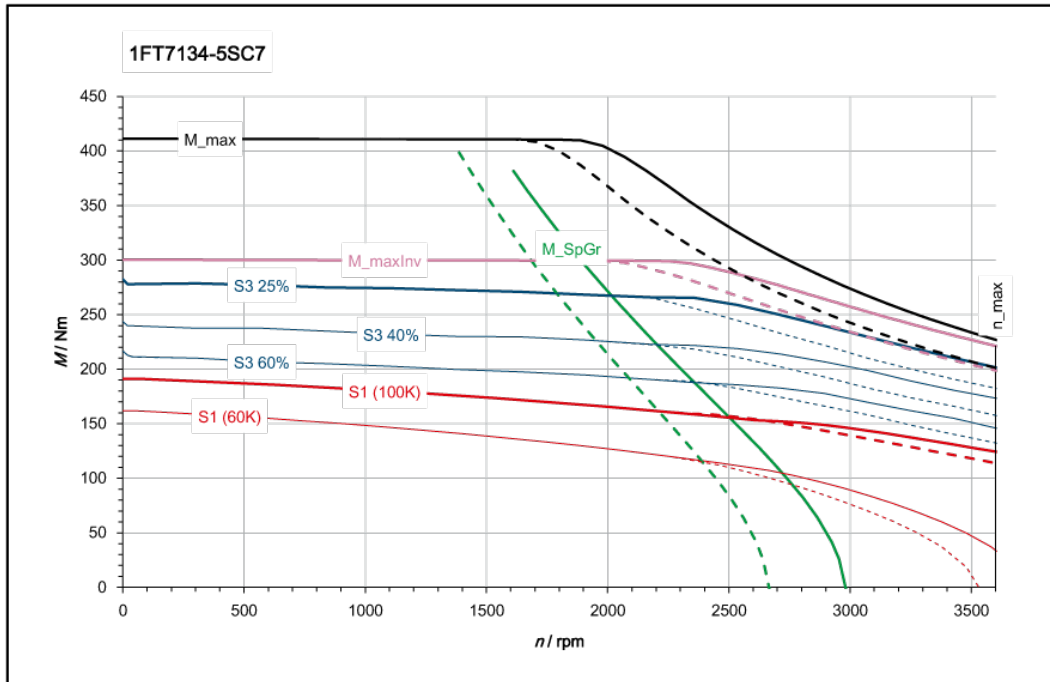

Three-phase servomotor 1FT7134 - 5SF7			
Technical specifications	Symbol	Unit	Value
Configuration data:			
Rated speed	n_N	rpm	3000
Rated torque (100K)	$M_{N(100K)}$	Nm	145
Rated current (100K)	$I_{N(100K)}$	A	91
Static torque (100K)	$M_{0(100K)}$	Nm	190
Stall current (100K)	$I_{0(100K)}$	A	115
Static torque (60K)	$M_{0(60K)}$	Nm	160
Stall current (60K)	$I_{0(60K)}$	A	97
Optimum operating point:			
Optimum speed	n_{opt}	rpm	3000
Optimum power	P_{opt}	kW	45.5
Limiting data:			
Max. permissible speed (mech.)	$n_{max\ mech}$	rpm	3600
Maximum torque	M_{max}	Nm	410
Maximum current	I_{max}	A	295
Motor data:			
No. of poles	$2p$		8
Torque constant (100K)	k_T	Nm/A	1.61
Voltage constant (at 20 °C)	k_E	V/1000 rpm	110
Winding resistance (at 20 °C)	R_{Str}	W	0.025
Rotating field inductance	L_D	mH	0.81
Electrical time constant	T_{el}	ms	32
Mechanical time constant	T_{mech}	ms	1.7
Thermal time constant	T_{th}	min	22
Moment of inertia	J_{mot}	$kgm^2 \cdot 10^{-4}$	604
Shaft torsional stiffness	C_t	Nm/rad	323000
Weight	m_{mot}	kg	97
Motor data with integrated brake:			
Moment of inertia (with brake)	J_{mot}	$kgm^2 \cdot 10^{-4}$	657
Shaft torsional stiffness (with brake)	C_t	Nm/rad	220000
Weight (with brake)	m_{Mot}	kg	108
Data with SINAMICS S120 Booksize:			
Rated converter current	$I_{N\ Inv}$	A	132
Maximum converter current	$I_{max\ Inv}$	A	210
Max. torque (converter operation)	$M_{max\ Inv}$	Nm	315
Max. permissible speed (converter operation)	$n_{max\ Inv}$	rpm	3600
The rated data are valid for a 600 V DC-link voltage			

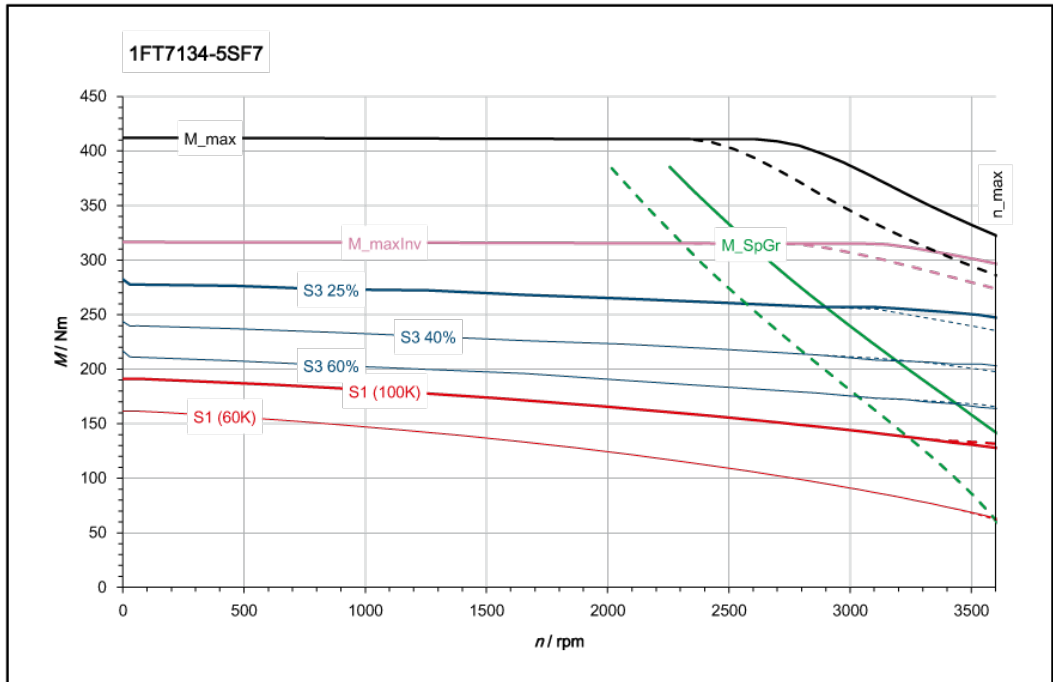

[———] SINAMICS ALM 400 V (600 V DC)
 [- - - -] SINAMICS BLM/SLM 400 V (540 V DC)

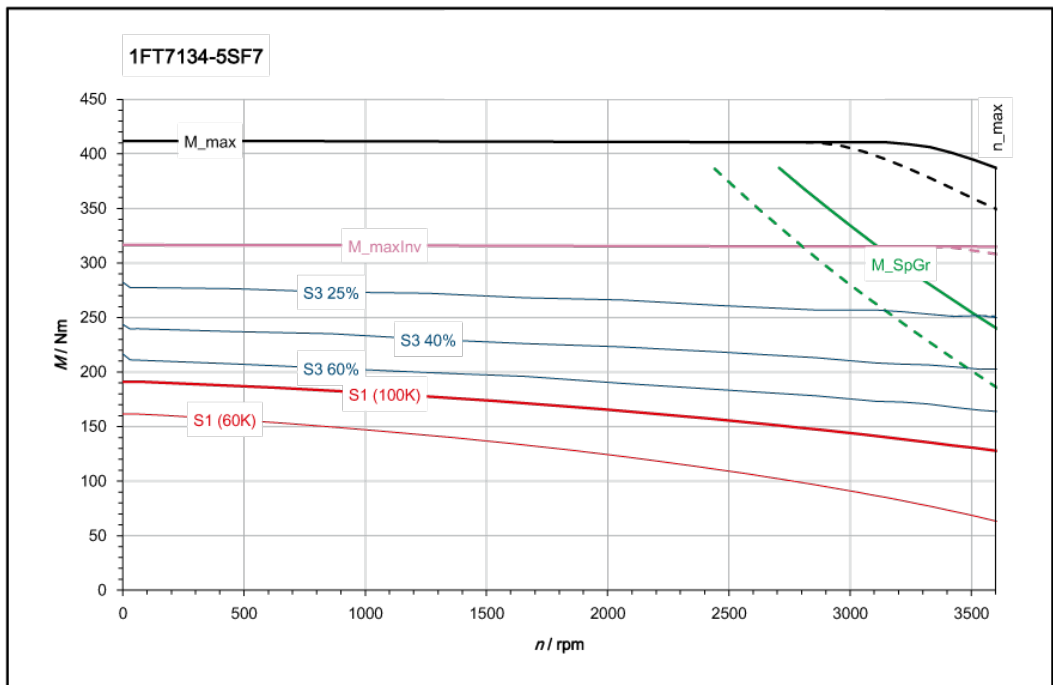

[———] SINAMICS ALM 480 V (720 V DC)
 [- - - -] SINAMICS BLM/SLM 480 V (650 V DC)

6.3.2.7 1FT7136_S

Three-phase servomotor 1FT7136 - 5SB7			
Technical specifications	Symbol	Unit	Value
Configuration data:			
Rated speed	n_N	rpm	1500
Rated torque (100K)	$M_{N(100K)}$	Nm	200
Rated current (100K)	$I_{N(100K)}$	A	60
Static torque (100K)	$M_{0(100K)}$	Nm	235
Stall current (100K)	$I_{0(100K)}$	A	70
Static torque (60K)	$M_{0(60K)}$	Nm	190
Stall current (60K)	$I_{0(60K)}$	A	56
Optimum operating point:			
Optimum speed	n_{opt}	rpm	1500
Optimum power	P_{opt}	kW	31.4
Limiting data:			
Max. permissible speed (mech.)	$n_{max\ mech}$	rpm	3600
Maximum torque	M_{max}	Nm	510
Maximum current	I_{max}	A	173
Motor data:			
No. of poles	2p		8
Torque constant (100K)	k_T	Nm/A	3.42
Voltage constant (at 20 °C)	k_E	V/1000 rpm	234
Winding resistance (at 20 °C)	R_{Str}	W	0.082
Rotating field inductance	L_D	mH	2.93
Electrical time constant	T_{el}	ms	36
Mechanical time constant	T_{mech}	ms	1.6
Thermal time constant	T_{th}	min	25
Moment of inertia	J_{mot}	$kgm^2 \cdot 10^{-4}$	748
Shaft torsional stiffness	C_t	Nm/rad	301000
Weight	m_{mot}	kg	114
Motor data with integrated brake:			
Moment of inertia (with brake)	J_{mot}	$kgm^2 \cdot 10^{-4}$	801
Shaft torsional stiffness (with brake)	C_t	Nm/rad	210000
Weight (with brake)	m_{Mot}	kg	125
Data with SINAMICS S120 Booksize:			
Rated converter current	$I_{N\ Inv}$	A	85
Maximum converter current	$I_{max\ Inv}$	A	141
Max. torque (converter operation)	$M_{max\ Inv}$	Nm	440
Max. permissible speed (converter operation)	$n_{max\ Inv}$	rpm	2400
The rated data are valid for a 600 V DC-link voltage			

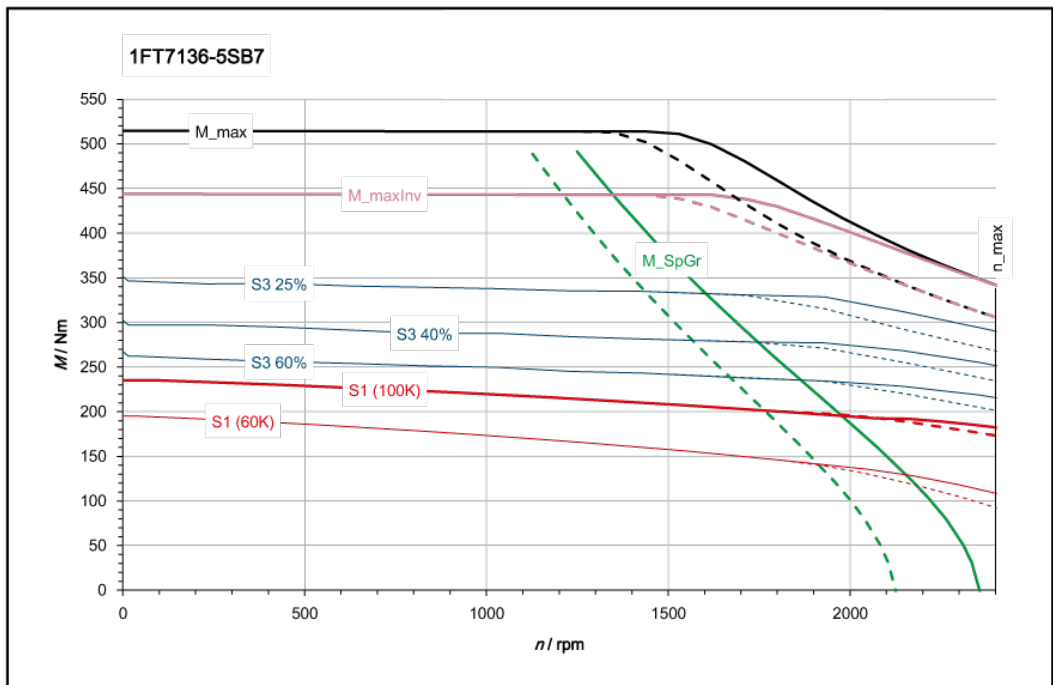
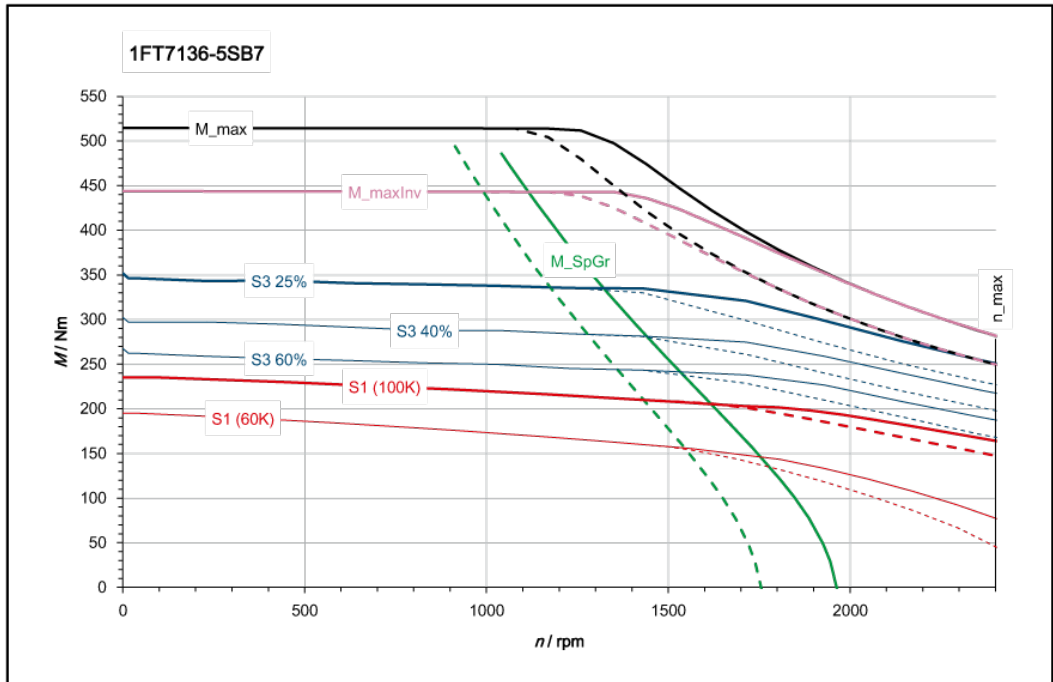

Three-phase servomotor 1FT7136 - 5SC7			
Technical specifications	Symbol	Unit	Value
Configuration data:			
Rated speed	n_N	rpm	2000
Rated torque (100K)	$M_{N(100K)}$	Nm	190
Rated current (100K)	$I_{N(100K)}$	A	81
Static torque (100K)	$M_{0(100K)}$	Nm	235
Stall current (100K)	$I_{0(100K)}$	A	98
Static torque (60K)	$M_{0(60K)}$	Nm	195
Stall current (60K)	$I_{0(60K)}$	A	79
Optimum operating point:			
Optimum speed	n_{opt}	rpm	2000
Optimum power	P_{opt}	kW	39.8
Limiting data:			
Max. permissible speed (mech.)	$n_{max\ mech}$	rpm	3600
Maximum torque	M_{max}	Nm	510
Maximum current	I_{max}	A	245
Motor data:			
No. of poles	$2p$		8
Torque constant (100K)	k_T	Nm/A	2.42
Voltage constant (at 20 °C)	k_E	V/1000 rpm	165
Winding resistance (at 20 °C)	R_{Str}	W	0.041
Rotating field inductance	L_D	mH	1.46
Electrical time constant	T_{el}	ms	36
Mechanical time constant	T_{mech}	ms	1.6
Thermal time constant	T_{th}	min	25
Moment of inertia	J_{mot}	$kgm^2 \cdot 10^{-4}$	748
Shaft torsional stiffness	C_t	Nm/rad	301000
Weight	m_{mot}	kg	114
Motor data with integrated brake:			
Moment of inertia (with brake)	J_{mot}	$kgm^2 \cdot 10^{-4}$	801
Shaft torsional stiffness (with brake)	C_t	Nm/rad	210000
Weight (with brake)	m_{Mot}	kg	125
Data with SINAMICS S120 Booksize:			
Rated converter current	$I_{N\ Inv}$	A	132
Maximum converter current	$I_{max\ Inv}$	A	210
Max. torque (converter operation)	$M_{max\ Inv}$	Nm	455
Max. permissible speed (converter operation)	$n_{max\ Inv}$	rpm	3500
The rated data are valid for a 600 V DC-link voltage			

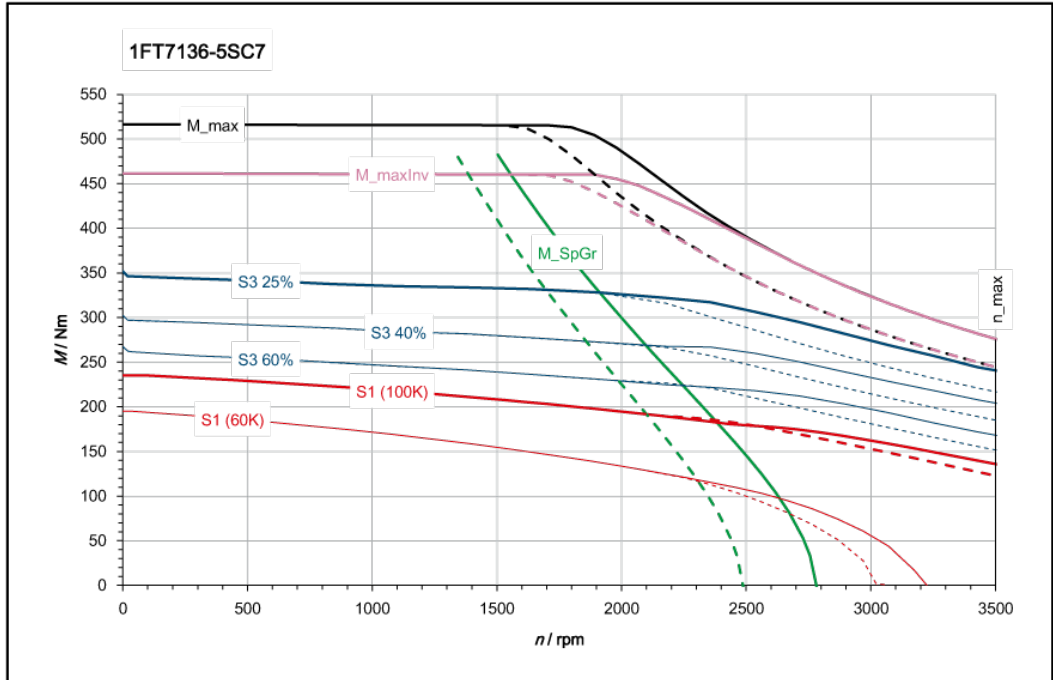

[———] SINAMICS ALM 400 V (600 V DC)
[- - - -] SINAMICS BLM/SLM 400 V (540 V DC)

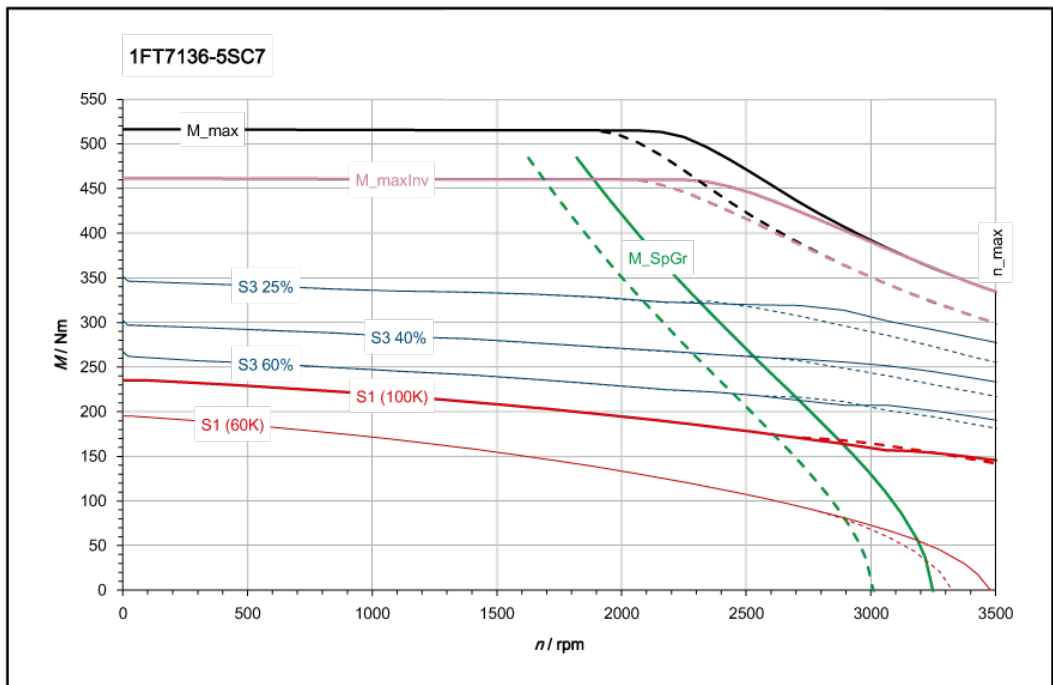

[———] SINAMICS ALM 480 V (720 V DC)
[- - - -] SINAMICS BLM/SLM 480 V (650 V DC)

6.3.2.8 1FT7138_S

Three-phase servomotor 1FT7138 - 5SB7			
Technical specifications	Symbol	Unit	Value
Configuration data:			
Rated speed	n_N	rpm	1500
Rated torque (100K)	$M_{N(100K)}$	Nm	250
Rated current (100K)	$I_{N(100K)}$	A	79
Static torque (100K)	$M_{0(100K)}$	Nm	280
Stall current (100K)	$I_{0(100K)}$	A	85
Static torque (60K)	$M_{0(60K)}$	Nm	230
Stall current (60K)	$I_{0(60K)}$	A	74
Optimum operating point:			
Optimum speed	n_{opt}	rpm	1500
Optimum power	P_{opt}	kW	39
Limiting data:			
Max. permissible speed (mech.)	$n_{max\ mech}$	rpm	3600
Maximum torque	M_{max}	Nm	605
Maximum current	I_{max}	A	225
Motor data:			
No. of poles	2p		8
Torque constant (100K)	k_T	Nm/A	3.2
Voltage constant (at 20 °C)	k_E	V/1000 rpm	211
Winding resistance (at 20 °C)	R_{Str}	W	0.052
Rotating field inductance	L_D	mH	1.96
Electrical time constant	T_{el}	ms	38
Mechanical time constant	T_{mech}	ms	1.4
Thermal time constant	T_{th}	min	28
Moment of inertia	J_{mot}	$kgm^2 \cdot 10^{-4}$	896
Shaft torsional stiffness	C_t	Nm/rad	283000
Weight	m_{mot}	kg	129
Motor data with integrated brake:			
Moment of inertia (with brake)	J_{mot}	$kgm^2 \cdot 10^{-4}$	--
Shaft torsional stiffness (with brake)	C_t	Nm/rad	--
Weight (with brake)	m_{Mot}	kg	--
Data with SINAMICS S120 Booksize:			
Rated converter current	$I_{N\ Inv}$	A	85
Maximum converter current	$I_{max\ Inv}$	A	141
Max. torque (converter operation)	$M_{max\ Inv}$	Nm	415
Max. permissible speed (converter operation)	$n_{max\ Inv}$	rpm	2700
The rated data are valid for a 600 V DC-link voltage			

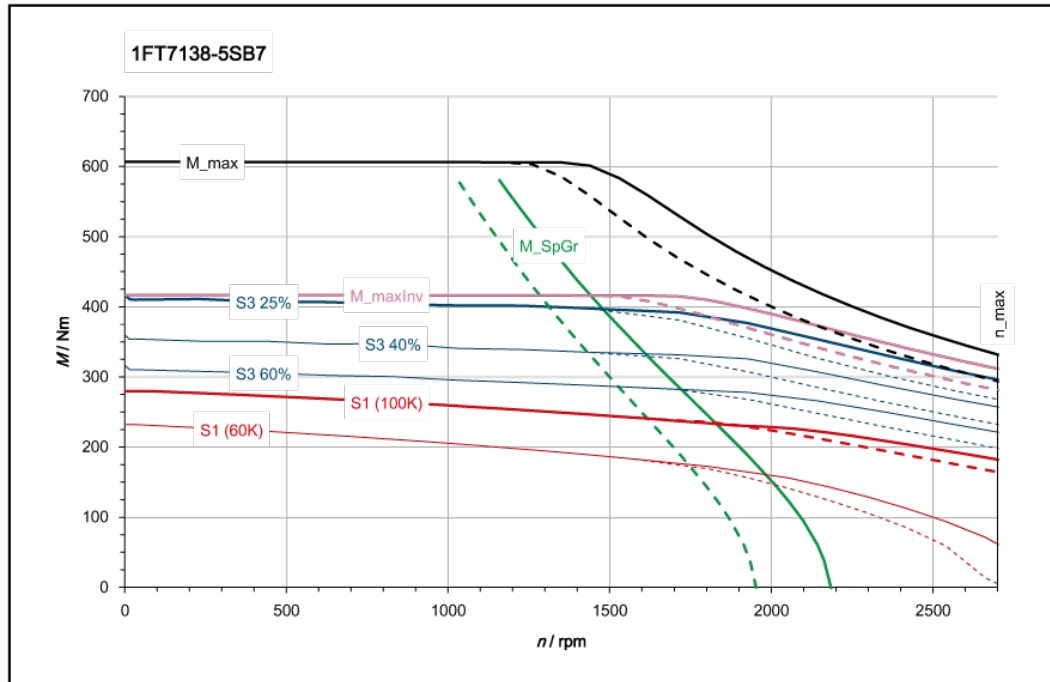

[———] SINAMICS ALM 400 V (600 V DC)
 [- - - -] SINAMICS BLM/SLM 400 V (540 V DC)

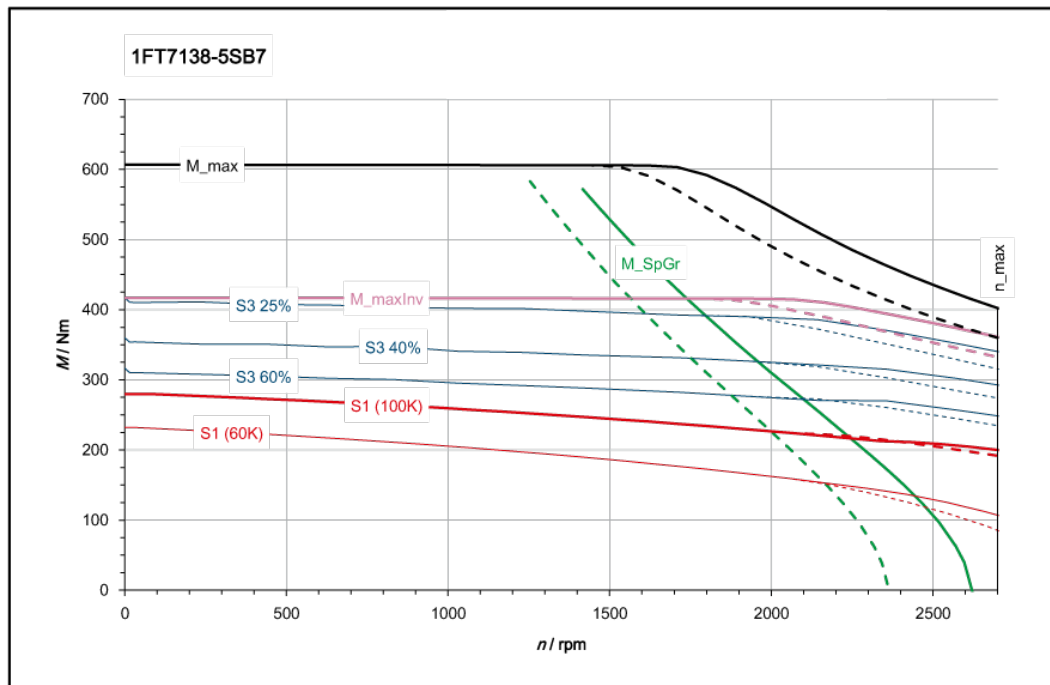

[———] SINAMICS ALM 480 V (720 V DC)
 [- - - -] SINAMICS BLM/SLM 480 V (650 V DC)

6.3.3 1FT7 Compact - water cooling

6.3.3.1 1FT7062-_W

Three-phase servomotor 1FT7062-5WF7			
Technical specifications	Symbol	Unit	Value
Configuration data:			
Rated speed	n_N	rpm	3000
Rated torque (100K)	$M_{N(100K)}$	Nm	10.0
Rated current (100K)	$I_{N(100K)}$	A	7.8
Static torque (100K)	$M_{0(100K)}$	Nm	10.0
Stall current (100K)	$I_{0(100K)}$	A	7.4
Static torque (60K)	$M_{0(60K)}$	Nm	8.0
Stall current (60K)	$I_{0(60K)}$	A	5.9
Optimum operating point:			
Optimum speed	n_{opt}	rpm	3000
Optimum power	P_{opt}	kW	3.14
Limiting data:			
Max. permissible speed (mech.)	$n_{max\ mech}$	rpm	9000
Maximum torque	M_{max}	Nm	26.0
Maximum current	I_{max}	A	27.2
Motor data:			
No. of poles	2p		10
Torque constant (100K)	k_T	Nm/A	1.35
Voltage constant (at 20 °C)	k_E	V/1000 rpm	85.5
Winding resistance (at 20 °C)	R_{Str}	W	1.0
Rotating field inductance	L_D	mH	9.1
Electrical time constant	T_{el}	ms	9
Mechanical time constant	T_{mech}	ms	1.3
Thermal time constant	T_{th}	min	1.5
Moment of inertia	J_{mot}	$kgm^2 \cdot 10^{-4}$	8.1
Shaft torsional stiffness	c_t	Nm/rad	39500
Weight	m_{mot}	kg	11.0
Motor data with integrated brake:			
Moment of inertia (with brake)	J_{mot}	$kgm^2 \cdot 10^{-4}$	10.6
Shaft torsional stiffness (with brake)	c_t	Nm/rad	28500
Weight (with brake)	m_{Mot}	kg	12.2
Data with SINAMICS S120 Booksize / S120 Booksize Compact			
Rated converter current	$I_{N\ Inv}$	A	9
Maximum converter current	$I_{max\ Inv}$	A	27
Max. torque (converter operation)	$M_{max\ Inv}$	Nm	26
Max. permissible speed (converter operation)	$n_{max\ Inv}$	rpm	6700
The rated data are valid for a 600 V DC-link voltage			

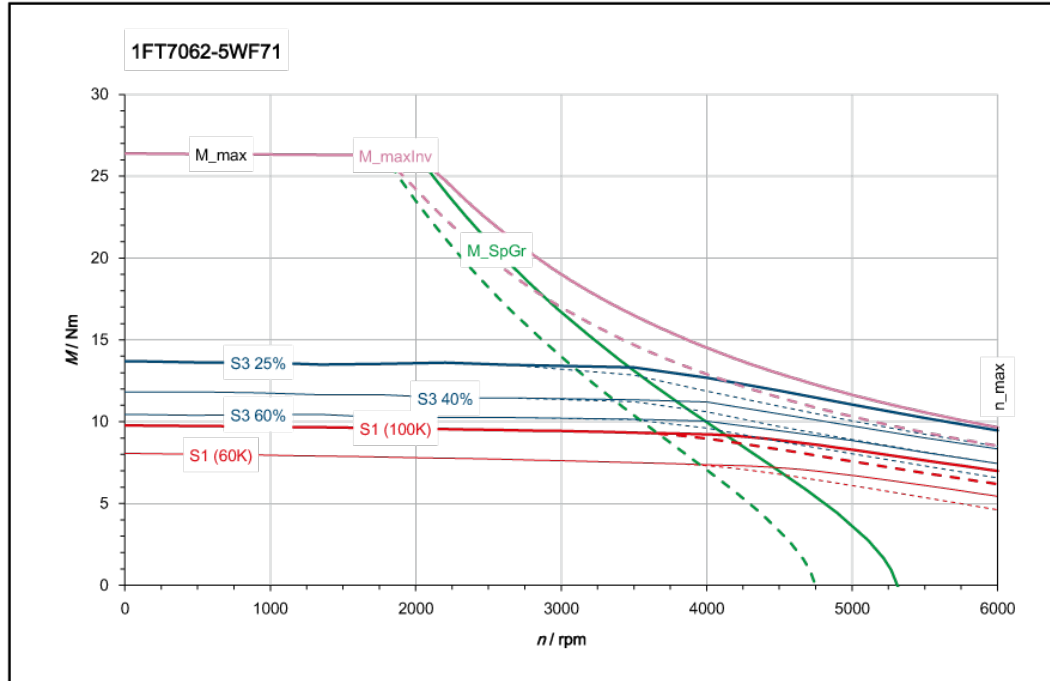

[—] SINAMICS ALM 400 V (600 V DC)
 [- - -] SINAMICS BLM/SLM 400 V (540 V DC)

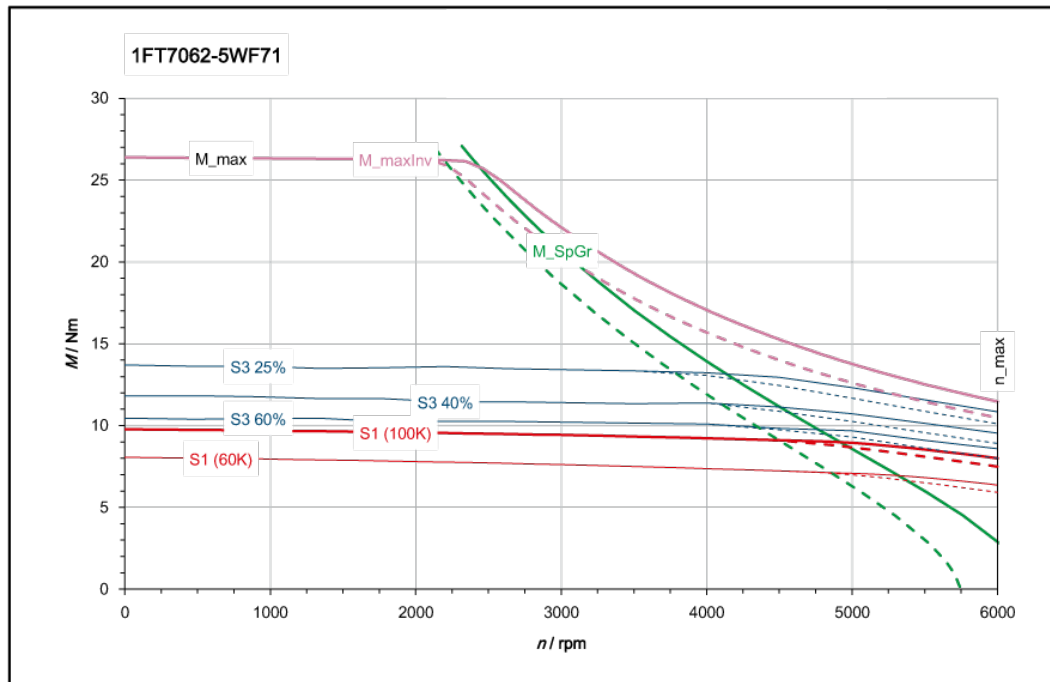

[—] SINAMICS ALM 480 V (720 V DC)
 [- - -] SINAMICS BLM/SLM 480 V (650 V DC)

Three-phase servomotor 1FT7062-5WK7			
Technical specifications	Symbol	Unit	Value
Configuration data:			
Rated speed	n_N	rpm	6000
Rated torque (100K)	$M_{N(100K)}$	Nm	9.2
Rated current (100K)	$I_{N(100K)}$	A	12.7
Static torque (100K)	$M_{0(100K)}$	Nm	10.0
Stall current (100K)	$I_{0(100K)}$	A	12.5
Static torque (60K)	$M_{0(60K)}$	Nm	8.0
Stall current (60K)	$I_{0(60K)}$	A	10.0
Optimum operating point:			
Optimum speed	n_{opt}	rpm	6000
Optimum power	P_{opt}	kW	5.78
Limiting data:			
Max. permissible speed (mech.)	$n_{max\ mech}$	rpm	9000
Maximum torque	M_{max}	Nm	26.0
Maximum current	I_{max}	A	45.7
Motor data:			
No. of poles	2p		10
Torque constant (100K)	k_T	Nm/A	0.8
Voltage constant (at 20 °C)	k_E	V/1000 rpm	50.5
Winding resistance (at 20 °C)	R_{Str}	W	0.355
Rotating field inductance	L_D	mH	3.2
Electrical time constant	T_{el}	ms	9.0
Mechanical time constant	T_{mech}	ms	1.3
Thermal time constant	T_{th}	min	1.5
Moment of inertia	J_{mot}	$kgm^2 \cdot 10^{-4}$	8.1
Shaft torsional stiffness	C_t	Nm/rad	39500
Weight	m_{mot}	kg	11.0
Motor data with integrated brake:			
Moment of inertia (with brake)	J_{mot}	$kgm^2 \cdot 10^{-4}$	10.6
Shaft torsional stiffness (with brake)	C_t	Nm/rad	28500
Weight (with brake)	m_{Mot}	kg	12.2
Data with SINAMICS S120 Booksize / S120 Booksize Compact:			
Rated converter current	$I_{N\ Inv}$	A	18
Maximum converter current	$I_{max\ Inv}$	A	54
Max. torque (converter operation)	$M_{max\ Inv}$	Nm	26
Max. permissible speed (converter operation)	$n_{max\ Inv}$	rpm	8000
The rated data are valid for a 600 V DC-link voltage			

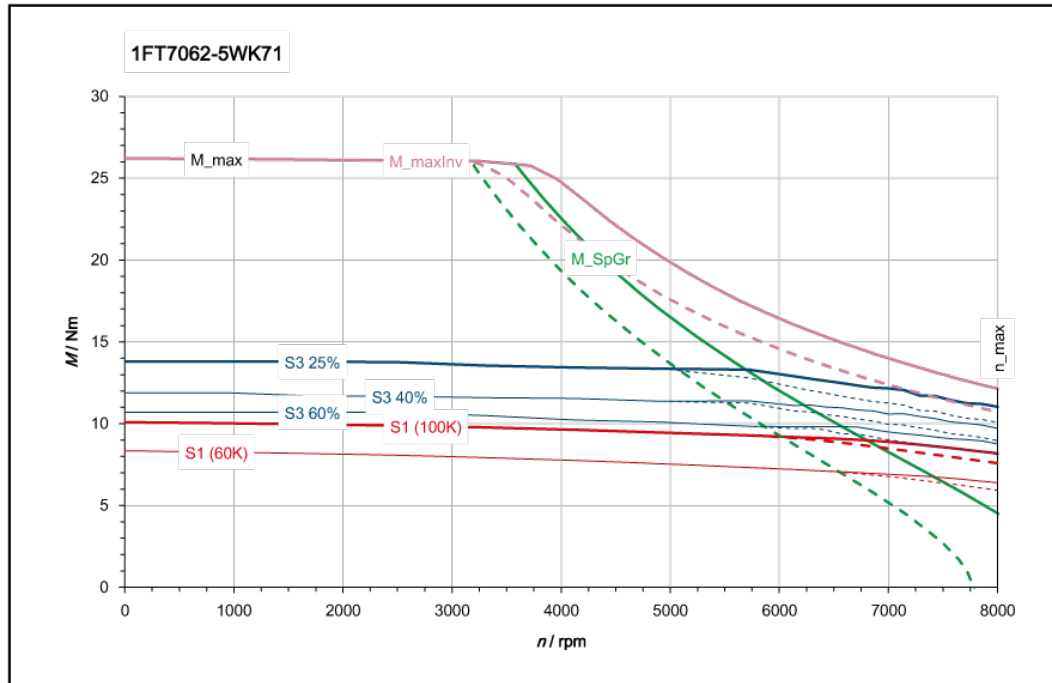

[———] SINAMICS ALM 400 V (600 V DC)
 [- - - -] SINAMICS BLM/SLM 400 V (540 V DC)

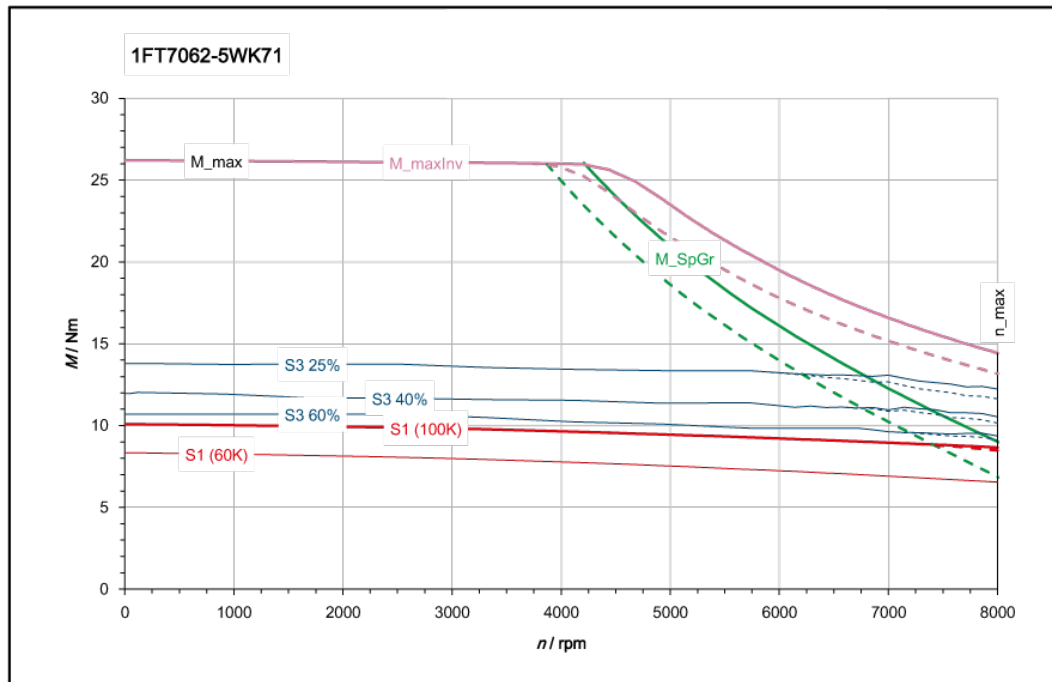

[———] SINAMICS ALM 480 V (720 V DC)
 [- - - -] SINAMICS BLM/SLM 480 V (650 V DC)

6.3.3.2 1FT7064-_W

Three-phase servomotor 1FT7064-5WF7			
Technical specifications	Symbol	Unit	Value
Configuration data:			
Rated speed	n_N	rpm	3000
Rated torque (100K)	$M_{N(100K)}$	Nm	16.0
Rated current (100K)	$I_{N(100K)}$	A	12.5
Static torque (100K)	$M_{0(100K)}$	Nm	16.0
Stall current (100K)	$I_{0(100K)}$	A	11.9
Static torque (60K)	$M_{0(60K)}$	Nm	12.8
Stall current (60K)	$I_{0(60K)}$	A	9.6
Optimum operating point:			
Optimum speed	n_{opt}	rpm	3000
Optimum power	P_{opt}	kW	5.03
Limiting data:			
Max. permissible speed (mech.)	$n_{max\ mech}$	rpm	9000
Maximum torque	M_{max}	Nm	40.0
Maximum current	I_{max}	A	39.3
Motor data:			
No. of poles	2p		10
Torque constant (100K)	k_T	Nm/A	1.34
Voltage constant (at 20 °C)	k_E	V/1000 rpm	84.5
Winding resistance (at 20 °C)	R_{Str}	W	0.5
Rotating field inductance	L_D	mH	5.3
Electrical time constant	T_{el}	ms	11
Mechanical time constant	T_{mech}	ms	1.1
Thermal time constant	T_{th}	min	1.5
Moment of inertia	J_{mot}	$kgm^2 \cdot 10^{-4}$	12.9
Shaft torsional stiffness	C_t	Nm/rad	35000
Weight	m_{mot}	kg	13.7
Motor data with integrated brake:			
Moment of inertia (with brake)	J_{mot}	$kgm^2 \cdot 10^{-4}$	15.4
Shaft torsional stiffness (with brake)	C_t	Nm/rad	26000
Weight (with brake)	m_{Mot}	kg	14.8
Data with SINAMICS S120 Booksize / S120 Booksize Compact:			
Rated converter current	$I_{N\ Inv}$	A	18
Maximum converter current	$I_{max\ Inv}$	A	54
Max. torque (converter operation)	$M_{max\ Inv}$	Nm	40
Max. permissible speed (converter operation)	$n_{max\ Inv}$	rpm	6800
The rated data are valid for a 600 V DC-link voltage			

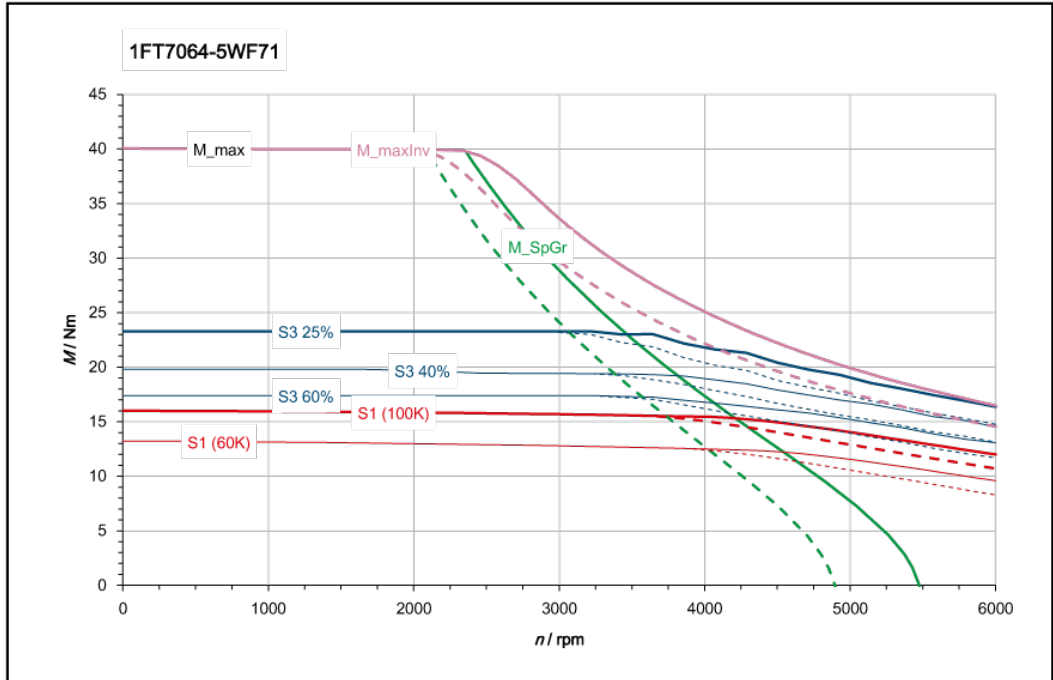

[———] SINAMICS ALM 400 V (600 V DC)
 [- - - -] SINAMICS BLM/SLM 400 V (540 V DC)

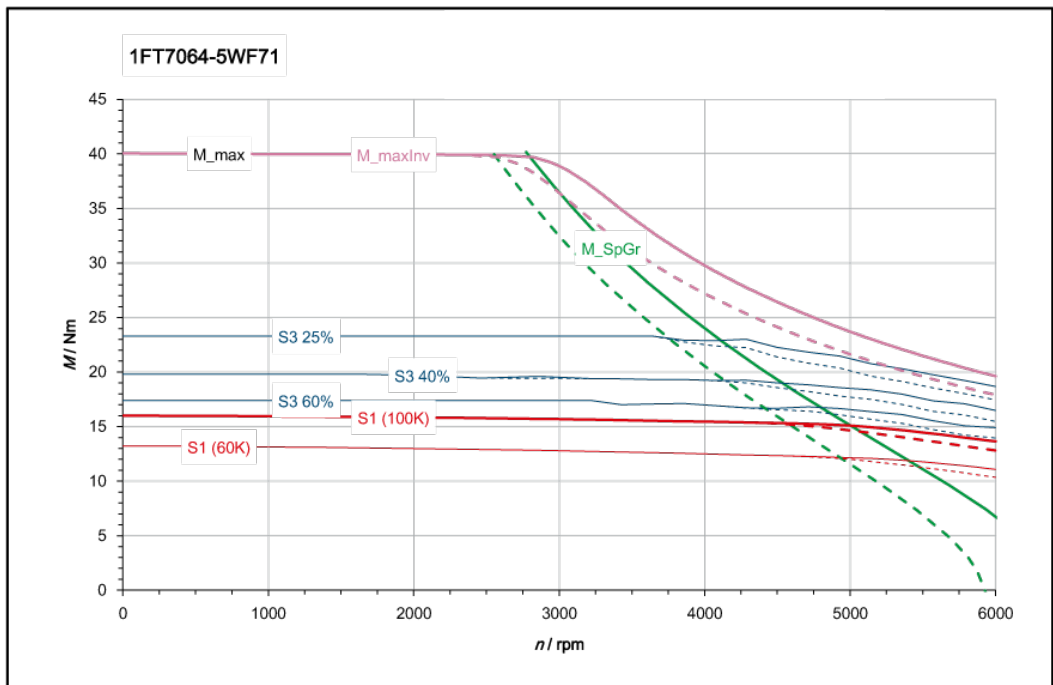

[———] SINAMICS ALM 480 V (720 V DC)
 [- - - -] SINAMICS BLM/SLM 480 V (650 V DC)

Three-phase servomotor 1FT7064-5WK7			
Technical specifications	Symbol	Unit	Value
Configuration data:			
Rated speed	n_N	rpm	6000
Rated torque (100K)	$M_{N(100K)}$	Nm	14.2
Rated current (100K)	$I_{N(100K)}$	A	20.0
Static torque (100K)	$M_{0(100K)}$	Nm	16.0
Stall current (100K)	$I_{0(100K)}$	A	20.2
Static torque (60K)	$M_{0(60K)}$	Nm	12.8
Stall current (60K)	$I_{0(60K)}$	A	16.3
Optimum operating point:			
Optimum speed	n_{opt}	rpm	6000
Optimum power	P_{opt}	kW	8.92
Limiting data:			
Max. permissible speed (mech.)	$n_{max\ mech}$	rpm	9000
Maximum torque	M_{max}	Nm	40.0
Maximum current	I_{max}	A	67
Motor data:			
No. of poles	$2p$		10
Torque constant (100K)	k_T	Nm/A	0.79
Voltage constant (at 20 °C)	k_E	V/1000 rpm	49.6
Winding resistance (at 20 °C)	R_{Str}	W	0.183
Rotating field inductance	L_D	mH	1.75
Electrical time constant	T_{el}	ms	10
Mechanical time constant	T_{mech}	ms	1.1
Thermal time constant	T_{th}	min	1.5
Moment of inertia	J_{mot}	$kgm^2 \cdot 10^{-4}$	12.9
Shaft torsional stiffness	C_t	Nm/rad	35000
Weight	m_{mot}	kg	13.7
Motor data with integrated brake:			
Moment of inertia (with brake)	J_{mot}	$kgm^2 \cdot 10^{-4}$	15.4
Shaft torsional stiffness (with brake)	C_t	Nm/rad	26000
Weight (with brake)	m_{Mot}	kg	14.8
Data with SINAMICS S120 Booksize:			
Rated converter current	$I_{N\ Inv}$	A	30
Maximum converter current	$I_{max\ Inv}$	A	90
Max. torque (converter operation)	$M_{max\ Inv}$	Nm	40
Max. permissible speed (converter operation)	$n_{max\ Inv}$	rpm	8000
The rated data are valid for a 600 V DC-link voltage			

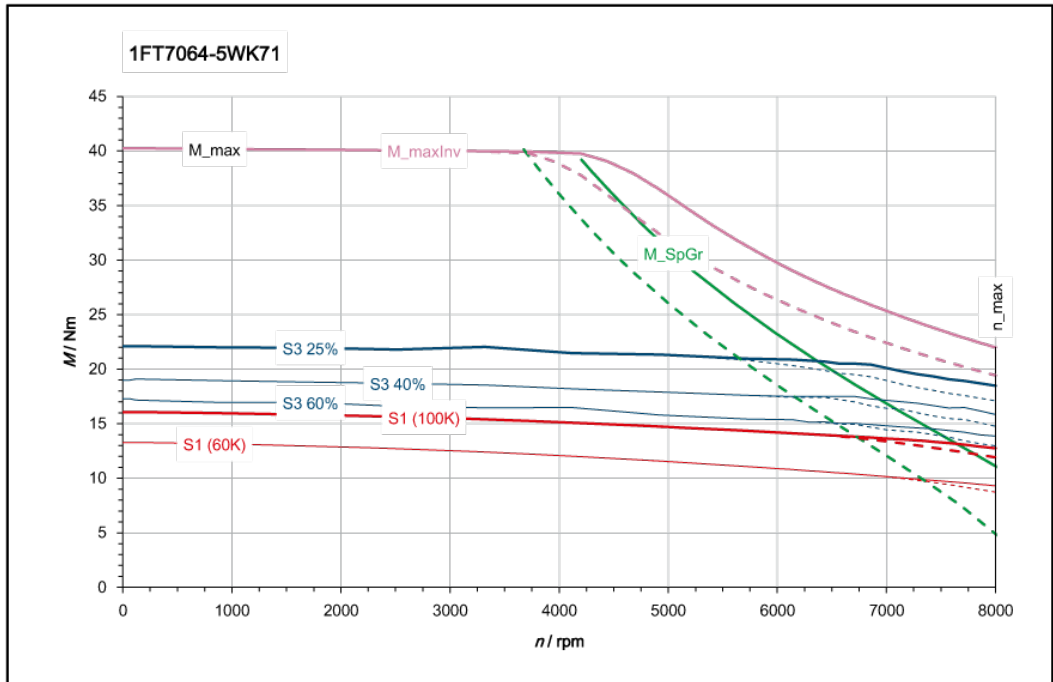

[———] SINAMICS ALM 400 V (600 V DC)
 [- - - -] SINAMICS BLM/SLM 400 V (540 V DC)

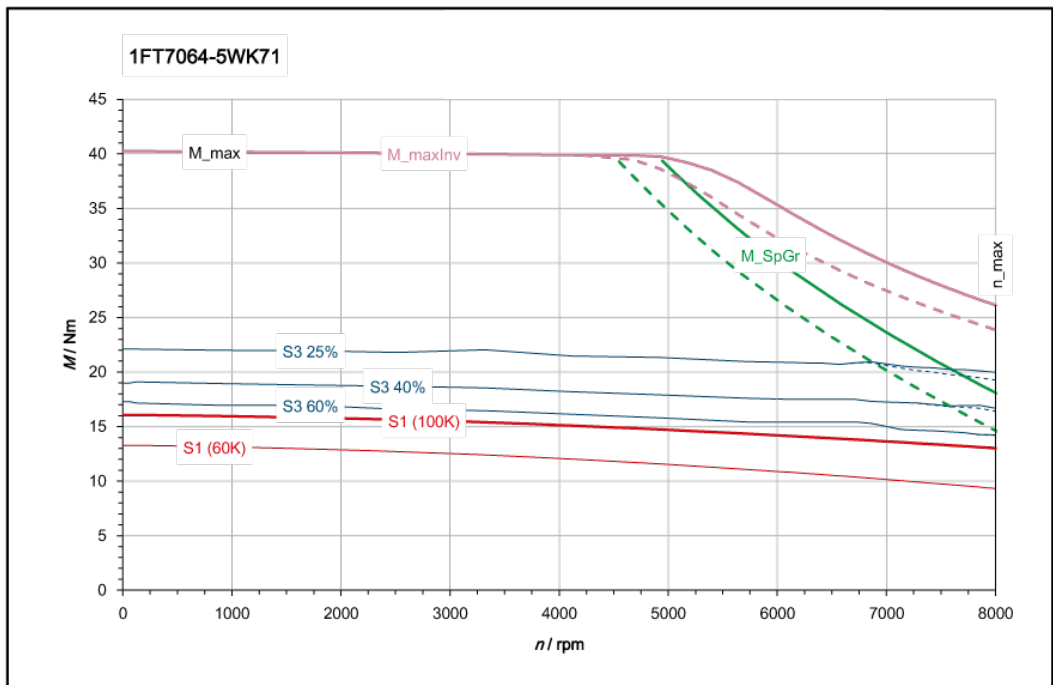

[———] SINAMICS ALM 480 V (720 V DC)
 [- - - -] SINAMICS BLM/SLM 480 V (650 V DC)

6.3.3.3 1FT7066-W

Three-phase servomotor 1FT7066-5WF7			
Technical specifications	Symbol	Unit	Value
Configuration data:			
Rated speed	n_N	rpm	3000
Rated torque (100K)	$M_{N(100K)}$	Nm	19.6
Rated current (100K)	$I_{N(100K)}$	A	14.4
Static torque (100K)	$M_{0(100K)}$	Nm	20.0
Stall current (100K)	$I_{0(100K)}$	A	14.0
Static torque (60K)	$M_{0(60K)}$	Nm	16.0
Stall current (60K)	$I_{0(60K)}$	A	11.3
Optimum operating point:			
Optimum speed	n_{opt}	rpm	3000
Optimum power	P_{opt}	kW	6.16
Limiting data:			
Max. permissible speed (mech.)	$n_{max\ mech}$	rpm	9000
Maximum torque	M_{max}	Nm	55
Maximum current	I_{max}	A	50
Motor data:			
No. of poles	2p		10
Torque constant (100K)	k_T	Nm/A	1.42
Voltage constant (at 20 °C)	k_E	V/1000 rpm	89.5
Winding resistance (at 20 °C)	R_{Str}	W	0.395
Rotating field inductance	L_D	mH	4.07
Electrical time constant	T_{el}	ms	10
Mechanical time constant	T_{mech}	ms	1.0
Thermal time constant	T_{th}	min	1.5
Moment of inertia	J_{mot}	$kgm^2 \cdot 10^{-4}$	17.7
Shaft torsional stiffness	C_t	Nm/rad	31500
Weight	m_{mot}	kg	16.3
Motor data with integrated brake:			
Moment of inertia (with brake)	J_{mot}	$kgm^2 \cdot 10^{-4}$	20.2
Shaft torsional stiffness (with brake)	C_t	Nm/rad	24000
Weight (with brake)	m_{Mot}	kg	17.4
Data with SINAMICS S120 Booksize / S120 Booksize Compact:			
Rated converter current	$I_{N\ Inv}$	A	18
Maximum converter current	$I_{max\ Inv}$	A	54
Max. torque (converter operation)	$M_{max\ Inv}$	Nm	55
Max. permissible speed (converter operation)	$n_{max\ Inv}$	rpm	6400
The rated data are valid for a 600 V DC-link voltage			

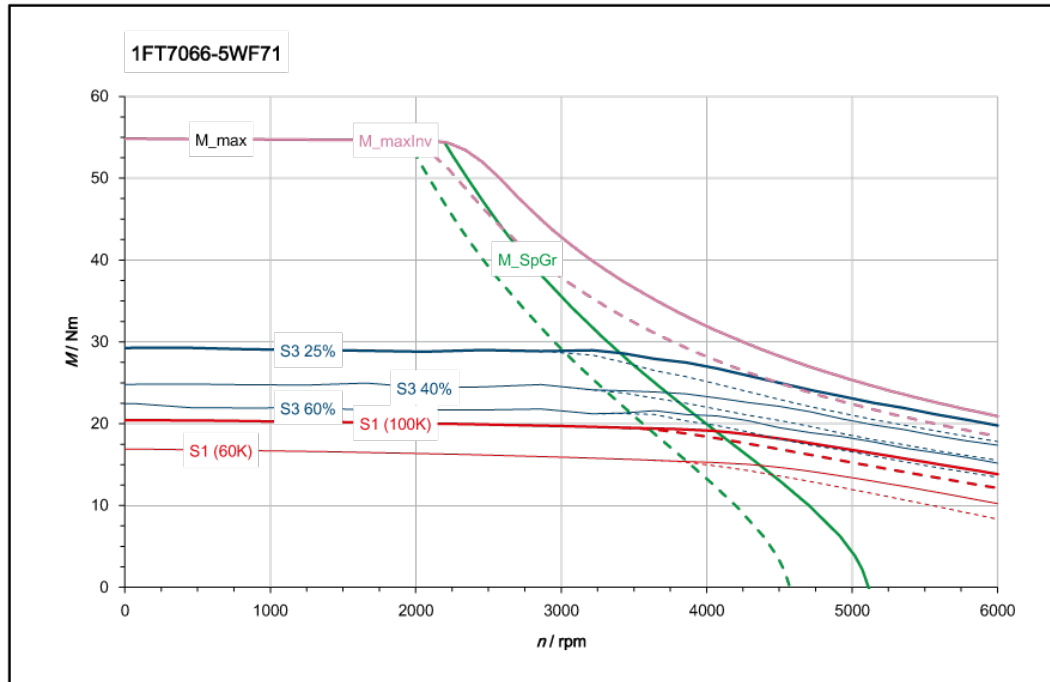

[———] SINAMICS ALM 400 V (600 V DC)
 [- - - -] SINAMICS BLM/SLM 400 V (540 V DC)

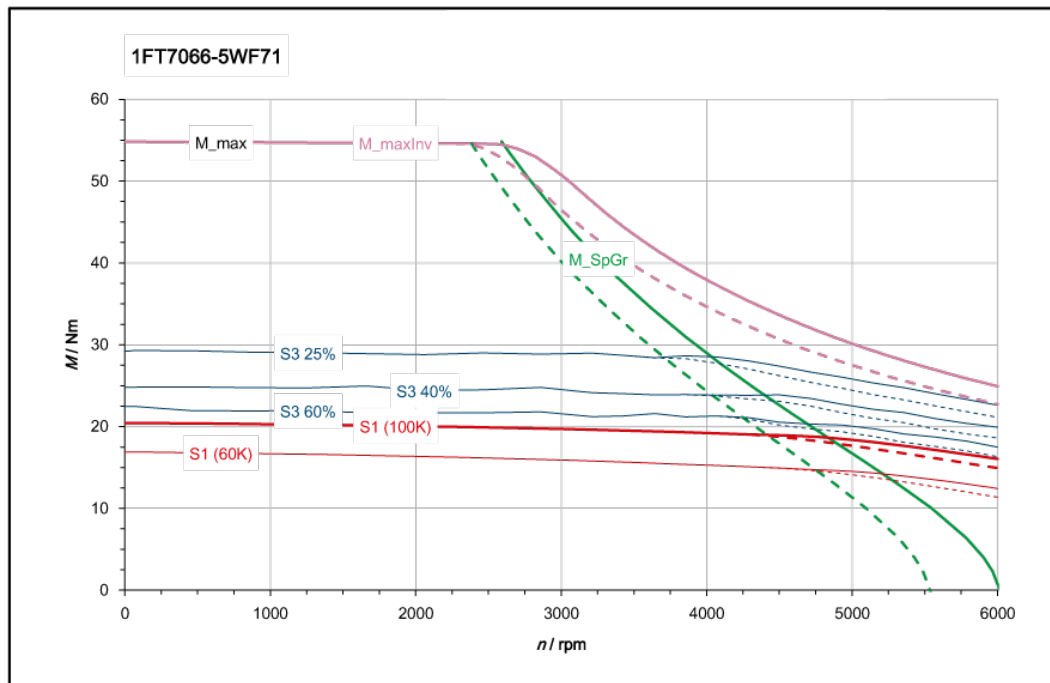

[———] SINAMICS ALM 480 V (720 V DC)
 [- - - -] SINAMICS BLM/SLM 480 V (650 V DC)

Three-phase servomotor 1FT7066-5WH7			
Technical specifications	Symbol	Unit	Value
Configuration data:			
Rated speed	n_N	rpm	4500
Rated torque (100K)	$M_{N(100K)}$	Nm	19.4
Rated current (100K)	$I_{N(100K)}$	A	20.8
Static torque (100K)	$M_{0(100K)}$	Nm	20.0
Stall current (100K)	$I_{0(100K)}$	A	19.7
Static torque (60K)	$M_{0(60K)}$	Nm	16.0
Stall current (60K)	$I_{0(60K)}$	A	15.9
Optimum operating point:			
Optimum speed	n_{opt}	rpm	4500
Optimum power	P_{opt}	kW	9.14
Limiting data:			
Max. permissible speed (mech.)	$n_{max\ mech}$	rpm	9000
Maximum torque	M_{max}	Nm	55
Maximum current	I_{max}	A	70.5
Motor data:			
No. of poles	$2p$		10
Torque constant (100K)	k_T	Nm/A	1.01
Voltage constant (at 20 °C)	k_E	V/1000 rpm	63.5
Winding resistance (at 20 °C)	R_{Str}	W	0.197
Rotating field inductance	L_D	mH	2.05
Electrical time constant	T_{el}	ms	10
Mechanical time constant	T_{mech}	ms	1.0
Thermal time constant	T_{th}	min	1.5
Moment of inertia	J_{mot}	$kgm^2 \cdot 10^{-4}$	17.7
Shaft torsional stiffness	C_t	Nm/rad	31500
Weight	m_{mot}	kg	16.3
Motor data with integrated brake:			
Moment of inertia (with brake)	J_{mot}	$kgm^2 \cdot 10^{-4}$	20.2
Shaft torsional stiffness (with brake)	C_t	Nm/rad	24000
Weight (with brake)	m_{Mot}	kg	17.4
Data with SINAMICS S120 Booksize:			
Rated converter current	$I_{N\ Inv}$	A	24
Maximum converter current	$I_{max\ Inv}$	A	72
Max. torque (converter operation)	$M_{max\ Inv}$	Nm	55
Max. permissible speed (converter operation)	$n_{max\ Inv}$	rpm	8000
The rated data are valid for a 600 V DC-link voltage			

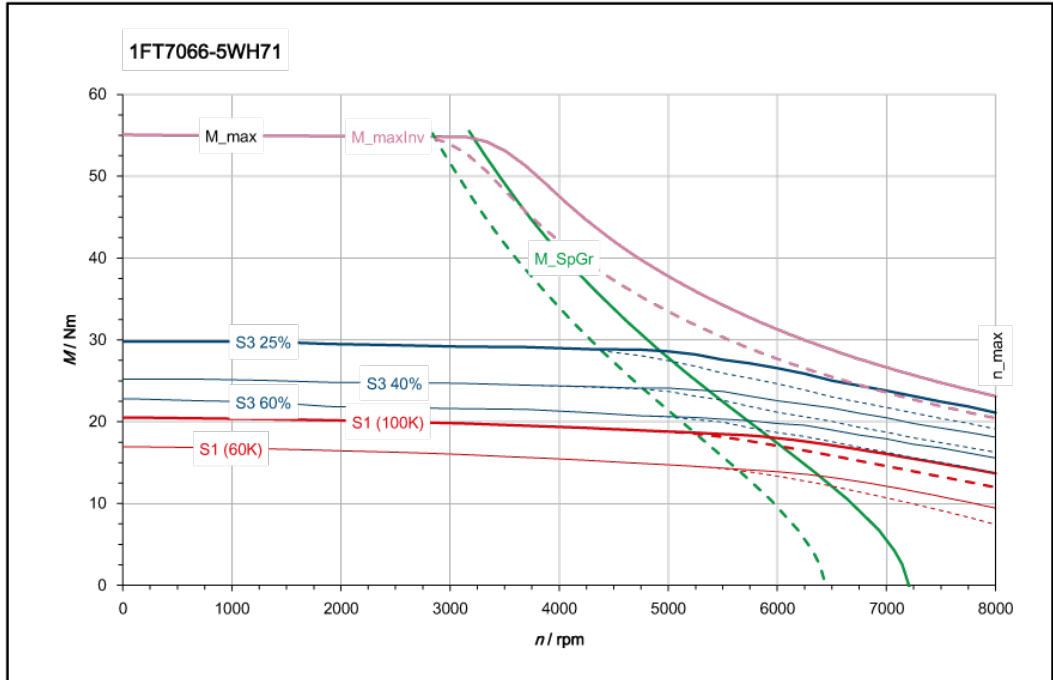

[—] SINAMICS ALM 400 V (600 V DC)
 [- - -] SINAMICS BLM/SLM 400 V (540 V DC)

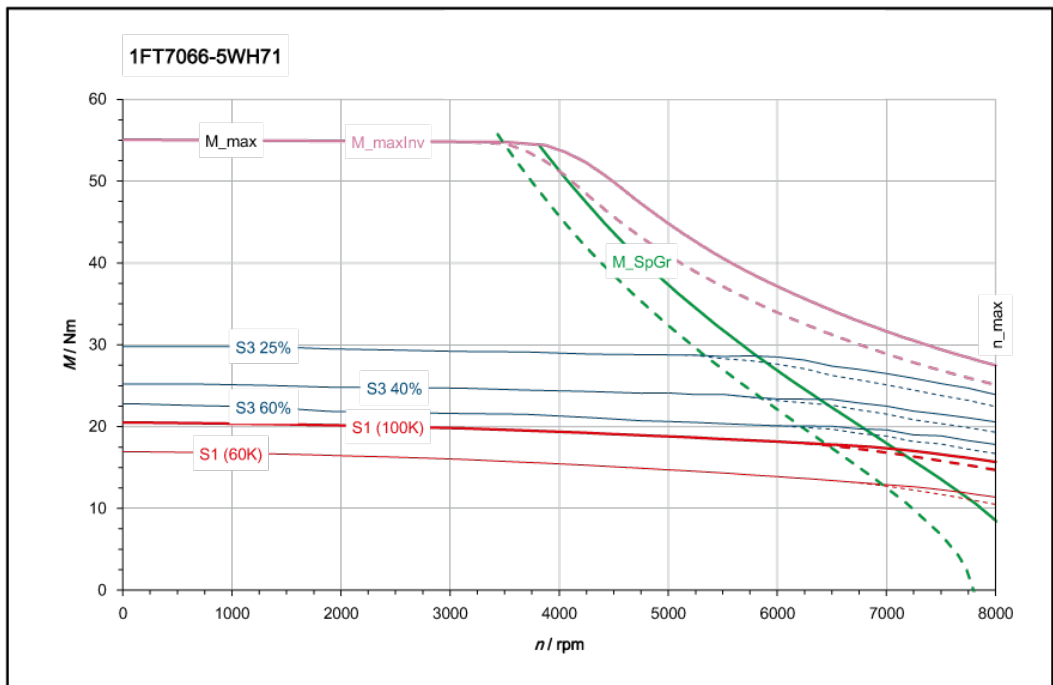

[—] SINAMICS ALM 480 V (720 V DC)
 [- - -] SINAMICS BLM/SLM 480 V (650 V DC)

6.3.3.4 1FT7068-_W

Three-phase servomotor 1FT7068-5WF7			
Technical specifications	Symbol	Unit	Value
Configuration data:			
Rated speed	n_N	rpm	3000
Rated torque (100K)	$M_{N(100K)}$	Nm	29.5
Rated current (100K)	$I_{N(100K)}$	A	19.6
Static torque (100K)	$M_{0(100K)}$	Nm	30.0
Stall current (100K)	$I_{0(100K)}$	A	19.0
Static torque (60K)	$M_{0(60K)}$	Nm	24
Stall current (60K)	$I_{0(60K)}$	A	15.3
Optimum operating point:			
Optimum speed	n_{opt}	rpm	3000
Optimum power	P_{opt}	kW	9.27
Limiting data:			
Max. permissible speed (mech.)	$n_{max\ mech}$	rpm	9000
Maximum torque	M_{max}	Nm	70
Maximum current	I_{max}	A	55.5
Motor data:			
No. of poles	2p		10
Torque constant (100K)	k_T	Nm/A	1.57
Voltage constant (at 20 °C)	k_E	V/1000 rpm	99.0
Winding resistance (at 20 °C)	R_{Str}	W	0.315
Rotating field inductance	L_D	mH	3.35
Electrical time constant	T_{el}	ms	11
Mechanical time constant	T_{mech}	ms	1
Thermal time constant	T_{th}	min	1.5
Moment of inertia	J_{mot}	$kgm^2 \cdot 10^{-4}$	24.8
Shaft torsional stiffness	C_t	Nm/rad	27500
Weight	m_{mot}	kg	20.1
Motor data with integrated brake:			
Moment of inertia (with brake)	J_{mot}	$kgm^2 \cdot 10^{-4}$	27.4
Shaft torsional stiffness (with brake)	C_t	Nm/rad	21500
Weight (with brake)	m_{Mot}	kg	21.3
Data with SINAMICS S120 Booksize / S120 Booksize Compact:			
Rated converter current	$I_{N\ Inv}$	A	18
Maximum converter current	$I_{max\ Inv}$	A	54
Max. torque (converter operation)	$M_{max\ Inv}$	Nm	68.5
Max. permissible speed (converter operation)	$n_{max\ Inv}$	rpm	5800
The rated data are valid for a 600 V DC-link voltage			

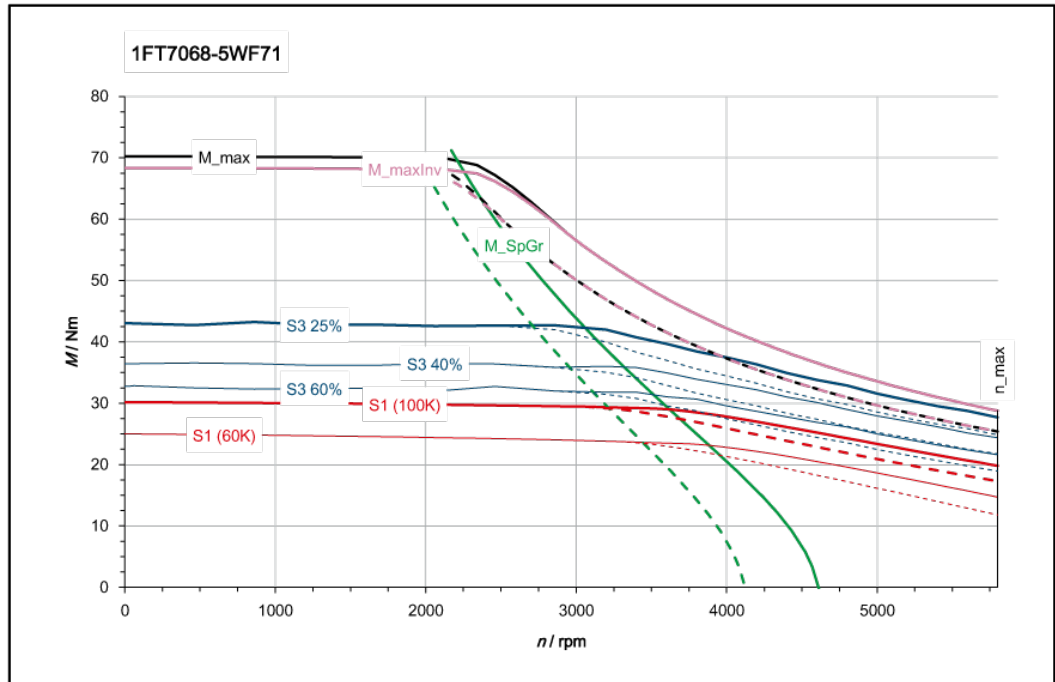

[———] SINAMICS ALM 400 V (600 V DC)
 [- - - -] SINAMICS BLM/SLM 400 V (540 V DC)

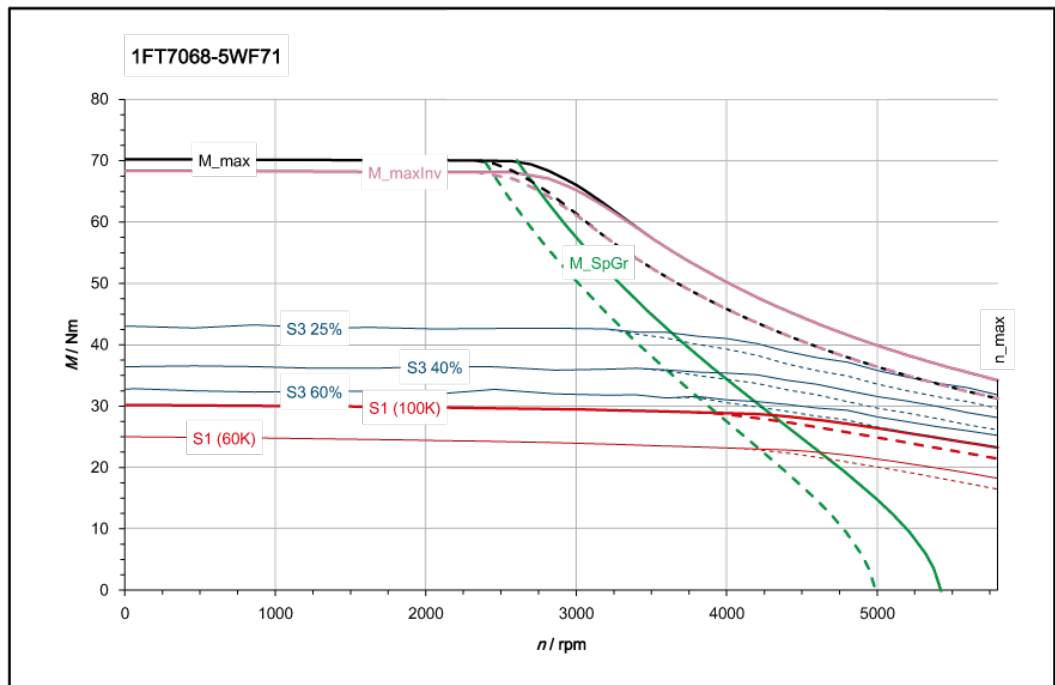

[———] SINAMICS ALM 480 V (720 V DC)
 [- - - -] SINAMICS BLM/SLM 480 V (650 V DC)

6.3.3.5 1FT7082-_W

Three-phase servomotor 1FT7082-5WC7			
Technical specifications	Symbol	Unit	Value
Configuration data:			
Rated speed	n_N	rpm	2000
Rated torque (100K)	$M_{N(100K)}$	Nm	21.0
Rated current (100K)	$I_{N(100K)}$	A	11.0
Static torque (100K)	$M_{0(100K)}$	Nm	21.0
Stall current (100K)	$I_{0(100K)}$	A	10.7
Static torque (60K)	$M_{0(60K)}$	Nm	17.5
Stall current (60K)	$I_{0(60K)}$	A	9.0
Optimum operating point:			
Optimum speed	n_{opt}	rpm	2000
Optimum power	P_{opt}	kW	4.4
Limiting data:			
Max. permissible speed (mech.)	$n_{max\ mech}$	rpm	8000
Maximum torque	M_{max}	Nm	55
Maximum current	I_{max}	A	36.3
Motor data:			
No. of poles	2p		10
Torque constant (100K)	k_T	Nm/A	1.95
Voltage constant (at 20 °C)	k_E	V/1000 rpm	123.0
Winding resistance (at 20 °C)	R_{Str}	W	0.6
Rotating field inductance	L_D	mH	9.15
Electrical time constant	T_{el}	ms	15
Mechanical time constant	T_{mech}	ms	1.4
Thermal time constant	T_{th}	min	1.5
Moment of inertia	J_{mot}	$kgm^2 \cdot 10^{-4}$	28.9
Shaft torsional stiffness	C_t	Nm/rad	108000
Weight	m_{mot}	kg	20.7
Motor data with integrated brake:			
Moment of inertia (with brake)	J_{mot}	$kgm^2 \cdot 10^{-4}$	43.0
Shaft torsional stiffness (with brake)	C_t	Nm/rad	76000
Weight (with brake)	m_{Mot}	kg	23.7
Data with SINAMICS S120 Booksize / S120 Booksize Compact:			
Rated converter current	$I_{N\ Inv}$	A	18
Maximum converter current	$I_{max\ Inv}$	A	54
Max. torque (converter operation)	$M_{max\ Inv}$	Nm	55
Max. permissible speed (converter operation)	$n_{max\ Inv}$	rpm	4700
The rated data are valid for a 600 V DC-link voltage			

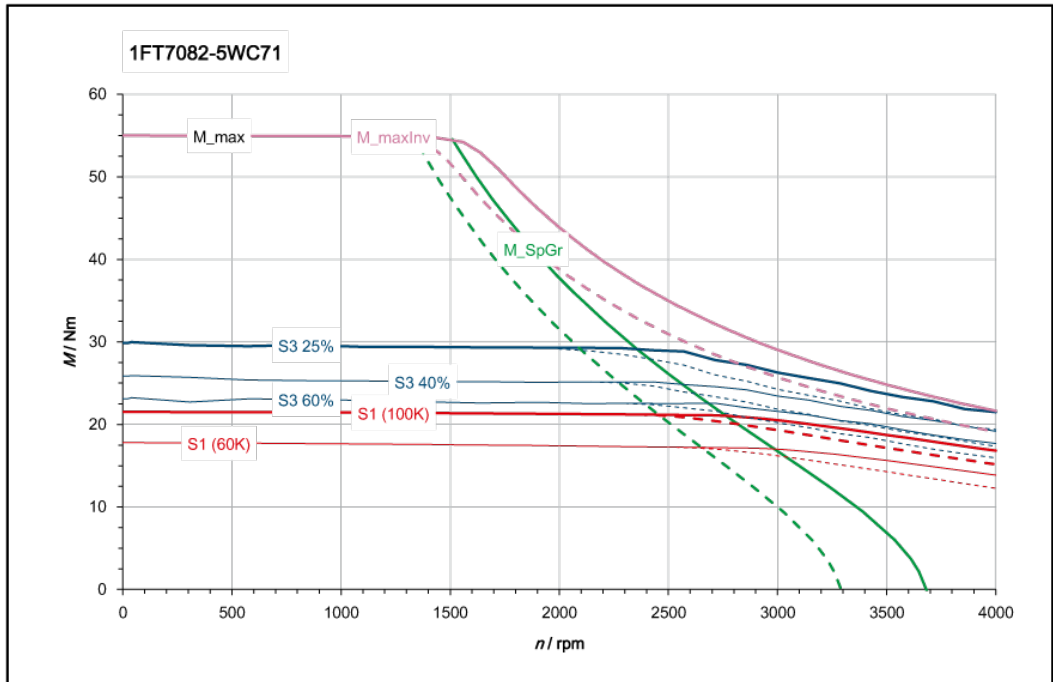

[———] SINAMICS ALM 400 V (600 V DC)
 [- - - -] SINAMICS BLM/SLM 400 V (540 V DC)

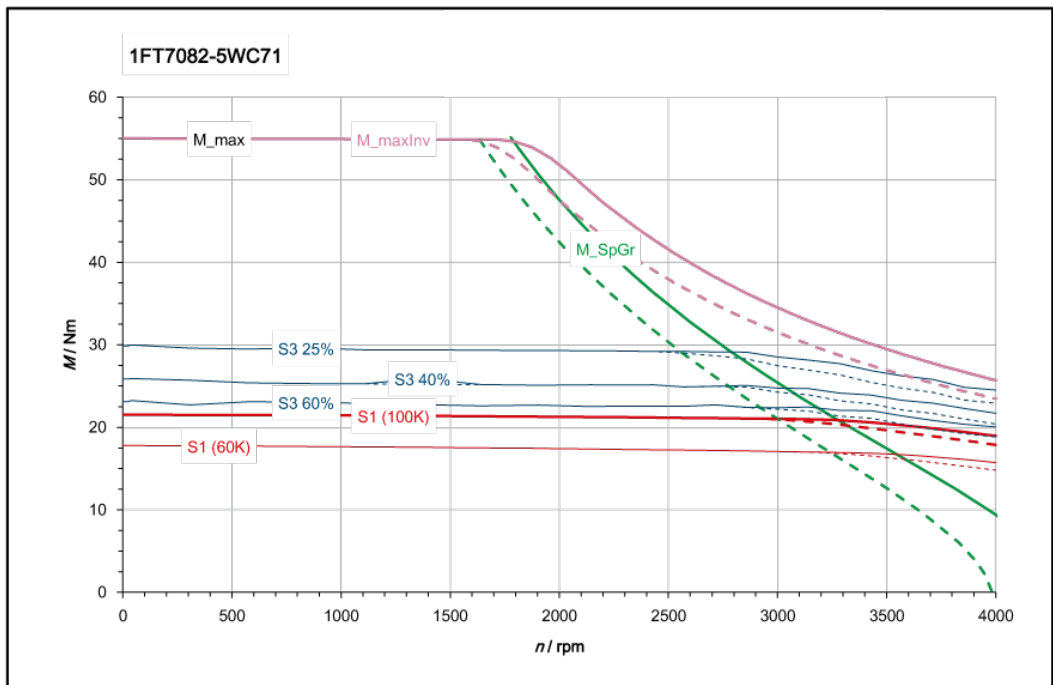

[———] SINAMICS ALM 480 V (720 V DC)
 [- - - -] SINAMICS BLM/SLM 480 V (650 V DC)

Three-phase servomotor 1FT7082-5WF7			
Technical specifications	Symbol	Unit	Value
Configuration data			
Rated speed	n_N	rpm	3000
Rated torque (100K)	$M_{N(100K)}$	Nm	20.5
Rated current (100K)	$I_{N(100K)}$	A	16.0
Static torque (100K)	$M_{0(100K)}$	Nm	21.0
Stall current (100K)	$I_{0(100K)}$	A	16.0
Static torque (60K)	$M_{0(60K)}$	Nm	17.5
Stall current (60K)	$I_{0(60K)}$	A	13.4
Optimum operating point:			
Optimum speed	n_{opt}	rpm	3000
Optimum power	P_{opt}	kW	6.44
Limiting data:			
Max. permissible speed (mech.)	$n_{max\ mech}$	rpm	8000
Maximum torque	M_{max}	Nm	55
Maximum current	I_{max}	A	54
Motor data:			
No. of poles	$2p$		10
Torque constant (100K)	k_T	Nm/A	1.31
Voltage constant (at 20 °C)	k_E	V/1000 rpm	82.5
Winding resistance (at 20 °C)	R_{Str}	W	0.285
Rotating field inductance	L_D	mH	4.15
Electrical time constant	T_{el}	ms	15
Mechanical time constant	T_{mech}	ms	1.4
Thermal time constant	T_{th}	min	1.5
Moment of inertia	J_{mot}	$kgm^2 \cdot 10^{-4}$	28.9
Shaft torsional stiffness	C_t	Nm/rad	108000
Weight	m_{mot}	kg	20.7
Motor data with integrated brake:			
Moment of inertia (with brake)	J_{mot}	$kgm^2 \cdot 10^{-4}$	43.0
Shaft torsional stiffness (with brake)	C_t	Nm/rad	76000
Weight (with brake)	m_{Mot}	kg	23.7
Data with SINAMICS S120 Booksize / S120 Booksize Compact:			
Rated converter current	$I_{N\ Inv}$	A	18
Maximum converter current	$I_{max\ Inv}$	A	54
Max. torque (converter operation)	$M_{max\ Inv}$	Nm	55
Max. permissible speed (converter operation)	$n_{max\ Inv}$	rpm	7000
The rated data are valid for a 600 V DC-link voltage			

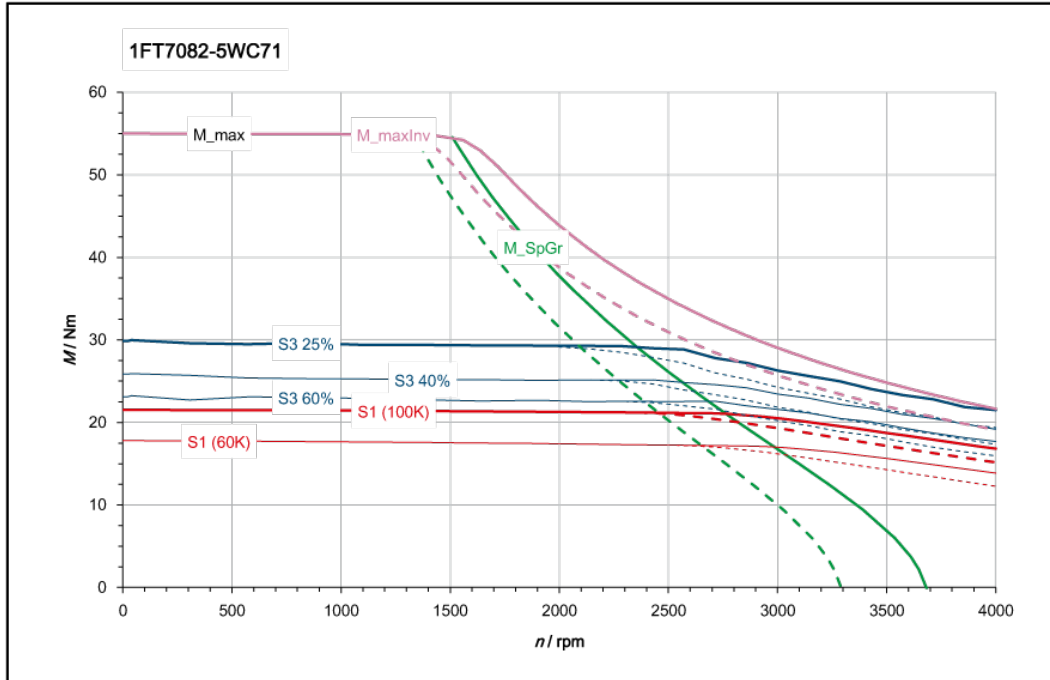

[———] SINAMICS ALM 400 V (600 V DC)
 [- - - -] SINAMICS BLM/SLM 400 V (540 V DC)

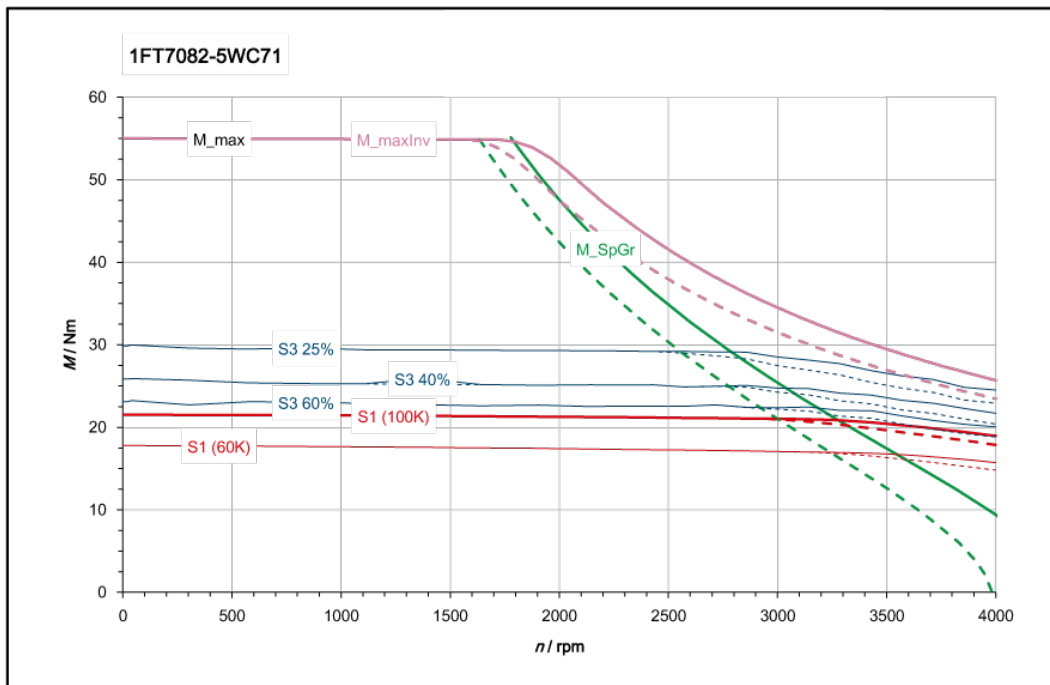

[———] SINAMICS ALM 480 V (720 V DC)
 [- - - -] SINAMICS BLM/SLM 480 V (650 V DC)

Three-phase servomotor 1FT7082-5WH7			
Technical specifications	Symbol	Unit	Value
Configuration data:			
Rated speed	n_N	rpm	4500
Rated torque (100K)	$M_{N(100K)}$	Nm	19.0
Rated current (100K)	$I_{N(100K)}$	A	23.9
Static torque (100K)	$M_{0(100K)}$	Nm	21
Stall current (100K)	$I_{0(100K)}$	A	24
Static torque (60K)	$M_{0(60K)}$	Nm	17.5
Stall current (60K)	$I_{0(60K)}$	A	20.5
Optimum operating point:			
Optimum speed	n_{opt}	rpm	4500
Optimum power	P_{opt}	kW	8.95
Limiting data:			
Max. permissible speed (mech.)	$n_{max\ mech}$	rpm	8000
Maximum torque	M_{max}	Nm	55
Maximum current	I_{max}	A	82
Motor data:			
No. of poles	$2p$		10
Torque constant (100K)	k_T	Nm/A	0.86
Voltage constant (at 20 °C)	k_E	V/1000 rpm	54.0
Winding resistance (at 20 °C)	R_{Str}	W	0.121
Rotating field inductance	L_D	mH	1.79
Electrical time constant	T_{el}	ms	15
Mechanical time constant	T_{mech}	ms	1.4
Thermal time constant	T_{th}	min	1.5
Moment of inertia	J_{mot}	$kgm^2 \cdot 10^{-4}$	28.9
Shaft torsional stiffness	C_t	Nm/rad	108000
Weight	m_{mot}	kg	20.7
Motor data with integrated brake:			
Moment of inertia (with brake)	J_{mot}	$kgm^2 \cdot 10^{-4}$	43.0
Shaft torsional stiffness (with brake)	C_t	Nm/rad	76000
Weight (with brake)	m_{Mot}	kg	23.7
Data with SINAMICS S120 Booksize:			
Rated converter current	$I_{N\ Inv}$	A	24
Maximum converter current	$I_{max\ Inv}$	A	72
Max. torque (converter operation)	$M_{max\ Inv}$	Nm	49.2
Max. permissible speed (converter operation)	$n_{max\ Inv}$	rpm	8000
The rated data are valid for a 600 V DC-link voltage			

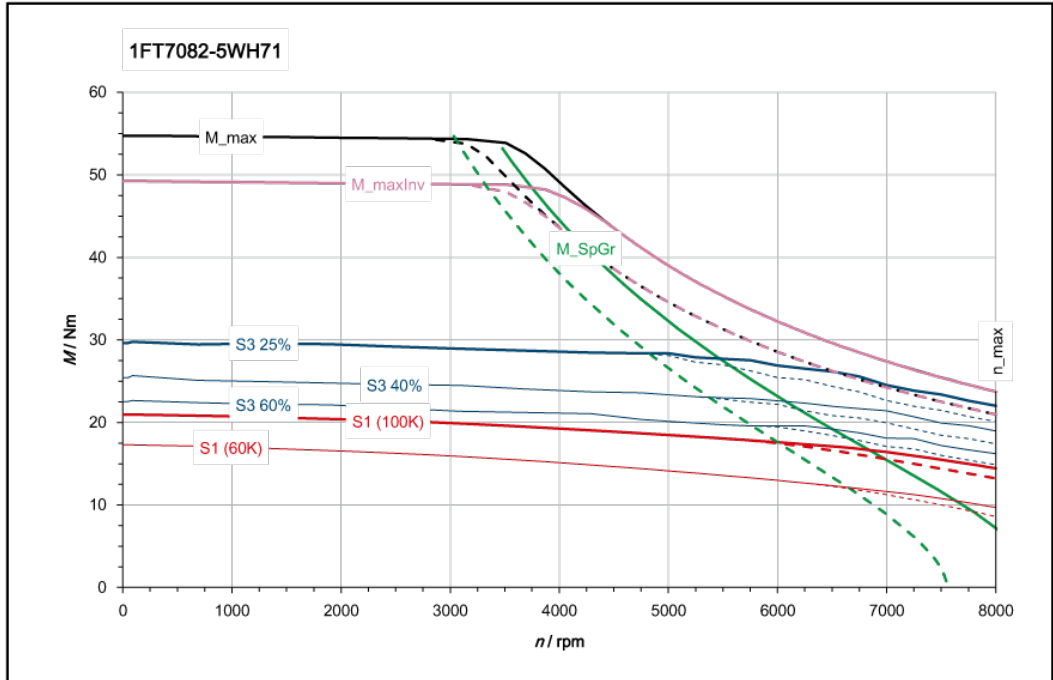

[———] SINAMICS ALM 400 V (600 V DC)
 [- - - -] SINAMICS BLM/SLM 400 V (540 V DC)

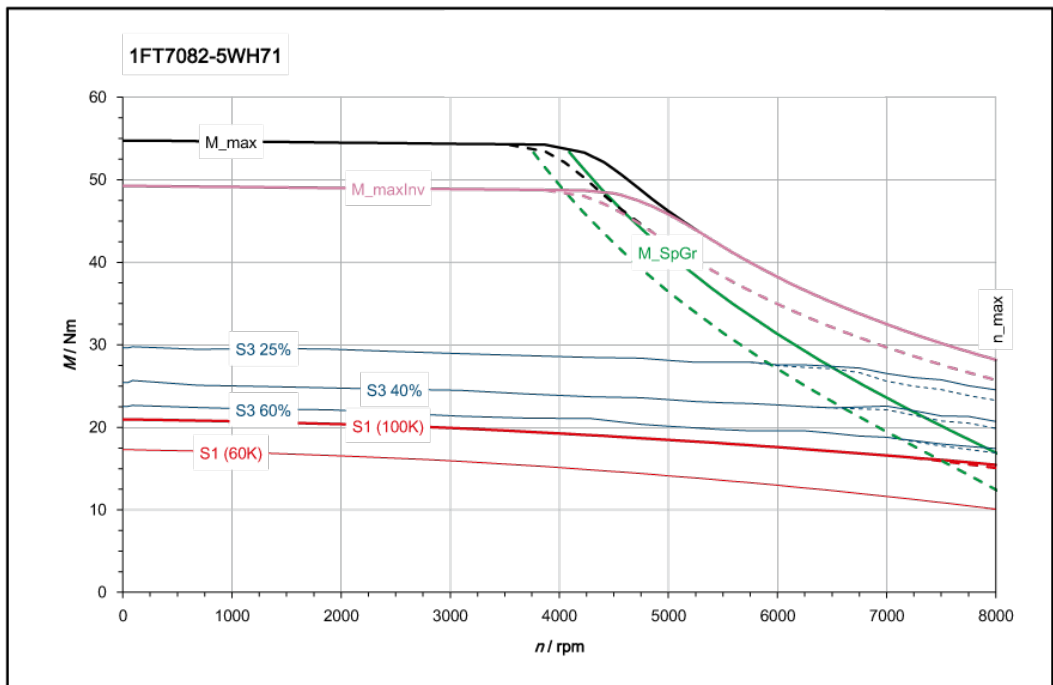

[———] SINAMICS ALM 480 V (720 V DC)
 [- - - -] SINAMICS BLM/SLM 480 V (650 V DC)

6.3.3.6 1FT7084-_W

Three-phase servomotor 1FT7084-5WC7			
Technical specifications	Symbol	Unit	Value
Configuration data:			
Rated speed	n_N	rpm	2000
Rated torque (100K)	$M_{N(100K)}$	Nm	35.0
Rated current (100K)	$I_{N(100K)}$	A	17.0
Static torque (100K)	$M_{0(100K)}$	Nm	35.0
Stall current (100K)	$I_{0(100K)}$	A	16.5
Static torque (60K)	$M_{0(60K)}$	Nm	29.0
Stall current (60K)	$I_{0(60K)}$	A	13.8
Optimum operating point:			
Optimum speed	n_{opt}	rpm	2000
Optimum power	P_{opt}	kW	7.33
Limiting data:			
Max. permissible speed (mech.)	$n_{max\ mech}$	rpm	8000
Maximum torque	M_{max}	Nm	90
Maximum current	I_{max}	A	56
Motor data:			
No. of poles	2p		10
Torque constant (100K)	k_T	Nm/A	2.1
Voltage constant (at 20 °C)	k_E	V/1000 rpm	132.5
Winding resistance (at 20 °C)	R_{Str}	W	0.345
Rotating field inductance	L_D	mH	5.9
Electrical time constant	T_{el}	ms	17
Mechanical time constant	T_{mech}	ms	1.1
Thermal time constant	T_{th}	min	1.5
Moment of inertia	J_{mot}	$kgm^2 \cdot 10^{-4}$	48.3
Shaft torsional stiffness	C_t	Nm/rad	88000
Weight	m_{mot}	kg	27.5
Motor data with integrated brake:			
Moment of inertia (with brake)	J_{mot}	$kgm^2 \cdot 10^{-4}$	62.5
Shaft torsional stiffness (with brake)	C_t	Nm/rad	65000
Weight (with brake)	m_{Mot}	kg	30.5
Data with SINAMICS S120 Booksize / S120 Booksize Compact:			
Rated converter current	$I_{N\ Inv}$	A	18
Maximum converter current	$I_{max\ Inv}$	A	54
Max. torque (converter operation)	$M_{max\ Inv}$	Nm	87
Max. permissible speed (converter operation)	$n_{max\ Inv}$	rpm	4400
The rated data are valid for a 600 V DC-link voltage			

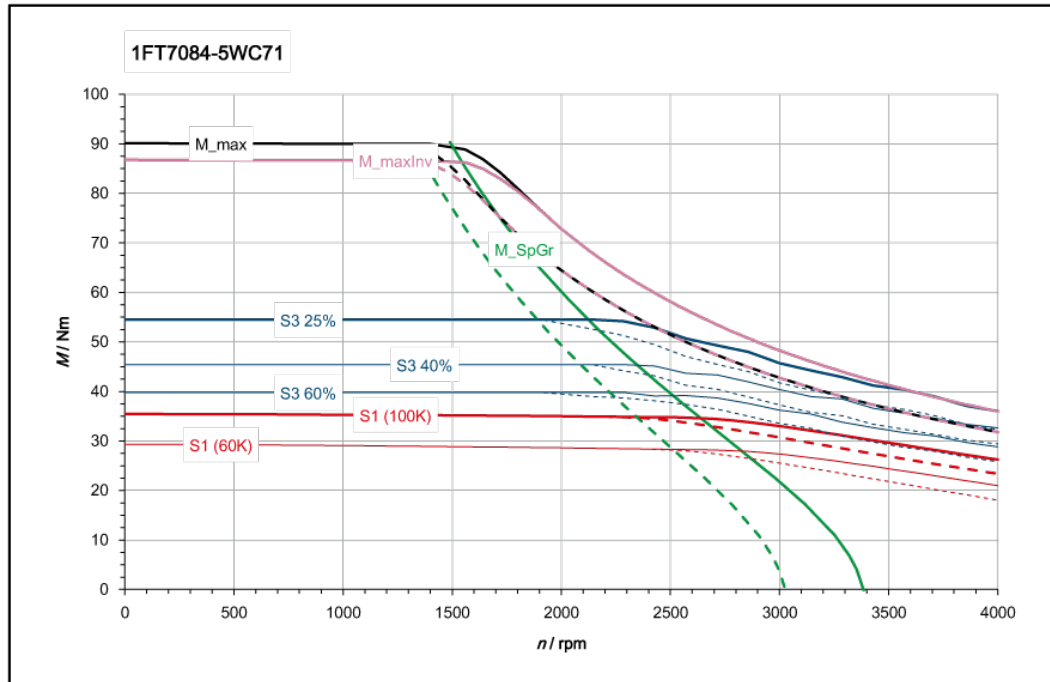

[—] SINAMICS ALM 400 V (600 V DC)
 [- - -] SINAMICS BLM/SLM 400 V (540 V DC)

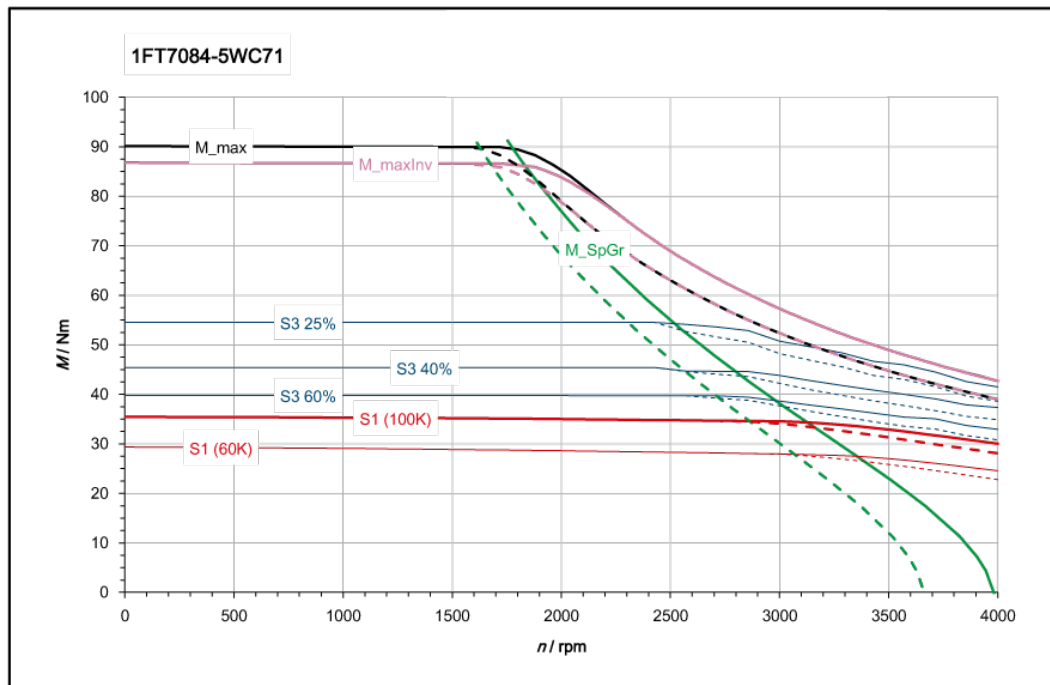

[—] SINAMICS ALM 480 V (720 V DC)
 [- - -] SINAMICS BLM/SLM 480 V (650 V DC)

Three-phase servomotor 1FT7084-5WF7			
Technical specifications	Symbol	Unit	Value
Configuration data:			
Rated speed	n_N	rpm	3000
Rated torque (100K)	$M_{N(100K)}$	Nm	35.0
Rated current (100K)	$I_{N(100K)}$	A	24.2
Static torque (100K)	$M_{0(100K)}$	Nm	35.0
Stall current (100K)	$I_{0(100K)}$	A	23.0
Static torque (60K)	$M_{0(60K)}$	Nm	29.0
Stall current (60K)	$I_{0(60K)}$	A	19.2
Optimum operating point:			
Optimum speed	n_{opt}	rpm	3000
Optimum power	P_{opt}	kW	11.0
Limiting data:			
Max. permissible speed (mech.)	$n_{max\ mech}$	rpm	8000
Maximum torque	M_{max}	Nm	90
Maximum current	I_{max}	A	78
Motor data:			
No. of poles	2p		10
Torque constant (100K)	k_T	Nm/A	1.51
Voltage constant (at 20 °C)	k_E	V/1000 rpm	95.0
Winding resistance (at 20 °C)	R_{Str}	W	0.182
Rotating field inductance	L_D	mH	3.1
Electrical time constant	T_{el}	ms	17
Mechanical time constant	T_{mech}	ms	1.2
Thermal time constant	T_{th}	min	1.5
Moment of inertia	J_{mot}	$kgm^2 \cdot 10^{-4}$	48.3
Shaft torsional stiffness	C_t	Nm/rad	88000
Weight	m_{mot}	kg	27.5
Motor data with integrated brake:			
Moment of inertia (with brake)	J_{mot}	$kgm^2 \cdot 10^{-4}$	62.5
Shaft torsional stiffness (with brake)	C_t	Nm/rad	65000
Weight (with brake)	m_{Mot}	kg	30.5
Data with SINAMICS S120 Booksize:			
Rated converter current	$I_{N\ Inv}$	A	24
Maximum converter current	$I_{max\ Inv}$	A	72
Max. torque (converter operation)	$M_{max\ Inv}$	Nm	84.5
Max. permissible speed (converter operation)	$n_{max\ Inv}$	rpm	6100
The rated data are valid for a 600 V DC-link voltage			

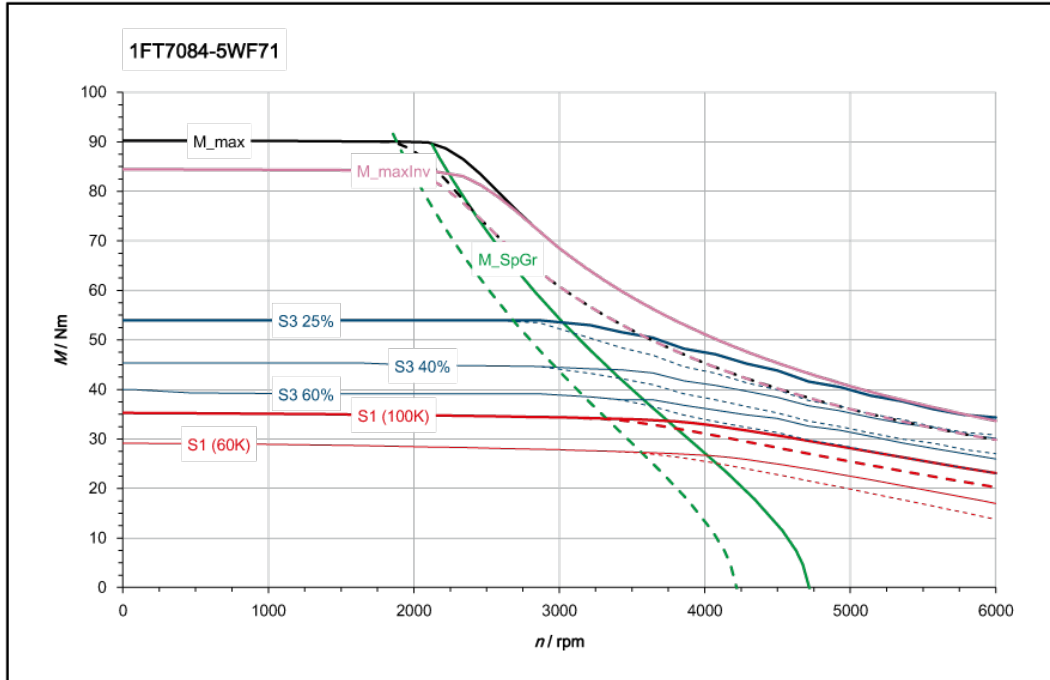

[———] SINAMICS ALM 400 V (600 V DC)
 [- - - -] SINAMICS BLM/SLM 400 V (540 V DC)

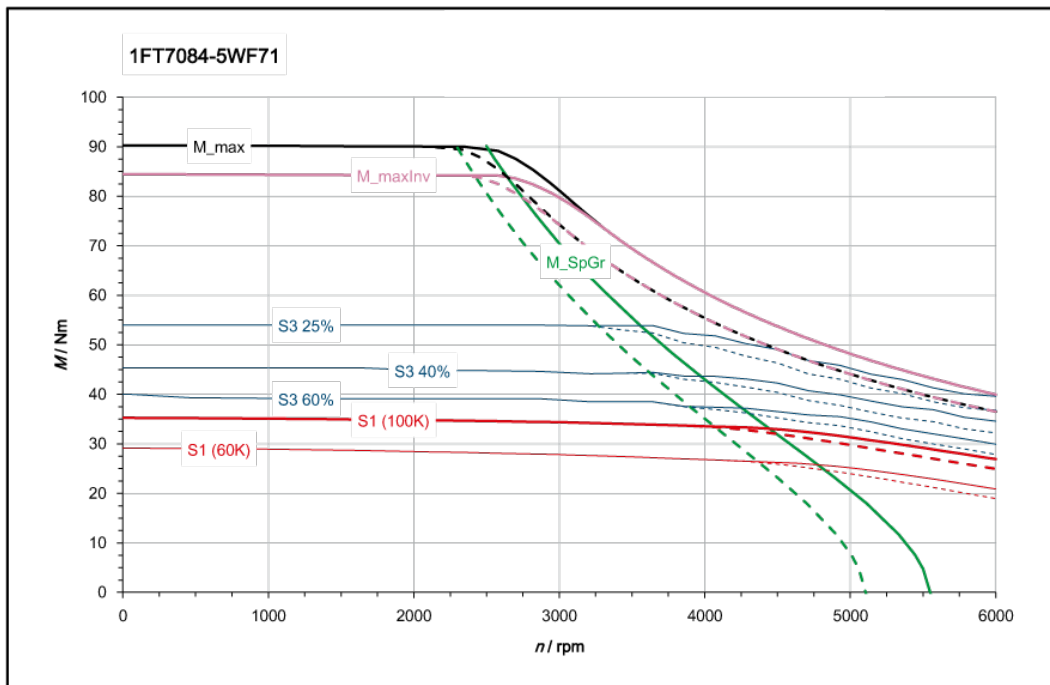

[———] SINAMICS ALM 480 V (720 V DC)
 [- - - -] SINAMICS BLM/SLM 480 V (650 V DC)

Three-phase servomotor 1FT7084-5WH7			
Technical specifications	Symbol	Unit	Value
Configuration data:			
Rated speed	n_N	rpm	4500
Rated torque (100K)	$M_{N(100K)}$	Nm	32
Rated current (100K)	$I_{N(100K)}$	A	34.5
Static torque (100K)	$M_{0(100K)}$	Nm	35.0
Stall current (100K)	$I_{0(100K)}$	A	34.3
Static torque (60K)	$M_{0(60K)}$	Nm	29.0
Stall current (60K)	$I_{0(60K)}$	A	28.4
Optimum operating point:			
Optimum speed	n_{opt}	rpm	4500
Optimum power	P_{opt}	kW	15.1
Limiting data:			
Max. permissible speed (mech.)	$n_{max\ mech}$	rpm	8000
Maximum torque	M_{max}	Nm	90
Maximum current	I_{max}	A	116
Motor data:			
No. of poles	2p		10
Torque constant (100K)	k_T	Nm/A	1.02
Voltage constant (at 20 °C)	k_E	V/1000 rpm	64.0
Winding resistance (at 20 °C)	R_{Str}	W	0.084
Rotating field inductance	L_D	mH	1.4
Electrical time constant	T_{el}	ms	17
Mechanical time constant	T_{mech}	ms	1.2
Thermal time constant	T_{th}	min	1.5
Moment of inertia	J_{mot}	$kgm^2 \cdot 10^{-4}$	48.3
Shaft torsional stiffness	C_t	Nm/rad	88000
Weight	m_{mot}	kg	27.5
Motor data with integrated brake:			
Moment of inertia (with brake)	J_{mot}	$kgm^2 \cdot 10^{-4}$	62.5
Shaft torsional stiffness (with brake)	C_t	Nm/rad	65000
Weight (with brake)	m_{Mot}	kg	30.5
Data with SINAMICS S120 Booksize:			
Rated converter current	$I_{N\ Inv}$	A	45
Maximum converter current	$I_{max\ Inv}$	A	90
Max. torque (converter operation)	$M_{max\ Inv}$	Nm	74
Max. permissible speed (converter operation)	$n_{max\ Inv}$	rpm	8000
The rated data are valid for a 600 V DC-link voltage			

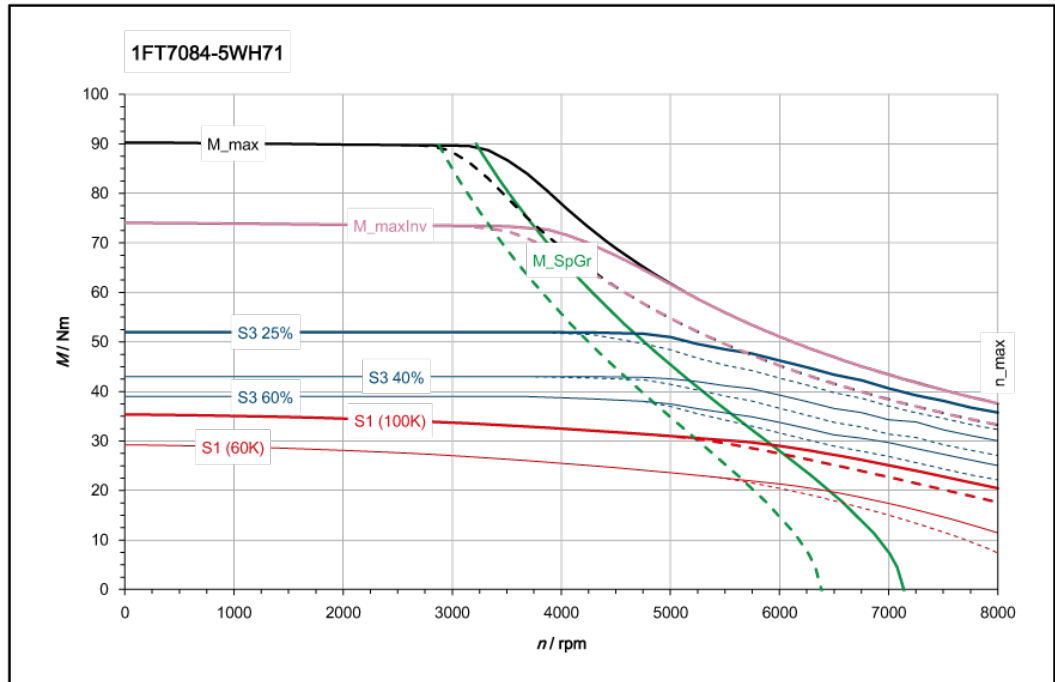

[—] SINAMICS ALM 400 V (600 V DC)
 [- - -] SINAMICS BLM/SLM 400 V (540 V DC)

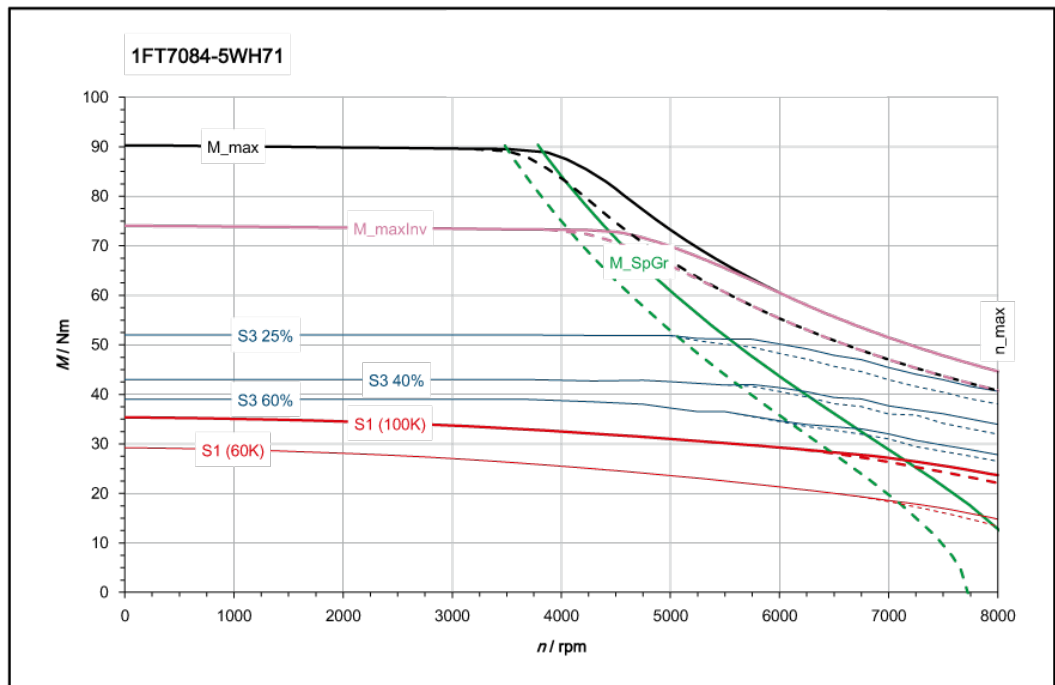

[—] SINAMICS ALM 480 V (720 V DC)
 [- - -] SINAMICS BLM/SLM 480 V (650 V DC)

6.3.3.7 1FT7086-W

Three-phase servomotor 1FT7086-5WC7			
Technical specifications	Symbol	Unit	Value
Configuration data:			
Rated speed	n_N	rpm	2000
Rated torque (100K)	$M_{N(100K)}$	Nm	50
Rated current (100K)	$I_{N(100K)}$	A	24.0
Static torque (100K)	$M_{0(100K)}$	Nm	50
Stall current (100K)	$I_{0(100K)}$	A	23
Static torque (60K)	$M_{0(60K)}$	Nm	41
Stall current (60K)	$I_{0(60K)}$	A	19.0
Optimum operating point:			
Optimum speed	n_{opt}	rpm	2000
Optimum power	P_{opt}	kW	10.5
Limiting data:			
Max. permissible speed (mech.)	$n_{max\ mech}$	rpm	8000
Maximum torque	M_{max}	Nm	125
Maximum current	I_{max}	A	75
Motor data:			
No. of poles	2p		10
Torque constant (100K)	k_T	Nm/A	2.16
Voltage constant (at 20 °C)	k_E	V/1000 rpm	136.5
Winding resistance (at 20 °C)	R_{Str}	W	0.245
Rotating field inductance	L_D	mH	4.8
Electrical time constant	T_{el}	ms	20
Mechanical time constant	T_{mech}	ms	1.1
Thermal time constant	T_{th}	min	1.5
Moment of inertia	J_{mot}	$kgm^2 \cdot 10^{-4}$	67.8
Shaft torsional stiffness	C_t	Nm/rad	74000
Weight	m_{mot}	kg	34.1
Motor data with integrated brake:			
Moment of inertia (with brake)	J_{mot}	$kgm^2 \cdot 10^{-4}$	81.9
Shaft torsional stiffness (with brake)	C_t	Nm/rad	57000
Weight (with brake)	m_{Mot}	kg	37.1
Data with SINAMICS S120 Booksize:			
Rated converter current	$I_{N\ Inv}$	A	24
Maximum converter current	$I_{max\ Inv}$	A	72
Max. torque (converter operation)	$M_{max\ Inv}$	Nm	121
Max. permissible speed (converter operation)	$n_{max\ Inv}$	rpm	4300
The rated data are valid for a 600 V DC-link voltage			

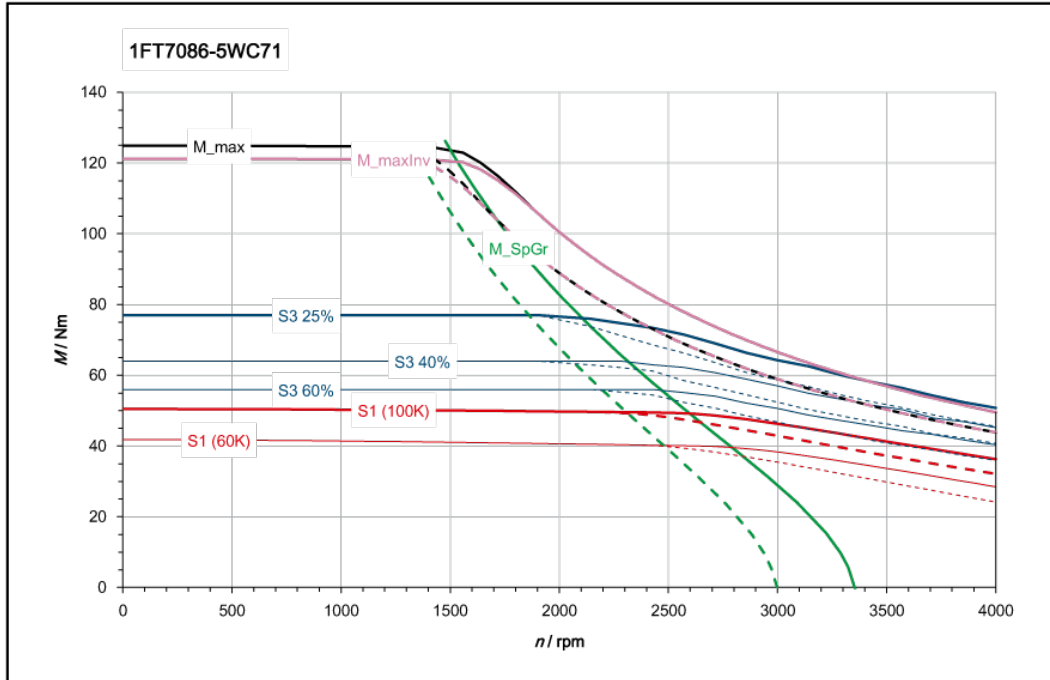

[———] SINAMICS ALM 400 V (600 V DC)
 [- - - -] SINAMICS BLM/SLM 400 V (540 V DC)

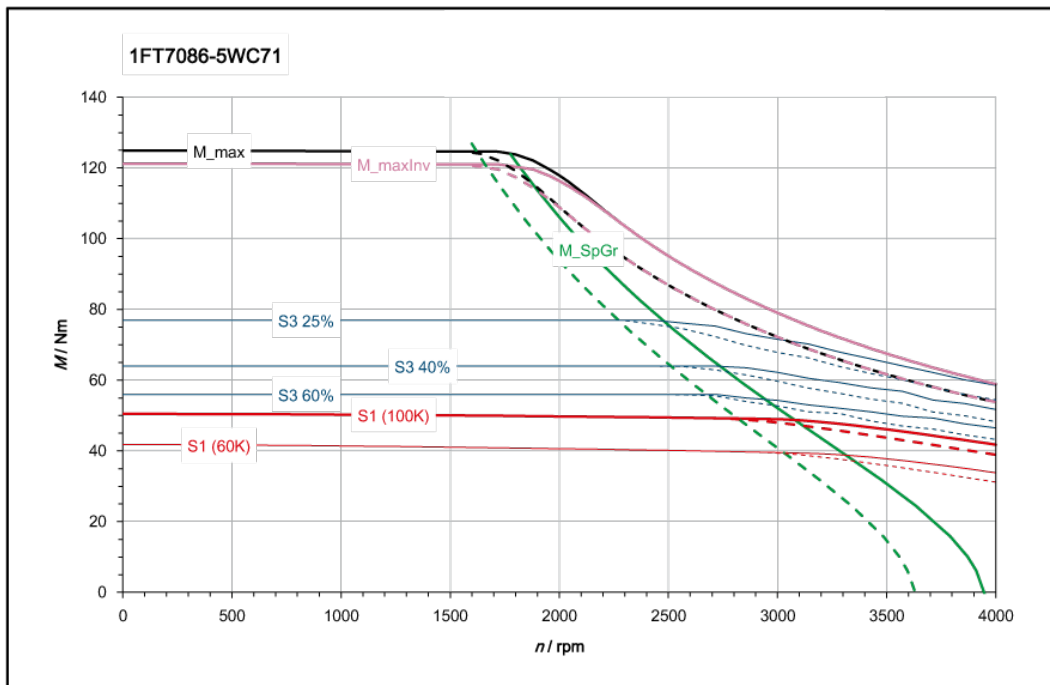

[———] SINAMICS ALM 480 V (720 V DC)
 [- - - -] SINAMICS BLM/SLM 480 V (650 V DC)

Three-phase servomotor 1FT7086-5WF7			
Technical specifications	Symbol	Unit	Value
Configuration data:			
Rated speed	n_N	rpm	3000
Rated torque (100K)	$M_{N(100K)}$	Nm	49
Rated current (100K)	$I_{N(100K)}$	A	36.0
Static torque (100K)	$M_{0(100K)}$	Nm	50
Stall current (100K)	$I_{0(100K)}$	A	34
Static torque (60K)	$M_{0(60K)}$	Nm	41
Stall current (60K)	$I_{0(60K)}$	A	28.1
Optimum operating point:			
Optimum speed	n_{opt}	rpm	3000
Optimum power	P_{opt}	kW	15.4
Limiting data:			
Max. permissible speed (mech.)	$n_{max\ mech}$	rpm	8000
Maximum torque	M_{max}	Nm	125
Maximum current	I_{max}	A	111
Motor data:			
No. of poles	$2p$		10
Torque constant (100K)	k_T	Nm/A	1.46
Voltage constant (at 20 °C)	k_E	V/1000 rpm	92.0
Winding resistance (at 20 °C)	R_{Str}	W	0.113
Rotating field inductance	L_D	mH	2.2
Electrical time constant	T_{el}	ms	19
Mechanical time constant	T_{mech}	ms	1.1
Thermal time constant	T_{th}	min	1.5
Moment of inertia	J_{mot}	$kgm^2 \cdot 10^{-4}$	67.8
Shaft torsional stiffness	C_t	Nm/rad	74000
Weight	m_{mot}	kg	34.1
Motor data with integrated brake:			
Moment of inertia (with brake)	J_{mot}	$kgm^2 \cdot 10^{-4}$	81.9
Shaft torsional stiffness (with brake)	C_t	Nm/rad	57000
Weight (with brake)	m_{Mot}	kg	37.1
Data with SINAMICS S120 Booksize:			
Rated converter current	$I_{N\ Inv}$	A	45
Maximum converter current	$I_{max\ Inv}$	A	90
Max. torque (converter operation)	$M_{max\ Inv}$	Nm	106
Max. permissible speed (converter operation)	$n_{max\ Inv}$	rpm	6300
The rated data are valid for a 600 V DC-link voltage			

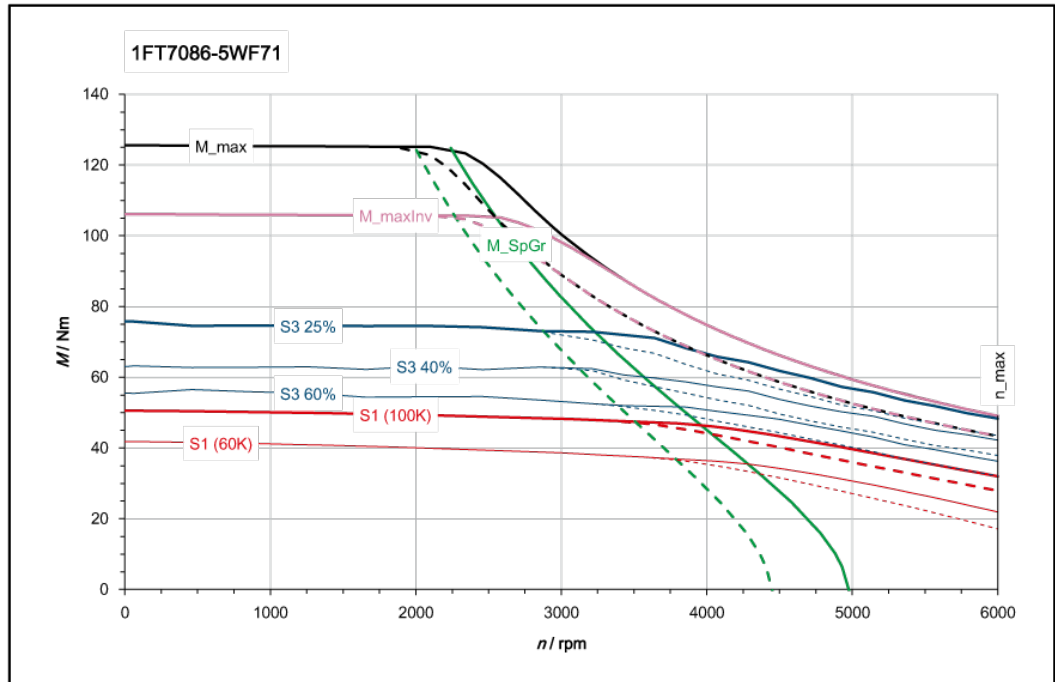

[———] SINAMICS ALM 400 V (600 V DC)
 [- - - -] SINAMICS BLM/SLM 400 V (540 V DC)

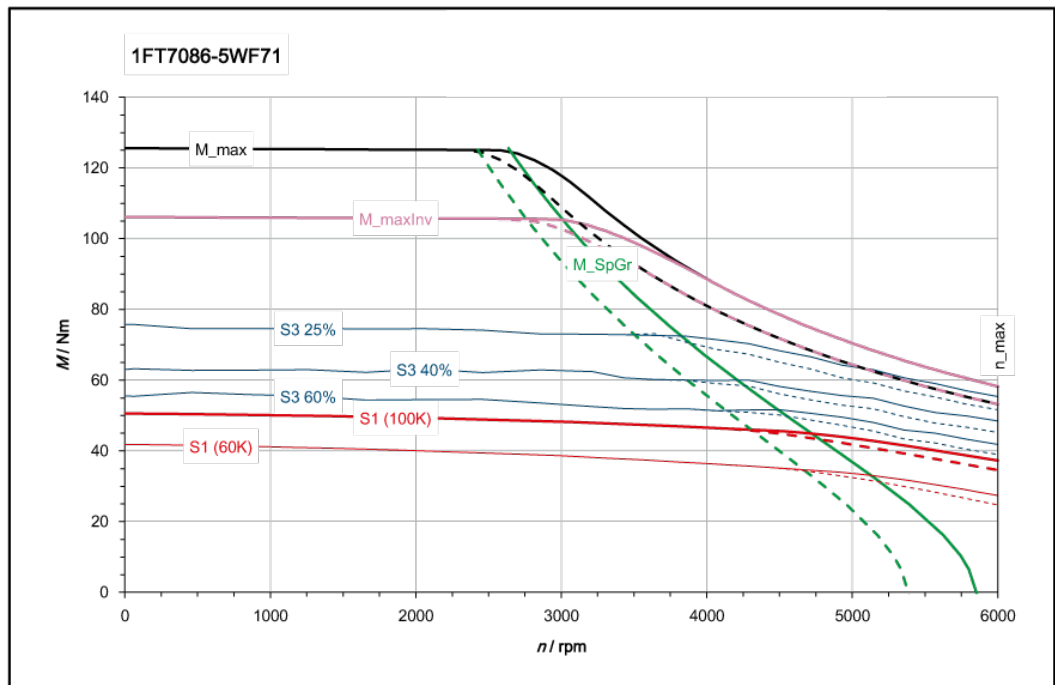

[———] SINAMICS ALM 480 V (720 V DC)
 [- - - -] SINAMICS BLM/SLM 480 V (650 V DC)

Three-phase servomotor 1FT7086-5WH7			
Technical specifications	Symbol	Unit	Value
Configuration data:			
Rated speed	n_N	rpm	4500
Rated torque (100K)	$M_{N(100K)}$	Nm	43
Rated current (100K)	$I_{N(100K)}$	A	38.0
Static torque (100K)	$M_{0(100K)}$	Nm	50
Stall current (100K)	$I_{0(100K)}$	A	40.5
Static torque (60K)	$M_{0(60K)}$	Nm	41.0
Stall current (60K)	$I_{0(60K)}$	A	33.6
Optimum operating point:			
Optimum speed	n_{opt}	rpm	4500
Optimum power	P_{opt}	kW	20.3
Limiting data:			
Max. permissible speed (mech.)	$n_{max\ mech}$	rpm	8000
Maximum torque	M_{max}	Nm	125
Maximum current	I_{max}	A	133
Motor data:			
No. of poles	$2p$		10
Torque constant (100K)	k_T	Nm/A	1.22
Voltage constant (at 20 °C)	k_E	V/1000 rpm	77.0
Winding resistance (at 20 °C)	R_{Str}	W	0.085
Rotating field inductance	L_D	mH	1.5
Electrical time constant	T_{el}	ms	18
Mechanical time constant	T_{mech}	ms	1.2
Thermal time constant	T_{th}	min	1.5
Moment of inertia	J_{mot}	$kgm^2 \cdot 10^{-4}$	67.8
Shaft torsional stiffness	C_t	Nm/rad	74000
Weight	m_{mot}	kg	34.1
Motor data with integrated brake:			
Moment of inertia (with brake)	J_{mot}	$kgm^2 \cdot 10^{-4}$	81.9
Shaft torsional stiffness (with brake)	C_t	Nm/rad	57000
Weight (with brake)	m_{Mot}	kg	37.1
Data with SINAMICS S120 Booksize:			
Rated converter current	$I_{N\ Inv}$	A	45
Maximum converter current	$I_{max\ Inv}$	A	90
Max. torque (converter operation)	$M_{max\ Inv}$	Nm	91.5
Max. permissible speed (converter operation)	$n_{max\ Inv}$	rpm	7500
The rated data are valid for a 600 V DC-link voltage			

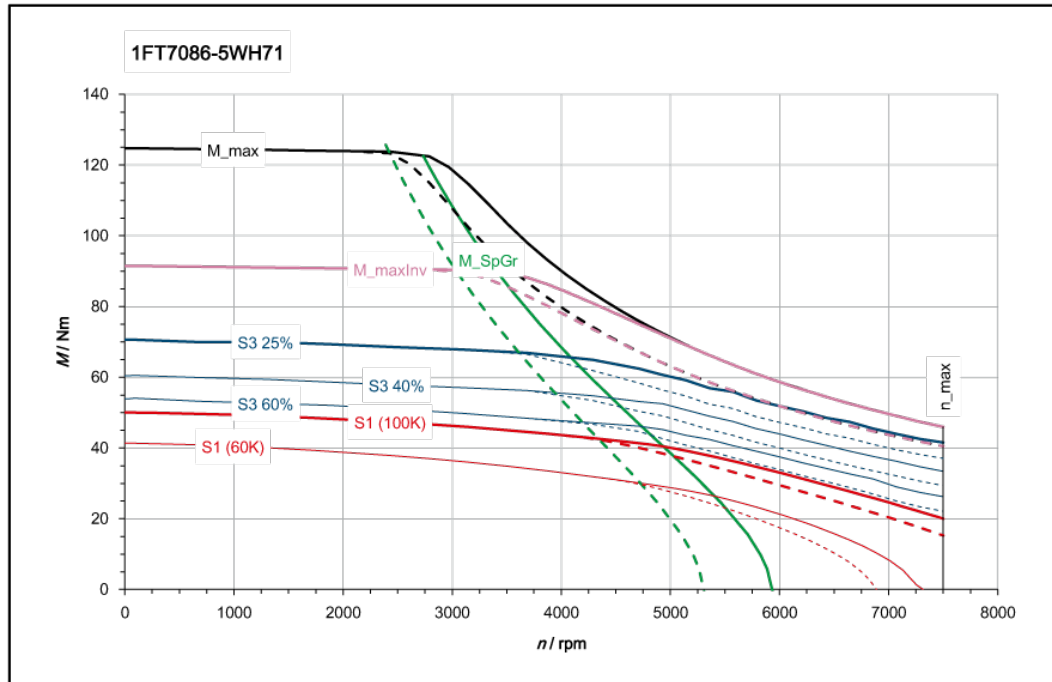

[———] SINAMICS ALM 400 V (600 V DC)
 [- - - -] SINAMICS BLM/SLM 400 V (540 V DC)

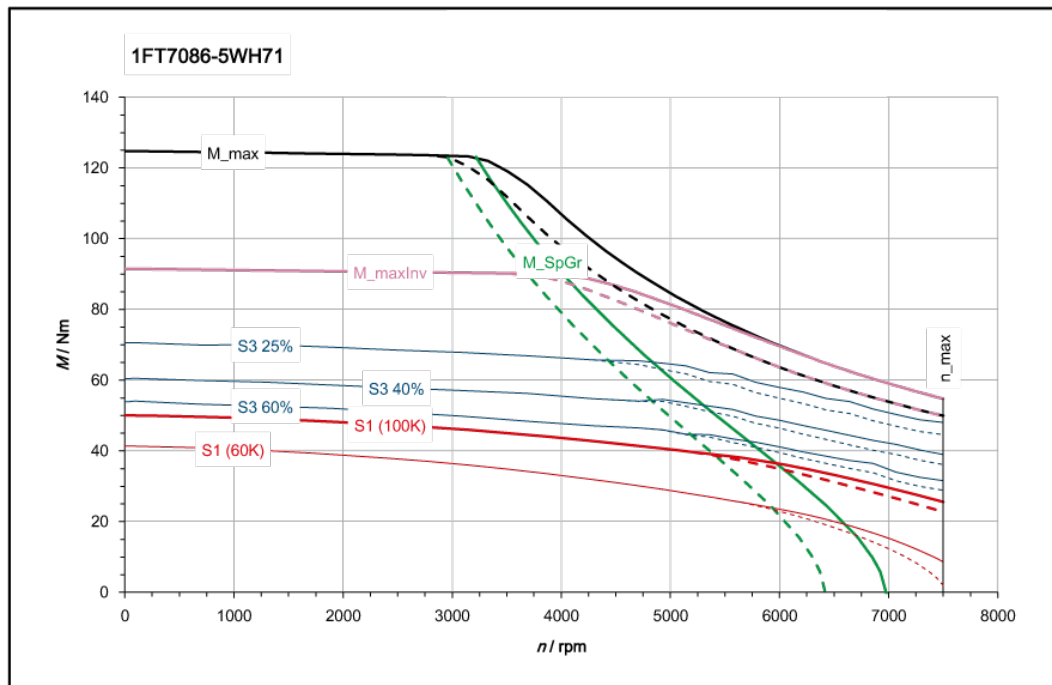

[———] SINAMICS ALM 480 V (720 V DC)
 [- - - -] SINAMICS BLM/SLM 480 V (650 V DC)

6.3.3.8 1FT7102-_W

Three-phase servomotor 1FT7102-5WB7			
Technical specifications	Symbol	Unit	Value
Configuration data:			
Rated speed	n_N	rpm	1500
Rated torque (100K)	$M_{N(100K)}$	Nm	50
Rated current (100K)	$I_{N(100K)}$	A	20.3
Static torque (100K)	$M_{0(100K)}$	Nm	50
Stall current (100K)	$I_{0(100K)}$	A	17.8
Static torque (60K)	$M_{0(60K)}$	Nm	40.0
Stall current (60K)	$I_{0(60K)}$	A	14.2
Optimum operating point:			
Optimum speed	n_{opt}	rpm	1500
Optimum power	P_{opt}	kW	7.85
Limiting data:			
Max. permissible speed (mech.)	$n_{max\ mech}$	rpm	6000
Maximum torque	M_{max}	Nm	130
Maximum current	I_{max}	A	59
Motor data:			
No. of poles	2p		10
Torque constant (100K)	k_T	Nm/A	2.81
Voltage constant (at 20 °C)	k_E	V/1000 rpm	177.0
Winding resistance (at 20 °C)	R_{Str}	W	0.305
Rotating field inductance	L_D	mH	6.2
Electrical time constant	T_{el}	ms	20
Mechanical time constant	T_{mech}	ms	1.1
Thermal time constant	T_{th}	min	1.5
Moment of inertia	J_{mot}	$kgm^2 \cdot 10^{-4}$	98.9
Shaft torsional stiffness	C_t	Nm/rad	181000
Weight	m_{mot}	kg	36.6
Motor data with integrated brake:			
Moment of inertia (with brake)	J_{mot}	$kgm^2 \cdot 10^{-4}$	125
Shaft torsional stiffness (with brake)	C_t	Nm/rad	124000
Weight (with brake)	m_{Mot}	kg	40.9
Data with SINAMICS S120 Booksize / S120 Booksize Compact:			
Rated converter current	$I_{N\ Inv}$	A	18
Maximum converter current	$I_{max\ Inv}$	A	54
Max. torque (converter operation)	$M_{max\ Inv}$	Nm	125
Max. permissible speed (converter operation)	$n_{max\ Inv}$	rpm	3200
The rated data are valid for a 600 V DC-link voltage			

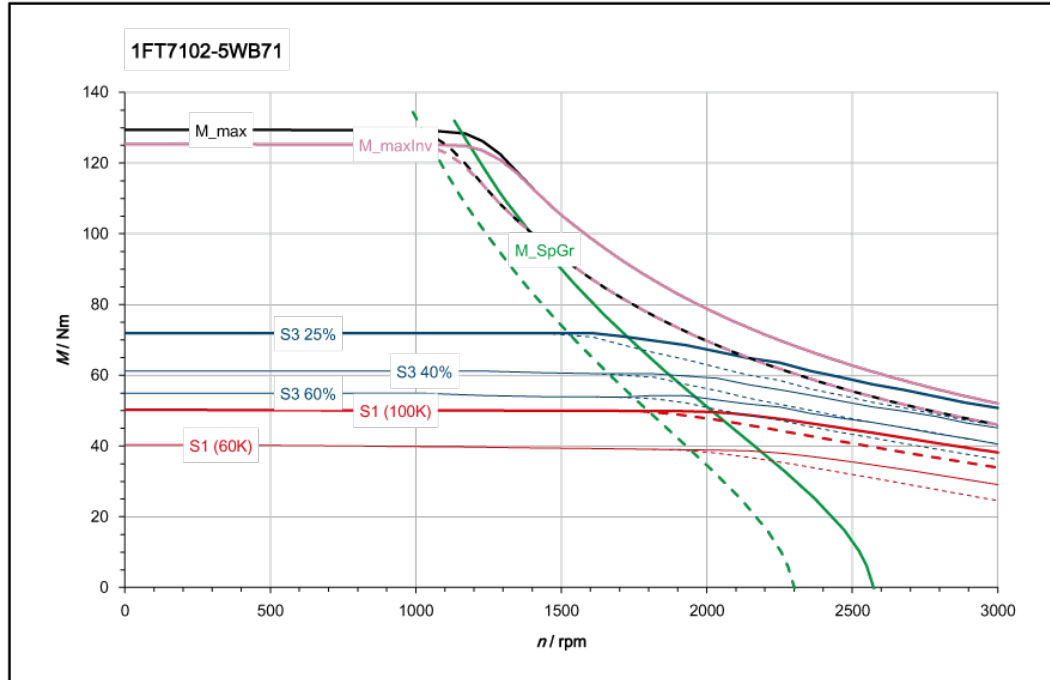

[———] SINAMICS ALM 400 V (600 V DC)
 [- - - -] SINAMICS BLM/SLM 400 V (540 V DC)

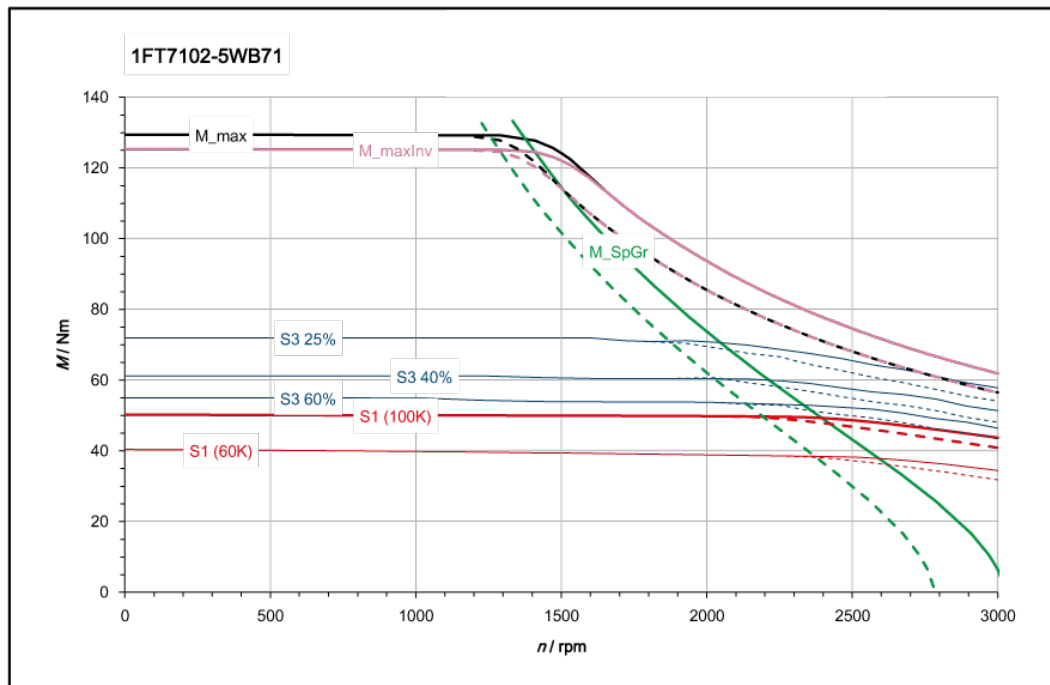

[———] SINAMICS ALM 480 V (720 V DC)
 [- - - -] SINAMICS BLM/SLM 480 V (650 V DC)

Three-phase servomotor 1FT7102-5WC7			
Technical specifications	Symbol	Unit	Value
Configuration data:			
Rated speed	n_N	rpm	2000
Rated torque (100K)	$M_{N(100K)}$	Nm	49.5
Rated current (100K)	$I_{N(100K)}$	A	29.3
Static torque (100K)	$M_{0(100K)}$	Nm	50
Stall current (100K)	$I_{0(100K)}$	A	25.5
Static torque (60K)	$M_{0(60K)}$	Nm	40.0
Stall current (60K)	$I_{0(60K)}$	A	20.4
Optimum operating point:			
Optimum speed	n_{opt}	rpm	2000
Optimum power	P_{opt}	kW	10.4
Limiting data:			
Max. permissible speed (mech.)	$n_{max\ mech}$	rpm	6000
Maximum torque	M_{max}	Nm	130
Maximum current	I_{max}	A	84.5
Motor data:			
No. of poles	$2p$		10
Torque constant (100K)	k_T	Nm/A	1.96
Voltage constant (at 20 °C)	k_E	V/1000 rpm	123.5
Winding resistance (at 20 °C)	R_{Str}	W	0.151
Rotating field inductance	L_D	mH	3.0
Electrical time constant	T_{el}	ms	20
Mechanical time constant	T_{mech}	ms	1.2
Thermal time constant	T_{th}	min	1.5
Moment of inertia	J_{mot}	$kgm^2 \cdot 10^{-4}$	98.9
Shaft torsional stiffness	C_t	Nm/rad	181000
Weight	m_{mot}	kg	36.6
Motor data with integrated brake:			
Moment of inertia (with brake)	J_{mot}	$kgm^2 \cdot 10^{-4}$	125
Shaft torsional stiffness (with brake)	C_t	Nm/rad	124000
Weight (with brake)	m_{Mot}	kg	40.9
Data with SINAMICS S120 Booksize:			
Rated converter current	$I_{N\ Inv}$	A	30
Maximum converter current	$I_{max\ Inv}$	A	90
Max. torque (converter operation)	$M_{max\ Inv}$	Nm	130.0
Max. permissible speed (converter operation)	$n_{max\ Inv}$	rpm	4700
The rated data are valid for a 600 V DC-link voltage			

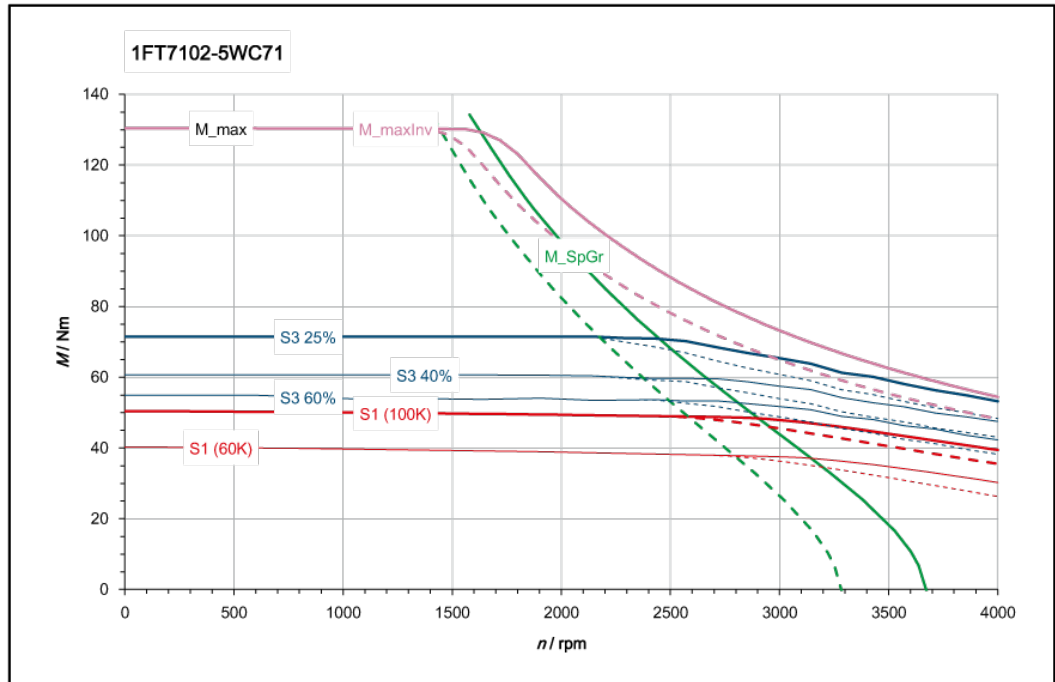

[———] SINAMICS ALM 400 V (600 V DC)
 [- - - -] SINAMICS BLM/SLM 400 V (540 V DC)

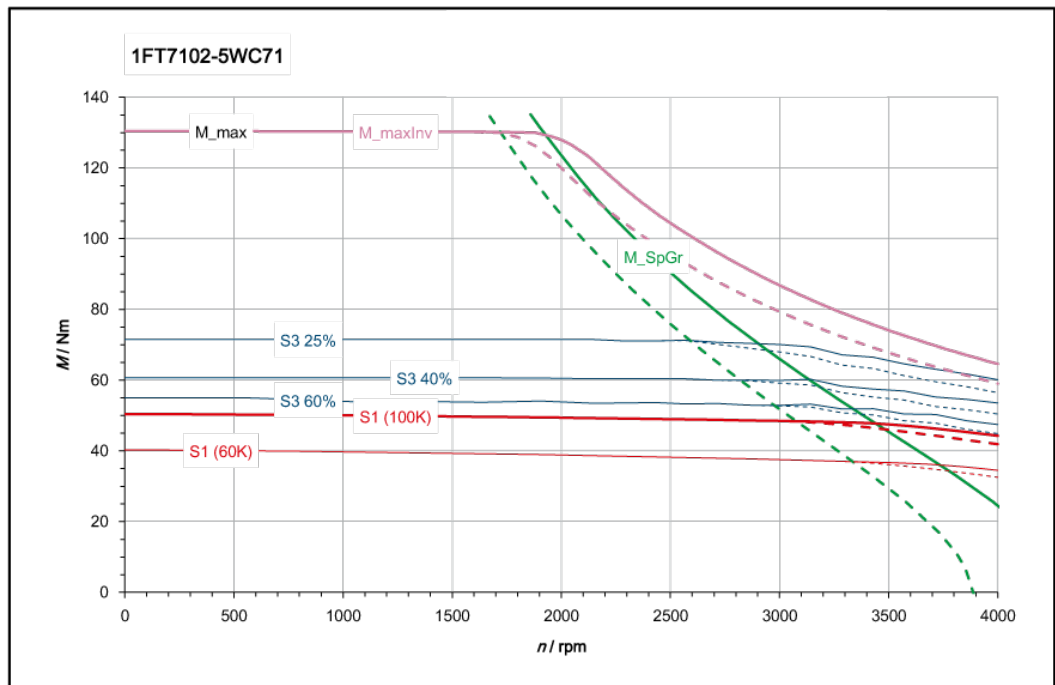

[———] SINAMICS ALM 480 V (720 V DC)
 [- - - -] SINAMICS BLM/SLM 480 V (650 V DC)

Three-phase servomotor 1FT7102-5WF7			
Technical specifications	Symbol	Unit	Value
Configuration data:			
Rated speed	n_N	rpm	3000
Rated torque (100K)	$M_{N(100K)}$	Nm	45.5
Rated current (100K)	$I_{N(100K)}$	A	38.8
Static torque (100K)	$M_{0(100K)}$	Nm	50
Stall current (100K)	$I_{0(100K)}$	A	40
Static torque (60K)	$M_{0(60K)}$	Nm	40.0
Stall current (60K)	$I_{0(60K)}$	A	32.8
Optimum operating point:			
Optimum speed	n_{opt}	rpm	3000
Optimum power	P_{opt}	kW	14.3
Limiting data:			
Max. permissible speed (mech.)	$n_{max\ mech}$	rpm	6000
Maximum torque	M_{max}	Nm	130
Maximum current	I_{max}	A	135
Motor data:			
No. of poles	$2p$		10
Torque constant (100K)	k_T	Nm/A	1.22
Voltage constant (at 20 °C)	k_E	V/1000 rpm	77.0
Winding resistance (at 20 °C)	R_{Str}	W	0.06
Rotating field inductance	L_D	mH	1.18
Electrical time constant	T_{el}	ms	20
Mechanical time constant	T_{mech}	ms	1.2
Thermal time constant	T_{th}	min	1.5
Moment of inertia	J_{mot}	$kgm^2 \cdot 10^{-4}$	98.9
Shaft torsional stiffness	C_t	Nm/rad	181000
Weight	m_{mot}	kg	36.6
Motor data with integrated brake:			
Moment of inertia (with brake)	J_{mot}	$kgm^2 \cdot 10^{-4}$	125
Shaft torsional stiffness (with brake)	C_t	Nm/rad	124000
Weight (with brake)	m_{Mot}	kg	40.9
Data with SINAMICS S120 Booksize:			
Rated converter current	$I_{N\ Inv}$	A	45
Maximum converter current	$I_{max\ Inv}$	A	90
Max. torque (converter operation)	$M_{max\ Inv}$	Nm	93.5
Max. permissible speed (converter operation)	$n_{max\ Inv}$	rpm	6000
The rated data are valid for a 600 V DC-link voltage			

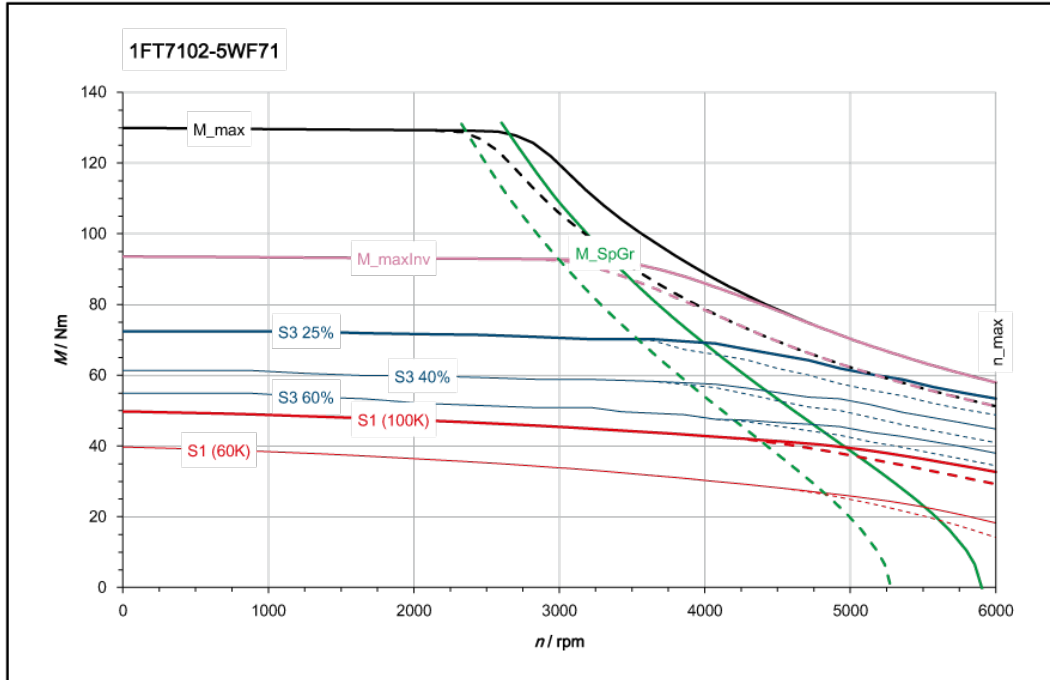

[———] SINAMICS ALM 400 V (600 V DC)
 [- - - -] SINAMICS BLM/SLM 400 V (540 V DC)

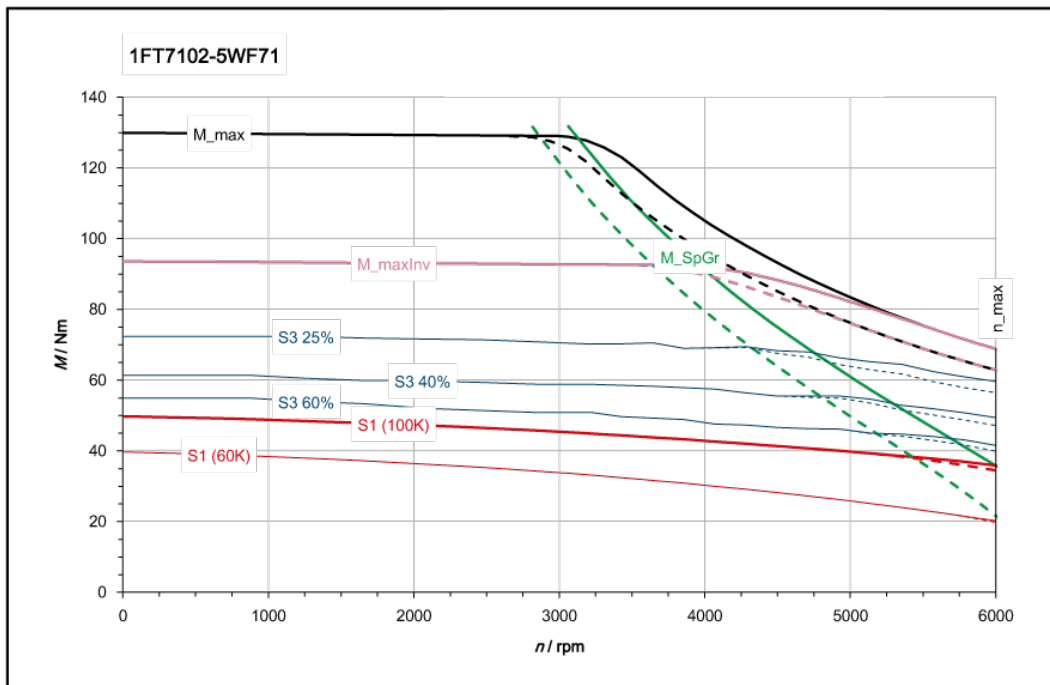

[———] SINAMICS ALM 480 V (720 V DC)
 [- - - -] SINAMICS BLM/SLM 480 V (650 V DC)

6.3.3.9 1FT7105_W

Three-phase servomotor 1FT7105-5WB7			
Technical specifications	Symbol	Unit	Value
Configuration data:			
Rated speed	n_N	rpm	1500
Rated torque (100K)	$M_{N(100K)}$	Nm	90
Rated current (100K)	$I_{N(100K)}$	A	29.5
Static torque (100K)	$M_{0(100K)}$	Nm	90
Stall current (100K)	$I_{0(100K)}$	A	28.2
Static torque (60K)	$M_{0(60K)}$	Nm	72
Stall current (60K)	$I_{0(60K)}$	A	23.1
Optimum operating point:			
Optimum speed	n_{opt}	rpm	1500
Optimum power	P_{opt}	kW	14.1
Limiting data:			
Max. permissible speed (mech.)	$n_{max\ mech}$	rpm	6000
Maximum torque	M_{max}	Nm	230
Maximum current	I_{max}	A	87
Motor data:			
No. of poles	2p		10
Torque constant (100K)	k_T	Nm/A	3.12
Voltage constant (at 20 °C)	k_E	V/1000 rpm	197.0
Winding resistance (at 20 °C)	R_{Str}	W	0.157
Rotating field inductance	L_D	mH	3.67
Electrical time constant	T_{el}	ms	23
Mechanical time constant	T_{mech}	ms	0.9
Thermal time constant	T_{th}	min	1.5
Moment of inertia	J_{mot}	$kgm^2 \cdot 10^{-4}$	191
Shaft torsional stiffness	C_t	Nm/rad	146000
Weight	m_{mot}	kg	54.8
Motor data with integrated brake:			
Moment of inertia (with brake)	J_{mot}	$kgm^2 \cdot 10^{-4}$	217
Shaft torsional stiffness (with brake)	C_t	Nm/rad	107000
Weight (with brake)	m_{Mot}	kg	59.1
Data with SINAMICS S120 Booksize:			
Rated converter current	$I_{N\ Inv}$	A	30
Maximum converter current	$I_{max\ Inv}$	A	90
Max. torque (converter operation)	$M_{max\ Inv}$	Nm	230
Max. permissible speed (converter operation)	$n_{max\ Inv}$	rpm	2900
The rated data are valid for a 600 V DC-link voltage			

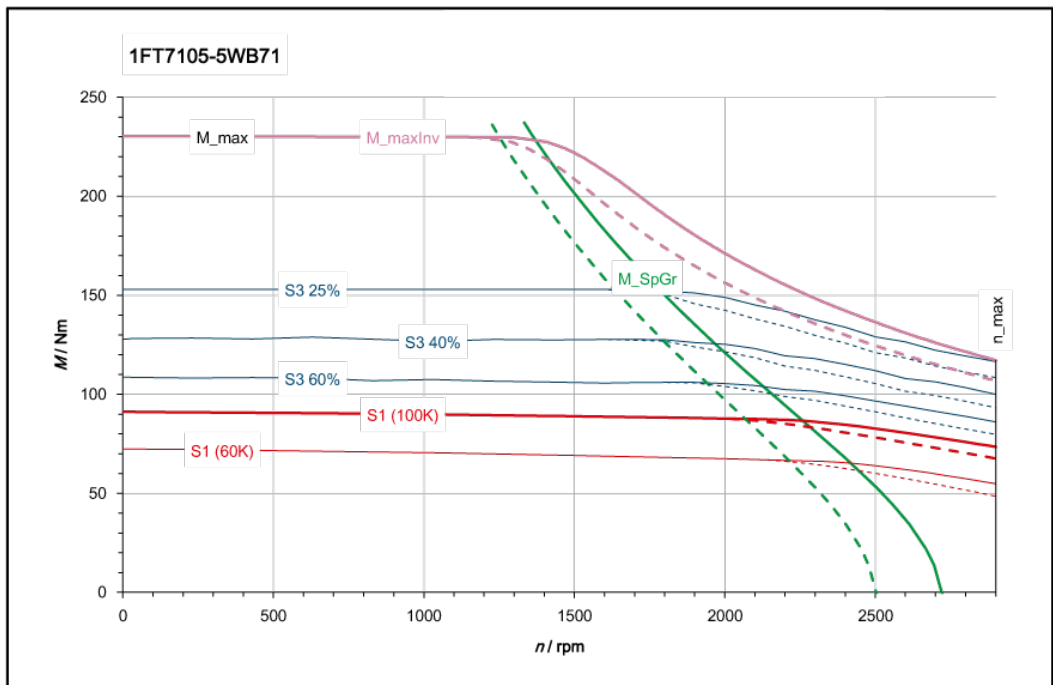
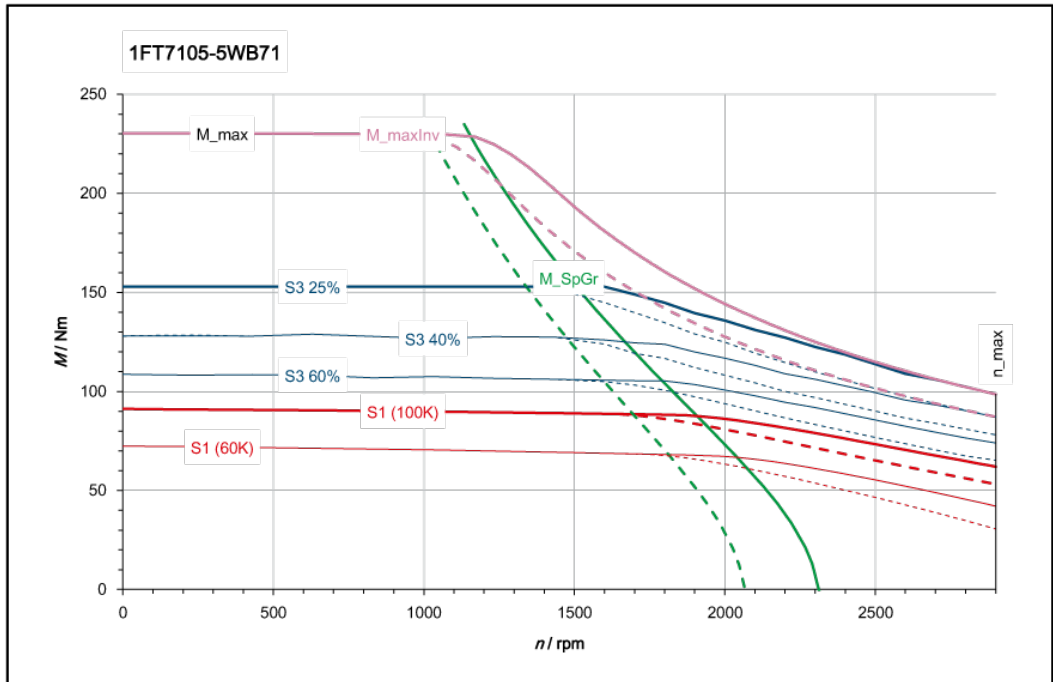

Three-phase servomotor 1FT7105-5WC7			
Technical specifications	Symbol	Unit	Value
Configuration data:			
Rated speed	n_N	rpm	2000
Rated torque (100K)	$M_{N(100K)}$	Nm	90
Rated current (100K)	$I_{N(100K)}$	A	40.8
Static torque (100K)	$M_{0(100K)}$	Nm	90
Stall current (100K)	$I_{0(100K)}$	A	39.0
Static torque (60K)	$M_{0(60K)}$	Nm	72
Stall current (60K)	$I_{0(60K)}$	A	31.9
Optimum operating point:			
Optimum speed	n_{opt}	rpm	2000
Optimum power	P_{opt}	kW	18.8
Limiting data:			
Max. permissible speed (mech.)	$n_{max\ mech}$	rpm	6000
Maximum torque	M_{max}	Nm	230
Maximum current	I_{max}	A	120.5
Motor data:			
No. of poles	$2p$		10
Torque constant (100K)	k_T	Nm/A	2.26
Voltage constant (at 20 °C)	k_E	V/1000 rpm	142.5
Winding resistance (at 20 °C)	R_{Str}	W	0.084
Rotating field inductance	L_D	mH	1.92
Electrical time constant	T_{el}	ms	23
Mechanical time constant	T_{mech}	ms	0.9
Thermal time constant	T_{th}	min	1.5
Moment of inertia	J_{mot}	$kgm^2 \cdot 10^{-4}$	191
Shaft torsional stiffness	C_t	Nm/rad	146000
Weight	m_{mot}	kg	54.8
Motor data with integrated brake:			
Moment of inertia (with brake)	J_{mot}	$kgm^2 \cdot 10^{-4}$	217
Shaft torsional stiffness (with brake)	C_t	Nm/rad	107000
Weight (with brake)	m_{Mot}	kg	59.1
Data with SINAMICS S120 Booksize			
Rated converter current	$I_{N\ Inv}$	A	45
Maximum converter current	$I_{max\ Inv}$	A	90
Max. torque (converter operation)	$M_{max\ Inv}$	Nm	176
Max. permissible speed (converter operation)	$n_{max\ Inv}$	rpm	4100
The rated data are valid for a 600 V DC-link voltage			

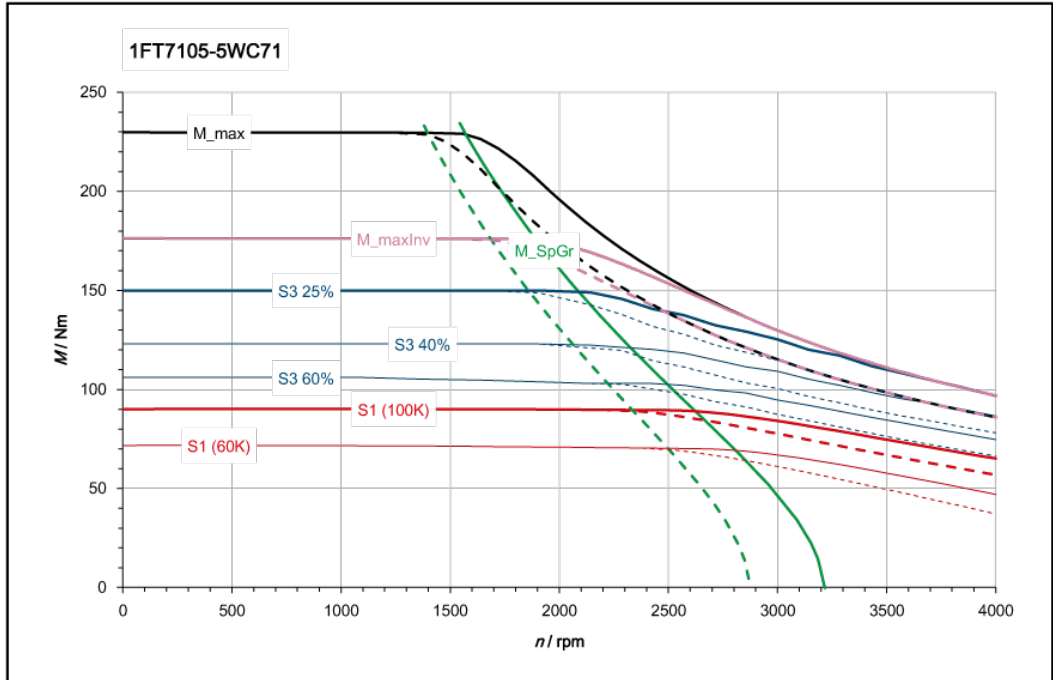

[———] SINAMICS ALM 400 V (600 V DC)
 [- - - -] SINAMICS BLM/SLM 400 V (540 V DC)

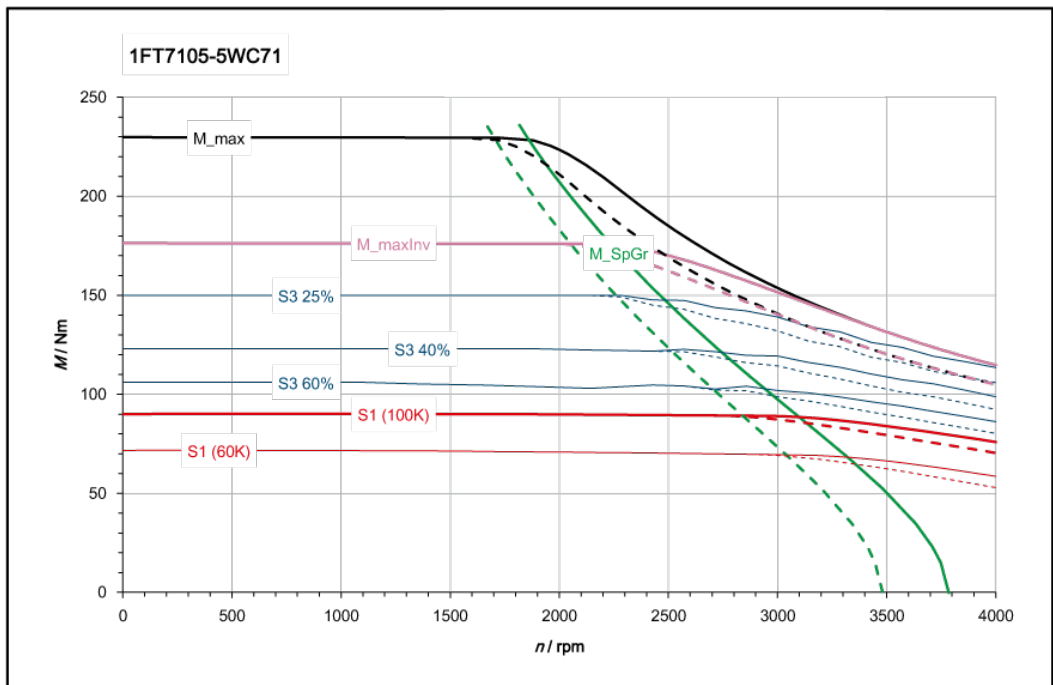

[———] SINAMICS ALM 480 V (720 V DC)
 [- - - -] SINAMICS BLM/SLM 480 V (650 V DC)

Three-phase servomotor 1FT7105-5WF7			
Technical specifications	Symbol	Unit	Value
Configuration data:			
Rated speed	n_N	rpm	3000
Rated torque (100K)	$M_{N(100K)}$	Nm	79
Rated current (100K)	$I_{N(100K)}$	A	49.5
Static torque (100K)	$M_{0(100K)}$	Nm	90
Stall current (100K)	$I_{0(100K)}$	A	53.2
Static torque (60K)	$M_{0(60K)}$	Nm	72
Stall current (60K)	$I_{0(60K)}$	A	43.1
Optimum operating point:			
Optimum speed	n_{opt}	rpm	3000
Optimum power	P_{opt}	kW	24.8
Limiting data:			
Max. permissible speed (mech.)	$n_{max\ mech}$	rpm	6000
Maximum torque	M_{max}	Nm	230
Maximum current	I_{max}	A	164
Motor data:			
No. of poles	$2p$		10
Torque constant (100K)	k_T	Nm/A	1.67
Voltage constant (at 20 °C)	k_E	V/1000 rpm	105.0
Winding resistance (at 20 °C)	R_{Str}	W	0.05
Rotating field inductance	L_D	mH	1.04
Electrical time constant	T_{el}	ms	21
Mechanical time constant	T_{mech}	ms	1.0
Thermal time constant	T_{th}	min	1.5
Moment of inertia	J_{mot}	$kgm^2 \cdot 10^{-4}$	191
Shaft torsional stiffness	C_t	Nm/rad	146000
Weight	m_{mot}	kg	54.8
Motor data with integrated brake:			
Moment of inertia (with brake)	J_{mot}	$kgm^2 \cdot 10^{-4}$	217
Shaft torsional stiffness (with brake)	C_t	Nm/rad	107000
Weight (with brake)	m_{Mot}	kg	59.1
Data with SINAMICS S120 Booksize:			
Rated converter current	$I_{N\ Inv}$	A	60
Maximum converter current	$I_{max\ Inv}$	A	120
Max. torque (converter operation)	$M_{max\ Inv}$	Nm	170
Max. permissible speed (converter operation)	$n_{max\ Inv}$	rpm	5500
The rated data are valid for a 600 V DC-link voltage			

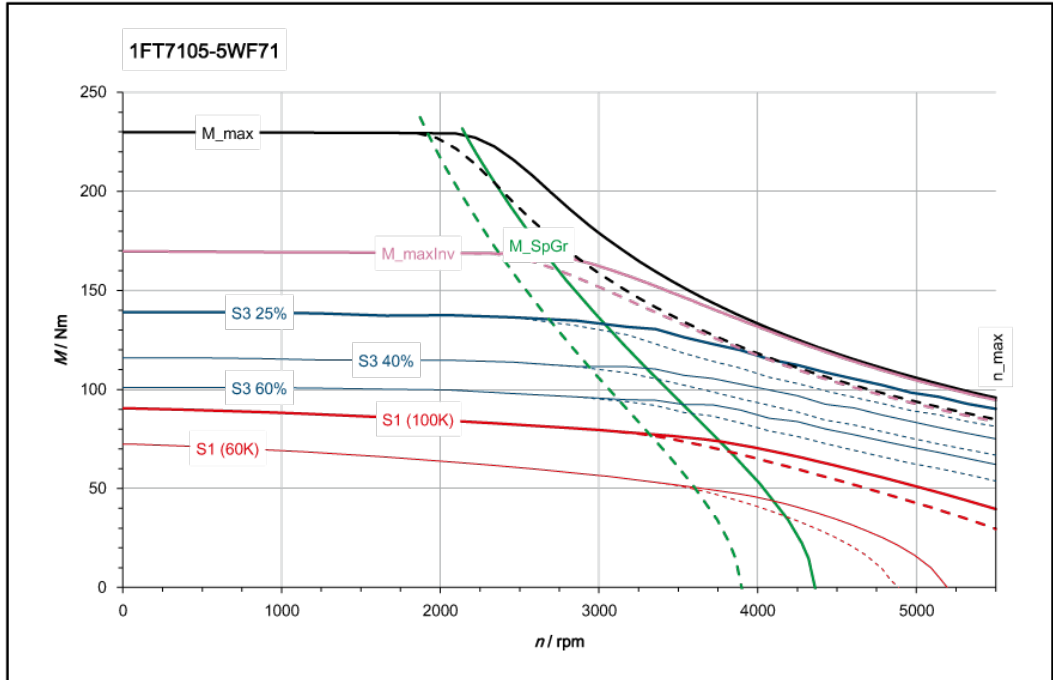

[———] SINAMICS ALM 400 V (600 V DC)
 [- - - -] SINAMICS BLM/SLM 400 V (540 V DC)

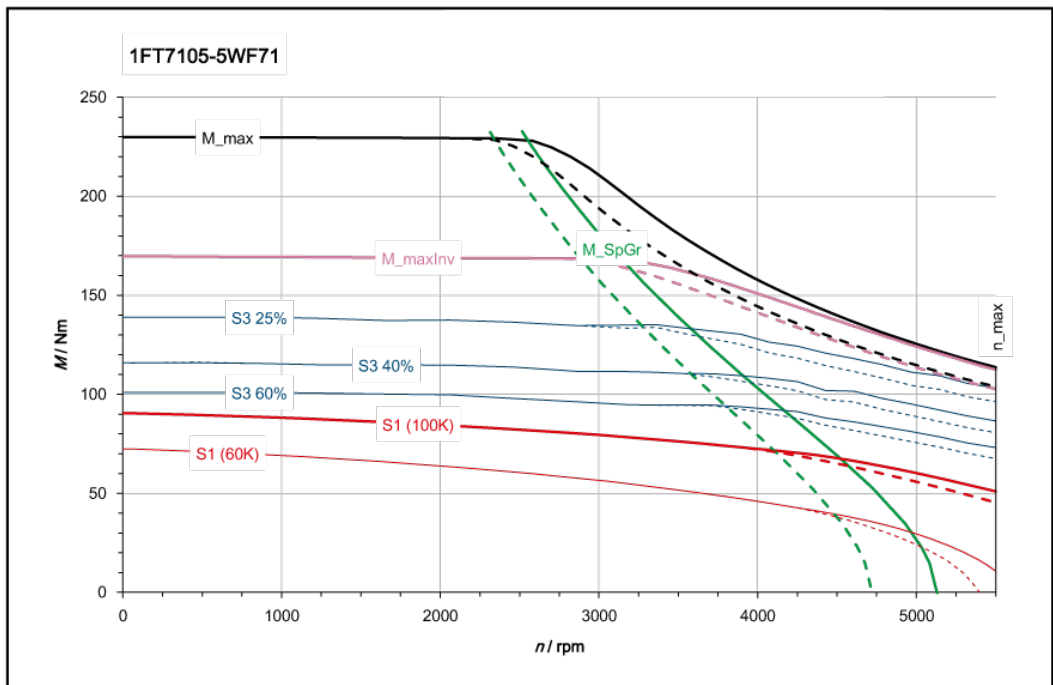

[———] SINAMICS ALM 480 V (720 V DC)
 [- - - -] SINAMICS BLM/SLM 480 V (650 V DC)

6.3.3.10 1FT7108-_W

Three-phase servomotor 1FT7108-5WB7			
Technical specifications	Symbol	Unit	Value
Configuration data:			
Rated speed	n_N	rpm	1500
Rated torque (100K)	$M_{N(100K)}$	Nm	125
Rated current (100K)	$I_{N(100K)}$	A	40.3
Static torque (100K)	$M_{0(100K)}$	Nm	125
Stall current (100K)	$I_{0(100K)}$	A	39.0
Static torque (60K)	$M_{0(60K)}$	Nm	100
Stall current (60K)	$I_{0(60K)}$	A	31.6
Optimum operating point			
Optimum speed	n_{opt}	rpm	1500
Optimum power	P_{opt}	kW	19.6
Limiting data:			
Max. permissible speed (mech.)	$n_{max\ mech}$	rpm	6000
Maximum torque	M_{max}	Nm	330
Maximum current	I_{max}	A	120.5
Motor data:			
No. of poles	2p		10
Torque constant (100K)	k_T	Nm/A	3.16
Voltage constant (at 20 °C)	k_E	V/1000 rpm	199.5
Winding resistance (at 20 °C)	R_{Str}	W	0.111
Rotating field inductance	L_D	mH	2.65
Electrical time constant	T_{el}	ms	24
Mechanical time constant	T_{mech}	ms	0.9
Thermal time constant	T_{th}	min	1.5
Moment of inertia	J_{mot}	$kgm^2 \cdot 10^{-4}$	265
Shaft torsional stiffness	C_t	Nm/rad	126000
Weight	m_{mot}	kg	68.6
Motor data with integrated brake:			
Moment of inertia (with brake)	J_{mot}	$kgm^2 \cdot 10^{-4}$	291
Shaft torsional stiffness (with brake)	C_t	Nm/rad	96000
Weight (with brake)	m_{Mot}	kg	72.9
Data with SINAMICS S120 Booksize:			
Rated converter current	$I_{N\ Inv}$	A	45
Maximum converter current	$I_{max\ Inv}$	A	90
Max. torque (converter operation)	$M_{max\ Inv}$	Nm	260.5
Max. permissible speed (converter operation)	$n_{max\ Inv}$	rpm	2900
The rated data are valid for a 600 V DC-link voltage			

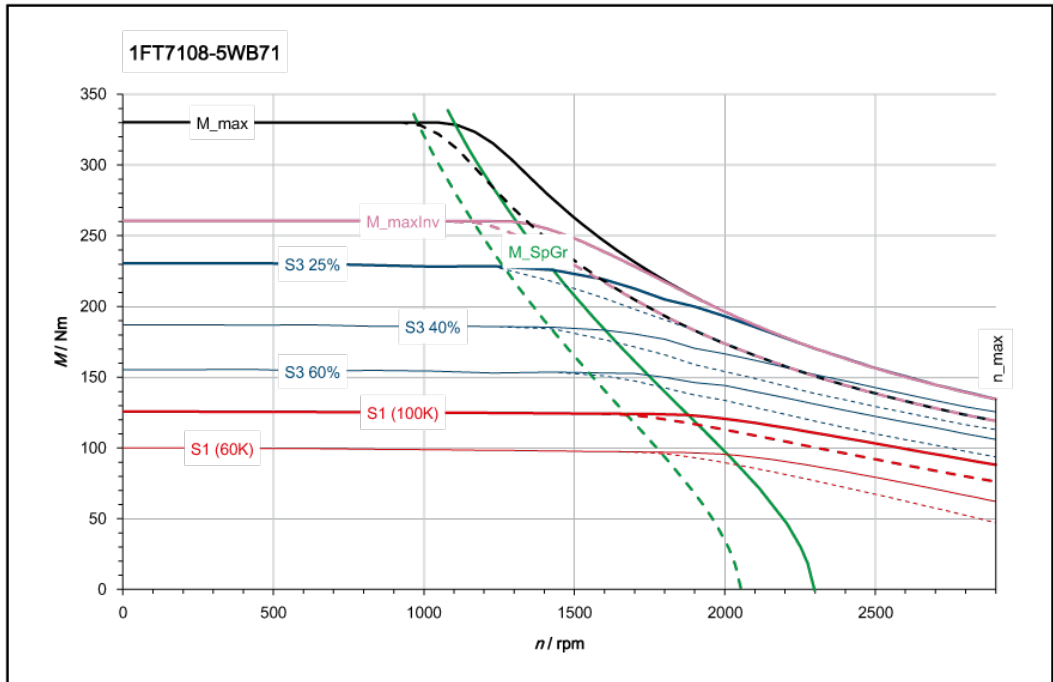

[———] SINAMICS ALM 400 V (600 V DC)
 [- - - -] SINAMICS BLM/SLM 400 V (540 V DC)

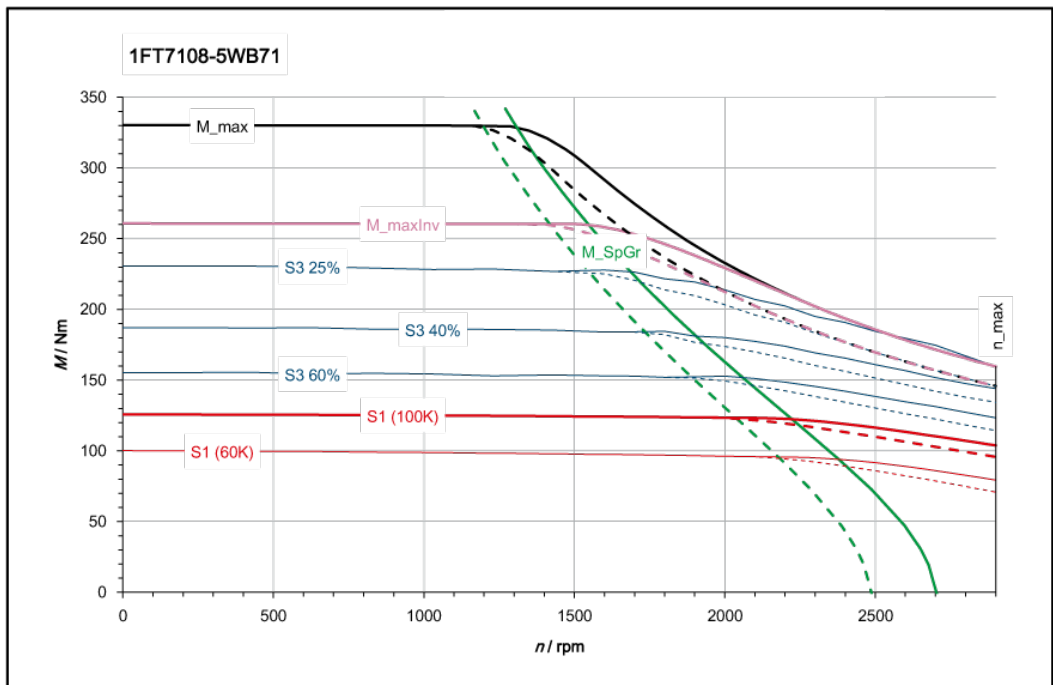

[———] SINAMICS ALM 480 V (720 V DC)
 [- - - -] SINAMICS BLM/SLM 480 V (650 V DC)

Three-phase servomotor 1FT7108-5WC7			
Technical specifications	Symbol	Unit	Value
Configuration data:			
Rated speed	n_N	rpm	2000
Rated torque (100K)	$M_{N(100K)}$	Nm	125
Rated current (100K)	$I_{N(100K)}$	A	47.5
Static torque (100K)	$M_{0(100K)}$	Nm	125
Stall current (100K)	$I_{0(100K)}$	A	45.3
Static torque (60K)	$M_{0(60K)}$	Nm	100
Stall current (60K)	$I_{0(60K)}$	A	37.2
Optimum operating point:			
Optimum speed	n_{opt}	rpm	2000
Optimum power	P_{opt}	kW	26.2
Limiting data:			
Max. permissible speed (mech.)	$n_{max\ mech}$	rpm	6000
Maximum torque	M_{max}	Nm	330
Maximum current	I_{max}	A	141.5
Motor data:			
No. of poles	2p		10
Torque constant (100K)	k_T	Nm/A	2.69
Voltage constant (at 20 °C)	k_E	V/1000 rpm	170.0
Winding resistance (at 20 °C)	R_{Str}	W	0.084
Rotating field inductance	L_D	mH	1.93
Electrical time constant	T_{el}	ms	23
Mechanical time constant	T_{mech}	ms	0.9
Thermal time constant	T_{th}	min	1.5
Moment of inertia	J_{mot}	kgm ²	265
Shaft torsional stiffness	C_{tMot}	Nm/rad	126000
Weight	m_{mot}	kg	68.6
Motor data with integrated brake:			
Moment of inertia (with brake)	J_{mot}	kgm ²	291
Shaft torsional stiffness	C_{tMot}	Nm/rad	96000
Weight (with brake)	m_{Mot}	kg	72.9
Data with SINAMICS S120 Booksize			
Rated converter current	$I_{N\ Inv}$	A	45
Maximum converter current	$I_{max\ Inv}$	A	90
Max. torque at I_{max_Inv}	$M_{max\ Inv}$	Nm	224
Max. permissible speed (converter operation)	$n_{max\ Inv}$	rpm	3400
The rated data are valid for a 600 V DC-link voltage			

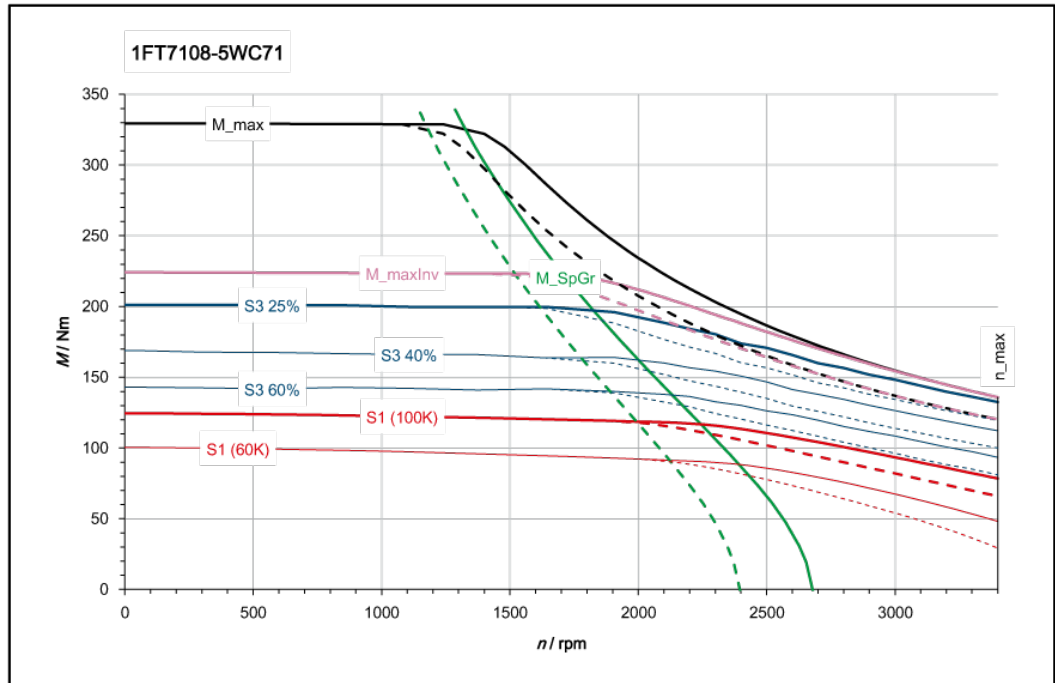

[———] SINAMICS ALM 400 V (600 V DC)
 [- - - -] SINAMICS BLM/SLM 400 V (540 V DC)

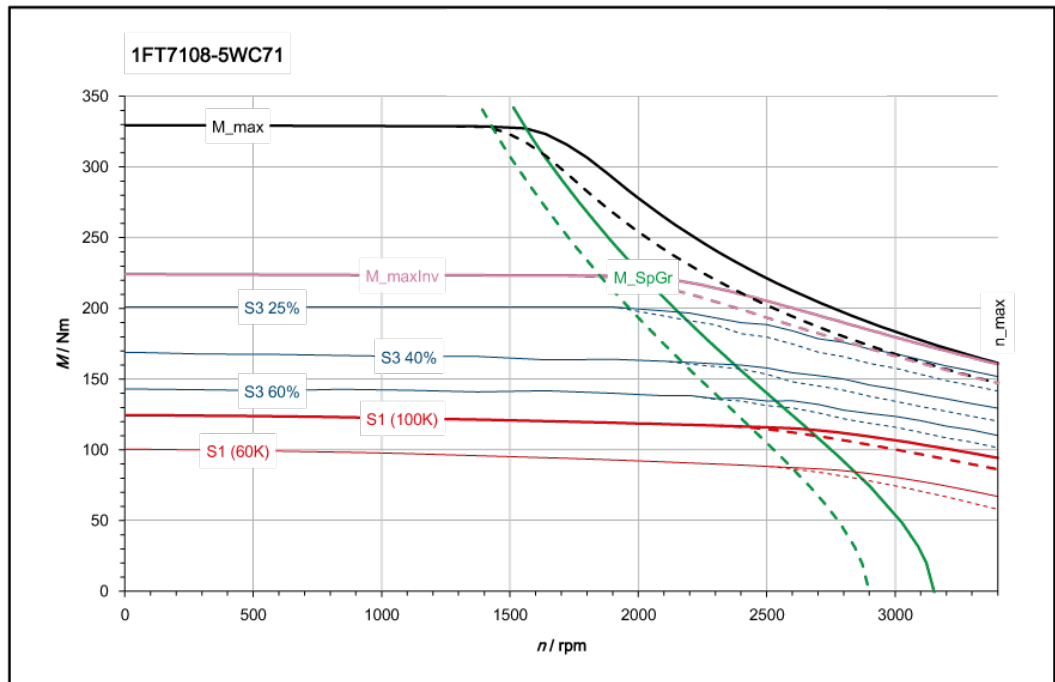

[———] SINAMICS ALM 480 V (720 V DC)
 [- - - -] SINAMICS BLM/SLM 480 V (650 V DC)

Three-phase servomotor 1FT7108-5WF7			
Technical specifications	Symbol	Unit	Value
Configuration data:			
Rated speed	n_N	rpm	3000
Rated torque (100K)	$M_{N(100K)}$	Nm	109
Rated current (100K)	$I_{N(100K)}$	A	60
Static torque (100K)	$M_{0(100K)}$	Nm	125
Stall current (100K)	$I_{0(100K)}$	A	65
Static torque (60K)	$M_{0(60K)}$	Nm	100
Stall current (60K)	$I_{0(60K)}$	A	53.8
Optimum operating point:			
Optimum speed	n_{opt}	rpm	3000
Optimum power	P_{opt}	kW	34.2
Limiting data:			
Max. permissible speed (mech.)	$n_{max\ mech}$	rpm	6000
Maximum torque	M_{max}	Nm	330
Maximum current	I_{max}	A	205
Motor data:			
No. of poles	2p		10
Torque constant (100K)	k_T	Nm/A	1.86
Voltage constant (at 20 °C)	k_E	V/1000 rpm	117.0
Winding resistance (at 20 °C)	R_{Str}	W	0.043
Rotating field inductance	L_D	mH	0.92
Electrical time constant	T_{el}	ms	21
Mechanical time constant	T_{mech}	ms	1
Thermal time constant	T_{th}	min	1.5
Moment of inertia	J_{mot}	$kgm^2 \cdot 10^{-4}$	265
Shaft torsional stiffness	C_t	Nm/rad	126000
Weight	m_{mot}	kg	68.6
Motor data with integrated brake:			
Moment of inertia (with brake)	J_{mot}	$kgm^2 \cdot 10^{-4}$	291
Shaft torsional stiffness (with brake)	C_t	Nm/rad	96000
Weight (with brake)	m_{Mot}	kg	72.9
Data with SINAMICS S120 Booksize:			
Rated converter current	$I_{N\ Inv}$	A	85
Maximum converter current	$I_{max\ Inv}$	A	141
Max. torque (converter operation)	$M_{max\ Inv}$	Nm	238.5
Max. permissible speed (converter operation)	$n_{max\ Inv}$	rpm	4900
The rated data are valid for a 600 V DC-link voltage			

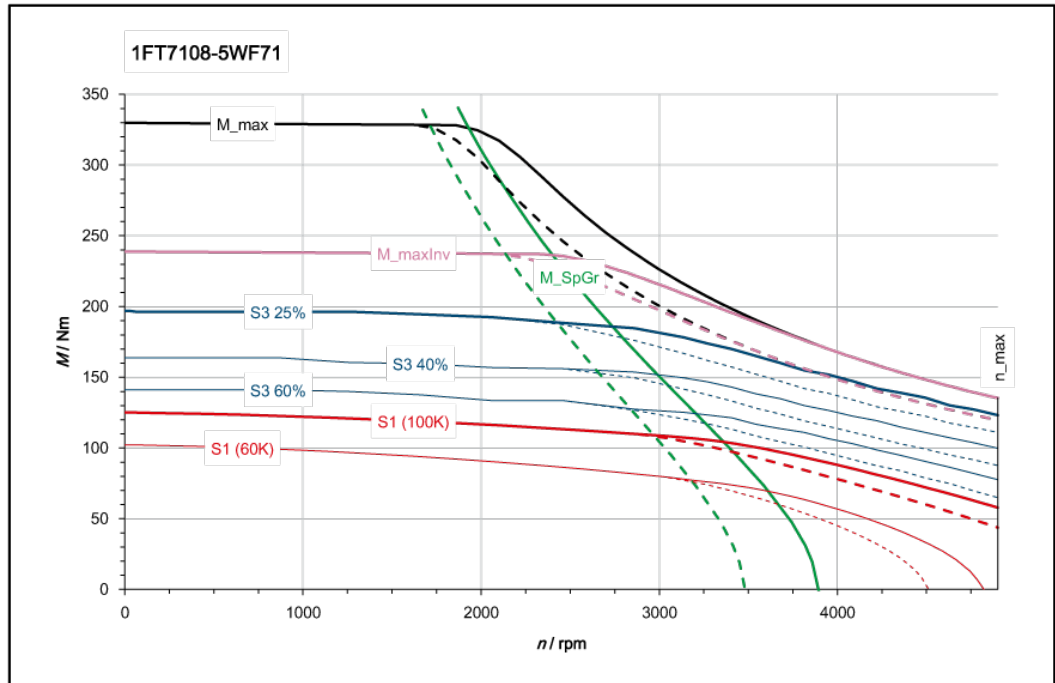

[———] SINAMICS ALM 400 V (600 V DC)
 [- - - -] SINAMICS BLM/SLM 400 V (540 V DC)

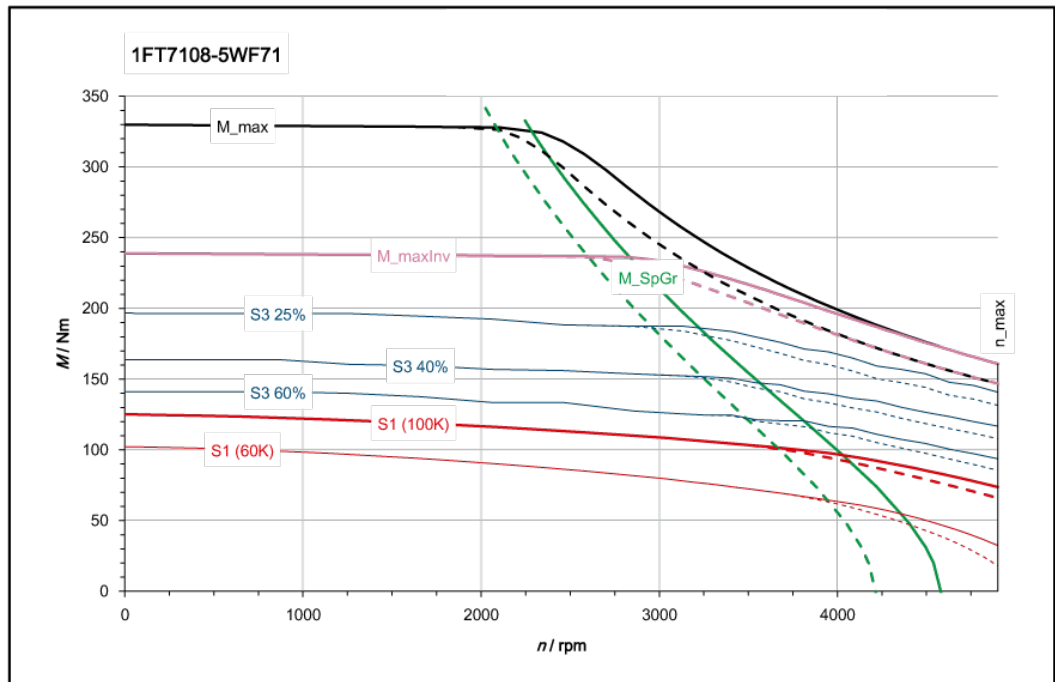

[———] SINAMICS ALM 480 V (720 V DC)
 [- - - -] SINAMICS BLM/SLM 480 V (650 V DC)

6.3.4 1FT7 High Dynamic - natural cooling

6.3.4.1 1FT7087-_A

Three-phase servomotor 1FT7087 - 7AF71			
Technical specifications	Symbol	Unit	Value
Configuration data:			
Rated speed	n_N	rpm	3000
Rated torque (100K)	$M_{N(100K)}$	Nm	10.5
Rated current (100K)	$I_{N(100K)}$	A	10.5
Static torque (100K)	$M_{0(100K)}$	Nm	33
Stall current (100K)	$I_{0(100K)}$	A	27.5
Static torque (60K)	$M_{0(60K)}$	Nm	27.5
Stall current (60K)	$I_{0(60K)}$	A	23
Optimum operating point:			
Optimum speed	n_{opt}	rpm	2150
Optimum power	P_{opt}	kW	4.25
Limiting data:			
Max. permissible speed (mech.)	$n_{max\ mech}$	rpm	6000
Maximum torque	M_{max}	Nm	150
Maximum current	I_{max}	A	170
Motor data:			
No. of poles	2p		8
Torque constant (100K)	k_T	Nm/A	1.2
Voltage constant (at 20 °C)	k_E	V/1000 rpm	77
Winding resistance (at 20 °C)	R_{Str}	W	0.08
Rotating field inductance	L_D	mH	2.1
Electrical time constant	T_{el}	ms	26
Mechanical time constant	T_{mech}	ms	0.5
Thermal time constant	T_{th}	min	40
Moment of inertia	J_{mot}	$kgm^2 \cdot 10^{-4}$	27.4
Shaft torsional stiffness	c_t	Nm/rad	60000
Weight	m_{mot}	kg	41
Motor data with integrated brake:			
Moment of inertia (with brake)	J_{mot}	$kgm^2 \cdot 10^{-4}$	41.6
Shaft torsional stiffness (with brake)	c_t	Nm/rad	45500
Weight (with brake)	m_{Mot}	kg	44
Data with SINAMICS S120 Booksize:			
Rated converter current	$I_{N\ Inv}$	A	45
Maximum converter current	$I_{max\ Inv}$	A	90
Max. torque (converter operation)	$M_{max\ Inv}$	Nm	99
Max. permissible speed (converter operation)	$n_{max\ Inv}$	rpm	6000
The rated data are valid for a 600 V DC-link voltage			

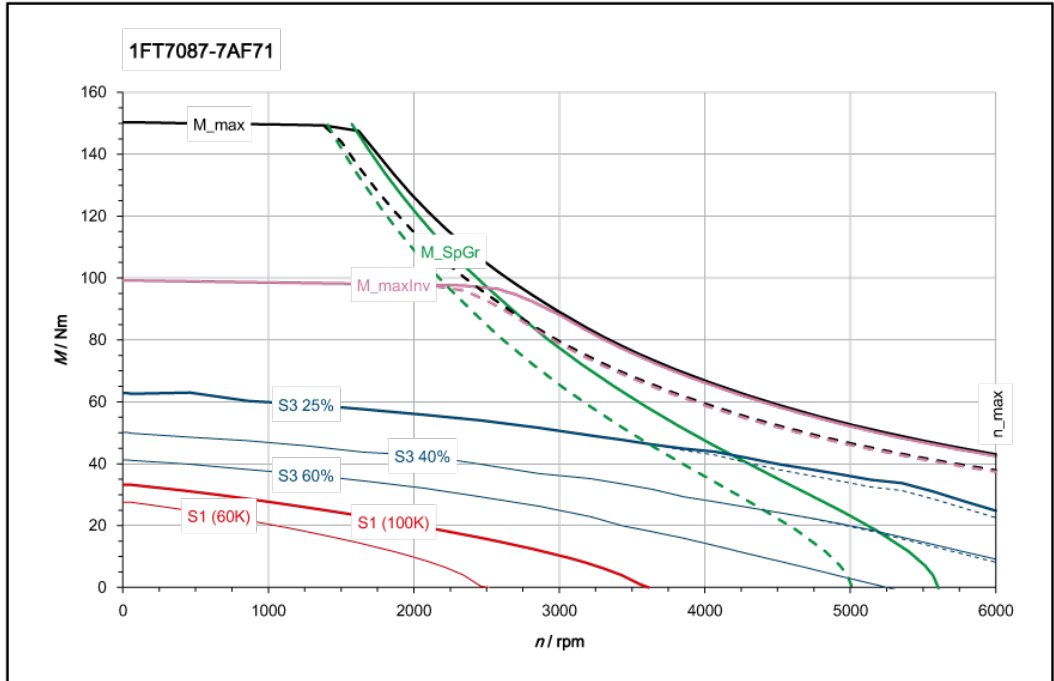

[———] SINAMICS ALM 400 V (600 V DC)
 [- - - -] SINAMICS BLM/SLM 400 V (540 V DC)

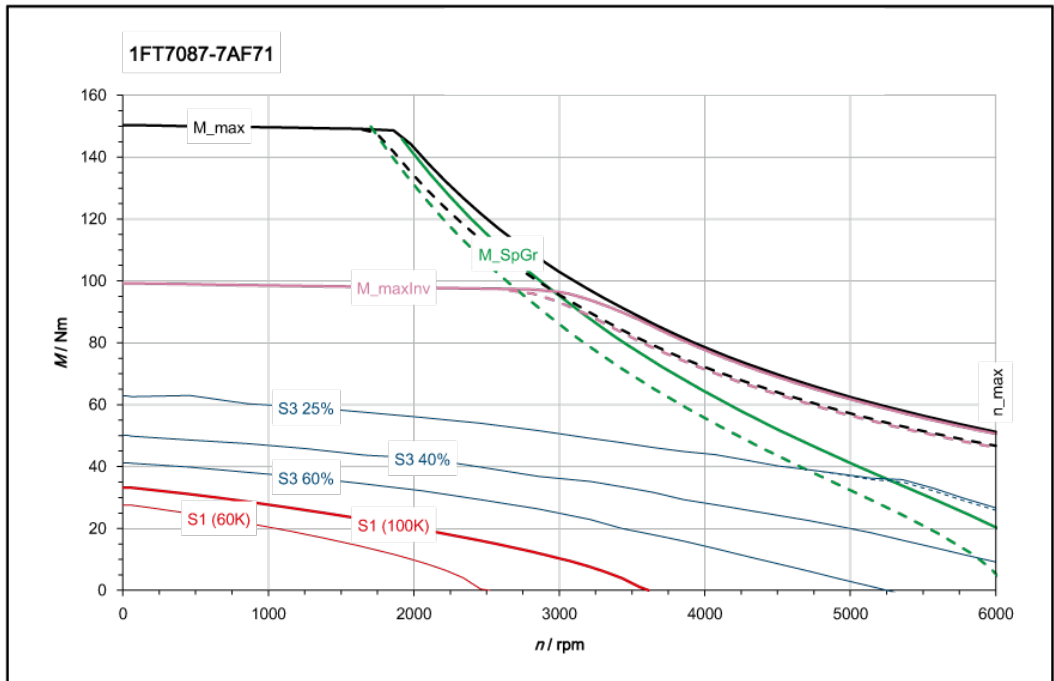

[———] SINAMICS ALM 480 V (720 V DC)
 [- - - -] SINAMICS BLM/SLM 480 V (650 V DC)

6.3.4.2 1FT7117-_A

Three-phase servomotor		1FT7117 - 7AC71	
Technical specifications	Symbol	Unit	Value
Configuration data:			
Rated speed	n_N	rpm	2000
Rated torque (100K)	$M_{N(100K)}$	Nm	55
Rated current (100K)	$I_{N(100K)}$	A	18.5
Static torque (100K)	$M_{0(100K)}$	Nm	81
Stall current (100K)	$I_{0(100K)}$	A	27.5
Static torque (60K)	$M_{0(60K)}$	Nm	67
Stall current (60K)	$I_{0(60K)}$	A	20.5
Optimum operating point:			
Optimum speed	n_{opt}	rpm	2000
Optimum power	P_{opt}	kW	11.5
Limiting data:			
Max. permissible speed (mech.)	$n_{max\ mech}$	rpm	5000
Maximum torque	M_{max}	Nm	290
Maximum current	I_{max}	A	140
Motor data:			
No. of poles	2p		8
Torque constant (100K)	k_T	Nm/A	2.95
Voltage constant (at 20 °C)	k_E	V/1000 rpm	186
Winding resistance (at 20 °C)	R_{Str}	W	0.123
Rotating field inductance	L_D	mH	3.7
Electrical time constant	T_{el}	ms	41
Mechanical time constant	T_{mech}	ms	0.3
Thermal time constant	T_{th}	min	80
Moment of inertia	J_{mot}	$kgm^2 \cdot 10^{-4}$	79.5
Shaft torsional stiffness	C_t	Nm/rad	62000
Weight	m_{mot}	kg	65
Motor data with integrated brake:			
Moment of inertia (with brake)	J_{mot}	$kgm^2 \cdot 10^{-4}$	106.5
Shaft torsional stiffness (with brake)	C_t	Nm/rad	62000
Weight (with brake)	m_{Mot}	kg	64
Data with SINAMICS S120 Booksize (Double Motor Module):			
Rated converter current	$I_{N\ Inv}$	A	60
Maximum converter current	$I_{max\ Inv}$	A	113
Max. torque converter	$M_{max\ Inv}$	Nm	260
Max. permissible speed converter	$n_{max\ Inv}$	rpm	3050
The rated data are valid for a 600 V DC-link voltage			

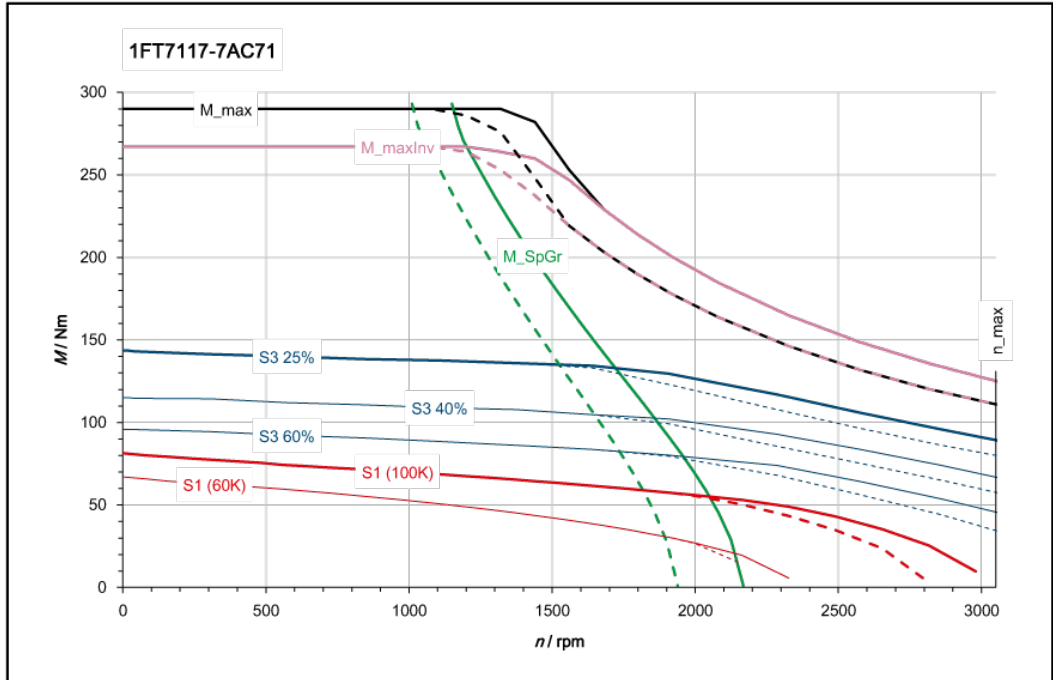

[———] SINAMICS ALM 400 V (600 V DC)
 [- - - -] SINAMICS BLM/SLM 400 V (540 V DC)

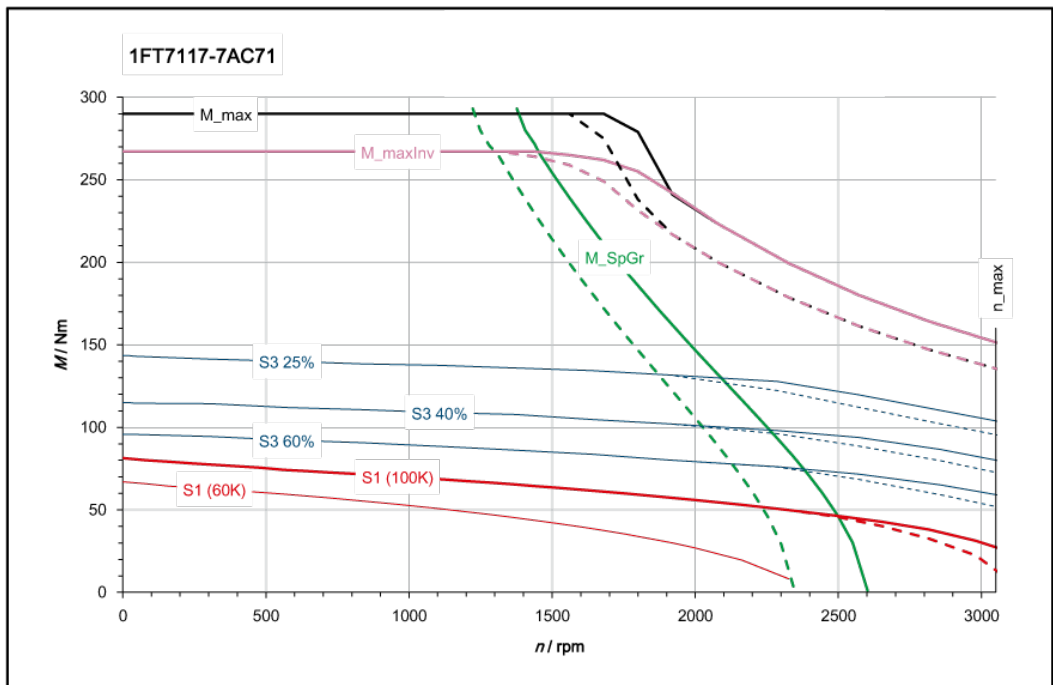

[———] SINAMICS ALM 480 V (720 V DC)
 [- - - -] SINAMICS BLM/SLM 480 V (650 V DC)

Three-phase servomotor 1FT7117 - 7AF71			
Technical specifications	Symbol	Unit	Value
Configuration data:			
Rated speed	n_N	rpm	3000
Rated torque (100K)	$M_{N(100K)}$	Nm	30
Rated current (100K)	$I_{N(100K)}$	A	17
Static torque (100K)	$M_{0(100K)}$	Nm	81
Stall current (100K)	$I_{0(100K)}$	A	41
Static torque (60K)	$M_{0(60K)}$	Nm	67
Stall current (60K)	$I_{0(60K)}$	A	30
Optimum operating point:			
Optimum speed	n_{opt}	rpm	3000
Optimum power	P_{opt}	kW	9.4
Limiting data:			
Max. permissible speed (mech.)	$n_{max\ mech}$	rpm	5000
Maximum torque	M_{max}	Nm	290
Maximum current	I_{max}	A	205
Motor data:			
No. of poles	2p		8
Torque constant (100K)	k_T	Nm/A	1.98
Voltage constant (at 20 °C)	k_E	V/1000 rpm	127
Winding resistance (at 20 °C)	R_{Str}	W	0.056
Rotating field inductance	L_D	mH	1.7
Electrical time constant	T_{el}	ms	30
Mechanical time constant	T_{mech}	ms	0.3
Thermal time constant	T_{th}	min	80
Moment of inertia	J_{mot}	$kgm^2 \cdot 10^{-4}$	79.5
Shaft torsional stiffness	C_t	Nm/rad	62000
Weight	m_{mot}	kg	65
Motor data with integrated brake:			
Moment of inertia (with brake)	J_{mot}	$kgm^2 \cdot 10^{-4}$	106.5
Shaft torsional stiffness (with brake)	C_t	Nm/rad	62000
Weight (with brake)	m_{Mot}	kg	64
Data with SINAMICS S120 Booksize (Double Motor Module):			
Rated converter current	$I_{N\ Inv}$	A	132
Maximum converter current	$I_{max\ Inv}$	A	210
Max. torque converter	$M_{max\ Inv}$	Nm	290
Max. permissible speed converter	$n_{max\ Inv}$	rpm	4500
The rated data are valid for a 600 V DC-link voltage			

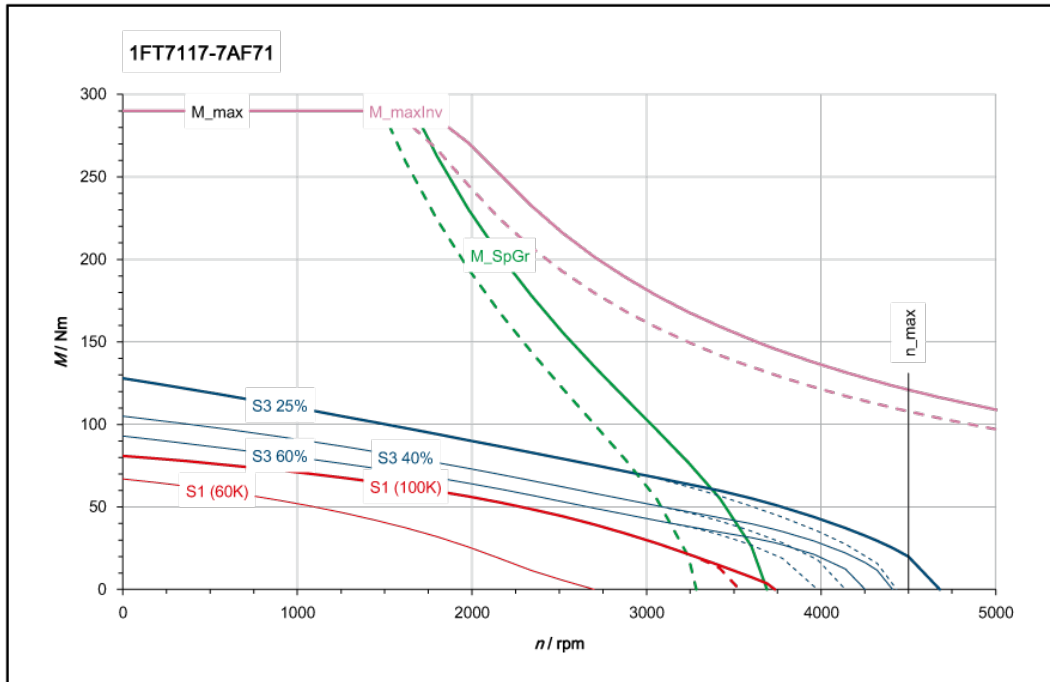

[———] SINAMICS ALM 400 V (600 V DC)
 [- - - -] SINAMICS BLM/SLM 400 V (540 V DC)

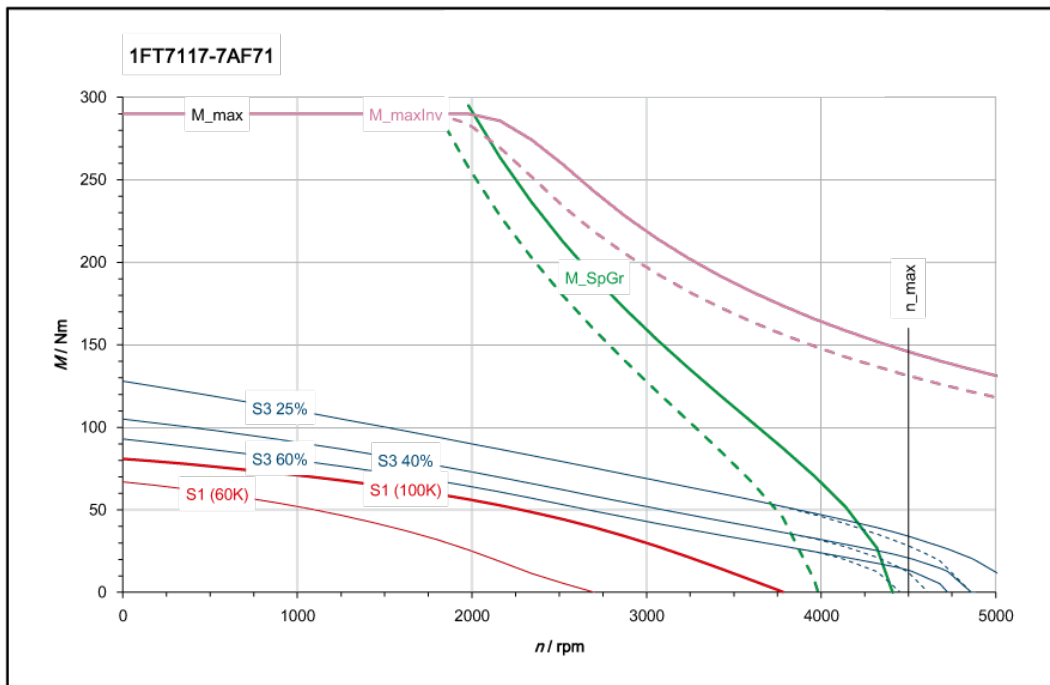

[———] SINAMICS ALM 480 V (720 V DC)
 [- - - -] SINAMICS BLM/SLM 480 V (650 V DC)

6.3.5 1FT7 High Dynamic - forced ventilation

6.3.5.1 1FT7065-_S

Three-phase servomotor		1FT7065 - 7SF7	
Technical specifications	Symbol	Unit	Value
Configuration data:			
Rated speed	n_N	rpm	3000
Rated torque (100K)	$M_{N(100K)}$	Nm	12
Rated current (100K)	$I_{N(100K)}$	A	10.5
Static torque (100K)	$M_{0(100K)}$	Nm	14
Stall current (100K)	$I_{0(100K)}$	A	12
Static torque (60K)	$M_{0(60K)}$	Nm	11
Stall current (60K)	$I_{0(60K)}$	A	9.5
Optimum operating point:			
Optimum speed	n_{opt}	rpm	3000
Optimum power	P_{opt}	kW	3.8
Limiting data:			
Max. permissible speed (mech.)	$n_{max\ mech}$	rpm	9000
Maximum torque	M_{max}	Nm	45
Maximum current	I_{max}	A	49
Motor data:			
No. of poles	2p		6
Torque constant (100K)	k_T	Nm/A	1.17
Voltage constant (at 20 °C)	k_E	V/1000 rpm	75
Winding resistance (at 20 °C)	R_{Str}	W	0.45
Rotating field inductance	L_D	mH	8.2
Electrical time constant	T_{el}	ms	18
Mechanical time constant	T_{mech}	ms	0.6
Thermal time constant	T_{th}	min	20
Moment of inertia	J_{mot}	$kgm^2 \cdot 10^{-4}$	6.4
Shaft torsional stiffness	c_t	Nm/rad	27500
Weight	m_{mot}	kg	19
Motor data with integrated brake:			
Moment of inertia (with brake)	J_{mot}	$kgm^2 \cdot 10^{-4}$	9.0
Shaft torsional stiffness (with brake)	c_t	Nm/rad	23500
Weight (with brake)	m_{Mot}	kg	20
Data with SINAMICS S120 Booksize / S120 Booksize Compact:			
Rated converter current	$I_{N\ Inv}$	A	18
Maximum converter current	$I_{max\ Inv}$	A	54
Max. torque (converter operation)	$M_{max\ Inv}$	Nm	45
Max. permissible speed (converter operation)	$n_{max\ Inv}$	rpm	7700
The rated data are valid for a 600 V DC-link voltage			

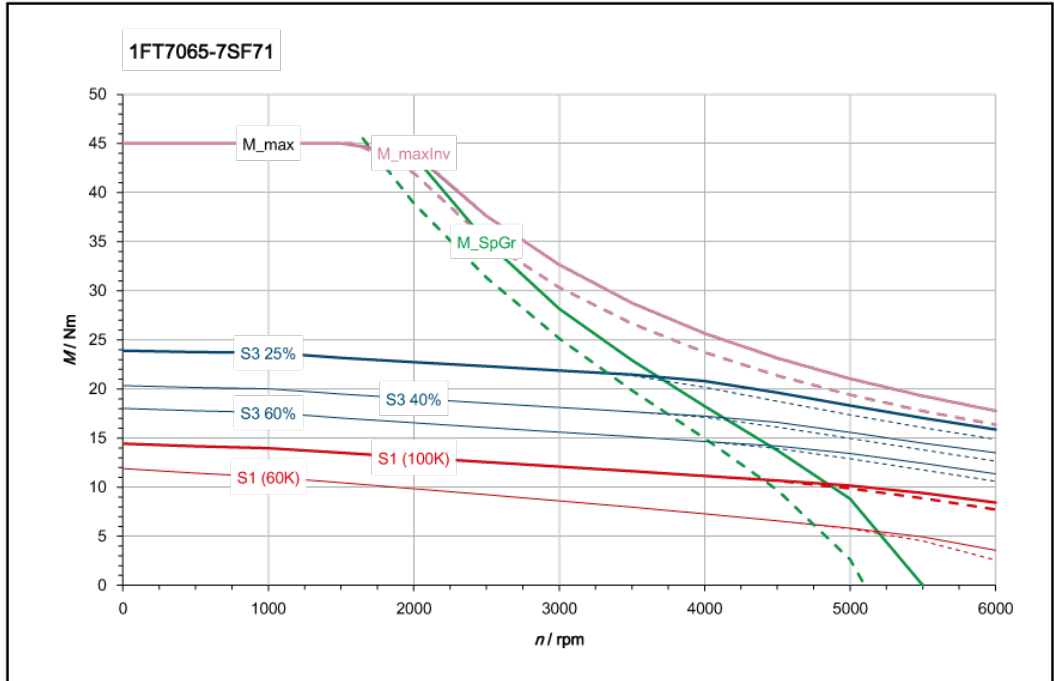

[———] SINAMICS ALM 400 V (600 V DC)
 [- - - -] SINAMICS BLM/SLM 400 V (540 V DC)

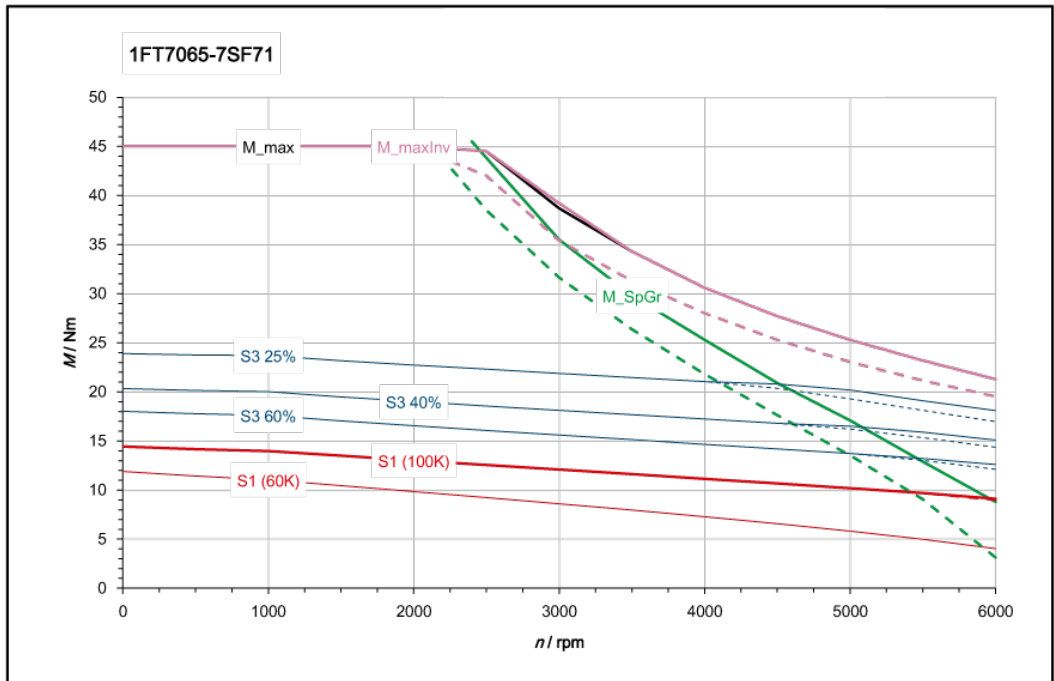

[———] SINAMICS ALM 480 V (720 V DC)
 [- - - -] SINAMICS BLM/SLM 480 V (650 V DC)

Three-phase servomotor		1FT7065 - 7SH7	
Technical specifications	Symbol	Unit	Value
Configuration data:			
Rated speed	n_N	rpm	4500
Rated torque (100K)	$M_{N(100K)}$	Nm	11
Rated current (100K)	$I_{N(100K)}$	A	13.5
Static torque (100K)	$M_{0(100K)}$	Nm	14
Stall current (100K)	$I_{0(100K)}$	A	16
Static torque (60K)	$M_{0(60K)}$	Nm	11
Stall current (60K)	$I_{0(60K)}$	A	13
Optimum operating point:			
Optimum speed	n_{opt}	rpm	4500
Optimum power	P_{opt}	kW	5.2
Limiting data:			
Max. permissible speed (mech.)	$n_{max\ mech}$	rpm	9000
Maximum torque	M_{max}	Nm	45
Maximum current	I_{max}	A	67
Motor data:			
No. of poles	2p		6
Torque constant (100K)	k_T	Nm/A	0.86
Voltage constant (at 20 °C)	k_E	V/1000 rpm	55
Winding resistance (at 20 °C)	R_{Str}	W	0.23
Rotating field inductance	L_D	mH	4.4
Electrical time constant	T_{el}	ms	19
Mechanical time constant	T_{mech}	ms	0.6
Thermal time constant	T_{th}	min	20
Moment of inertia	J_{mot}	$kgm^2 \cdot 10^{-4}$	6.4
Shaft torsional stiffness	C_t	Nm/rad	27500
Weight	m_{mot}	kg	19
Motor data with integrated brake:			
Moment of inertia (with brake)	J_{mot}	$kgm^2 \cdot 10^{-4}$	9.0
Shaft torsional stiffness (with brake)	C_t	Nm/rad	23500
Weight (with brake)	m_{Mot}	kg	20
Data with SINAMICS S120 Booksize / S120 Booksize Compact:			
Rated converter current	$I_{N\ Inv}$	A	18
Maximum converter current	$I_{max\ Inv}$	A	54
Max. torque (converter operation)	$M_{max\ Inv}$	Nm	39
Max. permissible speed (converter operation)	$n_{max\ Inv}$	rpm	9000
The rated data are valid for a 600 V DC-link voltage			

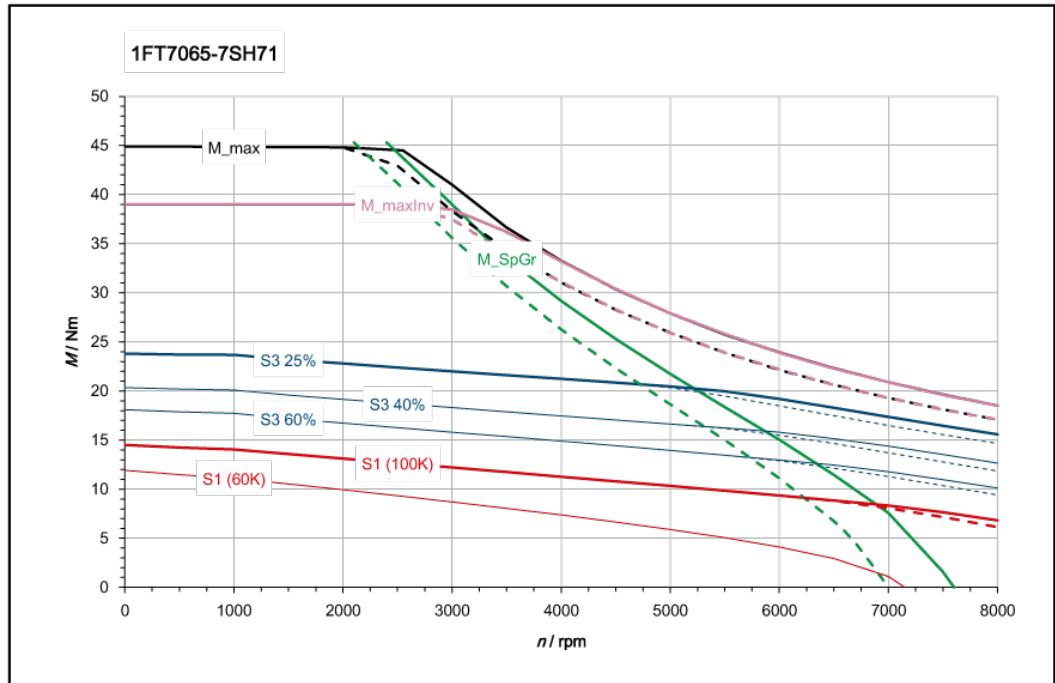

[———] SINAMICS ALM 400 V (600 V DC)
 [- - - -] SINAMICS BLM/SLM 400 V (540 V DC)

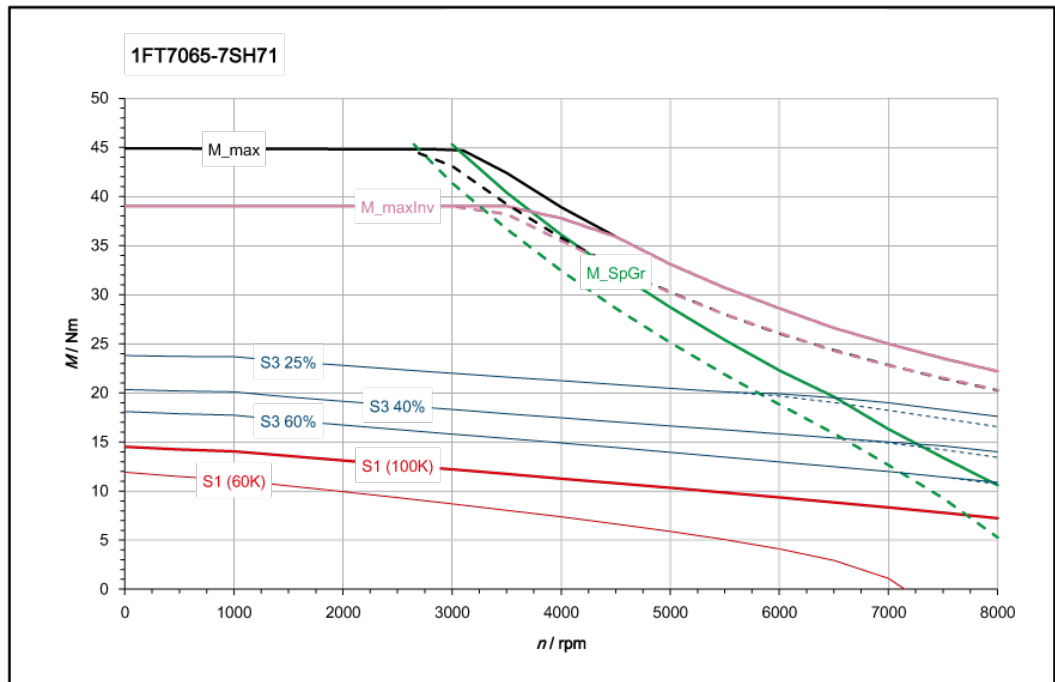

[———] SINAMICS ALM 480 V (720 V DC)
 [- - - -] SINAMICS BLM/SLM 480 V (650 V DC)

6.3.5.2 1FT7067-_S

Three-phase servomotor 1FT7067 - 7SF7			
Technical specifications	Symbol	Unit	Value
Configuration data:			
Rated speed	n_N	rpm	3000
Rated torque (100K)	$M_{N(100K)}$	Nm	14
Rated current (100K)	$I_{N(100K)}$	A	13
Static torque (100K)	$M_{0(100K)}$	Nm	17
Stall current (100K)	$I_{0(100K)}$	A	15
Static torque (60K)	$M_{0(60K)}$	Nm	14
Stall current (60K)	$I_{0(60K)}$	A	12.5
Optimum operating point:			
Optimum speed	n_{opt}	rpm	3000
Optimum power	P_{opt}	kW	4.4
Limiting data:			
Max. permissible speed (mech.)	$n_{max\ mech}$	rpm	9000
Maximum torque	M_{max}	Nm	60
Maximum current	I_{max}	A	63
Motor data:			
No. of poles	2p		6
Torque constant (100K)	k_T	Nm/A	1.14
Voltage constant (at 20 °C)	k_E	V/1000 rpm	73
Winding resistance (at 20 °C)	R_{Str}	W	0.3
Rotating field inductance	L_D	mH	5.7
Electrical time constant	T_{el}	ms	19
Mechanical time constant	T_{mech}	ms	0.6
Thermal time constant	T_{th}	min	20
Moment of inertia	J_{mot}	$kgm^2 \cdot 10^{-4}$	8.3
Shaft torsional stiffness	C_t	Nm/rad	24500
Weight	m_{mot}	kg	23
Motor data with integrated brake:			
Moment of inertia (with brake)	J_{mot}	$kgm^2 \cdot 10^{-4}$	10.9
Shaft torsional stiffness (with brake)	C_t	Nm/rad	21500
Weight (with brake)	m_{Mot}	kg	24
Data with SINAMICS S120 Booksize / S120 Booksize Compact:			
Rated converter current	$I_{N\ Inv}$	A	18
Maximum converter current	$I_{max\ Inv}$	A	54
Max. torque (converter operation)	$M_{max\ Inv}$	Nm	54
Max. permissible speed (converter operation)	$n_{max\ Inv}$	rpm	7900
The rated data are valid for a 600 V DC-link voltage			

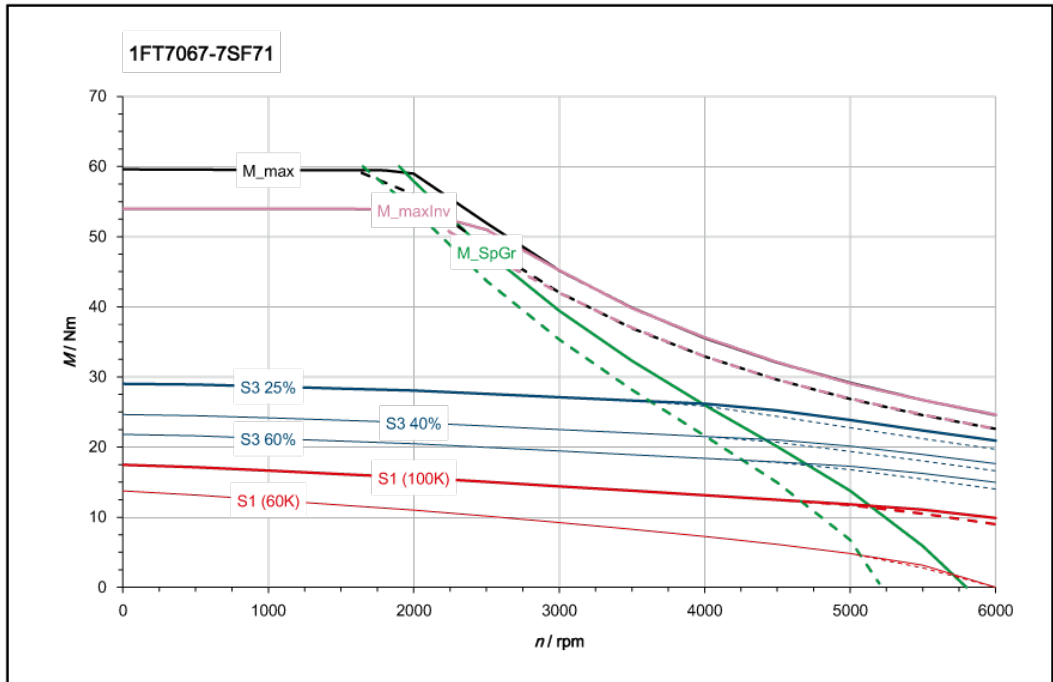

[———] SINAMICS ALM 400 V (600 V DC)
 [- - - -] SINAMICS BLM/SLM 400 V (540 V DC)

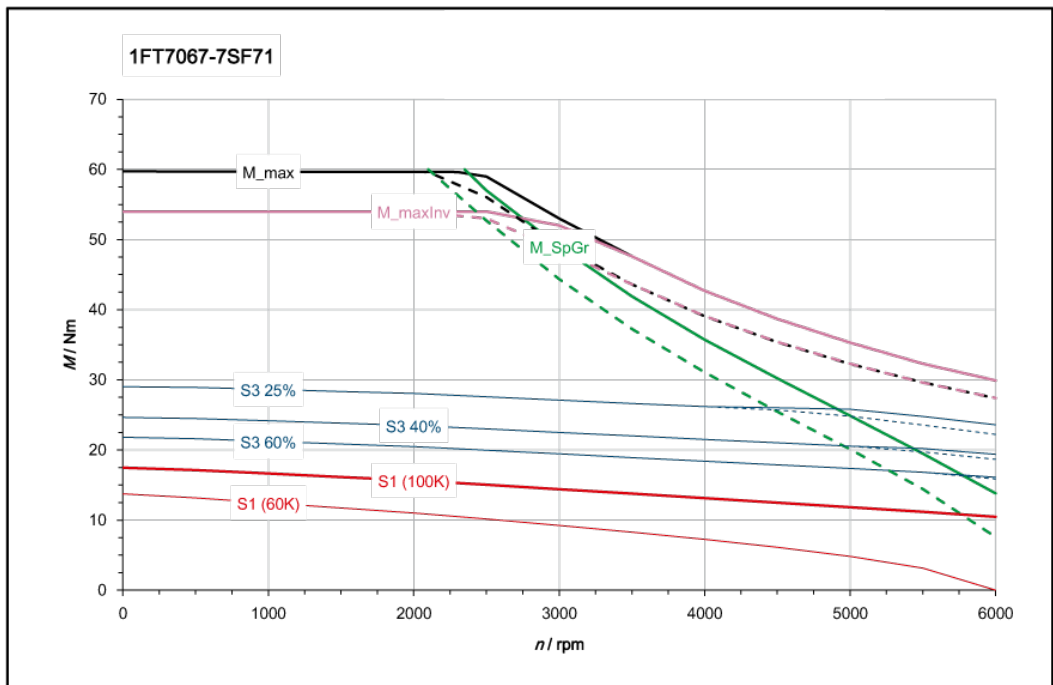

[———] SINAMICS ALM 480 V (720 V DC)
 [- - - -] SINAMICS BLM/SLM 480 V (650 V DC)

Three-phase servomotor 1FT7067 - 7SH7			
Technical specifications	Symbol	Unit	Value
Configuration data:			
Rated speed	n_N	rpm	4500
Rated torque (100K)	$M_{N(100K)}$	Nm	13
Rated current (100K)	$I_{N(100K)}$	A	15
Static torque (100K)	$M_{0(100K)}$	Nm	17
Stall current (100K)	$I_{0(100K)}$	A	19
Static torque (60K)	$M_{0(60K)}$	Nm	14
Stall current (60K)	$I_{0(60K)}$	A	16
Optimum operating point:			
Optimum speed	n_{opt}	rpm	4500
Optimum power	P_{opt}	kW	6.1
Limiting data:			
Max. permissible speed (mech.)	$n_{max\ mech}$	rpm	9000
Maximum torque	M_{max}	Nm	60
Maximum current	I_{max}	A	80
Motor data:			
No. of poles	$2p$		6
Torque constant (100K)	k_T	Nm/A	0.89
Voltage constant (at 20 °C)	k_E	V/1000 rpm	57
Winding resistance (at 20 °C)	R_{Str}	W	0.18
Rotating field inductance	L_D	mH	3.5
Electrical time constant	T_{el}	ms	19
Mechanical time constant	T_{mech}	ms	0.6
Thermal time constant	T_{th}	min	20
Moment of inertia	J_{mot}	$kgm^2 \cdot 10^{-4}$	8.3
Shaft torsional stiffness	C_t	Nm/rad	24500
Weight	m_{mot}	kg	23
Motor data with integrated brake:			
Moment of inertia (with brake)	J_{mot}	$kgm^2 \cdot 10^{-4}$	10.9
Shaft torsional stiffness (with brake)	C_t	Nm/rad	21500
Weight (with brake)	m_{Mot}	kg	24
Data with SINAMICS S120 Booksize:			
Rated converter current	$I_{N\ Inv}$	A	24
Maximum converter current	$I_{max\ Inv}$	A	72
Max. torque (converter operation)	$M_{max\ Inv}$	Nm	55
Max. permissible speed (converter operation)	$n_{max\ Inv}$	rpm	9000
The rated data are valid for a 600 V DC-link voltage			

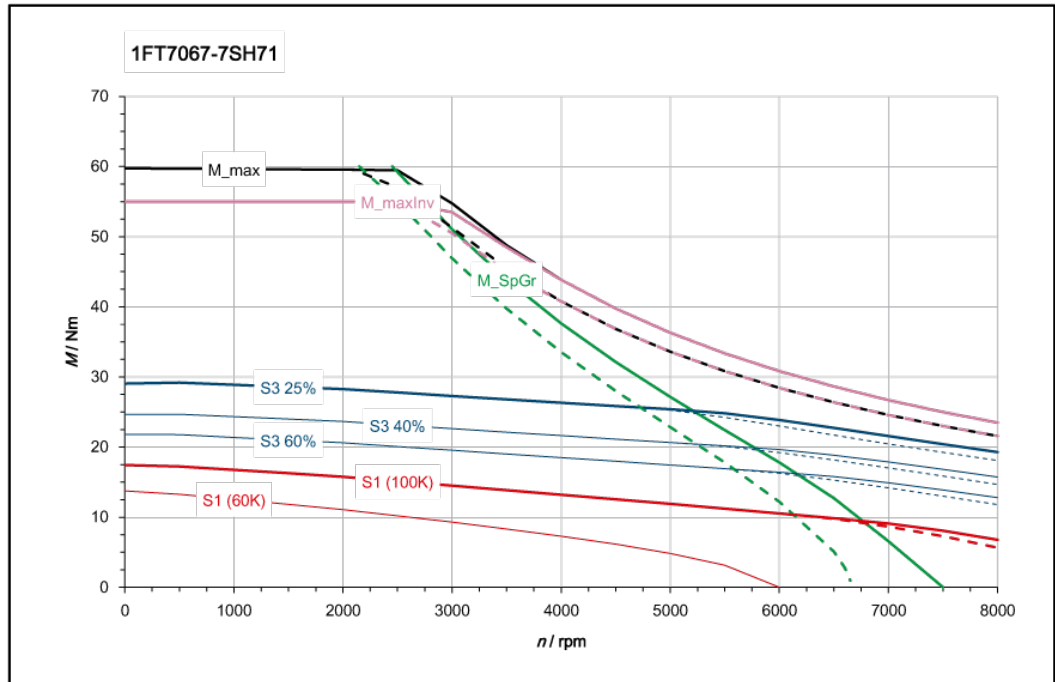

[———] SINAMICS ALM 400 V (600 V DC)
 [- - - -] SINAMICS BLM/SLM 400 V (540 V DC)

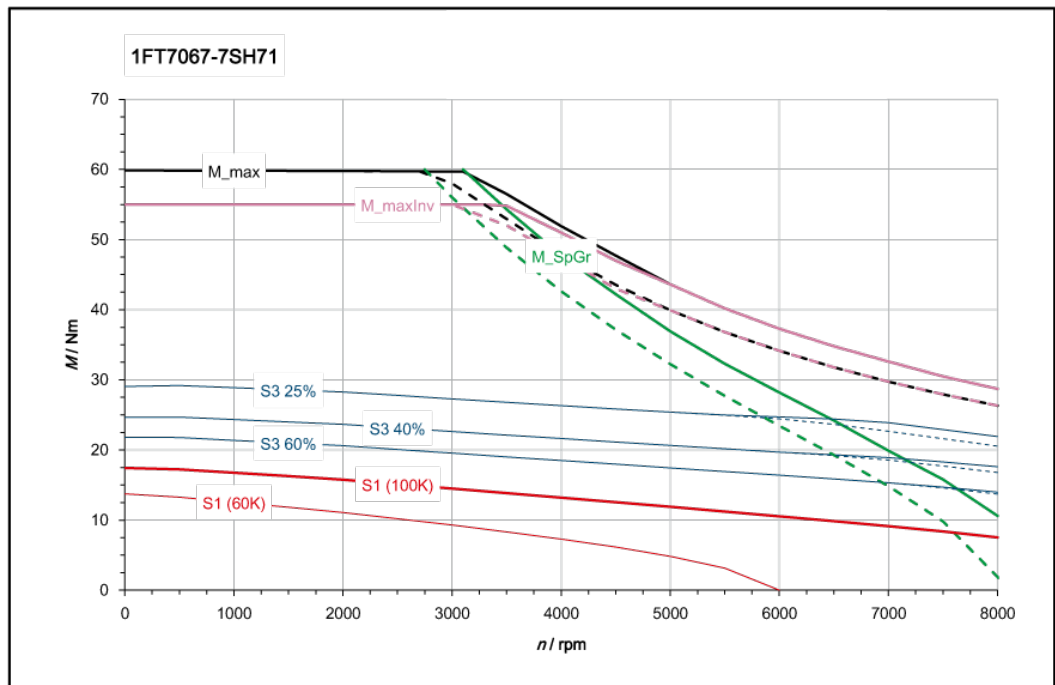

[———] SINAMICS ALM 480 V (720 V DC)
 [- - - -] SINAMICS BLM/SLM 480 V (650 V DC)

6.3.5.3 1FT7085-S

Three-phase servomotor		1FT7085 - 7SF7	
Technical specifications	Symbol	Unit	Value
Configuration data:			
Rated speed	n_N	rpm	3000
Rated torque (100K)	$M_{N(100K)}$	Nm	23
Rated current (100K)	$I_{N(100K)}$	A	20
Static torque (100K)	$M_{0(100K)}$	Nm	34
Stall current (100K)	$I_{0(100K)}$	A	28
Static torque (60K)	$M_{0(60K)}$	Nm	26
Stall current (60K)	$I_{0(60K)}$	A	22
Optimum operating point:			
Optimum speed	n_{opt}	rpm	3000
Optimum power	P_{opt}	kW	7.2
Limiting data:			
Max. permissible speed (mech.)	$n_{max\ mech}$	rpm	8000
Maximum torque	M_{max}	Nm	105
Maximum current	I_{max}	A	126
Motor data:			
No. of poles	2p		8
Torque constant (100K)	k_T	Nm/A	1.20
Voltage constant (at 20 °C)	k_E	V/1000 rpm	77
Winding resistance (at 20 °C)	R_{Str}	W	0.12
Rotating field inductance	L_D	mH	3.1
Electrical time constant	T_{el}	ms	26
Mechanical time constant	T_{mech}	ms	0.5
Thermal time constant	T_{th}	min	24
Moment of inertia	J_{mot}	$kgm^2 \cdot 10^{-4}$	20.7
Shaft torsional stiffness	C_t	Nm/rad	70000
Weight	m_{mot}	kg	34
Motor data with integrated brake:			
Moment of inertia (with brake)	J_{mot}	$kgm^2 \cdot 10^{-4}$	34.9
Shaft torsional stiffness (with brake)	C_t	Nm/rad	51000
Weight (with brake)	m_{Mot}	kg	37
Data with SINAMICS S120 Booksize:			
Rated converter current	$I_{N\ Inv}$	A	30
Maximum converter current	$I_{max\ Inv}$	A	90
Max. torque (converter operation)	$M_{max\ Inv}$	Nm	89
Max. permissible speed (converter operation)	$n_{max\ Inv}$	rpm	7500
The rated data are valid for a 600 V DC-link voltage			

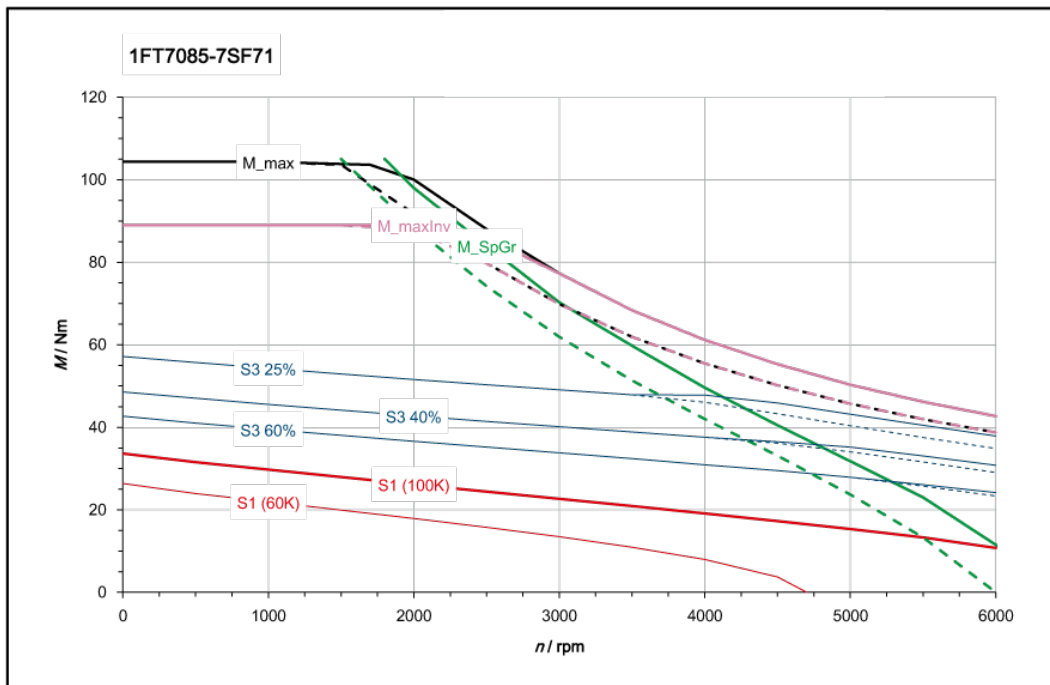
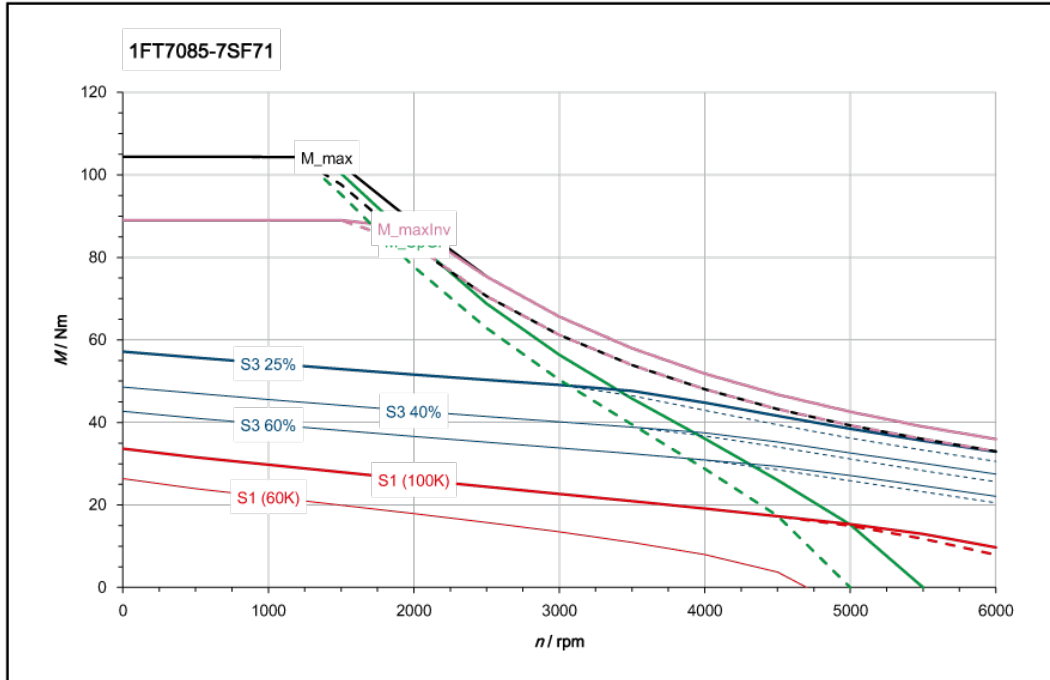

Three-phase servomotor		1FT7085 - 7SH7	
Technical specifications	Symbol	Unit	Value
Configuration data:			
Rated speed	n_N	rpm	4500
Rated torque (100K)	$M_{N(100K)}$	Nm	17.5
Rated current (100K)	$I_{N(100K)}$	A	22.5
Static torque (100K)	$M_{0(100K)}$	Nm	34
Stall current (100K)	$I_{0(100K)}$	A	40
Static torque (60K)	$M_{0(60K)}$	Nm	26
Stall current (60K)	$I_{0(60K)}$	A	30
Optimum operating point:			
Optimum speed	n_{opt}	rpm	4500
Optimum power	P_{opt}	kW	8.2
Limiting data:			
Max. permissible speed (mech.)	$n_{max\ mech}$	rpm	8000
Maximum torque	M_{max}	Nm	105
Maximum current	I_{max}	A	178
Motor data:			
No. of poles	2p		8
Torque constant (100K)	k_T	Nm/A	0.86
Voltage constant (at 20 °C)	k_E	V/1000 rpm	55
Winding resistance (at 20 °C)	R_{Str}	W	0.06
Rotating field inductance	L_D	mH	1.6
Electrical time constant	T_{el}	ms	27
Mechanical time constant	T_{mech}	ms	0.5
Thermal time constant	T_{th}	min	24
Moment of inertia	J_{mot}	$kgm^2 \cdot 10^{-4}$	20.7
Shaft torsional stiffness	C_t	Nm/rad	70000
Weight	m_{mot}	kg	34
Motor data with integrated brake:			
Moment of inertia (with brake)	J_{mot}	$kgm^2 \cdot 10^{-4}$	34.9
Shaft torsional stiffness (with brake)	C_t	Nm/rad	51000
Weight (with brake)	m_{Mot}	kg	37
Data with SINAMICS S120 Booksize:			
Rated converter current	$I_{N\ Inv}$	A	45
Maximum converter current	$I_{max\ Inv}$	A	90
Max. torque (converter operation)	$M_{max\ Inv}$	Nm	70
Max. permissible speed (converter operation)	$n_{max\ Inv}$	rpm	8000
The rated data are valid for a 600 V DC-link voltage			

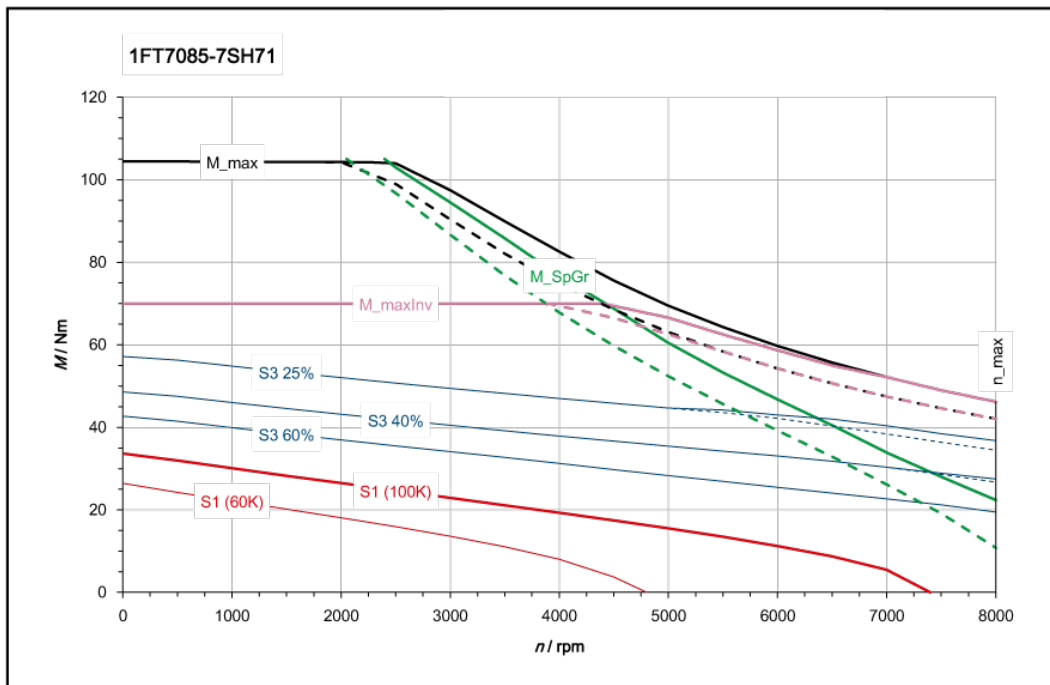
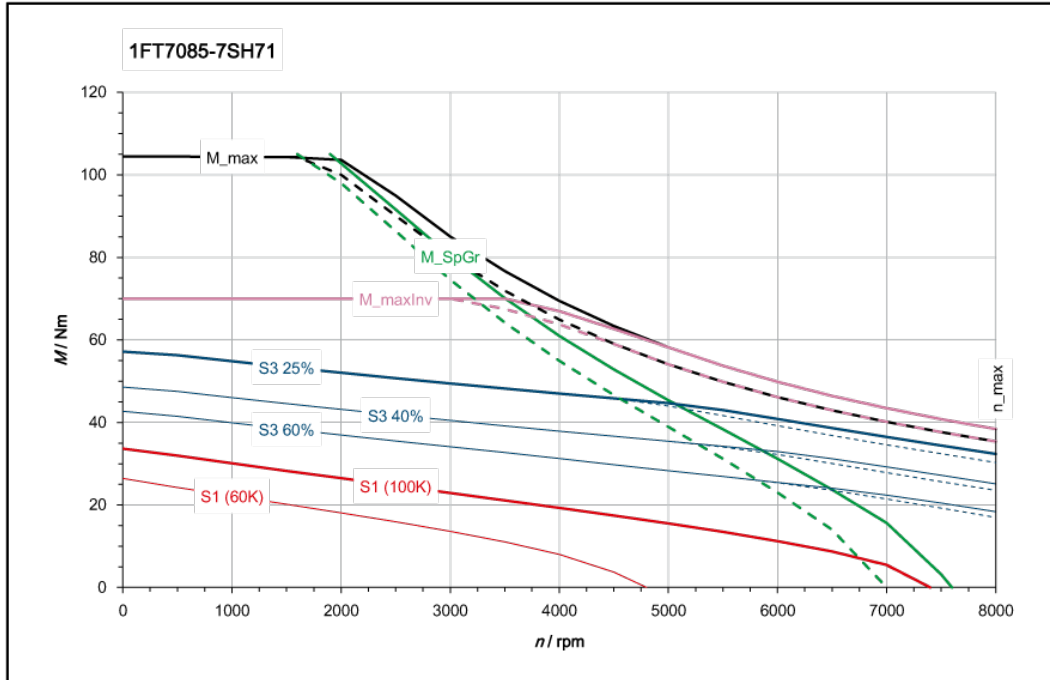

6.3.5.4 1FT7087-_S

Three-phase servomotor 1FT7087 - 7SF7			
Technical specifications	Symbol	Unit	Value
Configuration data:			
Rated speed	n_N	rpm	3000
Rated torque (100K)	$M_{N(100K)}$	Nm	33
Rated current (100K)	$I_{N(100K)}$	A	29
Static torque (100K)	$M_{0(100K)}$	Nm	48
Stall current (100K)	$I_{0(100K)}$	A	40
Static torque (60K)	$M_{0(60K)}$	Nm	37
Stall current (60K)	$I_{0(60K)}$	A	31
Optimum operating point:			
Optimum speed	n_{opt}	rpm	3000
Optimum power	P_{opt}	kW	10.4
Limiting data:			
Max. permissible speed (mech.)	$n_{max\ mech}$	rpm	8000
Maximum torque	M_{max}	Nm	150
Maximum current	I_{max}	A	170
Motor data:			
No. of poles	2p		8
Torque constant (100K)	k_T	Nm/A	1.20
Voltage constant (at 20 °C)	k_E	V/1000 rpm	77
Winding resistance (at 20 °C)	R_{Str}	W	0.08
Rotating field inductance	L_D	mH	2.1
Electrical time constant	T_{el}	ms	26
Mechanical time constant	T_{mech}	ms	0.5
Thermal time constant	T_{th}	min	25
Moment of inertia	J_{mot}	$kgm^2 \cdot 10^{-4}$	27.4
Shaft torsional stiffness	C_t	Nm/rad	60000
Weight	m_{mot}	kg	42
Motor data with integrated brake:			
Moment of inertia (with brake)	J_{mot}	$kgm^2 \cdot 10^{-4}$	41.6
Shaft torsional stiffness (with brake)	C_t	Nm/rad	45500
Weight (with brake)	m_{Mot}	kg	45
Data with SINAMICS S120 Booksize:			
Rated converter current	$I_{N\ Inv}$	A	45
Maximum converter current	$I_{max\ Inv}$	A	90
Max. torque (converter operation)	$M_{max\ Inv}$	Nm	99
Max. permissible speed (converter operation)	$n_{max\ Inv}$	rpm	7500
The rated data are valid for a 600 V DC-link voltage			

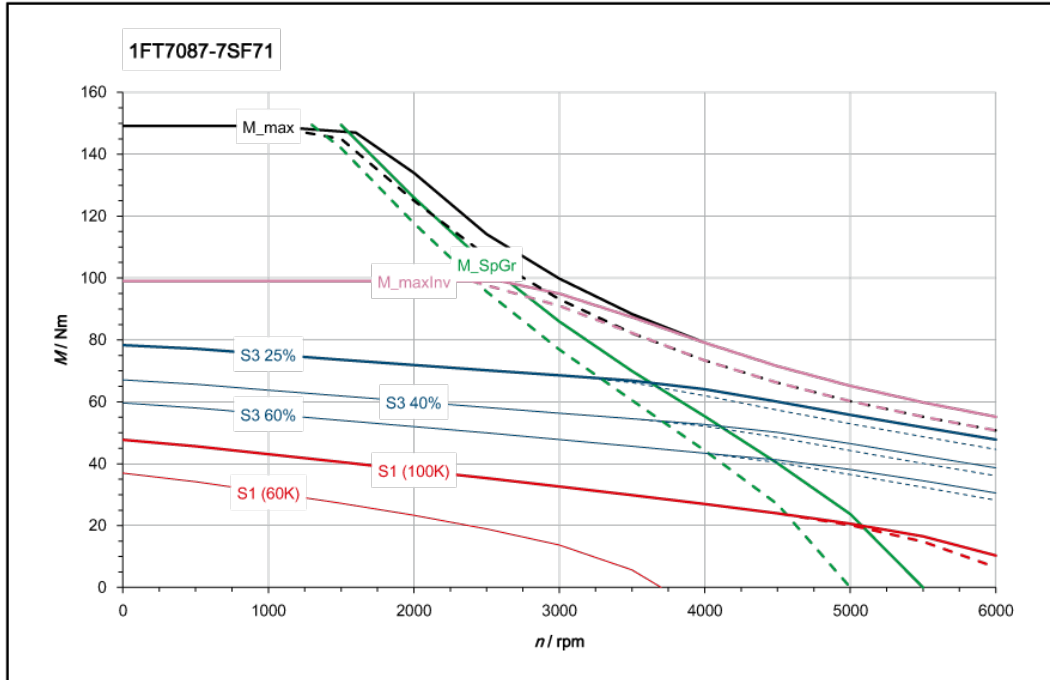

[———] SINAMICS ALM 400 V (600 V DC)
 [- - - -] SINAMICS BLM/SLM 400 V (540 V DC)

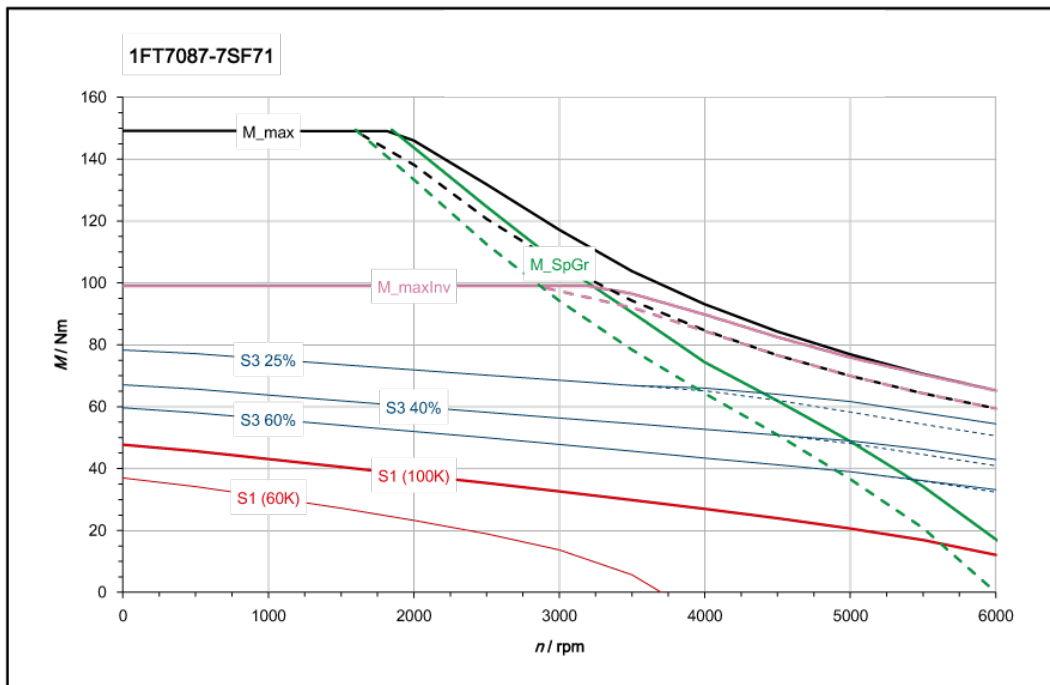

[———] SINAMICS ALM 480 V (720 V DC)
 [- - - -] SINAMICS BLM/SLM 480 V (650 V DC)

Three-phase servomotor 1FT7087 - 7SH7			
Technical specifications	Symbol	Unit	Value
Configuration data:			
Rated speed	n_N	rpm	4500
Rated torque (100K)	$M_{N(100K)}$	Nm	23
Rated current (100K)	$I_{N(100K)}$	A	24
Static torque (100K)	$M_{0(100K)}$	Nm	48
Stall current (100K)	$I_{0(100K)}$	A	45
Static torque (60K)	$M_{0(60K)}$	Nm	37
Stall current (60K)	$I_{0(60K)}$	A	35
Optimum operating point:			
Optimum speed	n_{opt}	rpm	4500
Optimum power	P_{opt}	kW	10.8
Limiting data:			
Max. permissible speed (mech.)	$n_{max\ mech}$	rpm	8000
Maximum torque	M_{max}	Nm	150
Maximum current	I_{max}	A	195
Motor data:			
No. of poles	2p		8
Torque constant (100K)	k_T	Nm/A	1.06
Voltage constant (at 20 °C)	k_E	V/1000 rpm	68
Winding resistance (at 20 °C)	R_{Str}	W	0.06
Rotating field inductance	L_D	mH	1.7
Electrical time constant	T_{el}	ms	28
Mechanical time constant	T_{mech}	ms	0.4
Thermal time constant	T_{th}	min	25
Moment of inertia	J_{mot}	$kgm^2 \cdot 10^{-4}$	27.4
Shaft torsional stiffness	C_t	Nm/rad	60000
Weight	m_{mot}	kg	43
Motor data with integrated brake:			
Moment of inertia (with brake)	J_{mot}	$kgm^2 \cdot 10^{-4}$	41.6
Shaft torsional stiffness (with brake)	C_t	Nm/rad	45500
Weight (with brake)	m_{Mot}	kg	46
Data with SINAMICS S120 Booksize:			
Rated converter current	$I_{N\ Inv}$	A	45
Maximum converter current	$I_{max\ Inv}$	A	90
Max. torque (converter operation)	$M_{max\ Inv}$	Nm	89
Max. permissible speed (converter operation)	$n_{max\ Inv}$	rpm	8000
The rated data are valid for a 600 V DC-link voltage			

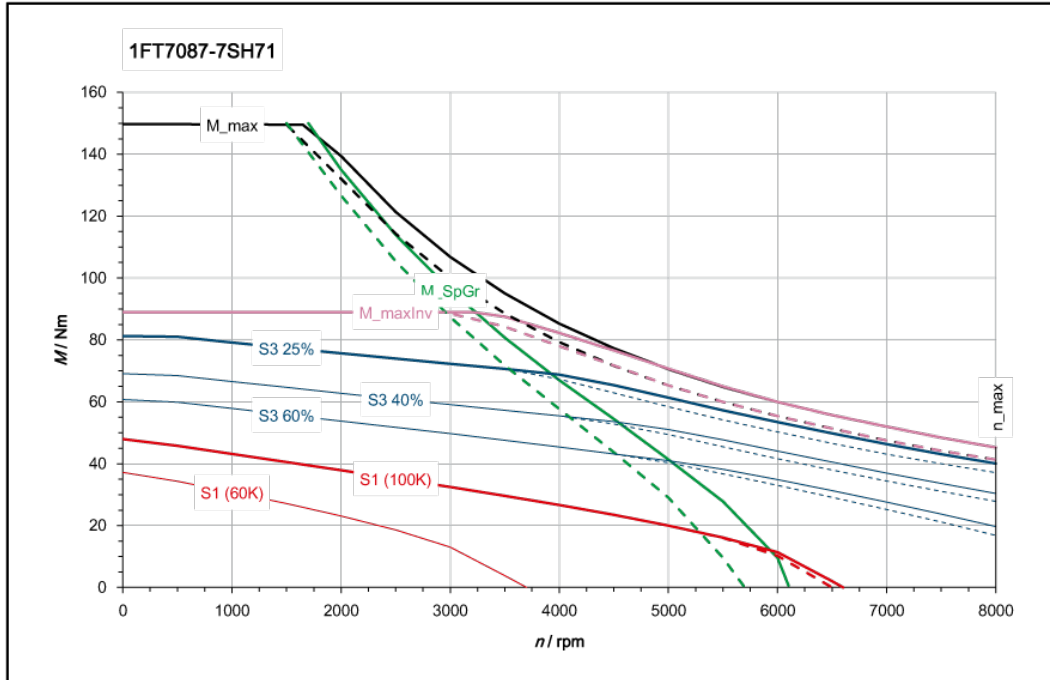

[———] SINAMICS ALM 400 V (600 V DC)
 [- - - -] SINAMICS BLM/SLM 400 V (540 V DC)

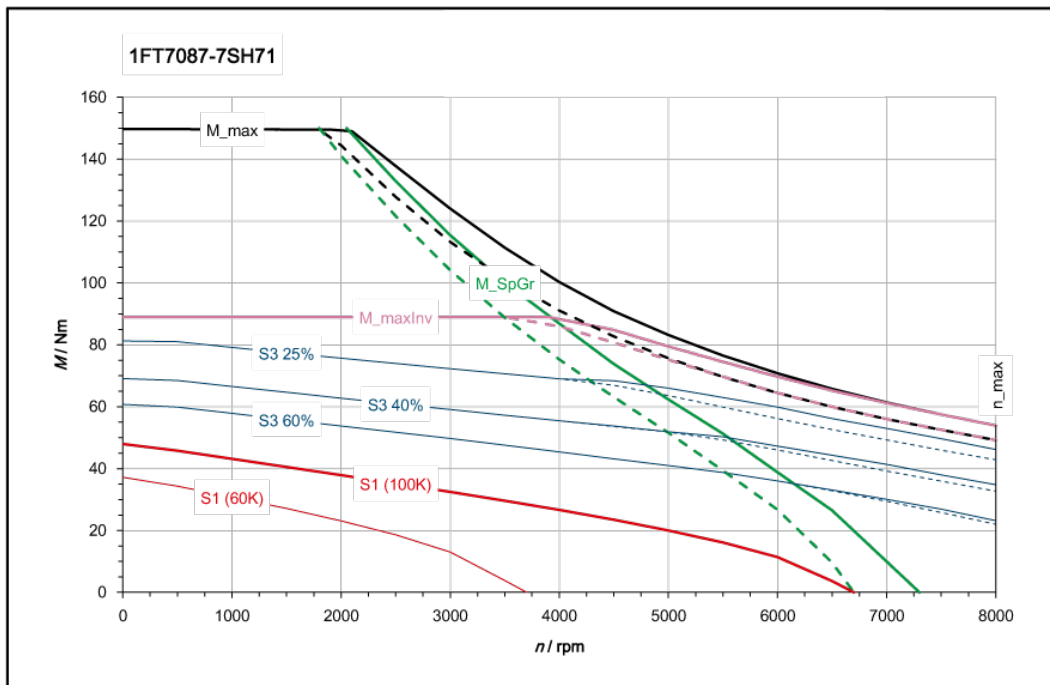

[———] SINAMICS ALM 480 V (720 V DC)
 [- - - -] SINAMICS BLM/SLM 480 V (650 V DC)

6.3.5.5 1FT7117-_S

Three-phase servomotor		1FT7117 - 7SC7	
Technical specifications	Symbol	Unit	Value
Configuration data:			
Rated speed	n_N	rpm	2000
Rated torque (100K)	$M_{N(100K)}$	Nm	82
Rated current (100K)	$I_{N(100K)}$	A	28
Static torque (100K)	$M_{0(100K)}$	Nm	105
Stall current (100K)	$I_{0(100K)}$	A	36
Static torque (60K)	$M_{0(60K)}$	Nm	87
Stall current (60K)	$I_{0(60K)}$	A	29
Optimum operating point:			
Optimum speed	n_{opt}	rpm	2000
Optimum power	P_{opt}	kW	17.2
Limiting data:			
Max. permissible speed (mech.)	$n_{max\ mech}$	rpm	5000
Maximum torque	M_{max}	Nm	290
Maximum current	I_{max}	A	140
Motor data:			
No. of poles	2p		8
Torque constant (100K)	k_T	Nm/A	2.95
Voltage constant (at 20 °C)	k_E	V/1000 rpm	186
Winding resistance (at 20 °C)	R_{Str}	W	0.123
Rotating field inductance	L_D	mH	3.7
Electrical time constant	T_{el}	ms	41
Mechanical time constant	T_{mech}	ms	0.3
Thermal time constant	T_{th}	min	55
Moment of inertia	J_{mot}	$kgm^2 \cdot 10^{-4}$	79.5
Shaft torsional stiffness	C_t	Nm/rad	62000
Weight	m_{mot}	kg	72
Motor data with integrated brake:			
Moment of inertia (with brake)	J_{mot}	$kgm^2 \cdot 10^{-4}$	106.5
Shaft torsional stiffness (with brake)	C_t	Nm/rad	62000
Weight (with brake)	m_{Mot}	kg	64
Data with SINAMICS S120 Booksize (Double Motor Module):			
Rated converter current	$I_{N\ Inv}$	A	60
Maximum converter current	$I_{max\ Inv}$	A	113
Max. torque (converter operation)	$M_{max\ Inv}$	Nm	260
Max. permissible speed (converter operation)	$n_{max\ Inv}$	rpm	3050
The rated data are valid for a 600 V DC-link voltage			

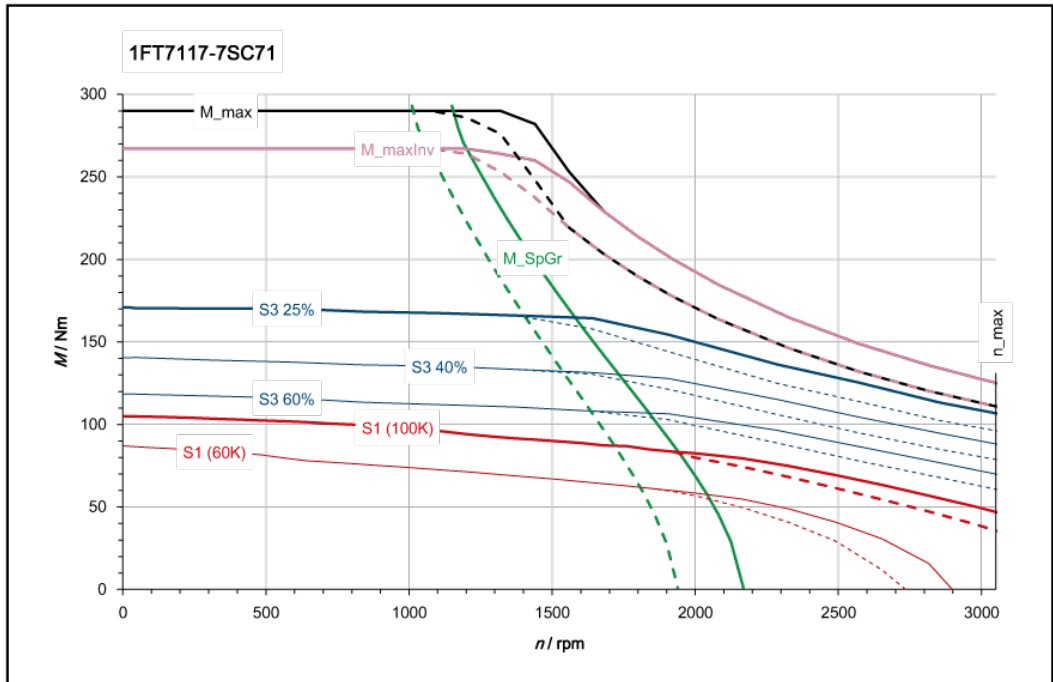

[—] SINAMICS ALM 400 V (600 V DC)
 [- - -] SINAMICS BLM/SLM 400 V (540 V DC)

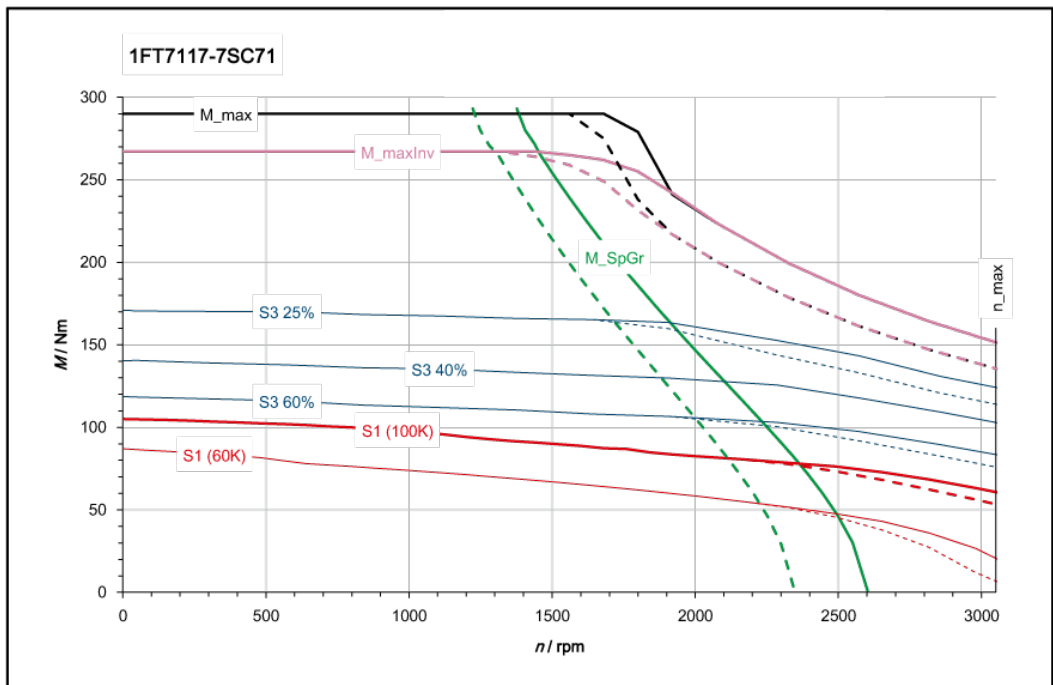

[—] SINAMICS ALM 480 V (720 V DC)
 [- - -] SINAMICS BLM/SLM 480 V (650 V DC)

Three-phase servomotor 1FT7117 - 7SF7			
Technical specifications	Symbol	Unit	Value
Configuration data:			
Rated speed	n_N	rpm	3000
Rated torque (100K)	$M_{N(100K)}$	Nm	54
Rated current (100K)	$I_{N(100K)}$	A	29
Static torque (100K)	$M_{0(100K)}$	Nm	105
Stall current (100K)	$I_{0(100K)}$	A	53
Static torque (60K)	$M_{0(60K)}$	Nm	87
Stall current (60K)	$I_{0(60K)}$	A	43
Optimum operating point:			
Optimum speed	n_{opt}	rpm	3000
Optimum power	P_{opt}	kW	17
Limiting data:			
Max. permissible speed (mech.)	$n_{max\ mech}$	rpm	5000
Maximum torque	M_{max}	Nm	290
Maximum current	I_{max}	A	205
Motor data:			
No. of poles	2p		8
Torque constant (100K)	k_T	Nm/A	1.98
Voltage constant (at 20 °C)	k_E	V/1000 rpm	127
Winding resistance (at 20 °C)	R_{Str}	W	0.056
Rotating field inductance	L_D	mH	1.7
Electrical time constant	T_{el}	ms	30
Mechanical time constant	T_{mech}	ms	0.3
Thermal time constant	T_{th}	min	55
Moment of inertia	J_{mot}	$kgm^2 \cdot 10^{-4}$	79.5
Shaft torsional stiffness	C_t	Nm/rad	62000
Weight	m_{mot}	kg	72
Motor data with integrated brake:			
Moment of inertia (with brake)	J_{mot}	$kgm^2 \cdot 10^{-4}$	106.5
Shaft torsional stiffness (with brake)	C_t	Nm/rad	62000
Weight (with brake)	m_{Mot}	kg	64
Data with SINAMICS S120 Booksize (Double Motor Module):			
Rated converter current	$I_{N\ Inv}$	A	132
Maximum converter current	$I_{max\ Inv}$	A	210
Max. torque (converter operation)	$M_{max\ Inv}$	Nm	290
Max. permissible speed (converter operation)	$n_{max\ Inv}$	rpm	4500
The rated data are valid for a 600 V DC-link voltage			

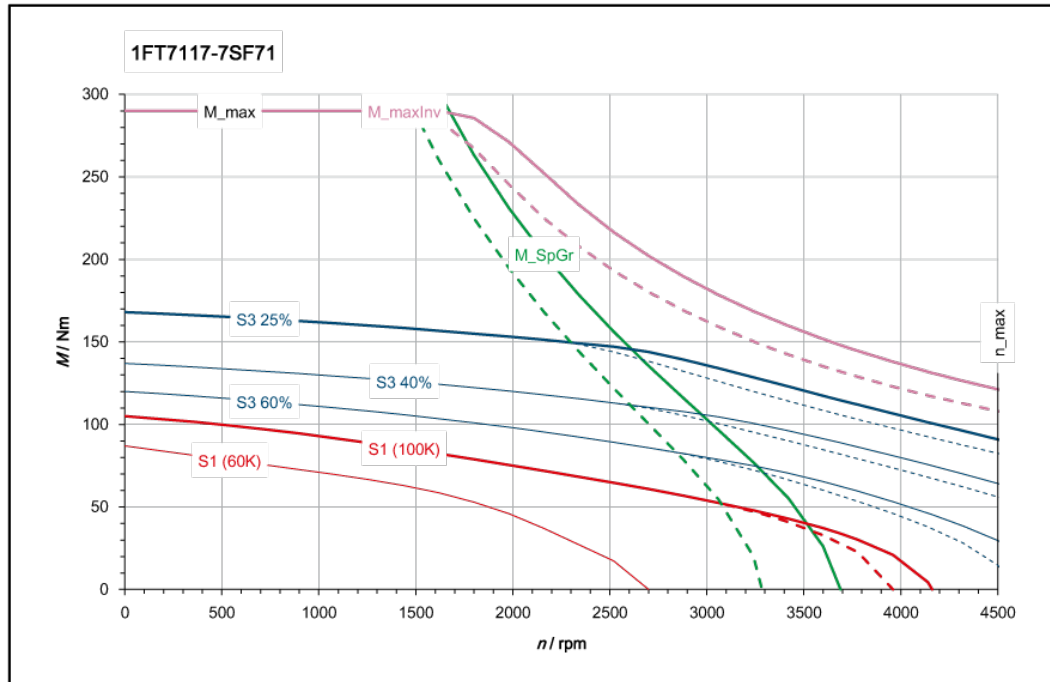

[———] SINAMICS ALM 400 V (600 V DC)
 [- - - -] SINAMICS BLM/SLM 400 V (540 V DC)

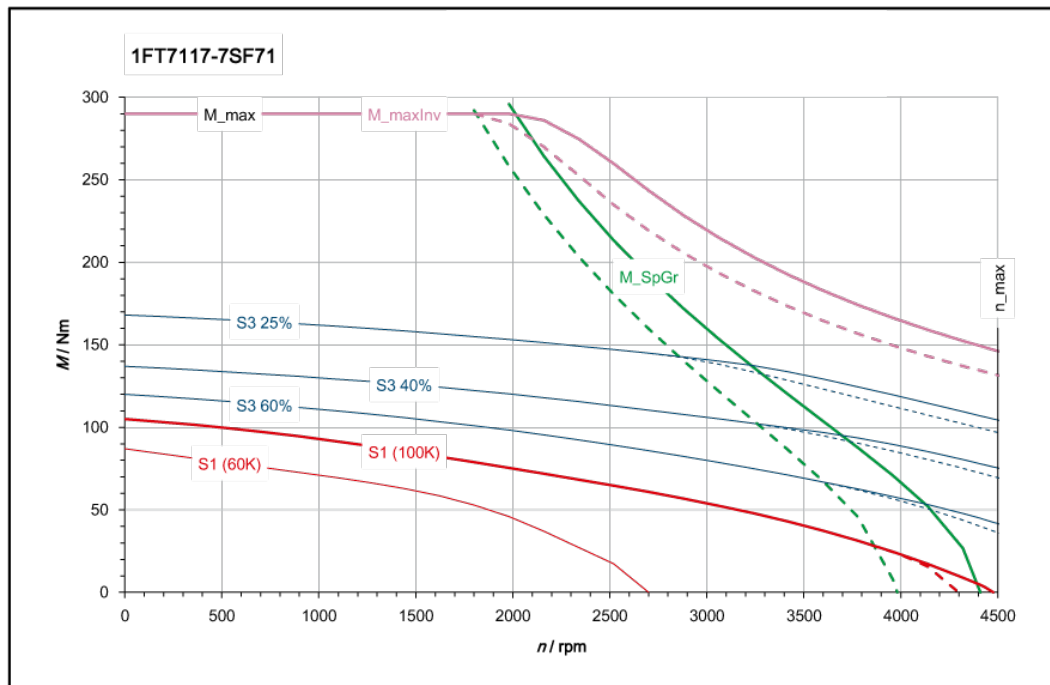

[———] SINAMICS ALM 480 V (720 V DC)
 [- - - -] SINAMICS BLM/SLM 480 V (650 V DC)

6.3.6 1FT7 High Dynamic - water cooling

6.3.6.1 1FT7065_W

Three-phase servomotor 1FT7065 - 7WF7			
Technical specifications	Symbol	Unit	Value
Configuration data:			
Rated speed	n_N	rpm	3000
Rated torque (100K)	$M_{N(100K)}$	Nm	18
Rated current (100K)	$I_{N(100K)}$	A	15
Static torque (100K)	$M_{0(100K)}$	Nm	19
Stall current (100K)	$I_{0(100K)}$	A	16
Static torque (60K)	$M_{0(60K)}$	Nm	16
Stall current (60K)	$I_{0(60K)}$	A	14
Optimum operating point:			
Optimum speed	n_{opt}	rpm	3000
Optimum power	P_{opt}	kW	5.7
Limiting data:			
Max. permissible speed (mech.)	$n_{max\ mech}$	rpm	9000
Maximum torque	M_{max}	Nm	45.0
Maximum current	I_{max}	A	49
Motor data:			
No. of poles	2p		6
Torque constant (100K)	k_T	Nm/A	1.17
Voltage constant (at 20 °C)	k_E	V/1000 rpm	75
Winding resistance (at 20 °C)	R_{Str}	W	0.43
Rotating field inductance	L_D	mH	8.2
Electrical time constant	T_{el}	ms	19
Mechanical time constant	T_{mech}	ms	0.6
Thermal time constant	T_{th}	min	9
Moment of inertia	J_{mot}	$kgm^2 \cdot 10^{-4}$	6.4
Shaft torsional stiffness	c_t	Nm/rad	27500
Weight	m_{mot}	kg	16
Motor data with integrated brake:			
Moment of inertia (with brake)	J_{mot}	$kgm^2 \cdot 10^{-4}$	9.0
Shaft torsional stiffness (with brake)	c_t	Nm/rad	23500
Weight (with brake)	m_{Mot}	kg	17
Data with SINAMICS S120 Booksize / S120 Booksize Compact:			
Rated converter current	$I_{N\ Inv}$	A	18
Maximum converter current	$I_{max\ Inv}$	A	54
Max. torque (converter operation)	$M_{max\ Inv}$	Nm	45
Max. permissible speed (converter operation)	$n_{max\ Inv}$	rpm	7700
The rated data are valid for a 600 V DC-link voltage			

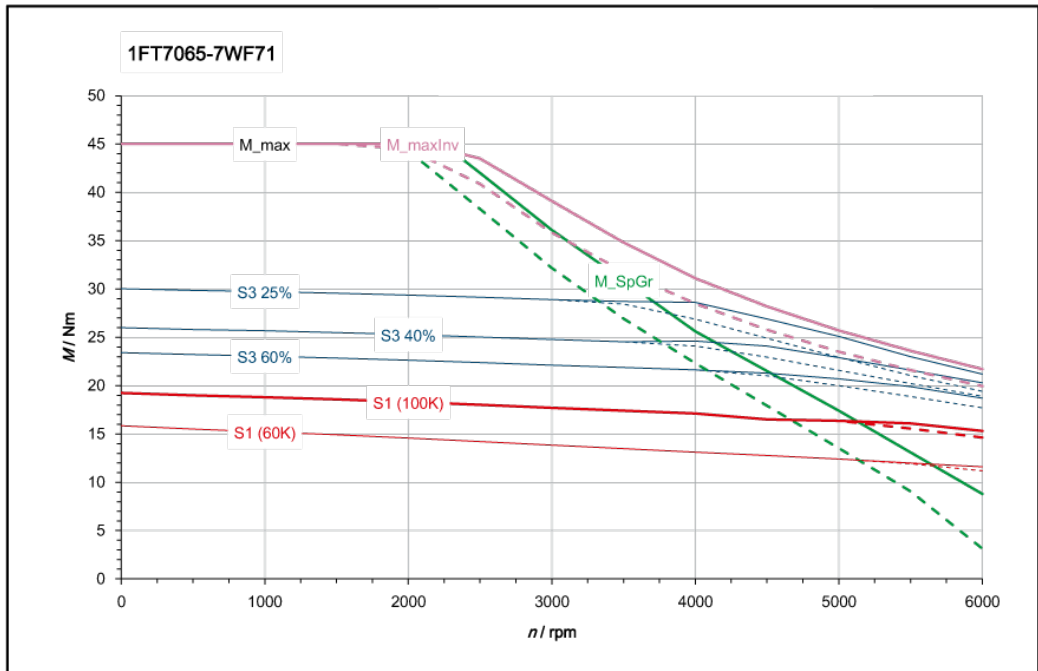
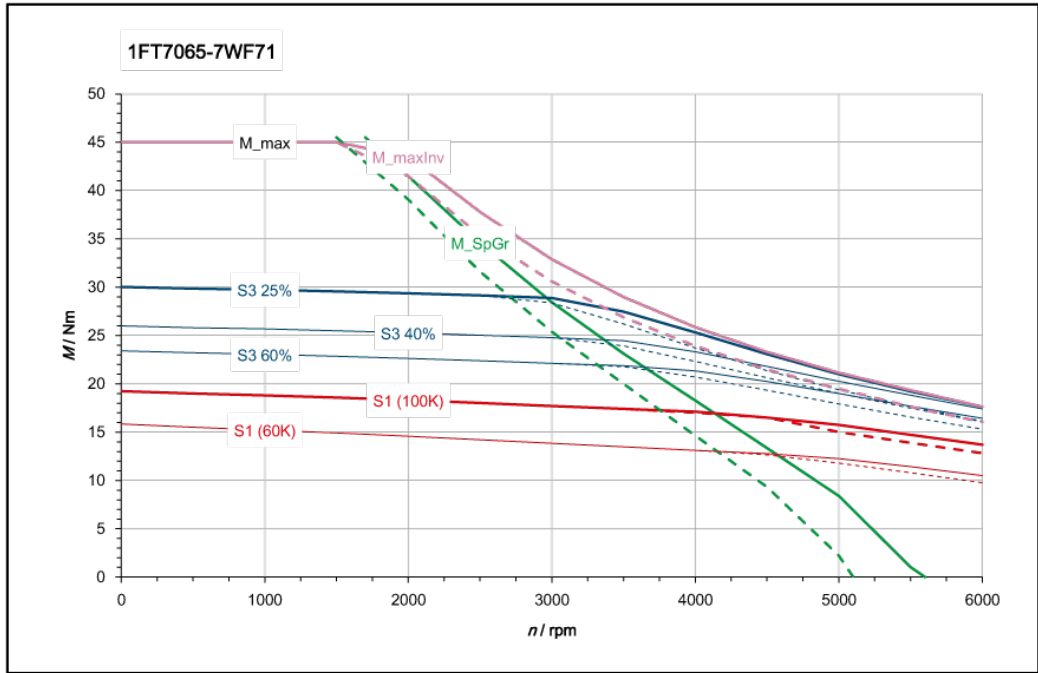

Three-phase servomotor 1FT7065 - 7WH7			
Technical specifications	Symbol	Unit	Value
Configuration data:			
Rated speed	n_N	rpm	4500
Rated torque (100K)	$M_{N(100K)}$	Nm	16.5
Rated current (100K)	$I_{N(100K)}$	A	20
Static torque (100K)	$M_{0(100K)}$	Nm	19
Stall current (100K)	$I_{0(100K)}$	A	22
Static torque (60K)	$M_{0(60K)}$	Nm	16
Stall current (60K)	$I_{0(60K)}$	A	18.5
Optimum operating point:			
Optimum speed	n_{opt}	rpm	4500
Optimum power	P_{opt}	kW	7.8
Limiting data:			
Max. permissible speed (mech.)	$n_{max\ mech}$	rpm	9000
Maximum torque	M_{max}	Nm	45
Maximum current	I_{max}	A	67
Motor data:			
No. of poles	2p		6
Torque constant (100K)	k_T	Nm/A	0.86
Voltage constant (at 20 °C)	k_E	V/1000 rpm	55
Winding resistance (at 20 °C)	R_{Str}	W	0.23
Rotating field inductance	L_D	mH	4.4
Electrical time constant	T_{el}	ms	19
Mechanical time constant	T_{mech}	ms	0.6
Thermal time constant	T_{th}	min	9
Moment of inertia	J_{mot}	$kgm^2 \cdot 10^{-4}$	6.4
Shaft torsional stiffness	C_t	Nm/rad	27500
Weight	m_{mot}	kg	16
Motor data with integrated brake:			
Moment of inertia (with brake)	J_{mot}	$kgm^2 \cdot 10^{-4}$	9.0
Shaft torsional stiffness (with brake)	C_t	Nm/rad	23500
Weight (with brake)	m_{Mot}	kg	17
Data with SINAMICS S120 Booksize:			
Rated converter current	$I_{N\ Inv}$	A	24
Maximum converter current	$I_{max\ Inv}$	A	72
Max. torque (converter operation)	$M_{max\ Inv}$	Nm	45
Max. permissible speed (converter operation)	$n_{max\ Inv}$	rpm	9000
The rated data are valid for a 600 V DC-link voltage			

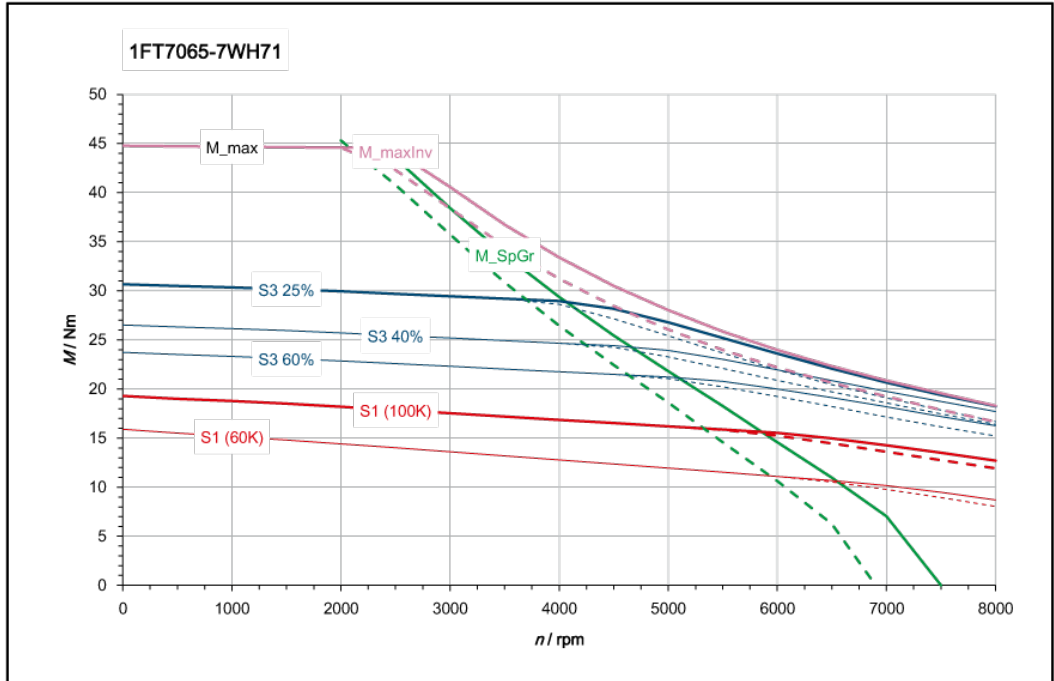

[———] SINAMICS ALM 400 V (600 V DC)
 [- - - -] SINAMICS BLM/SLM 400 V (540 V DC)

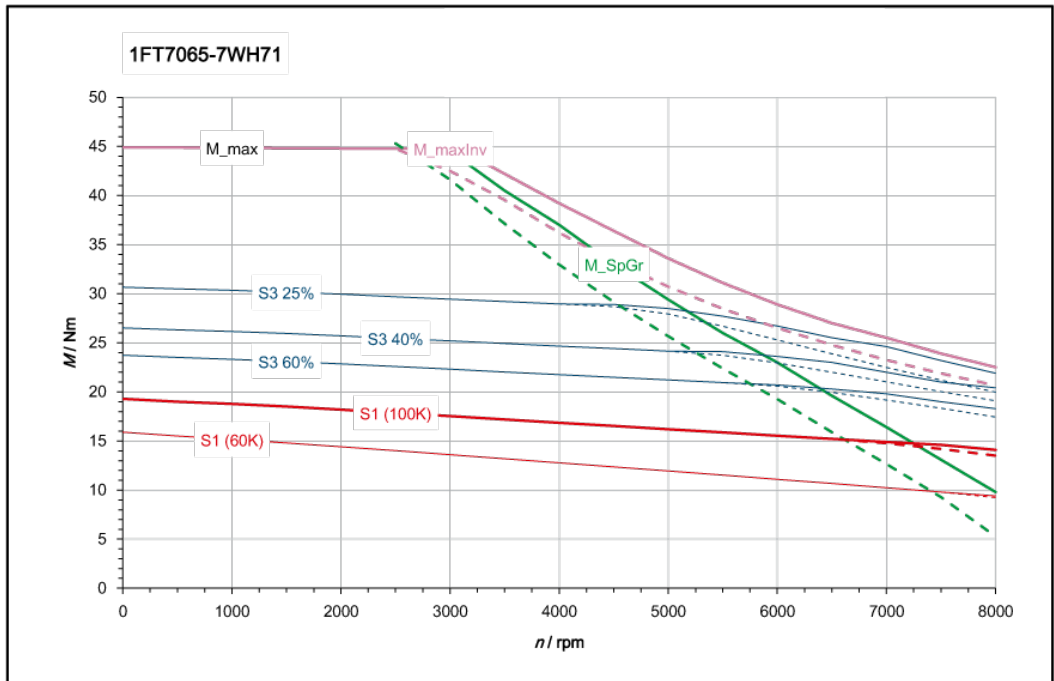

[———] SINAMICS ALM 480 V (720 V DC)
 [- - - -] SINAMICS BLM/SLM 480 V (650 V DC)

6.3.6.2 1FT7067-_W

Three-phase servomotor 1FT7067 - 7WF7			
Technical specifications	Symbol	Unit	Value
Configuration data:			
Rated speed	n_N	rpm	3000
Rated torque (100K)	$M_{N(100K)}$	Nm	23.5
Rated current (100K)	$I_{N(100K)}$	A	21
Static torque (100K)	$M_{0(100K)}$	Nm	25
Stall current (100K)	$I_{0(100K)}$	A	22
Static torque (60K)	$M_{0(60K)}$	Nm	20
Stall current (60K)	$I_{0(60K)}$	A	17.5
Optimum operating point:			
Optimum speed	n_{opt}	rpm	3000
Optimum power	P_{opt}	kW	7.4
Limiting data:			
Max. permissible speed (mech.)	$n_{max\ mech}$	rpm	9000
Maximum torque	M_{max}	Nm	60.0
Maximum current	I_{max}	A	63
Motor data:			
No. of poles	2p		6
Torque constant (100K)	k_T	Nm/A	1.14
Voltage constant (at 20 °C)	k_E	V/1000 rpm	73
Winding resistance (at 20 °C)	R_{Str}	W	0.3
Rotating field inductance	L_D	mH	5.7
Electrical time constant	T_{el}	ms	19
Mechanical time constant	T_{mech}	ms	0.6
Thermal time constant	T_{th}	min	11
Moment of inertia	J_{mot}	$kgm^2 \cdot 10^{-4}$	8.3
Shaft torsional stiffness	C_t	Nm/rad	24500
Weight	m_{mot}	kg	22
Motor data with integrated brake:			
Moment of inertia (with brake)	J_{mot}	$kgm^2 \cdot 10^{-4}$	10.9
Shaft torsional stiffness (with brake)	C_t	Nm/rad	21500
Weight (with brake)	m_{Mot}	kg	23
Data with SINAMICS S120 Booksize:			
Rated converter current	$I_{N\ Inv}$	A	24
Maximum converter current	$I_{max\ Inv}$	A	72
Max. torque (converter operation)	$M_{max\ Inv}$	Nm	60
Max. permissible speed (converter operation)	$n_{max\ Inv}$	rpm	7900
The rated data are valid for a 600 V DC-link voltage			

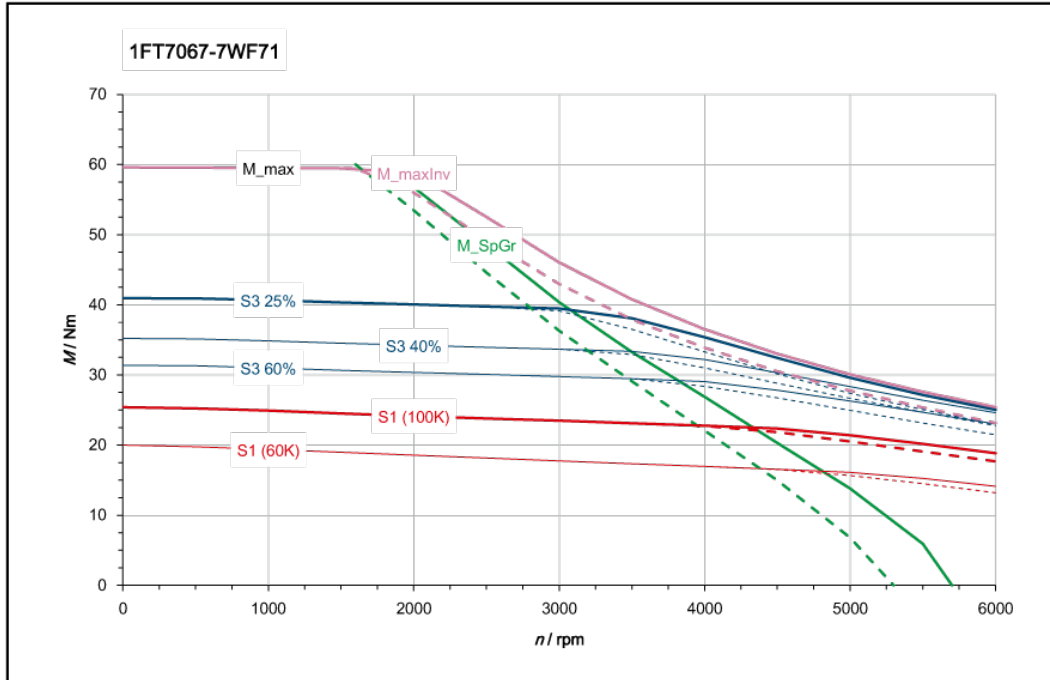

[———] SINAMICS ALM 400 V (600 V DC)
 [- - - -] SINAMICS BLM/SLM 400 V (540 V DC)

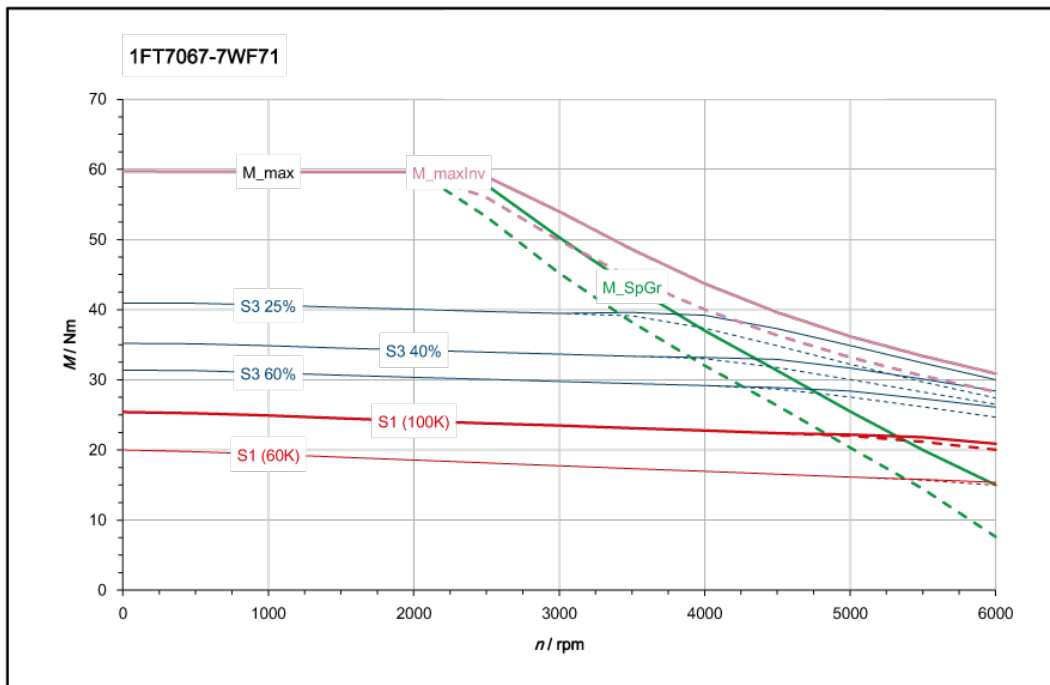

[———] SINAMICS ALM 480 V (720 V DC)
 [- - - -] SINAMICS BLM/SLM 480 V (650 V DC)

Three-phase servomotor 1FT7067 - 7WH7			
Technical specifications	Symbol	Unit	Value
Configuration data:			
Rated speed	n_N	rpm	4500
Rated torque (100K)	$M_{N(100K)}$	Nm	22
Rated current (100K)	$I_{N(100K)}$	A	25
Static torque (100K)	$M_{0(100K)}$	Nm	25
Stall current (100K)	$I_{0(100K)}$	A	28
Static torque (60K)	$M_{0(60K)}$	Nm	20
Stall current (60K)	$I_{0(60K)}$	A	20
Optimum operating point:			
Optimum speed	n_{opt}	rpm	4500
Optimum power	P_{opt}	kW	10.4
Limiting data:			
Max. permissible speed (mech.)	$n_{max\ mech}$	rpm	9000
Maximum torque	M_{max}	Nm	60
Maximum current	I_{max}	A	80
Motor data:			
No. of poles	$2p$		6
Torque constant (100K)	k_T	Nm/A	0.89
Voltage constant (at 20 °C)	k_E	V/1000 rpm	57
Winding resistance (at 20 °C)	R_{Str}	W	0.18
Rotating field inductance	L_D	mH	3.5
Electrical time constant	T_{el}	ms	19
Mechanical time constant	T_{mech}	ms	0.6
Thermal time constant	T_{th}	min	11
Moment of inertia	J_{mot}	$kgm^2 \cdot 10^{-4}$	8.3
Shaft torsional stiffness	C_t	Nm/rad	24500
Weight	m_{mot}	kg	22
Motor data with integrated brake:			
Moment of inertia (with brake)	J_{mot}	$kgm^2 \cdot 10^{-4}$	10.9
Shaft torsional stiffness (with brake)	C_t	Nm/rad	21500
Weight (with brake)	m_{Mot}	kg	23
Data with SINAMICS S120 Booksize:			
Rated converter current	$I_{N\ Inv}$	A	30
Maximum converter current	$I_{max\ Inv}$	A	90
Max. torque (converter operation)	$M_{max\ Inv}$	Nm	60
Max. permissible speed (converter operation)	$n_{max\ Inv}$	rpm	9000
The rated data are valid for a 600 V DC-link voltage			

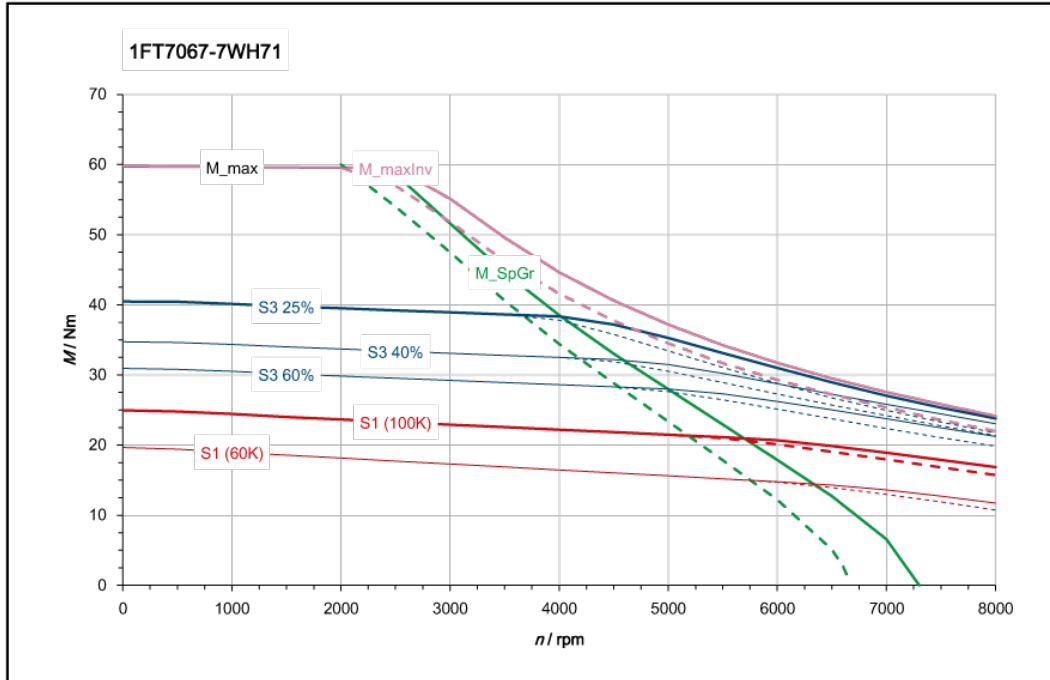

[———] SINAMICS ALM 400 V (600 V DC)
 [- - - -] SINAMICS BLM/SLM 400 V (540 V DC)

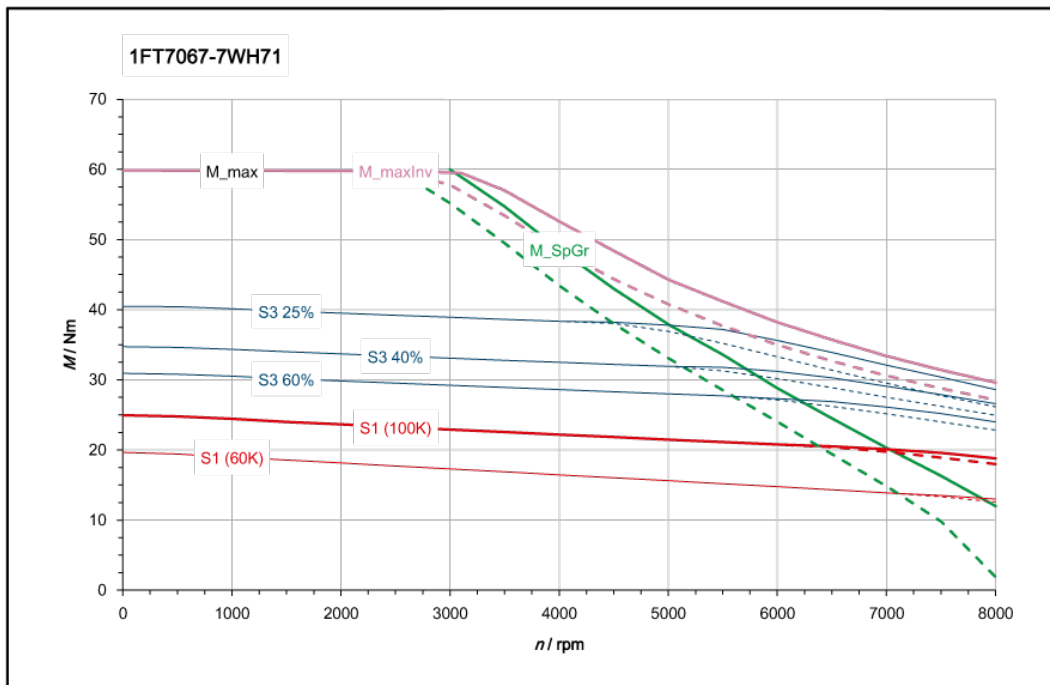

[———] SINAMICS ALM 480 V (720 V DC)
 [- - - -] SINAMICS BLM/SLM 480 V (650 V DC)

6.3.6.3 1FT7085_W

Three-phase servomotor 1FT7085 - 7WF7			
Technical specifications	Symbol	Unit	Value
Configuration data:			
Rated speed	n_N	rpm	3000
Rated torque (100K)	$M_{N(100K)}$	Nm	38
Rated current (100K)	$I_{N(100K)}$	A	32
Static torque (100K)	$M_{0(100K)}$	Nm	43
Stall current (100K)	$I_{0(100K)}$	A	36
Static torque (60K)	$M_{0(60K)}$	Nm	34
Stall current (60K)	$I_{0(60K)}$	A	28
Optimum operating point:			
Optimum speed	n_{opt}	rpm	3000
Optimum power	P_{opt}	kW	11.9
Limiting data:			
Max. permissible speed (mech.)	$n_{max\ mech}$	rpm	8000
Maximum torque	M_{max}	Nm	105
Maximum current	I_{max}	A	126
Motor data:			
No. of poles	$2p$		8
Torque constant (100K)	k_T	Nm/A	1.20
Voltage constant (at 20 °C)	k_E	V/1000 rpm	77
Winding resistance (at 20 °C)	R_{Str}	W	0.12
Rotating field inductance	L_D	mH	3.1
Electrical time constant	T_{el}	ms	26
Mechanical time constant	T_{mech}	ms	0.5
Thermal time constant	T_{th}	min	10
Moment of inertia	J_{mot}	$kgm^2 \cdot 10^{-4}$	20.7
Shaft torsional stiffness	C_t	Nm/rad	70000
Weight	m_{mot}	kg	32
Motor data with integrated brake:			
Moment of inertia (with brake)	J_{mot}	$kgm^2 \cdot 10^{-4}$	34.9
Shaft torsional stiffness (with brake)	C_t	Nm/rad	51000
Weight (with brake)	m_{Mot}	kg	35
Data with SINAMICS S120 Booksize:			
Rated converter current	$I_{N\ Inv}$	A	45
Maximum converter current	$I_{max\ Inv}$	A	90
Max. torque (converter operation)	$M_{max\ Inv}$	Nm	90
Max. permissible speed (converter operation)	$n_{max\ Inv}$	rpm	7500
The rated data are valid for a 600 V DC-link voltage			

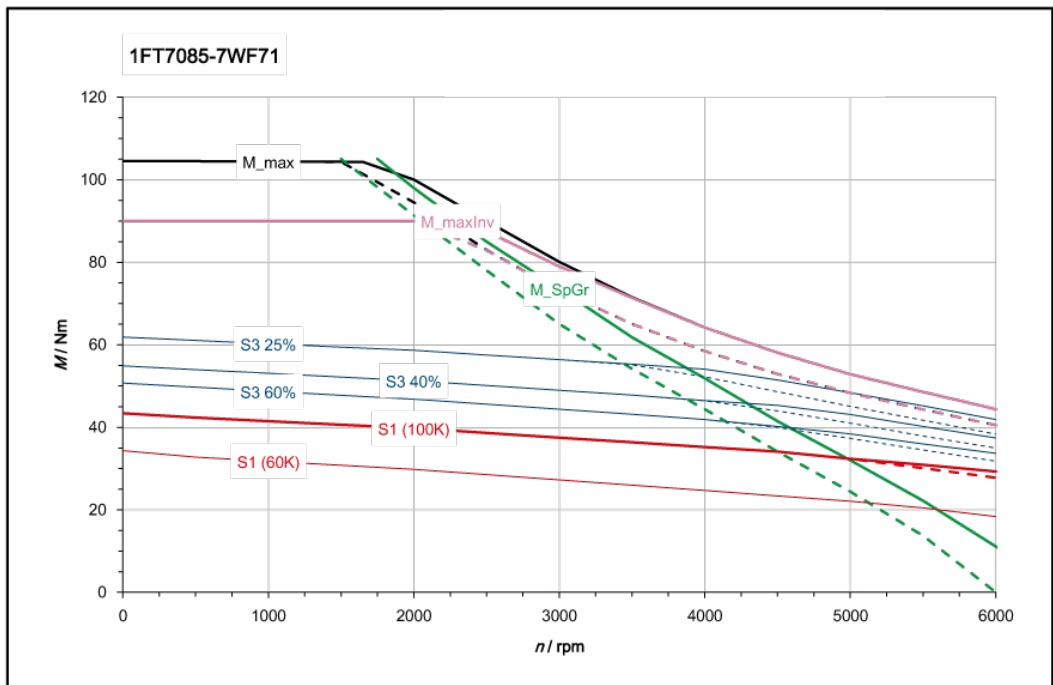
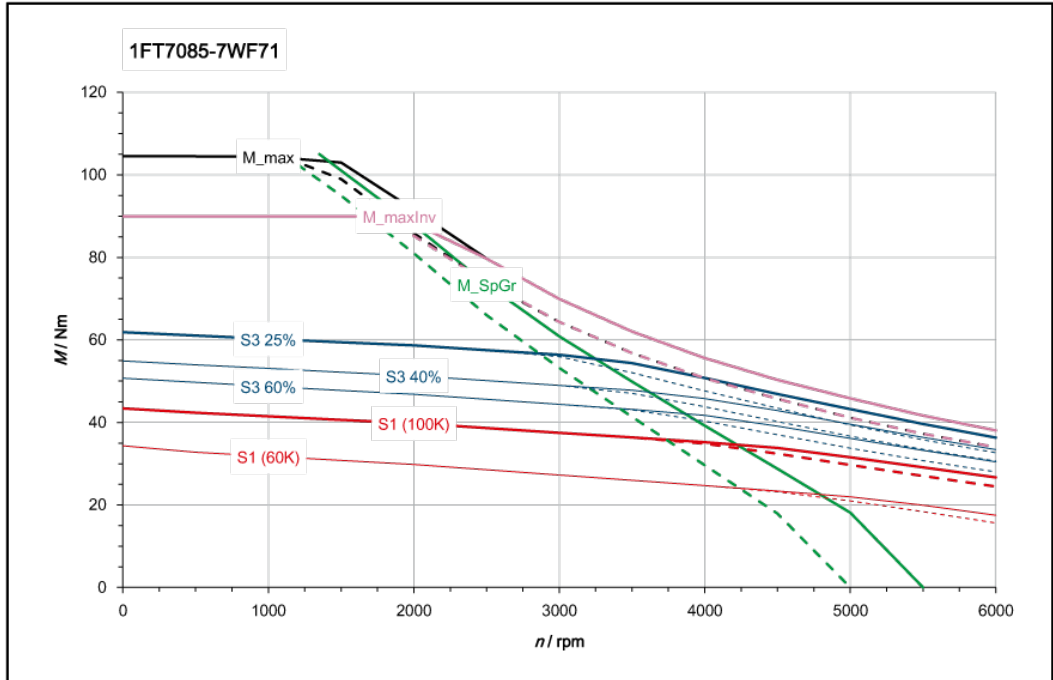

Three-phase servomotor 1FT7085 - 7WH7			
Technical specifications	Symbol	Unit	Value
Configuration data:			
Rated speed	n_N	rpm	4500
Rated torque (100K)	$M_{N(100K)}$	Nm	33
Rated current (100K)	$I_{N(100K)}$	A	48
Static torque (100K)	$M_{0(100K)}$	Nm	43
Stall current (100K)	$I_{0(100K)}$	A	58
Static torque (60K)	$M_{0(60K)}$	Nm	34
Stall current (60K)	$I_{0(60K)}$	A	46
Optimum operating point:			
Optimum speed	n_{opt}	rpm	4500
Optimum power	P_{opt}	kW	15.5
Limiting data:			
Max. permissible speed (mech.)	$n_{max\ mech}$	rpm	8000
Maximum torque	M_{max}	Nm	105
Maximum current	I_{max}	A	205
Motor data:			
No. of poles	2p		8
Torque constant (100K)	k_T	Nm/A	0.74
Voltage constant (at 20 °C)	k_E	V/1000 rpm	47.5
Winding resistance (at 20 °C)	R_{Str}	W	0.046
Rotating field inductance	L_D	mH	1.2
Electrical time constant	T_{el}	ms	26
Mechanical time constant	T_{mech}	ms	0.5
Thermal time constant	T_{th}	min	10
Moment of inertia	J_{mot}	$kgm^2 \cdot 10^{-4}$	20.7
Shaft torsional stiffness	C_t	Nm/rad	70000
Weight	m_{mot}	kg	32
Motor data with integrated brake:			
Moment of inertia (with brake)	J_{mot}	$kgm^2 \cdot 10^{-4}$	34.9
Shaft torsional stiffness (with brake)	C_t	Nm/rad	51000
Weight (with brake)	m_{Mot}	kg	35
Data with SINAMICS S120 Booksize:			
Rated converter current	$I_{N\ Inv}$	A	60
Maximum converter current	$I_{max\ Inv}$	A	120
Max. torque (converter operation)	$M_{max\ Inv}$	Nm	79
Max. permissible speed (converter operation)	$n_{max\ Inv}$	rpm	8000
The rated data are valid for a 600 V DC-link voltage			

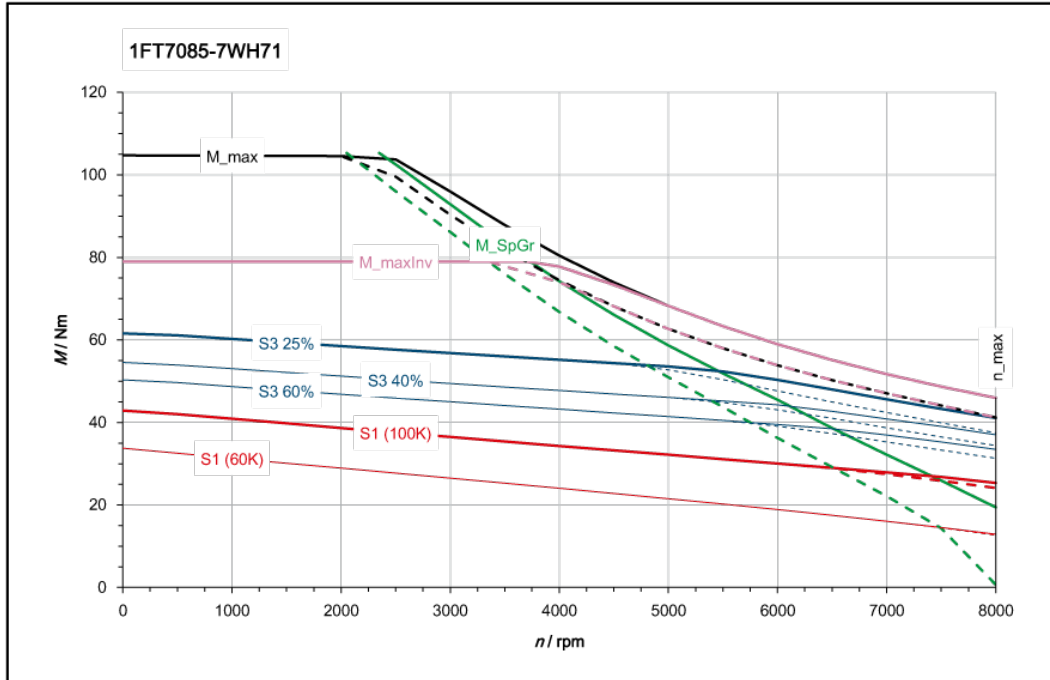

[———] SINAMICS ALM 400 V (600 V DC)
 [- - - -] SINAMICS BLM/SLM 400 V (540 V DC)

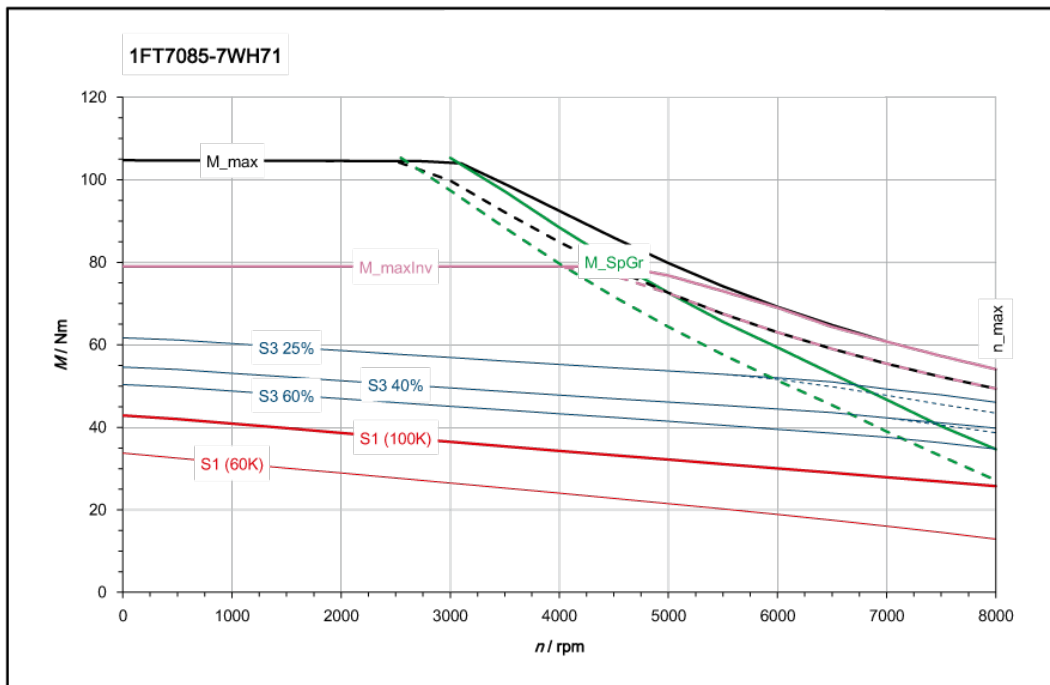

[———] SINAMICS ALM 480 V (720 V DC)
 [- - - -] SINAMICS BLM/SLM 480 V (650 V DC)

6.3.6.4 1FT7087-_W

Three-phase servomotor 1FT7087 - 7WF7			
Technical specifications	Symbol	Unit	Value
Configuration data:			
Rated speed	n_N	rpm	3000
Rated torque (100K)	$M_{N(100K)}$	Nm	51
Rated current (100K)	$I_{N(100K)}$	A	43
Static torque (100K)	$M_{0(100K)}$	Nm	61
Stall current (100K)	$I_{0(100K)}$	A	51
Static torque (60K)	$M_{0(60K)}$	Nm	48
Stall current (60K)	$I_{0(60K)}$	A	40
Optimum operating point:			
Optimum speed	n_{opt}	rpm	3000
Optimum power	P_{opt}	kW	16.0
Limiting data:			
Max. permissible speed (mech.)	$n_{max\ mech}$	rpm	8000
Maximum torque	M_{max}	Nm	150
Maximum current	I_{max}	A	170
Motor data:			
No. of poles	2p		8
Torque constant (100K)	k_T	Nm/A	1.20
Voltage constant (at 20 °C)	k_E	V/1000 rpm	77
Winding resistance (at 20 °C)	R_{Str}	W	0.08
Rotating field inductance	L_D	mH	2.1
Electrical time constant	T_{el}	ms	26
Mechanical time constant	T_{mech}	ms	0.5
Thermal time constant	T_{th}	min	11
Moment of inertia	J_{mot}	$kgm^2 \cdot 10^{-4}$	27.4
Shaft torsional stiffness	C_t	Nm/rad	60000
Weight	m_{mot}	kg	41
Motor data with integrated brake:			
Moment of inertia (with brake)	J_{mot}	$kgm^2 \cdot 10^{-4}$	41.6
Shaft torsional stiffness (with brake)	C_t	Nm/rad	45500
Weight (with brake)	m_{Mot}	kg	44
Data with SINAMICS S120 Booksize:			
Rated converter current	$I_{N\ Inv}$	A	60
Maximum converter current	$I_{max\ Inv}$	A	123.5
Max. torque (converter operation)	$M_{max\ Inv}$	Nm	120
Max. permissible speed (converter operation)	$n_{max\ Inv}$	rpm	7500
The rated data are valid for a 600 V DC-link voltage			

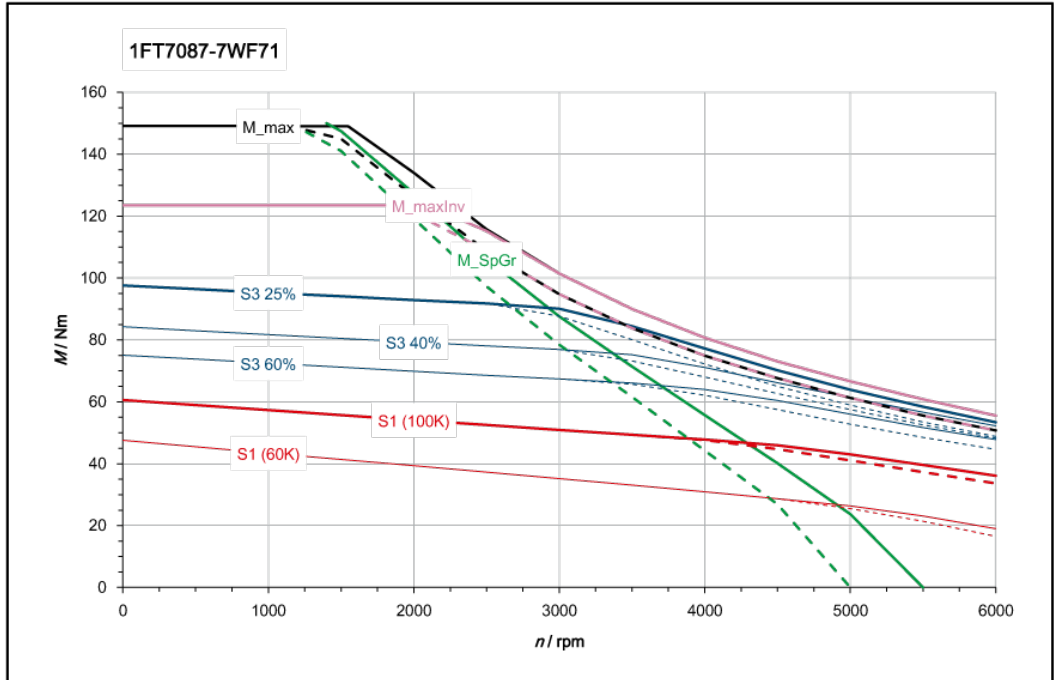

[———] SINAMICS ALM 400 V (600 V DC)
 [- - - -] SINAMICS BLM/SLM 400 V (540 V DC)

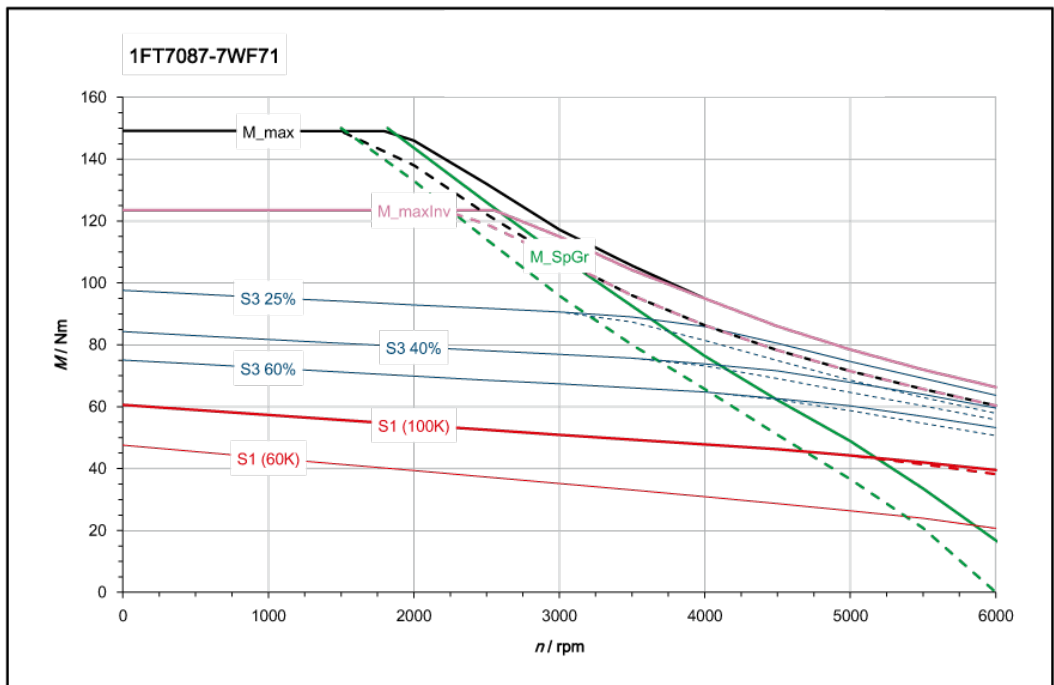

[———] SINAMICS ALM 480 V (720 V DC)
 [- - - -] SINAMICS BLM/SLM 480 V (650 V DC)

Three-phase servomotor		1FT7087 - 7WH7	
Technical specifications	Symbol	Unit	Value
Configuration data:			
Rated speed	n_N	rpm	4500
Rated torque (100K)	$M_{N(100K)}$	Nm	46
Rated current (100K)	$I_{N(100K)}$	A	53
Static torque (100K)	$M_{0(100K)}$	Nm	61
Stall current (100K)	$I_{0(100K)}$	A	67
Static torque (60K)	$M_{0(60K)}$	Nm	48
Stall current (60K)	$I_{0(60K)}$	A	53
Optimum operating point:			
Optimum speed	n_{opt}	rpm	4500
Optimum power	P_{opt}	kW	21.7
Limiting data:			
Max. permissible speed (mech.)	$n_{max\ mech}$	rpm	8000
Maximum torque	M_{max}	Nm	150
Maximum current	I_{max}	A	225
Motor data:			
No. of poles	2p		8
Torque constant (100K)	k_T	Nm/A	0.91
Voltage constant (at 20 °C)	k_E	V/1000 rpm	58
Winding resistance (at 20 °C)	R_{Str}	W	0.046
Rotating field inductance	L_D	mH	1.2
Electrical time constant	T_{el}	ms	26
Mechanical time constant	T_{mech}	ms	0.5
Thermal time constant	T_{th}	min	11
Moment of inertia	J_{mot}	$kgm^2 \cdot 10^{-4}$	27.4
Shaft torsional stiffness	C_t	Nm/rad	60000
Weight	m_{mot}	kg	41
Motor data with integrated brake:			
Moment of inertia (with brake)	J_{mot}	$kgm^2 \cdot 10^{-4}$	41.6
Shaft torsional stiffness (with brake)	C_t	Nm/rad	45500
Weight (with brake)	m_{Mot}	kg	44
Data with SINAMICS S120 Booksize:			
Rated converter current	$I_{N\ Inv}$	A	85
Maximum converter current	$I_{max\ Inv}$	A	141
Max. torque (converter operation)	$M_{max\ Inv}$	Nm	116
Max. permissible speed (converter operation)	$n_{max\ Inv}$	rpm	8000
The rated data are valid for a 600 V DC-link voltage			

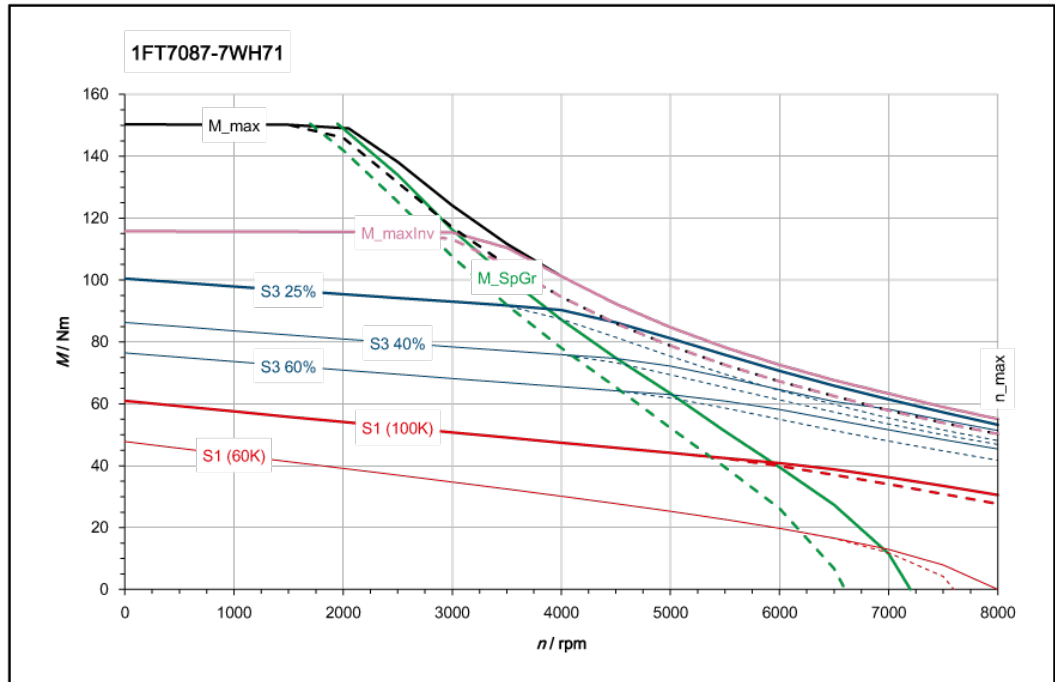

[———] SINAMICS ALM 400 V (600 V DC)
 [- - - -] SINAMICS BLM/SLM 400 V (540 V DC)

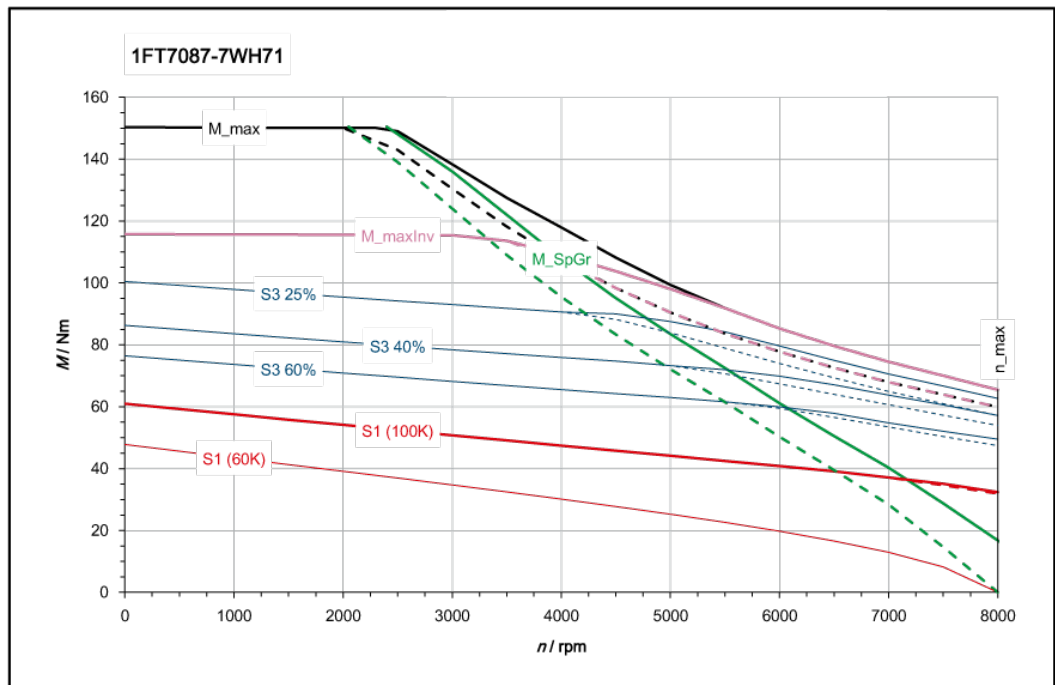

[———] SINAMICS ALM 480 V (720 V DC)
 [- - - -] SINAMICS BLM/SLM 480 V (650 V DC)

Preparation for use

7.1 Transporting

Note

Comply with the local national regulations for the transportation of motors.

Note

Observe the information on the original packaging when transporting and setting down the motor.

Transporting the motor

- Transport the motor in its original packaging.
- Use suitable load suspension devices when transporting the motor.
- Transport the motor carefully.

Environmental conditions for transporting the motor in the transport packaging according to Class 2K3 to EN 60721-3-2 - with the exception of environmental influencing quantities "Air temperature" and "Condensation"

Climatic ambient conditions	- 15 °C ... + 70 °C,
Highest relative humidity	< 95 % at 40 °C, condensation not permissible
Mechanical ambient conditions	Shock and vibration permissible according to 3M8 to EN 60721-3-3: Individual shocks (6 ms) max. 250 m/s ²
Protection against chemical substances	Protected in acc. with Class 2C2
Biological ambient conditions	Suitable in acc. with Class 2B2

Setting down the motor

1. Set the motor down on a hard, level surface.
2. Secure the motor against unintentional movements.

Transporting the unpacked motor

- Use suitable load suspension devices when transporting and installing the motor.

Lifting and transporting the motor using slings up to SH 80

Up to a shaft height of 80 mm, you can lift and transport the motor with slings.

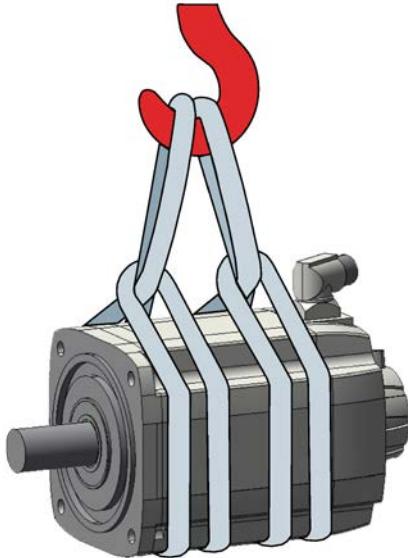

Figure 7-1 Transporting with slings



Lifting and transporting with lifting eyes as of SH 80

For motors as of a shaft height of 80 mm, use lifting eyes and a beam to lift and transport the motor.

The threads for the lifting eyes are provided for 1FT708□, 1FT710□ and 1FT7117 motors in M8 and for 1FT713□ motors in M10.

Note

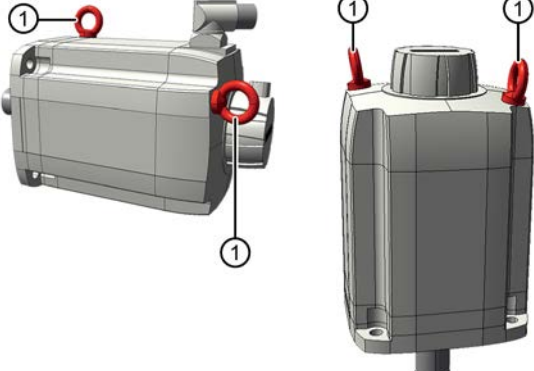
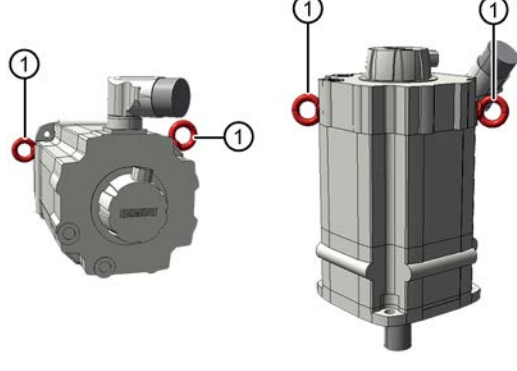
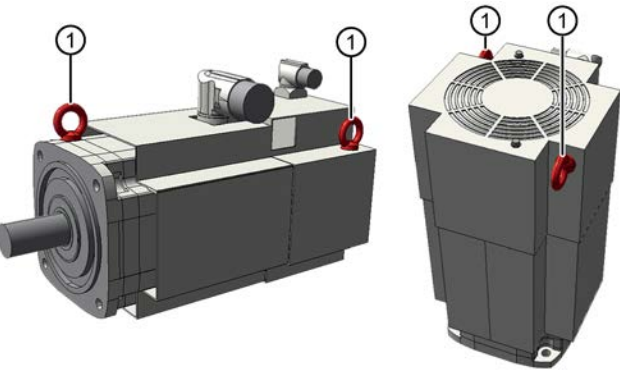
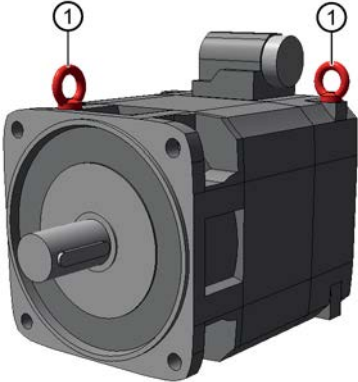
Use the threads for the lifting eyes exclusively for transportation.

	
<p>1FT7 with natural cooling (shaft height 80 - 100)</p>	<p>1FT7 with water cooling (shaft height 80 - 100)</p>
	
<p>1FT7 with forced ventilation (shaft height 80 - 100)</p>	
<p>① Lifting eyes</p>	
	
<p>1FT7 with natural cooling (shaft height 132)</p>	

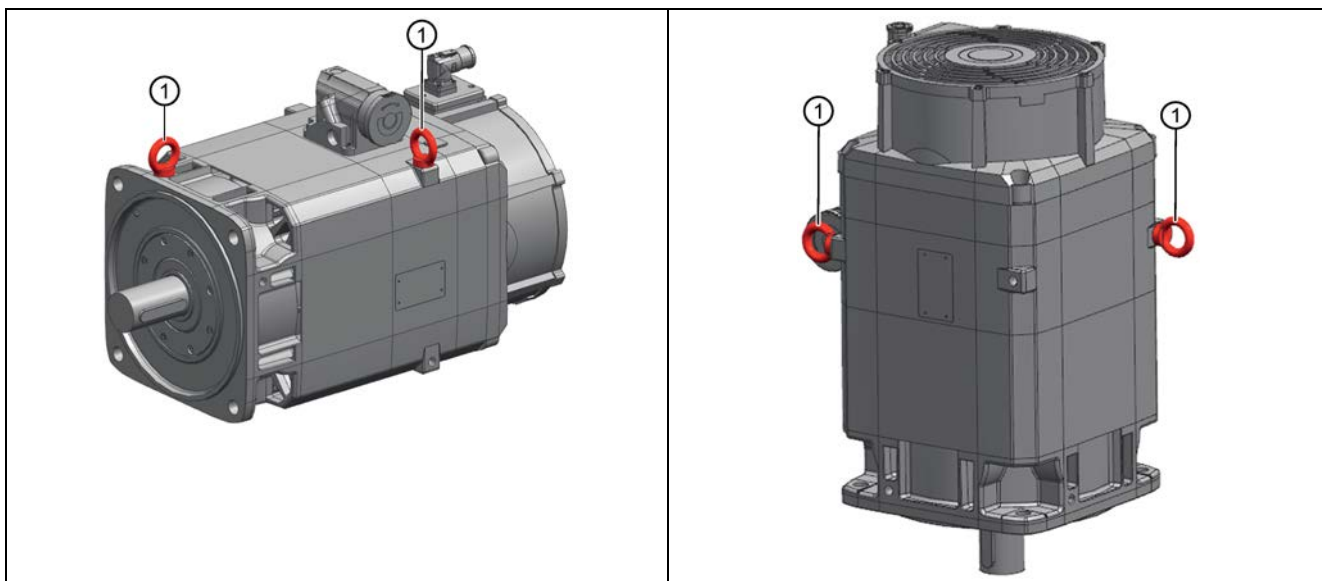

1FT7 with forced ventilation (shaft height 132)

① Lifting eyes

Example for attaching a cross beam



7.2 Storage

Note

If possible, store the motor in its original packaging.

NOTICE**Frost damage to water-cooled motors**

Water-cooled motors can be damaged by frost

- Remove the liquid coolant before storage.
- Blow out the cooling ducts with compressed air.

Preserve the free shaft ends, sealing elements, and flange surfaces with a protective coating.

NOTICE**Seizure damage to bearings**

If the motors are stored incorrectly, bearing seizure damage can occur, e.g. brinelling, as a result of vibration.

- Comply with the storage conditions.

Storage conditions

Please observe the warning instructions on the packaging and labels.

Store the motor in a dry, dust-free, and vibration-free indoor storage facility.

Adhere to the following values:

- $v_{rms} < 0.2$ mm/s
- Max. temperatures: -15 °C to 55 °C
- Mean relative humidity < 75 %

Long-term storage

Note**Storage time of up to a maximum of 2 years**

The storage time affects the properties of the roller bearing grease.

- Store the motor for a maximum of 2 years only.
-

If you store the motor for longer than 6 months, the storage area/room must meet the following environmental conditions:

Table 7- 1 **Environmental conditions for long-term storage in the transport packaging according to Class 1K3 to EN 60721-3-1 except for the "Air temperature", "Highest relative humidity" and "Condensation" environmental factors**

Climatic environmental conditions	- 15 °C ... + 55 °C
Highest relative humidity	< 60 %, condensation not permissible
Mechanical environmental conditions	Vibration-free storage space, $v_{rms} < 0.2$ mm/s
Protection against chemical substances	Protected according to Class 1C2
Biological environmental conditions	Suitable according to Class 1B2
Duration	<ul style="list-style-type: none"> • 6 months for the above-mentioned conditions. • Special preservation measures are required for storage periods of 6 months up to a maximum of 2 years.

Check the correct state of the motor every 6 months.

- Check the motor for any damage.
- Perform any necessary maintenance work.
- Check the state of the dehydrating agent and replace when necessary.
- Record the preservation work so that all preservation coating can be removed prior to the commissioning.

Condensation

The following ambient conditions favor the formation of condensation:

- Significant fluctuations of the ambient temperature
- Direct sunshine
- High humidity during storage

Avoid these environmental conditions.

Use a dehydrating agent in the packaging.

Electrical connection

8.1 Permissible line system types

In combination with the drive system, the motors are generally approved for operation on TN and TT systems with **grounded neutral** and on IT systems.

In operation on IT systems, the occurrence of a first fault between an active part and ground must be signaled by a monitoring device. According to IEC 60364-4-41, it is recommended that the first fault is removed as quickly as is practically possible.

In systems with a **grounded external conductor**, an isolating transformer with grounded neutral (secondary side) must be connected between the line supply and the drive system to protect the motor insulation from excessive stress. The majority of TT systems have a grounded external conductor, so in this case an isolating transformer must be used.

8.2 Circuit diagram of the motor

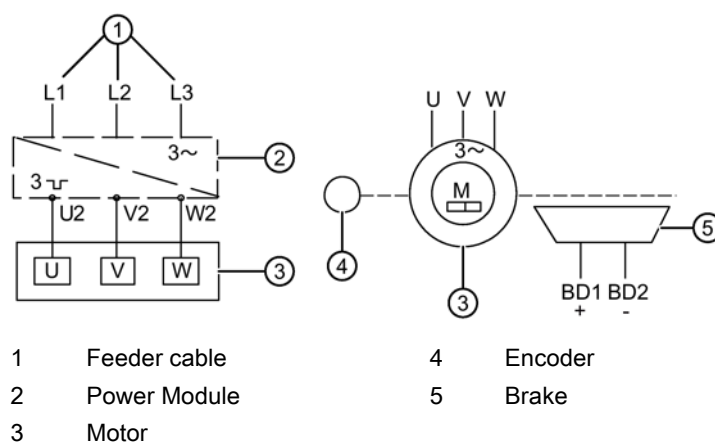

Figure 8-1 Circuit diagram

8.3 System integration

8.3.1 Connection notes

NOTICE
Destruction of the motor if it is directly connected to the three-phase line supply The motor will be destroyed if it is directly connected to the three-phase line supply. <ul style="list-style-type: none">• Only operate the motors with the appropriately configured converters.

NOTICE
Damage to electronic components as a result of electrostatic discharge Electrostatically sensitive devices (ESD) can be damaged or destroyed by electrostatic discharge. <ul style="list-style-type: none">• Observe the ESD protection measures.• Only grounded personnel with grounded tools may touch the component connections.• Heed the EMC information provided by the manufacturer of the converter.

- Use prefabricated cables from SIEMENS (not in the scope of delivery). These cables reduce installation costs and increase the operational reliability, see Chapter, "MOTION-CONNECT connection systems" in Catalog D 21.4 (<https://intranet.for.siemens.com/org/i-dt-mc/de/motion-control/support/infomaterial/kataloge/d-21-4-sinamics-s120-simotics/Seiten/d-21-4.aspx>).
- The manufacturer of the system/machine is responsible for the proper installation.
- Observe the data on the rating plate and the circuit diagrams.
- Adapt the connecting cables to the type of use and the voltages and currents that occur.
- When fed from a converter, high-frequency current and voltage oscillations in the motor feeder cables can cause electromagnetic interference. Therefore, use shielded power cables.
- Make sure that the inside of the connector is clean and free of cable cuttings and moisture.
- Avoid protruding wire ends.
- Check that the degree of protection is complied with at the seals and sealing surfaces of the connectors.
- Secure connecting cables against torsion, tensile and compressive strain, and protect them against kinking. It is not permissible to subject the connector to continuous force.

Current-carrying capacity for power and signal cables

The current-carrying capacity of PVC/PUR-insulated copper cables is specified for routing types B1, B2 and C under continuous operating conditions in the table with reference to an ambient air temperature of 40° C. For other ambient temperatures, the values must be corrected by the factors from the "Derating factors" table.

Table 8- 1 Cable cross-section and current-carrying capacity

Cross-section mm ²	Current-carrying capacity, AC rms 50/60 Hz or DC for routing type			
	B1 / A	B2 / A	C / A	E / A
Electronics (according to EN 60204-1)				
0.20	-	4.3	4.4	4.4
0.50	-	7.5	7.5	7.8
0.75	-	9	9.5	10
Power (according to EN 60204-1)				
0.75	8.6	8.5	9.8	10.4
1.00	10.3	10.1	11.7	12.4
1.50	13.5	13.1	15.2	16.1
2.50	18.3	17.4	21	22
4	24	23	28	30
6	31	30	36	37
10	44	40	50	52
16	59	54	66	70
25	77	70	84	88
35	96	86	104	110
50	117	103	125	133
70	149	130	160	171
95	180	165	194	207
120	208	179	225	240
Power (according to IEC 60364-5-52)				
150	239 ¹⁾	206 ¹⁾	259 ¹⁾	276 ¹⁾
185	274 ¹⁾	235 ¹⁾	296 ¹⁾	315 ¹⁾
> 185	Consult the standard for the values.			

¹⁾ Extrapolated values

Table 8- 2 Derating factors for power and signal cables

Ambient air temperature [°C]	Derating factor according to EN 60204-1, Table D1
30	1.15
35	1.08
40	1.00
45	0.91
50	0.82
55	0.71

8.3.1.1 Rotating a connector on the motor

Power connectors and signal connectors can be rotated to a different angle to a limited extent.

Use a suitable socket connector to rotate the angled connector.

Unscrew and open the socket connector completely to avoid damaging the pin contacts.

On encoders with an integrated Sensor Module (DQI), the cable outlet toward the top is fixed and cannot be changed.

Note

Rotating the connectors

- Do not exceed the permissible range of rotation.
- To ensure the degree of protection, do not rotate more than 10 times.
- Rotate the connector using a mating connector that matches the connector thread. Only rotate Sensor Modules by hand. Use of tools is not permissible.

Ability to rotate the power connector on motors with natural cooling / water water cooling and DRIVE-CLiQ interface 1FT7□□□□□A□□□□□X□□, 1FT7□□□□□W□□□□□X□□; X = B, C

Table 8- 3 Rotation range of the power connector

Motor	Angle α	Angle β	Connector size	Drawing
1FT703□ 1FT704□	130 °	130 °	M23	
1FT706□ 1FT708□	130 °	135 °	M23	
1FT706□	160 °	120 °	M40	
1FT708□	170 °	120 °		
1FT710□ 1FT713□	190 °	135 °		
1FT7117 1FT713□	cannot be rotated		M58	

① Figure power connector, connector size M23

Ability to rotate the connector on motors with natural cooling/water cooling without DRIVE-CLiQ interface (M23 round connector) and on motors with DRIVE-CLiQ interface via Sensor Modules or M17 round connector

1FT7□□□-□A□□□-□X□□, 1FT7□□□-□W□□□□-□X□□; X = K, L, M, N, D, F

Table 8- 4 Rotation range of the power connector ①

Motor	Angle α	Angle β	Connector size	Drawing
1FT703□ 1FT704□	115 °	145 °	M23	
1FT706□	130 °	145 °		
1FT708□	130 °	150 °		
1FT706□	130 °	135 °	M40	
1FT708□	140 °	135 °		
1FT708□ 1FT710□ 1FT713□	190 °	135 °		
1FT7117 1FT713□	cannot be rotated		M58	

① Figure power connector, connector size M23

② Figure signal connector, round connector M17

Table 8- 5 Rotation range of the signal connector ②

Motor	with DRIVE-CLiQ via Sensor Module		M23 connector		M17 connector		Drawing
	Angle α'	Angle β'	Angle α'	Angle β'	Angle α'	Angle β'	
1FT703□ 1FT704□	145 °	120 °	145 °	120 °	125 °	130 °	See table "Rotation range of the power connector (without DRIVE-CLiQ)"
1FT706□	100 °	95 °	115 °	110 °	115 °	110 °	
1FT708□	145 °	130 °	100 °	95 °	105 °	100 °	
1FT710□ 1FT7117 1FT713□	95 °	95 °	95 °	95 °	95 °	95 °	

**Ability to rotate the power connectors for the motor and the fan for motors with forced ventilation
1FT7□□□-□S□□□-□□□□**

Table 8- 6 Rotation range of the power connector for the motor ①

Motor	Angle α	Angle β	Connector size	Drawing
1FT706□	165 °	125 °	M40	
1FT708□	110 °	110 °		
1FT710□	185 °	135 °		
1FT7117 1FT713□	cannot be rotated		M58	

- ① Figure power connector, connector size M40
- ③ Figure power connector of fan, connector size M23

Table 8- 7 Ability to rotate the signal connector (not visible, under the fan cover or in the intermediate flange) ②

Motor	with DRIVE-CLiQ via Sensor Modules, M23 or M17 connector		Drawing
	Angle α'	Angle β'	
1FT706□ 1FT708□ 1FT710□ 1FT713□	Only 90° fixed adjustable ¹⁾	Only 90° fixed adjustable ¹⁾	See table "Rotation range of the power connector (for natural cooling/water cooling)"

1) For other angles, the signal cable can come into contact with the fan and so be damaged.

8.3.1.2 Routing cables in a damp environment

Note

If the motor is mounted in a humid environment, the power and signal cables must be routed as shown in the following figure.

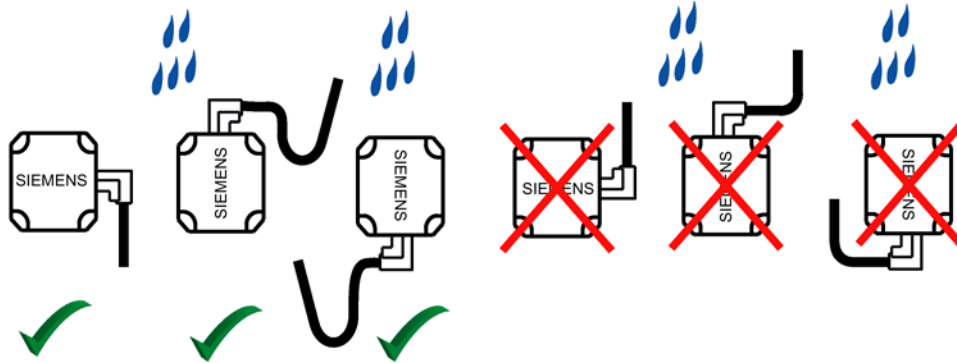

Figure 8-3 Routing cables in a damp environment

8.3.1.3 Handling the SPEED-CONNECT connection

The motors are equipped with SPEED-CONNECT connectors.

You can also connect quick-connection cables with SPEED-CONNECT to motor connectors as conventional cables with screw locks (fully threaded).

Note

We recommend cables with SPEED-CONNECT because they are easier to use.

Establishing a SPEED-CONNECT connection

Procedure

Note

- Only tighten the connector by hand.
 - Do not use any wrenches or similar tools.
-

1. Ensure that the union nut of the SPEED-CONNECT connector is rotated to the end stop in the direction of the "open" arrow.
2. Align the SPEED-CONNECT connector so that the triangles on the top of the connectors are opposite one another.



3. Push the power connector onto the motor connecting socket as far as it will go.
4. Turn the union nut by hand in the direction of "close" through at least 45° (position A) or up to the end stop (position B)



- A Minimum locking
B Maximum locking up to the end stop

Note

A secure connection is only guaranteed from position A onward.

You have established a secure connection.



Releasing a SPEED-CONNECT connection

Procedure

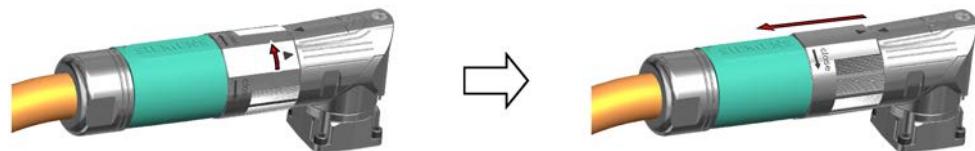

1. Turn the union nut of the SPEED-CONNECT connector in the direction of "open" to the end stop. The triangles on the top of the connectors must be opposite one another.
2. Withdraw the connector.

Note

Pull out the connector at the connector itself, do not pull on the cable.

You have disconnected the SPEED-CONNECT connection.



8.3.2 Connecting to a converter

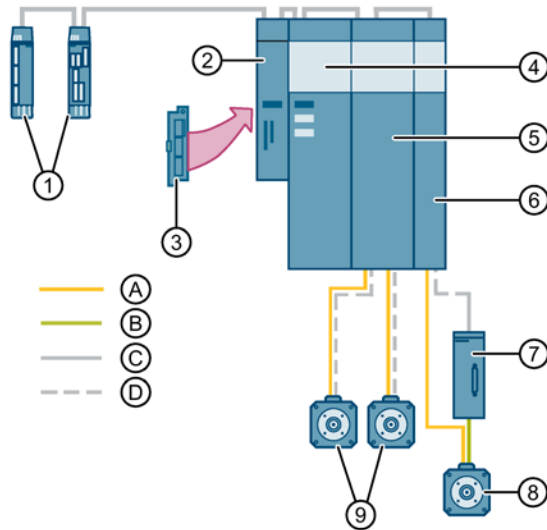

- | | | | |
|---|----------------------------------|---|--|
| 1 | Terminal Module | 8 | Motors without DRIVE-CLiQ interface |
| 2 | Control Unit | 9 | Motors with DRIVE-CLiQ interface |
| 3 | Operator control unit | A | MOTION-CONNECT power cable |
| 4 | Smart Line or Active Line Module | B | MOTION-CONNECT signal cable |
| 5 | Double Motor Module | C | DRIVE-CLiQ signal cable |
| 6 | Motor Module | D | MOTION-CONNECT DRIVE-CLiQ signal cable |
| 7 | Sensor Module | | |

Figure 8-4 SINAMICS S120 system overview

Designs of the motor connectors

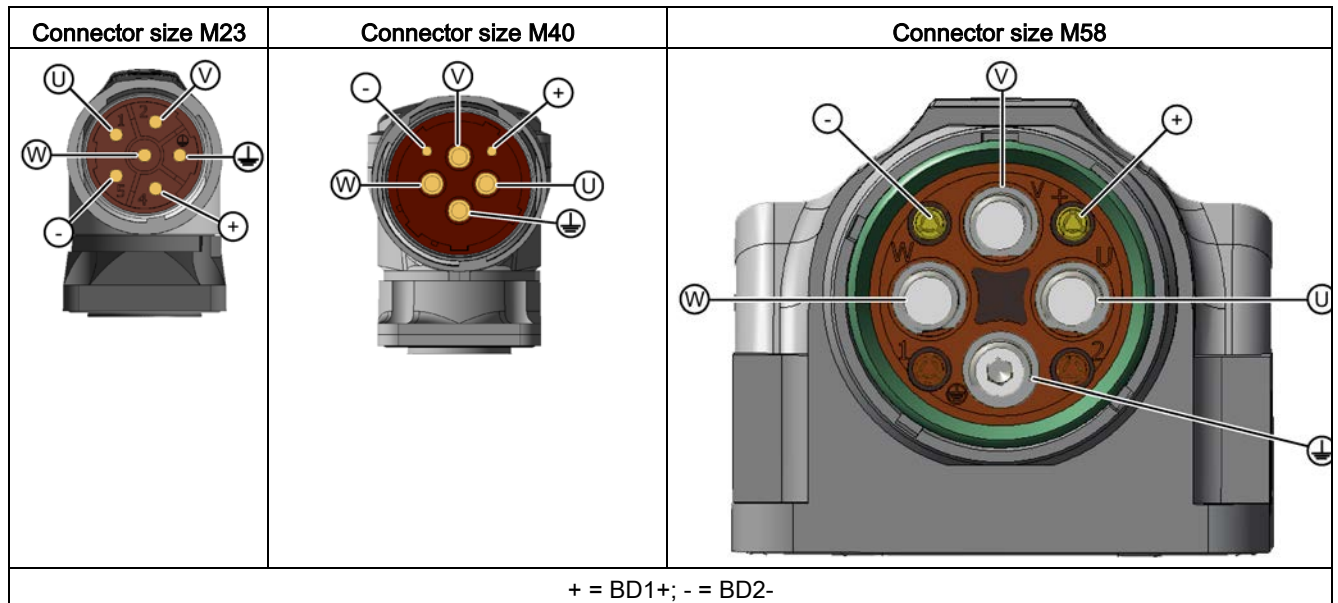

Selecting and connecting the cables

- To connect the motor to a converter, use MOTION-CONNECT cables or shielded connecting cables.

Note

The cable shielding, made up of as many strands as possible, must have a high electrical conductivity. Braided shields made of copper or aluminum are well suited.

Connection diagram for the motor to the S120 Power Module and Motor Module Booksized and Compact with a MOTION-CONNECT cable

For connector size M23

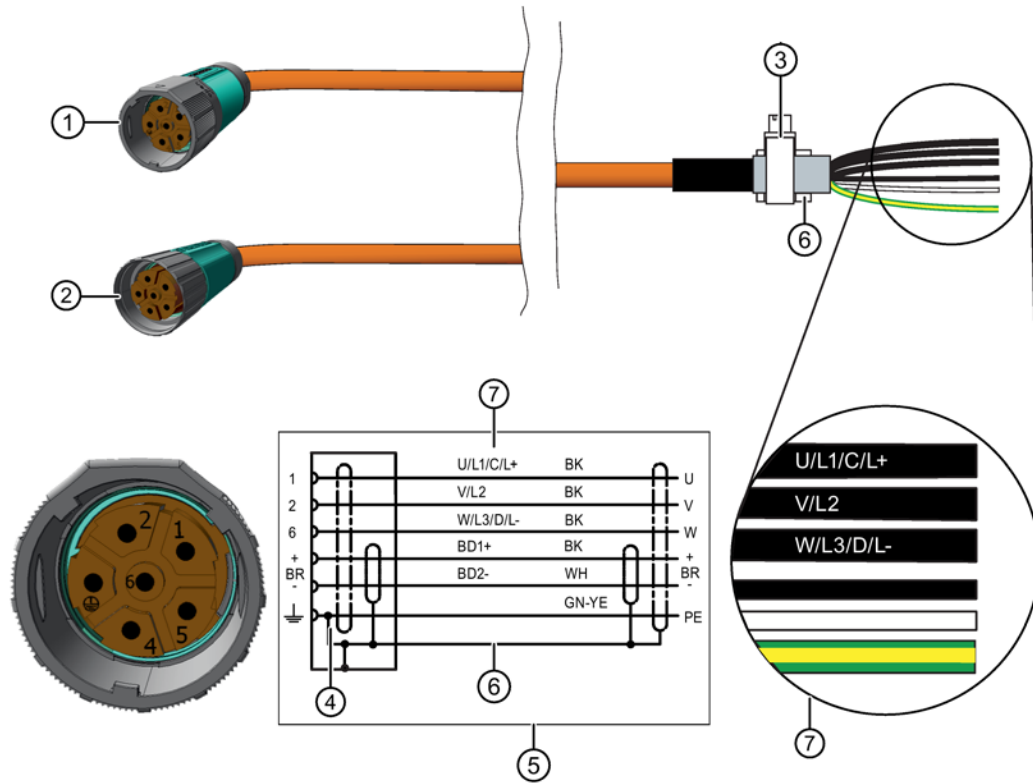

- 1 Connector size M23
- 2 Connector SPEED-CONNECT M23
- 3 Terminal for the cable shield
- 4 Pin assignment
- 5 Circuit diagram
- 6 Cable shield
- 7 Conductor designation:
 U, V, W = power cables, 1.5 mm², each cable separately shielded
 BD1+ and BD2- = brake cable without lettering, 1.5 mm², shared shield
 PE = protective conductor

For connector size M40

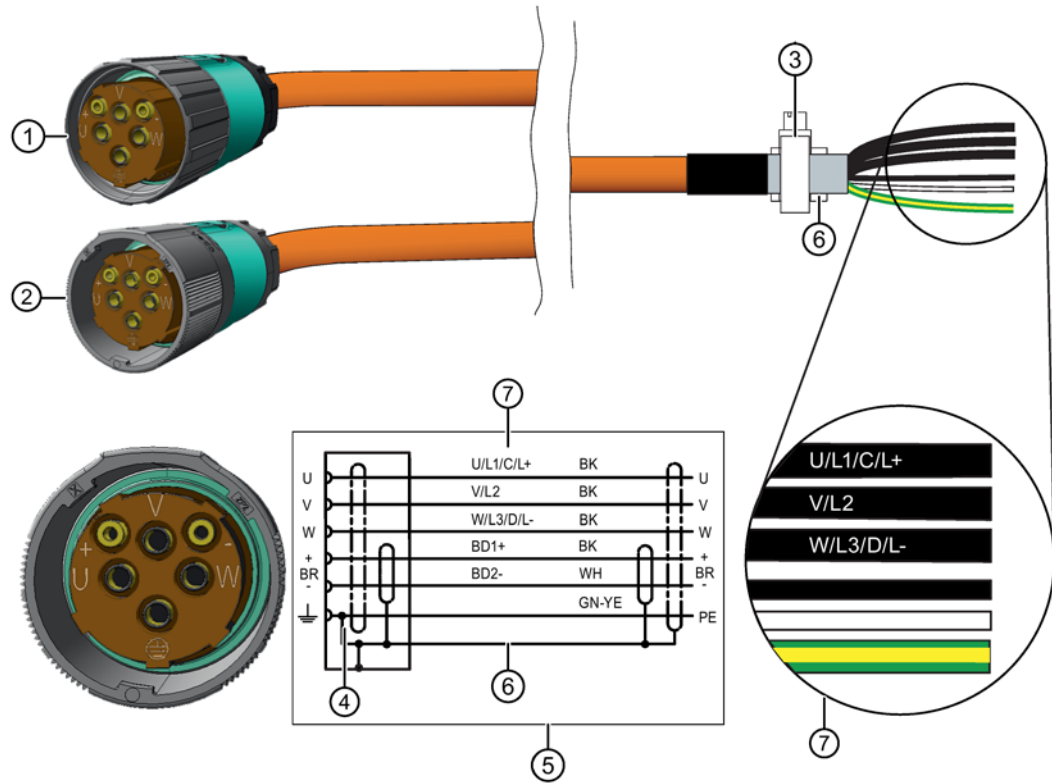

- 1 Connector size M40
- 2 Connector SPEED-CONNECT M40
- 3 Terminal for the cable shield
- 4 Pin assignment
- 5 Circuit diagram
- 6 Cable shield
- 7 Conductor designation:
 U; V; W = power cables, each cable separately shielded
 BD1+ and BD2- = brake cable without lettering, 1.5 mm², shared shield
 PE = protective conductor

For connector size M58

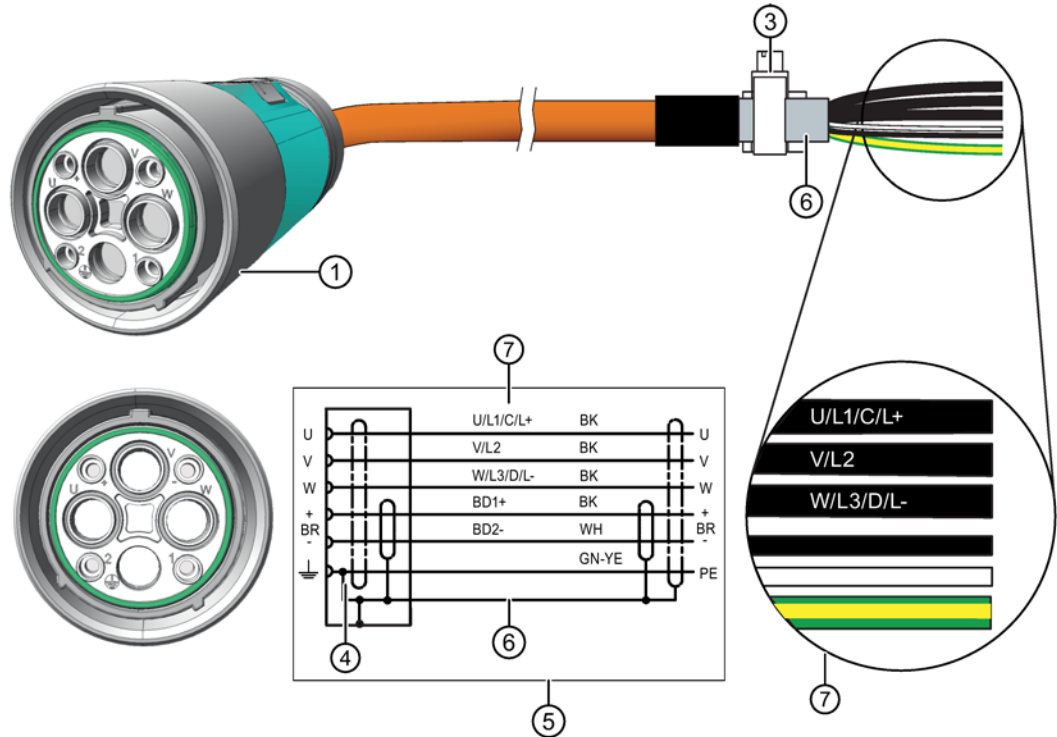

- 1 Connector size M58
- 2 n.a.
- 3 Terminal for the cable shield
- 4 Pin assignment
- 5 Circuit diagram
- 6 Cable shield
- 7 Conductor designation:
 U; V; W = power cables, each cable separately shielded
 BD1+ and BD2- = brake cable without lettering, 1.5 mm², shared shield
 PE = protective conductor

- Connect the shield at both ends at the motor and at the converter.
- Keep unshielded cable ends as short as possible.
- To ensure good conducting of high-frequency currents, provide contacting over a large surface area. Use EMC cable glands at the cable entries as 360° contacts on the converter, for example.

Power connection via terminal box

For electrical connection of the 1FT7, the following terminal boxes can be used for larger shaft heights:

GK 230	GK843
1FT7085 1FT7087 1FT7105 1FT7108	This terminal box is only available for motors of shaft height 1FT713 with connector size 3.

Information on connecting

- Use cable lugs according to DIN 46234 for connection.
- First connect the protective conductor.
- Implement the terminal assignment in the terminal box as shown in the diagram.
- Connect the brake if there is one.

Terminal diagram terminal box GK 230

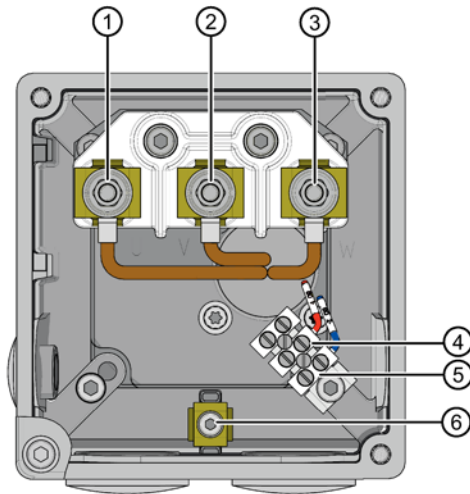

- 1, 2, 3 Main terminals U, V, W
- 4, 5 Brake connection (optional), 4 = BD1+, 5 = BD2-
- 6 Ground connection

Figure 8-5 Terminal box GK 230

Table 8- 12 Terminals for the terminal box GK 230

Terminal box type	GK 230
Cable entry	1 x PG 29 / 1 x PG 9
Max. outer cable diameter ¹⁾	30 mm
RMS current per terminal ²⁾	66 A
Number of main terminals U, V, W	3 x M5
Max. cross-section per terminal	1 x 16 mm ²
Ground connection	M4
Tightening torque [Nm]	0.8 - 1.2
Brake connection ³⁾	1.5 mm ²

1) Depends on the seal used

2) Data according to DIN EN 60204-1 (installation type C, ambient temperature 40 °C)

3) BD1+/BD2- (terminal strip, only for versions with brake)

Terminal diagram terminal box GK 843

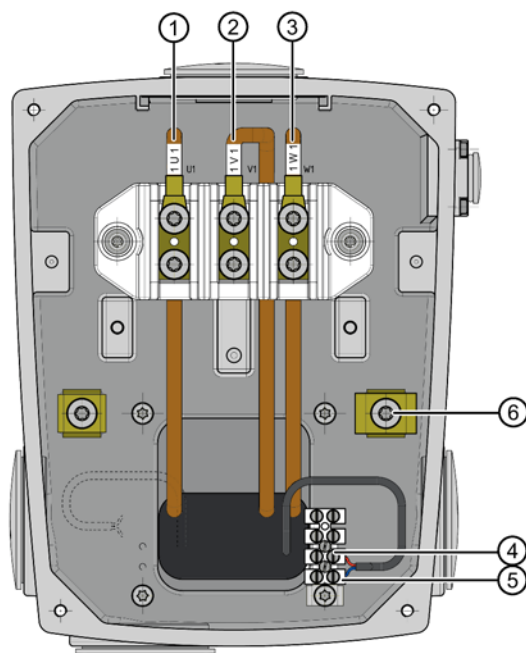

- 1, 2, 3 Main terminals U, V, W
- 4, 5 Brake connection (optional), 4 = BD1+, 5 = BD2-
- 6 Ground connection

Figure 8-6 Terminal box GK 843

Table 8- 13 Terminals for the terminal box GK 843

Terminal box type	GK 843
Cable entry	3 x M50 x 1.5 / 1 x M16 x 1.5
Max. outer cable diameter ¹⁾	38 mm
RMS current per terminal ²⁾	125 A
Number of main terminals U, V, W	3 x M6
Max. cross-section per terminal	1 x 50 mm ²
Ground connection	M6
Tightening torque [Nm]	2.7 - 4
Brake connection ³⁾	1.5 mm ²

¹⁾ Depends on the seal used

²⁾ Data according to DIN EN 60204-1 (installation type C, ambient temperature 40 °C)

³⁾ BD1+/BD2- (terminal strip, only for versions with brake)

See also

Selection based on the article number (Page 33)

8.3.3 Connecting a separately driven fan

Connection notes

The fan connection is a size M23 power connector.

- Use only cables that comply with the installation regulations.
- Before connecting the device, make sure that the line voltage matches the device voltage.
- Check whether the data on the fan rating plate matches the connection data.
- Lay the connection cables without tensile stress.

NOTICE
Damage to the fan when inappropriately operated
As supplied, the external fan does not provide an independently functioning protection against improper operation (blocking protection). The device can become hot and start to burn.
<ul style="list-style-type: none">• Use blocking protection (stall protection) to protect the fan against inappropriate operation. To do this, use a suitable motor circuit breaker where all poles can be disconnected or an appropriate activation device for the PTC thermistor. Operate the fan using the motor circuit breaker.• Provide a protective circuit that prevents the main motor from being switched on when the fan is not in operation.

Connection of a 1-phase separately driven fan

Table 8- 14 Connection values for a 1-phase separately driven fan for the 1FT7 up to shaft height 100

Shaft height	Max. current consumption at	
	230 V / 50 Hz ($\pm 10\%$) in A	230 V / 60 Hz ($\pm 10\%$) in A
63	0.12	0.12
80 to 100	0.40	0.40

Circuit diagram

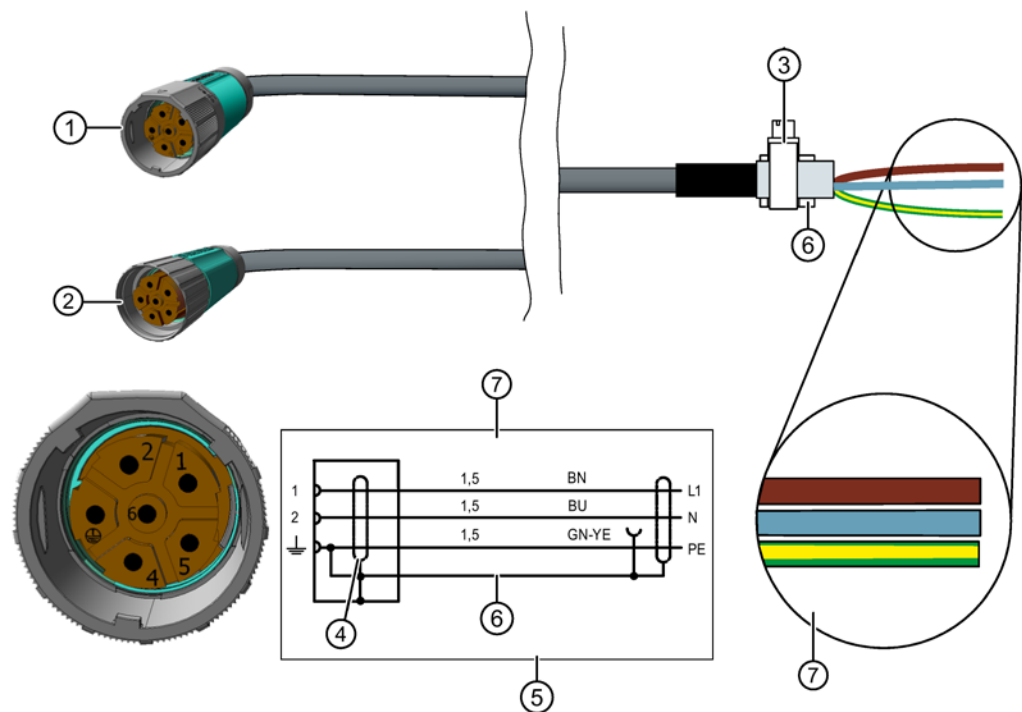

- 1 Connector size M23 (with full thread)
- 2 Connector SPEED-CONNECT size M23
- 3 Terminal for the cable shield
- 4 Pin assignment
- 5 Circuit diagram
- 6 Cable shield
- 7 Conductor designation:
Power cable, 1.5 mm²
PE = protective conductor, 1.5 mm²

Figure 8-7 Connecting to a 1-phase separately driven fan

Connection of a 3-phase separately driven fan

Table 8- 15 Connection values for a 3-phase separately driven fan for the 1FT7 shaft height 132

Shaft height	Max. current consumption at		
	400 V / 50 Hz (±10 %) in A	400 V / 60 Hz (±10 %) in A	480 V / 60 Hz (±10 %) in A
132	0.21	0.19	0.23

Circuit diagram

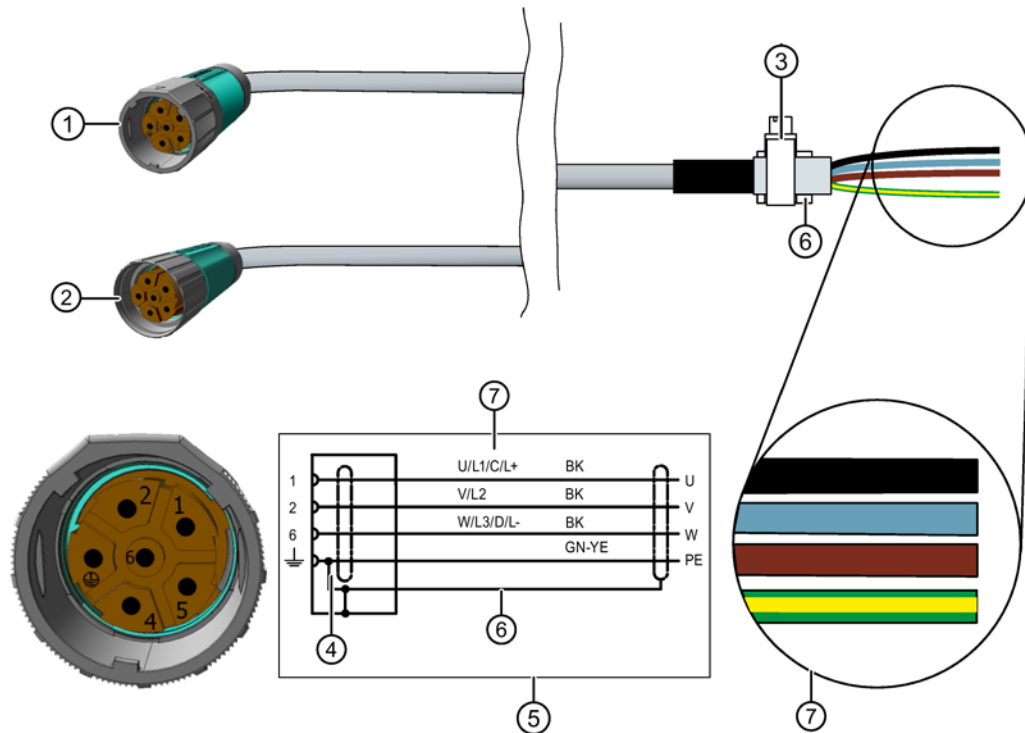

- 1 Connector size M23 (with full thread)
- 2 Connector SPEED-CONNECT size M23
- 3 Terminal for the cable shield
- 4 Pin assignment
- 5 Circuit diagram
- 6 Cable shield
- 7 Conductor designation:
 Power cable, 1.5 mm²
 PE = protective conductor, 1.5 mm²

Figure 8-8 Connecting to a 3-phase separately driven fan, connector size M23

Table 8- 16 Order numbers

	Order number (article number)
Connector size M23 with full thread	6FX2003-0LU00
Connector size M23 with SPEED-CONNECT	6FX2003-0LU30
Prefabricated cable with full thread	6FX5001-5CG10-□□□□ ¹⁾
Prefabricated cable with SPEED-CONNECT	6FX5002-5CG10-□□□□ ¹⁾

¹⁾ The last 4 digits are the length code. You can find additional information in Catalog D 21.4 (2017), from page 12/7 onwards

Link to the Chapter "SIMOTICS Servomotors" in Catalog D 21.4
(<https://support.industry.siemens.com/cs/document/109747019/>)

8.3.4 Connecting the holding brake

Direct connection

The holding brake in the motor is directly connected to the SINAMICS converter using MOTION-CONNECT power cables with integrated brake connecting cable. See Chapter "Connecting to a converter (Page 376)"

Connection to external power supply

You can also control the holding brake via an external power supply.

The external power supply can be a PELV (PELV = Protective Extra Low Voltage) power supply, if:

- Protective separation from the motor winding is guaranteed for the brake cable in the motor
- The power cable has reinforced insulation

Note

The relay K1, located between coil and contact, must also have reinforced insulation to protect the internal logic voltage.

If you control the holding brake via an external power supply, you must protect the holding brake from voltage peaks with a protective circuit. See figure "Suggested circuit for the external power supply"

The protective circuit also guarantees the specified switching times, see Chapter "Technical specifications (Page 76)".

The motor holding brake requires 24 V ± 10 % at the motor connection in order to reliably open.

- Take into account the voltage drops along the supply cable.
- Use a Control Supply Module (CSM) or a regulated DC power supply, whose setpoint is set to 26 V.
- Use power supply cables with a minimum cross-section of 1.5 mm².
- Calculate the maximum permissible cable length using the following formula.

If the maximum voltage of 24 V DC +10 % is exceeded, then the brake can close again.

You can approximately calculate the voltage drop ΔU for copper cables as follows:

$$\Delta U / V = 0.042 \cdot x \cdot I_{\text{Brake}} \quad // \text{ m} = \text{cable length}$$

$$x = // q \quad q / \text{ mm}^2 = \text{brake conductor cross-section}$$

$$I_{\text{Brake}} / \text{ A} = \text{brake DC current}$$

Note

Integrate a protective circuit into the incoming cable. In this way, you avoid switching overvoltages and possible influence of the installation environment. See the figure below

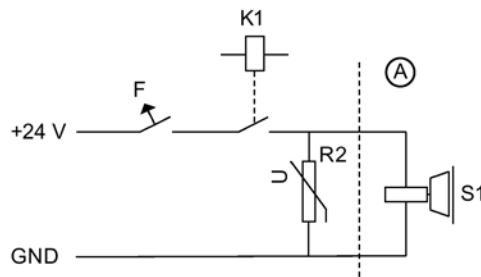

- A Motor
- K1 Contactor
- F Circuit-breaker
- S1 Holding brake
- R2 Varistors

Figure 8-9 Suggested circuit for the external power supply with protective circuit

Table 8- 17 Example: Electrical components for the suggested circuit

Electrical component	Examples		
F	3RV10 circuit-breaker with current paths connected in series (if required with mounted auxiliary contact 3RV1901 to provide a feedback signal for the drive).	or	Miniature circuit-breaker 5SX21 (if required with mounted auxiliary contact to provide a feedback signal for the drive).
K1	Auxiliary contactor 3RH11	or	Contactors 3RT10
R2	Varistor SIOVS14K30 (EPCOS)		

8.3.5 Signal connection / motor protection

The motors can be connected to the converter system as follows.

Via the DRIVE-CLiQ interface		Without DRIVE-CLiQ
RJ45 connector	M17 round connector, 10-pin	M23 round connector, 17-pin
Identifier at the 14th digit of the article number		
B, C, D or F	K or L	M or N

The connection is established using a MOTION-CONNECT cable

Additional information on connecting signals with DRIVE-CLiQ is provided at "Motors with DRIVE-CLiQ interface (Page 389)".

Additional information on connecting signals without DRIVE-CLiQ is provided at "Motors without DRIVE-CLiQ interface (Page 392)".

8.3.5.1 Motors with DRIVE-CLiQ interface

Motors designed for SINAMICS drive systems have an integrated encoder and temperature evaluation system as well as an electronic rating plate.

The motors are connected to the converter system via a DRIVE-CLiQ interface.

The DRIVE-CLiQ interface supplies the motor encoder with power via the integrated 24 VDC power supply. The DRIVE-CLiQ interface transfers the motor encoder and temperature signals and the electronic rating plate data, e.g. a unique identification number, rating data (voltage, current, torque) to the Control Unit.

Motors with a DRIVE-CLiQ interface can be connected to the associated Motor Module via a MOTION-CONNECT cable. The connection of the MOTION-CONNECT cable at the motor has degree of protection IP67.

NOTICE

Damage to electronic components as a result of electrostatic discharge

The encoder connections have direct contact with electrostatic sensitive devices that can be damaged or destroyed by electrostatic discharge (ESD).

- Ensure the ESD protection measures are taken (see Equipment damage due to electric fields or electrostatic discharge (Page 16)).
- Only grounded personnel with grounded tools may touch the component connections.
- Heed the EMC information provided by the manufacturer of the converter.

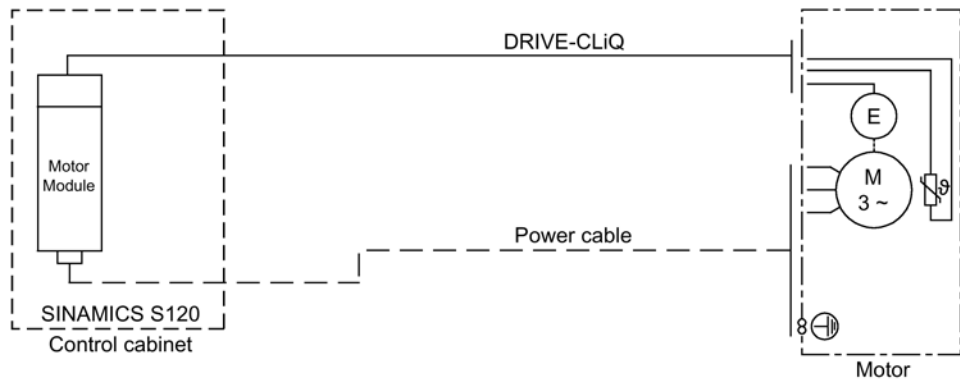
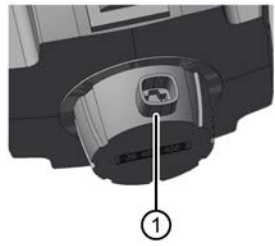
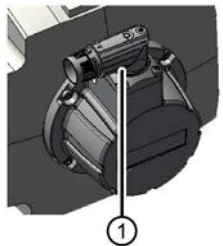

Figure 8-10 Encoder interface with DRIVE-CLiQ

Variants of the DRIVE-CLiQ connection

There are two variants of DRIVE-CLiQ connections on the motor:

RJ45plus socket	Round connector M17
	
1 10-pin RJ45plus socket	1 round connector M17

Requirement for using the round connector M17

Shaft height	36 - 132
Cooling method	Natural cooling or water cooling

Differences in connection with round connector M17 compared to RJ45plus socket

For the motors with round connector M17, the following deviations result in comparison to the RJ45 standard connector:

- The motor length increases by 5 mm and corresponds to the length of the motor without DRIVE-CLiQ interface.
- The connector is implemented as a rotatable angled connector.
- The height of the obstructing contour from the center of the motor is 82 mm.

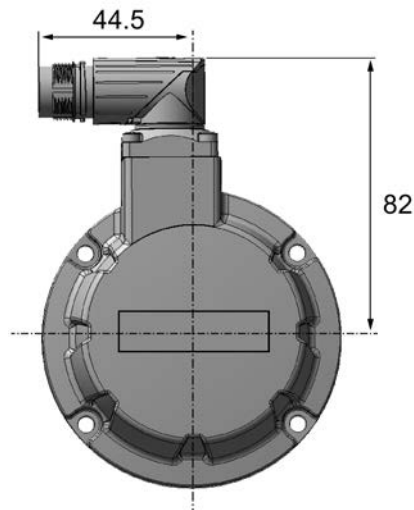

Figure 8-11 Installation dimensions encoder M17

- A signal cable that deviates from the standard is required (DRIVE-CLiQ round connector M17, IP67)

Information on the connector pin assignment is provided in Chapter "PIN assignment of the signal connectors (Page 393)".

8.3.5.2 Motors without DRIVE-CLiQ interface

If a motor is not equipped with a DRIVE-CLiQ interface, the speed encoder and temperature sensor are connected via a signal connector.

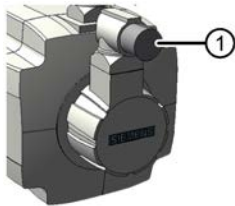

1 17-pin M23 signal connector

Figure 8-12 Motor with a signal connector

Motors without DRIVE-CLiQ require a Sensor Module Cabinet (SMC) for operation with a SINAMICS S120 drive system. The motor is connected with the SMC using a MOTION-CONNECT signal cable.

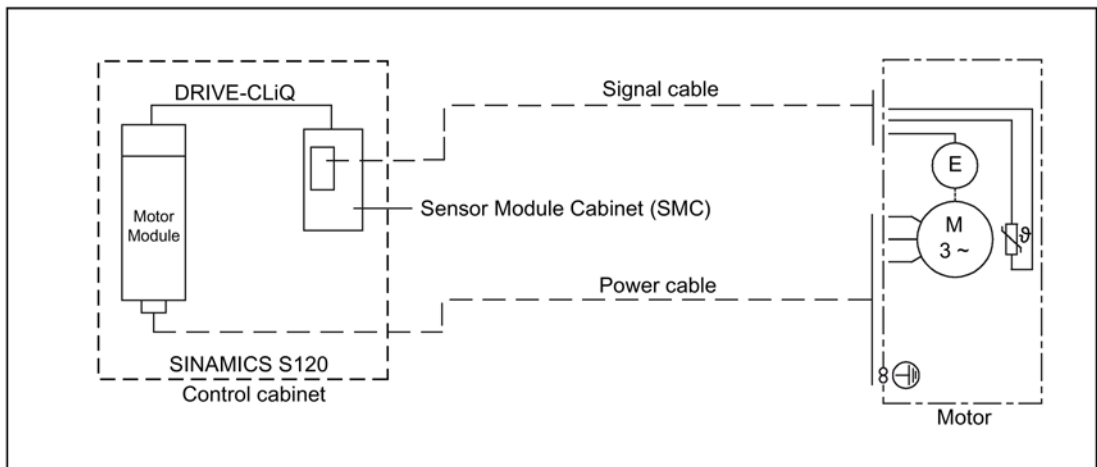
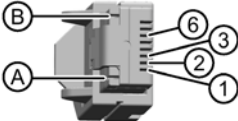

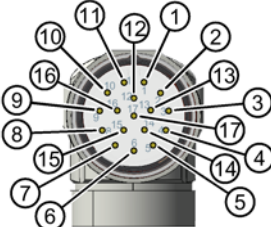

Figure 8-13 Encoder interface without DRIVE-CLiQ

Information on the connector pin assignment is provided in Chapter "PIN assignment of the signal connectors (Page 393)".

8.3.5.3 PIN assignment of the signal connectors

Pin assignment, RJ45 signal connector, with DRIVE-CLiQ, cable connector	Pin assignment, M17 signal connector, 10-pin, with DRIVE-CLiQ, encoder connector	Pin assignment, M23 signal connector, 17-pin, without DRIVE-CLiQ, encoder connector	
			
For DQI encoder with RJ45	DQI encoder with round connector M17	Incremental encoder sin/cos 1Vpp	Absolute encoder sin/cos 1 Vpp
1 = TX-P	1 = TX-P	1 = A	1 = A
2 = TX-N	2 = TX-N	2 = A*	2 = A*
3 = RX-P	3 = not connected	3 = R	3 = data
4 = not connected	4 = not connected	4 = D*	4 = not connected
5 = not connected	5 = RX-P	5 = C	5 = clock
6 = RX-N	6 = RX-N	6 = C*	6 = not connected
7 = not connected	7 = not connected	7 = M encoder	7 = M encoder
8 = not connected	8 = not connected	8 = +1R1	8 = +1R1
A = P 24 V	9 = P 24 V	9 = -1R2	9 = -1R2
B = M 0 V	10 = M 0 V	10 = P encoder	10 = P encoder
		11 = B	11 = B
		12 = B*	12 = B*
		13 = R*	13 = data*
		14 = D	14 = clock*
		15 = M sense	15 = M sense
		16 = P sense	16 = P sense
		17 = not connected	17 = not connected

8.3.5.4 Signal cables

Signal cables for the motor

Use prefabricated cables to connect motors.

Table 8- 18 Example of the article number structure for a prefabricated cable

Description	Position of the article number																	
	1	2	3	4	5	6	7	-	8	9	10	11	12	-	13	14	15	16
DRIVE-CLiQ signal cable (example)	6	F	X															
MOTION-CONNECT 500				5														
MOTION-CONNECT 800 PLUS				8														
				0														
Connectors mounted on both sides						0	2											
Loosely enclosed connector for the module side						1	2											
Loosely enclosed connector for the motor end						4	2											
								-	2									
	DRIVE-CLiQ									D	<input type="checkbox"/>							
	Connector variants											<input type="checkbox"/>	<input type="checkbox"/>	-				
	Length code ¹⁾														<input type="checkbox"/>	<input type="checkbox"/>	<input type="checkbox"/>	<input type="checkbox"/>

1) Detailed information on the structure of the length code can be found in the catalog, see link below.

Detailed information on the signal cables is provided in Chapter "Chapter, "MOTION-CONNECT connection systems" in Catalog D 21.4 (<https://intranet.for.siemens.com/org/i-dt-mc/de/motion-control/support/infomaterial/kataloge/d-21-4-sinamics-s120-simotics/Seiten/d-21-4.aspx>)".

8.3.5.5 Connecting the signal cable on a force-ventilated motor

The signal connection of the force-ventilated motor is located under the fan cover or in the intermediate flange, and cannot be seen.

The signal connection can be as shown below:

with DRIVE-CLiQ		Without DRIVE-CLiQ
RJ45 via Sensor Module	Round connector M17	Round connector M23

You must remove the fan cover or the intermediate flange to connect the signal cable. To remove the fan cover or the intermediate flange when the motor is installed, you need a minimum clearance s at the NDE.

Minimum clearance for 1FT706 ... 1FT710

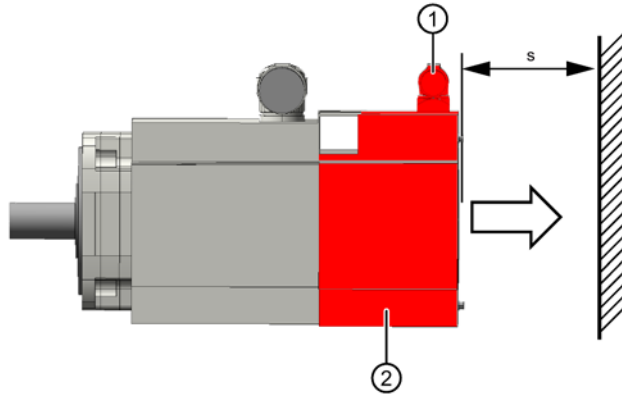

- 1 Fan connector
- 2 Fan cover
- s Minimum clearance 125 mm

Minimum clearance for 1FT713

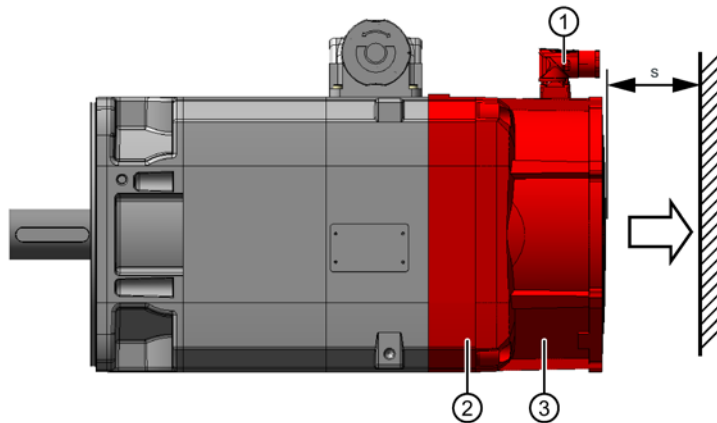

- 1 Fan connector
- 2 Intermediate flange
- 3 Fan housing
- s Minimum clearance 65 mm

Detailed information on suitable signal cables is provided in "Chapter, "MOTION-CONNECT connection systems" in Catalog D 21.4 (<https://intranet.for.siemens.com/org/i-dt-mc/de/motion-control/support/infomaterial/kataloge/d-21-4-sinamics-s120-simotics/Seiten/d-21-4.aspx>)".

Assembly drawings/dimension sheets

Current dimension drawings are provided in the DT-KONFIGURATOR or in Chapter "SIMOTICS Servomotors" in Catalog D 21.4 (<https://support.industry.siemens.com/cs/document/109747019/>) as print version or online.

DT CONFIGURATOR

In the DT CONFIGURATOR - you can simply and quickly find

- dimension drawings
- 2D/3D CAD data

The DT CONFIGURATOR supports you when generating plant/system documentation regarding project-specific information.

Note

The 3D model in the DT CONFIGURATOR is a simplified representation that does not show all of the details.

You can find further information on the Internet at DT Configurator (<http://siemens.de/dt-konfigurator>):

Recency of dimension drawings

Note

Changing motor dimensions

Siemens AG reserves the right to change the dimensions of the motors as part of mechanical design improvements without prior notice. This means that dimension drawings can become out of date.

Appendix

A.1 Glossary

Rated torque M_N

Thermally permissible continuous torque in S1 duty at the rated motor speed.

Rated speed n_N

The characteristic speed range for the motor is defined in the speed-torque diagram by the rated speed.

Rated current I_N

RMS motor phase current for generating the particular rated torque. Specification of the RMS value of a sinusoidal current.

Rated converter current $I_{N\ conv}$

RMS converter output current (per phase) that can be supplied on a continuing basis by the recommended Motor Module. The recommended Motor Module is determined with the stall current I_0 (100K).

Braking torque $M_{br\ rms}$

$M_{br\ eff}$ corresponds to the average braking torque for armature short-circuit braking.

Braking resistance R_{opt}

R_{opt} corresponds to the optimum resistance value per phase that is switched in series external to the motor winding for the armature short-circuit braking function.

DE

Drive end of the motor

Cyclic inductance L_D

The cyclic inductance is the sum of the air gap inductance and leakage inductance relative to the single-strand equivalent circuit diagram. It consists of the self-inductance of a phase and the coupled inductance to other phases.

Torque constant k_T (value for a 100 K average winding temperature rise)

Quotient obtained from the static torque and stall current.

Calculation: $k_T = M_{0(100\text{ K})} / I_{0(100\text{ K})}$

The constant is valid up to approx. $2 \cdot M_{0(60\text{ K})}$ for naturally cooled motors

Note

This constant is not applicable when configuring the necessary rated and acceleration currents (motor losses!).

The steady-state load and the frictional torques must also be included in the calculation.

Electrical time constant T_{el}

Quotient obtained from the rotating field inductance and winding resistance. $T_{el} = L_D / R_{Str}$

Maximum torque M_{max}

Torque that is generated at the maximum permissible current. The maximum torque is briefly available for high-speed operations (dynamic response to quickly changing loads).

The maximum torque is limited by the closed-loop control parameters.

Maximum torque (limited by converter) $M_{max\ conv}$

The maximum torque that can be applied (temporarily) for operation on the recommended motor module.

Max. current I_{max}

This current limit is only determined by the magnetic circuit. Even if this limit is only briefly exceeded, it can result in the irreversible de-magnetization > 2 % of the magnetic material. Specification of the RMS value of a sinusoidal current.

Maximum converter current $I_{max\ conv}$

RMS converter output current (per phase) that can be supplied temporarily by the recommended motor module

Maximum permissible speed (mechanical) n_{max} .

The maximum mechanically permissible speed is $n_{max\ mech}$. It is defined by the centrifugal forces and frictional forces in the bearing.

Maximum permissible speed at converter $n_{\max \text{ conv}}$

The maximum permissible operating speed for operation at a converter is $n_{\max \text{ conv}}$ (e.g. limited by withstand voltage, maximum frequency).

Mechanical time constant T_{mech}

The mechanical time constant is obtained from the tangent at a theoretical ramp-up function through the origin.

$$T_{\text{mech}} = 3 \cdot R_{\text{Str}} \cdot J_{\text{Mot}} / k_{\text{T}}^2, T_{\text{mech}} / \text{s}$$

J_{mot} = Moment of inertia of the servomotor / kgm^2

R_{Str} = Resistance of one phase of the stator winding / ohm

k_{T} = Torque constant / Nm/A

NDE

Non-drive end of the motor

Optimum operating point

Operating point at which the maximum continuous output of the motor is normally provided at high efficiency (see figure below).

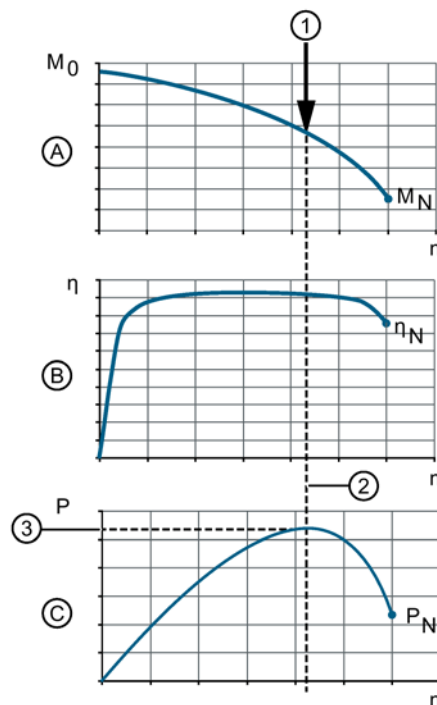

A	Torque	1	Optimum operating point
B	Efficiency	2	Optimum speed
C	Output power	3	Optimum power

Optimum speed n_{opt}

Speed at the optimum operating point.

If the optimum speed is above the rated speed, the rated speed is stated here.

Optimum power P_{opt}

Power achieved at the optimum speed.

The rated speed is the optimum speed (see optimum speed), the optimum power corresponds to the rated power.

Number of poles $2p$

Number of magnetic north and south poles on the rotor. p is the number of pole pairs.

Voltage constant k_E (value at 20° C rotor temperature)

Rms value of the induced motor voltage at a speed of 1000 rpm and a rotor temperature of 20 °C.

Static torque M_0

Thermal limit torque at motor standstill corresponding to a utilization according to 100 K or 60 K. M_0 is always higher than the rated torque M_N .

Stall current I_0

Motor phase current for generating the particular static torque ($M_0 = k_T \cdot I_0$). Specification of the RMS value of a sinusoidal current.

Thermal time constant T_{th}

Defines the increase in the motor frame temperature when the motor load is suddenly increased (step function) to the permissible S1 torque. If the power loss were constant, the motor would have reached 63% of its final temperature after T_{th} .

Moment of inertia J_{Mot}

Moment of inertia of rotating motor parts. J_{Mot} = without brake, J_{MotBr} = with brake.

Shaft torsional stiffness C_t Mot

This specifies the shaft torsional stiffness from the center of the rotor laminated core to the center of the shaft extension, C_t Mot = without brake, C_t MotBr = with brake.

Winding resistance R_{Str} at 20 °C winding temperature

The resistance of a phase at a winding temperature of 20°C is specified. The winding is in a star connection.

Index

A

Armature short-circuit braking, 120
Axial eccentricity, 61

B

Bearing change interval, 64
Belt pretension, 55
Braking resistors, 120

C

Certificates
 EAC, 25
 EC Declaration of Conformity, 25
 UL and cUL, 25
Concentricity, 61
Correct usage, 23, 23

D

DRIVE-CLiQ interface, 70, 389

E

Environmental conditions, 30

F

Forced ventilation, 39

H

Holding brake, 74
Hotline, 4

L

Lifting and transporting the motor, 361, 362

M

Maintenance intervals, 65
Mounting conditions, 37

N

Noise emission, 64

O

Output couplings, 77

P

Planetary gear unit, 78
Pt1000, 68

R

Radial force, 55
Rating plate, 36, 36
RoHS, 25

S

Sealing of the motor shaft, 51
Shaft extension, 54
Siemens Service Center, 4
Smooth running, 61
Sound pressure level, 64
STARTER, 107

T

Technical Support, 4
Thermal motor protection, 68
Third-party products, **Fehler! Textmarke nicht definiert.**
Training, 4
Transportation, 361, 362

V

Vibration response, 62, 63

Siemens AG
Digital Factory
Motion Control
Postfach 31 80
91050 ERLANGEN
Germany

Scan the QR code for
additional informati-
on about SIMOTICS.

