

ADI4 - Analog Drive Interface for 4 Axis

Device Manual

Preface, Contents

Hardware description

Parameter assignment

Startup

Boundary conditions

Index

1

2

3

4

Valid for

Controller

SINUMERIK 802D

SINUMERIK 840Di

SINUMERIK 840DiE (export version)

SIMOTION P

SIMOTION C

SIMOTION D

SIMATIC Technology CPU

Software

ADI4

version

1.3

6FC5 297-0BA01-0BP4

05.2005 Edition

Safety Information

This manual contains notices that you should observe to ensure your own personal safety, as well as to protect the product and connected equipment. These notices are highlighted in the manual by a warning triangle and are marked as follows according to the level of danger:



Danger

means that death, serious injury or considerable material damage **will** result if the appropriate safety precautions are not taken.



Warning

means that death, serious injury or considerable material damage **may** result if the appropriate safety precautions are not taken.



Caution

indicates that minor personal injury or property damage may result if proper precautions are not taken.

Caution

indicates that property damage may result if proper precautions are not taken.

Notice

indicates the risk of potential danger if the corresponding information is not observed.

Qualified personnel

Commissioning and operation of a device may only be performed by **qualified personnel**. Qualified persons are defined as persons who are authorized to commission, to ground, and to tag circuits, equipment, and systems in accordance with established safety practices and standards.

Correct usage

Note the following:



Warning

The unit may be used only for the applications described in the catalog or the technical description, and only in combination with the equipment, components and devices of other manufacturers where recommended or permitted by Siemens.

This product can only function correctly and safely if it is transported, stored, set up, and installed correctly, and operated and maintained as recommended.

Trademarks

SIMATIC®, SIMATIC HMI®, SIMATIC NET®, SINUMERIK®, and SIMOTION® are registered trademarks of SIEMENS AG.

Third parties using for their own purposes any other names in this document, which refer to trademarks, might infringe upon the rights of the trademark owners.

Copyright Siemens AG, 2005. All rights reserved

The reproduction, transmission or use of this document or its contents is not permitted without express written permission. Offenders will be liable for damages. All rights, including rights created by patent grant or registration of a utility model, are reserved.

Siemens AG
Automation and Drives
Postfach 4848
90437 Nuremberg
Germany

Disclaimer of Liability

We have checked that the contents of this document correspond to the hardware and software described. Since discrepancies cannot be precluded entirely, we cannot guarantee full agreement. The information given in this publication is reviewed at regular intervals and any corrections that might be necessary are made in the subsequent editions.

© Siemens AG, 2005
Technical data subject to change.

Preface

SINUMERIK Documentation

The SINUMERIK documentation is organized in 3 parts:

- General Documentation
- User documentation
- Manufacturer/Service Documentation

Please contact your local Siemens office for more detailed information about other SINUMERIK 840D sl/840D/840Di/810D publications and publications that apply to all SINUMERIK controls (e.g., universal interface, measuring cycles, etc.).

A list of documents, updated on a monthly basis, is available on the Internet for the available languages at:

<http://www.siemens.com/motioncontrol>

Select "Support", > "Technical Documentation" > "Overview of Documents".

The Internet version of the DOConCD (DOConWEB) is available at:

<http://www.automation.siemens.com/doconweb>

Target readership

This documentation is intended for machine tool manufacturers (project engineers, electricians and fitters, service and operating staff). The document contains all the information required to install, connect and parameterize the module.

Standard functionality

This documentation describes the standard functionality of the ADI4 module.

Other functions not described in this documentation may be executable in the module. This does not, however, represent an obligation to supply such functions with a new module or when servicing.

Hotline

A&D Technical Support

A&D Technical Support:

Phone: +49 (0) 180 5050-222

Fax: +49 (0) 180 5050-223

E-mail: adsupport@siemens.com

Internet: www.siemens.com/automation/support-request

If you have any comments, suggestions, or corrections regarding this documentation, please fax or e-mail them to:

Fax: +49 (0) 9131 98 - 63315

E-mail: motioncontrol.docu@siemens.com

Fax form: Refer to the reply form at the end of this manual

Internet address

<http://www.siemens.com/motioncontrol>

Changes in 04/2004 Edition

The 04/2004 Edition reflects changes to the previous version (02/2003 Edition) as follows:

Cons. No.	Change
1.	SIMATIC <ul style="list-style-type: none"> • Boundary conditions for: <ul style="list-style-type: none"> - SIMATIC Technology CPU

Changes in 04/2004 Edition

Cons. No.	Change
1.	General <ul style="list-style-type: none"> • Boundary conditions for: <ul style="list-style-type: none"> - Controlled axes (axes without encoders) - External encoder interface (encoders without an axis) - on-the-fly measurement • Parameter assignment <ul style="list-style-type: none"> - Minimum DP cycle of 1 ms
2.	SIMOTION <ul style="list-style-type: none"> • Requirements • Boundary conditions for: <ul style="list-style-type: none"> - Homing using external zero mark
3.	SIMATIC <ul style="list-style-type: none"> • Requirements

Changes in 05/2005 Edition

Cons. No.	Change
1.	General <ul style="list-style-type: none"> • Error codes in additional encoder actual value Gx_XIST2 • Spindles with low-resolution encoder • Corrections <ul style="list-style-type: none"> - Shutdown ramp and parameter value 0 - Homing using ext. zero mark: "Without 611U conformant mode" • The function: "Parking axis" is now available. • In the case of open-loop controlled axes (axes without encoder), it is no longer necessary to parameterize an encoder in order for a setpoint to be output.
2.	SINUMERIK <ul style="list-style-type: none"> • Linear encoder with distance-coded zero marks/reference marks <ul style="list-style-type: none"> - Startup - Approved linear encoders • Voltage level with unipolar spindle/motor and M3, M4, M5. • Corrections <ul style="list-style-type: none"> - Homing using external zero mark not possible: "Without 611U conformant mode" possible - Homing using encoder zero mark and ref. cam possible
3.	SIMOTION <ul style="list-style-type: none"> • Corrections <ul style="list-style-type: none"> - Homing using external zero mark not possible: "Without 611U conformant mode" possible

Contents

1	General Information	1-9
1.1	Overview	1-9
1.1.1	Properties	1-9
1.1.2	Main features	1-9
1.1.3	Order number and firmware version	1-9
1.1.4	Supplementary Conditions	1-10
2	Hardware Description	2-11
2.1	Overview of connections	2-11
2.2	Interface description	2-12
2.2.1	Interface overview	2-12
2.2.2	Interface (X1): external power supply	2-12
2.2.3	Interface (X2): PROFIBUS DP	2-13
2.2.4	Interface (S2): PROFIBUS address	2-13
2.2.5	Interface (X3): Analog setpoint interface	2-15
2.2.6	Interfaces(X4-1/X4-2/X5-1/X5-2): encoder interfaces	2-16
2.2.7	Interface (X6-1): Digital outputs	2-20
2.2.8	Interface (X6-2): Digital inputs	2-23
2.2.9	Interface (H1/H2): Module status	2-25
2.3	Control cabinet installation	2-26
2.4	Power supply	2-26
2.5	Grounding	2-28
2.6	Overview of connections	2-29
2.7	Dimension drawing	2-30
2.8	Technical data	2-31
3	Parameter Assignment	3-33
3.1	Requirements (SINUMERIK 802D)	3-33
3.2	Requirements (SINUMERIK 840Di)	3-33
3.3	Requirements (SIMOTION)	3-34
3.4	Requirements (SIMATIC Technology CPU)	3-34
3.5	PROFIBUS DP parameter assignment	3-35
3.5.1	Parameter assignment sequence	3-35
3.5.2	Inserting an ADI4 DP slave in the configuration	3-35
3.6	PROFIBUS parameters (SINUMERIK 802D)	3-37
3.7	PROFIBUS parameters (SINUMERIK 840Di), (SIMOTION) and (SIMATIC Technology CPU)	3-37
3.7.1	PROFIBUS address	3-37

3.7.2	Message frame type	3-39
3.7.3	I/O addresses	3-42
3.7.4	Consistency	3-43
3.8	Function parameters (SINUMERIK 802D)	3-43
3.9	Function parameters (SINUMERIK 840Di), (SIMOTION), and (SIMATIC Technology CPU)	3-44
3.9.1	Encoder type	3-45
3.9.2	Unipolar spindle (or unipolar motor)	3-46
3.9.3	Shutdown ramp	3-47
3.9.4	Shutdown delay time	3-47
3.9.5	Tolerable sign-of-life failures	3-47
3.9.6	Reserved bits for fine resolution	3-48
3.9.7	611U conformant mode	3-49
3.9.8	Homing using encoder zero mark	3-51
3.9.9	Homing using external zero mark	3-52
3.9.10	Homing using encoder zero mark and reference cam (SIMOTION)	3-53
3.9.11	Supplementary Conditions	3-54
3.9.12	Boundary conditions (SIMOTION)	3-54
3.9.13	Boundary conditions (SIMATIC Technology CPU)	3-54
3.10	Assigning parameters for DP communication	3-56
3.10.1	Activation of the equidistant DP cycle	3-56
3.10.2	Equidistant master cyclic component TDX	3-58
3.10.3	Equidistant DP cycle TDP	3-59
3.10.4	DP cycle TDP	3-60
3.10.5	Master application cycle TMAPC	3-60
3.10.6	Actual value acquisition Ti	3-63
3.10.7	Setpoint transfer To	3-63
3.10.8	Alignment	3-64
3.10.9	Supplementary Conditions	3-65
4	Startup	4-69
4.1	Controller startup	4-69
4.1.1	Linear encoder with distance-coded zero marks/reference marks (SINUMERIK 840Di)	4-69
5	Supplementary Conditions	5-73
	Index	Index-75

General Information

1.1 Overview

1.1.1 Properties

An ADI4 module (Analog Drive Interface for 4 Axis) is an interface module suitable for running up to four drives with an analog setpoint interface on the equidistant PROFIBUS DP.

Communication between the controller and the ADI4 is performed via an ADI4-specific message frame type which, in addition to digital input/output data, also contains a message frame type (standard message frame 3) for each drive specified according to a PROFIDrive profile. As part of cyclic DP communication, the actual drive values (encoder values) are transferred from the ADI4 module to the controller via PROFIBUS DP, and the speed setpoints calculated by the controller are transferred to the ADI4 module.

The transferred speed setpoints are then output from the ADI4 module to the drives as analog values.

1.1.2 Main features

The module has the following important features:

- PROFIBUS DP connection (max. 12 Mbps)
- 4 servo interfaces
 - Inputs: TTL/SSI encoders for incremental and absolute measuring systems
 - Outputs: ± 10 V analog
- General and drive-specific digital input/output signals
- Onboard status display by means of 4 diagnostic LEDs

To supply the module and digital outputs with power, an external voltage source (+24 V DC) is needed.

1.1.3 Order number and firmware version

Order number

Order number (MLFB): 6FC5 211 -0BA01 -0AA2

Firmware version

The firmware version is not displayed directly on the module. The order number and firmware version correlate as follows:

Order number	Firmware version
6FC5 211-0BA01-0AA0	1.1.4
6FC5 211-0BA01-0AA1	1.2.2
6FC5 211-0BA01-0AA2	1.3.1

1.1.4 Supplementary Conditions

The following boundary conditions must be taken into account for the module:

- An ADI4 DP slave can only be operated on an **equidistant** PROFIBUS DP (see Chapter 2, Page 2-11).
- An ADI4 DP slave is **not** a certified DP standard slave according to the PROFIBUS Drive profile. For example, the ADI4 DP slave does not allow acyclic communication.

Hardware Description

2.1 Overview of connections

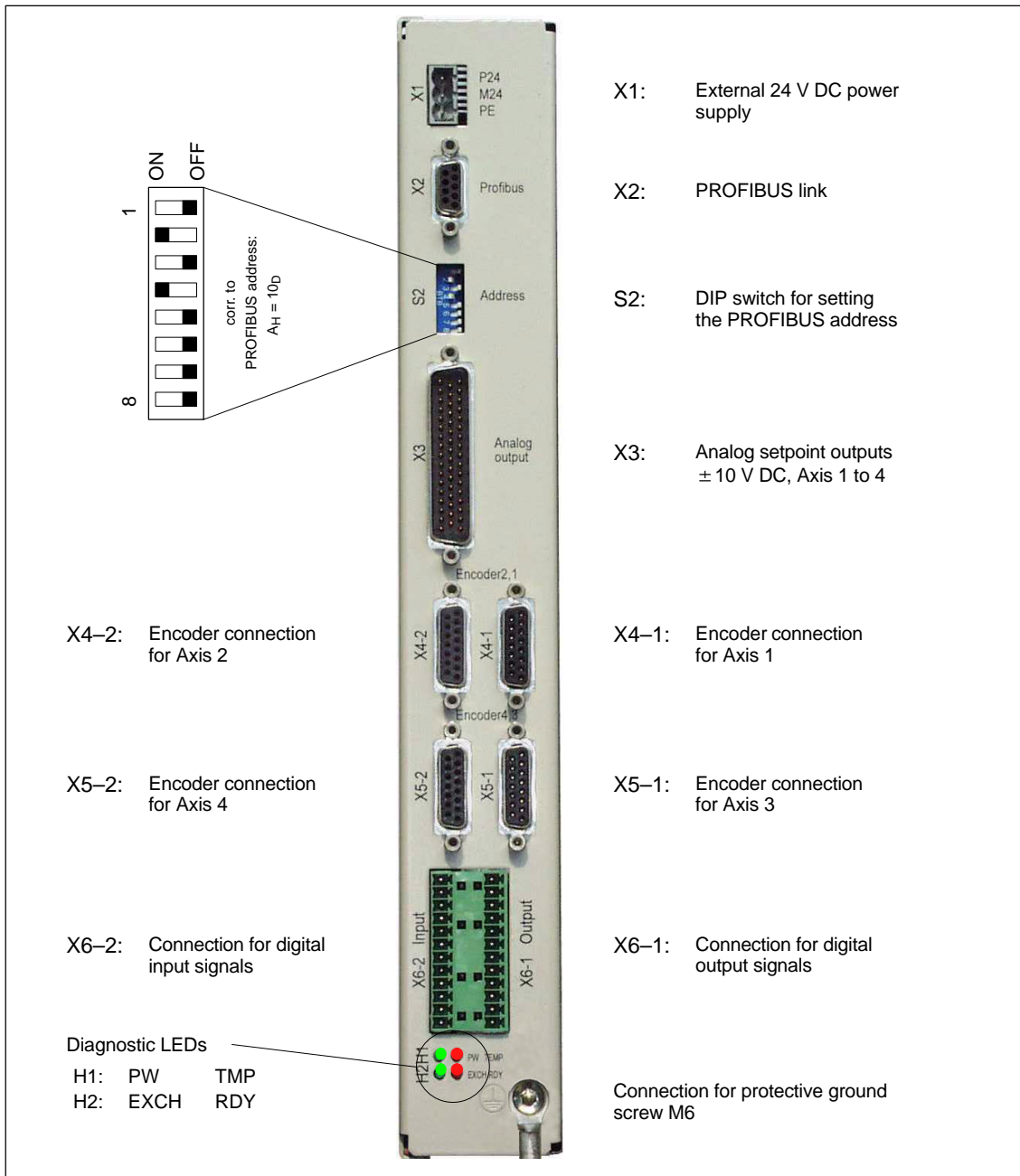

Fig. 2-1 Connection overview for ADI4

2.2 Interface description

2.2.1 Interface overview

The module has the following interfaces:

Table 2-1 Interface overview: ADI4

Interface	Name	Type
External +24 V power supply	X1	connector
PROFIBUS DP	X2	Socket
PROFIBUS DP address	S2	DIP switch
Analog setpoint interface	X3	connector
Encoder connection for Axis 1	X4-1	Socket
Encoder connection for Axis 2	X4-2	Socket
Encoder connection for Axis 3	X5-1	Socket
Encoder connection for Axis 4	X5-2	Socket
Digital outputs	X6-1	connector
Digital inputs	X6-2	connector
module status	H1/H2	LEDs

2.2.2 Interface (X1): external power supply

Connection

3-pin connector MSTB 2.5/3-ST-5.08 by Phoenix

Pin assignment

Table 2-2 Pin assignment: Ext. power supply (X1)

Pin	Name	Type ¹⁾	Function
1	P24EXT1	VI	External supply for module (+24 V)
2	M24EXT1	VI	Reference for external supply
3	PE	VI	Protective conductor of the external supply
1) VI Voltage input			

Connecting cables

The required connecting cables must be provided by the user:

Wire, conductor cross section: 1.0 to 1.5 mm² (AWG17 – AWG16)

Supply voltage

Specifications for the supply voltage are provided in Section 2.4 (Page 2-26).

2.2.3 Interface (X2): PROFIBUS DP

Connection

9-pin SUB D socket

Pin assignment

Table 2-3 Pin assignment: PROFIBUS DP (X2)

Pin	Name	Type ¹⁾	Function
1	–	–	–
2	–	–	–
3	RxD/TxD–P	B	Receive/transmit data P (B line)
4	RTS	O	Request to send
5	DGND	VO	Data reference potential (M5V)
6	VP	VO	Supply voltage plus (P5V)
7	–	–	–
8	RxD/TxD–N	B	Receive/transmit data N (A line)
9	–	–	–
1) VO Voltage Output O Output B Bidirectional			

Connector

- 6ES7 972-0BA41-0XA0; Outgoing cable 35⁰, without programming device socket
- 6ES7 972-0BB41-0XA0; Outgoing cable 35⁰, with programming device socket
- 6ES7 972-0BA12-0XA0; Outgoing cable 90⁰, without programming device socket
- 6ES7 972-0BB12-0XA0; Outgoing cable 90⁰, with programming device socket

Cable

- 6XV1 830-0EH10; By the meter; without trailing capability
- 6XV1 830-3EH10; By the meter; with trailing capability

Additional technical specifications

Maximum possible data rate: 12 Mbps

2.2.4 Interface (S2): PROFIBUS address

The PROFIBUS address of the ADI4 DP slave is set via switch S2.

- Adjustable PROFIBUS address: 1...127

Table 2-4 Meaning of switch S2

Switch	Meaning
1	PROFIBUS address: $2^0 = 1$
2	PROFIBUS address: $2^1 = 2$
3	PROFIBUS address: $2^2 = 4$
4	PROFIBUS address: $2^3 = 8$
5	PROFIBUS address: $2^4 = 16$
6	PROFIBUS address: $2^5 = 32$
7	PROFIBUS address: $2^6 = 64$
8	Not used

Notice

A new PROFIBUS address setting does not take effect until a power OFF/ON.

2.2.5 Interface (X3): Analog setpoint interface

Connection

50-pin SUB D connector

Pin assignment

Table 2-5 Pin assignment: Analog setpoint interface (X3)

Pin	Name	Type ¹⁾	Function
1	SW1	VO	Setpoint of Axis 1 (± 10 V; max 10 mA)
2	BS2	VO	Reference for setpoint of Axis 2
3	SW3	VO	Setpoint of Axis 3 (± 10 V; max 10 mA)
4	BS4	VO	Reference for setpoint of Axis 4
5–13	–	–	–
14	RF1_1	K ²⁾	“Drive enable” of Axis 1, Relay Contact 1
15	RF2_1	K ²⁾	“Drive enable” of Axis 2, Relay Contact 1
16	RF3_1	K ²⁾	“Drive enable” of Axis 3, Relay Contact 1
17	RF4_1	K ²⁾	“Drive enable” of Axis 4, Relay Contact 1
18–33	–	–	–
34	BS1	VO	Reference for setpoint of Axis 1
35	SW2	VO	Setpoint of Axis 2 (± 10 V; max 10 mA)
36	BS3	VO	Reference for setpoint of Axis 3
37	SW4	VO	Setpoint of Axis 4 (± 10 V; max 10 mA)
38–46	–	–	–
47	RF1_2	K ²⁾	“Drive enable” of Axis 1, Relay Contact 2
48	RF2_2	K ²⁾	“Drive enable” of Axis 2, Relay Contact 2
49	RF3_2	K ²⁾	“Drive enable” of Axis 3, Relay Contact 2
50	RF4_2	K ²⁾	“Drive enable” of Axis 4, Relay Contact 2

- 1) VO Voltage output
K Relay contact
- 2) Max. current carrying capacity: 2 A at 150 VDC or 125 VAC
Max. number of operating cycles:
– 24 VDC, 1 A: 10^7
– 24 VDC, 2 A: 10^5

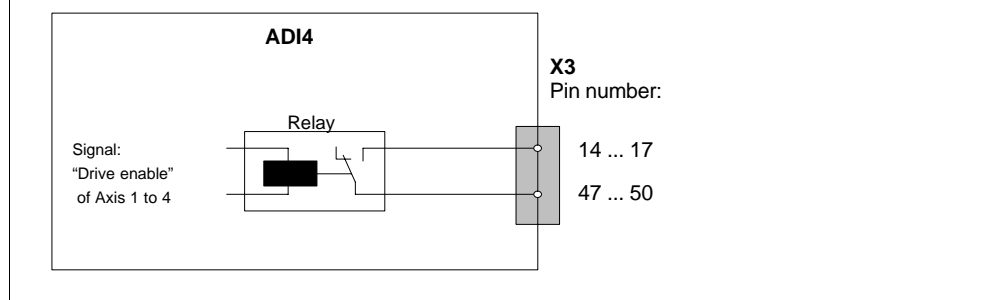

Preassembled cables

Order No. (MLFB): 6FX2 002-3AD01-

Cable length: 35 m

Information regarding the length codes is provided in:

References: /Z/ Catalog NC Z.

2.2.6 Interfaces(X4–1/X4–2/X5–1/X5–2): encoder interfaces

Connection

15-pin SUB D socket

Pin assignment

Table 2-6 Pin assignment: Encoder interface of Axis 1 to 4 (X4–1/X4–2/X5–1/X5–2) for incremental encoder (TTL) and absolute encoder (SSI)

Pin	Designation ¹⁾		Type ²⁾	Function
	Incremental	Absolute (SSI)		
1	Do not use		–	–
2	–	CLSx	O	SSI shift clock
3	–	CLSx_N	O	SSI shift clock inverted
4	P5MS		VO	5 V DC supply voltage
5	P24SSI		VO	24 V DC supply voltage
6	P5MS		VO	5 V DC supply voltage
7	MEXT		VO	Reference for supply voltage
8	Do not use		–	–
9	MEXT		VO	Reference for supply voltage
10	Rx_S	–	I	Zero mark signal (U _{a0})
11	XR _x _S	–	I	Zero mark signal inverted ($\overline{U_{a0}}$)
12	XB _x _S	–	I	Encoder signal Track B inverted ($\overline{U_{a2}}$)
13	B _x _S	–	I	Encoder signal Track B (U _{a2})
14	XAx_S	–	I	Encoder signal Track A inverted ($\overline{U_{a1}}$)
	–	DATA _x _N	I	SSI data inverse
15	A _x _S	–	I	Encoder signal Track A (U _{a1})
	–	DATA _x	I	SSI data

1) x Number of encoder interface with X4–1=1, X4–2=2, X5–1=3, X5–2=4
2) VO Voltage output
I Signal input
O Signal output

Preassembled cables

The following preassembled cables can be used, depending on the encoder type:

- **Incremental encoder (TTL) with RS422 (5 V or 24 V) 6FX2 001-2...**

Order number (MLFB): 6FX8 002-2CD01-1 0 (5 V)

Order number (MLFB): 6FX5 002-2CD24-1 0 (24 V)

Cable length: See "Maximum cable lengths" below.

- **Absolute encoder with SSI 6FX2 001-5...**

Order number (MLFB): 6FX8 002-2CC11- 0

Cable length: See "Maximum cable lengths" below.

- **1FT5 motor with installed ROD320 encoder**

Order number (MLFB): 6FX8 002-2CE02-1 0

Cable length: See "Maximum cable lengths" below.

Information regarding the length codes is provided in:

References: /Z/ Catalog NC Z.

Maximum cable lengths

The maximum cable length depends on the following two parameters:

- **Encoder supply voltage**

Table 2-7 Encoder supply voltage

Supply voltage: 5 V DC		
Tolerance	Current input	Max. cable length
4.75 V to 5.25 V	300 mA	25 m
4.75 V to 5.25 V	220 mA	35 m
Supply voltage: 24 V DC		
Tolerance	Current input	Max. cable length
20.4 V to 28.8 V	300 mA	100 m
11 V to 30 V	300 mA	300 m

- **Transmission frequency**

Table 2-8 Transmission frequency

Encoder type	Supply voltage	Frequency	Max. cable length
Incremental (TTL)	5 V	1 MHz	10 m
		500 kHz	35 m
	24 V	500 kHz	150 m
Absolute (SSI)	24 V	1.5 Mbps	10 m
		187.5 kbps	250 m

Note

If cable lengths longer than 25 m or 35 m are needed for incremental encoders, encoder types with a 24 VDC supply voltage can be used instead.

Caution

To ensure error-free transmission of encoder data, do not exceed the maximum cable lengths shown in these tables.

Encoder supply voltage

The encoder supply voltages must comply with the following specification:

Table 2-9 Specification of encoder supply voltages

	Supply voltage ¹⁾	
	P5MS	P24SSI
Voltage		
Minimum	4.75 V	20.4 V
Nominal	5 V	24 V
Maximum	5.25 V	28.8 V
Ripple		
Maximum	50 mVpp	3.6 Vpp
Current load		
Per encoder connection	0.3 A	
Maximum	1.35 A	1 A
1) P5MS: Supply voltage for encoder (+5 VDC) P24SSI: Supply voltage for encoder (+24 VDC)		

Connectable measuring systems

- **Incremental encoders (TTL)**
 - Differential transmission with RS422 (5 V or 24 V):
 Track A as true and inverted signal (U_{a1} , $\overline{U_{a1}}$)
 Track B as true and inverted signal (U_{a2} , $\overline{U_{a2}}$)
 Zero signal N as true and inverted signal (U_{a0} , $\overline{U_{a0}}$)
 - Maximum output frequency: 1.5 MHz
 - Phase shift of Track A to Track B: 90° ± 30°
 - Current consumption: Max. 300 mA
 - Encoders with distance-coded zero marks/reference marks are not generally enabled.

- **Absolute encoders (SSI)**

- Transmission procedure: Synchronous serial interface (SSI) with 5 V differential signal transmission (RS422 standard):
 - Output signal: Data as true and inverted signal
 - Input signal: Shift clock as true and inverted signal
- Output format for rotary encoder: "Tree"
- Resolution: Max. 25 bits
- Maximum transmission frequency: 1 Mbps
- Current consumption: Max. 300 mA

Notice

In conjunction with ADI4, synchronous serial data transmission for absolute encoders (SSI) must be operated in "fir tree" (TSSI) output format can be operated.

(SINUMERIK 802D)

- **Absolute encoder (SSI)**

The use of absolute encoders (SSI) is not approved.

(SINUMERIK 840Di)

- **Absolute encoder (SSI)**

- The use of single turn absolute encoders (SSI) is not- approved.
- The use of multiturn absolute encoders (SSI) is approved.

- **Linear encoder with distance-coded zero marks/reference marks**

The following linear encoders with distance-coded zero marks/reference marks have been approved for ADI4:

- Heidenhain: LS 476 C
- Heidenhain: LS 186 C,
in conjunction with external pulse-shaper electronics (EXE): e.g., IBV 610

Note

Encoders with SINE/COSINE signals (1 Vpp) can be connected using external pulse-shaper electronics (EXE), which convert the signals to the 5 V TTL level.

2.2.7 Interface (X6-1): Digital outputs

Connection

Two 12-pin connectors FK-MCP 1.5/15-ST-3.81 by Phoenix (X6-1 and X6-2).

Pin assignment

Table 2-10 Pin assignment: digital output interface (X6-1)

Pin	Name	Type ¹⁾	Function
1	P24EXT2	VI	ext. 24 V DC supply voltage
2	Q0	DO	Digital output signal 1
3	Q1	DO	Digital output signal 2
4	Q2	DO	Digital output signal 3
5	Q3	DO	Digital output signal 4
6	DIR1	DO	Digital output signal 5 or directional signal of Axis 1 ³⁾
7	DIR2	DO	Digital output signal 6 or directional signal of Axis 2 ³⁾
8	DIR3	DO	Digital output signal 7 or directional signal of Axis 3 ³⁾
9	DIR4	DO	Digital output signal 8 or directional signal of Axis 4 ³⁾
10	RDY1	K ²⁾	"Ready" signal of Relay Contact 1
11	RDY2	K ²⁾	"Ready" signal of Relay Contact 2
12	MEXT2	VI	Reference of the external supply voltage

- 1) VI Voltage input
DO Digital output (24 V)
K Relay contact
- 2) Max. current carrying capacity: 2 A
for 150 VDC or 125 VAC;
Max. number of operating cycles:
– 24 VDC, 1 A: 10⁷
– 24 VDC, 2 A: 10⁵
- 3) For "unipolar spindle" function j
(or unipolar motor)

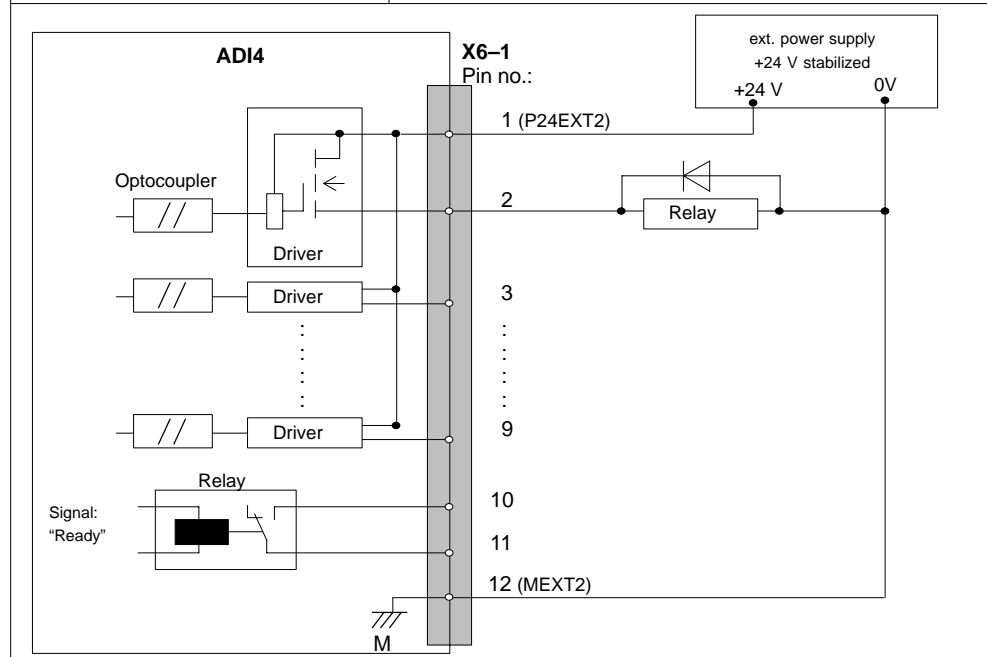
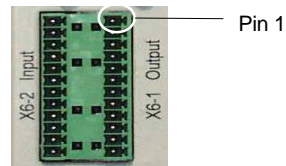

(SINUMERIK 802D)

The signals from pins 2 to 9 are not available on an ADI4 module connected to SINUMERIK 802D.

Supply voltage

To supply the digital outputs with power, an external 24 VDC voltage source must be connected to X6–1, Pin 1 (P24EXT2).

The reference ground of the external voltage source must be connected with X6–1, Pin 15 (MEXT2).

For further information, see Section 2.8 (Page 2-31).

Electrical specification

Table 2-11 Electrical specification for digital outputs

Digital outputs	Minimum	Standard	Maximum	Nominal
Voltage at high signal level (U_H)	$V_{CC} - 3\text{ V}$	1)	V_{CC}	24 V
Output current I_{OUT}	–	–	500 mA	–
Voltage at low signal level (U_L)	–	–	–	0 V
Leakage current at low signal level	–	50 μA	400 μA	–
Signal delay T_{PHL} , T_{PLH} 2)	–	0.5 ms	–	–
<ul style="list-style-type: none"> • Supply voltage for dig. outputs <ul style="list-style-type: none"> 1) Typical output voltage: $V_{CC} - I_{OUT} \cdot R_{ON} - 0.65\text{ V}$ V_{CC}: Current operating voltage P24EXT2 Max. output current I_{OUT}: 500 mA Max. short-circuit current: 4 A (max. 100μs, $V_{CC}= 24\text{ V}$) Internal resistance R_{ON}: 0.4Ω • 2) The PROFIBUS communication time and the application cycle time must also be taken into account. • A polarity reversal does not cause a high-signal level nor does it destroy the outputs. 				

General electrical properties

- Galvanic isolation using optocouplers
- Current limitation to a maximum of 500 mA
- Protection from: short circuit, overtemperature, and loss of ground
- Automatic disconnection in case of undervoltage

Relay contact: “Ready” signal

The relay contact remains/is open/opened if the module is in one of the following states:

- Initialization of the module after Power ON
- Power failure or hardware interrupt (NMI)
- No cyclic communication to the DP master
- PLL error
- Synchronization error
- Overtemperature

The relay contact is closed if both conditions are present:

- Module status “Ready”
- Cyclic communication with the DP master

Connecting cables

The required connecting cables must be provided by the user:

- Supply voltage X6–1, Pin 1 and 12 (P24EXT2):
Wire, conductor cross section of 1.5 mm² (AWG16)
- Digital outputs X6–1, Pins 2 to 9:
Wire, conductor cross section 0.5 to 1.5 mm² (AWG20 – AWG16)
- Ready X6–2, Pins 10 and 11:
Wire, conductor cross section of 1.5 to 3.5 mm² (AWG16 – AWG12)

Notice

The maximum length of the digital signal cables is 30 m.

2.2.8 Interface (X6–2): Digital inputs

Connection

Two 12-pin connectors FK–MCP 1.5/15–ST–3.81 by Phoenix (X6–1 and X6–2).

Pin assignment

Table 2-12 Pin assignment: digital input interface (X6–2)

Pin	Name	Type ¹⁾	Function
1	P24OUT	VI	24 V DC supply voltage
2	BERO1	DI	Input signal of BERO/external zero mark 1
3	BERO2	DI	Input signal of BERO/external zero mark 2
4	BERO3	DI	Input signal of BERO/external zero mark 3
5	BERO4	DI	Input signal of BERO/external zero mark 4
6	MEPU1	DI	Measuring signal of Measuring Input 1 (see Measuring Inputs , Page 2-25)
7	MEPU2	DI	Measuring signal of Measuring Input 2 (see Measuring Inputs , Page 2-25)
8	DRV1_RDY	DI	“Drive Ready” signal of Axis 1
9	DRV2_RDY	DI	“Drive Ready” signal of Axis 2
10	DRV3_RDY	DI	“Drive Ready” signal of Axis 3
11	DRV4_RDY	DI	“Drive Ready” signal of Axis 4
12	MOUT	VI	Reference of the supply voltage

1) VI Voltage input
DI Digital input (24 V)

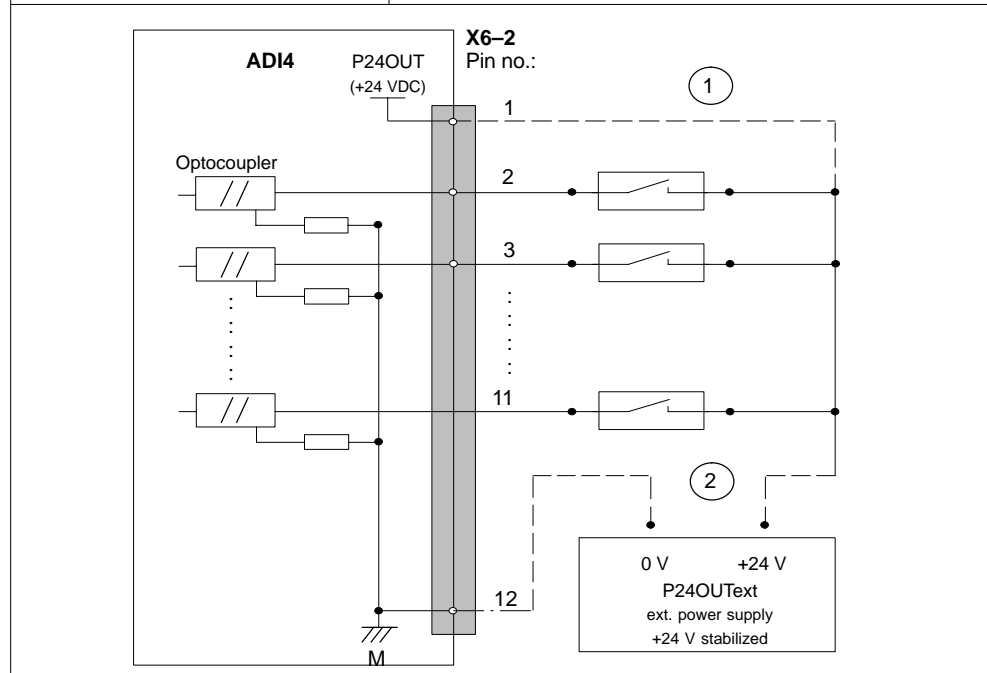
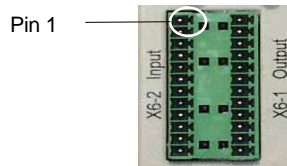

- ① Connection if the internal supply voltage P24OUT is used;
the connection in accordance with ② is no longer required.
- ② Connection if an external supply voltage P24OUText is used;
the connection in accordance with ① is no longer required.

(SINUMERIK 802D)

The signal from pin 7 is not available on an ADI4 module in combination with SINUMERIK 802D.

Internal supply voltage P24OUT

Specification of the internal supply voltage P24OUT available at X6–2, pin 1 for the digital inputs:

Table 2-13 Specification of the supply voltage P24OUT

Voltage	
Minimum	20.4 V
Nominal	24 V
Maximum	28.8 V
Ripple	
Maximum	3.6 Vpp
Current load	
Typical	0.1 A
Maximum	1 A
Power consumption	
Typical	3.02 W
Maximum	30.2 W
Insulation Class	
A, in accordance with DIN 57110b	
<ul style="list-style-type: none"> • Typical output voltage: $V_{CC} - I_{OUT} \cdot R_{ON} - 0.65 \text{ V}$ V_{CC}: Current P24OUT operating voltage Max. output current I_{OUT}: 1 A Internal resistance R_{ON}: 0.4 Ω • The supply voltage P24OUT is short-circuit proof. 	

External supply voltage P24OUText

If an external supply voltage is used, its reference ground must be connected to X6–2, Pin 12 (M).

X6–2, Pin 1 (P24OUT) then remains open.

Electrical specification

Table 2-14 Electrical specification for digital inputs

Digital inputs	Minimum	Standard	Maximum	Nominal
Voltage at high signal level (U_H)	15 V	1)	30 V	24 V
Input current I_{IN} at U_H	3.7 mA	–	7.5 mA	–
Voltage at low signal level (U_L)	–30 V	–	+5 V	0 V
Signal delay T_{PHL} , T_{PLH} 2)	–	3 μ s	–	–
<ul style="list-style-type: none"> • 1) see Table 2-13 (Page 2-24) • 2) The PROFIBUS communication time and the application cycle time must also be taken into account. • A polarity reversal does not cause a high signal level, nor does it destroy the inputs. 				

Connecting cables

The required connecting cables must be provided by the user:

- Supply voltage X6–2, Pin 1 (P24OUT), external supply voltage P24OUText: Wire, conductor cross section of 1.5 mm² (AWG16)
- Digital outputs X6–2, Pins 2 to –11: Wire, conductor cross section 0.5 to 1.5 mm² (AWG20 – AWG16)

General electrical properties

- Galvanic isolation using optocouplers
- Active current limitation of inputs
- Protection from negative input voltage

Measuring Input

ADI4 supports measurement of a rising or falling edge of the measuring input. A simultaneous request for measurement of a rising edge and a falling edge of the measuring input cannot be parameterized.

2.2.9 Interface (H1/H2): Module status

The module status is displayed on the front of the module via four diagnostic LEDs.

Table 2-15 Diagnostic LEDs (H1/H2)

	Name	Color	Description
H1	POWER	Green	Supply voltage
	OVTEMP	Red	Overtemperature indication
H2	EXCHANGE	Green	Cyclic data exchange with DP master in progress
	READY	Red	Ready for cyclic data exchange with DP master

2.3 Control cabinet installation

Installation/Mounting

For high frequency interference currents, the housing of the ADI4 module must be connected with low-resistance to the back wall of the control cabinet, and this wall in turn must be connected with low-resistance to the motors/machine. Ideally, the module should be installed on a bare mounting wall. The connection between the mounting wall and the motors/machine must be electrically conductive and have a large surface area. Coated cabinet walls and DIN rails, or similar mounting means with a small contact area, do not meet this requirement.

Cable routing

Power and signal cables must always be routed separately. All I/O interface (X6-1/X6-2) signal lines should exit jointly. Single strands that are related from the signal point of view must be twisted together. Ideally, signal cables and encoder cables should be installed separately.

All cables and lines within the control cabinet should always be placed as close as possible to the control cabinet walls. Extended installation through open space can cause interference injections (antenna effect). The proximity to sources of interference (contactors, transformers, etc.) must be avoided by placing a shield plate between the cable and the source of interference, if necessary. Cable and wire extensions through terminals, etc., must be avoided. To protect against interference injections from external sources, signal cables must be shielded.



Warning

The module has been designed for operation in an enclosed control cabinet. Operation outside an enclosed control cabinet is not permissible.

2.4 Power supply

ADI4 module

To supply the ADI4 module (+24 V DC), an external power source is needed. The power supply is connected through terminal X1 (P24EXT1) on the front panel of the ADI4 module. See Section 2.2 (Page 2-12).

Digital outputs

To supply (+24 VDC) the digital outputs, an external power source is needed. The power supply is connected through Terminal X6–1, Pin 1 (P24EXT2). See Section 2.2 (Page 2-12).

Digital inputs

If the digital inputs are not supplied with the internal supply voltage of X6–2, Pin 1 (P24OUT), this supply voltage can optionally be replaced with an external power source (+24 VDC, 1 A maximum).

The reference ground (GND) of the external power supply source must be connected with X6–2, Pin 12. X6–2, Pin 1 (P24OUT) remains open.

Specification of the supply voltages (+24 VDC)

The external supply voltages for the ADI4 module, the digital outputs and, optionally, the digital inputs must adhere to the specifications provided in Table 2-7.

Table 2-16 Specification of the external supply voltages

	Supply voltage ¹⁾		
	P24EXT1	P24EXT2	P24OUText
Voltage			
Minimum	18.5 V		
Nominal	24 V		
Maximum	30.2 V		
Ripple			
Maximum	3.6 Vpp		
Current load			
Typical	0.5A	–	0.1A
Maximum	1A	8A	1A
Power consumption			
Typical	12 W	–	3.02 W
Maximum	30.2 W	241.6 W	30.2 W
1) P24EXT1: Supply voltage of ADI4 module P24EXT2: Supply voltage for digital outputs P24OUText: Optional supply voltage for digital inputs			

Caution

The external supply voltages must each be generated as functional extra-low voltages with safe electrical isolation (DIN EN 60204–1, Section 6.4, PELV).

On the module side, supply voltages P24EXT1 and P24EXT2 must be protected against the following:

- Overvoltage
- Short circuit (electrical current limitation of outputs)
- Polarity reversal
- Overload
 - P24EXT1: Fuse 2.5 A/250 V
 - P24EXT2: Fuse 8 A/125 V

2.5 Grounding

The module must be installed according to EN 60204.

The user must ground each of the supply voltages. To do this, a connection must be established from Terminal X1, Pin 2 (MEXT1) or X6–1, Pin 15 (MEXT2) to a central grounding point of the system.

If a large-area, permanent metallic connection with the central grounding point is not possible using the rear panel, the module must be connected to the grounding rail by means of a wire (cross section $>10 \text{ mm}^2$).



Caution

A protective conductor must be connected. An M6 screw is provided on the lower right of the front of the housing to connect the protective conductor. See Section 2.1 (Page 2-11).

2.6 Overview of connections

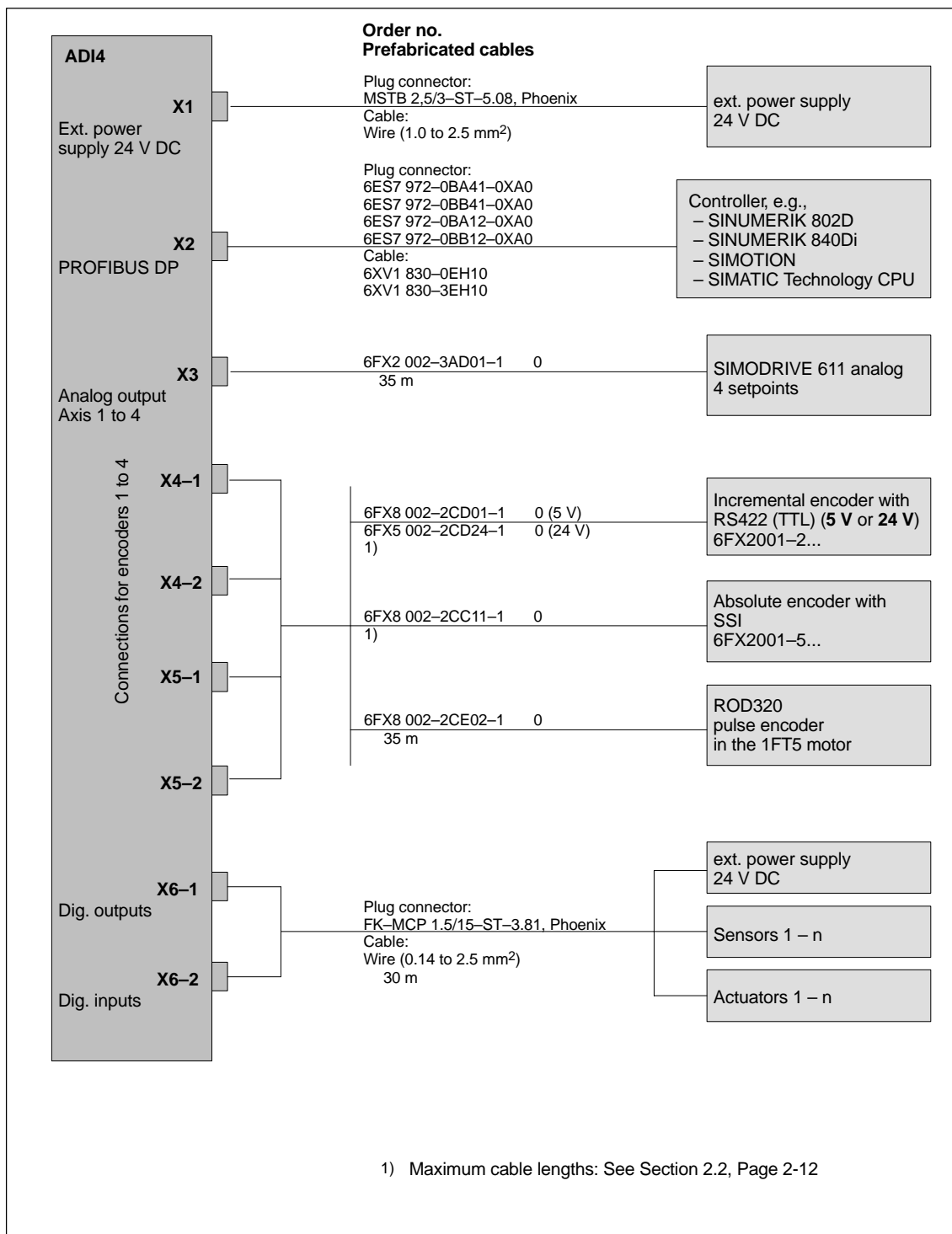

Fig. 2-2 ADI4 connection overview

2.7 Dimension drawing

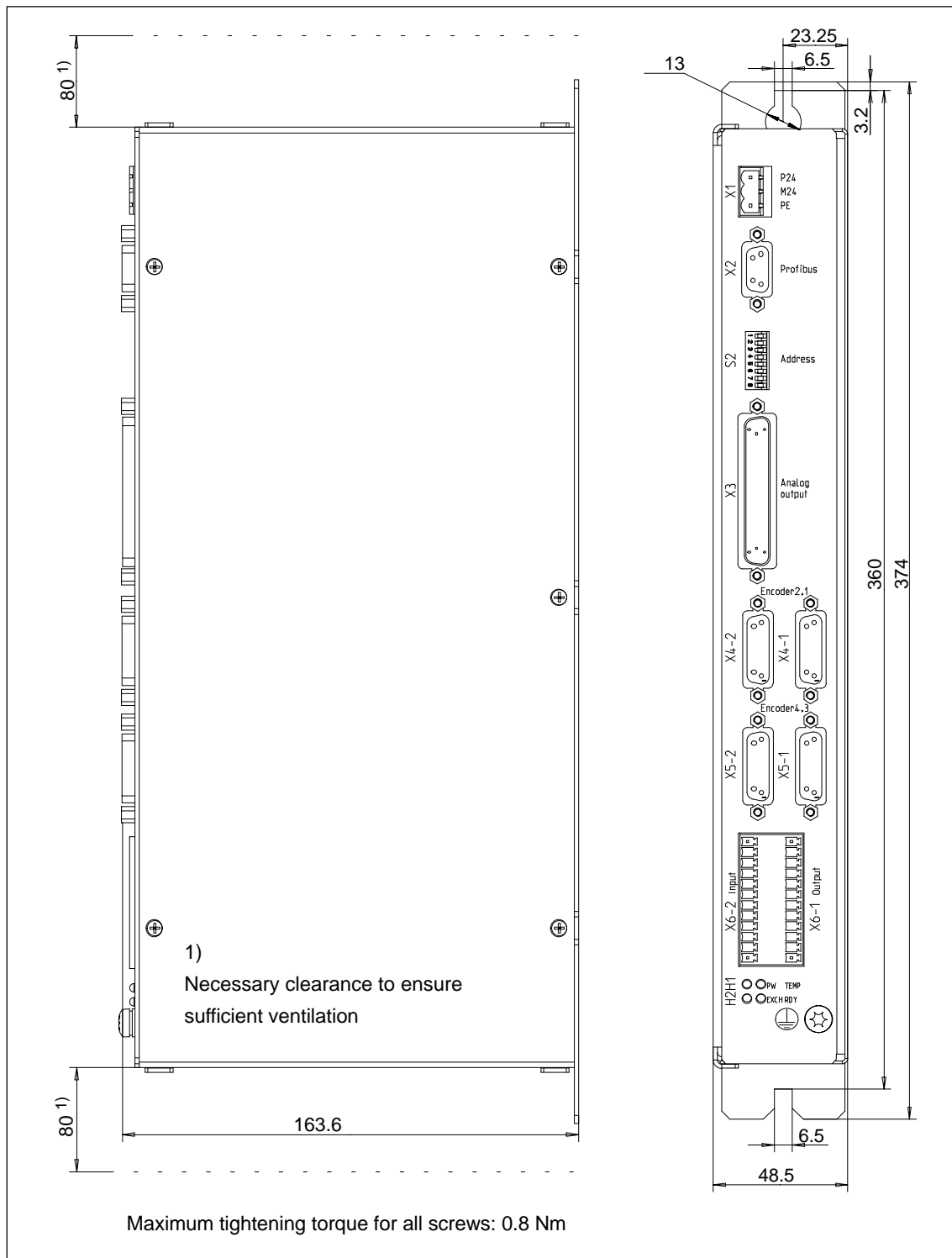

Fig. 2-3 Dimension drawing: ADI4

2.8 Technical data

Table 2-17 Technical data of the ADI4 module

Security		
Degree of protection	IP20	
Protection class	Protection class I, according to VDE 0106 T1: 1982 (IEC 536) Protection against ingress of foreign bodies and water in accordance with IEC 529	
Approvals	CE/CSA, CE	
Power consumption		
Nominal load	12 W	
Maximum	30.2 W	
Mechanical specifications		
Dimensions WxHxD [mm]	154.4 x 325 x 48.5	
Weight	approx. 1.5 kg	
Ambient environmental conditions		
Heat dissipation	Open-circuit-ventilated	
	Operation	Storage/transport
Temperature limits	0 ... 55 °C	-20 ... 55 °C/-40 ... 70 °C
Limits for relative humidity	5 ... 95 % without condensation	5 ... 95 % without condensation
	Per minute	Per hour
Condensation	Not permissible	
Air pressure	700 ... 1060 hPa	700 ... 1060 hPa
Transportation altitude	-	-1000 ... 3,000 m
Shock stress during transportation		
Free fall in transport packaging	1,000 mm	

Parameter Assignment

Notice

The following boundary conditions must be taken into account for the operation of an ADI4 DP slave on the PROFIBUS DP:

- An ADI4 DP slave is not a certified DP standard slave as defined by the PROFIDrive profile. For example, an ADI4 DP slave does not enable acyclic communication. Therefore, an ADI4 DP slave can only be operated on a DP master specially released for this purpose.
 - An ADI4 DP slave can only be operated on an equidistant PROFIBUS DP. The minimum DP cycle is 1 ms.
-

3.1 Requirements (SINUMERIK 802D)

The following components are required for assigning parameters for an ADI4 DP slave:

- SINUMERIK 802D system software: Version 02.01.05 and higher

Various preconfigured bus configurations (SDBs) are available in the SINUMERIK 802D Toolbox for assigning parameters for SINUMERIK 802D.

Once the appropriate bus configuration is enabled using machine data element:

- MD 11240: PROFIBUS_SDB_NUMBER

the parameter assignment for the ADI4 DP slave is completed.

3.2 Requirements (SINUMERIK 840Di)

The following components are required for assigning parameters for the NC (drive) or the corresponding ADI4 DP slave:

- References: /HBI/ SINUMERIK 840Di Manual
- SIMATIC STEP 7, Version 5, Service Pack 2 and higher
- SlaveOM (Slave Object Manager) for SINUMERIK 840Di, Version 5.1.1 and higher **or** Drive ES Basic, Version 5.1 and higher

SlaveOM

The SlaveOM for SINUMERIK 840Di enables dialog-based parameter assignment for SIMODRIVE drives and the ADI4 module as part of configuring with SIMATIC STEP 7 HW Config.

The SlaveOM object manager for SINUMERIK 840Di is included in the SINUMERIK 840Di installation.

Drive ES Basic

Drive ES Basic supports dialog-based parameter assignment for SIMODRIVE drives and the ADI4 module. In addition, Drive ES Basic can be used for assigning parameter parameters for additional drive systems not relevant to SINUMERIK 840Di.

Drive ES Basis can be purchased separately.

Note

- If SlaveOM for SINUMERIK 840Di is installed later on a SIMATIC S7 system with Drive ES Basic, the functionality is reduced to that of the SlaveOM.
 - When using the SlaveOM for SINUMERIK 840Di in connection with other PLC CPUs, a consistency error is reported during the configuration compilation and no system data blocks are generated.
-

3.3 Requirements (SIMOTION)

The following components are required for assigning parameters for an ADI4 DP slave:

- ADI4: Order no. (MLFB) and higher: 6FC5 211-0BA01-0AA1
Firmware Version 01.02.02 and higher
- SIMATIC STEP 7 Version 5.1 and higher
- SIMOTION
 - SIMOTION P or C: SIMOTION V2.1 and higher (SCOUT and Runtime)
 - SIMOTION D: SIMOTION V3.1 and higher (SCOUT and Runtime)

3.4 Requirements (SIMATIC Technology CPU)

The following components are required for assigning parameters for an ADI4 DP slave:

- ADI4: (MLFB) 6FC5 211-0BA01-0AA1 and higher
Firmware Version 01.02.02 and higher
- CPU 317T 2DP (MLFB) 6ES7 317-6TJ10-0AB0, V2.1.0/V3.0.1 and higher
- SIMATIC STEP 7, Version 5.3, Service Pack 1 and higher
- S7 Technology, Version 2.0 and higher

3.5 PROFIBUS DP parameter assignment

3.5.1 Parameter assignment sequence

The PROFIBUS DP parameter assignment for the ADI4 DP slave can be basically divided into two steps:

1. In the first step, after inserting the ADI4 DP slave in the configuration, the following parameters are assigned on a slave-specific basis:
 - PROFIBUS parameters (see Section 3.6, Page 3-37)
 - Function parameters (see Section 3.9, Page 3-44)

Step 1 should be carried out first for **all** ADI4 DP slaves needed in the configuration.

2. In the second step, parameters are assigned for the equidistant cyclic DP communication (see Section 3.10, Page 3-56).

Step 2 can be performed **last** on **any** ADI4 DP slave. These settings can be transferred to all other ADI4 DP slaves by means of the adjustment function of the SlaveOM.

3.5.2 Inserting an ADI4 DP slave in the configuration

To insert an ADI4 DP slave in the configuration, open the hardware catalog using the **View > Catalog** menu command.

The ADI4 DP slave is located under:

- Profile: **Standard**
PROFIBUS-DP > SINUMERIK > ADI4

(SIMATIC Technology CPU)

If S7 Technology was installed for the Technology CPU, the ADI4 DP slave is located under:

- Profile: **SIMATIC Technology CPU**
PROFIBUS-DP(DRIVE) > Other FIELD DEVICES > SINUMERIK > ADI4

Using a drag-and-drop operation, select the ADI4 DP slave and move onto to the DP master system in the station window.

The DP master system is displayed in the station window with the following symbol:



Releasing the left mouse button inserts the ADI4 DP slave in the configuration.

Note

As you drag the DP slave, the cursor appears as a circle with a slash through it. When the cursor is positioned exactly over the DP master system, it changes to a plus sign, and the DP slave can be added to the configuration.

3.6 PROFIBUS parameters (SINUMERIK 802D)

The PROFIBUS parameters are permanently specified in the preset configuration and cannot be changed. The values of the PROFIBUS parameters are described in:

References

SINUMERIK 802D Toolbox > Readme: ADI4_SDB.PDF

3.7 PROFIBUS parameters (SINUMERIK 840Di), (SIMOTION) and (SIMATIC Technology CPU)

The PROFIBUS parameters are a result of the following:

- PROFIBUS address
- Number of axes and encoders (message frame type)
- I/O addresses

3.7.1 PROFIBUS address

Inserting the ADI4 DP slave in the configuration opens the dialog: "Properties - PROFIBUS Interface ADI4", Tab: Parameter:

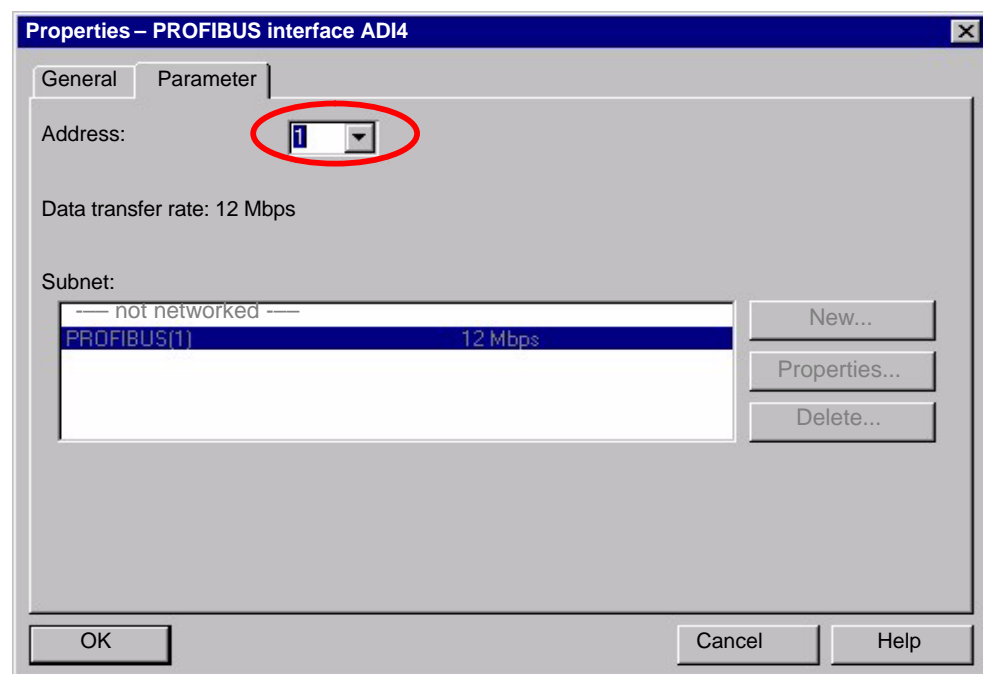

Fig. 3-1 PROFIBUS address

The displayed address value was automatically set by HW Config to the next available PROFIBUS address within the configuration.

Note

The dialog can also be called later. To do so, double-click the ADI4 DP slave icon in HW Config and activate the "PROFIBUS" button in the "General" tab of the displayed dialog.

Notice

The PROFIBUS address of the ADI4 DP slave can be set to any value, in principle. However, it must be ensured that the PROFIBUS address setting in HW Config matches the DIP switch setting on the ADI4 DP slave.

There is **no automatic adjustment!**

The following data must agree:

1. SIMATIC S7 configuration of the **PROFIBUS address** of the ADI4 DP slave
 2. ADI4 module DIP switch S2 **PROFIBUS address**
-

After you have confirmed this dialog box with "OK", the "DP Slave Properties" dialog opens. Continue with the parameter assignment for the message frame type.

3.7.2 Message frame type

The ADI4 DP slave is operated with a specific message frame type:

- 4 axes, each with one encoder (Standard message frame 3) and I/O data

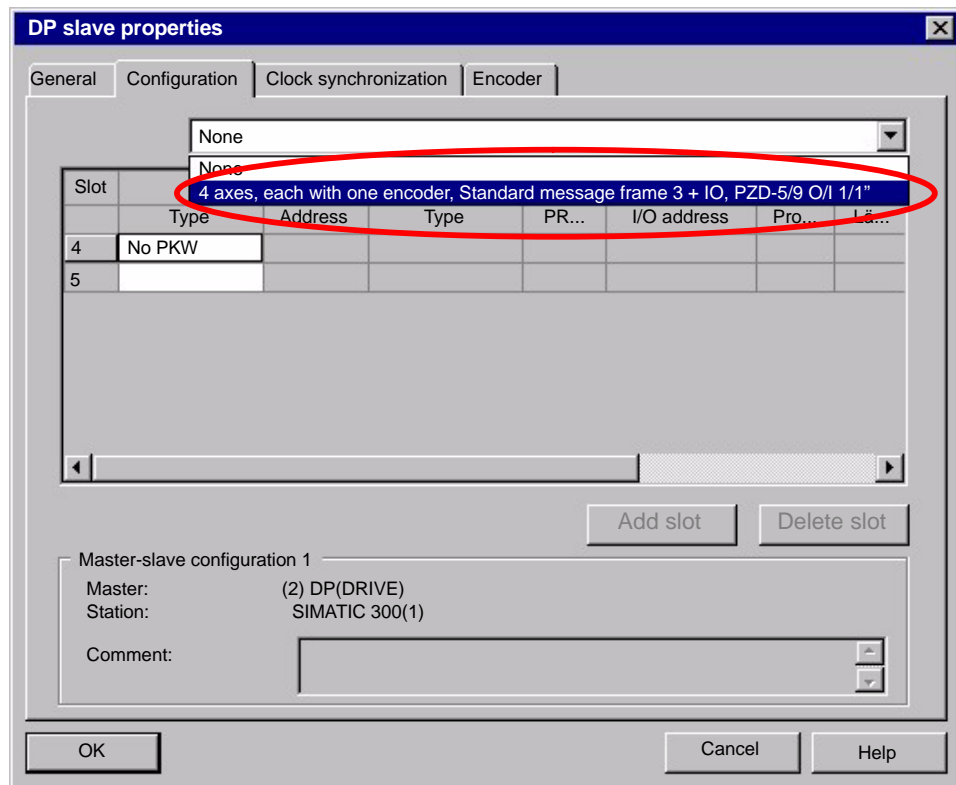

Fig. 3-2 Message frame type

By default, no message frame type is selected. The ADI4-specific message frame type must be explicitly selected in the “Configuration” tab.

Dialog

Dialog box: “DP Slave Properties”

Tab card: “Configuration”

List field: “Default setting”

4 axes, each with one encoder, Standard message frame 3 and IO, PZD-5/9 O/I 1/1”

OK

Message frame structure

The message frame is structured as follows:

Table 3-1 Message frame structure

Message frame type	Description																								
4 axes, each with one encoder, Standard message frame 3 + IO, PZD-5/9 O/I 1/1	4 x Standard message frame 3 and 1 PZD word each for digital I/O data																								
PZD x/y Number of process data words , x: Setpoint, y: Actual value e.g., PZD-5/9: 5 process data words for setpoints 9 process data words for actual values																									
<p>ADI4 message frame structure</p> <table border="1" style="width: 100%; border-collapse: collapse;"> <tr> <td style="text-align: center;">Axis1</td> <td style="text-align: center;">Axis2</td> <td style="text-align: center;">Axis3</td> <td style="text-align: center;">Axis4</td> <td style="text-align: center;">I/O</td> <td></td> </tr> <tr> <td style="text-align: center;">STD 3</td> <td style="text-align: center;">STD 3</td> <td style="text-align: center;">STD 3</td> <td style="text-align: center;">STD 3</td> <td style="text-align: center;">Q word</td> <td style="text-align: right;">Setpoints (master -> slave)</td> </tr> </table> <p>Low Axis1 Axis2 Axis3 Axis4 I/O High</p> <table border="1" style="width: 100%; border-collapse: collapse;"> <tr> <td style="text-align: center;">STD 3</td> <td style="text-align: center;">STD 3</td> <td style="text-align: center;">STD 3</td> <td style="text-align: center;">STD 3</td> <td style="text-align: center;">I word</td> <td style="text-align: right;">Actual values (slave -> master)</td> </tr> </table> <p>STD 3: standard message frame 3 per PROFIDrive V3.0 Q word: digital output data (16 bits) I word: digital input data (16 bits)</p>		Axis1	Axis2	Axis3	Axis4	I/O		STD 3	STD 3	STD 3	STD 3	Q word	Setpoints (master -> slave)	STD 3	STD 3	STD 3	STD 3	I word	Actual values (slave -> master)						
Axis1	Axis2	Axis3	Axis4	I/O																					
STD 3	STD 3	STD 3	STD 3	Q word	Setpoints (master -> slave)																				
STD 3	STD 3	STD 3	STD 3	I word	Actual values (slave -> master)																				
<p>Standard message frame 3: speed setpoint interface 32 bits with 1 encoder</p> <table border="1" style="width: 100%; border-collapse: collapse;"> <tr> <td style="text-align: center;">PZD1</td> <td style="text-align: center;">PZD2</td> <td style="text-align: center;">PZD 3</td> <td style="text-align: center;">PZD 4</td> <td style="text-align: center;">PZD 5</td> <td></td> </tr> <tr> <td style="text-align: center;">STW1</td> <td style="text-align: center;">NSET_B</td> <td style="text-align: center;">STW2</td> <td style="text-align: center;">G1_STW</td> <td></td> <td style="text-align: right;">Setpoint (master -> slave)</td> </tr> </table> <p>Low PZD1 PZD2 PZD 3 PZD 4 PZD 5 High PZD6 PZD7</p> <table border="1" style="width: 100%; border-collapse: collapse;"> <tr> <td style="text-align: center;">ZSW1</td> <td style="text-align: center;">NACT_B</td> <td style="text-align: center;">ZSW2</td> <td style="text-align: center;">G1_ZSW</td> <td style="text-align: center;">G1_XIST1</td> <td></td> </tr> <tr> <td colspan="4" style="text-align: center;">PZD8 PZD9</td> <td style="text-align: center;">G1_XIST2</td> <td style="text-align: right;">Actual value (slave -> master)</td> </tr> </table>		PZD1	PZD2	PZD 3	PZD 4	PZD 5		STW1	NSET_B	STW2	G1_STW		Setpoint (master -> slave)	ZSW1	NACT_B	ZSW2	G1_ZSW	G1_XIST1		PZD8 PZD9				G1_XIST2	Actual value (slave -> master)
PZD1	PZD2	PZD 3	PZD 4	PZD 5																					
STW1	NSET_B	STW2	G1_STW		Setpoint (master -> slave)																				
ZSW1	NACT_B	ZSW2	G1_ZSW	G1_XIST1																					
PZD8 PZD9				G1_XIST2	Actual value (slave -> master)																				
<p>Q word (dig. output data 16 bits)</p> <table border="1" style="width: 100%; border-collapse: collapse;"> <tr> <td colspan="4" style="text-align: center;">High byte</td> <td colspan="4" style="text-align: center;">Low byte</td> </tr> <tr> <td style="text-align: center;">15</td> <td style="text-align: center;">12</td> <td style="text-align: center;">11</td> <td style="text-align: center;">8</td> <td style="text-align: center;">7</td> <td style="text-align: center;">4</td> <td style="text-align: center;">3</td> <td style="text-align: center;">0</td> </tr> </table> <p>611U conformant mode Selection: homing using external Zero mark signals 1 to 4 Not used Dig. outputs 1-4 -> X6-1: Pins 2 to 5 Dig. outputs 5 to 8/direction signal 1 to 4 for unipolar spindle -> X6-1: Pins 6 to 9</p>		High byte				Low byte				15	12	11	8	7	4	3	0								
High byte				Low byte																					
15	12	11	8	7	4	3	0																		
<p>I word (dig. input data 16 bits)</p> <table border="1" style="width: 100%; border-collapse: collapse;"> <tr> <td colspan="4" style="text-align: center;">High byte</td> <td colspan="4" style="text-align: center;">Low byte</td> </tr> <tr> <td style="text-align: center;">15</td> <td style="text-align: center;">14</td> <td style="text-align: center;">13</td> <td style="text-align: center;">12</td> <td style="text-align: center;">11</td> <td style="text-align: center;">8</td> <td style="text-align: center;">7</td> <td style="text-align: center;">2</td> <td style="text-align: center;">1</td> <td style="text-align: center;">0</td> </tr> </table> <p>Dig. inputs 9 to 10/Drv_Rdy 3 to 4 -> X6-2: Pins 10 to 11 Not used Dig. inputs 1-4/ext. zero marks 1 to 4 -> X6-2: Pins 2 to 5 Dig. inputs 5 to 6/measuring inputs 1 to 2 -> X6-2: Pins 6 to 7 Dig. inputs 7 to 8/Drv_Rdy 1 to 2 -> X6-2: Pins 8 to 9</p>		High byte				Low byte				15	14	13	12	11	8	7	2	1	0						
High byte				Low byte																					
15	14	13	12	11	8	7	2	1	0																

Notice

The message frame type setting for the ADI4 DP slave in HW Config must agree with the message frame type setting in the controller.

There is **no automatic adjustment!**

Encoder control word Gx_STW

Description of the encoder control word (extract) for:

- Find reference mark
- Flying measurement
- Encoder error

Table 3-2 Encoder control word Gx_STW (extract)

Bit	Name	Signal state/description
0	Reference mark search or on-the-fly measurement	Bit 7 = 0 => Request: Reference mark search Bit Meaning Homing using: 0 Function 1: Encoder zero mark (except in "611U conformant mode") 1 Function 2: Rising edge of external zero mark 2 Function 3: Falling edge of external zero mark 3 Function 4: Not used
1		Bit 7 = 1 => Request: on-the-fly measurement Bit Meaning 0 Function 1 Measuring input 1 rising edge 1 Function 2 Measuring input 1 falling edge 2 Function 3 Measuring input 2 rising edge 3 Function 4 Measuring input 2 falling edge
2		Functions Note • Bit x = 1 Function requested Bit x = 0 Function not requested • If more than one function is enabled, the values for all functions cannot be read until all functions have ended and this has been signaled via the relevant status bit (G1_ZSW, Bit 0 – Bit 3 = 0). • on-the-fly measurement
3		The rising and falling edges of the measuring input can be enabled simultaneously. The measuring input signal is detected according to the direction of the signal change. The measured values are read out consecutively. Note ADI4 only supports measurement on a rising <u>or</u> falling edge.
4	Command	Bit 6, 5, 4 Meaning 000 --- 001 Enable Function x 010 Read Value x 011 Cancel Function x
5		
6		
7	Mode	0 Reference mark search
		1 on-the-fly measurement

Table 3-2 Encoder control word Gx_STW (extract), continued

Bit	Name	Signal state/description	
15	Encoder error	0	No fault
		1	Encoder error pending; error code in Gx_XIST2

Additional encoder actual value Gx_XIST2

Error codes in Gx_XIST2 where G1_ZSW, Bit15 == 1

Table 3-3 Error codes in Gx_XIST2

G1_XIST2	Meaning	Possible causes/description
1 _{Hex}	Encoder sum error	The encoder signal levels are too low, faulty (inadequate shielding) or open-circuit monitoring has been tripped.
2 _{Hex}	Zero mark monitoring	A fluctuation in the measured rotor position has arisen between 2 encoder zero marks (encoder pulses may be lost).

3.7.3 I/O addresses

For communication between the controller and the individual axes of an ADI4 DP slave, it is necessary that the setpoint and the actual value of an axis have the same I/O address.

HW Config takes this requirement into account automatically when an ADI4 DP slave is inserted in the configuration.

Dialog

Dialog box: "DP Slave Properties"

Tab card: "Configuration"

PROFIBUS partner, I/O address: <I/O addresses>

OK

Notice

- The setpoint and actual value of an axis must have the same I/O address.

I address (actual value) = Q address (setpoint)

If the ADI4 DP slave is inserted in an S7 project with a copy operation (for example, from another S7 project), the I/O addresses are assigned solely through "HW Config". This could result in an axis receiving a different I/O address for the setpoint and actual values. The I/O addresses must be manually corrected in this case.

- To avoid access conflicts between the PROFIBUS DP drives and the I/O modules, values **272** must be used for I/O addresses for the ADI4 DP slave.

3.7.4 Consistency

The default setting for I/O data consistency is:

- **Total length**

This setting means that direct access from the PLC user program (e.g., byte, word, or double word) to this address area is not permitted by the PLC operating system.

3.8 Function parameters (SINUMERIK 802D)

The function parameters are permanently specified in the preset configuration and cannot be changed.

The following parameter values are set:

- Encoder type: TTL ¹⁾
- Unipolar spindle: "Inactive"
- Shutdown ramp: 0
- Shutdown delay time: 0
- Tolerable sign-of-life failures: 0
- Reserved bits for fine resolution: 11
- 611U conformant mode: "Active"

1) Incremental encoder (TTL) with differential transmission of 5 V rectangular signals (RS 422 Standard).

3.9 Function parameters (SINUMERIK 840Di), (SIMOTION), and (SIMATIC Technology CPU)

In the “Encoder” tab, all further function-specific parameters of the ADI4 DP slave are set in addition to the encoder parameters:

- Encoder type
- Unipolar spindle (or unipolar motor)
- Shutdown ramp
- Shutdown delay time
- Tolerable sign-of-life failures
- Reserved bits for fine resolution
- 611U conformant mode

Figure 3-3 shows the corresponding dialog box with sample values for the various encoder types and parameters.

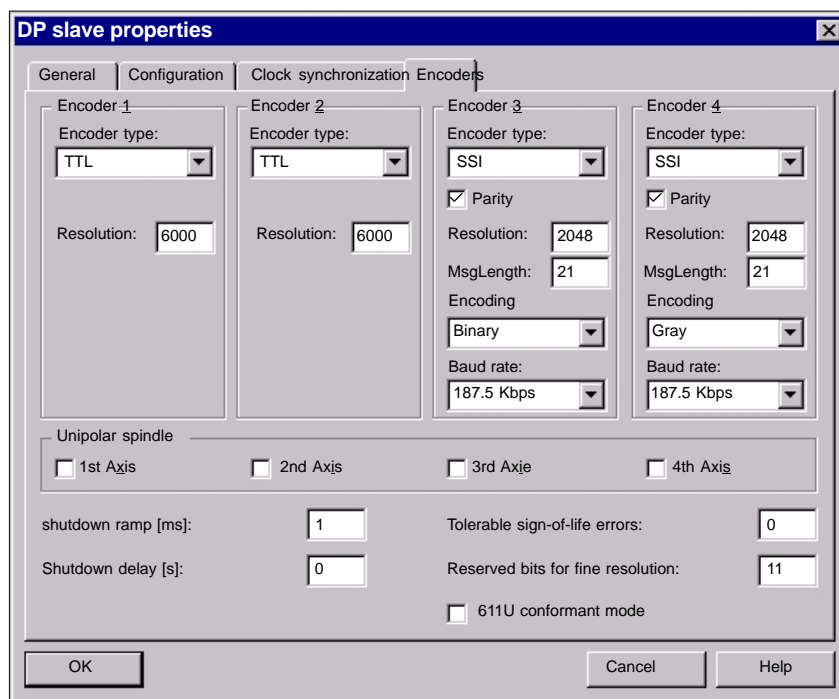

Fig. 3-3 Dialog: DP slave properties, Tab: Encoder

3.9.1 Encoder type

Encoder type: "Not available"

An encoder type setting of "not available" for Encoder x means that Axis x does not exist, or that it is not to be operated. Useful data transmitted for this axis in the PROFIBUS message frame are empty.

Encoder type: TTL

Encoder parameters:

- Resolution
Encoder resolution in increments per encoder revolution

Note

In the case of spindles a with a low-resolution encoder, the actual-value characteristic (incrementing) may be displayed in a non-linear fashion. The incrementing that is visible on the actual-value display is the result of the speed resolution (RR), where:

$$RR = 60000 / (Tdp * ER * PM)$$

RR (speed resolution):	[(revolutions/minute)/encoder pulse]
Tdp (position-control cycle = PROFIBUS clock pulse):	[ms]
ER (encoder resolution):	[encoder pulses/revolution]
PM (pulse multiplication)	

Example:

- Tdp (position-control cycle = PROFIBUS clock pulse): 2 ms
- ER (Encoder Resolution): 2500 pulses/revolution
- PM (ADI4-internal pulse multiplication): 4

$$RR = 60000 / (2 * 2500 * 4) = 3 \text{ (revolutions/minute)/encoder pulse}$$

(SINUMERIK 840Di)

Smoothing of the actual value for low-resolution encoders via machine data item:
MD34990 \$MA_ENC_ACTVAL_SMOOTH_TIME (smoothing time constant)

Encoder type: SSI

Encoder parameters:

- Parity
Select this check box if the encoder data are to be transmitted from the encoder to the ADI4 with a parity bit.
- Resolution
Encoder resolution in increments per encoder revolution
- MsgLength
Number of useful data bits transmitted by the encoder

- Encoding
The following encoder codes are supported:
 - Binary
 - Gray
- Transmission rate
The following transmission rates are supported:
 - 187.5 Kbps
 - 375 Kbps
 - 750 Kbps

Notice

- The transmission rate setting must be identical for all SSI encoders. If transmission rate settings are different, the transmission rate of the SSI encoder with the highest encoder number is used.
 - In conjunction with ADI4, only absolute encoders (SSI) with “fir tree” (TSSI) output format can be operated.
-

3.9.2 Unipolar spindle (or unipolar motor)

The drive can be moved in two directions. Selecting the “Unipolar spindle” check box switches the voltage range of the analog output voltage.

Unipolar spindle not selected

If the “Unipolar spindle” check box is not selected, an analog voltage in the range of **-10 V** to **+10 V** is output as the setpoint.

Unipolar spindle selected

If the “Unipolar spindle” check box is selected, an analog voltage in the range of **0 V** to **+10 V** is output as the setpoint. The direction of rotation is then output from the ADI4, depending on the current speed setpoint, via a digital output:

- Direction of rotation signal for Axis 1 → digital output X6-1, pin 6
- Direction of rotation signal for Axis 2 → digital output X6-1, pin 7
- Direction of rotation signal for Axis 3 → digital output X6-1, pin 8
- Direction of rotation signal for Axis 4 → digital output X6-1, pin 9

(SIMOTION) and (SIMATIC Technology CPU)

The function: Unipolar spindle (or Unipolar motor) is not available.

(SINUMERIK)

Voltage level of direction of rotation signals at digit. output X6-1, pin 6 - 9, where:

- M3 (spindle CW) = 24 V
- M4 (spindle CCW) = 0 V
- M5 (spindle stop) = 0 V

3.9.3 Shutdown ramp

The “Shutdown ramp” parameter specifies a function that is linear with respect to time. If an error is detected in the ADI4, all ADI4 drives are slowed down to Setpoint 0 in accordance with this function.

A parameter value of 0 brings the drives to an immediate stop (brake at current limit).

- Unit: [ms]

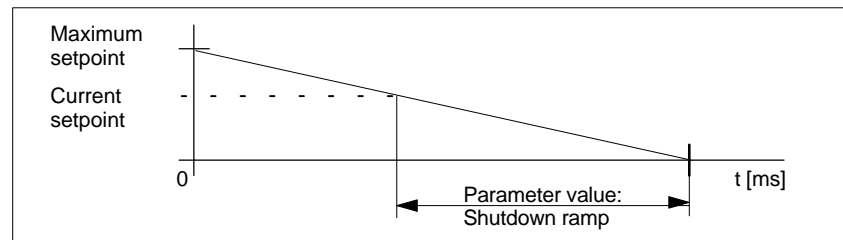

Fig. 3-4 Parameter: Shutdown ramp

3.9.4 Shutdown delay time

The “Shutdown delay time” parameter can be used to specify a time after which all ADI4 drives are slowed down to Setpoint 0 following a temperature alarm in the ADI4.

After the “Shutdown delay time” has elapsed, the “Shutdown ramp” is taken into account.

- Unit: [s]

3.9.5 Tolerable sign-of-life failures

The “Tolerable sign-of-life failures” parameter specifies the number of sign-of-life failures tolerated for the DP master. If the assigned number is exceeded, the setpoint interfaces of the drives are ramped down to a value of 0 using the “Shutdown ramp”.

Notice

Presently, the “Tolerable sign-of-life failures” parameter may only be used on values in the range of 0 to 13.

3.9.6 Reserved bits for fine resolution

The “Additional substitute bits for fine resolution” parameter specifies the desired pulse duplication of the encoder increments transmitted in actual encoder values G1_XIST1 and G1_XIST2.

Presently, the number of additional substitute bits for fine resolution must be set permanently to 11. This corresponds to a pulse duplication of: $2^{11} = 2048$.

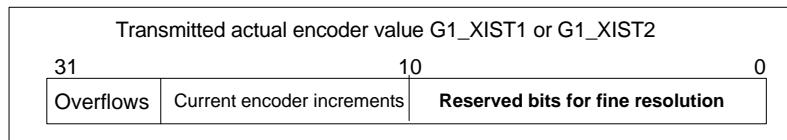

Notice

- Presently, the “Reserved bits for fine resolution” parameter setting must always be 11.
-

(SINUMERIK 840Di)

Notice

- Corresponding to the “Additional substitute bits for fine resolution” parameter, the following must be entered in the axis-specific NC machine data element:

MD30260: \$MA_ABS_INC_RATIO (ratio of the absolute resolution to the incremental resolution)

Value: $2^{\text{“Additional substitute bits for fine resolution”}} = 2^{11} = 2048$.

3.9.7 611U conformant mode

In 611U conformant mode, the signal source for homing of axes is no longer specified using the PROFIDrive standard message frame (STD3, encoder control word G1_STW, see Page 3-41), but rather using the additional digital output word in the PROFIBUS message frame of the ADI4 (see Table 3-1, Page 3-40).

611U conformant mode:

- Not selected
The signal source for homing is specified via the encoder control word Gx_STW (see page 3-41) in the PROFIDrive standard message frame.
- Selected
The signal source for homing is specified via the additional digital output word in the PROFIBUS message frame.

Digital output word

The signal sources for homing are selected on an axis-specific basis via the following bits of the output word (see also Q word: Table 3-1, Page 3-40):

Table 3-4 Output word: signal sources for homing

Bit	Value	Signal source for homing
0	0	Axis 1: Zero mark of Encoder 1 (X4-1)
	1	Axis 1: <u>Rising</u> edge of External zero mark 1 (X6-2, Pin 2)
1	0	Axis 2: Zero mark of Encoder 2 (X4-2)
	1	Axis 2: <u>Rising</u> edge of External zero mark 2 (X6-2, Pin 3)
2	0	Axis 3: Zero mark of Encoder 3 (X4-3)
	1	Axis 3: <u>Rising</u> edge of External zero mark 3 (X6-2, Pin 4)
3	0	Axis 4: Zero mark of Encoder 4 (X4-4)
	1	Axis 4: <u>Rising</u> edge of External zero mark 4 (X6-2, Pin 5)

If the 611U conformant mode has been parameterized for an axis to be homed, the axis-specific signal for selecting the signal source must be set in the digital output word of the ADI4 from the PLC user program, before the "Reference mark search" function is requested in the encoder control word.

Subsections 3.9.8 to 3.9.10 below show the basic system structure and the respective boundary conditions of the individual homing methods.

(SIMOTION)

With611U conformant mode

- For homing of an axis using an encoder zero mark and an external zero mark the appropriate axis-specific bit must be set to 0 (encoder zero mark) in the digital output word by the PLC user program.
- The signal source for homing can be switched during operation.

Without 611U conformant mode

- Homing is always performed in relation to the zero mark of the axis.

(SIMATIC Technology CPU)

S7 Technology Version 1.0

The 611U conformant mode calls for the connection of a bit in the digital output word (see Table 3-4). This is not possible from the user program with the Technology CPU (see also Subsection 3.9.13, Page 3-54). In the case of homing via:

- Encoder zero mark
- Encoder zero mark and reference cam

this has no effect. To enable homing using an external zero mark, the relevant output bit of the axis must be set using an "Output Cam" technology object.

S7 Technology Version 2.0 and higher

The following options are available for using 611U conformant mode with signal source selection:

- Use the Output Cam technology object for signal source selection. To do so, configure an output cam in S7TConfig with its output pointing to the relevant bit address for selection of the signal source on the corresponding axis.
- You place the address of the additional data word in the ADI4 message frame in the DP(DRIVE) I/O image. This address is placed using the "MC_ReadPeriphery" and "MC_WritePeriphery" technology functions. The address of the data word must be adapted manually for the module in HW Config; it must be within the address range of 0 to 63 bytes.

Dialog: End

When you click "OK" in the "DP Slave Properties" dialog, your data are applied and the dialog box is closed.

Step 1: End

This concludes Step 1 of the ADI4 DP slave parameter assignment (see Subsection 3.5.1, Page 3-35).

3.9.8 Homing using encoder zero mark

System structure

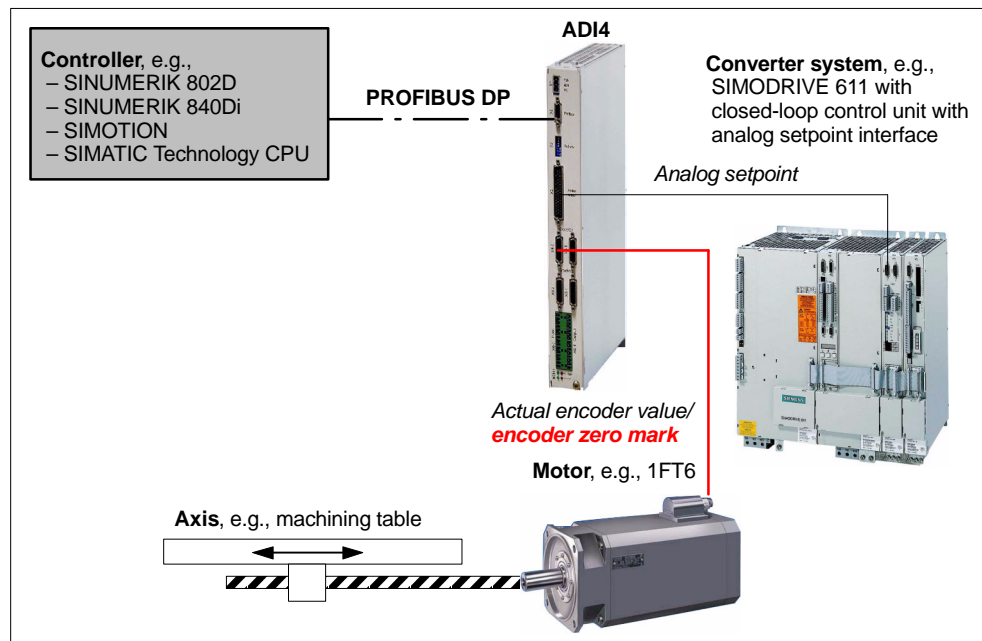

Fig. 3-5 Basic system structure: homing using encoder zero mark

Function

Once the controller requests homing, the ADI4 transmits the actual encoder value to the controller as the home position the next time it detects an encoder zero mark.

Without 611U conformant mode

No further actions are necessary.

With 611U conformant mode

The relevant signal for the axis to be homed (e.g., Axis 1) must be set in the digital output word:

- Digital output word:
Bit 0: = 0 => "Axis 1: Zero mark of Encoder 1 (X4-1)"

3.9.9 Homing using external zero mark

System structure

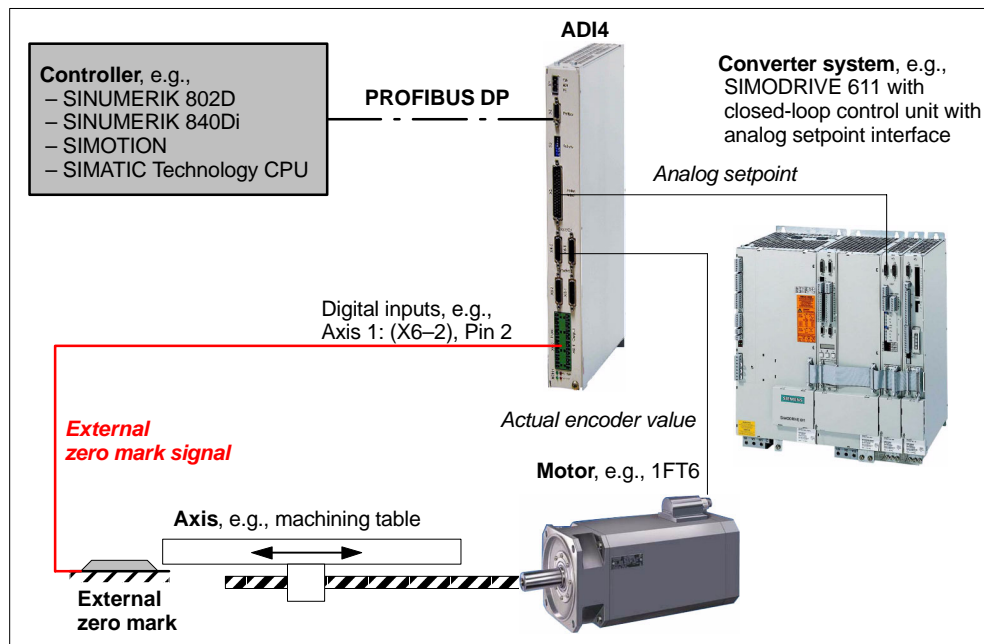

Fig. 3-6 Basic system structure: Homing using external zero mark

Function

Once the controller requests homing, the ADI4 transmits the actual encoder value to the controller as the home position the next time it detects an external zero mark signal.

Without 611U conformant mode

The controller must define the relevant function via encoder control word G1_STW:

- Function 2 (Homing via rising edge of external zero mark)
- Function 3 (Homing via falling edge of external zero mark)

With 611U conformant mode

The relevant signal for the axis to be homed (e.g., Axis 1) must be set in the digital output word:

- Digital output word:
Bit 0: = 1 => "Axis 1: rising edge of External zero mark 1 (X6-2, Pin 2)"

(SINUMERIK) (SIMOTION)

Homing using an external zero mark requires 611U conformant mode to be selected.

3.9.10 Homing using encoder zero mark and reference cam (SIMOTION)

System structure

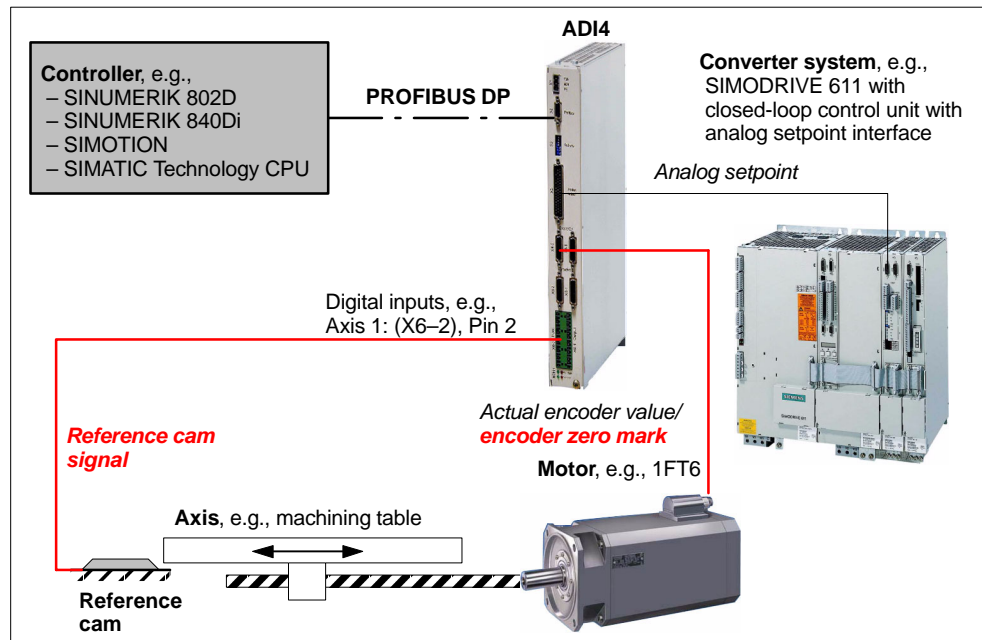

Fig. 3-7 Basic system structure: Homing using encoder zero mark and external zero mark

Function

The reference cam signal must be connected to a digital input on the ADI4 (X6-2, Pins 2 to 5). The reference cam signal is processed in the controller as part of the homing operation.

Once the reference cam signal is detected, the controller reduces the axis velocity to the homing approach velocity and requests the ADI4 to home to the next encoder zero mark. Once the request is detected, the ADI4 transmits the actual encoder value to the controller as the home position the next time it detects an encoder zero mark.

Without 611U conformant mode

No further actions are necessary.

With 611U conformant mode

The relevant signal for the axis to be homed (e.g., Axis 1) must be set in the digital output word:

- Digital output word:
Bit 0: = 0 => "Axis 1: Zero mark of Encoder 1 (X4-1)"

3.9.11 Boundary conditions

Measuring input or on-the-fly measurement

ADI4 supports only measurement using a rising or falling edge of the measuring input. It is not possible to parameterize simultaneous measurement on a rising edge and a negative edge.

Actual speed value

The actual speed value (PZD2/3: NACT_B) contained in Standard message frame 3 (see Table 3-1, Page 3-40) is not supported by the ADI4. The ADI4 always sends a value of 0 as the actual speed value.

External encoder interface (encoders without an axis)

If encoders are connected to an ADI4 without at least one axis being parameterized, i.e., the ADI4 uses the encoder as an external encoder interface only, a "Ready" signal (interface X6-1, Pin 10/11) will not be output. For information on the "Ready" signal, refer to Subsection 2.2.7, Page 2-20.

3.9.12 Boundary conditions (SIMOTION)

Error 20005

In conjunction with an ADI4 DP slave, the following message is displayed when the SIMOTION CPU switches from RUN to STOP mode:

- Error 20005: Device type: 1/2, log. address: x faulted. (Bit: 0, Reason: 0x...)

The message can be ignored.

This message is automatically deleted by the system the next time there is a transition from STOP to RUN mode.

Homing using external zero mark

Homing always occurs at a rising edge, irrespective of which external zero mark edge (rising or falling) was selected for homing in SIMOTION.

3.9.13 Boundary conditions (SIMATIC Technology CPU)

Homing using external zero mark

Homing always occurs at a rising edge, irrespective of which external zero mark edge (rising or falling) was selected for homing in SIMOTION.

Access to I/O data

S7 Technology Version 1.0

The address area of the ADI4 cannot be accessed from the user program.

S7 Technology Version 2.0

The I/O data of the ADI4 can only be accessed from the user program using the I/O image of DP(DRIVE). This requires the I/O data to be within the address range of 0 to 63. The I/O data are accessed using the "MC_ReadPeriphery" and "MC_WritePeriphery" technology functions.

You cannot access the axis message frames.

3.10 Assigning parameters for DP communication

Once all the intended DP slaves have been inserted in the configuration and their functional parameters have been assigned as described (Step 1), parameters are assigned for the equidistant cyclic DP communication in Step 2.

Parameters are also assigned to the equidistant cyclic DP communication in two steps:

Step 1

- Activation of the equidistant DP cycle
- Equidistance master cyclic component T_{DX}

Step 2

- Equidistant DP cycle T_{DP}
- Master application cycle T_{MAPC}
- Actual value acquisition T_i
- Setpoint transfer T_o

Notice

When assigning parameters for DP communication, you must observe the boundary conditions applicable to the individual parameters (see Subsection 3.10.9, Page 3-65).

3.10.1 Activation of the equidistant DP cycle

Double-click the ADI4 DP slave in the station window of HW Config to open the “DP Slave Properties” dialog.

Note

It is recommended that the equidistant DP cycle be enabled for all ADI4 DP slaves by enabling the equidistant DP cycle for the selected ADI4 DP slave, and then performing an alignment.

During an alignment, the values displayed in dialog:

- DP Slave Properties
Tab: Clock synchronization

are transferred to all DP slaves of the same type in the configuration, i.e., in this case, to all ADI4 DP slaves.

Dialog: Start

Dialog box: "DP Slave Properties"

Tab: "Clock synchronization"

Check box: "Synchronize drive to equidistant DP cycle" Button: *Adjustment*

Fig. 3-8 Dialog: DP slave properties

Note

If there are different equidistant DP slave types (for example, different SIMODRIVE drives, ADI4, etc.) in an S7 project, you must first perform the following two steps for each DP slave type:

1. Synchronize drive to equidistant DP cycle
2. Align

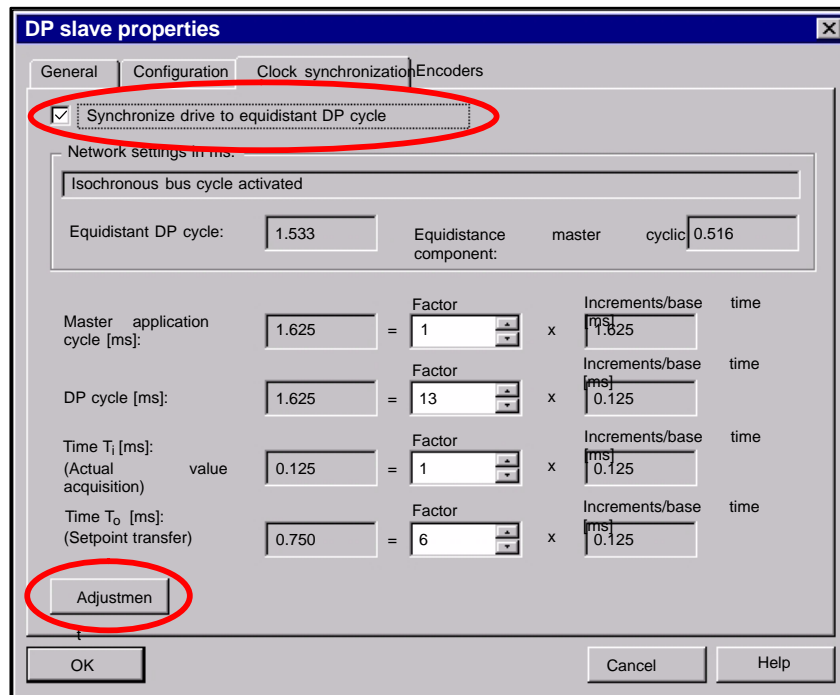
Then, you can continue setting the other parameters.

3.10.2 Equidistant master cyclic component T_{Dx}

Once synchronization to the equidistant DP cycle has been enabled for all DP slaves, the time required for the cyclic component of the DP communication must be recalculated.

The calculation is performed automatically by the DP master each time the equidistant bus cycle is enabled. This occurs in the dialog box below by selecting and clearing the "Enable equidistant bus cycle" check box.

Dialog: Continuation

Dialog box: "DP Slave Properties"

Tab: "General"

Group: "Station/Master System"

Button: *PROFIBUS...*

Dialog box: "Properties – PROFIBUS Interface ADI4 ..."

Tab: "Parameters"

Button: *Properties...*

Dialog box: "Properties of PROFIBUS"

Tab: "Network settings"

Button: *Options...*

Dialog box: "Options"

Tab: "Equidistance"

1st check box: Enable equidistant bus cycle

2nd check box: Enable equidistant bus cycle

See Figure 3-9, Page 3-59.

3.10.3 Equidistant DP cycle T_{DP}

When the cyclic component of the DP communication is calculated, the DP master automatically changes the value for the equidistant DP cycle to the minimum required time. This change must be undone by re-entering the intended value for the equidistant DP cycle.

Dialog: Continuation

Dialog box: "Options"

Equidistant DP cycle: **Equidistance time**

OK

OK

OK

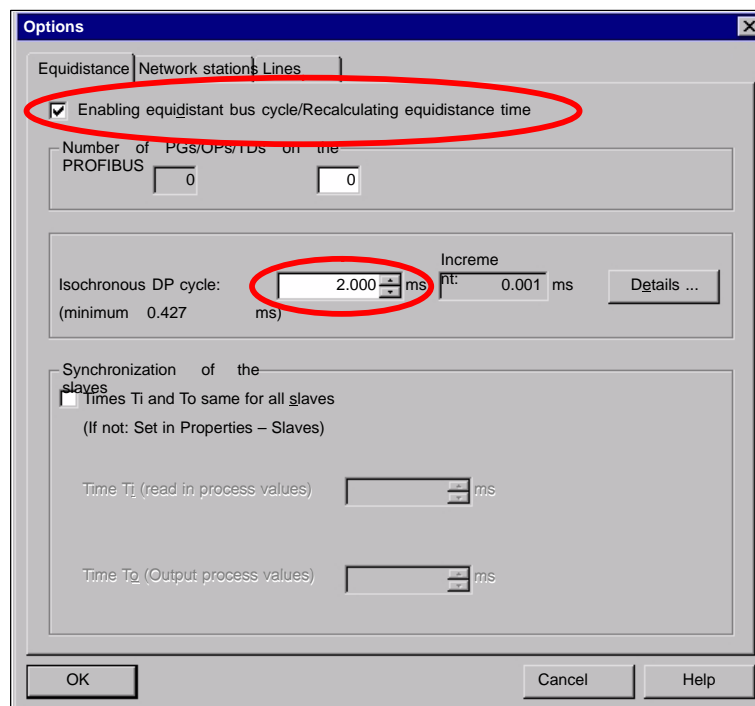

Fig. 3-9 Dialog: Options

3.10.4 DP cycle T_{DP}

Dialog: Continuation

Dialog box: "DP Slave Properties"
Tab: "Clock synchronization"
DP cycle (ms): < *Factor* >

The DP cycle time of the ADI4 DP slave must be set to the DP master cycle time displayed under "Equidistant DP cycle".

See Figure 3-12, Page 3-65.

Note

The DP cycle time (Parameter: DP cycle) of the ADI4 DP slave must be set to the same value as the DP cycle time setting for the DP master (Parameter: Equidistant DP cycle).

$$\text{DP cycle} = \text{equidistant DP cycle}$$

3.10.5 Master application cycle T_{MAPC}

The Master application cycle T_{MAPC} parameter specifies the integer ratio between the master application (position controller) and the equidistant DP cycle.

By setting a ratio other than 1:1, the dead bands of the position controller can be reduced for less powerful controller hardware.

See Figures 3-10 and 3-11, Page 3-61.

Dialog: Continuation

Dialog box: "DP Slave Properties"
Tab: "Clock synchronization"
Master application cycle [ms]: < *Factor* >

See Figure 3-12, Page 3-65.

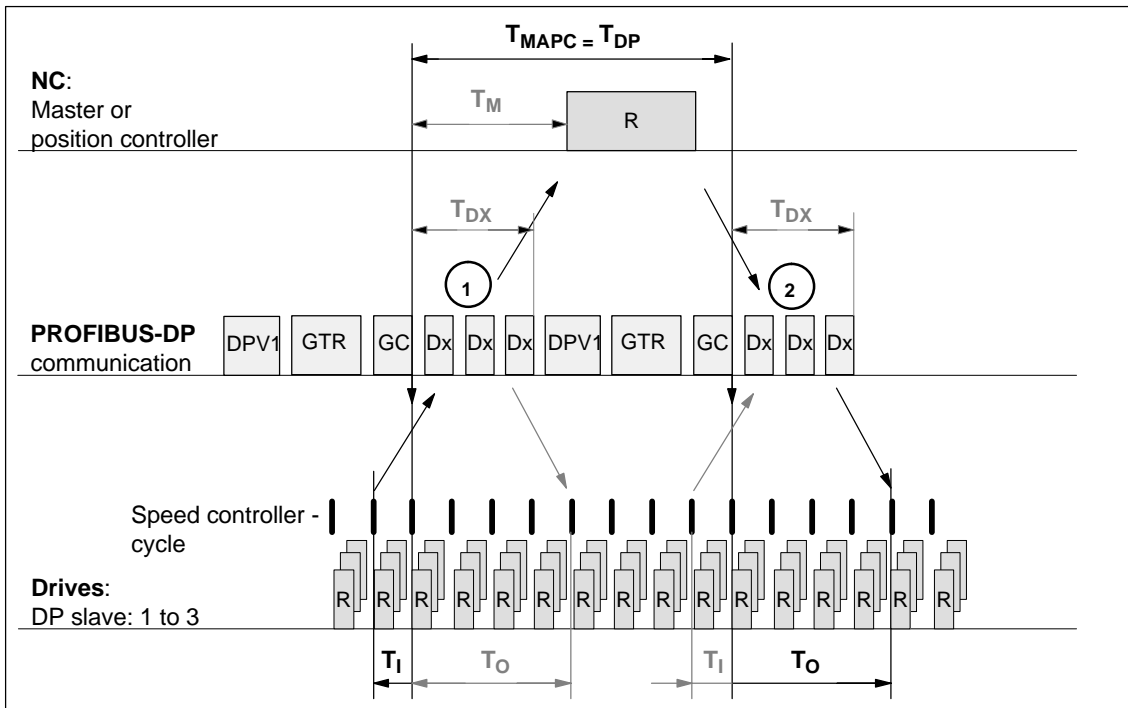

Fig. 3-10 Example: optimized DP cycle with $T_{MAPC} : T_{DP} = 1 : 1$

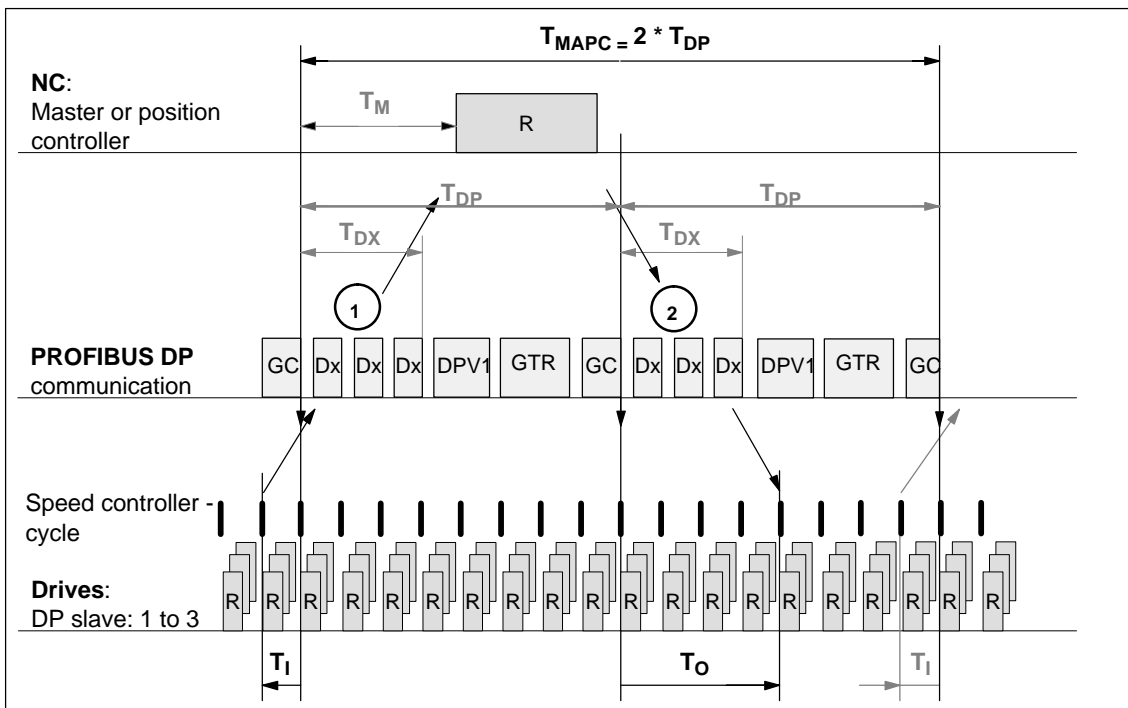

Fig. 3-11 Example: optimized DP cycle with $T_{MAPC} : T_{DP} = 2 : 1$

Explanations for Figures 3-10 and 3-11:

T_{MAPC}	Master application cycle: Position control cycle clock
T_{DP}	DP cycle time: DP cycle time
T_{DX}	Data exchange time: total transfer time for all DP slaves
T_M	Master time: Offset of start time for NC position control
T_I	Input time: Timing of actual value acquisition. The actual values are transferred to the DP master in the <u>next</u> DP cycle.
T_O	Output time: Timing of the setpoint transfer. The setpoints were generated by the DP master application in the <u>previous</u> DP cycle.
GC	Global control message frame (broadcast message frame) for cyclic synchronization of the equidistance between the DP master and DP slaves
R	Speed or position controller computing time
Dx	Useful data exchange between the DP master and DP slaves
DPV1	After cyclic communication, an acyclic service is sent, if the token holding time T_{TH} is not yet exceeded. T_{TH} is calculated by the configuring system.
GTR	GAP, TOKEN, RESERVE: GAP During GAP, an attempt is made to incorporate new active stations. TOKEN The station passes the token to itself or to another master. RESERVE The reserve is used as an "active pause" for the station to send the token to itself until the equidistant cycle expires.
①	The actual values for the current DP cycle/position control cycle are transferred from the DP slave drives to the NC position controller.
②	The setpoints computed by the NC position controller are transferred to the DP slave drives.

(SINUMERIK 802D)

The ratio between master application cycle T_{MAC} and DP cycle time T_{DP} can be set to a ratio other than 1:1.

(SINUMERIK 840Di), (SIMOTION), and (SIMATIC Technology CPU)

The ratio between master application cycle T_{MAC} and DP cycle time T_{DP} must be 1:1.

3.10.6 Actual value acquisition T_i

The actual value acquisition T_i parameter specifies the time when an ADI4 DP slave reads in the actual values (actual position value).

It is recommended that the time of the actual value acquisition T_i be set the same for all ADI4 DP slaves, particularly if axes of different ADI4 DP slaves travel on the same path by interpolation.

Dialog: Continuation

Dialog box: "DP Slave Properties"
 Tab: "Clock synchronization"
 Actual value acquisition [ms]: < *Factor* >

See Figure 3-12, Page 3-65.

Note

The following condition must be satisfied for actual value acquisition time T_i :

$$\text{DP cycle} \geq \text{actual value acquisition} \geq \text{base time}$$

3.10.7 Setpoint transfer T_o

The Setpoint transfer T_o parameter specifies the time when the ADI4 DP slave receives the speed setpoint from the position controller.

It is recommended that setpoint transfer time T_o be the same for all ADI4 DP slaves, particularly if axes are interpolated together.

Dialog: Continuation

Dialog box: "DP Slave Properties"
 Tab: "Clock synchronization"
 Setpoint transfer [ms]: < *Factor* >

See Figure 3-12, Page 3-65.

Note

The following condition must be satisfied for setpoint transfer time T_o :

$$\text{DP cycle} \geq \text{setpoint transfer} \geq \text{equidistant master cyclic component} + \text{base time}$$

3.10.8 Alignment

Alignment transfers all values for the current ADI4 DP slave displayed in the “Clock synchronization” tab to all other ADI4 DP slaves in the configuration.

Dialog: End

Dialog box: “DP Slave Properties”

Tab: “Clock synchronization”

Button: *Adjustment*

OK

See Figure 3-12, Page 3-65.

Note

If an S7 project includes different equidistant DP slave types, such as different SIMODRIVE drives, ADI4, etc., the following parameter settings must be made for each DP slave type as described above, and an alignment must be performed:

- Equidistant DP cycle T_{DP}
- Master application cycle T_{MAPC}
- Actual value acquisition T_i
- Setpoint transfer T_o

The alignment operation transfers the values displayed in the “Clock synchronization” tab only to DP slaves of the **same** type.

This align operation concludes the parameter assignment DP communication for all ADI4 slaves.

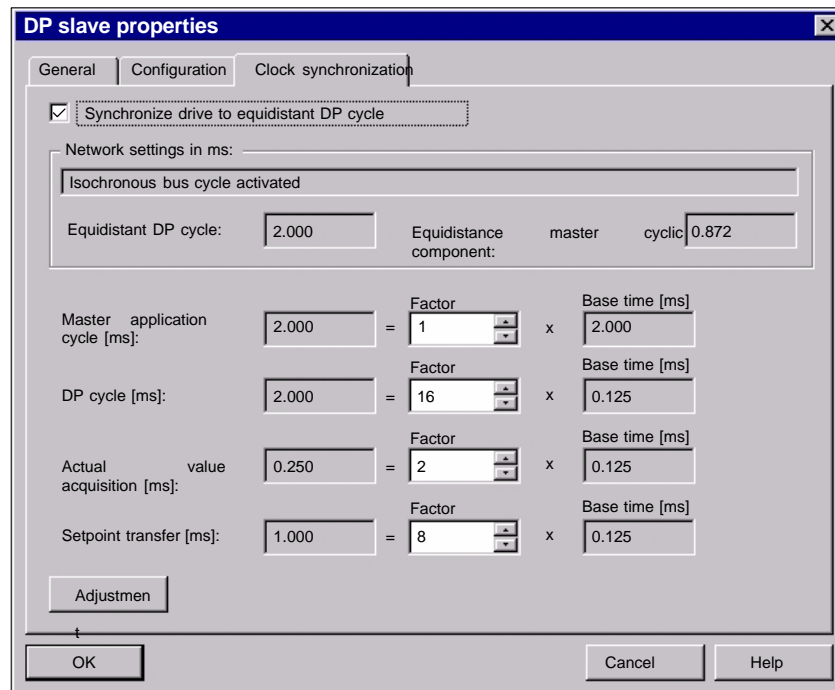

Fig. 3-12 Dialog: DP slave properties

3.10.9 Supplementary Conditions

ADI4, Order No.: 6FC5 211-0BA01-0AA1

The following boundary conditions must be taken into account in the final parameter assignment for the equidistant DP cycle in conjunction with ADI4 starting with MLFB: 6FC5 211-0BA01-0AA1:

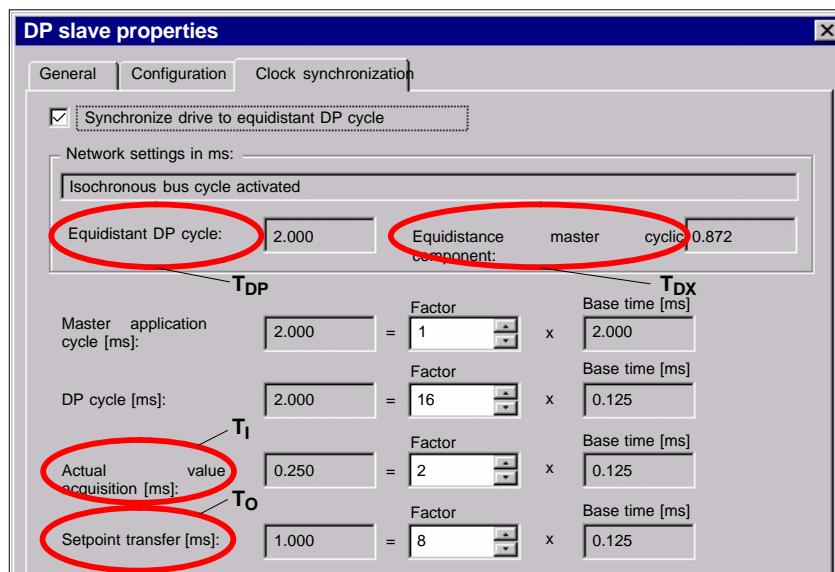

Fig. 3-13 Dialog: DP slave properties (excerpt)

1. Equidistant DP cycle (T_{DP})

$$T_{DP} = 2 * n * 125 \text{ us};$$

with $n \geq 4$ (\Rightarrow minimum $T_{DP} = 1 \text{ ms}$)

2. Setpoint transfer (T_O)

$$T_O = (T_{DX} + 125 \text{ us}) \cdot n \cdot T_{DP};$$

with $T_{DX} = T_{DX}$, rounded to an integral multiple of 125 us

3. Actual value acquisition (T_I)

$$T_I = 250 \text{ us} \cdot n \cdot T_{DP}$$

(SIMOTION) and (SIMATIC Technology CPU)

$$(250 \text{ us} \cdot T_I \cdot T_{DP}) \text{ and } (T_I \cdot 500 \text{ us})$$

4. T_I and T_O cannot be in the same 125 us cycle clock

$$T \neq 0; \text{ with } T = T_{DP} - T_I - T_O$$

5. If $T_O = (T_{DP} - 125 \text{ us})$

Then for T_I , the following must apply: $T_I \leq 3 * 125 \text{ us}$

6. If $T_O = (T_{DX} + 125 \text{ us})$

Then for $(T_I + T_O)$, the following must apply: $(T_I + T_O) \leq (T_{DP} + 125 \text{ us})$

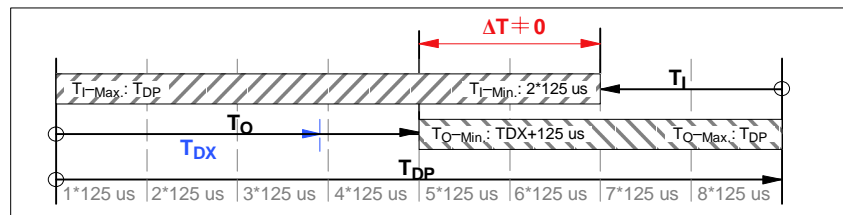

Fig. 3-14 Graphic illustration of boundary conditions

(SINUMERIK 802D)

Typical parameter values are:

- Equidistant DP cycle (T_{DP}): 2.000 ms
- Actual value acquisition (T_i): 0.250 ms
- Setpoint transfer (T_o): 1.000 ms

(SINUMERIK 840Di)

Typical parameter values are:

- Equidistant DP cycle (T_{DP}): 2.000 ms
- Actual value acquisition (T_i): 0.250 ms
- Setpoint transfer (T_o): 1.000 ms

(SIMOTION) and (SIMATIC Technology CPU)

Typical parameter values are:

– Equidistant DP cycle (T_{DP}):	2.000 ms	3.000 ms
– Actual value acquisition (T_i):	0.250 ms	0.250 ms
– Setpoint transfer (T_o):	1.250 ms	1.000 ms

Note

ADI4 DP slaves:

- Order number (MLFB): 6FC5 211-0BA01-0AA0
- Order number (MLFB): 6FC5 211-0BA01-0AA1 or ...-0AA2

display a different behavior for a parameter assignment deviating from the boundary conditions indicated above for actual value acquisition (T_i) and setpoint transfer (T_o).

- **ADI4 DP slave with MLFB ...-0AA0**
If parameters are assigned that deviate from the boundary conditions indicated above, they are ignored by this ADI4 DP slave, as parameters are fixed internally. The ADI4 DP slave establishes cyclic communication with the DP master – using the preset values not matching parameterization – without an error message.
 - **ADI4 DP slave with MLFB ...-0AA1 or ...-0AA2**
If parameters are assigned that deviate from the boundary conditions indicated above and these parameters are downloaded to the ADI4 DP slave, the ADI4 DP slave does not establish cyclic communication with the DP master.
-

Startup

4.1 Controller startup

4.1.1 Linear encoder with distance-coded zero marks/reference marks (SINUMERIK 840Di)

Machine data

The following machine data must be set for the purpose of starting up the measuring system of a machine axis with linear encoder featuring distance-coded zero marks/reference marks:

Number	Identifier: \$MA_	Meaning
30240	ENC_TYPE	Encoder type (data transmission)
31000	ENC_IS_LINEAR	Encoder type (type of construction) Linear encoders
31010	ENC_GRID_POINT_DIST	Signal division or scale division/EXE factor
31040	ENC_IS_DIRECT	Encoder type: Direct measuring system
32100	AX_MOTION_DIR	Traversing direction (does not affect control direction)
32110	ENC_FEEDBACK_POL	Encoder value polarity (affects control direction)
34090	REFP_MOVE_DIST_CORR	Zero point/reference point offset The offset between the machine zero point and the first reference mark.
34200	ENC_REFP_MODE	Homing mode
34300	ENC_REFP_MARKER_DIST	Reference mark distance (basic distance)
34310	ENC_MARKER_INC	Interval between two reference marks Note Heidenhain: For all linear encoders with distance-coded zero marks/reference marks 20 µm
34320	ENC_INVERS	Orientation of the measuring system in relation to axis motion

Example

The following example illustrates how the mounting conditions of the machine axis and linear encoder have to be taken into account in the machine data for the machine axis concerned.

Type of linear encoder with distance-coded zero marks/reference marks used:

Heidenhain: LS 476 C

Technical characteristics (extract)	Value
Measuring length	270 mm
Reference mark distance	20 mm
Signal division of incremental signals with scale division of 0.02 and integrated interpolation: x5	0.004 mm
Interval between two reference marks (specific to Heidenhain)	0.02 mm

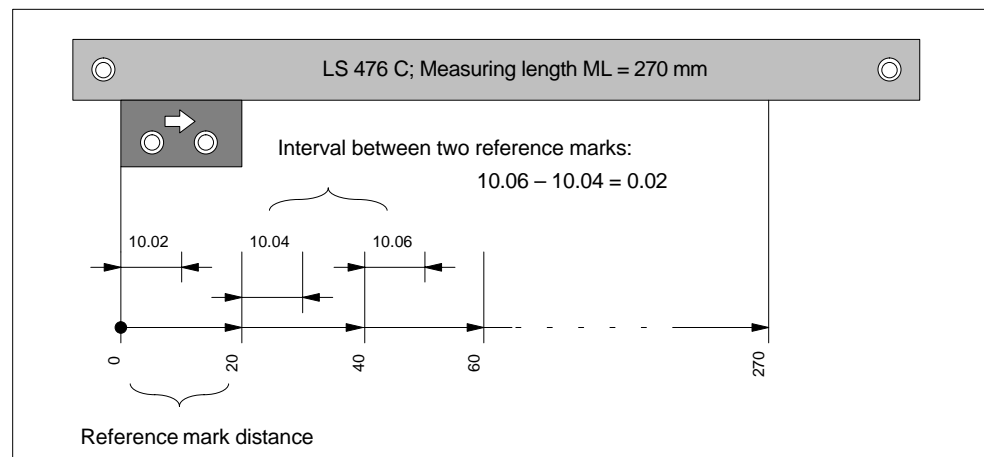

Fig. 4-1 linear encoder: LS 476 C

Because of the various possibilities regarding the orientation of the machine axis and linear encoder (equidirectional/counterdirectional) it is necessary to distinguish between 2 scenarios.

Machine data remains the same in both cases

Number	Identifier: \$MA_	Value
30240	ENC_TYPE	2
31000	ENC_IS_LINEAR	1
31010 *	ENC_GRID_POINT_DIST	0.004
31040	ENC_IS_DIRECT	1
34200	ENC_REFP_MODE	3
34300 *	ENC_REFP_MARKER_DIST	20
34310 *	ENC_MARKER_INC	0.02
*) Technical characteristics of the encoder		

Case 1: Equidirectional orientation

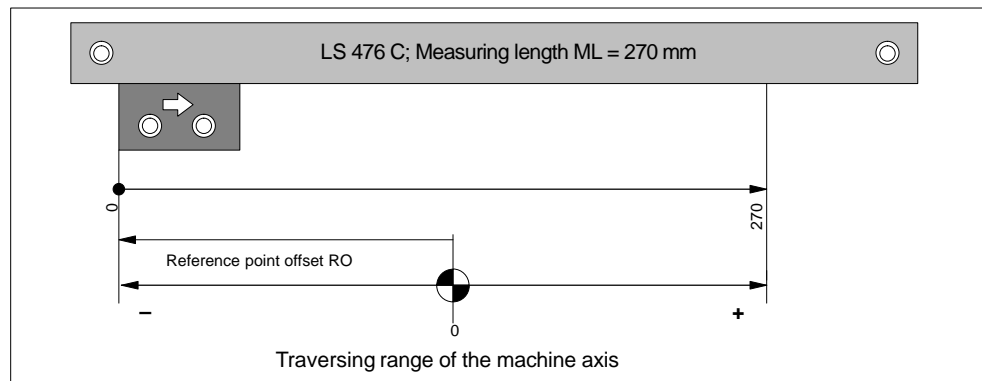

Fig. 4-2 Machine axis with linear encoder: Equidirectional orientation

Orientation-dependent machine data

32100	AX_MOTION_DIR	1
32110	ENC_FEEDBACK_POL	1
34090	REFP_MOVE_DIST_CORR	RO
34320	ENC_INVERS	0

Case 2: Counterdirectional orientation

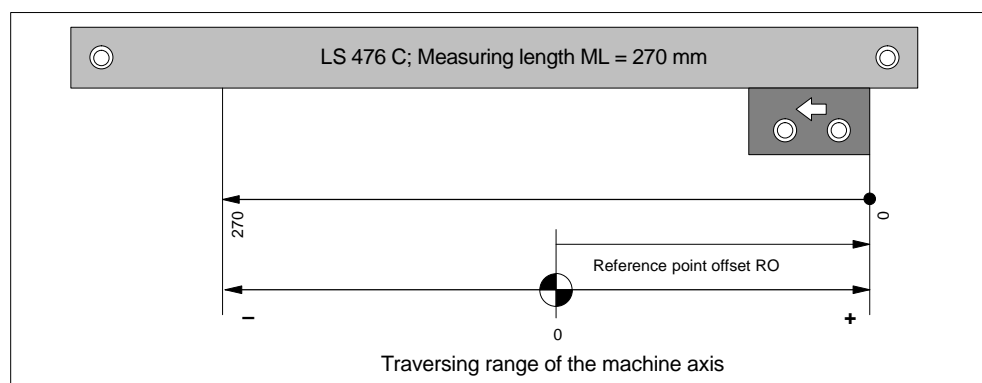

Fig. 4-3 Machine axis with linear encoder: Counterdirectional orientation

Orientation-dependent machine data

32100	AX_MOTION_DIR	1
32110	ENC_FEEDBACK_POL	-1
34090	REFP_MOVE_DIST_CORR	RO
34320	ENC_INVERS	1

Supplementary Conditions

5

There are no other supplementary conditions to note.

Index

Symbols

- (H1/H2): module status, 2-25
- (S2): PROFIBUS address, 2-13
- (SIMATIC Technology CPU), 3-34, 3-44, 3-46, 3-50, 3-54, 3-62, 3-66, 3-67
- (SIMOTION), 3-34, 3-37, 3-44, 3-46, 3-49, 3-52, 3-54, 3-62, 3-66, 3-67
- (SINUMERIK 802D), 2-19, 2-21, 2-24, 3-33, 3-37, 3-43, 3-62, 3-66
- (SINUMERIK 840Di), 2-19, 3-33, 3-37, 3-44, 3-45, 3-48, 3-62, 3-66, 4-69
- (SINUMERIK), 3-47, 3-52
- (X1): external power supply
 - Connecting cable, 2-12
 - Pin assignment, 2-12
 - Supply voltage, 2-12
 - Terminal, 2-12
- (X2): PROFIBUS DP
 - Cables, 2-13
 - Connector, 2-13
 - Data rate, 2-13
 - Pin assignment, 2-13
 - Terminal, 2-13
- (X3): Analog setpoint interface
 - Pin assignment, 2-15
 - Preassembled cables, 2-16
 - Terminal, 2-15
- (X4-1/X4-2/X5-1/X5-2): encoder interfaces
 - Connectable measuring systems, 2-18
 - Encoder supply voltages, 2-18
 - Maximum cable lengths, 2-17
 - Pin assignment, 2-16
 - Preassembled cables, 2-17
 - Terminal, 2-16
- (X6-1): Digital outputs
 - Connecting cable, 2-22
 - Electrical specification, 2-21
 - General electrical properties, 2-21
 - Pin assignment, 2-20
 - Relay contact: "Ready" signal, 2-22
 - Supply voltage, 2-21
 - Terminal, 2-20

- (X6-2): Digital inputs
 - Connecting cable, 2-25
 - Electrical specification, 2-25
 - External supply voltage P24OUText, 2-24
 - General electrical properties, 2-25
 - internal supply voltage P24OUT, 2-24
 - Pin assignment, 2-23
 - Terminal, 2-23

Numbers

- 611U conformant mode, 3-40, 3-41, 3-43, 3-44, 3-49
- SIMATIC Technology CPU, 3-50
- SIMOTION, 3-49, 3-52
- SINUMERIK, 3-52
- With, 3-51, 3-52, 3-53
- Without, 3-51, 3-52, 3-53

A

- Absolute encoder, SSI, 2-19
- Actual speed value, 3-54
- Actual value acquisition, 3-63
- Additional encoder actual value, 3-42
- ADI4 module, 2-26
- Adjustment, 3-64
- Approved encoders, Linear encoder with distance-coded zero marks/reference marks, 2-19
- Assigning parameters for DP communication, 3-56

B

Boundary conditions, 1-10, 3-54, 3-65, 5-73
 Actual speed value, 3-54
 Encoders with axes, 3-54
 Error 20005, 3-54
 External encoder interface, 3-54
 Homing using external zero mark, 3-54
 Measuring Input, 3-54
 On-the-fly measurement, 3-54
 SIMATIC Technology CPU, 3-54, 3-66, 3-67
 SIMOTION, 3-54, 3-66, 3-67
 SINUMERIK 802D, 3-66
 SINUMERIK 840Di, 3-66

C

Cable routing, 2-26
Configuration, 3-35
Connection overview, 1-9, 2-11, 2-29
Consistency, 3-43
Control cabinet installation, 2-26
Controller startup, 4-69
CPU 317T, 3-34

D

Data exchange time, 3-62
Digital inputs, 2-27
Digital outputs, 2-27
Dimension drawing, 2-30
Direction of rotation signal, 3-46
Direction of rotation signals, 3-47
Distance-coded zero marks, 2-19
 SINUMERIK 840Di, 4-69
DP cycle, 3-61
DP cycle time, 3-62
Drive ES Basic, 3-34
Dx, 3-62

E

Encoder control word, 3-41
Encoder error, 3-41
Encoder type, 3-45
 SSI, 3-45
 TTL, 3-45
Encoder zero mark, 3-49, 3-50, 3-51, 3-53
Encoders with axes, 3-54

Equidistance master cyclic component, 3-58
Error codes, Gx_XIST2, 3-42
EXCHANGE, LED: ADI4, 2-25
External encoder interface, 3-54
External zero mark, 3-49, 3-52, 3-53

F

Fine resolution, 3-48
 SINUMERIK 840Di, 3-48
Fir tree, 2-19, 3-46
Firmware version, 1-9
Function parameters
 SIMATIC Technology CPU, 3-44
 SIMOTION, 3-44
 SINUMERIK 802D, 3-43
 SINUMERIK 840Di, 3-44

G

GAP, 3-62
GC, 3-62
General, 1-9
Global control message frame, 3-62
Grounding, 2-28
GTR, 3-62
Gx_STW, 3-41
Gx_XIST2, 3-42

H

Hardware description, 2-11
Homing
 Encoder zero mark, 3-51
 Encoder zero mark and external
 zero mark, 3-53
 External zero mark, 3-52
 SIMATIC Technology CPU, 3-50
 SIMOTION, 3-49, 3-52
 SINUMERIK, 3-52

I

I/O addresses, 3-42
Incremental encoders, TTL, 2-18
Input time, 3-62
Input word, 3-40
Installation/Mounting, 2-26

Interface

- (H1/H2): module status, 2-25
- (S2): PROFIBUS address, 2-13
- (X1): external power supply, 2-12
- (X2): PROFIBUS DP, 2-13
- (X3): Analog setpoint interface, 2-15
- (X4-1/X4-2/X5-1/X5-2): encoder interfaces, 2-16
- (X6-1): Digital outputs, 2-20
- (X6-2): Digital inputs, 2-23

Interface description, 2-12

Interface overview, 2-12

Isochronous DP cycle, 3-56, 3-59

L

- Linear encoders, 2-19
 - SINUMERIK, 4-69

M

- M3, 3-47
- M4, 3-47
- M5, 3-47
- Main features, 1-9
- Master application cycle, 3-60, 3-62
 - SIMATIC Technology CPU, 3-62
 - SIMOTION, 3-62
 - SINUMERIK 802D, 3-62
 - SINUMERIK 840Di, 3-62
- Master time, 3-62
- MD34990, SINUMERIK 840Di, 3-45
- Measuring Input, 2-25, 3-54
- Message frame structure, 3-40
- Message frame type, 3-39
- MLFB: 6FC5 211-0BA01-0AA0, 1-9, 3-67
- MLFB: 6FC5 211-0BA01-0AA1, 3-34, 3-65, 3-67

N

- NC startup, 4-69

O

- On-the-fly measurement, 3-41, 3-54
- Order number, 1-9
- Output time, 3-62
- Output word, 3-40
- OVTEMP, LED: ADI4, 2-25

P

- Parameter assignment, 3-33
- Parameter assignment sequence, 3-35
- POWER, LED: ADI4, 2-25
- Power supply, 2-26
- PROFIBUS address, 3-37
- PROFIBUS parameters
 - SIMOTION, 3-37
 - SINUMERIK 802D, 3-37
 - SINUMERIK 840D, 3-37
- PROFIBUS DP parameter assignment, 3-35
- Properties, 1-9

R

- READY, LED: ADI4, 2-25
- Reference mark search, 3-41, 3-49
- Reference marks, 2-19
 - SINUMERIK 840Di, 4-69
- Requirements
 - SIMATIC Technology CPU, 3-34
 - SIMOTION, 3-34
 - SINUMERIK 802D, 3-33
 - SINUMERIK 840Di, 3-33
- RESERVE, 3-62
- Reserved bits for fine resolution, 3-48
 - SINUMERIK 840Di, 3-48

S

- S7 Technology, 3-34
- Setpoint transfer, 3-63
- Shutdown delay time, 3-47
- Shutdown ramp, 3-47
- Sign-of-life failures, 3-47
- SIMATIC STEP 7, 3-34
- SIMOTION C, 3-34
- SIMOTION D, 3-34
- SIMOTION P, 3-34
- SlaveOM, 3-33
- Smoothing time constant,
 - SINUMERIK 840Di, 3-45
- STEP 7 SIMATIC Manager, 3-34
- Supply voltages (+24 VDC), 2-27

T

- TDP, 3-59, 3-60, 3-62
- TDX, 3-58, 3-62
- Technical specifications, 2-31
- Technology CPU, 3-34
- TI, 3-62, 3-63

TM, 3-62
TMAPC, 3-60, 3-62
 SIMATIC Technology CPU, 3-62
 SIMOTION, 3-62
 SINUMERIK 802D, 3-62
 SINUMERIK 840Di, 3-62
TO, 3-62, 3-63
TOKEN, 3-62
Tolerable sign-of-life failures, 3-47
Total length, 3-43

U

Unipolar motor, 3-46
 SIMATIC Technology CPU, 3-46
 SIMOTION, 3-46
 SINUMERIK, 3-47
Unipolar spindle, 3-46
 SIMATIC Technology CPU, 3-46
 SIMOTION, 3-46
 SINUMERIK, 3-47

To
SIEMENS AG
A&D MC BMS
P.O. Box 3180
D-91050 Erlangen
 Phone: +49 (0) 180 5050 - 222 [Hotline]
 Fax: +49 (0) 9131 98 - 63315 [Documentation]
 E-mail: motioncontrol.docu@siemens.com

From Name _____ Company/Dept. _____ Street _____ Postal code: _____ Town: _____ Phone: _____ / _____ Fax: _____ / _____	Suggestions Corrections For Publication/Manual: ADI4 - Analog Drive Interface for 4 Axes SIMATIC, SIMOTION, SINUMERIK Manufacturer/Service Documentation Product Manual Order No.: 6FC5 297-0BA01-0BP4 Edition: 05.2005
	If you find any errors when reading this publication, please use this form to notify us. Suggestions for improvement are also welcome.

Suggestions and/or corrections