

Desigo™

## Automation stations

PXC7



### To automate building automation and control systems

- Modular automation station and system controller for HVAC and building automation and control systems
- BACnet/IP communication (BTL certified)
- BACnet Secure Connect communication
- Comprehensive management and system functions
- Freely programmable automation stations for maximum flexibility
- Connects TXM input/output modules
- KNX PL-Link bus to connect RDG2..KN room thermostats, sensors, and operator units (including bus power)
- Integration of M-bus energy meters directly (integrated mini power supply) or via RS485 level-converter
- Integration of Modbus data points via RTU and / or TCP
- Integration of BACnet MS/TP devices
- WLAN interface for engineering and commissioning
- Operating voltage AC or DC 24 V
- Mounted on standard rails or on the wall
- Plug-in screw terminal blocks
- Building X integration

Optimized, flexible automation station for HVAC and building automation and control systems

- System functions (alarming, scheduling, trending, access protection with individually definable user profiles and categories)
- System controller for system networks with PXC3, PXC4, PXC5, PXC7 and DXR controllers over BACnet/IP, BACnet/SC, or BACnet MS/TP
- Integrates data points and/or subsystems via Modbus RTU and/or Modbus TCP
- Integrates MS/TP devices
- Integration of wired M-bus meters via RS485 level-converter or onboard M-bus interface (EN 13757-2):
  - Offline and/or online engineering with ABT Site. No additional M-bus tool required
  - Primary and/or secondary device addressing
- The following functions are available with KNX PL-Link bus:
  - Communication with RDG2..KN room thermostats, sensors, and operator units
  - Plug-and-play connection of Siemens field devices with KNX PL-Link
- Integrated power supply for TX-IO modules
- Integrated AC/DC 24 V power supply for field devices (e.g. actuators and sensors)
- Engineering and commissioning with the ABT Site Tool using graphical function charts
- Freely programmable. All function blocks, available in libraries, can be graphically connected.
- BTL tested BACnet communication on IP (BACnet/IP or BACnet/SC) or BACnet MS/TP, in compliance with the BACnet standard including B-BC profile (Rev. 1.16)
- IT security including HTTPS, IEC-62443 4-2 (Security Level 2), and BACnet Secure Connect
- BACnet Secure Connect support as BACnet/SC hub
- Generic operation via embedded web interface
- Cloud connectivity to Building X for remote access and data points time series
- 2-port Ethernet switch for low-cost cabling
- WLAN interface for engineering and commissioning
- Operating voltage AC 24 V or DC 24 V
- DIN rail or screw mounting
- Plug-in screw terminal blocks

## Standardized hardware

PXC7.E400S, M, and L are based on the same hardware and all have the same look and feel. Interfaces like RS485 are enabled and disabled according to the type specification.

| PXC7 variants  | E400S                     | E400M                               | E400L                               |
|--|---------------------------|-------------------------------------|-------------------------------------|
| Order number   | S55375-C111 <sup>1)</sup> | S55375-C110 <sup>1)</sup>           | S55375-C105 <sup>1)</sup>           |
| Number of TXM inputs and outputs   | up to 100                 | up to 200                           | up to 400                           |
| Number of integration data points (M-bus, Modbus TCP and / or RTU)                                   | up to 100                 | up to 200                           | up to 400                           |
| Total number TXM-I/Os and integration DPs  | 100 <sup>2)</sup>         | 250 <sup>2)</sup>                   | 600 <sup>2)</sup>                   |
| Number of digital inputs for potential-free contacts for signaling functions NO or NC (onboard)      | 1                         | 1                                   | 1                                   |
| Number of BACnet/SC devices connected as nodes   | up to 100                 | up to 100                           | up to 100                           |
| Number of BACnet MS/TP devices in a field level network  | up to 60 <sup>3)</sup>    | up to 120 <sup>3)</sup><br>(2 x 60) | up to 240 <sup>3)</sup><br>(4 x 60) |
| Number of KNX PL-Link devices  | up to 64                  | up to 64                            | up to 64                            |
| Number of configurable RS485 interfaces either for integration of Modbus RTU, BACnet MS/TP, or M-bus | 1                         | 2                                   | 4                                   |

<sup>1)</sup> For details on engineering, see PXC4, PXC5 & PXC7 Planning overview, [A6V13054435](#).

<sup>2)</sup> KNX PL-Link data points do not count as integration points. For KNX PL-Link, only the limits on BACnet objects are considered.

<sup>3)</sup> Depending on the behavior of the third-party MS/TP devices.

## Onboard inputs

|    |   |
|----|---|
| DI | Digital inputs for potential-free contacts for signaling functions (NO, NC) |
|----|---|

## TXM I/O modules

| Description   | Type <sup>1)</sup>  | Data sheet |
|---|---------------------|------------|
| Digital input module 8 or 16 I/O points                       | TXM1.8D, TXM1.16D   | CM2N8172   |
| Universal module without / with local operation and LCD       | TXM1.8U, TXM1.8U-ML | CM2N8173   |
| Super universal module without / with local operation and LCD | TXM1.8X, TXM1.8X-ML | CM2N8174   |
| Relay module without / with local operation                   | TXM1.6R, TXM1.6R-M  | CM2N8175   |
| Resistance measuring module (for Pt100 4-wire)                | TXM1.8P             | CM2N8176   |
| Triac module (only if PXC7.E400 is powered with AC)           | TXM1.8T             | CM2N8179   |
| Digital input and relay module                                | TXM1.4D3R           | CM2N8188   |
| Power module  | TXS1.12F10          | CM2N8183   |
| Bus connection module   | TXS1.EF10           | CM2N8183   |
| Island bus extension module                                   | TXA1.IBE            | CM2N8184   |

<sup>1)</sup> Module series B and higher. In following use cases only series D can be used (available as of 2012):

- I/O bus communication mode "Event"

PXC7 can power TXM extensions modules (see Interfaces [▶ 9]).

For further details see PXC4, PXC5 & PXC7 Planning overview [A6V13054435](#) and data sheets.

## KNX PL-Link devices

| Description  | Type  | Data sheet  |
|--|---|-------------|
| Wall-mounted temperature sensor  | QMX3.P30  | CM2N1602    |
| Wall-mounted temperature and humidity sensor   | QMX3.P40  |             |
| Wall-mounted temperature, humidity, and CO <sub>2</sub> sensor   | QMX3.P70  |             |
| Wall-mounted temperature sensor and room operator unit   | QMX3.P34  |             |
| Wall-mounted temperature and humidity sensor and room operator unit  | QMX3.P44  |             |
| Wall-mounted temperature, humidity, and CO <sub>2</sub> sensor and room operator unit  | QMX3.P74  |             |
| Wall-mounted temperature sensor and room operator unit   | QMX2.P33  | A6V10733768 |
| Wall-mounted temperature and humidity sensor and room operator unit  | QMX2.P43  |             |
| Flush-mounted room sensors base and front modules: <ul style="list-style-type: none"> <li>• Base module for temperature and / or humidity measurement <sup>1)</sup></li> <li>• Base module for CO<sub>2</sub> measurement <sup>1)</sup></li> <li>• Front module for base module without sensor</li> <li>• Front module for base module with temperature sensor</li> <li>• Front module for base module with humidity and temperature sensor</li> <li>• Front module for base module with humidity, temperature sensor, and CO<sub>2</sub> indicator LED</li> </ul> | <ul style="list-style-type: none"> <li>• AQR2570</li> <li>• AQR2576</li> <li>• AQR2530NNW</li> <li>• AQR2532NNW</li> <li>• AQR2535NNW</li> <li>• AQR2535NNWQ</li> </ul> | CE1N1411    |
| Passive infrared presence detector   | UP 258D12   | A6V10489489 |
| Presence detector WIDE with temperature sensor   | UP 258D31   | A6V11894530 |
| Presence detector WIDE with temperature and humidity sensor  | UP 258D41   |             |
| Presence detector WIDE with temperature, humidity, and CO <sub>2</sub> sensor  | UP 258D51   |             |
| Presence detector WIDE with temperature sensor and ultrasound  | UP 258D61   |             |
| Room thermostat with temperature and humidity sensor   | RDG200KN<br>RDG260KN  |             |
| Room thermostat with temperature, humidity, and CO <sub>2</sub> sensor   | RDG204KN<br>RDG264KN  |             |

<sup>1)</sup> Physical data points on the base module AQR257.. for use in HVAC functions:

- 2 x Binary potential-free contacts (NO, NC)
- 1 x Passive sensor NTC10K (Type II / Beta (0-50 °C) = 3892 K)

For details see PXC4, PXC5 & PXC7 Planning overview [A6V13054435](#) and data sheets.

## Desigo Control Point

| Description   | Type                          | Data sheet  |
|---|-------------------------------|-------------|
| BACnet touch panels with integrated data storage and web server functionality:<br>7.0 "<br>10.1 "<br>15.6 " | PXM30.E<br>PXM40.E<br>PXM50.E | A6V11664137 |
| TCP/IP client touch panels with data storage in web server PXG3.Wx00-2:<br>7.0 "<br>10.1 "<br>15.6 "        | PXM30-1<br>PXM40-1<br>PXM50-1 | A6V11664139 |
| BACnet/IP web server with standard functionality<br>BACnet/IP web server with extended functionality        | PXG3.W100-2<br>PXG3.W200-2    | A6V12304192 |



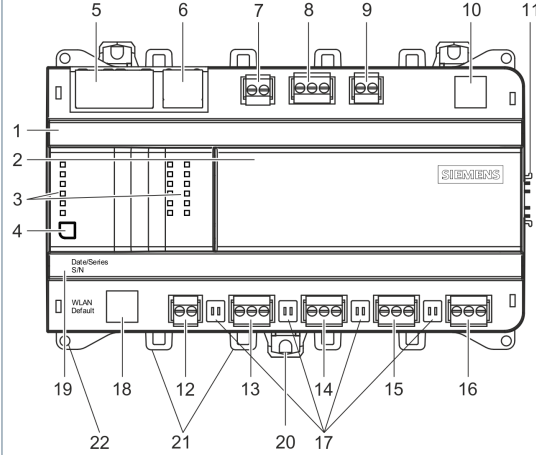

## Technical and mechanical design

The compact build allows for mounting the devices on a standard rail or a wall.

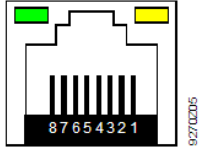

|    |  |
|----|--|
| 4  | Service button (ID on network and WLAN on/off)                         |
| 5  | 2-port Ethernet switch (with 2 LEDs per port for display purposes)     |
| 6  | Ethernet port (for future use)   |
| 7  | Plug-in terminal block with screw terminals KNX PL-Link                |
| 8  | Plug-in terminal blocks with screw terminals Power supply              |
| 9  | Plug-in terminal block with screw terminals Digital input              |
| 10 | Data matrix code   |
| 11 | Connection for TXM modules (island bus)                                |
| 12 | Plug-in terminal block with screw terminals M-bus                      |
| 13 | Plug-in terminal block with screw terminals (M-bus, Modbus, or MS/TP)  |
| 14 | COM1 interface   |
| 15 | COM2 interface   |
| 16 | COM3 interface   |
| 17 | COM4 interface   |
| 18 | Activation of COM 1/2/3/4 depending on Type (S,M,L)                    |
| 19 | DIP switches for bus termination and polarization COM                  |
| 20 | QR code for default WLAN access<br>Description see Technical data [ 8] |
| 21 | Date/series and serial number  |
| 22 | Slider for mounting on DIN rails                                       |
| 1  | Eyelets for cable ties   |
| 2  | Holes for wall mounting  |
| 3  | Plastic housing  |
| 2  | Battery cover  |
| 3  | LEDs for communication and state                                       |

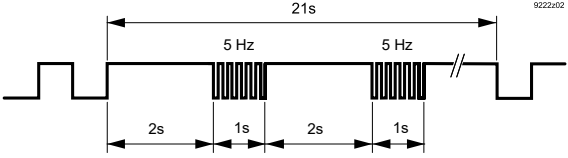
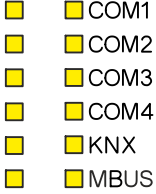
## LED displays

| Activity   | LED   | Color  | Activity                                  | Function   |
|--|---|--------|---|--|
|             | Ethernet  | Green  | Steady ON<br>Steady OFF<br>Flashing       | Link active<br>No connection<br>Network traffic  |
|  |   | Yellow | Steady ON<br>Steady OFF                   | Link 100 Mbps<br>Link 10 Mbps  |
|             | RUN   | Green  | Steady ON<br>Steady OFF<br>Flashing       | Device operational<br>Device not operational<br>Start-up or program stop   |
|  |   | Red    | Steady OFF<br>Steady ON<br>Rapid flashing | OK<br>HW or SW fault<br>Firmware or application missing/corrupted  |
|  |  | Blue   | Steady ON<br>Blinking<br><br>Steady OFF   | Cloud connection OK<br>Cloud connection enabled but no connection available<br>Cloud connection disabled   |
|  | BAT   | Red    | Steady OFF<br>Steady ON                   | Optional battery OK<br>Optional battery empty - replace  |
|  | TXM   | Yellow | Flashing<br>Steady OFF                    | Communication<br>No communication with TXM modules   |
|  | SVC   | Red    | Steady OFF<br>Flashing                    | OK<br>Device not configured  |
|  |   |        | Flashing after wink command               | Device ID after receipt of wink command  |
|           |   |        |   |  |
| TX RX<br> | COM...  | Yellow | Flashing<br><br>Steady OFF                | Communication (TX: Transmit, RX: Receive)<br>No communication to subsystem   |
|  | KNX   | Yellow | Flashing<br><br>Steady OFF                | Communication (TX: Transmit, RX: Receive)<br>No communication to subsystem   |
|  | M-bus   | Yellow | Flashing<br><br>Steady OFF                | Communication (TX: Transmit, RX: Receive)<br>No communication to subsystem   |
|  SVC      | Service button  |        | Press 0.2 ... 1 s<br>Press 1 ... 3 s      | ID in the network<br>WLAN enable/disable<br>WLAN disables automatically after 10 minutes if no client is connected   |
|  |   |        | Factory reset                             | <ol style="list-style-type: none"> <li>Power off the device.</li> <li>Power on the device.</li> <li>Wait until all LEDs light up and turn off again, then press the Service button.</li> <li>Keep the Service button pressed until all LEDs light up, then release the button. All LEDs go off, the device restarts.</li> <li>Wait until the device has fully started – unconfigured (green RUN LED and red SVC LED are flashing)</li> </ol> |

Related documents such as the environmental declarations, declarations of conformity, etc., can be downloaded from the following Internet address:

[www.siemens.com/bt/download](http://www.siemens.com/bt/download)

Notes



Safety

|  <b>CAUTION</b> |  |
|--|--|
|                 | <p><b>National safety regulations</b></p> <p>Failure to comply with national safety regulations may result in personal injury and property damage.</p> <ul style="list-style-type: none"> <li>Observe national provisions and comply with the appropriate safety regulations.</li> </ul> |



Mounting position and ambient temperature

The devices can be snapped onto standard rails or screwed onto a flat surface. Plug-in screw terminals connect power and interfaces.

| Ambient temperature -5...50 °C (23...122 °F)   | Ambient temperature -5...45 °C (23...113 °F)  |
|--|---|
| <ul style="list-style-type: none"> <li>Wall, horizontal                             <ul style="list-style-type: none"> <li>From left to right</li> <li>From right to left</li> </ul> </li> </ul> | <ul style="list-style-type: none"> <li>Overhead</li> <li>Wall, vertically                             <ul style="list-style-type: none"> <li>From top to bottom</li> <li>From bottom to top</li> </ul> </li> <li>On a horizontal surface</li> </ul> |

|  <b>CAUTION</b> |   |
|--|---|
|                 | <p><b>Risk of overheating for failure to comply with ambient temperature</b></p> <p>Burning and damage to the device</p> <ul style="list-style-type: none"> <li>Ensure sufficient ventilation to comply with the permissible ambient temperature within the panel or installation box. The temperature must be at least 10 K (18° F) lower outside the installation box.</li> </ul> |

Installation

|  <b>WARNING</b> |   |
|--|---|
|                 | <p><b>Electric shock</b></p> <p>Incorrect installation of the device may lead to electric shock injuries when touching the device!</p> <ul style="list-style-type: none"> <li>Install the device in a lockable cabinet or use terminal covers.</li> <li>Do not install the device in locations where children are likely to be present.</li> <li>Conductors with a cross-section of 0.5 mm<sup>2</sup> (AWG24) or greater shall comply with the requirements of IEC 60332-1-2 and IEC 60332-1-3 or IEC TS 60695-11-21.</li> </ul> |

Disposal



This symbol or any other national label indicate that the product, its packaging, and, where applicable, any batteries may not be disposed of as domestic waste. Delete all personal data and dispose of the item(s) at separate collection and recycling facilities in accordance with local and national legislation.  
For additional details, refer to [Siemens information on disposal](#).

## Warranty

Technical data on specific applications are valid only together with Siemens products listed under "Equipment combinations". Siemens rejects any and all warranties in the event that third-party products are used.

## Technical data

### Power supply

|  |  |
|--|--|
| Operating voltage AC 24 V (24 V~, $\perp$ , $\text{⏚}$ ) | AC 24 V -15 / +20 % (PELV)<br>AC 24 V Class 2 (US)<br>48...63 Hz   |
| Operating voltage DC 24 V (24 V~, $\perp$ , $\text{⏚}$ ) | DC 24 V -15 / +20 % (PELV)<br>DC 24 V Class 2 (US)   |
| Functional ground (US)<br>Functional earth $\text{⏚}$    | The terminal for the functional ground must be connected on the installation side with the building grounding system (PE).   |
| Screw terminals for wire cross sections up to            | Max. 2.5 mm <sup>2</sup> (14 AWG)  |
| Internal fusing  | 4 A irreversible / non-replaceable   |
| External supply line fusing (EU)                         | Non-renewable fuse max. 10 A slow-blow<br>or<br>circuit breaker max. 13 A<br>Tripping characteristic B, C, D per EN 60898<br>or<br>Power supply with current limitation of max. 10 A |
| Protection   | Reverse connection protection for DC 24 V  |

### Power consumption (for transformer / power supply planning)

|   | Operating voltage<br>AC 24 V                                     | Operating voltage<br>DC 24 V |
|---|--|------------------------------|
| Full load   | 71 VA / 3.0 A  | 66 W / 2.8 A                 |
| Base load (without loading by I/O modules TXM, KNX PL-Link, M-bus, and field devices) | 15.4 VA / 0.64 A   | 7.8 W / 0.33 A               |
| I/O modules TXM supply  | 15 VA / 0.6 A  | 8 W / 0.3 A                  |
| KNX PL-Link supply  | 4 VA / 0.17 A  | 2.2 W / 0.09 A               |
| M-bus supply  | 3 VA / 0.13 A  | 1.7 W / 0.07 A               |
| Field device supply V~  | Max. 2 A, total of the connected field devices<br>< 48 VA / 48 W |                              |



## Function data

| Hardware information |                              |
|----------------------|------------------------------|
| Processor            | NXP i.MX8 QuadXPlus, 1.2 GHz |
| Storage              | 2 GByte RAM<br>8 GByte eMMC  |

| Data backup in the event of power failure   |
|---|
| Energy reserve (supercapacitor) to support real-time clock (7 days).<br>Energy reserve to support real-time clock can be extended using optional battery BR2032: depending on the life time of the battery and use, typically 10 years.<br><i>(Battery safety requirement and specification for BR2032 according to IEC 60086-4 or UL1642.<br/>Battery must be rated for ambient temperature 85 °C (185 °F))</i><br>Low power of battery will be indicated by LED and a system alarm will be generated. |
| Data available if stored to flash memory: Every 5 minutes.<br>The interval of 5 minutes is only valid for change log but not for trending.<br>In case of a power failure, trend log data can be lost up to 30 minutes.  |

## Interfaces

| Ethernet interface                          |   |
|---|---|
| Plug  | 3 x RJ45, shielded  |
| Interface type                              | 10Base-T / 100Base-TX, IEEE 802.3 compatible  |
| Bit rate                                    | 10/100 Mbps, autosensing  |
| Protocol                                    | BACnet/IP on UDP/IP, BACnet/SC on TCP/IP, and HTTPS on TCP/IP   |
| Cabling (in-house cabling only), cable type | 10 Mbps: Min. CAT3, shielded cable is recommended<br>100 Mbps: Min. CAT5, shielded cable is recommended |
| Cable length                                | Max. 100 m (330 ft)   |

The COM interfaces can be used either for M-bus, Modbus, or for MS/TP, according to type and configuration.

| M-bus interface on COM interface (RS485)                |  |
|---|--|
| Interface type  | EIA-485, electrically isolated   |
| Baud rate   | 300, 600, 1200, 2400, 4800, 9600, 19200, 38400.<br>The maximum baud rate is depending on the configuration of M-bus-S devices (subordinate devices) and M-bus repeater.  |
| Internal bus termination                                | 120 Ohm, switchable with DIP switch  |
| Internal bus polarization                               | 270 Ohm pull-up/pull-down resistances, switchable with DIP switch  |
| Cabling (in-house cabling only)<br>Cable length         | 3-wire cable, shielded cable recommended (shield must be connected to building earth in the mounting panel)<br>Max. 1000 m (3300 ft)   |
| Protection  | Short-circuit proof<br>Protection against faulty wiring with AC 24 V and DC 24 V   |
| M-bus level converter including power supply (required) | Configuration examples (simple M-bus loads à 1.5 mA): <ul style="list-style-type: none"> <li>• Up to 2 M-bus devices: STV Electronic, MPW-2 <sup>1</sup></li> <li>• Up to 6 M-bus devices: STV Electronic, MPW-6 <sup>1</sup></li> <li>• Up to 60 M-bus devices: Relay GmbH, PW60 <sup>1</sup></li> <li>• Up to 250 M-bus devices: Siemens, WTX631-GA0090</li> </ul> |

<sup>1</sup> For STV Electronic level converters, refer to <https://www.stv-electronic.de/>. For Relay GmbH level converters, refer to <https://www.relay.de/>.

The use of these products is a recommendation only. Siemens cannot guarantee functionality nor take over any warranty for third-party products. This information is subject to change without notice.

| <b>Modbus RTU interface</b>                     |  |
|---|--|
| Interface type                                  | EIA-485, electrically isolated   |
| Baud rate                                       | 300, 600, 1200, 2400, 4800, 9600, 19200, 38400, 57600, 76800, 115200 (depending on the configuration)                                |
| Internal bus termination                        | 120 Ohm, switchable with DIP switch  |
| Internal bus polarization                       | 270 Ohm pull-up/pull-down resistances, switchable with DIP switch  |
| Cabling (in-house cabling only)<br>Cable length | 3-wire cable, shielded cable recommended (shield must be connected to building earth in the mounting panel)<br>Max. 1000 m (3300 ft) |
| Protection                                      | Short-circuit proof<br>Protection against faulty wiring with AC 24 V and DC 24 V   |

| <b>BACnet MS/TP interface</b>   |  |
|---|--|
| Interface type  | EIA-485, electrically isolated   |
| Baud rate   | 9600, 19200, 38400, 76800, 115200 (depending on the configuration)               |
| Internal bus termination  | 120 Ohm, switchable with DIP switch  |
| Internal bus polarization   | 270 Ohm pull-up/pull-down resistances, switchable with DIP switch                |
| Cabling (in-house cabling only)<br>Distance between 2 devices<br>Length of the MS/TP line | 3-wire cable, shielded<br>Max. 500 m (1650 ft)<br>Max. 1000 m (3300 ft)          |
| Protection  | Short-circuit proof<br>Protection against faulty wiring with AC 24 V and DC 24 V |

| <b>WLAN interface</b>  |   |
|--|---|
| Interface type   | Wireless access point   |
| Supported standards  | IEEE 802.11b/g/n  |
| Frequency band   | 2.412...2.462 GHz   |
| WLAN channels  | 1...11  |
| Maximum radio-frequency power  | 16.4 dBm  |
| Distance (unobstructed field)  | Min. 5 m (16 ft)  |
| Device pairing   | Activation / deactivation with service button<br>Automatic switch off after 10 minutes if no WLAN-client is connected.<br>Optionally, for cyber security reasons, the WLAN can be permanently disabled via configuration. |
| <p><b>Default SSID and WLAN password:</b> Scan the QR code.<br/>It will display something like WIFI:S:PXC7.E400_0000550;T:WPA;P:1400052738;;<br/>Then SSID = PXC7.E400_0000550 and password = 1400052738<br/>Determine manually: Use the information from the Date/Series/SN block It will display something like:<br/>Date/Series: 202104230000550<br/>S/N: 1400052738<br/>SSID = &lt;ASN&gt;_&lt;Running number after the series letter&gt; and password = &lt;S/N&gt;</p> |   |

| <b>M-bus manager with integrated power supply</b>   |   |
|---|---|
| Interface type  | M-bus manager according to EN 13757-2 for max. 7.5 mA, galvanically isolated<br>Max. 4 M-bus meters as subordinates (4 simple M-bus loads à 1.5 mA)   |
| Baud rate   | 300, 2400 (default), 9600.<br>The maximum baud rate is depending on M-bus device configuration and M-bus repeater.  |
| Cabling (in-house cabling only)<br>Cable length   | 2-wire cable, interchangeable according to M-bus standard<br>Max. 100 m (330 ft)  |
| Protection  | Short-circuit proof<br>Protection against faulty wiring with AC 24 V and DC 24 V  |
| M-bus level converter used as repeater (optional) to extend number of connected M-bus-S devices | Configuration examples (simple M-bus loads à 1.5 mA): <ul style="list-style-type: none"> <li>Up to 60 M-bus-S devices: WTV531-GA5060</li> <li>Up to 250 M-bus-S devices: WTX631.GA0090</li> </ul> |

ABT Site checks the number of data points and not the number of M-bus-S devices. The max. number of devices per network depends on the individual load of each device and the given power supply by the M-bus manager (PXC4/5/7) or converter.

| <b>KNX PL-Link interface</b>                    |   |
|---|---|
| Type  | KNX TP1 PL-Link, galvanic isolation<br>Baud rate: 9.6 kbps  |
| Cabling (in-house cabling only)<br>Cable length | 2-wire cable, 0.75 mm <sup>2</sup> / AWG20<br>or 1 mm <sup>2</sup> / AWG18<br>With internal supply: Max. 80 m (262 ft)<br>With external supply: Max. 1000 m (3300 ft) |
| Internal bus power                              | Max. 50 mA<br>When using external bus power for KNX PL-Link, switch off the internal bus power via the ABT Site Tool.   |

| <b>I/O modules TXM bus interface</b>                                  |  |
|---|--|
| Nominal voltage   | DC 24 V  |
| Supply current for I/O modules TXM                                    | Max. 300 mA  |
| Connectable in parallel with DC 24 V power supply module TXS1.12F4    | For details, see: TX-I/O- engineering and installation, CM110562 |
| Protection  | Short-circuit proof  |
| TXM I/O module plug: No protection against faulty wiring with AC 24 V | No electric protection.<br>Use cover                             |

| <b>Field device supply (I/O module TXM)</b>            |  |
|--|--|
| AC 24 V output current (terminal V~ on the TXM module) | Max. 2 A, short-circuit proof (only if PXC7 is powered by AC voltage)<br>If PXC7 is powered by DC voltage, the field device supply on terminal V~ of the TXM modules is also DC voltage. |

| <b>Screw terminals, plug-in</b>           |   |
|---|---|
| Cu-wire or Cu-strand with wire end sleeve | 1 x 0.6 mm Ø to 2.5 mm <sup>2</sup> (22 to 14 AWG)<br>or 2 x 0.6 mm Ø to 1.0 mm <sup>2</sup> (22 to 18 AWG) |
| Cu-strand without wire end sleeve         | 1 x 0.6 mm Ø to 2.5 mm <sup>2</sup> (22 to 14 AWG)<br>or 2 x 0.6 mm Ø to 1.5 mm <sup>2</sup> (22 to 16 AWG) |
| Stripping length                          | 6...7.5 mm (0.24...0.29 in)   |
| Screwdriver                               | Slot screws, screwdriver size 1 with shaft Ø = 3 mm   |
| Max. tightening torque                    | 0.6 Nm (0.44 lb ft)   |

| Ambient conditions and protection classification  |  |
|---|--|
| Classification as per EN 60730<br>Automatic action<br>Control function<br>Pollution degree<br>Overvoltage category  | Type 1<br>Class A<br>2<br>I  |
| Protection against electric shock   | Protection class III   |
| Protection degree of housing to EN 60529<br>Front parts in DIN cut-out<br>Terminal part   | IP30<br>IP20   |
| Climatic ambient conditions <ul style="list-style-type: none"> <li>Storage / Transport (packaged for transport) as per IEC EN 60721-3-2</li> <li>Operation as per IEC/EN 60721-3-3</li> </ul> | <ul style="list-style-type: none"> <li>Class 1K22 / 2K12<br/>Temperature -25...70 °C (-13...158 °F)<br/>Air humidity 5...95 % (non-condensing)</li> <li>Class 3K23<br/>Operation in enclosed dry locations, having no temperature or humidity control<br/>Temperature -5...50 °C (23...122 °F)<br/><i>(for details see chapter Mounting)</i><br/>Air humidity 5...95 % (non-condensing)</li> </ul> |
| Mechanical ambient conditions <ul style="list-style-type: none"> <li>Transport per IEC/EN 60721-3-2</li> <li>Operation as per IEC/EN 60721-3-3</li> </ul>                                     | <ul style="list-style-type: none"> <li>Class 2M4</li> <li>Class 3M11</li> </ul>  |

| Standards, directives, and approvals      |  |
|---|--|
| Product standards                         | IEC/EN 60730-1   |
| Product family standard                   | IEC/EN 63044-x   |
| Electromagnetic compatibility (EMC)       | For residential, commercial, and industrial environments   |
| EU conformity (CE)                        | See CE declaration <sup>1)</sup>   |
| UK conformity (UKCA)                      | See UK declaration <sup>1)</sup>   |
| EAC conformity                            | Eurasian compliance  |
| RCM conformity                            | See RCM declaration <sup>1)</sup>  |
| UL/cUL certification (US / Canada)        | UL916, <a href="http://ul.com/database">http://ul.com/database</a><br>UL94, housing material meets classification V-0 <sup>2)</sup>  |
| CSA certification                         | C22.2, <a href="http://csagroup.org/services-industries/product-listing">http://csagroup.org/services-industries/product-listing</a>   |
| FCC                                       | CFR 47 Part 15C  |
| BACnet                                    | Profile: B-BC<br>Revision: 1.16<br>Detailed information on BACnet certificates, BTL listings, and PICS can be found on the BACnet website ( <a href="#">filtered for Siemens products</a> )                          |
| AMEV profile (BACnet 2017)                | AS-B   |
| KBOB profile (BACnet 2017)                | AS-CH <sup>3)</sup>  |
| Environmental compatibility <sup>1)</sup> | The product environmental declaration <sup>1)</sup> contains data on environmentally compatible product design and assessments (RoHS compliance, materials composition, packaging, environmental benefit, disposal). |
| OSHPD seismic certification               | Product meets OSHPD Special Seismic Certification Preapproval ( <a href="#">OSH-0217</a> ) under California Building Code 2022 (CBC 2022) <sup>4)</sup>  |

<sup>1)</sup> Documents can be downloaded at [www.siemens.com/bt/download](http://www.siemens.com/bt/download).

<sup>2)</sup> Material level

<sup>3)</sup> AS-CH pending

<sup>4)</sup> When installed within the following Siemens enclosures: PXA-ENC18, PXA-ENC19, or PXA-ENC34.

### European Union conformity

Contact for regulatory topics: (EU) Siemens AG, Berliner Ring 23, DE-76437 Rastatt

### United Kingdom conformity assessed

Contact for regulatory topics: (GB) Siemens plc, Sir William Siemens House, Princess Road, Manchester, M20 2UR

### FCC Statement

This equipment has been tested and found to comply with the limits for a Class B digital device, pursuant to part 15 of the FCC Rules. These limits are designed to provide reasonable protection against harmful interference in a residential installation. This equipment generates, uses and can radiate radio frequency energy and, if not installed and used in accordance with the instructions, may cause harmful interference to radio communications. However, there is no guarantee that interference will not occur in a particular installation. If this equipment does cause harmful interference to radio or television reception, which can be determined by turning the equipment off and on, the user is encouraged to try to correct the interference by one or more of the following measures:

- Reorient or relocate the receiving antenna.
- Increase the separation between the equipment and receiver.
- Connect the equipment into an outlet on a circuit different from that to which the receiver is connected.
- Consult the dealer or an experienced radio/TV technician for help.

This device complies with Part 15 of the FCC rules. Operation is subject to the following two conditions:

1. This device may not cause harmful interference, and
2. this device must accept any interference received, including interference that may cause undesired operation

**FCC Caution:** Changes or modifications not expressly approved by Siemens Switzerland Ltd. could void user authority to operate the equipment. United States representative <https://new.siemens.com/us/en/products/buildingtechnologies/home.html>

### Industry Canada statement

This device complies with ISED's license-exempt RSSs. Operation is subject to the following two conditions:

1. This device may not cause interference, and
2. This device must accept any interference received, including interference that may cause undesired operation.

### Radiofrequency radiation exposure statement

This equipment complies with FCC and IC radiation exposure limits set forth for an uncontrolled environment. This equipment should be installed and operated with a minimum distance of 20 cm between the radiator and your body.

This transmitter must not be co-located or operated in conjunction with any other antenna or transmitter.

## Housing

|                                 |                               |
|---------------------------------|-------------------------------|
| Color top / bottom              | 2003 Ti-Grey / 804 Black      |
| Dimensions                      | per DIN 43880, see Dimensions |
| Weight without / with packaging | 516 g / 581 g                 |

## Connection terminals

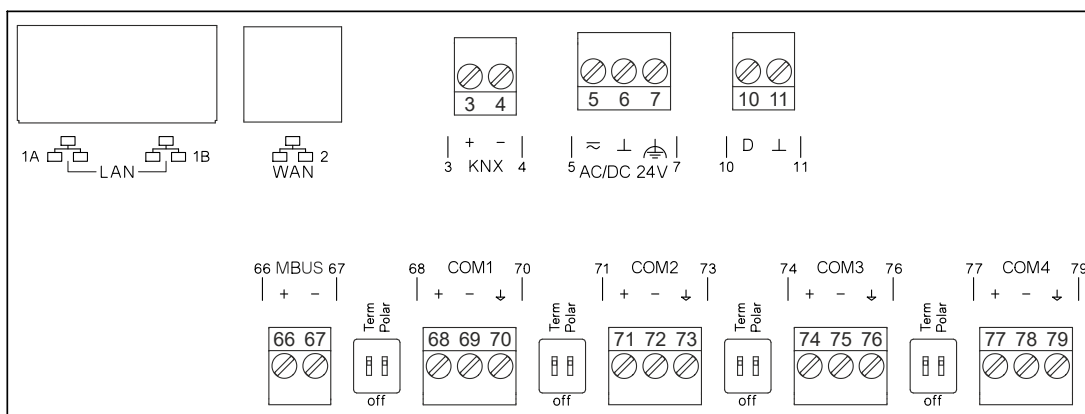

| Terminal             | Symbol  | Description   |
|----------------------|---------|---|
| 1A, 1B               |         | 2 x RJ45 interface for Ethernet with switch   |
| 2                    |         | 1 x RJ45 interface (for future use)   |
| 3, 4                 | KNX     | KNX PL-Link   |
| 5, 6                 | ≈, ⊥    | Operating voltage AC 24 V or DC 24 V  |
| 7                    |         | Functional ground (must be connected on the installation side with the building grounding system (PE)). |
| 10, 11               | D, ⊥    | Digital input   |
| Term                 | on, off | Switch for bus termination  |
| Polar                | on, off | Switch for polarization   |
| 66, 67               | MBUS    | M-bus interface   |
| 68, 69, 70           | COM1    | Interface EIA-485 (M-bus, Modbus RTU, BACnet MS/TP)   |
| 71, 72, 73           | COM2    | Remark: Activation of COM1/2/3/4 depending on Type (S, M, L)  |
| 74, 75, 79           | COM3    |   |
| 77, 78, 79           | COM4    |   |
| Right side of device |         | Interface for connecting TXM I/O modules  |

## Dimensions

All dimensions in mm and inches.

### PXC7

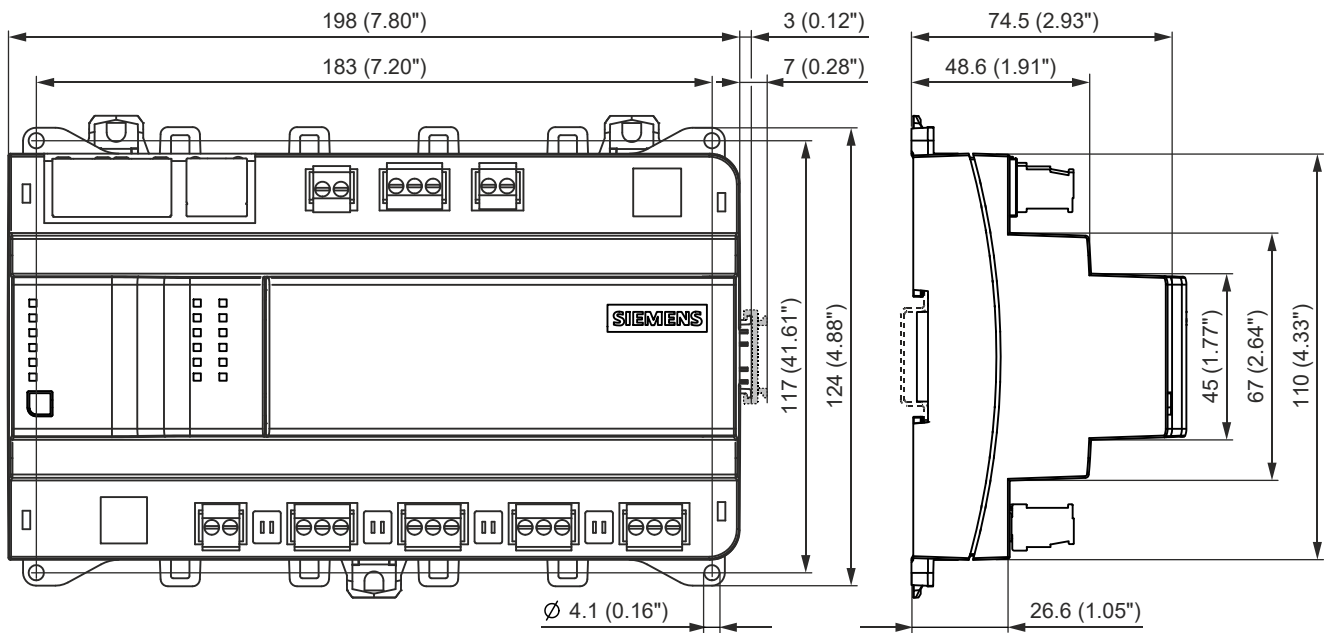

### PXC7 with four TXM modules

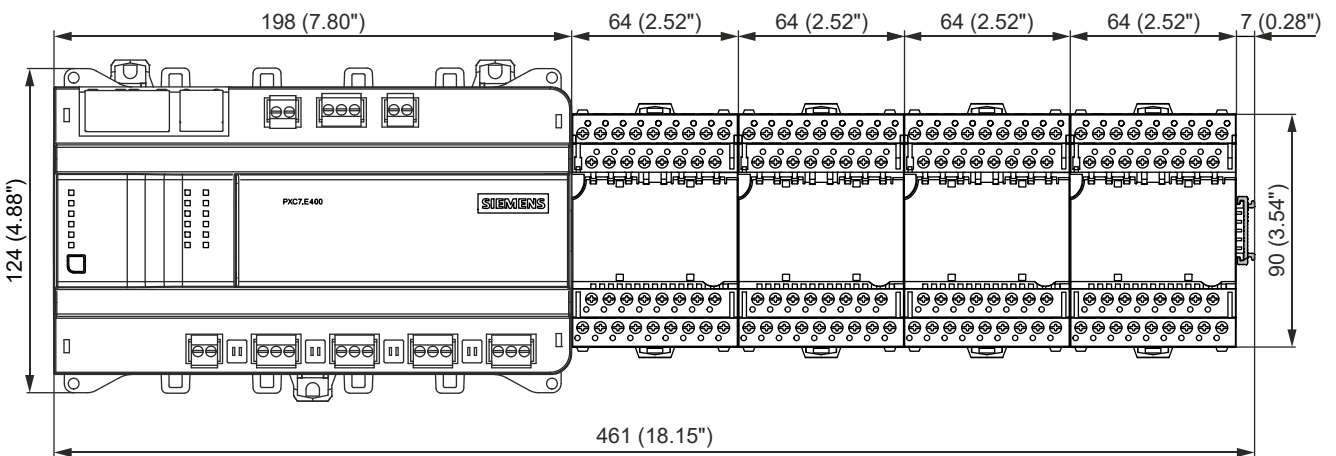

Issued by  
Siemens Switzerland Ltd  
Smart Infrastructure  
Global Headquarters  
Theilerstrasse 1a  
CH-6300 Zug  
+41 58 724 2424  
[www.siemens.com/buildingtechnologies](http://www.siemens.com/buildingtechnologies)

© Siemens 2022  
Technical specifications and availability subject to change without notice.

---

Document ID    A6V12505052\_en--\_e  
Edition        2023-12-22