

## SIMOVERT MASTERDRIVES Application Manual



No guarantee can be accepted for the general validity of the calculation techniques described and presented here. As previously, the configuring engineer is fully responsible for the results and the subsequently selected motors and drive converters.

## Contents

<b>1</b>	<b>FOREWORD.....</b>	<b>7</b>
<b>2</b>	<b>FORMULAS AND EQUATIONS .....</b>	<b>9</b>
<b>3</b>	<b>VARIOUS SPECIAL DRIVE TASKS .....</b>	<b>25</b>
3.1	Traction- and hoisting drives .....	25
3.1.1	General information.....	25
3.1.2	Traction drive with brake motor .....	38
3.1.3	Hoisting drive with brake motor .....	49
3.1.4	High-bay racking vehicle .....	60
3.1.5	Hoisting drive for a 20 t gantry crane.....	77
3.1.6	Elevator (lift) drive .....	83
3.1.7	Traction drive along an incline.....	92
3.2	Winder drives .....	103
3.2.1	General information.....	103
3.2.2	Unwind stand with closed-loop tension control using a tension transducer.....	110
3.2.3	Winder with closed-loop tension control using a tension transducer.....	117
3.2.4	Unwinder with 1FT6 motor .....	123
3.2.5	Unwind stand with intermittent operation.....	131
3.3	Positioning drives .....	139
3.3.1	General information.....	139
3.3.2	Traction drive with open-loop controlled positioning using Beros .....	147
3.3.3	Elevator drive with closed-loop positioning control (direct approach).....	149
3.4	Drives with periodic load changes and surge loads .....	151
3.4.1	General information.....	151
3.4.2	Single-cylinder reciprocating compressor.....	161
3.4.3	Three-cylinder pump .....	167
3.4.4	Transport system for freight wagons .....	171
3.4.5	Drive for an eccentric press.....	184
3.5	Load distribution for mechanically-coupled drives .....	197
3.5.1	General information.....	197
3.5.2	Group drive for a traction unit.....	204
3.5.3	Drive for an extraction tower with 10 mechanically-coupled motors.....	207
3.6	Crank drive.....	208
3.7	Rotary table drive .....	221

3.8	Pivot drive .....	227
3.9	Spindle drive with leadscrew .....	238
3.10	Cross-cutter drive .....	254
3.11	Centrifugal drive .....	261
3.12	Cross-cutter with variable cutting length .....	272
3.13	Saw drive with crank .....	293
3.14	Saw drive as four-jointed system .....	306
3.15	Mesh welding machine .....	323
3.16	Drive for a pantograph .....	357
3.17	Drive for a foil feed with $\sin^2$ rounding-off .....	377
<b>4</b>	<b>INFORMATION FOR SPECIFIC APPLICATIONS .....</b>	<b>387</b>
4.1	Accelerating time for loads with square-law torque characteristics .....	387
4.1.1	General information .....	387
4.1.2	Accelerating time for a fan drive .....	389
4.1.3	Accelerating time for a blower drive (using the field-weakening range) .....	392
4.1.4	Re-accelerating time for a fan drive after a brief supply failure .....	398
4.1.5	Calculating the minimum braking time for a fan drive .....	406
4.2	Connecting higher output motors to a drive converter than is normally permissible....	418
4.2.1	General information .....	418
4.2.2	Operating a 600 kW motor under no-load conditions .....	422
4.3	Using a transformer at the drive converter output .....	425
4.3.1	General information .....	425
4.3.2	Operating a 660 V pump motor through an isolating transformer .....	427
4.3.3	Operating 135V/200 Hz handheld grinding machines through an isolating transformer .....	428
4.4	Emergency off .....	430
4.4.1	General information .....	430
4.5	Accelerating- and decelerating time with a constant load torque in the field-weakening range .....	436
4.5.1	General information .....	436
4.5.2	Braking time for a grinding wheel drive .....	438

4.6	Influence of a rounding-off function .....	442
4.7	Possible braking torques due to system losses .....	453
4.7.1	General information.....	453
4.7.2	Braking time for a fan drive .....	460
4.8	Minimum acceleration time for fan drives with a linear acceleration characteristic .....	465
4.8.1	General information.....	465
4.8.2	Example .....	471
4.9	Buffering multi-motor drives with kinetic energy .....	474
4.9.1	General information.....	474
4.9.2	Example for buffering with an additional buffer drive .....	479
4.10	Harmonics fed back into the supply in regenerative operation .....	483
4.11	Calculating the braking energy of a mechanical brake .....	491
4.11.1	General information.....	491
4.11.2	Hoisting drive with counterweight .....	491
4.11.3	Traversing drive .....	495
4.12	Criteria for selecting motors for clocked drives.....	499
4.12.1	General information.....	499
4.12.2	Example 1, rotary table drive with $i=4$ and short no-load interval.....	507
4.12.3	Example 2, rotary table drive with $i=4$ and long no-load interval .....	510
4.12.4	Example 3, rotary table drive with a selectable ratio and short no-load interval....	512
4.12.5	Example 4, rotary table drive with selectable ratio and long no-load interval .....	515
4.12.6	Example 5, traversing drive with selectable ratio and longer no-load time.....	517
4.13	Optimum traversing characteristics regarding the maximum motor torque and RMS torque .....	520
4.13.1	Relationships for pure flywheel drives (high-inertia drives) .....	520
4.13.2	Relationships for flywheel drives (high-inertia drives) with a constant load torque	524
4.13.3	Summary.....	526
4.13.4	Example with 1PA6 motor .....	527
<b>5</b>	<b>INDEX.....</b>	<b>533</b>
<b>6</b>	<b>LITERATURE.....</b>	<b>536</b>



# 1 Foreword

This Application Manual for the new SIMOVERT MASTERDRIVES drive converter series is conceived as supplement to the Engineering Manual and the PFAD configuring/engineering program. Using numerous examples, it provides support when engineering complex drive tasks, such as for example traction- and hoisting drives, winders etc. It is shown how to calculate the torque- and motor outputs from the mechanical drive data and how to select the motor, drive converter, control type and additional components. As result of the diversity of the various drive tasks, it is not possible to provide detailed instructions with wiring diagrams, parameter settings etc. This would also go far beyond the scope of this particular document. In some cases, the examples are based on applications using previous drive converter systems and actual inquiries with the appropriate drive data.

Further, this Application Manual provides information for specific applications, for example, using a transformer at the converter output, accelerating time for square-law load torque characteristics etc. This is supplemented by a summary of formulas and equations with units, formulas and equations for induction motors, converting linear into rotational motion, the use of gearboxes and spindles as well specifying and converting moments of inertia.

Your support is required in updating the Application Manual, which means improvements, corrections, and the inclusion of new examples. This document can only become a real support tool when we receive the appropriate feedback as far as its contents are concerned and inquiries regarding the application in conjunction with the new SIMOVERT MASTERDRIVES drive converter series.

This Application Manual is conceived as a working document for sales/marketing personnel. At the present time, it is not intended to be passed on to customers.





## 2 Formulas and equations

### Units, conversion

1 N = 1 kgm/s <sup>2</sup> = 0.102 kp	force
1 kg	mass
1 W	power
1 Ws = 1 Nm = 1 J	work, energy
1 kgm <sup>2</sup> = 1 Ws <sup>3</sup> = 1 Nms <sup>2</sup>	moment of inertia
g = 9.81 m/s <sup>2</sup>	acceleration due to the force of gravity

### Induction motor

$$n_0 = \frac{f}{p} \cdot 60$$

synchronous speed

f in Hz, n in RPM  
p: Pole pair number, f: Line supply frequency

$$s = \frac{n_0 - n}{n_0}$$

slip

$$f_s = \frac{n_0 - n}{n_0} \cdot f$$

slip frequency

$$P = \sqrt{3} \cdot U \cdot I \cdot \cos \varphi \cdot \eta = \frac{M \cdot n}{9550}$$

shaft output

$$M = \frac{9550 \cdot P}{n}$$

torque

M in Nm, P in kW, n in RPM

$$M \approx \frac{n_0 - n}{n_0 - n_n} \cdot M_n$$

torque in the range  $n_0$  to  $n_n$

$M_n$ : Rated torque,  $n_n$ : Rated speed

$$M_{stall} \approx \left(\frac{V}{V_n}\right)^2 \cdot M_{stall n}$$

stall torque at reduced voltage

$$M_{stall} \approx \left(\frac{f_n}{f}\right)^2 \cdot M_{stall n}$$

stall torque in the field-weakening range

$V_n$ : Rated voltage,  $f_n$ : Rated frequency

$M_{stall n}$ : Rated stall torque

### RMS torque

The RMS torque can be calculated as follows if the load duty cycle is small with respect to the motor thermal time constant:

$$M_{RMS} = \sqrt{\frac{\sum_i M_i^2 \cdot t_i}{t_e + k_f \cdot t_p}}$$

The following must be true:  $M_{RMS} \leq M_{permissible}$  for S1 duty

$t_i$	time segments with constant torque $M_i$
$t_e$	power-on duration
$t_p$	no load time
$k_f$	reduction factor (de-rating factor)

Factor  $k_f$  for the no-load time is a derating factor for self-ventilated motors. For 1LA5/1LA6 motors it is 0.33. For 1PQ6 motors, 1PA6 motors and 1FT6/1FK6 motors, this factor should be set to 1.

### Example



Comparison of the parameters for linear- and rotational motion

Linear motion			Rotational motion		
$a = \frac{dv}{dt}$	[m/s <sup>2</sup> ]	acceleration	$\alpha = \frac{d\omega}{dt}$	[s <sup>-2</sup> ]	angular acceler.
$v = \frac{ds}{dt} = \int a \cdot dt$	[m/s]	velocity	$\omega = \frac{d\varphi}{dt} = \int \alpha \cdot dt$	[s <sup>-1</sup> ]	angular velocity
$s = \int v \cdot dt$	[m]	distance	$\varphi = \int \omega \cdot dt$	[rad]	angle
$m$	[kg]	mass	$J$	[kgm <sup>2</sup> ]	moment of inertia
$F$	[N]	force	$M$	[Nm]	torque
$F = m \cdot a$	[N]	accelerating force	$M = J \cdot \alpha$	[Nm]	acceler. torque
$P = F \cdot v$	[W]	power	$P = M \cdot \omega$	[W]	power
$W = F \cdot s$	[Ws]	work	$W = M \cdot \varphi$	[Ws]	work
$W = \frac{1}{2} \cdot m \cdot v^2$	[Ws]	kinetic energy	$W = \frac{1}{2} \cdot J \cdot \omega^2$	[Ws]	rotational energy

Example : Relationships between acceleration, velocity and distance for linear motion



Converting linear- into rotational motion

Example: Hoisting a load with constant velocity



$v$	velocity	[m/s]
$r$	roll radius	[m]
$t$	time	[s]
$\omega = \frac{v}{r}$	angular velocity	[s <sup>-1</sup> ]
$n = \frac{\omega}{2 \cdot \pi} \cdot 60 = \frac{v}{2 \cdot \pi \cdot r} \cdot 60$	speed	[RPM]
$\varphi = \omega \cdot t$	angle	[rad]
$s = v \cdot t = \varphi \cdot r$	distance	[m]
$m$	mass moved	[kg]
$F = m \cdot g$	hoisting force	[N]
$M = F \cdot r = m \cdot g \cdot r$	torque	[Nm]
$P = M \cdot \omega = F \cdot v = m \cdot g \cdot v$	power	[W]
$W = F \cdot s = M \cdot \varphi = m \cdot g \cdot s$	hoisting work	[Ws]

Example: Accelerating a mass on a conveyor belt with constant acceleration



$a$	acceleration	[m/s <sup>2</sup> ]
$r$	roll radius	[m]
$t$	accelerating time	[s]
$\alpha = \frac{a}{r}$	angular acceleration	[s <sup>-2</sup> ]
$v = a \cdot t = \alpha \cdot r \cdot t$	velocity	[m/s]
$\omega = \frac{v}{r} = \alpha \cdot t$	angular velocity	[s <sup>-1</sup> ]
$n = \frac{\omega}{2 \cdot \pi} \cdot 60 = \frac{v}{2 \cdot \pi \cdot r} \cdot 60$	speed	[RPM]
$\phi = \alpha \cdot \frac{t^2}{2}$	angle	[rad]
$s = a \cdot \frac{t^2}{2} = \frac{v \cdot t}{2}$	distance	[m]
$m$	mass moved	[kg]
$F = m \cdot a$	accelerating force	[N]
$M = F \cdot r = m \cdot a \cdot r$	accelerating torque	[Nm]
$P = M \cdot \omega = F \cdot v = m \cdot a \cdot v$	accelerating power	[W]
$W = F \cdot s = M \cdot \phi = \frac{1}{2} \cdot m \cdot v^2 = \frac{1}{2} \cdot m \cdot r^2 \cdot \omega^2$	accelerating work	[Ws]

### Converting linearly moved masses into moments of inertia

The conversion is realized by equating the kinetic energy to the rotational energy, i. e.

$$\frac{1}{2} \cdot m \cdot v^2 = \frac{1}{2} \cdot J \cdot \omega^2 \quad \text{and} \quad J = m \cdot \left(\frac{v}{\omega}\right)^2$$

Example: Conveyor belt



$J = m \cdot r^2$	moment of inertia referred to the roll	[kgm <sup>2</sup> ]
$m$	mass	[kg]
$r$	radius	[m]

Example: Hoisting drive



$J = \frac{1}{4} \cdot m \cdot r^2$	moment of inertia referred to the fixed roll	[kgm <sup>2</sup> ]
$m$	mass	[kg]
$r$	fixed roll radius	[m]

Using gearboxes

$$i = \frac{n_{Motor}}{n_{load}} \quad \text{gearbox ratio}$$

$$\eta \quad \text{gearbox efficiency}$$

*Referring moments of inertia to the motor shaft*

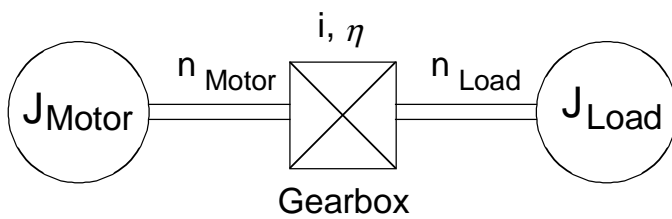

$$J_{load}^* = \frac{J_{load}}{i^2} \quad \text{load moment of inertia referred to the motor shaft} \quad [\text{kgm}^2]$$

$$J^* = J_{motor} + \frac{J_{load}}{i^2} \quad \text{total moment of inertia referred to the motor shaft (without gearbox and coupling)} \quad [\text{kgm}^2]$$

*Referring load torques to the motor shaft*

Example: Hoisting drive, hoisting and lowering with constant velocity

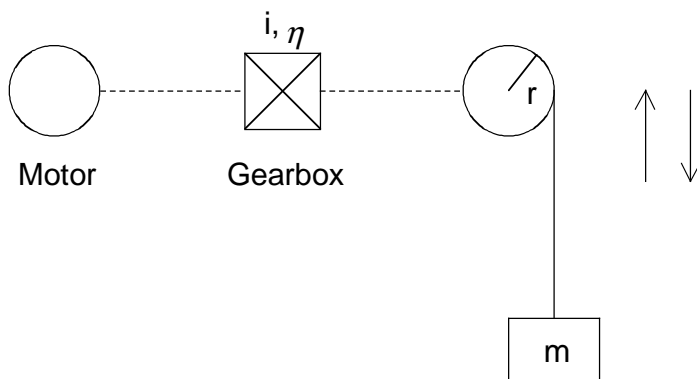



$r$	roll radius	[m]
$F_H = m \cdot g$	hoisting force	[N]
$M_{load} = m \cdot g \cdot r$	load torque at the roll	[Nm]
$M_{load}^* = \frac{M_{load}}{i \cdot \eta}$	load torque referred to the motor shaft when hoisting (energy flow from the motor to the load)	[Nm]
$M_{load}^* = \frac{M_{load}}{i} \cdot \eta$	load torque referred to the motor shaft when lowering (energy flow from the load to the motor)	[Nm]

*Gearbox ratio for the shortest accelerating time with a constant motor torque*

a)  $M_{load} = 0$ , i. e., pure high-inertia drive without friction

$$i = \sqrt{\frac{J_{load}}{J_{motor}}} \quad \text{and} \quad \frac{J_{load}}{i^2} = J_{motor}$$

this means, that the load moment of inertia, referred to the motor shaft, must be the same as the motor moment of inertia

b)  $M_{load} \neq 0$ , i. e., the drive accelerates against frictional forces

$$i = \frac{M_{load}}{M_{motor}} + \sqrt{\left(\frac{M_{load}}{M_{motor}}\right)^2 + \frac{J_{load}}{J_{motor}}}$$

Using spindle drives

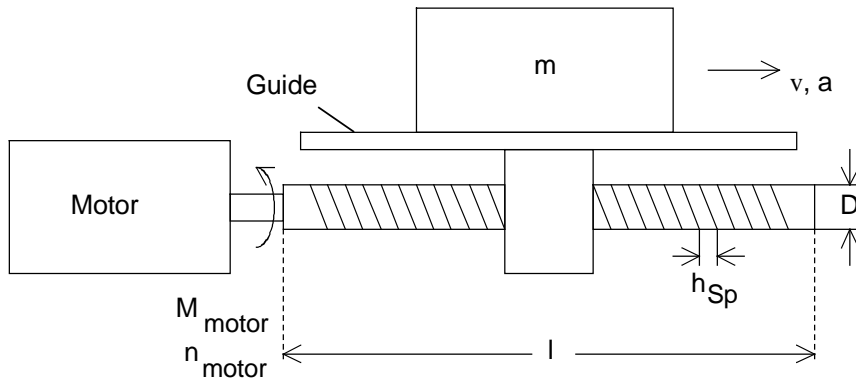

$v$	feed velocity	[m/s]
$h_{Sp}$	pitch	[m]
$D$	spindle diameter	[m]
$l$	spindle length	[m]
$J_{spindle} \approx \frac{\pi}{2} \cdot l \cdot 7.85 \cdot \left(\frac{D}{2}\right)^4 \cdot 1000$	spindle moment of inertia (steel)	[kgm <sup>2</sup> ]
$m$	moved masses	[kg]
$n_{motor} = \frac{v \cdot 60}{h_{Sp}}$	motor speed	[RPM]
$\alpha_{SW} = \arctan \frac{h_{Sp}}{\pi \cdot D}$	spindle pitch angle	[rad]
$\rho = \arctan \frac{h_{Sp}}{\pi \cdot D \cdot \eta} - \alpha_{SW}$	friction angle of the spindle	[rad]
$\eta$	spindle efficiency	
$\alpha_{b,v Sp} = a_{b,v} \cdot \frac{2 \cdot \pi}{h_{Sp}}$	angular acceleration - deceleration of the spindle	[s <sup>-2</sup> ]
$a_{b,v}$	acceleration- deceleration of the load	[m/s <sup>2</sup> ]
$M_{b,v motor} = J_{mot} \cdot \alpha_{b,v Sp}$	accelerating- and decelerating torque for the motor	[Nm]
$M_{b,v Sp} = J_{Sp} \cdot \alpha_{b,v Sp}$	accelerating- and decelerating torque for the spindle	[Nm]
$F_{b,v} = m \cdot a_{b,v}$	accelerating- and deceleration force for mass m	[N]

*Horizontal spindle drive*

$$F_R = m \cdot g \cdot w_F \quad \text{frictional force in the guide} \quad [\text{N}]$$

$$w_F \quad \text{specific traversing resistance}$$

## Motor torque when accelerating

$$M_{motor} = M_{b\ motor} + M_{b\ Sp} + (F_b + F_R) \cdot \frac{D}{2} \cdot \tan(\alpha_{SW} + \rho) \quad [\text{Nm}]$$

## Motor torque when decelerating

$$M_{motor} = -M_{v\ motor} - M_{v\ Sp} + (-F_v + F_R) \cdot \frac{D}{2} \cdot \tan(\alpha_{SW} + \rho \cdot \text{sign}(-F_v + F_R)) \quad [\text{Nm}]$$

*Vertical spindle drive*

$$F_H = m \cdot g \quad \text{hoisting force} \quad [\text{N}]$$

## Motor torque when accelerating upwards

$$M_{motor} = M_{b\ motor} + M_{b\ Sp} + (F_b + F_H) \cdot \frac{D}{2} \cdot \tan(\alpha_{SW} + \rho) \quad [\text{Nm}]$$

## Motor torque when decelerating downwards

$$M_{motor} = -M_{v\ motor} - M_{v\ Sp} + (-F_v + F_H) \cdot \frac{D}{2} \cdot \tan(\alpha_{SW} + \rho \cdot \text{sign}(-F_v + F_R)) \quad [\text{Nm}]$$

## Motor torque when accelerating upwards

$$M_{motor} = -M_{b\ motor} - M_{b\ Sp} + (-F_b + F_H) \cdot \frac{D}{2} \cdot \tan(\alpha_{SW} - \rho \cdot \text{sign}(-F_b + F_H)) \quad [\text{Nm}]$$

## Motor torque when decelerating downwards

$$M_{motor} = M_{v\ motor} + M_{v\ Sp} + (F_v + F_H) \cdot \frac{D}{2} \cdot \tan(\alpha_{SW} - \rho) \quad [\text{Nm}]$$

Blocking occurred for a downwards movement for  $\rho > \alpha_{SW}$

Accelerating- and braking time at constant motor torque and constant load torque

$$t_a = \frac{2 \cdot \pi \cdot n_{\max} \cdot J^*}{60 \cdot (M_{\text{motor}} - M_{\text{load}}^*)} \quad \text{accelerating time from 0 to } n_{\max} \quad [\text{s}]$$

$$t_{br} = \frac{2 \cdot \pi \cdot n_{\max} \cdot J^*}{60 \cdot (M_{\text{motor}} + M_{\text{load}}^*)} \quad \text{braking time from } n_{\max} \text{ to 0} \quad [\text{s}]$$

J in kgm<sup>2</sup>, M in Nm, n<sub>max</sub> in RPM (final motor speed)

(moment of inertia and load torques converted to the motor shaft)

Accelerating time at constant motor torque and for a square-law load torque

Example: Fan

$$M_{\text{load}} = M_{\text{load max}} \cdot \left(\frac{n}{n_{\max}}\right)^2$$

$$t_a = \frac{\pi \cdot n_{\max} \cdot J}{60 \cdot \sqrt{M_{\text{motor}} \cdot M_{\text{load max}}}} \cdot \ln \frac{\sqrt{\frac{M_{\text{motor}}}{M_{\text{load max}}} + 1}}{\sqrt{\frac{M_{\text{motor}}}{M_{\text{load max}}} - 1}} \quad \text{accelerating time from 0 to } n_{\max} \quad [\text{s}]$$

J in kgm<sup>2</sup>, M in Nm, n<sub>max</sub> in RPM (final motor speed)

M<sub>motor</sub> > M<sub>load max</sub> when accelerating, otherwise the final speed will not be reached.

Moments of inertia of various bodies (shapes)

## Solid cylinder



$$J = \frac{1}{2} \cdot m \cdot r^2 = \frac{\pi}{2} \cdot l \cdot \rho \cdot r^4 \cdot 10^3$$

## Hollow cylinder



$$J = \frac{1}{2} \cdot m \cdot (R^2 + r^2) = \frac{\pi}{2} \cdot l \cdot \rho \cdot (R^4 - r^4) \cdot 10^3$$

## Thin-walled hollow cylinder



$$J = m \cdot r_m^2 = 2 \cdot \pi \cdot l \cdot \delta \cdot \rho \cdot r_m^3 \cdot 10^3$$

$$(r \approx R \approx r_m)$$

J in kgm<sup>2</sup>

l, r, R, r<sub>m</sub>,  $\delta$  in m

m in kg

$\rho$  in kg/dm<sup>3</sup> (e. g. steel: 7.85 kg/dm<sup>3</sup>)

Calculating the moment of inertia of a body

If the moment of inertia of a body around the center of gravity S is known, then the moment of inertia to a parallel axis A is:



$$J = J_S + m \cdot s^2$$

Example: Disk, thickness d with 4 holes

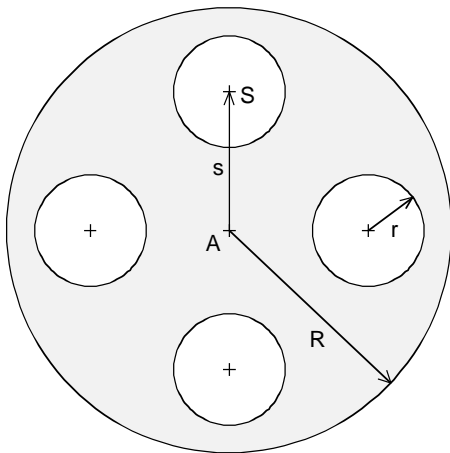

$$J = J_{disk\ without\ hole} - 4 \cdot (J_{S\ hole} + m_{hole} \cdot s^2)$$

$$= \rho \cdot 10^3 \cdot \left[ \frac{\pi}{2} \cdot d \cdot R^4 - 4 \cdot \left( \frac{\pi}{2} \cdot d \cdot r^4 + r^2 \cdot \pi \cdot d \cdot s^2 \right) \right]$$

J in kgm<sup>2</sup>

d, r, R, s in m

m in kg

ρ in kg/dm<sup>3</sup>

### Traction drives - friction components

For traction drives, the friction consists of the components for rolling friction, bearing friction and wheel flange friction. The following is valid for the frictional force (resistance force):

$$F_W = m \cdot g \cdot w_F \quad \text{resistance force} \quad [\text{N}]$$

$$m \quad \text{mass of the traction drive} \quad [\text{kg}]$$

$$w_F \quad \text{specific traction resistance}$$

If factor  $w_F$  is not known, it can be calculated as follows:

$$w_F = \frac{2}{D} \cdot \left( \frac{D_W}{2} \cdot \mu_r + f \right) + c$$

$$D \quad \text{wheel diameter} \quad [\text{m}]$$

$$D_W \quad \text{shaft diameter for bearing friction} \quad [\text{m}]$$

$$\mu_r \quad \text{bearing friction coefficient}$$

$$f \quad \text{lever arm of the rolling friction} \quad [\text{m}]$$

$$c \quad \text{coefficient for wheel flange friction}$$

Values for  $w_F$  can be taken from the appropriate equations/formulas (e. g. /5/, /6/).







## 3 Various special drive tasks

### 3.1 Traction- and hoisting drives

#### 3.1.1 General information

##### Traction drives



##### Basic traction drive

##### *Travelling at constant velocity*

$F_W = m \cdot g \cdot w_F$	drag force (this always acts against the direction of motion, i. e. it has a braking effect)	[N]
$m$	mass being moved	[kg]
$w_F$	specific traction resistance (this takes into account the influence of the rolling- and bearing friction)	
$M_{load} = F_W \cdot \frac{D}{2}$	load torque at the drive wheel	[Nm]
$D$	drive wheel diameter	[m]
$P_{motor} = \frac{F_W \cdot v_{max}}{\eta \cdot 10^3}$	motor output (power) at maximum velocity full-load, steady-state output	[kW]
$M_{motor} = \frac{M_{load}}{i \cdot \eta}$	motor torque	[Nm]

$v_{\max}$	max. velocity	[m/s]
$\eta$	mech. efficiency	
$i = \frac{n_{\text{motor}}}{n_{\text{wheel}}}$	gearbox ratio	
$n_{\text{motor max}} = i \cdot \frac{v_{\max} \cdot 60}{\pi \cdot D}$	motor speed at $v_{\max}$	[RPM]

**Note:**

For traction units used outside, in addition to resistance force  $F_W$ , there is also the wind force (wind resistance)  $F_{Wi}$ .

$F_{Wi} = A_{Wi} \cdot p_{Wi}$	wind resistance (wind force)	[N]
$A_{Wi}$	surface exposed to the force of the wind	[m <sup>2</sup> ]
$p_{Wi}$	wind pressure	[N/m <sup>2</sup> ]

**Accelerating and braking**

$\alpha_{b,v \text{ motor}} = i \cdot a_{b,v \text{ max}} \cdot \frac{2}{D}$	angular motor acceleration and -braking of the motor	[s <sup>-2</sup> ]
$a_{b,v \text{ max}}$	max. acceleration and braking of the traction unit	[m/s <sup>2</sup> ]
$M_{b,v \text{ motor}} = J_{\text{motor}} \cdot \alpha_{b,v \text{ motor}}$	accelerating- and braking torque for the motor	[Nm]
$J_{\text{motor}}$	motor moment of inertia	[kgm <sup>2</sup> ]
$M_{b,v \text{ load}} = J_{\text{load}} \cdot \frac{\alpha_{b,v \text{ motor}}}{i}$	accelerating- and braking torque for the load, referred to the drive wheel	[Nm]
$J_{\text{load}} = m \cdot \left(\frac{D}{2}\right)^2$	moment of inertia of the linearly-moved masses, referred to the drive wheel	[kgm <sup>2</sup> ]

The component of other moments of inertia such as couplings, gearboxes, drive wheels etc., is generally low, and can be neglected with respect to the load moment of inertia and the motor moment of inertia. Often, the rotating masses are taken into account by adding between 10 and 20 % to the linearly-moving masses.

Motor torque when accelerating (starting torque):

$$M_{motor} = M_{b\ motor} + (M_{b\ load} + M_{load}) \cdot \frac{1}{i \cdot \eta} \quad [\text{Nm}]$$

Motor torque when decelerating (braking):

$$M_{motor} = -M_{v\ motor} + (-M_{v\ load} + M_{load})^{1)} \cdot \frac{\eta}{i} \quad (\text{regenerative operation}) \quad [\text{Nm}]$$

1) If the expression in brackets should be  $> 0$  for very low deceleration values, then the factor  $\eta$  must be changed to  $1/\eta$  (so that the deceleration component is not predominant).

When accelerating (starting) the drive wheels should not spin.

Force which can be transferred through a drive wheel:

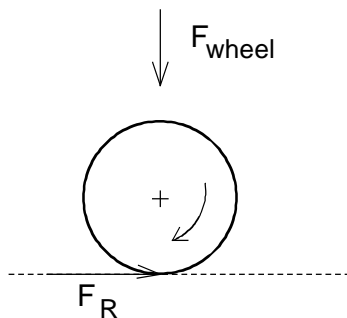

$$F_R = F_{wheel} \cdot \mu \quad \text{frictional force due to static friction (stiction)} \quad [\text{N}]$$

$$F_{wheel} \quad \text{force due to the weight acting on the drive wheel} \quad [\text{N}]$$

$\mu$  coefficient of friction for the static friction, e. g. 0.15 for steel on steel

The following must be valid for the rotating masses if the accelerating forces are neglected:

$$\sum F_R > F_b$$

$$F_b = m \cdot a_{b \max} \quad \text{accelerating force for linear motion} \quad [\text{N}]$$

The maximum permissible acceleration is obtained as follows if all of the wheels are driven:

$$a_{b \max} < g \cdot \mu \quad [\text{m/s}^2]$$

Example of a traction cycle

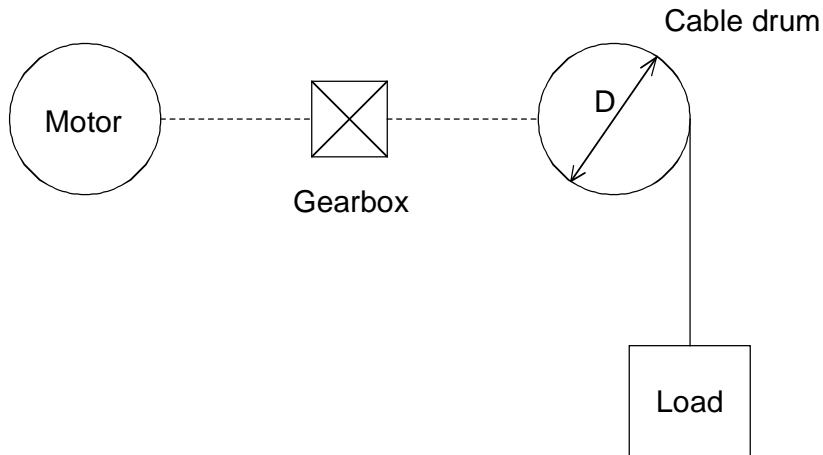

Hoisting drives

Principle of operation of a hoisting drive (single-cable)

*Hoisting a load with constant velocity*

$F_H = m \cdot g$	hoisting force	[N]
$m$	load	[kg]
$M_{load} = F_H \cdot \frac{D}{2}$	load torque at the cable drum (it always acts in the same direction)	[Nm]
$D$	cable drum diameter	[m]
$P_{motor} = \frac{F_H \cdot v_{max}}{\eta \cdot 10^3}$	motor output at the maximum hoisting velocity (steady-state full-load output)	[kW]
$M_{motor} = \frac{M_{load}}{i \cdot \eta}$	motor torque	[Nm]
$v_{max}$	max. hoisting velocity	[m/s]
$\eta$	mechanical efficiency	
$i = \frac{n_{motor}}{n_{drum}}$	gearbox ratio	

$$n_{motor\ max} = i \cdot \frac{v_{max} \cdot 60}{\pi \cdot D} \quad \text{motor speed at } v_{max} \quad [\text{RPM}]$$

Lowering the load at constant velocity

$$P_{motor} = -\frac{F_H \cdot v_{max}}{10^3} \cdot \eta \quad \text{motor output (regenerative operation)} \quad [\text{kW}]$$

$$M_{motor} = \frac{M_{load}}{i} \cdot \eta \quad \text{motor torque} \quad [\text{Nm}]$$

Acceleration and deceleration

$$\alpha_{b,v\ motor} = i \cdot a_{b,v\ max} \cdot \frac{2}{D} \quad \text{angular acceleration and angular deceleration of the motor} \quad [\text{s}^{-2}]$$

$$a_{b,v\ max} \quad \text{max. acceleration or deceleration of the load} \quad [\text{m/s}^2]$$

$$M_{b,v\ motor} = J_{motor} \cdot \alpha_{b,v\ motor} \quad \text{accelerating- or decelerating torque for the motor} \quad [\text{Nm}]$$

$$J_{motor} \quad \text{motor moment of inertia} \quad [\text{kgm}^2]$$

$$M_{b,v\ load} = J_{load} \cdot \frac{\alpha_{b,v\ motor}}{i} \quad \text{accelerating- or decelerating torque for the load referred to the cable drum} \quad [\text{Nm}]$$

$$J_{load} = m \cdot \left(\frac{D}{2}\right)^2 \quad \text{load moment of inertia referred to the cable drum} \quad [\text{kgm}^2]$$

Hoisting the load, motor torque when accelerating (starting torque):

$$M_{motor} = M_{b\ motor} + (M_{b\ load} + M_{load}) \cdot \frac{1}{i \cdot \eta} \quad [\text{Nm}]$$

Hoisting the load, motor torque when decelerating:

$$M_{motor} = -M_{v\ motor} + (-M_{v\ load} + M_{load}) \cdot \frac{1}{i \cdot \eta} \quad [\text{Nm}]$$

Lowering the load, motor torque when accelerating:

$$M_{motor} = -M_{b\ motor} + (-M_{b\ load} + M_{load}) \cdot \frac{\eta}{i} \quad (\text{regenerative operation}) \quad [\text{Nm}]$$

Lowering the load, motor torque when decelerating:

$$M_{motor} = M_{v\ motor} + (M_{v\ load} + M_{load}) \cdot \frac{\eta}{i} \quad (\text{regenerative operation}) \quad [\text{Nm}]$$

For hoisting drives, the influence of the masses to be accelerated (load and rotating masses) is generally low with respect to the load torque. Often, these are taken into account by adding 10% to the load torque.

Example of a hoisting and lowering cycle

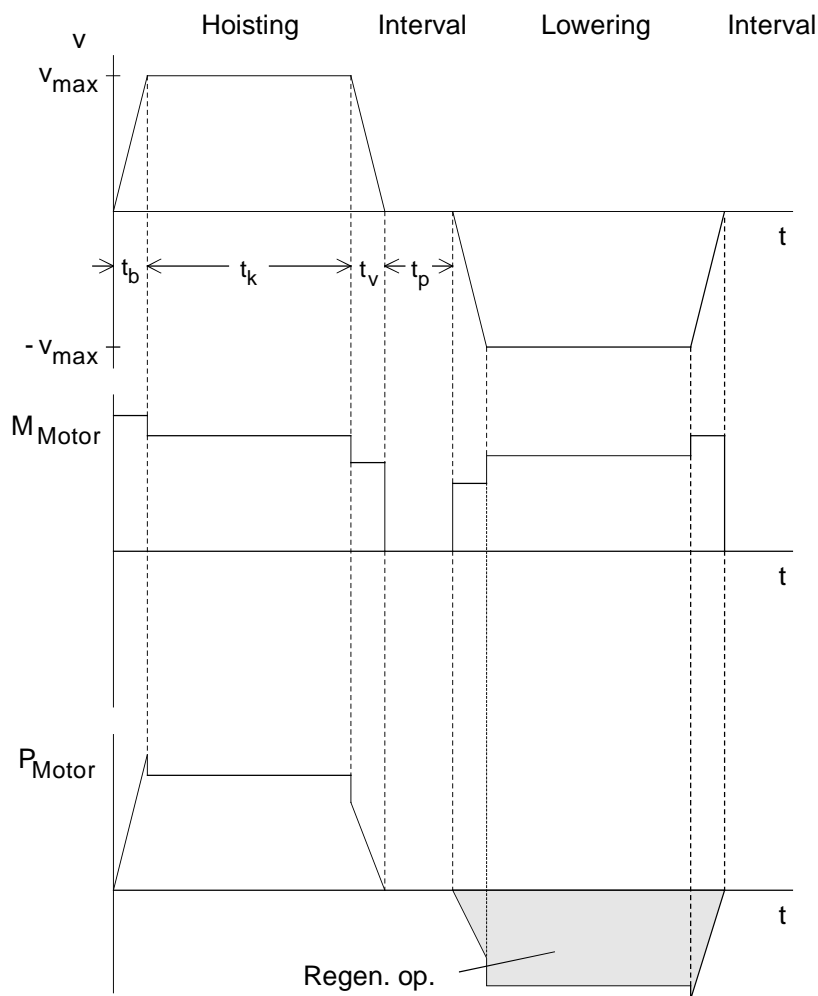

Selecting an induction motor

For traction- and hoisting drives, when selecting the induction motor, intermittent duty S3 can be applied (power-on duration  $\approx$  20 to 60%). Depending on the relative power-on duration and motor type, the thermally permissible motor output is increased according to the following formula:

$$P_{th} \leq P_{permissible} \cdot \sqrt{1 + \frac{(1-t_r) \cdot h}{(1-k_0) \cdot t_r}} \quad (\text{for load duty cycles } < 10 \text{ min; } h, k_0, \text{ refer to Catalog M11}) \quad [\text{kW}]$$

$P_{permissible}$                       permissible output at the drive converter for S1 duty      [kW]  
(control range 1:2)

$$t_r = \frac{PON}{100\%} \quad \text{PON = power-on duration}$$

Thus, for example, for a 4-pole 1LA6 motor, frame size 180 and 40% power-on duration, the output can be increased by approx. 25% referred to  $P_{permissible}$ . This value is used as basis for the steady-state full-load output. When utilizing motors according to temperature rise class F, the rated output can generally be used for  $P_{permissible}$ .

For traction drives with high accelerating torques, the maximum torque is decisive when selecting the motor. It must have an adequate safety margin to the motor stall torque, and at least:

$$M_{stall} > 1.3 \cdot M_{max}$$

Thus, even for line supply undervoltage conditions, safe, reliable operation is guaranteed. In order to guarantee the correct functioning of the closed-loop control, 200% of the rated motor torque should not be exceeded, i. e.:

$$M_{max} \leq 2 \cdot M_n \quad (\text{for SIMOVERT VC})$$

If acceleration and braking have a significant influence on the load duty cycle, the RMS motor torque should also be calculated. The following must be true:

$$M_{RMS} = \sqrt{\frac{\sum M_i^2 \cdot t_i}{t_e + k_f \cdot t_p}} \leq M_{perm.} \quad (\text{for load duty cycles } < 10 \text{ min}) \quad [\text{Nm}]$$

$M_{perm.}$                       permissible torque demanded from the drive                      [Nm]  
converter for S1 duty (e.g. control range 1:2)

$t_i$                               time segments with constant torque  $M_i$                               [s]

$t_e$                               power-on duration                                                              [s]



$k_f$  derating factor

$t_p$  no-load time [s]

Factor  $k_f$  for the no-load time is a derating factor for self-ventilated motors. For 1LA5/1LA6 motors it is 0.33. This factor should be set to 1 for 1PQ6 motors, 1PA6 motors and 1FT6/1FK6 motors.

If the proportion of low speed duty within the load duty cycle cannot be neglected (e. g. a high proportion of time is taken for accelerating and decelerating or longer periods of duty at low speeds), then this must be appropriately taken into account. In this case, the arithmetic average of the speeds within the cycle time T is generated, so that the appropriate reduction factor can be taken from the reduction characteristic for S1 duty.

$$n_{mot\ average} = \frac{\sum_i \left| \frac{n_{mot\ i\ A} + n_{mot\ i\ E}}{2} \right| \cdot t_i}{t_e + k_f \cdot t_p} \quad [\text{RPM}]$$

$\frac{|n_{mot\ i\ A} + n_{mot\ i\ E}|}{2}$  average motor speed in time sector  $t_i$  (A: Initial value, [RPM]  
I: Final value)

It is possible to also calculate the motor RMS current for a load duty cycle instead of  $M_{RMS}$  for a more accurate analysis and for operation in the field-weakening range. The following must be true:

$$I_{RMS} = \sqrt{\frac{\sum_i \left( \frac{I_{mot\ i\ A} + I_{mot\ i\ E}}{2} \right)^2 \cdot t_i}{t_e + k_f \cdot t_p}} \leq I_{perm.} \quad [\text{A}]$$

$\frac{I_{mot\ i\ A} + I_{mot\ i\ E}}{2}$  average motor current in time sector  $t_i$  (A: Initial value, I: Final value) [A]

$I_{perm.}$  permissible current at the drive converter for S1 duty [A]  
at  $n_{average}$  (this is derived from the  $M_{per}$  S1 curve;  
for example, for 1PA6 motors,  $I_{per} = I_{mot\ n}$ )

Refer to the next Section „Selecting the drive converter“ to calculate the motor current.

Selecting the drive converter*Traction drives*

For acceleration and braking, the drive converter overload capability can be used for 60 s, as the accelerating- and braking times are generally low. The induction motor current at the maximum motor torque is approximately given by:

$$I_{motor\ max} \approx \sqrt{\left(\frac{M_{motor\ max}}{M_{motor\ n}}\right)^2 \cdot (I_{motor\ n}^2 - I_{\mu n}^2) \cdot k_n^2 + I_{\mu n}^2 \cdot \frac{1}{k_n^2}} \quad [A]$$

$$I_{\mu n} \quad \text{rated motor magnetization current} \quad [A]$$

$$k_n = 1 \quad \text{for } n_{mot} \leq n_{mot\ n} \quad \text{constant flux range}$$

$$k_n = \frac{n_{mot}}{n_{mot\ n}} \quad \text{for } n_{mot} > n_{mot\ n} \quad \text{field-weakening range}$$

From approx.  $M_{mot} \geq 1.5 M_{mot\ n}$ , saturation effects occur in the motor current which can no longer be neglected. This can be taken into account by linearly increasing the motor current in the range from  $M_{mot\ n}$  to  $2 M_{mot\ n}$  (0% at  $M_{mot\ n}$ , approx. 10% at  $2 M_{mot\ n}$ ).

When selecting the drive converter, in addition to the maximum motor current, the RMS motor current, referred to the load duty cycle, must also be taken into account (in this case,  $k_f$  must always be set to 1). The rated drive converter current must be greater than or equal to the RMS motor current within a 300 s interval. For a motor matched to the drive converter, this condition is generally fulfilled. It may be necessary to make a check, for example, for induction motors with high magnetizing currents and short no-load intervals.

For traction drives, vector control is preferable due to the improved control characteristics (e. g. accelerating along the current limit) and also due to the improved immunity to stalling. Generally, vector control is also possible, even when several motors are connected to a single drive converter, as normally, the motors are similarly loaded.

*Hoisting drives*

For hoisting drives, the maximum induction motor current is calculated the same way as for traction drives. The proportion of accelerating- and decelerating torques in the load torque is generally low. Generally, the maximum motor current is only approximately 100 to 120 % of the rated motor current. As hoisting drives must be able to accelerate suspended loads, it is recommended that a higher safety margin is used between the calculated maximum motor current and the maximum drive converter current. Depending on the accelerating time, the starting current

should be approximately 150 to 200 % of the required motor current. Vector control is also preferable for hoisting drives due to the improved control characteristics, and as it is possible to impress a defined current when starting. A speed encoder improves the dynamic characteristics. Further, the tachometer can be used to monitor the setpoint- actual values (to identify if the load has dropped) .

Generally, holding brakes are used to hold a suspended load. In order that the load doesn't drop when the brake is released, the motor must first develop an opposing torque to the brake. This means:

- An appropriately high motor current setpoint is entered for closed-loop frequency control (depending on the starting torque)
- The motor flux has been established (approx. 0.1 to 1 s depending on the motor size)
- A slip frequency is specified for closed-loop frequency control
- Speed controller pre-control for closed-loop speed control if the load is to be held at zero speed

For closed-loop frequency control, after the signal to release the brake has been output, a short delay should be inserted before starting. This prevents the drive starting, in the open-loop controlled range, against a brake which still hasn't been completely released. After the load has been hoisted, the signal to close the brake is output at  $f_U=0$ . The inverter is only inhibited somewhat later when it is ensured that the brake has been applied. During this delay time, the motor develops a holding torque as result of the DC current braking as  $f_U=0$ .



Example for inverter enable, brake control and acceleration enable for a hoisting drive with closed-loop frequency control.

Dimensioning the braking resistor

When dimensioning the brake resistor, the motor output in the regenerative mode as well as the load duty cycle are important. The maximum output in regenerative operation occurs when the drive is braked at maximum speed. Thus, the max. braking power of the brake resistor is given by:

$$P_{br W \max} = P_{br motor \max} \cdot \eta_{motor} = \frac{M_{motor v} \cdot n_{motor \max}}{9550} \cdot \eta_{motor} \quad [\text{kW}]$$

$\eta_{motor}$  motor efficiency

The maximum braking power of the brake resistor may not exceed the permissible peak braking power. Further, the following must also be true:

$$\frac{W_{br}}{T} \leq P_{br cont.}$$

$$W_{br} = \int_0^T P_{br W} \cdot dt \quad \text{braking energy for one cycle} \quad [\text{kWs}]$$

$T$  cycle time ( $\leq 90$  s) [s]

$P_{br cont.}$  permissible continuous braking power [kW]

For cycle times greater than 90 s, for the condition

$$\frac{W_{br}}{T} \leq P_{br cont.}$$

a time segment  $T = 90$  s is selected from the load duty cycle so that the highest average braking power occurs in that segment.

For traction drives, the following is obtained, for example, when braking from  $v_{\max}$  to 0 within time  $t_v$ :

$$W_{br} = \frac{P_{br W \max} \cdot t_v}{2} \quad [\text{kWs}]$$

For hoisting drives, the braking power is constant when the load is lowered at constant velocity  $v_{\max}$ :

$$P_{br W const} = \frac{F_H \cdot v_{\max}}{10^3} \cdot \eta \cdot \eta_{motor} \quad [\text{kW}]$$

Thus, the braking power during lowering is approximately given by:

$$W_{br} \approx P_{br W const} \cdot \left( \frac{1}{2} \cdot t_b + t_k + \frac{1}{2} \cdot t_v \right) \quad [\text{kWs}]$$

$t_b$  accelerating time [s]

$t_k$  lowering time at constant velocity  $v_{\max}$  [s]

$t_v$  decelerating time [s]

## 3.1.2 Traction drive with brake motor

This application involves a traction drive with brake motor (sliding-rotor motor). The motor is operated at a crawl speed for positioning. When the limit switch is reached, the motor is shutdown, and is mechanically braked down to standstill using the integral brake.

*Drive data*

Mass to be moved	$m$	= 4200 kg
Load wheel diameter	$D$	= 0.27 m
Specific traction resistance	$w_F$	= 0.03
Gearbox ratio	$i$	= 18.2
Mech. efficiency	$\eta$	= 0.85
Max. traversing speed	$v_{\max}$	= 1.1 m/s
Min. traversing velocity (crawl velocity)	$v_{\min}$	= 0.1 m/s
Max. acceleration	$a_{b \max}$	= 0.35 m/s <sup>2</sup>
Max. deceleration	$a_{v \max}$	= 0.5 m/s <sup>2</sup>
Rated motor output	$P_n$	= 2.3 kW
Rated motor current	$I_{\text{motor } n}$	= 6.2 A
Rated motor torque	$M_n$	= 15.4 Nm
Rated motor speed	$n_n$	= 1425 RPM
Motor efficiency	$\eta_{\text{motor}}$	= 0.79
Motor moment of inertia	$J_{\text{motor}}$	= 0.012 kgm <sup>2</sup>
Coupling moment of inertia	$J_K$	= 0.00028 kgm <sup>2</sup>
Max. distance moved	$s_{\max}$	= 3.377 m
Cycle time	$t_{\text{cycle}}$	= 60 s
Crawl operation time	$t_s$	= 1.2 s
Brake application time	$t_E$	= 0.1 s
Mechanical brake torque	$M_{\text{mech}}$	= 38 Nm

*Constant velocity motion*

Resistance force, load torque:

$$F_W = m \cdot g \cdot w_F$$

$$= 4200 \cdot 9.81 \cdot 0.03 = 1236.1 \text{ N}$$

$$M_{load} = F_W \cdot \frac{D}{2}$$

$$= 1236.1 \cdot \frac{0.27}{2} = 166.9 \text{ Nm}$$

Motor output, motor torque:

$$P_{motor} = \frac{F_W \cdot v_{max}}{\eta \cdot 10^3} = \frac{1236.1 \cdot 1.1}{0.85 \cdot 10^3} = 1.6 \text{ kW}$$

$$M_{motor} = \frac{M_{load}}{i \cdot \eta} = \frac{166.9}{18.2 \cdot 0.85} = 10.8 \text{ Nm}$$

Motor speed at  $v_{max}$ :

$$n_{motor \max} = i \cdot n_{load \max} = i \cdot \frac{v_{max} \cdot 60}{\pi \cdot D} = 18.2 \cdot \frac{1.1 \cdot 60}{\pi \cdot 0.27} = 1416 \text{ RPM}$$

Motor speed at  $v_{min}$ :

$$n_{motor \min} = i \cdot n_{load \min} = i \cdot \frac{v_{min} \cdot 60}{\pi \cdot D} = 18.2 \cdot \frac{0.1 \cdot 60}{\pi \cdot 0.27} = 128.7 \text{ RPM}$$

*Calculating the motor torques when accelerating and decelerating*

Angular acceleration and angular deceleration of the motor:

$$\alpha_{b \text{ motor}} = i \cdot a_{b \max} \cdot \frac{2}{D} = 18.2 \cdot 0.35 \cdot \frac{2}{0.27} = 47.2 \text{ s}^{-2}$$

$$\alpha_{v \text{ motor}} = i \cdot a_{v \max} \cdot \frac{2}{D} = 18.2 \cdot 0.5 \cdot \frac{2}{0.27} = 67.4 \text{ s}^{-2}$$

Accelerating torque and decelerating torque for motor and coupling:

$$M_{b \text{ motor}+K} = (J_{motor} + J_K) \cdot \alpha_{b \text{ motor}}$$

$$= (0.012 + 0.00028) \cdot 47.2 = 0.58 \text{ Nm}$$

$$\begin{aligned}
 M_{v\ motor+K} &= (J_{motor} + J_K) \cdot \alpha_{v\ motor} \\
 &= (0.012 + 0.00028) \cdot 67.4 = 0.828\ Nm
 \end{aligned}$$

Load moment of inertia referred to the load wheel:

$$\begin{aligned}
 J_{load} &= m \cdot \left(\frac{D}{2}\right)^2 \\
 &= 4200 \cdot \left(\frac{0,27}{2}\right)^2 = 76.55\ kgm^2
 \end{aligned}$$

Accelerating torque and decelerating torque for the load:

$$\begin{aligned}
 M_{b\ load} &= J_{load} \cdot \frac{\alpha_{b\ motor}}{i} = 76.55 \cdot \frac{47.2}{18.2} = 198.5\ Nm \\
 M_{v\ load} &= J_{load} \cdot \frac{\alpha_{v\ motor}}{i} = 76.55 \cdot \frac{67.4}{18.2} = 283.5\ Nm
 \end{aligned}$$

Motor torque when accelerating:

$$\begin{aligned}
 M_{motor} &= M_{b\ motor+K} + (M_{b\ load} + M_{load}) \cdot \frac{1}{i \cdot \eta} \\
 &= 0.58 + (198.5 + 166.9) \cdot \frac{1}{18.2 \cdot 0.85} = 24.2\ Nm
 \end{aligned}$$

Motor torque when decelerating:

$$\begin{aligned}
 M_{motor} &= -M_{v\ motor+K} + (-M_{v\ load} + M_{load}) \cdot \frac{\eta}{i} \\
 &= -0.828 + (-283.5 + 166.9) \cdot \frac{0.85}{18.2} = -6.27\ Nm \quad (\text{regenerative operation})
 \end{aligned}$$

The highest motor torque is required when accelerating, namely 157 % of the motor rated torque.

The moments of inertia for the gearbox and other rotating masses have been neglected.

Accelerating time:

$$t_b = \frac{v_{\max}}{a_{b\ \max}} = \frac{1.1}{0.35} = 3.14\ s$$



### Calculating the maximum braking power

The maximum motor output in the regenerative mode occurs when the drive starts to decelerate from the maximum motor speed.

$$P_{br\ motor\ max} = \frac{M_{motor\ v} \cdot n_{motor\ max}}{9550} = -\frac{6.27 \cdot 1416}{9550} = -0.93\ kW$$

### Drive converter selection

For the highest required motor torque, a motor current of approximately:

$$I_{motor\ max} \approx \sqrt{\left(\frac{M_{motor\ max}}{M_{motor\ n}}\right)^2 \cdot (I_{motor\ n}^2 - I_{\mu n}^2) + I_{\mu n}^2}$$

is obtained.

The following is obtained with  $I_{\mu n} = 0.7 \cdot I_{motor\ n}$  (assumption):

$$I_{motor\ max} \approx \sqrt{\left(\frac{24.2}{15.4}\right)^2 \cdot (6.2^2 - 0.7^2 \cdot 6.2^2) + 0.7^2 \cdot 6.2^2} = 8.2\ A\ \text{for } t_b=3.14\ s$$

Selected drive converter:

6SE7018-0EA61

$P_{Vn}=3\ kW$ ;  $I_{Vn}=8\ A$ ,  $I_{Vmax}=11\ A$

Closed-loop frequency control type

*Dimensioning the brake resistor*

The brake resistor is used during deceleration (braking). As the braking characteristics are the same for forwards as well as reverse motion, only forwards motion must be analyzed.

## Velocity-time diagram for forwards motion

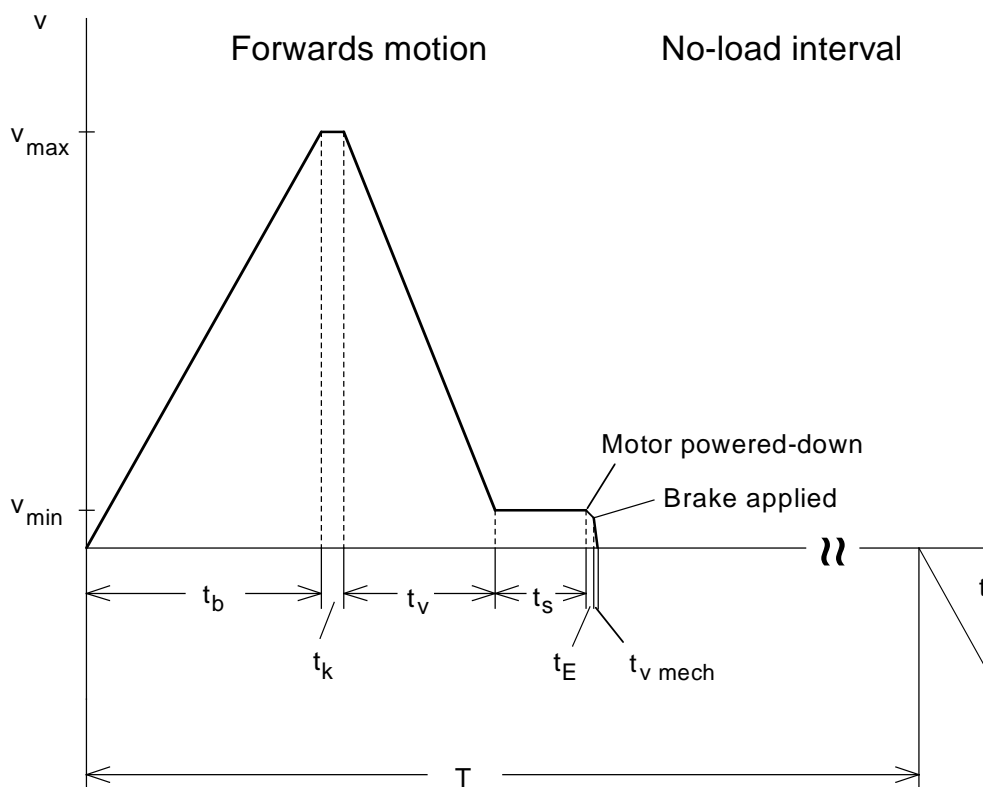

Maximum distance moved:

$$s_{max} = 3.377 \text{ m}$$

Cycle time for forwards- and reverse motion:

$$T = \frac{t_{cycle}}{2} = 30 \text{ s}$$

Time for operation at the crawl speed:

$$t_s = 1.2 \text{ s} \quad (\text{specified})$$

Accelerating time from 0 to  $v_{\max}$ :

$$t_b = 3.14 \text{ s}$$

Decelerating time from  $v_{\max}$  to  $v_{\min}$ :

$$t_v = \frac{v_{\max} - v_{\min}}{a_{v \max}} = \frac{1.1 - 0.1}{0.5} = 2 \text{ s}$$

When neglecting the distance travelled during the brake application time  $t_E$  and the deceleration time as a result of the mechanical brake  $t_{v \text{ mech}}$ ,  $s_{\max}$  is given by the area in the v-t diagram:

$$s_{\max} \approx \frac{v_{\max} \cdot t_b}{2} + v_{\max} \cdot t_k + \frac{v_{\max} + v_{\min}}{2} \cdot t_v + v_{\min} \cdot t_s$$

The travelling time at constant velocity  $v_{\max}$  is given by:

$$t_k \approx \frac{s_{\max} - \frac{v_{\max} \cdot t_b}{2} - \frac{v_{\max} + v_{\min}}{2} \cdot t_v - v_{\min} \cdot t_s}{v_{\max}}$$

$$\approx \frac{3.377 - \frac{1.1 \cdot 3.143}{2} - \frac{1.1 + 0.1}{2} \cdot 2 - 0.1 \cdot 1.2}{1.1} = 0.3 \text{ s}$$

No-load time:

$$t_p = T - t_{\text{total}} = T - (t_b + t_k + t_v + t_s)$$

$$= 30 - (3.14 + 0.3 + 2 + 1.2) = 23.4 \text{ s}$$

Max. braking power of the brake resistor when decelerating from  $v_{\max}$  to  $v_{\min}$ :

$$P_{br W \max} = P_{br \text{ motor max}} \cdot \eta_{\text{motor}} = 0.93 \cdot 0.79 = 0.73 \text{ kW}$$

Min. braking power of the brake resistor when decelerating from  $v_{\max}$  to  $v_{\min}$ :

$$P_{br W \min} = P_{br \text{ motor min}} \cdot \eta_{\text{motor}} = \frac{M_{\text{motor v}} \cdot n_{\text{motor min}}}{9550} \cdot \eta_{\text{motor}}$$

$$= \frac{6.27 \cdot 128.7}{9550} \cdot 0.79 = 0.067 \text{ kW}$$

## Braking diagram

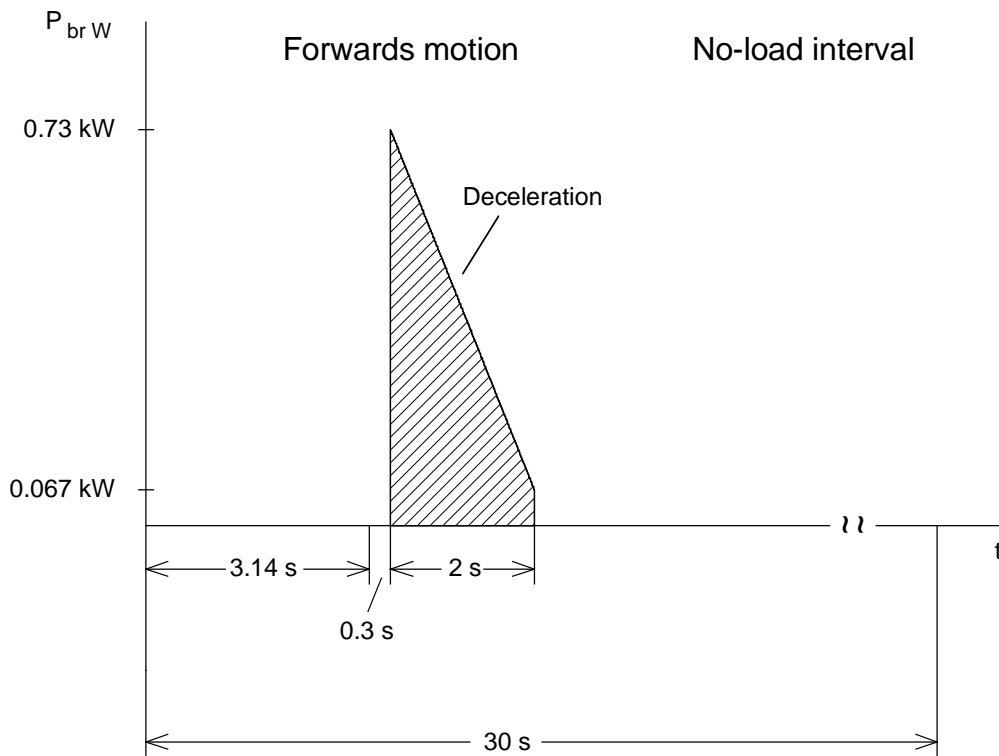

Braking energy for one cycle (corresponds to the area in the braking diagram):

$$W_{br} = \frac{P_{br W \max} + P_{br W \min}}{2} \cdot t_v = \frac{0.73 + 0.067}{2} \cdot 2 = 0.8 \text{ kW}_s$$

The following must be valid for the brake resistor:

$$\frac{W_{br}}{T} = \frac{0.8}{30} = 0.027 \text{ kW} \leq P_{br \text{ cont.}}$$

With

$$P_{br \text{ cont.}} = \frac{P_{20}}{36} \quad (\text{with an internal brake resistor})$$

the following is obtained

$$36 \cdot 0.027 = 0.972 \text{ kW} \leq P_{20}$$

Thus, the smallest braking unit is selected with  $P_{20} = 5 \text{ kW}$  (6SE7018-0ES87-2DA0). The internal braking resistor is adequate.

### Thermal motor analysis

#### Torque characteristics for forwards motion

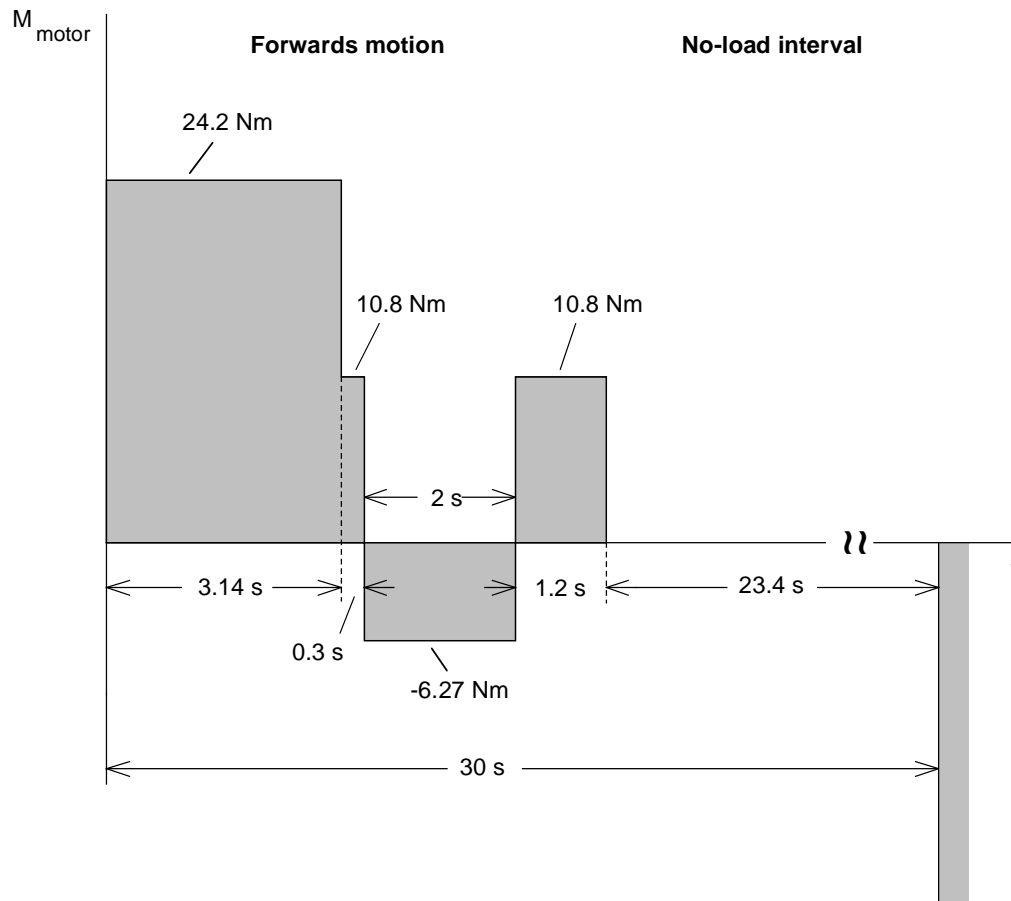

The RMS torque is obtained from the torque characteristics:

$$\begin{aligned}
 M_{RMS} &= \sqrt{\frac{24.2^2 \cdot 3.14 + 10.8^2 \cdot 0.3 + 6.27^2 \cdot 2 + 10.8^2 \cdot 1.2}{3.14 + 0.3 + 2 + 1.2 + 0.33 \cdot 23.4}} \\
 &= \sqrt{\frac{2092.5}{14.4}} \\
 &= 12.05 \text{ Nm}
 \end{aligned}$$

Calculating the average speed

$$n_{motor, average} = \frac{\sum \left| \frac{n_{mot i A} + n_{mot i E}}{2} \right| \cdot t_i}{t_e + k_f \cdot t_p} = \frac{\frac{1}{2} \cdot n_{max} \cdot t_b + n_{max} \cdot t_k + \frac{n_{max} + n_{min}}{2} \cdot t_v + n_{min} \cdot t_s}{t_b + t_k + t_v + t_s + k_f \cdot t_p}$$

$$= \frac{\frac{1}{2} \cdot 1416 \cdot 3.14 + 1416 \cdot 0.3 + \frac{1416 + 128.7}{2} \cdot 2 + 128.7 \cdot 1.2}{3.14 + 0.3 + 2 + 1.2 + 0.33 \cdot 23.4} = 301 \text{ RPM}$$

For a reduction factor of 0.8 (control range 1:5), a permissible torque is obtained as follows:

$$0.8 \cdot M_{mot n} = 0.8 \cdot 15.4 = 12.32 \text{ Nm}$$

Operation is thermally permissible.

*Calculating the distance travelled after the brake motor has been powered-down*

When the traction unit reaches the limit switch at the crawl speed, the brake motor is powered-down by inhibiting the drive converter pulses. The brake application delay time  $t_E$  now starts before the mechanical brake starts to become effective. The traction unit continues to move without any motor torque and is only braked by the effect of drag and the mechanical efficiency. After the brake is applied, it takes time  $t_{v mech}$  to reach standstill.



To calculate the distance travelled after the brake motor has been shutdown, a sub-division is made into range 1 (deceleration due to drag and the mechanical efficiency) and range 2 (deceleration as a result of the mechanical brake).

Calculating the deceleration after shutdown (range 1)

The following is obtained with  $M_{\text{motor}}=0$ :

$$M_{\text{motor}} = 0 = -M_{v \text{ motor}+K} + (-M_{v \text{ load}} + M_{\text{load}}) \cdot \frac{\eta}{i}$$

or

$$0 = -(J_{\text{motor}} + J_K) \cdot \alpha_{v1 \text{ motor}} - J_{\text{load}} \cdot \frac{\eta}{i^2} \cdot \alpha_{v1 \text{ motor}} + M_{\text{load}} \cdot \frac{\eta}{i}$$

The motor angular deceleration is then given by:

$$\alpha_{v1 \text{ motor}} = \frac{M_{\text{load}} \cdot \frac{\eta}{i}}{J_{\text{motor}} + J_K + J_{\text{load}} \cdot \frac{\eta}{i^2}} = \frac{166.9 \cdot \frac{0.85}{18.2}}{0.012 + 0.00028 + 76.55 \cdot \frac{0.85}{18.2^2}} = 37.35 \text{ s}^{-2}$$

and for the deceleration of the traction unit:

$$a_{v1} = \frac{\alpha_{v1 \text{ motor}}}{i} \cdot \frac{D}{2} = \frac{37.35}{18.2} \cdot \frac{0.27}{2} = 0.277 \text{ m/s}^2$$

Distance travelled during  $t_E$ :

$$\begin{aligned} s_E &= v_{\min} \cdot t_E - \frac{1}{2} \cdot a_{v1} \cdot t_E^2 \\ &= 0.1 \cdot 0.1 - \frac{1}{2} \cdot 0.277 \cdot 0.1^2 = 0.0086 \text{ m} \end{aligned}$$

Velocity after  $t_E$ :

$$v_{\max E} = v_{\min} - a_{v1} \cdot t_E = 0.1 - 0.277 \cdot 0.1 = 0.0723 \text{ m/s}$$

Calculating the deceleration as result of the mechanical brake (range 2)

The following is obtained with  $M_{\text{motor}}=-M_{\text{mech}}$ :

$$M_{\text{motor}} = -M_{\text{mech}} = -M_{v \text{ motor}+K} + (-M_{v \text{ load}} + M_{\text{load}}) \cdot \frac{\eta}{i}$$

and

$$-M_{mech} = -(J_{motor} + J_K) \cdot \alpha_{v2\ motor} - J_{load} \cdot \frac{\eta}{i^2} \cdot \alpha_{v2\ motor} + M_{load} \cdot \frac{\eta}{i}$$

The motor angular deceleration is then given by:

$$\alpha_{v2\ motor} = \frac{M_{mech} + M_{load} \cdot \frac{\eta}{i}}{J_{motor} + J_K + J_{load} \cdot \frac{\eta}{i^2}} = \frac{38 + 166.9 \cdot \frac{0.85}{18.2}}{0.012 + 0.00028 + 76.55 \cdot \frac{0.85}{18.2^2}} = 219.4 \text{ s}^{-2}$$

and for the traction unit deceleration:

$$a_{v2} = \frac{\alpha_{v2\ motor}}{i} \cdot \frac{D}{2} = \frac{219.4}{18.2} \cdot \frac{0.27}{2} = 1.627 \text{ m/s}^2$$

Deceleration time as the result of the mechanical brake:

$$t_{v\ mech} = \frac{v_E}{a_{v2}} = \frac{0.0723}{1.627} = 0.044 \text{ s}$$

Distance travelled during deceleration caused by the mechanical brake:

$$s_v = \frac{v_E \cdot t_{v\ mech}}{2} = \frac{0.0723 \cdot 0.044}{2} = 0.0016 \text{ m}$$

As the mechanical brake is only applied after a delay time  $t_E$ , the traction unit travels a total distance of

$$s_{ges} = s_E + s_v = 0.0086 + 0.0016 = 0.01 \text{ m} = 10 \text{ mm}$$

This load-dependent distance must be taken into account by the positioning control.



### 3.1.3 Hoisting drive with brake motor

This application involves a hoisting drive with brake motor (shift-rotor motor). Positioning is realized at the crawl speed.

#### *Drive data*

Mass to be moved	$m_L$	= 146 kg
Intrinsic mass	$m_E$	= 66 kg
Cable drum diameter	$D$	= 0.1 m
Gearbox ratio	$i$	= 20.5
Mech. efficiency	$\eta$	= 0.85
Max. hoisting velocity	$v_{max}$	= 0.348 m/s
Min. hoisting velocity (crawl velocity)	$v_{min}$	= 0.025 m/s
Max. acceleration	$a_{max}$	= 0.58 m/s <sup>2</sup>
Rated motor output	$P_n$	= 1.05 kW
Rated motor current	$I_{motor n}$	= 3.8 A
Rated motor torque	$M_n$	= 7.35 Nm
Rated motor speed	$n_n$	= 1365 RPM
Motor efficiency	$\eta_{motor}$	= 0.75
Motor moment of inertia	$J_{motor}$	= 0.0035 kgm <sup>2</sup>
Coupling moment of inertia	$J_K$	= 0.00028 kgm <sup>2</sup>
Max. hoisting height	$h_{max}$	= 0.8 m
Cycle time	$t_{cycle}$	= 90 s
Crawl time	$t_s$	= 0.4 s
Brake application time	$t_E$	= 0.04 s
Mechanical brake torque	$M_{mech}$	= 14.5 Nm

*Hoisting the load with constant velocity*

Hoisting force, load torque:

$$\begin{aligned} F_H &= (m_L + m_E) \cdot g \\ &= (146 + 66) \cdot 9.81 = 2079.7 \text{ N} \end{aligned}$$

$$\begin{aligned} M_{load} &= F_H \cdot \frac{D}{2} \\ &= 2079.7 \cdot \frac{0.1}{2} = 104 \text{ Nm} \end{aligned}$$

Motor output, motor torque:

$$P_{motor} = \frac{F_H \cdot v_{max}}{\eta \cdot 10^3} = \frac{2079.7 \cdot 0.348}{0.85 \cdot 10^3} = 0.852 \text{ kW}$$

$$M_{motor} = \frac{M_{load}}{i \cdot \eta} = \frac{104}{20.5 \cdot 0.85} = 5.97 \text{ Nm}$$

Motor speed at  $v_{max}$ :

$$n_{motor \max} = i \cdot n_{load \max} = i \cdot \frac{v_{max} \cdot 60}{\pi \cdot D} = 20.5 \cdot \frac{0.348 \cdot 60}{\pi \cdot 0.1} = 1362 \text{ RPM}$$

Motor speed at  $v_{min}$ :

$$n_{motor \min} = i \cdot n_{load \min} = i \cdot \frac{v_{min} \cdot 60}{\pi \cdot D} = 20.5 \cdot \frac{0.025 \cdot 60}{\pi \cdot 0.1} = 97.9 \text{ RPM}$$

*Lowering the load at constant velocity*

Motor output, motor torque:

$$P_{motor} = -\frac{F_H \cdot v_{max}}{10^3} \cdot \eta = -\frac{2079.7 \cdot 0.348}{10^3} \cdot 0.85 = -0.615 \text{ kW} \quad (\text{regenerative operation})$$

$$M_{motor} = \frac{M_{load}}{i} \cdot \eta = \frac{104}{20.5} \cdot 0.85 = 4.31 \text{ Nm}$$

Calculating the motor torques when accelerating and decelerating

Motor angular acceleration:

$$\alpha_{motor} = i \cdot a_{max} \cdot \frac{2}{D} = 20.5 \cdot 0.58 \cdot \frac{2}{0.1} = 237.8 \text{ s}^{-2}$$

Accelerating torque for motor and coupling:

$$\begin{aligned} M_{b\ motor+K} &= (J_{motor} + J_K) \cdot \alpha_{motor} \\ &= (0.0035 + 0.00028) \cdot 237.8 = 0.899 \text{ Nm} \end{aligned}$$

Load moment of inertia referred to the cable drum:

$$\begin{aligned} J_{load} &= (m_L + m_E) \cdot \left(\frac{D}{2}\right)^2 \\ &= (146 + 66) \cdot \left(\frac{0.1}{2}\right)^2 = 0.53 \text{ kgm}^2 \end{aligned}$$

Load accelerating torque:

$$\begin{aligned} M_{b\ load} &= J_{load} \cdot \frac{\alpha_{motor}}{i} \\ &= 0.53 \cdot \frac{237.8}{20.5} = 6.15 \text{ Nm} \end{aligned}$$

As deceleration is the same as acceleration, the following is true:

$$\begin{aligned} M_{v\ motor+K} &= M_{b\ motor+K} \\ M_{v\ load} &= M_{b\ load} \end{aligned}$$

Hoisting the load, motor torque when accelerating:

$$\begin{aligned} M_{motor} &= M_{b\ motor+K} + (M_{b\ load} + M_{load}) \cdot \frac{1}{i \cdot \eta} \\ &= 0.899 + (6.15 + 104) \cdot \frac{1}{20.5 \cdot 0.85} = 7.22 \text{ Nm} \end{aligned}$$

Hoisting the load, motor torque when decelerating:

$$M_{motor} = -M_{v\ motor+K} + (-M_{v\ load} + M_{load}) \cdot \frac{1}{i \cdot \eta}$$

$$M_{motor} = -0.899 + (-6.15 + 104) \cdot \frac{1}{20.5 \cdot 0.85} = 4.72 \text{ Nm}$$

Lowering the load, motor torque when accelerating:

$$\begin{aligned} M_{motor} &= -M_{b\ motor+K} + (-M_{b\ load} + M_{load}) \cdot \frac{\eta}{i} \\ &= -0.899 + (-6.15 + 104) \cdot \frac{0.85}{20.5} = 3.16 \text{ Nm} \quad (\text{regenerative operation}) \end{aligned}$$

Lowering the load, motor torque when decelerating:

$$\begin{aligned} M_{motor} &= M_{v\ motor+K} + (M_{v\ load} + M_{load}) \cdot \frac{\eta}{i} \\ &= 0.899 + (6.15 + 104) \cdot \frac{0.85}{20.5} = 5.47 \text{ Nm} \quad (\text{regenerative operation}) \end{aligned}$$

The highest motor torque is required when accelerating and hoisting the load, namely 98 % of the rated motor torque. The highest motor torque in regenerative operation is required when decelerating the drive while the load is being lowered.

#### *Calculating the maximum braking power*

The maximum motor output in regenerative operation occurs when the drive starts to decelerate from the maximum motor speed while the load is being lowered.

$$P_{br\ motor\ max} = \frac{M_{motor\ v} \cdot n_{motor\ max}}{9550} = -\frac{5.47 \cdot 1362}{9550} = -0.78 \text{ kW}$$

#### *Selecting the drive converter*

The highest required motor torque approximately corresponds to the rated motor torque. An appropriate overload capability is required to start the hoisting drive, i. e. the drive converter should be able to provide approximately double the rated motor current as  $I_{U\ max}$ .

Selected drive converter:

6SE7016-1EA61

$P_{Vn}=2.2 \text{ kW}$ ;  $I_{Vn}=6.1 \text{ A}$ ;  $I_{Vmax}=8.3 \text{ A}$

Closed-loop frequency control type

### Dimensioning the brake resistor

The brake resistor is used when the load is lowered.

Velocity-time diagram for hoisting and lowering



Maximum distance travelled when hoisting and lowering:

$$h_{\max} = 0.8 \text{ m}$$

Cycle time for hoisting and lowering:

$$T = t_{\text{cycle}} = 90 \text{ s}$$

Time when the drive operates at the crawl velocity:

$$t_s = 0.4 \text{ s} \quad (\text{specified})$$

Accelerating time from 0 to  $v_{\max}$ :

$$t_b = \frac{v_{\max}}{a_{\max}} = \frac{0.348}{0.58} = 0.6 \text{ s}$$

Decelerating time from  $v_{\max}$  to  $v_{\min}$ :

$$t_{v1} = \frac{v_{\max} - v_{\min}}{a_{\max}} = \frac{0.348 - 0.025}{0.58} = 0.557 \text{ s}$$

Deceleration time from  $v_{\min}$  to 0:

$$t_{v2} = \frac{v_{\min}}{a_{\max}} = \frac{0.025}{0.58} = 0.043 \text{ s}$$

From the area in the v-t diagram,  $h_{\max}$  is given by:

$$h_{\max} = \frac{v_{\max} \cdot t_b}{2} + v_{\max} \cdot t_k + \frac{v_{\max} + v_{\min}}{2} \cdot t_{v1} + v_{\min} \cdot t_s + \frac{v_{\min} \cdot t_{v2}}{2}$$

The unit travels at constant velocity  $v_{\max}$  for:

$$t_k = \frac{h_{\max} - \frac{v_{\max} \cdot t_b}{2} - \frac{v_{\max} + v_{\min}}{2} \cdot t_{v1} - v_{\min} \cdot t_s - \frac{v_{\min} \cdot t_{v2}}{2}}{v_{\max}}$$

$$= \frac{0.8 - \frac{0.348 \cdot 0.6}{2} - \frac{0.348 + 0.025}{2} \cdot 0.557 - 0.025 \cdot 0.4 - \frac{0.025 \cdot 0.043}{2}}{0.348} = 1.67 \text{ s}$$

Thus, the total travelling time for  $h_{\max}$  is given by:

$$t_{total} = t_b + t_k + t_{v1} + t_s + t_{v2}$$

$$= 0.6 + 1.67 + 0.557 + 0.4 + 0.043 = 3.27 \text{ s}$$

Max. braking power rating while accelerating from 0 to  $v_{\max}$ :

$$\begin{aligned} P_{br W \max (0 \rightarrow v_{\max})} &= P_{br motor \max (0 \rightarrow v_{\max})} \cdot \eta_{motor} = \frac{M_{motor b} \cdot n_{motor \max}}{9550} \cdot \eta_{motor} \\ &= \frac{3.16 \cdot 1362}{9550} \cdot 0.75 = 0.338 \text{ kW} \end{aligned}$$

Braking power while travelling at constant velocity,  $v_{\max}$ :

$$\begin{aligned} P_{br W const (v=v_{\max})} &= P_{br motor const (v=v_{\max})} \cdot \eta_{motor} = \frac{M_{motor const} \cdot n_{motor \max}}{9550} \cdot \eta_{motor} \\ &= \frac{4.31 \cdot 1362}{9550} \cdot 0.75 = 0.46 \text{ kW} \end{aligned}$$

Max. braking power while decelerating from  $v_{\max}$  to  $v_{\min}$ :

$$\begin{aligned} P_{br W \max (v_{\max} \rightarrow v_{\min})} &= P_{br motor \max (v_{\max} \rightarrow v_{\min})} \cdot \eta_{motor} = \frac{M_{motor v} \cdot n_{motor \max}}{9550} \cdot \eta_{motor} \\ &= \frac{5.47 \cdot 1362}{9550} \cdot 0.75 = 0.585 \text{ kW} \end{aligned}$$

Min. braking power while decelerating from  $v_{\max}$  to  $v_{\min}$ :

$$\begin{aligned} P_{br W \min (v_{\max} \rightarrow v_{\min})} &= P_{br motor \min (v_{\max} \rightarrow v_{\min})} \cdot \eta_{motor} = \frac{M_{motor v} \cdot n_{motor \min}}{9550} \cdot \eta_{motor} \\ &= \frac{5.47 \cdot 97.9}{9550} \cdot 0.75 = 0.042 \text{ kW} \end{aligned}$$

Braking power while travelling at constant velocity  $v_{\min}$ :

$$\begin{aligned} P_{br W const (v=v_{\min})} &= P_{br motor const (v=v_{\min})} \cdot \eta_{motor} = \frac{M_{motor const} \cdot n_{motor \min}}{9550} \cdot \eta_{motor} \\ &= \frac{4.31 \cdot 97.9}{9550} \cdot 0.75 = 0.033 \text{ kW} \end{aligned}$$

Max. braking power while decelerating from  $v_{\min}$  to 0:

$$\begin{aligned} P_{br W \max (v_{\min} \rightarrow 0)} &= P_{br motor \max (v_{\min} \rightarrow 0)} \cdot \eta_{motor} = \frac{M_{motor v} \cdot n_{motor \min}}{9550} \cdot \eta_{motor} \\ &= P_{br motor \min (v_{\max} \rightarrow v_{\min})} \cdot \eta_{motor} = 0.042 \text{ kW} \end{aligned}$$

## Braking diagram

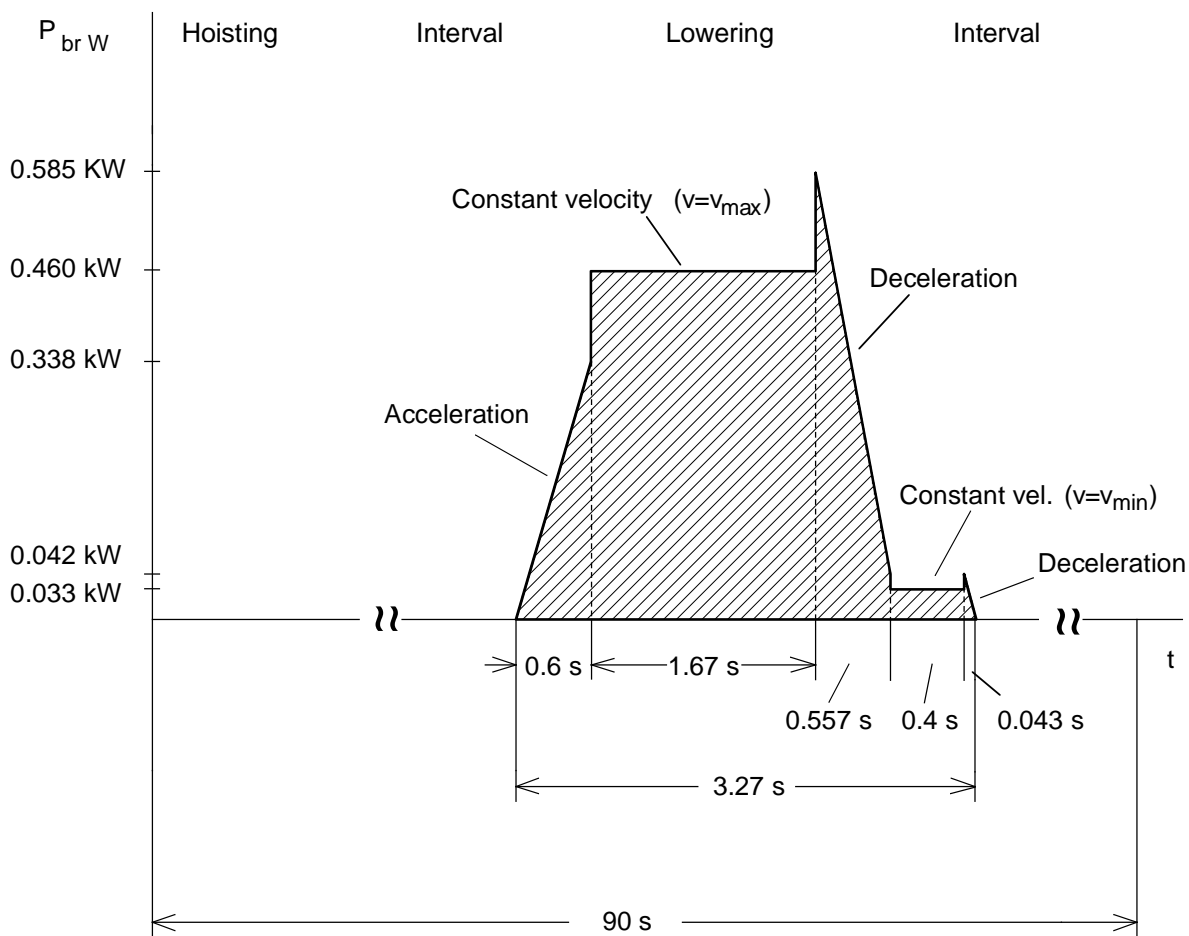

Braking energy for one cycle (corresponds to the area in the braking diagram)

Precise calculation:

$$\begin{aligned}
 W_{br} &= \frac{1}{2} \cdot P_{br W \max(0 \rightarrow v_{\max})} \cdot t_b + P_{br W \text{ const}(v=v_{\max})} \cdot t_k + \frac{P_{br W \max(v_{\max} \rightarrow v_{\min})} + P_{br W \min(v_{\max} \rightarrow v_{\min})}}{2} \cdot t_{v1} \\
 &\quad + P_{br W \text{ const}(v=v_{\min})} \cdot t_s + \frac{1}{2} \cdot P_{br W \max(v_{\min} \rightarrow 0)} \cdot t_{v2} \\
 &= \frac{1}{2} \cdot 0.338 \cdot 0.6 + 0.46 \cdot 1.67 + \frac{0.585 + 0.042}{2} \cdot 0.557 \\
 &\quad + 0.033 \cdot 0.4 + \frac{1}{2} \cdot 0.042 \cdot 0.043 = 1.058 \text{ kW s}
 \end{aligned}$$

In this particular case, the following estimation can be made:

$$\begin{aligned}
 W_{br} &\approx P_{br W \text{ const}(v=v_{\max})} \cdot (t_b + t_k) + P_{br W \text{ const}(v=v_{\min})} \cdot t_s \\
 &\approx 0.46 \cdot (0.6 + 1.67) + 0.033 \cdot 0.4 = 1.057 \text{ kW s}
 \end{aligned}$$



The following must be valid for the brake resistor:

$$\frac{W_{br}}{T} = \frac{1.057}{90} = 0.012 \text{ kW} \leq P_{br \text{ cont.}}$$

With

$$P_{br \text{ cont.}} = \frac{P_{20}}{36} \quad (\text{with internal braking resistor})$$

the following is obtained

$$36 \cdot 0.012 = 0.432 \text{ kW} \leq P_{20}$$

Thus, the smallest braking unit is selected with  $P_{20} = 5 \text{ kW}$  (6SE7018-0ES87-2DA0). The internal brake resistor is adequate.

#### *Thermally checking the motor*

As the motor is only subject to a maximum load of approx. rated torque, and is only powered-up for approx. 7 s from a total of 90 s, a thermal analysis is not required.

#### *Positioning error as result of the brake application time $t_E$*

After the brake motor is powered-down by inhibiting the drive converter pulses, there is first a brake application delay time  $t_E$  before the mechanical brake becomes effective. The drive is shutdown at  $f_U=0$  and  $n \approx 0$  (the slip speed is neglected). The load drops, accelerating due to its own weight, as there is no opposing motor torque. After the brake has been applied, standstill is reached after time  $t_{v \text{ mech}}$ .



The positioning error calculation is sub-divided into range 1 (acceleration due to the load itself) and range 2 (deceleration due to the mechanical brake).

Calculating the acceleration caused by the load itself (range 1)

For  $M_{\text{motor}}=0$ :

$$M_{\text{motor}} = 0 = -M_{b \text{ motor}+K} + (-M_{b \text{ load}} + M_{\text{load}}) \cdot \frac{\eta}{i}$$

and

$$0 = -(J_{\text{motor}} + J_K) \cdot \alpha_{b \text{ motor}} - J_{\text{load}} \cdot \frac{\eta}{i^2} \cdot \alpha_{b \text{ motor}} + M_{\text{load}} \cdot \frac{\eta}{i}$$

The motor angular acceleration is then given by:

$$\alpha_{b \text{ motor}} = \frac{M_{\text{load}} \cdot \frac{\eta}{i}}{J_{\text{motor}} + J_K + J_{\text{load}} \cdot \frac{\eta}{i^2}} = \frac{104 \cdot \frac{0.85}{20.5}}{0.0035 + 0.00028 + 0.53 \cdot \frac{0.85}{20.5^2}} = 889 \text{ s}^{-2}$$

and for the load acceleration:

$$a_b = \frac{\alpha_{b \text{ motor}}}{i} \cdot \frac{D}{2} = \frac{889}{20.5} \cdot \frac{0.1}{2} = 2.17 \text{ m / s}^2$$

The distance moved while the system accelerates due to the load:

$$s_E = \frac{1}{2} \cdot a_b \cdot t_E^2 = \frac{1}{2} \cdot 2.17 \cdot 0.04^2 = 0.0017 \text{ m}$$

Velocity after the brake application time has expired:

$$v_{\text{max } E} = a_b \cdot t_E = 2.17 \cdot 0.04 = 0.087 \text{ m / s}$$

Calculating the deceleration as result of the mechanical brake (range 2)

For  $M_{\text{motor}}=M_{\text{mech}}$ :

$$M_{\text{motor}} = M_{\text{mech}} = M_{v \text{ motor}+K} + (M_{v \text{ load}} + M_{\text{load}}) \cdot \frac{\eta}{i}$$

and

$$M_{\text{mech}} = (J_{\text{motor}} + J_K) \cdot \alpha_{v \text{ motor}} + J_{\text{load}} \cdot \frac{\eta}{i^2} \cdot \alpha_{v \text{ motor}} + M_{\text{load}} \cdot \frac{\eta}{i}$$

The angular deceleration of the motor is then given by:

$$\alpha_{v \text{ motor}} = \frac{M_{\text{mech}} - M_{\text{load}} \cdot \frac{\eta}{i}}{J_{\text{motor}} + J_K + J_{\text{load}} \cdot \frac{\eta}{i^2}} = \frac{14.5 - 104 \cdot \frac{0.85}{20.5}}{0.0035 + 0.00028 + 0.53 \cdot \frac{0.85}{20.5^2}} = 2100 \text{ s}^{-2}$$

and the deceleration of the load itself:

$$a_v = \frac{\alpha_{v \text{ motor}}}{i} \cdot \frac{D}{2} = \frac{2100}{20.5} \cdot \frac{0.1}{2} = 5.12 \text{ m/s}^2$$

Delay time as result of the mechanical brake:

$$t_{v \text{ mech}} = \frac{v_{\text{max } E}}{a_v} = \frac{0.087}{5.12} = 0.017 \text{ s}$$

Distance moved during the delay caused by the mechanical brake:

$$s_v = \frac{v_{\text{max } E} \cdot t_{v \text{ mech}}}{2} = \frac{0.087 \cdot 0.017}{2} = 0.00074 \text{ m}$$

Due to the delayed application of the mechanical brake after the brake motor has been powered down - time  $t_E$  - the load moves a total distance of

$$s_{\text{total}} = s_E + s_v = 0.0017 + 0.00074 = 0.00244 \text{ m} = 2.44 \text{ mm}$$

downwards. This load-dependent positioning error must be taken into account by the positioning system.

## 3.1.4 High-bay racking vehicle

This application involves a high-bay racking vehicle with traversing drive, elevating drive and telescopic drive. In this case, only the traversing- and elevating drives are investigated. 1PA6 compact induction motors are to be used.

Traversing drive*Drive data*

Mass to be moved	m	= 5500 kg
Load wheel diameter	D	= 0.34 m
Specific traction resistance	w <sub>F</sub>	= 0.02
Gearbox ratio	i	= 16
Mech. efficiency	η	= 0.75
Max. traversing velocity	v <sub>max</sub>	= 2.66 m/s
Max. acceleration	a <sub>max</sub>	= 0.44 m/s <sup>2</sup>
Max. traversing distance	s <sub>max</sub>	= 42.6 m
No-load interval after a traversing sequence	t <sub>p</sub>	= 10 s

*Traversing at constant velocity*

Resistance force, load torque:

$$F_W = m \cdot g \cdot w_F$$

$$= 5500 \cdot 9.81 \cdot 0.02 = 1079.1 \text{ N}$$

$$M_{load} = F_W \cdot \frac{D}{2}$$

$$= 1079.1 \cdot \frac{0.34}{2} = 183.45 \text{ Nm}$$

Motor output, motor torque:

$$P_{motor} = \frac{F_w \cdot v_{max}}{\eta \cdot 10^3} = \frac{1079.1 \cdot 2.66}{0.75 \cdot 10^3} = 3.83 \text{ kW}$$

$$M_{motor} = \frac{M_{load}}{i \cdot \eta} = \frac{183.45}{16 \cdot 0.75} = 15.29 \text{ Nm}$$

Motor speed at  $v_{max}$ :

$$n_{motor \max} = i \cdot n_{load \max} = i \cdot \frac{v_{max} \cdot 60}{\pi \cdot D} = 16 \cdot \frac{2.66 \cdot 60}{\pi \cdot 0.34} = 2391 \text{ RPM}$$

*Calculating the load torques when accelerating and decelerating*

Angular acceleration of the load wheel:

$$\alpha_{load} = a_{max} \cdot \frac{2}{D} = 0.44 \cdot \frac{2}{0.34} = 2.59 \text{ s}^{-2}$$

Load moment of inertia referred to the load wheel:

$$\begin{aligned} J_{load} &= m \cdot \left(\frac{D}{2}\right)^2 \\ &= 5500 \cdot \left(\frac{0.34}{2}\right)^2 = 158.95 \text{ kgm}^2 \end{aligned}$$

Load accelerating torque:

$$\begin{aligned} M_{bload} &= J_{load} \cdot \alpha_{load} \\ &= 158.95 \cdot 2.59 = 411.4 \text{ Nm} \end{aligned}$$

As deceleration is the same as acceleration, the following is true:

$$M_{vload} = M_{bload}$$

*Motor selection*

The following motor is selected (refer to Calculating the motor torques):

1PA6 103-4HG.,  $P_n=7.5 \text{ kW}$ ,  $M_n=31 \text{ Nm}$ ,  $n_n=2300 \text{ RPM}$ ,  $I_n=17 \text{ A}$ ,  $I_\mu=8.2 \text{ A}$   
 $J_{motor}=0.017 \text{ kgm}^2$ ,  $\eta_{motor}=0.866$

*Calculating the motor torques when accelerating and decelerating*

Motor accelerating- and decelerating torques:

$$\begin{aligned} M_{b\ motor} &= M_{v\ motor} & &= J_{motor} \cdot \alpha_{load} \cdot i \\ &= 0.017 \cdot 2.59 \cdot 16 = 0.704\ Nm \end{aligned}$$

Motor torque when accelerating:

$$\begin{aligned} M_{motor} &= M_{b\ motor} + (M_{b\ load} + M_{load}) \cdot \frac{1}{i \cdot \eta} \\ &= 0.704 + (411.38 + 183.45) \cdot \frac{1}{16 \cdot 0.75} = 50.27\ Nm \end{aligned}$$

Motor torque when decelerating:

$$\begin{aligned} M_{motor} &= -M_{v\ motor} + (-M_{v\ load} + M_{load}) \cdot \frac{\eta}{i} \\ &= -0.704 + (-411.38 + 183.45) \cdot \frac{0.75}{16} = -11.39\ Nm \quad (\text{regenerative operation}) \end{aligned}$$

The highest motor torque is required when accelerating, namely 162 % of the rated motor torque. The moments of inertia of the gearbox, coupling, brake and other rotating masses have been neglected.

Accelerating- and decelerating time:

$$t_b = t_v = \frac{v_{\max}}{a_{\max}} = \frac{2.66}{0.44} = 6\ s$$

*Investigating the condition so that the wheels do not spin when starting*

The following must be true so that the drive wheels don't spin when starting:

$$\sum F_R > F_b$$

Whereby:

$$F_b = m \cdot a_{b\ \max} = 5500 \cdot 0.44 = 2420\ N \quad (\text{accelerating force})$$

For two axes where one is driven, and when assuming that the driven axis carries half of the vehicle weight:

$$\sum F_R = \frac{1}{2} \cdot m \cdot g \cdot \mu = \frac{1}{2} \cdot 5500 \cdot 9.81 \cdot 0.15 = 4047 \text{ N} \quad (\text{sum of the frictional forces})$$

Thus, the above condition is fulfilled.

#### Calculating the maximum braking power

The maximum motor output in regenerative operation occurs when the drive starts to decelerate from the maximum motor speed.

$$P_{br \text{ motor max}} = \frac{M_{\text{motor v}} \cdot n_{\text{motor max}}}{9550} = -\frac{11.39 \cdot 2391}{9550} = -2.85 \text{ kW}$$

#### Selecting the drive converter

For the highest required motor torque, the approximate motor current is given by:

$$I_{\text{motor max}} \approx \sqrt{\left(\frac{M_{\text{motor max}}}{M_{\text{motor n}}}\right)^2 \cdot (I_{\text{motor n}}^2 - I_{\mu n}^2) \cdot k_n^2 + I_{\mu n}^2 \cdot \frac{1}{k_n^2}}$$

$$k_n = \frac{n_{\text{mot max}}}{n_{\text{mot n}}} = \frac{2391}{2300} = 1.0396 \quad \text{field weakening factor}$$

With  $I_{\mu n} = 8.2 \text{ A}$ , the following is obtained:

$$I_{\text{motor max}} \approx \sqrt{\left(\frac{50.27}{31}\right)^2 \cdot (17^2 - 8.2^2) \cdot 1.0396^2 + 8.2^2 \cdot \frac{1}{1.0396^2}} = 26.3 \text{ A} \quad \text{for } t_b = 6 \text{ s}$$

Selected drive converter:

6SE7022-6EC61

$P_{Vn} = 11 \text{ kW}$ ;  $I_{Vn} = 25.5 \text{ A}$ ;  $I_{Vmax} = 34.8 \text{ A}$

Closed-loop speed control

*Dimensioning the brake resistor*

The brake resistor is used during deceleration. As the braking characteristics are the same for both forwards- and reverse motion, only forwards motion has to be investigated.

## Velocity-time diagram for forwards motion

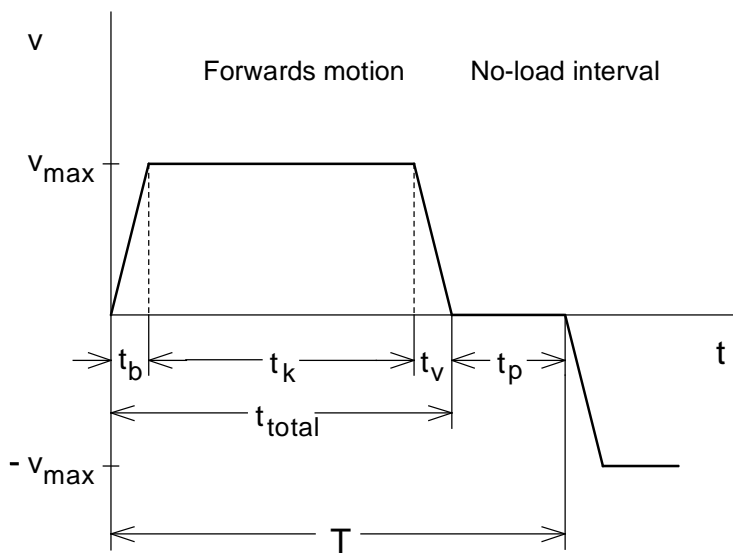

$$t_p = 10 \text{ s}$$

$$t_v = t_b = 6 \text{ s}$$

$$s_{\max} = 42.6 \text{ m}$$

Thus, the total time for the maximum travel (distance) is obtained as follows:

$$\begin{aligned} t_{\text{total}} &= 2 \cdot t_b + \frac{s_{\max} - v_{\max} \cdot t_b}{v_{\max}} \\ &= 2 \cdot 6 + \frac{42.6 - 2.66 \cdot 6}{2.66} = 22 \text{ s} \end{aligned}$$

Time for traversing at constant velocity:

$$t_k = t_{\text{total}} - 2 \cdot t_b = 22 - 2 \cdot 6 = 10 \text{ s}$$



Cycle time for forwards- and reverse travel:

$$T = t_{total} + t_p = 22 + 10 = 32 \text{ s}$$

Maximum braking power for the brake resistor:

$$P_{brW \max} = P_{br \text{ motor } \max} \cdot \eta_{motor} \cdot \eta_{Inv} = 2.85 \cdot 0.866 \cdot 0.98 = 2.42 \text{ kW}$$

Braking diagram



Braking energy for a cycle (corresponds to the area in the braking diagram):

$$W_{br} = \frac{1}{2} \cdot P_{brW \max} \cdot t_v = \frac{1}{2} \cdot 2.42 \cdot 6 = 7.26 \text{ kW s}$$

The following must be valid for the brake resistor:

$$\frac{W_{br}}{T} = \frac{7.26}{32} = 0.227 \text{ kW} \leq P_{br \text{ cont.}}$$

With

$$P_{br \text{ cont.}} = \frac{P_{20}}{36} \quad (\text{with an internal brake resistor})$$

the following is obtained

$$36 \cdot 0.227 = 8.17 \text{ kW} \leq P_{20}$$

Thus, a braking unit is selected with  $P_{20} = 10 \text{ kW}$  (6SE7021-6ES87-2DA0). The internal brake resistor is adequate.

### Thermally checking the motor

Torque characteristic for forwards motion



The RMS torque is obtained from the torque characteristic as follows:

$$\begin{aligned}
 M_{RMS} &= \sqrt{\frac{50.27^2 \cdot 6 + 15.29^2 \cdot 10 + 11.39^2 \cdot 6}{6 + 10 + 6 + 10}} \\
 &= \sqrt{\frac{18278.7}{23}} \\
 &= 23.9 \text{ Nm}
 \end{aligned}$$

The calculated RMS torque is lower than the rated motor torque with 30 Nm. Thus, operation is thermally permissible. When calculating the RMS value, the slight field-weakening range is neglected.

### Elevating drive

#### *Drive data*

Mass to be moved	$m$	= 1350 kg
Load wheel diameter	$D$	= 0.315 m
Gearbox ratio	$i$	= 63.3
Mech. efficiency	$\eta$	= 0.7
Max. elevating velocity	$v_{\max}$	= 0.6 m/s
Max. acceleration	$a_{\max}$	= 0.6 m/s <sup>2</sup>
Max. height	$h_{\max}$	= 6 m
No-load interval after elevating or lowering	$t_p$	= 8 s

#### *Elevating the load at constant velocity*

Elevating force, load torque:

$$F_H = m \cdot g$$

$$= 1350 \cdot 9.81 = 132435 \text{ N}$$

$$M_{load} = F_H \cdot \frac{D}{2}$$

$$= 132435 \cdot \frac{0.315}{2} = 2085.9 \text{ Nm}$$

Motor output, motor torque:

$$P_{motor} = \frac{F_H \cdot v_{max}}{\eta \cdot 10^3} = \frac{13243.5 \cdot 0.6}{0.7 \cdot 10^3} = 11.35 \text{ kW}$$

$$M_{motor} = \frac{M_{load}}{i \cdot \eta} = \frac{2085.9}{63.3 \cdot 0.7} = 47.1 \text{ Nm}$$

Motor speed at  $v_{max}$ :

$$n_{motor \max} = i \cdot n_{load \max} = i \cdot \frac{v_{max} \cdot 60}{\pi \cdot D} = 63.3 \cdot \frac{0.6 \cdot 60}{\pi \cdot 0.315} = 2303 \text{ RPM}$$

*Lowering the load at constant velocity*

Motor output, motor torque:

$$P_{motor} = -\frac{F_H \cdot v_{max}}{10^3} \cdot \eta = -\frac{13243.5 \cdot 0.6}{10^3} \cdot 0.7 = -5.56 \text{ kW} \quad (\text{regenerative operation})$$

$$M_{motor} = \frac{M_{load}}{i} \cdot \eta = \frac{2085.9}{63.3} \cdot 0.7 = 23.07 \text{ Nm}$$

*Calculating the load torques when accelerating and decelerating*

Angular acceleration of the load wheel:

$$\alpha_{load} = a_{max} \cdot \frac{2}{D} = 0.6 \cdot \frac{2}{0.315} = 3.81 \text{ s}^{-2}$$

Load moment of inertia referred to the load wheel:

$$\begin{aligned} J_{load} &= m \cdot \left(\frac{D}{2}\right)^2 \\ &= 1350 \cdot \left(\frac{0.315}{2}\right)^2 = 33.49 \text{ kgm}^2 \end{aligned}$$

Load accelerating torque:

$$\begin{aligned} M_{b\ load} &= J_{\ load} \cdot \alpha_{\ load} \\ &= 33.49 \cdot 3.81 = 127.58 \text{ Nm} \end{aligned}$$

As deceleration is the same as acceleration, the following is true:

$$M_{v\ load} = M_{b\ load}$$

### Motor selection

The following motor is selected (refer to Calculating the motor torques):

1PA6 103-4HG.,  $P_n=7.5$  kW,  $M_n=31$  Nm,  $n_n=2300$  RPM,  $I_n=17$  A,  $I_\mu=8.2$  A  
 $J_{\ motor}=0.017$  kgm<sup>2</sup>,  $\eta_{\ motor}=0.866$

### Calculating the motor torques when accelerating and decelerating

Accelerating- and decelerating torque for the motor:

$$\begin{aligned} M_{b\ motor} = M_{v\ motor} &= J_{\ motor} \cdot \alpha_{\ load} \cdot i \\ &= 0.017 \cdot 3.81 \cdot 63.3 = 4.1 \text{ Nm} \end{aligned}$$

Elevating the load, motor torque when accelerating:

$$\begin{aligned} M_{\ motor} &= M_{b\ motor} + (M_{b\ load} + M_{\ load}) \cdot \frac{1}{i \cdot \eta} \\ &= 4.1 + (127.58 + 2085.9) \cdot \frac{1}{63.3 \cdot 0.7} = 54.05 \text{ Nm} \end{aligned}$$

Elevating the load, motor torque when decelerating:

$$\begin{aligned} M_{\ motor} &= -M_{v\ motor} + (-M_{v\ load} + M_{\ load}) \cdot \frac{1}{i \cdot \eta} \\ &= -4.1 + (-127.58 + 2085.9) \cdot \frac{1}{63.3 \cdot 0.7} = 40.1 \text{ Nm} \end{aligned}$$

Lowering the load, motor torque when accelerating:

$$\begin{aligned} M_{motor} &= -M_{b\ motor} + (-M_{b\ load} + M_{load}) \cdot \frac{\eta}{i} \\ &= -4.1 + (-127.58 + 2085.9) \cdot \frac{0.7}{63.3} = 17.55 \text{ Nm} \quad (\text{regenerative operation}) \end{aligned}$$

Lowering the load, motor torque when decelerating:

$$\begin{aligned} M_{motor} &= M_{v\ motor} + (M_{v\ load} + M_{load}) \cdot \frac{\eta}{i} \\ &= 4.1 + (127.58 + 2085.9) \cdot \frac{0.7}{62.3} = 28.58 \text{ Nm} \quad (\text{regenerative operation}) \end{aligned}$$

The highest motor torque is required when accelerating, while elevating the load, namely 174 % of the rated motor torque. The highest motor torque in regenerative operation is required when decelerating while the load is being lowered. The accelerating- or decelerating component in this case is low with respect to the load torque. The moments of inertia for gearbox, brake and coupling have been neglected.

Accelerating and decelerating time:

$$t_b = t_v = \frac{v_{\max}}{a_{\max}} = \frac{0.6}{0.6} = 1 \text{ s}$$

### *Calculating the maximum braking power*

The maximum motor output in regenerative operation occurs when the drive starts to decelerate from the maximum motor speed while the load is being lowered.

$$P_{br\ motor\ max} = \frac{M_{motor\ v} \cdot n_{motor\ max}}{9550} = -\frac{28.58 \cdot 2303}{9550} = -6.89 \text{ kW}$$

### *Drive converter selection*

For the highest motor torque, the approximate motor current is given by:

$$I_{motor\ max} \approx \sqrt{\left(\frac{M_{motor\ max}}{M_{motor\ n}}\right)^2 \cdot (I_{motor\ n}^2 - I_{\mu n}^2) + I_{\mu n}^2}$$

With  $I_{\mu n} = 8.2 \text{ A}$ , the following is obtained:

$$I_{\text{motor max}} \approx \sqrt{\left(\frac{54.05}{31}\right)^2 \cdot (17^2 - 8.2^2) + 8.2^2} = 27.2 \text{ A} \quad \text{for } t_b=1 \text{ s}$$

5% is added for saturation effects, so that a max. motor current of 28.5 A is obtained.

Selected drive converter:

6SE7022-6EC61

$P_{Vn}=11 \text{ kW}$ ;  $I_{Vn}=25.5 \text{ A}$ ;  $I_{Vmax}=34.8 \text{ A}$

Closed-loop speed control

### Dimensioning the brake resistor

The brake resistor is used when lowering the load.

Velocity-time diagram for elevating and lowering

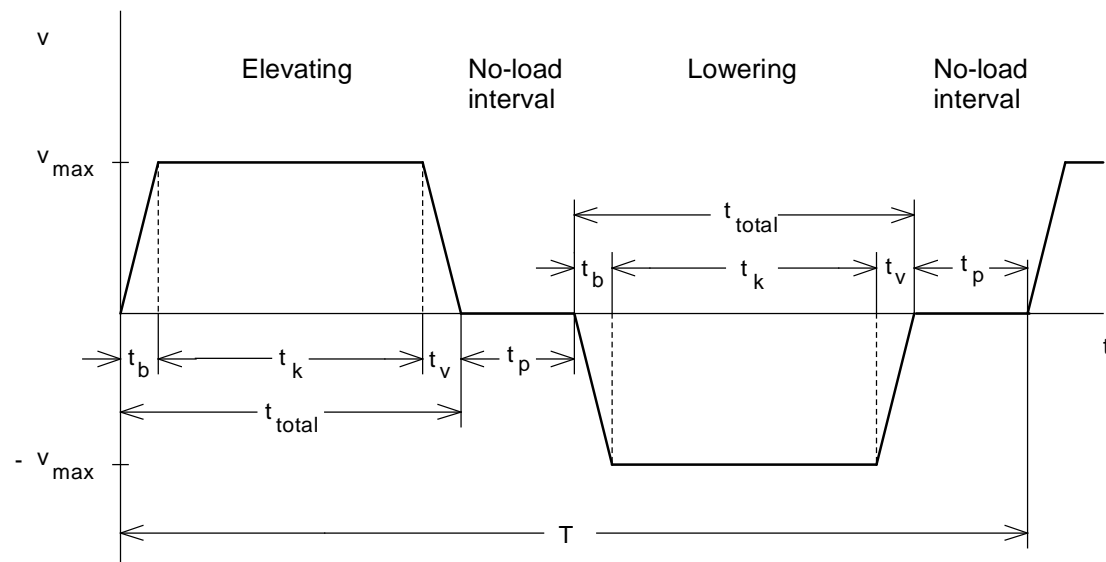

$$t_p = 8 \text{ s}$$

$$t_v = t_b = 1 \text{ s}$$

$$h_{\text{max}} = 6 \text{ m}$$

Thus, a total time is obtained for  $h_{\max}$ :

$$t_{\text{total}} = 2 \cdot t_b + \frac{h_{\max} - v_{\max} \cdot t_b}{v_{\max}}$$

$$= 2 \cdot 1 + \frac{6 - 0.6 \cdot 1}{0.6} = 11 \text{ s}$$

Time for travel at constant velocity:

$$t_k = t_{\text{total}} - 2 \cdot t_b = 11 - 2 \cdot 1 = 9 \text{ s}$$

Cycle time for elevating and lowering:

$$T = 2 \cdot (t_{\text{total}} + t_p) = 2 \cdot (11 + 8) = 38 \text{ s}$$

Max. braking power for the brake resistor when decelerating:

$$P_{br W \max v} = P_{br \text{ motor max } v} \cdot \eta_{\text{motor}} \cdot \eta_{\text{Inv}} = 6.89 \cdot 0.866 \cdot 0.98 = 5.85 \text{ kW}$$

Max. braking power for the brake resistor when accelerating:

$$P_{br W \max b} = P_{br \text{ motor max } b} \cdot \eta_{\text{motor}} \cdot \eta_{\text{Inv}} = \frac{M_{\text{motor } b} \cdot n_{\text{motor max}}}{9550} \cdot \eta_{\text{motor}} \cdot \eta_{\text{Inv}}$$

$$= \frac{17.55 \cdot 2303}{9550} \cdot 0.866 \cdot 0.98 = 3.59 \text{ kW}$$

Braking power for the brake resistor when travelling at constant velocity:

$$P_{br W \text{ const}} = P_{br \text{ motor const}} \cdot \eta_{\text{motor}} \cdot \eta_{\text{Inv}} = 5.56 \cdot 0.866 \cdot 0.98 = 4.72 \text{ kW}$$



## Braking diagram



Braking energy for a cycle (corresponds to the area in the brake diagram):

$$\begin{aligned}
 W_{br} &= \frac{1}{2} \cdot P_{br W \max b} \cdot t_b + P_{br W \text{ const}} \cdot t_k + \frac{1}{2} \cdot P_{br W \max v} \cdot t_v \\
 &= \frac{1}{2} \cdot 3.59 \cdot 1 + 4.72 \cdot 9 + \frac{1}{2} \cdot 5.85 \cdot 1 = 47.2 \text{ kW}_S
 \end{aligned}$$

The following must be valid for the brake resistor:

$$\frac{W_{br}}{T} = \frac{47.2}{38} = 1.24 \text{ kW} \leq P_{br \text{ cont.}}$$

With

$$P_{br \text{ cont.}} = \frac{P_{20}}{4.5} \quad (\text{for an external brake resistor})$$

the following is obtained

$$4.5 \cdot 1.24 = 5.58 \text{ kW} \leq P_{20}$$

Thus, a braking unit is selected with  $P_{20} = 10 \text{ kW}$  (6SE7021-6ES87-2DA0), with an external brake resistor (6SE7021-6ES87-2DC0).

*Thermally checking the motor*

## Motor characteristic when hoisting and lowering



The RMS torque is obtained from the torque characteristic:

$$\begin{aligned}
 M_{RMS} &= \sqrt{\frac{54.05^2 \cdot 1 + 47.1^2 \cdot 9 + 40.1^2 \cdot 1 + 17.55^2 \cdot 1 + 23.07^2 \cdot 9 + 28.58^2 \cdot 1}{2 \cdot (1 + 9 + 1 + 8)}} \\
 &= \sqrt{\frac{30410}{38}} \\
 &= 28.3 \text{ Nm}
 \end{aligned}$$

The calculated RMS torque is less than the rated motor torque with 31 Nm. Thus, operation is thermally permissible.

### Using a rectifier/regenerative feedback unit with inverters

As an alternative, instead of using 3 drive converters with braking units, a multi-motor drive system can also be configured using a rectifier/regenerative feedback unit, DC bus and 3 inverters.

#### *Selecting the rectifier/regenerative feedback unit*

The low output of the telescopic drive with respect to the traversing- and elevating drive, can be neglected when dimensioning the rectifier/regenerative feedback unit, as the telescopic drive is always operational just by itself. On the other hand, the traversing- and elevating drive can operate simultaneously. When selecting the rectifier/regenerative feedback unit, it is assumed, that under worst case conditions, when accelerating, the maximum power and therefore the maximum DC link current of both drives occur simultaneously.

Maximum motor power and maximum DC link current for the traversing drive:

$$P_{motor \max \text{ traverse}} = \frac{M_{motor \max \text{ traverse}} \cdot n_{\max \text{ traverse}}}{9550} = \frac{50.27 \cdot 2391}{9550} = 12.59 \text{ kW}$$

$$I_{DClink \max \text{ traverse}} = \frac{P_{motor \max \text{ traverse}}}{U_{ZK} \cdot \eta_{motor \text{ traverse}} \cdot \eta_{inv}} = \frac{12.59 \cdot 10^3}{1.35 \cdot 400 \cdot 0.866 \cdot 0.98} = 27.47 \text{ A}$$

Max. motor power and maximum DC link current for the elevating drive:

$$P_{motor \max \text{ hoist}} = \frac{M_{motor \max \text{ hoist}} \cdot n_{\max \text{ hoist}}}{9550} = \frac{54.05 \cdot 2303}{9550} = 13.03 \text{ kW}$$

$$I_{DClink \max \text{ hoist}} = \frac{P_{motor \max \text{ hoist}}}{U_{DClink} \cdot \eta_{motor \text{ hoist}} \cdot \eta_{inv}} = \frac{13.03 \cdot 10^3}{1.35 \cdot 400 \cdot 0.866 \cdot 0.98} = 28.43 \text{ A}$$

Thus, the maximum DC link current is given by:

$$I_{DClink \max \text{ total}} = I_{DClink \max \text{ traverse}} + I_{DClink \max \text{ hoist}} = 27.47 + 28.43 = 55.9 \text{ A}$$

Selected rectifier/regenerative feedback unit:

6SE7024-1EC85-1AA0

$P_n=15 \text{ kW}$ ;  $I_{DC \text{ link } n}=41 \text{ A}$ ;  $I_{DC \text{ link } \max}=56 \text{ A}$

### Selecting the regenerative feedback transformer

When selecting the regenerative feedback transformer, the RMS DC link current for the rectifier/regenerative feedback unit is calculated in the regenerative mode. Previously, to dimension the braking resistors, the braking powers  $P_{br W} = P_{br DC link}$  in the DC link, were already calculated for the traversing- and elevating drive. In this case, the inverter efficiency was neglected. Thus, the calculation is on the safe side. Using the equation

$$I_{DClink gen} = \frac{P_{br DClink}}{V_{DClink}}$$

the RMS value in regenerative operation is obtained:

$$I_{DClink gen RMS} = \frac{P_{br DClink RMS}}{V_{DClink}}$$

The RMS value of the DC link braking power is obtained with the braking powers  $P_{br W}$ , specified in the brake diagrams for the traversing- and elevating drive:

$$P_{br DClink RMS} = \sqrt{\frac{\frac{1}{3} \cdot 2.42^2 \cdot 6 + \frac{1}{3} \cdot 3.59^2 \cdot 1 + 4.72^2 \cdot 9 + \frac{1}{3} \cdot 5.85^2 \cdot 1}{38}} = 2.45 \text{ kW}$$

To calculate the RMS value of the non-constant segments, the following equation is used.

$$\int_i^{i+1} P_{br W}^2 \cdot dt = \frac{1}{3} \cdot (P_{br W i}^2 + P_{br W i+1}^2 + P_{br W i} \cdot P_{br W i+1}) \cdot \Delta t_i$$

The cycle time for the elevating drive, 38 s, was used as time interval.

The following is now obtained for the RMS value of the DC link current:

$$I_{DClink gen RMS} = \frac{2.45 \cdot 10^3}{1.35 \cdot 400} = 4.54 \text{ A}$$

The permissible RMS value is as follows for a regenerative feedback transformer with 25% duty ratio:

$$I_{DClink RMS permissible} = I_{DClink n} \cdot 0.92 \cdot \sqrt{\frac{25}{100}} = I_{DClink n} \cdot 0.46 = 41 \cdot 0.46 = 18.86 \text{ A}$$

Thus, a regenerative feedback transformer 4AP2795-0UA01-8A with a 25% duty ratio is sufficient. In addition, a 4%  $u_k$  line reactor 4EP3900-5US is required.

### 3.1.5 Hoisting drive for a 20 t gantry crane

This application involves a four-line hoisting unit with 2 cable runs. The test load is 25 t. Previously, a 6-pole wound-rotor motor (US: slipring motor) was used, directly connected to the line supply with  $P_n=21.5$  kW; this has now been replaced by a 6-pole induction motor with  $P_n=22$  kW.

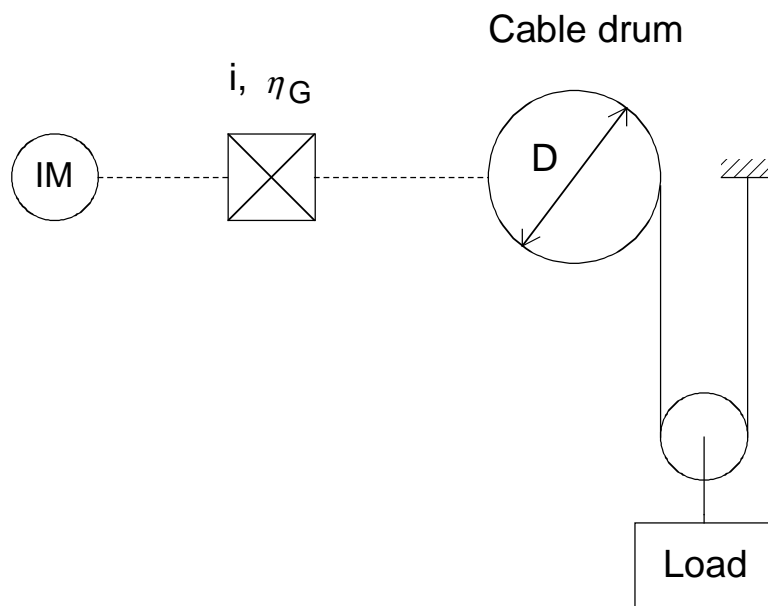

#### Hoisting unit data

Cable drum diameter	D	= 0.6 m
Gearbox ratio	i	= 177
Gearbox efficiency	η <sub>G</sub>	= 0.9
Permissible load	Q	= 20 t
Test load	Q <sub>max</sub>	= 25 t
Accelerating time, decelerating time	t <sub>b</sub> , t <sub>v</sub>	= 10 s
Rated motor output	P <sub>n</sub>	= 22 kW
Rated motor torque	M <sub>n</sub>	= 215 Nm
Rated motor speed	n <sub>n</sub>	= 975 RPM
Motor moment of inertia	J <sub>Motor</sub>	= 0.33 kgm <sup>2</sup>
Maximum hoisting height	h <sub>max</sub>	= 5 m

*Hoisting the load at constant velocity*

Hoisting force and load torque at the cable drum:

$$F_H = \frac{m_{load} \cdot g}{2} = \frac{20 \cdot 10^3 \cdot 9.81}{2} = 98100 \text{ N}$$

$$M_{load} = F_H \cdot \frac{D}{2} = 98100 \cdot \frac{0.6}{2} = 29430 \text{ Nm}$$

Circumferential speed at the cable drum:

$$\begin{aligned} v_{drum \max} &= \frac{\omega_{n \text{ motor}}}{i} \cdot \frac{D}{2} = \frac{2 \cdot \pi \cdot n_{n \text{ motor}}}{i \cdot 60} \cdot \frac{D}{2} \\ &= \frac{2 \cdot \pi \cdot 975}{177 \cdot 60} \cdot \frac{0.6}{2} = 0.173 \text{ m/s} \end{aligned}$$

Motor output, motor torque:

$$P_{motor} = \frac{F_H \cdot v_{drum \max}}{\eta_G \cdot 10^3} = \frac{98100 \cdot 0.173}{0.9 \cdot 10^3} = 18.86 \text{ kW}$$

$$M_{motor} = \frac{M_{load}}{i \cdot \eta_G} = \frac{29430}{177 \cdot 0.9} = 184.7 \text{ Nm}$$

For a 25 t test load, a motor output of 23.57 kW and a motor torque of 231 Nm are obtained. The selected 22 kW motor is sufficient, as it involves a drive with intermittent duty.

*Lowering the load at constant velocity*

Motor output, motor torque:

$$P_{motor} = -\frac{F_H \cdot v_{drum \max}}{10^3} \cdot \eta_G = -\frac{98100 \cdot 0.173}{10^3} \cdot 0.9 = -15.27 \text{ kW} \quad (\text{regenerative operation})$$

$$M_{motor} = \frac{M_{load}}{i} \cdot \eta_G = \frac{29430}{177} \cdot 0.9 = 149.6 \text{ Nm}$$

### Calculating the motor torques when accelerating

Motor angular acceleration:

$$\begin{aligned}\alpha_{motor} &= \frac{\omega_{n\,motor}}{t_b} = \frac{2 \cdot \pi \cdot n_{n\,motor}}{60 \cdot t_b} \\ &= \frac{2 \cdot \pi \cdot 975}{60 \cdot 10} = 10.2 \text{ s}^{-2}\end{aligned}$$

Accelerating torque for motor+gearbox:

$$\begin{aligned}M_{b\,motor+gearbox} &= (J_{motor} + J_{gearbox}) \cdot \alpha_{motor} \\ &= (0.33 + 0) \cdot 10.2 = 3.37 \text{ Nm}\end{aligned}$$

( $J_{gearbox}$  neglected)

Moment of inertia of the load referred to the cable drum:

$$\begin{aligned}J_{load} &= \frac{1}{4} \cdot m_{load} \cdot \left(\frac{D}{2}\right)^2 \\ &= \frac{1}{4} \cdot 20 \cdot 10^3 \cdot \left(\frac{0.6}{2}\right)^2 = 450 \text{ kgm}^2\end{aligned}$$

Moment of inertia of the cable drum:

$$J_{Tr}=20 \text{ kgm}^2 \text{ (estimated)}$$

Accelerating torque for the load+wire drum:

$$\begin{aligned}M_{b\,load+drum} &= (J_{load} + J_{drum}) \cdot \alpha_{drum} = (J_{load} + J_{drum}) \cdot \frac{\alpha_{motor}}{i} \\ &= (450 + 20) \cdot \frac{10.2}{177} = 27.08 \text{ Nm}\end{aligned}$$

Hoisting the load, motor torque when accelerating:

$$\begin{aligned}M_{motor} &= M_{b\,motor+gearbox} + (M_{b\,load+drum} + M_{load}) \cdot \frac{1}{i \cdot \eta_G} \\ &= 3.37 + (27.08 + 29430) \cdot \frac{1}{177 \cdot 0.9}\end{aligned}$$

Due to the relatively long accelerating time, the accelerating torques are low with respect to the load torque.

### *Selecting the motor and drive converter*

Selected motor:

1LA5 207-6

$P_n=22$  kW;  $I_{\text{motor } n}=42.5$  A;  $M_n=215$  Nm;  $\eta_{\text{motor}}=90.8\%$ ;  $J_{\text{motor}}=0.33$  kgm<sup>2</sup>

Selected drive converter:

6SE7027-2ED61

$P_{V n}=37$  kW;  $I_{V n}=72$  A;  $I_{V \text{ max}}=98$  A

Closed-loop frequency control

The maximum current of the 37 kW drive converter is 98 A. Thus, the 22 kW motor ( $I_{\text{motor } n}=42.5$  A) can also easily start even with a suspended test load of 25 t. The starting current must be set high enough, so that the load doesn't slip when the brake is released and there are no problems at the transition from open-loop controlled operation to closed-loop controlled operation. It is practical to set the slip frequency for the brake release somewhat higher than the rated slip frequency.

Rated motor slip frequency:

$$f_{\text{slip } n} = \frac{n_s - n_n}{n_s} \cdot 50 \text{ Hz} = \frac{1000 - 975}{1000} \cdot 50 = 1.25 \text{ Hz}$$

As a result of the relatively long accelerating time from 10 s to 50 Hz, the brake enable signal can be simply realized using the signal  $f_V \geq f_x$ , with  $f_x = 2$  Hz. In the still available time from 0.4 s to when the brake is released, the flux will have had time to establish itself.

### *Dimensioning the brake resistor*

The brake resistor is used when the load is lowered. As result of the low influence of the accelerating- and decelerating torques, only the braking power due to the constant load torque when the load is being lowered is taken into account. The worst case situation is investigated, when the nominal load is lowered from the full height.



Velocity-time diagram when lowering the load from  $h_{\max}=5$  m



$$v_{load\ max} = \frac{v_{drum\ max}}{2} = 0.0865\ m/s$$

$$t_v = t_b = 10\ s$$

Total time for the load to be lowered:

$$\begin{aligned} t_{total} = t_{br} &= 2 \cdot t_b + \frac{h_{\max} - v_{load\ max} \cdot t_b}{v_{load\ max}} \\ &= 2 \cdot 10 + \frac{5 - 0.0865 \cdot 10}{0.0865} = 67.8\ s \end{aligned}$$

Max. braking power of the braking resistor:

$$\begin{aligned} P_{br\ W\ max} &= \frac{F_H \cdot v_{Tr\ max}}{10^3} \cdot \eta_G \cdot \eta_{motor} \\ &= \frac{98100 \cdot 0.173}{10^3} \cdot 0.9 \cdot 0.908 = 13.87\ kW \end{aligned}$$

## Braking diagram



Braking energy for a 90 s cycle (corresponds to the area in the braking diagram):

$$W_{br} = P_{br W \max} \cdot (t_{total} - t_b) = 13.87 \cdot (67.8 - 10) = 801.7 \text{ kW s}$$

The following must be true for the brake resistor:

$$\frac{W_{br}}{T} = \frac{801.7}{90} = 8.91 \text{ kW} \leq P_{br \text{ cont.}}$$

With

$$P_{br \text{ cont.}} = \frac{P_{20}}{4.5} \quad (\text{for an external brake resistor})$$

the following is obtained

$$8.91 \cdot 4.5 = 40.1 \text{ kW} \leq P_{20}$$

Thus, a braking unit is selected with  $P_{20} = 50 \text{ kW}$  (6SE7028-0EA87-2DA0) with an external brake resistor (6SE7028-0ES87-2DC0).

### 3.1.6 Elevator (lift) drive

This drive involves an elevator with a 1:1 suspension system, and a load capability of 1080 kg for 14 people. The elevator moves through a total height of 23 m with 8 floors. The elevator approaches the floors directly without crawl using a closed-loop position control function.



#### Elevator data

Driving pulley diameter	$D$	= 0.64 m
Gearbox ratio	$i$	= 35
Gearbox efficiency	$\eta_G$	= 0.69
Load capability	$Q$	= 1080 kg
Max. weight of the elevator cabin	$F_{\max}$	= 1200 kg
Max. counter-weight ( $F_{\max} + 0.5Q$ )	$G_{\max}$	= 1740 kg
1/2 suspended cable weight	$1/2 m_{HK}$	= 28.75 kg
Cable weight	$m_{\text{cable}}$	= 48.3 kg
Operational velocity	$v_{\max}$	= 1.25 m/s
Acceleration	$a_{\max}$	= 0.9 m/s <sup>2</sup>

Rated motor output	$P_n = 13.5 \text{ kW}$
Rated motor current	$I_{\text{Motor } n} = 33.5 \text{ A}$
Rated motor torque	$M_n = 94 \text{ Nm}$
Rated motor speed	$n_n = 1455 \text{ RPM}$
Motor efficiency	$\eta_{\text{Motor}} = 0.89$
Motor moment of inertia	$J_{\text{Motor}} = 0.21 \text{ kgm}^2$
Moment of inertia of the hoist (referred to the drive pulley)	$J_W = 105.7 \text{ kgm}^2$
Moment of inertia of the handwheel (referred to the drive pulley)	$J_H = 27 \text{ kgm}^2$
Elevator height range	$FH = 23 \text{ m}$

Ascending with a full load and at constant velocity

Hoisting force:

$$\begin{aligned}
 F_H &= (1.02 \cdot (m_F + m_Q) - 0.97 \cdot m_G + m_{\text{cable}}) \cdot g \\
 &= (1.02 \cdot (1200 + 1080) - 0.97 \cdot 1740 + 48.3) \cdot 9.81 \\
 &= 6730.6 \text{ N}
 \end{aligned}$$

(1,02; 0,97: additional factors)

Load torque, motor torque:

$$\begin{aligned}
 M_{\text{load}} &= F_H \cdot \frac{D}{2} = 6730.6 \cdot \frac{0.64}{2} = 2153.8 \text{ Nm} \\
 M_{\text{motor}} &= \frac{M_{\text{load}}}{i \cdot \eta_G} = \frac{2153.8}{35 \cdot 0.69} = 89.18 \text{ Nm}
 \end{aligned}$$

Motor output:

$$P_{\text{motor}} = \frac{F_H \cdot v_{\text{max}}}{\eta_G \cdot 10^3} = \frac{6730.6 \cdot 1.25}{0.69 \cdot 10^3} = 12.2 \text{ kW}$$

The existing 13.5 kW motor is sufficient, as the drive operation is intermittent (refer to the thermal check later in the text).

Motor speed at  $v_{\text{max}}$ :

$$n_{\text{motor max}} = i \cdot n_{\text{drum max}} = i \cdot \frac{v_{\text{max}} \cdot 60}{\pi \cdot D} = 35 \cdot \frac{1.25 \cdot 60}{\pi \cdot 0.64} = 1305 \text{ RPM}$$

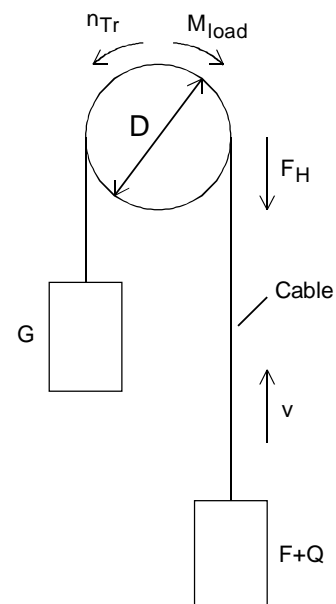

Descending with full load and constant velocity

Motor torque, motor output:

$$M_{motor} = \frac{M_{load}}{i} \cdot \eta_G = \frac{2153.8}{35} \cdot 0.69 = 42.46 \text{ Nm}$$

$$P_{motor} = -\frac{F_H \cdot v_{max}}{10^3} \cdot \eta_G = -\frac{6730.6 \cdot 1.25}{10^3} \cdot 0.69 = -5.8 \text{ kW}$$

(regenerative operation)

Calculating the motor torques when accelerating and decelerating

Motor angular acceleration:

$$\alpha_{motor} = i \cdot a_{max} \cdot \frac{2}{D} = 35 \cdot 0.9 \cdot \frac{2}{0.64} = 98.44 \text{ s}^{-2}$$

Accelerating torque for the motor:

$$\begin{aligned} M_{b\ motor} &= J_{motor} \cdot \alpha_{motor} \\ &= 0.21 \cdot 98.44 = 20.67 \text{ Nm} \end{aligned}$$

Load moment of inertia referred to the drive pulley:

$$\begin{aligned} \sum m_{linear} &= 1.02 \cdot (m_F + m_Q + m_G + m_{Seil} + \frac{1}{2} m_{HK}) \\ &= 1.02 \cdot (1200 + 1080 + 1740 + 48.3 + 28.75) = 4180 \text{ kg} \end{aligned}$$

$$\begin{aligned} J_{load} &= \sum m_{linear} \cdot \left(\frac{D}{2}\right)^2 \\ &= 4180 \cdot \left(\frac{0.64}{2}\right)^2 = 428 \text{ kgm}^2 \end{aligned}$$

Accelerating torque for load+hoist+handwheel:

$$\begin{aligned} M_{b\ load+W+H} &= (J_{load} + J_W + J_H) \cdot \frac{\alpha_{motor}}{i} \\ &= (428 + 105.7 + 27) \cdot \frac{98.44}{35} = 1577 \text{ Nm} \end{aligned}$$



As deceleration is the same as acceleration, the following is valid:

$$M_{v\ motor} = M_{b\ motor}$$

$$M_{v\ load+W+H} = M_{b\ load+W+H}$$

Ascending with full load, motor torque when accelerating:

$$\begin{aligned} M_{motor} &= M_{b\ motor} + (M_{b\ load+W+H} + M_{load}) \cdot \frac{1}{i \cdot \eta_G} \\ &= 20.67 + (1577 + 2153.8) \cdot \frac{1}{35 \cdot 0.69} = 175.2\ Nm \end{aligned}$$

Ascending with full load, motor torque when decelerating:

$$\begin{aligned} M_{motor} &= -M_{v\ motor} + (-M_{v\ load+W+H} + M_{load}) \cdot \frac{1}{i \cdot \eta_G} \\ &= -20.67 + (-1577 + 2153.8) \cdot \frac{1}{35 \cdot 0.69} = 3.2\ Nm \end{aligned}$$

Descending with full load, motor torque when accelerating:

$$\begin{aligned} M_{motor} &= -M_{b\ motor} + (-M_{b\ load+W+H} + M_{load}) \cdot \frac{\eta_G}{i} \\ &= -20.67 + (-1577 + 2153.8) \cdot \frac{0.69}{35} = -9.3\ Nm \end{aligned}$$

Descending with full load, motor torque when decelerating:

$$\begin{aligned} M_{motor} &= M_{v\ motor} + (M_{v\ load+W+H} + M_{load}) \cdot \frac{\eta_G}{i} \\ &= 20.67 + (1577 + 2153.8) \cdot \frac{0.69}{35} = 94.22\ Nm \quad (\text{regenerative operation}) \end{aligned}$$

The highest motor torque is required when accelerating while ascending with a full load. The highest motor torque in the regenerative mode is when decelerating while descending with a full load.

Accelerating- and decelerating times:

$$t_b = t_v = \frac{v_{\max}}{a_{\max}} = \frac{1.25}{0.9} = 1.39\ s$$

### Calculating the maximum braking power

The maximum motor output in regenerative operation occurs when the drive starts to decelerate from the maximum motor speed while descending with full load.

$$P_{br\ motor\ max} = \frac{M_{motor\ v} \cdot n_{motor\ max}}{9550} = -\frac{94.22 \cdot 1305}{9550} = -12.88\ kW$$

### Selecting the drive converter

Selected drive converter:

6SE7026-0ED61

$P_{Vn}=30\ kW$ ;  $I_{Vn}=59\ A$ ;  $I_{V\ max}=80.5\ A$

T300 technology board with closed-loop elevator control

The drive converter is adequately dimensioned, as the rated converter current corresponds to 176 % of the rated motor current. For the highest required motor torque, the approx. motor current is given by:

$$I_{motor\ max} \approx \sqrt{\left(\frac{M_{motor\ max}}{M_{motor\ n}}\right)^2 \cdot (I_{motor\ n}^2 - I_{\mu n}^2) + I_{\mu n}^2}$$

With  $I_{\mu n} = 0.35 \cdot I_{motor\ n}$  (assumption), the following is obtained:

$$I_{motor\ max} \approx \sqrt{\left(\frac{175.2}{94}\right)^2 \cdot (33.5^2 - 0.35^2 \cdot 33.5^2) + 0.35^2 \cdot 33.5^2} = 59.7\ A$$

### Dimensioning the brake resistor

When dimensioning the brake resistor, the worst case situation is investigated which is when the elevator is descending with a full load through all the floors. An 8 s no-load interval is assumed between ending a descent and starting to make an ascent.

Velocity-time diagram for a descent and an ascent through all of the floors (max. height)



$$t_p = 8 \text{ s}$$

$$t_v = t_b = 1.39 \text{ s}$$

$$h_{\max} = 23 \text{ m}$$

Thus, the following total time is obtained for travelling through the full height:

$$t_{\text{total}} = 2 \cdot t_b + \frac{h_{\max} - v_{\max} \cdot t_b}{v_{\max}} = 2 \cdot 1.39 + \frac{23 - 1.25 \cdot 1.39}{1.25} = 19.79 \text{ s}$$

Constant travel velocity time:

$$t_k = t_{\text{total}} - 2 \cdot t_b = 19.79 - 2 \cdot 1.39 = 17 \text{ s}$$

Cycle time for the descent and ascent:

$$T = 2 \cdot (t_{\text{total}} + t_p) = 2 \cdot (19.79 + 8) = 55.58 \text{ s}$$

Max. braking power of the brake resistor:

$$P_{br W \max} = P_{br motor \max} \cdot \eta_{motor} = 12.88 \cdot 0.89 = 11.46 \text{ kW}$$

Brake resistor power when the elevator is moving at a constant velocity:

$$P_{br W const} = P_{br motor const} \cdot \eta_{mot} = 5.8 \cdot 0.89 = 5.16 \text{ kW}$$



## Braking diagram

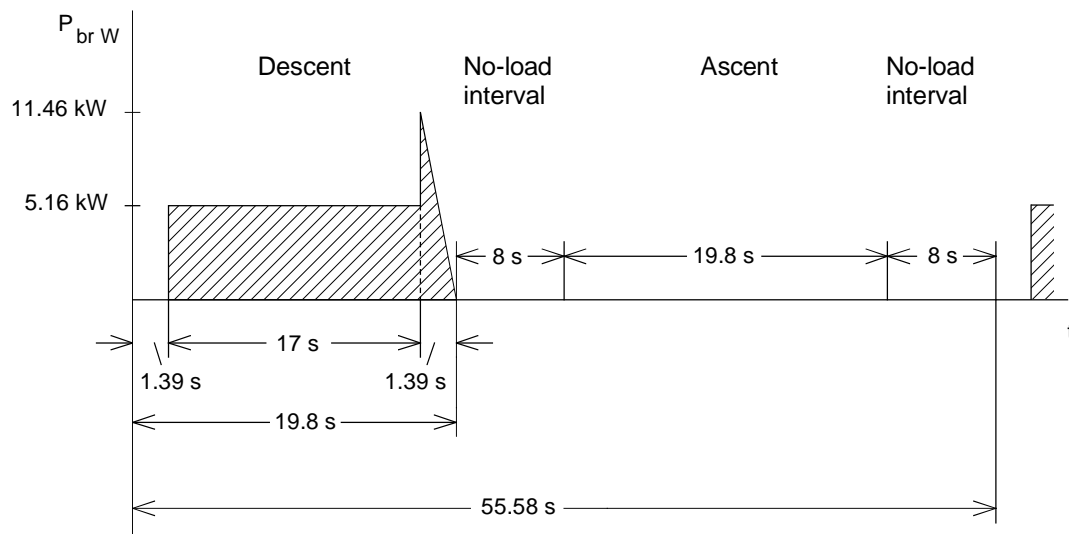

Braking energy for a cycle (corresponds to the area in the braking diagram):

$$\begin{aligned}
 W_{br} &= P_{br W \text{ const}} \cdot t_k + \frac{1}{2} \cdot P_{br W \text{ max}} \cdot t_v \\
 &= 5.16 \cdot 17 + \frac{1}{2} \cdot 11.46 \cdot 1.39 \\
 &= 87.7 + 7.96 = 95.7 \text{ kW}_s
 \end{aligned}$$

The following must be valid for the brake resistor:

$$\frac{W_{br}}{T} = \frac{95.7}{55.58} = 1.72 \text{ kW} \leq P_{br \text{ cont.}}$$

With

$$P_{br \text{ cont.}} = \frac{P_{20}}{4.5} \quad (\text{with an external brake resistor})$$

the following is obtained

$$4.5 \cdot 1.72 = 7.74 \text{ kW} \leq P_{20}$$

Thus, a braking unit is selected with  $P_{20} = 10 \text{ kW}$  (6SE7021-6ES87-2DA0) with an external brake resistor (6SE7021-6ES87-2DC0).

*Thermally checking the motor*

This elevator makes 180 ascents/descents per hour, i. e. 20 s per ascent/descent including 8 s no-load interval. Thus, when thermally checking the motor, a duty cycle at full load through 5 floors has been assumed.

Height difference between the bottom and top floors (5 floors):

$$h_5 = 5 \cdot \frac{23}{8} = 14.4 \text{ m}$$

Total time to travel from the first to the fifth floor (through 5 floors):

$$t_{total} = 2 \cdot t_b + \frac{h_5 - v_{max} \cdot t_b}{v_{max}} = 2 \cdot 1.39 + \frac{14.4 - 1.25 \cdot 1.39}{1.25} = 12.91 \text{ s}$$

Cycle time for a descent and an ascent:

$$T = 2 \cdot (t_{total} + t_p) = 2 \cdot (12.91 + 8) = 41.82$$

Time for which the elevator moves with continuous velocity:

$$t_k = t_{total} - 2 \cdot t_b = 12.91 - 2 \cdot 1.39 = 10.13 \text{ s}$$

Torque characteristics when descending and ascending

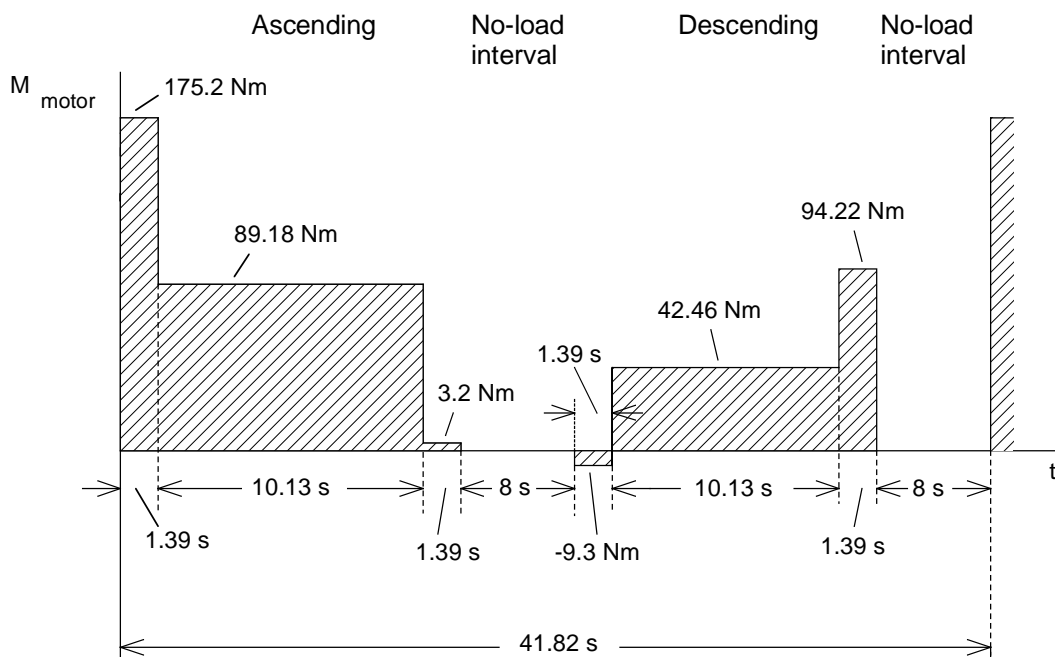

The RMS torque is obtained from the torque characteristic:

$$\begin{aligned}
 M_{RMS} &= \sqrt{\frac{175.2^2 \cdot 1.39 + 89.18^2 \cdot 10.13 + 3.2^2 \cdot 1.39 + 9.3^2 \cdot 1.39 + 42.46^2 \cdot 10.13 + 94.22^2 \cdot 1.39}{2 \cdot (12.91 + 0.33 \cdot 8)}} \\
 &= \sqrt{\frac{153967.7}{31.1}} \\
 &= 70.4 \text{ Nm}
 \end{aligned}$$

Calculating the average speed:

$$\begin{aligned}
 n_{mot \text{ average}} &= \frac{\sum \frac{|n_{mot i A} + n_{mot i E}|}{2} \cdot t_i}{t_e + k_f \cdot t_p} = \frac{\frac{1}{2} \cdot n_{max} \cdot t_b \cdot 2 + n_{max} \cdot t_k}{2 \cdot t_b + t_k + k_f \cdot t_p} \\
 &= \frac{\frac{1}{2} \cdot 1305 \cdot 1.39 \cdot 2 + 1305 \cdot 10.13}{2 \cdot 1.39 + 10.13 + 0.33 \cdot 8} = 967 \text{ RPM}
 \end{aligned}$$

The average motor speed is greater than half the rated motor speed (control range 1:2) and the calculated RMS torque is less than the motor rated torque with 94 Nm. Thus, operation is thermally permissible.

## 3.1.7 Traction drive along an incline

In this case, it involves a rack and pinion drive. The gradient is 3 degrees. At standstill, the vehicle is held at standstill by the motor holding brake.

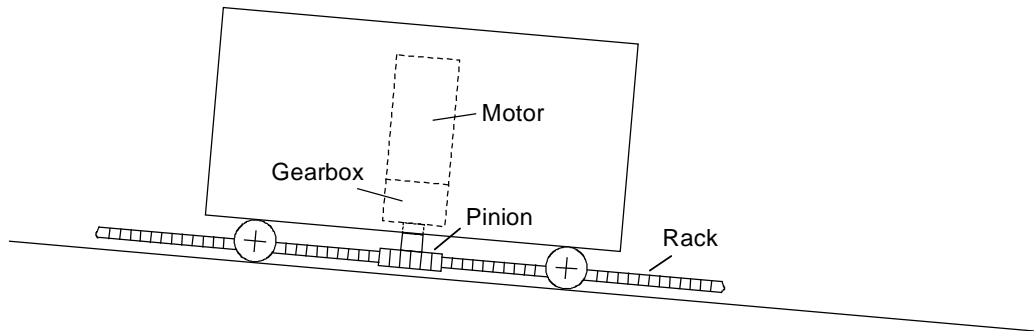
*Drive data*

Mass to be moved (fully laden)	$m$	= 3500 kg
Mass to be moved (empty)	$m$	= 3000 kg
Pinion diameter	$D$	= 0.12 m
Angle of inclination (gradient)	$\alpha$	= 3 degrees
Specific traction resistance	$w_F$	= 0.05
Mech. efficiency	$\eta$	= 0.9
Max. velocity	$v_{\max}$	= 0.2 m/s
Max. acceleration	$a_{b \max}$	= 0.8 m/s <sup>2</sup>
Max. deceleration	$a_{v \max}$	= 0.8 m/s <sup>2</sup>
Max. distance moved	$s_{\max}$	= 2.4 m
Cycle time	$t_{\text{cycle}}$	= 210 s

## Specified motion characteristic



## Distances travelled (as specified):

Range 1:  $s_1 = 1.4$  m                      with  $m = 3500$  kg                      (ascending)

Range 2:  $s_2 = 1$  m

---

Total                      2.4 m

Range 3:  $s_3 = 0.15$  m                      with  $m = 3000$  kg                      (descending)

Range 4:  $s_4 = 0.65$  m                      with  $m = 3000$  kg                      (descending)

Range 5:  $s_5 = 0.2$  m                      with  $m = 3000$  kg                      (descending)

Range 6:  $s_6 = 1.4$  m                      with  $m = 3500$  kg                      (descending)

---

Total                      2.4 m

## No-load intervals (as specified):

$t_{p1} = t_{p5} = 2$  s

$t_{p2} = t_{p3} = t_{p4} = 8$  s

Accelerating time, decelerating time:

$$t_b = t_v = \frac{v_{\max}}{a_{b \max}} = \frac{0.2}{0.8} = 0.25 \text{ s}$$

With

$$t_{ki} = \frac{s_i - 0.5 \cdot v_{\max} \cdot (t_b + t_v)}{v_{\max}}$$

the following times are obtained when moving at a constant velocity:

$$t_{k1} = 6.75 \text{ s}$$

$$t_{k2} = 4.75 \text{ s}$$

$$t_{k3} = 0.5 \text{ s}$$

$$t_{k4} = 3 \text{ s}$$

$$t_{k5} = 0.75 \text{ s}$$

$$t_{k6} = 6.75 \text{ s}$$

Thus, the time for the complete distance moved is given by:

$$t_{\text{ascent+descent}} = \sum_{i=1}^{i=5} t_{pi} + \sum_{i=1}^{i=6} t_{ki} + 6 \cdot (t_b + t_v) = 28 + 22.5 + 3 = 53.5 \text{ s}$$

With the cycle time (specified)

$$T = t_{\text{cycle}} = 210 \text{ s}$$

the remaining no-load interval is given by:

$$t_{p6} = T - t_{\text{ascent+descent}} = 210 - 53.5 = 156.5 \text{ s}$$

Precise positioning is only possible using a servo drive due to the short accelerating- and decelerating times.

Ascending at constant velocity (loaded)



Component of gravity down the incline, normal component of force, drag:

$$F_H = m \cdot g \cdot \sin \alpha$$

$$= 3500 \cdot 9.81 \cdot \sin 3^\circ = 1797 \text{ N}$$

$$F_N = m \cdot g \cdot \cos \alpha$$

$$= 3500 \cdot 9.81 \cdot \cos 3^\circ = 34288 \text{ N}$$

$$F_W = F_N \cdot w_F$$

$$= 34288 \cdot 0.05 = 1714.4 \text{ N}$$

Force due to the load, load torque:

$$F_{load, ascend} = F_H + F_W = 1797 + 1714.4 = 3511.4 \text{ N}$$

$$M_{load, ascend} = F_{load} \cdot \frac{D}{2}$$

$$= 3511.4 \cdot \frac{0.12}{2} = 210.7 \text{ Nm}$$

Descending at constant velocity (loaded)



Force due to the load, load torque:

$$F_{load\ descend} = F_H - F_W = 1797 - 1714.4 = 82.6 \text{ N}$$

$$\begin{aligned} M_{load\ descend} &= F_{load} \cdot \frac{D}{2} \\ &= 82.6 \cdot \frac{0.12}{2} = 4.95 \text{ Nm} \end{aligned}$$

Calculating the load torques when accelerating and decelerating (loaded)

Angular acceleration of the pinion:

$$\alpha_{b\ pinion} = a_{b\ max} \cdot \frac{2}{D} = 0.8 \cdot \frac{2}{0.12} = 13.33 \text{ s}^{-2}$$

Load moment of inertia:

$$J_{load} = m \cdot \left(\frac{D}{2}\right)^2 = 3500 \cdot \left(\frac{0.12}{2}\right)^2 = 12.6 \text{ kgm}^2$$

As acceleration is the same as deceleration, the following is valid for the load torques:

$$M_{b\ load} = M_{v\ load} = J_{load} \cdot \alpha_{b\ pinion} = 12.6 \cdot 13.33 = 168 \text{ Nm}$$



### Selecting the motor

The following motor is empirically selected (refer to calculating the motor torques):

1FT6 041-4AF7 with gearbox  $i=81$ ,  $n_n=3000$  RPM,  $M_{n(100)}=2.2$  Nm,  $I_{n(100)}=1.7$  A,  $\eta_{\text{motor}}=0.86$   
 $J_{\text{motor+brake}}=0.00039$  kgm<sup>2</sup>,  $J_{\text{gearbox}}=0.0008$  kgm<sup>2</sup>

Motor speed at  $v_{\text{max}}$ :

$$n_{\text{motor max}} = i \cdot \frac{v_{\text{max}} \cdot 60}{\pi \cdot D} = 81 \cdot \frac{0.2 \cdot 60}{\pi \cdot 0.12} = 2578.3 \text{ RPM}$$

### Calculating the motor torques while the vehicle is moving at constant velocity (loaded)

Ascending:

$$M_{\text{motor}} = M_{\text{load ascend}} \cdot \frac{1}{i \cdot \eta} = 210.7 \cdot \frac{1}{81 \cdot 0.9} = 2.89 \text{ Nm}$$

Descending:

$$M_{\text{motor}} = M_{\text{load descend}} \cdot \frac{\eta}{i} = 4.95 \cdot \frac{0.9}{81} = 0.055 \text{ Nm} \quad (\text{regenerative operation})^1)$$

1) Regenerative operation is obtained from the various signs for torque and speed

### Calculating the motor torques when accelerating and decelerating (loaded)

Motor accelerating- and decelerating torques:

$$\begin{aligned} M_{b \text{ motor}} = M_{v \text{ motor}} &= J_{\text{motor}} \cdot i \cdot \alpha_{b \text{ pinion}} \\ &= 0.00039 \cdot 81 \cdot 13.33 = 0.42 \text{ Nm} \end{aligned}$$

The accelerating- and decelerating torques for the gearbox, referred to the pinion:

$$\begin{aligned} M_{b \text{ gearbox}} = M_{v \text{ gearbox}} &= J_{\text{gearbox}} \cdot i^2 \cdot \alpha_{b \text{ pinion}} \\ &= 0.0008 \cdot 81^2 \cdot 13.33 = 70 \text{ Nm} \end{aligned}$$

Ascending, motor torque when accelerating:

$$\begin{aligned} M_{motor} &= M_{b\ motor} + (M_{b\ load} + M_{b\ gearbox} + M_{load\ ascend}) \cdot \frac{1}{i \cdot \eta} \\ &= 0.42 + (168 + 70 + 210.7) \cdot \frac{1}{81 \cdot 0.9} = 6.58\ Nm \end{aligned}$$

Ascending, motor torque when decelerating:

$$\begin{aligned} M_{motor} &= -M_{v\ motor} + (-M_{v\ load} - M_{v\ gearbox} + M_{load\ ascend})^1 \cdot \frac{1}{i \cdot \eta^{sign(\dots)}} \\ &= -0.42 + (-168 - 70 + 210.7) \cdot \frac{1}{81 \cdot 0.9^{-1}} = -0.72\ Nm \quad (\text{regenerative operation}) \end{aligned}$$

Descending, motor torque when accelerating:

$$\begin{aligned} M_{motor} &= -M_{b\ motor} + (-M_{b\ load} - M_{b\ gearbox} + M_{load\ descend})^1 \cdot \frac{\eta^{sign(\dots)}}{i} \\ &= -0.42 + (-168 - 70 + 4.95) \cdot \frac{0.9^{-1}}{81} = -3.62\ Nm \end{aligned}$$

Descending, motor torque when decelerating:

$$\begin{aligned} M_{motor} &= M_{v\ motor} + (M_{v\ load} + M_{v\ gearbox} + M_{load\ descend}) \cdot \frac{\eta}{i} \\ &= 0.42 + (168 + 70 + 4.95) \cdot \frac{0.9}{81} = 3.12\ Nm \quad (\text{regenerative operation}) \end{aligned}$$

1) For a negative expression in brackets,  $\eta$  changes to  $\eta^{-1}$

The highest motor torque is required when accelerating as the vehicle ascends. The highest motor torque in regenerative operation is required when decelerating as the vehicle descends. The selected motor is adequately dimensioned, as it can be overloaded up to approx. 7 Nm at  $n_{\max}=2578.3$  RPM and 400 V supply voltage.

The steady-state holding brake torque corresponds to the motor torque when descending at constant velocity:

$$M_{hold} = 0.055\ Nm$$

### Selecting the drive converter

For the highest required motor torque, the motor current is given by:

$$I_{motor\ max} = I_{motor\ n} \cdot \frac{M_{motor\ max}}{M_{motor\ n}} = 1.7 \cdot \frac{6.58}{2.2} = 5.08\ A \quad (\text{hardly any saturation effect for this motor})$$

Selected drive converter:

6SE7013-0EP50 (Kompakt Plus type)

$P_{V\ n}=1.1\ kW$ ;  $I_{V\ n}=3\ A$ ,  $I_{V\ max}=9\ A$  (300% overload capability)

### Dimensioning the brake resistor

The brake resistor is used when the vehicle decelerates as it ascends and when it descends at constant velocity and when decelerating. In the following calculation, the slight decrease in the motor torque during motion without load is neglected (thus the calculation is on the safe side).

Max. braking power for the brake resistor when decelerating from  $v_{max}$  to 0:

$$\begin{aligned} P_{br\ W\ max\ (v_{max} \rightarrow 0)} &= P_{br\ motor\ max\ (v_{max} \rightarrow 0)} \cdot \eta_{motor} = \frac{M_{motor\ v\ (v_{max} \rightarrow 0)} \cdot n_{motor\ max}}{9550} \cdot \eta_{motor} \\ &= \frac{0.72 \cdot 2578.3}{9550} \cdot 0.86 = 0.168\ kW \end{aligned}$$

Braking power for the brake resistor while moving at constant velocity with  $-v_{max}$ :

$$\begin{aligned} P_{br\ W\ const\ (v=-v_{max})} &= P_{br\ motor\ const\ (v=-v_{max})} \cdot \eta_{motor} = \frac{M_{motor\ const\ (v=-v_{max})} \cdot n_{motor\ max}}{9550} \cdot \eta_{motor} \\ &= \frac{0.055 \cdot 2578.3}{9550} \cdot 0.86 = 0.013\ kW \end{aligned}$$

Max. braking power for the brake resistor when decelerating from  $-v_{max}$  to 0:

$$\begin{aligned} P_{br\ W\ max\ (-v_{max} \rightarrow 0)} &= P_{br\ motor\ max\ (-v_{max} \rightarrow 0)} \cdot \eta_{motor} = \frac{M_{motor\ v\ (-v_{max} \rightarrow 0)} \cdot n_{motor\ max}}{9550} \cdot \eta_{motor} \\ &= \frac{3.12 \cdot 2578.3}{9550} \cdot 0.86 = 0.724\ kW \end{aligned}$$

## Brake diagram



Braking energy for a cycle (corresponds to the area in the braking diagram):

$$\begin{aligned}
 W_{br} &= 2 \cdot \frac{1}{2} \cdot P_{br W \max (v_{\max} \rightarrow 0)} \cdot t_v + P_{br W \text{ const } (v=-v_{\max})} \cdot (t_{k3} + t_{k4} + t_{k5} + t_{k6}) + 4 \cdot \frac{1}{2} \cdot P_{br W \max (-v_{\max} \rightarrow 0)} \cdot t_v \\
 &= 2 \cdot \frac{1}{2} \cdot 0.168 \cdot 0.25 + 0.013 \cdot (0.5 + 3 + 0.75 + 6.75) + 4 \cdot \frac{1}{2} \cdot 0.724 \cdot 0.25 = 0.545 \text{ kW} \cdot \text{s}
 \end{aligned}$$

The following must be valid for the brake resistor:

$$\frac{W_{br}}{T} = \frac{0.545}{90} = 0.0061 \text{ kW} \leq P_{br \text{ cont.}}$$

As the cycle time with 121 s is greater than 90 s, T is set to 90 s.

With

$$P_{br \text{ cont.}} = \frac{P_{20}}{4,5} \quad (\text{for Compact Plus, only an external brake resistor})$$

the following is obtained

$$4.5 \cdot 0.0061 = 0.027 \text{ kW} \leq P_{20}$$

Thus, the smallest braking resistor is selected with  $P_{20} = 5 \text{ kW}$  (6SE7018-0ES87-2DC0).

### Thermally checking the motor

In the following calculation, the slight decrease in the motor torque when the vehicle is not carrying a load is neglected (thus, the calculation is on the safe side).

### Torque characteristics

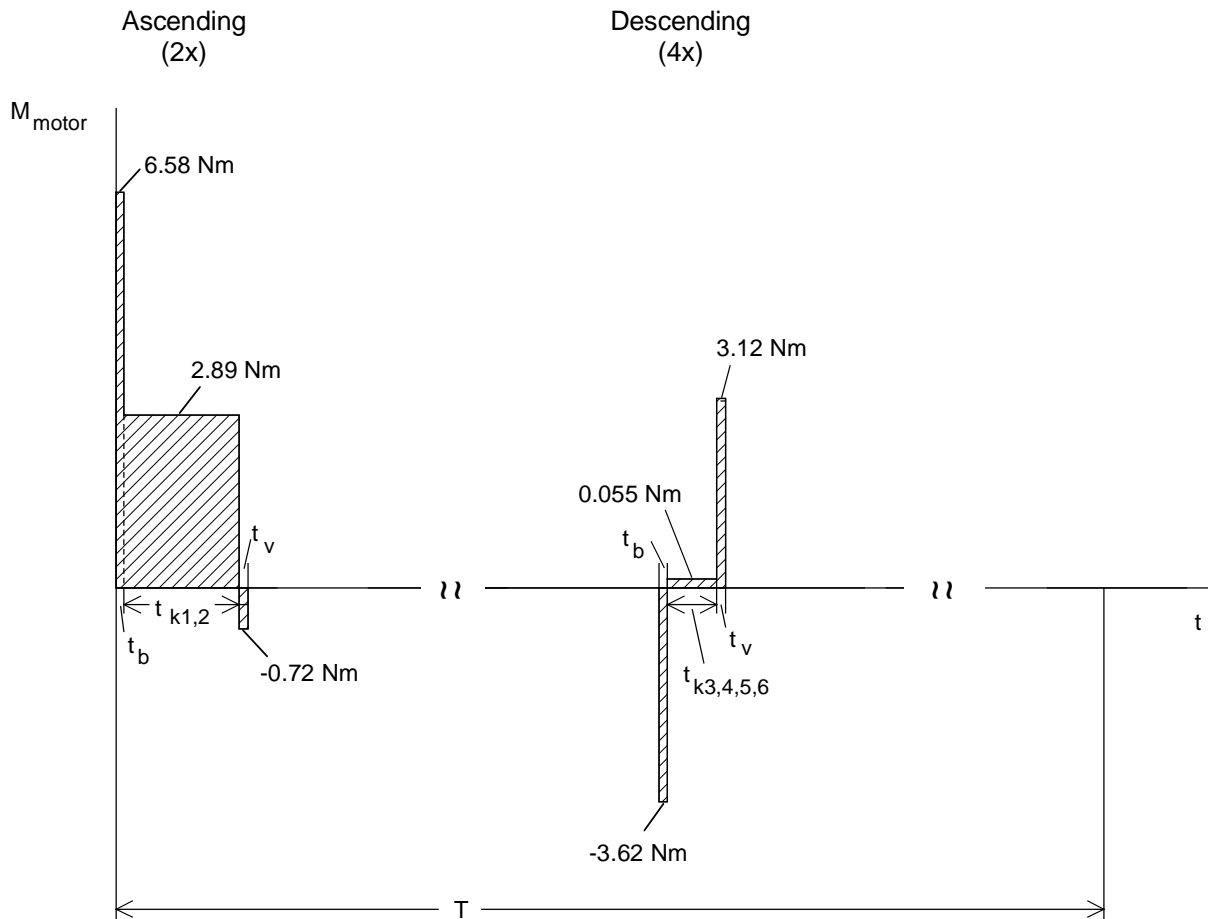

The RMS torque is obtained from the torque characteristic as follows

$$t_{k1} + t_{k2} = 6.75 + 4.75 = 11.5 \text{ s}$$

$$t_{k3} + t_{k4} + t_{k5} + t_{k6} = 0.5 + 3 + 0.75 + 6.75 = 11 \text{ s}$$

Thus,

$$M_{RMS} = \sqrt{\frac{2 \cdot (6.58^2 + 0.72^2) \cdot 0.25 + 2.89^2 \cdot 11.5 + 4 \cdot (3.62^2 + 3.12^2) \cdot 0.25 + 0.055^2 \cdot 11}{6 \cdot 0.25 \cdot 2 + 11.5 + 11 + 1 \cdot (2 + 8 + 8 + 8 + 2 + 156.5)}} = 0.82 \text{ Nm}$$

For the 1FT6 motor, factor  $k_f$  is set to 1 for the no-load intervals. The calculated RMS torque is less than the rated motor torque with 2.2 Nm. Thus, operation is thermally permissible.

*Information regarding the calculation*

Due to the tedious calculations required when trying-out various motors and gearbox ratios, it is recommended that a spreadsheet program such as Excel is used.

## 3.2 Winder drives

### 3.2.1 General information



#### Mode of operation of an axial winder

A material web, with width  $b$ , is wound or unwound at constant velocity and tension.

$$n_W = \frac{v \cdot 60}{\pi \cdot D} \quad \text{reel speed} \quad [\text{RPM}]$$

$$v \quad \text{web velocity} \quad [\text{m/s}]$$

$$D \quad \text{actual reel diameter} \quad [\text{m}]$$

$$n_{W \min} = \frac{v \cdot 60}{\pi \cdot D_{\max}} \quad \text{minimum speed of the reel at } D=D_{\max} \quad [\text{RPM}]$$

$$n_{W \max} = \frac{v \cdot 60}{\pi \cdot D_{\text{Kern}}} \quad \text{max. speed of the reel at } D=D_{\text{core}} \quad [\text{RPM}]$$

$$F_Z = z \cdot b \quad \text{web tension} \quad [\text{N}]$$

$$z \quad \text{web tension/m} \quad [\text{N/m}]$$

$$b \quad \text{web width} \quad [\text{m}]$$

$$M_W = F_Z \cdot \frac{D}{2} = F_Z \cdot \frac{v \cdot 60}{2 \cdot \pi} \cdot \frac{1}{n_W} \quad \text{winding torque (proportional to } 1/n_W) \quad [\text{Nm}]$$

$$M_{W \max} = F_Z \cdot \frac{D_{\max}}{2} \quad \text{max. winding torque at } D=D_{\max} \quad [\text{Nm}]$$

$$M_{W \min} = F_Z \cdot \frac{D_{\text{core}}}{2} \quad \text{min. winding torque at } D=D_{\text{core}} \quad [\text{Nm}]$$

$$P_W = \frac{F_Z \cdot v}{10^3} \quad \text{winding power (constant)} \quad [\text{kW}]$$

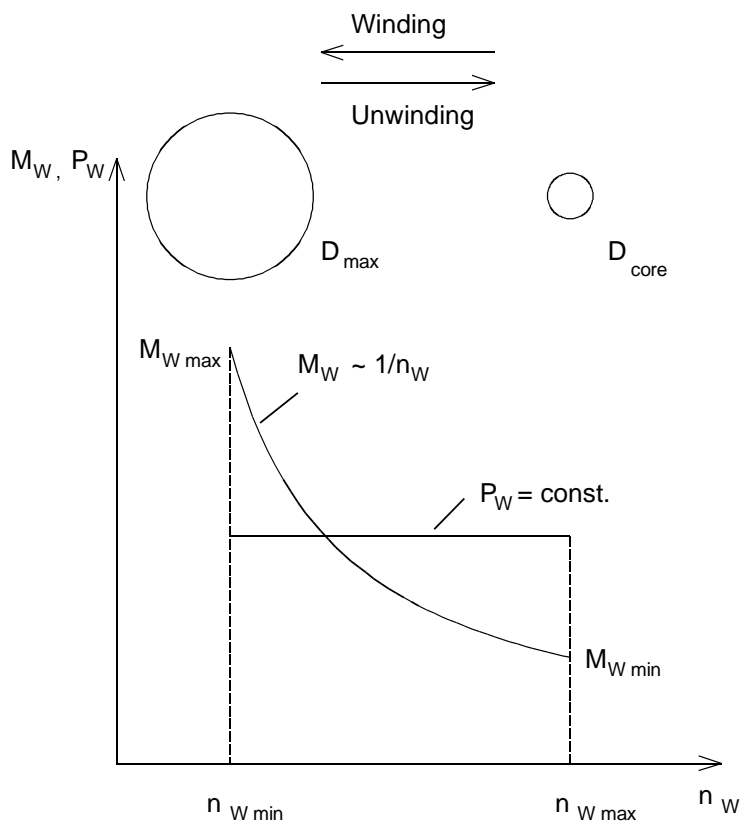

Winding torque and winding power at  $v = \text{const.}$  and  $z = \text{const.}$



*Influence of the friction*

Further, a speed-dependent frictional torque is present due to the bearing friction and other effects. Thus, the winding torque is increased when winding and reduced when unwinding.

$M_R$	speed-dependent frictional torque	[Nm]
$M_{W_{res}} = M_W + M_R$	resulting winding torque when winding	[Nm]
$M_{W_{res}} = M_W - M_R$	resulting winding torque when unwinding	[Nm]

*Motor torque, motor output (steady-state operation)*

With

$$i = \frac{n_{motor}}{n_W} = \frac{\pi \cdot D_{core} \cdot n_{motor \max}}{v \cdot 60} \quad \text{gearbox ratio}$$

$$\eta_G \quad \text{gearbox efficiency}$$

the following is obtained for the motor:

$$M_{motor} = \frac{M_W + M_R}{i \cdot \eta_G} \quad \text{motor torque when winding} \quad \text{[Nm]}$$

$$P_{motor} = \frac{M_W + M_R}{9550 \cdot \eta_G} \cdot n_W \quad \text{motor output when winding} \quad \text{[kW]}$$

(energy flow from the motor to the load)

$$M_{motor} = -\frac{M_W - M_R}{i} \cdot \eta_G \quad \text{motor torque when unwinding} \quad \text{[Nm]}$$

$$P_{motor} = -\frac{M_W - M_R}{9550} \cdot n_W \cdot \eta_G \quad \text{motor output when unwinding} \quad \text{[kW]}$$

(energy flow from the load to the motor)

*Acceleration, deceleration*

When accelerating and decelerating the reel at constant web tension, additional accelerating- and deceleration torques are present. The effective moment of inertia consists of a fixed component (motor, gearbox/coupling = supplementary, winding core) and a variable component (reel as hollow cylinder).

$$J_F = J_{motor} + J_{supplementary} + \frac{J_{core}}{i^2} \quad \text{fixed moment of inertia referred to the motor shaft} \quad [\text{kgm}^2]$$

$$J_V = \frac{\pi \cdot b \cdot \rho_w}{32} \cdot 10^3 \cdot (D^4 - D_{core}^4) \quad \text{variable reel moment of inertia (as a function of reel diameter D)} \quad [\text{kgm}^2]$$

and

$$J_V = \frac{1}{8} \cdot m_w \cdot (D^2 + D_{core}^2) \quad [\text{kgm}^2]$$

$$J_{V \max} = \frac{\pi \cdot b \cdot \rho_w}{32} \cdot 10^3 \cdot (D_{\max}^4 - D_{core}^4) \quad \text{maximum reel moment of inertia} \quad [\text{kgm}^2]$$

and

$$J_{V \max} = \frac{1}{8} \cdot m_w \cdot (D_{\max}^2 + D_{core}^2) \quad [\text{kgm}^2]$$

$$J_{V \min} = 0 \quad \text{for } D = D_{core} \quad \text{min. reel moment of inertia}$$

b, D in m;  $\rho$  in kg/dm<sup>3</sup>; m in kg

Accelerating- and decelerating torque for the motor + gearbox/coupling referred to the motor shaft:

$$M_{b,v \text{ motor+suplement}} = (J_{motor} + J_{suplement}) \cdot i \cdot \frac{2}{D} \cdot \frac{v}{t_{b,v}} \quad [\text{Nm}]$$

Accelerating- and decelerating torque for core+reel referred to the reel:

$$M_{b,v \text{ core+reel}} = (J_{core} + J_V) \cdot \frac{2}{D} \cdot \frac{v}{t_{b,v}} \quad [\text{Nm}]$$

$t_b$	accelerating time from 0 to v	[s]
$t_v$	decelerating time from v to 0	[s]

When accelerating and decelerating, the variable moment of inertia is assumed to be constant.

For constant tension during acceleration and deceleration, the motor torque is given by:

Winding, motor torque when accelerating from 0 to v:

$$M_{motor} = M_{b\ motor+sup\ plement} + (M_{b\ core+reel} + M_W + M_R) \cdot \frac{1}{i \cdot \eta_G} \quad [\text{Nm}]$$

Winding, motor torque when decelerating from v to 0:

$$M_{motor} = -M_{v\ motor+sup\ plement} + (-M_{v\ core+reel} + M_W + M_R)^{1)} \cdot \frac{1}{i \cdot \eta_G} \quad [\text{Nm}]$$

1) If the expression in the brackets is < 0, the factor  $1/\eta_G$  must be changed to  $\eta_G$  (the deceleration component is predominant)

Unwinding, motor torque when accelerating from 0 to v:

$$M_{motor} = M_{b\ motor+sup\ plement} + (M_{b\ core+reel} - M_W + M_R)^{2)} \cdot \frac{\eta_G}{i} \quad [\text{Nm}]$$

Unwinding, motor torque when decelerating from v to 0:

$$M_{motor} = -M_{v\ motor+sup\ plement} + (-M_{v\ core+reel} - M_W + M_R) \cdot \frac{\eta_G}{i} \quad [\text{Nm}]$$

2) If the expression in brackets is > 0, factor  $\eta_G$  must be changed to  $1/\eta_G$  (acceleration component is predominant)

The motor output is obtained from the motor torque as follows

$$P_{motor} = \frac{M_{motor} \cdot n_{motor}}{9550} \quad [\text{kW}]$$

### Motor selection

The motor is selected according to the maximum torque at  $n_{min}$  and the maximum speed. For additional accelerating- and decelerating torques, it may be possible to utilize the overload capability of the drive. As the winding torque is proportional to  $1/n$ , then it is possible to use the field-weakening range, with  $M_{perm.} \sim 1/n$ . Further, there must be sufficient safety margin to the stall torque in the field-weakening range.

The winding power  $P_W$  is constant over the speed. Thus, the motor must provide this output at  $n_{min}$ .



Motor torque under steady-state operating conditions and permissible torque for S1 duty

### *Closed-loop winder control*

There are several ways of providing constant tension:

- indirect closed-loop tension control (without tension transducer)

In this case, the constant tension is implemented using a torque reference value input adapted by the diameter. It is important to accurately compensate the frictional- and accelerating torques, as these parameters cannot be compensated without using a tension transducer.

- direct closed-loop tension control with dancer roll

The tension is entered using a position-controlled dancer roll.

- direct closed-loop tension control with tension transducer

The tension actual value is sensed using a tension transducer and is appropriately controlled.

Note:

An Excel program is available to dimension winders: "McWin - Motorcalculation for Winder". Also refer to ASI Information E20125-J3001-J409-X-7400 from September 94.

## 3.2.2 Unwind stand with closed-loop tension control using a tension transducer

This application involves an unwind stand with "flying" roll change. Before the reel is changed, the new reel is prepared for splicing. When the old reel falls below a specific diameter, the new reel is accelerated until the circumferential speed corresponds to the web velocity of the paper. The reel support mechanism then rotates into the splice position. The new reel is automatically spliced, and the old reel retracted.

*Unwind stand data*

Max. reel diameter	$D_{\max}$	= 1.27 m
Core diameter	$D_{\text{core}}$	= 0.11 m
Web width	$b$	= 1.7 m
Material density	$\rho_W$	= 0.93 kg/dm <sup>3</sup>
Max. web velocity	$v_{\max}$	= 15 m/s
Web tension	$z$	= 100 N/m
Acceleration	$t_b$	= 40 s
Stop (coast down)	$t_v$	= 40 s
Friction	$M_R$	= 20 Nm at $D_{\max}$
Gearbox ratio	$i$	= 1 to 3

*Steady-state operation*

$$n_{W \min} = \frac{v_{\max} \cdot 60}{\pi \cdot D_{\max}} = \frac{15 \cdot 60}{\pi \cdot 1.27} = 226 \text{ RPM}$$

$$n_{W \max} = \frac{v_{\max} \cdot 60}{\pi \cdot D_{\text{core}}} = \frac{15 \cdot 60}{\pi \cdot 0.11} = 2604 \text{ RPM}$$

$$F_z = z \cdot b = 100 \cdot 1.7 = 170 \text{ N}$$

$$M_{W \max} = F_z \cdot \frac{D_{\max}}{2} = 170 \cdot \frac{1.27}{2} = 108 \text{ Nm}$$

$$M_{W \min} = F_z \cdot \frac{D_{\text{core}}}{2} = 170 \cdot \frac{0.11}{2} = 9.4 \text{ Nm}$$

$$P_W = \frac{F_Z \cdot v_{\max}}{10^3} = \frac{170 \cdot 15}{10^3} = 2.55 \text{ kW}$$

Gearbox ratio  $i = 2$  is selected

The gearbox efficiency  $\eta_G$  is assumed to be  $\approx 1$  (belt-driven gearbox, pinion wheel)

$$n_{\text{motor min}} = i \cdot n_{W \text{ min}} = 2 \cdot 226 = 452 \text{ RPM}$$

$$n_{\text{motor max}} = i \cdot n_{W \text{ max}} = 2 \cdot 2604 = 5208 \text{ RPM}$$

$$M_{\text{motor max}} = -\frac{M_{W \text{ max}} - M_R}{i} = -\frac{108 - 20}{2} = -44 \text{ Nm}$$

$$M_{\text{motor min}} = -\frac{M_{W \text{ min}} - M_R}{i} = -\frac{9.4 - 0}{2} = -4.7 \text{ Nm}$$

The frictional torque at  $n_{W \text{ min}}$  was assumed to be 0. The motor torques are negative, as this involves an unwind stand (regenerative operation).

*Calculating the maximum motor torques when accelerating and decelerating*

$$\begin{aligned} J_{V \text{ max}} &= \frac{\pi \cdot b \cdot \rho_W \cdot 10^3}{32} \cdot (D_{\text{max}}^4 - D_{\text{core}}^4) \\ &= \frac{\pi \cdot 1.7 \cdot 0.93}{32} \cdot 10^3 \cdot (1.27^4 - 0.11^4) = 403.76 \text{ kgm}^2 \end{aligned}$$

$$J_{\text{core}} \approx 0 \text{ (cardboard core)}$$

$$J_F = J_{\text{motor}} + J_{\text{supplement}} \approx 0.08 \text{ kgm}^2 \text{ (estimated)}$$

Relationships at  $D=D_{\text{max}}$

$$\begin{aligned} M_{b \text{ motor+supplement}} &= (J_{\text{motor}} + J_{\text{supplement}}) \cdot i \cdot \frac{2}{D_{\text{max}}} \cdot \frac{v_{\max}}{t_b} \\ &= 0.08 \cdot 2 \cdot \frac{2}{1.27} \cdot \frac{15}{40} = 0.094 \text{ Nm} \end{aligned}$$

$$\begin{aligned} M_{b \text{ core+reel}} &= (J_{\text{core}} + J_{\text{roll}}) \cdot \frac{2}{D_{\text{max}}} \cdot \frac{v_{\max}}{t_b} \\ &= (0 + 403.76) \cdot \frac{2}{1.27} \cdot \frac{15}{40} = 238.4 \text{ Nm} \end{aligned}$$

$$M_v = M_b \text{ (as } t_b = t_v)$$

Accelerating from 0 to  $v_{\max}$  (without tension, with friction):

$$\begin{aligned}
 M_{motor} &= M_{b\ motor+sup\ plement} + (M_{b\ core+reel} - M_{W\ max} + M_R) \cdot \frac{1}{i} \\
 &= 0.094 + (238.4 - 0 + 20) \cdot \frac{1}{2} \\
 &= 0.094 + 129.2 = 129.3\ Nm
 \end{aligned}$$

Decelerating from  $v_{\max}$  to 0 (with tension, with friction):

$$\begin{aligned}
 M_{motor} &= -M_{v\ motor+sup\ plement} + (-M_{v\ core+reel} - M_{W\ max} + M_R) \cdot \frac{1}{i} \\
 &= -0.094 + (-238.4 - 108 + 20) \cdot \frac{1}{2} \\
 &= -0.094 - 163.2 = -163.3\ Nm
 \end{aligned}$$

The highest motor torque is required when decelerating with tension applied. At  $D_{\max}$  the accelerating- or decelerating torque for the motor+supplement is essentially of no significance.

Relationships at  $D=D_{core}$ :

$$\begin{aligned}
 M_{b\ motor+sup\ plement} &= (J_{motor} + J_{sup\ plement}) \cdot i \cdot \frac{2}{D_{core}} \cdot \frac{v_{\max}}{t_b} \\
 &= 0.08 \cdot 2 \cdot \frac{2}{0.11} \cdot \frac{15}{40} = 1.09\ Nm
 \end{aligned}$$

$$M_{b\ core+reel} \approx 0 \quad (J_v = 0, J_{core} \approx 0)$$

$$M_v = M_b \quad (\text{as } t_b = t_v)$$

Accelerating from 0 to  $v_{\max}$  (without tension, without friction):

$$\begin{aligned}
 M_{motor} &= M_{b\ motor+sup\ plement} + (M_{b\ core+reel} - M_{W\ min} + M_R) \cdot \frac{1}{i} \\
 &= 1.09 + (0 - 0 + 0) \cdot \frac{1}{2} = 1.09\ Nm
 \end{aligned}$$



Decelerating from  $v_{\max}$  to 0 (with tension, without friction):

$$\begin{aligned} M_{\text{motor}} &= -M_{\text{v motor+sup plement}} + (-M_{\text{v core+reel}} - M_{\text{W min}} + M_{\text{R}}) \cdot \frac{1}{i} \\ &= -1.09 + (0 - 9.4 + 0) \cdot \frac{1}{2} = -5.79 \text{ Nm} \end{aligned}$$

The highest motor torque is required when decelerating with tension.

### Motor selection

The motor selected as result of the calculated maximum motor torques:

1PA6 133-4HD.

$P_n=13.5 \text{ kW}$ ;  $M_n=112 \text{ Nm}$ ;  $n_n=1150 \text{ RPM}$ ;  $n_1=2500 \text{ RPM}$ ;  $I_n=29 \text{ A}$ ;  $I_\mu=13 \text{ A}$ ;  $J_{\text{motor}}=0.076 \text{ kgm}^2$

When decelerating from  $v_{\max}$  to 0 (with tension, with friction), at  $n_{\min}$ , the motor must provide

$$\frac{163.3}{112} = 1.46 \times$$

rated motor torque for 40 s. The maximum motor output is then given by:

$$P_{\text{motor}} = \frac{M_{\text{motor}} \cdot n_{\text{motor min}}}{9550} = \frac{163.3 \cdot 452}{9550} = 7.73 \text{ kW}$$

The 44 Nm steady-state winding torque is permissible for the motor at  $n_{\min}$ .

To check the motor in the field-weakening range, the permissible motor output at  $n_{\max}$ , with 130 % safety margin, is given by:

$$P_{\text{perm. } n_{\max}} = P_n \cdot \frac{n_1}{n_{\max}} = 13.5 \cdot \frac{2500}{5208} = 6.48 \text{ kW}$$

Permissible motor torque at  $n_{\max}$  and 130 % safety margin from the stall torque:

$$M_{\text{perm. } n_{\max}} = \frac{P_{\text{perm. } n_{\max}} \cdot 9550}{n_{\max}} = \frac{6.48 \cdot 9550}{5208} = 11.9 \text{ Nm}$$

Thus, the motor can also provide the required torque of 5.79 Nm, at  $n_{\max}$ , when decelerating with tension. The maximum motor output is then given by:

$$P_{\text{motor}} = \frac{M_{\text{motor}} \cdot n_{\text{motor max}}}{9550} = \frac{5.79 \cdot 5208}{9550} = 3.16 \text{ kW}$$

*Selecting the inverter and the rectifier/regenerative feedback unit*

The maximum motor current in dynamic operation is given by:

$$I_{motor \max dyn} \approx \sqrt{\left(\frac{M_{motor \max dyn}}{M_{motor n}}\right)^2 \cdot (I_{motor n}^2 - I_{\mu n}^2) + I_{\mu n}^2}$$

With  $I_{\mu n} = 13 \text{ A}$ , the following is obtained:

$$I_{motor \max dyn} \approx \sqrt{\left(\frac{163.3}{112}\right)^2 \cdot (29^2 - 13^2) + 13^2} = 40 \text{ A}$$

The maximum motor current for winding operation is:

$$I_{motor \max stat} \approx \sqrt{\left(\frac{M_{motor \max stat}}{M_{motor n}}\right)^2 \cdot (I_{Motor n}^2 - I_{\mu n}^2) + I_{\mu n}^2}$$

$$I_{motor \max stat} \approx \sqrt{\left(\frac{44}{112}\right)^2 \cdot (29^2 - 13^2) + 13^2} = 16,5 \text{ A}$$

Thus, an inverter is selected (2x):

6SE7023-4TC20

$P_{V n} = 15 \text{ kW}$ ;  $I_{V n} = 34 \text{ A}$ ;  $I_{V \max} = 46.4 \text{ A}$

T300 technology board with closed-loop winder control

Infeed/regenerative feedback unit:

6SE7024-1EC85-1AA0

$P_n = 15 \text{ kW}$ ;  $I_{DC \text{ link } n} = 41 \text{ A}$

Autotransformer with 25% duty ratio:

4AP2795-0UA01-8A (25% is sufficient, as the power when winding is only 2.55 kW)

4%  $u_k$  line reactor:

4EP3900-5UK



Diagram for the winding torque ( $M_{\text{mot stat}}$ ) and the  $M_{S1}$  characteristic

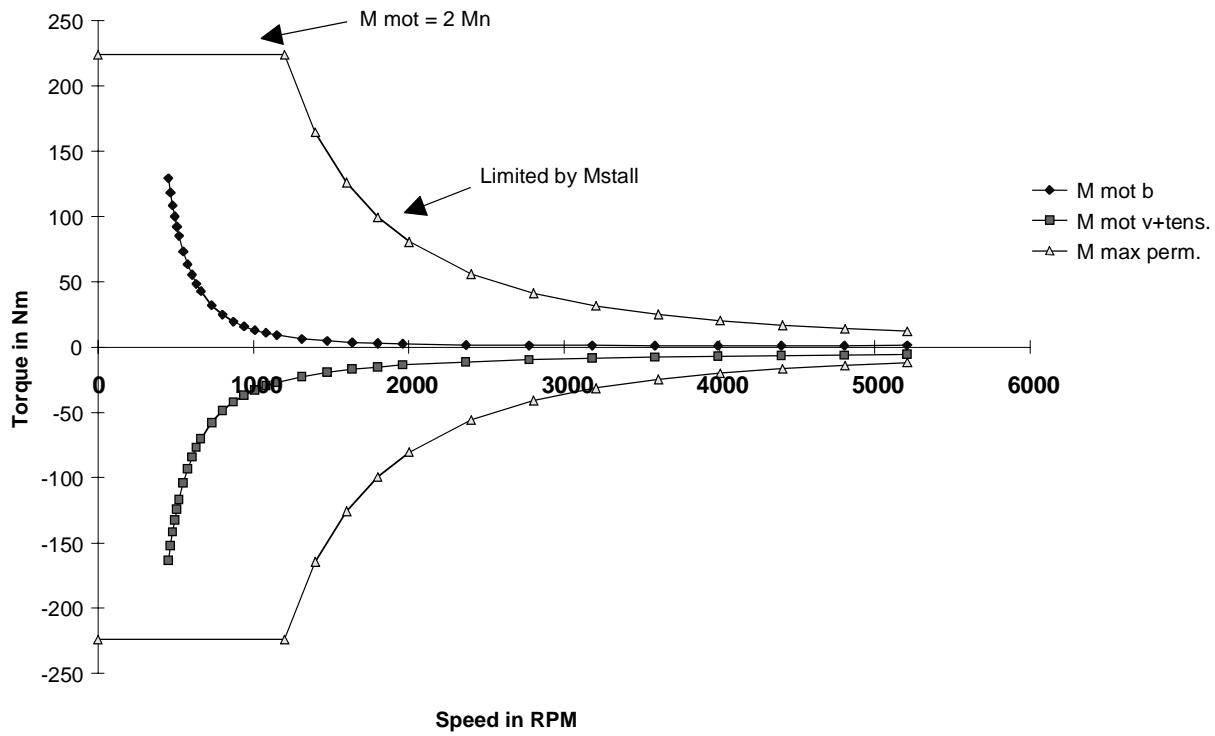

Diagram for the accelerating torque without tension ( $M_{mot\ b}$ ), the deceleration torque with tension ( $M_{mot\ v+tension}$ ) and the  $M_{perm\ max}$  characteristic

### 3.2.3 Winder with closed-loop tension control using a tension transducer

This involves a winder with accumulator. The material web, running at max. 50 m/min, is wound-up, tension controlled. Just before the final diameter is reached, the reel support assembly is rotated, the winder is stopped, the paper web cut, and the second reel spliced to the empty core. The material accumulator must accept the web coming from the machine during this time (approx. 15-20 s).

After the empty reel starts, this runs, speed-controlled, 17.8 m/min faster than the web speed of the machine. Thus, the material accumulator is emptied in approx. 60 s. After this, the closed-loop tension controlled mode is selected.

#### *Winder data*

Max. reel diameter	$D_{\max}$	= 1 m
Core diameter	$D_{\text{core}}$	= 0.12 m
Max. reel weight	$m_W$	= 870 kg
Max. web velocity in operation	$v_{\max B}$	= 50 m/min = 0.833 m/s
Max. web velocity when retrieving paper from the accumulator	$v_{\max L}$	= 67.8 m/min = 1.13 m/s
Web tension	$F_Z$	= 600 N
Acceleration	$t_b$	= 2 s
Fast stop	$t_v$	= 2 s
Material thickness	$d$	= 2 mm

#### *Steady-state operation*

$$n_{W \min} = \frac{v_{\max B} \cdot 60}{\pi \cdot D_{\max}} = \frac{0.833 \cdot 60}{\pi \cdot 1} = 15.9 \text{ RPM}$$

$$n_{W \max} = \frac{v_{\max L} \cdot 60}{\pi \cdot D_{\text{core}}} = \frac{1.13 \cdot 60}{\pi \cdot 0.12} = 180 \text{ RPM}$$

$$M_{W \max} = F_Z \cdot \frac{D_{\max}}{2} = 600 \cdot \frac{1}{2} = 300 \text{ Nm}$$

$$M_{W \min} = F_Z \cdot \frac{D_{\text{core}}}{2} = 600 \cdot \frac{0.12}{2} = 36 \text{ Nm}$$

$$P_W = \frac{F_Z \cdot v_{\max B}}{10^3} = \frac{600 \cdot 0.833}{10^3} = 0.5 \text{ kW}$$

Selected gearbox ratio,  $i = 20$

The gearbox efficiency  $\eta_G$  is assumed to be 0.9

$$n_{\text{motor min}} = i \cdot n_{W \text{ min}} = 20 \cdot 15.9 = 318 \text{ RPM}$$

$$n_{\text{motor max}} = i \cdot n_{W \text{ max}} = 20 \cdot 180 = 3600 \text{ RPM}$$

$$M_{\text{motor max}} = \frac{M_{W \text{ max}}}{i \cdot \eta_G} = \frac{300}{20 \cdot 0.9} = 16.7 \text{ Nm}$$

$$M_{\text{motor min}} = \frac{M_{W \text{ min}}}{i \cdot \eta_G} = \frac{36}{20 \cdot 0.9} = 2 \text{ Nm}$$

*Calculating the maximum motor torques when accelerating and decelerating*

$$\begin{aligned} J_{V \text{ max}} &= \frac{1}{8} \cdot m_W \cdot (D_{\text{max}}^2 + D_{\text{core}}^2) \\ &= \frac{1}{8} \cdot 870 \cdot (1^2 + 0.12^2) = 110.3 \text{ kgm}^2 \end{aligned}$$

$$J_{\text{core}} \approx 0 \text{ (cardboard core)}$$

$$J_F = J_{\text{motor}} + J_{\text{supplement}} \approx 0.03 \text{ kgm}^2 \text{ (estimated)}$$

Relationships at  $D=D_{\text{max}}$

$$\begin{aligned} M_{b \text{ motor+supplement}} &= (J_{\text{motor}} + J_{\text{supplement}}) \cdot i \cdot \frac{2}{D_{\text{max}}} \cdot \frac{v_{\max B}}{t_b} \\ &= 0.03 \cdot 20 \cdot \frac{2}{1} \cdot \frac{0.833}{2} = 0.5 \text{ Nm} \end{aligned}$$

$$\begin{aligned} M_{b \text{ core+reel}} &= (J_{\text{core}} + J_{\text{reel}}) \cdot \frac{2}{D_{\text{max}}} \cdot \frac{v_{\max B}}{t_b} \\ &= (0 + 110.3) \cdot \frac{2}{1} \cdot \frac{0.833}{2} = 91.92 \text{ Nm} \end{aligned}$$

$$M_v = M_b \text{ (as } t_b = t_v)$$

Accelerating from 0 to  $v_{\max B}$  (with tension):

$$\begin{aligned} M_{motor} &= M_{b\ motor+sup\ plement} + (M_{b\ core+reel} + M_{W\ max}) \cdot \frac{1}{i \cdot \eta_G} \\ &= 0.5 + (91.92 + 300) \cdot \frac{1}{20 \cdot 0.9} \\ &= 0.5 + 21.77 = 22.27\ Nm \end{aligned}$$

Decelerating from  $v_{\max B}$  to 0 (with tension):

$$\begin{aligned} M_{motor} &= -M_{v\ motor+sup\ plement} + (-M_{v\ core+reel} + M_{W\ max}) \cdot \frac{1}{i \cdot \eta_G} \\ &= -0.5 + (-91.92 + 300) \cdot \frac{1}{20 \cdot 0.9} \\ &= -0.5 + 11.56 = 11.06\ Nm \end{aligned}$$

Decelerating from  $v_{\max B}$  to 0 (without tension, e. g. material web broken):

$$\begin{aligned} M_{motor} &= -0.5 + (-91.92) \cdot \frac{0.9}{20} && \text{(the factor } 1/\eta_G \text{ is changed into } \eta_G, \text{ as} \\ & && \text{the expression in brackets is } < 0) \\ &= -0.5 - 4.14 = -4.64\ Nm \end{aligned}$$

The highest motor torque is required when the winder is accelerating with tension. The highest regenerative motor torque is required when decelerating without tension. The accelerating- and decelerating torque for motor+supplement practically plays no role at  $D_{\max}$ .

Relationships at  $D=D_{\text{core}}$ :

$$\begin{aligned} M_{b\ motor+sup\ plement} &= (J_{motor} + J_{sup\ plement}) \cdot i \cdot \frac{2}{D_{core}} \cdot \frac{v_{\max L}}{t_b} \\ &= 0.03 \cdot 20 \cdot \frac{2}{0.12} \cdot \frac{1.13}{2} = 5.65\ Nm \end{aligned}$$

$$M_{b\ core+reel} \approx 0 \quad (J_v = 0, J_{core} \approx 0)$$

$$M_v = M_b \quad (\text{as } t_b = t_v)$$

Accelerating from 0 to  $v_{\max L}$  (with tension):

$$\begin{aligned} M_{motor} &= M_{b\ motor+sup\ plement} + (M_{b\ core+reel} + M_{W\ min}) \cdot \frac{1}{i \cdot \eta_G} \\ &= 5.65 + (0 + 36) \cdot \frac{1}{20 \cdot 0.9} = 7.65\ Nm \end{aligned}$$

Decelerating from  $v_{\max L}$  to 0 (with tension):

$$\begin{aligned} M_{motor} &= -M_{v\ motor+sup\ plement} + (-M_{v\ core+reel} + M_{W\ min}) \cdot \frac{1}{i \cdot \eta_G} \\ &= -5.65 + (0 + 36) \cdot \frac{1}{20 \cdot 0.9} \\ &= -5.65 + 2 = -3.65\ Nm \end{aligned}$$

Decelerating from  $v_{\max L}$  to 0 (without tension):

$$M_{motor} = -5.65\ Nm$$

The highest motor torque is required when accelerating with tension. The highest regenerative motor torque is required when decelerating without tension.

### *Calculating the maximum braking power*

The following is valid for the motor output:

$$P_{motor} = \frac{M_{motor} \cdot n_{motor}}{9550}$$

The maximum motor output in the regenerative mode occurs when decelerating without tension at maximum speed (i. e. at  $D=D_{core}$ ).

$$P_{br\ motor\ max} = \frac{-5.65 \cdot 3600}{9550} = -2.13\ kW$$



*Motor selection*

The motor was selected as a result of the calculated maximum motor torques:

1PQ5 113-4AA20-Z

$P_n=4$  kW;  $M_n=27$  Nm;  $n_n=1435$  RPM;  $I_n=9.2$  A;

$M_{stall}=3 M_n$ ;  $\eta_{motor}=0.83$ ;  $J_{motor}=0.011$  kgm<sup>2</sup>

Checking the motor in the field-weakening range at  $n_{max}$

Motor stall torque in the field-weakening range:

$$M_{stall} = M_{stall n} \cdot \left(\frac{n_n}{n}\right)^2$$

Permissible motor torque at  $n_{max}$  and 130 % safety margin from the stall torque:

$$M_{perm.} = \frac{M_{stall}}{1.3} = \frac{M_{stall n}}{1.3} \cdot \left(\frac{n_n}{n_{max}}\right)^2 = \frac{3 \cdot 27}{1.3} \cdot \left(\frac{1435}{3600}\right)^2 = 9.9 \text{ Nm}$$

The motor can also provide the demanded torque of 7.65 Nm when accelerating with tension, at  $n_{max}$ .

*Selecting the drive converter*

Selected drive converter:

6SE7021-0EA61

$P_{Vn}=4$  kW;  $I_n=10.2$  A

T300 technology board with closed-loop winder control

*Dimensioning the brake resistor*

The max. braking power for the brake resistor is:

$$P_{br W max} = P_{br motor max} \cdot \eta_{motor} = 2.13 \cdot 0.83 = 1.77 \text{ kW}$$

Braking energy:

$$W_{br} = \frac{P_{br W \max} \cdot t_v}{2} = \frac{1.77 \cdot 2}{2} = 1.77 \text{ kW s}$$

Winding time:

$$t_w = \frac{D_{\max}^2 - D_{\text{core}}^2}{4 \cdot d \cdot v_{\max}} \cdot \pi = \frac{1^2 - 0.12^2}{4 \cdot 0.002 \cdot 50} \cdot \pi = 7.74 \text{ min} > 90 \text{ s}$$

Thus, the cycle time for braking is set to 90 s. The following must be valid for the brake resistor:

$$\frac{W_{br}}{T} = \frac{1.77}{90} = 0.02 \text{ kW} \leq P_{br \text{ cont.}}$$

With

$$P_{br \text{ cont.}} = \frac{P_{20}}{36} \quad (\text{with an internal brake resistor})$$

the following is obtained

$$36 \cdot 0.02 = 0.72 \text{ kW} \leq P_{20}$$

The lowest braking unit is selected with  $P_{20} = 5 \text{ kW}$  (6SE7018-0ES87-2DA0). The internal brake resistor is sufficient.

### 3.2.4 Unwinder with 1FT6 motor

A 1FT6086-8SF71-1AA0 motor has been selected for a winder with flying roll change. The dimensioning and correct motor selection are to be checked. The unwinder inverter is to be integrated into a multi-motor group.

#### Unwind stand data

Max.reel diameter	$D_{\max}$	= 0.8 m
Core diameter	$D_{\text{core}}$	= 0.09 m
Reel weight	$m$	= 100 kg
Max.web velocity	$v_{\max}$	= 200 m/min
Steady-state torque referred to the motor speed at $D_{\max}$	$M_{\text{steady-st. max}}$	= 31 Nm
Required acceleration time	$t_b$	= 0.5 s
Required deceleration time	$t_v$	= 0.5 s
Gearbox ratio (belt driven)	$i$	= 4
Moment of inertia of the mandrel	$J_{\text{mandrel}}$	= 0.08 kgm <sup>2</sup>
Diameter of the large gear wheel on the mandrel (112 teeth)	$D_{Z \text{ mandrel}}$	= 290 mm
Diameter of the small gear wheel at the motor (28 teeth)	$D_{Z \text{ mot}}$	= 72.5 mm
Width of the gear wheels	$b$	= 38 mm
Gear wheel material: Steel		

#### Motor data

Rated output	$P_n$	= 9.7 kW
Rated speed	$n_{\text{mot n}}$	= 3000 RPM
Moment of inertia	$J_{\text{mot}}$	= 0.00665 kgm <sup>2</sup>
Efficiency	$\eta_{\text{mot}}$	= 0.91
Torque constant	$kT_0$	= 1.33 Nm/A
Stall torque	$M_0$	= 35 Nm
Stall current	$I_0$	= 26.4 A
Max. permissible torque	$M_{\max}$	= 90 Nm
Max. permissible current	$I_{\max}$	= 84 A

Max. web velocity in m/s:

$$v_{\max} = \frac{200}{60} = 3.33 \text{ m/s}$$

Web tension:

$$F_Z = M_{\text{stat max}} \cdot i \cdot \frac{2}{D_{\max}} = 31 \cdot 4 \cdot \frac{2}{0.8} = 310 \text{ N}$$

*Steady-state operation*

$$P_W = -\frac{F_Z \cdot v_{\max}}{1000} = -\frac{310 \cdot 3.33}{1000} = -1.03 \text{ kW}$$

$$n_{\text{mot min}} = i \cdot \frac{v_{\max} \cdot 60}{\pi \cdot D_{\max}} = 4 \cdot \frac{3.33 \cdot 60}{\pi \cdot 0.8} = 318.3 \text{ RPM}$$

$$n_{\text{mot max}} = i \cdot \frac{v_{\max} \cdot 60}{\pi \cdot D_{\text{core}}} = 4 \cdot \frac{3.33 \cdot 60}{\pi \cdot 0.09} = 2829.4 \text{ RPM}$$

Steady-state motor torque as a function of the motor speed:

$$M_{\text{mot steady-state}} = -M_{\text{steady-state max}} \cdot \frac{n_{\text{mot min}}}{n_{\text{mot}}}$$

*Determining the motor torques when accelerating and decelerating as a function of the motor speed*

Max. moment of inertia of the full roll:

$$J_{v \max} = \frac{m}{2} \cdot \left( \left( \frac{D_{\max}}{2} \right)^2 + \left( \frac{D_{\text{core}}}{2} \right)^2 \right) = \frac{100}{2} \cdot \left( \left( \frac{0.8}{2} \right)^2 + \left( \frac{0.09}{2} \right)^2 \right) = 8.1 \text{ kgm}^2$$

Estimating the additional moments of inertia:

$$J_{Z_{\text{mandrel}}} \approx \frac{1}{2} \cdot b \cdot 7.85 \cdot r^4 \cdot 10^3 = \frac{1}{2} \cdot 0.038 \cdot 7.85 \cdot \left( \frac{0.29}{2} \right)^4 \cdot 10^3 = 0.066 \text{ kgm}^2$$

$$J_{Z_{\text{mot}}} \approx \frac{1}{2} \cdot b \cdot 7.85 \cdot r^4 \cdot 10^3 = \frac{1}{2} \cdot 0.038 \cdot 7.85 \cdot \left( \frac{0.08}{2} \right)^4 \cdot 10^3 = 0.00026 \text{ kgm}^2$$

Thus, the supplementary moment of inertia, referred to the motor is given by:

$$J_{\text{supplement}} = \frac{J_{\text{mandrel}} + J_{Z_{\text{mandrel}}}}{i^2} + J_{Z_{\text{mot}}} = \frac{0.066 + 0.08}{4^2} + 0.00026 \approx 0.01 \text{ kgm}^2$$

Accelerating from 0 to  $v_{\text{max}}$  without tension (with tension)

$$M_{\text{mot } b} = (J_{\text{mot}} + J_{\text{supplement}}) \cdot i \cdot \frac{2}{D_{\text{max}}} \cdot \frac{v_{\text{max}}}{t_b} \cdot \frac{n_{\text{mot}}}{n_{\text{mot min}}} \quad \text{component, motor+supplement}$$

$$+ J_{v \text{ max}} \cdot \frac{2}{D_{\text{max}}} \cdot \frac{v_{\text{max}}}{t_b} \cdot \frac{D_{\text{max}}^4 \cdot \left(\frac{n_{\text{mot min}}}{n_{\text{mot}}}\right)^4 - D_{\text{core}}^4}{D_{\text{max}}^4 - D_{\text{core}}^4} \cdot \frac{1}{i} \quad \text{component, winder}$$

$$\left(-M_{\text{steady-state max}} \cdot \frac{n_{\text{mot min}}}{n_{\text{mot}}}\right) \quad \text{(component tension)}$$

The maximum motor torques when accelerating are obtained without tension. As this unwind stand has a flying roll change, the accelerating curve is calculated without tension. At a roll change, the full or partially full roll must first be accelerated in preparation for the flying roll change (where the two material webs are glued together). In operation, after standstill, acceleration only with tension.

Decelerating from  $v_{\text{max}}$  to 0 with tension

$$M_{\text{mot } v} = -(J_{\text{mot}} + J_{\text{supplement}}) \cdot i \cdot \frac{2}{D_{\text{max}}} \cdot \frac{v_{\text{max}}}{t_v} \cdot \frac{n_{\text{mot}}}{n_{\text{mot min}}} \quad \text{component, motor+supplement}$$

$$- J_{v \text{ max}} \cdot \frac{2}{D_{\text{max}}} \cdot \frac{v_{\text{max}}}{t_v} \cdot \frac{D_{\text{max}}^4 \cdot \left(\frac{n_{\text{mot min}}}{n_{\text{mot}}}\right)^4 - D_{\text{core}}^4}{D_{\text{max}}^4 - D_{\text{core}}^4} \cdot \frac{1}{i} \quad \text{component, winder}$$

$$- M_{\text{steady-state max}} \cdot \frac{n_{\text{mot min}}}{n_{\text{mot}}} \quad \text{component tension}$$

### Checking the selected motor

The steady-state and dynamic torque characteristics, together with the motor limiting characteristics are plotted to check the selected motor. As can be seen from the following characteristics, operation with the selected motor is permissible.



Steady-state torque characteristic and  $M_{perm S1}$  characteristic



Acceleration characteristic without tension, deceleration characteristic with tension and  $M_{perm max}$  characteristic

### Selecting the inverter

The inverter is selected according to the peak current in dynamic operation and according to the highest motor current when winding. The highest motor current when winding must be less than the inverter base load current so that the overload capability of the inverter can be used. Thus, the following must be valid:

$$I_{mot \max \text{ dyn}} \leq 1.6 \cdot I_{INV n}$$

$$I_{mot \text{ steady-state max}} \leq 0.91 \cdot I_{INV n}$$

The motor current is given by, taking into account saturation:

$$I_{mot} = \frac{|M_{mot}|}{kT_0 \cdot b_1} \quad \text{for } |M_{mot}| \leq M_0$$

$$I_{mot} = \frac{|M_{mot}|}{kT_0 \cdot b_1 \cdot \left(1 - \left(\frac{|M_{mot}| - M_0}{M_{\max} - M_0}\right)^2 \cdot \left(1 - \frac{M_{\max} \cdot I_0}{M_0 \cdot I_{\max}}\right)\right)} \quad \text{for } |M_{mot}| > M_0$$

with

$$b_1 = 1 - b \cdot \left(\frac{|n_{mot}|}{6000}\right)^{1.5} \quad (b=0.1 \text{ for frame size } < 100, \text{ otherwise } 0.15)$$

The max. motor current when winding is 23.34 A. The max. motor current in dynamic operation is 52.77 A. Thus, the following inverter is selected:

6SE7023-4TC51 SIMOVERT MASTERDRIVES Motion Control

$P_{INV n} = 15 \text{ kW}$

$I_{INV n} = 34 \text{ A}$

$I_{INV \max} = 54.5 \text{ A}$



Motor current when winding, inverter base load current



Motor currents when accelerating without tension and when decelerating with tension, maximum inverter current



*DC link currents*

In order to integrate the inverter into a multi-motor drive group, the maximum DC link currents must be calculated in dynamic operation as well as the constant DC link current when winding. The DC link power is obtained from:

$$P_{DC\ link} = M_{mot} \cdot \frac{2 \cdot \pi \cdot n_{mot}}{60} \cdot \frac{1}{(\eta_{mot} \cdot \eta_{INV})^{VZ}}$$

with

$$VZ = \text{sign}(M_{mot})$$

Thus, the DC link current is:

$$I_{DC\ link} = \frac{P_{DC\ link}}{1.35 \cdot U_{supply}}$$

The maximum DC link powers, and therefore also the maximum DC link currents occur at the maximum speed. As acceleration without tension at maximum speed does not occur (empty roll), acceleration with tension is used when dimensioning (accelerating after a standstill). The following values are obtained with  $U_{supply}=400\text{ V}$ :

$$I_{DC\ link\ b\ max} = 3.92\text{ A} \quad \text{acceleration with tension}$$

$$I_{DC\ link\ v\ max} = -6.53\text{ A} \quad \text{deceleration with tension}$$

$$I_{DC\ link\ steady-state} = -1.71\text{ A} \quad \text{winding operation}$$



DC link current when accelerating with tension and when decelerating with tension

### 3.2.5 Unwind stand with intermittent operation

An unwind stand is to be operated using two mechanically-coupled 1PA6 motors. The inverters for the two motors are supplied from a rectifier/regenerative feedback unit. The web velocity is not constant, but it is specified by the following characteristic.



#### Unwind stand data

Max. roll diameter	$D_{\max}$	= 1,25 m
Core diameter	$D_{\text{core}}$	= 0,125 m
Roll weight	$m$	= 2000 kg
Max. web velocity	$v_{\max}$	= 600 m/min
Web tension	$F_z$	= 500 N
Required accelerating time	$t_b$	= 7 s
Required braking time	$t_v$	= 7 s
Constant-velocity time	$t_k$	= 1 s
Cycle time	$T$	= 25 s
Gearbox ratio	$i$	= 3

Max. web velocity in m/s:

$$v_{\max} = \frac{600}{60} = 10 \text{ m/s}$$

Each motor should accept 50 % of the load. Thus, for the calculation, the weight of the roll and the web tension is always divided by two.

*Steady-state operation*

$$P_W = -\frac{\frac{F_z}{2} \cdot v_{\max}}{1000} = -\frac{\frac{500}{2} \cdot 10}{1000} = -2.5 \text{ kW}$$

$$n_{\text{mot min}} = i \cdot \frac{v_{\max} \cdot 60}{\pi \cdot D_{\max}} = 3 \cdot \frac{10 \cdot 60}{\pi \cdot 1.25} = 458.4 \text{ RPM}$$

$$n_{\text{mot max}} = i \cdot \frac{v_{\max} \cdot 60}{\pi \cdot D_{\text{core}}} = 3 \cdot \frac{10 \cdot 60}{\pi \cdot 0.125} = 4583.7 \text{ RPM}$$

Steady-state motor torque as a function of the motor speed:

$$M_{\text{mot stat}} = -M_{\text{mot stat max}} \cdot \frac{n_{\text{mot min}}}{n_{\text{mot}}}$$

with

$$M_{\text{mot stat max}} = -\frac{F_z}{2} \cdot \frac{D_{\max}}{2} \cdot \frac{1}{i} = -\frac{500}{2} \cdot \frac{1.25}{2} \cdot \frac{1}{3} = -52.08 \text{ Nm}$$

*Determining the motor torques when accelerating and decelerating as a function of the motor speed*

Max. moment of inertia of the full roll:

$$J_{v \max} = \frac{m}{2} \cdot \left( \left( \frac{D_{\max}}{2} \right)^2 + \left( \frac{D_{\text{core}}}{2} \right)^2 \right) = \frac{2000}{2} \cdot \left( \left( \frac{1.25}{2} \right)^2 + \left( \frac{0.125}{2} \right)^2 \right) = 197.27 \text{ kgm}^2$$

Estimating the additional moments of inertia (referred to the motor):

$$J_{\text{supplementary}} \approx 0.1 \text{ kgm}^2$$

Accelerating from 0 to  $v_{\max}$  with tension

$$M_{\text{motb}} = (J_{\text{mot}} + J_{\text{supplementary}}) \cdot i \cdot \frac{2}{D_{\max}} \cdot \frac{v_{\max}}{t_b} \cdot \frac{n_{\text{mot}}}{n_{\text{motmin}}} \quad \text{component, motor+supplementary}$$

$$+ J_{v\max} \cdot \frac{2}{D_{\max}} \cdot \frac{v_{\max}}{t_b} \cdot \frac{D_{\max}^4 \cdot \left(\frac{n_{\text{motmin}}}{n_{\text{mot}}}\right)^4 - D_{\text{core}}^4}{D_{\max}^4 - D_{\text{core}}^4} \cdot \frac{1}{i} \quad \text{winding component}$$

$$- M_{\text{statmax}} \cdot \frac{n_{\text{motmin}}}{n_{\text{mot}}} \quad \text{tension component}$$

Deceleration from  $v_{\max}$  to 0 with tension

$$M_{\text{motv}} = -(J_{\text{mot}} + J_{\text{sup pl.}}) \cdot i \cdot \frac{2}{D_{\max}} \cdot \frac{v_{\max}}{t_v} \cdot \frac{n_{\text{mot}}}{n_{\text{motmin}}} \quad \text{component, motor+supplementary}$$

$$- J_{v\max} \cdot \frac{2}{D_{\max}} \cdot \frac{v_{\max}}{t_v} \cdot \frac{D_{\max}^4 \cdot \left(\frac{n_{\text{motmin}}}{n_{\text{mot}}}\right)^4 - D_{\text{core}}^4}{D_{\max}^4 - D_{\text{core}}^4} \cdot \frac{1}{i} \quad \text{winding component}$$

$$- M_{\text{statmax}} \cdot \frac{n_{\text{motmin}}}{n_{\text{mot}}} \quad \text{tension component}$$

### Selecting the motor

The following motor is selected:

1PA6 137-4HF.

$P_n=25$  kW;  $M_n=136$  Nm;  $n_n=1750$  RPM;  $M_{\text{stall}}=485$  Nm;  $I_n=56$  A;  $I_{\mu}=23$  A;  $J_{\text{motor}}=0.109$  kgm<sup>2</sup>  
 $\eta_{\text{motor}}=0.902$

When selecting the motor, it must be taken into account that the motor accelerating torque and the motor decelerating torque at each speed must be below the dynamic limiting curve of the motor. In addition, the RMS current, obtained from the traversing characteristic must be less or equal to the rated motor current at each speed. The highest torques, and therefore also the highest RMS current is obtained at  $n_{\text{mot}}=n_{\text{mot min}}$  as follows:

$$M_{\text{mot b max}} = 99.65 \text{ Nm} \quad \text{max. accelerating torque}$$

$$M_{\text{mot v max}} = -203.81 \text{ Nm} \quad \text{max. decelerating torque}$$

With

$$I_{mot} \approx \sqrt{\left(\frac{M_{mot}}{M_{mot n}}\right)^2 \cdot (I_{mot n}^2 - I_{\mu n}^2) + I_{\mu n}^2} \quad (\text{in the constant flux range})$$

the maximum motor currents when accelerating, when decelerating and when unwinding with constant velocity are given by:

$$I_{mot b \max} = 43.9 \text{ A}$$

$$I_{mot v \max} = 79.9 \text{ A}$$

$$I_{mot stat \max} = 30.2 \text{ A}$$



Thus, the following RMS value is obtained:

$$I_{RMS} = \sqrt{\frac{I_{mot b \max}^2 \cdot t_b + I_{mot stat \max}^2 \cdot t_k + I_{mot v \max}^2 \cdot t_v + I_{\mu n}^2 \cdot t_p}{T}} = 50.75 \text{ A}$$

This value lies below the rated motor current with 56 A.

To check the dynamic relationships, the dynamic limiting curve of the motor together with the accelerating and decelerating torque will be investigated.



### Selecting the inverter

The inverter is selected according to the peak current in dynamic operation and according to the highest RMS current. The following must therefore be valid:

$$I_{mot \max \text{ dyn}} \leq 1.36 \cdot I_{INV n} \quad \text{or} \quad I_{mot \max \text{ dyn}} \leq 1.6 \cdot I_{INV n} \quad (\text{for } 160 \% \text{ overload capability})$$

$$I_{mot \text{ rms max}} \leq I_{INV n}$$

The max. RMS motor current is 50.75 A. The max. motor current in dynamic operation is 79.9 A. Thus, the following inverters are selected:

6SE7026-0TD61 SIMOVERT MASTERDRIVES Vector Control

$P_{INV n}=30 \text{ kW}$ ;  $I_{INV n}=59 \text{ A}$ ;  $I_{INV \max}=94.4 \text{ A}$  (160 % overload capability)

The 160 % overload capability can be used here, as the motor torque and therefore also the motor current decrease as the speeds increase, and as the maximum motor current is required in the constant flux range. Thus, the fact that field weakening is entered somewhat earlier (at 90 % rated speed) is of no importance.

### Selecting the rectifier/regenerative feedback unit

The rectifier/regenerative feedback unit is dimensioned according to the maximum DC link current in dynamic operation and according to the highest RMS DC link current. The DC link currents for each inverter is calculated using the DC link power.

$$P_{DClink} = M_{mot} \cdot \frac{2 \cdot \pi \cdot n_{mot}}{60} \cdot \frac{1}{(\eta_{mot} \cdot \eta_{INV})^{VZ}}$$

with

$$VZ = \text{sign}(M_{mot})$$

Thus, the DC link current is given by:

$$I_{DClink} = \frac{P_{DClink}}{1.35 \cdot V_{supply}}$$

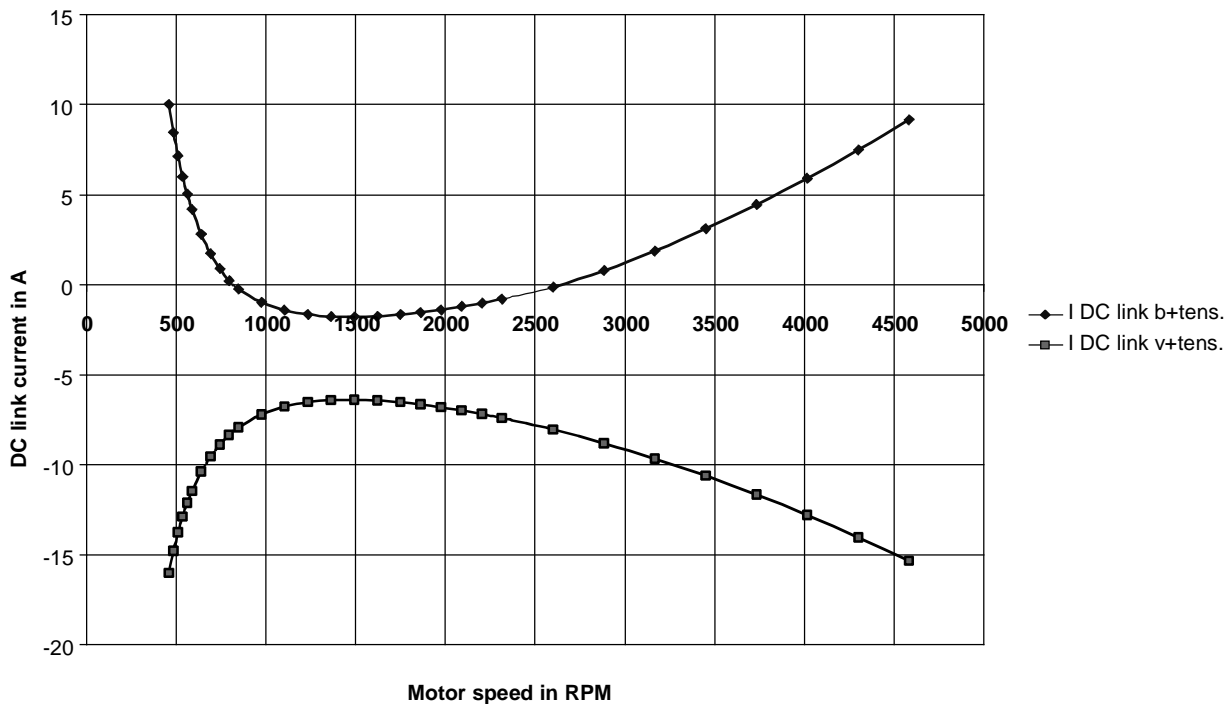



The maximum DC link powers when accelerating and when decelerating, and therefore also the maximum DC link currents, occur at the minimum speed. Thus, with  $V_{\text{supply}}=400\text{ V}$ , the following values are obtained for one motor:

$$I_{DClink\ b\ max} = 10.02\text{ A} \quad \text{max. DC link current when accelerating}$$

$$I_{DClink\ v\ max} = -16.01\text{ A} \quad \text{max. DC link current when decelerating}$$

$$I_{DClink\ stat} = -4.09\text{ A} \quad \text{DC link current at constant velocity}$$



The following is valid for the RMS value when motoring, for one motor:

$$I_{DClink\ RMS\ mot} = \sqrt{\frac{I_{DClink\ b\ max}^2 \cdot t_b}{\frac{3}{T}}} = 3.06\text{ A}$$

The following is valid for the RMS value when generating for one motor:

$$I_{DClink\ RMS\ gen} = \sqrt{\frac{I_{DClink\ stat}^2 \cdot t_k + \frac{I_{DClink\ v\ max}^2 \cdot t_v}{3}}{T}} = 4.96\text{ A}$$

The rectifier/regenerative feedback unit is selected according to the following criteria for the summed currents of both motors:

$$\begin{aligned} \sum I_{DClink\ b\ max} &= 2 \cdot 10.02 = 20.04 \leq 1.36 \cdot I_{DClink\ R/Re\ n} && \text{maximum value, motoring} \\ \sum |I_{DClink\ v\ max}| &= 2 \cdot 16.01 = 32.02 \leq 1.36 \cdot 0.92 \cdot I_{DClink\ R/Re\ n} && \text{maximum value, generating} \\ \sum I_{DClink\ rms\ mot} &= 2 \cdot 3.06 = 6.12 \leq I_{DClink\ R/Re\ n} && \text{RMS value, motoring} \\ \sum I_{DClink\ rms\ gen} &= 2 \cdot 4.96 = 9.92 \leq 0.92 \cdot I_{DClink\ R/Re\ n} && \text{RMS value, generating} \end{aligned}$$

This results in a 15 kW rectifier/regenerative feedback unit with  $I_{DC\ link\ R/Re\ n}=41\ A$ . However, as the output of the rectifier/regenerative feedback unit should be at least 30% of the power rating of the connected inverter, a 37 kW rectifier/regenerative feedback unit is selected.

6SE7028-6EC85-1AA0

$P_n=37\ kW$ ;  $I_{DC\ link\ n}=86\ A$

The permissible RMS value for a regenerative feedback transformer with 25% duty cycle is given by:

$$I_{DClink\ rms\ perm.} = I_{DClink\ R/Re\ n} \cdot 0.92 \cdot \sqrt{\frac{25}{100}} = I_{DClink\ R/Re\ n} \cdot 0.46 = 86 \cdot 0.46\ A = 39.56\ A$$

As this value is greater than the regenerative RMS value, regenerative feedback transformer with a 25% duty cycle is sufficient. In addition, a 4%  $u_k$  line reactor 4EU2451-4UA00 is required.

## 3.3 Positioning drives

### 3.3.1 General information

#### Positioning procedure

Positioning is possible in two ways:

- open-loop controlled
- closed-loop controlled

#### *Open-loop controlled positioning*

With open-loop controlled positioning, during positioning, there is no feedback regarding the actual position. Thus, it is not guaranteed that the actual end position coincides with the desired end position. A reference point transmitter with a time-dependent velocity signal or a position sensor (e.g. Bero, opto-barrier) is required for open-loop controlled positioning.

#### Effects on the accuracy

- changing deadtimes (reading-in, processing) in the setpoint processing and when processing the control commands
- reference point transmitter and position sensor resolution
- play in the mechanical system (gearbox, joints etc.)
- dependency on the load condition (e. g. motor slip)

Example showing the influence of changing deadtimes when reading-in/processing control commands



The maximum response time to the shutdown command is, in the most unfavorable case,  $\Delta t_{\max}$ . Thus, the maximum positioning error is:

$$\Delta s_{\max} = v_{\max} \cdot \Delta t_{\max}$$

Positioning errors can be reduced by approaching the end position at crawl speed (rapid traverse, crawl speed positioning).

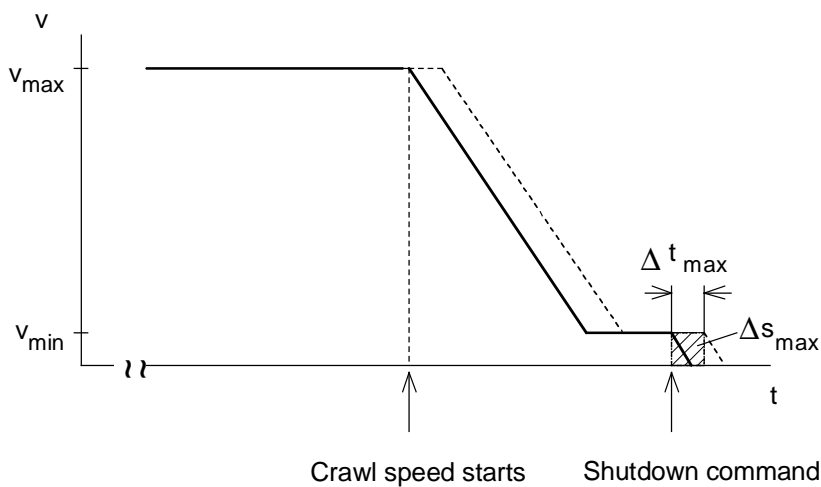

The dwell time at  $v_{\min}$  must be at least  $\Delta t_{\max}$ , otherwise, positioning could be completed prematurely.

The maximum positioning error is now only:

$$\Delta s_{\max} = v_{\min} \cdot \Delta t_{\max}$$

The disadvantage when using a crawl speed is the longer positioning time.

### *Closed-loop controlled positioning*

For closed-loop controlled positioning, the current position is compared to the reference value from the reference value transmitter. Deviations are equalized through the closed-loop position controller.



Block diagram for closed-loop controlled positioning

$x_d$ : Position difference

The reference point generator and closed-loop position controller can be externally set-up in the PLC or can also be integrated into a technology board in the drive converter. Instead of entering a motion characteristic via the reference point transmitter, the complete position difference can be fed to the closed-loop position controller. In this case, quantities  $v_{\max}$  and  $a_{\max}$  during positioning are kept constant elsewhere (ramp-function generator, limiter, square-root function).

The accuracy is influenced by the following factors

- position encoder resolution
- play in the mechanical system
- deadtimes in the reference value processing
- drive speed control range

For high requirements regarding fast and precise positioning without overshoot, the drive must have the highest possible limiting frequency ( $> 40$  Hz) and a high speed control range ( $> 1:1000$ ). For applications, for example, feed drives, packing machines etc., servo drives are preferably used (SIMOVERT MC). If the requirements regarding dynamic performance are not as high, e. g. for high-bay racking vehicles, elevators etc., even standard AC drives can be used (SIMOVERT VC). The somewhat restricted speed control range can be compensated for using an appropriate gearbox ratio and a longer positioning time.

Example for the influence of the encoder resolution when using a double-pulse encoder



Block diagram

Distance  $s$  moved during one motor revolution is:

$$s = \frac{D \cdot \pi}{i} \quad [\text{mm}]$$

$D$  drive wheel diameter [mm]

$i$  gearbox ratio

Thus, smallest detectable position difference  $x_{di}$  at an edge change is given by:

$$x_{di} = \frac{D \cdot \pi}{i \cdot 4 \cdot z} \quad [\text{mm}]$$

$z$  pulses per encoder revolution

The lowest detectable position difference  $x_{di}$  should be at least smaller than the required accuracy by a factor of 4.

If the drive is still to respond to a specific position difference  $x_d$ , then it must still be possible to adjust a minimum velocity of

$$v_{\min} = x_d \cdot k_v \quad [\text{mm/s}]$$

$k_v$  position controller gain factor  $[\text{s}^{-1}]$

The position controller gain must not be too high for stability reasons. It is dependent on the drive configuration (moment of inertia, gearbox play, deadtimes etc.) and the required characteristics.

Values which can be implemented are:

$k_{v \max} = 10$  to  $20$  for standard AC drives (SIMOVERT VC)

$k_{v \max} = 50$  to  $100$  for servo drives (SIMOVERT MC)

With the minimum velocity, the minimum motor speed is given by:

$$n_{\min} = \frac{i \cdot 60 \cdot v_{\min}}{D \cdot \pi} \quad [\text{RPM}]$$

The required speed control range can be determined via the minimum motor speed.

Fast positioning

In order to achieve fast positioning, the drive must accelerate and brake at the maximum possible values, and the constant velocity range must be traversed at the maximum velocity.

Example for fast positioning with  $t_b = t_v$

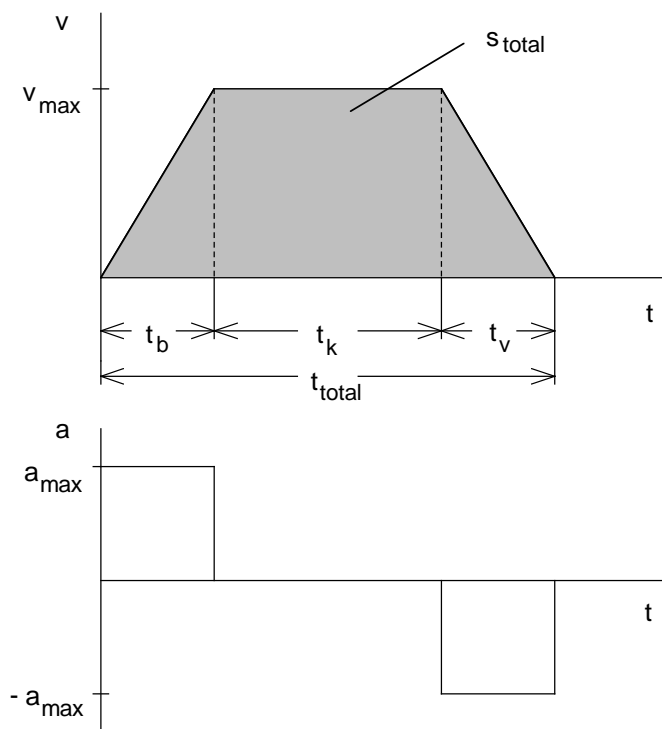

With

$$t_b = t_v = \frac{v_{max}}{a_{max}} \quad (\text{acceleration} = \text{deceleration}) \quad [\text{s}]$$

$$a_{max} \quad \text{max. acceleration} \quad [\text{m/s}^2]$$

$$v_{max} \quad \text{max. velocity} \quad [\text{m/s}]$$

results in the distance travelled  $s_{total}$ :

$$s_{total} = v_{max} \cdot t_{total} - \frac{v_{max}^2}{a_{max}} \quad [\text{m}]$$



or for positioning time  $t_{total}$  for the specified distance travelled:

$$t_{total} = \frac{v_{max}}{a_{max}} + \frac{s_{total}}{v_{max}} \quad [s]$$

If the positioning time  $t_{total}$  and the distance travelled  $s_{total}$  are specified, then  $v_{max}$  is given by:

$$v_{max} = \frac{a_{max} \cdot t_{total}}{2} - \sqrt{\left(\frac{a_{max} \cdot t_{total}}{2}\right)^2 - a_{max} \cdot s_{total}} \quad [m/s]$$

The constant velocity time  $t_k$  is obtained from:

$$t_k = t_{total} - \frac{2 \cdot v_{max}}{a_{max}} \quad [s]$$

For the special case with  $t_k=0$ , the trapezoidal velocity characteristic changes into a triangular characteristic.

Example for fastest positioning with  $t_b=t_v$ , special case,  $t_k=0$



With

$$t_b = t_v = \frac{v_{\max}}{a_{\max}} \quad (\text{acceleration=deceleration}) \quad [\text{s}]$$

the following is obtained:

$$s_{\text{total}} = \frac{v_{\max} \cdot t_{\text{total}}}{2} = \frac{v_{\max}^2}{a_{\max}} \quad [\text{m}]$$

$$t_{\text{total}} = \frac{2 \cdot s_{\text{total}}}{v_{\max}} = \frac{2 \cdot v_{\max}}{a_{\max}} \quad [\text{s}]$$

$$v_{\max} = \frac{a_{\max} \cdot t_{\text{total}}}{2} = \sqrt{a_{\max} \cdot s_{\text{total}}} \quad [\text{m/s}]$$

### Other acceleration characteristics

In addition to fast positioning with constant acceleration, other acceleration characteristics are possible, especially for servo drives, e. g.:

- Sawtooth acceleration

This characteristic results in positioning with minimum motor losses. However, for the same positioning time, the maximum acceleration increases with respect to fastest positioning and the end position is rapidly approached (mechanical stressing).

- Sinusoidal acceleration

In this case, acceleration steps, which occur for fastest positioning or for sawtooth acceleration characteristics, are eliminated as well as the associated high mechanical stresses. However, disadvantages are the higher maximum acceleration for the same positioning time with respect to fastest positioning and the complex implementation.

- Jerk-free acceleration characteristic

The acceleration can be smoothly entered (jerk-free) to keep the stressing on the mechanical system low and to prevent oscillations being excited, i. e., no steps and transitions in the accelerating characteristic. However, disadvantages are the higher maximum acceleration for the same positioning time with respect to fastest positioning and the somewhat complex implementation.

### 3.3.2 Traction drive with open-loop controlled positioning using Beros

The maximum positioning error due to the changing deadtime when reading-in/processing control commands at the SIMOVERT VC drive converter are to be determined.

Drive data

Max. traversing velocity	$v_{\max}$	= 36 m/min
Min. traversing velocity (crawl velocity)	$v_{\min}$	= 2 m/min
Max. deadtime when processing the control commands	$\Delta t_{\max}$	= $4 \times T_0 = 4.8$ ms

Velocity-time diagram



Bero 1: Changeover from  $v_{\max}$  to  $v_{\min}$  via fixed reference values (terminal strip)

Bero 2: Off1 command via the terminal strip (the brake is energized at  $f_U = 0$ )

The maximum positioning error as result of the changing deadtime is:

$$\begin{aligned} \Delta s_{\max} &= v_{\min} \cdot \Delta t_{\max} \\ &= 2 \text{ m / min} \cdot 4.8 \text{ ms} = 0.016 \text{ cm} \end{aligned}$$

Without using a crawl velocity, a maximum positioning error, given by the following, would be obtained:

$$\begin{aligned}\Delta s_{\max} &= v_{\max} \cdot \Delta t_{\max} \\ &= 36 \text{ m / min} \cdot 4.8 \text{ ms} = 0.29 \text{ cm} !\end{aligned}$$

Closed-loop frequency control is used as result of the enhanced control characteristics. Using closed-loop frequency control and the possibility of impressing the current at low frequencies, it is possible to obtain defined characteristics when ramping down from the crawl speed to 0. Closed-loop speed control can also be used to prevent an excessive dependency on the load.

### 3.3.3 Elevator drive with closed-loop positioning control (direct approach)

A SIMOVERT VC drive converter with T300 technology board for positioning is used. The required accuracy when stopping at floors is  $\pm 2.5$  mm.

Drive data

Gearbox ratio	$i$	= 35
Drive wheel diameter	$D$	= 640 mm
Max. velocity	$v_{\max}$	= 1.25 m/s
Max. acceleration	$a_{\max}$	= 0.9 m/s <sup>2</sup>

#### Checking the accuracy

A double-pulse encoder with 1024 pulses per revolution is used. Thus, the smallest detectable position difference is given by:

$$x_{di} = \frac{D \cdot \pi}{i \cdot 4 \cdot z} = \frac{640 \cdot \pi}{35 \cdot 4 \cdot 1024} = 0.014 \text{ mm}$$

This value is more than 400 % less than the required accuracy of  $\pm 2.5$  mm. Thus, the selected encoder is adequate as far as the resolution is concerned. The maximum motor speed is given by:

$$n_{\max} = \frac{v_{\max} \cdot i \cdot 60}{\pi \cdot D} = \frac{1.25 \cdot 35 \cdot 60}{\pi \cdot 0.64} = 1305 \text{ RPM}$$

For a speed control range of 1:1000 and a rated motor speed of  $n_n=1500$  RPM, the minimum velocity is given by:

$$v_{\min} = \frac{n_n \cdot \pi \cdot D}{1000 \cdot i \cdot 60} = \frac{1500 \cdot \pi \cdot 640}{1000 \cdot 35 \cdot 60} = 1.44 \text{ mm/s}$$

If the closed-loop control should still respond to a position difference of

$$x_d = \frac{2.5 \text{ mm}}{4} = 0.625 \text{ mm}$$

the following  $k_v$  factor must be able to be set for the closed-loop position controller:

$$k_v = \frac{v_{\min}}{x_d} = \frac{1.44}{0.625} = 2.3 \text{ s}^{-1}$$

This value can be realized for VC drive converters using T300.

## Velocity characteristic when moving between floors

With

$$s_{total} = h_1 = 2.875 \text{ m}$$

this results in a positioning time for a floor of:

$$t_{total} = \frac{v_{max}}{a_{max}} + \frac{s_{total}}{v_{max}} = \frac{1.25}{0.9} + \frac{2.875}{1.25} = 3.96 \text{ s}$$

Accelerating- and decelerating time:

$$t_b = t_v = \frac{v_{max}}{a_{max}} = \frac{1.25}{0.9} = 1.39 \text{ s}$$

The constant velocity time is given by:

$$t_k = t_{total} - \frac{2 \cdot v_{max}}{a_{max}} = 3.69 - \frac{2 \cdot 1.25}{0.9} = 0.91 \text{ s}$$

## Velocity characteristic when moving between floors



## 3.4 Drives with periodic load changes and surge loads

### 3.4.1 General information

Periodic load changes and surge loads can occur, for example, for reciprocating compressor or press drives.

For drives with periodic load changes, the following must be observed:

- In order that the drive stability is guaranteed, a drive converter with vector control should be used.
- If the excitation frequency of the load changes is higher than the limiting frequency of the closed-loop control (nominal values for closed-loop frequency control: Approx. 5 Hz, closed-loop speed control: Approx. 15 Hz), then the closed-loop frequency/speed controller must be set as slow as possible, so that it does not attempt to compensate the speed fluctuations.
- The motor torque to be generated is reduced by the drive moment of inertia, and for the extreme case, to the arithmetic average value of the load torque. This damping effect decreases as the speed decreases.
- For drives with a low moment of inertia and high load torque changes (e. g. a single-cylinder reciprocating compressor), the motor cannot be simply dimensioned according to the RMS value of the load torque and the speed control range. In this case, the rated motor torque should be at least 80% of the maximum load torque.
- When starting loaded (open-loop controlled range), under certain circumstances, the rated motor torque must be 130 to 150 % of the maximum load torque when starting. Vector control with tachometer is preferably used. In this case, it is sufficient when the rated motor torque approximately corresponds to the maximum load torque.
- If the motor and load are elastically coupled (e. g. through a belt drive), then torsional oscillations can be generated. The excitation frequency of the load changes may not coincide with the resonant frequency.

Drives with surge/shock loading:

- If the drive moment of inertia is appropriately high, the surge torque can briefly be a multiple of the rated motor torque.
- If there are only low moments of inertia, the motor can be braked down to standstill when load surges occur. Under certain circumstances, the drive can even briefly accelerate in the opposing direction of rotation (e. g. a driven vehicle collides with a stationary vehicle). In order to handle cases such as this, vector control with tachometer must be used in order to prevent the motor stalling.

### Supplementary moment of inertia

By using a supplementary moment of inertia, it is possible to reduce the motor peak torques. When using a gearbox, it makes the most sense to locate this supplementary moment of inertia at the gearbox side with the higher speed. This results in smaller dimensions.

### Calculating the motor torque

Under the assumption that the motor and load are rigidly coupled (no two-mass system with elastic coupling) and when neglecting the electrical motor time constants, the following differential equation is valid:

$$T_{mech} \cdot \frac{dM_{motor}}{dt} + M_{motor} = M_{load}(t)$$

with

$T_{mech} = \frac{J_{total} \cdot 2\pi \cdot n_0 \cdot s_n}{M_n \cdot 60}$	mech. time constant	[s]
$J_{total}$	total moment of inertia	[kgm <sup>2</sup> ]
$M_n$	rated motor torque	[Nm]
$s_n = \frac{n_0 - n_n}{n_0}$	rated motor slip	
$n_0$	motor synchronous speed	[RPM]
$n_n$	motor rated speed	[RPM]

If the moment of inertia is known, for simple cases, the motor torque can be calculated.

However, this calculation assumes that the drive is not in the closed-loop speed controlled mode. When using closed-loop speed control, depending on the setting, higher motor torques are obtained. In the extreme case, if the speed control could keep the speed precisely constant, the motor torque would precisely correspond to the load torque.



## Case 1

The load torque is specified in the form of an arithmetic average value component with superimposed oscillation:

$$M_{load}(t) = \overline{M_{load}} + \Delta M_{load} \cdot \sin(\omega_{load} \cdot t)$$

Thus, the motor torque is given by:

$$M_{motor}(t) = \overline{M_{load}} + \frac{\Delta M_{load}}{\sqrt{1 + (\omega_{load} \cdot T_{mech})^2}} \cdot \sin(\omega_{load} \cdot t - \varphi)$$

with

$$\varphi = \arctan(\omega_{load} \cdot T_{mech})$$

The ratio of the amplitudes is then given by:

$$\frac{\Delta M_{motor}}{\Delta M_{load}} = \frac{1}{\sqrt{1 + (\omega_{load} \cdot T_{mech})^2}}$$

Thus, load torque oscillations are better damped the higher the mechanical time constant, and the higher the frequency of the load torque oscillation.



Example of load torque oscillation with  $\omega_{load} \cdot T_{mech} = 3$

## Case 2

The load torque is a surge torque in the form of a step function. Thus, the motor torque is given by:

$$M_{motor}(t) = M_{load\ max} \cdot \left(1 - e^{-\frac{t}{T_{mech}}}\right) \quad 0 \leq t \leq t_0$$

and

$$M_{motor}(t) = M_{load\ max} \cdot \left(1 - e^{-\frac{t_0}{T_{mech}}}\right) \cdot e^{-\frac{t-t_0}{T_{mech}}} \quad t \geq t_0$$

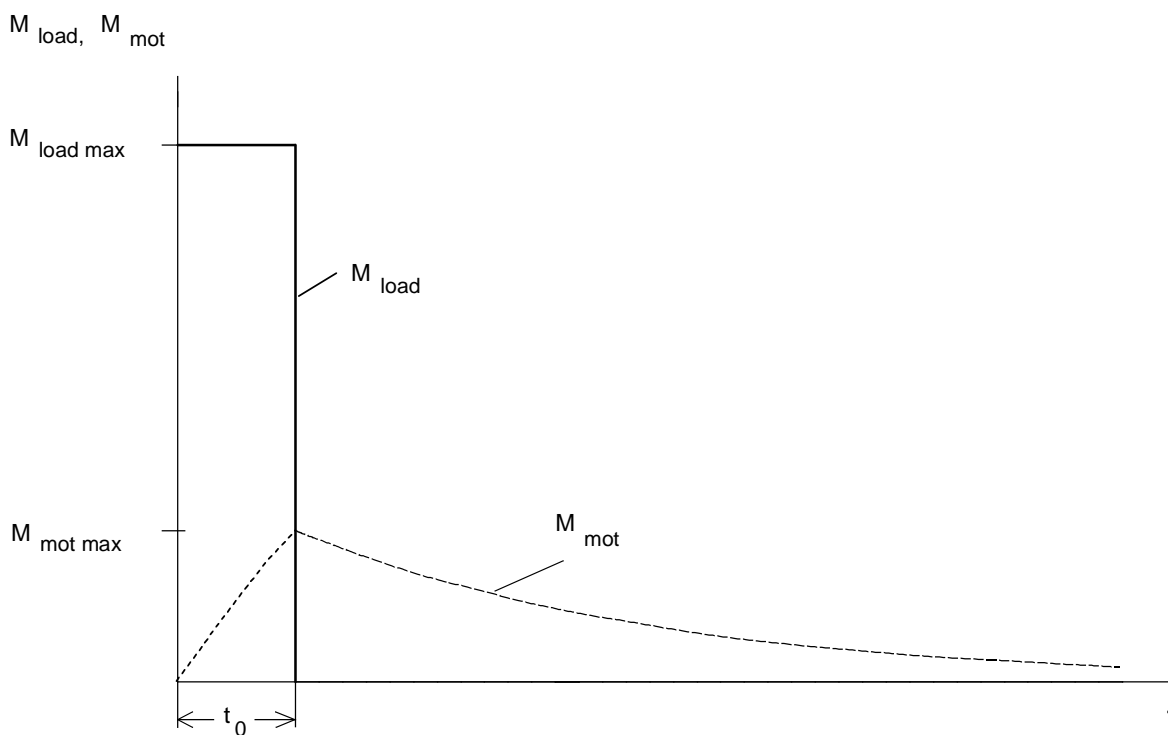

Example for a load surge with  $T_{mech} = 3 \cdot t_0$

If  $T_{mech}$  is significantly longer than  $t_0$ , the motor only has to provide a fraction of the maximum load torque. In this case, the maximum motor torque can be approximately calculated as follows:

$$M_{motor\ max} \approx M_{load\ max} \cdot \frac{t_0}{T_{mech}}$$

## Case 3

The load torque is a periodic sequence of torque steps. Thus, the motor torque is given by:

$$M_{motor}(t) = M_{load\ max} + C_1 \cdot e^{-\frac{t}{T_{mech}}} \quad 0 \leq t \leq t_0$$

and

$$M_{motor}(t) = C_2 \cdot e^{-\frac{t-t_0}{T_{mech}}} \quad t_0 \leq t \leq T$$

With

$$C_1 = -M_{load\ max} \cdot \frac{1 - e^{-\frac{t_p}{T_{mech}}}}{1 - e^{-\frac{T}{T_{mech}}}}$$

$$C_2 = M_{load\ max} + C_1 \cdot e^{-\frac{t_0}{T_{mech}}}$$

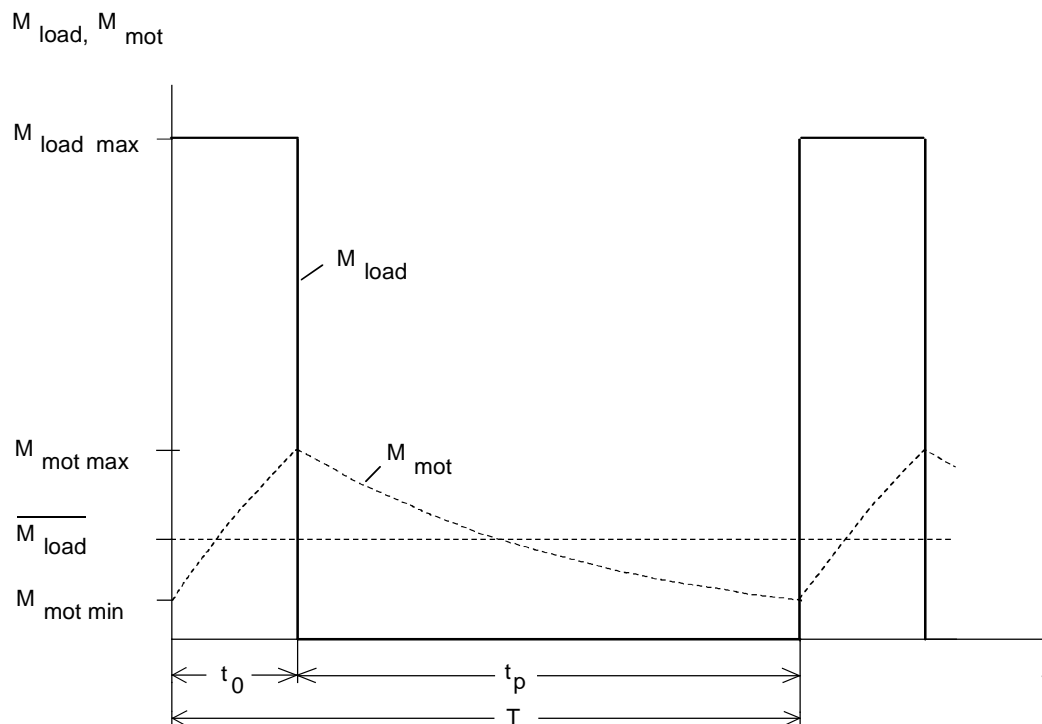

Example of a periodic sequence of load steps with  $T_{mech} = 2.5 \cdot t_0$

If  $T_{mech}$  is significantly longer than  $t_0$ , the maximum and minimum motor torques can be approximately calculated as follows:

$$M_{motor\ max} \approx \overline{M_{load}} + M_{load\ max} \cdot \frac{t_0}{2 \cdot T_{mech}}$$

$$M_{motor\ min} \approx \overline{M_{load}} - M_{load\ max} \cdot \frac{t_0}{2 \cdot T_{mech}}$$

with

$$\overline{M_{load}} = M_{load\ max} \cdot \frac{t_0}{T} \quad (\text{arithmetic average value component of the load torque})$$

#### Case 4

The load torque is specified as diagram. The following calculation procedures can be used for the motor torque:

- The load torque characteristic can be approximated using simple functions, which can be solved using differential equations.
- Fourier analysis of the load torque characteristic, and therefore effective as for case 1. In this case, in addition to the basic fundamental, only the harmonics have to be taken into account, which represent a significant proportion of the motor torque.
- Numerical integration, e. g., using the Runge Kutta technique

## Example

The load torque characteristic of a single-cylinder reciprocating compressor can be approximately represented as:

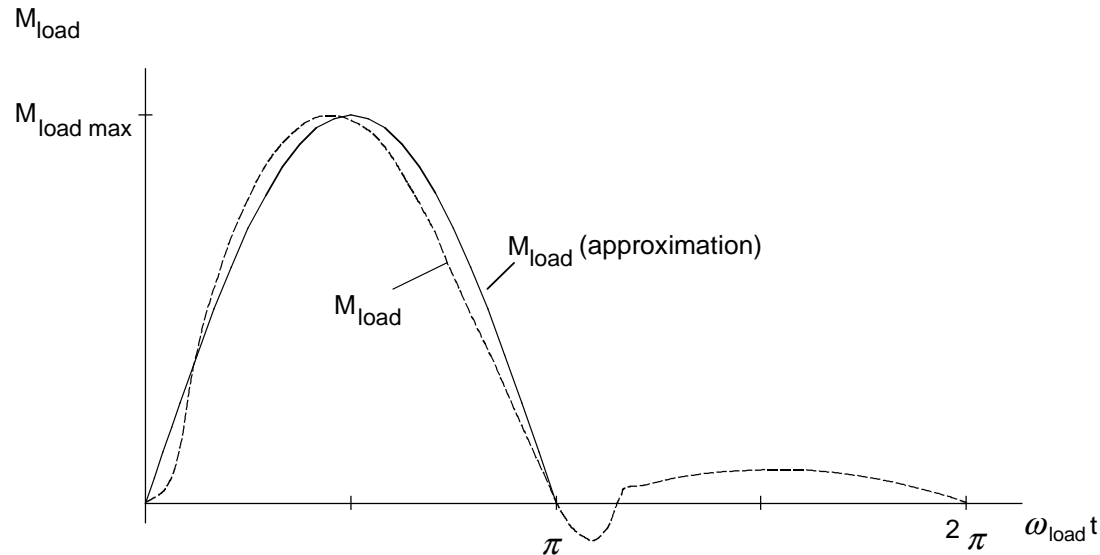

$2\pi$  corresponds to a crank revolution

The following is valid for the approximation:

$$M_{load}(t) = M_{load\ max} \cdot \sin(\omega_{load} \cdot t) \quad 0 \leq \omega_{load} \cdot t \leq \pi$$

$$M_{load}(t) = 0 \quad \pi \leq \omega_{load} \cdot t \leq 2\pi$$

with

$$\omega_{load} = \frac{2\pi \cdot n_{motor}}{i \cdot 60} = 2\pi \cdot f_{load} \quad \text{load torque oscillation frequency}$$

$i$  gearbox ratio

Thus, the motor torque is obtained from the following differential equation:

$$M_{mot}(t) \approx C \cdot e^{-\frac{\omega_{load} \cdot t}{\omega_{load} \cdot T_{mech}}} + \frac{M_{load\ max}}{\sqrt{1 + (\omega_{load} \cdot T_{mech})^2}} \cdot \sin(\omega_{load} \cdot t - \varphi) \quad 0 \leq \omega_{load} \cdot t \leq \pi$$

$$M_{mot}(t) \approx C \cdot e^{-\frac{\omega_{load} \cdot t - \pi}{\omega_{load} \cdot T_{mech}}} \quad \pi \leq \omega_{load} \cdot t \leq 2\pi$$

with

$$C = \frac{M_{load\ max} \cdot \sin \varphi}{(1 - e^{-\frac{\pi}{\omega_{load} \cdot T_{mech}}}) \cdot \sqrt{1 + (\omega_{load} \cdot T_{mech})^2}}$$

$$\varphi = \arctan(\omega_{load} \cdot T_{mech})$$

The motor torque is now to be represented for a control range of 1:4.  $\omega_{load} \cdot T_{mech} = 1.5$  for  $n_{motor} = n_{motor\ n}$ . For  $n_{motor} = n_{motor\ n} / 4$ , a value of 0.375 is obtained.



Motor torque at  $n_{motor} = n_{motor\ n}$  and  $\omega_{load} \cdot T_{mech} = 1.5$

Using the  $M_{load}$  characteristic, the arithmetic average value component of the load torque is approximately given by:

$$\overline{M_{load}} \approx \frac{M_{load\ max}}{\pi}$$

The calculation indicates that the maximum motor torque is only approximately 65 % of the maximum load torque.

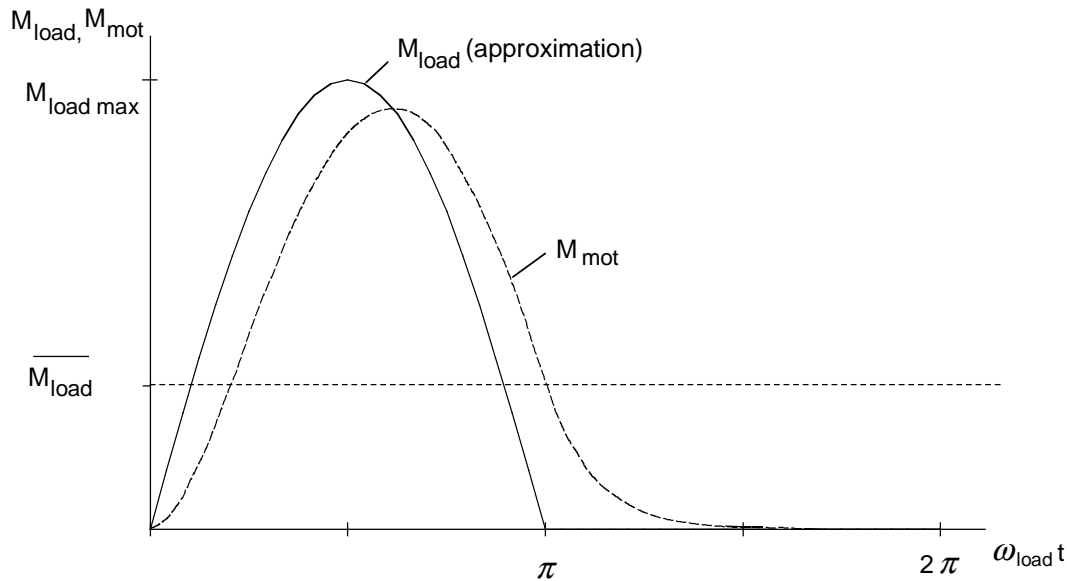

Motor torque at  $n_{motor} = \frac{n_{motor\ n}}{4}$  and  $\omega_{load} \cdot T_{mech} = 0.375$

As a result of the low influence of the moment of inertia at low speeds, the maximum motor torque is almost as high as the maximum load torque.

This approximation does not take into account that the load torque is also briefly negative. For low moments of inertia, or low speeds, the motor torque can also be negative (regenerative operation).

Instead of directly solving a differential equation, the motor torque can also be calculated using Fourier analysis. The load torque is approximated by:

$$\begin{aligned}
 M_{load}(t) &= M_{load\ max} \cdot \left[ \frac{1}{2} \cdot \sin(\omega_{load} \cdot t) + \frac{1}{\pi} \cdot \left( 1 - 2 \cdot \sum_{v=1}^{\infty} \frac{\cos(2v \cdot \omega_{load} \cdot t)}{4v^2 - 1} \right) \right] \\
 &\approx M_{load\ max} \cdot \left[ \frac{1}{\pi} + \frac{1}{2} \cdot \sin(\omega_{load} \cdot t) - \frac{2}{3\pi} \sin\left(2\omega_{load} \cdot t + \frac{\pi}{2}\right) - \frac{2}{15\pi} \cdot \sin\left(4\omega_{load} \cdot t + \frac{\pi}{2}\right) \right]
 \end{aligned}$$

(terminated after 4 terms of the progression)

Thus, the motor torque is given by:

$$M_{motor}(t) \approx M_{load\ max} \cdot \left[ \frac{1}{\pi} + \frac{1}{2 \cdot \sqrt{1 + (\omega_{load} \cdot T_{mech})^2}} \sin(\omega_{load} \cdot t - \varphi_1) \right. \\ \left. - \frac{2}{3 \cdot \pi \cdot \sqrt{1 + (2\omega_{load} \cdot T_{mech})^2}} \cdot \sin(2\omega_{load} \cdot t - \varphi_2 + \frac{\pi}{2}) \right. \\ \left. - \frac{2}{15 \cdot \pi \cdot \sqrt{1 + (4\omega_{load} \cdot T_{mech})^2}} \cdot \sin(4\omega_{load} \cdot t - \varphi_4 + \frac{\pi}{2}) \right]$$

with

$$\varphi_1 = \arctan(\omega_{load} \cdot T_{mech})$$

$$\varphi_2 = \arctan(2\omega_{load} \cdot T_{mech})$$

$$\varphi_4 = \arctan(4\omega_{load} \cdot T_{mech})$$

The calculation method using 4 terms of the progression practically provides the same results as the previous direct calculation.



### 3.4.2 Single-cylinder reciprocating compressor

A single-cylinder reciprocating compressor is to be operated in a speed control range from 94 to 281 RPM. A gearbox with  $i = 5.33$  is used. The load torque characteristic is known, and the load moment of inertia referred to the motor shaft.



Load torque characteristic of a single-cylinder reciprocating compressor referred to the motor shaft

#### Drive data

Max. load torque referred to the motor shaft

$$M_{load\ max}^*$$

Min. load torque referred to the motor shaft

$$M_{load\ min}^* = -15\ Nm$$

Load moment of inertia referred to the motor shaft

$$J_{load}^* = 0.0213\ kgm^2$$

Max. motor speed

$$n_{motor\ max} = 1500\ RPM$$

Min. motor speed

$$n_{motor\ min} = 500\ RPM$$

As there is no significant moment of inertia, a motor is required with a rated torque of at least 80% of the maximum load torque referred to the motor shaft.

$$M_{motor\ n} \geq 0.8 \cdot M_{load\ max}^* = 0.8 \cdot 153 = 122.4\ Nm$$

A 22 kW, 4-pole motor is selected (1LA5 186-4AA..)

$M_n = 144 \text{ Nm}$ ,  $n_n = 1460 \text{ RPM}$ ,  $I_{\text{motor } n} = 41 \text{ A}$ ,  $J_{\text{motor}} = 0.15 \text{ kgm}^2$ ,  $\eta_{\text{motor}} = 0.912$

*Estimating the influence of the moment of inertia on the maximum motor torque*

Total moment of inertia referred to the motor shaft:

$$J_{\text{total}} = J_{\text{motor}} + J_{\text{load}}^* = 0.15 + 0.0213 = 0.1713 \text{ kgm}^2$$

Rated motor slip:

$$s_n = \frac{n_0 - n_n}{n_0} = \frac{1500 - 1460}{1500} = 0.0267$$

Mechanical time constant:

$$T_{\text{mech}} = \frac{J_{\text{total}} \cdot 2\pi \cdot n_0 \cdot s_n}{M_n \cdot 60} = \frac{0.1713 \cdot 2\pi \cdot 1500 \cdot 0.0267}{144 \cdot 60} = 0.005 \text{ s}$$

Excitation frequency at  $n_{\text{motor max}} = 1500 \text{ RPM}$ :

$$\omega_{\text{load}} = \frac{2\pi \cdot n_{\text{motor max}}}{i \cdot 60} = \frac{2\pi \cdot 1500}{5.33 \cdot 60} = 29.47 \text{ s}^{-1}$$

or

$$f_{\text{load}} = \frac{\omega_{\text{load}}}{2\pi} = \frac{29.47}{2\pi} = 4.69 \text{ Hz}$$

Thus, the following is obtained for  $\omega_{\text{load}} \cdot T_{\text{mech}}$  at  $n_{\text{motor max}} = 1500 \text{ RPM}$ :

$$\omega_{\text{load}} \cdot T_{\text{mech}} = 29.47 \cdot 0.005 = 0.147$$

The basic fundamental amplitude ratio is then given by:

$$\frac{\Delta M_{\text{motor}}}{\Delta M_{\text{load}}^*} = \frac{1}{\sqrt{1 + (\omega_{\text{load}} \cdot T_{\text{mech}})^2}} = \frac{1}{\sqrt{1 + 0.147^2}} = 0.99$$

The damping effect of the moment of inertia can in this case, even at maximum speed, be neglected for the basic fundamental. This means, that the maximum motor torque, mainly determined by the basic fundamental, is practically the same as the maximum load torque referred to the motor shaft.

### Estimating the braking energy



#### Section of the load torque characteristic

The motor tracks the positive section of the load torque characteristic practically 1:1, with the exception of a phase shift. In the negative section, the peak of the load torque is better damped as a result of the higher frequency. In order to estimate the maximum negative motor torque, a sinusoidal oscillation with  $180/27.5 = 654\%$  frequency is assumed. The approximate motor torque at the maximum motor speed is given by:

$$\Delta M_{motor} \approx \frac{\Delta M_{load}}{\sqrt{1 + (6.54 \cdot \omega_{load} \cdot T_{mech})^2}} = \frac{15}{\sqrt{1 + (6.54 \cdot 0.147)^2}} = 10.8 \text{ Nm}$$

The maximum braking power is given by:

$$P_{br \max} \approx \frac{\Delta M_{motor} \cdot n_{motor \max} \cdot \eta_{motor}}{9550} = \frac{10.8 \cdot 1500 \cdot 0.912}{9550} = 155 \text{ kW}$$

## Braking diagram



The braking energy of a cycle corresponds to the area in the braking diagram. The braking characteristic is given by:

$$P_{br} \approx P_{br \max} \cdot \sin(6.54 \cdot \omega_{load} \cdot t)$$

Thus, the braking energy at  $n_{\text{motor max}} = 1500$  RPM is given by:

$$W_{br} \approx \frac{2 \cdot P_{br \max}}{6.54 \cdot \omega_{load}} = \frac{2 \cdot 155}{6.54 \cdot 29.47} = 0.0161 \text{ kW s} = 16.1 \text{ W s}$$

It should now be checked, as to whether the drive converter DC link can accept this energy. The maximum amount of energy which can be accepted by the DC link for a 22 kW drive converter on the 400 V line supply is as follows:

$$\Delta W_{\max} = \frac{1}{2} \cdot C \cdot (V_{d \max}^2 - V_{d n}^2) = \frac{1}{2} \cdot 2700 \cdot 10^{-6} \cdot (820^2 - 540^2) = 514.1 \text{ W s}$$

Thus, the braking energy, which occurs during the brief regenerative phase, can be temporarily accepted by the DC link. It is then reduced to zero in the subsequent motor operation. Thus, a pulsed resistor is not necessary.

*Drive converter selection*

6SE7024-7ED61

$P_{Vn} = 22 \text{ kW}$ ,  $I_{Vn} = 47 \text{ A}$

Closed-loop frequency control

### Thermally checking the motor

As the motor torque practically corresponds to the load torque referred to the motor shaft, when calculating the RMS motor torque, the RMS load torque can be used as basis. The load torque is approximated using a sinusoidal half wave (as described previously under "General information").

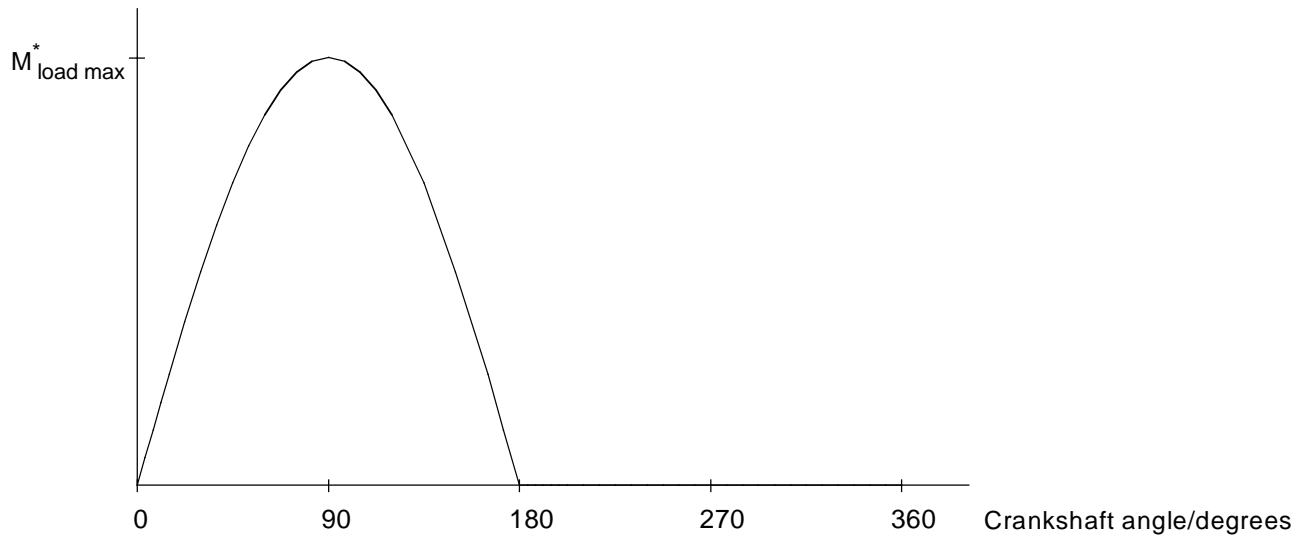

### Approximation of the load torque characteristic

The RMS motor torque is approximately given by:

$$M_{motor\ RMS} \approx \frac{M_{load\ max}^*}{2} = \frac{153}{2} = 76.5\ Nm$$

In a speed control range 1:3 for the 22 kW motor, the permissible torque for S1 duty is approximately 111 Nm. Thus, there is sufficient reserve.

### Starting under load

If a single-cylinder reciprocating compressor is to start under load, for closed-loop frequency control, a 30 kW motor and a 30 kW drive converter are required (6SE7026-0ED61).

Motor torque calculated using the Runge Kutta technique

**Reciprocating compressor ( $n=1500$  RPM,  $i=5.33$ ,  
 $T_{\text{mech}}=0.005$  s)**



### 3.4.3 Three-cylinder pump

A three-cylinder pump is to be operated in a control range 102 to 238 RPM. A gearbox with  $i = 6.11$  and  $\eta = 0.97$  is used. The load torque characteristic is specified and the torque at the pump shaft is 796 Nm.

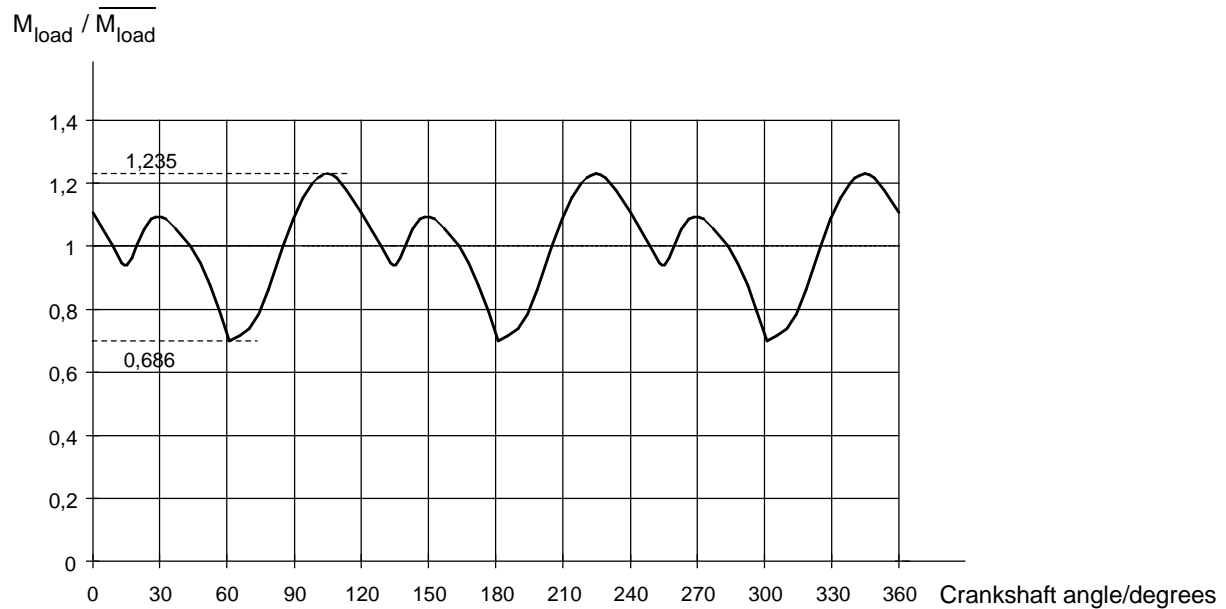

#### Load torque characteristic of the three-cylinder pump

With the average torque at the pump shaft and a gearbox efficiency of 0.97, the average torque at the motor shaft is obtained as follows:

$$\overline{M}_{motor} = \frac{\overline{M}_{load}}{i \cdot \eta} = \frac{796}{6.11 \cdot 0.97} = 134.3 \text{ Nm}$$

The load moment of inertia is not known, but can probably be neglected with respect to the motor moment of inertia. Thus, it is assumed that the motor torque has the same ripple as the load torque. The maximum and minimum motor torques are given by:

$$M_{motor \max} = 1.235 \cdot \overline{M}_{motor} = 1.235 \cdot 134.3 = 165.9 \text{ Nm}$$

$$M_{motor \min} = 0.686 \cdot \overline{M}_{motor} = 0.686 \cdot 134.3 = 92.1 \text{ Nm}$$

The maximum and minimum motor speeds are given by:

$$n_{motor \max} = n_{load \max} \cdot i = 238 \cdot 6.11 = 1454.2 \text{ RPM}$$

$$n_{motor \min} = n_{load \min} \cdot i = 102 \cdot 6.11 = 623.2 \text{ RPM}$$

As result of the relatively low load torque oscillations, the RMS motor torque and the RMS load torque can be used to dimension and select the motor. The load torque characteristic is approximated using individual sinusoidal half waves to estimate the RMS value.

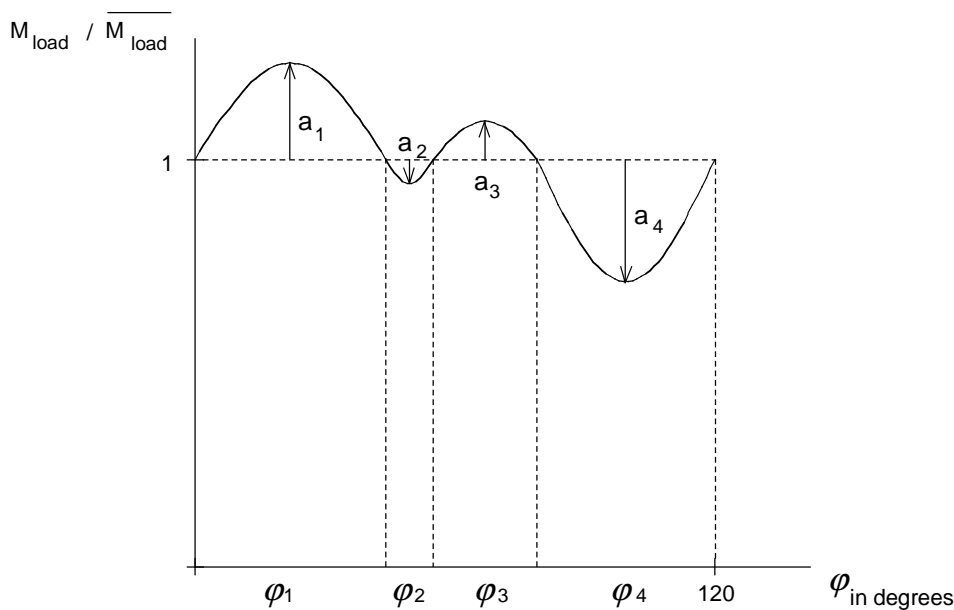

The load characteristic is approximated using sinusoidal half waves

The approximate RMS value is obtained as follows:

$$M_{load \text{ RMS}} = \overline{M_{load}} \cdot \sqrt{\frac{\sum_{i=1}^{i=4} \varphi_i \cdot \left(1 + \frac{4 \cdot a_i}{\pi} + \frac{a_i^2}{2}\right)}{120}}$$

With

$$a_1 = 0.235, \quad a_2 = -0.061, \quad a_3 = 0.093, \quad a_4 = -0.3$$

$$\varphi_1 = 44, \quad \varphi_2 = 11, \quad \varphi_3 = 24, \quad \varphi_4 = 41$$

1.0111 is obtained as the square root. Thus, the RMS motor torque is approximated as follows:



$$M_{motor\ RMS} \approx \overline{M_{motor}} \cdot 1.0111 = 134.3 \cdot 1.0111 = 135.8\ Nm$$

If the arithmetic average value is high with respect to the oscillating torque amplitudes, then the RMS value practically corresponds to the average value.

A 4-pole, 30 kW motor is selected due to the speed control range 1:2.33 (1LA5 207-4AA..)

$$M_n = 196\ Nm, n_n = 1465\ RPM, I_{motor\ n} = 55\ A, J_{motor} = 0.24\ kgm^2$$

*Estimating the influence of the moment of inertia on the maximum motor torque*

Total moment of inertia referred to the motor shaft:

$$J_{total} \approx J_{motor} = 0.24\ kgm^2$$

Rated motor slip:

$$s_n = \frac{n_0 - n_n}{n_0} = \frac{1500 - 1465}{1500} = 0.0233$$

Mechanical time constant:

$$T_{mech} = \frac{J_{total} \cdot 2\pi \cdot n_0 \cdot s_n}{M_n \cdot 60} = \frac{0.24 \cdot 2\pi \cdot 1500 \cdot 0.0233}{196 \cdot 60} = 0.0045\ s$$

Excitation frequency at  $n_{motor\ max} = 1454.2\ RPM$ :

$$\omega_{load} = 3 \cdot \frac{2\pi \cdot n_{motor\ max}}{i \cdot 60} = 3 \cdot \frac{2\pi \cdot 1454.2}{6.11 \cdot 60} = 74.8\ s^{-1} \quad (3\ periods\ for\ a\ crankshaft\ revolution)$$

and

$$f_{load} = \frac{\omega_{load}}{2\pi} = \frac{74.8}{2\pi} = 11.9\ Hz$$

Thus,  $\omega_{load} \cdot T_{mech}$  at  $n_{motor\ max} = 1454.2\ RPM$  is given by:

$$\omega_{load} \cdot T_{mech} = 74.8 \cdot 0.0045 = 0.336$$

The basic fundamental amplitude ratio is now given by:

$$\frac{\Delta M_{motor}}{\Delta M_{load}^*} = \frac{1}{\sqrt{1 + (\omega_{load} \cdot T_{mech})^2}} = \frac{1}{\sqrt{1 + 0.336^2}} = 0.95$$

Thus, the damping effect of the moment of inertia, even at maximum speed can be neglected for the basic fundamental.

### Selected drive converter

6SE7027-2ED61

$P_{Vn} = 37 \text{ kW}$ ,  $I_{Vn} = 72 \text{ A}$

Closed-loop frequency control type

### Motor torque numerically calculated using the Runge Kutta technique

Three-cylinder pump (n=1454 RPM, i=6.11, T<sub>mech</sub>=0.0045 s)

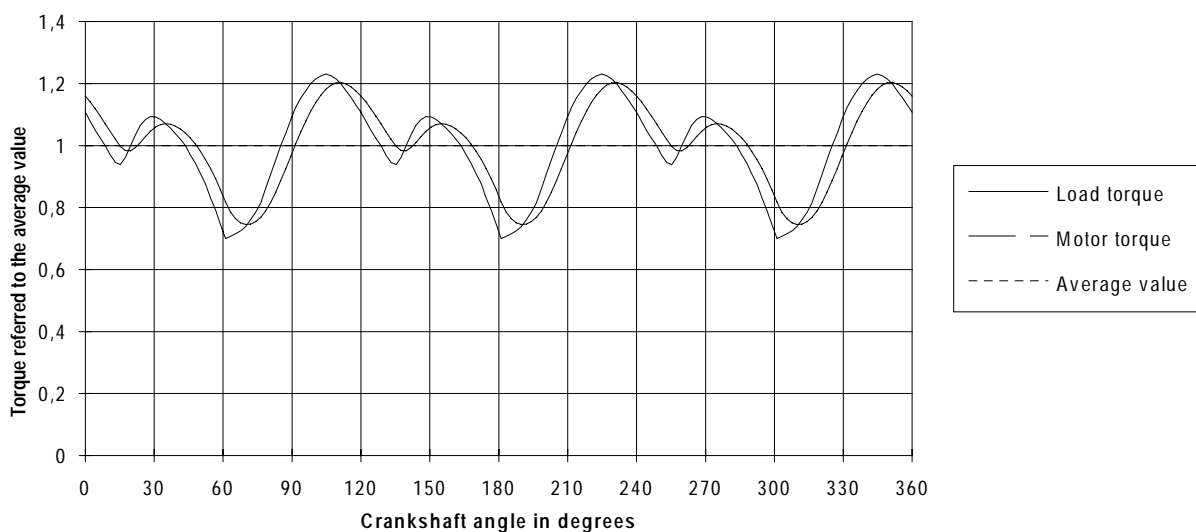

### 3.4.4 Transport system for freight wagons

This drive is for a trolley that pushes freight wagons to form train units on a 500 m rail section. The vehicle is driven using a fixed 37 kW AC motor with gearbox.



Schematic of the trolley system!

For a 50 Hz motor frequency, the trolley runs at a constant velocity of 1.25 m/s towards the wagons. The cable tension is established after a delay due to the spring effect of the steel cable. If the wagons are braked, or if a group of several wagons doesn't accelerate quickly enough due to the high mass, then a slip coupling between the motor and gearbox is activated when a maximum motor torque is reached. The pulley wheel speed decreases. If the wagon group doesn't move or the pulley wheel speed does not increase after a specific time, the trolley is retracted.

In order to eliminate the slip coupling, the motor is now to be fed from a drive converter. Further, in order to save time, the trolley can be withdrawn at twice the velocity. The slip coupling is now replaced by a closed-loop speed/torque control. If the motor torque, transferred via the cable, reaches the set torque limit, the closed-loop speed control can no longer maintain the reference speed, and the drive system automatically goes over into the closed-loop torque controlled mode. The motor maintains the torque, the speed decreases, and is now defined by the load. However, without the damping effect of the slip coupling, problems can occur as the motor-cable-wagon combination represents a system which can oscillate. This will now be shown using the following simplified diagram. The friction and gearbox efficiency have, in this case, been neglected.

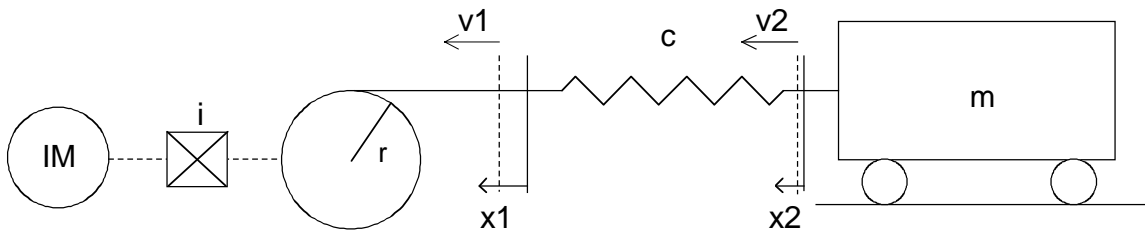

Equivalent diagram for system behavior after the trolley has „hit“ the wagon

$x_1$	cable motion over the drive wheel
$x_2$	wagon motion
$v_1$	velocity of the cable over the drive wheel
$v_2$	velocity of the wagon(s)
$r$	drive wheel radius
$c$	spring constant of the cable (dependent on the cable length)
$m$	mass of the wagon(s)
$i$	gearbox ratio
$J_{\text{motor}}$	motor moment of inertia
$n_0$	motor no-load speed at rated frequency

The following is valid for the drive wheel:

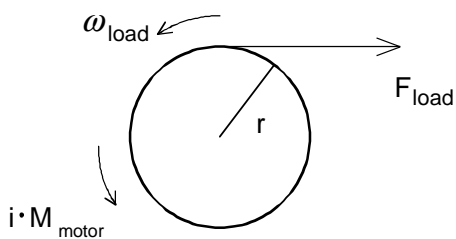

$$i \cdot M_{\text{motor}} - M_{\text{load}} = i^2 \cdot J_{\text{motor}} \cdot \frac{d\omega_{\text{load}}}{dt}$$

with

$$M_{load} = F_{load} \cdot r = c \cdot (x_1 - x_2) \cdot r$$

$$\omega_{load} = \frac{v_1}{r} = \frac{1}{r} \cdot \frac{dx_1}{dt}$$

The following is valid for the wagon(s):

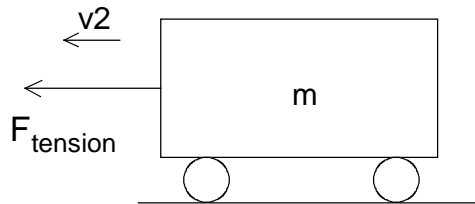

$$F_{tension} = m \cdot \frac{dv_2}{dt} = m \cdot \frac{d^2 x_2}{dt^2}$$

with

$$F_{tension} = c \cdot (x_1 - x_2)$$

### *Behavior when a wagon is braked*

To start of with, the behavior is investigated when the trolley hits a braked wagon. In this case,  $v_2=0$  and  $x_2=0$ . It is now assumed, that the speed remains constant due to the closed-loop speed control, until  $M_{motor}=M_{max}$ . Thus, the following is true for this range:

$$\omega_{load} = const = \frac{v_{10}}{r} = \frac{2\pi \cdot n_0}{i \cdot 60} = \frac{1}{r} \cdot \frac{dx_1}{dt}$$

Solution:

$$x_1 = v_{10} \cdot t$$

$$M_{motor} = \frac{c \cdot r \cdot v_{10}}{i} \cdot t$$

$M_{\text{motor}}=M_{\text{max}}$  is reached at

$$t_1 = \frac{i \cdot M_{\text{max}}}{c \cdot r \cdot v_{10}}$$

After the torque limit has been reached,  $M_{\text{motor}}=M_{\text{max}}$  remains constant. The following is valid for this range:

$$\frac{d^2 x_1}{dt^2} + \frac{c \cdot r^2}{i^2 \cdot J_{\text{motor}}} \cdot x_1 = \frac{i \cdot M_{\text{max}} \cdot r}{i^2 \cdot J_{\text{motor}}}$$

Solution:

$$x_1 = \frac{v_{10}}{\omega_{m1}} \cdot \sin(\omega_{m1} \cdot (t - t_1)) + \frac{i \cdot M_{\text{max}}}{c \cdot r}$$

$$\frac{dx_1}{dt} = v_1 = v_{10} \cdot \cos(\omega_{m1} \cdot (t - t_1))$$

with

$$\omega_{m1} = \sqrt{\frac{c \cdot r^2}{i^2 \cdot J_{\text{motor}}}} \quad \text{mechanical oscillation frequency}$$

For operation at the torque limit, undamped oscillation occurs. However, in practice there is always some damping due to the cable friction and gearbox losses, which in this particular analysis, have been neglected. Additional damping can be achieved by compensating the speed to the torque limit. This compensation has, in this case, the following form:

$$M_{\text{motor}} = M_{\text{max}} - k_D \cdot M_{\text{max}} \cdot \frac{n}{n_0} = M_{\text{max}} - k_D \cdot M_{\text{max}} \cdot \frac{v_1}{v_{10}}$$

For example, for  $k_D=0.1$ , a 10 % change in the torque limit is achieved at  $n=n_0$ . With this compensation, the differential equation now has a damping component:

$$\frac{d^2 x_1}{dt^2} + \frac{i \cdot k_D \cdot M_{\text{max}} \cdot r}{v_{10} \cdot i^2 \cdot J_{\text{motor}}} \cdot \frac{dx_1}{dt} + \frac{c \cdot r^2}{i^2 \cdot J_{\text{motor}}} \cdot x_1 = \frac{i \cdot M_{\text{max}} \cdot r}{i^2 \cdot J_{\text{motor}}}$$

If, for example, the start of compensation is set to  $M_{\text{motor}}=0.2 M_{\text{max}}$ , then, for non-periodic damping, the solution is as follows:

$$x_1 = C_1 \cdot e^{p_1(t-t_2)} + C_2 \cdot e^{p_2(t-t_2)} + \frac{i \cdot M_{\text{max}}}{c \cdot r}$$

$$\frac{dx_1}{dt} = v_1 = C_1 \cdot p_1 \cdot e^{p_1(t-t_2)} + C_2 \cdot p_2 \cdot e^{p_2(t-t_2)}$$

with

$$p_{1,2} = -\frac{a_1}{2} \pm \sqrt{\left(\frac{a_1}{2}\right)^2 - \omega_{m1}^2}$$

$$a_1 = \frac{i \cdot k_D \cdot M_{\text{max}} \cdot r}{v_{10} \cdot i^2 \cdot J_{\text{motor}}}$$

$$C_1 = \frac{p_2 \cdot (v_{10} \cdot t_2 - \frac{i \cdot M_{\text{max}}}{c \cdot r}) - v_{10}}{p_2 - p_1}$$

$$C_2 = \frac{v_{10} - p_1 \cdot (v_{10} \cdot t_2 - \frac{i \cdot M_{\text{max}}}{c \cdot r})}{p_2 - p_1}$$

$$t_2 = \frac{0,2 \cdot M_{\text{max}} \cdot i}{c \cdot r \cdot v_{10}}$$

With the following values

$$\begin{aligned} r &= 0.36 \text{ m} \\ c &= 20000 \text{ N/m} \\ i &= 22.5 \\ J_{\text{motor}} &= 1.2 \text{ kgm}^2 \\ M_n &= 483 \text{ Nm} \\ n_0 &= 750 \text{ RPM} \end{aligned}$$

when the trolley hits the braked wagons and for  $M_{\text{max}}=M_n$ , the following characteristics are obtained for the cable motion along the drive wheel  $x_1$ , velocity of the cable along driving wheel  $v_1$ , the motor torque  $M_{\text{motor}}$  and tension  $F_{\text{tension}}$ . In order to keep the equation transparent, the quantities are referred to the relevant nominal values:

$$x_{10} = \frac{i \cdot M_n}{c \cdot r} \quad \text{and} \quad F_n = c \cdot x_{10}$$

### Cable velocity across the drive wheel ( $v_1$ ), Cable route along the drive wheel ( $x_1$ )

$k_D=0$

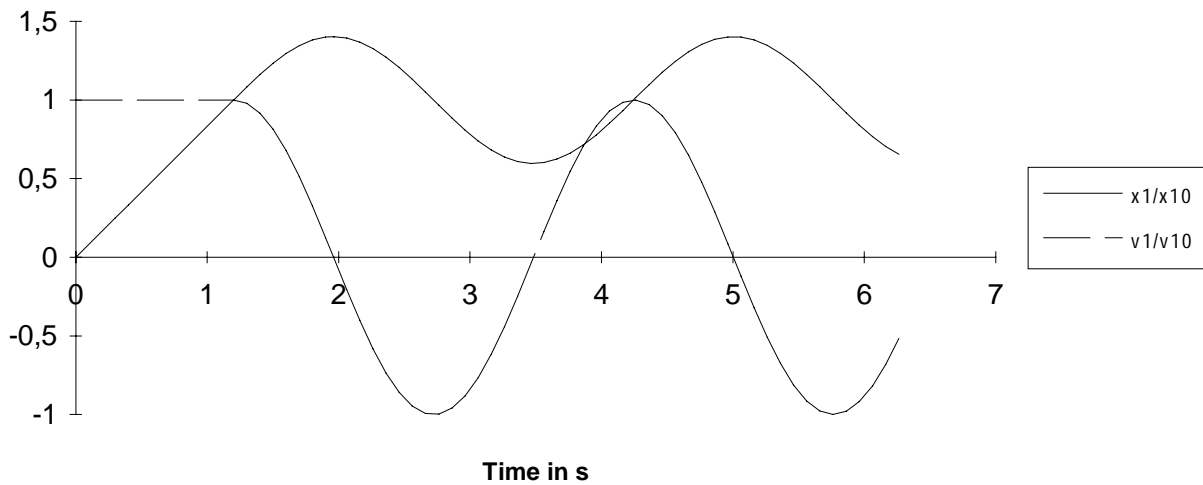

### Motor torque ( $M_{Mot}$ ), tension ( $F_{tension}$ )

$k_D=0$



Behavior when the trolley hits the wagon(s) which is(are) braked. Without compensation, the system continuously oscillates ( $k_D=0$ ).



### Cable velocity across the drive wheel ( $v_1$ ), Cable route along the drive wheel ( $x_1$ )



### Motor torque (M Mot), tension (F tension)



Behavior when the vehicle impacts wagon(s) which is(are) braked. With the appropriate compensation (e. g.  $k_D=1.4$ ) a non-periodic damped oscillation is obtained. Compensation starts at  $M_{motor}=0.2 M_{max}$ .

*Behavior when accelerating the wagon(s)*

To start of with, the acceleration of an unbraked group of wagons will be investigated. As  $v_2$  and  $x_2$  now also change, the analytical calculation is significantly more complex. The equations are now changed-over as follows:

$$\frac{dx_1}{dt} = v_1$$

$$\frac{dx_2}{dt} = v_2$$

$$\frac{dv_2}{dt} = \frac{c}{m} \cdot (x_1 - x_2)$$

as well as

$$\frac{dv_1}{dt} = 0 \quad \text{without compensation and for } v_1 = v_{10}$$

$$\frac{dv_1}{dt} = \frac{r \cdot i}{i^2 \cdot J_{motor}} \cdot \left( M_{max} - k_D \cdot M_{max} \cdot \frac{v_1}{v_{10}} \right) - \frac{c \cdot r^2}{i^2 \cdot J_{motor}} \cdot (x_1 - x_2) \quad \text{with compensation}$$

This equation system can be solved using the Runge Kutta technique.

Using the same numerical values as before for braked wagons,  $M_{max}=M_n$ , and mass  $m$  of 400 t or 10 t, the following characteristics are obtained for the velocity of the cable over drive wheel  $v_1$ , the velocity of the wagon(s)  $v_2$ , motor torque  $M_{motor}$  and tension  $F_{tension}$ . Motor limit compensation is again withdrawn after approx. 1.5 s using a PT1 element with a time constant of approx. 5 s; otherwise, the motor torque during acceleration would be permanently reduced by factor  $k_D$ .

The overshoot of velocity  $v_2$  of the wagon(s) is certainly lower as friction has been neglected. This effect can be significantly reduced, for example, by decreasing the setpoint to approx. 80% after the vehicle has hit the wagon. If the motor speed again reaches this 80%, the setpoint is slowly increased to 100% along a slow ramp (ramp-function generator). Thus, the cable tension (and also overshoot) is reduced before the final velocity is reached.

### Cable velocity across the drive wheel ( $v_1$ ), velocity of the wagons ( $v_2$ )



### Motor torque ( $M_{\text{Mot}}$ ), tension ( $F_{\text{tension}}$ )

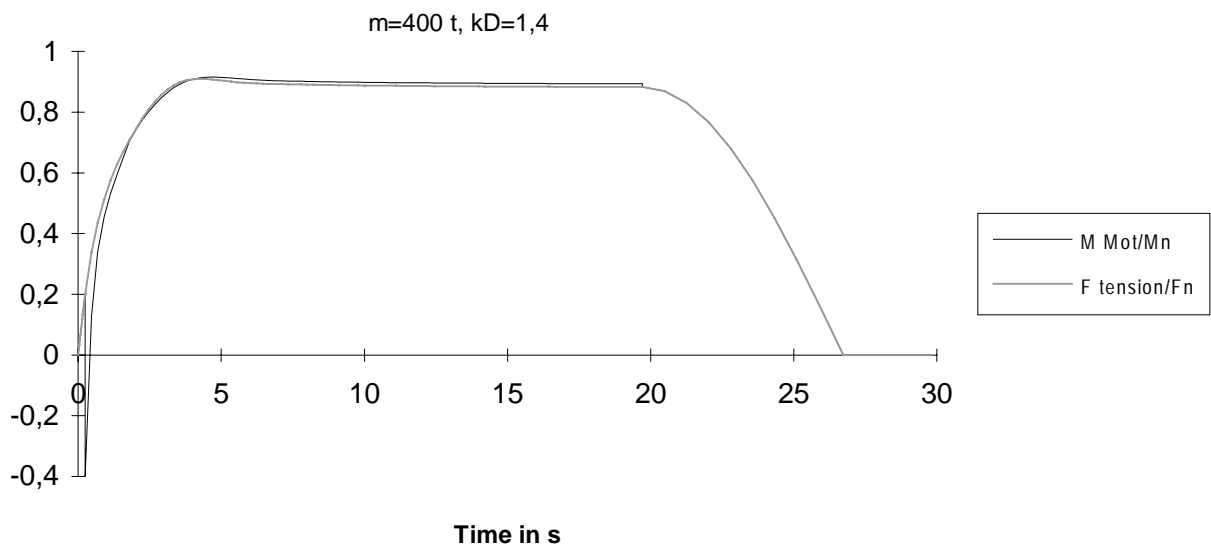

Behavior when accelerating the wagons with  $m=400\text{ t}$  and a compensation of  $k_D=1.4$ .

### Cable velocity across the drive wheel ( $v_1$ ), velocity of the wagons ( $v_2$ )

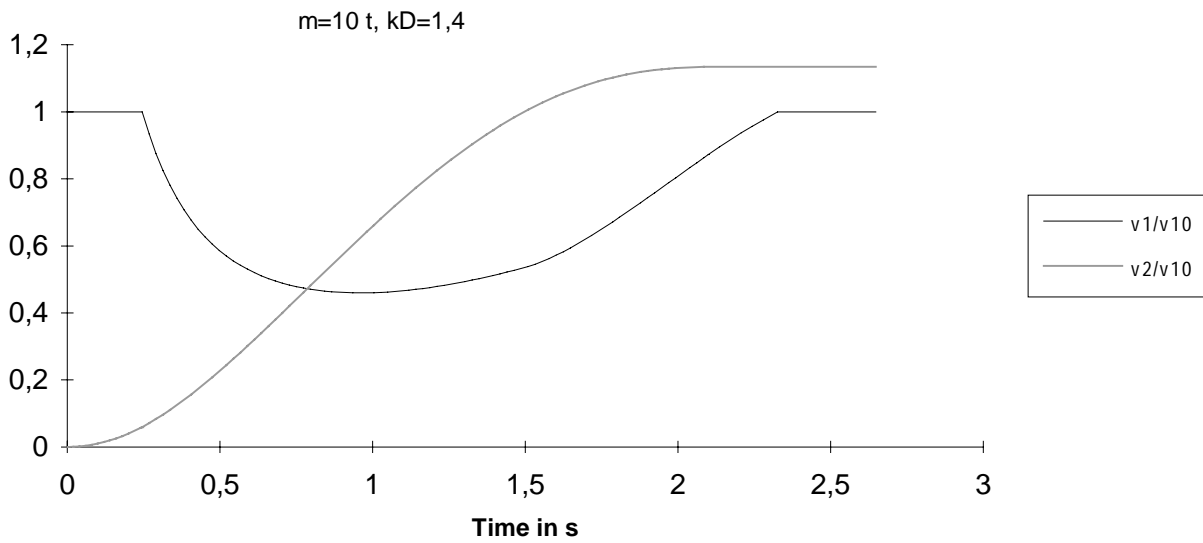

### Motor torque ( $M_{\text{Mot}}$ ), tension ( $F_{\text{tension}}$ )



Behavior when accelerating a wagon with  $m=10\text{ t}$  and a compensation of  $k_D=1.4$ .

### Implementing the torque compensation function



Switch  $S_2$  is closed before impact. Switch  $S_1$  closes after impact at  $M_{\text{motor}}=0.2 M_{\text{max}}$ .  $S_2$  opens after 1.5 s and ensures that compensation is slowly withdrawn. This can be realized, for example, using the T100 technology board.

### Selecting the motor and drive converter

The motor already exists.

Type: ABB with  $I_n=81$  A;  $n_n=735$  RPM;  $J_{\text{motor}}=1.2$  kgm<sup>2</sup>;  $\eta=0.93$ ;  $M_n=483$  Nm;  $M_{\text{stall}}/M_n=2.2$

Drive converter selected:

6SE7031-0EE60

$P_{Vn}=45$  kW;  $I_{Vn}=92$  A;  $I_{V\text{max}}=125.6$  A

Closed-loop speed control

T100 technology board

### Dimensioning the brake resistor

Braking energy is generated when:

- the trolley brakes to 0 after it moves backwards at 2.5 m/s (twice the velocity)

- b) the trolley brakes from 1.25 m/s to 0 while moving forwards  
 c) during impact

Case a)

When braking from twice the velocity in the speed range between 1500 RPM and 750 RPM, the motor is operated in the field-weakening range. Permissible motor torque at  $n_{\max}$  and 130 % safety margin from the stall torque:

$$M_{perm.} = \frac{M_{stall}}{1.3} = \frac{M_{stall} \cdot n}{1.3 \cdot n_{\max}} \cdot \left(\frac{n_0}{n_{\max}}\right)^2 = \frac{2.2 \cdot 483}{1.3} \cdot \left(\frac{750}{1500}\right)^2 = 204.4 \text{ Nm}$$

For  $M_{motor} = M_{perm.} = \text{constant}$  while braking, then the maximum braking power is given by:

$$P_{br \max} = \frac{M_{perm.} \cdot n_{\max}}{9550} \cdot \eta_{motor} = \frac{204.4 \cdot 1500}{9550} \cdot 0.93 = 29.9 \text{ kW}$$

The load moment of inertia is required to determine the braking time. The linearly-moved masses (trolley and cable) are assumed to be 1000 kg. Then, the following is true:

$$J_{load} = m \cdot r^2 = 1000 \cdot 0.36^2 = 129.6 \text{ kgm}^2$$

or, referred to the motor

$$J_{load}^* = \frac{J_{load}}{i^2} = \frac{129.6}{22.5^2} = 0.256 \text{ kgm}^2$$

Thus, when neglecting the friction and gearbox losses, the braking time is given by:

$$t_{br} = \frac{(J_{motor} + J_{load}^*) \cdot 2\pi \cdot n_{\max}}{60 \cdot M_{perm.}} = \frac{(1.2 + 0.256) \cdot 2\pi \cdot 1500}{60 \cdot 204.4} = 1.12 \text{ s}$$

Case b)

Braking from 750 RPM to 0 in the constant-flux range is to be realized in, for example, 0.5 s. Thus, the motor torque is given by:

$$M_{motor} = \frac{(J_{motor} + J_{load}^*) \cdot 2\pi \cdot n_0}{60 \cdot t_{br}} = \frac{(1.2 + 0.256) \cdot 2\pi \cdot 750}{60 \cdot 0.5} = 228.7 \text{ Nm}$$

Thus, the maximum braking power is given by:

$$P_{br \max} = \frac{M_{motor} \cdot n_0}{9550} \cdot \eta_{motor} = \frac{228.7 \cdot 750}{9550} \cdot 0.93 = 16.7 \text{ kW}$$

Case c)

As can be seen from the diagrams, the most unfavorable case is when the wagon(s) is(are) braked without torque compensation. The theoretical maximum braking power for  $M_{\text{motor}}=M_n$  and  $n=-n_0$  is obtained as follows:

$$P_{br \max} = \frac{M_n \cdot n_0}{9550} \cdot \eta_{\text{motor}} = \frac{483 \cdot 750}{9550} \cdot 0.93 = 35.3 \text{ kW}$$

However, this value does not actually occur in practice as the cable friction and gearbox losses were neglected. The behavior with a damping compensation of  $k_D=1.4$  is more realistic. In this case, the maximum braking power after impact with  $M_{\text{motor}}=-0.4 M_n$  and  $n=-n_0$  is given by:

$$P_{br \max} = \frac{0.4 M_n \cdot n_0}{9550} \cdot \eta_{\text{motor}} = \frac{0.4 \cdot 483 \cdot 750}{9550} \cdot 0.93 = 14.1 \text{ kW}$$

Thus, a maximum braking power for case a) of 29.9 kW is obtained. A braking unit with  $P_{20}=20$  kW (6SE7023-2EA87-2DA0) and external brake resistor (6SE7023-2ES87-2DC0) would be sufficient. This allows a peak braking power of  $1.5 P_{20}=30$  kW to be achieved for 3 s.

## 3.4.5 Drive for an eccentric press

A press drive with a 160 kW DC motor and  $n_n = 2400$  RPM is to be replaced by a three-phase drive. The DC motor speed control range is 436 RPM (setting-up speed) up to 2400 RPM (maximum speed).



Simplified function schematic

Drive data

Max. pressing force 25 mm before lower end stop

Max. deforming work

Diameter of the motor pulley wheel

Diameter of the drive wheel

Moment of inertia of the flywheel

Crank radius

$$F_{\text{load max}} = 10000 \text{ kN}$$

$$W_{\text{max}} = 250 \text{ kWs}$$

$$D_M = 300 \text{ mm}$$

$$D_S = 1670 \text{ mm}$$

$$J_S = 2845 \text{ kgm}^2$$

$$r = 470 \text{ mm}$$



Effective crank angle during impact	$\alpha_{St}$	= 18.8 degrees
Number of strokes at 436 RPM (crawl speed $n_{min}$ )	$z_{min}$	= 4/min
Number of strokes at 873 RPM (base speed $n_G$ )	$z_G$	= 8/min
Number of strokes at 2400 RPM (max. speed $n_{max}$ )	$z_{max}$	= 22/min
Required accelerating time from 0 to $n_{max}$	$t_h$	< 60 s
Required braking (deceleration) time from $n_{max}$ to 0	$t_{br}$	< 60 s

Using this drive data, it has to be checked whether a 4-pole 160 kW induction motor is suitable for the press drive.

Motor data

1LA6 316-4AA;  $n_n=1485$  RPM;  $M_n=1030$  Nm;  $J_{motor}=3.2$  kgm<sup>2</sup>;  $\eta_{motor}=0.958$ ;

$M_{stall}=2.7 M_n$ ;  $I_{motor n}=275$  A

The average motor power at maximum speed and an assumed press efficiency of 0.8:

$$P_{motor\ average} = \frac{W_{max} \cdot z_{max}}{\eta_{press}} = \frac{250\ kW_s \cdot 22\ RPM}{\eta_{press}} = \frac{250 \cdot 22}{0.8 \cdot 60} = 114.6\ kW$$

As far as the average power is concerned, this motor is adequate. However, the behavior during impact as well as the RMS motor loading should now be investigated.

*Calculating the ratios*

The ratio between the motor and gearbox is obtained as follows:

$$i_s = \frac{D_s}{D_M} = \frac{1670}{300} = 5.57$$

The total ratio between the motor and the crank wheel is obtained from the number of teeth as follows:

$$i_{total} = \frac{1670}{300} \cdot \frac{64}{19} \cdot \frac{170}{31} = 102.83$$

## Calculating the load torque

In the following calculation, the press efficiency, additional frictional forces and the moment of inertia of the gear are neglected. Further, it is assumed that the load force is constant during impact.



$F_T$ : Tangential force

$h$ : Ram displacement during pressing

$$M_{load} = F_T \cdot r = F_{load \max} \cdot r \cdot \frac{\sin(\alpha + \beta)}{\cos \beta}$$

$$h = r \cdot (1 - \cos \alpha_{St})$$

For  $l/r \gg 1$ , or for a small angle  $\alpha$ , the equation for  $M_{load}$  is simplified as follows:

$$M_{load} = F_T \cdot r \approx F_{load \max} \cdot r \cdot \sin \alpha$$

For  $\alpha = \alpha_{St} = 18.8$  degrees, the maximum load torque referred to the motor is obtained as follows:

$$M_{load \max}^* = \frac{F_{load \max} \cdot r \cdot \sin \alpha_{St}}{i_{total}} = \frac{10000 \text{ kN} \cdot 0.47 \cdot \sin(18.8 \cdot \frac{\pi}{180})}{102.83} = 14.73 \text{ kNm}$$

The motor cannot produce this torque. It must be provided by the flywheel.

Calculating the mechanical time constant:

$$T_{mech} = \frac{J^* \cdot 2\pi \cdot n_n \cdot s_n}{M_n \cdot 60}$$

With

$$J^* = \frac{J_S}{i_S^2} + J_{motor} = \frac{2845}{5.57^2} + 3.2 = 94.9 \text{ kgm}^2 \quad (\text{total moment of inertia referred to the motor})$$

$$s_n = \frac{n_{syn} - n_n}{n_{syn}} = \frac{1500 - 1485}{1500} = 0.01 \quad (\text{motor slip})$$

the following is obtained:

$$T_{mech} = \frac{94.9 \cdot 2\pi \cdot 1485 \cdot 0.01}{1030 \cdot 60} = 0.143 \text{ s}$$

The worst case condition, with impact at the lowest operating speed, is now investigated i.e. at the base speed. The time for the impact at  $n_G = 873$  RPM, but neglecting the speed dip, is obtained as follows:

$$t_{St} \approx \frac{\alpha}{\omega_{load}} = \frac{\alpha \cdot i_{total} \cdot 60}{2\pi \cdot n_G} = \frac{18.8 \cdot \frac{\pi}{180} \cdot 102.83 \cdot 60}{2\pi \cdot 873} = 0.369 \text{ s}$$

As the following is not valid for the mechanical time constant:  $T_{mech} \gg t_{St}$ , the motor quickly reaches the torque limit. The motor speed is then mainly defined by the load. In order to simplify the calculation, it is assumed that the torque is limited at the start of impact. Then, the following is true:

$$i_{total} \cdot M_{motor \max} - F_{load \max} \cdot r \cdot \sin \alpha = J_{load} \cdot \frac{d\omega_{load}}{dt}$$

$$\omega_{load} = -\frac{d\alpha}{dt}$$

With

$$J_{load} = J^* \cdot i_{total}^2$$

$$M_{motor\ max} = \text{torque limit}$$

This differential equation system can be solved, for example, using the Runge Kutta technique. For a small angle  $\alpha$ , with  $\sin \alpha \approx \alpha$ , a differential equation can be analytically solved as follows:

$$\frac{d^2 \alpha}{dt^2} - \frac{F_{load\ max} \cdot r}{J_{load}} \cdot \alpha = - \frac{i_{total} \cdot M_{motor\ max}}{J_{load}}$$

Solution:

$$\alpha = C_1 \cdot e^{p_1 \cdot t} + C_2 \cdot e^{p_2 \cdot t} + \frac{i_{total} \cdot M_{motor\ max}}{F_{load\ max} \cdot r}$$

$$\omega_{load} = - \frac{d\alpha}{dt} = -C_1 \cdot p_1 \cdot e^{p_1 \cdot t} - C_2 \cdot p_2 \cdot e^{p_2 \cdot t}$$

$$n_{motor} = i_{total} \cdot \omega_{load} \cdot \frac{60}{2\pi}$$

with

$$p_{1,2} = \pm \sqrt{\frac{F_{load\ max} \cdot r}{J_{load}}}$$

$$C_1 = \frac{1}{2} \cdot \left( \alpha_{St} - \frac{i_{total} \cdot M_{motor\ max}}{F_{load\ max} \cdot r} - \frac{2\pi \cdot n_{motor\ 1}}{p_1 \cdot 60 \cdot i_{total}} \right)$$

$$C_2 = \frac{1}{2} \cdot \left( \alpha_{St} - \frac{i_{total} \cdot M_{motor\ max}}{F_{load\ max} \cdot r} + \frac{2\pi \cdot n_{motor\ 1}}{p_1 \cdot 60 \cdot i_{total}} \right)$$

With the specified data, and the specification  $M_{motor\ max} = 1.5 \cdot M_n$ , the characteristic of  $\omega_{load}$  and  $n_{motor}$  can be calculated during the impact. For  $n_{motor\ 1} = n_G$  (motor speed before impact), by iterating for  $\alpha=0$ , the following values are obtained:

$$n_{motor\ 2} = 613 \text{ RPM} \quad (\text{motor speed after the impact})$$

$$t_{St} = 0.47 \text{ s} \quad (\text{impact time})$$

Towards the end of the impact, if the motor torque exceeds the load torque, the flywheel is again accelerated with  $M_{motor} = M_{motor\ max}$ . The following is valid:

$$i_{total} \cdot M_{motor\ max} = J_{load} \cdot \frac{d\omega_{load}}{dt}$$

Thus, the motor speed is given by:

$$n_{motor} = n_{motor\ 2} + \frac{i_{total}^2 \cdot M_{motor\ max} \cdot 60}{J_{load} \cdot 2\pi} \cdot (t - t_{St})$$

or for the accelerating time from  $n_{motor\ 2}$  to  $n_{motor\ 1}$ :

$$\begin{aligned} t_b &= \frac{J^* \cdot 2\pi}{M_{motor\ max} \cdot 60} \cdot (n_{motor\ 1} - n_{motor\ 2}) \\ &= \frac{94.9 \cdot 2\pi}{15 \cdot 1030 \cdot 60} \cdot (873 - 613) = 1.67\ s \end{aligned}$$

The time from the start of impact until the original speed has been reached again, is given by:

$$t_{St} + t_b = 0.47 + 1.67 = 2.14\ s$$

The maximum available time at  $n_G$ , with 8 strokes/min is obtained as follows:

$$t_{max} = \frac{1}{z_G} = \frac{\min}{8} = \frac{60\ s}{8} = 7.5\ s$$

The load torque and the motor speed at the lowest operating speed  $n_{motor\ 1} = n_G = 873\ \text{RPM}$  is illustrated in the following diagrams.



Load torque and motor speed at  $n_{motor 1} = n_G = 873$  RPM

*Simplified calculation*

Using the conservation of energy equation, the magnitude of the speed dip as well as the impact time can be approximately calculated. The energy supplied from the flywheel is:

$$\Delta W = \frac{1}{2} \cdot J^* \cdot \left(\frac{2\pi}{60}\right)^2 \cdot (n_{motor\ 1}^2 - n_{motor\ 2}^2) = W_{max} - W_{motor}$$

$W_{motor}$  is the energy supplied from the motor during impact:

$$W_{motor} = \int_0^{\alpha_{St}} M_{motor} \cdot i_{total} \cdot d\alpha = M_{motor\ max} \cdot i_{total} \cdot \alpha_{St}$$

Thus, the motor speed after the impact is given by:

$$n_{motor\ 2} = \sqrt{n_{motor\ 1}^2 - \frac{W_{max} - M_{motor\ max} \cdot i_{total} \cdot \alpha_{St}}{\frac{1}{2} \cdot J^* \cdot \left(\frac{2\pi}{60}\right)^2}}$$

The approximate impact time is given by:

$$t_{St} \approx \frac{i_{total} \cdot \alpha_{St}}{\omega_{motor}}$$

with the average motor speed:

$$\omega_{motor} = \frac{2\pi}{60} \cdot \frac{n_{motor\ 1} + n_{motor\ 2}}{2}$$

Using these formulas, the speed dip and the impact time for  $n_{motor\ 1}=873$  RPM are again checked.

$$n_{motor\ 2} = \sqrt{873^2 - \frac{250 \cdot 10^3 - 15 \cdot 1030 \cdot 102.83 \cdot 18.8 \cdot \frac{\pi}{180}}{\frac{1}{2} \cdot 94.9 \cdot \left(\frac{2\pi}{60}\right)^2}} = 618 \text{ RPM}$$

$$t_{St} \approx \frac{102.83 \cdot 18.8 \cdot \frac{\pi}{180}}{\frac{2\pi}{60} \cdot \frac{873 + 618}{2}} = 0.43 \text{ s}$$

*Behavior in the field-weakening range*

The drive is to be operated with constant power in the field-weakening range. Further, there should be a 130 % safety margin to the stall limit. Thus, the permissible motor torque is represented by the following characteristics.



If a torque of  $1.5 M_n$  is assumed in the constant-flux range, then the permissible torque at constant power for  $n_{\text{max}}$  is obtained as follows:

$$M_{\text{perm.}(n_{\text{max}})} = \frac{n_n}{n_{\text{max}}} \cdot 1.5 \cdot M_n = \frac{1485}{2400} \cdot 1.5 \cdot 1030 = 966 \text{ Nm}$$

On the other hand, with  $M_{\text{stall}} = 2.7 M_n$ , for  $n_{\text{max}}$ , the permissible torque for a 130 % safety margin is obtained as follows:

$$M_{\text{perm.}(n_{\text{max}})} = \frac{M'_{\text{stall}}}{1.3} = \left(\frac{n_n}{n_{\text{max}}}\right)^2 \cdot \frac{2.7 \cdot M_n}{1.3} = \left(\frac{1485}{2400}\right)^2 \cdot \frac{2.7 \cdot 1030}{1.3} = 819 \text{ Nm}$$

Thus, the limit for  $M_{\text{perm.}(n_{\text{max}})}$  is defined by the stall torque.

With  $M_{\text{perm.}(n_{\text{max}})}$ , the speed dip and the impact time can be calculated for  $n_{\text{motor}} = n_{\text{max}} = 2400$  RPM.

$$n_{\text{motor } 2} = \sqrt{2400^2 - \frac{250 \cdot 10^3 - 819 \cdot 102.83 \cdot 18.8 \cdot \frac{\pi}{180}}{\frac{1}{2} \cdot 94.9 \cdot \left(\frac{2\pi}{60}\right)^2}} = 2309 \text{ RPM}$$



$$t_{St} \approx \frac{102.83 \cdot 18.8 \cdot \frac{\pi}{180}}{\frac{2\pi}{60} \cdot \frac{2400 + 2309}{2}} = 0.137 \text{ s}$$

The following is valid for the accelerating time from  $n_{\text{motor 2}}$  to  $n_{\text{motor 1}}$ :

$$t_b = \frac{J^* \cdot 2\pi}{M_{\text{motor perm.}(n_{\text{max}})} \cdot 60} \cdot (n_{\text{motor 1}} - n_{\text{motor 2}}) = \frac{94.9 \cdot 2\pi}{819 \cdot 60} \cdot (2400 - 2309) = 1.1 \text{ s}$$

The condition

$$t_{St} + t_b < t_{\text{max}} = \frac{1}{z_{\text{max}}}$$

$$1.24 \text{ s} < \frac{60 \text{ s}}{22} = 2.73 \text{ s}$$

is also fulfilled.

#### *Calculating the accelerating- and decelerating times*

If the drive is accelerated from 0 to  $n_{\text{max}}$ , with the torque permissible at  $n_{\text{motor}} = n_{\text{max}}$  in the field weakening range, or is braked from  $n_{\text{max}}$  to 0, the accelerating- and decelerating times are given by:

$$t_h = t_{br} = \frac{J^* \cdot 2\pi \cdot n_{\text{max}}}{60 \cdot M_{\text{motor perm.}(n_{\text{max}})}} = \frac{94.9 \cdot 2\pi \cdot 2400}{60 \cdot 819} = 29.12 \text{ s}$$

This time is less than the specified 60 s.

## Thermally checking the motor

## Torque characteristic

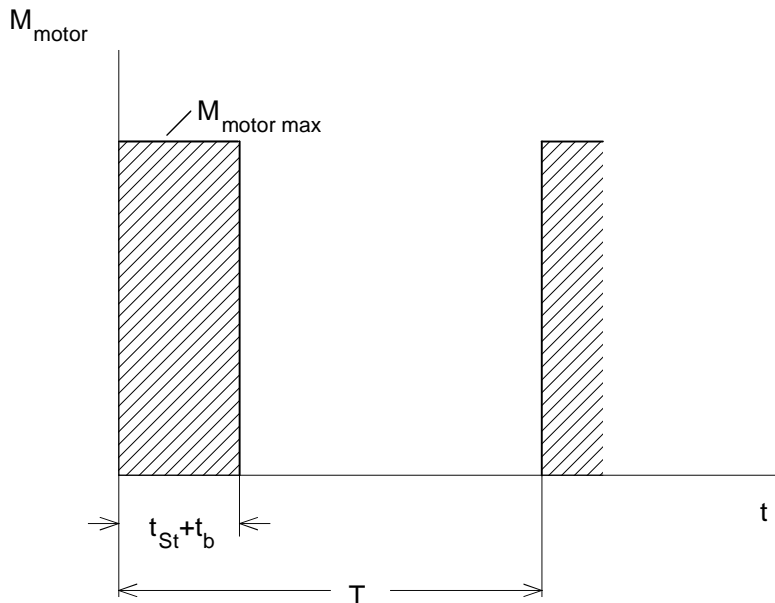

The RMS torque is obtained from the torque characteristic:

$$M_{RMS} = M_{\text{motor max}} \cdot \sqrt{\frac{t_{St} + t_b}{T}}$$

With

$$T = \frac{1}{z}$$

In this case, factor  $k_f$  is 1, as it involves continuous operation. The most unfavorable case is obtained at the lowest operating speed  $n_G$ , as in this case, the speed dip, and thus also the ratio  $t_{St} + t_b / T$  is its highest (at  $n_{\text{max}}$ , the RMS torque is always less than  $M_n$  due to  $M_{\text{motor max}} < M_n$ ).

For  $n_{\text{motor}} = n_G$ , the following value is obtained for  $M_{RMS}$ :

$$M_{RMS} = 15 \cdot M_n \cdot \sqrt{\frac{t_{St} + t_b}{\frac{1}{z_G}}} = 15 \cdot 1030 \cdot \sqrt{\frac{2.14}{7.5}} = 825 \text{ Nm}$$

Thus, the calculated RMS torque is less than the permissible motor torque in the speed control range 1:2. Thus, operation is thermally permissible.

### Selecting the drive converter

At 150 % motor torque, the maximum motor current is given by:

$$I_{motor\ max} \approx \sqrt{1.5^2 \cdot (I_{motor\ n}^2 - I_{\mu n}^2) + I_{\mu n}^2}$$

With  $I_{\mu n} = 0.27 \cdot I_{motor\ n}$ , the following is obtained:

$$I_{motor\ max} \approx \sqrt{1.5^2 \cdot (275^2 - 0.27^2 \cdot 275^2) + 0.27^2 \cdot 275^2} = 404\ A$$

Thus, the RMS motor current can be calculated for the most unfavorable case at  $n_{motor} = n_G$ .

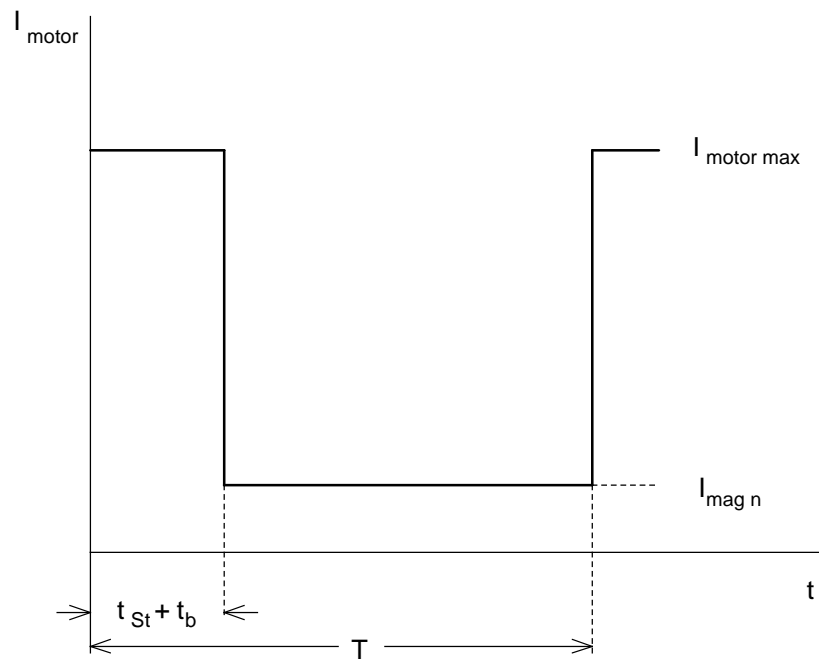

From the diagram above, the following is obtained for  $I_{motor\ RMS}$ :

$$I_{motor\ RMS} = \sqrt{\frac{I_{motor\ max}^2 \cdot (t_{St} + t_b) + I_{\mu n}^2 \cdot (T - (t_{St} + t_b))}{T}}$$

$$= \sqrt{\frac{404^2 \cdot 2.14 + 0.27^2 \cdot 275^2 \cdot (7.5 - 2.14)}{7.5}} = 225\ A$$

Selected drive converter:

6SE7033-2EG60

$P_{Vn}=160 \text{ kW}$ ;  $I_{Vn}=315 \text{ A}$ ;  $I_{Vmax}=430 \text{ A}$

Closed-loop frequency control mode

The rated drive converter current is greater than the RMS motor current. The maximum motor current therefore does not exceed the maximum drive converter current.

### *Dimensioning the brake resistor*

If the drive is also braked with the permissible torque at  $n_{max}$  in the field-weakening range, the maximum braking power for the brake resistor is obtained as follows:

$$P_{brWmax} = \frac{M_{motor\ perm. (n_{max})} \cdot n_{max}}{9550} \cdot \eta_{motor} = \frac{819 \cdot 2400}{9550} \cdot 0.958 = 197.2 \text{ kW}$$

The braking energy when braking from  $n_{max}$  to 0 at  $t_{br}=t_h$  is then as follows:

$$W_{br} = \frac{1}{2} \cdot P_{brWmax} \cdot t_{br} = \frac{1}{2} \cdot 197.2 \cdot 29.12 = 2871 \text{ kW s}$$

The following must then be valid for the brake resistor:

$$\frac{W_{br}}{T} = \frac{2871}{90} = 31.9 \text{ kW} \leq P_{br\ cont.}$$

With

$$P_{br\ cont.} = \frac{P_{20}}{4.5} \quad (\text{with an external brake resistor})$$

the following is obtained

$$31.9 \cdot 4.5 = 143.6 \text{ kW} \leq P_{20}$$

Thus, a braking unit is selected with  $P_{20} = 170 \text{ kW}$  (6SE7032-7EB87-2DA0) with an external brake resistor (6SE7032-7ES87-2DC0).

## 3.5 Load distribution for mechanically-coupled drives

### 3.5.1 General information

For mechanically-coupled drives, for example traction drives with several driven axes, or roller table drives which are coupling through the material, it is important to uniformly distribute the load over the individual drive motors. Depending on the particular application case, this can be implemented by using a group (sectional) drive with one drive converter, or using individual drives, each with its own dedicated drive converter.



Example of a mechanically-coupled drive

#### Multi-motor drive configuration

The simplest way of achieving a uniform load distribution for mechanically-coupled drives with motors having the same output is by using a multi-motor drive configuration. In this case, all of the motors are connected to a drive converter, and are therefore supplied with the same stator frequency. As a result of the mechanical coupling, the motors have the same speed with symmetrical relationships (identical gearbox ratio, identical roll diameter etc.). Deviations in the load distribution can therefore only come if the individual motors have different slip characteristics. In accordance with DIN VDE 0530, deviations of up to 20% are permissible. A specially-selected motor can also help. Problems can also occur for traction units with slightly different drive wheel diameters. The thus obtained speed differences increasingly influence the load distribution the lower the rated motor slip is.

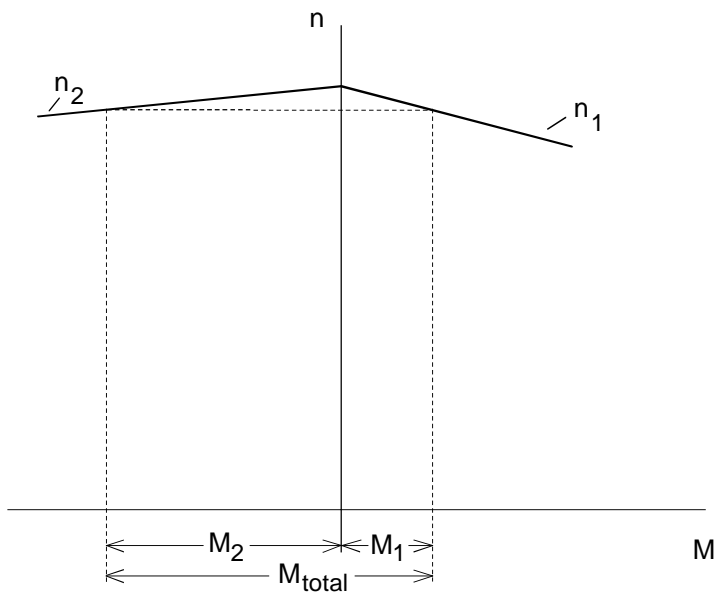

Example for the load distribution of 2 mechanically-coupled motors with different slip characteristics (the motor with the flatter characteristic accepts the higher load component)

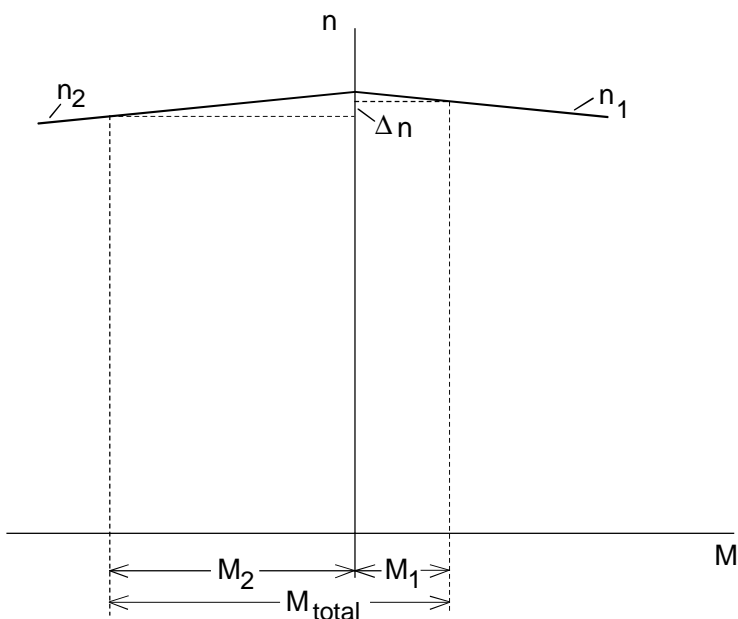

Example for the load distribution of 2 mechanically-coupled motors with different speeds, e. g. as a result of different wheel diameters (the motor with the lowest speed accepts the higher load component)

Group drives cannot be used with different motor outputs to provide a uniform load distribution if technological requirements oppose this (e. g. redundancy), or if the speed differences are too high.

### Single-motor drive configuration

For single-motor drives with motors having the same output, when the same setpoint is entered at all of the drive converters, characteristics can be achieved which are similar to those for a group drive. The setpoints should be digitally entered so that the stator frequencies, are, as far as possible, identical (e. g. via a peer-to-peer connection of the individual drive converters). Further, the same ramp-up and ramp-down times must be selected for all of the drive converters. When using the V/f characteristic or closed-loop frequency control, slip compensation must be disabled. Otherwise, load distribution cannot be realized through the motor slip. It is also not possible to use closed-loop speed control for the same reason (i.e. without "droop").

Further, it is possible to influence the load distribution by activating the so-called "droop" characteristic.

### *Droop characteristic*

SIMOVERT VC drive converters must be used when implementing the droop function. The droop function can be used for closed-loop frequency- or for closed-loop speed control. For closed-loop frequency control, it is only effective in the controlled range (from approx. 5 Hz).

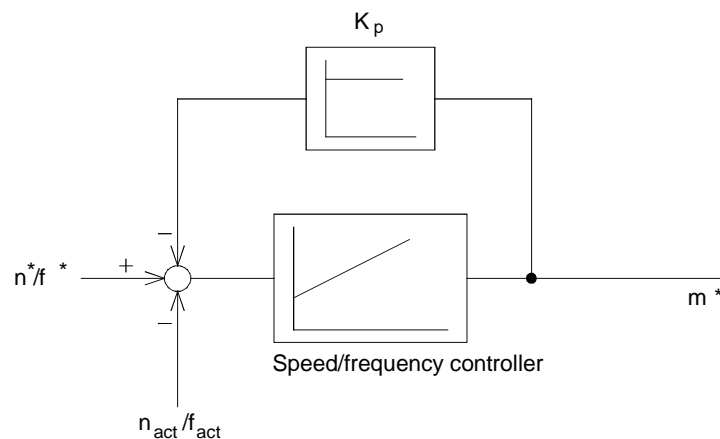

### Block diagram of "droop" for SIMOVERT VC

The droop function causes the motor slip to increase when a load is applied to the drive due to the negative feedback of the torque setpoint to the speed / frequency setpoint. Thus, under steady-state conditions, uniform load distribution can be achieved by setting the same slip characteristic.

"Load equalization control" and "master/slave drive" techniques provide a flexible way of ensuring unified load distribution, even at various speeds.

*Load equalization control*

SIMOVER VC drive converters must be used when implementing load equalization control. Closed-loop frequency control must be set. All of the drive converters receive the same frequency setpoint, and the same ramp-up and ramp-down times must be set. A uniform load distribution is achieved by comparing the torque setpoint of the first drive with the torque setpoints of all other drives, and then a frequency correction setpoint for these drives is generated by the PI controller, provided as standard in SIMOVER VC drive converters. This correction setpoint must be limited to approx. 300 to 400 % of the motor rated slip frequency. The load equalization control may only be enabled, if the closed-loop frequency control is fully operational (from approx. 5 Hz). Below this range, the open-loop controlled mode is used.

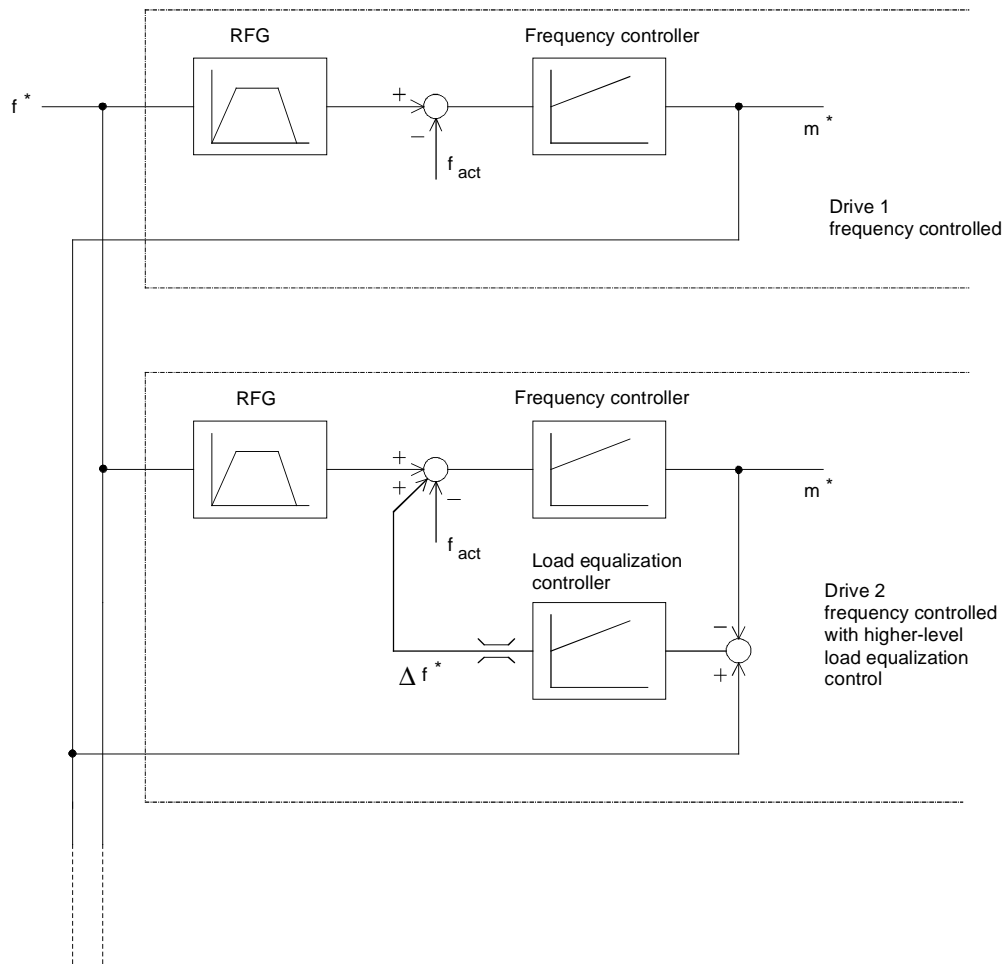

Block diagram of a load equalization control function



The frequency setpoint, torque setpoint and the control commands from the first converter are transferred to all of the other drive converters, for example, through a peer-to-peer coupling. In this case, the drive converters require an SCB2 board.



Example of a load equalization control function with peer-to-peer connection (RS485)

*Master/slave drive*

SIMOVERT VC drive converters are required to implement master/slave drives. Each drive requires a speed tachometer (preferably a pulse encoder due to the enhanced accuracy). For master/slave drives, the load is uniformly distributed over the complete speed range by transferring the torque setpoint of the speed-controlled master drive to the torque-controlled slave drive.

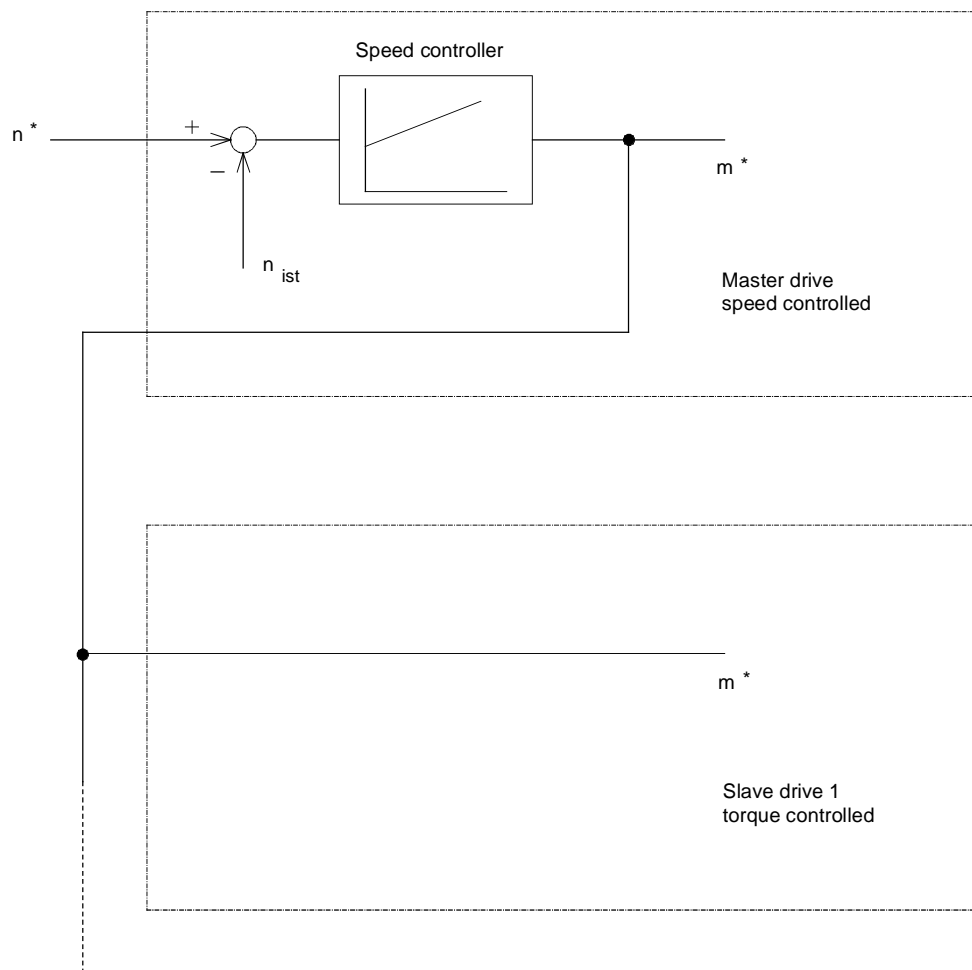

Block diagram of a master/slave drive

In order that the slave drives don't accelerate up to excessive speeds when the load is removed (e. g. this could happen if the material web breaks), the closed-loop torque control of the slave drive can be implemented using a speed control, overdriven with  $\Delta n^*$  with an appropriate torque limit. In this case, each slave drive requires, in addition to the torque setpoint of the master drive, the speed setpoint of the master drive.

From the master drive



Block diagram of a slave drive with over-driven closed-loop speed control

The torque setpoint, speed setpoint and the control commands can be transferred to the slave drives, for example, via a peer-to-peer connection.

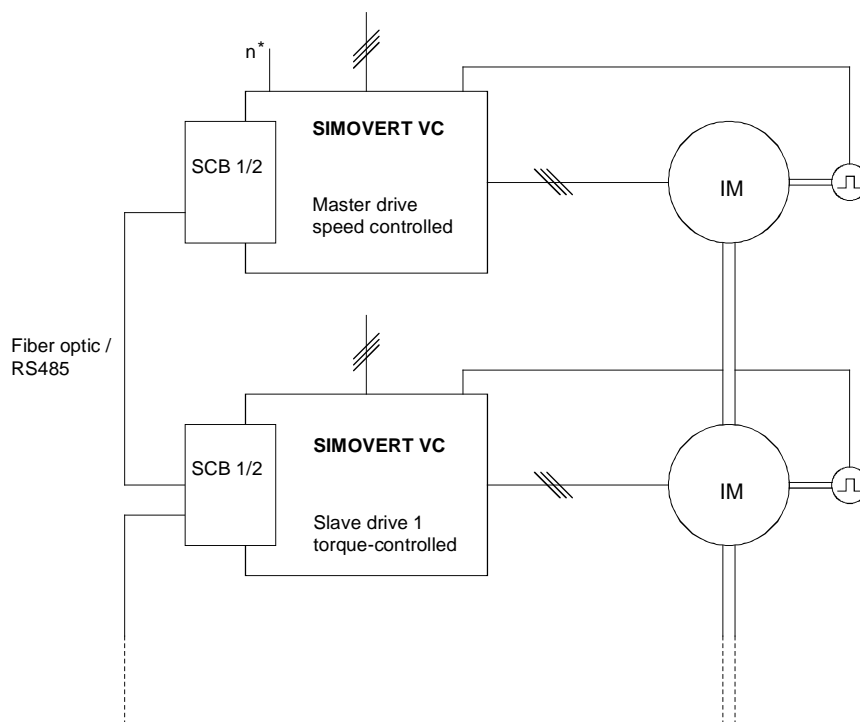

Example of a master/slave drive with peer-to-peer connection (SCB1: Fiber-optic cable, SCB2: RS485)

## 3.5.2 Group drive for a traction unit

The four wheels of a traction unit are each driven by a motor. The two motors on one side of the traction unit are fed from one converter. As result of the different wheel loads, the wheels are subject to different wear factors. The load distribution of the motors on one side of the traction unit at maximum different wheel diameters and maximum velocity are to be determined.

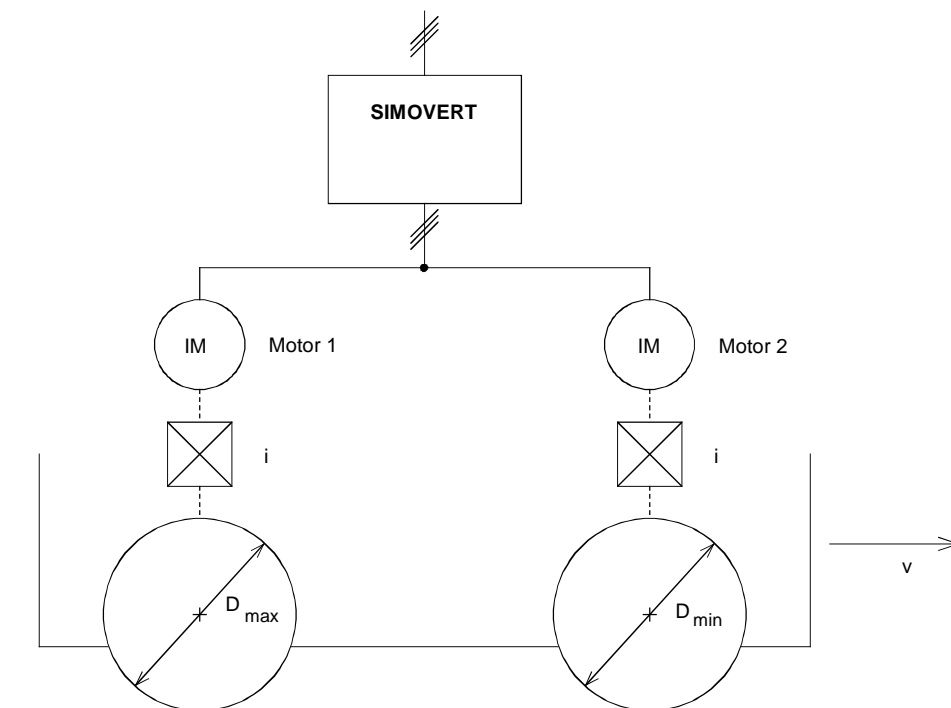

Block diagram of a traction unit side

## Drive data

Rated motor output (8-pole)	$P_n$	= 40 kW
Motor rated speed	$n_n$	= 740 RPM
Max. velocity	$v_{\max}$	= 49.73 m/min
Wheel diameter, new	$D_{\max}$	= 1.2 m
Wheel diameter, after wear	$D_{\min}$	= 1.19 m
Gearbox ratio	$i$	= 55.345

With  $v = v_{\max} = 49.73/60 = 0.829$  m/s, the motor speeds are given by:

$$n_1 = \frac{v_{\max} \cdot 60 \cdot i}{\pi \cdot D_{\max}} = \frac{0.829 \cdot 60 \cdot 55.345}{\pi \cdot 1.2} = 730 \text{ RPM}$$

$$n_2 = \frac{v_{\max} \cdot 60 \cdot i}{\pi \cdot D_{\min}} = \frac{0.829 \cdot 60 \cdot 55.345}{\pi \cdot 1.19} = 736 \text{ RPM}$$

The following assumption is made to calculate the motor torques:

$$n_1 = n_0 - n_{\text{slip } n} \cdot \frac{M_1}{M_n}$$

$$n_2 = n_0 - n_{\text{slip } n} \cdot \frac{M_2}{M_n}$$

$$M_1 + M_2 = M_{\text{load}}$$

With

$$n_{\text{slip } n} = n_{0n} - n_n = 750 - 740 = 10 \text{ RPM}$$

Thus, the motor torques are given by:

$$M_1 = \frac{M_{\text{load}}}{2} + \frac{(n_2 - n_1) \cdot M_n}{2 \cdot n_{\text{slip } n}}$$

$$M_2 = \frac{M_{\text{load}}}{2} - \frac{(n_2 - n_1) \cdot M_n}{2 \cdot n_{\text{slip } n}}$$

With the differential torque:

$$\Delta M = \frac{(n_2 - n_1) \cdot M_n}{2 \cdot n_{\text{slip } n}} = \frac{(736 - 730) \cdot M_n}{2 \cdot 10} = 0.3 \cdot M_n$$

The motor with the larger wheel diameter is loaded with 30% higher rated motor torque and the motor with the lower wheel diameter, with 30% less rated motor torque. When low velocities are approached, the difference between the torques becomes less. The different loading must be taken into account when dimensioning the motors and defining the closed-loop control type. A vector control can no longer be optimally set for such different torque loads. If vector control is required, e. g. as an angular synchronous control is being used for both traction unit sides, then a configuration with 4 individual drives could be considered. The two single-motor drives on a traction unit side are designed as master/slave drives, and the master drives coupled through the angular synchronous control function.



Example with  $M_{load} = 2 M_n$

For the above example with  $M_{load} = 2 M_n$ ,  $n_0$  is obtained as:

$$n_0 = n_1 + n_{slip n} \cdot \left( \frac{M_{load}}{2 \cdot M_n} + \frac{\Delta M}{M_n} \right) = 730 + 10 \cdot (1 + 0.3) = 743 \text{ RPM}$$

### 3.5.3 Drive for an extraction tower with 10 mechanically-coupled motors

An extraction tower is to be driven through a ring gear, pinion and gearbox with 10 motors, each 37 kW/ 6-pole,  $n_n = 980$  RPM. For redundancy reasons, each motor is provided with its own drive converter.

In order to reduce gear stressing, the motors may only generate torque in one direction (motoring). Braking is not required. As result of the symmetrical configuration, regenerative operation of the individual motors can practically only occur under no-load conditions without material, as even the smallest differences here influence the stator frequency. The rated slip frequency of the motors is given by:

$$f_{\text{slip } n} = \frac{1000 - 980}{1000} \cdot 50 \text{ Hz} = 1 \text{ Hz}$$

Thus, for a 0.01 Hz resolution stator frequency reference, the torque error lies below 1%. This can be achieved with a digital setpoint input. A peer-to-peer connection cannot be considered due to the required redundancy. Either a SINEC L2 DP bus connection via the CB1 board or an USS bus connection via the SCB2 board can be used. A V/f characteristic without slip compensation should be used. The ramp-up and ramp-down times must be the same for all drive converters.



#### Implementing a bus connection via SINEC L2-DP

### 3.6 Crank drive

Mass  $m$  is to be raised by  $2r$ , within  $0.25$  s, to the upper deadpoint ( $\varphi = \pi$ ) using a crank drive configuration, starting from the lower deadpoint ( $\varphi = 0$ ). The return stroke is realized after a  $0.25$  s delay time. The stroke cycle time is  $5$  s.



#### Drive data

Mass to be moved	$m$	= 300 kg
Crank radius	$r$	= 0.06 m
Connecting rod length	$l$	= 0.3 m
Positioning time	$t_{\text{total}}$	= 0.25 s
Cycle time	$T$	= 5 s



Angular velocity  $\omega$  and angular acceleration  $\alpha$

Positioning should be as fast as possible, i. e. a triangular characteristic with  $t_b = t_v = 0.125$  s is used.



The maximum angular velocity during the upwards motion occurs at  $t = t_{\text{total}}/2 = 0.125$  s or at an angle of  $\varphi = \pi/2$ .



Using the following equation

$$\varphi = \frac{\omega_{\max} \cdot \frac{t_{\text{total}}}{2}}{2} = \frac{\pi}{2}$$

the maximum angular velocity is given by:

$$\omega_{\max} = \frac{2 \cdot \pi}{t_{\text{total}}} = \frac{2 \cdot \pi}{0.25} = 25.13 \text{ s}^{-1}$$

With

$$\omega_{\max} = \alpha_{\max} \cdot \frac{t_{\text{total}}}{2}$$

the maximum angular acceleration is given by:

$$\alpha_{\max} = \frac{\omega_{\max}}{\frac{t_{\text{total}}}{2}} = \frac{25.13}{0.125} = 201.06 \text{ s}^{-2}$$

The maximum speed at  $\omega = \omega_{\max}$  is given by:

$$n_{\max} = \frac{\omega_{\max} \cdot 60}{2 \cdot \pi} = \frac{25.13 \cdot 60}{2 \cdot \pi} = 240 \text{ RPM}$$

Due to the short accelerating- and decelerating times, precise positioning is only possible using a servo drive.

Converting the circular motion into a linear movement



$$x_{\min} = l - r \quad (\text{lower deadpoint})$$

$$x_{\max} = l + r \quad (\text{upper deadpoint})$$

From the diagram,  $x$  is obtained as follows:

$$x = \sqrt{l^2 - r^2 \cdot \sin^2 \varphi} - r \cdot \cos \varphi$$

$$\approx l - \frac{r^2}{2 \cdot l} \cdot \sin^2 \varphi - r \cdot \cos \varphi \quad (\text{approximation})$$

Thus, the following is obtained for velocity  $v_x$  and acceleration  $a_x$ :

$$v_x = \frac{dx}{d\varphi} \cdot \frac{d\varphi}{dt} \approx \omega \cdot r \cdot \left( \sin \varphi - \frac{r}{2 \cdot l} \cdot \sin 2\varphi \right)$$

$$a_x = \frac{dv_x}{d\varphi} \cdot \frac{d\varphi}{dt} \approx r \cdot (\omega^2 \cdot \cos \varphi + \alpha \cdot \sin \varphi) - \frac{r^2}{l} \cdot (\omega^2 \cdot \cos 2\varphi + \frac{\alpha}{2} \cdot \sin 2\varphi)$$

To evaluate these equations for  $v_x$  and  $a_x$ , angular velocity  $\omega$ , angular acceleration  $\alpha$  and angle  $\varphi$  should be determined as a function of time  $t$ . To realize this, motion is sub-divided into four ranges.

Range 1  $(0 \leq t \leq 0.125 \text{ s and } 0 \leq \varphi \leq \frac{\pi}{2})$  upwards motion, accelerating

$$\alpha_1 = \alpha_{\max}$$

$$\omega_1 = \alpha_{\max} \cdot t$$

$$\varphi_1 = \frac{1}{2} \cdot \alpha_{\max} \cdot t^2$$

Range 2  $(0.125 \text{ s} \leq t \leq 0.25 \text{ s and } \frac{\pi}{2} \leq \varphi \leq \pi)$  upwards motion, decelerating

$$\alpha_2 = -\alpha_{\max}$$

$$\omega_2 = \alpha_{\max} \cdot (0.25 \text{ s} - t)$$

$$\varphi_2 = \pi - \frac{1}{2} \cdot \alpha_{\max} \cdot (0.25 \text{ s} - t)^2$$

Range 3  $(0.5 \text{ s} \leq \varphi \leq 0.625 \text{ s and } \pi \leq \varphi \leq 3\frac{\pi}{2})$  downwards motion, accelerating

$$\alpha_3 = \alpha_{\max}$$

$$\omega_3 = \alpha_{\max} \cdot (t - 0.5 \text{ s})$$

$$\varphi_3 = \pi + \frac{1}{2} \cdot \alpha_{\max} \cdot (t - 0.5 \text{ s})^2$$

Range 4  $(0.625 \text{ s} \leq \varphi \leq 0.75 \text{ s and } \frac{3}{2}\pi \leq \varphi \leq 2\pi)$  downwards motion, decelerating

$$\alpha_4 = -\alpha_{\max}$$

$$\omega_4 = \alpha_{\max} \cdot (0.75 \text{ s} - t)$$

$$\varphi_4 = 2\pi - \frac{1}{2} \cdot \alpha_{\max} \cdot (0.75 \text{ s} - t)^2$$

## Calculating the load torque



$$\delta = \pi - \varphi$$

$$\delta + \beta + \gamma = \pi$$

$$r \cdot \sin \delta = r \cdot \sin \varphi = l \cdot \sin \beta$$

With linear acceleration  $a_x$ , the following force acts on mass  $m$ :

$$F = m \cdot g + m \cdot a_x \quad \text{linear force}$$

Using the angular relationships, which can be derived from the diagram above, the connecting rod force, the tangential force and the load force are obtained as follows:

$$F_S = \frac{F}{\cos \beta} \quad \text{connecting rod force}$$

$$F_T = F_S \cdot \sin(\delta + \beta) = F_S \cdot \sin(\pi - \varphi + \beta) \quad \text{tangential force}$$

$$M_{load} = F_T \cdot r = m \cdot (g + a_x) \cdot \frac{\sin(\pi - \varphi + \beta)}{\cos \beta} \cdot r \quad \text{load torque}$$

With

$$\beta = \arcsin\left(\frac{r}{l} \cdot \sin \varphi\right)$$

As result of the irregular angular velocity and the complex angular relationships, it is relatively complex to calculate the load torque. In order to evaluate the equations, it is recommended that a program such as Excel is used.

If  $l$  is much greater than  $r$  (approx. from  $r / l < 0.1$ ), the following approximation can be used as a function of  $\varphi$  to calculate the load torque:

$$M_{load(\varphi)} \approx m \cdot r \cdot (g \cdot \sin \varphi + \alpha_{max} \cdot r \cdot \varphi \cdot \sin 2\varphi + \alpha_{max} \cdot r \cdot \sin^2 \varphi) \quad \text{for } 0 \leq \varphi \leq \frac{\pi}{2}$$

$$M_{load(\varphi)} \approx m \cdot r \cdot (g \cdot \sin \varphi + \alpha_{max} \cdot r \cdot (\pi - \varphi) \cdot \sin 2\varphi - \alpha_{max} \cdot r \cdot \sin^2 \varphi) \quad \text{for } \frac{\pi}{2} \leq \varphi \leq \pi$$

The range  $\pi \leq \varphi \leq 2\pi$  is a mirror image of range  $0 \leq \varphi \leq \pi$ .

The maximum load torque can be determined using this approximation. The maximum lies within the range  $\pi/4 < \varphi < \pi/2$ . If the approximation is used for this particular case, the maximum for  $M_{load}$  is obtained at  $\varphi = 1.185$  to 530 Nm. Angle  $\varphi$ , at which the maximum occurs, can also be determined by trial and error or by iteration.

Without this approximation, for the particular case, the following load torque characteristic is obtained



The maximum load torque when accelerating upwards is 572 Nm and when decelerating downwards, -572 Nm.

### Motor selection

Selected motor:

1FK6 103-8AF71 with gearbox  $i=10$  ( $\eta = 0.95$ ),  $n_n=3000$  RPM,  $J_{\text{motor}}=0.01215$  kgm<sup>2</sup>  
 $M_n(100)=17$  Nm,  $M_0(100)=36$  Nm,  $I_0(100)=23.8$  A,  $\eta_{\text{motor}}=0.94$ ,  $J_{\text{Gearbox}}=0.00174$  kgm<sup>2</sup>

Maximum motor speed:

$$n_{\text{motor max}} = i \cdot n_{\text{max}} = 10 \cdot 240 = 2400 \text{ RPM}$$

### Calculating the motor torques

Accelerating- and decelerating torques for the motor and the gearbox:

$$M_{b \text{ motor+gearbox}} = M_{v \text{ motor+gearbox}} = J_{\text{motor+gearbox}} \cdot i \cdot \alpha_{\text{max}} = (0.01215 + 0.00174) \cdot 10 \cdot 201.06 = 27.93 \text{ Nm}$$

Motor torque when accelerating:

$$M_{\text{motor}(t)} = M_{b \text{ motor}} + \frac{M_{\text{load}(t)}}{i \cdot \eta} \quad \text{for } 0 \leq t \leq 0.125 \text{ s and } 0.5 \text{ s} \leq t \leq 0.625 \text{ s } \quad 1)$$

1) If the load torque is negative in these ranges, then at the appropriate locations, factor  $1/\eta$  must be changed to  $\eta$ .

Motor torque when decelerating:

$$M_{\text{motor}(t)} = -M_{v \text{ motor}} + \frac{M_{\text{load}(t)}}{i} \cdot \eta \quad \text{for } 0.125 \text{ s} \leq t \leq 0.25 \text{ s and } 0.625 \text{ s} \leq t \leq 0.75 \text{ s } \quad 2)$$

2) If the load torque is positive in these ranges, at the appropriate locations, factor  $\eta$  must be changed into  $1/\eta$ .

The highest motor torque is required when accelerating upwards at  $n_{\text{motor}}=2220$  RPM:

$$M_{\text{motor max } b} = 27.93 + \frac{572}{10 \cdot 0.95} = 88.1 \text{ Nm}$$

The highest motor torque in regenerative operation is required when decelerating during downwards motion:

$$M_{\text{motor max } v} = -27.93 + \frac{-572}{10} \cdot 0.95 = -82.3 \text{ Nm}$$

Frictional forces and forces due to other moving masses have been neglected. The selected motor is adequately dimensioned, as at  $n_{\text{motor}}=2220$  RPM and 400 V supply voltage, it can be overloaded up to approx. 102 Nm.

Motor torque characteristic for this particular case

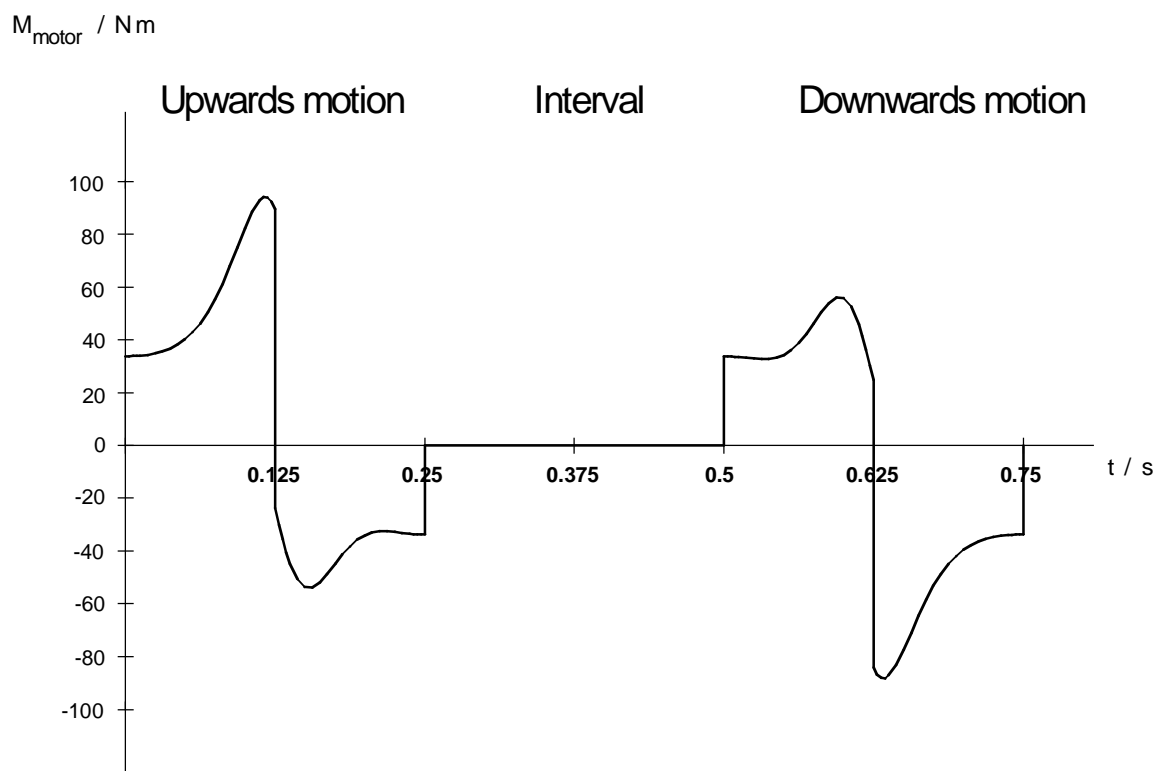



### Calculating the maximum motor output

The motor output is obtained from the motor torque and the angular velocity:

$$P_{motor(t)} = M_{motor(t)} \cdot i \cdot \omega_{(t)}$$

From the calculation, the maximum motor output is 21.2 kW when accelerating during upwards motion. The maximum motor output in regenerative operation is -19.8 kW. It occurs when decelerating during downwards motion.

Motor output characteristic for this particular case



### Thermally checking the motor

The RMS torque for 1FT6 motors is generally obtained as follows for any torque characteristics:

$$M_{RMS} = \sqrt{\frac{\int M^2 dt}{T}}$$

The integral expression can be approximately solved as follows by sub-dividing it into m segments:

$$\int M^2 dt \approx \sum_{i=1}^{i=m} \frac{M_{i-1}^2 + M_i^2}{2} \cdot (t_i - t_{i-1})$$

To evaluate this approximation,  $M_{\text{motor}}$  must be available in tabular form. The following is obtained (refer to the table later on in the text):

$$\int_{t=0\text{ s}}^{t=0.25\text{ s}} M^2 dt + \int_{t=0.5\text{ s}}^{t=0.75\text{ s}} M^2 dt \approx 1009 \text{ N}^2 \text{ m}^2 \text{ s}$$

Thus, the following is obtained:

$$M_{RMS} \approx \sqrt{\frac{1009}{5}} = 14.2 \text{ Nm}$$

The average motor speed is given by:

$$n_{\text{average}} = \frac{\frac{n_{\text{mot max}}}{2} \cdot 4 \cdot t_b}{T} = \frac{2400 \cdot 2 \cdot 0.125}{5} = 120 \text{ RPM}$$

The calculated RMS torque lies, at  $n_{\text{average}}$ , below the  $M_{S1}$  characteristic. Thus, operation is permissible.

### Dimensioning the brake resistor

Maximum braking power for the brake resistor:

$$P_{br W \text{ max}} = P_{br \text{ motor max}} \cdot \eta_{\text{motor}} = 19.8 \cdot 0.94 = 18.6 \text{ kW}$$

Using the motor output, the braking energy for a cycle can be calculated as follows:

$$W_{br} = \int_{t=0.125\text{ s}}^{t=0.25\text{ s}} P_{\text{motor}} \cdot \eta_{\text{motor}} dt + \int_{t=0.625\text{ s}}^{t=0.75\text{ s}} P_{\text{motor}} \cdot \eta_{\text{motor}} dt$$

The integral expansion can be solved as follows by sub-dividing into m segments:

$$\int P_{\text{motor}} \cdot \eta_{\text{motor}} dt \approx \sum_{i=1}^{i=m} \eta_{\text{motor}} \cdot \frac{P_{\text{motor } i-1} + P_{\text{motor } i}}{2} \cdot (t_i - t_{i-1})$$

The calculation results in (refer to the table later in the text):

$$W_{br} \approx 1.4 \text{ kW s}$$

The following must be true for the brake resistor:

$$\frac{W_{br}}{T} = \frac{1.4}{5} = 0.28 \text{ kW} \leq P_{br \text{ cont.}}$$

With

$$P_{br \text{ cont.}} = \frac{P_{20}}{36} \quad (\text{with an internal brake resistor})$$

the following is obtained

$$36 \cdot 0.28 = 10.08 \text{ kW} \leq P_{20}$$

Further, the following must also be true:

$$P_{br \text{ W max}} = 18.6 \text{ kW} \leq 1.5 \cdot P_{20}$$

Thus, a braking unit is selected with  $P_{20} = 20 \text{ kW}$  (6SE7023-3EA87-2DA0). The internal brake resistor is adequate.

### *Selecting the drive converter*

The highest required motor torque is given by:

$$\frac{M_{motor \text{ max}}}{M_{0(100)}} = \frac{88.1}{36} = 2.45$$

The following value is obtained from the torque/current characteristic:

$$\frac{I_{motor \text{ max}}}{I_{0(100)}} = 2.7$$

and

$$I_{motor \text{ max}} = I_{0(100)} \cdot 2.7 = 23.8 \cdot 2.7 = 64.3 \text{ A}$$

Drive converter selected:

6SE7024-7ED51

$P_{Vn}=22$  kW;  $I_{Vn}=47$  A;  $I_{Vmax}=75.2$  A

Table for the approximate computation of the integral expression

t	$M_{load}$	$M_{motor}$	$P_{motor}$	$\approx \int M^2 \cdot dt$	$\approx \int P \cdot \eta \cdot dt$
0	0.00	27.93	0.00	0.00	0.00
0.025	10.52	29.03	1.46	20.29	0.00
0.05	61.48	34.40	3.46	45.62	0.00
0.072	180.63	46.94	6.80	82.87	0.00
0.094	394.58	69.46	13.13	160.19	0.00
0.116	572.09	88.15	20.56	298.73	0.00
0.1205	564.89	87.39	21.17	333.39	0.00
0.125	530.16	83.73	21.04	366.35	0.00
0.125	95.87	-17.84	-4.48	366.35	0.00
0.1375	-115.74	-38.92	-8.80	377.81	-0.08
0.15	-208.92	-47.77	-9.61	401.54	-0.19
0.15625	-210.25	-47.90	-9.03	415.85	-0.24
0.18125	-79.76	-35.50	-4.91	460.29	-0.40
0.20625	6.72	-27.22	-2.39	485.31	-0.49
0.25	0.00	-27.93	0.00	518.57	-0.54
0.5	0.00	27.93	0.00	518.57	-0.54
0.54375	-6.72	27.29	2.40	551.93	-0.54
0.56875	79.76	36.32	5.02	577.73	-0.54
0.59375	210.25	50.06	9.44	625.54	-0.54
0.6	208.92	49.92	10.04	641.16	-0.54
0.6125	115.74	40.11	9.073	666.79	-0.54
0.625	-95.87	18.82	4.73	679.06	-0.54
0.625	-530.16	-78.29	-19.68	679.06	-0.54
0.6295	-564.89	-81.59	-19.77	707.83	-0.62
0.634	-572.09	-82.28	-19.19	738.04	-0.71
0.656	-394.58	-65.41	-12.36	859.57	-1.03
0.678	-180.63	-45.09	-6.53	929.00	-1.23
0.7	-61.48	-33.77	-3.39	963.90	-1.33
0.725	-10.52	-28.93	-1.45	988.62	-1.39
0.75	0.00	-27.93	0.00	1008.83	-1.40

### 3.7 Rotary table drive

This involves a so-called applicator drive with a maximum of 36000 applications per hour. An application means a rotation through 18 degrees within 50 ms and a subsequent interval of 50 ms.



#### *Drive data*

Angle for an application (i.e. attaching a label)	$\Delta \varphi$	= 18 degrees
Rotary table moment of inertia	$J_{load}$	= 0.05 kgm <sup>2</sup>
Positioning time	$t_{total}$	= 50 ms
Cycle time	T	= 100 ms

Positioning must be as fast as possible, i. e., a triangular characteristic with  $t_b = t_v = t_{total}/2 = 25 \text{ ms}$  is used.



With the following angle

$$\Delta \varphi = \frac{\omega_{load \max} \cdot t_{total}}{2} = \frac{\pi}{10}$$

the maximum angular velocity is given by:

$$\omega_{load \max} = \frac{2 \cdot \Delta \varphi}{t_{total}} = \frac{2 \cdot \frac{\pi}{10}}{0.05} = 12.57 \text{ s}^{-1}$$

With

$$\omega_{load \max} = \alpha_{load \max} \cdot \frac{t_{total}}{2}$$

the following is obtained for the maximum angular acceleration:

$$\alpha_{load \max} = \frac{2 \cdot \omega_{load \max}}{t_{total}} = \frac{2 \cdot 12.57}{0.05} = 502.7 \text{ s}^{-2}$$

The maximum load speed at  $\omega = \omega_{load\ max}$  is obtained as follows:

$$n_{load\ max} = \frac{\omega_{load\ max} \cdot 60}{2\pi} = 120\ RPM$$

As a result of the short accelerating- and decelerating times, precise positioning is only possible using a servo drive.

#### *Calculating the load torques when accelerating and decelerating*

As acceleration is the same as deceleration, the load torques are given by:

$$M_{b\ load} = M_{v\ load} = J_{load} \cdot \alpha_{load\ max} = 0.05 \cdot 502.7 = 25.13\ Nm$$

#### *Selecting the motor*

The following motor is selected (refer to Calculating the motor torques):

1FT6 062-6AC7 with gearbox  $i=5$  ( $\eta=0.95$ ),  $n_n=2000\ RPM$ ,  $J_{motor}=0.00085\ kgm^2$   
 $J_{gearbox}=0.0003\ kgm^2$ ,  $M_n(100)=5.2\ Nm$ ,  $I_n(100)=2.6\ A$ ,  $\eta_{motor}=0.84$

The gearbox ratio was selected close to the optimum:

$$i_{opt} = \sqrt{\frac{J_{load}}{J_{motor} + J_{gearbox}}} = \sqrt{\frac{0.05}{0.00085 + 0.0003}} = 6.6$$

Thus, the maximum motor speed is given by:

$$n_{motor\ max} = i \cdot n_{load\ max} = 5 \cdot 120 = 600\ RPM$$

#### *Calculating the motor torques when accelerating and decelerating*

Accelerating- and decelerating torques for the motor:

$$M_{b\ motor} = M_{v\ motor} = J_{motor} \cdot i \cdot \alpha_{load\ max} = 0.00085 \cdot 5 \cdot 502.7 = 2.14\ Nm$$

Accelerating- and decelerating torque for the gearbox:

$$M_{b \text{ gearbox}} = M_{v \text{ gearbox}} = J_{\text{gearbox}} \cdot i \cdot \alpha_{\text{load max}} = 0.0003 \cdot 5 \cdot 502.7 = 0.754 \text{ Nm}$$

Motor torque when accelerating:

$$\begin{aligned} M_{\text{motor}} &= M_{b \text{ motor}} + M_{b \text{ gearbox}} + M_{b \text{ load}} \cdot \frac{1}{i \cdot \eta} \\ &= 2.14 + 0.754 + 25.13 \cdot \frac{1}{5 \cdot 0.95} = 8.18 \text{ Nm} \end{aligned}$$

Motor torque when decelerating:

$$\begin{aligned} M_{\text{motor}} &= -M_{v \text{ motor}} - M_{v \text{ gearbox}} - M_{v \text{ load}} \cdot \frac{\eta}{i} \\ &= -2.14 - 0.754 - 25.13 \cdot \frac{0.95}{5} = -7.67 \text{ Nm} \quad (\text{regenerative operation}) \end{aligned}$$

The highest motor torque is required when accelerating. The selected motor is adequately dimensioned, as it can be overloaded up to approx. 24 Nm at  $n_{\text{max}}=600$  RPM and a 400 V supply voltage.

### Selecting the drive converter

A motor current, for the highest required motor torque, is obtained as follows:

$$I_{\text{motor max}} = I_{\text{motor n}} \cdot \frac{M_{\text{motor max}}}{M_{\text{motor n}}} = 2.6 \cdot \frac{8.18}{5.2} = 4.1 \text{ A} \quad (\text{for this motor there is hardly any saturation effect})$$

Selected drive converter:

6SE7013-0EP50 (Compact Plus)

$P_{Vn}=1.1$  kW;  $I_{Vn}=3$  A,  $I_{Vmax}=4.8$  A (160% overload capability)



### Dimensioning the brake resistor

Max. braking power for the brake resistor during deceleration from  $\omega_{\text{load max}}$  to 0:

$$\begin{aligned}
 P_{br W \max} &= P_{br motor \max} \cdot \eta_{motor} = \frac{M_{motor v} \cdot n_{motor \max}}{9550} \cdot \eta_{motor} \\
 &= \frac{7.67 \cdot 600}{9550} \cdot 0.84 = 0.405 \text{ kW}
 \end{aligned}$$

### Braking diagram

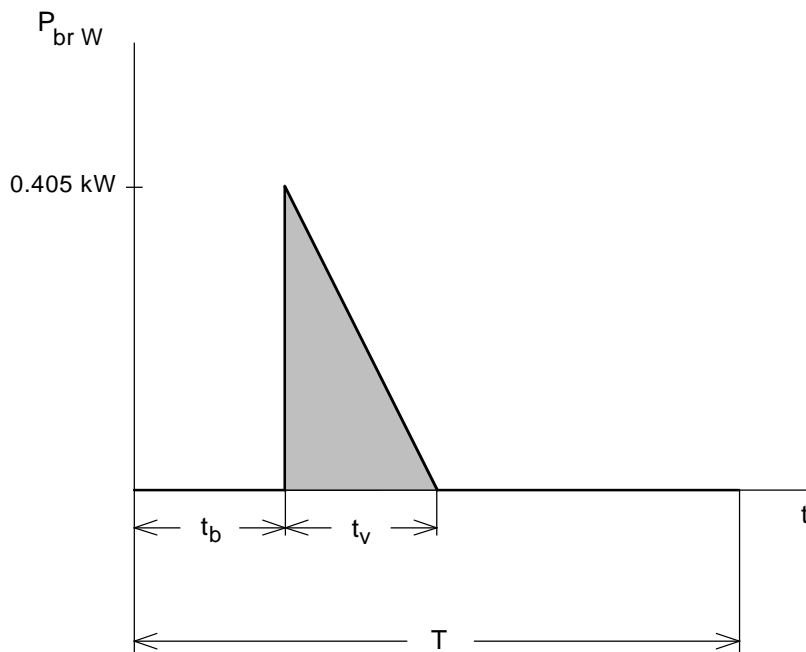

Braking energy for a cycle (corresponds to the area in the braking diagram):

$$\begin{aligned}
 W_{br} &= \frac{1}{2} \cdot P_{br W \max} \cdot t_v \\
 &= \frac{1}{2} \cdot 0.405 \cdot 0.025 = 0.005 \text{ kW} \cdot \text{s}
 \end{aligned}$$

The following must be true for the brake resistor:

$$\frac{W_{br}}{T} = \frac{0.005}{0.1} = 0.05 \text{ kW} \leq P_{br cont.}$$

With

$$P_{br\ cont.} = \frac{P_{20}}{4.5} \quad (\text{for an external brake resistor})$$

the following is obtained

$$4.5 \cdot 0.05 = 0.225 \text{ kW} \leq P_{20}$$

Thus, the smallest braking resistor is selected with  $P_{20} = 5 \text{ kW}$  (6SE7018-0ES87-2DC0).

*Thermally checking the motor*

Torque characteristic



The RMS torque and the average motor speed is given by:

$$M_{RMS} = \sqrt{\frac{8.18^2 \cdot 0.025 + 7.67^2 \cdot 0.025}{0.1}} = 5.61 \text{ Nm}$$

$$n_{\text{average}} = \frac{\frac{n_{\text{mot max}}}{2} \cdot 2 \cdot t_b}{T} = \frac{600 \cdot 0.025}{0.1} = 150 \text{ RPM}$$

The calculated RMS torque lies, at  $n_{\text{average}}$ , below the  $M_{S1}$  characteristic. Thus, operation is thermally permissible.

### 3.8 Pivot drive

This involves a pivot drive with an 180 degree rotational movement forwards and backwards through a horizontal axis. A servo drive is to be used. After the drive has rotated, it is held in the initial position by a mechanical brake.

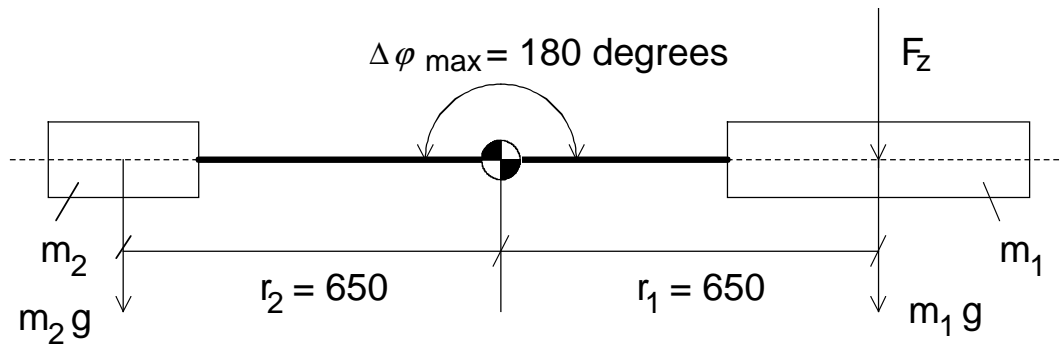

Initial position of the pivot drive

#### Drive data

Angle of rotation	$\Delta\varphi_{\max} = 180$ degrees
Weight	$m_1 = 170$ kg
Opposing weight	$m_2 = 130$ kg
Supplementary force	$F_z = 500$ N
Pivot time when moving through 180 degrees	$t_{\text{total}} = 3$ s
Delay time before the start (drive on)	$t_w = 3$ s
Interval between forwards and return motion (drive on)	$t_p = 1$ s
Cycle time	$T = 45$ s

Positioning should be as fast as possible, i. e., a triangular accelerating characteristic with  $t_b = t_v = t_{\text{total}}/2 = 1.5 \text{ s}$  is used. Thus, the following motion diagram is obtained.

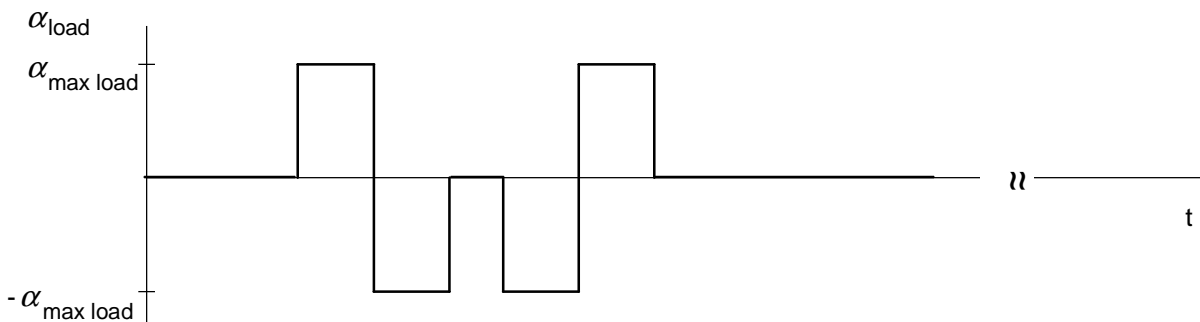
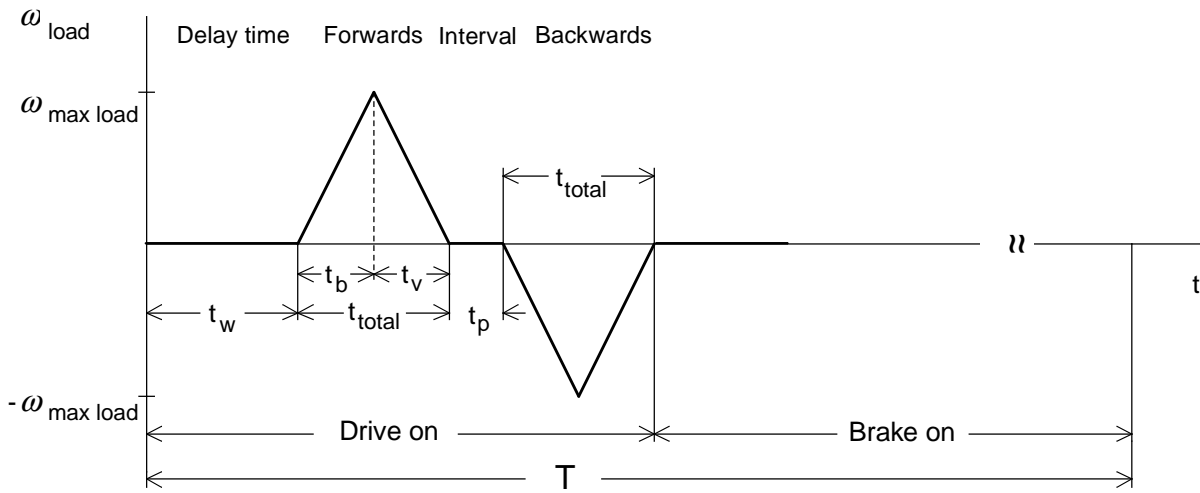

The maximum angular velocity and the maximum angular acceleration are given by:

$$\omega_{load \max} = \frac{2 \cdot \varphi_{\max}}{t_{\text{total}}} = \frac{2 \cdot \pi}{3} = 2.094 \text{ s}^{-1}$$

$$\alpha_{load \max} = \frac{\omega_{load \max} \cdot 2}{t_{\text{total}}} = \frac{2.094 \cdot 2}{3} = 1.396 \text{ s}^{-2}$$

The maximum load speed at  $\omega_{load} = \omega_{load\ max}$  is given by:

$$n_{load\ max} = \frac{\omega_{load\ max} \cdot 60}{2 \cdot \pi} = \frac{2.094 \cdot 60}{2 \cdot \pi} = 20\ RPM$$

As the geometrical dimensions of the weights are not known, it is assumed that their centers of gravity act at single points. Thus, the load moment of inertia is calculated as follows:

$$J_{load} = m_1 \cdot r_1^2 + m_2 \cdot r_2^2 = 170 \cdot 0.65^2 + 130 \cdot 0.65^2 = 126.75\ kgm^2$$

*Calculating the load torques*

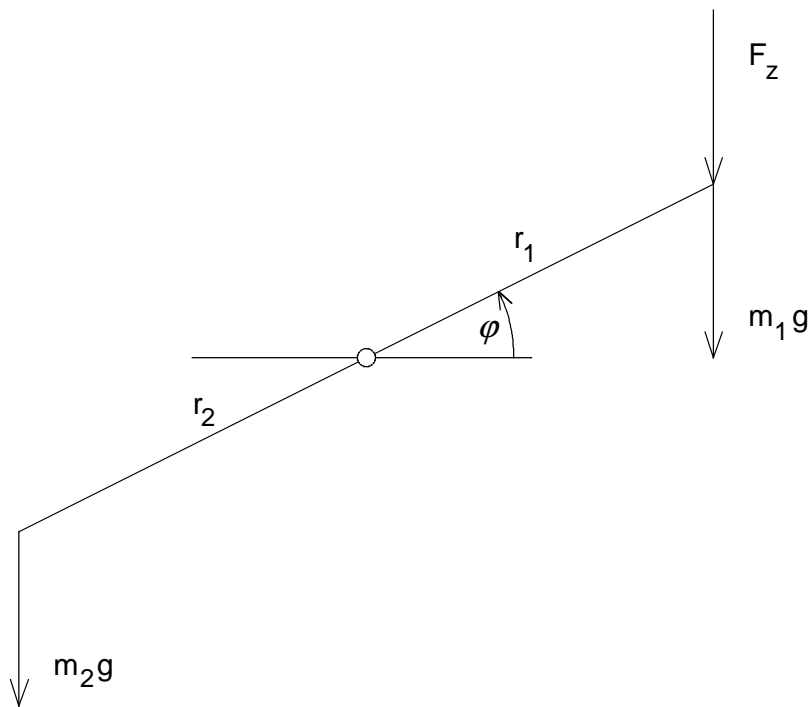

$$\begin{aligned} M_{load} &= (m_1 \cdot g + F_z) \cdot r_1 \cdot \cos \varphi - m_2 \cdot g \cdot r_2 \cdot \cos \varphi \\ &= ((170 \cdot 9.81 + 500) \cdot 0.65 - 130 \cdot 9.81 \cdot 0.65) \cdot \cos \varphi = 580.06\ Nm \cdot \cos \varphi \end{aligned}$$

The accelerating- and decelerating torque of the load is given by:

$$M_{b\ load} = M_{v\ load} = J_{load} \cdot \alpha_{load\ max} = 126.75 \cdot 1.396 = 177\ Nm$$

*Selecting the motor*

The following motor is selected (refer to Calculating the motor torques):

1FT6 062-1AF71 with gearbox  $i=150$  ( $\eta = 0.95$ );  $n_n=3000$  RPM;  $J_{\text{motor+brake}}=0.00105$  kgm<sup>2</sup>  
 $M_{n(100)}=4.6$  Nm;  $I_{n(100)}=3.4$  A;  $\eta_{\text{motor}}=0.88$

Maximum motor speed:

$$n_{\text{motor max}} = i \cdot n_{\text{load max}} = 150 \cdot 20 = 3000 \text{ RPM}$$

*Calculating the motor torques*

Accelerating- and decelerating torque for the motor:

$$M_{b \text{ motor}} = M_{v \text{ motor}} = J_{\text{motor}} \cdot i \cdot \alpha_{\text{load max}} = 0.00105 \cdot 150 \cdot 1.396 = 0.22 \text{ Nm}$$

Holding torque for the motor during delay time at  $\varphi = 0$  and during the no-load interval at  $\varphi = 180$  degrees:

$$M_{H \text{ motor}} = \frac{M_{\text{load}}}{i} = \frac{580.06}{150} = 3.87 \text{ Nm}$$

Motor torque when accelerating forwards:

$$\begin{aligned} M_{\text{motor}(t)} &= M_{b \text{ motor}} + (M_{\text{load}(t)} + M_{b \text{ load}}) \cdot \frac{1}{i \cdot \eta} && \text{for } 3 \text{ s} \leq t \leq 4.5 \text{ s} \text{ and } 0 \leq \varphi \leq \frac{\pi}{2} \\ &= 0.22 + (580.06 \cdot \cos \varphi + 177) \cdot \frac{1}{150 \cdot 0.95} \\ &= 1.46 \text{ Nm} + 4.07 \text{ Nm} \cdot \cos \varphi \end{aligned}$$

With

$$\varphi = \frac{1}{2} \cdot \alpha_{\text{load max}} \cdot (t - t_w)^2$$

Motor torque when decelerating forwards:

$$\begin{aligned}
 M_{motor(t)} &= -M_{v\ motor} + (M_{load(t)} - M_{v\ load}) \cdot \frac{\eta}{i} && \text{for } 4.5\ s \leq t \leq 6\ s \text{ and } \frac{\pi}{2} \leq \varphi \leq \pi \\
 &= -0.22 + (580.06 \cdot \cos\varphi - 177) \cdot \frac{0.95}{150} \\
 &= -1.34\ Nm + 3.67\ Nm \cdot \cos\varphi && \text{(regenerative operation)}
 \end{aligned}$$

With

$$\varphi = \pi - \frac{1}{2} \cdot \alpha_{load\ max} \cdot (t_w + t_{total} - t)^2$$

Motor torque when accelerating backwards:

$$\begin{aligned}
 M_{motor(t)} &= -M_{b\ motor} + (M_{load(t)} - M_{b\ load}) \cdot \frac{1}{i \cdot \eta} && \text{for } 7\ s \leq t \leq 8.5\ s \text{ and } \pi \geq \varphi \geq \frac{\pi}{2} \\
 &= -0.22 + (580.06 \cdot \cos\varphi - 177) \cdot \frac{1}{150 \cdot 0.95} \\
 &= -1.46\ Nm + 4.07\ Nm \cdot \cos\varphi
 \end{aligned}$$

With

$$\varphi = \pi - \frac{1}{2} \cdot \alpha_{load\ max} \cdot (t - t_{total} - t_p - t_w)^2$$

Motor torque when decelerating backwards:

$$\begin{aligned}
 M_{motor(t)} &= M_{v\ motor} + (M_{load(t)} + M_{v\ load}) \cdot \frac{\eta}{i} && \text{for } 8.5\ s \leq t \leq 10\ s \text{ and } \frac{\pi}{2} \geq \varphi \geq 0 \\
 &= 0.22 + (580.06 \cdot \cos\varphi + 177) \cdot \frac{0.95}{150} \\
 &= 1.34\ Nm + 3.67\ Nm \cdot \cos\varphi && \text{(regenerative operation)}
 \end{aligned}$$

With

$$\varphi = \frac{1}{2} \cdot \alpha_{load\ max} \cdot (2 \cdot t_{total} + t_p + t_w - t)^2$$

The highest motor torque is required when accelerating forwards at  $\varphi = 0$  and when accelerating backwards at  $\varphi = \pi$ :

$$M_{motor \max b} = 1.46 + 4.07 \cdot \cos 0 = 5.53 \text{ Nm}$$

The highest motor torque in regenerative operation is required when decelerating forwards at  $\varphi = \pi$  and when decelerating backwards at  $\varphi = 0$ :

$$M_{motor \max v} = -1.34 + 3.67 \cdot \cos \pi = -5.01 \text{ Nm}$$

The gearbox moment of inertia was neglected.

Motor torque characteristic for this particular case

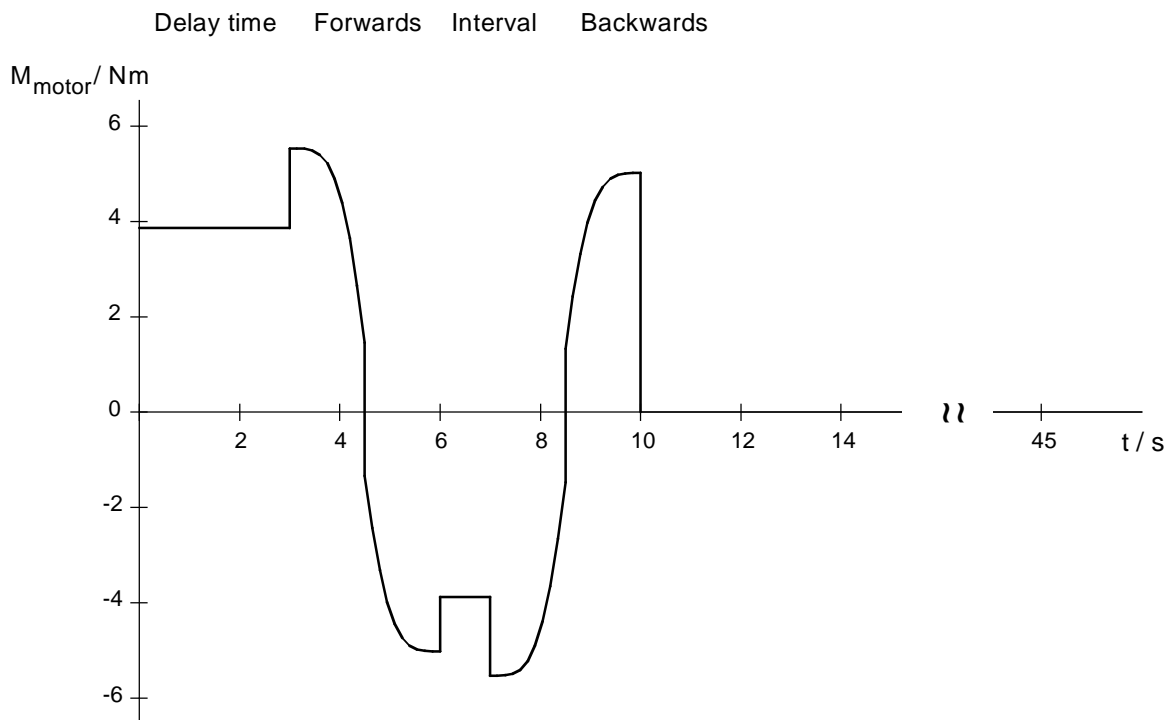



### Selecting the drive converter

For the highest required motor torque, the motor current is given by:

$$I_{motor\ max} = I_{motor\ n} \cdot \frac{M_{motor\ max}}{M_{motor\ n}} = 3.4 \cdot \frac{5.53}{4.6} = 4.09\ A \quad (\text{for this motor there is hardly any saturation effect})$$

Drive converter selected:

6SE7013-0EP50 (Compact Plus)

$P_{V\ n}=1.1\ kW$ ;  $I_{V\ n}=3\ A$ ;  $I_{V\ max}=4.8\ A$  (160% overload capability)

### Dimensioning the brake resistor

The motor output must be determined when dimensioning the brake resistor.

$$P_{motor} = M_{motor} \cdot \omega_{load} \cdot i$$

With

$\omega_{load} = 0$	for $0 \leq t \leq 3\ s$ and $\varphi = 0$
$\omega_{load} = \alpha_{load\ max} \cdot (t - t_w)$	for $3\ s \leq t \leq 4.5\ s$ and $0 \leq \varphi \leq \frac{\pi}{2}$
$\omega_{load} = \alpha_{load\ max} \cdot (t_w + t_{total} - t)$	for $4.5\ s \leq t \leq 6\ s$ and $\frac{\pi}{2} \leq \varphi \leq \pi$
$\omega_{load} = 0$	for $6\ s \leq t \leq 7\ s$ and $\varphi = \pi$
$\omega_{load} = -\alpha_{load\ max} \cdot (t - t_{total} - t_p - t_w)$	for $7\ s \leq t \leq 8.5\ s$ and $\pi \geq \varphi \geq \frac{\pi}{2}$
$\omega_{load} = -\alpha_{load\ max} \cdot (2 \cdot t_{total} + t_p + t_w - t)$	for $8.5\ s \leq t \leq 10\ s$ and $\frac{\pi}{2} \geq \varphi \geq 0$

Motor output characteristic for this particular case

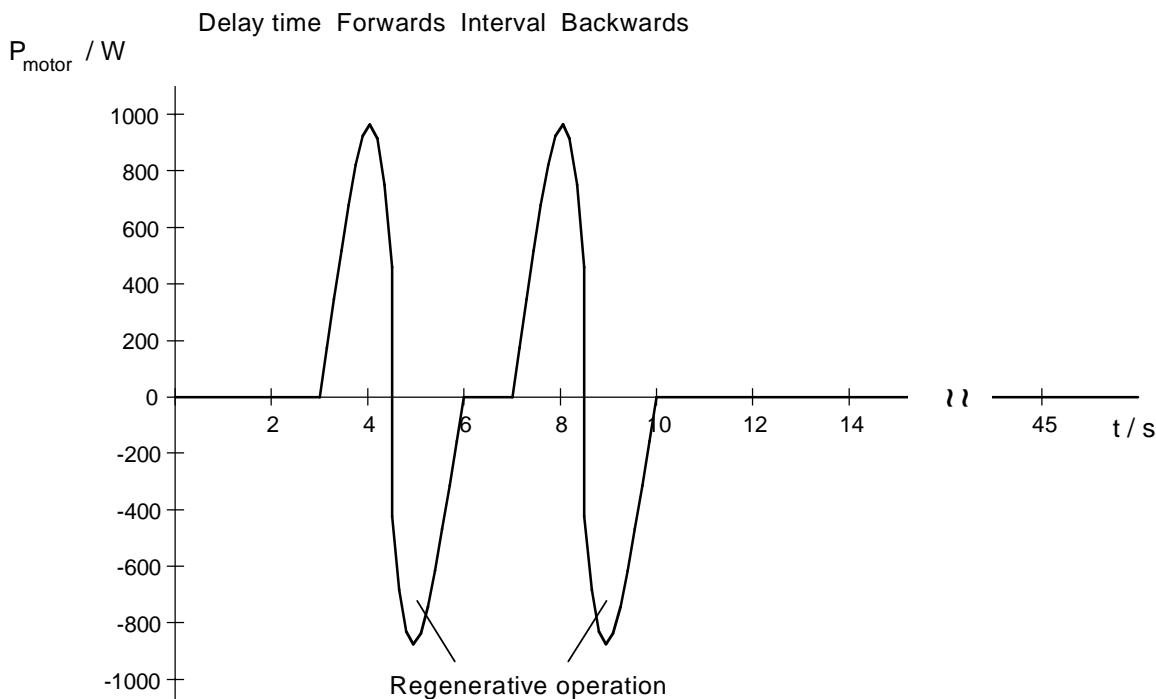

Regenerative operation occurs when decelerating in the ranges  $4.5 \text{ s} \leq t \leq 6 \text{ s}$  and  $8.5 \text{ s} \leq t \leq 10 \text{ s}$ .

From the calculation, the maximum motor output in regenerative operation is -875 W. Thus, the maximum braking power for the brake resistor is given by:

$$P_{br W \max} = P_{br \text{ motor } \max} \cdot \eta_{\text{motor}} = -875 \cdot 0.88 = -770 \text{ W}$$

The braking energy for a cycle can be calculated as follows from the motor output:

$$W_{br} = \int_{t=4.5 \text{ s}}^{t=6 \text{ s}} P_{\text{motor}} \cdot \eta_{\text{motor}} dt + \int_{t=8.5 \text{ s}}^{t=10 \text{ s}} P_{\text{motor}} \cdot \eta_{\text{motor}} dt$$

The integrals can be approximately calculated as follows by sub-dividing into  $m$  segments:

$$\int P_{\text{motor}} \cdot \eta_{\text{motor}} dt \approx \sum_{i=1}^{i=m} \eta_{\text{motor}} \cdot \frac{P_{\text{motor } i-1} + P_{\text{motor } i}}{2} \cdot (t_i - t_{i-1})$$

To evaluate this approximation formula,  $P_{\text{motor}}$  must be available in tabular form.

The calculation provides the following results (refer to the table later in the text):

$$\begin{aligned} W_{br} &\approx -757.67 - 757.67 \\ &\approx -1515.34 \text{ Ws} \end{aligned}$$

The following must be true for the brake resistor:

$$\frac{W_{br}}{T} = \frac{1515.34}{45} = 33.67 \text{ W} \leq P_{br \text{ cont.}}$$

With

$$P_{br \text{ cont.}} = \frac{P_{20}}{4.5} \quad (\text{with an external brake resistor})$$

the following is obtained

$$4.5 \cdot 33.67 = 151.5 \text{ W} \leq P_{20}$$

Further, the following must be true:

$$P_{br \text{ W max}} = 770 \text{ W} \leq 15 \cdot P_{20}$$

Thus, the smallest braking resistor is selected with  $P_{20} = 5 \text{ kW}$  (6SE7018-0ES87-2DC0).

#### *Thermally checking the motor*

For the RMS torque for 1FT6 motors, generally the following torque characteristics are valid:

$$M_{RMS} = \sqrt{\frac{\int M^2 dt}{T}}$$

The integral expression can be approximately calculated by sub-dividing into  $m$  segments:

$$\int M^2 dt \approx \sum_{i=1}^{i=m} \frac{M_{i-1}^2 + M_i^2}{2} \cdot (t_i - t_{i-1})$$

To evaluate this approximation formula,  $M_{\text{motor}}$  must be available in tabular form. The calculation provides the following results (refer to the table later in the text):

$$\int_{t=0 \text{ s}}^{t=10 \text{ s}} M^2 dt \approx 183.54 \text{ N}^2 \text{ m}^2 \text{ s}$$

Thus, the following is obtained:

$$M_{RMS} \approx \sqrt{\frac{183.54}{45}} \approx 2.02 \text{ Nm}$$

The calculated RMS torque is less than the torque permissible in S1 duty. Thus, operation is permissible.

Table for approximately calculating the integral expressions

t	M <sub>motor</sub>	P <sub>motor</sub>	$\approx \int M^2 \cdot dt$	$\approx \int P \cdot \eta \cdot dt$
0.00	3.87	0.00	0.00	0.00
3.00	3.87	0.00	44.86	0.00
3.00	5.53	0.00	44.86	0.00
3.15	5.53	173.79	49.45	0.00
3.30	5.52	347.11	54.03	0.00
3.45	5.49	517.59	58.55	0.00
3.60	5.40	679.16	62.94	0.00
3.75	5.22	820.36	67.03	0.00
3.90	4.90	923.40	70.63	0.00
4.05	4.39	964.32	73.51	0.00
4.20	3.64	915.58	75.50	0.00
4.35	2.66	751.75	76.56	0.00
4.50	1.46	459.25	76.88	0.00
4.50	-1.34	-421.21	76.88	0.00
4.65	-2.42	-684.52	77.76	-72.98
4.80	-3.31	-831.70	79.41	-173.05
4.95	-3.98	-875.02	81.78	-285.69
5.10	-4.44	-837.41	84.74	-398.71
5.25	-4.73	-743.75	88.10	-503.07
5.40	-4.90	-615.63	91.70	-592.79
5.55	-4.98	-469.15	95.42	-664.38
5.70	-5.01	-314.61	99.18	-716.11
5.85	-5.01	-157.52	102.95	-747.27
6.00	-5.01	0.00	106.72	-757.67

Continued on the next page

t	M <sub>motor</sub>	P <sub>motor</sub>	$\approx \int M^2 \cdot dt$	$\approx \int P \cdot \eta \cdot dt$
6.00	-3.87	0.00	106.72	-757.67
7.00	-3.87	0.00	121.68	-757.67
7.00	-5.53	0.00	121.68	-757.67
7.15	-5.53	173.79	126.27	-757.67
7.30	-5.52	347.11	130.85	-757.67
7.45	-5.49	517.59	135.37	-757.67
7.60	-5.40	679.16	139.75	-757.67
7.75	-5.22	820.36	143.84	-757.67
7.90	-4.90	923.40	147.44	-757.67
8.05	-4.39	964.32	150.33	-757.67
8.20	-3.64	915.58	152.32	-757.67
8.35	-2.66	751.75	153.38	-757.67
8.50	-1.46	459.25	153.70	-757.67
8.50	1.34	-421.21	153.70	-757.67
8.65	2.42	-684.52	154.58	-830.65
8.80	3.31	-831.70	156.22	-930.72
8.95	3.98	-875.02	158.60	-1043.36
9.10	4.44	-837.41	161.56	-1156.38
9.25	4.73	-743.75	164.92	-1260.74
9.40	4.90	-615.63	168.52	-1350.46
9.55	4.98	-469.15	172.24	-1422.05
9.70	5.01	-314.61	176.00	-1473.78
9.85	5.01	-157.52	179.77	-1504.94
10.00	5.01	0.00	183.54	-1515.34

### 3.9 Spindle drive with leadscrew

This drive involves a plastic machining unit, with vertical- and horizontal spindle drives without gearbox. Servo drives with Compact Plus as 2-axis system should be used.



Principle of operation

#### Vertical drive

##### *Drive data*

Total mass to be raised	$m_{\text{total}}$	= 116 kg
Spindle diameter	$D$	= 0.04 m
Spindle pitch	$h$	= 0.01 m
Spindle length	$l$	= 1.2 m
Spindle efficiency	$\eta_{\text{Sp}}$	= 0.9
Moment of inertia of the coupling (acc. to the manufacturer)	$J_K$	= 0.00039 kgm <sup>2</sup>
Max. elevating	$v_{\text{max}}$	= 0.33 m/s
Accelerating time	$t_b$	= 0.1 s
Decelerating time	$t_v$	= 0.1 s
Max. distance raise	$h_{\text{max}}$	= 0.651 m
No-load interval between elevating and lowering	$t_p$	= 10 s
Cycle time	$T$	= 20 s

Elevating force, acceleration force:

$$F_H = m_{total} \cdot g = 116 \cdot 9.81 = 1138 \text{ N}$$

$$F_b = F_v = m_{total} \cdot a = m_{total} \cdot \frac{v_{max}}{t_b} = 116 \cdot \frac{0.33}{0.1} = 382.8 \text{ N}$$

Spindle pitch angle:

$$\alpha_{sw} = \arctan \frac{h}{\pi \cdot D} = \arctan \frac{0.01}{\pi \cdot 0.04} = 0.07941 \text{ rad}$$

Friction angle of the spindle:

$$\rho = \arctan \frac{h}{\pi \cdot D \cdot \eta_{sp}} - \alpha_{sw} = \arctan \frac{0.01}{\pi \cdot 0.04 \cdot 0.95} - 0.07941 = 0.00416 \text{ rad}$$

*Calculating the torques for spindle and coupling when accelerating and decelerating*

Angular velocity of the spindle at  $v_{max}$ :

$$\omega_{max\ sp} = \frac{2 \cdot \pi \cdot v_{max}}{h} = \frac{2 \cdot \pi \cdot 0.33}{0.01} = 207.3 \text{ s}^{-1}$$

Angular acceleration of the spindle:

$$\alpha_{b\ sp} = \frac{\omega_{max\ sp}}{t_b} = \frac{207.3}{0.1} = 2073 \text{ s}^{-2}$$

According to the manufacturer, the spindle moment of inertia 40x10 is as follows:

$$J_{sp} = 119.27 \cdot 10^{-6} + 1.607 \cdot 10^{-3} \cdot l = 119.27 \cdot 10^{-6} + 1.607 \cdot 10^{-3} \cdot 1.2 = 0.00205 \text{ kgm}^2$$

The first component is a constant value and the second component represents the formula for the moment of inertia of the solid cylinder.

Accelerating- and decelerating torque for spindle+coupling:

$$M_{b\ sp+c} = M_{v\ sp+c} = (J_{sp} + J_c) \cdot \alpha_{b\ sp} = (0.00205 + 0.00039) \cdot 2073 = 5.06 \text{ Nm}$$

*Motor selection*

The following motor is selected (refer to Calculating the motor torques):

1FK6 042-6AF71,  $n_n=3000$  RPM,  $M_n(100)=2.6$  Nm,  $M_0(100)=3.2$  Nm,  $I_0(100)=2.7$  A,  $\eta_{\text{motor}}=0.89$   
 $J_{\text{motor+brake}}=0.000368$  kgm<sup>2</sup>,  $M_{\text{motor perm.}}=10.3$  Nm

Motor speed at  $v_{\text{max}}$ :

$$n_{\text{motor max}} = \frac{\omega_{\text{max sp}} \cdot 60}{2\pi} = \frac{207.3 \cdot 60}{2\pi} = 1980 \text{ RPM}$$

*Calculating the motor torques during the constant-velocity phase*

Upwards:

$$M_{\text{motor}} = F_H \cdot \frac{D}{2} \cdot \tan(\alpha_{\text{SW}} + \rho) = 1138 \cdot \frac{0.04}{2} \cdot \tan(0.07941 + 0.00416) = 191 \text{ Nm}$$

Downwards:

$$M_{\text{motor}} = F_H \cdot \frac{D}{2} \cdot \tan(\alpha_{\text{SW}} - \rho) = 1138 \cdot \frac{0.04}{2} \cdot \tan(0.07941 - 0.00416) = 1.72 \text{ Nm} \quad (\text{reg. op.})$$

*Calculating the motor torques when accelerating and decelerating*

Motor accelerating- and decelerating torque:

$$\begin{aligned} M_{b \text{ motor}} = M_{v \text{ motor}} &= J_{\text{motor}} \cdot \alpha_{b \text{ sp}} \\ &= 0.000368 \cdot 2073 = 0.763 \text{ Nm} \end{aligned}$$

Upwards, motor torque when accelerating:

$$\begin{aligned} M_{\text{motor}} &= M_{b \text{ motor}} + M_{b \text{ sp+c}} + (F_b + F_H) \cdot \frac{D}{2} \cdot \tan(\alpha_{\text{SW}} + \rho) \\ &= 0.763 + 5.06 + (382.8 + 1138) \cdot \frac{0.04}{2} \cdot \tan(0.07941 + 0.00416) = 8.37 \text{ Nm} \end{aligned}$$



Upwards, motor torque when decelerating:

$$\begin{aligned} M_{motor} &= -M_{v\ motor} - M_{v\ sp+c} + (-F_v + F_H)^{1)} \cdot \frac{D}{2} \cdot \tan(\alpha_{sw} + \rho \cdot \text{sign}(\dots)) \\ &= -0.763 - 5.06 + (-382.8 + 1138) \cdot \frac{0.04}{2} \cdot \tan(0.07941 + 0.00416) = -4.56 \text{ Nm} \quad (\text{reg. op.}) \end{aligned}$$

Downwards, motor torque when accelerating:

$$\begin{aligned} M_{motor} &= -M_{b\ Motor} - M_{b\ sp+c} + (-F_b + F_H)^{1)} \cdot \frac{D}{2} \cdot \tan(\alpha_{sw} - \rho \cdot \text{sign}(\dots)) \\ &= -0.763 - 5.06 + (-382.8 + 1138) \cdot \frac{0.04}{2} \cdot \tan(0.07941 - 0.00416) = -4.68 \text{ Nm} \end{aligned}$$

Downwards, motor torque when decelerating:

$$\begin{aligned} M_{motor} &= M_{v\ Motor} + M_{v\ sp+c} + (F_v + F_H) \cdot \frac{D}{2} \cdot \tan(\alpha_{sw} - \rho) \\ &= 0.763 + 5.06 + (382.8 + 1138) \cdot \frac{0.04}{2} \cdot \tan(0.07941 - 0.00416) = 8.12 \text{ Nm} \quad (\text{reg. op.}) \end{aligned}$$

1) If the expression in brackets has a negative sign, the sign of  $\rho$  changes

The highest motor torque is required when accelerating upwards. The highest motor torque in regenerative operation is required for deceleration when moving downwards. The selected motor is adequately dimensioned, as it can be overloaded up to approx. 10.3 Nm at  $n_{\max}=1980$  RPM and for a 400 V line supply voltage.

### Selecting the drive converter

The following is valid for the highest required motor torque:

$$\frac{M_{motor\ max}}{M_{0(100)}} = \frac{8.37}{3.2} = 2.62$$

Thus, the following value is obtained from the torque/current characteristic:

$$\frac{I_{motor\ max}}{I_{0(100)}} = 2.7 \quad \text{and} \quad I_{motor\ max} = I_{0(100)} \cdot 2.7 = 2.7 \cdot 2.7 = 7.3 \text{ A}$$

Drive converter selected:

6SE7013-0EP50 (Compact Plus)

$P_{Vn}=1.1$  kW;  $I_{Vn}=3$  A;  $I_{Vmax}=9$  A (300% overload capability)

### Calculating of the braking power and the braking energy

The brake resistor is used when the drive decelerates when descending or ascending.

Velocity-time diagram

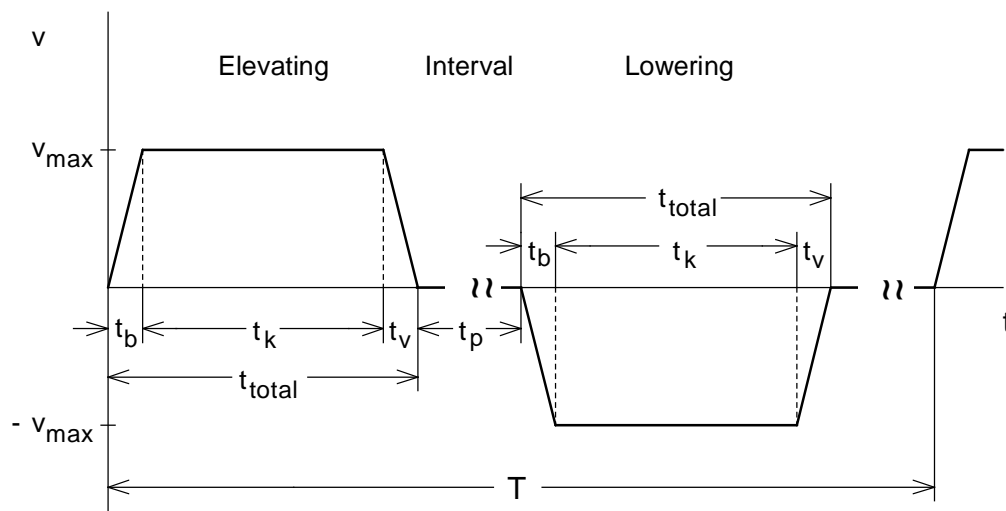

The traversing time is given by:

$$t_{total} = \frac{h_{max} + v_{max} \cdot t_b}{v_{max}} = \frac{0.651 + 0.33 \cdot 0.1}{0.33} = 2.07 \text{ s}$$

Time for constant-velocity motion:

$$t_k = t_{total} - 2 \cdot t_b = 2.07 - 2 \cdot 0.1 = 1.87 \text{ s}$$

Max. braking power for the brake resistor when decelerating from  $v_{max}$  to 0:

$$\begin{aligned} P_{br W \max (v_{max} \rightarrow 0)} &= P_{br motor \max (v_{max} \rightarrow 0)} \cdot \eta_{motor} = \frac{M_{motor v (v_{max} \rightarrow 0)} \cdot n_{motor \max}}{9550} \cdot \eta_{motor} \\ &= \frac{4.56 \cdot 1980}{9550} \cdot 0.89 = 0.84 \text{ kW} \end{aligned}$$

Max. braking power for the brake resistor when decelerating from  $-v_{\max}$  to 0:

$$\begin{aligned} P_{br W \max (-v_{\max} \rightarrow 0)} &= P_{br \text{ motor max } (-v_{\max} \rightarrow 0)} \cdot \eta_{\text{motor}} = \frac{M_{\text{motor } v (-v_{\max} \rightarrow 0)} \cdot n_{\text{motor max}}}{9550} \cdot \eta_{\text{motor}} \\ &= \frac{8.12 \cdot 1980}{9550} \cdot 0.89 = 1.5 \text{ kW} \end{aligned}$$

Braking power while travelling at constant velocity downwards:

$$\begin{aligned} P_{br W \text{ konst } (v=-v_{\max})} &= P_{br \text{ Motor konst } (v=-v_{\max})} \cdot \eta_{\text{Motor}} = \frac{M_{\text{Motor } v (v=-v_{\max})} \cdot n_{\text{Motor max}}}{9550} \cdot \eta_{\text{Motor}} \\ &= \frac{1.72 \cdot 1980}{9550} \cdot 0.89 = 0.317 \text{ kW} \end{aligned}$$

Braking diagram



Braking energy for a cycle (corresponds to the area in the braking diagram):

$$\begin{aligned} W_{br} &= \frac{1}{2} \cdot P_{br W \max (v_{\max} \rightarrow 0)} \cdot t_v + P_{br W \text{ konst } (v=-v_{\max})} \cdot t_k + \frac{1}{2} \cdot P_{br W \max (-v_{\max} \rightarrow 0)} \cdot t_v \\ &= \frac{1}{2} \cdot 0.84 \cdot 0.1 + 0.317 \cdot 1.87 + \frac{1}{2} \cdot 1.5 \cdot 0.1 = 0.71 \text{ kW} \end{aligned}$$

## Thermally checking the motor

## Torque characteristic



The RMS torque is obtained from the torque characteristic as follows:

$$M_{RMS} = \sqrt{\frac{8.37^2 \cdot 0.1 + 1.91^2 \cdot 1.87 + 4.56^2 \cdot 0.1 + 4.68^2 \cdot 0.1 + 1.72^2 \cdot 1.87 + 8.12^2 \cdot 0.1}{20}} = 1.23 \text{ Nm}$$

The average motor speed is given by:

$$n_{\text{average}} = \frac{2 \cdot \left( \frac{n_{\text{motor max}}}{2} \cdot t_b \cdot 2 + n_{\text{motor max}} \cdot t_k \right)}{T} = \frac{2 \cdot \left( \frac{1980}{2} \cdot 0.1 \cdot 2 + 1980 \cdot 1.87 \right)}{20} = 390 \text{ RPM}$$

The calculated RMS torque lies, at  $n_{\text{average}}$ , below the  $M_{S1}$  characteristic. Thus, operation is permissible.



Absolute motor torque and dynamic limiting characteristic



RMS motor torque at  $n_{average}$  and  $M_{perm} S1$  characteristic

Horizontal drive*Drive data*

Mass to be moved	$m_{\text{total}} = 100 \text{ kg}$
Spindle diameter	$D = 0.032 \text{ m}$
Spindle pitch	$h = 0.01 \text{ m}$
Spindle length	$l = 1 \text{ m}$
Spindle efficiency	$\eta_{\text{Sp}} = 0.95$
Slide friction	$w_F = 0,02$
Coupling moment of inertia (acc. to the manufacturer)	$J_K = 0.0002 \text{ kgm}^2$
Max. traversing velocity	$v_{\text{max}} = 0.4 \text{ m/s}$
Accelerating time	$t_b = 0.16 \text{ s}$
Decelerating time	$t_v = 0.16 \text{ s}$
Max. distance moved	$h_{\text{max}} = 0.427 \text{ m}$
Interval between feed and retraction	$t_p = 5 \text{ s}$
Cycle time	$T = 20 \text{ s}$

Frictional force, accelerating force:

$$F_R = m_{\text{total}} \cdot g \cdot w_F = 100 \cdot 9.81 \cdot 0.02 = 19.62 \text{ N}$$

$$F_b = F_v = m_{\text{total}} \cdot a = m_{\text{total}} \cdot \frac{v_{\text{max}}}{t_b} = 100 \cdot \frac{0.4}{0.16} = 250 \text{ N}$$

Spindle pitch angle:

$$\alpha_{\text{sw}} = \arctan \frac{h}{\pi \cdot D} = \arctan \frac{0.01}{\pi \cdot 0.032} = 0.09915 \text{ rad}$$

Friction angle of the spindle:

$$\rho = \arctan \frac{h}{\pi \cdot D \cdot \eta_{\text{Sp}}} - \alpha_{\text{sw}} = \arctan \frac{0.01}{\pi \cdot 0.032 \cdot 0.95} - 0.09915 = 0.00518 \text{ rad}$$

*Calculating the torques for spindle and coupling when accelerating and decelerating*

Angular velocity of the spindle at  $v_{\text{max}}$ :

$$\omega_{\text{max sp}} = \frac{2 \cdot \pi \cdot v_{\text{max}}}{h} = \frac{2 \cdot \pi \cdot 0.4}{0.01} = 251.3 \text{ s}^{-1}$$

Angular acceleration of the spindle:

$$\alpha_{b\ sp} = \frac{\omega_{\max\ sp}}{t_b} = \frac{251.3}{0.16} = 1571\ s^{-2}$$

According to the manufacturer, the spindle moment of inertia 32x10 is calculated as follows:

$$J_{sp} = 33573 \cdot 10^{-6} + 0.712 \cdot 10^{-3} \cdot l = 33573 \cdot 10^{-6} + 0.712 \cdot 10^{-3} \cdot 1 = 0.000746\ kgm^2$$

The first component is a constant value and the second component represents the formula for the moment of inertia of a solid cylinder.

Accelerating torque and decelerating torque for spindle+coupling:

$$M_{b\ sp+c} = M_{v\ sp+c} = (J_{sp} + J_c) \cdot \alpha_{b\ sp} = (0.000746 + 0.0002) \cdot 1571 = 1.49\ Nm$$

### Selecting the motor

The following motor is selected (refer to calculating the motor torques):

1FK6 042-6AF71,  $n_n=3000\ RPM$ ,  $M_n(100)=2.6\ Nm$ ,  $M_0(100)=3.2\ Nm$ ,  $I_0(100)=2.7\ A$ ,  $\eta_{motor}=0.89$   
 $J_{motor+brake}=0.000368\ kgm^2$ ,  $M_{motor\ perm.}=10.3\ Nm$

Motor speed at  $v_{\max}$ :

$$n_{motor\ max} = \frac{\omega_{\max\ sp} \cdot 60}{2\pi} = \frac{251.3 \cdot 60}{2\pi} = 2400\ RPM$$

### Calculating the motor torques during the constant-velocity phase

$$M_{motor} = F_R \cdot \frac{D}{2} \cdot \tan(\alpha_{sw} + \rho) = 19.62 \cdot \frac{0.032}{2} \cdot \tan(0.09915 + 0.00518) = 0.0329\ Nm$$

### Calculating the motor torques when accelerating and decelerating

Accelerating- and decelerating torque for the motor:

$$\begin{aligned} M_{b\ motor} = M_{v\ motor} &= J_{motor} \cdot \alpha_{b\ sp} \\ &= 0.000368 \cdot 1571 = 0.578\ Nm \end{aligned}$$

Motor torque when accelerating:

$$\begin{aligned}
 M_{motor} &= M_{b\ motor} + M_{b\ sp+c} + (F_b + F_R) \cdot \frac{D}{2} \cdot \tan(\alpha_{sw} + \rho) \\
 &= 0.578 + 1.49 + (250 + 19.62) \cdot \frac{0.032}{2} \cdot \tan(0.09915 + 0.00518) = 2.52 \text{ Nm}
 \end{aligned}$$

Motor torque when decelerating:

$$\begin{aligned}
 M_{motor} &= -M_{v\ Motor} - M_{v\ sp+c} + (-F_v + F_R)^{1)} \cdot \frac{D}{2} \cdot \tan(\alpha_{sw} + \rho \cdot \text{sign}(\dots)) \\
 &= -0.578 - 1.49 + (-250 + 19.62) \cdot \frac{0.032}{2} \cdot \tan(0.09915 - 0.00518) = -2.42 \text{ Nm} \quad (\text{reg. op.})
 \end{aligned}$$

1) If the expression in brackets has a negative sign, the sign of  $\rho$  changes

The highest motor torque is required when accelerating. The highest motor torque in the regenerative mode is required when decelerating. The selected motor is adequately dimensioned, as it can be overloaded up to approx. 10.3 Nm for  $n_{\max}=2400$  RPM and a 400 V line supply voltage.

### Selecting the drive converter

The highest required motor torque is given by:

$$\frac{M_{motor\ max}}{M_{0(100)}} = \frac{2.52}{3.2} = 0.788$$

The following value is obtained from the torque/current characteristic:

$$\frac{I_{motor\ max}}{I_{0(100)}} = 0.788$$

and

$$I_{motor\ max} = I_{0(100)} \cdot 0.788 = 2.7 \cdot 0.788 = 2.13 \text{ A}$$

Drive converter selected:

6SE7012-0TP50 (Compact Plus)

$P_{Vn}=0.75$  kW;  $I_{Vn}=2$  A;  $I_{Vmax}=6$  A (300% overload capability)



This inverter is connected to the previously selected drive converter for the horizontal drive (2-axis operation)

### Calculating of the braking power and the braking energy

The brake resistor is used when the drive decelerates.

Velocity-time diagram



The traversing time is obtained as follows:

$$t_{total} = \frac{s_{max} + v_{max} \cdot t_b}{v_{max}} = \frac{0.427 + 0.4 \cdot 0.16}{0.4} = 1.23 \text{ s}$$

Time where the drive moves with a constant velocity:

$$t_k = t_{total} - 2 \cdot t_b = 1.23 - 2 \cdot 0.16 = 0.91 \text{ s}$$

Max. braking power for the brake resistor when decelerating from v\_max to 0:

$$\begin{aligned} P_{br W \max (v_{max} \rightarrow 0)} &= P_{br motor \max (v_{max} \rightarrow 0)} \cdot \eta_{motor} = \frac{M_{motor v (v_{max} \rightarrow 0)} \cdot n_{motor \max}}{9550} \cdot \eta_{motor} \\ &= \frac{2.42 \cdot 2400}{9550} \cdot 0.89 = 0.541 \text{ kW} \end{aligned}$$

## Braking diagram

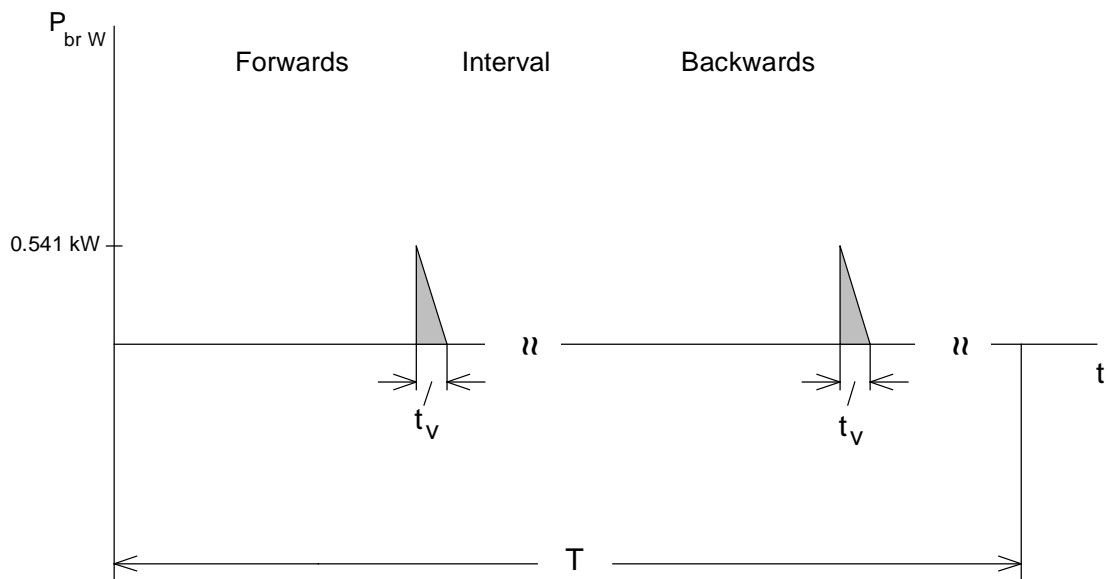

Braking energy for a cycle (corresponds to the area in the braking diagram):

$$\begin{aligned}
 W_{br} &= 2 \cdot \frac{1}{2} \cdot P_{br W \max (v_{\max} \rightarrow 0)} \cdot t_v \\
 &= 2 \cdot \frac{1}{2} \cdot 0.541 \cdot 0.16 = 0.087 \text{ kW}_s
 \end{aligned}$$

### Thermally checking the motor

#### Torque characteristic



The RMS torque is obtained from the torque characteristic as follows:

$$M_{RMS} = \sqrt{\frac{2 \cdot (2.32^2 \cdot 0.16 + 0.0329^2 \cdot 0.91 + 2.42^2 \cdot 0.16)}{20}} = 0.442 \text{ Nm}$$

The average motor speed is given by:

$$n_{average} = \frac{2 \cdot \left( \frac{n_{motor \max}}{2} \cdot t_b \cdot 2 + n_{motor \max} \cdot t_k \right)}{T} = \frac{2 \cdot \left( \frac{2400}{2} \cdot 0.16 \cdot 2 + 2400 \cdot 0.91 \right)}{20} = 257 \text{ RPM}$$

The calculated RMS torque lies, at  $n_{average}$ , below the  $M_{S1}$  characteristic. Thus, operation is permissible.



Absolute motor torque and dynamic limiting characteristic

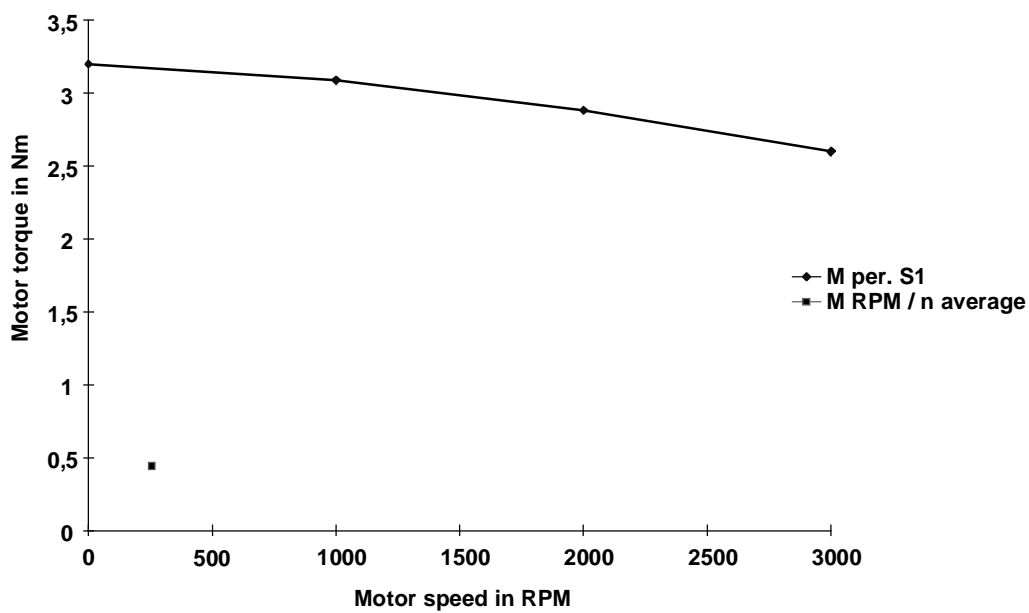

RMS motor torque at  $n_{average}$  and  $M_{perm}$  S1 characteristic

*Dimensioning the brake resistor*

When dimensioning the common brake resistor, it is assumed that the max. brake power of the two drives can occur simultaneously. Thus, the following is true:

$$P_{br\ W\ max\ tot.} = P_{br\ W\ max1} + P_{br\ W\ max2} = 1.5 + 0.541 = 2.041\ kW \leq 1.5 \cdot P_{20}$$

Further, the following must be true for the brake resistor:

$$\frac{W_{br1} + W_{br2}}{T} = \frac{0.71 + 0.087}{20} = 0.0399 \leq P_{br\ cont}$$

With

$$P_{br\ cont} = \frac{P_{20}}{4.5} \quad (\text{for Compact Plus, only an external brake resistor})$$

the following is obtained

$$4.5 \cdot 0.0399 = 0.18\ kW \leq P_{20}$$

Thus, the smallest brake resistor is selected with  $P_{20} = 5\ kW$  (6SE7018-0ES87-2DC0).

### 3.10 Cross-cutter drive

This drive involves a cross-cutter drive with a directly driven knife roll. A servo drive is to be used.



#### Drive data

Reel diameter	$D$	= 150 mm
Reel weight	$m_W$	= 1 kg
Web velocity	$v_{web}$	= 100 m/min
Cut length	$s$	= 250 mm

The feed time for the 250 mm cut is calculated from the web velocity as follows:

$$t_s = \frac{s}{v_{web}} = \frac{250 \text{ mm}}{100 \text{ m/min}} = \frac{0.25 \cdot 60}{100} = 0.15 \text{ s}$$

When cutting, the knife roll must rotate with the same circumferential velocity as the web velocity.

If this velocity is maintained, then a feed time per cut is obtained as follows:

$$t'_s = \frac{D \cdot \pi}{v_{web}} = \frac{150 \text{ mm} \cdot \pi}{100 \text{ m/min}} = \frac{0.15 \cdot \pi \cdot 60}{100} = 0.283 \text{ s}$$

After each cut, the knife roll must be accelerated so that it has the same velocity as the web, and it must then be decelerated to a circumferential velocity which is the same as the feed velocity.

This should be realized as fast as possible, e.g. a triangular characteristic is used with

$$t_b = t_v = \frac{t_s}{2} - 10 \text{ ms} = \frac{150 \text{ ms}}{2} - 10 \text{ ms} = 65 \text{ ms}$$

The 10 ms takes into account deadtimes and controller stabilization.

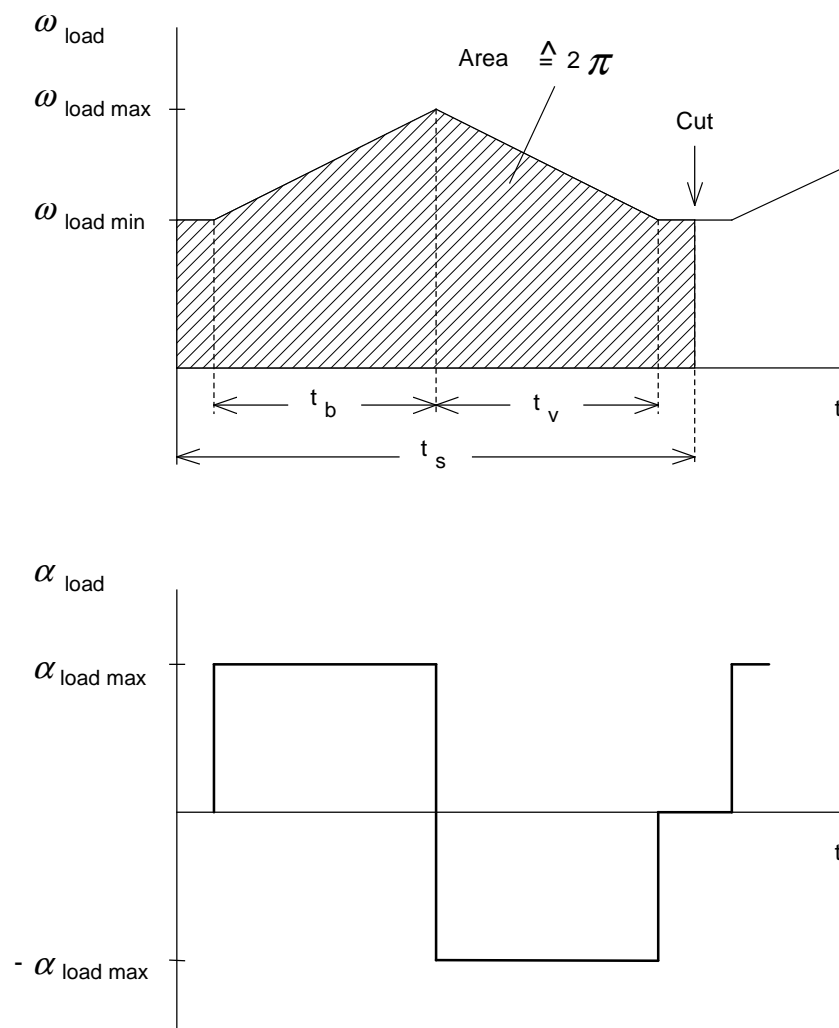

The minimum angular velocity of the knife roll is obtained from the web velocity:

$$\omega_{\text{load min}} = v_{\text{web}} \cdot \frac{2}{D} = 100 \text{ m/min} \cdot \frac{2}{150 \text{ mm}} = \frac{100}{60} \cdot \frac{2}{0.15} = 22.22 \text{ s}^{-1}$$

The maximum angular velocity is derived from the angle through which the knife roll has moved per revolution. This angle corresponds to  $2\pi$ . Thus, the following is true:

$$2\pi = \omega_{load\ min} \cdot t_s + \frac{\omega_{load\ max} - \omega_{load\ min}}{2} \cdot (t_b + t_v) \quad (\text{corresponds to the area under } \omega_{load})$$

and

$$\omega_{load\ max} = \omega_{load\ min} + \frac{2}{t_b + t_v} \cdot (2\pi - \omega_{load\ min} \cdot t_s) = 22.22 + \frac{2}{0.13} \cdot (2\pi - 22.22 \cdot 0.15) = 67.6\ s^{-1}$$

The maximum angular acceleration of the knife roll is given by:

$$\alpha_{load\ max} = \frac{\omega_{load\ max} - \omega_{load\ min}}{t_b} = \frac{67.6 - 22.22}{0.065} = 698.2\ s^{-2}$$

The maximum speed of the knife roll is:

$$n_{load\ max} = \frac{\omega_{load\ max} \cdot 60}{2\pi} = \frac{67.6 \cdot 60}{2\pi} = 645.6\ RPM$$

#### *Calculating the load torques when accelerating and decelerating*

Moment of inertia of the load:

$$J_{load} = \frac{1}{2} \cdot m_W \cdot \left(\frac{D}{2}\right)^2 = \frac{1}{2} \cdot 1 \cdot \left(\frac{0.15}{2}\right)^2 = 0.00281\ kgm^2$$

As acceleration is the same as deceleration, the load torques are given by:

$$M_{b\ load} = M_{v\ load} = J_{load} \cdot \alpha_{load\ max} = 0.00281 \cdot 698.2 = 1.96\ Nm$$

#### *Selecting the motor*

The following motor is selected (refer to calculating the motor torques):

$$1FT6\ 061-6AC7, n_n=2000\ RPM, J_{motor}=0.0006\ kgm^2$$

$$M_n(100)=3.7\ Nm, M_0(100)=4\ Nm, I_0(100)=2\ A, \eta_{motor}=0.82$$



*Calculating the motor torques when accelerating and decelerating*

Accelerating- and decelerating torque for the motor:

$$M_{b\ motor} = M_{v\ motor} = J_{motor} \cdot \alpha_{load\ max} = 0.0006 \cdot 698.2 = 0.42\ Nm$$

Motor torque when accelerating:

$$\begin{aligned} M_{motor} &= M_{b\ motor} + M_{b\ load} \\ &= 0.42 + 1.96 = 2.38\ Nm \end{aligned}$$

Motor torque when decelerating:

$$\begin{aligned} M_{motor} &= -M_{v\ motor} - M_{v\ load} \\ &= -0.42 - 1.96 = -2.38\ Nm \end{aligned} \quad \text{(regenerative operation)}$$

The highest motor torque is required when accelerating and when decelerating. The selected motor is adequately dimensioned, as it has sufficient reserves at  $n_{max}=645.6$  RPM and a 400 V supply voltage. The coupling moment of inertia was neglected. Further, no frictional forces were taken into account.

*Selecting the drive converter*

The following is valid for the highest required motor torque:

$$\frac{M_{motor\ max}}{M_{0(100)}} = \frac{2.38}{4} = 0.6$$

The following value is obtained from the torque/current characteristic:

$$\frac{I_{motor\ max}}{I_{0(100)}} = 0.6$$

and

$$I_{motor\ max} = I_{0(100)} \cdot 0.6 = 2 \cdot 0.6 = 1.2\ A$$

Selected drive converter:

6SE7011-5EP50 (Compact Plus)

$P_{Vn}=0.55$  kW;  $I_{Vn}=1.5$  A,  $I_{Vmax}=2.4$  A (160% overload capability)

*Dimensioning the brake resistor*

The maximum braking power for the brake resistor when decelerating from  $\omega_{load\ max}$  to  $\omega_{load\ min}$ :

$$\begin{aligned} P_{br\ W\ max} &= M_{motor\ v} \cdot \omega_{load\ max} \cdot \eta_{motor} \\ &= 2.38 \cdot 67.6 \cdot 0.82 = 132\ W \end{aligned}$$

Braking power for the brake resistor at  $\omega_{load\ min}$ :

$$\begin{aligned} P_{br\ W\ (\omega_{load\ min})} &= M_{motor\ v} \cdot \omega_{load\ min} \cdot \eta_{motor} \\ &= 2.38 \cdot 22.22 \cdot 0.82 = 43.4\ W \end{aligned}$$

## Braking diagram



Braking energy for a cycle (corresponds to the area in the braking diagram):

$$\begin{aligned} W_{br} &= \frac{P_{br\ W\ max} + P_{br\ W\ (\omega_{load\ min})}}{2} \cdot t_v \\ &= \frac{132 + 43.4}{2} \cdot 0.065 = 5.7\ Ws \end{aligned}$$

The following must be valid for the brake resistor:

$$\frac{W_{br}}{t_s} = \frac{0.0057}{0.15} = 0.038 \text{ kW} \leq P_{br \text{ cont.}}$$

with

$$P_{br \text{ cont.}} = \frac{P_{20}}{4.5} \quad (\text{with an external brake resistor})$$

the following is obtained

$$4.5 \cdot 0.038 = 0.171 \text{ kW} \leq P_{20}$$

Thus, the smallest braking resistor is selected with  $P_{20} = 5 \text{ kW}$  (6SE7018-0ES87-2DC0).

*Thermally checking the motor*

Torque characteristic



The RMS torque is obtained from the torque characteristic:

$$M_{RMS} = \sqrt{\frac{2 \cdot 2.38^2 \cdot 0.065}{0.15}} = 2.22 \text{ Nm}$$

With the following

$$n_{load\ min} = \frac{\omega_{load\ min} \cdot 60}{2 \cdot \pi} = \frac{22.22 \cdot 60}{2 \cdot \pi} = 212.2\ RPM$$

the average motor speed is given by:

$$n_{average} = \frac{n_{load\ min} \cdot (t_s - 2 \cdot t_b) + \frac{n_{load\ min} + n_{load\ max}}{2} \cdot 2 \cdot t_b}{t_s}$$

$$= \frac{212.2 \cdot (0.15 - 2 \cdot 0.065) + (212.2 + 645.6) \cdot 0.065}{0.15} = 400\ RPM$$

The calculated RMS torque is, at  $n_{average}$ , below the S1 curve. Thus, operation is thermally permissible.

### 3.11 Centrifugal drive

This involves a centrifugal drive with a specified load duty cycle. A 6-pole 250 kW induction motor is to be used (force-ventilated).

#### *Drive data*

Moment of inertia of the empty drum	$J_L$	= 565 kgm <sup>2</sup>
Moment of inertia of the full drum	$J_V$	= 1165 kgm <sup>2</sup>
Moment of inertia of the drum, water removed	$J_E$	= 945 kgm <sup>2</sup>
Filling speed	$n_F$	= 180 RPM
Centrifuging speed	$n_S$	= 1240 RPM
Discharge speed	$n_R$	= 70 RPM
Filling time	$t_F$	= 34 s
Centrifuging time	$t_S$	= 35 s
Discharge time	$t_R$	= 31.83 s
Accelerating time from $n_F$ to $n_S$	$t_{bS}$	= 45 s
Braking time from $n_S$ to $n_R$	$t_v$	= 39 s
Discharge torque	$M_R$	= 500 Nm
Frictional torque	$M_{\text{friction}}$	= 120 Nm
Rated motor output	$P_n$	= 250 kW
Rated motor current	$I_n$	= 430 A
Rated motor torque	$M_n$	= 2410 Nm
Rated motor speed	$n_n$	= 989 RPM
Motor efficiency	$\eta_{\text{motor}}$	= 0.96
Motor moment of inertia	$J_{\text{motor}}$	= 7.3 kgm <sup>2</sup>

Speed characteristic required for a cycle



Range 1:	Accelerating from the discharge- to the filling speed	$\Delta t_1 = t_{bF}$
Range 2:	Filling at the filling speed	$\Delta t_2 = t_F$
Range 3:	Accelerating from the filling- to the centrifuging speed	$\Delta t_3 = t_{bS}$
Range 4:	Centrifuging speed	$\Delta t_4 = t_S$
Range 5:	Braking from the centrifuging- to the discharge speed	$\Delta t_5 = t_v$
Range 6:	Discharging at the discharge speed	$\Delta t_6 = t_R$

Times  $t_F$ ,  $t_{bS}$ ,  $t_S$ ,  $t_v$  and  $t_R$  are specified. Acceleration from  $n_R$  to  $n_F$  should be realized with the same increase in speed as when accelerating to the centrifugal speed. Thus, the following is obtained for  $t_{bF}$ :

$$t_{bF} = t_{bS} \cdot \frac{n_F - n_R}{n_S - n_F} = 45 \cdot \frac{180 - 70}{1240 - 180} = 4.67 \text{ s}$$

The cycle time is given by:

$$T = t_{bF} + t_F + t_{bS} + t_S + t_v + t_R = 4.67 + 34 + 45 + 35 + 39 + 31.83 = 189.5 \text{ s}$$

It is assumed that the moment of inertia linearly increases and decreases during the filling phase (range 2), the accelerating phase to the centrifuging speed (range 3) and the discharge phase (range 6). Thus, the following moment of inertia characteristic is obtained over a cycle.



The following is generally true for the drive torque for changing speed and changing moment of inertia:

$$M = J \cdot \frac{2\pi}{60} \cdot \frac{dn}{dt} + \frac{\pi \cdot n}{60} \cdot \frac{dJ}{dt} \quad [\text{Nm}]$$

J in  $\text{kgm}^2$ , n in RPM

Using the linear characteristics of curves  $n(t)$  and  $J(t)$ , the following are obtained for the derivatives:

$$\frac{dn}{dt} = \frac{\Delta n}{\Delta t}$$

$$\frac{dJ}{dt} = \frac{\Delta J}{\Delta t}$$

### Calculating the motor torques

The motor torques in each range are calculated, at the start (index 0) and the end (index 1). The characteristic is linear between these two points.

Range 1, accelerating from the discharge- to the filling speed ( $\Delta n \neq 0$ ,  $\Delta J = 0$ )

$$\begin{aligned} M_{motor\ 10} = M_{motor\ 11} &= (J_L + J_{motor}) \cdot \frac{2\pi}{60} \cdot \frac{n_F - n_R}{t_{bF}} + M_{friction} \\ &= (565 + 7.3) \cdot \frac{2\pi}{60} \cdot \frac{180 - 70}{4.67} + 120 = 1532 \text{ Nm} \end{aligned}$$

Range 2, filling at the filling speed ( $\Delta n = 0$ ,  $\Delta J \neq 0$ )

$$\begin{aligned} M_{motor\ 20} = M_{motor\ 21} &= \frac{\pi \cdot n_F}{60} \cdot \frac{J_V - J_L}{t_F} + M_{friction} \\ &= \frac{\pi \cdot 180}{60} \cdot \frac{1165 - 565}{34} + 120 = 286 \text{ Nm} \end{aligned}$$

Range 3, accelerating, from the filling- to the centrifuging speed ( $\Delta n \neq 0$ ,  $\Delta J \neq 0$ )

$$\begin{aligned} M_{motor\ 30} &= (J_V + J_{motor}) \cdot \frac{2\pi}{60} \cdot \frac{n_S - n_F}{t_{bS}} + \frac{\pi \cdot n_F}{60} \cdot \frac{J_E - J_V}{t_{bS}} + M_{friction} \\ &= (1165 + 7.3) \cdot \frac{2\pi}{60} \cdot \frac{1240 - 180}{45} + \frac{\pi \cdot 180}{60} \cdot \frac{945 - 1165}{45} + 120 = 2966 \text{ Nm} \end{aligned}$$

$$\begin{aligned} M_{motor\ 31} &= (J_E + J_{motor}) \cdot \frac{2\pi}{60} \cdot \frac{n_S - n_F}{t_{bS}} + \frac{\pi \cdot n_S}{60} \cdot \frac{J_E - J_V}{t_{bS}} + M_{friction} \\ &= (945 + 7.3) \cdot \frac{2\pi}{60} \cdot \frac{1240 - 180}{45} + \frac{\pi \cdot 1240}{60} \cdot \frac{945 - 1165}{45} + 120 = 2152 \text{ Nm} \end{aligned}$$

Range 4, centrifuging at the centrifuging speed ( $\Delta n = 0$ ,  $\Delta J = 0$ )

$$M_{motor\ 40} = M_{motor\ 41} = M_{friction} = 120 \text{ Nm}$$

Range 5, braking from the centrifuging- to the discharge speed ( $\Delta n \neq 0$ ,  $\Delta J = 0$ )

$$\begin{aligned} M_{motor\ 50} = M_{motor\ 51} &= (J_E + J_{motor}) \cdot \frac{2\pi}{60} \cdot \frac{n_R - n_S}{t_v} + M_{friction} \\ &= (945 + 7.3) \cdot \frac{2\pi}{60} \cdot \frac{70 - 1240}{39} + 120 = -2872 \text{ Nm} \end{aligned}$$



Range 6, discharging at the discharge speed ( $\Delta n=0$ ,  $\Delta J \neq 0$ )

$$M_{motor\ 60} = M_{motor\ 61} = \frac{\pi \cdot n_R}{60} \cdot \frac{J_L - J_E}{t_R} + M_{friction} + M_R$$

$$= \frac{\pi \cdot 70}{60} \cdot \frac{565 - 945}{31.83} + 120 + 500 = 576\ Nm$$

Torque characteristic for a cycle

$M_{motor} / Nm$



*Thermally checking the motor*

The motor enters the field-weakening range above the rated speed. In this range, a higher current for the same torque is required than in the constant-flux range. In order to thermally check the motor, the RMS motor torque is not used, but instead, the RMS motor current.

The motor current is calculated in the constant-flux range as follows:

$$I_{motor(\Phi=const)} = \sqrt{\left(\frac{M_{motor}}{M_{motor n}}\right)^2 \cdot (I_{motor n}^2 - I_{\mu n}^2) + I_{\mu n}^2} \quad \text{for } n \leq n_n$$

The following is obtained in the field-weakening range:

$$I_{motor(field)} = \sqrt{\left(\frac{M_{motor}}{M_{motor n}}\right)^2 \cdot (I_{motor n}^2 - I_{\mu n}^2) \cdot \left(\frac{n_{motor}}{n_{motor n}}\right)^2 + I_{\mu n}^2 \cdot \left(\frac{n_{motor n}}{n_{motor}}\right)^2} \quad \text{for } n \geq n_n$$

Thus, the motor currents in each range, are calculated at the start (index 0) and at the end (index 1) and in ranges 3 and 5 in addition to the start of the field-weakening range (index FW). In ranges 3 and 5, a simplification has been made by assuming that the motor current has a linear characteristic between the two points. The field-weakening range is obtained from the following speed diagram.

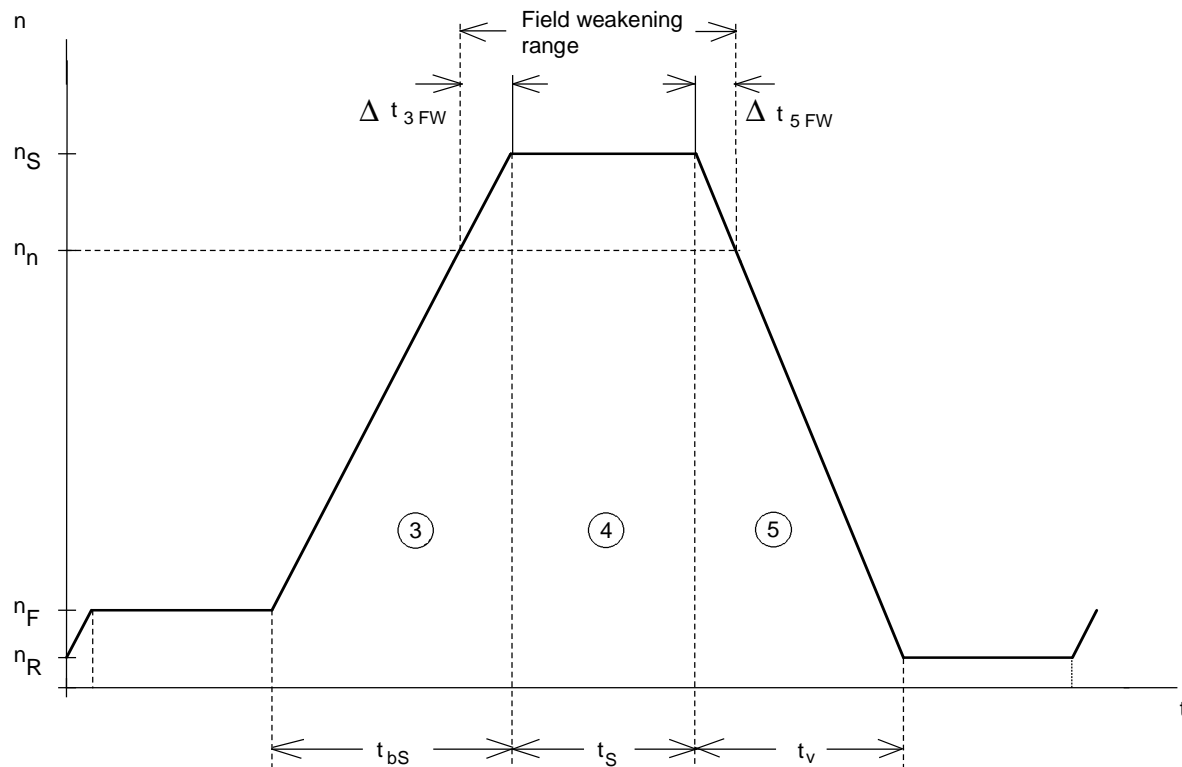

$$\Delta t_{3FW} = t_{bs} \cdot \frac{n_S - n_n}{n_S - n_F} = 45 \cdot \frac{1240 - 989}{1240 - 180} = 10.66 \text{ s}$$

$$\Delta t_{5FW} = t_v \cdot \frac{n_S - n_n}{n_S - n_R} = 39 \cdot \frac{1240 - 989}{1240 - 70} = 8.37 \text{ s}$$

Range 1, accelerating from the discharge- to the filling speed

$$M_{motor\ 10} = M_{motor\ 11} = 1532\ Nm$$

$$I_{motor\ 10} = I_{motor\ 11} = \sqrt{\left(\frac{1532}{2410}\right)^2 \cdot (430^2 - 133.3^2) + 133.3^2} = 292\ A$$

Range 2, filling at the filling speed

$$M_{motor\ 20} = M_{motor\ 21} = 286\ Nm$$

$$I_{motor\ 20} = I_{motor\ 21} = \sqrt{\left(\frac{286}{2410}\right)^2 \cdot (430^2 - 133.3^2) + 133.3^2} = 142\ A$$

Range 3, accelerating from the filling- to centrifuging speed (field-weakening range from  $n_n$  to  $n_S$ )

$$M_{motor\ 30} = 2966\ Nm$$

$$I_{motor\ 30} = \sqrt{\left(\frac{2966}{2410}\right)^2 \cdot (430^2 - 133.3^2) + 133.3^2} = 520\ A$$

$$M_{motor\ 3\ FW} = M_{motor\ 31} - \frac{M_{motor\ 31} - M_{motor\ 30}}{t_{bS}} \cdot \Delta t_{3\ FW} = 2152 - \frac{2152 - 2966}{45} \cdot 10.66 = 2344.8\ Nm$$

$$I_{motor\ 3\ FW} = \sqrt{\left(\frac{2344.8}{2410}\right)^2 \cdot (430^2 - 133.3^2) + 133.3^2} = 419.5\ A$$

$$M_{motor\ 31} = 2152\ Nm$$

$$I_{motor\ 31} = \sqrt{\left(\frac{2152}{2410}\right)^2 \cdot (430^2 - 133.3^2) \cdot \left(\frac{1240}{989}\right)^2 + 133.3^2 \cdot \left(\frac{989}{1240}\right)^2} = 469.9\ A$$

Range 4, centrifuging at the centrifuging speed (field-weakening range)

$$M_{motor\ 40} = M_{motor\ 41} = M_{friction} = 120\ Nm$$

$$I_{motor\ 40} = I_{motor\ 41} = \sqrt{\left(\frac{120}{2410}\right)^2 \cdot (430^2 - 133.3^2) \cdot \left(\frac{1240}{989}\right)^2 + 133.3^2 \cdot \left(\frac{989}{1240}\right)^2} = 109.3\ A$$

Range 5, braking from the centrifuging- to the discharge speed (field-weakening range from  $n_S$  to  $n_n$ )

$$M_{motor\ 50} = M_{motor\ 5\ FW} = M_{motor\ 51} = -2872\ Nm$$

$$I_{motor\ 50} = \sqrt{\left(\frac{2872}{2410}\right)^2 \cdot (430^2 - 133.3^2) \cdot \left(\frac{1240}{989}\right)^2 + 133.3^2 \cdot \left(\frac{989}{1240}\right)^2} = 620\ A$$

$$I_{motor\ 5\ FW} = I_{motor\ 51} = \sqrt{\left(\frac{2872}{2410}\right)^2 \cdot (430^2 - 133.3^2) + 133.3^2} = 505\ A$$

Range 6, discharge at the discharge speed

$$M_{motor\ 60} = M_{motor\ 61} = 576\ Nm$$

$$I_{motor\ 60} = I_{motor\ 61} = \sqrt{\left(\frac{576}{2410}\right)^2 \cdot (430^2 - 133.3^2) + 133.3^2} = 165.3\ A$$

Current characteristic for a cycle

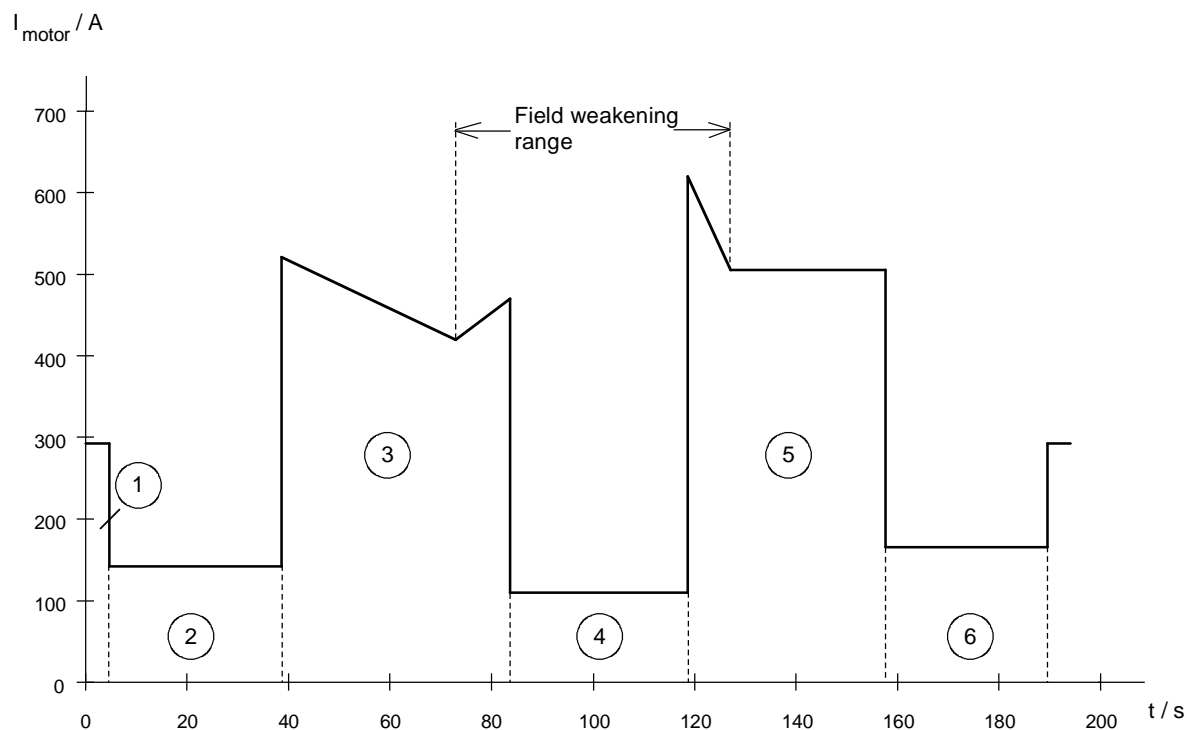

The RMS motor current is calculated from the current characteristic. For non-constant currents in ranges 3 and 5, the following is obtained for an interval:

$$\int_i^{i+1} I^2 \cdot dt = \frac{1}{3} \cdot (I_i^2 + I_{i+1}^2 + I_i \cdot I_{i+1}) \cdot \Delta t_i$$

Thus, the following is true:

$$\begin{aligned} I_{motor\ RMS}^2 \cdot T &= I_{10}^2 \cdot t_{bF} + I_{20}^2 \cdot t_F + \frac{1}{3} \cdot (I_{30}^2 + I_{3FW}^2 + I_{30} \cdot I_{3FW}) \cdot (t_{bS} - \Delta t_{3FW}) \\ &\quad + \frac{1}{3} \cdot (I_{3FW}^2 + I_{31}^2 + I_{3FW} \cdot I_{31}) \cdot \Delta t_{3FW} + I_{40}^2 \cdot t_S \\ &\quad + \frac{1}{3} \cdot (I_{50}^2 + I_{5FW}^2 + I_{50} \cdot I_{5FW}) \cdot \Delta t_{5FW} + I_{5FW}^2 \cdot (t_v - \Delta t_{5FW}) + I_{60}^2 \cdot t_R \\ &= 292^2 \cdot 4.67 + 142^2 \cdot 34 + \frac{1}{3} \cdot (520^2 + 419.5^2 + 520 \cdot 419.5) \cdot (45 - 10.66) \\ &\quad + \frac{1}{3} \cdot (419.5^2 + 469.9^2 + 419.5 \cdot 469.9) \cdot 10.66 + 109.3^2 \cdot 35 \\ &\quad + \frac{1}{3} \cdot (620^2 + 505^2 + 620 \cdot 505) \cdot 8.37 + 505^2 \cdot (39 - 8.37) + 165.3^2 \cdot 31.83 \\ &= 22557472\ A^2s \end{aligned}$$

and

$$I_{motor\ RMS} = \sqrt{\frac{22557472}{1895}} = 345\ A$$

This RMS motor current is permissible as the rated motor current is 430 A.

### Calculating the braking power

Braking occurs when decelerating from the centrifuging speed to the discharge speed. In this case, the drive is braked with a constant motor torque of 2872 Nm.

Max. braking power in the DC link at  $n_S$ :

$$P_{br\ DClink\ max} = \frac{M_{motor\ v} \cdot n_S}{9550} \cdot \eta_{motor} \cdot \eta_{WR} = \frac{2872 \cdot 1240}{9550} \cdot 0.96 \cdot 0.98 = 350.8\ kW$$

Minimum braking power in the DC link at  $n_R$ :

$$P_{br\ DClink\ min} = \frac{M_{motor\ v} \cdot n_R}{9550} \cdot \eta_{motor} \cdot \eta_{WR} = \frac{2872 \cdot 70}{9550} \cdot 0.96 \cdot 0.98 = 19.8\ kW$$

Braking power characteristic for a cycle



Braking energy for a cycle (corresponds to the area in the braking diagram):

$$W_{br} = \frac{P_{br\ DClink\ max} + P_{br\ DClink\ min}}{2} \cdot t_v = \frac{350.8 + 19.8}{2} \cdot 39 = 7226.7\ kW_s$$

The following is obtained for the average braking power:

$$P_{br\ DClink\ average} = \frac{W_{br}}{T} = \frac{7226.7}{189.5} = 38\ kW$$

As a result of the high average braking power, a brake resistor is not used, but instead, a drive converter with regenerative feedback into the line supply.

### Selecting the drive converter

The maximum motor current is 620 A (braking mode) and the RMS motor current is 345 A. Thus, the following drive converter is selected with regenerative feedback into the line supply.

6SE7135-1EF62-4AB0

$P_{Vn}=250\ kW$ ;  $I_{Vn}=510\ A$ ,  $I_{Vmax}=694\ A$ ,  $I_{DC\ link\ n}=605\ A$

It must still be checked whether the maximum DC link current when braking, in regenerative operation, is permissible.

$$I_{DClink\ gen\ max} = \frac{P_{br\ DClink\ max}}{U_{ZK}} = \frac{P_{br\ DClink\ max}}{1.35 \cdot V_{supply}} = \frac{350.8 \cdot 10^3}{1.35 \cdot 400} = 650\ A$$

The permissible DC link current in regenerative operation is 92% of the value permissible for motor operation:

$$I_{DClink\ gen\ perm.} = I_{DClink\ n} \cdot 1.36 \cdot 0.92 = 605 \cdot 1.36 \cdot 0.92 = 757\ A$$

Thus, the infeed/regenerative feedback unit is adequately dimensioned.

### Selecting the regenerative feedback transformer

When selecting the regenerative feedback transformer, the RMS DC link current in regenerative feedback operation is first calculated.

$$I_{DClink\ gen} = \frac{P_{br\ DClink}}{V_{DClink}}$$

The RMS value in regenerative feedback operation is obtained using the following equation:

$$\begin{aligned} I_{DClink\ gen\ RMS} &= \frac{P_{br\ DClink\ RMS}}{V_{DClink}} = \frac{1}{V_{DClink}} \cdot \sqrt{\frac{\frac{1}{3} \cdot (P_{br\ DClink\ max}^2 + P_{br\ DClink\ min}^2 + P_{br\ DClink\ max} \cdot P_{br\ DClink\ min}) \cdot t_v}{T}} \\ &= \frac{1}{540} \cdot \sqrt{\frac{\frac{1}{3} \cdot (350.8^2 + 19.8^2 + 350.8 \cdot 19.8) \cdot 39}{189.5}} = 175\ A \end{aligned}$$

The permissible RMS value for a regenerative feedback transformer with 25% duty ratio factor is given by:

$$I_{DClink\ RMS\ perm.} = I_{DClink\ n} \cdot 0.92 \cdot \sqrt{\frac{25}{100}} = I_{DClink\ n} \cdot 0.46 = 605 \cdot 0.46 = 278.3\ A$$

Thus, a regenerative feedback transformer 4BU5195-0UA31-8A, with 25% duty ratio factor is adequate.

For several centrifugal drives, a multi-motor drive can be configured, consisting of a rectifier/regenerative feedback unit, a DC link bus and an inverter for each centrifuge. Energy is transferred through the DC link bus by appropriately harmonizing the individual cycles. Thus, a lower-rating rectifier/regenerative feedback unit can be selected.

### 3.12 Cross-cutter with variable cutting length

For a force-ventilated induction motor, the possible web speed should be defined as a function of the cut length. The mechanical configuration is as follows.



#### Drive data

Diameter of the knife rolls	$D$	= 284 mm
Moment of inertia of the knife rolls	$J_{load}$	= 6.43 kgm <sup>2</sup>
Mechanical efficiency	$\eta_{mech}$	= 0.95
Overlap angle	$\varphi_{\ddot{u}}$	= 60 degrees
Max. permissible web velocity	$v_{B\ per.}$	= 349 m/min
Max. permissible circumferential velocity of the knife rolls	$v_{UW\ per.}$	= 363 m/min
Min. cutting length	$s_{L\ min}$	= 372 mm
Max. cutting length	$s_{L\ max}$	= 1600 mm
Gearbox ratio	$i$	= 2.029
Supplementary moment of inertia, motor side	$J_{mot\ suppl.}$	= 0.18 kgm <sup>2</sup>
Cutting torque	$M_S$	= 115 Nm
Rated motor output	$P_{mot\ n}$	= 90 kW
Rated motor torque	$M_{mot\ n}$	= 1150 Nm
Motor stall torque	$M_{stall}$	= 3105 Nm
Rated motor speed	$n_{mot\ n}$	= 750 RPM
Motor moment of inertia	$J_{mot}$	= 0.67 kgm <sup>2</sup>



Rated motor current	$I_{\text{mot } n}$	= 200 A
Magnetizing current	$I_{\text{mag}}$	= 97 A
Efficiency	$\eta_{\text{mot}}$	= 0.92
Rated motor voltage	$U_{\text{mot } n}$	= 340 V

When defining the possible web velocity as a function of the cut length, the following limits must be observed.

- Permissible limiting torque for the motor ( $M_{\text{mot max}} \leq M_{\text{per.}}$ )
- Thermal limit for the motor ( $I_{\text{rms}} \leq I_{\text{mot } n}$ )
- Max. permissible web velocity
- Max. permissible circumferential velocity of the knife rolls

The maximum motor torque when accelerating is obtained from

$$M_{\text{Mot max}} = M_{\text{Mot b}} = (J_{\text{Mot}} + J_{\text{Mot sup pl.}}) \cdot i \cdot \alpha_b + J_{\text{load}} \cdot \alpha_b \cdot \frac{1}{i \cdot \eta_{\text{mech}}}$$

$\alpha_b$  angular acceleration of the knife rolls

When decelerating, the motor torque is given by  $\alpha_v = -\alpha_b$

$$M_{\text{Mot v}} = -(J_{\text{Mot}} + J_{\text{Mot sup pl.}}) \cdot i \cdot \alpha_b - J_{\text{load}} \cdot \alpha_b \cdot \frac{\eta_{\text{mech}}}{i}$$

Precisely during the overlap phase (constant motor speed), the motor should provide the cutting torque.

$$M_{\text{Mot k}} = \frac{M_S}{i \cdot \eta_{\text{mech}}}$$

The motor current is obtained from the motor torque:

$$I_{\text{Mot}} \approx I_{\text{Mot } n} \cdot \sqrt{\left(\frac{M_{\text{Mot}}}{M_{\text{Mot } n}}\right)^2 \cdot \left(1 - \left(\frac{I_{\text{mag}}}{I_{\text{Mot } n}}\right)^2\right) \cdot kn^2 + \left(\frac{I_{\text{mag}}}{I_{\text{Mot } n}}\right)^2 \cdot \frac{1}{kn^2}}$$

$kn = 1$  for  $n_{\text{Mot}} \leq n_{\text{Mot } n}$  constant flux range

$kn = \frac{n_{\text{Mot}}}{n_{\text{Mot } n}}$  for  $n_{\text{Mot}} > n_{\text{Mot } n}$  field weakening

In order to calculate the characteristic of the motor torque and motor current over time as well as the RMS motor current, the motion sequences of the knife rolls must first be defined as a function of the cut length.

### Motion sequences of the knife rolls

For the specified overlap angle  $\varphi_{\ddot{u}}$ , the web speed and the circumferential velocity of the knife rolls should be in synchronism.



$\varphi_{\ddot{u}}$  overlap angle

$v_B$  constant web velocity

$\omega_B = v_B \cdot \frac{2}{D}$  angular velocity of the knife rolls during the overlap

$D$  diameter of the knife rolls

Depending on the cut length  $s_L$ , for the remaining angular range, the following different situations are relevant for the angular velocity characteristic of the knife rolls.

### 1. Sub-synchronous lengths ( $s_L < \pi \cdot D$ )

For  $s_L < \pi \cdot D$ , the cut length is less than the circumference of the knife rolls. This means, it must be appropriately accelerated to "catch-up" and then decelerated. The following diagram is obtained.



$\omega_d$  angular velocity of the knife rolls at the reversal point

$t_k = \frac{\varphi_{ii}}{\omega_B}$  time interval with constant angular velocity  $\omega_B$

$t_b = t_v = \frac{\omega_d - \omega_B}{\alpha_b}$  accelerating time, decelerating time of the knife rolls

$\alpha_b$  angular acceleration of the knife rolls

$t_s = \frac{s_L}{v_B} = \frac{2 \cdot s_L}{\omega_B \cdot D} = t_k + 2 \cdot t_b$  time between 2 cuts

For one revolution of the knife rolls, the area under the curve in the diagram is given by:

$$2 \cdot \pi = \omega_B \cdot t_s + (\omega_d - \omega_B) \cdot t_b$$

By inserting this, the following equations are obtained for the quantities which are required.

$$t_b = \sqrt{\frac{2 \cdot \pi - \frac{2 \cdot s_L}{D}}{\alpha_b}}$$

$$\omega_B = \frac{\frac{s_L}{D} - \frac{\varphi_{ii}}{2}}{t_b}$$

$$\omega_d = \omega_B + \frac{2 \cdot \pi - \frac{2 \cdot s_L}{D}}{t_b}$$

If  $\omega_B$  is known, then times  $t_k$  and  $t_s$  can be calculated with the previously specified formulas. The angular acceleration  $\alpha_b$  is then obtained as follows from the maximum motor torque when accelerating,

$$\alpha_b = \frac{M_{Mot \max}}{i \cdot (J_{Mot} + J_{Mot \text{ suppl.}}) + \frac{J_{load}}{i \cdot \eta_{mech}}}$$

The maximum motor speed is given by:

$$n_{Mot \max} = \frac{\omega_d \cdot 60 \cdot i}{2 \cdot \pi}$$

The following condition must be maintained for  $s_{L \min}$  :

$$s_{L \min} > \frac{\varphi_{ii} \cdot D}{2}$$

## 2. Synchronous length ( $s_L = \pi \cdot D$ )

For  $s_L = \pi \cdot D$  (the cut length corresponds to the circumference of the knife rolls),  $\omega_d = \omega_B$ . This means, that there is neither acceleration nor deceleration. The web velocity could theoretically be set as required. However, in practice it is limited by  $v_{B \text{ per.}}$ .

### 3. Above-synchronous lengths ( $s_L > \pi \cdot D$ )

For  $s_L > \pi \cdot D$ , the cut length is greater than the circumference of the knife rolls. Therefore, after the cut, the system must be braked and then re-accelerated. This results in the following diagram.



In this case,

$$t_b = t_v = \frac{\omega_B - \omega_d}{\alpha_b}$$

Thus, the acceleration time is given by:

$$t_b = \sqrt{\frac{2 \cdot s_L - 2 \cdot \pi}{D} \frac{1}{\alpha_b}}$$

The maximum motor speed is now defined by  $\omega_B$ :

$$n_{Mot \max} = \frac{\omega_B \cdot 60 \cdot i}{2 \cdot \pi}$$

All other equations correspond to those of the sub-synchronous length.

In the limiting case,  $\omega_d = 0$ . The following is valid for the associated cut length:

$$s_{L\text{ limit}} = 2 \cdot \pi \cdot D - \frac{\varphi_{ii} \cdot D}{2}$$

If the cut length is increased even further, an interval must be inserted with  $\omega_d = 0$ . Thus, the following diagram is obtained

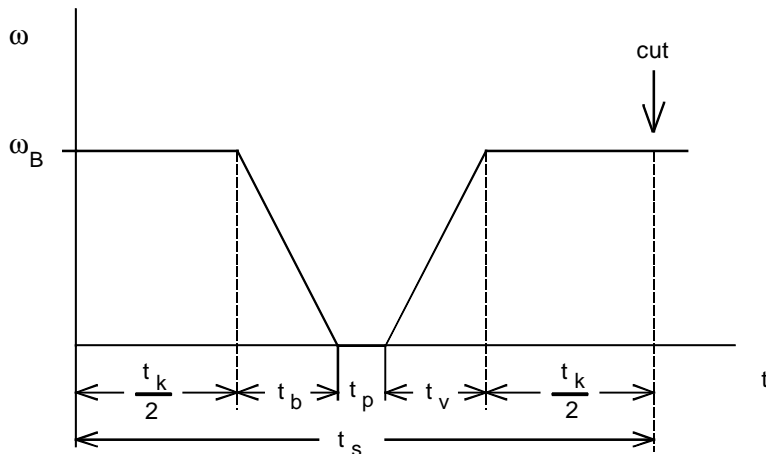

For the area under the curve in the diagram, the following is obtained for one revolution of the knife rolls:

$$2 \cdot \pi = \varphi_{ii} + \omega_B \cdot t_b$$

The following is still true

$$\alpha_b = \frac{\omega_B}{t_b}$$

Thus, the following is obtained:

$$t_b = \sqrt{\frac{2 \cdot \pi - \varphi_{ii}}{\alpha_b}}$$

$$\omega_B = \frac{2 \cdot \pi - \varphi_{ii}}{t_b}$$

$$t_p = t_s - t_k - 2 \cdot t_b \quad \text{interval for } \omega_d = 0$$

All of the other equations correspond to those of the sub-synchronous lengths.

### Making the calculation

The calculation is made using an Excel/VBA program for a specific cut length according to the following schematic:

- 1) Enter  $M_{\text{mot max}}$  and calculate the motor RMS current
- 2) Interrogate  $I_{\text{rms}} \leq I_{\text{mot n}}$ , when required, iterate up to  $I_{\text{rms}} = I_{\text{mot n}}$
- 3) Interrogate  $M_{\text{mot max}} \leq M_{\text{stall}}(n_{\text{mot max}})$ , when required, iterate up to  $M_{\text{mot max}} = M_{\text{stall}}(n_{\text{mot max}})$
- 4) Interrogate  $v_B \leq v_{B \text{ per.}}$ , when required limit
- 5) Interrogate  $v_{UW \text{ max}} \leq v_{UW \text{ per.}}$ , when required limit

To Point 1)

Initially,  $M_{\text{mot max}}$  is set to  $M_{\text{per.}}$  (e.g.  $2 M_{\text{mot n}}$ ). The angular acceleration  $\alpha_b$  is obtained with  $M_{\text{mot max}}$ .

Depending on the range (sub-synchronous, above-synchronous, above-synchronous with  $s_L > s_{L \text{ limit}}$ ), the quantities  $v_B$ ,  $n_{\text{mot max}}$ ,  $t_k$ ,  $t_b$ ,  $t_s$  and  $t_p$  quantities are defined. If  $n_{\text{mot max}} > n_{\text{mot n}}$ , the instant where the field weakening becomes active must be calculated for the current calculation.

Naturally,  $n_{\text{mot max}}$  may not exceed the permissible limiting speed of the motor. If an interval  $t_p$  occurs for above-synchronous length, then the motor torque is set to zero in this range. The characteristic of the motor torque with respect to time, and therefore also the motor RMS current, can be calculated.

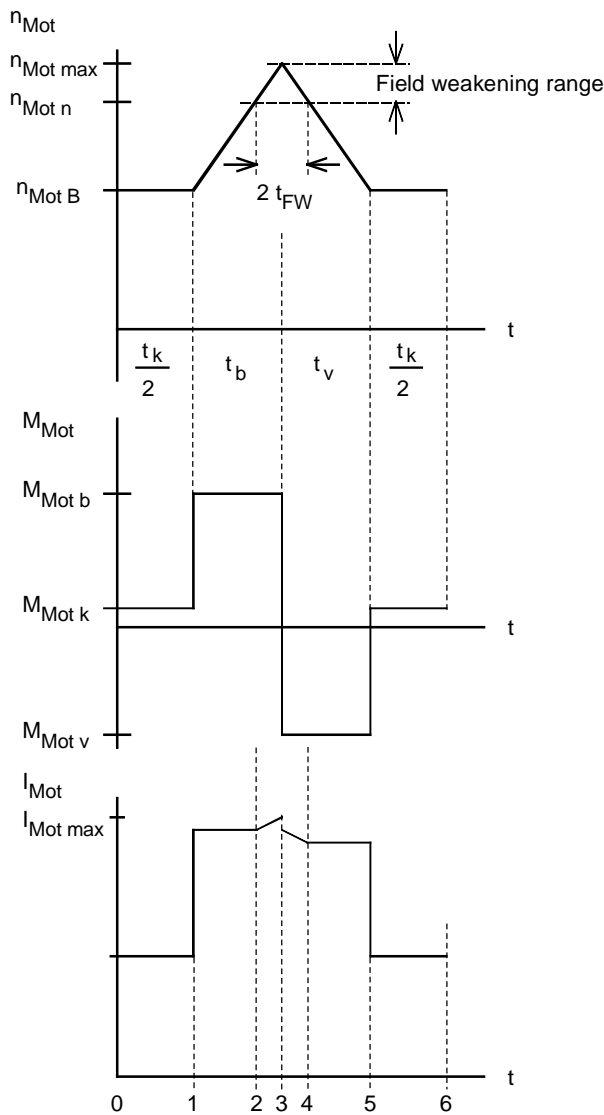

$$t_{FW} = \frac{n_{Mot\ max} - n_{Mot\ n}}{n_{Mot\ max} - n_{Mot\ B}} \cdot t_b$$

Example for motor speed, motor torque and motor current for sub-synchronous lengths

As a result of the efficiency when accelerating, the motor torque is greater than when decelerating, and the motor max current when accelerating is correspondingly higher. The current increases in the field-weakening range. The RMS value is obtained for the motor torque and the motor current with the formulas specified previously:

$$I_{rms} = \sqrt{\frac{\sum_{i=1}^{i=6} \left( \frac{I_{Mot\ i-1} + I_{Mot\ i}}{2} \right)^2 \cdot (t_i - t_{i-1})}{t_s}}$$

For above-synchronous lengths with  $s_L > s_{L\ limit}$ , there is also an interval with  $M_{mot}=0$ .



To Point 2)

If  $I_{rms} \leq I_{mot n}$ , then continue with Point 3). For  $I_{rms} > I_{mot n}$ ,  $M_{mot max}$  is reduced until  $I_{rms} = I_{mot n}$ . This is an iterative procedure. After this, the calculation continues with Point 3).

To Point 3)

First, a check is made whether  $n_{mot max} \leq n_{limit}$  ( $n_{limit}$  is the application point for the stall limit, decreasing with  $1/n_{Mot}^2$ ).

$$n_{limit} = n_{Mot n} \cdot \sqrt{\frac{M_{stall}}{M_{per.} \cdot 1,3}}$$



If  $n_{mot max} \leq n_{limit}$ , the calculation continues with Point 4). Otherwise, the stall limit is checked:

$$M_{Mot max} \leq \frac{M_{stall}}{1,3} \cdot \left(\frac{n_{Mot n}}{n_{Mot max}}\right)^2$$

If this condition is fulfilled, continue with Point 4). Otherwise,  $M_{mot max}$  is reduced until the stall limit is just reached. This is an iterative procedure. Then continue with Point 4).

To Point 4)

If  $v_B \leq v_{B \text{ per.}}$  then continue with Point 5). Otherwise,  $v_B$  is limited to  $v_{B \text{ per.}}$ . The remaining values ( $\omega_d$ ,  $t_k$ ,  $t_b$ ,  $t_s$ ,  $t_p$ ) must be appropriately converted according to the reduced  $v_B$ .

With

$$\omega_{B \text{ per.}} = v_{B \text{ per.}} \cdot \frac{2}{D}$$

the remaining values are obtained:

$$\omega_d = \omega_{B \text{ per.}} \cdot \left(1 + \frac{2 \cdot \pi - \frac{2 \cdot s_L}{D}}{\frac{s_L}{D} - \frac{\varphi_{ii}}{2}}\right) \quad \text{or } \omega_d = 0 \quad \text{for } s_L > s_{L \text{ limit}}$$

$$t_b = \frac{\frac{s_L}{D} - \frac{\varphi_{ii}}{2}}{\omega_{B \text{ per.}}} \quad \text{or } t_b = \frac{2 \cdot \pi - \varphi_{ii}}{\omega_{B \text{ per.}}} \quad \text{for } s_L > s_{L \text{ limit}}$$

$$t_k = \frac{\varphi_{ii}}{\omega_{B \text{ per.}}}$$

$$t_s = \frac{2 \cdot s_L}{\omega_{B \text{ per.}} \cdot D}$$

$$t_p = 0 \quad \text{or } t_p = t_s - t_k - 2 \cdot t_b \quad \text{for } s_L > s_{L \text{ limit}}$$

Due to the fact, that when  $v_B$  is limited, the maximum circumferential velocity  $v_{UW \text{ max}}$  of the knife rolls can no longer increase, the interrogation operations are therefore completed.

To Point 5)

For above-synchronous lengths, the interrogation operations have been completed, as, in this case, the maximum circumferential velocity of the knife rolls is defined by  $v_B$ . For sub-synchronous lengths, the maximum circumferential velocity of the knife rolls is defined by  $\omega_d$ :

$$v_{UW \text{ max}} = \omega_d \cdot \frac{D}{2}$$

For  $v_{UW \text{ max}} \leq v_{UW \text{ per.}}$ , the interrogation operations have been completed. Otherwise,  $v_{UW \text{ max}}$  is limited to  $v_{UW \text{ per.}}$ . The remaining values ( $\omega_B$ ,  $t_k$ ,  $t_b$ ,  $t_s$ ) must be converted corresponding to the reduced  $v_{UW \text{ max}}$ .

With

$$\omega_{d \text{ per.}} = v_{UW \text{ per.}} \cdot \frac{2}{D}$$

the remaining values are obtained:

$$\omega_B = \omega_{d\ per.} \cdot \frac{1}{2 \cdot \pi - \frac{2 \cdot s_L}{D} + \frac{s_L - \frac{\varphi_{ii}}{2}}{D}}$$

$$t_b = \frac{\frac{s_L - \frac{\varphi_{ii}}{2}}{D}}{\omega_B}$$

$$t_k = \frac{\frac{\varphi_{ii}}{2}}{\omega_B}$$

$$t_s = \frac{2 \cdot s_L}{\omega_B \cdot D}$$

Dimensioning a capacitor battery

A capacitor battery can be used for buffering, to prevent power oscillations between the motor and line supply. This capacitor battery is dimensioned, so that in operation, energy is neither fed back into the line supply nor converted into heat in the pulsed resistor. Without taking into account the losses, the regenerative feedback energy from the kinetic energy is obtained as follows:

$$W_{gen} = W_{kin} = \frac{1}{2} \cdot J_{tot.} \cdot |w_d^2 - w_B^2| \quad \text{sub-synchronous and above-synchronous}$$

with

$$J_{tot.} = J_{load} + (J_{Mot} + J_{Mot\ sup\ pl.}) \cdot i^2$$

Using the capacitor energy

$$W_C = \frac{1}{2} \cdot C \cdot (U_{d\ max}^2 - U_{d\ n}^2)$$

the following is obtained for the capacitor:

$$C = \frac{2 \cdot W_{kin\ max}}{U_{d\ max}^2 - U_{d\ n}^2}$$

The maximum kinetic energy generally occurs at  $s_{L\ min}$ . When dimensioning the capacitor battery, the existing capacitance in the drive converter DC link or inverter, must be taken into account.

If one takes into account the efficiencies  $\eta_{mech}$ ,  $\eta_{mot}$ ,  $\eta_{WR}$ , the regenerative feedback energy must be calculated using the negative area under the curve of the DC link power.

$$W_{gen} = \int P_{DC\ link\ gen} \cdot dt = \frac{1}{2} \cdot M_{Mot\ v} \cdot (\omega_d + \omega_B) \cdot \eta_{Mot} \cdot \eta_{WR} \cdot i \cdot t_v$$

After several rearrangements, the following is obtained:

$$W_{gen} = \frac{1}{2} \cdot J'_{tot.} \cdot |\omega_d^2 - \omega_B^2| \cdot \eta_{Mot} \cdot \eta_{WR}$$

with

$$J'_{tot.} = J_{load} \cdot \eta_{mech} + (J_{Mot} + J_{Mot\ sup\ pl.}) \cdot i^2$$

### Results as characteristics

The following characteristics are obtained with the specified numerical values.



Web velocity  $v_B$



Angular velocities  $\omega_B$  and  $\omega_d$  with limits  $v_{B\text{ per.}}$  and  $v_{UW\text{ per.}}$

(intersection at the synchronous cut length  $s_{L,\text{syn}} = \pi \cdot D = 892,2\text{ mm}$ )



Motor RMS current referred to the rated motor current



Max. motor torque referred to the rated motor torque



Max. motor current referred to the rated motor current



Energy when motoring and generating

The following characteristics (over time) are obtained for 2 various cut lengths (sub-synchronous and above-synchronous).

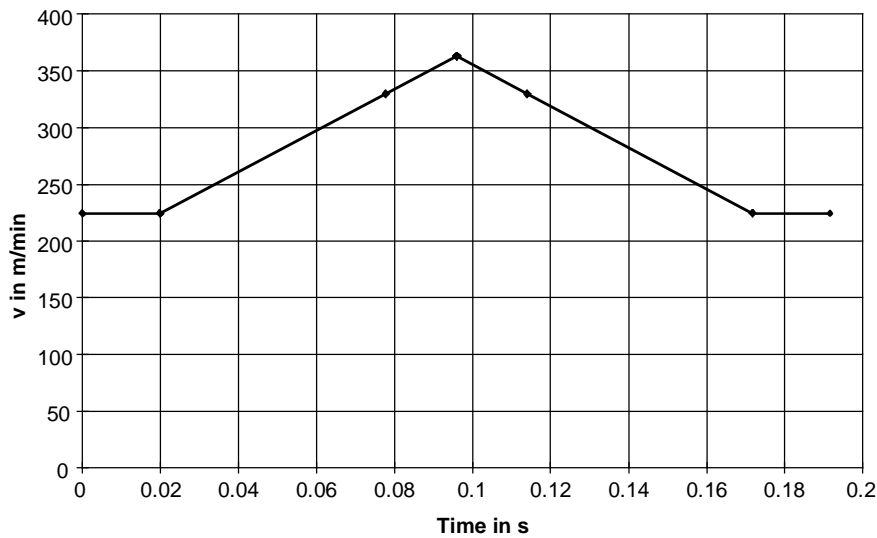

Circumferential velocity of the knife rolls for  $s_L=716$  mm (sub-synchronous)

The intervention point for field-weakening is  $v=329.8$  m/min



Motor torque for  $s_L=716$  mm (sub-synchronous)



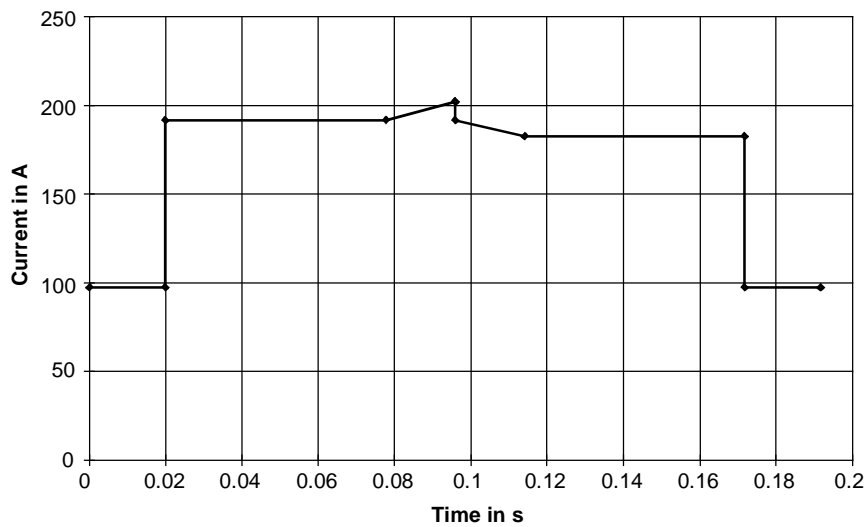

Motor current for  $s_L=716$  mm (sub-synchronous)

Current increase in the field-weakening range

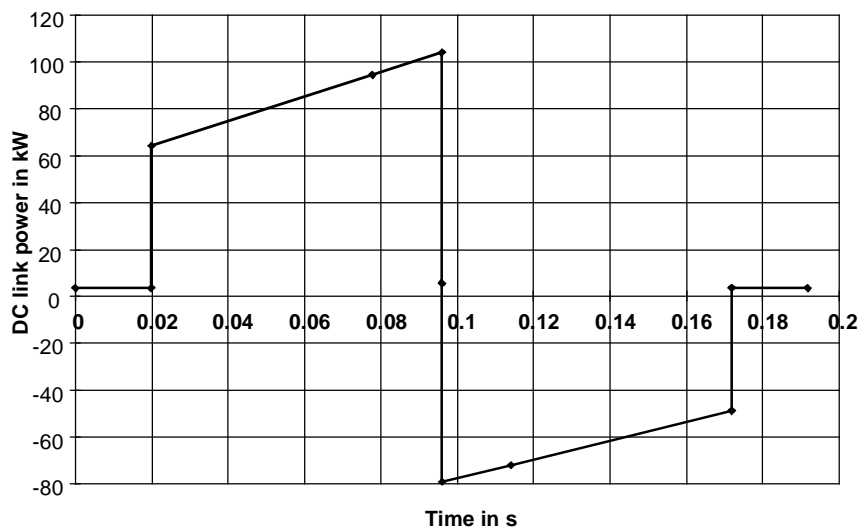

DC link power for  $s_L=716$  mm (sub-synchronous)

The negative area under the curve corresponds to the regenerative energy



Circumferential velocity of the knife rolls for  $s_L=1016$  mm (above-synchronous)  
 The intervention for field-weakening is  $v=329.8$  m/min



Motor torque for  $s_L=1016$  mm (above-synchronous)



Motor current for  $s_L=1016$  mm (above-synchronous)

Current increase in the field-weakening range

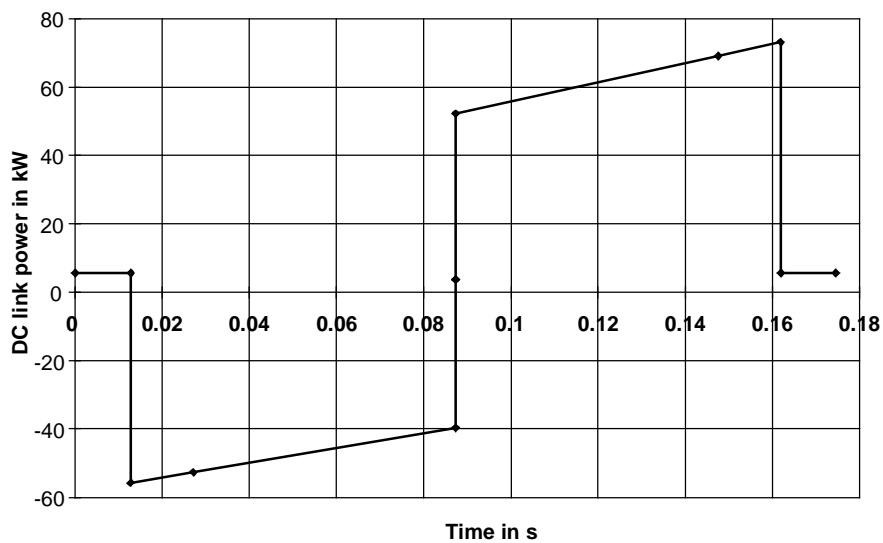

DC link power for  $s_L=1016$  mm (above synchronous)

The negative area under the curve corresponds to the regenerative energy

Drive converter selection

The drive converter is selected according to the maximum motor current and the maximum RMS value of the motor current for all cut lengths. The maximum RMS value is exactly the same as the rated motor current (200 A). The maximum motor current is obtained when accelerating and at the maximum motor speed (in the field-weakening range). The maximum value is at precisely the minimum cut length with  $I_{\text{mot max}}=259.2$  A. Thus, the following SIMOVERT MASTERDRIVES MOTION CONTROL drive converter is obtained:

6SE7032-6EG50

$P_{Vn}=110$  kW

$I_{Vn}=218$  A

$I_{Vmax}=345$  A

Selecting the additional capacitor battery

The maximum regenerative energy occurs in this case, at the minimum cut length.

$$W_{gen\ max} = 6,77\ kW_s$$

Thus, the required capacitance is given by

$$C = \frac{2 \cdot W_{gen\ max}}{U_{d\ max}^2 - U_{dn}^2} = \frac{2 \cdot 6770}{675^2 - 520^2} = 73\ mF$$

The DC link capacitance of the drive converter is 14.1 mF. This means that an additional capacitance of 58.9 mF is required. The pre-charging of the external capacitor battery is realized after internal charging has been completed, using a separate pre-charging circuit.

### 3.13 Saw drive with crank

Stacks of paper napkins should be cut using a series of circular saw blades, connected to a crank pinion. The saw blades, driven using a toothed belt, are moved in a vertical direction via the crank drive.



Mode of operation

Drive data

Weight of the saw blades	$m_{\text{saw}}$	= 80 kg
Weight of the crank pinion	$m_{\text{pinion}}$	= 13.5 kg
Weight of the connecting rod	$m_{\text{rod}}$	= 6.5 kg

Weight of the crank disk	$m_{\text{disk}}$	= 10 kg
Length of the crank pinion	$r_2$	= 1.25 m
Length of the connecting rod	$l$	= 0.6 m
Radius of the crank disk	$r$	= 0.12 m
Clearance between the center of the saw blades and the fixed point of rotation	$r_1$	= 0.8 m
Cycle time	$T$	= 0.625 s

### Motion sequence

Starting from the upper dead center of the cam disk, it accelerates through 180 degrees to the lower dead center, followed by deceleration through 180 degrees back to the upper dead center followed by a no-load interval.



The 180 degree angular range between points a and b should be traveled through within 160 ms. The cycle time is 625 ms. The characteristics for the angular velocity and the angular acceleration of the crank disk are as follows.



$\omega_{\max}$  and  $t_{\text{tot}}$  are given by:

$$\omega_{\max} = \frac{2 \cdot \pi}{0,16} \cdot \frac{\sqrt{2}}{1 + \sqrt{2}} = 23 \text{ s}^{-1}$$

$$t_{\text{tot.}} = 0,16 \cdot (2 + \sqrt{2}) = 0,546 \text{ s}$$

Thus, the angular acceleration of the crank disk is given by:

$$\alpha_{\max} = \frac{\omega_{\max}}{\frac{t_{\text{tot.}}}{2}} = \frac{23 \cdot 2}{0,546} = 84,2 \text{ s}^{-2}$$

The maximum crank disk speed is given by:

$$n_{\max} = \frac{\omega_{\max} \cdot 60}{2 \cdot \pi} = \frac{23 \cdot 60}{2 \cdot \pi} = 219,6 \text{ RPM}$$

The angular acceleration  $\alpha$ , the angular velocity  $\omega$  and the angle  $\varphi$  of the crank disk can now be represented as a function of time. The zero point of the angle is at the lower dead center.

Acceleration range:  $0 \leq t \leq \frac{t_{tot.}}{2}$  or  $-\pi \leq \varphi \leq 0$

$$\alpha = \alpha_{\max}$$

$$\omega = \alpha_{\max} \cdot t$$

$$\varphi = -\pi + \frac{1}{2} \cdot \alpha_{\max} \cdot t^2$$

Deceleration range:  $\frac{t_{tot.}}{2} \leq t \leq t_{tot.}$  or  $0 \leq \varphi \leq \pi$

$$\alpha = -\alpha_{\max}$$

$$\omega = \alpha_{\max} \cdot (t_{tot.} - t)$$

$$\varphi = \pi - \frac{1}{2} \cdot \alpha_{\max} \cdot (t_{tot.} - t)^2$$

The following simplifications were made when calculating the forces and torques.



The weight of the saw blades including the mounting, are assumed to act at a single point at a distance  $r_1$  from the fixed point of rotation 0. The weight of the connecting rod  $m_{rod}$  is distributed evenly between points A and B. The crank pinion is assumed to be a thin bar with mass  $m_{pinion}$ . The cutting torque of the saw blades is neglected.



### Forces at the crank pinion

With the previously specified simplifications, the force  $F_x$  in the x axis, acting at point A is obtained. This force consists of the accelerating component  $F_{bx}$  and a weight component  $F_{Gx}$ . The accelerating force  $F_{bx}$  acts in the opposite direction to acceleration  $a_x$ .



The moment of inertia of this arrangement referred to the fixed point of rotation 0:

$$J_{tot.} = \frac{m_{rod}}{2} \cdot r_2^2 + m_{saw} \cdot r_1^2 + \frac{1}{3} \cdot m_{pinion} \cdot r_2^2$$

With acceleration  $a_x$ , the accelerating force at point A is obtained as follows:

$$F_{bx} \cdot r_2 = J_{tot.} \cdot \frac{a_x}{r_2}$$

or

$$F_{bx} = J_{tot.} \cdot \frac{a_x}{r_2^2} = \left( \frac{m_{St}}{2} + m_{saw} \cdot \left( \frac{r_1}{r_2} \right)^2 + \frac{1}{3} \cdot m_{pinion} \right) \cdot a_x$$

The acceleration  $a_x$ , initiated by the crank movement is, with  $\omega$  and  $\alpha$  (also refer to Example 3.6), given by:

$$a_x \approx r \cdot (\omega^2 \cdot \cos \varphi + \alpha \cdot \sin \varphi) - \frac{r^2}{l} \cdot (\omega^2 \cdot \cos 2\varphi + \frac{\alpha}{2} \cdot \sin 2\varphi)$$

The following is valid for the force due to the weight at point A:

$$F_{Gx} = \left( \frac{m_{rod}}{2} + m_{saw} \cdot \frac{r_1}{r_2} + m_{pinion} \cdot \frac{1}{2} \right) \cdot g$$

*Torques at the crank disk*

The torque at the crank disk due to force  $F_x$  (also refer to Example 3.6) is given by:

$$M_{Fx} = (F_{bx} + F_{Gx}) \cdot \frac{\sin(\pi - \varphi + \beta)}{\cos \beta} \cdot r$$

with

$$\beta = \arcsin\left(\frac{r}{l} \cdot \sin \varphi\right)$$

In addition, a torque is effective due to the weight of half of the rod mass at Point B.



$$M_{rod/2} = \frac{m_{rod}}{2} \cdot g \cdot r \cdot \sin \varphi$$

The moment of inertia of the crank disk is calculated as follows when assuming a full cylinder:

$$J_{disk} = \frac{1}{2} \cdot m_{disk} \cdot r^2$$

For half of the rod mass at point B, the moment of inertia is given by:

$$J_{rod/2} = \frac{1}{2} \cdot m_{rod} \cdot r^2$$

The total torque which must be provided at the crank disk:

$$M_{crank} = M_{Fx} + M_{rod/2} + (J_{disk} + J_{rod/2}) \cdot \alpha$$

With the specified numerical values, the torque required at the crank disk can be calculated, e.g. using an Excel program.



### Selecting the motor

Selected motor:

1FT6044-4AF7 with gearbox  $i=10$  ( $\eta_{gearbox}=0.95$ ),  $n_n=3000$  RPM,  $J_{mot}=0.00062$   $kgm^2$  (with brake),  
 $\eta_{mot}=0.89$ ,  $J_{gearbox}=0.000133$   $kgm^2$ ,  $kT_0=1.67$  Nm/A,  $M_0=5$  Nm,  $I_0=3$  A,  $M_{max}=20$  Nm,  $I_{max}=11$  A

Maximum motor speed:

$$n_{Mot\max} = i \cdot n_{\max} = 10 \cdot 219.6 = 2196 \text{ RPM}$$

Motor torque

The following is valid for the motor torque:

$$M_{mot} = J_{Mot} \cdot \alpha \cdot i + J_{gearbox} \cdot \alpha \cdot i + M_{crank} \cdot \frac{1}{i \cdot \eta_{gearbox}^{VZ}}$$

with

$$VZ = \text{sign}(M_{crank})$$



The highest motor torque is required during the upwards motion when motoring. This torque is 11.91 Nm. The motor torque during the downwards motion, in regenerative operation, is less as a result of the gearbox efficiency.

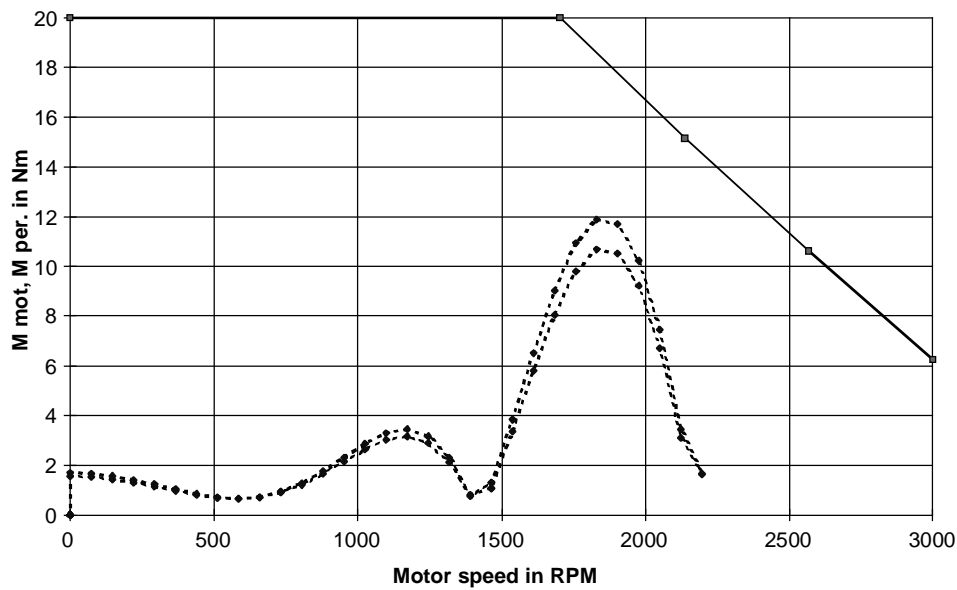

The motor torque lies below the limiting characteristic. Thus, the motor is suitable as far as the dynamic limits are concerned.

#### *Thermally checking the motor*

The motor RMS torque is approximately given by:

$$M_{rms} = \sqrt{\frac{\int M_{Mot}^2 \cdot dt}{T}} \approx \sqrt{\frac{\sum \frac{M_{Mot i-1}^2 + M_{Mot i}^2 + M_{Mot i-1} \cdot M_{Mot i}}{3} \cdot (t_i - t_{i-1})}{0.625}} = 4.5 \text{ Nm}$$

The average motor speed is obtained from:

$$n_{average} = \frac{\sum \frac{|n_{Mot i-1} + n_{Mot i}|}{2} \cdot (t_i - t_{i-1})}{T} = \frac{\frac{n_{Mot \max}}{2} \cdot \frac{t_{tot.}}{2} \cdot 2}{T} = \frac{2196 \cdot 0.546}{2 \cdot 0.625} = 959.2 \text{ RPM}$$

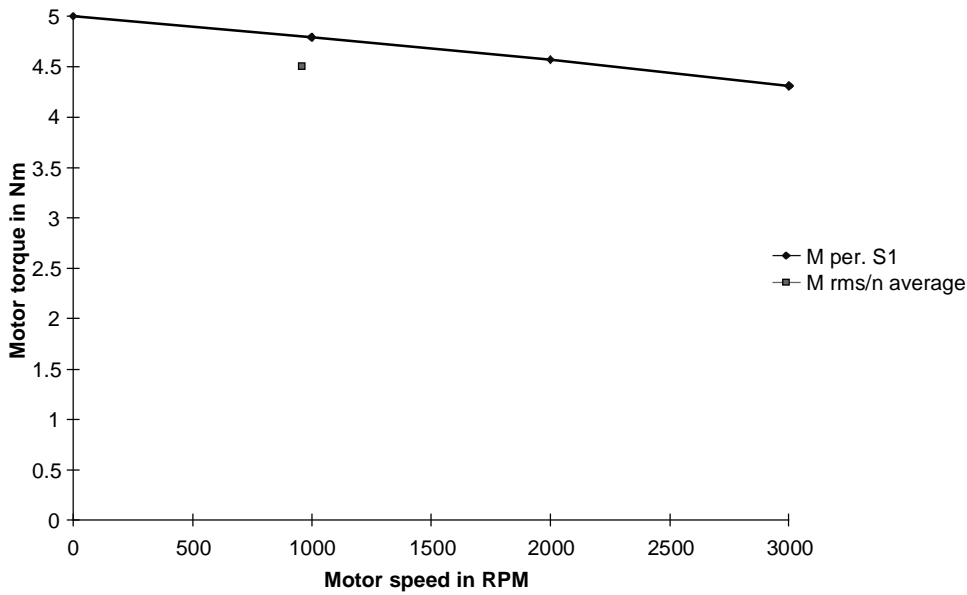

The effective motor torque lies, at  $n_{average}$ , below the  $M_{S1}$  characteristic. This means that the motor is also suitable as far as the thermal limits are concerned.

*Dimensioning the brake resistor*

The motor output is obtained from the motor torque and the angular velocity as follows:

$$P_{Mot} = M_{Mot} \cdot i \cdot \omega$$

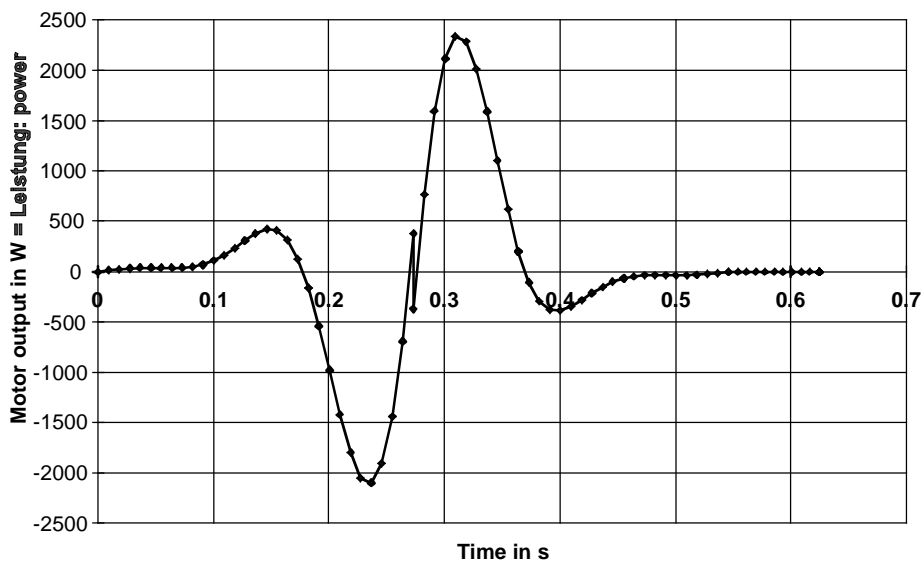

The maximum braking power for the brake resistor is obtained from the maximum negative motor output (=motor braking power):

$$P_{br W \max} = P_{br Mot \max} \cdot \eta_{Mot} \cdot \eta_{WR} = -2100 \cdot 0,89 \cdot 0,98 = -1832 \text{ W}$$

The braking energy for a cycle can be calculated using the negative area under the curve within the motor output characteristic.

$$W_{br} = \int P_{Mot} \cdot \eta_{Mot} \cdot \eta_{WR} \cdot dt \quad \text{for } P_{Mot} \leq 0$$

$$\approx \sum \eta_{Mot} \cdot \eta_{WR} \cdot \frac{P_{Mot i-1} + P_{Mot i}}{2} \cdot (t_i - t_{i-1}) \quad \text{for } P_{Mot i-1}, P_{Mot i} \leq 0$$

The zero positions of the motor output must be calculated using linear interpolation. A zero position between two points is obtained with the condition

$$P_{Mot i-1} \cdot P_{Mot i} < 0$$

to

$$t_x = t_{i-1} + \frac{t_i - t_{i-1}}{P_{Mot i-1} - P_{Mot i}} \cdot P_{Mot i-1}$$

The calculation results in:

$$W_{br} = -123,8 \text{ Ws}$$

The following is valid for the brake resistor:

$$\frac{W_{br}}{T} = \frac{123,8}{0,625} = 198,1 \text{ W} \leq P_{br \text{ duration}}$$

With

$$P_{br \text{ dur.}} = \frac{P_{20}}{4,5} \quad (\text{ext. brake resistor})$$

the following is obtained

$$4,5 \cdot 198,1 = 891,4 \text{ W} \leq P_{20}$$

The following must also be valid:

$$P_{br W \max} = 1832 \text{ W} \leq 1.5 \cdot P_{20}$$

Thus, when selecting a compact type of drive converter, a brake unit with  $P_{20}=5 \text{ kW}$  (6SE7018-0ES87-2DA0) and external brake resistor 5 kW (6SE7018-0ES87-2DC0) are required. When selecting a Compact Plus drive converter, only the external brake resistor is required (the chopper is integrated in the drive converter).

### Selecting the drive converter

The drive converter is selected according to the peak value and the motor RMS current. The motor current is given by, taking into account saturation:

$$I_{Mot} = \frac{|M_{Mot}|}{kT_0 \cdot b_1} \quad \text{for } |M_{Mot}| \leq M_0$$

$$I_{Mot} = \frac{|M_{Mot}|}{kT_0 \cdot b_1 \cdot \left(1 - \left(\frac{|M_{Mot}| - M_0}{M_{\max} - M_0}\right)^2 \cdot \left(1 - \frac{M_{\max} \cdot I_0}{M_0 \cdot I_{\max}}\right)\right)} \quad \text{for } |M_{Mot}| > M_0$$

with

$$b_1 = 1 - b \cdot \left(\frac{|n_{Mot}|}{6000}\right)^{1.5} \quad (b=0.1 \text{ for frame size } <100, \text{ otherwise } 0.15)$$

7.13 A is obtained for the peak current. The RMS value is obtained from:

$$I_{rms} \approx \sqrt{\frac{\sum \frac{I_{Mot i-1}^2 + I_{Mot i}^2 + I_{Mot i-1} \cdot I_{Mot i}}{3} \cdot (t_i - t_{i-1})}{T}} = 2.73 \text{ A}$$

Selected SIMOVERT MASTERDRIVES MOTION CONTROL drive converter:

6SE7015-0EP50 (Compact Plus type)

$P_{U n}=1.5 \text{ kW}$ ;  $I_{U n}=5 \text{ A}$ ;  $I_{U \max}=8 \text{ A}$

with external 5 kW brake resistor (6SE7018-0ES87-2DC0)



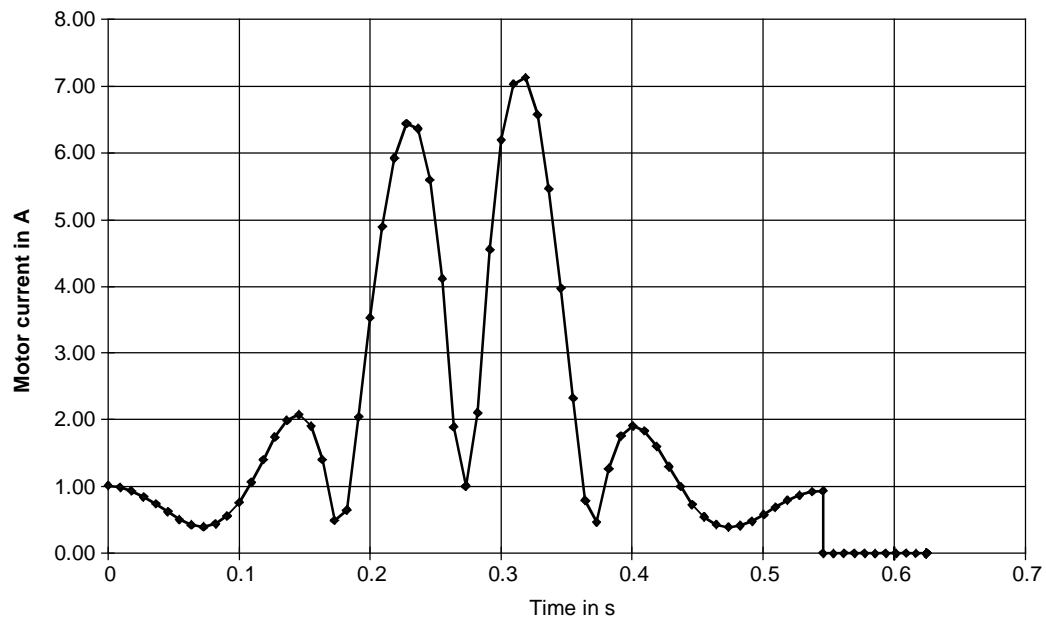

### 3.14 Saw drive as four-jointed system

The saw drive, investigated in 3.13, will now be re-calculated with modified data. The geometrical arrangement is such that the approximation with the crank disk, can no longer be used. Thus, this arrangement is known as the so-called four-jointed system.



Mode of operation

## Drive data

Weight of the saw blades	$m_{\text{saw}}$	= 21.5 kg
Weight of the crank pinion	$m_{\text{pinion}}$	= 26.5 kg
Weight of the connecting rod	$m_{\text{rod}}$	= 7.5 kg
Moment of inertia of the crank disk	$J_{\text{disk}}$	= 0.21 kgm <sup>2</sup>
Length of the crank pinion	$l_{\text{pinion}}$	= 0.59 m
Width of the crank pinion	$b_{\text{pinion}}$	= 0.18 m
Length of the connecting rod	$l$	= 0.4 m
Radius of the crank disk	$r$	= 0.1 m
Clearance, center of the saw blades to the fixed center of rotation 2 (x axis)	$x_{r1}$	= 0.54 m
Clearance, center of the saw blades to the fixed center of rotation 2 (y axis)	$y_{r1}$	= 0.0325 m
Clearance, point 3 to the fixed center of rotation 2 (x axis)	$x_{r2}$	= 0.43 m
Clearance, point 3 to the fixed center of rotation 2 (y axis)	$y_{r2}$	= 0.035 m
Clearance, point 1 to point 2 (x axis)	$x_A$	= 0.35 m
Clearance, point 1 to point 2 (y axis)	$y_A$	= 0.5285 m
Cycle time	$T$	= 1 s

*Motion sequence*

Starting from the upper dead center (i. e. connecting rod and crank pinion in one line), the crank disk rotates clockwise through 360 degrees within 0.5 s. This is then followed by an interval of 0.5 s. The maximum speed of the crank disk should be 192 RPM. Thus, the angular velocity and angular acceleration characteristics for the crank disk are as follows.

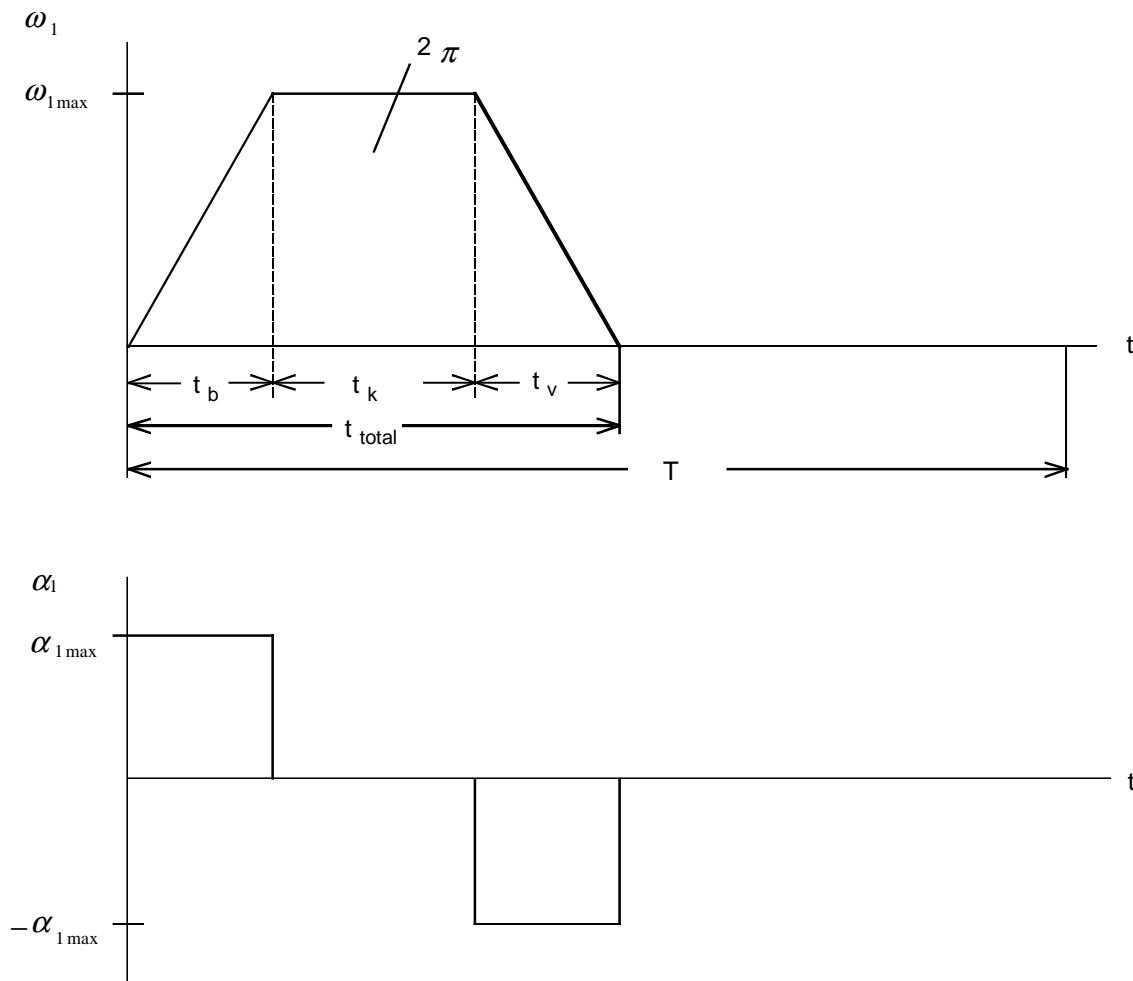

For  $\omega_{1\max}$ ,  $t_b$ ,  $t_v$  and  $t_k$ , the following is obtained:

$$\omega_{1\max} = \frac{2 \cdot \pi \cdot n_{1\max}}{60} = \frac{2 \cdot \pi \cdot 192}{60} = 20.106 \text{ s}^{-1}$$

$$t_b = t_v = \frac{\omega_{1\max} \cdot t_{\text{tot}} - 2 \cdot \pi}{\omega_{1\max}} = \frac{20.106 \cdot 0.5 - 2 \cdot \pi}{20.106} = 0.1875 \text{ s}$$

$$t_k = t_{\text{tot}} - 2 \cdot t_b = 0.5 - 2 \cdot 0.1875 = 0.125 \text{ s}$$

Thus, the angular acceleration of the crank disk is given by:

$$\alpha_{1\max} = \frac{\omega_{1\max}}{t_b} = \frac{20.106}{0.1875} = 107.232 \text{ s}^{-2}$$



Diagram to determine the starting angle at the upper dead center

The starting angle at the upper dead center at  $t=0$  is given by:

$$\varphi_{10} = \arctan \frac{y_A - y_{r2}}{x_{r2} - x_A} = \arctan \frac{0.5285 - 0.035}{0.43 - 0.35} = 1.4101 \text{ rad} \quad (\text{corresponds to } 80.79 \text{ degrees})$$

The angular acceleration  $\alpha_1$ , the angular velocity  $\omega_1$  and the angle  $\varphi_1$  of the cam disk can now be represented as a function of time.

Range:  $0 \leq t \leq t_b$  (acceleration)

$$\alpha_1 = \alpha_{1\max}$$

$$\omega_1 = \alpha_{1\max} \cdot t$$

$$\varphi_1 = \varphi_{10} + \frac{1}{2} \cdot \alpha_{1\max} \cdot t^2$$

Range:  $t_b \leq t \leq t_b + t_k$  (constant angular velocity)

$$\alpha_1 = 0$$

$$\omega_1 = \omega_{1\max}$$

$$\varphi_1 = \varphi_{10} + \frac{1}{2} \cdot \omega_{1\max} \cdot t_b + \omega_{1\max} \cdot (t - t_b)$$

Range:  $t_b + t_k \leq t \leq t_{tot}$  (deceleration)

$$\alpha_1 = -\alpha_{1\max}$$

$$\omega_1 = \omega_{1\max} - \alpha_{1\max} \cdot (t - t_b - t_k)$$

$$\varphi_1 = \varphi_{10} + \frac{1}{2} \cdot \omega_{1\max} \cdot t_b + \omega_{1\max} \cdot t_k + \omega_{1\max} \cdot (t - t_b - t_k) - \frac{1}{2} \cdot \alpha_{1\max} \cdot (t - t_b - t_k)^2$$

Angular relationships in a four-jointed system

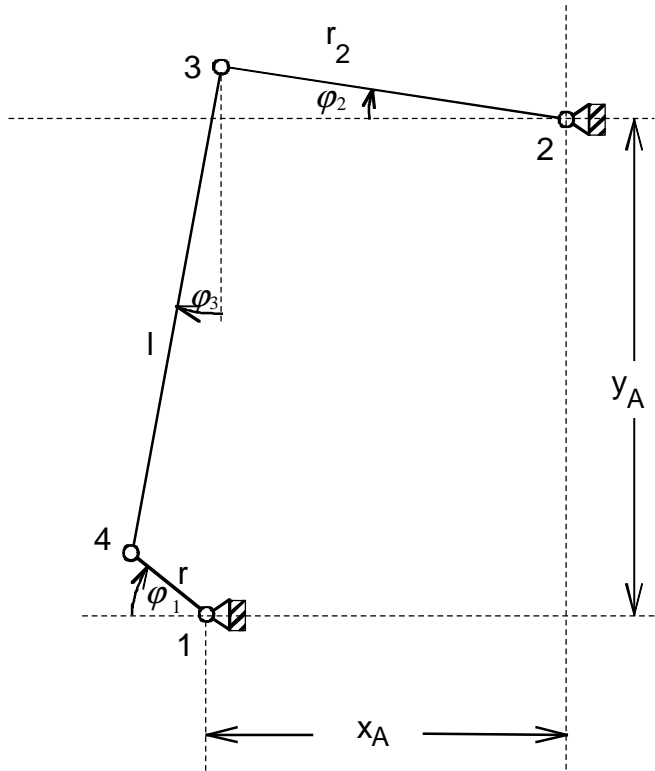

The following relationships are valid for angles  $\varphi_1$ ,  $\varphi_2$  and  $\varphi_3$ :

$$l^2 = (x_A + r \cdot \cos \varphi_1 - r_2 \cdot \cos \varphi_2)^2 + (y_A - r \cdot \sin \varphi_1 + r_2 \cdot \sin \varphi_2)^2 \quad \text{Equation 1}$$

$$\tan \varphi_3 = \frac{x_A + r \cdot \cos \varphi_1 - r_2 \cdot \cos \varphi_2}{y_A - r \cdot \sin \varphi_1 + r_2 \cdot \sin \varphi_2} \quad \text{Equation 2}$$

with

$$r_2 = \sqrt{x_{r2}^2 + y_{r2}^2}$$

Angle  $\varphi_1$  is valid over the motion sequence. Angle  $\varphi_2$  can be determined using Equation 1 (however, only iteratively). Angle  $\varphi_3$  is obtained with  $\varphi_1$  and  $\varphi_2$  using Equation 2.

### Torques at the crank pinion

In order to calculate the accelerating torques at the crank pinion, the moments of inertia with reference to the fixed center of rotation 2 must be known. The following simplifications are made.



The weight of the saw blades including their mounting, is assumed to act at a single point at a distance  $r_1$  from the fixed center of rotation 2. The weight of the connecting rod  $m_{\text{rod}}$  is distributed

evenly between points 3 and 4. The crank pinion is assumed to be a square with length  $l_{\text{pinion}}$ , width  $b_{\text{pinion}}$  and with mass  $m_{\text{pinion}}$ . The moment of inertia with respect to the fixed center of rotation 2 is then given by:

$$J_2 = m_{\text{saw}} \cdot r_1^2 + \frac{m_{\text{rod}}}{2} \cdot r_2^2 + m_{\text{pinion}} \cdot \left( \frac{l_{\text{pinion}}^2}{3} + \frac{b_{\text{pinion}}^2}{12} \right)$$

with

$$r_1 = \sqrt{x_{r1}^2 + y_{r1}^2}$$

The accelerating torque with the angular acceleration of the crank pinion  $\alpha_2$  is given by:

$$M_{2b} = J_2 \cdot \alpha_2$$

The angular velocity  $\omega_2$  of the crank pinion is obtained by implicitly differentiating Equation 1.

$$\omega_2 = \frac{r \cdot \omega_1 \cdot (A \cdot \sin \varphi_1 + B \cdot \cos \varphi_1)}{r_2 \cdot (A \cdot \sin \varphi_2 + B \cdot \cos \varphi_2)}$$

with

$$A = x_A + r \cdot \cos \varphi_1 - r_2 \cdot \cos \varphi_2$$

$$B = y_A - r \cdot \sin \varphi_1 + r_2 \cdot \sin \varphi_2$$

The required angular acceleration  $\alpha_2$  is obtained by differentiating  $\omega_2$ :

$$\alpha_2 = \frac{r \cdot (\alpha_1 \cdot Z + \omega_1 \cdot \dot{Z}) - r_2 \cdot \omega_2 \cdot \dot{N}}{r_2 \cdot N}$$

with

$$Z = A \cdot \sin \varphi_1 + B \cdot \cos \varphi_1$$

$$N = A \cdot \sin \varphi_2 + B \cdot \cos \varphi_2$$

$$\dot{Z} = \sin \varphi_1 \cdot (\dot{A} - B \cdot \omega_1) + \cos \varphi_1 \cdot (\dot{B} + A \cdot \omega_1)$$

$$\dot{N} = \sin \varphi_2 \cdot (\dot{A} - B \cdot \omega_2) + \cos \varphi_2 \cdot (\dot{B} + A \cdot \omega_2)$$

$$\dot{A} = -r \cdot \omega_1 \cdot \sin \varphi_1 + r_2 \cdot \omega_2 \cdot \sin \varphi_2$$

$$\dot{B} = -r \cdot \omega_1 \cdot \cos \varphi_1 + r_2 \cdot \omega_2 \cdot \cos \varphi_2$$



In order to calculate the torques due to the weight applied at the crank pinion, the angular difference to  $r_2$  must be known. The cutting torque of the saw blades is neglected.



$$\Delta\varphi_{r1} = \arctan \frac{y_{r2}}{x_{r2}} + \arctan \frac{y_{r1}}{x_{r1}} \quad \text{angle between } r_1 \text{ and } r_2$$

$$\Delta\varphi_s = \arctan \frac{y_{r2}}{x_{r2}} \quad \text{angle between the center of gravity axis and } r_2$$

Thus, the torque due to the weight is given by:

$$M_{2G} = m_{saw} \cdot g \cdot r_1 \cdot \cos(\varphi_2 + \Delta\varphi_{r1}) + m_{pinion} \cdot g \cdot \frac{l_{pinion}}{2} \cdot \cos(\varphi_2 + \Delta\varphi_s) + \frac{m_{rod}}{2} \cdot g \cdot r_2 \cdot \cos \varphi_2$$

*Calculating the connecting rod force*

The connecting rod force can be calculated using torques  $M_{2b}$  and  $M_{2G}$ .



$$M_2 = M_{2b} + M_{2G}$$

torque around point 2

$$F_{pinionT} = \frac{M_{2b} + M_{2G}}{r_2}$$

tangential force vertical to  $r_2$

$$F_{rod} = \frac{F_{pinionT}}{\cos(\varphi_3 - \varphi_2)} = \frac{M_{2b} + M_{2G}}{r_2 \cdot \cos(\varphi_3 - \varphi_2)}$$

connecting rod force in direction I

### Torques at the crank disk

The connecting rod force can be broken down into a tangential component vertical to  $r$ .



$$F_{crank T} = F_{rod} \cdot \cos(\varphi_1 - \varphi_3)$$

Thus, the torque as result of the connecting rod force is given by:

$$M_{F_{rod}} = F_{crank T} \cdot r = F_{rod} \cdot r \cdot \cos(\varphi_1 - \varphi_3)$$

In addition, a torque is effective due to the weight of half of the connecting rod mass in Point 4.

$$M_{m_{rod/2}} = \frac{m_{rod}}{2} \cdot g \cdot r \cdot \cos \varphi_1$$

The moment of inertia for half of the connecting rod mass in Point 4 is given by:

$$J_{m_{rod/2}} = \frac{1}{2} \cdot m_{rod} \cdot r^2$$

Thus, the torque required at the crank disk is given by:

$$M_{crank} = M_{F_{rod}} + M_{m_{rod/2}} + (J_{disk} + J_{m_{rod/2}}) \cdot \alpha_1$$

With the specified numerical values, the torque required at the crank disk can be calculated, e.g. using an Excel program.



### Selecting the motor

Selected motor:

1FK6063-6AF71 with gearbox  $i=10$  ( $\eta_{gearbox}=0.95$ ),  $n_n=3000RPM$ ,  $J_{mot}=0.00167 \text{ kgm}^2$  (with brake),  $\eta_{mot}=0.89$ ,  $J_{gearbox}=0.000542 \text{ kgm}^2$ ,  $kT_0=1.33 \text{ Nm/A}$ ,  $M_0=11 \text{ Nm}$ ,  $I_0=8.3 \text{ A}$ ,  $M_{max}=37 \text{ Nm}$ ,  $I_{max}=28 \text{ A}$

Maximum motor speed:

$$n_{mot \max} = i \cdot n_{1 \max} = 10 \cdot 192 = 1920 \text{ RPM}$$

### Motor torque

The following is valid for the motor torque:

$$M_{mot} = J_{mot} \cdot \alpha_1 \cdot i + J_{gearbox} \cdot \alpha_1 \cdot i + M_{crank} \cdot \frac{1}{i \cdot \eta_{gearbox}^{VZ}}$$

with

$$VZ = \text{sign}(M_{crank})$$



The highest motor torque is required when moving upwards when motoring. This is 18.19 Nm. The motor torque when moving downwards when generating is lower due to the gearbox efficiency. During the pause interval at  $\varphi_1 = \varphi_{10}$ , a holding torque is obtained due to  $\varphi_{10} \neq 90$  degrees. Only the weight of the connecting rod can participate in the holding torque, as the connecting rod and crank disk are in one line. This is:

$$M_{mot\ hold} = \frac{m_{rod}}{2} \cdot g \cdot r \cdot \cos \varphi_{10} \cdot \frac{1}{i} = \frac{7.5}{2} \cdot 9.81 \cdot 0.1 \cdot \cos 1.4101 \cdot \frac{1}{10} = 0.0589 \text{ Nm}$$

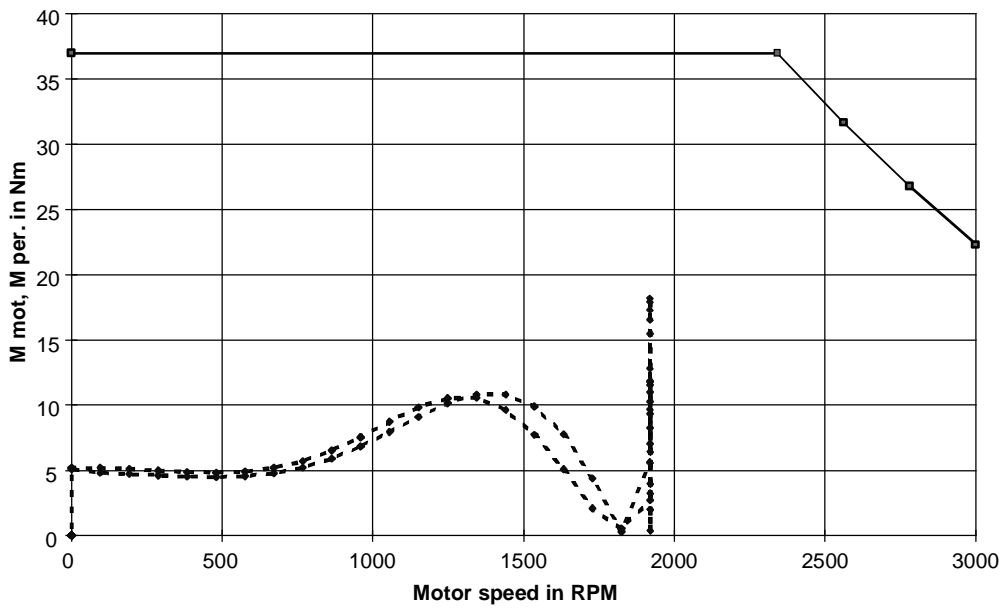

The motor torque lies below the limiting characteristic. Thus, the motor is suitable as far as the dynamic limits are concerned

*Thermally checking the motor*

The motor RMS torque is approximately given by:

$$M_{RMS} = \sqrt{\frac{\int M_{mot}^2 \cdot dt}{T}} \approx \sqrt{\frac{\sum \frac{M_{mot\ i-1}^2 + M_{mot\ i}^2 + M_{mot\ i-1} \cdot M_{mot\ i}}{3} \cdot (t_i - t_{i-1})}{1}} = 5.71\ Nm$$

The average motor speed is obtained from:

$$n_{average} = \frac{\sum \frac{|n_{mot\ i-1} + n_{mot\ i}|}{2} \cdot (t_i - t_{i-1})}{T} = \frac{\frac{n_{mot\ max}}{2} \cdot t_b \cdot 2 + n_{mot\ max} \cdot t_k}{1} = \frac{1920 \cdot (0.1875 + 0.125)}{1} = 600\ RPM$$



The effective motor torque lies, at  $n_{\text{average}}$ , below the  $M_{S1}$  characteristic. This means that the motor is also suitable as far as the thermal limits are concerned.

#### Dimensioning the brake resistor

The motor output is obtained from the motor torque and the angular velocity as follows:

$$P_{\text{mot}} = M_{\text{mot}} \cdot i \cdot \omega_1$$



The maximum braking power for the brake resistor is obtained from the maximum negative motor output (=motor braking power):

$$P_{br W \max} = P_{br \text{ mot } \max} \cdot \eta_{\text{mot}} \cdot \eta_{WR} = -2379 \cdot 0.89 \cdot 0.98 = -2075 \text{ W}$$

The braking energy for a cycle can be calculated using the negative area under the curve within the motor output characteristic.

$$W_{br} = \int P_{\text{mot}} \cdot \eta_{\text{mot}} \cdot \eta_{WR} \cdot dt \quad \text{für } P_{\text{mot}} \leq 0$$

$$\approx \sum \eta_{\text{mot}} \cdot \eta_{WR} \cdot \frac{P_{\text{mot } i-1} + P_{\text{mot } i}}{2} \cdot (t_i - t_{i-1}) \quad \text{für } P_{\text{mot } i-1}, P_{\text{mot } i} \leq 0$$

The zero positions of the motor output must be calculated using linear interpolation. A zero position between two points is obtained with the condition

$$P_{\text{mot } i-1} \cdot P_{\text{mot } i} < 0$$

to

$$t_x = t_{i-1} + \frac{t_i - t_{i-1}}{P_{\text{mot } i-1} - P_{\text{mot } i}} \cdot P_{\text{mot } i-1}$$

The calculation results in:

$$W_{br} = -204.7 \text{ Ws}$$

The following is valid for the brake resistor:

$$\frac{W_{br}}{T} = \frac{204.7}{1} = 204.7 \text{ W} \leq P_{br \text{ duration}}$$

With

$$P_{br \text{ dur.}} = \frac{P_{20}}{4.5} \quad (\text{ext. Brake resistor})$$

the following is obtained

$$4.5 \cdot 204.7 = 921 \text{ W} \leq P_{20}$$



The following must also be valid:

$$P_{br W \max} = 2075 \text{ W} \leq 1.5 \cdot P_{20}$$

Thus, when selecting a compact type of drive converter, a brake unit with  $P_{20}=5 \text{ kW}$  (6SE7018-0ES87-2DA0) and external brake resistor 5 kW (6SE7018-0ES87-2DC0) are required. When selecting a Compact Plus drive converter, only the external brake resistor is required (the chopper is integrated in the drive converter).

### Selecting the drive converter

The drive converter is selected according to the peak value and the motor RMS current. The motor current is given by, taking into account saturation:

$$I_{mot} = \frac{|M_{mot}|}{kT_0 \cdot b_1} \quad \text{for } |M_{mot}| \leq M_0$$

$$I_{mot} = \frac{|M_{mot}|}{kT_0 \cdot b_1 \cdot \left(1 - \left(\frac{|M_{mot}| - M_0}{M_{\max} - M_0}\right)^2 \cdot \left(1 - \frac{M_{\max} \cdot I_0}{M_0 \cdot I_{\max}}\right)\right)} \quad \text{for } |M_{mot}| > M_0$$

with

$$b_1 = 1 - b \cdot \left(\frac{|n_{mot}|}{6000}\right)^{1.5} \quad (b=0.1 \text{ for frame size } <100, \text{ otherwise } 0.15)$$

13.93 A is obtained for the peak current. The RMS value is obtained from:

$$I_{eff} \approx \sqrt{\frac{\sum \frac{I_{mot\ i-1}^2 + I_{mot\ i}^2 + I_{mot\ i-1} \cdot I_{mot\ i}}{3} \cdot (t_i - t_{i-1})}{T}} = 4.35 \text{ A}$$

Selected SIMOVERT MASTERDRIVES MOTION CONTROL drive converter:

6SE7021-0EP50 (Compact Plus type)

$P_{U n}=4 \text{ kW}$ ;  $I_{U n}=10 \text{ A}$ ;  $I_{U \max}=16 \text{ A}$  (160% overload capability)

with external 5 kW brake resistor (6SE7018-0ES87-2DC0)

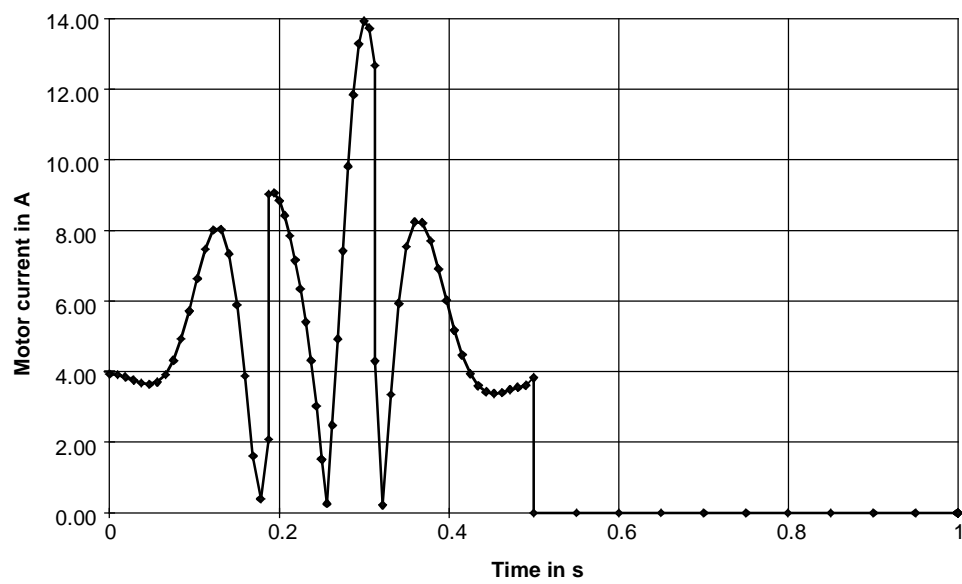

### 3.15 Mesh welding machine

The drives for a mesh welding machine are to be dimensioned. In this case it involves the 4 drives: Trolley, roller feed, transverse wire feed and mesh transport. Synchronous servo motors with inverters, rectifier unit and central brake resistor are to be used.

#### Trolley

The trolley drive is a traversing drive to pull-in the longitudinal wires. A breakaway force is assumed at the start of pull-in for 200 ms, and is then further calculated with a steady-state pull-in force. When dimensioning the drive, there should be 100% safety margin regarding the breakaway force and pull-in force.

#### Drive data

Trolley mass	$m_{\text{trolley}}$	= 350 kg
Load mass (wires)	$m_{\text{load}}$	= 100 kg
Breakaway force (for 200 ms)	$F_{\text{LB}}$	= 2750 N
Pull-in force, steady-state	$F_{\text{Z}}$	= 600 N
Frictional force	$F_{\text{R}}$	= 400 N
Travel	$s$	= 6 m
Max. traversing velocity	$v_{\text{max}}$	= 2.5 m/s
Traversing time, forwards	$t_{\text{tot, forwards}}$	= 4 s
Traversing time, backwards	$t_{\text{tot, backwards}}$	= 3.25 s
Pinion diameter	$D$	= 0.15152 m
Clock cycle time	$T$	= 16 s

## Traversing characteristic

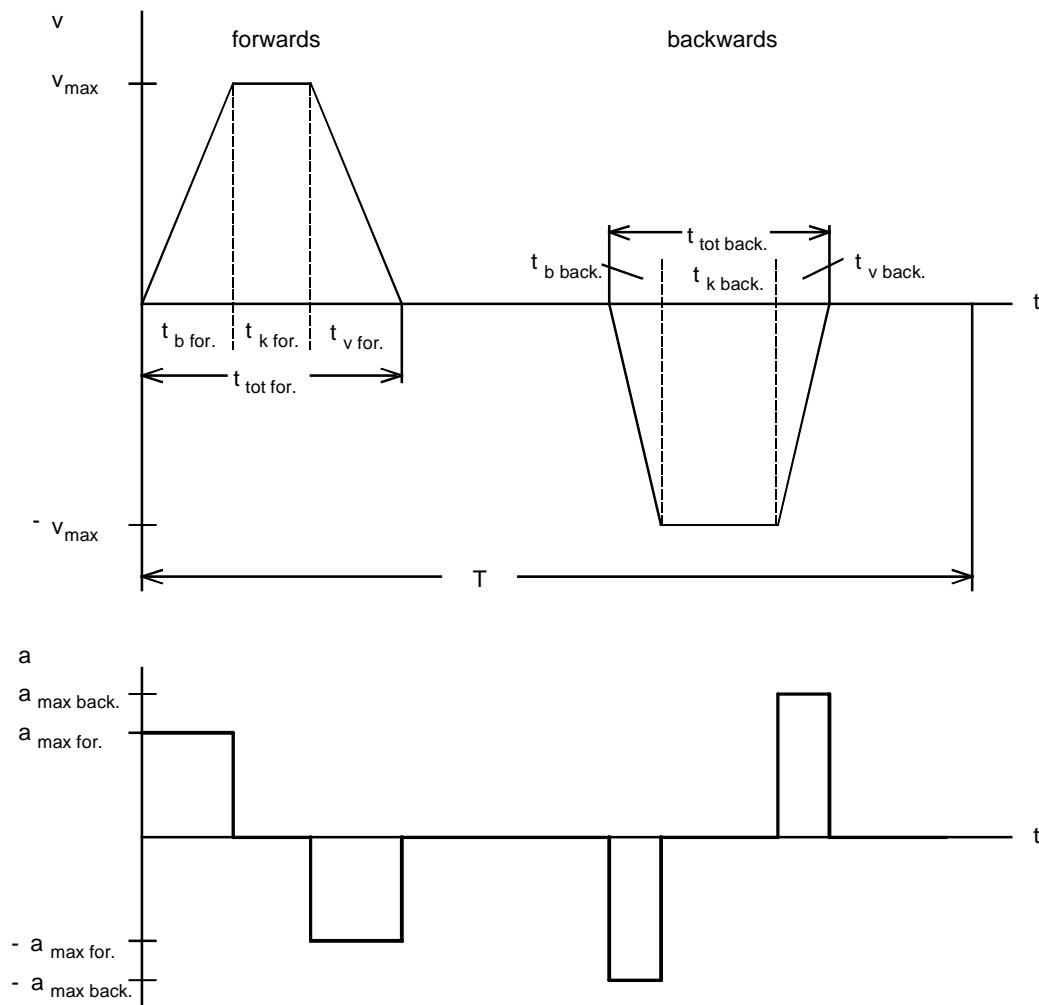

$$t_{b \text{ for.}} = t_{v \text{ for.}} = t_{\text{tot for.}} \cdot \frac{s}{v_{\max}} = 4 - \frac{6}{2.5} = 1.6 \text{ s}$$

$$t_{k \text{ for.}} = t_{\text{tot for.}} - 2 \cdot t_{b \text{ for.}} = 4 - 2 \cdot 1.6 = 0.8 \text{ s}$$

$$a_{\text{max for.}} = \frac{v_{\max}}{t_{b \text{ for.}}} = \frac{2.5}{1.6} = 1.5625 \text{ m/s}^2$$

$$t_{b \text{ back.}} = t_{v \text{ back.}} = t_{\text{tot back.}} \cdot \frac{s}{v_{\max}} = 3.25 - \frac{6}{2.5} = 0.85 \text{ s}$$

$$t_{k \text{ back.}} = t_{\text{tot back.}} - 2 \cdot t_{b \text{ back.}} = 3.25 - 2 \cdot 0.85 = 1.55 \text{ s}$$

$$a_{\text{max back.}} = \frac{v_{\text{max}}}{t_{b \text{ back.}}} = \frac{2.5}{0.85} = 2.94 \text{ m/s}^2$$

### Load-force characteristic



The safety margin of 100% for the breakaway force and the steady-state pull-in force are taken into account in the load-force characteristic. The traversing velocity until the breakaway force becomes effective, is given by:

$$v_{\text{LB}} = v_{\text{max}} \cdot \frac{0.2 \text{ s}}{t_{b \text{ for.}}} = 2.5 \cdot \frac{0.2}{1.6} = 0.3125 \text{ m/s}$$

The following is valid for the load torque:

$$M_{load\ for.} = J_{load\ for.} \cdot \alpha_{load} + F_{load} \cdot \frac{D}{2}$$

$$M_{load\ back.} = J_{load\ back.} \cdot \alpha_{load} + F_{load} \cdot \frac{D}{2}$$

with

$$\alpha_{load} = a \cdot \frac{2}{D}$$

$$J_{load\ for.} = (m_{trolley} + m_{load}) \cdot \left(\frac{D}{2}\right)^2$$

$$J_{load\ back.} = m_{trolley} \cdot \left(\frac{D}{2}\right)^2$$

$a$  from the characteristic  $a(t)$

$F_{load}$  from the characteristic  $F_{load}(t)$



### Selecting the motor

Selected motor:

1FT6082-8AK7 with gearbox  $i=16$  ( $\eta_{\text{gearbox}}=0,95$ ),  $n_n=6000$  RPM,  $J_{\text{mot}}=0,003$  kgm<sup>2</sup>,  $\eta_{\text{mot}}=0,88$ ,  
 $J_{\text{gearbox}}=0,00082$  kgm<sup>2</sup>,  $kT_0=0,71$  Nm/A,  $M_0=13$  Nm,  $I_0=18,3$  A,  $M_{\text{max}}=42$  Nm,  $I_{\text{max}}=73$  A

Maximum motor speed:

$$n_{\text{mot max}} = \frac{v_{\text{max}} \cdot 60 \cdot i}{\pi \cdot D} = \frac{2,5 \cdot 60 \cdot 16}{\pi \cdot 0,15152} = 5042 \text{ RPM}$$

### Motor torque

The following is valid for the motor torque:

$$M_{\text{mot for.}} = J_{\text{mot}} \cdot \alpha_{\text{load}} \cdot i + J_{\text{gear}} \cdot \alpha_{\text{load}} \cdot i + M_{\text{load for.}} \cdot \frac{1}{i \cdot \eta_{\text{gear}}^{\text{VZ}}}$$

$$M_{\text{mot back.}} = J_{\text{mot}} \cdot \alpha_{\text{load}} \cdot i + J_{\text{gear}} \cdot \alpha_{\text{load}} \cdot i + M_{\text{load back.}} \cdot \frac{\eta_{\text{gear}}^{\text{VZ}}}{i}$$

with

$$\text{VZ} = \text{sign}(M_{\text{load for.,back.}})$$



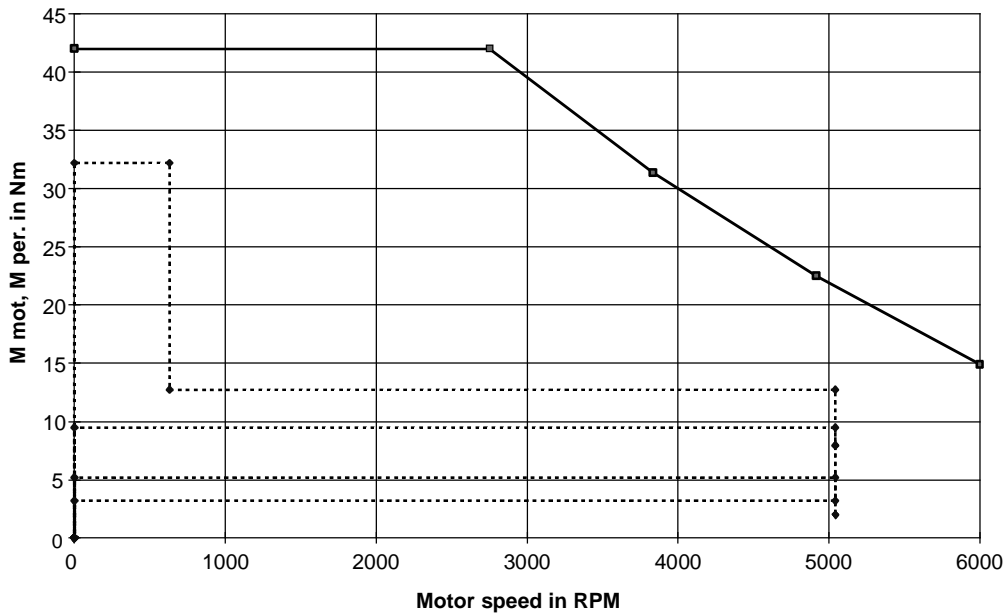

The motor torque lies below the limiting characteristic. Thus, the motor is suitable as far as the dynamic limits are concerned.

#### Thermally checking the motor

The RMS motor torque is calculated from the motor torque characteristics

$$M_{RMS} = \sqrt{\frac{\sum m_{Mot i}^2 \cdot \Delta t_i}{T}} = 6.16 \text{ Nm}$$

The average motor speed is obtained from:

$$n_{average} = \frac{\sum \frac{|n_{mot i-1} + n_{mot i}|}{2} \cdot \Delta t_i}{T} = \frac{\frac{n_{mot \max}}{2} \cdot t_{b \text{ for}} \cdot 2 + n_{mot \max} \cdot t_{k \text{ for}} + \frac{n_{mot \max}}{2} \cdot t_{b \text{ back}} \cdot 2 + n_{mot \max} \cdot t_{k \text{ back}}}{T}$$

$$= \frac{5042 \cdot (1.6 + 0.8 + 0.85 + 1.55)}{16} = 1512.6 \text{ RPM}$$



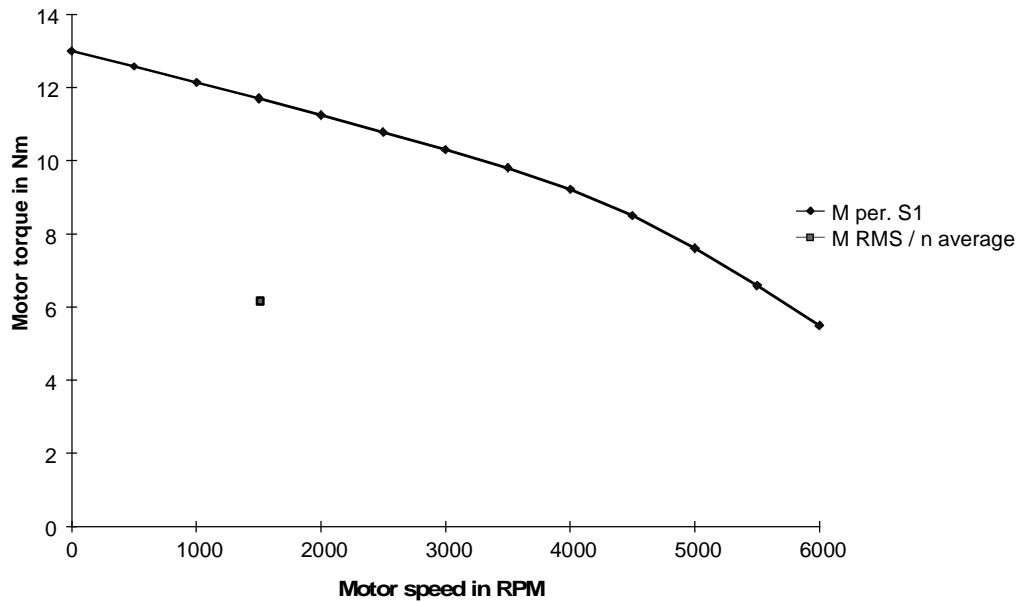

The effective motor torque lies, at  $n_{\text{average}}$ , below the  $M_{S1}$  characteristic. This means that the motor is also suitable as far as the thermal limits are concerned.

### Selecting the inverter

The inverter is selected according to the peak value and RMS value of the motor current. Refer to example 3.13 for the current calculation.

49.6 A is obtained for the peak current. The RMS current is 9.23 A. In this particular case, the 300 % overload capability of the Compact Plus type of construction can be used, as the overload time is less than 250 ms; after the overload, the current returns to below 0.91 x of the rated current, and the recovery time is greater than 750 ms.

Selected SIMOVERT MASTERDRIVES MOTION CONTROL inverter:

6SE7022-0TP50 (Compact Plus type of construction)

$P_{\text{inv } n}=11 \text{ kW}$ ;  $I_{\text{inv } n}=25.4 \text{ A}$ ;  $I_{\text{DC link } n}=30.4 \text{ A}$ ;  $I_{\text{inv max}}=76.5 \text{ A}$  (300 % overload capability)

A 15 kW inverter would be considered if the 300 % overload capability was not to be used

$I_{\text{inv max}}=54.4 \text{ A}$  (160 % overload capability).



*Calculating the braking power and braking energy*

The motor output is obtained from the motor torque and the traversing velocity as follows:

$$P_{mot} = M_{mot} \cdot i \cdot \frac{2 \cdot v}{D}$$

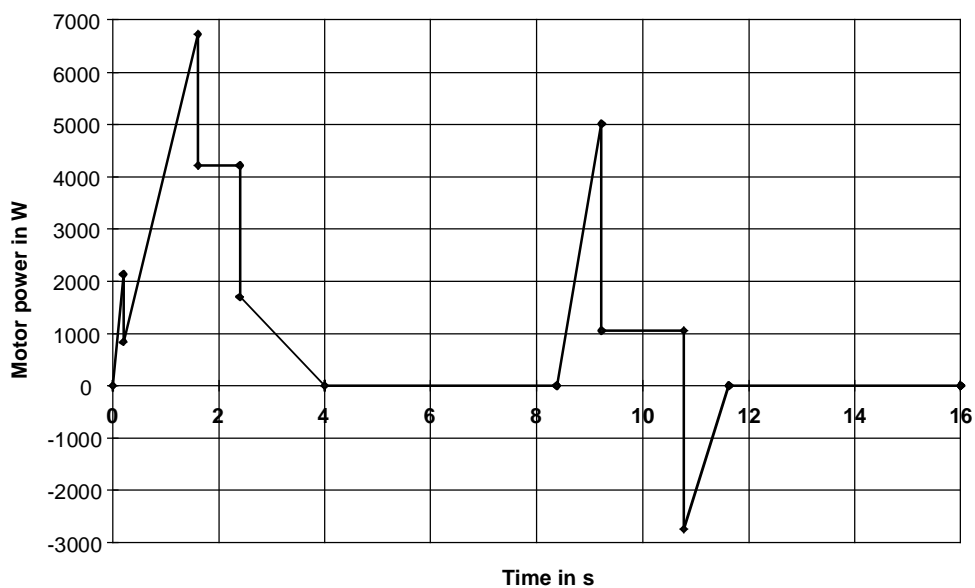

The max. braking power for the brake resistor is obtained from the max. negative motor output (=motor braking power):

$$P_{br W \max} = P_{br \text{ mot } \max} \cdot \eta_{\text{mot}} \cdot \eta_{\text{inv}} = -2747.7 \cdot 0.88 \cdot 0.98 = -2370 \text{ W}$$

The braking energy for one cycle is obtained from the negative surface area under the motor output characteristic

$$W_{br} = \frac{1}{2} \cdot P_{br \text{ mot } \max} \cdot t_{v \text{ down}} \cdot \eta_{\text{mot}} \cdot \eta_{\text{inv}} = -\frac{1}{2} \cdot 2747.7 \cdot 0.85 \cdot 0.88 \cdot 0.98 = -1007 \text{ Ws}$$

The average braking power for one cycle is

$$P_{br \text{ average}} = \frac{W_{br}}{T} = -\frac{1007}{16} = -62.94 \text{ W}$$

#### Calculating the DC link currents when motoring

The maximum DC link current and the RMS DC link current when motoring are required to dimension the rectifier unit. These currents are obtained from the positive motor output. The following is valid for the max. DC link current:

$$I_{DC \text{ link } \max} = \frac{P_{\text{mot } \max}}{\eta_{\text{mot}} \cdot \eta_{\text{inv}} \cdot U_{DC \text{ link}}} = \frac{6726.4}{0.88 \cdot 0.98 \cdot 1.35 \cdot 400} = 14.44 \text{ A}$$

The RMS DC link current is obtained as follows:

$$I_{DC \text{ link } RMS} = \frac{1}{\eta_{\text{mot}} \cdot \eta_{\text{inv}} \cdot U_{DC \text{ link}}} \cdot \sqrt{\frac{\sum (P_{\text{mot } i-1}^2 + P_{\text{mot } i}^2 + P_{\text{mot } i} \cdot P_{\text{mot } i-1}) \cdot \frac{\Delta t_i}{3}}{T}} \quad \text{for } P_{\text{mot } i-1}, P_{\text{mot } i} \geq 0$$

A value of 3.76 A is obtained

Roller feed

For a roller feed drive, it involves a rotating drive to position the mesh to weld the transverse wires. A 50% safety margin for the feed torque should be taken into account.

## Drive data

Load moment of inertia	$J_{\text{load}}$	= 1.48 kgm <sup>2</sup>
Intrinsic moment of inertia	$J_E$	= 0.35 kgm <sup>2</sup>
Feed torque	$M_v$	= 450 Nm
Traversing angle per transverse wire	$\varphi$	= 5 rad
Max. angular velocity	$\omega_{\text{max}}$	= 20 s <sup>-1</sup>
Traversing time per transverse wire	$t_{\text{tot.}}$	= 0.45 s
Cycle time per transverse wire	$T$	= 0.75 s

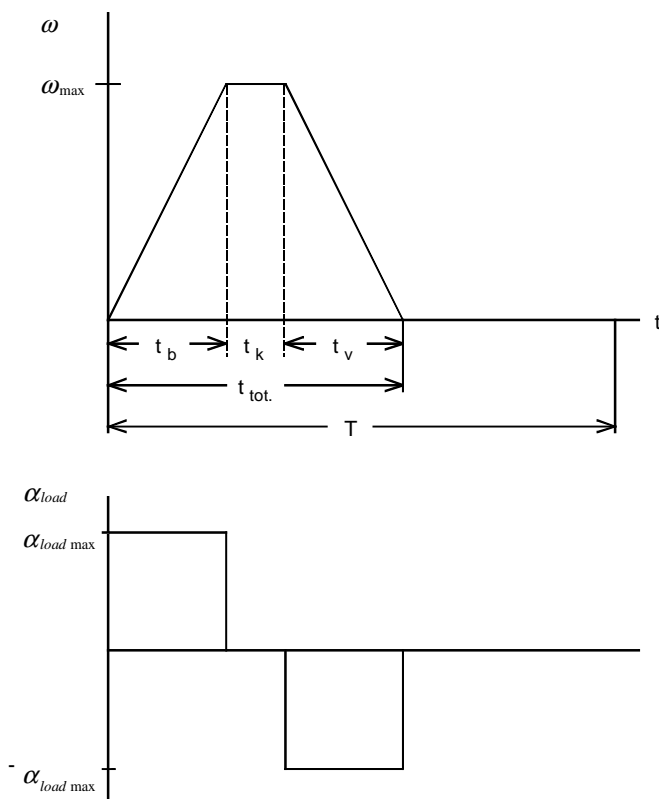
*Traversing characteristic*

$$t_b = t_v = t_{tot.} - \frac{\varphi}{\omega_{max}} = 0.45 - \frac{5}{20} = 0.2 \text{ s}$$

$$t_k = t_{tot.} - 2 \cdot t_b = 0.45 - 2 \cdot 0.2 = 0.05 \text{ s}$$

$$\alpha_{load \text{ max}} = \frac{\omega_{max}}{t_b} = \frac{20}{0.2} = 100 \text{ s}^{-1}$$

Load torque

The load torque is given by:

$$M_{load} = (J_{load} + J_E) \cdot \alpha_{load} + 1.5 \cdot M_v$$

$\alpha_{load}$  from the characteristic  $\alpha_{load}(t)$



*Selecting the motor*

selected motor:

1FT6134-6SB. with gearbox  $i=7$  ( $\eta_{\text{gearbox}}=0.95$ ),  $n_n=1500$  RPM,  $J_{\text{mot}}=0.0547$  kgm<sup>2</sup>,  $\eta_{\text{mot}}=0.94$ ,  
 $J_{\text{gearbox}}=0.00471$  kgm<sup>2</sup>,  $kT_0=2.92$  Nm/A,  $M_0=140$  Nm,  $I_0=48$  A,  $M_{\text{max}}=316$  Nm,  $I_{\text{max}}=139$  A

Maximum motor speed:

$$n_{\text{mot max}} = \frac{\omega_{\text{max}} \cdot 60 \cdot i}{2 \cdot \pi} = \frac{20 \cdot 60 \cdot 7}{2 \cdot \pi} = 1337 \text{ RPM}$$

*Motor torque*

The following is valid for the motor torque:

$$M_{\text{mot}} = J_{\text{mot}} \cdot \alpha_{\text{load}} \cdot i + J_{\text{gearbox}} \cdot \alpha_{\text{load}} \cdot i + M_{\text{load}} \cdot \frac{1}{i \cdot \eta_{\text{gearbox}}^{\text{VZ}}}$$

with

$$\text{VZ} = \text{sign}(M_{\text{load}})$$

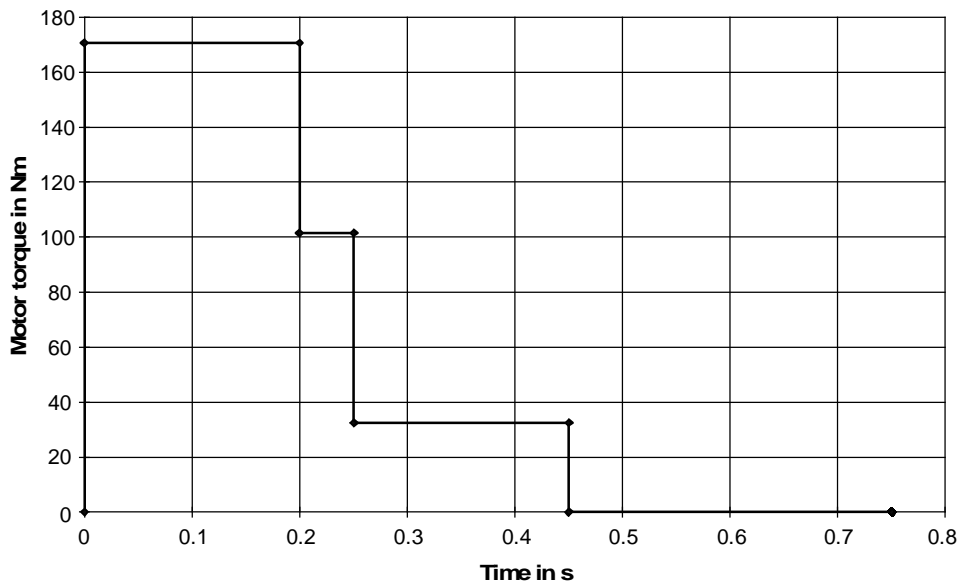

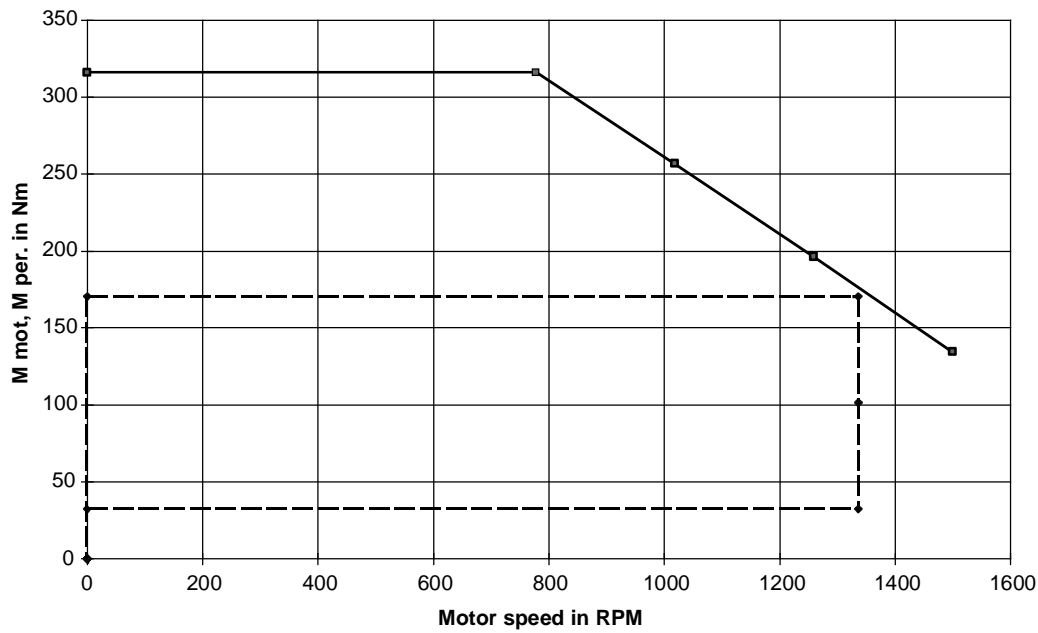

The motor torque lies below the limiting characteristic. Thus, the motor is suitable as far as the dynamic limits are concerned.

#### *Thermally checking the motor*

The RMS motor torque is obtained from the motor torque characteristic as follows:

$$M_{RMS} = \sqrt{\frac{\sum M_{mot i}^2 \cdot \Delta t_i}{T}} = 93.43 \text{ Nm}$$

The average motor speed is obtained as follows:

$$n_{average} = \frac{\sum \frac{|n_{mot i-1} + n_{mot i}|}{2} \cdot \Delta t_i}{T} = \frac{\frac{n_{mot max}}{2} \cdot t_b \cdot 2 + n_{mot max} \cdot t_k}{T} = \frac{1337 \cdot (0.2 + 0.05)}{0.75} = 445.7 \text{ RPM}$$

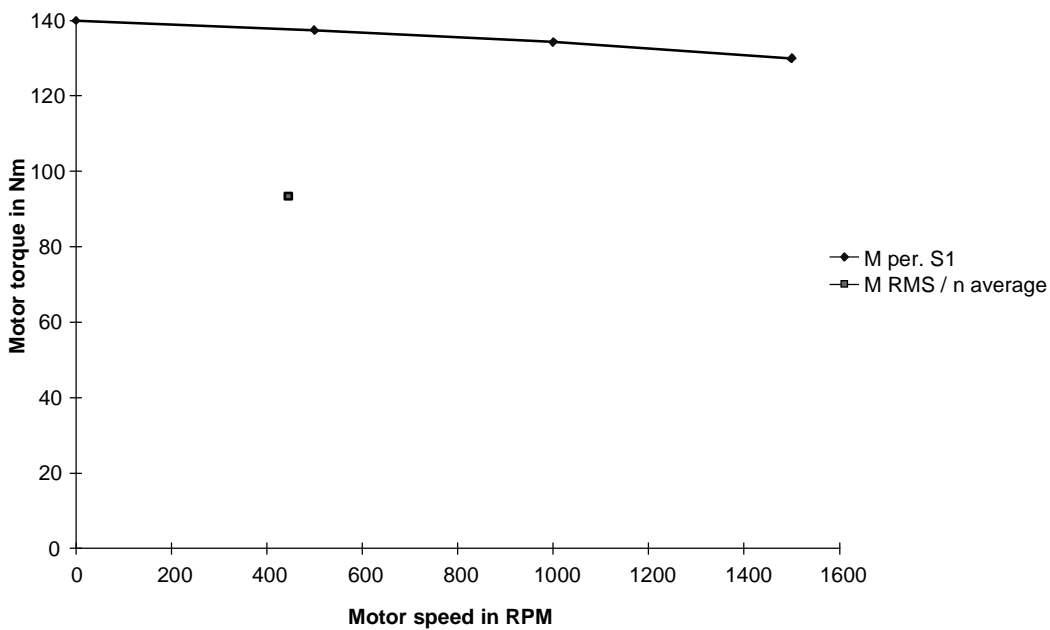

The effective motor torque lies, at  $n_{\text{average}}$ , below the  $M_{S1}$  characteristic. This means that the motor is also suitable as far as the thermal limits are concerned.

### Selecting the inverter

59.76 A is obtained for the peak current. The RMS value is 32.47 A.

Selected SIMOVERT MASTERDRIVES MOTION CONTROL inverter:

6SE7023-8TP50 (Compact Plus type of construction)

$P_{\text{inv } n} = 18.5 \text{ kW}$ ;  $I_{\text{inv } n} = 37.5 \text{ A}$ ;  $I_{\text{DC link } n} = 44.6 \text{ A}$ ;  $I_{\text{inv max}} = 60 \text{ A}$  (160 % overload capability)





### Calculating the braking power and the braking energy

As can be seen from the motor torque characteristic, no braking power is obtained in normal operation. However, as braking without load and feed torque must also be taken into account, the braking power and braking energy are also calculated for this particular situation. The motor torque during the deceleration phase is given by:

$$\begin{aligned}
 M_{\text{mot } v} &= -(J_{\text{mot}} + J_{\text{gearbox}}) \cdot \alpha_{\text{load max}} \cdot i - J_E \cdot \alpha_{\text{load max}} \cdot \frac{\eta_{\text{gearbox}}}{i} \\
 &= -(0.0547 + 0.00471) \cdot 100 \cdot 7 - 0.35 \cdot 100 \cdot \frac{0.95}{7} = -46.34 \text{ Nm}
 \end{aligned}$$

The max. braking power for the brake resistor is given by:

$$P_{brW \text{ max}} = M_{\text{mot } v} \cdot \omega_{\text{max}} \cdot i \cdot \eta_{\text{mot}} \cdot \eta_{WR} = -46.34 \cdot 20 \cdot 7 \cdot 0.94 \cdot 0.98 = -5.98 \text{ kW}$$

Braking energy and average braking power for one cycle:

$$W_{br} = \frac{1}{2} \cdot P_{brW \text{ max}} \cdot t_v = -\frac{1}{2} \cdot 5.98 \cdot 0.2 = -0.6 \text{ kWs}$$

$$P_{br \text{ average}} = \frac{W_{br}}{T} = -\frac{600}{0.75} = -800 \text{ W}$$

### Calculating the DC link currents when motoring

The motor power is calculated from the motor torque and angular velocity as follows:

$$P_{mot} = M_{mot} \cdot i \cdot \omega$$



The following is valid for the max. DC link current:

$$I_{DC\ link\ max} = \frac{P_{mot\ max}}{\eta_{mot} \cdot \eta_{inv} \cdot U_{DC\ link}} = \frac{23885}{0.94 \cdot 0.98 \cdot 1.35 \cdot 400} = 48.02\ A$$

The DC link RMS current is given by:

$$I_{DC\ link\ RMS} = \frac{1}{\eta_{mot} \cdot \eta_{inv} \cdot U_{DC\ link}} \cdot \sqrt{\frac{\sum (P_{mot\ i-1}^2 + P_{mot\ i}^2 + P_{mot\ i} \cdot P_{mot\ i-1}) \cdot \frac{\Delta t_i}{3}}{T}} \quad \text{for } P_{mot\ i-1}, P_{mot\ i} \geq 0$$

A value of 16.33 A is obtained

### Transverse wire feed

The transverse wire feed drive comprises two disks, which clamp the transverse wire. These disks are each moved from a motor in opposing directions to transport the transverse wire.

#### Drive data

Load moment of inertia per motor	$J_{load}$	= 0.0053 kgm <sup>2</sup>
Intrinsic moment of inertia per motor	$J_E$	= 0.0463 kgm <sup>2</sup>
Feed torque per motor	$M_v$	= 180 Nm
Traversing angle per transverse wire	$\varphi$	= 10.05 rad
Max. angular velocity	$\omega_{max}$	= 29 s <sup>-1</sup>
Traversing time per transverse wire	$t_{tot.}$	= 0.5 s
Clock cycle time per transverse wire	$T$	= 0.75 s

#### *Traversing characteristic*



$$t_b = t_v = t_{tot} - \frac{\varphi}{\omega_{max}} = 0.5 - \frac{10.05}{29} = 0.1534 \text{ s}$$

$$t_k = t_{tot} - 2 \cdot t_b = 0.5 - 2 \cdot 0.1534 = 0.1931 \text{ s}$$

$$\alpha_{load \max} = \frac{\omega_{max}}{t_b} = \frac{29}{0.1534} = 189 \text{ s}^{-1}$$

### Load torque

The load torque is given by:

$$M_{load} = (J_{load} + J_E) \cdot \alpha_{load} + M_v$$

$\alpha_{load}$  from the characteristic  $\alpha_{load}(t)$

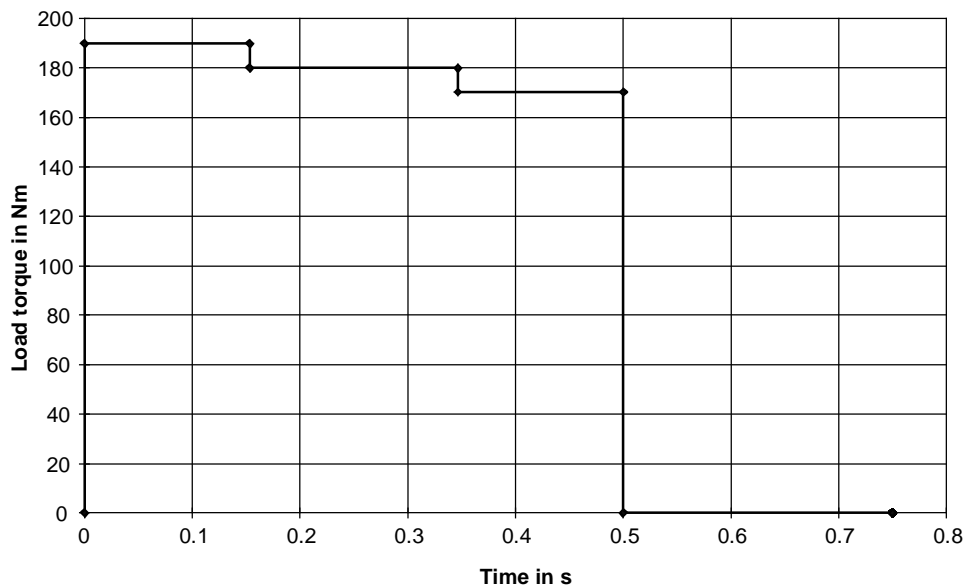

### Selecting the motor

Selected motor:

1FT6086-8AF7. with gearbox  $i=7$  ( $\eta_{\text{gearbox}}=0.95$ ),  $n_n=3000\text{RPM}$ ,  $J_{\text{mot}}=0.00665\text{ kgm}^2$ ,  $\eta_{\text{mot}}=0.91$ ,  
 $J_{\text{gearbox}}=0.00174\text{ kgm}^2$ ,  $kT_0=1.56\text{ Nm/A}$ ,  $M_0=18.5\text{ Nm}$ ,  $I_0=17.3\text{ A}$ ,  $M_{\text{max}}=90\text{ Nm}$ ,  $I_{\text{max}}=72\text{ A}$

Maximum motor speed:

$$n_{\text{mot max}} = \frac{\omega_{\text{max}} \cdot 60 \cdot i}{2 \cdot \pi} = \frac{29 \cdot 60 \cdot 7}{2 \cdot \pi} = 1938.5\text{ RPM}$$

### Motor torque

The motor torque is given by:

$$M_{\text{mot}} = J_{\text{mot}} \cdot \alpha_{\text{load}} \cdot i + J_{\text{gearbox}} \cdot \alpha_{\text{load}} \cdot i + M_{\text{load}} \cdot \frac{1}{i \cdot \eta_{\text{gearbox}}^{VZ}}$$

with

$$VZ = \text{sign}(M_{\text{load}})$$

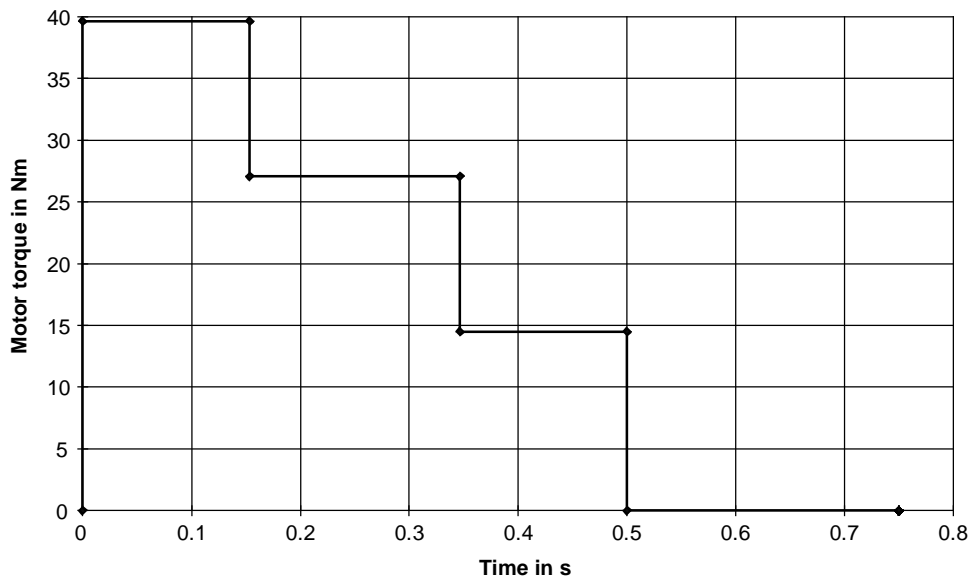

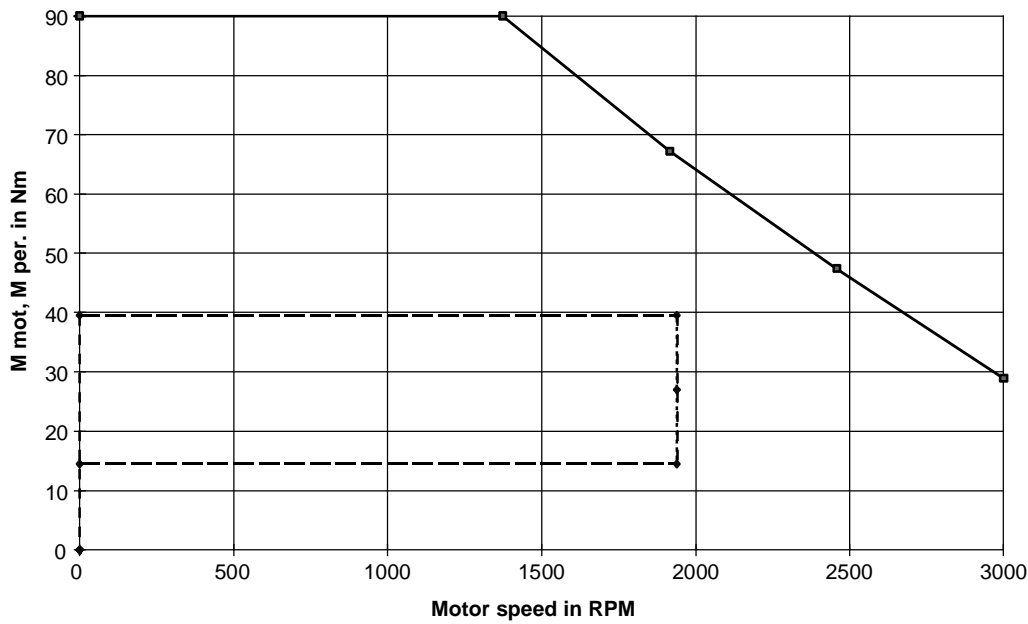

The motor torque lies below the limiting characteristic. Thus, the motor is suitable as far as the dynamic limits are concerned.

#### Thermally checking the motor

The motor RMS torque is calculated from the motor torque characteristic as follows:

$$M_{RMS} = \sqrt{\frac{\sum M_{mot\ i}^2 \cdot \Delta t_i}{T}} = 23.52\ Nm$$

The average motor speed is given by:

$$n_{average} = \frac{\sum \frac{|n_{mot\ i-1} + n_{mot\ i}|}{2} \cdot \Delta t_i}{T} = \frac{\frac{n_{mot\ max}}{2} \cdot t_b \cdot 2 + n_{mot\ max} \cdot t_k}{T} = \frac{1938.5 \cdot (0.1534 + 0.1931)}{0.75} = 895.6\ RPM$$

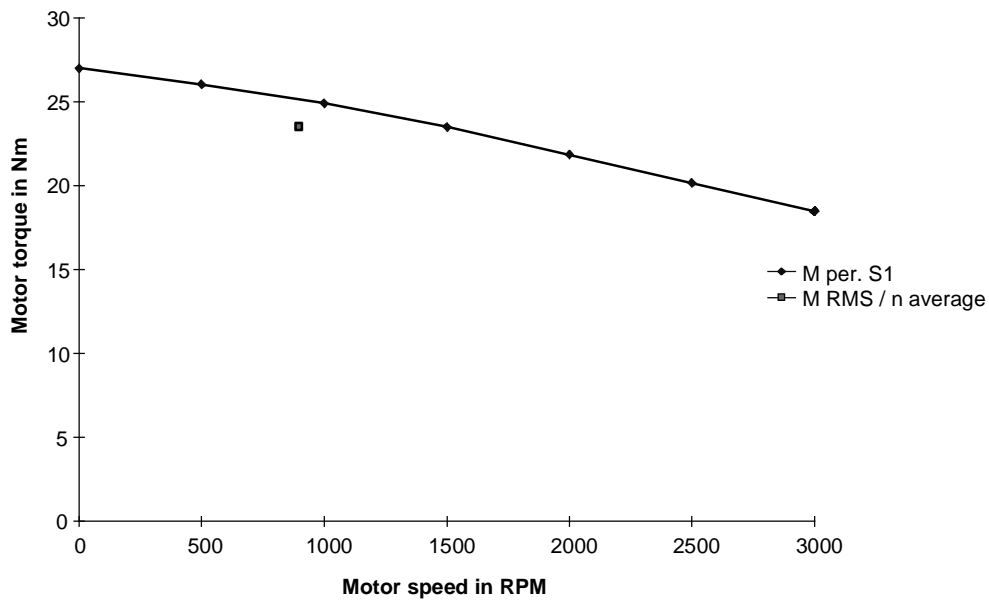

The effective motor torque lies, at  $n_{\text{average}}$ , below the  $M_{S1}$  characteristic. This means that the motor is also suitable as far as the thermal limits are concerned.

### Selecting the inverter

26.1 A is obtained for the peak current. The RMS value is 15.34 A.

Selected SIMOVERT MASTERDRIVES MOTION CONTROL inverter:

6SE7021-8TP50 (Compact Plus type)

$P_{\text{inv } n} = 7.5 \text{ kW}$ ;  $I_{\text{inv } n} = 17.5 \text{ A}$ ;  $I_{\text{DC link } n} = 20.8 \text{ A}$ ;  $I_{\text{inv max}} = 28 \text{ A}$  (160 % overload capability)

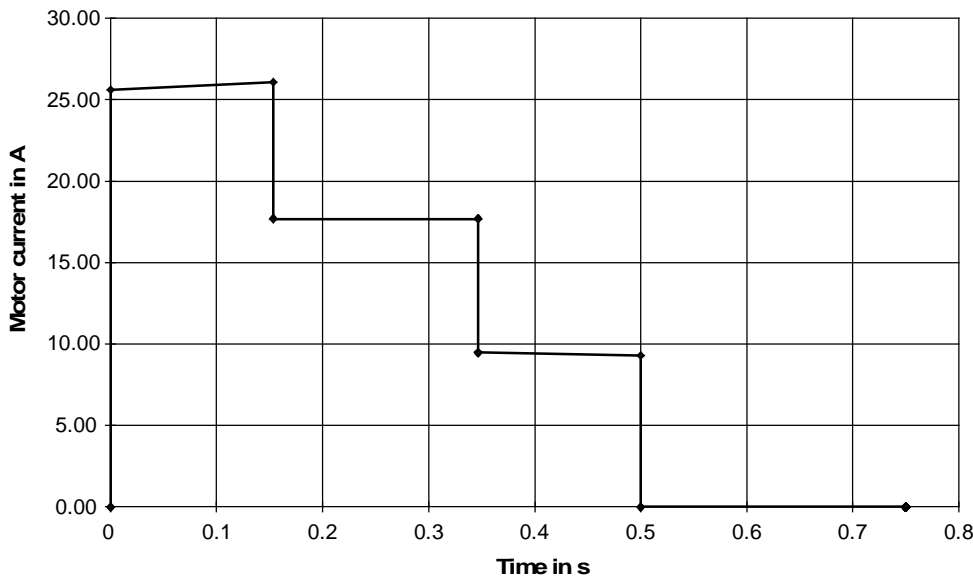

### Calculating the braking power and the braking energy

As can be seen from the motor torque characteristic, there is no braking power under normal operating conditions. However, as braking without load and feed torque must be taken into account, the braking power and braking energy are also calculated. In this case, the motor torque is obtained during the deceleration phase:

$$\begin{aligned}
 M_{mot\ v} &= -(J_{mot} + J_{gearbox}) \cdot \alpha_{load\ max} \cdot i - J_E \cdot \alpha_{load\ max} \cdot \frac{\eta_{gearbox}}{i} \\
 &= -(0.00665 + 0.00174) \cdot 189 \cdot 7 - 0.0463 \cdot 189 \cdot \frac{0.95}{7} = -12.29\ Nm
 \end{aligned}$$

The max. braking power for the brake resistor is:

$$P_{br\ W\ max} = M_{mot\ v} \cdot \omega_{max} \cdot i \cdot \eta_{mot} \cdot \eta_{WR} = -12.29 \cdot 29 \cdot 7 \cdot 0.91 \cdot 0.98 = -2.22\ kW$$

Braking energy and average braking power for one cycle:

$$W_{br} = \frac{1}{2} \cdot P_{br\ W\ max} \cdot t_v = -\frac{1}{2} \cdot 2.22 \cdot 0.1534 = -0.17\ kW\ s$$

$$P_{br\ average} = \frac{W_{br}}{T} = -\frac{170}{0.75} = -226.7\ W$$



### Calculating the DC link currents when motoring

The motor output is calculated from the motor torque and angular velocity:

$$P_{mot} = M_{mot} \cdot i \cdot \omega$$



The following is valid for the max. DC link current:

$$I_{DC\ link\ max} = \frac{P_{mot\ max}}{\eta_{mot} \cdot \eta_{INV} \cdot U_{DC\ link}} = \frac{8046}{0.91 \cdot 0.98 \cdot 1.35 \cdot 400} = 16.71\ A$$

The RMS value of the DC link current is given by:

$$I_{DC\ link\ RMS} = \frac{1}{\eta_{mot} \cdot \eta_{INV} \cdot U_{DC\ link}} \cdot \sqrt{\frac{\sum (P_{mot\ i-1}^2 + P_{mot\ i}^2 + P_{mot\ i} \cdot P_{mot\ i-1}) \cdot \frac{\Delta t_i}{3}}{T}} \quad \text{for } P_{mot\ i-1}, P_{mot\ i} \geq 0$$

A value of 7.42 A is obtained

Mesh removal drive

The mesh removal is a traversing drive which transports the meshes away. The transport is realized in 3 stages over a distance of 4.85 m. Initially, two movements are made, each with 0.5 m with intermediate pauses and then the remaining 3.85 m is traversed in one step. The drive traverses back to the initial position without any pause.

## Drive data

Trolley weight	$m_{\text{trolley}}$	= 200 kg
Load mass (mesh)	$m_{\text{load}}$	= 120 kg
Tension force	$F_Z$	= 1900 N
Friction force	$F_R$	= 100 N
Distance, total	$s$	= 4.85 m
Max. traversing velocity	$v_{\text{max}}$	= 2.5 m/s
Partial traversing distance	$s_1$	= 0.5 m/s
Traversing time for the partial traversing distance	$t_{\text{tot. 1}}$	= 0.5 s
Pause times	$t_P$	= 0.375 s
Pinion diameter	$D$	= 0.15152 m
Clock cycle time	$T$	= 16 s

## Traversing characteristics



A triangular velocity characteristic is used for the 2 partial traversing distances. Thus, the maximum velocity and the maximum acceleration are obtained as follows:

$$v_{\max 1} = \frac{2 \cdot s_1}{t_{\text{tot. 1}}} = \frac{2 \cdot 0.5}{0.5} = 2 \text{ m/s}$$

$$a_{\max} = \frac{2 \cdot v_{\max 1}}{t_{\text{tot. 1}}} = \frac{2 \cdot 2}{0.5} = 8 \text{ m/s}^2$$

The same acceleration is assumed for the remaining distances. The missing times are obtained as follows:

$$t_{b2} = t_{v2} = \frac{v_{\max 2}}{a_{\max}} = \frac{2.5}{8} = 0.3125 \text{ s}$$

$$t_{k2} = \frac{s_2 - v_{\max 2} \cdot t_{b2}}{v_{\max 2}} = \frac{3.85 - 2.5 \cdot 0.3125}{2.5} = 1.2275 \text{ s}$$

$$t_{b3} = t_{v3} = \frac{v_{\max 3}}{a_{\max}} = \frac{2.5}{8} = 0.3125 \text{ s}$$

$$t_{k3} = \frac{s_3 - v_{\max 3} \cdot t_{b3}}{v_{\max 3}} = \frac{4.85 - 2.5 \cdot 0.3125}{2.5} = 1.6275 \text{ s}$$

### Load force characteristics



### Load torque

The load torque is given by:

$$M_{load\ forwards} = J_{load\ forwards} \cdot \alpha_{load} + F_{load} \cdot \frac{D}{2}$$

$$M_{load\ backwards} = J_{load\ backwards} \cdot \alpha_{load} + F_{load} \cdot \frac{D}{2}$$

with

$$\alpha_{load} = a \cdot \frac{2}{D}$$

$$J_{load\ forwards} = (m_{trolley} + m_{load}) \cdot \left(\frac{D}{2}\right)^2$$

$$J_{load\ backwards} = m_{trolley} \cdot \left(\frac{D}{2}\right)^2$$

$a$  from characteristic  $a(t)$

$F_{load}$  from the characteristic  $F_{load}(t)$

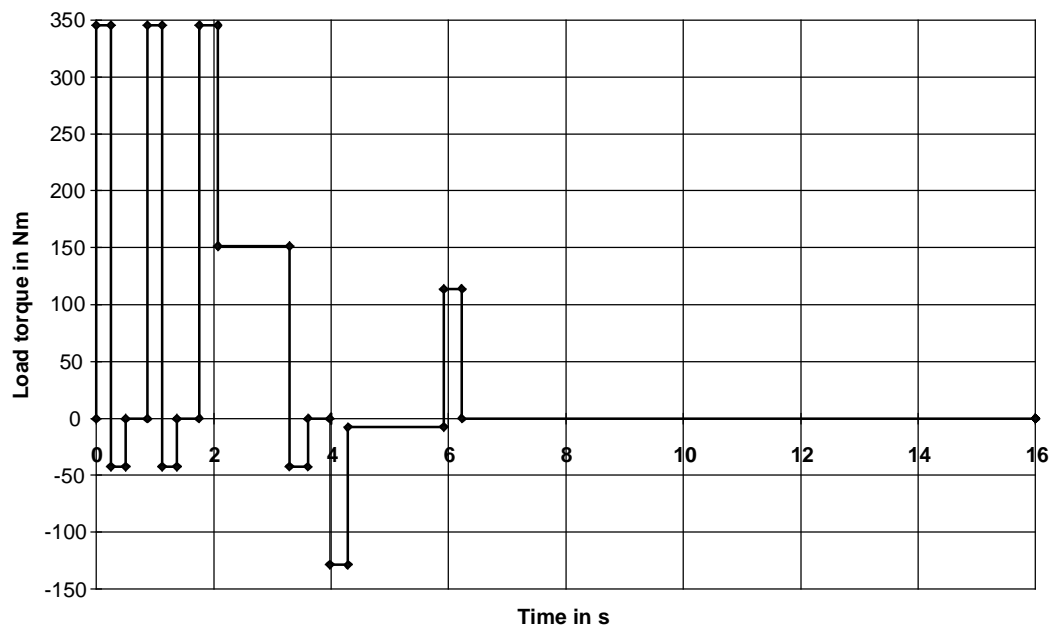

### Selecting the motor

Selected motor:

1FK6103-8AF71. with gearbox  $i=7$  ( $\eta_{\text{gearbox}}=0.95$ ),  $n_n=3000$  RPM,  $J_{\text{mot}}=0.01215$  kgm<sup>2</sup>,  $\eta_{\text{mot}}=0.94$ ,  
 $J_{\text{gearbox}}=0.00185$  kgm<sup>2</sup>,  $kT_0=1.51$  Nm/A,  $M_0=36$  Nm,  $I_0=23.8$  A,  $M_{\text{max}}=102$  Nm,  $I_{\text{max}}=78$  A

Maximum motor speed:

$$n_{\text{mot max}} = \frac{v_{\text{max}} \cdot 60 \cdot i}{\pi \cdot D} = \frac{2.5 \cdot 60 \cdot 7}{\pi \cdot 0.15152} = 2206 \text{ RPM}$$

### Motor torque

The motor torque is given by:

$$M_{\text{mot forwards}} = J_{\text{mot}} \cdot \alpha_{\text{load}} \cdot i + J_{\text{gearbox}} \cdot \alpha_{\text{load}} \cdot i + M_{\text{load forwards}} \cdot \frac{1}{i \cdot \eta_{\text{gearbox}}^{\text{VZ}}}$$

$$M_{\text{mot backwards}} = J_{\text{mot}} \cdot \alpha_{\text{load}} \cdot i + J_{\text{gearbox}} \cdot \alpha_{\text{load}} \cdot i + M_{\text{load backwards}} \cdot \frac{\eta_{\text{gearbox}}^{\text{VZ}}}{i}$$

with

$$\text{VZ} = \text{sign}(M_{\text{load forwards, backwards}})$$

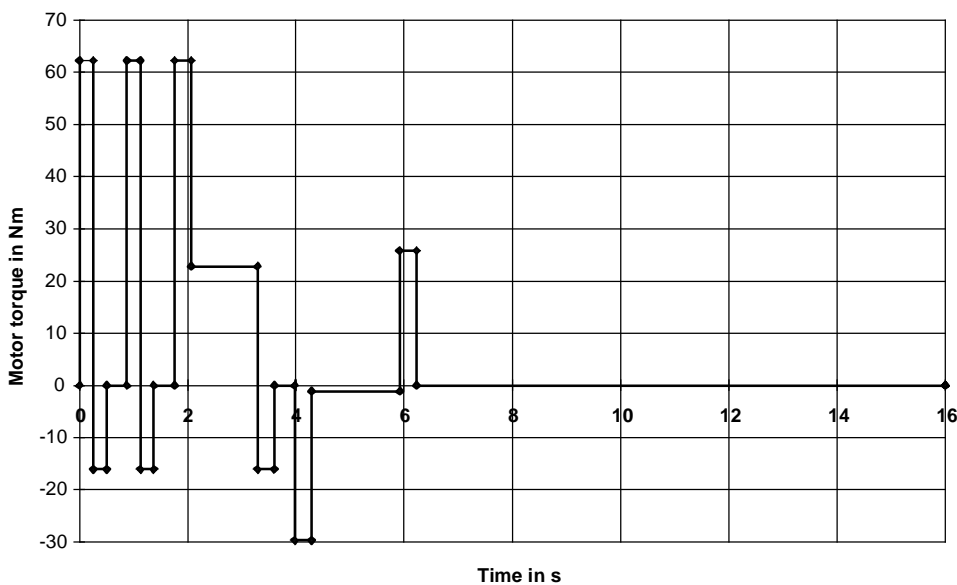



The motor torque lies below the limiting characteristic. Thus, the motor is suitable as far as the dynamic limits are concerned.

#### Thermally checking the motor

The RMS motor torque is calculated from the motor torque characteristic:

$$M_{RMS} = \sqrt{\frac{\sum M_{mot i}^2 \cdot \Delta t_i}{T}} = 16.75 \text{ Nm}$$

The average motor speed is given by:

$$n_{average} = \frac{\sum \frac{|n_{mot i-1} + n_{mot i}|}{2} \cdot \Delta t_i}{T} = \frac{\frac{n_{mot \max 1}}{2} \cdot t_{b1} \cdot 4 + n_{mot \max} \cdot (t_{b2} \cdot 2 + t_{k2} + t_{k3})}{T}$$

$$= \frac{2 \cdot 60 \cdot 7}{2 \cdot \pi \cdot 0.15152} \cdot 0.25 \cdot 4 + 2206 \cdot (0.3125 \cdot 2 + 1.2275 + 1.6275)}{16} = 534.9 \text{ RPM}$$



The effective motor torque lies, at  $n_{\text{average}}$ , below the  $M_{S1}$  characteristic. This means that the motor is also suitable as far as the thermal limits are concerned.

### Selecting the inverter

43.6 A is obtained for the peak current. The RMS value is 11.44 A.

Selected SIMOVERT MASTERDRIVES MOTION CONTROL inverter:

6SE7023-0TP50 (Compact Plus type of construction)

$P_{\text{inv } n} = 15 \text{ kW}$ ;  $I_{\text{inv } n} = 34 \text{ A}$ ;  $I_{\text{DC link } n} = 40.5 \text{ A}$ ;  $I_{\text{inv max}} = 54.4 \text{ A}$  (160 % overload capability)





*Calculating the braking power and the braking energy*

The motor output is obtained from the motor torque and the traversing velocity:

$$P_{mot} = M_{mot} \cdot i \cdot \frac{2 \cdot v}{D}$$



The max. braking power for the braking resistor is obtained through the maximum negative motor output (=motor braking power):

$$P_{br W \max} = P_{br \text{ mot max}} \cdot \eta_{mot} \cdot \eta_{inv} = -5952.9 \cdot 0.94 \cdot 0.98 = -5483.8 \text{ W}$$

The braking energy for one cycle is obtained through the negative surface area under the motor output characteristic

$$W_{br} = \eta_{mot} \cdot \eta_{inv} \cdot \frac{1}{2} \cdot \sum P_{br \text{ mot max } i} \cdot t_{vi} = -2078 \text{ Ws}$$

The average braking power for one cycle is

$$P_{br \text{ average}} = \frac{W_{br}}{T} = -\frac{2078}{16} = -129.9 \text{ W}$$

*Calculating the DC link currents when motoring*

The following is valid for the max. DC link current:

$$I_{DC \text{ link max}} = \frac{P_{mot \text{ max}}}{\eta_{mot} \cdot \eta_{inv} \cdot U_{DC \text{ link}}} = \frac{14390}{0.94 \cdot 0.98 \cdot 1.35 \cdot 400} = 28.93 \text{ A}$$

The DC link RMS current is obtained as follows:

$$I_{DC \text{ link RMS}} = \frac{1}{\eta_{mot} \cdot \eta_{inv} \cdot U_{DC \text{ link}}} \cdot \sqrt{\frac{\sum (P_{mot \text{ } i-1}^2 + P_{mot \text{ } i}^2 + P_{mot \text{ } i} \cdot P_{mot \text{ } i-1}) \cdot \frac{\Delta t_i}{3}}{T}} \quad \text{for } P_{mot \text{ } i-1}, P_{mot \text{ } i} \geq 0$$

A value of 4.75 A is obtained

### Selecting the rectifier unit

The rectifier unit is selected according to the peak DC link current and the DC link RMS current.

$$I_{DC\ link\ max} \leq I_{DC\ link\ EE\ max}$$

$$I_{DC\ link\ RMS} \leq I_{DC\ link\ EE\ n}$$

Further, the rated DC link current of the rectifier unit should be at least 30% of the total of the rated DC link currents of the connected inverters.

$$0.3 \cdot \sum I_{DC\ link\ INV\ n} \leq I_{DC\ link\ EE\ n}$$

For the 15 kW rectifier unit Compact Plus, the sum of the rated DC link currents of the connected inverters may not be greater than 80 A due to the resistor pre-charging.

As the four drives can operate simultaneously, the sum of the peak values of the individual inverters is used to estimate  $I_{DC\ link\ max}$  (this means that the calculation is on the safe side).

$$I_{DC\ link\ max} \approx \sum I_{DC\ link\ INV\ max} = 14.44 + 48.02 + 2 \cdot 16.71 + 28.93 = 124.8\ A$$

The RMS values of the individual inverters are added to determine  $I_{DC\ link\ RMS}$ . In principle, the RMS values of the total DC link currents must be generated, but to save time this has not been done and the error neglected.

$$I_{DC\ link\ RMS} \approx \sum I_{DC\ link\ INV\ RMS} = 3.76 + 16.33 + 2 \cdot 7.42 + 4.75 = 39.68\ A$$

When the rated DC link currents are added for the individual inverters, the following is obtained:

$$\sum I_{DC\ link\ INV\ n} = 30.4 + 44.6 + 2 \cdot 20.8 + 40.5 = 157.1\ A$$

Selected SIMOVERT MASTERDRIVES MOTION CONTROL rectifier unit  
6SE7031-2EP85-0AA0 (Compact Plus type)

$P_n=50$  kW;  $I_{DC\ link\ n}=120$  A;  $I_{DC\ link\ max}=192$  A (160 % overload capability)

### Selecting the brake resistor

When selecting the brake resistor, it is assumed that the four drives must brake simultaneously. Thus, the sum of the individual peak braking powers is formed (in this case you will always be on the safe side).

$$P_{br\ max} \approx \sum P_{br\ INV\ max} = 2370 + 5980 + 2 \cdot 2220 + 5484 = 18274\ W$$

The average braking powers of the individual inverters are also added.

$$P_{br\ average} \approx \sum P_{br\ INV\ average} = 62.94 + 800 + 2 \cdot 226.7 + 129.9 = 1447\ W$$

With the conditions

$$P_{br\ max} \leq 15 \cdot P_{20}$$

$$P_{br\ average} \leq \frac{P_{20}}{4.5}$$

a braking resistor with  $P_{20}=20$  kW (6SE7023-2ES87-2DC0) is obtained. The chopper for this inverter is, for Compact Plus, integrated in the rectifier unit.

### 3.16 Drive for a pantograph

For the systems which have been implemented up until now, the pantograph is brought into the up (operating position) using a spring which is tensioned in the quiescent (down) position. This spring also provides the contact force between the pantograph bar and the overhead wire. The disadvantage with this arrangement is that the spring is continuously tensioned in the quiescent position, which means that the components are subject to increased mechanical stressing. The pantograph is brought back into the quiescent state, and the spring is either pneumatically tensioned or tensioned using an auxiliary electric drive.



#### Principle mode of operation

When the spring is replaced by an electric drive, the drive must fulfill the following requirements:

- The pantograph must be retracted from the overhead wire within approx. 1 s
- After the bar comes into contact with the overhead wire, it must be pressed onto the overhead wire with a constant force
- When the overhead wire height changes, the drive must appropriately correct the pantograph so that the contact force is, as far as possible, constant.

Initially, the load torque is investigated at one of the two lower joints of the pantograph as a function of angle  $\varphi$ . The motor torque can, for example, be applied through a gearbox, or an additional lever arm with rack and pinion. Positioning can be implemented using a suitable traversing cam. After the pantograph bar makes contact with the overhead wire, the motor must be closed-loop torque controlled using a torque limiting function as a function of the height in order to guarantee a constant contact force.

### Pantograph data

Weight of the upper pantograph assembly (left and righthand section)	$m_o = 64 \text{ kg}$
Weight of the lower pantograph assembly (left and righthand section)	$m_u = 80 \text{ kg}$
Weight of the bar	$m_w = 60 \text{ kg}$
Length of the upper bars	$l_o = 1.751 \text{ m}$
Length of the lower bars	$l_u = 1.25 \text{ m}$
Contact force	$F_A = 160 \text{ Nm}$
Height in the lower position	$y_u = 0.416 \text{ m}$
Height in the upper position	$y_o = 2.481 \text{ m}$
Distance between the lower joints	$2a = 1 \text{ m}$
Positioning time	$t_{\text{tot}} = 1 \text{ s}$

### Angular relationships



The height  $y$  of the pantograph is a function of angle  $\varphi$ :

$$y = l_u \cdot \sin \varphi + \sqrt{l_o^2 - (a + l_u \cdot \cos \varphi)^2} \quad \text{Equation 1}$$

The following is valid for the angle:

$$\beta = \arcsin \frac{\sqrt{l_o^2 - (a + l_u \cdot \cos \varphi)^2}}{l_o}, \quad \gamma = \frac{\pi}{2} - \beta$$

Using equation 1, and the given heights  $y_u$  and  $y_o$ , the associated angle  $\varphi_u$  and  $\varphi_o$  can be iteratively determined. The following is obtained:

$$\varphi_u = 0.15 \text{ rad} \quad (\text{lower quiescent position})$$

$$\varphi_o = 1.085 \text{ rad} \quad (\text{working (up) position})$$

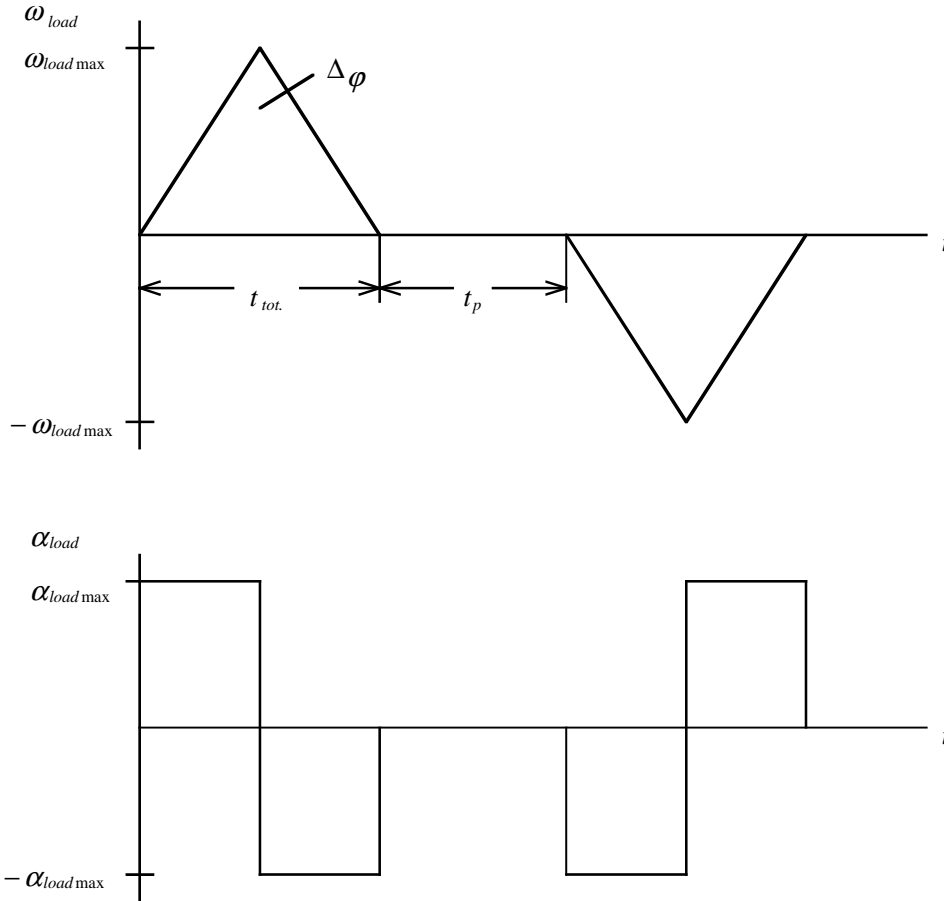

Diagram to determine the initial values for iteration

### Movement

Starting from the lower quiescent position, the pantograph should be brought into its final position within 1 s. It must also be retracted to its final position in the lower quiescent position also within

1 s. The angular velocity at the lower joint 1 is specified as symmetrical triangular traversing characteristic. Thus, the following characteristic is obtained for the angular velocity and the angular acceleration.



The following is obtained for the max. angular velocity, max. angular acceleration and the max. load speed:

$$\omega_{load\ max} = \frac{2 \cdot \Delta\varphi}{t_{ges}} = \frac{2 \cdot (\varphi_o - \varphi_u)}{t_{ges}} = \frac{2 \cdot (1.085 - 0,15)}{1} = 1.87\ s^{-1}$$

$$\alpha_{load\ max} = \frac{2 \cdot \omega_{load\ max}}{t_{ges}} = \frac{2 \cdot 1.87}{1} = 3.74\ s^{-2}$$

$$n_{load\ max} = \frac{\omega_{load\ max} \cdot 60}{2 \cdot \pi} = \frac{1.87 \cdot 60}{2 \cdot \pi} = 17.86\ min^{-1}$$



The angular acceleration  $\alpha_{load}$ , the angular velocity  $\omega_{load}$  and the angle  $\varphi$  can now be represented as a function of time.

Range:  $0 \leq t \leq t_b$  (acceleration upwards)

$$\alpha_{load} = \alpha_{load \max}$$

$$\omega_{load} = \alpha_{load \max} \cdot t$$

$$\varphi = \varphi_u + \frac{1}{2} \cdot \alpha_{load \max} \cdot t^2$$

Range:  $t_b \leq t \leq t_{total}$  (acceleration downwards)

$$\alpha_{load} = -\alpha_{load \max}$$

$$\omega_{load} = -\alpha_{load \max} \cdot (t - t_{total})$$

$$\varphi = \varphi_u + \Delta\varphi - \frac{1}{2} \cdot \alpha_{load \max} \cdot (t - t_{total})^2$$

Range:  $t_{total} + t_p \leq t \leq t_{total} + t_p + t_b$  (acceleration upwards)

$$\alpha_{load} = -\alpha_{load \max}$$

$$\omega_{load} = -\alpha_{load \max} \cdot (t - t_{total} - t_p)$$

$$\varphi = \varphi_u + \Delta\varphi - \frac{1}{2} \cdot \alpha_{load \max} \cdot (t - t_{total} - t_p)^2$$

Range:  $t_{total} + t_p + t_b \leq t \leq t_{total} + t_p + t_{total}$  (acceleration downwards)

$$\alpha_{load} = -\alpha_{load \max}$$

$$\omega_{load} = \alpha_{load \max} \cdot (t - 2 \cdot t_{total} - t_p)$$

$$\varphi = \varphi_u + \frac{1}{2} \cdot \alpha_{load \max} \cdot (t - 2 \cdot t_{total} - t_p)^2$$

### Calculating the load torque when raising and lowering the pantograph

When raising and lowering the pantograph, the load torque is calculated, without taking into account the contact force.

Torque as result of the forces due to the various weights



The forces associated with only one half of the pantograph are investigated due to the symmetry. Half of the weight of the upper assembly  $F_o/2$  is distributed, extending from the center of gravity, 50% to point 2 and 3 in order to simplify the calculation. The torque associated with point 1 does not change. Half of the weight of the lower assembly  $F_u/2$  acts at the center of gravity. Only half the weight of the counterpoise  $F_w/2$  acts at point 3. The force  $F_o/4 + F_w/2$ , acting vertically at point 3, is broken down into a bar stress for bar  $l_o$ , and then into a normal component force for bar  $l_u$ .

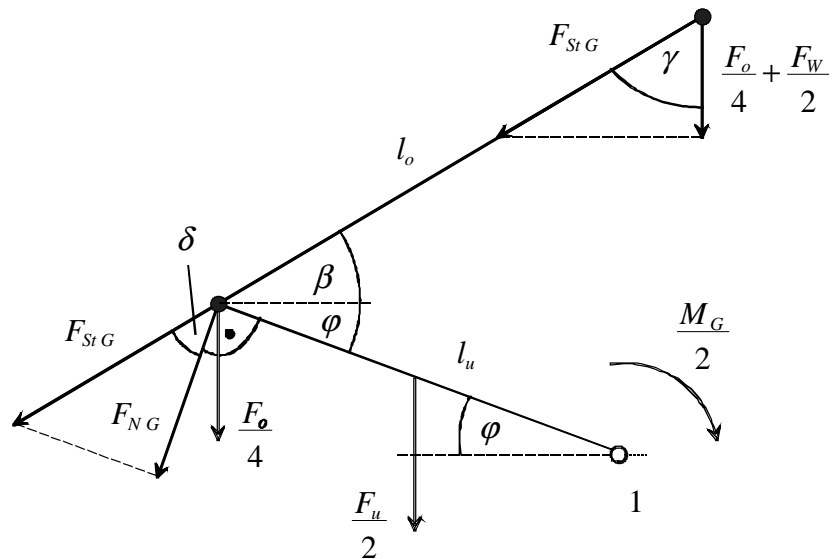

The following is obtained for the bar stress and the normal component of the force:

$$F_{StG} = \frac{\frac{F_o}{4} + \frac{F_w}{2}}{\cos \gamma} = \frac{(\frac{m_o}{4} + \frac{m_w}{2}) \cdot g}{\cos \gamma}$$

$$F_{NG} = F_{StG} \cdot \cos \delta$$

with

$$\delta = \frac{\pi}{2} - \varphi - \beta$$

Thus, the torque as result of the various weights is given by:

$$\begin{aligned} \frac{M_G}{2} &= \frac{F_u}{2} \cdot \frac{l_u}{2} \cdot \cos \varphi + \frac{F_o}{4} \cdot l_u \cdot \cos \varphi + F_{NG} \cdot l_u \\ &= \frac{m_u}{2} \cdot g \cdot \frac{l_u}{2} \cdot \cos \varphi + \frac{m_o}{4} \cdot g \cdot l_u \cdot \cos \varphi + F_{NG} \cdot l_u \end{aligned}$$

Torque due to the acceleration of the various masses

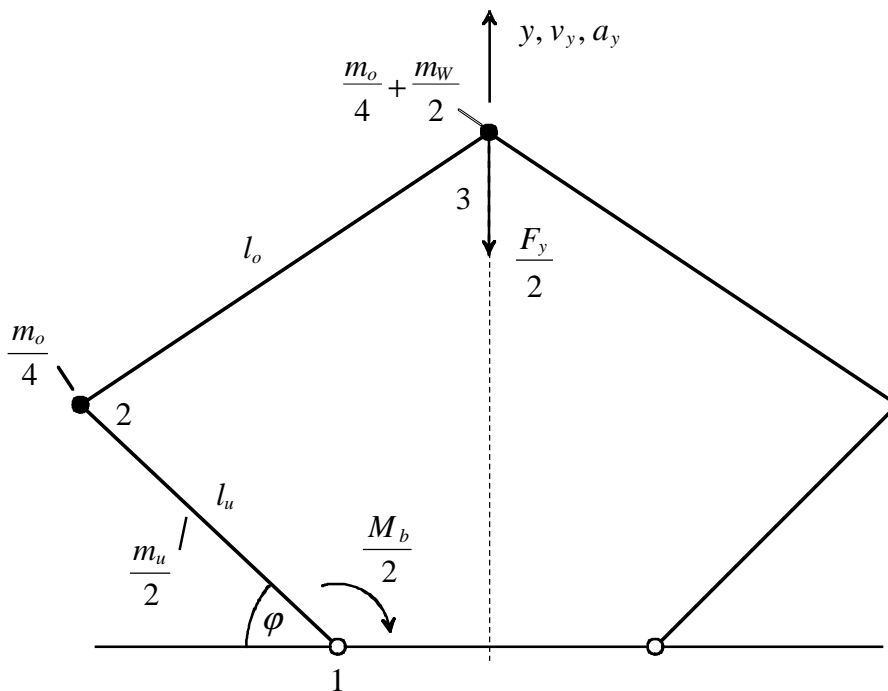

Also here, due to the symmetry, only the forces associated with half of the pantograph are investigated. The force  $F_y/2$  is obtained from the acceleration in the y axis:

$$\frac{F_y}{2} = \left(\frac{m_o}{4} + \frac{m_w}{2}\right) \cdot a_y$$

The velocity  $v_y$  and acceleration  $a_y$  is obtained using equation 1 by differentiation.

$$v_y = \frac{dy}{d\varphi} \cdot \frac{d\varphi}{dt} = l_u \cdot \omega_{load} \cdot \cos \varphi + \frac{(a + l_u \cdot \cos \varphi) \cdot l_u \cdot \omega_{load} \cdot \sin \varphi}{y - l_u \cdot \sin \varphi}$$

$$a_y = \frac{dv_y}{d\varphi} \cdot \frac{d\varphi}{dt} = \frac{T}{y - l_u \cdot \sin \varphi}$$

with

$$T = a \cdot l_u \cdot (\omega_{load}^2 \cdot \cos \varphi + \alpha_{load} \cdot \sin \varphi) + l_u \cdot (-y \cdot \omega_{load}^2 \cdot \sin \varphi + \cos \varphi \cdot (y \cdot \alpha_{load} + 2 \cdot v_y \cdot \omega_{load})) - v_y^2$$

Also here the force  $F_y/2$ , acting vertically in point 3, is broken down into a bar force regarding bar  $l_o$  and then into a force to the vertical regarding bar  $l_u$ .



The bar stress and the normal component of the force as result of the acceleration are given by:

$$F_{Stb} = \frac{\frac{F_y}{2}}{\cos \gamma}$$

$$F_{Nb} = F_{Stb} \cdot \cos \delta$$

Thus, the torque due to acceleration is given by:

$$\frac{M_b}{2} = J_1 \cdot \alpha_{load} + F_{Nb} \cdot l_u$$

In this case,  $J_1$  is the moment of inertia of bar  $l_u$  with weight  $m_u/2$  and the weight  $m_o/4$ , acting at point 2, referred to point 1.

$$J_1 = \frac{1}{3} \cdot \frac{m_u}{2} \cdot l_u^2 + \frac{m_o}{4} \cdot l_u^2$$

The load torque at point 1, when taking into account both halves of the pantograph is given by:

$$M_{load} = 2 \cdot \left( \frac{M_G}{2} + \frac{M_b}{2} \right)$$

Using the numerical values, the load torque can be calculated, for example, using an Excel program.



Load torque when the pantograph is being raised and lowered (pantograph moving up and down)

#### Calculating the steady-state load torque

When calculating the steady-state load torque during operation, the contact force  $F_A$  is taken into account. The following is obtained:

$$M_{load\ stat} = 2 \cdot \left( \frac{m_u}{2} \cdot g \cdot \frac{l_u}{2} \cdot \cos \varphi + \frac{m_o}{4} \cdot g \cdot l_u \cdot \cos \varphi + F_{N\ stat} \cdot l_u \right)$$

with

$$F_{N\ stat} = \frac{\left(\frac{m_o}{4} + \frac{m_w}{2}\right) \cdot g + \frac{F_A}{2}}{\cos \gamma} \cdot \cos \delta$$



Steady-state load torque with contact force as a function of angle  $\varphi$

### Selecting the motor

When selecting the motor a simplification is made in so much that it is assumed that the motor torque is converted to the load torque linearly through a gearbox.

Selected motor:

1PA6105-4HF. with gearbox  $i=110$  ( $\eta_{\text{gear}}=0.9$ ),  $M_n=44$  Nm,  $n_n=17500$  RPM,  $M_{\text{stall}}=114.4$  Nm,  $I_n=17.5$  A,  $I_\mu=9.3$  A,  $J_{\text{Mot}}=0.029$  kgm<sup>2</sup>,  $J_{\text{gear}}=0.02$  kgm<sup>2</sup>,  $\eta_{\text{Mot}}=0.875$

Maximum motor speed:

$$n_{\text{mot max}} = i \cdot n_{\text{load max}} = 110 \cdot 17.86 = 1964.3 \text{ RPM}$$

### Motor torque

The following is valid for the motor torque:

$$M_{mot\ up} = J_{mot} \cdot \alpha_{load} \cdot i + J_{gear} \cdot \alpha_{load} \cdot i + M_{load} \cdot \frac{1}{i \cdot \eta_{gear}^{VZ}}$$

$$M_{mot\ down} = J_{mot} \cdot \alpha_{load} \cdot i + J_{gear} \cdot \alpha_{load} \cdot i + M_{load} \cdot \frac{\eta_{gear}^{VZ}}{i}$$

$$M_{mot\ stat} = M_{load\ stat} \cdot \frac{1}{i}$$

with

$$VZ = \text{sign}(M_{load})$$

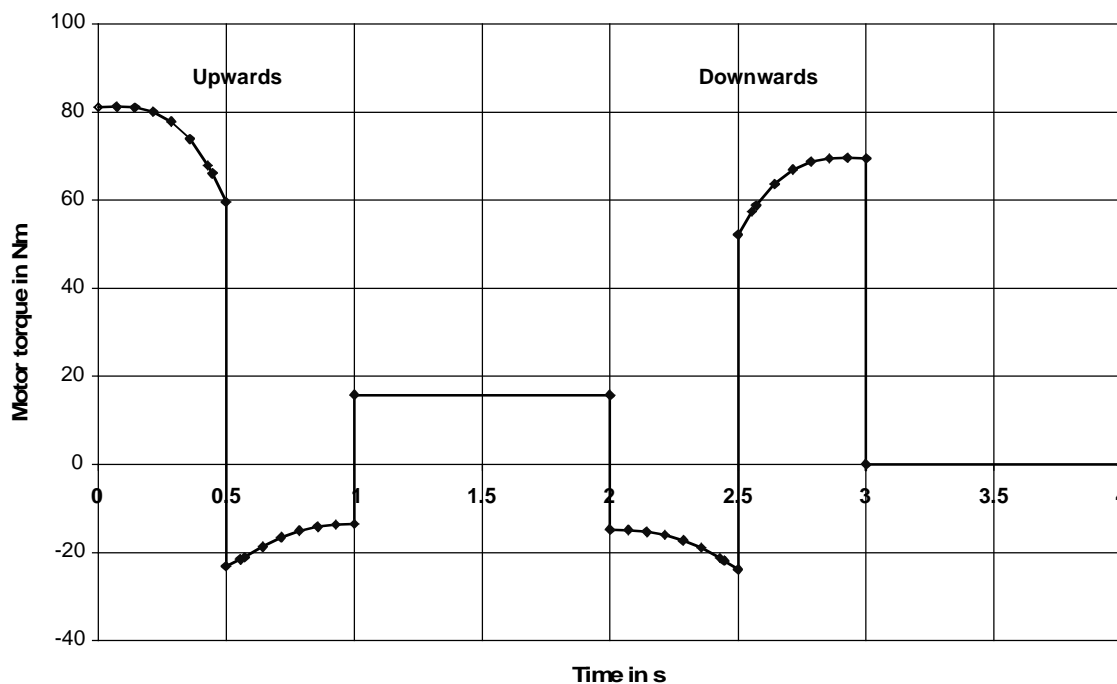

Motor torque when the pantograph is being raised and lowered (pantograph is moved up and down)



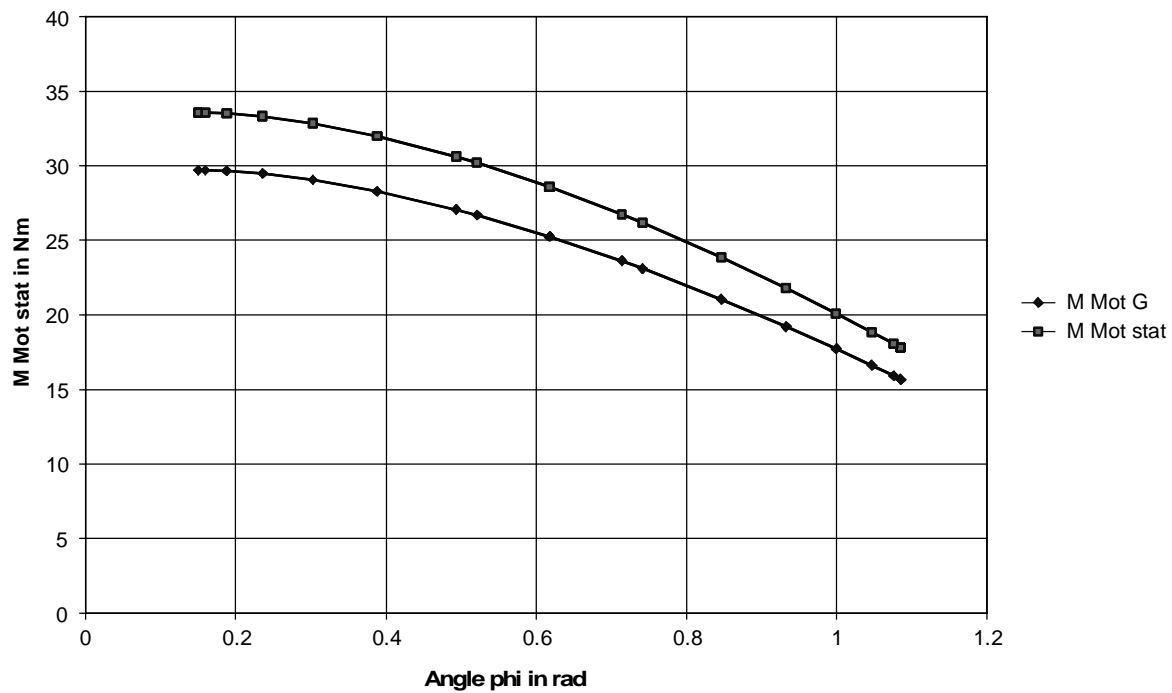

Steady-state motor torque with contact force ( $M_{\text{mot stat}}$ ) and without contact force ( $M_{\text{mot G}}$ ) as a function of angle  $\varphi$

The highest motor torque in dynamic operation is required when the pantograph is being raised (moved upwards). This torque is 81.13 Nm. The motor torque when the pantograph is being lowered (moved downwards) is less due to the efficiency of the gear.

In order to achieve a constant contact force in steady-state operation, the motor torque limit must be entered as a function of angle  $\varphi$  according to the characteristic  $M_{\text{mot stat}}$ .

This can be realized, for example, by sensing the angle using an absolute value encoder and entering the torque limit via a characteristic block. In order to compensate overhead wire height changes more quickly, a torque increase can be used which is dependent on the differentiated angle  $\varphi$ .  $M_{\text{mot stat}}$  is greater than torque  $M_{\text{mot G}}$ , caused by the weight, by the component of the contact force  $F_A$ . The maximum steady-state motor torque is 33.55 Nm. However, this value is not reached, as the overhead wire height only varies by 0.5 m. Thus, using equation 1, an angle of 0.8 rad and a steady-state motor torque of approximately 25 Nm is obtained. Thus, the motor is thermally suitable, as the rated torque is 44 Nm.



The dynamic motor torque lies below the limiting curve. Thus, the motor is also suitable regarding the dynamic limits.

#### *Dimensioning the brake resistor*

The motor output is obtained from the motor torque and the angular velocity as follows:

$$P_{mot} = M_{mot} \cdot i \cdot \omega_{load}$$

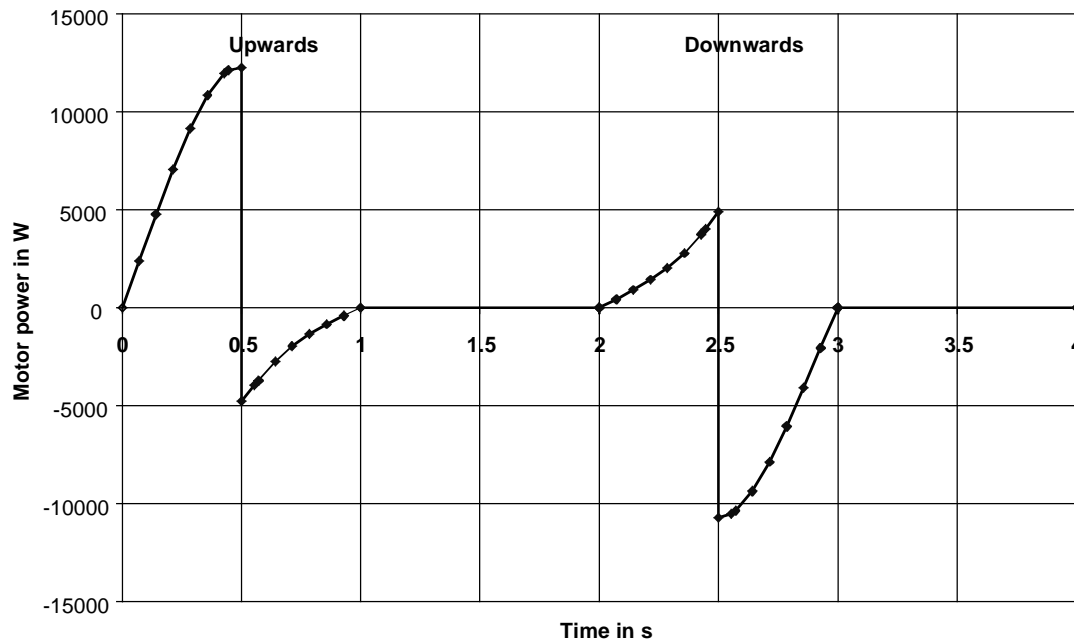

Motor output while the pantograph is being raised and lowered (pantograph moving up and down)

The max. braking power for the brake resistor is obtained from the max. negative motor output (=motor braking power):

$$P_{br W \max} = P_{br mot \max} \cdot \eta_{mot} \cdot \eta_{INV} = -10.7 \cdot 0.875 \cdot 0.98 = -9.17 \text{ kW}$$

As a result of the condition

$$P_{br W \max} \leq 1.5 \cdot P_{20}$$

a braking unit with minimum  $P_{20}=10 \text{ kW}$  must be used.

The braking energy when raising and lowering the pantograph can be calculated using the area under the negative motor power curve.

$$W_{br} = \int P_{mot} \cdot \eta_{mot} \cdot \eta_{INV} \cdot dt \quad \text{for } P_{mot} \leq 0$$

$$\approx \sum \eta_{mot} \cdot \eta_{INV} \cdot \frac{P_{moti-1} + P_{moti}}{2} \cdot (t_i - t_{i-1}) \quad \text{for } P_{moti-1}, P_{moti} \leq 0$$

The calculation results in:

$$W_{br} = -3.58 \text{ kWs}$$

The following must be valid for a braking unit with internal brake resistor:

$$\frac{W_{br}}{T} \leq \frac{P_{20}}{36}$$

or

$$T \geq \frac{W_{br} \cdot 36}{P_{20}} = \frac{3.58 \cdot 36}{10} = 12.9 \text{ s} \quad (\text{at } P_{20}=10 \text{ kW})$$

When a 10 kW braking unit with internal brake resistor is used, the cycle time for upwards and downwards motion must therefore be a minimum of 12.9 s. Otherwise, an external brake resistor must be used or possibly a larger braking unit.

### Selecting the drive converter

The drive converter is selected according to the max. motor current when accelerating and the max. motor current under steady-state operating conditions. The motor current is calculated from the motor torque as follows:

$$I_{mot} \approx I_{motn} \cdot \sqrt{\left(\frac{M_{mot}}{M_{motn}}\right)^2 \cdot \left(1 - \left(\frac{I_{mag}}{I_{motn}}\right)^2\right) \cdot kn^2 + \left(\frac{I_{mag}}{I_{motn}}\right)^2 \cdot \frac{1}{kn^2}}$$

$$kn = 1 \quad \text{for} \quad n_{mot} \leq n_{motn} \quad \text{constant flux range}$$

$$kn = \frac{n_{mot}}{n_{motn}} \quad \text{for} \quad n_{mot} > n_{motn} \quad \text{field weakening}$$

Thus, the following is obtained:

$$I_{mot \text{ b max}} = 31.2 \text{ A} \quad \text{max. motor current when accelerating with 81.13 Nm}$$

$$I_{mot \text{ stat max}} = 12.6 \text{ A} \quad \text{max. motor current under steady-state operating conditions with 25 Nm}$$

8 % is added for  $I_{mot \text{ b max}}$  for saturation effects.

Selected drive converter SIMOVERT MASTERDRIVES VECTOR CONTROL:

6SE7022-6EC61

$P_{U_n}=11$  kW;  $I_{U_n}=25.5$  A;  $I_{U_{max}}=34.8$  A (136 % overload capability)

with 10 kW braking unit (6SE7021-6ES87-2DA0)

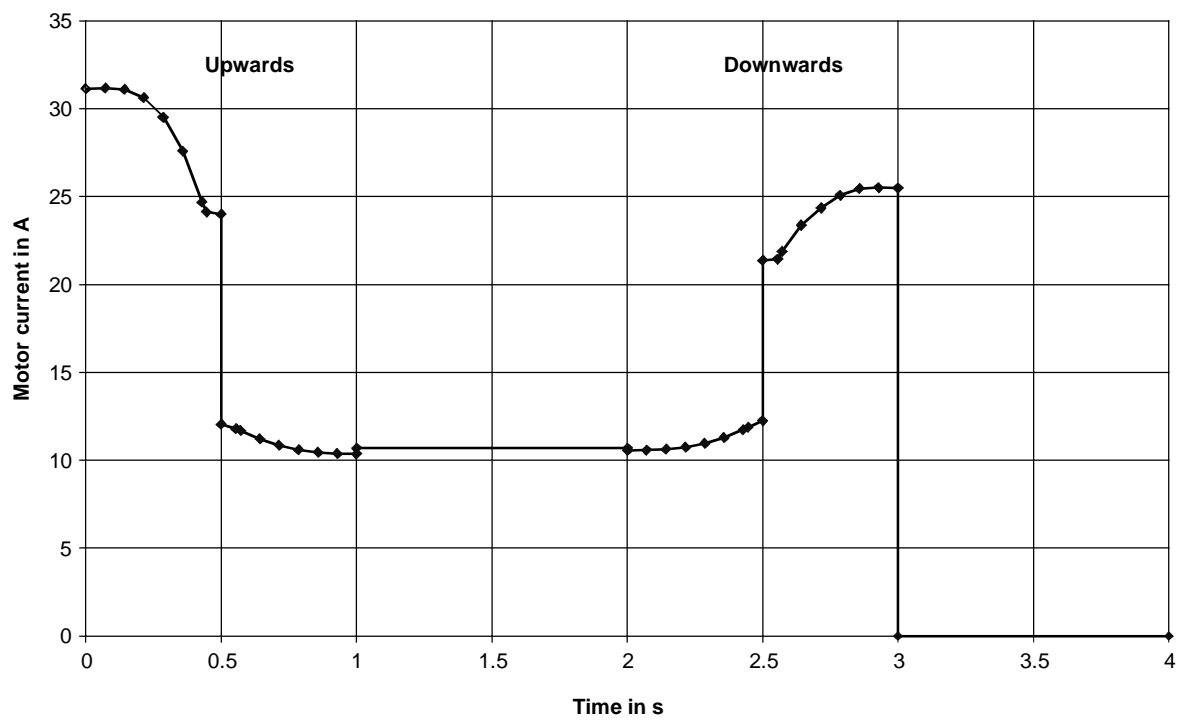

Motor current when the pantograph is being raised and lowered.

*Estimating the accuracy of the contact force*

If the steady-state torque characteristics at an operating point are investigated, then the most unfavorable case at the lowest required motor torque is obtained, i. e. at the maximum height:

$$M_{mot\ stat} = 17.8\ Nm \quad \text{steady-state motor torque}$$

$$M_{mot\ G} = 15.7\ Nm \quad \begin{array}{l} \text{motor torque component for the forces} \\ \text{due to the weight} \end{array}$$

and therefore

$$M_{mot\ A} = M_{mot\ stat} - M_{mot\ G} = 2.1\ Nm \sim F_A \quad \text{motor torque component for the contact force}$$

If a 1% torque accuracy is used for the drive, then the following is obtained:

$$\Delta M_{mot} = \frac{M_n}{100\%} \cdot 1\% = \frac{44}{100} = 0.44\ Nm$$

Thus, the accuracy of the contact force is given by:

$$\frac{\Delta M_{mot\ A}}{M_{mot\ A}} = \frac{\Delta F_A}{F_A} = \frac{\Delta M_{mot}}{M_A} = \frac{0.44}{2.1} \cdot 100\% = 21\%$$

Due to the fact that the motor has been dimensioned according to the dynamic requirements, the required steady-state motor torque is relatively small with respect to the rated motor torque and because the component responsible for the contact force is only approximately 12 % of the steady-state motor torque, a larger error is obtained regarding the accuracy of the contact force. Better results would be achieved if the component of the weight could be kept lower, e. g. using an equalization weight, or a spring, which would compensate the weight component in the operating range.

### Checking the calculation using the potential energy

The calculation can be checked using the potential energy to move the masses from the quiescent position into the operating position. To realize this, the center of gravity travel of weights  $m_o$ ,  $m_u$  and  $m_w$  is calculated.

$$\Delta h m_o = \frac{y_o + l_u \cdot \sin \varphi_o}{2} - \frac{y_u + l_u \cdot \sin \varphi_u}{2} = \frac{2.481 + 1.25 \cdot \sin 1.085}{2} - \frac{0.416 + 1.25 \cdot \sin 0.15}{2} = 1.492 \text{ m}$$

$$\Delta h m_u = \frac{l_u \cdot \sin \varphi_o}{2} - \frac{l_u \cdot \sin \varphi_u}{2} = \frac{1.25 \cdot \sin 1.085}{2} - \frac{1.25 \cdot \sin 0.15}{2} = 0.459 \text{ m}$$

$$\Delta h m_w = y_o - y_u = 2.481 - 0.416 = 2.065 \text{ m}$$

Thus, the following is obtained for the potential energy:

$$\begin{aligned} W_{pot} &= m_o \cdot g \cdot \Delta h m_o + m_u \cdot g \cdot \Delta h m_u + m_w \cdot g \cdot \Delta h m_w \\ &= (64 \cdot 1.492 + 80 \cdot 0.459 + 60 \cdot 2.065) \cdot 9.81 = 2512 \text{ Ws} \end{aligned}$$

The following is obtained for the average power:

$$P_{average} = \frac{W_{pot}}{t_{total}} = \frac{2512}{1} = 2512 \text{ W}$$

On the other hand, the energy for the upwards motion is calculated as follows:

$$W_{up} = \int_0^{t_{total}} P_{load} \cdot dt = \int_0^{t_{total}} M_{load} \cdot \omega_{load} \cdot dt \approx \sum \frac{M_{load i-1} \cdot \omega_{load i-1} + M_{load i} \cdot \omega_{load i}}{2} \cdot (t_i - t_{i-1})$$

When this relationship is evaluated, for appropriately smaller steps, the same value is determined as for  $W_{pot}$ . The kinetic energy, required when accelerating, is completely fed back when decelerating.



Load power  $P_{load}$  and average power  $P_{average}$  when moving upwards (pantograph being raised)



### 3.17 Drive for a foil feed with $\sin^2$ rounding-off

The drive will be investigated, simplified as a pure flywheel drive. An 1FK6 motor is to be used. In order to avoid torque steps, the speed setpoint is rounded-off according to a  $\sin^2$  characteristic (also refer under 4.6).

#### Drive data

Load moment of inertia	$J_{\text{load}}$	= 0.75 kgm <sup>2</sup>
Gearbox ratio	$i$	= 15.57
Gearbox moment of inertia	$J_G$	= 0.000151
Gearbox efficiency	$\eta_G$	= 0.95
Max. motor speed	$n_{\text{Mot max}}$	= 3000 RPM
Accelerating time	$t_b$	= 70 ms
Deceleration time	$t_v$	= 70 ms
Constant speed time	$t_k$	= 70 ms
No-load time	$t_p$	= 0.8 s

The maximum angular velocity of the load is given by:

$$\omega_{\text{load max}} = \frac{2 \cdot \pi \cdot n_{\text{mot max}}}{60 \cdot i} = \frac{2 \cdot \pi \cdot 3000}{60 \cdot 15.57} = 20.1772 \text{ s}^{-1}$$

For a  $\sin^2$  rounding-off function, the maximum angular acceleration of the load is given by:

$$\alpha_{\text{load max}} = \frac{\omega_{\text{load max}}}{t_b} \cdot \frac{\pi}{2} = \frac{20.1772}{0.07} \cdot \frac{\pi}{2} = 452.8 \text{ s}^{-2}$$

## Traversing curve



The traversing curve is symmetrical due to  $t_b=t_v$ .

The angular velocity  $\omega_{load}$  and the angular acceleration  $\alpha_{load}$  can be represented as a function of the time as follows:

Range:  $0 \leq t \leq t_b$  (acceleration)

$$\omega_{load} = \omega_{load \max} \cdot \sin^2\left(\frac{\pi \cdot t}{2 \cdot t_b}\right)$$

$$\alpha_{load} = \alpha_{load \max} \cdot \sin\left(\frac{\pi \cdot t}{t_b}\right)$$

Range:  $t_b \leq t \leq t_b + t_k$  (constant speed)

$$\omega_{load} = \omega_{load \max}$$

$$\alpha_{load} = 0$$

Range:  $t_b + t_k \leq t \leq t_b + t_k + t_v$  (deceleration)

$$\omega_{load} = \omega_{load \max} \cdot \cos^2\left(\frac{\pi \cdot (t - t_b - t_k)}{2 \cdot t_v}\right)$$

$$\alpha_{load} = -\alpha_{load \max} \cdot \sin\left(\frac{\pi \cdot (t - t_b - t_k)}{t_v}\right)$$

### Load torque

The following is valid for the load torque:

$$M_{load} = J_{load} \cdot \alpha_{load}$$

The maximum load torque is given by:

$$M_{load \max} = J_{load} \cdot \alpha_{load \max} = 0.75 \cdot 452.8 = 339.6 \text{ Nm}$$

### Selecting the motor

Selected motor:

1FK6063-6AF71,  $n_n=3000$  RPM,  $J_{Mot}=0.00161$  kgm<sup>2</sup>,  $\eta_{Mot}=0.89$ ,  $kT_0=1.33$  Nm/A,  $M_0=11$  Nm,  $I_0=8.3$  A,  $M_{max}=37$  Nm,  $I_{max}=28$  A

### Motor torque

The following is valid for the motor torque:

$$M_{mot\ b} = ((J_{mot} + J_G) \cdot i + J_{load} \cdot \frac{1}{i \cdot \eta_G}) \cdot \alpha_{load\ max} \cdot \sin\left(\frac{\pi \cdot t}{t_b}\right) \quad (\text{acceleration, motoring})$$

$$M_{mot\ v} = -((J_{mot} + J_G) \cdot i + J_{load} \cdot \frac{\eta_G}{i}) \cdot \alpha_{load\ max} \cdot \sin\left(\frac{\pi \cdot (t - t_b - t_k)}{t_v}\right) \quad (\text{deceleration, generating})$$



The highest motor torque is achieved when accelerating, with:

$$\begin{aligned} M_{mot\ b\ max} &= ((J_{mot} + J_G) \cdot i + J_{load} \cdot \frac{1}{i \cdot \eta_G}) \cdot \alpha_{load\ max} \\ &= ((0.00161 + 0.000151) \cdot 15.57 + 0.75 \cdot \frac{1}{15.57 \cdot 0.95}) \cdot 452.8 = 35.37 \text{ Nm} \end{aligned}$$

The max. motor torque when decelerating is lower as a result of the gearbox efficiency:

$$M_{\text{mot v max}} = -((J_{\text{mot}} + J_G) \cdot i + J_{\text{load}} \cdot \frac{\eta_G}{i}) \cdot \alpha_{\text{load max}}$$

$$= -((0.00161 + 0.000151) \cdot 15.57 + 0.75 \cdot \frac{0.95}{15.57}) \cdot 452.8 = -33.14 \text{ Nm}$$



The motor torque lies below the limiting curve. Thus, the motor is suitable as far as the dynamic limits are concerned.

### Thermally checking the motor

The RMS motor torque is given by:

$$M_{\text{RMS}} = \sqrt{\frac{\int_0^{t_b} M_{\text{mot b}}^2 \cdot dt + \int_{t_b+t_k}^{t_b+t_k+t_v} M_{\text{mot v}}^2 \cdot dt}{t_b + t_k + t_v + t_p}}$$

After inserting, the following is obtained:

$$M_{RMS} = \sqrt{\frac{\int_0^{t_b} M_{mot\ b\ max}^2 \cdot \sin^2\left(\frac{\pi \cdot t}{t_b}\right) \cdot dt + \int_{t_b+t_k}^{t_b+t_k+t_v} M_{mot\ v\ max}^2 \cdot \sin^2\left(\frac{\pi \cdot (t-t_b-t_k)}{t_v}\right) \cdot dt}{t_b + t_k + t_v + t_p}}$$

$$= \sqrt{\frac{M_{mot\ b\ max}^2 \cdot \frac{t_b}{2} + M_{mot\ v\ max}^2 \cdot \frac{t_v}{2}}{t_b + t_k + t_v + t_p}} = \sqrt{\frac{35.37^2 \cdot \frac{0.07}{2} + 33.14^2 \cdot \frac{0.07}{2}}{0.07 + 0.07 + 0.07 + 0.8}} = 9.02\ Nm$$

The average motor speed is given by, with  $n_{mot} \sim \omega_{load}$ :

$$n_{average} = \frac{\int_0^{t_b+t_k+t_v} n_{mot} \cdot dt}{t_b + t_k + t_v + t_p} = \frac{n_{mot\ max} \cdot \left( \int_0^{t_b} \sin^2\left(\frac{\pi \cdot t}{2 \cdot t_b}\right) \cdot dt + \int_{t_b}^{t_b+t_k} dt + \int_{t_b+t_k}^{t_b+t_k+t_v} \cos^2\left(\frac{\pi \cdot (t-t_b-t_k)}{2 \cdot t_v}\right) \cdot dt \right)}{t_b + t_k + t_v + t_p}$$

$$= \frac{n_{mot\ max} \cdot \left( \frac{t_b}{2} + t_k + \frac{t_v}{2} \right)}{t_b + t_k + t_v + t_p} = \frac{3000 \cdot \left( \frac{0.07}{2} + 0.07 + \frac{0.07}{2} \right)}{0.07 + 0.07 + 0.07 + 0.8} = 415.8\ RPM$$



The RMS motor torque is, at  $n_{\text{average}}$  below the  $M_{S1}$  characteristic. Thus, the motor is suitable as far as the thermal limits are concerned.

### Dimensioning the brake resistor

The motor output is obtained from the motor torque and the angular velocity as follows:

$$P_{\text{mot}} = M_{\text{mot}} \cdot i \cdot \omega_{\text{load}}$$



The following is valid when generating:

$$P_{\text{mot } v} = -M_{\text{mot } v \text{ max}} \cdot \sin\left(\frac{\pi \cdot (t - t_b - t_k)}{t_v}\right) \cdot i \cdot \omega_{\text{load max}} \cdot \cos^2\left(\frac{\pi \cdot (t - t_b - t_k)}{2 \cdot t_v}\right)$$

The max. braking power of the brake resistor is obtained from the max. motor output when generating:

$$P_{\text{br } W \text{ max}} = P_{\text{mot } v \text{ max}} \cdot \eta_{\text{mot}} \cdot \eta_{\text{INV}}$$

If the following is used

$$\frac{\pi \cdot (t - t_b - t_k)}{2 \cdot t_v} = \varphi$$

then the maximum of  $P_{\text{mot } v}$  is obtained as follows, with

$$\frac{dP_{\text{mot } v}}{d\varphi} = 0 = -M_{\text{mot } v \text{ max}} \cdot i \cdot \omega_{\text{load max}} \cdot (2 \cdot \cos(2 \cdot \varphi) \cdot \cos^2(\varphi) - 2 \cdot \sin(2 \cdot \varphi) \cdot \cos(\varphi) \cdot \sin(\varphi))$$

for

$$\varphi = \arcsin\left(\frac{1}{2}\right) = 0.5236 \text{ rad}$$

By inserting  $\varphi$ , the maximum braking power for the brake resistor is given by:

$$\begin{aligned} P_{br W \text{ max}} &= -M_{\text{mot } v \text{ max}} \cdot i \cdot \omega_{\text{load max}} \cdot \eta_{\text{mot}} \cdot \eta_{\text{INV}} \cdot \sin(2 \cdot 0.5236) \cdot \cos^2(0.5236) \\ &= -33.14 \cdot 15.57 \cdot 20.1772 \cdot 0.89 \cdot 0.98 \cdot \sin(2 \cdot 0.5236) \cdot \cos^2(0.5236) = -5898 \text{ W} \end{aligned}$$

The braking energy for a cycle is calculated as follows:

$$\begin{aligned} W_{br} &= \int_{t_b+t_k}^{t_b+t_k+t_v} P_{\text{mot } v} \cdot \eta_{\text{mot}} \cdot \eta_{\text{INV}} \cdot dt \\ &= -M_{\text{mot } v \text{ max}} \cdot i \cdot \omega_{\text{load max}} \cdot \eta_{\text{mot}} \cdot \eta_{\text{INV}} \cdot \int_{t_b+t_k}^{t_b+t_k+t_v} \sin\left(\frac{\pi \cdot (t - t_b - t_k)}{t_v}\right) \cdot \cos^2\left(\frac{\pi \cdot (t - t_b - t_k)}{2 \cdot t_v}\right) \cdot dt \\ &= -M_{\text{mot } v \text{ max}} \cdot i \cdot \omega_{\text{load max}} \cdot \eta_{\text{mot}} \cdot \eta_{\text{INV}} \cdot \frac{t_v}{\pi} = -33.14 \cdot 15.57 \cdot 20.1772 \cdot 0.89 \cdot 0.98 \cdot \frac{0.07}{\pi} = -202.3 \text{ Ws} \end{aligned}$$

The following is valid for the brake resistor:

$$P_{br W \text{ max}} = 5898 \text{ W} \leq 1.5 \cdot P_{20}$$

$$\frac{W_{br}}{T} = \frac{202.3}{0.07 + 0.07 + 0.07 + 0.8} = 200.3 \text{ W} \leq \frac{P_{20}}{4.5} \quad (\text{ext. brake resistor})$$

Thus, when selecting a drive converter, type of construction Compact Plus, an external 5 kW brake resistor is required (6SE7018-0ES87-2DC0). The chopper is integrated into the drive converter.



### Selecting the drive converter

The drive converter is selected according to the peak- and the RMS value of the motor current.

Refer to example 3.13 for a precise calculation of the current.

The peak current is 27.1 A. The RMS value is 6.86 A. In this case, 300 % overload capability can be utilized for type of construction Compact Plus, as the overload time is less than 250 ms, after the overload current drops back down again to below 0.91 x of the rated current, and the recovery time is greater than 750 ms.

An approximate calculation of the motor current results in:

$$I_{mot\ max} \approx \frac{M_{mot\ max}}{kT_0} = \frac{35.37}{1.33} = 26.6\ A$$

$$I_{RMS} \approx \frac{M_{RMS}}{kT_0} = \frac{9.02}{1.33} = 6.78\ A$$

Selected SIMOVERT MASTERDRIVES MOTION CONTROL drive converter:

6SE7021-0EP50 (Compact Plus type of construction)

$P_{INV\ n}=4\ kW$ ;  $I_{U\ n}=10\ A$ ;  $I_{U\ max}=30\ A$  (300 % overload capability)

A 7.5 kW drive converter could be used without utilizing the 300 % overload capability

$I_{U\ max}=32.8\ A$  (160 % overload capability).

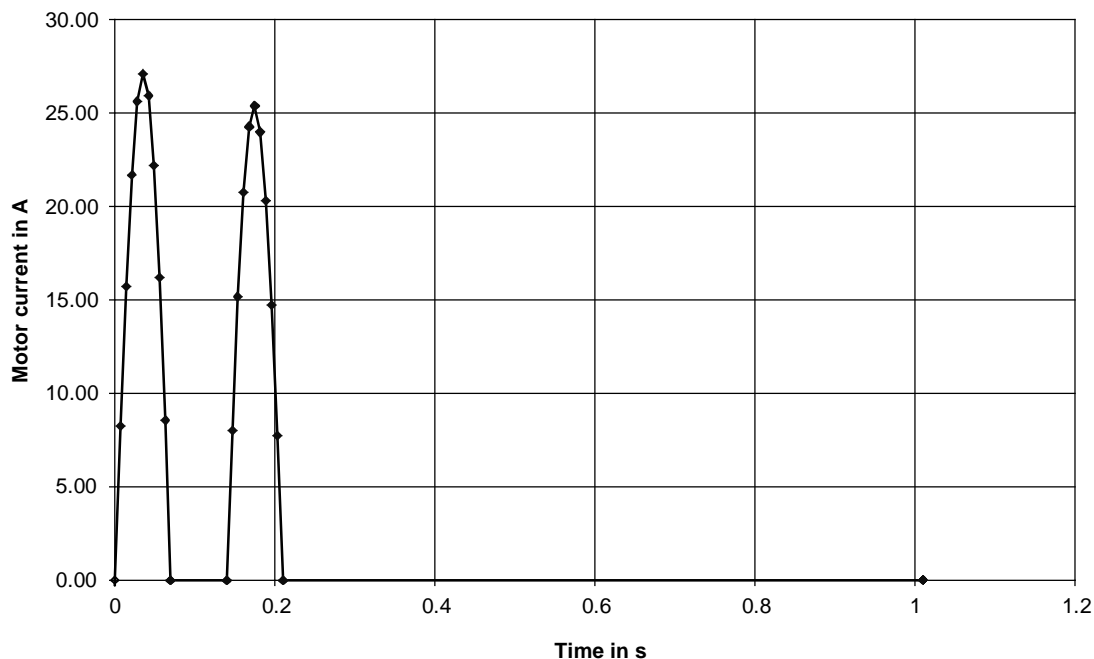



## 4 Information for specific applications

### 4.1 Accelerating time for loads with square-law torque characteristics

#### 4.1.1 General information

If the load torque is specified in the following form for fan and pump drives

$$M_{load} = M_{load\ max} \cdot \left(\frac{n}{n_{max}}\right)^2$$

at constant motor torque (e.g. when accelerating along the current limit in the constant-flux range), the accelerating time can be calculated using the following formula:

$$t_a = \frac{\pi \cdot n_{max} \cdot J}{60 \cdot \sqrt{M_{motor} \cdot M_{load\ max}}} \cdot \ln \frac{\sqrt{\frac{M_{motor}}{M_{load\ max}} + 1}}{\sqrt{\frac{M_{motor}}{M_{load\ max}} - 1}} \quad \text{accelerating time from 0 to } n_{max} \quad [\text{s}]$$

J in kgm<sup>2</sup> (moment of inertia of the motor, load and coupling), M in Nm, n in RPM

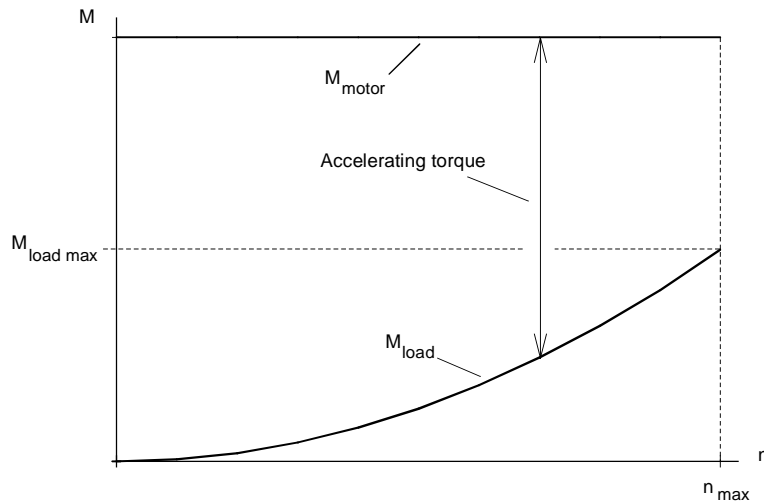

Example of the motor- and load torque when starting

The difference between the motor- and load torque acts as accelerating torque. After acceleration to  $n_{\max}$  the motor torque and the load torque are the same. Acceleration is faster, the higher the ratio  $M_{\text{motor}} / M_{\text{load max}}$  and the lower the total moment of inertia.

If the load torque is not a square-load torque, or if the motor torque is not constant when accelerating, then the accelerating time must be numerically calculated using the following equation:

$$t_a = \frac{J \cdot \pi}{30} \cdot \int_0^{n_{\max}} \frac{dn}{M_{\text{motor}}(n) - M_{\text{load}}(n)}$$

By sub-dividing the function into  $m$  segments, the following approximation is obtained:

$$t_a \approx \frac{J \cdot \pi}{30} \cdot \sum_{i=1}^{i=m} \frac{1}{2} \cdot \left( \frac{1}{M_{\text{motor } i-1} - M_{\text{load } i-1}} + \frac{1}{M_{\text{motor } i} - M_{\text{load } i}} \right) \cdot (n_i - n_{i-1})$$

$M_{\text{motor}}$  and  $M_{\text{load}}$  must be available in tabular form in order to evaluate this approximation.

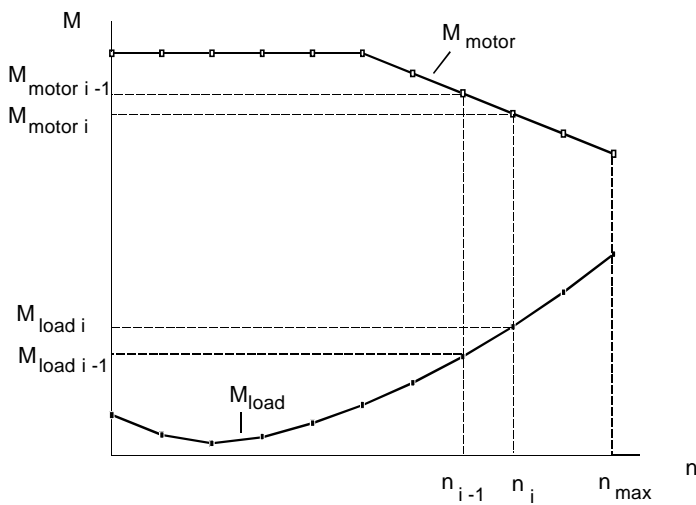

Example for the motor torque- and load torque characteristics when sub-divided into segments

### 4.1.2 Accelerating time for a fan drive

A fan is to accelerate up to  $n_{\max}=4450$  RPM. A gearbox with  $i = 1/3$  is used. The power requirement at  $n_{\max}$  is 67 kW. The load torque characteristic and moment of inertia of the fan are known.

$M_{\text{load}} / M_{\text{load max}}$

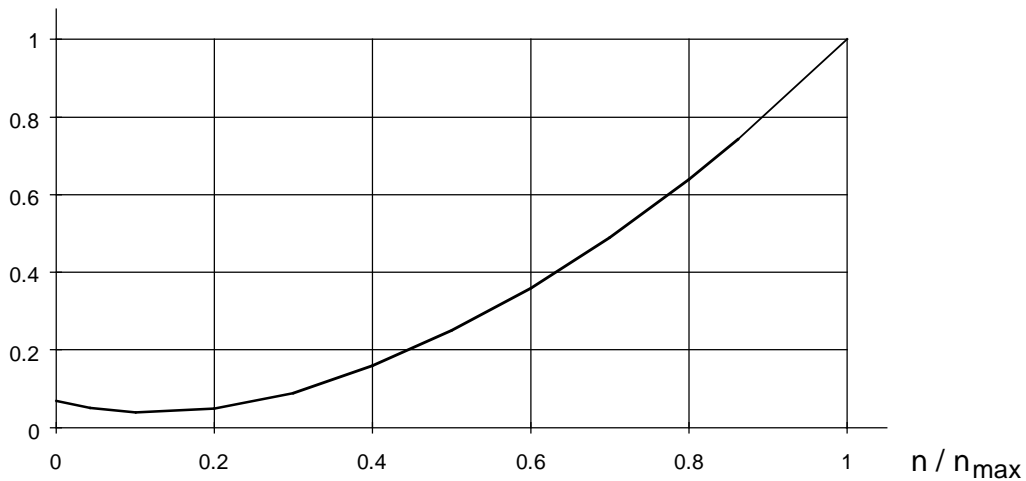

Load torque characteristic of the fan

The maximum load torque is:

$$M_{\text{load max}} = \frac{P_{\max} \cdot 9550}{n_{\max}} = \frac{67 \cdot 9550}{4450} = 143.8 \text{ Nm}$$

Thus, the load torque characteristic is approximately obtained from the following:

$$M_{\text{load}} \approx 143.8 \text{ Nm} \cdot \left(\frac{n}{4450}\right)^2$$

Moment of inertia of the fan:

$$J_{\text{fan}} = 25 \text{ kgm}^2$$

A 4-pole 75 KW motor is selected (1LA6 280-4AA..).

$M_n=484 \text{ Nm}$ ,  $n_n=1480 \text{ RPM}$ ,  $I_{\text{motor } n}=134 \text{ A}$ ,  $J_{\text{motor}}=1.4 \text{ kgm}^2$

Total moment of inertia referred to the motor shaft:

$$J^* = \frac{J_{fan}}{i^2} + J_{motor}$$

$$= 3^2 \cdot 25 + 1.4 = 225 + 1.4 = 226.4 \text{ kgm}^2$$

The load torque characteristic, referred to the motor shaft, is approximately obtained as follows:

$$M_{load}^* \approx \frac{M_{load \max}}{i \cdot \eta_G} \cdot \left(\frac{n_{motor}}{i \cdot 4450}\right)^2$$

When assuming that the gearbox efficiency  $\eta_G$  is 1, the following is obtained:

$$M_{load}^* \approx 3 \cdot 143.8 \text{ Nm} \cdot \left(\frac{n_{motor}}{4450/3}\right)^2 = 431.4 \text{ Nm} \cdot \left(\frac{n_{motor}}{1483}\right)^2$$

The following drive converter is to be used:

6SE7031-8EF60

$P_{Vn} = 90 \text{ kW}$ ;  $I_{Vn} = I_{V \text{ continuous}} = 186 \text{ A}$

Closed-loop frequency control type

The motor is to be accelerated with a current corresponding to the continuous drive converter current. Thus, the possible motor torque is approximated as follows:

$$M_{\max} \approx M_n \cdot \sqrt{\frac{I_{motor \max}^2 - I_{\mu n}^2}{I_{motor n}^2 - I_{\mu n}^2}}$$

The following is obtained with  $I_{motor n} = 134 \text{ A}$ ,  $I_{motor \max} = I_{V \text{ continuous}} = 186 \text{ A}$  and  $I_{\mu n} = 0.35 \cdot I_{motor n}$ :

$$M_{\max} \approx 484 \cdot \sqrt{\frac{186^2 - 0.35^2 \cdot 134^2}{134^2 - 0.35^2 \cdot 134^2}} = 694 \text{ Nm}$$

The accelerating time from  $n_{\max} = 4450 \text{ RPM}$  to  $n_{motor \max} = 1483 \text{ RPM}$  is given by:

$$t_a = \frac{\pi \cdot n_{motor \max} \cdot J^*}{60 \cdot \sqrt{M_{motor} \cdot M_{load \max}^*}} \cdot \ln \frac{\sqrt{\frac{M_{motor}}{M_{load \max}^*}} + 1}{\sqrt{\frac{M_{motor}}{M_{load \max}^*}} - 1}$$

$$t_a = \frac{\pi \cdot 1483 \cdot 226,4}{60 \cdot \sqrt{694 \cdot 431,4}} \cdot \ln \frac{\sqrt{\frac{694}{431,4}} + 1}{\sqrt{\frac{694}{431,4}} - 1} = 68,6 \text{ s}$$

As the accelerating time is greater than 60 s, the maximum drive converter current cannot be used for acceleration.

## 4.1.3 Accelerating time for a blower drive (using the field-weakening range)

A blower is to be accelerated as fast as possible to  $n_{\max}=3445$  RPM using a drive converter. The load torque characteristic and the moment of inertia of the blower and coupling are known.

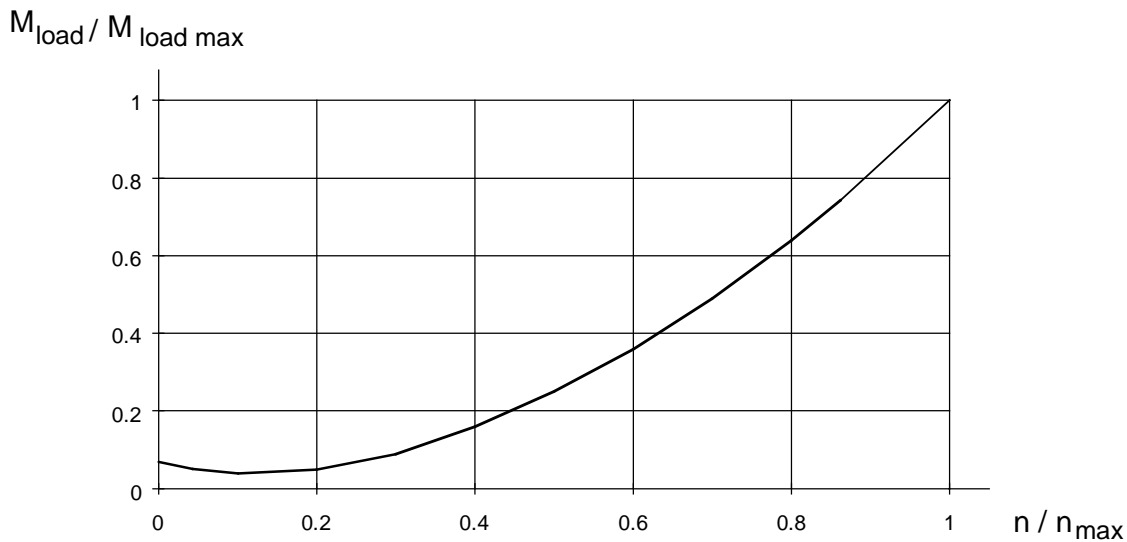

Load torque characteristic of the blower with  $M_{\text{load max}}=116.7$  Nm and  $n_{\max}=3445$  RPM

The load torque characteristic is approximated as follows:

$$M_{\text{load}} \approx 116.7 \text{ Nm} \cdot \left(\frac{n}{3445}\right)^2$$

Moment of inertia of the blower and coupling:

$$J_{\text{blower}} + J_{\text{coupling}} = 9.275 \text{ kgm}^2 + 0.1 \text{ kgm}^2 = 9.375 \text{ kgm}^2$$

A 2-pole 90 KW motor is selected (1LA6 283-2AC..).

$M_n=289$  Nm,  $n_n=2970$  RPM,  $I_{\text{motor } n}=152$  A,  $J_{\text{motor}}=0.92$  kgm<sup>2</sup>

Total moment of inertia:

$$\begin{aligned} J &= J_{\text{blower}} + J_{\text{coupling}} + J_{\text{motor}} \\ &= 9.375 \text{ kgm}^2 + 0.92 \text{ kgm}^2 = 10.295 \text{ kgm}^2 \end{aligned}$$



The motor should accelerate, in the constant-flux range, up to  $n_n=2970$  RPM with 200% of the rated torque along the current limit, and in the field-weakening range from  $n_n=2970$  RPM up to  $n_{max}=3445$  RPM, with a current limit corresponding to the torque. Acceleration is sub-divided into two segments for the calculation.

### Range 1 (constant-flux range)

The load torque is obtained as follows at the rated motor speed:

$$M_{load\ 2970} = 116.7 \cdot \left(\frac{2970}{3445}\right)^2 = 86.74\ Nm$$



### Relationships/behavior in the constant-flux range

In the constant-flux range, with  $M_{motor}=2 M_n$  the accelerating time to  $n_n=2970$  RPM can be calculated as follows:

$$t_{a1} = \frac{\pi \cdot 2970 \cdot J}{60 \cdot \sqrt{2 \cdot M_n \cdot M_{load\ 2970}}} \cdot \ln \frac{\sqrt{\frac{2 \cdot M_n}{M_{load\ 2970}} + 1}}{\sqrt{\frac{2 \cdot M_n}{M_{load\ 2970}} - 1}}$$

$$t_{a1} = \frac{\pi \cdot 2970 \cdot 10,295}{60 \cdot \sqrt{2 \cdot 289 \cdot 86.74}} \cdot \ln \frac{\sqrt{\frac{2 \cdot 289}{86.74}} + 1}{\sqrt{\frac{2 \cdot 289}{86.74}} - 1} = 5.84 \text{ s}$$

### Range 2 (field-weakening range)

For a constant motor current  $I_{motor}$ , the motor torque ratios are approximated by:

$$\frac{M_{field}}{M_{\phi=const}} \approx \frac{f_n}{f} \sqrt{\frac{I_{motor}^2 - I_{\mu n}^2 \cdot \left(\frac{f_n}{f}\right)^2}{I_{motor}^2 - I_{\mu n}^2}} \quad \text{for } f \geq f_n$$

As  $I_{motor}^2 \gg I_{\mu n}^2$  when starting, the expression can be simplified as follows:

$$\frac{M_{field}}{M_{\phi=const}} \approx \frac{f_n}{f} \approx \frac{n_n}{n} \quad \text{for } f \geq f_n \text{ (and } n \geq n_n)$$

Thus, the motor torque at  $n_{max}=3445$  RPM is given by:

$$M_{3445} \approx M_{2970} \cdot \frac{n_n}{n_{max}} = 2 \cdot M_n \cdot \frac{n_n}{n_{max}} = 2 \cdot 289 \cdot \frac{2970}{3445} = 498.3 \text{ Nm}$$



### Relationships in the field-weakening range

The accelerating time in the field-weakening range can now be calculated as follows in one step:

$$t_{a2} = \frac{J \cdot \pi}{30} \cdot \frac{1}{2} \cdot \left( \frac{1}{M_{motor\ 2970} - M_{load\ 2970}} + \frac{1}{M_{motor\ 3445} - M_{load\ 3445}} \right) \cdot (3445 - 2970)$$

$$= \frac{10.295 \cdot \pi}{30} \cdot \frac{1}{2} \cdot \left( \frac{1}{578 - 86.74} + \frac{1}{498.3 - 116.7} \right) \cdot 475 = 1.19\ s$$

Total accelerating time:

$$t_a = t_{a1} + t_{a2} = 5.84 + 1.19 = 7.03\ s$$

### Comparing the accelerating time for direct online starting (without drive converter)

For comparison purposes, the accelerating time to  $n_n=2970$  RPM is to be calculated when connected directly online to the 50 Hz line supply. The following torque characteristic is used as basis for the 90 KW motor with rotor class 10,  $M_A/M_n=2$  and  $M_{stall}/M_n=2.7$ . The starting characteristic is sub-divided into 15 segments.



Motor- and load torque when starting

i	n	M <sub>load</sub>	M <sub>motor</sub>	t <sub>a</sub>
0	0	8.17	578	0
1	148	6	550	0.287
2	297	4.67	535	0.586
3	594	5.5	520	1.2
4	891	9	520	1.82
5	1188	13.9	530	2.45
6	1485	21.7	560	3.05
7	1782	31.2	600	3.63
8	2079	42.5	650	4.18
9	2376	55.5	710	4.69
10	2600	66.5	770	5.04
11	2673	70.3	780	5.15
12	2750	74.4	770	5.27
13	2800	77.1	740	5.35
14	2900	82.7	580	5.54
15	2970	86.7	289	5.8

Table to numerically calculate the starting (accelerating) time

The accelerating time in the last column of the table, is calculated using the values entered for n, M<sub>load</sub> and M<sub>motor</sub> by summing them according to the following approximation:

$$t_a = \frac{J \cdot \pi}{30} \cdot \sum_{i=1}^{i=15} \frac{1}{2} \cdot \left( \frac{1}{M_{motor\ i-1} - M_{load\ i-1}} + \frac{1}{M_{motor\ i} - M_{load\ i}} \right) \cdot (n_i - n_{i-1})$$

$$= 5.8\ s$$

It is preferable to use a program such as Excel to evaluate this approximation formula. The direct online starting time is somewhat shorter, but the maximum speed of 3445 RPM is not reached.



Speed characteristics for direct online starting up to  $n_n=2970$  RPM

### Selecting the drive converter

The drive converter must be able to provide the necessary motor current to accelerate the 90 KW motor with 200% rated torque. The motor current, as a function of the motor torque is approximately given by:

$$I_{motor} \approx \sqrt{\left(\frac{M}{M_n}\right)^2 \cdot (I_{motor\ n}^2 - I_{\mu\ n}^2) + I_{\mu\ n}^2}$$

The following is obtained with  $I_{motor\ n} = 152\ A$  and  $I_{\mu\ n} = 0.25 \cdot I_{motor\ n}$  for the 2-pole 90 KW motor:

$$I_{motor} \approx \sqrt{2^2 \cdot (152^2 - 0.25^2 \cdot 152^2) + 0.25^2 \cdot 152^2} = 296.8\ A$$

Drive converter selected:

6SE7032-6EG60

$P_{V\ n}=132\ kW$ ;  $I_{V\ n}=260\ A$ ;  $I_{V\ max}=355\ A$

Closed-loop frequency control type

#### 4.1.4 Re-accelerating time for a fan drive after a brief supply failure

A fan drive is to accelerate to its previous (old) speed after a brief supply failure. The maximum power failure duration is 2 s. As a result of the relatively high drive moment of inertia, the kinetic buffering function is used to buffer the supply failure. Thus, the dead-times, which would occur if a restart-on-the-fly circuit was to be used, are eliminated: They include the motor de-excitation/excitation times, the time to establish the power supply voltages and initialize the microprocessor system as well as the search time (the search time is eliminated when a tachometer/encoder is used).

##### Drive data

Rated motor output	$P_{\text{motor n}} = 75 \text{ kW}$
Rated motor current (at 500 V)	$I_{\text{motor n}} = 102,4 \text{ A}$
Rated motor torque	$M_{\text{motor n}} = 241 \text{ Nm}$
Maximum fan speed	$n_{\text{max}} = 2970 \text{ RPM}$
Power requirement at $n_{\text{max}}$	$P_{\text{max}} = 44.9 \text{ kW}$
Moment of inertia of the fan	$J_{\text{fan}} = 4.75 \text{ kgm}^2$
Moment of inertia of the motor	$J_{\text{motor}} = 0.79 \text{ kgm}^2$

The maximum load torque is given by:

$$M_{\text{load max}} = \frac{P_{\text{max}} \cdot 9550}{n_{\text{max}}} = \frac{44.9 \cdot 9550}{2970} = 144.4 \text{ Nm}$$

Thus, the load torque characteristic is approximated by:

$$M_{\text{load}} \approx 144.4 \text{ Nm} \cdot \left(\frac{n}{2970}\right)^2$$

Total moment of inertia:

$$J_{\text{total}} = J_{\text{fan}} + J_{\text{motor}} = 4.75 + 0.79 = 5.54 \text{ kgm}^2$$

To start off with, the motor speed must be defined at the instant that the line supply returns. The worst case condition is assumed with a maximum 2 s line supply failure and maximum speed when the power actually failed. The speed dip is the highest at maximum speed, as in this case, the highest load torque is effective.

The kinetic buffering is active during the line supply failure. The motor speed is further decreased, in addition to the effect of the load torque, to cover the losses in the motor, inverter and in the

power supply. The additional braking torque as a result of the losses can be neglected here, as the speed decrease during the line supply failure is low due to the relatively high moment of inertia and in the vicinity of  $n_{\max}$ , the load torque component is the most significant.

With this assumption, the following equation is obtained for the speed characteristic during line supply failure, starting from  $n_{\max}$ , in the vicinity of  $n_{\max}$ :

$$n_{\min} \approx \frac{1}{\frac{1}{n_{\max}} + \frac{30 \cdot M_{\text{load max}}}{J_{\text{total}} \cdot \pi \cdot n_{\max}^2} \cdot t_A}$$

The following is obtained for  $t_A=2$  s (line supply failure time)

$$n_{\min} \approx \frac{1}{\frac{1}{2970} + \frac{30 \cdot 144.4}{554 \cdot \pi \cdot 2970^2} \cdot 2} = 2544 \text{ RPM}$$

The following drive converter is to be used:

6SE7031-3FG60

$P_{Vn}=90$  kW;  $I_{Vn}=128$  A;  $I_{V\max}=174$  A

Closed-loop frequency control type

The motor is to be accelerated with a current corresponding to the maximum drive converter current. The possible motor torque is approximated by:

$$M_{\max} \approx M_n \cdot \sqrt{\frac{I_{\text{motor max}}^2 - I_{\mu n}^2}{I_{\text{motor n}}^2 - I_{\mu n}^2}}$$

The following is obtained with  $I_{\text{motor n}} = 102.4$  A,  $I_{\text{motor max}} = I_{V\max} = 174$  A and  $I_{\mu n} = 0.28 \cdot I_{\text{motor n}}$ :

$$M_{\max} \approx 241 \cdot \sqrt{\frac{174^2 - 0.28^2 \cdot 102.4^2}{102.4^2 - 0.28^2 \cdot 102.4^2}} = 420.7 \text{ Nm}$$

The motor can therefore develop  $420.7/241=175\%$  rated torque when re-accelerating up to  $n_{\max}$ .

The re-accelerating time from  $n_{\min}=2544$  RPM to  $n_{\max}=2970$  RPM is given by:

$$t_H = \frac{\pi \cdot n_{\max} \cdot J_{\text{total}}}{60 \cdot \sqrt{M_{\text{motor}} \cdot M_{\text{load max}}}} \cdot \left( \ln \frac{\sqrt{\frac{M_{\text{motor}}}{M_{\text{load max}}} + 1}}{\sqrt{\frac{M_{\text{motor}}}{M_{\text{load max}}} - 1}} - \ln \frac{\sqrt{\frac{M_{\text{motor}}}{M_{\text{load max}}} + \frac{n_{\min}}{n_{\max}}}}{\sqrt{\frac{M_{\text{motor}}}{M_{\text{load max}}} - \frac{n_{\min}}{n_{\max}}}} \right)$$

$$= \frac{\pi \cdot 2970 \cdot 5.54}{60 \cdot \sqrt{420.7 \cdot 144.4}} \cdot \left( \ln \frac{\sqrt{\frac{420.7}{144.4} + 1}}{\sqrt{\frac{420.7}{144.4} - 1}} - \ln \frac{\sqrt{\frac{420.7}{144.4} + \frac{2544}{2970}}}{\sqrt{\frac{420.7}{144.4} - \frac{2544}{2970}}} \right) = 0.84 \text{ s}$$

Thus, the overall time from the start of the line supply failure up to when  $n_{\max}$  is again reached is given by:

$$t_{\text{total}} = t_A + t_H = 2 + 0.84 = 2.84 \text{ s}$$



Speed characteristic for line supply failure (0 to 2 s) and re-starting (2 to 2.84 s)



### Taking into account the losses during kinetic buffering

At low speeds, the braking torque due to the losses can no longer be neglected with respect to the load torque. Thus, the speed characteristic should now be determined during the kinetic buffer period by estimating the losses.

Motor losses at the rated operating point:

$$P_{V \text{ motor } n} = \frac{P_{\text{motor } n}}{\eta_{\text{motor}}} - P_{\text{motor } n} = \frac{75}{0.944} - 75 = 4.45 \text{ kW}$$

Under the assumption, that the motor is in a no-load condition during the kinetic buffering phase, and that the losses are then constant and approximately only half as high as they are at the rated operating point, then the following is obtained:

$$P_{V \text{ no-load}} \approx \frac{P_{V \text{ motor } n}}{2} = \frac{4.45}{2} = 2.23 \text{ kW}$$

If the losses in the inverter and in the power supply are neglected, then the additional braking torque is given by:

$$\begin{aligned} M_{\text{brake}} &\approx \frac{P_{V \text{ no-load}} \cdot 9550}{n} = \frac{P_{V \text{ no-load}} \cdot 9550}{n_{\text{max}}} \cdot \frac{n_{\text{max}}}{n} = M_{\text{brake } n_{\text{max}}} \cdot \frac{n_{\text{max}}}{n} \\ &\approx \frac{2.23 \cdot 9550}{2970} \cdot \frac{n_{\text{max}}}{n} = 7.2 \text{ Nm} \cdot \frac{n_{\text{max}}}{n} \end{aligned}$$

The braking torque becomes higher at lower speeds.

With this basis (assumption) for  $M_{\text{brake}}$ , the speed characteristic during line supply failure, starting from  $n_{\text{set}}$ , is given by:

$$\begin{aligned} t \approx c \cdot &\left( \frac{1}{6} \cdot \ln\left(\frac{|a^2 - a \cdot n_{\text{set}} + n_{\text{set}}^2|}{(a + n_{\text{set}})^2}\right) + \frac{1}{\sqrt{3}} \cdot \arctan\left(\frac{2 \cdot n_{\text{set}} - a}{a\sqrt{3}}\right) \right. \\ &\left. - \frac{1}{6} \cdot \ln\left(\frac{|a^2 - a \cdot n + n^2|}{(a + n)^2}\right) - \frac{1}{\sqrt{3}} \cdot \arctan\left(\frac{2 \cdot n - a}{a\sqrt{3}}\right) \right) \end{aligned}$$

with

$$a = n_{\text{max}} \sqrt[3]{\frac{M_{\text{brake } n_{\text{max}}}}{M_{\text{load max}}}} \quad c = \frac{\pi \cdot n_{\text{max}} \cdot J_{\text{total}}}{30 \cdot \sqrt[3]{M_{\text{load max}}^2 \cdot M_{\text{brake } n_{\text{max}}}}}$$

This formula can no longer be used for speeds less than approximately 25 to 30% of the maximum speed, as the load torque characteristic approximation is too inaccurate (influence of the friction). As the formula cannot be changed-over for  $n$ ,  $n_{\min}$  must be found by inserting various values for  $n$ , with subsequent interpolation.

Example for  $n_{\text{set}}=750$  RPM

With

$$a = 2970 \sqrt[3]{\frac{7.2}{144.4}} = 1093 \text{ RPM} \quad c = \frac{\pi \cdot 2970 \cdot 5.54}{30 \cdot \sqrt[3]{144.4^2 \cdot 7.2}} = 32.42 \text{ s}$$

and  $\Delta n=25$  RPM, then  $t$  is shown in the following table

i	n	t
0	750	0.00
1	725	0.38
2	700	0.76
3	675	1.13
4	650	1.50
5	625	1.86
6	600	2.22

The following value is obtained for  $n_{\min}$  by linearly interpolating the values above and below  $t_A=2$  s (1.86 s and 2.22 s):

$$n_{\min} \approx n_6 + \frac{n_5 - n_6}{t_6 - t_5} \cdot (t_6 - t_A) = 600 + \frac{625 - 600}{2.22 - 1.86} \cdot (2.22 - 2) = 615.3 \text{ RPM}$$

The re-accelerating time from  $n_{\min}=615.3$  RPM to  $n_{\text{set}}=750$  RPM is then given by:

$$t_H = \frac{\pi \cdot n_{\max} \cdot J_{\text{total}}}{60 \cdot \sqrt{M_{\text{motor}} \cdot M_{\text{load max}}}} \cdot \left( \ln \sqrt{\frac{M_{\text{motor}}}{M_{\text{load max}}} + \frac{n_{\text{set}}}{n_{\max}}} - \ln \sqrt{\frac{M_{\text{motor}}}{M_{\text{load max}}} + \frac{n_{\min}}{n_{\max}}} \right)$$

$$t_H = \frac{\pi \cdot 2970 \cdot 5,54}{60 \cdot \sqrt{420,7 \cdot 144,4}} \cdot \left( \ln \frac{\sqrt{\frac{420,7}{144,4} + \frac{750}{2970}}}{\sqrt{\frac{420,7}{144,4} - \frac{750}{2970}}} - \ln \frac{\sqrt{\frac{420,7}{144,4} + \frac{615,3}{2970}}}{\sqrt{\frac{420,7}{144,4} - \frac{615,3}{2970}}} \right) = 0,19 \text{ s}$$

Thus, the total time from the start of the line supply failure until  $n_{\text{set}}$  is again reached is obtained from:

$$t_{\text{total}} = t_A + t_H = 2 + 0,19 = 2,19 \text{ s}$$



Speed characteristic for a line power failure (0 to 2 s) and re-acceleration (re-starting) (2 to 2.19 s) taking into account the losses during kinetic buffering (for comparison purposes, a curve is also shown where the losses were not taken into account)

*Estimating  $n_{min}$  and  $t_H$* 

$n_{min}$  and  $t_H$  can be estimated for short line supply failure times and high moments of inertia.

## Characteristics when coasting down

With the gradient of the speed characteristic at the point  $n=n_{set}$

$$\left. \frac{dn}{dt} \right|_{n=n_{set}} = - \frac{M_{load\ max} \cdot \left(\frac{n_{set}}{n_{max}}\right)^2 + M_{brake\ n_{max}} \cdot \frac{n_{max}}{n_{set}}}{\frac{J_{total} \cdot \pi}{30}}$$

then  $n_{min}$  is given by:

$$n_{min} \approx n_{set} + t_A \cdot \left. \frac{dn}{dt} \right|_{n=n_{set}}$$

If  $n_{set}$  is close to  $n_{max}$ , then the approximation used earlier can be applied:

$$n_{min} \approx \frac{1}{\frac{1}{n_{set}} + \frac{30 \cdot M_{load\ max}}{J_{total} \cdot \pi \cdot n_{max}^2} \cdot t_A}$$

## Characteristics when re-accelerating

With the gradient of the speed characteristic at the point  $n=n_{min}$

$$\left. \frac{dn}{dt} \right|_{n=n_{min}} = \frac{M_{motor} - M_{load\ max} \cdot \left(\frac{n_{min}}{n_{max}}\right)^2}{\frac{J_{total} \cdot \pi}{30}}$$

then  $t_H$  is given by:

$$t_H \approx \frac{n_{set} - n_{min}}{\left. \frac{dn}{dt} \right|_{n=n_{min}}}$$

Example for  $n_{\text{set}}=750$  RPM and  $t_A=2$  s (as previously calculated)

$$\left. \frac{dn}{dt} \right|_{n=n_{\text{set}}} = - \frac{144.4 \cdot \left(\frac{750}{2970}\right)^2 + 7.2 \cdot \frac{2970}{750}}{\frac{5.54 \cdot \pi}{30}} = -65 \text{ RPM / s}$$

$$n_{\text{min}} \approx 750 + 2 \cdot (-65) = 620 \text{ RPM}$$

$$\left. \frac{dn}{dt} \right|_{n=n_{\text{min}}} = \frac{420.7 - 144.4 \cdot \left(\frac{620}{2970}\right)^2}{\frac{5.54 \cdot \pi}{30}} = 714.3 \text{ RPM / s}$$

$$t_H \approx \frac{750 - 620}{714.3} = 0.182 \text{ s}$$

Thus, the total time from the start of the line supply failure up to when  $n_{\text{set}}$  is again reached is given by:

$$t_{\text{total}} = t_A + t_H = 2 + 0.182 = 2.182 \text{ s}$$

#### 4.1.5 Calculating the minimum braking time for a fan drive

A fan drive is to be braked from  $n_{\max}=1500$  RPM to standstill using the existing brake resistor. It is assumed that the load has a square-law characteristic.

##### *Drive data*

Rated motor output (4 pole)	$P_{\text{motor } n} = 250 \text{ kW}$
Rated motor current	$I_{\text{motor } n} = 430 \text{ A}$
Rated motor torque	$M_{\text{motor } n} = 1600 \text{ Nm}$
Maximum fan speed	$n_{\max} = 1500 \text{ RPM}$
Power requirement at $n_{\max}$	$P_{\max} = 198 \text{ kW}$
Moment of inertia of the fan	$J_{\text{fan}} = 223 \text{ kgm}^2$
Moment of inertia of the motor	$J_{\text{motor}} = 3.6 \text{ kgm}^2$
Motor efficiency	$\eta_{\text{motor}} = 0.962$
Rated converter outputs	$P_{U n} = 250 \text{ kW}$
Brake resistor power using an ext. brake resistor	$P_{20} = 100 \text{ kW}$
Peak braking power	$1.5 P_{20} = 150 \text{ kW}$

The fan load torque helps to brake the drive - especially in the high speed range. To optimally utilize the brake resistor, it is therefore more favorable to brake with constant deceleration and not with constant braking torque (operation at the current limit). When decelerating with a constant braking torque, a higher peak braking power would be generated for the same braking time (refer to the comparison later on in the text).

To optimally utilize the brake resistor, the peak braking power and the braking energy are important. Both values must remain below the permissible limits.

##### Braking with constant deceleration

##### *Calculating the peak braking power for the brake resistor*

The motor torque when braking is given by:

$$M_{\text{motor } br} = M_{\text{load}} + J \cdot \frac{d\omega}{dt}$$

Whereby

$$M_{load} \approx M_{load\ max} \cdot \left(\frac{n}{n_{max}}\right)^2$$

$$M_{load\ max} = \frac{P_{max} \cdot 60}{2\pi \cdot n_{max}} = \frac{198000 \cdot 60}{2\pi \cdot 1500} = 1260.5\ Nm$$

$$\frac{d\omega}{dt} = -\frac{2\pi \cdot n_{max}}{60 \cdot t_{br}} \quad (\text{constant deceleration})$$

Thus, the motor torque is given by:

$$M_{motor\ br} = M_{load\ max} \cdot \left(\frac{n}{n_{max}}\right)^2 - \frac{J \cdot 2\pi \cdot n_{max}}{60 \cdot t_{br}}$$

and the motor output by:

$$\begin{aligned} P_{motor\ br} &= M_{motor\ br} \cdot \frac{2\pi \cdot n}{60} \\ &= \frac{2\pi}{60} \cdot \left( M_{load\ max} \cdot \left(\frac{n}{n_{max}}\right)^2 - \frac{J \cdot 2\pi \cdot n_{max}}{60 \cdot t_{br}} \right) \cdot n \end{aligned}$$

The maximum motor output when braking, for

$$n = \sqrt{\frac{J \cdot 2\pi \cdot n_{max}^3}{3 \cdot 60 \cdot M_{load\ max}}} \cdot \frac{1}{\sqrt{t_{br}}}$$

is given by

$$P_{motor\ br\ max} = -\frac{J \cdot \pi^2 \cdot n_{max}^2}{4050} \cdot \sqrt{\frac{J \cdot \pi \cdot n_{max}}{10 \cdot M_{load\ max}}} \cdot \frac{1}{\sqrt{t_{br}^3}}$$

With a specified peak braking power  $P_{br\ W\ max}$  for the brake resistor, and the following relationship

$$P_{motor\ br\ max} = \frac{P_{br\ W\ max}}{\eta_{motor}}$$

Then the minimum permissible braking time can be calculated as follows:

$$\begin{aligned} t_{br\ min} &= J \cdot \pi \cdot n_{max} \cdot \sqrt[3]{\frac{\pi^2 \cdot n_{max}^2 \cdot \eta_{motor}^2}{10 \cdot 4050^2 \cdot M_{load\ max} \cdot P_{br\ W\ max}^2}} \\ &= (223 + 3.6) \cdot \pi \cdot 1500 \cdot \sqrt[3]{\frac{\pi^2 \cdot 1500^2 \cdot 0.962^2}{10 \cdot 4050^2 \cdot 1260.5 \cdot 150000^2}} = 17.52\ s \end{aligned}$$

### Calculating the braking energy when braking

It must now be checked as to whether the permissible braking energy is exceeded. For a constant deceleration, the speed is given by:

$$n = n_{\max} \cdot \left(1 - \frac{t}{t_{br}}\right)$$

and thus the motor output when braking

$$P_{motor\ br} = \frac{2\pi}{60} \cdot \left( M_{load\ max} \cdot n_{\max} \cdot \left(1 - \frac{t}{t_{br}}\right)^3 - \frac{J \cdot 2\pi \cdot n_{\max}^2}{60 \cdot t_{br}} \cdot \left(1 - \frac{t}{t_{br}}\right) \right)$$



Example for the motor output when braking with a square-law load torque characteristic

The braking energy for the brake resistor is then given by:

$$\begin{aligned} W_{br} &= \eta_{motor} \cdot \int_{t_0}^{t_{br}} P_{motor\ br} \cdot dt \\ &= \frac{\eta_{motor} \cdot 2\pi \cdot t_{br}}{60} \cdot \left( \frac{M_{load\ max} \cdot n_{\max}}{4} \cdot \left(1 - \frac{t_0}{t_{br}}\right)^4 - \frac{J \cdot 2\pi \cdot n_{\max}^2}{2 \cdot 60 \cdot t_{br}} \cdot \left(1 - \frac{t_0}{t_{br}}\right)^2 \right) \end{aligned}$$

Time  $t_0$  is obtained by setting  $P_{motor\ br}$  to zero:

$$t_0 = \left(1 - \sqrt{\frac{J \cdot 2\pi \cdot n_{\max}}{60 \cdot M_{load\ max} \cdot t_{br}}}\right) \cdot t_{br}$$



If  $t_0$  is negative, a zero should be entered for  $t_0$  in the braking energy equation. In this case, even at the start of braking, the deceleration torque exceeds the load torque and  $t_0$  is given by:

$$t_0 = \left(1 - \sqrt{\frac{226.6 \cdot 2\pi \cdot 1500}{60 \cdot 1260.5 \cdot 17.52}}\right) \cdot 17.52 = -4.72 \text{ s}$$

$t_0$  is therefore set to zero when calculating the braking energy, and the following is obtained:

$$W_{br} = \frac{0.962 \cdot 2\pi \cdot 17.52}{60} \cdot \left(\frac{1260.5 \cdot 1500}{4} - \frac{226.6 \cdot 2\pi \cdot 1500^2}{2 \cdot 60 \cdot 17.52}\right) = -1855 \text{ kW s}$$

The permissible braking energy for the external brake resistor is, for the 90 s interval:

$$W_{br \text{ perm.}} = P_{br \text{ W time}} \cdot 90 \text{ s} = 25 \cdot 90 = 2250 \text{ kW s}$$

Thus, the second condition is also fulfilled for intervals, which are not less than

$$T = \frac{W_{br}}{W_{br \text{ perm.}}} \cdot 90 \text{ s} = \frac{1855}{2250} \cdot 90 = 74.2 \text{ s}$$

*Diagrams for motor output and motor torque when braking with constant deceleration*

**Motor braking power for  $t_{br}=17.52 \text{ s}$**

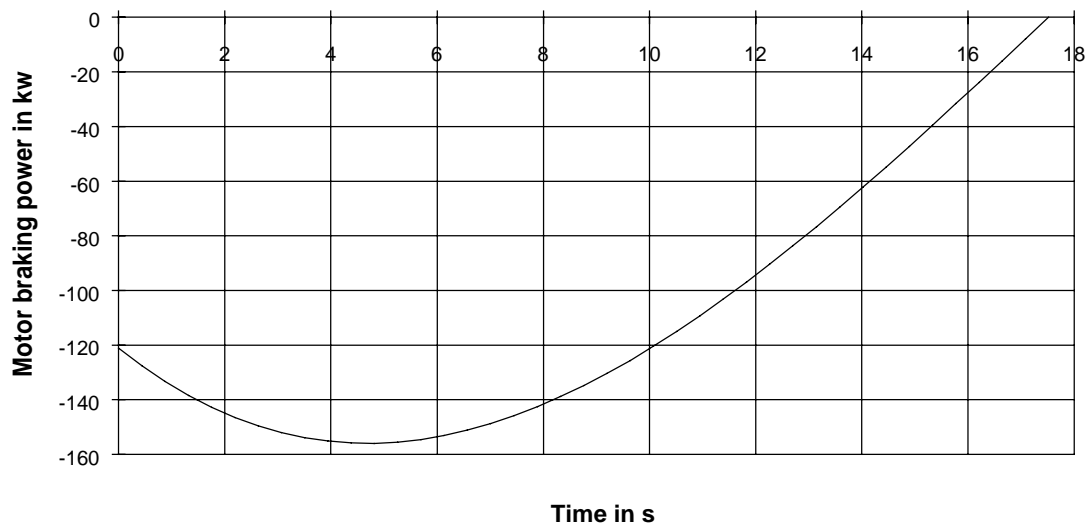

### Motor torque for $t_{br}=17.52$ s



#### Checking the drive converter dimensioning

The maximum motor torque when braking occurs at  $n = 0$ , and is given by:

$$M_{motor\ br\ max} = -\frac{J \cdot 2\pi \cdot n_{max}}{60 \cdot t_{br}} = -\frac{226.6 \cdot 2\pi \cdot 1500}{60 \cdot 17.52} = -2032\ Nm$$

For the highest required motor torque when braking, an approximate motor current is given by:

$$I_{motor\ max} \approx \sqrt{\left(\frac{M_{motor\ max}}{M_{motor\ n}}\right)^2 \cdot (I_{motor\ n}^2 - I_{\mu n}^2) + I_{\mu n}^2}$$

With  $I_{\mu n} = 0.31 \cdot I_{motor\ n}$  (assumption), the following is obtained:

$$I_{motor\ max} \approx \sqrt{\left(\frac{2032}{1600}\right)^2 \cdot (430^2 - 0.31^2 \cdot 430^2) + 0.31^2 \cdot 430^2} = 536\ A$$

Drive converter selected:

6SE7035-1EK60

$P_{Vn}=250$  kW;  $I_{Vn}=510$  A;  $I_{Vmax}=694$  A

This drive converter is adequately dimensioned for braking.

### Comparison, braking with a constant motor torque

The maximum braking power is then always at  $n=n_{\max}$ . The following is obtained for the required motor torque using the specified peak rating of the brake resistor :

$$M_{\text{motor br}} = -\frac{P_{br W \max} \cdot 60}{2\pi \cdot n_{\max} \cdot \eta_{\text{motor}}} = -\frac{150000 \cdot 60}{2\pi \cdot 1500 \cdot 0.962} = -993 \text{ Nm}$$

Thus, the minimum braking time is obtained as follows:

$$\begin{aligned} t_{br \min} &= \frac{J \cdot 2\pi \cdot n_{\max}}{60 \cdot \sqrt{M_{\text{load max}} \cdot M_{\text{motor br}}}} \cdot \arctan \sqrt{\frac{M_{\text{load max}}}{M_{\text{motor br}}}} \\ &= \frac{226.6 \cdot 2\pi \cdot 1500}{60 \cdot \sqrt{1260.5 \cdot 993}} \cdot \arctan \sqrt{\frac{1260.5}{993}} = 26.9 \text{ s} \end{aligned}$$

Thus, with the same peak braking power, the braking time is longer, than when braking with constant motor torque. The motor output during braking is given by:

$$P_{\text{motor br}} = M_{\text{motor br}} \cdot \frac{2\pi \cdot n}{60}$$

with

$$n = \frac{n_{\max}}{\sqrt{\frac{M_{\text{load max}}}{M_{\text{motor br}}}}} \cdot \tan\left(\arctan\left(\sqrt{\frac{M_{\text{load max}}}{M_{\text{motor br}}}}\right) - \frac{60 \cdot \sqrt{M_{\text{load max}} \cdot M_{\text{motor br}}}}{J \cdot 2\pi \cdot n_{\max}} \cdot t\right)$$

In this case, the braking energy can only be numerically calculated. When sub-dividing into  $m$  segments, for example, the following approximation can be used:

$$W_{br} \approx \eta_{\text{motor}} \cdot \sum_{i=1}^{i=m} \frac{P_{\text{motor br } i} + P_{\text{motor br } i+1}}{2} \cdot (t_{i+1} - t_i)$$

The following is obtained by sub-dividing into 10 segments:

$$W_{br} \approx -1739 \text{ Ws}$$

i	t	P <sub>motor</sub>	$\approx \eta_{motor} \cdot \int P_{motor} dt$
0	0	-155.93	0
1	2.69	-131.64	-371.91
2	5.38	-110.98	-685.69
3	8.07	-92.94	-949.42
4	10.76	-76.85	-1169.02
5	13.44	-62.21	-1348.87
6	16.13	-48.63	-1492.21
7	18.82	-35.85	-1601.47
8	21.51	-23.61	-1678.37
9	24.20	-11.72	-1724.06
10	26.89	0.00	-1739.22

Table to numerically calculate the braking energy

Diagrams for motor output and motor speed when braking with a constant motor torque

**Motor output for t<sub>br</sub>=26.9 s**



**Motor speed for  $t_{br}=26.9$  s**

### Braking with constant deceleration and subsequent torque limiting

When braking with constant deceleration, the motor torque increases as the motor speed approaches zero. Under certain circumstances, it is practical to limit the torque, for instance, to the rated motor torque. Naturally the braking time is then extended. In order that the brake resistor is optimally utilized, torque limiting should only be used, if the maximum motor output was reached when braking.

The maximum motor output when braking occurs at :

$$n = \sqrt{\frac{J \cdot 2\pi \cdot n_{\max}^3}{3 \cdot 60 \cdot M_{\text{load max}} \cdot t_{br}}} = \sqrt{\frac{226.6 \cdot 2\pi \cdot 1500^3}{180 \cdot 1260.5 \cdot 17.52}} = 1099.5 \text{ RPM}$$

The value, previously calculated when braking with constant deceleration without torque limiting, is inserted for  $t_{br}$ . The associated motor torque is given by:

$$\begin{aligned} M_{\text{motor br}} &= M_{\text{load max}} \cdot \left(\frac{n}{n_{\max}}\right)^2 - \frac{J \cdot 2\pi \cdot n_{\max}}{60 \cdot t_{br}} \\ &= 1260.5 \cdot \left(\frac{1099.5}{1500}\right)^2 - \frac{226.6 \cdot 2\pi \cdot 1500}{60 \cdot 17.52} = -1354.4 \text{ Nm} \end{aligned}$$

The motor torque at  $n=0$ , without torque limiting, is given by:

$$M_{\text{motor br}} = -\frac{J \cdot 2\pi \cdot n_{\max}}{60 \cdot t_{br}} = -\frac{226.6 \cdot 2\pi \cdot 1500}{60 \cdot 17.52} = -2032 \text{ Nm}$$

Thus, torque limiting can lie between -1354.4 Nm and -2032 Nm. In this particular case, the motor torque should be limited to the rated torque (-1600 Nm) when braking.



Example for torque limiting when braking (in this case to the rated torque)

Initially, the speed  $n_1$  at  $t_1$  must be calculated.

$$\begin{aligned} n_1 &= n_{\max} \cdot \sqrt{\frac{1}{M_{\text{load max}}} \cdot \left( \frac{J \cdot 2\pi \cdot n_{\max}}{60 \cdot t_{br}} - M_n \right)} \\ &= 1500 \cdot \sqrt{\frac{1}{1260.5} \cdot \left( \frac{226.6 \cdot 2\pi \cdot 1500}{60 \cdot 17.52} - 1600 \right)} = 877.8 \text{ RPM} \end{aligned}$$

Thus,  $t_1$  is given by:

$$t_1 = t_{br} \cdot \left( 1 - \frac{n_1}{n_{\max}} \right) = 17.52 \cdot \left( 1 - \frac{877.8}{1500} \right) = 7.27 \text{ s}$$

The following is obtained for the „extended“ braking time:

$$\begin{aligned} t'_{br} &= t_1 + \frac{J \cdot 2\pi \cdot n_{\max}}{60 \cdot \sqrt{M_{\text{load max}} \cdot M_n}} \cdot \arctan\left( \sqrt{\frac{M_{\text{load max}}}{M_n}} \cdot \frac{n_1}{n_{\max}} \right) \\ &= 7.27 + \frac{226.6 \cdot 2\pi \cdot 1500}{60 \cdot \sqrt{1260.5 \cdot 1600}} \cdot \arctan\left( \sqrt{\frac{1260.5}{1600}} \cdot \frac{877.8}{1500} \right) = 19.28 \text{ s} \end{aligned}$$

For  $t_0=0$ , up to time  $t_1$ , the braking energy is given by:

$$\begin{aligned} W_{br1} &= \frac{\eta_{\text{motor}} \cdot 2\pi \cdot t_{br}}{60} \cdot \left( \frac{M_{\text{load max}} \cdot n_{\max}}{4} \cdot \left( 1 - \left( 1 - \frac{t_1}{t_{br}} \right)^4 \right) - \frac{J \cdot 2\pi \cdot n_{\max}^2}{2 \cdot 60 \cdot t_{br}} \cdot \left( 1 - \left( 1 - \frac{t_1}{t_{br}} \right)^2 \right) \right) \\ &= \frac{0.962 \cdot 2\pi \cdot 17.52}{60} \cdot \left( \frac{1260.5 \cdot 1500}{4} \cdot \left( 1 - \left( 1 - \frac{7.27}{17.52} \right)^4 \right) - \frac{226.6 \cdot 2\pi \cdot 1500^2}{2 \cdot 60 \cdot 17.52} \cdot \left( 1 - \left( 1 - \frac{7.27}{17.52} \right)^2 \right) \right) \\ &= -1032 \text{ kW} \cdot \text{s} \end{aligned}$$

To calculate the braking energy in the range  $t_1$  to  $t'_{br}$  the motor output in this range must first be determined. The following is true:

$$P_{\text{motor br}} = -M_n \cdot \frac{2\pi \cdot n}{60}$$

with

$$n = \frac{n_{\max}}{\sqrt{\frac{M_{\text{load max}}}{M_n}}} \cdot \tan\left( \arctan\left( \sqrt{\frac{M_{\text{load max}}}{M_n}} \cdot \frac{n_1}{n_{\max}} \right) - \frac{60 \cdot \sqrt{M_{\text{load max}} \cdot M_n}}{J \cdot 2\pi \cdot n_{\max}} \cdot (t - t_1) \right)$$

In this case, the braking energy can only be numerically determined. The following is obtained using the previous approximation and by sub-dividing into 10 segments:

$$W_{br2} \approx -815 \text{ kW}_s$$

Thus, the total braking energy is given by:

$$W_{br} \approx -1032 - 815 = -1847 \text{ kW}_s$$

i	t	P <sub>motor</sub>	$\approx \eta_{motor} \cdot \int P_{motor} dt$
0	7.27	-147.05	0
1	8.47	-130.23	-160.11
2	9.67	-114.14	-301.22
3	10.87	-98.66	-424.10
4	12.07	-83.69	-529.40
5	13.27	-69.14	-617.65
6	14.47	-54.92	-689.28
7	15.67	-40.97	-744.66
8	16.87	-27.21	-784.02
9	18.07	-13.57	-807.57
10	19.27	0.00	-815.41

Table to numerically calculate the braking energy

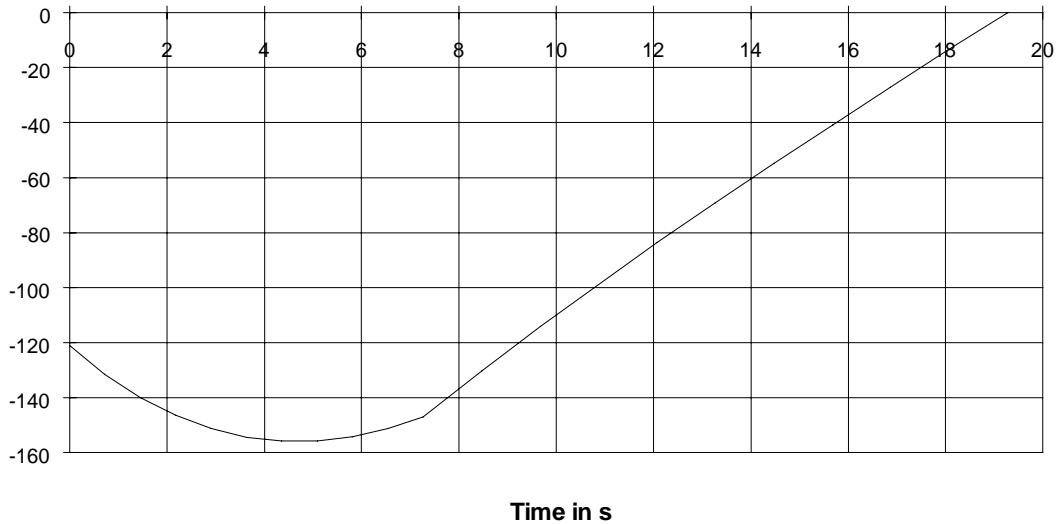

*Motor output and motor torque diagrams***Motor output for  $t_{br}=19.28$  s****Motor torque for  $t_{br}=19.28$  s**

## 4.2 Connecting higher output motors to a drive converter than is normally permissible

### 4.2.1 General information

Motor and drive converter are optimally utilized when the induction motor is assigned to the drive converter, as specified in the Catalog and Engineering Manual. However, in special cases, it may be necessary to use a higher-rating motor than is generally permissible with the particular drive converter, taking into account a poorer utilization level. Reasons could include:

- A large motor is only to be operated under no-load conditions for test purposes
- The motor is only operated at partial load, e.g. derating factors up to 0.5 are obtained for  $M_{\text{permissible}}/M_n$  for a speed control range of 1:100 and utilization to temperature rise class B.

In cases such as these, a standard motor/drive converter assignment could result in a drive converter with an excessive rating and thus far higher costs.

The following must be observed when connecting a higher-rating induction motor to the drive converter than is permissible according to the Catalog or Engineering Manual:

- Higher current peaks are obtained due to the lower leakage inductance of higher-rating motors, which under certain circumstances, could cause the drive converter to be tripped by overcurrent. Thus, the maximum drive converter current must be reduced corresponding to the higher rated motor current. Another possibility is to compensate the low leakage inductance using an additional output reactor, or to increase the leakage inductance using  $\Delta/Y$  changeover.
- At constant flux, the motor power factor deteriorates in partial load operation. The transferrable drive converter active power is then decreased, especially for motors with a high magnetization current component. Thus, in the partial load range, a larger motor cannot generate the same shaft output as the adapted smaller motor.
- The motor data, required when vector control is used, may, under certain circumstances, no longer be able to be set when a larger motor is used. Thus, a smaller motor must be parameterized. The motor model values are correctly set via the motor identification function.
- If the motor is only to be essentially operated under no-load conditions, it mainly draws reactive current. This reactive current is not supplied from the line supply, but from the DC link capacitors. For reasons of stability, the reactive current component should not be more than approx. 60% of the rated drive converter current.

### *Reduction factor if the leakage inductance of the motor is too low*

As long as the motor leakage reactance does not fall below approximately 10% of the rated drive converter impedance, operation is uncritical. This is the case for the standard induction motors listed in the Catalog and Engineering Manual. When connecting a higher-rating motor without taking any measures (refer below), the following rated motor current limit should not be exceeded in order to prevent higher peak currents:

$$I_{motor\ n} \leq 1.36 \cdot I_{U\ n}$$

Further, the maximum drive converter current should be reduced as follows:

$$I_{V\ max} = 1.36 \cdot I_{V\ n} - \frac{0.6}{\sqrt{2}} \cdot I_{V\ n} \cdot \left( \frac{I_{motor\ n}}{I_{V\ n}} - 1 \right) \quad \text{for } I_{V\ n} \leq I_{motor\ n} \leq 1.36 \cdot I_{V\ n}$$

### *Compensating the leakage inductance using an additional output reactor*

If the motor leakage inductance is to be raised to at least 10% of the drive converter rated impedance using an additional output reactor, then the following must be true:

$$X_{\sigma\ motor} + X_{reactor} = 0.1 \cdot Z_{V\ n} = 0.1 \cdot \frac{U_{V\ n}}{\sqrt{3} \cdot I_{V\ n}}$$

If the motor leakage is assumed to be 10%, then the reactor inductance is given by:

$$L_{reactor} \approx \frac{0.1 \cdot U_{V\ n} \cdot 10^3}{\sqrt{3} \cdot 314} \cdot \left( \frac{1}{I_{V\ n}} - \frac{1}{I_{motor\ n}} \right) \quad [\text{mH}]$$

As the standard output reactors are designed for approx. 1.2 to 0.6% of the rated drive converter impedance, then, for example when connecting a motor with twice the rating as normally permissible, approximately 4 to 8 standard output reactors would be required.

### *Increasing the leakage inductance using $\Delta/Y$ motor winding changeover*

The leakage inductance is increased by a factor of 3 using  $\Delta/Y$  changeover of the motor winding. Thus, a motor with 3 times the output normally permissible can be fed from the converter under partial load conditions. However, the permissible motor output is then only one third of the rated motor output.

*Permissible motor torque*

The following approximation is valid for the permissible motor torque referred to the rated motor torque for a higher-rating motor:

$$\frac{M_{perm.}}{M_n} \approx \frac{I_\mu}{I_{\mu n}} \cdot \sqrt{\frac{\left(\frac{I_{V perm.}}{I_{mot n}}\right)^2 - \left(\frac{I_\mu}{I_{mot n}}\right)^2}{1 - \left(\frac{I_{\mu n}}{I_{mot n}}\right)^2}}$$

$I_{V perm.}$ : permissible drive converter current at the operating point

$I_{mot n}$ : rated motor current

$I_\mu$ : motor magnetizing current at the operating point

$I_{\mu n}$ : rated motor magnetizing current

## Example 1

A motor with 300% output of that normally permissible in a Y circuit configuration (660 V) is to be fed from a 380 V drive converter. The rated motor current in the  $\Delta$  circuit configuration should be  $3 \cdot I_{U_n}$  and in the Y circuit configuration  $\sqrt{3} \cdot I_{V_n}$ . Under the assumption that:

$$I_{V perm.} = I_{V_n} \quad \rightarrow \quad \frac{I_{V perm.}}{I_{mot n}} = \frac{1}{\sqrt{3}}$$

and with

$$I_\mu \approx \frac{I_{\mu n}}{\sqrt{3}} \quad (\text{field weakening as a result of the Y circuit})$$

the permissible motor torque is given by:

$$\frac{M_{perm.}}{M_n} \approx \frac{1}{\sqrt{3}} \cdot \sqrt{\frac{\frac{1}{3} - \frac{1}{3} \cdot \left(\frac{I_{\mu n}}{I_{mot n}}\right)^2}{1 - \left(\frac{I_{\mu n}}{I_{mot n}}\right)^2}} = \frac{1}{3}$$

The possible output at rated speed is therefore 1/3 of the rated motor output.

## Example 2

A 4-pole 7.5 kW motor is to be fed from a 5.5 kW drive converter as fan/pump drive. The continuous drive converter current (rated drive converter current) is fully utilized.

Rated motor current: 15.4 A

Rated magnetizing current: 53%

Rated converter current: 13.2 A

The condition  $I_{motor\ n} \leq 1.36 \cdot I_{V\ n}$  is in this case fulfilled.

With  $I_{\mu} = I_{\mu\ n}$  the permissible motor torque at rated speed is given by:

$$\frac{M_{perm.}}{M_n} \approx \sqrt{\frac{\left(\frac{13.2}{15.4}\right)^2 - 0.53^2}{1 - 0.53^2}} = 0.79$$

The output at rated speed is then  $0.79 \cdot 7.5\ kW = 5.9\ kW$ . 5.5 kW can be achieved as fan/pump drive using the adapted 4-pole 5.5 kW motor connected to the 5.5 kW drive converter.

### 4.2.2 Operating a 600 kW motor under no-load conditions

After service work, traction motors are to be checked for symmetrical (balanced) phase currents under no-load conditions and mechanical running characteristics. A motor is accelerated up to maximum speed using a PWM drive converter connected to the 400 V line supply.

#### Motor data

Rated output	$P_n$	= 600 kW
Rated voltage	$V_n$	= 1638 V
Rated current	$I_n$	= 266 A
Rated speed	$n_n$	= 1670 RPM
Rated frequency	$f_n$	= 85 Hz
Max. speed	$n_{\max}$	= 3145 RPM
Max. frequency	$f_{\max}$	= 160 Hz
Leakage inductance	$L_\sigma$	= 2.04 mH
Rotor resistance	$R_2'$	= 0.0691 $\Omega$
No-load current at the rated operating point	$I_{\mu n}$	= 85 A

#### *Estimating the required drive converter output according to the no-load current*

The motor voltage at 50 Hz is:

$$V_{50 \text{ Hz}} \approx \frac{50}{85} \cdot 1638 = 963 \text{ V}$$

As the drive converter can only supply 400 V, the magnetizing current is given by:

$$I_\mu \approx \frac{400}{963} \cdot I_{\mu n} = \frac{400}{963} \cdot 85 = 35 \text{ A}$$

The magnetizing current component should not exceed 60% of the rated drive converter current.

Thus, the drive converter current is given by:

$$I_{V_n} = \frac{100}{60} \cdot 35 = 58.3 \text{ A}$$

According to this criterium, then at least a 30 kW drive converter with  $I_{U_n} = 59 \text{ A}$  is required.

### Estimating the stall torque at 160 Hz

The motor stall torque can be approximated as follows:

$$M_{stall n} \approx \frac{M_n}{2} \cdot \left( \frac{s_n}{s_K} + \frac{s_K}{s_n} \right)$$

With

$$s_n = \frac{n_0 - n_n}{n_0} = \frac{1700 - 1670}{1700} = 0.0176$$

$$s_K = \frac{R'_2}{X_{1\sigma} + X'_{2\sigma}} = \frac{R'_2}{2 \cdot \pi \cdot f_n \cdot L_\sigma} = \frac{0.0691}{2 \cdot \pi \cdot 85 \cdot 2.04 \cdot 10^{-3}} = 0.0634$$

The following is obtained

$$M_{stall n} \approx \frac{3430}{2} \cdot \left( \frac{0.0176}{0.0634} + \frac{0.0634}{0.0176} \right) = 6654 \text{ Nm}$$

The motor is fed from a drive converter with constant voltage from 50 Hz to 160 Hz. The following is obtained for the stall torque at 160 Hz:

$$M_{stall (160 \text{ Hz})} \approx M_{stall n} \cdot \left( \frac{V_{\max}}{V_{50 \text{ Hz}}} \right)^2 \cdot \left( \frac{f_{\text{transition}}}{f_{\max}} \right)^2 = 6654 \cdot \left( \frac{400}{963} \right)^2 \cdot \left( \frac{50}{160} \right)^2 = 113 \text{ Nm}$$

Thus, with a 1.3 safety margin from the stall torque, only 87 Nm is available for acceleration. This represents 2.54% of the rated motor torque. The associated accelerating power is thus given by:

$$P_b = \frac{M_b \cdot n_{\max}}{9550} = \frac{87 \cdot 3145}{9550} = 28.6 \text{ kW}$$

A 37 kW drive converter is to be used (6SE7027-2ED61 with  $I_{Vn}=72 \text{ A}$ ).

### Permissible motor leakage inductance

The permissible motor leakage inductance is given by:

$$L_\sigma \geq \frac{0.1 \cdot U_{Vn} \cdot 10^3}{\sqrt{3} \cdot 314 \cdot I_{Vn}} = \frac{0.1 \cdot 400 \cdot 10^3}{\sqrt{3} \cdot 314 \cdot 72} = 1.02 \text{ mH}$$

The motor leakage inductance of 2.04 mH is therefore sufficiently high (this is a function of the high motor rated motor voltage).

#### *Closed-loop control type and setting*

Closed-loop frequency control is preferable due to the improved stability. When parameterizing the system, a 6-pole 30 kW motor (1LA6 223-6) can be used as basis.



## 4.3 Using a transformer at the drive converter output

### 4.3.1 General information

Normally, the rated motor voltage and the maximum drive converter output voltage are harmonized with one another, thus ensuring optimum drive converter utilization. Occasionally, the rated motor voltage and maximum drive converter output voltage are not the same. In this case, it may be necessary to adapt the voltage using an output transformer, e.g.:

- Operating processing machines with a lower line supply voltage, e.g. grinding machines, which up until now, were fed from a motor-generator set.
- To step-up the motor voltage to keep the cable losses low if long motor feeder cables are used.

The following must be observed when using a transformer at the drive converter output:

- If there is no sinusoidal filter between the drive converter and transformer, the transformer must be designed for operation at the converter output. Contrary to a transformer connected to the line supply, the frequencies are higher (pulse frequency), and the current spikes. In order to prevent the effects of saturation due to the high current spikes, and as a result of possible current dissymmetries (i.e. unbalance), the inductance of the transformer must be utilized to a lower level than otherwise.
- DC current braking is no longer possible as the transformer can't conduct DC current.
- The achievable motor starting torque is generally lower than if a transformer was not used, as the transformer can only effectively transform above a specific minimum frequency. For rated torque starting, the transformer must be designed to operate, for example, at the rated motor slip frequency.
- The drive converter must additionally supply the losses as well as the transformer magnetizing current.
- When using an autotransformer, it is not permissible to ground the transformer neutral (star) point, as this would represent a ground fault for the drive converter. An isolating transformer is preferable if long motor feeder cables are used, as otherwise, the influence of the cable capacitance with respect to ground would be significantly reduced (lower charging currents due to the almost sinusoidal voltages, even with respect to ground on the motor side).

- When a sinusoidal filter is used, the maximum output voltage is only approx. 85% of the line supply voltage. The transformer ratio must take this into account. Depending on the drive converter output, it may even be necessary to de-rate it due to the high pulse frequency required (6 kHz at 380 to 460 V).

### 4.3.2 Operating a 660 V pump motor through an isolating transformer

A 23 kW pump motor, located in a well, is connected to a 30 kW drive converter installed 1 km away in an equipment room. In order to keep the motor cable losses as low as possible, the motor is connected in a Y circuit configuration at 660 V. In order to adapt the maximum 380 V drive converter output voltage, an isolating transformer is used. In this case, it is not cost-effective to use a 660 V drive converter due to the low motor output. Further, a sinusoidal filter is required between the drive converter and isolating transformer due to the 1000 m feeder cable and as a result of the high 660 V motor voltage (a third-party motor is being used). 1000 m feeder cables are permissible as the isolating transformer de-couples the motor cable ground capacitances. The isolating transformer ratio was selected to compensate the 15% lower output voltage when using the sinusoidal filter. De-rating is not required for the 30 kW drive converter at a 6 kHz pulse frequency.



Block diagram

### 4.3.3 Operating 135V/200 Hz handheld grinding machines through an isolating transformer

Handheld grinding machines equipped with three-phase motors are to be fed from a drive converter which is connected to a 380 V supply. In this case, the converter acts as three-phase supply with a fixed voltage and frequency. A maximum of 9 motors can be connected through sockets. The motors can either run individually or all together. An isolating transformer is used to match the voltage. Further, a sinusoidal filter is used as the motors are not designed for converter operation. In addition, EMC disturbances/noise via the motor cables are significantly reduced. Ground currents flowing through cable capacitances are essentially eliminated using the isolating transformer.

#### Motor data

Rated voltage	$V_n = 135 \text{ V}$
Rated frequency	$f_n = 200 \text{ Hz}$
Rated speed	$n_n = 6000 \text{ RPM}$

Rated output/rated current of the motors to be connected:

2 motors with	260 W / 1.41 A
6 motors with	1000 W / 5.6 A
1 motor with	1800 W / 8.6 A

It is assumed, that an 1800 W motor will be switched-in, in addition to 2 x 260 W motors and 6x1000 W motors running at rated load. The starting current (inrush current) is 600%  $I_n$ . Thus, the maximum current is given by:

$$I_{\max} \approx 2 \cdot 1.41 \text{ A} + 6 \cdot 5.6 \text{ A} + 6 \cdot 1 \cdot 8.6 \text{ A} = 88 \text{ A}$$

If all of the motors are operated at rated load, then the following is true:

$$I_{n \text{ total}} \approx 2 \cdot 1.41 \text{ A} + 6 \cdot 5.6 \text{ A} + 1 \cdot 8.6 \text{ A} = 45 \text{ A}$$

As the currents are geometrically summed, the algebraic addition made here means that the calculation is on the safe side. The 150% overload capability of the drive converter can be utilized for the maximum current when the highest-rating motor starts.

Thus, the basic drive converter load current must be at least

$$I_{UG} \geq \frac{I_{\max}}{15 \cdot \ddot{u}} = \frac{88}{15 \cdot 323 / 135} = 24.5 \text{ A}$$

A 15 kW drive converter, 6SE7023-4EC61 with 30.9 A base load current is selected. Thus, there is sufficient reserve for the magnetizing current and the transformer losses. The transformer ratio takes into account that only 85 % of the maximum drive converter output voltage can be reached due to the sinusoidal filter. De-rating is not required for the 15 kW drive converter and 6 kHz pulse frequency.



Block diagram

## 4.4 Emergency off

### 4.4.1 General information

According to VDE 0113, stop functions fall under the following categories:

- Category 0  
Uncontrolled shutdown by immediately disconnecting the power feed (the motor coasts down).
- Category 1  
Controlled shutdown, whereby power is still fed to the drive so that it can shutdown in a controlled fashion. The power is only disconnected once the drive comes to a standstill.
- Category 2  
Controlled shutdown, whereby the power is still connected even after the drive comes to a standstill.

Further, the following additional requirements are valid for emergency off:

- Emergency off has priority over all other functions
- The power should be disconnected as quickly as possible
- It is not permissible that a reset initiates a restart

Emergency off must either be effective as a category 0- or category 1 stop function. The actual category must be defined as a result of the machine risk evaluation. For an emergency off function, stop category 0, only permanently-wired (hardwired) electromagnetic components may be used (e.g. neither the drive converter electronics nor PLC controls can be used). For an emergency off function, stop category 1, the power supply must be reliably disconnected, and as for category 0, by just electromechanical components.

*Emergency off via a category 1 stop function (fast stop)*

In this case, shutdown is initiated with an emergency off command using the „off 3“ command (fast stop with a suitably selected ramp function). The line contactor is opened to disconnect the power after the drive comes to a standstill. In addition, a time relay is provided to positively disconnect the power so that the line contactor is reliably opened, even if the drive converter electronics develops a fault. When the delay expires, the „external fault“ command is also output, in order to prevent restarting without first acknowledging the fault. Fast shutdown is only possible if the drive is equipped with a pulsed resistor or regenerative feedback.

Fast shutdown does not function if the drive converter or line supply develops a fault. Thus, normally safety-critical drives (e.g. cranes) always have a mechanical brake, which can brake the drive to standstill within a specific time. Further, using this brake, the drive is held at standstill when the electronics fails even if the DC link voltage is still available (the DC link voltage only decays slowly).

*Emergency off via a category 0 stop function (electrical shutdown)*

In this case, the system must be shutdown (into a no-voltage condition) as quickly as possible (the motor coasts down or is mechanically braked). There are two methods of achieving this:

a) Disconnecting the line supply voltage in front of the drive converter

For safety reasons, it is not permissible to open the line contactor using the internal drive converter electronics (the drive converter electronics could fail). Thus, the line contactor is directly opened via the emergency off button/switch. In order to prevent switching under load, an „external fault“ command is simultaneously output to inhibit the drive pulses (processing time:  $4T_0$ ). This also prevents the drive starting without first acknowledging the fault.

b) Disconnecting the line supply voltage in front of the drive converter and disconnecting the motor

If only the line supply voltage is disconnected in front of the converter (feeding the drive converter), the DC link still remains charged for a specific time. Thus, voltage is still present at the motor terminals. In order to ensure that the voltage at the motor terminals is zero, a motor contactor located between the motor and drive converter must open. The motor contactor must be closed before the drive converter is powered-up, and it may only be opened if there is no current flowing through the motor. This can be realized using the main contactor checkback signal.

*Contactor opening when the line supply fails*

When the line supply fails, the contactors can, under certain circumstances, drop-out (open), before the drive converter monitoring function can output a pulse inhibit command. This is the case, for example, in the partial load range, during short line supply dips, or when kinetic buffering becomes active. Thus, in this case, the contactor opens under load. Especially for motor contactors, switching under load must be prevented. If the contactor switches under load at low output frequencies, a quasi DC current could be interrupted which could result in arcing. To prevent this happening, the contactors (control circuit) must be supplied from an uninterruptable power supply.



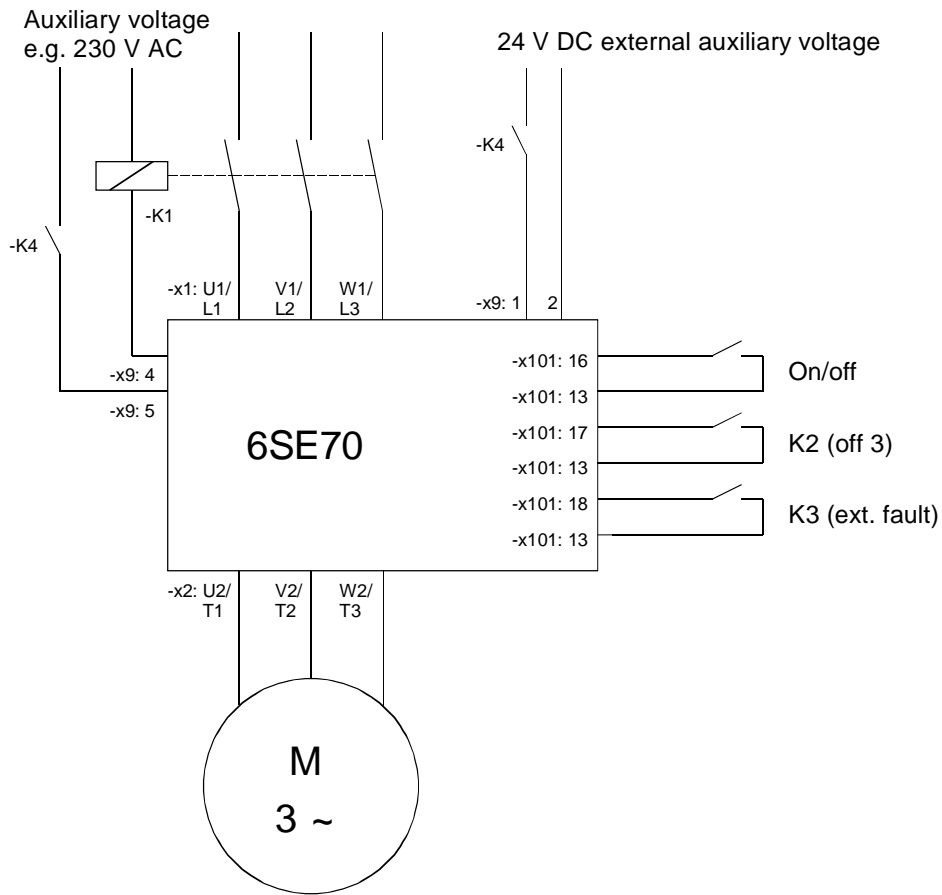

Example of an emergency off circuit using a category 1 stop (fast stop and then the power is disconnected)

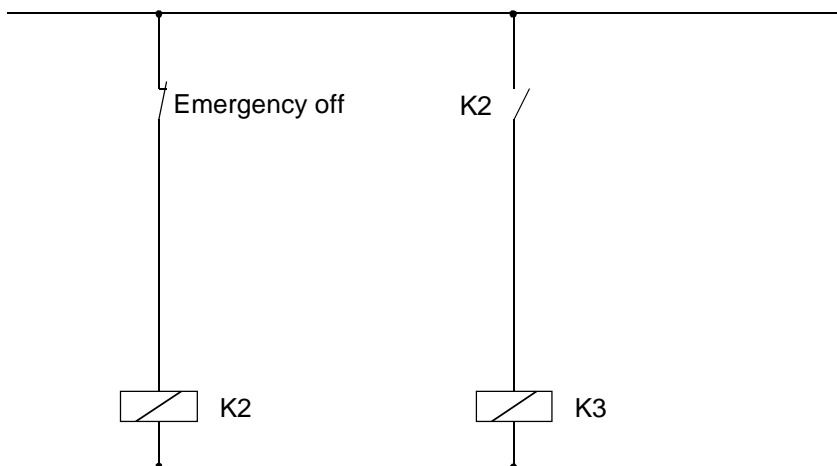

Example of an emergency off circuit using a category 0 stop (the line supply voltage is disconnected)

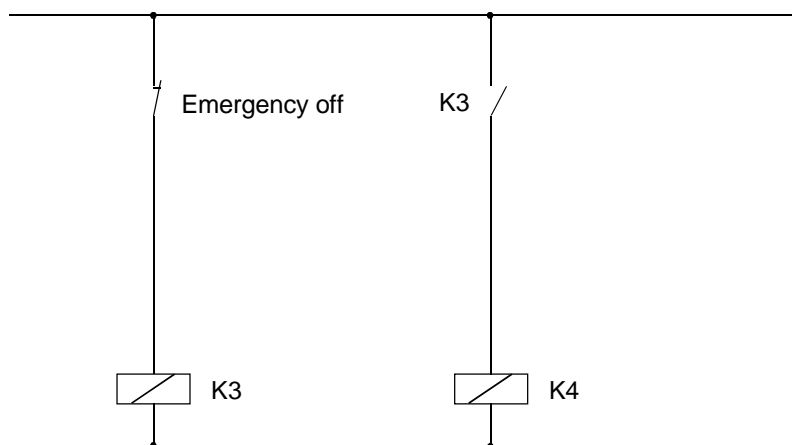

An example of an emergency off circuit using a category 0 stop. (the line supply voltage is disconnected and the motor is disconnected). Caution: Observe the maximum switching capability of contact X9: 4.5.

## 4.5 Accelerating- and decelerating time with a constant load torque in the field-weakening range

### 4.5.1 General information

The prerequisite for the calculation is a constant motor torque in the constant-flux range and a constant motor output in the field-weakening range (e.g. accelerating along the current limit). Thus, the motor torque is given by:

$$M_{motor} = M_{motor\ max} = const \quad (\text{constant flux range})$$

$$M_{motor} = M_{motor\ max} \cdot \frac{n_n}{n} \quad (\text{field-weakening range, } n \geq n_n)$$

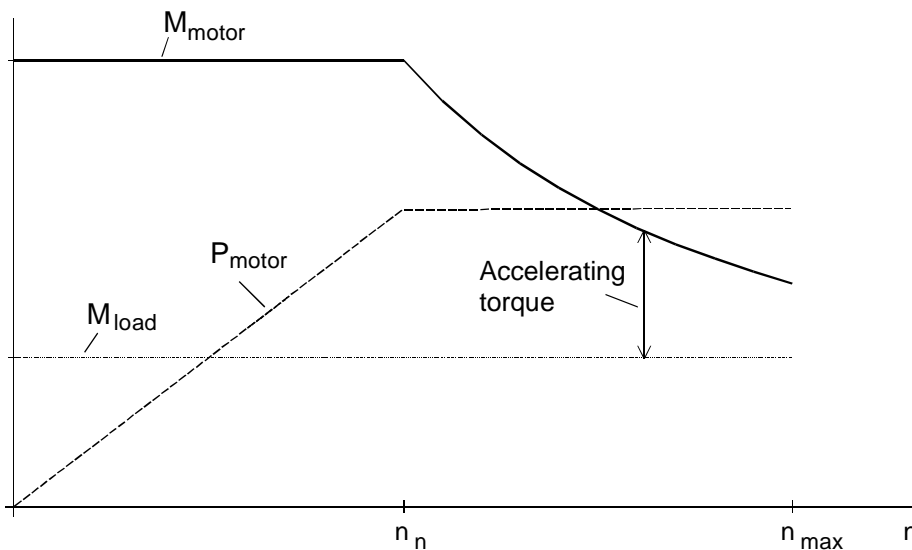

### Example for starting in the field-weakening range

Under these assumptions, the accelerating time ( $t_a$ ) and the decelerating time ( $t_{br}$ ) can be calculated as follows.

**Case 1** ( $M_{load}^* = 0$ , i.e. pure high-inertia drive (flywheel))

In the constant-flux range, with  $0 \leq n \leq n_n$  the following is true:

$$t_{a,br} = \frac{J_{total}^* \cdot 2\pi \cdot n_n}{60 \cdot M_{motor\ max}}$$

In the field-weakening range, with  $n_n \leq n \leq n_{max}$  the following is true:

$$t_{a,br} = \frac{J_{total}^* \cdot \pi \cdot (n_{max}^2 - n_n^2)}{60 \cdot M_{motor\ max} \cdot n_n}$$

**Case 2** ( $M_{load}^* \neq 0$ , e.g. friction present)

In the constant-flux range, with  $0 \leq n \leq n_n$  the following is true:

$$t_{a,br} = \frac{J_{total}^* \cdot 2\pi \cdot n_n}{60 \cdot (M_{motor\ max} \mp M_{load}^*)}$$

In the field-weakening range with  $n_n \leq n \leq n_{max}$  the following is true:

$$t_{a,br} = \frac{J_{total}^* \cdot 2\pi}{60} \cdot \left( \pm \frac{n_n - n_{max}}{M_{load}^*} + \frac{M_{motor\ max} \cdot n_n}{M_{load}^{*2}} \cdot \ln \frac{M_{motor\ max} \mp M_{load}^*}{M_{motor\ max} \mp \frac{n_{max}}{n_n} \cdot M_{load}^*} \right)$$

The lower sign in the last two formulas is true when the drive brakes

$M_{load}^*$	Constant load torque referred to the motor	[Nm]
$J_{total}^*$	Total moment of inertia referred to the motor	[kgm <sup>2</sup> ]
$M_{motor\ max}$	Motor torque in the constant-flux range	[Nm]
$n_n$	Rated motor speed (start of field weakening)	[RPM]
$n_{max}$	Max. motor speed in the field-weakening range	[RPM]

## 4.5.2 Braking time for a grinding wheel drive

The motor of a grinding wheel drive is operated in the field-weakening range from 50 Hz to 60 Hz. The minimum braking time is to be determined when a drive converter with brake resistor is used. The load torque when braking is assumed to be zero (friction has been neglected). There is no gearbox.

## Drive data

Rated motor output	$P_{\text{motor } n} = 11 \text{ kW}$
Rated motor current	$I_{\text{motor } n} = 21.4 \text{ A}$
Rated motor torque	$M_{\text{motor } n} = 36 \text{ Nm}$
Rated motor speed (2 pole)	$n_n = 2915 \text{ RPM}$
Motor efficiency	$\eta_{\text{motor}} = 0.87$
Motor moment of inertia	$J_{\text{motor}} = 0.034 \text{ kgm}^2$
Ratio of the stall torque to the rated motor torque	$M_{\text{stall}}/M_n = 2.6$
Maximum speed of the grinding wheel	$n_{\text{max}} = 3600 \text{ RPM}$
Moment of inertia of the grinding wheel	$J_{\text{wheel}} = 0.34 \text{ kgm}^2$
Rated drive converter output	$P_{V n} = 11 \text{ kW}$
Max. drive converter current	$I_{U \text{ max}} = 34.8 \text{ A}$
External brake resistor rating	$P_{20} = 20 \text{ kW}$
Peak braking power	$1.5 P_{20} = 30 \text{ kW}$

*Determining the maximum motor torque*

The maximum possible motor torque at the maximum drive converter current is:

$$M_{\text{motor max}} \approx M_{\text{motor } n} \cdot \sqrt{\frac{I_{V \text{ max}}^2 - I_{\mu n}^2}{I_{\text{motor } n}^2 - I_{\mu n}^2}}$$

With  $I_{\mu n} = 0.41 \cdot I_{\text{motor } n}$  the following is obtained:

$$M_{\text{motor max}} \approx 36 \cdot \sqrt{\frac{34.8^2 - 0.41^2 \cdot 21.4^2}{21.4^2 - 0.41^2 \cdot 21.4^2}} = 62 \text{ Nm}$$

In the field-weakening range at  $n_{\max}$  and at constant motor output, the motor torque is then only given by:

$$M_{\text{motor } (3600)} = M_{\text{motor max}} \cdot \frac{n_n}{n_{\max}} = 62 \cdot \frac{2915}{3600} = 50.2 \text{ Nm}$$

On the other hand, the permissible motor torque at  $n_{\max}$  and 130% margin for the stall torque is given by:

$$M_{\text{motor perm. } (3600)} = \frac{2.6 \cdot M_{\text{motor n}}}{1.3} \cdot \left(\frac{n_n}{n_{\max}}\right)^2 = \frac{2.6 \cdot 36}{1.3} \cdot \left(\frac{2915}{3600}\right)^2 = 47.2 \text{ Nm}$$

Thus, the maximum permissible motor torque is reduced to:

$$M_{\text{motor max}} = M_{\text{motor perm. } (3600)} \cdot \frac{n_{\max}}{n_n} = 47.2 \cdot \frac{3600}{2915} = 58.3 \text{ Nm}$$

Thus, the drive converter is not fully utilized when braking.

### Determining the braking times

Total moment of inertia:

$$J_{\text{total}} = J_{\text{motor}} + J_{\text{wheel}} = 0.034 + 0.34 = 0.374 \text{ kgm}^2$$

Braking time in the field-weakening range:

$$t_{br1} = \frac{J_{\text{total}} \cdot \pi \cdot (n_{\max}^2 - n_n^2)}{60 \cdot M_{\text{motor max}} \cdot n_n} = \frac{0.374 \cdot \pi \cdot (3600^2 - 2915^2)}{60 \cdot 58.3 \cdot 2915} = 0.51 \text{ s}$$

Braking time in the constant-flux range:

$$t_{br2} = \frac{J_{\text{total}} \cdot 2\pi \cdot n_n}{60 \cdot M_{\text{motor max}}} = \frac{0.374 \cdot 2 \cdot \pi \cdot 2915}{60 \cdot 58.3} = 1.96 \text{ s}$$

Thus, the total braking time is given by:

$$t_{br \text{ total}} = t_{br1} + t_{br2} = 0.51 + 1.96 = 2.47 \text{ s}$$

*Determining the maximum braking power and braking energy*

The maximum braking power is given by:

$$P_{br \max} = \frac{M_{motor \max} \cdot n_n}{9550} \cdot \eta_{motor} = \frac{58.3 \cdot 2915}{9550} \cdot 0.87 = 15.48 \text{ kW}$$

The brake resistor with  $P_{20}=20 \text{ kW}$  and a peak braking power of  $30 \text{ kW}$  is more than adequately dimensioned.

The braking energy corresponds to the area in the braking diagram.

## Braking diagram

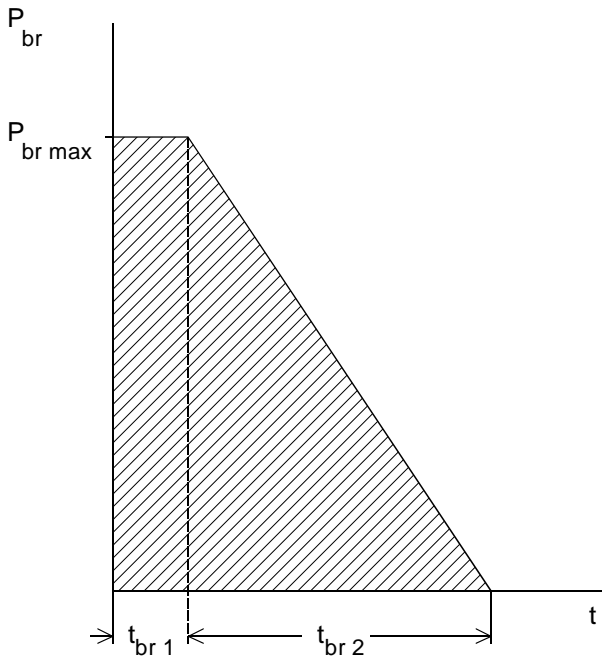

$$W_{br} = P_{br \max} \cdot t_{br 1} + \frac{P_{br \max} \cdot t_{br 2}}{2} = 15.48 \cdot 0.51 + \frac{15.48 \cdot 1.96}{2} = 23.07 \text{ kW}_s$$

With

$$\frac{W_{br}}{T} \leq P_{br \text{ cont.}} = \frac{P_{20}}{4.5} \quad (\text{with an external brake resistor})$$



The permissible period is given by:

$$T \geq \frac{W_{br} \cdot 4.5}{P_{20}} = \frac{23.07 \cdot 4.5}{20} = 5.2 \text{ s}$$

Thus, braking can be realized every 5.2 s.

## 4.6 Influence of a rounding-off function

Acceleration steps are eliminated, and therefore softer positioning achieved, using a rounding-off function for a traversing characteristic. We will now investigate the influence of such a rounding-off function on the motor- and drive converter dimensioning. These investigations are based on the square-law rounding-off, the  $\sin^2$  rounding-off, as well as rounding-off for jerk-free motion. These various rounding-off functions are compared with the behavior without rounding-off, i.e. acceleration as a step function.

### *Square-law rounding-off function*

For a square-law rounding-off function, acceleration is entered as a trapezoid. This results in a square-law characteristic of the velocity during linearly increasing or linearly decreasing acceleration.



with  $0 \leq k \leq 1$



Acceleration in the areas 1, 2, 3:

$$a_1 = 2 \cdot a_{\max} \cdot \frac{t}{k \cdot t_b}$$

$$a_2 = a_{\max}$$

$$a_3 = 2 \cdot a_{\max} \cdot \frac{t_b - t}{k \cdot t_b}$$

The following is true for the ratio between maximum acceleration and maximum velocity:

$$a_{\max} = \frac{v_{\max}}{t_b \cdot \left(1 - \frac{k}{2}\right)}$$

Velocity in areas 1, 2, 3:

$$v_1 = \frac{a_{\max}}{k \cdot t_b} \cdot t^2 \quad \text{square-law}$$

$$v_2 = \frac{a_{\max} \cdot k \cdot t_b}{4} + a_{\max} \cdot \left(t - \frac{k \cdot t_b}{2}\right) \quad \text{linear}$$

$$v_3 = a_{\max} \cdot t_b \cdot \left(1 - \frac{k}{2}\right) - \frac{a_{\max}}{k \cdot t_b} \cdot (t_b - t)^2 \quad \text{square-law}$$

For  $k=0$  (0% rounding-off), areas 1 and 2 are omitted. Acceleration is a step function. For  $k=1$  (100% rounding-off), area 2 is omitted. Acceleration is triangular.

The relationships without rounding-off (step-function acceleration) will now be compared with 100% rounding-off (triangular acceleration). This assumes, traversing motion with the same travel, same travel time and the same maximum velocity.



Comparison of the traversing curve with and without rounding-off

The area under the traversing curve  $v$  corresponds to the travel  $s_{\text{total}}$ . In this case,  $t_b = t_v$ .

With

$$a_{\text{max}} = \frac{v_{\text{max}}}{t_b \cdot \left(1 - \frac{k}{2}\right)}$$

the following is obtained if  $k=1$ :

$$a_{\text{max}} = 2 \cdot \frac{v_{\text{max}}}{t_b}$$

With the same travel  $s_{\text{total}}$ , the same travel time  $t_{\text{total}}$  and the same maximum velocity  $v_{\text{max}}$ , the maximum acceleration for 100% rounding-off is exactly double. For a pure accelerating drive, the motor torque would also then double (the motor must be appropriately dimensioned) and, corresponding to this torque, also the motor current (drive converter dimension). However, the maximum motor torque only occurs at half the maximum motor speed.

In the following, for the previously described traversing motion, the motor torque characteristics are shown as a function of the speed using a pure accelerating drive. The motor torque must lie below the permissible limits (in this case, the limiting curve for an 1FK6 motor). The motor torque for 100% rounding-off ( $k=1$ ) is compared with the motor torque without rounding-off ( $k=0$ ).



Comparison of the motor torque with and without rounding-off

*Sin<sup>2</sup> rounding-off*

For a sin<sup>2</sup> rounding-off, the velocity is entered according to a sin<sup>2</sup> function. For the acceleration, a sinusoidal function is obtained with twice the frequency.

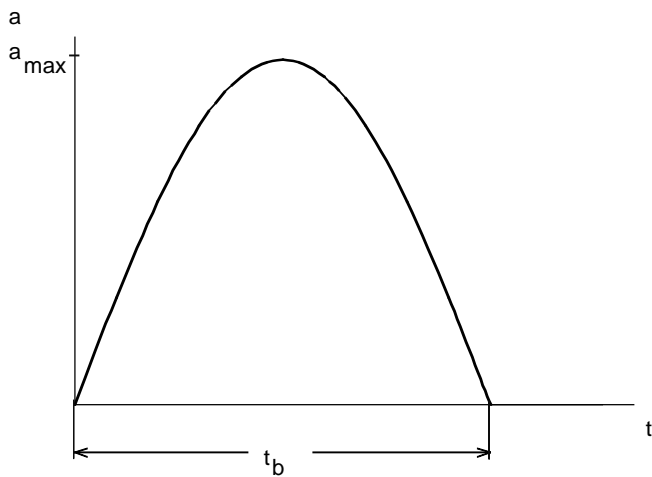

Velocity:

$$v = v_{\max} \cdot \sin^2(\omega \cdot t) \quad \text{for } 0 \leq t \leq t_b$$

with

$$\omega = \frac{\pi}{2 \cdot t_b}$$

Acceleration:

$$a = a_{\max} \cdot \sin(2 \cdot \omega \cdot t) \quad \text{for } 0 \leq t \leq t_b$$

with

$$a_{\max} = v_{\max} \cdot \omega$$

The relationships without rounding-off (step-function acceleration) will now be compared with  $\sin^2$  rounding-off (sinusoidal acceleration). It is assumed that the traversing operation has the same travel, the same travel time and the same maximum velocity.

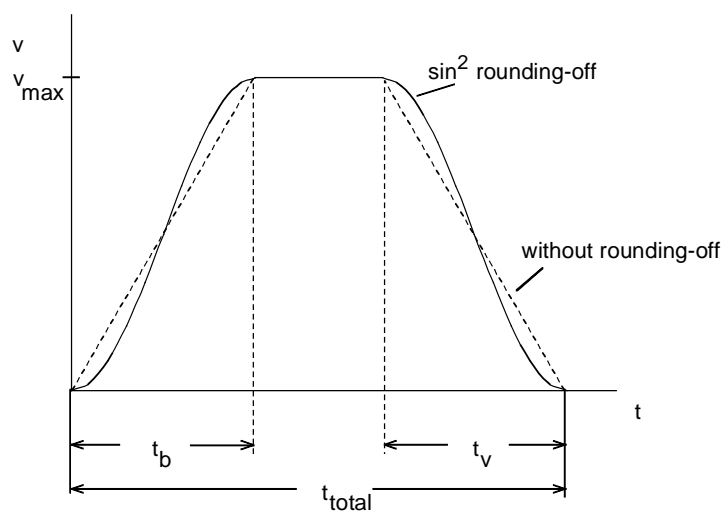
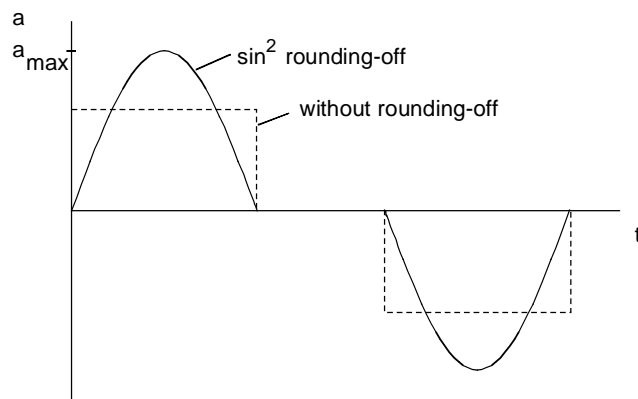

Comparison of the traversing curve, with and without rounding-off

The area under the traversing curve  $v$  corresponds to the travel  $s_{\text{total}}$ . In this case,  $t_b = t_v$ .

With

$$a_{\text{max}} = v_{\text{max}} \cdot \omega = \frac{\pi}{2} \cdot \frac{v_{\text{max}}}{t_b}$$

a factor of  $\pi/2$  is obtained with respect to the acceleration value without rounding-off. For the same travel  $s_{\text{total}}$ , the same travel time  $t_{\text{total}}$  and the same maximum velocity  $v_{\text{max}}$ , the maximum acceleration for  $\sin^2$  rounding-off is therefore greater by a factor  $\pi/2$ . For a pure accelerating drive, the motor torque would thus be increased by this factor (the motor must be appropriately dimensioned), and, corresponding to this torque, also the motor current (the drive converter must be appropriately dimensioned). However, the maximum motor torque only occurs at half the maximum motor speed.

The previously described traversing motion is illustrated in the following using a pure accelerating drive, showing the motor torque as a function of the speed. The motor torque must lie within the permissible limits (in this case, the limiting curve for an 1FK6 motor). The motor torque for  $\sin^2$  rounding-off is compared with the motor torque without rounding-off.



Comparison with and without rounding-off



### Rounding-off for jerk-free motion

For jerk-free motion, the acceleration must be specified so that the derivative at the transitions is 0. For example, this is achieved with a  $\sin^2$  function for the acceleration.



Acceleration:

$$a = a_{\max} \cdot \sin^2(\omega \cdot t) \quad \text{for } 0 \leq t \leq t_b$$

with

$$\omega = \frac{\pi}{t_b}$$

Velocity:

$$v = v_{\max} \cdot \left( \frac{t}{t_b} - \frac{1}{2 \cdot \omega \cdot t_b} \cdot \sin(2 \cdot \omega \cdot t) \right) \quad \text{for } 0 \leq t \leq t_b$$

with

$$v_{\max} = \frac{1}{2} \cdot a_{\max} \cdot t_b$$

The relationships without rounding-off (step-function acceleration) with rounding-off for jerk-free movement ( $\sin^2$ -function acceleration) will now be compared. It is assumed that the traversing operation has the same travel, the same travel time and the same maximum velocity.

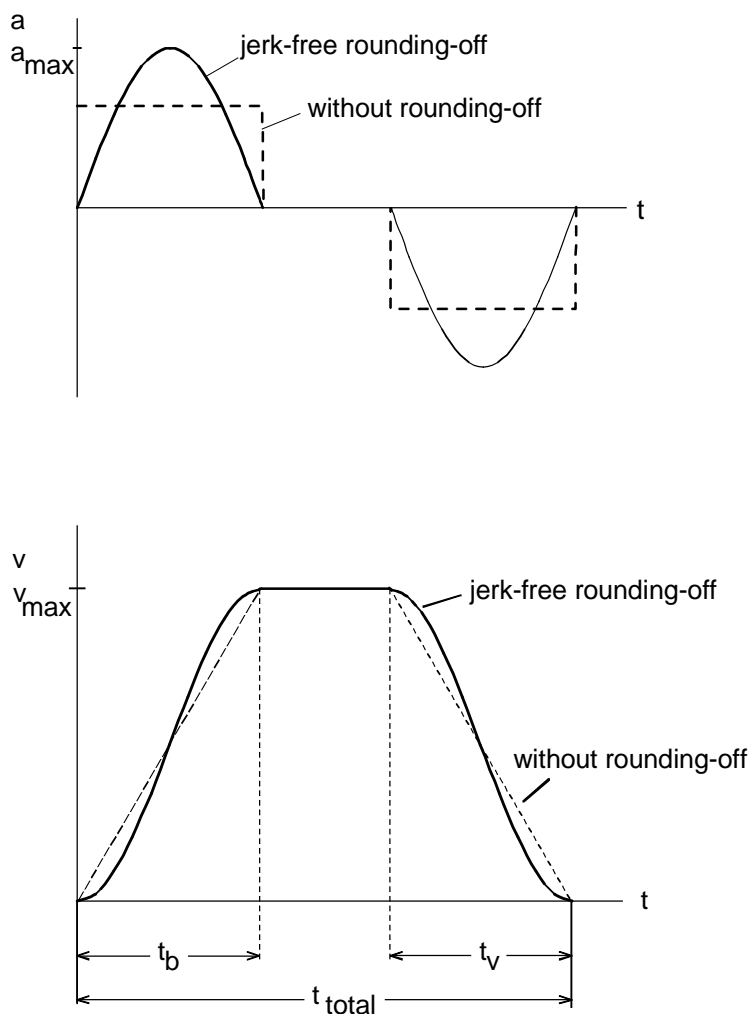

Comparison of the traversing curve with and without rounding-off

The area under the traversing curve  $v$  corresponds to the travel  $s_{\text{total}}$ . In this case,  $t_b = t_v$ .

With

$$a_{\text{max}} = 2 \cdot \frac{v_{\text{max}}}{t_b}$$

the same travel  $s_{\text{total}}$ , the same travel time  $t_{\text{total}}$  and the same maximum velocity  $v_{\text{max}}$  results in twice the acceleration value with respect to the traversing curve without rounding-off. For a pure accelerating drive, the motor torque would thus be increased by this factor (the motor must be appropriately dimensioned), and, corresponding to this torque, also the motor current (the drive converter must be appropriately dimensioned). However, the maximum motor torque only occurs at half the maximum motor speed.

The previously described traversing motion is illustrated in the following using a pure accelerating drive, as an example for the motor torque characteristic as a function of the speed. The motor torque must lie within the permissible limits (in this case, the limiting curve for an 1FK6 motor). The motor torque for  $\sin^2$  rounding-off is compared with the motor torque without rounding-off.



Comparison of the motor torque, with and without rounding-off

### *Summary*

If, for a positioning drive, the same traversing sequence is investigated with and without rounding-off, then, for the same positioning time, and the same maximum velocity, the traversing curve with rounding-off, requires a higher acceleration and deceleration. Thus, the motor torque and therefore the motor current increases. Due to the higher motor torque, the RMS torque also increases. Under certain circumstances, a larger motor and a larger drive converter must be used. By appropriately increasing the acceleration- and deceleration times, acceleration and deceleration can be reduced. Naturally, the positioning time then increases.

For square-law rounding-off and  $\sin^2$  rounding-off, the acceleration steps are avoided, but completely jerk-free motion is not achieved. This is only achieved when the  $\sin^2$ -type acceleration function is applied. This type of acceleration setpoint doubles the value for the acceleration, and also results in the highest increase in the RMS value.

## 4.7 Possible braking torques due to system losses

### 4.7.1 General information

Normally, when braking, the braking energy is either dissipated in a brake resistor, fed back into the line supply, or, when using DC current braking, converted in the motor itself. There are only a very limited number of ways of storing the braking energy in the DC link. Below is an example of a 4-pole 55 kW motor connected to a 55 kW drive converter with a 400 V supply voltage.

With

$$J_{Mot} = 0.79 \text{ kgm}^2 \quad \text{motor moment of inertia}$$

$$C_{DClink} = 9 \text{ mF} \quad \text{drive converter DC link capacitance}$$

the kinetic energy  $W_{kin}$ , to shutdown the motor and the energy  $W_C$  which can be stored in the DC link capacitor is given by:

$$W_{kin Mot} = \frac{1}{2} \cdot J_{Mot} \cdot \left( \frac{2 \cdot \pi \cdot n_{Mot}}{60} \right)^2 = \frac{1}{2} \cdot 0.79 \cdot \left( \frac{2 \cdot \pi \cdot 1475}{60} \right)^2 = 9424 \text{ Ws}$$

$$W_C = \frac{1}{2} \cdot C_{DClink} \cdot (U_{DClink max}^2 - U_{DClink n}^2) = \frac{1}{2} \cdot 9 \cdot 10^{-3} \cdot (800^2 - 530^2) = 1616 \text{ Ws}$$

Using the energy stored in the DC link capacitor, not even the motor alone can be shutdown without taking into account the losses. Thus, in the following, the possible braking torque is determined, taking into account the loss equation. The following diagram makes the situation clear.

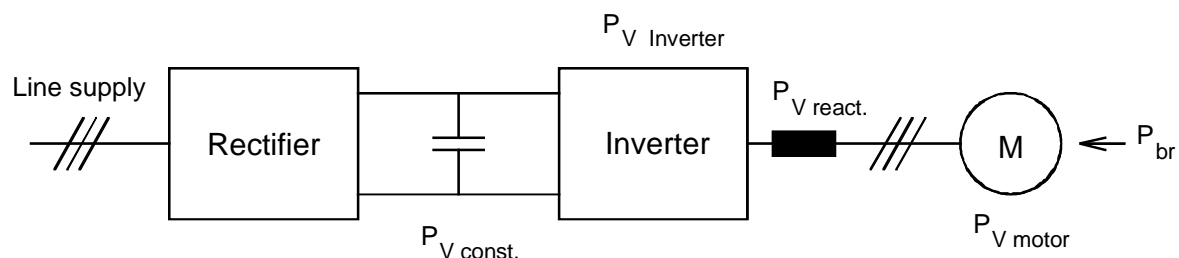

The motor braking power may not exceed the sum of the losses in the motor, in the output reactor, in the inverter and in the power supply (constant losses). Thus, the following must be true:

$$P_{V \text{ Mot}} + P_{V \text{ react}} + P_{V \text{ inv.}} + P_{V \text{ const}} \geq P_{br}$$

With

$$P_{br} = \frac{M_{br} \cdot n_{Mot}}{9550}$$

the following is obtained:

$$M_{br} \leq \frac{(P_{V \text{ Mot}} + P_{V \text{ react.r}} + P_{V \text{ inv.}} + P_{V \text{ const}}) \cdot 9550}{n_{Mot}}$$

There is somewhat of a problem in so much that the inverter losses are load-dependent, and the motor- and reactor losses, load- and speed-dependent. As the speed decreases, the iron losses of the motor and reactor decrease while the current-dependent losses of the motor, reactor and inverter increase due to the increasing braking torque. As a first approximation, it is assumed that the sum of the losses is constant. As the expected braking torques at rated speed are low, an operating point close to the no-load motor is assumed. In this case, the magnetizing current can be considered to be the motor current. Thus, useable results can be obtained at rated speed using the formula above for the braking torque. The calculation becomes increasingly more inaccurate as the speed decreases.

For  $I_{Mot} \approx I_{mag}$ , the losses at rated speed can be estimated as follows:

$$P_{V \text{ Mot}} \approx 0.4 \dots 0.5 \cdot P_{V \text{ Mot } n} = 0.4 \dots 0.5 \cdot P_{Mot n} \cdot \left( \frac{1}{\eta_{Mot n}} - 1 \right)$$

$$P_{V \text{ Dr}} \approx P_{V \text{ Cu } n} \cdot \left( \frac{I_{mag}}{I_{Dr n}} \right)^2 + P_{V \text{ Fe } n}$$

$$P_{V \text{ inv.}} \approx (P_{V \text{ Dn}} + P_{V \text{ Sch } n} \cdot \frac{0.93}{3} \cdot \left( \frac{500}{400} \right)^2) \cdot \frac{I_{mag}}{I_{Un}}$$

The constant losses comprise of the losses of the power supply, switching losses in the DC link capacitors, and for small units, additionally the losses due to the DC fan.

### Examples for the losses and braking torques at rated speed

For a 4-pole 5.5 kW motor with output reactor connected to a 5.5 kW drive converter with 400 V supply voltage, the losses are given by:

$$\sum P_V \approx 0.58 \text{ kW}$$

or for the rated torque at rated speed:

$$M_{br} \approx \frac{\sum P_V \cdot 9550}{n_n} = \frac{0.58 \cdot 9550}{1450} = 3.82 \text{ Nm}$$

This corresponds to 10.6% of the rated torque.

For a 4-pole 55 kW motor with output reactor connected to a 55 kW drive converter with 400 V supply voltage, the losses are given by:

$$\sum P_V \approx 2.07 \text{ kW}$$

and, at rated speed the torque is:

$$M_{br} \approx \frac{\sum P_V \cdot 9550}{n_n} = \frac{2.07 \cdot 9550}{1475} = 13.4 \text{ Nm}$$

This corresponds to 3.8% of the rated torque.

This means that the possible braking torque decreases with increasing power.

Calculating the braking time for a pure high-inertia drive (flywheel drive)

In this case

$$M_{br} = -J_{tot.} \cdot \frac{2\pi}{60} \cdot \frac{dn}{dt}$$

For a constant braking torque, a linear braking ramp is obtained with

$$t_{br} = \frac{J_{tot.} \cdot \pi \cdot n_{max}}{30 \cdot M_{br}}$$

If the equation, derived from the losses, is now used for  $M_{br}$

$$M_{br} = \frac{\sum P_V \cdot 9550}{n} = \frac{\sum P_V \cdot 9550}{n_{max}} \cdot \frac{n_{max}}{n} = M_{br n_{max}} \cdot \frac{n_{max}}{n}$$

then  $t$ , as a function of  $n$  is given by:

$$t = -\frac{J_{tot.} \cdot \pi}{30 \cdot M_{br n_{max}} \cdot n_{max}} \cdot \int_{n_{max}}^n n \, dn = \frac{J_{tot.} \cdot \pi}{60 \cdot M_{br n_{max}} \cdot n_{max}} \cdot (n_{max}^2 - n^2)$$

or

$$t_{br} = \frac{J_{tot.} \cdot \pi \cdot n_{max}}{60 \cdot M_{br n_{max}}}$$

The motor speed, as a function of time is:

$$n = \sqrt{n_{max}^2 - \frac{60 \cdot M_{br n_{max}} \cdot n_{max}}{J_{tot.} \cdot \pi} \cdot t}$$

The braking time, with the braking torque assumed as  $\sim 1/n$ , is precisely half as long as for a constant braking torque. It is assumed, that the  $U_{d max}$  control automatically ensures a down ramp with a square-root characteristic.



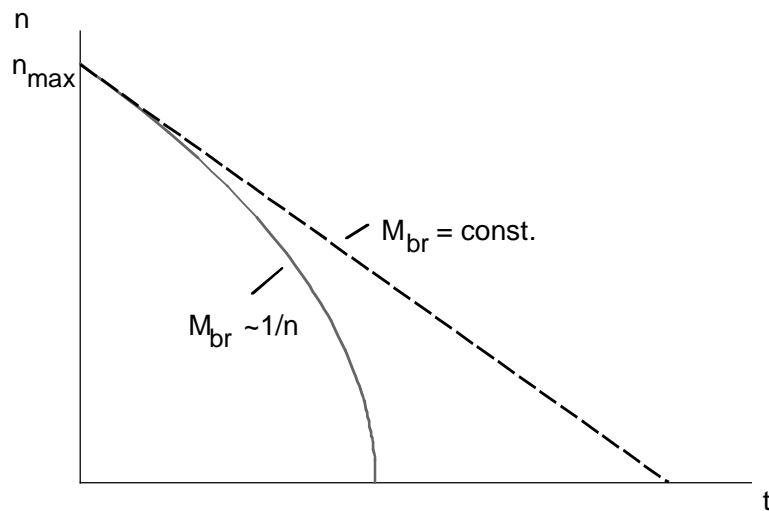

Example of a braking characteristic for a pure high-inertia drive (flywheel drive)

#### Calculating the braking time for a fan drive

In this case

$$M_{br} + M_{load} = -J_{tot.} \cdot \frac{2\pi}{60} \cdot \frac{dn}{dt}$$

The load torque of the fan is given by:

$$M_{load} = M_{load\ max} \cdot \left(\frac{n}{n_{max}}\right)^2$$

With

$$M_{br} = M_{br\ n_{max}} \cdot \frac{n_{max}}{n}$$

t, as a function of n, is given by:

$$t = -\frac{J_{tot.} \cdot \pi}{30} \cdot \int_{n_{max}}^n \frac{dn}{M_{br\ n_{max}} \cdot \frac{n_{max}}{n} + M_{load\ max} \cdot \left(\frac{n}{n_{max}}\right)^2}$$

$$= \frac{J_{tot.} \cdot \pi \cdot n_{max}^2}{30 \cdot M_{load\ max}} \cdot \left[ \frac{1}{6 \cdot a} \cdot \left( \ln \frac{|a^2 - a \cdot n_{max} + n_{max}^2|}{(a + n_{max})^2} - \ln \frac{|a^2 - a \cdot n + n^2|}{(a + n)^2} \right) + \frac{1}{a \cdot \sqrt{3}} \cdot \left( \arctan \left( \frac{2 \cdot n_{max} - a}{a \cdot \sqrt{3}} \right) - \arctan \left( \frac{2 \cdot n - a}{a \cdot \sqrt{3}} \right) \right) \right]$$

or

$$t_{br} = \frac{J_{tot.} \cdot \pi \cdot n_{max}^2}{30 \cdot M_{load\ max}} \cdot \left[ \frac{1}{6 \cdot a} \cdot \ln \frac{|a^2 - a \cdot n_{max} + n_{max}^2|}{(a + n_{max})^2} + \frac{1}{a \cdot \sqrt{3}} \cdot \left( \arctan \left( \frac{2 \cdot n_{max} - a}{a \cdot \sqrt{3}} \right) + \frac{\pi}{6} \right) \right]$$

With

$$a = n_{max} \cdot \sqrt[3]{\frac{M_{br\ n_{max}}}{M_{load\ max}}}$$

Without taking into account the motor braking torque, the speed, as a function of time, is given by:

$$n = \frac{1}{\frac{1}{n_{max}} + \frac{30 \cdot M_{load\ max} \cdot t}{J_{tot.} \cdot \pi \cdot n_{max}^2}}$$

Zero speed is in this case, only reached for  $t \rightarrow \infty$ .

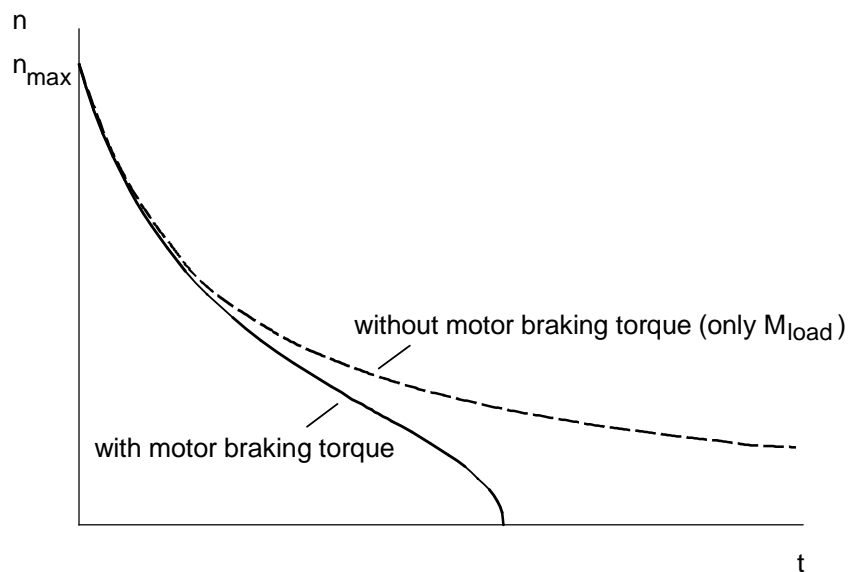

Example of a braking characteristic for a fan drive

### Summary

When braking using the losses, only low braking torques can be achieved at the rated operating point (approximately 2 to 10%  $M_n$  depending on the motor size). This technique can only be used, where, on one hand short braking times are not important, and where on the other hand, due to large moments of inertia and low friction losses, run-down takes minutes. This occurs, e.g. for large fan drives. In this case, at high speed, the load torque initially has a high braking effect, but which decreases according to an  $n^2$  function.

## 4.7.2 Braking time for a fan drive

The braking time is to be estimated for a 200 kW fan drive with 4-pole 1LA6 317-4.. motor and 200 kW drive converter connected to 400 V. There is no brake resistor.

*Drive data*

Rated motor current	$I_{\text{motor } n}$	= 345 A
Rated motor torque	$M_{\text{mot } n}$	= 1280 Nm
Motor efficiency for drive converter operation	$\eta_{\text{motor}}$	= 0.95
Motor magnetizing current	$I_{\text{mag}}$	= 107 A
Motor moment of inertia	$J_{\text{mot}}$	= 4.2 kgm <sup>2</sup>
Rated drive converter current	$I_{U n}$	= 370 A
Power requirement at $n_{\text{max}}$	$P_{\text{max}}$	= 196 kW
Maximum fan speed	$n_{\text{max}}$	= 1485 RPM
Moment of inertia of the fan	$J_{\text{load}}$	= 75 kgm <sup>2</sup>

Determining the losses at  $n_{\text{max}}$  with  $I_{\text{mot}}=I_{\text{mag}}$  (values for the drive converter from the Engineering Manual for Drive Converters)

$$P_{V \text{ Mot}} \approx 0.4 \cdot P_{\text{Mot } n} \cdot \left( \frac{1}{\eta_{\text{Mot } n}} - 1 \right) = 0.4 \cdot 200 \cdot \left( \frac{1}{0.95} - 1 \right) = 4.2 \text{ kW}$$

$$P_{V \text{ react.}} \approx P_{V \text{ Cu } n} \cdot \left( \frac{I_{\text{mag}}}{I_{\text{react. } n}} \right)^2 + P_{V \text{ Fe } n} = 0.138 \cdot \left( \frac{107}{370} \right)^2 + 0.088 = 0.1 \text{ kW}$$

$$P_{V \text{ inv.}} \approx (P_{V \text{ Dn}} + P_{V \text{ Schn}} \cdot \frac{0.93}{3} \cdot \left( \frac{500}{400} \right)^2) \cdot \frac{I_{\text{mag}}}{I_{U n}} = (3.02 + 0.89 \cdot \frac{0.93}{3} \cdot \left( \frac{500}{400} \right)^2) \cdot \frac{107}{370} = 1 \text{ kW}$$

$$P_{V \text{ const}} \approx 0.15 \text{ kW} \quad (\text{fan losses are subtracted})$$

Thus, the sum of the losses is

$$\sum P_V = 5.45 \text{ kW}$$

The braking time is now calculated with these losses which are assumed constant. It is assumed, that the closed-loop  $U_{d \text{ max}}$  control automatically defines the downramp.

Maximum load torque:

$$M_{load\ max} = \frac{P_{max} \cdot 9550}{n_{max}} = \frac{196 \cdot 9550}{1485} = 1260\ Nm$$

Motor braking torque at  $n_{max}$ :

$$M_{br\ n_{max}} = \frac{\sum P_V \cdot 9550}{n_{max}} = \frac{5.45 \cdot 9550}{1485} = 35\ Nm$$

Thus, the ratio of the braking torque to the rated motor torque at  $n_{max}$  is:

$$\frac{M_{br\ n_{max}}}{M_{Mot\ n}} = \frac{35}{1280} = 0.0273 = 2.73\%$$

At  $n_{max}$ , this braking torque is small with respect to the braking effect of the fan load torque. The braking effect due to losses only becomes effective at a lower speed.

Calculating the braking time

$$a = n_{max} \cdot \sqrt[3]{\frac{M_{br\ n_{max}}}{M_{load\ max}}} = 1485 \cdot \sqrt[3]{\frac{35}{1260}} = 449.74\ RPM$$

$$t_{br} = \frac{J_{tot} \cdot \pi \cdot n_{max}^2}{30 \cdot M_{load\ max}} \cdot \left[ \frac{1}{6 \cdot a} \cdot \ln \frac{|a^2 - a \cdot n_{max} + n_{max}^2|}{(a + n_{max})^2} + \frac{1}{a \cdot \sqrt{3}} \cdot \left( \arctan \left( \frac{2 \cdot n_{max} - a}{a \cdot \sqrt{3}} \right) + \frac{\pi}{6} \right) \right]$$

$$= \frac{79.2 \cdot \pi \cdot 1485^2}{30 \cdot 1260} \cdot \left[ \frac{1}{6 \cdot 449.74} \cdot \ln \frac{|449.74^2 - 449.74 \cdot 1485 + 1485^2|}{(449.74 + 1485)^2} + \frac{1}{449.74 \cdot \sqrt{3}} \cdot \left( \arctan \left( \frac{2 \cdot 1485 - 449.74}{449.74 \cdot \sqrt{3}} \right) + \frac{\pi}{6} \right) \right] = 29.32\ s$$



Braking characteristic for the fan drive

#### Estimating the influence of the energy which can be stored in the DC link capacitor

The closed-loop  $U_{dmax}$  control limits the DC link voltage to the following value in generator operation:

$$U_{DClink\ max} = 1.19 \cdot \sqrt{2} \cdot U_{line} = 1.19 \cdot \sqrt{2} \cdot 400 = 675\ V$$

The following is obtained for the energy which can be stored in the DC link capacitor with  $C_{DClink}=18.8\ mF$ :

$$W_C = \frac{1}{2} \cdot C_{DClink} \cdot (U_{DClink\ max}^2 - U_{DClink\ n}^2) = \frac{1}{2} \cdot 18.8 \cdot 10^{-3} \cdot (675^2 - 530^2) = 1.64\ kW_s$$

The average power which can be absorbed in the capacitor, during braking is given by:

$$P_{Cm} = \frac{W_C}{t_{br}} = \frac{1.64}{29.32} = 0.056\ kW$$

This component is low with respect to the total losses of 5.45 kW, and can therefore be neglected in the calculation.

### Comparison with DC braking

As a comparison, the possible braking torques using DC current braking will be estimated for this fan drive.

The DC current braking torque can be given by:

$$M_{br} \approx M_a \cdot \left(\frac{I_1}{I_a}\right)^2 \cdot \frac{1}{s + \frac{R_2^2}{X_h^2 \cdot s}}$$

with

$$s = \frac{n}{n_s} \quad \text{slip when braking}$$

$n_s$  synchronous speed

$I_a$  starting current (inrush current)

$M_a$  starting torque

$I_1$  equivalent three-phase current to generate the braking torque

$I_1$  can be converted as follows into a DC braking current  $I_g$ :

$$I_1 = \sqrt{\frac{2}{3}} \cdot I_g$$



Example of a braking torque curve for DC current braking

The braking torque, for speeds which are not too low, can be approximated as:

$$M_{br} \approx M_a \cdot \left(\frac{I_1}{I_a}\right)^2 \cdot \frac{n_s}{n} = M_a \cdot \frac{2}{3} \cdot \left(\frac{I_g}{I_a}\right)^2 \cdot \frac{n_s}{n} \sim \frac{1}{n}$$

Thus, also when braking using the losses, a braking torque is obtained which is proportional to  $1/n$ . This allows the braking torque to be calculated for the 200 kW motor at rated speed. With

$$I_a = 7 \cdot I_n = 7 \cdot 345 = 2415 \text{ A}$$

$$M_a = 2.7 \cdot M_n = 2.7 \cdot 1280 = 3456 \text{ Nm}$$

$$I_g = I_{Un} = 370 \text{ A} \quad (\text{braking with the rated drive converter current})$$

the following is obtained at rated speed ( $n_n \approx n_s$ )

$$M_{br} \approx 3456 \cdot \frac{2}{3} \cdot \left(\frac{370}{2415}\right)^2 = 54 \text{ Nm}$$

The braking torque which can be achieved with the rated drive converter current and DC current braking is therefore somewhat greater than the braking torque calculated using the losses (35 Nm).

Estimating the braking time

$$a = n_{\max} \cdot \sqrt[3]{\frac{M_{br n_{\max}}}{M_{load \max}}} = 1485 \cdot \sqrt[3]{\frac{54}{1260}} = 519.68 \text{ RPM}$$

$$t_{br} \approx \frac{J_{tot} \cdot \pi \cdot n_{\max}^2}{30 \cdot M_{load \max}} \cdot \left[ \frac{1}{6 \cdot a} \cdot \ln \frac{a^2 - a \cdot n_{\max} + n_{\max}^2}{(a + n_{\max})^2} + \frac{1}{a \cdot \sqrt{3}} \cdot \left( \arctan\left(\frac{2 \cdot n_{\max} - a}{a \cdot \sqrt{3}}\right) + \frac{\pi}{6} \right) \right]$$

$$= \frac{79.2 \cdot \pi \cdot 1485^2}{30 \cdot 1260} \cdot \left[ \frac{1}{6 \cdot 519.68} \cdot \ln \frac{519.68^2 - 519.68 \cdot 1485 + 1485^2}{(519.68 + 1485)^2} + \frac{1}{519.68 \cdot \sqrt{3}} \cdot \left( \arctan\left(\frac{2 \cdot 1485 - 519.68}{519.68 \cdot \sqrt{3}}\right) + \frac{\pi}{6} \right) \right] = 24.1 \text{ s}$$

A somewhat shorter braking time is obtained due to the higher braking torque. In comparison to braking using the losses, for DC current braking, the total motor braking power is converted in the rotor. In addition, stator copper losses occur due to the DC current supply.



## 4.8 Minimum acceleration time for fan drives with a linear acceleration characteristic

### 4.8.1 General information

The linear acceleration of a fan drive with square-law load torque characteristic is to be investigated. At starting, a breakaway torque, decreasing as square-law, must be additionally taken into account. The following is obtained for the load torque as a function of speed  $n$ :

$$M_{load} = M_{load\ max} \cdot \left(\frac{n}{n_{max}}\right)^2 + M_{LB} \cdot \left(1 - \frac{n}{n_{LB}}\right)^2 \quad 0 \leq n \leq n_{LB}$$

$$M_{load} = M_{load\ max} \cdot \left(\frac{n}{n_{max}}\right)^2 \quad n_{LB} \leq n \leq n_{max}$$



Example of a load torque characteristic with breakaway torque

The maximum motor torque during acceleration is obtained with  $M_{LB} < M_{load\ max}$

$$M_{Mot\ max} = (J_{Mot} + J_{load}) \cdot \alpha + M_{load\ max}$$

with

$$\alpha = \frac{2 \cdot \pi \cdot n_{max}}{60 \cdot t_H}$$

Thus, the minimum acceleration time is given by:

$$t_H = \frac{2 \cdot \pi \cdot n_{max} \cdot (J_{Mot} + J_{load})}{60 \cdot (M_{Mot\ max} - M_{load\ max})}$$

For the given drive converter, the maximum motor torque is obtained from the maximum permissible drive converter current  $I_{U \max} = I_{\text{mot max}}$ :

$$M_{\text{Mot max}} = \frac{M_{\text{Mot n}}}{kn} \cdot \sqrt{\frac{I_{U \max}^2 - \left(\frac{I_{\text{mag}}}{kn}\right)^2}{I_{\text{Mot n}}^2 - I_{\text{mag}}^2}}$$

$$kn = 1 \quad \text{for} \quad n_{\max} \leq n_n \quad \text{constant flux range}$$

$$kn = \frac{n_{\max}}{n_n} \quad \text{for} \quad n_{\max} > n_n \quad \text{field-weakening range}$$

The maximum motor torque should not exceed  $2 M_n$  for reasons of stability. For operation in the field-weakening range at  $n_{\max}$ , sufficient clearance must still be kept to the stall limit:

$$M_{\text{Mot max}} \leq \frac{M_{\text{stall}}}{1.3} \cdot \left(\frac{n_n}{n_{\max}}\right)^2$$

Thus, the maximum motor torque must lie below the following characteristic:



Where:

$$n_{\text{limit}} = n_n \cdot \sqrt{\frac{M_{\text{stall}}}{2 \cdot M_{\text{Mot n}} \cdot 1.3}}$$

We still have to check whether the motor RMS current (corresponds to the drive converter RMS current) is less than or equal to the rated drive converter current when accelerating. The motor RMS current is calculated in a 300 s interval. The following is valid for  $t_H \leq 300$  s:

$$I_{rms} = \sqrt{\frac{\int_0^{300\text{ s}} I_{Mot}^2 \cdot dt}{300\text{ s}}} = \sqrt{\frac{\int_0^{t_H} I_{Mot}^2 \cdot dt + I_{Mot\ k}^2 \cdot (300\text{ s} - t_H)}{300\text{ s}}}$$

$I_{Mot\ k}$  : constant motor current at the operating point  $M_{mot}=M_{load\ max}$



Example of the motor current characteristic ( $t_H \leq 300$  s)

If the acceleration time  $t_H$  is to be greater than 300 s, the interval from  $t_H - 300$ s to  $t_H$  is used in the calculation for the maximum RMS value during acceleration. The RMS value is then given by:

$$I_{rms\ max} = \sqrt{\frac{\int_{t_H - 300\text{ s}}^{t_H} I_{Mot}^2 \cdot dt}{300\text{ s}}}$$



Example for the motor current characteristic ( $t_H > 300$  s)

In order to calculate the RMS value, the motor current must be determined as a function of the time. The motor current is obtained as follows from the motor torque:

$$I_{Mot} = I_{Mot n} \cdot \sqrt{\left(\frac{M_{Mot}}{M_{Mot n}}\right)^2 \cdot \left(1 - \left(\frac{I_{mag}}{I_{Mot n}}\right)^2\right) \cdot kn^2 + \left(\frac{I_{mag}}{I_{Mot n}}\right)^2 \cdot \frac{1}{kn^2}}$$

$$kn = 1 \quad \text{for} \quad n \leq n_n$$

$$kn = \frac{n}{n_n} \quad \text{for} \quad n > n_n$$

The motor torque during acceleration is given by:

$$M_{Mot} = (J_{Mot} + J_{load}) \cdot \alpha + M_{load}(n)$$

After acceleration, the following is true

$$M_{Mot} = M_{load \max}$$

For  $M_{load}(n)$  and  $\alpha$ , the equations shown at the beginning of this text are valid. The following is now inserted for  $n$ :

$$n = n_{\max} \cdot \frac{t}{t_H} \quad (\text{linear acceleration})$$

The motor current is then known as a function of time. The RMS value is calculated for  $t_H \leq 300$  s in 4 ranges:

$$0 \leq t \leq \frac{n_{LB}}{n_{max}} \cdot t_H \quad \text{breakaway, constant flux range}$$

$$\frac{n_{LB}}{n_{max}} \cdot t_H < t \leq \frac{n_n}{n_{max}} \cdot t_H \quad \text{constant flux range}$$

$$\frac{n_n}{n_{max}} \cdot t_H < t \leq t_H \quad \text{field-weakening range (if available)}$$

$$t_H < t \leq 300 \text{ s} \quad \text{steady-state with } M_{mot} = M_{load \max}$$

For  $t_H > 300$  s, the last range is eliminated, and the starting point for the calculation is within one of the first 3 ranges.

The integral to calculate the RMS value is numerically evaluated using an Excel table. Further, the table of the curve output is used as Excel graphics.

i	$t_i$	$n_i$	$M_{load \ i}$	$M_{mot \ i}$	$kn_i$	$I_{mot \ i}$	$\approx \int I_{Mot}^2 \cdot dt$
0	0	0	$M_{LB}$	..	1	..	0
1	..	..	..	..	..	..	..
2	..	..	..	..	..	..	..
..	$t(n_{LB})$	$n_{LB}$					
	$t(n_n)$	$n_n$			1		
	$t_H$	$n_{max}$	$M_{load \ max}$	$M_{mot \ max}$	$n_i/n_n$	$I_{mot \ max}$	
m-1	$t_H$	$n_{max}$	$M_{load \ max}$	$M_{load \ max}$		$I_{mot \ k}$	
m	300 s	$n_{max}$	$M_{load \ max}$	$M_{load \ max}$		$I_{mot \ k}$	$I_{rms}^2 \cdot 300 \text{ s}$

Calculation table for  $t_H \leq 300$  s

The following is formed in the last column:

$$\sum_{i=1}^{i=m} \left( \frac{I_{Mot \ i-1} + I_{Mot \ i}}{2} \right)^2 \cdot (t_i - t_{i-1})$$

This approximately corresponds to the expression:

$$\int_0^{300 \text{ s}} I_{Mot}^2 \cdot dt \quad \text{or} \quad \int_0^{t_H} I_{Mot}^2 \cdot dt + I_{Mot k}^2 \cdot (300 \text{ s} - t_H)$$

A zero is in the first line (i=0).

### 4.8.2 Example

The minimum acceleration time for linear acceleration for a fan drive with breakaway torque, decreasing according to a square-law characteristic, is to be calculated. Further, the RMS value of the drive converter current when accelerating, should be checked. The output of the 4-pole fan motor is 90 kW for a 400 V volt supply voltage. A 90 kW drive converter is used.

#### Drive data

Rated motor output	$P_{\text{mot } n}$	= 90 kW
Rated motor torque	$M_{\text{mot } n}$	= 581 Nm
Rated motor current	$I_{\text{mot } n}$	= 160 A
Magnetizing current	$I_{\text{mag}}$	= 52.8 A
Rated motor speed	$n_n$	= 1480 RPM
Max. speed	$n_{\text{max}}$	= 1600 RPM
Motor moment of inertia	$J_{\text{mot}}$	= 1.6 kgm <sup>2</sup>
Stall torque	$M_{\text{stall}}$	= 1568.7 Nm
Load moment of inertia	$J_{\text{load}}$	= 200 kgm <sup>2</sup>
Max. load torque	$M_{\text{load max}}$	= 500 Nm
Fan breakaway torque	$M_{\text{LB}}$	= 100 Nm
Fan breakaway speed	$n_{\text{LB}}$	= 200 RPM
Rated drive converter current	$I_{U n}$	= 186 A
Max. drive converter current	$I_{U \text{max}}$	= 253 A

The max. motor torque is given by

$$kn = \frac{n_{\text{max}}}{n_n} = \frac{1600}{1480} = 1.081$$

for

$$M_{\text{Mot max}} = \frac{M_{\text{Mot } n}}{kn} \cdot \sqrt{\frac{I_{U \text{max}}^2 - \left(\frac{I_{\text{mag}}}{kn}\right)^2}{I_{\text{Mot } n}^2 - I_{\text{mag}}^2}} = \frac{581}{1.081} \cdot \sqrt{\frac{253^2 - \left(\frac{52.8}{1.081}\right)^2}{160^2 - 52.8^2}} = 883.3 \text{ Nm} < 2 \cdot M_{\text{Mot } n}$$

Thus, the minimum acceleration time is given by:

$$t_H = \frac{2 \cdot \pi \cdot n_{\text{max}} \cdot (J_{\text{Mot}} + J_{\text{load}})}{60 \cdot (M_{\text{Mot max}} - M_{\text{load max}})} = \frac{2 \cdot \pi \cdot 1600 \cdot (1.6 + 200)}{60 \cdot (883.3 - 500)} = 88.13 \text{ s} < 300 \text{ s}$$

Checking the stall limit:

$$\frac{M_{stall}}{1.3} \cdot \left(\frac{n_n}{n_{max}}\right)^2 = \frac{1568.7}{1.3} \cdot \left(\frac{1480}{1600}\right)^2 = 1032.5 \text{ Nm} > M_{Mot \text{ max}}$$

In order to calculate the RMS value, the speed range from 0 to  $n_{LB}$  is sub-divided into 5 identical sections, the speed range from  $n_{LB}$  up to  $n_n$ , into 10 identical sections, and the speed range from  $n_n$  to  $n_{max}$ , into 5 identical sections. Time  $t_i$  is calculated over the speed  $n_i$  as follows:

$$t_i = \frac{n_i}{n_{max}} \cdot t_H$$

Thus, the following calculation table is obtained.

i	t i	n i	M load i	M mot i	kn i	I mot i	$\approx \int I_{Mot}^2 \cdot dt$
0	0	0	100	483,298127		1 136,282178	0
1	2,20314175	40	64,3125014	447,610629		1 127,779981	38405,6206
2	4,40628349	80	37,2500055	420,548133		1 121,408307	72606,5335
3	6,60942524	120	18,8125123	402,11064		1 117,11084	103941,479
4	8,81256698	160	9,00002188	392,298149		1 114,83971	133574,318
5	11,0157087	200	7,81253418	391,110662		1 114,565661	162560,407
6	18,0657623	328	21,0125919	404,310719		1 117,621629	257579,157
7	25,1158159	456	40,6126777	423,910805		1 122,196064	358945,754
8	32,1658695	584	66,6127914	449,910919		1 128,324764	469562,303
9	39,2159231	712	99,0129332	482,311061		1 136,045657	592747,395
10	46,2659766	840	137,813103	521,11123		1 145,394241	732353,29
11	53,3160302	968	183,013301	566,311428		1 156,400536	892883,165
12	60,3660838	1096	234,613526	617,911654		1 169,087684	1079608,38
13	67,4161374	1224	292,61378	675,911908		1 183,471912	1298685,75
14	74,466191	1352	357,014062	740,312189		1 199,563359	1557274,69
15	81,5162446	1480	427,814372	811,112499		1 217,367301	1863654,47
16	82,8381296	1504	441,801933	825,10006	1,01621622	224,078497	1928054,86
17	84,1600147	1528	456,014495	839,312622	1,03243243	230,99668	1996493,28
18	85,4818997	1552	470,452058	853,750186	1,04864865	238,122442	2069221
19	86,8037848	1576	485,114622	868,41275	1,06486486	245,456565	2146501,26
20	88,1256698	1600	500,000000	883,300315	1,08108108	253	2228609,8
21	88,1256698	1600	500,000000	500,000000	1,08108108	148,765367	2228609,8
22	300	1600	500,000000	500,000000	1,08108108	148,765367	6917629,08

The RMS value is then obtained using the last value from the column  $\approx \int I_{Mot}^2 \cdot dt$ :

$$I_{rms} = \sqrt{\frac{6917629}{300}} = 151.8 \text{ A} < I_{Un}$$





Load torque, motor torque and permissible torque as a function of the speed



Motor current in a 300 s interval during acceleration and after acceleration

## 4.9 Buffering multi-motor drives with kinetic energy

### 4.9.1 General information

In addition to buffering the system at power failure using additional capacitors in the DC link, it is also possible to buffer the system using the kinetic energy of the drives. For a multi-motor drive with common DC link bus, for stability reasons, only one drive can be used for the kinetic buffering. This drive must have sufficient kinetic energy, to cover the power requirement of the multi-motor drive during the power failure (power outage) time. During the buffering phase, the speed of the buffer drive drops, depending on the moment of inertia and the power requirement. If a specific speed ratio is required for the individual drives, then this must be ensured using the buffer drive as master drive.

If, within the multi-motor group, there is no drive with sufficient kinetic energy, then an additional motor with coupled flywheel can be used as buffer drive. This motor is connected to the common DC link bus via an appropriate inverter. With this arrangement, the speed of the driven loads can be maintained during buffering, only the speed of the buffer drive decreases.

The kinetic buffering function must be activated for all inverters. For the buffer drive inverter, the threshold when the kinetic buffering kicks-in, must be set as high as possible (e.g. 85%); for all of the other inverters, it should be set as low as possible (e.g. 65%). This prevents the drives from mutually influencing one another. The kinetic buffering is activated in the inverters of the remaining drives to prevent shutdown with DC link undervoltage.

When dimensioning the system, it must be taken into account, that during buffering, the required power of the remaining drives including the losses, flows through the motor and the inverter of the buffer drive. For reasons of stability, the motor torque of the buffer drive should not exceed the rated torque.



Power relationships during buffering

#### Buffering using a drive in the multi-motor drive group

For simplification, all drives are considered to be constant-torque drives. Only the moment of inertia of the buffer drive is taken into account. During buffering, the speed ratios should be maintained between the drives. The required power in the DC link during buffering is then obtained from:

$$P_{DClink} = \sum_i \frac{P_{load\ max\ i}}{\eta_{Mot\ i} \cdot \eta_{WR}} \cdot \frac{\omega_{Mot\ P}}{\omega_{Mot\ P\ max}} \quad \text{motoring}$$

The buffer drive feeds back into the DC link:

$$P_{DClink} = P_{Mot\ P} \cdot \eta_{Mot\ P} \cdot \eta_{WR} \quad \text{generating}$$

The following must be true:

$$\sum_i \frac{P_{load\ max\ i}}{\eta_{Mot\ i} \cdot \eta_{WR}} \cdot \frac{\omega_{Mot\ P}}{\omega_{Mot\ P\ max}} = -P_{Mot\ P} \cdot \eta_{Mot\ P} \cdot \eta_{WR}$$

During buffering, the buffer drive must provide a variable-speed power of

$$P_{Mot P} = - \sum_i \frac{P_{load\ max\ i}}{\eta_{Mot\ i} \cdot \eta_{Mot\ P} \cdot \eta_{WR}^2} \cdot \frac{\omega_{Mot\ P}}{\omega_{Mot\ P\ max}} = -P_{erf\ max} \cdot \frac{\omega_{Mot\ P}}{\omega_{Mot\ P\ max}}$$

The following is true:

$$P_{Mot P} = M_{Mot P} \cdot \omega_{Mot P} = (J_P \cdot \frac{d\omega_{Mot P}}{dt} + M_{load P}) \cdot \omega_{Mot P} = -P_{kin} + P_{load P}$$

A linear speed reduction is obtained with the simplifications/approximations which have been made. It is:

$$\frac{d\omega_{Mot P}}{dt} = - \frac{1}{J_P} \left( \frac{P_{erf\ max}}{\omega_{Mot P\ max}} + M_{load P} \right)$$

with

$$\omega_{Mot P} = \frac{2 \cdot \pi \cdot n_{Mot P}}{60}$$

$n_{Mot P}$ : buffer drive speed

$n_{Mot P\ max}$ : buffer drive speed at the start of buffering

$J_P$ : moment of inertia of the buffer drive including motor

For the characteristics of the motor speed of the buffer drive with respect to time, during buffering, the following expression is obtained:

$$n_{Mot P} = n_{Mot P\ max} - \frac{60}{2 \cdot \pi \cdot J_P} \cdot \left( \frac{P_{erf\ max}}{\omega_{Mot P\ max}} + M_{Last P} \right) \cdot t$$

The motor torque of the buffer drive should not be greater than the rated torque during buffering, i.e.:

$$M_{Mot P} \leq M_{Mot P n}$$

With

$$M_{Mot P} = \frac{P_{Mot P}}{\omega_{Mot P}} = \frac{P_{erf\ max}}{\omega_{Mot P\ max}} = \text{constant}$$

the max. required power is given by the following:

$$P_{erf\ max} \leq M_{Mot P n} \cdot \omega_{Mot P\ max}$$

### Buffering via an additional buffer drive

The speed of the driven load should, during buffering, be maintained for a specific time  $t_p$ . The following is therefore true for the power required in the DC link:

$$P_{DClink} = \sum_i \frac{P_{load\ i}}{\eta_{Mot\ i} \cdot \eta_{WR}} \quad \text{motoring}$$

The buffer drive feeds back into the DC link (regenerative power):

$$P_{DClink} = P_{Mot\ P} \cdot \eta_{Mot\ P} \cdot \eta_{WR} \quad \text{generating}$$

Thus, during buffering, the buffer drive must provide a constant power of

$$P_{Mot\ P} = - \sum_i \frac{P_{load\ i}}{\eta_{Mot\ i} \cdot \eta_{Mot\ P} \cdot \eta_{WR}^2} = -P_{erf}$$

The energy is given by:

$$W_P = W_{kin} = \frac{1}{2} \cdot J_P \cdot (\omega_{Mot\ P\ max}^2 - \omega_{Mot\ P\ min}^2) = P_{erf} \cdot t_P$$

For the characteristics of the motor speed of the buffer drive over time, during buffering, the following expression is obtained:

$$n_{Mot\ P} = \frac{60}{2 \cdot \pi} \cdot \sqrt{\omega_{Mot\ P\ n}^2 - \frac{2 \cdot P_{erf}}{J_P} \cdot t}$$

The motor torque of the buffer drive is given by

$$M_{Mot\ P} = \frac{P_{erf}}{\omega_{Mot\ P}} \quad \text{increases with decreasing speed}$$

At  $\omega_{mot\ P} = \omega_{mot\ P\ min}$ , it should be the same as the rated torque. If the buffer drive is only used up to the rated speed, i.e.  $\omega_{mot\ P\ max} = \omega_{mot\ P\ n}$ , then the required rated motor output is given by:

$$P_{Mot\ P\ n} = M_{Mot\ P\ n} \cdot \omega_{Mot\ P\ n} = P_{erf} \cdot \frac{\omega_{Mot\ P\ n}}{\omega_{Mot\ P\ min}}$$

The required rated motor output therefore increases with  $\omega_{mot\ P\ n} / \omega_{mot\ P\ min}$ . Thus, for example,  $\omega_{mot\ P\ n} / \omega_{mot\ P\ min}$  is set to 1.1. The required quantities are obtained as follows:

$$P_{Mot\ P\ n} = P_{erf} \cdot 1.1$$

$$J_P = J_{Mot\ P} + J_{sup\ pl} = \frac{2 \cdot P_{erf} \cdot t_P}{\omega_{Mot\ P\ n}^2 \cdot \left(1 - \frac{1}{1.1^2}\right)}$$

with

$$\omega_{Mot P n} = \frac{2 \cdot \pi \cdot n_{Mot P n}}{60}$$

As the  $\eta_{mot P}$  and  $n_{mot P n}$  values, required to calculate  $P_{erf}$  and  $J_P$ , are still not known, a motor must be assumed.

#### 4.9.2 Example for buffering with an additional buffer drive

A multi-motor drive, comprising 5 motors 30 kW/4-pole, 5 inverters 30 kW and a rectifier unit 160 kW, should continue to operate for a maximum of 1 second with the same motor speeds when power failures occur. The power requirement is 150 kW. The required energy during buffering, including the losses, should be covered by the kinetic energy of a high-inertia flywheel load. In this case an additional inverter with induction motor and coupled flywheel should be connected. With this arrangement, the speed of the driven loads can be maintained during buffering; only the buffer drive speed decreases (flywheel drive). The following configuration is obtained.



When the system is powered-up, at first, the induction motor with the coupled flywheel is accelerated. The driven loads are then powered-up. This prevents the rectifier unit from being overloaded. In operation, the buffer drive practically only draws the reactive power. The DC link current of the associated inverter is therefore  $\approx 0$ , as only the losses of the motor, running under no-load conditions, and the inverter losses have to be covered. When a power failure occurs, the buffer drive supplies the required power to the DC link.

Dimensioning the buffer drive

For the given multi-motor drive, with the following data

$$P_{load} = 30 \text{ kW} \quad (\text{the same load for every motor}),$$

$$\eta_{Mot} = 0.918$$

the following dimensioning data are obtained for the buffer drive. In this case, a 2-pole motor is to be used. The following assumption is made: A 200 kW motor with  $\eta_{mot P} = 0.959$  and  $n_{mot P n} = 2980$  RPM. The inverter efficiency is assumed to be  $\eta_{INV} = 0.98$ . The following is therefore obtained:

$$P_{erf} = \sum_i \frac{P_{load i}}{\eta_{Mot i} \cdot \eta_{Mot P} \cdot \eta_{WR}^2} = 5 \cdot \frac{30}{0.918 \cdot 0.959 \cdot 0.98^2} = 177.4 \text{ kW}$$

$$P_{Mot P n} = P_{erf} \cdot 1.1 = 177.4 \cdot 1.2 = 195.2 \text{ kW}$$

$$\omega_{Mot P n} = \frac{2 \cdot \pi \cdot n_{Mot P n}}{60} = \frac{2 \cdot \pi \cdot 2980}{60} = 312.06 \text{ s}^{-1}$$

$$J_P = \frac{2 \cdot P_{erf} \cdot t_P}{\omega_{Mot P n}^2 \cdot \left(1 - \frac{1}{1.1^2}\right)} = \frac{2 \cdot 177.4 \cdot 10^3 \cdot 1}{312.06^2 \cdot \left(1 - \frac{1}{1.1^2}\right)} = 21 \text{ kgm}^2$$

The minimum motor speed of the buffer drive is given by:

$$n_{Mot P \min} = \frac{n_{Mot P n}}{1.1} = \frac{2980}{1.1} = 2709 \text{ RPM}$$

Thus, a 200 kW motor 1LA6 317-2AC.. and a 200 kW inverter 6SE7033-7TG60 with vector control is therefore used for the buffer drive. The additional moment of inertia is then given by:

$$J_{sup pl} = J_P - J_{Mot} = 21 - 2.3 = 18.7 \text{ kgm}^2$$

The calculated additional moment of inertia can, for example, be implemented using a steel flywheel. The following is valid:

$$J = \frac{\pi}{2} \cdot d \cdot 7.85 \cdot r^4 \cdot 1000 \quad [\text{kgm}^2] \quad d, r \text{ in m}$$

The following is obtained for r if d is set to 0.1 m:

$$r = \sqrt[4]{\frac{2 \cdot J}{\pi \cdot d \cdot \rho \cdot 10^3}} = \sqrt[4]{\frac{2 \cdot 18.7}{\pi \cdot 0.1 \cdot 7.85 \cdot 10^3}} = 0.351 \text{ m}$$



The diameter of the 10 cm thick flywheel is therefore 70.2 cm.

The additional 200 kW inverter in conjunction with the 160 kW rectifier unit is permissible, as, in operation, the buffer drive practically requires no active power, and, additionally, the following condition is fulfilled:

$$P_{EE} \geq 0.3 \cdot \sum P_{inv.} = 0.3 \cdot (5 \cdot 30 + 200) = 105 \text{ kW}$$

In order not to overload the rectifier unit while the flywheel drive is accelerating, the acceleration time is, for example, adjusted, so that when the rated speed is reached, precisely 160 kW motor output is required (=rated output of the rectifier unit). The motor output is given by:

$$P_{Mot P \max} = M_b \cdot \omega_{Mot P n} = J_P \cdot \frac{\omega_{Mot P n}}{t_H} \cdot \omega_{Mot P n} = J_P \cdot \left( \frac{2 \cdot \pi \cdot n_{Mot P n}}{60} \right)^2 \cdot \frac{1}{t_H}$$

or for the acceleration time:

$$t_H = J_P \cdot \left( \frac{2 \cdot \pi \cdot n_{Mot P n}}{60} \right)^2 \cdot \frac{1}{P_{Mot P \max}} = 21 \cdot \left( \frac{2 \cdot \pi \cdot 2980}{60} \right)^2 \cdot \frac{1}{160 \cdot 10^3} = 12.8 \text{ s}$$

As the acceleration time in this case, is less than 60 s, a shorter acceleration time can be achieved by utilizing the overload capability of the rectifier unit.

### Checking the inverter rating

For the multi-motor drive inverters, it must be observed, that the connected motors must go into the field-weakening mode earlier, due to the fact that the DC link voltage is reduced to 85% in buffer operation. This means that a higher current is drawn. Depending on the pre-loading condition and duration of the buffer time, this can result in an inverter overload. The maximum motor current in field-weakening operation is given by:

$$I_{Mot \max} = I_{Mot n} \cdot \sqrt{\left( \frac{M_{load}}{M_{Mot n}} \right)^2 \cdot \left( 1 - \left( \frac{I_{mag}}{I_{Mot n}} \right)^2 \right) \cdot kn^2 + \left( \frac{I_{mag}}{I_{Mot n}} \right)^2 \cdot \frac{1}{kn^2}}$$

$$kn = \frac{n_{Mot \max}}{0.85 \cdot n_{Mot n}}$$

In this particular case, the 30 kW motors are operated with rated torque and rated speed. Then the following is true:

$$\frac{M_{load}}{M_{Mot n}} = 1$$

$$kn = \frac{n_{Mot n}}{0.85 \cdot n_{Mot n}} = \frac{1}{0.85}$$

With

$$\frac{I_{mag}}{I_{Mot n}} = 0.41$$

$$I_{Mot n} = 55 \text{ A}$$

the maximum motor current is given by:

$$I_{Mot max} = 62 \text{ A}$$

The RMS value in a 300 s interval is then calculated as follows:

$$I_{eff} = \sqrt{\frac{I_{Mot max}^2 \cdot t_P + I_{Mot n}^2 \cdot (300 - t_P)}{300}} = \sqrt{\frac{62^2 \cdot 1 + 55^2 \cdot (300 - 1)}{300}} = 55.02 \text{ A}$$

The 30 kW inverter, with a rated current of 59 A and a maximum current of 80.2 A, are therefore adequately dimensioned. For the inverter of the buffer drive, there are practically no restrictions due to the reduced DC link voltage, as in this case, there is no pre-loading, and because, at  $n_{mot P max}$ , the motor current increase as a result of the field-weakening factor  $kn=1/0.85$ , is partially compensated by the low motor torque ( $M_{mot P}=M_{mot P n}/1.1$ ).

## 4.10 Harmonics fed back into the supply in regenerative operation

Presently, harmonics fed back into the supply can only be calculated using the PATH configuring program, for 1Q operation. Thus, the basic differences between motoring using an uncontrolled rectifier and generating using a rectifier/regenerative feedback unit are to be investigated here. The following equivalent circuit diagrams are used as basis for these investigations.



Equivalent circuit diagram when motoring with an uncontrolled rectifier



Equivalent circuit diagram when generating with a rectifier/regenerative feedback unit

The load current  $I_{load}$  is assumed to be constant. It is calculated as follows:

$$I_{load} = \frac{P_{Mot}}{U_{DC\ link} \cdot \eta_{Mot} \cdot \eta_{INV}} \quad \text{motoring}$$

$$I_{load} = \frac{P_{Mot} \cdot \eta_{Mot} \cdot \eta_{INV}}{U_{DC\ link}} \quad \text{generating}$$

The approximate DC link voltage is obtained, when motoring, without taking into account the voltage drops as follows:

$$U_{DC\ link} \approx 1.35 \cdot U_{supply}$$

When generating with the rectifier/regenerative feedback unit, the DC link voltage is specified through the closed-loop control.

The DC link capacitor  $C_{DC\ link}$  is provided through the inverter or drive converter. The inductance  $L_{supply}$  is calculated from the fault level on the high voltage side  $S_{KHS}$ , the nominal transformer rating  $S_{Trn}$ , the  $u_k$  of the transformer, the  $u_k$  of the commutating reactor and the rated apparent power of the inverter or inverter  $S_{Un}$ . For regenerative operation with the rectifier/regenerative feedback unit, the autotransformer  $u_k$  is also included. The total inductance  $L_{supply}$  is given by:

$$L_{supply} = L'_{KHS} + L_{KTr} + L_{KDr} + (L_{KSpTr})$$

with

$$L'_{KHS} = \frac{U_{supply}^2}{S_{KHS} \cdot \omega} \quad \text{component of the high voltage network}$$

$$L_{KTr} = \frac{U_{supply}^2 \cdot u_{kTr}}{S_{Trn} \cdot \omega} \quad \text{component of the converter transformer}$$

$$L_{KDr} = \frac{U_{supply}^2 \cdot u_{kDr}}{S_{Un} \cdot \omega} \quad \text{component of the reactor}$$

$$L_{KSpTr} = \frac{U_{supply}^2 \cdot u_{kSpTr}}{S_{Un} \cdot \omega} \quad \text{component of the autotransformer}$$

(for rectifier/regenerative feedback unit)

$$\omega = 2 \cdot \pi \cdot f$$

When calculating using an Excel/VBA program, the characteristics of the line current over 3 periods of the line supply voltage are calculated, starting from practical initial values. The steady-state condition is then achieved. The 4th period is therefore output, and Fourier analysis applied. Depending on the load and line supply inductance, operation with continuous current or discontinuous current is obtained. When motoring using an uncontrolled rectifier, the DC link voltage is obtained according to the line supply voltage and load. The load current must be determined iteratively. When generating with a rectifier/regenerative feedback unit, the DC link voltage is controlled (closed-loop). The firing angle  $\alpha_{St}$  is therefore iteratively determined corresponding to the control input for the DC link voltage.

### Calculation example

For a drive with a 90 kW load, the relationships regarding the harmonics fed back into the line supply are to be investigated, when motoring/generating. When motoring, a 90 kW drive converter with 2%  $u_k$  line reactor is assumed, and for generating, a 90 kW inverter with 90 kW rectifier/regenerative feedback unit and 4%  $u_k$  line reactor. A  $u_k$  of 2% is assumed for the autotransformer. The data regarding supply voltage (2.2 kV/400 V), transformer ( $S_{Tr}=150$  kVA,  $u_{kTr}=4\%$ ) and line supply fault level ( $S_{KHS}=10$  MVA) are the same. The motor efficiency is 94.9% and the inverter efficiency is assumed to be 98%. The DC link capacitance of the drive converter and inverter is 12 mF.

The inductance  $L_{supply}$  is given by

$$L'_{KHS} = \frac{400^2}{10 \cdot 10^6 \cdot 314} = 51 \mu H$$

$$L_{KTr} = \frac{400^2 \cdot 0.04}{150 \cdot 10^3 \cdot 314} = 136 \mu H$$

$$L_{KDr 2\%} = \frac{400^2 \cdot 0.02}{\sqrt{3} \cdot 400 \cdot 186 \cdot 314} = 79 \mu H \quad (\text{with } I_{Un}=186 \text{ A})$$

$$L_{KDr 4\%} = 158 \mu H$$

$$L_{KSpTr 2\%} = 79 \mu H$$

to

$$L_{supply mot} = L_{KHS} + L_{KTr} + L_{KDr 2\%} = 266 \mu H$$

$$L_{supply gen} = L_{KHS} + L_{KTr} + L_{KDr 4\%} + L_{KSpTr 2\%} = 424 \mu H$$

The calculation results in a 521 V DC link voltage when motoring. The load current is then given by

$$I_{load} = \frac{P_{Mot}}{U_{DC\ link} \cdot \eta_{Mot} \cdot \eta_{INV}} = \frac{90 \cdot 10^3}{521 \cdot 0.949 \cdot 0.98} = 186\text{ A}$$

The same DC link voltage is assumed when generating. The load current is then obtained as follows

$$I_{load} = \frac{P_{Mot} \cdot \eta_{Mot} \cdot \eta_{INV}}{U_{DC\ link}} = \frac{90 \cdot 10^3 \cdot 0.949 \cdot 0.98}{521} = 161\text{ A}$$

#### Additional results

When motoring:

$I_{sup\ ply(1)} = 145.5\text{ A}$	basic line current fundamental, secondary side
$\cos \varphi_{(1)} = 0.963$	power factor of the basic fundamental
$I_{sup\ ply\ RMS} = 153.2\text{ A}$	RMS line current, secondary side
$DF_{sec} = 7.2\%$	distortion factor on the secondary side
$DF_{prim} = 2\%$	distortion factor on the primary side

Generating operation:

$I_{sup\ ply(1)} = 152\text{ A}$	basic fundamental of the line current, secondary side
$\cos \varphi_{(1)} = 0.796$	power factor of the basic fundamental
$I_{sup\ ply\ RMS} = 162.5\text{ A}$	RMS line current, secondary side
$DF_{sec} = 8.6\%$	distortion factor on the secondary side
$DF_{prim} = 2.4\%$	distortion factor on the primary side
$\alpha_{St} = 141.3^\circ$	rectifier firing angle

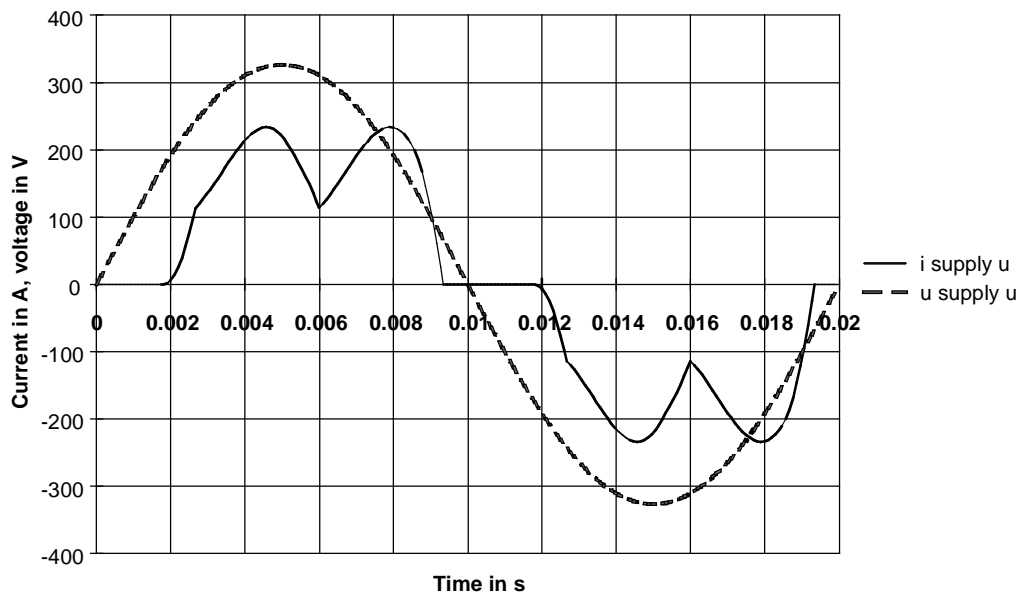

Line current and associated phase voltage when motoring

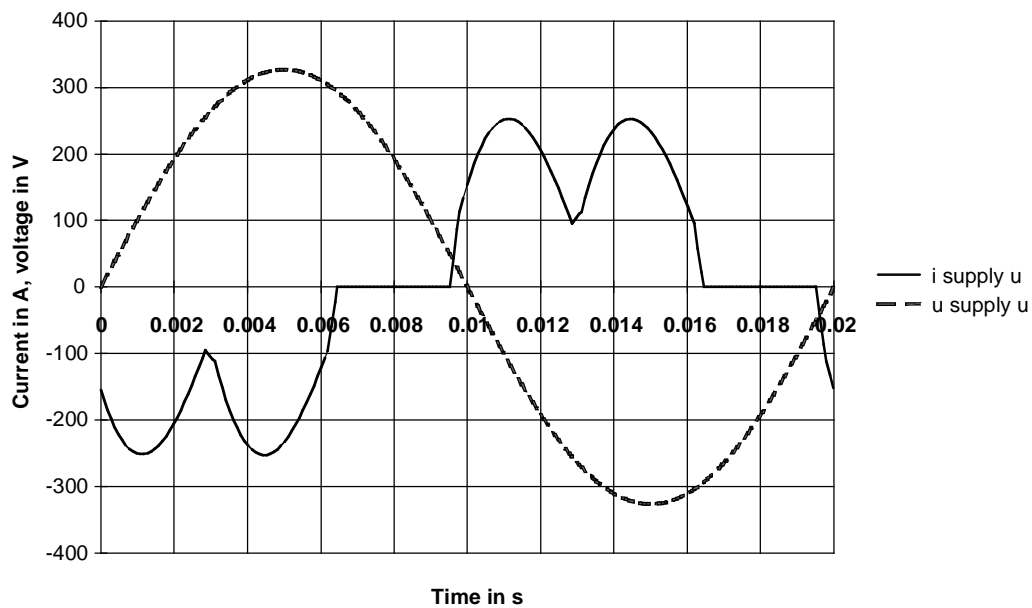

Line current and associated phase voltage when generating



DC link voltage and DC link current when motoring



DC link voltage and DC link current when generating



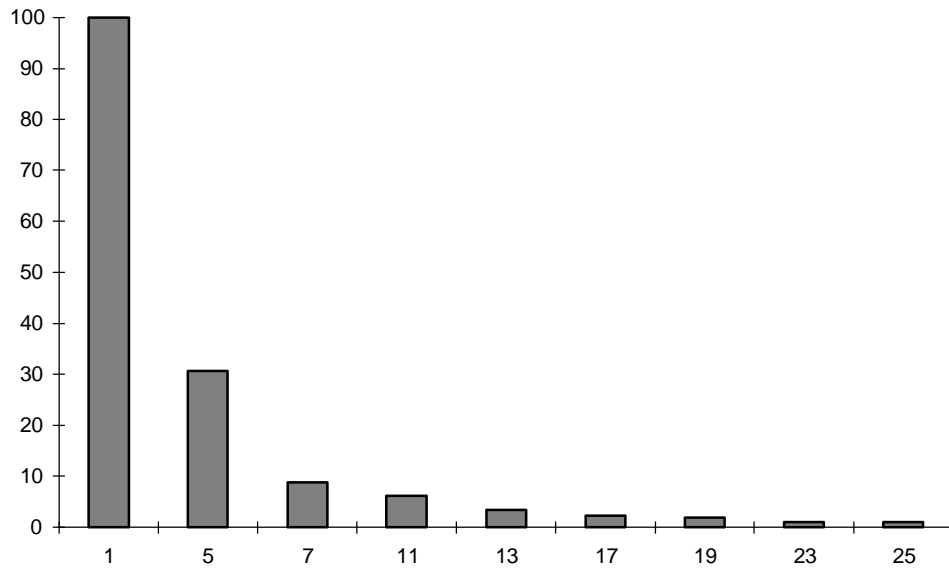

Line harmonic currents as a % of the basic fundamental when motoring



Line harmonic currents as a % of the basic fundamental when generating

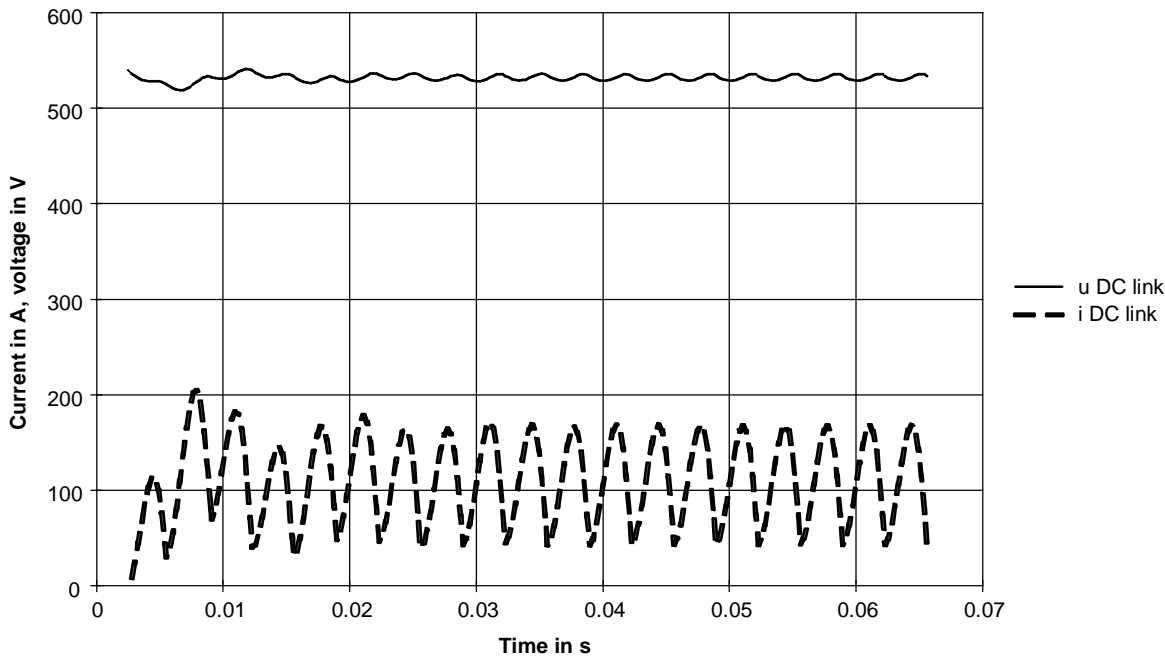

DC link current and DC link voltage stabilizing over three line supply periods when motoring

### Summary

When generating, the load current in the DC link is lower than when motoring, due to the influence of the efficiencies. However, a higher line current  $I_{\text{supply}(1)}$  is obtained than when motoring due to the fact that when generating, the  $\cos \varphi_{(1)}$  is poorer (the firing angle is not 0), and due to the ratio of the autotransformer of 1.2 (the current is transformed up).

In spite of the higher line inductance, higher harmonic currents are obtained due to the unfavorable firing angle of the rectifier when generating.

## 4.11 Calculating the braking energy of a mechanical brake

### 4.11.1 General information

Many drives are equipped with a mechanical holding brake. At standstill with the motor shutdown, this brake is intended to prevent any motion. This is extremely important for drives with a significant holding torque, for example, hoisting and elevator drives. When the electrical braking function fails, the mechanical holding brake must also assume an emergency stop function. Two examples to calculate the braking energy are now shown. As a result of supplementary torques (hoisting torque and frictional torque), with these examples, it is not possible to simply apply the condition "max. external moment of inertia = motor intrinsic moment of inertia".

### 4.11.2 Hoisting drive with counterweight

The braking energy is to be calculated for the most unfavorable case for a mechanical brake for a hoisting drive with counterweight. It has been assumed that the electrical braking has failed.

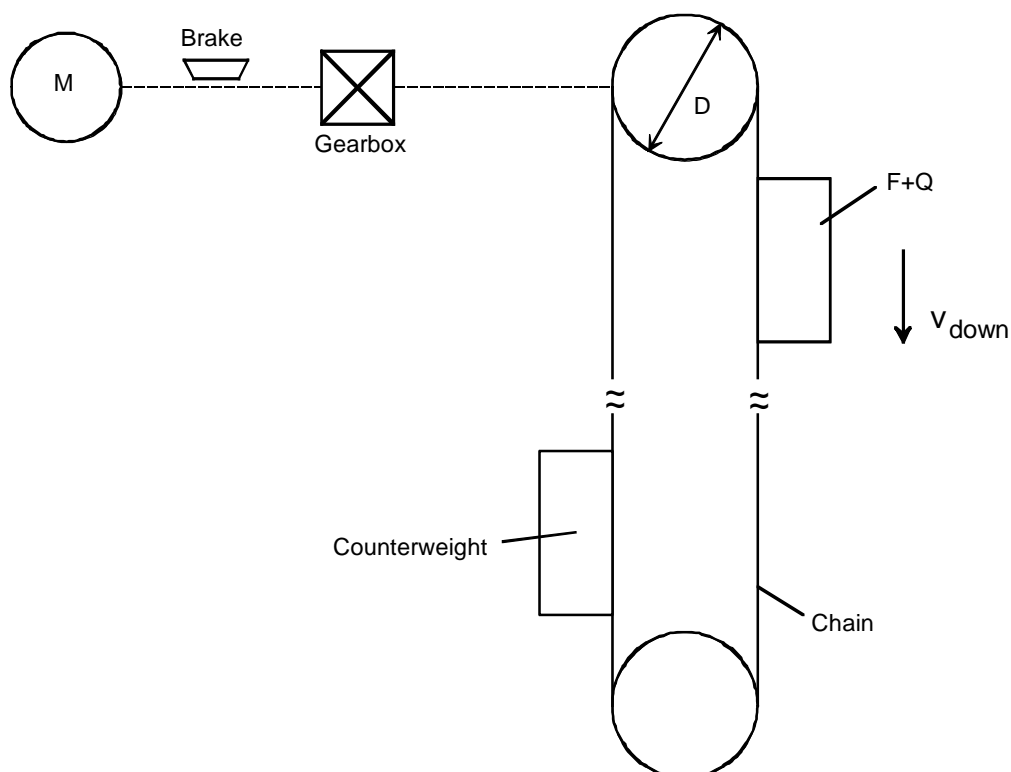

Block diagram of the hoisting drive

## Drive data

Weight of the elevator cabin	$m_F$	= 2000 kg
Weight of the load	$m_Q$	= 5100 kg
Weight of the counterweight	$m_G$	= 4500 kg
Weight of the chain	$m_{chain}$	= 200 kg
Moment of inertia, motor	$J_{Mot}$	= 0.36 kgm <sup>2</sup>
Moment of inertia, gearbox	$J_{gearbox}$	= 0.012 kgm <sup>2</sup>
Moment of inertia, brake	$J_{brake}$	= 0.02 kgm <sup>2</sup>
Gearbox ratio	$i$	= 16.79
Pulley diameter	$D$	= 0.26 m
Max. traversing velocity	$v_{max}$	= 1.3 m/s
Braking torque of the mechanical brake	$M_{br}$	= 400 Nm
Permissible braking energy of the mechanical brake	$W_{br max}$	= 100 kJ
Mechanical hoisting drive efficiency	$\eta_{mech}$	= 0.9
Gearbox efficiency	$\eta_{gearbox}$	= 0.95

The worst case is motion downwards at full velocity and with a full load. In this case, there is the highest kinetic energy and the mass difference acts to accelerate the cabin downwards. The braking energy can be calculated using the energy balance equation. The following is true:

$$W_{br} = W_{kin mot+Z} + \eta_{mech} \cdot \eta_{gearbox} \cdot (W_{kin load} + W_{pot load})$$

with

$$W_{kin mot+Z} = \frac{1}{2} \cdot (J_{mot} + J_{brake} + J_{gear}) \cdot (\omega_{mot max})^2 = \frac{1}{2} \cdot \sum J_{mot+Z} \cdot \left(i \cdot \frac{2 \cdot v_{max}}{D}\right)^2$$

$$W_{kin load} = \frac{1}{2} \cdot \sum m \cdot v_{max}^2$$

$$W_{pot load} = \Delta m \cdot g \cdot h$$

Further,

$$h = v_{max} \cdot \frac{t_{br}}{2}$$

$$W_{br} = M_{br} \cdot \omega_{mot \max} \cdot \frac{t_{br}}{2} = M_{br} \cdot i \cdot \frac{2 \cdot v_{\max}}{D} \cdot \frac{t_{br}}{2}$$

$$\sum m = m_F + m_Q + m_G + m_{chain}$$

$$\Delta m = m_F + m_Q - m_G$$

Appropriately combined, the following is obtained:

$$W_{br} = \frac{\frac{1}{2} \cdot \sum J_{mot+Z} \cdot \left(i \cdot \frac{2 \cdot v_{\max}}{D}\right)^2 + \eta_{mech} \cdot \eta_{gear} \cdot \frac{1}{2} \cdot \sum m \cdot v_{\max}^2}{1 - \frac{\eta_{mech} \cdot \eta_{gear} \cdot \Delta m \cdot g \cdot \frac{D}{2}}{M_{br} \cdot i}}$$

From this formula it can be seen that braking can only function, if:

$$M_{br} > \frac{\eta_{mech} \cdot \eta_{gear} \cdot \Delta m \cdot g \cdot \frac{D}{2}}{i}$$

The steady-state load torque, referred to the motor speed must therefore be lower than the braking torque of the mechanical brake which is available.

The following is obtained with the specified numbers:

$$\sum m = 2000 + 5100 + 4500 + 200 = 11800 \text{ kg}$$

$$\Delta m = 2000 + 5100 - 4500 = 2600 \text{ kg}$$

$$\sum J_{Mot+Z} = 0.36 + 0.02 + 0.012 = 0.392 \text{ kgm}^2$$

$$W_{br} = \frac{\frac{1}{2} \cdot 0.392 \cdot \left(16.79 \cdot \frac{2 \cdot 1.3}{0.26}\right)^2 + 0.9 \cdot 0.95 \cdot \frac{1}{2} \cdot 11800 \cdot 1.3^2}{1 - \frac{0.9 \cdot 0.95 \cdot 2600 \cdot 9.81 \cdot \frac{0.26}{2}}{400 \cdot 16.79}} = 24314 \text{ Ws} = 24.314 \text{ kJ}$$

$$t_{br} = \frac{W_{br} \cdot D}{M_{br} \cdot i \cdot v_{\max}} = \frac{24314 \cdot 0.26}{400 \cdot 16.79 \cdot 1.3} = 0.724 \text{ s}$$

Thus, the braking energy which occurs, is less than the permissible braking energy of the mechanical brake.

The braking energy can also be calculated by analyzing the torques.

The braking torque when moving downwards is as follows:

$$M_{br} = \sum J_{mot+Z} \cdot i \cdot \alpha_{load} + (J_{load} \cdot \alpha_{load} + M_{load}) \cdot \frac{\eta_{mech} \cdot \eta_{gearbox}}{i}$$

with

$$\alpha_{load} = \frac{\omega_{load \max}}{t_{br}} = \frac{2 \cdot v_{\max}}{D \cdot t_{br}}$$

$$J_{load} = \sum m \cdot \left(\frac{D}{2}\right)^2$$

$$M_{load} = \Delta m \cdot g \cdot \frac{D}{2}$$

Further,

$$W_{br} = M_{br} \cdot \omega_{mot \max} \cdot \frac{t_{br}}{2} = M_{br} \cdot i \cdot \frac{2 \cdot v_{\max}}{D} \cdot \frac{t_{br}}{2}$$

$$\sum J_{mot+Z} = J_{mot} + J_{brake} + J_{gear}$$

$$\sum m = m_F + m_Q + m_G + m_{chain}$$

$$\Delta m = m_F + m_Q - m_G$$

The same formula as for  $W_{br}$  is obtained by appropriately inserting.

## 4.11.3 Traversing drive

For a traversing drive at maximum velocity, the braking energy occurring at the mechanical brake is to be calculated. It is assumed that the electrical braking has failed.



Block diagram of the traversing drive

## Drive data

Weight of the load	$m$	= 5500 kg
Moment of inertia, motor	$J_{\text{mot}}$	= 0.017 kgm <sup>2</sup>
Moment of inertia, gearbox	$J_{\text{gearbox}}$	= 0.00164 kgm <sup>2</sup>
Moment of inertia, brake	$J_{\text{brake}}$	= 0.00063 kgm <sup>2</sup>
Gear ratio	$i$	= 16
Wheel diameter	$D$	= 0.34 m
Max. traversing velocity	$v_{\text{max}}$	= 2.66 m/s
Braking torque of the mechanical brake	$M_{\text{br}}$	= 60 Nm
Permissible braking energy of the mechanical brake	$W_{\text{br max}}$	= 25 kJ
Traversing resistance	$w_{\text{F}}$	= 0.02
Gearbox efficiency	$\eta_{\text{gearbox}}$	= 0.95

The braking energy is calculated using the energy equation. The following is valid:

$$W_{br} = W_{kin\ mot+Z} + (W_{kin\ load} - W_{friction}) \cdot \eta_{gear}^{VZ}$$

with

$$VZ = \text{sign}(W_{kin\ load} - W_{friction}) \quad (\text{normally positive})$$

$$W_{kin\ mot+Z} = \frac{1}{2} \cdot (J_{mot} + J_{brake} + J_{gear}) \cdot (\omega_{mot\ max})^2 = \frac{1}{2} \cdot \sum J_{mot+Z} \cdot \left(i \cdot \frac{2 \cdot v_{max}}{D}\right)^2$$

$$W_{kin\ load} = \frac{1}{2} \cdot m \cdot v_{max}^2$$

$$W_{friction} = m \cdot g \cdot w_F \cdot s$$

Further,

$$s = v_{max} \cdot \frac{t_{br}}{2}$$

$$W_{br} = M_{br} \cdot \omega_{mot\ max} \cdot \frac{t_{br}}{2} = M_{br} \cdot i \cdot \frac{2 \cdot v_{max}}{D} \cdot \frac{t_{br}}{2}$$

Re-arranging, the following is obtained:

$$W_{br} = \frac{\frac{1}{2} \cdot \sum J_{mot+Z} \cdot \left(i \cdot \frac{2 \cdot v_{max}}{D}\right)^2 + \eta_{gear}^{VZ} \cdot \frac{1}{2} \cdot m \cdot v_{max}^2}{1 + \frac{\eta_{gear}^{VZ} \cdot m \cdot g \cdot w_F \cdot \frac{D}{2}}{M_{br} \cdot i}}$$

To start off with, the sign of the gearbox efficiency must be determined. The limiting case with  $W_{kin\ load} = W_{friction}$  is investigated. The following is obtained for  $W_{br}$ :

$$W_{br} = \frac{1}{2} \cdot \sum J_{mot+Z} \cdot \left(i \cdot \frac{2 \cdot v_{max}}{D}\right)^2 = M_{br} \cdot i \cdot \frac{2 \cdot v_{max}}{D} \cdot \frac{t_{br}}{2}$$

Further, with  $W_{kin\ load} = W_{friction}$ , the following is obtained

$$\frac{1}{2} \cdot m \cdot v_{max}^2 = m \cdot g \cdot w_F \cdot v_{max} \cdot \frac{t_{br}}{2}$$



After eliminating  $t_{br}$ , an equation is obtained for  $w_F$ :

$$w_F = \frac{D \cdot M_{br}}{\sum J_{mot+Z} \cdot i \cdot 2 \cdot g}$$

If the following is now valid

$$w_F \leq \frac{D \cdot M_{br}}{\sum J_{mot+Z} \cdot i \cdot 2 \cdot g}$$

the sign should be set positive. Otherwise, set the sign negative ( $\eta^{-1}=1/\eta$ ).

The following is obtained with the specified numerical values:

$$\sum J_{mot+Z} = 0.017 + 0.00063 + 0.00164 = 0.01927 \text{ kgm}^2$$

$$\frac{D \cdot M_{br}}{\sum J_{mot+Z} \cdot i \cdot 2 \cdot g} = \frac{0.34 \cdot 60}{0.01927 \cdot 16 \cdot 2 \cdot 9.81} = 3.372 > 0.02 \quad (\text{i. e. the sign is positive})$$

$$W_{br} = \frac{\frac{1}{2} \cdot 0.01927 \cdot \left(16 \cdot \frac{2 \cdot 2.66}{0.34}\right)^2 + 0.95 \cdot \frac{1}{2} \cdot 5500 \cdot 2.66^2}{1 + \frac{0.95 \cdot 5500 \cdot 9.81 \cdot 0.02 \cdot \frac{0.34}{2}}{60 \cdot 16}} = 16156 \text{ Ws} = 16.156 \text{ kJ}$$

$$t_{br} = \frac{W_{br} \cdot D}{M_{br} \cdot i \cdot v_{\max}} = \frac{16156 \cdot 0.34}{60 \cdot 16 \cdot 2.66} = 2.151 \text{ s}$$

The braking energy obtained is therefore less than the permissible braking energy of the mechanical brake.

The braking energy can also be calculated by investigating the torques. The following is valid for the braking torque:

$$M_{br} = \sum J_{mot+Z} \cdot i \cdot \alpha_{load} + (J_{load} \cdot \alpha_{load} - M_{friction}) \cdot \frac{\eta_{gearbox}^{VZ}}{i}$$

with

$$VZ = \text{sign}(J_{load} \cdot \alpha_{load} - M_{friction})$$

$$\alpha_{load} = \frac{\omega_{load \max}}{t_{br}} = \frac{2 \cdot v_{\max}}{D \cdot t_{br}}$$

$$J_{load} = m \cdot \left(\frac{D}{2}\right)^2$$

$$\sum J_{mot+Z} = J_{mot} + J_{brake} + J_{gearbox}$$

$$M_{friction} = m \cdot g \cdot w_F \cdot \frac{D}{2}$$

Further,

$$W_{br} = M_{br} \cdot \omega_{mot \max} \cdot \frac{t_{br}}{2} = M_{br} \cdot i \cdot \frac{2 \cdot v_{\max}}{D} \cdot \frac{t_{br}}{2}$$

The same formula is obtained for  $W_{br}$  by appropriately applying.

## 4.12 Criteria for selecting motors for clocked drives

### 4.12.1 General information

Clocked drives with 1FK6/1FT6 synchronous servomotors or 1PA6 induction servomotors are to be investigated. These can include, for example, traversing drives, rotary table drives and spindle drives. The motors must fulfill, on one hand the dynamic requirements when accelerating and decelerating, and on the other hand, operation must be permissible from a thermal perspective. A drive task can generally be solved using several motors with various rated speeds. The rated speed is selected according to the following criteria:

- minimum motor size
- minimum motor current (drive converter selection)
- preferred motor series, e. g. 1FK6 with  $n_n=3000$  RPM and  $n_n=6000$  RPM
- existing motor outputs at a specific rated speed

A gearbox is generally used to adapt the load torque and load speed. In this case, a differentiation must be made between wheels:

- a gearbox ratio is specified (e. g. toothed belt ratio)
- the gearbox ratio can be selected (e. g. planetary gearbox for motor mounting)

For the latter, an additional degree of freedom is obtained when selecting the motor. For example, the optimum gearbox ratio for a minimum motor torque can be defined. However, the gearbox ratio which can be selected is restricted by the maximum permissible motor speed, as well as the possible ratios for certain gearboxes. Other restrictions are obtained due to the size, efficiency and costs. These must be taken into account when finally selecting the drive package, comprising motor, gearbox and drive converter.

#### Basic considerations regarding motor utilization

##### *Optimum motor utilization according to the dynamic requirements*

In order to determine the optimum dynamic utilization of a motor, the dynamic limiting curve of the motor is investigated with the resulting permissible motor output. This is given by:

$$P_{mot\,perm\,dyn} = M_{mot\,perm\,dyn} \cdot \frac{2 \cdot \pi \cdot n_{mot}}{60} \quad (n_{mot} \text{ in RPM})$$



Example for the dynamic limiting curve and the dynamic permissible motor output for 1FT6082-8AF7

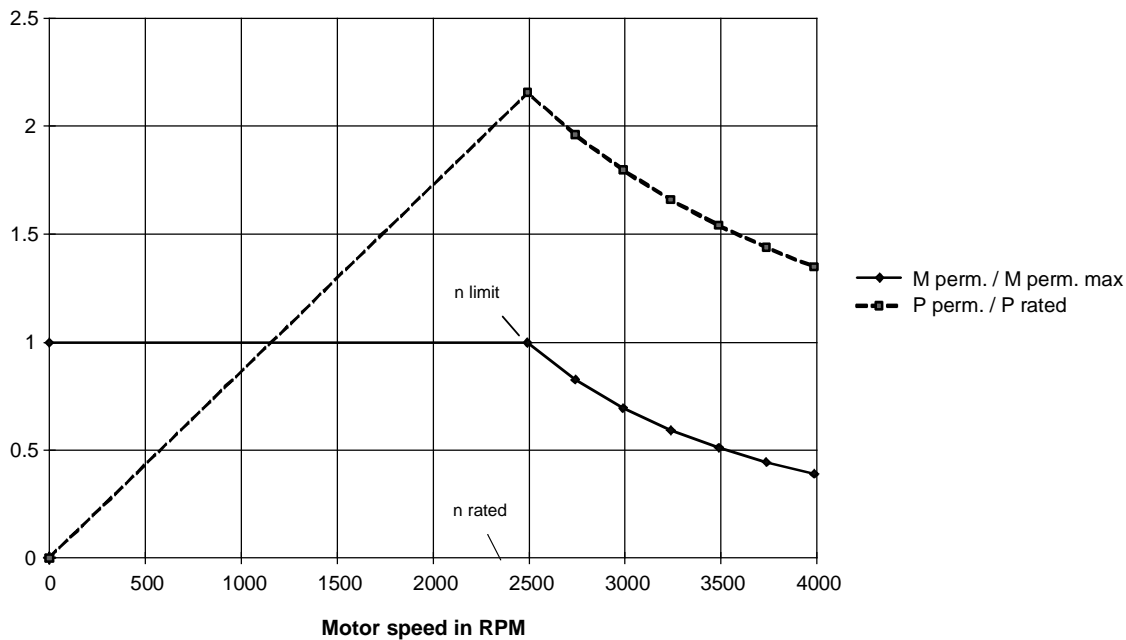

Example for the dynamic limiting curve and the dynamic permissible motor output for 1PA6103-4HG

$$M_{perm.} = M_{perm.max} = 2 \cdot M_{motn} \quad \text{for } n_{mot} \leq n_{limit}, \quad M_{perm.} = \frac{M_{stall}}{1.3} \cdot \left(\frac{n_{motn}}{n_{mot}}\right)^2 \quad \text{for } n_{mot} > n_{limit}$$

A motor is dynamically suitable for a particular application if all of the torque/speed points lie below the dynamic limiting curve. The maximum permissible motor torque  $M_{perm. max}$  can only be utilized up to the limiting speed  $n_{limit}$ . After this, there is a decrease due to the voltage limiting curve and the stall torque limiting curve. However, for synchronous servomotors, the maximum possible motor output is generally achieved for a motor speed, which lies somewhat higher than  $n_{limit}$ , but is less than  $n_{rated}$ . For induction servomotors, the maximum possible motor output is always reached at  $n_{limit}$ , as the stall torque limit characteristic is proportional to  $1/n_{mot}^2$ .

A pure flywheel drive (high-inertia drive) with constant acceleration is now to be investigated. For the specified max. load speed  $n_{load max}$  and when using a gearbox with moment of inertia  $J_G$ , the maximum motor torque and the maximum motor output when accelerating are given by:

$$M_{mot max} = (J_{mot} + J_G) \cdot \alpha_{load max} \cdot i + J_{load} \cdot \alpha_{load max} \cdot \frac{1}{i}$$

$$P_{mot max} = M_{mot max} \cdot \frac{2 \cdot \pi \cdot n_{mot max}}{60} \quad (n_{mot max} \text{ in RPM})$$

$$= P_{load max} + (J_{mot} + J_G) \cdot \alpha_{load max} \cdot i \cdot \frac{2 \cdot \pi \cdot n_{mot max}}{60}$$

with

$$i = \frac{n_{mot max}}{n_{load max}}$$

$$P_{load max} = J_{load max} \cdot \alpha_{load max} \cdot \frac{2 \cdot \pi \cdot n_{load max}}{60} \quad (n_{load max} \text{ in RPM})$$

$$= J_{load} \cdot \frac{2 \cdot \pi \cdot n_{load max}}{60} \cdot \frac{M_{mot max}}{(J_{mot} + J_G) \cdot i + J_{load} \cdot \frac{1}{i}}$$

The following curves are obtained, if the points  $P_{mot max}/n_{mot max}$  and  $P_{load max}/n_{mot max}$  are entered for a constant  $M_{mot max}$  for various values of  $i$ .



Example for the max. motor output and the max. load power as a function of the gearbox ratio  $i$

The optimum gearbox ratio for the highest power output to the load, and therefore for the shortest accelerating time, is given by

$$\frac{dP_{load\ max}}{di} = 0 = -J_{load} \cdot \frac{2 \cdot \pi \cdot n_{load\ max}}{60} \cdot \frac{M_{mot\ max}}{\left( (J_{mot} + J_G) \cdot i + J_{load} \cdot \frac{1}{i} \right)^2} \cdot \left( J_{mot} + J_G - J_{load} \cdot \frac{1}{i^2} \right)$$

to

$$i_{opt} = \sqrt{\frac{J_{load}}{J_{mot} + J_G}}$$

If the acceleration  $\alpha_{load\ max}$  is specified, with the optimum gearbox ratio, the lowest accelerating torque  $M_{mot\ max}$  can be achieved, and therefore also the lowest motor current.

The following is obtained for the max. motor output with  $i=i_{opt}$ :

$$P_{mot\ max} = 2 \cdot P_{load\ max} \quad (\text{i. e. power adaption})$$

From the output perspective, a motor is best utilized when it comes to the dynamic limiting characteristic, if the required max. motor output lies close to the max. possible motor output. The max. load power is reached at a constant max. motor torque using the optimum gearbox ratio. If the max. motor speed, achieved with the optimum gearbox ratio, is higher than  $n_{\text{limit}}$ , then the maximum of the load output is obtained at  $n_{\text{limit}}$ .

Depending on the ratio of the motor moment of inertia to the load moment of inertia, a differentiation can be made between 2 limiting cases.

a) The motor moment of inertia has no significant influence on the acceleration

For all of the gearbox ratios coming into question the following is valid:

$$J_{\text{mot}} + J_G \ll J_{\text{load}} / i^2$$

As far as the  $P_{\text{load max}}/n_{\text{mot max}}$  characteristic is concerned,  $n_{\text{mot max}}$  lies to the far left away from the optimum position.

The following is obtained for  $P_{\text{load max}}$ :

$$P_{\text{load max}} \approx P_{\text{mot max}}$$

The required output  $P_{\text{load max}}$  can be achieved with a high torque at a low speed, or with a low torque at a high speed. As far as the dimensions are concerned, generally, motors with a higher rated speed are more favorable, as the maximum possible motor output increases, for the same dimensions, with higher rated speeds. The utilization is at an optimum, if the motor is being precisely operated at the maximum possible motor output.

b) The motor moment of inertia has a significant influence on the acceleration

In this case, it is favorable to set the optimum gearbox ratio. For  $i = i_{\text{opt}}$ , the following is obtained for  $P_{\text{load max}}$ :

$$P_{\text{load max}} = \frac{P_{\text{mot max}}}{2}$$

Also here, as far as the dimensions are concerned, generally motors with higher rated speeds are more favorable. The motor utilization is at an optimum, if the motor is operated at  $n_{\text{limit}}$  with the maximum motor output possible at that point.

### Optimum utilization of a motor according to the thermal requirements

In order to determine the optimum thermal utilization of a motor, the S1 limiting characteristic of the motor is investigated and the resulting permissible motor output. This is given by:

$$P_{mot\ perm.stat} = M_{mot\ perm.stat} \cdot \frac{2 \cdot \pi \cdot n_{mot}}{60} \quad (n_{mot} \text{ in RPM})$$



Example for the S1 limiting curve and the steady-state permissible motor output for 1FT6086-8AH7





Example for the S1 limiting curve and the permissible steady-state motor output for 1PA6103-4HG

A motor is thermally suitable for a particular drive situation, if the RMS motor torque at  $n_{\text{average}}$  lies below the S1 limiting characteristic. For synchronous servomotors, the thermally permissible torque decreases with increasing motor speed. The maximum possible motor output is however reached for a motor speed which generally lies above the rated speed. For synchronous servomotors with higher rated speeds and higher rated outputs, this value can also lie below the rated speed. For induction servomotors, the thermally permissible torque for motor speeds greater than  $n_{\text{rated}}$  linearly decreases with  $1/n_{\text{mot}}$ . Thus, the maximum possible motor output is achieved at  $n_{\text{rated}}$  and then remains constant.

Thus, a motor would be well utilized, as far as the S1 limiting characteristic is concerned, if the average motor speed is close to the power optimum. However, for clocked drives, this is generally not possible due to a reduction in the permissible dynamic motor torque at  $n_{\text{mot max}}$  due to the voltage limiting characteristic and the stall torque limiting characteristic. Thus, if a drive with a constant accelerating torque is investigated, the average motor speed may only be so high, that at  $n_{\text{mot max}}$ , the accelerating torque is just below the dynamic limiting characteristic. The optimum utilization is achieved, if, in addition, the RMS motor torque is close to the S1 limiting characteristic and if the average motor speed is just reached with the optimum gearbox ratio for the lowest RMS motor torque (for a pure flywheel drive [high-inertia drive]), the minimum of the RMS motor torque coincides with the minimum of the accelerating torque).

Of course, these conditions can only seldomly be simultaneously fulfilled.

Procedure when selecting the rated speed for a specific drive task

## a) Gearbox ratio is specified

- motors with various rated speeds are determined using the PATH configuring program
- a suitable motor/drive converter combination is selected

## b) The gearbox ratio can be selected

- a motor with the smallest frame size for a specific rated speed is determined using the PATH configuring program, by varying the gearbox ratio within the possible limits
- this technique is then applied for other rated speeds
- a suitable motor/gearbox/drive converter combination is selected

Depending on whether the motor is selected according to the RMS value (e. g. short no-load intervals), according to the maximum motor torque (e. g. long no-load intervals) or additionally according to the optimum gearbox ratio, for a specific drive task, a motor with lower or higher rated speed might be more favorable. The following examples will clearly illustrate this.

4.12.2 Example 1, rotary table drive with  $i=4$  and short no-load interval

Drive data

Load moment of inertia

$$J_{\text{load}} = 0.4 \text{ kgm}^2$$

Moment of inertia of the gearbox (toothed belt pulleys)

$$J_G = 0.002 \text{ kgm}^2$$

Angle

$$\varphi_{\text{tot.}} = 180 \text{ degrees}$$

Positioning time

$$t_{\text{tot.}} = 0.2 \text{ s}$$

No-load interval

$$t_p = 0.2 \text{ s}$$

A 1FT6 motor is to be used.

Traversing characteristic

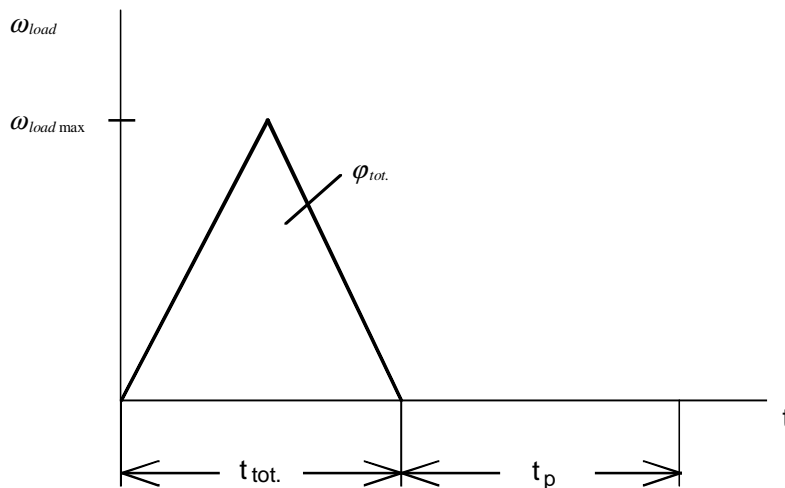

$$\omega_{\text{load max}} = \frac{2 \cdot \varphi_{\text{tot.}}}{t_{\text{tot.}}} = \frac{2 \cdot \pi}{0.2} = 31.42 \text{ s}^{-1}$$

$$\alpha_{\text{load max}} = \frac{\omega_{\text{load max}}}{\frac{t_{\text{tot.}}}{2}} = \frac{2 \cdot 31.42}{0.2} = 314.2 \text{ s}^{-2}$$

$$n_{\text{load max}} = \frac{\omega_{\text{load max}} \cdot 60}{2 \cdot \pi} = \frac{31.42 \cdot 60}{2 \cdot \pi} = 300 \text{ RPM}$$

$$n_{\text{mot max}} = i \cdot n_{\text{load max}} = 4 \cdot 300 = 1200 \text{ RPM}$$

Thus, the maximum motor torque when accelerating or decelerating is given by:

$$M_{mot\max} = (J_{mot} + J_G) \cdot \alpha_{load\max} \cdot i + J_{load} \cdot \alpha_{load\max} \cdot \frac{1}{i}$$

The RMS motor torque and the average motor speed are given by:

$$M_{rms} = \sqrt{\frac{M_{mot\max}^2 \cdot t_{tot.}}{t_{tot.} + t_p}} = M_{mot\max} \cdot \sqrt{\frac{t_{tot.}}{t_{tot.} + t_p}} = M_{mot\max} \cdot \sqrt{\frac{0.2}{0.2 + 0.2}} = M_{mot\max} \cdot 0.707$$

$$n_{average} = \frac{\frac{n_{mot\max} \cdot t_{tot.}}{2} \cdot 2}{t_{tot.} + t_p} = \frac{1200 \cdot 0.2}{0.2 + 0.2} = 300RPM$$

For the specified gearbox, the maximum motor torque and the RMS motor torque only depend on  $J_{mot}$ .

When selecting an 1FT6 motor, the following 3 motors are obtained

Rated speed	RMS motor current	Motor type / rated output	Drive converter / rated output
1500 RPM	13.09 A	1FT6105-8AB7 / 6.6 kW	6SE7021-4EP50 / 5.5 kW
2000 RPM	17.45 A	1FT6105-8AC7 / 8 kW	6SE7022-1EP50 / 7.5 kW
3000 RPM	26.18 A	1FT6105-8AF7 / 9.7 kW	6SE7022-7EP50 / 11 kW

Due to the short no-load interval, the motor is selected according to the RMS value. The 3 motors have the same frame size and length, have different rated speeds and rated outputs, but the same motor moment of inertia and the same S1 characteristic. In this case, the most favorable motor is that with the lowest motor current, i. e. in this case, the motor whose rated speed is located close to the average motor speed  $n_{average}=300$  RPM. The motor type with 1500 RPM fulfills this condition the best, and the smallest converter, with 5.5 kW is obtained.



$M_{S1}$  characteristics and  $M_{RMS}$  at  $n_{average}$  for motors with  $n_n=1500$  RPM,  $n_n=2000$  RPM and  $n_n=3000$  RPM

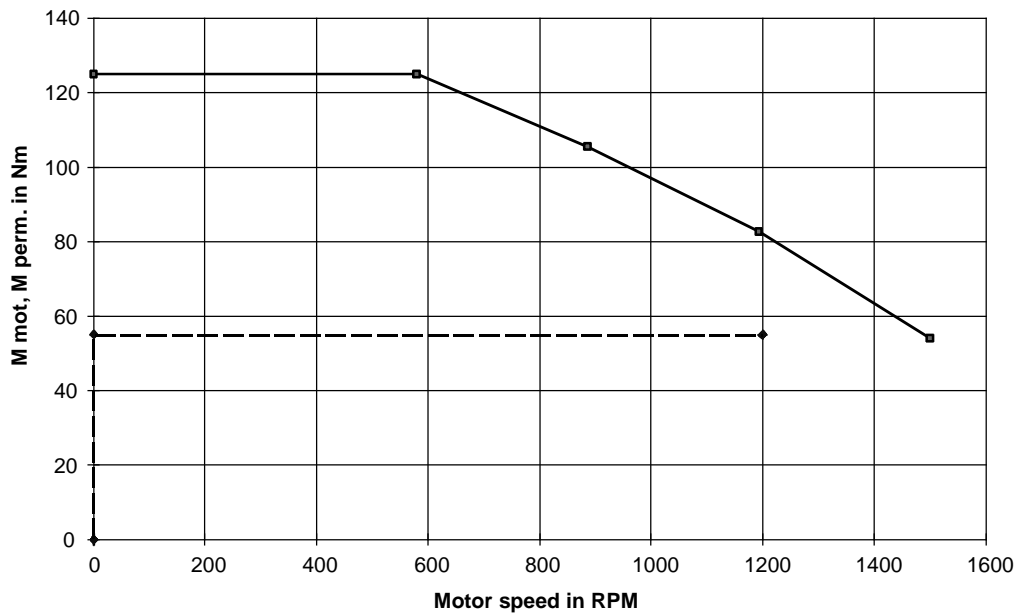

Dynamic limiting curve and motor torque characteristic for the motor with  $n_n=1500$  RPM

4.12.3 Example 2, rotary table drive with  $i=4$  and long no-load interval

The rotary table drive from example 1, with otherwise identical data, but a no-load interval of 4 s is now to be investigated. The average motor speed is:

$$n_{average} = \frac{\frac{n_{mot\ max} \cdot t_{tot.} \cdot 2}{2}}{t_{tot.} + t_p} = \frac{\frac{1200 \cdot 0.2}{2}}{0.2 + 4} = 28.57\text{RPM}$$

The ratio of the RMS torque to the maximum torque is given by:

$$M_{rms} = M_{mot\ max} \cdot \sqrt{\frac{0.2}{0.2 + 4}} = M_{mot\ max} \cdot 0.22$$

The following 4 1FT6 motors are selected

Rated speed	Max. motor current	Motor type / rated output	Drive converter / rated output
2000 RPM	19.52 A	1FT6084-8AC7 / 3.5 kW	6SE7018-0EP50 / 3 kW
3000 RPM	29.42 A	1FT6064-6AF7 / 2.2 kW	6SE7021-0EP50 / 4 kW
4500 RPM	44.15 A	1FT6064-6AH7 / 2.3 kW	6SE7022-1EP50 / 7.5 kW
6000 RPM	62.15 A	1FT6082-8AK7 / 3.5 kW	6SE7022-7EP50 / 11 kW

As a result of the longer no-load time, in this case the motor is selected according to the dynamic limiting characteristic. The selected drive converter, type of construction Compact Plus, is utilized for a 300 % rated current. This is possible, as the current flows for less than 250 ms and the no-load time is greater than 750 ms. From the two smallest motors with  $n_n=3000$  RPM and  $n_n=4500$  RPM, that motor with the lowest rated speed is more favorable, as in this case the motor torque characteristic can be better adapted to the dynamic limiting characteristic, thus resulting in a lower motor current. Although the motor with  $n_n=2000$  RPM is larger, it has a lower motor current. The reason for this is that the maximum speed is closer to the rated speed. The optimum combination is the motor with  $n_n=3000$  RPM together with the 4 kW drive converter.



Dynamic limiting characteristic and motor torque characteristic for motors with  $n_n=3000$  RPM and  $n_n=4500$  RPM

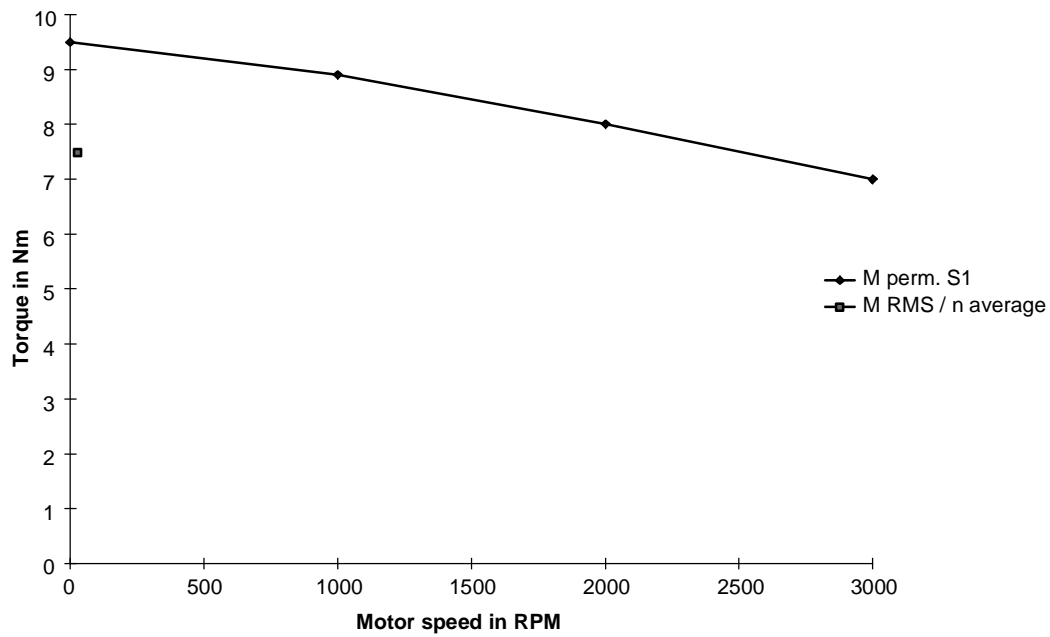

$M_{S1}$  characteristic and  $M_{rms}$  at  $n_{average}$  for the motor with  $n_n=3000$  RPM

## 4.12.4 Example 3, rotary table drive with a selectable ratio and short no-load interval

Drive data

Load moment of inertia	$J_{load} = 0.075 \text{ kgm}^2$
Moment of inertia, gearbox	$J_G = 0.0003 \text{ kgm}^2$
Angle	$\varphi_{tot.} = 18 \text{ degrees}$
Positioning time	$t_{tot.} = 0.05 \text{ s}$
No-load time	$t_p = 0.05 \text{ s}$

A 1FT6 motor is to be used.

$$\omega_{load\max} = \frac{2 \cdot \varphi_{tot.}}{t_{tot.}} = \frac{2 \cdot \frac{\pi}{10}}{0.05} = 12.566 \text{ s}^{-1}$$

$$\alpha_{load\max} = \frac{\omega_{load\max}}{\frac{t_{tot.}}{2}} = \frac{2 \cdot 12.566}{0.05} = 502.65 \text{ s}^{-2}$$

$$n_{load\max} = \frac{\omega_{load\max} \cdot 60}{2 \cdot \pi} = \frac{12.566 \cdot 60}{2 \cdot \pi} = 120 \text{ RPM}$$

$$n_{mot\max} = i \cdot n_{load\max}$$

The maximum motor torque when accelerating and when decelerating as well as the RMS motor torque is obtained, as in example 1, as follows:

$$M_{mot\max} = (J_{mot} + J_G) \cdot \alpha_{load\max} \cdot i + J_{load} \cdot \alpha_{load\max} \cdot \frac{1}{i}$$

$$M_{RMS} = \sqrt{\frac{M_{mot\max}^2 \cdot t_{tot.}}{t_{tot.} + t_p}} = M_{mot\max} \cdot \sqrt{\frac{t_{tot.}}{t_{tot.} + t_p}} = M_{mot\max} \cdot \sqrt{\frac{0.05}{0.05 + 0.05}} = M_{mot\max} \cdot 0.707$$

For a selectable gearbox ratio, the maximum motor torque and the RMS motor torque are dependent on  $J_{mot}$ ,  $J_G$  and  $i$ . The average motor speed is given by:

$$n_{average} = \frac{\frac{i \cdot n_{load\max}}{2} \cdot \frac{t_{tot.}}{2} \cdot 2}{t_{tot.} + t_p}$$



3 1FT6 motors are selected, taking into account the optimum gearbox ratio.

Rated speed	RMS motor current	Motor type / rated output	Drive converter / rated output
2000 RPM	3.44 A	1FT6064-6AC7 / 1.7 kW	6SE7015-0EP50 / 1.5 kW
3000 RPM	4.98 A	1FT6064-6AF7 / 2.2 kW	6SE7015-0EP50 / 1.5 kW
4500 RPM	7.51 A	1FT6064-6AH7 / 2.3 kW	6SE7018-0EP50 / 3 kW

As a result of the short no-load time, the motor is selected according to the RMS value. The 3 motors have the same frame size and length, but have different rated speeds and rated outputs, and the same motor moment of inertia and the same S1 characteristic. Thus, when the gearbox is optimized, the same value is obtained for all of the 3 motors

$$i_{opt} = \sqrt{\frac{J_{load}}{J_{mot} + J_G}} = \sqrt{\frac{0.075}{0.0013 + 0.0003}} = 6.85$$

In the table above, 7 was used as the basis. The most favorable motor is that motor with the lowest motor current, i. e. the motor whose rated speed is the closest to the average motor speed. The motor type with 2000 RPM fulfills this condition. The motor with  $n_n=1500$  RPM cannot be used, as the smallest motor with this rated speed is the 1FT6102-8AB7 with a rated output of 3.8 kW. The maximum speed and the average motor speed are given by:

$$n_{mot\max} = i \cdot n_{load\max} = 7 \cdot 120 = 840RPM$$

$$n_{average} = \frac{\frac{i \cdot n_{load\max}}{2} \cdot \frac{t_{tot.}}{2} \cdot 2}{t_{tot.} + t_p} = \frac{\frac{7 \cdot 120}{2} \cdot 0.05}{0.05 + 0.05} = 210RPM$$

The following diagram is obtained if the points  $M_{rms}$ ,  $n_{average}$  are entered into diagram  $M_{perm. S1}$  for the various gearbox ratios.



Optimizing  $M_{RMS}$  for the motor with  $n_n=2000$  RPM

If the transition points  $M_{mot\ max}$ ,  $n_{mot\ max}$  are entered into the diagram  $M_{perm.\ max}$ , for the various gearbox ratios, the following diagram is obtained.



Optimizing  $M_{mot\ max}$  for a motor with  $n_n=2000$  RPM

#### 4.12.5 Example 4, rotary table drive with selectable ratio and long no-load interval

The rotary table drive from example 1, with otherwise the same data but a no-load time of 4 s is now to be investigated with a selectable ratio (planetary gear). The appropriate gearbox moment of inertia is used depending on the selected motor type.

The following 4 1FT6 motors were selected

Rated speed	Max. motor current	Motor type / rated output	Drive converter / rated output
2000 RPM	16.33 A	1FT6084-8AC7 / 3.5 kW	6SE7018-0EP50 / 3 kW
3000 RPM	14.55 A	1FT6064-6AF7 / 2.2 kW	6SE7015-0EP50 / 1.5 kW
4500 RPM	17.56 A	1FT6064-6AH7 / 2.3 kW	6SE7018-0EP50 / 3 kW
6000 RPM	14.23 A	1FT6044-4AK7 / 1.9 kW	6SE7015-0EP50 / 1.5 kW

In this case, depending on the motor type, the following values are used for  $i$  and  $J_G$ .

Rated speed	$i$	$i_{opt}$	$N_{mot\ max}$	$J_G$
2000 RPM	5	8.48	1500 RPM	0.00084 kgm <sup>2</sup>
3000 RPM	7	16.12	2100 RPM	0.00024 kgm <sup>2</sup>
4500 RPM	10	16.33	3000 RPM	0.0002 kgm <sup>2</sup>
6000 RPM	16 (2stage)	24.08	4800 RPM	0.00018 kgm <sup>2</sup>

In this case,  $i_{opt}$  cannot be used as gearbox ratio due to the dynamic limiting characteristic. The selected drive converters, type of construction Compact Plus were utilized for a 300 % rated current. This is possible, as the current flows for less than 250 ms, and the no-load time is greater than 750 ms. Contrary to example 2 with a fixed gearbox ratio, by optimizing the gearbox ratio, the smallest motor is obtained at the highest rated speed  $n_n=6000$  RPM.

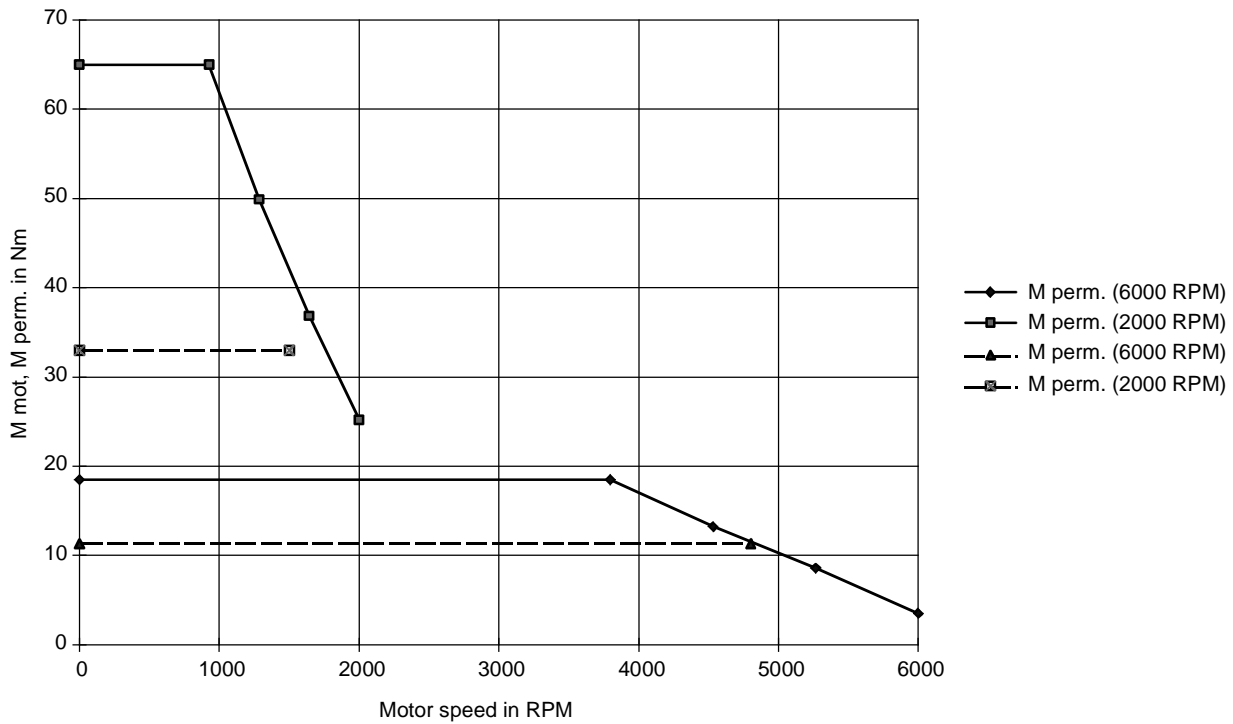

Dynamic limiting characteristics and motor torque curves for motors with  $n_n=2000$  RPM (frame size 80) and  $n_n=6000$  RPM (frame size 48)

## 4.12.6 Example 5, traversing drive with selectable ratio and longer no-load time

## Drive data

Weight to be moved (transported)	$m$	= 5500 kg
Load wheel diameter	$D$	= 0.34 m
Specific traversing resistance	$w_F$	= 0.02
Gearbox ratio	$i$	= 16
Mech. efficiency	$\eta$	= 0.75
Max. traversing velocity	$v_{max}$	= 2.66 m/s
Max. acceleration	$a_{max}$	= 0.44 m/s <sup>2</sup>
Max. traversing travel	$s_{max}$	= 42.6 m
No-load time after a traversing sequence	$t_p$	= 10 s

In this case, it involves the traversing drive for the high-bay racking vehicle from Section 3.1.4. In this case, a 1PA6 motor is to be used.

The following 3 1PA6 motors are selected.

Rated speed	Max. motor current	Motor type / rated output	Inverter / rated output
1150 RPM	32.82 A	1PA6107-4HD / 7.2 kW	6SE7022-6TC61 / 11 kW
1750 RPM	30.66 A	1PA6105-4HF / 8 kW	6SE7022-6TC61 / 11 kW
2300 RPM	26.97 A	1PA6103-4HG / 7.5 kW	6SE7022-6TC61 / 11 kW

In this case, depending on the motor type, the following values were used for  $i$ .

Rated speed	$i$	$i_{opt}$	$N_{mot\ max}$	$N_{limit}$
1150 RPM	7	103	1046 RPM	1313 RPM
1750 RPM	10	103	1494 RPM	1750 RPM
2300 RPM	16 (2stage)	134	2391 RPM	2492 RPM

The gearbox ratios were selected, so that the maximum motor speed is as close as possible to speed  $n_{limit}$ . In this case,  $i_{opt}$  cannot be used as gearbox ratio, due to the dynamic limiting characteristic and the limit imposed by the maximum permissible motor speed. The gearbox moment of inertia was neglected as a result of the high load moment of inertia. The smallest motor is the 1PA6103-4HG with  $n_n=2300$  RPM. This motor also draws the lowest current, as it is the most favorable regarding  $n_{limit}$  and  $i_{opt}$ . Motors with  $n_n=400$  RPM and  $n_n=2900$  RPM cannot be used as the smallest motor with  $n_n=400$  RPM is the 1PA6163-4HB, and the smallest motor with  $n_n=2900$  RPM, 1PA6184-4HL.

In this case, the optimum gearbox ratio is calculated using the motor torque when accelerating

$$M_{mot\max} = J_{mot} \cdot \alpha_{load\max} \cdot i + (J_{load} \cdot \alpha_{load\max} + M_{load}) \cdot \frac{1}{\eta_{mech} \cdot i}$$

to

$$i_{opt} = \sqrt{\frac{J_{load} + \frac{M_{load}}{\alpha_{load\max}}}{J_{mot} \cdot \eta_{mech}}}$$

The following is true

$$M_{load} = m \cdot g \cdot w_F \cdot \frac{D}{2} = 5500 \cdot 9.81 \cdot 0.02 \cdot \frac{0.34}{2} = 183.45 Nm$$

$$\alpha_{load\max} = a_{\max} \cdot \frac{2}{D} = 0.44 \cdot \frac{2}{0.34} = 2.59 s^{-2}$$

$$J_{load} = m \cdot \left(\frac{D}{2}\right)^2 = 5500 \cdot \left(\frac{0.34}{2}\right)^2 = 158.95 kgm^2$$

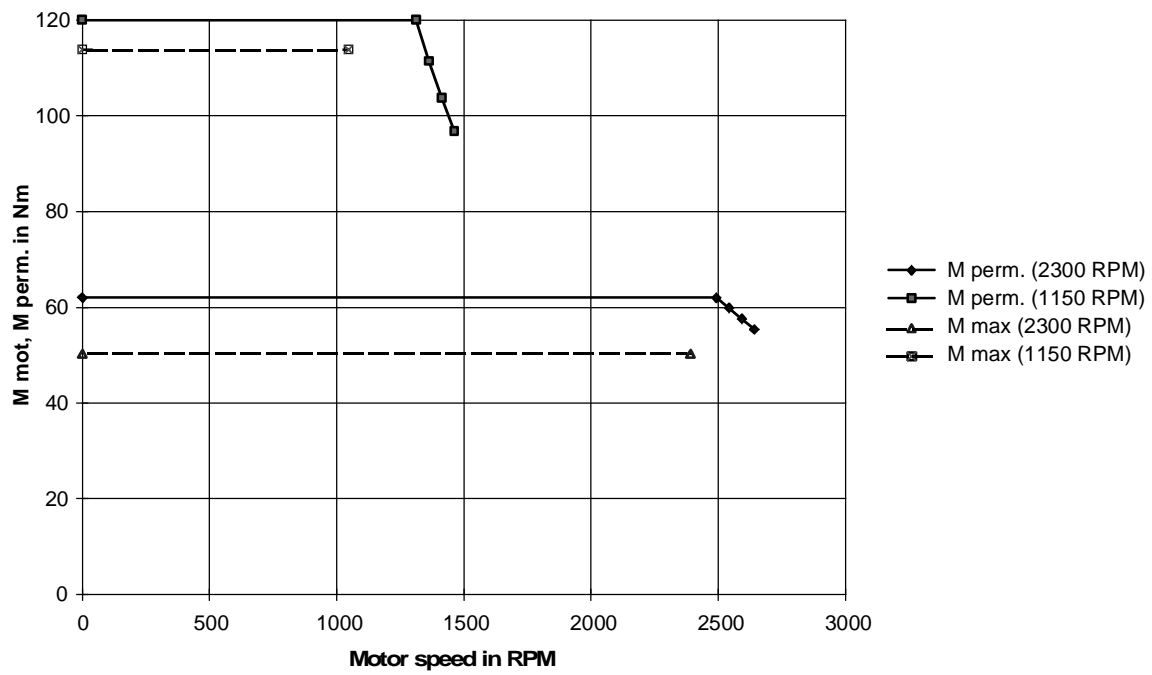

Dynamic limiting characteristics and motor torque characteristics ( $M_{\text{mot max}}$  when accelerating) for motors with  $n_n=1150$  RPM and  $n_n=2300$  RPM

## 4.13 Optimum traversing characteristics regarding the maximum motor torque and RMS torque

### 4.13.1 Relationships for pure flywheel drives (high-inertia drives)

For pure flywheel drives (high-inertia drives), optimum traversing characteristics are to be determined regarding the maximum motor torque and RMS torque. As an example, a rotary table drive will be investigated with the following traversing characteristics.



Angle  $\varphi_{tot.}$ , positioning time  $t_{tot.}$  as well as the no-load interval  $t_p$  are specified. The traversing characteristic should be symmetrical with  $t_b=t_v$ .



Then the following is true

$$\omega_{load\max} = \frac{\varphi_{tot.}}{t_{tot.} - t_b} \quad \text{for } 2 \cdot t_b \leq t_{tot.}$$

$$\alpha_{load\max} = \frac{\omega_{load\max}}{t_b}$$

$$n_{mot\max} = \frac{\omega_{load\max} \cdot 60 \cdot i}{2 \cdot \pi} \quad \text{in RPM}$$

The maximum motor torque when accelerating or decelerating is then given by

$$\begin{aligned} M_{mot\max} &= ((J_{mot} + J_G) \cdot i + \frac{J_{load.}}{i}) \cdot \alpha_{load\max} \\ &= ((J_{mot} + J_G) \cdot i + \frac{J_{load.}}{i}) \cdot \frac{\varphi_{tot.}}{t_b \cdot t_{tot.} - t_b^2} \end{aligned}$$

with

$J_G$  moment of inertia, gearbox

$J_{load}$  moment of inertia, load

$i$  gearbox ratio

The RMS motor torque and the average motor speed are then given by

$$M_{rms} = \sqrt{\frac{M_{mot\max}^2 \cdot t_b \cdot 2}{t_{tot.} + t_p}} = M_{mot\max} \cdot \sqrt{\frac{t_b \cdot 2}{t_{tot.} + t_p}}$$

$$n_{average} = \frac{\frac{n_{mot\max}}{2} \cdot t_b \cdot 2 + n_{mot\max} \cdot (t_{tot.} - 2 \cdot t_b)}{t_{tot.} + t_p} = \frac{\varphi_{tot.} \cdot 60 \cdot i}{2 \cdot \pi \cdot (t_{tot.} + t_p)}$$

The maximum motor torque and the RMS torque can be represented as a function of  $t_b$ , with  $t_{tot.}$ ,  $t_p$  and  $\varphi_{tot.}$  specified. The average speed is independent of  $t_b$  and is given by:

$$M_{mot\max} = ((J_{mot} + J_G) \cdot i + \frac{J_{load.}}{i}) \cdot \varphi_{tot.} \cdot \frac{1}{t_b \cdot t_{tot.} - t_b^2} = k \cdot \frac{1}{t_b \cdot t_{tot.} - t_b^2}$$

$$M_{rms} = M_{mot\max} \cdot \sqrt{\frac{2}{t_{tot.} + t_p}} \cdot \sqrt{t_b}$$

It will now be investigated for which value of  $t_b$ , the maximum motor torque is at a minimum. The minimum for  $M_{\text{mot max}}$  is given by

$$\frac{dM_{\text{mot max}}}{dt_b} = 0 = -k \cdot \frac{1}{(t_b \cdot t_{\text{tot.}} - t_b^2)^2} \cdot (t_{\text{tot.}} - 2 \cdot t_b)$$

for

$$t_b = \frac{t_{\text{tot.}}}{2}$$

The optimum traversing characteristic for the lowest motor torque when accelerating or decelerating is therefore a triangular characteristic. However, for a triangular characteristic, the highest motor speed is also reached. If the maximum motor torque and the maximum motor speed are referred respectively to the values for the triangular traversing characteristic ( $t_b = t_{\text{tot.}}/2$ ) then the following is obtained:

$$\frac{M_{\text{mot max}}}{M_{\text{mot max triangular}}} = \frac{1}{4} \cdot \frac{1}{\frac{t_b}{t_{\text{tot.}}} - \left(\frac{t_b}{t_{\text{tot.}}}\right)^2}$$

$$\frac{n_{\text{mot max}}}{n_{\text{mot max triangular}}} = \frac{1}{2} \cdot \frac{1}{1 - \frac{t_b}{t_{\text{tot.}}}}$$

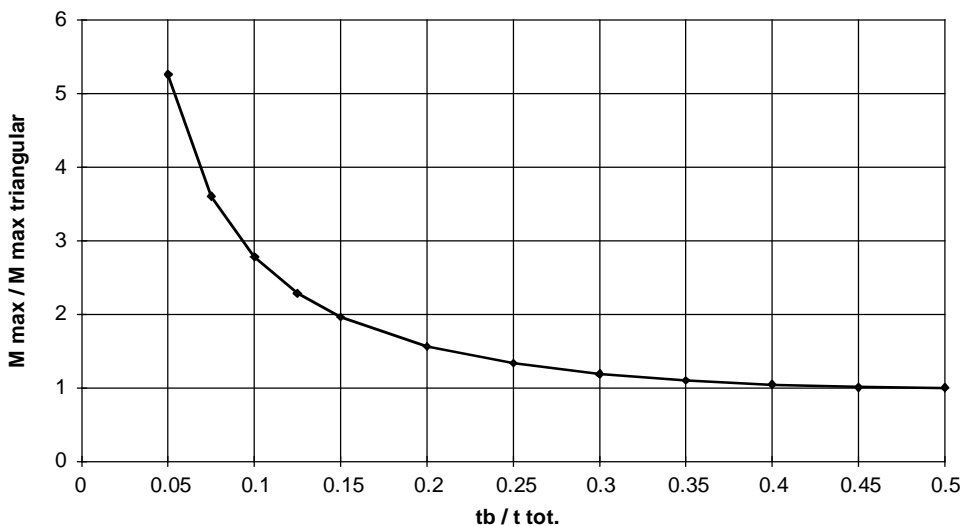

Maximum motor torque as a function of  $t_b/t_{\text{tot}}$



Max. motor speed as a function of  $t_b/t_{tot}$ .

It will now be investigated, for which value of  $t_b$ , the RMS motor torque has a minimum. The minimum for  $M_{rms}$  is then given by

$$\begin{aligned} \frac{dM_{rms}}{dt_b} = 0 &= \sqrt{\frac{2}{t_{tot.} + t_p}} \cdot \left( \frac{dM_{mot\ max}}{dt_b} \cdot \sqrt{t_b} + M_{mot\ max} \cdot \frac{1}{2 \cdot \sqrt{t_b}} \right) \\ &= \sqrt{\frac{2}{t_{tot.} + t_p}} \cdot \left( -k \cdot \frac{t_{tot.} - 2 \cdot t_b}{(t_b \cdot t_{tot.} - t_b^2)^2} \cdot \sqrt{t_b} + k \cdot \frac{1}{t_b \cdot t_{tot.} - t_b^2} \cdot \frac{1}{2 \cdot \sqrt{t_b}} \right) \end{aligned}$$

for

$$t_b = \frac{t_{tot.}}{3}$$

The optimum traversing characteristic for the lowest RMS motor torque is therefore a trapezoidal traversing characteristic with the same accelerating time, decelerating time and constant velocity time components (i.e. same ratios between them). If the RMS motor torque is referred to the values for the triangular traversing characteristic ( $t_b = t_{tot.}/2$ ), then the following is obtained:

$$\frac{M_{rms}}{M_{rms\ triangular}} = \frac{\sqrt{2}}{4} \cdot \sqrt{\frac{t_b}{t_{tot.}}} \cdot \frac{1}{\frac{t_b}{t_{tot.}} - \left(\frac{t_b}{t_{tot.}}\right)^2}$$

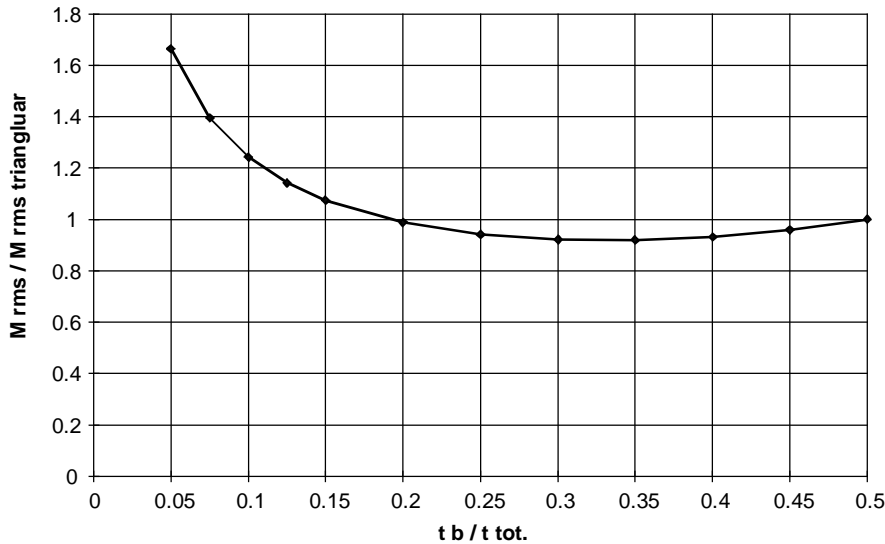

RMS motor torque as a function of  $t_b/t_{tot}$ .

#### 4.13.2 Relationships for flywheel drives (high-inertia drives) with a constant load torque

If the same example is used as basis as under Point 4.13.1, then, taking into account a constant load torque, the following changes are obtained. The maximum motor torque is obtained when accelerating, as follows

$$M_{motmax} = \left( (J_{mot} + J_G) \cdot i + \frac{J_{load}}{i} \right) \cdot \frac{\varphi_{tot.}}{t_b \cdot t_{tot.} - t_b^2} + \frac{M_{load}}{i}$$

$$= M_b + \frac{M_{load}}{i}$$

The RMS motor torque is then given by

$$M_{rms} = \sqrt{\frac{\left( M_b + \frac{M_{load}}{i} \right)^2 \cdot t_b + \left( \frac{M_{load}}{i} \right)^2 \cdot (t_{tot.} - 2 \cdot t_b) + \left( M_v - \frac{M_{load}}{i} \right)^2 \cdot t_b}{t_{tot.} + t_p}}$$

or with  $M_b=M_v$ ,

$$M_{rms} = \sqrt{\frac{2 \cdot M_b^2 \cdot t_b + \left(\frac{M_{load}}{i}\right)^2 \cdot t_{tot.}}{t_{tot.} + t_p}}$$

The expression for the average speed does not change. As a result of the constant factor  $M_{load}/i$  at  $M_{mot\ max}$ , the minimum for the motor torque is again obtained at  $t_b=t_{tot.}/2$ , i. e. for a triangular traversing characteristic. The minimum for the RMS motor torque is then given by

$$M_b = k \cdot \frac{1}{t_b \cdot t_{tot.} - t_b^2}$$

$$M_{rms} = \frac{1}{\sqrt{t_{tot.} + t_p}} \cdot \sqrt{\frac{2 \cdot k^2}{t_b \cdot (t_{tot.} - t_b)^2} + \left(\frac{M_{load}}{i}\right)^2 \cdot t_{tot.}}$$

and

$$\frac{dM_{rms}}{dt_b} = 0 = \frac{1}{\sqrt{t_{tot.} + t_p}} \cdot \frac{-2 \cdot k^2}{2 \cdot \sqrt{\frac{2 \cdot k^2}{t_b \cdot (t_{tot.} - t_b)^2} + \left(\frac{M_{load}}{i}\right)^2}} \cdot \frac{(t_{tot.} - t_b)^2 - 2 \cdot t_b \cdot (t_{tot.} - t_b)}{(t_b \cdot (t_{tot.} - t_b^2))^2}$$

for

$$t_b = \frac{t_{tot.}}{3}$$

Also here, nothing changes.

### 4.13.3 Summary

Pure flywheel drives (high-inertia drives) without additional load torques

The optimum traversing characteristic for the lowest motor torque when accelerating or when decelerating is a triangular traversing characteristic. However, the highest motor speed is also obtained. If the maximum motor torque is available (e. g. as a result of the dynamic limiting characteristic), then with the triangular traversing characteristic, the shortest positioning time is achieved.

The optimum traversing characteristic regarding the lowest RMS motor torque is then obtained for a trapezoidal traversing characteristic with the same sub-division of accelerating time, decelerating time and constant velocity time. Using this traversing characteristic, the lowest motor temperature rise is achieved and a motor speed which is 25% lower with respect to the triangular traversing characteristic; however, the maximum motor torque is 12.5% higher.

Flywheel drives (high-inertia drives) with a constant load torque (e. g. friction torque)

It can be proven that the triangular traversing characteristic results in the lowest motor torque and the trapezoidal characteristic with  $t_b = t_{tot}/3$  results in the minimum RMS value.

#### 4.13.4 Example with 1PA6 motor

The optimum traversing characteristic for a rotary drive is to be determined. This drive turns tree trunks through 90 degrees within 1 s. This is then followed by a no-load interval of 0.5 s. During this no-load interval, the magnetizing current still continues to flow through the motor.

Drive data

Load moment of inertia	$J_{load}$	= 1000 kgm <sup>2</sup>
Moment of inertia, gearbox	$J_G$	= 0.00831 kgm <sup>2</sup>
Gearbox ratio	$i$	= 80
Gearbox efficiency	$\eta_G$	= 0.95
Mech. efficiency	$\eta_{mech}$	= 0.9
Angle	$\varphi_{tot.}$	= 90 degrees
Positioning time	$t_{tot.}$	= 1 s
No-load interval	$t_p$	= 0.5 s

As this involves an induction motor, the minimum RMS torque is not investigated, but instead, the minimum RMS current. The condition  $t_b = t_{tot.}/3$  for the minimum RMS value is also approximately true for the RMS current.

The motor torque is given by

$$M_{mot} = ((J_{mot} + J_G) \cdot i + \frac{J_{load}}{i \cdot (\eta_{mech} \cdot \eta_G)^{VZ}}) \cdot \alpha_{load}$$

with

$$VZ = \text{sign}(\alpha_{load})$$

$$\alpha_{load} = \alpha_{load\max} \quad \text{when accelerating}$$

$$\alpha_{load} = -\alpha_{load\max} \quad \text{when decelerating}$$

$$\alpha_{load} = 0 \quad \text{constant velocity motion, no-load interval}$$

$$\alpha_{load\max} = \frac{\varphi_{tot.}}{t_b \cdot t_{tot.} - t_b^2}$$

The maximum motor torque when accelerating is given by

$$M_{mot\max} = ((J_{mot} + J_G) \cdot i + \frac{J_{load}}{i \cdot \eta_{mech} \cdot \eta_G}) \cdot \alpha_{load\max}$$

The following is valid for the motor current (without taking into account saturation):

$$I_{mot} \approx I_{motn} \cdot \sqrt{\left(\frac{M_{mot}}{M_{motn}}\right)^2 \cdot \left(1 - \left(\frac{I_{mag}}{I_{motn}}\right)^2\right) \cdot k_n^2 + \left(\frac{I_{mag}}{I_{motn}}\right)^2 \cdot \frac{1}{k_n^2}}$$

$$k_n = 1 \quad \text{for} \quad n_{mot} \leq n_{motn} \quad \text{constant flux range}$$

$$k_n = \frac{n_{mot}}{n_{motn}} \quad \text{for} \quad n_{mot} > n_{motn} \quad \text{field-weakening range}$$

The following is valid for the RMS motor current and the average motor speed

$$I_{rms} \approx \sqrt{\frac{\sum_i \left(\frac{I_{moti-1} + I_{moti}}{2}\right)^2 \cdot (t_i - t_{i-1})}{t_{tot.} + t_p}}$$

$$n_{average} = \frac{\varphi_{tot.} \cdot 60 \cdot i}{2 \cdot \pi \cdot (t_{tot.} + t_p)} = \frac{\pi \cdot 60 \cdot 80}{2 \cdot \pi \cdot (1 + 0.5)} = 800RPM$$

The two limiting values with  $t_b=t_{tot.}/2$  (triangular) and  $t_b=t_{tot.}/3$  (trapezoidal characteristic with  $t_b=t_v=t_k$ ) is calculated using the PATH configuring program. In this case, both cases are possible for the same motor. The following results are obtained:

Triangular

$$M_{mot\max} = 150.83 \text{ Nm}$$

$$n_{mot\max} = 2400 \text{ RPM}$$

$$I_{rms} = 53.44 \text{ A}$$

$$I_{mot\max} = 71 \text{ A}$$

$$P_{br\max} = 28.05 \text{ kW}$$

$$P_{br\text{average}} = 4.67 \text{ kW}$$

Braking unit:

$$P_{20} = 50 \text{ kW} + \text{ext. brake resistor}$$

trapezoidal (with  $t_b=t_v=t_k$ )

$$M_{mot\max} = 169.7 \text{ Nm}$$

$$n_{mot\max} = 1800 \text{ RPM}$$

$$I_{rms} = 49.76 \text{ A}$$

$$I_{mot\max} = 76.35 \text{ A}$$

$$P_{br\max} = 23.67 \text{ kW}$$

$$P_{br\text{average}} = 2.63 \text{ kW}$$

braking unit:

$$P_{20} = 20 \text{ kW} + \text{ext. brake resistor}$$



The same drive converter is also obtained for both of the traversing characteristics.

Motor:

1PA6 137-4HG.

$P_n=29$  kW,  $M_n=120$  Nm,  $M_{perm.}=240$  Nm,  $n_n=2300$  RPM,  $I_n=56$  A,  $I_{mag}=21$  A,  $J_{mot}=0.109$  kgm<sup>2</sup>

Drive converter:

6SE7026-0ED61

$P_{U_n}=30$  kW,  $I_{U_n}=59$  A,  $I_{U_{max}}=80.5$  A

The more favorable case is the trapezoidal characteristic with  $t_b=t_{tot}/3$ , as the RMS current is lower here (i. e. a lower motor temperature rise), and, in addition, a lower rating braking unit is adequate. For the triangular traversing characteristic, the drive operates in the field-weakening range due to the higher speed. The resulting higher peak current is compensated by the lower maximum motor torque. For the triangular traversing characteristic, a higher braking power is obtained, as the speed increases more than the maximum motor torque decreases. The higher peak current for the trapezoidal traversing characteristic can be explained due to the higher maximum motor torque, and the therefore associated motor saturation effects.



Maximum motor torque and dynamic limiting characteristic as a function of  $t_b/t_{tot}$ .



RMS motor current and rated motor current as a function of  $t_b/t_{tot}$ .



Angular velocity for the trapezoidal traversing characteristic with  $t_b=t_{tot}/3$



Angular acceleration for the trapezoidal traversing characteristic with  $t_b=t_{tot}/3$

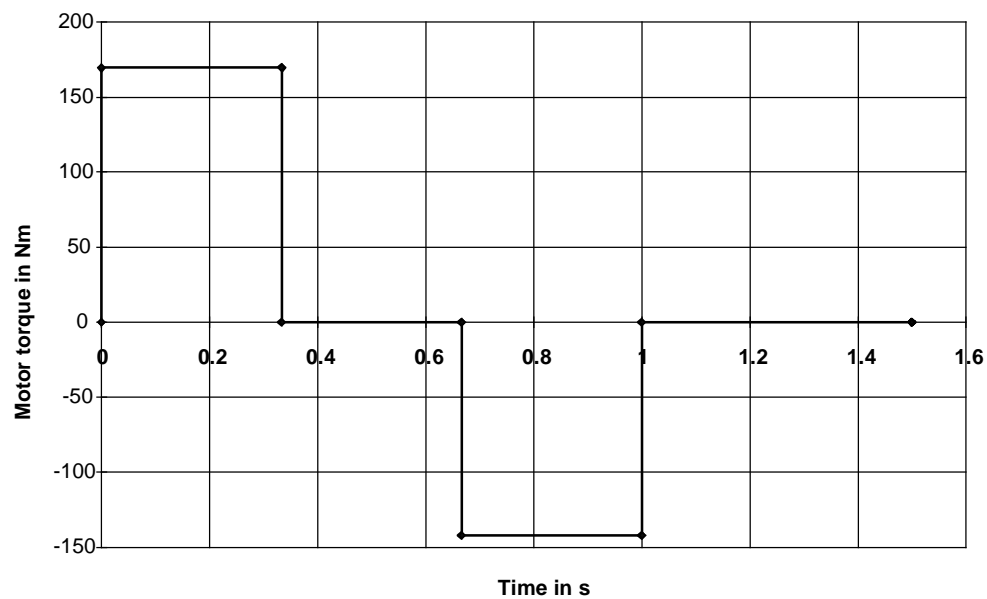

Motor torque for the trapezoidal traversing characteristic with  $t_b=t_{tot}/3$

The motor torque when decelerating is lower as a result of the efficiency.



Motor output for the trapezoidal traversing characteristic with  $t_b=t_{tot}/3$



Motor current for the trapezoidal traversing characteristic with  $t_b=t_{tot}/3$

## 5 Index

### A

Accelerating force .....	11
Accelerating power .....	14
Accelerating time .....	14, 20
Accelerating time from the line supply .....	395
Accelerating time, shortest .....	17
Accelerating torque .....	14
Accelerating work.....	14
Acceleration .....	11
Acceleration due to the force of gravity.....	9
Acceleration torque .....	26
Angle.....	11
Angle of rotation.....	13
Angular acceleration .....	11, 26
Angular deceleration .....	26
Angular velocity.....	11
Autotransformer .....	425

### B

Brake application time.....	38
Brake control.....	35
Brake motor .....	38
Brake resistor.....	36
Braking energy.....	36, 491
Braking time .....	20
Braking time, minimum .....	406
Breakaway torque .....	465

### C

Cable drum .....	29
Capacitor battery.....	284
Centrifugal drive.....	261
Connecting bar force.....	186, 213
Conservation of energy law.....	191
Constant power .....	192
Contact force.....	313
Continuous braking power .....	36
Crank angle.....	185
Crank drive.....	208

Crawl velocity .....	38, 140
Cross-cutter drive.....	254
Cut length.....	254, 272
Cut length, above synchronous.....	277
Cut length, sub-synchronous .....	275
Cut length, synchronous .....	276
Cycle time .....	36

### D

DC current braking.....	463
Dead center.....	208, 294, 307
Deadtimes, changing .....	139
Deceleration torque.....	26
Deforming work.....	184
Distance .....	11, 13
Distance traveled .....	144
Drag force .....	25
Drive wheel .....	25
Droop .....	199

### E

Eccentric press .....	184
Elevator drive .....	83
Elevator height .....	83
Emergency off .....	430
Energy.....	9
Energy equation .....	492

### F

Feed force.....	18
Feed velocity .....	18
Field-weakening range.....	192, 392
Flywheel .....	184
Force .....	9
Force-ventilated .....	33
Four-jointed system.....	306
Frame size, minimum.....	499
Friction angle, spindle .....	18
Friction coefficient .....	27
Full-load steady-state output.....	29

<b>G</b>		<b>M</b>	
Gantry crane.....	77	Mass.....	9
Gearbox .....	16	Master/slave drive .....	199
Gearbox efficiency .....	16	Mechanical brake .....	491
Gearbox ratio .....	16	Mechanical efficiency .....	26
Gearbox ratio, optimum .....	503	Mechanically-coupled drives .....	197
<b>H</b>		Mesh welding machine.....	323
Harmonics and disturbances fed back into the line supply .....	483	Moment of inertia.....	9, 161
High-bay racking vehicle .....	60	Moment of inertia, roll.....	106
Hoisting drive.....	25, 34	Moment of inertia, spindle .....	18
hoisting force.....	13	Motor utilization .....	499
Hoisting force .....	29	Multi-motor drives.....	474
Hoisting unit.....	77	<b>N</b>	
Hoisting work.....	13	No-load interval time .....	33
Holding brake .....	35, 491	<b>O</b>	
<b>I</b>		Oscillation frequency, mechanical.....	174
Inclination angle .....	92	Overhead wire height .....	357
Incline plane .....	92	Overlap angle .....	274
Intermittent duty.....	32	<b>P</b>	
Isolating transformer .....	427	Pantograph.....	357
<b>K</b>		Partial load range .....	418
Kinetic buffering .....	398, 474	Permissible acceleration .....	28
Kinetic energy.....	11	Pitch angle, spindle .....	18
Knife roll .....	254	Pivot drive.....	227
<b>L</b>		Pivot motion.....	227
Leakage inductance .....	418	Position change, periodic .....	151
Line failure.....	398	Position controller .....	141
Linear motion .....	11	Position difference.....	141, 143
Load distribution.....	197	Positioning drives .....	139
Load duty cycle .....	32, 36	Positioning error .....	140
Load equalization control .....	200	Positioning time .....	145
Load mass.....	29	Positioning, closed-loop control.....	139
Load sinking .....	35	Positioning, closed-loop control.....	149
Load torque .....	16, 186	Positioning, fastest .....	144
Load torque characteristic.....	361	Positioning, open-loop control .....	139, 147
Load torque oscillation .....	153	Power .....	9
Load torque, square-law .....	387	Power adaption.....	502
		Power-on duration .....	32
		Press drive .....	184
		Press force .....	184

**R**

Ram distance .....	186
Ram time (surge time) .....	187
Re-accelerating time .....	398
Reciprocating compressor, single-cylinder .....	161
Reduction factor $k_f$ .....	10
Reel .....	103
Regenerative operation .....	36, 483
Resistance force .....	25
Risk evaluation .....	430
RMS motor current .....	195
RMS torque .....	10, 32
Roll radius .....	13
Rotary table drive .....	221
Rotational .....	11
Rotational energy .....	11
Rounding-off .....	442
Rraction cycle .....	28

**S**

Saw drive .....	293
Self locking .....	19
Self-ventilated .....	33
Shaft output .....	9
Sinusoidal filter .....	425
Slip .....	9
Slip frequency .....	9
Specific traction resistance .....	25
Speed (RPM) .....	13
Spindle diameter .....	18
Spindle drive .....	18, 238
Spindle efficiency .....	18
Spindle length .....	18
Spindle pitch .....	18
Spindle, horizontal .....	246
Spindle, vertical .....	238
Stall torque .....	9, 192

Static friction .....	27
Supplementary moment of inertia .....	152
Surge loading .....	151
Switch-on duration .....	32
Synchronous speed .....	9
System losses .....	453

**T**

Tangential force .....	186, 213
Three-cylinder pump .....	167
Time constant, mechanical .....	152
Torque .....	9
Torque compensation .....	174
Torque limit .....	174
Traction drive .....	25, 34
Transformer at the drive converter output .....	425
Traversing curves, optimum .....	520
Trolley .....	171

**U**

Unwind stand with closed-loop tension control .....	110
Unwinding .....	105

**V**

Velocity .....	11
----------------	----

**W**

Web velocity .....	103, 254, 272
Wind force .....	26
Wind pressure .....	26
Wind surface .....	26
Winder control .....	117
Winder drive .....	103
Winder with closed-loop tension control ..	109, 117
Winding .....	105
Winding power .....	104
Winding torque .....	104
Work .....	9

## 6 Literature

- /1/ Moderne Stromrichtertechnik  
Peter F. Brosch  
Vogel Fachbuch Kamprath-Reihe  
ISBN 3-8023-0241-9
  
- /2/ Grundlagen der elektrischen Antriebstechnik mit Berechnungsbeispielen  
J. Vogel  
Hüthig Verlag, 1991  
ISBN 3-7785-2103-9
  
- /3/ AC-Servo-Antriebstechnik  
Lehmann, R.  
Franzis-Verlag, 1990  
ISBN 3-7723-6212-5
  
- /4/ Elektrische Vorschubantriebe für Werkzeugmaschinen  
H. Groß  
Siemens AG  
ISBN 3-8009-1338-0
  
- /5/ Das 1x1 der Antriebsauslegung  
W. Garbrecht, J. Schäfer  
VDE Verlag, 1994  
ISBN 3-8007-2005-1
  
- /6/ Lenze Formelsammlung  
Carsten Fräger  
Lenze GmbH&Co KG Aerzen
  
- /7/ Technische Formeln für die Praxis  
Walter (u.a.)  
Buch-und Zeit-Verlagsgesellschaft mbH Köln, 1992  
ISBN 3-8166-0192-8