

Cranes

Camera measuring system SIMOCRANE CenSOR

Operating Instructions

Valid for the device with the following order number:
Camera 6GA7202-0AA00-0AA1

Valid for software version
SIMOCRANE CenSOR V2.0 HF3

Introduction	1
Basic safety instructions	2
Safety instructions for SIMOCRANE CenSOR	3
Description	4
Application planning	5
Attachment/connection	6
Commissioning	7
Parameter assignment	8
Integration in a controller	9
Maintenance and service	10
Technical data	11
Dimension drawings	12
Components of the product/ spares/accessories	13
Appendix	A
ESD guidelines	B
List of abbreviations and acronyms	C
Glossary	14

Legal information

Warning notice system

This manual contains notices you have to observe in order to ensure your personal safety, as well as to prevent damage to property. The notices referring to your personal safety are highlighted in the manual by a safety alert symbol, notices referring only to property damage have no safety alert symbol. These notices shown below are graded according to the degree of danger.

 DANGER

indicates that death or severe personal injury will result if proper precautions are not taken.
--

 WARNING
--

indicates that death or severe personal injury may result if proper precautions are not taken.

 CAUTION
--

indicates that minor personal injury can result if proper precautions are not taken.
--

NOTICE

indicates that property damage can result if proper precautions are not taken.
--

If more than one degree of danger is present, the warning notice representing the highest degree of danger will be used. A notice warning of injury to persons with a safety alert symbol may also include a warning relating to property damage.

Qualified Personnel

The product/system described in this documentation may be operated only by **personnel qualified** for the specific task in accordance with the relevant documentation, in particular its warning notices and safety instructions. Qualified personnel are those who, based on their training and experience, are capable of identifying risks and avoiding potential hazards when working with these products/systems.

Proper use of Siemens products

Note the following:

 WARNING
--

Siemens products may only be used for the applications described in the catalog and in the relevant technical documentation. If products and components from other manufacturers are used, these must be recommended or approved by Siemens. Proper transport, storage, installation, assembly, commissioning, operation and maintenance are required to ensure that the products operate safely and without any problems. The permissible ambient conditions must be complied with. The information in the relevant documentation must be observed.
--

Trademarks

All names identified by ® are registered trademarks of Siemens AG. The remaining trademarks in this publication may be trademarks whose use by third parties for their own purposes could violate the rights of the owner.

Disclaimer of Liability

We have reviewed the contents of this publication to ensure consistency with the hardware and software described. Since variance cannot be precluded entirely, we cannot guarantee full consistency. However, the information in this publication is reviewed regularly and any necessary corrections are included in subsequent editions.

Table of contents

1	Introduction.....	7
1.1	Purpose of this documentation.....	7
1.2	Meaning of the term "setup" used in these operating instructions.....	8
1.3	Using checklists.....	9
2	Basic safety instructions.....	11
2.1	General safety instructions relating to hardware.....	11
2.2	General safety instructions relating to software.....	13
2.2.1	Malfunctions of the machine as a result of incorrect or changed parameter settings.....	13
2.3	Industrial security.....	14
2.4	Additional specific "security measures".....	15
3	Safety instructions for SIMOCRANE CenSOR.....	17
4	Description.....	21
4.1	Overview.....	21
4.2	Variants.....	23
4.3	Product features of the camera SIMOCRANE CenSOR MV440.....	24
4.4	Functions.....	25
4.5	Components.....	27
4.5.1	Camera SIMOCRANE CenSOR MV440.....	27
4.5.2	Power supply.....	27
4.5.3	IR flash.....	28
4.5.4	Reflector.....	28
4.5.5	Housing (only outdoor crane variant).....	30
4.6	Commissioning and diagnostics.....	32
4.7	Global "commissioning" checklist for SIMOCRANE CenSOR.....	33
5	Application planning.....	37
6	Attachment/connection.....	39
6.1	"Unpacking, attaching and connecting" checklist.....	39
6.2	SIMOCRANE CenSOR for an indoor crane.....	41
6.2.1	Attaching the SIMOCRANE CenSOR MV440 camera and reflector to an indoor crane.....	41
6.2.2	Connect components on the indoor crane.....	44
6.3	SIMOCRANE CenSOR for an outdoor crane.....	47
6.3.1	Attaching the camera housing and reflector to the outdoor crane.....	47
6.3.2	Connect components on the outdoor crane.....	50
6.4	Connecting SIMOCRANE CenSOR to SIMOTION.....	52
6.4.1	Linking SIMOCRANE CenSOR to SIMOTION C240PN.....	52

6.4.2	Connecting SIMOCRANE CenSOR to SIMOTION D435-2 DP/PN with CBE30-2.....	52
6.4.3	Connecting SIMOCRANE CenSOR to SIMOTION D435-2 DP/PN without CBE30-2.....	54
7	Commissioning.....	59
7.1	"Setting up interfaces for the user interface" checklist.....	59
7.2	Setting up interfaces for the user interface.....	60
7.2.1	Prerequisites.....	60
7.2.2	Establishing the connection to the SIMOCRANE CenSOR MV440 camera and starting the user interface.....	61
7.2.2.1	Steps for the initial commissioning of the camera.....	61
7.2.2.2	Connecting the camera and PC via Ethernet cable (step 1).....	62
7.2.2.3	Activating the camera (step 2).....	62
7.2.2.4	Configuring the Ethernet connection between the camera and PC (step 3).....	62
7.2.2.5	Starting the user interface (step 4).....	70
7.2.2.6	Setting the lighting parameters (step 5).....	71
7.2.2.7	Setting up the camera (step 6).....	72
8	Parameter assignment.....	75
8.1	"Parameter assignment" checklist.....	75
8.2	User interface.....	77
8.3	Commissioning the SIMOCRANE CenSOR.....	83
8.3.1	Options.....	83
8.3.1.1	Options - Image acquisition	83
8.3.1.2	Options - Lighting.....	84
8.3.1.3	Options - Security (optional).....	84
8.3.1.4	Options - Diagnostics & monitoring (optional).....	85
8.3.2	CenSOR.....	87
8.3.2.1	CenSOR - Reflector.....	88
8.3.2.2	CenSOR - Camera	91
8.3.2.3	CenSOR - Measured values.....	94
8.3.3	Adjustment - Set image.....	98
8.3.4	Adjustment - Save code.....	101
8.3.5	Calibrate.....	102
8.3.6	Run.....	106
8.3.7	Information.....	108
8.3.7.1	Information - Codes.....	108
8.3.7.2	Information - Diagnostics.....	109
8.3.7.3	Information - Device Information.....	111
8.3.8	Management.....	112
8.3.9	Stop.....	116
8.3.10	Monitoring via HTML pages.....	117
9	Integration in a controller.....	125
9.1	"Integration in a controller" checklist.....	125
9.2	Integrating via PROFINET IO.....	126
9.2.1	Preparing the SIMOCRANE CenSOR MV440 camera for PROFINET IO.....	126
9.2.2	Principle of data exchange for PROFINET IO.....	128
9.2.3	Assignment of the interfaces relevant to PROFINET IO.....	129
9.2.4	Data processing and handshake.....	133
9.2.5	Control functions via PROFINET IO.....	134

9.2.6	Sample application for integration in a SIMOTION controller for PROFINET IO (SIMOCRANE SC integrated only).....	136
9.2.6.1	Configuring the hardware (step 1).....	138
9.2.6.2	Entering the device name (step 2).....	140
9.2.6.3	Assign the device names to the camera (step 3).....	140
9.2.6.4	Configuring NetPro (step 4).....	141
9.2.6.5	Creating I/O variables (step 5).....	143
9.2.6.6	Copy the MCC source file "Camera" (step 6).....	146
9.2.6.7	Copying the library (step 7).....	147
9.2.6.8	Integrating the camera in the runtime system (step 8).....	148
9.2.6.9	Saving, compiling and checking consistency (step 9).....	149
9.2.6.10	Transferring the project to SIMOTION (step 10).....	149
9.2.7	Block description "FB_ReadWrite_MV440" (only SIMOCRANE SC integrated).....	150
9.3	Integrating using Ethernet UDP.....	152
9.3.1	Preparing the SIMOCRANE CenSOR MV440 camera for UDP.....	152
9.3.2	Principle of data exchange for UDP.....	155
9.3.3	Sample application for integration in a SIMOTION controller for UDP.....	156
10	Maintenance and service.....	157
10.1	Maintenance.....	157
10.2	Repairs.....	158
11	Technical data.....	159
11.1	SIMOCRANE CenSOR MV440 camera.....	159
11.1.1	Mechanical ambient conditions.....	159
11.1.2	Climatic ambient conditions.....	160
11.1.3	Transportation and storage.....	160
11.1.4	Power supply.....	160
11.1.5	Electromagnetic compatibility.....	161
11.1.6	Properties.....	161
11.1.7	Interfaces.....	162
11.2	Stainless steel enclosure.....	163
11.3	Lenses.....	164
11.4	Retro reflective reflector 300x300.....	165
11.5	Retro reflective reflector 500x500	166
12	Dimension drawings.....	167
13	Components of the product/spares/accessories.....	175
13.1	Components of the product.....	175
13.2	Order information and ordering data	176
A	Appendix.....	177
A.1	Service and Support.....	177
A.1.1	Technical Support.....	177
A.2	Standards and certifications.....	178
A.2.1	Directives and declarations.....	178

B	ESD guidelines.....	181
C	List of abbreviations and acronyms.....	183
14	Glossary.....	185
	Index.....	193

Introduction

1.1 Purpose of this documentation

Contents of this document

The operating instructions contain a description of the SIMOCRANE CenSOR camera measuring system. SIMOCRANE CenSOR is used in combination with SIMOCRANE SC Integrated or SIMOCRANE CeSAR standalone to eliminate load swaying effects:

- Container cranes
- Overhead bridge cranes
- Gantry cranes
- RTGs and RMGs

This includes information about environmental conditions, configuration and installation as well as instructions on maintenance and servicing.

1.2 Meaning of the term "setup" used in these operating instructions

To help you comprehend the term "setup", we distinguish between two meanings in these operating instructions.

Aligning the camera and reflector

Alignment of the camera and reflector for applications that need a camera image: the term "setup" is used in this document to denote all mechanical adjustments of the arrangement.

"Setup" of the interface to the user interface

In the context of commissioning, the term denotes parameterization and customization of the connection configuration and flash unit configuration.

1.3 Using checklists

To ensure successful commissioning of SIMOCRANE CenSOR, you are strongly advised to use the checklists provided in these operating instructions.

At the start of the following chapter, you will find the relevant checklists for the following topics:

- Attachment/connection (Page 39)
- Commissioning (Page 59)
- Parameter assignment (Page 75)
- Integration in a controller (Page 125)

Full checklist

You will find an overall checklist of all relevant topics in the chapter Global "commissioning" checklist for SIMOCRANE CenSOR (Page 33).

Basic safety instructions

2.1 General safety instructions relating to hardware

The camera measuring system is operated in the vicinity of electrical installations. This area may contain high voltages, moving machine parts, hydraulic and pneumatic systems. Consequently, follow the following general safety instructions.



WARNING

Electric shock and danger to life due to other energy sources

Touching live components can result in death or severe injury.

- Only work on electrical devices when you are qualified for this job.
- Always observe the country-specific safety rules.

Generally, the following six steps apply when establishing safety:

1. Prepare for disconnection. Notify all those who will be affected by the procedure.
2. Isolate the drive system from the power supply and take measures to prevent it being switched back on again.
3. Wait until the discharge time specified on the warning labels has elapsed.
4. Check that there is no voltage between any of the power connections, and between any of the power connections and the protective conductor connection.
5. Check whether the existing auxiliary supply circuits are de-energized.
6. Ensure that the motors cannot move.
7. Identify all other dangerous energy sources, e.g. compressed air, hydraulic systems, or water. Switch the energy sources to a safe state.
8. Check that the correct drive system is completely locked.

After you have completed the work, restore the operational readiness in the inverse sequence.



WARNING

Electric shock due to connection to an unsuitable power supply

When equipment is connected to an unsuitable power supply, exposed components may carry a hazardous voltage that might result in serious injury or death.

- Only use power supplies that provide SELV (Safety Extra Low Voltage) or PELV- (Protective Extra Low Voltage) output voltages for all connections and terminals of the electronics modules.



 **WARNING**

Electric shock due to equipment damage

Improper handling may cause damage to equipment. For damaged devices, hazardous voltages can be present at the enclosure or at exposed components; if touched, this can result in death or severe injury.

- Ensure compliance with the limit values specified in the technical data during transport, storage and operation.
- Do not use any damaged devices.

2.2 General safety instructions relating to software

WARNING

Danger to life if the safety instructions and residual risks are not observed

If the safety instructions and residual risks in the associated hardware documentation are not observed, accidents involving severe injuries or death can occur.

- Observe the safety instructions given in the hardware documentation.
- Consider the residual risks for the risk evaluation.

2.2.1 Malfunctions of the machine as a result of incorrect or changed parameter settings

WARNING

Malfunctions of the machine as a result of incorrect or changed parameter settings

As a result of incorrect or changed parameterization, machines can malfunction, which in turn can lead to injuries or death.

- Protect the parameterization (parameter assignments) against unauthorized access.
- Handle possible malfunctions by taking suitable measures, e.g. emergency stop or emergency off.

WARNING

Malfunction due to uncontrolled changeover between operating states

Uncontrolled change of the operating state can cause malfunctions on machines that can result in injuries or death.

- Assess the effects of changeover between operating states in the risk analysis.
- Provide appropriate safety measures, e.g. EMERGENCY OFF.

2.3 Industrial security

Note

Industrial security

Siemens provides products and solutions with industrial security functions that support the secure operation of plants, systems, machines and networks.

In order to protect plants, systems, machines and networks against cyber threats, it is necessary to implement – and continuously maintain – a holistic, state-of-the-art industrial security concept. Siemens' products and solutions constitute one element of such a concept.

Customers are responsible for preventing unauthorized access to their plants, systems, machines and networks. Such systems, machines and components should only be connected to an enterprise network or the Internet if and to the extent such a connection is necessary and only when appropriate security measures (e.g. firewalls and/or network segmentation) are in place.

For additional information on industrial security measures that may be implemented, please visit:

Industrial security (<http://www.siemens.com/industrialsecurity>)

Siemens' products and solutions undergo continuous development to make them more secure. Siemens strongly recommends that product updates are applied as soon as they are available and that the latest product versions are used. Use of product versions that are no longer supported, and failure to apply the latest updates may increase customer's exposure to cyber threats.

To stay informed about product updates, subscribe to the Siemens Industrial Security RSS Feed at:

Industrial security (<http://www.siemens.com/industrialsecurity>)

Further information is provided on the Internet:

Industrial Security Configuration Manual (<https://support.industry.siemens.com/cs/mdm/108862708?c=89854859915&lc=en-WW>)



WARNING

Unsafe operating states resulting from software manipulation

Software manipulations (e.g. viruses, trojans, malware or worms) can cause unsafe operating states in your system that may lead to death, serious injury, and property damage.

- Keep the software up to date.
- Incorporate the automation and drive components into a holistic, state-of-the-art industrial security concept for the installation or machine.
- Make sure that you include all installed products into the holistic industrial security concept.
- Protect files stored on exchangeable storage media from malicious software by with suitable protection measures, e.g. virus scanners.
- Protect the drive against unauthorized changes by activating the "know-how protection" drive function.

2.4 Additional specific "security measures"

The customer is responsible for preventing unauthorized access to its plants, systems, machines and networks, see also safety instruction Industrial security (<http://www.siemens.com/industrialsecurity>).

In order to protect plants, systems, machines and networks against cyber attack, Siemens industrial security functions can be incorporated into a customized industrial security concept.

For more information about the industrial security functions of SIMATIC/SIMOTION/SINAMICS, please go to:

- SIMOTION/SINAMICS (<https://support.industry.siemens.com/cs/ww/de/view/108862708>)
- SIMATIC (<https://support.industry.siemens.com/cs/ww/de/view/90885010>).

Safety instructions for SIMOCRANE CenSOR

This device conforms to the pertinent safety regulations according to IEC, VDE and EN. If you have doubts regarding the installation of the device in the planned environment, please get in touch with our service contact.

Qualified personnel

Startup and operation of the device/system in question must only be performed using this documentation. Commissioning and operation of a device/system may only be performed by qualified personnel. Qualified personnel as referred to in the safety guidelines in this documentation are those who are authorized to start up, earth and label units, systems and circuits in accordance with the relevant safety standards.

Proper use

The unit may be used only for the applications described in the catalog or the technical description, and only in combination with the equipment, components and devices of other manufacturers where recommended or permitted by Siemens. This product can only function correctly and safely if it is transported, stored, set up, and installed correctly, and operated and maintained as recommended.

Repairs

Repairs to the device may only be performed by authorized specialists.

 WARNING
Damage due to incorrect repairs
Unauthorized opening or improperly performed repairs can cause considerable damage to property or danger to users.

System expansions

Install only system expansions that are intended for this device. Installing other expansions can damage the system or violate the safety provisions and regulations for radio interference suppression. You can obtain information on system expansions suitable for installation from the technical customer service or from the sales office responsible for your area.

NOTICE
Warranty on system expansions
The guarantee is nullified if defects are caused to the device by installing or replacing system expansions.

NOTICE

Modules sensitive to electrostatic discharge

The device contains modules that are sensitive to electrostatic discharge. ESD devices can be destroyed by voltages well below the threshold of human perception. Such voltages occur if you touch a component or electrical connectors of a module without first discharging the static from your body. The damage caused by overvoltage on a module cannot normally be detected immediately and only becomes apparent after a longer period of operation.

Measures for protecting against discharge of static electricity:

- Always discharge your body's static electricity before handling modules, for example, by touching a grounded object.
- The devices and tools used must also be free of static charges.
- Pick up the modules only on their edges and do not touch any pins or printed conductors.

Connecting the 24 V DC power supply

 **CAUTION**

Connection to the 24 V DC power supply

The device should only be connected to a 24 V DC power supply that satisfies the requirements of safe extra low voltage (SELV).

When the device is operated on a wall, in an open rack or other similar locations, an NEC Class 2 current source is required for the compliance of the UL requirements (in accordance with UL 60950-1). In all other cases (in accordance with IEC/EN/DIN EN 60950-1) either a power source of limited performance (LPS = Low Power Source), or a line-side fuse or a line-side power switch is necessary.

24 V DC power supply (19.2 to 28.8 V)

The generation of the 24 V DC supply voltage by the line-side power supply must be implemented as functional extra-low voltage with safe electrical isolation according (floating) to IEC 80364-4-41, or as SELV to IEC/EN/DIN EN 60950-1 and LPS/NEC class 2.

Connecting the 230 V AC power supply

 **WARNING**

Risk of electric shock

The retro reflective reflectors for the outdoor crane are equipped with a 230 V AC foil heating inside the housing.

The power must be turned off before performing any work on the retro reflective reflectors. The foil heating must not be damaged.

Danger from falling objects

 **WARNING**

Make sure there is nobody below the crane

To prevent the risk of injury through falling objects, nobody may be present in the area below the crane during installation.

The installation must be performed according to the installation instructions.

 **WARNING**

Risk of falling SIMOCRANE CenSOR components

All screwed joints are equipped with suitable screw locks to safely prevent SIMOCRANE CenSOR components from falling down after installation.

- Always use these screw locks for installation.
- The screw locks may not be disabled or removed.

Description

4.1 Overview

The SIMOCRANE CenSOR camera measuring system continuously detects the position of a reflector. The camera measuring system is a non-contact system and has a very high resolution.

SIMOCRANE CenSOR is mainly used together with SIMOCRANE SC Integrated (on SIMOTION D435-2 DP/PN) or SIMOCRANE CeSAR standalone (on SIMOTION C240PN).

Components

SIMOCRANE CenSOR consists of the following components:

- Digital camera (SIMOCRANE CenSOR MV440) with integrated DSP for image processing.
- IP54 enclosure made of stainless steel; with integrated heating system for variant 2 (outdoor crane).
- Infrared flash (can be synchronized with the camera's image recording).
- Reflector with retroreflective foil.

SIMOCRANE CenSOR MV440

The SIMOCRANE CenSOR MV440 camera is modified for crane applications.

With the SIMOCRANE CenSOR MV440, particular attention was paid to robustness, reliability and simple operation.

The main features of the camera are its extremely compact design and extremely simple operation and commissioning:

- All components, including the exchangeable C-mount lenses, can be protected against environmental influences with degree of protection IP 67.
- The system is commissioned using an integrated Web server via an Internet browser without prior software installation.

Overview of the hardware

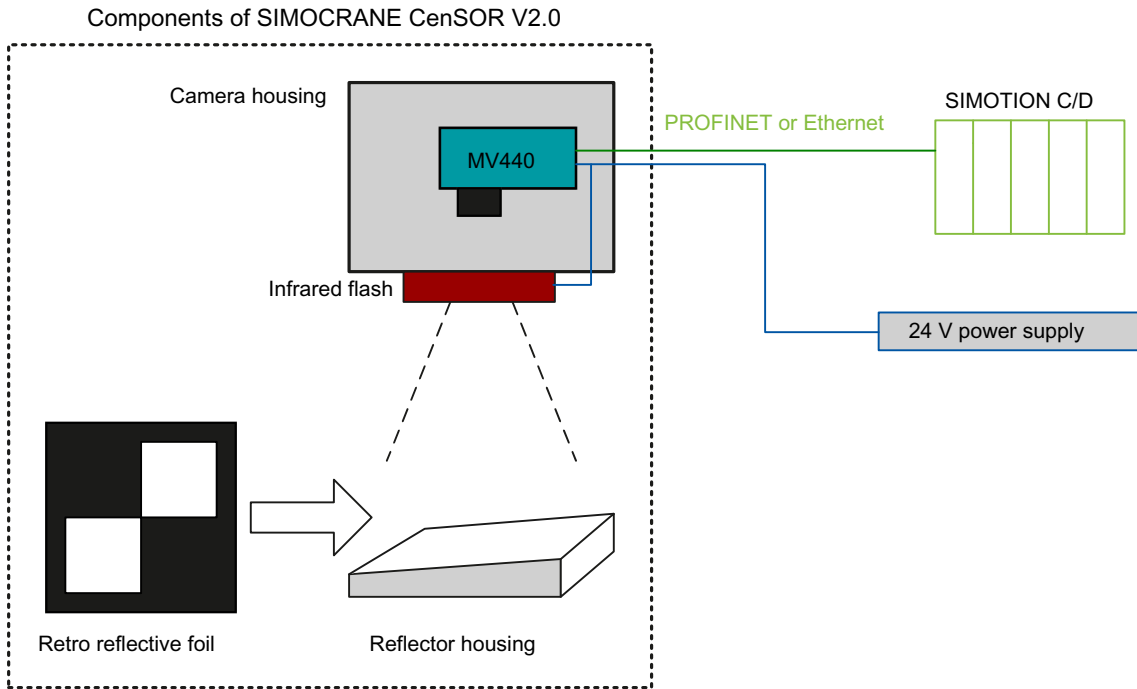

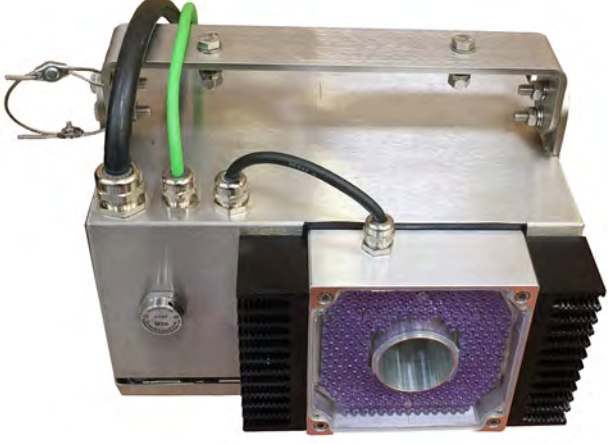

Figure 4-1 Overview of the hardware (power supply for heating in the camera housing not shown)

4.2 Variants

Two variants are on offer:

Variant 1 (indoor crane)	Variant 2 (outdoor crane)
	
<ul style="list-style-type: none"> • SIMOCRANE CenSOR MV440 camera • C-mount lenses • Lens protection housing (for degree of protection IP67) • IR flash (ring shaped) • Mounting bracket • Retro reflective reflector (300 mm x 300 mm, stainless steel) 	<ul style="list-style-type: none"> • SIMOCRANE CenSOR MV440 camera • C-mount lenses • Stainless steel enclosure • IR flash • Retro reflective reflector (310mm x 310 mm or 500 mm x 500 mm, stainless steel with heating) • Degree of protection IP54

4.3 Product features of the camera SIMOCRANE CenSOR MV440

SIMOCRANE CenSOR MV440 camera

- Ethernet 10/100 Mbps for UDP and PROFINET IO
- 640 x 480 pixels resolution
- 1 trigger input and 1 flash output
- Robust construction, suitable for industry
- Class of protection IP67 (with protective lens tube mounted)
- Selectable optics thanks to C-mount lenses
- Lighting by external infrared flash
- User interface
 - Fully Web-based user interface for programming device or PC
 - Versatile HTML pages for monitoring the camera using an Internet browser, for example in WinCC flexible.
 - Extensive operator control and monitoring functions, even in processing range
 - Wide-ranging diagnostics and logging functions (bad image memory, event logging)
- Firmware update
- System backup

4.4 Functions

Functional principles

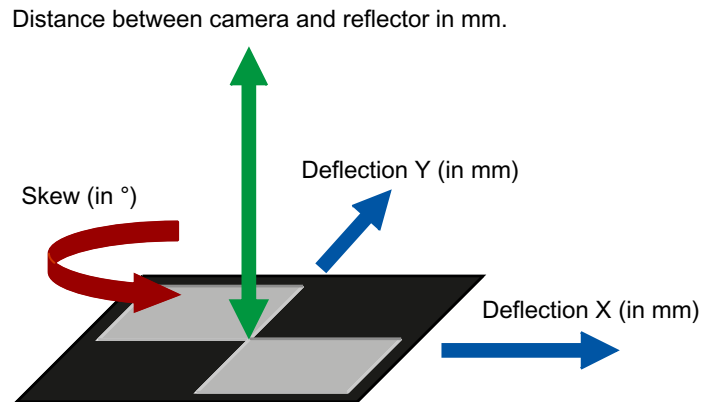

Figure 4-2 Measured values

The camera system detects the vertical offset to the camera axis in millimeters, the distance between the reflector and camera, and skew around the camera axis. Reflector skew is registered in degrees. The reliability of the measured data is checked and corrected based on various algorithms.

The following measured values are acquired:

- deflection of the reflector along the x and y axis
- Angle of rotation of the reflector
- Distance between the camera and the reflector

The measured values are refreshed at a fixed interval of 50 ms (factory default).

The installation parameters are calculated with an automatic calibration function. To achieve this, the reflector is measured in the home position at various distances.

The measuring system is configured using parameters.

Measuring deflection

The camera measuring system detects deflection in two axes.

The absolute measurement precision of the camera measuring system depends on the distance between the camera and the reflector.

When using lenses with greater focal length:

- increase of measurement precision.
- The range of measurement is reduced due to a smaller aperture angle.

A precision of approximately 1 mm per 1 m distance between camera and reflector can be reached.

A distance between 1 m and 50 m may be set between the camera and reflector. The reflector size increases proportionally to the maximum distance.

Measuring the rotation angle

Based on the rotation of the reflector, the camera calculates the rotation angle. The resolution depends on the reflector size and the distance.

The maximum measurable rotation angle is $\pm 15^\circ$. If the rotation is greater, the pattern of the reflector is no longer recognized by the camera.

Measuring the distance between the camera and reflector

Based on the size of the reflector, the camera measuring system calculates the distance between camera and reflector. The accuracy of the distance measurement is approximately 2 to 10 %.

Image acquisition

The camera acquires the reflector image to be processed using digital image acquisition. Following image acquisition, the image is analyzed by a powerful digital signal processor. During the analysis, multistage complex algorithms are used.

The results of the evaluation are transferred to an automation system connected via the communications interfaces.

When working with the camera, the user is supported because the parameter settings for the image acquisition and processing are made by the device. Once it is installed and set up, the camera starts to search for a reflector in the image.

4.5 Components

4.5.1 Camera SIMOCRANE CenSOR MV440

The SIMOCRANE CenSOR MV440 camera represents the core of the SIMOCRANE CenSOR measurement system. Depending on the variant, the camera is supplied as turn-key unit with IR flash in a stainless steel enclosure, or mounted on a simple bracket.

4.5.2 Power supply

Variant 1 (indoor crane)

- Regulated switched-mode power supply, 24 V/> 2 A, surge-proof

Component to be supplied with 24 V:

- SIMOCRANE CenSOR MV440 camera
- SIMATIC VS100 rail-mount power supply for SIMATIC VS100 ring lamps:

A SIMATIC VS100 power supply with order number 6GF9002-8PS is included in the scope of delivery for operation of the external lighting unit (16.5 V):

- Input voltage: 110 to 230 V AC
- Output voltage: 16.5 V DC

Variant 2 (outdoor crane)

- Regulated switched-mode power supply, 24 V/10 A, surge-proof

Components to be supplied with 24 V:

- SIMOCRANE CenSOR MV440 camera
- IR flash
- Heating (50 W)

4.5 Components

4.5.3 IR flash

To improve detection, the system is used with a flash.

The resulting shorter exposure times make higher sampling rates possible.

- When using SIMOCRANE CenSOR in combination with SIMOCRANE SC integrated or SIMOCRANE CeSAR standalone:
the flash accelerates controller reaction times to interference.

Flashes used

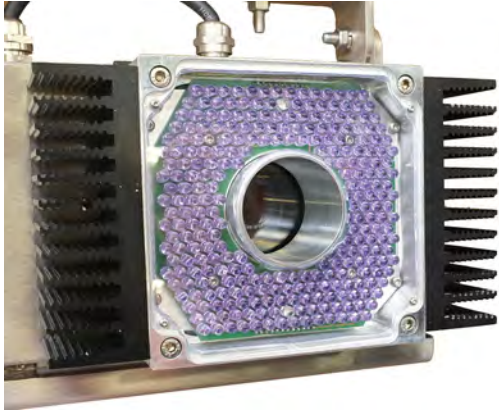

Variant 1 (indoor crane)	Variant 2 (outdoor crane)
	
<p>The flash is attached to the camera by means of a bracket. The IR flash consists of a large number of IR LEDs. A permanently lit red LED indicates the presence of the power supply.</p>	<p>The IR flash is mounted on the stainless steel enclosure. The flash function is indicated by two green LEDs that light up at the same interval as the flash pulse.</p>

4.5.4 Reflector

<p>⚠ WARNING</p> <p>Risk of electric shock</p> <p>The retro reflective reflectors for the outdoor crane are equipped with a 230 V AC foil heating inside the housing.</p> <p>During operation, a dangerous voltage is present in the heater. A damaged heating foil can result in severe injury or death.</p> <ul style="list-style-type: none"> • Make sure that the power is turned off before performing any work on the retro reflective reflectors. • Do not damage the foil heating. • To ensure reliable recognition, clean the reflectors regularly. Note the information in chapter Maintenance (Page 157).

The reflector is a special construction designed for the typical jolting caused by cranes. A reflector is required for each SIMOCRANE CenSOR MV440 camera and its dimensions depend on the maximum distance to the camera.

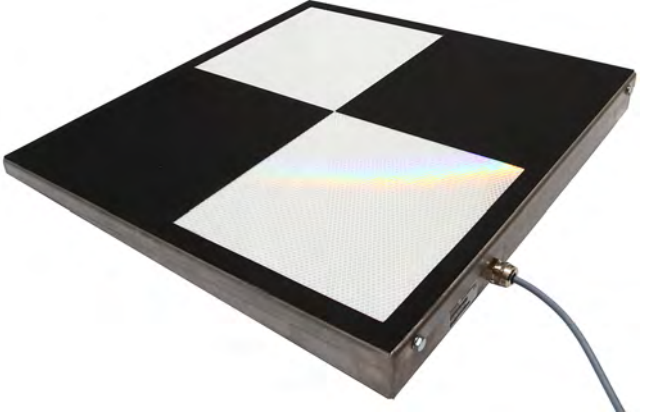
Available reflector types

Variant 1 (indoor crane)	Variant 2 (outdoor crane)
	
<p>Retro reflective reflector 300 x 300 mm, stainless steel</p>	<ul style="list-style-type: none"> • Retro reflective reflector 310 x 310 mm, stainless steel with heating. • Retro reflective reflector 500 x 500 mm, stainless steel with heating. <p>The reflector is heated electrically for outdoor applications to prevent snow or ice from impairing visibility. To allow rain water or dew to flow off, the top of the reflector is slightly inclined.</p> <p>The heated retroreflective reflectors are mounted in stainless steel enclosures without degree of protection. The internal components (heating elements and switch box) are protected against environmental influences with degree of protection IP53 to DIN EN 60529.</p> 

Features of the reflectors

The white areas of the reflector are equipped with a retro reflective foil.

The retro reflective foil acts like a "cat's eye" and is illuminated by an infrared LED flash fitted directly beside the SIMOCRANE CenSOR MV440 camera.

- The light of the flash is reflected in the SIMOCRANE CenSOR MV440 camera.
- Sunlight or other extraneous light is thrown back in the direction of the source.

4.5 Components

Heating

The reflectors are equipped with two flat heating elements underneath the white surfaces. The heaters switch on automatically at temperatures below 15° C and ensure that snow and ice thaws. However, at extreme weather conditions it may still be necessary to clear the reflector of snow and ice.

Power supply

- Retroreflective reflector 310 x 310 mm, stainless steel with heating: 230 V AC; 80 W
- Retroreflective reflector 500 x 500 mm, stainless steel with heating: 230 V AC; 500 W

4.5.5 Housing (only outdoor crane variant)

The enclosure of SIMOCRANE CenSOR is designed to withstand the harsh operating conditions on outdoor cranes. This applies particularly to weather conditions on harbor cranes, for example salty air/rain, and heat.



Front and rear of the enclosure for outdoor use

- The housing is supplied with the SIMOCRANE CenSOR MV440 camera in a stainless steel V4A version.
- The integrated heating prevents damage by frost and fogging of the protective disc.

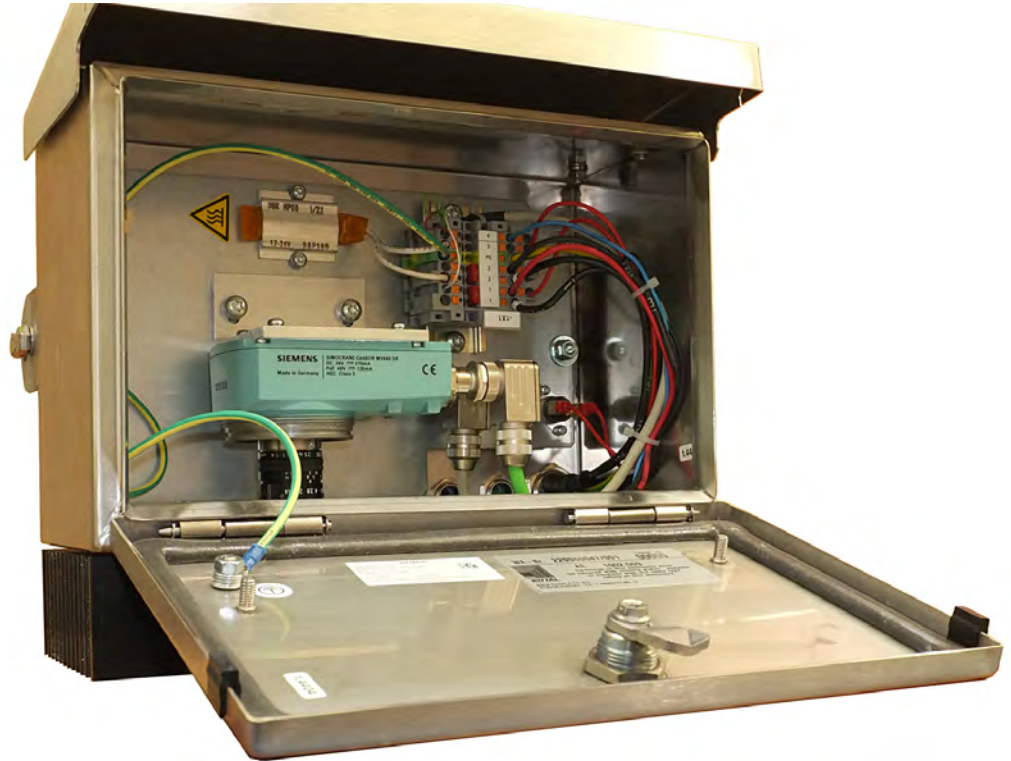

Figure 4-3 Open enclosure

4.6 Commissioning and diagnostics

User interface

The user interface is based on "Web server technology". This means that a computer with an Internet browser connected to the SIMOCRANE CenSOR MV440 camera via Ethernet is sufficient.

- The SIMOCRANE CenSOR MV440 camera is called using its IP address.
The display of the user interface appears in the display window of the Web browser.
- Display via Ethernet allows convenient setting and operator control of all parameters of the camera.
- Operator control of the camera is supported by context-sensitive online help.

If the defaults do not produce an ideal result due to special conditions, you can manually re-adjust individual parameters of the camera using the user interface. You can store 14 different settings (= codes) on the camera.

All the settings for communication with other devices must be performed in the user interface.

The actual image processing takes place in processing mode and is handled by the SIMOCRANE CenSOR MV440 camera automatically.

Diagnostic functions

The SIMOCRANE CenSOR MV440 camera has comprehensive diagnostics functions. If the reflector is not found, the diagnostics functions can be used to find reasons for the errors based on the recorded images. If, for example, malfunctions occur in the previous marking process, you need the diagnostic functions to identify the error source.

4.7 Global "commissioning" checklist for SIMOCRANE CenSOR

The following steps need to be completed for successful commissioning of SIMOCRANE CenSOR.

Chapter	What needs to be done?	OK?
Attachment/connection (Page 39)	Unpack, fit and connect up SIMOCRANE CenSOR components. → Select the variant	
	→ Indoor crane selected	<ul style="list-style-type: none"> Mount the camera housing on the trolley of the indoor crane (Page 41) Mount the reflector on the load carrying device of the indoor crane (Page 41) Connect components on the indoor crane (Page 44)
	→ Outdoor crane selected	<ul style="list-style-type: none"> Mount the camera housing on the trolley of the outdoor crane (Page 47) Mount the reflector on the load carrying device of the outdoor crane (Page 47) Connect components on the outdoor crane (Page 50)
Commissioning (Page 59)	Set up the interface (applies to both variants)	
	→ Make the required preparations	<ul style="list-style-type: none"> Check that everything is prepared (Page 60) Install the SIMATIC Primary Setup Tool (PST) on the PC/programming device (Page 60).
	→ Establish the connection to the SIMOCRANE CenSOR MV440 camera and start the user interface	<ul style="list-style-type: none"> Connect the SIMOCRANE CenSOR MV440 camera and the PC using an Ethernet cable (Page 62). Turn on the SIMOCRANE CenSOR MV440 camera (Page 62). Configure the Ethernet connection between the SIMOCRANE CenSOR MV440 camera and PC (Page 62). Start the user interface with Internet Explorer (Page 70). Configure the flash (if available) (Page 71). Adjust the SIMOCRANE CenSOR MV440 camera using the user interface (Page 72).

4.7 Global "commissioning" checklist for SIMOCRANE CenSOR

Chapter	What needs to be done?	OK?	
Parameter assignment (Page 75)	Commission the SIMOCRANE CenSOR (applies to both variants)		
	→ "Options" page:	<ul style="list-style-type: none"> • "Image acquisition" tab, enable Auto trigger (Page 83) • "Lighting" tab, select lamp (Page 84) 	
	→ "Adjustment" page	<ul style="list-style-type: none"> • Set exposure time and brightness (Page 98) 	
	→ "CenSOR" page	"Reflector" page → set following parameters: (Page 88)	
		• Reflector type	
		• Edge length of the white reflector area in mm	
		• Reliability of the size measurement with the SIMOCRANE CenSOR MV440 camera	
		• Reflector recognition limit (complete image)	
		• Reflector recognition limit (reflector proximity)	
		• External value for reflector distance	
		• Alignment of the reflector	
	"Camera" tab → set following parameters: (Page 91)	• Focal length of the lens	
		• Minimum reflector contrast	
		• Monochrome limit	
		• Limiting of the global search (X)	
		• Limiting of the global search (Y)	
		• Reflector-dependent exposure	
	"Measured values" tab → set following parameters: (Page 94)	• Resolution	
		• Offset	
		• Smoothing time constant	
• Reflector distance min.			
• Reflector distance max.			
→ "Adjustment" page	<ul style="list-style-type: none"> • Save the parameter settings with "Save code" (Page 101) 		
→ "Calibration" page	<ul style="list-style-type: none"> • Perform the calibration steps (Page 102) 		
→ "Processing" page	<ul style="list-style-type: none"> • Start processing (Page 106) 		

4.7 Global "commissioning" checklist for SIMOCRANE CenSOR

Chapter	What needs to be done?	OK?	
Integration in a controller (Page 125)	Integrating SIMOCRANE CenSOR in a controller	<ul style="list-style-type: none"> Integrate SIMOCRANE CenSOR via PROFINET IO (Page 126) 	
		<ul style="list-style-type: none"> Integrate SIMOCRANE CenSOR with UDP via Ethernet (Page 152) 	

"Attachment/connection", "Commissioning", "Parameter assignment", "Integration in a controller" checklist

Description

4.7 Global "commissioning" checklist for SIMOCRANE CenSOR

Application planning

Conditions of use, SIMOCRANE CenSOR MV440 camera

The SIMOCRANE CenSOR MV440 camera is designed for use in stationary, weather-protected locations and complies with the operating conditions according to:

- DIN IEC 60721-3-3 class 3M3 (mechanical requirements)
- DIN IEC 60721-3-3 class 3K3 (climatic ambient conditions)

Conditions of use variant 1 (indoor crane)

Conditions of use variant 2 (outdoor crane)

NOTICE
Protect the stainless steel enclosure against exposure to direct sunlight
The specified temperature range of + 50 °C can only be achieved if the stainless steel housing is protected from direct sunlight.
During installation, make sure that suitable protection is available.

The components of the SIMOCRANE CenSOR system located outside a control cabinet, including the reflector, are designed to withstand the harsh conditions on harbor and industrial cranes. The SIMOCRANE CenSOR MV440 camera is installed along with the lens, IR filter and heating in a V4A stainless steel housing with degree of protection IP54.

The reflectors are also made of V4A stainless steel and a reflector foil which is tried-and-tested for outdoor use.

The heated retroreflective reflectors are mounted in stainless steel enclosures without degree of protection. The internal components (heating elements and switch box) are protected against environmental influences with degree of protection IP53 to DIN EN 60529.

This means that resistance to the following ambient conditions is guaranteed:

- Salty air
- Snowfall
- Ambient temperature without heating: 15 to +50 °C
- Ambient temperature with active heating: -25 to +50 °C
- Heavy continuous rain, dust
- Mechanical resistance to vibration and impact to DIN IEC 60721-3-3, class 3M1.

Attachment/connection

6.1 "Unpacking, attaching and connecting" checklist

SIMOCRANE CenSOR is conceived primarily for use in combination with:

- SIMOCRANE SC Integrated (on SIMOTION D435-2 DP/PN with CBE30-2)
- SIMOCRANE CeSAR standalone (on SIMOTION C240PN)

You do not need an industrial Ethernet switch for installation and wiring. The CBE30-2 Communication Board Ethernet and the PROFINET I/O interface of the SIMOTION C240PN already have switch functionality.

SIMOTION module: Connecting the Ethernet interface with the PROFINET interface

To connect the Ethernet interface of the SIMOTION module to the PROFINET interface of the SIMOTION module, proceed as described in these Operating Instructions, Connecting SIMOCRANE CenSOR to SIMOTION (Page 52).

Operating with SIMOCRANE SC Integrated

SIMOCRANE CenSOR can also be operated with SIMOCRANE SC Integrated, on SIMOTION D435- 2 DP/PN without CBE30-2.

- Only the UPD protocol is available as the communication protocol between SIMOCRANE CenSOR and the SIMOTION D435- 2 DP/PN.
- You need to install an industrial Ethernet switch for commissioning.

Unpacking, attaching and connecting

Before you start to commission SIMOCRANE CenSOR:

1. Select the variant you are using.
2. Follow the "Attachment/connection" checklist.

6.1 "Unpacking, attaching and connecting" checklist

Chapter	What needs to be done?	OK?	
Attachment/connection	Unpack, fit and connect up SIMOCRANE CenSOR components. → Select the variant		
	→ Indoor crane selected	• Mount the camera housing on the trolley of the indoor crane (Page 41)	
		• Mount the reflector on the load carrying device of the indoor crane (Page 41)	
		• Connect components on the indoor crane (Page 44)	
	→ Outdoor crane selected	• Mount the camera housing on the trolley of the outdoor crane (Page 47)	
		• Mount the reflector on the load carrying device of the outdoor crane (Page 47)	
		• Connect components on the outdoor crane (Page 50)	
Continue with Chapter Commissioning (Page 59)			

"Attachment/connection" checklist

See also

Connecting SIMOCRANE CenSOR to SIMOTION D435-2 DP/PN without CBE30-2 (Page 54)

6.2 SIMOCRANE CenSOR for an indoor crane

6.2.1 Attaching the SIMOCRANE CenSOR MV440 camera and reflector to an indoor crane

Mount the camera on the trolley of the indoor crane

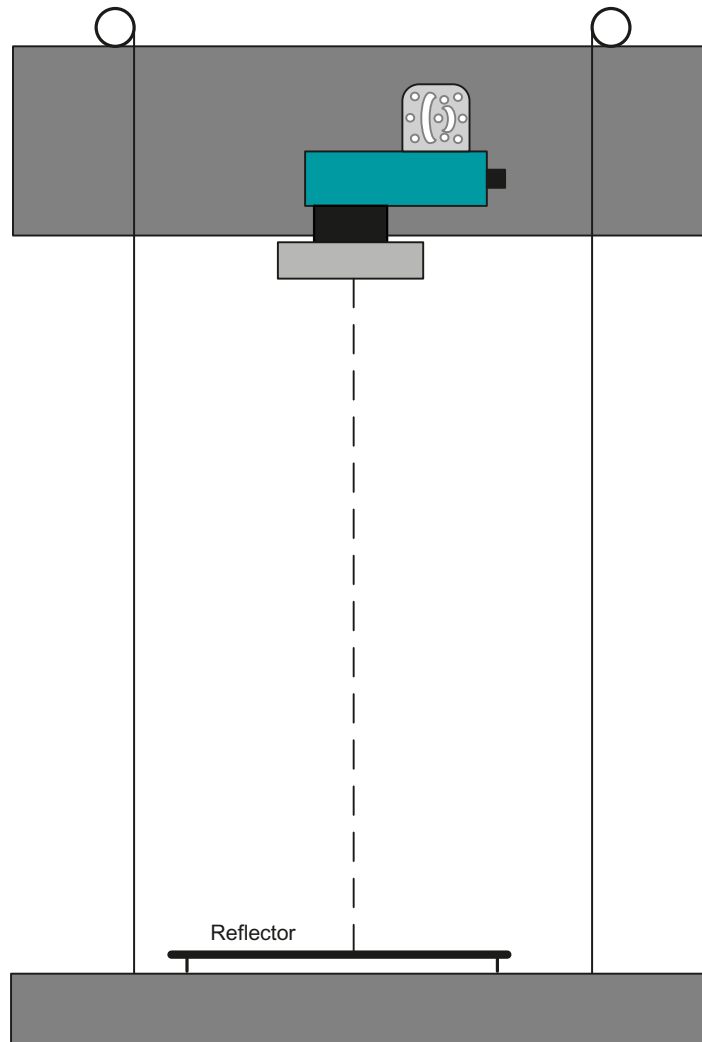

Figure 6-1 Mounting drawing for the SIMOCRANE CenSOR MV440 camera

⚠ WARNING

Make sure there is nobody below the crane trolley

To prevent the risk of injury through falling objects, nobody may be present in the area below the crane trolley during installation of the SIMOCRANE CenSOR MV440 camera.

⚠ WARNING

Risk of falling SIMOCRANE CenSOR components

All screwed joints are equipped with suitable screw locks to safely prevent SIMOCRANE CenSOR components from falling down after installation.

- Always use these screw locks for installation.
- The screw locks may not be disabled or removed.

Note

Mounting the camera vertically

Mount the SIMOCRANE CenSOR MV440 camera on the trolley in perpendicular position above the reflector that is attached to the hoist unit.
The camera lens must face the reflector

Secure the camera unit to the trolley with the mounting plate; see figure below:

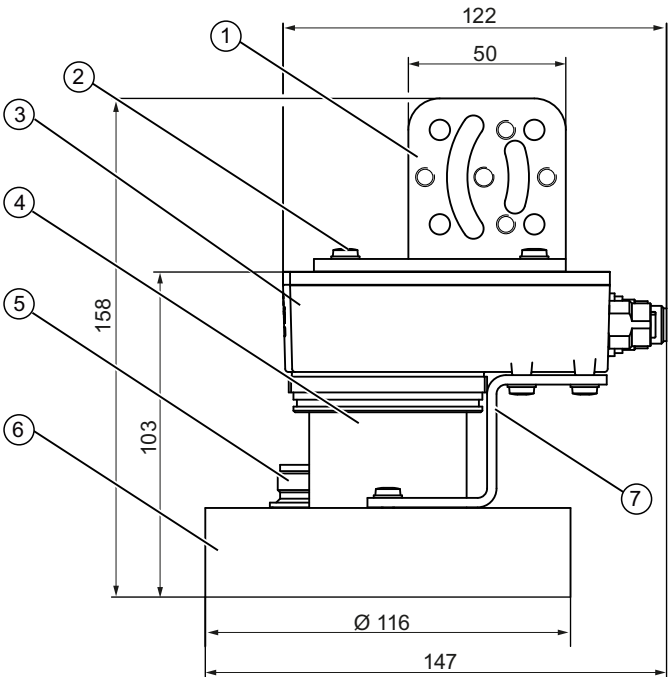

- ① SIMOCRANE CenSOR MV440 camera mounting plate
- ② Torx screws M4x8
- ③ SIMOCRANE CenSOR MV440 camera
- ④ IP65 protective lens housing Ø 50
- ⑤ Socket for lighting unit
- ⑥ Lighting unit SIMATIC Vision Sensor VS100
- ⑦ Ring lamp holder (external)

Figure 6-2 SIMOCRANE CenSOR MV440 with lighting unit and mounting plate

Mount the reflector on the load carrying device of the indoor crane

NOTICE

Proper mounting of the reflector

Improper mounting will damage the reflector.

Note

The reflector must be easily visible from above / maximum skew of the reflector

- The reflector must be clearly visible vertically from above and must not be hidden by structural elements.
- If the measured angle of skew is used, the reflector must be rotated no more than 1° to 2° in its zero position.
- If the measured angle of skew is not used, the reflector must be rotated no more than 10° in its zero position.
The maximum measurable angle of skew is $\pm 15^\circ$. A larger skew would prevent the camera from recognizing the pattern of the reflector.

- Secure the reflector to the load carrying device as shown in the "reflector mounting drawing".

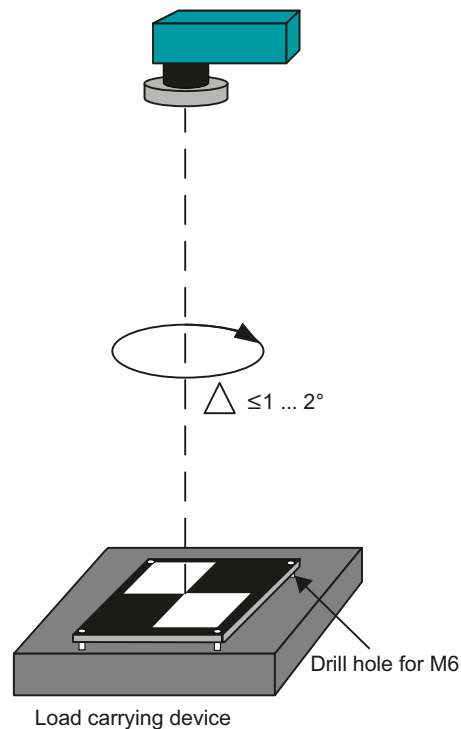

Figure 6-3 Reflector assembly drawing

- Bolt the reflector to the mounting points provided on the hoist unit using four M8 bolts. For more information on dimensions, refer to the included product documentation; see Dimension drawings (Page 167).

6.2.2 Connect components on the indoor crane

Note

Using the stabilized switched-mode power supply

Always use the stabilized switched-mode power supply supplied: 24 V/10 A, surge-proof.

Next, connect the SIMOCRANE CenSOR components.

Camera and flash

- Connect the following cables that are included in the scope of delivery:
 - RJ45 Ethernet
 - Power-IO-RS232 cable, open cable end
 - Lamp cable, open cable end
- Connect the camera and flash unit in accordance with the following table:

6.2 SIMOCRANE CenSOR for an indoor crane

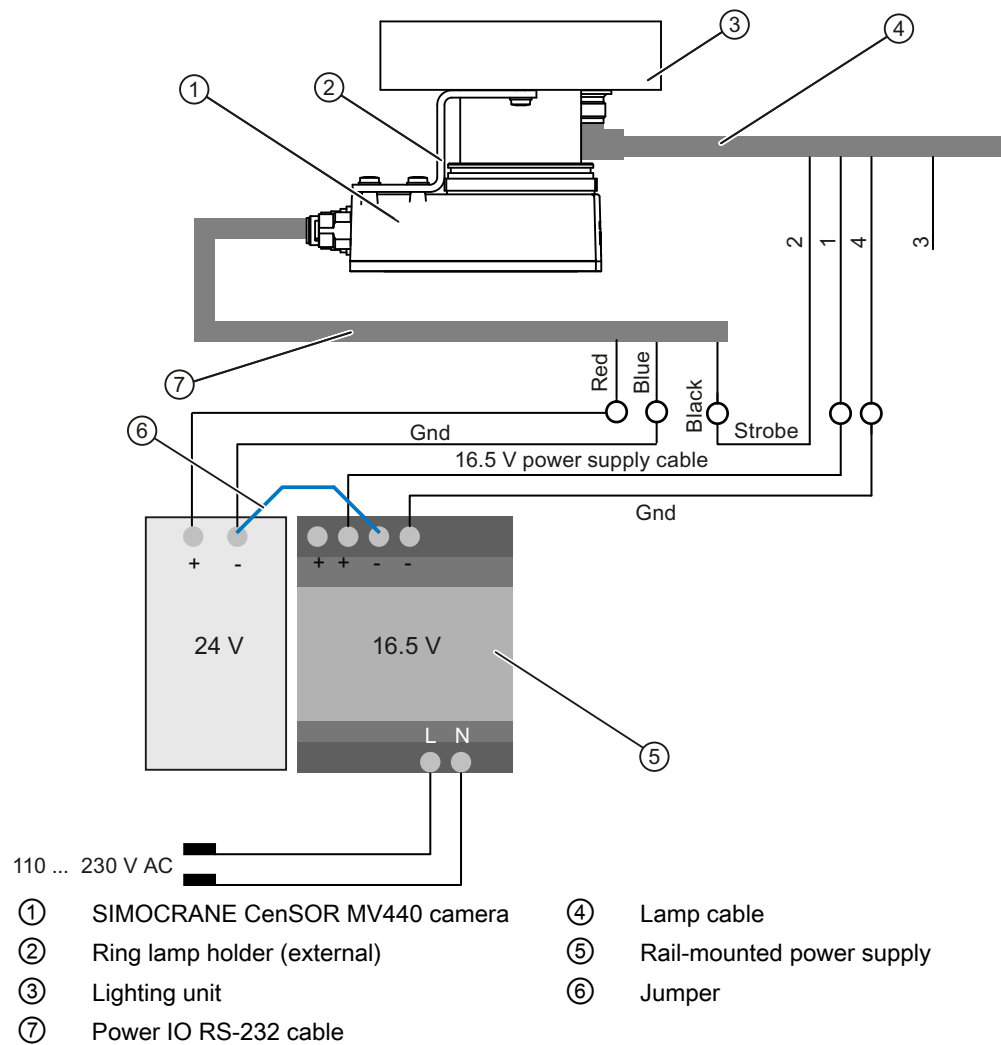

Figure 6-4 Circuit diagram for the camera and flash unit of the indoor crane

Interface pin assignment

Table 6-1 Interface of the evaluation unit to the "LAMP" lighting unit (socket)

Terminal	Name	Function	Direction
1	+16 V	16.5 V power supply	-
2	LIGHT	Flash trigger pulse (24 V)	Input
3	-	-	-
4	M	Mass	-

Reflector (only for heated variants)

- Wire the reflector to 230 V AC.
 - 230 V, 3 x 0.75 mm², open cable end
- Wire the reflector power supply according to the circuit diagram. The circuit diagram is on the SIMOCRANE CenSOR product DVD.

The following table lists the pin assignment of the cable:

Table 6-2 Pin assignment of the cable.

ID	Power
L1 / phase	230 V AC
N neutral	
PE	Ground PE

Diagnostics PC (during commissioning)

- Connect the diagnostics PC to the computer unit via an Ethernet cable, either directly or via a switch.

6.3 SIMOCRANE CenSOR for an outdoor crane

6.3.1 Attaching the camera housing and reflector to the outdoor crane

Mount the camera housing on the trolley of the outdoor crane

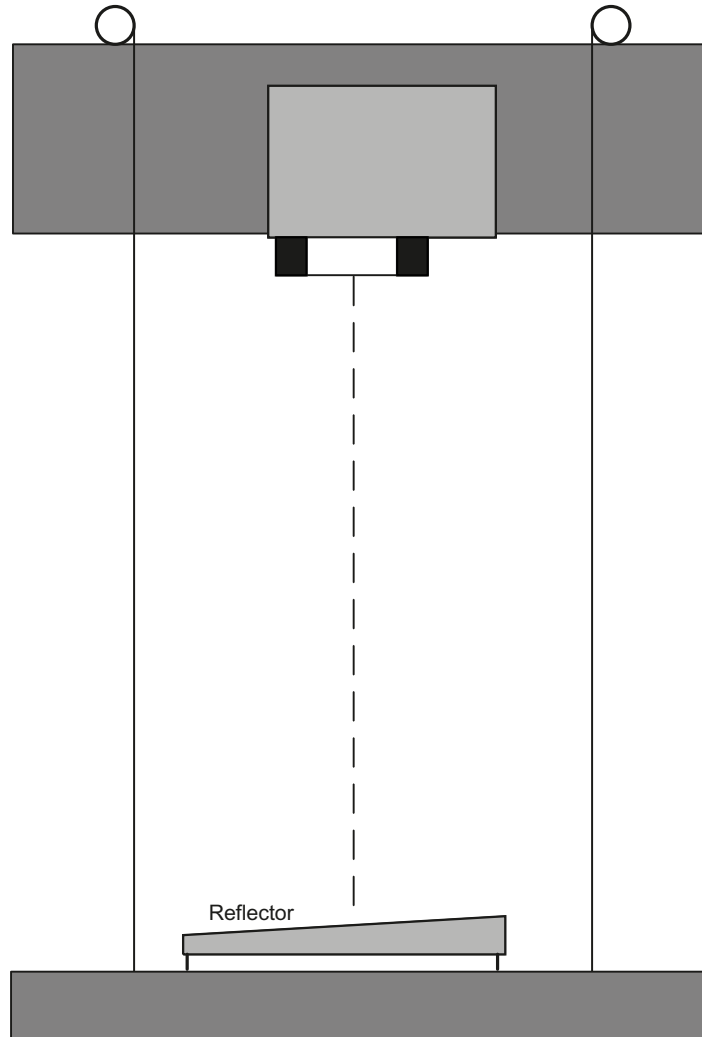



Figure 6-5 Camera housing mounting drawing

⚠ WARNING

Make sure there is nobody below the crane trolley

To prevent the risk of injury through falling objects, nobody may be present in the area below the crane trolley during installation of the SIMOCRANE CenSOR MV440 camera.

 WARNING
Risk of falling SIMOCRANE CenSOR components
All screwed joints are equipped with suitable screw locks to safely prevent SIMOCRANE CenSOR components from falling down after installation.
<ul style="list-style-type: none">• Always use these screw locks for installation.• The screw locks may not be disabled or removed.

NOTICE
Protect the stainless steel enclosure against exposure to direct sunlight
The specified temperature range of + 50 °C can only be achieved if the stainless steel housing is protected from direct sunlight.
During installation, make sure that suitable protection is available.

Note

Mounting the camera protective housing vertically

Mount the protective enclosure of the camera to the trolley in perpendicular position above the reflector that is attached to the hoist unit.
The glass pane of the enclosure must face the reflector

Note

Mounting the camera's protective enclosure in operating direction of the trolley

During installation, observe the marking on the camera's protective enclosure that represents the operating direction of the trolley. Install the camera's protective enclosure with the arrow pointing towards the direction of movement of the trolley.

Due to its internal imaging chip, the angle of vision of the CenSOR MV440 camera is extended by 33% in direction of trolley movement. Proper positioning of the camera ensures that the reflector stays in the field of vision of the camera even at greater deflection angles.

Note

Applying a bolt tightening torque of approximately 20 Nm

Apply a bolt tightening torque of approximately 20 Nm:

- When bolting the bracket to the trolley
- When tightening the four setscrews at the ends of the bracket

- Use the two included M8 screws to bolt the enclosure and bracket to the trolley; see Figure 12-3 Dimension drawing: Camera housing view from above in the direction of the load carrying device (Page 169) and Figure 12-4 Dimension drawing of the mounting bracket on the stainless steel housing (outdoor crane) (Page 170).

Use the two setscrews at each end of the bracket for precise perpendicular alignment; see Figure 12-2 Dimension drawing: Camera housing side view (Page 169).

Mount the reflector on the load carrying device of the outdoor crane

NOTICE

Proper mounting of the reflector

Improper mounting will damage the reflector.

Note

The reflector must be easily visible from above / maximum skew of the reflector

- The reflector must be clearly visible vertically from above and must not be hidden by structural elements.
- If the measured angle of skew is used, the reflector must be rotated no more than 1° to 2° in its zero position.
- If the measured angle of skew is not used, the reflector must be rotated no more than 10° in its zero position.
The maximum measurable angle of skew is $\pm 15^\circ$. A larger skew would prevent the camera from recognizing the pattern of the reflector.

- Secure the reflector to the load carrying device as shown in the "reflector mounting drawing".

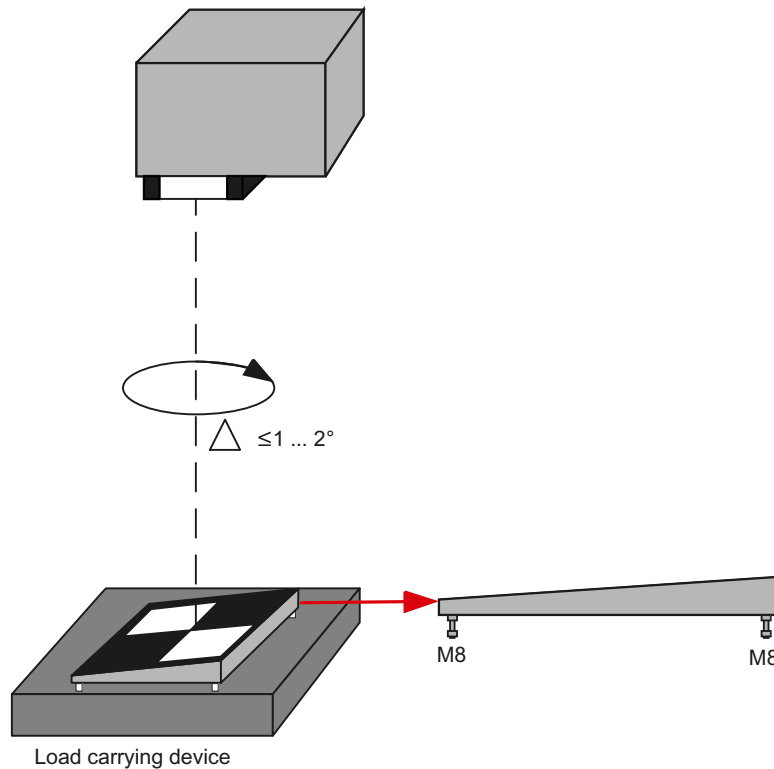

Figure 6-6 Reflector assembly drawing

- Use four M8 screws to bolt the reflector to the mounting points provided on the hoist unit. For more information on dimensions, refer to the product documentation.

6.3.2 Connect components on the outdoor crane

Note

Using the stabilized switched-mode power supply

Always use the stabilized switched-mode power supply supplied: 24 V/10 A, surge-proof.

Next, connect the SIMOCRANE CenSOR components.

Heaters

The heaters of the camera housing and the reflector are self-regulating: the heaters are equipped with a temperature sensor. If the ambient temperature never falls below 15 °C, it is not necessary to connect the heaters to the power supply.

Stainless steel enclosure

NOTICE
An appropriate strain relief must be available for the cable
The camera enclosure may not subject to mechanical load of the cable (24 V 3 x 4 mm ²).
Always prevent the cable from being torn out of the PG bushing by securing it to the crane by means of cable ties and loops.
Provide adequate strain relief by proper routing of the cable to the power supply.

- Connect the following cables that are included in the scope of delivery:
 - RJ45 Ethernet
 - 24 V, 3 x 4 mm² open cable end; for wiring the power supply to the camera and integrated heating of the enclosure.
- Wire the power supply to the camera housing according to the circuit diagram. The circuit diagram is available on the SIMOCRANE CenSOR product CD.

The following table lists the pin assignment of the cable:

Table 6-3 Pin assignment of the cable.

ID (color code)	Power
1 (black)	24 V
2 (black)	0 V (black)
Green/yellow	Ground PE

Reflector

 WARNING
<p>Risk of electrical shock</p> <p>The retro reflective reflectors for the outdoor crane are equipped with a 230 V AC foil heating inside the housing.</p> <p>During operation, a dangerous voltage is present in the heater. A damaged heating foil can result in severe injury or death.</p> <ul style="list-style-type: none"> • Make sure that the power is turned off before performing any work on the retro reflective reflectors. • Do not damage the foil heating.

- Wire the reflector to 230 V AC.
 - 230 V, 3 x 0.75 mm², open cable end
- Wire the reflector power supply according to the circuit diagram. The circuit diagram is available on the SIMOCRANE CenSOR product CD.

The following table lists the pin assignment of the cable:

Table 6-4 Pin assignment of the cable.

ID	Power
L1 / phase	230 V AC
N neutral	
PE	Ground PE

Diagnostics PC (during commissioning)

Connect the diagnostics PC to the computer unit via an Ethernet cable, either directly or via a switch.

6.4 Connecting SIMOCRANE CenSOR to SIMOTION

6.4.1 Linking SIMOCRANE CenSOR to SIMOTION C240PN

Complete the connections as shown in the following graphic diagrams.

Over PROFINET or UDP

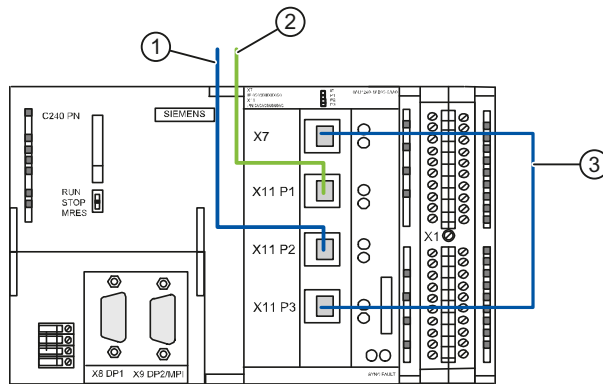

- ① Ethernet connection to the programming device/PC
- ② PROFINET or UDP connection to SIMOCRANE CenSOR MV440
- ③ Ethernet cable

Figure 6-7 SIMOTION C240PN

6.4.2 Connecting SIMOCRANE CenSOR to SIMOTION D435-2 DP/PN with CBE30-2

Complete the connections as shown in the following graphic diagrams.

Via PROFINET or UDP with the CBE30-2 Communication Board Ethernet

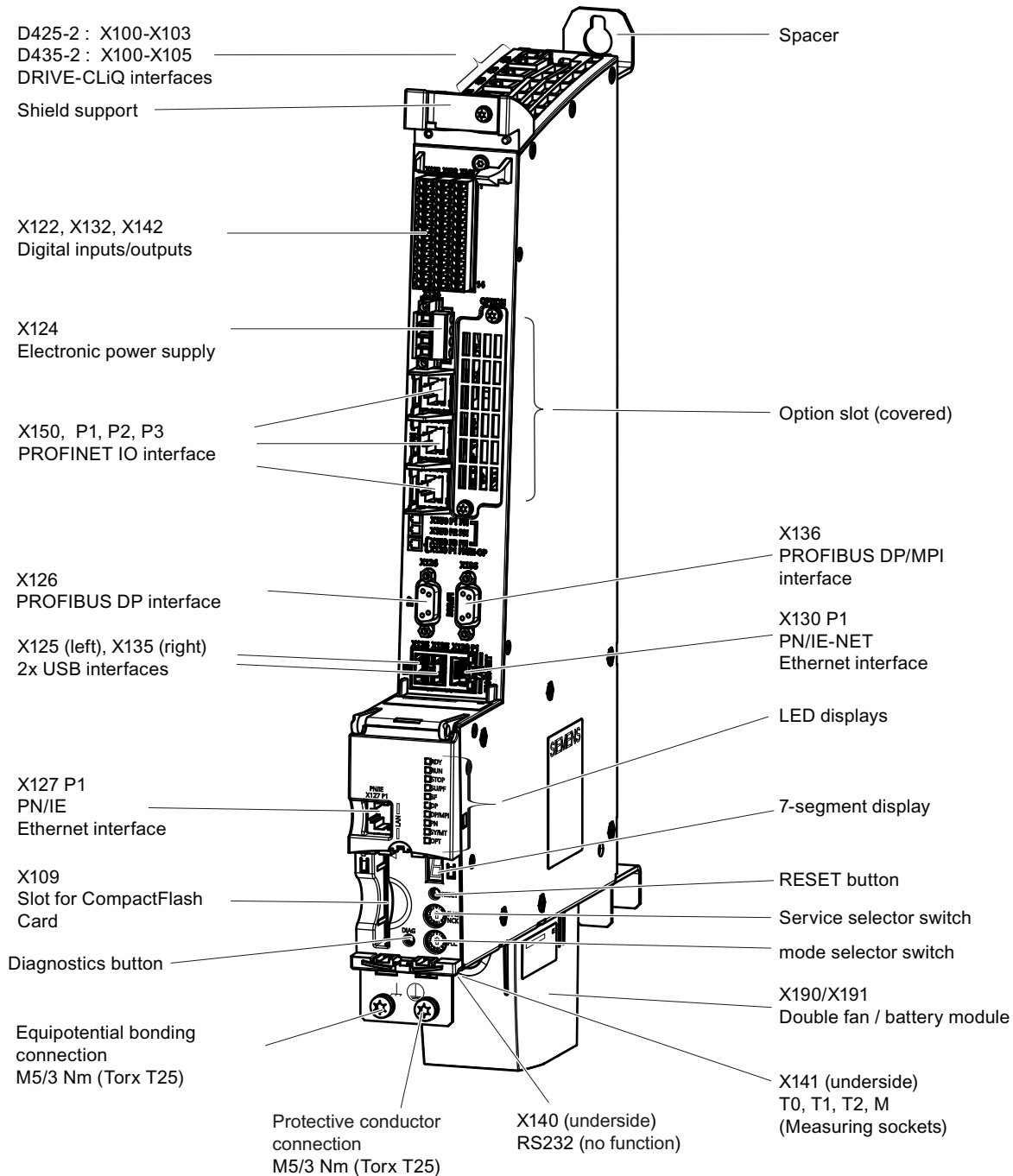

Figure 6-8 SIMOTION D435-2

6.4 Connecting SIMOCRANE CenSOR to SIMOTION

Interface	Connection
Ethernet interface X120	Port 3 or Port 4 on CBE30-2

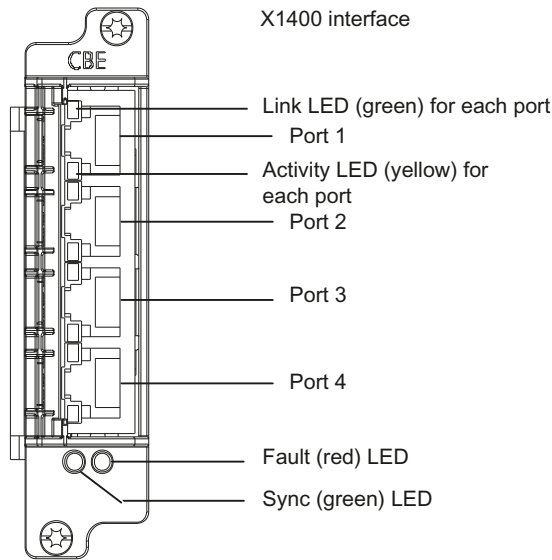

Figure 6-9 CBE30-2

Port	Connection
Port 1	PROFINET or UDP connection to SIMOCRANE CenSOR MV440
Port 2	Ethernet connection to programming device or PC
Port 3 or Port 4	Ethernet connection on X120 Ethernet interface

6.4.3 Connecting SIMOCRANE CenSOR to SIMOTION D435-2 DP/PN without CBE30-2

Requirement

Note

Using an industrial switch

The Ethernet switch is not included in the scope of delivery. Siemens strongly recommends the use of an industrial switch from the Siemens SCALANCE product line.

Note

For communication over PROFINET

Select the PN ports according to the SIMOTION configuration.

Only the UDP protocol can be used/you need an industrial Ethernet switch

You can operate SIMOCRANE CenSOR MV440 on a SIMOTION D435-2 DP/PN without CBE30-2 under the following conditions:

- You can only use the UDP communication protocol.
- You need to install an industrial Ethernet switch.

6.4 Connecting SIMOCRANE CenSOR to SIMOTION

Over UDP

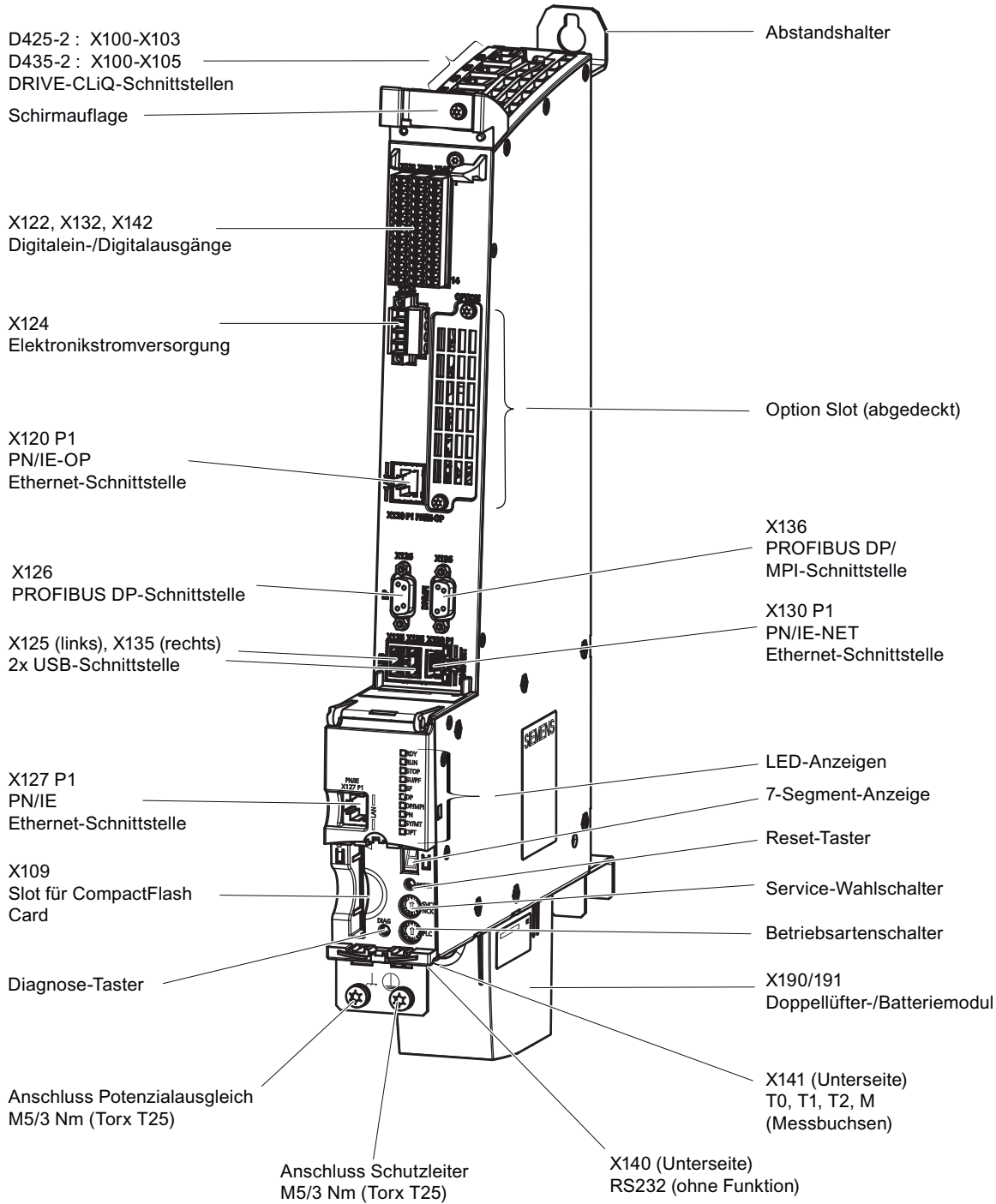

Figure 6-10 SIMOTION D435-2

Interface	Connection
X120	Ethernet connection to the switch
Option slot	without CBE30-2
X136	PROFIBUS DP2/MPI

Commissioning

7.1 "Setting up interfaces for the user interface" checklist

Procedure when setting up the interfaces

- Follow the checklist "Setting up interfaces to the user interface".

Chapter	What needs to be done?	OK?	
Commissioning	Set up the interface to the user interface (applies to both variants)		
	→ Make the required preparations	• Check that everything is prepared (Page 60)	
		• Install the SIMATIC Primary Setup Tool (PST) on the PC/programming device (Page 60).	
	→ Establish the connection to the SIMOCRANE CenSOR MV440 camera and start the user interface	• Connect the SIMOCRANE CenSOR MV440 camera and the PC using an Ethernet cable (Page 62).	
		• Turn on the SIMOCRANE CenSOR MV440 camera (Page 62).	
		• Configure the Ethernet connection between the SIMOCRANE CenSOR MV440 camera and PC (Page 62).	
		• Start the user interface with Internet Explorer (Page 70).	
		• Configure the flash (if available) (Page 71).	
• Adjust the SIMOCRANE CenSOR MV440 camera using the user interface (Page 72).			
Continue at chapter Parameter assignment (Page 75).			

"Setting up interfaces for the user interface" checklist

7.2 Setting up interfaces for the user interface

7.2.1 Prerequisites

These operating instructions contain a practical example of the Primary Setup Tool (PST).

PC requirements

To commission the device, you require a PC that meets the following requirements:

- Operating system Microsoft Windows 7 or higher
- An Internet browser with Java Runtime Environment
- SIMATIC Primary Setup Tool (PST) is installed.
- There is a network connection via Ethernet TCP/IP.

Administrator rights required

You need administrator rights to edit the network settings of your PC.

- Check the settings of your PC.

Java Runtime Environment required

You need the Java Runtime Environment to work with the user interface. It is also possible that Java is installed on your PC but is not activated.

- Check the corresponding settings of your Internet browser.

Using the current Java version

Use the current Java version. You will find information on this on the Internet at (www.java.com) or ask your system administrator.

Primary Setup Tool (PST) required for initial commissioning

You need the SIMATIC system software Primary Setup Tool (PST) for initial commissioning. This software is used:

- to search your network for the SIMOCRANE CenSOR MV440 camera
- to integrate the SIMOCRANE CenSOR MV440 camera in your network
- to configure the connection of your SIMOCRANE CenSOR MV440 camera
- You have direct access to the SIMOCRANE CenSOR MV440 camera to modify the IP addresses.

Changes to the project not possible. You need the Scout configuration tool to make such changes.

Where do I find the Primary Setup Tool (PST)?

You will find the Primary Setup Tool (PST) either:

- In your SIMATIC installation
- On the product DVD of the SIMOCRANE CenSOR MV440 camera
- As free download on the SIMATIC Support Internet pages (<http://support.automation.siemens.com/WW/view/en/19440762>).

7.2.2 Establishing the connection to the SIMOCRANE CenSOR MV440 camera and starting the user interface

7.2.2.1 Steps for the initial commissioning of the camera

Note

User interface

The user interface is stored in the form of a Java applet on the camera and is activated with the help of an Internet browser.

Note

Online help

Each screen of the user interface provides a "?" button on the top right that you can use to access the online help at any time. Depending on your current task, the online help opens with the context-sensitive help text.

Steps for the initial commissioning of the camera

Step	Activity
1	Connecting the camera and PC via Ethernet cable (step 1) (Page 62).
2	Activating the camera (step 2) (Page 62).
3	Configuring the Ethernet connection between the camera and PC (step 3) (Page 62).
4	Starting the user interface (step 4) (Page 70).
5	Setting the lighting parameters (step 5) (Page 71)
6	Setting up the camera (step 6) (Page 72).

7.2.2.2 Connecting the camera and PC via Ethernet cable (step 1)

The SIMOCRANE CenSOR MV440 camera and the PC are interconnected using an Ethernet cable

Note

No crossover cable necessary

You do not need a crossover cable because the camera is capable of auto-crossing and automatically detects the type of cable you are using.

- Connect the camera directly to your PC/programming device using an Ethernet cable.

7.2.2.3 Activating the camera (step 2)

Turn on the SIMOCRANE CenSOR MV440 camera

- Switch on the power supply to the camera.
 - Power is supplied to the camera of variant 1 (indoor crane) via Power IO RS-232 cable.
 - Power is supplied to the camera of variant 2 (outdoor crane) via the power supply cable of the stainless steel enclosure.

Each time it is started, the camera runs a self test indicated by the Power LED flashing.

Result

After a time between a few seconds and two minutes, the self test is completed. the Power LED then changes to a steady green. The camera is ready for operation.

7.2.2.4 Configuring the Ethernet connection between the camera and PC (step 3)

Configuring an Ethernet connection

1. Assign a static IP address to your PC (Network connections → Local Area Connection → Properties → Internet Protocol (TCP/IP) → Properties → Fixed address).
2. Launch the Primary Setup Tool (Start menu → Start → SIMATIC → Primary Setup Tool → Primary Setup Tool).

3. Select the network card as follows:

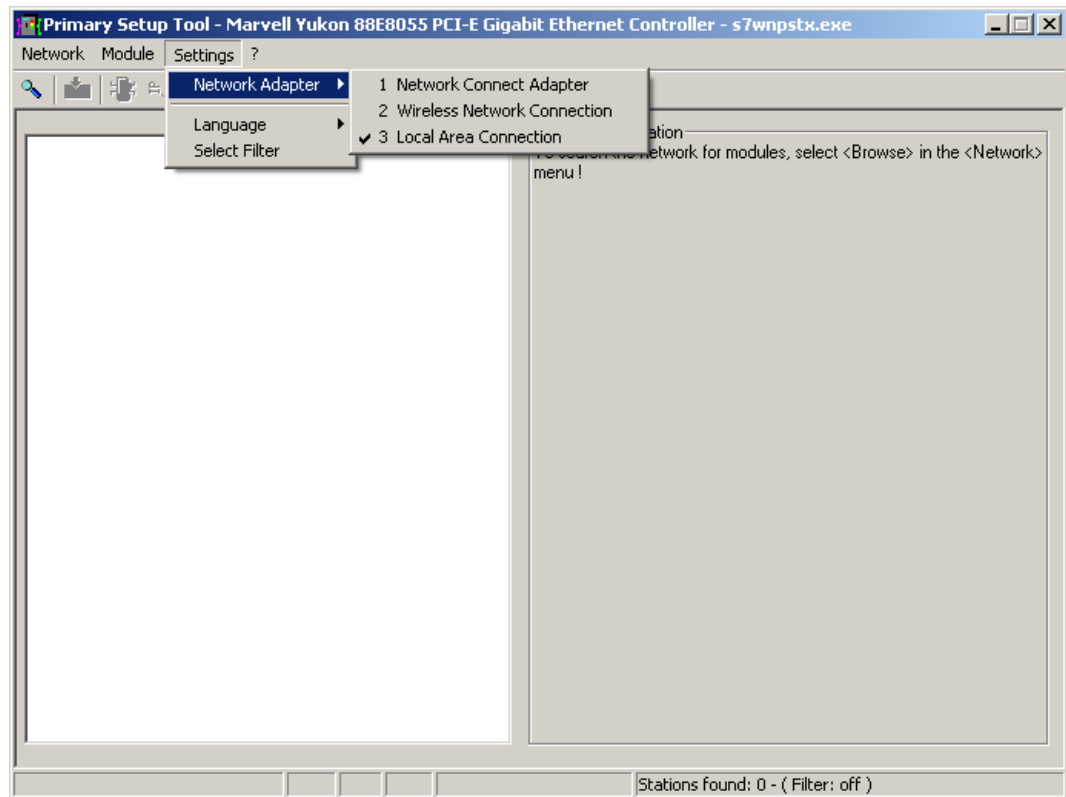

- 4. Start the network search in the Primary Setup Tool (Network → Browse).

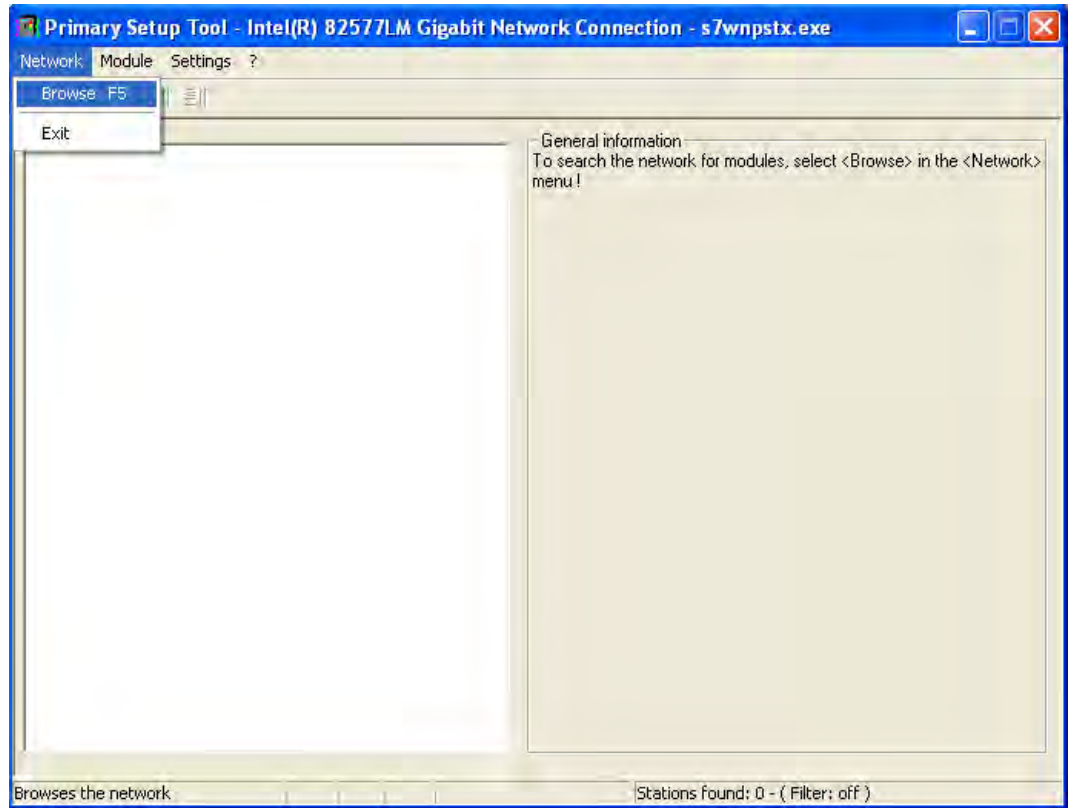

Figure 7-1 Menu: Network → Browse

5. Select the displayed device and double-click on it.

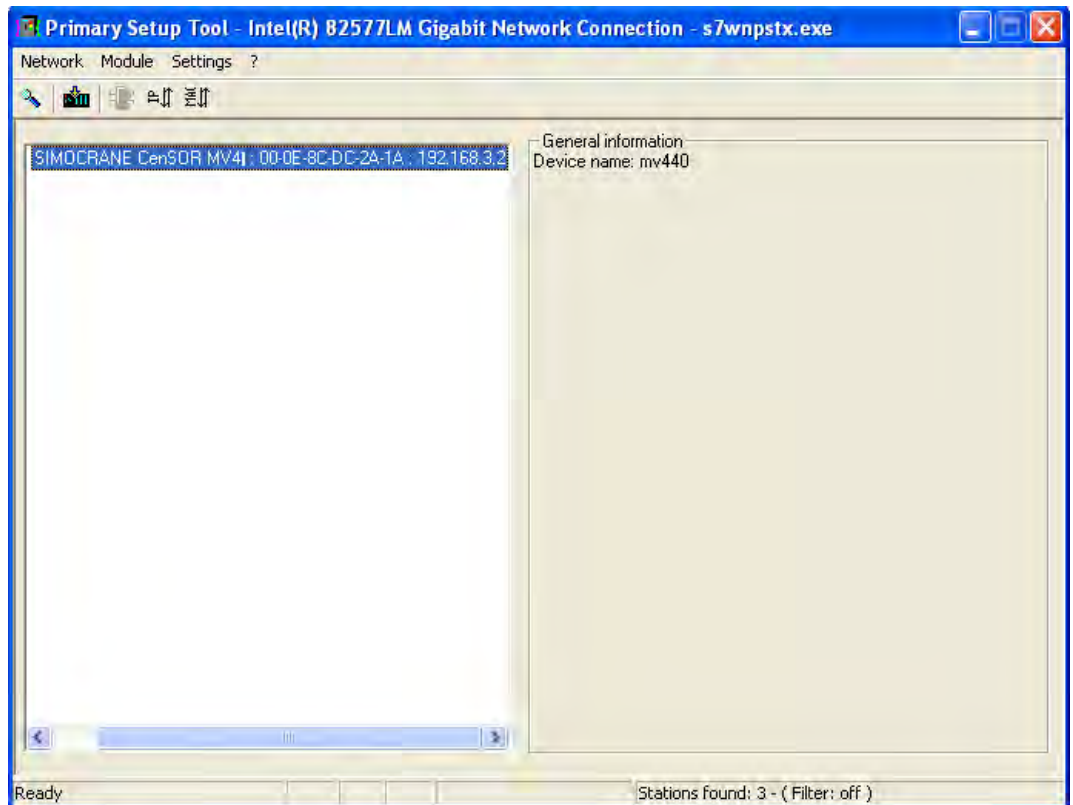

Figure 7-2 Selecting the displayed device

- 6. Clicking on the displayed Ethernet interface displays the properties of the interface.

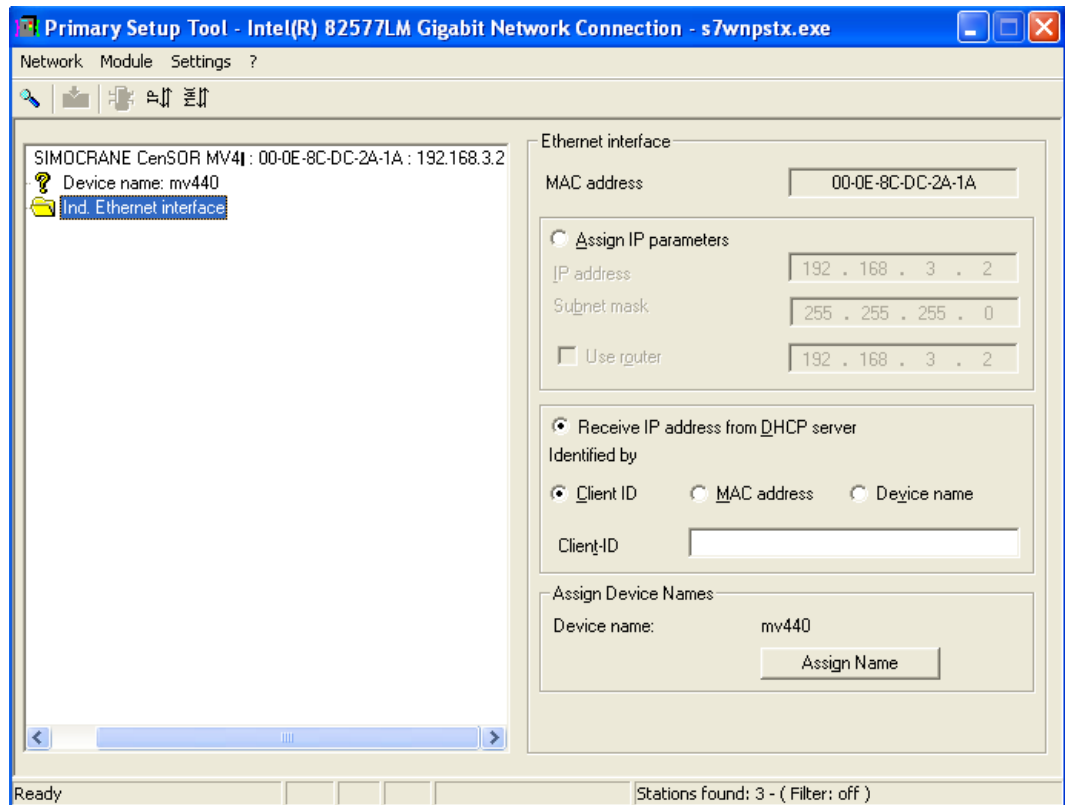

Figure 7-3 Properties of the interface

7. Select "Assign IP address" and enter the values for the IP address (same network as your own PC) and subnet mask as shown below.

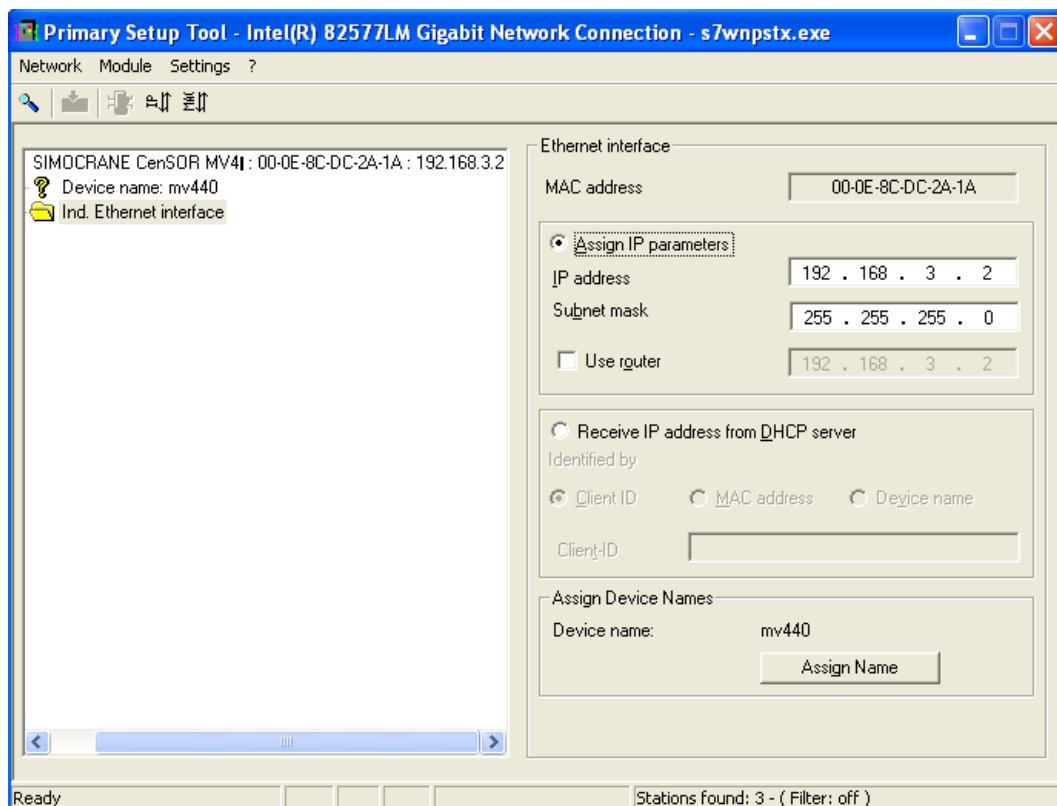

Figure 7-4 Assigning the IP address

Note

Configuring the camera as DHCP Server

- You can assign IP address 192.168.100.100 to the SIMOCRANE CenSOR MV440 camera to set it up as DHCP server as well. This means that the camera can automatically assign an IP address to a connected PC. You may use addresses that differ from this IP address and that are not 0.0.0.1 to assign a static IP address to the camera. Networked PCs are usually configured for operation as DHCP client and obtain their IP address from a server.
- Contact your network administrator if your PC network configuration differs from this setup, or if you do not know how your PC is configured.

8. Select "Assign Name" and assign a name to your SIMOCRANE CenSOR MV440 camera (for example, MV440).

- 9. Select the the MV440 module again.
Download the configuration to the SIMOCRANE CenSOR MV440 camera:
Click the "Download" command in the "Module" menu.

Note

Module not selected

If the module is not selected, the icon for downloading the configuration or the "Download" menu command is disabled.

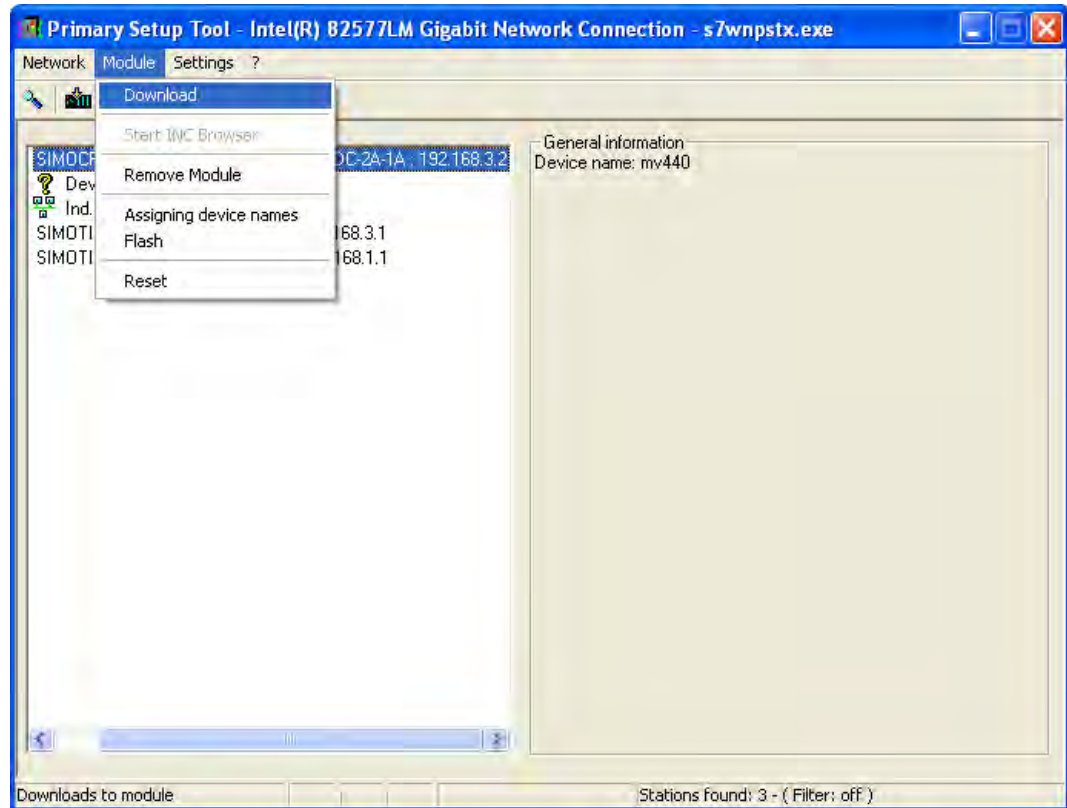

Figure 7-5 Downloading to the module

- 10. Confirm the following message with "Yes".

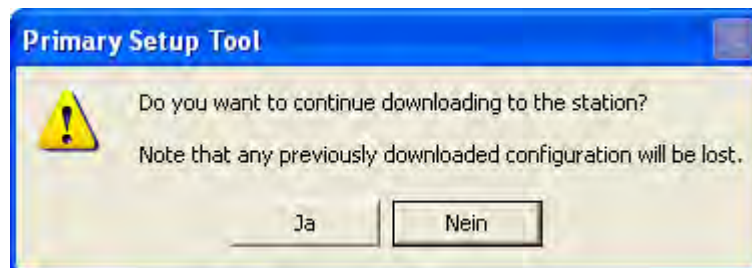

Figure 7-6 Click "Yes"

Result

You completed the configuration of the SIMOCRANE CenSOR MV440 camera.

You can access the camera from your PC using the IP address that was assigned to the camera.

Note

Restart may be necessary

Depending on the operating mode being used, you may need to restart the camera by turning the power off and on again.

7.2.2.5 Starting the user interface (step 4)

1. Open the Internet Explorer.
2. Enter the address that you have assigned in the address line and confirm your entry with the enter key.

Result

The SIMOCRANE CenSOR MV440 camera home page is loaded.

The user interface initially opens in English.

At the top right, there is drop-down list where you can select the language. You can change the language setting for the entire user interface and online help at any time.

The following languages are available:

- German
- English



Figure 7-7 Home page

3. Click on the image of the SIMOCRANE CenSOR MV440 camera or the "Setup" menu command.

Note

Connecting the first time: Click "Adjustment" again

The first time you connect, the "Stop" screen is displayed and you will need to enable "Adjustment" again.

Result

The user interface of the camera opens after a short loading time.

This is followed by the Adjustment page of the user interface in the Internet Explorer.

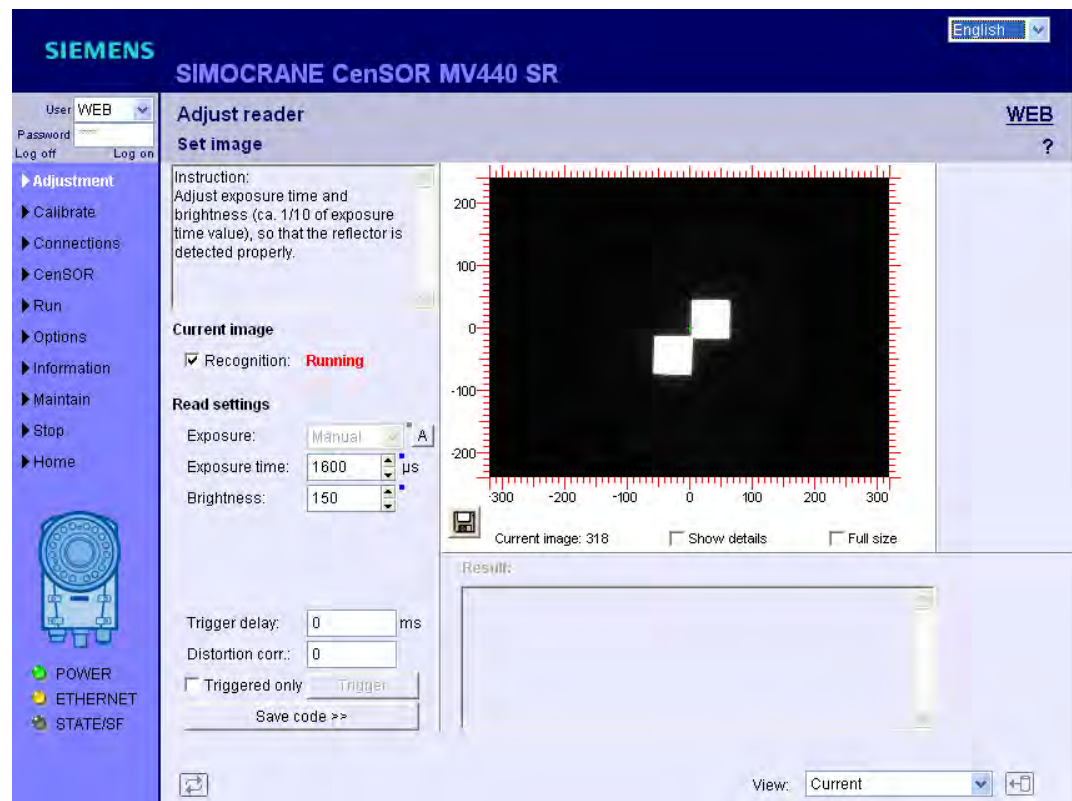

Figure 7-8 Adjustment – Recognition running

Result

- You are now connected to the SIMOCRANE CenSOR MV440 camera and can use the user interface to operate or configure it and view the image acquisition live.
- You can now perform the next step and adjust the camera and display the first read results.
- You can also get further support by clicking the "?" button at the top right. This opens the online help.

7.2.2.6 Setting the lighting parameters (step 5)

In this step, you specify which flash is connected to the SIMOCRANE CenSOR MV440 camera.

- Go to "Options" → "Lighting".

By specifying the most important characteristics of the flash, the overload protection integrated in the SIMOCRANE CenSOR MV440 camera can protect against overload.

Using the term "Setup"

Note the different meanings of the term "setup" in chapter Meaning of the term "setup" used in these operating instructions (Page 8).

Select the variant; setting the flash and flash parameters

- Under "Lighting", select the ring lamp for the "indoor crane": selection by means of order number 6GF9004-7BA01
- Under "Lighting", select the external flash for the outdoor crane variant: select this with "Other (ext.)" and enter the flash parameters
 - Flash delay: 500 µs
 - Max. flash duration: 4000 µs
 - Max. duty cycle: 10%
 - Wavelength: 880 nm
 - Color: IR

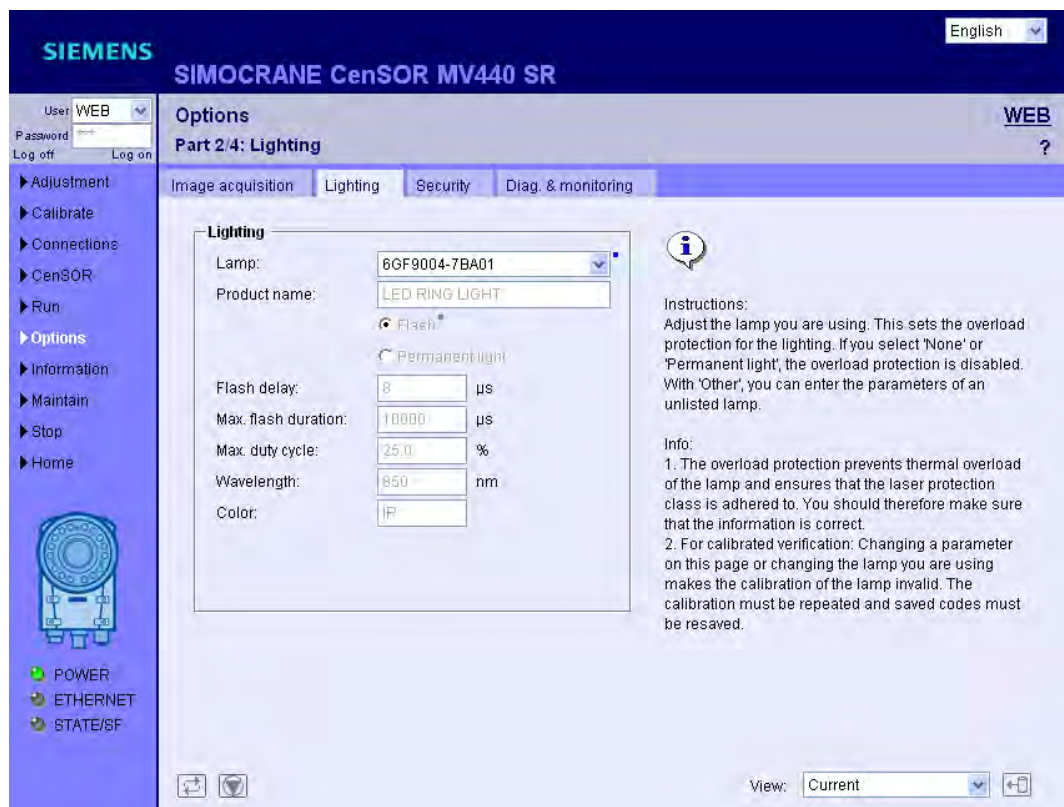

Figure 7-9 Options - Lighting

7.2.2.7 Setting up the camera (step 6)

Using the term "Setup"

Note the different meanings of the term "setup" in chapter Meaning of the term "setup" used in these operating instructions (Page 8).

Adjusting the SIMOCRANE CenSOR MV440 camera

Proper setup of the camera is prerequisite for its error-free operation.

Note

Note the attachment instructions on the reflector housing and camera

You should also note the attachment instructions on the reflector housing and the camera.

- Run the setup on the user interface by selecting the "Setup" menu command. The dialog display the image section as seen by the camera.

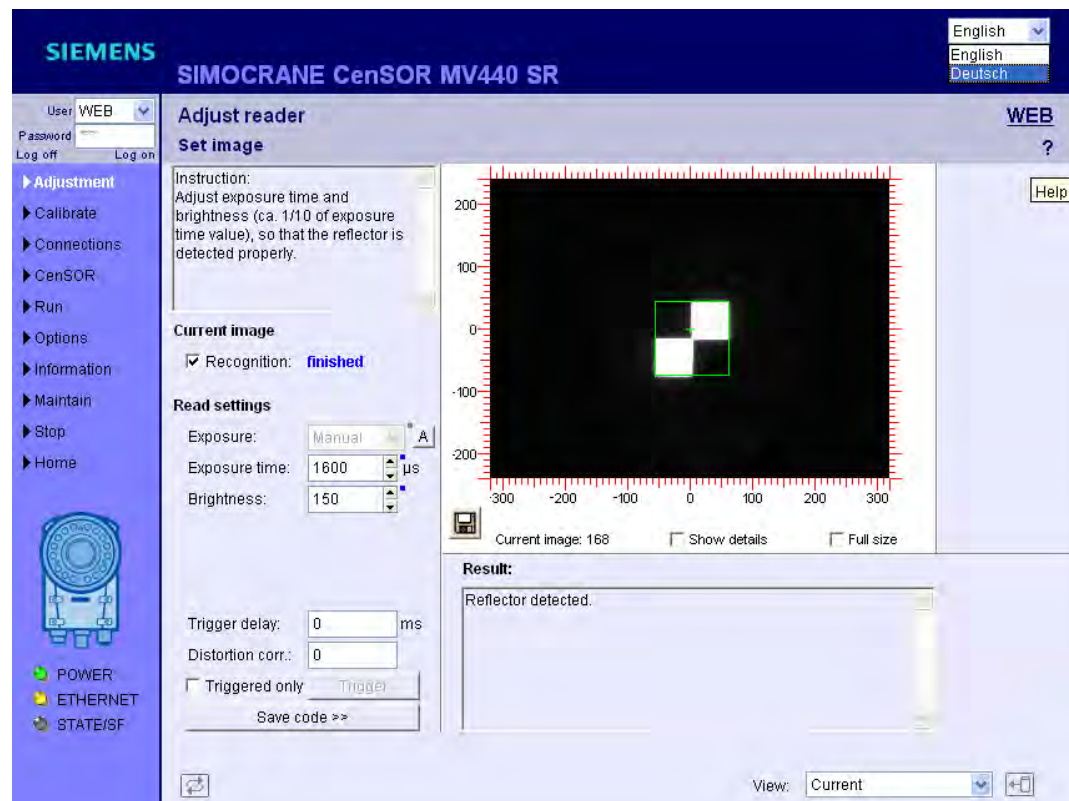

Figure 7-10 Adjustment – Recognition successfully completed

1. Position the camera in such a way that the reflector appears in the center of the image and is focused sharply. The green cross must approximately cover the center of the reflector.
 - With the outdoor crane variant, you align the entire camera housing with the adjustment options of the mounting bracket.
 - For the indoor crane variant, align the SIMOCRANE CenSOR MV440 camera using the adjustment options of the mounting plate.

The camera automatically attempts to recognize the reflector. You can recognize a successful read by the green frame around the reflector. The greater the contrast of the reflector image, the better the read result.

2. If necessary, correct the settings with the CenSOR (Page 87) menu command.
3. If you make modifications, save your new settings by clicking the "Apply" button.

Result

You have successfully adjusted the SIMOCRANE CenSOR MV440 camera.

Parameter assignment

8.1 "Parameter assignment" checklist

Procedure for assigning parameters

- Keep to the "Parameter assignment" checklist.

8.1 "Parameter assignment" checklist

Chapter	What needs to be done?	OK?	
Parameter assignment	Commission the SIMOCRANE CenSOR (applies to both variants)		
	→ "Options" page:	<ul style="list-style-type: none"> • "Image acquisition" tab, enable Auto trigger (Page 83) • "Lighting" tab, select lamp (Page 84) 	
	→ "Adjustment" page	<ul style="list-style-type: none"> • Set exposure time and brightness (Page 98) 	
	→ "CenSOR" page	"Reflector" page → set following parameters: (Page 88)	
		• Reflector type	
		• Edge length of the white reflector area in mm	
		• Reliability of the size measurement with the SIMOCRANE CenSOR MV440 camera	
		• Reflector recognition limit (complete image)	
		• Reflector recognition limit (reflector proximity)	
		• External value for reflector distance	
		"Camera" tab → set following parameters: (Page 91)	
		• Focal length of the lens	
		• Minimum reflector contrast	
		• Monochrome limit	
		• Limiting of the global search (X)	
		• Limiting of the global search (Y)	
		"Measured values" tab → set following parameters: (Page 94)	
• Resolution			
• Offset			
• Smoothing time constant			
• Reflector distance min.			
• Reflector distance max.			
→ "Adjustment" page	<ul style="list-style-type: none"> • Save the parameter settings with "Save code" (Page 101) 		
→ "Calibration" page	<ul style="list-style-type: none"> • Perform the calibration steps (Page 102) 		
→ "Processing" page	<ul style="list-style-type: none"> • Start processing (Page 106) 		
Continue at chapter Integration in a controller (Page 125)			

"Parameter assignment" checklist

8.2 User interface

Tasks

In the left-hand part of the user interface, you will find a selection of tasks in the form of buttons.

- You can start the required task by clicking the appropriate button.

The corresponding task is displayed in the right section of the user interface. At the same time, the text of the buttons changes to bold and the font color becomes white.

You can select the following tasks:

- Setup
- Calibrate
- Connections
- CenSOR
- Run
- Options
- Information
- Manage
- Stop
- Home page

The user interface uses your PC's Internet browser.

The user interface of the SIMOCRANE CenSOR MV440 camera uses the Internet browser of your PC. The user interface is stored on the camera and is loaded when it starts up and executed in Internet Explorer.

This device version has the following advantages:

- You do not need to install the software on your PC.
- You can start the user interface from any PC.
- You can monitor the camera from more than one PC at the same time.
- The user interface always executes in a way suitable for your camera. This means that no version conflicts occur.

You will find the requirements for your PC in the chapter Prerequisites (Page 60).

Structure of the user interface

To open the user interface, follow the instructions in the chapter Establishing the connection to the SIMOCRANE CenSOR MV440 camera and starting the user interface (Page 61).

The structure is represented based on the example of the user interface "Setup". This information applies to all tasks of the user interface.

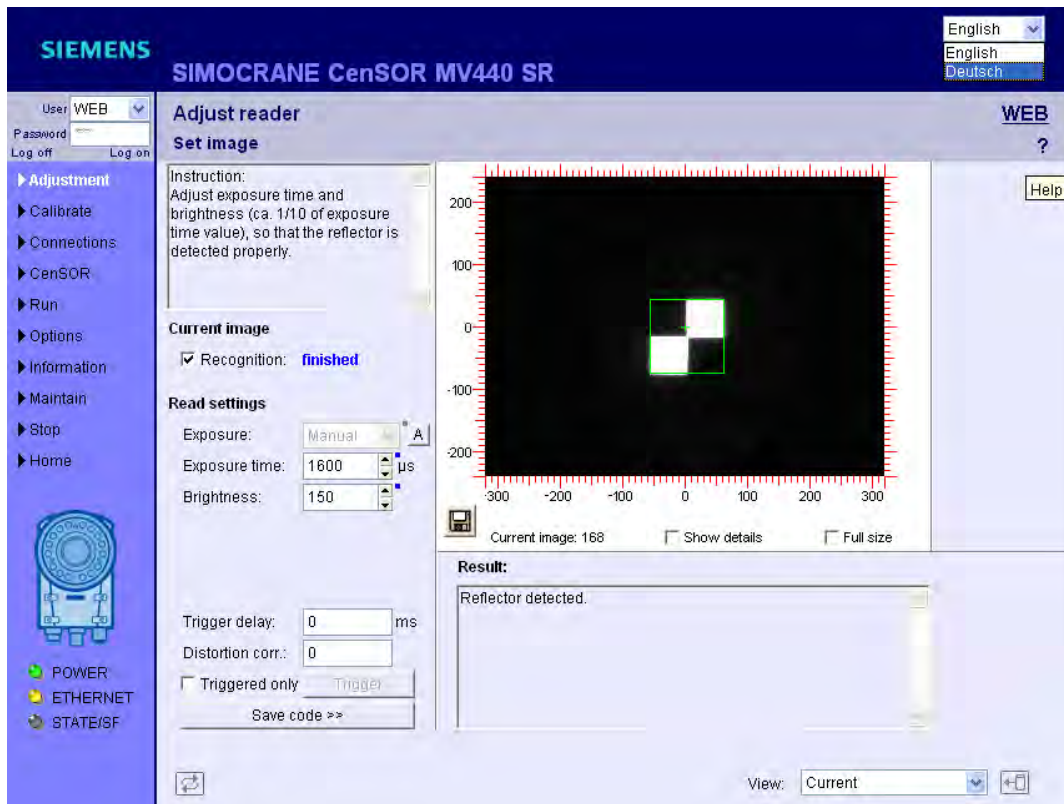

Figure 8-1 Structure of the user interface

Language setting

At the top right, there is drop-down list where you can select the language. You can change the language setting for the entire user interface and online help at any time.

The following languages are available:

- English
- German

Online help

Each screen of the user interface provides a "?" button on the top right that you can use to access the online help at any time. Depending on your current task, the online help opens with the context-sensitive help text.

Note

The online help is stored on the DVD and you can also use the online help offline.

Changing/saving the view

The bottom right of the task shows the "View" drop-down list box and the "Save" icon  on the right side next to the list box.

If you have already saved a certain number of codes and the settings for "Save code" under one of the code numbers 1 to 14, you can view the settings by selecting the code number from this drop-down list box. You can also use the settings for save further codes by clicking the "Save" icon. The parameters saved under the selected code number are then activated in the current settings.

Apply

The "Apply" button is located on the bottom left of the task . Once you have completed changes, click this button to transfer the data to the reading device.

Users and access rights

The camera allows different levels of access control for different users.

Logging on users

The "logon" area is displayed above the tasks. Here, users log on and can then work with the permissions assigned by the administrator.

Note

Hardware access protection (DISA bit) enabled

If the hardware access protection (DISA bit) is enabled, a user can only log on when the "Options Part 3/4: Security (optional)" page is active.

- To do this, click on the currently logged on user at the top right.
-

The following users are possible

Note

"WEB" setting

The "WEB" setting effectively means no user. It simply indicates that there is a connection between the Web browser and the user interface.

- WEB (default): General user who can perform tasks without explicitly logging on.
- Service: Service technician
- User1: freely available
You may create users and change passwords.
- Admin: Administrator
The "Admin" user assigns rights to all users.

"Password" input box

Note

The "WEB" user does not have a password.

Users enter their current password in the "Password" input box and then click the "Log on" button.

The following table shows the defaults for the passwords.

User	Default password
WEB	-
Service	Service
User1	User1
Admin	Admin

Note

If the SIMOCRANE CenSOR MV440 camera is controlled via an automation system, in other words, with the DISA bit set, you will need to log on at the camera as follows:

1. Make sure that only one PC is accessing the camera (padlock with red/gray marking).
2. Place the mouse pointer on the currently logged-on user (top right) and click. This brings you to the "Options → Security" page.
3. Log on as "User1" or "Service" user to control the camera. This is only possible if the "Take control" check box is selected for the relevant user.

Remember that with your logon, you intervene in the camera control by the automation system.



Note:





This is relevant to functions that need the DISA bit, e.g., for changing and saving code. You may need to restart the camera by cycling power off and on, depending on the operating mode used.

Currently logged-on user and mode of the user interface

The following is displayed at the top right:

- The currently logged-on user (for example, WEB).
- The following icons or no icon.

	Padlock with red marking: Read-only mode. In other words, no further operator input is possible because the user interface of a different PC is currently controlling the SIMOCRANE CenSOR MV440 camera.
	Padlock with gray marking The logged on user is not allowed to edit settings.

	<p>Padlock with red/gray marking DISA is active. Only the "Service" and "User1" users can take over control of the camera from the controller.</p> <p>Note: If the hardware access protection (DISA bit) is enabled, a user can only log on when the "Options Part 3/4: Security (optional)" page is active.</p> <ul style="list-style-type: none"> To do this, click on the currently logged on user at the top right
	<p>Padlock with green/gray marking The currently logged-on user is controlling the camera, or has taken over control from the controller.</p>
	<p>DMC Code The evaluation mode of the SIMOCRANE CenSOR MV440 camera is active.</p> <ul style="list-style-type: none"> Before you can make changes, you first need to change the camera to STOP. <p>Note: You may also use the following button  on the bottom left for switching to the "Stop" mode without leaving the current page.</p>

Status display

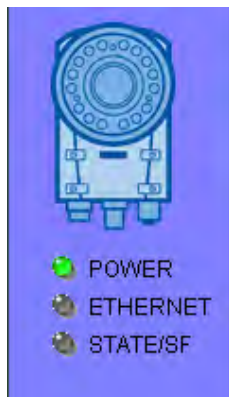

Figure 8-2 SIMOCRANE CenSOR MV440 status display

8.2 User interface

Below the task buttons, you can see an image of the camera with its three status LEDs. The status LEDs indicate the current status of the camera.

LED designation	Meaning
POWER	GREEN, lit constantly The camera must be turned on so that it can be reached from the user interface. This LED therefore lights up a constant green.
ETHERNET	Permanently off The camera does not have an Ethernet connection. Either the camera is turned off or the Ethernet cable has been disconnected. YELLOW flashing There is an active connection to the user interface.
STATE/SF	Permanently off The camera is in "Stop" mode (no error). GREEN, lit constantly The camera is in RUN mode (no error). RED, lit constantly The camera has the "Group error" status.

8.3 Commissioning the SIMOCRANE CenSOR

Successful commissioning of the SIMOCRANE CenSOR MV440

To commission the SIMOCRANE CenSOR MV440 successfully, proceed according to the "Parameter assignment" checklist (Page 75).

Note

The data marked with a blue rectangle

Data flagged with the blue rectangle icon is saved under the selected code number when code is saved. In processing mode, the value stored in the code number of this data is used.

Example

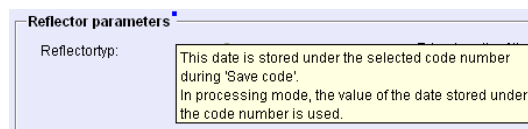

8.3.1 Options

Note

The "Security" and "Diagnostics & monitoring" tabs are not necessary for commissioning

You do not need the "Security" and "Diagnostics & monitoring" tabs for commissioning SIMOCRANE CenSOR.

The "Options" dialog consists of the following four sections:

- Image acquisition
- Lighting
- Security
- Diagnostics & monitoring

8.3.1.1 Options - Image acquisition

Note

"Auto Trigger" - do not select a recording interval of < 50 ms

It is not advisable to employ values < 50 ms because these may lead to overheating and destruction of the flash unit.

Note

Settings that are not needed

"Single trigger" and "Scan" under "Controller" and "Exposure" are not required and cannot be modified.

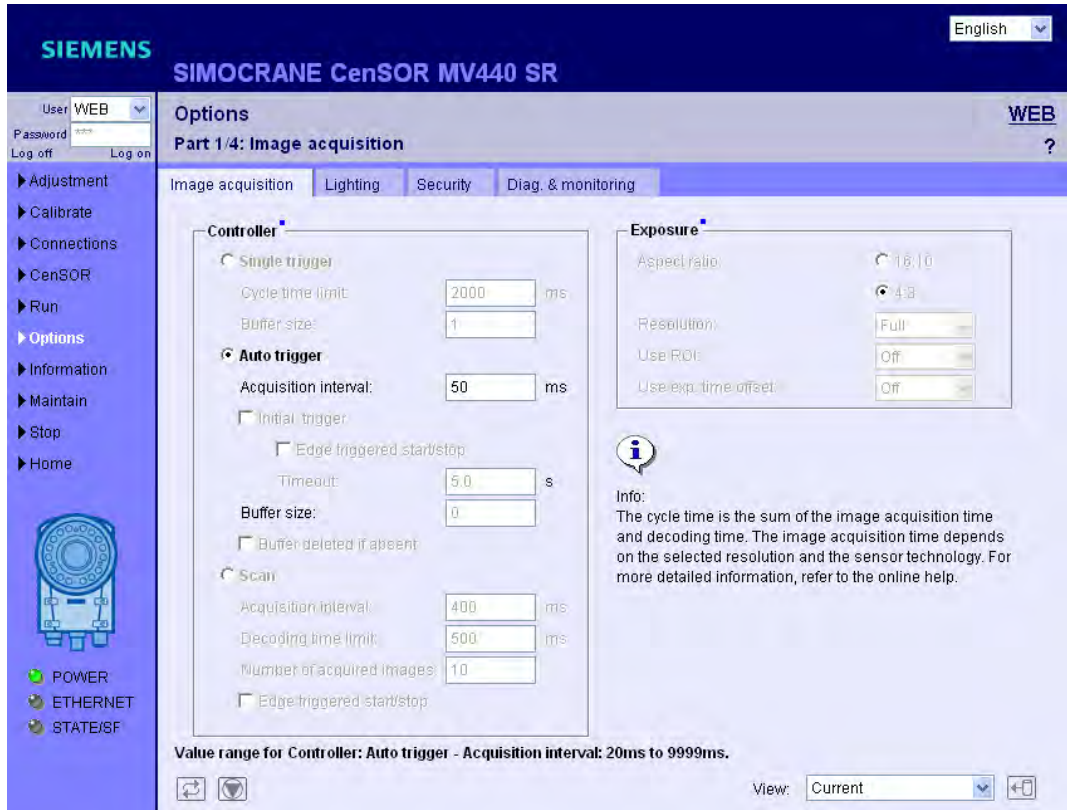

Figure 8-3 Options - Image acquisition

Only the "Auto trigger" option with an acquisition interval of 50 ms is necessary for SIMOCRANE CenSOR.

8.3.1.2 Options - Lighting

The setting for the lighting (flash) was described earlier in the chapter Setting the lighting parameters (step 5) (Page 71).

8.3.1.3 Options - Security (optional)

Note

"Security" is not necessary for commissioning

You do not need the "Security" tab for commissioning SIMOCRANE CenSOR.

In the "Security" tab, the administrator specifies which user is permitted to execute which tasks and, when necessary, changes the administrator password or the passwords of the users.

Note

Changing authorizations

The permissions can only be changed by the administrator.

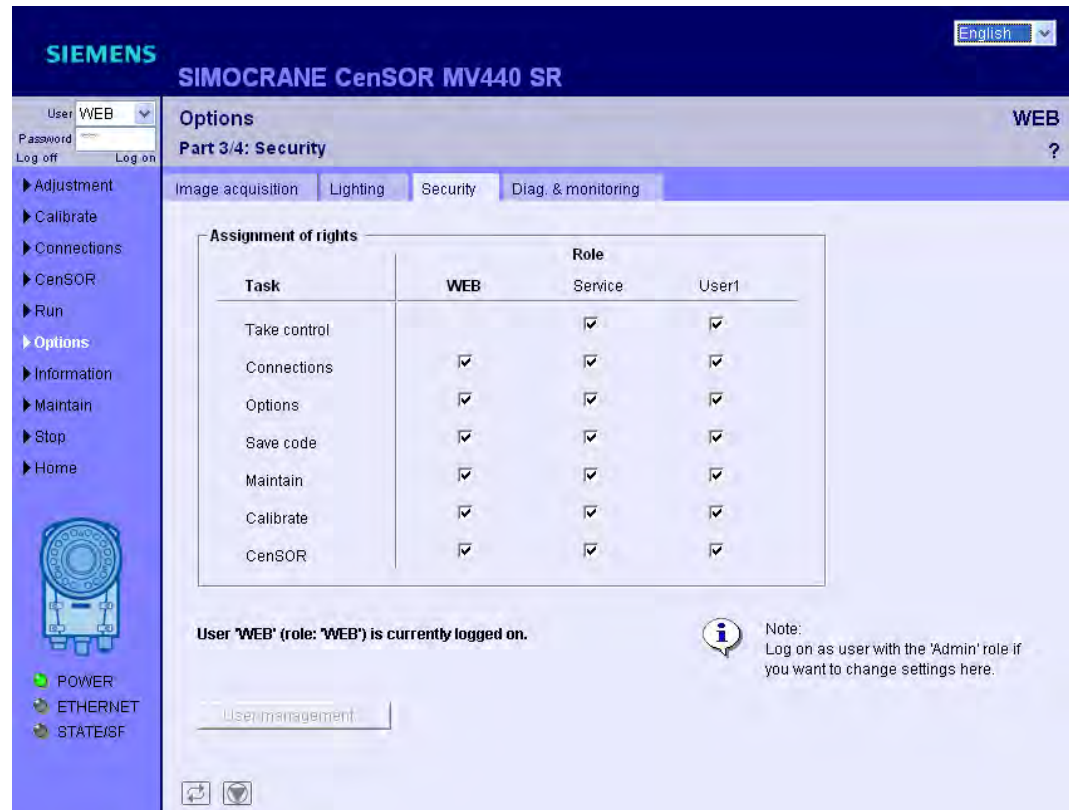

Figure 8-4 Options - Security

The SIMOCRANE CenSOR MV440 camera allows different levels of access control for different users.

8.3.1.4 Options - Diagnostics & monitoring (optional)

Note

The "Diagnostics & monitoring" tab is not necessary for commissioning

You do not need the "Diagnostics & monitoring" tab for commissioning SIMOCRANE CenSOR.

In "Options", "Diag. & monitoring" tab, you specify the information to be stored for diagnostic purposes.

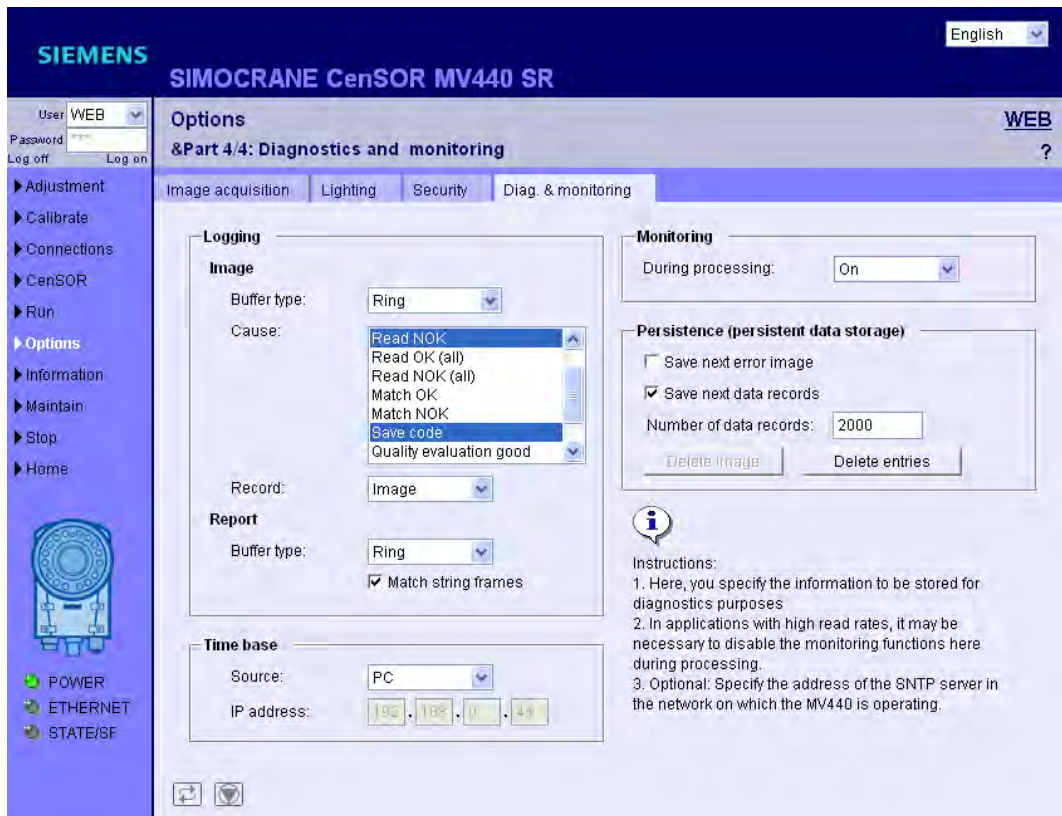

Figure 8-5 Options - Diagnostics & monitoring

Logging/Image

Select the "Image" box in the "Logging" task field to specify the images and their corresponding format to be stored in the SIMOCRANE CenSOR MV440 camera.

Note

Cause:

Only the options "Read NOK", "Read OK" and "Save code" are supported.

Logging/Report

In "Report", you specify the format in which the diagnostics events will be stored on the camera.

Time base

Select the "Time base" task field to specify whether to provide the time stamp of the diagnostics events from the PC or from an SNTP server on the network. If you specify SNTP as the source, you will also need to specify the IP address of the server.

Monitoring

Select the "Monitoring" task field to specify whether or not a live image will be displayed in evaluation mode.

Persistence (persistent data storage)

Select the "Persistence" task field to specify the diagnostic data to be written permanently to EPROM.

If the "Save diag. entries" check box is enabled, the number of diagnostics entries you specify in the input box from the time of enabling will be entered in the EPROM. Existing entries are deleted when you switch over to "On". If the diagnostics buffer in the EPROM reaches the number of permanently storable diagnostic data records, no further entries are made.

8.3.2 CenSOR

Using the term "Setup"

Note the different meanings of the term "setup" in the Meaning of the term "Setup" chapter in these operating instructions.

8.3.2.1 CenSOR - Reflector

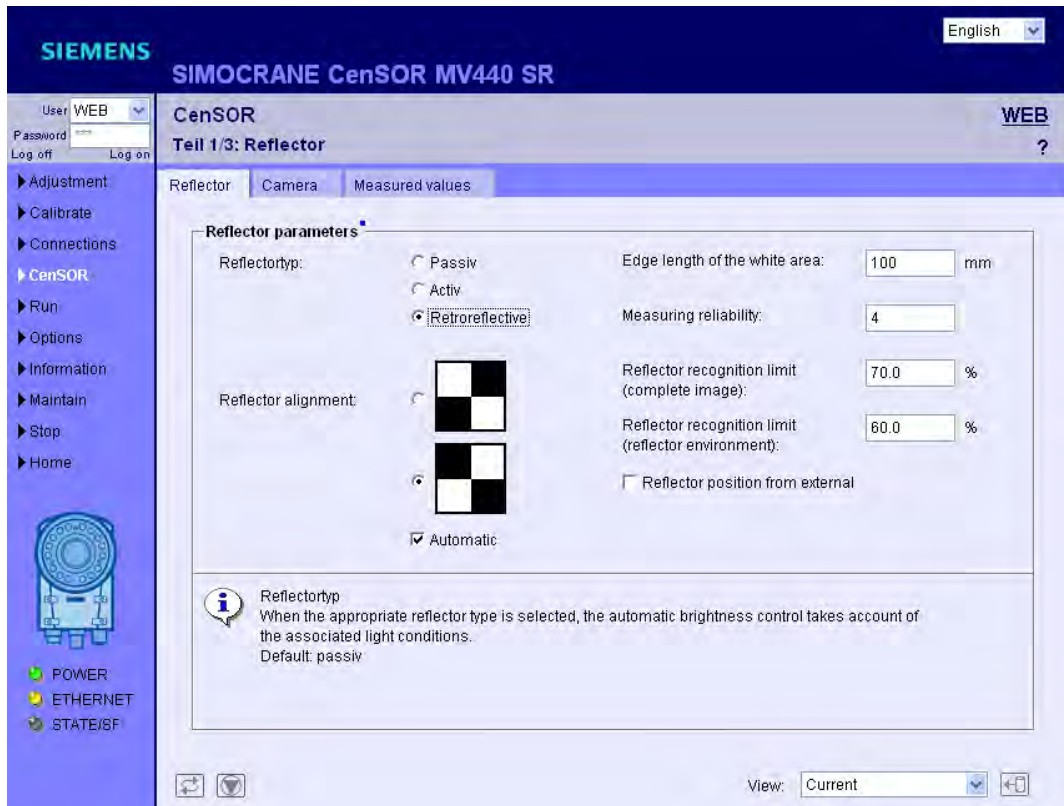

Figure 8-6 CenSOR - Reflector

Reflector type

When the appropriate reflector type is selected, the automatic brightness control takes account of the associated light conditions.

Settings

Passive, Active, Retro reflective

Factory setting

Retro reflective

Edge length of the white reflector area in mm

Width of the white reflector area in mm

This parameter is used to determine the distance between the camera and the reflector.

Reflector dimensions	Edge length to be entered
300 x 300 mm	125 mm
500 x 500 mm	230 mm

Adjustment range

10 mm to 1000 mm

Factory setting

230 mm

Reliability of the size measurement

The value specifies the degree of measurement reliability that is necessary to determine the reflector size. The maximum value of 15 is valid.

- The requirements for values less than 8 are less stringent. In complex environments there is a risk of incorrect assignment of the reflector and, therefore, malfunction of the system.
- With values greater than 8 the requirements for reflector detection are more stringent. This means that it is more than likely that the reflector detected in the image is the correct one. However, a reflector is possibly rejected if the set value is too high.

Factory setting

12

Reflector recognition limit (complete image)

The probability for the recognition of the reflector calculated by the correlation function is compared with this factor. Only when the calculated probability has at least this value is the reflector accepted as being recognized.

- This value is used for the search in the entire image and must be higher than the value for the search in the vicinity of the reflector.
- Set the value at least to the default ($\geq 70\%$) to avoid incorrect detection.

Factory setting

70 %

Reflector recognition limit (reflector proximity)

The probability for the recognition of the reflector calculated by the correlation function is compared with this factor. Only when the calculated probability has at least this value is the reflector accepted as being recognized.

- This value is only used for the search in the vicinity of a recognized reflector and must be lower than the value for the search in the entire image.
- Set the value at least to the default ($\geq 60\%$) to avoid incorrect detection.

Factory setting

60 %

External value for reflector distance

- 0 - Reflector distance is calculated from the size of the reflector.
- 1 - Reflector distance is read in via the interface.

The "Edge length of the white area" and "Focal length of the lens" must be correctly set to obtain a valid measurement. The "External distance" value (reflector distance, chapter Integration in a controller (Page 125)) is used exclusively for the automatic adjustment of the window size (see Calibrate (Page 102)), depending on the external distance. This avoids incorrect recognition.

Factory setting

0

Alignment of the reflector

The parameter specifies how the white areas of the standard reflector are aligned. Lower right and upper left or upper right and lower left.

- During adjustment or when calibrating, leave the check mark set for "Automatic". This means that when you call the "Adjustment" or "Calibrate" pages, the reflector alignment is calculated automatically. This overwrites the "Alignment of the reflector" parameter.

Factory setting

Top right white, automatic

Note

Save code

Then save the code (Page 101).

8.3.2.2 CenSOR - Camera

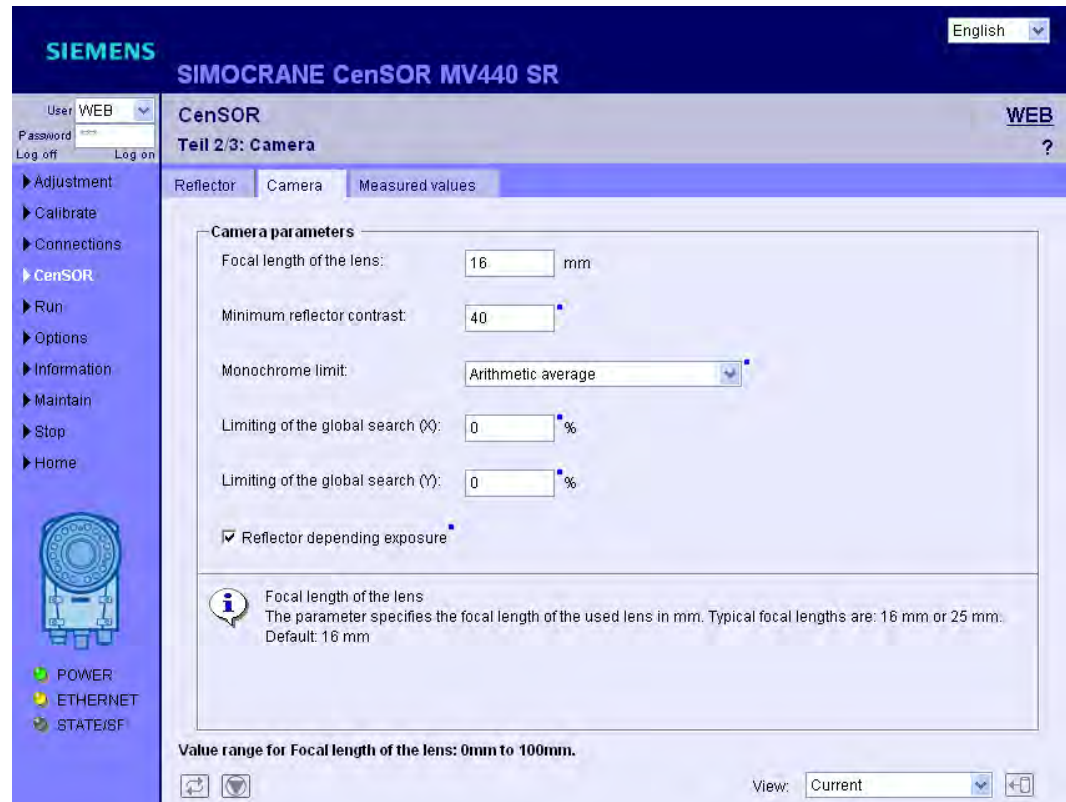

Figure 8-7 CenSOR - Camera

Focal length of the lens

The parameter specifies the focal length of the lens being used in mm.

Settings

Typical focal lengths are: 16 mm, 25 mm.

Factory setting

16 mm

Minimum reflector contrast

During image evaluation, the contrast between the bright and dark areas must have at least this value. The measured contrast can be between 0 and 255. The contrast of a reflector is usually between 40 and 100. The contrast of an active or retroreflective reflector is greater than that of a passive reflector.

Factory setting

40

Monochrome limit

This parameter can be used to specify the light-dark limit.

Settings

- Arithmetic average of the reflector (default)
- Suppress dark disturbances on white areas (shadows)
- Suppress light disturbances on dark areas

Factory setting

Arithmetic average of the reflector (default)

Limiting of the global search (X)

If the reflector was not found, you can limit the horizontal image area in which the reflector is searched for. At 0%, all 640 image columns or at 90 % only the middle 64 image columns will be searched for a reflector.

Factory setting

0 %

Limiting of the global search (Y)

If the reflector was not found, you can limit the vertical image area in which the reflector is searched for. At 0%, all 480 image rows or at 90 % only the middle 48 image rows will be searched for a reflector.

Factory setting

0 %

Reflector-dependent exposure

The exposure time is controlled depending on the brightness of the reflector found.

Factory setting

Active (check mark is set)

Note

"Reflector-dependent exposure" is disabled: Problems in diffuse light conditions

Diffuse light conditions may cause problems with regard to reflector detection if the "Reflector-dependent exposure" parameter is disabled ("Off"; check mark not set).

The exposure parameters will not be optimized for image acquisition if the "Reflector-dependent exposure" parameter is set to "Off" (no check mark set). The values set at the time the "Save code" function was executed will always be used for the exposure parameters (you can view these on the "Setup" (Page 98) task page).

- Set this parameter to "On" to compensate for diffuse light conditions. Maintain the factory setting.
-

8.3.2.3 CenSOR - Measured values

Calculating the distance between the camera and reflector as a function of the hoisting height

The hoisting height K1 and the camera - reflector S1 distance measured by the camera form a linear relation. You can calculate this linear relation as a function of the "resolution" and "offset" variables.

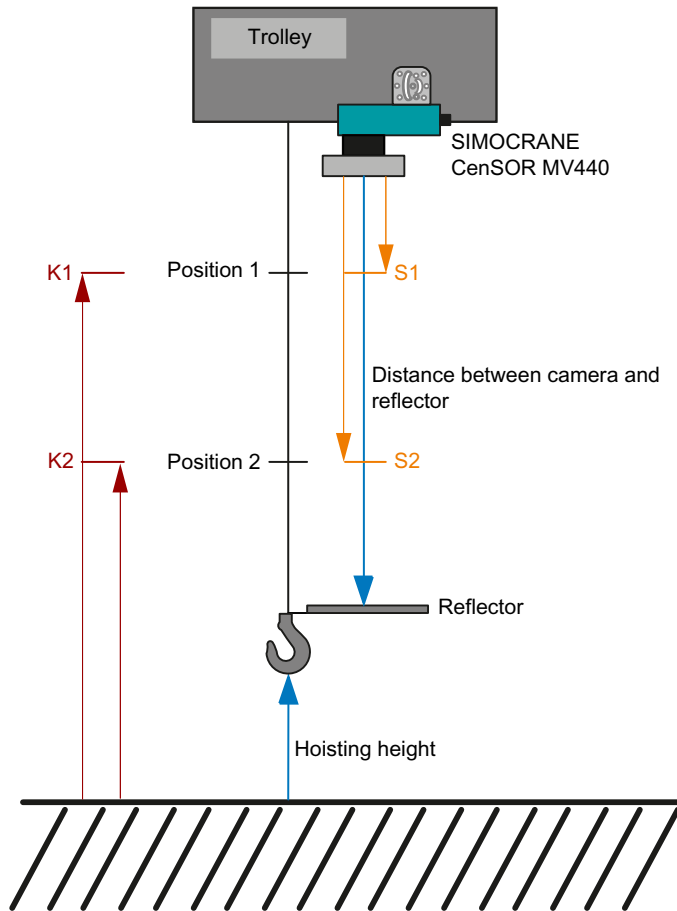

Figure 8-8 Relation between the hoisting height and distance

Calculating the "resolution" and "offset"

Complete the following steps to calculate the "resolution" and "offset":

1. Run the hoist to position 1 (figure "Relation between the hoisting height and distance"). In the table, note down the corresponding position values for the hub of your crane at K1 and for the SIMOCRANE CenSOR MV440 at S1.
 - You can read the actual value of K1 (current hoist position) from the Kinematic [1] dialog, "Monitor" tab (CeCOMM user interface).
 - You can read off the current value for S1 in "Calibrate" → "Actual value" → "Actual distance".
2. Run the hoist to position 2 (figure "Relation between the hoisting height and distance"). In the table, note down the corresponding position values for the hub of your crane at K2 and for the SIMOCRANE CenSOR MV440 at S2.
 - You can read the actual value of K2 (current hoist position) from the Kinematic [1] dialog, "Monitor" tab (CeCOMM user interface).
 - To read the actual value of S2, select "Calibrate" → "Actual value" → "Actual distance".
3. Put the calculated values (K1, K2, S1, S2) into the two formulas:
 - Resolution = $(S1-S2) / (K1-K2)$
 - Offset = $S1 - \text{resolution} * K1$
4. Enter the calculated "resolution" and "offset" values in the "CenSOR" task, "Measured values" tab.

Settings: CenSOR - Measured values

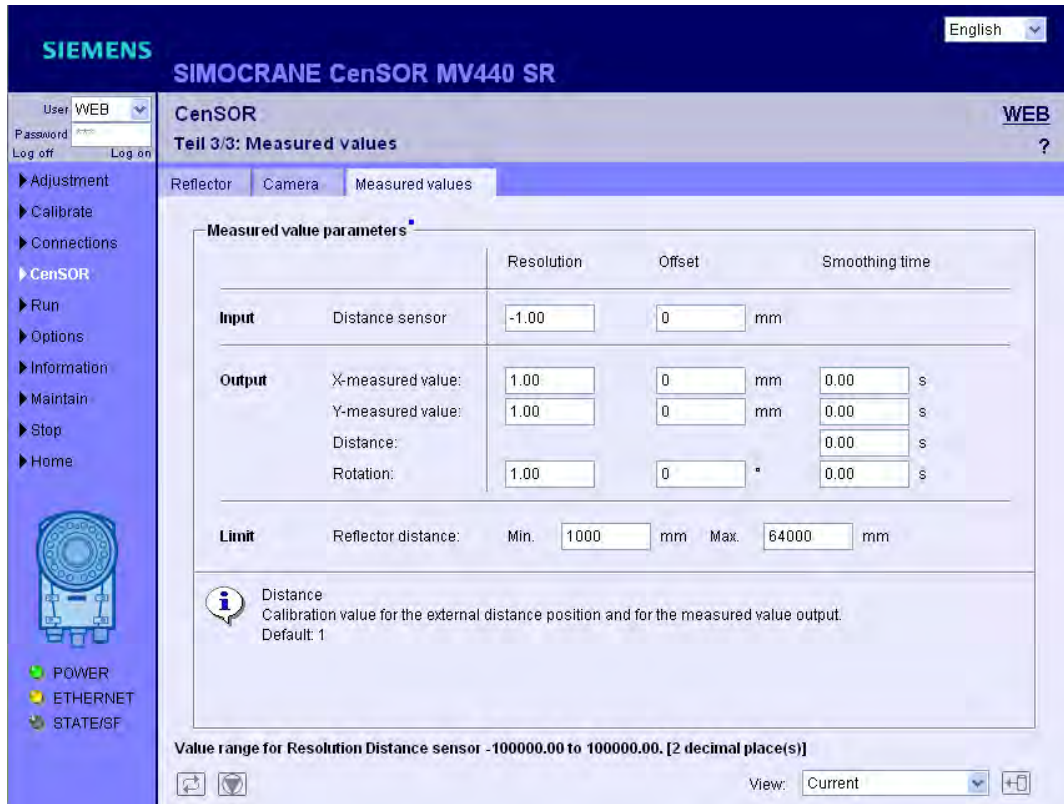

Figure 8-9 CenSOR - Measured values

Note

Enabling/disabling the input for the current hoisting height (distance sensor)

Enable or disable the "external reflector distance" input in the "Reflector" tab.

Set measured value parameters for:

- Input
- Output
- Limitation

On this page, you make important parameter settings for the input and output of the following measured values:

Parameter name	Explanation
Distance sensor	Current hoisting height
X measured value	Deflection in X direction
Y measured value	Deflection in Y direction
Distance	Distance between the camera and the reflector
Skew	Rotation of the reflector

The following settings are available:

Resolution

Calibration value for the external distance position and for the measured value output.

Factory setting

1

Offset

Calibration value for the external distance position and for the measured value output.

Factory setting

0

Smoothing time

Smoothing time constant for the measured value (delay element of the first order).

- If the parameter value is zero, the smoothing is deactivated.

Factory setting

0

Reflector distance limit**Min.**

The reflector distance must have a value at least as high as the set value. Otherwise it will be set to this value.

Factory setting

1000 mm

Max.

The reflector distance must not be higher than the set value. Otherwise it will be set to this value.

Factory setting

64 000 mm

8.3.3 Adjustment - Set image

Using the term "Setup"

Note the different meanings of the term "setup" in chapter Meaning of the term "setup" used in these operating instructions (Page 8).

- Start the adjustment of the SIMOCRANE CenSOR MV440 camera on this page.

Note

Meaning of the term "setup" in this chapter

In the context of commissioning, the term denotes parameterization and customization of the connection configuration and flash unit configuration.

Note

Retaining factory settings for "Trigger delay", "Correct distortion" and "Triggered only"

The "Trigger delay", "Correct distortion" and "Triggered only" parameters do not need to be adapted. Maintain the factory settings.

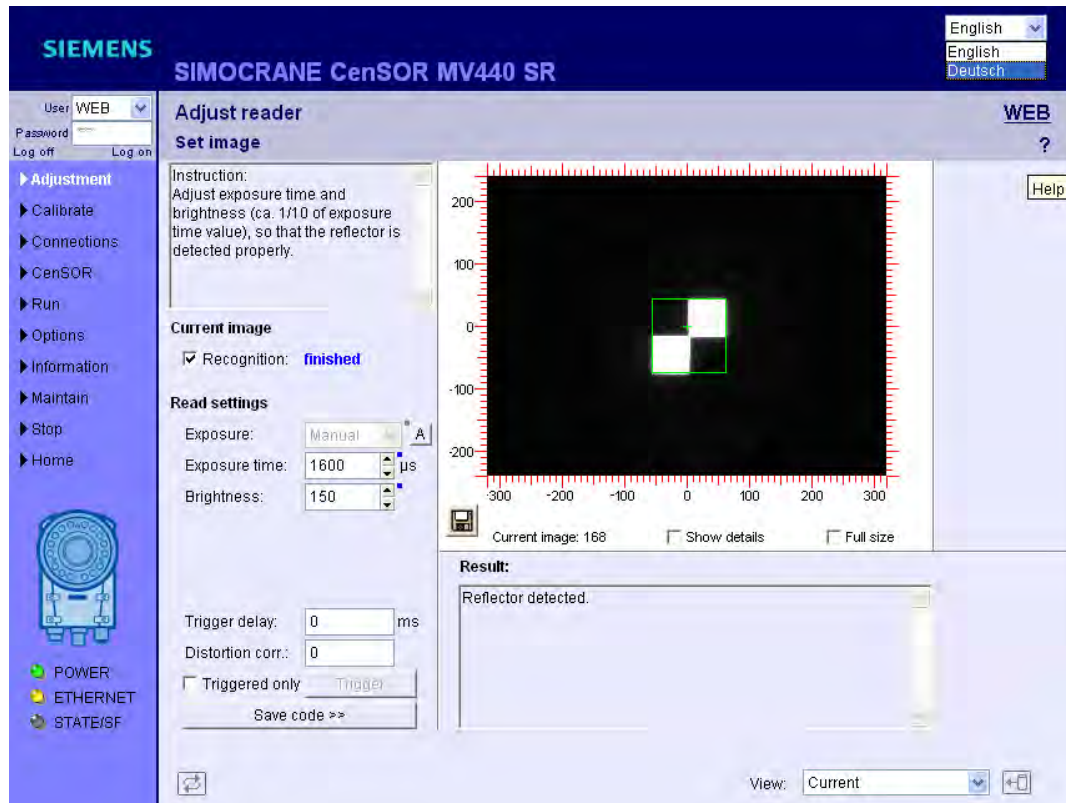

Figure 8-10 Adjustment - Set image

Read settings

The exposure is normally adapted automatically in processing mode. You can, however, change this setting in "CenSOR" → "Camera" → "Reflector-dependent exposure".

- Optimize the exposure time and the brightness so that the white areas of the reflector appear white without blooming. When setting the brightness, a value of approximately 10% of the exposure time is recommended.
- If you do not use a flash, you can click on "A" to get a first rough guideline for the exposure time and brightness. The SIMOCRANE CenSOR MV440 camera then calculates the exposure time and brightness once. You can adapt the exposure time and brightness manually.

Note

Button "A" is inactive with the flash

When the flash is used, button "A" for automatic adaptation is not active (irrespective of the internal automatic function).

Current image

During "Recognition", the status of image recognition is displayed:

- If the currently read reflector was successfully recognized, "finished" in a blue font. A recognized reflector is displayed with a green frame. The result box is active.
- If the recognition of the reflector is unsuccessful, the word "running" is displayed in a red font. In this case, the camera makes further recognition attempts. The images are displayed without a green border.

Save code button

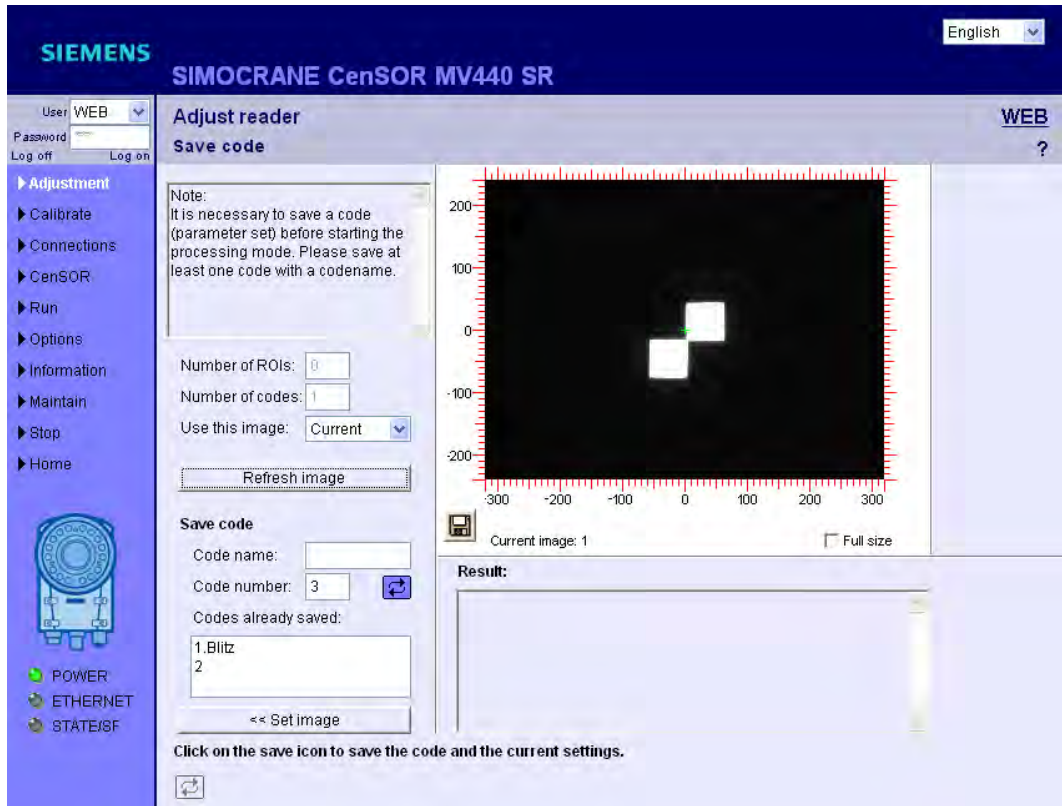

Figure 8-11 Adjustment - Save code

This brings you to the "Adjustment" - "Save code" page.

To be able to use the successfully recognized reflector in processing mode, the code must be saved.

Image display

Below the screen display, there is a diskette icon with which you can create an image acquisition with the camera. The image is saved in BMP format.

- With the "Full size" check box, you can view a section of the image in its original size or the entire image in a reduced size.
- With the "Show details" check box, you can display additional information on the read coded in the image.

Current image

The consecutive number of the currently displayed image is displayed.

Result

The result of reflector recognition is displayed in text form.

8.3.4 Adjustment - Save code

Using the term "Setup"

Note the different meanings of the term "setup" in chapter Meaning of the term "setup" used in these operating instructions (Page 8).

Once you have made the settings on the CenSOR pages, save the code:

- Go to the "Adjustment" - "Set image" page and select the "Save code>>" button.

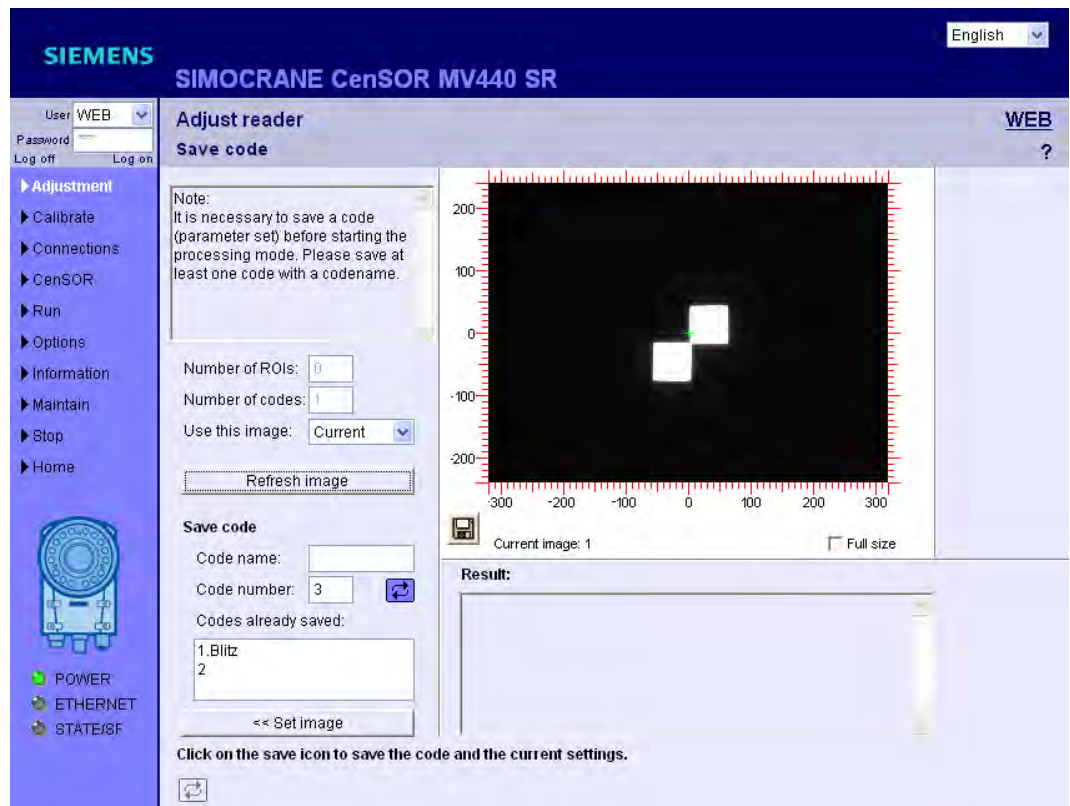

Figure 8-12 Adjustment - Save code

Note

Storage not possible with a PROFINET error

You cannot open the page for saving the code as long as a PROFINET error is pending.

"Save code" / "Code number" input field

Specify here the code number under which the current settings and the code are to be saved.

Possible values: 1 to 14

"Refresh image" button

Updates the image acquisition and displays it.

"Save code" button

Click this button to save the current settings and the code under the specified code number.

Note

Parameters marked in blue are saved along with the code

The parameters marked in blue are saved along with the code. These parameters are:

- Adjustment - Set image
 - Adjustment - Save code
 - Options
 - Tab: Image acquisition, Lighting
 - CenSOR
 - Tab: Reflector, Camera, Measured values
-

8.3.5 Calibrate

Requirement

Calibration is only possible if there is a camera measurement error.

Calibrating the camera system

Note

Calibrating the camera measuring system after installation

To achieve a high measurement reliability and accuracy, you need to calibrate the camera measuring system after installation.

During the calibration, the smallest size of the reflector in the image is identified. The image is always searched for a reflector with this minimum size and all similar patterns smaller than this are ignored.

The calibration also calculates the height-dependent zero position of the reflector. To achieve this the reflector is measured at two heights.

Steps in calibration

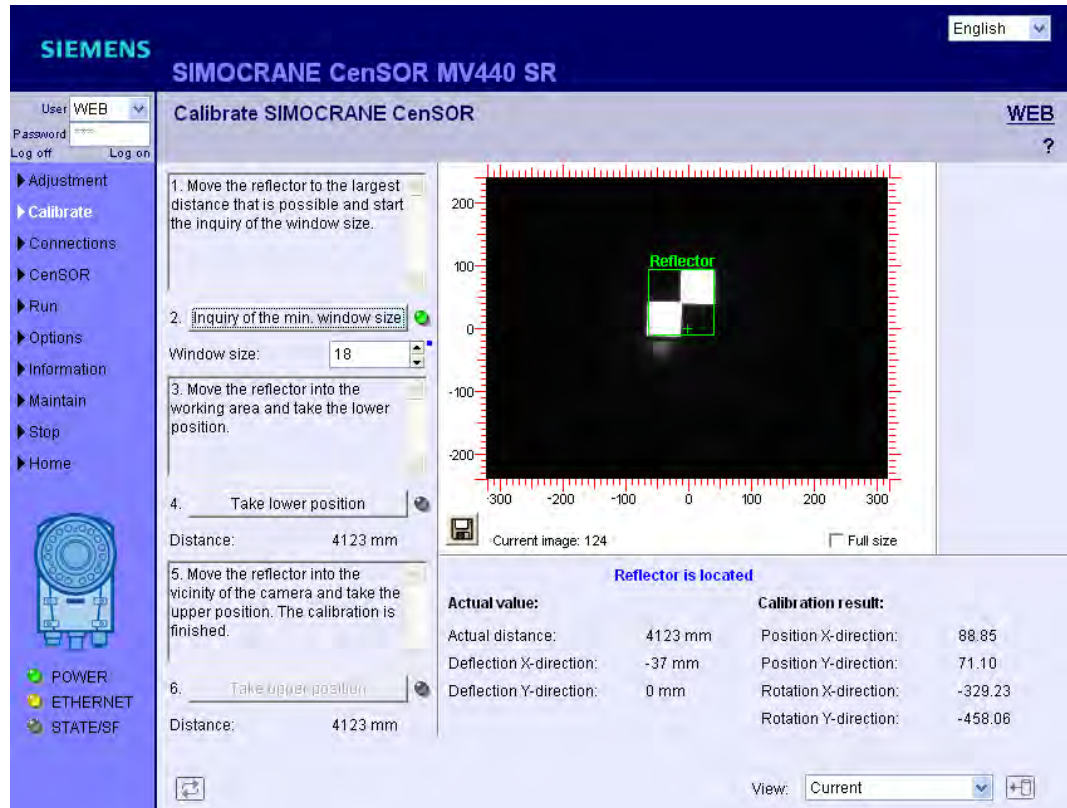

Figure 8-13 Calibrating the camera: Calculating the minimum window size

Distance

Value that corresponds exclusively to the distance to the reflector calculated by the camera measurement.

The following steps must be performed in the order specified here:

1. Increase the distance between camera and reflector as far as possible.
2. Press the "Inquiry of the min. window size" button.
The gray lamp beside it changes to green. The calculated value for the minimum window size is explained below.
3. Move the reflector to the lower work area.
4. Press the "Take lower position" button.
The gray lamp beside it changes to green.
5. Move the reflector close to the camera.
6. Press the "Take upper position" button.
The gray lamp beside it changes to green.

Calibration successful

If calibration was successful, all three lamps are lit green and you can read off the calibration results below the reflector image on the right-hand side.

Note

Calibration unsuccessful

If the calibration cannot be completed successfully:

- Adapt the parameters in "Adjustment" - "Set image" and "Options" - "Lighting" so that the camera shows the white reflector area as being clearly visible.
- You should also make sure that no objects are blocking the camera's view of the reflector.

Saving the results

The results of the camera calibration are not saved in the code but rather globally for the camera. They are saved when the the code is saved/restores and can therefore also be exported.

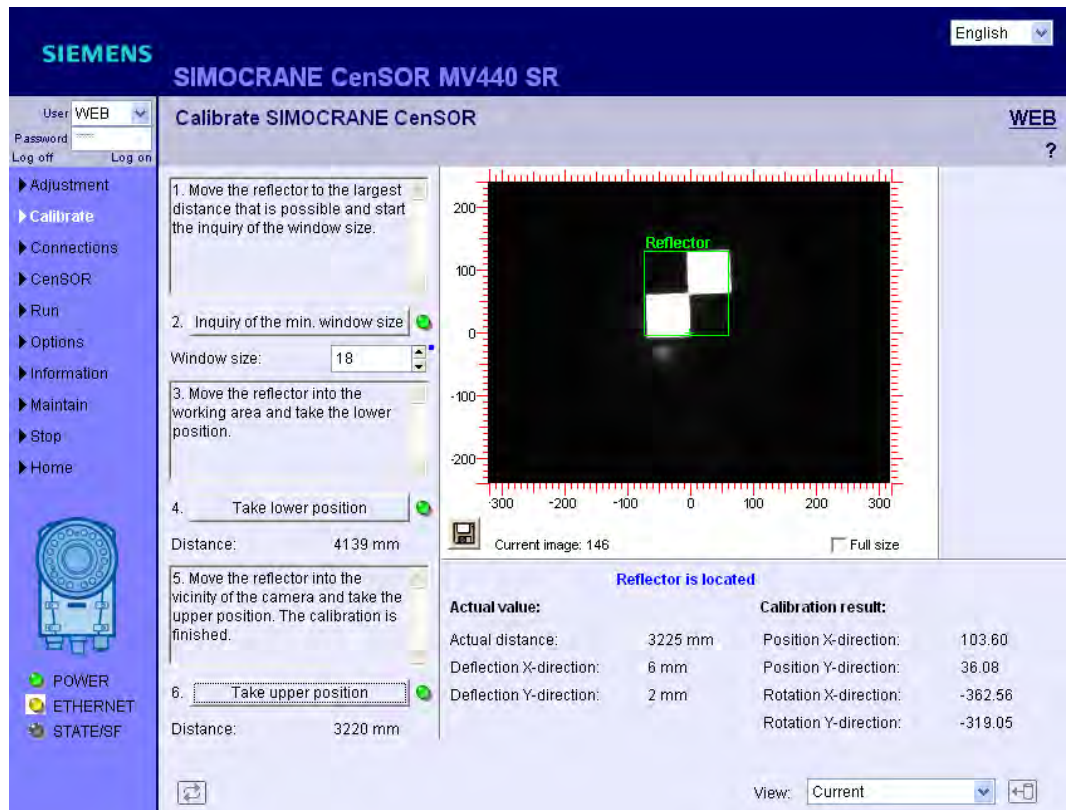

Figure 8-14 SIMOCRANE CenSOR MV440 camera: calibration completed

Values for the minimum window size

The result of the commissioning step is an integer value between 11 and 20. Whereas 11 means that the reflector in the image is very small, 20 means very large.

Factors > 10 (window size determined: +10) mean that, after commissioning, the window size is automatically varied depending on the distance.

- If you do not want the window size to be automatically adapted, reduce the calculated window size by 10 (for example 19 → 9).

Calibration completed

Note

Calculated load deflection close to zero

On completion of the calibration, the calculated load deflection in both directions must be close to zero: see "Actual value" display.

8.3.6 Run

The change to "processing mode" means the start of the evaluation. The reflector is searched for.

Requirement

Note

Change the camera to processing mode on completion of parameter assignment

On completion of parameter assignment, the camera needs to be changed to processing mode. Only then does the cyclic processing of the acquired reflector images and communication with the controller start.

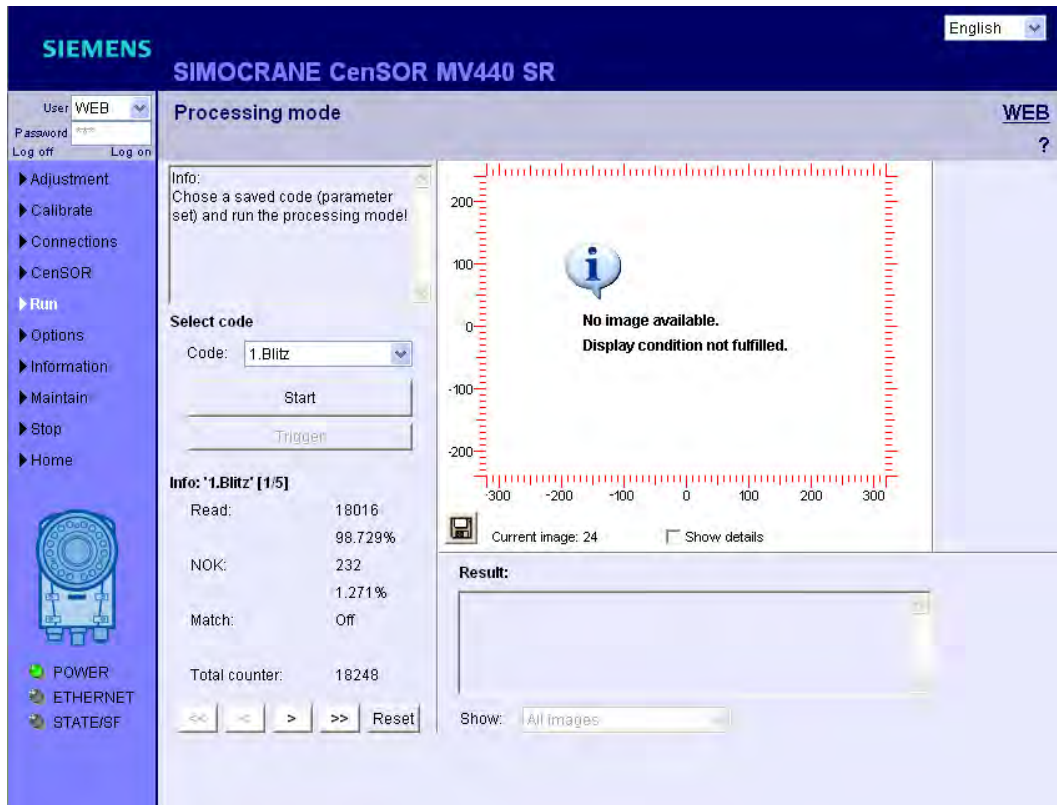

Figure 8-15 Processing mode before selecting "Start"

Text box

The top left of the dialog displays a static text that provides important information on the evaluation mode.

"Start" button

Figure 8-16 Processing mode after selecting "Start"

If you have selected the number of a previously saved code in the "Code" drop-down list:

- Click the "Start" button to start processing mode (RUN mode).

Information

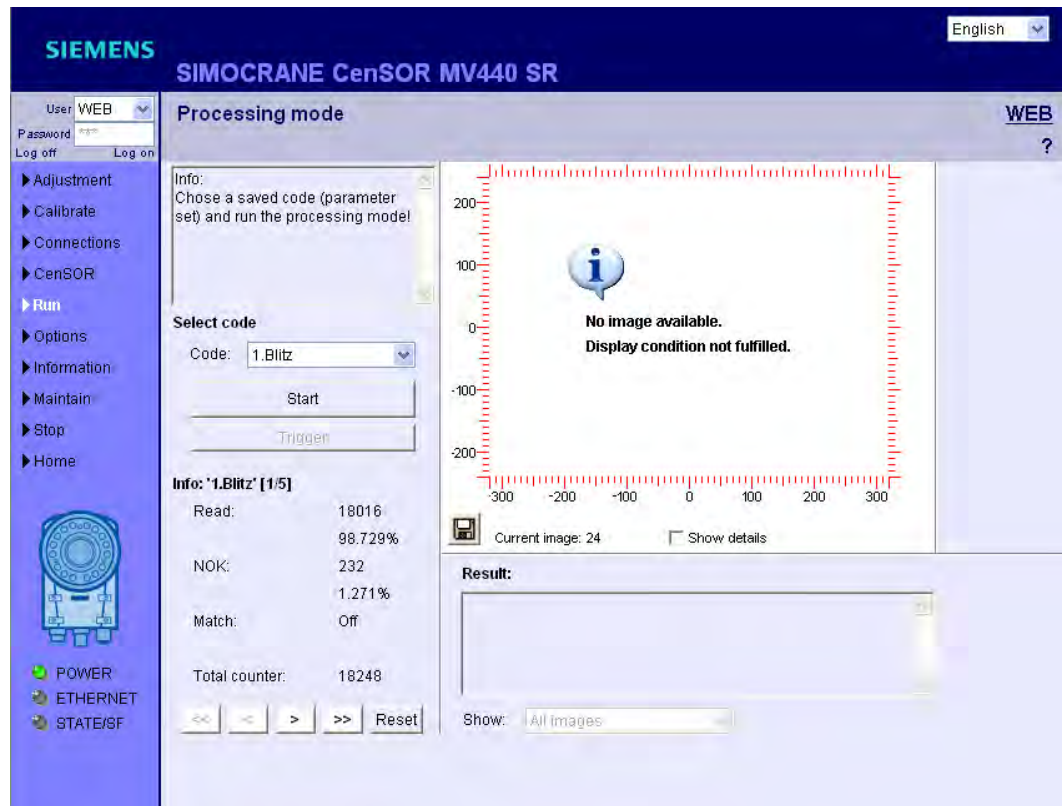
- In the "Information" area, you can monitor different characteristic values and statistics of the reflector recognition on a total of five pages.
- The info area can also be used to display error messages.

Quality

Tag	Meaning	Explanation and unit
Reliability	Recognition reliability	Recognition reliability of the reflector as a percentage
XD	X direction:	Deflection of the reflector in the X direction in mm.
YD	Y direction:	Deflection of the reflector in the Y direction in mm.
DIS	Distance:	Distance between camera and reflector in mm.
ROT	Rotation:	Rotation of the reflector in degrees.
SZ	Size:	Edge length of a white reflector area in pixels.

Tag	Meaning	Explanation and unit
EXP	Exposure time	Exposure time in μs
GN	Gain	

8.3.7 Information

The "Info" dialog consists of three sections:

- Codes
- Diagnostics
- Device information

8.3.7.1 Information - Codes

This task section shows you all the most important information on the selected parameter record (code).



Figure 8-17 Information - Codes

You obtain the following information:

- Exposure and properties of a saved code
- Settings of a code to be read
- Display of image and result text of the selected code

Select code

In "Select code", you can specify the number of the saved code whose properties you want to see.

Information code

The "Information Code" task field displays the exposure time, the exposure time offset, and the brightness values for image acquisition with which the image was acquired when the code was saved.

8.3.7.2 Information - Diagnostics

In this task section, you can view, delete and save diagnostics images and reports.

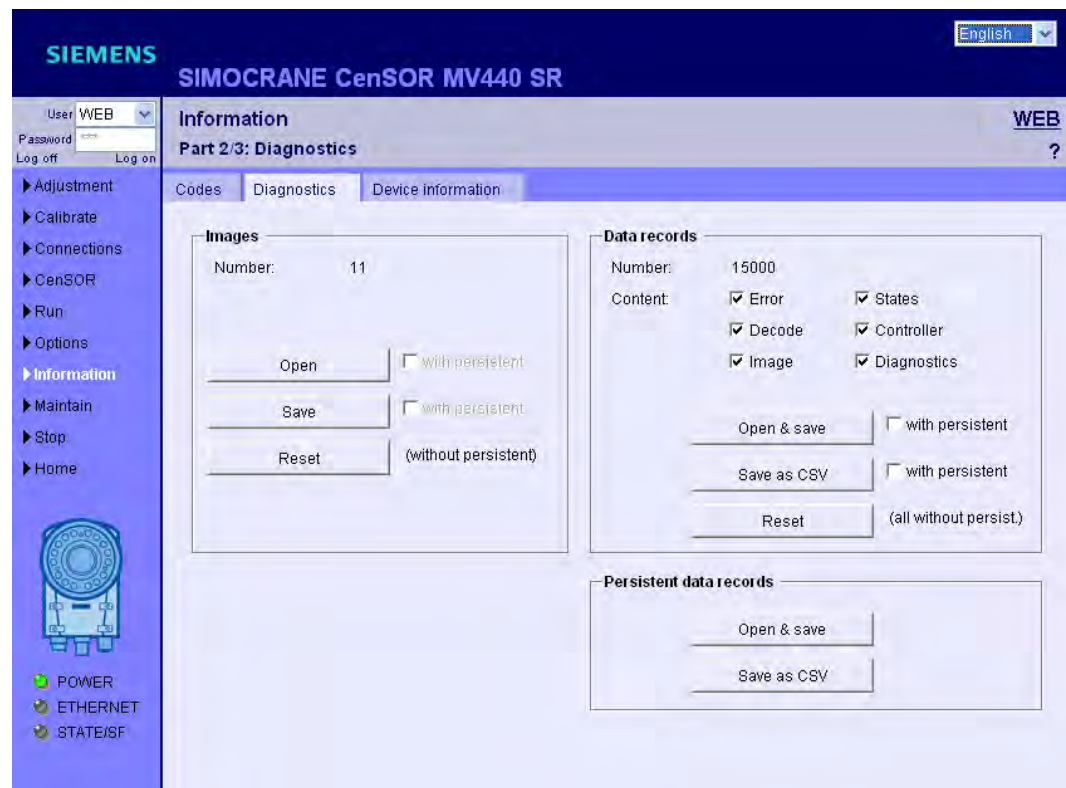

Figure 8-18 Information - Diagnostics

Images

In "Images", you can see the number of images currently in the image buffer.

- If you click the "Reset" button, you delete all images in the image buffer.
- Clicking the "Open" button opens a Web page with all the images of the image buffer. If you click on one of these images, the image is magnified.
- Clicking the "Save" button opens a Web page with all the images of the image buffer. You can save this Web page on your PC in various formats.

Data records

The "Data records" task field displays the current number of diagnostics events in the event buffer.

In "Content", you can use the check boxes to select the information you want to display about the diagnostics events in the buffer:

Error	Information on the occurrence and acknowledgment (manual or automatic) of errors
Decode	Processing result
Image	Information on the image acquisition, for example exposure time, brightness
States	Operating mode change (transition to RUN, ADJUST, Self test, etc.)
Controller	Change of control of the camera (control by keyboard, WEB, CPU)
Diagnostics	Changes that affect diagnostics, for example, changing the diagnostics options or fetching a time stamp from an SNTP server

- If you click the "Reset" button, you delete all entries in the events buffer. The entries relating to temporary PROFINET IO errors are also deleted.
- If you click the "Save as CSV" button, a dialog opens. In the dialog box, you initiate the saving of the events selected under "Content" as a csv file.
- Clicking the "Open & save" button opens a Web page with all the events of the events buffer. You can save this Web page on your PC in various formats.

Persistent data records

- Clicking the "Open & save" button opens a Web page with all the diagnostics entries saved permanently on the camera. You can save this Web page on your PC.
- If you click the "Save as CSV" button, a dialog opens. In the dialog box, you initiate the saving of the diagnostics entries stored permanently on the camera as a csv file.

8.3.7.3 Information - Device Information

This task section provides information on the SIMOCRANE CenSOR MV440, on the firmware, and on the optionally integrated internal lamp.

The screenshot displays the web interface for the SIMOCRANE CenSOR MV440 SR. The interface is divided into a left sidebar and a main content area. The sidebar contains navigation options: Adjustment, Calibrate, Connections, CenSOR, Run, Options, Information (highlighted), Maintain, Stop, and Home. Below these are status indicators for POWER, ETHERNET, and STATE/SF. The main content area is titled 'Information' and 'Part 3/3: Device information'. It features three tabs: Codes, Diagnostics, and Device information (selected). The 'Device information' tab displays the following data:

Reader	
Product version:	1
MLFB:	6GA7202-0AA00-0AA1
MAC address:	00:0E:8C:F3:DB:98
FPGA version:	V1.5
Current IP address:	192.168.1.155
PNIO device name/ host name:	mv440x

Firmware	
Version:	V04.01.08_02 (O)

Internal lamp	
Color:	-
MLFB:	-

On the right side of the interface, there is a photograph of the SIMOCRANE CenSOR MV440 SR device, which is a teal-colored industrial camera with a lens and various connectors.

Figure 8-19 Information - Device Information

8.3.8 Management

The "Management" task provides the following options:

- Deleting codes
- Exporting settings and code to an XML file.
- Saving or restoring settings and codes in XML file format.
- Resetting the SIMOCRANE CenSOR MV440 camera to factory settings
- When necessary, running firmware updates

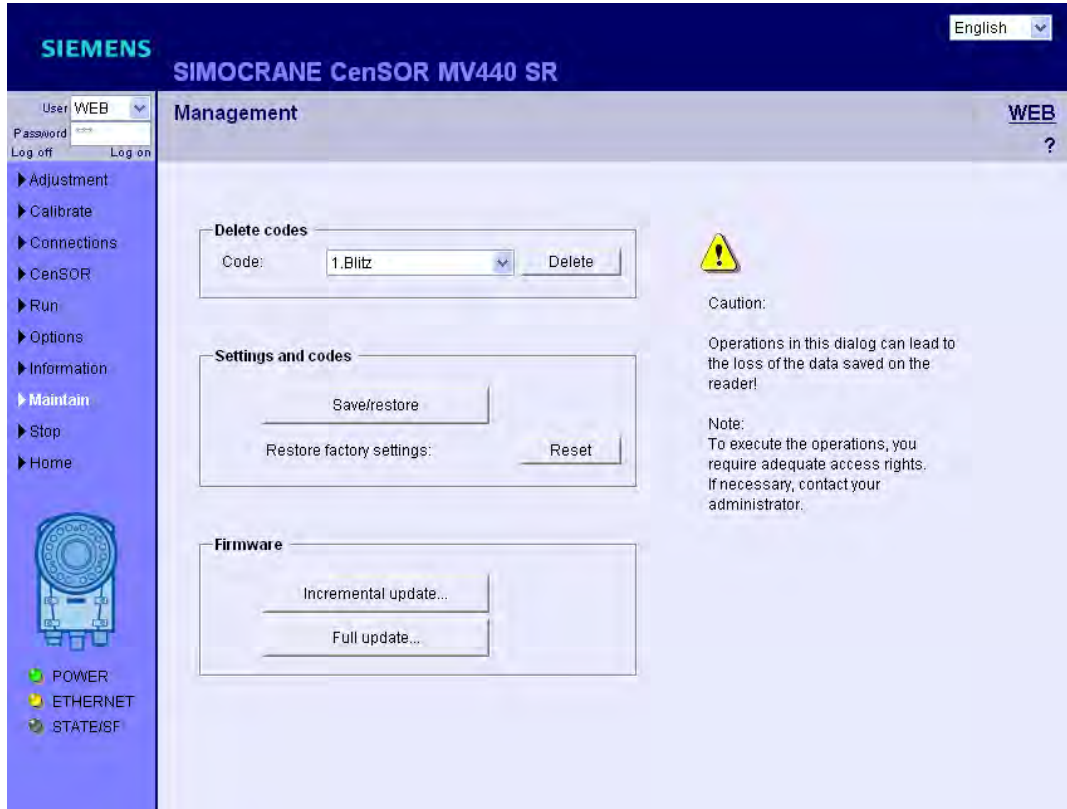

Figure 8-20 Management

Delete codes

In this task field, you can delete codes from memory by selecting the relevant code number from the drop-down list box and clicking the "Delete" button.

Settings and codes

The "Save/restore" button is used open a Web page at which you can export codes to an XML file, or re-import these as XML file to the camera.

Note

Imported XML file of a code: Parameters were loaded and valid

The parameters saved with the code are included and therefore valid when you import the XML files of a code to the SIMOCRANE CenSOR MV440 camera.

You can use the "Reset" button to reset all parameters to factory settings. This action will also delete all codes exported as XML file.

Note

"Reset": resets the network settings

Since the network settings are also reset, you need to repeat steps 3 to 5 specified in chapter Establishing the connection to the SIMOCRANE CenSOR MV440 camera and starting the user interface (Page 61)

Firmware

Procedure on an update

On an update, the SIMOCRANE CenSOR MV440 camera is reset to the factory settings.

For this reason, save important settings and codes before the update:

1. Click "Save/restore" in the "Management" dialog to open the Web page and create a backup copy of your data.
2. Save the settings and codes in an XML file on your programming device/PC.
3. After updating the camera, you transfer the settings and codes again using the same Web page.

The "Full update..." button opens a Web page where you can update the firmware.

Note

Controlling the camera by means of automation system: Do not set the DISA bit

If you control the camera from an automation system, make sure that the DISA bit is not set during the firmware update. This prevents an automation system from changing the camera to "RUN".



Figure 8-21 Updating the firmware of the SIMOCRANE CenSOR MV440 camera

- From the left-hand navigation bar, select "Update EPROM". The following page appears:

SIEMENS
SIMOCRANE CenSOR MV440 SR

Code reading systems

► Full update
► Update EPROM

Full update

Update file:

(File extension must be '.bin')

- Clicking 'Submit' will delete all settings and stored codes on the Code Reader. Make sure you have saved it before continuing.
- Do not turn off the Code Reader while update is running.
- Do not click on any links or buttons until update is finished.
- The update process may take several minutes. The current status of the update can be seen on the progress bar below.
- Wait until the following page is updated and successfully completed. This is prompted on a new page. Interrupted or otherwise incomplete EPROM updates will render the device inoperable.

This page does not support updates with a '.VSX' or '.VSZ' file.
If you have a file with one of these file extensions, use the 'Incremental update...' function which can be initiated from the Maintain panel of the Code Reader user interface.

© Siemens AG 2011. All rights reserved/Alle Rechte vorbehalten.

Figure 8-22 Update EPROM

- With "Browse", go to the tab where the "Update" (file with the extension .bin) is located.
- Transfer with "Submit" and follow the instructions on the screen.

8.3.9 Stop

If the SIMOCRANE CenSOR MV440 camera is in "Stop", this page is displayed.

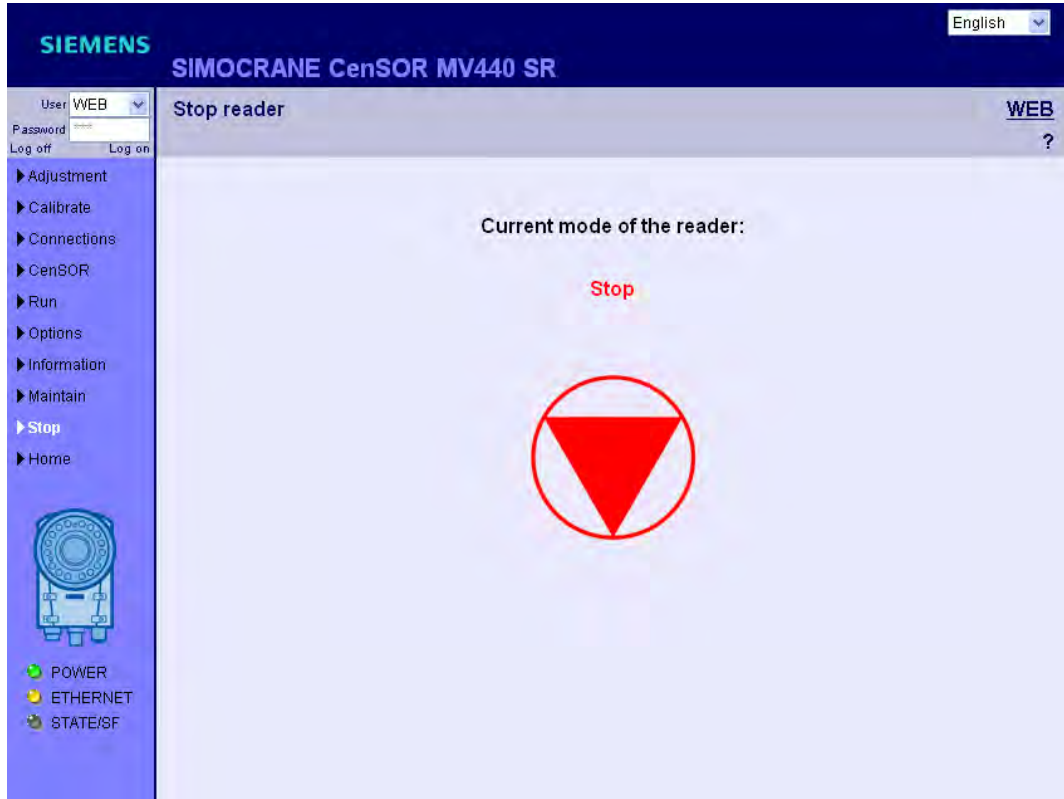

Figure 8-23 SIMOCRANE CenSOR MV440 camera in stop mode

Error display

If an error occurs, the STATE/SF LED changes to red and the following messages are displayed:

- The corresponding error message
- The meaning of the error
- The options for eliminating the error

Acknowledge the error by clicking the "Acknowledge" button.

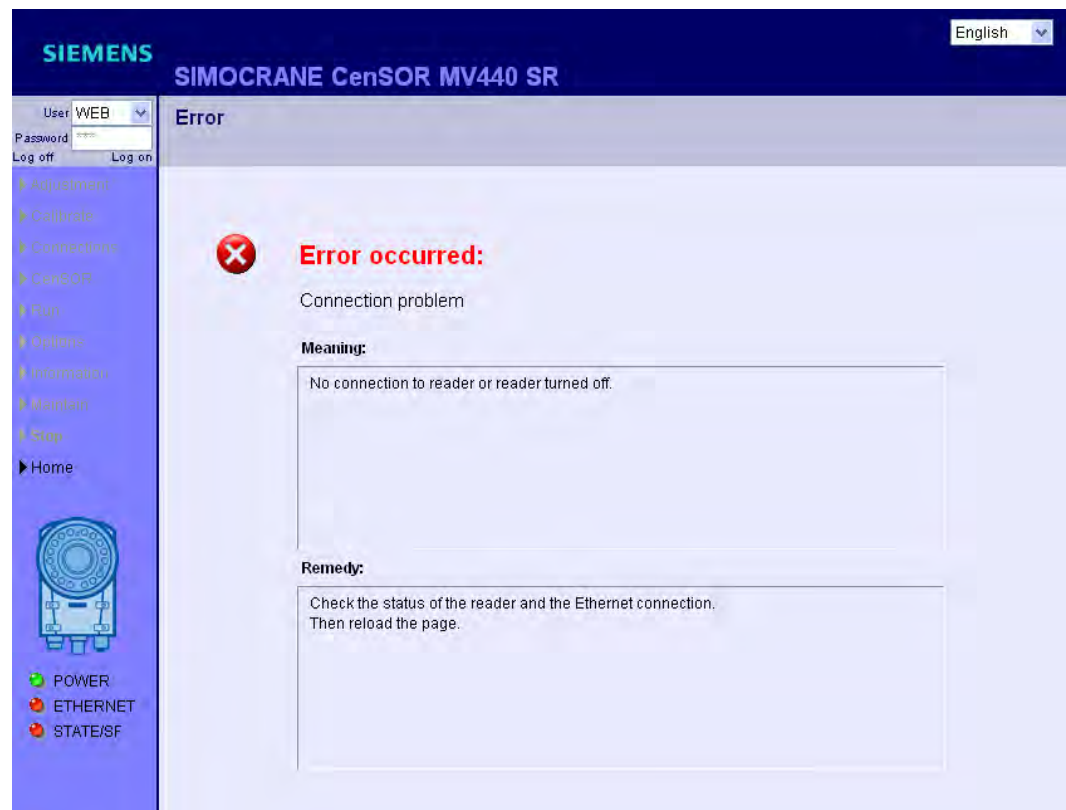

Figure 8-24 Error message

8.3.10 Monitoring via HTML pages

What do the HTML pages provide?

The HTML pages integrated on the camera provide the following:

- An option that can be integrated in many environments
- Obtaining important information from the SIMOCRANE CenSOR MV440 camera
- Monitoring the recognition process

Benefits

- Independent of the operating system or the browser you are using.
- Does not require Java Runtime on the visualization device.
- Requires little memory and performance on the visualization device.
- Can be integrated easily in existing applications.
- Display normally available in two languages, language can be changed online.

Available URLs

Using the following URLs, you can open the pages described above in the language of your choice. Example of a URL: `http://<IP address of camera>/peeklive.html`

Overview of the HTML pages for monitoring the camera

Page	English	German
Home page	index.html	index_de.html
Adjustment (applet)	adj_en.cgi	adj_de.cgi
Diagnostics records	diagrecs.cgi	diagrecs.cgi
Diagnostics screens	diagimgs.cgi	diagimgs.cgi
Extended diagnostics images	ediagimghtml.cgi	ediagimghtml.cgi
Live image with links	peeklive.html	peeklive_de.html
Live image without links	epeeklive.html	epeeklive.html
Last image	live.cgi	live.cgi



Figure 8-25 Home page

Shows current device information on:

- Device reader revision level
- Firmware version

- PROFINET IO device name
- Network identification

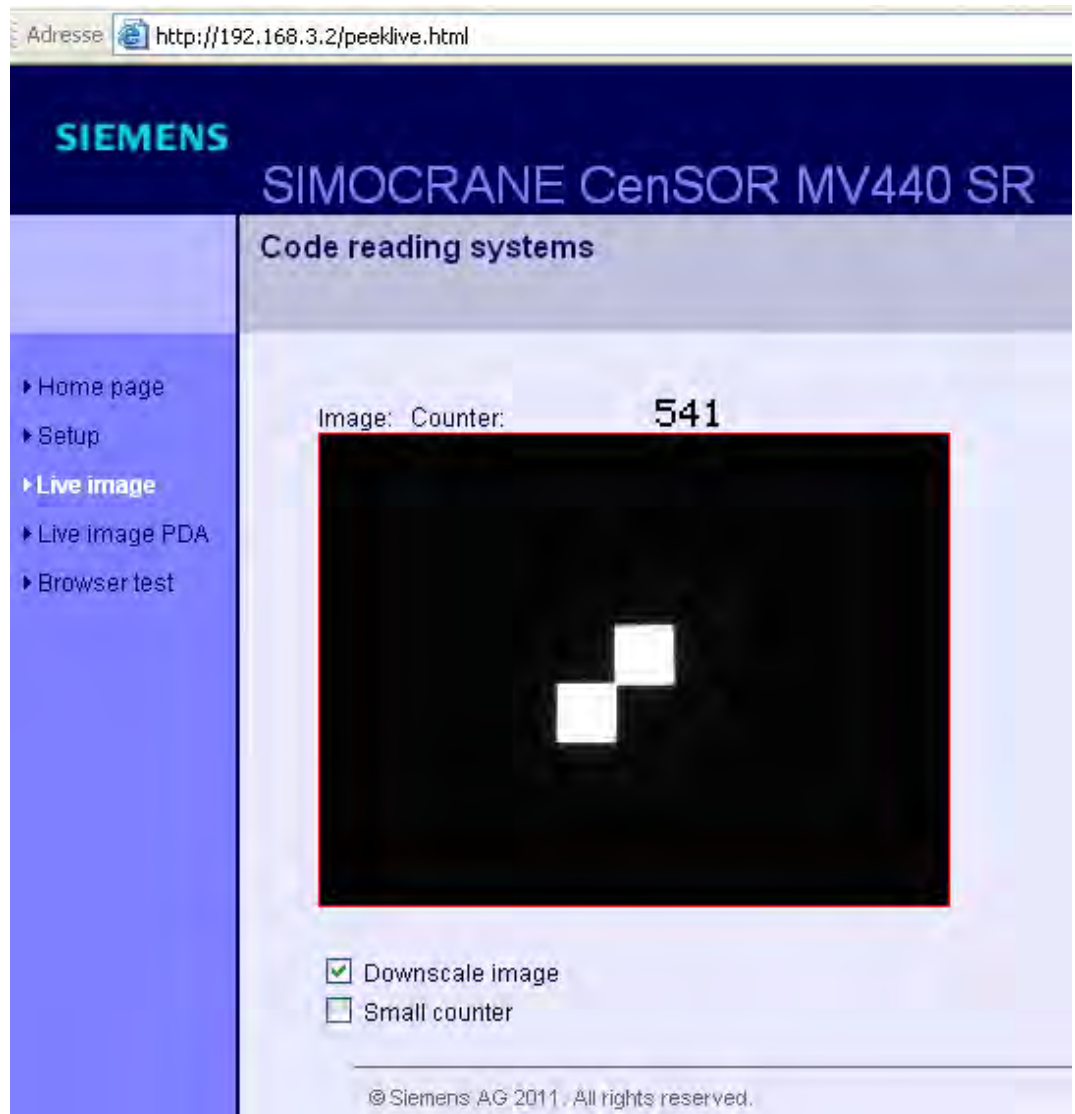

Figure 8-26 Live image display with links

Displays the images acquired by the camera in adjustment mode or processing mode. If the visualization device provides Java script support, the displayed image is automatically updated. With the displayed links, you can call up other pages.



Figure 8-27 Live image display without links

Displays the images acquired by the camera in adjustment mode or processing mode. If the visualization device provides Java script support, the displayed image is automatically updated. This page does not provide any links to other pages.

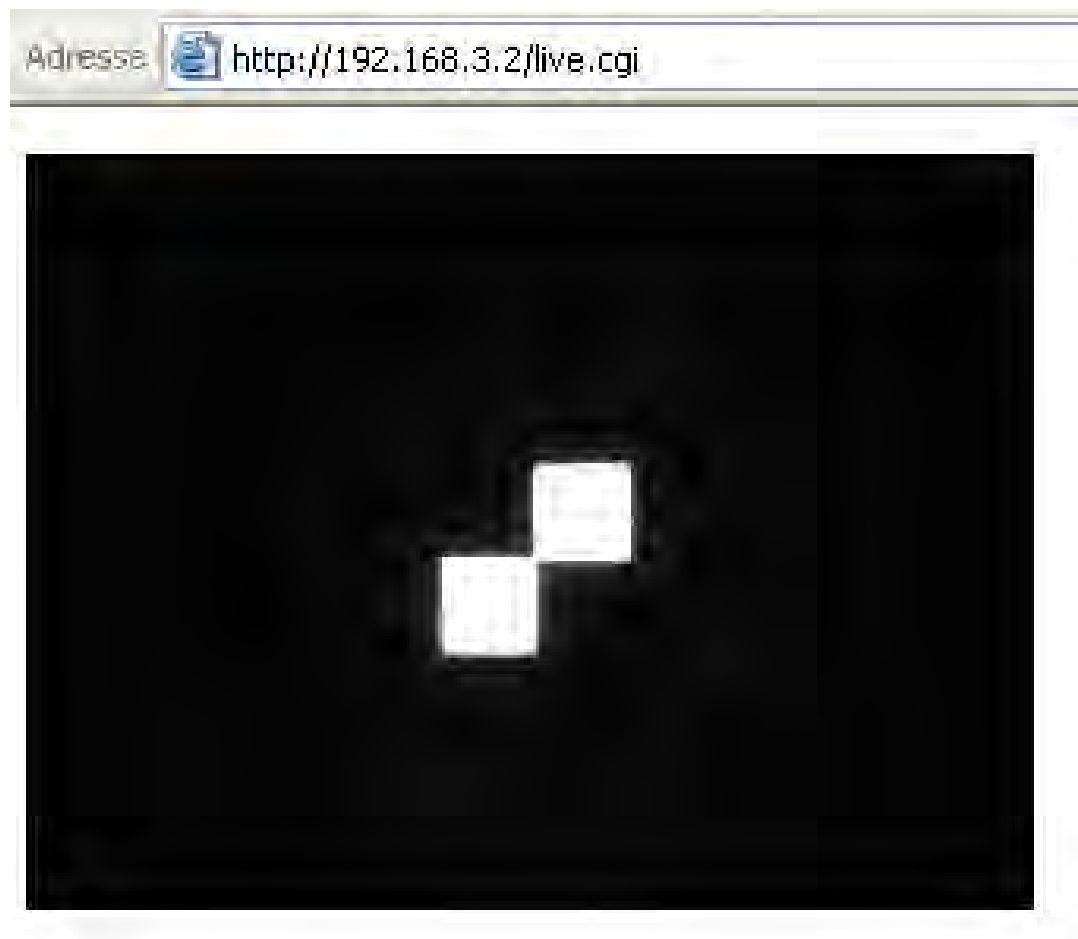

Figure 8-28 Last image

Purely display of the last recorded image without any further information and without automatic image updating.

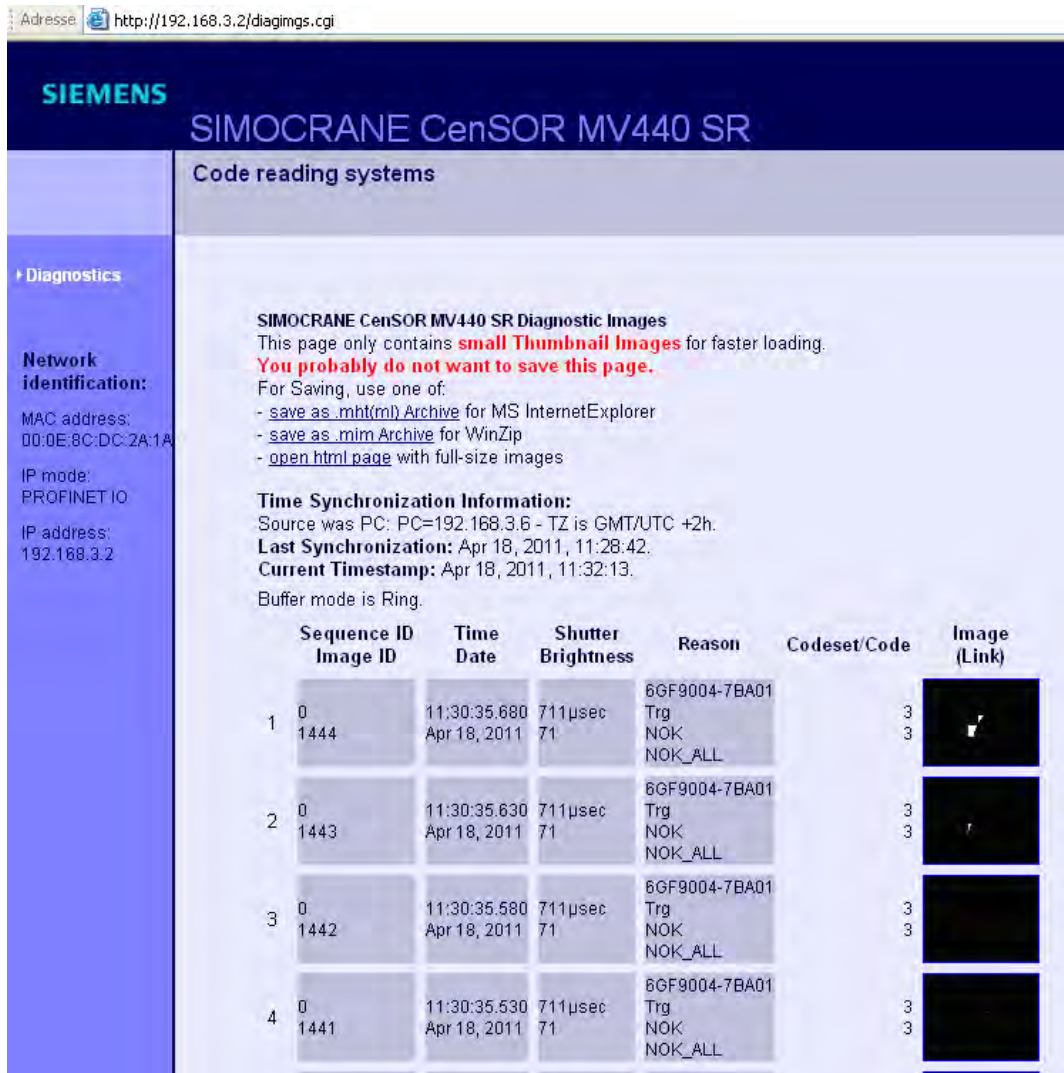

Figure 8-29 Diagnostics screens

This page combines a large format image display with the most important additional information about the image such as the read result and display of the quality values.

This page is particularly suitable when using touch panels.

Navigation is made easier by the large area navigation symbols at the left edge.

The screenshot shows a web browser window with the address `http://192.168.3.2/diagreccs.cgi`. The page title is "SIMOCRANE CenSOR MV440 SR" and the main heading is "Code reading systems". A left sidebar contains a "Diagnostics" menu and "Network identification" details: MAC address 00:0E:8C:DC:2A:1A, IP mode PROFINET IO, and IP address 192.168.3.2. The main content area displays "SIMOCRANE CenSOR MV440 SR Diagnostic Records" with synchronization information: Source was PC: PC=192.168.3.6 - TZ is GMT/UTC +2h, Last Synchronization: Apr 18, 2011, 10:59:22, Current Timestamp: Apr 18, 2011, 11:02:39. It also notes "Buffer mode is Ring" and "Selected Reason Groups: None". A "Save as CSV file" link is present. A table of diagnostic records shows one entry: ID 14373, Time Date 10:52:08.154 Apr 18, 2011, Event Source Power On PWR, Ctrl-Bits (Output) (none), and Additional Info. The page ends with "End of Records." and a copyright notice: © Siemens AG 2011. All rights reserved.

Figure 8-30 Diagnostics recordings

Provides a dynamically created HTML page with which you can display diagnostics recordings buffered on the camera relating to errors that occurred, signal changes etc.

Integration in a controller

9.1 "Integration in a controller" checklist

Procedure for integration in a controller

- Keep to the "Integration in a controller" checklist.

Chapter	What needs to be done?	OK?
Integration in a controller	Integrating SIMOCRANE CenSOR in a controller	• Integrate SIMOCRANE CenSOR via PROFINET IO (Page 126)
		• Integrate SIMOCRANE CenSOR with UDP via Ethernet (Page 152)

"Integration in a controller" checklist

Requirement

The camera is connected to the controller according to the specs in chapter Attachment/ connection (Page 39).

Two integration options

There are two ways of integrating the SIMOCRANE CenSOR MV440 camera in a controller.

- PROFINET IO is recommended for new systems.
- The option of linking via Ethernet UDP is intended for controllers that do not yet support PROFINET. The UDP interface is compatible with the interface of SIMOCRANE CenSOR M.

9.2 Integrating via PROFINET IO

9.2.1 Preparing the SIMOCRANE CenSOR MV440 camera for PROFINET IO

Step 1

Note

Online help

Please refer to the online help for a detailed description.

1. Open the "Connections" task in the user interface of the SIMOCRANE CenSOR MV440 camera. In the "Interfaces" tab, you specify the communications interface and the parameters for the interfaces.
2. Select "PROFINET mode" in "Ethernet" → "IP mode".
 - If you have selected "PROFINET mode" in the drop-down list, the input boxes under PROFINET IO are enabled.
 - Do not change the factory defaults.
 - Simply adapt the "Device name". The "Device name" must match the name entered in "HW Config" of the SIMOTION controller and be unique in the network.

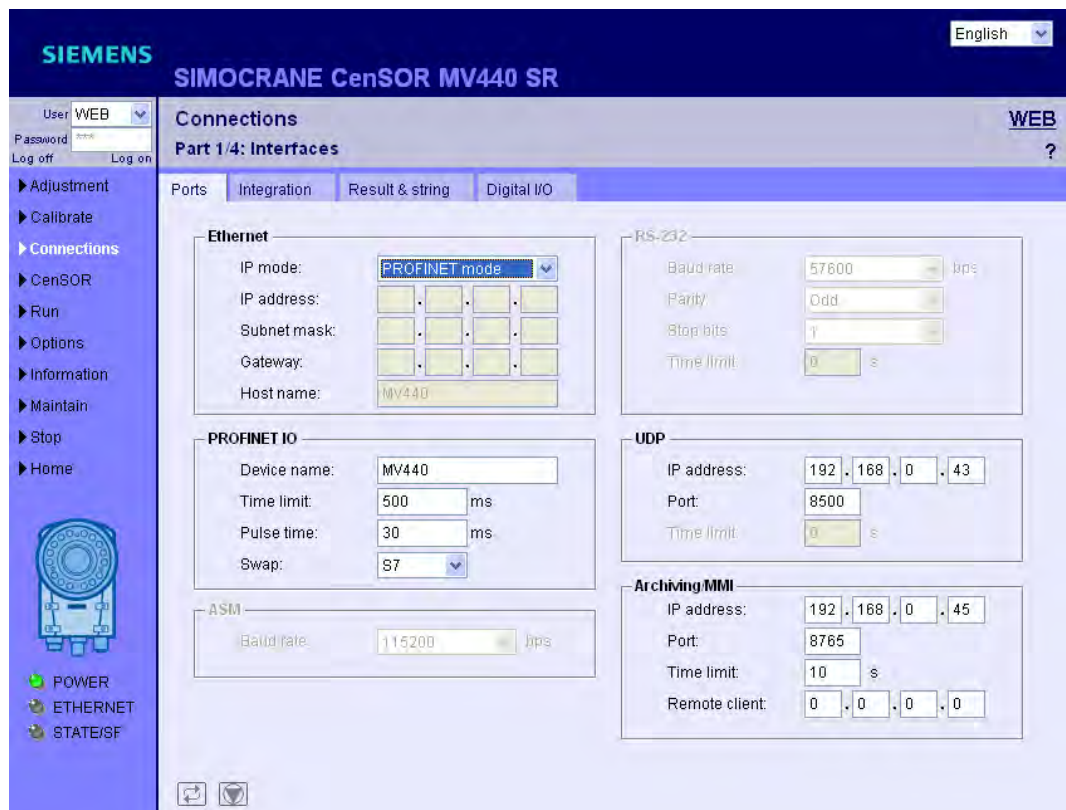

Figure 9-1 Connections - Ports

3. After accepting these settings, the SIMOCRANE CenSOR MV440 camera is restarted.
4. If unknown, determine the new IP address using the Primary Setup Tool (PST) (Page 62).

Step 2

Note

For a detailed description of the possible combinations of interface assignments, refer to the online help.

1. Change to the "Integration" tab.
You specify the following in the "Integration" tab:
 - How the signals reach the SIMOCRANE CenSOR MV440 camera.
 - How the results and diagnostics data are output.
2. Select "PROFINET IO" in the "String", "Result" and "Control" drop-down lists.

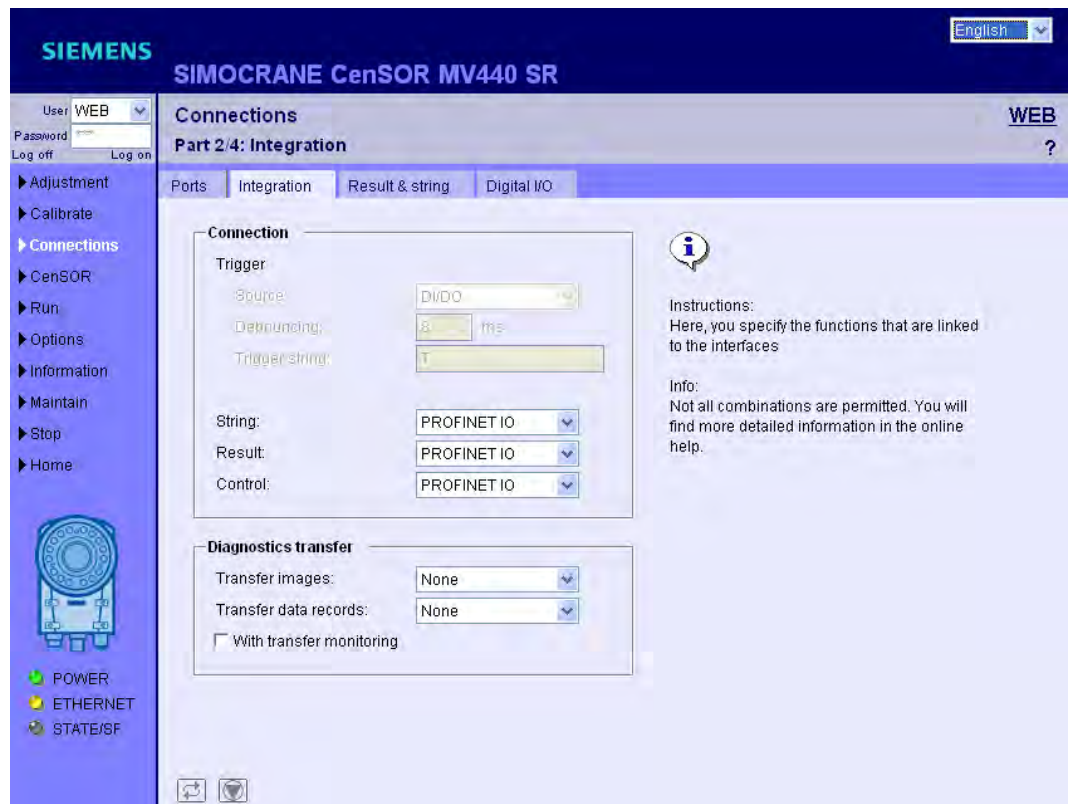

Figure 9-2 Connections - Integration

3. Complete the configuration of PROFINET IO with "Apply".

9.2.2 Principle of data exchange for PROFINET IO

Data transmission PROFINET IO

The following schematic shows the interfaces of the SIMOCRANE CenSOR MV440 camera relevant for data transmission.

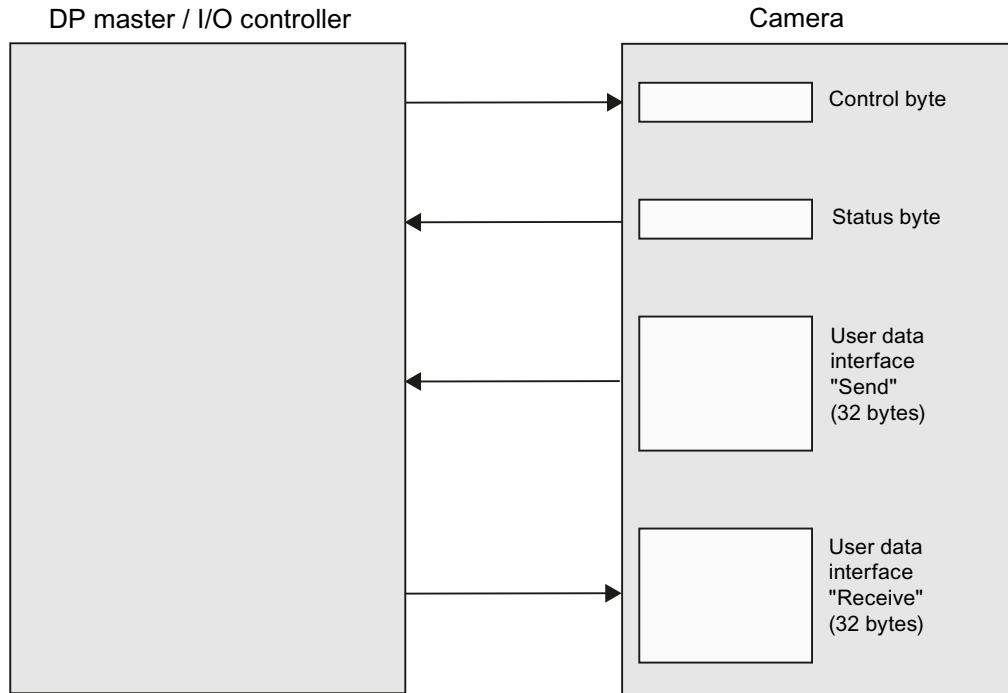

Figure 9-3 Principle of data transmission via PROFINET IO

Note

Relevant bytes

- Bytes 1 to 26 of the "Send" user data interface are relevant.
- Bytes 1 to 8 of the "Receive" user data interface are relevant.

After the camera has been turned on and a connection established to the controller via PROFINET IO, a simple handshaking technique is used so that the camera sends its data continuously.

9.2.3 Assignment of the interfaces relevant to PROFINET IO

Control byte

Note

The SEL0, SEL1, SEL2, SEL3, and TRN signals are effective only when DISA=1.

Bit no.	Corresponds to signal	Function
0	DISA	Disable: Disables the manual keyboard input, code selection and code saving, error acknowledgment, starting the processing unit
1	SEL0	Select 0: Code selection bit 0
2	SEL1	Select 1: Code selection bit 1 (when TRN=0) / Save code (when TRN=1)
3	SEL2	Select 2: Code selection bit 2
4	SEL3	Select 3: Code selection bit 3
5	TRN	Save code: Save new code.
6	TRG	Trigger: Processing starts on a positive edge.
7	RES	Reset: Reset error.

Status byte

Note

Writing the control byte and reading and evaluating the status byte is as described in Control functions via PROFINET IO (Page 134).

Bit no.	Corresponds to signal	Function
0	IN_OP	In operation: <ul style="list-style-type: none"> • 0 = error message is displayed • 1 = camera functional, no error
1	TRD	Save code: <ul style="list-style-type: none"> • In run: <ul style="list-style-type: none"> – 0 = selected code has not been saved – 1 = selected code has been saved • When saving code (TRN=1) <ul style="list-style-type: none"> – 0 = Save code active – 1 = acknowledgment signal (RDY=0)
2	RDY	Ready: <ul style="list-style-type: none"> • 0 = startup of the camera, or camera in stop state • 1 = camera in run state

Bit no.	Corresponds to signal	Function
3	READ	Processing result: Code was localized and decoded
4	MATCH	Processing result: Code matches learned code
5	N_OK	Code was not legible
6	-	Reserved
7	-	Reserved

Status byte

"Send" user data interface

Note

The "data ID of the supplied data" defines the data transferred. The coding matches byte "4" of the "Receive" user data interface. With a read job on the "Receive" user data interface, the ID of the data currently being transferred is entered here.

Byte no.	Meaning
0	Reserved
1	Consecutive number of the current data packet received correctly by the I/O controller
2	Total net length of the data to be transmitted in bytes
3	= 22 bytes
4	Data ID of the supplied data
5	Error bits
6	<ul style="list-style-type: none"> • Data type: Word • ...
7	Deflection in X direction
8	<ul style="list-style-type: none"> • Data type: Int16 • Unit: mm
9	Deflection in Y direction
10	<ul style="list-style-type: none"> • Data type: Int16 • Unit: mm
11	Rotation
12	<ul style="list-style-type: none"> • Data type: Int32
13	<ul style="list-style-type: none"> • Unit: 1/100 degree
14	
15	Distance between the camera and the reflector
16	<ul style="list-style-type: none"> • Data type: Int32
17	<ul style="list-style-type: none"> • Unit: mm
18	

Byte no.	Meaning
19	Speed in X direction
20	<ul style="list-style-type: none"> • Data type: Int16 • Unit: mm/s
21	Speed in Y direction
22	<ul style="list-style-type: none"> • Data type: Int16 • Unit: mm/s
23	Speed of rotation
24	<ul style="list-style-type: none"> • Data type: Int16 • Unit: 1/100 degree/s
25	Distance change
26	<ul style="list-style-type: none"> • Data type: Int16 • Unit: mm/s
27 ... 31	Reserved

"Send" user data interface

Note

Ensuring reliable monitoring for measuring errors

Bit 4 only triggers "Camera system malfunction" (see the table of "Error bits") in response to a non-recognized window size if the "Reliability of the size measurement" parameter is set to ≥ 8 .

Note

Transferring and evaluating the error bits

The camera transfers the error messages listed in the table of "Error bits" to SIMOTION for evaluation. The master controller of SIMOTION only receives a message with regard to the functional state of the camera: Error message E4 "Camera measuring system malfunction".

Table 9-1 Error bits

Bit no.	Designation	Description	Information - Diagnostics: Data record entry	Data record: Content category	Remedy
0 to 2	reserved	-	-	-	
3	Camera measuring system impaired	Due to contamination or poor lighting or viewing conditions, the quality of the camera measurement has deteriorated. The reflector is nevertheless still recognized adequately well.	-	-	Clean the reflector, improve the lighting and viewing conditions.

Bit no.	Designation	Description	Information - Diagnostics: Data record entry	Data record: Content category	Remedy
4	Camera measuring system disrupted	<p>The camera does not recognize a reflector any more. The following causes are possible:</p> <ul style="list-style-type: none"> • The reflector is no longer in the field of view of the camera. • The reflector is 90° out of alignment. • The reflector is too small for the selected window size; in other words, too far away. • The light from the surroundings is too bright or too dark. • The camera image is not sharp. 	Reflector not detected	Decode	Eliminate the causes listed above.
5	Invalid distance	The external distance is outside the set limits.	CenSOR: External distance invalid!	Error	Check the external distance and parameters.

"Receive" user data interface

Byte no.	Meaning
0	Reserved
1	Consecutive number of the data packet to be transferred to the I/O controller
2	Total net length of the data to be transferred in bytes
3	
4	Data ID of the supplied data
5	Current position of the hoist unit.
6	This value is used as shown in chapter CenSOR - Measured values (Page 94) to calculate the distance between the camera and reflector.
7	
8	
9 ... 31	Reserved

"Receive" user data interface

The "data ID of the requested data" defines the data to be read. The data ID can have the following values:

ID (B#16#)	Meaning
09	<ul style="list-style-type: none"> User data byte 1: Output the code number selected on the SIMOCRANE CenSOR MV440 camera. User data byte 2: If the DISA bit is set, the display indicates whether a user is logged on via the user interface who has the right to overrule the DISA signal: 00H: "Take control" is activated, 01H: "Take control" is deactivated.
81	Result frame

Data ID

9.2.4 Data processing and handshake

Continuous data exchange between camera and PROFINET controller

For continuous data exchange between the camera and the PROFINET controller, a simple handshake mechanism needs to be adhered to.

The camera sends new process data only when the transferred data has been confirmed by the recipient. To achieve this, the consecutive number in the data packets is used as the acknowledgement signal. This means that the consecutive number of the transferred packet in byte 1 of the "Send" user data interface is returned as an echo in byte 1 of the "Receive" user data interface.

This consecutive number can also be used to recognize that new data has been sent by the camera.

- The value = 0 as the consecutive number in byte 1 signals the end of the current data transfer to the PROFINET controller.
- With the value = 1 in byte 1, the camera indicates that valid process data is available and this can be used by the PROFINET controller.

Sequence for one-time data exchange

The sequence of one-time data exchange is as follows:

- The camera sends new process data byte 1 (send) = 1.
- The PROFINET controller acknowledges with byte 1 (receive) = 1 and requests a new frame from the camera in byte 4 (receipt) = B#16#81.
- The camera acknowledges and terminates the current data transfer with byte 1 (send) = 0.
- The PROFINET controller again acknowledges with byte 1 (receive) = 0 and requests a new frame from the camera in byte 4 (receipt) = B#16#81.

This sequence is then repeated continuously.

9.2.5 Control functions via PROFINET IO

The following control functions are available:

- Select code
- Start processing

Select code

To select a code, apply the relevant bit pattern at the inputs SEL0 to SEL3. You can select codes 1 to 15. If you select code 0, the last selected code is retained.

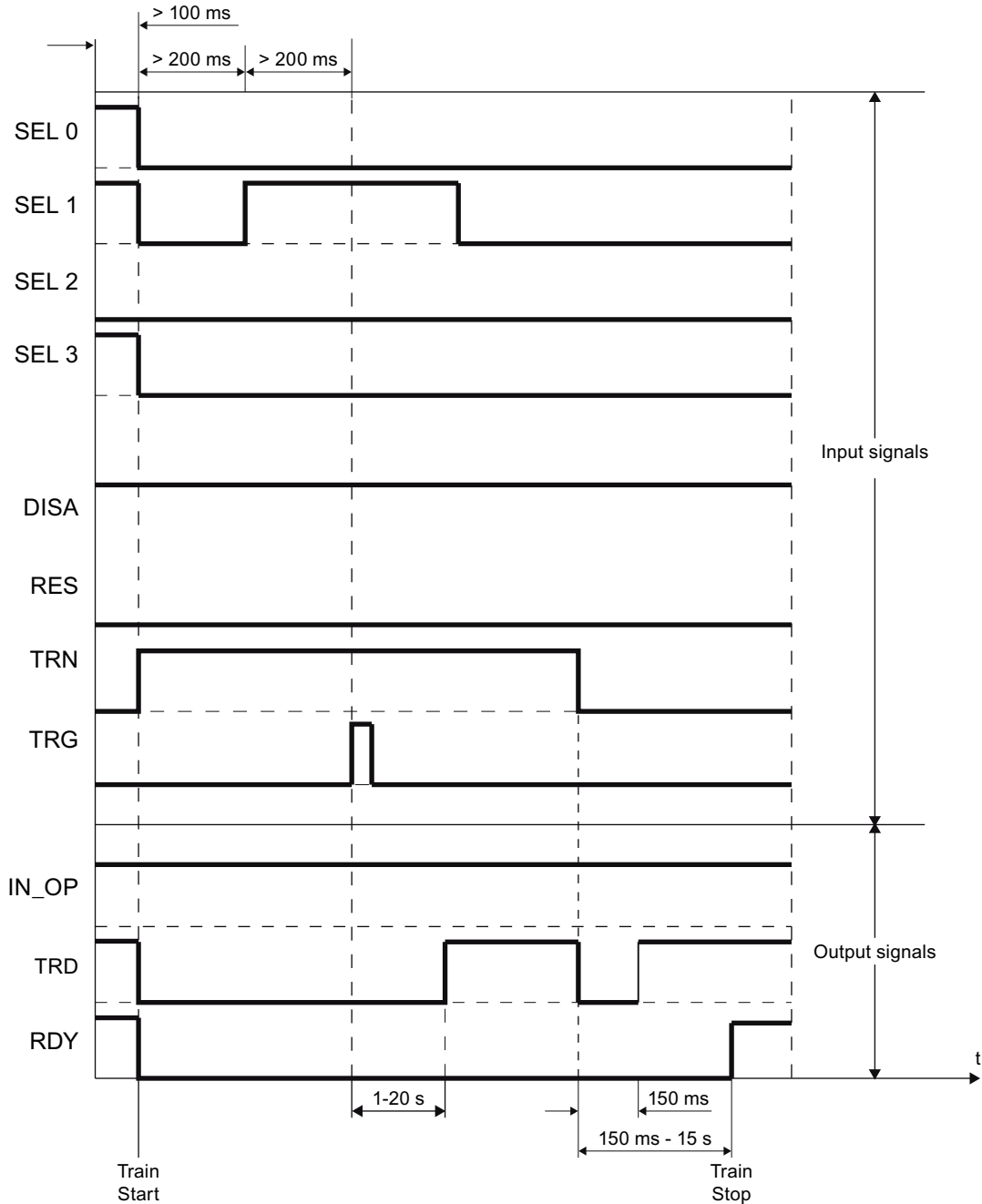

Step	Input	Output	Description
1	DISA=1 TRN=0 TRG=0 RES=0		Code selection is prepared. DISA must have the value 1. No edge change is necessary.
2	SEL0=1 SEL1=1 SEL2=0 SEL3=1		Select code, for example code 11.
3		TRD=0 RDY=0	Code change is started.
5		TRD=1 RDY=1	Code change is completed after approximately 150 ms to 15 s.

Start processing

1. If the camera is in the stop status, DISA = 1 must be set so that processing is started. Stop: the status bits are IN_OP = 1 and RDY = 0.
2. With RDY = 1, the camera then signals that it is in processing mode.

See also

Parameter assignment (Page 75)

9.2.6 Sample application for integration in a SIMOTION controller for PROFINET IO (SIMOCRANE SC integrated only)

This chapter describes the integration of the SIMOCRANE CenSOR MV440 camera in a SIMOTION D project with SIMOCRANE SC Integrated.

SIMOCRANE CeSAR standalone

You do not need to complete the configuration specified in this chapter because SIMOCRANE CeSAR standalone is delivered with a memory card that contains a turn-key program.

SIMOCRANE SC integrated

Complete the configuration as described in this chapter.

Note

SIMOCRANE CenSOR MV440 only supports PROFINET version 2.2

The camera only supports PROFINET version 2.2.

1. Check whether your SIMOTION firmware has the identifier "PN 2.2".
2. If this is not the case, you will need to adapt the firmware accordingly.

For additional information, refer to the relevant SIMOTION documentation.

Product DVD

On the product DVD, you will find:

- The sample project that contains the sources and that is referred to in this chapter.

Optimum procedure

To work through the steps ideally:

- Open SIMOTION SCOUT twice.
 - In the 1st application window, open the example product from the product DVD.
 - In the 2nd application window, open the project you are editing.

Steps for integrating in a SIMOTION controller for PROFINET IO

Step	Activity
1	Configuring the hardware (step 1) (Page 138)
2	Entering the device name (step 2) (Page 140)
3	Assign the device names to the camera (step 3) (Page 140)
4	Configuring NetPro (step 4) (Page 141)
5	Creating I/O variables (step 5) (Page 143)
6	Copy the MCC source file "Camera" (step 6) (Page 146)
7	Copying the library (step 7) (Page 147)
8	Integrating the camera in the runtime system (step 8) (Page 148)
9	Saving, compiling and checking consistency (step 9) (Page 149)
10	Transferring the project to SIMOTION (step 10) (Page 149)

9.2.6.1 Configuring the hardware (step 1)

The properties of the PROFINET IO device MV440 are stored in the supplied GSD file.

Note

The GSD file and MV440.bmp can be downloaded from the Internet

The GSD and the BMP files can be downloaded from the Internet as required from this address:
Downloading the GSD file (<http://support.automation.siemens.com/WW/view/en/23379628/133100>)

Note

MV440.bmp in the same folder as the GSD file

You can only integrate the camera if the corresponding bitmap file MV440.bmp is located in the same folder as the GSD file.

If the module catalog of "HW Config" in your SIMOTION Scout version does not yet contain the SIMOCRANE CenSOR MV440 camera:

1. Link in the camera using "Options" → "Install GSD files...".
The camera appears in the module catalog at "PROFINET IO \ Ident Systems \ SIMATIC Code Reading Systems \ MV440".
2. In the next step, configure a PROFINET IO system.
In the example shown, configuration is performed via a CBE30-2 communication module. Since PROFINET communication depends on the hardware, check the documentation of your module.

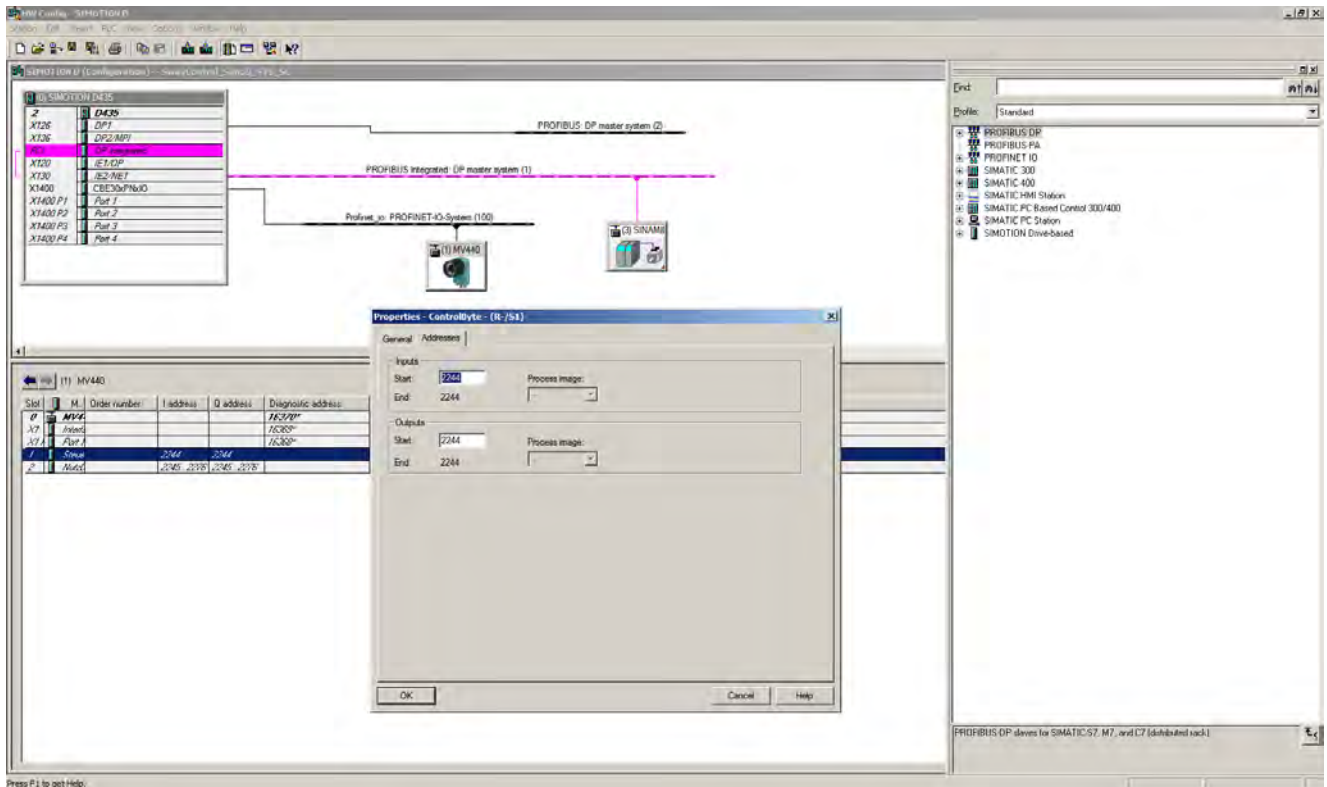

Figure 9-4 HW Config with SIMOTION D and CBE30-2 and a SIMOCRANE CenSOR MV440 camera

3. Then drag-and-drop the camera to connect it to your PROFINET.
4. Configure the address ranges. Make sure that the selected addresses are not being used by other I/O modules.
 - In the configuration example, the control byte of the camera was placed at output address "2244" and the status byte at input address "2244" of the SIMOTION controller (slot 1).
 - The start of the 16-word long consistent communications area of the camera is placed at input address "2245" and output address "2245" (slot 2) in the configuration example. The camera detects the transmission speed of PROFINET automatically. PROFINET operates in 100 Mbps full duplex mode.

9.2.6.2 Entering the device name (step 2)

Follow the steps below to assign the device name to the camera:

1. Open the properties window of the camera in "HW Config".
2. Enter the device name.
3. Save and compile the hardware configuration.

9.2.6.3 Assign the device names to the camera (step 3)

Inform the camera of the device name you have just assigned. There are three ways of doing this.

Method 1

Note

The camera must be in IP mode "PROFINET mode"

The camera must be in IP mode "PROFINET Mode", otherwise the mode will not be displayed.

1. In "HW Config", select "PLC" → "Ethernet" → "Edit Ethernet Address..."
2. Click the "Browse" button. All devices connected to the PROFINET mode system are displayed..
3. Select the camera using its MAC address. Identify the camera with the "Flash" button. The "Ethernet" LED on the camera enclosure flashes.
4. Enter the device name.
5. Click the "Assign name" button.

Method 2

Setup using the Primary Setup Tool; refer to chapter Establishing the connection to the SIMOCRANE CenSOR MV440 camera and starting the user interface (Page 61).

Method 3

Assign and transfer the device name by means of the user interface:
"Connections Part 1/4: Interfaces", "PROFINET IO", "Devicename" parameter.

9.2.6.4 Configuring NetPro (step 4)

1. Open "NetPro"

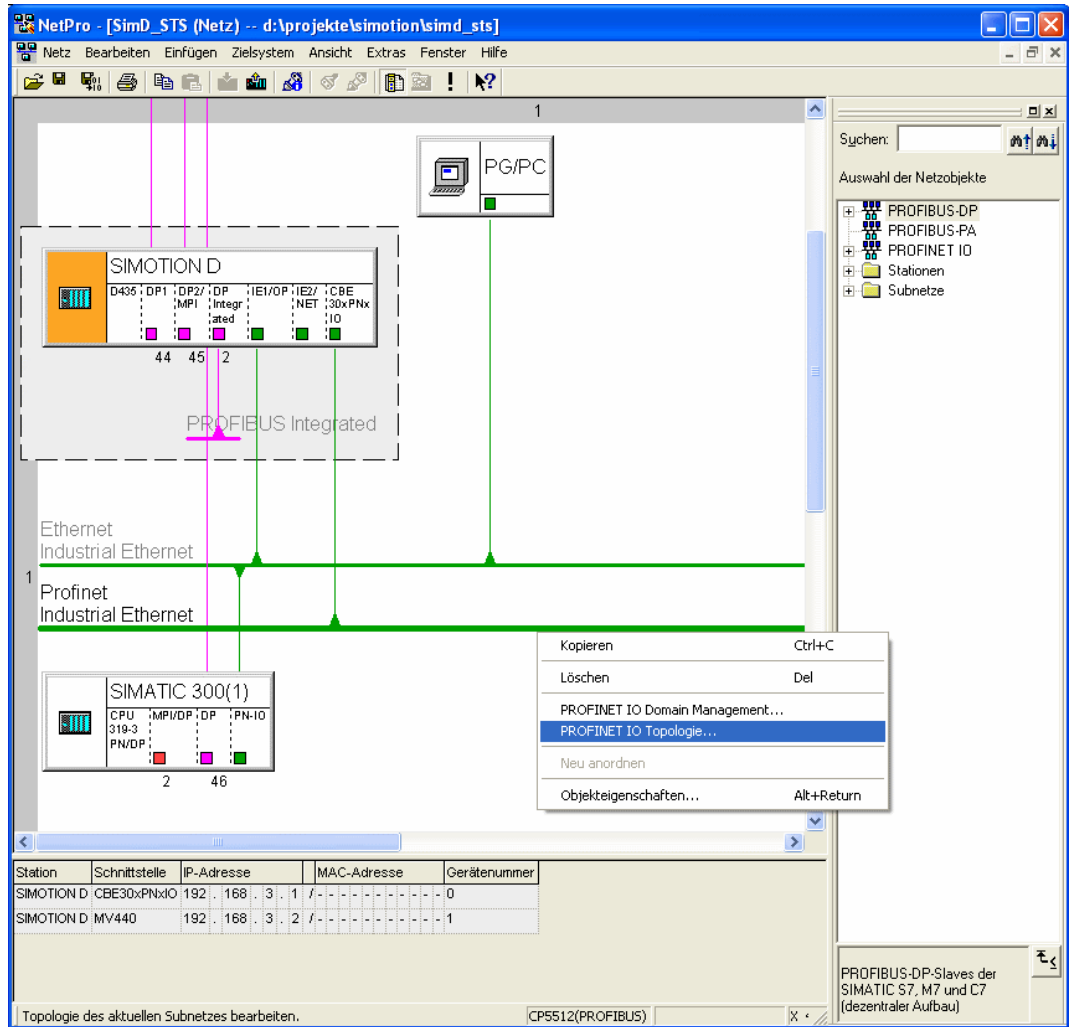

Figure 9-5 The "NetPro" view opens

- In the "NetPro", you open the topology editor by right-clicking the PROFINET line and you configure a connection between the camera and the CBE30-2 of the SIMOTION D.

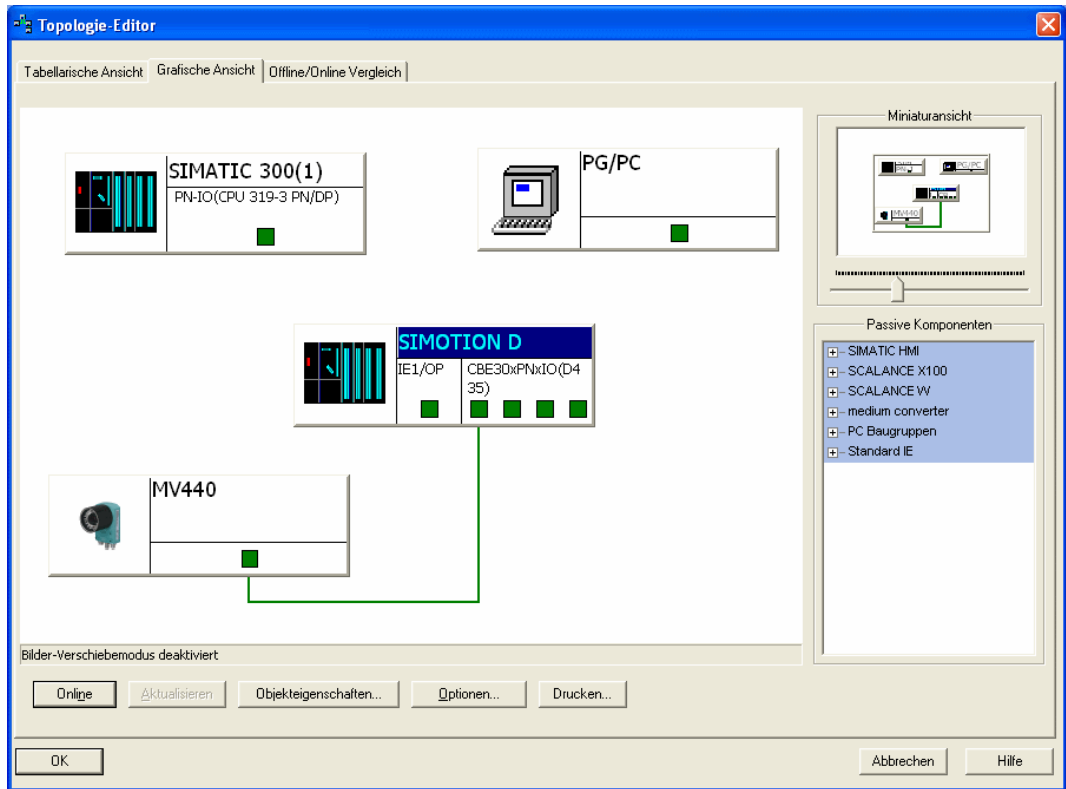

Figure 9-6 Topology editor

9.2.6.5 Creating I/O variables (step 5)

Copying the I/O variables

1. Open the list of I/O variables by double clicking on the "I/O" icon in the project tree.

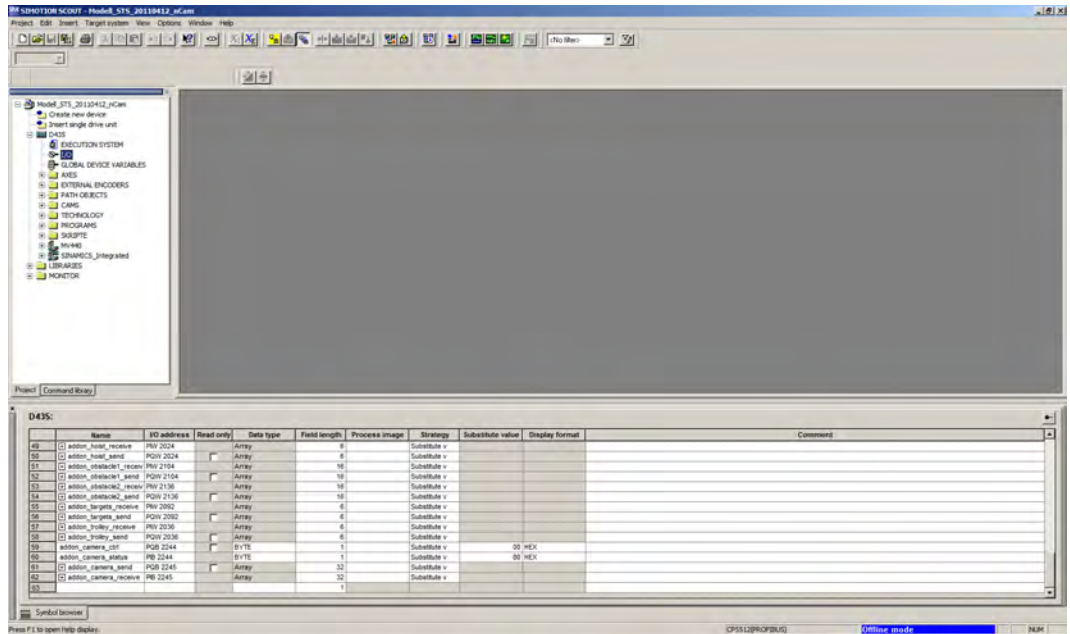

Figure 9-7 Opening the I/O variable list

2. As shown in the following figure, select the four variables that begin with "addon_camera".
3. Copy the four variables. Add the variables to your project.

Inserting the copied I/O variables

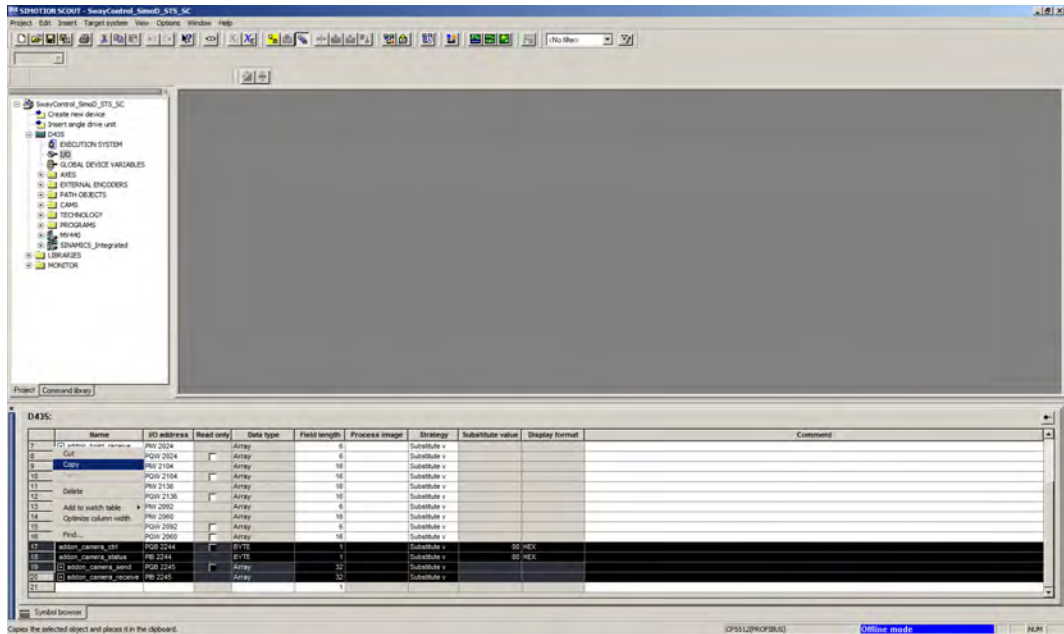

Figure 9-8 Select the I/O variable list

1. Select the last free row in the I/O variable list in the project you are editing.
2. Paste the variables you have just copied by right clicking as shown in the following figure.

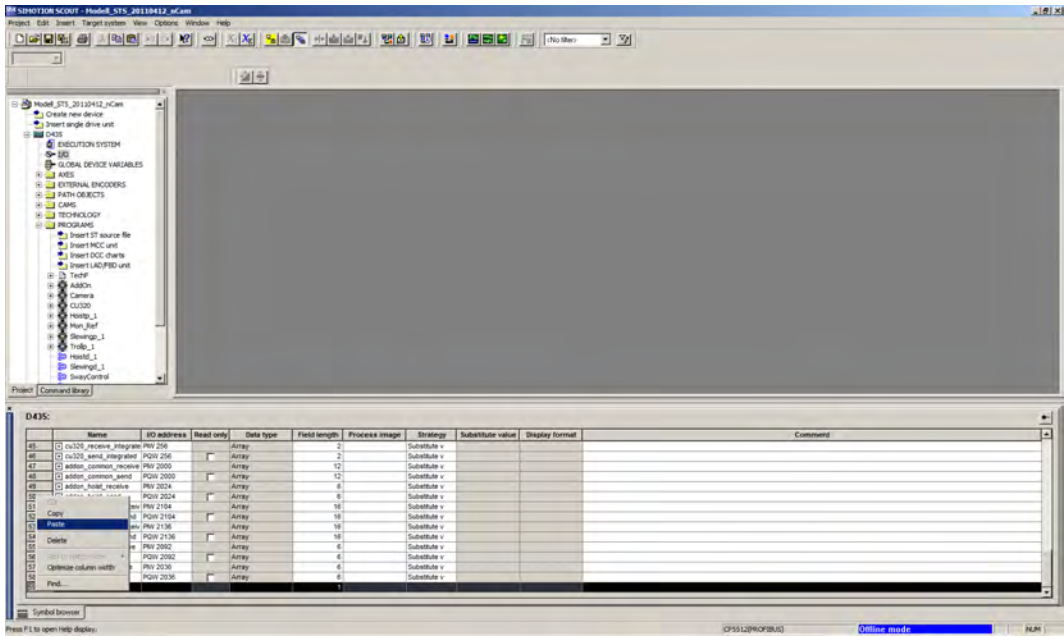

Figure 9-9 Inserting the I/O variables

Customizing the I/O addresses

1. Customize the I/O addresses that you have selected in the hardware configuration.

The screenshot shows the SIMATIC Manager HW Config interface. On the left, a table lists modules for SIMOTION D435. On the right, a network diagram shows connections to PROFIBUS and PROFINET systems. Below the diagram, a table details the configuration for the MV440 module.

Slot	Module	Order number	I address	Q address	Diagnostic address:	Comment
0	MV440				16370*	
X1	Interface				16369*	
X1	Port 1				16368*	
1	SteuerByte		2044	2044		
2	NutzDaten		2045...2076	2045...2076		

Figure 9-10 Customizing I/O addresses

9.2.6.6 Copy the MCC source file "Camera" (step 6)

1. Open the "Programs" folder in the project tree of the sample project.
2. Right-click on the MCC source file "Camera".
3. Copy this MCC source file.

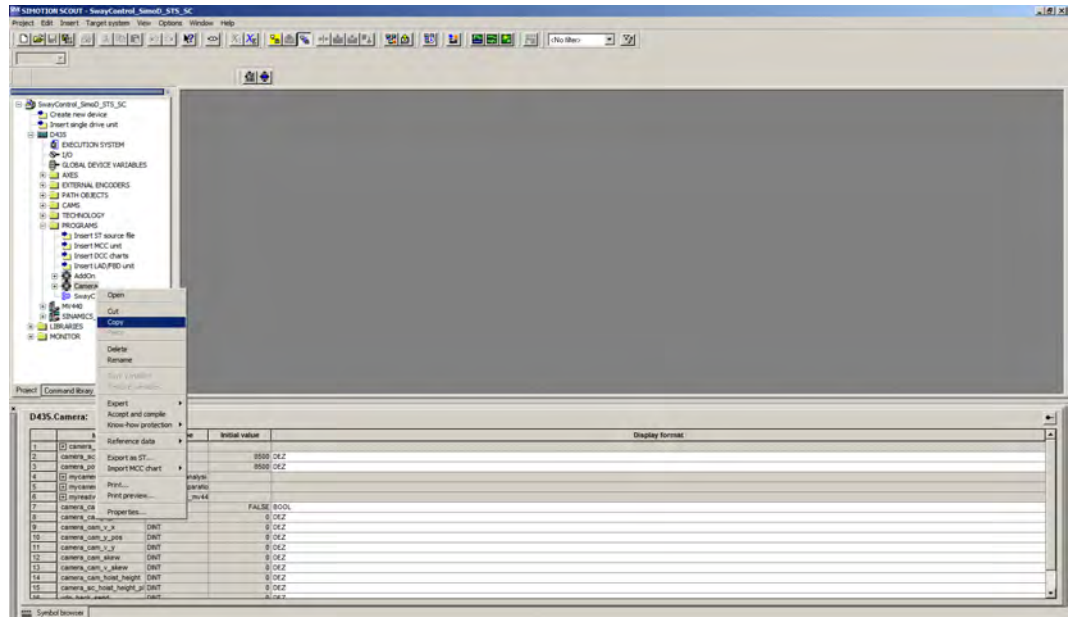

Figure 9-11 Copying the MCC source file "Camera"

4. Open your project.
5. Insert the unit by right clicking on the "Programs" folder in the project tree and selecting the "Paste" menu command.

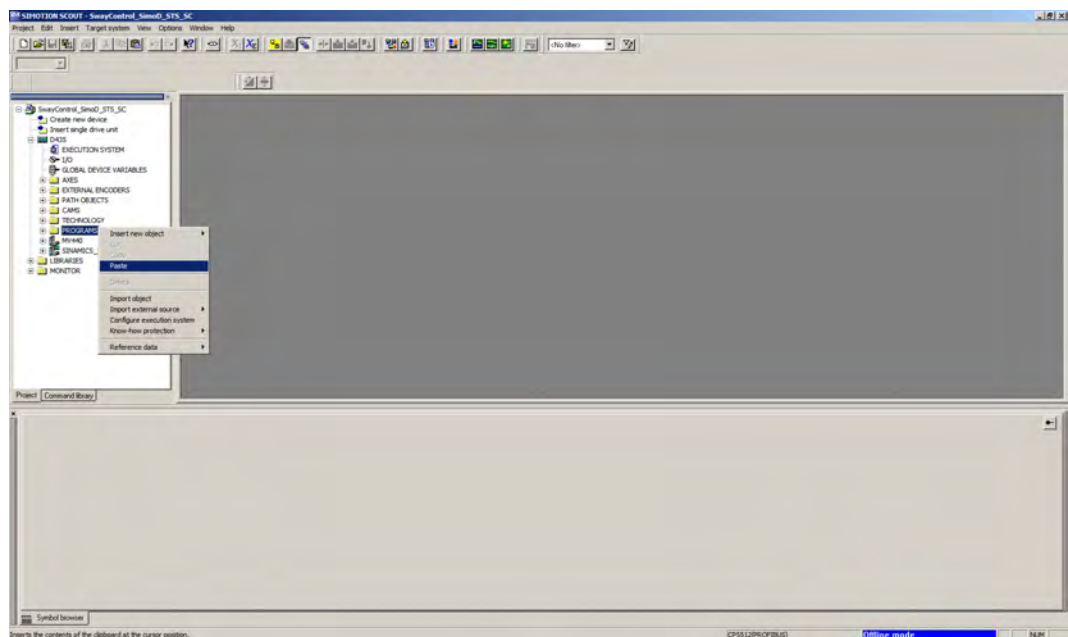

Figure 9-12 Inserting the MCC source file "Camera"

9.2.6.7 Copying the library (step 7)

1. Select the "AddOn_FB_Library" library and copy it.

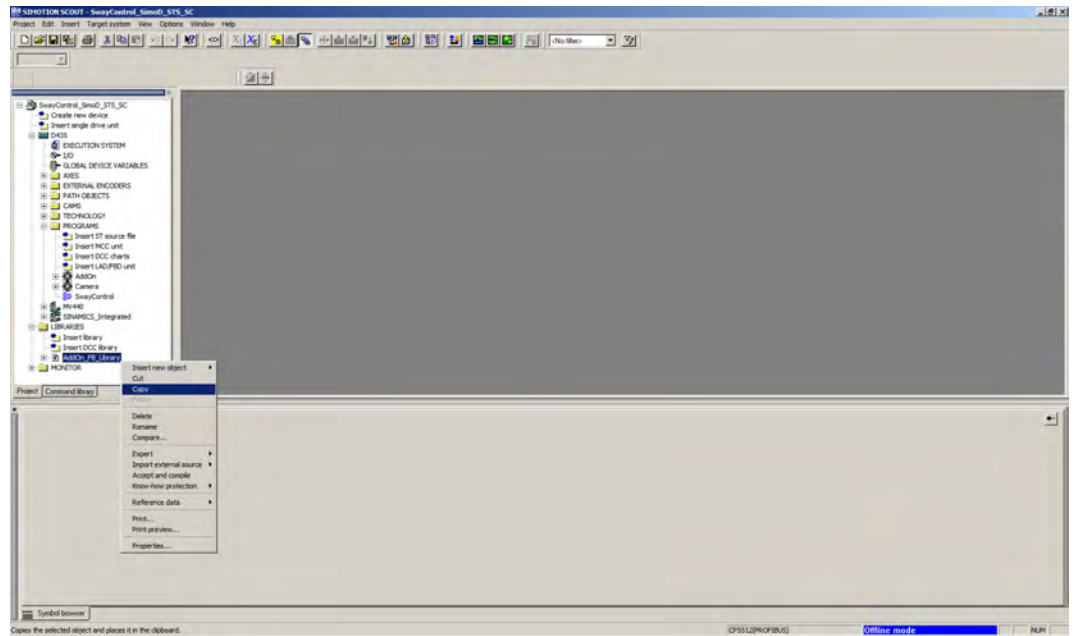

Figure 9-13 Copying the "AddOn_FB_Library" library

2. Select the "Libraries" folder in the project tree.
3. Insert the library you just copied.

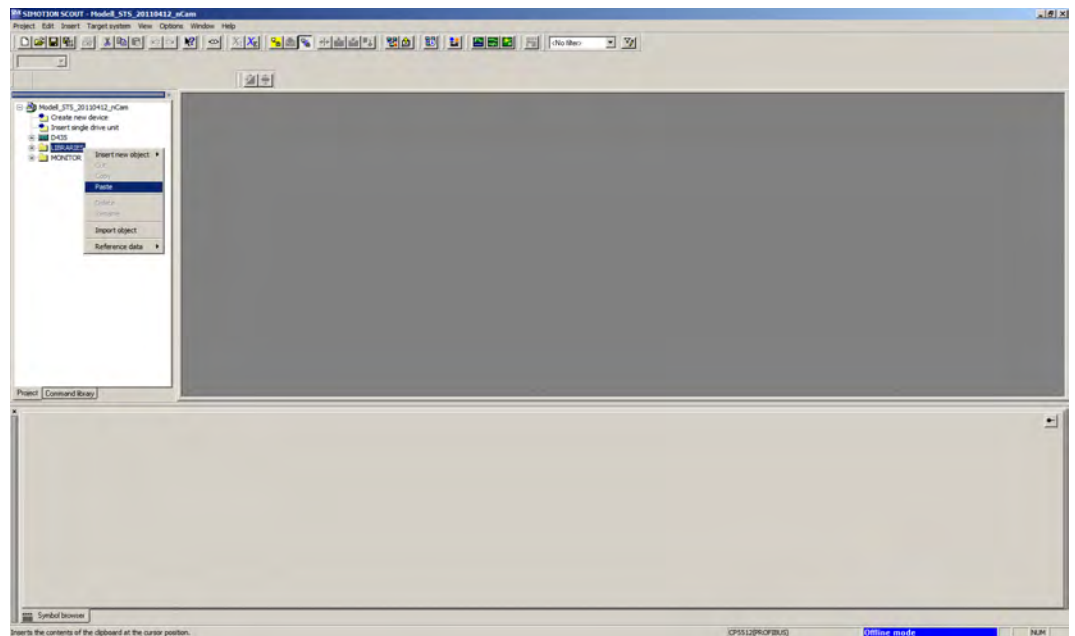

Figure 9-14 Inserting the "AddOn_FB_Library" library

9.2.6.8 Integrating the camera in the runtime system (step 8)

So that the programs of the MCC source file "Camera" can be processed, they must be linked into the runtime system in the project you are editing.

1. Link the "cameramcc" program into the "BackgroundTask".
2. Link the "cam_mv440_mcc" program into a synchronous, cyclically time-monitored task, for example "IPOsynchronousTask" as shown in the two figures below.

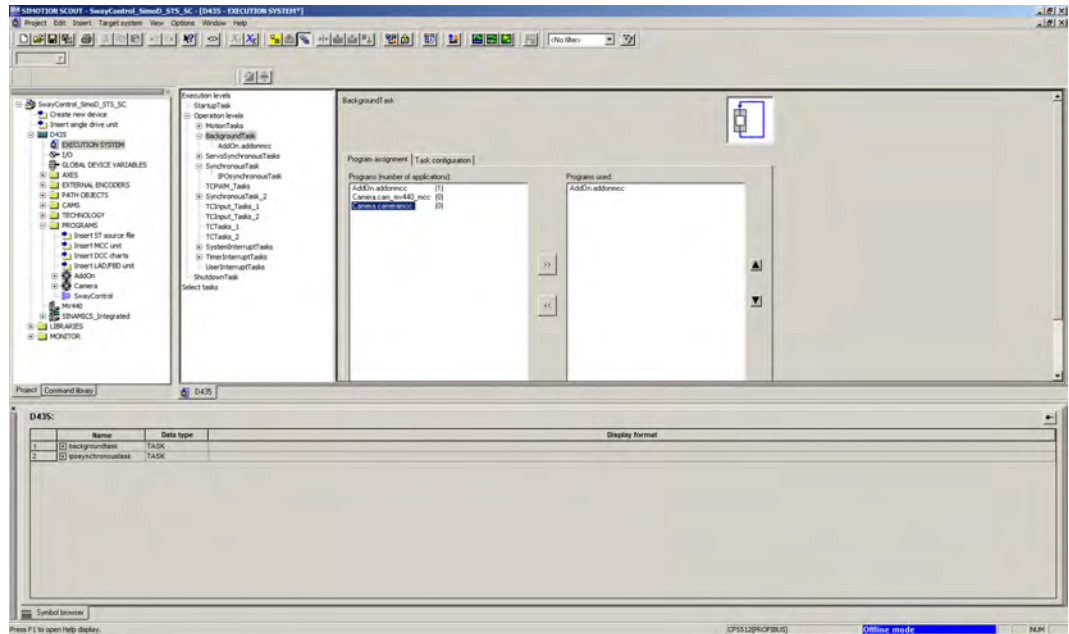

Figure 9-15 Inserting the "cameramcc" program into the "BackgroundTask"

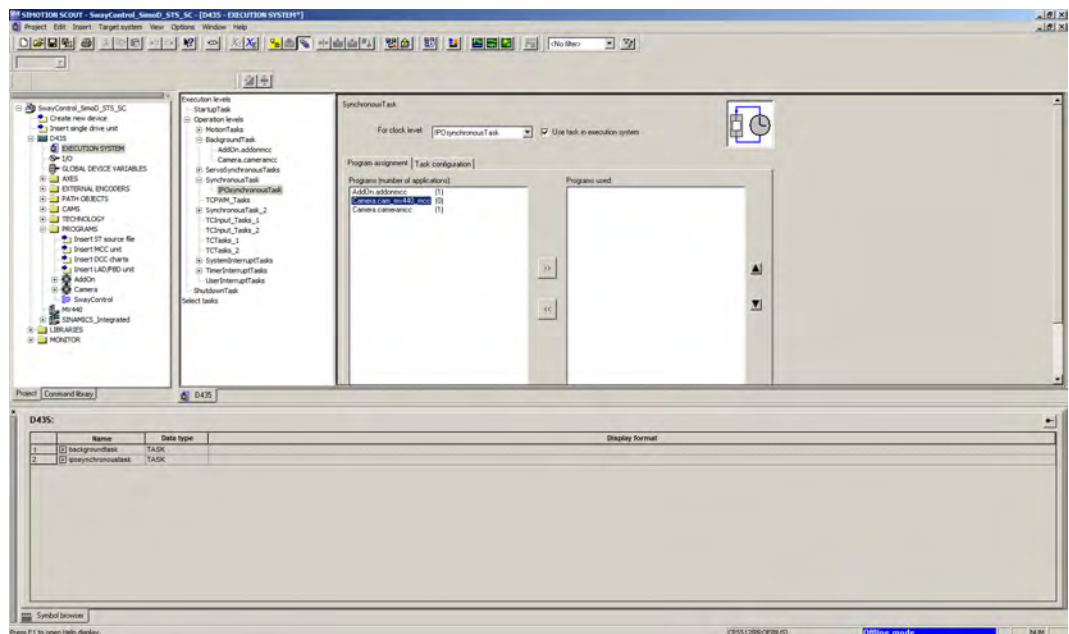

Figure 9-16 Inserting the "cam_mv440_mcc" program in a synchronous, cyclically time-monitored task

9.2.6.9 Saving, compiling and checking consistency (step 9)

Once you have completed all steps, save and compile the project. Continue with a consistency check.

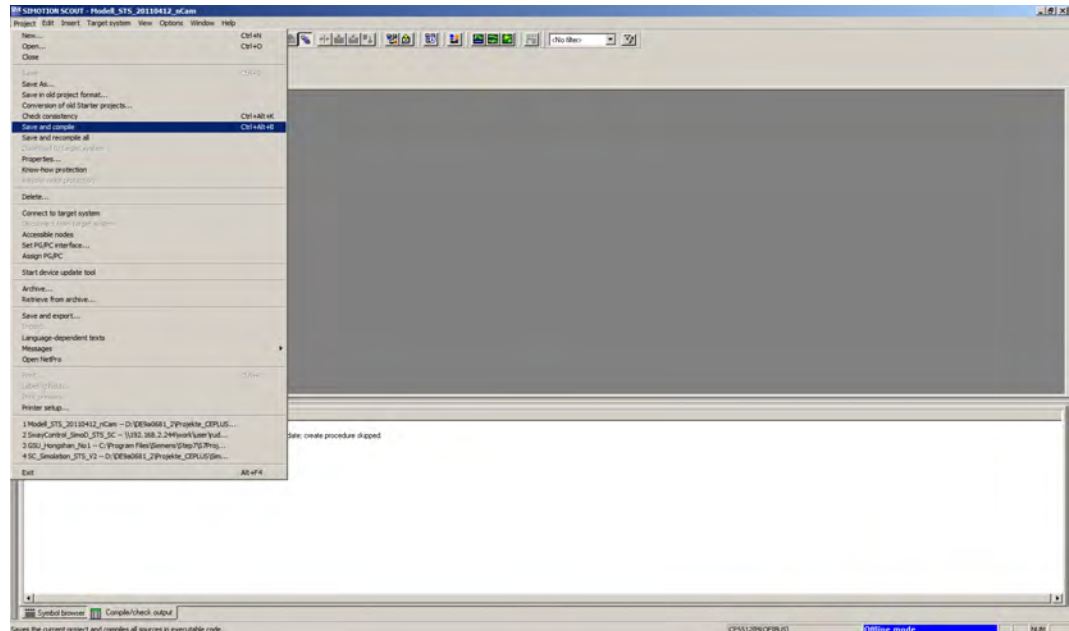

Figure 9-17 Save and compile all - Check consistency

1. Select "Save and compile all" from the "Project" menu.
2. Select "Check consistency" from the "Project" menu.

The project must now be free of errors.

Configuration steps to complete prior to the project transfer

Prior to the project transfer you need to complete various steps for customizing the "AddOn Sway Control" to suit crane-specific conditions. For more information, refer to chapter "Configuration" in the "SIMOCRANE SC integrated" operating instructions.

9.2.6.10 Transferring the project to SIMOTION (step 10)

Transfer the project

Transfer the error-free compiled project to the CF card. You need an online connection to SIMOTION to transfer the data. Alternatively, you may also use a card reader.

9.2.7 Block description "FB_ReadWrite_MV440" (only SIMOCRANE SC integrated)

The block "FB_ReadWrite_MV440" is part of the library supplied and it is called as an instance in the MCC source file "MCC_Kamera".

The block implements the data exchange with the SIMOCRANE CenSOR MV440 camera.

Symbol (Function Block Diagram representation)

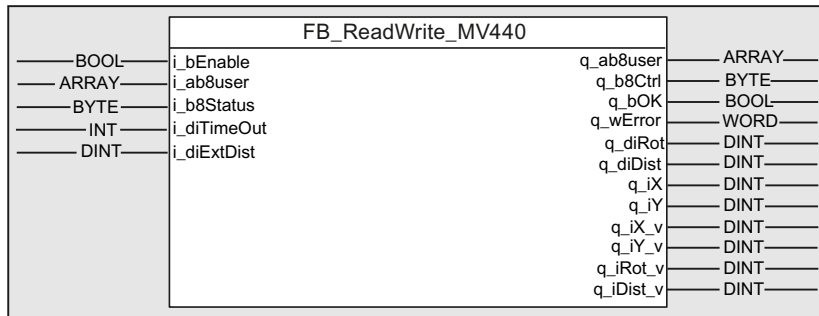

Task of the block

With this block, the data of the SIMOCRANE CenSOR MV440 camera received via PROFINET is analyzed and processed.

Calling the block and assigning parameters to it

Note

Call the block in the IPO task of the SIMOTION runtime system.

You can call the ST block in an ST or MCC source and assign suitable parameters to it there. For use with SIMOCRANE SwayControl, look at the preconfigured example projects on the SIMOCRANE product DVD that contain a camera connection.

The "camera_CAM_Camera_OK" bit (data acceptance) always changes to "TRUE" state only for the duration of one SIMOTION cycle, regardless of whether the camera has received new data.

Since the clock cycle of the camera is usually slower than that of the SIMOTION controller, a pulse signal with extended pause times is set at this output.

Connections

Name	Type	Default	Data type	Meaning
i_bEnable	IN	FALSE	BOOL	Block enable
i_ab8user	IN	0	ARRAY[0..31] OF BYTE	I/O user data input
i_b8Status	IN	0	BYTE	I/O status byte

Name	Type	Default	Data type	Meaning
i_diTimeOut	IN	1 000	INT	Timeout in ms
i_diExtDist	IN	0	DINT	External distance

FB_ReadWrite_MV440- Inputs

Name	Type	Default	Data type	Meaning
q_ab8user	OUT	0	ARRAY[0..31] OF BYTE	I/O user data output
q_b8Ctrl	OUT	0	BYTE	I/O control byte
q_bok	OUT	0	BOOL	Camera O.K.
q_wError	OUT	0	WORD	Error word
q_diX	OUT	0	DINT	Deflection in X direction
q_diY	OUT	0	DINT	Deflection in Y direction
q_diRot	OUT	0	DINT	Reflector rotation
q_diDist	OUT	0	DINT	Reflector distance (measured from camera)
q_diX_v	OUT	0	DINT	Sway speed in X direction
q_diY_v	OUT	0	DINT	Sway speed in Y direction
q_diRot_v	OUT	0	DINT	Speed of the rotation
q_diDist_v	OUT	0	DINT	Distance change

FB_ReadWrite_MV440- Outputs

9.3 Integrating using Ethernet UDP

The connection option using UDP:

- Serves to achieve compatibility with SIMOCRANE CenSOR M
- To allow use of automation systems that do not support PROFINET IO communication

If PROFINET IO is supported: You should give this preference over UDP communication since this achieves more reliable communication.

Optimum procedure

To process the steps optimally:

- Open SIMOTION SCOUT twice.
 - In the 1st application window, open the example product from the product DVD.
 - In the 2nd application window, open the project you are editing.

9.3.1 Preparing the SIMOCRANE CenSOR MV440 camera for UDP

Step 1

Note

Online help

Please refer to the online help for a detailed description.

1. Open the "Connections" task in the user interface of the SIMOCRANE CenSOR MV440 camera. In the "Interfaces" tab, you specify the communications interface and the parameters for the interfaces.
-

Note

Activating IP address changes

You cannot manipulate the device name in the project. The device name is set to the factory default "MV440".

- You can activate a modified IP address by editing the device name in the "Host name" area of the user interface.
-

2. Select "Manual" under "Ethernet" → "IP mode".

3. Adapt the IP address.

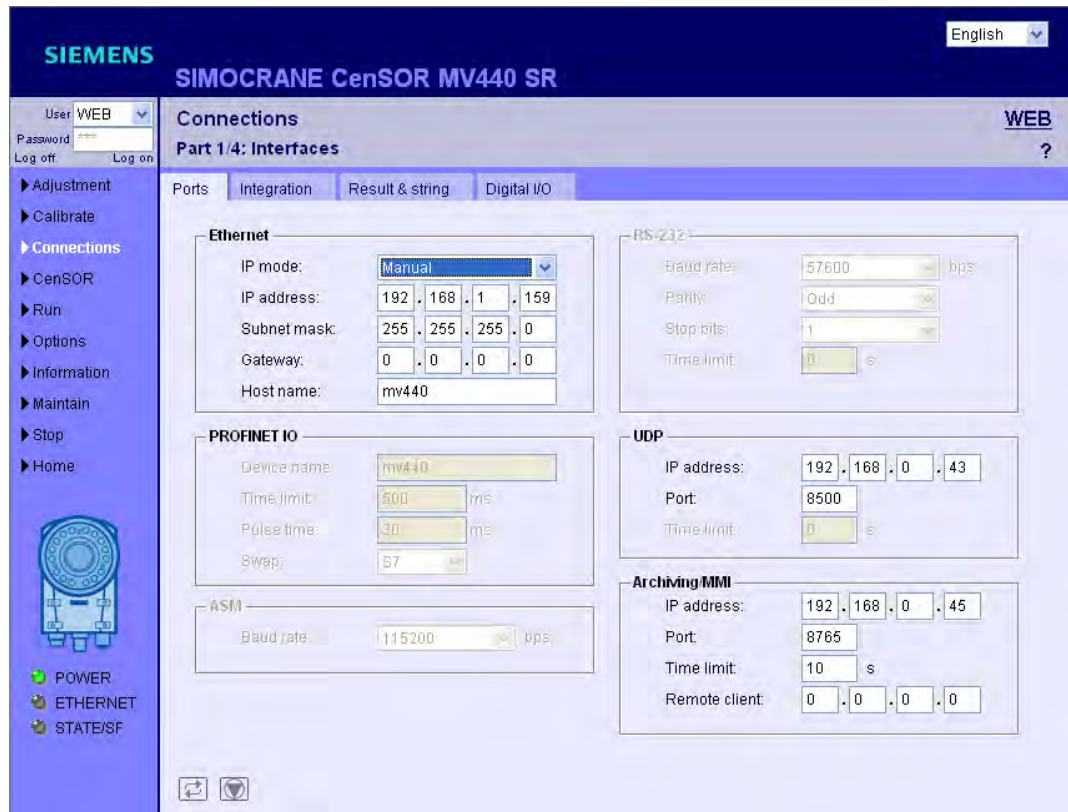

Figure 9-18 Connections - Ports

4. Select "UDP" to enter the IP address and the SIMOTION port:

- Port "8500" is set as factory default.
- IP address "192.168.1.155" is set as factory default.

Step 2

1. Change to the "Integration" tab.
You specify the following in the "Integration" tab:
 - How the signals reach the SIMOCRANE CenSOR MV440 camera.
 - How the results and diagnostics data are output.
2. Select "UDP" in the "String" drop-down list.

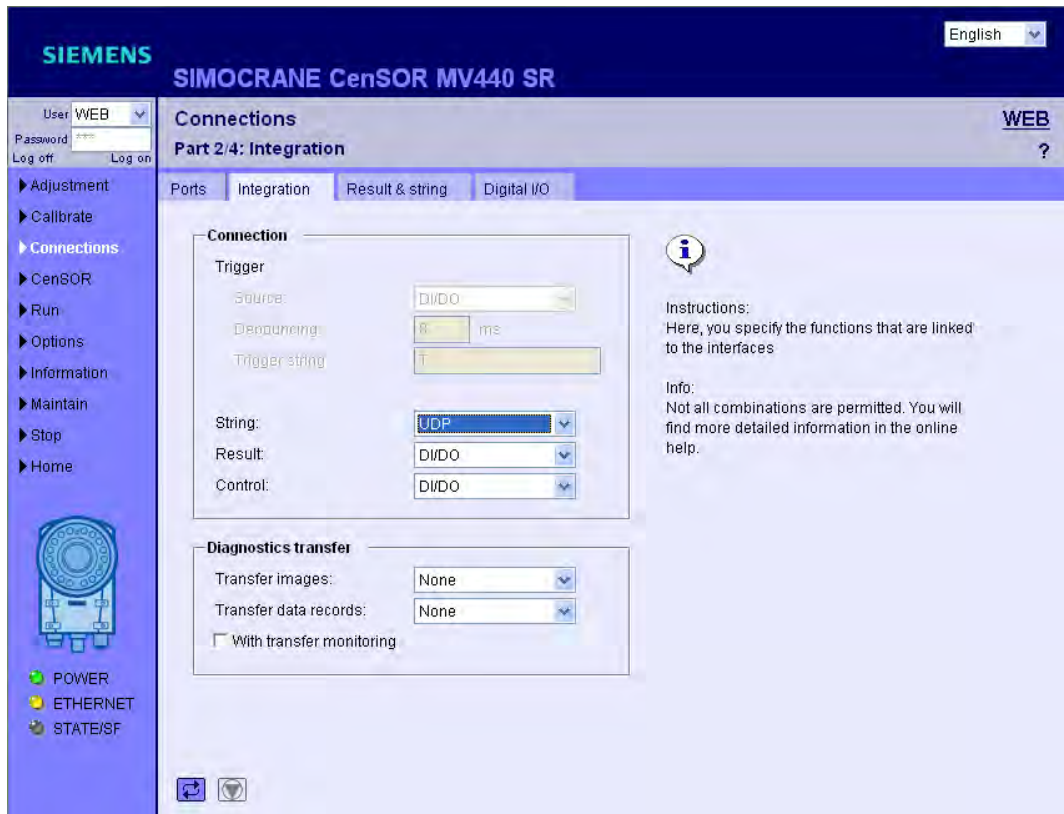

Figure 9-19 Connections - Integration

9.3.2 Principle of data exchange for UDP

The option of connecting using UDP allows compatibility with SIMOCRANE CenSOR M.

Data structures

The "Input data UDP" and "Output data UDP" tables show the data structures that are exchanged cyclically. Compared with the SIMOCRANE CenSOR M product, the data structures remain identical. However, only part of the input data structure is evaluated and only part of the output data structure is completed.

- *Rows shown in italics* contain data that has no further significance.

Type	Name	Meaning	Unit
<i>Uint16</i>	-	<i>Not used</i>	
<i>Uint16</i>	-	<i>Not used</i>	
Int32	ext_Dist	The distance between the SIMOCRANE CenSOR MV440 camera and reflector that is measured by a sensor.	mm

Input data UDP

Type	Name	Meaning	Unit
<i>Uint16</i>	-	<i>General status bits</i>	
Uint16	Err_PD	Error bits	Binary coded, see Table 9-1 Error bits Error bits (Page 131)
Int32	X	Deflection in x direction	mm
Int32	Y	Deflection in y direction	mm
Int32	skew	Rotation	0.01 degrees (= 1/100°)
Int32	distance	Distance between the SIMOCRANE CenSOR MV440 camera and the reflector	mm
Int32	VX	Speed in X direction	mm/s
Int32	VY	Speed in Y direction	mm/s
Int32	vSkew	Speed of rotation	1/100°/s
Int32	vDist	Distance change	mm/s
Uint32	Cnt	Frame counter	

Output data UDP

9.3.3 Sample application for integration in a SIMOTION controller for UDP

ST source contained on the SIMOCRANE product DVD

The UDP coupling is defined in the ST source "Camera". Data exchange within the SIMOTION controller is via global variables. You will find the ST source in the example project supplied on the product DVD.

- Call up UDP communication in the background task of the SIMOTION runtime system.

Maintenance and service

10.1 Maintenance

Maintenance of the reflector

NOTICE
Do not use any sharp objects when cleaning
<ul style="list-style-type: none">• To clean the reflector, use only a soft cloth and household cleaner.• Do not use any sharp objects on the retro reflective foil.

Cleaning depending on the degree of soiling

Clean the reflector depending on its degree of soiling. The camera is possibly unable to detect a soiled reflector.

- It is appropriate to check/clean the reflector annually in case of slight soiling.
- If heavily soiled, clean the reflector at intervals of 4 to 6 weeks: Remove contamination or paint remnants.

Checking the reflector mounting

During the regular inspections of the crane, check that the reflector is firmly secured.

Maintenance of the SIMOCRANE CenSOR MV440 camera

Variant 1 (indoor crane)

The device is maintenance-free. You merely need to clean the protective enclosure of the lens to maintain a constant reading performance.

Variant 2 (outdoor crane)

- The stainless steel enclosure is equipped with a combination drain and bleeder element (Figure 12-3 Dimension drawing: Camera housing view from above in the direction of the load carrying device (Page 169)). The outer section of this element features three drilled holes.
 - Verify the unobstructed state of these drilled holes at cyclic intervals.
- Siemens AG advises you to properly clean the protective enclosure of the lens, particularly the acrylic glass pane that protect the lens. This ensures that you obtain a constant reading performance.

See also

Dimension drawings (Page 167)

10.2 Repairs

NOTICE
Always commission repairs to the manufacturer
Repairs may only be carried out by the manufacturer.

If repairs are required: First, contact the Service department

Contact the Service Hotline specified in chapter Service and Support (Page 177) before you send in components for repair.

Indoor crane variant

- Send only the element affected without any other accessories to Siemens AG for repair.

The elements affected could be, for example, the SIMOCRANE CenSOR MV440 camera, the lighting unit or the reflector.

Outdoor crane variant

- Submit only the element in question to Siemens AG for repair.

The elements affected encompass the enclosure including all contents, or the reflector.

Technical data

11.1 SIMOCRANE CenSOR MV440 camera

11.1.1 Mechanical ambient conditions

Mechanical ambient conditions for operation

SIMOCRANE CenSOR MV440 is designed for fixed installation in an environment protected from the weather and meets the conditions for use complying with DIN IEC 60721-3-3:

- Class 3M3 (mechanical requirements)
 - Class 3K3 (climatic ambient conditions)
-

Mechanical ambient conditions, sinusoidal oscillations

Frequency range in Hz	Test values
$10 \leq f < 58$	0.075 mm amplitude
$58 \leq f < 500$	1 g constant acceleration

Test for mechanical ambient conditions

Test for / test standard	Comments
Vibrations Vibration test complying with IEC 60068-2-6 (sine)	<ul style="list-style-type: none"> • Vibration type: Frequency cycles with a rate of change of 1 octave/minute. <ul style="list-style-type: none"> – $10 \text{ Hz} \leq f < 58 \text{ Hz}$, constant amplitude 0.075 mm – $58 \text{ Hz} \leq f < 500 \text{ Hz}$, constant acceleration 1 g – $10 \text{ Hz} \leq f \leq 55 \text{ Hz}$, amplitude 1 mm (only sensor head and lighting unit) • Vibration duration: 10 frequency cycles per axis in each of the 3 mutually perpendicular axes.
Shock	<ul style="list-style-type: none"> • Type of shock: Half-sine • Strength of the shock for the SIMOCRANE CenSOR MV440 camera: <ul style="list-style-type: none"> – 10 g peak value – 16 ms duration • Direction of shock: 100 shocks in each of the 3 mutually perpendicular axes

11.1.2 Climatic ambient conditions

Ambient climatic conditions for operation		
Ambient conditions	Permitted range	Comments
Temperature	0 to +50 °C	
Temperature change	Max. 10 °C/h	
Relative humidity	max. 95 % at +25 °C	No condensation, corresponds to relative humidity degree 2 to IEC 61131-2.

11.1.3 Transportation and storage

Transportation and storage of modules

SIMOCRANE CenSOR MV440 exceeds the requirements of IEC 61131-2 for transportation and storage conditions. The following information applies to modules transported or stored in their original packaging.

The climatic conditions correspond to IEC 60721-3-3, Class 3K7 for storage and IEC 60721-3-2, Class 2K4 for transportation.

The mechanical conditions correspond to IEC 60721-3-2, Class 2M2.

Conditions	Permitted range
Free fall	≤ 1 m (up to 10 kg)
Temperature	-30 to +70 °C
Atmospheric pressure	660 ... 1080 hPa, corresponds to a height of 0 ... 3500 m
Relative humidity (at +25 °C)	5 to 95%, without condensation
Sine-shaped oscillations complying with IEC 60068-2-6	5 to 9 Hz: 3.5 mm 9 to 500 Hz: 9.8 m/s ²
Shock complying with IEC 60068-2-29	250 m/s ² , 6 ms, 1000 shocks

11.1.4 Power supply

Power supply	
Supply voltage (UN)	24 V DC; (20.4...28.8 V DC, safety extra low voltage, SELV).
Fuse	Max. 10 A
Safety requirements complying with	IEC 61131-2 corresponds to DIN EN 61131-2

11.1.5 Electromagnetic compatibility

Electromagnetic compatibility		
Pulse-shaped interference		
Interference	Test voltage	Corr. to severity
Electrostatic discharge according to IEC 61000-4-2	<ul style="list-style-type: none"> Air discharge: ±8 kV Contact discharge: ±6 kV 	3
Burst pulse (fast transients) complying with IEC 61000-4-4	<ul style="list-style-type: none"> 2 kV (power supply cable) 2 kV (signal line) 	3
Surge complying with IEC 61000-4-5		
Coupling	Test voltage	Corr. to severity
Asymmetrical	2 kV (power supply cable) direct voltage with protective elements	3
Symmetrical	1 kV (power supply cable) direct voltage with protective elements	3
Sine-shaped interference		
RF interference (electromagnetic fields)	Test values	Corr. to severity
Conforming to IEC 61000-4-3	10 V/m at 80% amplitude modulation of 1 kHz in the range from 80 to 1000 MHz	3
Conforming to IEC 61000-4-3	10 V/m at 50% pulse modulation at 900 MHz	3
RF interference on cable/cable shields	Test values	Corr. to severity
Conforming to IEC 61000-4-6	Test voltage 10 V at 80% amplitude modulation of 1 kHz in the range from 9 kHz to 80 MHz	3
Emission		
Limit class	<ul style="list-style-type: none"> Emitted interference of electromagnetic fields in accordance with EN 55011: Limit class A, group 1; Emitted interference via the AC input power supply in accordance with EN 55011: Limit class A, group 1. 	

11.1.6 Properties

Camera	
Image acquisition	<ul style="list-style-type: none"> CCD chip 1/3", 640 x 480, square pixels; full-frame shutter CCD chip 1/3", 1024 x 768, square pixels; full-frame shutter
Image data transfer	Triggered image acquisition
Casing	Die-cast aluminum
Dimensions (W x H x D) in mm	65 x 122 x 55

11.1 SIMOCRANE CenSOR MV440 camera

Camera	
Weight	<ul style="list-style-type: none"> • Approx. 0.45 kg without protective lens housing • Approx. 0.55 kg with protective lens housing
Degree of protection	IP 67 to IEC 60529
Input voltage range	24 V DC +20 % ... - 15 %
Max. power consumption at 24 V DC	270 mA (without I/O signals)
Starting current	I ₁ max. 2 A; < 1 ms
Mains buffering time (at 24 V DC)	10 ms

Digital output signals	
Floating and short-circuit-proof with max. load current:	50 mA
Max. short-circuit current	240 mA
Delay times during switch ON and switch OFF	0 to 2 ms

11.1.7 Interfaces

Ethernet interface (socket)		
Connector	Name	Function
1	TxD _P	Send data +
2	RxD _P	Received data +
3	TxD _N	Send data -
4	RxD _N	Received data -

11.2 Stainless steel enclosure

Stainless steel enclosure for variant 2 (outdoor crane)	
Weight	17.2 kg (without connecting cable)
Dimensions (width x depth x height) in mm	300 x 215 x 250
Ambient temperature	-25 to +50 °C
Storage temperature	-30 to +70 °C
Power supply	24 V DC/10 A, surge-proof
Degree of protection	IP54

11.3 Lenses

Note

The lens and reflector are selected depending on the hoisting height of the crane

The lens and reflector are selected depending on the hoisting height of the crane. Select a lens with extended focal length for more stringent requirements in terms of precision. The resultant smaller aperture reduces the range of measurement.

Focal length of the lens	16 mm (standard)	25 mm
Resolution in mm/m (relative to the distance)	0.12	0.08
Field length in x direction	17°	11°
Field length in y direction	13°	8°
Measuring range in x direction (relative to the distance)	292	187
Measuring range in y direction (relative to the distance)	216	138

Recommended maximum distance	16 mm (standard)	25 mm
Reflector 300 x 300 mm	up to 23 m	up to 37 m
Reflector 500 x 500 mm	up to 35 m	up to 55 m

11.4 Retro reflective reflector 300x300

Reflector 300	
Weight	4.6 kg
Dimensions (width x depth x height) in mm	312 x 312 x 72
Operating temperature	-25 to +70 °C
Storage temperature	-30 to +70 °C
Power supply	230 V AC
Power	80 W
Degree of protection	
<ul style="list-style-type: none"> • Heating element and internal interface box 	IP53

11.5 Retro reflective reflector 500x500

Reflector 500	
Weight	10.7 kg
Dimensions (width x depth x height) in mm	504 x 504 x 78
Operating temperature	-25 to +70 °C
Storage temperature	-30 to +70 °C
Power supply	230 V AC
Power	500 W
Degree of protection	
• Heating element and internal interface box	IP53

Dimension drawings

All dimensions in mm

SIMOCRANE CenSOR MV440 camera enclosure, variant 2 (outdoor crane)

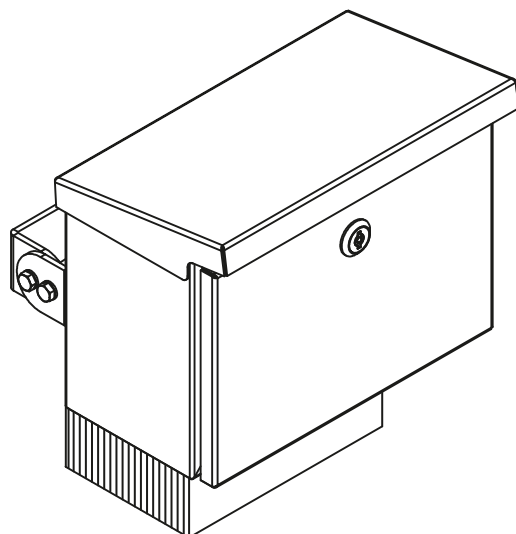

- Stainless steel V4A
- Connecting cable configurable up to 25 m.

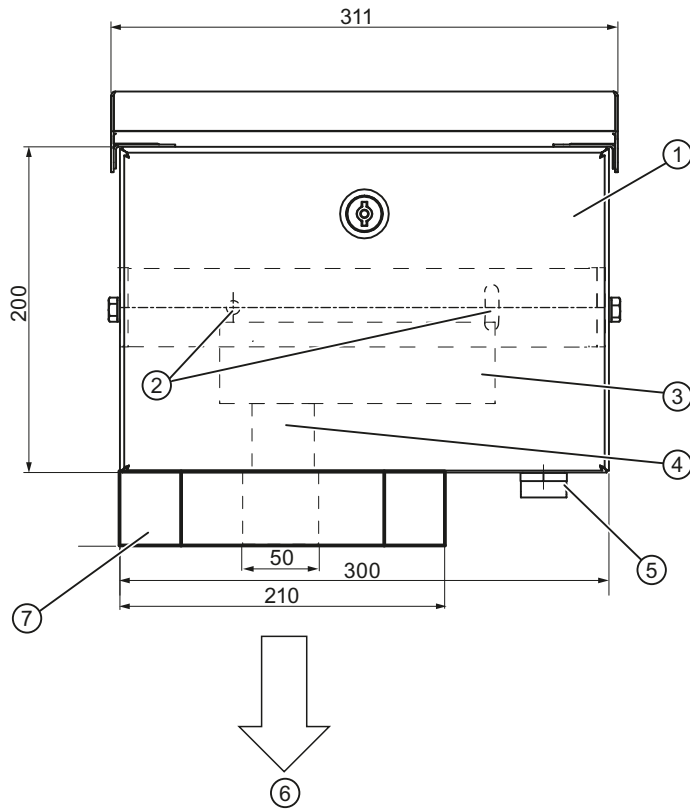

- ① Housing panel opens downwards
- ② Mounting holes; d = 8.5 mm/8.5 mm long slot for adjustment
- ③ SIMOCRANE CenSOR MV440 camera
- ④ Lens
- ⑤ Drainage
- ⑥ Direction of view of the reflector
- ⑦ IR flash

Figure 12-1 Dimension drawing: Camera housing view from above

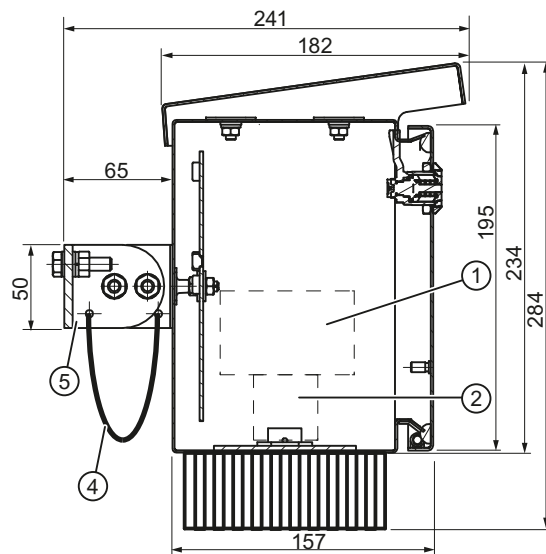

- ① SIMOCRANE CenSOR MV440 camera
- ② Lens
- ③ Trolley direction
- ④ Fall protection wire
- ⑤ Bracket for mounting on the crane

Figure 12-2 Dimension drawing: Camera housing side view

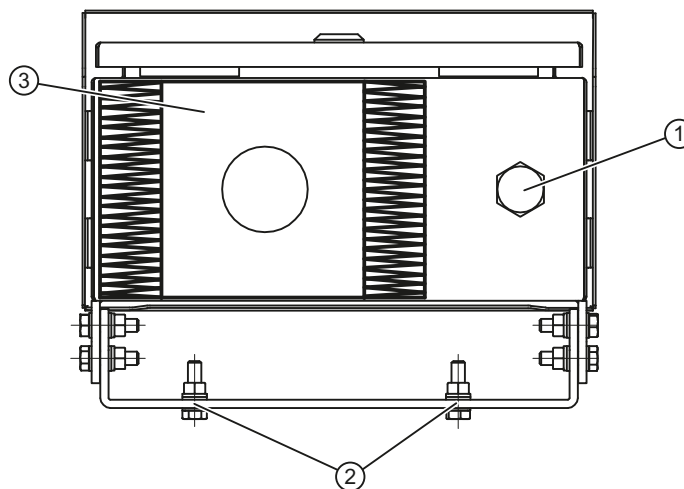

- ① Drainage
- ② Mounting holes; $d = 8.5 \text{ mm}/8.5 \text{ mm}$, slotted for adjustment (tightening torque approximately 20 Nm)
- ③ IR flash

Figure 12-3 Dimension drawing: Camera housing view from above in the direction of the load carrying device

SIMOCRANE CenSOR MV440 mounting bracket

Stainless steel V4A, 5 mm

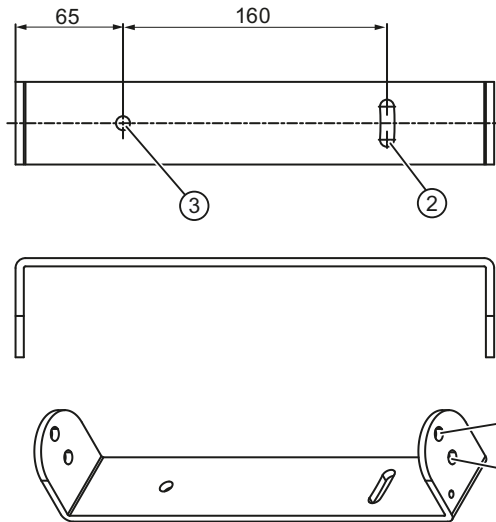

- ① Mounting holes; $d = 8.5$ mm (tightening torque approximately 20 Nm)
- ② Slotted hole for adjustment; $l = 20$ mm/ $d = 9$ mm (tightening torque approximately 20 Nm)
- ③ Mounting hole; $d = 9$ mm (tightening torque approximately 20 Nm)

Figure 12-4 Dimension drawing of the mounting bracket on the stainless steel housing (outdoor crane)

Retro reflective reflector 300x300

- Stainless steel V4A
- 4.6 kg

- 3 m connecting cable
- 230 V AC; 80 W

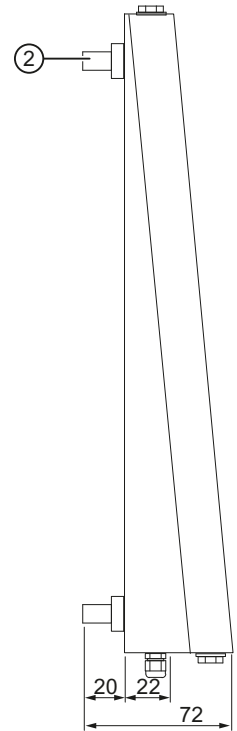
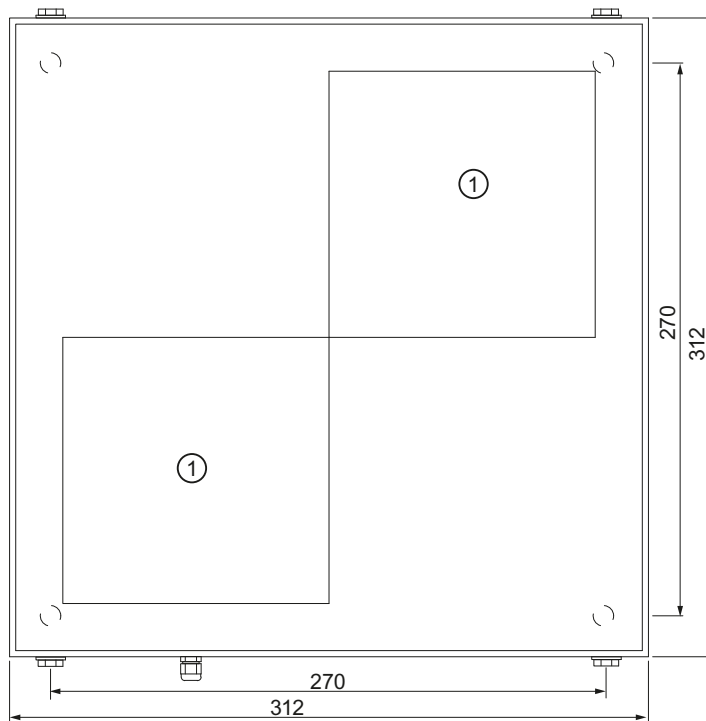

- ① Reflective surfaces
- ② M5 x 20; tightening torque approximately 6 Nm

Figure 12-5 Dimension drawing: Retro reflective reflector 300

Retro reflective reflector 500x500

- Stainless steel V4A
- 10.7 kg

- 3 m connecting cable
- 230 V AC; 500 W

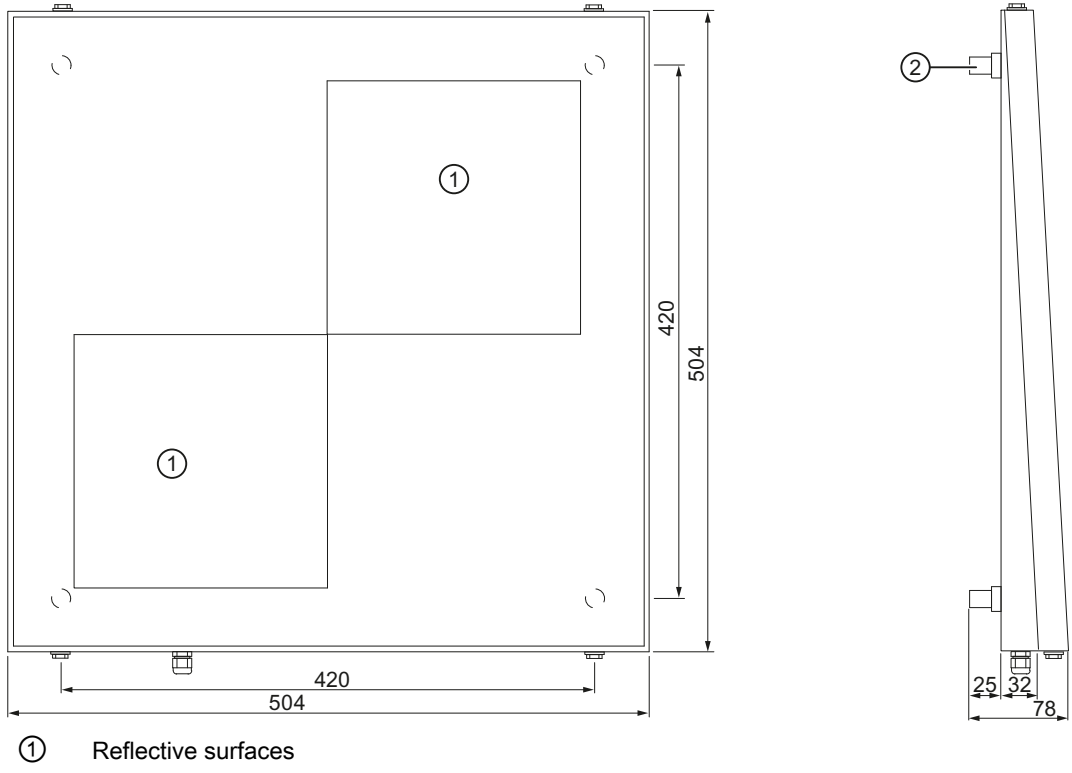

① Reflective surfaces
 ② M8 x 25; tightening torque approximately 20 Nm
 Figure 12-6 Dimension drawing: Retro reflective reflector 500

SIMOCRANE CenSOR MV440 camera

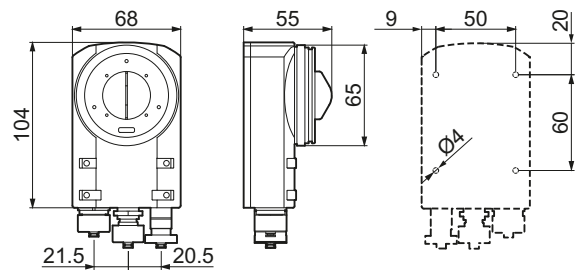

Figure 12-7 Dimension drawing: SIMOCRANE CenSOR MV440 camera

Lighting unit ring light SIMOCRANE CenSOR Vision Sensor VS100

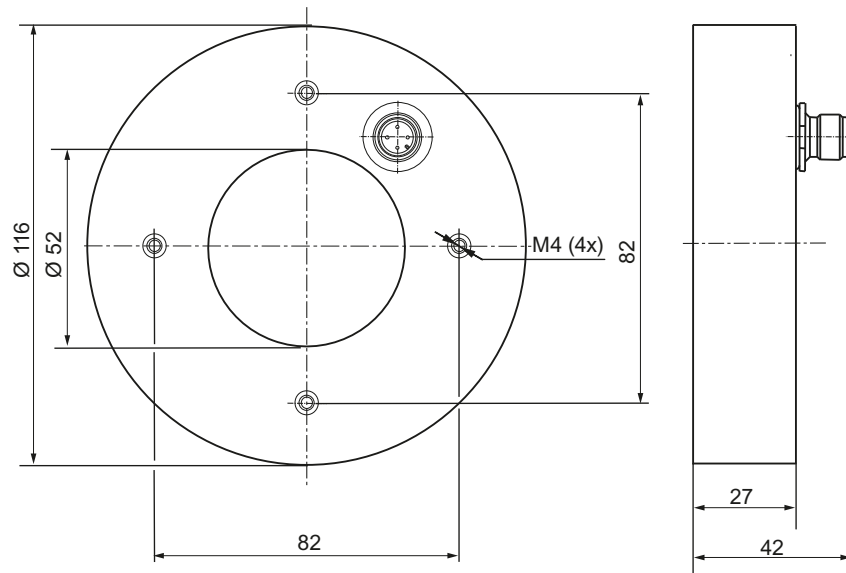

Figure 12-8 Dimension drawing: Lighting unit

SIMOCRANE CenSOR MV440 ring light holder

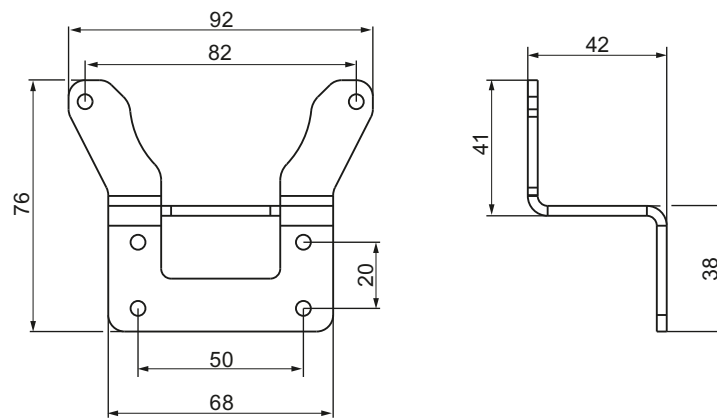

Figure 12-9 Dimension drawing: Ring light holder

SIMOCRANE CenSOR MV440 mounting plate

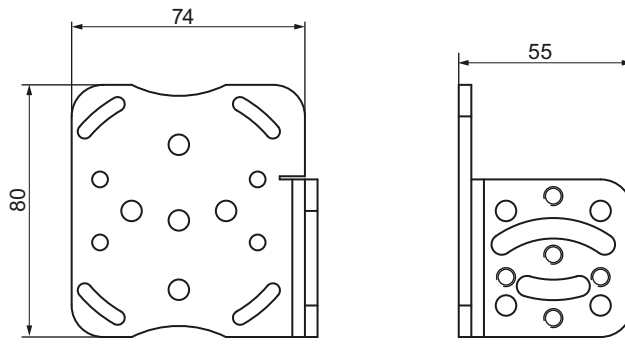

Figure 12-10 Dimension drawing: Mounting plate

Components of the product/spares/accessories

13.1 Components of the product

This chapter describes the scope of delivery of the SIMOCRANE CenSOR camera measuring system and its accessories. The SIMOCRANE CenSOR MV440 camera can be ordered with various performance features, for example with standard resolution or high resolution. Depending on the requirements and the application, the camera can be fitted with accessories.

Variant 1 (indoor crane)

- SIMOCRANE CenSOR MV440 camera
- C-mount lens
- IR filter
- Protective lens housing
Serves to protect the mounted C-mount lens with a very low IP class of protection from influences such as water and oil.
- IR flash (ring shaped)
- SIMATIC VS100 rail-mounted power supply for the IR flash unit (ring shape)
- Mounting brackets (1x for camera, 1x for IR flash unit)
- RJ45 Ethernet cable
- Power-IO-RS232 cable, open cable end
- Lamp cable for the IR flash unit (ring shape)
- Product DVD
- Retroreflective reflector

Variant 2 (outdoor crane)

- SIMOCRANE CenSOR MV440 camera
- C-mount lens
- IR filter
- Stainless steel enclosure
- IR flash unit (mounted to the stainless steel enclosure)
- RJ45 Ethernet cable
- 24 V, 3 x 4 mm², open cable end
- Product DVD
- Retroreflective reflector

13.2 Order information and ordering data

Information and Download Center for Industrial Automation and Drive Technology

Extensive order information with regard to the SIMOCRANE CenSOR camera measurement system and accessories is available in Catalog CR 1:

Drive and control components for cranes (https://www.automation.siemens.com/mcms/infocenter/content/en/Pages/order_form.aspx?nodeKey=key_518533&InfoType=catalogs)

Appendix

A.1 Service and Support

A.1.1 Technical Support

Siemens product support for SIMOCRANE

The following addresses provide support for your SIMOCRANE products:

- Internet:
 - You will find the latest information on SIMOCRANE products, product support, and FAQs on the Internet here (<https://support.industry.siemens.com/cs/ww/en/ps/20087>).
 - You will find continuously updated information on Crane Application Notes on the Internet here (<https://support.industry.siemens.com/cs/ww/en/ps/20087/ae>).
- Support request on the Internet:
 - Support request (<https://support.industry.siemens.com/cs/?lc=en-WW>)
- Hotline for Europe:
 - Phone: +49(0)911 895 7 222
 - Fax: +49 (0)911 895 7 223
 - Email: Support Europe (<mailto:support.automation@siemens.com>)
- Hotline for America:
 - Phone: +1 423 262 5710
 - Fax: +1 423 262 2231
 - Email: Support America (<mailto:support.america.automation@siemens.com>)
- Hotline for Asia/Pacific
 - Phone: +86 10 6475 7575
 - Fax: +86 10 6474 7474
 - Email: Support Asia/Pacific (<mailto:support.asia.automation@siemens.com>)

Siemens product support for SIMOTION and SINAMICS

The latest information about SIMOTION products, product support, and FAQs can be found on the Internet here (<http://support.automation.siemens.com/WW/view/en/10805436/130000>).

The latest information about SINAMICS products, product support, and FAQs can be found on the Internet here (<https://support.industry.siemens.com/cs/ww/en/ps/13229>).

A.2 Standards and certifications

A.2.1 Directives and declarations

CE mark

The SIMOCRANE CenSOR camera measuring system complies with the requirements and safety objectives of the following EC directive.

EMC Directive

The devices meet the requirements of the EU directive "89/336/EEC

Electromagnetic Compatibility" (modified by 91/263/EEC, 92/31/EEC and 93/68/EEC) is designed for use in an industrial environment in accordance with the CE mark.

Area of application	Requirements	
	Emission	Immunity
Industry	EN 61000-6-4: 2001	EN 61000-6-2: 2001

Declaration of Conformity

The EC Declaration of Conformity and corresponding documentation is available for the responsible authorities according to the above-mentioned EC Directive at the following address:

Siemens AG
Drive Technologies Division
Motion Control Systems
Frauenauracherstrasse 80
91056 ERLANGEN
GERMANY

Your marketing contact can provide these if requested.

Installation guidelines

The installation guidelines and safety notices specified in the documentation must be adhered to during commissioning and operation.

DIN ISO 9001 certificate

The SIMOCRANE CenSOR system was developed according to the quality directives of ISO 9001

License agreement for supplied software

The device is supplied with software installed. Please note the corresponding license agreements.

EMC

USA	
Federal Communications Commission Radio Frequency Interference Statement	This equipment has been tested and found to comply with the limits for a Class A digital device, pursuant to Part 15 of the FCC Rules. These limits are designed to provide reasonable protection against harmful interference when the equipment is operated in a commercial environment. This equipment generates, uses, and can radiate radio frequency energy and, if not installed and used in accordance with the instruction manual, may cause harmful interference to radio communications. Operation of this equipment in a residential area is likely to cause harmful interference in which case the user will be required to correct the interference at his own expense.
Shielded Cables	Shielded cables must be used with this equipment to maintain compliance with FCC regulations.
Modifications	Changes or modifications not expressly approved by the manufacturer could void the user's authority to operate the equipment.
Conditions of Operations	This device complies with Part 15 of the FCC Rules. Operation is subject to the following two conditions: (1) this device may not cause harmful interference, and (2) this device must accept any interference received, including interference that may cause undesired operation.

CANADA	
Canadian Notice	This Class B digital apparatus complies with Canadian ICES-003.
Avis Canadien	Cet appareil numérique de la classe b est conforme à la norme NMB-003 du Canada.

AUSTRALIA	
	This product meets the requirements of the AS/NZS 3548 Norm (Class A).

ESD guidelines

Definition of ESD

All electronic modules are equipped with large-scale integrated ICs or components. Due to their design, these electronic elements are highly sensitive to overvoltage, and thus to any electrostatic discharge.

The electrostatic sensitive components/modules are commonly referred to as ESD devices. This is also the international abbreviation for such devices.

ESD modules are identified by the following symbol:



NOTICE

Modules sensitive to electrostatic discharge

The device contains modules that are sensitive to electrostatic discharge. ESD devices can be destroyed by voltages well below the threshold of human perception. Such voltages occur if you touch a component or electrical connectors of a module without first discharging the static from your body. The damage caused by overvoltage on a module cannot normally be detected immediately and only becomes apparent after a longer period of operation.

Measures for protecting against discharge of static electricity:

- Always discharge your body's static electricity before handling modules, for example, by touching a grounded object.
- The devices and tools used must also be free of static charges.
- Pick up the modules only on their edges and do not touch any pins or printed conductors.

Electrostatic charging

Anyone who is not connected to the electrical potential of their surroundings can be electrostatically charged.

The figure below shows the maximum electrostatic voltage which may build up on a person coming into contact with the materials indicated. These values correspond to IEC 801-2 specifications.

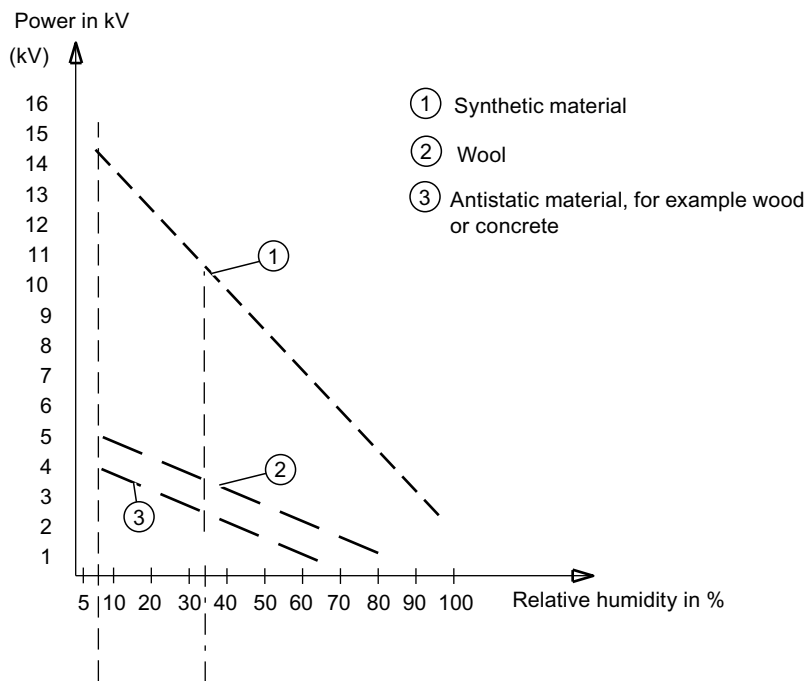

Figure B-1 Electrostatic voltages on an operator

Basic protective measures against electrostatic discharge

- **Ensure good equipotential bonding:**
When handling electrostatic sensitive devices, ensure that your body, the workplace and packaging are grounded. This prevents electrostatic charge.
- **Avoid direct contact:**
As a general rule, only touch electrostatic sensitive devices when this is unavoidable (e.g. during maintenance work). Handle the modules without touching any chip pins or PCB traces. In this way, the discharged energy can not affect the sensitive devices. Discharge your body before you start taking any measurements on a module. Do so by touching grounded metallic parts. Always use grounded measuring instruments.

List of abbreviations and acronyms

Abbreviation/symbol	Explanation
Bit	Binary digit
Byte	Binary term (1 byte = 8 bits)
CBE30-2	Communication Board Ethernet
DVD	Digital Versatile Disc
CCD	Charge Coupled Device
CE	Communautés Européenes (French for European Communities)
cgr	a hundredth of a degree (centi grade)
CPU	Central Processing Unit
DC	Direct Current
DHCP	Dynamic Host Configuration Protocol
DIN	Deutsches Institut für Normung e. V. (German standards association)
DISA	Disable
DMC	Data Matrix Code
DNS	Domain Name System
DP	Distributed Peripheral I/O
DSP	Digital Signalprocessor
EMC	Electro Magnetic Compatibility
EN	Europäische Norm (European standard)
ESD	Electrostatic Discharge
FB	Function Block
GSD	Generic Station Description
I/O	Input/Output
ISO	International Organization for Standardization (from Gr.: " isos " meaning "equal")
IEC	International Electrotechnical Commission
IP	Internet Protocol or International Protection
IR	Infrared radiation (heat radiation)
HF	High Frequency
hPa	Hectopascal
HR	High Resolution
HTML	Hypertext Markup Language
HTTP	Hypertext Transfer Protocol
Hardware	Hardware Configuration
IR	Infrared radiation
LAN	Local Area Network
LED	Light emitting diode
MAC	Media Access Control
MCC	Motion Control Chart

Abbreviation/symbol	Explanation
MHz	M egahertz
PC	P ersonal C omputer, a stationary single-user computer
PG	Programming device
PROFIBUS	P rocess F ield B us, international fieldbus standard to EN 50170/IEC 61158
PROFINET	P rocess F ield N etwork
PST	P rimarily S etup T ool
RMG	R ail M ounted G antry
ROM	R ead O nly M emory
RS	R ecommended S tandard
RTG	R ubber T yred G antry
Rx	Receive (Rx) identifies a receiver
SELV	S afety E xtra L ow V oltage
SF	Group error (German S ammelfehler)
SNTP	S imple N etwork T ime P rotocol
PLC	P rogrammable L ogic C ontroller
SR	S tandard R esolution
ST	S tructured T ext
TCP/IP	T ransmission C ontrol P rotocol/ I nternet P rotocol; a reference module for communication on the Internet
Tx	Transmit (Tx) identifies a transmitter
UDP	U ser D atagram P rotocol
URL	U niform R esource L ocator
V4A	Stainless steel
VDE	V erband d er E lektrotechnik, E lektronik und I nformationstechnik (German Association for Electrical, Electronic and Information Technologies)
XML	E Xtensible M arkup L anguage
VS100	V ision S ensor 100

Glossary

Automation system

An automation system is a programmable logic controller consisting of at least a central processing unit, a variety of input and output modules as well as operator control and monitoring (HMI) devices.

User interface

Software: Web server application, in which most operator actions are performed on the PC screen using a mouse and keyboard. The software processes and displays models.

Bus

A cable or conductor system used for data transfer among the components of a computer system. Buses are characterized by the number of bits they transfer at any one time. There are serial bus systems (one bit after the other) and parallel bus systems (multiple bits simultaneously over several lines).

Code

In the context of the SIMOCRANE CenSOR camera measuring system, the code stands for the parameter set. The SIMOCRANE CenSOR MV440 camera stores up to 14 independent codes.

There are two types of parameters:

- Global parameters are written in all "codes"
- Parameters that are only taken over into the "selected" code

CSV file

A CSV file is a text file for storage or for exchange of simply structured data; these files can be read, for example, with Microsoft Excel.

DHCP client

Each device with network capability that supports communication with a DHCP server to obtain dynamically leased IP configurations and other optional parameter information.

DHCP server

A computer on which the DHCP service runs. This service provides active DHCP clients with dynamic configurations of IP addresses and related information.

Download

In communications, to transfer a data copies from a remote computer to the requesting computer, for example, to send the operating system from a PC to a controller.

Endian

Data is sometimes saved in a different order in certain computer architectures. Intel-based computers, for example, save the data differently from the Siemens controllers (S7), namely, in reverse sequence. The byte sequence from Intel, known as **Little Endian**, is therefore the reverse of the S7 byte sequence, **Big Endian**. It applies to:

- Little Endian: The most significant byte is located at the right-hand end of a word. This byte contains the highest memory address.
- Big Endian: The most significant byte is located at the left-hand end of a word. This byte contains the lowest memory address.

Ethernet

This is a specific type of local network that works according to a standard defined by Intel, DEC and Xerox.

Firmware

Software routines stored in the Read-Only Memory (ROM). Startup routines and local machine I/O commands are stored in firmware. In terms of user friendliness, firmware takes an intermediate position between software and hardware.

Function Block Diagram

Function Block Diagram is a graphic representation of control functions. Each control function has a corresponding symbol.

HW Config

Part of STEP 7 for configuring hardware.

IP address

A 32-bit address to identify a node in an IP network. Each node in the IP network is be assigned a unique IP address. This consists of the network ID and a unique host ID. This address is typically represented with the decimal value of each octet separated by a period (for example, 192.168.7.27). In this version of Windows, you can configure a static IP address or have it assigned dynamically by DHCP.

MAC address

The MAC address is the hardware address for each network device (network card, switch , etc.) and is used for unique identification of the device in the network. The MAC address is burned into a chip and cannot normally be modified.

Master

The device configured as master in a communications system passes on data to the device configured as slave. The master is always the active partner.

Motion Control Chart (MCC)

is a "flow chart language" that provides an easy means of expressing the process sequences of machinery or cranes in graphic form.

NetPro

Editor for graphic configuration of networks. NetPro is launched in SIMATIC Manager or HW Config. NetPro facilitates time-controlled cyclic data transmission over MPI.

Persistence

Persistence is the capability of storing data structures or objects in non-volatile storage media such as file systems or databases. Data is saved to non-volatile memory in the camera.

Port or port address

Address for a channel for data transfer between an input or output device and the processor. From the CPU's perspective, a port represents one or more memory addresses to which it can send data or from which it can receive data. Special hardware such as expansion boards places data from a device in the memory addresses and sends data from these addresses to the device. Some ports are only for input and some only for output.

Power IO RS-232 cable

The power IO RS-232 cable is used for the power supply, to connect to the digital I/O and the communication interface of an automation device via RS-232 interface.

PROFINET device

A PROFINET IO system is made up of the following devices:

- An I/O controller is a controller or PC that controls automation tasks.
- An I/O device is a field device that is configured and controlled by an I/O controller. An I/O device is made up of several modules and submodules.
- I/O Supervisor is a development tool typically based on a PC that is used to assign parameters to and perform diagnostics on individual I/O devices, and to configure the entire plant. The I/O controller gets its data from the I/O Supervisor and configures the I/O device based on this.

An application relation (AR) is formed between an I/O controller and I/O device. Communication relations (CR) with varying properties are specified for the transfer of parameters, cyclic data communication and alarm handling based on this AR.

The properties and options of an I/O device are described in a Generic Station Description (GSD) file. This file is written in GSDML (GSD Markup Language) - an extension of XML - and is used as a planning tool to plan the configuration for PROFINET IO systems.

PROFINET IO

PROFINET IO (Input Output) is used to control cameras and other actuators by means of a central controller in production engineering.

Proxy

A computer that receives broadcast name queries and answers to names that do not go to the local subnet. To evaluate the names, the proxy communicates with a WINS server and retains the names in the cache for a certain time.

Reflector

The reflector is an optical marker with two diagonally arranged square white areas. Following image acquisition, this pattern is detected and processed by the SIMOCRANE CenSOR MV440 camera based on an image processing algorithm. The reflector design can be passive, active with IR LED or retro reflective.

Ring light

A ring-shaped infrared flash fitted with LEDs.

Sensor

In electrical engineering, a sensor is a component that can qualitatively measure not only specific physical or chemical properties (such as heat radiation, temperature, humidity, pressure, excess pressure, sound, luminance, magnetism, acceleration, force) but also the physical condition of its surroundings or register them as measured variables.

Server

Network station that provides services and resources to other stations. For example, a computer that manages databases and passes the data on to the other computers as required.

Shutter speed: Shutter speed

The shutter speed decides how long the CCD sensor of a camera is exposed. When more light is available, the operator can select a faster shutter speed and vice versa. At slow shutter speeds, there is greater risk that the image will suffer from "camera shake".

SIMATIC S7

Siemens automation system with controller families SIMATIC S7-300 and SIMATIC S7-400.

SIMOTION

Siemens automation system for all machines with motion control tasks.

based on merging Motion Control with two other control functions that are commonly available on machinery: PLC and technology functions.

The SIMOTION system consists of three components:

- Engineering System
- Runtime system
- Hardware platforms

The hardware platforms form the basis of Motion Control Systems SIMOTION. The application created with the Engineering System and the corresponding Runtime software modules can be used on different hardware platforms.

SIMOTION C

for analog, stepper, PROFIBUS and PROFINET drives.

is the controller variant of the SIMOTION family with the proven configuration technology of SIMATIC S7-300. The modules of the SIMATIC S7 portfolio provide diverse options for modular expansion of SIMOTION C.

SIMOTION C240P

The Motion Controller is available in two variants:

- SIMOTION C240
- SIMOTION C240 PN

The C240 and C240 PN variants feature the same PLC and Motion Control performance, but differ with regard to their interfaces.

SIMOTION D

A Control Unit SIMOTION D is used for coordinated motion control tasks such as synchronous operation, electronic gearing, cams, or complex electronic functions.
The SIMOTION D control units are available in several performance variants.

SIMOTION D435-2 DP/PN

SIMOTION D435-2 DP/PN for controlling up to 32 axes

SIMOTION Scout

Scout is the software package for configuring and programming SIMOTION automation systems.

Slave

The device configured as slave in a communications system receives data from the device configured as master. The slave is always the passive partner.

SNTP: Simple Network Time Protocol

SNTP is a simplified version of NTP. NTP is a standard for synchronizing clocks in computer systems via packet-based communications networks.

SR

SR stands for the resolution 640 × 480 or 768 × 480 regardless of other parameters.

D-sub

Type identification for a connector.

Switch:

A switch is an electronic device for connecting several computers or network segments in a local network (LAN) - similar to a hub. A switch is also known as an intelligent hub. In its original form, the switch operates on layer 2 (Data Link layer) of the OSI model. The switch processes 48-bit MAC addresses and creates an SAT (Source Address Table).

The switch has properties similar to a bridge and is also known as a multi-port bridge. Ethernet switch is the shortened form, of *switching hub* and indicates the ability to operate switched Ethernet.

TCP/IP

The Transmission Control Protocol/Internet Protocol (TCP/IP) is a family of network protocols. Due to its considerable significance for the Internet, this family is also known as the Internet protocol family.

Trigger

A trigger is a switch that activates an action when a specific event occurs.

URL: Uniform Resource Locator

An address uniquely identifying a location on the Internet. A URL for a WWW page is preceded by http://. A URL can contain other details such as the name of a hypertext page normally identified by the file name extension HTML or HTM.

Counter

A counter registers the state changes (edges) of a digital signal. With each state change, the counter increments or decrements a value that is then processed by SIMATIC S7 or a PLC

Index

A

Ambient conditions, 37

C

CE mark, 178

Checklist

Attachment/connection, 40

Attachment/connection, Commissioning,
Parameter assignment, Integration in a
controller, 59

Attachment/wiring, commissioning, parameter
assignment, integration in controller, 35

Integration in a controller, 125

Parameter assignment, 76

Climatic ambient conditions, 160

Climatic conditions

Atmospheric pressure, 160

Temperature, 160

Codes, 108

Information, 108

Communication Board Ethernet

CBE30-2, 53

Components, 21

Connecting SIMOTION D435-2 DP/PN to CBE30-2

SIMOCRANE CenSOR MV440 via PROFINET or
UDP, 53

Connecting the power supply, 18

D

Data exchange

between camera and PROFINET controller, 133

Declaration of Conformity, 178

Delete codes, 112

Design Guidelines, 178

Device information, 111

Information, 111

Diag. & monitoring, 85

Options, 85

Diagnostic functions, 32

Diagnostics, 109

Information, 109

Diagnostics recordings, 123

Diagnostics screens, 122

DISA bit, 113

E

Electromagnetic compatibility, 161

EMC Directive, 178

Error bits, 131

Error display, 116

ESD guidelines, 181

Ethernet socket, 162

F

Firmware, 113

Full update, 113

Fuse, 160

G

Guarantee, 17

Guidelines

ESD guidelines, 181

I

Image acquisition, 26, 84

Options, 84

Image processing, 32

Information

Codes, 108

Device information, 108, 111

Diagnostics, 108, 109

Model, 108

Initial commissioning of the camera, 61

Integration

PROFINET IO device, 139

L

LED

ETHERNET, 82

STATE/SF, 82

Lens

Focal lengths, 164

Lighting, 84

Options, 84

Lighting unit, 173

Live image display
 With links, 119
 Without links, 120

M

Maintenance of SIMOCRANE CenSOR MV440, 157
Maintenance of the reflector, 157
Measuring the offset, 25
Measuring the rotation angle, 26
Module
 Electrostatic discharge, 18
Module sensitive to electrostatic discharge, 18
Mounting plate, 174

O

Online help, 61
Operating status
 Stop, 116
Options
 Diag. & monitoring, 85
 Image acquisition, 84
 Lighting, 84
 Security, 85
Overview of the hardware, 22

P

Power supply, 160
Processing mode, 106
PROFINET IO device
 Integration, 139

R

Reflectors
 Maximum distances, 164
Relative humidity, 160
Ring light holder, 173

S

Security, 85
 Options, 85
Select code, 135
Service, 177
SIMOTION C240PN
 Integrating SIMOCRANE CenSOR MV440 over
 PROFINET or UDP, 52

SIMOTION D435-2 without CBE30-2
 Connecting SIMOCRANE CenSOR MV440 via
 UDP, 56
ST source
 SIMOCRANE product DVD, 156
Start processing, 136
Stop, 116
System expansions, 17

T

Temperature, 160

U

User interface, 32
 Language setting, 78
 Online help, 78
 Users and access rights, 79