

Edition

11/2023

SYSTEM MANUAL

SIMATIC

ET 200SP

ET 200SP Distributed I/O System

SIEMENS

SIMATIC ET 200SP Distributed I/O system

System Manual

Introduction	1
Safety information	2
New properties/functions	3
Industrial cybersecurity	4
System overview	5
Application planning	6
Installation	7
Wiring	8
Configuring	9
Basics of program execution	10
Protection	11
Configuration control (option handling)	12
Commissioning	13
Maintenance	14
Test and service functions	15

ET 200SP Distributed I/O system

System Manual

Continued

Technical specifications	16
--------------------------	----

Dimension drawings	A
--------------------	---



Accessories/spare parts	B
-------------------------	---

Calculating the leakage resistance	C
------------------------------------	---

Legal information

Warning notice system

This manual contains notices you have to observe in order to ensure your personal safety, as well as to prevent damage to property. The notices referring to your personal safety are highlighted in the manual by a safety alert symbol, notices referring only to property damage have no safety alert symbol. These notices shown below are graded according to the degree of danger.

 DANGER
indicates that death or severe personal injury will result if proper precautions are not taken.
 WARNING
indicates that death or severe personal injury may result if proper precautions are not taken.
 CAUTION
indicates that minor personal injury can result if proper precautions are not taken.
NOTICE
indicates that property damage can result if proper precautions are not taken.

If more than one degree of danger is present, the warning notice representing the highest degree of danger will be used. A notice warning of injury to persons with a safety alert symbol may also include a warning relating to property damage.

Qualified Personnel

The product/system described in this documentation may be operated only by **personnel qualified** for the specific task in accordance with the relevant documentation, in particular its warning notices and safety instructions. Qualified personnel are those who, based on their training and experience, are capable of identifying risks and avoiding potential hazards when working with these products/systems.

Proper use of Siemens products

Note the following:

 WARNING
Siemens products may only be used for the applications described in the catalog and in the relevant technical documentation. If products and components from other manufacturers are used, these must be recommended or approved by Siemens. Proper transport, storage, installation, assembly, commissioning, operation and maintenance are required to ensure that the products operate safely and without any problems. The permissible ambient conditions must be complied with. The information in the relevant documentation must be observed.

Trademarks

All names identified by ® are registered trademarks of Siemens AG. The remaining trademarks in this publication may be trademarks whose use by third parties for their own purposes could violate the rights of the owner.

Disclaimer of Liability

We have reviewed the contents of this publication to ensure consistency with the hardware and software described. Since variance cannot be precluded entirely, we cannot guarantee full consistency. However, the information in this publication is reviewed regularly and any necessary corrections are included in subsequent editions.

Table of contents

1	Introduction.....	12
1.1	Siemens Industry Online Support.....	14
1.2	Industry Mall.....	15
1.3	ET 200SP Documentation Guide.....	15
1.3.1	Information classes ET 200SP.....	15
1.3.2	Basic tools.....	17
1.3.3	MultiFieldbus Configuration Tool (MFCT).....	19
1.3.4	SIMATIC Technical Documentation.....	20
2	Safety information.....	22
2.1	Warnings in this document.....	22
2.2	Safety-related symbols.....	22
2.2.1	Devices without explosion protection.....	22
2.2.2	Devices with explosion protection.....	23
2.3	Intended use.....	24
2.4	Changes to the device and spare parts.....	24
2.5	Target group and personnel qualifications.....	24
2.6	Personal protective equipment.....	25
2.7	Safe working.....	25
2.7.1	Working on electrical parts.....	25
2.8	Residual risks.....	26
2.8.1	Live parts.....	26
2.8.2	Conductive pollution.....	26
2.8.3	Laser radiation.....	27
2.8.4	Overheating.....	27
2.8.5	Uncontrolled movements.....	28
2.8.6	Unsafe operating states.....	28
2.9	Behavior in case of emergency.....	28
2.10	Material damage.....	28
2.10.1	Transport and storage.....	28
2.10.2	Installation and connection.....	29
3	New properties/functions.....	30
4	Industrial cybersecurity.....	32
4.1	Cybersecurity information.....	32
4.2	Security update notification.....	33
4.3	Basic information on industrial cybersecurity.....	33
4.3.1	Definition of industrial cybersecurity.....	33

4.3.2	Objectives of industrial cybersecurity.....	33
4.4	Integrated security concept and security strategies.....	34
4.4.1	Comprehensive security concept "Defense in Depth".....	34
4.4.2	Security management.....	34
4.5	Operational environment and security assumptions.....	36
4.5.1	Intended use.....	36
4.5.2	Requirements for the operational application environment and security assumptions.....	37
4.6	Security properties of the devices.....	38
4.7	Secure operation of the system.....	38
4.7.1	Hardening measures.....	38
4.7.2	Secure configuration.....	38
4.7.3	Access control.....	39
4.7.4	Handling of sensitive data.....	39
4.7.5	Regular firmware updates.....	39
4.7.6	Notifications about security vulnerabilities (Siemens Security Advisories).....	40
4.7.7	Data backup.....	40
4.7.8	Security checks.....	40
4.7.9	Secure decommissioning.....	41
4.7.9.1	Securely removing data.....	41
4.7.9.2	Recycling and disposal.....	44
4.8	Secure operation of the engineering software.....	44
4.9	Secure operation of CPUs.....	44
4.9.1	Secure configuration.....	44
4.9.2	User management and access control.....	44
4.9.2.1	Administration of user accounts.....	44
4.9.2.2	Assigning secure passwords.....	45
4.9.2.3	Password management.....	46
4.9.2.4	Setting protection levels.....	46
4.9.2.5	Certificate management.....	46
4.9.3	Protection functions.....	46
4.9.4	Web server.....	47
4.9.5	Secure Communication/OPC UA.....	47
4.9.6	Sensitive data.....	47
4.9.7	Backups and data backups.....	48
4.9.8	Additional measures for network security.....	48
4.9.9	Remote access to CPU.....	48
4.9.9.1	Using a Web server.....	48
4.9.10	Recording Security events.....	49
4.9.11	Syslog messages.....	50
4.9.11.1	Introduction.....	50
4.9.11.2	Transfer the syslog messages to a syslog server.....	52
4.9.11.3	Structure of the Syslog messages.....	55
4.10	Secure operation of interface modules.....	57
4.10.1	Data integrity.....	57
4.10.2	Signed firmware update.....	59
4.11	Secure operation of I/O modules.....	60

4.12	Secure operation of the power supply modules.....	60
5	System overview.....	61
5.1	What is the SIMATIC ET 200SP distributed I/O system?.....	61
5.2	What are fail-safe automation systems and fail-safe modules?.....	65
5.3	How are SIMATIC Safety F-systems structured with ET 200SP?.....	66
5.4	Components.....	70
6	Application planning.....	80
6.1	Selecting the BaseUnit for I/O modules.....	84
6.1.1	Digital, fail-safe, communication, technology or analog modules without temperature measurement	84
6.1.2	Analog modules with temperature measurement.....	85
6.2	Selecting motor starters with a suitable BaseUnit.....	86
6.2.1	Selecting a BaseUnit for motor starters.....	86
6.2.2	Selecting the motor starter.....	88
6.2.3	Selecting accessories for motor starters.....	89
6.3	Selecting potential distributor modules.....	90
6.3.1	Selecting a PotDis-BaseUnit.....	90
6.3.2	Selecting a PotDis-TerminalBlock.....	91
6.4	Hardware configuration.....	92
6.5	Forming potential groups.....	94
6.5.1	Basics.....	94
6.5.2	Forming potential groups with BaseUnit type B1.....	99
6.5.3	Forming potential groups with fail-safe modules.....	101
6.5.4	Forming potential groups with Ex modules.....	102
6.5.5	Forming potential groups with motor starters.....	102
6.6	Configuration examples for potential groups.....	104
6.6.1	Configuration examples with BaseUnits.....	104
6.6.2	Configuration examples with potential distributor modules.....	106
6.7	System redundancy R1.....	108
6.7.1	General notes on operating an ET 200SP R1 system.....	108
6.7.1.1	Example configuration of a system with ET 200SP R1.....	108
6.7.1.2	Commissioning an R1 station.....	109
6.7.1.3	Increased availability.....	110
6.7.2	Improving the switchover time of the ET 200SP R1 system.....	110
7	Installation.....	112
7.1	Basics.....	112
7.2	Installation conditions for motor starters.....	116
7.3	Mounting the CPU/interface module.....	118
7.4	Installing ET 200SP R1.....	119
7.5	Installing the CM DP communication module.....	121

7.6	Mounting BaseUnits for I/O modules.....	122
7.7	Mounting and dismantling BaseUnits for motor starters.....	124
7.8	Installing potential distributor modules.....	126
7.9	Installing the server module.....	127
7.10	Mounting further accessories for motor starters.....	128
7.10.1	Mounting the cover for the 500 V AC infeed bus.....	128
7.10.2	Mounting the mechanical bracket for the BaseUnit.....	129
7.10.3	Mounting the BU cover.....	131
8	Wiring.....	133
8.1	Rules and regulations for operation.....	133
8.2	Additional rules and regulations for the operation of the ET 200SP with fail-safe modules	136
8.2.1	Safety extra-low voltage (SELV, PELV) for failsafe modules and failsafe motor starters.....	136
8.2.2	Requirements for sensors and actuators for fail-safe modules and fail-safe motor starters	137
8.2.3	Crosstalk of digital input/output signals.....	139
8.3	Additional rules and regulations for operation of an Ex module group.....	140
8.4	Additional rules and instructions for operation with motor starters.....	140
8.4.1	Protection against short circuit.....	140
8.5	Operating the ET 200SP on grounded incoming supply.....	140
8.6	Electrical configuration of the ET 200SP.....	145
8.7	Wiring rules.....	146
8.8	Wiring BaseUnits for I/O modules.....	149
8.9	Connecting cable shields for I/O modules.....	151
8.10	Wiring BaseUnits for motor starters.....	154
8.11	Connecting the 3DI/LC module for the motor starter.....	157
8.12	Connecting the supply voltage to the CPU/interface module.....	158
8.13	Connecting interfaces for communication.....	160
8.13.1	Connecting PROFINET IO (port P3) to the CPU.....	160
8.13.2	Connecting the PROFIBUS DP interface to the interface module/communications module CM DP	162
8.14	Inserting I/O modules / motor starters and BU covers.....	163
8.15	Mounting/disassembly of motor starters.....	165
8.15.1	Mounting the fan.....	165
8.15.2	Mounting/disassembly of motor starters.....	166
8.15.3	3DI/LC module.....	168
8.16	Labeling ET 200SP.....	171
8.16.1	Factory markings.....	171
8.16.2	Optional markings.....	173
8.16.3	Applying color identification labels.....	175
8.16.4	Applying labeling strips.....	176

8.16.5	Applying reference identification labels.....	176
9	Configuring.....	178
9.1	Configuring ET 200SP.....	178
9.2	Configuring the CPU.....	180
9.2.1	Reading out the configuration.....	180
9.2.2	Addressing.....	183
9.2.3	Process images and process image partitions.....	185
9.2.3.1	Process image - overview.....	185
9.2.3.2	Automatically updating process image partitions.....	186
9.2.3.3	Update process image partitions in the user program.....	186
9.3	Configuring the interface module.....	187
9.4	Module-to-Module Communication (MtM).....	188
9.5	Value status.....	189
10	Basics of program execution.....	191
10.1	Events and OBs.....	191
10.2	Asynchronous instructions.....	193
11	Protection.....	203
11.1	Overview of the protective functions of the CPU.....	203
11.2	Protection of confidential configuration data.....	204
11.3	Local user management.....	204
11.3.1	Useful information on local user management and access control.....	204
11.3.2	Advantages of local user management and access control.....	207
11.3.3	From access level to user function rights.....	209
11.3.4	Information regarding compatibility.....	212
11.4	Configuring access protection for the CPU.....	213
11.5	Using the user program to set additional access protection.....	216
11.6	Know-how protection.....	216
11.7	Copy protection.....	220
12	Configuration control (option handling).....	222
12.1	Configuring.....	224
12.2	Creating the control data record.....	226
12.2.1	Introduction.....	226
12.2.2	Control data record for an ET 200SP CPU.....	228
12.2.3	Control data record for an interface module.....	230
12.2.4	Feedback data record for interface modules.....	233
12.2.5	Data records and functions.....	235
12.3	Transferring control data record in the startup program of the CPU.....	236
12.4	Behavior during operation.....	239

12.5	Examples of configuration control.....	241
13	Commissioning.....	246
13.1	Overview.....	246
13.2	Commissioning the ET 200SP for PROFINET IO.....	248
13.2.1	ET 200SP CPU as an IO controller.....	248
13.2.2	ET 200SP CPU as an I-device.....	250
13.2.3	ET 200SP as an IO device.....	251
13.3	Commissioning the ET 200SP on PROFIBUS DP.....	252
13.3.1	ET 200SP as a DP master.....	253
13.3.2	ET 200SP as I-slave.....	254
13.3.3	ET 200SP as a DP slave.....	256
13.4	Startup of the ET 200SP with empty slots.....	257
13.5	Removing/inserting a SIMATIC memory card on the CPU.....	258
13.6	Operating modes of the CPU.....	259
13.6.1	STARTUP mode.....	260
13.6.2	STOP mode.....	262
13.6.3	RUN mode.....	263
13.6.4	Operating mode transitions.....	263
13.7	CPU memory reset.....	265
13.7.1	Automatic memory reset.....	266
13.7.2	Manual memory reset.....	267
13.8	Reassigning parameters during operation.....	268
13.9	Backing up and restoring the CPU configuration.....	269
13.9.1	Overview.....	269
13.10	Time synchronization.....	272
13.10.1	Example: Configuring and changing NTP server.....	273
13.11	Identification and maintenance data.....	275
13.11.1	Reading out and entering I&M data.....	275
13.11.2	Data record structure for I&M data.....	277
13.11.3	Example: Read out firmware version of the CPU with Get_IM_Data.....	280
13.12	Shared commissioning of projects.....	282
14	Maintenance.....	283
14.1	Removing and inserting I/O modules/motor starters (hot swapping).....	283
14.2	Changing the type of an I/O module.....	287
14.3	Replacing an I/O module.....	288
14.4	Replacing a motor starter.....	289
14.5	Replacing the terminal box on the BaseUnit.....	290
14.6	Firmware update.....	291
14.7	Resetting CPU/interface module (PROFINET) to factory settings.....	298
14.7.1	Resetting the CPU to factory settings.....	298

14.7.2	Resetting interface module (PROFINET IO) to factory settings.....	301
14.7.3	Resetting the interface module (PROFINET IO) to factory settings with a RESET button.....	302
14.8	Reaction to faults in fail-safe modules and fail-safe motor starters.....	303
14.9	Maintenance and repair.....	305
14.10	Warranty.....	306
15	Test and service functions.....	307
15.1	Test functions.....	307
15.2	Reading out/saving service data.....	312
16	Technical specifications.....	314
16.1	Introduction.....	314
16.2	Safety information.....	315
16.3	Marks and approvals.....	316
16.4	Certificates.....	321
16.5	Standards and requirements.....	322
16.6	Electromagnetic compatibility.....	324
16.7	Electromagnetic compatibility of fail-safe modules.....	326
16.8	Shipping and storage conditions.....	329
16.9	Mechanical and climatic environmental conditions.....	330
16.10	Insulation, protection class, degree of protection and rated voltage.....	333
16.11	Use of the ET 200SP distributed I/O system in zone 2 potentially explosive atmospheres.....	335
A	Dimension drawings.....	336
A.1	SIMATIC system rail.....	336
A.2	Shield connector.....	337
A.3	Labeling strip.....	337
A.4	Reference identification labels.....	338
B	Accessories/spare parts.....	339
B.1	Lightning protection and overvoltage protection for fail-safe modules.....	343
C	Calculating the leakage resistance.....	344
	Glossary.....	346
	Index.....	360

Introduction

Purpose of the documentation

This documentation provides important information on configuring, installing, wiring and commissioning the ET 200SP distributed I/O system.

Basic knowledge required

A basic knowledge of automation technology is required to understand the documentation.

Validity of the documentation

This documentation applies to the distributed I/O system, ET 200SP.

Definition

In this document, " motor starter" always refers to all variants of the ET 200SP motor starters.

Conventions

Please pay particular attention to notes highlighted as follows:

NOTE

Notes contain important information on the product, handling the product or on part of the documentation to which you should pay particular attention.

ID link for the digital nameplate



The ID link is a globally unique identifier according to IEC 61406, which you will find in the future as a QR code on your product and the product packaging.

The figure shows an example of an ID link for the digital input module DI 8x24 VDC HF.

You can recognize the ID link by the frame with a black frame corner at the bottom right. The ID link takes you to the digital nameplate of your product.

Scan the QR code on the product or on the packaging label with a smartphone camera, barcode scanner or reader app. Call the ID link.

In the digital nameplate, you will find product data, manuals, declarations of conformity, certificates and other helpful information about your product.

Standards

You can find a dated reference to the respective standards or the EC Declaration of Conformity on the Internet

(<https://support.industry.siemens.com/cs/ww/en/ps/14031/cert?ct=444&ci=526>)

Special information

 WARNING
Hazardous Voltage Can Cause Death, Serious Injury, or Property Damage. Proper use of hardware products This equipment is only allowed to be used for the applications described in the catalog and in the technical description, and only in conjunction with non-Siemens equipment and components recommended by Siemens. Correct transport, storage, installation and assembly, as well as careful operation and maintenance, are required to ensure that the product operates safely and without faults. EU note: Start-up/commissioning is absolutely prohibited until it has been ensured that the machine in which the component described here is to be installed fulfills the regulations/specifications of Directive 2006/42/EC.

NOTE**Important note for maintaining operational safety of your plant**

Plants with safety-related features are subject to special operational safety requirements on the part of the operator. Even suppliers are required to observe special measures during product monitoring. For this reason, we inform you in the form of personal notifications about product developments and features that are (or could be) relevant to operation of systems from a safety perspective.

By subscribing to the appropriate notifications, you will ensure that you are always up-to-date and able to make changes to your system, when necessary.

Log onto Industry Online Support. Go to the following links and, on the side, right click on "email on update":

- SIMATIC S7-300/S7-300F (<https://support.industry.siemens.com/cs/ww/en/ps/13751>)
 - SIMATIC S7-400/S7-400H/S7-400F/FH (<https://support.industry.siemens.com/cs/ww/en/ps/13828>)
 - SIMATIC WinAC RTX (F) (<https://support.industry.siemens.com/cs/ww/en/ps/13915>)
 - SIMATIC S7-1500/SIMATIC S7-1500F (<https://support.industry.siemens.com/cs/ww/en/ps/13716>)
 - SIMATIC S7-1200/SIMATIC S7-1200F (<https://support.industry.siemens.com/cs/ww/en/ps/13683>)
 - Distributed I/O (<https://support.industry.siemens.com/cs/ww/en/ps/14029>)
 - STEP 7 (TIA Portal) (<https://support.industry.siemens.com/cs/ww/en/ps/14667>)
-

NOTE

When using F-CPU's in safety mode and fail-safe modules, observe the description of the SIMATIC Industrial Software SIMATIC Safety - Configuring and Programming (<https://support.industry.siemens.com/cs/ww/de/view/54110126/en>) fail-safe system.

1.1 Siemens Industry Online Support

You can find current information on the following topics quickly and easily here:

- **Product support**
All the information and extensive know-how on your product, technical specifications, FAQs, certificates, downloads, and manuals.
- **Application examples**
Tools and examples to solve your automation tasks – as well as function blocks, performance information and videos.
- **Services**
Information about Industry Services, Field Services, Technical Support, spare parts and training offers.
- **Forums**
For answers and solutions concerning automation technology.
- **mySupport**
Your personal working area in Industry Online Support for messages, support queries, and configurable documents.

This information is provided by the Siemens Industry Online Support in the Internet (<https://support.industry.siemens.com>).

1.2 Industry Mall

The Industry Mall is the catalog and order system of Siemens AG for automation and drive solutions on the basis of Totally Integrated Automation (TIA) and Totally Integrated Power (TIP).

You can find catalogs for all automation and drive products on the Internet (<https://mall.industry.siemens.com>).

1.3 ET 200SP Documentation Guide

1.3.1 Information classes ET 200SP



The documentation for the SIMATIC ET 200SP distributed I/O system is arranged into three areas.

This arrangement enables you to access the specific content you require. You can download the documentation free of charge from the Internet (<https://support.industry.siemens.com/cs/ww/en/view/109742709>).

Basic information



The System Manual describes in detail the configuration, installation, wiring and commissioning of the SIMATIC ET 200SP distributed I/O system.

The STEP 7 online help supports you in the configuration and programming.

Examples:

- ET 200SP System Manual
- System Manual ET 200SP HA/ET 200SP modules for devices used in a hazardous area
- Online help TIA Portal

Device information



Equipment manuals contain a compact description of the module-specific information, such as properties, wiring diagrams, characteristics and technical specifications.

Examples:

- Equipment Manuals CPUs
- Equipment Manuals Interface Modules
- Equipment Manuals Digital Modules
- Equipment Manuals Analog Modules
- Equipment Manuals Motor Starter
- BaseUnits Equipment Manuals
- Equipment Manual Server Module
- Equipment Manuals Communications Modules
- Equipment Manuals Technology Modules

General information



The function manuals contain detailed descriptions on general topics relating to the SIMATIC ET 200SP distributed I/O system.

Examples:

- Function Manual ET 200AL/ET 200SP Mixed Configuration
- Function Manual Diagnostics
- Function Manual Communication
- PROFINET Function Manual
- PROFIBUS Function Manual
- Function Manual Designing Interference-free Controllers
- MultiFieldbus Function Manual

Product Information

Changes and supplements to the manuals are documented in a Product Information. The Product Information takes precedence over the device and system manuals. You can find the latest Product Information on the ET 200SP distributed I/O system on the Internet. (<https://support.industry.siemens.com/cs/de/en/view/73021864>)

Manual Collection ET 200SP

The Manual Collection contains the complete documentation on the SIMATIC ET 200SP distributed I/O system gathered together in one file.

You can find the Manual Collection on the Internet.

(<https://support.industry.siemens.com/cs/cn/en/view/84133942>)

Manual Collection fail-safe modules

The Manual Collection contains the complete documentation on the fail-safe SIMATIC modules, gathered together in one file.

You can find the Manual Collection on the Internet.

(<https://support.industry.siemens.com/cs/ww/en/view/109806400>)

1.3.2 Basic tools

Tools

The tools described below support you in all steps: from planning, over commissioning, all the way to analysis of your system.

TIA Selection Tool

The TIA Selection Tool tool supports you in the selection, configuration, and ordering of devices for Totally Integrated Automation (TIA).

As successor of the SIMATIC Selection Tools, the TIA Selection Tool assembles the already known configurators for automation technology into a single tool.

With the TIA Selection Tool, you can generate a complete order list from your product selection or product configuration.

You can find the TIA Selection Tool on the Internet.

<https://support.industry.siemens.com/cs/ww/en/view/109767888>

SIMATIC Automation Tool

You can use the SIMATIC Automation Tool to perform commissioning and maintenance activities on various SIMATIC S7 stations as bulk operations independent of TIA Portal.

The SIMATIC Automation Tool offers a wide range of functions:

- Scanning of a PROFINET/Ethernet system network and identification of all connected CPUs
- Assignment of addresses (IP, subnet, Gateway) and device name (PROFINET device) to a CPU
- Transfer of the date and the programming device/PC time converted to UTC time to the module
- Program download to CPU
- RUN/STOP mode switchover
- CPU localization through LED flashing
- Reading out of CPU error information
- Reading the CPU diagnostic buffer
- Reset to factory settings
- Firmware update of the CPU and connected modules

You can find the SIMATIC Automation Tool on the Internet.

<https://support.industry.siemens.com/cs/ww/en/view/98161300>

PRONETA

SIEMENS PRONETA (PROFINET network analysis) is a commissioning and diagnostic tool for PROFINET networks. PRONETA Basic has two core functions:

- In the network analysis, you get an overview of the PROFINET topology. Compare a real configuration with a reference installation or make simple parameter changes, e.g. to the names and IP addresses of the devices.
- The "IO test" is a simple and rapid test of the wiring and the module configuration of a plant, including documentation of the test results.

You can find SIEMENS PRONETA Basic on the Internet:

(<https://support.industry.siemens.com/cs/ww/en/view/67460624>)

SIEMENS PRONETA Professional is a licensed product that offers you additional functions. It offers you simple asset management in PROFINET networks and supports operators of automation systems in automatic data collection/acquisition of the components used through various functions:

- The user interface (API) offers an access point to the automation cell to automate the scan functions using MQTT or a command line.
- With PROFlenergy diagnostics, you can quickly detect the current pause mode or the readiness for operation of devices that support PROFlenergy and change these as needed.
- The data record wizard supports PROFINET developers in reading and writing acyclic PROFINET data records quickly and easily without PLC and engineering.

You can find SIEMENS PRONETA Professional on the Internet.

(<https://www.siemens.com/proneta-professional>)

SINETPLAN

SINETPLAN, the Siemens Network Planner, supports you in planning automation systems and networks based on PROFINET. The tool facilitates professional and predictive dimensioning of your PROFINET installation as early as in the planning stage. In addition, SINETPLAN supports you during network optimization and helps you to exploit network resources optimally and to plan reserves. This helps to prevent problems in commissioning or failures during productive operation even in advance of a planned operation. This increases the availability of the production plant and helps improve operational safety.

The advantages at a glance

- Network optimization thanks to port-specific calculation of the network load
- Increased production availability thanks to online scan and verification of existing systems
- Transparency before commissioning through importing and simulation of existing STEP 7 projects
- Efficiency through securing existing investments in the long term and the optimal use of resources

You can find SINETPLAN on the Internet

(<https://new.siemens.com/global/en/products/automation/industrial-communication/profinet/sinetplan.html>).

1.3.3 MultiFieldbus Configuration Tool (MFCT)

MultiFieldbus Configuration Tool

MultiFieldbus Configuration Tool (MFCT) is a PC-based software and supports the configuration of MultiFieldbus- and DALI-devices. In addition, the MFCT offers convenient options for mass firmware updates of ET 200 devices with MultiFieldbus- support and reading service data for many other Siemens devices.

Functional scope of the MFCT

- MultiFieldbus configuration:
Engineering, configuration and diagnostics of MultiFieldbus-devices, provision of the required project files (project, UDT-, CSV- and EDS-file), transfer/export of the files to device and/or data memory.
- DALI configuration:
Device selection and online configuration of DALI devices.
- TM FAST:
Generation and download of FPGA-UPD- and FPGA-DB-files.
- Maintenance:
Topology scan of a Ethernet network, reading of service data, parameter assignment and firmware update.
- Settings:
Language switching German / English, network scanner speed, setting of the network adapter, installation of GSDML-and EDS-files.

System/installation requirements for MFCT

The MFCT runs under Microsoft Windows and does not require installation or administrator rights.

For MFCT you must also install the following software:

- Microsoft .NET Framework 4.8 (You can find an Offline Installer on the Internet. (<https://support.microsoft.com/en-us/topic/microsoft-net-framework-4-8-offline-installer-for-windows-9d23f658-3b97-68ab-d013-aa3c3e7495e0>))
- NPcap from directory "Misc"
- PG/PC interface from directory "Misc"
- Microsoft C++ Redistributable for x86-systems (you can find the installation data for download on the Internet. (https://aka.ms/vs/15/release/vc_redist.x86.exe))

The download of the tool and further information as well as documentation on the individual functions of the MFCT can be found on the Internet.

(<https://support.industry.siemens.com/cs/de/en/view/109773881>)

1.3.4 SIMATIC Technical Documentation

Additional SIMATIC documents will complete your information. You can find these documents and their use at the following links and QR codes.

The Industry Online Support gives you the option to get information on all topics. Application examples support you in solving your automation tasks.

Overview of the SIMATIC Technical Documentation

Here you will find an overview of the SIMATIC documentation available in Siemens Industry Online Support:



Industry Online Support International

<https://support.industry.siemens.com/cs/ww/en/view/109742705>

Watch this short video to find out where you can find the overview directly in Siemens Industry Online Support and how to use Siemens Industry Online Support on your mobile device:



Quick introduction to the technical documentation of automation products per video <https://support.industry.siemens.com/cs/us/en/view/109780491>



YouTube video: Siemens Automation Products - Technical Documentation at a Glance <https://youtu.be/TwLSxxRQqSA>

Retention of the documentation

Retain the documentation for later use.

For documentation provided in digital form:

1. Download the associated documentation after receiving your product and before initial installation/commissioning. Use the following download options:
 - Industry Online Support International: <https://support.industry.siemens.com>
The article number is used to assign the documentation to the product. The article number is specified on the product and on the packaging label. Products with new, non-compatible functions are provided with a new article number and documentation.
 - ID link:
Your product may have an ID link. The ID link is a QR code with a frame and a black frame corner at the bottom right. The ID link takes you to the digital nameplate of your product. Scan the QR code on the product or on the packaging label with a smartphone camera, barcode scanner, or reader app. Call up the ID link.
2. Retain this version of the documentation.

Updating the documentation

The documentation of the product is updated in digital form. In particular in the case of function extensions, the new performance features are provided in an updated version.

1. Download the current version as described above via the Industry Online Support or the ID link.
2. Also retain this version of the documentation.

mySupport

With "mySupport" you can get the most out of your Industry Online Support.

Registration	You must register once to use the full functionality of "mySupport". After registration, you can create filters, favorites and tabs in your personal workspace.
Support requests	Your data is already filled out in support requests, and you can get an overview of your current requests at any time.
Documentation	In the Documentation area you can build your personal library.
Favorites	You can use the "Add to mySupport favorites" to flag especially interesting or frequently needed content. Under "Favorites", you will find a list of your flagged entries.
Recently viewed articles	The most recently viewed pages in mySupport are available under "Recently viewed articles".
CAX data	The CAX data area gives you access to the latest product data for your CAX or CAe system. You configure your own download package with a few clicks: <ul style="list-style-type: none"> • Product images, 2D dimension drawings, 3D models, internal circuit diagrams, EPLAN macro files • Manuals, characteristics, operating manuals, certificates • Product master data

You can find "mySupport" on the Internet. (<https://support.industry.siemens.com/My/ww/en>)

Application examples

The application examples support you with various tools and examples for solving your automation tasks. Solutions are shown in interplay with multiple components in the system - separated from the focus on individual products.

You can find the application examples on the Internet.
(<https://support.industry.siemens.com/cs/ww/en/ps/ae>)

Safety information









2.1 Warnings in this document

You can find explanations of the warnings used in this document in the "Legal information" section.

2.2 Safety-related symbols

2.2.1 Devices without explosion protection











The following table contains an explanation of the symbols located in your SIMATIC device, its packaging or the accompanying documentation.

Symbol	Meaning
	General warning sign Caution/Notice You must read the product documentation. The product documentation contains information about the potential risks and enable you to recognize risks and implement countermeasures.
	Read the information provided by the product documentation. ISO 7010 M002
	Ensure the device is only installed by electrically skilled person. IEC 60417 No. 6182
 CABLE SPEC.	Note that connected mains lines must be designed according to the expected minimum and maximum ambient temperature.
 EMC	Note that the device must be constructed and connected in accordance with EMC regulations.
 230V MODULES	Note that a 230 V device can be exposed to electrical voltages which can be dangerous. ANSI Z535.2
 24V MODULES	Note that a device of Protection Class III may only be supplied with a protective low voltage according to the standard SELV/PELV. IEC 60417-1-5180 "Class III equipment"
 INDOOR USE ONLY INDUSTRIAL USE ONLY	Be aware that the device is only approved for the industrial field and only for indoor use.



Symbol	Meaning
	Note that an enclosure is required for installing the device. Enclosures are considered: <ul style="list-style-type: none"> • Standing control cabinet • Serial control cabinet • Terminal boxes • Wall enclosure

2.2.2 Devices with explosion protection

The following table contains an explanation of the symbols located in your SIMATIC device, its packaging or the accompanying documentation.

Symbol	Meaning
  ONLY EX MODULES	The assigned safety symbols apply to devices with Ex approval . You must read the product documentation. The product documentation contains information about the potential risks and enable you to recognize risks and implement countermeasures.
	Read the information provided by the product documentation. ISO 7010 M002
	Ensure the device is only installed by electrically skilled person. IEC 60417 No. 6182
 F<2N DISPLAY F<4N HOUSING	Observe the mechanical rating of the device.
 CABLE SPEC.	Note that connected mains lines must be designed according to the expected minimum and maximum ambient temperature.
 EMC	Note that the device must be constructed and connected in accordance with EMC regulations.
 U = 0V	When the device is under voltage, note that it may not be installed or removed, or plugged or pulled.
 230V MODULES	Note that a 230 V device can be exposed to electrical voltages which can be dangerous. ANSI Z535.2
 24V MODULES	Note that a device of Protection Class III may only be supplied with a protective low voltage according to the standard SELV/PELV. IEC 60417-1-5180 "Class III equipment"

2.5 Target group and personnel qualifications

Symbol	Meaning
	Be aware that the device is only approved for the industrial field and only for indoor use.
	For Zone 2 potentially explosive atmospheres, be aware that the device may only be used when it is installed in an enclosure with a degree of protection \geq IP54.
	For Zone 22 potentially explosive atmospheres, be aware that the device may only be used when it is installed in an enclosure with a degree of protection \geq IP6x.

2.3 Intended use

The system is used to control machines and plants.

Intended use also includes observance of this documentation, in particular the safety instructions and conditions of use. See Technical specifications ([Page 314](#)) section.

2.4 Changes to the device and spare parts

Modifications to the device can impair the safety and function of the device:

- Do not make any changes or modifications to the device.
- Do not remove or tape over safety instructions on the device.
- Do not tape over, cover or obstruct ventilation slots.
- Only use original spare parts and accessories.

2.5 Target group and personnel qualifications

All persons working with this device require the following knowledge:

- Contents of this document as well as contents of the enclosed documents
- Handling the device (after instruction)
- Relevant standards and regulations
- Accident prevention regulations

The following activities are reserved for specially qualified personnel:

Working on electrical parts

Work on electrical parts may only be performed by the following persons:

- Qualified electricians
- Persons trained in electrical engineering under the direction and supervision of qualified personnel

Commissioning and configuration

Commissioning and configuration requires general knowledge in the field of automation technology.

2.6 Personal protective equipment

The personal protective equipment depends on the activity and is determined by the operator.

To avoid material damage during packing, unpacking and installation activities we recommend:

- ESD wrist strap
- ESD shoes

2.7 Safe working

2.7.1 Working on electrical parts

- Only work on electrical parts if you are a qualified specialist (see section Target group and personnel qualifications ([Page 24](#))).
- Always observe the country-specific safety rules.
- Notify all those who will be affected by the procedure.
- Follow the 5 safety rules according to DIN EN 50110-1 (VDE 0105-1):

1. Disconnect
2. Secure to prevent reconnection
3. Verify safe isolation from the supply (all poles)
4. Ground and short-circuit
5. Erect barriers around or cover adjacent live parts

After completing work:

- Restore operational readiness in reverse order.

2.8 Residual risks

Despite all the technical and procedural risk reductions that have been carried out, not all dangers can be avoided.

The following sections describe these residual risks and measures to avoid them.

2.8.1 Live parts

Electrocution on contact with live parts leads to life-threatening injuries (death).

Operation

- Do not open the device.
- Never use damaged devices.
- Pull the plug and not the cable.

Installation and connection

- Only work on electrical parts if you are a qualified specialist (see section Target group and personnel qualifications [\(Page 24\)](#)).
- Adhere to the protective measures for safe working on electrical parts (see section Working on electrical parts [\(Page 25\)](#)).
- Fuse the connection cables according to the current-carrying capacity of the cable used, taking into account the applicable standards.
- Install the device in a control cabinet. The enclosures, cabinets or electrical equipment rooms must guarantee protection against electric shock and spread of fire.
- Ground the device in compliance with the applicable regulations.
- For the 24 V DC supply (SELV/PELV), only use power supply units that provide safe electrical extra-low voltage in accordance with IEC 61131-2 or IEC 61010-2-201.

Maintenance

- Only work on electrical parts if you are a qualified specialist (see section Target group and personnel qualifications [\(Page 24\)](#)).
- Adhere to the protective measures for safe working on electrical parts (see section Working on electrical parts [\(Page 25\)](#)).

2.8.2 Conductive pollution

Electrocution during transmission of electrical energy via conductive contamination to the body leads to life-threatening injuries (death).

- Install the device in a control cabinet.
- Keep the control cabinet free of conductive contamination.

2.8.3 Laser radiation

BusAdapters for fiber-optic cables contain a laser system and are classified as a "CLASS 1 LASER PRODUCT" in accordance with IEC 60825-1.

Laser beams falling on the retina cause blindness.

- Avoid direct eye contact with the laser beam.
- Do not open the BusAdapter.

2.8.4 Overheating

Smoke development and fire due to overheating of the device and cables lead to burns and life-threatening injuries (death).

To avoid overheating:

- Ensure the correct installation position.
- Ensure sufficient air supply (e.g. do not tape over or cover ventilation slots, maintain mounting clearances).
- Only use undamaged cables.

Installation and connection

- Follow the instructions for the mounting position.
- Adhere to the specified ventilation clearances.
- Fuse the connecting cables according to the cable cross-section.

Maintenance

- Check plug-in connections and cables regularly for damage.

2.8.5 Uncontrolled movements

Uncontrolled movements of driven machine or system parts during commissioning, operation, maintenance and repair.

- Follow the safety instructions described in the function manuals.

2.8.6 Unsafe operating states

Unsafe operating states may result in personal injury of unknown extent.

The following factors can be triggers:

- Manipulation of the software, e.g. viruses, trojans or worms

Manipulation of the software, e.g. viruses, trojans or worms

- Adhere to the protective measures against tampering with the software (see section Industrial cybersecurity [\(Page 32\)](#)).
- Perform available updates in a timely manner.
- Protect files stored on removable media from malware with appropriate protective measures, e.g. virus scanner.
- Set up access protection for the CPU.

2.9 Behavior in case of emergency

- Force EMERGENCY OFF

When the safe operating state has been restored:

- Unlock the EMERGENCY OFF mechanism.
- The person responsible for the system ensures that the system starts up in a controlled and defined manner.

2.10 Material damage

2.10.1 Transport and storage

- Only pack, store, transport and ship electronic components, modules or devices in the original product packaging or in other suitable materials, e.g. conductive foam rubber or aluminum foil.
- Observe the limits during transport and storage. See Technical specifications [\(Page 314\)](#) section.

2.10.2 Installation and connection

- We recommend touching components, modules and devices only if they are grounded by one of the following measures:
 - With an ESD wrist strap.
 - With ESD shoes or ESD grounding strips in ESD areas with conductive flooring.
- Place electronic components, modules and devices only on conductive surfaces (e.g. tables with ESD coating, conducting ESD plastic foam, ESD packing bags, ESD transport containers).
- Ensure that there is sufficient overvoltage protection.

Do not install/remove the following elements when the power is on

- Read the section Removing and inserting I/O modules/motor starters (hot swapping) (Page 283).
- Observe the special conditions for hazardous areas in the section Marks and approvals (Page 316).

New properties/functions

What's new in Edition 11/2023 of the ET 200SP System Manual compared with Edition 11/2022?

What's new?		What are the customer benefits?	Where can I find the information?
New contents	General safety information	The section contains a compilation of general safety information for the ET 200SP distributed I/O system.	Section General safety information
	Section "Industrial cybersecurity"	Due to the digitalization and increasing networking of machines and industrial plants, the risk of cyberattacks is also growing. Appropriate protective measures are therefore mandatory, particularly in the case of critical infrastructure facilities. The section contains the following information: <ul style="list-style-type: none"> • Basic information on the subject of industrial cybersecurity • Measures to protect individual components and the entire system against manipulation and unwanted access. 	Section Industrial cybersecurity (Page 32)
	Syslog messages	As of TIA Portal version V19 and FW version V3.1, you can forward the syslog messages of an ET 200SP CPU to a syslog server.	
	Local user management	As of TIA Portal version V19 and FW version V3.1, ET 200SP CPUs have improved management of users, roles and CPU function rights (User Management & Access Control, UMAC). As of the above-mentioned version, you manage all project users along with their rights (e.g. access rights) for all CPUs in the project. You do this in the editor for users and roles in the TIA Portal.	Section Local user management (Page 204)

What's new in Edition 11/2022 of the ET 200SP System Manual compared with Edition 04/2022?

What's new?		What are the customer benefits?	Where can I find the information?
New contents	Support of PROFINET system redundancy R1	The redundant ET 200SP R1 system ensures high availability through redundant PROFINET connections. In contrast to S2 devices, R1 devices are equipped with two interface modules. If one interface module fails, the R1 device can still be reached by the H-CPU via the second interface module. Thus, R1 devices have a higher availability than S2 devices.	Starting with section System overview (Page 61)
	BaseUnit BU type M0		Starting with section System overview (Page 61)
	IM 155-6 PN R1 interface module		Starting with section System overview (Page 61)

What's new in Edition 04/2022 of the ET 200SP System Manual compared with Edition 05/2021?

What's new?		What are the customer benefits?	Where can I find the information?
New contents	New shield terminal for connecting cable shields	The new stacked shield terminal provides extended space for clamping thanks to two clamping positions. In addition, a supporting element absorbs torsional and bending forces.	Section Connecting cable shields for I/O modules (Page 151)

What's new in Edition 05/2021 of the ET 200SP System Manual compared with Edition 09/2019?

What's new?		What are the customer benefits?	Where can I find the information?
New contents	Modules for hazardous area	The Ex BaseUnits and Ex I/O modules enable the connection of intrinsically safe devices from the hazardous area Zone 0 and Zone 1.	System Manual ET 200SP HA Distributed I/O system / ET 200SP Modules for devices used in an explosion hazardous environment (https://support.industry.siemens.com/cs/ww/de/view/109795533/en) Starting from section System overview (Page 61)

What's new in Edition 09/2019 of the ET 200SP System Manual compared with Edition 02/2018?

What's new?		What are the customer benefits?	Where can I find the information?
New contents	BaseUnits BU30-MS7, BU30-MS8, BU30-MS9 and BU30-MS10 for fail-safe motor starters	A simple, wire-saving group shutdown for fail-safe motor starters. In contrast to the earlier solution (BU30-MS5 and BU30-MS6), the fail-safe signal only has to be wired to the first motor starter. The fail-safe signal is internally routed via the BaseUnits.	Section Selecting motor starters with a suitable BaseUnit (Page 86) Section Forming potential groups (Page 94) Section Wiring BaseUnits for motor starters (Page 154)

Industrial cybersecurity

Due to the digitalization and increasing networking of machines and industrial plants, the risk of cyberattacks is also growing. Appropriate protective measures are therefore mandatory, particularly in the case of critical infrastructure facilities.

In the first part of this section you will find basic information on the subject of industrial cybersecurity. In the following sections, measures for the entire system and individual components are recommended to protect against manipulation and unwanted access.

NOTE

Security-relevant changes to software or devices are documented in the section New properties/functions ([Page 30](#)).

4.1 Cybersecurity information

Siemens provides products and solutions with industrial cybersecurity functions that support the secure operation of plants, systems, machines, and networks.

In order to protect plants, systems, machines, and networks against cyber threats, it is necessary to implement – and continuously maintain – a holistic, state-of-the-art industrial cybersecurity concept. Siemens' products and solutions constitute one element of such a concept.

Customers are responsible for preventing unauthorized access to their plants, systems, machines and networks. Such systems, machines and components should only be connected to an enterprise network or the internet if and to the extent such a connection is necessary and only when appropriate security measures (e.g. firewalls and/or network segmentation) are in place.

For more information on protective industrial cybersecurity measures for implementation, please visit (<https://www.siemens.com/global/en/products/automation/topic-areas/industrial-cybersecurity.html>).

Siemens' products and solutions undergo continuous development to make them more secure. Siemens strongly recommends that product updates are applied as soon as they are available and that the latest product versions are used. Use of product versions that are no longer supported, and failure to apply the latest updates may increase customers' exposure to cyber threats.

To stay informed about product updates at all times, subscribe to the Siemens Industrial Cybersecurity RSS Feed under (<https://new.siemens.com/global/en/products/services/cert.html>).

4.2 Security update notification

Observe the special information on maintaining the operational security of your plant in the section Introduction ([Page 12](#)).

Set up notification of security updates

To receive notifications about security updates, proceed as follows:

1. Register on mySiePortal (<https://sieportal.siemens.com/en-ww/home>).
2. Enter the keyword "Security" in the search engine.
3. Choose the "Search in Knowledge base" option.
4. Select the "Other types" option from the filter menu for "Type" and then choose "Download" and "Product note".
5. Select the document from which you want to create notifications.
6. For information on setting up email notification, watch the video Custom notifications and filters (https://cache.industry.siemens.com/dl/dl-media/691/90000691/att_1036866/v1/How-to_Videos-SIOS_EN/story_html5.html?lang=en).

4.3 Basic information on industrial cybersecurity

4.3.1 Definition of industrial cybersecurity

Industrial cybersecurity is generally understood to mean all measures to protect against the following threats:

- Loss of confidentiality due to unauthorized access to data
- Loss of integrity due to manipulation of data
- Loss of availability (e.g. due to the destruction of data or denial of service (DoS))

4.3.2 Objectives of industrial cybersecurity

The objectives of industrial cybersecurity are:

- Trouble-free operation and ensuring the availability of industrial plants and production processes
- Prevention of risks to people and production from cybersecurity attacks
- Protection of industrial communication against espionage and manipulation
- Protection of industrial automation systems and components against unauthorized access and data loss
- Provision of a practical and cost-effective concept for securing existing plants and devices without their own security functions
- Use of existing, open, and proven industrial security standards
- Compliance with legal requirements

An optimized and adapted security concept applies to automation and drive technology. The security measures must not impede or endanger production.

4.4 Integrated security concept and security strategies

4.4.1 Comprehensive security concept "Defense in Depth"

With Defense in Depth, Siemens provides a multi-layer security concept that offers industrial plants comprehensive and far-reaching protection in accordance with the recommendations of the IEC 62443 international standard.

Productivity and know-how are protected on 3 levels:

Plant security

Plant security uses various methods to secure the physical access of people to critical components. This starts with classic building access and extends to securing sensitive areas using access control (for example, code card, iris scan, fingerprint or access code).

Network security

Automation networks must be protected against unauthorized access. This is achieved through security measures on the product, but also those in the product-related environment.

System integrity

Targeted measures must be taken to protect existing know-how or to prevent unauthorized access to automation processes.

You can find more information on the topics of Defense in Depth, plant security, network security, and system integrity on the SIEMENS Industrial cybersecurity

(<https://www.siemens.com/us/en/company/topic-areas/cybersecurity/industrial-security.html>) Web page.

You can also visit the download center (<https://www.siemens.com/us/en/company/topic-areas/cybersecurity/industrial-security/downloads.html>) to obtain more information on the topic of industrial cybersecurity. The "Operational Guidelines", for example, provide recommendations on basic security measures for secure machine and plant operation in an industrial environment.

4.4.2 Security management

The ISO 27001 and IEC 62443 standards call for a comprehensive approach in IT and OT to protect against cyberattacks.

Responsibility for cybersecurity and IT security

Every operator of machinery and equipment is responsible for:

- Establishment of cybersecurity and IT security as an important criterion in the procurement and selection of machines and software applications.
- Use of suitable measures to protect production resources, data, and communication from manipulation and theft
- Provision of all necessary resources and training to employees to fully support these goals

For this purpose, suitable measures must be selected after a risk assessment and a cost-benefit analysis in order to protect material and intellectual property and prevent damage from occurring. These measures should be integrated into corporate processes and procedures, evaluated regularly, and firmly anchored in the corporate culture. In addition to protecting intellectual property, the protection of personal data must be ensured at all organizational units and levels.

Siemens will provide you with information and support. Subscribe to the RSS feed (<https://www.siemens.com/cert>) for vulnerabilities. Register on mySiePortal (<https://sieportal.siemens.com/en-ww/home>) and create filters to be notified when important information is published. Consider using Siemens Cybersecurity Services.

Responsibility in the digital supply chain

Cybersecurity should play a critical role in the evaluation and procurement process. The entire life cycle of a product should be considered to ensure protection against current and future risks. These include, for example, security updates throughout the product life cycle, including guidelines for secure disposal of the product.

Siemens plans and announces the release of security updates, discontinuation of products and cancellation of product support.

Employee awareness

Regular training in cybersecurity and continuous testing of training success are essential so that cybersecurity measures are internalized in processes and work instructions. This involves general training in the use of software and IT hardware for company communication and as work tools, e.g.:

- secure handling of USB devices
- encrypted communication
- use of VPN
- rules for passwords and use of access
- setting up two-factor authentication
- educating employees about the dangers posed by malware, phishing, social engineering, etc.

Furthermore, if applicable, production equipment and software training should always include the topic of cybersecurity.

Maintaining the security concept through updates

Keeping software up-to-date is essential, for example, to benefit from the following measures:

- Implementation of new security strategies, protocols and techniques
- Closing of security vulnerabilities
- Elimination of security vulnerabilities

To this end, it is necessary to keep a constant eye on the further development of protective measures and, if necessary, the expansion of requirements.

It is recommended to:

- Set up notifications for (security) updates
- Subscribe to information on vulnerabilities
- Monitor and implement the further development of the technology, especially in the area of cybersecurity

In short: Always keep technology and knowledge up to date.

Consideration of the risks posed by cyber attacks in the Threat and Risk Assessment (TRA)

Make an inventory of all software, hardware, and infrastructure devices, in order to identify risks to the location or organization. Incident response procedures must be incorporated into all IT and manufacturing processes. The choice of risk mitigation measures should be based on a cost-benefit analysis and classification of risks. This is followed by the introduction of cybersecurity rules and procedures and the training of personnel.

Living the concept

Technical solutions alone are not sufficient to effectively counter threats. Cybersecurity must be part of the corporate culture and process landscape and must be internalized and lived by all employees.

Continuously monitoring the security situation

Continuous monitoring of the cybersecurity situation through:

- Setting anomaly references and creating allow and deny lists based on normal network communication and production machine behavior
- Establishment of an intrusion detection system (IDS) that generates alarms when unusual behavior occurs in the network
- Introduction of a Security Incident and Event Management (SIEM) system to collect, analyze, and evaluate events in real time to enable early countermeasures
- Measures regarding network security: e.g. network segmentation, firewalls, VPN, DMZ (demilitarized zones)

4.5 Operational environment and security assumptions

4.5.1 Intended use

SIMATIC products are intended for use in industry. If you plan to use the product in a different environment, check the conditions required for such use.

The product may be operated only by personnel qualified for the specific task in accordance with the relevant documentation, in particular its warning notices and safety information. Qualified personnel are those who, based on their training and experience, are capable of identifying risks and avoiding potential hazards when working with these products.

Operational reliability and intended use

Observe the "Special information" section in Introduction [\(Page 12\)](#).

Area of application

Observe the "Area of application" section in System overview [\(Page 61\)](#).

4.5.2 Requirements for the operational application environment and security assumptions

Siemens recommends the following security measures:

- Conducting a threat and risk assessment (as part of security management)
- Network security concepts
 - Network segmentation
 - Asset and network management
 - Network protection
 - Remote access
- Access control concepts (utilizing access control systems)
 - Physical protection
 - Physical enterprise security
 - Physical product security

Threat and Risk Assessment

Vulnerabilities and risks are identified, and countermeasures are proposed to ensure the security of the system, networks, and data.

Network security concepts

You can find information on network security in the white paper "Industrial Network Security Architecture", available from the Download Center (<https://www.siemens.com/us/en/company/topic-areas/cybersecurity/industrial-security/downloads.html>) on the Industrial Cybersecurity (<https://www.siemens.com/us/en/company/topic-areas/cybersecurity/industrial-security.html>) website.

Access control concepts

Physical protection

In addition to closing off and/or monitoring entire production facilities, it may be necessary to physically secure cabinets or even individual components such as circuit breakers.

Physical enterprise security

Physical enterprise security can be ensured by the following measures:

- Closed off and monitored company premises
- Access control, locks/card readers, and/or security personnel
- Accompaniment of non-employees by company personnel
- Employees are trained on and embrace security processes within the company

Physical production security

Physical production security can be ensured through measures such as:

- Separate access control for critical areas, such as production areas.
- Installation of critical components in lockable cabinets/control rooms with monitoring and alarm capabilities. The cabinets/control rooms must be secured with a cylinder lock. Do not use simple locks, such as universal, triangular/square, or double-bit locks.

4.7 Secure operation of the system

- Radio field planning to limit WLAN coverage areas, preventing them from extending beyond defined zones (e.g. factory floor).
- Guidelines that prohibit the use of external, insecure data storage media (such as USB flash drives) and IT devices (such as laptops) on systems.

4.6 Security properties of the devices

The security properties of the individual devices are listed in the Equipment Manuals.

4.7 Secure operation of the system

This section describes measures recommended by Siemens to protect your system from manipulation and unauthorized access.

4.7.1 Hardening measures

System hardening, also referred to simply as hardening, is the secure configuration of products or systems. The aim is to close vulnerabilities and take various measures to reduce the attack surfaces for cyberattacks.

Measures for system hardening include, for example:

- Secure configuration in which only software components and services actually needed for operation are installed or activated.
- Access control in which restrictive user and rights management system is implemented.

4.7.2 Secure configuration

Secure configuration involves control over all software components, along with their interfaces, ports, and services.

Activated services and ports pose a risk.

- One possible risk is unauthorized access to the network.
- Another risk is unauthorized access to programs.

To minimize risks, only the necessary services should be activated for all automation components.

- Take into account all activated services (especially web servers, FTP, remote maintenance etc.) in the security concept.
- Consider the default states of ports and services in your security concept.

You can find an overview of all ports and services used in the Communication Function Manual (<https://support.industry.siemens.com/cs/ww/en/view/59192925>).

4.7.3 Access control

In addition to physical protection, also establish logical safeguards to control access to your system:

- Use a restrictive user and rights management system (e.g. for accessing TIA Portal)
- Observe the information regarding password management in the section Protection (Page 203) and in the STEP 7 online help (TIA Portal).

4.7.4 Handling of sensitive data

When storing your security-relevant data on your PC, independently ensure secure data storage.

Observe also the section Data worth protecting (Page 47).

4.7.5 Regular firmware updates

NOTE

Outdated firmware versions might not be monitored for security vulnerabilities.

- Always keep your plant/products up to date to benefit from bug fixes and to minimize potential risks.
 - Use email notifications to be automatically informed about firmware updates.
-

There are two ways of being automatically informed about firmware updates:

- Use "Enable notification" and "Add to mySupport favorites" functions, see the section Notification of security updates (Page 33).
- Consult the firmware collection on SIOS. To do this, register in the download section on mySiePortal (<https://sieportal.siemens.com/en-ww/home>).

Observe also the basic cybersecurity information in the section Cybersecurity information. For more information, see also section Firmware update (Page 291).

4.7.6 Notifications about security vulnerabilities (Siemens Security Advisories)

A vulnerability is a security vulnerability in information security. It can pose a threat as it provides intruders with the opportunity to access system resources and manipulate or steal data.

Siemens ProductCERT

When Siemens identifies Vulnerabilities in their products, this is published in Security Advisories.

You can find the documents for SIMATIC on the following Siemens AG Web page: Siemens ProductCERT and Siemens CERT

(<https://new.siemens.com/global/en/products/services/cert.html?s=SIMATIC#SecurityPublications>)

Enter "SIMATIC" in the search box "Search Security Advisories".

On this page, you will also find all necessary information on handling vulnerabilities:

- Contact persons for matters related to vulnerabilities
- Options for automated notifications regarding vulnerabilities
- Notifications are also possible in CSAF format
- Option to subscribe to RSS feeds and newsletters
- List of all current vulnerabilities and detailed information such as:
 - Description
 - Score according to Common Vulnerability Scoring System (CVSS)
 - Measures
 - Availability
 - Etc.
- Report possible vulnerabilities yourself at (<https://new.siemens.com/global/en/products/services/cert.html#ContactInformation>)

Set up an RSS feed to receive notifications about security-related topics.

4.7.7 Data backup

Secure your configuration and parameter settings so that you can quickly restore this data if needed.

4.7.8 Security checks

Security checks for data, files and archives serve to protect data integrity at the storage location and during file transfer from manipulation and transmission errors. This is often achieved using digital checksums that are provided alongside the data. Tools (such as SHA-256 or SHA-512) for calculating and verifying these checksums are provided in many systems and named according to their respective calculation methods.

- File Integrity Guidelines describe the prescribed procedure for integrity checks
- Integrity protection is a protection function for engineering data and firmware files
- Communication integrity means protecting communication against unauthorized manipulations to ensure high system availability. A central element in this regard is, for example, the use of digital checksums when accessing controllers. (Source: Industrial Cybersecurity website (<https://www.siemens.com/us/en/company/topic-areas/cybersecurity/industrial-security.html>))

4.7.9 Secure decommissioning

In the following section, you will find information on how to properly decommission individual components of your automation system. Decommissioning is necessary when the component has reached the end of its service life.

Decommissioning includes environmentally sound disposal and secure removal of all digital data of electronic components with storage medium.

4.7.9.1 Securely removing data

Before disposing of components of your automation system, you should securely delete all data from the storage media of these components. How to securely delete data from the devices so that it cannot be recovered is described below.

NOTICE
Data misuse resulting from non-secure deletion of data
Incomplete or non-secure deletion of data from data memories can result in data misuse by third parties.
For this reason, ensure secure deletion of data from all storage media used before disposing of the product.

Secure erasure of data from the CPU and SIMATIC Memory Card

To delete all data from the data memories of the CPU, reset the CPU to factory settings. The function deletes all information that was saved internally on the module.

For secure deletion of the data, follow these steps in the order given:

1. Format the SIMATIC Memory Card.

The formatting deletes all contents from the SIMATIC Memory Card.

Formatting with STEP 7:

- Establish an online connection.
- Open the online and diagnostics view of the CPU (either from the project context or via "Accessible devices").
- In the dialog window, select "Functions > Format memory card" and then click the "Format" button.

2. Reset the CPU to factory settings.

We recommend resetting the CPU in STEP 7. When you reset a CPU to factory settings, select the options shown in the figure before the reset.

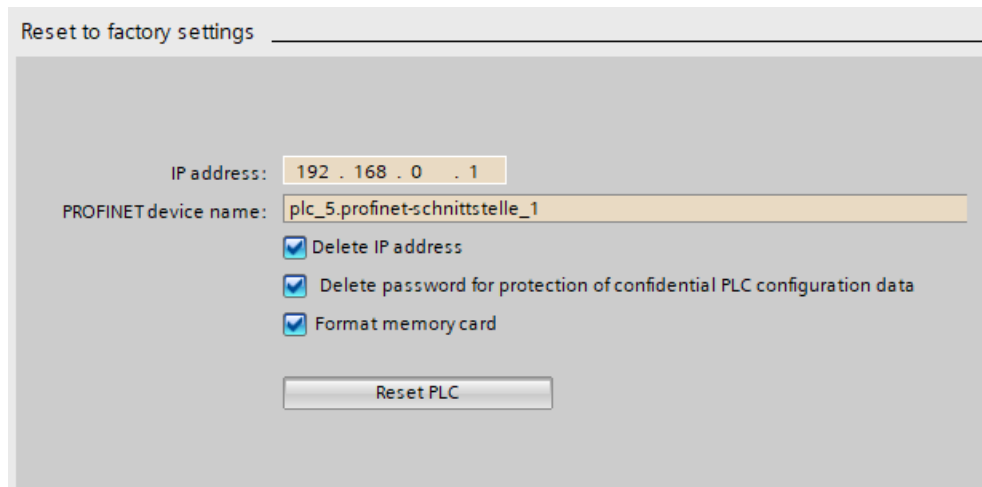

Figure 4-1 Resetting the CPU to factory settings

NOTE

If you reset the CPU using STEP 7 and you have selected the "Format memory card" option, you can skip step 1 of the described sequence of steps.

Result: All data that was still contained in the data memories of the modules and the SIMATIC Memory Card has been deleted. You can now dispose of the components.

For more information on resetting the CPU to factory settings, refer to the section [Resetting the CPU to factory settings \(Page 298\)](#).

NOTE

If you no longer plan to use the SIMATIC Memory Card after formatting it, destroy it before disposing of it.

A secure destruction method is to shred the card to such a degree that it cannot be reconstructed. For this, you can also use a waste disposal service that specializes in data storage medium destruction.

Secure erasure of data from the interface module

With the following tools, you can securely erase the data from the interface module:

- STEP 7 < V19
- SIMATIC Automation Tool
- MultiFieldbus Configuration Tool (MFCT)
- PRONETA

Follow these steps in the order given:

1. Establish an online connection.
2. Open the Online and Diagnostics view of the IM (either from the project context or via "Accessible devices").
3. In the dialog box "Functions > Reset to factory settings", select the option "Delete I&M data" and then the "Reset" button.

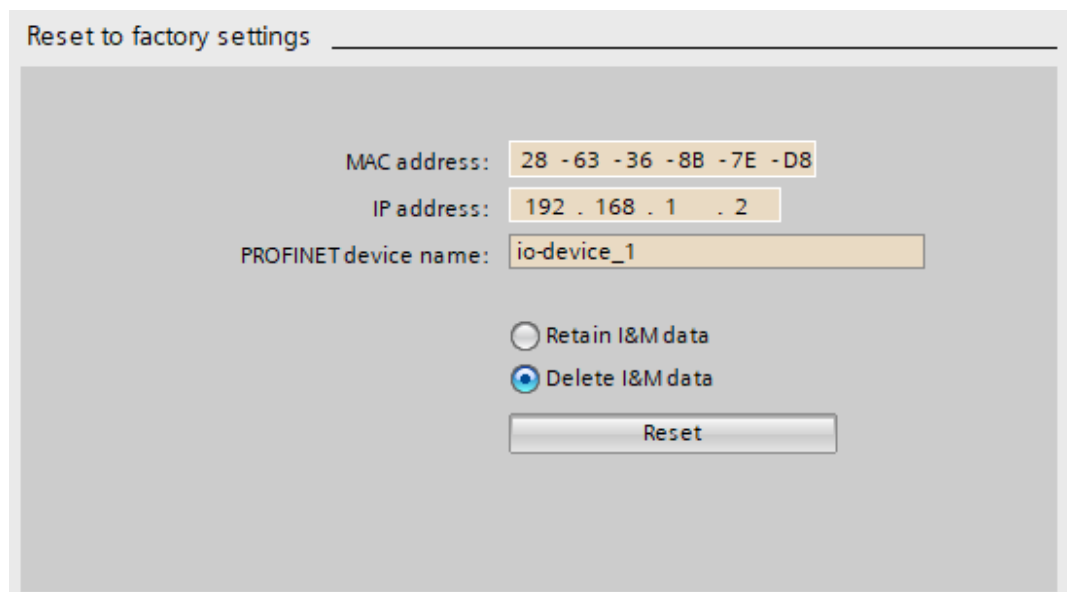

Figure 4-2 Resetting an interface module to factory settings

Result: All the data that was still in the data memories of the interface module was deleted. You can now dispose of the components.

For more information on resetting the interface module to factory settings, refer to the section [Resetting an interface module to factory settings \(Page 301\)](#).

NOTE

TIA Portal V19

Only the communication parameters will be securely deleted on "Reset to factory settings" with the "Delete I&M data" option enabled when you use TIA Portal V19.

Deleted communication parameters:

- IP address
- Device name
- PROFINET configuration data

If you want to securely remove all data, use one of the tools listed above for this purpose.

4.7.9.2 Recycling and disposal

For environmentally sustainable recycling and disposal of your old equipment, contact a certified electronic waste disposal service and dispose of the equipment according to the applicable regulations in your country.

4.8 Secure operation of the engineering software

For more information on secure operation of the engineering software, refer to the TIA Portal online help.

4.9 Secure operation of CPUs

This section describes measures recommended by Siemens to protect your device from manipulation and unauthorized access.

4.9.1 Secure configuration

Information about ports, services and default states can be found in the Communication Function Manual (<https://support.industry.siemens.com/cs/ww/en/view/59192925>) and the Equipment Manual.

4.9.2 User management and access control

4.9.2.1 Administration of user accounts

Creating and managing user accounts with appropriate usage rights is an important measure, as every active user represents a potential security risk.

Take the following security measures:

- Train your personnel in understanding their rights and password assignment
- Regularly check the user accounts

You can find information on creating and managing user accounts in the section Local user management ([Page 204](#)) and in the STEP 7 online help (TIA Portal).

4.9.2.2 Assigning secure passwords

Using non-secure passwords can easily lead to data misuse. Non-secure passwords can be easily guessed or decrypted.

- Therefore, always change the default passwords during commissioning and use different passwords for different functions and devices.
- When changing passwords, do not use passwords (or parts of passwords) that have been used in the past.
- Also, change passwords for functions you don't personally use to prevent misuse of such unused functions.
- Always keep your passwords confidential and ensure that only authorized individuals have access to the respective passwords.
- Exceed the required minimum password length and use a combination of lowercase letters, uppercase letters, numbers and special characters.

You can find information on assigning secure passwords in the STEP 7 online help (TIA Portal).

Overview of all components and functions with password protection

Components and functions with password protection	Comment
SIMATIC S7 app	See the section SIMATIC S7 app (https://new.siemens.com/global/en/produkte/software/mobile-apps/simatic2go.html)
CPU	See the Communication Function Manual (https://support.industry.siemens.com/cs/ww/en/view/59192925), section Secure Communication
OPC UA	See the Communication Function Manual (https://support.industry.siemens.com/cs/ww/en/view/59192925), section OPC UA Communication
SNMP Community-String (similar to a password)	See the Communication Function Manual (https://support.industry.siemens.com/cs/ww/en/view/59192925), section SNMP
Secure communication (with certificate protection)	See the Communication Function Manual (https://support.industry.siemens.com/cs/ww/en/view/59192925), section Secure Communication
Web server	See the Web Server Function Manual (https://support.industry.siemens.com/cs/ww/en/view/59193560)

4.9.2.3 Password management

- You can find comprehensive recommendations for assigning secure passwords in the Industrial Security Configuration Manual (<https://support.industry.siemens.com/cs/us/en/view/108862708>).
- Set guidelines for assigning passwords and intervals for password changes.
- Settings can be made in the TIA Portal to check new or changed passwords for adherence to the guidelines. You can find more information in the Communication Function Manual (<https://support.industry.siemens.com/cs/ww/en/view/59192925>).
- Changing and resetting the password for protection of confidential configuration data. You can find information on the following topics in the Communication Function Manual (<https://support.industry.siemens.com/cs/ww/en/view/59192925>):
 - Description on how to change the password
 - Description on how to delete or reset the password
 - Description on how to assign the password via a SIMATIC Memory Card.
- For user management and access control, use the Local user management.
- Using a password provider: A password provider can be set up in STEP 7, see the section Know-how protection (Page 216).
- Alternatively, commercially available password management programs can be used.

See also

[Local user management \(Page 204\)](#)

4.9.2.4 Setting protection levels

For detailed information about setting up protection levels for the CPU and assigning user authorizations, refer to the Configuring access protection for the CPU (Page 213) section and the STEP 7 online help (TIA Portal).

4.9.2.5 Certificate management

You can find all the relevant information about "Certificate management" in the Communication Function Manual (<https://support.industry.siemens.com/cs/ww/en/view/59192925>).

4.9.3 Protection functions

Integrated protection functions of the CPU protect against unauthorized access.

You can find an overview of the protection functions supported by your CPU in the respective equipment manual.

A description of the protection functions and their activation can be found in the section Protection (Page 203).

4.9.4 Web server

The CPUs of the S7-1500 series have an integrated Web server.

It comes with built-in security features:

- Access via the secure transmission protocol "HTTPS" using the CA-signed Web server certificate
- User authorization you can configure by means of user list
- Activation for specific interfaces

The functions are described in detail in the Web server

(<https://support.industry.siemens.com/cs/ww/en/view/59193560>) Function Manual.

4.9.5 Secure Communication/OPC UA

Additional protection is provided by the protection functions of the secure communication and OPC UA protocols.

Information about the protocols Secure Communication and OPC UA can be found in the Communication Function Manual

(<https://support.industry.siemens.com/cs/ww/en/view/59192925>).

4.9.6 Sensitive data

Security-relevant and sensitive data can be protected through appropriate measures such as passwords and protection functions.

For certain data, protection is already essential and implemented within the system (e.g. certificate management in the TIA Portal).

Sensitive data	Comment	Where can I find more information?
Confidential configuration data (private keys, passwords/access data)	Protection by using a strong password	Communication Function Manual (https://support.industry.siemens.com/cs/ww/en/view/59192925), section Protection of confidential configuration data
User management data	-	STEP 7 online help
Configuration of CPUs and interface modules	Protection through PROFINET Security Class 1	PROFINET with STEP 7 Function Manual (https://support.industry.siemens.com/cs/ww/en/view/49948856)
Blocks (data blocks, logic blocks)	Know-how protection, copy protection, write protection	Section Protection (Page 203)
Data deemed sensitive by the operator	Backups, other configuration data, analysis data	Section Backing up and restoring the CPU configuration (Page 269)

4.9.7 Backups and data backups

Regular backups or data backups after successful installation should be part of a successful security concept. Whether for restoring a project if required, if the changes made do not yield the desired results, or for saving an installation in an emergency.

Options for backing up STEP 7 project:

- Project backup via online backup, see article Online backup (<https://support.industry.siemens.com/cs/us/en/view/109759862/91508694411>)
- Project backup via the TIA Portal, see article What options are there in STEP 7 (TIA Portal) for backing up projects and what is the significance of the backup files of the projects? (<https://support.industry.siemens.com/cs/us/en/view/92561565>)

You can find more information in the section Backing up and restoring the CPU configuration (Page 269).

4.9.8 Additional measures for network security

To secure a CPU via further measures, the following options are available:

- Deployment of CP 1543SP-1 with security functions
The CP 1543SP-1 features security functions for network security, such as firewall and VPN. This enables secure access to the ET 200SP. See also the Operating Instructions SIMATIC NET, CP 1543SP-1 (<https://support.industry.siemens.com/cs/us/en/view/109741690>).
- The following measures additionally increase the protection against unauthorized access to functions and data of the CPU from external sources and via the network: You can find information on these topics in the section Further measures for protecting the CPU in Overview of the protective functions of the CPU (Page 203).
- You can find information on network security and network components for protection from unauthorized access in the PROFINET Function Manual (<https://support.industry.siemens.com/cs/ww/en/view/49948856>), section Network security.

4.9.9 Remote access to CPU

4.9.9.1 Using a Web server

When using Web servers, traditional firewalls are no longer sufficient to protect modern networks.

You can find information on potential risks when using web servers in the Web Server Function Manual (<https://support.industry.siemens.com/cs/ww/en/view/59193560>).

4.9.10 Recording Security events

Syslog storage

Syslog stands for "System Logging Protocol", a standard for storing, transmitting and collecting log messages triggered by security events. Predefined events in a network device are collected as security events in the device (syslog client) and stored as syslog messages in the local cache.

A syslog server collects and categorizes syslog messages, which can then be analyzed and filtered and displayed in various ways. Additionally, notifications for critical events can be configured.

These security events are collected in the CPU diagnostic buffer:

- Going online with the correct or incorrect password
- Manipulated communication data detected
- Manipulated data detected on memory card
- Manipulated firmware update file detected
- Changed protection level (access protection) downloaded to the CPU
- Password legitimization restricted or enabled (via an instruction or, if applicable, the CPU display)
- Online access denied due to the possible number of simultaneous access attempts being exceeded
- Timeout when an existing online connection is inactive
- Logging on to the Web server with the correct or incorrect password
- Creating a backup of the CPU
- Restoring the CPU configuration (Restore)

The above-listed security events are also stored as syslog messages in the local cache of a CPU as of firmware version V3.1. You can find an overview of all syslog messages in the following Entry (<https://support.industry.siemens.com/cs/ww/en/view/109823696>).

The content of a syslog message is based on IEC 62443-3-3.

You can find more information in the section Syslog messages ([Page 50](#)).

Connection to a SIEM system

A SIEM system (Security Information and Event Management) analyzes security events in real time and can be installed, for example, on the syslog server.

4.9.11 Syslog messages

4.9.11.1 Introduction

Using syslog messages

International standards and national regulations for the IT security of automation components require, for example, the ability to log safety-related events.

Syslog (System Logging) is an IETF standard protocol (RFC 5424) for the transfer of recorded events and meets this requirement. A CPU records the following events, for example:

- Security events
- Firmware updates
- Changes to the user program
- Changes to the configuration
- Changes to the operating state

The collecting of security-relevant events cannot be deactivated. Each CPU as of FW version V3.1 saves syslog messages in a local cache. By querying this cache, you can view the syslog messages and identify potential security risks.

The local cache of a CPU is organized as a ring buffer. If the storage limit of the cache is reached and additional security events occur, the oldest messages in the cache are overwritten.

If you want to access the local cache with the syslog messages, use the Web API of the web server (API method Syslog.Browse). You can find information on the procedure in the "Web server (<https://support.industry.siemens.com/cs/us/en/view/59193560>)" Function Manual.

You have the option of transferring the events collected by the CPU to a syslog server in the network.

Forwarding to a syslog server

From STEP 7 V19 and a CPU as of FW version V3.1, it is possible to transfer syslog messages to a server, e.g. SINEC INS. The syslog messages are transferred to the syslog server via the syslog protocol. The syslog server saves all syslog messages from its connected devices. Messages of system and network events are stored centrally in a storage location in the syslog server. At the syslog server interface, you can view the collected syslog messages and thereby determine the source of potential security risks or problems.

Syslog messages are sent to the syslog server via port 514 (UDP) or port 6514 (TLS over TCP) by default.

NOTE

If you are using UDP as the transport protocol, the data is transmitted unencrypted. Authentication is also omitted with UDP.

Processing in a Security Information and Event Management system (SIEM system)

In order to be able to accept the incoming syslog messages, a SIEM-system must understand the syslog protocol according to RFC 5424. Otherwise, the SIEM system cannot accept or process the incoming messages.

The SIEM system breaks down the incoming syslog messages into individual elements. These elements are assigned to their own event within the SIEM system. Within this event, it is analyzed whether there are connections between the individual syslog messages. In this way, the SIEM system detects possible attack vectors and, if necessary, informs the user, e.g. in the event of multiple attacks at several points in the system.

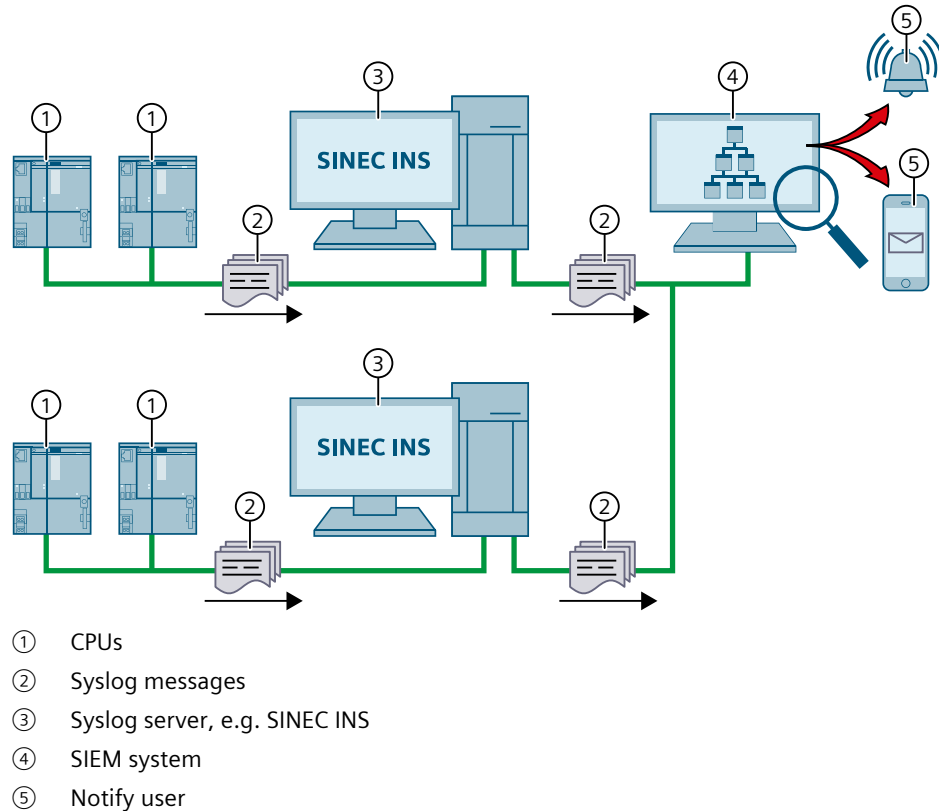

Figure 4-3 Forwarding and processing of syslog messages

More information

More information on network management with SINEC INS is available in the "SIMATIC NET: Network management SINEC INS V1.0 SP2"

(<https://support.industry.siemens.com/cs/us/en/view/109781023>) manual.

You can find information on the structure of syslog messages in the Structure of the Syslog messages (Page 55) section.

4.9.11.2 Transfer the syslog messages to a syslog server

Requirements

If you want to transfer the syslog messages of a CPU to a syslog server, the following requirements must be met:

- STEP 7 as of version V19
- CPU as of FW version V3.1
- A project has been created in STEP 7
- The device or network view of STEP 7 is open

Procedure

To configure the CPU to transfer syslog messages to a syslog server, following these steps:

1. Select the required CPU in the device or network view of STEP 7.
2. In the Inspector window, navigate to "Properties > Protection & Security > Syslog > Syslog server".
3. In the "Connection to syslog server" area, select the "Enable transfer of syslog messages to a syslog server" option. The selection options below become editable.
4. Select one of the following options from the "Transport protocol" drop-down list:
 - "Transport Layer Security (TLS) - server and client authentication": Encrypted data transfer, syslog server and client (CPU) must authenticate themselves.
 - "Transport Layer Security (TLS) - only server authentication": Encrypted data transfer, only the syslog server needs to authenticate itself.
 - "UDP": Unencrypted data transfer, syslog server and client (CPU) do not need to authenticate themselves.

In the next sections you can read how to select the certificates for authentication (logon) depending on the settings specified.

5. In the "Addresses of the syslog servers" column, enter a valid server address.
6. In the "Port" column, enter one of the following port numbers depending on the transport protocol used:
 - Standard TCP port for TLS: 6514
 - Standard UDP port: 514

Result: You have configured the transfer of syslog messages to a syslog server.

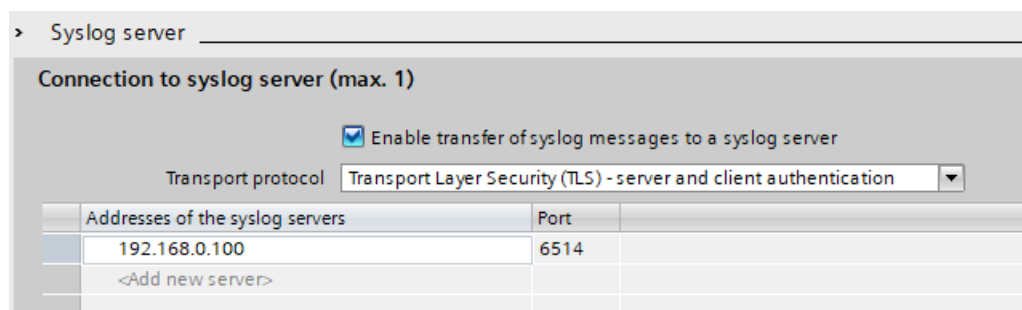
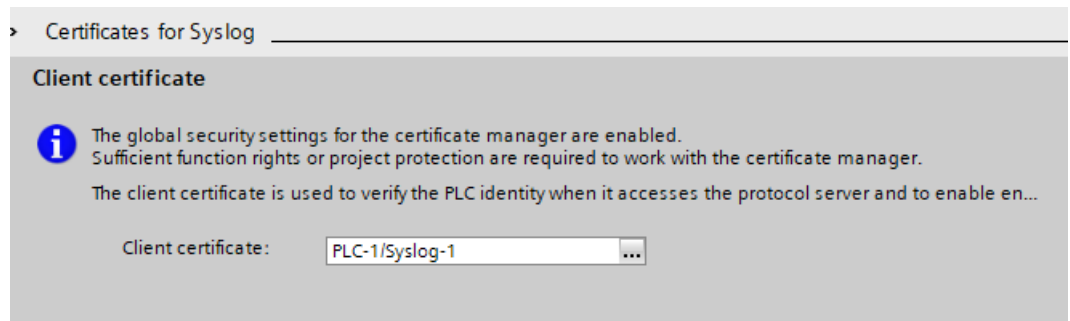

Figure 4-4 Transfer of syslog messages to a syslog server configured

Selecting the client certificate

STEP 7 provides the required client certificate for a CPU for the TLS transport protocol. If the certificate is managed within the CPU, you can either choose an existing certificate or create a new certificate. To do so, follow these steps:

1. Select the required CPU in the device or network view of STEP 7.
2. In the Inspector window, navigate to "Properties > Protection & Security > Syslog > Certificates for Syslog".
3. Select the appropriate certificate in the "Client certificate" field.



Selecting the server authentication

After selecting the TLS transport protocol, the configured syslog server must authenticate itself. This ensures that the CPU only connects to a trusted server. If you want to waive server authentication, activate the automatic acceptance of server certificates during runtime. To configure these settings, follow these steps:

1. Select the required CPU in the device or network view of STEP 7.
2. In the Inspector window, navigate to "Properties > Protection & Security > Syslog > Certificates for Syslog".
3. In the "Trusted servers" area, specify whether the connected syslog server is to be authenticated. In this case, it is necessary to complete the following information:
 - Add trusted server: Add a valid server certificate in the "Common name of subject" column.
 - Automatically accept certificates during runtime: Activate the "Automatically accept server certificates during runtime" option. Editing in the table is then not possible.

NOTE

No authentication with automatically accepted server certificates

If you enable the "Automatically accept server certificates during runtime" option, a server does not need to authenticate itself. This means that the CPU can also connect to unknown servers that could represent a security risk.

Only select this option during commissioning or in a protected environment.

4.9.11.3 Structure of the Syslog messages

A CPU collects syslog messages in a local cache. These syslog messages are structured according to the syslog protocol (RFC 5424) and consist of the following elements:

- HEADER
- STRUCTURED-DATA
- MSG (Message)

The following sections describe the structure and parameters of the individual elements.

Structure of the HEADER element

The header contains all the data required for further processing of the syslog message. A space separates the individual parts of the header (exception: No space between PRI and VERSION). A CPU transmits the following header in syslog messages, for example:

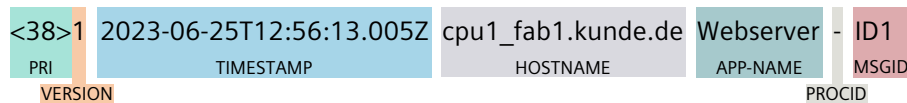

Figure 4-5 Example: HEADER of the syslog message of a CPU

The following table describes the parameters in the prescribed order.

Parameter	Description
PRI	<p>PRI encodes the priority of the syslog message, divided into Severity (severity of the message) and Facility (origin of the message). The PRI value is formed as follows:</p> <ul style="list-style-type: none"> • $PRI = Facility \times 8 + Severity$ <p>Possible values:</p> <ul style="list-style-type: none"> • Severity <ul style="list-style-type: none"> – 0 = Emergency: system is unusable – 1 = Alert: action must be taken immediately – 2 = Critical: critical conditions – 3 = Error: error conditions – 4 = Warning: warning conditions – 5 = Notice: normal but significant condition – 6 = Informational: informational messages – 7 = Debug: debug-level messages • Facility <ul style="list-style-type: none"> – 1 = User-level messages – 2 = Mail system – 3 = System daemons – 4 = Security/authorization messages – 5 = Messages generated internally by syslog – 6 = Line printer subsystem – 7 = Network news subsystem – 8 = UUCP subsystem – 9 = Clock daemon – 10 = Security/authorization messages – 11 = FTP daemon – 12 = NTP subsystem – 13 = Log audit – 14 = Log alert <p>A CPU does not use all of the listed severity/facility values.</p>

Parameter	Description
VERSION	Version number of the syslog specification.
TIMESTAMP	The device sends the time stamp in the format "2023-06-25T12:56:13.005Z" as UTC time without time zone and correction for daylight-saving/standard time.
HOSTNAME	Contains the name or IP address of the device or system from which the syslog message has been sent. IPv4 address according to RFC1035: Bytes in decimal representation: XXX.XXX.XXX.XXX IPv6 address according to RFC4291 Section 2.2 "-" is output if information is missing.
APP-NAME	Contains the component (device part or application) from which the message has been generated. "-" is output if information is missing.
PROCID	The process ID serves to clearly identify the individual processes, for example during analysis and troubleshooting. "-" is output if information is missing.
MSGID	ID to identify the message. "-" is output if information is missing.

Structure of the STRUCTURED-DATA element

STRUCTURED-DATA provides information in an interpretable and decomposable data format. The following applications are possible, for example:

- More information about the syslog message
- Application specific information

STRUCTURED-DATA can contain one or more elements (SD-ELEMENT). Each SD element must be enclosed in square brackets. If STRUCTURED-DATA consists of multiple SD elements, the individual SD elements are separated by a space.

Each SD-ELEMENT consists of its name (SD-ID) and one or more name-value pairs (SD-PARAM). Each name-value pair consists of a parameter name (PARAM-NAME) and the associated value (PARAM-VALUE). A space separates the individual components (SD-ID and SD-PARAM) within an SD element.

A CPU transmits the following SD ELEMENT in a syslog message, for example:

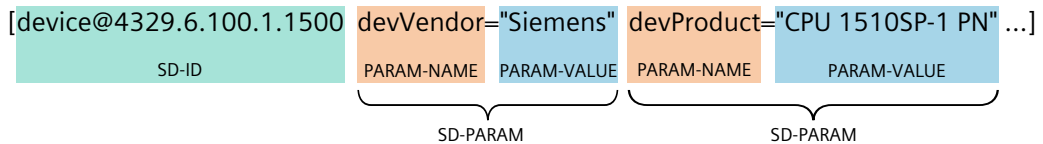

Figure 4-6 Example: SD ELEMENT of the syslog message of a CPU

Structure of the MSG element

In the MSG (MESSAGE) element, a CPU transmits the simplified name of the event in English. The following table shows what the content of a message of the MESSAGE element can look like.

MESSAGE	Description
SE_LOCAL_SUCCESSFUL_LOGON	The local logon has been successful (e.g. on the operator display of the CPU).

More information

You can read more information about the structure and transmission of syslog messages in the following RFCs (Request for Comments):

- The syslog protocol (RFC 5424) (<https://tools.ietf.org/html/rfc5424>)
- Transferring syslog messages via Transport Layer Security (RFC 5425) (<https://tools.ietf.org/html/rfc5425>)
- Transferring syslog messages via UDP (RFC 5426) (<https://tools.ietf.org/html/rfc5426>)

4.10 Secure operation of interface modules

Device-specific security information and instructions for interface modules can be found in the respective Equipment Manual.

4.10.1 Data integrity

Data integrity refers to the completeness and correctness (integrity) of data, which is an essential prerequisite for the proper functioning of systems.

Measures for data privacy, data consistency, and data security ensure that data used within devices cannot be damaged, altered (manipulated), or deleted during processing or transmission, and at the very least, any changes to the data are detected.

Data integrity for interface modules

To detect intentional or accidental changes to data within an interface module and its associated modules, the possibility of dynamic integrity checking is introduced for PROFINET interface modules.

The ability to detect integrity breaches enhances the resilience of the distributed I/O system. Data integrity within a distributed I/O system is entirely covered within the interface module and does not pertain to other components of the automation system.

Principle

The interface module calculates checksums based on its used data and the supplied data from the associated modules, such as parameter settings, IP address, device name, MAC address and I&M data. The interface module stores the checksums in the I&M4 data area.

A CRC (Cyclic Redundancy Check) is always the same for a specific, unchanged memory content. When the memory content changes, the interface module (IM) calculates a different checksum for this content by reading and comparing the I&M4 data. By comparing with the initial CRC, you can determine whether the data in the memory has been modified or not:

- CRC stayed the same: No change in the data within this memory area of the interface module IM
- CRC changed: The data within this memory area of the IM was modified

Only you, as the user, know whether changes to the data of an interface module were intentional or not. If changes were not intentional, you can detect that the data of the interface module has been compromised through changed CRCs and respond accordingly.

I&M data

PROFINET devices provide Identification and Maintenance data (I&M data), which is a set of predefined data structures containing the internal module status. With this data, a module can be identified, its serial number can be determined, etc.

The CRC checksums are mapped in the maintenance data **I&M4** of the interface module.

NOTE

Requirements for calculating the CRCs

The CRCs via the memory contents of the interface module are calculated only when you request to read the I&M4 data.

The CRCs cover not only the interface module itself but can also take into consideration combined checksums from associated modules (refer to the section on the structure of the data record for I&M data). Process data is not included in the calculation of CRCs.

Example:

- You put your distributed I/O system into operation and read the CRC CHK_OVERALL with the value "0x55AAA678" ("16#55AAA678") from the interface module via the I&M4 data.
- As long as no changes have been made to the data of the interface module or the associated modules, each subsequent read will give the value "0x55AAA678" or "16#55AAA678".
- Once you read a different CRC CHK_OVERALL, for example, "0xCC9876FF", you will realize that there must have been changes to the data of the interface module or the associated modules.

The quality of the statement regarding the data integrity of the distributed I/O system improves with each module associated with the interface module that supports I&M4 data. Refer to the Equipment Manual of the respective module to find out if and from which firmware version the module supports I&M4 data.

You can find the structure of I&M data 0 to 4 in the section "Record structure for I&M data".

Spare parts scenario

The spare parts scenario is still ensured. This means that you can replace interface modules with the same article number. For the "new" interface module, the static data such as the serial number and MAC addresses will change. Note that this is why the replacement will be reflected in the changed identification data `CHK_STATIC_LOCAL` and consequently also in `CHK_OVERALL`.

More information on the spare parts scenario and compatibility can be found in the Equipment Manual of the interface module.

4.10.2 Signed firmware update

Signed firmware update

A signed firmware update ensures the authenticity and integrity of the firmware loaded onto a device.

It protects you against installing malicious firmware in case:

- Firmware was modified
- Firmware was downloaded from an incorrect internet source

Principle of signed firmware updates for interface modules

Firmware updates for interface modules starting from article number 6ES7155-6AU02-0BNO include a digital signature. The digitally signed firmware update files are available for download on the Siemens Support website.

The interface module verifies the authenticity and integrity of the firmware update file before installation using the digital signature with standardized asymmetric cryptography methods. As a result, the interface module can detect a manipulated or corrupted firmware update file and reject it.

Note that the interface module performs the verification only after the complete firmware download has taken place.

Subsequently, a notification is sent to the firmware update tool regarding the success or failure of the signature verification.

You still have all the options for firmware updates, as described in the Firmware update section, when performing signed firmware updates for interface modules.

Diagnostics alarms and remedy

When performing a firmware update for an interface module with an established connection between the IM and CPU, there are the following options for notifications in the CPU's diagnostic buffer:

- Successful integrity check of the firmware for the interface module
- Rejection of non-secure firmware for the interface module

You can find more information in the channel diagnostics table in the equipment manual of the interface module.

In case of firmware update rejection, proceed as follows:

1. Verify if the firmware update file you are using comes from a secure source.
2. Download the firmware again from the Siemens Support website.
3. Repeat the firmware update.

4.11 Secure operation of I/O modules

Device-specific security information and instructions for I/O modules can be found in the respective Equipment Manual.

4.12 Secure operation of the power supply modules

Device-specific security information and instructions for the power supply modules can be found in the respective Equipment Manual.

System overview

5.1 What is the SIMATIC ET 200SP distributed I/O system?

SIMATIC ET 200SP

SIMATIC ET 200SP is a scalable and highly flexible distributed I/O system for connecting process signals to a higher-level controller via a fieldbus.

Customer benefits of the system



Figure 5-1 SIMATIC ET 200SP distributed I/O system - Customer benefits

Area of application

Thanks to its multifunctionality, the SIMATIC ET 200SP distributed I/O system is suitable for a wide range of applications. Its scalable design allows you to tailor your configuration to local requirements. Various CPUs/interface modules are available for connection to PROFINET IO, PROFIBUS DP, EtherNet/IP or Modbus TCP.

SIMATIC ET 200SP with CPU allows intelligent pre-processing to relieve the higher-level controller. The CPU can also be used as standalone device.

By using fail-safe CPUs, you can implement applications for safety engineering. Configuration and programming of your safety program takes place the same way as for standard CPUs.

An extensive range of I/O modules extends the area of application of the ET 200SP system. SIMATIC ET 200SP is designed with degree of protection IP20 and is intended for installation in a control cabinet.

With use of an ET 200SP R1, you increase the availability of the system through redundant interface modules.

Configuration

The SIMATIC ET 200SP distributed I/O system is installed on a mounting rail. It consists of:

- CPU/interface module
- Up to 64 I/O modules, which can be plugged into BaseUnits in any combination
- Up to 31 motor starters
- A server module that completes the configuration of the ET 200SP.

Configuration example

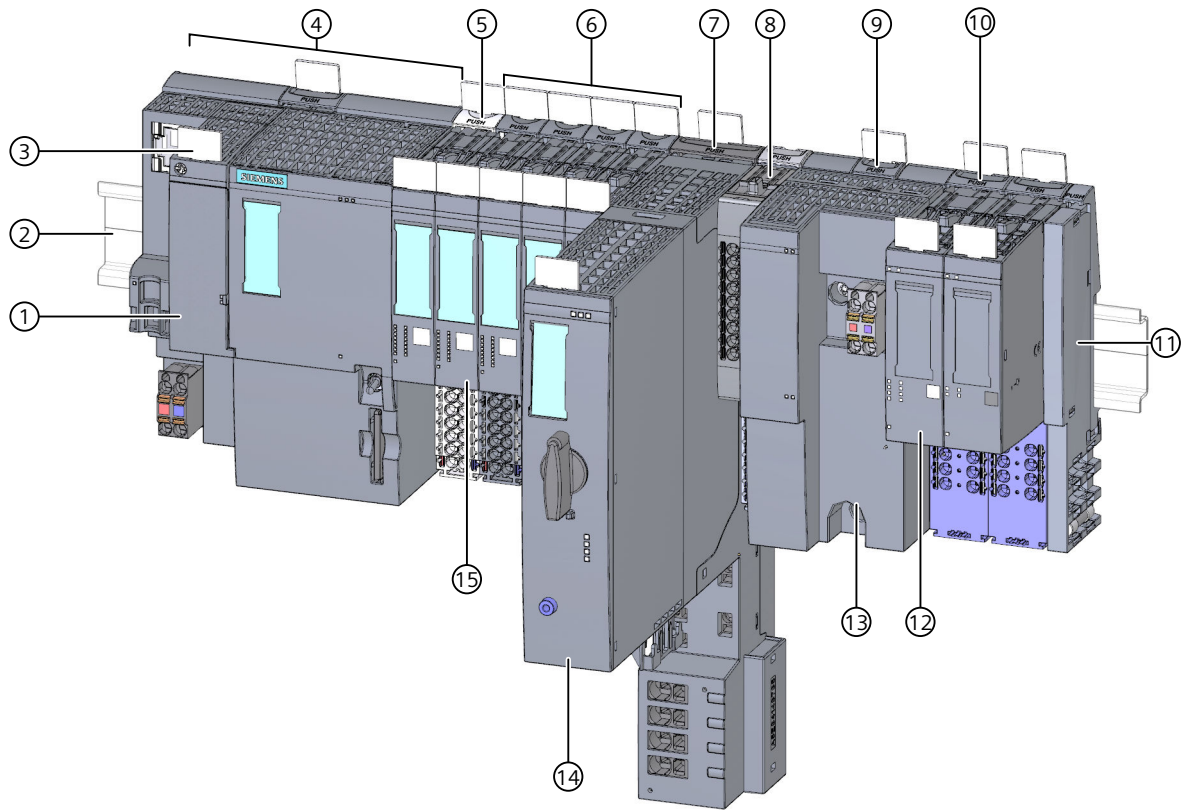

- ① BusAdapter
- ② Mounting rail
- ③ Reference identification label
- ④ CPU/interface module
- ⑤ Light-colored BaseUnit BU..D with infeed of supply voltage
- ⑥ Dark-colored BaseUnits BU..B for conducting the potential group further
- ⑦ BaseUnit for motor starters
- ⑧ Potential distributor module
- ⑨ Ex BaseUnit for Ex power module
- ⑩ Ex BaseUnit for Ex I/O module
- ⑪ Server module (included in the scope of supply of the CPU/interface module)
- ⑫ Ex I/O module
- ⑬ Ex power module
- ⑭ ET 200SP motor starter
- ⑮ I/O module

Figure 5-2 Configuration example of the ET 200SP

5.2 What are fail-safe automation systems and fail-safe modules?

Fail-safe automation systems

Fail-safe automation systems (F-systems) are used in systems with higher safety requirements. F-systems control processes and ensure that they are in a safe state immediately after shutdown. In other words, F-systems control processes in which an immediate shutdown does not endanger persons or the environment.

Safety Integrated

Safety Integrated is the integrated safety concept for automation and drive technology from Siemens.

Proven technologies and systems from automation technology are used for safety systems. Safety Integrated includes the complete safety sequence, ranging from sensor, actuator and fail-safe modules right through to the controller, including safety-related communication via standard fieldbuses. Drives and controllers handle safety tasks in addition to their actual functions.

Fail-safe modules

The key difference between fail-safe modules (F-modules) and standard modules is that they have an internal two-channel design. This means the two integrated processors monitor each other, automatically test the input and output circuits, and switch the fail-safe module to a safe state in the event of a fault.

The F-CPU communicates with a fail-safe module via the safety-related PROFIsafe bus profile.

Fail-safe motor starters

Fail-safe motor starters enable safety-related tripping of motor loads. Fail-safe motor starters are not PROFIsafe nodes. Motor starters operate together with the fail-safe modules of the ET 200SP system.

Area of application of ET 200SP with fail-safe I/O modules

By using the ET 200SP distributed I/O system with fail-safe I/O modules, you are replacing conventional safety engineering configurations. This includes the replacement of switching devices for emergency STOP, protective door monitors, two-hand operation, etc.

5.3 How are SIMATIC Safety F-systems structured with ET 200SP?

SIMATIC Safety F-system with ET 200SP

The figure below shows an example of a configuration for a SIMATIC Safety F-system with ET 200SP distributed I/O system and PROFINET IO. You can configure the PROFINET IO lines with copper cable, fiber-optic cable or WLAN.

Fail-safe I/O modules and non-fail-safe I/O modules can be combined in an ET 200SP configuration.

The fail-safe IO controller (F-CPU) exchanges safety-related and non-safety-related data with fail-safe and non-fail-safe ET 200SP modules.

ET 200SP Fe.g. CPU 1512SP F-1 PN and CM DP

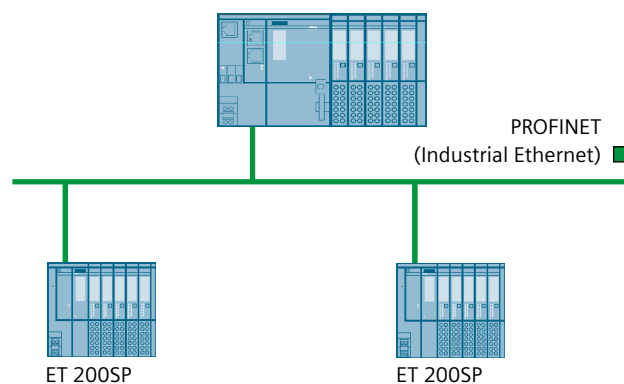

Figure 5-3 Fail-safe SIMATIC Safety automation system (sample configuration)

Fail-safe ET 200SP I/O modules

The following fail-safe I/O modules are available for the ET 200SP distributed I/O system:

- Fail-safe power modules are used to supply the potential group load voltage and for the safety-related tripping of the load voltage for non-fail-safe output modules.
- Fail-safe digital input modules detect the signal states of safety-related sensors and send the relevant safety frames to the F-CPU.
- Fail-safe digital output modules are suitable for safety-related shutdown procedures with short circuit and cross-circuit protection up to the actuator.

ET 200SP fail-safe motor starters

Fail-safe motor starters are suitable for safety-related tripping of motor loads.

Example of a configuration with fail-safe I/O modules

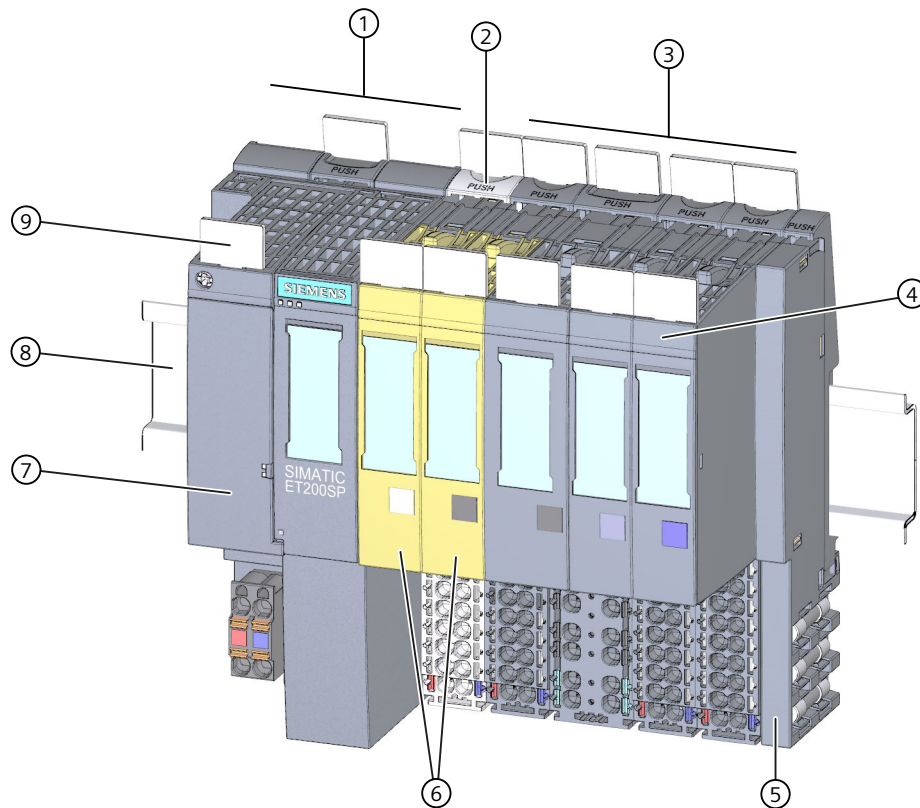

- ① Interface module
- ② Light-colored BaseUnit BU..D with infeed of supply voltage
- ③ Dark-colored BaseUnits BU..B for conducting the potential group further
- ④ I/O module
- ⑤ Server module (ships with the interface module)
- ⑥ Fail-safe I/O modules
- ⑦ BusAdapter
- ⑧ Mounting rail
- ⑨ Reference identification label

Figure 5-4 Example of a configuration of the ET 200SP with fail-safe I/O modules

Hardware and software requirements

Fail-safe modules ET 200SP are supported by IM155-6PN ST interface modules as of firmware V1.1.1, IM155-6PN HF as of firmware V2.0, IM155-6PN HS as of firmware V4.0 and IM155-6DP HF as of firmware V1.0.

You require the STEP 7 Safety Advanced option package, V12 or higher including HSP 54, for configuration and programming of the ET 200SP fail-safe modules with the SIMATIC Safety fail-safe system.

You require the F-Configuration Pack V5.5 SP10 or later for configuring and programming the ET 200SP failsafe modules with the Distributed Safety failsafe system.

You require the F-Configuration Pack V5.5 SP12 or later for configuring and programming the ET 200SP failsafe modules with the F/FH Systems failsafe system.

ET 200SP fail-safe motor starters are supported by interface modules IM155-6PN BA, firmware V3.2 or higher, IM155-6PN ST, firmware V3.1 or higher, IM155-6PN HF, firmware V3.1 or higher and IM155-6DP HF firmware V3.0 or higher.

You require SIMATIC Step 7 V14 or higher for configuration and programming of ET 200SP fail-safe motor starters. The F-Configuration Pack is not needed for configuration and programming of the ET 200SP fail-safe motor starter.

NOTE

Configuration of ET 200SP motor starters, SIMATIC Step 7 V13 or higher, is possible with a GSD file (GSDML).

Use in safety mode only

Safety mode is the F-I/O operating mode that allows safety-related communication using safety frames.

Safety mode of motor starters is characterized by the fail-safe digital input (F-DI) and availability of the 24 V power supply.

You can only use the ET 200SP fail-safe I/O modules in safety mode. They cannot be used in non-fail-safe mode.

Achievable safety classes

The fail-safe modules are equipped with integrated safety functions for safety mode.

You can achieve the safety classes of the table below:

- With the appropriate parameter assignment of the safety functions in STEP 7
- With a specific combination of fail-safe and non-fail-safe I/O modules
- With a special arrangement and wiring of the sensors and actuators

Table 5-1 Safety classes that can be achieved with ET 200SP in safety mode

Safety class in safety mode		
According to IEC 61508	According to ISO 13849-1	
SIL2	Category 3	(PL) Performance Level d
SIL3	Category 3	(PL) Performance Level e
SIL3	Category 4	(PL) Performance Level e

More information

You will find the use cases and wiring for the relevant safety class in the manuals of the fail-safe I/Os and the fail-safe motor starters.

5.4 Components

Overview of ET 200SP modules and accessories

NOTE

A complete overview of the ET 200SP modules and accessories is available in the Product information on documentation of the ET 200SP distributed I/O system (<https://support.industry.siemens.com/cs/de/de/view/73021864/en>).

Basic components of the ET 200SP distributed I/O system

Table 5-2 Basic components of the ET 200SP

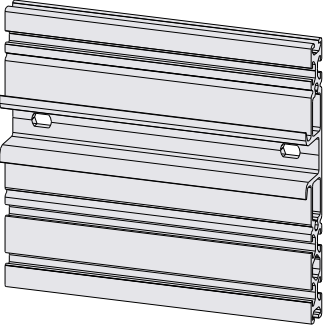
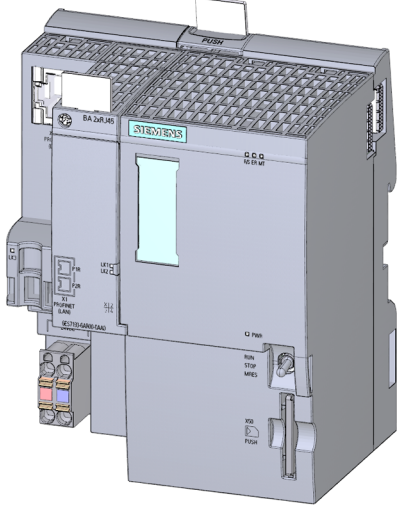
Basic component	Function	Figure
Mounting rail in accordance with EN 60715	The mounting rail is the rack of the ET 200SP distributed I/O system. You install the ET 200SP system on the mounting rail. The mounting rail is 35 mm high.	
SIMATIC system rail	The system rail is the mounting rack of the ET 200SP R1 distributed I/O system. The ET 200SP R1 system must be installed on the system rail. You can also mount all other interface modules on the system rail to improve the stability of the system.	
CPU/Fail-safe CPU	<p>The (F) CPU:</p> <ul style="list-style-type: none"> • Runs the user program. The F-CPU also runs the safety program. • Can be used as an IO controller or I-Device on PROFINET IO or as a standalone CPU • Links the ET 200SP to the IO devices or the IO controller • Exchanges data with the I/O modules via the backplane bus. <p>Additional CPU functions:</p> <ul style="list-style-type: none"> • Communication via PROFIBUS DP (the CPU can be used as a DP master or DP slave in combination with the CM DP communication module) • Integrated Web server • Integrated technology • Integrated trace functionality • Integrated system diagnostics • Integrated safety • Safety mode (when using fail-safe CPUs) 	

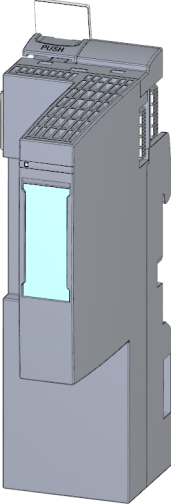
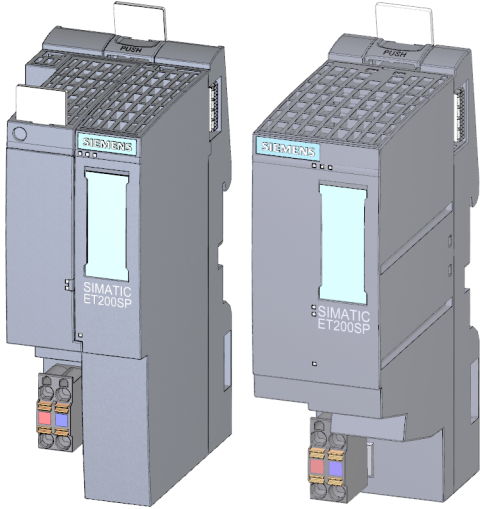
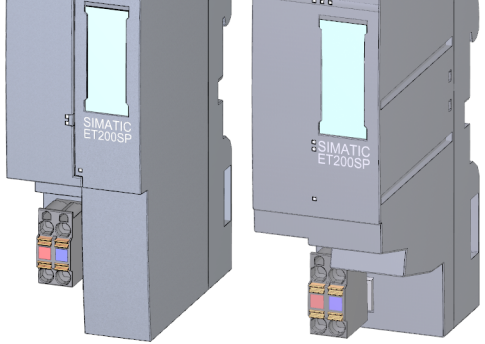
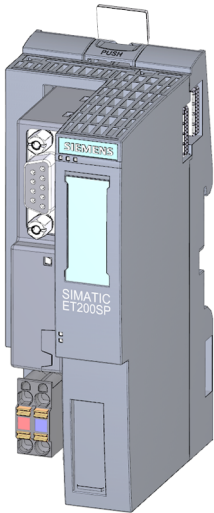

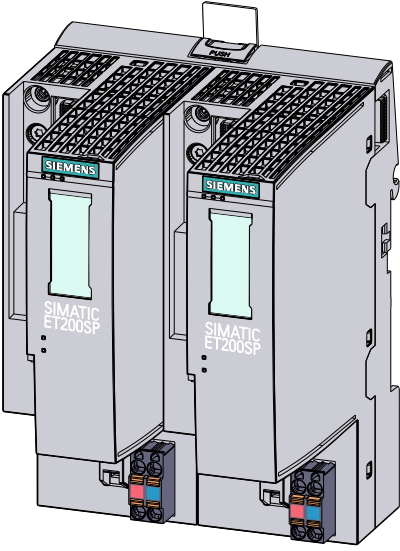
Basic component	Function	Figure
Communication module CM DP	The communication module CM DP <ul style="list-style-type: none"> Connects the CPU with PROFIBUS DP The bus connection is an RS485 interface. 	
Interface module for PROFINET IO	The interface module: <ul style="list-style-type: none"> Can be used as IO device on PROFINET IO Links the ET 200SP with the IO controller Exchanges data with the I/O modules via the backplane bus. 	
Interface module for MultiFieldbus	The interface module: <ul style="list-style-type: none"> Use as IO device on PROFINET IO Links the ET 200SP with the IO controller Links the ET 200SP via EtherNet/IP Links the ET 200SP via Modbus TCP Exchanges data with the I/O modules via the backplane bus You can find more information about MultiFieldbus in the MultiFieldbus Function Manual (https://support.industry.siemens.com/cs/ww/en/view/109773209) and in the Interface Module IM 155-6 MF HF Equipment Manual (https://support.industry.siemens.com/cs/ww/en/view/109773210).	
Interface module for PROFIBUS DP	The interface module: <ul style="list-style-type: none"> Can be used as DP slave on PROFIBUS DP Links the ET 200SP with the DP master Exchanges data with the I/O modules via the backplane bus. 	

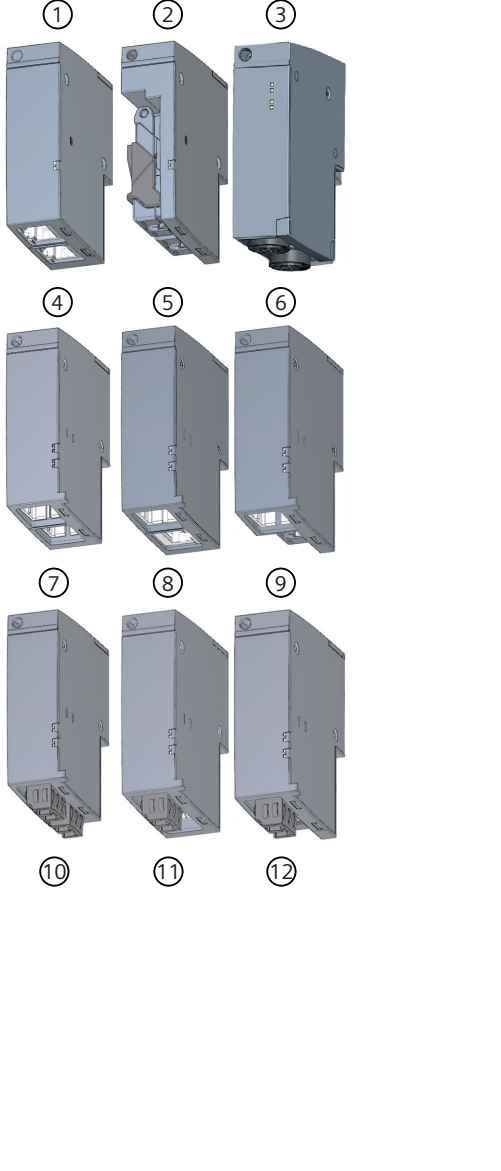
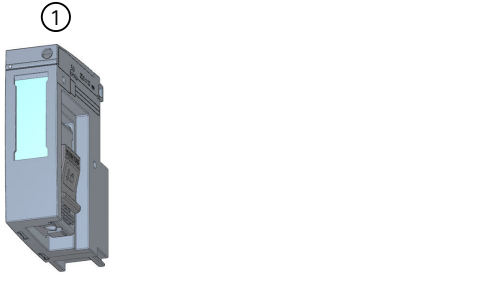

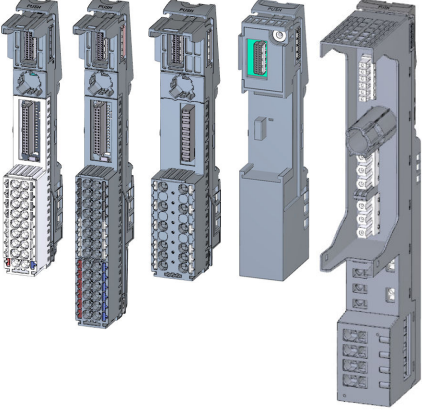
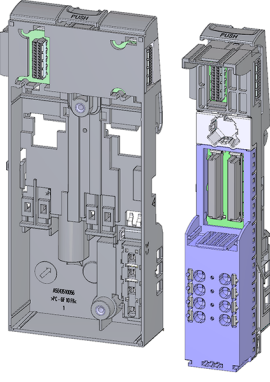
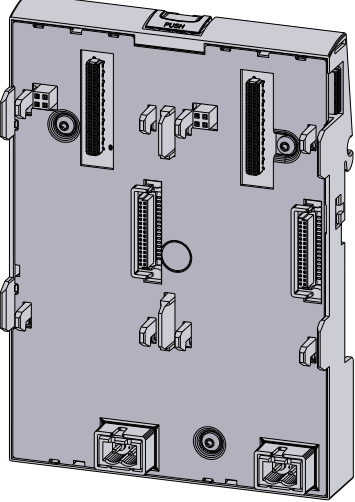
Basic component	Function	Figure
<p>Interface modules and BaseUnit BU type M0 for redundant connection</p>	<p>The ET 200SP R1 system:</p> <ul style="list-style-type: none"> • Use as redundant IO device on PROFINET IO • Connects the ET 200SP to the IO controller • Exchanges data with the I/O modules via the backplane bus. 	

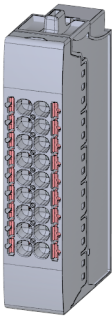
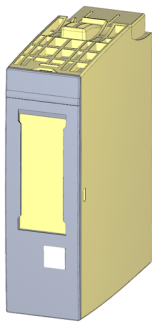
Basic component	Function	Figure
BusAdapter	<p>The BusAdapters allow free selection of the connection technology for PROFINET IO. The following versions are available for PROFINET CPU/interface modules:</p> <ul style="list-style-type: none"> • For standard RJ45 connector (BA 2xRJ45) ① • For direct connection of the bus cable (BA 2xFC) ② • For standard M12 connector (D-coded) with screw-type terminal or plug-in push-pull version (BA 2xM12) ③ • For POF/PCF fiber-optic cable (BA 2xSCRJ) ④ • As media converter for POF/PCF fiber-optic cable ↔ standard RJ45 plug (BA SCRJ/RJ45) ⑤ • As media converter for POF/PCF fiber-optic cable ↔ direct connection of the bus cable (BA SCRJ/FC) ⑥ • For glass fiber-optic cable (BA 2xLC) ⑦ • As media converter for glass fiber-optic cable ↔ standard RJ45 plug (BA LC/RJ45) ⑧ • As media converter for glass fiber-optic cable ↔ direct connection of the bus cable (BA LC/FC) ⑨ • For single-mode fiber-optic cable with maximum length of 20 km (BA 2xLC-LD, long distance) ⑩ • As media converter for glass fiber-optic cable with an LC plug connector ↔ standard RJ45 connector (BA LC-LD/RJ45) ⑪ • As media converter for glass fiber-optic cable with an LC plug connector ↔ standard M12 plug or M12 push-pull connector (BA LC-LD/M12) ⑫ 	
	<p>For mixed ET 200SP/ET 200AL configuration, you require the BusAdapter BA-Send 1xFC ① (plugged into the BaseUnit BU-Send). Connect the bus cable for ET-Connection to the BusAdapter BA-Send 1xFC.</p>	

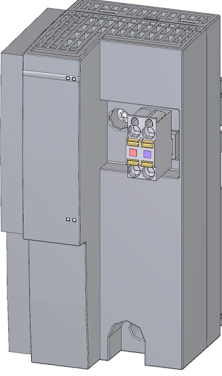
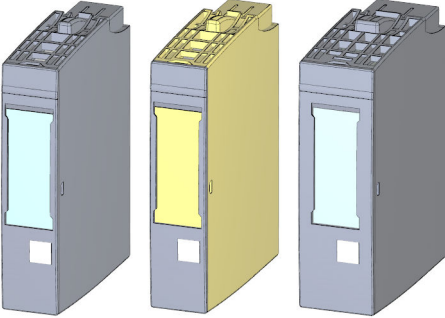
Basic component	Function	Figure
BaseUnit	<p>The BaseUnits provide the electrical and mechanical connection of the ET 200SP modules. Place the I/O modules or the motor starter onto the BaseUnits.</p> <p>Suitable BaseUnits are available in each case for the different requirements. You can find additional information in section Selecting the BaseUnit for I/O modules (Page 84).</p>	
Ex BaseUnit	<p>You need the following BaseUnits for an Ex module group:</p> <ul style="list-style-type: none"> • Ex BaseUnit for Ex power module • Ex BaseUnit for Ex I/O module 	
BaseUnit ET 200SP R1	<p>Connects the IM 155-6 PN R1 redundant interface modules to the backplane bus. It enables data exchange with the I/O modules.</p> <p>Note: Interface modules cannot be plugged in if the supply voltage connector is plugged in. Only use BusAdapters of the same type.</p>	

Basic component	Function	Figure
PotDis-BaseUnit potential distributor module	<p>You use the potential distributor module to distribute a variety of potentials (P1, P2). This allows you to implement a multi-cable connection without external terminals with 16-channel digital modules.</p> <p>The assembly has two parts:</p> <ul style="list-style-type: none"> • If you need additional potential terminals, plug a PotDis-TerminalBlock in the PotDis-BaseUnit. • Alternatively, plug a BU cover (15 mm) on the PotDis-BaseUnit. <p>With potential distributor modules, you may only connect to the PotDis-TB versions BR-W and n.c.-G potential, which exceed the voltage level of SELV/PELV. Other SELV/PELV potential groups should be separated with light-colored PotDis BUs. Suitable PotDis-BaseUnits are available in each case for the different requirements. You can find additional information in section Selecting a PotDis-BaseUnit (Page 90).</p>	
PotDis-TerminalBlock	<p>If you need additional potential terminals for a PotDis-BaseUnit, plug a PotDis-TerminalBlock in the PotDis-BaseUnit.</p> <p>Voltages greater than SELV/PELV are only permitted for the PO PotDis-TBs BR (bridged) and NC (not connected). The same applies to PE. Voltages at the terminals of the PotDis modules connected to the P1/P2 rails must not be greater than SELV/PELV.</p> <p>Suitable PotDis-TerminalBlocks are available in each case for the different requirements. You can find additional information in section Selecting a PotDis-TerminalBlock (Page 91).</p>	
Fail-safe power module	<p>The fail-safe power module allows the safety-related shutdown of digital output modules / fail-safe digital output modules.</p>	

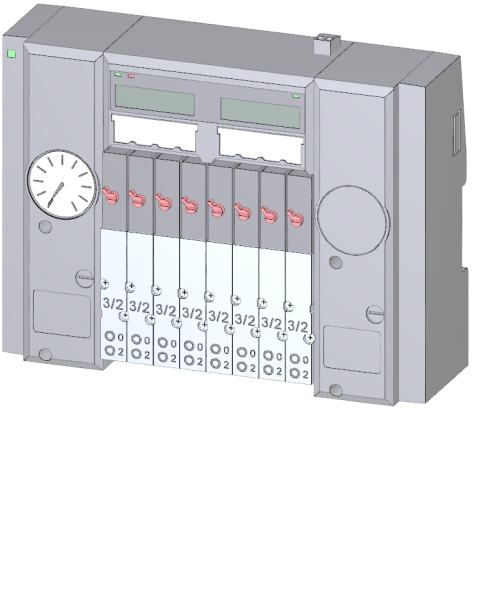
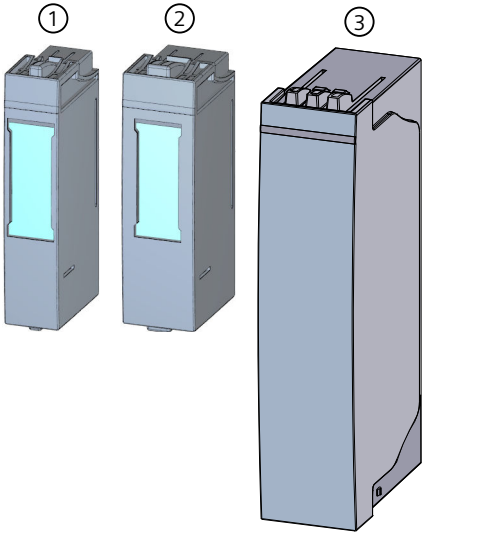
Basic component	Function	Figure
Ex power module	<p>The Ex power module supplies the downstream Ex I/O modules via the power bus on the Ex BaseUnit of the Ex power module. An Ex BaseUnit is required for installing the Ex power module.</p>	
I/O module / Fail-safe I/O module/ Ex I/O module	<p>The I/O module determines the function at the terminals. The controller detects the current process state via the connected sensors and actuators, and triggers the corresponding reactions. I/O modules are divided into the following module types:</p> <ul style="list-style-type: none"> • Digital input (DI, F-DI, Ex-DI) • Digital output (DQ, F-DQ PM, F-DQ PP, F-RQ, Ex-DQ) • Analog input (AI, F-AI, Ex-AI) • Analog output (AQ, Ex-AQ) • Technology module (TM, F-TM-C) • Communication module (CM) • Power module (F-PM-E) 	
Motor starter/fail-safe motor starter	<p>The motor starter is a switching and protection device for 1-phase and 3-phase loads. The motor starter is available as a direct-on-line and reversing starter.</p>	

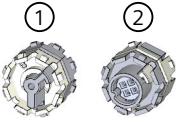

Basic component	Function	Figure
Vale terminal AirLINE SP type 8647 (Bürkert GmbH & Co. KG) ^{1) 2)}	<p>Basic component: Valve terminal AirLINE SP type 8647 (Bürkert). For more information on the AirLINE SP, type 8647 (e.g. data sheet and operating instructions), please contact Bürkert (https://www.burkert.co.uk/en/type/8647) directly.</p> <p>Function: Valve terminals are common in industrial automation and are used as pilot valves for controlling pneumatic actuators, for example in areas of the food, pharmaceutical and water treatment industries. The ET 200SP in combination with the AirLINE SP, type 8647 from Bürkert provides a universal interface between process and plant control that enables the flexible, modular configuration of pilot valves and I/O modules. The valve terminal can also be fitted to the base of the control cabinet with the help of the AirLINE Quick Adapter. This further reduces the space required in the control cabinet and considerably simplifies installation of the pneumatic system. ^{1) 2)}</p>	
BU cover	<p>Insert the BU cover on the BaseUnits:</p> <ul style="list-style-type: none"> • Whose slots are not equipped with I/O modules/ motor starters//PotDis-TerminalBlocks • Whose slots have been reserved for future expansion (as empty slots). <p>You can keep a reference identification label for the planned I/O module inside the BU cover. There are three versions:</p> <ul style="list-style-type: none"> • For BaseUnits with a width of 15 mm ① • For BaseUnits/Ex BaseUnits with a width of 20 mm ② • For BaseUnits of motor starters with a width of 30 mm ③ 	
Server module	<p>The server module completes the configuration of the ET 200SP. The server module includes holders for 3 spare fuses (5 × 20 mm). The server module ships with the CPU/interface module and is available as spare part.</p>	

Basic component	Function	Figure
Coding element	<p>The coding element codes the I/O module with the BaseUnit.</p> <p>There are two versions:</p> <ul style="list-style-type: none"> Mechanical coding element ①: Ensures the coding Electronic coding element ②: This version also has an electronic, rewritable memory for module-specific configuration data (such as the F-destination address for fail-safe modules, parameter data for the IO link master). 	

- Note: The description contains non-binding information on supplementary products that are manufactured and marketed not by Siemens but by third-parties outside the Siemens group ("third-party firms"). These third parties organize the manufacture, sale and delivery of their products independently and their terms and conditions apply.
- Disclaimer/Use of hyperlinks: Siemens has put together this description with great care. However, Siemens is unable to check whether the data provided by third-party firms is complete, accurate and up to date. Certain items of information may therefore potentially be incorrect, incomplete or no longer up to date. Siemens shall not accept any liability should this be the case, nor shall it accept liability for the usability of the data or of the product for the user unless it has a statutory obligation to do so.

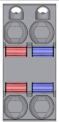
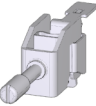
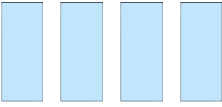

Accessories of the ET 200SP distributed I/O system

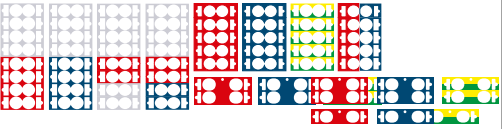
Table 5-3 Accessories of the ET 200SP

Accessories	Function	Figure
24 V DC connector	<p>Application of the 24 V DC supply to the connector, and connection, e.g. to the CPU/interface module/Ex power module.</p> <p>The 24 V DC connector is available as a spare part.</p>	
Shield connection	<p>The shield connection allows the low-impedance contacting of cable shields with minimum installation times.</p>	
Labeling strips	<p>Attach the labeling strips to the modules for system-specific labeling of the ET 200SP distributed I/O system. The labeling strips can be printed.</p> <p>The labeling strips can be ordered as accessories (Page 339) on a roll for thermal transfer printers or as DIN A4 format sheets for laser printers.</p>	
Reference identification labels	<p>The labels enable the reference identification labeling of the ET 200SP components.</p> <p>The labels can be ordered on a mat for thermal transfer and inkjet printers as accessories (Page 339).</p>	
Color identification labels	<p>The color identification labels are module-specific and can be ordered for the process terminals, AUX terminals and additional terminals as accessories (Page 339).</p>	

Accessories of the SIMATIC ET 200SP motor starters

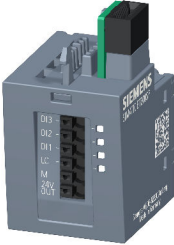
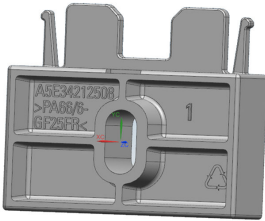
Table 5-4 SIMATIC ET 200SP motor starter accessories

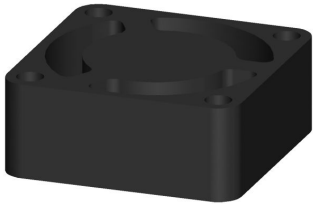
Accessories	Function	Figure
3DI/LC module	<p>The optional 3DI/LC module has three digital inputs and one LC input. For reasons of operational safety, input LC is permanently set to manual local mode. By parameterizing the inputs DI1 - DI3 with motor CLOCKWISE or motor COUNTER-CLOCKWISE, you can control the motor in manual local mode. The functions of the 3DI/LC module are not relevant to functional safety. Detailed information on the functions when using a 3DI/LC module can be found in the Manual (https://support.industry.siemens.com/cs/ww/en/view/109479973).</p>	
Mechanical bracket for BaseUnit	<p>Use the mechanical bracket for additional fixing of the motor starter. You can use the mechanical bracket on 7.5 mm and 15 mm mounting rails.</p>	
Infeed bus cover	<p>For finger-safe termination of the infeed bus, use the cover.</p>	
Fan	<p>You can use the motor starter at higher ambient temperatures if a fan is installed.</p>	

Application planning

Overview

The BaseUnits (BU) are classified according to different types. Every BaseUnit type is distinguished by characteristics that match certain I/O modules and motor starters (see the following table and graphics).

You recognize the BU type for an I/O module by the last two digits of an I/O module's article number.

The BU type onto which you can plug the respective I/O module is printed on the I/O modules. You can therefore read which BU type you need straight from the I/O module (see Factory labels (Page 171) (page 122)).

Example: On the output module DQ 16x24VDC/0.5A ST with article number 6ES7132-6BH01-0BA0 the information "BU: A0" is printed. This means you can plug this I/O module into a BaseUnit of BU type "A0", which means any BaseUnit whose article number ends in "A0". I/O modules that are suitable for two BU types are labeled accordingly, for example "BU: A0, A1".

NOTE

You will find a complete module overview of the ET 200SP distributed I/O system and an overview of possibilities of combining BaseUnits and I/O modules / motor starters in the Product information for documentation of the ET 200SP distributed I/O system (<https://support.industry.siemens.com/cs/de/de/view/73021864/en>).

NOTE

Use of Ex modules

If you are using Ex I/O modules for the connection of intrinsically safe devices from Zone 0 or Zone 1 in the ET 200SP configuration, observe the information for plant planning in the System Manual ET 200SP HA Distributed I/O system / ET 200SP Modules for devices used in an explosion hazardous environment

(<https://support.industry.siemens.com/cs/ww/de/view/109795533/en>).

Table 6-1 Selecting a suitable BaseUnit for interface modules

Select BaseUnit	Interface module (example)	Examples of suitable interface modules for BU types	
		Interface module (example)	BaseUnit
BU type M0	Interface module <ul style="list-style-type: none"> • 6ES7...M0 • 24 V DC • 100 mm wide 	IM 155-6 PN R1 (6ES7155-6AU00-0HM0)	BU (6ES7193-6BR00-0HM0)

Table 6-2 Selecting a suitable BaseUnit for I/O modules

Select BaseUnit	I/O module (example)	Examples of suitable I/O modules for BU types	
		I/O module (example)	BaseUnit
BU type A0 See Digital, fail-safe, communication, technology or analog modules without temperature measurement (Page 84)	Digital, fail-safe, technology or communication module <ul style="list-style-type: none"> • 6ES7...A0 • 24 V DC • 15 mm wide 	DI 16×24VDC ST (6ES7131-6BH00-0 BA0)	BU15-P16+A0+2D (6ES7193-6BP00-0 DA0)
BU type A1 See Analog modules with temperature measurement (Page 85)	Analog module with temperature measurement* <ul style="list-style-type: none"> • 6ES7...A1 • 24 V DC • 15 mm wide 	AI 4×RTD/TC 2-/3-/4-wire HF (6ES7134-6JD00-0 CA1)	BU15-P16+A0+2D/T (6ES7193-6BP00-0 DA1)
	Analog module without temperature measurement** <ul style="list-style-type: none"> • 6ES7...A1 • 24 V DC • 15 mm wide 	AI 4xU/I 2-wire ST (6ES7134-6HD00-0 BA1)	
BU type B0 (BU..B, dark-colored BaseUnit)	Digital output module with relay <ul style="list-style-type: none"> • 6ES7...B0 • Up to 230 V AC • 20 mm wide 	RQ 4×120VDC-230VAC/5A NO ST (6ES7132-6HD00-0 BB0)	BU20-P12+A4+0B (6ES7193-6BP20-0 BB0)
BU type B1 (BU..B, dark-colored BaseUnit)	Digital modules <ul style="list-style-type: none"> • 6ES7...B1 • Up to 230 V AC • 20 mm wide 	DI 4×120..230VAC ST (6ES7131-6FD00-0 BB1)	BU20-P12+A0+4B (6ES7193-6BP20-0 BB1)
BU type C0 (BU..D, light-colored BaseUnit)	Fail-safe power module <ul style="list-style-type: none"> • 6ES7...C0 • 24 V DC • 20 mm wide CM AS-i Master ST/F- CM AS-i Safety ST <ul style="list-style-type: none"> • 6ES7...C1 • Up to 30 V DC • 20 mm wide 	CM AS-i Master ST (3RK7137-6SA00-0 BC1)	BU20-P6+A2+4D (6ES7193-6BP20-0 DC0)

* For compensation of the reference junction temperature for thermocouples. BU type A1 is required if you measure the reference junction temperature with an internal temperature sensor or if you need the additional 2×5 terminals.

If you use the internal reference junction temperature with BU type A1, ensure an even temperature distribution at the terminals. The specified accuracy of the utilized analog module is then adhered to. If necessary, you can increase the accuracy via user calibration.

** Analog modules **with and without** temperature measurement can also be plugged into BU type A0.

Select BaseUnit	I/O module (example)	Examples of suitable I/O modules for BU types	
		I/O module (example)	BaseUnit
BU type C1 (BU..B, dark-colored BaseUnit)	F-CM AS-i Safety ST <ul style="list-style-type: none"> 6ES7...C1 Up to 30 V DC 20 mm wide 	F-CM AS-i Safety ST (3RK7136-6SC00-0BC1)	BU20-P6+A2+4B (6ES7193-6BP20-0BC1)
BU type D0	AI Energy Meter <ul style="list-style-type: none"> 6ES7...D0 Up to 400 V AC/ 480 V AC 20 mm wide 	AI Energy Meter 480VAC ST (6ES7134-6PA20-0BD0)	BU20-P12+A0+0B (6ES7193-6BP00-0BD0)
BU type F0	F-RQ 1×24VDC/24...230VAC/5A <ul style="list-style-type: none"> 6ES7...F0 Up to 230 V AC 20 mm wide 	F-RQ 1×24VDC/24...230VAC/5A (6ES7136-6RA00-0BF0)	BU20-P8+A4+0B (6ES7193-6BP20-0BF0)
BU type U0	DQ 4×24...230VAC/2A HF <ul style="list-style-type: none"> 6ES7...U0 Up to 400 V AC/480 V AC 20 mm wide 	DQ 4×24...230VAC/2A HF (6ES7132-6FD00-0CU0)	BU20-P16+A0+2D (6ES7193-6BP00-0BU0)

* For compensation of the reference junction temperature for thermocouples. BU type A1 is required if you measure the reference junction temperature with an internal temperature sensor or if you need the additional 2×5 terminals.

If you use the internal reference junction temperature with BU type A1, ensure an even temperature distribution at the terminals. The specified accuracy of the utilized analog module is then adhered to. If necessary, you can increase the accuracy via user calibration.

** Analog modules **with and without** temperature measurement can also be plugged into BU type A0.

Table 6-3 BaseUnit for motor starters

	Selecting the BaseUnit									
	BU-30--MS1	BU-30--MS2	BU-30--MS3	BU-30--MS4	BU-30--MS5	BU-30--MS6	BU-30--MS7	BU-30--MS8	BU-30--MS9	BU-30--MS10
24 V infeed	x		x							
500 V infeed	x	x			x		x	x		
(no routing of the F-DI signal possible)F-DI terminals					x	x				
F-DI infeed							x			x
F-DI routing								x	x	
Motor starters										
DS 0.1 - 0.4 A HF	3RK1308-0A-A00-0CPO	x	x	x	x	x*	x*	x*	x*	x*

* The F-DI terminals or F-DI infeed/routing have no function with this combination.

DS 0.3 - 1A HF	3RK1308-0A-B00-OCPO	x	x	x	x	x*	x*	x*	x*	x*	x*
DS 0.9 - 3A HF	3RK1308-0A-C00-OCPO	x	x	x	x	x*	x*	x*	x*	x*	x*
DS 2.8 - 9A HF	3RK1308-0A-D00-OCPO	x	x	x	x	x*	x*	x*	x*	x*	x*
DS 4.0 - 12A HF	3RK1308-0AE-00-OCPO	x	x	x	x	x*	x*	x*	x*	x*	x*
RS 0.1 - 0.4 A HF	3RK1308-0B-A00-OCPO	x	x	x	x	x*	x*	x*	x*	x*	x*
RS 0.3 - 1A HF	3RK1308-0BB-00-OCPO	x	x	x	x	x*	x*	x*	x*	x*	x*
RS 0.9 - 3A HF	3RK1308-0BC-00-OCPO	x	x	x	x	x*	x*	x*	x*	x*	x*
RS 2.8 - 9A HF	3RK1308-0B-D00-OCPO	x	x	x	x	x*	x*	x*	x*	x*	x*
RS 4.0 - 12A HF	3RK1308-0BE-00-OCPO	x	x	x	x	x*	x*	x*	x*	x*	x*
F-DS 0.1 - 0.4 A HF	3RK1308-0C-A00-OCPO	x	x	x	x	x	x	x	x	x	x
F-DS 0.3 - 1A HF	3RK1308-0CB-00-OCPO	x	x	x	x	x	x	x	x	x	x
F-DS 0.9 - 3A HF	3RK1308-0C-C00-OCPO	x	x	x	x	x	x	x	x	x	x
F-DS 2.8 - 9A HF	3RK1308-0C-D00-OCPO	x	x	x	x	x	x	x	x	x	x
F-DS 4.0 - 12A HF	3RK1308-0CE-00-OCPO	x	x	x	x	x	x	x	x	x	x
F-RS 0.1 - 0.4 A HF	3RK1308-0D-A00-OCPO	x	x	x	x	x	x	x	x	x	x
F-RS 0.3 - 1A HF	3RK1308-0D-B00-OCPO	x	x	x	x	x	x	x	x	x	x
F-RS 0.9 - 3A HF	3RK1308-0D-C00-OCPO	x	x	x	x	x	x	x	x	x	x
F-RS 2.8 - 9A HF	3RK1308-0D-D00-OCPO	x	x	x	x	x	x	x	x	x	x
F-RS 4.0 - 12A HF	3RK1308-0D-E00-OCPO	x	x	x	x	x	x	x	x	x	x

* The F-DI terminals or F-DI infeed/routing have no function with this combination.

Additional information

Additional information on the functional assignment of the terminals and on the associated BaseUnits can be found in one of the following manuals:

- Manual for the relevant I/O module (<https://support.industry.siemens.com/cs/ww/en/ps/14039/man>)
- Manual BaseUnits (<https://support.industry.siemens.com/cs/ww/de/view/59753521/en>)
- Motor starter (<https://support.industry.siemens.com/cs/ww/en/view/109479973>) manual

6.1 Selecting the BaseUnit for I/O modules

6.1.1 Digital, fail-safe, communication, technology or analog modules without temperature measurement

Selection of a suitable BaseUnit

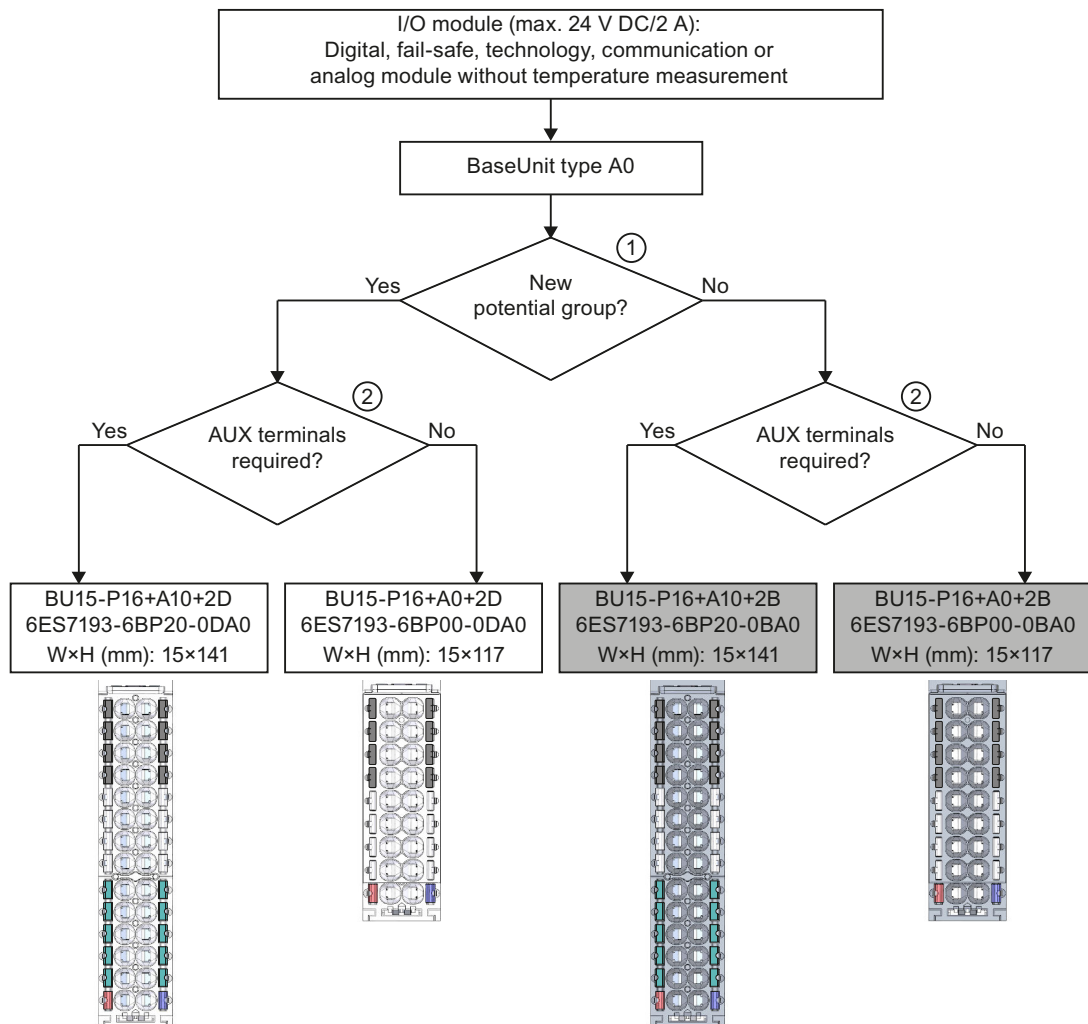

- ① Light-colored BaseUnit: Configuration of a new potential group, electrical isolation from adjacent module on the left. The first BaseUnit of the ET 200SP is usually a light-colored BaseUnit for feeding the supply voltage L+. A potential group opened with a light-colored BU type U0 must not contain any dark-colored BaseUnit of BU type A0 or A1.
Exception: If you insert, as the first I/O module, an AC I/O module, a AI Energy Meter 400VAC or a AI Energy Meter 480VAC, then the first BaseUnit in the ET 200SP configuration can be a dark-colored BaseUnit. The requirement is that you use a CPU or IM 155-6 (as of V3.0).
Dark-colored BaseUnit: Conduction of the internal power and AUX buses from the adjacent module on the left.
- ② AUX terminal: 10 internally bridged terminals for individual use up to 24 V DC/10 A or as protective conductors.
Example: Multiple cable connection for DI 8×24VDC ST

Figure 6-1 Digital, fail-safe, communication, technology or analog modules without temperature measurement

6.1.2 Analog modules with temperature measurement

Selection of a suitable BaseUnit

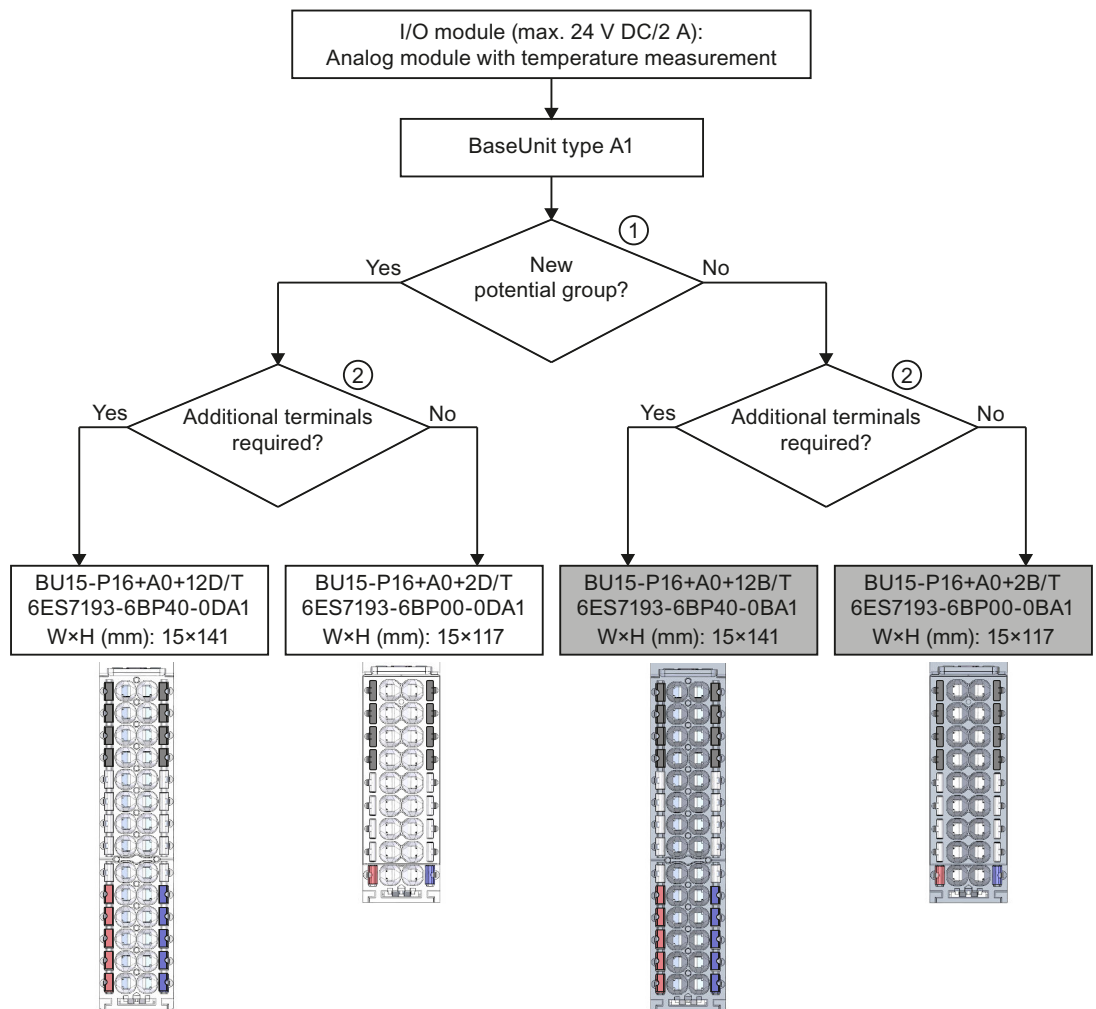

6.2 Selecting motor starters with a suitable BaseUnit

- ① Light-colored BaseUnit: Configuration of a new potential group, electrical isolation from adjacent module on the left. The first BaseUnit of the ET 200SP is usually a light-colored BaseUnit for feeding the supply voltage L+.
Dark-colored BaseUnit: Continuation of the internal power and AUX buses from the adjacent module on the left.
- ② Additional terminals: 2×5 internally bridged terminals for individual use up to 24 V DC/2 A
Example: Sensor supply for AI 4×U/I 2-wire ST

Figure 6-2 Analog modules with temperature measurement

6.2 Selecting motor starters with a suitable BaseUnit

6.2.1 Selecting a BaseUnit for motor starters

The motor starter BaseUnits "BU30-MS1", "BU30-MS2", "BU30-MS3" and "BU30-MS4" are compatible with all non-fail-safe motor starters. The motor starter BaseUnits "BU30-MS1", "BU30-MS2", "BU30-MS3", "BU30-MS4", "BU30-MS5", "BU30-MS6", "BU30-MS7", "BU30-MS8", "BU30-MS9" and "BU30-MS10" are compatible with all fail-safe motor starters. You will find an overview of available BaseUnits for motor starters here ([Page 80](#)). With the different BaseUnits, you can form different potential groups for the 24 V DC electronics supply (L+/M) and for the AC infeed.

Voltage range

The voltage range of the AC infeed is between 48 V AC and 500 V AC.

Selection criteria for the BaseUnit

The figure below shows the criteria you use to select the appropriate BaseUnit:

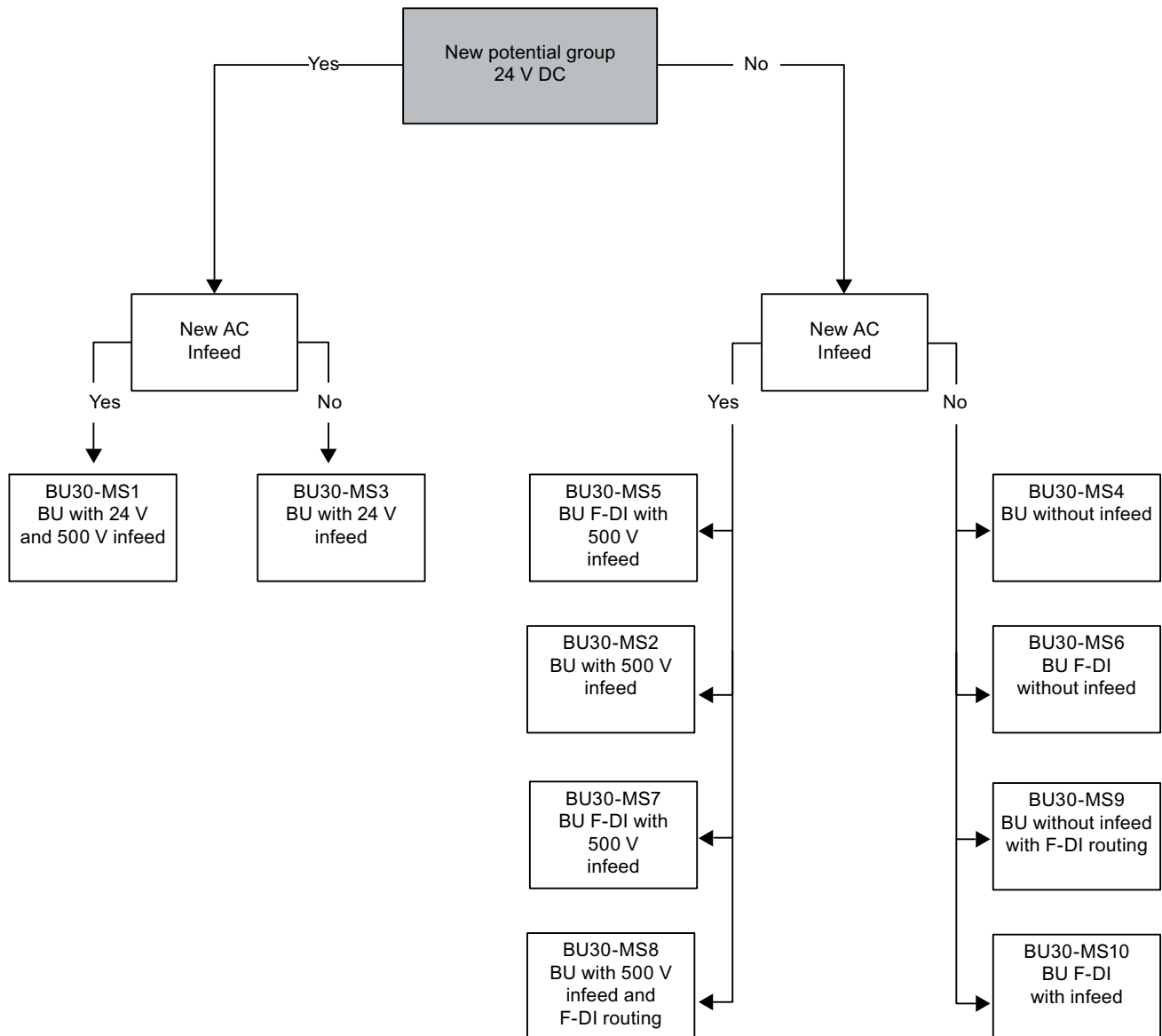

Form separate potential groups on the infeed bus for single-phase (L, N, PE) and three-phase (L1, L2, L3, PE) operation.

6.2.2 Selecting the motor starter

You select the suitable motor starter using the load type according to the following scheme:

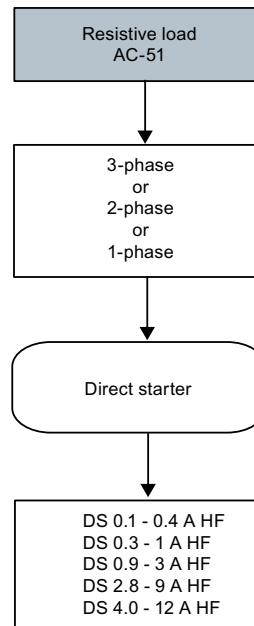
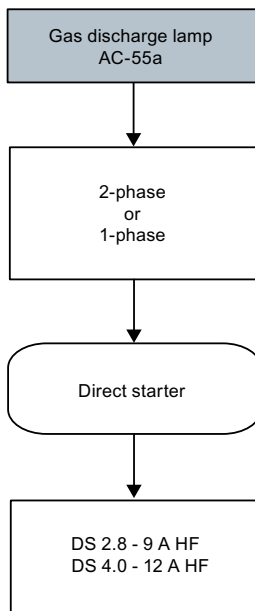
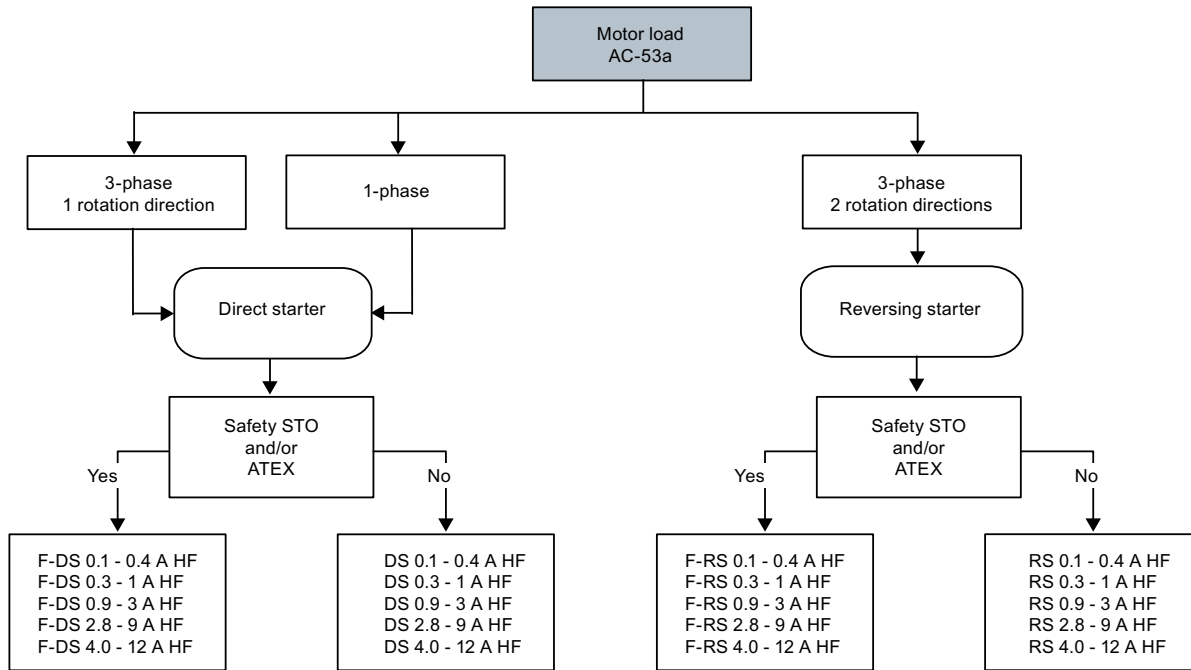

6.2.3 Selecting accessories for motor starters

Observe the installation conditions of the station with ET 200SP motor starters. The figure below shows the criteria the station must meet:

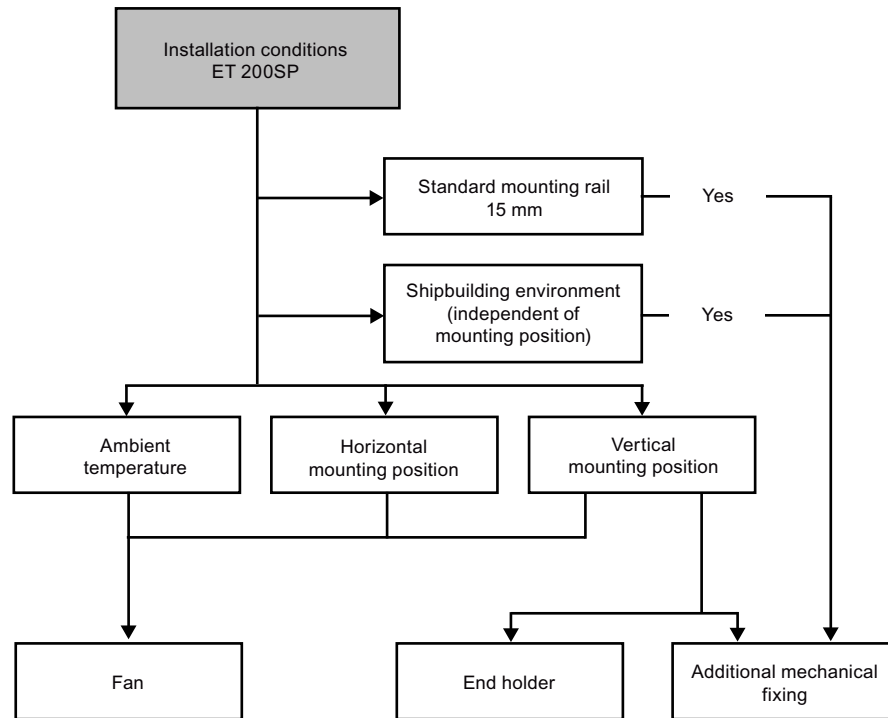

6.3 Selecting potential distributor modules

6.3.1 Selecting a PotDis-BaseUnit

Selection of a suitable PotDis-BaseUnit potential distributor module

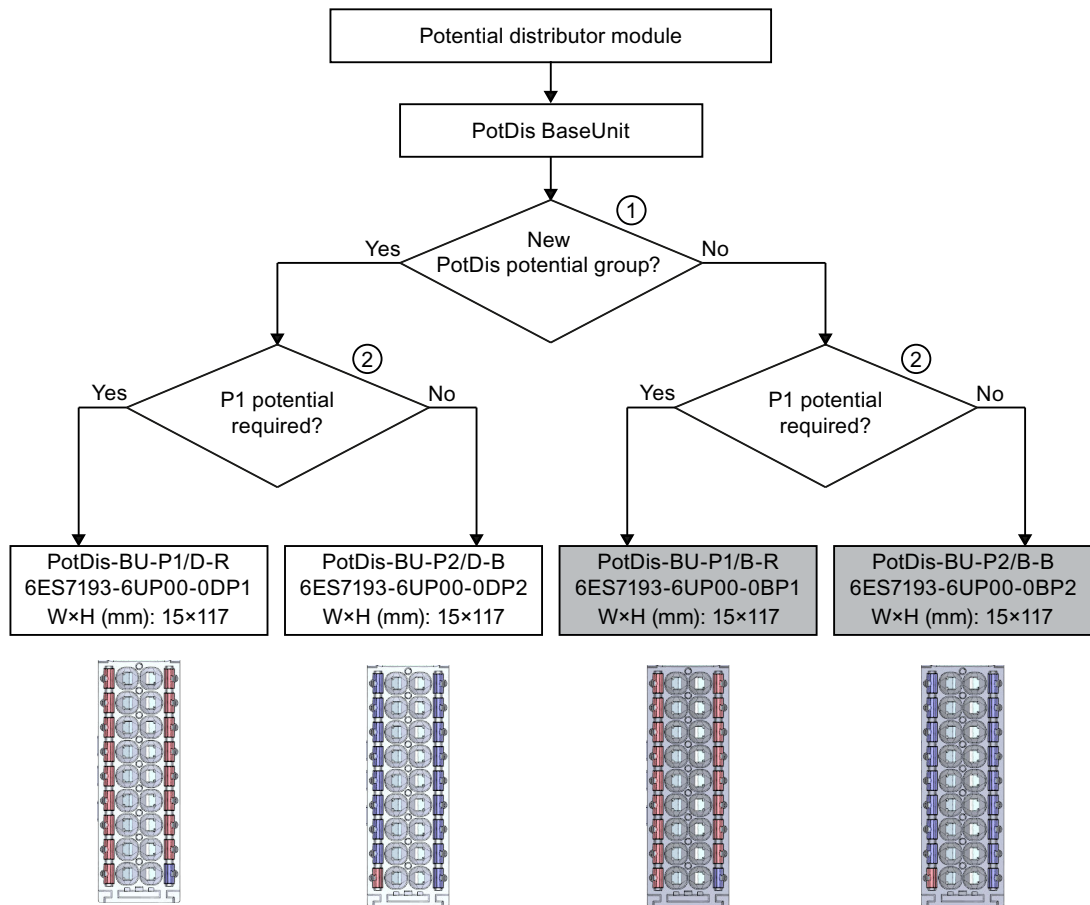

- ① Light-colored PotDis-BaseUnit: Configuration of a new potential group, electrical isolation from adjacent module on the left. The first BaseUnit of the ET 200SP is usually a light-colored BaseUnit for the incoming supply voltage.
- ② P1 terminal: 16 internally bridged terminals for individual use up to 48 V DC/10 A
Example: Multiple cable connection for DI 16x24VDC ST

Figure 6-3 PotDis-BaseUnits

Please note:

- The potential groups opened with a light-colored PotDis-BU must not contain any I/O modules. You can integrate any dark-colored PotDis-BUs into I/O module potential groups provided they are based on an SELV/PELV supply.
- If you do not need the additional terminals of the PotDis-TB in a potential distributor module, replace the PotDis-TB with a BU cover. You may only connect one potential group within a combination of PotDis-BU and PotDis-TB.

- Only SELV/PELV potentials are permitted on PotDis-BUs. Separate different SELV/PELV potential groups using light-colored PotDis-BUs.
- With potential distributor modules, you may only connect to the PotDis-TB versions BR-W and n.c.-G potential, which exceed the voltage level of SELV/PELV.
- PotDis terminals are not directly configurable as PotDis via GSD/GSDML. When configuring with GSD, always use a dummy module; with GSDML, integrate a free space.

Additional information

Additional information on the potential distributor modules (PotDis-BaseUnits and PotDis-TerminalBlocks) is available in the BaseUnits

(<https://support.industry.siemens.com/cs/ww/de/view/59753521/en>) manual.

6.3.2 Selecting a PotDis-TerminalBlock

Selection of a suitable PotDis-TerminalBlock

With a PotDis-TerminalBlock you are expanding a PotDis-BaseUnit potential distributor module by an additional 18 potential terminals.

You can freely combine PotDis-TerminalBlocks and PotDis-BaseUnits.

The following PotDis-TerminalBlocks are available:

Table 6-4 Selection of TerminalBlock PotDis-TB

PotDis-TerminalBlocks		
TerminalBlock	Explanation	Application
PotDis-TB-P1-R	Terminal block with 18 terminals with red spring releases with connection to the supply voltage P1 of the PotDis-BaseUnit with SELV/PELV.	Provision of 18 x P1 potential, e.g. for P1 sensor supply with 3-wire connection for 16-channel digital input modules
PotDis-TB-P2-B	Terminal block with 18 terminals with blue spring releases with connection to ground (P2) of the PotDis-BaseUnit	Provision of 18 x P2 potential, e.g. for ground of the sensor supply with 2-wire connection for 16-channel digital output modules
PotDis-TB-n.c.-G	Terminal block with 18 terminals with gray spring releases without connection to each other or to a voltage bus of the PotDis-BaseUnit	Provision of 18 x n.c. (not connected), for reserving ("parking") unused signals/lines, e.g. for antivalent sensors in the same potential group
PotDis-TB-BR-W	Terminal block with 18 terminals connected to each other with white spring releases without connection to a voltage bus of the PotDis-BaseUnit	Provision of 17 terminals with shared potential (the 18th terminal is used for infeed) for supply of external consumers

Additional information

Additional information on the potential distributor modules (PotDis-BaseUnits and PotDis-TerminalBlocks) is available in the BaseUnits

(<https://support.industry.siemens.com/cs/ww/de/view/59753521/en>) manual.

6.4 Hardware configuration

Maximum mechanical configuration

As soon as **one** of the following rules applies, the maximum configuration of the ET 200SP has been reached:

Table 6-5 Maximum mechanical configuration

Properties	Rule
Number of modules	Maximum of 12/30/32/64 I/O modules (depending on the CPU used/the interface module used; see CPU (https://support.automation.siemens.com/WW/view/en/90466439/133300) and interface module (https://support.automation.siemens.com/WW/view/en/55683316/133300) manuals) For every 6 F-modules F-RQ 1x24VDC/24..230VAC/5A (6ES7136-6RA00-0BF0), the maximum configuration is reduced by 1 module.
Number of motor starters	Maximum of 31 motor starters
Backplane bus length of the ET 200SP	maximum 1 m mounting width (without CPU/interface module, including server module)

Electrical maximum configuration for I/O modules

The number of operable I/O modules of a potential group is limited by the following factors:

- Power consumption of the I/O modules
- Power consumption of the components supplied via these I/O modules

The maximum current carrying capacity of the terminals on the BaseUnit L+/M is 10 A.

Current carrying capacity refers to the current load via the power bus and the infeed bus of the ET 200SP station. Consider the current carrying capacity when using a motor starter.

Maximum electrical configuration for motor starter power bus (24 V DC)

To determine the current requirement of an individual motor starter via the power bus, take account of the following parameters:

- Current consumption via DC infeed in the ON state
- Current consumption via DC infeed when switching on (40 ms peak load)
- Increased power consumption through fan operation
- Current requirement via encoder supply of the connected DI module

The maximum current carrying capacity of the 24 V potential group is 7 A across the entire permissible temperature range.

Maximum electrical configuration for motor starter infeed bus (500 V AC)

To determine the current requirement of an individual motor starter via the infeed bus, proceed as follows:

Calculate the current requirement via the main current paths of the individual motor starter. In doing so, take into account the parameter I_e (set rated operational current of the motor starter). The permissible overload characteristics of the motor feeder for motors are determined with the thermal motor model. You calculate the current value ($I_{\text{infeed bus}}$) for the infeed bus of the ET 200SP system according to the following formula:

$$I_{\text{infeed bus}} = \sum_n (I_e * 1.125)$$

n = number of motor starters of a potential group on the infeed bus

Refer to the Manual (<https://support.industry.siemens.com/cs/ww/en/view/109479973>) for details of how to assign the basic rated operational current I_e parameter.

The following values apply for the potential group of the AC infeed:

- The maximum current carrying capacity is 32 A at an ambient temperature of up to 50 °C.
- The maximum current carrying capacity is 27 A at an ambient temperature of up to 60 °C.
- The maximum current carrying capacity for applications according to UL requirements is 24 A at an ambient temperature of up to 60 °C.

Address space

The address space depends on the CPU/interface module (see CPU (<https://support.automation.siemens.com/WW/view/en/90466439/133300>) Manual) and the interface module used (see Interface module (<https://support.automation.siemens.com/WW/view/en/55683316/133300>) Manual):

- For PROFINET IO: Dependent on the IO controller/IO device used
- For PROFIBUS DP: Dependent on the DP master used

6.5 Forming potential groups

6.5.1 Basics

Introduction

Potential groups for the ET 200SP distributed I/O system are formed by systematically arranging the BaseUnits.

Requirements

For formation of potential groups, the ET 200SP distinguishes between the following BaseUnits:

- BaseUnits BU...D (recognizable by the light-colored terminal box and the light-colored mounting rail release button):
 - Opening of a new potential group (power busbar and AUX bus are interrupted to the left)
 - Feeding in the supply voltages (DC or AC) up to an infeed current of 10 A, depending on the BaseUnit used.
- BaseUnits BU...B (recognizable by the dark-colored terminal box and the dark-colored mounting rail release button):
 - Conduction of the potential group (power busbar and AUX bus continued)
 - Tapping the supply voltages (DC or AC) for external components or looping through with a maximum total current of 10 A, depending on the BaseUnit used.
- BaseUnits BU30-MSx (BaseUnit for the motor starter only)
Depending on the version, the BaseUnits in the "BU30-MSx" model series possess the following properties:
 - Opening a new potential group or continuing an existing one
 - Feeding in the supply voltage L+ up to an infeed current of 7 A DC
 - Opening a new load group or continuing an existing one by means of 500 V AC infeed bus
 - Feeding in the line voltage up to an infeed current of 32 A AC
 - Feeding in and routing the F-DI signal

NOTE

The BaseUnits BU...B of type B1 and D0 loop through the voltage buses P1/P2 and the AUX bus. The buses are not tapped by the module.

Placement and grouping of I/O modules

Each BaseUnit BU...D that you install in the ET 200SP configuration opens a new potential group and supplies all subsequent I/O modules (on BaseUnits BU...B) with the necessary supply voltage. The first 24 V DC I/O module to the right of the CPU/interface module must be installed on a light-colored BaseUnit BU...D. Exception: If you insert an AC I/O module or an AI Energy Meter as the first I/O module, the first BaseUnit in the ET 200SP configuration can be a dark-colored BaseUnit. The requirement is that you use a CPU or IM 155-6 (as of V3.0). If you want to place another BaseUnit BU...B after a BaseUnit BU...D, disconnect the power and AUX buses and open a new potential group at the same time. This allows individual grouping of the supply voltages.

NOTE

All BaseUnits placed in a load group must match the infeed potential of the corresponding light-colored BaseUnits.

Do not connect any BaseUnit of the "BU...B" type on the right of a motor starter's BaseUnit (BU30-MSxx).

Placing and connecting potential distributor modules

Potential distributor modules provide potential distributors integrated into the system that you can use to configure a rapid, space-saving customized replacement for standard potential distribution systems.

You can place potential distributor modules at any location within the ET 200SP distributed I/O system. To do so, you must observe the same design rules as for placing and connecting I/O modules. Potential distributor modules are only suitable for SELV/PELV.

A potential distributor module consists of a potential distributor BaseUnit (PotDis-BU) and (if necessary) a potential distributor TerminalBlock (PotDis-TB) plugged onto it. If you do not need the additional terminals of the PotDis-TB, install a BU cover (15 mm) on the PotDis-BaseUnit.

You must not place a BaseUnit for I/O modules in a PotDis potential group formed with a light-colored PotDis-BaseUnit.

NOTE

Identical voltages with potential distributor modules

You can only connect identical (supplied) SELV/PELV voltages to the terminals of a potential distributor module or PotDis potential group. Example: You only connect 24 V DC.

Placement and grouping of I/O modules and motor starters

For the potential group (L+/M), the following slot rules apply within the motor starter modules and other I/O modules of the ET 200SP:

- An unassembled BaseUnit (BaseUnit with BU cover) must be inserted between the CPU, an interface module or an I/O module and the motor starter. This is not necessary between the motor starters.
- The empty slot can take on the potential (24 V DC) of the potential group on the left of it (L+, M), i.e. I/O modules and motor starters can be operated in the same potential group.
- If you would like to insert an I/O module on the right of a motor starter, then use only one BaseUnit of the BU...D Typ A0 type (light terminal box).
- The BaseUnits BU30-MS2, BU30-MS4, BU30-MS5, BU30-MS6, BU30-MS7, BU30-MS8, BU30-MS9 and BU30-MS10 can continue the potential group of other BaseUnit types. However, note the following exceptions:
 - Only a BaseUnit of type BU30-MS1 or BU30-MS3 may follow an AS-i module (AS-i potential group).
 - Only BaseUnits with fail-safe motor starters can be connected together in the same potential group of an F-PM-E.

 **WARNING**

**Hazardous Voltage
Can Cause Death, Serious Injury, or Property Damage.**

Hazardous electrical voltage can cause electric shock, burns and property damage.

Disconnect your system and devices from the power supply before starting any assembly tasks.

AUX bus (AUX(iliary) bus)

BaseUnits with additional AUX terminals (e.g. BU15-P16+A10+2D) enable the additional connection of a potential (up to the maximum supply voltage of the module), which is applied via the AUX bus.

In the case of light-colored BaseUnits, the AUX bus is interrupted to the left. In the case of BaseUnits BU30-MS1 to BU30-MS7 and BU30-MS10, the AUX bus is interrupted to the left. The AUX bus of BU30-MS8 and BU30-MS9 is used for F-DI routing.

The AUX bus can be used individually:

- As a PE bar, in which case you may plug a maximum of 8 BaseUnits in the corresponding potential group
- For additionally required voltage

NOTICE

AUX bus as PE bar

If you use an AUX bus as a protective conductor bar, attach the yellow-green color identification labels to the AUX terminals, and establish a functional connection to the central protective conductor connection.

If you stop using the AUX bus as a protective conductor bar, make sure you remove the yellow-green color identification labels and remove the connection to the central protective conductor connection again.

If you use the AUX bus as a protective conductor bar, the corresponding protective conductor tests must be conducted by the installer of the system before commissioning. In addition, both ends of the ET 200SP system assembly must be mechanically fixed to the mounting rail in this case (e.g. using 8WA1010-1PH01 ground terminals); this connection can only be detached by using a tool.

The AUX bus is designed as follows:

- Maximum current carrying capacity (at 60 °C ambient air temperature): 10 A
- Permissible voltage: Depending on the BaseUnit type (see BaseUnit manual (<https://support.automation.siemens.com/WW/view/en/59753521>))

NOTE

The AUX potential must always be identical to the potential group of the supply voltage if it is not being used as PE.

Self-assembling voltage buses

You must feed in the supply voltage L+ via the BaseUnit BU...D, BU30-MS1 or BU30-MS3. Each BaseUnit BU...B allows access to the supply voltage L+ via terminals (red/blue). The motor starter BaseUnits "BU30-MS1", "BU30-MS2", "BU30-MS3", "BU30-MS4", "BU30-MS5", "BU30-MS6", "BU30-MS7", "BU30-MS8", "BU30-MS9" and "BU30-MS10" do not have this access.

Operating principle

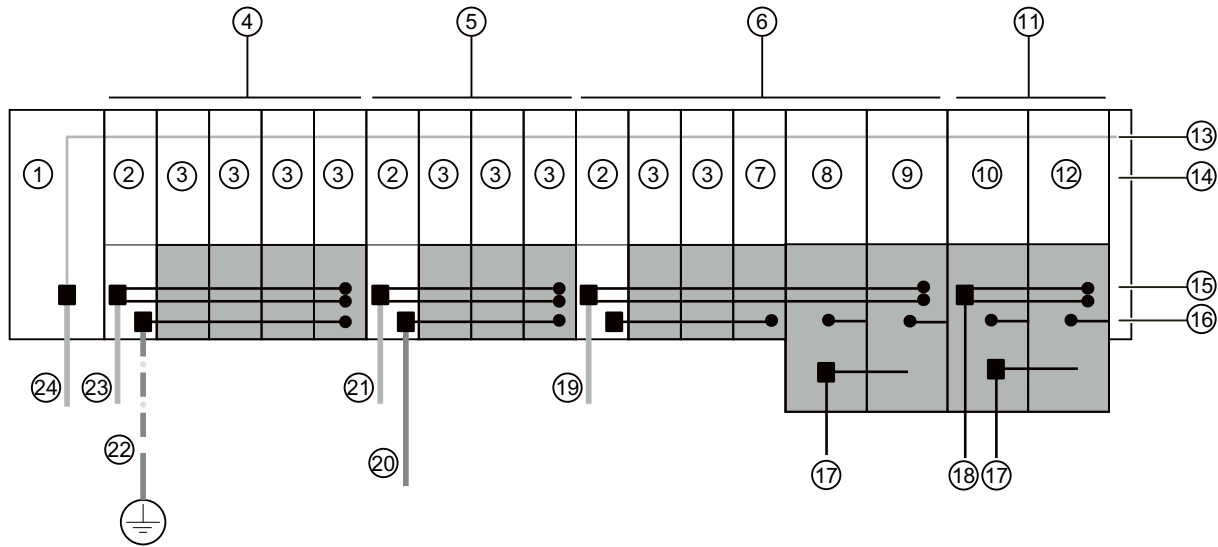

- | | | | |
|----|-----------------------------------|----|---|
| 1 | CPU/interface module | 14 | Server module |
| 2 | BaseUnit BU...D | 15 | Self-assembling voltage buses P1/P2 |
| 3 | BaseUnit BU...B | 16 | AUX bus |
| 4 | Potential group 1 | 17 | Infeed bus 500 V AC (L1, L2(N), L3, PE) |
| 5 | Potential group 2 | 18 | Supply voltage L+ |
| 6 | Potential group 3 | 19 | Supply voltage L+ (3) |
| 7 | BaseUnit BU...B with dummy module | 20 | Additionally required voltage |
| 8 | BaseUnit BU30-MS2 | 21 | Supply voltage L+ (2) |
| 9 | BaseUnit BU30-MS4 | 22 | Protective conductor (green/yellow) |
| 10 | BaseUnit BU30-MS1 | 23 | Supply voltage L+ (1) |
| 11 | Potential group 4 | 24 | Supply voltage 1L+ |
| 12 | BaseUnit BU30-MS4 | | |
| 13 | Backplane bus | | |

Figure 6-4 Placing the BaseUnits

Connecting different potentials to the power or AUX bus

NOTE

If you apply different potentials to the power or AUX bus within an ET 200SP station, you need to separate the potential groups with a BaseUnit BU...D.

6.5.2 Forming potential groups with BaseUnit type B1

Introduction

The AC I/O modules of the ET 200SP are required to connect sensors/actuators with alternating voltage 24 to 230 V AC.

Requirements

BaseUnits BU20-P12+A0+4B (BU type B1) and

- DI 4x120..230VAC ST digital input module
- DQ 4x24..230VAC/2A ST digital output module

Operating principle

Connect the needed module-dependent alternating voltage for the AC I/O modules directly to the BaseUnits BU20-P12+A0+4B (terminals 1L, 2L/1N, 2N). Insert the AC I/O modules on the BaseUnits.

NOTE

Placing the BaseUnits for AC I/O modules

If you insert an AC I/O module as the first I/O module, then a BaseUnit BU20-P12+A0+4B can also be the first BaseUnit to the right of the CPU/interface module in the ET 200SP configuration.

The requirement is that you use a CPU as of V3.0 or IM 155-6 (as of V3.0).

- The BaseUnits BU20-P12+A0+4B do not monitor the connected alternating voltage. Please note the information on limiting the overvoltage and power rating in the AC I/O module manuals.
 - Pay attention to the type of the BaseUnits during configuration.
-

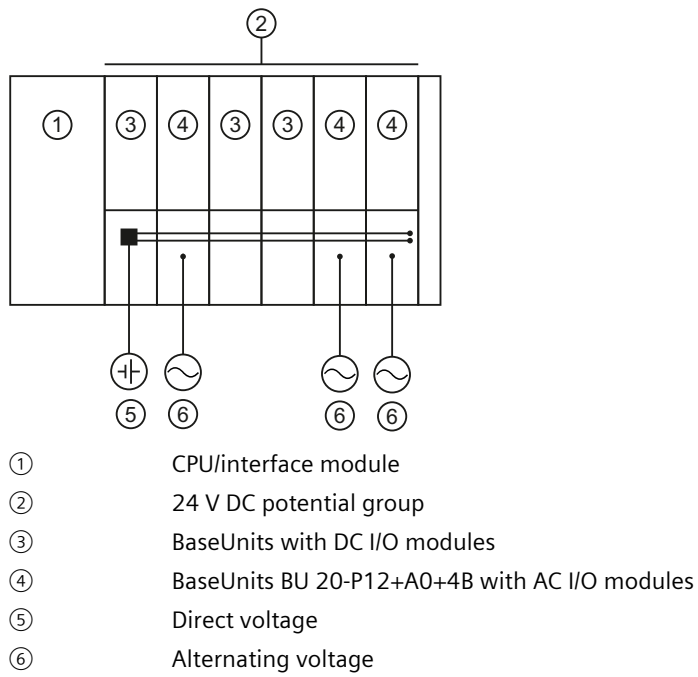

Figure 6-5 Placing the BaseUnits for the AC I/O modules

6.5.3 Forming potential groups with fail-safe modules

Introduction

ET 200SP distributed I/O systems can be configured using fail-safe and non-fail-safe modules. This chapter provides an example of a mixed configuration comprising fail-safe and non-fail-safe modules.

Example of an ET 200SP configuration with fail-safe and non-fail-safe modules

In principle, it is not necessary to operate fail-safe and non-fail-safe modules in separate potential groups. You can divide the modules into fail-safe and non-fail-safe potential groups and install them.

The figure below shows an example of a configuration with fail-safe and non-fail-safe modules within a single ET 200SP distributed I/O system.

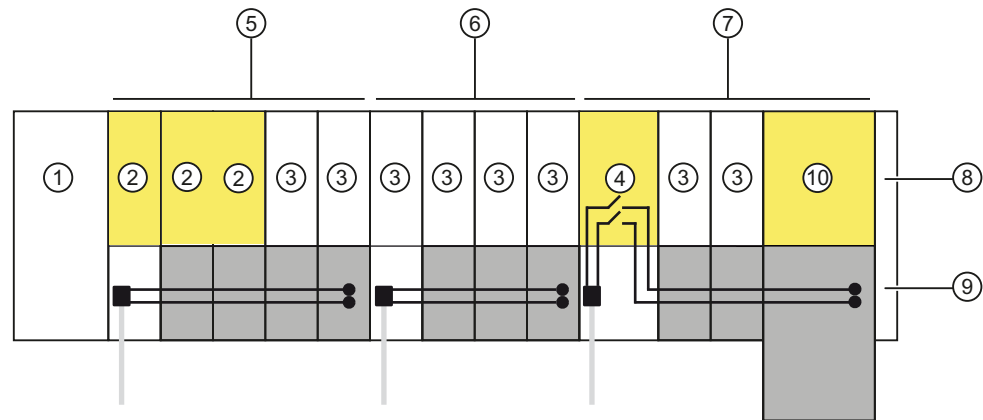

- ① IM 155-6 PN HF interface module
- ② F-module
- ③ Non-fail-safe module
- ④ Power module F-PM-E 24VDC/8A PPM ST
- ⑤ Mixed fail-safe and non-fail-safe potential group with BaseUnits BU15..D and BU15..B. You achieve SIL3/Cat. 4/PLe for the fail-safe modules. No safety category can be achieved with the non-fail-safe motor starter.
- ⑥ Non-fail-safe potential group with BaseUnits BU15..D and BU15..B
- ⑦ Fail-safe potential group with BaseUnits BU20..D, BU15..B and BU30-MSx. Up to SIL2/Cat. 3/PLd is possible if you disconnect the self-assembling voltage bus and thus the non-failsafe modules.
- ⑧ Server module
- ⑨ Self-assembling voltage buses P1/P2
- ⑩ Fail-safe motor starter F-DS HF

Figure 6-6 ET 200SP - example of a configuration with fail-safe modules

6.5.4 Forming potential groups with Ex modules

Ex module group

When you form an Ex module group with Ex BaseUnits and Ex power module/Ex I/O modules, observe the information in the System Manual ET 200SP HA Distributed I/O system / ET 200SP Modules for devices used in an explosion hazardous environment (<https://support.industry.siemens.com/cs/ww/de/view/109795533/en>).

NOTE

Thermal decoupling required

For thermal decoupling of ET 200SP modules and Ex module groups, you must install the following in front of the first Ex power module:

- An empty slot with BU cover
or
- Recommendation: Potential distributor (PotDis-TerminalBlock PotDis-TB-P1-R on a PotDis-BaseUnit PotDis-BU-P2/B-B). This allows for a distribution of the supply voltage for the downstream Ex power modules.

6.5.5 Forming potential groups with motor starters

Overview of the functions of the BaseUnits

	24 V infeed	24 V continuation from left module	24 V transmission	500 V infeed	500 V continuation from left module	500 V transmission	F-DI infeed	F-DI continuation from left module	F-DI routing
3RK1908-0AP00-0APO	✓	--	✓	✓	--	✓	--	--	--
3RK1908-0AP00-0CPO	--	✓	✓	✓	--	✓	--	--	--
3RK1908-0AP00-0BPO	✓	--	✓	--	✓	✓	--	--	--
3RK1908-0AP00-0DPO	--	✓	✓	--	✓	✓	--	--	--
3RK1908-0AP00-0EPO	--	✓	✓	✓	--	✓	✓	--	--
3RK1908-0AP00-0FPO	--	✓	✓	--	✓	✓	✓	--	--
3RK1908-0AP00-0GPO	--	✓	✓	✓	--	✓	✓	--	✓
3RK1908-0AP00-0HPO	--	✓	✓	✓	--	✓	--	✓	✓
3RK1908-0AP00-0JPO	--	✓	✓	--	✓	✓	--	✓	✓
3RK1908-0AP00-0KPO	--	✓	✓	--	✓	✓	✓	--	✓

✓ Function available

-- Function not available

Properties of the 500 V AC infeed bus

The infeed bus has the following properties:

- The infeed bus is assembled by lining up the motor starter BaseUnits "BU30-MSx".
- The infeed bus distributes the energy to the SIMATIC ET 200SP motor starter within one load group.
- You can open load groups by plugging in a 500 V infeed BaseUnit (BU30-MS1, BU30-MS2, BU30-MS5, BU30-MS7 or BU30-MS8). With BaseUnits BU30-MS3, BU30-MS4, BU30-MS6, BU30-MS9 or BU30-MS10, you can continue the infeed bus from the left BaseUnit.
- Via the infeed bus, you have the option of supplying three-phase load groups via L1, L2 and L3 or with single-phase load groups via L and N.
- The permissible voltage range is between 48 and 500 V AC.
- The maximum current carrying capacity is up to 32 A (3-phase) at 50 °C and 500 V. Pay attention to the derating values depending on the configuration.

Properties of the self-assembling voltage bus (L+)

Self-assembling voltage buses have the following properties:

- Maximum current: 7 A
- Rated voltage: 24 V

Pay attention to the derating values depending on the configuration.

The AUX1 bus is not supported in the BaseUnits of the SIMATIC ET 200SP motor starters. The AUX1 bus is used in ET 200SP motor starters for routing the F-DI signal in BU30-MS7 to BU30-MS10.

WARNING

Electric shock when operating the infeed bus without touch protection cover

There is a risk of electric shock when touching the infeed bus if you have not fitted a touch protection cover on the infeed bus on the right.

Always fit a touch protection cover on the infeed bus on the right (article number: 3RK1908-1DA00-2BP0).

WARNING

Electric shock when operating a BaseUnit without an inserted motor starter

If you fit a BaseUnit for motor starters without cover (e.g. option handling), there is a risk of an electric shock when touching the BaseUnit.

Always fit a cover on the BaseUnit (article number: 3RK1908-1CA00-0BP0).

Requirements

Use the following devices to form potential groups with motor starters:

- BaseUnits BU30-MSx
- 3RK1308-0xx00-0CP0 motor starters

Operating principle

Feed in the supply voltage L+ via the BaseUnit BU30-MS1 and BU30-MS3 at the 24V DC and M terminals.

You can operate the motor starter on a single-phase (L1, N, PE) or a three-phase (L1, L2, L3, PE) AC voltage system. You connect the required AC voltage directly to the BaseUnits BU30-MSx (terminals L1, L2(N), L3, PE). You plug the motor starter onto the BaseUnits.

NOTE

The motor starters' AC power supply is not connected to the AC power supply for the AC I/O modules (see Chapter "Forming potential groups with BaseUnit type B1 (Page 99)").

6.6 Configuration examples for potential groups

6.6.1 Configuration examples with BaseUnits

Table 6-6 Configuration examples with BaseUnits

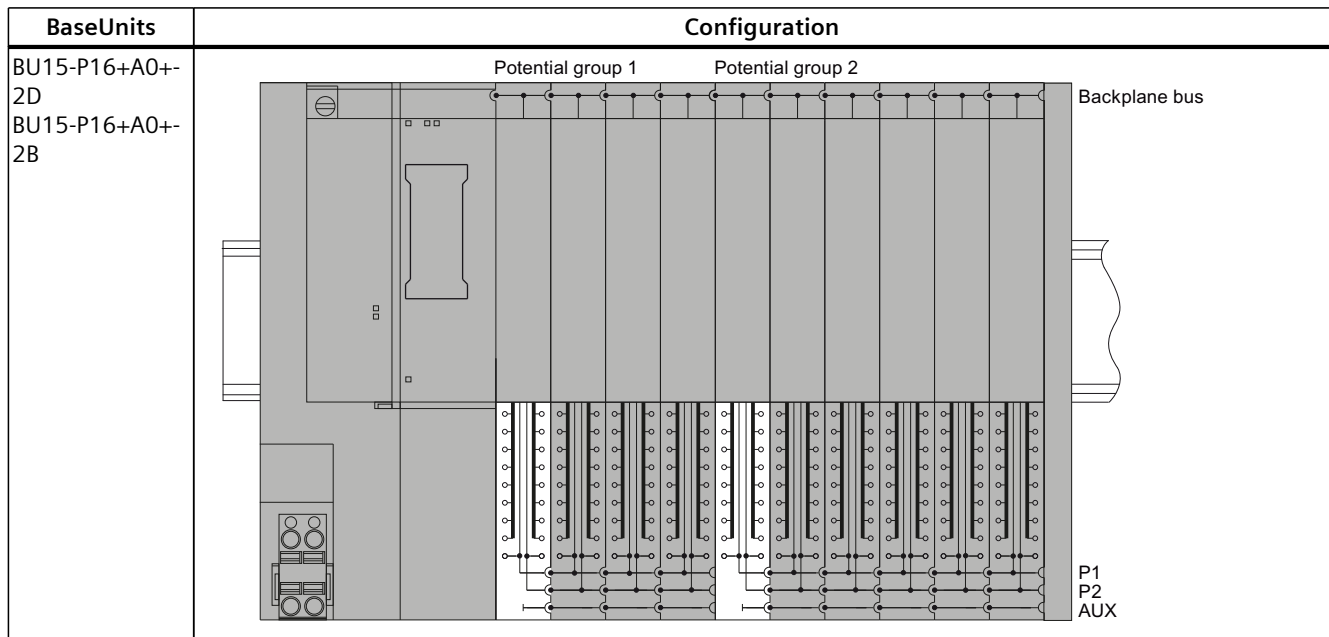

6.6 Configuration examples for potential groups

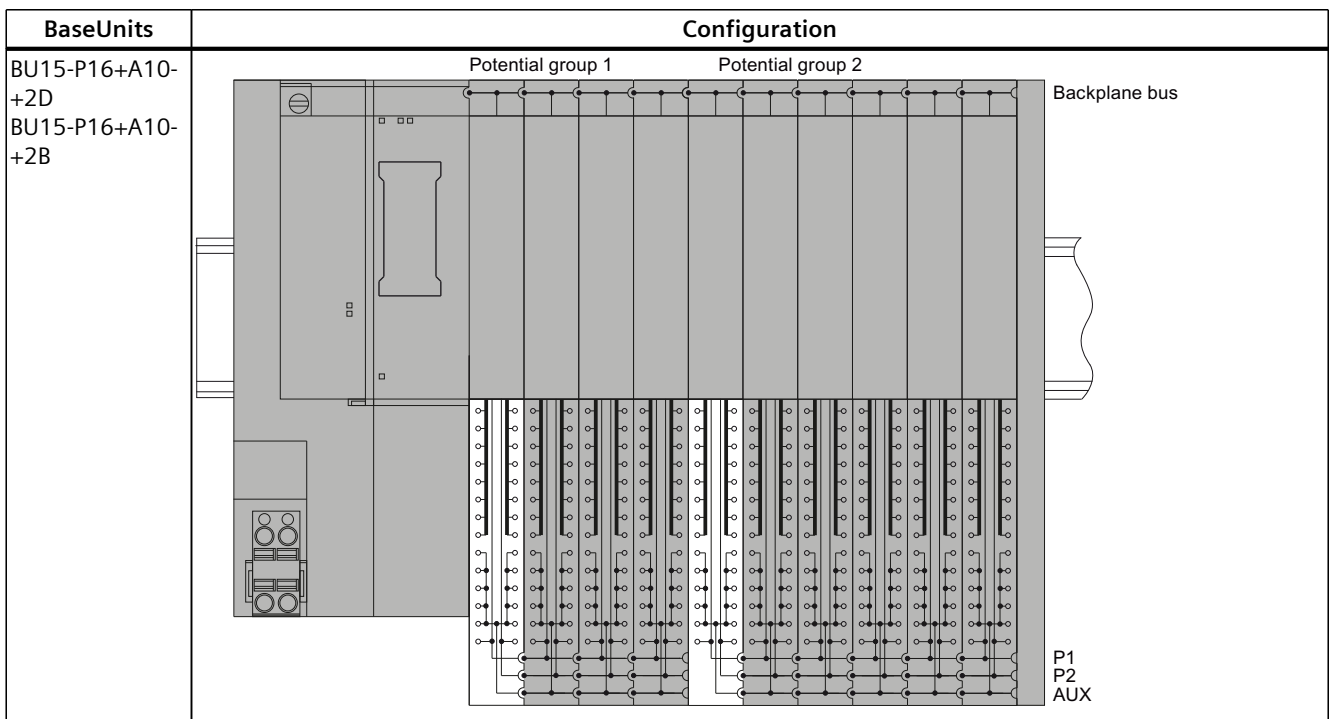
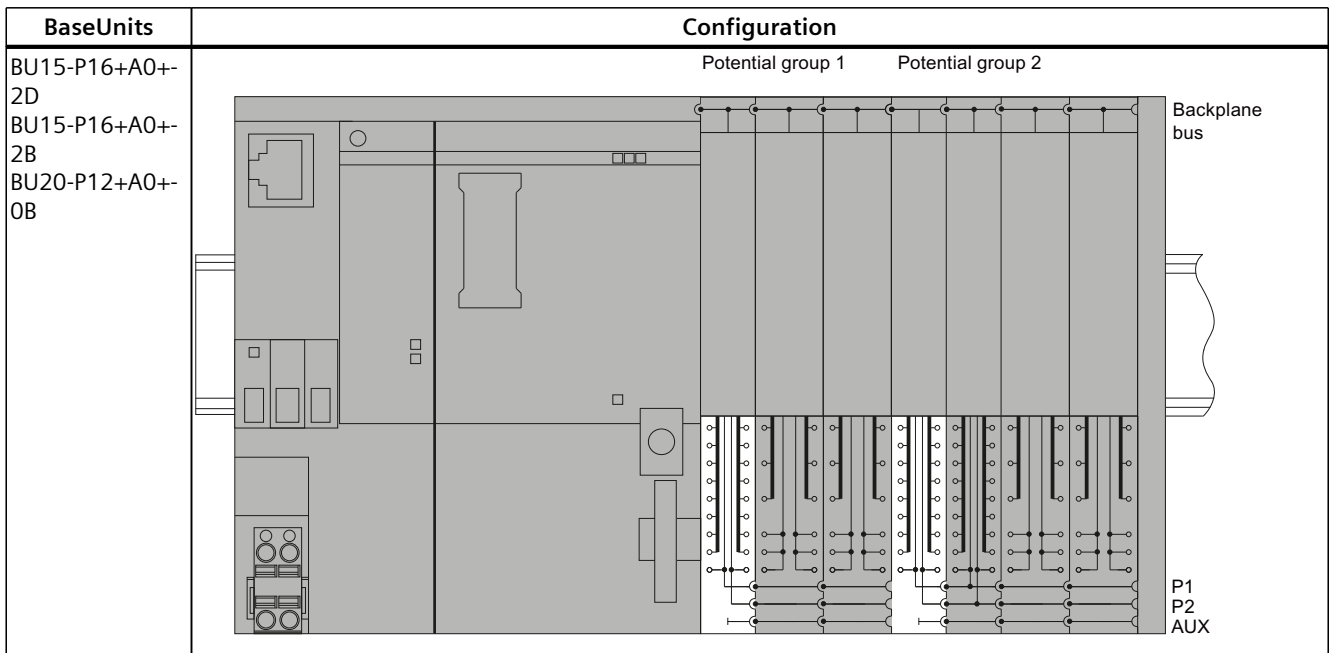

6.6.2 Configuration examples with potential distributor modules

3-wire connection

The potential distributor modules allow for a space-saving design. For a 3-wire connection, you can, for example, replace two digital input modules with 8 channels on a 141 mm long BaseUnit with a digital input module with 16 channels and a potential distributor module, each of which is only 117 mm long.

NOTE

You must not place a BaseUnit for I/O modules in a PotDis potential group formed with a light-colored PotDis-BaseUnit.

The figure below shows a configuration example with a DI 16×24VDC ST digital input module on a BU15-P16+A0+2B BaseUnit and a PotDis-TerminalBlock PotDis-TB-P1-R on a PotDis-BaseUnit PotDis-BU-P2/B-B.

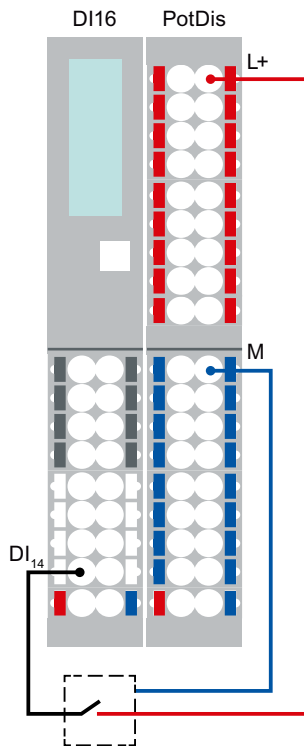

Figure 6-7 Example: 3-wire connection

Supply of external components

Another application of the potential distributor modules is the supply of potentials for external components. Potential distributor modules enable simple, compact, integrated and clear design.

Observe the current carrying capacity of each terminal: max. 10 A.

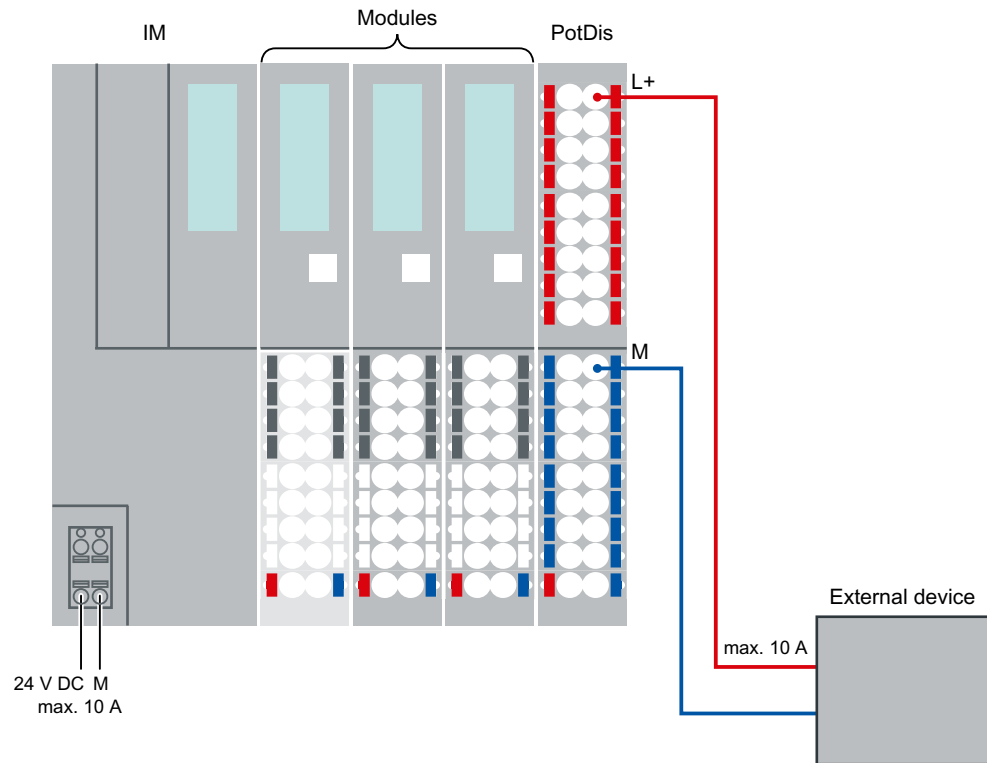

Figure 6-8 Example: Supply of external components

6.7 System redundancy R1

6.7.1 General notes on operating an ET 200SP R1 system

6.7.1.1 Example configuration of a system with ET 200SP R1

You need at least the following components for configuration of an ET 200SP R1 station:

- SIMATIC system rail (1 unit)
- BaseUnit BU type M0 (1 unit)
- Interface module IM 155-6 PN R1 (2 units)
- SIMATIC BusAdapter (2 units, e.g. BA 2×M12)
- BaseUnits and electronic modules (see section Configuration examples for potential groups (Page 104))
- Server module (1 unit)
- To operate a station with R1 system redundancy, you also need a set of R1-compatible S7-1500 CPUs (e.g. CPU 1517H-3 PN or CPU 1518HF-4 PN, 2 units).

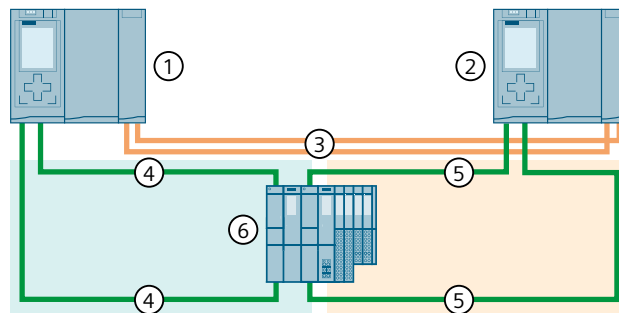

- ① CPU 1
- ② CPU 2
- ③ Two fiber-optic cables (redundancy connections)
- ④ PROFINET cable (PROFINET ring 1)
- ⑤ PROFINET cable (PROFINET ring 2)
- ⑥ ET 200SP I/O device (with system redundancy R1)

Figure 6-9 Configuration of S7-1500H with R1 devices in the PROFINET ring

You can find additional configuration examples in the SIMATIC S7-1500 S7-1500R/H Redundant System (<https://support.industry.siemens.com/cs/ww/de/view/109754833>) System Manual.

6.7.1.2 Commissioning an R1 station

After you configure an ET 200SP R1 station, you perform a commissioning maintenance cycle before the deployment in productive operation. This ensures that both redundant interface modules have been correctly contacted and can operate the electronic modules. The following is checked at the same time:

- Test for hardware integrity. Especially for hardware units that are not used while the device is passive and has no access to the SP bus. To ensure that the hardware is fully intact, perform at least a temporary takeover of the SP bus.
- After the maintenance cycle, the redundancy group must return to its pre-maintenance state.

To perform a commissioning maintenance cycle, proceed as follows:

The initial state is: The S7-1500H redundant system is in the RUN-Redundant system state. The ACT LED of one of the two interface modules (IM 1: regardless whether slot 0 or slot 1) is continuously lit.

1. Test step: Disconnect the interface module with the continuously lit ACT LED (IM 1) from the operating voltage by removing the connector from the 24 V connection. The station must assume the following state:
 - The LEDs of interface module 1 all go out.
 - The ACT LED of interface module 2 starts to flash.
 - In the CPU user program, an OB 70 (loss of redundancy) is reported on the station.
 - In the CPU user program, no OB 86 (station failure) is reported on the station.
2. Test step: Check the inputs and outputs via interface module 2. Use the engineering or configuration tool (e.g. user program or tag table).
3. Test step: Restore the operating voltage of interface module 1. The station must assume the following state after restart of interface module 1:
 - The ACT LED of interface module 2 lights up continuously.
 - In the CPU user program, an OB 70 (redundancy return) is reported.
 - The S7-1500H redundant system is again in the RUN-Redundant system state.
4. Test step: Disconnect the interface module with the permanently lit LED ACT (IM 2) from the operating voltage by pulling the plug out of the 24 V connection. The station must assume the following state:
 - The LEDs of interface module 2 all go out.
 - The ACT LED of the interface module 1 starts to flash.
 - In the CPU user program, an OB 70 (loss of redundancy) is reported on the station.
 - In the CPU user program, no OB 86 (station failure) is reported on the station.
5. Test step: Check the inputs and outputs via interface module 1. Use the engineering or configuration tool (e.g. user program or tag table).
6. Test step: Restore the operating voltage of interface module 2. The station must assume the following state after restart from interface module 2:
 - The ACT of interface module 1 is lit continuously.
 - In the CPU user program, an OB 70 (redundancy return) is reported.
 - The S7-1500H redundant system is again in the RUN-Redundant system state.
 - The system is again in the same state as before test step 1. The commissioning maintenance cycle has been successfully completed.

6.7.1.3 Increased availability

Compared to other ET 200SP interface modules, the system availability has been increased through use of PROFINET R1 redundancy. Even if one interface module fails, the function of the station is maintained.

The module automatically restarts to quickly return to the redundant state if one of the two redundant interface modules of a station fails (e.g. due to a critical error). This eliminates repair time.

Critical failures are stored in the device for later evaluation. You make this information available to Customer Support by reading the service data. You can find information on reading out the service data in the Interface Module IM 155-6 PN R1 Equipment Manual.

6.7.2 Improving the switchover time of the ET 200SP R1 system

Definition

The switchover time of the ET 200SP R1 station is the time that elapses after failure of the primary connection until the back-up IM has established the primary connection and takes control of the process. The response time is extended once during a redundancy switchover.

Composition of the cycle time and response time

You can find information and notes on the configuration of the CPU, the general composition of the cycle time and response time and how you can improve these times in the Cycle and Response Times (<https://support.industry.siemens.com/cs/ww/en/view/59193558>) Function Manual.

Improving the switchover time through configuration of the ET 200SP R1 station

To improve response times for an R1 system, we recommend that you follow the instructions below when configuring the ET 200SP R1 station:

- The shorter the PROFINET update time of an IO device, the shorter the response time of the R1 system tends to be.
- The fewer the number of I/O modules plugged into an R1 station, the shorter the response time of the R1 system tends to be.
- The smaller the input and output data range of the I/O modules, the shorter the response time of the R1 system tends to be.
- Certain module types increase the switchover time. Therefore, configure the stations in such a way that these module types are configured in a separate ET 200SP R1 station. This ensures that the switchover time of the ET 200SP R1 station that does not contain these module types is shorter.

The following table provides you an overview of the modules that belong to these module types.

Name	MLFB
SIMATIC ET 200SP, Analog Input Module, AI Energy Meter 480VAC/CT HF for 1 A or 5 A current transformer, with network analysis functions	6ES7134-6PA00-0CU0 (no longer available)
SIMATIC ET 200SP, Analog Input Module, AI Energy Meter CT ST, for 1 A or 5 A current transformer	6ES7134-6PA01-0BU0
SIMATIC ET 200SP, Analog Input Module, AI Energy Meter CT HF, for 1 A or 5 A current transformer, with network analysis functions	6ES7134-6PA01-0CU0
SIMATIC ET 200SP, Analog Input Module, AI Energy Meter 480V AC ST	6ES7134-6PA20-0BDO
SIMATIC ET 200SP, Analog Input Module, AI Energy Meter 480V AC/RC HF for Rogowski coils, current/voltage transformer 333 mV, with network analysis functions	6ES7134-6PA20-0CU0 (no longer available)
SIMATIC ET 200SP, Analog Input Module, AI Energy Meter RC HF, for Rogowski coils or current/voltage transformer 333 mV, with network analysis functions	6ES7134-6PA21-0CU0
SIMATIC ET 200SP, Analog Input Module, AI Energy Meter RC ST, for Rogowski coils or current/voltage transformer 333 mV	6ES7134-6PA21-0BU0
SIMATIC ET 200SP, CM 4xIO-Link ST Communication module IO-Link Master V1.1	6ES7137-6BD00-0BA0
Technology Module SITRANS FST070 Ultrasonic Flow Transmitter	7ME3448-6AA00-0BB1
Technology Module SITRANS FCT070 Coriolis Flow Transmitter	7ME4138-6AA00-0BB1

NOTE

You can find additional information on switchover times from SIEMENS Customer Support.

Installation

7.1 Basics

Introduction

All modules of the ET 200SP distributed I/O system are open equipment. This means you may only install the ET 200SP distributed I/O system in housings, cabinets or electrical operating rooms and in a dry indoor environment (degree of protection IP20). The housings, cabinets and electrical operating rooms must guarantee protection against electric shock and spread of fire. The requirements regarding mechanical strength must also be met. The housings, cabinets, and electrical operating rooms must not be accessible without a key or tool. Personnel with access must have been trained or authorized.

Installation location

Install the ET 200SP distributed I/O system in a suitable enclosure/control cabinet with sufficient mechanical strength and fire protection. Take into account the environmental conditions for operating the devices.

Mounting position

You can mount the ET 200SP distributed I/O system in any position. The preferred mounting position is horizontal mounting on a vertical wall.

The ambient temperature may be restricted in certain installation positions. You will find more information in section Mechanical and climatic environmental conditions ([Page 330](#)). Pay attention to chapter "Installation conditions for motor starters ([Page 116](#))" when using motor starters.

Mounting rail

Install the ET 200SP distributed I/O system on a mounting rail in accordance with ISO 60715 (35 × 7.5 mm or 35 × 15 mm) or on a SIMATIC system rail.

The ET 200SP R1 system must be mounted on the SIMATIC system rail only.

You need to ground the mounting rail separately in the control cabinet. Exception: If you install the rail on grounded, zinc-plated mounting plates, there is no need to ground the rail separately.

NOTE

If the ET 200SP distributed I/O system is exposed to vibration and shock loads, both ends of the ET 200SP system assembly must be mechanically fixed to the mounting rail (e.g using 8WA1010-1PH01 ground terminals). This measure prevents the ET 200SP distributed I/O system from shifting to the side.

NOTE

If the ET 200SP, distributed IO system is exposed to increased vibrations and shock, fasten the mounting rail to the mounting surface at intervals of approx. 200 mm.

For increased vibration and shock loads, you can mount the ET 200SP system on the SIMATIC system rail.

The following are suitable surfaces for the mounting rails:

- Steel strip in accordance with Appendix A of EN 60715 or
 - Tinned steel strip. We recommend these in conjunction with the mounting rails in the section Accessories/spare parts ([Page 339](#)).
-

NOTE

If you use mounting rails from other manufacturers, make sure that they have the required properties for your ambient climatic conditions.

Minimum clearances

The figure below shows the minimum clearances you must observe when installing or dismantling the ET 200SP distributed I/O system.

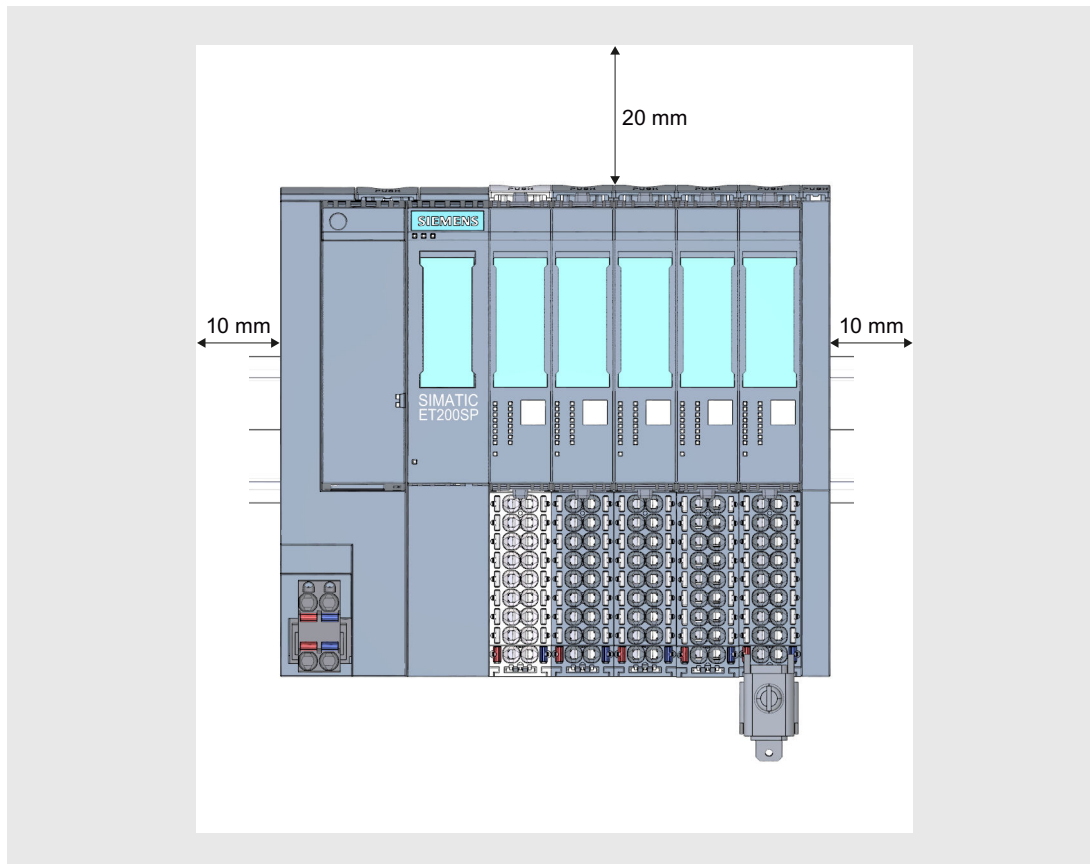

Figure 7-1 Minimum clearances

NOTE

Ex module group

When you are using an Ex module group in your configuration, you must observe other minimum clearances.

Additional information on minimum clearances and installing/removing Ex modules is available in the System Manual ET 200SP HA Distributed I/O system / ET 200SP Modules for devices used in an explosion hazardous environment

(<https://support.industry.siemens.com/cs/ww/de/view/109795533/en>).

General rules for installation

⚠ WARNING**Hazardous Voltage
Can Cause Death, Serious Injury, or Property Damage.**

Hazardous electrical voltage can cause electric shock, burns and property damage.

Disconnect your system and devices from the power supply before starting any assembly tasks.

Observe the following rules:

- Installation starts on the left-hand side with the CPU/interface module.
- A light-colored BaseUnit BU..D0, BU30-MS1 or BU30-MS3 with infeed of supply voltage L+ follows the CPU/interface module or is placed at the start of each potential group. If you use a CPU or IM 155-6 (V3.0 or higher), the first BaseUnit in the installation of the ET 200SP may also be a dark-colored BaseUnit of type B1 or D0.
- This is followed by BaseUnits BU..B, BU30-MS2 or BU30-MS4 (with a dark-colored terminal box).
- The matching I/O modules / motor starters can be plugged onto the BaseUnits. You will find matching combinations of BaseUnits and I/O modules / motor starters in Application planning ([Page 80](#)).
- The server module completes the configuration of the ET 200SP distributed I/O system.

NOTE

Mount the ET 200SP distributed I/O system only with disconnected supply voltage.

⚠ WARNING**Protection from conductive contamination**

Taking into account the environmental conditions, the devices must be protected from conductive contamination.

This can be achieved, for example, by installing the devices in a control cabinet with the appropriate degree of protection.

Mounting rules for reducing the thermal load

The following rules reduce the thermal load of the ET 200SP distributed I/O system in the control cabinet:

- Separate 2 modules with high power dissipation with a module of low power dissipation or by an empty space.
- Mix modules with higher power dissipation and modules with less power dissipation. For example, modules with 16 outputs have a higher power dissipation than modules with 8 outputs.
- You should give preference to the horizontal mounting position.
- For vertical mounting position, plug modules with high power dissipation at the top, the interface module/CPU at the bottom.

7.2 Installation conditions for motor starters

- Mount an ET 200SP station with modules with high power dissipation in the lower area of the control cabinet.
- For a multi-tier configuration, plug modules with high power dissipation on the sides so that the waste heat can rise to the top unhindered.
- Avoid air movements at the terminals when using TC measurement with internal compensation.

7.2 Installation conditions for motor starters

Observe the following installation conditions when using an ET 200SP motor starter:

- Mounting position

You can fit the motor starter vertically or horizontally. The mounting position refers to the alignment of the mounting rail. The maximum permissible ambient temperature range depends on the mounting position:

- Up to 60° C: Horizontal mounting position
- Up to 50° C: Vertical installation position

You also need to consider the current carrying capacity of the ET 200SP components.

In the case of a vertical mounting position, use end retainers "8WA1808" at both ends of the ET 200SP station:

- Mounting rail

Use one of the following mounting rails:

- 35x15 mm DIN rail in accordance with DIN EN 60715
- 35x7.5 mm DIN rail in accordance with DIN EN 60715
- SIMATIC S7 mounting rail

- Current carrying capacity of the ET 200SP station

Current carrying capacity refers to the current load via the power bus and the infeed bus of the ET 200SP station.

Depending on the ambient conditions and mounting position, you have to take account of the fan unit or additional mechanical fixings.

Mechanical brackets

Use the mechanical brackets in the following situations:

- When using a 15 mm mounting rail with a single motor starter installation, i.e. no motor starter mounted directly next to it in the system
- With a vertical mounting position
- For applications according to shipbuilding standards in all mounting positions with 7.5 mm and 15 mm mounting rails

Designing interference-free motor starters

For interference-free operation of the ET 200SP station in accordance with standard IEC 60947-4-2, use a dummy module before the first motor starter. No dummy module is required to the right of the motor starter.

Note the following mounting rules:

Use the following dummy module on the standard mounting rail between the previous module and the SIMATIC ET 200SP motor starter:

BU cover 15 mm: 6ES7133-6CV15-1AM0 with BaseUnit 6ES7193-6BP00-0BA0

For operation of the ET 200SP station with an unused BaseUnit, a cover must be provided for the open BaseUnit plug contacts (power connector, power bus connector, and backplane bus connector).

The cover protects the plug contacts against dirt. The BU cover can be ordered as an accessory.

Mount the dummy module

The figure below provides a schematic representation of how to implement measures for improving interference immunity.

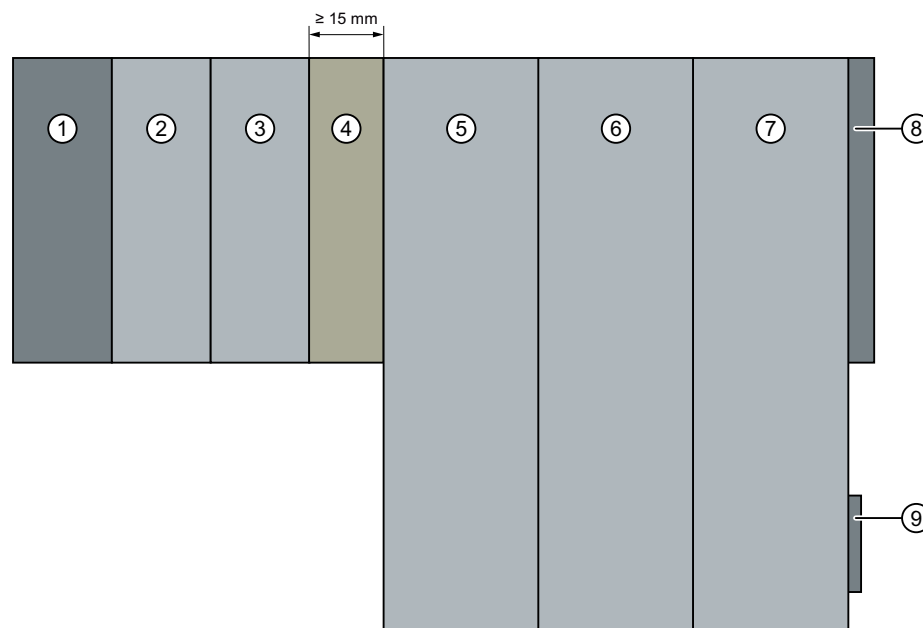

- | | | | |
|---|-----------------------|---|------------------|
| ① | Interface module | ⑥ | Motor starter |
| ② | Digital input module | ⑦ | Motor starter |
| ③ | Digital output module | ⑧ | Server module |
| ④ | Dummy module | ⑨ | Infeed bus cover |
| ⑤ | Motor starter | | |

NOTICE

Ensure interference immunity

You must not plug any other module into the BaseUnit of the dummy module, otherwise interference immunity is no longer ensured.

7.3 Mounting the CPU/interface module

Introduction

The CPU/the interface module connects the ET 200SP distributed I/O system to the fieldbus and exchanges the data between the higher-level control system and the I/O modules / motor starters.

Requirement

The mounting rail is fitted.

Required tools

3 to 3.5 mm screwdriver (only for mounting and removing the BusAdapter)

Mounting the CPU/interface module

Watch the video sequence (<https://support.automation.siemens.com/WW/view/en/95886218>)

To install a CPU/interface module, follow these steps:

1. Install the CPU/interface module on the mounting rail.
2. Swivel the CPU/interface module towards the back until you hear the mounting rail release button click into place.

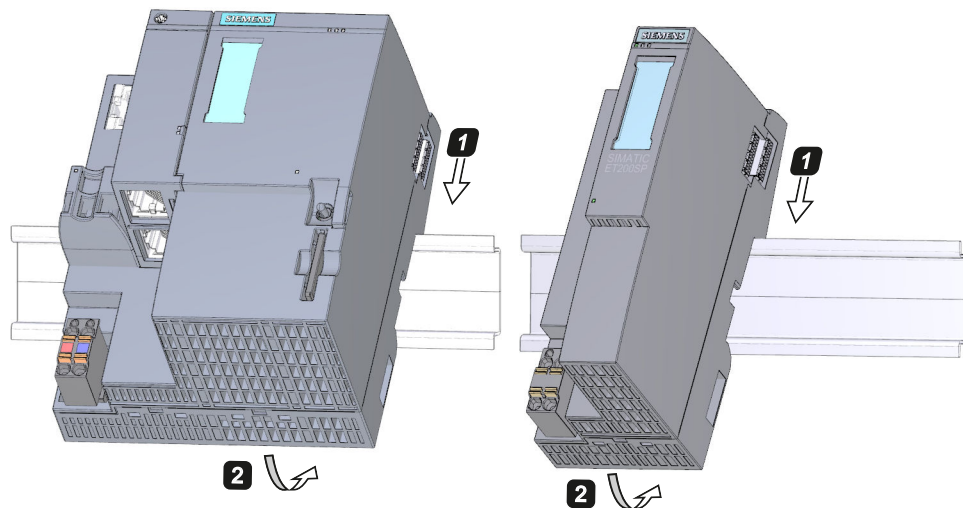

Figure 7-2 Mounting the CPU/interface module

Dismantling the CPU/interface module

The CPU/interface module is wired and BaseUnits are located to its right.

To remove the CPU/interface module, follow these steps:

1. Switch off the supply voltage for the CPU/interface module. Remove the 24 V DC connector from the CPU/interface module.
2. Press the mounting rail release button on the first BaseUnit. At the same time, shift the CPU/interface module parallel to the left until it detaches from the rest of the module group.
Note: The mounting rail release button is located above the CPU/interface module or BaseUnit.
3. While pressing the mounting rail release button on the CPU/interface module, swivel the CPU/interface module off of the mounting rail.

NOTE

It is not necessary to remove the BusAdapter from the CPU/interface module.

7.4 Installing ET 200SP R1

Introduction

The ET 200SP R1 system connects the ET 200SP distributed I/O system to the fieldbus and exchanges the data between the higher-level controller and the I/O modules / motor starters.

Requirement

The SIMATIC system rail is installed.

Tools required

3 to 3.5 mm screwdriver (only for mounting and removing the BusAdapter)

Mounting the ET 200SP R1 system

To mount the ET 200SP R1 system, proceed as follows:

1. Hang the BaseUnit BU type M0 onto the SIMATIC system rail.
2. Swivel the BaseUnit BU type M0 backwards until the system rail release audibly engages.
3. Plug the IM 155-6 PN R1 interface modules onto the BaseUnit BU type M0 until the lock audibly engages.
4. Plug the 24 V DC connectors into both interface modules.
5. Connect a BusAdapter to each interface module. Screw the BusAdapter to the interface module.

Removing the ET 200SP R1 system

To remove the ET 200SP R1 system, proceed as follows:

1. Switch off the supply voltage for the ET 200SP R1 system. Unplug the 24 V DC connectors from both interface modules.
2. Press the interface module release on the BaseUnit BU type M0. Detach the interface modules from the BaseUnit BU type M0.
3. Press the system rail release on the BaseUnit. Move the BaseUnit BU type M0 parallel to the left until it detaches from the rest of the module group.
Note: The system rail release is located above the BaseUnit BU type M0.
4. With the system rail release pressed on the BaseUnit, swivel the BaseUnit BU type M0 off of the system rail.

NOTE

It is not necessary to remove the BusAdapter from the IM 155-6 PN R1 interface modules.

7.5 Installing the CM DP communication module

Introduction

You need the CM DP communication module to use the CPU with a DP master or DP slave.

Requirements

- The mounting rail is fitted.
- The CPU is installed.

Installing CM DP

To install the CM DP communication module, follow these steps:

1. Install the CM DP to the right of the CPU.
2. Swivel the CM DP towards the back until you hear the mounting rail release button click into place.
3. Slide the CM DP to the left until you hear it click into the CPU.

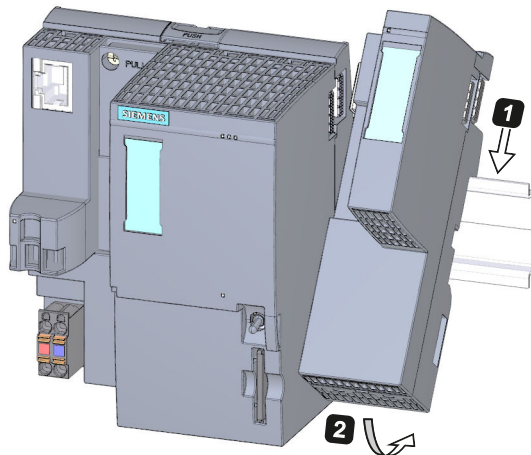

Figure 7-3 Installing CM DP

Removing a CM DP

The CPU and the CM DP are wired and BaseUnits are located to its right.

To remove the CM DP communication module, follow these steps:

1. Switch off the supply voltage on the CPU.
2. Press the mounting rail release button on the first BaseUnit and, at the same time, move the CPU and the CM DP parallel to the left until they detach from the rest of the module group (clearance about 16 mm).
3. Press the mounting rail release button on the CM DP and move it to the right until it detaches from the CPU (clearance about 8 mm).
4. While pressing the mounting rail release button on the CM DP, swivel the CM DP off of the mounting rail.

NOTE

It is not necessary to remove the bus connector from the CM DP unless you have to replace the CM DP.

7.6 Mounting BaseUnits for I/O modules

Introduction

The BaseUnits are used for electromechanical connection between the individual ET 200SP components. They also provide terminals for connecting external sensors, actuators and other devices.

Requirements

The mounting rail is fitted.

Required tools

3 to 3.5 mm screwdriver (only for dismantling the terminal box and the encoding element)

Installing a BaseUnit

Watch "Install configuration" video sequence

(<https://support.automation.siemens.com/WW/view/en/95886218>)

To install a BaseUnit, follow these steps:

1. Hook the BaseUnit onto the mounting rail.
2. Swivel the BaseUnit backwards until you hear it click into place on the mounting rail.
3. Slide the BaseUnit parallel to the left until you hear it latch onto the preceding CPU/interface module or BaseUnit.

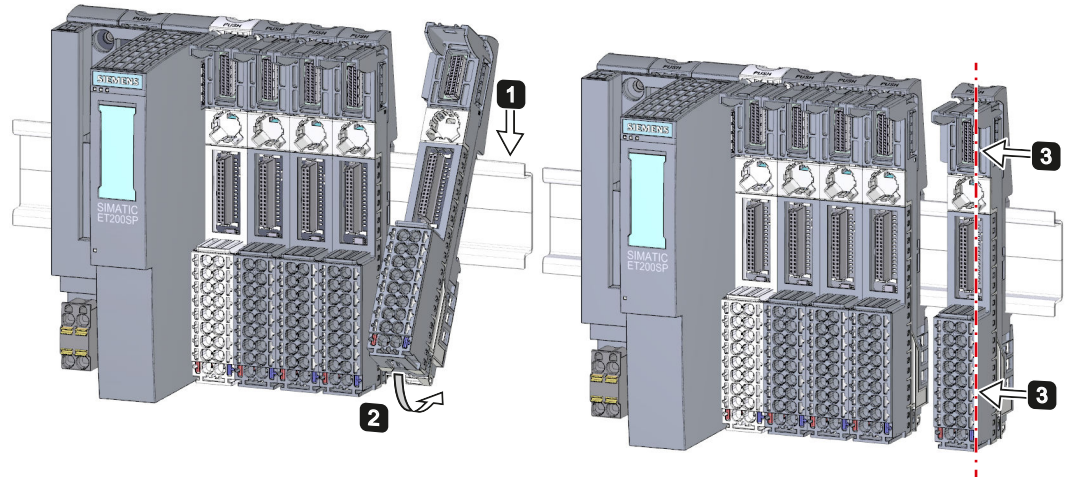

Figure 7-4 Installing a BaseUnit

Removing a BaseUnit

⚠ WARNING

Hazardous Voltage

Hazardous electrical voltage can cause electric shock, burns and property damage.

Disconnect your system and devices from the power supply before starting any assembly tasks.

To remove a BaseUnit, follow these steps:

The BaseUnit is wired and there are other BaseUnits to its right and left.

To remove a specific BaseUnit, move the adjacent modules. As soon as you have created a clearance of about 8 mm from the adjacent BaseUnits, you can remove the BaseUnit.

NOTE

You can replace the terminal box without removing the BaseUnit. Refer to section Replacing the terminal box on the BaseUnit ([Page 290](#)).

To remove a BaseUnit, follow these steps:

1. Switch off all supply voltages on the ET 200SP distributed I/O system.
2. Loosen the wiring on the BaseUnit (with a 3 to 3.5 mm screwdriver).

3. Removing (from the right):

Press the mounting rail release on the relevant BaseUnit. Move the BaseUnit parallel to the right and swivel the BaseUnit off of the mounting rail while pressing the mounting rail release.

Removing (from the left):

Press the mounting rail release on the relevant BaseUnit and the BaseUnit located to its right. Move the BaseUnit parallel to the left and swivel the BaseUnit off of the mounting rail while pressing the mounting rail release.

Note: The mounting rail release is located above the BaseUnit

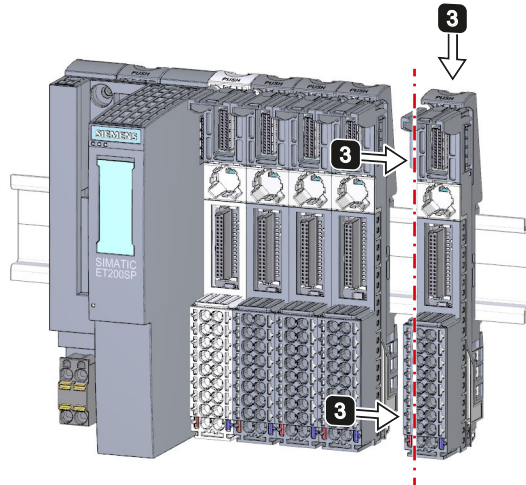

Figure 7-5 Removing the BaseUnit (removing from the right)

7.7 Mounting and dismantling BaseUnits for motor starters

Requirements

- The mounting rail is fitted.
- When using a 15 mm mounting rail, you must install the additional mechanical mounting (3RK1908-1EA00-1BP0).

NOTE

Mechanical bracket for BaseUnit

You will find out how to mount the mechanical bracket for the BaseUnit in chapter "Mounting the mechanical bracket for the BaseUnit ([Page 129](#))".

<p>⚠ CAUTION</p> <p>Protection against electrostatic charge</p> <p>When handling and installing the SIMATIC ET 200SP motor starter, ensure protection against electrostatic charging of the components. Changes to the system configuration and wiring are only permissible after disconnection from the power supply.</p>
--

Mounting a BaseUnit

Proceed as follows to mount a BaseUnit for motor starters:

1. Hook the BaseUnit into the DIN rail from above.
2. Swing the BaseUnit to the rear until the BaseUnit audibly engages.

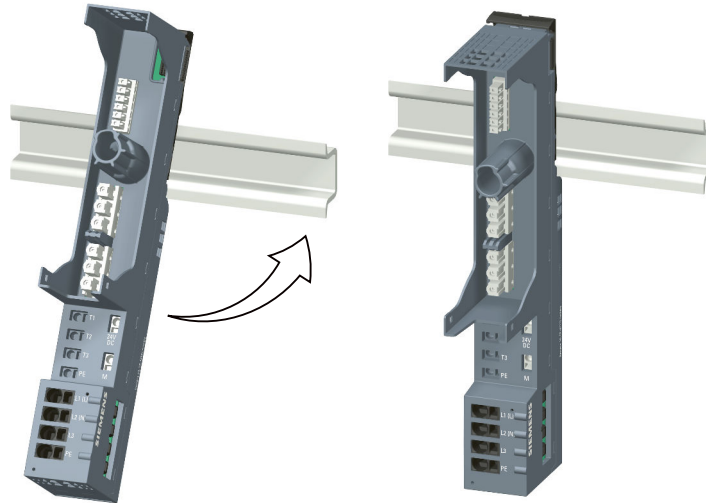

3. Slide the individual BaseUnits to the left to the previous BaseUnit until they audibly engage.
Assemble the BaseUnits only on the DIN rail.

NOTE

The BaseUnits for motor starters can be plugged together with the BaseUnits for I/O modules.

Disassembling the BaseUnit

WARNING

Hazardous Voltage

Hazardous electrical voltage can cause electric shock, burns and property damage.

Disconnect your system and devices from the power supply before starting any assembly tasks.

To disassemble the BaseUnit, proceed as follows:

1. Disconnect the main power supply and the control current supply of the SIMATIC ET 200SP motor starter.
2. Actuate the DIN rail release on the BaseUnit of the motor starter.
3. Move the BaseUnit to the left. As soon as there is a clearance of approximately 8 mm to the neighboring BaseUnits, you can disassemble the BaseUnit of the motor starter.

- Swing the BaseUnit away from the DIN rail while pressing the DIN rail release.

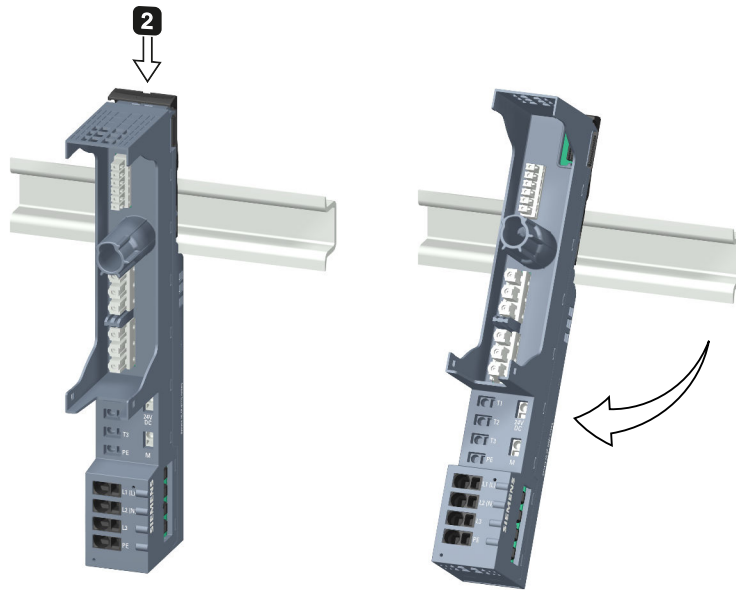

7.8 Installing potential distributor modules

Introduction

You use the potential distributor module to distribute a variety of potentials (P1, P2).

Requirements

The mounting rail is installed.

Installing and uninstalling PotDis-BaseUnit

You install/uninstall PotDis-BaseUnits as you would the BaseUnits for I/O modules. You can find additional information in section Mounting BaseUnits for I/O modules ([Page 122](#)).

Installing and uninstalling PotDis-TerminalBlock

Installing

Plug the PotDis-TerminalBlock in die PotDis-BaseUnit. Proceed exactly as described in Section Inserting I/O modules / motor starters and BU covers ([Page 163](#)).

Uninstalling

To remove a PotDis-TerminalBlock, follow these steps:

- Switch off all supply voltages on the ET 200SP distributed I/O system.
- Simultaneously press the top and bottom release buttons of the PotDis-TerminalBlock.
- Remove the PotDis-TerminalBlock from the front of the PotDis-BaseUnit.

7.9 Installing the server module

Introduction

The server module on the far right of the assembly/line completes the ET 200SP distributed I/O system.

Requirement

The last BaseUnit is mounted.

Installing the server module

Watch "Install configuration" video sequence

(<https://support.automation.siemens.com/WW/view/en/95886218>)

Proceed as follows to install a server module:

1. Hook the server module onto the mounting rail to the right of the last BaseUnit.
2. Swivel the server module backwards on the mounting rail.
3. Move the server module parallel to the left until you hear it latch onto the last BaseUnit that precedes it.

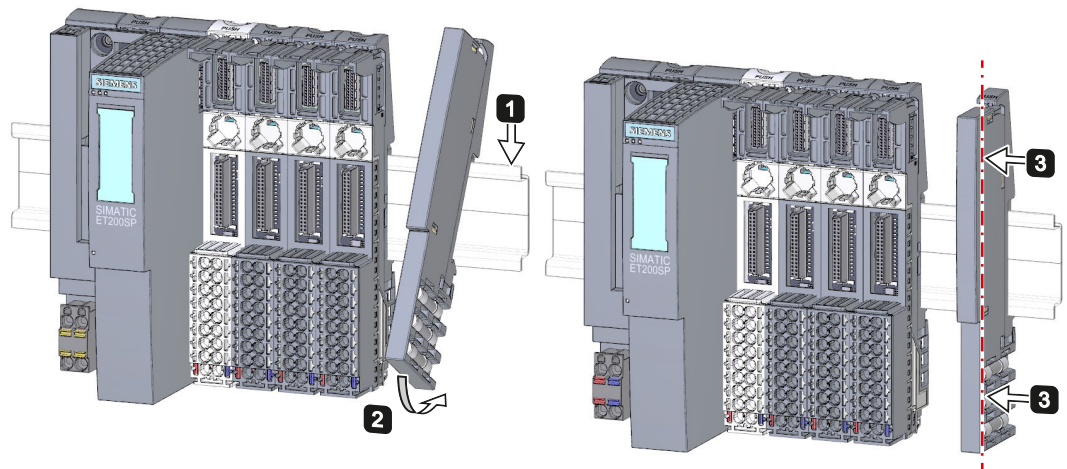

Figure 7-6 Installing the server module

Removing the server module

Proceed as follows to remove a server module:

1. Press the mounting rail release button on the server module.
2. Move the server module parallel to the right.
3. While pressing the mounting rail release button, swivel the server module off the mounting rail.

7.10 Mounting further accessories for motor starters

7.10.1 Mounting the cover for the 500 V AC infeed bus

Introduction

The 500 V infeed bus connects all SIMATIC ET 200SP motor starters. For finger-safe termination of the infeed bus, you must use the cover.

 **DANGER**

Hazardous Voltage

Can Cause Death, Serious Injury, or Property Damage.

Hazardous electrical voltage causes electric shock, burns and property damage.

Disconnect your system and devices from the power supply before starting any assembly tasks.

 **DANGER**

Infeed bus - electric shock

You must provide the infeed bus with a touch protection cover on the right (Article No.: 3RK1308-1DA00-2BP0).

Failure to do so will result in the danger of electric shock.

 **WARNING**

Personal injury may occur

On the last plugged-in BaseUnit of a motor starter, place a cover on the opening of the contacts of the infeed bus.

Procedure

Proceed as follows to mount the infeed bus cover on a SIMATIC ET 200SP motor starter:

1. Press the cover onto the opening of the BaseUnit on the right until it audibly engages.

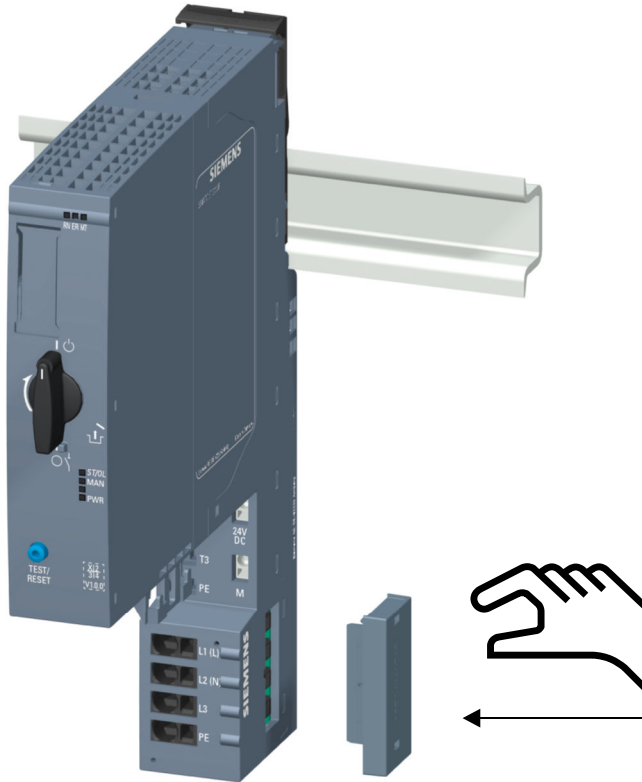

The cover can be removed again using 2 fingers and without tools.

7.10.2 Mounting the mechanical bracket for the BaseUnit

Introduction

To achieve higher stability, you can use a mechanical bracket on 7.5 mm and 15 mm mounting rails.

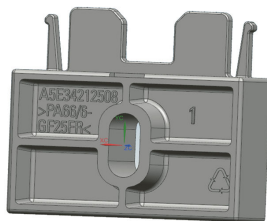

You must use the mechanical bracket in the following situations:

- When using a 15 mm mounting rail
- With a vertical mounting position
- For applications according to shipbuilding standards in all mounting positions with 7.5 mm and 15 mm mounting rails

You can find further information on the mechanical bracket in chapter "Installation conditions for motor starters (Page 116)".

Procedure

To mount the mechanical bracket, proceed as follows:

1. Insert the mechanical bracket into the opening at the bottom of the BaseUnit.
You use the same mechanical bracket for both mounting rails, rotated through 180° respectively.

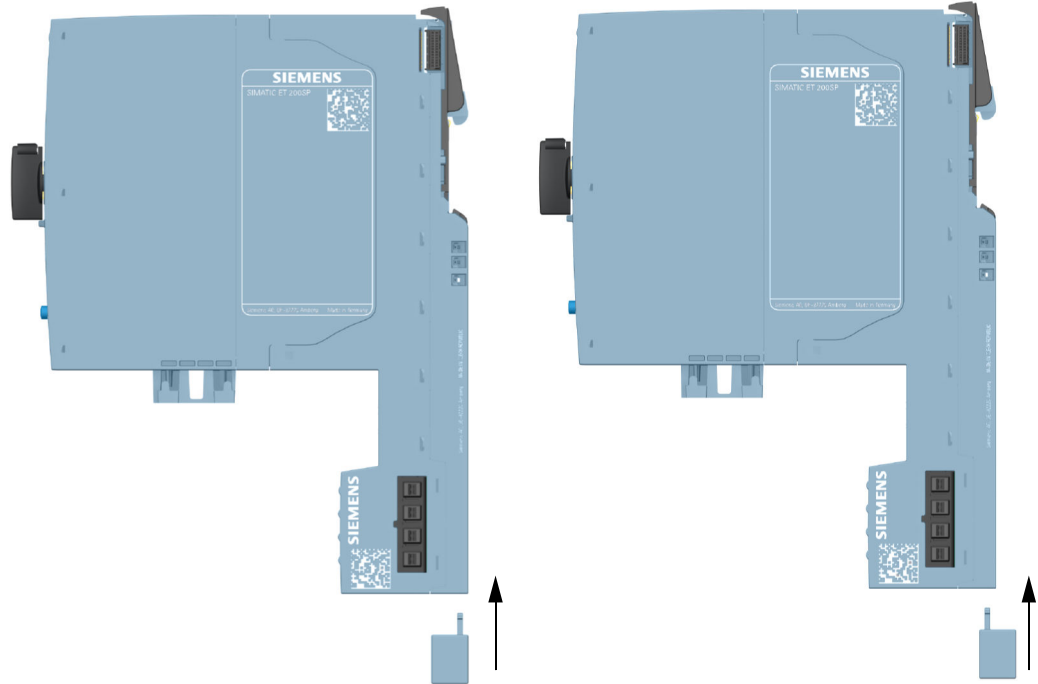

2. Hook the BaseUnit into the mounting rail.
3. Insert the mechanical bracket into the BaseUnit.
4. Screw the mechanical bracket securely onto the mounting panel. Use an M4 screw and a suitable washer.

The figures below show the mechanical bracket after installation on a 7.5 mm or 15 mm mounting rail.

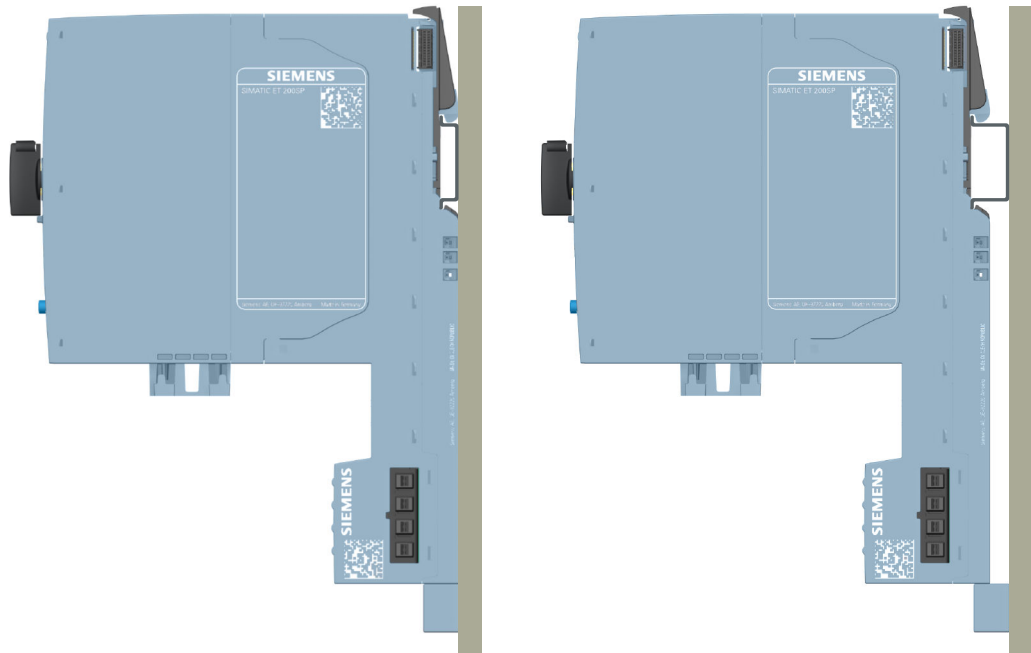

7.10.3 Mounting the BU cover

Introduction

BU covers are plugged onto BaseUnits whose slots have been reserved for future expansion (as empty slots). The BU covers for motor starters serve as touch protection covers for unoccupied slots.

⚠ DANGER

**Hazardous Voltage
Can Cause Death, Serious Injury, or Property Damage.**

Hazardous electrical voltage causes electric shock, burns and property damage.

Disconnect your system and devices from the power supply before starting any assembly tasks.

⚠ DANGER

BaseUnit without motor starter - electric shock

If you install a BaseUnit without motor starter in the ET 200SP system (e.g. options handling), you must provide the BaseUnit with a BU cover (Article No: 3RK1908-1CA00-0BP0).

Failure to do so will result in the danger of electric shock.

Procedure

To mount the BU cover onto a SIMATIC ET 200SP motor starter, insert the BU cover in the BaseUnit in parallel until both interlocks audibly engage.

Wiring

8.1 Rules and regulations for operation

Introduction

When installing the ET 200SP distributed I/O system as part of a plant or system, special rules and regulations need to be adhered to depending on the area of application.

This section provides an overview of the most important rules that must be observed for the integration of the ET 200SP distributed I/O system in a plant or system.

Specific application

Adhere to the safety and accident prevention regulations applying to specific applications, for example machine protection guidelines.

EMERGENCY STOP devices

EMERGENCY STOP devices in accordance with IEC 60204 (corresponds to DIN VDE 0113) must remain effective in all operating modes of the plant or system.

External fuses/switches

Install the external fuses/switches in the proximity of the ET 200SP distributed I/O system.

Excluding hazardous plant states

Hazardous operating states must not occur when

- the plant restarts after a voltage dip or power failure.
- Bus communication is reestablished following a fault.

If necessary, EMERGENCY STOP must be forced!

An uncontrolled or undefined startup must not occur after the EMERGENCY STOP is unlocked.

Line voltage

Below, everything you need to consider in terms of line voltage is described (refer to section Insulation, protection class, degree of protection and rated voltage (Page 333)):

- For fixed plants or systems without an all-pole mains disconnection switch, a mains disconnection device (all-pole) must be available in the building installation.
- For load power supplies, the configured rated voltage range must correspond to the local line voltage.
- For all power circuits of the ET 200SP distributed I/O system, the fluctuation/deviation of the line voltage from the rated value must be within the permitted tolerance.

24 V DC supply

Below you will find a description of what you need to pay attention to with 24 V DC supply:

- In the event of danger through overload, you must provide lightning protection measures:
 - For external lightning protection
 - For internal lightning protection: Only if greater values (phase - ground) or (phase - phase) are required for the power surge than those specified in the section Electromagnetic compatibility (Page 333).
- For 24 V DC supply: Ensure protection by electrical separation and separate cable routing or increased insulation of circuits with dangerous potentials from extra low voltage (SELV/PELV) in accordance with IEC 61131-2 / IEC 61010-2-201.

Requirements for power supplies in the event of voltage interruption

NOTE

To ensure adherence to IEC 61131-2, only use power packs/power supply units (e.g. 230/400 V AC → 24 V DC) with a mains buffering time of at least 10 ms. Observe the relevant requirements in your application (e.g. product standard for "burners" 30 ms according to EN 298 or 20 ms according to NAMUR recommendation NE 21) with respect to possible voltage interruptions. The latest up-to-date information on PS components is available on the Internet (<https://mall.industry.siemens.com>).

Of course, these requirements also apply to power packs/power supply units not constructed using ET 200SP or S7-1500/S7-300-/S7-400 design.

Protection against outside electrical influences

Below is a description of what you must pay attention to in terms of protection against electrical impacts and/or faults:

- Make sure that the system for discharging electromagnetic interference is connected to a functional earth or to protective conductor with a sufficient cross-section for all plants with an ET 200SP distributed I/O system.
- For supply, signal and bus lines, you must ensure that the laying of the lines and the installation is correct.
- For signal and bus lines, you must ensure that a wire/cable break or a cross-circuit does not lead to undefined states of the plant or system.

Reference

You can find more information in the Designing interference-free controllers (<https://support.automation.siemens.com/WW/view/en/59193566>) function manual.

8.2 Additional rules and regulations for the operation of the ET 200SP with fail-safe modules

8.2.1 Safety extra-low voltage (SELV, PELV) for failsafe modules and failsafe motor starters

WARNING

The failsafe modules must be operated with safety extra-low voltage (SELV, PELV).

You can find more information on safety extra-low voltage (SELV, PELV) in the data sheets of the applicable power supplies, for example.

The fail-safe modules operate with the 24 V DC rated voltage. The tolerance range is 19.2 V DC to 28.8 V DC.

The fail-safe motor starters operate with the 24 V DC rated voltage. The tolerance range is 20.4 V DC to 28.8 V DC.

Within the overvoltage range from 32 V DC to 36 V DC, the F-modules react in a fail-safe manner and the inputs and outputs are passivated. For overvoltages greater than 36 V DC, the F-modules are permanently de-energized.

Use a power supply unit that does not exceed $U_m = 36$ V DC even in the event of a fault. For more on this, refer to the information in the data sheet on overvoltage protection in the case of an internal error. Or implement appropriate measures to limit the voltage, e.g. use of an overvoltage protector.

All system components that can supply electrical energy in any form whatsoever must fulfill this condition.

Each additional circuit (24 V DC) used in the system must have a safety extra-low voltage (SELV, PELV). Refer to the relevant data sheets or contact the manufacturer.

Sensors and actuators with an external power supply can also be connected to F-modules. Make sure that power is supplied to these components from safety extra-low voltage (SELV, PELV) as well. The process signal of a 24 V DC digital module may not exceed a fault voltage U_m in the event of a fault.

WARNING

Even when a fault occurs, the permissible potential difference between the supply of the interface module (bus voltage) and the load voltage must not be exceeded.

An external direct electrical connection is one way to meet this requirement. This also prevents potential differences from causing voltage additions at the individual voltage sources, which would cause the fault voltage U_m to be exceeded.

8.2.2 Requirements for sensors and actuators for fail-safe modules and fail-safe motor starters

General requirements for sensors and actuators

Note the following important warning regarding safety-related use of sensors and actuators:

 WARNING
<p>Note that instrumentation with sensors and actuators bears a considerable safety responsibility. Also bear in mind that sensors and actuators generally do not have proof-test intervals of 20 years as defined in IEC 61508:2010 without considerable loss of safety.</p> <p>The probability of hazardous faults and the rate of hazardous faults of safety functions must comply with an SIL-defined high limit. A listing of values achieved by F-modules in the technical specifications of the F-modules is available under "Fail-safe performance characteristics".</p> <p>To achieve the required safety class, suitably qualified sensors and actuators are necessary.</p>

Additional sensor requirements

General rule: To achieve SIL3/Cat. 3/PLe, a single-channel sensor is adequate. However, to achieve SIL3/Cat. 3/PLe with a single-channel sensor, the sensor itself must be SIL3/Cat. 3/PLe-capable; otherwise the sensor must be connected by two channels to achieve this safety level.

To achieve SIL3/Cat. 4/PLe, sensors must be connected by two channels.

 WARNING
<p>In the case of fail-safe input modules, the value "0" is output to the F-CPU after detection of faults. You therefore need to make sure that the sensors are implemented in such a way as to ensure the reliable reaction of the safety program when the sensor is in the "0" state.</p> <p>Example: In its safety program, an EMERGENCY-STOP sensor must achieve the shutdown of the relevant actuator when it is in the "0" state (EMERGENCY-STOP button pressed).</p>

Additional requirements for sensors for fail-safe motor starters

Only single-channel sensors that fulfill the required safety category themselves may be connected to the fail-safe motor starter's F-DI. Fail-safe laying must be observed in accordance with the required safety category.

⚠ WARNING**Safety-related shutdown using the F-DI**

Depending on the I/O used, the shutdown takes place via one or two output channels (terminals):

- PM-switching: The shutdown takes place via two output channels.
- PP-switching: The shutdown takes place via one output channel.

Shutdown via only one output channel (PP-switching) achieves SIL 3 according to ISO 62061 and PLe/Cat.4 according to EN ISO 13849-1, if it is ensured that the cabling is installed in a cross-circuit-proof/P-short-circuit-proof manner.

Duration requirements for sensor signals

⚠ WARNING

Observe the following requirements for sensor signals:

- To ensure the correct detection of the sensor signals via fail-safe modules with inputs, you need to make sure that the sensor signals are output for a minimum duration.
- For pulses to be detected with certainty, the time between two signal changes (pulse duration) must be greater than the PROFIsafe monitoring time.

Reliable detection by F-modules with inputs

The minimum duration of sensor signals for F-modules with inputs depends on the configured input delay, the parameters of the short circuit test of the sensor supplies, and the configured discrepancy behavior for 1oo2 evaluation. The signal must be greater than the maximum response time of the configured application. Information on calculating the maximum response time can be found in the section "Response times" of the relevant F-module.

The maximum permitted switching frequency of the sensor signals results from the minimum duration.

Additional requirements for actuators

The fail-safe output modules test the outputs at regular intervals. The F-module briefly switches off the activated outputs and, if necessary, switches on the deactivated outputs. You can assign the maximum duration of the test pulses (dark and light period) with parameters. Fast reacting actuators may briefly drop out or be activated during the test. If your process does not tolerate this, set the pulse duration of the light or dark test correspondingly or use actuators that have sufficient lag.

⚠ WARNING

If the actuators switch voltages greater than 24 V DC (e.g. 230 V AC), the outputs of a fail-safe output module and the parts carrying a higher voltage must be electrically isolated (in accordance with IEC 60664-1).

This is generally the case for relays and contactors. Particular attention must be paid to this with semiconductor switching devices.

Technical specifications of sensors and actuators

Refer to the manuals of the fail-safe modules for technical specifications to assist you in selecting sensors and actuators.

8.2.3 Crosstalk of digital input/output signals

When fail-safe digital output and input signals are in a single cable, F-DQ modules and F-PM-E modules may experience readback errors.

Cause: capacitive crosstalk

During the bit pattern test of the outputs or the sensor supply of the inputs, the steep switching edge of the output drivers caused by the coupling capacitance of the line may result in crosstalk to other non-activated output or input channels. This may then lead to a response of the readback circuit in these channels. A cross circuit/short-circuit is detected, which leads to safety-related tripping.

Remedy:

- Separate cables for F-DI modules, F-DQ modules, and F-PM-E modules or non-fail-safe DQ modules
- Separate cables for F-DQ channel and F-DI channels for the F-PM-E module
- Coupling relay or diodes in the outputs
- Disable the sensor supply test if safety class requirements allow it.

Cause: magnetic crosstalk

Note that an inductive load connected to the F-DQ channels can induce coupling of a strong magnetic field.

Remedy:

- Separate the inductive loads spatially or shield against the magnetic field.
- Configure the readback time to 50 ms or higher.

8.3 Additional rules and regulations for operation of an Ex module group

Ex module group

You can find the rules and regulations for operation of an Ex module group in the System Manual ET 200SP HA Distributed I/O system / ET 200SP Modules for devices used in an explosion hazardous environment

(<https://support.industry.siemens.com/cs/ww/de/view/109795533/en>)

8.4 Additional rules and instructions for operation with motor starters

8.4.1 Protection against short circuit

The motor starter complies with type of coordination 1. Secure the feeder cable for the infeed bus according to current, country-specific rules for conductor protection.

⚠ WARNING

**Hazardous Voltage at the Motor
Can Cause Death, Serious Injury, or Property Damage.**

Following a short-circuit, the SIMATIC ET 200SP motor starter is defective. Replace the motor starter following a short-circuit.

8.5 Operating the ET 200SP on grounded incoming supply

Introduction

Below you will find information on the overall configuration of an ET 200SP distributed I/O system on a grounded incoming supply (e.g. TN-S network). The specific subjects discussed are:

- Disconnecting devices and short-circuit and overload protection according to IEC 60364 (corresponds to DIN VDE 0100) and IEC 60204 (corresponds to DIN VDE 0113)
- Load power supplies and load circuits.

Grounded incoming supply

In the case of grounded incoming supplies (TN-S system) the neutral conductor (N) and the protective conductor (PE) are each grounded. Both conductors form a part of the overvoltage concept. When a plant is in operation, the current flows across the neutral conductor. When a fault occurs, for example, a single ground fault between a live conductor and ground, the current flows through the protective conductor.

Safe electrical separation (SELV in accordance with IEC 61131-2 or IEC 61010-2-201)

Load power supplies/power supply modules with 24 V DC output voltage require safe electrical separation and voltage limiting (extra low voltage). Load power supplies/power supply modules with 24 V DC output voltage are not connected to the protective conductor. According to IEC 61131-2 and IEC 61010-2-201, this protection is referred to as SELV (Safety Extra Low Voltage).

The wiring of SELV circuits must be safely separated from the wiring of other circuits that are not SELV, or the insulation of all conductors must be dimensioned for the higher voltage.

Grounded extra-low voltage (PELV in accordance with IEC 61131-2 or IEC 61010-2-201)

Load power supplies/power supply modules with grounded 24 V DC output voltage require safe connection to the protective conductor and voltage limiting (extra low voltage).

According to IEC 61131-2 and IEC 61010-2-201, this protection is referred to as PELV (Protective Extra Low Voltage).

The wiring of PELV circuits must be safely separated from the wiring of other circuits that are not PELV, or the insulation of all conductors must be dimensioned for the higher voltage.

Configuration of ET 200SP with ungrounded reference potential

To conduct interference currents, the reference potential of the CPU/interface module and the BaseUnits BU15...D is connected internally via an RC combination (IM/CPU: $R = 10 \text{ M}\Omega / C = 100 \text{ nF}$, BU15...D: $R = 10 \text{ M}\Omega / C = 4 \text{ nF}$) with the mounting rail (functional grounding).

- This configuration conducts high-frequency interference currents and prevents static charges.
- It is always possible to configure an ungrounded setup of the ET 200SP distributed I/O system as the ET 200SP distributed I/O system has no fixed ground connection. The power pack/power supply module for 24 V DC must also be ungrounded and electrically isolated.

If you want to configure the ET 200SP distributed I/O system with grounded reference potential, connect the 1M connection of the CPU/interface module electrically with the protective conductor.

Short-circuit / overload protection

Various measures as protection against short-circuits and overloads are required for setting up a full installation. The type of components and the binding protective measures depend on which IEC (DIN VDE) regulation applies to your system configuration. The table refers to the figure below and compares the IEC (DIN VDE) regulations.

Table 8-1 Components and protective measures

	Refer to figure	IEC 60364 (DIN VDE 0100)	IEC 60204 (DIN VDE 0113)
Disconnecting device for controller, sensors, and actuators	①	Main switch	Disconnecter
Short-circuit / overload protection: In groups for sensors and actuators	② ③	Single-pole protection of circuits	With grounded secondary circuit: single-pole protection otherwise: all-pole protection
Load current supply for AC load circuits with more than five items of electro-magnetic equipment	②	Galvanic isolation by transformer recommended	Galvanic isolation by transformer recommended

Cable temperature measurement threshold

NOTE

Cable temperature measurement threshold

When choosing a cable, remember that the cable temperature in operation can be up to 30 °C higher than the ambient temperature of the ET200SP system (example: at an ambient temperature of 60 °C, a connection conductor must be dimensioned for a temperature range of at least 90 °C).

You should specify other connection types and material requirements based on the electrical characteristics of the circuits you use and the installation environment.

ET 200SP in the overall configuration

The figure below shows the overall configuration of the ET 200SP distributed I/O system (load current supply and grounding concept) with supply from a TN-S network.

Own distribution/Zone B

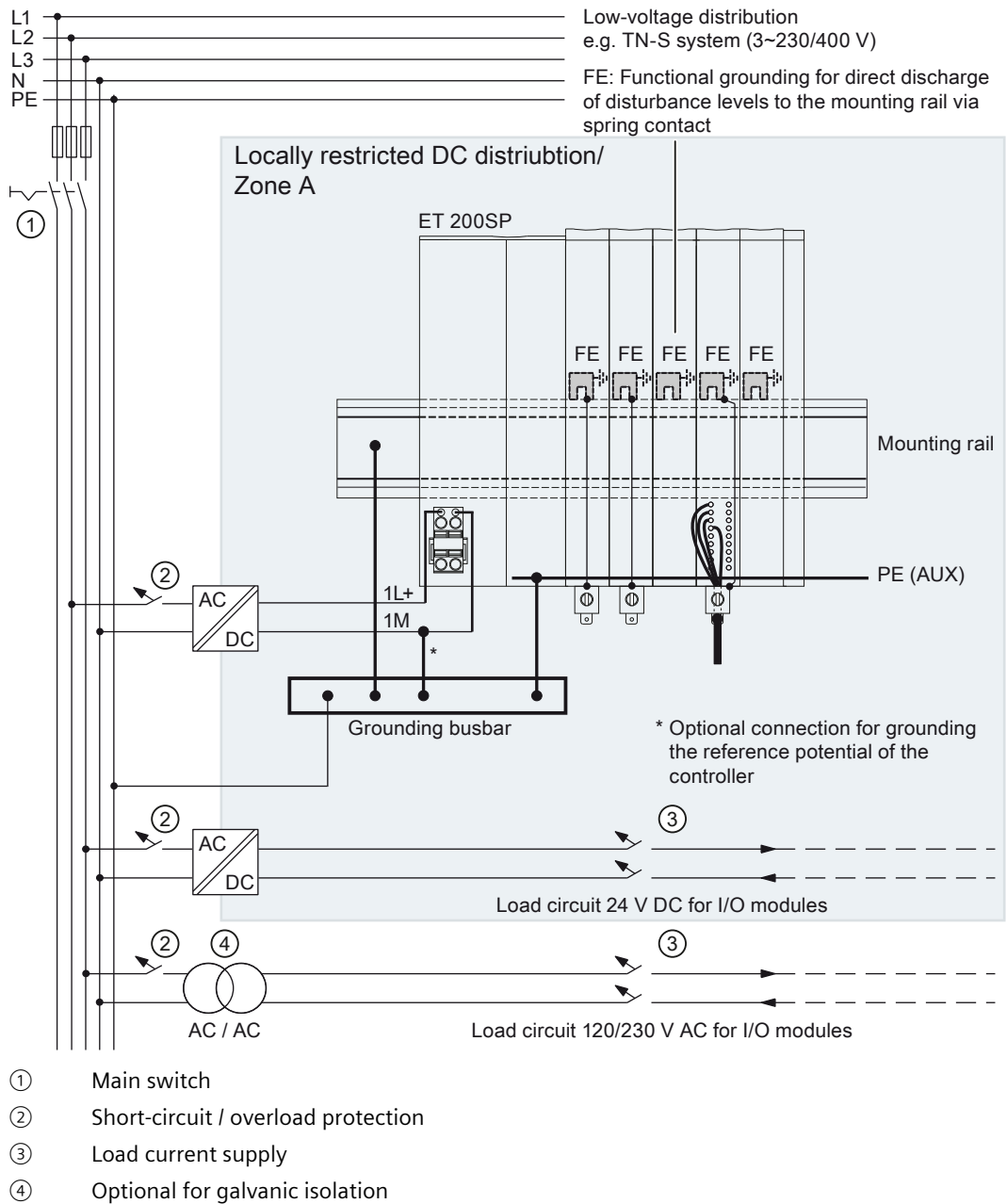

Figure 8-1 ET 200SP in the total configuration

8.5 Operating the ET 200SP on grounded incoming supply

NOTE

In general, you need to connect the DC I/O modules of the ET 200SP distributed I/O system to your own distribution (or batteries) via an upstream, local power supply unit.
If you connect the DC I/O modules directly to your own distribution, you need to provide additional protective measures against overvoltages.

8.6 Electrical configuration of the ET 200SP

Electrical isolation

Electrical relationships

With the ET 200SP distributed I/O system, there is electrical isolation between:

- The load circuits/process and all other circuit components of the ET 200SP distributed I/O system.
- The communication interfaces of the CPU (PROFINET) or of the interface module (PROFINET/PROFIBUS) and all other circuit components.

The figures below show the electrical relationships of the ET 200SP distributed I/O system with the CPU and the interface module. Only the most important components are represented in the figures.

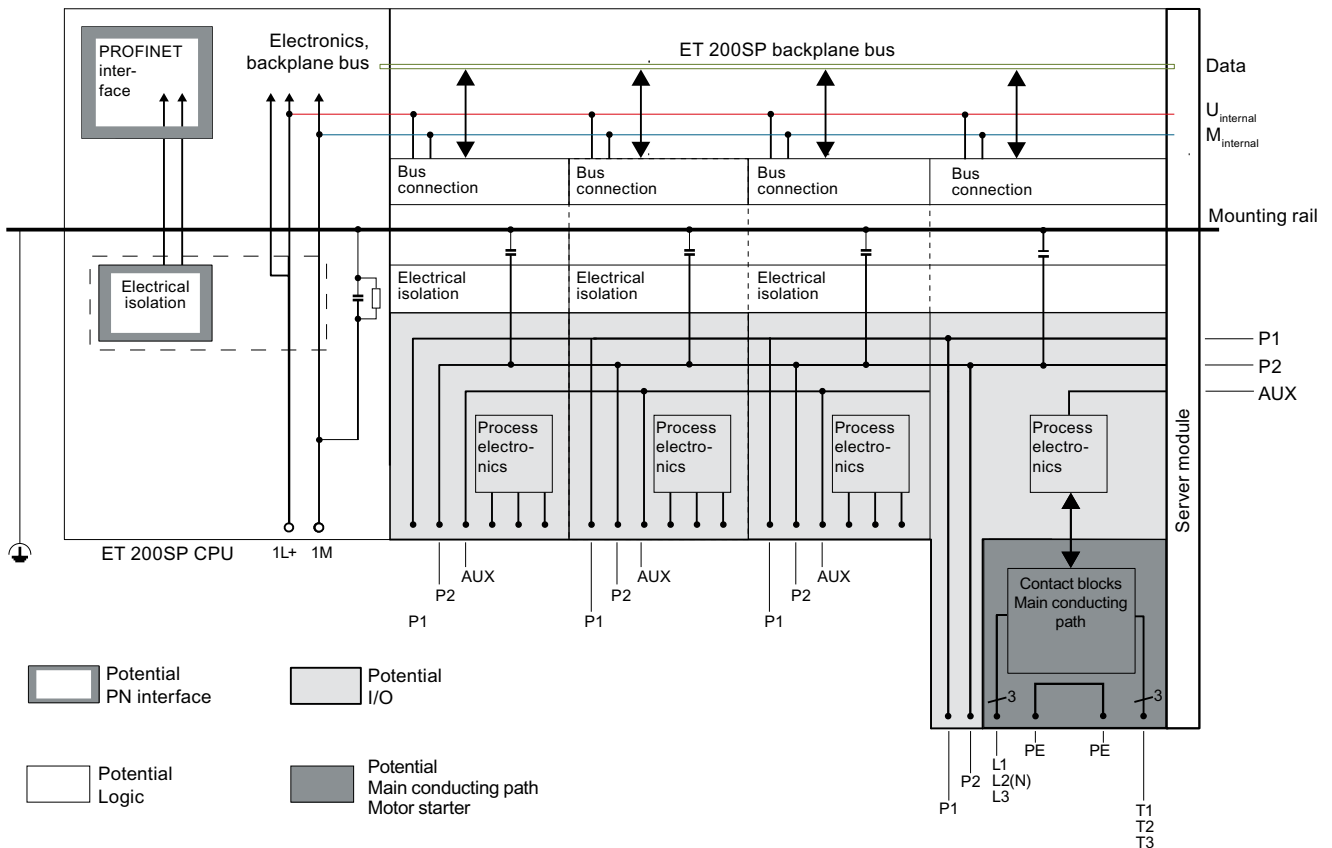

Figure 8-2 Electrical relationships for ET 200SP with CPU

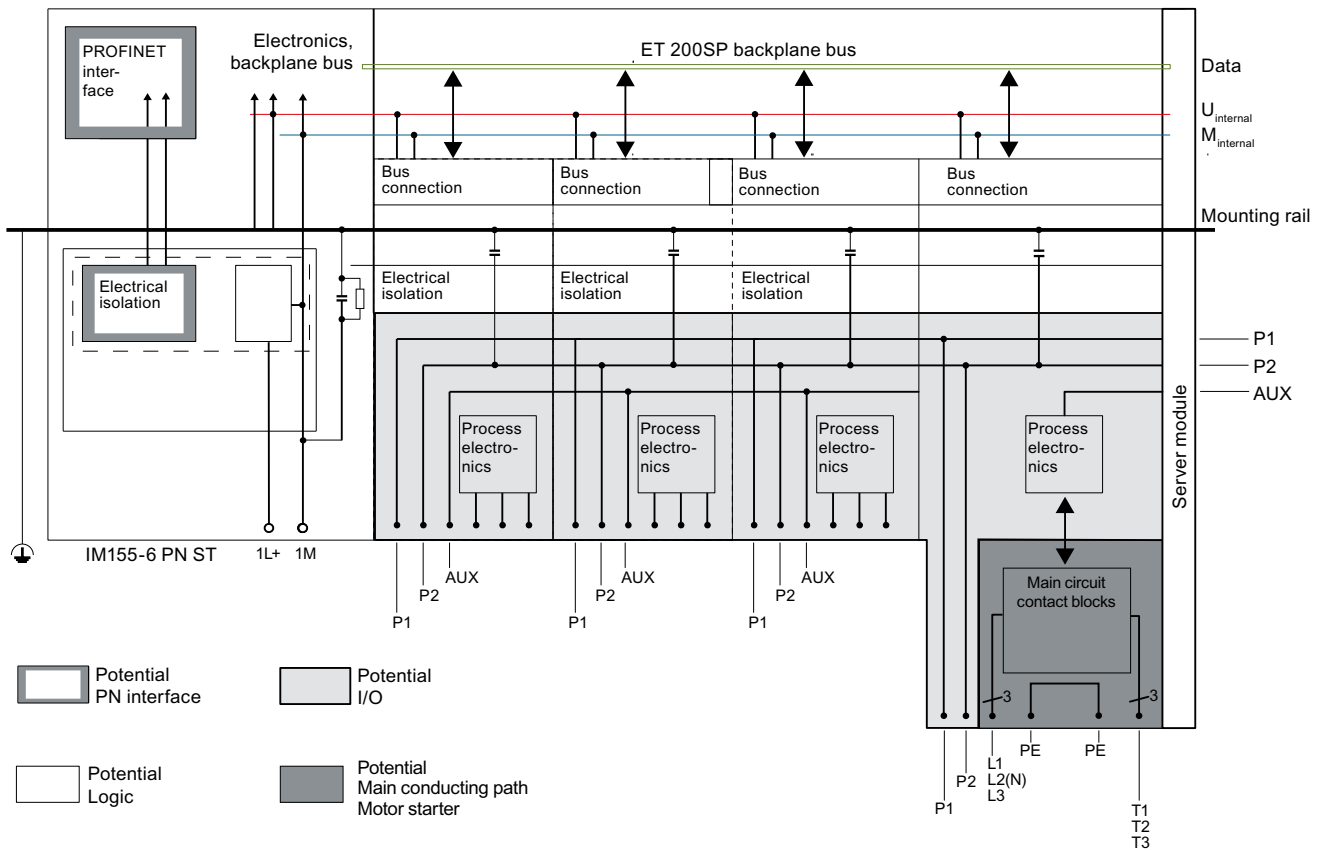

Figure 8-3 Electrical relationships for ET 200SP with interface module (using IM 155-6 PN ST as an example)

8.7 Wiring rules

Introduction

Use suitable cables to connect the ET 200SP distributed I/O system. Also select the cable insulation corresponding to the applied voltage. The tables below set out the wiring rules for CPU/interface module, BaseUnits and motor starter.

Wiring rules for the CPU/interface module and BaseUnits for I/O modules

Wiring rules for ...		CPU/interface module (supply voltage)	BaseUnits (push-in terminal)
Permitted cable cross-sections of solid cables (Cu)		0.2 to 2.5 mm ²	
		AWG*: 24 to 13	
Permitted cable cross-	Without end sleeve	0.2 to 2.5 mm ²	

* AWG: American Wire Gauge

** End sleeves without plastic sleeve: 0.25 to 2.5 mm²/AWG: 24 to 13

*** See note on end sleeves

Wiring rules for ...		CPU/interface module (supply voltage)	BaseUnits (push-in terminal)
sections of flexible cables (Cu)	Without end sleeve	AWG [*] : 24 to 13	AWG [*] : 24 to 14
	With end sleeve (with plastic sleeve) ^{***}	0.25 mm to 1.5 mm ^{2**}	0.14 mm to 1.5 mm ²
		AWG [*] : 24 to 16	AWG [*] : 26 to 16
	With TWIN end sleeve ^{***}	0.5 mm to 1 mm ²	0.5 to 0.75 mm ² (see below)
AWG [*] : 20 to 17		AWG [*] : 20 to 18	
Stripping length of the wires		8 to 10 mm	
End sleeves in accordance with DIN 46228 with plastic sleeve ^{***}		8 and 10 mm long	
TWIN end sleeves		12 mm long	

* AWG: American Wire Gauge

** End sleeves without plastic sleeve: 0.25 to 2.5 mm²/AWG: 24 to 13

*** See note on end sleeves

Note the following for BaseUnits with function version < FS10:

NOTE

End sleeves

Optimum results with respect to a high-quality and permanent electrical connection with maximum conductor pull forces at the same time can be achieved by using crimping dies, preferably with smooth surfaces, which are provided, for example, with rectangular and trapezoidal crimp cross-sections.

Crimping dies with a pronounced wave profile are unsuitable.

TWIN end sleeves for the cables of the I/O modules' push-in terminals

Due to the space required by TWIN end sleeves with 0.75 mm^2 cross-section, you must ensure a correct angle for the cable arrangement when crimping the TWIN end sleeve so that the cables are optimally arranged.

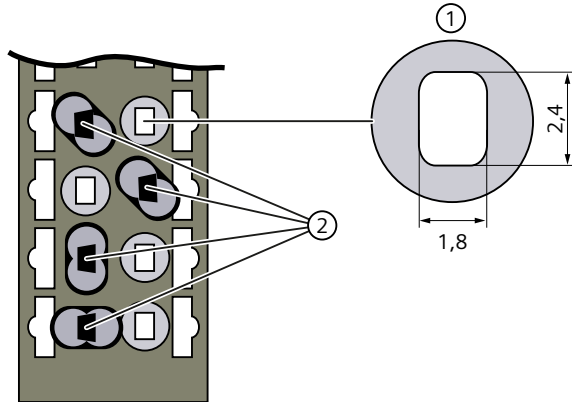

- ① Cross-section of the terminal compartment
 ② Crimping TWIN end sleeves at the correct angle

Figure 8-4 TWIN end sleeves

Wiring rules for motor starters

Wiring rules for ...		L1(L), L2(N), L3, PE	T1, T2, T3, PE, 24 V DC, F-DI, M	DI1 ... DI3, LC, M, 24 V OUT
Permitted cable cross-sections of solid cables (Cu)		1 to 6 mm ²	0.5 to 2.5 mm ²	0.2 to 1.5 mm ²
		AWG: 18 to 10	AWG: 20 to 12	AWG: 24 to 16
Permitted cable cross-sections of flexible cables (Cu)	Without end sleeve	1 to 6 mm ²	0.5 to 2.5 mm ²	0.2 to 1.5 mm ²
		AWG: 18 to 10	AWG: 20 to 12	AWG: 24 to 16
	With end sleeve	1 to 6 mm ²	0.5 to 2.5 mm ²	0.25 to 1.5 mm ²
		AWG: 18 to 10	AWG: 20 to 12	AWG: 24 to 16
	With end sleeve (with plastic sleeve)	1 to 4 mm ²	0.5 to 1.5 mm ²	0.25 to 0.75 mm ²
		AWG: 18 to 11	AWG: 20 to 16	AWG: 24 to 18
Stripping length of the wires		15 mm	10 mm	8 mm
End sleeves according to DIN 46228 with plastic sleeve		15 mm long	10 mm long	8 mm long

Safety standards for fail-safe motor starters

Fail-safe motor starters fulfill the following standards under certain conditions:

- PLe/Cat.4 according to EN ISO 13849-1
- Safety Integrity Level SIL 3 according to IEC 62061

To fulfill both standards, lay cross-circuit proof and P-cross-circuit proof control cables from the safe output of a sensor or F-DQ to the safe input of the motor starter, e.g. as a separately sheathed cable or in a separate cable duct.

Line protection

The line protection of the SIMATIC ET 200SP motor starter is provided for the motor outgoing feeder cable when the following condition is met:

The cross-section of the motor outgoing feeder cable must be dimensioned for the load ratios of the motor and for the cable-laying method.

Comply with national regulations. The user is responsible for the correct selection and dimensioning of the motor connection cable to DIN VDE 0100 and DIN VDE 0298-4 and/or UL 508.

The conductor protection for the incoming feeders must be ensured by the owner of the installation depending on the cross-section.

Cable temperature measurement threshold

NOTE

Cable temperature measurement threshold

When choosing a cable, remember that the cable temperature in operation can be up to 30 °C higher than the ambient temperature of the ET200SP system (example: at an ambient temperature of 60 °C, a connection conductor must be dimensioned for a temperature range of at least 90 °C).

You should specify other connection types and material requirements based on the electrical characteristics of the circuits you use and the installation environment.

8.8 Wiring BaseUnits for I/O modules

Introduction

The BaseUnits connect the ET 200SP distributed I/O system to the process. The following versions of the BaseUnits can be used:

- BaseUnits (with light-colored terminal box) for opening a potential group: BU..D
- BaseUnits (with dark-colored terminal box) for extending the potential group: BU..B
- BaseUnits with additional AUX terminals or additional terminals: BU..+10..
- BaseUnits with integrated thermal resistor for compensation of the reference junction temperature when connecting thermocouples: BU..T
- PotDis-BaseUnits (with light-colored terminal box) for opening a PotDis potential group: PotDis-BU..D

- PotDis-BaseUnits (with dark-colored terminal box) for extending the potential group:
PotDis-BU..B

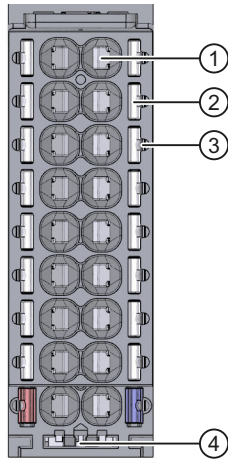

- ① Push-in terminal
- ② Spring release
- ③ Measuring probe (suitable probes: 1 mm diameter, length \geq 10 mm while observing the permitted voltage category)
- ④ Holder for shield connection

Figure 8-5 View of the BaseUnit

NOTE

The pin assignment of the BaseUnit depends on the connected I/O module. Information on the BaseUnits and I/O modules can be found in the associated manuals.

Replacement of the terminal box on the BaseUnit is described in the section Replacing the terminal box on the BaseUnit ([Page 290](#)).

NOTE

Special terminal designations in the wiring and block diagrams of the I/O modules/BaseUnits

- **RES:** Reserve, these terminals must remain unconnected so that they can be used for future expansions
 - **n.c.:** Not connected, these terminals have no function. However, they can be connected to potentials specifically defined for a module, for example, for the laying unused wires.
-

Requirements

- The supply voltages are turned off.
- Follow the wiring rules.
- Color identification labels ([Page 175](#)) (optional) have been applied.

Required tools

3 to 3.5 mm screwdriver

Tool-free connection of cables: single-wire without wire end ferrule, multi-wire (stranded) with wire end ferrule or ultrasonically sealed

Watch the video sequence (<https://support.automation.siemens.com/WW/view/en/95886218>)

To connect a wire without tools, follow these steps:

1. Strip 8 to 10 mm of the wires.
2. Only in the case of stranded conductors (except for 2.5 mm² cross-section): Seal or crimp the wire with wire end ferrules.
3. Insert the wire into the push-in terminal as far as it will go.

Connection of cables: multi-wire (stranded), without wire end ferrule, unprocessed

To connect a wire without a wire end ferrule, follow these steps:

1. Strip 8 to 10 mm of the wires.
2. Push with the screwdriver into the spring release.
3. Insert the wire into the push-in terminal as far as it will go.
4. Pull the screwdriver out of the spring release.

Removing wires

Using the screwdriver, press the spring release of the terminal as far as it will go and pull out the wire.

NOTE

When you press the spring release, you should not pull on the wire/cable at the same time. This prevents you from damaging the terminal.

8.9 Connecting cable shields for I/O modules

Introduction

- You need the shield connector to contact cable shields (e.g. for analog modules). The shield connector conducts interference currents on cable shields to ground via the mounting rail. It is not necessary to contact the shield at where the cable enters the cabinet.
- Attach the shield connector to the BaseUnit.
- The shield connection consists of a shield support, a shield terminal and a supporting element.
- The shield connector is automatically connected to the functional ground (FG) of the mounting rail after installation.

Requirements

- BaseUnit must be one of the following types:
 - A0, A1
 - B0
 - C0, C1
 - F0
 - U0
- The shield terminal is suitable for cables with max. \varnothing 7 mm each.

Required tools

- Stripping tool
- Slotted screwdriver with a 3.5 mm blade or Torx T10

Procedure

Watch the "Wiring BaseUnits" video sequence (<https://support.automation.siemens.com/WW/view/en/95886218>)

To connect the cable shield, follow these steps:

1. If necessary, connect the supply voltage L+ and ground to the BaseUnit.
2. Push the supporting element with the shield support into the guideway till the supporting element clicks into place.
If you use a 7.5 mm mounting rail, you must first shorten the supporting element. To do so, unscrew the spacer of the support element.
3. Remove the cable insulation material around the shield terminal.
Connect the cable to the BaseUnit and place the cable in the shield contact.
4. Insert the shield terminal into the corresponding clamping position of the shield support.
 - Clamping space height 1: 1.9 mm to 15.5 mm
 - Clamping space height 2: 10.9 mm to 23.5 mm

5. Tighten the shield terminal with approximately 0.5 Nm.
When doing this, ensure that the terminal is completely in contact with the exposed protective braided shield.

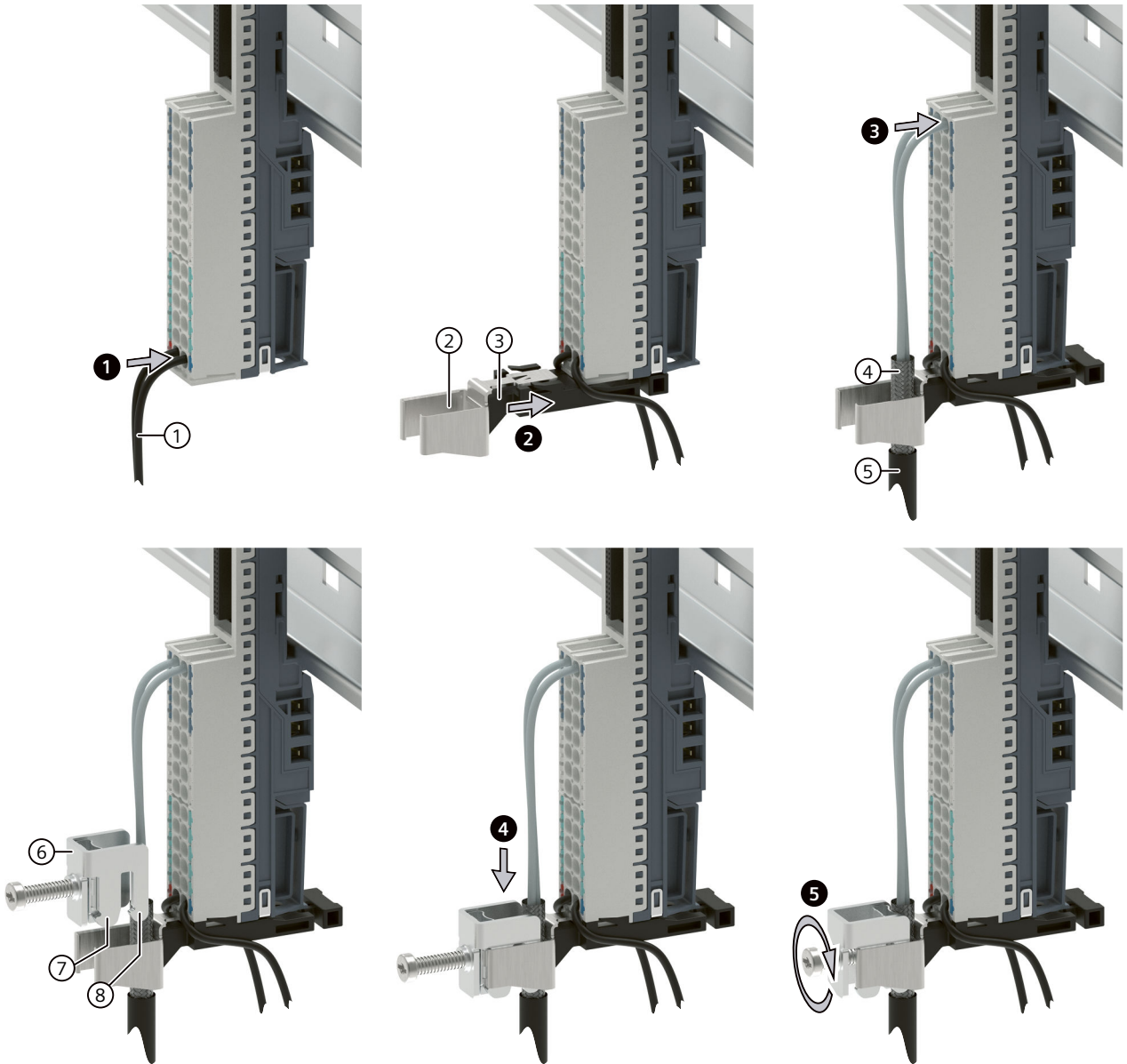

① Supply voltage L+, M

② Shield support

③ Supporting element

④ Insulation material removed (approx. 20 mm)

⑤ Cable to the encoder

⑥ Shield terminal

⑦ Suspension for clamping position 1

⑧ Suspension for clamping position 2

Figure 8-6 Mounting the shield contact

NOTE

Shield terminal does not have a null terminal.

Fix the shield terminal only when there is at least one inserted cable.

8.10 Wiring BaseUnits for motor starters

Introduction

The following versions of BaseUnits can be used:

- BU30-MS1 (with 24 V DC and 500 V AC infeed)
- BU30-MS2 (with 500 V AC infeed)
- BU30-MS3 (with 24 V DC infeed)
- BU30-MS4 (without infeed)
- BU30-MS5 (with 500 V AC infeed and single F-DI)
- BU30-MS6 (without infeed and with single F-DI)
- BU30-MS7 (with F-DI and 500 V AC infeed)
- BU30-MS8 (with 500 V AC infeed and F-DI routing)
- BU30-MS9 (with F-DI routing)
- BU30-MS10 (with F-DI infeed)

The following figure shows an example of a BaseUnit BU30-MS1 (with the maximum number of terminals):

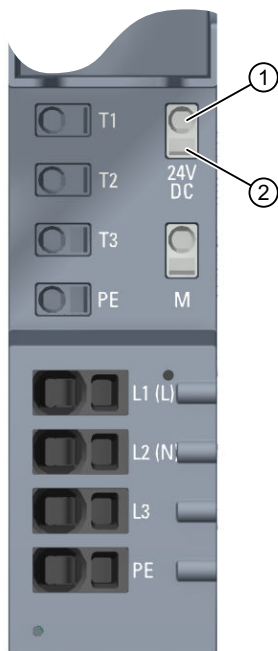

- ① Push-in terminal
- ② Spring release

Figure 8-7 Terminals on a BaseUnit BU30-MS1

The following figure shows an example of a BaseUnit BU30-MS5 (with the maximum number of terminals):

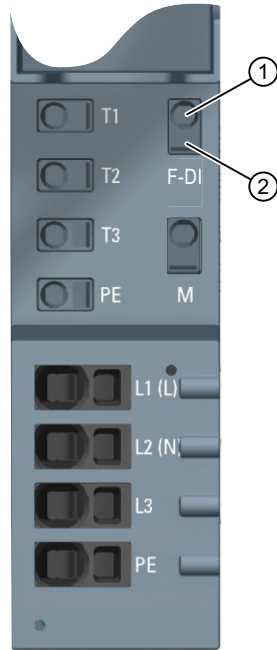

- ① Push-in terminal
- ② Spring release

Figure 8-8 Terminals on a BaseUnit BU30-MS5

⚠ DANGER

**Hazardous Voltage
Can Cause Death, Serious Injury, or Property Damage.**

Hazardous electrical voltage can cause electric shock, burns and property damage.

Turn off and lock out all power supplying this device before working on this device.

For wiring finely-stranded or stranded conductors without end sleeves on push-in connections, a screwdriver is required.

Requirements

- The supply voltages are switched off
- Observe the wiring rules

NOTICE

Interconnection of the F-DI input of BaseUnits BU-30-MS5, BU-30-MS6, BU-30-MS7 and BU-30-MS10 with surge filters

If your system requires overvoltage protection, you must interconnect the F-DI input of the BaseUnits BU-30-MS5, BU-30-MS6, BU-30-MS7 and BU-30-MS10 with surge filters. Please see "Electromagnetic Compatibility" in the technical specifications.

Required tools

Use the screwdriver "SZF 1-0.6x3.5" (for finely-stranded cables only).

Connecting conductors: Solid without end sleeve, stranded (stranded wire) with end sleeve

To connect a cable, proceed as follows:

1. Insulate the cables in accordance with the table in chapter "Electromagnetic compatibility of fail-safe modules (Page 326)".
2. Only in the case of stranded conductors:
Crimp the cable with end sleeves.
3. Insert the cable into the push-in terminal as far as it will go.
4. Pull on the cable to ensure it is tight.

Connecting conductors: multi-wire (stranded), without end sleeve, unfinished

To connect a cable, proceed as follows:

1. Insulate the cables in accordance with the table in chapter "Wiring rules (Page 146)".
2. Press the screwdriver into the spring release.
3. Insert the conductor into the push-in terminal until it engages.
4. Pull the screwdriver out of the spring release.
5. Check whether or not the conductor is firmly connected by pulling on the cable.

Video sequence

At the following Internet link, you can see a video about connecting conductors: Wire BaseUnits (<http://support.automation.siemens.com/WW/view/en/95886218>)

Releasing conductors

To release a conductor, proceed as follows:

1. Press the screwdriver into the spring release of the terminal until it engages.
2. Pull the conductor out.

NOTE

When pressing the spring release, you must not pull on the wire/cable at the same time. In this way, you avoid damaging the terminal.

8.11 Connecting the 3DI/LC module for the motor starter

You will find further information on the 3DI/LC module in the ET 200SP motor starter (<https://support.industry.siemens.com/cs/ww/en/view/109479973>) manual.

Procedure

The figure below shows the connections of the 3DI/LC module.

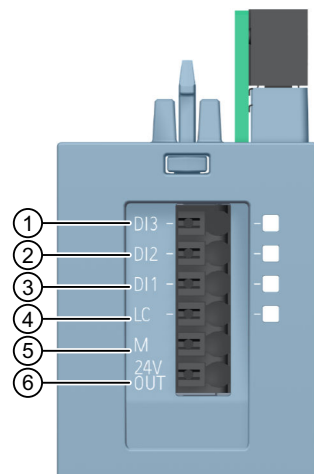

- ① Digital input 3
- ② Digital input 2
- ③ Digital input 1
- ④ Local control (manual local)
- ⑤ Ground
- ⑥ 24 V DC/ 100 mA output

NOTE

The digital inputs (1 to 4) are not isolated. The reference potential is M (5). Control the digital inputs only via a unit supplied from the 24 V DC output (6).

Connect only cables of a width not exceeding 30 m to the 3DI/LC module.

The supply (5 and 6) is protected against short-circuits.

Terminal sketch of the 3DI/LC module

The following diagram shows a terminal sketch of the 3DI/LC module:

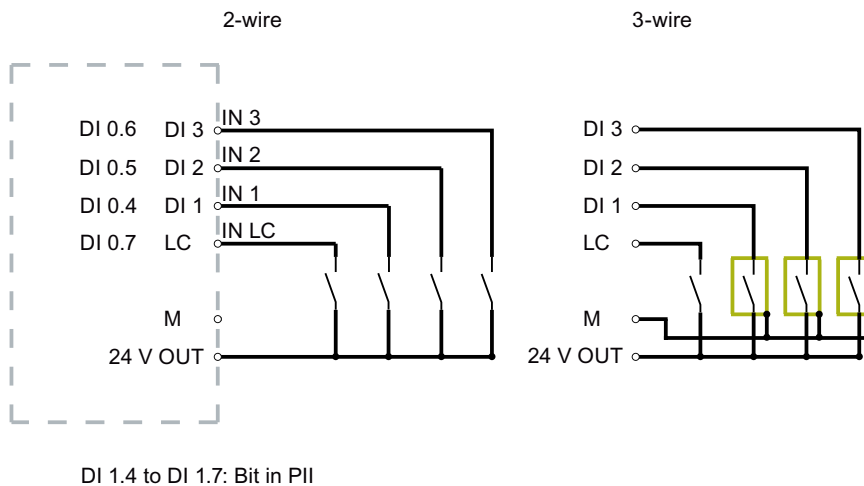

Figure 8-9 Connection example of inputs

8.12 Connecting the supply voltage to the CPU/interface module

Introduction

The supply voltage of the CPU/interface module is supplied by means of a 4-pin connector plug located on the front of the CPU/interface module.

Power supply unit

Only use power supply units of type SELV/PELV with safe electrically isolated functional extra low voltage (≤ 28.8 V DC).

Connection for supply voltage (X80)

The connections of the 4-pole connector have the following meaning:

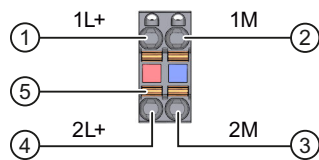

- ① +24 V DC of the supply voltage (current limited to 10 A)
 - ② Ground of the supply voltage (current limited to 10 A)
 - ③ Ground of the supply voltage for loop-through
 - ④ +24 V DC of the supply voltage for loop-through
 - ⑤ Spring opener (one spring opener per terminal)
- 1L+ and 2L+ and 1M and 2M are internally jumpered

Figure 8-10 Supply voltage connection

A strain relief is not present. The cable connector offers you the option of looping the supply voltage uninterrupted, even when it is unplugged.

For the maximum wire cross-sections, observe the information in the tables of the wiring rules (Page 146).

Requirements

- Only wire up the connector plug when the supply voltage is turned off.
- Follow the wiring rules (Page 146).

Required tools

3 to 3.5 mm screwdriver

Tool-free connection of cables: single-wire without end sleeve, multi-wire (stranded) with end sleeve or ultrasonically sealed

Watch video sequence: "Connect BusAdapter to the interface module"
(<https://support.automation.siemens.com/WW/view/en/95886218>)

To connect a wire without tools, follow these steps:

1. Strip 8 to 10 mm of the wires.
2. Only in the case of stranded conductors:
Seal or crimp the wire with end sleeves.
3. Insert the cable into the push-in terminal as far as it will go.
4. Push the wired connector plug into the plug socket of the interface module.

Connection of cables: multi-wire (stranded), without end sleeve, unfinished

To connect a wire without an end sleeve, follow these steps:

1. Strip 8 to 10 mm of the wires.
2. Using a screwdriver, press the spring release and insert the wire into the push-in terminal as far as it will go.
3. Pull the screwdriver out of the spring release.
4. Push the wired connector plug into the socket in the interface module.

Removing a wire

Using the screwdriver, press the spring release as far as it will go and pull out the wire.

8.13 Connecting interfaces for communication

Connect the communication interfaces of the ET 200SP distributed I/O system using the standardized connector or directly. If you want to prepare communication cables yourself, the interface assignment is specified in the manuals of the corresponding modules. Observe the mounting instructions for the connectors.

Detailed information on the available BusAdapters and the procedure for connecting PROFINET IO to the CPU/interface module is available in the BusAdapter (<https://support.industry.siemens.com/cs/ww/en/view/109751716>) manual.

8.13.1 Connecting PROFINET IO (port P3) to the CPU**Introduction**

You use the RJ-45 bus connector to connect PROFINET IO (port P3) directly to the CPU.

Required accessories

- Cable ties with standard width of 2.5 mm or 3.6 mm for strain relief
- Please observe the specifications in the PROFINET Installation Guide (<https://www.profibus.com>).

Mounting the bus connector

Mount the PROFINET connector in accordance with the instructions in the PROFINET Installation Guide (<https://www.profibus.com>).

Procedure

Insert the RJ45 bus connector into the PROFINET port (port P3) on the CPU.

NOTE

Cable support and strain relief

If you are using a FastConnect RJ45 bus connector with 90° cable outlet (6GK1901-1BB20-2AA0), we recommend you provide strain relief for the PROFINET connecting cable. For this you need a cable tie with a standard width of 2.5 mm or 3.6 mm. Use it to fasten the PROFINET connecting cable directly after it exits the bus connector to the provided cable support on the CPU (on the front directly below the PROFINET interface X1P3).

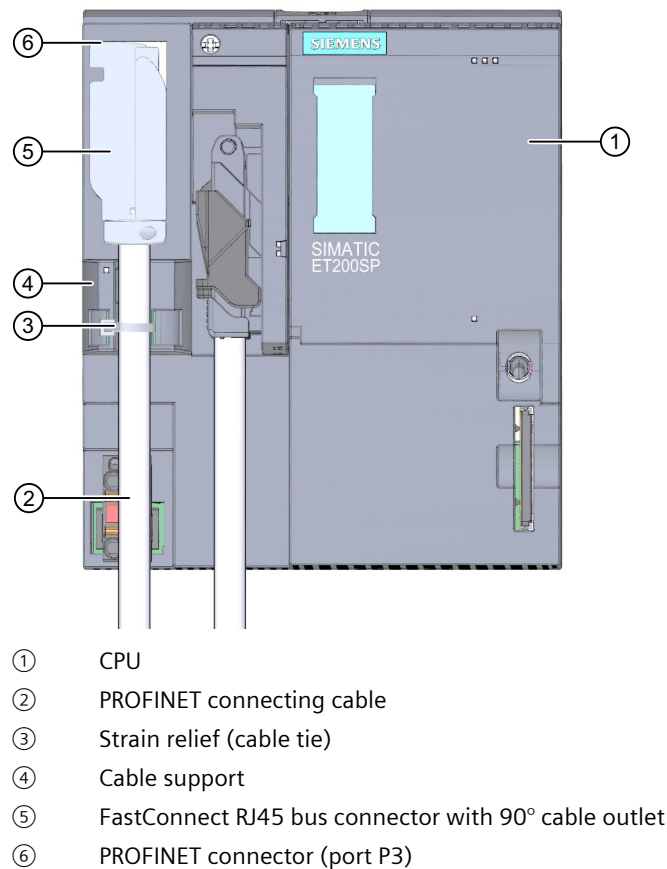

Figure 8-11 Connecting PROFINET IO (port P3) to the CPU

8.13.2 Connecting the PROFIBUS DP interface to the interface module/communications module CM DP

Introduction

Using the bus connector (RS485), connect the PROFIBUS DP to the interface module/communications module CM DP.

Required tools

3 to 3.5 mm screwdriver

Procedure

To connect the PROFIBUS DP interface to the interface module / DP communication module CM DP, follow these steps:

1. Connect the PROFIBUS cable to the bus connector.
2. Plug the bus connector into the PROFIBUS DP connector.
3. Securely tighten the fixing screws of the bus connector (0.3 Nm).

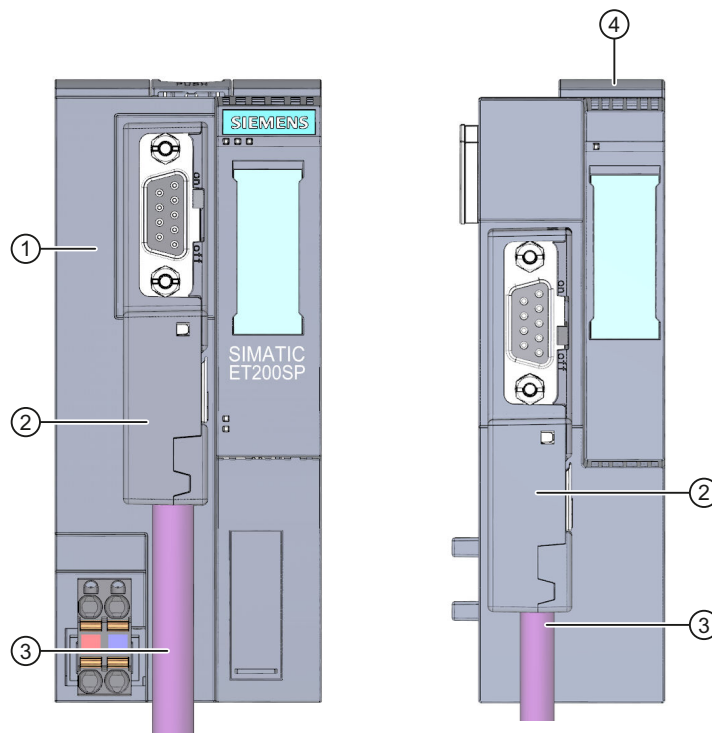

- ① Interface module
- ② PROFIBUS FastConnect bus connector
- ③ PROFIBUS connecting cable
- ④ Communications module CM DP

Figure 8-12 Connect PROFIBUS DP to the interface module/communications module CM DP

Reference

You can find additional information on the PROFIBUS FastConnect bus connector in the corresponding product information on the Internet

(<https://support.industry.siemens.com/cs/ww/de/view/109793857/en>).

8.14 Inserting I/O modules / motor starters and BU covers

Introduction

- You insert the I/O modules on the BaseUnits. The I/O modules are self-coding and type-coded.
- You insert the PotDis-TerminalBlocks on the PotDis-BaseUnits.
- You insert the BU covers on BaseUnits whose slots are not equipped with I/O modules/PotDis-TerminalBlocks.
- You insert the BU covers on BaseUnits whose slots have been reserved for future expansion (as empty slots).
- The BU covers for motor starters serve as touch protection covers for unoccupied slots. The BU covers have a holder for the reference identification label on the inside. For future expansion of the ET 200SP, remove the reference identification label from the holder and insert it into the final I/O module.

It is not possible to attach a reference identification label to the BU cover itself.

There are three versions:

- BU cover with a width of 15 mm
- BU cover with a width of 20 mm
- BU cover with a width of 30 mm (for motor starters)

Requirement

Refer to chapter "Application planning (Page 80)".

Plugging in I/O modules and BU covers

Watch video sequence: "Insert I/O modules"

(<https://support.automation.siemens.com/WW/view/en/95886218>)

Insert the I/O module or BU cover parallel into the BaseUnit until you hear both latches click into place.

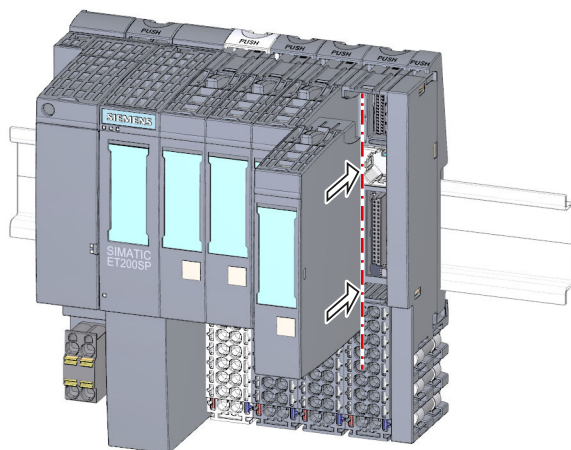

Figure 8-13 Plugging in I/O modules or BU covers (using an I/O module as example)

8.15 Mounting/disassembly of motor starters

8.15.1 Mounting the fan

Procedure

Proceed as follows to mount a fan on a SIMATIC ET 200SP motor starter:

1. Slide the fan onto the motor starter until you can hear the fan engage.
Observe the blowing direction of the fan when mounting. The air stream must be directed to the inside of the motor starter. The correct blowing direction is indicated by arrows on the bottom of the fan.
2. Insert the connection plug into the opening above the fan.

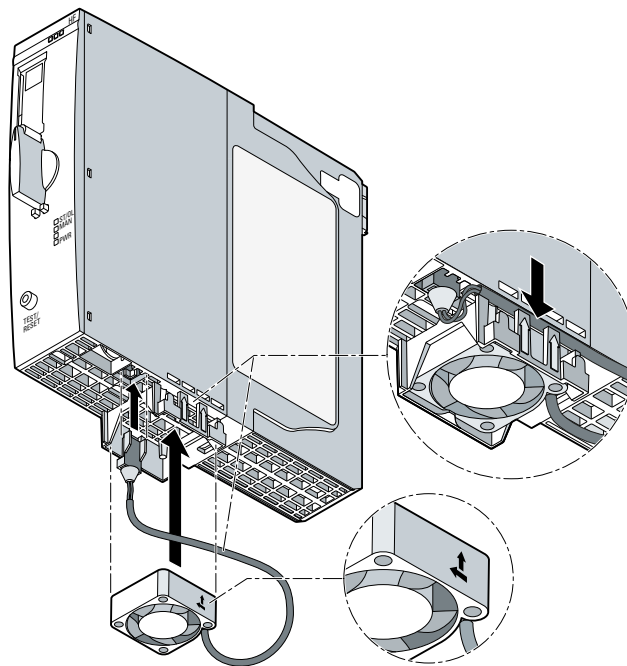

3. Secure the fan cable to the fixing eyes on the right-hand side of the fan cover.

NOTE

Specified ambient temperatures are not reached if the fan is incorrectly installed

If you do not observe the blowing direction of the fan when mounting, the specified ambient temperatures will not be reached. The device shuts down prematurely due to excessively high temperature.

8.15.2 Mounting/disassembly of motor starters

Procedure

⚠ CAUTION

Protection against electrostatic charge

When handling and installing the SIMATIC ET 200SP motor starter, ensure protection against electrostatic charging of the components. Changes to the system configuration and wiring are only permissible after disconnection from the power supply.

To assemble a SIMATIC ET 200SP motor starter, proceed as follows:

- Position the mechanical interlock of the SIMATIC ET 200SP motor starter in the assembly/disassembly position ②
- Place the SIMATIC ET 200SP motor starter onto the BaseUnit.
- Turn the mechanical interlock clockwise to the parking position ③
- Turn the mechanical interlock counterclockwise to the operating position (= end position) ①

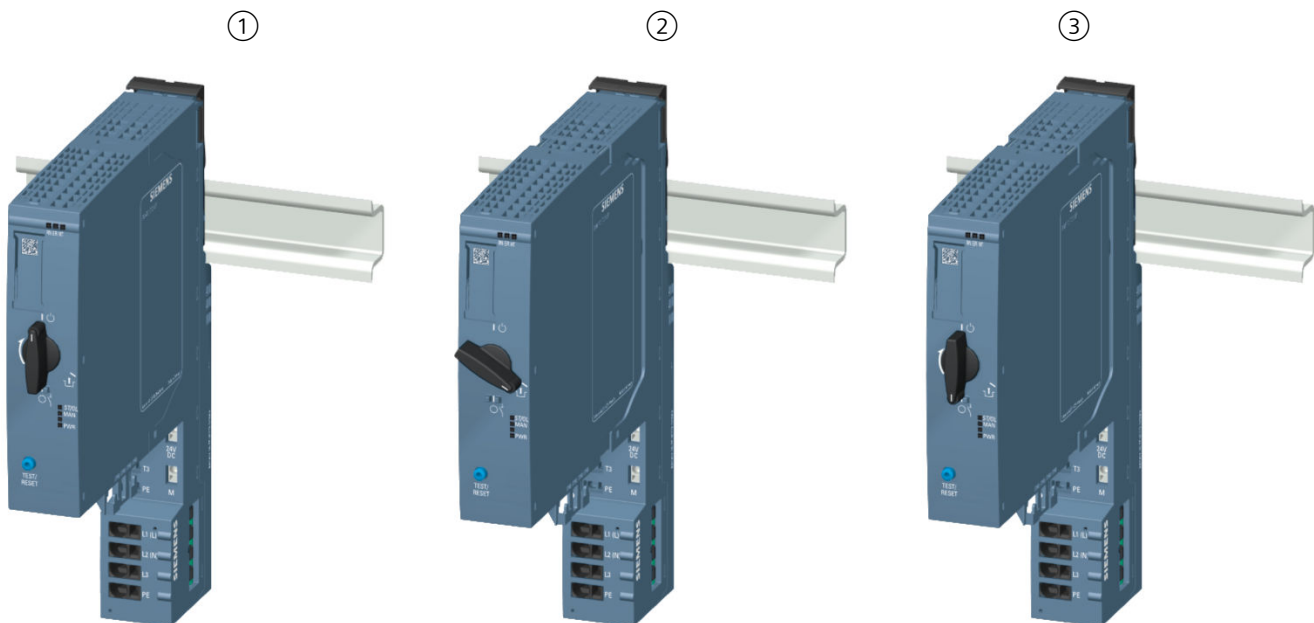

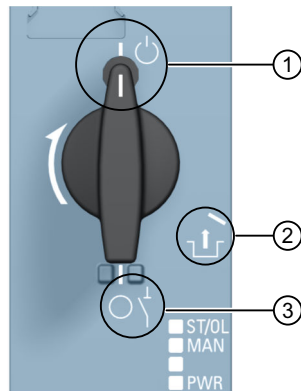

- ① **Operating position/READY**
The motor starter is firmly locked in the BaseUnit, and all electrical contacts are connected.
- ② **Assembly/disassembly position**
All electrical contacts are open, and you can use the SIMATIC ET 200SP motor starter in the BaseUnit, or you can remove it from the BaseUnit.
- ③ **Parking position/OFF**
In this position, you cannot remove the SIMATIC ET 200SP motor starter from the BaseUnit, but all electrical contacts are open. In addition, you can open the locking lever on the mechanical rotary interlock in this position, and fix the position with a padlock (shackle diameter 3 mm). This ensures the isolating function in accordance with IEC 60947-1.
In the parking position, the motor starter counts as a disconnected element for the head module. During operation, the parking position is therefore a hot swapping state. See also Removing and inserting I/O modules/motor starters (hot swapping) (Page 283)

**NOTE****Parking position/OFF**

This position is only permissible for maintenance purposes and not for continuous operation. In this position, dust protection and mechanical durability are not ensured.

If you do not use the motor starter for an extended period, remove it and attach the BU cover (3RK1908-1CA00-0BPO).

Mount the touch protection cover for the infeed bus on the last BaseUnit.

NOTE**Touch protection cover for the infeed bus**

You will find out how to mount the touch protection cover of the infeed bus on a SIMATIC ET 200SP motor starter in chapter "Mounting the cover for the 500 V AC infeed bus (Page 128)".

To connect the assembly, mount the server module after the last BaseUnit.

NOTE**Server module**

You can find out how to assemble/disassemble the server module in chapter "Installing the server module (Page 127)".

NOTE**Removing the motor starter**

You will find out how to remove the motor starter in chapter "Replacing a motor starter (Page 289)".

8.15.3 3DI/LC module

Introduction

The optional 3DI/LC module with three inputs and one further LC input can be connected to the motor starter. The status of the inputs of the 3DI/LC module can be seen via the process image input (PII) of the motor starter.

NOTE

The 3DI/LC module can be used for the motor starter and the fail-safe motor starter.

The input actions can be parameterized. For reasons of operational safety, the LC input is permanently set to manual local mode. For example, by parameterizing the inputs DI1 - DI3 with motor CLOCKWISE or motor COUNTER-CLOCKWISE, you can control the motor in manual local mode.

The figure below shows the 3DI/LC module.

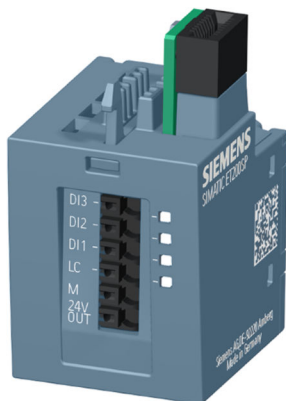

Assembly

WARNING

Risk of injury from automatic restart

When you mount the the 3DI/LC module, the motor starter can switch on autonomously if an ON command (DI1 to DI3) is active. This can result in property damage or serious injury caused by connected devices that are automatically started up.

Revoke the ON commands at DI1 to DI3 before mounting the 3DI/LC module.

Proceed as follows to mount a 3DI/LC module onto a motor starter:

1. Wire the 3DI/LC module according to the connection diagram.

NOTE

Connecting the 3DI/LC module

You will find out how to connect the 3DI/LC module in chapter "Connecting the 3DI/LC module for the motor starter (Page 157)".

2. Slide the 3DI/LC module into the motor starter until the 3DI/LC module engages.

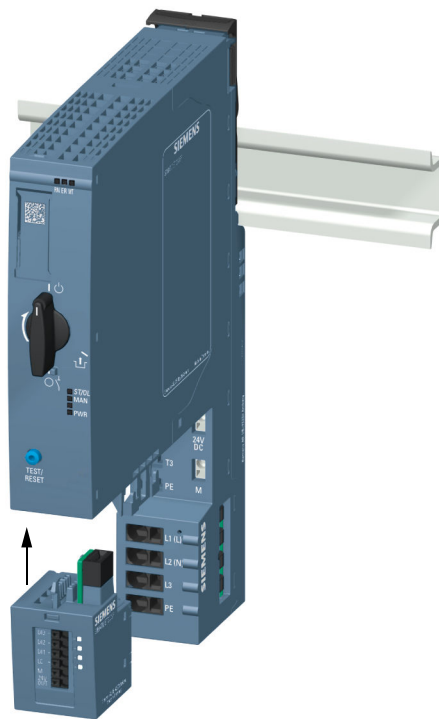

The figure below shows a motor starter with a mounted 3DI/LC module.

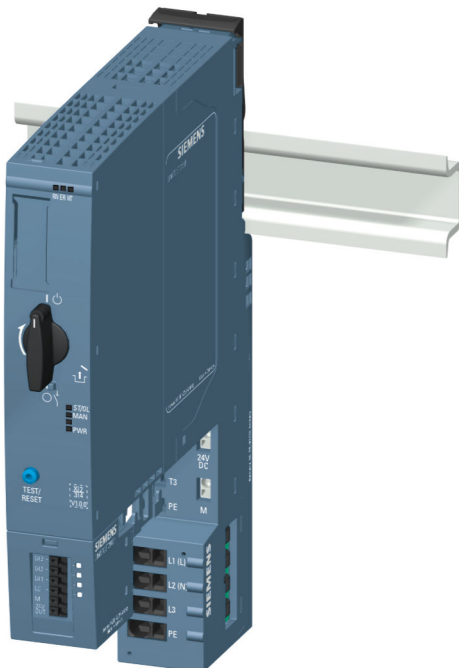

Disassembly

Proceed as follows to remove a 3DI/LC module from a motor starter:

1. Push the release lever on the rear of the 3DI/LC module.

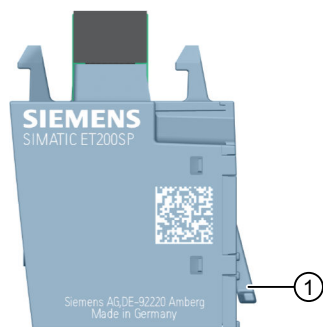

① Release lever

2. Remove the 3DI/LC module from the motor starter while pressing the release lever.

8.16 Labeling ET 200SP

8.16.1 Factory markings

Introduction

For better orientation, the ET 200SP is equipped with various markings ex factory, which help in the configuration and connection of the modules.

Factory markings

- Module labeling
- Color coding of module type
 - Digital input modules: white
 - Digital output modules: black
 - Analog input modules: light blue
 - Analog output modules: dark blue
 - Technology module: turquoise
 - Communication module: light gray
 - Special module: mint green
- Module information
 - Functional version of the module, e.g. "X/2/3/4" (= functional version 1)
 - Firmware version of the module at delivery, e.g. "V1.0.0"
 - Color code for usable color identification label, e.g. "CC0"
 - Usable BaseUnit type, e.g. "BU: A0"
- Color coding of the potential group
 - Opening the potential group: Light-colored terminal box and light-colored mounting rail release button
 - Further conduction of the potential group: Dark-colored terminal box and dark-colored mounting rail release button
- Color coding of the spring releases
 - Process terminals: gray, white
 - AUX terminals: turquoise
 - Additional terminals: red, blue

- Terminals for self-assembling voltage buses P1, P2: red, blue

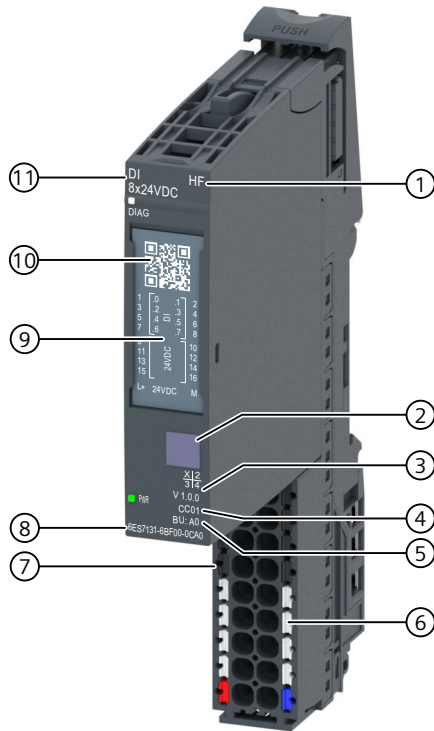

- ① Function class
- ② Color coding of module type
- ③ Function and firmware version
- ④ Color code for selection of the color coding labels
- ⑤ BU type
- ⑥ Color coding of the spring releases (by group)
- ⑦ Color coding of the potential group
- ⑧ Article number
- ⑨ Wiring diagram
- ⑩ 2D matrix code
- ⑪ Module type and designation

Figure 8-14 Factory markings

8.16.2 Optional markings

Introduction

In addition to the factory markings, there are also other options for labeling and/or marking terminals, BaseUnits and I/O modules for the ET 200SP distributed I/O system.

Optional markings

Color identification labels

The color identification labels are module-specific labels for color coding the potentials of the I/O modules. A color code (e.g. 01) is printed on each color identification label and I/O module. The color code allows you to read which color identification label is required for the terminals of the associated BaseUnit directly from the I/O module.

The following versions of color coded labels are available:

- Module-specific color combinations for the process terminals (see the device manuals I/O modules (<https://support.automation.siemens.com/WW/view/en/55679691/133300>)). The different colors have the following meaning: Gray = input or output signal, red = potential +, blue = ground.
- For the AUX terminals in the colors yellow-green, blue or red
- For the add-on terminals in the colors blue-red
- For the potential distributor modules (see manual BaseUnits (<https://support.automation.siemens.com/WW/view/en/59753521>)):
 - For PotDis-BaseUnit PotDis-BU-P1/x-R: red
For PotDis-BaseUnit PotDis-BU-P2/x-B: blue
 - For PotDis-TB-P1-R: red or gray
For PotDis-TB-P2-B: blue or gray
For PotDis-TB-BR-W: depending on application, yellow/green, blue, red or gray
For PotDis-TB-n.c.-G: gray

Reference identification labels

The reference identification labels (in accordance with EN 81346) can be inserted onto each CPU/interface module, BusAdapter, BaseUnit, I/O module and PotDis-TerminalBlock. This makes it possible to create a fixed assignment between the reference identification label of the BaseUnit and the I/O module/PotDis-TerminalBlock.

With the standard plotter setting, the reference identification label is suitable for automatic labeling with E-CAD systems.

Labeling strips

The labeling strips can be inserted in the CPU/interface module, I/O module and BU cover and allow identification of the ET 200SP distributed I/O system. The labeling strips can be ordered on a roll for thermal transfer printers or as DIN A4 format sheets for laser printers.

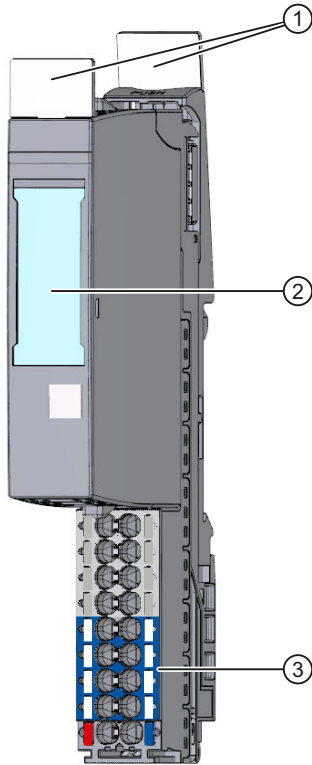

- ① Reference identification labels
- ② Labeling strips
- ③ Color identification labels

Figure 8-15 Optional markings

8.16.3 Applying color identification labels

Requirements

The BaseUnits must not be wired when you apply the color identification labels.

Required tools

3 mm screwdriver (only for removing the color identification labels)

Applying color identification labels

Press color identification labels into the terminal box of the BaseUnit.

NOTE

To remove the color identification labels, you must first disconnect the wiring on the BaseUnit and then carefully lever the color identification labels out of the holder using a screwdriver.

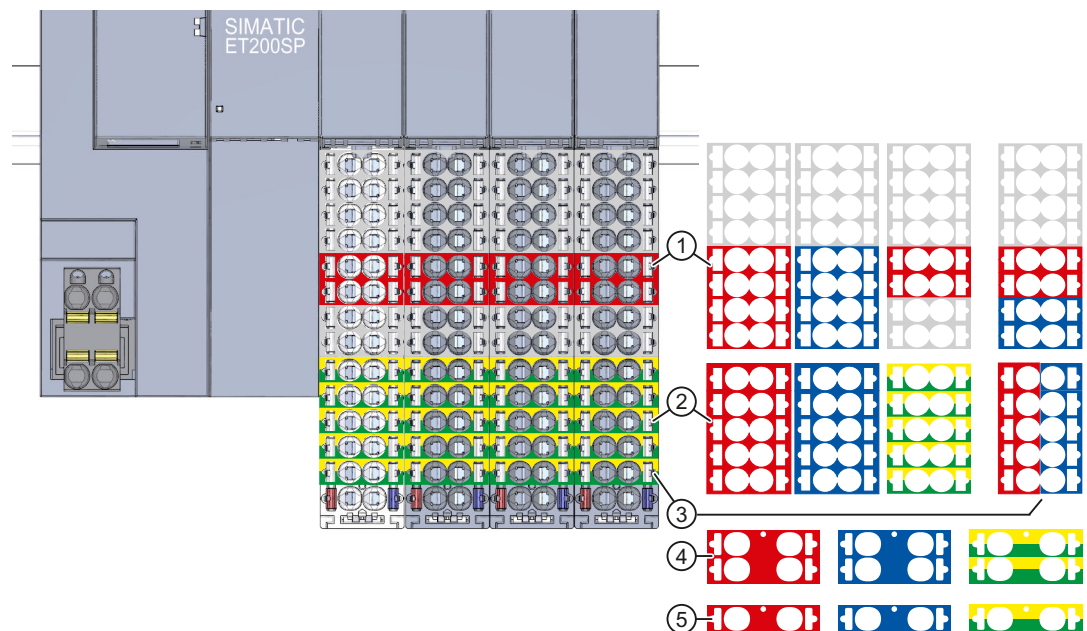

- ① Module-specific color identification labels (15 mm) for the process terminals. You can find additional information in the I/O Module <https://support.automation.siemens.com/WW/view/en/55679691/133300> manual.
- ② Color identification labels (15 mm) for the 10 AUX terminals
- ③ Color identification label (15 mm) for the 10 add-on terminals
- ④ Color identification labels (20 mm) for the 4 AUX terminals
- ⑤ Color identification labels (20 mm) for the 2 AUX terminals

Figure 8-16 Applying color identification labels (example)

NOTICE**AUX bus as PE bar**

If you use an AUX bus as a protective conductor (PE), attach the yellow-green color identification labels to the AUX terminals.

If you stop using the AUX terminals as a protective conductor bar, remove the yellow-green color identification labels and make sure that the system is still protected.

NOTICE**Supply of incorrect potential possible**

Check that the color-coded labels/wiring is correct before commissioning the plant.

8.16.4 Applying labeling strips

Procedure

Watch video sequence: "Labeling"

(<https://support.automation.siemens.com/WW/view/en/95886218>)

Proceed as follows to install a labeling strip:

1. Label the strips.
2. Insert the labeling strip into the interface module or I/O module.

8.16.5 Applying reference identification labels

Procedure

Watch video sequence: "Labeling"

(<https://support.automation.siemens.com/WW/view/en/95886218>)

Proceed as follows to install a reference identification label:

1. Break off the reference identification labels from the sheet.
2. Insert the reference identification labels into the opening on the CPU/interface module, BusAdapter, BaseUnit, I/O module and PotDis-TerminalBlock. The insertion opening is located on top of the BaseUnit or the I/O module/PotDis-TerminalBlock.

NOTE**Reference identification label**

The printable side of the reference identification label must be facing forward.

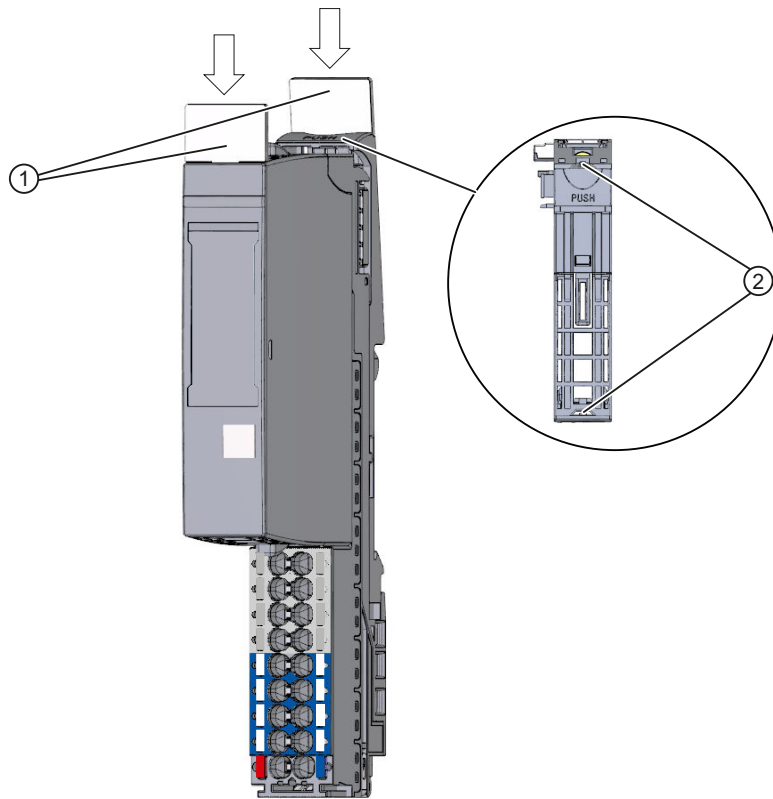

- ① Reference identification labels
- ② Opening for label

Figure 8-17 Applying reference identification labels

Configuring

9.1 Configuring ET 200SP

Introduction

The ET 200SP distributed I/O system is configured and assigned parameters with STEP 7 (CPU/interface module, I/O modules, motor starter and server module) or using configuration software of a third-party manufacturer (interface module, I/O modules, motor starter and server module).

"**Configuring**" is understood to mean the arranging, setup and networking of devices and modules within the device view or network view. STEP 7 graphically represents modules and racks. Just like "real" module racks, the device view allows the insertion of a defined number of modules.

When the modules are inserted, STEP 7 automatically assigns the addresses and a unique hardware identifier (HW identifier). You can change the addresses later. The hardware identifiers cannot be changed.

When the automation system is started, the CPU/interface module compares the configured planned configuration with the system's actual configuration. You can make parameter settings to control the response of the CPU/interface module to errors in the hardware configuration.

"**Parameterizing**" the components used signifies setting their properties. During parameter assignment, the hardware parameters are set and the settings for data exchange are made:

- Properties of the modules to which parameters can be assigned
- Settings for data exchange between components

STEP 7 compiles the hardware configuration (result of "configuring" and "assigning parameters") and downloads it to the CPU/interface module. The CPU/interface module then connects to the configured components and transfers their configuration and parameters. Modules can be replaced very easily because STEP 7 transfers the configuration and parameters when a new module is inserted.

Requirements for configuration of the CPU

Table 9-1 Requirement for installing the CPU

Configuration software	Requirements	Installation information
CPU 151xSP-1 PN: STEP 7 (TIA Portal) as of V13 Update 3	<ul style="list-style-type: none"> PROFINET IO PROFIBUS DP (optional): With the communication module CM DP 	STEP 7 online help
CPU 151xSP F-1 PN: STEP 7 (TIA Portal) as of V13 SP1		
CPU 151xSP-1PN (as of FW ver- sion V1.8), CPU 151xSP F-1 PN (as of FW version V1.8): STEP 7 (TIA Portal) as of V13 SP1 Update 4		

Integrity protection of the SIMATIC Memory Card, CPU as of FW version V3.1

For CPUs as of FW version V3.1, the integrity protection of the SIMATIC Memory Card is dependent on the password for protection of confidential configuration data that you assigned when configuring the CPU. This results in the following changes when using SIMATIC Memory Cards:

- Transferring a CPU to a card reader/USB memory using drag-and-drop:
For CPUs as of FW version V3.1, you must enter the password of the CPU you want to use the SIMATIC Memory Card with. If you enter an incorrect password, the CPU does not start booting after power on and reports the content of the SIMATIC Memory Card as faulty.
- Inserting a CPU from a card reader/USB memory:
To check the integrity of the contained configuration in STEP 7, you must enter the password of the CPU from which the configuration was loaded. In this case, STEP 7 checks the data on the SIMATIC Memory Card and reports potential damage.
Entry of the password entry is optional. If you do not want to use the integrity check, you do not need to enter the password (restoring a project).

Configuring a motor starter

You configure SIMATIC ET 200SP motor starters in exactly the same way as the I/O modules of the ET 200SP distributed I/O system. The GSD files can be used with STEP 7 V5.5 SP4 and higher, and TIA Portal V13 SP1 and higher.

Configuration of the ET 200SP

See the STEP 7 online help or the documentation of the configuration software manufacturer.

NOTE

For I/O modules that are installed on a BaseUnit BU..D (light-colored BaseUnit), you always have to set the parameter "Potential group" to "Enable new potential group". If you do not set this parameter correctly, the CPU/interface module goes to STOP and generates a parameter error.

NOTE

For PROFIBUS with configuration via GSD file

In the configuration software, you must set for the BU covers whether these are on a light-colored or dark-colored BaseUnit.

Configuring F-modules with a GSD file

If you want to configure F-modules with a GSD file, you need S7-FCT in order to calculate the F_iPar_CRC and assign the PROFIsafe addresses. Additional information can be found on the Internet (<https://support.industry.siemens.com/cs/ww/en/view/109763833>).

You can find S7-FCT on the Internet

(<https://support.industry.siemens.com/cs/ww/en/view/109762827>).

See also

GSDML file (<https://support.automation.siemens.com/WW/view/en/19698639/130000>)

GSD file (<https://support.automation.siemens.com/WW/view/en/10805317/14280>)

9.2 Configuring the CPU

9.2.1 Reading out the configuration

Introduction

When a connection to a CPU present in the configuration exists, you use the "Hardware detection" function to read out the configuration of this CPU, including centrally configured modules, and apply it to your project. You do not need to manually configure the CPU and the centrally present modules, as the physical configuration is read out automatically.

If you have already configured a CPU and the centrally present modules and you want to load the current configuration and parameters in a new project, it is advisable to use the "Upload device as new station" function. For additional information about this function, refer to section Backing up and restoring the CPU configuration ([Page 269](#)).

Procedure for reading out an existing configuration

1. Create a new project and configure an "Unspecified CPU".



Figure 9-1 Unspecified CPU in the device view

2. In the device view (or in the network view), select the "Hardware detection" command in the "Online" menu.

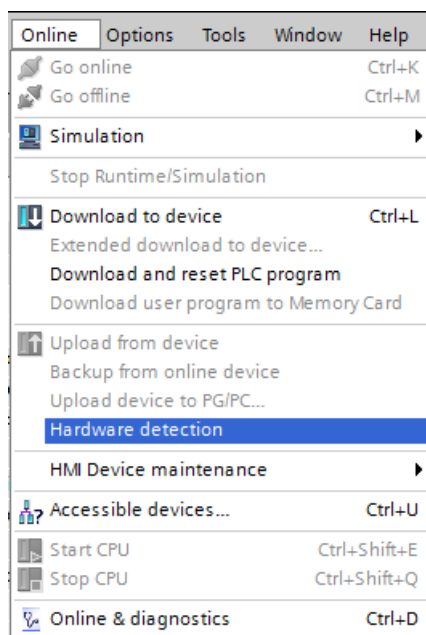

Figure 9-2 Hardware detection in the Online menu

You can also double-click the CPU and click "Detect" in the message.

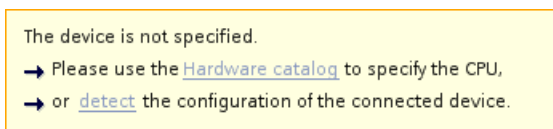

Figure 9-3 Hardware detection message in the device view

3. In the "Hardware detection for PLC_x" dialog box, click "Refresh". Then, select the CPU and the PG/PC interface and click "Detect".
STEP 7 downloads the hardware configuration including the modules from the CPU to your project.

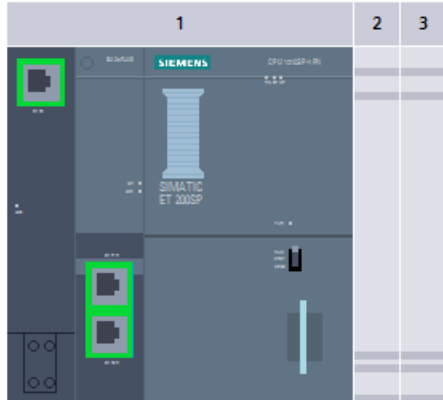

Figure 9-4 Result of the hardware detection in the device view

STEP 7 assigns a valid default parameter assignment for all modules. You can change the parameter assignment subsequently.

NOTE

If you want to go online after the hardware detection, you have to first download the detected configuration to the CPU; otherwise, an error may occur due to inconsistent configurations.

Properties of central modules

The properties of the CPUs have special significance for system behavior. You can set the following for a CPU using STEP 7:

- Startup behavior
- Parameter assignment of the interface(s), for example, IP address, subnet mask
- Web server, e.g. activation, user administration, and languages
- OPC UA server
- Global Security Certificate Manager
- Cycle times, e.g. maximum cycle time
- System and clock memory
- Protection level for access protection with assigned password parameter
- Time and day settings (daylight saving/standard)

The properties that can be set and the corresponding value ranges are specified by STEP 7. Fields that cannot be edited are grayed out.

Reference

Information about the individual settings can be found in the online help and in the manuals of the relevant CPUs.

9.2.2 Addressing

Introduction

In order to address the automation components or I/O modules, they have to have unique addresses. The following section explains the various address areas.

I/O address

I/O addresses (input/output addresses) are required in the user program to read inputs and set outputs.

STEP 7 automatically assigns input and output addresses when you connect the modules. Each module uses a continuous area in the input and/or output addresses corresponding to its volume of input and output data.

Module	Rack	Slot	I address	Q addr...	Type	Order no.	Firmware
▼ PLC_1	0	1			CPU 1510SP-1 PN	6ES7 510-1DJ00-0AB0	V1.6
▼ PROFINET-Schnittstelle_1	0	1 X1			PROFINET interface		
Port_1	0	1 X1 P1			Port		
Port_2	0	1 X1 P2			Port		
Port_3	0	1 X1 P3			Port		
	0	1 X2					
DI 4x120...230VAC ST_1	0	2	0		DI 4x120...230VAC ST	6ES7 131-6FD00-0BB1	V1.0
DQ 8x24VDC/0.5A ST_1	0	3		0	DQ 8x24VDC/0.5A ST	6ES7 132-6BF00-0BA0	V1.1
AI 8xRTD/TC 2-wire HF_1	0	4	1...16		AI 8xRTD/TC 2-wire ...	6ES7 134-6JF00-0CA1	V2.0
AQ 2xUI HF_1	0	5		1...4	AQ 2xUI HF	6ES7 135-6HB00-0CA1	V1.0

Figure 9-5 Example with input / output addresses from STEP 7

STEP 7 assigns the address areas of the modules by default to the process image partition 0 ("Automatic updating"). This process image partition is updated in the main cycle of the CPU.

Device address (e.g. Ethernet address)

Device addresses are addresses of programmable modules with interfaces to a subnet (e.g., IP address or PROFIBUS address). They are required to address the various devices on a subnet, for example, to download a user program.

Hardware identifier

STEP 7 automatically assigns a hardware identifier to identify and address modules and submodules. You use the hardware identifier in the case of diagnostic messages or operations, for example, to identify a defective module or the module addressed.

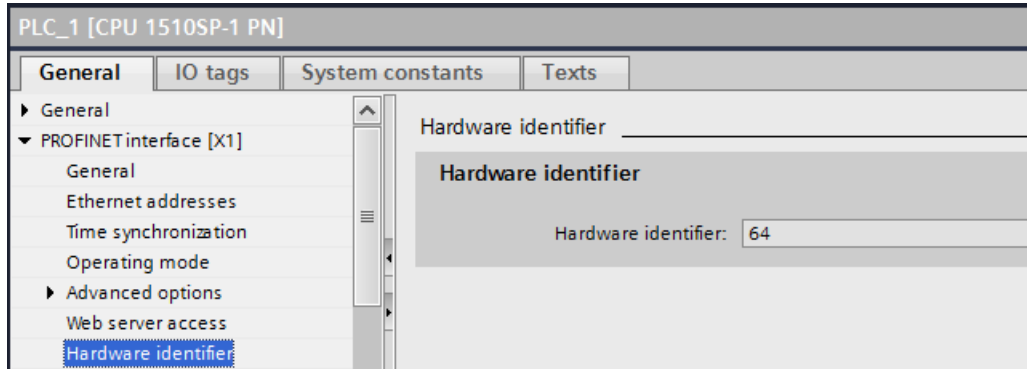

Figure 9-6 Example of a hardware identifier from STEP 7

In the "System constants" tab, you will find all hardware identifiers and their symbolic names (of the hardware identifier) for the selected module.

You can also find the hardware identifiers and names for all modules of a device in the default tag table of the "System constants" tab.

The screenshot shows the 'System constants' tab in STEP 7. It displays a table titled 'Standard-Variablen-tabelle' with the following data:

	Name	Data type	Value	Comment
39	PROFINET-Schnittstelle_1	Hw_Interface	64	
40	Port_3[PN]	Hw_Interface	67	
41	Port_1[PN]	Hw_Interface	65	
42	Port_2[PN]	Hw_Interface	66	
43	OB_Main	OB_PCYLE	1	
44	DI_4x120..230VAC_ST_1[DI]	Hw_SubModule	260	
45	DQ_8x24VDC_0.5A_ST_1[DO]	Hw_SubModule	261	
46	AI_8xRTD_TC_2-wire_HF_1[AI]	Hw_SubModule	262	
47	AQ_2xU_I_HF_1[AO]	Hw_SubModule	263	

Figure 9-7 Example of an excerpt from a default tag table in STEP 7

9.2.3 Process images and process image partitions

9.2.3.1 Process image - overview

Process image of the inputs and outputs

The process image input and output is an image of the signal states. The CPU transfers the values from the input and output modules to the process image input and output. At the start of the cyclic program, the CPU transfers the process image output as a signal state to the output modules. Afterwards the CPU transfers the signal states of the input modules to the process image input.

Advantages of the process image

The process image accesses a consistent image of the process signals during cyclic program execution. If a signal state at an input module changes during program processing, the signal state is retained in the process image. The CPU does not update the process image until the next cycle.

You can only assign the addresses of a module to a single process image partition.

32 process image partitions

By means of process image partitions, the CPU synchronizes the updated inputs/outputs of particular modules with defined user program sections.

The overall process image is subdivided into up to 32 process image partitions (PIP).

The CPU updates PIP 0 in each program cycle (automatic update) and assigns it to OB 1.

You can assign the process image partitions PIP 1 to PIP 31 to the other OBs during configuration of the input/output modules in STEP 7.

After the OB has been started, the CPU updates the assigned process image partition for inputs and reads in the process signals. At the end of the OB the CPU writes the outputs of the assigned process image partition directly to the peripheral outputs without having to wait for the completion of the cyclic program processing.

9.2.3.2 Automatically updating process image partitions

You can assign one process image partition to each organization block. In this case, the user program automatically updates the process image partition. The exceptions are PIP 0 and isochronous OBs.

Updating the process image partition

The process image partition is divided into two parts:

- Process image partition of the inputs (PIPI)
- Process image partition of the outputs (PIPQ)

The CPU always updates/reads the process image partition of the inputs (PIPI) before processing of the associated OB. The CPU outputs the process image of the outputs (PIPQ) at the end of the OB.

The figure below illustrates the updating of the process image partitions.

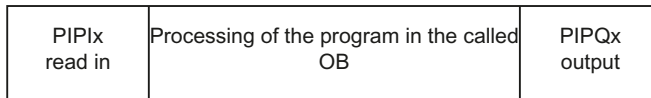

Figure 9-8 Updating process image partitions

9.2.3.3 Update process image partitions in the user program

Requirements

Alternatively, you can also use the following instructions for the process image update:

- "UPDAT_PI" instruction
- "UPDAT_PO" instruction

You will find the instructions in STEP 7 in the "Instructions" task card under "Extended instructions". The instructions can be called from any point in the program.

Requirements for updating process image partitions with the "UPDAT_PI" and "UPDAT_PO" instructions:

- The process image partitions must not be assigned to any OB. This means the process image partitions are not automatically updated.

NOTE

Update of PPI 0

PIP 0 (automatic update) cannot be updated with the "UPDAT_PI" and "UPDAT_PO" instructions.

UPDAT_PI: updates the process image partition of the inputs

With this instruction you read the signal states from the input modules into the process image partition of the inputs (PIPI).

UPDAT_PO: updates the process image partition of the outputs

With this instruction you transfer the process image partition of the outputs to the output modules.

Synchronous cycle interrupt OB

In the synchronous cycle interrupt OBs, you use the "SYNC_PI" and "SYNC_PO" operations to update the process image partitions of the operations. For additional information on the synchronous cycle interrupt OBs, refer to the STEP 7 Online Help.

Direct I/O access to the inputs and outputs of the module

As an alternative to access via the process image, you can directly access the I/O (write and read access) if this is necessary for program-related reasons. Direct (write) access to I/O also writes to the process image. This prevents a subsequent output of the process image from again overwriting the value written by direct access.

Reference

Additional information on process image partitions is available in the function manual, Cycle and response times (<https://support.automation.siemens.com/WW/view/en/59193558>).

9.3 Configuring the interface module

Configuring

Read the STEP 7 online help and/or the documentation of the configuration software manufacturer when configuring the interface module.

The F-destination address is saved permanently on the coding element of the ET 200SP fail-safe modules. Fail-safe motor starters do not need an F-destination address or a coding element.

NOTE

The supply voltage L+ must be applied to the F-module when the F-destination address is assigned.

NOTE

Note the following in conjunction with configuration control:

Before you can use configuration control together with F-modules, you must assign the F-destination address to the F-modules at the designated slots. For this, each F-module must be inserted in the slot configured for it. The actual configuration can then differ from the specified configuration.

For additional information on assigning the F-destination address, refer to the SIMATIC Safety - Configuring and Programming

(<https://support.automation.siemens.com/WW/view/en/54110126>) Programming and Operating Manual and to the online help for the *S7 Configuration Pack*.

9.4 Module-to-Module Communication (MtM)

Introduction

Module-to-Module Communication (MtM) offers the following advantages:

- Improved performance during transmission of data by bypassing the IO controller.
- Deterministic cycle times
- Cost-effective, high-performance solutions for applications where the performance of a specific technology module is not required.

Module-to-Module Communication (MtM)

Module-to-Module Communication (MtM) enables direct exchange of data between specific IO modules within a station via the interface module. This enables you to move small and/or time-critical tasks to the IO module. You achieve better performance while reducing the load on the CPU.

With Module-to-Module Communication (MtM), the interface module copies the input data of an IO module directly to a different IO module via the ET 200SP backplane bus. The IO module (data sink) carries out application-specific processing of the data.

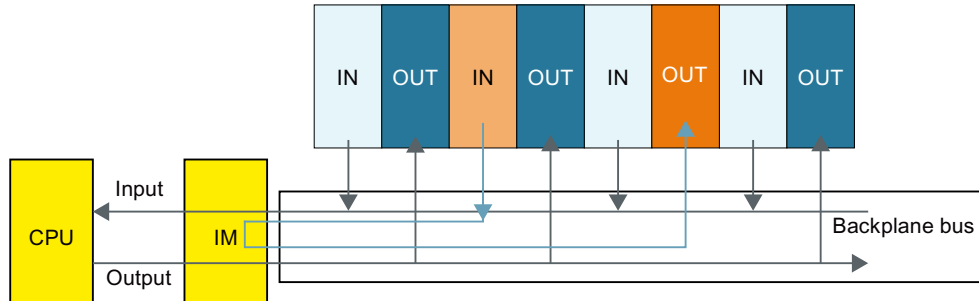

You configure the data source and data sink for Module-to-Module Communication (MtM) in the hardware configuration of the respective output module. Programming of the user program is **not** required in the variant for Module-to-Module Communication (MtM).

NOTE

The preparation of the input data in the output module (mapping) and the output of the data to the outputs are application- and technology-specific.

Example: The DQ 4x24VDC/2A HS digital output module supports

- the application cam control with Module-to-Module Communication (MtM) under the designation DQ 4x24VDC/2A HS **MCC MtM**

Additional information can be found in the manuals of the corresponding IO modules. An overview of which I/O modules support module-to-module communication (MtM) can be found in the ET 200SP

(<https://support.industry.siemens.com/cs/ww/en/view/73021864>) Product Information.

Information on which interface module supports module-to-module communication (MtM) can be found in the Equipment Manuals of the interface modules.

See also

FAQ "How do you parameterize module-to-module communication?"
(<https://support.industry.siemens.com/cs/ww/en/view/109767618>)

9.5 Value status

Introduction

Value status (QI, quality information) refers to status information of I/O channels that is made available to the user program via the process image input (PII). However, since the value status is partly derived from the diagnostics, there may be a time delay between the occurrence of the error and the message depending on the diagnostics.

Each bit of the value status is assigned to a channel and provides information about the validity of the process value of the respective channel (1 = no errors on the channel of the I/O module, 0 = value is bad).

The assignment of the value status bytes in the process image input depends on the module used. Detailed information can be found in the manual for the relevant I/O module.

Summary: Possible cause for value status = 0:

- A channel has an error (overflow/underflow, wire break, short-circuit, etc.)
- The supply voltage L+ is missing at the terminals or is not sufficient
- A channel has been deactivated
- PROFlenergy pause is activated
- Outputs are inactive (value status = 0: Module not plugged in. Value status is generated via interface module in distributed mode)

If, for example, there is a wire break at an input but the wire break diagnostics is disabled, the value status of the channel is set to "0" but no diagnostics is triggered. Diagnostics is only also triggered if the wire break diagnostics is enabled.

With module-by-module channel diagnostics of the I/O modules, these also map the value status module-by-module. The channels are mapped here module-by-module to value status = 0 or value status = 1.

Which interface modules support the value status?

The following interface modules support the value status:

- IM 155-6 PN ST
- IM 155-6 PN HS
- IM 155-6 PN/2 HF
- IM 155-6 PN/3 HF
- IM 155-6 PN R1
- IM 155-6 MF HF
- IM 155-6 DP HF

Which I/O modules support the value status?

The I/O modules of the function classes Standard, High Feature and High Speed support the value status.

Activating value status

Table 9-2 Value status depending on the respective configuration variant

	STEP 7 TIA (integrated I/O module; PROFINET and PROFIBUS)	STEP 7 HSP (PROFINET and PROFIBUS)	GSD PROFINET (can be integrated in STEP 7 TIA and STEP 7)	GSD PROFIBUS (can be integrated in STEP 7 TIA and STEP 7)
Select the I/O module from the hardware catalog and activate the value status	There is only one entry in the hardware catalog for each I/O module. In the configuration dialog, you can set whether the I/O module is to be operated with or without value status.		There are multiple entries in the hardware catalog for each I/O module. On selection in the hardware catalog, it must be determined whether the I/O module is to be operated with or without value status. The value status can be recognized by the suffix "Q!".	
Input substitute value behavior	The "Input values with module failure" parameter (input substitute value behavior) is available for CPUs 1500 from FW version V2.0. If the I/O module is configured with value status, the parameter is fixed at "Input value 0". Input substitute value behavior can only be configured if no value status has been configured.	The "Input values with module failure" parameter is not available.	The "Input values with module failure" parameter (input substitute value behavior) is available for CPUs 1500 from FW version V2.0. The same restrictions apply as for I/O modules integrated in STEP 7 TIA. Due to the limited capabilities of the GSD, however, these are not locked in the GSD interface.	The "Input values with module failure" parameter is not available.

Special features for modules with MSI/MSO

The meaning of the value status of the basic submodule is described above. The value status of the MSI/MSO submodules are copies of the base submodule. The value status of the MSI/MSO submodules remains set to "0" as long as the base submodule has not been configured.

Basics of program execution

10.1 Events and OBs

Start events

The table below gives an overview of the possible event sources for start events and their OBs.

Table 10-1 Start events

Types of event sources	Possible priorities (default priority)	Possible OB numbers	Default system response ¹⁾	Number of OBs
Starting ²⁾	1	100, ≥ 123	Ignore	0 to 100
Cyclic program ²⁾	1	1, ≥ 123	Ignore	0 to 100
Time-of-day interrupt ²⁾	2 to 24 (2)	10 to 17, ≥ 123	Not applicable	0 to 20
Time-delay interrupt ²⁾	2 to 24 (3)	20 to 23, ≥ 123	Not applicable	0 to 20
Cyclic interrupt ²⁾	2 to 24 (8 to 17, frequency dependent)	30 to 38, ≥ 123	Not applicable	0 to 20
Hardware interrupt ²⁾	2 to 26 (18)	40 to 47, ≥ 123	Ignore	0 to 50
Status interrupt	2 to 24 (4)	55	Ignore	0 or 1
Update interrupt	2 to 24 (4)	56	Ignore	0 or 1
Manufacturer-specific or profile-specific interrupt	2 to 24 (4)	57	Ignore	0 or 1
Synchronous cycle interrupt	16 to 26 (21)	61 to 64, ≥ 123	Ignore	0 to 2
Time error ³⁾	22	80	Ignore	0 or 1
Cycle monitoring time exceeded once			STOP	
Diagnostics interrupt	2 to 26 (5)	82	Ignore	0 or 1
Pull/plug interrupt for modules	2 to 26 (6)	83	Ignore	0 or 1
Rack error	2 to 26 (6)	86	Ignore	0 or 1

1) If you have not configured the OB.

2) In the case of these event sources, besides the permanently assigned OB numbers (see column: Possible OB numbers) in STEP 7 you can assign OB numbers from the range ≥ 123 .

3) If the maximum cycle time has been exceeded twice within one cycle, the CPU always assumes the STOP state, regardless of whether you have configured OB 80.

4) You will find more information on these event sources and the starting behavior in the S7-1500 Motion Control function manual.

Types of event sources	Possible priorities (default priority)	Possible OB numbers	Default system response ¹⁾	Number of OBs
MC-servo ⁴⁾	17 to 26 (25)	91	Not applicable	0 or 1
MC-PreServo ⁴⁾	17 to 26 (25)	67	Not applicable	0 or 1
MC-PostServo ⁴⁾	17 to 26 (25)	95	Not applicable	0 or 1
MC-Interpolator ⁴⁾	16 to 26 (24)	92	Not applicable	0 or 1
Programming error (only for global error handling)	2 to 26 (7)	121	STOP	0 or 1
I/O access error (only for global error handling)	2 to 26 (7)	122	Ignore	0 or 1

- 1) If you have not configured the OB.
- 2) In the case of these event sources, besides the permanently assigned OB numbers (see column: Possible OB numbers) in STEP 7 you can assign OB numbers from the range ≥ 123 .
- 3) If the maximum cycle time has been exceeded twice within one cycle, the CPU always assumes the STOP state, regardless of whether you have configured OB 80.
- 4) You will find more information on these event sources and the starting behavior in the S7-1500 Motion Control function manual.

Response to triggers

The occurrence of a start event results in the following reaction:

- If the event comes from an event source to which you have assigned an OB, this event triggers the execution of the assigned OB. The event enters the queue according to its priority.
- If the event comes from an event source to which you have not assigned an OB, the CPU executes the default system reaction.

NOTE

Some event sources, such as startup, pull/plug, exist even if you do not configure them.

Assignment between event source and OBs

The type of OB determines where you make the assignment between OB and event source:

- With hardware interrupts and isochronous mode interrupts, the assignment is made during the configuration of the hardware or when the OB is created.
- In the case of the MC-Servo, MC-PreServo, MC-PostServo and MC-Interpolator, STEP 7 automatically assigns the OBs 91/92 as soon as you add a technology object.
- For all other types of OB, the assignment is made when the OB is created, where applicable after you have configured the event source.

For hardware interrupts, you can change an assignment which has already been made during runtime with the instructions ATTACH and DETACH. In this case, only the actually effective assignment changes, and not the configured assignment. The configured assignment takes effect after loading, and at startup.

The CPU ignores hardware interrupts to which you did not assign an OB in your configuration or which occur after the DETACH instruction. The CPU does not check whether an OB is

assigned to this event when an event arrives, but only prior to the actual processing of the hardware interrupt.

OB priority and runtime behavior

If you have assigned an OB to the event, the OB has the priority of the event. The CPU supports the priority classes 1 (lowest priority) to 26 (highest priority). The following items are essential to the processing of an event:

- Calling and processing of the assigned OB
- The update of the process image partition of the assigned OB

The user program processes the OBs exclusively on a priority basis. This means the program processes the OB with the highest priority first when multiple OB requests occur at the same time. If an event occurs that has a higher priority than the currently active OB, this OB is interrupted. The user program processes events of the same priority in order of occurrence.

NOTE

Communication

Communication (e.g. test functions with the PG) always works permanently with the priority 15. So as not to unnecessarily prolong program runtime in the case of time-critical applications, these OBs should not be interrupted by communication. Assign a priority >15 for these OBs.

Reference

You can find more information on organization blocks in the STEP 7 online help.

10.2 Asynchronous instructions

Introduction

In program processing, a differentiation is made between synchronous and asynchronous instructions.

The "synchronous" and "asynchronous" properties relate to the temporal relationship between the call and execution of the instruction.

The following applies to synchronous instructions: When the call of a synchronous instruction is ended, the execution is also ended.

This is different in the case of asynchronous instructions: When the call of an asynchronous instruction is ended, the execution of the asynchronous instruction is not necessarily ended yet. This means the execution of an asynchronous instruction can extend over multiple calls. The CPU processes asynchronous instructions in parallel with the cyclic user program.

Asynchronous instructions generate jobs in the CPU for their processing.

Asynchronous instructions are usually instructions for transferring data (data records for modules, communication data, diagnostics data).

Difference between synchronous/asynchronous instructions

The figure below shows the difference between processing an asynchronous instruction and processing a synchronous instruction. In this figure the asynchronous instruction is called five times before the execution is completed, for example, a data record is completely transferred. With a synchronous instruction, the instruction is fully executed in each call.

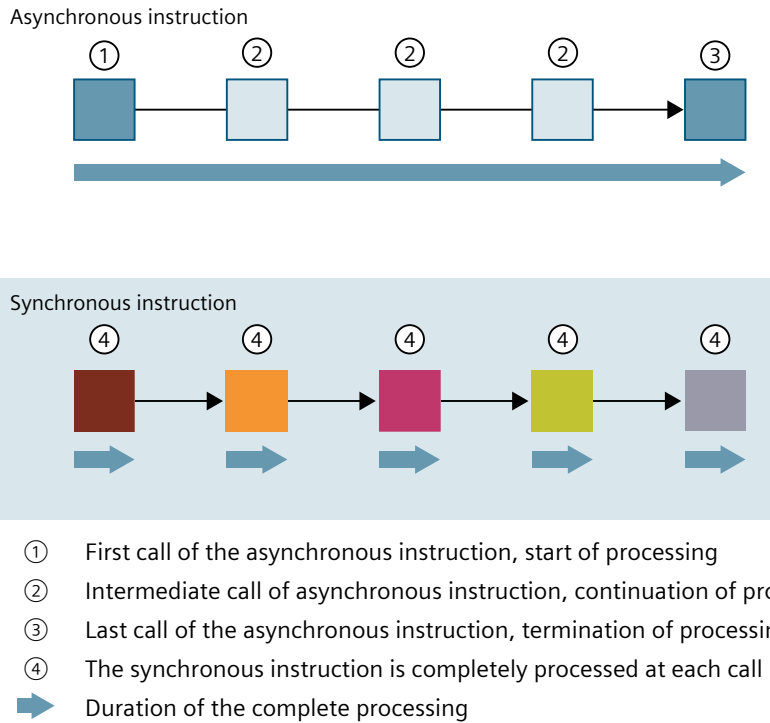

Figure 10-1 Difference between synchronous and asynchronous instructions

Parallel processing of asynchronous instruction jobs

A CPU can process several asynchronous instruction jobs in parallel. The CPU processes the jobs in parallel under the following conditions:

- Several asynchronous instruction jobs are called at the same time.
- The maximum number of concurrently running jobs for the instruction is not exceeded.

The figure below shows the parallel processing of two jobs of the instruction WRREC. The two instructions are processed in parallel for a specific period here.

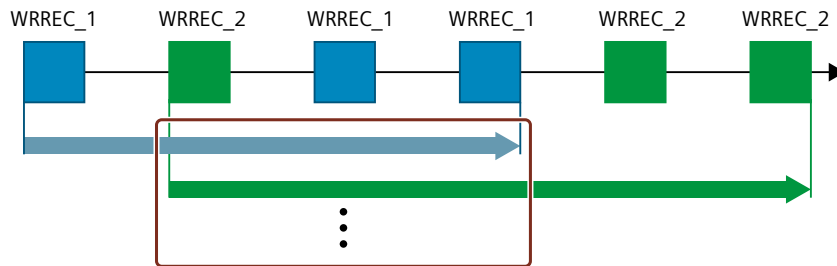

Figure 10-2 Parallel processing of the asynchronous instruction WRREC

NOTE

Dependencies between asynchronous instructions

The call sequence in the user program may differ from the processing sequence of the asynchronous instructions. This can lead to problems with dependencies between asynchronous instructions.

Solution: To ensure correct timing of processing, use the status outputs of the asynchronous instructions in a sequencer. If an asynchronous instruction is finished and this is acknowledged via the parameter DONE, then only the next asynchronous instruction should start.

Example: For the RecipeImport and RecipeExport recipe functions, you need a CSV file for the recipe data. If you use the same CSV file for import and export, then the two asynchronous statements are dependent on each other. Link the status of the DONE parameter of the RecipeImport instruction in a sequencer to the next step where the RecipeExport is executed. The link thus ensures correct processing.

Assignment of call to job of the instruction

To execute an instruction over multiple calls, the CPU must be able to uniquely assign a subsequent call to a running job of the instruction.

To assign a call to a job, the CPU uses one of the following two mechanisms, depending on the type of the instruction:

- Via the instance data block of the instruction (in the case of the "SFB" type)
- The input parameters of the instruction identifying the job. These input parameters must match in each call during processing of the asynchronous instruction.

Example: A "Create_DB" instruction job is identified by the input parameters LOW_LIMIT, UP_LIMIT, COUNT, ATTRIB and SRCBLK.

The following table shows which instruction you can identify with which input parameters.

Instruction	Job is identified by
DPSYC_FR	LADDR, GROUP, MODE
D_ACT_DP	LADDR
DPNRM_DG	LADDR
WR_DPARM	LADDR, RECNUM
WR_REC	LADDR, RECNUM
RD_REC	LADDR, RECNUM
CREATE_DB	LOW_LIMIT, UP_LIMIT, COUNT, ATTRIB, SRCBLK
READ_DBL	SRCBLK, DSTBLK
WRIT_DBL	SRCBLK, DSTBLK
RD_DPARA	LADDR, RECNUM
DP_TOPOL	DP_ID

Status of an asynchronous instruction

An asynchronous instruction shows its status via the block parameters STATUS/RET_VAL and BUSY. Many asynchronous instructions also use the block parameters DONE and ERROR. The figure below shows the two asynchronous instructions WRREC and CREATE_DB.

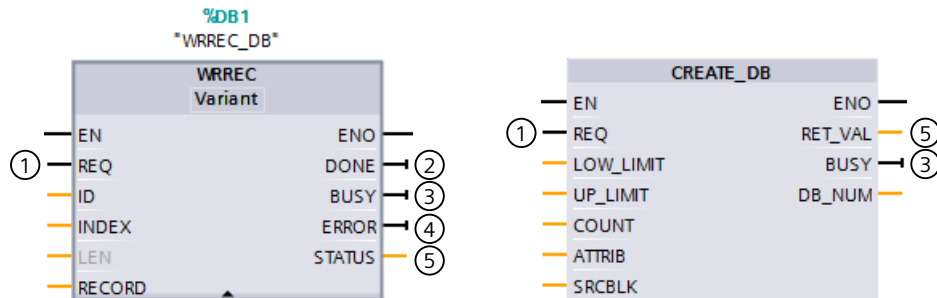

- ① The input parameter REQ starts the job to execute the asynchronous instruction.
- ② The output parameter DONE indicates that the job was completed without error.
- ③ The output parameter BUSY indicates whether the job is currently being processed. When BUSY = 1, a resource is assigned for the asynchronous instruction. If BUSY = 0, then the resource is free.
- ④ The output parameter ERROR indicates that an error has occurred.
- ⑤ The output parameter STATUS/RET_VAL provides information on the status of the job execution. The output parameter STATUS/RET_VAL receives the error information after the occurrence of an error.

Figure 10-3 Block parameters of asynchronous instructions using the instructions WRREC and CREATE_DB as examples.

Summary

The table below provides you with an overview of the relationships described above. It shows in particular the possible values of the output parameters if processing is not completed after a call.

NOTE

Following every call, you must evaluate the relevant output parameters in your program.

Relationship between REQ, STATUS/RET_VAL, BUSY and DONE during a "running" job.

Seq. no. of the call	Type of call	REQ	STATUS/RET_VAL	BUSY	DONE	ERROR
1	First call	1	W#16#7001	1	0	0
			Error code (for example, W#16#80C3 for lack of resources)	0	0	1

Seq. no. of the call	Type of call	REQ	STATUS/RET_VAL	BUSY	DONE	ERROR
2 to (n - 1)	Intermediate call	Not relevant	W#16#7002	1	0	0
n	Last call	Not relevant	W#16#0000, if no errors have occurred.	0	1	0
			Error code, if errors have occurred	0	0	1

Consumption of resources

Asynchronous instructions occupy resources in the CPU while they are being processed. The resources are limited depending on the type of CPU and instruction; the CPU can only process a maximum number of asynchronous instruction jobs simultaneously. The resources are available again after a job has been successfully completed or processed with an error.

Example: For the RDREC instruction, a 1512SP-1 PN CPU can process up to 20 jobs in parallel. If the maximum number of concurrent jobs for an instruction is exceeded, the following occurs:

- The instruction returns error code 80C3 (lack of resources) in the block parameter STATUS.
- The CPU does not execute the job until a resource becomes free again.

NOTE

Lower-level asynchronous instructions

Several asynchronous instructions use one or more lower-level asynchronous instructions for their processing. This dependence is shown in the tables below.

Please note that, if there are several lower-level instructions, typically only one lower-level instruction is occupied at one time.

Extended instructions: maximum number of concurrently running jobs

Table 10-2 Maximum number of concurrently running jobs for asynchronous extended instructions and lower-level instructions used

Extended instructions	CPU 1510SP-1 PN CPU 1510SP F-1 PN	CPU 1512SP-1 PN CPU 1512SP F-1 PN
Distributed I/O		
RDREC		20
RD_REC		10
WRREC		20
WR_REC		10
D_ACT_DP		8
ReconfigIOSystem	uses RDREC, WRREC, D_ACT_DP,	
DPSYC_FR		2

Extended instructions	CPU 1510SP-1 PN CPU 1510SP F-1 PN	CPU 1512SP-1 PN CPU 1512SP F-1 PN
DPNRM_DG		8
DP_TOPOL		1
ASI_CTRL	uses RDREC, WRREC	
PROFlenergy		
PE_START_END	uses RDREC, WRREC	
PE_CMD	uses RDREC, WRREC	
PE_DS3_Write_ET200S	uses RDREC, WRREC	
PE_WOL	uses RDREC, WRREC, TUSEND, TURCV, TCON, TDISCON	
Module parameter assignment		
RD_DPAR		10
RD_DPARA		10
RD_DPARM		10
WR_DPARM		10
Diagnostics		
Get_IM_Data		10
GetStationInfo		10
Recipes and data logging		
RecipeExport		10
RecipeImport		10
DataLogCreate		10
DataLogOpen		10
DataLogWrite		10
DataLogClear		10
DataLogClose		10
DataLogDelete		10
DataLogNewFile		10
Data block functions		
CREATE_DB		10
READ_DBL		10
WRIT_DBL		10
DELETE_DB		10
File handling		
FileReadC		10
FileWriteC		10
Reference information		
ResolveSymbols		10
GetSymbolForReference		10

Basic instructions: maximum number of concurrently running jobs

Table 10-3 Lower-level instructions used for asynchronous basic instructions

Basic instructions	CPU 1510SP-1 PN CPU 1510SP F-1 PN	CPU 1512SP-1 PN CPU 1512SP F-1 PN
Array DB		
ReadFromArrayDBL	uses READ_DBL (see Extended instructions)	
WriteToArrayDBL	uses READ_DBL, WRIT_DBL (see Extended instructions)	

Communication: maximum number of concurrently running jobs

Table 10-4 Maximum number of concurrently running jobs for asynchronous instructions and lower-level instructions used for Open User Communication

Open User Communication	CPU 1510SP-1 PN CPU 1510SP F-1 PN	CPU 1512SP-1 PN CPU 1512SP F-1 PN
TSEND TUSEND	64	88
TRCV TURCV	64	88
TCON	64	88
TDISCON	64	88
T_RESET	64	88
T_DIAG	64	88
T_CONFIG	1	
TSEND_C	uses TSEND, TUSEND, TRCV, TCON, TDISCON	
TRCV_C	uses TSEND, TUSEND, TRCV, TURCV, TCON, TDISCON	
TMAIL_C	uses TSEND, TUSEND, TRCV, TURCV, TCON, TDISCON	

Table 10-5 Lower-level instructions used for asynchronous instructions for MODBUS TCP

MODBUS TCP	CPU 1510SP-1 PN CPU 1510P F-1 PN	CPU 1512SP-1 PN CPU 1512SP F-1 PN
MB_CLIENT	uses TSEND, TUSEND, TRCV, TURCV, TCON, TDISCON	
MB_SERVER	uses TSEND, TUSEND, TRCV, TURCV, TCON, TDISCON	

Table 10-6 Maximum number of concurrently running jobs for asynchronous instructions for S7 communication. The S7 communication instructions use a common pool of resources.

S7 communication	CPU 1510SP-1 PN CPU 1510SP F-1 PN	CPU 1512SP-1 PN CPU 1512SP F-1 PN
PUT GET USEND URCV BSEND BRCV	192	264

Table 10-7 Lower-level instructions used for asynchronous instructions for communications processors

Communications processors	CPU 1510SP-1 PN CPU 1510SP F-1 PN	CPU 1512SP-1 PN CPU 1512SP F-1 PN
PtP communication		
Port_Config	uses RDDEC, WRREC	
Send_Config	uses RDDEC, WRREC	
Receive_Config	uses RDDEC, WRREC	
Send_P2P	uses RDDEC, WRREC	
Receive_P2P	uses RDDEC, WRREC	
Receive_Reset	uses RDDEC, WRREC	
Signal_Get	uses RDDEC, WRREC	
Signal_Set	uses RDDEC, WRREC	
Get_Features	uses RDDEC, WRREC	
Set_Features	uses RDDEC, WRREC	
USS communication		
USS_Port_Scan	uses RDDEC, WRREC	
USS_Port_Scan_31	uses RDDEC, WRREC	
MODBUS (RTU)		
Modbus_Comm_Load	uses RDDEC, WRREC	
Modbus_Master	uses RDDEC, WRREC	
Modbus_Slave	uses RDDEC, WRREC	
ET 200S serial interface		
S_USSI	uses CREATE_DB	
SIMATIC NET		
FTP_CMD	uses TSEND, TRCV, TCON, TDISCON	

Table 10-8 Maximum number of concurrently running jobs for asynchronous instructions for OPC UA

OPC_UA	CPU 1510SP-1 PN CPU 1510SP F-1 PN	CPU 1512SP-1 PN CPU 1512SP F-1 PN
OPC_UA_Connect		10
OPC_UA_Disconnect		10
OPC_UA_NamespaceGetIn- dexList		10
OPC_UA_NodeGetHandleList		10
OPC_UA_NodeRelease- HandleList		10
OPC_UA_TranslatePathList		10
OPC_UA_ReadList		10
OPC_UA_WriteList		10
OPC_UA_MethodGetHandleL- ist		10
OPC_UA_MethodRelease- HandleList		10

OPC_UA	CPU 1510SP-1 PN CPU 1510SP F-1 PN	CPU 1512SP-1 PN CPU 1512SP F-1 PN
OPC_UA_MethodCall		10
OPC_UA_ServerMethodPre		10
OPC_UA_ServerMethodPost		10
OPC_UA_ConnectionGetStatus		10

Technology: maximum number of concurrently running jobs

Table 10-9 Maximum number of concurrently running jobs for asynchronous instructions for technology. The instructions for technology use a common pool of resources.

Technology	CPU 1510SP-1 PN CPU 1510SP F-1 PN CPU 1512SP-1 PN CPU 1512SP F-1 PN
Motion Control	
MC_Power	300
MC_Reset	
MC_Home	
MC_Halt	
MC_MoveAbsolute	
MC_MoveRelative	
MC_MoveVelocity	
MC_MoveJog	
MC_MoveSuperimposed	
MC_Stop	
MC_WriteParameter	
MC_SetAxisSTW	
MC_MeasuringInput	
MC_MeasuringInputCyclic	
MC_AbortMeasuringInput	
MC_OutputCam	
MC_CamTrack	
MC_GearIn	
MC_TorqueLimiting	
MC_TorqueAdditive	
MC_TorqueRange	

More information

You can find additional information on block parameter assignment in the STEP 7 online help.

Protection

11.1 Overview of the protective functions of the CPU

Introduction

This chapter describes the following functions for protecting the ET 200SP against unauthorized access:

- Protection of confidential configuration data
- Access protection
- Know-how protection
- Copy protection

Further measures for protecting the CPU

The following measures additionally increase the protection against unauthorized access to functions and data of the CPU from external sources and via the network:

- Deactivation of the Web server
- Deactivation of the OPC UA server (you will find further information on the security mechanisms for OPC UA servers in the Communication [\(<https://support.industry.siemens.com/cs/ww/en/view/59192925>\)](https://support.industry.siemens.com/cs/ww/en/view/59192925) function manual)
- Deactivation of time synchronization via an NTP server
- Deactivation of PUT/GET communication

When using the Web server, you protect your ET 200SP distributed I/O system against unauthorized access

- By setting password-protected access rights for certain users in user management.
- By using the default "Allow access via HTTPS only" option.
This option allows access to the Web server with the secure Hypertext transfer protocol HTTPS only.

11.2 Protection of confidential configuration data

As of STEP 7 V17, you have the option of assigning a password for protecting confidential configuration data of the respective CPU. This refers to data such as private keys that are required for the proper functioning of certificate-based protocols.

You can find detailed information on protecting confidential configuration data in the Communication (<https://support.industry.siemens.com/cs/ww/en/view/59192925>) function manual.

NOTE**Replacement part scenario**

Replacing the CPU in a replacement part scenario has an impact on the password for protection of confidential configuration data. When you replace the CPU, observe the rules for the replacement part scenario in the Communication

(<https://support.industry.siemens.com/cs/ww/en/view/59192925>) function manual.

11.3 Local user management

11.3.1 Useful information on local user management and access control

As of TIA Portal version V19 and CPU firmware version V3.1, ET 200SP CPUs have an improved way to manage users, roles and CPU function rights (User Management & Access Control, UMAC).

Starting from the above-named versions, you manage all project users along with their rights (e.g. access rights) for CPUs in the project in the editor for users and roles of the project in TIA Portal:

- To manage users along with their rights, for example, to control access rights, navigate to the "Security Settings > Users and roles" area in the project tree.

TIA Portal saves the assignment of the function rights of a CPU to user-defined roles and the assignment of these roles to users for each CPU. There are no system-defined roles with predefined function rights for CPUs.

The user management becomes effective in the respective CPUs after the configuration is loaded. Each CPU then "knows" who may access which service and execute specific functions. This new approach is also referred to hereinafter as "local user management and access control".

NOTE**No support of global users for CPU function rights**

UMC (User Management Component) can also be used to manage users centrally in TIA Portal. With this component you manage global users on connected servers, e.g. by connecting an MS Active Directory. The authentication is then implemented using UMC. Global user management for CPU-specific function rights using UMC is currently not supported.

Users, roles and function rights - details of new approach

Users and roles were also managed in the predecessor versions of TIA Portal under "Security settings > Users and roles". In addition to the existing user management options, e.g. for HMI devices, you can also manage all CPU function rights in this editor starting from TIA Portal Version V19.

The CPU function rights are effective in runtime, which is why you will find these rights on the "Runtime rights" tab in the editor for users and roles. For each CPU in the project, there is a section with all CPU function rights to choose from - separated according to CPU services such as PG/HMI communication (engineering access, access levels), web server and OPC UA. Besides the user management for projects, additional user management possibilities were available for the web server and OPC UA server in the CPU properties (static user management for CPUs up to FW version V3.0):

- Users for the OPC UA server (authentication)
- Users for the web server (authentication and access control)

These additional user management possibilities have been integrated in the local user management in the project tree as of TIA Portal V19 and CPU FW version V3.1.

Introduction to local user management and access control

For CPUs up to firmware version V3.0, users were managed under the respective CPU properties for the individual services "Web server", "OPC UA", etc. Web server users were managed in the "Web server" area, OPC UA users in the "OPC UA" area.

To restrict access by the PG/HMI to the CPU using access levels, you assigned passwords for the respective levels. With this approach, for example, HMI accesses could be permitted without restriction, but write accesses could be made dependent on the knowledge of a password. You assigned the passwords for the different access levels in the "Protection & Security" area of the CPU properties. As a result, the access protection always applied to groups having the corresponding passwords and not to individual users.

With the introduction of local user management and access control in TIA Portal version V19, you use the "Security settings > Users and roles" area in the project tree in TIA Portal to manage all users, together with their roles and function rights, of a CPU. This same holds for the access protection for engineering/HMI accesses, which as of TIA Portal version V19 no longer relies on access levels with password protection by default but instead on the user management.

You can find more information on the new access protection here [\(Page 209\)](#).

As already introduced, e.g. for engineering rights, you use role assignments for combining individual function rights. In a further step, you assign the roles to individual users. The "Assigned rights" tab lists all function rights that were assigned to a user via roles and that the user can exercise for the corresponding CPU.

11.3 Local user management

The following figure shows an example of the available and activated function rights of a CPU. At least one user must have full access to the CPU. Otherwise, the configuration cannot be compiled. A role with full access to the CPU must be created for this.

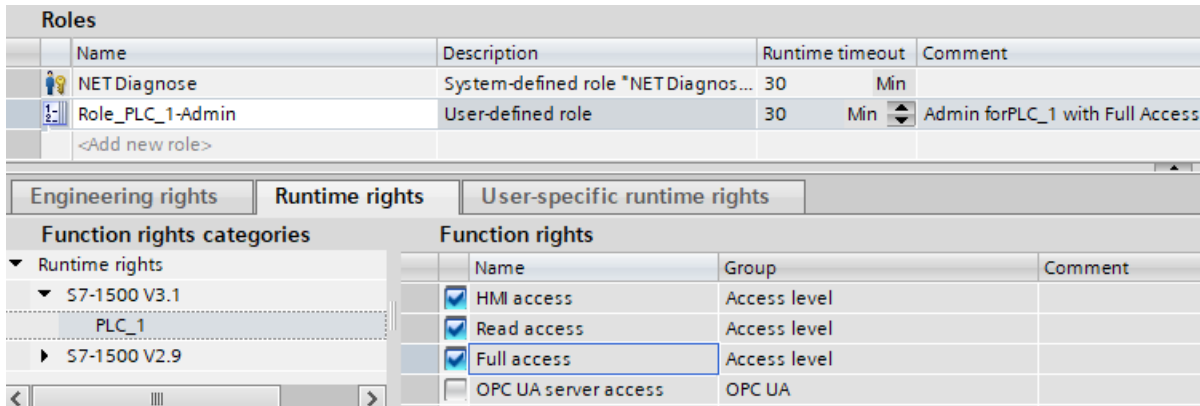

Figure 11-1 Assigning function rights of a CPU to a role

The following figure shows the assignment of the role with full access to a user ("Admin").

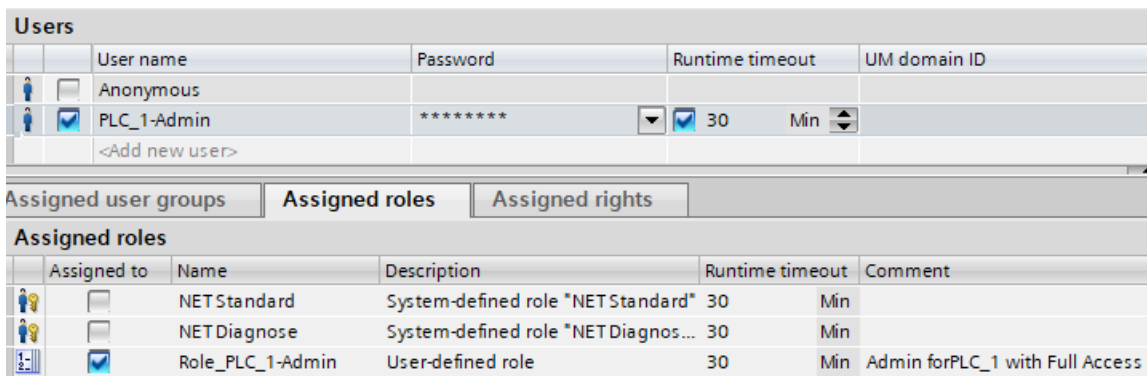

Figure 11-2 Assigning a role to a user

Requirement

CPU parameter assignment: To make use of users, roles and function rights for a CPU, the "Enable access control" option must be selected in the "Protection & Security > Access control" area.

No project protection is necessary for local user management.

Default characteristics

The "Enable access control" option is selected by default for the access control. Users can be configured with their assigned passwords and their roles and function rights.

Loading to device

You can load changes to the local user management and access control configuration in STOP and RUN of the CPU.

Runtime timeout

You can set a runtime timeout for both the role and the user in "Security settings > Users and roles".

For an ET 200SP CPU, these settings are taken into account by the various services as follows:

- By means of the Web API you can, for example, create a web page or application that takes the settings for the runtime timeout into account. Standard web pages do not take the settings for the runtime timeout into account and use the default value.
- The other services (PG/HMI communication and OPC UA server) do not use the runtime timeout; the logged-in user is not logged out after the set time.

11.3.2 Advantages of local user management and access control

The advantages of the new local user management for CPUs and the changes associated with it are described in the following.

Quick activation/deactivation of local user management

The options for user management can be found in the "Protection & Security > Access control" area:

- Access control disabled: Every user has full access to all functions with the exception of the GDS Push function for the online transfer of certificates.

 DANGER
Disabled access control carries the risk of unauthorized access and thus the risk of personal injury and property damage.
Only use this setting in a protected environment, such as during commissioning.

- Access control enabled: The configured users with their assigned roles and associated function rights become effective after the configuration is loaded.

Access protection for PG/HMI accesses, now with user authentication

While it was possible to assign passwords for access levels for CPUs with firmware versions <V3.1, you can configure users with corresponding function rights for the current CPUs. This means that PG/HMI accesses can be authenticated in the same way as OPC UA and web server accesses.

Everything in one place

Irrespective of the service for which you configure users, roles and rights for a CPU: you manage the data at the same place.

All users, no matter if you're managing their engineering rights for the project or their local runtime rights for individual CPUs in the project, can be found in the editor for users and roles in the project tree.

Powerful password functions

- Support for compliance with complexity rules for password creation:
Already at the password creation stage, you can have the TIA Portal check for compliance with complexity rules, such as rules on password length, uppercase/lowercase letters (project tree, "Security settings > Settings" area).
The complexity rules are also saved in the CPU when the user management is loaded. When the password is changed online, the CPU identifies and applies these rules. This prevents a user from overriding the complexity rules set by the configuration engineer and assigning an insecure password.
- The period of validity of passwords can be set:
To ensure that a user does not have access to the CPU with a compromised password for an unlimited time, you can assign a period of validity. The time remaining until the validity expires is then displayed on login so that each user can change his password in time.

Loading the user management during operation

As of firmware version V3.1, certain security-relevant configuration data can be loaded in both STOP and RUN system state. This means that loading the hardware configuration does not necessarily lead to a CPU STOP.

You can load the following changes in both STOP and RUN system state (Download to device > Hardware configuration):

- Local user management extended/changed
- TIA Portal-configured certificates added/modified
- Syslog configuration changed

If you made additional changes to the hardware configuration (for example, added modules, reassigned parameters, etc.), then the CPU automatically prompts for the STOP state before loading the configuration.

Thus, for example, simply loading a user with modified roles/function rights to the CPU does not require the CPU to be in STOP state.

The load preview dialog contains a security area where you can define how the CPU is to handle user data changed since the last load operation (not when loading for the first time). This allows changes to user data (e.g. password changes during runtime) to be retained.

Loading the device as a new station - with user data

If you load a previously configured CPU into a new project, for example, because you do not have the original project, the user data is also loaded into the project and is available for further editing of the CPU settings.

Changing passwords during operation

You can use the web server API to write an application that any user can use to change his password at runtime, provided that the original password was entered correctly and the new password complies with the configured password policy.

Requirement: You have enabled access control for the CPU.

A user can change his own password at any time, even if the password has expired. If the password has expired, the user must change his password. Login is not possible with an expired password.

API methods used:

- Api.ChangePassword
- Api.GetPasswordPolicy

More information on the API methods is available in the Web Server for S7-1500 CPUs function manual.

NOTE

Passwords changed at runtime take precedence over loaded passwords

If you changed your password during operation and subsequently load your project, the password assigned during runtime takes precedence over the password set in the project (default setting).

If you want to overwrite the passwords changed during runtime by loading the project, you must select the option "Load all user management data (reset to project data)". In this case, **all** passwords changed during runtime will be lost.

11.3.3 From access level to user function rights

The implementation of access protection for CPUs with the new local user management is described in the following.

Access levels as function rights

While access could only be controlled using passwords for ET 200SP CPUs up to FW version V3.0, you create corresponding users and roles with the necessary function rights for access control for CPUs as of FW version V3.1. The assignment between access level and the associated function right results from the already known access levels:

- Users who are to have full access must have a role with the function right "Full access".
A CPU configuration can only be compiled and loaded if at least one user has the function right "Full access" or "Full access incl. fail-safe".
- Users who are to have read access must have a role with the function right "Read access".
- Users who are to have HMI access must have a role with the function right "HMI access".

If a user has none of these function rights, that user also has no access to the CPU.

The hierarchical organization of the access levels also remains the same for the corresponding function rights:

- A user with full access also has the function rights "Read access" and "HMI access".
- A user with read access also has the function right "HMI access".

NOTE**Compatibility of the "ENDIS_PW" instruction**

The "ENDIS_PW" instruction can be used only to disable or enable passwords for protection levels. The "ENDIS_PW" instruction has no effect on assigned rights for users or roles.

Continued use of access levels

Even though the new local user management replaces the familiar access protection using corresponding function rights of individual users, the option exists to continue using this familiar access protection. This is required, for example, for HMI devices that only support access levels and are unable to make use of the new user management.

If you need configuration of an access level, for example, to grant access to an HMI device without user and password assignment, select the "Use legacy access control via access levels" option in the CPU properties.

NOTE**Users for OPC UA and web server**

Independent of the access protection, you always have to configure the users for the web server and OPC UA server in the project tree ("Security settings > Users and roles" area).

Restrictions on continued use of the access levels

When using the "Legacy access control" option, you cannot select the access level directly in the table for setting the access levels. This selection can only be made for the new local user management in one way: using the access protection function rights of the "Anonymous" user.

The system creates the local "Anonymous" user in a project by default. With the help of this user, you define the behavior of the CPUs in the project for anyone who logs in without a user name and password. For security reasons, the anonymous user is deactivated and must be activated before use.

A link in the area where you set the access levels takes you to the editor for the required settings for the "Anonymous" user.

Examples:

- If the "Anonymous" user is deactivated or if the "Anonymous" user is activated and no function rights have been assigned to that user, then nobody can log in without a user name and password (corresponds to the access level "No access (complete protection)").
- If the "Anonymous" user is activated and the "Full access" function right for a CPU is assigned to that user via a corresponding role, the result of this setting is "No protection". You achieve the same effect with regard to access protection by setting "No access protection" in the "Protection & Security" area of the CPU properties.

Procedure

To activate the "Legacy access control" and set the required access level, follow these steps:

1. In the CPU properties, go to "Protection & Security > Access control".
2. Select the option "Enable access control" and, in addition, select the "Use legacy access control via access levels" check box.
The access level selection cannot be used in this setting. You set the access level using the "Anonymous" user of the CPU.
The "Anonymous" user is deactivated by default. This means that the resulting access level for users without a password is "No access (complete protection)" (default setting).
3. Go to "Security Settings > Users and roles" in the project tree.
4. Activate the "Anonymous" user, if you want to set a different access level than "No access (complete protection)". You can assign a role with function rights that grants access to the CPU without password input only to the activated "Anonymous" user.
5. You cannot assign function rights for a CPU directly to a user. You must first create a role: Therefore switch to the "Roles" tab and add a new role. Assign a meaningful name, e.g. "PLC1-Read-Access-Role". If you assign this role to a user, this user is to have read access to PLC1 during operation.
6. Assign the required function right for accessing the CPU named "PLC1" – in this case "Read access" – to the role "PLC1-Read-Access-Role".
7. Switch to the "Users" tab and assign the "PLC1-Read-Access-Role" role to the activated "Anonymous" user.

Result: The "Anonymous" user has read access for PLC1. This means that the access level tables of the CPU "PLC1" in the project are preset to "Read access" (cannot be changed) and users who are not logged in only have read access.

For full access, or full access including fail-safe, you must configure a password for the full access in the table for the access protection. Anyone performing an action at runtime requiring full access to the CPU, e.g. a project is to be loaded to the CPU, must legitimize themselves for this action with this password.

Tip

To make the user rights transparent, use meaningful names for the respective roles. You create users and roles for the entire project; you must select the function rights of a role individually for each CPU in the project. A descriptive name allows you to recognize immediately the CPUs for which read access is granted and the CPUs for which no access is granted (complete protection).

11.3.4 Information regarding compatibility

In the following sections, you will find information on the behavior of the CPUs with local user administration when, for example, modules are exchanged in STEP 7 and on further use of projects and programs without local user administration.

Replacement part scenario

If you replace a CPU with firmware version <V3.1 with a CPU with firmware version V3.1 or higher, the program stored on the memory card runs the same as on the original CPU. The behavior with regard to the configured access levels and the users for the OPC UA server and web server corresponds to the behavior of the predecessor CPU.

In this case, the "Change password function" via the web server API is not accepted by the CPU because the CPU has been configured for firmware version < V3.1 and has no local user management.

Exchanging the CPU (upgrade)

If you exchange a CPU (FW <V3.1) in the TIA Portal for a current CPU (FW V3.1 or higher), the configured user data is affected as follows:

- The user data of the OPC UA server and web server is transferred to the "Users and roles" editor in the project tree.

NOTICE
Passwords are lost when the CPU is exchanged
Make sure that the passwords are available before exchanging the CPU. They must be entered again in the "Users and roles" editor. Otherwise, you have to assign new passwords and inform the users.

- A corresponding role is created for each web server user in the "Users and roles" editor; the name of the role contains the CPU name, the string "Web" and the already configured web server user name. In this way, you can easily restore the original rights for each CPU by assigning these roles in the "Users and roles" editor.
- The "OPC UA server access" role is created for each OPC UA server user.
- OPC UA guest access and the web server user "Everybody" are migrated to the "Anonymous" user.
- Each OPC UA user and each web server user is listed in the "User" column in the "Users and roles" editor. If there is a web server user and a OPC UA user with the same name, only one user is created.
- For a protected project, you can select which action the CPU performs:
 - Migrate users (requirement: you are logged in as a user with the right to manage users and roles and the right to edit the project/configuration)
 - Remove users
 - Cancel
- The "Legacy access control via access levels" option is set for access protection.

Exchanging the CPU (downgrade)

If you exchange a CPU (FW V3.1 or higher) in the TIA Portal for a predecessor CPU (< FW V3.1), the configured user data is affected as follows:

- The local user management is no longer available.
- Users with function rights for the web server are not transferred.
- Users of the OPC UA server remain with their user rights in the "Users and roles" editor. No users are moved to the "OPC UA" area of the CPU parameters.
- It is no longer possible for users to change passwords during runtime (via web server API).

11.4 Configuring access protection for the CPU

Introduction

The following section describes how to use the individual access levels of the CPUs. The description applies to ET 200SP CPUs up to firmware version V3.0. In later firmware versions, you use the local user management ([Page 204](#)) in the "Users and roles" editor in the project tree. The access levels are represented there by function rights of the same name, which you assign to individual users via roles.

The CPU offers four access levels to limit access to specific functions.

By setting up the access levels and the passwords for a CPU, you limit the functions and memory areas that are accessible without entering a password. You specify the individual access levels as well as the entry of their associated passwords in the object properties of the CPU.

Rules for passwords

Ensure that passwords are sufficiently secure. Passwords must not follow a machine-recognizable pattern. Follow the rules below:

- Assign a password that is at least 8 characters long.
- Use different cases and characters: uppercase/lowercase, numbers and special characters.

Access levels of the CPU

Table 11-1 Access levels and access restrictions

Access levels	Access restrictions
Full access (no protection)	Any user can read and change the hardware configuration and the blocks.
Read access	<p>With this access level, read-only access to the hardware configuration and the blocks is possible without entering a password, which means you can download the hardware configuration and blocks to the programming device. In addition, HMI access and access to diagnostics data is possible.</p> <p>Without entering the password, you cannot load any blocks or hardware configuration into the CPU. Additionally, the following are not possible without the password:</p> <ul style="list-style-type: none"> • Writing test functions • Firmware update (online)

Access levels	Access restrictions
HMI access	<p>With this access level only HMI access and access to diagnostics data are possible without entering the password.</p> <p>Without entering the password, you can neither load blocks nor the hardware configuration into the CPU, nor load blocks and hardware configuration from the CPU into the programming device. Additionally, the following are not possible without the password:</p> <ul style="list-style-type: none"> • Writing test functions • Changing the mode (RUN/STOP) • Firmware update (online) • Display of the online/offline comparison status
No access (complete protection)	<p>When the CPU has complete protection, no read or write access to the hardware configuration and the blocks is possible (without access authorization in the form of a password). HMI access is also not possible. The server function for PUT/GET communication is disabled in this access level (cannot be changed).</p> <p>Authentication with the password will again provide you full access to the CPU.</p>

An enumeration of which functions are available in the different protection levels is available in the "Setting options for the protection" entry in the STEP 7 online help.

Properties of the access levels

Each access level allows unrestricted access to certain functions without entering a password, for example, identification using the "Accessible devices" function.

The default setting of the CPUs is "No access (complete protection)". In the default access level, the user is not allowed to read or modify the hardware configuration or the blocks. To obtain access to the CPUs, assign parameters alternatively in the properties of the CPU:

- A password for the protection level "No access (complete protection)"
- Another protection level, e.g. "Full access (no protection)".

Communication between the CPUs (via the communication functions in the blocks) is not restricted by the access level of the CPU, unless PUT/GET communication is deactivated in the "No access" (complete protection) access level.

Entry of the right password allows access to all the functions that are allowed in the corresponding level.

NOTE

Configuring an access level does not replace know-how protection

Configuring access levels offers a high degree of protection against unauthorized changes to the CPU by restricting the rights to download the hardware and software configuration to the CPU. However, blocks on the SIMATIC memory card are not write- or read-protected. Use know-how protection to protect the code of blocks on the SIMATIC memory card.

Behavior of functions with different access levels

The STEP 7 online help includes a table which lists the online functions that are available in the different access levels.

Selecting the access levels

To configure the access levels of a CPU, follow these steps:

1. Open the properties of the CPU in the Inspector window.
2. Open the "Protection" entry in the area navigation.

A table with the possible access levels is available in the Inspector window.

Access level	Access			Access permission
	HMI	Read	Write	Password
<input type="radio"/> Full access (no protection)	✓	✓	✓	
<input checked="" type="radio"/> Read access	✓	✓		
<input type="radio"/> HMI access	✓			
<input type="radio"/> No access (complete protection)				

Enter password:

Confirm password:

Read access:
TIA Portal users will have read access to all functions.
HMI applications can access all functions.

Mandatory password:
For additional write access, TIA Portal users need to enter the "full access" password.

Figure 11-3 Possible access levels

3. Activate the desired protection level in the first column of the table. The green check marks in the columns to the right of the access level show you which operations are still available without entering the password. In the example (see above), read access and HMI access are still possible without a password.
4. In the "Enter password" column, specify a password for the access level "Full access" in the first row. In the "Confirm password" column, enter the selected password again to guard against incorrect entries.
5. Assign additional passwords as required for other access levels.
6. Download the hardware configuration for the access level to take effect.

The CPU logs the following actions with an entry in the diagnostic buffer:

- Input of the correct or incorrect password, as the case may be
- Changes in the configuration of access levels

Behavior of a password-protected CPU during operation

The CPU protection takes effect after you have downloaded the settings to the CPU.

Before an online function is executed, the CPU checks the necessary permission and, if necessary, prompts the user to enter a password. You can only execute password-protected functions from one programming device/PC at any time. Another programming device/PC cannot log on.

Access authorization to the protected data is in effect for the duration of the online connection or until you rescind the access authorization manually with "Online > Delete access rights".

Access levels for F-CPUs

For the fail-safe CPUs, there is an additional access level in addition to the four described access levels. For additional information on this access level, refer to the description of the fail-safe system SIMATIC Safety Programming and Operating Manual SIMATIC Safety - Configuring and Programming (<https://support.automation.siemens.com/WW/view/en/54110126>).

11.5 Using the user program to set additional access protection

Access protection via user program

You can also restrict access to a password-protected CPU in STEP 7 via the ENDIS_PW operation. You can find a description of this block in the online help under the keyword "ENDIS_PW: Limit and enable password legitimation".

11.6 Know-how protection

Application

You can use know-how protection to protect one or more OB, FB or FC blocks as well as global data blocks in your program from unauthorized access. Enter a password to restrict access to a block. The password offers high-level protection against unauthorized reading or manipulation of the block.

Password provider

As an alternative to manual entry of password, you can connect a password provider to STEP 7. When using a password provider, you select a password from a list of available passwords. When a protected block is opened, STEP 7 connects to the password provider and retrieves the corresponding password.

To connect a password provider you have to install and activate it. A settings file in which you define the use of a password provider is also required.

A password provider offers the following advantages:

- The password provider defines and manages the passwords. When know-how protected blocks are opened, you work with symbolic names for passwords. A password is marked, for example, with the symbolic name "Machine_1" in the password provider. The actual password behind "Machine1" remains hidden from you. A password provider therefore offers you optimum block protection as the users do not know the password themselves.
- STEP 7 automatically opens know-how protected blocks without the direct entry of a password. This saves you time.

You will find more information on connecting a password provider in the STEP 7 online help.

Readable data

If a block is know-how protected, only the following data is readable without the correct password:

- Block title, comments and block properties
- Block parameters (INPUT, OUTPUT, IN, OUT, RETURN)
- Call structure of the program
- Global tags without information on the point of use

Further actions

Further actions that can be carried out with a know-how protected block:

- Copying and deleting
- Calling in a program
- Online/offline comparison
- Load

Global data blocks and array data blocks

You protect global data blocks (global DBs) from unauthorized access with know-how protection. If you do not have the valid password, you can read the global data block but not change it.

Know-how protection is not available for array data blocks (array DBs).

Setting up block know-how protection

To set up block know-how protection, follow these steps:

1. Open the properties of the block in question.
2. Select the "Protection" option under "General".

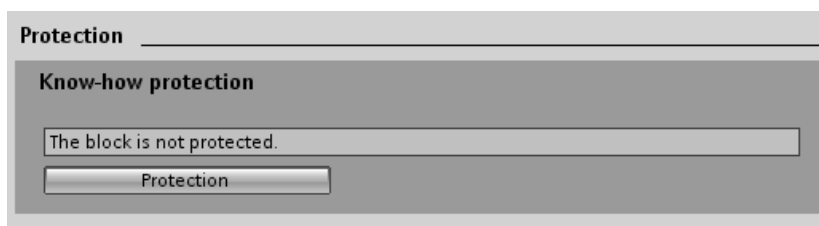

Figure 11-4 Setting up block know-how protection (1)

- Click the "Protection" button to display the "Know-how protection" dialog.



Figure 11-5 Setting up block know-how protection (2)

- Click the "Define" button to open the "Define Password" dialog.

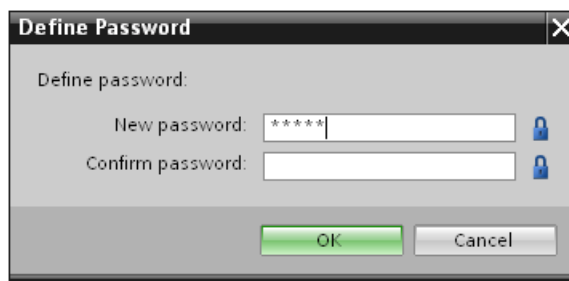

Figure 11-6 Setting up block know-how protection (3)

- Enter the new password in the "New password" box. Enter the same password in the "Confirm password" box.
- Click "OK" to confirm your entry.
- Close the "Know-how protection" dialog by clicking "OK".

Result: The selected blocks are now know-how protected. Know-how protected blocks are marked with a lock in the project tree. The password entered applies to all blocks selected.

NOTE

Password provider

Alternatively, you can set up know-how protection for blocks with a password provider.

Opening know-how protected blocks

To open a know-how protected block, follow these steps:

- Double-click the block to open the "Access protection" dialog.
- Enter the password for the know-how protected block.
- Click "OK" to confirm your entry.

Result: The know-how-protected block is open.

Once you have opened the block, you can edit the program code and the block interface of the block for as long as the block or STEP 7 is open. You must enter the password again the next time you open the block. If you close the "Access protection" dialog with "Cancel", you will be able to open the block but you cannot display the block code or edit the block.

If you copy the block or add it to a library, for example, this does not cancel the know-how protection of the block. The copies will also be know-how-protected.

Removing block know-how protection

To remove block know-how protection, follow these steps:

1. Select the block from which you want to remove know-how protection. The protected block must not be open in the program editor.
2. In the "Edit" menu, select the "Know-how protection" command to open the "Know-how protection" dialog.
3. Clear the "Hide code (Know-how protection)" check box.

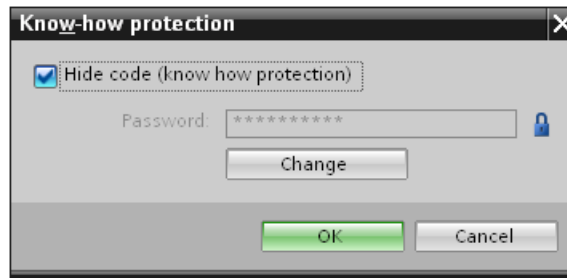

Figure 11-7 Removing block know-how protection (1)

4. Enter the password.



Figure 11-8 Removing block know-how protection (2)

5. Click "OK" to confirm your entry.

Result: Know-how protection is removed from the selected block.

See also

[Copy protection \(Page 220\)](#)

11.7 Copy protection

Application

The copy protection allows you to protect your program against unauthorized duplication. With copy protection you associate the blocks with a specific SIMATIC memory card or CPU. Through the linking of the serial number of a SIMATIC memory card or of a CPU the use of this program or of this block is only possible in conjunction with a specific SIMATIC memory card or CPU.

Copy and know-how protection

Recommendation: to prevent unauthorized reset of copy protection, additionally apply know-how protection to a copy-protected block. To do this, first set up copy protection and then apply know-how protection for the block. You can find further information on setting up know-how protection in section Know-how protection [\(Page 216\)](#)

Setting up copy protection

To set up copy protection, follow these steps:

1. Open the properties of the block in question.
2. Select the "Protection" option under "General".



Figure 11-9 Setting up copy protection (1)

3. In the "Copy protection" area, select either the "Bind to serial number of the CPU" entry or the "Bind to serial number of the memory card" entry from the drop-down list.

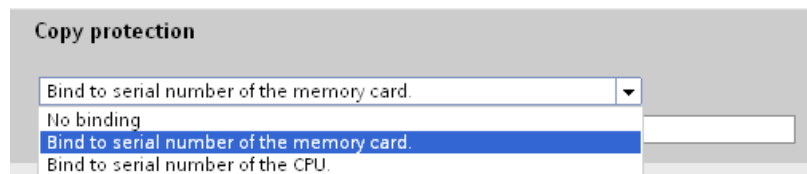

Figure 11-10 Setting up copy protection (2)

4. Activate the option "Serial number is inserted when downloading to a device or a memory card" if the serial number is to be inserted automatically during the uploading process (dynamic binding). Assign a password using the "Define password" button to link the use of a block additionally to the input of a password.
Activate the option "Enter serial number" if you want to manually bind the serial number of the CPU or the SIMATIC memory card to a block (static binding).

5. You can now set up the know-how protection for the block in the "Know-how protection" area.

NOTE

If you download a copy-protected block to a device that does not match the specified serial number, the entire download operation will be rejected. This means that blocks without copy protection will also not be downloaded.

Removing copy protection

To remove copy protection, follow these steps:

1. Remove any existing know-how protection.
2. Open the properties of the block in question.
3. Select the "Protection" option under "General".
4. In the "Copy protection" area, select the "No binding" entry from the drop-down list.

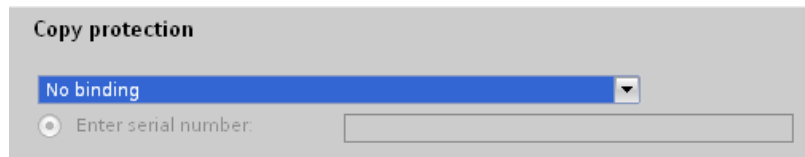

Figure 11-11 Removing copy protection

Configuration control (option handling)

Introduction

Configuration control (option handling) is used to operate various standard machine configuration levels in one project without changing the configuration or the user program.

Operating principle of configuration control

You can use configuration control to operate different standard machine configurations with a single configuration of the ET 200SP distributed I/O system.

- A station master is configured in a project (maximum configuration). The station master comprises all modules needed for all possible plant parts of a modular standard machine.
- The project's user program provides for several station options for various standard machine configuration levels as well as selection of a station option. A station option uses, for example, only some of the configured modules of the station master and these modules are inserted in the slots in a different order.
- The standard machine manufacturer selects a station option for a configuration of the standard machine. To do this, the project need not be modified, and it is not necessary to load a modified configuration.

You use a control data record you have programmed to notify the CPU/interface module as to which modules are missing or located on different slots in a station option as compared to the station master. The configuration control does not have an impact on the parameter assignment of the modules.

Configuration control allows you to flexibly vary the centralized/distributed configuration. This is only possible if the station option can be derived from the station master.

The following figure shows three configurations of a standard machine with the corresponding station options of the ET 200SP distributed I/O system.

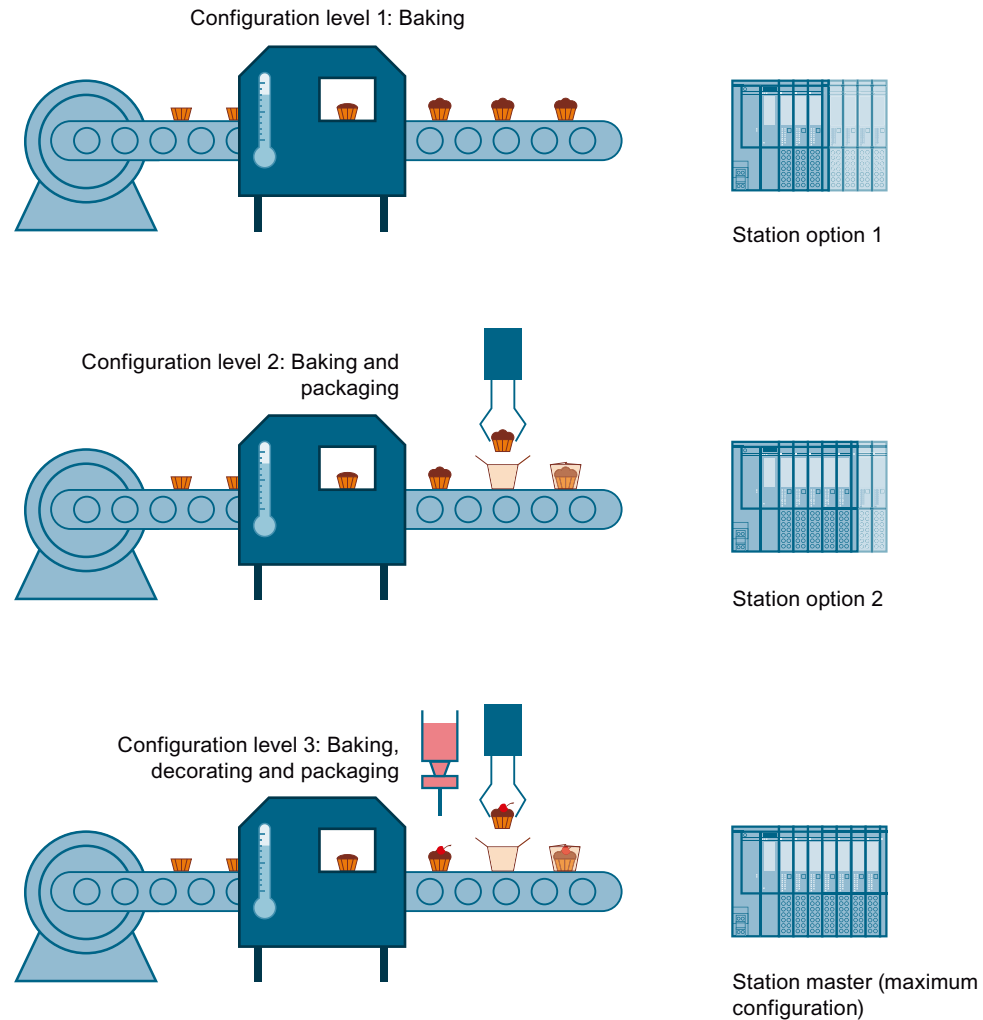

Figure 12-1 Various configuration levels of a standard machine with the corresponding station options of the ET 200SP distributed I/O system.

Advantages

- Simple project management and commissioning by using a single STEP 7 project for all station options.
- Simple handling for maintenance, versioning and upgrade:
- Hardware savings: Only those I/O modules are installed that are required for the machine's current station option.
- Savings potential in the creation, commissioning and the documentation for standard machines.
- Simple station expansion by using pre-wired empty slots. To expand, you simply exchange the BU cover for the new model. You can find further information on this in section Examples of configuration control (Page 241).

Procedure

To set up the configuration control, follow these steps:

Step	Procedure	See...
1	Enable configuration control in STEP 7	Section Configuring (Page 224)
2	Create control data record	Section Creating the control data record (Page 226)
3	Transfer control data record	Section Transferring the control data record in the startup program of the CPU (Page 236)

Library for configuration control

A library for configuration control is available on the Internet for download (<https://support.industry.siemens.com/cs/#document/29430270?lc=en-WW>). The library contains data types with the structure of the control data records for the ET 200SP distributed I/O system. You can implement your flexible automation solution inexpensively with the help of these data types.

NOTE

Configuration control in the case of motor starters

"Manual local" mode is possible in the case of motor starters when configuration control is active. The motor starter works with the last valid parameters. Do not change the parameterization while "manual local" mode is active.

12.1 Configuring

Requirements

Configuration control is supported by the ET 200SP distributed I/O system with both an ET 200SP CPU and with interface modules via PROFINET IO and PROFIBUS DP.

Centrally for ET 200SP CPU:

- STEP 7 Professional V13 Update 3 or higher
- CPU 1510SP-1 PN/CPU 1512SP-1 PN
- Firmware version V1.6 or higher
- All modules of the CPU must be able to start up even with different configurations.
 - The startup parameter "Comparison preset to actual configuration" of the CPU is set to "Startup CPU even if mismatch" (default setting) and the module parameter "Comparison preset to actual module" of the module is set to "From CPU" (default setting).
 - or**
 - The module parameter "Comparison preset to actual module" for the module is set to "Startup CPU even if mismatch".

Distributed via PROFINET IO:

- Engineering Tool (e.g. STEP 7)
- IM 155-6 PN BA/ST/HF/HS, IM 155-6 MF HF
- You have assigned the interface module to an IO controller.

Distributed via PROFIBUS DP:

- Engineering Tool (e.g. STEP 7)
- IM 155-6 DP HF
- You have assigned the interface module to a DP master.
- The startup parameter is set to "Operate if preset configuration does not match actual configuration"

Modules with submodules distributed across different ARs/fieldbuses may not be a part of the AR for the active configuration control.

Required steps

Enable the "Allow to reconfigure the device via the user program" parameter when configuring the CPU/interface module in STEP 7 (TIA Portal).

- The "Allow to reconfigure the device via the user program" parameter is located in the "Configuration control" area for an ET 200SP CPU.
- The "Allow to reconfigure the device via the user program" parameter is located in the "Module parameter" area under "General" for an IM 155-6 PN or IM 155-6 MF HF interface module.

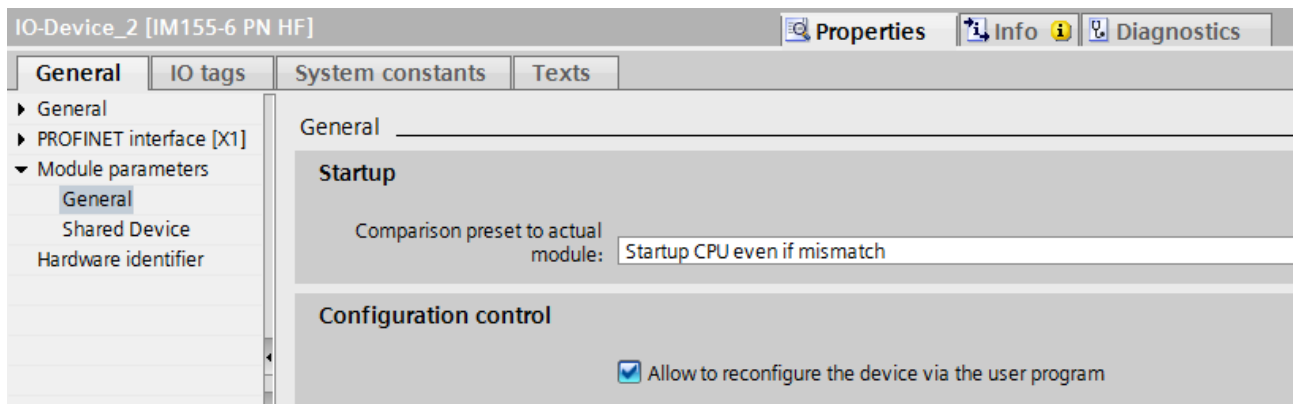

Figure 12-2 Enabling configuration control using an IM 155-6 PN HF as an example

12.2 Creating the control data record

12.2.1 Introduction

Required steps

To create a control data record for the configuration control, follow these steps:

1. Create a PLC data type that contains the structure of the control data record.
The following figure shows a PLC data type "CTR_REC", which contains the structure of the control data record for an ET 200SP interface module.

CTR_REC							
	Name	Data type	Default value	A...	V...	S...	Comment
1	Block_Lenght	USInt	134	<input checked="" type="checkbox"/>	<input checked="" type="checkbox"/>	<input type="checkbox"/>	4 + (2 x number of Slots)
2	Block_ID	USInt	196	<input checked="" type="checkbox"/>	<input checked="" type="checkbox"/>	<input type="checkbox"/>	
3	Version	USInt	2	<input checked="" type="checkbox"/>	<input checked="" type="checkbox"/>	<input type="checkbox"/>	ET 200SP
4	Subversion	USInt	0	<input checked="" type="checkbox"/>	<input checked="" type="checkbox"/>	<input type="checkbox"/>	
5	Slot 1	USInt	1	<input checked="" type="checkbox"/>	<input checked="" type="checkbox"/>	<input type="checkbox"/>	assigned "real" slot
6	Add 1	USInt	0	<input checked="" type="checkbox"/>	<input checked="" type="checkbox"/>	<input type="checkbox"/>	additional function
7	Slot 2	USInt	2	<input checked="" type="checkbox"/>	<input checked="" type="checkbox"/>	<input type="checkbox"/>	assigned "real" slot
8	Add 2	USInt	0	<input checked="" type="checkbox"/>	<input checked="" type="checkbox"/>	<input type="checkbox"/>	additional function
9	Slot 3	USInt	3	<input checked="" type="checkbox"/>	<input checked="" type="checkbox"/>	<input type="checkbox"/>	assigned "real" slot
10	Add 3	USInt	0	<input checked="" type="checkbox"/>	<input checked="" type="checkbox"/>	<input type="checkbox"/>	additional function
11	Slot 4	USInt	4	<input checked="" type="checkbox"/>	<input checked="" type="checkbox"/>	<input type="checkbox"/>	assigned "real" slot
12	Add 4	USInt	0	<input checked="" type="checkbox"/>	<input checked="" type="checkbox"/>	<input type="checkbox"/>	additional function
		USInt	5	<input checked="" type="checkbox"/>	<input checked="" type="checkbox"/>	<input type="checkbox"/>	

Figure 12-3 Creating control data record 196 using an IM 155-6 PN HF as an example

2. Create a global data block.
3. In the data block, create an array that is based on the created PLC data type.

4. In the control data records, enter the slot assignments in the "Start value" column. The figure below shows the global data block "ConfDB". The data block "ConfDB" contains an array [0..5] of the PLC_DataType "CTR_REC".

ConfDB									
	Name	Data type	Start value	R..	A...	V...	S..	Comment	
1	Static			<input type="checkbox"/>	<input type="checkbox"/>	<input type="checkbox"/>	<input type="checkbox"/>		
2	Option	Int	0	<input checked="" type="checkbox"/>	<input checked="" type="checkbox"/>	<input checked="" type="checkbox"/>	<input type="checkbox"/>	Selection of record	
3	ConfigControl	Array[0..5] of "CTR_REC"		<input type="checkbox"/>	<input checked="" type="checkbox"/>	<input checked="" type="checkbox"/>	<input type="checkbox"/>		
4	ConfigControl[0]	"CTR_REC"		<input type="checkbox"/>	<input checked="" type="checkbox"/>	<input checked="" type="checkbox"/>	<input type="checkbox"/>		
5	ConfigControl[1]	"CTR_REC"		<input type="checkbox"/>	<input checked="" type="checkbox"/>	<input checked="" type="checkbox"/>	<input type="checkbox"/>		
6	Block_Length	USInt	0	<input type="checkbox"/>	<input checked="" type="checkbox"/>	<input checked="" type="checkbox"/>	<input type="checkbox"/>	4 + (2 x number of slots)	
7	Block_ID	USInt	196	<input type="checkbox"/>	<input checked="" type="checkbox"/>	<input checked="" type="checkbox"/>	<input type="checkbox"/>		
8	Version	USInt	2	<input type="checkbox"/>	<input checked="" type="checkbox"/>	<input checked="" type="checkbox"/>	<input type="checkbox"/>	ET 200SP	
9	Subversion	USInt	0	<input type="checkbox"/>	<input checked="" type="checkbox"/>	<input checked="" type="checkbox"/>	<input type="checkbox"/>		
10	Slot 1	USInt	1	<input type="checkbox"/>	<input checked="" type="checkbox"/>	<input checked="" type="checkbox"/>	<input type="checkbox"/>	assigned "real" slot	
11	Add 1	USInt	0	<input type="checkbox"/>	<input checked="" type="checkbox"/>	<input checked="" type="checkbox"/>	<input type="checkbox"/>	additional function	
12	Slot 2	USInt	2	<input type="checkbox"/>	<input checked="" type="checkbox"/>	<input checked="" type="checkbox"/>	<input type="checkbox"/>	assigned "real" slot	
13	Add 2	USInt	0	<input type="checkbox"/>	<input checked="" type="checkbox"/>	<input checked="" type="checkbox"/>	<input type="checkbox"/>	additional function	
14	Slot 3	USInt	3	<input type="checkbox"/>	<input checked="" type="checkbox"/>	<input checked="" type="checkbox"/>	<input type="checkbox"/>	assigned "real" slot	
15	Add 3	USInt	0	<input type="checkbox"/>	<input checked="" type="checkbox"/>	<input checked="" type="checkbox"/>	<input type="checkbox"/>	additional function	
16	Slot 4	USInt	4	<input type="checkbox"/>	<input checked="" type="checkbox"/>	<input checked="" type="checkbox"/>	<input type="checkbox"/>	assigned "real" slot	
17	Add 4	USInt	0	<input type="checkbox"/>	<input checked="" type="checkbox"/>	<input checked="" type="checkbox"/>	<input type="checkbox"/>	additional function	

Figure 12-4 Data block for configuration control

Rules

Observe the following rules:

- Slot entries in the control data record outside the station master are ignored by the CPU/interface module.
- The control data record must contain the entries up to the last slot of the station option.
- Multiple configured slots may not be assigned to the same actual slot. In other words, each station option slot may be present only once in the control data record.

Using communication modules

When configuration control (option handling) is used, you may insert the following communication modules:

- CM DP
- CP 1542SP-1
- CP 1543SP-1
- CP 1542SP-1 IRC
- BusAdapter BA-Send 1xFC

For the communication modules listed above, special slot rules apply for use with the ET 200SP CPUs:

If you insert the communication modules as mentioned above (e.g. CM DP) in the central configuration, then these modules cannot be influenced by the configuration control. You must therefore leave these modules in the slots preassigned in the station master and enter

12.2 Creating the control data record

the slot numbers from the station master in the control data record ("Station option slot = Station master slot").

In a station option, all slots up to the module furthest from the CPU (see list above) must be present in the control data record.

The CM AS-i Master and F-CM AS-i Safety communication modules can be used for configuration control without the above-mentioned restrictions relating to slot numbers.

12.2.2 Control data record for an ET 200SP CPU

Slot assignment

The following table shows the possible slots for the various modules for an ET 200SP CPU:

Table 12-1 Slot assignment

Modules	Possible slots	Comment
CPU	1	Slot 1 is always the CPU
Station extension BA-Send	2	In a mixed configuration with ET 200AL modules, BA-Send is always on slot 2.
I/O modules	2 - 65	Downstream of CPU
Server module	2 - 66	The server module completes the configuration of the ET 200SP station after the CPU/the last I/O module.
ET 200AL I/O modules	67 - 82	For mixed configuration with ET 200AL modules

Control data record

For the configuration control of an ET 200SP CPU, you define a control data record 196 V2.0, which includes a slot assignment. The maximum slot of the configuration corresponds to the slot of the server module or last slot of an ET 200AL I/O module (in a mixed ET 200SP/ET 200AL configuration).

The table below shows the structure of a control data record with explanations of the individual elements.

Table 12-2 Configuration control: Structure of control data record 196

Byte	Element	Code	Explanation
0	Block length	4 + (maximum slot × 2)	Header
1	Block ID	196	
2	Version	2	
3	Version	0	
4	Slot 1 of the station master	Slot assignment 1 in the station option (always 1, because the CPU is always in slot 1)	Control element Contains the information on which module is inserted in which slot.
5	Additional function for slot 1		
6	Slot 2 of the station master	Slot assignment in the station option	

* The server module must be present in the station option and must not be marked as empty slot (BU cover).

Byte	Element	Code	Explanation
7	Additional function for slot 2		<p>The value that you need to enter in the corresponding byte depends on the following rule:</p> <ul style="list-style-type: none"> If the module exists in the station option, enter the slot number of the module. If the module exists as empty slot (with BU cover), enter the slot number of the module + 128. (Example: module as empty slot on slot 3: Enter 131 in the control element) If the module does not exist in the station option, enter 0. <p>Additional function Contains information on whether a new potential group will be opened in the station option - by replacing a dark-colored BaseUnit with a light-colored BaseUnit.</p> <ul style="list-style-type: none"> If you replace a dark-colored BaseUnit with a light-colored BaseUnit, enter 1 as additional function. If you accept the BaseUnit from the station master, enter 0 as additional function.
8	Slot 3 of the station master	Slot assignment in the station option	
9	Additional function for slot 3		
:	:	:	
$4 + ((\text{server module slot} - 1) \times 2)$	Server module slot	Server module slot assignment in the station option*	
$4 + ((\text{server module slot} - 1) \times 2) + 1$	Additional function for server module slot		
:	:	:	:
136	First slot of ET 200AL (slot 67)	Slot assignment in the station option	<p>Control element ET 200AL Contains information on which ET 200AL module is inserted in which slot.</p> <p>The value that you need to enter in the corresponding byte depends on the following rule:</p> <ul style="list-style-type: none"> If the module exists in the station option, enter the slot number of the module. If the module does not exist in the station option, enter 0.
137	Reserved		
:	:	:	
166	Last slot of ET 200AL (slot 82)	Slot assignment in the station option	
167	Reserved		

* The server module must be present in the station option and must not be marked as empty slot (BU cover).

12.2.3 Control data record for an interface module

Slot assignment

The following table shows the possible slots for the various modules for an ET 200SP interface module:

Table 12-3 Slot assignment

Modules	Possible slots	Comment	
Interface module	0	The interface module (slot 0) is not an element of the configuration control, but instead controls this.	
Station extension BA-Send	1	For mixed configuration with ET 200AL modules, BA-Send is always on slot 1.	
ET 200SP I/O module	1 - 12	for IM 155-6 PN BA	Downstream from the interface module
	1 - 30	for IM 155-6 PN HS	
	1 - 32	for IM 155-6 PN ST, IM 155-6 DP HF	
	1 - 64	for IM 155-6 PN HF, IM 155-6 PN/3 HF, IM 155-6 MF HF	
Server module	1 - 13	for IM 155-6 PN BA	The server module completes the configuration of the ET 200SP station after the last I/O module.
	1 - 31	for IM 155-6 PN HS	
	1 - 33	for IM 155-6 PN ST, IM 155-6 DP HF, IM 155-6 MF HF	
	1 - 65	for IM 155-6 PN HF, IM 155-6 PN/3 HF	
ET 200AL I/O module	34 - 49	for IM 155-6 DP HF	For mixed configuration with ET 200AL modules
	66 - 81	for IM 155-6 PN ST, IM 155-6 PN HF, IM 155-6 PN/3 HF, IM 155-6 MF HF	

Simplified control data record (V1)

For the configuration control of interface modules of the ET 200SP distributed I/O system, you define a control data record 196 V1.0, which includes a slot assignment. The maximum slot of the configuration corresponds to the slot of the server module or ET 200AL I/O module (in a mixed ET 200SP / ET 200AL configuration).

The table below shows the structure of a control data record with explanations of the individual elements.

Table 12-4 Structure of the simplified control data record V1.0

Byte	Element	Code	Explanation
0	Block length	4 + maximum slot	Header
1	Block ID	196	

* The server module must be present in the station option and must not be marked as empty slot (BU cover).

Byte	Element	Code	Explanation
2	Version	1	Header
3	Version	0	
4	Slot 1 of the station master	Slot assignment in the station option	Control element ET 200SP Contains the information on which ET 200SP module is inserted in which slot. The value that you need to enter in the corresponding byte depends on the following rule: <ul style="list-style-type: none"> • If the module exists in the station option, enter the slot number of the module. • If the module exists as empty slot (with BU cover), enter the slot number of the module + 128. (Example: module as empty slot on slot 3: Enter 131 in the control element) • If the module does not exist in the station option, enter 0.
5	Slot 2 of the station master	Slot assignment in the station option	
:	:	:	
4 + (slot server module - 1)	Server module slot	Server module slot assignment in the station option*	
:	:	:	
4 + (first slot ET 200AL - 1)	First slot ET 200AL	Slot assignment in the station option	Control element ET 200AL Contains information on which ET 200AL module is inserted in which slot. The value that you need to enter in the corresponding byte depends on the following rule: <ul style="list-style-type: none"> • If the module exists in the station option, enter the slot number of the module. • If the module does not exist in the station option, enter 0.
:	:	:	
4 + (last slot ET 200AL - 1)	Last slot ET 200AL	Slot assignment in the station option	

* The server module must be present in the station option and must not be marked as empty slot (BU cover).

Control data record (V2)

If you change the potential groups in the station option compared to the station master, define a control data record 196 V2.0 for the ET 200SP interface module which contains a slot assignment. The maximum slot of the configuration corresponds to the slot of the server module or ET 200AL I/O module (in a mixed ET 200SP / ET 200AL configuration).

The table below shows the structure of a control data record with explanations of the individual elements.

Table 12-5 Structure of control data record 196 V2.0

Byte	Element	Code	Explanation
0	Block length	4 + (maximum slot x 2)	Header
1	Block ID	196	
2	Version	2	
3	Version	0	

* The server module must be present in the station option and must not be marked as empty slot (BU cover).

Byte	Element	Code	Explanation
4	Slot 1 of the station master	Slot assignment in the station option	<p>Control element ET 200SP Contains the information on which ET 200SP module is inserted in which slot. The value that you need to enter in the corresponding byte depends on the following rule:</p> <ul style="list-style-type: none"> If the module exists in the station option, enter the slot number of the module. If the module exists as empty slot (with BU cover), enter the slot number of the module + 128. (Example: module as empty slot on slot 3: Enter 131 in the control element) If the module does not exist in the station option, enter 0. <p>Additional function Contains information on whether a new potential group will be opened in the station option - by replacing a dark-colored BaseUnit with a light-colored BaseUnit.</p> <ul style="list-style-type: none"> If you replace a dark-colored BaseUnit with a light-colored BaseUnit, enter 1 as additional function. If you accept the BaseUnit from the station master, enter 0 as additional function.
5	Additional function for slot 1		
6	Slot 2 of the station master	Slot assignment in the station option	
7	Additional function for slot 2		
8	Slot 3 of the station master	Slot assignment in the station option	
9	Additional function for slot 3		
:	:	:	
4 + ((server module slot - 1) × 2)	Server module slot	Server module slot assignment in the station option*	
4 + ((server module slot - 1) × 2) + 1	Additional function for server module slot		
:	:	:	
4 + ((first slot ET 200AL - 1) × 2)	First slot ET 200AL	Slot assignment in the station option	<p>Control element ET 200AL Contains information on which ET 200AL module is inserted in which slot. The value that you need to enter in the corresponding byte depends on the following rule:</p> <ul style="list-style-type: none"> If the module exists in the station option, enter the slot number of the module. If the module does not exist in the station option, enter 0.
4 + ((first slot ET 200AL - 1) × 2) + 1	Reserved		
:	:	:	
4 + ((last slot ET 200AL - 1) × 2)	Last slot ET 200AL	Slot assignment in the station option	
4 + ((last slot ET 200AL - 1) × 2) + 1	Reserved		

* The server module must be present in the station option and must not be marked as empty slot (BU cover).

NOTE

If a BU cover or no I/O module is plugged on a light-colored BaseUnit, you should enter 1 in the additional function for the slot.

The function "Group diagnostics: Missing supply voltage L+" requires proper assignment of the slots to a shared supply voltage L+ (potential group). All light-colored BaseUnits must be known to the interface module. By entering 1 in the additional function, you make a light-colored BaseUnit known to the interface module, even if an I/O module is not inserted.

Combination of configuration control and shared device (for PROFINET)

The configuration control function in a shared device is therefore only for the I/O modules of the IO controller to which the interface module has subscribed. I/O modules that are assigned to no controller or a different controller behave like a station without activated configuration control.

You cannot make any change to the slot assignment for modules that are assigned to another IO controller or are not assigned to an IO controller (shared device on module level). The CPU assumes a one-to-one assignment for the modules.

If additional IO controllers subscribe to a module intended for configuration control (shared device on submodule level), only one-to-one assignment is permitted for this module. It is not possible to deselect such a module using the control data record (code 0 for this slot in the control data record). This means the combination of "Configuration control" and "Shared device on submodule level" is only possible to a limited extent.

Please note that all modules affected by the configuration control including all assigned submodules are reset when you change the module assignment. Submodules that are assigned to a second IO controller are affected as well.

12.2.4 Feedback data record for interface modules

Operating principle

The feedback data record informs you about the accuracy of the module assignment and gives you the option of detecting assignment errors in the control data record. The feedback data record is mapped via a separate data record 197 V2.0. The feedback data record exists only with configured configuration control.

Slot assignment

The feedback data record refers to the configured station configuration and always includes the maximum configuration limits. The maximum configuration limits comprise 13/49/81 slots depending on the interface module in use. Partial reading of the feedback data record is possible.

The following table shows the slot assignment of the modules:

Table 12-6 Slot assignment

Modules	Possible slots	Comment
Station extension BA-Send	1	For mixed configuration with ET 200AL modules, BA-Send is always on slot 1.
ET 200SP I/O module	1 - 12	for IM 155-6 PN BA
	1 - 30	for IM 155-6 PN HS
	1 - 32	for IM 155-6 PN ST, IM 155-6 DP HF
	1 - 64	for IM 155-6 PN HF, IM 155-6 PN/3 HF, IM 155-6 MF HF
Server module	1 - 13	for IM 155-6 PN BA
	1 - 31	for IM 155-6 PN HS
		The server module completes the configuration of the ET 200SP station after the last I/O module.

Modules	Possible slots		Comment
Server module	1 - 33	for IM 155-6 PN ST, IM 155-6 DP HF	
	1 - 65	for IM 155-6 PN HF, IM 155-6 PN/3 HF, IM 155-6 MF HF	
ET 200AL I/O module	34 - 49	for IM 155-6 DP HF	For mixed configuration with ET 200AL modules
	66 - 81	for IM 155-6 PN ST, IM 155-6 PN HF, IM 155-6 PN/3 HF, IM 155-6 MF HF	

Feedback data record

Table 12-7 Feedback data record

Byte	Element	Code	Explanation
0	Block length	4 + (number of slots x 2)	Header
1	Block ID	197	
2	Version	2	
3		0	
4	Slot 1 status	0/1	Status = 1:
5	Reserved	0	
6	Slot 2 status	0/1	<ul style="list-style-type: none"> Module from station master is inserted in the station option Slot is marked as not available in the control data record
7	Reserved	0	
:	:	:	Status = 0:
4 + ((max. slot - 1) x 2)	Max. slot status	0/1	<ul style="list-style-type: none"> Module pulled Incorrect module is inserted in the station option*
4 + ((max. slot - 1) x 2) + 1	Reserved	0	

* Not possible if the slot is marked as not available.

NOTE

The data in the feedback data record is always mapped for all modules. In a shared device configuration, it is therefore irrelevant which IO controller the respective modules are assigned to.

As long as no control data record has been sent, a one-to-one module assignment is assumed for the compilation of data record 197 (station master → station option).

Error messages

In case of error, the RDREC instruction returns the following error messages via the STATUS block parameter while reading the feedback data record:

Table 12-8 Error messages

Error code	Meaning
80B1 _H	Invalid length; the length information in data record 197 is not correct.
80B5 _H	Configuration control not configured
80B8 _H	Parameter error The following events cause a parameter error: <ul style="list-style-type: none"> • Incorrect block ID in the header (not equal to 197) • Invalid version identifier in the header • A reserved bit has been set • The same slot in the station option has been assigned to more than one slot in the station master

12.2.5 Data records and functions

Supported data records and functions

The table below shows a comparison of the supported data records and functions depending on the CPU/interface module used.

Supported data records and functions	CPU...		Interface module (IM...)					
	1510SP-1 PN 1510SP F-- 1 PN	1512SP-1 PN 1512SP F-- 1 PN	155-6 PN HS	155-6 PN HF 155-6 MF HF	155-6 PN/2 HF 155-6 PN/3 HF	155-6 PN ST	155-6 PN BA	155-6 DP HF
Control data record (V2)	✓	✓	✓	✓	✓	✓	✓	✓
Simplified control data record (V1)	--	--	✓	✓	✓	✓	✓	--
Read back control data record *	✓	✓	✓	✓	✓	✓	✓	✓
Read feedback data record	--	--	✓	✓	✓	✓	✓	✓

* You can read back the control data record with the RDREC instruction.

12.3 Transferring control data record in the startup program of the CPU

Required steps

Transfer the created control data record 196 to the CPU/the interface module using the instruction WRREC (Write data record) instruction.

Parameters of the instruction WRREC

Below, you will find explanations of individual parameters of the WRREC instruction which you must supply with specific values in the configuration control context. You can find additional information on the WRREC instruction in the STEP 7 online help.

ID	<p>Hardware identifier</p> <ul style="list-style-type: none"> Use the HW identifier of the CPU for the configuration control for centrally arranged modules. If you have selected the CPU in the network view or device view, the HW identifier is available in the System constants tab of the Inspector window. Use the value of the system constant "Local~Configuration". Use the HW identifier of the interface module for the configuration control for distributed I/O. If you have selected the interface module in the network view or device view, the HW identifier is available in the System constants tab of the Inspector window. Use the value of the system constant "<Name_of_the_interface_module>~Head".
INDEX	Data record number: 196 (decimal)
RECORD	<p>Control data record to be transferred.</p> <p>See the section Creating the control data record (Page 226) for the structure of the control data record.</p>

Error messages

In case of error, the instruction WRREC returns the following error messages via the STATUS block parameter:

Table 12-9 Error messages

Error code	Meaning
80B1 _H	Invalid length; the length information in data record 196 is not correct.
80B5 _H	Configuration control parameters not assigned.
80E2 _H	Data record was transferred in the wrong OB context. The data record must be transferred in the startup program.
80B8 _H	Parameter error

Error code	Meaning
	<p>A parameter error is caused by:</p> <ul style="list-style-type: none"> • Incorrect block ID in the header (not equal to 196) • Invalid version identifier in the header • A reserved bit was set • A station master slot was assigned an invalid slot in the station option • Multiple slots in the station master are assigned to the same slot in the station option • For shared device on submodule level: Violation of defined restrictions

Selection of the station option in the user program

In order for the CPU to know which station option you want to operate, you must set up a possibility to select between the various control data records in the user program. You can implement the selection, for example, via an Int tag which references an array element. Note that the tag used to select the control data record must be stored in the retentive memory area. If the tag is not retentive it will be initialized during the startup of the CPU and thus be unavailable for selection of the station option.

Special aspects relating to the transfer of the control data record to the CPU

- If you have enabled configuration control, the CPU is not ready for operation without a control data record. The CPU returns from startup to STOP if a valid control data record is not transferred in the startup OB. The central I/O is not initialized in this case. The cause for the STOP mode is entered in the diagnostics buffer.

NOTE

If an incorrect control data record is transferred to the CPU in the startup OB, the startup of the CPU may be prevented.

In this case, perform a reset to factory settings of the CPU and then transfer a correct control data record.

- The CPU processes the WRREC instruction for transfer of the control data record asynchronously. For this reason, you must call WRREC in the startup OB repeatedly in a loop until the output parameters "BUSY" or "DONE" indicate that the data record has been transferred.

- Tip: To program the loop, use the SCL programming language with the REPEAT ... UNTIL instruction.

```

REPEAT
  "WRREC_DB" (REQ := "start_config_control",
             ID := "Local~Configuration",
             INDEX := 196,
             LEN := "conf_LEN",
             DONE => "conf_DONE",
             BUSY => "conf_BUSY",
             RECORD := "ConfDB".ConfigControl["ConfDB".Option],
             //Selection of control data record

```

12.3 Transferring control data record in the startup program of the CPU

```

        ERROR => "conf_ERROR",
        STATUS => "conf_STATUS");
UNTIL NOT "conf_BUSY"
END_REPEAT;

```

- In the graphical programming languages, you implement the loop using instructions for program control.

Example in FBD: Use the LABEL (jump label) and JMP (jump at RLO=1) instructions to program a loop.

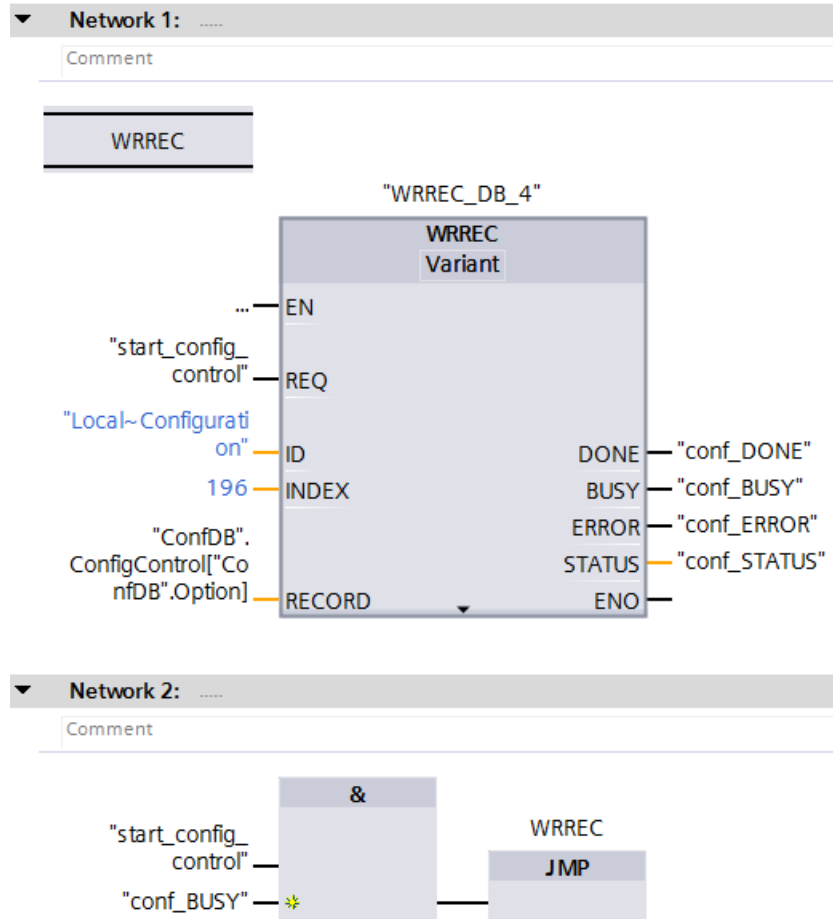

Figure 12-5 WRREC

- The control data record is stored retentively in the CPU. Note:
 - The retentivity of the control data record is independent of the retentivity settings in the STEP 7 memory area. This means that the memory area in which the control data record is configured does not have to be configured as retentive for this purpose.
 - If you write a control data record with modified configuration, the original data record 196 is deleted and the new data record 196 is saved retentively. The CPU will then restart with the modified configuration.
 - The control data record is saved retentively in the CPU, which means that it is not necessary to write the control data record 196 again at a restart if the configuration is unchanged. We recommend that a memory reset of the CPU be performed prior to commissioning to delete any control data record that may be present.

Special aspects relating to the transfer of the control data record to the interface module

- If you have enabled configuration control, the ET 200SP station is not ready for operation without a control data record. As long as no valid control data record has been transferred, the I/O modules are considered as failed by the CPU and exhibit substitute value behavior. The interface module continues to exchange data.
- The control data record is stored retentively in the interface module. Note:
 - If there have been no changes to the configuration, you do not need to rewrite the control data record 196 during restart.
 - If you write a control data record with modified configuration to the interface module, it will result in a station failure in the distributed I/O system. The original data record 196 is deleted and the new data record 196 is saved retentively. The station will then restart with the modified configuration.

12.4 Behavior during operation

Effect of discrepancy between station master and station option

For the online display and for the display in the diagnostics buffer (module OK or module faulty), the station master is always used and not the differing station option.

Example: A module supplies diagnostic information. This module is configured in slot 4 in the station master, but is inserted in slot 3 in the station option (missing module; see example in the next section). The online view (station master) shows a faulty module in slot 4. In the real configuration, the module in slot 3 indicates an error via an LED display.

Response when modules are missing

If modules are entered as not present in the control data record, the automation system behaves as follows:

- Modules designated as not present in the control data record do not supply diagnostics and their status is always OK. The value status is OK.
- Direct write access to the outputs that are not present or write access to the process image of the outputs that are not present: Remains without effect; no access error is signaled.
- Direct read access to the inputs that are not present or read access to the process image of the inputs that are not present: Value "0" is supplied; no access error is signaled.
- Write data record to module that is not present: Remains without effect; no error is signaled.
- Read data record from module that is not present: An error is signaled because a valid data record cannot be returned.

Inserting modules on empty slots

If you replace a BU cover placed on an empty slot with an I/O module when configuration control is enabled, the ET 200SP distributed I/O system behaves as follows:

- Interface module: When the BU cover is removed, a removal interrupt is signaled. When the I/O module is inserted, an insertion alarm (wrong module) is signaled.
- CPU: A removal/insertion interrupt is not signaled when the BU cover is removed or when the I/O module is inserted.

12.5 Examples of configuration control

A station master consisting of an interface module, three I/O modules and the server module is configured in STEP 7 in the following section.

Four station options are derived from the station master with the configuration control:

- Station option 1 with module that is not present
- Station option 2 with modified order of modules
- Station option 3 with empty slot
- Station option 4: Opening a new potential group

Station option 1 with module that is not present

The module that is located in slot 3 in the station master is not present in the station option 1. Slot 3 must be designated in the control data record accordingly with 0 (= not present). The server module is located in slot 3 in the station option.

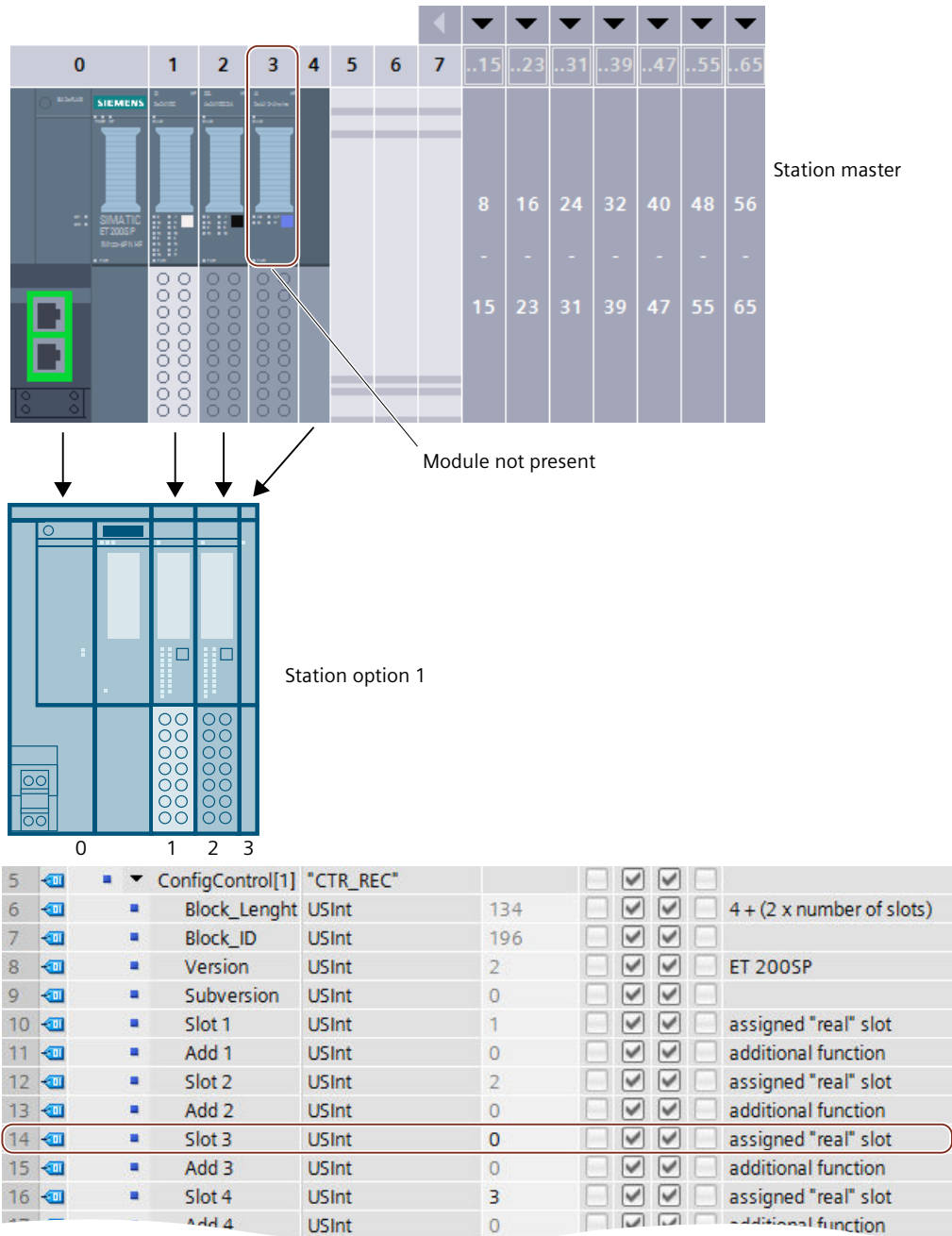

Figure 12-6 Example: Hardware configuration of station option 1 with the associated control data record in STEP 7

Station option 2 with modified order of modules

The order of the modules at slots 2 and 3 is interchanged.

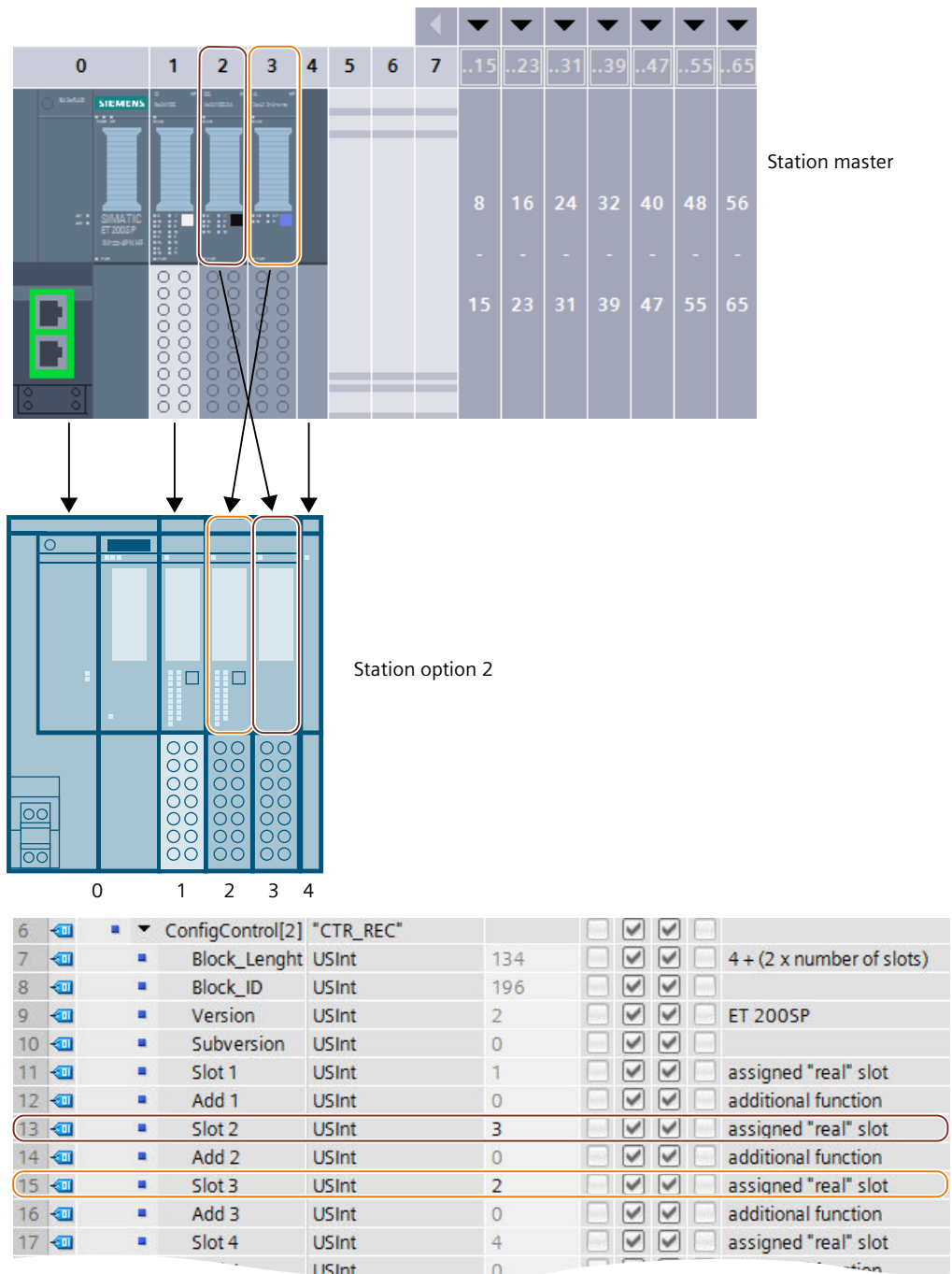

Figure 12-7 Example: Hardware configuration of station option 2 with the associated control data record in STEP 7

Station option 3 with empty slot

The module that is located in slot 3 in the station master occupies an empty slot with BU cover in the station option. Enter the value 130 in slot 3 in the control data record.

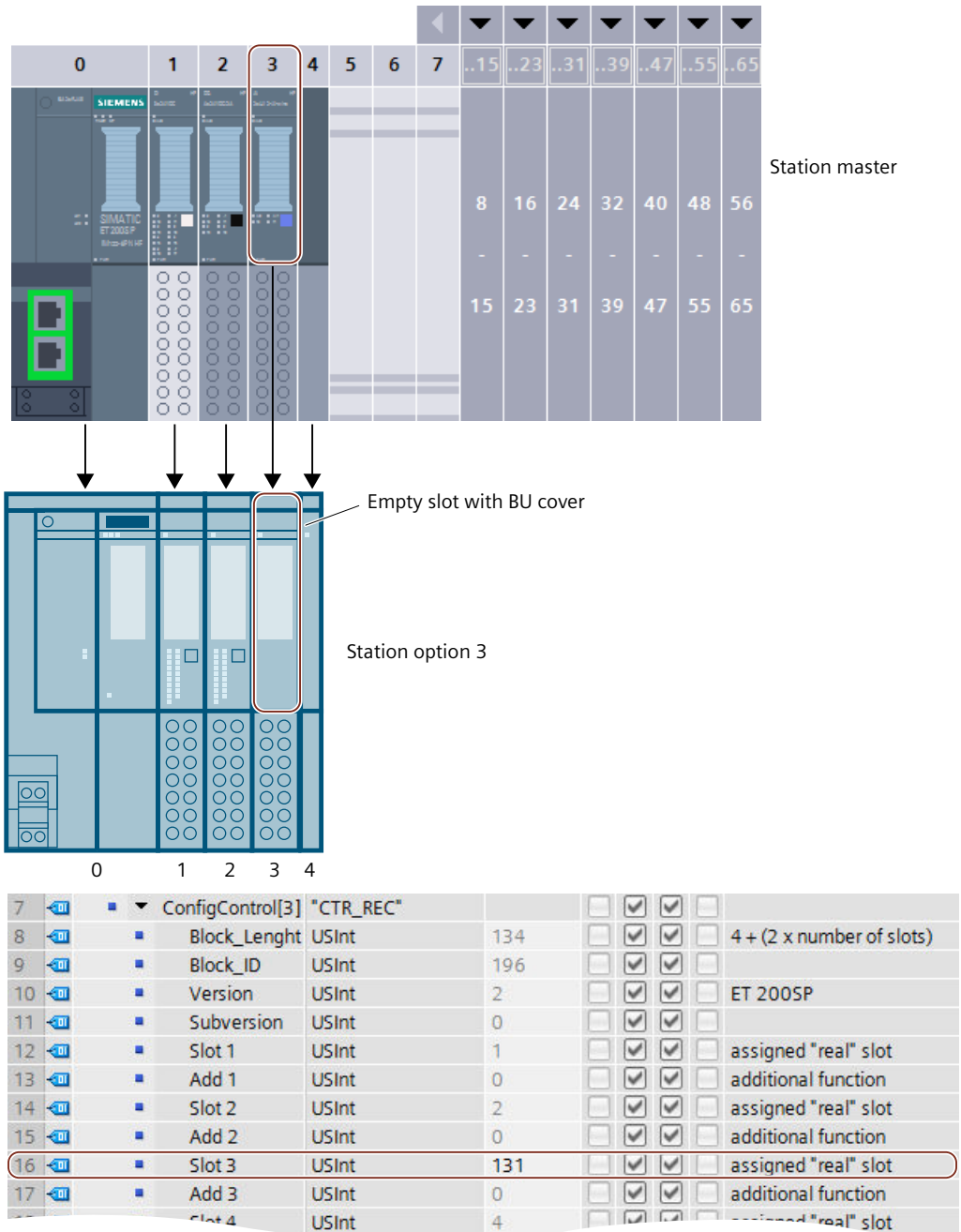

Figure 12-8 Example: Hardware configuration of station option 3 with the associated control data record in STEP 7

Station option 4: Opening a new potential group

A new potential group is opened at slot 3 of station option 4. In contrast to the station master, a dark-colored BaseUnit has been replaced by a light-colored BaseUnit. Enter the value 1 as additional function.

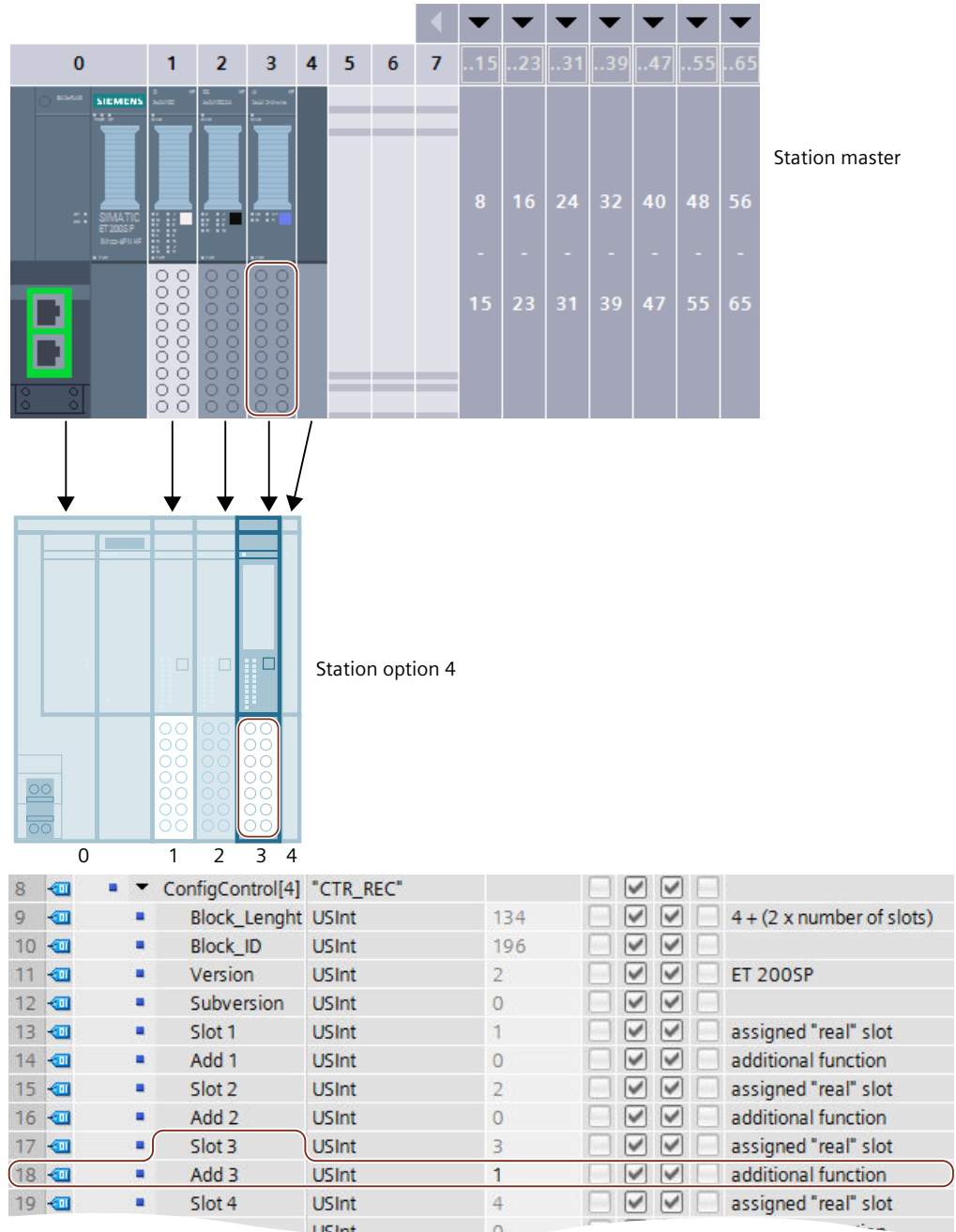

Figure 12-9 Example: Hardware configuration of station option 4 with the associated control data record in STEP 7

Commissioning

13.1 Overview

Introduction

This section includes information on the following topics:

- Commissioning the ET 200SP distributed I/O system on the PROFINET IO
- Commissioning the ET 200SP distributed I/O system on the PROFIBUS DP
- Startup of the ET 200SP distributed I/O system with empty slots
- Removing/inserting the SIMATIC memory card
- Operating modes of the CPU
- CPU memory reset
- Reassigning parameters during operation
- Identification and maintenance data

Commissioning requirements

NOTE**Performing tests**

You must ensure the safety of your plant. You therefore need to run a complete functional test and make the necessary safety checks before the final commissioning of a plant.

Also allow for any possible foreseeable errors in the tests. This avoids endangering persons or equipment during operation.

NOTE**Check coding element in the I/O module**

Make sure that the coding element is present in the I/O module before you plug in the I/O module for the first time. This reduces the risk of plugging the wrong type of module onto a wired BaseUnit when replacing a module.

PRONETA

With SIEMENS PRONETA (PROFINET network analysis), you analyze the system network during commissioning. PRONETA features two core functions:

- The topology overview independently scans PROFINET and all connected components.
- The IO check is a fast test of the wiring and the module configuration of a system.

You can find SIEMENS PRONETA on the Internet

(<https://support.automation.siemens.com/WW/view/en/67460624>).

MultiFieldbus Configuration Tool (MFCT)

MultiFieldbus Configuration Tool (MFCT) is a PC-based software and supports the configuration of MultiFieldbus- and DALI-devices. In addition, the MFCT offers convenient options for bulk firmware update of ET 200 devices with MultiFieldbus-support and reading of service data for many other Siemens devices.

You can find MFCT on the Internet

(<https://support.industry.siemens.com/cs/ww/en/view/109773881>).

SIMATIC Automation Tool

You can use the SIMATIC Automation Tool to perform commissioning and maintenance activities simultaneously on various SIMATIC S7 stations as a bulk operation independent of the TIA Portal.

General function overview:

- Network browsing and creation of a table showing the accessible devices in the network.
- Flashing of device LEDs or HMI display to locate a device
- Loading addresses (IP, subnet, gateway) into a device
- Loading the PROFINET name (station name) into a device name
- Placing a CPU in RUN or STOP mode
- Setting the time in a CPU to the current time of your programming device/PC
- Downloading a new program to a CPU or an HMI device
- Downloading from CPU, downloading to CPU or deleting recipe data from a CPU
- Downloading from CPU or deleting data log data from a CPU
- Backup/restore of data from/to a backup file for CPUs and HMI devices
- Downloading service data from a CPU
- Reading the diagnostics buffer of a CPU
- General reset of a CPU's memory
- Resetting devices to factory settings
- Downloading a firmware update to a device

You can find the SIMATIC Automation Tool on the Internet

(<https://support.industry.siemens.com/cs/ww/de/view/98161300>).

13.2 Commissioning the ET 200SP for PROFINET IO

Requirements

- The CPU/interface module is in the "Factory settings" status or has been reset to factory settings (see section Interface module (<https://support.automation.siemens.com/WW/view/en/55683316/133300>)).
- For CPU: The SIMATIC memory card is as delivered or has been formatted.

13.2.1 ET 200SP CPU as an IO controller

Configuration example

To use the ET 200SP distributed I/O system as an IO controller, you require the CPU 151xSP-1 PN.

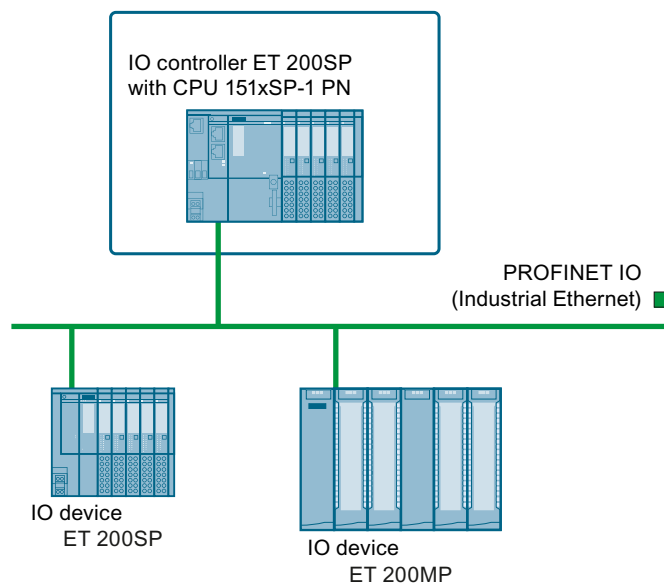

Figure 13-1 ET 200SP CPU as an IO controller

Commissioning procedure

To commission the ET 200SP distributed I/O system CPU as an IO controller for PROFINET IO, we recommend the following procedure:

Table 13-1 Procedure for commissioning the ET 200SP CPU as an IO controller for PROFINET IO

Step	Procedure	See ...
1	Installing ET 200SP	Section Installation (Page 112)
2	Connecting ET 200SP <ul style="list-style-type: none"> Supply voltages PROFINET IO Sensors and actuators 	Section Wiring (Page 133)
3	Inserting a SIMATIC memory card in the IO controller	Section Removing/inserting a SIMATIC memory card on the CPU (Page 258)
4	Configuring the IO controller ¹	Section Configuring (Page 178)
5	Checking the protective measures	-
6	Switching on supply voltages for the IO controller	CPU 15xxSP-1 PN (https://support.automation.siemens.com/WW/view/en/90466439/133300) manual
7	Switching on supply voltages for IO devices	Documentation of the IO device
8	Downloading the configuration to the IO controller	STEP 7 online help
9	Switching IO controller to RUN mode	CPU 15xxSP-1 PN (https://support.automation.siemens.com/WW/view/en/90466439/133300) manual
10	Checking LEDs	CPU 15xxSP-1 PN (https://support.automation.siemens.com/WW/view/en/90466439/133300) manual
11	Testing inputs and outputs	The following functions are helpful: Monitoring and modifying tags, testing with program status, forcing, controlling the outputs. See section Test and service functions (Page 307)

¹ The IO devices are configured with the IO controller.

13.2.2 ET 200SP CPU as an I-device

Configuration example

You need the CPU 151xSP-1 PN to use the ET 200SP distributed I/O system as an I-device.

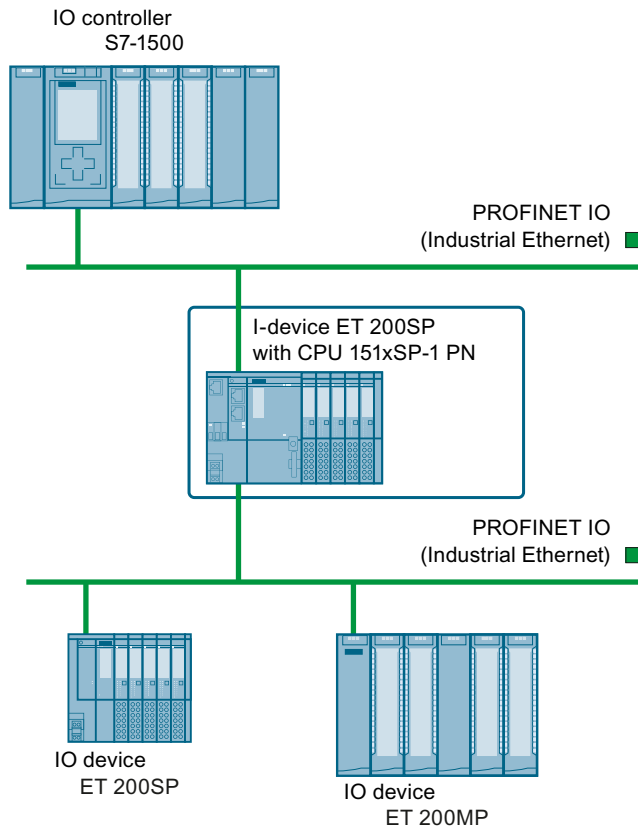

Figure 13-2 ET 200SP CPU as an I-device

Commissioning procedure

For commissioning of the ET 200SP distributed I/O system as an I-device on the PROFINET IO, we recommend the following procedure:

Table 13-2 Procedure for commissioning the ET 200SP as an I-device on the PROFINET IO

Step	Procedure	See ...
1	Installing ET 200SP	Section Installation (Page 112)
2	Connecting ET 200SP <ul style="list-style-type: none"> • Supply voltages • PROFINET IO • Sensors and actuators 	Section Wiring (Page 133)
3	Inserting a SIMATIC memory card in the I-device	Section Removing/inserting a SIMATIC memory card on the CPU (Page 258)
4	Configuring the I-device	Section Configuring (Page 178)

Step	Procedure	See ...
5	Checking the protective measures	-
6	Switching on supply voltages for the IO controller	Documentation of the IO controller
7	Switching on supply voltages for I-device and IO devices	CPU 15xxSP-1 PN (https://support.automation.siemens.com/WW/view/en/90466439/133300) manual and documentation of the IO devices
8	Download configuration to the I-device	STEP 7 online help
9	Switching IO controller and I-device to RUN mode	Documentation of the IO controller and CPU 15xxSP-1 PN (https://support.automation.siemens.com/WW/view/en/90466439/133300) manual
10	Checking LEDs	CPU 15xxSP-1 PN (https://support.automation.siemens.com/WW/view/en/90466439/133300) manual
11	Testing inputs and outputs	The following functions are helpful: Monitoring and modifying tags, testing with program status, forcing, controlling the outputs. See section Test and service functions (Page 307)

13.2.3 ET 200SP as an IO device

Configuration example

To use the ET 200SP distributed I/O system as an IO device, you need the IM 155-6 PNxx interface module.

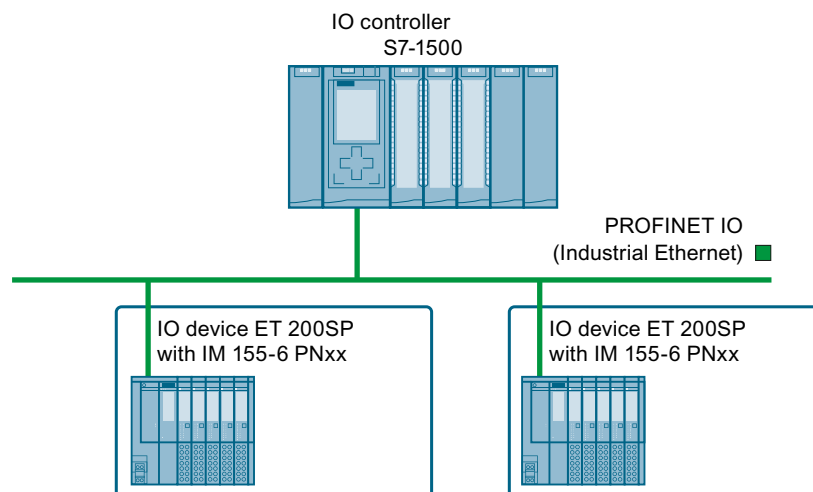

Figure 13-3 ET 200SP as an IO device

You can find information on further configuration variants of the ET 200SP distributed I/O system in redundancy mode in section "Configuration variants" of the Redundant System S7-1500R/H (<https://support.industry.siemens.com/cs/ww/en/view/109754833>) System Manual.

Commissioning procedure

For commissioning of the ET 200SP distributed I/O system as an IO device on the PROFINET IO, we recommend the following procedure:

Table 13-3 Procedure for commissioning the ET 200SP as an IO device for PROFINET IO

Step	Procedure	See ...
1	Installing ET 200SP	Section Installation (Page 112)
2	Connecting ET 200SP <ul style="list-style-type: none"> • Supply voltages • PROFINET IO • Sensors and actuators 	Section Wiring (Page 133)
4	Configuring IO controller	Documentation of the IO controller
5	Checking the protective measures	-
6	Switching on supply voltages for the IO controller	Documentation of the IO controller
7	Switching on supply voltages for IO devices	Interface module (https://support.automation.siemens.com/WW/view/en/55683316/133300) Manual
8	Downloading the configuration to the IO controller	STEP 7 online help
9	Switching IO controller to RUN mode	Documentation of the IO controller
10	Checking LEDs	Interface module (https://support.automation.siemens.com/WW/view/en/55683316/133300) Manual
11	Testing inputs and outputs	The following functions are helpful: Monitoring and modifying tags, testing with program status, forcing, controlling the outputs. Refer to section Test and service functions (Page 307)

13.3 Commissioning the ET 200SP on PROFIBUS DP

Requirements

- The CPU/interface module is in the "Factory settings" status or has been reset to factory settings (see section Interface module (<https://support.automation.siemens.com/WW/view/en/55683316/133300>)).
- For CPU: The SIMATIC memory card is as delivered or has been formatted.

13.3.1 ET 200SP as a DP master

Configuration example

To use the ET 200SP distributed I/O system as a DP master, you need the CPU 151xSP-1 PN and the CM DP communication module.

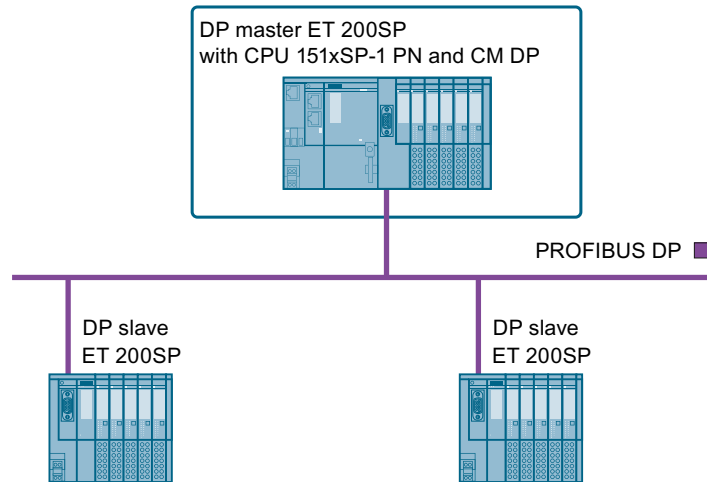

Figure 13-4 ET 200SP as a DP master

Commissioning procedure

To commission the ET 200SP distributed I/O system as a DP master on PROFIBUS DP, we recommend the following procedure:

Table 13-4 Procedure for commissioning the ET 200SP as a DP master on the PROFIBUS DP

Step	Procedure	See ...
1	Installing ET 200SP (with CPU and CM DP)	Section Installation (Page 112)
2	Connecting ET 200SP <ul style="list-style-type: none"> Supply voltages PROFIBUS DP Sensors and actuators 	Section Wiring (Page 133)
3	Inserting a SIMATIC memory card in the DP master (CPU)	Section Removing/inserting a SIMATIC memory card on the CPU (Page 258)
4	Configuring DP master (including PROFIBUS address)	CPU 15xxSP-1 PN (https://support.automation.siemens.com/WW/view/en/90466439/133300) and CM DP manual
5	Switching on supply voltages for DP master	CPU 15xxSP-1 PN (https://support.automation.siemens.com/WW/view/en/90466439/133300) manual
6	Switching on supply voltages for DP slaves	Documentation of the DP slave

Step	Procedure	See ...
7	Download configuration to the DP master	STEP 7 online help
8	Switching DP master to RUN	CPU 15xxSP-1 PN (https://support.automation.siemens.com/WW/view/en/90466439/133300) manual
9	Checking LEDs	CPU 15xxSP-1 PN (https://support.automation.siemens.com/WW/view/en/90466439/133300) manual
10	Testing inputs and outputs	The following functions are helpful: Monitoring and modifying tags, testing with program status, forcing, controlling the outputs. See section Test and service functions (Page 307)

13.3.2 ET 200SP as I-slave

Configuration example

To use the ET 200SP distributed I/O system as I-slave, you need the CPU 151xSP-1 PN and the CM DP communication module.

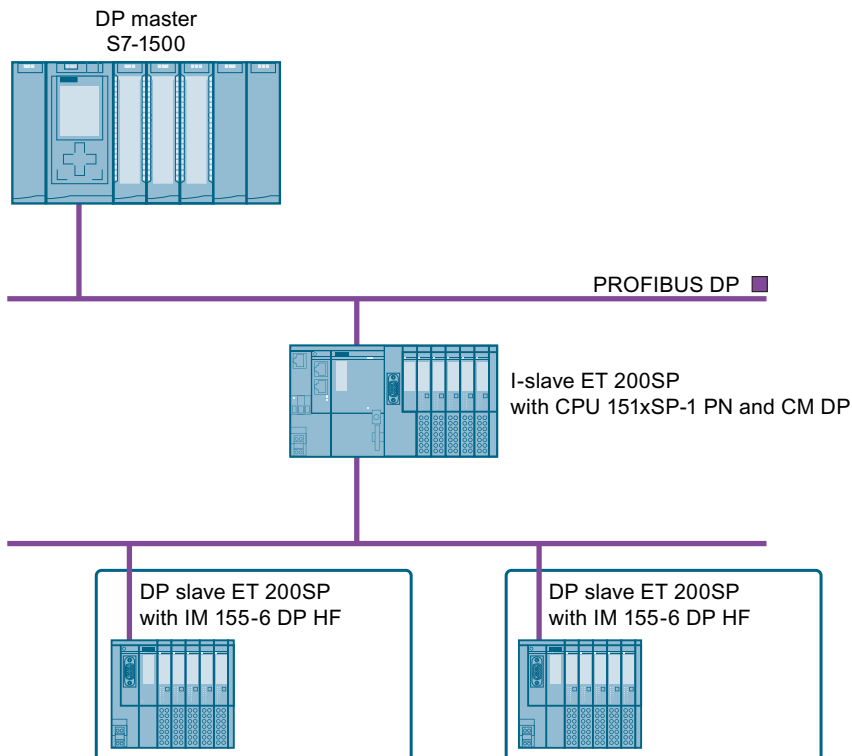

Figure 13-5 ET 200SP as I-slave

Commissioning procedure

For commissioning of the ET 200SP distributed I/O system as an I-slave on the PROFIBUS DP, we recommend the following procedure:

Table 13-5 Procedure for commissioning the ET 200SP as an I-slave for PROFIBUS DP

Step	Procedure	See ...
1	Installing ET 200SP (with CPU and CM DP)	Section Installation (Page 112)
2	Connecting ET 200SP <ul style="list-style-type: none"> Supply voltages PROFIBUS DP Sensors and actuators 	Section Wiring (Page 133)
3	Configuring DP master (including PROFIBUS address)	Documentation of the DP master
4	Inserting a SIMATIC memory card in the I-slave (CPU)	Section Removing/inserting a SIMATIC memory card on the CPU (Page 258)
5	Configuring I-slave (including PROFIBUS address)	CPU 15xxSP-1 PN (https://support.automation.siemens.com/WW/view/en/90466439/133300) and CM DP manual
6	Switching on supply voltages for DP master	Documentation of the DP master
7	Switching on supply voltages for I-slaves	CPU 15xxSP-1 PN (https://support.automation.siemens.com/WW/view/en/90466439/133300) manual
8	Loading configuration in the DP master and I-slaves	STEP 7 online help
9	Switching DP master and I-slaves to RUN	Documentation of the DP master and CPU 15xxSP-1 PN (https://support.automation.siemens.com/WW/view/en/90466439/133300) manual
10	Checking LEDs	CPU 15xxSP-1 PN (https://support.automation.siemens.com/WW/view/en/90466439/133300) manual
11	Testing inputs and outputs	The following functions are helpful: Monitoring and modifying tags, testing with program status, forcing, controlling the outputs. See the Test functions and fault resolution (https://support.automation.siemens.com/WW/view/en/90466439/133300) section

13.3.3 ET 200SP as a DP slave

Configuration example

To use the ET 200SP distributed I/O system as a DP slave, you need the IM 155-6 DP HF.

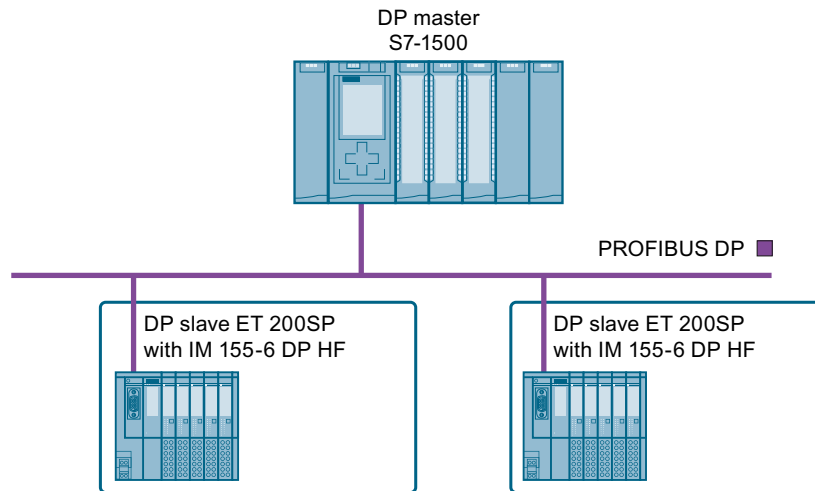

Figure 13-6 ET 200SP as a DP slave

Commissioning procedure

To commission the ET 200SP distributed I/O system as a DP slave on PROFIBUS DP, we recommend the following procedure:

Table 13-6 Procedure for commissioning the ET 200SP as a DP master for PROFIBUS DP

Step	Procedure	See ...
1	Installing ET 200SP (with IM 155-6 DP HF)	Section Installation (Page 112)
2	Setting the PROFIBUS address on the interface module	Section Interface module (http://support.automation.siemens.com/WW/view/en/55683316/133300)
3	Connecting ET 200SP <ul style="list-style-type: none"> • Supply voltages • PROFIBUS DP • Sensors and actuators 	Section Wiring (Page 133)
4	Configuring DP master (including PROFIBUS address)	Documentation of the DP master
5	Switching on supply voltages for DP master	Documentation of the DP master
6	Switching on supply voltages for DP slaves	Interface module (http://support.automation.siemens.com/WW/view/en/55683316/133300) Manual
7	Download configuration to the DP master	STEP 7 online help

Step	Procedure	See ...
8	Switching DP master to RUN	Documentation of the DP master
9	Checking LEDs	Interface module (http://support.automation.siemens.com/WW/view/en/55683316/133300) Manual
10	Testing inputs and outputs	The following functions are helpful: Monitoring and modifying tags, testing with program status, forcing, controlling the outputs. Refer to section Test and service functions (Page 307)

13.4 Startup of the ET 200SP with empty slots

Procedure

You can configure the ET 200SP distributed I/O system with any number of empty slots. To build the ET 200SP distributed I/O system with any number of empty slots, follow these steps:

1. Cover all empty slots with BU covers.
2. Finish the configuration with a server module.

Special consideration: A "Module missing in slot x" diagnostic message is generated by the CPU/interface module for empty slots in which I/O modules are configured.

13.5 Removing/inserting a SIMATIC memory card on the CPU

Requirement

The CPU only supports pre-formatted SIMATIC memory cards. If necessary, delete all previously stored data before using the SIMATIC memory card. You can find more information on deleting the content of the SIMATIC memory card in the function manual Structure and use of the CPU memory.

In order to work with the SIMATIC memory card, first ensure that the SIMATIC memory card is not write-protected. If it is, move the slider out of the lock position.

Inserting the SIMATIC memory card

To insert a SIMATIC memory card, follow these steps:

1. Ensure that the CPU is either switched off or in STOP mode.
2. Insert the SIMATIC memory card, as depicted on the CPU, into the slot for the SIMATIC memory card.

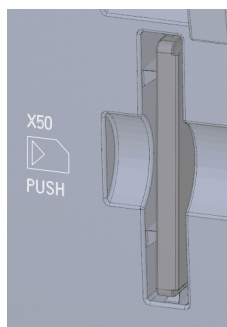

Figure 13-7 Slot for the SIMATIC memory card

3. Insert the SIMATIC memory card with light pressure into the CPU, until the SIMATIC memory card latches.

Removal of the SIMATIC memory card

To remove a SIMATIC memory card, follow these steps:

1. Switch the CPU to STOP mode.
2. Press the SIMATIC memory card into the CPU with light pressure. After audible unlatching of the SIMATIC memory card, remove it.

Only remove the SIMATIC memory card in POWER OFF or STOP mode of the CPU. Ensure that no writing functions (online functions with the programming device, e.g. loading/deleting a block, test functions) are active in STOP mode or were active before POWER OFF.

Reactions after removing/inserting the SIMATIC memory card

Inserting and removing the SIMATIC memory card in STOP, STARTUP or RUN mode triggers a re-evaluation of the SIMATIC memory card. The CPU hereby compares the content of the configuration on the SIMATIC memory card with the backed-up retentive data. If the backed-up retentive data matches the data of the configuration on the SIMATIC memory card, the retentive data is retained. If the data differs, the CPU automatically performs a memory reset (which means the retentive data is deleted) and then goes to STOP.

The CPU evaluates the SIMATIC memory card, and this is indicated by the RUN/STOP LED flashing.

Reference

You can find more information on the SIMATIC memory card in the function manual Structure and use of the CPU memory

(<https://support.industry.siemens.com/cs/ww/en/view/59193101>).

13.6 Operating modes of the CPU

Introduction

Operating modes describe the status of the CPU. The following operating modes are possible using the mode selector:

- STARTUP
- RUN
- STOP

In these operating modes, the CPU can communicate, for example, via the PROFINET interface.

The status LEDs on the front of the CPU indicate the current operating mode.

13.6.1 STARTUP mode

Behavior

Before the CPU starts to execute the cyclic user program, a startup program is executed. By suitably programming startup OBs, you can specify initialization tags for your cyclic program in the startup program. You have the option of programming no, one or several startup OBs.

Special features during startup

Note the following points regarding STARTUP mode:

- The CPU resets the process image input.
- All outputs are disabled or respond as configured for the given module: They provide a substitute value as set in the parameters or retain the last value output and bring the controlled process to a safe operational status.
- Before processing the start-up routine, the CPU transfers the I/O inputs to the process image input.
- After processing the start-up routine, the CPU releases the peripheral outputs.

NOTE

To read the current state of inputs during STARTUP, you can access inputs via the process image or via direct I/O access.

To initialize outputs during STARTUP, you can write values via the process image or via direct I/O access. The values are output to the outputs during the transition to RUN mode.

- The CPU always starts up in warm restart mode.
 - The non-retentive bit memory, timers and counters are initialized.
 - The non-retentive tags in data blocks are initialized.
- During startup, cycle-time monitoring is not yet running
- The CPU processes the startup OBs in the order of the startup OB numbers. The CPU processes all programmed startup OBs regardless of the selected startup mode. (Figure "Setting the startup behavior").
- If a corresponding event occurs, the CPU can start the following OBs during startup:
 - OB 82: Diagnostics interrupt
 - OB 83: Pull/plug interrupt for modules
 - OB 86: Rack error
 - OB 121: Programming error (only for global error handling)
 - OB 122: I/O access error (only for global error handling)You can find a description of how to use global and local error handling in the STEP 7 online help.

The CPU does not start all the other OBs until the transition to RUN mode.

Response when expected and actual configurations do not match

The configuration downloaded to the CPU represents the expected configuration. The actual configuration is the actual configuration of the ET 200SP distributed I/O system. If the expected configuration and actual configuration do not match, the setting of the "Comparison preset to actual configuration" parameter determines the behavior of the CPU. You can find additional information on hardware compatibility in the section Operating mode transitions (Page 263).

Cancellation of startup

If errors occur during startup, the CPU cancels startup and returns to STOP mode. The CPU does not perform the startup or interrupts the startup under the following conditions:

- You have not inserted a SIMATIC memory card or have inserted an invalid one.
- You have not downloaded a hardware configuration to the CPU.

Configuring the startup behavior

You configure the behavior of the CPU in the Startup group in the CPU properties.

Setting the startup behavior

To set the startup behavior, follow these steps:

1. Select the CPU in the device view of the STEP 7 hardware network editor.
2. In the properties under "General" select the "Startup" area.

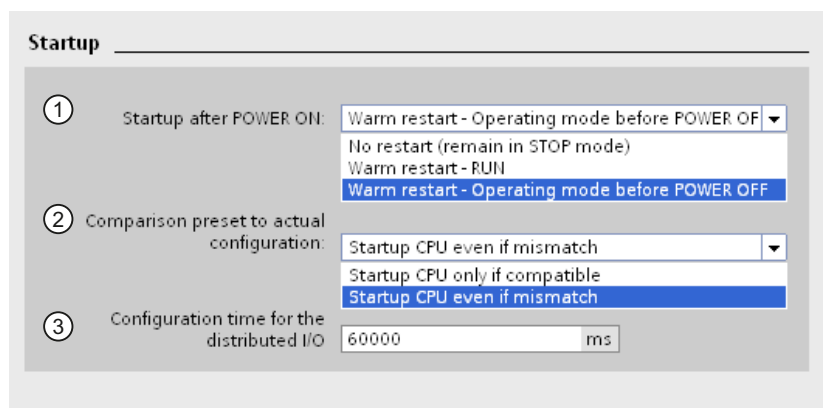

Figure 13-8 Setting the startup behavior

- ① Sets the startup type after POWER ON

- ② Defines the startup behavior when a module in a slot does not correspond to the configured module. You can set this parameter centrally, on the CPU or for each module. When you change the setting for a module, the setting made centrally for this module no longer applies.
 - Startup CPU only if compatible: In this setting a module on a configured slot has to be compatible with the configured module. Compatible means that the module matches in terms of the number of inputs and outputs and with respect to its electrical and functional properties.
 - Startup CPU even if mismatch: With this setting the CPU starts up regardless of the type of module plugged in.
- ③ Specifies a maximum period (default: 60000 ms) in which the I/O must be ready for operation. The CPU changes to RUN.

If the central and distributed I/O is not ready for operation within the configuration time, the startup characteristics of the CPU depends on the setting of the "Comparison preset to actual configuration" parameter.

Example for the "Comparison preset to actual configuration" parameter

"Startup CPU only if compatible":

The DI 16x24VDC ST input module with 16 digital inputs is a compatible replacement for a DI 8x24VDC ST input module with 8 digital inputs. The pin assignment and all electrical and functional properties are identical.

"Startup CPU even if mismatch":

Instead of a configured digital input module, you insert an analog output module or no module is present in this slot and thus in all subsequent slots. Although the configured inputs cannot be accessed, the CPU starts up.

Note that the user program cannot function correctly in this case and take the appropriate measures.

13.6.2 STOP mode

Behavior

The CPU does not execute the user program in STOP mode.

All outputs are disabled or react according to the parameter settings for the particular I/O module: They provide a substitute value as set in the parameters or retain the last value output keeping the controlled process in a safe operating status.

In STOP mode, the motor starter responds according to how it was parameterized for the CPU STOP state. The CPU STOP state can be circumvented with the manual local control (Local Control) function. If the CPU is switched off, a motor can be switched on in the motor starter's commissioning mode.

You will find additional information in the Motor starter

(<https://support.industry.siemens.com/cs/ww/en/view/109479973>) manual.

13.6.3 RUN mode

Behavior

In "RUN" mode the cyclic, time-driven, and interrupt-driven program is executed. Addresses that are in the "Automatic Update" process image are automatically updated in each program cycle. See also the section Process images and process image partitions (Page 185).

Execution of the user program

Once the CPU has read the inputs, the cyclic program is executed from the first instruction to the last instruction.

If you have configured a minimum cycle time, the CPU will not end the cycle until this minimum cycle time is finished even if the user program is completed sooner.

A cycle monitoring time is set to ensure that the cyclic program is completed within a specified time. You can change the cycle monitoring time to suit your requirements. If the cyclic program has not finished running within this time, the system responds with a time error.

Further events such as hardware interrupts and diagnostics interrupts can interrupt the cyclic program flow and prolong the cycle time.

Reference

Further information about cycle and response times is available in the Function Manual Cycle and response times (<https://support.automation.siemens.com/WW/view/en/59193558>).

13.6.4 Operating mode transitions

Operating modes and operating mode transitions

The following figure shows the operating modes and the operating mode transitions:

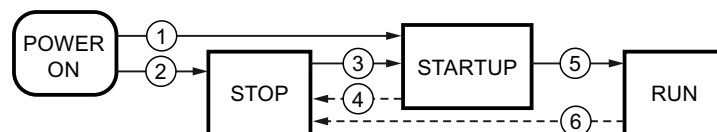

Figure 13-9 Operating modes and operating mode transitions

The table below shows the effects of the operating mode transitions:

Table 13-7 Operating mode transitions

No.	Operating mode transitions		Effects
①	POWER ON → STARTUP	After switching on, the CPU switches to "STARTUP" mode if:	The CPU clears the non-retentive memory, and resets the content of non-retentive DBs to the start values of the load memory. Retentive memory and retentive DB contents are retained. The 500 newest entries in the diagnostics buffer are retained.

No.	Operating mode transitions	Effects
	<ul style="list-style-type: none"> • The hardware configuration and program blocks are consistent. • The preceding "POWER OFF" was triggered by an interruption in the power supply. • Startup type "Warm restart - RUN" is set. Or • Startup type "Warm restart - mode before POWER OFF" is set and the CPU was in RUN mode before POWER OFF. 	
②	<p>POWER ON → STOP</p> <p>After switching on, the CPU goes to "STOP" mode if:</p> <ul style="list-style-type: none"> • The hardware configuration and program blocks are inconsistent. Or • The "No restart" startup type is set. Or • Startup type "Warm restart - mode before POWER OFF" is set and the CPU was in STOP mode before POWER OFF. 	<p>The CPU clears the non-retentive memory, and resets the content of non-retentive DBs to the start values of the load memory. Retentive memory and retentive DB contents are retained.</p> <p>The 500 newest entries in the diagnostics buffer are retained.</p>
③	<p>STOP → STARTUP</p> <p>The CPU switches to "STARTUP" mode if:</p> <ul style="list-style-type: none"> • The hardware configuration and program blocks are consistent. • You set the CPU to "RUN" mode via the programming device and the mode switch in is RUN position. Or • You set the mode switch from STOP to RUN. 	<p>The CPU clears the non-retentive memory, and resets the content of non-retentive DBs to the start values of the load memory. Retentive memory and retentive DB contents are retained.</p> <p>The 500 newest entries in the diagnostics buffer are retained.</p>
④	<p>STARTUP → STOP</p> <p>In the following cases, the CPU goes from "STARTUP" to "STOP" mode when:</p> <ul style="list-style-type: none"> • The CPU detects an error during startup. • You set the CPU to "STOP" via the programming device or mode switch. • The CPU executes a STOP command in the Startup OB. 	<p>These operating mode transitions have no effect on data.</p>
⑤	<p>STARTUP → RUN</p> <p>In the following cases, the CPU goes from "STARTUP" to "RUN" mode when:</p> <ul style="list-style-type: none"> • The CPU has initialized the PLC tags. • The CPU has executed the startup blocks successfully. 	
⑥	<p>RUN → STOP</p> <p>In the following cases, the CPU goes from "RUN" back to "STOP" mode when:</p> <ul style="list-style-type: none"> • The CPU detects an error which prevents further work. • The CPU executes a STOP command in the user program. • You set the CPU to "STOP" via the programming device or mode switch. 	

13.7 CPU memory reset

Basics of a memory reset

The CPU must be in STOP mode for a memory reset.

A memory reset returns the CPU to its "initial state".

Memory reset means:

- An existing online connection between your programming device/PC and the CPU is terminated.
- The content of the work memory and the retentive and non-retentive data (applies only to manual memory reset by the user) are deleted.
- The diagnostics buffer, time of day, IP address and the device name are retained.
- Subsequently the CPU is initialized with the loaded project data (hardware configuration, code and data blocks, force jobs). The CPU copies this data from the load memory to the work memory.

Result:

- If you set an IP address in the hardware configuration ("Set IP address in the project" option) and a SIMATIC memory card with the project is in the CPU, this IP address is valid after the memory reset.
- Data blocks no longer have current values but rather their configured start values.
- Force jobs remain active.

Detecting a CPU memory reset

The RUN/STOP LED flashes yellow at 2 Hz. After completion, the CPU switches to STOP. The RUN/STOP LED is on (constant yellow light).

Result after memory reset

The following table provides an overview of the contents of the memory objects after memory reset.

Table 13-8 Memory objects after memory reset

Memory object	Content
Actual values of the data blocks, instance data blocks	Initialized
Bit memory, timers and counters	Initialized
Retentive tags from technology objects (for example, adjustment values of absolute encoders)*	Retained
Diagnostics buffer entries	Retained
IP address	Retained
Device name	Retained
Counter readings of the runtime meters	Retained
Time of day	Retained

* The retentive tags from technology objects are retained but the content of certain tags is re-initialized in some cases.

NOTE

Password for protection of confidential configuration data

The password for protection of confidential configuration data is retained after a memory reset of the CPU. The password is only deleted when the "Delete password for protection of confidential PLC configuration data" option is set.

You can find additional information on the password for protection of confidential configuration data in the Communication <https://support.industry.siemens.com/cs/ww/en/view/59192925> function manual.

13.7.1 Automatic memory reset

Possible causes of automatic memory reset

The CPU executes an automatic memory reset if an error occurs that prevents normal further processing.

Causes of such errors are:

- User program is too large, and cannot be completely loaded into work memory.
- The project data on the SIMATIC memory card is corrupt, for example, because a file was deleted.
- If you remove or insert the SIMATIC memory card and the backed-up retentive data differs in structure from that of the configuration on the SIMATIC memory card.

13.7.2 Manual memory reset

Reason for a manual memory reset

CPU memory reset is required to reset the CPU to its "original state".

CPU memory reset

Two options are available for performing a CPU memory reset:

- Using the mode selector
- Using STEP 7

Procedure using the mode selector

NOTE

Memory reset ↔ Reset to factory settings

The procedure described below also corresponds to the procedure for resetting to factory settings:

- Selector operation with inserted SIMATIC memory card: CPU executes a memory reset
- Selector operation without inserted SIMATIC memory card: CPU executes reset to factory settings

To reset the CPU memory using the mode selector, proceed as follows:

1. Set the mode selector to the STOP position.
Result: The RUN/STOP LED lights up yellow.
2. Set the mode selector to the MRES position. Hold the selector in this position until the RUN/STOP LED lights up for the 2nd time and remains continuously lit (this takes three seconds). After this, release the switch.
3. Within the next three seconds, switch the mode selector back to the MRES position, and then back to STOP again.

Result: The CPU executes memory reset.

For information on resetting the CPU to factory settings, refer to the section Resetting the CPU to factory settings ([Page 298](#)).

Procedure using STEP 7

For a memory reset of the CPU using STEP 7 proceed as follows:

1. Open the "Online Tools" task card of the CPU.
2. Click the "MRES" button in the "CPU control panel" pane.
3. Click "OK" in response to the confirmation prompt.

Result: The CPU switches to STOP mode and performs a memory reset.

13.8 Reassigning parameters during operation

Introduction

You have the option of reassigning the parameters for the ET 200SP I/O modules during operation.

Changing parameters during operation

You make the parameter settings of the I/O modules using data records. Each I/O module has a separate data record. The instruction "WRREC" applies the changed parameters to the I/O module. The parameters that you have set with STEP 7 are not changed. After a POWER OFF/POWER ON of the ET 200SP, the parameters set with STEP 7 are valid again.

If you are using the CPU as an I-device, you reassign the parameters of the I/O modules via the I-device.

NOTE

If you write data records from the user program to the modules of the distributed I/O, make sure that these modules actually exist and are available. You can evaluate OB83 for this purpose. After inserting a module, the CPU does not call OB83 until the module has started up and its parameters are assigned. This ensures the execution of the data record operations without errors.

NOTE

You need to transfer the new parameters with the "WRREC" instruction after a POWER OFF/POWER ON of the ET 200SP.

Instruction for parameter assignment

The following instruction is provided for assigning parameters to the I/O module in the user program:

Instruction	Application
"WRREC"	Transfer the modifiable parameters to the addressed ET 200SP module.

Error message

In the event of an error, the following return values are reported:

Table 13-9 Error message

Error code	Meaning
80E0 _H	Error in header information
80E1 _H	Parameter error

Reference

You will find the setup of the parameter data record in the manuals of the I/O modules (<https://support.automation.siemens.com/WW/view/es/55679691/133300>).

13.9 Backing up and restoring the CPU configuration

13.9.1 Overview

Backup from online device

You make changes where necessary in the system operation. You add new devices, replace existing devices or adapt the user program. If these changes result in undesirable behavior, you can restore the plant to an earlier state. Before you load a changed configuration to the CPU, first use the option "Backup from online device" to create a complete backup of the current device status. If you have assigned a password to protect confidential PLC configuration data, then this password is not secured. For more information on the password, refer to the section Protection of confidential configuration data (Page 204).

Upload from device (software)

With the option "Upload from device (software)", you load the software project data from the CPU to an existing CPU in the project.

Upload device as new station

If you are operating a new PG/PC on a system, the STEP 7 project that was used to create the system configuration might not be available. In this case, you upload the data to a project in your PG/PC with the "Upload device as new station" option.

Snapshot of the monitor values

To allow you to restore the actual values after changes, back up the actual values of the data blocks with the "Snapshot of the monitor values" option.

Overview of backup types

The table below shows the backup of CPU data depending on the selected type of backup and its specific characteristics:

	Backup from online device	Upload from device (software)	Upload device as new station	Snapshot of the monitor values
Current values of all DBs (global and instance data blocks) ¹⁾	✓	✓	✓	✓
Blocks of the type OB, FC, FB and DB	✓	✓	✓	--
PLC tags (tag names and constant names)	✓	✓	✓	--
Technology objects	✓	✓	✓	✓ ³⁾
Hardware configuration	✓	--	✓	--
Actual values (bit memories, timers, counters)*	✓	--	--	--

¹⁾ Only the values of the tags that are set as retentive are saved.

²⁾ Only possible in the STOP operating state and for individual fail-safe blocks.

³⁾ Nur die High_Speed_Counter and SSI_Absolute_Encoder modules

	Backup from online device	Upload from device (software)	Upload device as new station	Snapshot of the monitor values
Contents of the SIMATIC memory card	✓	--	--	--
Archives, recipes	✓	--	--	--
Entries in the diagnostics buffer	--	--	--	--
Current time	--	--	--	--
Properties of the type of backup				
Backup possible for fail-safe CPUs	✓	✓ ²⁾	--	✓
Backup can be edited	--	✓	✓	✓
Backup possible in operating mode	STOP	RUN, STOP	RUN, STOP	RUN, STOP

1) Only the values of the tags that are set as retentive are saved.

2) Only possible in the STOP operating state and for individual fail-safe blocks.

3) Nur die High_Speed_Counter and SSI_Absolute_Encoder modules

Reference

You can find more information on the different backup types in the STEP 7 online help.

Emergency address (emergency IP)

The emergency address (emergency IP address) of a CPU was conceived for diagnostic and downloading functions, e.g. if the CPU can no longer be reached via the IP protocol due to loading of an incorrect project. You can find information on the emergency address in the Communication (<https://support.industry.siemens.com/cs/ww/de/view/59192925/en>) function manual.

Archiving multilingual project texts

When you configure a CPU, different categories of texts come into being, e.g.

- Object names (names of blocks, modules, tags, etc.)
- Comments (for blocks, networks, watch tables, etc.)
- Messages and diagnostic texts

Texts are provided by the system (e.g. diagnostic buffer texts) or are created during configuration (e.g. messages).

In a project, texts exist in one single language or in several languages after a translation process. You can maintain project texts in all languages, which are at your disposal in the project navigator (Languages & Resources > Project Texts). The texts arising during configuration can be loaded into the CPU.

The following texts containing the project data are loaded into the CPU in the chosen languages and are also used by the Web server:

- Diagnostic buffer texts (not editable)
- Module status texts (not editable)
- Message texts with associated text lists
- Tag comments and step comments for S7 GRAPH and PLC Code Viewer
- Comments in watch tables

The following texts containing the project languages are also loaded into the CPU in the chosen languages, but are not used by the Web server:

- Comments in tag tables (for tags and constants)
- Comments in global data blocks
- Comments of elements in block interfaces of FBs, FCs, DBs and UDTs
- Network titles in data blocks that are written in ladder logic (LAD), function block diagram (FBD) or statement list (STL)
- Block comments
- Network comments
- Comments of LAD and FBD elements

The CPUs support archiving of multilingual project texts in up to three different project languages. If the project texts for a particular project language nevertheless exceed the memory space reserved for them, the project cannot be downloaded to the CPU. The download is aborted with a notice that not enough memory space is available. In such a case, take measures to reduce the required storage space, for example by shortening comments.

NOTE**Size of the SIMATIC memory card**

If, when loading projects, the required memory space is more extensive/larger than the memory space on the

SIMATIC memory card used, the download to the CPU is canceled. You receive an error message.

Therefore, make sure that there is enough available storage space on your SIMATIC memory card for loading projects.

You will find information on reading out the storage space capacity utilization of the CPU and the SIMATIC memory card in the Structure and use of the CPU memory (<https://support.industry.siemens.com/cs/de/de/view/59193101/en>) function manual.

You will find information on parameterization of multilingual project texts in STEP 7 in the STEP 7 online help.

13.10 Time synchronization

Introduction

All CPUs are equipped with an internal clock. The clock shows:

- The time of day with a resolution of 1 millisecond
- The date and the day of the week

The CPU takes into account the time change caused by daylight saving time.

You can synchronize the time of the CPUs with an NTP server in NTP mode (NTP: Network Time Protocol).

Operating principle

In NTP mode, the device sends time queries at regular intervals (in client mode) to the NTP server in the subnet (LAN). Based on the replies of the servers, the most reliable and most accurate time is calculated and the time of day of the CPU is synchronized. The advantage of this mode is that it allows the time to be synchronized across subnets. You can synchronize the time of day of up to a maximum of four NTP servers. You address a communications processor or an HMI device, for example, as sources for time synchronization via the IP addresses.

The update interval defines the interval between the time queries (in seconds). The value range of the interval is between 10 seconds and one day. In NTP mode, it is generally UTC (Universal Time Coordinated) that is transferred. UTC corresponds to GMT (Greenwich Mean Time).

NTP server for the ET 200SP CPU

You can assign an ET 200SP CPU to up to 4 NTP servers.

You have the following options to reset the IP addresses of the NTP servers:

- Configure IP addresses of the NTP servers in STEP 7.
- Set IP addresses of the NTP servers with the "T_CONFIG" instruction.
- Obtain IP addresses of the NTP servers via DHCP.

As of firmware version V2.9, the CPU can also obtain the NTP servers via DHCP. You can find more information on the procedure and the DHCP communication protocol in the Communication (<https://support.industry.siemens.com/cs/ww/de/view/59192925/en>) function manual.

Configuring IP addresses of the NTP servers in STEP 7

To configure the IP addresses of the NTP servers in STEP 7, follow these steps:

1. Select the ET 200SP CPU in STEP 7.
2. In the properties of the CPU, navigate to "Time of day" > "Time synchronization" > "NTP mode".
3. For "Time synchronization:", select "Set NTP server in the project" from the drop-down list.
4. Enter the IP addresses of up to four NTP servers for "Server 1" to "Server 4".
5. Set the time interval of time queries for "Update interval". Set the update interval to between 10 s and 86400 s.

Setting the IP addresses of the NTP servers with the "T_CONFIG" instruction

Requirements:

- You selected the option "Set NTP server directly on the device (e.g. PLC program, display)" in the "Time synchronization" drop-down list in STEP 7.

Proceed as follows to set the IP addresses of the NTP servers with the T_CONFIG instruction:

1. Enter the IP addresses of up to four NTP servers in a tag of the data type IF_CONF_NTP.
2. Interconnect the tag of data type IF_CONF_NTP at the block parameter CONF_DATA of the T_CONFIG instruction.
3. Call the T_CONFIG instruction in the user program.

Result: The addresses of the NTP servers from the T_CONFIG instruction are transferred to the CPU.

If necessary, you can change the addresses of the NTP servers several times with T_CONFIG.

Reference

For additional information on time synchronization in the automation environment, refer to the following FAQ on the Internet

(<https://support.industry.siemens.com/cs/de/en/view/86535497>).

13.10.1 Example: Configuring and changing NTP server

Automation task

You are using your own NTP server in your network with the IP address 192.168.1.15. Your own server provides you with the following advantages:

- Protection against unauthorized accesses from outside
- Every device that you synchronize with your own NTP server uses the same time.

You want to synchronize the ET 200SP CPU with this NTP server.

The following sections describe how to configure the IP address of the NTP server in STEP 7 or set it in the user program.

Configuring the IP address of the NTP server in STEP 7

Procedure

1. Select the ET 200SP CPU in STEP 7.
2. In the properties of the CPU, navigate to "Time of day" > "Time synchronization"> "NTP mode".
3. For "Time synchronization:", select "Set NTP server in the project" from the drop-down list.
4. For "Server 1:", enter the IP address of the NTP server: 192.168.1.15.
5. Download the hardware configuration to the CPU.

Result

The CPU synchronizes the time with the NTP server 192.168.1.15.

Set IP addresses of the NTP server with the "T_CONFIG" instruction

Requirements:

- You selected the option "Set NTP server directly on the device (e.g. PLC program, display)" in the "Time synchronization" drop-down list in STEP 7.

To set the IP address for the NTP server, use the following block parameters of the "T_CONFIG" instruction:

- Req: A positive edge at the block parameter "Req" starts a job of the "T_CONFIG" instruction.
- Interface: Enter the HW ID of the PROFINET interface 1 of the CPU at the block parameter "Interface". In this example, the HW ID is "64".
- Conf_Data: Area in which you save the IP addresses of the NTP server. Use the data type "IF_CONF_NTP" for this purpose.

Procedure

Proceed as follows to set the IP address of the NTP server in the user program to "192.168.1.15":

- Create a global data block in the project tree under "Program blocks > Add new block". Name the global data block "NTP".
- Create a tag of the data type "IF_CONF_NTP" in the global data block "NTP".

NTP				
	Name	Data type	Start value	Comment
1	Static			
2	NTP_Server	IF_CONF_NTP		
3	Id	UInt	17	
4	Length	UInt	22	
5	Mode	UInt	0	
6	NTP_IP	Array[1..4] of IP_V4		
7	NTP_IP[1]	IP_V4		
8	ADDR	Array[1..4] of Byte		IPv4 address
9	ADDR[1]	Byte	192	IPv4 address
10	ADDR[2]	Byte	168	IPv4 address
11	ADDR[3]	Byte	1	IPv4 address
12	ADDR[4]	Byte	10	IPv4 address
13	NTP_IP[2]	IP_V4		
14	NTP_IP[3]	IP_V4		
15	NTP_IP[4]	IP_V4		
16	change_NTP-Server	Bool	false	
17	done	Bool	false	
18	busy	Bool	false	
19	error	Bool	false	
20	status	DWord	16#0	
21	err_loc	DWord	16#0	

Figure 13-10 Example: Data block with IF_CONF_NTP

- Create a "T_CONFIG" instruction in the user program.

4. Connect the "T_CONFIG" instruction as follows.

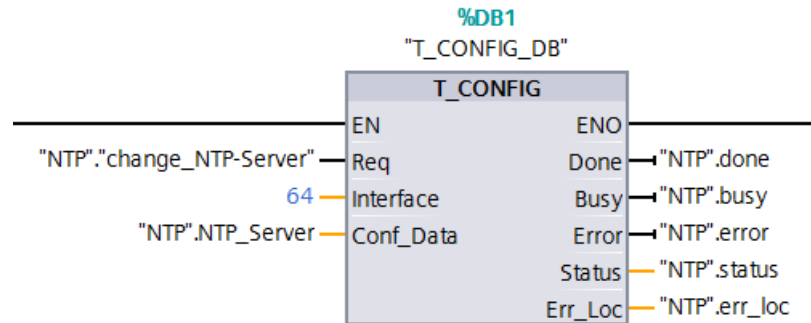

Figure 13-11 Example T_CONFIG: Changing the NTP server

5. In the user program, assign the IP address 192.168.1.15 to the data type "IF_CONF_NTP":

```
"NTP".NTP_Server.NTP_IP[1].ADDR[1] := 192;
"NTP".NTP_Server.NTP_IP[1].ADDR[2] := 168;
"NTP".NTP_Server.NTP_IP[1].ADDR[3] := 1;
"NTP".NTP_Server.NTP_IP[1].ADDR[4] := 15;
```
6. Generate a positive edge for the tag "change_NTP-Server" in the user program:

```
"NTP"."change_NTP-Server" := true;
```

Result

The CPU synchronizes the time with the NTP server 192.168.1.15.

13.11 Identification and maintenance data

13.11.1 Reading out and entering I&M data

I&M data

Identification and maintenance data (I&M data) is information saved on the module. The data is:

- Read-only (I-data) or
- Readable/writable (M-data)

Identification data (I&M0): Manufacturer information about the module that can only be read. Some identification data is also printed on the housing of the module, for example article number and serial number.

Maintenance data (I&M1, 2, 3): Plant-dependent information, e.g. installation location. Maintenance data is created during configuration and downloaded to the module. All modules of the ET 200SP distributed I/O system support identification data (I&M0 to I&M3).

The I&M identification data supports you in the following activities:

- Checking the plant configuration
- Locating hardware changes in a plant
- Correcting errors in a plant

Modules can be clearly identified online using the I&M identification data.

Maintenance data (I&M4): Storage of a CRC checksum for interface modules IM 155-6 PN ST for ensuring data integrity of data used by the interface module.

NOTE

The BusAdapter and the interface module IM 155-6 PN HF support the identification data I&M0 to I&M4 (signature).

Options for reading out I&M data

- Via the user program
- Via STEP 7 or HMI devices
- Via the CPU web server

Reading I&M data via the user program

You have the following options to read the modules' I&M data in the user program:

- Using the RDREC instruction
The record structure for distributed modules that are accessible via PROFINET IO/PROFIBUS DP, is described in the chapter Record structure for I&M data ([Page 277](#)).
- Using the Get_IM_Data instruction

Reference

The description of the instructions can be found in the STEP 7 online help.

Reading I&M data via STEP 7

Requirements: There must be an online connection to the CPU/interface module.

To read I&M data using STEP 7, follow these steps:

1. In the project tree, under "Distributed I/O" select the IO device IM 155-6 PN ST (for example)
2. Select **> IO device > Online & diagnostics > Identification & Maintenance.**

Entering maintenance data via STEP 7

STEP 7 assigns a default module name. You can enter the following information:

- Plant designation (I&M1)
- Location identifier (I&M1)
- Installation date (I&M2)
- Additional information (I&M3)

To enter maintenance data via STEP 7, follow these steps:

1. In the device view of the STEP 7 hardware network editor, select the interface module, for example.
2. In the properties under "General", select the "Identification & Maintenance" area and enter the data.

During the loading of the hardware configuration, the I&M data is also loaded.

Procedure for reading I&M data via the Web server

The procedure is described in detail in the Web server

(<https://support.automation.siemens.com/WW/view/en/59193560>) Function Manual.

13.11.2 Data record structure for I&M data

Reading I&M records via the user program (distributed via PROFINET IO)

You directly access specific identification data using **Read data record** ("RDREC" instruction). You obtain the corresponding part of the identification data under the relevant data record index.

The data records are structured as follows:

Table 13-10 Basic structure of data records with I&M identification data

Content	Length (bytes)	Coding (hex)
Header information		
BlockType	2	I&M0: 0020 _H I&M1: 0021 _H I&M2: 0022 _H I&M3: 0023 _H I&M4: 0024 _H
BlockLength	2	I&M0: 0038 _H I&M1: 0038 _H I&M2: 0012 _H I&M3: 0038 _H I&M4: 0038 _H
BlockVersionHigh	1	01

13.11 Identification and maintenance data

Content	Length (bytes)	Coding (hex)
BlockVersionLow	1	00
Identification data		
Identification data (see table below)	I&M0/index AFF0 _H : 54 I&M1/index AFF1 _H : 54 I&M2/index AFF2 _H : 16 I&M3/index AFF3 _H : 54 I&M4/index AFF4 _H : 54	

Table 13-11 Data record structure for I&M identification data

Identification data	Access	Default	Explanation
Identification data 0: (data record index AFF0 hex)			
VendorIDHigh	Read (1 byte)	00 _H	This is where the name of the manufacturer is stored (42 _D = SIEMENS AG).
VendorIDLow	Read (1 byte)	2 A _H	
Order_ID	Read (20 bytes)	6E57155-6AU02-0BNO	Article number of the module (e.g. of the IM 155-6 PN ST interface module)
IM_SERIAL_NUMBER	Read (16 bytes)	-	Serial number (device-specific)
IM_HARDWARE_REVISION	Read (2 bytes)	1	Corresponding HW version
IM_SOFTWARE_REVISION	Read	Firmware version	Provides information about the firmware version of the module
• SWRevisionPrefix	(1 byte)	V	
• IM_SWRevision_Functional_Enhancement	(1 byte)	00 - FF _H	
• IM_SWRevision_Bug_Fix	(1 byte)	00 - FF _H	
• IM_SWRevision_Internal_Change	(1 byte)	00 - FF _H	
IM_REVISION_COUNTER	Read (2 bytes)	0000 _H	Provides information about parameter changes on the module (not used)
IM_PROFILE_ID	Read (2 bytes)	0000 _H	Generic Device
IM_PROFILE_SPECIFIC_TYPE	Read (2 bytes)	0005 _H	Interface modules/BusAdapters
		0003 _H	I/O modules and motor starters
		0001 _H	CPU
IM_VERSION	Read	0101 _H	Provides information on the version of the identification data (0101 _H = Version 1.1)
• IM_Version_Major	(1 byte)		
• IM_Version_Minor	(1 byte)		
IM_SUPPORTED	Read (2 bytes)	000E _H	Provides information about the available identification data (I&M1 to I&M3)
Maintenance data 1: (data record index AFF1 hex)			
IM_TAG_FUNCTION	Read/write (32 bytes)	-	Enter a module identifier here that is unique plant-wide.

* A value of 0 indicates that the IM firmware does not yet support the CRC calculation of the assigned modules. If the value is ≠ 0, the IM supports this function, regardless of whether the assigned modules support I&M4 data.

Identification data	Access	Default	Explanation
IM_TAG_LOCATION	Read/write (22 bytes)	-	Enter the installation location of the module here.
Maintenance data 2: (data record index AFF2 hex)			
IM_DATE	Read/write (16 bytes)	YYYY-MM-DD HH:MM	Enter the installation date of the module here.
Maintenance data 3: (data record index AFF3 hex)			
IM_DESCRIPTOR	Read/write (54 bytes)	-	Enter a comment describing the module.
Maintenance data 4: (data record index AFF4 hex)			
USI	Read (4 bytes)	0x63726331	UserstructureIdentifier: Internal, fixed value
CHK_OVERALL	Read (4 bytes)	-	Overall CRC of all individual CRCs
CHK_OVERALL_SUBS	Read (4 bytes)	0 or value*	Overall CRC of all assigned modules of the IM
CHK_STATIC_LOCAL	Read (4 bytes)	-	CRC of static data of the IM
CHK_STATIC_SUBS	Read (4 bytes)	0 or value*	CRC of all static data of the modules of the IM
CHK_OVERALL_SETUP	Read (4 bytes)	-	Overall CRC of all setup data of the IM and modules of the IM
CHK_REMANENT_LOCAL	Read (4 bytes)	-	CRC of retentive data of the IM
CHK_REMANENT_SUBS	Read (4 bytes)	0 or value*	CRC of all retentive data of the modules of the IM
CHK_WORKING_LOCAL	Read (4 bytes)	-	CRC of the parameters in STEP 7 for the IM
CHK_WORKING_SUBS	Read (4 bytes)	0 or value*	CRC of all parameters in STEP 7 for the modules of the IM
NOT USED	Read (14 bytes)	0	14 reserved bytes

* A value of 0 indicates that the IM firmware does not yet support the CRC calculation of the assigned modules. If the value is ≠ 0, the IM supports this function, regardless of whether the assigned modules support I&M4 data.

Reading I&M data records with data record 255 (distributed via PROFIBUS DP)

The modules support standardized access to identification data via DS 255 (index 65000 to 65003). For more information on the DS 255 data structure, refer to the specifications of the Profile Guidelines Part 1: Identification & Maintenance Functions, Order No.: 3.502, Version 2.1, May 2016

13.11.3 Example: Read out firmware version of the CPU with Get_IM_Data

Automation task

You want to check whether the modules in your automation system have the current firmware. You can find the firmware version of the modules in the I&M0 data. The I&M0 data is the basic information for a device. The I&M0 data contains information such as:

- Manufacturer ID
- Order number, serial number
- Hardware and firmware version

To read out the I&M0 data, use the "Get_IM_Data" instruction. You read the I&M0 data of all the modules in the user program of the CPU using "Get_IM_Data" instructions and store it in a data block.

Conditions and parameters

To read out the I&M data of the CPU, use the following block parameters of the "Get_IM_Data" instruction:

- LADDR: Enter the HW ID of the module at the block parameter "LADDR".
- IM_TYPE: Enter the I&M data number (e.g. "0" for I&M0 data) at the "IM_TYPE" block parameter.
- DATA: Area for storing the read I&M data (e.g. in a global data block). Store I&M0 data in an area of data type "IM0_Data".

This example shows you how to read out the I&M0 data of an ET 200SP CPU. To read out the I&M0 data of a different module, simply use the HW ID of the module at the LADDR parameter.

Solution

Proceed as follows to read out the I&M0 data of the CPU:

1. Create a global data block to store the I&M0 data.
2. Create a structure of the data type "IM0_Data" in the global data block. You can assign any name to the structure ("imData") in this case.

SLI_gDB_Get_IM_Data			
	Name	Data type	Start value
1	Static		
2	imData	IM0_Data	
3	done	Bool	false
4	busy	Bool	false
5	error	Bool	false
6	status	Word	16#0

Figure 13-12 Example: Data block for I&M data

3. Create the "Get_IM_Data" instruction in the user program, e.g. in OB 1.

4. Connect the "Get_IM_Data" instruction as follows:

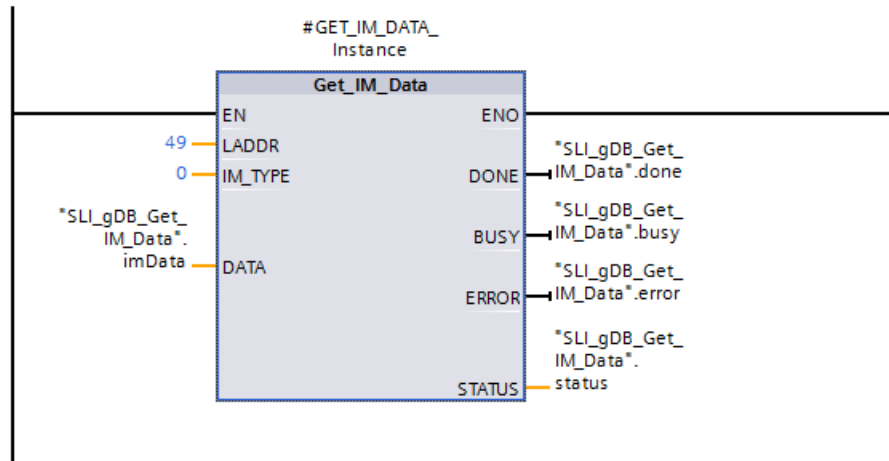

Figure 13-13 Example: Calling the "Get_IM_Data" instruction

5. Call the "Get_IM_Data" instruction in the user program.

Result

The "Get_IM_Data" instruction has stored the I&M0 data in the data block.

You can view the I&M0 data online in STEP 7, for example, in the data block with the "Monitor all" button. The CPU in the example is a 1512SP-1 PN (6ES7512-1DK01-0AK0) with the firmware version V2.5.

SLI_gDB_Get_IM_Data				
	Name	Data type	Start value	Monitor value
1	Static			
2	imData	IMO_Data		
3	Manufacturer_ID	UInt	0	42
4	Order_ID	String[20]	"	'6ES7 512-1DK01-0...
5	Serial_Number	String[16]	"	'S C-DOS710132013'
6	Hardware_Revision	UInt	0	3
7	Software_Revision	IMO_Version		
8	Type	Char	''	'V'
9	Functional	USInt	0	2
10	Bugfix	USInt	0	5
11	Internal	USInt	0	0
12	Revision_Counter	UInt	0	0
13	Profile_ID	UInt	0	0
14	Profile_Specific_Ty...	UInt	0	0
15	IM_Version	Word	16#0	16#0101
16	IM_Supported	Word	16#0	16#001E
17	done	Bool	false	TRUE
18	busy	Bool	false	FALSE
19	error	Bool	false	FALSE
20	status	Word	16#0	16#0000

Figure 13-14 Example: I&M0 data of an ET 200SP CPU

13.12 Shared commissioning of projects

Team Engineering

In Team Engineering several users from various engineering systems work on a project at the same time and access one ET 200SP CPU.

The users can edit separate parts of a master project independently of one another at the same time. The changes of the other editors are displayed in a synchronization dialog during the loading of the configuration in the CPU and synchronized automatically, if possible.

Certain online functions can also be executed at the same time from several engineering systems on a shared CPU, such as:

- Monitoring blocks on the CPU
- Modifying blocks on the CPU
- Trace functions

You can find detailed information on the topic of Team Engineering in the STEP 7 online help.

Maintenance

Maintenance of Ex modules

When you use an Ex module group, observe the information in the System Manual ET 200SP HA Distributed I/O system / ET 200SP Modules for devices used in an explosion hazardous environment (<https://support.industry.siemens.com/cs/ww/de/view/109795533/en>).

14.1 Removing and inserting I/O modules/motor starters (hot swapping)

Introduction

The ET 200SP distributed I/O system supports removal and insertion of I/O modules and motor starters (hot swapping) during operation (RUN mode):

- CPU/interface module HF, HS, R1: You can remove and insert any number of I/O modules/motor starters.
- ST, BA interface module: You can only remove and insert one I/O module/motor starter.

This section provides more information on removing and inserting I/O modules/motor starters.

I/O modules/motor starters must not be removed or inserted during operation (RUN operating state) in hazardous areas.

Requirements

The following table describes which modules you may insert and remove under which conditions:

Table 14-1 Removal and insertion of modules

Modules	Removal and insertion	Conditions
CPU	No	---
BusAdapter	No	---
CM DP module	No	---
Interface module	No	---
Interface module R1	Yes	The second interface module must be operational.

1) The motor starter also counts as removed in the parking position

14.1 Removing and inserting I/O modules/motor starters (hot swapping)

Modules	Removal and insertion	Conditions
I/O modules	Yes	<ul style="list-style-type: none"> • Digital output modules: Only when load is switched off • Digital modules: For load voltage above the safe extra-low voltage: Only with switched off load voltage supply • Technology modules: Only with switched off supply voltage L+ • AI Energy Meter: <ul style="list-style-type: none"> – Only when measuring voltage on primary side is switched off, or – Without the special current transformer terminal, measuring voltage and load current must be through the converters, which means the machine or the load must be switched off in the process. With the special terminal, the process can continue because the current transformer is isolated safely. However, the measuring voltage on the module, at connections UL1-UL3, still needs to be isolated.
PotDis-TerminalBlock	Yes	Only in de-energized state.
Motor starter	Yes ¹⁾	Only when the load is disconnected; when switched on, the motor starter switches off automatically when the rotary interlock is operated.
Server module	No	---

1) The motor starter also counts as removed in the parking position

NOTICE**Risk of hazardous system states**

If you remove and insert digital output modules with the load switched on or technology modules with the supply voltage switched on, this can result in hazardous system states. The ET 200SP distributed I/O system or the connected sensors may be damaged as a result. Therefore, a digital output module may only be inserted and removed when the load is switched off and a technology module may only be inserted and removed when the supply voltage is switched off.

NOTICE**Risk of hazardous system states**

If you remove and insert the AI Energy Meter ST with the primary-side voltage switched on at the current transformer, this can result in hazardous system states.

The ET 200SP distributed I/O system may be damaged as a result.

For this reason, remove and insert the AI Energy Meter ST only in the following cases:

- When measuring voltage is switched off on the primary side, or
- When a special current transformer terminal is used that short-circuits the secondary side of the transformer when the module is removed

Do not remove or insert the AI Energy Meter ST until you have removed this current transformer terminal. With the special terminal, the process can continue because the current transformer is isolated safely. However, the measuring voltage on the module at the connections UL1-UL3 still needs to be isolated.

⚠ WARNING**Risk of injury from automatic restart**

Inserting a motor starter can result in dangerous system states. The motor starter can restart again autonomously if an ON command is active.

This can result in serious injury caused by connected devices that are automatically started up.

Withdraw and insert a motor starter only after disconnecting the load.

Removing and inserting an I/O module or a motor starter in case of CPU/interface module HF, HS, R1

You can remove and insert any number of I/O modules/motor starters during operation. The CPU/interface module and the inserted I/O modules/motor starters remain in operation.

NOTICE**Reaction of the CPU to removal and insertion of the ET 200SP server module**

Please note that the backplane bus is deactivated when you remove the server module, regardless of the CPU operating state. Also note that the outputs do not adopt their configured substitute value behavior when you remove the server module.

This means you should not remove the server module when the CPU is in STARTUP, RUN and STOP modes. If you have nevertheless removed the server module, perform a POWER OFF/POWER ON after you have inserted the server module again.

Removing and inserting BusAdapter or CM DP module

Do not remove or insert the BusAdapter or CM DP module when the supply voltage is switched on. If you remove the BusAdapter or CM DP module after CPU startup, the supply voltage of the BusAdapter or CM DP module is switched off automatically. To switch on the supply voltage again, you need to perform a POWER OFF/POWER ON after inserting the BusAdapter/CM DP module.

Removing and inserting I/O module or motor starter with interface module ST, BA

1. You can remove **one** I/O module/**one** motor starter during operation. If you remove another I/O module/motor starter, this results in a station stop of the ET 200SP distributed I/O system:
 - All I/O modules/motor starters of the ET 200SP distributed I/O system fail → Substitute value behavior.
 - The interface module continues to exchange data with the IO controller and report diagnostics.

NOTE

If you want to replace several I/O modules/motor starters during operation, you must replace them one after the other.

2. If you insert all but one of the I/O modules/motor starters withdrawn during operation, all I/O modules will start up again.

NOTE

I/O modules/motor starters inserted in empty slots and then removed are also regarded as withdrawn during operation.

3. After a POWER OFF/POWER ON of the supply voltage 1L+ of the interface module, all available I/O modules/motor starters start up again in line with the configuration. Evaluation of the I/O modules/motor starters removed during operation starts again (see 1).

Removing I/O modules

To remove an I/O module, follow these steps:

1. Simultaneously press the top and bottom release buttons of the I/O module.
2. Pull the I/O module out of the BaseUnit, parallel in a forward direction.

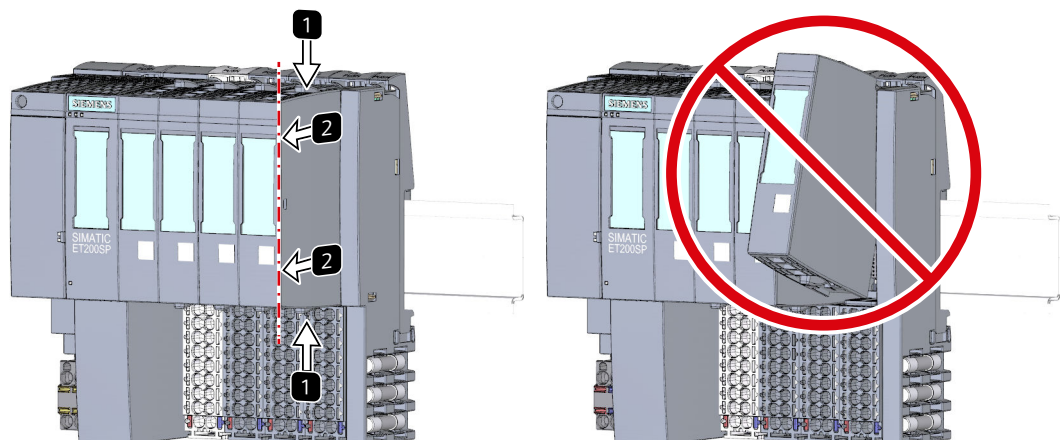

Figure 14-1 Removing I/O modules

14.2 Changing the type of an I/O module

Introduction

The coding element is a two-part element. When shipped from the factory, both parts are in the I/O module. When an I/O module is installed for the first time, a part of the coding element clicks into the BaseUnit. This mechanically prevents the insertion of a different module type.

There are two versions of the ET 200SP distributed I/O system:

- Mechanical coding element: Ensures the mechanical coding described above.
- Electronic coding element: In addition to the above-mentioned mechanical coding, this version also has an electronic, rewritable memory for module-specific configuration data (such as the F-destination address for fail-safe modules, parameter data for IO link master).

Requirement

Refer to section Application planning ([Page 80](#)).

NOTICE
Do not manipulate the coding element
Making changes to the coding element may cause dangerous conditions in your plant and/or result in damage to the outputs of the ET 200SP distributed I/O system.
To avoid physical damage, do not manipulate the coding.

Changing the type of an I/O module

You have already removed the I/O module.

To make a type change for an I/O module, follow these steps:

1. Push the coding element out of the BaseUnit using a screwdriver.
2. Put the coding element back onto the removed I/O module.
3. Insert the new I/O module (other module type) into the BaseUnit until you hear it click into place.
4. Label the new I/O module.

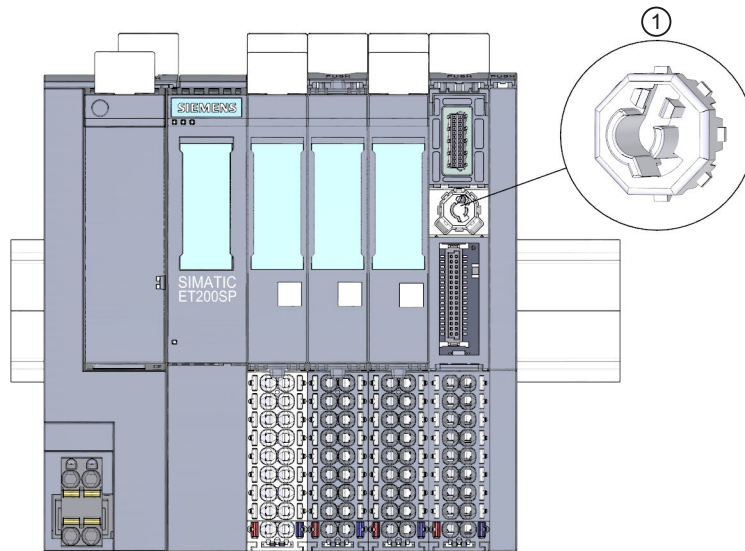

① Coding element

Figure 14-2 Changing the type of an I/O module

14.3 Replacing an I/O module

Introduction

When an I/O module is installed for the first time, a part of the coding element clicks into the BaseUnit. When you replace an I/O module with the same type of module, the correct coding element is already present in the BaseUnit.

Requirement

Refer to section Application planning ([Page 80](#)).

Replacing an I/O module

You have already removed the I/O module.

To replace an I/O module, follow these steps:

1. Remove the coding element (part) from the underside of the new I/O module.
2. Insert the new I/O module (same module type) into the BaseUnit until you hear it click into place.
3. Mark the new I/O module (labeling strip, equipment labeling plate).

14.4 Replacing a motor starter

The SIMATIC ET 200SP motor starter is wired.

To replace a SIMATIC ET 200SP motor starter, proceed as follows:

1. Turn the mechanical rotary interlock counter-clockwise to the assembly/disassembly position.

NOTE

Operating position/READY

Turn the mechanical rotary interlock out of the READY position only in the current-free state (motor off).

2. Remove the SIMATIC ET 200SP motor starter from the BaseUnit.
3. Assemble the new motor starter as described.

NOTE

Mounting the motor starter

You will find out how to mount the motor starter in chapter "Mounting/disassembly of motor starters (Page 165)".

WARNING

Risk of injury from automatic restart

When you replace the motor starter, the motor starter can restart again autonomously if an ON command is active. This can result in property damage or serious injury caused by connected devices that are automatically started up.

Revoke the ON commands on the motor starter before replacing the motor starter.

CAUTION

Protection against electrostatic charge

When handling and installing the SIMATIC ET 200SP motor starter, ensure protection against electrostatic charging of the components. Changes to the system configuration and wiring are only permissible after disconnection from the power supply.

14.5 Replacing the terminal box on the BaseUnit

Introduction

The terminal box is part of the BaseUnit. You can replace the terminal box if necessary. You do not need to dismantle the BaseUnit to do this.

The power and AUX buses of the potential group are not interrupted when you replace the terminal box.

Requirements

- The BaseUnit is mounted, wired and fitted with an I/O module.
- The terminal may only be replaced when the supply voltage is switched off.

Required tools

3 to 3.5 mm screwdriver

Procedure

Watch the video sequence: "Replace terminal box on BaseUnit"
(<https://support.automation.siemens.com/WW/view/en/95886218>)

Proceed as follows to replace the terminal box on a BaseUnit:

1. If present, turn off the supply voltage on the BaseUnit.
2. Simultaneously press the top and bottom release buttons of the I/O module and pull the module out of the BaseUnit.
3. Disconnect the wiring on the BaseUnit.
4. The release button of the terminal box is located on the underside of the BaseUnit. Use a screwdriver to push in the small opening at an angle from above.
5. Swivel the screwdriver slightly upwards to loosen the locking mechanism of the terminal box and lever the terminal box up out of the BaseUnit at the same time.
6. Remove the coding element (part) from the terminal box and press it onto the coding element (part) of the I/O module that you removed in step 2.
7. Insert the new terminal box into the BaseUnit at the top and swivel it downwards until it clips into the BaseUnit.
8. Wire up the BaseUnit.
9. Insert the I/O module into the BaseUnit.

10. Switch on a supply voltage on the BaseUnit.

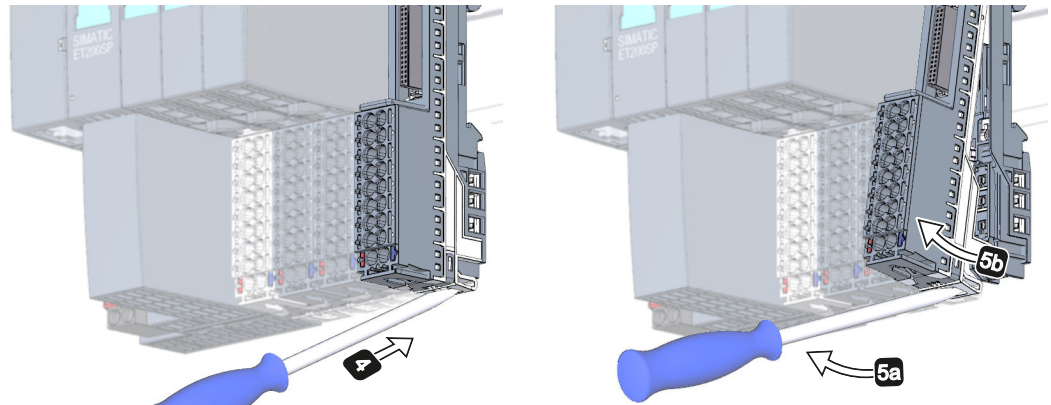

Figure 14-3 Replacing the terminal box on the BaseUnit

NOTE

When replacing the terminal box outside the control cabinet, make sure that you only mount light-colored terminal boxes on the matching BaseUnits with light-colored latch.

14.6 Firmware update

Introduction

During operation it may be necessary to update the firmware (e.g. to extend the available functions).

Update the firmware of the CPU/interface module and the I/O modules using firmware files. The retentive data is retained after the firmware has been updated.

We recommend that you always update to the latest firmware version available for the respective article number. The previous versions of the firmware are only intended as a backup to enable you to downgrade to the original version.

A firmware update has no effects on the user program of the CPU on which the update was performed. However, a downgrade can have effects on the user program if you use new functions in the user program which were not yet supported by the firmware of the CPU.

The following entry (<https://support.industry.siemens.com/cs/ww/en/view/109804718>) contains the current firmware statuses of the interface modules and modules of the ET 200SP.

The following entry (<https://support.industry.siemens.com/cs/de/en/view/109478459>) lists all firmware versions for the CPUs. You will also find a description of the new functions of the respective firmware versions.

Requirement

- You have downloaded the file(s) for the firmware update from the Product Support (<https://support.industry.siemens.com/cs/ww/en/ps>) web page.
On this web page, select:
 - Automation Technology > Automation Systems > Industrial Automation Systems
SIMATIC > SIMATIC ET 200 I/O Systems > ET 200 systems for the cabinet > ET 200SP.

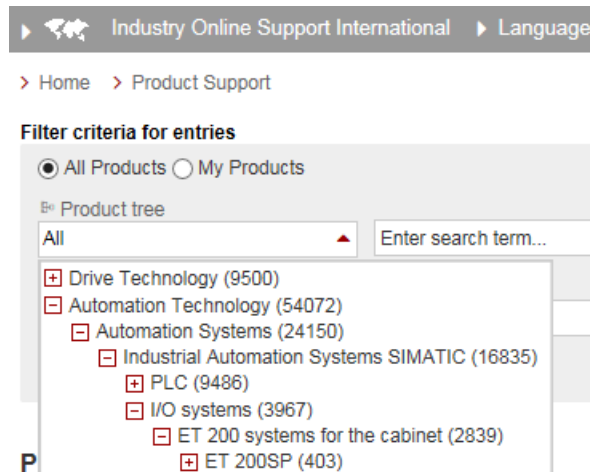

Figure 14-4 ET 200SP in the product tree

From this position, navigate to the specific type of module that you want to update. To continue, click on the "Software downloads" link under "Support". Save the desired firmware update files.

All information on ET 200SP

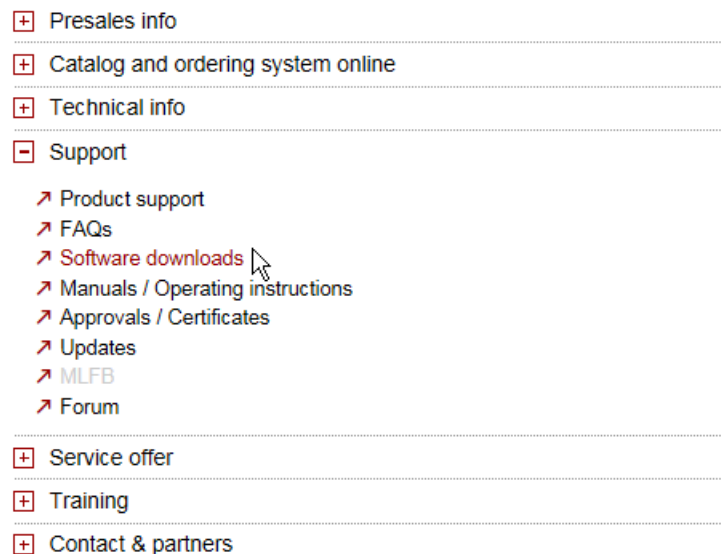



Figure 14-5 Selecting the software downloads

- Before installing the firmware update, make sure that the modules are not being used.
- Modules with firmware version V0.0.0 do not support the "firmware update" function.

NOTE**Firmware update of I/O modules**

The L+ supply voltage must be present on the module at the start of and during the firmware update.

Additional requirement for fail-safe modules

 WARNING
Check the firmware version for fail-safe approval
When using a new firmware version, always check that the version is approved for use in the module in question.
The attachments of the certificate (https://support.automation.siemens.com/WW/view/en/49368678/134200) for SIMATIC Safety specify the firmware version that is approved.

Options for the firmware update

The following options are available for updating firmware:

- Online in STEP 7 via Online & Diagnostics
- Online in STEP 7 via accessible devices (PROFINET)
- Online with the MultiFieldbus Configuration Tool (MFCT)
(<https://support.industry.siemens.com/cs/ww/en/view/109781837>)
- Using a SIMATIC memory card (possible for CPU and central I/O modules)
- Via the integrated Web server (possible for CPU as well as centralized and distributed I/O modules)
- Online via the SIMATIC Automation Tool

NOTE**Firmware files of the CPU**

If you perform a CPU update with STEP 7, you require STEP 7 (TIA Portal as of V13 Update 3).

The table below provides an overview of the media that can be used to update the firmware of a specific module.

Table 14-2 Overview of firmware update options

Firmware update	CPU	Interface module	I/O module
STEP 7 (TIA Portal)	✓ ¹⁾	✓	✓
STEP 7 (V5.5 SP2 or higher) ²⁾	--	✓	✓
Accessible devices	✓	✓	✓
MFCT	--	✓	✓

¹⁾ V13 update 3 or higher

²⁾ If the firmware files are only available in this format, you can also install the files using STEP 7 (TIA Portal) but not the SIMATIC memory card or the Web server.

Firmware update	CPU	Interface module	I/O module
SIMATIC memory card	✓	--	✓
Web server of the CPU	✓	--	✓
SIMATIC Automation Tool	✓	✓	✓

1) V13 update 3 or higher

2) If the firmware files are only available in this format, you can also install the files using STEP 7 (TIA Portal) but not the SIMATIC memory card or the Web server.

Firmware update for the motor starter

The following options are available for updating firmware for the motor starter.

- Online via PROFINET IO/PROFIBUS DP (with STEP 7)
- Via the integrated Web server (possible for CPU as well as centralized and distributed I/O modules)
- With the TIA Portal:
 - As of SIMATIC STEP 7 V13 SP1 with installed HSP for the ET 200SP motor starter
 - SIMATIC STEP 7 V14 and higher
 Over a SIMATIC memory card
- With SIMATIC STEP 7 version V5.5 SP4 and higher
- For fail-safe motor starters with the TIA Portal Version V14 SP1 or higher and installed HSP.

NOTE

The firmware update for fail-safe motor starters must take place in a separate ET 200SP system in which only the fail-safe motor starter that is to be updated is inserted.

Installation of the firmware update

WARNING

Risk of impermissible system states

The CPU switches to STOP mode or the interface module to "station failure" as a result of the firmware update being installed. STOP or station failure can have an adverse effect on the operation of an online process or a machine.

Unexpected operation of a process or a machine can lead to fatal or severe injuries and/or to material damages.

Make sure that the CPU/interface module is not executing any active process before installing the firmware update.

Procedure online in STEP 7 via Online & Diagnostics

Requirements: There is an online connection between the CPU/module and PG/PC.

Proceed as follows to perform an online firmware update via STEP 7:

1. Select the module in the device view.
2. Select the "Online & diagnostics" command from the shortcut menu.
3. Select the "Firmware update" group in the "Functions" folder.
4. Click the "Browse" button to select the path to the firmware update files in the "Firmware update" area.
5. Select the suitable firmware file. The table in the firmware update area lists all modules for which an update is possible with the selected firmware file.
6. Click the "Run update" button. If the module can interpret the selected file, the file is downloaded to the module.

Updating the firmware

The "Run firmware after update" check box is always selected.

When the loading process is complete, the CPU adopts the firmware and then operates with this new firmware.

NOTE

If a firmware update is interrupted, you need to remove and insert the module before starting the firmware update again.

Procedure online in STEP 7 via accessible devices

To perform a firmware update online via accessible devices, follow these steps:

1. From the "Online" menu, select the "Accessible devices" menu item.
2. In the "Accessible devices" dialog, search for the accessible devices for the selected PROFINET interface.
3. To go to a device in the project tree, select the desired device from the list of accessible devices and click the "Show" button.
4. In the project tree, select the "Online & diagnostics" option of the relevant device and perform the firmware update under the category "Functions/Firmware Update" (CPU, Local modules).

You can find information on how to perform a firmware update when your project has no connection to a CPU in the following FAQ on the Internet

(<https://support.industry.siemens.com/cs/ww/en/view/89257657>).

Procedure using the SIMATIC memory card

To perform a firmware update using the SIMATIC memory card, follow these steps:

1. Insert a SIMATIC memory card into the SD card reader of your programming device/computer.
2. To store the update file on the SIMATIC memory card, select the SIMATIC memory card in the "Card Reader/USB memory" folder in the project tree.
3. Select the "Card Reader/USB memory > Create firmware update memory card" command in the "Project" menu.
4. Use a file selection dialog to navigate to the firmware update file. In a further step you can decide whether you want to delete the content of the SIMATIC memory card or whether you want to add the firmware update files to the SIMATIC memory card.
5. Insert the SIMATIC memory card with the firmware update files into the CPU.

Point to note when updating firmware for analog modules and the IO-Link Master CM 4xIO-Link communication module

If you want to update firmware for analog modules or the IO-Link Master CM 4xIO-Link communication module, you must supply a load current of 24 V DC to the modules through the infeed element.

Procedure

1. Remove any inserted SIMATIC memory card.
2. Insert the SIMATIC memory card with the firmware update files into the CPU.
3. The firmware update begins shortly after the SIMATIC memory card has been inserted.
4. Remove the SIMATIC memory card after the firmware update has been completed.
The RUN LED on the CPU lights up yellow, the MAINT LED flashes yellow.

If you want to use the SIMATIC memory card later as a program card, delete the firmware update files manually.

NOTE

If your hardware configuration contains several modules, the CPU updates all affected modules in the slot sequence, which means in ascending order of the module position in the STEP 7 device configuration.

NOTE

Memory size of the SIMATIC memory card

If you perform a firmware update via the SIMATIC memory card, you must use a large enough card based on the CPU used and the associated I/O modules.

Note the specified file sizes of the update files when downloading them from Siemens Industry Online Support. The file size information is especially important when you perform the firmware update not only for the CPU but also for the associated I/O modules, communication modules, etc. The total size of the update files must not exceed the available memory size of your SIMATIC memory card.

You can find more information on the capacity of SIMATIC memory cards in the section Accessories/spare parts (Page 339) and in the function manual Structure and use of the CPU memory (<https://support.industry.siemens.com/cs/de/en/view/59193101>).

Procedure: via the integrated Web server

The procedure is described in the Web server (<https://support.automation.siemens.com/WW/view/en/59193560>) function manual.

Procedure: online via the SIMATIC Automation Tool

The procedure is described in the SIMATIC Automation Tool (<https://support.industry.siemens.com/cs/ww/en/view/98161300>) manual (included in the SIMATIC Automation Tool).

Behavior during the firmware update

Note the following behavior of the relevant I/O module when carrying out a firmware update:

- The DIAG LED display flashes red.
- The I/O module retains its current diagnostic status.
- Diagnostics alarm: Channel temporarily unavailable (error code 31_D/1F_H)
- All outputs are in a current-free/voltage-free state

Note the following behavior when carrying out the firmware update of the motor starter:

- RN flashes green and ER flashes red.
- ST/OL flashes green and MAN flashes yellow.
- The motor starter powers up after completion of the firmware update. Diagnoses are reset. The firmware update does not affect the TMM and the cooling time.
- The sensor supply of the DI module remains active.

Behavior after the firmware update

After the firmware update, check the firmware version of the updated module.

Reference

You will find more information on these procedures in the STEP 7 online help.

14.7 Resetting CPU/interface module (PROFINET) to factory settings

14.7.1 Resetting the CPU to factory settings

Introduction

The CPU can be reset to its delivery state using "Reset to factory settings". The function deletes all information saved internally on the CPU.

If you want to remove a PROFINET CPU and use it elsewhere with a different program, or put it into storage, we recommend that you reset the CPU to its factory settings. When restoring the factory settings, remember that you also delete the IP address parameters.

Recommendation

Put the CPU into its delivery state if:

- You remove a CPU and use it elsewhere with a different program
- You return the CPU to stock

When resetting to factory settings, remember that the IP address parameters are also deleted.

Options for resetting a CPU to factory settings

The following options are available for resetting the CPU to its factory settings:

- Using the mode selector
- Using STEP 7
- Using the SIMATIC Automation Tool

Procedure using the mode selector

Make sure that there is no SIMATIC memory card in the CPU and that the CPU is in STOP mode (the RUN/STOP LED is lit yellow).

NOTE

Reset to factory settings ↔ Memory reset

The procedure described below also corresponds to the procedure for a memory reset:

- Selector operation with inserted SIMATIC memory card: CPU executes a memory reset
 - Selector operation without inserted SIMATIC memory card: CPU executes reset to factory settings
-

Perform a reset to factory settings when there is no SIMATIC memory card inserted as follows:

1. Set the mode selector to the STOP position.
Result: The RUN/STOP LED lights up yellow.
2. Set the mode selector to the MRES position. Hold the mode selector in this position until the RUN/STOP LED lights up for the second time and remains lit (this takes 3 seconds). After this, release the switch.
3. Within the next three seconds, switch the mode selector back to the MRES position, and then back to STOP again.

Result: The CPU executes the "Reset to factory settings", during which time the RUN/STOP LED flashes yellow. When the RUN/STOP LED lights up yellow, the CPU has been reset to factory settings and is in the STOP mode. The "Reset to factory settings" event is entered in the diagnostics buffer.

NOTE

The IP address of the CPU is also deleted when the CPU is reset to the factory settings through the mode selector.

For information on the memory reset of the CPU, refer to the section CPU memory reset ([Page 265](#)).

Procedure using STEP 7

Make sure that an online connection to the CPU exists.

To reset a CPU to factory settings using STEP 7, follow these steps:

1. Open the Online and Diagnostics view of the CPU.
2. In the "Functions" folder, select the "Reset to factory settings" group.
3. If you want to keep the IP address, select the "Retain IP address" option button. If you want to delete the IP address, select the "Reset IP address" option button.

NOTE

"Delete IP address" deletes all IP addresses, regardless of how you established the online connection.

If there is a SIMATIC memory card inserted, selecting the "Delete IP address" option has the following effect:

- The IP addresses are deleted and the CPU is reset to factory settings.
 - The configuration (including IP address) on the SIMATIC memory card is then downloaded to the CPU. If there is no saved configuration (because the SIMATIC memory card has been cleared or formatted, for example), no new IP address is assigned.
-

4. Click the "Reset" button.
5. Click "OK" in response to the confirmation prompts.

Result: The CPU executes the "Reset to factory settings", during which time the RUN/STOP LED flashes yellow. When the RUN/STOP LED lights up yellow, the CPU has been reset to factory settings and is in the STOP mode. The "Reset to factory settings" event is entered in the diagnostics buffer.

Procedure using the SIMATIC Automation Tool

The procedure is described in the SIMATIC Automation Tool (<https://support.industry.siemens.com/cs/ww/en/view/98161300>) manual (included in the SIMATIC Automation Tool).

Result after resetting to factory settings

The following table provides an overview of the contents of the memory objects after the reset to factory settings.

Table 14-3 Result after resetting to factory settings

Memory object	Content
Actual values of the data blocks, instance data blocks	Initialized
Bit memory, timers and counters	Initialized
Certain retentive tags from technology objects (e.g. adjustment values of absolute encoders)	Initialized
Diagnostics buffer entries	Initialized
IP address	Depends on the procedure: <ul style="list-style-type: none"> Using mode switch: is deleted Using STEP 7: Depending on the setting of the "Keep IP address"/"Delete IP address" option buttons
Device name	Is set to "CPU"
Counter readings of the runtime meters	Initialized
Time of day	Is set to "00:00:00, 01.01.2012"

If a SIMATIC memory card was inserted prior to the factory reset, the CPU downloads the configuration contained on the SIMATIC memory card (hardware and software). A configured IP address then becomes valid again.

NOTE

Password for protection of confidential configuration data

The password for protection of confidential configuration data is retained after the CPU is reset to factory settings. The password is only deleted when the "Delete password for protection of confidential PLC configuration data" option is set.

You can find additional information on the password for protection of confidential configuration data in the Communication

(<https://support.industry.siemens.com/cs/ww/en/view/59192925>) function manual.

Reference

Additional information on the topic "Resetting to factory settings" can be found in the Structure and use of the CPU memory

(<https://support.automation.siemens.com/WW/view/en/59193101>) function manual, section on memory areas and retentivity, and in the STEP 7 online help.

14.7.2 Resetting interface module (PROFINET IO) to factory settings

Function

The "Reset to factory settings" function returns the interface module (PROFINET) to its delivery state.

Reset options

- Using STEP 7 (online via PROFINET IO)
- Using a reset button on the interface module (on rear). Exception: There is no reset button on the IM 155-6 PN BA and the IM 155-6 PN R1. See section Resetting the interface module (PROFINET IO) to factory settings with a RESET button ([Page 302](#)).

Procedure using STEP 7

To reset an interface module to factory settings using STEP 7, follow these steps:
Make sure that an online connection to the interface module exists.

1. Open the online and diagnostics view of the interface module.
2. In the "Functions" folder, select the "Reset to factory settings" group.
3. Click the "Reset" button.
4. Click "OK" in response to the confirmation prompt.

Result: The interface module then performs "Reset to factory settings".

Result after resetting to factory settings

The following table shows the values of the interface module properties after a factory reset:

Table 14-4 Properties of the interface module as shipped

Properties	Value
Parameters	Default setting
IP address	Not available
Device name	Not available
MAC address	Available
I&M data	Identification data (I&M0) available Maintenance data (I&M1, 2, 3, 4) reset *
Firmware version	Available

NOTE

Failure of downstream stations is possible

Downstream stations on a bus segment can fail when the factory settings are restored on an interface module.

NOTE

Behavior of the installed I/O modules during reset to factory settings

The I/O modules of the ET 200SP distributed I/O system assume the unconfigured state after a reset to factory settings. The interface module does not acquire any input data and does not output any output data.

Reference

You will find more information on the procedure in the STEP 7 online help.

14.7.3 Resetting the interface module (PROFINET IO) to factory settings with a RESET button

Requirement

The supply voltage to the interface module is turned on.

Required tools

3 to 3.5 mm screwdriver (for resetting with a RESET button)

Procedure

Proceed as follows to reset an interface module to factory settings by means of the RESET button:

1. Remove the interface module from the mounting rail (see Mounting the CPU/interface module [\(Page 118\)](#)) and swivel it downwards.
2. The RESET button is located on the rear of the interface module behind a small opening: Press a screwdriver into the small opening for at least 3 seconds to activate the RESET button.
3. Install the interface module back on the mounting rail (see Mounting the CPU/interface module [\(Page 118\)](#)).

4. Assign parameters to the interface module again.

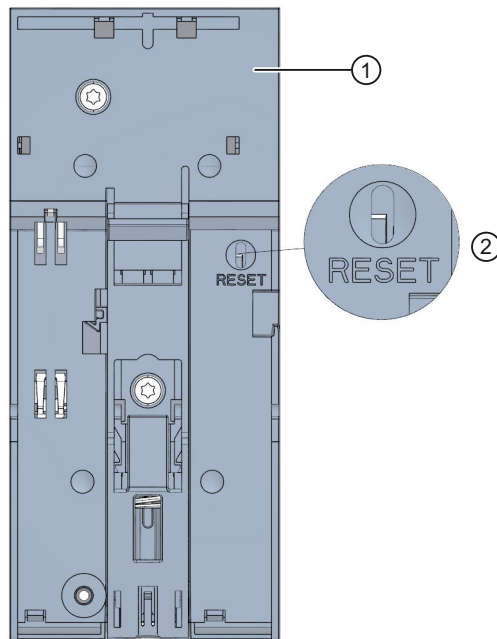

- ① Rear of the interface module
- ② RESET button

Figure 14-6 RESET button

14.8 Reaction to faults in fail-safe modules and fail-safe motor starters

Safe state (safety concept)

The basic principle behind the safety concept is the existence of a safe state for all process variables.

NOTE

For digital F-modules, this safe state is the value "0". This applies to both sensors and actuators. In the case of the fail-safe motor starters, the load is shut down in a fail-safe manner.

Fault reactions and startup of the F-system

The safety function means that fail-safe modules use substitute values (safe state) instead of process values (**passivation of the fail-safe module**) in the following situations:

- When the F-system is started up
- If errors are detected during safety-related communication between the F-CPU and the F-module via the PROFIsafe safety protocol (communication error)
- If F-I/O faults or channel faults are detected (e.g. crossover or discrepancy errors)

Detected faults are written to the diagnostic buffer of the F-CPU and communicated to the safety program in the F-CPU.

F-modules cannot save errors as retentive data. After a POWER OFF / POWER ON, any faults still existing are detected again during startup. However, you have the option of saving faults in your safety program.

WARNING

For channels that you set to "deactivated" in STEP 7, no diagnostic response or error handling is triggered when a channel fault occurs, not even when such a channel is affected indirectly by a channel group fault ("Channel activated/deactivated" parameter).

Remedying faults in the F-system

To remedy faults in your F-system, follow the procedure described in IEC 61508-1:2010 section 7.15.2.4 and IEC 61508-2:2010 section 7.6.2.1 e.

The following steps must be performed:

1. Diagnosing and repairing the fault
2. Revalidation of the safety function
3. Recording in the service report

Substitute value output for fail-safe modules

In the case of F-modules with inputs, if there is passivation, the F-system provides substitute values (0) for the safety program instead of the process data pending at the fail-safe inputs.

In the case of F-modules with outputs, if there is passivation, the F-system transfers substitute values (0) to the fail-safe outputs instead of the output values provided by the safety program. The output channels are de-energized. This also applies when the F-CPU goes to STOP mode. Assignment of substitute values is not possible.

Substitute values are used either for the relevant channel only or for all channels of the relevant failsafe module depending on:

- The F-system used
- The type of error that occurred (F-I/O, channel fault or communication error)
- The F-module parameter assignment

Reintegration of a fail-safe module

The system changes from fail-safe to process values (reintegration of an F-module) either automatically or only after user acknowledgment in the safety program. If channel faults occur, it may be necessary to remove and reinsert the F-module. A detailed listing of faults requiring removal and insertion of the F-module can be found in the section Diagnostic messages of the respective F-module.

After reintegration, the following occurs:

- In the case of an F-module with inputs, the process data pending at the fail-safe inputs is made available to the safety program again
- In the case of an F-module with outputs, the output values provided in the safety program are transferred to the fail-safe outputs again

Additional information on passivation and reintegration

For additional information on passivation and reintegration of F-I/O, refer to the SIMATIC Safety, Configuring and Programming

(<https://support.automation.siemens.com/WW/view/en/54110126>) manual.

Behavior of the fail-safe module with inputs in the event of a communication disruption

F-modules with inputs respond differently to communication errors compared to other errors. If a communication error is detected, the current process values remain set at the inputs of the F-module. There is no passivation of the channels. The current process values are passivated in the F-CPU.

14.9 Maintenance and repair

The components of the ET 200SP distributed I/O system are maintenance-free.

NOTE

Repairs to a SIMATIC ET 200SP system may only be carried out by the manufacturer.

NOTE

Cleaning the ET 200SP

Requirement: All supply voltages on the ET 200SP distributed I/O system are switched off. Observe the five safety rules for working in and on electrical installations.

If you need to clean the devices, use dry ESD cleaning cloths (observing the ESD protective measures).

14.10 Warranty

To meet the conditions of the warranty, you must observe the safety and commissioning instructions.

Test and service functions

15.1 Test functions

Introduction

You can test the flow of your user program on the CPU. You monitor signal states and values of tags, and preassign tags with values so that you can simulate specific situations for the program flow.

NOTE**Using test functions**

The use of test functions can influence the program execution time and thus the cycle and response times of the controller to a slight extent (a few milliseconds).

Requirements

- There is an online connection to the relevant CPU.
- An executable program is in the CPU.

Test options

- Testing with program status
- Testing with breakpoints
- Testing with a watch table
- Testing with a force table
- Testing with PLC tag table
- Testing with data block editor
- Testing with the LED flash test
- Testing with trace function

Testing with program status

The program status allows you to monitor the execution of the program. You can display the values of operands and the results of logic operations (RLO) allowing you to recognize and fix logical errors in your program.

NOTE

Restrictions for the "Program status" function

The monitoring of loops can significantly increase the cycle time. The increase in cycle time depends on the following factors:

- The number of tags to be monitored
 - The actual number of loops run through
-

 WARNING
--

Testing with program status

A test with the "Program status" function can produce serious property damage and personal injury in the event of malfunctions or program errors.

Make sure that you take appropriate measures to exclude the risk of hazardous conditions occurring before running a test with the "Program status" function.
--

Testing with breakpoints

With this test option, you set breakpoints in your program, establish an online connection, and enable the breakpoints on the CPU. You then execute a program from one breakpoint to another.

Requirements:

- Setting breakpoints is possible in the programming language SCL or STL.

Testing with breakpoints provides you with the following advantages:

- Localization of logic errors step by step
 - Simple and quick analysis of complex programs prior to actual commissioning
 - Recording of current values within individual executed loops
 - Use of breakpoints for program validation also possible in SCL/STL networks within LAD/FBD blocks
-

NOTE

Restriction during testing with breakpoints

- When you test with breakpoints, there is a risk of overwriting the cycle time of the CPU.
 - If you are using technology objects and test them with breakpoints, the CPU switches to STOP mode.
-

NOTE**F-System SIMATIC Safety**

The setting of breakpoints in the standard user program results in errors in the safety program:

- Sequence of F cycle time monitoring
- Error in communication with the fail-safe I/O
- Error during safety-oriented CPU-CPU communication
- Internal CPU error

If you still wish to use breakpoints for testing, you must deactivate the safety mode beforehand. This will result in the following errors:

- Error in communication with the fail-safe I/O
 - Error during safety-oriented CPU-CPU communication
-

Testing with watch tables

The following functions are available in the watch table:

- **Monitoring of tags**
With watch tables, you can monitor the current values of individual tags of a user program or a CPU on the PG/PC and Web server. For the Web server to be able to display the value of tags, you must specify a symbolic name for each tag in the "Name" column of the watch table.
You can monitor the following operand areas:
 - Inputs and outputs (process image) and bit memory
 - Contents of data blocks
 - Peripheral inputs and peripheral outputs
 - Timers and counters
- **Modifying tags**
Use this function to assign fixed values to the individual tags of a user program or CPU. Modifying is also possible for testing with program status.
You can control the following operand areas:
 - Inputs and outputs (process image) and bit memory
 - Contents of data blocks
 - Peripheral inputs and peripheral outputs (for example, %I0.0:P, %Q0.0:P)
 - Timers and counters
- **"Enable peripheral outputs" and "Control immediately"**
These two functions enable you to assign fixed values to individual peripheral outputs of a CPU in the STOP mode. You can also use them to check your wiring.

Testing with the force table

The following functions are available in the force table.

- **Monitoring of tags**

With force tables, you can display the current values of individual tags of a user program or a CPU on the PG/PC and Web server. You can monitor the table with or without a trigger condition. For the Web server to be able to display the value of tags, you must specify a symbolic name for each tag in the "Name" column of the force table.

You can monitor the following tags:

 - Bit memory
 - Contents of data blocks
 - Peripheral inputs (e.g. %I0.0:P)
- **Modifying tags**

With this function, you assign fixed values to the individual tags of a user program or a CPU on the PG/PC and Web server. Modifying is also possible for testing with program status.

You can control the following tags:

 - Bit memories
 - Contents of data blocks
 - Peripheral inputs (e.g. %I0.0:P)
- **Forcing of peripheral inputs and peripheral outputs**

You can force individual peripheral inputs or peripheral outputs.

 - Peripheral inputs: Forcing of peripheral inputs (for example %I0.0:P) represents the "bypassing" of sensors/inputs by specifying fixed values to the program. Instead of the actual input value (via process image or via direct access) the program receives the force value.
 - Peripheral outputs: Forcing of peripheral outputs (for example %Q0.0:P) represents the "bypassing" of the complete program by setting fixed values for the actuators.

You can use the force table to simulate different test environments and also overwrite tags in the CPU with a fixed value. This enables you to intervene in the running process to control it.

Difference between modifying and forcing

The fundamental difference between the modifying and forcing functions consists in the storage behavior:

- **Modifying:** Modifying of tags is an online function and is not stored in the CPU. You can end modifying of tags in the watch table or by disconnecting the online connection.
- **Forcing:** A force job is written to the SIMATIC memory card and is retained after a POWER OFF. You can only end the forcing of peripheral inputs and peripheral outputs in the force table.

Testing with PLC tag table

You can monitor the data values that tags currently assume in the CPU directly in the PLC tag table. To do this, open the PLC tag table and start monitoring.

Additionally, you have a possibility of copying PLC tags to a monitoring or force table and of monitoring, controlling or forcing them there.

Testing with data block editor

Various possibilities of monitoring and controlling tags are at your disposal in the data block editor. These functions directly access the current values of the tags in the online program. Current values are the values that the tags assume at the current time during program execution in the CPU's work memory. The following functions for monitoring and control are possible via the data block editor:

- Monitoring tags online
- Controlling individual actual values
- Creating a snapshot of the actual values
- Overwriting actual values with a snapshot

NOTE

Setting data values during commissioning

During commissioning of a system, data values often have to be adjusted to optimally adapt the program to the general conditions prevailing locally. To this end, the declaration table offers a few functions for data blocks.

Testing with the LED flash test

In many online dialogs, you can perform an LED flash test. This function is useful, for example, when you are not sure which device in the hardware configuration corresponds to the device currently selected in the software.

When you click the "Flash LED" button, an LED flashes on the currently selected device. In the case of the CPU, the RUN/STOP, ERROR and MAINT LEDs flash. They flash until you cancel the flashing test.

Testing with trace function

The trace function is used to record the CPU tags, depending on the settable trigger conditions. Tags are, for example, the drive parameters or system and user tags of a CPU. The CPU saves the recordings. You can display and evaluate the recordings with STEP 7, if necessary.

The trace function can be called from the CPU's folder in the project tree, under the name "Traces".

In connection with trace functions, also pay attention to the following FAQ on the Internet (<https://support.industry.siemens.com/cs/ww/en/view/102781176>).

Simulation

With STEP 7 you can run and test the hardware and software of the project in a simulated environment. Start the simulation using the menu command "Online" > "Simulation" > "Start".

Reference

You can find more information on test functions in the STEP 7 online help. Further information about testing with trace and logic analyzer functions is available in the Function Manual Using the trace and logic analyzer function (<https://support.automation.siemens.com/WW/view/en/64897128>).

15.2 Reading out/saving service data

Service data

In addition to the contents of the diagnostics buffer, the service data contains a wide range of extra information about the internal status of the CPU. If a problem occurs with the CPU that cannot be solved with other methods, send the service data to Service & Support. The service data allows Service & Support to run fast analysis of the problems that have occurred.

NOTE

You cannot simultaneously execute a download to the device while reading out the service data of the CPU.

Methods of reading service data

You can read service data with:

- The Web server
- STEP 7
- the SIMATIC memory card
- MultiFieldbus Configuration Tool (MFCT)

Procedure using the Web server

To read service data using the Web server, follow these steps:

1. Open a Web browser that is suitable for communication with the CPU.
2. Enter the following address in the address bar of the web browser:
https://<CPU IP address>/save_service_data, e.g. https://172.23.15.3/save_service_data
3. The service data page will appear on your screen, with a button for saving the service data.



Figure 15-1 Reading out service data with the Web server

4. Save the service data locally on your PC/programming device, by clicking "Save ServiceData".

Result: The CPU stores the data in a .dmp file with the following naming convention: "<Article number> <Serial number> <Time stamp>.dmp". The file name cannot be changed.

NOTE

If you have defined your user page as the Web server's home page, direct access to the service data by entering the CPU's IP address is not possible. You will find more information on reading out service data via a user-defined page in the Web server (<https://support.automation.siemens.com/WW/view/en/59193560>) function manual.

Procedure using STEP 7

You can find more information on saving service data of the CPU (and interface module) in the STEP 7 online help using keyword "Saving service data".

Procedure via the SIMATIC memory card

If Ethernet communication with the CPU is not possible, use the SIMATIC memory card to read out the service data. In all other cases, read the service data via the web server or STEP 7..

The procedure using the SIMATIC memory card is more time-consuming than the other options for reading out the service data. You must also ensure before reading out that there is sufficient memory space on the SIMATIC memory card.

To read service data using the SIMATIC memory card, follow these steps:

1. Insert the SIMATIC memory card into the card reader of your PC / programming device.
2. Open the job file S7_JOB.S7S in an editor.
3. Overwrite the entry PROGRAM with the string DUMP in the editor.
Do not use any spaces/line breaks/quotation marks to ensure that the file size is exactly 4 bytes.
4. Save the file under the existing file name.
5. Ensure that the SIMATIC memory card is not write-protected and insert the SIMATIC memory card in the card slot of the CPU. Pay attention to the procedure described in Removing/inserting the SIMATIC memory card on the CPU ([Page 258](#)).

Result: The CPU writes the service data file DUMP.S7S to the SIMATIC memory card and remains in STOP mode.

Service data transfer is complete when the STOP LED stops flashing and is lit continuously. If the service data transfer was successful, only the STOP LED lights up.

In the event of errors during the transfer, the STOP LED is lit continuously and the ERROR LED flashes. The CPU also stores a text file with information on the error that occurred in the DUMP.S7S folder.

Technical specifications

16.1 Introduction

Introduction

This chapter lists the technical specifications of the system:

- The standards and test values that the ET 200SP distributed I/O system complies with and fulfills.
- The test criteria according to which the ET 200SP distributed I/O system was tested.

Technical specifications of the (F-)modules

The technical specifications of the individual (F-)modules can be found in the equipment manuals of the corresponding (F-)modules. In the event of deviations between the statements in this document and the manuals, the statements in the manuals take priority.

Technical specifications of the Ex modules

You can find the technical specifications of the Ex modules in the System Manual ET 200SP HA Distributed I/O system / ET 200SP Modules for devices used in an explosion hazardous environment (<https://support.industry.siemens.com/cs/ww/en/view/109795533>) and in the Ex I/O modules manuals.

Technical specifications of the motor starters

You can find the technical specifications of the motor starters in the ET 200SP Motor Starter (<https://support.industry.siemens.com/cs/ww/en/view/109479973>) Equipment Manual.

16.2 Safety information

Safety information

 WARNING
Personal injury and damage to property may occur In hazardous areas, personal injury and damage to property may occur if you disconnect plug-in connections during operation of an ET 200SP distributed I/O system. Always switch off the power to the ET 200SP distributed I/O system when disconnecting plug-in connections in hazardous areas.

 WARNING
Explosion hazard If you replace components, compliance with Class I, Div. 2 or zone 2 may become invalid.

 WARNING
Area of application This device is only suitable for use in Class I, Div. 2, Group A, B, C, D; Class I, zone 2, Group IIC, or in non-hazardous areas.

Safety of the plant or the system

NOTICE
Safety is the responsibility of the assembler The safety of any plant or system incorporating the equipment is the responsibility of the assembler of the plant or system.

Five safety rules for work in or on electrical installations

To prevent electrical accidents when working in or on electrical installations, a set of rules have been defined, which are summarized in EN 50110-1 (VDE 0105-1) as the "five safety rules":

1. Isolate
2. Secure against switching on again
3. Verify that the equipment is not live
4. Ground and short-circuit
5. Erect barriers around or cover adjacent live parts

These five safety rules must be applied in the above order prior to starting work on an electrical system. After completing the work, proceed in the reverse order.

It is assumed that every electrician is familiar with these rules.

16.3 Marks and approvals

Marks and approvals on the nameplate

The following overview provides information about the possible marks and approvals. Only the marks and approvals specified on the nameplate apply to the device.

You can find the associated certificates for download on the Internet

(<https://support.industry.siemens.com/cs/ww/en/ps/14031/cert>).

CE marking



The ET 200SP distributed I/O system meets the requirements and protection targets of the following directives. The distributed I/O system complies with the harmonized European standards (EN) for programmable logic controllers published in the official journals of the European Union.

- 2014/35/EU "Electrical equipment designed for use within certain voltage limits" (Low Voltage Directive)
- 2014/30/EU "Electromagnetic Compatibility" (EMC Directive)
- 2014/34/EU "Equipment and protective systems intended for use in potentially explosive atmospheres" (ATEX directive)
- 2011/65/EU "Restriction of the use of certain hazardous substances in electrical and electronic equipment" (RoHS Directive)
- 2006/42/EC "Machinery Directive" for ET 200SP fail-safe modules

The EC Declarations of Conformity are available for the responsible authorities and are kept at the following address:

Siemens AG
Digital Industries
Factory Automation
DI FA TI COS TT
P.O. Box 1963
D-92209 Amberg

You can also find the EC Declarations of Conformity on the Internet

(<https://support.industry.siemens.com/cs/ww/es/ps/14031/cert?ct=444&ci=526>).

UK Conformity Assessed marking



The ET 200SP distributed I/O system complies with the designated British standards (BS) for programmable logic controllers published in the official consolidated list of the British Government. The ET 200SP distributed I/O system meets the requirements and protection targets of the following regulations and associated supplements:

- The Electrical Equipment (Safety) Regulations 2016 (S.I. 2016 No. 1101), and related amendments
- Electromagnetic Compatibility Regulations 2016 (S.I. 2016 No. 1091), and related amendments
- Equipment and Protective Systems Intended for Use in Potentially Explosive Atmospheres Regulations 2016 (S.I. 2016 No. 1107), and related amendments

- Restriction of the Use of Certain Hazardous Substances in Electrical and Electronic Equipment Regulations 2012 (S.I. 2012 No. 3032), and related amendments
- Supply of Machinery (Safety) Regulations 2008 (S.I. 2008 No. 1597), and related amendments for ET 200SP safety components (fail-safe modules)

The UK Declarations of Conformity are available to the relevant authorities at the following address:

Siemens AG
Digital Industries
Factory Automation
DI FA TI COS TT
P.O. Box 1963
D-92209 Amberg

You can also find the UK Declarations of Conformity on the Internet

<https://support.industry.siemens.com/cs/ww/en/ps/14031/cert?ct=444&ci=5596>.

cULus approval



Underwriters Laboratories Inc.:

- UL 508 (Industrial Control Equipment) OR UL 61010-1 and UL 61010-2-201
- CAN/CSA C22.2 No. 142 (Process Control Equipment) OR CAN/CSA C22.2 No. 61010-1 and CAN/CSA C22.2 No. 61010-2-201

cULus HAZ. LOC. approval



Underwriters Laboratories Inc.:

- UL 508 (Industrial Control Equipment) OR UL 61010-1 and UL 61010-2-201
- CAN/CSA C22.2 No. 142 (Process Control Equipment) OR CAN/CSA C22.2 No. 61010-1 and CAN/CSA C22.2 No. 61010-2-201
- ANSI/ISA 12.12.01
- CAN/CSA C22.2 No. 213 (Hazardous Location)

APPROVED for use in

Class I, Division 2, Group A, B, C, D T4;

Class I, Zone 2, Group IIC T4

Installation Instructions for cULus haz.loc.

- WARNING – Explosion Hazard – Do not disconnect while circuit is live unless area is known to be non-hazardous.
- WARNING - Explosion Hazard - Substitution of components may impair suitability for Class I, Division 2 or Zone 2.
- This equipment is suitable for use in Class I, Division 2, Groups A, B, C, D; Class I, Zone 2, Group IIC; or non-hazardous locations.

WARNING: EXPOSURE TO SOME CHEMICALS MAY DEGRADE THE SEALING PROPERTIES OF MATERIALS USED IN THE RELAYS.

CSA



CSA C22.2 (Industrial Control Equipment Motor Controllers)

UL



UL 60947-4-2 Low-Voltage Switchgear and Controlgear

FM approval



Factory Mutual Research (FM):

- Approval Standard Class Number 3600, 3611, 3810
- ANSI/UL 121201
- ANSI/UL 61010-1
- CAN/CSA C22.2 No. 213
- CAN/CSA C22.2 No. 61010-1

APPROVED for use in Class I, Division 2, Group A, B, C, D T4;
Class I, Zone 2, Group IIC T4

Installation Instructions for FM

- WARNING – Explosion Hazard – Do not disconnect while circuit is live unless area is known to be non-hazardous.
- WARNING - Explosion Hazard - Substitution of components may impair suitability for Class I, Division 2 or Zone 2.
- This equipment is suitable for use in Class I, Division 2, Groups A, B, C, D; Class I, Zone 2, Group IIC; or non-hazardous locations.

WARNING: EXPOSURE TO SOME CHEMICALS MAY DEGRADE THE SEALING PROPERTIES OF MATERIALS USED IN THE RELAYS.

ATEX approval



According to EN 60079-15 (Electrical apparatus for potentially explosive atmospheres - Part 15: Type of protection "n") and EN 60079-0 (Electrical apparatus for potentially explosive gas atmospheres - Part 0: General Requirements).

II 3 G Ex nA IIC T4 Gc
DEKRA 12ATEX0038 X

OR

According to EN 60079-7 (Electrical apparatus for potentially explosive atmospheres - Part 7: Increased safety "e") and EN IEC 60079-0 (Electrical apparatus for potentially explosive gas atmospheres - Part 0: General Requirements).

II 3 G Ex ec IIC T4 Gc
DEKRA 20ATEX0002 X

T-CPUs:

According to EN 60079-7 (Electrical apparatus for potentially explosive atmospheres - Part 7: Increased safety "e") and EN IEC 60079-0 (Electrical apparatus for potentially explosive gas atmospheres - Part 0: General requirements).

II 3 G Ex ec IIC T4 Gc
DEKRA 23ATEX0006 X

Special conditions in hazardous areas:

1. The equipment shall only be used in an area of not more than pollution degree 2, as defined in EN 60664-1.
2. The equipment shall be installed in a suitable enclosure providing a degree of protection not less than IP54 in accordance with EN IEC 60079-0. The ambient conditions must be taken into consideration for use.
3. Provisions shall be made to prevent the rated voltage from being exceeded by transient disturbances of more than 119V.

UKEX approval



According to EN 60079-7 (Explosive atmospheres – Part 7: Equipment protection by increased safety "e") and EN IEC 60079-0 (Explosive atmospheres - Part 0: Equipment - General requirements).

II 3 G Ex ec IIC T4 Gc
DEKRA 21UKEX0009 X

T-CPUs:

According to EN 60079-7 (Explosive atmospheres – Part 7: Equipment protection by increased safety "e") and EN IEC 60079-0 (Explosive atmospheres - Part 0: Equipment - General requirements).

II 3 G Ex ec IIC T4 Gc
DEKRA 23UKEX6001 X

Special conditions in explosive atmospheres:

1. The equipment shall only be used in an area of not more than degree of pollution 2, as defined in EN 60664-1.
2. The equipment shall be installed in a suitable enclosure providing a degree of protection not less than IP54 in accordance with EN IEC 60079-0. The ambient conditions must be taken into consideration for use.
3. Provisions shall be made to prevent the rated voltage from being exceeded by transient disturbances of more than 119 V.

IECEX approval



According to IEC 60079-15 (Explosive atmospheres - Part 15: Equipment protection by type of protection "n") and IEC 60079-0 (Explosive atmospheres - Part 0: Equipment - General requirements).

Ex nA IIC T4 Gc
IECEX DEK 13.0011X

OR

According to IEC 60079-7 (Explosive atmospheres - Part 7: Equipment protection by increased safety "e") and IEC 60079-0 (Explosive atmospheres - Part 0: Equipment - General requirements).

Ex ec IIC T4 Gc
IECEX DEK 19.0086 X

T-CPUs:

According to IEC 60079-7 (Explosive atmospheres - Part 7: Equipment protection by increased safety "e") and IEC 60079-0 (Explosive atmospheres - Part 0: Equipment - General requirements).

Ex ec IIC T4 Gc
IECEX DEK 23.0005 X

Special conditions in hazardous areas:

1. The equipment shall only be used in an area of not more than pollution degree 2, as defined in IEC 60664-1.
2. The equipment shall be installed in a suitable enclosure providing a degree of protection not less than IP54 in accordance with EN IEC 60079-0. The ambient conditions must be taken into consideration for use.
3. Provisions shall be made to prevent the rated voltage from being exceeded by transient disturbances of more than 119V.

CCCEX approval



In accordance with GB/T 3836.3 (Explosive atmospheres - Part 3: Equipment protection by increased safety "e"), GB/T 3836.1 (Explosive atmospheres - Part 1: Equipment - General requirements).

Ex ec IIC T4 Gc

Special conditions in hazardous areas:

- The equipment shall only be used in an area of not more than pollution degree 2, as defined in GB/T 16935.1.
- The equipment must be installed in a suitable enclosure providing a degree of protection not less than IP54 in accordance with GB/T 3836.1. The ambient conditions must be taken into consideration for use.
- Provisions shall be made to prevent the rated voltage from being exceeded by transient disturbances of more than 119V.

RCM Australia/New Zealand



The ET 200SP distributed I/O system meets the requirements of EN 61000-6-4 Generic standards – Emission standard for industrial environments.

Korea Certificate



Note that this device conforms to Limit Class A for emission of radio interference. This device is not intended to be used in residential areas.

이 기기는 업무용(A급) 전자파 적합기기로서 판매자 또는 사용자는 이 점을 주의하시기 바라며 가정 외의 지역에서 사용하는 것을 목적으로 합니다.

Mark for Eurasian Economic Union



The EAC (Eurasian Conformity) mark confirms conformity with the technical regulations (TR) of the Eurasian Economic Union.

16.4 Certificates

Shipbuilding certificates

The following shipbuilding certificates are planned:

- ABS (American Bureau of Shipping)
- BV (Bureau Veritas)
- DNV (Det Norske Veritas)
- LRS (Lloyds Register of Shipping)
- Class NK (Nippon Kaiji Kyokai)
- KR (Korean Register of Shipping)
- CCS (China Classification Society)
- RINA (Registro Italiano Navale)

Following approval, you will find the certificates with the certified article numbers on the Internet (<https://support.industry.siemens.com/cs/ww/en/ps/14031/cert?ct=446>).

16.5 Standards and requirements

The ET 200SP distributed I/O system meets the following standards and requirements.

IEC 61131-2

The ET 200SP distributed I/O system fulfills the requirements and criteria of IEC 61131-2 (Programmable controllers, Part 2: Equipment requirements and tests) and the EMC requirements for use in Zone B.

IEC 61010-2-201

The ET 200SP distributed I/O system fulfills the requirements and criteria of standard IEC 61010-2-201 (Safety requirements for electrical equipment for measurement, control, and laboratory use Part 2-201: Particular requirements for control equipment).

IEC 60695-11-10

The ET 200SP distributed I/O system fulfills the requirements and criteria of standard IEC 60695-11-10 (Fire hazard testing - Part 11-10: Test flames - 50 W horizontal and vertical flames test methods).

UL 94

The ET 200SP distributed I/O system fulfills the requirements and criteria of UL 94 (Tests for Flammability of Plastic Materials for Parts in Devices and Appliances).

IEC 60947

The motor starters belonging to the ET 200SP distributed I/O system meet the requirements and criteria of the IEC 60947 standard.

PROFINET

The PROFINET interfaces of the ET 200SP distributed I/O system are based on IEC 61158 Type 10.

PROFIBUS

The PROFIBUS interfaces of the ET 200SP distributed I/O system are based on IEC 61158 Type 3.

IO-Link

The ET 200SP distributed I/O system is based on IEC 61131-9.

Use in industrial environments

The ET 200SP distributed I/O system is suitable for use in industrial environments. It meets the following standards for this type of use:

- Requirements on interference emission EN 61000-6-4: 2007 + A1: 2011
- Requirements on immunity EN 61000-6-2: 2005

Use in mixed areas

Under specific prerequisites you can use the ET 200SP distributed I/O system in a mixed area. A mixed area is used for residential purposes and for commercial operations that do not significantly impact the residential purpose.

If you want to use the ET 200SP distributed I/O system in residential areas, you must ensure that its radio frequency interference emission complies with limit class B in accordance with EN 61000-6-3. Suitable measures for observing these limits for use in a mixed area are, for example:

- Installation of the ET 200SP distributed I/O system in grounded control cabinets
- Use of filters in the supply lines

An additional individual acceptance test is also required.

Use in residential areas

The ET 200SP distributed I/O system is **not** intended for use in residential areas. If you are using the ET 200SP distributed I/O system in residential areas, radio and TV reception may be affected.

Environmental Product Declaration (EPD)

Siemens is committed to the development and production of environmentally compatible and sustainably produced equipment.

With the help of an Environmental Product Declaration (EPD), you can obtain information on the "ecological footprint" of your Siemens product.

The EPD is based on the international ISO 14021 standard "Environmental labels and declarations – Self declared environmental claims – Type II".

EPDs are based on independently verified data from life cycle assessments, life cycle inventory analyses and information modules that comply with the ISO 14040 series of standards. The EPD contains comprehensive data relating to ingredients and substances (REACH, RoHS), fire load, energy consumption, packaging and disposal information for your Siemens product.

You can find the current Environmental Product Declarations (EPDs) for the ET 200SP distributed I/O system on the Internet

(<https://support.industry.siemens.com/cs/ww/en/ps/14031/cert?ct=5669>).

16.6 Electromagnetic compatibility

Definition

Electromagnetic compatibility (EMC) is the ability of an electrical installation to function satisfactorily in its electromagnetic environment without interfering with that environment. The ET 200SP distributed I/O system meets the legal requirements for electromagnetic compatibility of equipment. The prerequisite is that the ET 200SP distributed I/O system complies with the requirements and guidelines relating to electrical equipment.

EMC in accordance with NE21

The ET 200SP distributed I/O system meets the EMC specifications of the NAMUR recommendation NE21.

Pulse-shaped disturbance variables of the ET 200SP system

The table below shows the electromagnetic compatibility of the ET 200SP distributed I/O system with regard to pulse-shaped disturbance variables.

Table 16-1 Pulse-shaped disturbance variables

Pulse-shaped disturbance variable	Tested with	Equivalent to severity
Electrostatic discharge in accordance with IEC 61000-4-2 *)	Air discharge ± 8 kV	3
	Contact discharge: ± 6 kV	3
Burst pulses (fast transient interference) in accordance with IEC 61000-4-4 *)	± 2 kV (power supply line)	3
	± 2 kV (signal line >30 m)	4
	± 1 kV (signal cable <30 m)	3
High-energy single pulse (surge) in accordance with IEC 61000-4-5 **)		
• Asymmetric coupling (phase-ground) ***)	± 1 kV (24 V DC supply cable)	2
	± 1 kV (24 V DC signal/data line only > 30 m)	2
	2 kV (230 V AC supply cable)	3
• Symmetric coupling (phase-phase) ***)	± 0.5 kV (24 V DC supply cable)	2
	± 1 kV (230 V AC supply cable)	3
*) The maximum short-term influence of analog modules during the duration of the EMC tests can be $\pm 10\%$ of the full-scale value. **) Analog value deviation beyond the limits of the nominal range and diagnostics possible. ***) If higher phase-ground or phase-phase values are required, you will need an additional external protective circuit (see Designing interference-free controllers (https://support.automation.siemens.com/WW/view/en/59193566) Function Manual).		

Pulse-shaped disturbance variables of motor starters

The following table shows the electromagnetic compatibility of the ET 200SP motor starters with regard to pulse-shaped interference.

Table 16-2 Pulse-shaped disturbance variables

Pulse-shaped disturbance variable	Tested with	Equivalent to severity
Burst pulses (fast transients) in accordance with IEC 61000-4-4, tested with 5 kHz.	±2 kV (24 V supply cables) ±2 kV (500 V AC infeed*) ±1 kV (signal cable <30 m)	3
If you mount the motor starter to the right of a 15 mm or 20 mm I/O module or immediately next to a head module, use a dummy module. You will find more information in "Selecting motor starters with a suitable BaseUnit (Page 86)".		
High-energy single pulse (surge) in accordance with IEC 61000-4-5	500 V AC infeed: ±2 kV conducted interference - phase to ground ±1 kV conducted interference - phase to phase 24 V supply cable: ±1 kV conducted interference - phase to ground **) ±0.5 kV conducted interference - phase to phase **)	3
**) An RC circuit is not required for hybrid switching devices. If higher values 2 kV (phase-ground) or 1 kV (phase-phase) are required, you will need an additional external protective circuit (see Designing interference-free controllers (https://support.automation.siemens.com/WW/view/en/59193566) Function Manual).		

Sinusoidal disturbance variables

The tables below show the electromagnetic compatibility of the ET 200SP distributed I/O system with regard to sinusoidal disturbance variables.

- RF radiation

RF radiation in accordance with IEC 61000-4-3/NAMUR 21 Electromagnetic RF field, amplitude-modulated		Corresponds to degree of severity
80 MHz to 2.7 GHz	10 V/m	3
2.7 GHz to 6 GHz	3 V/m	2
80% AM (1 kHz)		

- RF coupling

RF coupling in accordance with IEC 61000-4-6		Corresponds to degree of severity
(10 kHz) 150 kHz to 80 MHz		3
10 V _{rms} unmodulated		
80% AM (1 kHz)		
150 Ω source impedance		

16.7 Electromagnetic compatibility of fail-safe modules

The maximum short-term influence of analog modules during the duration of the EMC tests can be $\pm 1\%$ of the full-scale value.

Emission of radio frequency interference

Interference emission of electromagnetic fields according to EN 55016.

Table 16-3 Interference emission of electromagnetic fields

Frequency	Interference emission	Measuring distance
30 MHz to 230 MHz	<40 dB ($\mu\text{V/m}$) Q	10 m
230 MHz to 1000 MHz	<47 dB ($\mu\text{V/m}$) Q	10 m
1 GHz to 3 GHz	<76 dB ($\mu\text{V/m}$) P	3 m
3 GHz to 6 GHz	<80 dB ($\mu\text{V/m}$) P	3 m

Interference emission via the AC power supply according to EN 55016.

Table 16-4 Interference emission via the AC power supply

Frequency	Interference emission
0.15 MHz to 0.5 MHz	<89 dB (μV) Q < 66 dB ($\mu\text{V/m}$) M
0.5 MHz to 30 MHz	< 73 dB ($\mu\text{V/m}$)Q < 60 dB ($\mu\text{V/m}$) M

16.7 Electromagnetic compatibility of fail-safe modules

Protecting ET 200SP with fail-safe modules against overvoltages

If your equipment requires protection from overvoltage, we recommend that you use an external protective circuit (surge filter) between the load voltage power supply and the load voltage input of the BaseUnits to ensure surge immunity for the ET 200SP with fail-safe modules.

NOTE

Overvoltage protection measures always require a case-by-case examination of the entire plant. Almost complete protection from overvoltages, however, can only be achieved if the entire building surroundings have been designed for overvoltage protection. In particular, this involves structural measures in the building design phase.

For detailed information regarding overvoltage protection, we recommend that you contact your Siemens representative or a company specializing in lightning protection.

The following figure shows an example configuration with fail-safe modules. Voltage is supplied by one power supply unit. Note, however, that the total current of the modules fed by the power supply unit must not exceed the permissible limits. You can also use multiple power supply units.

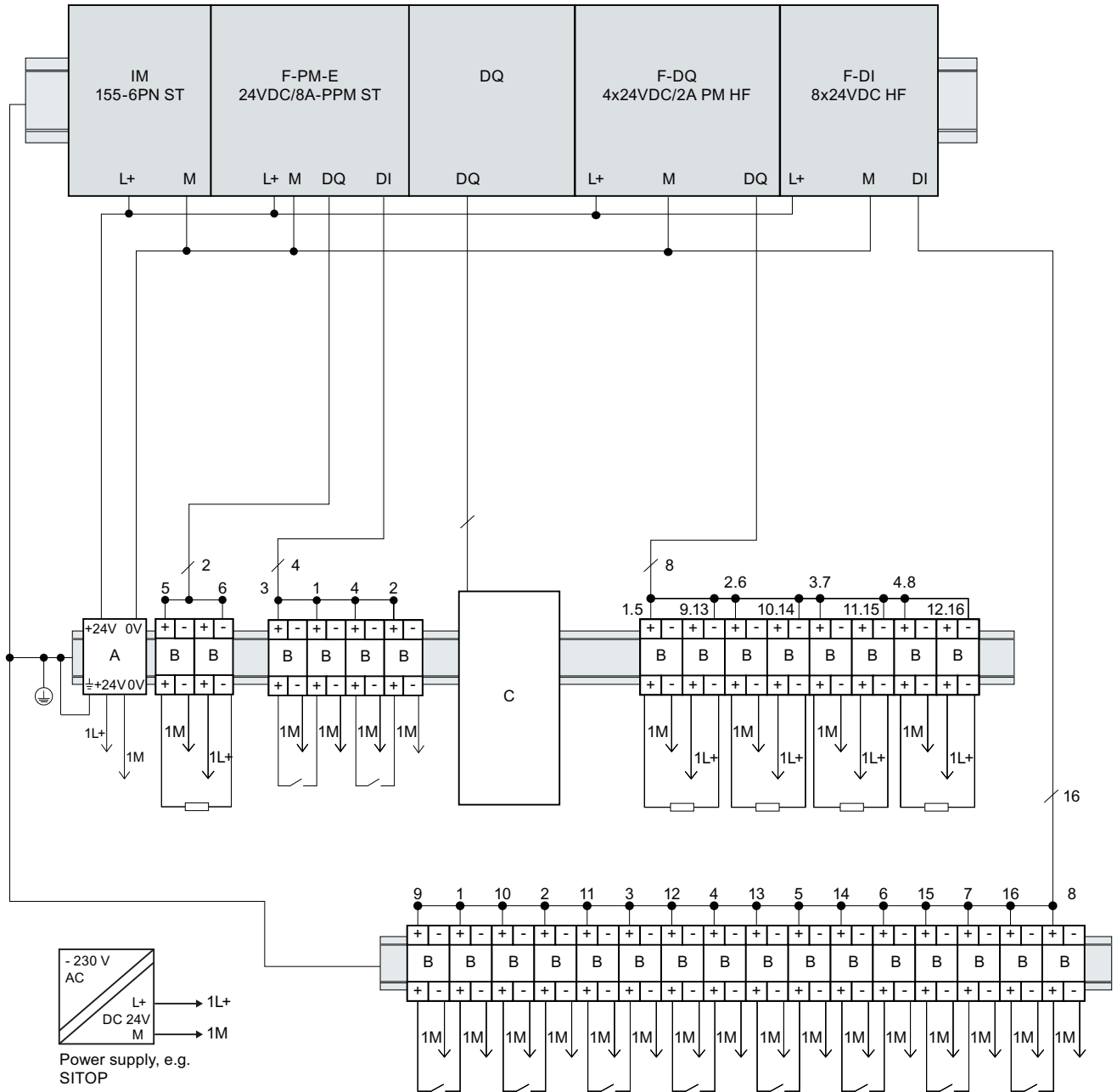

Figure 16-1 External protective circuit (surge filter) for ET 200SP with failsafe modules

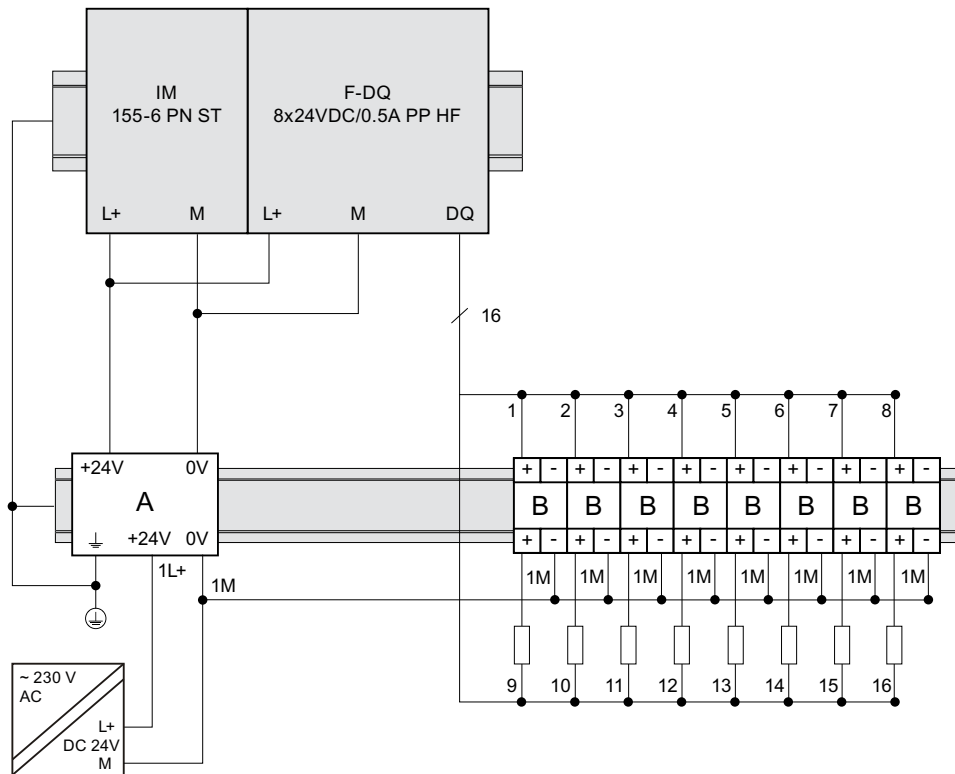

Figure 16-2 External protective circuit (surge filter) for ET 200SP with fail-safe modules

Name	Part number of Dehn Co.
A = BVT AVD 24	918 422
B = DCO RK D 5 24	919 986
C = The external protective circuit required at the outputs of the modules F-PM-E power module load group can be found in the Designing interference-free controllers (https://support.automation.siemens.com/WW/view/en/59193566) function manual.	

Electromagnetic compatibility of fail-safe motor starters

The safety versions of the motor starters are additionally tested according to the requirements of IEC 61000-6-7:2014 (taking into consideration the failure criteria for the STO safety function).

16.8 Shipping and storage conditions

Introduction

The ET 200SP distributed I/O system meets the requirements in terms of shipping and storage conditions according to IEC 61131-2. The following information applies to modules that are shipped and/or stored in their original packaging.

Table 16-5 Shipping and storage conditions for modules

Type of condition	Permissible range
Free fall (in shipping package)	≤1 m
Temperature	From -40 °C to +70 °C
Barometric pressure	from 1140 to 660 hPa (corresponds to an elevation of -1000 to 3500 m)
Relative humidity	5% to 95%, without condensation
Sinusoidal oscillations according to IEC 60068-2-6	5 - 8.4 Hz: 3.5 mm 8.4 - 500 Hz: 9.8 m/s ²
Impact acc. to IEC 60068-2-27 ¹⁾	250 m/s ² , 6 ms, 1000 shocks

1) Not applicable to motor starters

16.9 Mechanical and climatic environmental conditions

Operating conditions

The ET 200SP distributed I/O system is suitable for use in weather-proof, fixed locations. The operating conditions are based on the requirements of IEC 61131-2:2017.

- OTH4 (Minimum ambient temperature, see the Climatic ambient temperatures table)
- STH4 (Minimum ambient temperature -40 °C, minimum relative humidity 5%)
- TTH4 (Minimum relative humidity 5%)

You will find the permissible ambient conditions for the motor starter in the Technical data of the motor starter (<https://support.industry.siemens.com/cs/ww/en/ps/21859/td>).

Mechanical environmental conditions

The following table shows the mechanical environmental conditions in the form of sinusoidal vibrations.

Table 16-6 Mechanical environmental conditions

Frequency band	ET 200SP with IM 155-6 DP HF, BusAdapters BA 2×FC, BA 2×SCRJ, BA SCRJ/FC, BA 2×LC, BA LC/FC, BA 2×M12, BA 2×LC-LD and BA LC-LD/M12	ET 200SP with BusAdapters BA 2×RJ45, BA SCRJ/RJ45, BA LC/RJ45 and BA LC-LD/RJ45	ET 200SP with IM 155-6 PN BA and IM 155-6 PN R1	ET 200SP with digital output module F-RQ 1×24VDC/24..230V-AC/5A
$5 \leq f \leq 8.4 \text{ Hz}$	3.5 mm amplitude			
$8.4 \leq f \leq 150 \text{ Hz}$	1 g constant acceleration			
$10 \leq f \leq 60 \text{ Hz}$	0.35 mm amplitude	---	---	---
$60 \leq f \leq 1000 \text{ Hz}$	5 g constant acceleration	---	---	---

The mechanical ambient conditions for the Ex modules can be found in the system manual. T 200SP HA Distributed I/O system / ET 200SP Modules for devices used in an explosion hazardous environment (<https://support.industry.siemens.com/cs/ww/en/view/109795533>).

Tests of mechanical environmental conditions

The following table provides important information with respect to the type and scope of the tests of environmental mechanical conditions.

Table 16-7 Tests of mechanical environmental conditions

Condition tested	Test standard	Comment
Vibrations ²⁾	Vibration test according to IEC 60068-2-6 (sinusoidal)	Type of vibration: Frequency sweeps with a rate of change of 1 octave/minute. BA 2xRJ45, BA SCRJ/RJ45, BA LC/RJ45, BA LC-LD/RJ45, IM 155-6 PN BA, IM 155-6 PN R1, digital output module F-RQ 1x24VDC/24..230VAC/5A <ul style="list-style-type: none"> • 5 Hz ≤ f ≤ 8.4 Hz, 3.5 mm constant amplitude • 8.4 Hz ≤ f ≤ 150 Hz, 1 g constant acceleration IM 155-6 DP HF, BA 2xFC, BA 2xSCRJ, BA SCRJ/FC, BA 2xLC, BA LC/FC, BA 2xM12, BA 2xLC-LD, BA LC-LD/M12 <ul style="list-style-type: none"> • 10 Hz ≤ f ≤ 60 Hz, 0.35 mm constant amplitude • 60 Hz ≤ f ≤ 1000 Hz, 5 g constant acceleration Duration of vibration: 10 frequency sweeps per axis at each of three vertically aligned axes
Shock ²⁾	Shock, tested according to IEC 60068-2-27	Type of shock: Half-sine Shock intensity: 150 m/s ² peak value, 11 ms duration Direction of shock: 3 shocks in each direction (+/-) at each of three vertically aligned axes
Repetitive shock ^{1) 2)}	Shock, tested according to IEC 60068-2-27	Type of shock: Half-sine Shock intensity: 25 g peak value, 6 ms duration Direction of shock: 1000 shocks in each direction (+/-) at each of three vertically aligned axes

1) Not applicable in the case of the digital output module F-RQ 1x24VDC/24..230VAC/5A

2) Not applicable for motor starters

The type and scope of the tests for mechanical ambient conditions for the Ex modules can be found in the system manual. ET 200SP HA Distributed I/O system / ET 200SP Modules for devices used in an explosion hazardous environment

(<https://support.industry.siemens.com/cs/ww/en/view/109795533>).

Climatic environmental conditions

The following table shows the permissible climatic ambient conditions for the ET 200SP distributed I/O system during operation.

Table 16-8 Climatic environmental conditions

Environmental conditions	Permissible range	Comments
Temperature: horiz. mounting position: vertical mounting position:	-30 °C to 60 °C -30 °C to 50 °C	The lower permissible ambient temperature was extended for the ET 200SP system to -30 °C. Differences may exist for specific modules and depending on the mounting position and, if applicable, load. Detailed information on this is described in the technical specifications of the respective equipment manual. The product data sheets with daily updated technical specifications can be found on the Internet (https://support.industry.siemens.com/cs/ww/en/ps/td) at Industry Online Sup-

Environmental conditions	Permissible range	Comments
		port. Enter the article number or the short description of the desired module on the website.
Permitted temperature change	10 K/h	-
Relative humidity	from 10 to 95%	Without condensation or icing.
Barometric pressure	from 1140 to 795 hPa	Corresponds to an altitude of -1000 to 2000 m. Note the following section "Using the distributed I/O system ET 200SP more than 2000 m above sea level".
Pollutant concentration	ANSI/ISA-71.04 severity level G1; G2; G3	-

SIPLUS products based on ET 200SP are offered for reliable operation under heavy to extreme operating conditions.

Using the distributed I/O system ET 200SP more than 2000 m above sea level

The maximum "operating height above sea level" depends on the module and is described in the technical specifications of the respective module. The product data sheets with daily updated technical specifications can be found on the Internet

(<https://support.industry.siemens.com/cs/ww/en/ps/td>) at Industry Online Support. Enter the article number or the short description of the desired module on the website.

For altitudes > 2000 m, the following constraints apply to the maximum specified ambient temperature:

Restrictions of the specified maximum ambient temperature in reference to the installation altitude

Installation altitude	Derating factor for ambient temperature ¹⁾
-1000 m to 2000 m	1.0
2000 m to 3000 m	0.9
3000 m to 4000 m	0.8
4000 m to 5000 m	0.7

¹⁾ Base value for application of the derating factor is the maximum permissible ambient temperature in °C for 2000 m.

NOTE

- Linear interpolation between altitudes is permissible.
- The derating factors compensate for the decreasing cooling effect of air at higher altitudes due to lower density.
- Note the mounting position of the respective module in the technical specifications. The basis is the standard IEC 61131-2:2017.
- Make sure that the power supplies you use are rated for altitudes > 2000 m.

16.10 Insulation, protection class, degree of protection and rated voltage

Effects on the availability of modules

The higher cosmic radiation present during operation at altitudes above 2000 m will also start to have an effect on the failure rate of electronic components (the so-called soft error rate). In rare cases this can result in a transition of modules to the safe state, especially for fail-safe modules. However, the functional safety of the modules is fully retained.

NOTE

Fail-safe modules are certified for operation in safety mode up to the maximum altitude listed in the product data sheet.

All other markings and certifications are currently based on an altitude of up to 2000 m.

Information on PFDavg, PFH values for ET 200SP F

PFDavg and PFH values for F-CPU at operating altitudes up to 5,000 m. Below you will find the probability of failure values (PFDavg and PFH values) for the F-CPU with a service life of 20 years and with a repair time of 100 hours:

<p>Operation in low demand mode low demand mode According to IEC 61508:2010: PFDavg = Average probability of a dangerous failure on demand</p>	<p>Operation in high demand or continuous mode high demand/continuous mode According to IEC 61508:2010: PFH = Average frequency of a dangerous failure [h-1]</p>
< 2E-05	< 1E-09

NOTE

For fail-safe I/O modules, you can find the relevant details on PFDavg and PFH values on the Internet (<https://support.industry.siemens.com/cs/ww/en/view/109481784>).

16.10 Insulation, protection class, degree of protection and rated voltage

Insulation

The insulation for the I/O modules is dimensioned according to the requirements of EN 61131-2:2007 and EN 61010-2-201: The insulation for the motor starters is designed in accordance with the requirements of IEC 60947-1.

NOTE

In the case of modules with 24 V DC (SELV/PELV) supply voltage, galvanic isolations are tested with 707 V DC (type test).

Severity for voltage interruption according to IEC 61131-2

Interface modules, CPUs meet the severity class PS1 for voltage interruptions (1 ms).

Pollution degree/overvoltage category in accordance with IEC 61131 and IEC 61010-2-201

- Pollution degree 2
- Overvoltage category: II

Pollution degree/overvoltage category according to IEC 60947

- Pollution degree 2
- Overvoltage category: III

Protection class according to IEC 61131-2:2007 and IEC 61010-2-201

The ET 200SP distributed I/O system meets protection class I and includes parts of protection classes II and III.

The grounding of the mounting rail must meet the requirements for a functional earth FE.

Recommendation: For an interference-proof installation, the ground conductor should have a cross-section $> 6 \text{ mm}^2$.

The installation location (e.g. enclosure, control cabinet) must have a protective conductor connection that meets the standard to maintain protection class I.

Degree of protection IP20

Degree of protection IP20 according to IEC 60529 for all modules of the ET 200SP distributed I/O system, which means:

- Protection against contact with standard probes
- Protection against foreign objects with diameters in excess of 12.5 mm
- No protection against water

NOTE

Use a BU cover

To meet the requirements of the degree of protection "IP20", fit a BU cover onto unfitted BaseUnits.

To ensure touch safety, fit a cover onto the opening of the infeed bus contacts belonging to the last plugged-in motor starter BaseUnit.

16.11 Use of the ET 200SP distributed I/O system in zone 2 potentially explosive atmospheres

Rated voltage for operation

The ET 200SP distributed I/O system works with the rated voltage and corresponding tolerances listed in the following table.

Note the supply voltage of each module when selecting the rated voltage.

Table 16-9 Rated voltage for operation

Rated voltage	Tolerance range
24 V DC	19.2 to 28.8 V DC ¹⁾
	18.5 to 30.2 V DC ²⁾
120 V AC (50/60 Hz)	93 to 132 V AC
230 V AC (50/60 Hz)	187 to 264 V AC
400 V AC (50/60 Hz) ³⁾	48 to 500 V AC

¹⁾ Static value: Generation as protective extra low voltage with safe electrical separation in accordance with IEC 61131-2 or IEC 61010-2-201.

²⁾ Dynamic value: Including ripple, e.g. as in the case of three-phase bridge power rectification

³⁾ Valid for the infeed bus of the modules and BaseUnits of motor starters only

16.11 Use of the ET 200SP distributed I/O system in zone 2 potentially explosive atmospheres

See product information "Use of subassemblies/modules in Zone 2 Hazardous Area" (<https://support.automation.siemens.com/WW/view/en/19692172>).

NOTE

Use of Ex modules

When you use Ex modules and the ET 200SP is located in a hazardous area of Zone 2, observe the notes in the System Manual ET 200SP HA Distributed I/O system / ET 200SP Modules for devices used in an explosion hazardous environment

(<https://support.industry.siemens.com/cs/ww/de/view/109795533/en>).

NOTE

Zone 22: Observe standards and regulations, and individual acceptance test required

If you install, use and maintain the ET 200SP in hazardous area Zone 22, you must comply with the relevant standards, installation/setup regulations and country-specific regulations for Zone 22 (for example, the ET 200SP must be installed in an enclosure suitable for Zone 22). A individual acceptance test by a certification body (Ex) is also required.

Dimension drawings

A.1 SIMATIC system rail

SIMATIC system rail dimension drawing

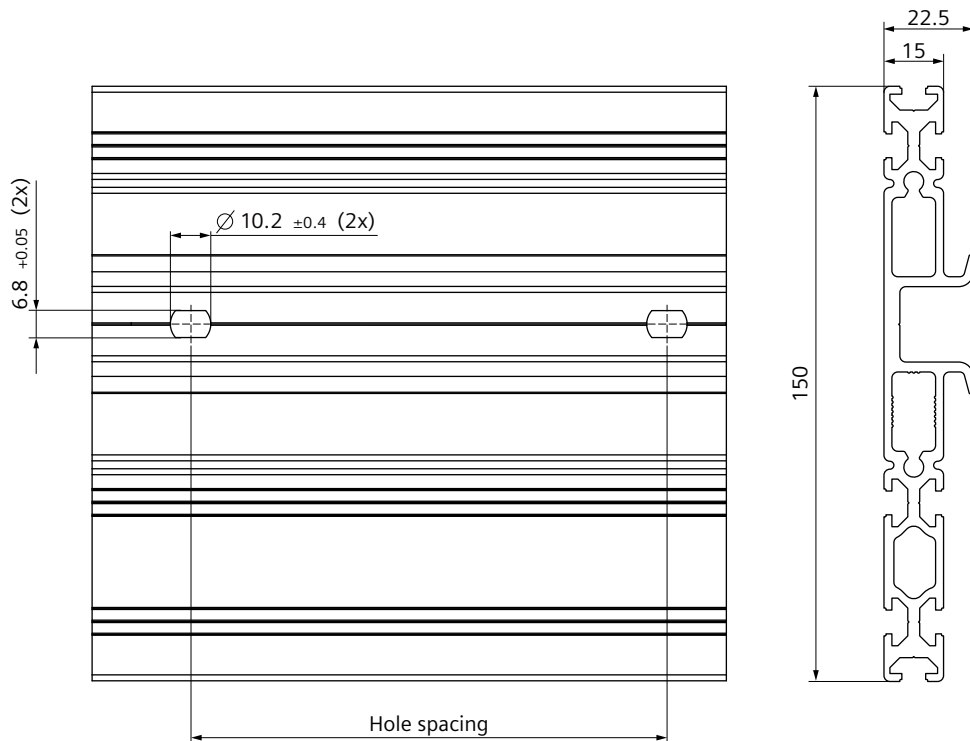

Figure A-1 SIMATIC system rail dimension drawing

Article number	Hole spacing	Comment
6ES7193-6MR00-0AA0	466 ± 0.4 mm	With holes
6ES7193-6MR00-0BA0	500 ± 0.4 mm	With holes
6ES7193-6MR00-0CA0	800 ± 0.4 mm	With holes
6ES7193-6MR00-0DA0	-	Without holes

You can find additional dimensions of the SIMATIC system rail in section Accessories/Spare parts ([Page 339](#)).

A.2 Shield connector

Dimensional diagram of the shield connector

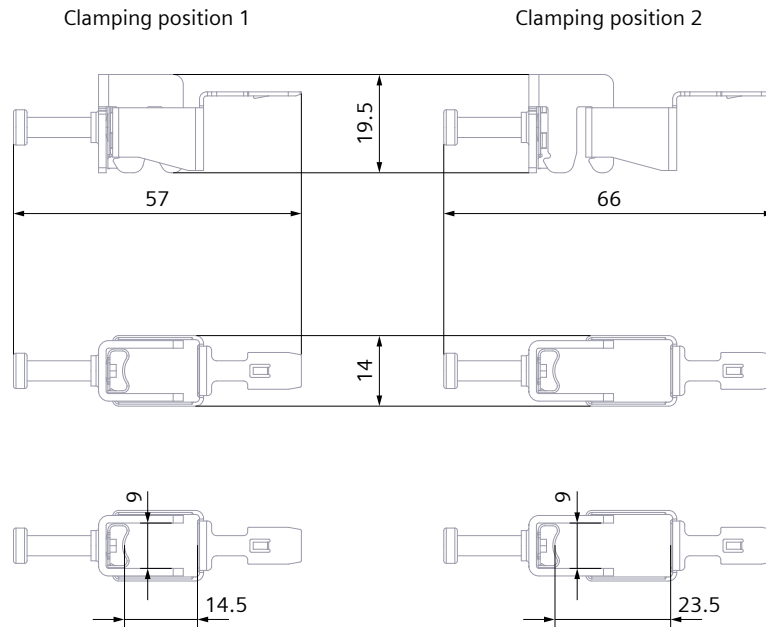

Figure A-2 Dimensional diagram of the shield connector

A.3 Labeling strip

Dimension drawing of the labeling strips (roll)

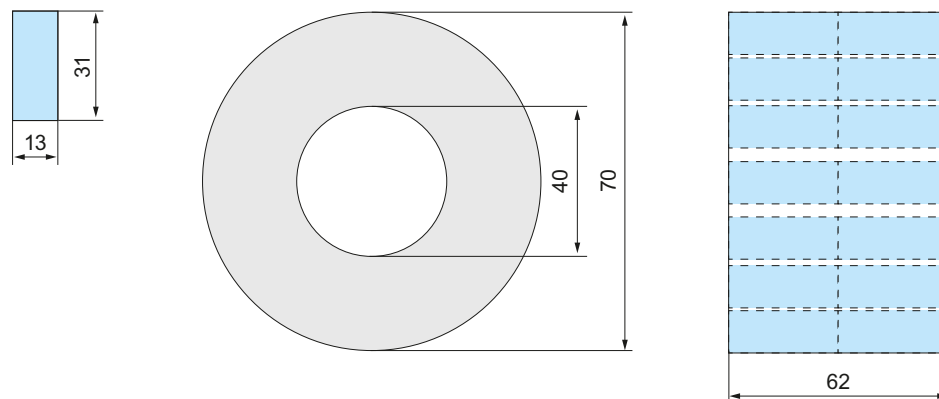

Figure A-3 Dimension drawing of the labeling strips (roll)

Dimension drawing of the labeling strips (DIN A4 sheet)

The product information for the labeling strips (DIN A4 sheets) is available for download on the Internet

(<https://mall.industry.siemens.com/mall/en/de/Catalog/Product/6ES7193-6LA10-0AA0>).

A.4 Reference identification labels

Dimensional diagram of reference identification label and sheet

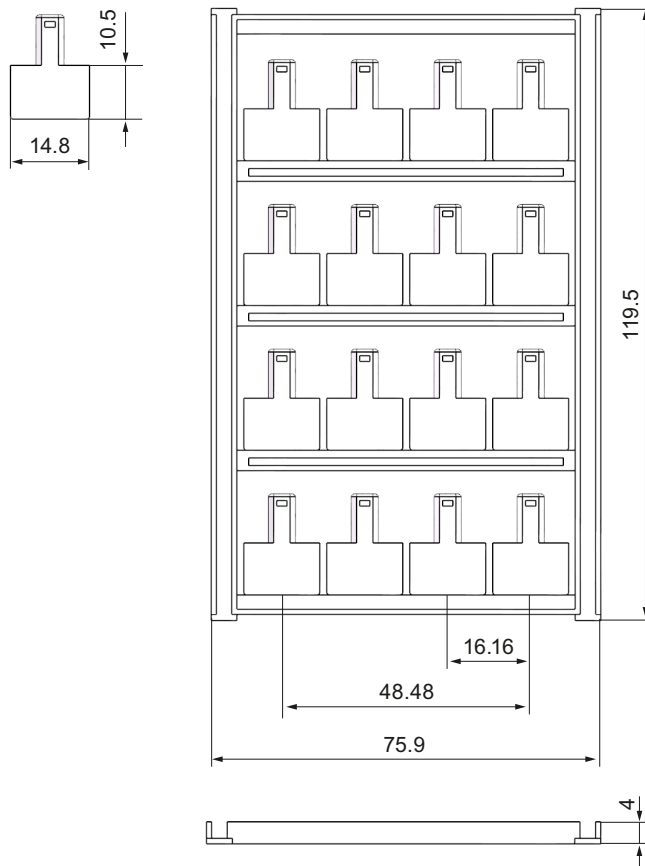

Figure A-4 Dimensional diagram of reference identification label and sheet

Accessories/spare parts

Accessories for the ET 200SP distributed I/O system

Table B-1 Accessories, general

Accessories, general	Packing unit	Article number
Strain relief units incl. screws	5 units	6ES7193-6RA00-1AN0
Cover for the BusAdapter interface	5 units	6ES7591-3AA00-0AA0
PROFIBUS FastConnect bus connector	1 unit	6ES7972-0BB70-0XA0
Server module (spare part)	1 unit	6ES7193-6PA00-0AA0
BU cover		
• 15 mm wide	5 units	6ES7133-6CV15-1AM0
• 20 mm wide	5 units	6ES7133-6CV20-1AM0
24 V DC connector (spare part)	10 units	6ES7193-4JB00-0AA0
Shield connection for BaseUnit (shield contacts and shield terminals)	5 units	6ES7193-6SC20-1AM0
Reference identification label, sheet with 16 labels	10 units	6ES7193-6LF30-0AW0
Labeling strips (for labeling the I/O modules)		
• Roll, light gray labeling strips (with a total of 500 strips), film, for labeling with thermal transfer roll printer	1 unit	6ES7193-6LR10-0AA0
• Roll, yellow labeling strips (with a total of 500 strips), film, for labeling with thermal transfer roll printer	1 unit	6ES7193-6LR10-0AG0
• DIN A4 sheets, light gray labeling strips (with a total of 1000 labels), paper, perforated, for labeling with laser printer	10 units	6ES7193-6LA10-0AA0
• DIN A4 sheets, yellow labeling strips (with a total of 1000 labels), paper, perforated, for labeling with laser printer	10 units	6ES7193-6LA10-0AG0
Mechanical coding element (spare part) ¹⁾		
• Coding element (type A)	20 units	6ES7193-6KA00-3AA0
• Coding element (type B)	20 units	6ES7193-6KB00-3AA0
• Coding element (type C)	20 units	6ES7193-6KC00-3AA0
• Coding element (type D)	20 units	6ES7193-6KD00-3AA0
Electronic coding element (spare part) ¹⁾		
• Coding element (type F, for fail-safe modules)	5 units	6ES7193-6EF00-1AA0
• Coding element (type H)	5 units	6ES7193-6EH00-1AA0
Mounting rails, tinned steel strip ²⁾		
• Length: 483 mm	1 unit	6ES5710-8MA11
• Length: 530 mm	1 unit	6ES5710-8MA21

Accessories, general	Packing unit	Article number
• Length: 830 mm	1 unit	6ES5710-8MA31
• Length 2000 mm	1 unit	6ES5710-8MA41
SIMATIC system rails ²⁾		
• Length 483 mm	1 unit	6ES7193-6MR00-0AA0
• Length 530 mm	1 unit	6ES7193-6MR00-0BA0
• Length 830 mm	1 unit	6ES7193-6MR00-0CA0
• Length 2000 mm	1 unit	6ES7193-6MR00-0DA0

¹⁾ For the I/O modules, mechanical or electronic coding elements are supplied ex works, depending on the module. Variants A, B, C, D, F and H are available as spare parts. The appropriate coding element can be found in the technical specifications of the respective I/O module. The procedure for changing the coding element is described in the section Changing the type of an I/O module (Page 287).

²⁾ The length of the DIN rails and SIMATIC system rails can be shortened as required.

Table B-2 Accessories, color identification labels (push-in terminals), 15 mm wide

Accessories, color identification labels (push-in terminals), 15 mm wide	Packing unit	Article number
16 process terminals (see I/O module manual)		
• Gray (terminals 1 to 16); color code CC00	10 units	6ES7193-6CP00-2MA0
• Gray (terminals 1 to 8), red (terminals 9 to 16); color code CC01	10 units	6ES7193-6CP01-2MA0
• Gray (terminals 1 to 8), red (terminals 9 to 16); color code CC01	50 units	6ES7193-6CP01-4MA0
• Gray (terminals 1 to 8), blue (terminals 9 to 16); color code CC02	10 units	6ES7193-6CP02-2MA0
• Gray (terminals 1 to 8), blue (terminals 9 to 16); color code CC02	50 units	6ES7193-6CP02-4MA0
• Gray (terminals 1 to 8), red (terminals 9 to 12), gray (terminals 13 to 16); color code CC03	10 units	6ES7193-6CP03-2MA0
• Gray (terminals 1 to 8), red (terminals 9 to 12), blue (terminals 13 to 16); color code CC04	10 units	6ES7193-6CP04-2MA0
• Gray (terminals 1 to 12), red (terminals 13 and 14), blue (terminals 15 and 16)	10 units	6ES7193-6CP05-2MA0
10 AUX terminals (for BU15-P16+A10+2D, BU15-P16+A10+2B)		
• Yellow-green (terminals 1 A to 10 A); color code CC71	10 units	6ES7193-6CP71-2AA0
• Red (terminals 1 A to 10 A); color code CC72	10 units	6ES7193-6CP72-2AA0
• Blue (terminals 1 A to 10 A); color code CC73	10 units	6ES7193-6CP73-2AA0
• Blue (terminals 1 A to 10 A); color code CC73	50 units	6ES7193-6CP73-4AA0
10 add-on terminals (for BU15-P16+A0+12D/T, BU15-P16+A0+12B/T)		
• Red (terminals 1B to 5B), blue (terminals 1 to 5C); color code CC74	10 units	6ES7193-6CP74-2AA0
16 potential terminals (for PotDis-BU-P1/x-R)		
• Red (terminals 1 to 16); color code CC62	10 units	6ES7193-6CP62-2MA0

Accessories, color identification labels (push-in terminals), 15 mm wide	Packing unit	Article number
16 potential terminals (for PotDis-BU-P2/x-B)		
• Blue (terminals 1 to 16); color code CC63	10 units	6ES7193-6CP63-2MA0
18 potential terminals (for PotDis-TB-P1-R)		
• Red (terminals 1 to 18); color code CC12	10 units	6ES7193-6CP12-2MT0
• Gray (terminals 1 to 18); color code CC10	10 units	6ES7193-6CP10-2MT0
18 potential terminals (for PotDis-TB-P2-B)		
• Blue (terminals 1 to 18); color code CC13	10 units	6ES7193-6CP13-2MT0
• Gray (terminals 1 to 18); color code CC10	10 units	6ES7193-6CP10-2MT0
18 potential terminals (for PotDis-TB-BR-W)		
• Yellow/green (terminals 1 to 18); color code CC11	10 units	6ES7193-6CP11-2MT0
• Red (terminals 1 to 18); color code CC12	10 units	6ES7193-6CP12-2MT0
• Blue (terminals 1 to 18); color code CC13	10 units	6ES7193-6CP13-2MT0
• Gray (terminals 1 to 18); color code CC10	10 units	6ES7193-6CP10-2MT0
18 potential terminals (for PotDis-TB-n.c.-G)		
• Gray (terminals 1 to 18); color code CC10	10 units	6ES7193-6CP10-2MT0

Table B-3 Accessories, color identification labels (push-in terminals), 20 mm wide

Accessories, color identification labels (push-in terminals), 20 mm wide	Packing unit	Article number
12 process terminals (see I/O module manual)		
• Gray (terminals 1 to 4), red (terminals 5 to 8), blue (terminals 9 to 12); color code CC41	10 units	6ES7193-6CP41-2MB0
• Gray (terminals 1 to 8), red (terminals 9 and 10), blue (terminals 11 and 12), color code CC42	10 units	6ES7193-6CP42-2MB0
6 process terminals (see I/O module manual)		
• Gray (terminals 1 to 4), red (terminal 5), blue (terminal 6); color code CC51	10 units	6ES7193-6CP51-2MC0
• Gray (terminals 1, 2 and 5), red (terminals 3 and 4), blue (terminal 6); color code CC52	10 units	6ES7193-6CP52-2MC0
4 AUX terminals (for BU20-P12+A4+0B)		
• Yellow-green (terminals 1 A to 4 A); color code CC81	10 units	6ES7193-6CP81-2AB0
• Red (terminals 1 A to 4 A); color code CC82	10 units	6ES7193-6CP82-2AB0
• Blue (terminals 1 A to 4 A); color code CC83	10 units	6ES7193-6CP83-2AB0
2 AUX terminals (for BU20-P6+A2+4D, BU20-P6+A2+4B)		
• Yellow-green (terminals 1 A and 2 A); color code CC84	10 units	6ES7193-6CP84-2AC0
• Red (terminals 1 A and 2 A); color code CC85	10 units	6ES7193-6CP85-2AC0
• Blue (terminals 1 A and 2 A); color code CC86	10 units	6ES7193-6CP86-2AC0

Table B-4 SIMATIC memory card accessories

Capacity	Packing unit	Article number
4 MB	1 unit	6ES7954-8LCxx-0AA0
12 MB	1 unit	6ES7954-8LExx-0AA0
24 MB	1 unit	6ES7954-8LFxx-0AA0
256 MB	1 unit	6ES7954-8LL02-0AA0
2 GB	1 unit	6ES7954-8LPxx-0AA0
32 GB	1 unit	6ES7954-8LTxx-0AA0

Table B-5 Accessories for motor starters

Short designation	Packing unit	Article number
3DI/LC module (connecting terminal)	1 unit	3RK1908-1AA00-0BP0
Fan	1 unit	3RW4928-8VB00
BU cover 30	1 unit	3RK1908-1CA00-0BP0
Touch protection cover for the infeed bus	10 units	3RK1908-1DA00-2BP0
Mechanical bracket for BaseUnit	5 units	3RK1908-1EA00-1BP0

Components for lightning protection

If you need surge protection devices for lightning protection, you can find additional information in the function manual *Designing interference-free controllers* (<https://support.automation.siemens.com/WW/view/en/59193566>).

Online catalog

Additional article numbers for ET 200SP can be found on the Internet (<https://mall.industry.siemens.com>) in the online catalog and online ordering system.

See also

[Firmware update \(Page 291\)](#)

B.1 Lightning protection and overvoltage protection for fail-safe modules

Overvoltage arrestors for fail-safe modules

NOTE

This section only lists the overvoltage arrestors that may be used to protect the fail-safe modules.

Be sure to observe the detailed information on lightning protection and overvoltage protection of the ET 200SP distributed I/O system in Electromagnetic compatibility of fail-safe modules ([Page 326](#)).

Components for overvoltage protection of fail-safe modules (lightning protection zone transition 0_B to 1)

The overvoltage arrestors are only required for unshielded cables. The Configuring interference-free controllers (<https://support.automation.siemens.com/WW/view/en/59193566>) Function Manual lists the overvoltage arrestors which you may use for fail-safe modules.

Calculating the leakage resistance

Introduction

If you wish to protect the ET 200SP using a ground-fault detector or a residual current circuit breaker, then you need the leakage resistance to select the correct safety components.

Ohmic resistance

When determining the leakage resistance of the ET 200SP, you must take into account the ohmic resistance from the RC combination of the module in question:

Table C-1 Ohmic resistance

Module	Ohmic resistance from RC network
CPU/interface module	10 MΩ (±5 %)
BaseUnit BU15...D	10 MΩ (±5 %)
BaseUnit BU30-MSx	10 MΩ (±5 %)

Formula

You can calculate the leakage resistance of the ET 200SP using the following formula if you protect all of the modules listed above with one ground-fault detector:

$$R_{ET200SP} = R_{module} / N$$

$R_{ET200SP}$ = Leakage resistance of the ET 200SP
 R_{module} = Leakage resistance of a module
 N = Number of BaseUnits BU15...D and interface module in the ET 200SP
 $R_{CPU/IM} = R_{BU15...D} = R_{Module} = 9.5 \text{ M}\Omega$
 $R_{CPU/IM}$ = Leakage resistance of CP/interface module
 $R_{BU15...D}$ = Leakage resistance of the BaseUnit BU15...D

If you protect the modules listed above within an ET 200SP with several ground-fault detectors, you must determine the leakage resistance for each individual ground-fault detector.

Example

The structure of an ET 200SP system consists of an IM 155-6 PN ST, two BaseUnits BU15...D and various input and output modules. The entire ET 200SP is protected with **one** ground-fault detector:

$$R_{\text{ET 200SP}} = \frac{9.5 \text{ M}\Omega}{3} = 3.17 \text{ M}\Omega$$

Figure C-1 Calculation example for leakage resistance

Glossary

1oo1 evaluation

Type of → sensor evaluation – in the case of the 1oo1 evaluation, there → is one sensor with a 1-channel connection to the F module.

1oo2 evaluation

Type of → sensor evaluation – in the case of 1oo2 evaluation , two input channels are assigned one two-channel sensor or two one-channel sensors. The input signals are compared internally for equivalence or nonequivalence.

Acknowledgment time

During the acknowledgment time, the → F-I/O acknowledge the sign of life specified by the → F-CPU. The acknowledgment time is included in the calculation of the → monitoring time and → response time of the overall fail-safe system.

Actuator

Actuators are, for example, power relays or contactors for switching on load devices or load devices themselves (e.g. directly controlled solenoid valves).

Automation system

Programmable logic controller for the open-loop and closed-loop control of process sequences of the process engineering industry and manufacturing technology. The automation system consists of different components and integrated system functions depending on the automation task.

AUX bus

Self-assembling bus, can be used individually, for example, as a protective conductor bus or for additional required voltage. Observe the corresponding information/warnings in the ET 200SP system manual.

Availability

Availability is the probability that a system is functional at a specific point in time. Availability can be increased by redundancy, e.g., by using multiple → sensors at the same measuring point.

AWG (American Wire Gauge)

A standard measure for conductors used in the USA, which is assigned to a specific cross-sectional area of a conductor or wire. Each AWG number represents a jump of 26% in the cross-sectional area. The thicker the wire, the smaller the AWG number.

BaseUnit

BaseUnits realize the electrical and mechanical connection of the I/O modules with the interface module and the server module.

The inserted I/O module determines the signals at the terminals of the BaseUnits. Depending on the selected BaseUnit, only certain terminals are available.

BaseUnit, dark-colored

Conduction of the internal power and AUX buses from the left adjacent module to the subsequent modules on the right.

BaseUnit, light-colored

Inserted as first BaseUnit and opens a new potential group with electrical isolation. The power and AUX buses are separate from the adjacent module on the left. It feeds the supply voltage.

Baud rate

Speed at which data is transferred, indicating the number of transmitted bits per second (baud rate = bit rate).

BU cover

Cover for unused slots on the BaseUnit or placeholder for planned I/O modules. For a future expansion, the reference identification label of the planned I/O module can be kept here.

Bus

Joint transmission path to which all participants of a fieldbus system are connected; has two defined ends.

BusAdapter

Enables free selection of the connection technology for the PROFINET fieldbus.

Channel fault

Channel-specific fault, such as a wire break or short circuit.

In channel-specific passivation, the affected channel is either automatically reintegrated or the fail-safe module must be removed and reinserted after the fault has been eliminated.

Channel group

The channels of a module are grouped together in a channel group. Certain parameters in STEP 7 can only be assigned to channel groups, rather than to individual channels.

Channel number

Channel numbers are used to uniquely identify the inputs and outputs of a module and to assign channel-specific diagnostic messages.

Channel-specific passivation

With this type of passivation, only the affected channel is passivated in the event of a → channel fault. In the event of a → module fault, all channels of the → fail-safe module are passivated.

Configuration

Systematic arrangement of the individual modules.

Configuration control

Function that enables a flexible adjustment of the actual configuration based on a configured maximum configuration via the user program. Input, output and diagnostics addresses remain unchanged.

Connecting to common potential

Configuring a new potential group for which a new infeed is set up for the supply voltage.

Connection plug

Physical connection between device and cable.

CPU

The CPU uses the integrated system power supply to supply the electronics of the modules via the backplane bus. The CPU contains the operating system and executes the user program. The user program is located on the SIMATIC memory card and is processed in the work memory of the CPU. The PROFINET interfaces of the CPU establish an Industrial Ethernet connection. The CPUs of the ET 200SP support operation as an IO controller, I-device or standalone CPU.

CRC

Cyclic Redundancy Check

CRC signature

The validity of the process values in the safety frame, the accuracy of the assigned address references, and the safety-related parameters are validated by means of the CRC signature in the safety frame.

Crimping

Procedure in which two components, e.g. end sleeve and cable, are connected with each other by plastic strain.

Dark period

Dark periods occur during shutdown tests and complete bit pattern tests. The fail-safe output module switches test-related zero signals to the active output. This output is then briefly disabled (= dark period). An adequate carrier → actuator will not respond to this and will remain activated.

Derating

Derating allows devices to be used even in harsh operating conditions by selectively restricting the output capacity. In the case of motor starters, this usually refers to operation at high ambient temperatures.

Device name

Before an IO device can be addressed by an IO controller, it must have a device name. An IO device is delivered without a device name. An IO device can only be addressed by the IO controller after it has been assigned a device name via the PG/PC or via the topology, e.g. for the transfer of configuration data (such as IP address) during startup or for the exchange of user data during cyclic operation.

Diagnostics

Monitoring functions for the recognition, localization, classification, display and further evaluation of errors, faults and alarms. They run automatically during plant operation. This increases the availability of plants because commissioning times and downtimes are reduced.

Discrepancy analysis

The discrepancy analysis for equivalence/non-equivalence is used for fail-safe applications to prevent errors from time differences between two signals for the same function. The discrepancy analysis is initiated when different levels are detected in two associated input signals (when testing for non-equivalence: the same levels). A check is performed to determine whether the difference (for nonequivalence testing: the same levels) has disappeared after an assignable time period, the so-called discrepancy time. If not, this means that a discrepancy error exists.

The discrepancy analysis compares the two input signals of the 1oo2 sensor evaluation in the fail-safe input module.

Discrepancy time

Configurable time for the → discrepancy analysis. If the discrepancy time is set too high, the fault detection time and → fault reaction time are extended unnecessarily. If the discrepancy time is set too low, availability is decreased unnecessarily since a discrepancy error is detected when, in reality, no error exists.

Distributed I/O system

System with input and output modules that are configured on a distributed basis, far away from the CPU controlling them.

DP

→ Distributed I/O system

Earth

Conductive earth whose electrical potential can be set equal to zero at any point.

Equipotential bonding

Electrical connection (potential equalization conductor) that brings the bodies of electrical equipment and other conductive bodies to the same or almost the same potential, in order to prevent disruptive or dangerous voltages between these bodies.

Fail-safe modules

ET 200SP modules with integrated safety functions that can be used for safety-related operation (safety mode).

Fail-safe systems

Fail-safe systems (F-systems) remain in a safe state or immediately assume another safe state as soon as particular failures occur.

Fault reaction time

The maximum fault reaction time of an F-system defines the interval between the occurrence of any fault and a safe reaction at all affected fail-safe outputs.

For → F-system overall: The maximum fault reaction time defines the interval between the occurrence of any fault in any → F-I/O and a safe response at the relevant fail-safe output.

For digital inputs: The maximum fault reaction time defines the interval between the occurrence of the fault and the safe reaction on the backplane bus.

For digital outputs: The maximum fault reaction time defines the interval between the occurrence of the fault and the safe reaction at the digital output.

Fault tolerance time

The fault tolerance time of a process is the time a process can be left unattended without risk to life and limb of the operating personnel, or damage to the environment.

Any type of F-system control is tolerated within this fault tolerance time, i.e. the → F-system can control its processes incorrectly or even not at all. The fault tolerance time depends on the type of process and must be determined on a case-by-case basis.

F-CPU

An F-CPU is a central processing unit with fail-safe capability that is permitted for use in SIMATIC Safety. A standard user program can also be run on the F-CPU.

F-I/O

Collective name for fail-safe inputs and outputs available in SIMATIC S7 for integration into the SIMATIC Safety F-system. Available F-I/O modules:

- Fail-safe I/O module for ET 200eco
- Fail-safe signal modules S7-300 (F-SMs)
- Fail-safe modules for ET 200S
- Fail-safe modules for ET 200SP
- Fail-safe modules for ET 200MP
- Fail-safe DP standard slaves
- Fail-safe PA field devices
- Fail-safe IO devices

Firmware update

Upgrade of firmware for modules (interface modules, I/O modules etc.), e.g. after function extensions, to the newest firmware version (update).

F-monitoring time

→ PROFIsafe monitoring time

F-Systems

→ fail-safe systems

Functional ground

Functional ground is a low-impedance current path between electric circuits and ground. It is not designed as a safety measure but instead, for example, as a measure to improve interference immunity.

Ground

All interconnected, inactive parts of a piece of equipment that cannot accept any dangerous contact voltage, even in the event of a fault.

Grounding

Grounding means connecting an electrically conductive part to a grounding electrode by means of a grounding system.

GSD file

As a Generic Station Description, this file contains all properties of a PROFINET or PROFIBUS device that are necessary for its configuration in XML format.

I/O modules

All modules, with the exception of the motor starters, that can be operated with a CPU or an interface module.

Identification data

Information that is saved in modules and that supports the user in checking the plant configuration and locating hardware changes.

Infeed system

The infeed system with the terminals L1(L), L2(N), L3, PE enables several SIMATIC ET 200SP motor starters to be supplied using a single infeed terminal.

Interface module

Module in the distributed I/O system. The interface module connects the distributed I/O system via a fieldbus to the CPU (IO controller) and prepares the data for and from I/O modules.

IO-Link

IO-Link is a point-to-point connection to conventional and intelligent sensors/actuators by unshielded standard cables in proven 3-wire technology. IO-Link is downward compatible to all DI/DQ sensors/actuators. Switching status channel and data channel are designed in proven 24 V DC technology.

Line

All the modules attached to a mounting rail.

Load current supply

Supply of modules like the interface module, power supply modules, I/O modules, and (if applicable) sensors and actuators.

MAC address

Device identification unique worldwide, which is already assigned to each PROFINET device in the factory. Its 6 bytes are divided into 3 bytes for the manufacturer ID and 3 bytes for the device ID (serial number). The MAC address is usually legible on the device.

Main switch

Every industrial machine that falls under the scope of DIN EN 60204 Part 1 (VDE 0113, Part 1) must be equipped with a main switch that disconnects all electrical equipment from the network while cleaning, maintenance, and repair work is being carried out, as well as during long periods of downtime. Usually a switch which can be operated by hand that is stipulated for electrical or mechanical prevention of a hazard. The main switch can also function as an EMERGENCY STOP device.

The main switch must meet the following requirements:

- Externally accessible mechanical rotary lock.
- Only one OFF position and one ON position with allocated stops.
- Two positions labeled "0" and "I". 4th lockable OFF position.
- Cover for the power supply terminals to protect against accidental contact.
- The switching capacity must correspond to AC-23 for motor switches and AC-22 for load-break switches (utilization category).
- Switch position displayed automatically.

Module fault

Module faults can be external faults (e.g. missing load voltage) or internal faults (e.g. processor failure). Internal faults always require module replacement.

Monitoring time

→ PROFIsafe monitoring time

Motor starter

Motor starter is the generic term for direct-on-line and reversing starters.

M-switch

Each fail-safe digital output of ET 200SP F-modules consists of a P-switch DO-P_x (current sourcing) and an M-switch DO-M_x (current sinking). The load is connected between the P-switch and M-switch. The two switches are always activated so that voltage is applied to the load.

Node

Device that can send, receive or amplify data via the bus, e.g. IO device via PROFINET IO.

Nonequivalent sensor

A nonequivalent → sensor is a two-way switch that is connected to two inputs of an → F-I/O (via 2 channels) in → fail-safe systems (for → 1oo2 evaluation of sensor signals).

Overload release

Overcurrent release that provides protection against overload.

Parameter assignment

Parameter assignment is the transfer of parameters from the IO controller/DP master to the IO device/DP slave.

Passivation

If an → F-I/O module detects a fault it switches either the affected channel or all channels to a → safe state, i.e. the channels of this F-I/O module are passivated. The F-I/O module signals the detected faults to the → F-CPU.

When passivating channels at F-I/O with inputs, the → F-System provides fail-safe values for the → safety program instead of the process values pending at the fail-safe inputs.

When passivating channels at F-I/O with outputs, the F-system returns fail-safe values (0) to the fail-safe outputs instead of the output values provided by the safety program.

PELV

Protective Extra Low Voltage

Performance Level

Performance Level (PL) in accordance with ISO 13849-1 or EN ISO 13849-1

Potential group

Group of I/O modules that are jointly supplied with voltage.

Prewiring

Wiring the electrics on a mounting rail before the I/O modules are connected.

Process image (I/O)

The CPU transfers the values from the input and output modules to this memory area. At the start of the cyclic program, the signal states of the input modules are transmitted to the

process image input. At the end of the cyclic program, the process image output is transmitted as signal state to the output modules.

Product version (ES) = Functional status (FS)

The product version or functional status provides information on the hardware version of the module.

PROFIBUS

PROcess Field BUS, process and fieldbus standard that is specified in IEC 61158 Type 3. It specifies functional, electrical and mechanical properties for a bit-serial fieldbus system. PROFIBUS is available with the following protocols: DP (= Distributed Periphery), FMS (= Fieldbus Message Specification), PA (= Process Automation) or TF (= Technological Functions).

PROFINET

PROcess Field NETwork, open industrial Ethernet standard which continues PROFIBUS and Industrial Ethernet. A cross-manufacturer communication, automation and engineering model by PROFIBUS International e.V., defined as an automation standard.

PROFINET IO controller

Device used to address connected I/O devices (e.g. distributed I/O systems). This means: The IO controller exchanges input and output signals with assigned I/O devices. The IO controller often corresponds to the CPU in which the automation program is running.

PROFINET IO

Communication concept for the realization of modular, distributed applications within the scope of PROFINET.

PROFINET IO device

Distributed field device that can be assigned to one or more IO controllers (e.g. distributed I/O system, valve terminals, frequency converters, switches).

PROFIsafe

Safety-oriented PROFINET I/O bus profile for communication between the → safety program and the → F-I/O module in a → fail-safe system.

PROFIsafe address

The PROFIsafe address (code name according to IEC 61784-3-3: 2010) is used to protect standard addressing mechanisms such as IP addresses. The PROFIsafe address consists of the F-source address and F-destination address. Every → fail-safe module therefore has two address portions, the F-source address and the F-destination address.

The PROFIsafe address must be configured in the hardware and network editor.

PROFIsafe monitoring time

Monitoring time for safety-related communication between the F-CPU and F-I/O

Proof-test interval

Period after which a component must be forced to fail-safe state, that is, it is either replaced with an unused component, or is proven faultless.

Provider-Consumer principle

Principle of data communication on the PROFINET IO: in contrast to PROFIBUS, both parties are independent providers when sending data.

P-switch

→ M-switch

Push-in terminal

Push-in connections are a form of spring-loaded terminals allowing wiring without tools for rigid conductors or conductors equipped with end sleeves.

Redundancy, availability-enhancing

Multiple instances of components with the objective of maintaining component functionality in the event of hardware faults.

Redundancy, safety-enhancing

Multiple availability of components with the aim of exposing hardware faults based on comparison; such as → 1oo2 evaluation in → fail-safe modules.

Reference identification

In accordance with EN 81346, a specific object is clearly referenced in relation to the system to whose components the object belongs. Thus, unique identification of the modules in the entire system is possible.

Reference potential

Potential from which the voltages of the participating circuits are considered and/or measured.

Reintegration

After the elimination of a fault, it is necessary to ensure the reintegration (depassivation) of the → F-I/O. Reintegration (switchover from fail-safe values to process values) occurs either automatically or only after a user acknowledgment in the safety program.

In the case of a fail-safe input module, the process values pending at the fail-safe inputs are made available to the safety program again after reintegration. In the case of a fail-safe output module, the → fail-safe system transfers the output values in the safety program to the fail-safe outputs again.

RIOforFA-Safety

Remote IO for Factory Automation with PROFIsafe; Profile for F-I/O

RoHS

EC Directive 2011/65/EU concerning the restriction of certain dangerous substances in electrical and electronic devices regulates the use of hazardous substances in devices and components. The English abbreviation RoHS is used to refer to this directive: (Restriction of the use of certain hazardous substances), as well as all related measures for implementing it into national legislation.

Safe Direction (SDI)

The SDI function (Safe Direction) monitors the direction of the motion.

Safe Operating Stop (SOS)

The SOS function (Safe Operating Stop) protects from unintentional motions.

Safe state

The basic principle of the safety concept in F-systems is the existence of a safe state for all process variables. For the digital F-I/O, for example, the safe state is the value "0".

Safety class

Safety level (Safety Integrity Level) SIL according to IEC 61508:2010. The higher the Safety Integrity Level, the more rigid the measures for prevention of systematic faults and for management of systematic faults and hardware failures.

The fail-safe modules support operation in safety mode up to safety class SIL3.

Safety frame

In safety mode, data are transferred between the → F-CPU and → F-I/O in a safety frame.

Safety function

A mechanism integrated in the → F-CPU and → F-I/O that enables their use in → the fail-safe system SIMATIC Safety.

According to IEC 61508:2010: A safety function is implemented by a safety system in order to maintain or force a system safe state in the event of a specific fault.

Safety Limited Speed (SLS)

The SLS function (Safely Limited Speed) monitors the calculated speeds in both directions.

Safety mode

Operating mode of → F-I/O that enables → safety-related communication via → safety frames.

→ ET 200SP fail-safe modules can only be used in safety mode.

Safety program

Safety-related user program

Safety-related communication

Communication used to exchange fail-safe data.

Self-assembling voltage buses

Three internal, self-assembling buses (P1, P2 and AUX) that supply the I/O modules with power.

SELV

Safety Extra Low Voltage

Sensor evaluation

There are two types of sensor evaluation:

→ 1oo1 evaluation – sensor signal is read once

→ 1oo2 evaluation – sensor signal is read in twice by the same F-module and compared internally

Sensors

Sensors are used for the accurate detection of routes, positions, velocities, rotational speeds, masses, etc. in the form of digital and analog signals.

Server module

The server module completes the configuration of the ET 200SP.

Service life

Period of time for which the switching device will work properly under normal operating conditions. This is specified as the number of operating cycles, the electrical durability (e.g. contact erosion), and the mechanical durability (e.g. operating cycles without load).

SIL (Safety Integrity Level)

Discrete level (one of three possibilities) for defining safety integrity specifications of safety-related control functions. Safety integrity level 3 is the highest possible level, level 1 the lowest.

Slave station

A slave can only exchange data after being requested to do so by the master.

SNMP

SNMP (Simple Network Management Protocol) is the standardized protocol for diagnosing and also configuring the Ethernet infrastructure.

In the office area and in automation technology, devices support a wide range of manufacturers on the Ethernet SNMP.

SNMP-based applications can be operated on the same network in parallel to applications with PROFINET.

Standard mode

Operating mode of F-I/O in which standard communication is possible by means of → safety frames, but not → safety-related communication.

Fail-safe ET 200SP modules can only be operated in safety mode.

Switch

PROFIBUS is a linear network. The communication nodes are linked by means of a passive cable - the bus.

By contrast, Industrial Ethernet consists of point-to-point connections: each communication node is interconnected directly with precisely one other communication node.

If a communication node is linked to several communication nodes, this communication node is connected to the port of an active network component - the switch. Other communications devices (including switches) can then be connected to the other ports of the switch. The connection between a communication node and the switch remains a point-to-point connection.

The task of a switch is thus to regenerate and distribute received signals. The switch "learns" the Ethernet address(es) of a connected PROFINET device or additional switches and only forwards those signals that are intended for the connected PROFINET device or switch.

A switch has a specific number of connections (ports). You connect at most one PROFINET device or additional switch to each port.

Technology object

A technology object supports you in the configuration and commissioning of a technological function.

The properties of real objects are represented by the technology objects in the controller. Real objects can be, for example, controlled systems or drives.

The technology object includes all data of the real object that is required for its open-loop or closed-loop control, and it signals the status information.

TIA Portal

Totally Integrated Automation Portal

The TIA Portal is the key to the full performance capability of Totally Integrated Automation. The software optimizes all operating, machine and process sequences.

Total current

Sum of the currents of all output channels of a digital output module.

TWIN end sleeve

End sleeve for two cables

Type of coordination 1

The motor starter may be non-operational after a short circuit has been cleared. Damage to the motor starter is permissible.

Types of coordination

The IEC 60947-4-1 (VDE 0660 Part 102) standard distinguishes between two types of coordination referred to as coordination type "1" and coordination type "2". The short circuit that needs to be dealt with is cleared reliably and safely with both types of coordination; the only differences are in the extent of the damage sustained by the device following a short circuit.

Index

- 2**
 - 24 V DC supply, [134](#)
- 3**
 - 3DI/LC module, [79](#)
 - Functions, [157](#)
 - Connections, [157](#)
 - Assembling, [169](#)
 - Disassembling, [170](#)
 - 3-wire connection, [106](#)
- A**
 - Accessible devices
 - Firmware update, [295](#)
 - Accessories, [339](#)
 - Addressing, [183](#)
 - Basics, [183](#)
 - Approvals, [316](#)
 - Assembling, [124](#)
 - Infeed bus, [128](#)
 - BU cover, [131](#)
 - 3DI/LC module, [168](#)
 - Assembly/disassembly position, [167](#)
 - AUX bus (AUX(iliary) bus), [97](#)
- B**
 - BaseUnit, [72](#)
 - Types, [80](#)
 - Modules without temperature measurement, [84](#)
 - Modules with temperature measurement, [85](#)
 - Potential group, [94](#)
 - Potential group, [99](#)
 - Mounting, dismantling, [122](#)
 - Assembling, [125](#)
 - Wiring rules, [146](#)
 - wiring, [149](#)
 - Wiring, [154](#)
 - Assembling, [166](#)
 - Disassembling, [289](#)
 - Replacing the terminal box, [290](#)
 - BaseUnit ET 200SP R1, [74](#)
 - BU cover
 - Description, [77](#)
 - Assembling, [132](#)
 - Installation, [163](#)
 - BusAdapter, [73](#)
- C**
 - Cable shield, [151](#)
 - Changes
 - Compared with previous version, [30](#)
 - Changing type
 - Coding element, [287](#)
 - I/O module, [288](#)
 - Climatic environmental conditions, [331](#)
 - Coding element, [78](#)
 - Color identification label, [78](#)
 - Description, [78](#)
 - Installing, [175](#)
 - Commissioning, [246](#)
 - Startup, [257](#)
 - Removing/inserting a SIMATIC memory card, [258](#)
 - Reset to factory settings, [301](#)
 - Communication module, [71](#)

Components

- ET 200SP at a glance, [70](#)
- In accordance with DIN VDE regulation, [142](#)

Configuration, [63](#)

- On grounded reference potential, [140](#)
- Electrical, [145](#)
- Basics, [181](#)

Configuration control, [222](#)**Configuration example, [248](#), [250](#), [251](#), [253](#), [254](#), [256](#)****Configuration software, [178](#)****Configuring, [178](#)**

- Properties of the CPUs, [182](#)

Connecting

- Cable shield, [151](#)

Connecting the PROFIBUS DP interface to the interface module, [162](#)**Control data record, [228](#)**

- S7-1500, [228](#)

CPU, [70](#)

- Backup/restore contents, [269](#)
- Synchronizing the time, [272](#)
- Reset to factory settings, [298](#)
- Reading out service data, [312](#)

D**Degree of protection, [334](#)****Dimensional diagram**

- Shield connector, [337](#)
- Labeling strip, [337](#)
- Reference identification label, [338](#)

Disassembling, [289](#)**Dummy module**

- mounting, [117](#)

E**Electrical isolation, [145](#)****Electrical relationships, [145](#)****Electromagnetic compatibility (EMC), [324](#)****EMC (Electromagnetic compatibility), [324](#)****EMERGENCY STOP devices, [133](#)****Environmental conditions**

- Mechanical, [330](#)
- Climatic, [331](#)

ET 200SP

- Area of application, [63](#)
- Configuration example, [64](#)
- Configuration example, [67](#)
- Components, [70](#)
- Selecting a BaseUnit, [80](#)
- Rules and regulations for operation, [133](#)
- Short-circuit / overload protection, [142](#)
- Overall configuration, [143](#)
- Configuring, [178](#)
- Commissioning, [246](#)

Example

- ET 200SP configuration, [64](#)
- ET 200SP configuration, [67](#)
- Potential group, configuration, [104](#)
- Leakage resistance, [345](#)

Ex BaseUnit, [74](#)**Ex I/O module, [76](#)****Ex module group, [102](#), [114](#), [140](#)****Ex modules, [335](#)****Ex power module, [76](#)****External fuses/switches, [133](#)****F****Factory settings, [298](#)****Fail-safe power module, [75](#)****Fan, [79](#)**

- Mounting, [165](#)

FAQ

- Emergency address, [270](#)
- Trace function, [311](#)

Firmware update, [291](#)

- ## G
- Grounded extra-low-voltage, [141](#)
 - Grounding
 - Configuration on grounded reference potential, [140](#)
 - Graphical overview of ET 200SP, [143](#)
- ## I
- I/O module, [76](#)
 - Installation, [163](#)
 - Inserting or removing, [283](#)
 - Changing type, [288](#)
 - replace, [289](#)
 - Identification data, [275](#)
 - Incoming supply, grounded, [140](#)
 - Infeed bus
 - Cover, [79](#)
 - Assembling, [129](#)
 - Infeed bus cover, [79](#)
 - Installation
 - Mounting position, [112](#)
 - Mounting rail, [113](#)
 - Minimum clearances, [114](#)
 - Rules, [115](#)
 - Interface module, [118](#)
 - BaseUnit, [122](#)
 - Server module, [127](#)
 - I/O module, [163](#)
 - BU cover, [163](#)
 - I/O module, [283](#)
 - Insulation, [333](#)
 - Interface module, [71](#)
 - Mounting, dismantling, [118](#)
 - Wiring rules, [146](#)
 - Connecting the supply voltage, [158](#)
 - Reset to factory settings, [301](#)
 - RESET, [302](#)
 - Interference-free design, [117](#)
- ## L
- Labeling strip
 - Dimensional diagram, [337](#)
 - Labeling strips, [78](#)
 - Installing, [176](#)
 - Leakage resistance, [344](#)
 - Lightning protection, [134](#)
 - Line voltage, [134](#)
- ## M
- Maintenance, [283](#)
 - Removal and insertion, [283](#)
 - Changing type, [288](#)
 - Replacing modules, [288](#)
 - Replacing the terminal box, [290](#)
 - Firmware update, [291](#)
 - Reset to factory settings, [298](#)
 - Test functions, [307](#)
 - Reading out service data, [312](#)
 - Marking, [171](#)
 - Color coding, factory setting, [171](#)
 - Optional, [173](#)
 - Maximum configuration, [92](#)
 - Maximum cycle time, [191](#)
 - Mechanical bracket, [79](#)
 - Mounting, [130](#)
 - Mechanical environmental conditions, [330](#)
 - Memory reset
 - Basics, [265](#)
 - Automatic, [266](#)
 - Manual, [267](#)
 - MFCT, [247](#)
 - Minimum clearances, [114](#)
 - Motor starter, [76](#)
 - Assembling, [125](#)
 - Assembling, [166](#)
 - Disassembling, [166](#)
 - Disassembling, [289](#)
 - Mounting, [96](#)
 - Dummy module, [117](#)
 - Mechanical bracket, [129](#)
 - Mounting position, [112](#)

Mounting rail, [70](#), [113](#)

Mounting the ET 200SP R1 system, [119](#)

MultiFieldbus, [71](#), [247](#)

N

Network Time Protocol, [272](#)

NTP procedure, [272](#)

O

OBs, [192](#)

Queue, [192](#)

Priorities, [192](#)

Start events, [192](#)

Event source, [192](#)

Priorities and runtime behavior, [193](#)

Operating modes

Basics, [259](#)

STARTUP, [260](#)

Setting the startup behavior, [261](#)

STOP, [262](#)

RUN, [263](#)

Operating mode transitions, [263](#)

Operating position, [167](#)

Option handling, [222](#)

Overall configuration, [143](#)

Overview, graphic

Grounding the ET 200SP, [143](#)

P

Parking position/OFF, [167](#)

Password provider, [216](#)

PELV

Grounded extra-low-voltage, [141](#)

Pollution degree, [334](#)

PotDis-TerminalBlock, [75](#)

Potential distributor module, [75](#)

Selecting a PotDis-BaseUnit, [90](#)

Selecting a PotDis-TerminalBlock, [91](#)

Installing, [126](#)

Potential group

Forming, [94](#)

Operating principle, graphical overview, [98](#)

Forming, [99](#)

Operating principle, graphical overview, [99](#)

Configuration example, [104](#)

Process image

Inputs and outputs, [185](#)

Process image partition

updating, automatically, [186](#)

Updating in the user program, [186](#)

PROFINET IO, [246](#)

Protection, [213](#)

Access levels, [213](#)

Behavior of a password-protected CPU, [215](#)

Know-how protection, [217](#)

Copy protection, [220](#)

Protection against short circuit, [140](#)

Protection class, [333](#), [334](#)

Protection concept, [206](#)

R

Radio interference, [326](#)

Rated voltage, [335](#)

Reading out service data, [312](#)

Reassigning parameters, [268](#)

Reference identification label, [78](#)

Installing, [176](#)

Dimensional diagram, [338](#)

Remove, [283](#)

Replacement

Coding element, [288](#)

I/O module, [289](#)

Terminal box on the BaseUnit, [290](#)

Replacing the terminal box, [290](#)

RESET, [302](#)

Reset to factory settings, [301](#)

with RESET button, [302](#)

S

S7-FCT, [180](#)

Safe electrical separation, [141](#)

- Safety rules, [315](#)
- SELV
 - Safe electrical separation, [141](#)
- Server module, [77](#)
 - Mounting, dismantling, [127](#)
- Shield connection
 - Description, [78](#)
- Shield connector
 - Dimensional diagram, [337](#)
- Shipping conditions, [329](#)
- Short-circuit and overload protection according to DIN VDE regulation , [142](#)
- Short-circuit protection, [140](#)
- SIMATIC ET 200SP, [62](#)
- Spare parts, [339](#)
- Standards, [316](#)
 - IEC 61131-2, [322](#)
 - IEC 61010-2-201, [322](#)
 - IEC 60695-11-10, [322](#)
 - UL 94, [322](#)
 - IEC 60947, [322](#)
 - PROFINET, [322](#)
 - PROFIBUS, [322](#)
 - IO-Link, [322](#)
 - Use in industrial environments, [323](#)
 - Use in mixed areas , [323](#)
 - Use in residential areas, [323](#)
 - Environmental Product Declaration, [323](#)
- Starting up the ET 200SP, [257](#)
- Storage conditions, [329](#)
- Supply of external components, [107](#)
- Supply voltage, [94](#)
 - Potential group, [94](#)
 - Potential group, [99](#)
 - Connecting, [159](#)
- Synchronizing the time, [272](#)
- System rail, [70](#)

T

- Technical specifications
 - Standards and approvals, [316](#)
 - Electromagnetic compatibility (EMC), [324](#)
 - Shipping and storage conditions, [329](#)
 - Mechanical environmental conditions, [330](#)
 - Climatic environmental conditions, [331](#)
- Test functions, [307](#)
- Test voltage, [333](#)

V

- Value status, [189](#)
- Valve terminal, [77](#)
- Video sequence, [156](#)

W

- Wiring
 - General rules for ET 200SP, [133](#)
 - Rules, [146](#)
 - BaseUnits, [149](#)
 - BaseUnit, [154](#)

Z

- Zone 2 hazardous area, [335](#)