

SIEMENS

SIMATIC HMI

HMI device Mobile Panel 177 (WinCC flexible)

Operating Instructions

Foreword	
Overview	1
Safety instructions and general notes	2
Planning Use	3
Mounting and Connection	4
Operator elements and displays	5
Configuring the operating system	6
Preparing and backing up a project	7
Operating a project	8
Operating alarms	9
Operating recipes	10
Maintenance and service	11
Specifications	12
Appendix	A
Abbreviations	B

Order No. 6AV6691-1DK01-0AB0

Edition 07/2005

A5E00457412-01

Safety Guidelines

This manual contains notices you have to observe in order to ensure your personal safety, as well as to prevent damage to property. The notices referring to your personal safety are highlighted in the manual by a safety alert symbol, notices referring only to property damage have no safety alert symbol. These notices shown below are graded according to the degree of danger.



Danger

indicates that death or severe personal injury **will** result if proper precautions are not taken.



Warning

indicates that death or severe personal injury **may** result if proper precautions are not taken.



Caution

with a safety alert symbol, indicates that minor personal injury can result if proper precautions are not taken.

Caution

without a safety alert symbol, indicates that property damage can result if proper precautions are not taken.

Notice

indicates that an unintended result or situation can occur if the corresponding information is not taken into account.

If more than one degree of danger is present, the warning notice representing the highest degree of danger will be used. A notice warning of injury to persons with a safety alert symbol may also include a warning relating to property damage.

Qualified Personnel

The device/system may only be set up and used in conjunction with this documentation. Commissioning and operation of a device/system may only be performed by **qualified personnel**. Within the context of the safety notes in this documentation qualified persons are defined as persons who are authorized to commission, ground and label devices, systems and circuits in accordance with established safety practices and standards.

Prescribed Usage

Note the following:



Warning

This device may only be used for the applications described in the catalog or the technical description and only in connection with devices or components from other manufacturers which have been approved or recommended by Siemens. Correct, reliable operation of the product requires proper transport, storage, positioning and assembly as well as careful operation and maintenance.

Trademarks

All names identified by ® are registered trademarks of the Siemens AG. The remaining trademarks in this publication may be trademarks whose use by third parties for their own purposes could violate the rights of the owner.

Disclaimer of Liability

We have reviewed the contents of this publication to ensure consistency with the hardware and software described. Since variance cannot be precluded entirely, we cannot guarantee full consistency. However, the information in this publication is reviewed regularly and any necessary corrections are included in subsequent editions.

(A)

가

Foreword

Purpose of the Operating Instructions

This operating instruction manual provides information based on the requirements defined by DIN 8418 for mechanical engineering documentation. This information relates to the device, its place of use, transport, storage, installation, use and maintenance.

These operating instructions are intended for:

- Users
- Commissioning engineers
- Service technicians
- Maintenance technicians

Please read the section "Safety instructions and general notes" carefully.

The help integrated in WinCC flexible, the WinCC flexible Information System, contains detailed information. The information system contains instructions, examples and reference information in electronic form.

Basic Knowledge Requirements

General knowledge of automation technology and process communication is needed to understand the operating instructions.

It is also assumed that those using the manual have experience in using personal computers and knowledge of Microsoft operating systems.

Operating Instructions' Range of Validity

The operating instructions apply to the HMI device Mobile Panel 177 in conjunction with the software package WinCC flexible.

Position in the Information Scheme

These operating instructions form part of the SIMATIC HMI documentation. The following information provides you with an overview of the SIMATIC HMI information landscape:

User manuals

- WinCC flexible Micro:
Describes basic principles of configuration using the WinCC flexible Micro Engineering System.
- WinCC flexible Compact/Standard/Advanced:
Describes basic principles of configuration using the WinCC flexible Compact Engineering System/WinCC flexible Standard/WinCC flexible Advanced.
- WinCC flexible Runtime:
Describes how to commission and operate your runtime project on a PC.
- WinCC flexible Migration:
 - Describes how to convert an existing ProTool project to WinCC flexible.
 - Describes how to convert an existing WinCC project to WinCC flexible.
 - Describes how to convert an existing ProTool project including a change of the HMI device, e.g. from OP3 to OP 73 or OP7 to OP 77B.
 - Describes how to convert an existing ProTool project including a change from a graphics device to a Windows CE device.
- Communication:
 - Communication Part 1 describes the connection of the HMI device to SIMATIC PLCs.
 - Communication Part 2 describes the connection of the HMI device to third-party PLCs.

Operating Instructions

- Operating instructions for SIMATIC HMI devices:
 - OP 73, OP 77A, OP 77B
 - TP 170micro, TP 170A, TP 170B, OP 170B
 - OP 73micro, TP 177micro
 - TP 177A, TP 177B, OP 177B
 - TP 270, OP 270
 - MP 270B
 - MP 370
- Operating instructions for mobile SIMATIC HMI devices:
 - Mobile Panel 170
 - Mobile Panel 177
- Operating instructions (compact) for SIMATIC HMI devices:
 - OP 77B
 - Mobile Panel 170
 - Mobile Panel 177

Getting Started

- WinCC flexible for first time users:
Based on an example project, this is a step-by-step introduction to the basics of configuring screens, alarms, recipes and screen navigation.
- WinCC flexible for advanced users:
Based on an example project, this is a step-by-step introduction to the basics of configuring logs, project reports, scripts, user management and multilingual projects and integration in STEP 7.
- WinCC flexible options:
Based on an example project, this is a step-by-step introduction to the basics of configuring the WinCC flexible Sm@rtServices, Sm@rtAccess and OPC Server options.

Online Availability

Technical documentation on SIMATIC products and SIMATIC systems is available in PDF format in various languages at the following addresses:

- SIMATIC Guide Technische Dokumentation in Deutsch:
["http://www.ad.siemens.de/simatic/portal/html_00/techdoku.htm"](http://www.ad.siemens.de/simatic/portal/html_00/techdoku.htm)
- SIMATIC Guide for Technical Documentation in English:
["http://www.ad.siemens.de/simatic/portal/html_76/techdoku.htm"](http://www.ad.siemens.de/simatic/portal/html_76/techdoku.htm)

Conventions

Configuration and runtime software differ with regard to their names as follows:

- "WinCC flexible 2005," for example, refers to the configuration software.
The term "WinCC flexible" is used in a general context. The full name, for example "WinCC flexible 2005", is always used when it is necessary to differentiate between different versions of the configuration software.
- "WinCC flexible Runtime" refers to the runtime software that can run on HMI devices.

Text is highlighted as follows to simplify reading the operating instructions:

Representational Form	Scope
"Add screen"	<ul style="list-style-type: none"> • Terminology that appears in the user interface, e.g., dialog names, tabs, buttons, menu entries • Inputs required, e.g., limit values, tag values • Path information
"File > Edit"	Operational sequences, e.g., menu commands, context menu commands
<F1>, <Alt+P>	Keyboard operation

Please observe notes labeled as follows:

Note

Notes contain important information concerning the product, its use or a specific section of the documentation to which you should pay particular attention.

Trademarks

Names labeled with a ® symbol are registered trademarks of the Siemens AG. Other names used in this documentation may be trademarks, the use of which by third parties for their own purposes could violate the rights of the owner.

- HMI®
- SIMATIC®
- SIMATIC HMI®
- SIMATIC ProTool®
- SIMATIC WinCC®
- SIMATIC WinCC flexible®
- SIMATIC Mobile Panel 177®

Representatives and offices

If you have any further questions relating to the products described in this manual, please contact your local representative at the SIEMENS branch nearest you.

You can locate your contact partner on this Internet URL:

["http://www.siemens.com/automation/partner"](http://www.siemens.com/automation/partner)

Training Center

Siemens AG offers a variety of training courses in order to familiarize you with automation systems. Please contact your regional Training Center, or the central Training Center in D90327 Nuremberg.

Phone: +49 (911) 895-3200

Internet: ["http://www.sitrain.com"](http://www.sitrain.com)

Technical Support

You can reach the Technical Support for all A&D products

- using the support request form on the web:
["http://www.siemens.de/automation/support-request"](http://www.siemens.de/automation/support-request)

Phone: + 49 180 5050 222

Fax: + 49 180 5050 223

Further information about our technical support is available on the Internet at ["http://www.siemens.com/automation/service"](http://www.siemens.com/automation/service)

Service & Support on the Internet

Service & Support provides additional comprehensive information on SIMATIC products through online services at "<http://www.siemens.de/automation/support>":

- The newsletter provides up-to-date information relating to your products.
- Our Service & Support search engine provides you access to all available documentation.
- A forum for global exchange of information by users and experts
- Current product information, FAQs and downloads
- Your local Automation & Drives representative
- Information about on-site services, repairs, spare parts and much more is available on our "Services" pages.

Table of contents

	Foreword	i
1	Overview.....	1-7
1.1	Product Overview.....	1-7
1.2	Design of the HMI Device	1-8
1.2.1	Overview	1-8
1.2.2	Mobile Panel 177	1-9
1.2.3	Terminal box	1-12
1.2.4	Connecting cables	1-14
1.2.5	Wall holder	1-16
1.3	Accessories.....	1-16
1.3.1	Memory card	1-16
1.3.2	Miscellaneous	1-17
1.3.3	Optional Accumulator Package.....	1-17
1.4	Range of HMI software functions.....	1-18
1.5	Communication	1-20
2	Safety instructions and general notes	2-1
2.1	Safety information	2-1
2.2	Standards and Approvals.....	2-2
2.3	Operating safety.....	2-5
2.4	Voltage supply.....	2-6
2.5	Notes on applications.....	2-6
2.6	Risk analysis	2-6
2.7	Enable switch.....	2-7
2.8	STOP button	2-8
2.9	Electromagnetic compatibility	2-9
2.10	Transport and storage conditions	2-11
3	Planning Use	3-1
3.1	Notes about Usage	3-1
3.2	Mounting positions and type of fixation.....	3-4
3.3	Preparing mounting.....	3-4
3.4	Specifications for Insulation Tests, Protection Class and Degree of Protection.....	3-6
3.5	Nominal Voltages.....	3-6
4	Mounting and Connection.....	4-1
4.1	Checking the package contents.....	4-1

4.2	Mounting the terminal box and wall holder	4-1
4.3	Electrical installation.....	4-3
4.4	Connecting the terminal box	4-3
4.4.1	Opening and closing the terminal box.....	4-4
4.4.2	Interfaces to the Terminal Box DP	4-6
4.4.3	Interfaces to the Terminal Box PN	4-7
4.4.4	Setting the box ID at the terminal box.....	4-8
4.4.5	Stripping the insulation of cables	4-9
4.4.6	Connecting the Equipotential Bonding Circuit.....	4-10
4.4.7	Connecting the configuration computer	4-11
4.4.8	Connecting the PLC	4-13
4.4.9	Connect a printer.....	4-16
4.4.10	Connecting the Power Supply.....	4-17
4.4.11	Connecting the connecting cable.....	4-19
4.5	Connecting Mobile Panel 177	4-21
4.5.1	Opening and closing the terminal compartment	4-21
4.5.2	Interfaces on the Mobile Panel 177 DP	4-23
4.5.3	Interfaces on Mobile Panel 177 PN	4-23
4.5.4	Connecting the configuration computer	4-24
4.6	Switching on and testing the HMI device	4-25
5	Operator elements and displays	5-1
5.1	Mobile Panel	5-1
5.1.1	Operator control elements.....	5-1
5.1.2	Front-side operator control elements	5-2
5.1.3	Enable switch	5-3
5.1.4	STOP button	5-5
5.1.4.1	Overview	5-5
5.1.4.2	Safety functions of the STOP button.....	5-7
5.1.4.3	STOP button on Terminal Box Plus	5-8
5.1.4.4	STOP button on Terminal Box Basic	5-9
5.1.5	Hand wheel	5-11
5.1.6	Key-operated switch.....	5-12
5.1.7	Illuminated pushbutton	5-13
5.2	Holding and placing the Mobile Panel.....	5-14
5.3	Terminal Box PN	5-16
6	Configuring the operating system	6-1
6.1	Overview	6-1
6.2	Control Panel	6-3
6.2.1	Overview	6-3
6.2.2	Entry using the screen keyboard	6-5
6.2.3	Configuring the screen keyboard	6-6
6.2.4	Setting the character repetition of the screen keyboard	6-8
6.2.5	Setting the double-click on the touch screen	6-9
6.2.6	Backup and restore using a memory card	6-10
6.2.7	Setting the date and time	6-13
6.2.8	Saving tab entries	6-15
6.2.9	Modifying the screen contrast	6-16
6.2.10	Displaying information about the HMI	6-17
6.2.11	Calibrating the touch screen	6-18
6.2.12	Changing the password properties	6-20

6.2.13	Changing the printer properties	6-21
6.2.14	Changing regional settings	6-23
6.2.15	Changing MPI/DP settings – only at Mobile Panel 177 DP	6-24
6.2.16	Setting the delay	6-27
6.2.17	Setting the screen saver	6-28
6.2.18	Displaying the system information	6-29
6.2.19	Configuring the data channel	6-31
6.2.20	Configuring network operation	6-33
6.2.20.1	Overview	6-33
6.2.20.2	Setting the computer name of the HMI device	6-35
6.2.20.3	Activating the direct connection	6-36
6.2.20.4	Changing the network configuration	6-37
6.2.20.5	Changing the logon data	6-39
6.2.20.6	Changing the internet settings – only at Mobile Panel 177 PN	6-40
7	Preparing and backing up a project	7-1
7.1	Overview	7-1
7.1.1	Setting the operating mode	7-2
7.1.2	Reusing existing projects	7-3
7.1.3	Data transmission options	7-4
7.2	Transfer	7-5
7.2.1	Overview	7-5
7.2.2	Starting the transfer manually	7-5
7.2.3	Starting the transfer automatically	7-6
7.2.4	Testing a project	7-7
7.3	Backup and restore	7-9
7.3.1	Overview	7-9
7.3.2	Backup and restore operations in WinCC flexible	7-10
7.3.3	Backup and restore operations using ProSave	7-12
7.4	Updating the operating system	7-14
7.4.1	Overview	7-14
7.4.2	Updating the Operating System Using WinCC flexible	7-15
7.4.3	Updating the operating system in ProSave	7-16
7.5	Installing and uninstalling options	7-17
7.5.1	Overview	7-17
7.5.2	Installing and uninstalling options via WinCC flexible	7-17
7.5.3	Installing and uninstalling options via ProSave	7-19
7.6	Transferring license keys in both directions	7-20
7.6.1	Overview	7-20
7.6.2	Transferring License Keys and Transferring Them Back	7-20
8	Operating a project	8-1
8.1	Overview	8-1
8.2	Key operation	8-3
8.3	Direct keys	8-4
8.4	Setting the project language	8-5
8.5	Entries and help within a project	8-6
8.5.1	Overview	8-6
8.5.2	Entering and editing numerical values	8-7
8.5.3	Entering and editing alphanumeric values	8-9
8.5.4	Entering and editing symbolic values	8-11

8.5.5	Entering the date and time	8-11
8.5.6	Operating switches.....	8-12
8.5.7	Operating sliding controllers	8-13
8.5.8	Displaying infotext	8-14
8.6	Status / control	8-15
8.7	Pointer instrument	8-17
8.8	Sm@rtClient view.....	8-18
8.9	Operating trends	8-20
8.9.1	Overview	8-20
8.9.2	Operating the trend display	8-21
8.10	Project security.....	8-22
8.10.1	Overview	8-22
8.10.2	User login	8-24
8.10.3	User logoff.....	8-25
8.10.4	Creating a user.....	8-26
8.10.5	Changing user data.....	8-27
8.10.6	Deleting a user	8-29
8.11	Closing the project	8-31
9	Operating alarms	9-1
9.1	Overview	9-1
9.2	Displaying alarms.....	9-2
9.3	Acknowledge alarm.....	9-5
9.4	Edit alarm	9-6
10	Operating recipes	10-1
10.1	Purpose of and applications for recipes.....	10-1
10.2	Structure of a recipe.....	10-2
10.3	Display recipes.....	10-4
10.4	Operating recipe handling.....	10-7
10.4.1	Operating the recipe view	10-7
10.4.2	Operator input in the overview	10-9
10.4.3	Creating recipe records.....	10-10
10.4.4	Editing a recipe data record	10-11
10.4.5	Delete recipe data record.....	10-12
10.4.6	Export recipe data record.....	10-13
10.4.7	Import recipe records	10-13
10.4.8	Synchronizing tags.....	10-14
10.5	Using recipes	10-15
10.5.1	Configuring the transfer of recipe data records	10-15
10.5.2	Reading a recipe data record from the PLC	10-17
10.5.3	Transferring a recipe record to the PLC.....	10-18
10.6	Displaying production sequences schematically	10-19
10.6.1	Entering a recipe data record.....	10-19
10.6.2	Manual production sequence	10-20
10.6.3	Automatic production sequence.....	10-21
11	Maintenance and service	11-1

11.1	Maintenance and upkeep.....	11-1
11.2	Servicing and spare parts	11-2
12	Specifications	12-1
12.1	Dimensional Drawings	12-1
12.1.1	Mobile Panel	12-1
12.1.2	Wall holder	12-3
12.1.3	Terminal Box DP	12-4
12.1.4	Terminal Box PN	12-5
12.2	Technical specifications	12-6
12.2.1	Mobile Panel	12-6
12.2.2	Terminal Box DP	12-7
12.2.3	Terminal Box PN	12-8
12.3	Interface allocation Mobile Panel 177 DP	12-9
12.3.1	RS 485 (IF 2).....	12-9
12.3.2	RJ45.....	12-9
12.3.3	Female header	12-10
12.4	Interface assignment Mobile Panel 177 PN.....	12-10
12.4.1	RS 485 (IF 2).....	12-10
12.4.2	RJ45.....	12-11
12.4.3	Female header	12-11
12.5	Interface assignment Terminal Box DP	12-12
12.6	Interface assignment Terminal Box PN	12-15
12.7	Connection examples for Enable switch and STOP button.....	12-18
A	Appendix.....	A-1
A.1	Connection point recognition	A-1
A.1.1	Function method	A-1
A.1.2	Connection point recognition via box ID	A-2
A.2	Evaluation of the operator control elements	A-4
A.2.1	Overview	A-4
A.2.2	Evaluating operator control elements as direct keys	A-5
A.2.3	Evaluating operator control elements via WinCC flexible system functions.....	A-8
A.2.3.1	LED control of the softkeys	A-8
A.2.3.2	Basic procedure	A-9
A.2.3.3	Illuminated pushbutton.....	A-12
A.2.3.4	Key-operated switch	A-13
A.2.3.5	Handwheel	A-13
A.3	ESD Guidelines.....	A-14
A.4	System alarms	A-16
B	Abbreviations.....	B-1
	Glossary	Glossary-1
	Index	

Overview

1.1 Product Overview

Extended possible applications – with the Mobile Panel 177

The Mobile Panel 177 represents a further development step in the well-known mobile HMI devices of the "170" series. With the Mobile Panel 177 you can utilize text- or graphics-based projects for simple and medium-sized control and monitoring tasks on machines and plants.

SIMATIC Mobile Panels offer the option of making safety functions available on a mobile basis at any point of a machine or plant. In addition, the Mobile Panel 177 disposes of interfaces for connection to PROFIBUS or Ethernet – depending on the specific characteristics.

The Mobile Panel 177 is characterized by short start-up times, large user memory and high performance and is optimized for projects based on WinCC flexible.

1.2 Design of the HMI Device

1.2.1 Overview

Design

The following figure shows the Mobile Panel 177 with a terminal box. For stationary operation, the Mobile Panel 177 can be securely placed in a wall holder (not shown).

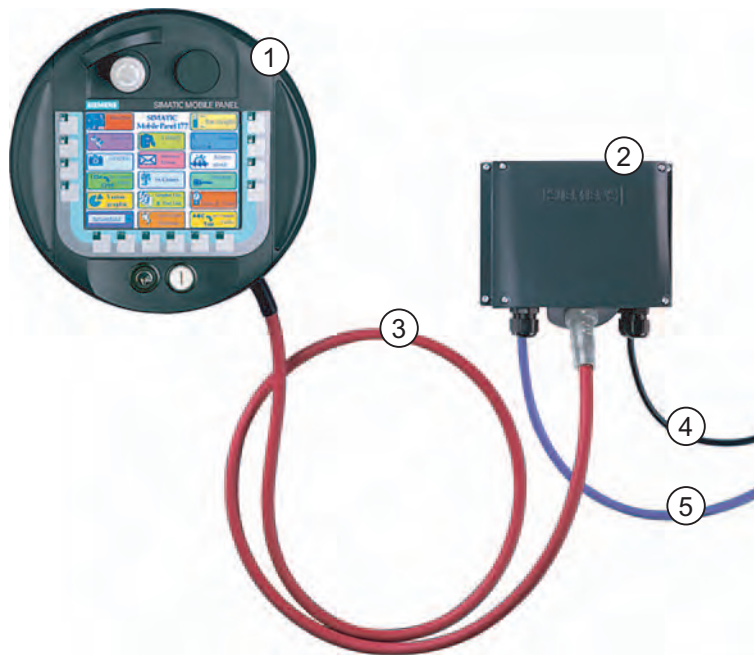

Figure 1-1 Mobile Panel design, example Mobile Panel 177 DP

- ① Mobile Panel 177 DP
- ② Terminal Box DP
- ③ Connecting cable DP
- ④ Cable for power supply and safety functions
- ⑤ Cable for process connection

Cables for process connection are available in different lengths and must be purchased separately.

Cables for the power supply and safety functions must be selected specifically for the system.

1.2.2 Mobile Panel 177

Introduction

The Mobile Panel 177 comes equipped in the following three ways:

- With enabling switches
- With enabling switches and STOP button
- With enabling switches, STOP button, handwheel, key-operated switch, and illuminated pushbutton

This variant is shown in the following illustrations.

Views of the Mobile Panel 177

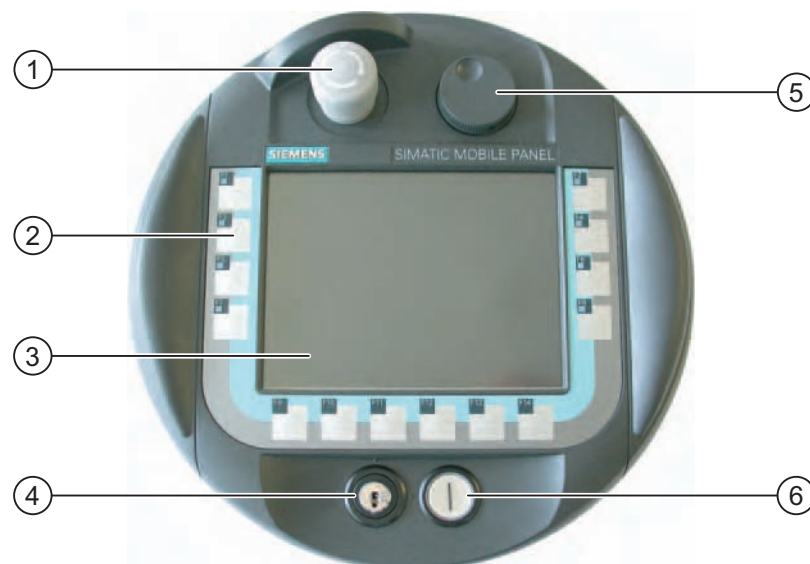

Figure 1-2 Front view

- ① STOP button, optional
- ② Control keys
- ③ Display / Touch screen
- ④ Key-operated switch, optional
- ⑤ Handwheel, optional
- ⑥ Illuminated pushbutton, optional



Figure 1-3 Side view

- ① Fall protection for the STOP pushbutton
- ② STOP button, optional
- ③ Enabling switches, located on both sides of the Mobile Panel 177
- ④ Grip

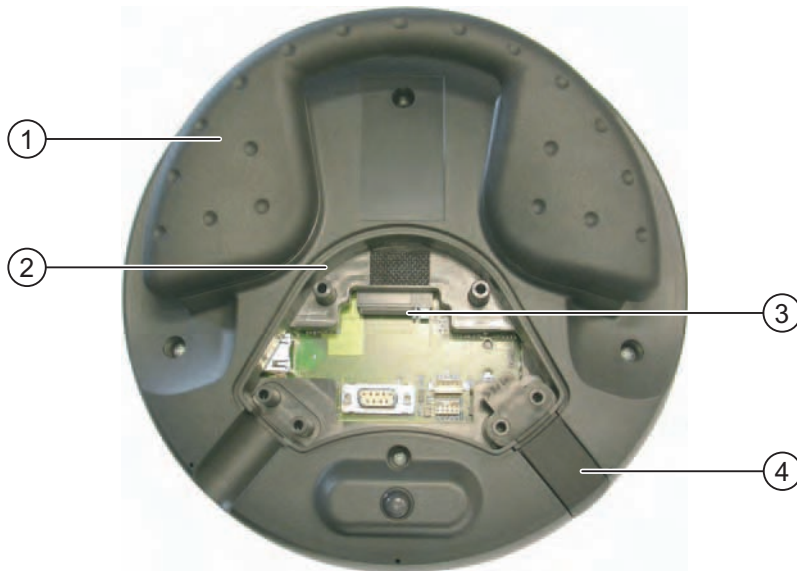

Figure 1-4 Rear view with opened terminal compartment on Mobile Panel 177 DP

- ① Grip
- ② Terminal compartment
- ③ Slot for MultiMediaCard
- ④ Sealing plug, to guarantee maintenance of protection class IP65

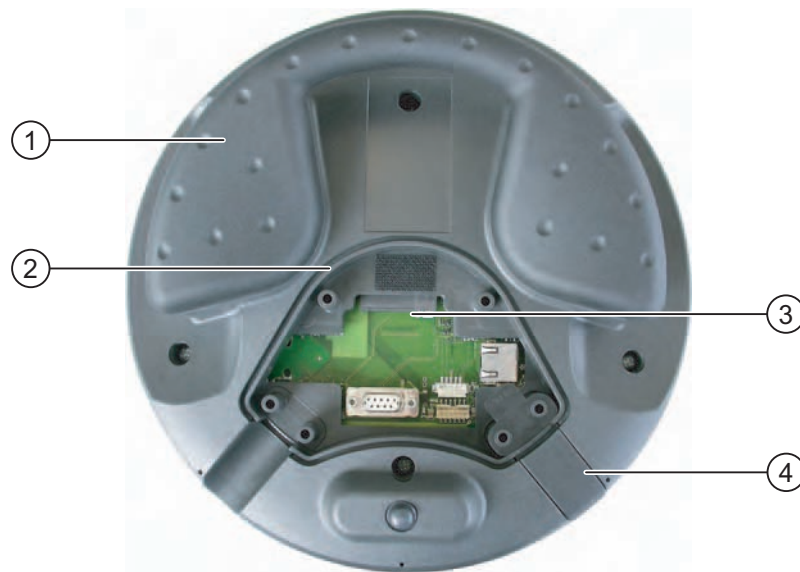

Figure 1-5 Rear view with opened terminal compartment on Mobile Panel 177 PN

- ① Grip
- ② Terminal compartment
- ③ Slot for MultiMediaCard
- ④ Sealing plug, to guarantee maintenance of protection class IP65

1.2.3 Terminal box

Design



Figure 1-6 Terminal Box DP

- ① Screwed joint for process data line
- ② Screwed joint for power supply cable and shield
- ③ Screwed joint for cable with supplementary Stop and enabling switch signals and for PLC-accompanying signals
- ④ Connecting socket for the connecting cable
- ⑤ Dummy cap



Figure 1-7 Terminal Box PN

- ① Screwed joint for process data line
- ② LED displays
- ③ Screwed joint for power supply cable and shield
- ④ Screwed joint for cable with supplementary Stop and enabling switch signals and for PLC-accompanying signals
- ⑤ Connecting socket for the connecting cable – covered with dummy cap

Notice**Protection class IP65**

Protection class IP65 at the terminal box is ensured with plugged-in Mobile Panel 177 or plugged-in dummy cap.

Variants

The terminal boxes are available in the following variants:

- Terminal Box Basic
- Terminal Box Plus

The two types of terminal boxes differ in the manner in which the circuit evaluates the Stop Circuit or Emergency Stop signal of the system to be monitored and the corresponding response to the system itself that is being monitored.

Note

The exterior of the terminal box variants differ only in the printing on the side.

Note**Recovery time**

Wait for approx. one second after you have removed the connecting cable from the terminal box before you plug the connecting cable back in.

After power failures of less than one second the connecting cable has to be disconnected.

Division of the system into zones

You can divide a system into several zones or functional areas by using several terminal boxes, whereby the safety functions can also be set up to be zone-specific. This means that both enabling switches and STOP buttons can act in only one particular zone and not in others.

Connection point recognition

You can set an individual box ID for each terminal box. The box ID allows connection point recognition to be implemented.

Combination of connecting cable and terminal box

It is ensured by mechanical means that only the following combinations can be plugged:

- Mobile Panel 177 DP with connecting cable DP to the terminal box DP
- Mobile Panel 177 PN with connecting cable PN to the terminal box PN

Compatibility with the Mobile Panel 170

You can operate a Mobile Panel 170 on a terminal box DP for the Mobile Panel 177 DP. The additional features of the new terminal box, for example the box ID, cannot be used with the Mobile Panel 170.

You can operate a Mobile Panel 177 DP on a terminal box for the Mobile Panel 170.

1.2.4 Connecting cables

Introduction

The connecting cable is connected to the Mobile Panel 177 and is plugged with a quick-connect plug connector to the terminal box. The connecting cable is an industrial cable and, thus, resistant to many solvents and lubricants. The flexural strength of the connecting cable is geared to the actual usage conditions.

The connecting cable is available in two models:

- Connecting cable DP
For connecting the Mobile Panel 177 DP to the terminal box DP.
- Connecting cable PN
For connecting the Mobile Panel 177 PN to the terminal box PN.

The connecting cables are available in different lengths. Further information can be found in the Siemens ST 80 catalog.

Design of the connecting cable



Figure 1-8 Connecting cable DP

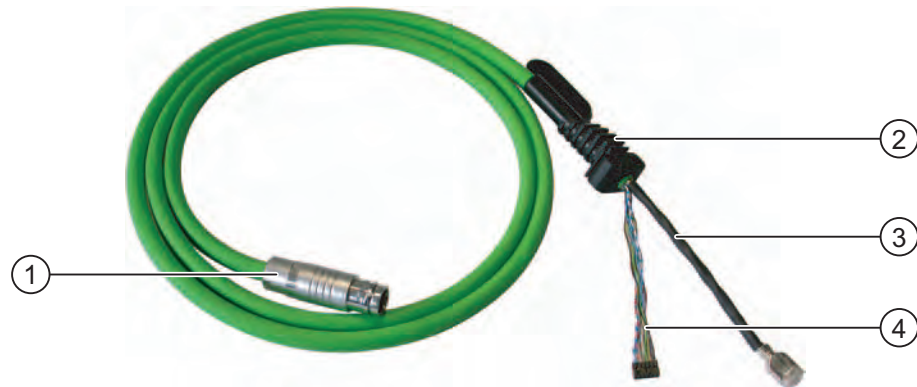

Figure 1-9 Connecting cable PN

- ① Metallic push-pull circular connector
- ② Strain relief and kink protection for connecting cable
- ③ RJ45 plug
- ④ Plug connector

Connections on the Mobile Panel 177 DP

- RJ45, 8-pin
- Plug connector, 10-pin

Connections on the Mobile Panel 177 PN:

- RJ45, 8-pin
- Plug connector, 12-pin

Connections on the terminal box side:

- Metallic push-pull circular connector, 22-pin

Note

Protection class

When inserted, the circular connector guarantees the rating of protection class IP65.

1.2.5 Wall holder

Function

The wall holder is used to securely mount the Mobile Panel 177 for stationary operation.

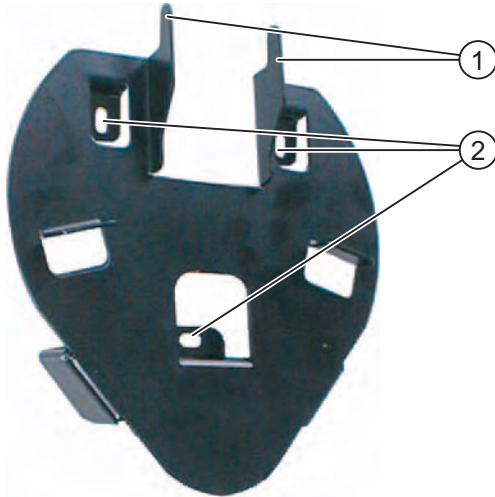

Figure 1-10 Wall holder

- ① Hook for the grip on the HMI device
- ② Screw-on hole

1.3 Accessories

1.3.1 Memory card

MultiMediaCard

A MultiMediaCard that has been tested and approved by Siemens AG can be used as an external storage medium for the Mobile Panel 177. You can order a tested and approved MultiMediaCard from a Siemens representative or Siemens office. The order number for the MultiMediaCard is 6AV6671-1CB00-0AX0.

Notice

MultiMediaCard

The MultiMediaCard of the SIMATIC S7 controller cannot be used.

1.3.2 Miscellaneous

Protective sleeve

To protect your customized keyboard labeling on the Mobile Panel 177, protective sleeves are available for the labeling strips. The order number for the protective sleeves is 6AV6574-1AB04-4AA0. The set contains five protective sleeves.

Protective film

Protective films are available for the touch screen. The protective film prevents the touch screen from being scratched or soiled. The order number for the protective films is 6AV6574-1AD04-4AA0. The set contains ten protective films.

PC-PPI adapter

For conversion from RS 232 to RS 485, order the PC-PPI adapter, Order No. 6ES7 901- 3CB30-0XA0, from Siemens AG. You need the PC-PPI adapter, for example, to update the operating system by means of bootstrap. Moreover, you can use the PC-PPI adapter for transferring.

1.3.3 Optional Accumulator Package

Purpose

The optional accumulator package allows you to reduce the booting time of the Mobile Panel when changing from one terminal box to another.

The maximum stored energy time amounts to 10 minutes, after which the Mobile Panel is switched off.

The accumulator is charged automatically when the Mobile Panel is connected to a terminal box.

Notice

Recharging and discharging the accumulator

Polarity reversal and short-circuiting while improperly recharging and discharging the accumulator can lead to a risk of fire and even, in extreme cases, explosion. The accumulator can only be recharged in the Mobile Panel.

Note

The same system messages as during faulty communication can be output on the HMI device while the HMI device is being plugged to a different terminal.

Note

You cannot use the optional accumulator package with Mobile Panel 170.

Safety information

The accumulator is a Li-ion accumulator. The following safety notes apply for these accumulators:

- Do not crush
- Do not heat or burn
- Do not short-circuit
- Do not take apart
- Keep out of liquids – the accumulator may crack or burst

1.4 Range of HMI software functions

General

The following tables show the objects which can be integrated in a project for a Mobile Panel 177.

Alarms

Object	Specification	Mobile Panel 177
Alarm	Number of discrete alarms	2000
	Number of analog alarms	50
	Length of the alarm text	80 characters
	Number of tags in an alarm	Max. 8
	Display	Alarm view, alarm window
	Acknowledge single error alarms	Yes
	Acknowledge several error alarms simultaneously (group acknowledgement)	16 acknowledgment groups
	Edit alarm	Yes
	Alarm indicator	Yes
Alarm buffer, retentive	Alarm buffer capacity	256 alarms
	Simultaneously queued alarm events	Max. 64
	View alarm	Yes
	Delete alarm buffer	Yes

Tags, values and lists

Object	Specification	Mobile Panel 177
Tag	Number	1000
Limit-value monitoring	Input/Output	Yes
Linear scaling	Input/Output	Yes
Text List	Number	300

Screens

Object	Specification	Mobile Panel 177
Screen	Number	500
	Fields per screen	50
	Tags per screen	50
	Complex objects per screen (e.g. bars)	5
	Template	Yes

Recipes

Object	Specification	Mobile Panel 177
Recipe	Number	100
	Data records per recipe	200
	Entries per recipe	200

Infotext

Object	Specification	Mobile Panel 177
Infotext	Length (no. of characters)	320 characters
	For alarms	Yes
	For screens	Yes
	For screen objects (for example IO fields)	Yes

Additional functions

Object	Specification	Mobile Panel 177
Monitor settings	Touch screen calibration	Yes
	Setting the contrast	Yes
Language change	Number of languages	16
Graphic object	Vector and pixel graphics	Yes
Graphs	Number	50
Task planner	Number of tasks	10
Text object	Number	2500
Security	Number of users	50

1.5 Communication

Number of connections

Connection	Mobile Panel 177 DP	Mobile Panel 177 PN
Number using a point-to-point connection	1	–
Number using a bus connection	4 on the same bus	

Siemens PLCs

The following table lists the Siemens PLCs that can be used with the Mobile Panel 177 and allocates the protocols and profiles that can be used.

Controller	Protocol/Profile	Mobile Panel 177 DP	Mobile Panel 177 PN
SIMATIC S7-300/400	MPI	Yes	No
	PROFIBUS DP up to 12 Mbps	Yes	No
	PROFINET	No	Yes
	Standard S7 via TCP/IP	No	Yes
SIMATIC S7-200	PPI	Yes	No
	MPI	Yes	No
	PROFIBUS DP (DP-T)	Yes	No
	Standard S7 via TCP/IP	No	Yes
SIMATIC S5	AS 511 via RS 232/TTY adapter 1)	Yes	No
	PROFIBUS DP up to 12 Mbps	Yes	No
SIMATIC 505	NITP	Yes	No
	PROFIBUS DP up to 12 Mbps	Yes	No

1) The converter 6ES5 734-1BD20 is optional

PLCs from other manufacturers

The following table lists the controllers of other manufacturers that can be used with the Mobile Panel 177 and allocates the protocols and profiles that can be used.

Controller	Protocol for Mobile Panel 177 DP	Protocol for Mobile Panel 177 PN
Allen-Bradley PLC series: SLC500, SLC501, SLC502 PLC series: SLC503, SLC504, SLC505, MicroLogix	DH485 via DF1-Gateway DH485 DH485 via DF1-Gateway DH485 DF1 DH+ via DF1-Gateway	No or via HTTP protocol
Allen-Bradley PLC series PLC5/20	DF11) DH+ using DF1-Gateway	No or via HTTP protocol
GE Fanuc Automation PLC series 90-30, 90-70, 90-Micro	SNP	No or via HTTP protocol
LG Industrial Systems (Lucky Goldstar)/IMO PLC series GLOFA-GM/G4, G6, G7M	Dedicated communication	No or via HTTP protocol
Mitsubishi Electric PLC series MELSEC FX, MELSEC FX0	FX	No or via HTTP protocol
Mitsubishi Melsec PLC series FX, A, Ans, Q, QnAS	Protocol 4	No or via HTTP protocol
OMRON PLC series SYSMAC C, SYSMAC CV, SYSMAC CS1, SYSMAC alpha, CP	Hostlink/Multilink (SYSMAC Way)	No or via HTTP protocol
Schneider Automation (Modicon) PLC series Modicon 984, TSX Quantum, TSX Compact	Modicon Modbus	No or via HTTP protocol

Safety instructions and general notes

2.1 Safety information

Safety regulations



Warning

Strictly observe all instructions in these operating instructions at all times. Otherwise, hazardous situations can arise or the safety mechanisms in the HMI device can be rendered ineffective.

Observe the safety and accident prevention instructions applicable to your application in addition to the safety instructions given in this manual.



Warning

The configuring engineer for a machine or system controller must take precautions so that an interrupted program can be restarted normally after a voltage dips or power failures. Dangerous operating conditions must not occur, even temporarily.

If faults in the system may cause bodily injury or significant property damage, additional measures must be taken outside of the system. These measures must also ensure safe operating conditions in the system in the event of a fault.

The configuring engineer for the system must take precautions to ensure that only authorized personnel can make changes to the memory that could result in a hazardous situation.

The STOP button must be checked periodically for proper functioning.



Warning

Following a heavy shock to the HMI device, e.g., the device was dropped, check the safety-relevant parts for proper functioning.

Manual actions performed with the HMI device may only occur in conjunction with the enabling switches and at reduced velocity.

If the system is operated with the HMI device, ensure that operation during this time is only possible via the HMI device and not from any other point of the system.

High frequency radiation

Notice

Unintentional operating situations

High frequency radiation, from mobile phones for example, can cause unintentional operating situations.

2.2 Standards and Approvals

Valid approvals



Caution

Valid approvals

The overview below provides information on available approvals

The only valid approvals for the HMI device and the terminal box itself are those shown on the label on the rear panel.

CE approval



The HMI device and the terminal box meet the general and safety-related requirements of the following EC directives and conform to the harmonized European standards (EN) for programmable logic controllers published in the official gazettes of the European Union:

- 89/336/EEC "Electromagnetic Compatibility" (EMC Directive)
- 98/37/EG Directive of the European Parliament and Council of 22 June 1998 on the approximation of the laws and administrative regulations of the Member States concerning machinery

EC declaration of conformity

The EC declarations of conformity are kept available for the responsible authorities at the following address:

Siemens Aktiengesellschaft
Automation & Drives
A&D AS RD ST PLC
PO Box 1963
D-92209 Amberg

UL approval



Underwriters Laboratories Inc. conforming to

- UL 508 (Industrial Control Equipment)
- CSA C22.2 No. 142, (Process Control Equipment)

or



HAZ. LOC.

Underwriters Laboratories Inc. conforming to

- UL 508 (Industrial Control Equipment)
- CSA C22.2 No. 142, (Process Control Equipment)
- UL 1604 (Hazardous Location)
- CSA-213 (Hazardous Location)

Approved for use in

- Class I, Division 2, Group A, B, C, D T4
- Class I, Zone 2, Group IIC T4

FM approval



Factory Mutual Research (FM) conforming to

- Approval Standard Class Number 3611, 3600, 3810

Approved for use in

- Class I, Division 2, Group A, B, C, D T4
- Class I, Zone 2, Group IIC T4

Ex approval



In compliance with EN 50021 (Electrical apparatus for potentially explosive atmospheres;
Type of protection "n")

- II 3 G/D EEx nA II T4
- IP65
- 04 ATEX 1297X

Label for Australia



The HMI device and the terminal box fulfill the requirements of standard AS/NZS 2064 (Class A).

SIBE Switzerland Certification Service



The HMI device and the terminal box fulfil Safety Category 3 in accordance with EN 954-1.

The safety function enabling device for special operation control and the STOP button fulfil Safety Category 3 in accordance with EN 954-1 and the requirements of EN 60204-1, in as far as the safety instructions in the operating instructions are observed.

IEC 61131

The HMI device fulfills the requirements and criteria conforming to IEC 61131-2, Programmable Logic Controllers, Part 2: Operating resource requirements and tests.

2.3 Operating safety

Standards

The HMI device complies with the following standards:

- EN 60204-1
Safety of Machinery – Electrical Equipment of Machines
- EN 61131-1 and EN 61131-2
Programmable Logic Controllers
- The HMI device was tested for EMC in accordance with the following standards:
 - EN 50081-2, EMC – Emitted Interference
 - EN 61000-6-2, Generic standard, Immunity, industrial environments
 - IEC 61131-2, Draft 10.03.02, Programmable logic controllers
- STOP button for fast machine stops:
EN 60947-5-1:1997, K 2.2, Low-voltage Switchgear and Control Gear, Positive-Opening Contacts

EN 954 Category 3 can be achieved with an external monitoring device. Two floating break contacts for connection of external I/O, rated voltage of 24 V (safety extra-low voltage in accordance with EN 61131-2 or EN 50179, Equipment of Electrical Power Installations with Electronic Devices), maximum current of 500 mA
- Enabling equipment in accordance with EN 60204-1 in safety categories defined in EN 954-1:1996, Safety-Related Parts of Control Systems:
 - EN 954 Category 3 can be achieved with an external monitoring device.
 - 2 parallel switched floating make contacts for connection of external I/O, rated voltage of 24 VDC (safety extra-low voltage in accordance with EN 61131-2 or EN 50178), maximum current of 400 mA.

If the HMI device is used in a system, the following standards are fulfilled:

- prEN 1921, Industrial Automation Systems – Safety of Integrated Manufacturing Systems
- EN 12417:2001, Machine Tools – Safety - Machining Centers
- UL 508, Industrial Control Equipment
- CSA C22.2 No.14, Industrial Control Equipment

2.4 Voltage supply

Safety specifications



Warning

The HMI device conforms to protection class III in accordance with EN 61131-2 or EN 50178. The 24 VDC supply must be ensured by safe separation of extra low voltage from dangerous contact voltages, e.g., using a safety isolation transformer or equivalent devices.

The supply circuit must be protected against short circuits with a 3.15 A fuse.

Therefore, when sizing the supply, you must pay attention to the voltage drop on the connecting cable.

2.5 Notes on applications

Use in an industrial environment

The HMI device is designed for industrial use. The following standards are met:

- Requirements in terms of the emission of interference EN 61000-6-4: 2001
- Requirements in terms of noise immunity EN 61000-6-2: 2001

Use in residential areas

If the HMI device is used in a residential area, you must take measures to achieve Limit Class B conforming to EN 55011 for RF interference.

A suitable measure to achieve Limit Class B for suppression of radio interference is, for example:

- Use of filters in electrical supply lines

2.6 Risk analysis

Carrying out a risk analysis

The following standards must be used to perform the risk analysis:

- EN 292, General Machinery Directives
- EN 1050 Risk Assessment for Machinery
- EN 954-1 Safety of Machinery

These considerations lead to a safety category (B, 1, 2, 3, 4) in accordance with EN 954-1 that ultimately dictates how the safety-related aspects of the system to be monitored are to be furnished.

The connection examples with three different monitoring devices show how Category 3 in accordance with EN 954-1 can be achieved with the safety-related features of the Mobile Panel 177. Attention must be paid that the overall concept of the system is designed with this in mind.

2.7 Enable switch

Introduction

Enabling equipment consists of the enabling switches positioned on both sides of the Mobile Panel 177.

Numerically controlled machines and systems are equipped with the operating modes "Automatic mode" and "Special operation".

Safety is ensured in automatic mode by means of closed, isolating protective devices and/or with functional non-isolating protective devices that block access.

In special operation the safety has to be ensured in a different manner than in automatic mode. In special operation mode the danger zones of the machine or system are entered, where controlled movements have to be possible.

Special operation

A reduced speed on the machine or in the system has to be specified for special operation based on the risk assessment. An action must be possible only when the enabling equipment is activated. The operator must have the necessary qualifications and be acquainted with the details of the intended application.

Safety information

The safety-related aspects of the velocity reduction control and those for the enabling equipment are designed in such a way that they satisfy the EN 954-1 safety category determined by the risk analysis.

Safety Category 3 in accordance with EN 954-1:1996 can be achieved by implementing enabling equipment with two circuits. The draft C standard for machine tools notes the following:

"Enabling equipment can either be a 2-position command device in conjunction with a Stop device or a 3-position command device. The 3-position command device is preferable."

The operating principles of enabling equipment are described in EN 60204. Through the findings from accident investigations and the existence of technical solutions, the 3-stage enabling switch became state of the art. Positions 1 and 3 of the enabling switch are Off functions. Only the middle position allows the enabling function. EN 60204-1:1997 is identical to IEC 60204-1, whereby the 3-stage enabling switch is gaining international importance.

The Stop category of the enabling equipment must be selected on the basis of a risk assessment and correspond to a Category 0 or 1 Stop.



Warning

Enabling switches may only be used if the person activating them promptly recognizes a danger to personnel and can immediately take steps to avoid the danger!

Commands for unsafe conditions are not permitted to be issued with one enabling switch alone. For this purpose, a second deliberate start command via a button on the Mobile Panel 177 is required. The only person allowed to remain in the danger zone is the person who is activating the enabling switch.

In special operating modes, safety is achieved through use of the enabling switch in combination with reduction in the velocity of the drives that are posing the danger.

Risk from improper use

To avoid risk from improper use of the enabling switches, the following actions must be deliberately taken:

- Scan the enabling switches.

The scan has to be carried out for the followed processes:

- When the system being monitored is being switched on
- When the operating mode changes from "Automatic" to "Manual mode"

In both cases, the enabling function may not be used.

- The enabling switch must be released within a specified time frame and returned to the "Enable" setting.

Select the time frame according to the activity on the system being monitored.

2.8 STOP button

Safety information

The STOP button on the HMI device brings about a safety-related stop of the system or machine in accordance with EN 60204-1:1997, Section 9.2.5.3. You have the option of implementing a Category 0, 1 or 2 Stop function in accordance with EN 60204-1: 1997, Section 9.2.2. The Stop function category must be selected on the basis of a risk assessment.

The Stop function of the HMI device can, therefore, be used as a reliable machine stop as well as for looping in the Emergency Stop circuit of the system.

The signals of the STOP button are connected up differently in the Terminal Box Plus and in the Terminal Box Basic.

- Terminal Box Plus

In the terminal box, the signals control the Stop or Emergency Stop circuit of the system or machine. If the HMI device is not connected, the Stop or Emergency Stop circuit is closed.

- Terminal Box Basic

With the Terminal Box Basic the signals of the Stop or Emergency Stop circuit are controlled via the STOP button. If the Mobile Panel 177 is not connected, the Stop or Emergency Stop circuit of the system or machine is open.

Stop loop through

The Stop or Emergency Off circuit of the system or machine is looped through the Terminal Box Plus and not interrupted. The Stop or Emergency Stop circuit is interrupted if:

- The STOP button is pressed on a connected Mobile Panel 177
- A Mobile Panel 177 with pressed STOP button is connected

This functionality is only available in the Terminal Box Plus.



Warning

HMI device with STOP button

If the HMI device is equipped with a STOP button and is not connected to the terminal box, a Stop cannot be initiated using the HMI device. The STOP button of the HMI device is then ineffective!

Install stationary Emergency Off buttons that are available at all times in the system.

Stop of Category 0 or 1:

If the circuit is implemented as a category 0 or 1 Stop, the Stop function must be effective regardless of the operating mode. A Category 0 Stop must have priority. Releasing the STOP button must not initiate a dangerous situation (see also EN 60204-1:1997, Section 9.2.5.3).

The Stop function is not to be used to replace safety equipment.

Notice

Terminal boxes in a system

Install only one type of terminal box (i.e., only Terminal Box Plus or only Terminal Box Basic) in your system.

Mobile Panel 177 connected

If the Mobile Panel 177 is connected to the terminal box, the STOP button on the Mobile Panel 177 can trip if it comes off, thus causing the system to come to a standstill.

2.9 Electromagnetic compatibility

Introduction

The HMI device fulfills requirements of the EMC Directive of the domestic European market and other requirements.

EMC-compliant installation of HMI devices

An EMC-compliant installation of the HMI device and the use of interference-proof cables form the basis of trouble-free operation. The "Directives for interference-free installation of PLCs" and the "PROFIBUS Networks" manual also apply to the installation of the HMI device.

Pulse-shaped interferences

The following table shows the EMC properties of the modules with respect to pulse-shaped interference. A requirement for this is that the HMI device meets the specifications and directives regarding electrical installation.

Pulse-shaped interferences

Pulse-Shaped Interference	Tested with	Corresponds to test intensity
Electrostatic discharge conforming to IEC 61000-4-2	Air discharge: 8 kV Contact discharge: 4 kV	3
Burst pulses (high-speed transient interference) conforming to IEC 61000-4-4	2 KV power supply cable 2 KV signal cable, > 30 m 1 KV signal cable, < 30 m	3
High-power surge pulses conforming to IEC 61000-4-5, external protective circuit required (see S7 300 Automation System Manual, Installation, chapter on lightning and overvoltage protection).		
<ul style="list-style-type: none"> Asymmetric coupling 	2 kV power cable DC voltage with protective elements 2 KV signal/data cable, > 30 m, with protective elements as required	3
<ul style="list-style-type: none"> Asymmetric coupling 	1 kV power cable DC voltage with protective elements 1 KV signal cable, > 30 m, with protective elements as required	3

Sinusoidal interferences

The table below shows the EMC properties of the modules with respect to sinusoidal interference. A requirement for this is that the HMI device meets the specifications and directives regarding electrical installation.

Sinusoidal interferences

Sinusoidal interference	Test values	Corresponds to test intensity
RF interference (electromagnetic fields) <ul style="list-style-type: none"> conforming to IEC 61000-4-3 conforming to IEC 61000-4-3 	10 V/m with 80 % amplitude modulation of 1 kHz in the range from 80 MHz to 1 GHz and 1.4 GHz to 2 GHz 10 V/m with 50% pulse modulation at 900 MHz 10 V/m with 50% pulse modulation at 1.89 GHz	3
RF interference current on cables and cable shielding conforming to IEC 61000-4-6	Test voltage 10 V with 80% amplitude modulation of 1 kHz in the range from 9 kHz to 80 MHz	3

Emission of radio interference

Emission of electromagnetic interference conforming to 55011, Limit value class A, Group 1, measured at a distance of 10 m:

From 30 MHz to 230 MHz	< 40 dB (V/m) quasi-peak
From 230 MHz to 1000 MHz	< 47 dB (V/m) quasi-peak

Additional measures

Before you connect an HMI device to the public network, ensure that it is compliant with Limit Class B conforming to EN 55022.

2.10 Transport and storage conditions

Mechanical and climatic transport and storage conditions

The transport and storage conditions of this HMI device exceed requirements conforming to IEC 61131-2. The following specifications apply to the transport and storage of an HMI device in its original packaging.

The climatic conditions comply to the following standards:

- IEC 60721-3-3, Class 3K7 for storage
- IEC 60721-3-2, Class 2K4 for transport

The mechanical requirements are compliant with EC 60721-3-2, Class 2M2.

Transport and storage conditions for the HMI device

Type of Condition	Permissible range
Drop test (in transport package)	≤ 1 m
Temperature	From -20 to +60°C
Air pressure	from 1080 hPa to 660 hPa, corresponding to an elevation of - 1000 m to 3500 m
Relative humidity	from 5% to 90%, without condensation
Sinusoidal vibration conforming to IEC 60068-2-6	5 Hz to 9 Hz: 3.5 mm 9 Hz to 150 Hz: 9.8 m/s ²
Shock conforming to IEC 60068-2-29	250 m/s ² , 6 ms, 1000 shocks

Transport and storage conditions for the terminal box

Type of Condition	Permissible range
Drop test (in transport package)	≤ 1 m
Temperature	From -20 to +70 °C
Air pressure	from 1080 hPa to 660 hPa, corresponds to an elevation of - 1000 m to 3500 m
Relative humidity	from 35% to 85%, without condensation
Sinusoidal vibration conforming to IEC 60068-2-6	5 Hz to 9 Hz: 3.5 mm 9 Hz to 150 Hz: 9.8 m/s ²
Shock conforming to IEC 60068-2-29	250 m/s ² , 6 ms, 1000 shocks

Notice

Ensure that no condensation (dewing) develops on or inside the HMI device after transporting it at low temperatures or after it has been exposed to extreme temperature fluctuations.

The HMI device must have acquired room temperature before it is put into operation. Do not expose the HMI device to direct radiation from a heater in order to warm it up. If dewing has developed, wait approximately four hours after it is completely dry before you switch on the HMI device.

Prerequisite for the trouble-free and safe operation of the HMI device is proper transport and storage, installation and assembly and careful operation and maintenance.

Warranty for the HMI device is deemed void if these specifications are ignored.

Planning Use

3.1 Notes about Usage

Mechanical and Climatic Conditions of Use

The HMI device is designed for use in a sheltered location. The conditions of use are compliant with requirements according to DIN IEC 60721-3-3:

- Class 3M3 (mechanical requirements)
- Class 3K3 (climatic requirements)

Use with additional measures

Examples of applications where the use of the HMI device requires additional measures:

- In locations with a high degree of ionizing radiation
- In locations with extreme operating conditions resulting from situations as follows:
 - Corrosive vapors, gases, oils or chemicals
 - Electrical or magnetic fields of high intensity
- In plants requiring special monitoring, for example:
 - Elevator systems
 - Systems in especially hazardous rooms

Mechanical ambient conditions

The mechanical ambient conditions for the HMI device are specified in the following table in terms of sinusoidal vibration.

Mechanical environmental conditions

Frequency range in Hz	Constant	Intermittent
$10 \leq f \leq 58$	Amplitude 0.0375 mm	Amplitude 0.075 mm
$58 \leq f \leq 150$	Constant acceleration 0.5 g	Constant acceleration 1 g

Reduction of vibration

If the HMI device is subjected to greater shocks or vibrations, you must take appropriate measures to reduce acceleration or amplitudes.

We recommend fitting the HMI device onto vibration-absorbent materials (on metal shock absorbers, for example).

Testing for Mechanical Ambient Conditions

The following table provides information on the type and scope of tests for mechanical environmental conditions.

Check of mechanical ambient conditions

The check includes	Test standard	Remarks
Vibrations	Vibration test conforming to IEC 60068, part 2-6 (sinusoidal)	Type of vibration: Transitional rate of the frequency sweeps: 1 octave/minute. $10 \leq f \leq 58$, Constant amplitude 0.075 mm $58 \leq f \leq 150$, Constant acceleration 1 g Vibration duration: 10 frequency cycles per axis in each of the three axes vertical to each other
Shock	Shock testing in accordance with IEC 60068, Part 2 -29	Type of shock: Half sine Shock intensity: Peak value 5 g, duration 11 ms Direction of impact: 3 shocks in \pm direction of axis in each of the three axes vertical to each other
Falling	Drop test in accordance with EN 60068-2-32EN 60068-2-32	

Climatic ambient conditions for the Mobile Panel

The Mobile Panel may be used under the following climatic ambient conditions:

Climatic ambient conditions

Ambient conditions	Permissible range	Remarks
Temperature <ul style="list-style-type: none"> • Operation • Storage/Transport 	From 0 to 40 °C From -20 to 60 °C	See the "Mounting positions and type of fixation" section
Relative humidity <ul style="list-style-type: none"> • Operation • Storage/Transport 	20 to 80 % 5 to 90 %	Without condensation, corresponds to relative humidity, stress class 2 conforming to IEC 61131, part 2
Air pressure	1080 to 795 hPa	Corresponds to an altitude of -1000 m to 2000 m
Pollutant concentration	SO ₂ : < 0,5 ppm; relative humidity < 60 %, no condensation H ₂ S: < 0.1 ppm; relative humidity < 60%, no condensation	Check: 10 ppm; 4 days Check: 1 ppm; 4 days

Climatic ambient conditions for the terminal box

The terminal box may be used under the following climatic ambient conditions:

Climatic ambient conditions

Ambient conditions	Permissible range	Remarks
Temperature <ul style="list-style-type: none"> • Operation • Storage/Transport 	From 0 to 50 °C From -20 to 70 °C	See the "Mounting positions and type of fixation" section
Relative humidity <ul style="list-style-type: none"> • Operation • Storage/Transport 	35 to 85 % 35 to 85 %	Without condensation, corresponds to relative humidity, stress class 2 conforming to IEC 61131, part 2
Air pressure	1080 to 795 hPa	Corresponds to an altitude of -1000 m to 2000 m
Pollutant concentration	SO ₂ : < 0.5 ppm; relative humidity < 60%, no condensation H ₂ S: < 0.1 ppm; relative humidity < 60%, no condensation	Check: 10 ppm; 4 days Check: 1 ppm; 4 days

3.2 Mounting positions and type of fixation

Mounting position

The wall holder is designed for vertical mounting.

The terminal box is designed for surface mounting independently of cabinets or control panels.

The terminal box is self-ventilated and is approved for all mounting positions. Note that the guaranteed protection rating is only ensured if the connecting cable or the dummy cap is plugged into the terminal box.

3.3 Preparing mounting

Selecting the mounting location for the HMI device holder

Observe the following points when selecting the mounting location:

- Position the wall holder so that the display of the hooked-in HMI device is not exposed to direct sunlight.
- Position the wall holder so that the HMI device can be hooked in ergonomically by the user. Choose a suitable mounting height.

Maintaining clearances

The following clearances are required around the wall holder:

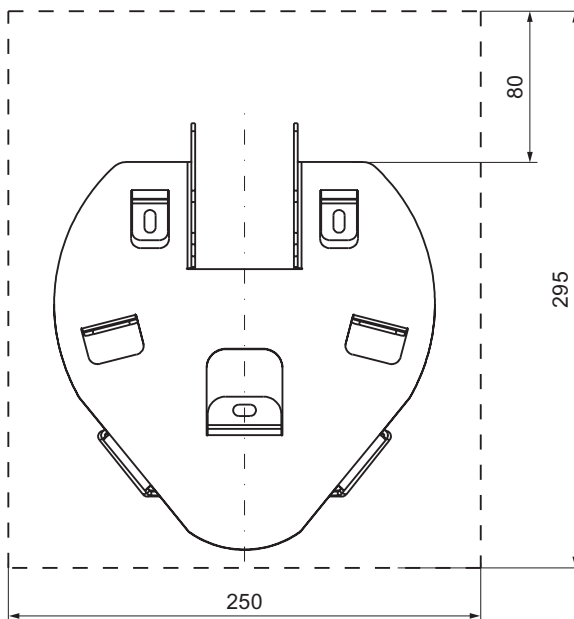

The following clearances are required around the Terminal Box DP:

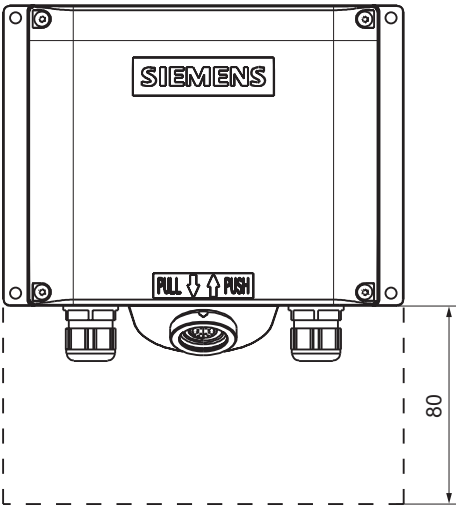

The following clearances are required around the Terminal Box PN.

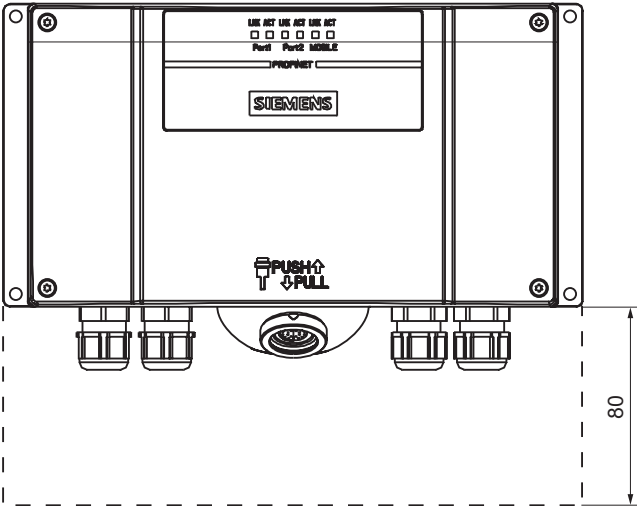

3.4 Specifications for Insulation Tests, Protection Class and Degree of Protection

Test voltages

Insulation resistance is demonstrated in the type test with the following test voltages conforming to IEC 61131-2:

Circuits with a nominal voltage of U_n to other circuits or ground	Test voltage
< 50 V	500 V DC

Protection class

Protection Class I conforming to IEC 60536, i.e. equipotential bonding conductor to profile rail required!

Protection from foreign objects and water

Degree of protection conforming to IEC 60529	Explanation
Front panel and rear panel	In installed status: <ul style="list-style-type: none"> • IP65 Only for the terminal box: <ul style="list-style-type: none"> • NEMA 4X/NEMA 12 (indoor use only)

3.5 Nominal Voltages

The following table shows the permitted nominal voltage and the corresponding tolerance range.

Permitted nominal voltages

Nominal voltage	Tolerance range
+24 V DC	20.4 V to 28.8 V (-15%, +20%)

Mounting and Connection

4.1 Checking the package contents

Check the package contents for visible signs of transport damage and for completeness.

Notice

Do not install parts delivered damaged. In the case of damaged parts, contact your Siemens representative.

Keep the accompanying documentation in a safe place. The documentation belongs to the HMI device and is required for subsequent commissioning.

4.2 Mounting the terminal box and wall holder

Requirements

The following are required for mounting:

- Three M5 cylinder head screws for the wall mounting of the HMI device
- Four M4 cylinder head screws for the terminal box

If the HMI device is to be operated while hooked into the wall holder, ensure that the connecting cable is sufficiently long.

Procedure – mounting the wall holder

Notice

In order to ensure that the HMI device can be hooked in securely, select a vertical surface or one inclined slightly to the rear as the mounting surface.

For HMI device with STOP button:

The HMI device can fall down if it cannot be hooked in securely. In the process the STOP button can be triggered unintentionally, thus causing the machine or system to stop.

Note

Positioning

A position at eye level is recommended. This permits the Mobile Panel 177 to be operated even if it is hooked into the wall holder.

Proceed as follows:

1. Select a position for the wall holder that can be reached easily and without danger.
2. Place the wall holder onto the mounting surface from the front.
3. Mark the mounting holes using a scribe.
4. Drill three through holes or three M5 threaded holes
5. Fasten the wall holder

Procedure – mounting the terminal box

Note

Length of the connecting cable

Take into account the maximum length of the connecting cable when selecting the position for the terminal box.

Proceed as follows:

1. Select a position for the terminal box that can be reached easily and without danger.
2. Place the terminal box onto the mounting surface from the front.
3. Mark the mounting holes with a scribe.
4. Drill four through holes or four M4 threaded holes

Notice

Permissible torque

The terminal box housing is made of plastic. Do not exceed 0.4 to 0.5 Nm of torque when tightening the screws.

5. Fastening the terminal box

See also

Mounting positions and type of fixation (Page 3-4)

4.3 Electrical installation

Electrical connections

The following section describes the electrical installation. It applies to the following components:

- Mobile Panel 177
- Terminal box

The following devices and control elements can be connected to these components:

Device/Control element	Mobile Panel 177	Terminal box
Configuration computer	Yes	Yes
Printer	–	yes ¹⁾
Controller	–	Yes
Supply voltage	–	Yes
Connection to Stop circuit	–	Yes
Monitoring signal of the STOP button	–	Yes
Connection to Enable circuit	–	Yes
Cable for input bit for connection detection	–	Yes

- 1) Applies to Mobile Panel 177 PN with network printer

4.4 Connecting the terminal box

Requirements

- The terminal box is mounted in accordance with the specifications of these operating instructions.
- Always use shielded standard cables.

Note

The maximum length of the cable for connecting the Stop button and the Enable switch may not exceed 30 m.

For further information, refer to the SIMATIC HMI Catalog ST 80.

Connection sequence

Connect the terminal box in the following sequence:

1. Equipotential bonding
2. Supply voltage
3. PLC/configuration computer as necessary

Notice

Connection sequence

Always follow the correct sequence for connecting the terminal box. Non-observance can cause damage to the terminal box.

4.4.1 Opening and closing the terminal box

Introduction

Please note:



Caution

Short circuits in the terminal box can impair the function of the Mobile Panel 177.

When carrying out work in the opened terminal box ensure that conductive materials, such as cable residues, do not come into contact with electrical circuits.

Caution

When working in the open housing, ensure that current-carrying conductors do not come into contact with electrical circuits.

Note the ESD instructions.

Requirements

Torx screwdriver, Size 2

Procedure



Figure 4-1 Opening the terminal box – example with Terminal Box DP

- ① Screws
- ② Cover
- ③ Screwed connections

Proceed as follows:

1. Loosen the four screws
2. Put down the screws and cover
3. Put the opened terminal box down securely

Protective cover of the Terminal Box PN

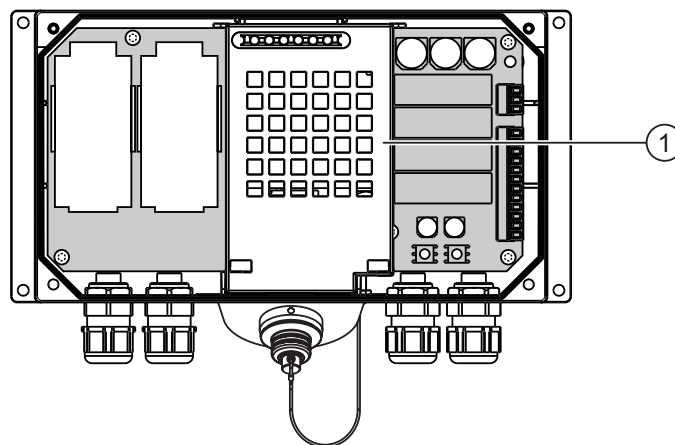

- ① Protective cover

Note

Protective cover

Do not remove the protective cover, because otherwise the electronics of the terminal box may be damaged or destroyed.

Notes on closing

Notice

Permissible torque

The terminal box housing is made of plastic. Therefore, the mounting hole threads cannot handle the same amount of stress as a comparable metallic housing. Do not exceed 0.4 to 0.5 Nm of torque when tightening the screws.

If the screws are tightened more than 20 times, there is risk of damage to the threads.

Protection class IP65

Upon conclusion of your work on the connections, check to make sure that the unused threaded cable entry holes are fitted with rubber seals. Otherwise, protection class IP65 is not guaranteed.

4.4.2 Interfaces to the Terminal Box DP

The following interfaces are available on the terminal box:

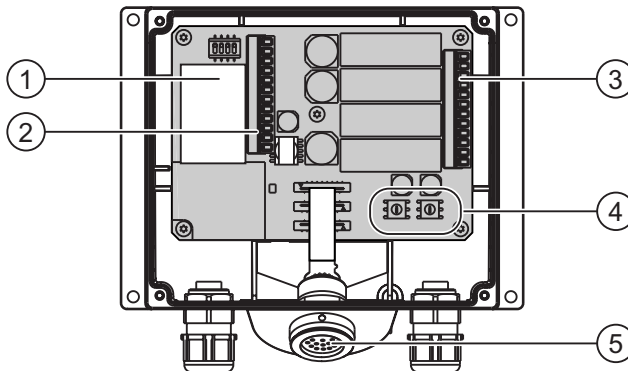

Figure 4-2 Interfaces to the Terminal Box DP

- ① Fast connector
- ② Terminal strip 1 for RS 232, RS 422, RS 485 and power supply
- ③ Terminal strip 2 for safety function for STOP button and Enable switch and for additional control system functions
- ④ Rotary encoder switch for entering the box ID
- ⑤ Socket for the connecting cable

Two PROFIBUS cables can be connected to the Fast Connector in order to loop the PROFIBUS through.

4.4.3 Interfaces to the Terminal Box PN

The following interfaces are available on the terminal box:

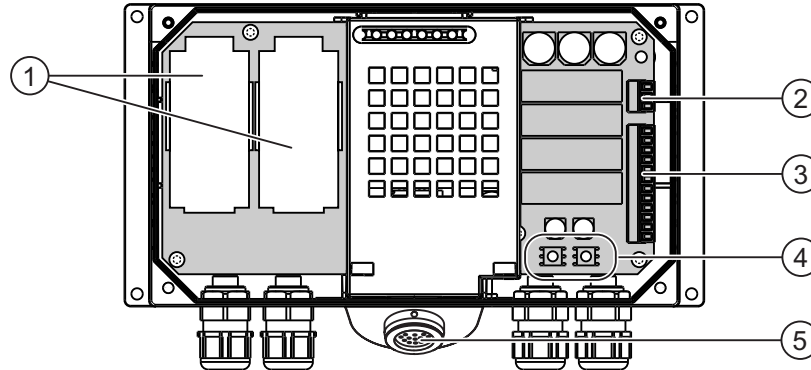

Figure 4-3 Interfaces to the Terminal Box PN

- ① Fast connector
- ② Terminal strip 1 for supply voltage
- ③ Terminal strip 2 for safety function for STOP button and Enable switch and for additional control system functions
- ④ Rotary encoder switch for entering the box ID
- ⑤ Socket for the connecting cable

Two PROFINET cables can be connected to each Fast Connector in order to loop the PROFINET through.

4.4.4 Setting the box ID at the terminal box

Introduction

You can set a unique box ID for station identification in each terminal box. If configured correspondingly, the box ID can be read out of the HMI device and transmitted to the controller.

Rotary encoder switch

The following figures show the position of the two rotary encoder switches in the terminal box:

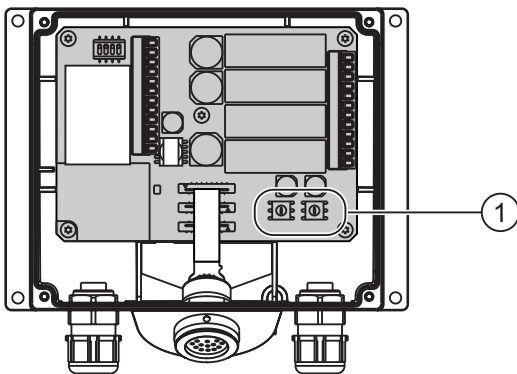

Figure 4-4 Terminal Box DP

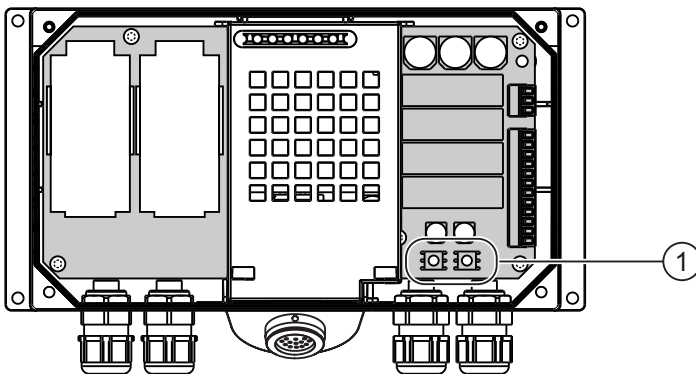

Figure 4-5 Terminal Box PN

① Rotary encoder switch

Example for setting the box ID

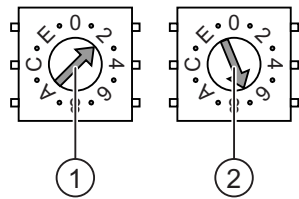

Figure 4-6 Example for the address "27H"

- ① Rotary encoding switch for more significant bits
- ② Rotary encoding switch for less significant bits

The figure shows the set address 27H, which is the same as address 39 in decimal format.

Procedure

Proceed as follows:

1. Open the terminal box.
2. Use a screwdriver to set the box ID
The input is in hexadecimal format Values between 0 and 255 can be set in decimal format.
3. Closing the terminal box

Result

The box ID is set.

See also

Opening and closing the terminal box (Page 4-4)

4.4.5 Stripping the insulation of cables

Stripping the insulation

Strip the insulation of the cables in accordance with the following figures

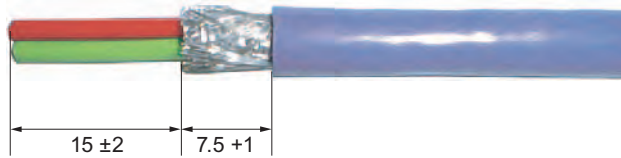

Figure 4-7 Stripping the insulation from the MPI/PROFIBUS-DP cable

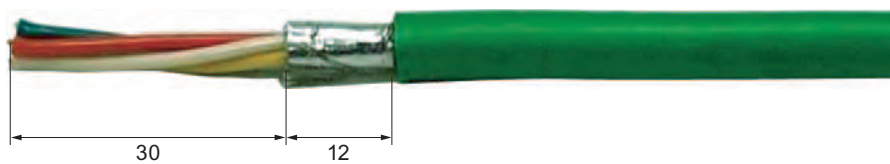

Figure 4-8 Stripping the PROFINET cable

Note

Use the cable stripper listed in the Siemens IK 10 catalog in order to enable you to strip the insulation from the cables faster and to the proper length.

4.4.6 Connecting the Equipotential Bonding Circuit

Potential differences

Differences in potential between spatially separated system parts can lead to high equalizing currents via the data cables and therefore to the destruction of their interfaces. This situation may arise if the cable shields are fitted at both ends and grounded at different system parts.

Potential differences may develop when a system is connected to different network inputs.

General requirements of equipotential bonding

Potential differences must be reduced by means of equipotential bonding in order to ensure trouble-free operation of the relevant components of the electronic system. The following must therefore be observed when installing the equipotential bonding circuit:

- The effectiveness of equipotential bonding increases as the impedance of the equipotential bonding conductor decreases or as the size of its cross-section increases.
- If two system parts are connected to each other via shielded data lines with shielding connected to the grounding/protective conductor on both sides, the impedance of the additionally installed equipotential bonding cables may not exceed 10% of the shielding impedance.
- The cross-section of a selected equipotential bonding conductor must be capable of handling the maximum equalizing current. Experience shows that the best results for equipotential bonding between cabinets are achieved with a minimum conductor cross-section of 16 mm².
- Use equipotential bonding conductors made of copper or galvanized steel. Establish a large-surface contact between the equipotential bonding conductors and the grounding/protective conductor and protect these from corrosion.
- Clamp the shielding of the data cable on the HMI device onto the equipotential bonding strip so that it is flush and near using suitable cable clamps.
- Route the equipotential bonding conductor and data cables in parallel with minimum clearance between these.

Notice

Equipotential bonding conduction

Cable shielding is not suitable for equipotential bonding. Always use the prescribed equipotential bonding conductors. The minimum cross-section of a conductor used for equipotential bonding is 16 mm². When you install MPI and PROFIBUS DP networks, always use cables with a sufficient crosssection since otherwise the interface modules may be damaged or destroyed.

4.4.7 Connecting the configuration computer

Introduction

Standard cables are available for the connections shown (refer to the Siemens ST80 catalog).

Connection configurator

The following figures show the connection between the terminal box and the configuration computer via the network.

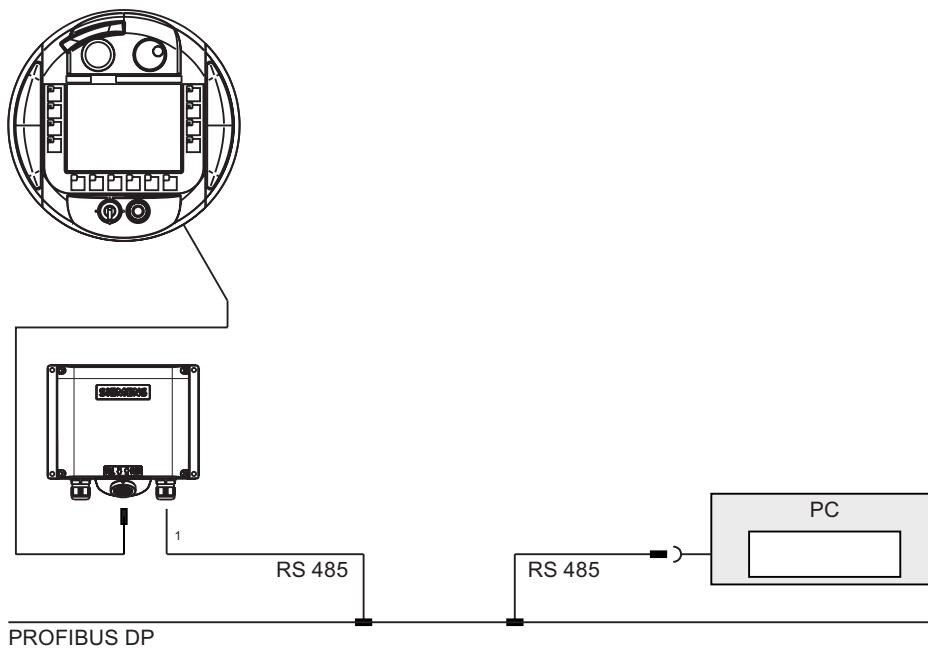

Figure 4-9 Connect the configuration computer via MPI/PROFIBUS DP to a Terminal Box DP

- 1 When a serial interface is used during operation, IF1 (RS 232) and (RS 422/485) may only be connected alternately. IF1 is positioned on Terminal strip 1 of the Terminal Box DP.

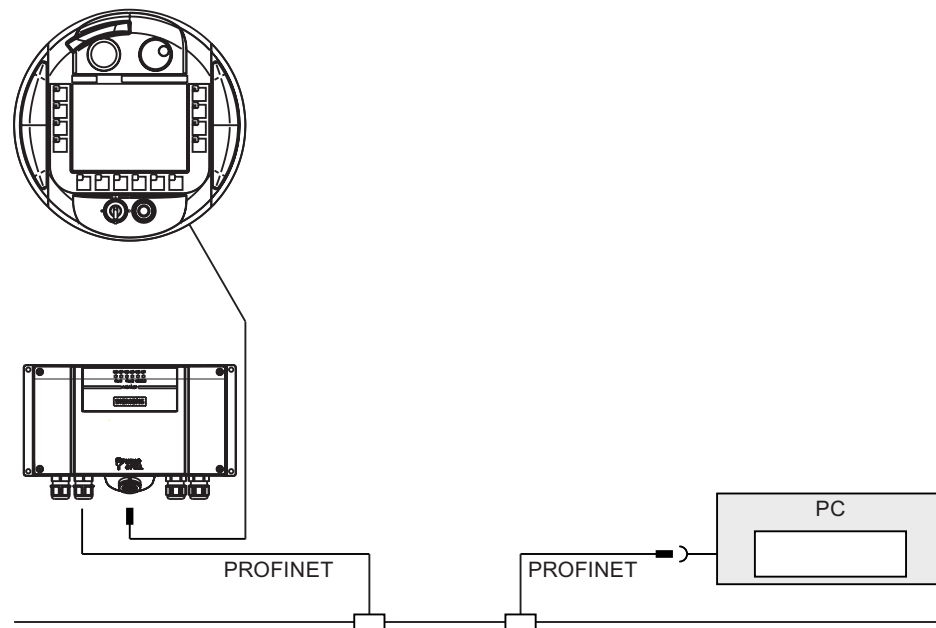
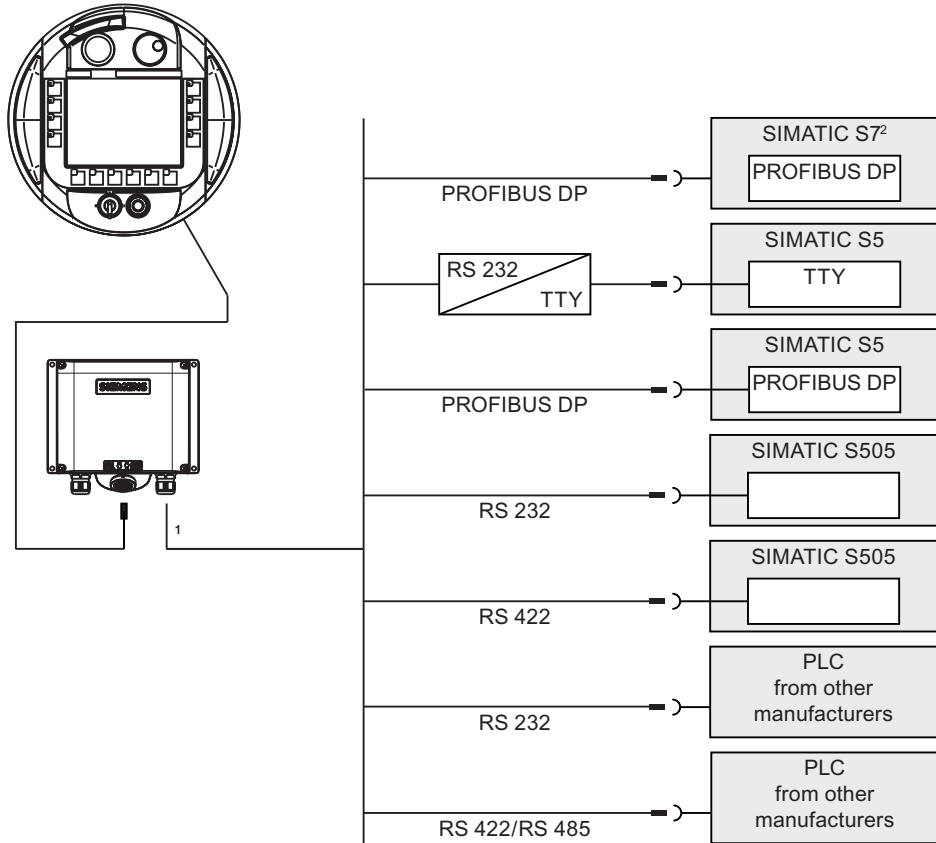

Figure 4-10 Connect the configuration computer via PROFINET to a Terminal Box PN

4.4.8 Connecting the PLC

Connecting a PLC to a Terminal Box DP

The following figure shows the connection of the PLC to the Terminal Box DP.



- 1 When a serial interface is used during operation, IF1 (RS 232) and (RS 422/485) may only be connected alternately at the terminal box
- 2 Use only the cables approved for that purpose to connect to a SIMATIC S7.

Notice

Protection rating

The adapter must be set up in such a way the an IP65 protection rating is ensured.

Always use the approved cables to connect a SIMATIC S7 PLC. Note also the maximum permissible cable lengths for the process interface. Standard cables are available for the connection. For further information, refer to the SIMATIC HMI Catalog ST 80.

Configure the interfaces IF1 on the Terminal Box DP

The IF1 interface can be configured using the DIL switch.

The figure below shows the position of the DIL switch.

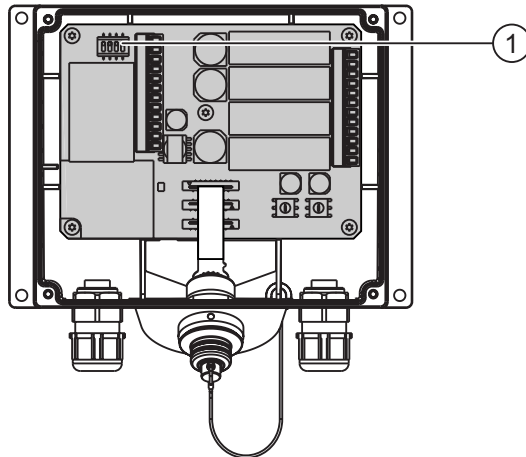

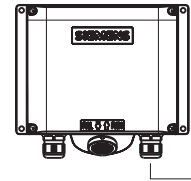

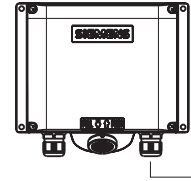

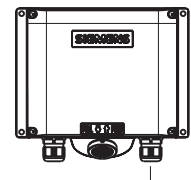



Figure 4-11 Position of the DIL switch

- ① DIL switch

Note

Note the diagrams of the DIL switch settings on the inside of the cover.

The following table shows the settings of the DIL switch. The transmitting and receiving direction is switched internally with the RTS signal.

Communication	Switch setting
 <p>MPI/PROFIBUS DP RS 485</p>	
 <p>MPI/PROFIBUS DP RS 485</p> <p>Last node</p>	
 <p>RS 232/RS 422</p>	
<p>Button  ON</p>	

Compressing the internal program memory with SIMATIC S5



Caution

Compressing the internal program memory

Compressing the internal program memory of the SIMATIC S5 PLC ("Compress" PU function, integrated FB COMPR) is not permitted if an HMI device is connected! When memory is compressed, the absolute addresses of the blocks in the program memory change. Since the HMI device only reads the address list during startup, it does not recognize the address change and accesses the wrong memory areas.

If you cannot avoid compressing memory during operation, turn off the HMI device before running the compress function.

Connecting a PLC to a Terminal Box PN

The following figure shows the connection of the PLC to the Terminal Box PN.

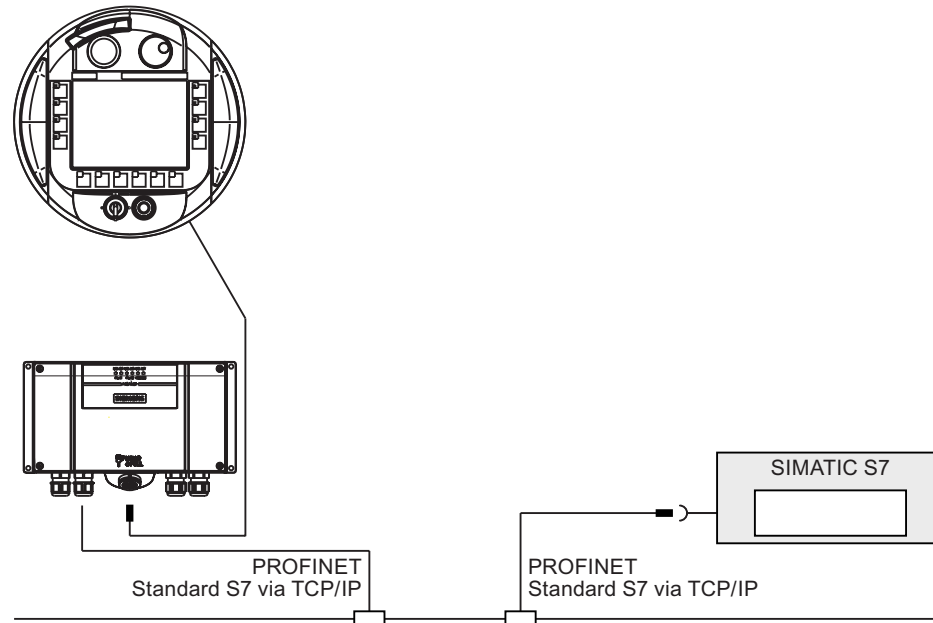

4.4.9 Connect a printer.

Introduction

You can connect a printer to the Terminal Box PN via PROFINET:

The Mobile Panel 177 supports the following printer standards:

- Compatible with ESC/P, 9-pin ESC/P or ESC/P2 (EPSON)
For example EPSON LQ 300+
- Compatible with PCL3 (Hewlett Packard)
For example Brother HL 1450

The list of current printers and the required settings for operator control devices can be found on the Internet at: <http://www4.ad.siemens.de/view/cs/en/11376409>.

Requirements

The terminal box is connected.

Connection configurator

The following figure shows the connection between the Terminal Box PN and a printer.

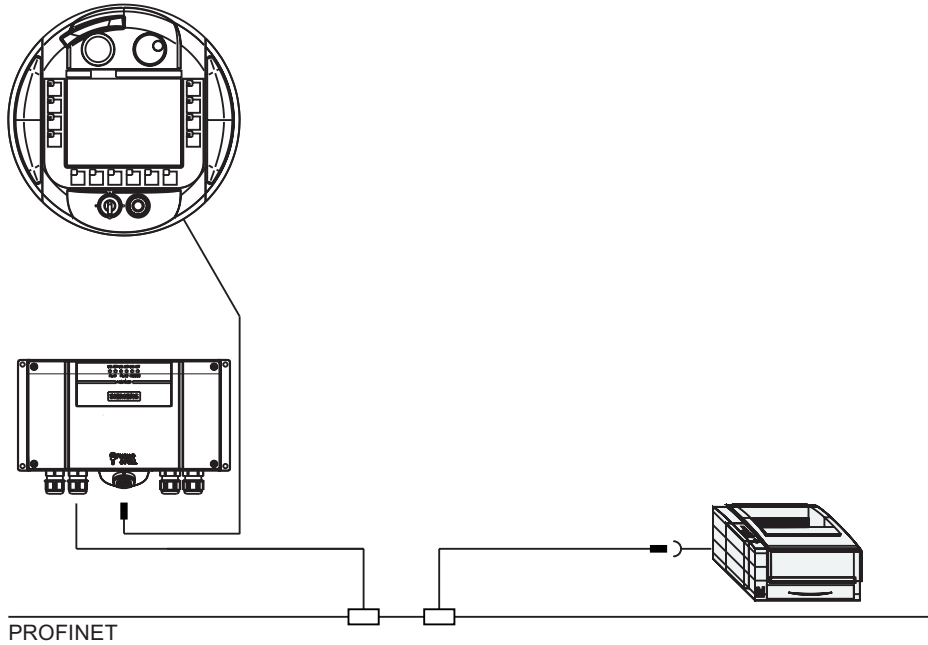

PROFINET
Figure 4-12 Connect the printer via PROFINET to the Terminal Box PN

Note

ASCII character set

On some printers you may also have to set the ASCII character set used in the project.

Note

Printer documentation

Observe the printer documentation when you connect the printer.

4.4.10 Connecting the Power Supply

Introduction

The supply voltage for the HMI device is connected to a terminal strip in the terminal box. The terminal block is designed for cables with a maximum cross-section of 1,5 mm².

Connect the ground terminal of the terminal box to the cabinet ground.

Note

Polarity reversal protection

The terminal box has polarity reversal protection.

Wiring diagram

The following figures show the connection of the power supply to the terminal box.

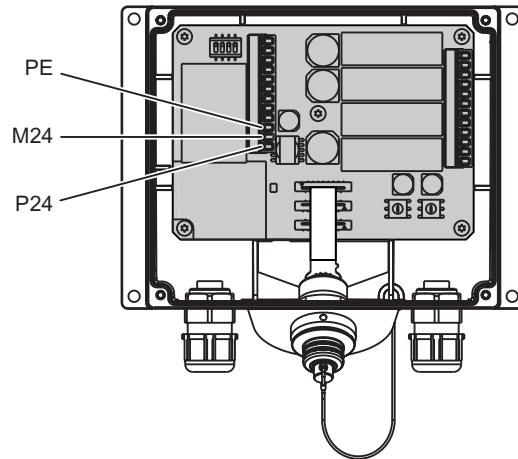

Figure 4-13 Connecting the power supply to the Terminal Box DP

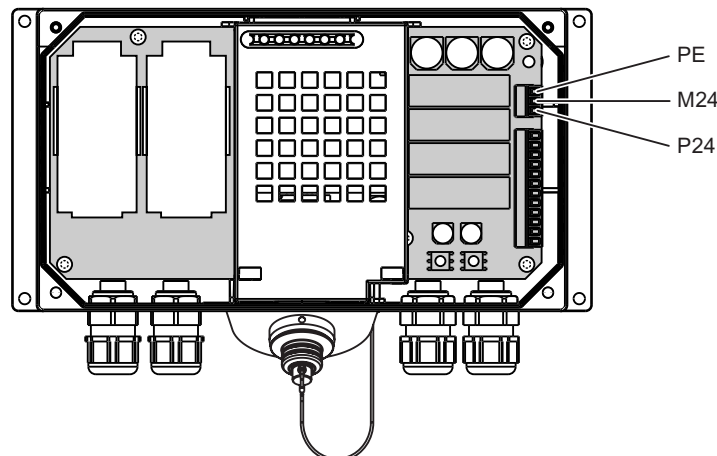

Figure 4-14 Connecting the power supply to the Terminal Box PN

The abbreviations in the figure are defined as follows:

- PE stands for equipment grounding conductor
- M stands for ground
- P24 stands for +24 VDC

Please refer to Technical Data for information on the voltage supply requirements.



Warning

24 V DC -supply

Personal injury and equipment damage can occur. Rate the 24 V DC power supply of the Mobile Panel 177 correctly. Otherwise components of your automation system can be damaged and persons can be injured.

Use only voltage generated as safety extra-low voltage (SELV) for the 24 VDC supply of the Mobile Panel 177.

Caution

Safe electrical isolation

When using a 24 VDC supply, make sure that the extra-low voltage is isolated safely. Always use power supply modules that conform to IEC 364-4-41 or HD 384.04.41 (VDE 0100, Part 410).

The supply voltage must be within the specified range. Otherwise malfunctions in the HMI device may result.

The 24 V output of the power supply must be connected to the equipotential bonding; because the potential difference between the PLC and the HMI device can destroy the communication interface.

4.4.11 Connecting the connecting cable

Introduction

The connecting cable can be connected to the terminal box using the plug connector (metallic push-pull circular connector). The plug connector is coded anti-rotationally using a slot and key system.

Interlocking mechanism

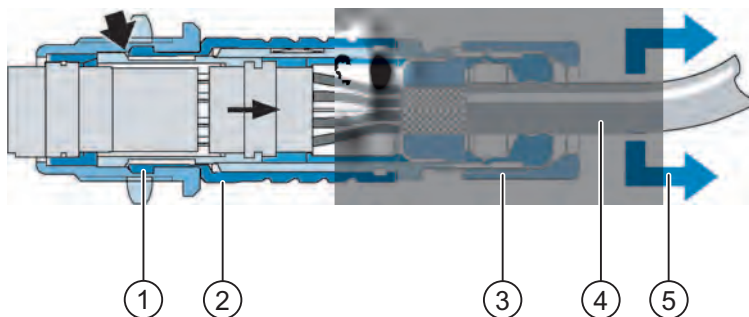

Figure 4-15 Interlocking mechanism

- ① Interlocking claws
- ② Outer sleeve
- ③ Clamping nut
- ④ Cable
- ⑤ Strain direction

If you pull on the cable or the clamping nut, the taper sleeve moves under the interlocking claws and presses them into the interlocking slot. The plug connection cannot be separated.

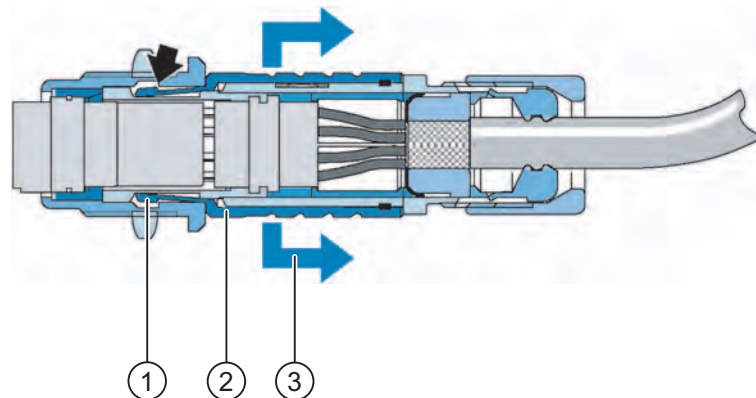

Figure 4-16 Detaching the plug connector

- ① Interlocking claws
- ② Outer sleeve
- ③ Strain direction

If you pull on the outer sleeve, the interlocking claws slide out of the interlocking slot. The plug connection can be separated.

Procedure – plugging the connector

Proceed as follows:

1. Pull back the outer sleeve on the plug connector
2. With the outer sleeve retracted, insert the plug connector into the socket of the terminal box.
3. Release the outer sleeve

This automatically slides in the direction of the terminal box, thereby interlocking the plug connector.

Procedure – removing the connector

Proceed as follows:

1. Pull back the outer sleeve on the plug connector
2. With the outer sleeve retracted, pull the plug connector out of the socket of the terminal box.

If you do not intend to use the Mobile Panel 177 on another terminal box, place the Mobile Panel 177 securely in the wall holder.

4.5 Connecting Mobile Panel 177

Connecting the Cables

When connecting the cables, ensure that you do not bend any of the contact pins. Secure the connectors with screws.

The pin assignment of the interfaces is described in the specifications.

4.5.1 Opening and closing the terminal compartment

Introduction

Before you begin:

Caution

Malfunctions

If the HMI device lies on its front, the STOP button can trigger. Other operating elements (key-operated switches, illuminated pushbuttons) can be triggered unintentionally, thus causing malfunctions.

If you open the terminal compartment, you must therefore remove the connecting cable belonging to the Mobile Panel 177 from the terminal box.

ESD guidelines

Note the ESD instructions.

Note

Pay attention to cleanliness. Foreign bodies or liquids must not come into contact with the printed circuit board or penetrate the inside of the HMI device.

Place the HMI device with the front side on a flat, clean surface to protect against damage.

Requirements

Crosstip screwdriver, Size 2

Procedure

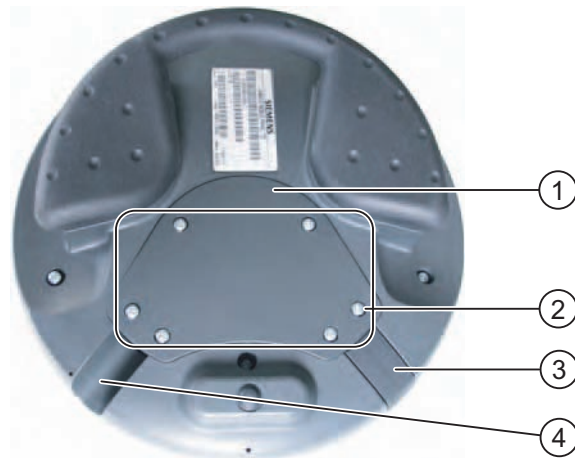

Figure 4-17 Opening the terminal compartment

- ① Cover
- ② Screws on the cover
- ③ Plugs
- ④ Outlet

Proceed as follows:

1. Screw out the six screws of the cover about 1 cm

The cover is designed in such a way that the screws cannot be lost. Therefore, do not screw the screws out further than 1 cm. They can then be removed together with the cover where they will remain intact.

2. Lay down the cover with the screws
3. Plug the plug into the outlet that is not used

Notes for closing

Notice

Permissible torque

The housing of the Mobile Panel 177 is made of plastic. Therefore, the mounting hole threads cannot handle the same amount of stress as a comparable metallic housing. Do not exceed 0.4 to 0.5 Nm of torque when tightening the screws.

If the screws are tightened more than 20 times, there is risk of damage to the threads.

Protection class IP65

Ensure that the seal belonging to the cover is present during mounting. Upon conclusion of your work on the connections, check to make sure that the unused outlet is fitted with the plug. Otherwise, protection class IP65 is not guaranteed.

4.5.2 Interfaces on the Mobile Panel 177 DP

The following interfaces are available on the Mobile Panel 177 DP:

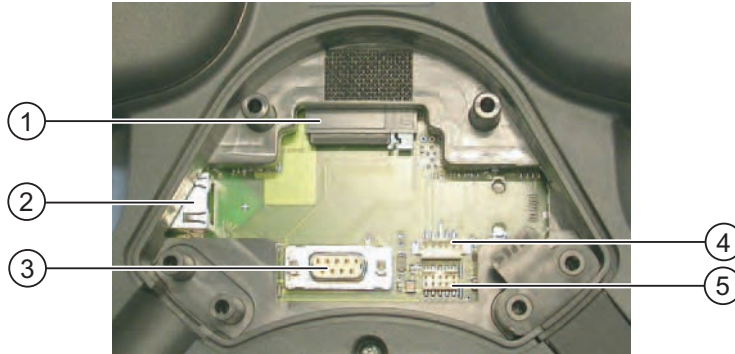

Figure 4-18 Interfaces on the Mobile Panel 177 DP

- ① Slot with a MultiMediaCard
- ② RJ45 connector for the connecting cable
- ③ RS 485 interface (IF 2)
- ④ Connection for optional accumulator
- ⑤ Female header, 10-pin for the connecting cable

Note

RJ45 connector

Use the RJ45 connector only for the connecting cable to the terminal box.

4.5.3 Interfaces on Mobile Panel 177 PN

The following interfaces are available on the Mobile Panel 177 PN:

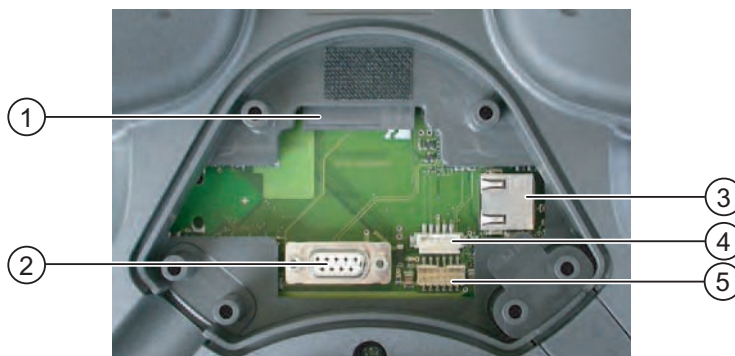

Figure 4-19 Interfaces on Mobile Panel 177 PN

- ① Slot with MultiMediaCard
- ② RS 485 interface (IF 2)
- ③ RJ45 connector for the connecting cable
- ④ Connection for optional accumulator
- ⑤ Female header, 12-pin for the connecting cable

Note

RJ45 connector

Use the RJ45 connector only for the connecting cable to the terminal box.

4.5.4 Connecting the configuration computer

Requirements

- The cover of the terminal compartment at the Mobile Panel 177 is removed.
- The Mobile Panel 177 is connected to the terminal box.

Wiring diagram

The following figure shows the serial connection via RS 485 between the HMI device and the configuration computer for transferring the image, project and other project data.

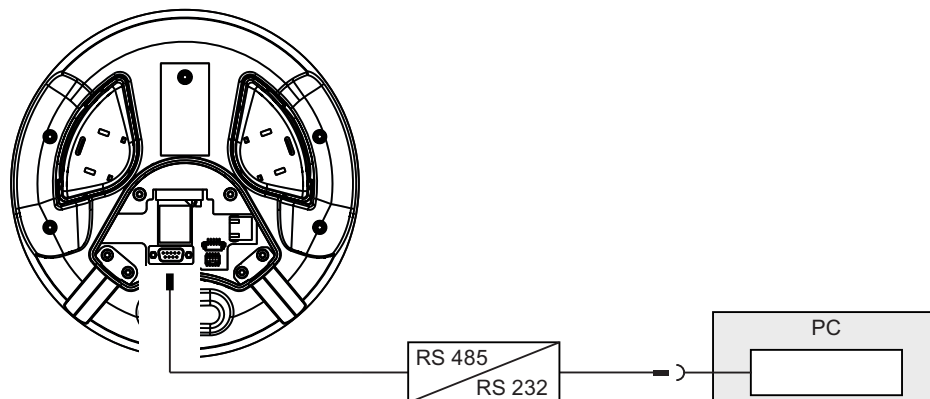

Figure 4-20 Connecting the configuration computer to the Mobile Panel 177, example Mobile Panel 177 PN

For the conversion from RS 232 to RS 485, order the PC-PPI adapter, Order No. 6ES7 901- 3CB30-0XA0, from Siemens AG.

The interfaces are described in the Technical Data.

Notice

You cannot fasten the cover of the terminal compartment while a configuration computer is connected directly to the Mobile Panel 177.

Therefore only connect a configuration computer briefly directly to the Mobile Panel 177, for example during commissioning.

4.6 Switching on and testing the HMI device

Procedure

Proceed as follows:

1. Switching on the power supply

The display lights up after power is switched on. A progress bar is displayed during startup.

If the HMI device does not start, it is possible the wires on the terminal block have been crossed. Check the connected wires and change the connections if necessary. The Loader is displayed once the operating system has started.

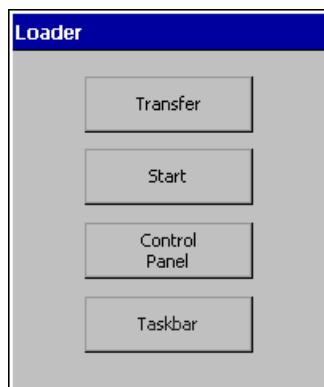

Figure 4-21 Display of the loader on the Mobile Panel 177

The HMI device automatically switches to "Transfer" mode during initial startup if no project is already loaded on the device and at least one data channel is configured. During this process the following dialog appears:

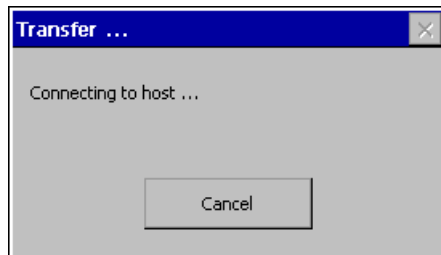

Figure 4-22 "Transfer" dialog

2. Touch "Cancel" to stop the transfer.

Result

The Loader appears again.

Note

When restarting the system, a project may already be loaded on the HMI device. The system then skips "Transfer" mode and starts the project.

Use the relevant operator control object to close the project.

Further information on this may be available in your plant documentation.

Function test

Perform a function test following commissioning. The HMI device is fully functional when one of the following states is indicated:

- The "Transfer" dialog is displayed.
- The Loader is displayed.
- A project is started.

Switching off the HMI device

Options for switching off the HMI device:

- Switch off the power supply.
- Pull the connecting cable on the terminal box

Note

Recovery time

Wait for approx. one second after you have removed the connecting cable from the terminal box before you plug the connecting cable back into the terminal box.

Wait approx. one second after switching off the power supply before you switch it back on again.

After power failures lasting less than one second the connecting cable has to be disconnected.

See also

Configuring the data channel (Page 6-31)

Operator elements and displays

5.1 Mobile Panel

5.1.1 Operator control elements

The Mobile Panel 177 has the following operator control elements:

- Color STN-LC display, Q-VGA, with touch screen, analog, resistive
- Membrane keyboard
- Enable switch

The Mobile Panel 177 offers the following optional elements:

- Handwheel
- STOP button
- Illuminated pushbutton
- Key-operated switch

5.1.2 Front-side operator control elements

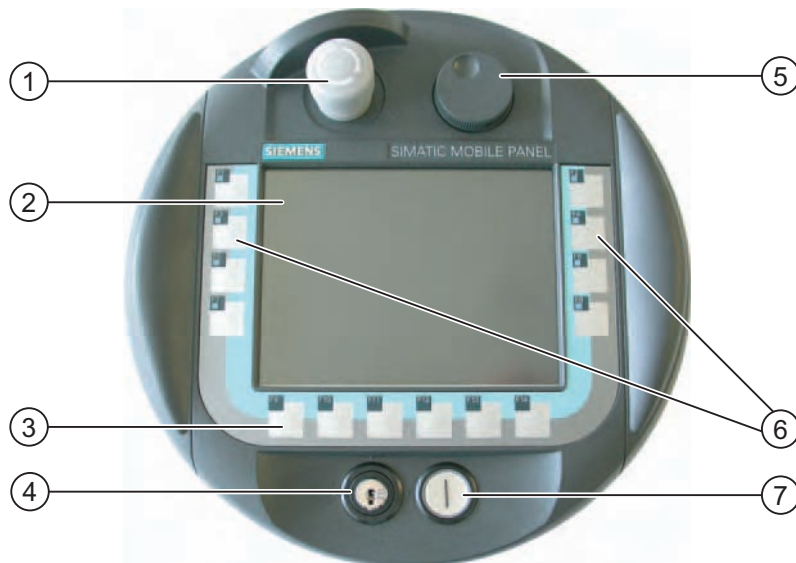

Figure 5-1 Operator control elements of the Mobile Panel 177

- ① STOP button
- ② Display with touch screen
- ③ Function keys without LED
- ④ Key-operated switch
- ⑤ Handwheel
- ⑥ Function keys with LED
- ⑦ Illuminated pushbutton

The standard input unit on the HMI device is the touch screen. All operator control objects required for touch operation are displayed on the touch screen once the HMI device has started.

The function assigned to a specific softkey is defined during configuration. The softkeys do not have any function outside projects.

The state of the softkeys is evaluated in the project or as a direct button. The state of the LEDs of the softkeys can be set by the controller.

Notice

Damaging the touch screen

Touching the touch screen with hard, sharp or pointed objects or applying excessive pressure when operating the touch screen will substantially reduce its useful life and can even lead to total failure.

Always operate the HMI touch screen with your fingers or with a touch pen.

Keyboard damage

Only use your fingers to operate the HMI device keys.

Pressing the keys with hard instruments considerably reduces the service life of the key mechanism.

5.1.3 Enable switch

Introduction

Enabling equipment consists of two enabling switches arranged on both sides of the Mobile Panel 177. The switch setting of the two enabling switches is determined by electrical momentary contact switches. The associated evaluating logic involves two channels for each enabling switch. Each channel converts the information of the enabling switch into digital and analog information (diversity).



Figure 5-2 Enable switch

① Enable switch

Operation

You only have to activate one enabling switch. No feedback is provided to the PLC on whether the Mobile Panel 177 is operated with one hand or two hands.

Note

Because there is no electrical connection between the enabling switch and the membrane keyboard, the enabling switches and the membrane keyboard can be operated simultaneously.

When an external monitoring device is used, the enabling switches satisfy Category 3 safety requirements as defined in EN 954.

Switch settings

The primary function of the evaluating logic is to recognize the three switch settings:

Switch setting	Function	Enable switch	Switch state
1	Neutral position	Not activated	OFF (open)
2	Enable	Activated	ON (closed)
3	Panic	Pressed	OFF (open)

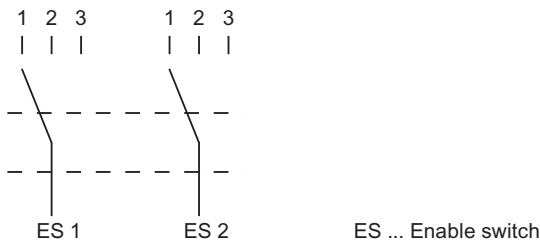

Figure 5-3 Switch settings of enabling switch

When the enabling switch is activated, the following switch sequences are possible:

Normal activation

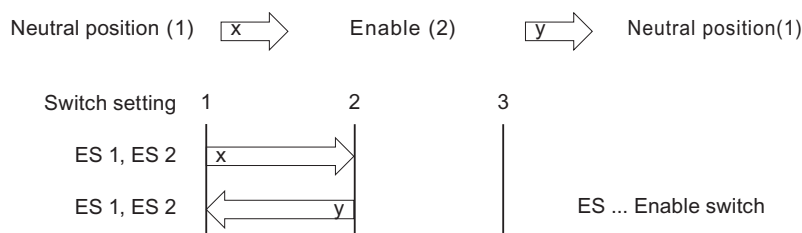

Figure 5-4 Interlinking of switch settings for normal operation

Panic activation

If the operator has pressed the enabling switch through to the "Panic" setting, the "Enable" setting will be skipped when the switch is released.

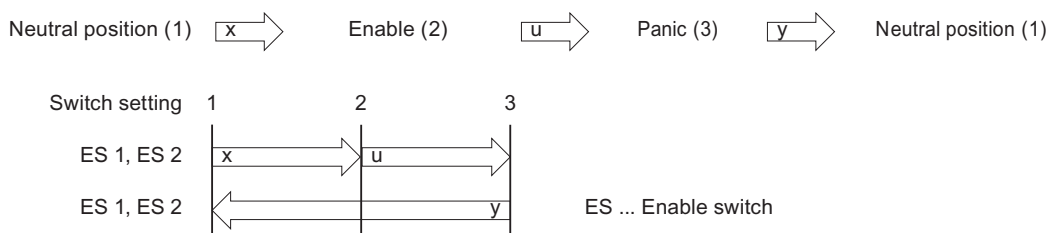

Figure 5-5 Interlinking of switch settings for panic activation

The signals of the enabling switch are fed to the terminal box via the connecting cable. For manual special operating modes, these signals must be interconnected from the terminal box to the safety circuit using two channels for power interruption.

The position of the enabling switch can be scanned in the Mobile Panel 177 via the CPU and evaluated for non-safety relevant functions by the software.

The safety shutdown does not require an acknowledgement when an enabling switch is released or pressed through to the panic setting!

5.1.4 STOP button

5.1.4.1 Overview

Introduction

The STOP button is an optional control element on Mobile Panel 177. The STOP button is designed with 2 circuits and allows a safety-related stop of the system being monitored.

When an external monitoring device is used, the STOP button fulfils Category 3 safety requirements as defined in EN 954. For further safety instructions please refer to the safety instructions and general notes chapter.

Depending on the terminal box utilized, the stop circuit will be opened when the Mobile Panel 177 is unplugged or the circuit will be automatically short-circuited by the terminal box.

Possible application areas for the STOP button:

- The STOP button can be used to quickly stop the system being monitored (system, machine, or machine zone) according to the process cycle. The Stop operation can occur with or without a power shutdown.

Advantages:

- Containing the sphere of action
- Faster restart
- No loss of machine coordinates and, thus, no recalibration upon restart
- Preservation of tool and workpiece
- Triggering the Emergency Stop function of a system being monitored by looping it in in the Emergency Stop circuit.

Advantage:

Simple integration in an existing Emergency Stop circuit when the system to be monitored has no option for a fast process stop.

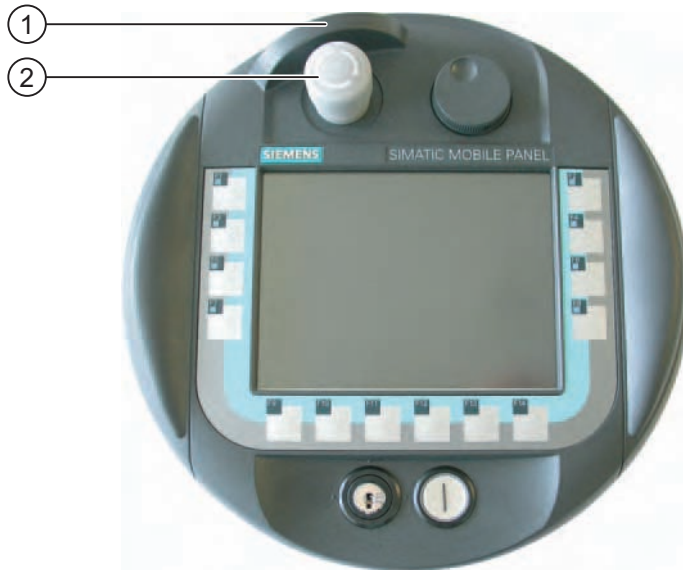

Figure 5-6 STOP button

- ① Fall protection
- ② STOP button

Due to its placement, the STOP button is equally accessible to both left-handed and right-handed individuals.

Due to its profiled design, the STOP button is easily accessible. The STOP button is fall protected by a special collar. As a result, while the STOP button can still be triggered if the Mobile Panel 177 is dropped, it is nonetheless largely protected from damage.

Operation

The STOP button is operated by pressing the button. Once the stop operation has been initiated, the STOP button remains engaged in the stop position.

Note

The STOP button engages compulsorily when activated.

Releasing the STOP button



Warning

If you activate the STOP button, thus bringing the system being monitored to a standstill, you may only release the STOP button if the reason for stopping the system has been eliminated and a safe restart is provided for.

To release the STOP button, it must be turned in a clockwise direction. The STOP button then returns on its own to the starting position.

5.1.4.2 Safety functions of the STOP button

A STOP button is available as an optional operator control element on the Mobile Panel 177.

The STOP button on the Mobile Panel 177 brings about a safety-related Stop of the system being monitored in accordance with EN 60204-1:1997, Section 9.2.5.3. You have the option of implementing a Category 0, 1, or 2 Stop function in accordance with EN 60204-1: 1997, Section 9.2.2. The stop function category must be selected on the basis of a risk assessment.

The Mobile Panel 177's stop function can, therefore, be used as a reliable machine stop as well as for looping in the Emergency Stop circuit of the system to be monitored.

The signals of the STOP button are wired differently in the two versions of the terminal box. In the Terminal Box Plus, the signals control the Stop or Emergency Stop circuit of the system being monitored. If the Mobile Panel 177 is not connected, the Stop or Emergency Stop circuit is closed. In the Terminal Box Basic, on the other hand, the signals of the Stop or Emergency Stop circuit are fed via the STOP button. If the Mobile Panel 177 is not connected, the Stop or Emergency Stop circuit of the system being monitored is open.

The term "Stop loop through" has the following meaning:

The Stop or Emergency Stop circuit of the system being monitored is looped through the terminal box and not interrupted, irrespective of whether the Mobile Panel 177 is connected to the terminal box (and STOP button not activated).

This functionality is only available in the Terminal Box Plus.



Warning

Mobile Panel 177 with STOP button

If the Mobile Panel 177 is equipped with a STOP button and is not connected to the terminal box, a Stop cannot be initiated using the Mobile Panel 177. The STOP button of the Mobile Panel 177 is then ineffective.

Install stationary Emergency Off buttons that are available at all times on the system being monitored.

Category 0 or 1 stop

If a Category 0 or 1 stop circuit is implemented, the stop function must be in effect regardless of the operating mode. A Category 0 Stop must have precedence. Releasing the STOP button must not initiate a dangerous situation (see also EN 60204-1:1997, Section 9.2.5.3).

The stop function is not to be used as a replacement for safety equipment.

Notice

Several terminal boxes

Install only one type of terminal box (i.e., Terminal Box Plus or Terminal Box Basic) for monitoring your system.

STOP button can trigger when falling down

If the Mobile Panel 177 is connected to the terminal box, the STOP button on the Mobile Panel 177 can trip if it comes off, thus causing the system to come to a standstill.

5.1.4.3 STOP button on Terminal Box Plus

Introduction

A Terminal Box Plus differs from a Terminal Box Basic due to four relays that are mounted on the board.

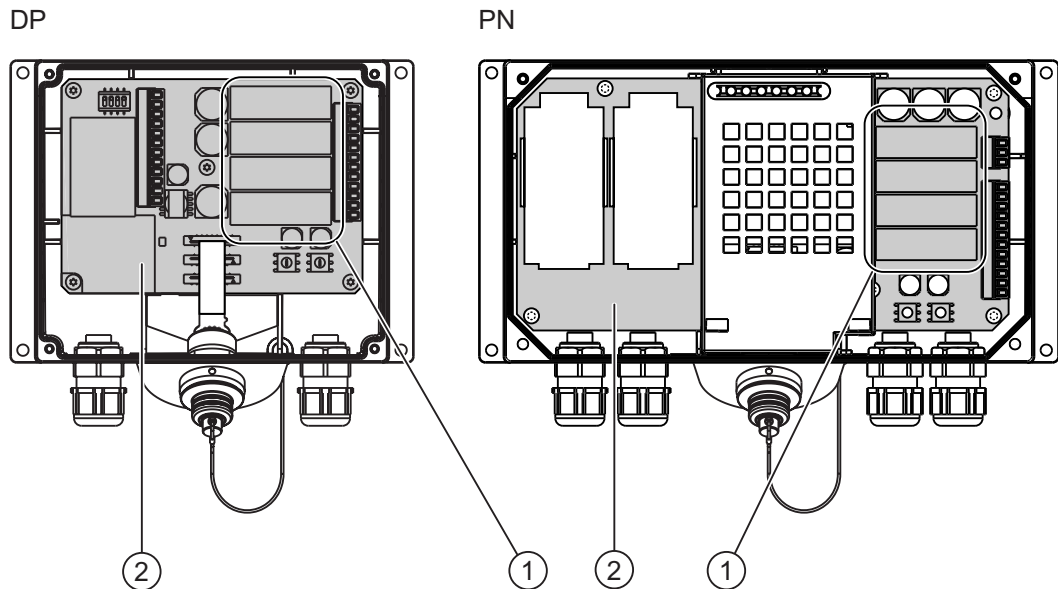

Figure 5-7 Terminal Box Plus

- ① Relay
- ② Board

Switching states of the Stop or Emergency Stop circuit with Terminal Box Plus

The Stop or Emergency Stop circuit switching statuses for a connected Mobile Panel 177 with a STOP button and Terminal Box Plus are:

Mobile Panel 177	STOP button	Status of the Stop or Emergency Stop circuit
Connected	Not pressed	The Stop or Emergency Stop circuit remains closed.
Connected	Pressed	The Stop or Emergency Stop circuit is open. The system being monitored is shut down.
Not connected	-	The Stop or Emergency Stop circuit remains closed.

The Stop or Emergency Stop circuit switching statuses for a connected Mobile Panel 177 without a STOP button and Terminal Box Plus are:

Mobile Panel 177	STOP button	Status of the Stop or Emergency Stop circuit
Connected	Not present	The Stop or Emergency Stop circuit remains closed.
Not connected	Not present	The Stop or Emergency Stop circuit remains closed.



Warning

Disconnecting the Mobile Panel 177

If you disconnect the Mobile Panel 177 from the Terminal Box Plus, the Stop or Emergency Stop circuit is closed and the Stop status of the system being monitored will be nullified. This occurs irrespective of whether the STOP button has been pressed on the Mobile Panel 177.

Notice

Approximately 100 ms elapse between the time the STOP button is pressed and the Stop contacts respond at the Terminal Box Plus.

5.1.4.4 STOP button on Terminal Box Basic

Introduction

In contrast to the Terminal Box Plus, the "Stop loop through" function is not implemented on the Terminal Box Basic. Relays, such as those contained on the Terminal Box Plus are thus not required.

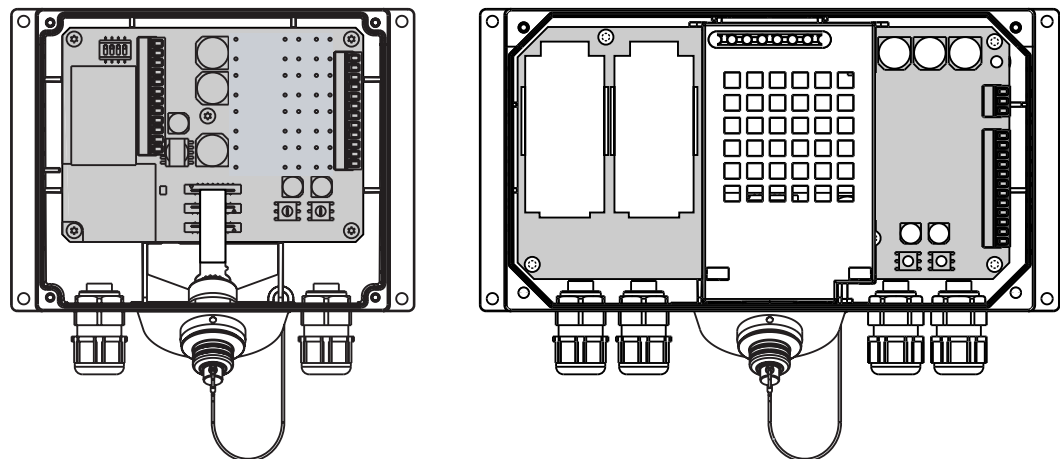

Figure 5-8 Terminal Box Basic



Caution

If the Mobile Panel 177 is connected, the Stop or Emergency Stop circuit is controlled via the STOP button. If the connecting cable of the Mobile Panel 177 is disconnected from the Terminal Box Basic, the Stop or Emergency Stop circuit is interrupted and a safe shutdown of the system being monitored or Emergency Stop is executed.

Switching states of the Stop or Emergency Stop circuit with Terminal Box Basic

The Stop or Emergency Stop circuit switching statuses for a connected Mobile Panel 177 with a STOP button and Terminal Box Basic are:

Mobile Panel 177	STOP button	Status of the Stop or Emergency Stop circuit
Connected	Not pressed	The Stop or Emergency Stop circuit remains closed.
Connected	Pressed	The Stop or Emergency Stop circuit is open. The system being monitored is shut down.
Not connected	-	The Stop or Emergency Stop circuit is open. The system being monitored is shut down.

The stop circuit switch states for a connected Mobile Panel 177 without a STOP button and Terminal Box Basic are:

Mobile Panel 177	STOP button	Status of the Stop or Emergency Stop circuit
Connected	Not present	The Stop or Emergency Stop circuit remains closed.
Not connected	Not present	The Stop or Emergency Stop circuit is open. The system being monitored is shut down.



Warning

If you have shut down the system, you can only release the STOP button or place the system being monitored back into operation if the condition triggering the Stop function has been corrected and a safe restart is provided for.

5.1.5 Hand wheel

Introduction

The hand wheel is an optional control element at the Mobile Panel 177. The hand wheel can be turned without a stop and does not have a zero position.

You can use the hand wheel to input incremental values.

The status of the hand wheel is evaluated as a direct button or via WinCC flexible system functions.



Figure 5-9 Hand wheel

- ① Hand wheel with recess

Operation

To facilitate operation, the hand wheel has a small recess.

5.1.6 Key-operated switch

Introduction

The key switch is an optional control element of the Mobile Panel 177. The key switch is used to lock functions that are triggered by the Mobile Panel 177.

The status of the key switch is evaluated as a direct button or via WinCC flexible system functions.



Figure 5-10 Key-operated switch

- ① Key-operated switch

Operation

The key-operated switch has three positions: I-0-II.

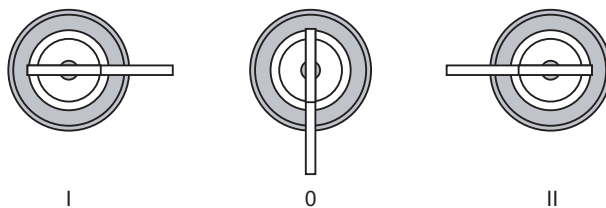

Figure 5-11 Key-operated switch settings

The key can be removed in the Switch Setting 0.

Remove the key after use. This avoids possible damage to the key if the HMI device falls.

Note

The key for the key-operated switch is enclosed with the HMI device. Its coding is not specific to the device. Therefore, the key can be used for any Mobile Panel 177.

5.1.7 Illuminated pushbutton

Introduction

The illuminated pushbutton is an optional control element on the Mobile Panel 177. The illuminated pushbutton is available for rapid digital inputs.

The status of the illuminated pushbutton is evaluated as a direct button or via WinCC flexible system functions. The state of the LEDs of the illuminated pushbuttons can be set by the controller.



Figure 5-12 Illuminated pushbutton

① Illuminated pushbutton

Operation

The illuminated pushbutton acts by touch-control.

5.2 Holding and placing the Mobile Panel

Mobile Panel 177 position for manual operation



Figure 5-13 Underarm position for right or left handed individuals

The positions shown above enable actions to be performed on the system being monitored, e.g., during maintenance.

In the underarm position shown, both right and left handed individuals can operate the HMI device equally well. All operator control elements on the front can be reached with your free hand. The hand holding the HMI device can also be used to activate the enabling switch. Control inputs are enabled when just one of the enabling switches is activated.

The enabling switch is required to confirm the action. The enabling switch is optimally placed for reachability. It triggers a safety shutdown in the event of panic situations involving potential danger (release or clench).

The STOP button can also be quickly reached with your free hand.

Handling the HMI device when manipulating data

This position is only permitted when you are manipulating data on the system being monitored.

Notice

If you are manually controlling unsafe actions in special operating modes, you must use one of the underarm positions shown above, so that you can quickly reach the STOP button or enabling switch, for example, should a dangerous situation arise.



Figure 5-14 Two hand position

Placing the Mobile Panel 177

A wall holder is available for secure and location-specific placement of the HMI device. The wall holder enables you to use the Mobile Panel 177 as a stationary HMI device.



Figure 5-15 Mobile Panel 177 in the wall holder

Notice

If the Mobile Panel 177 is hung on an unsuitable holder, the ability to operate the STOP button may be compromised.

5.3 Terminal Box PN

Introduction

Six LEDs that display the communication status are positioned on the front of the Terminal Box PN

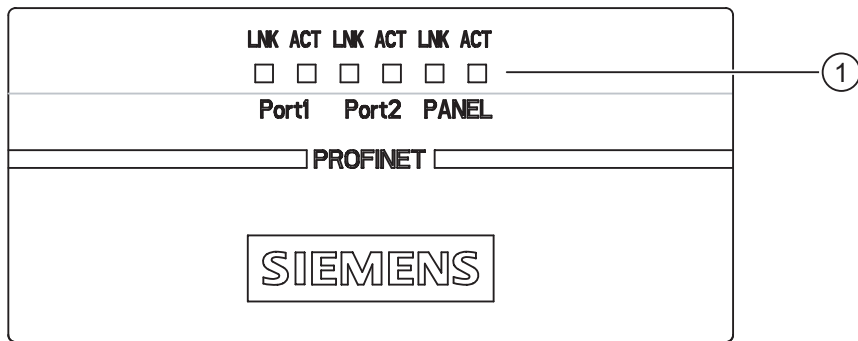

① LED displays (green LED "LNK", yellow LED "ACT")

Two LED displays "LNK" and "ACT" each exist for the following connections:

- PROFINET connection Port1
- PROFINET connection Port2
- Mobile Panel 177

Meaning of the LED displays

- The LED "LNK" lights up if a cable is connected and the connection is error-free at the corresponding interface of the Terminal Box PN.
- The LED "ACT" flashes when data are being transferred via the corresponding interface.

Configuring the operating system

6.1 Overview

Loader

The figure below shows the Loader.

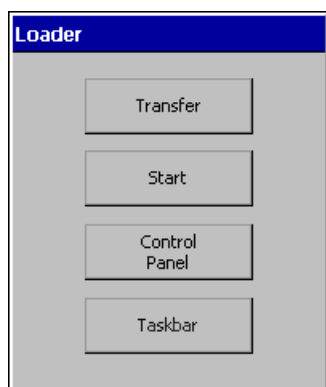

Figure 6-1 HMI device Loader

The Loader buttons have the following functions:

- Use the "Transfer" button to set "Transfer" mode on the HMI device.
The transfer mode can only be activated when at least one data channel has been enabled for the transfer.
- Press the "Start" button to open the project stored on the HMI device.
- Press "Control Panel" to open the HMI device Control Panel
The Control Panel is used to configure various settings such as the transfer settings.

- Press the "Taskbar" button to activate the taskbar containing the open Windows CE Start menu.

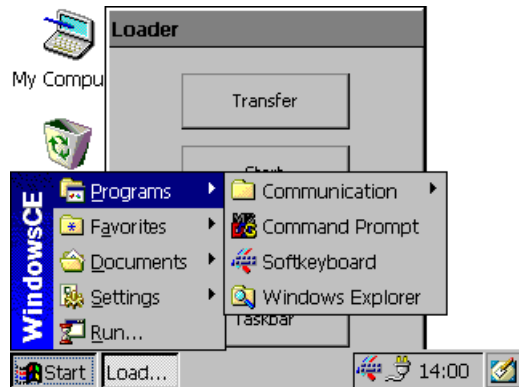

Figure 6-2 Windows CE Start menu

Password Protection

You can protect the Control Panel and taskbar from unauthorized access. When password protection is enabled, the message "[password protect]DNT" is displayed in the Loader.

If the password is not entered, only the "Transfer" and "Start" buttons are operable.

This prevents inadvertent operations and increases security for the plant or machine because the settings cannot be changed when a project is not open.

Notice

If the password is no longer available, you cannot change settings in the Control Panel and taskbar unless you update the operating system.

All data on the HMI device will be overwritten when you update the operating system.

See also

Switching on and testing the HMI device (Page 4-26)

Configuring the data channel (Page 6-31)

6.2 Control Panel

6.2.1 Overview

Control Panel of the HMI Device

The settings you can make in the Control Panel of the HMI device include:

- Communication
- Date/time
- Screen saver
- Backup and restore
- Regional settings
- Transfer settings
- Delay time
- Password

Opening the Control Panel

Touch the "Control Panel" button in the Loader to open the HMI device Control Panel.

The following options are available to open the Loader:

- The Loader appears briefly after starting the HMI device.
- Closing a Project

If configured, touch the relevant operator control object to stop the project. The Loader opens. Further information on this may be available in your plant documentation.

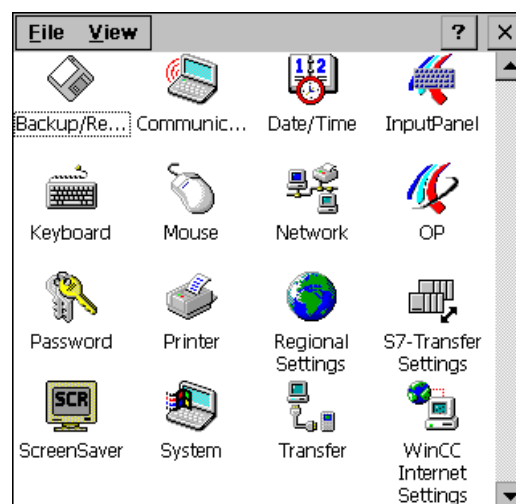

Figure 6-3 Control Panel of the HMI device

"Backup/Restore"	Backing and restoring the HMI device image and the project on memory cards
"Communication Properties"	Setting device names for network operation
"Date/Time"	Setting the data and time of day on the HMI device
"InputPanel"	Configuring the screen keyboard
"Keyboard"	Setting the character repeat for the screen keyboard
"Mouse"	Setting the double-click on the touch screen
"Network"	Setting network parameters
"OP"	Changing screen settings, displaying information about HMI device, calibrating the touch screen
"Password"	Setting password protection for the Control Panel
"Printer"	Configuring printers
"Regional Settings"	Making local region settings
"S7 Transfer Settings"	Setting the transfer parameters for MPI/DP
"Screen Saver"	Configuring the screen saver
"System"	Displaying information about the operating system, processor and memory
"Transfer"	Configuring a data channel for the transfer
"WinCC Internet Settings"	Parameters for using the Internet - for PN HMI devices only



Procedure

Proceed as follows to change settings in the Control Panel:

1. You must exit the project before changing settings in the Control Panel.
Use the provided operating control component..
2. Open the Control Panel as described above.
3. Open the desired dialog by double-clicking on the corresponding icon in the Control Panel.
Enter the required password if the Control Panel is protected against unauthorized access.
4. Change settings for your HMI device in the Control Panel.
To change settings, touch the respective input field or check box and use the displayed screen keyboard if necessary.
5. Press **OK** to close the dialog.
6. Press the button or **OK** to close the Control Panel.
7. Open the project in the Loader.

6.2.2 Entry using the screen keyboard

Introduction

A variety of screen keyboards are available to input information outside an open project, for example in the Control Panel. A screen keyboard appears as soon as you touch an input field. You can switch the screen keyboard and change its position on screen. Confirm your entries with  or discard your entries with . Either action closes the screen keyboard.

Screen Keyboard Outside an Open Project

- Numerical screen keyboard

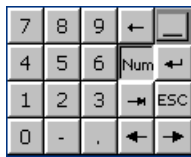



- Alphanumerical screen keyboard









Figure 6-4 Alphanumerical screen keyboard, normal level

The alphanumerical keyboard has multiple levels.

- Normal level
- Shift level
- Level on which the control keys are activated

You can also reduce both screen keyboards:   

Switching between Screen Keyboards

-  switches between the alphanumerical and numerical screen keyboards
-  switches between the normal level and Shift level of the alphanumerical screen keyboard
-  activates and deactivates the numerical and alphanumerical keys of the alphanumerical screen keyboard
-  switches from full display to reduced display
-  switches from reduced display to full display
-  closes the reduced display of the screen keyboard

Moving the Screen Keyboard on the Touch Screen

You can move the screen keyboard if it blocks you from operating a dialog in any way.

1. Touch .

Keep touch contact to move the screen keyboard on the touch screen. Release touch contact on the icon when the required position is reached.

6.2.3 Configuring the screen keyboard

Introduction

In the Control Panel you can configure the screen keyboard that is used to make entries outside an open project.

Requirements

The "Siemens HMI Input Panel - Options" dialog has been opened with the "Input Panel"  icon.

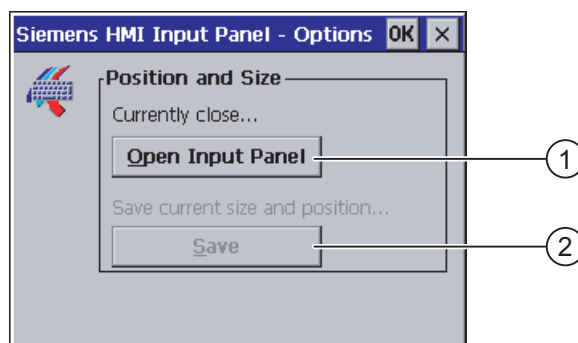

Figure 6-5 "Siemens HMI Input Panel – Options" dialog

- ① Button for displaying the screen keyboard
- ② Button for saving the screen keyboard

Procedure

1. Touch the "Open Input Panel" button.

The screen keyboard is displayed.

The "Siemens HMI Input Panel – Options" dialog changes its appearance.

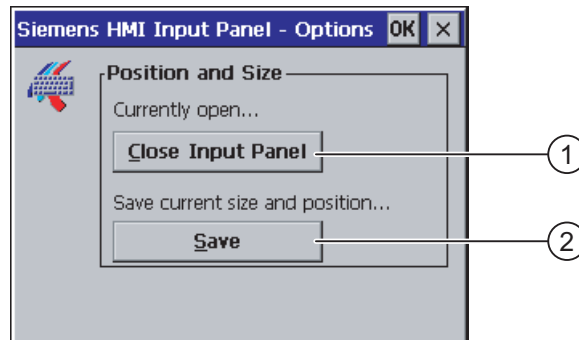

- ① Button for closing the screen keyboard
- ② Button for saving the screen keyboard

2. Touch the <Num> button of the screen keyboard two toggle between the numerical and alphanumerical screen keyboard.
Set the position of the screen keyboard.
3. Touch the "Save" button to save the settings.
4. Touch the "Close Input Panel" button to close the screen keyboard.
5. Close the dialog with **OK** or **X**.

Result

The screen keyboard settings have been modified.

See also

Entry using the screen keyboard (Page 6-5)

6.2.4 Setting the character repetition of the screen keyboard

Introduction

In the Control Panel you can set the character repeat for the screen keyboard that is used to make entries outside an open project.

Requirements

The "Keyboard Properties" dialog has been opened with the "Keyboard"  icon.

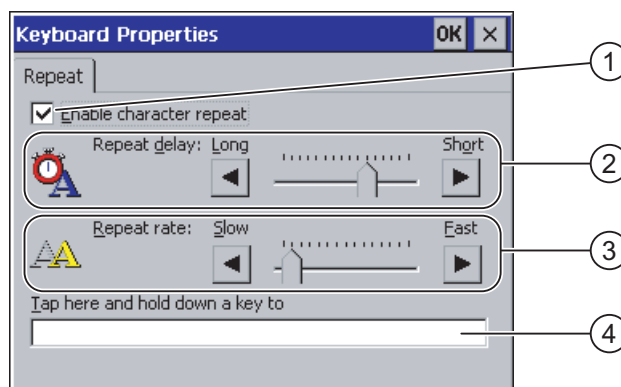

Figure 6-6 "Keyboard Properties" dialog

- ① Check box for activating the character repeat
- ② Slide bar and buttons for the delay time before character repeat
- ③ Slide bar and buttons for the rate of the character repeat
- ④ Test field

You can change the settings in the "Keyboard Properties" dialog with the buttons and slide bar.

Procedure

Proceed as follows:

1. Specify whether or not the character repeat of the keyboard should be activated.
 - Activate the "Enable character repeat" check box to enable the character repeat.
 - Deactivate the "Enable character repeat" check box to disable the character repeat.
2. Use the buttons or slide bar to set use and rate of the character repeat.
3. Verify your settings.
 - Touch the test field. The screen keyboard opens.
 - Move the screen keyboard as needed.
 - Touch any character and keep it pressed.
 - Check the activation of the character repeat and its rate in the test field.
 - Correct your setting if necessary.
4. Close the dialog and save your entries with **OK**. Touch **X** to discard the entries.

Result

The character repeat for the keyboard is now set.

6.2.5 Setting the double-click on the touch screen

Introduction

You can start application in the Control Panel and in Windows CE with a double-click, two brief touches is sequence.

Set the time between two touches in the Control Panel.

Requirements

The "Mouse Properties" dialog has been opened with the "Mouse"  icon.

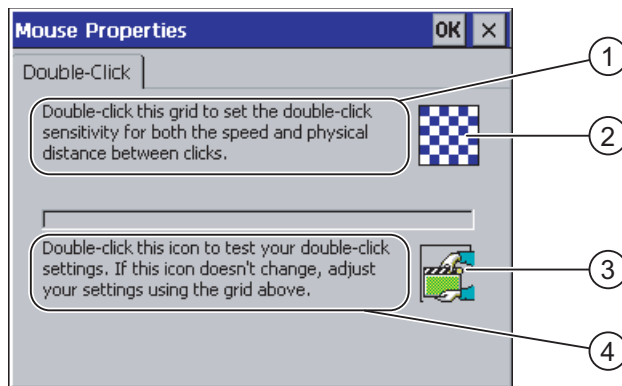

Figure 6-7 "Mouse Properties" dialog

- ① Touch the pattern ② twice in sequence to set the time and spatial distance between the touches on the screen.
- ② Pattern
- ③ Symbol
- ④ Touch the ③ icon twice in sequence to check the setting of your double-click. If the icon does not change, adjust your settings using the ② pattern again.

Procedure

Proceed as follows:

1. Touch the pattern twice.
 - The pattern is displayed in inverse colors at the second touch.



2. Touch the icon twice.

If the double-click is detected, the icon is displayed as follows at the second touch.



3. If the icon remains unchanged, double-click on the pattern again.
4. Close the dialog and save your entries with **OK**. Touch **X** to discard the entries.

Result

The double-click on the touch screen is now set.

6.2.6 Backup and restore using a memory card

Introduction

A backup involves copying the operating system, applications and data in flash memory of the HMI device to a memory card.

A restore operation deletes all old data from flash memory of the HMI device on confirmation. The data stored on the memory card is then copied to the internal flash memory.

Requirements

A memory card with ≥ 16 MB capacity is inserted in the HMI device.

The "Backup/Restore" dialog has been opened with the "Backup/Restore"  icon.

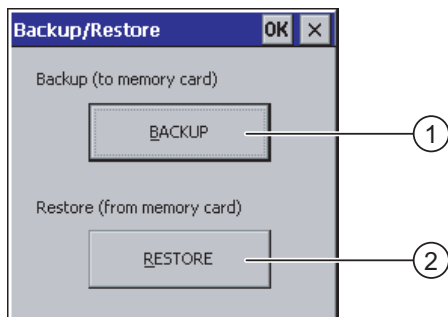

Figure 6-8 "Backup/Restore" dialog

- ① Button for data backup
- ② Button for data restore

Procedure - Backup

Proceed as follows:

1. Touch the "BACKUP" button.

The message "Starting backup" is displayed.

The following message appears if no memory card is inserted in the card slot or if the memory card is damaged:

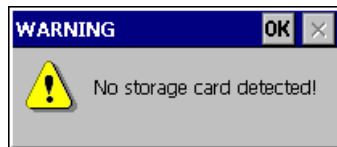

Then perform steps 2 and 3.

2. Touch **OK**.

This message is displayed: "Backup aborted".

3. Confirm with "OK".

The Control Panel is displayed again.

Repeat the procedure with a suitable memory card.

1. Using the memory card
2. Touch the "BACKUP" button.

The message "Storage card detected" is displayed.

- A warning is displayed if the available space is insufficient. The backup is aborted. Delete any unneeded data on the memory card using the Windows CE Explorer.
- If the memory card contains data, the following message is displayed: "You have an old backup on the storage card. Do you want to delete it?".

3. Press "Yes" if you want to delete the data.

Press "No" if you want to retain the data.

The messages "Checking the registry settings" and "Saving CE image" are displayed in sequence when the backup begins. A progress bar shows the status of the process.

The backup ends with the following message: "Backup successfully completed. Touch OK and remove memory card."

4. Touch the "OK" button.

The Control Panel is displayed.

Result

The HMI device data is now on the memory card.

Procedure – Restore

Proceed as follows:

1. Touch the "RESTORE" button.

The message "Restore started" is displayed.

The following message appears if no memory card is inserted in the card slot or if the memory card is damaged:

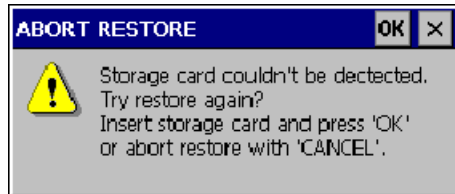

Then perform steps 2 and 4.

2. Touch **OK**.

This message is displayed: "Restore aborted". Remove the memory card".

3. Remove the memory card.
4. Confirm with "OK".

The Control Panel is displayed again.

Repeat the procedure with a suitable memory card.

1. Using the memory card
2. Touch the "RESTORE" button.

This message is displayed: "Restore started". The following message appears: "Checking data". When the data has been checked, the following message appears: "You are starting a restore. All files files except those on the memory card and the registry files will be deleted. Are you sure?"

3. Press "Yes" if you want to restore the data.

Press "No" if you want to cancel the restore.

The messages "Deleting files in the internal Flash memory" and "Restoring CE image" are displayed in sequence once the restore process begins. A progress bar shows the status of the process.

The restore ends with the message "The restore of the CE images is completed. The HMI device will now be restarted. Do not remove the memory card."

4. Touch the "OK" button.

The operating system boots, opening the Loader and Control Panel in sequence. Two messages appear.

Then the final message appears: "Restore successfully completed. Touch OK and remove memory card."

5. Touch the "OK" button.

The HMI device boots. The Control Panel is then displayed.

6. Remove the memory card, if necessary.

Store the memory card in a safe place.

Result

The data from the memory card is now in the HMI device. The existing licenses are retained on the HMI device, all other files have been deleted.

6.2.7 Setting the date and time

Requirements

The "Date/Time Properties" dialog has been opened with the "Date/Time Properties" icon.

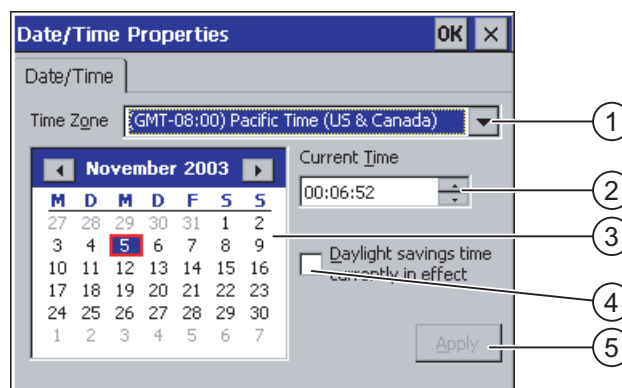

Figure 6-9 "Date/Time Properties" dialog

- ① Time zone
- ② Time
- ③ Date
- ④ "Summertime" checkbox
- ⑤ Button for saving changes

Procedure

Proceed as follows:

1. Select the appropriate time zone for the HMI device in the "Time Zone" selection field.
Touch the selection field. A selection list is displayed.
2. Press "Apply".
The time of day shown in the "Current Time" field is adjusted correspondingly to the selected time zone.
3. Set the date.
Touch the desired date on the calendar.
4. Set the current time of day in the "Current Time" input field.
Touch the input field. The alphanumerical screen keyboard is displayed.
5. If you want the change from standard time to daylight savings time to be performed automatically:
Activate the "Daylight savings time currently in effect" check box.
6. Press "Apply".
The values you have set are now in effect.
7. Close the dialog and save your entries with **OK**.
Touch **X** to discard the entries.

Notice

Reboot the HMI device if you have made changes to the time zone.

Result

The settings for the data and time of day have now been changed.

Synchronizing the Date and Time with the Controller

The date and time of the HMI device can be synchronized with the controller, if this has been configured in the project and the controller program..

Further information on this subject is available in the "WinCC flexible" system manual.

Notice

Synchronize the date and time when time-controlled responses should be triggered in the PLC by the HMI device.

6.2.8 Saving tab entries

Introduction

If you are running your own programs on the HMI device under MS Windows CE, you should back up the registry information after installing the programs. There are several ways to save files:

- Save the registry information to the Flash memory.
- Save files in a temporary folder to the Flash memory.

Saving to the Flash memory allows you to automatically restore the file system on the HMI device.

Requirements

The "OP Properties" dialog has been opened with the "OP"  icon.

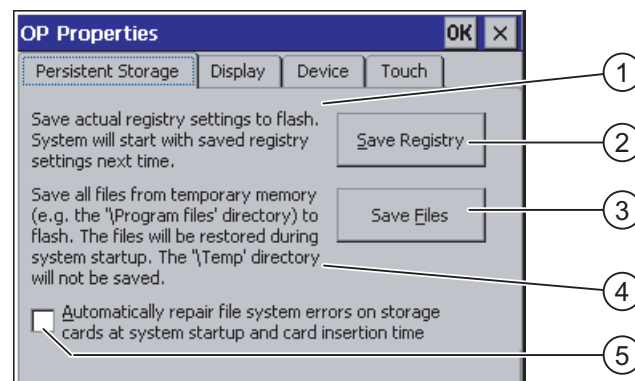

Figure 6-10 "OP Properties" dialog, "Persistent Storage" tab

- ① Saves the current registry information to the Flash memory. The HMI device loads the saved registry information the next time it boots.
- ② Button for saving registry information
- ③ Button for saving temporary files
- ④ Saves all the files in temporary storage to the Flash memory (for example, from the "Program Files" directory). These files are written back the next time the HMI device starts. The "\Temp" directory is not saved.
- ⑤ Check box for automatically restoring the file system on the memory card when the HMI device starts up and when a memory card is inserted.

Procedure

Proceed as follows:

1. Touch the "Save Registry" button to save the current registry settings.
2. Touch the "Save Files" button to save temporary files.
3. Specify whether or not the file system on the memory card should be restored when the HMI device starts up or when a memory card is inserted.
 - Activate the check box "Automatically Repair ...", if you wish to have the files system restored automatically.
 - Deactivate the check box "Automatically Repair ...", if you wish to have the files system restored only upon prompting.
4. Close the dialog and save your entries with **OK**. Touch **X** to discard the entries.

Result

The HMI device uses the saved registry information the next time it starts. The temporary files are copied back.

6.2.9 Modifying the screen contrast

Requirements

The "OP Properties" dialog has been opened with the "OP"  icon.

Procedure

Proceed as follows:

1. From the "OP Properties" dialog, select the "Display" tab.

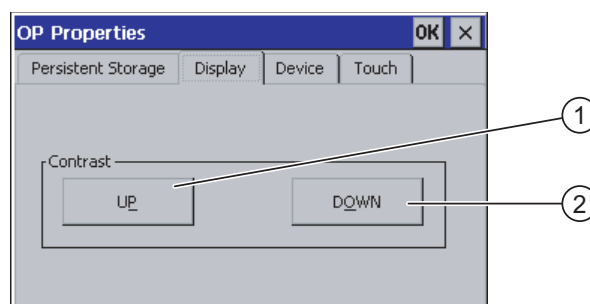

Figure 6-11 "OP Properties" dialog, "Display" tab

- ① Button for increasing the contrast
- ② Button for reducing contrast

2. To adjust the screen contrast:
 - Touch the "UP" button to increase screen contrast
 - Touch the "DOWN" button to reduce screen contrast
3. Close the dialog and save your entries with **OK**. Touch **X** to discard the entries.

Result

The HMI device screen settings have now been changed.

Note

You can also adjust the contrast within an open project. Refer to the corresponding system documentation for more information in this regard.

6.2.10 Displaying information about the HMI

Requirements

The "OP"  icon on the Control Panel has been touched.

Procedure

Proceed as follows:

1. Open the "OP Properties" dialog, then select the "Device" tab.

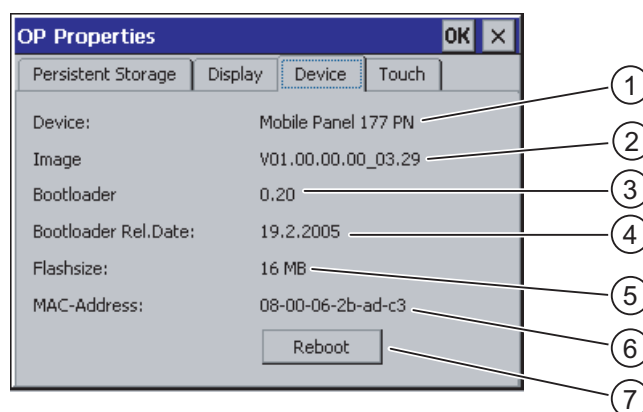

Figure 6-12 "OP Properties" dialog, "Device" tab , example

- ① HMI device name
- ② Version of the HMI device image
- ③ Version of the boot loader
- ④ Boot loader release date
- ⑤ Size of the Flash memory in which the HMI device image and project are stored
- ⑥ MAC address of the HMI device
- ⑦ Command button for restating the HMI device

2. The device-specific information is displayed in the "Device" tab.

This information is required when you contact A&D Technical Support.

3. Activate the "Reboot" command button if you want to reboot the HMI device

After you have activated the "Reboot" command button, a warning is displayed on the screen. If you acknowledge this with "OK", the HMI device is rebooted immediately.

4. Use **OK** or **X** to close the dialog when the information is no longer required.



Caution

Data loss when the HMI device is restarted

All volatile data is lost when the HMI device is rebooted. No check is carried out whether or not the project on the HMI device is running, the communication is active whether data are currently being written into the flash memory or not.

Note

The size of the internal flash memory does not correspond to the available working memory for a project.

6.2.11 Calibrating the touch screen

Introduction

Depending on the mounting position and viewing angle, it is possible that parallax may occur when operating the HMI device. In order to prevent any operating errors as a result, calibrate the touch screen again in the startup phase or during runtime.

Requirements

The "OP Properties" dialog has been opened with the "OP"  icon.

Procedure

Proceed as follows:

1. Open the "OP Properties" dialog, then select the "Touch" tab.

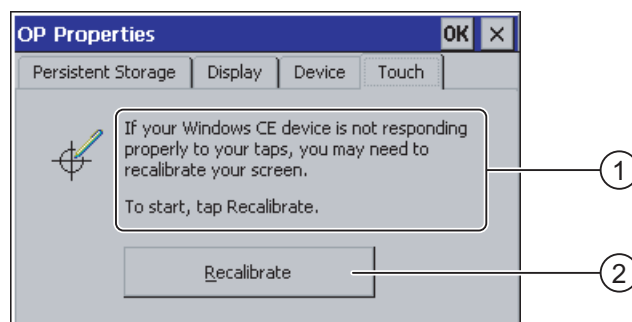
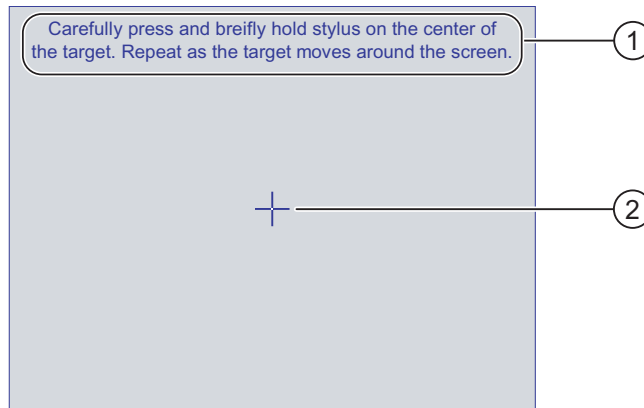

Figure 6-13 "OP Properties" dialog, "Touch" tab

- ① If the HMI device does not react precisely to a touch, the touch screen may require calibration.
- ② Button for calibrating the touch screen

2. Touch the "Recalibrate" button.

The following dialog appears.



- ① Carefully press the middle of the calibration crosshairs. Repeat the process as long as the calibration crosshairs move on the touch screen.
- ② Calibration crosshairs

3. Briefly touch the calibration crosshairs.

The calibration crosshairs then goes to four more positions. Touch the middle of the calibration crosshairs for each position. If you do not touch the middle of the calibration crosshairs, the procedure is repeated.

Once you have touched the calibration crosshairs for all positions, the following dialog appears:

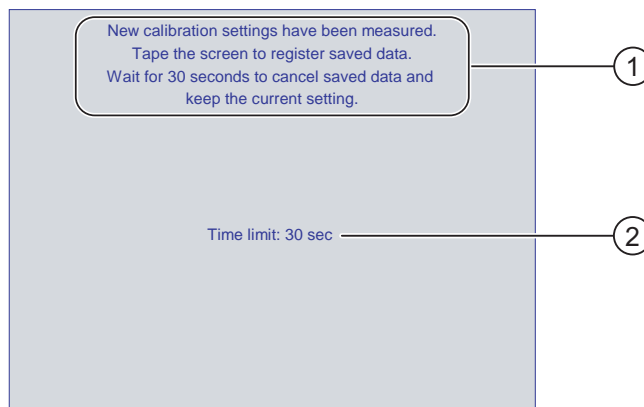

- ① The new calibration values are measured. Touch the touch screen to save the calibration values. If you do not within touch the screen within 30 seconds, the new calibration values will be discarded.
- ② Time remaining until the calibration values are discarded

4. Touch the screen within 30 seconds

The new calibration is saved. If you wait longer than 30 seconds, the new calibration is discarded and the original calibration remains in effect.

5. Close the dialog with **OK**.

The Control Panel is displayed.

Result

The HMI device touch screen is now recalibrated.

6.2.12 Changing the password properties

Introduction

You can protect the Control Panel and Windows CE taskbar with a password.

Requirements

The "Password Properties" dialog has been opened with the "Password"  icon.

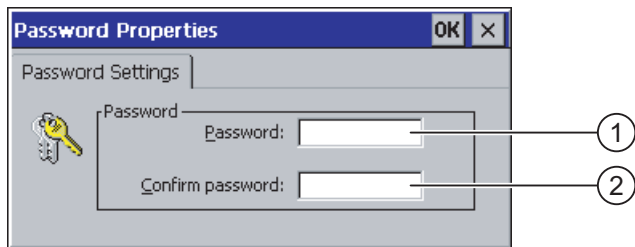

Figure 6-14 "Password Properties" dialog

- ① Password input field
- ② Input field for entering the password a second time

Procedure – Entering a Password

Proceed as follows:

1. Enter a password in the "Password" input field.
Touch the input field. The alphanumerical screen keyboard is displayed.
2. Repeat the password entry in the "Confirm Password" input field.
3. Close the dialog with **OK**.

Notice

The password may not contain space characters or the special characters * ? . % / \ ' " .

Result

You cannot open the Control Panel or Windows CE taskbar without entering a password.

Notice

If the password is no longer available, you cannot make changes in the Control Panel or use the Windows CE taskbar unless you update the operating system.

All data on the HMI device will be overwritten when you update the operating system.

Procedure – Deleting a Password

Proceed as follows:

1. Delete the entries for "Password" and "Confirm Password".
2. Close the dialog with **OK**.

Result

Password protection for the Control Panel and Windows CE taskbar is disabled.

6.2.13 Changing the printer properties

Introduction

HMI devices with a PROFINET interface can print via network printers. You can print hardcopies and logs on a network printer. Spontaneous printing out of coming or going individual messages is not possible.

Requirements

The "Printer Properties" dialog has been opened with the "Printer"  symbol.

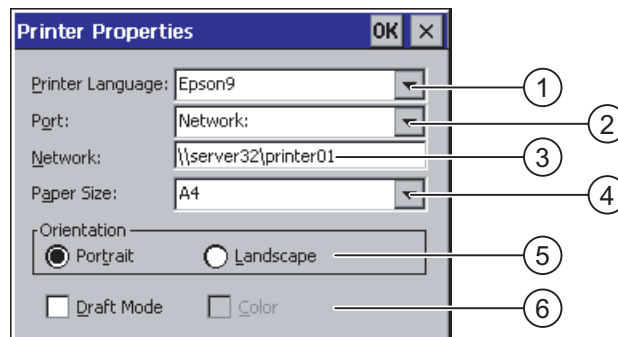

Figure 6-15 "Printer Properties" dialog box, example

- ① Printer selection field
- ② Interface
- ③ Network address of the printer
- ④ Paper format selection box
- ⑤ Orientation setting
- ⑥ Print quality setting

Procedure

Proceed as follows:

1. Activate the "Printer Language" selection box and select the printer.
2. Activate the "Ports" selection box and set the "Network:" to On
3. Enter the network address of the printer in the "Network:" input box
Touch the input box. The screen keyboard is displayed
4. Activate the "Paper Size" input box and select the paper format.
5. Activate the corresponding radio button in the "Orientation" group:
 - "Portrait" for vertical format
 - "Landscape" for horizontal format
6. Set the print quality.
 - Activate the "Draft Mode" check box if you want to print out in draft quality
 - De-activate the "Draft Mode" check box if you want to print out in better quality
7. Set the color mode
 - Activate the "Color" check box if you want to print out in color. When de-activated, the printout is in black-and-white
8. Close the dialog and save your values with **OK**. Touch **X** to discard the values.

Result

The settings for the printer are modified.

Note

The list of current printers and the required settings for operator control devices can be found on the Internet at: <http://www4.ad.siemens.de/view/cs/en/11376409>.

6.2.14 Changing regional settings

Introduction

The display format of the date, time and decimal point etc. differ from region to region. You can adjust the regional settings on the HMI device to meet local requirements.

Requirements

The "Regional Settings Properties" dialog has been opened with the "Regional Settings"

 icon.



Figure 6-16 "Regional Settings" dialog, "Regional" tab

Procedure - Changing Regional Settings

Proceed as follows:

1. Touch the "Region" selection field for the language in the "Regional Settings" tab.
2. Select the desired language.

To do this, touch the input field. The symbolic screen keyboard is displayed.

Procedure - Changing the Number Format

Proceed as follows:

1. Open the "Number" tab.
2. Set the following in the selection fields:
 - The character for the decimal separator
 - The character for the thousand separator
 - The separator character for number sequences
3. Touch the respective selection field and set the desired value using the screen keyboard.

Procedure - Changing the Time Format

1. Open the "Time" tab.
2. Set the following in the selection fields:
 - Time of day format
 - Define the separator between hours, minutes and seconds.
 - The format for the time before 12:00 noon.
 - The format for the time after 12:00 noon.
3. Touch the respective selection field and set the desired value using the screen keyboard.

Procedure - Changing the Date Format

1. Open the "Date" tab.
2. Set the following in the selection fields:
 - Define the separator between year, month and day.
 - The abbreviated format of the date
 - The full format of the date
3. Touch the respective selection field and set the desired value using the screen keyboard.

Procedure - Closing the Dialog

1. Close the dialog and save your entries with **OK**.
Touch **X** to discard the entries.

Result

The regional settings for the HMI device screen have now been changed.

6.2.15 Changing MPI/DP settings – only at Mobile Panel 177 DP

Requirements

The "S7 Transfer Settings" dialog has been opened with the "S7 Transfer"  icon.

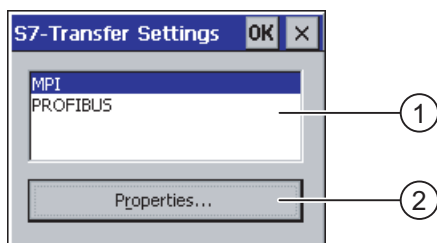

Figure 6-17 "S7-Transfer Settings" dialog

- ① Network selection
- ② Button for opening the properties dialog

Procedure

Proceed as follows:

1. Select a network and then touch the "Properties" button.

One of the two following dialogs is displayed.

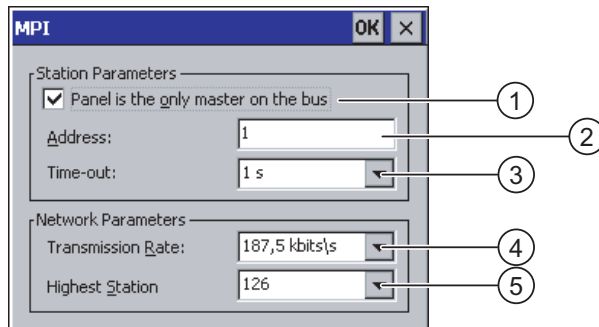

Figure 6-18 "MPI" dialog

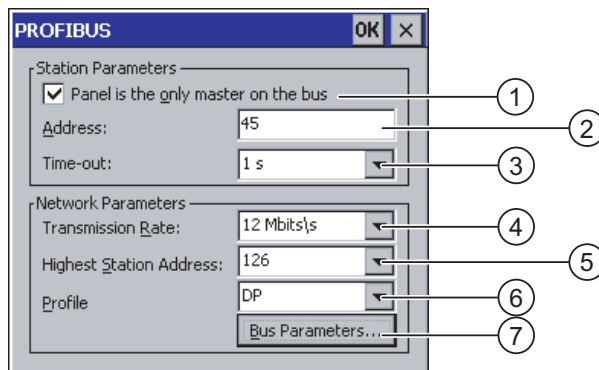

Figure 6-19 "PROFIBUS" dialog

- ① The HMI device is the only master on the bus.
- ② Bus address of the HMI device
- ③ Time-out
- ④ Data transmission rate in total network
- ⑤ Highest station address in the network
- ⑥ Profile
- ⑦ Button for displaying the bus parameters

2. If more masters are connected to the bus, deactivate the check box "Panel is the only master on the bus".
3. Enter the bus address for the HMI device in the "Address" input field.
Touch the input field. A selection list is displayed.
4. Select the highest transmission rate from the "Transmission rate" selection field.
Touch the input field. The symbolic screen keyboard is displayed.
5. Select the highest station address on the bus in the "Highest Station Address" field.
Touch the input field. The symbolic screen keyboard is displayed.
6. Select the desired profile from the "Profile" selection field. Touch the input field. The symbolic screen keyboard is displayed.

- The profile information is displayed when you press the "Bus Parameters" button in the PROFIBUS dialog. This dialog is read-only.

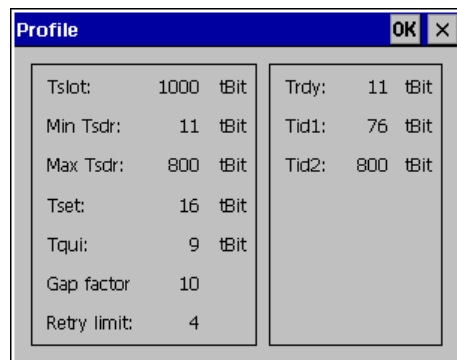

Figure 6-20 Profile parameters

Press **OK** or **X** to close the dialog.

- Close the dialog and save your entries with **OK**. Touch **X** to discard the entries.

Notice

Address in MPI/PROFIBUS DP Network

The value assigned in the "Address" input field may only be used once in a MPI/PROFIBUS DP network.

Bus Parameters in the MPI/PROFIBUS DP Network

The bus parameters must be the same for all stations in the MPI/PROFIBUS DP network.

Note

When a project is opened, the MPI/DP settings are overwritten with the values from the project.

General information

Notice

Transfer Mode Using MPI/PROFIBUS DP

For MPI/PROFIBUS DP transfer, the bus parameters, for example the MPI/PROFIBUS DP address of the HMI device, are read from the current project on the HMI device.

The settings for MPI/PROFIBUS DP transfer can be modified. For this, you must first close the project and then change the settings on the HMI device. Then go back to Transfer mode.

The HMI device uses the new MPI/PROFIBUS DP settings until you start a project or transfer a project to it. The MPI/PROFIBUS DP settings are then overwritten by the values from this project.

Transfer Settings

A project can only be transferred from the configuration computer to the HMI device when at least one of the data channels is enabled on the HMI device.

Do not edit the transfer settings while a project is active or the HMI device is in transfer mode.

Result

The MPI/DP settings of the HMI device have been changed.

6.2.16 Setting the delay**Introduction**

The project is opened following a delay time when the HMI device is switched on. The Loader is displayed during the delay time.

Requirements

The "Transfer Settings" dialog has been opened with the "Transfer"  icon. You have opened the "Directories" tab.

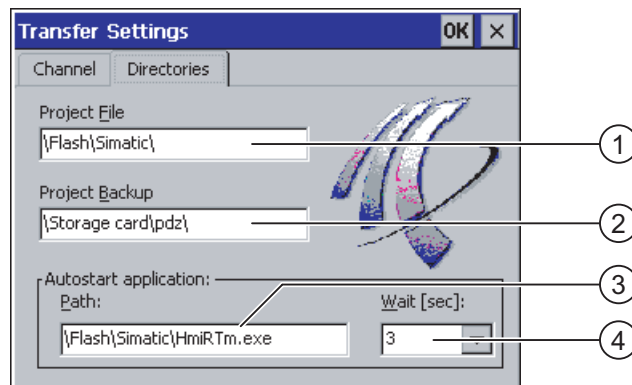

Figure 6-21 "Transfer Settings" dialog, "Directories" tab

- ① Directory where the project file is saved
- ② Directory where the compressed source file of your project are saved
The external memory card or the network connection can be defined as the storage location. During the next backup process, the project's source file is stored in the specified location.
- ③ Storage location and initialization file of the HMI device for process mode
- ④ Selection field for the delay time

Notice**Settings in "Project File" and "Path"**

Do not change the settings in the "Project File" and "Path" fields when working with a project. The project may not open at the next start of the HMI if changes are made here.

Procedure - Setting the Delay Time

1. Touch the "Wait [sec]" section field.
A selection list is displayed. Select the desired delay time.
With the value "0", the project starts immediately. It is then no longer possible to call the Loader after switching on the HMI device. If you still wish to access the Loader, an operator control must be configured to close the project.
2. Close the dialog and save your entries with **OK**. Touch **X** to discard the entries.

Result

The delay time for the HMI device is now set.

6.2.17 Setting the screen saver

Introduction

You can set a period of time for automatic activation of the screen saver on the HMI device. The screen saver is automatically activated if the HMI device is not operated within the specified period of time.

The screen saver is deactivated when any key is pressed or the touch screen is touched. The function assigned to that key is not triggered.

Requirements

The "Screen Saver" dialog has been opened with the "Screen Saver"  icon.

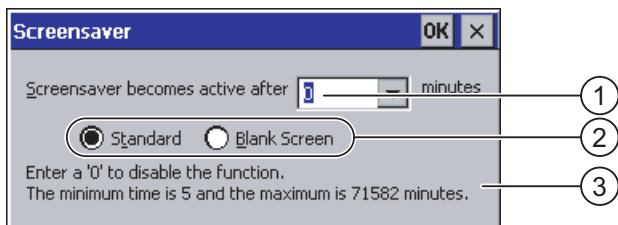

Figure 6-22 "Screen saver" dialog

- ① Period of time in minutes before the screen is activated
- ② Screen saver setting
- ③ Enter '0' to disable the screen saver. The minimum value is 5 and the maximum value is 71582 minutes.

Procedure

Proceed as follows:

1. Enter the number of minutes before the screen saver is to be activated.
Touch the input field. A selection list is displayed. "0" disables the screen saver.
2. Select either the standard screen saver or an empty screen.
 - Activate the "Standard" check box to enable the screen saver.
 - Activate the "Blank Screen" check box to enable a blank screen as the screen saver.

3. Close the dialog and save your entries with **OK**. Touch **X** to discard the entries.

Notice

Activating the Screen Saver

You should always activate the screen saver. Otherwise, the screen contents may leave a burn-in effect in the background if they appear too long.

This effect is reversible, however.

Result

The screen saver for the HMI device has now been set.

6.2.18 Displaying the system information

Requirements

The "System Properties" dialog has been opened with the "System"  icon.

Procedure - Displaying System Information

Proceed as follows:

1. Open the "General" tab.
The system information is displayed. This dialog is read-only.

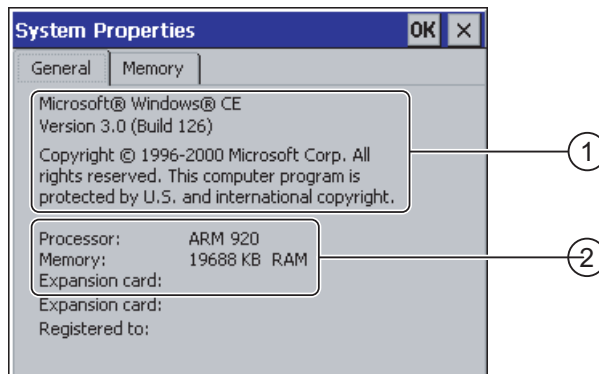

Figure 6-23 "System Properties" dialog, "General" tab

- ① Copyright to Microsoft Windows CE
- ② Information about the processor, amount of the internal Flash memory, and capacity of a memory card when inserted

2. Close the dialog with **OK** or **X**.

Procedure - Displaying Memory Information

Proceed as follows:

1. Open the "Memory" tab.
The memory information is displayed.

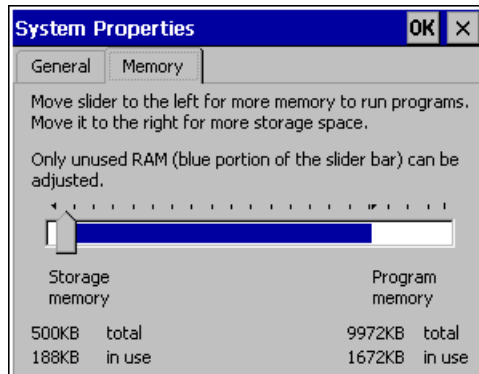

Figure 6-24 "System Properties" dialog, "Memory" tab

2. Close the dialog with **OK** or **X**.

Notice

"Memory" Tab

Do not change the amount of memory in the "Memory" tab.

6.2.19 Configuring the data channel

Introduction

If you block all data channels, the HMI device is protected against unintentional overwriting of the project data and HMI device image.

Requirements

The "Transfer Settings" dialog has been opened with the "Transfer"  icon.

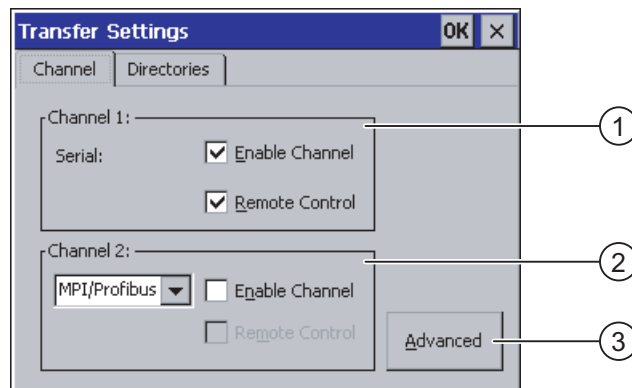

Figure 6-25 "Transfer Settings" dialog, "Channel" tab

- ① Group for data channel 1 (Channel 1)
- ② Group for data channel 2 (Channel 2)
- ③ Button for the "MPI/DP - Transfer Settings" dialog or "Network Configuration"

Procedure

Proceed as follows:

1. Configure the data channel that you want to use.

Activate the respective data channel with the "Enable Channel" check box in the "Channel 1" or "Channel 2" group. In the "Channel 1" group, the RS -485 interface is configured for the serial data transfer.

- Activate the "Enable Channel" check box to enable the data channel.
- Deactivate the "Enable Channel" check box to lock the data channel.

2. Configure automatic transfer.

- Deactivate the "Remote Control" check box to disable automatic transfer.
- Activate the "Remote Control" check box to enable automatic transfer.



Warning

Unintentional Transfer Mode

Ensure that the configuration computer does not inadvertently switch the HMI device to Transfer mode during ongoing operation. This could cause unintentional actions to be triggered in the plant.

3. Enter the required protocol for "Channel 2".

Touch the input field. A selection list is displayed.

4. Touch the "Advanced" button.

- Applies to the "MPI/PROFIBUS DP" protocol:

Touch the "Advanced" button if you wish to switch to the "S7 Transfer Settings" dialog. You can change the settings for MPI/PROFIBUS DP there.

Close the "S7 Transfer Settings" dialog with **OK** after making the changes.

- Applies to the "ETHERNET" protocol:

Touch the "Advanced" button if you wish to switch to the "Network Configuration" dialog. You can change the settings for TCP/IP there.

Close the "Network Configuration" dialog with **OK** after making the changes.

5. Close the "Transfer Settings" dialog and save your entries with **OK**. Touch **X** to discard the entries.

Result

The data channel is configured.

General information

Note

Making Changes in "Transfer" Mode

If the HMI device is in "Transfer" mode while changes are made to the transfer settings, the settings only go into effect after the transfer function is restarted. This may occur if the Control Panel is opened to change the transfer properties in an active project.

Notice

Transfer Mode via Channel 2

The bus parameters, such as the address of the HMI device, are read from the project currently loaded on the HMI device.

You can change the settings for the transfer via Channel 2. For this, you must first close the project and then change the settings on the HMI device. Then go back to "Transfer" mode.

The next time the project is started on the HMI device, the settings will be overwritten by the values from the project.

Transfer Settings

A project can only be transferred from the configuration computer to the HMI device when at least one of the data channels is enabled on the HMI device.

See also

Changing the internet settings – only at Mobile Panel 177 PN (Page 6-40)

Changing MPI/DP settings – only at Mobile Panel 177 DP (Page 6-24)

6.2.20 Configuring network operation

6.2.20.1 Overview

Introduction

The HMI device with a PROFINET interface can be connected to a TCP/IP network. Connection to a TCP/IP network can offer the following advantages:

- Printing via a network printer
- Saving recipe records to a server
- Exporting recipe records
- Importing recipe records
- Transferring a project
- Backing up data

These advantages are not available with a direct PC connection. However, peripherals connected to the PC can be used. For example, you can use a local printer for printing.

Notice

The HMI device can only be used in TCP/IP and PROFINET networks.

The HMI device only has client functionality in the PC network. This means that users can access files of a subscriber with TCP/IP server functionality from the HMI device via the network. However, it is not possible to access files on the HMI device via the network from a PC.

Note

Information on communication using SIMATIC S7 via PROFINET is provided in the "WinCC flexible Communication" user manual.

Requirements

Within a TCP/IP or PROFINET network, computers are addressed using network names. These network names are translated from a DNS or WINS server to TCP/IP and PROFINET addresses. Direct addressing via TCP/IP and PROFINET addresses is also supported by the operating system. This is why a DNS or WINS server is needed for addressing via device name names when the HMI device is in a TCP/IP or PROFINET network. Appropriate servers are available in common TCP/IP and PROFINET networks. Consult your network administrator if you have questions in this regard.

Printing via a Network Printer

The HMI device's operating system does not support the direct alarm logging via a network printer. All other printer functions, such as printing hardcopies or logs, are possible via the network without restriction.

General Procedure for Configuring the Network

The HMI device must be appropriately configured before setting into network operation. The configuration is basically divided into the following steps:

- Set device name of the HMI device.
- Configure the network address.
- Set the logon information.
- Save the settings.
- Switch off the HMI device once the network is configured.

If your network address is assigned automatically:

Before switching the HMI device on, insert the network cable in the corresponding interface so that a unique IP address for the HMI device can be assigned during startup.

- Switch on the HMI device.

Preparation

Before beginning the configuration, request the following network parameters from your network administrator.

- Does the network use DHCP for dynamic assignment of network addresses?
If not, get a new TCP/IP network address for the HMI device.
- What is the TCP/IP address of the default gateway?
- If a DNS network is used, what is the address of the name server?
- If a WINS network is used, what is the address of the name server?

6.2.20.2 Setting the computer name of the HMI device

Requirements

The "Communication Properties" dialog box has been opened with the "Communications"  symbol.

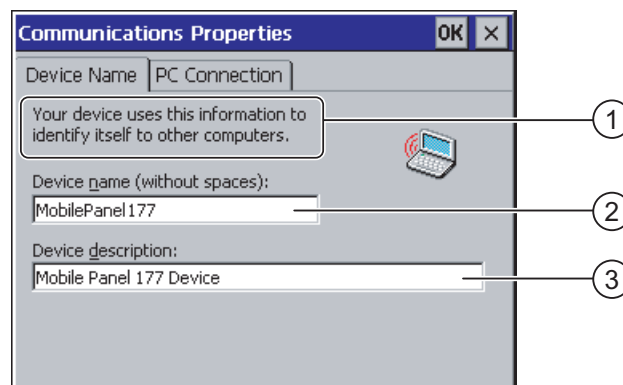

Figure 6-26 "Communications Properties" dialog, "Device Name" tab register

- ① The HMI device uses this information to identify itself to other PCs.
- ② Computer name of the HMI device
- ③ Description for the HMI device (optional)

Procedure

Proceed as follows:

1. Enter the computer name of the HMI device in the "Device name" input box.
Touch the input field. The screen keyboard is displayed.
2. Enter a description of the HMI device in the "Device description" input box.
Touch the input field. The screen keyboard is displayed.
3. Close the dialog and save your entries with **OK**. Touch **X** to discard the entries.

Result

The computer name for the HMI device is set.

Note

Change the computer name in the "Device name" input box in order to activate the network functionality.

6.2.20.3 Activating the direct connection

Requirements

The "Communications Properties" dialog has been opened with the "Communications"  icon.

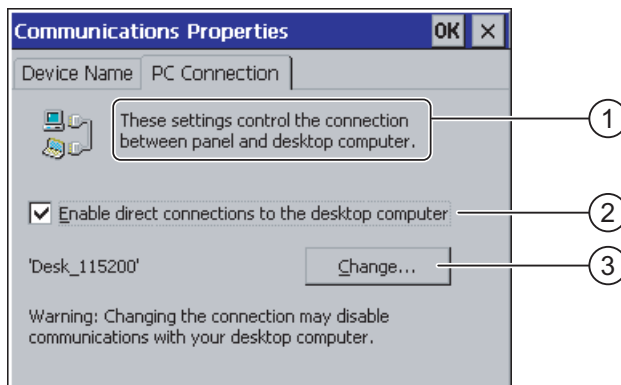



Figure 6-27 "Communications Properties" dialog, "PC Connection" tab register

- ① These settings control the connection between the HMI device and a desktop computer.
- ② Enabling a direct connection
- ③ Button for changing the desktop computer

Procedure

Proceed as follows:

1. Open the "PC Connection" tab.
The information about the direct connection is displayed.
2. Close the dialog with .

Notice

"PC Connection" Tab

If you want to operate a project on the HMI device, do not change the information in the "PC Connection" tab.

6.2.20.4 Changing the network configuration

Requirements

The "Network Configuration" dialog has been opened with the "Network"  icon.

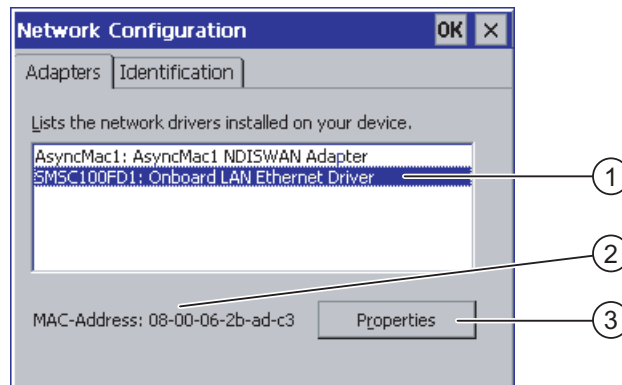

Figure 6-28 "Network Configuration" dialog, "Adapters" tab , example

- ① Selection for PROFINET adapters
- ② MAC address of the HMI device
- ③ Button for the properties dialog

Procedure

Proceed as follows:

1. Touch " SMSC100FD1: Onboard LAN Ethernet Driver"
2. Touch the "Properties" button.

The "Onboard LAN Ethernet Driver" dialog is displayed.

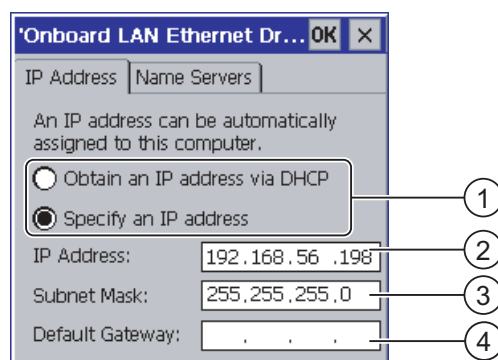

Figure 6-29 "Onboard LAN Ethernet Driver" dialog, "IP Address" tab

- ① Address assignment
- ② Input field for the IP address
- ③ Input field for the address of the subnet mask
- ④ Input field for the address of the default gateway

3. Select either automatic address assignment via DHCP or manual address assignment
4. If you set the address yourself, use the screen keyboard enter the respective addresses in the input fields for "IP Address", "Subnet Mask" and, if used, "Default Gateway".
5. If a name server (DNS) is used in the network, open the "Name Server" tab.

The "Name Servers" tab of the "Onboard LAN Ethernet Driver" dialog is displayed.

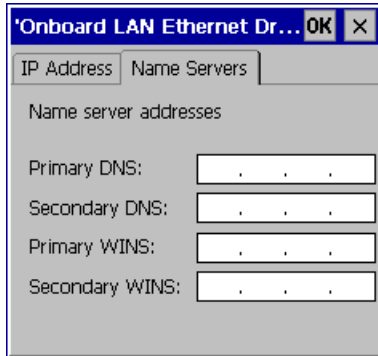

Figure 6-30 "Onboard LAN Ethernet Driver" dialog, "Name Servers" tab

6. Enter the respective addresses in the input fields using the screen keyboard.
7. Close the dialog and save your entries with **OK**. Touch **X** to discard the entries.
Once you have applied the settings, you are prompted to reboot the HMI device.
8. When prompted, open the "Device" tab of the "OP Properties" dialog and reboot the HMI device.

Result

The network parameters for the HMI device have now been set.

See also

Overview (Page 6-33)

Displaying information about the HMI (Page 6-17)

6.2.20.5 Changing the logon data

Requirements

The "Network Configuration" dialog has been opened with the "Network"  icon.

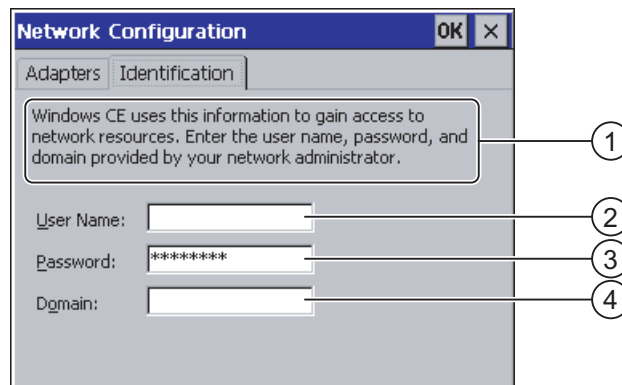

Figure 6-31 "Network Configuration" dialog, "Identification" tab

- ① Windows CE uses this information to gain access to the network resources. Enter the user name, password and domain you have received from your administrator.
- ② Input field for the user name
- ③ Password input field
- ④ Input field for the domain

Procedure

Proceed as follows:

1. Enter the user name in the "User name" input field.
2. Touch the input field. The screen keyboard is displayed.
3. Enter your password in the "Password" input field.
Touch the input field. The screen keyboard is displayed.
4. Enter the domain name in the "Domain" input field.
Touch the input field. The screen keyboard is displayed.
5. Close the dialog and save your entries with **OK**. Touch **X** to discard the entries.

Result

The logon information has now been set.

See also

Overview (Page 6-33)

6.2.20.6 Changing the internet settings – only at Mobile Panel 177 PN

Requirements

The "WinCC flexible Internet Settings" dialog has been opened with the "WinCC Internet Settings"  icon.

Procedure - Changing E-mail Settings

Proceed as follows:

1. Select the "Email" tab.

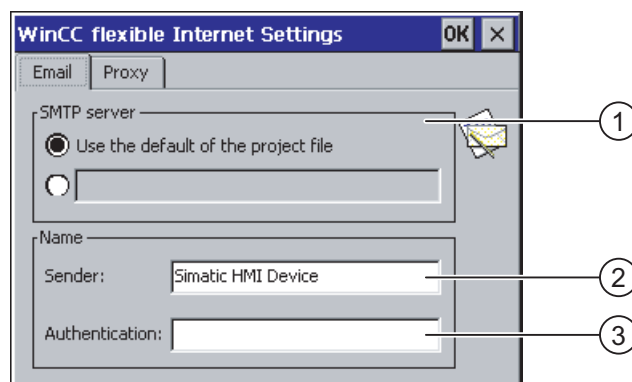

Figure 6-32 "WinCC flexible Internet Settings" dialog, "Email" tab

- ① Setting for the SMTP server
- ② Name for the sender
- ③ E-mail account

2. Specify the SMTP server.

- Activate the check box "Use the default of the project file" if you want to use the SMTP server permanently configured in the project.
- Deactivate the check box "Use the default of the project file" if you do not want to use the SMTP server permanently configured in the project.

Touch the input field to enter the SMTP server. The screen keyboard is displayed.

3. Enter the name for the sender in the "Sender" input field.

Touch the input field. The screen keyboard is displayed.

4. Enter the e-mail account for your e-mail in the "Authentication" input field.

Touch the input field. The screen keyboard is displayed.

Some e-mail providers only allow you to send mail if you specify the e-mail account. The "Authentication" field can remain empty if your e-mail provider allows you to send mail without checking the account.

Procedure - Changing Proxy Settings

Proceed as follows:

1. Select the "Proxy" tab.

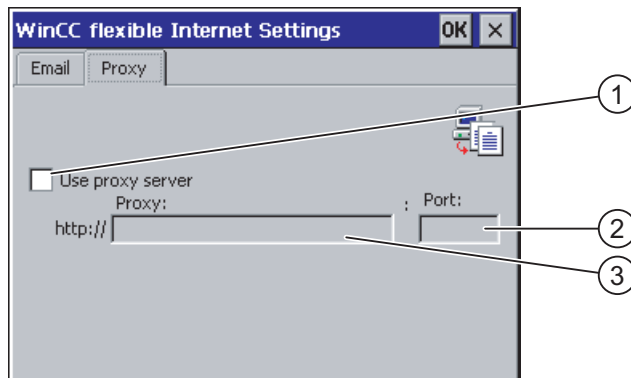

Figure 6-33 "WinCC flexible Internet Settings" dialog, "Proxy" tab

- ① Check box for using a proxy server
 - ② Address of the proxy server
 - ③ Port
2. Activate the check box "Use proxy server" if you want to use a proxy server.
 3. If you use a proxy server:
Specify the address of the proxy server and the desired port. Touch the corresponding input field. The screen keyboard is displayed.
 4. Close the dialog and save your entries with **OK**. Touch **X** to discard the entries.

Result

The Internet settings have now been changed.

Note

Options

Additional tabs may appear in the "WinCC Internet Settings" tab. This depends on the options that have been enabled for network operation in the project.

Further information on this may be available in your plant documentation.

Preparing and backing up a project

7.1 Overview

Configuration and Process Control Phases

HMI devices can be used to operate and monitor tasks in process and production automation. The plant screens on the HMI devices are used to provide a clearer overview of active processes. The HMI device project, which includes the plant screens, is created during the configuration phase.

Once the project is transferred to the HMI device and the HMI device is connected to a PLC in the automation system, processes can be operated and monitored in the process control phase.

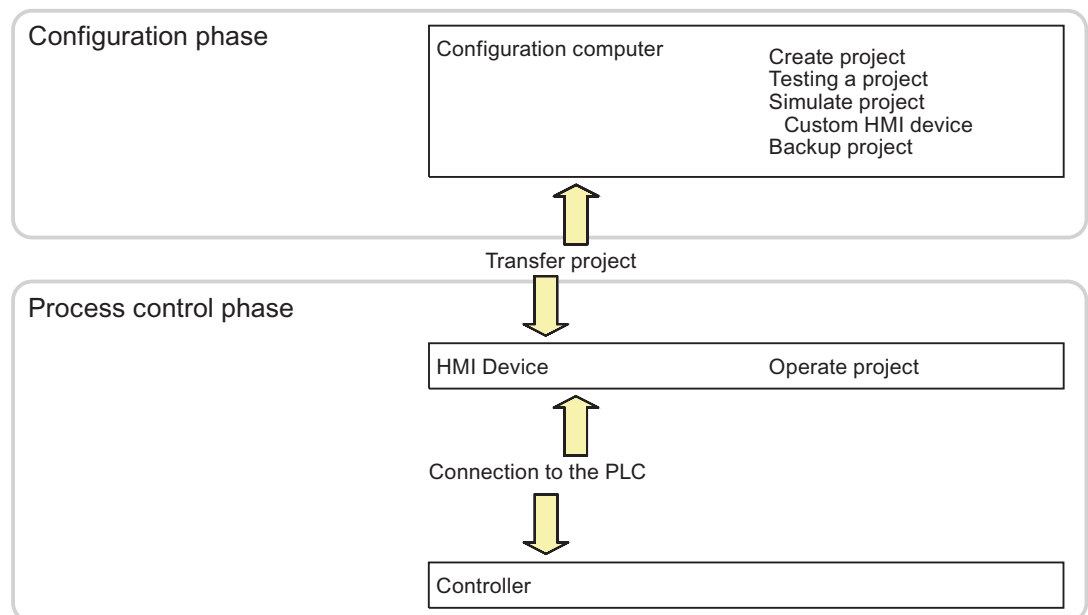

Figure 7-1 Configuration and process control phases

Transferring the Project to the HMI Device

The following can be performed to transfer a project to an HMI device:

- Transfer the project from the configuration computer
- Restore the project from a PC using ProSave

In this case, an archived project is transferred from a PC to the HMI device. The configuration software need not be installed on this PC.

These procedures are available for commissioning and recommissioning a project.

Commissioning and Recommissioning

- When the HMI device is commissioned there is no project at first.
The HMI device is also in this state after the operating system has been updated.
- When recommissioning, any project on the HMI device is replaced.

7.1.1 Setting the operating mode

Operating Modes

Operating modes of the HMI device:

- Offline
- Online
- Transfer

"Offline mode" and "Online mode" can be set on the configuration computer and on the HMI device. To set these modes on the HMI device, use a corresponding operator control object of the project.

Switching the Operating Mode

The configuration engineer must have configured an appropriate operator control object to allow a change of the operating mode on the HMI device during ongoing operation.

Further information on this may be available in your plant documentation.

"Offline" Operating Mode

In this mode, there is no communication between the HMI device and PLC. Although the HMI device can be operated, it cannot exchange data with the PLC.

"Online" Operating Mode

In this mode, the HMI device and PLC communicate. You can operate the plant on the HMI device according to your system configuration.

"Transfer" Operating Mode

In this mode, you can transfer a project from the configuration computer to the HMI device or backup and restore HMI device data, for example.

The following options are available for setting "Transfer" mode on the HMI device:

- When the HMI device starts up
Start "Transfer" mode manually in the HMI device Loader.
- During ongoing operation
Start the "Transfer" mode manually within the project using an operator control object.
The HMI device toggles to "Transfer" mode when automatic mode is set and a transfer is initiated on the configuration computer.

7.1.2 Reusing existing projects

You can reuse existing Mobile Panel 170 projects.

The following cases are possible:

1. Old project exists in ProTool
Migrate the project to WinCC flexible and then switch the HMI device.
2. Old project exists in WinCC flexible
Switch the HMI device in WinCC flexible.

For more information, please see the online help for WinCC flexible or the "WinCC flexible Migration" user manual.

7.1.3 Data transmission options

Overview

The table below shows the options of transferring data between the Mobile Panel 177 and a configuration computer.

Type	Type	Mobile Panel 177 DP	Mobile Panel 177 PN
Backup	Serial	Yes	Yes
	MPI/PROFIBUS DP ¹⁾	Yes	–
	Ethernet ²⁾	–	Yes
Restore	Serial	Yes	Yes
	MPI/PROFIBUS DP ¹⁾	Yes	–
	Ethernet ²⁾	–	Yes
Updating the operating system	Serial (with bootstrapping)	Yes	Yes
	Serial	Yes	Yes
	MPI/PROFIBUS DP ¹⁾	Yes	–
	Ethernet ²⁾	–	Yes
Transferring a project	Serial	Yes	Yes
	MPI/PROFIBUS DP ¹⁾	Yes	–
	Ethernet ²⁾	–	Yes
Installing or uninstalling an option	Serial	Yes	Yes
	MPI/PROFIBUS DP ¹⁾	Yes	–
	Ethernet ²⁾	–	Yes
Transferring authorization in both directions	Serial	Yes	Yes
	MPI/PROFIBUS DP ¹⁾	Yes	–
	Ethernet ²⁾	–	Yes

1) Applies for Mobile Panel 177 DP

2) Applies for Mobile Panel 177 PN

Note

Point-to-point coupling with a PC-PPI cable is necessary for serial transfer.

7.2 Transfer

7.2.1 Overview

Transfer

During transfer, the project is downloaded from the configuration computer to the HMI device.

The "Transfer" mode can be started manually or automatically on the HMI device.

Transferred data is written directly to the flash memory on the HMI device. The transfer function uses a data channel you need to configure before you initiate any transfers.

7.2.2 Starting the transfer manually

Introduction

You can set "Transfer" mode manually on the HMI device using a configured operator control object and during ongoing operation.

Requirements

- The *.hmi project is opened in WinCC flexible.
- The HMI device is connected to a configuration computer.
- The data channel is configured on the HMI device.
- The HMI device Loader is opened.

Procedure

Proceed as follows to initiate the transfer:

1. Switch to "Transfer" mode on the HMI device.
2. Proceed as follows on the configuration computer:
 - Select the "Project ▶Transfer ▶Transfer Settings" menu command in WinCC flexible.
 - Select the HMI device and define the parameters for the connection.
 - Start the download with "Transfer".

The configuration computer verifies its connection to the HMI device. If the connection is not available or is faulty, the configuration computer outputs an alarm. If no communication error is detected, the project is transferred to the HMI device.

Result

When the transfer is completed successfully, the data can be found on the HMI device. The transferred project is then started automatically.

See also

Setting the operating mode (Page 7-2)

Data transmission options (Page 7-4)

Configuring the data channel (Page 6-31)

7.2.3 Starting the transfer automatically

Introduction

The HMI device can be automatically switched to "Transfer" mode during runtime as soon as transfer is started on the configuration computer connected.

Automatic startup is particularly suited for the test phase of a new project since transfer is completed without interfering with the HMI device.

Automatic transfer is available for the following data channels:

- MPI/PROFIBUS DP
- PROFINET
- Serial

Notice

If the automatic transfer has been activated on the HMI device and a transfer is initiated on the configuration computer, the project currently running is automatically stopped. The HMI device then automatically switches to "Transfer" mode.

After the commissioning phase, deactivate the automatic transfer so that the HMI device cannot be inadvertently switched to Transfer mode. The transfer mode can trigger unintentional actions in the device.

You can set a password for the Loader of the HMI device to restrict access to the transfer settings and thus avoid unauthorized modifications.

Requirements

- The *.hmi project is opened in WinCC flexible.
- The HMI device is connected to a configuration computer.
- The data channel is configured on the HMI device.
- The automatic transfer is activated in the data channel for the transfer.
- The project is started.

Procedure

Proceed as follows:

1. In WinCC flexible, select the menu command "Project ► Transfer ► Transfer Settings".
2. Select the HMI device
3. Set the connection parameters
4. Start the transfer with "Transfer"

The connection to the HMI device is checked. If the connection is not available or defective, the configuration computer issues the corresponding error message. In the case of an error-free connection, the HMI device ends the running project and switches to "Transfer" mode. The selected data is transferred to the HMI device.

Result

When the transfer has been completed successfully, the data can be found on the HMI device. The transferred project is then started automatically.

See also

Data transmission options (Page 7-4)

Configuring the data channel (Page 6-31)

7.2.4 Testing a project

Introduction

There are two options on the HMI device testing a project:

- Offline testing of the project
Offline testing means that communication between the HMI device and PLC is down while the test is being carried out.
- Online testing of the project
Online testing means that the HMI device and PLC communicate with each other during testing.

Perform both tests, starting with the "Offline test", followed by the "Online test".

Note

You should always test the project on the HMI device on which the project will be used.

Check the following:

1. Check the correct layout of the screens.
2. Check the screen structure.
3. Check the input objects.
4. Enter the tag values.

The test increases the certainty that the project will run error-free on the HMI device.

Requirements for Offline Testing

- The project has been transferred to the HMI device.
- The HMI device is in "Offline" mode.

Procedure

In "Offline" mode, you can test the various project functions on the HMI device without them being affected by the PLC. PLC tags, therefore, are not updated.

Test the operator control objects and visualization of the project as far as possible without connecting to the PLC.

Requirements of Online Testing

- The project has been transferred to the HMI device.
- The HMI device is in "Online" mode.

Procedure

In "Online" mode, you can test the various project functions on the HMI device without them being affected by the PLC. PLC tags are updated in this case.

Test the operator control objects and views of the project.

See also

Setting the operating mode (Page 7-2)

7.3 Backup and restore

7.3.1 Overview

Introduction

Data located on the HMI device can be backed up using a PC external to the HMI device and can be restored from it.

The following data in the internal Flash memory can be backed up and restored:

- Project and HMI device image
- Password list
- recipe data

Note

Licenses

Backing up and restoring licenses is not necessary, since these are stored non-deletably in the working memory of the HMI device.

Backup and restoring can be performed in the following ways:

- WinCC flexible
- ProSave

General information

Notice

Power failure

If an operation for restoring data is interrupted due to power failure on the HMI device, the operating system of the HMI device may be deleted! The operating system then has to be updated.

Compatibility conflict

If a message is output on the HMI device warning of a compatibility conflict during the restore operation, the operating system must be updated.

Licenses

Licenses are excluded from backing up and restoring.

7.3.2 Backup and restore operations in WinCC flexible

Introduction

Backup and restore operations transfer the relevant data between flash memory on the HMI device and a configuration computer.

Requirements

- The HMI device is connected to a configuration computer.
- No project is open in WinCC flexible.
- The data channel is configured on the HMI device.

Procedure - Backup

Proceed as follows:

1. Select the menu command "Project ▶ Transfer ▶ Communication Settings" in WinCC flexible on the configuration computer.

The "Communication Settings" dialog opens.

2. Select the HMI device type.
3. Select the type of connection between the HMI device and the configuration computer, then set the communication parameters.
4. Close the dialog with "OK".
5. In WinCC flexible, select the menu command "Project ▶ Transfer ▶ Backup".

The "Backup Settings" dialog opens.

6. Select the data to be backed up.
7. Select a destination folder and a file name for the *.psb backup file.
8. Set "Transfer" mode on the HMI device.

If automatic transfer mode is enabled on the HMI device, the device automatically sets "Transfer" mode when a backup is initiated.

9. Start the backup operation in WinCC flexible with "OK" on the configuration computer.

Follow the instructions in WinCC flexible.

A status view opens to indicate the progress of the operation.

Result

The system outputs a message when the backup is completed.

The relevant data is now backed up on the configuration computer.

Procedure - Restore

Proceed as follows:

1. Select the menu command "Project ► Transfer ► Communication Settings" in WinCC flexible on the configuration computer.
The "Communication Settings" dialog opens.
2. Select the HMI device type.
3. Select the type of connection between the HMI device and the configuration computer, then set the communication parameters.
4. Close the dialog with "OK".
5. In WinCC flexible, select the menu command "Project ► Transfer ► Restore".
The "Restore Settings" dialog opens.
6. Select the *.psb backup file to be restored from the "Open" dialog.
The view shows from which HMI device the backup file originates and the type of data it contains.
7. Set the HMI device to the "Transfer" mode
If automatic transfer mode is enabled on the HMI device, the device automatically sets "Transfer" mode when a restore operation is initiated.
8. Start the restore operation in WinCC flexible with "OK" on the configuration computer.
Follow the instructions in WinCC flexible.
A status view opens to indicate the progress of the operation.

Result

The transfer is completed when the backup data is restored from the configuration computer to the HMI device.

See also

Overview (Page 7-9)

Data transmission options (Page 7-4)

7.3.3 Backup and restore operations using ProSave

Introduction

Backup and restore operations transfer the relevant data between flash memory on the HMI device and a PC.

Requirements

- The HMI device is connected to a PC on which ProSave is installed.
- The data channel is configured on the HMI device.

Procedure - Backup

Proceed as follows:

1. From the Windows Start menu, run ProSave on the PC.
2. Select the HMI device type from the "General" tab.
3. Select the type of connection between the HMI device and the configuration computer, then set the communication parameters.
4. Use the "Backup" tab to select the relevant data.
5. Select a destination folder and a file name for the *.psb backup file.
6. Set "Transfer" mode on the HMI device.

If automatic transfer mode is enabled on the HMI device, the device automatically sets "Transfer" mode when a backup is initiated.

7. Start the backup operation in ProSave with "Start Backup".

Follow the instructions in ProSave.

A status view opens to indicate the progress of the operation.

Result

The system outputs a message when the backup is completed.

The relevant data is now backed up on the PC.

Procedure - Restore

Proceed as follows:

1. From the Windows Start menu, run ProSave on the PC.
2. Select the HMI device type from the "General" tab.
3. Select the type of connection between the HMI device and the configuration computer, then set the communication parameters.
4. Select the *.psb backup file to be restored from the "Restore" tab.
The view shows from which HMI device the backup file originates and the type of data it contains.
5. Set the HMI device to the "Transfer" mode
If automatic transfer mode is enabled on the HMI device, the device automatically sets "Transfer" mode when a restore operation is initiated.
6. Start the restore operation in ProSave with "Start Restore".
Follow the instructions in ProSave.
A status view opens to indicate the progress of the operation.

Result

The transfer is completed when the backup data is restored from the PC to the HMI device.

See also

Overview (Page 7-9)

Data transmission options (Page 7-4)

7.4 Updating the operating system

7.4.1 Overview

Overview

A compatibility conflict may occur when transferring a project to the HMI device. This is caused by difference between the versions of the configuration software used and the HMI device image available on the HMI device. If there are different versions, the configuration computer cancels the transfer of the project with a message indicating a compatibility conflict.

There are several ways to match the versions:

- Update the HMI device image if the project was created with the most recent version of the configuration software.
- Load a previous version of the HMI device image if you do not want to adapt the loaded project to the most recent version of the configuration software.

Notice

Data loss

An operating system update deletes all data such as projects, passwords and license from the HMI device.

Data channels

An operating system update resets all parameters for the data channels. You then have to configure the data channels again before starting a transfer in the Loader.

Bootstrapping

In ProSave or WinCC flexible, you can update the operating system with or without bootstrapping, depending on the HMI device used.

- Updating the operating system without bootstrapping

First, set "Transfer" mode on the HMI device or use the automatic transfer function if the project is active. Then start the operating system update in ProSave or WinCC flexible.

- Updating the operating system with bootstrapping

First, start the operating system update in ProSave or WinCC flexible. Then switch the power on the HMI device off and on again.

Note

You have to perform an operating system update with bootstrapping if the HMI device does not yet have an operating system or if the operating system of the HMI device is corrupt.

Point-to-point coupling with a PC-PPI cable is necessary in order to update the operating system with bootstrapping.

In ProSave or WinCC flexible, set the "Bootstrap" check box status according to your selected operating system update mode.

7.4.2 Updating the Operating System Using WinCC flexible

Requirements

- The HMI device is connected to a configuration computer.
- No project is open in WinCC flexible.
- Relevant only to operating system update without bootstrapping:
The data channel is configured on the HMI device.

Procedure

Proceed as follows:

1. Relevant to operating system update with bootstrapping:
Switch off power to the HMI device.
2. Select the menu command "Project ▶ Transfer ▶ Communication Settings" in WinCC flexible on the configuration computer.
This opens the "Communication Settings" dialog.
3. Select the HMI device type.
4. Select the type of connection between the HMI device and the configuration computer, then set the communication parameters.
5. Close the dialog with "OK".
6. In WinCC flexible, select the menu command "Project ▶ Transfer ▶ Update operating system".
7. Select whether to update the operating system with/without bootstrapping by setting the "Bootstrap" check box accordingly.
8. In "Image path," select the folder which contains the HMI device image file, *.img.
The HMI device image files are available under "WinCC flexible Images" in the WinCC flexible installation folder and on the corresponding WinCC flexible installation CD.
9. Select "Open".
In the output area, you are provided information on the version of the HMI device image file after it is opened.
10. Applies only when updating without bootstrapping:
Set "Transfer" mode on the HMI device.
If automatic transfer mode is enabled on the HMI device, the device automatically sets "Transfer" mode when an update is initiated.
11. In WinCC flexible, select "Update OS" to run the operating system update.
12. Applies only when updating with bootstrapping:
Switch on the power supply to the HMI device.
13. Follow the instructions in WinCC flexible.
A status view opens to indicate progress.

Result

The system outputs and alarm when the operating system update is completed.

This operation has deleted the project data from the HMI device.

7.4.3 Updating the operating system in ProSave

Requirements

- The HMI device is connected to a PC on which ProSave is installed.
- When updating the operating system without bootstrapping:
The data channel is configured on the HMI device.

Procedure

Proceed as follows:

1. When updating the operating system with bootstrapping:
Switch off power to the HMI device.
2. From the Windows Start menu, run ProSave on the PC.
3. Select the HMI device type from the "General" tab.
4. Select the type of connection between the HMI device and the configuration computer, then set the communication parameters.
5. Open the "OS Update" tab.
6. Select whether to update the operating system with/without bootstrapping by setting the "Bootstrap" check box accordingly.
7. In "Image path," select the folder which contains the HMI device image file, *.img.
The HMI device image file is available on the corresponding WinCC flexible installation CD and in the installation directory of WinCC flexible.
8. Select "Open".
In the output area, you are provided information on the version of the HMI device image file after it is opened.
9. When updating without bootstrapping:
Set "Transfer" mode on the HMI device.
If automatic transfer mode is enabled on the HMI device, the device automatically sets "Transfer" mode when an update is initiated.
10. Start the update of the operating system on the PC with "Update OS".
11. Applies only when updating with bootstrapping:
Switch on the power supply to the HMI device.
12. Follow the instructions in ProSave.
A status view opens to indicate progress.

Result

The system outputs and alarm when the operating system update is completed.
This operation has deleted the project data from the HMI device.

7.5 Installing and uninstalling options

7.5.1 Overview

Options

You can install options on for the HMI device, for example, additional programs developed especially for the HMI device.

You can also remove options from the HMI device.

Note

A license key may be need to run an option. The license key unlocks the option for use.

7.5.2 Installing and uninstalling options via WinCC flexible

Requirements

- The HMI device is connected to a configuration computer.
- No project is open in WinCC flexible.
- The data channel is configured on the HMI device.

Procedure – Installing an Option

Proceed as follows:

1. Select the menu command "Project ► Transfer ► Communication Settings" in WinCC flexible on the configuration computer.
The "Communication Settings" dialog opens.
2. Select the HMI device type.
3. Select the type of connection between the HMI device and the configuration computer, then set the communication parameters.
4. Close the dialog with "OK".
5. In WinCC flexible, select the menu command "Project ► Transfer ► Options".

6. Select the desired option under "Available options."
7. Set "Transfer" mode on the HMI device.
If automatic transfer mode is enabled on the HMI device, the device automatically sets "Transfer" mode when the installation of an option is initiated.
8. Start the installation of the option in WinCC flexible on the configuration computer with 
Follow the instructions in WinCC flexible.
A status display appears indicating the progress of the installation.

Result

The option has now been installed on the HMI device.

Procedure – Removing an Option

Proceed as follows:

1. Select the menu command "Project ► Transfer ► Communication Settings" in WinCC flexible on the configuration computer.
The "Communication Settings" dialog opens.
2. Select the HMI device type.
3. Select the type of connection between the HMI device and the configuration computer, then set the communication parameters.
4. Close the dialog with "OK".
5. In WinCC flexible, select the menu command "Project ► Transfer ► Options".
6. Select the desired option under "Installed options."
7. Set "Transfer" mode on the HMI device.
If automatic transfer mode is enabled on the HMI device, the device automatically sets "Transfer" mode when the removal of an option is initiated.
8. Start the removal of the option in WinCC flexible on the configuration computer with 
Follow the instructions in WinCC flexible.
A status display appears indicating the progress of the removal.

Result

The option has now been removed on the HMI device.

See also

- Setting the operating mode (Page 7-2)
- Overview (Page 7-17)
- Configuring the data channel (Page 6-31)
- Data transmission options (Page 7-4)

7.5.3 Installing and uninstalling options via ProSave

Requirements

- The HMI device is connected to a PC on which ProSave is installed.
- The data channel is configured on the HMI device.

Procedure – Installing an Option

Proceed as follows:

1. From the Windows Start menu, run ProSave on the PC.
2. Select the HMI device type from the "General" tab.
3. Select the type of connection between the HMI device and the configuration computer, then set the communication parameters.
4. Open the "Options" tab.
5. Select the desired option under "Available options."
6. Set "Transfer" mode on the HMI device.

If automatic transfer mode is enabled on the HMI device, the device automatically sets "Transfer" mode when the installation of an option is initiated.

7. Start the installation of the option in ProSave with 

Follow the instructions in ProSave.

A status display appears indicating the progress of the installation.

Result

The option has now been installed on the HMI device.

Procedure – Removing an Option

Proceed as follows:

1. From the Windows Start menu, run ProSave on the PC.
2. Select the HMI device type from the "General" tab.
3. Select the type of connection between the HMI device and the configuration computer, then set the communication parameters.
4. Open the "Options" tab.
5. Select the desired option under "Installed options."
6. Set "Transfer" mode on the HMI device.

If automatic transfer mode is enabled on the HMI device, the device automatically sets "Transfer" mode when the removal of an option is initiated.

7. Start the removal of the option in ProSave with 

Follow the instructions in ProSave.

A status display appears indicating the progress of the removal.

Result

The option has now been removed on the HMI device.

See also

- Overview (Page 7-17)
- Configuring the data channel (Page 6-31)
- Setting the operating mode (Page 7-2)
- Data transmission options (Page 7-4)

7.6 Transferring license keys in both directions

7.6.1 Overview

License Keys

With the purchase of a optional package, you obtain a specific user license with an associated license key. Once you have installed an option, transfer a license key to the HMI device. The license key unlocks the option for use.

You can also transfer the license key from the HMI device back to a license diskette.

Note

License keys can only be transfered back and forth with the Automation License Manager and WinCC flexible.

7.6.2 Transferring License Keys and Transferring Them Back

Introduction

You can transfer license keys stand-alone with the Automation License Manager or from within WinCC flexible.

If you want to transfer license keys from WinCC flexible, start the Automation License Manager from within a project. You then no longer need to perform the general settings such as HMI device and connection selection, since these settings are transferred from the project.

Requirements

- The HMI device is connected to a configuration computer.
- When transferring back and forth using WinCC flexible:
No project is open in WinCC flexible.
- The data channel is configured on the HMI device.
- The license diskette with the license key to be transferred must be inserted in the floppy drive of the configuration computer.

Procedure – Transferring a License Key

Proceed as follows:

1. Switch to "Transfer" mode on the HMI device.
2. When transferring using WinCC flexible:
Select "Project ► Transfer ► Authorizations...".
3. When transferring using the Automation License Manager:
Start the Automation License Manager via "Start ► Simatic ► License Management ► Automation License Manager."
4. Select "Edit ► Connect Target System ► Connect HMI Device."
The "Connect Target System" dialog appears.
5. Under "Device Type," select the appropriate device type.
6. Under "Connection," select the type of connection.
Depending on the type of connection selected, the appropriate fields for the connection settings appear under "Connection parameters."
7. Select the required connection parameters and click "OK."
The connection to the HMI device is established. The connected HMI device is displayed in the left window of the Automation License Manager.
8. In the left window, select the source drive. The right window displays the available license keys.
9. Drag one or more license keys from the right window and drop them on the HMI device in the left window.
The license keys are then transferred to the HMI device.

Result

The license key has now been transferred from the license diskette to the HMI device.

Procedure – Transferring a License Key Back

Proceed as follows:

1. Switch to "Transfer" mode on the HMI device.
2. When transferring back using WinCC flexible:
Select "Project ► Transfer ► Authorizations...".
3. When transferring back using the Automation License Manager:
Start the Automation License Manager via "Start ► Simatic ► License Management ► Automation License Manager."
4. Select "Edit ► Connect Target System ► Connect HMI Device."
The "Connect Target System" dialog appears.
5. Under "Device Type," select the appropriate device type.
6. Under "Connection," select the type of connection.
Depending on the type of connection selected, the appropriate fields for the connection settings appear under "Connection parameters."
7. Select the required connection parameters and click "OK."
The connection to the HMI device is established. The connected HMI device is displayed in the left window of the Automation License Manager.
8. In the left window, select the HMI device. The right window displays the available license keys.
9. Drag one or more license keys from the right window and drop them on the destination drive in the left window.
The license keys are then transferred back to the license diskette.

Result

The license key has now been transferred back from HMI device to the license diskette.

See also

- Overview (Page 7-20)
- Configuring the data channel (Page 6-31)
- Setting the operating mode (Page 7-2)
- Data transmission options (Page 7-4)

Operating a project

8.1 Overview

Using Operator Controls on the Touch Screen

Operator controls are touch-sensitive objects on the HMI screen such as buttons, I/O fields and alarm windows. Touch objects are basically operated in the same way as mechanical keys. You activate operator controls by touching them with your finger.

Some operations with the project may require in-depth knowledge about the specific plant on the part of the operator. It is therefore important to take special care, for example, in displaying typing. Further information on this may be available in your plant documentation.



Caution

Always touch only one operator control on the screen. Never touch more than one operator control at a time, otherwise you may trigger unintentional actions.

Caution

Do not use any pointed or sharp objects when operating the touch screen as this may damage the plastic membrane of the touch screen.

Locking operator controls

The HMI provides optical feedback when it detects that an operator control has been touched. This feedback is independent of any communication with the PLC. Therefore, this feedback does not indicate whether the relevant action is actually executed or not.

The configuration engineer may also have configured the feedback function in a different manner. Further information on this may be available in your plant documentation.

Optical Feedback from Operator Controls

The type of optical feedback depends on the operator control object:

- Buttons

The HMI outputs different views of the "Touched" and "Untouched" states, provided the configuration engineer has configured a 3D effect:

- "Touched" state:

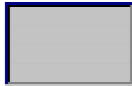

- "Untouched" state:

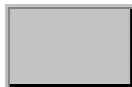

The configuration engineer defines the appearance of a selected field, for example, its line width and color for the focus.

- Invisible buttons

The focus for invisible buttons is not identified after selection by default. No optical operation feedback is provided in this case.

The configuration engineer may, however, configure invisible buttons so that their outline appears as lines when touched. This outline remains visible until the you select another operator control object.

- I/O fields

After you touch an I/O field, a screen keyboard appears as optical operation feedback.

8.2 Key operation

Soft keys with global function assignment

A soft key with global function assignment always triggers the same action on the HMI device or in the PLC, regardless of the current screen. An example of such an action is the activation of a screen or the closing an alarm window.

Soft keys with local function assignment

A soft key with local function assignment is screen-specific and is therefore only effective within the active screen.

The function assigned to a soft key can vary from screen to screen.

The soft key of a screen can be assigned one function only, either a global or local one. The local assignment function takes priority over the global setting.

Soft Keys as System Keys for the OP 177B

Soft keys can also be configured as system keys. For example, they can function as the numerical keypad, the cursor keypad or as a section of the alphanumeric keypad.

Multi-key operation

Unwanted actions may be triggered if the operator unintentionally actuates a key combination.



Caution

Unintentional actions

In "Online" mode, simultaneous operation of more than two keys may cause unintentional actions in the plant.

Never press more than two keys simultaneously.

8.3 Direct keys

Introduction

Direct keys on the HMI device are used to set bits in the I/O area of a SIMATIC S7.

This makes rapid key operations possible. For example, jog mode requires rapid operator inputs using keys.

Notice

Direct keys are still active when the HMI device is in "offline" mode.

Notice

Removing the connecting cable

Take into account when removing the connecting cable that this corresponds to the failure of a PROFIBUS DP slave or PROFINET slaves and therefore causes the controller to be stopped.

Therefore, take appropriate programming measures in the PLC to prevent this from occurring. For more detailed information, refer to the PLC manufacturer's documentation.

Note

Direct keys cause an additional base load of the HMI device.

Direct keys

The following objects can be configured as direct keys at a PROFIBUS DP coupling or PROFINET coupling:

- Buttons
- Screens (building and removal)
- Softkeys
- Hand wheel
- Illuminated pushbutton
- Key-operated switch

Note

PROFINET direct keys are available as from WinCC flexible 2005 SP1.

Further information about direct keys is available in the system manual "WinCC flexible communication".

8.4 Setting the project language

Introduction

The HMI device supports multilingual projects. You need to configure a corresponding operator control object which lets you change the language setting on the HMI device during runtime.

The project always starts with the language set in the previous session.

Requirements

- The relevant project language must be available on the HMI device.
- The language changeover function must be logically linked to a configured operator control object such as a button.

Selecting a language

You can change project languages at any time. Language-specific objects are immediately output to the screen in the relevant language when you switch languages.

The following options are available for switching the language:

1. A configured operator control object switches from one project language to the next in a list.
2. A configured operator control directly sets the desired project language.

Further information on this may be available in your plant documentation.

8.5 Entries and help within a project

8.5.1 Overview

Procedure for Input Fields

Values are entered in the project input fields. The values are transferred from the input fields to the PLC.

Proceed as follows:

1. Touch the required input field on the screen.

The screen keyboard opens.

Based on your configuration, you can enter the following type of values in the input field:

- Numerical
- Alphanumerical
- Symbolic
- Date/time

2. Set the value.
3. Confirm the entry.

Screen keyboard

When you touch an input object such as an IO field on the HMI touch screen, a screen keyboard appears. This screen keyboard is also displayed when it is necessary to enter a password to access protected functions. The keyboard is automatically hidden again when input is complete.

Based on the configuration of the input object, the system opens a screen keyboard for entering numerical, alphanumerical or symbolic values.

Note

The screen keyboard display is independent of the configured project language.

Numerical values

You can enter numerical values character-by-character using the numerical screen keyboard

Formats for Numerical values

You can enter values in numerical input fields based on the following formats:

- Decimal
- Hexadecimal
- Binary

Limit value test of numerical values

Tags can be assigned limit values. The current limit values are indicated in the numerical screen keyboard. If an Alarm window has been configured, a system message is automatically output to indicate any violation of the configured input value limits. For example, 80 exceeds the configured limit value of 78. The entered value is therefore rejected and the original value is displayed again.

Decimal places for numerical values

If a numerical input field is configured for a specific number of decimal points, decimal places in excess of the limit are ignored. Empty decimal places are filled with "0" after the number is confirmed.

Alphanumerical values

Alphanumerical values (numbers and letters) can be entered character-by-character using the alphanumerical screen keyboard.

Symbolic values

Symbolic values are entered from a list of predefined entries using the symbolic IO fields.

Date and time of day

You can enter date/time values character-by-character using the alphanumerical screen keyboard

8.5.2 Entering and editing numerical values

Numerical screen keyboard

When you touch an IO field on the HMI touch screen, the numerical screen keyboard appears. The keyboard is automatically hidden again when input is complete.

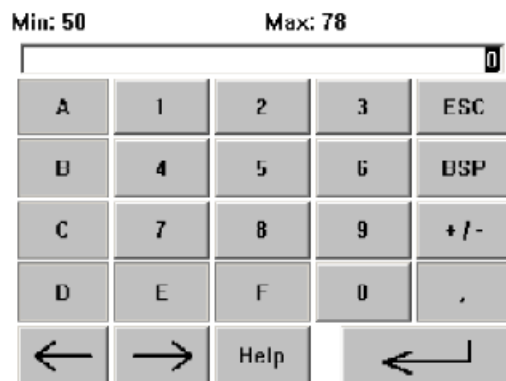

Figure 8-1 Numerical screen keyboard

Procedure

You can enter numerical and hexadecimal values character-by-character using the numerical screen keyboard

Proceed as follows:

1. Touch the relevant IO field on the screen.



The numerical screen keyboard opens and displays the current value.

2. Set the value.

You can only operate keys which are visualized in 3D format. The type of value to be entered determines whether a key is enabled or disabled.

The following options for entering values are available:

- The current value is deleted when you enter the first character. Enter the value again.



- Use the  and  keys to move the cursor within the current value. You can now edit the characters of the current value or add characters.

Use the  key to delete the character to the left of the cursor.

- Use the  key to change the sign of the value.

- Select  to view the infotext of the IO field.

This key is only enabled if infotext or the current screen has been configured for the input object.

3. Select  to confirm your entries or cancel them with . Both actions close the screen keyboard.

Note

Numerical IO fields

Numerical I/O fields can be assigned limit values. In this case, values are only accepted if they lie within configured limits. Any entered values that are outside the range are rejected. A system alarm is triggered on the HMI device in this case.

When the screen keyboard appears, the high and low limit values are indicated if configured.

Opened screen keyboard

When the on-screen keyboard is open, PLC job 51, "Select Screen" has no function.

Language switching

Switching the language in the project has no effect on the numerical screen keyboard. This is why Cyrillic characters cannot be input at this time.

Result

You have changed the numerical value or entered a new one.

8.5.3 Entering and editing alphanumerical values

Alphanumerical Screen Keyboard

When you touch an IO field on the HMI touch screen, the alphanumerical screen keyboard appears. The keyboard is automatically hidden again when input is complete.

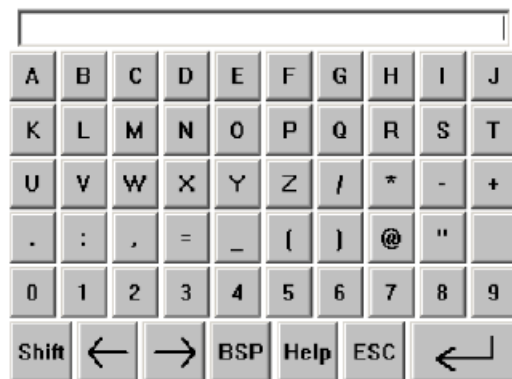

Figure 8-2 Alphanumerical screen keyboard, normal level

Keyboard levels

The alphanumerical keyboard is organized in several levels:

- Normal level
- Shift level

Procedure

You can enter alphanumerical values character-by-character using the alphanumerical screen keyboard.



Proceed as follows:

1. Touch the relevant IO field on the screen.



The alphanumerical screen keyboard opens and displays the current value.

2. Set the value.



The following options for entering values are available:

- The current value is deleted when you enter the first character. Enter the value again.
- Use the  and  keys to move the cursor within the current value. You can now edit the characters of the current value or add characters.

Use the  key to delete the character to the left of the cursor.

- You can quickly switch between screen keyboard level using the  key. When you toggle the level, the key labels on the screen keyboard change.
- Select  to view the infotext of the IO field.

This key is only enabled if infotext or the current screen has been configured for the input object.

3. Select  to confirm your entries or cancel them with . Both actions close the screen keyboard.

Note

Opened screen keyboard

When the on-screen keyboard is open, PLC job 51, "Select Screen" has no function.

Language switching

Switching the language in the project has no effect on the alphanumerical screen keyboard. This is why Cyrillic characters cannot be input at this time.

Result

You have changed the alphanumerical value or entered a new one.

8.5.4 Entering and editing symbolic values

Selection list

When you touch a symbolic IO field on the HMI touch screen, a selection list appears.

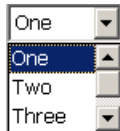



Figure 8-3 Symbolic IO field after touch, example

Procedure

Proceed as follows:

1. Touch the required IO field.
The selection list of the symbolic IO field is displayed. You can scroll through the selection list with the  and  buttons.
2. Select an entry in the selection list.
Touch an entry to select it. This is then taken by the controller.

Result

You have changed the symbolic value or entered a new one.

8.5.5 Entering the date and time

Entering the date and time

Enter the date and time in the same way you enter alphanumerical values.

Note

When entering the date and time, please note that the format is determined by the configured project language.

See also

- Setting the project language (Page 8-5)
- Entering and editing alphanumerical values (Page 8-9)

8.5.6 Operating switches

Introduction

The switches described in the following have two circuit states. Each circuit state is assigned a fixed value. When you operate the switch, it changes to the opposite circuit state and thereby activates the configured value.

Switches can contain sliders, texts or graphics for a specific project.

Procedure - Switch with Slider

Proceed as follows:

Move the slider on the touch screen of the HMI device to the other position or double-click the slider area.

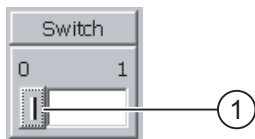

Figure 8-4 Switch

① Slider

Result

The slider is now in the other position. The assigned value is activated.

Procedure - Slider with Text or Graphic

Proceed as follows:

Touch the switch on the touch screen of the HMI device.



Figure 8-5 Switch with graphic – example

Result

The switch changes its appearance. The assigned value is switched.

8.5.7 Operating sliding controllers

Introduction

With the slider control you can change and monitor process values within a defined range. The slider control can also be configured without a slider. No value is entered in this case. The slider control servers only to display values.

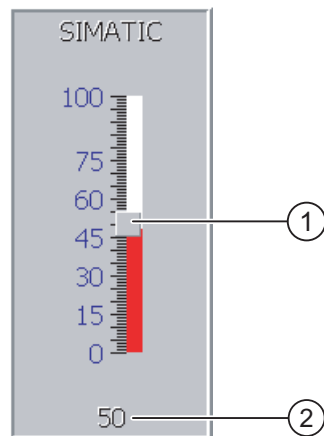

Figure 8-6 Slider control – example

- ① Slider control for entering values
- ② Value display with current value

Appearance

You can configure the appearance and the elements of the slider control. The slider control can contain a label and a setting range, for example. The current value can be configured to appear below the area of the slider control.

Procedure

Proceed as follows:

1. Touch the slider.
2. Move the slider to the required value.
If a value display has been configured, you can check the exact value that has been set.
3. Release the slider.
The set value is applied.

Result

The assigned value has been changed.

8.5.8 Displaying infotext

Purpose

The configuration engineer uses infotext to provide additional information and operating instructions with respect to screens and operable screen objects.

Infotext can provide information on the value to be entered in an IO field, for example.

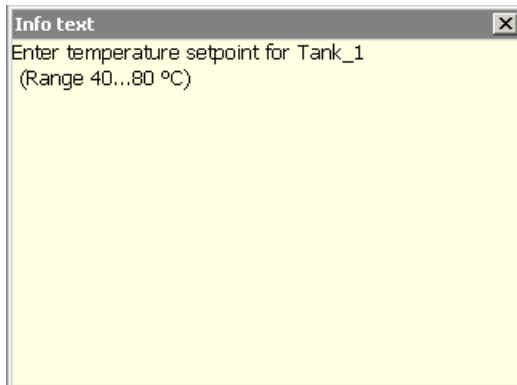



Figure 8-7 Infotext for an IO field, example

Infotext for Input Objects

Touch the  key on the screen keyboard. This key is only enabled if infotext or the current screen has been configured for the input object.

Note

Switching between Displayed Infotexts

If infotext has been configured for an IO field and a screen, touching the infotext window toggles between the two.

Infotext for Other Operator Controls

Infotext can also be configured for operator controls, such as buttons. The infotext of the selected operator control can be displayed by pressing a configured soft key.

Further information on this may be available in your plant documentation.

Infotext for the Current Screen

Infotext can also be configured for screens. The infotext for the current screen is called up or by the screen keyboard or by an operator control object assigned to this function .

Further information on this may be available in your plant documentation.

Closing the Infotext

Close the infotext with .

8.6 Status / control

Application

You read or write access values of the connected controller directly in the status force view. The status force view allows you to carry out operations such as monitoring or modifying the addresses of the controller program, without the need of an online connection via PC or PG.

Note

The status force view can only be used in combination with SIMATIC S5 or SIMATIC S7 controllers.

Appearance

The figure shows the general layout of the status force display. A value can be monitored and controlled on every line.

Connection	Type	Offset	Format	Control Value
PLC_1	M	120	DEC	33
PLC_1	T	40	T	24,00
PLC_1	O	50	DEC	0
PLC_1	O	50	HEX	0A0D

Figure 8-8 Status force display – example

The configuration engineer specifies which columns appear in the status force display. The table shows the significance of the potential columns.



Column	Function
"Connection"	The PLC of which the address ranges are to be displayed
"Type", "DB Number", "Offset", "Bit"	The address range of the value.
"Data Type", "Format"	The data type of the value.
"Status Value"	The value read from the specified address.
"Control Value"	The value to be written to the specified address.

Change the Column Sequence

You change the column arrangement if this has been configured. To reverse the "Format" and "Control Value" columns, for example, touch the "Format" header on the touch screen of the HMI device. Keep the touch screen pressed and drag the column heading to the "Control Value" heading.

Operator Controls

The buttons have the following functions when configured:

Button	Function
	"Read" button Updates the display in the "Status Value" column. The button engages when it is pressed. You cannot operate any input fields until the button is actuated again and the refresh is stopped.
	"Write" button Applies the new value in the "Control Value" column. The control value is then written to the controller.

Procedure - Reading the Status Value

Proceed as follows:

1. Enter the address and the desired format of a value for each line. Touch the respective column to display the screen keyboard.
2. Once you have entered all of the desired values, touch the  button.

Result

All values are read cyclically by the controller and entered in the "Status Value" column until the  button is touched again.

Requirements for Forcing

The following requirements must be fulfilled in order to force values:

- The "Control Value" column must be available.
- The "Write" column must be available.

Procedure - Forcing a Value

Proceed as follows:

1. Enter the address of a value for each line. Enter the desired value in the "Control Value" column. Touch the respective column to display the screen keyboard.
2. Once you have entered all of the desired values, touch the  button.

Result

The values from the "Control Value" column are transferred once to the controller.

8.7 Pointer instrument

Introduction

The gauge displays analog numerical values using a pointer. The operator at the HMI device can thus see at a glance, for example, that the boiler pressure is in the normal range.

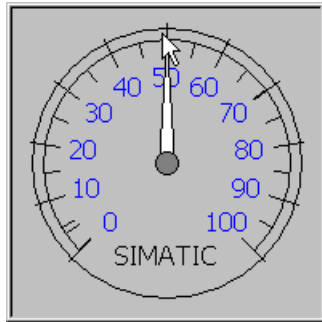

Appearance

The appearance of the gauge depends on the configuration.

- A trailing pointer can display the maximum value reached so far on the scale. The trailing pointer is reset when the screen is reloaded.
- The label on the scale can show the measured variable, e.g. boiler pressure, and the physical unit, e.g. bar.

Operation

The gauge is for display only and cannot be controlled by the operator.

8.8 Sm@rtClient view

Overview

The Sm@rtClient view at PN HMI devices can be used to monitor and operate the current project on a different HMI device remotely. In case of a corresponding configuration it is also possible for several equal HMI devices to access a remote HMI device.

Procedure - starting remote control

Proceed as follows:

1. Change on the HMI device to the screen with the Sm@rtClient view.

The following options are available for establishing the connection to the remote HMI device:

- The connection is established automatically.
- The connection has to be established by touching the corresponding command button.

It may be necessary to enter the address of the remote HMI device and a password.

2. The current screen of the project running on the remote device is displayed on the screen of your HMI device.
3. You can now monitor and control this screens according to your configuration.

Scroll bars are displayed if the screen of the remote HMI device is larger than that of the current HMI device.

Monitoring mode

On a Sm@rtClient view which is configured for monitoring mode, you can only monitor the remote HMI device. You cannot control its operation.

Operating the softkeys

The following options are available for operating the softkeys:

- A function is configured locally at the softkey:
The softkey acts locally on your HMI device.
- No function is configured locally to the softkey:
The softkey acts on the remote HMI device.

Procedure - Forcing the operating permission

If several HMI devices access an HMI device, only one HMI device has permission to operate.

Two cases must be distinguished for this case:

- If another HMI device is already controlling the remote HMI device, you can, in an emergency and if configured, force permission to operate the remote HMI device.
 - You are trying to operate the remote HMI device.
 - A dialog box is displayed in which you have to enter the corresponding password for forcing the remote control permission.
 - You can now operate the remote HMI device.
- If another HMI device accesses your HMI device via the Sm@rtClient view, you can force the local operating permission for your HMI device.
 - Touch the screen of your HMI device five times consecutively.
 - You are given permission to operate your local HMI device.

Procedure - terminating remote control

You can terminate the remote monitoring or the remote control by one of the following steps, depending on the configuration:

- Touch the command button configured to this purpose.
- Exit the screen that contains the Sm@rtClient view.
- If configured, a menu is displayed after you have touched an empty space over a longer period. Touch the menu item "((DoNotTranslate[Close]DNT))".

Further information on this may be available in your plant documentation.

Note

If another HMI device accesses your HMI device via the Sm@rtClient view, this leads to an additional load on your HMI device.

8.9 Operating trends

8.9.1 Overview

Trends

Trends continuously display the current process data.

Trend View

Trends are displayed in the Trend view. A Trend view can display several trends simultaneously.

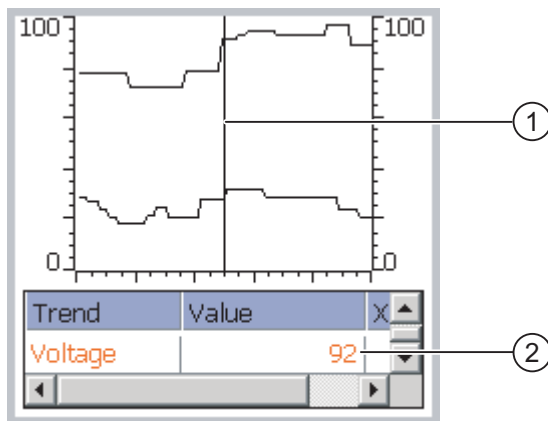

Figure 8-9 Trend view - example

- ① Ruler
- ② Trend value in the value table

The appearance, axes, value range and labels of the Trend view can be set by the configuration engineer.

The configuration engineer can set limits for the trend values. A color transition can be configured when the limits are exceeded.

Further information on this may be available in your plant documentation.

Value Table

The trend values can be read from the value table, if this is configured.

Ruler

The exact trend values can be read from the ruler, if this is configured.

8.9.2 Operating the trend display

Value Table

The trend values are displayed in the value table. When the ruler is displayed, the trend values are shown at a position of the ruler. When the ruler is hidden, the latest trend values are displayed.

Ruler

When configured, a ruler is available to provide an exact reading of the individual values.

The position of the ruler can be changed by touching and dragging it on the touch screen.

The configuration engineer can configure the following actions for operator controls outside the Trend display:

- Display or hide ruler
- Move ruler forward
- Move ruler backward

Further information on this may be available in your plant documentation.

Other Operator Actions

The configuration engineer can configure the following actions for operator controls outside the Trend display:

- Enlarge display of time intervals
- Reduce display of time intervals
- Scroll back by one display width
- Scroll forward by one display width
- Stop or resume trend recording

Further information on this may be available in your plant documentation.

8.10 Project security

8.10.1 Overview

Overview

The configuration engineer can protect the operation of a project by implementing a security system.

The security system of the HMI device is based on permissions, user groups and users.

If operator control objects protected by a password are operated, the HMI device requests the entry of a password. A logon screen is displayed in which you enter your user name and password. After logging in, you can operate the operator control objects for which you have the necessary permissions.

The logon dialog can be set up by the configuration engineer via an individual operator control object.

In the same way, the configuration engineer can set up an operator control object to log off. After logging off, objects assigned password protection can no longer be operated; to do so, log in again.

Further information on this may be available in your plant documentation.

User Groups and Permissions

Project-specific user groups are created by the configuration engineer. The "Administrators" group is included in all projects by default. User groups are assigned permissions. Permission required for an operation is specifically defined for each individual object and function in the project.

Users

Each user is assigned to exactly one user group.

Users can be created as follows:

- By the configuration engineer during configuration
- By the administrator on the HMI device
- By a user with user management permission on the HMI device

Logoff Times

A logoff time is specified in the system for each user. If the time between any two user actions, e.g. entering a value or changing screens, exceeds this logoff time, the user is automatically logged off. The user must then log in again to continue to operate objects assigned password protection.

Passwords

If an administrator or a user with administrator permission is logged on, all users on the HMI device are displayed in the User view.

If no administrator or user with administrator permission is logged on, only the personal user entry is displayed.

The permissions of a user after logging in depends on the user group to the user is assigned. Further information on this may be available in your plant documentation.

The user data is encrypted and saved on the HMI device to protect it from loss due to power failure.

Note

Depending on the transfer settings, changes to the user data are overwritten when the project is transferred again.

User View

Use the User view to display the users on the HMI device.

All users on the HMI device system are displayed in the User view to the administrator or to a user with administrator permissions. When user management permission is lacking, only the personal user entry is displayed.

The configuration engineer can implement simple or advanced User view in the project. The two user views offer the same functions and differ only in the display of information.

Simple User View

The simple user view only displays the user name and user group.



Admin	Group (9)
PLC User	Group (1)
User 1	Group (1)
<New user>	

Advanced User View

The advanced user view displays more information about the users.

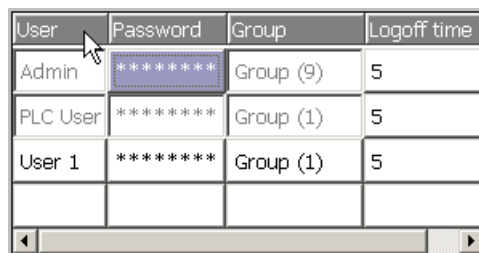

User	Password	Group	Logoff time
Admin	*****	Group (9)	5
PLC User	*****	Group (1)	5
User 1	*****	Group (1)	5

Backup and Restore

The users, passwords, group assignments and logoff times can be backed up and restored on the HMI device. This prevents you having to enter all of the data again on another HMI device.

Notice

During a restore, the currently valid user data is overwritten. The restored user data and passwords are valid immediately.

Limits for User, Password and User View

	Number of characters
Length of user name, maximum	40
Length of password, minimum	3
Length of password, maximum	24
Entry in user view, maximum	50

8.10.2 User login

Requirements

Use the logon dialog to log into the security system of the HMI device. Enter user name and password in the logon dialog.

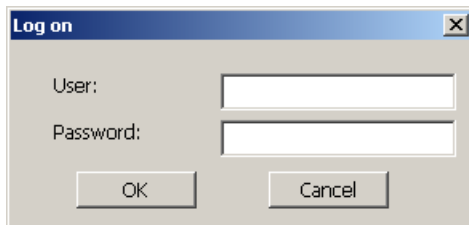

Figure 8-10 Logon dialog

You have the following options for displaying the logon dialog:

- Touch the operator control object with password protection.
- Touch an operator control object that was configured for displaying the logon dialog.
- Double-click on the "<ENTER>" entry in the simple User view.
- At the beginning of the project, the logon dialog will be automatically displayed in certain circumstances.

Further information on this may be available in your plant documentation.

Procedure

Proceed as follows:

1. Enter the user name and password.
Touch the corresponding input field. The alphanumerical screen keyboard is displayed.
2. Touch the "OK" button.

Note

The user name is not case-sensitive.

The password is case-sensitive.

Result

After successful logon to the security system, you can execute password-protected functions on the HMI device for which you have permissions.

If you enter a wrong password, an error message is displayed when an Alarm window has been configured.

8.10.3 User logoff

Requirements

You have logged into the security system of the HMI device.

Procedure

You have the following options for logging off:

- The user is logged off automatically if no operations are carried out and if the logoff time has been exceeded
- By touching the operating object that was configured for logging off

Further information on this may be available in your plant documentation.

If an incorrect password is entered, the logged-on user is also logged off.

Result

The user is no longer logged into the project. In order to operate an operator control object with password protection, you must first log in again.

8.10.4 Creating a user

Requirements

New users are created in the user view.

To display the user view, switch to the screen that contains the user view.

To create a new user, you must have user management permission.

Procedure - Creating a User in the Simple User View

Proceed as follows:

1. Touch the "<New User>" entry in the user view.

The following dialog appears:

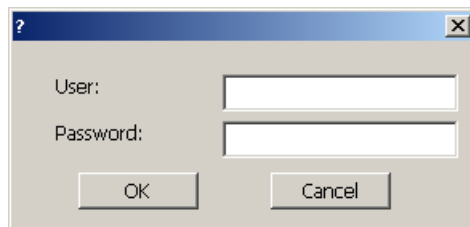

2. Enter the desired user information.

Touch the corresponding input field. The alphanumerical screen keyboard is displayed.

The password may not contain space characters or the special characters * ? . % / \ ' " .

3. Touch the "OK" button.

The following dialog appears:

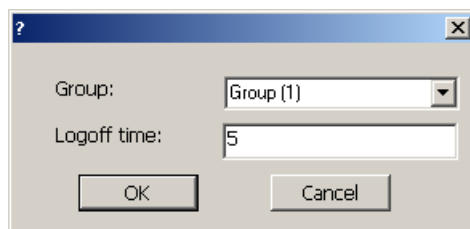

4. Enter the desired user information.

Touch the corresponding input field. The appropriate screen keyboard is displayed.

For the logoff time, you can use values of 0 to 60 minutes. The value 0 stands for "no automatic logoff."

5. Touch the "OK" button.

Result

The new user is created.

Procedure - Creating a User in the Advanced User View

Proceed as follows:

Enter the required user information on the empty lines of the User view.

Touch the corresponding input field. The appropriate screen keyboard is displayed.

- The password may not contain space characters or the special characters * ? . % / \ ' " .
- For the logoff time, you can use values of 0 to 60 minutes. The value 0 stands for "no automatic logoff."

Result

The new user is created.

8.10.5 Changing user data

Requirements

Change user data in the user view.

To display the user view, switch to the screen that contains the user view.

The following options are available for the range of changes that can be made:

- The administrator or a user with user management permission can change the data for all users on the HMI device system in the user view.
 - User name
 - Group assignment
 - Password
 - Logoff time
- Users without user management permission can only change their own user data.
 - Password
 - Logoff time, if configured

Note

You can only change the logoff time and password for the "Admin" user.

You can only change the logoff time for the "PLC_User". This user entry is used for logging in via the PLC.

Procedure - Changing User Data in the Simple User View

This procedure describes changing user data by the administrator or a user with user management permission.

Proceed as follows:

1. In the user view, touch the user whose user data you want to change.

The following dialog appears:

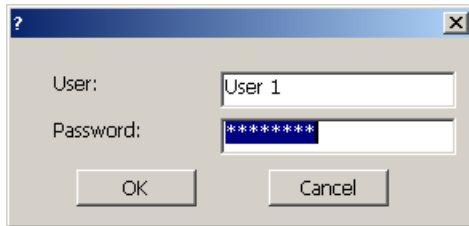

2. Change the desired user data.

Touch the corresponding input field. The appropriate screen keyboard is displayed.

3. Touch the "OK" button.

The following dialog appears:

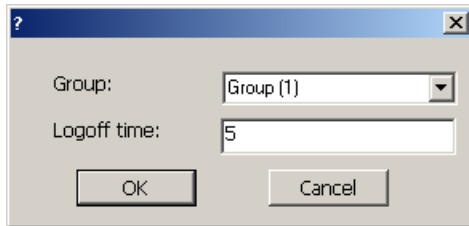

4. Change the desired user data.

Touch the corresponding input field. The appropriate screen keyboard is displayed.

5. Touch the "OK" button.

Result

The user data for the user is changed.

Procedure - Changing User Data in the Advanced User View

This procedure describes changing user data by the administrator or a user with user management permission.

Proceed as follows:

1. In the user view, touch the user whose user data you want to change.

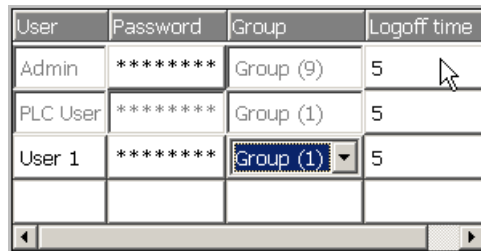

User	Password	Group	Logoff time
Admin	*****	Group (9)	5
PLC User	*****	Group (1)	5
User 1	*****	Group (1)	5

The appropriate screen keyboard is displayed.

2. Change the desired user data.

Result

The user data for the user is changed.

8.10.6 Deleting a user

Requirements

You delete users in the user view:

To display the user view, switch to the screen that contains the user view.

To delete a user, you must have user management permission.

Note



The "Admin" and "PLC_User" users exist by default and cannot be deleted.

Procedure - Deleting a User in the Simple User View

1. Touch the user that you want to delete in the User view.

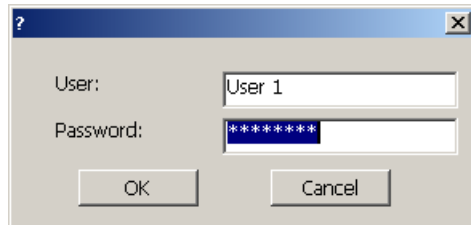
The following dialog appears:



2. Touch the "User" input field.
The alphanumerical screen keyboard is displayed.
3. Touch the  button on the screen keyboard.
The existing user name is deleted from the screen keyboard.
4. Touch the  button on the screen keyboard.
The user name in the "User" input field is deleted.

The following dialog appears:

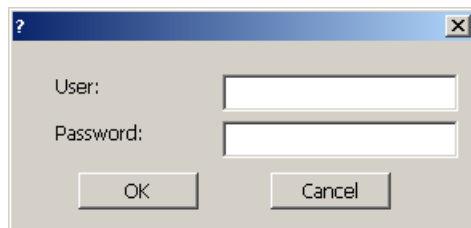



5. Touch the "OK" button.

Result

The user is deleted. The User view appears again.

Procedure - Deleting a User in the Advanced User View

Proceed as follows:

1. Touch the user you want to delete in the "User" input field of the User view.
The alphanumerical screen keyboard is displayed.
2. Touch the  button on the screen keyboard.
The existing user name is deleted from the screen keyboard.
3. Touch the  button on the screen keyboard.
The user name in the "User" input field is deleted.

Result

The user is deleted.

8.11 Closing the project

Procedure

Proceed as follows:

1. Use the corresponding operator control object to close the project.
Wait for the Loader to open after you closed the project.
2. Switch off power to the HMI device.

Note

Recovery time

Wait for approx. one second after you have removed the connecting cable from the terminal box before you plug the connecting cable back into the terminal box.

Operating alarms

9.1 Overview

Alarms

Alarms indicate events and states on the HMI device which have occurred in the system, in the process or on the HMI device itself. A status is reported when it is received.

An alarm could trigger one of the following alarm events:

- Incoming
- Outgoing
- Acknowledge

The configuration engineer defines which alarms must be acknowledged by the user.

An alarm may contain the following information:

- Date
- Time
- Alarm text
- Error location
- State
- Alarm class
- Alarm number
- Acknowledgement group
- Diagnostics capability

Alarm Classes

Alarms are assigned to various alarm classes:

- Error
Alarms in this class must always be acknowledged. Alarms normally indicate critical errors within the plant such as "Motor temperature too high".
- Warning
Warning alarms usually indicate states of a plant such as "Motor switched on".
- System
System alarms indicate states or events which occur on the HMI device.
- SIMATIC diagnostic alarms
SIMATIC diagnostic alarms show states and events of the SIMATIC S7 or SIMOTION controllers.
- User-specific alarm classes
The properties of this alarm class must be defined in the configuration.
Further information on this may be available in your plant documentation.

Alarm Buffer

Alarm events are saved to an internal buffer. The size of this alarm buffer depends on the HMI device type.

9.2 Displaying alarms

Alarm View

Alarms are indicated in the Alarm view or in the Alarm window on the HMI device.

The Alarm view can be implemented with the following components:

- Alarm numbers and alarm texts are displayed as single lines.
- As simple Alarm view
- As advanced Alarm view

In the simple or advanced Alarm views the configuration engineer specifies the alarm information to be displayed.

Alarm Window

The layout and operation of the Alarm window correspond to that of the Alarm view.



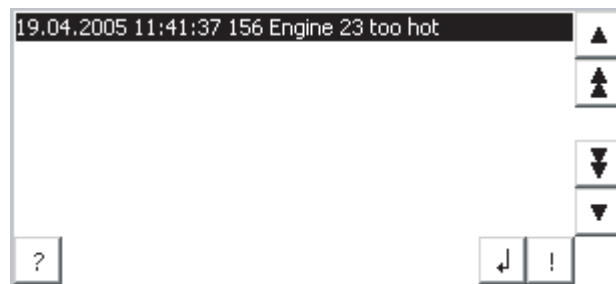

The Alarm window is independent of the process screen. Depending on the configuration, the Alarm window appears automatically as soon as a new, unacknowledged alarm has been received. The Alarm window can be configured so that it only closes after all the alarms have been acknowledged.

Further information on this may be available in your plant documentation.

Simple Alarm View





The buttons have the following functions:

Button	Function
	Displays an alarm operator note
	Edit alarm
	Acknowledge alarm
	Select the next or previous alarm from the list
	To scroll one page up or down

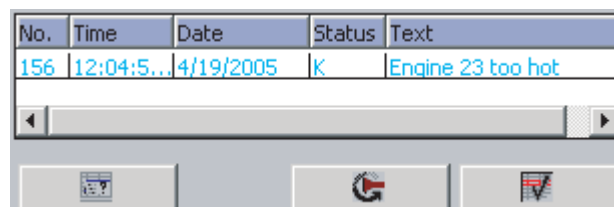
Advanced Alarm View



The buttons have the following functions:

Button	Function
	Displays an alarm operator note
	Edit alarm
	Acknowledge alarm

Changing the Column Sequence and Sorting in the Advanced Alarm View

You can change the column sequence and sorting to suit the project.

- Change column sequence

To reverse the "Time" and "Date" columns, for example, touch the "Date" header on the HMI device touch screen. Continue to press the touch screen and drag the column heading to the "Time" heading.

- Change sorting order

To change the sorting of the alarms, touch the respective column heading on the touch screen of the HMI device.

Representation of Alarm Classes

The various alarm classes are identified in order to distinguish between them in the Alarm view.



Symbol	Alarm class
!	Error
(empty)	Warning
(depends on the configuration)	User-defined alarm classes
S7	SIMATIC or SIMOTION Diagnostic Alarms
\$	System

The configuration engineer can edit the alarm class symbols. Further information on this may be available in your plant documentation.

Viewing Infotext

The configuration engineer can also supply infotext for alarms.

To view an alarm infotext:

1. Select the required alarm in the Alarm view
2. Touch the  button in the simple Alarm view or  in the advanced Alarm view.

The infotext assigned to this alarm is displayed.

3. Close the infotext window with 

Alarm Indicator

The alarm indicator is a graphical symbol that shows current errors or errors which need to be acknowledged, depending on the configuration.



Figure 9-1 Alarm indicator with three queued alarms

The alarm indicator flashes as long as alarms are queued for acknowledgment. The number indicates the number of queued alarms. The configuration engineer can assign functions to be executed when the alarm indicator is touched.

Usually, the alarm indicator is only used for error alarms. Further information may be available in your plant documentation.



9.3 Acknowledge alarm

Requirements

- The alarm which is to be acknowledged is displayed in the Alarm window or in the Alarm view.
- Either the Alarm window or the Alarm view is enabled.
- The alarm must be acknowledged.

Procedure

Proceed as follows:

1. Select the alarm by touching it in the Alarm view or Alarm window.
2. Touch the  button in the simple Alarm view or  in the advanced Alarm view.

A soft key can also be configured to acknowledge alarms.

Result

The alarm or all alarms of the corresponding acknowledgement group are acknowledged.
Further information about acknowledgment may be available in your plant documentation.

See also

Displaying alarms (Page 9-2)

9.4 Edit alarm

Introduction



The configuration engineer can assign additional functions to each alarm. These functions are executed when the alarm is processed.

Requirements

- The alarm to be edited is indicated in the Alarm window or in the Alarm view.
- Either the Alarm window or the Alarm view is enabled.

Procedure

Proceed as follows:

1. Select the alarm by touching it in the Alarm view or Alarm window.
2. Touch the  button in the simple Alarm view or  in the advanced Alarm view.

Result

The system executes the additional functions of the alarm. Further information on this may be available in your plant documentation.

Note

When you edit an unacknowledged alarm, it is acknowledged automatically.

See also

Displaying alarms (Page 9-2)

Operating recipes

10.1 Purpose of and applications for recipes

Introduction

A product is often manufactured in different variants. These variants can be based on varying numbers and types of product components. The variation of the product components can be saved in a recipe.

Application Areas

A recipe can be used everywhere the same product components can be used in variable combinations to create different product variants.

The following are examples:

- Beverage industry
- Food processing industry
- Pharmaceutical industry
- Paint industry
- Building materials industry
- Steel industry

10.2 Structure of a recipe

What is a recipe?

A recipe is a configurable object in WinCC flexible and consists of at least one recipe record. It can be compared to a drawer in a file cabinet.

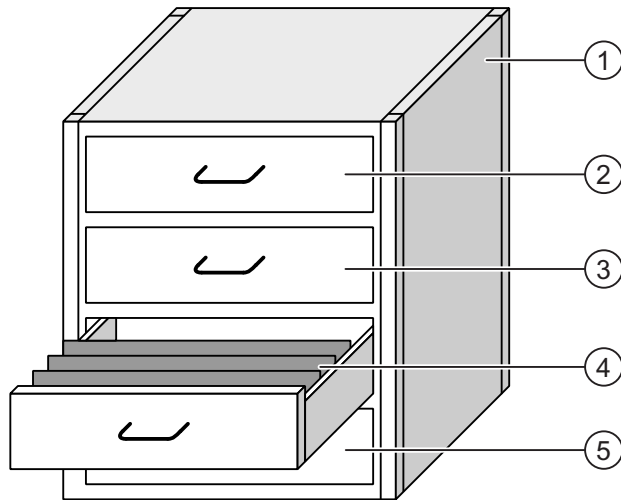

Figure 10-1 Graphical representation of recipes

			Example
①	File cabinet	Recipe collection	Recipes for a fruit juice plant
②	Drawer	Recipe	Beverage variants made of grapefruit juice
③	Drawer	Recipe	Beverage variants made of apple juice
④	Hanging folder	Recipe record	Juice made from apples
⑤	Drawer	Recipe	Beverage variants made of orange juice

The hanging folders in the drawers represent records required for manufacturing various product variants, such as beverage variants. What is special about a recipe is that the records can involve the same product components. The records of a recipe, therefore, only differ in the quantities combining the same product components.

Product variants of a recipe for a fruit juice plant might be a soft drink, a juice and a nectar, for example. The product components are the same but at least the proportion of fruit juice differs.

By exchanging the fruit juice as the product component, additional recipes can be created for similar products. For example, in a fruit juice plant this might involve:

- A soft drink, juice and nectar made of grapefruit juice
- A soft drink, juice and nectar made of apple juice
- A soft drink, juice and nectar made of orange juice
- A soft drink, juice and nectar made of pineapple juice

The recipe is therefore built by the collection of all records belonging to the recipe, the recipe records. The following graphic shows this from a configurational point of view.

Elements		Data records	
Name	Display name	Number	
Beverage	Beverage	1	
Nectar	Nectar	2	
Juice	Juice	3	

①
②
③

Figure 10-2 Structure of a recipe

- ① List of records in a recipe
- ② List of the recipe elements.
The recipe elements are shown in the Recipe view. These are displayed as names in the Recipe view.
- ③ List of the recipe numbers.
The recipe numbers are shown in the Recipe view.

Structure of a Recipe Record

Using the analogy of a file cabinet once again, a recipe record corresponds to a hanging folder. Each page in the hanging folder can be compared to a variable in the recipe record.

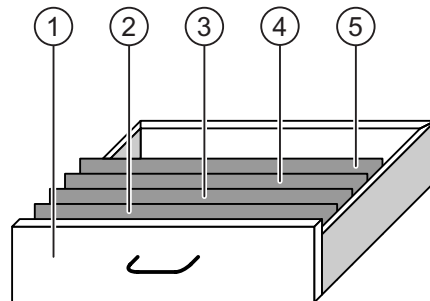

Figure 10-3 Graphical representation of recipe records

			Example
①	Drawer	Recipe	For beverage variants made of apple juice
②	Hanging folder	Recipe record	Juice made from apples
③	Hanging folder	Recipe record	Juice made from oranges
④	Hanging folder	Recipe record	Juice made from red currants
⑤	Hanging folder	Recipe record	Juice made from grapes

A recipe record consists of a set number of elements. A value is save in each element.

The number of elements is the same for all recipe records in a recipe.

The following graphic shows the relationship between elements and values from a configurational point of view.

	Name	Display name	Number	Water	Concentrate	Sugar	Flavor
☰	Beverage	Beverage	1	60	50	45	50
☰	Juice	Juice	3	20	100	15	0
☰	Nectar	Nectar	2	40	70	30	30

Figure 10-4 Structure of a recipe record

- ① Elements belonging to a recipe record.
These are displayed as names in the Recipe view.
- ② Values for the nectar recipe record

The "Display name" and "Number" are used in the Recipe view and in the Recipe screen as explained below.

10.3 Display recipes

Introduction

In order to display recipes and the accompanying recipe records on the HMI device, appropriate operator controls need to be configured. This is a component of the project and consists of one of the following two objects:

- Recipe view

The Recipe view can take the form of a simple or an advanced view.

- Recipe screen

The Recipe view itself is a component of a Recipe screen. Depending on the requirements, not all IO fields and buttons need to be configured. Several Recipe views can be used in multiple Recipe screens.

Advanced Recipe View

A Recipe view is a screen object used to manage recipe records. The Recipe view is configured according to the requirements for the input and output and contains corresponding fields and buttons.

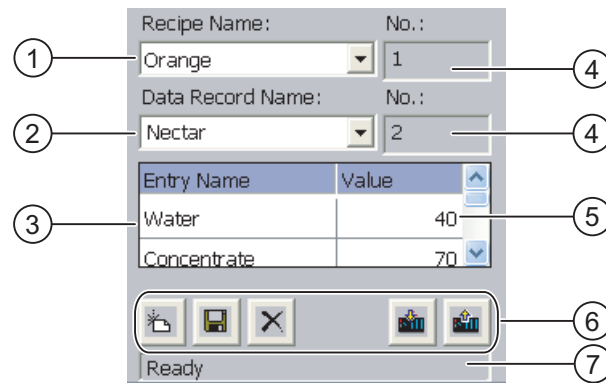

Figure 10-5 Example of an advanced Recipe view

- ① Selection field for the recipe
- ② Selection field for the recipe record
- ③ Element name
The element name represents a specific element in the recipe record.
- ④ Display field
This show the number of the selected recipe or the selected recipe record.
- ⑤ Value of the element
- ⑥ Buttons for editing a recipe record
- ⑦ Status bar display the status messages

The recipe view shows recipe records in tabular form. The Recipe view is especially useful when there are only a few elements in the recipe record or only a few values that need to be changed.

Simple Recipe View

The simple view (simple Recipe view) is used to display and edit recipes on HMI devices which have a display smaller than 6".

The simple recipe view consists of three areas:

- Recipe selection
- Recipe record selection
- Recipe entries

In the simple recipe view, each area is shown separately on the HMI device. The simple recipe view always begins with the recipe selection.

The following graphic show the selection of a recipe record.

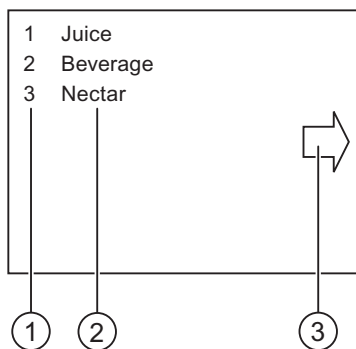

Figure 10-6 Example of an simple Recipe view – selection of a recipe record

- ① Number of selected recipe records
- ② Recipe records
- ③ Button for calling up recipe entries

Recipe Screen

A Recipe screen is a process screen which you configure by combining I/O fields and screen objects to form a custom input screen. This enables you to input parameters in the context of a machine visualization. The IO fields of a recipe can be distributed over several Recipe screens. This allows recipe elements to be arranged by subject. The required operator control functions in the Recipe screen can be called using buttons. A modified Recipe view can itself be a component of a Recipe screen.

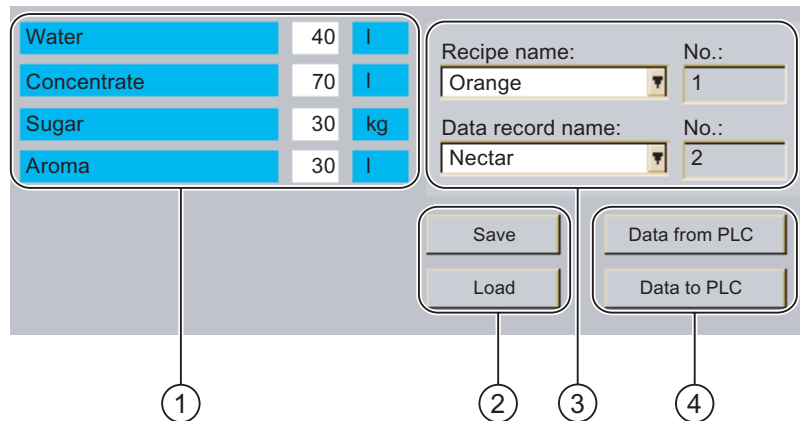

Figure 10-7 Example of a Recipe screen

- ① Element names and corresponding values
The element name represents a specific element in the recipe record.
- ② Buttons for editing a recipe record
- ③ Modified Recipe view
- ④ Buttons for transferring recipe data

10.4 Operating recipe handling







10.4.1 Operating the recipe view

Introduction

As a component of a project the recipe structure cannot be changed on the HMI device. The values in the recipe structure that can be stored as recipe data records can be changed. This means that it is possible to adapt the product variants that are to be manufactured to the specific production conditions. In addition, the obtained recipe data records can be transferred to other HMI devices. For this purpose operator control elements are contained in the recipe view or in the recipe screen. These are explained below.

Operating the recipe view

The presence of the following symbols and the functions connected therewith depends on the project.

Function	Action on pressing
 Create recipe data records	A new recipe data record is created. If a starting count has been configured, it is displayed in the input box.
 Save recipe data records	The displayed values are saved. The storage location is specified by the project.
 Delete a recipe data record	The displayed recipe data record is deleted.
 Transfer recipe data record from the PLC	The values of the recipe data records are transferred from the PLC into the recipe that is set at the HMI device.
 Transfer recipe data record to the PLC	The values of the set recipe data record are transferred from the HMI device to the PLC.
 Synchronize tags	The values of the recipe view are synchronized with the corresponding tags. In the process the values that changed during processing are written into the corresponding tags. Subsequently all the values of the tags are read out and updated in the table. The button is only active in the case of recipes with synchronized tags.
 Save recipe data records as	Irrespective of the recipe view a recipe data record can be saved under a different name on the data medium. A dialog box is opened in which the name is entered.

The procedure for operating these functions is explained below, whereby the displayed symbols are used. Correspondingly configured command buttons apply for a recipe view.

Operating the recipe view

Screen-specific command buttons that correspond functionally to the icons of the recipe view are available for operation in the recipe view.

Entering the value.

If you want to change the value of a tag, call up the screen keyboard.

The functions listed in the table and the entry of values can also have been configured to a softkey. Further information on this may be available in your plant documentation.

Displaying a value

Notice

Changing the recipe data record in the background

Applies for the processing of a recipe data record:

If values of the corresponding recipe data record are changed by a control job, the recipe view is not updated automatically.

10.4.2 Operator input in the overview

Overview

The following figure shows the possible data flows with an HMI device and externally.

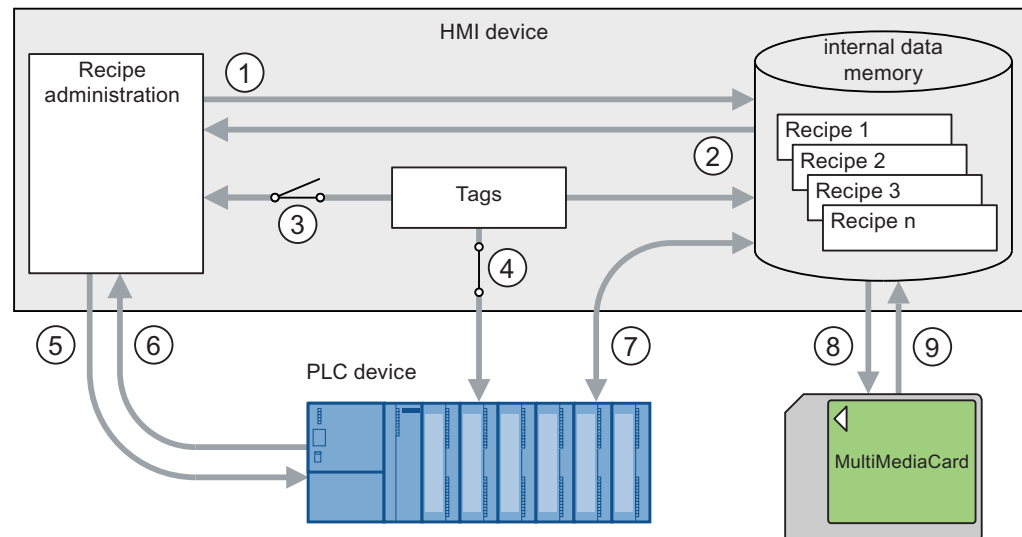

Figure 10-8 Schematic drawing of the data flow

- ① Delete, save or save recipe record as
- ② Load recipe record
- ③ Synchronize / do not synchronize tags
- ④ Tags are online for controller
- ⑤ Recipe record transfer – writing to the controller
- ⑥ Recipe record transfer – reading from the controller
- ⑦ Recipe record transfer – data communication between the data store of the HMI device and the controller
- ⑧ Backup/restore – exporting recipe records
- ⑨ Backup/restore – importing recipe records

"Recipe record transfer" data transfer between HMI device and controller is according represented by the graphic.

10.4.3 Creating recipe records

Introduction

There are several ways to create a recipe record on the HMI device:

- Using the Recipe view
- Using the Recipe function
- Using PLC jobs

This involves saving a recipe record in the controller, opening and modifying it. It can then be saved as a new recipe record.

Requirements

- The "Create data record" and "Save data record" functions have been configured.
- The recipe for which a new recipe record should be created has been selected on the HMI device.

Procedure

Proceed as follows:

1. Touch .

A new recipe record with the next available number is created.

If you change the new recipe record number to an existing recipe record number, the recipe record is overwritten.

2. Enter the name for the recipe record.
3. Enter values for the recipe record.

The tags of the recipe record can be assigned default values depending on the project.

4. Touch .

The recipe record is deleted. If the recipe record already exists, a system alarm will be output to the screen.

Result

The new recipe records will be saved to the selected recipe.

Using the "Export data record" function you can transfer new recipe records to an external storage medium.

See also

Operator input in the overview (Page 10-9)

10.4.4 Editing a recipe data record

Introduction

Recipes can be edited as follows:

- Offline

You can only edit values offline in the Recipe view.

- Online

Values editing in the Recipe screen are immediately transferred to the controller.

The configuration of the recipe screen determines whether the recipe data are edited offline or online.

When working in the Recipe view and offline in the Recipe screen, you have to transfer an edited recipe record using the function "Transfer to PLC".

Requirements

- The "Save data record" function has been configured.
- A recipe containing the recipe record to be changed has been selected on the HMI device.

Procedure

Proceed as follows:

1. Select the recipe record to be edited.
2. Change the entries and values as required.
3. Touch .

The recipe record is deleted. If you wish to save the recipe record under another name, press .

Result

The edited recipe record has now been saved in the selected recipe. The values are now in effect if you are working in the online mode of the Recipe view.

See also

Operator input in the overview (Page 10-9)

10.4.5 Delete recipe data record

Introduction

The number of recipe records in a recipe can be changed. Unneeded recipe records can be deleted. If necessary, even all the recipe records can be deleted.

Requirements

- The "Delete data record" function has been configured.
- A recipe containing the recipe record to be deleted has been selected on the HMI device.

Procedure

Proceed as follows:

1. Select a recipe record for deletion based on the data record name.
2. Touch .

The recipe record is deleted.

Result

The recipe record has now been deleted on the HMI device.

See also

Operator input in the overview (Page 10-9)

10.4.6 Export recipe data record

Introduction

The ability to export a recipe record to a CSV file depends on the project. The values in the recipe record can be manipulated in a spreadsheet program such as MS Excel. The degree to which you can influence the export depends on the project: Various input fields may be configured on the user interface of a project:

- File path of the CSV file
- Selection field for the recipe record to be exported
- Overwrite CSV file

Requirements

- The "Export data record" function has been configured.
- A recipe containing the recipe record to be exported has been selected on the HMI device.

Procedure

Proceed as follows:

1. Select a recipe record for export based on the data record name.
2. Touch the "Export data record" button.

The data record is exported to a CSV file on an external data medium.

Result

The recipe record is exported.

See also

Operator input in the overview (Page 10-9)

10.4.7 Import recipe records

Introduction

An import involves importing values from a CSV file into a data record.

Requirements

- The "Import data record" function has been configured.
- A recipe containing the recipe record to be imported has been selected on the HMI device.

Procedure

Proceed as follows:

1. Touch the "Import data record" button.

The data record is imported from an external data medium as a CSV file and then displayed in the Recipe view.

Result

The imported recipe record is saved on the HMI device.

If the structure of the CSV file differs from the structure of the recipe, deviations are handled as follows:

- Any additional values in the CSV file will be rejected.
- The system applies the configured default value to the recipe record if the CSV file contains an insufficient number of values.
- If the CSV file contains values of the wrong data type, the configured default value is set in the recipe record.

Example:

The CSV file contains values that were entered as floating point numbers.

However, the corresponding tag expects an integer value. In this case, the system discards the imported value and uses the configured default.

See also

Operator input in the overview (Page 10-9)

10.4.8 Synchronizing tags

Introduction

Differences may occur between the display values in the Recipe view and the actual values of tags in an ongoing project when input is made in the Recipe view or when tags are changed. To avoid such differences, the "Synchronize data record" function can be configured.

Depending on the project, the values displayed in the Recipe view can be synchronized as follows:

- With the values of the tags
- With the values of the controller

This synchronization is performed for each one of the tags contained in the recipe record.

Requirements

- The "Synchronize data record" function has been configured.
- A recipe containing the recipe record to be synchronized has been selected on the HMI device.

Procedure

Proceed as follows:

1. Select the recipe record to be synchronized.
2. Touch .

The elements of the recipe record are synchronized with the values of the controller. It is synchronized as follows:

- When the value of a tag has more recent value than the Recipe view, the most recent value is applied to the Recipe view.
- When the displayed value in the recipe view is more recent than the tag value, the most recent value is applied to the tag.

Notice

Changed Tag Names

Synchronization cannot be performed if the tag names in the data records to be synchronized do not match. The tags in question are not synchronized.

Result

After synchronization, both the tags in the controller and the tags in the Recipe view contain the most recently updated values. The values in the Recipe view and the values in the tags are now identical.

See also

Operator input in the overview (Page 10-9)

10.5 Using recipes

10.5.1 Configuring the transfer of recipe data records

Introduction

The transfer of recipe records needs to be configured to suit the application. To write a value to a recipe record on your HMI device without disturbing the current process in the plant, you need configuration settings other than those required for assigning parameters to a machine.

Principle

The settings in the recipe determine if the data records are to be synchronized and immediately transferred to the controller. The following figure is a schematic representation of this possibility. The settings cannot be made on the HMI device.

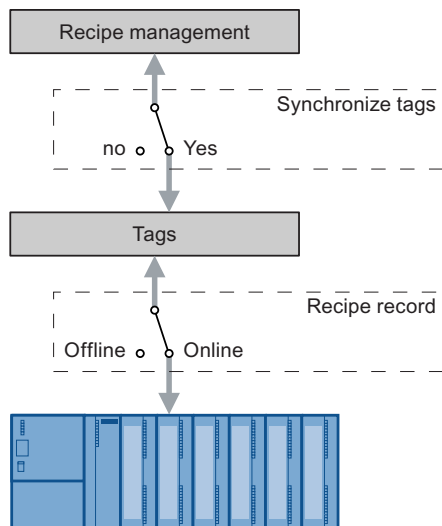

Figure 10-9 Recipe settings

The following three configurations can be made with the settings:

- Recipe without "Synchronize tags"
- Recipe with "Synchronize tags" and with "Tags offline"
- Recipe with "Synchronize tags" and with "Tags online"

Recipe without "Synchronize tags"

The data of a recipe record are only displayed in the Recipe view or Recipe screen and can only be edited there. If you use the same tags outside the Recipe view or Recipe screen, this has no effect on the values in the Recipe view or Recipe screen.

Recipe with "Synchronize tags" and with "Tags offline"

The "Synchronize tags" setting specifies if the values in a recipe record that have been read from the controller or a data store, is written to the tags in a recipe record on the HMI device. The data transfer can also be performed in the opposite direction, from the HMI device to the controller or to external data store.

The "offline" setting causes the entered values to be saved but not automatically transferred to the controller or HMI device.

Recipe with "Synchronize tags" and with "Tags online"

The "Synchronize tags" setting specifies if the values in a recipe record that have been read from the controller or memory, is written to the tags in a recipe record on the HMI device. The data transfer can also be performed in the opposite direction, from the HMI device to the controller or to external data store.

The input or read data are transferred immediately to the controller:

10.5.2 Reading a recipe data record from the PLC

Introduction

You can read values from the PLC and write them to a recipe data record. For example, you can do this in machine teach-in mode in order to save the positioning data of axes as a recipe record.

The read values are written to the recipe record that is currently displayed on the HMI device.

The "Read from PLC" function causes the displayed tag values to be updated to match those in the controller. The function overwrites any data changed on the Recipe view or Recipe screen.

Requirements

- The "Read from PLC" function has been configured.
- On the HMI device, a recipe has been selected containing the recipe record with the values that should be read from the controller.

Procedure

Proceed as follows:

1. Select a recipe record with the values that should be read from the controller.
2. Touch the "From PLC" button.

The values are read from the controller.

3. Touch .

The recipe record is deleted. If the recipe record already exists, an alarm appears on the screen.

Result

The values are read from the controller, displayed on the HMI device and saved to the selected recipe record.

See also

Operator input in the overview (Page 10-9)

Configuring the transfer of recipe data records (Page 10-15)

10.5.3 Transferring a recipe record to the PLC

Introduction

If you have changed values in the Recipe display or Recipe screen, you can transfer the changed recipe record using the "Write record to PLC" function.

You can edit recipe records in the Recipe display or Recipe screen both offline and online.

You can only edit values offline in the Recipe display or Recipe screen. The configuration of the recipe screen determines whether the recipe data are edited offline or online.

- Tags offline

Data are only sent to the controller when the "To PLC" button is pressed.

- Tags online

Data are transferred immediately to the controller.

Requirements

- The "Write to controller" function has been configured.
- On the HMI device, a recipe has been selected containing the recipe record with the values that should be transferred to the controller.

Procedure

Proceed as follows:

1. Select a recipe record containing the values that should be transferred to the controller.
2. Touch the "To PLC" button.

Result

The values of the recipe record are transferred to the controller.

See also

Operator input in the overview (Page 10-9)

Configuring the transfer of recipe data records (Page 10-15)

10.6 Displaying production sequences schematically

10.6.1 Entering a recipe data record

Introduction

You would like to enter production data on the HMI device without interrupting the process in the machine or plant. Therefore, the production data should not be transferred to the PLC.

Procedure

Proceed as follows:

1. Open the Recipe view or Recipe screen.
2. Enter the name of a recipe record.
3. Enter the values for the elements.
4. Save recipe data record

The recipe record is saved in the internal data store of the HMI device.

The following figure shows the dataflow schematically.

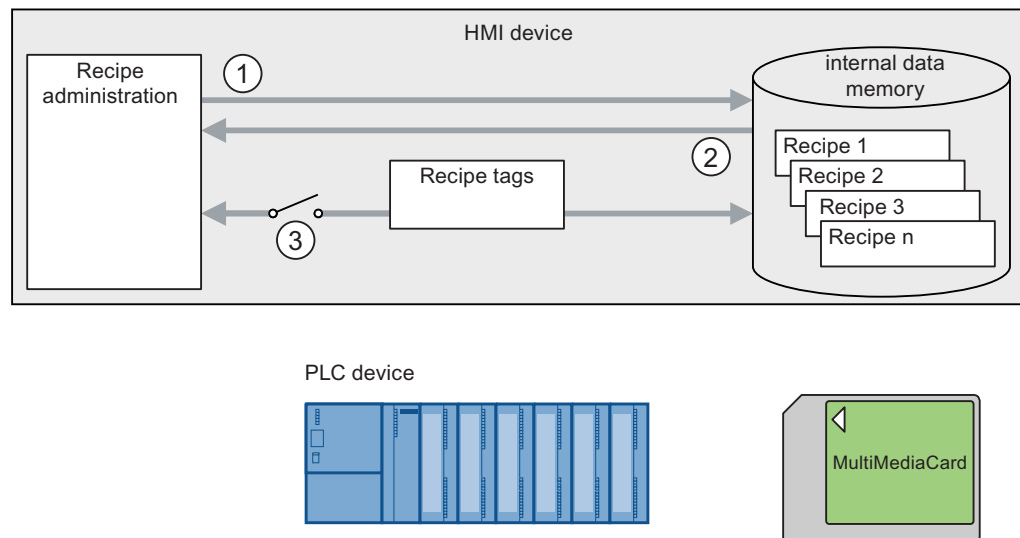

Figure 10-10 Schematic representation for entering a recipe record

- ① Delete, save or save recipe record as
- ② Load recipe record
- ③ Tags are not synchronized

10.6.2 Manual production sequence

Introduction

The production data are requested by the controller based on the workpiece to be processed and displayed on the HMI device for inspection. You want to correct the transferred production data online, if necessary.

Procedure

A scanner connected to the controller reads the barcode of a workpiece. The barcode names correspond to the names in the recipe record. Based on the barcode name, the controller can read the required recipe record from the data store of the HMI device. The recipe record is displayed for inspection on the HMI device. Changes made to the recipe record on the HMI device are immediately transferred to the controller.

The following figure shows the dataflow schematically.

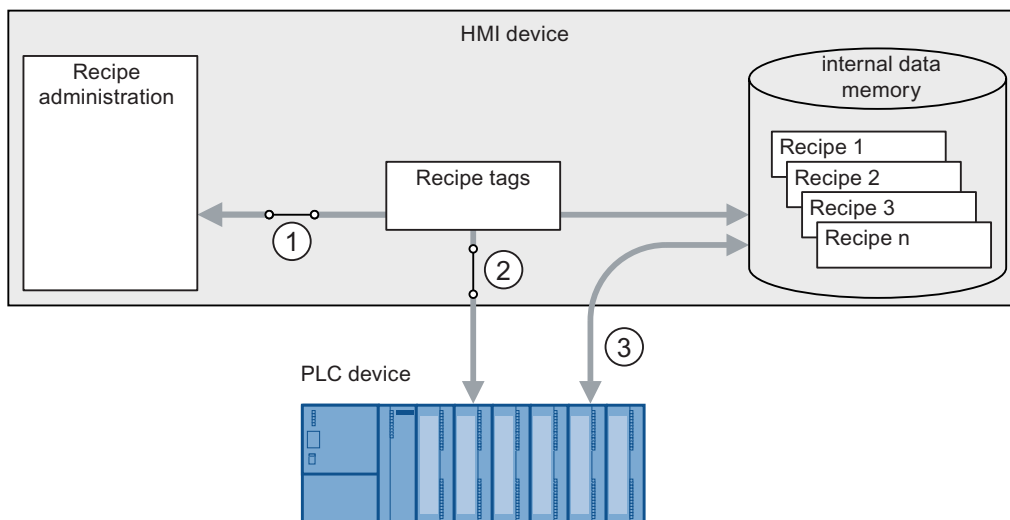

Figure 10-11 Schematic representation of a manual production sequence

- ① Tags are synchronized
- ② Tags are online for controller
- ③ Recipe record transfer – data communication between the data store of the HMI device and the controller

10.6.3 Automatic production sequence

Introduction

A production process is running automatically. The production data are transferred directly to the controller either from the data medium in the HMI device or from an external data medium. The values do not have to be displayed.

Procedure

Production can be controlled using one or more "Scripts", which transfer production records automatically to the controller. The sequence of scripts can be checked using the return values of the utilized functions.

The following figure shows the dataflow schematically.

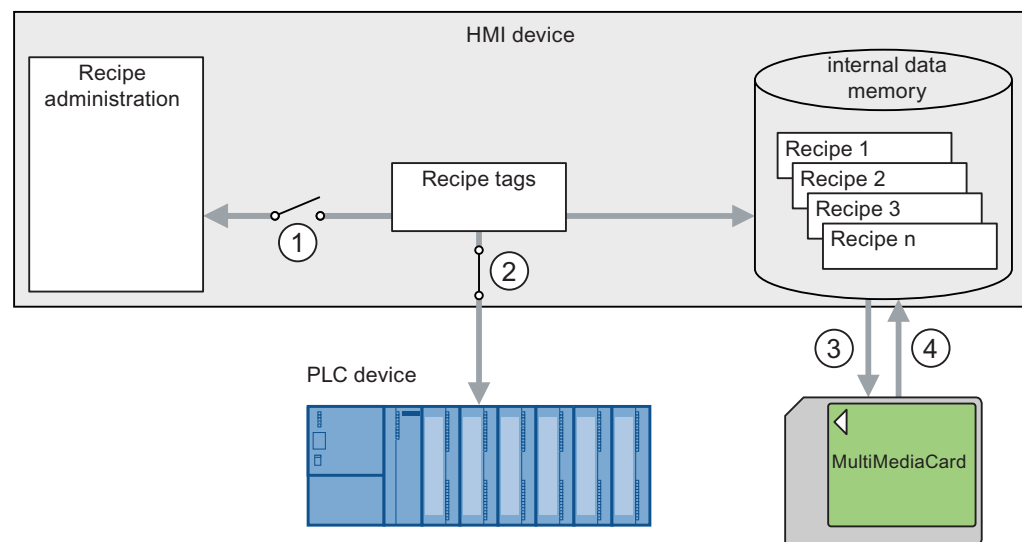

Figure 10-12 Schematic representation of an automatic production sequence

- ① Tags are not synchronized
- ② Tags are online for controller
- ③ Backup/restore – exporting recipe records
- ④ Backup/restore – importing recipe records

Maintenance and service

11.1 Maintenance and upkeep

Scope of maintenance

The HMI device is designed for low maintenance operation. The touch screen and keyboard membrane should nevertheless be cleaned regularly.

Preparation



Caution**Inadvertent operation**

Always switch off the HMI device before cleaning it. This will ensure that you do not trigger unintended functions when you touch the keys.

Requirements

Use a cleaning cloth dampened with a cleaning agent to clean the equipment. Only use water with a little liquid soap or a screen cleaning foam.

Caution

Do not clean the HMI device with compressed air or steam jet blowers. Never use aggressive solvents or scouring powder.

Procedure

Proceed as follows:

1. Switch off the HMI device
2. Spray a cleaning agent onto the cleaning cloth
Do not spray directly onto the HMI device.
3. Clean the HMI device
When cleaning the display wipe from the screen edge inwards.

11.2 Servicing and spare parts

Repairs

A defective device must be returned to the manufacturer's site for repair. The HMI device may only be repaired at the manufacturer's site.

Service pack

A service pack can be ordered for servicing purposes. It contains the following spare parts:

- Blind plugs for cable compartment
- 2 x screw joints for terminal box
- 1 set of screws for terminal box cover
- 2 x plug-in terminal strip (12-pin)
- 1 plug-in terminal strip (three-set block)
- Blind flap for terminal box

Set of spare keys

If necessary, you can order a set of spare keys.

The service pack and the set of spare keys can be ordered from your Siemens agent.

Specifications

12.1 Dimensional Drawings

12.1.1 Mobile Panel

Device dimensions

Dimensions of Mobile Panel 177

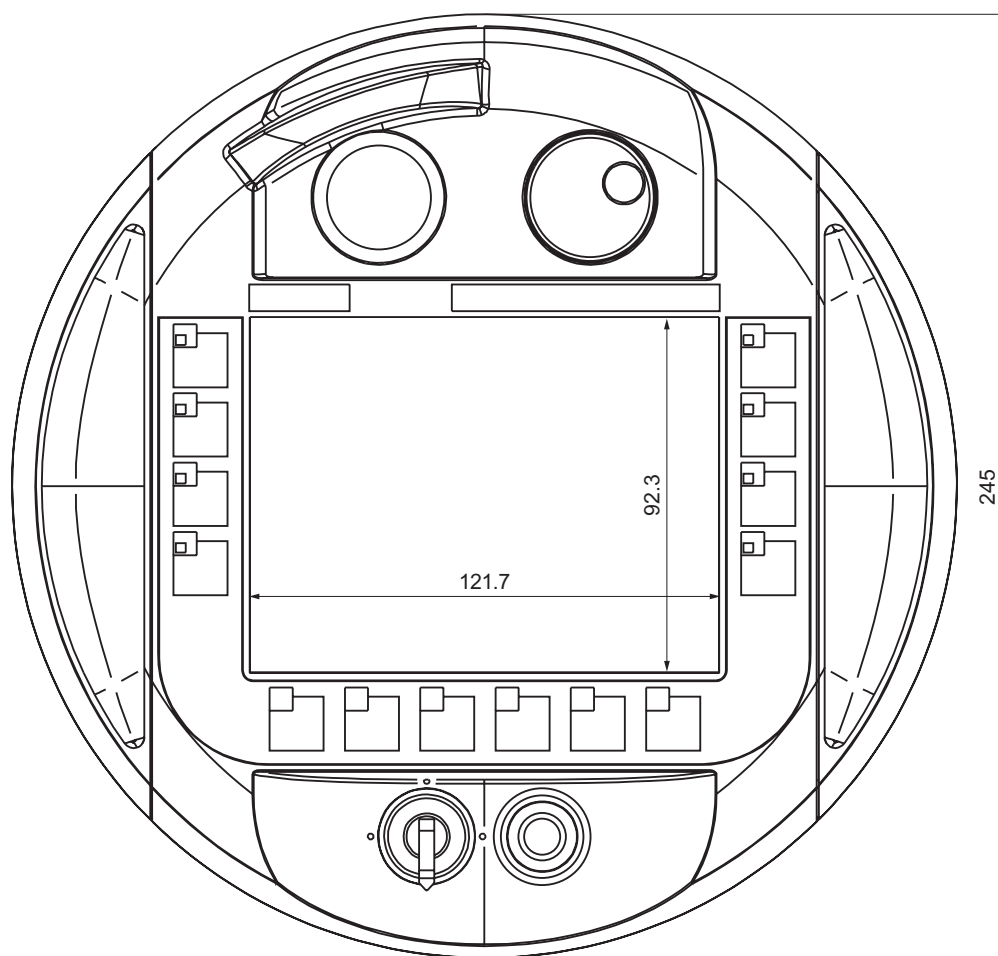

Overall dimensions of the Mobile Panel 177 HMI device in the front view

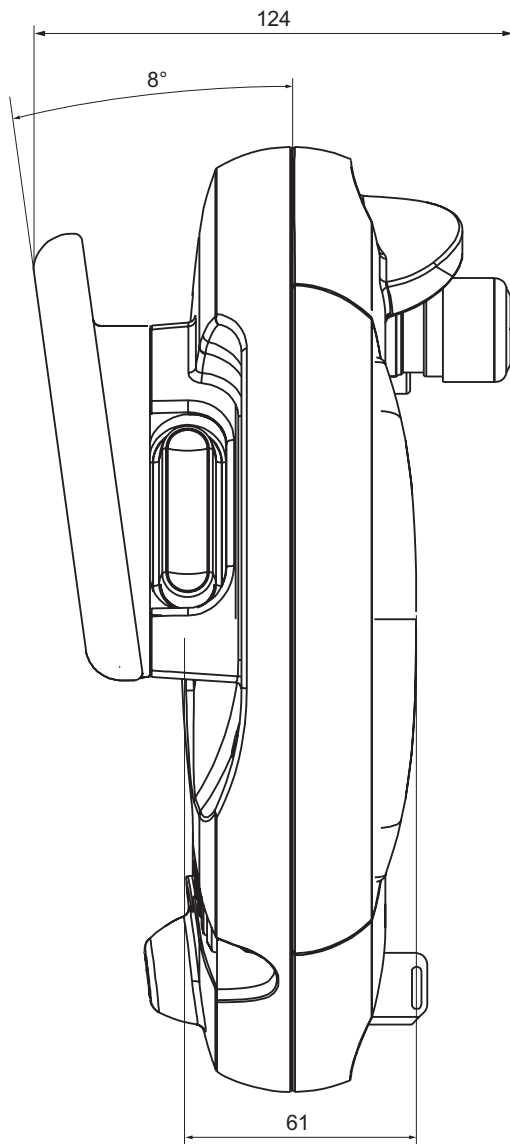

Overall dimensions of the Mobile Panel 177 HMI device in the side view

12.1.2 Wall holder

Device dimensions

Dimensions of wall mount

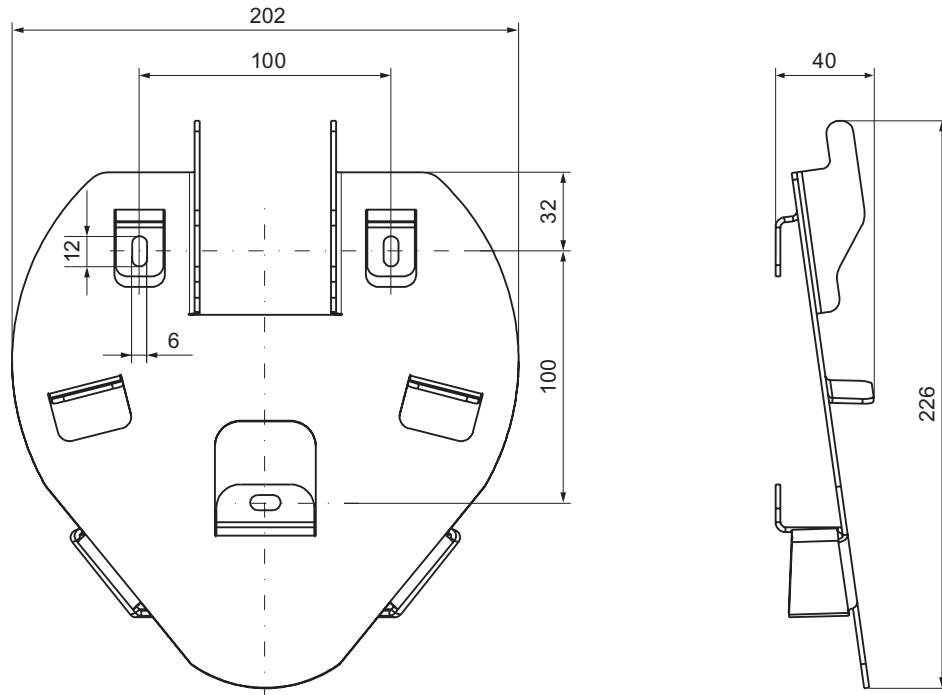

Figure 12-1 Dimensions of wall mount

12.1.3 Terminal Box DP

Device dimensions

Dimensions of terminal box

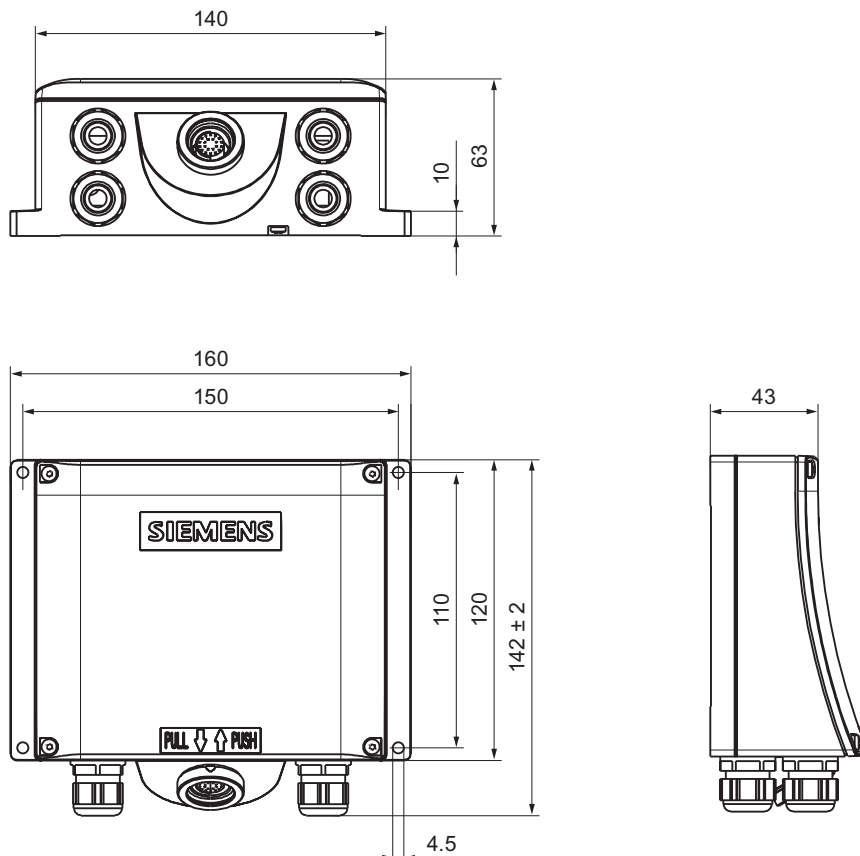

Figure 12-2 Dimensions of terminal box

12.1.4 Terminal Box PN

Device dimensions

Dimensions of the Terminal Box PN

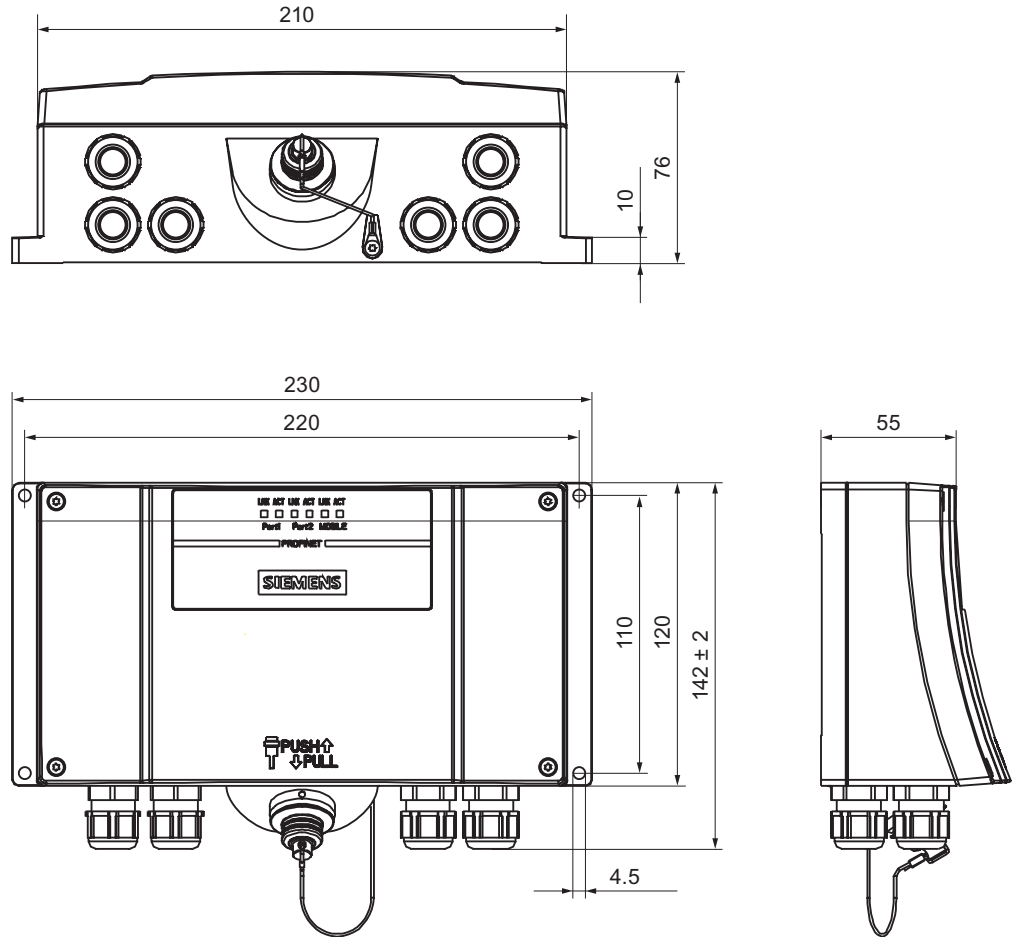

Figure 12-3 Dimensions of the Terminal Box PN

12.2 Technical specifications

12.2.1 Mobile Panel

HMI device

Weight without packaging	Approx. 1.3 kg
--------------------------	----------------

Display

Type	Color-STN LCD
Display area, active	115 mm x 86 mm (5.7")
Resolution	320 x 240 pixels
Colors, displayable	256 colors
Contrast control	Yes
Back-lighting	CCFL
Half Brightness Life Time, typical	50 000 h

Input unit

Type	Touch screen, analog, resistive Membrane keyboard
Softkeys	14 (F1 to F8 with LED)
Enable switch	2-circuit, 3-stage supply voltage: 24 V DC amperage, max.: 400 mA amperage, min.: 10 mA
STOP button (optional)	2-circuit supply voltage: 24 V DC amperage, max.: 500 mA amperage, min.: 10 mA These are normally closed contacts.
Handwheel (optional)	–
Key-operated switch (optional)	3 switch settings
Illuminated pushbutton (optional)	–

Memory

Application memory	2048 KB
--------------------	---------

Voltage supply

Voltage supply	Via terminal box
----------------	------------------

Additional specifications

Fall height	max. 1.5 m
-------------	------------

12.2.2 Terminal Box DP

Terminal Box DP

Weight without packaging	Approx. 500 g
--------------------------	---------------

Voltage supply

Nominal voltage	+24 V DC
Range, permissible	20.4 V to 28.8 V (–15%, +20%)
Transients, maximum permissible	35 V (500 msec)
Time between two transients, minimum	50 s
Current consumption Terminal Box DP without panel	
<ul style="list-style-type: none"> • Typical • Constant current, maximum • Power on current surge I²t 	<ul style="list-style-type: none"> • Approx. 100 mA • Approx. 150 mA • Approx. 0.5 A²s
Current consumption Terminal Box DP with panel	
<ul style="list-style-type: none"> • Typical • Constant current, maximum • Power on current surge I²t 	<ul style="list-style-type: none"> • Approx. 350 mA • Approx. 450 mA • Approx. 0.5 A²s
Fuse protection, internal	Electronic
Current load PLC-accompanying signals	Max. 100 mA

Note

Recovery time

Wait for approx. one second after you have removed the connecting cable from the terminal box before you plug the connecting cable back into the terminal box.

After power failures lasting less than one second the connecting cable has to be disconnected.

12.2.3 Terminal Box PN

Terminal Box PN

Weight without packaging	Approx. 700 g
--------------------------	---------------

Voltage supply

Nominal voltage	+24 V DC
Range, permissible	20.4 V to 28.8 V (-15%, +20%)
Transients, maximum permissible	35 V (500 msec)
Time between two transients, minimum	50 s
Current consumption Terminal Box PN without panel <ul style="list-style-type: none"> • Typical • Constant current, maximum • Power on current surge I²t 	<ul style="list-style-type: none"> • Approx. 100 mA • Approx. 150 mA • Approx. 0.5 A²s
Current consumption Terminal Box PN with panel <ul style="list-style-type: none"> • Typical • Constant current, maximum • Power on current surge I²t 	<ul style="list-style-type: none"> • Approx. 450 mA • Approx. 500 mA • Approx. 0.5 A²s
Fuse protection, internal	Electronic
Current load PLC-accompanying signals	Max. 100 mA

Note

Recovery time

Wait for approx. one second after you have removed the connecting cable from the terminal box before you plug the connecting cable back into the terminal box.

After power failures lasting less than one second the connecting cable has to be disconnected.

12.3 Interface allocation Mobile Panel 177 DP

12.3.1 RS 485 (IF 2)

Sub-d socket, 9-pin, with screw lock

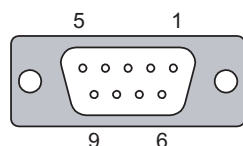

Figure 12-4 RS 485 interface pin assignment

PIN	Assignment
1	n. c.
2	GND 24 V
3	Data channel B (+)
4	n. c.
5	GND 5 V, floating potential
6	+5 V DC, floating potential
7	+24 V DC, out (max. 100 mA)
8	Data channel A (-)
9	n. c.

12.3.2 RJ45

RJ45 connector for the connecting cable

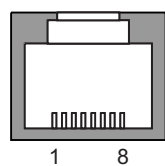

Figure 12-5 Pin assignment of the RJ45 connector

PIN	Assignment
1	RxD-B
2	RxD-A
3	CTS-B / ID-
4	RTS-B / IC-
5	RTS-A / IC+
6	CTS-A / ID+
7	TxD-B
8	TxD-A

12.3.3 Female header

Female header for the connecting cable

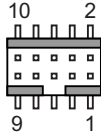

Figure 12-6 Pin assignment of 10-pin female header

PIN	Assignment	Circuit
1	+24 V DC	Power supply
2	GND 24 V	
3	Stop 23	Stop circuit
4	Stop 24	
5	Stop 13	
6	Stop 14	
7	Enable 1+	Enable circuit
8	Enable 1-	
9	Enable 2+	
10	Enable 2-	

12.4 Interface assignment Mobile Panel 177 PN

12.4.1 RS 485 (IF 2)

Sub-d socket, 9-pin, with screw lock

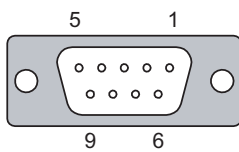

Figure 12-7 RS 485 interface pin assignment

PIN	Assignment
1	n. c.
2	GND 24 V
3	Data channel B (+)
4	n. c.
5	GND 5 V, floating potential
6	+5 V DC, floating potential
7	+24 V DC, out (max. 100 mA)
8	Data channel A (-)
9	n. c.

12.4.2 RJ45

RJ45 connector for the connecting cable

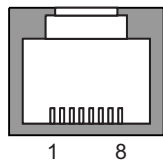

Figure 12-8 Pin assignment of the RJ45 connector

PIN	Assignment
1	TD+
2	TD-
3	RD+
4	n. c.
5	n. c.
6	RD-
7	ICD+
8	ICD-

12.4.3 Female header

Female header for the connecting cable

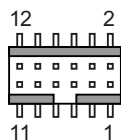

Figure 12-9 Pin assignment of 12-pin female header

PIN	Assignment	Circuit
1	+24 V DC	Power supply
2	GND 24 V	
3	Stop 23	Stop circuit
4	Stop 24	
5	Stop 13	
6	Stop 14	
7	Enable 1+	Enable circuit
8	Enable 1-	
9	Enable 2+	
10	Enable 2-	
11	ICD+	Box ID
12	ICD-	

12.5 Interface assignment Terminal Box DP

Position of the ports

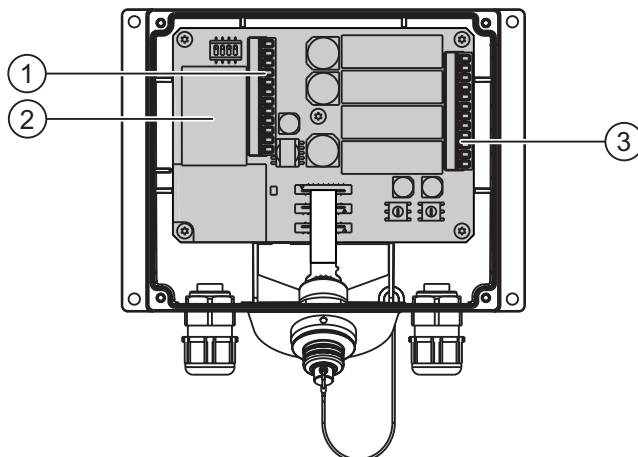

Figure 12-10 Position of the ports

- ① Terminal strip 1
- ② Fast connector
- ③ Terminal strip 2



Caution

When connecting the cables to the terminal strips ensure that the assignments for Terminal strips 1 and 2 are not reversed.

Terminal strip 1: IF1 and power supply

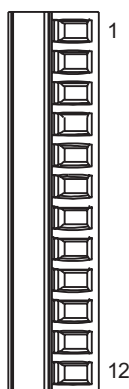

Figure 12-11 Assignment of 12-pin terminal strip 1

Pin	RS 232 IF 1A 9-pin pin	RS 232 IF 1A 15-pin socket	RS 422 IF 1B 9-pin socket	RS 485 IF 1B 9-pin socket	Power supply
1	CTS (8)	CTS (5)	n. c.	n. c.	n. c.
2	RTS (7)	RTS (10)	n. c.	n. c.	n. c.
3	TxD (3)	TxD (4)	n. c.	n. c.	n. c.
4	RxD (2)	RxD (3)	n. c.	n. c.	n. c.
5	M (5)	M (15)	M (5)	M (5)	n. c.
6	n. c.	n. c.	TxD+ (3)	Bus + (B) (3)	n. c.
7	n. c.	n. c.	TxD- (8)	Bus - (A) (8)	n. c.
8	n. c.	n. c.	RxD+ (4)	n. c.	n. c.
9	n. c.	n. c.	RxD- (9)	n. c.	n. c.
10	PI	PE	PE	PE	PE
11	n. c.	n. c.	n. c.	n. c.	M24
12	n. c.	n. c.	n. c.	n. c.	P24

The values in parentheses in the table correspond to the pin numbers of the standard cables described in the WinCC flexible online help for each coupling.

Fast connector

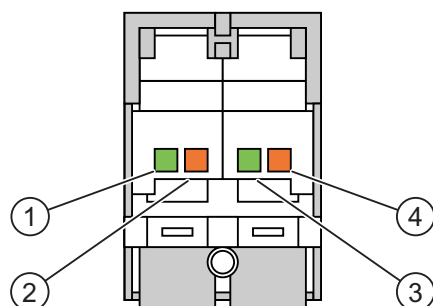

Figure 12-12 Assignment of 4-pin Fast Connector

Pin	Assignment
1	LTG-A (-) IN
2	LTG-B (+) IN
3	LTG-A (-) OUT
4	LTG-B (+) OUT

Terminal strip 2: Safety Functions and Supplemental Functions

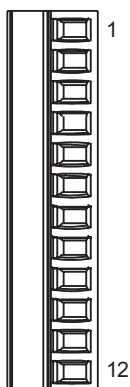

Figure 12-13 Assignment of 12-pin terminal strip 2

Pin	Internal interconnection	Name	Circuit
1		Stop 13	STOP button See Female header
2		Stop 14	
3		Stop 23	PLC-accompanying signals
4		Stop 24	
5		+24 V ¹⁾	
6		STOP button depressed 32 ¹⁾	
7		Mobile Panel plugged 31	
8		+24 V ¹⁾	
9		Enable 2+	Enable switch See Female header
10		Enable 1-	
11		Enable 1+	
12		Enable 2-	

1) Applies to Terminal Box Plus

The Terminal Box Basic does not have the "STOP button pressed" signal.

The "STOP button depressed" signal has no error detection and, therefore, must not be used for safety-critical applications!

"Mobile Panel plugged" signal

Mobile Panel on the Terminal Box	Signal at the digital input of the controller
Not plugged	"0"
Plugged	"1"

Note

The "Mobile Panel plugged" output of the Terminal Box Basic is connected to the power supply. In the case of the Terminal Box Plus, this output is fed to a relay using two pins.

Observe the following points when connecting the "Mobile Panel plugged" signal:

- Connect terminal strip 2, pin 7 of the terminal box to the digital input of the controller
- Terminal Box Basic Terminal strip 2, pin 8 of the terminal box remains free
- Terminal Box Plus: +24 V have to be supplied to terminal strip 2, pin 8

12.6 Interface assignment Terminal Box PN**Position of the ports**

Figure 12-14 Position of the ports

- ① Fast connector
- ② Terminal strip 1
- ③ Terminal strip 2

Fast connector

The terminal box contains two fast connectors for connecting to PROFINET.

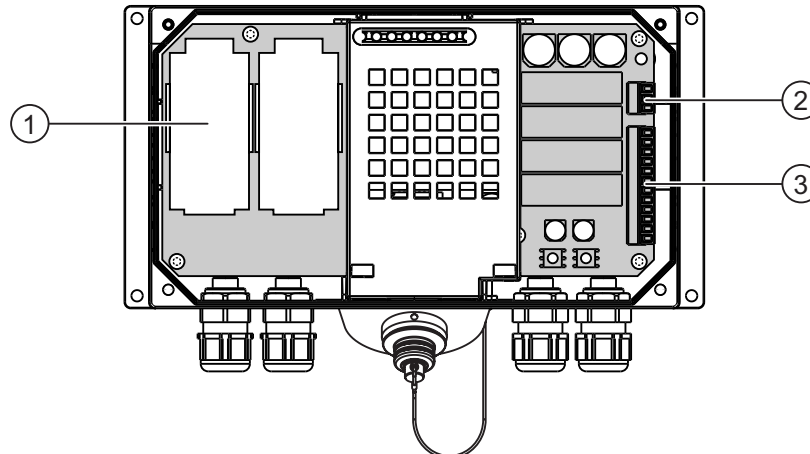
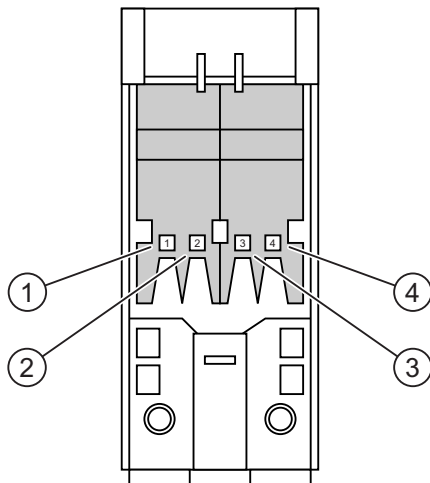

Figure 12-15 Assignment of 4-pin fast connector

Pin	Assignment
1	TD+
2	RD+
3	TD-
4	RD-

Terminal strip 1: Power supply



Figure 12-16 Assignment of 3-pin terminal strip 1

Pin	Power supply
1	PE
2	M24
3	P24

Terminal strip 2: Safety Functions and supplemental functions

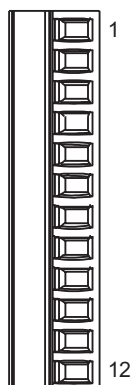

Figure 12-17 Assignment of 12-pin terminal strip 2

Pin	Internal interconnection	Name	Circuit
1	}	Stop 13	STOP button
2		Stop 14	See female header
3	}	Stop 23	
4		Stop 24	
5		+24 V ¹⁾	PLC-accompanying signals
6		STOP button depressed 32 ¹⁾	
7		Mobile Panel plugged 31	
8		+24 V ¹⁾	
9	}	Enable 2+	Enable switch
10		Enable 1-	See female header
11		Enable 1+	
12		Enable 2-	

1) Applies to Terminal Box Plus

The Terminal Box Basic does not have the "STOP button pressed" signal.

The "STOP button depressed" signal has no error detection and, therefore, must not be used for safety-critical applications!

"Mobile Panel plugged" signal

Mobile Panel on the Terminal Box	Signal at the digital input of the controller
Not plugged	"0"
Plugged	"1"

Note

The "Mobile Panel plugged" output of the Terminal Box Basic is connected to the power supply. In the case of the Terminal Box Plus, this output is fed to a relay using two pins.

Observe the following points when connecting the "Mobile Panel plugged" signal:

- Connect terminal strip 2, pin 7 of the terminal box to the digital input of the controller
- Terminal Box Basic Terminal strip 2, pin 8 of the terminal box remains free
- Terminal Box Plus: +24 V have to be supplied to terminal strip 2, pin 8

12.7 Connection examples for Enable switch and STOP button

Introduction

This section presents connection examples for the Enable switch and STOP button for safety category 3 in accordance with EN 954-1.

All KA and KB contacts must be positively driven.

Notice

To ensure safety category 3 in accordance with EN 954-1, be sure to follow the operating instructions for the monitoring device being used.

Connection example 1: Enabling switch with monitoring device ELAN SRB-NA-R-C.27/S1

The following figure shows the connection of a monitoring device ELAN SRB-NA-R-C.27/S1 to the enabling switch of the Mobile Panel.

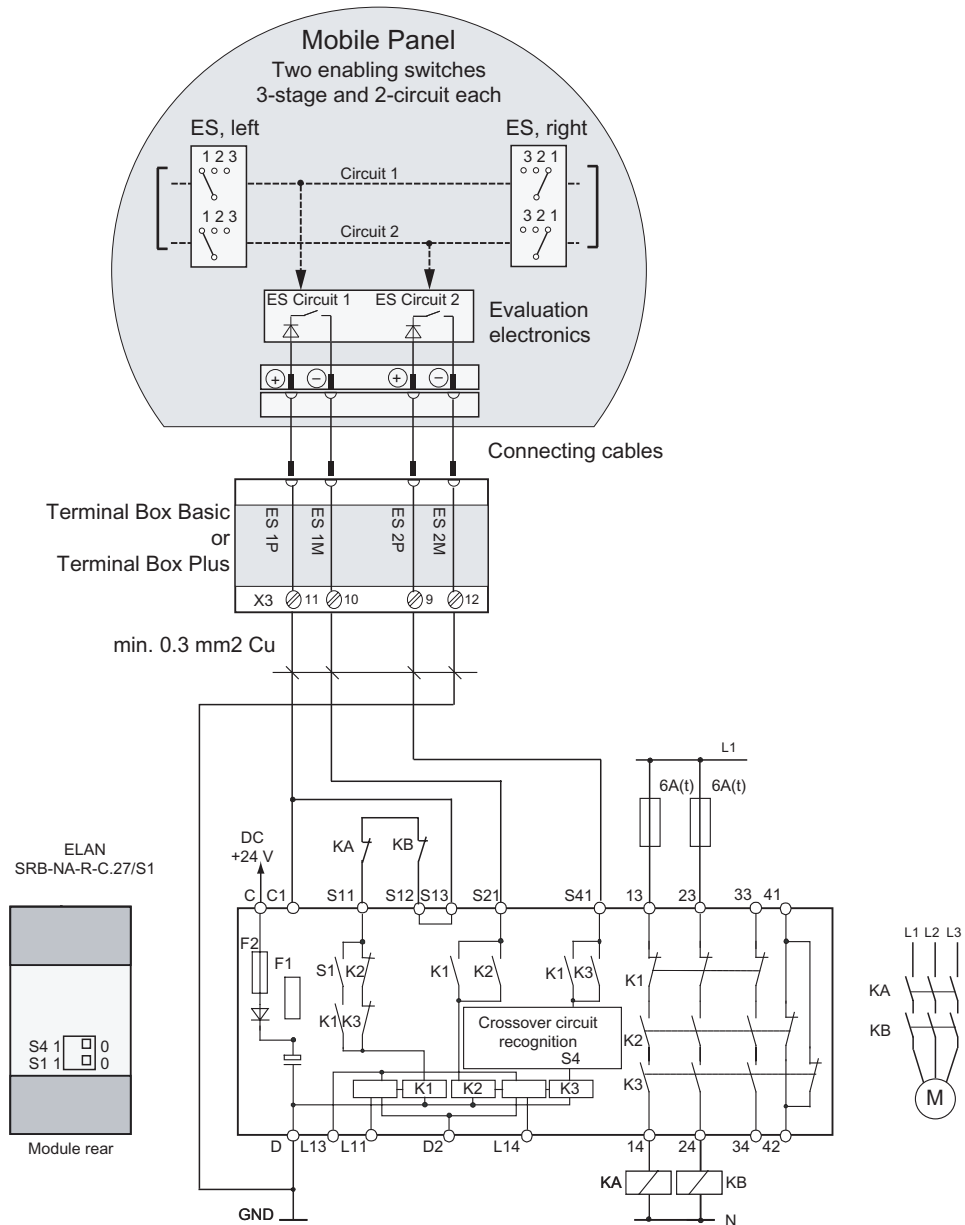

Figure 12-18 Wiring diagram: Enabling switch with monitoring device ELAN SRB-NA-R-C.27/S1
S1 and S4 switches on the rear of the module must be at Position 0.

Connection example 2: Enabling switch on monitoring device PILZ PST1

The following figure shows the connection of a monitoring device PILZ PST1 to the enabling switch of the Mobile Panel.

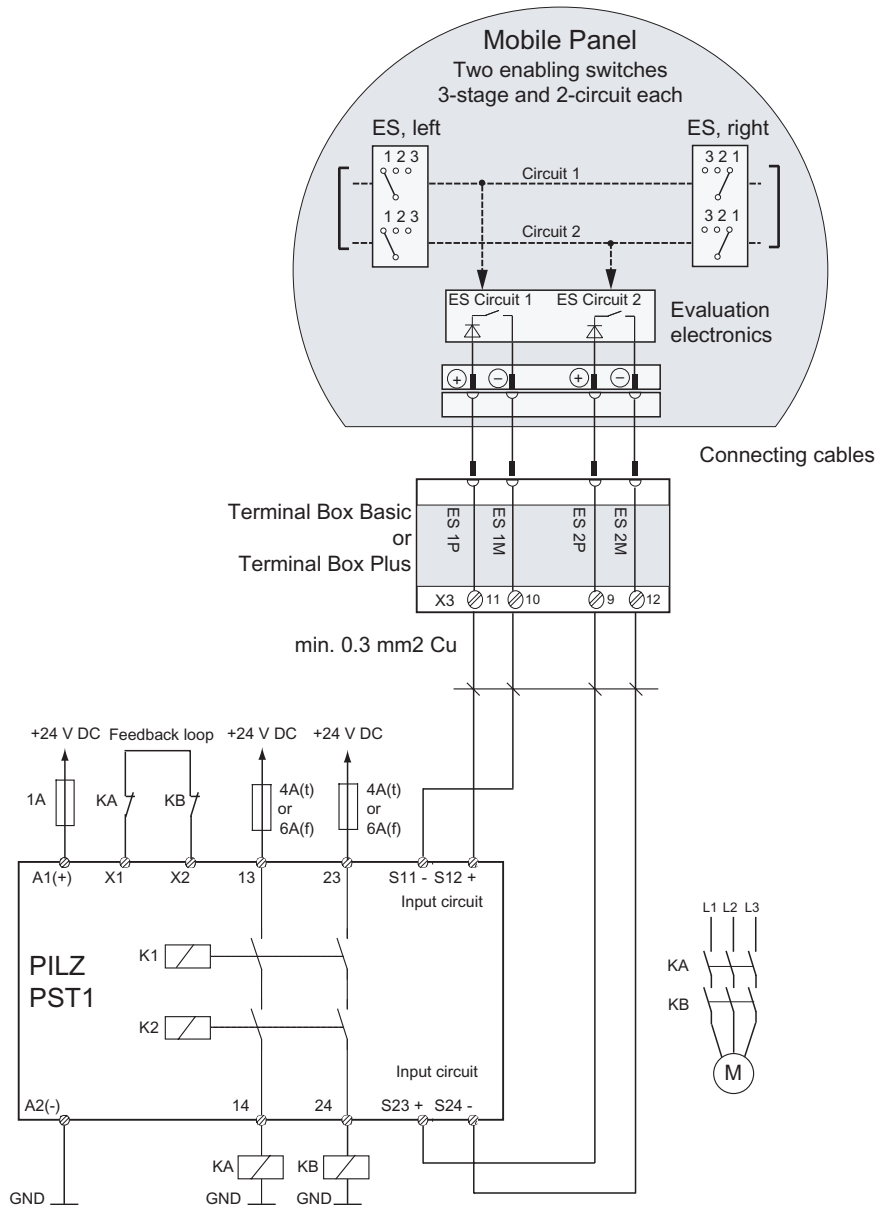

Figure 12-19 Wiring diagram: Enabling switch on monitoring device PILZ PST1

Connection example 3: STOP button with SIGUARD 3TK2840 monitoring device

The following figure shows the connection of a monitoring device SIGUARD 3TK2840 to the STOP button of the Mobile Panel.

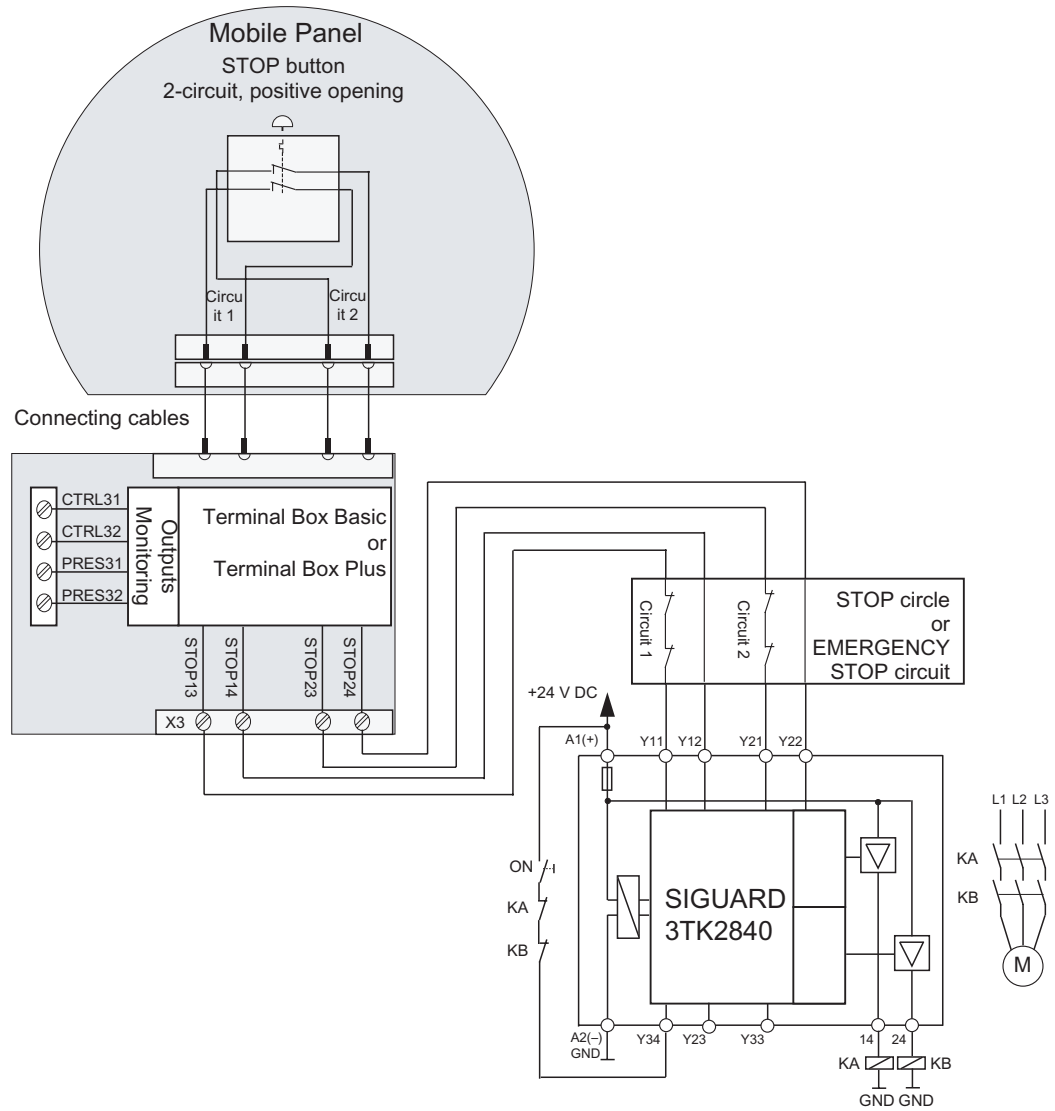

Figure 12-20 Wiring diagram: STOP button with SIGUARD 3TK2840 monitoring device
Monitoring outputs may not be used for safety-related functions.

Appendix

A.1 Connection point recognition

A.1.1 Function method

Introduction

You can divide a system into several zones or functional areas by using several terminal boxes. For this purpose it may be necessary for different system screens to be displayed, depending on the terminal box used.

This is achieved by means of connection point recognition.

Note

The following sections are intended for the configuring engineer of the HMI device.

Note

If the same screens and functions are used predominantly for all PLCs and the PLCs are of the same type, the configuration can be designed in such a way that only one PLC connection is configured.

The configuring engineer can enable you to switch between the various PLCs using a single operating object.

Connection point recognition

You can implement the connection point recognition as follows:

- Reading out of the box ID set in the terminal box by the HMI device
- Wiring the terminal box to a digital input of the PLC.

Note

Connection point recognition via box ID

The solution with box ID functions for different system configurations.

Note

The "Project ID" range pointer can be used to ensure that the HMI device is connected to the PLC that forms the basis of the project.

The "Project ID" range pointer can be assigned to only one PLC for each project (see "WinCC flexible Communication" user manual).

Note

A box ID cannot be set in a terminal box of the Mobile Panel 170. In this case connection point recognition is only possible via the digital input of the controller.

A.1.2 Connection point recognition via box ID

Box ID

You can read out the box ID of the terminal box to which the Mobile Panel 177 is connected in the project.

Note

If you connect the Mobile Panel 177 to a terminal box of the Mobile Panel 170, the value 255 is always supplied as the box ID.

Requirements

You have set the respective box ID in each of the terminal boxes. Each terminal box must have a unique box ID assigned to it.

Example for the evaluation of the current box ID

In order to ensure that the box ID is transferred correctly to the controller when the HMI device is plugged in, proceed as follows when carrying out configuration in WinCC flexible:

1. Specify the connection to the PLC in the "Connections" editor. Activate the "Coordination" area pointer to ensure that the live bit is available on the PLC side.
2. Create three tags in the "Tag" editor.
 - Internal tag: "Internal_Box-ID"
 - External tag: "Auxiliary Tag"
 - External tag: "External_Box-ID"
3. Open the "Device settings" editor.
4. Select the "Internal_Box-ID" tag in the "Settings for runtime" section at the "Access point". When you connect the HMI device to the terminal box, the box ID is written automatically into the "Internal_Box-ID" tag.

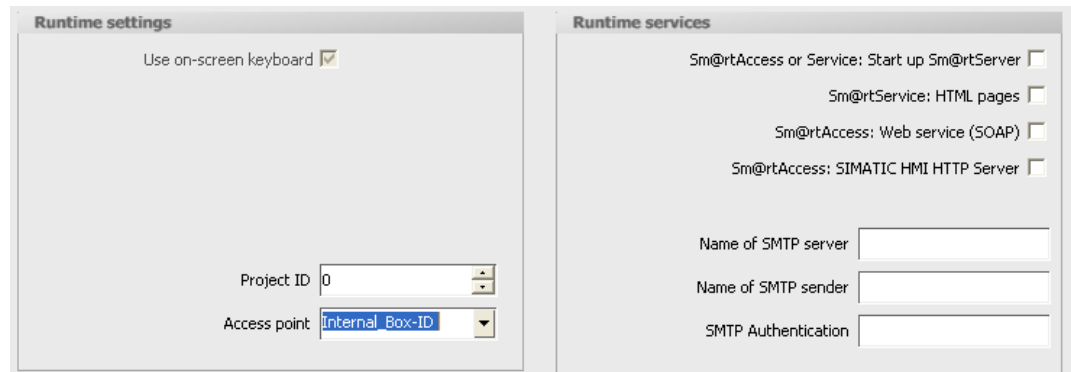

5. When communication is established between the HMI device and controller, the old value currently existing in the controller is then written automatically into the "External_Box-ID" tag. The "Auxiliary Tag" is required so that the current value of the box ID can be transferred to the PLC.
6. A program in the PLC evaluates the live bit. After the control program has determined that communication has been established, the control program changes the current value of the "Auxiliary_ Tag" tag once in order to induce a change in value.
7. The value change in the "Auxiliary_ Tag" executes the "SetValue" system function. The system function now re-assigns the value of the "Internal_Box-ID" tags to the "External_Box-ID" tags.
8. To configure this system function open the properties view of the "Auxiliary Tag". Click "Change value" in the properties view of the "Auxiliary_Tag" tag in the "Events" group. The "Function list" dialog box opens. Click the first line of the function list. The list opens, showing the system functions available in the project.
9. Select the system function "SetValue" from the "Calculation" group. Select the "External_Box-ID" tag at "Tag (output)". Select the "Internal_Box-ID" tag at "Value".

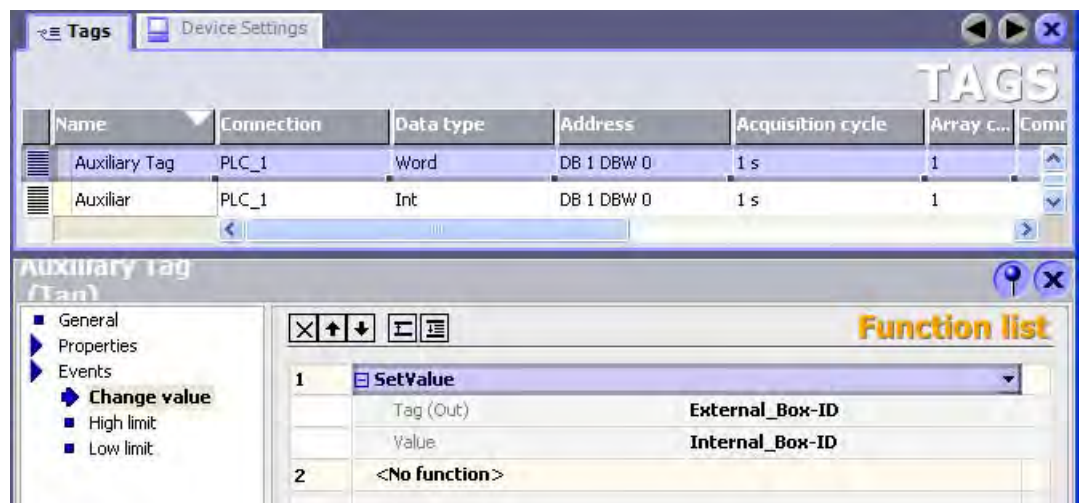

Result

The box ID of the terminal box to which the Mobile Panel 177 is connected is transferred to the controller.

See also

Setting the box ID at the terminal box (Page 4-8)

A.2 Evaluation of the operator control elements

A.2.1 Overview

Operator control elements

The following information can be transferred between the HMI device and the controller:

- Direction pulses of the handwheel
- Status of the softkeys
- Status of the key-operated switch
- Status of the illuminated pushbutton
- Status of the LEDs of softkeys and illuminated pushbuttons

There are two alternatives:

- Direct keys
- System functions of WnCC flexible

Note

The following sections are intended for the configuring engineer of the HMI device.

See also

Direct keys (Page 8-4)

A.2.2 Evaluating operator control elements as direct keys

Introduction

You can configure the operator control elements of the HMI device as direct keys.

Direction pulses of the handwheel and the switch state of the softkeys, key-operated switch, or illuminated pushbutton are then directly available in the I/O area of the PLC.

Byte assignment

The following figure shows the byte assignment in the I/O area for the operator control elements of the HMI device.

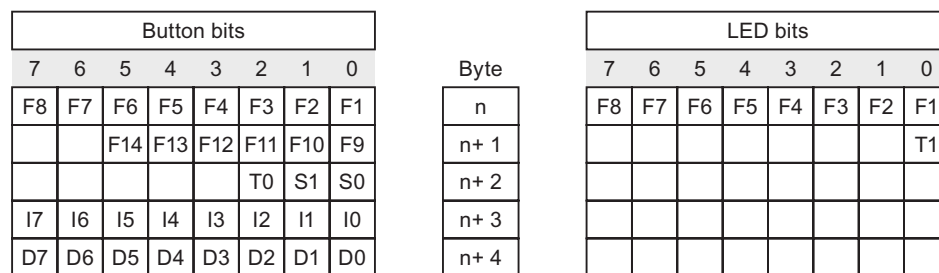

Figure A-1 Byte assignment of the keys and LEDs in the I/O area of the PLC

- F Bit for softkey
- S Bit for key-operated switch
- T Bit for illuminated pushbutton
- I Bit for handwheel pulses, forwards
- D Bit for handwheel pulses, backwards

Bit coding

The following tables show the bit coding for softkeys, key-operated switch, illuminated pushbutton and handwheel:

- Bit coding of fsoftkeys

Status	F1 to F14
Not pressed	0
Pressed	1

- Bit coding of LEDs of softkeys

Status	F1 to F8
LED not illuminated	0
LED is illuminated	1

- Bit coding of key-operated switch

Status	S1	S0	Key position
Position 0	0	0	In middle position
Position I	0	1	Turned clockwise to the end stop
Position II	1	0	Turned counterclockwise to the end stop

- Bit coding of illuminated pushbutton

Status	T0
Not pressed	0
Pressed	1

LED status	T1
Off	0
Continuously illuminated	1

- Bit coding of handwheel

- A setpoint is not specified for the handwheel.
- After startup of the HMI device, bytes n+3 to n+4 (see figure) are set to zero.

Rotation of the handwheel produces positive or negative pulses depending on the rotation direction. The number of positive pulses is stored in bits I0-I7, and the number of negative pulses is stored in Bits D0-D7.

Values are entered in binary format, whereby Bit 0 is the least significant bit and Bit 7 is the most significant bit.

A complete handwheel revolution yields 50 pulses.

- Each pulse of the handwheel is added to the appropriate byte (n+3 or n+4), depending on the direction of rotation. There are no negative values. If the possible value range is exceeded, an overflow occurs.

If a value of 255 is increased by one pulse, a value of 0 results.

Example of bit coding for handwheel

The following table contains an example showing how to determine the rotation direction using pulses stored in Bytes n+3 and n+4 that were measured between time t_1 and t_4 .

The numbers in the following table represent a byte in the PLC.

Evaluation time	Handwheel		Evaluation
	Pulses, forwards	Pulses, backwards	
t_1	255 ($\hat{=}$ -1)	245 ($\hat{=}$ -11)	--
t_2	10	245 ($\hat{=}$ -11)	Pulses, forwards: 11 Pulses, backwards: 0 Resulting value: +11
t_3	10	4	Pulses, forwards: 0 Pulses, backwards: 15 Resulting value: -15
t_4	15	5	Pulses, forwards: 5 Pulses, backwards: 1 Resulting value: +4

Based on the difference in pulses at times t_n and t_{n+1} , the resulting value and, thus, the rotation direction can be determined. From the table, take the number of pulses forwards and pulses backwards

- at the time t_n and
- at time t_{n+1} .

From this, you determine the resulting value. This is calculated as:

Resulting value =

pulses, forwards, t_{n+1} - pulses, backwards, t_n - (pulses, backwards, t_{n+1} - pulses, backwards, t_n)

Response time

Bytes n+3 and n+4 must be scanned on the PLC side within a second and cyclically. This ensures that no more than 256 pulses can be added between two scans of the handwheel. For 256 pulses, approximately 4.5 revolutions of the handwheel are required.

The rotary pulse encoder supplies a maximum of 200 pulses per second.

Notice

The input pulses should take effect immediately on the PLC and cause a response in the system. Therefore, set up a scan cycle \leq 100 ms in the PLC to achieve this.

See also

Direct keys (Page 8-4)

A.2.3 Evaluating operator control elements via WinCC flexible system functions

A.2.3.1 LED control of the softkeys

Application

LEDs are integrated in the softkeys F1 to F8 of the Mobile Panel 177. The integrated LEDs can be activated by the controller.

The LED can assume the following states:

- Off
- Slow flashing
- Rapid flashing
- On

This allows the LED to signalise to the operator that he should press the softkey in an active project.

Bit assignment

The following table shows the bit assignment for the LED tag of the softkey LEDs:

Bit n+1	Bit n	LED status
0	0	Off
0	1	Rapid flashing
1	0	Slow flashing
1	1	On (continuous)

A.2.3.2 Basic procedure

Introduction

You can use WinCC flexible system functions to evaluate the operator control elements of the HMI device or to control the LEDs of the softkeys and of the illuminated pushbutton.

Direction pulses of the handwheel and the switch state of the softkeys, key-operated switch, or illuminated pushbutton are then transferred via tags to the PLC.

Consistent data

If tags with process interface are assigned directly to the operator control elements, this may, for example, result in inconsistent values of the operator control elements between operator control element, HMI device and PLC.

1. The HMI device is connected directly to the terminal box.
2. The HMI device starts.
3. The values of the operator control elements are determined and entered in the tags in the HMI device.
4. Communication between the HMI device and PLC is established.
5. After communication has been established, the old values of the tags are transferred from the PLC into the tags of the HMI device.
6. Not until a change has been carried out to an operator control element, is the valid value written into the tag of the HMI device and transferred to the PLC.

Procedure

In order to ensure consistent values for the operator control elements, proceed as follows when configuring in WinCC flexible:

1. Specify the connection to the PLC in the "Connections" editor. Activate the "Coordination" area pointer to ensure that the live bit is available to the PLC side.
2. Create three tags in the "Tag" editor.
 - Internal tag: "Status_Control_Element"
 - External tag: "Auxiliary_Tag"
 - External tag: "Control_Element_PLC"

3. For illuminated pushbuttons, key-operated switches and handwheels (global assignment): Open the template in the "Screens" editor. Select the operator control element in the template. Click on the "General" group in the properties window. Select the "Status_Control_Element" tag at "Tag" in the "Settings" section. When you operate the operator control element, the value is written into the "Status_Control_Element" tag. For illuminated pushbuttons you can additionally configure the "LED_Tag" tag in order to control the integrated LED.

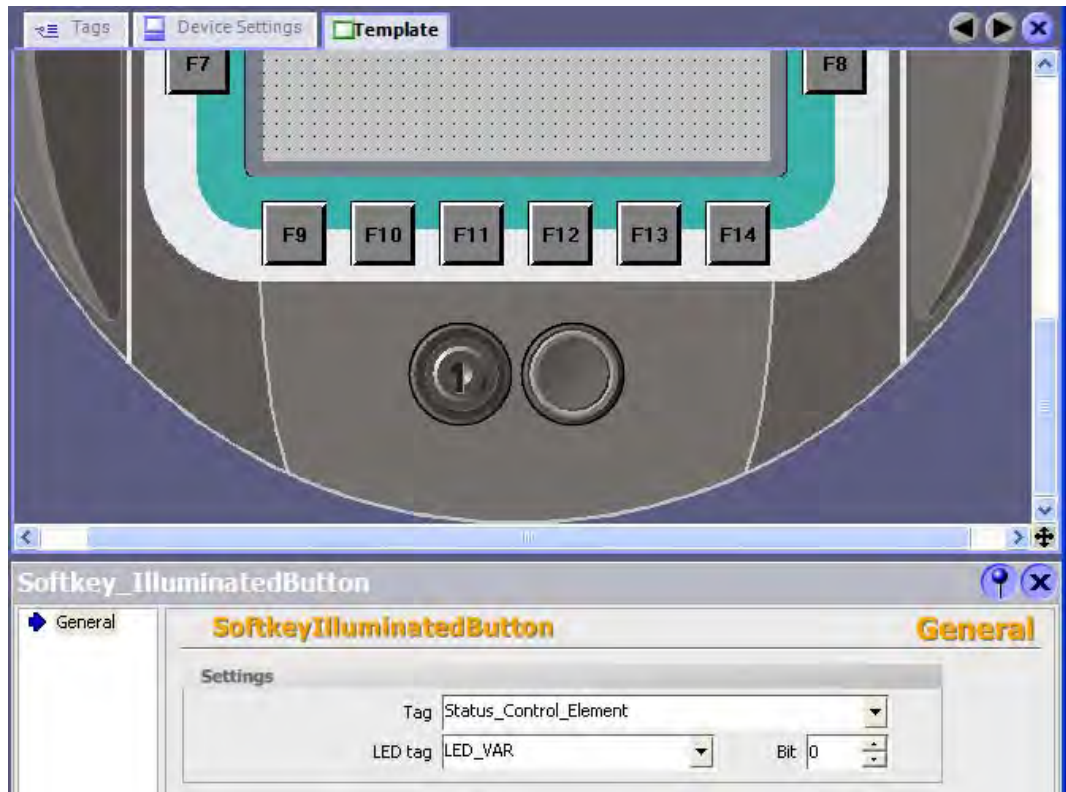
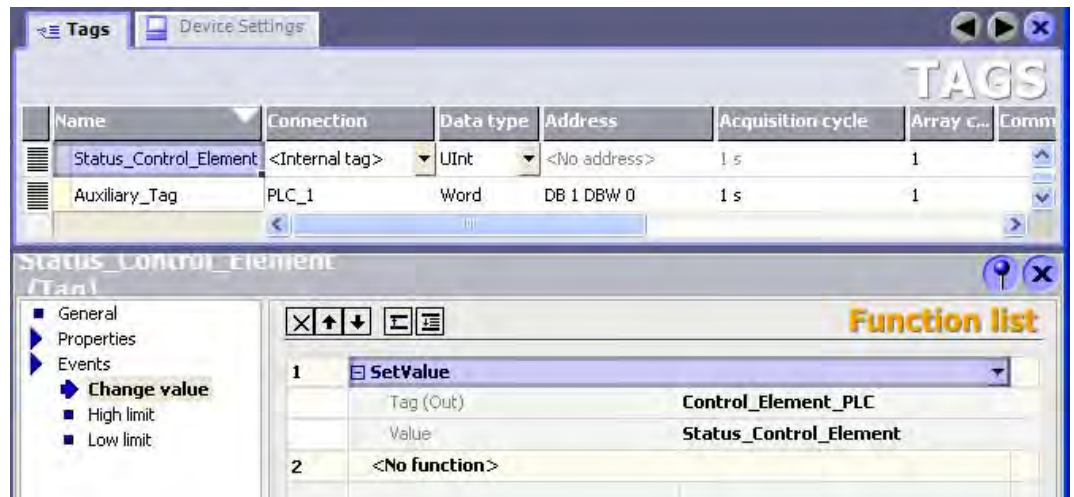

Figure A-2 Tag assignment using illuminated pushbuttons as an example

4. For a handwheel (local assignment): Open the screen in which you want to assign the handwheel locally in the "Screens" editor. Configure the function "ConnectTagWithHandwheel" on a command button or directly into the screen structure. Select the "Status_Control_Element" tag at "Value". When you operate the operator control element, the value is written into the "Status_Control_Element" tag.
5. The "Control_Element_PLC" tag writes the value of the "Status_Control_Element" tags into the PLC. The "SetValue" system function has to be configured at the "Status_Control_Element" tag in order for the value to be transferred.
6. Open the properties window of the "Status_Control_Element" tag. Click "Change value" in the properties view of the "Status_Control_Element" tag in the "Events" group. The "Function list" dialog box opens. Click the first line of the function list. The list appears, showing the available project functions.

7. Select the system function "SetValue" from the "Calculation" group. Select the "Control_Element_PLC" tag at "Tag (output)". Select the "Status_Control_Element" tag at "Value".



8. When communication is established, the possibly old value currently existing in the controller is then written automatically into the "Control_Element_PLC" tag. The "Auxiliary Tag" is required for transfer of the current status of the operator control element to the PLC.
9. A program in the PLC evaluates the live bit. After the control program has determined that communication has been established, the control program changes the current value of the "Auxiliary_Tag" tag once in order to induce a change in value. The value change in the "Auxiliary_Tag" triggers performance of the "SetValue" system function. The system function assigns the value of the "Status_Control_Element" tag again to the "Control_Element_PLC" tag. In order to configure the system function, open the properties window of the "Auxiliary Tag".
10. Click "Change value" in the properties window of the "Auxiliary_Tag" tag in the "Events" group. The "Function list" dialog box appears. Click the first line of the function list. The list opens, showing the available project functions.
11. Select the system function "SetValue" from the "Calculation" group. Select the "Control_Element_PLC" tag at "Tag (output)". Select the "Status_Control_Element" tag at "Value".

Result

The values for the operator control elements are consistent between operator control element, HMI device and PLC.

A.2.3.3 Illuminated pushbutton

Application

The illuminated pushbutton is an optional operator control element of the Mobile Panel 177. The integrated LED can be actuated from the PLC.

The LED can assume the following states:

- Off
- Slow flashing
- Rapid flashing
- On

This allows the LED to signalise to the operator that he should operate the illuminated pushbutton in the active project.

Bit assignment

The following table shows the bit assignment for the status tag of the illuminated pushbutton:

Bit 0	Status of the illuminated pushbutton
0	Pressed
1	Not pressed

The following table shows the bit assignment for the LED tag of the illuminated pushbutton:

Bit n+1	Bit n	LED status
0	0	Off
0	1	Rapid flashing
1	0	Slow flashing
1	1	On (continuous)

A.2.3.4 Key-operated switch

Application

The key-operated switch is an optional operator control element of the Mobile Panel 177. In an active project the key-operated switch is used to lock functions that are triggered by the Mobile Panel 177.

Bit assignment

The following table shows the bit assignment for the tag of the key-operated switch:

Bit 1	Bit 0	Key position
0	0	In central position
1	0	Turned clockwise to the end stop
0	1	Turned counterclockwise to the end stop

Note

If you use a tag of the "Boolean" type for the key-operated switch, the following assignment applies:

- Status "0": Central position of the key-operated switch
- Status "1": Key-operated switch turned clockwise or counterclockwise to the end stop

A.2.3.5 Handwheel

Application

The handwheel is an optional operator control element of the Mobile Panel 177. In an active project you can input incremental values with the handwheel.

Evaluation of the incremental values

If the signals of the handwheel are assigned to a WinCC flexible tag, the forwards and backwards increments are offset against each other and the absolute value of the increments is specified. The maximum or minimum value of the increments until an overflow depends on the type of tags assigned.

A complete handwheel revolution yields 50 pulses. The rotary pulse encoder supplies a maximum of 200 pulses per second.

Example

The handwheel has a starting value of 120 increments.

The wheel rotates 10 increments forwards and 3 increments backwards.

This results in a new value of 127 increments.

A.3 ESD Guidelines

What does ESD mean?

All electronic modules are equipped with highly integrated modules or components. Based on their design, these electronic components are highly sensitive to overvoltage and thus to discharge of static electricity. These electronic components are therefore specially identified as ESD.

Abbreviations

The following abbreviations are commonly used for electrostatic sensitive devices:

- ESD – **E**lectrostatic **S**ensitive **D**evelopments
- ESD – **E**lectrostatic **S**ensitive **D**evice as common international designation

Labels

ESD modules are labeled with the following symbol:



Figure A-3 ESD label

Electrostatic Charge

Caution

Electrostatic Charge

ESDs may be destroyed by voltages well below the perception threshold of persons. Voltages of this kind develop when a component or an assembly is touched by a person who is not grounded against static electricity. Usually, it is unlikely that damage to an ESD as a result of overvoltage is detected immediately but may become apparent only after a longer period of operation.

Prevent electrostatic charge of your body before you touch the ESD!

Anyone who is not connected to the electrical potential of their surroundings is subjected to electrostatic charge.

The figure indicates the maximum electrostatic charge anyone is subjected to when contacting the materials shown. These values correspond with specifications to IEC 801-2.

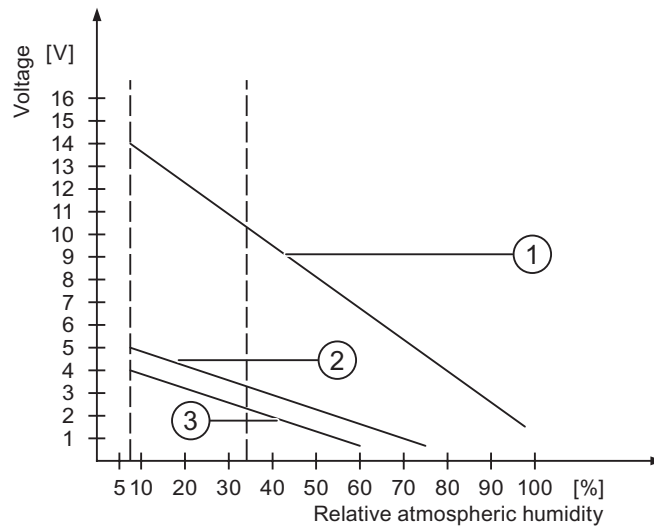

Figure A-4 Electrostatic voltages with which a person can be charged.

- ① Synthetic materials
- ② Wool
- ③ Antistatic materials such as wood or concrete

Protective Measures against Discharge of Static Electricity

Caution

Grounding Measures

When working with electrostatic sensitive devices, make sure that the person, the workplace and the packaging are properly grounded. This helps to avoid electrostatic charge.

As a rule, only touch the ESD if this is unavoidable. Example: for maintenance. When you touch modules, make sure that you do not touch the pins on the modules or the PCB tracks. This prevents any discharge of static electricity to sensitive component and thus avoids damage.

Discharge electrostatic electricity from your body if you are performing measurements on an ESD. To do so, touch a grounded metallic object.

Always use grounded measuring instruments.

A.4 System alarms

Introduction

System alarms on the HMI device provide information about internal states of the HMI device and PLC.

The overview below shows the causes of system alarms and how to eliminate the cause of error.

Depending on scope of functions, only parts of the system alarms described in this section apply to the various HMI devices.

Note

System alarms are only indicated if an alarm window was configured. System alarms are output in the language currently set on your HMI device.

System Alarm Parameters

System alarms may contain encrypted parameters which are relevant to troubleshooting because they provide a reference to the source code of the Runtime software. These parameters are output after the text "Error code:"

Meaning of the System Alarms

Number	Effect/cause	Remedy
10000	The print job could not be started or was canceled due to an unknown error. Faulty printer setup. Or: No permission is available for accessing the network printer. Power supply failure during data transfer.	Check the printer settings, cable connections and the power supply. Set up the printer once again. Obtain a network printer authorization. If the error persists, contact the Hotline!
10001	No printer is installed or a default printer has not been set up.	Install a printer and/or select it as the default printer.
10002	Overflow of the graphics buffer for printing. Up to two images are buffered.	Allow sufficient intervals between successive print jobs.
10003	Images can now be buffered again.	—
10004	Overflow of the buffer for printing lines in text mode (e.g.alarms). Up to 1000 lines are buffered.	Allow sufficient intervals between successive print jobs.
10005	Text lines can now be buffered again.	—
10006	The Windows printing system reports an error. Refer to the output text and the error ID to determine the possible causes. Nothing is printed or the print is faulty.	Repeat the action if necessary.
20010	An error has occurred in the specified script line. Execution of the script was therefore aborted. Note the system alarm that may have occurred prior to this.	Select the specified script line in the configuration. Ensure that the tags used are of the allowed types. Check system functions for the correct number and types of parameters.
20011	An error has occurred in a script that was called by the specified script. Execution of the script was therefore aborted in the called script. Take the system alarm that may have occurred prior to this into account.	In the configuration, select the script that has been called directly or indirectly by the specified script. Ensure that the tags used are of the allowed types. Check the system functions for the correct number and type of parameters.
20012	The configuration data is inconsistent. The script could therefore not be generated.	Recompile the configuration.
20013	The scripting component of WinCC flexible Runtime is not correctly installed. Therefore, no scripts can be executed.	Reinstall WinCC flexible Runtime.
20014	The system function returns a value that is not written in any return tag.	Select the specified script in the configuration. Check if the script name has been assigned a value.
20015	Too many successive scripts have been triggered in short intervals. When more than 20 scripts are queued for processing, any subsequent scripts are rejected. In this case, the script indicated in the alarm is not executed.	Find what is triggering the scripts. Extend the times, e.g. the polling time of the tags which trigger the scripts.
30010	The tag could not accept the function result, e.g. when it has exceeded the value range.	Check the tag type of the system function parameter.
30011	A system function could not be executed because the function was assigned an invalid value or type in the parameter.	Check the parameter value and tag type of the invalid parameter. If a tag is used as a parameter, check its value.
40010	The system function could not be executed since the parameters could not be converted to a common tag type.	Check the parameter types in the configuration.

Number	Effect/cause	Remedy
40011	The system function could not be executed since the parameters could not be converted to a common tag type.	Check the parameter types in the configuration.
50000	The HMI device is receiving data faster than it is capable of processing. Therefore, no further data is accepted until all current data have been processed. Data exchange then resumes.	—
50001	Data exchange has been resumed.	—
60000	This alarm is generated by the "DisplaySystemAlarms" function. The text to be displayed is transferred to the function as a parameter.	—
60010	The file could not be copied in the direction defined because one of the two files is currently open or the source/target path is not available. It is possible that the Windows user has no access rights to one of the two files.	Restart the system function or check the paths of the source/target files. Using Windows NT/2000/XP: The user executing WinCC flexible Runtime must be granted access rights for the files.
60011	An attempt was made to copy a file to itself. It is possible that the Windows user has no access rights to one of the two files.	Check the path of the source/target file. Using Windows NT/2000/XP with NTFS: The user executing WinCC flexible Runtime must be granted access rights for the files.
70010	The application could not be started because it could not be found in the path specified or there is insufficient memory space.	Check if the application exists in the specified path or close other applications.
70011	The system time could not be modified. The error alarm only appears in connection with area pointer "Date/time PC". Possible causes: <ul style="list-style-type: none"> An invalid time was transferred in the job mailbox. The Windows user has no right to modify the system time. If the first parameter in the system alarm is displayed with the value 13, the second parameter indicates the byte containing the incorrect value.	Check the time which is to be set. Using Windows NT/2000/XP: The user executing WinCC flexible Runtime must be granted the right to change the system time of the operating system.
70012	An error occurred when executing the function "StopRuntime" with the option "Runtime and operating system". Windows and WinCC flexible Runtime are not closed. One possible cause is that other programs cannot be closed.	Close all programs currently running. Then close Windows.
70013	The system time could not be modified because an invalid value was entered. Incorrect separators may have been used.	Check the time which is to be set.
70014	The system time could not be modified. Possible causes: <ul style="list-style-type: none"> An invalid time was transferred. The Windows user has no right to modify the system time. Windows rejects the setting request. 	Check the time which is to be set. Using Windows NT/2000/XP: The user executing WinCC flexible Runtime must be granted the right to change the system time of the operating system.

Number	Effect/cause	Remedy
70015	The system time could not be read because Windows rejects the reading function.	—
70016	An attempt was made to select a screen by means of a system function or job. This is not possible because the screen number specified does not exist. Or: A screen could not be generated due to insufficient system memory.	Check the screen number in the function or job with the screen numbers configured. Assign the number to a screen if necessary.
70017	Date/Time is not read from the area pointer because the address set in the controller is either not available or has not been set up.	Change the address or set up the address in the controller.
70018	Acknowledgment that the password list has been successfully imported.	—
70019	Acknowledgment that the password list has been successfully exported.	—
70020	Acknowledgment for activation of alarm reporting.	—
70021	Acknowledgment for deactivation of alarm reporting.	—
70022	Acknowledgment to starting the Import Password List action.	—
70023	Acknowledgment to starting the Export Password List action.	—
70024	The value range of the tag has been exceeded in the system function. The calculation of the system function is not performed.	Check the desired calculation and correct it if necessary.
70025	The value range of the tag has been exceeded in the system function. The calculation of the system function is not performed.	Check the desired calculation and correct it if necessary.
70026	No other screens are stored in the internal screen memory. No other screens can be selected.	—
70027	The backup of the RAM file system has been started.	—
70028	The files from the RAM have been copied in the Flash memory. The files from the RAM have been copied in the Flash memory. Following a restart, these saved files are copied back to the RAM file system.	—
70029	Backup of the RAM file system has failed. No backup copy of the RAM file system has been made.	Check the settings in the "Control Panel > OP" dialog and save the RAM file system using the "Save Files" button in the "Persistent Storage" tab.
70030	The parameters configured for the system function are faulty. The connection to the new controller was not established.	Compare the parameters configured for the system function with the parameters configured for the controllers and correct them as necessary.
70031	The controller configured in the system function is not an S7 controller. The connection to the new controller was not established.	Compare the S7 controller name parameter configured for the system function with the parameters configured for the controller and correct them as necessary.

Number	Effect/cause	Remedy
70032	The object configured with this number in the tab order is not available in the selected screen. The screen changes but the focus is set to the first object.	Check the number of the tab order and correct it if necessary.
70033	An e-mail cannot be sent because a TCP/IP connection to the SMTP server no longer exists. This system alarm is generated only at the first attempt. All subsequent unsuccessful attempts to send an e-mail will no longer generate a system alarm. The event is regenerated when an e-mail has been successfully sent in the meantime. The central e-mail component in WinCC flexible Runtime attempts, in regular intervals (1 minute), to establish the connection to the SMTP server and to send the remaining e-mails.	Check the network connection to the SMTP server and re-establish it if necessary.
70034	Following a disruption, the TCP/IP connection to the SMTP server could be re-established. The queued e-mails are then sent.	—
70036	No SMTP server for sending e-mails is configured. An attempt to connect to an SMTP server has failed and it is not possible to send e-mails. WinCC flexible Runtime generates the system alarm after the first attempt to send an e-mail.	Configure an SMTP server: In WinCC flexible Engineering System using "Device settings > Device settings" In the Windows CE operating system using "Control Panel > Internet Settings > E-mail > SMTP Server"
70037	An e-mail cannot be sent for unknown reasons. The contents of the e-mail are lost.	Check the e-mail parameters (recipient etc.).
70038	The SMTP server has rejected sending or forwarding an e-mail because the domain of the recipient is unknown to the server or because the SMTP server requires authentication. The contents of the e-mail are lost.	Check the domain of the recipient address or deactivate the authentication on the SMTP server if possible. SMTP authentication is currently not used in WinCC flexible Runtime.
70039	The syntax of the e-mail address is incorrect or contains illegal characters. The contents of the e-mail are discarded.	Check the e-mail address of the recipient.
70040	The syntax of the e-mail address is incorrect or contains illegal characters.	—
70041	The import of the user management was aborted due to an error. Nothing was imported.	Check your user management or transfer it again to the panel.
80001	The log specified is filled to the size defined (in percent) and must be stored elsewhere.	Store the file or table by executing a 'move' or 'copy' function.
80002	A line is missing in the specified log.	—
80003	The copying process for logging was not successful. In this case, it is advisable to check any subsequent system alarms, too.	—
80006	Since logging is not possible, this causes a permanent loss of the functionality.	In the case of databases, check if the corresponding data source exists and start up the system again.
80009	A copying action has been completed successfully.	—

Number	Effect/cause	Remedy
80010	Since the storage location was incorrectly entered in WinCC flexible, this causes a permanent loss of the functionality.	Configure the storage location for the respective log again and restart the system when the full functionality is required.
80012	Log entries are stored in a buffer. If the values are read to the buffer faster than they can be physically written (using a hard disk, for example), overloading may occur and recording is then stopped.	Archive fewer values. Or: Increase the logging cycle.
80013	The overload status no longer applies. Archiving resumes the recording of all values.	—
80014	The same action was triggered twice in quick succession. Since the process is already in operation, the action is only carried out once.	—
80015	This system alarm is used to report DOS or database errors to the user.	—
80016	The logs are separated by the system function "CloseAllLogs" and the incoming entries exceed the defined buffer size. All entries in the buffer are deleted.	Reconnect the logs.
80017	The number of incoming events cause a buffer overflow. This can be caused, for example, by several copying actions being activated at the same time. All copy jobs are deleted.	Stop the copy action.
80019	The connection between WinCC flexible and all logs were closed, for example, after executing the system function "CloseAllLogs". Entries are written to the buffer and are then written to the logs when a connection is re-established. There is no connection to the storage location and the storage medium may be replaced, for example.	—
80020	The maximum number of simultaneously copy operations has been exceeded. Copying is not executed.	Wait until the current copying actions have been completed, then restart the last copy action.
80021	An attempt was made to delete a log which is still busy with a copy action. Deletion has not been executed.	Wait until the current copying actions have been completed, then restart the last action
80022	An attempt was made to start a sequence log, which is not a sequence log, from a log using the system function "StartSequenceLog". No sequence log file is created.	In the project, check <ul style="list-style-type: none"> • if the "StartSequenceLog" system function was properly configured • if the tag parameters are properly provided with data on the HMI device
80023	An attempt was made to copy a log to itself. The log is not copied.	In the project, check <ul style="list-style-type: none"> • if the "CopyLog" system function was properly configured • if the tag parameters are properly provided with data on the HMI device
80024	The "CopyLog" system function does not allow copying when the target log already contains data ("Mode" parameter). The log is not copied.	Edit the "CopyLog" system function in the project if necessary. Before you initiate the system function, delete the destination log file.

Number	Effect/cause	Remedy
80025	You have canceled the copy operation. Data written up to this point are retained. The destination log file (if configured) is not deleted. The cancellation is reported by an error entry \$RT_ERR\$ at the end of the destination log.	—
80026	This alarm is output after all logs are initialized. Values are written to the logs from then on. Prior to this, no entries are written to the logs, irrespective whether WinCC flexible Runtime is active or not.	—
80027	The internal Flash memory has been specified as the storage location for a log. This is not permissible. No values are written to this log and the log file is not created.	Configure "Storage Card" or a network path as the storage location.
80028	The alarm returns a status report indicating that the logs are currently being initialized. No values are logged until the alarm 80026 is output.	—
80029	The number of logs specified in the alarm could not be initialized. The logs are initialized. The faulty log files are not available for logging jobs.	Evaluate the additional system alarms , related to this alarm which is also generated. Check the configuration, the ODBC (Open Database Connectivity) and the specified drive.
80030	The structure of the existing log file does not match the expected structure. Logging is stopped for this log.	Delete the existing log data manually, in advance.
80031	The log in CSV format is corrupted. The log cannot be used.	Delete the faulty file.
80032	Logs can be assigned events. These are triggered as soon as the log is full. If WinCC flexible Runtime is started and the log is already full, the event is not triggered. The log specified no longer logs data because it is full.	Close WinCC flexible Runtime, delete the log, then restart WinCC flexible Runtime. Or: Configure a button which contains the same actions as the event and press it.
80033	"System Defined" is set in the data log file as the data source name. This causes an error. No data is written to the database logs, whereas the logging to the CSV logs works.	Install MSDE again.
80034	An error has occurred in the initialization of the logs. An attempt has been made to create the tables as a backup. This action was successful. A backup has been made of the tables of the corrupted log file and the cleared log was restarted.	No action is necessary. However, it is recommended to save the backup files or delete them in order to make the space available again.
80035	An error has occurred in the initialization of the logs. An attempt has been made to create backups of the tables and this has failed. No logging or backup has been performed.	It is recommended to save the backups or to delete them in order to release memory.
80044	The export of a log was interrupted because Runtime was closed or due to a power failure. It was detected that the export needed to be resume when Runtime restarted.	The export resumes automatically.

Number	Effect/cause	Remedy
80045	The export of a log was interrupted due to an error in the connection to the server or at the server itself.	The export is repeated automatically. Check: <ul style="list-style-type: none"> • the connection to the server • if the server is running • if there is enough free space on the server.
80046	The destination file could not be written while exporting the log.	Check if there is enough space on the server and if you have permission to create the log file.
80047	The log could not be read while exporting it.	Check if the storage medium is correctly inserted.
80048	—	—
80049	The log could not be renamed while preparing to export it. The job can not be completed."	Check if the storage medium is correctly inserted and if there is sufficient space on the medium.
80050	The log which shall be exported is not closed. The job can not be completed.	Make sure the "CloseAll Logs" system function is called before using the "ExportLog" system function. Change the configuration as required.
90024	No operator actions can be logged due to lack of space on the storage medium for log. The operator action will therefore not be executed.	Make more space available by inserting an empty storage medium or swapping out the log files on the server using "ExportLog".
90025	Because of error state of the archive no user actions can be logged. Therefore the user action will not be executed.	Check if the storage medium is correctly inserted.
90026	No operator actions can be logged because the log is closed. The operator action will therefore not be executed.	Before further operator actions are carried out, the log must be opened again using the system function "OpenAllLogs". Change the configuration as required.
90029	Runtime was closed during ongoing operation (perhaps due to a power failure) or an a storage medium in use is incompatible with Audit Trail. An Audit Trail is not suitable if it belongs to another project or has already be archived.	Ensure that you are using the correct storage medium.
90030	Runtime was closed during ongoing operation (perhaps due to a power failure).	—
90031	Runtime was closed during ongoing operation (perhaps due to a power failure).	—
90032	Running out of space on the storage medium for log.	Make more space available by inserting an empty storage medium or swapping out the log files on the server using "ExportLog".
90033	No more space on the storage medium for log. As of now, no more operator actions requiring logging will be executed.	Make more space available by inserting an empty storage medium or swapping out the log files on the server using "ExportLog".
90040	Audit Trail is switched off because of a forced user action.	Activate the "Audit Trail" again using the system function "StartLog".
90041	A user action which has to be logged has been executed without a logged on user.	A user action requiring logging should only be possible with permission. Change the configuration by setting a required permission for the input object.
90044	A user action which has to be confirmed was blocked, because there is another user action pending.	Repeat the user action if necessary.
110000	The operating mode was changed. "Offline" mode is now set.	—
110001	The operating mode was changed. "Online" mode is now set.	—

Number	Effect/cause	Remedy
110002	The operating mode was not changed.	Check the connection to the controllers. Check if the address area for the area pointer 88 "Coordination" in the controller is available.
110003	The operating mode of the specified controller was changed by the system function "SetConnectionMode". The operating mode is now "offline".	—
110004	The operating mode of the specified controller has been changed by the system function "SetConnectionMode". The operating mode is now "online".	—
110005	An attempt was made to use the system function SetConnectionMode to switch the specified controller to "online" mode, although the entire system is in "offline" mode. This changeover is not allowed. The controller remains in "offline" mode.	Switch the complete system to "online" mode, then execute the system function again.
110006	The content of the "project version" area pointer does not match the user version configured in WinCC flexible. WinCC flexible Runtime is therefore closed.	Check: <ul style="list-style-type: none"> the project version entered on the controller the project version entered in WinCC flexible
120000	The trend is not displayed because you configured an incorrect axis to the trend or an incorrect trend.	Change the configuration.
120001	The trend is not displayed because you configured an incorrect axis to the trend or an incorrect trend.	Change the configuration.
120002	The trend is not displayed because the tag assigned attempts to access an invalid controller address.	Check if the data area for the tag exists in the controller, the configured address is correct and the value range for the tag is correct.
130000	The action was not executed.	Close all other programs. Delete files no longer required from the hard disk.
130001	The action was not executed.	Delete files no longer required from the hard disk.
130002	The action was not executed.	Close all other programs. Delete files no longer required from the hard disk.
130003	No data medium found. The operation is canceled.	Check, for example, if <ul style="list-style-type: none"> the correct data medium is being accessed the data medium is inserted
130004	The data medium is write-protected. The operation is canceled.	Check if access has been made to the correct data carrier. Remove the write protection.
130005	The file is read only. The operation is canceled.	Check if access has been made to the correct file. Edit the file attributes if necessary.
130006	Access to file failed. The operation is canceled.	Check, for example, if <ul style="list-style-type: none"> the correct file is being accessed the file exists another action is preventing simultaneous access to the file
130007	The network connection is interrupted. Data records cannot be saved or read over the network connection.	Check the network connection and eliminate the cause of error.
130008	The storage card is not available. Data records cannot be saved to / read from the storage card.	Insert the storage card.

Number	Effect/cause	Remedy
130009	The specified folder does not exist on the storage card. Any files saved to this directory are not backed up when you switch off the HMI device.	Insert the storage card.
130010	The maximum nesting depth can be exhausted when, for example, a value change in a script results in the call of another script and the second script in turn has a value change that results in the call of yet a further script etc. The configured functionality is not supported.	Check the configuration.
140000	An online connection to the controller is established.	—
140001	The online connection to the controller was shut down.	—
140003	No tag updating or writing is executed.	Check the connection and if the controller is switched on. Check the parameter definitions in the Control Panel using "Set PG/PC interface". Restart the system.
140004	No tag update or write operations are executed because the access point or the module configuration is faulty.	Verify the connection and check if the controller is switched on. Check the access point or the module configuration (MPI, PPI, PROFIBUS) in the Control Panel with "Set PG/PC interface". Restart the system.
140005	No tag updating or writing is executed because the HMI device address is incorrect (possibly too high).	Use a different HMI device address. Verify the connection and check if the controller is switched on. Check the parameter definitions in the Control Panel using "Set PG/PC interface". Restart the system.
140006	No tag updating or writing is executed because the baud rate is incorrect.	Select a different baud rate in WinCC flexible (according to module, profile, communication peer, etc.).
140007	Tag are not updated or written because the bus profile is incorrect (see %1). The following parameter could not be written to the registry: 1: Tslot 2: Tqui 3: Tset 4: MinTsdr 5: MaxTsdr 6: Trdy 7: Tid1 8: Tid2 9: Gap Factor 10: Retry Limit	Check the user-defined bus profile. Check the connection and if the controller is switched on. Check the parameter definitions in the Control Panel using "Set PG/PC interface". Restart the system.

Number	Effect/cause	Remedy
140008	No tag updating or writing is executed because baud rate is incorrect. The following parameters could not be written to the registry: 0: General error 1: Wrong version 2: Profile cannot be written to the registry. 3: The subnet type cannot be written to the registry. 4: The Target Rotation Time cannot be written to the registry. 5: Faulty Highest Address (HSA).	Check the connection and if the controller is switched on. Check the parameter definitions in the Control Panel using "Set PG/PC interface". Restart the system.
140009	Tags are not updated or written because the module for S7 communication was not found.	Reinstall the module in the Control Panel using "Set PG/PC interface".
140010	No S7 communication partner found because the controller is shut down. DP/T: The option "PG/PC is the only master" is not set in the Control Panel under "Set PG/PC interface."	Switch the controller on. DP/T: If only one master is connected to the network, disable "PG/PC is the only master" in "Set PG/PC interface". If several masters are connected to the network, enable these. Do not change any settings, for this will cause bus errors.
140011	No tag updating or writing is executed because communication is down.	Check the connection and that the communication partner is switched on.
140012	There is an initialization problem (e.g. when WinCC flexible Runtime was closed in Task Manager). Or: Another application (e.g. STEP7) with different bus parameters is active and the driver cannot be started with the new bus parameters (transmission rate, for example).	Restart the HMI device. Or: Run WinCC flexible Runtime, then start your other applications.
140013	The MPI cable is disconnected and, thus, there is no power supply.	Check the connections.
140014	The configured bus address is in already in use by another application.	Edit the HMI device address in the controller configuration.
140015	Wrong transmission rate Or: Faulty bus parameters (e.g.HSA) Or: OP address > HSA or: Wrong interrupt vector (interrupt does not arrive at the driver)	Correct the relevant parameters.
140016	The hardware does not support the configured interrupt.	Change the interrupt number.
140017	The set interrupt is in use by another driver.	Change the interrupt number.
140018	The consistency check was disabled by SIMOTION Scout. Only a corresponding note appears.	Enable the consistency check with SIMOTION Scout and once again download the project to the PLC.
140019	SIMOTION Scout is downloading a new project to the controller. Connection to the controller is canceled.	Wait until the end of the reconfiguration.

Number	Effect/cause	Remedy
140020	The version in the controller and that of the project (FWX file) do not match. Connection to the controller is canceled	The following remedies are available: Download the current version to the PLC using SIMOTION Scout. Regenerate the project using WinCC flexible ES, close WinCC flexible Runtime and restart with a new configuration.
150000	No more data is read or written. Possible causes: <ul style="list-style-type: none"> • The cable is defective. • The PLC does not respond, is defective, etc. • The wrong port is used for the connection. • System overload. 	Ensure that the cable is plugged in, the controller is operational, the correct interface is being used. Restart the system if the system alarm persists.
150001	Connection is up because the cause of the interruption has been eliminated.	—
160000	No more data is read or written. Possible causes: <ul style="list-style-type: none"> • The cable is defective. • The PLC does not respond, is defective, etc. • The wrong port is used for the connection. • System overload. 	Ensure that the cable is plugged in, the controller is operational, the correct interface is being used. Restart the system if the system alarm persists.
160001	Connection is up because the cause of the interruption has been eliminated.	—
160010	No connection to the server because the server identification (CLS-ID) cannot be determined. Values cannot be read or written.	Check access rights.
160011	No connection to the server because the server identification (CLS-ID) cannot be determined. Values cannot be read or written.	Check, for example, if <ul style="list-style-type: none"> • the server name is correct • the computer name is correct • the server is registered
160012	No connection to the server because the server identification (CLS-ID) cannot be determined. Values cannot be read or written.	Check, for example, if <ul style="list-style-type: none"> • the server name is correct • the computer name is correct • the server is registered Note for advanced users: Interpret the value from HRESULT.
160013	The specified server was started as InProc server. This has not been released and may possibly lead to incorrect behavior because the server is running in the same process area as the WinCC flexible Runtime software.	Configure the server as OutProc Server or Local Server.
160014	Only one OPC server project can be started on a PC/MP. An alarm is output when an attempt is made to start a second project. The second project has no OPC server functionality and cannot be located as an OPC server by external sources.	Do not start a second project with OPC server functionality on the computer.
170000	S7 diagnostics events are not indicated because it is not possible to log in to the S7 diagnostics functions at this device. The service is not supported.	—

Number	Effect/cause	Remedy
170001	The S7 diagnostics buffer cannot be viewed because communication with the controller is shut down.	Set the controller to online mode.
170002	The S7 diagnostics buffer cannot be viewed because reading of the diagnostics buffer (SSL) was canceled with error.	—
170003	An S7 diagnostics event cannot be visualized. The system returns internal error %2.	—
170004	An S7 diagnostics event cannot be visualized. The system returns an internal error of error class %2, error number %3.	—
170007	It is not possible to read the S7 diagnostics buffer (SSL) because this operation was canceled with an internal error of class %2 and error code %3.	—
180000	A component/OCX received configuration data with a version ID which is not supported.	Install a newer component.
180001	System overload because too many actions running in parallel. Not all the actions can be executed, some are rejected.	Several remedies are available: <ul style="list-style-type: none"> • Increase the configured cycle times or basic clock. • Generate the alarms at a slower rate (polling). • Initiate scripts and functions at greater intervals. If the alarm appears more frequently: Restart the HMI device.
180002	The on-screen keyboard could not be activated. Possible causes: "TouchInputPC.exe" was not registered due to a faulty Setup.	Reinstall WinCC flexible Runtime.
190000	It is possible that the tag is not updated.	—
190001	The tag is updated after the cause of the last error state has been eliminated (return to normal operation).	—
190002	The tag is not updated because communication with the controller is down.	Select the system function "SetOnline" to go online.
190004	The tag is not updated because the configured tag address does not exist.	Check the configuration.
190005	The tag is not updated because the configured controller type does not exist for this tag.	Check the configuration.
190006	The tag is not updated because it is not possible to map the controller type in the data type of the tag.	Check the configuration.
190007	The tag value is not modified because the connection to the controller is interrupted or the tag is offline.	Set online mode or reconnect to the controller.
190008	The threshold values configured for the tag have been violated, for example, by <ul style="list-style-type: none"> • a value entered • a system function • a script 	Observe the configured or current threshold values of the tag.

Number	Effect/cause	Remedy
190009	An attempt has been made to assign the tag a value which is outside the permitted range of values for this data type. For example, a value of 260 was entered for a byte tag or a value of -3 for an unsigned word tag.	Observe the range of values for the data type of the tags.
190010	Too many values are written to the tag (for example, in a loop triggered by a script). Values are lost because only up to 100 actions are saved to the buffer.	Increase the time interval between multiple write actions.
190011	Possible cause 1: The value entered could not be written to the configured controller tag because the high or low limit was exceeded. The system discards the entry and restores the original value. Possible cause 2: The connection to the controller was interrupted.	Make sure that the value entered lies within the range of values of the control tags. Check the connection to the PLC.
190012	It is not possible to convert a value from a source format to a target format, for example: An attempt is being made to assign a value to a counter that is outside the valid, PLC-specific value range. A tag of the type Integer should be assigned a value of the type String.	Check the range of values or the data type of the tags.
190100	The area pointer is not updated because the address configured for this pointer does not exist. Type 1 Warning alarms 2 Error alarms 3 Controller acknowledgment 4 HMI device acknowledgment 5 LED mapping 6 Trend request 7 Trend transfer 1 8 Trend transfer 2 No.: consecutive number shown in WinCC flexible ES.	Check the configuration.
190101	The area pointer is not updated because it is not possible to map the PLC type to the area pointer type. Parameter type and no.: see alarm 190100	—
190102	The area pointer is updated after the cause of the last error state has been eliminated (return to normal operation). Parameter type and no.: See alarm 190100.	—
200000	Coordination is not executed because the address configured in the controller does not exist/is not set.	Change the address or set up the address in the controller.
200001	Coordination is canceled because the write access to the address configured in the PLC is not possible.	Change the address or set the address in the controller at an area which allows write access.

Number	Effect/cause	Remedy
200002	Coordination is not carried out at the moment because the address format of the area pointer does not match the internal storage format.	Internal error
200003	Coordination can be executed again because the last error state is eliminated (return to normal operation).	—
200004	The coordination may not be executed.	—
200005	No more data is read or written. Possible causes: <ul style="list-style-type: none"> • The cable is defective. • The PLC does not respond, is defective, etc. • System overload. 	Ensure that the cable is plugged in and the controller is operational. Restart the system if the system alarm persists.
200100	Coordination is not executed because the address configured in the controller does not exist/is not set.	Change the address or set up the address in the controller.
200101	Coordination is canceled because the write access to the address configured in the PLC is not possible.	Change the address or set the address in the controller at an area which allows write access.
200102	Coordination is not carried out at the moment because the address format of the area pointer does not match the internal storage format.	Internal error
200103	Coordination can be executed again because the last error state is eliminated (return to normal operation).	—
200104	The coordination may not be executed.	—
200105	No more data is read or written. Possible causes: <ul style="list-style-type: none"> • The cable is defective. • The PLC does not respond, is defective, etc. • System overload. 	Ensure that the cable is plugged in and the controller is operational. Restart the system if the system alarm persists.
210000	Jobs are not processed because the address configured in the controller does not exist/has not been set up.	Change the address or set up the address in the controller.
210001	Jobs are not processed because read/write access to the address configured in the controller is not possible.	Change the address or set up the address in the controller in an area which allows read/write access.
210002	Jobs are not executed because the address format of the area pointer does not match the internal storage format.	Internal error
210003	The job buffer is processed again because the last error status has been eliminated (return to normal operation).	—
210004	It is possible that the job buffer will not be processed.	—
210005	A control request with an illegal number was initiated.	Check the controller program.
210006	An error occurred while attempting to execute the control request. As a result, the control request is not executed. Observe the next/previous system alarms.	Check the parameters of the control request. Recompile the configuration.

Number	Effect/cause	Remedy
220001	The tag is not downloaded because the associated communication driver / HMI device does not support the download of Boolean/discrete data types.	Change the configuration.
220002	The tag is not downloaded because the associated communication driver / HMI device does not support write access to the data type BYTE.	Change the configuration.
220003	The communication driver cannot be loaded. The driver may not be installed.	Install the driver by reinstalling WinCC flexible Runtime.
220004	Communication is down and no update data is transferred because the cable is not connected or defective etc.	Check the connection.
220005	Communication is up.	—
220006	The connection between the specified PLC and the specified port is active.	—
220007	The connection to the specified controller is interrupted at the specified port.	Check if <ul style="list-style-type: none"> • the cable is plugged in • the controller is OK • the correct port is used • your configuration is OK (interface parameters, protocol settings, PLC address). Restart the system if the system alarm persists.
220008	The communication driver cannot access or open the specified port. The port may be in use by another application or the port used is not available on the destination device. There is no communication with the controller.	Close all the applications which access this port and restart the computer. Use another port of the system.
230000	The value entered could not be accepted. The system discards the entry and restores the previous value. Either <ul style="list-style-type: none"> • the value range has been exceeded • illegal characters have been entered • the maximum permitted number of users has been exceeded 	Enter a practical value or delete any unneeded users.
230002	The currently logged in user is not granted write access rights. The system therefore discards the input and restored the previous value.	Log on as a user with appropriate rights.
230003	Changeover to the specified screen failed because the screen is not available/configured. The current screen remains selected.	Configure the screen and check the screen selection function.
230005	The value range of the tag has been exceeded in the IO field. The original value of the tag is retained.	Observe the range of values for the tag when entering a value.
230100	During navigation in the web browser, the system returned a message which may be of interest to the user. The web browser continues to run but may not (fully) show the new page.	Navigate to another page.

Number	Effect/cause	Remedy
230200	The connection to the HTTP channel was interrupted due to an error. This error is explained in detail by another system alarm. Data is no longer exchanged.	Check the network connection. Check the server configuration.
230201	The connection to HTTP channel was established. Data is exchanged.	—
230202	WININET.DLL has detected an error. This error usually occurs when an attempt to connect to the server fails or the server refuses to connect because the client lacks the proper authorization. An unknown server certificate may also be the cause if the connection is encrypted by means of SSL. The alarm text provides details. This text is always in the language of the Windows installation because it is returned by the Windows OS. Process values are no longer exchanged.	Depending on the cause: When an attempt to connect fails or a timeout error occurs: <ul style="list-style-type: none"> • Check the network connection and the network. • Check the server address. • Check if the web server is actually running on the destination computer. Faulty authorization: <ul style="list-style-type: none"> • The configured user name and/or password do not match those on the server. Establish consistency. When the server certificate is rejected: Certificate signed by an unknown CA (): <ul style="list-style-type: none"> • Either ignore this item in your project, or • Install a certificate that has been signed with a root certificate known to the client computer. The date of the certificate is invalid: <ul style="list-style-type: none"> • Either ignore this item in your project, or • Install a certificate with a valid date on the server. Invalid CN (Common Name or Computer Name): <ul style="list-style-type: none"> • Either ignore this item in your project, or • Install a certificate with a name that corresponds to that of the server address.
230203	Although a connection can be made to the server, the HTTP server refuses to connect because <ul style="list-style-type: none"> • WinCC flexible Runtime is not running on the server, or • the HTTP channel is not supported (503 Service unavailable). Other errors can only occur if the web server does not support the HTTP channel. The language of the alarm text depends on the web server. Data is not exchanged.	Error 503 Service unavailable: Check if WinCC flexible Runtime is running on the server the HTTP channel is supported.
230301	An internal error has occurred. An English text explains the error in more detail. This may be caused by insufficient memory. OCX does not work.	—
230302	The name of the remote server cannot be resolved. The attempt to connect failed.	Check the configured server address. Check if the DNS service is available on the network.
230303	The remote server is not running on the addressed computer. Wrong server address. The attempt to connect failed	Check the configured server address. Check if the remote server is running on the target computer.

Number	Effect/cause	Remedy
230304	The remote server on the addressed computer is incompatible to VNCOCX. The attempt to connect failed.	Use a compatible remote server.
230305	The authentication has failed because the password is incorrect. The attempt to connect failed.	Configure the correct password.
230306	Error in the connection to the remote server. This may occur as a result of network problems. The attempt to connect failed.	Check if <ul style="list-style-type: none"> the bus cable is plugged in there are network problems
230307	The connection to the remote server was shut down because <ul style="list-style-type: none"> the remote server was shut down, or the user instructed the server to close all connections. The connection is closed.	—
230308	This alarm provides information on the connection status. An attempt is made to connect.	—
240000	WinCC flexible Runtime is operating in demo mode. You have no authorization or your authorization is corrupted.	Install the authorization.
240001	WinCC flexible Runtime is operating in demo mode. Too many tags are configured for the installed version.	Load an adequate authorization / powerpack.
240002	WinCC flexible Runtime is operating with a time-limited emergency authorization.	Restore the full authorization.
240003	Authorization failed. Without authorization, WinCC will run in demo mode.	Restart WinCC flexible Runtime or reinstall it.
240004	Error while reading the emergency authorization. WinCC flexible Runtime is operating in demo mode.	Restart WinCC flexible Runtime, install the authorization or repair the authorization (see Commissioning Instructions Software Protection).
240005	The Automation License Manager has detected an internal system fault. Possible causes: <ul style="list-style-type: none"> A corrupt file A defective installation No free space for the Automation License Manager etc. 	Reboot the HMI device or PC. If this does not solve the problem, remove the Automation License Manager and install it again.
250000	The tag in the specified line in "Status force" is not updated because the address configured for this tag is not available.	Check the set address and then verify that the address is set up in the controller.
250001	The tag in the specified line in "Status force" is not updated because the controller type configured for this tag does not exist.	Check the set address.
250002	The tag in the specified line in "Status force" is not updated because it is not possible to map the controller type in the tag type.	Check the set address.
250003	An attempt to connect to the PLC failed. The tags are not updated.	Check the connection to the PLC. Check that the controller is switched on and is online.

Number	Effect/cause	Remedy
260000	An unknown user or an unknown password has been entered in the system. The current user is logged off from the system.	Log on to the system as a user with a valid password.
260001	The logged in user does not have sufficient authorization to execute the protected functions on the system.	Log on to the system as a user with sufficient authorization.
260002	This alarm is triggered by the system function "TrackUserChange".	—
260003	The user has logged off from the system.	—
260004	The user name entered into the user view already exists in the user management.	Select another user name because user names have to be unique in the user management.
260005	The entry is discarded.	Use a shorter user name.
260006	The entry is discarded.	Use a shorter or longer password.
260007	The logon timeout value entered is outside the valid range of 0 to 60 minutes. The new value is discarded and the original value is retained.	Enter a logon timeout value between 0 and 60 minutes.
260008	An attempt was made to read a PTProRun.pwl file created with ProTool V 6.0 in WinCC flexible. Reading the file was canceled due to incompatibility of the format.	—
260009	You have attempted to delete the user "Admin" or "PLC User". These users are fixed components of the user management and cannot be deleted.	If you need to delete a user, because perhaps you have exceeded the maximum number permitted, delete another user.
260012	The passwords entered in the "Change Password" dialog and the confirmation field are not identical. The password has not been changed. User will be logged off.	You have to log on to the system again. Then enter the identical password twice to be able to change the password.
260013	The password entered in the "Change Password" dialog is invalid because it is already in use. The password has not been changed. User will be logged off.	You have to log on to the system again. Then enter a new password that has not been used before.
260014	User has unsuccessfully attempted to log on 3 times in succession. The user has been locked out and assigned to group no. 0.	You can log on to the system with your correct password. Only an administrator can change the assignment to a group.
270000	A tag is not indicated in the alarm because it attempts to access an invalid address in the controller.	Check if the data area for the tag exists in the controller, the configured address is correct and the value range for the tag is correct.
270001	There is a device-specific limit as to how many alarms may be queued for output (see the operating instructions). This limit has been exceeded. The view no longer contains all the alarms. However, all alarms are written to the alarm buffer.	—
270002	The view shows alarms of a log for which there is no data in the current project. Wildcards are output for the alarms.	Delete older log data if necessary.

Number	Effect/cause	Remedy
270003	The service cannot be set up because too many devices want to use this service. A maximum of four devices may execute this action.	Reduce the number of HMI devices which want to use the service.
270004	Access to persistent buffer is not possible. Alarms cannot be restored or saved.	If the problems persist at the next startup, contact Customer Support (delete Flash).
270005	Persistent buffer damaged: Alarms cannot be restored.	If the problems persist at the next startup, contact Customer Support (delete Flash).
270006	Project modified: Alarms cannot be restored from the persistent buffer.	The project was generated and transferred new to the HMI device; The error should no longer occur when the device starts again.
270007	A configuration problem is preventing the restore (a DLL is missing, a directory is unknown, etc.).	Update the operating system and then transfer your project again to the HMI device.
280000	Connection is up because the cause of the interruption has been eliminated.	—
280001	No more data is read or written. Possible causes: <ul style="list-style-type: none"> • The cable is defective. • The PLC does not respond, is defective, etc. • The wrong port is used for the connection. • System overload. 	Check if <ul style="list-style-type: none"> • the cable is plugged in • the controller is OK • the correct port is used Restart the system if the system alarm persists.
280002	The connection used requires a function block in the controller. The function block has responded. Communication is now enabled.	—
280003	The connection used requires a function block in the controller. The function block has not responded.	Check if <ul style="list-style-type: none"> • the cable is plugged in • the controller is OK • the correct port is used Restart the system if the system alarm persists. Remedy depends on the error code: <ol style="list-style-type: none"> 1: The function block must set the COM bit in the response container. 2: The function block must not set the ERROR bit in the response container. 3: The function block must respond within the specified time (timeout). 4: Go online to the PLC.
280004	The connection to the controller is interrupted. There is no data exchange at present.	Check the connection parameters in WinCC flexible. Ensure that the cable is plugged in, the controller is operational, the correct interface is being used. Restart the system if the system alarm persists.
290000	The recipe tag could not be read or written. It is assigned the start value. The alarm can be entered in the alarm buffer for up to four more failed tags if necessary. After that, alarm 290003 is output.	Check in the configuration that the address has been set up in the controller.

Number	Effect/cause	Remedy
290001	An attempt has been made to assign a value to a recipe tag which is outside the value range permitted for this type. The alarm can be entered in the alarm buffer for up to four more failed tags if necessary. After that, alarm 290004 is output.	Observe the value range for the tag type.
290002	It is not possible to convert a value from a source format to a target format. The alarm can be entered in the alarm buffer for up to four more failed recipe tags if necessary. After that, alarm 290005 is output.	Check the value range or type of the tag.
290003	This alarm is output when alarm number 290000 is triggered more than five times. In this case, no further separate alarms are generated.	Check in the configuration that the tag addresses have been set up in the controller.
290004	This alarm is output when alarm number 290001 is triggered more than five times. In this case, no further separate alarms are generated.	Observe the value range for the tag type.
290005	This alarm is output when alarm number 290002 is triggered more than five times. In this case, no further separate alarms are generated.	Check the value range or type of the tag.
290006	The threshold values configured for the tag have been violated by values entered.	Observe the configured or current threshold values of the tag.
290007	There is a difference between the source and target structure of the recipe currently being processed. The target structure contains an additional data recipe tag which is not available in the source structure. The data recipe tag specified is assigned its start value.	Insert the specified data recipe tag in the source structure.
290008	There is a difference between the source and target structure of the recipe currently being processed. The source structure contains an additional data recipe tag which is not available in the target structure and therefore cannot be assigned. The value is rejected.	Remove the specified data recipe tag in the specified recipe from the project.
290010	The storage location configured for the recipe is not permitted. Possible causes: Illegal characters, write protection, data carrier out of space or does not exist.	Check the configured storage location.
290011	The data record with the specified number does not exist.	Check the source for the number (constant or tag value).
290012	The recipe with the specified number does not exist.	Check the source for the number (constant or tag value).
290013	An attempt was made to save a data record under a data record number which already exists. The action is not executed.	The following remedies are available: <ul style="list-style-type: none"> • Check the source for the number (constant or tag value). • First, delete the data record. • Change the "Overwrite" function parameter.

Number	Effect/cause	Remedy
290014	The file specified to be imported could not be found.	Check: <ul style="list-style-type: none"> • The file name • Ensure that the file is in the specified directory.
290020	Message reporting that the download of data records from the HMI device to the PLC has started.	—
290021	Message reporting that the download of data records from the HMI device to the PLC was completed.	—
290022	Message reporting that the download of data records from the HMI device to the PLC was canceled due to an error.	Check in the configuration whether: <ul style="list-style-type: none"> • The tag addresses are configured in the controller • The recipe number exists • The data record number exist • The "Overwrite" function parameter is set
290023	Message reporting that the download of data records from the PLC to the HMI device has started.	—
290024	Message reporting that the download of data records from the PLC to the HMI device was completed.	—
290025	Message reporting that the download of data records from the PLC to the HMI device was canceled due to an error.	Check in the configuration whether: <ul style="list-style-type: none"> • The tag addresses are configured in the controller • The recipe number exists • The data record number exist • The "Overwrite" function parameter is set
290026	An attempt has been made to read/write a data record although the data record is not free at present. This error may occur in the case of recipes for which downloading with synchronization has been configured.	Set the data record status to zero.
290027	Unable to connect to the controller at present. As a result, the data record can neither be read nor written. Possible causes: No physical connection to the controller (no cable plugged in, cable is defect) or the controller is switched off.	Check the connection to the PLC.
290030	This alarm is output after you selected screen which contains a recipe view in which a data record is already selected.	Reload the data record from the storage location or retain the current values.
290031	While saving, it was detected that a data record with the specified number already exists.	Overwrite the data record or cancel the action.
290032	While exporting data records it was detected that a file with the specified name already exists.	Overwrite the file or cancel the process.
290033	Confirmation request before deleting data records.	—

Number	Effect/cause	Remedy
290040	A data record error with error code %1 that cannot be described in more detail occurred. The action is canceled. It is possible that the data record was not installed correctly on the controller.	Check the storage location, the data record, the "Data record" area pointer and if necessary, the connection to the controller. Restart the action after a short time. If the error persists, contact Customer Support. Forward the relevant error code to Customer Support.
290041	A data record or file cannot be saved because the storage location is full.	Delete files no longer required.
290042	An attempt was made to execute several recipe actions simultaneously. The last action was not executed.	Trigger the action again after waiting a short period.
290043	Confirmation request before storing data records.	—
290044	The data store for the recipe has been destroyed and is deleted.	—
290050	Message reporting that the export of data records has started.	—
290051	Message reporting that the export of data records was completed.	—
290052	Message reporting that the export of data records was canceled due to an error.	Ensure that the structure of the data records at the storage location and the current recipe structure on the HMI device are identical.
290053	Message reporting that the import of data records has started.	—
290054	Message reporting that the import of data records was completed.	—
290055	Message reporting that the import of data records was canceled due to an error.	Ensure that the structure of the data records at the storage location and the current recipe structure on the HMI device are identical.
290056	Error when reading/writing the value in the specified line/column. The action was canceled.	Check the specified line/column.
290057	The tags of the recipe specified were toggled from "offline" to "online" mode. Each change of a tag in this recipe is now immediately downloaded to the controller.	—
290058	The tags of the specified recipe were toggled from "offline" to "online" mode. Modifications to tags in this recipe are no longer immediately transferred to the controller but must be transferred there explicitly by downloading a data record.	—
290059	Message reporting that the specified data record was saved.	—
290060	Message reporting that the specified data record memory was cleared.	—
290061	Message reporting that clearing of data record memory was canceled due to an error.	—
290062	The data record number is above the maximum of 65536. This data record cannot be created.	Select another number.

Number	Effect/cause	Remedy
290063	This occurs with the system function "ExportDataRecords" when the parameter "Overwrite" is set to No. An attempt has been made to save a recipe under a file name which already exists. The export is canceled.	Check the "ExportDataRecords" system function.
290064	Message reporting that the deletion of data records has started.	—
290065	Message reporting that the deletion of data records has successfully completed.	—
290066	Confirmation request before deleting data records.	—
290068	Security request to confirm if all data records in the recipe should be deleted.	—
290069	Security request to confirm if all data records in the recipe should be deleted.	—
290070	The data record specified is not in the import file.	Check the source of the data record number or data record name (constant or tag value).
290071	During the editing of data record values, a value was entered which exceeded the low limit of the recipe tag. The entry is discarded.	Enter a value within the limits of the recipe tag.
290072	When editing data record values, a value was entered which exceeds the high limit of the recipe tag. The entry is discarded.	Enter a value within the limits of the recipe tag.
290073	An action (e.g. saving a data record) failed due to an unknown error. The error corresponds to the status alarm IDS_OUT_CMD_EXE_ERR in the large recipe view.	—
290074	While saving, it was detected that a data record with the specified number already exists but under another name.	Overwrite the data record, change the data record number or cancel the action.
290075	A data record with this name already exists. The data record is not saved.	Please select a different data record name.
300000	Faulty configuration of process monitoring (e.g. using PDiag or S7-Graph): More alarms are queued than specified in the specifications of the CPU. No further ALARM_S alarms can be managed by the PLC and reported to the HMI devices.	Change the controller configuration.
300001	ALARM_S is not registered on this controller.	Select a controller that supports the ALARM_S service.
310000	An attempt is being made to print too many reports in parallel. Only one log file can be output to the printer at a given time; the print job is therefore rejected.	Wait until the previous active log was printed. Repeat the print job if necessary.
310001	An error occurred on triggering the printer. The report is either not printed or printed with errors.	Evaluate the additional system alarms related to this alarm. Repeat the print job if necessary.

Number	Effect/cause	Remedy
320000	The movements have already been indicated by another device. The movements can no longer be controlled.	Deselect the movements on the other display units and select the motion control screen on the required display unit.
320001	The network is too complex. The faulty addresses cannot be indicated.	View the network in STL.
320002	No diagnostics alarm selected. The unit belonging to the alarm could not be selected.	Select a diagnostics alarm from the ZP_ALARM alarm screen.
320003	No alarms exists for the selected unit. The detail view cannot visualize any networks.	Select the defective unit from the overview screen.
320004	The required signal states could not be read by the PLC. The faulty addresses cannot be found.	Check the consistency between the configuration on the display unit and the PLC program.
320005	The project contains ProAgent elements which are not installed. ProAgent diagnostic functions cannot be performed.	In order to run the project, install the optional ProAgent package.
320006	You have attempted to execute a function which is not supported in the current constellation.	Check the type of the selected unit.
320007	No error-triggering addresses were found on the networks. ProAgent cannot indicate any faulty addresses.	Switch the detail screen to STL layout mode and check the status of the addresses and exclusion addresses.
320008	The diagnostic data stored in the configuration are not synchronized with those in the PLC. ProAgent can only indicate the diagnostic units.	Download the project to the HMI device again.
320009	The diagnostic data stored in the configuration are not synchronized with those in the PLC. The diagnostic screens can be operated as usual. ProAgent may be unable to show all diagnostic texts.	Download the project to the HMI device again.
320010	The diagnostic data stored in the configuration are not synchronized with those in STEP7. The ProAgent diagnostics data is not up-to-date.	Download the project to the HMI device again.
320011	A unit with the corresponding DB number and FB number does not exist. The function cannot be executed.	Check the parameters of the "SelectUnit" function and the units selected in the project.
320012	The "Step sequence mode" dialog is no longer supported.	Use the ZP_STEP step sequence screen from the corresponding standard project for your project. Instead of calling the Overview_Step_Sequence_Mode function, call the "FixedScreenSelection" function using ZP_STEP as the screen name.
320014	The selected controller cannot be evaluated for ProAgent. The Alarm view assigned to the "EvaluateAlarmDisplayFault" system function could not be found.	Check the parameters of the "EvaluateAlarmDisplayFault" system function.
330022	Too many dialogs are open on the HMI device.	Close all dialogs you do not require on the HMI device.

Abbreviations

CPU	Central Processing Unit
CSV	Comma Separated Values
CTS	Clear To Send
DC	Direct Current
DCD	Data Carrier Detect
DIL	Dual-in-Line (electronic chip housing design)
DP	Distributed I/O
DSN	Data Source Name
DSR	Data Set Ready
DTR	Data Terminal Ready
EMC	Electromagnetic Compatibility
EN	European standard
ES	Engineering System
ESD	Electrostatic Discharge, the components and modules endangered by such
ESD	Electrostatic Sensitive Device
GND	Ground
HF	High Frequency
HMI	Human Machine Interface
IEC	International Electronic Commission
IF	Interface
LED	Light Emitting Diode
MOS	Metal Oxide Semiconductor
MPI	Multipoint Interface (SIMATIC S7)
MS	Microsoft
MTBF	Mean Time Between Failures
n. c.	Not connected
OP	Operator Panel
PC/	Personal Computer
PG	Programming device
PLC	Programmable Logic Controller
PPI	Point-to-Point Interface (SIMATIC S7)
RAM	Random Access Memory
RJ45	Registered Jack Type 45
RTS	Request To Send
RxD	Receive Data
SELV	Safety Extra Low Voltage
SP	Service Pack
STN	Super Twisted Nematic

Abbreviations

Sub-D	Subminiature D (plug)
TAB	Tabulator
TCP/IP	Transmission Control Protocol/Internet Protocol
TFT	Thin Film Transistor
TxD	Transmit Data
UL	Underwriter's Laboratory

Glossary

"Transfer" mode

HMI device operating mode, set to transfer an executable project from the configuration computer to the HMI device.

Acknowledge

Acknowledgement of an alarm confirms that it has been noted.

AG

PLC of the SIMATIC S5 series such as the AG S5-115U, for example

Alarm logging

Output of user-specific alarms to a printer, in parallel to their output to the HMI device screen.

Alarm, acknowledging

Acknowledgement of an alarm confirms that it has been noted.

Alarm, activated

Moment at which an alarm is triggered by the PLC or HMI device.

Alarm, deactivated

Moment at which the initiation of an alarm is reset by the PLC.

Alarm, user-specific

A user-specific alarm can be assigned to one of the following alarm classes:

- Error
- Operation
- User-specific alarm classes

A user-specific alarm designates a certain operating status of the plant connected to the HMI device via the PLC.

array

Area reserved in configured screens for the input and output of values.

AS

PLC of the SIMATIC S7 series such as a SIMATIC S7-300

AS 511

Protocol of the programming device interface of a SIMATIC S5 PLC

Bootloader

Used to start the operating system. Automatically started when the HMI device is switched on. A start screen appears during startup. After the operating system has been loaded, the Loader opens.

Bootstrapping

Function called when updating the operating system. When a functional operating system is available, updates can be performed without bootstrapping. Otherwise, updating with bootstrapping is necessary. In this case, the configuration computer communicates with the HMI device by means of the HMI device bootloader.

Configuration computer

General term for programming devices (PGs) and PCs on which plant projects are created using an engineering software.

Control request

Triggers a function via the PLC.

Controller

General term for devices and systems with which the HMI device communicates, e.g. SIMATIC S7.

Display duration

Defines whether and how long a system alarm is displayed on the HMI device.

EMC

Electromagnetic compatibility is the ability of electrical equipment to function properly in its electromagnetic environment without influencing this environment.

Engineering software

Software for the creation of projects for process visualization – see also project, process visualization and runtime software

Event

Functions are triggered by defined incoming events. Events can be configured. Events which can be assigned to a button include "Press" and "Release", for example.

Fault time

Refers to the time interval between an activated and deactivated alarm.

Figure

Form of the visualization of all logically related process data for a plant. The visualization of the process data can be supported by graphic objects.

Flash memory

Non-volatile memory with EEPROM chips, used as mobile storage medium or as memory module installed permanently on the motherboard.

Half Brightness Life Time

Time period until the brightness degrades to 50% of its original value. The specified value is dependent on the operating temperature.

Hardcopy

Output of the screen content to a printer.

HMI device image

File which can be transferred from the programming device to the HMI device. The HMI device image contains the operating system and elements of the runtime software required to run a project.

Infotext

Configured information on objects within a project. An alarm infotext, for example, may contain information on the cause of the fault and troubleshooting routines.

IO field

Enables the input or output of values on the HMI device which are transferred to the PLC.

Notation

System consisting of characters, symbols and rules. In particular used to define the write format of a programming language in data processing.

Object

Component of a project. Example: screen or alarm. Objects are used to view or enter texts and values on the HMI device.

Operator control object

Component of a project which is used to enter values and trigger functions. A button, for example, is an operator control object.

Plant

General term referring to machines, processing centers, systems, plants and processes which are operated and monitored on an HMI device.

Process visualization

Visualization of processes from the areas of production, logistics and services in text-based and graphics format. Configured plant screens allow operator intervention in active plant processes by means of the input and output data.

project

Result of a configuration using an engineering software. The project normally contains several screens with embedded system-specific objects, basic settings and alarms. The project file of a project configured in WinCC flexible is saved under the file name extension *.hmi.

You distinguish between the project on the configuration computer and that on an HMI device. A project may be available in more languages on the configuration computer than can be managed on the HMI device. The project on the configuration computer can also be set up for different HMI devices. Only the project set up for a particular HMI device can be transferred to that HMI device.

Project file

File which is generated based on a source file for a specific HMI device when the configuration is completed. The project file is transferred to the corresponding HMI device and is used to operate and monitor plants. Refer to Source file.

Recipe

Combination of tags forming a fixed data structure. The data structure configured can be assigned data on the HMI device and is then referred to as a data record. The use of recipes ensures that when a data record is downloaded, all the assigned data is transferred synchronously to the PLC.

Runtime software

Process visualization software which can be used to debug a project on a configuration computer. Also refer to "Project" and "Engineering software".

Screen object

Configured object for operating and monitoring the system, e.g. a rectangle, an IO field or a recipe view.

Softkey

Key on the HMI device which supports user-specific functions. A function is assigned to the key in the configuration. The assignment of the keys may be specific to an active screen or not.

Source file

File from which various project files can be created, depending on the configuration. The source file is not transferred and remains on the configuration computer.

The file name extension of a source file is *.hmi. Refer to Source file, compressed and Project file.

Source file, compressed

Compressed form of the source file. Can be transferred in addition to the project file to the corresponding HMI device. "Enable Upload" must be set in the project on the configuration computer. The file extension of a compressed source file is *.pdz. The standard memory location for a compressed source file is the external MMC. Refer to Source file.

To restore a source file, it is necessary to use the same WinCC flexible version which was used to configure the project.

STEP 7

Programming software SIMATIC S7, SIMATIC C7 and SIMATIC WinAC PLCs.

STEP 7 Micro/WIN

Programming software for PLCs of the SIMATIC S7-200 series.

Symbolic IO field

Box for the input/output of a parameter. Contains a list of default entries from which one can be selected.

System alarms

Assigned to the "System" alarm class. A system alarm refers to internal states on the HMI device and the PLC.

Tab order

In the configuration, this sets the sequence in which objects are focused on pressing the <TAB> key.

Tag

Defined memory location to which values can be written to and read from. This can be done from the PLC or the HMI device. Based on whether the tag is interconnected with the PLC or not, we distinguish between "external" tags (process tags) and "internal" tags.

Transfer

The transfer of an executable project to the HMI device.

Index

A

- Accumulator
 - Optional, 1-17
- Acknowledging
 - Alarm, 9-5
 - Error alarm, 9-5
- Address assignment
 - in the TCP/IP network, 6-37
- Admin, 8-27, 8-29
- Alarm, 9-1
 - Acknowledging, 9-5
 - Editing, 9-6
- Alarm buffer, 1-18, 9-2
- Alarm class, 9-2, 9-4
- Alarm event, 9-1
- Alarm indicator, 9-4
- Alarm line, 9-2
- Alarm view, 9-2
- Alarm window, 9-2
- Alarms, 1-18
 - Displaying, 9-2
- Alphanumerical screen keyboard, 8-8, 8-9
- Alphanumerical values, 8-7
 - Changing, 8-10
 - Entering, 8-10
- Appearance
 - Slider control, 8-13
- Application
 - Handwheel, A-13
 - Illuminated pushbutton, A-12
 - Key-operated switch, A-13
 - LED of the softkeys, A-8
- Applications
 - In industry, 2-6
- Approvals, 2-3
- Automatic production sequence, 10-21
- Automatic transfer, 7-6
- Automation License Manager, 7-20

B

- Backing up, 7-4, 7-9, 7-10, 7-12
 - About ProSave, 7-12
 - About Wincc flexible, 7-10
- Backup
 - to memory card, 6-10
- Bootstrapping, 7-4, 7-14
- Box ID, A-1
- Byte assignment, A-5

C

- Cable cross section, 4-18
- Calibrating
 - Touch screen, 6-18
- Climatic
 - Storage conditions, 2-11
 - Transport conditions, 2-11
- Commissioning
 - HMI device, 7-2
- Communications Properties, 6-35
- Compatibility, 1-13
- Computer name
 - For network operation, 6-35
- Configuration computer
 - Connecting to the terminal box, 4-11
- Configuration phase, 7-1
- Configuring
 - Data channel, 6-31
 - Interfaces, 4-14
 - Network, 6-33
 - Operating system, 6-1
- Configuring the network
 - General procedure, 6-34
- Connect a printer.
 - Connection configurator, 4-17

- Connecting
 - Configuration computer, 4-11, 4-24
 - Connecting cables, 4-19
 - Connection sequence, 4-4
 - Controller, 4-16
 - Equipotential bonding, 4-10
 - Terminal box, 4-4
- Connecting the configuration computer
 - Connection configurator, 4-24
- Connecting the connecting cable, 4-19
- Connecting the PLC
 - Wiring diagram, 4-16
- Connection
 - Electrical, 4-3
- Connection configurator
 - Configuration computer, 4-11, 4-24
 - MPI/PROFIBUS DP, 4-11
 - Printer, 4-17
- Connection examples, 12-18
 - For safety category 3: enabling switch, 12-19, 12-20
 - For safety category 3: STOP button, 12-21
- Connection point recognition, 1-13, A-1
- Connection sequence, 4-4
- Connections
 - Number, 1-20
- Contrast
 - Changing, 6-16
- Control Panel, 6-3
 - MPI/DP settings, 6-25
 - opening, 6-3
 - Password protection, 6-2
- Controller
 - Configuring the interface, 4-14
- Controllers
 - Number, 1-20

D

- Data channel
 - Configuring, 6-31
 - Enabling, 6-31
 - Locking, 6-31
- Data set
 - Reading, 10-17
- Date and time
 - Entering, 8-11
- Date and time of day, 8-7
 - Synchronizing, 6-14
- Decimal places, 8-7
- Default gateway, 6-38
- Design, 1-8
 - Wall holder, 1-16

- DHCP, 6-38
- Direct connection, 6-36
- Direct keys, A-4
- Display, 12-6
- DNS, 6-38
- DNS server, 6-34
- Domain
 - Logon, 6-39

E

- EC declaration of conformity, 2-2
- Electrical connections, 4-3
- Electrical installation, 4-3
- Electrostatic charge, A-14
- Enable switch, 2-7, 5-3
 - Normal activation, 5-4
 - Panic activation, 5-4
 - Switch settings, 5-4
- Enabling equipment, 2-7
- Entering
 - Alphanumerical values, 8-7, 8-10
 - Date and time, 8-11
 - Date and time of day, 8-7
 - Numerical values, 8-6, 8-8
 - Symbolic values, 8-7, 8-11
- Entering a Recipe Record, 10-19
- Equipotential bonding
 - Connecting, 4-10
 - Requirements, 4-10
- Equipotential bonding cable, 4-11
- Error alarm
 - Acknowledging, 9-5

F

- Fast connector
 - Assignment, 12-13, 12-16
- Feedback
 - Optical, 8-2
- File
 - Backing up, 6-16
- Forcing
 - Permissions in remote operation, 8-19
- Format patterns, 8-6
- Front view, 1-9
- Function
 - Additional, 1-19
- Function test, 4-26

Functional scope
 Additional, 1-19
 Alarm, 1-18
 Alarm buffer, 1-18
 Infotext, 1-19
 Limit-value monitoring, 1-18
 Recipe, 1-19
 scaling, 1-18
 Screen, 1-19
 Tag, 1-18
 Text List, 1-18

G

Gauge, 8-17

H

Hand wheel, 5-11
 Handwheel
 Application, A-13
 Evaluation of incremental values, A-13
 High frequency radiation, 2-2
 HMI device, 12-6, 12-7, 12-8
 Commissioning, 7-2
 EMC-compliant installation, 2-9
 Front view, 1-9
 Holding, 5-14
 Interfaces, 4-23
 Mounting position, 3-4, 4-1
 Placing, 5-14
 Recommissioning, 7-2
 Side view, 1-10
 Switch off, 4-26
 Switching on, 4-25
 Testing, 4-25
 HMI device image, 6-17

I

IF1 interface
 Assignment, 12-12, 12-16
 Illuminated pushbutton, 5-13
 Application, A-12
 Bit assignment, A-12
 Infotext, 1-19
 Displaying, 8-14, 9-4
 Input on the HMI device
 Using operator controls, 8-1
 Using soft keys, 8-3
 Input unit, 12-6

Installation
 Configuration computer, 4-11
 Electrical, 4-3
 EMC-compliant, 2-9
 Installing
 option, 7-17, 7-19
 Instructions
 General, 2-6
 Safety, 2-2
 Interfaces, 4-6, 4-7, 4-11, 4-23
 Configuring, 4-14
 Interference
 Pulse-shaped, 2-9
 Sinusoidal, 2-10
 Interlocking mechanism, 4-19
 Internet settings, 6-40

K

Keyboard properties, 6-8
 Key-operated switch, 5-12
 Application, A-13
 Bit assignment, A-13

L

Labels
 Approvals, 2-3
 EC declaration of conformity, 2-2
 Language
 Setting, 8-5
 LED display, 5-16
 LED softkey
 Bit assignment, A-8
 LED softkeys, A-8
 License key, 7-20
 Transferring, 7-21
 Transferring back, 7-22
 Limit value test, 8-7
 Limits
 For password, 8-24
 For User view, 8-24
 For users, 8-24
 Loader, 6-1
 Logoff
 User, 8-25
 Logoff time, 8-22
 Logon
 Users, 8-24
 Logon information
 in the TCP/IP network, 6-39

- M**
 - MAC address, 6-37
 - Maintenance, 11-1
 - Manual production sequence, 10-20
 - Manual transfer, 7-5
 - Mechanical
 - Storage conditions, 2-11
 - Transport conditions, 2-11
 - Memory, 12-6
 - Memory card, 1-16
 - Backup to, 6-10
 - Restoring from, 6-10
 - Mobile Panel 177
 - Enable switch, 5-3
 - Operator control elements, 5-1
 - STOP button, 5-5
 - Monitoring device
 - ELAN SRB-NA-R-C.27/S, 12-19
 - PILZ PST1, 12-20
 - SIGUARD 3TK2840, 12-21
 - Monitoring mode
 - Sm@rtClient view, 8-18
 - Mounting position, 4-1
 - HMI device, 3-4
 - Mouse properties, 6-9
 - MPI/DP settings, 6-25
 - Multi-key operation, 8-3
 - MultiMediaCard, 1-16
- N**
 - Name server, 6-38
 - Network settings, 6-37
 - Nominal voltage, 3-6
 - Numerical screen keyboard, 8-7
 - Numerical values
 - Changing, 8-8
 - Decimal places, 8-7
 - Entering, 8-6, 8-8
 - Formats, 8-6
 - Limit value test, 8-7
- O**
 - Offices, iv
 - Offline, 7-2
 - Offline test, 7-8
 - Online, 7-2
 - Online test, 7-8
 - OP properties, 6-17, 6-18, 6-28
 - Opening the terminal box, 4-5
 - Operating mode
 - Offline, 7-2
 - Online, 7-2
 - Overview, 7-2
 - Switching, 7-2
 - Transfer, 4-25, 7-3
 - Operating recipes
 - Read recipe data record, 10-17
 - Operating safety
 - Standards, 2-5
 - Operating system
 - Configuring, 6-1
 - Updating, 7-4, 7-14
 - Operation, 5-14
 - Enable switch, 5-3
 - General, 5-14
 - Hand wheel, 5-11
 - Illuminated pushbutton, 5-13
 - Key-operated switch, 5-12
 - STOP button, 5-5
 - Operation feedback, 8-1
 - Operator control elements, 5-1, 5-2
 - Optical feedback, 8-2
 - option, 7-17
 - Installing, 7-17, 7-19
 - Removing, 7-18, 7-19
 - Optional Accumulator Package, 1-17
 - Overall dimensions
 - Mobile Panel 177, 12-1, 12-2
- P**
 - Panic activation, 5-4
 - Password
 - Deleting, 6-21
 - Entering, 6-20
 - Password, 8-23
 - Backing up, 8-23
 - Restoring, 8-23
 - Password list, 8-23
 - Password properties, 6-20
 - Password protection, 6-2
 - PC
 - Connecting, 4-11
 - PC connection, 6-36
 - Permission, 8-22
 - Pin assignment
 - Female header, 12-10, 12-11
 - RJ45 plug connector, 12-9
 - RJ45 plug connector, 12-11
 - RS 485 interface, 12-9, 12-10
 - PLC_User, 8-27, 8-29

- PLCs from other manufacturers
 - Protocols, 1-21
- Polarity reversal protection, 4-17
- Potential differences, 4-10
- Power supply
 - Cable cross section, 4-18
 - Wiring diagram, 4-18
- Printing
 - via a network printer, 6-34
- Process control phase, 7-1
- Production sequence
 - Automatic, 10-21
 - Manual, 10-20
- PROFINET, 6-33
- Project
 - Closing, 8-31
 - Operating, 8-1
 - Testing, 7-7
 - Testing offline, 7-8
 - Testing online, 7-8
 - Transferring, 7-2
- Protective cover, 4-5
- Protective film, 1-17
- Protective sleeve, 1-17
- Protocol
 - PLCs from other manufacturers, 1-21
 - SIMATIC PLCs, 1-20
- Proxy server, 6-40

- R**
- Radiation
 - High frequency, 2-2
- Recipe, 1-19
 - Recipe screen, 10-4
 - Recipe view, 10-4
- Recipe screen, 10-7
 - Overview, 10-7
- Recipe view, 10-5
 - Advanced view, 10-5
 - Simple view, 10-6
- Recommissioning
 - HMI device, 7-2
- Recovery time, 1-13, 4-26, 8-31, 12-7, 12-8
- Regional settings
 - Changing, 6-23
- Registry information
 - Backing up, 6-16
- Remote control
 - Forcing permission, 8-19
- Removing
 - option, 7-18, 7-19
- Representatives, iv

- Response time
 - Handwheel, A-7
- Restore
 - from memory card, 6-10
- Restoring, 7-4, 7-9, 7-11, 7-13
 - About ProSave, 7-13
 - About WinCC flexible, 7-11
 - In the case of compatibility conflict, 7-9
- Risk analysis, 2-6
- Ruler, 8-20

- S**
- Safety
 - Operating safety, 2-5
 - STOP button, 5-7
 - Voltage supply, 2-6
- Safety category 3
 - Connection examples, 12-18
- Safety information
 - Enable switch, 2-7
 - High frequency radiation, 2-2
 - STOP button, 2-8
- Safety regulations, 2-1
- Scope of maintenance, 11-1
- Screen, 1-19
- Screen keyboard, 8-6
 - Alphanumerical, 8-9
 - Keyboard levels, 8-9
 - Numerical, 8-7, 8-10
 - Setting the character repeat, 6-8
- Screen keyboard
 - Outside an open project, 6-5
- Screen saver
 - Setting, 6-28
- Screen settings
 - Changing, 6-16
- Security, 2-1, 8-22
 - Safety regulations, 2-1
- Security system, 8-22
- Selection list, 8-11
- Service, 11-2
 - On the Internet, v
- Service pack, 11-2
- Setting
 - Date, 6-13
 - Time, 6-13
- Setting the box ID, 4-9
- Setting the date, 6-13
- Setting the delay, 6-28
- Setting the double-click, 6-9
- Setting the station number, 4-9
- Setting the time, 6-13

- Setting the time zone, 6-13
- Side view, 1-10
- SIMATIC PLC
 - Protocols, 1-20
- Simple recipe view, 10-6
- Slider control, 8-13
 - Appearance, 8-13
- Sm@rtClient view, 8-18
 - Application, 8-18
 - Monitoring mode, 8-18
- SMTP server, 6-40
- Soft keys
 - Global function assignment, 8-3
 - Local function assignment, 8-3
- Standards, 2-5, 2-6
- Starting
 - HMI device, 6-17
- Status force, 8-15
 - Operator controls, 8-16
- Status force display, 8-15
- STOP button, 2-8, 5-5, 5-7
- Storage conditions, 2-11
- Storage directory, 6-27
- Stripping insulation
 - MPI/PROFIBUS-DP cable, 4-9
 - PROFINET cables, 4-9
- Subnet mask, 6-38
- Support
 - On the Internet, v
- Switch off
 - HMI device, 4-26
- Switching on
 - HMI device, 4-25
- Symbolic values, 8-7
 - Changing, 8-11
 - Entering, 8-11
- Synchronizing, 6-14
- System, 6-29
- System alarms
 - Parameter, A-16
- System functions, A-4
- System information
 - Displaying, 6-29

T

- Tags, limit value monitoring, scaling, text list, 1-18
- TCP/IP address, 6-37
- Technical data
 - Female header, 12-10, 12-11
 - RJ45 plug connector, 12-9
 - RJ45 plug connector, 12-11

- Technical specifications
 - Display, 12-6
 - HMI device, 12-6, 12-7, 12-8
 - Input unit, 12-6
 - Memory, 12-6
 - Overall dimensions, 12-1, 12-2
 - RS 485 interface, 12-9, 12-10
 - Voltage supply, 12-7, 12-8
- Technical support, iv
- Technical Support, 6-17
- Terminal box
 - Connecting, 4-4
 - DIL switch, 4-14
 - Fast connector, 12-16
 - IF1 interface, 12-16
 - Interfaces, 4-6, 4-7
 - Terminal strip 1, 12-16
 - Terminal strip 2, 12-17
 - Variants, 1-13
- Terminal Box DP
 - Fast connector, 12-13
 - IF1 interface, 12-12
 - Terminal strip 1, 12-12
 - Terminal strip 2, 12-14
- Terminal Box PN
 - LED display, 5-16
- Testing
 - HMI device, 4-25
 - Project, 7-7
- Time
 - Entering, 8-11
- Touch screen
 - Calibrating, 6-18
 - Note, 5-2
- Trademarks, iv
- Training center, iv
- Transfer, 7-3, 7-4
 - Automatic, 7-6
 - Cancel, 4-25
 - Manual, 7-5
- Transfer mode
 - Unintentional, 6-32
- Transfer settings, 6-33
- Transferring
 - License key, 7-21
 - Project, 7-2
- Transferring back
 - License key, 7-22
- Transport conditions, 2-11
- Trend view, 8-20
 - Value table, 8-20
- Trends
 - Limit violation, 8-20
- Trends, 8-20

U

Unintentional Transfer Mode, 6-32

Upkeep, 11-1

Use

Conditions, 3-1

In residential areas, 2-6

With additional measures, 3-1

User

Logoff, 8-25

User data

Backing up, 8-23

Restoring, 8-23

User group, 8-22

User view, 8-23

Users, 8-22

Admin, 8-27, 8-29

Creating, 8-26

Deleting, 8-29

Logon, 8-24

PLC_User, 8-27, 8-29

V

Value table, 8-20

Voltage supply, 2-6, 12-7, 12-8

W

WinCC flexible internet settings, 6-40

Windows CE taskbar, 6-2

Password protection, 6-2

WINS server, 6-34

Wiring diagram

Connecting the PLC, 4-16

Connecting the Power Supply, 4-18

