

SIEMENS

SIMATIC HMI

Multi Panel MP 370

Equipment Manual

Preface, Contents

Introduction **1**

Functionality **2**

Commissioning **3**

Operating the MP 370 **4**

Operating Screens and
Screen Objects **5**

Recipes **6**

Archives **7**

System Settings **8**

Installation **9**

Dimensions **10**

Options **11**

Maintenance/Upkeep **12**

Operating System Update **13**

Appendices **A**
▽
D

Glossary, Index

Order No.: 6AV6591-1DB10-2AB0

Release 09/02

A5E00175775

Safety Guidelines

This manual contains notices which you should observe to ensure your own personal safety, as well as to protect the product and connected equipment. These notices are marked as follows according to the level of danger:



Danger

indicates an imminently hazardous situation which, if not avoided, will result in death or serious injury.



Warning

indicates a potentially hazardous situation which, if not avoided, could result in death or serious injury.



Caution

used with the safety alert symbol indicates a potentially hazardous situation which, if not avoided, may result in minor or moderate injury.

Caution

used without the safety alert symbol indicates a potentially hazardous situation which, if not avoided, may result in property damage.

Notice

indicates that unwanted events or status can occur if the relevant information is not observed.

Note

draws your attention to particularly important information on the product, handling the product, or to a particular part of the documentation.

Qualified Personnel

Equipment may be commissioned and operated only by qualified personnel. Qualified personnel within the meaning of the safety notices in this manual are persons who are authorized to commission, ground and identify equipment, systems and circuits in accordance with safety engineering standards.

Correct Usage

Please note the following:



Warning

The device may only be used for the application cases specified in the catalog and the technical description and may only be used in combination with third-party equipment and components recommended or approved by Siemens.

Startup must not take place until it is established that the machine which is to accommodate this component is conforms with the guideline 98/37 EC.

Appropriate transport, and appropriate storage, installation and assembly, as well as careful operation and maintenance, are required to ensure that the product operates perfectly and safely.

Trademarks

The registered trademarks of the Siemens AG can be found in the preface. The remaining trademarks in this publication may be trademarks, whose use by third parties for their own purposes could violate the rights of the owner.

Impressum

Editor and Publisher: A&D PT1 D1

Copyright Siemens AG 2001 All rights reserved

The transmission and reproduction of this documentation and the exploitation and communication of its contents are not permitted without express authority. Offenders will be liable for compensation for damage. All rights reserved, especially in the case of the granting of a patent or registration of a utility model or design

Siemens AG
Automation & Drives
SIMATIC Human Machine Interface
Postfach 4848, D-90327 Nürnberg

Siemens Aktiengesellschaft

Exclusion of Liability

We have checked the content of this publication for compliance with the described hardware and software. However, discrepancies cannot be excluded, with the result that we cannot guarantee total compliance. The information in this publication is, however, checked regularly, and any necessary corrections are included in the following editions. We welcome any suggestions for improvement.

© Siemens AG 2001
Technical data subject to change.

Order no. 6AV6591-1DB10-2AB0

For your notes

Preface

This manual

The MP 370 Equipment Manual for touch panels and keyboard units is part of the SIMATIC HMI documentation. It provides operation, installation, configuration and system personnel with information concerning installation, functionality, operation and technical design of the MP 370.

Organization of the manual

The equipment manual is organized into the following chapters:

Chapter	Contents
1 - 2	Introduction and overview of features and functional scope of the MP 370
3 - 5	Commissioning and operation
6 - 7	Recipes and archives
8	System settings
9 - 12	Mechanical and electrical installation, dimensions, retrofitting of options as well as maintenance and upkeep of the MP 370
13	Information on updating the operating system.
Appendix	<ul style="list-style-type: none">• Technical Data• Interface Assignments• HMI System Messages• ESD Guidelines

Conventions

The following conventions are used throughout this manual:

<i>Motor off</i>	Text in the operating unit display is presented in this typewriter font.
<i>Tag</i>	Symbolic names representing tag values on the screen are presented in this italic typewriter font.
<i>Screens</i>	Functions available for selection are presented in this italic font.
ESC	The names of keys and buttons are displayed in a different font.

History

The various releases of this manual correspond to the following versions of the ProTool CS configuration software:

Edition	Comment	ProTool Version
01/01	First release of the MP 370 equipment manual for touch and keyboard units	From V5.2 + SP3
12/01	New ProTool software, more screen objects, new transfer, download and communication options	From V6.0
09/02	Addition of the new MP 370 15" touch panel unit.	From V6.0 SP2

Trademarks

The following names are registered trademarks of the Siemens AG:

- HMI®
- IndustrialX®
- MP 270®
- MP 270B®
- MP 370®
- ProAgent®
- ProTool®
- ProTool/Lite®
- ProTool/Pro®
- SIMATIC®
- SIMATIC HMI®
- SIMATIC Multi Panel®
- SIMATIC Multifunctional Platform®
- WinCC®
- WinCC Add-on®

Customer and Technical Support

Available round the clock, worldwide:



<p>Worldwide (Nuremberg) Technical Support (FreeContact)</p> <p>Local time: Mon.-Fri. 8:00 to 17:00 Telephone: +49 (180) 5050-222 Fax: +49 (180) 5050-223 E-Mail: techsupport@ad.siemens.de GMT: +1:00</p>	<p>Worldwide (Nuremberg) Technical Support (fee-based, only with SIMATIC Card)</p> <p>Local time: Mon.-Fri. 0:00 to 24:00 Telephone: +49 (911) 895-7777 Fax: +49 (911) 895-7001 GMT: +01:00</p>	
<p>Europe / Africa (Nuremberg) Authorization</p> <p>Local time: Mon.-Fri. 8:00 to 17:00 Telephone: +49 (911) 895-7200 Fax: +49 (911) 895-7201 E-Mail: authorization@nbgm.siemens.de GMT: +1:00</p>	<p>America (Johnson City) Technical Support and Authorization</p> <p>Local time: Mon.-Fri. 8:00 to 19:00 Telephone: +1 423 461-2522 Fax: +1 423 461-2289 E-Mail: simatic.hotline@sea.siemens.com GMT: -5:00</p>	<p>Asia / Australia (Singapore) Technical Support and Authorization</p> <p>Local time: Mon.-Fri. 8:30 to 17:30 Telephone: +65 740-7000 Fax: +65 740-7001 E-Mail: simatic.hotline@sae.siemens.com.sg GMT: +8:00</p>

The languages spoken by the SIMATIC Hotlines are generally German and English, the Authorization Hotline is also provided in French, Italian and Spanish.

SIMATIC Customer Support Online Services

The SIMATIC Customer Support provides you with additional information about SIMATIC products through online services:

- General current information can be obtained
 - in the **Internet** under <http://www.ad.siemens.de/simatic>
- Current product information and downloads which you may find useful are available:
 - in the **Internet** under <http://www.ad.siemens.de/simatic-cs> and
 - via the **Bulletin Board System (BBS)** in Nuremberg (*SIMATIC Customer Support Mailbox*) under the number +49 (911) 895-7100

To dial the mailbox, use a modem with a capacity up to V.34 (28.8 kBaud) whose parameters are set as follows:

- 8, N, 1, ANSI, or
 - dial via ISDN (x.75, 64 kBit).
- Your contact partner for Automation & Drives can be found in the contact partner database
 - in the **Internet** under <http://www3.ad.siemens.de/partner/search.asp>

Abbreviations

The abbreviations used in this manual have the following meaning:

AG (PLC)	Programmable Logic Controller
ANSI	American National Standards Institute
AS 511	Protocol of the PU interface to SIMATIC S5
ASCII	American Standard Code for Information Interchange
CCFL	Cold Cathode Fluorescence Lamp
CF	Compact Flash
CPU	Central Processing Unit
CSV	Comma Separated Values
DC	Direct Current
DHCP	Dynamic Host Configuration Protocol
DNS	Domain Name Service
DP	Decentralized Periphery
DSN	Data Source Name
ESD	Electrostatically Sensitive Device
EMC	Electromagnetic Compatibility
HMI	Human Machine Interface
IF	Interface

LCD	Liquid Crystal Display
LED	Light Emitting Diode
MP	Multi Panel
MPI	Multipoint Interface (SIMATIC S7)
OP	Operator Panel
PC	Personal Computer
PCL	Printer Control Language
PELV	Protected Extra Low Voltage
PU	Programming Unit
PPI	Point to Point Interface (SIMATIC S7)
QVGA	Quarter Video Graphics Array
RISC	Reduced Instruction Set Computer
SELV	Safety Extra Low Voltage
PLC	Programmable Logic Controller
SRAM	Static Random Access Memory
STN	Super Twisted Nematic
TCP/IP	Transmission Control Protocol/Internet Protocol
TFT	Thin Film Transistor
TTL	Transistor-Transistor Logic
UPS	Uninterruptible Power Supply (USV)
USB	Universal Serial Bus
UPS	Uninterruptible Power Supply
VGA	Video Graphics Array
WINS	Windows Internet Name Service
XGA	Extended Graphics Adapter

A list of all the specialist terms together with their explanations is provided in the Glossary at the end of this manual.

SIMATIC HMI Documentation

Target groups

This manual is part of the SIMATIC HMI Documentation. The documentation is aimed at the following target groups:

- Beginners
- Users
- Configuration planners
- Programmers
- Service engineers

Documentation structure

The SIMATIC HMI Documentation includes the following components:

- User guides for
 - configuration software
 - runtime software
 - communication between PLC and operating unit
- Equipment manuals for the following operating units:
 - SIMATIC PC
 - MP (Multi Panel)
 - OP (Operator Panel)
 - TP (Touch Panel)
 - TD (Text Display)
 - PP (Pushbutton Panel)
- Online help for the configuration software
- Installation guides
- Quick reference manuals

The following table provides an overview of the SIMATIC HMI Documentation helpful for this manual.

Documentation	Target group	Contents
Getting Started Quick Reference Manual	Beginners	<p>These documents provide a step by step guide to the configuration of</p> <ul style="list-style-type: none"> • a screen with various objects, • changing screens, • a message. <p>This documentation is available for</p> <ul style="list-style-type: none"> • text-based displays, • graphics displays, • touch panels, • Windows-based systems.
ProTool Configuring Windows-based Systems User's Guide	Configuration planners	<p>Provides information for working with the configuration software:</p> <ul style="list-style-type: none"> • principles of the configuration, • detailed description of objects and functions which can be configured, • examples
ProTool Online Help	Configuration planners	<p>Contains the following information while working with ProTool on the configuration computer:</p> <ul style="list-style-type: none"> • context-sensitive help, • detailed instructions and examples, • reference information, • all information from the user guides.
Communication for Windows-based Systems User's Guide	Programmers	<p>Provides information on connecting Windows-based systems to the following PLCs:</p> <ul style="list-style-type: none"> • SIMATIC S5 • SIMATIC S7 • SIMATIC 505 • SIMATIC WinAC • SIMOTION • PLCs from other manufacturers <p>This documentation describes</p> <ul style="list-style-type: none"> • the configuration and parameters necessary to connect the units to the PLC and network, • the user data areas which serve for data exchange between the operating unit and PLC.

Contents

1	Introduction	1-1
2	Functionality	2-1
3	Commissioning	3-1
3.1	Initial Startup	3-3
3.2	Recommissioning	3-4
3.2.1	Start downloading manually	3-4
3.2.2	Start downloading automatically during normal operation	3-5
3.3	MP 370 Start Menu (Loader)	3-6
3.4	Options for Download Mode	3-7
3.5	Test the Configuration on the MP 370	3-10
3.6	Uploading	3-12
3.7	Backup/Restore the Internal Flash Memory	3-14
3.7.1	Backup/Restore on memory cards	3-15
3.7.2	Backup/Restore using ProSave	3-16
3.8	License Transfer (Authorization) Using ProSave	3-19
3.9	Load Application	3-21
3.9.1	Load application using ProSave	3-21
3.9.2	Load applications using Active Sync	3-23
3.10	ProSave Service Tool	3-24
4	Operating the MP 370	4-1
4.1	Touch Panel Operation	4-2
4.1.1	Operating touch elements	4-2
4.1.2	Enter numeric values	4-5
4.1.3	Enter alphanumeric values	4-6
4.1.4	Navigation using buttons	4-7
4.1.5	Call help text	4-7
4.2	Operating Keyboard Units	4-8
4.2.1	Function keys/Softkeys	4-9
4.2.2	System keys	4-11
4.2.3	Key combinations	4-14
4.2.4	Entering values	4-16
4.2.5	Call help text	4-18
4.3	Operating Using an External Keyboard/Mouse	4-19

5	Operating Screens and Screen Objects	5-1
5.1	Operating Screens	5-1
5.2	Logging On and Off from the MP 370	5-5
5.3	Overview of Screen Objects	5-6
5.4	Input Field	5-9
5.5	Selection Field	5-11
5.6	Date/Time	5-13
5.7	Graphic Box	5-15
5.8	Buttons	5-16
5.9	Status Button	5-18
5.10	Switch	5-20
5.11	Messages	5-21
5.11.1	ALARM_S	5-24
5.11.2	Message line	5-25
5.11.3	Message window	5-25
5.11.4	Message page	5-27
5.11.5	Message buffer	5-28
5.11.6	Message display	5-29
5.11.7	Single message display	5-31
5.12	Bar Graphs	5-32
5.13	Trend View	5-33
5.14	Slider Control	5-36
5.15	Analog Display	5-38
5.16	Digital/Analog Clock	5-39
5.17	Password List	5-40
5.17.1	Password management	5-42
5.17.2	Export/Import password list	5-43
5.18	Status/Force	5-44
5.19	SIMATIC HMI Symbol Library	5-46
6	Recipes	6-1
6.1	Overview	6-1
6.2	Use of Recipes	6-3
6.2.1	Data flow for recipes	6-3
6.2.2	Application examples	6-4
6.3	Recipe Configuration	6-7
6.4	Editing Data Records	6-10
6.4.1	Recipe view	6-11
6.4.2	Recipe screens	6-19
6.4.3	Functions and PLC jobs	6-23
6.4.4	Import/Export data records	6-25
6.4.5	Reaction on changing the recipe structure	6-28

7	Archives	7-1
8	System Settings	8-1
8.1	Language	8-2
8.2	Setting an Operating Mode	8-3
8.3	Windows CE Control Panel Settings	8-4
8.3.1	Device properties	8-6
8.3.2	Screen saver	8-9
8.3.3	Communication	8-10
8.3.4	Set date/time	8-10
8.3.5	Network	8-10
8.3.6	Regional setting	8-11
8.3.7	Screen keyboard	8-11
8.3.8	Volume	8-11
8.3.9	Set printer	8-11
8.3.10	Uninterruptible Power Supply UPS (only loadable as an option)	8-13
8.3.11	System properties	8-14
8.4	Network Operation	8-15
8.4.1	Configuring the MP 370 for network operation	8-16
8.4.2	Test network	8-17
8.4.3	Configure network functions	8-18
9	Installation	9-1
9.1	Mechanical Installation	9-1
9.1.1	Install keyboard unit	9-2
9.1.2	Install touch panel	9-4
9.2	Electrical Installation	9-6
9.2.1	Equipotential	9-9
9.2.2	Connect configuration computer	9-12
9.2.3	Connect PLC	9-13
9.2.4	Connect printer	9-15
9.2.5	Connect external keyboard and mouse	9-16
9.2.6	Connecting an Uninterruptible Power Supply (UPS)	9-17
10	Dimensions	10-1
10.1	MP 370 12" Touch Panel	10-2
10.2	MP 370 15" Touch Panel	10-4
10.3	Keyboard Unit	10-6
10.3.1	Unit dimensions	10-6
10.3.2	Labeling function keys	10-7
11	Options	11-1
11.1	Hardware Options	11-2
11.1.1	Backup battery	11-2
11.1.2	PC card / CF card	11-3
11.2	Software Option	11-5
11.2.1	Internet Explorer	11-5

12	Maintenance/Upkeep	12-1
12.1	Clean Screen/Keyboard	12-1
12.1.1	General notes	12-1
12.1.2	Notes on the touch panel	12-2
12.2	Replacing the Optional Backup Battery	12-3
13	Operating System Update	13-1
13.1	Operating system update with ProSave	13-1
13.2	Operating system update using PtUpdate	13-5

Appendix

A	Technical Data	A-1
B	Interface Assignments	B-1
C	HMI System Messages	C-1
D	ESD Guidelines	D-1

Introduction

Multifunctional platform

The SIMATIC Multi Panels are included in the new “*Multifunctional Platform*” product category. This product category is positioned in the product hierarchy between the optimized process and application components, such as operator panels and PLCs on the one hand, and industrial PCs on the other. The category is now completed by the introduction of the new unit, MP 370 15” Touch, intended for the high-end sector.

The multifunctional platform is based on the innovative standard operating system Microsoft Windows CE. It combines the robustness of the dedicated hardware solutions with the flexibility of the PC world.

Multi Panels provide the following advantages:

- High degrees of configuration efficiency,
- Simulation of the configuration on the configuration computer (no PLC required),
- Clear display and easy operation of the process by means of a Windows-based user interface,
- Large selection of predefined screen objects during configuration,
- Dynamic use of screen objects (e.g. moving objects),
- Uncomplicated and quick handling of recipes and data records in recipe screens and recipe views,
- Archiving of messages, process values and login/logout procedures,
- Creation of vector graphics using the SIMATIC ProTool CS configuration software without an external graphics editor,
- Visual Basic Script for the realization of customized functions,
- ALARM_S message procedure in connection with the SIMATIC S7,
- Downloading:
 - Automatic switchover to Download mode,
 - Transfer via MPI, PROFIBUS/DP, USB and Ethernet,
 - Serial downloading,
 - Downloading via TeleService,
- Standard connections to SIMATIC S5/DP, SIMATIC S7 and SIMATIC 505 as well as to PLCs from other manufacturers.

Positioning in the SIMATIC HMI unit landscape

The MP 370 extends the multifunctional platform product category for the upper performance range. It fulfills the high demands made on performance, display possibilities and price/performance ratio, and extend communication potential of the office-world, for example. The requirements of customers for new possibilities, e.g. in respect of downloading and data transfer functions, simpler operation and related increased acceptance when compared with CE units, were taken into account during the development of the new units and implemented. The introduction of the new touch panel unit with a 15" display means that this product category is now provided with a large-scale screen with an increased visualization area.

The MP 370 realizes the conception of multifunctionality. In addition to supporting the classic HMI applications (visualization with SIMATIC ProTool), it also supports other applications such as process diagnostics (SIMATIC ProAgent/MP), UPS, Terminal Client (SIMATIC ThinClient/MP) for the touchscreen units and Soft PLC (SIMATIC WinAC) for the MP 370 12"- unit models. In addition, the MP 370 can also be used within the scope of the OPP (Open Platform Program).

The MP 370 is available as different models with operation via touch panel or membrane keyboard according to the respective visualization tasks.

A complete overview of the functional range of the MP 370 is provided Chapter 2.

Area of use

The MP 370 enables operating statuses, current process data and faults concerning a connected PLC to be graphically displayed and the relevant machine or system to be easily monitored and operated.

The MP 370 has been conceived for easy machine operation and monitoring. It provides a realistic graphical representation of the machine or system to be monitored. They can be used, for example, in machine and apparatus construction sectors, in the printing and packing industries, in the automobile and electrical industries and in the chemical and pharmaceutical industries.

The high degree of protection (IP65 on the front side) and non-implementation of moving storage media, such as hard disks and floppy disks, ensure the MP 370 is also suitable for use in hostile industrial environments and directly on site on the respective machine.

Installation locations for the MP 370:

- Panels/Consoles
- 19" racks (keyboard units)

Connection options for external periphery units (keyboard, mouse and printer), e.g. via a USB interface, and the possible use of CF and PC boards support multifunctionality. Due to the fact that the MP 370 is equipped with high performance basic hardware and has a minimum installation depth means that it fulfills all the requirements for operation in the vicinity of the machine.

The MP 370 can be used to:

- operate and monitor the process by means of the menu system. Setpoint values or control element settings, for instance, can be modified by entering values or activating configured function keys;
- display processes, machines and systems on full-graphic, dynamic screens;
- display and edit messages and process tags e.g. in output fields, bar graphs, trend curves or status displays;
- intervene directly in the running process by input.

Configuration using ProTool CS

Graphics, texts, user-defined functions and operating and display elements which need to be represented on the MP 370 must first be created on a configuration computer (PC or PU) using the SIMATIC ProTool CS configuration software. In order to download the configuration to the MP 370, the configuration computer must be connected to the MP 370 (refer to “Configuration phase” in Figure 1-1). The connection can be established by a serial, an MPI/PROFIBUS-DP network, a USB or an Ethernet interface or via a standard modem path.

Once the configuration has been successfully downloaded, connect the MP 370 to the PLC. The MP 370 can then communicate with the PLC and respond according to the information configured for running the program in the PLC (refer to “Process running phase” in Figure 1-1).

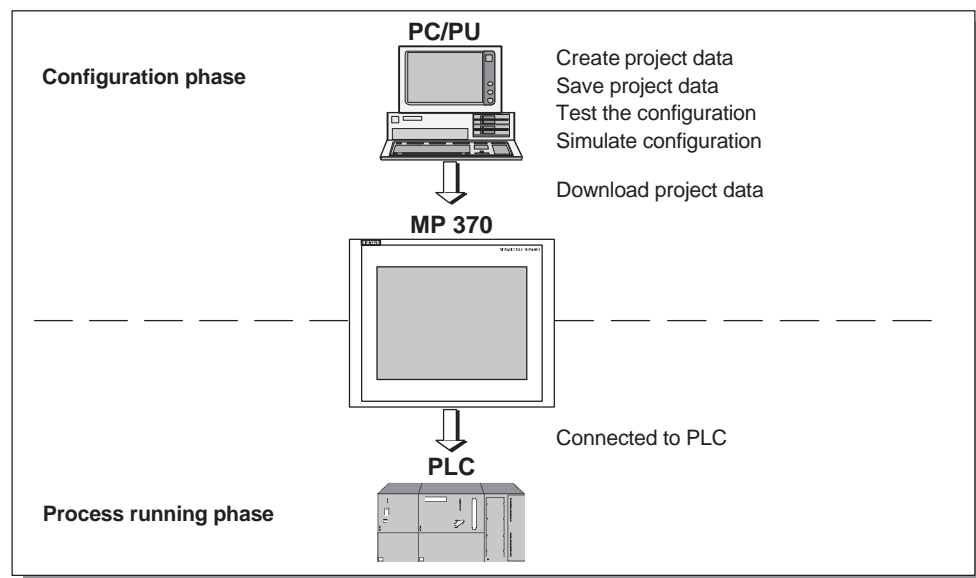

Figure 1-1 Configuration and process running phase

General overview of the MP 370

Performance features		Keyboard unit	MP 370 12" touch panel	MP 370 15" touch panel
Processor	Type	64 bit RISC CPU		
Memory	Capacity (max.)	Free for user data: Flash memory 12 Mbyte (max. 7 Mbyte for ProTool configurations)		
Software	Operating system	Microsoft Windows CE		
Interfaces	Standard HMI interfaces for connection to PLC, PC/PU and printer	1 × RS 232/TTY (active/passive) 1 × RS 232 (9-pin) 1 × RS 422/RS485		
	S7 connection	MPI/PROFIBUS-DP		
	Further interfaces for network, external keyboard and mouse	1 × Ethernet (10/100 Mbit) 1 × USB (12 Mbaud/Host)		
Color display	Type	TFT LCD	TFT LCD with touch panel (analog resistive)	
	Active screen diagonal	12.1 "		15.1 "
	Resolution (pixels)	800 × 600 (Super VGA)		1024 × 768 (XGA)
	Possible colors	256		
	Back-lighting Service life, approx. (h)	CCFL tube 50,000		
Membrane key-board	System keys with dedicated functions	38 (3 with LEDs)	–	
	Function keys with configurable functions	36 (with LED)	–	
	Those usable as softkeys	36	–	
	Function key labeling	System-specific with labeling strips	–	
Acoustic acknowledgement	In the case of touch operation	–	×	

Performance features		Keyboard unit	MP 370 12" touch panel	MP 370 15" touch panel
Special features	External memory extension for recipes, archives, messages, etc.: <ul style="list-style-type: none"> • Slot for PC card • Slot for CF card 		x	x

Further information

Detailed information on the technical data of the MP 370 is provided in Appendix A of this manual.

Detailed descriptions of the creation of projects for the MP 370 and configuration software functions are provided in the *ProTool Configuring Windows-based Systems User's Guide* and in the online help for ProTool CS.

Connection of the MP 370 to the PLC is described in the *Communication for Windows-based Systems User's Guide*.

Any new information which could not be taken into account for printing in the guides is provided in the *Readme.wri* file on the ProTool CD.

Functionality

2

The following table summarizes the range of functions provided by the MP 370. The values specified are the maximum values which can be managed by the MP 370. These values are not accumulative, i.e. 4000 messages can be configured if no further objects are used. However, it is not possible to define 4000 messages and 300 pictures each with 400 tags simultaneously. The defined values are limited by the size of the configuration memory.

Function		Keyboard unit	Touch panel unit
Messages	Number	4,000	
	Display	In message line/message window/message display	
	View all queued messages	Message page/Message display	
	Message length	70 character (font-dependent) for message texts configurable in ProTool, 255 character for message texts configurable in Step 7	
	Process values in message text	8	
	Color-coding of different message states	x	
	Event messages	x	
	Alarm messages <ul style="list-style-type: none"> • Type of display • Acknowledge individual messages • Acknowledge several alarm messages simultaneously (group acknowledgement) 	x First/last, selectable x 16 acknowledgment groups	
ALARM_S	Display S7 messages	x	
Message logging	Output to printer	x	

Function		Keyboard unit	Touch panel unit
Volatile message buffer	Capacity	1,024 message events	
	View messages	x	
	Delete	x	
	Print	x	
	Capacity	1,024 message events	
	Message events queued simultaneously (max.)	500	
	• Event messages or • Alarm messages/ALARM_S	250	
Message buffer archive	Memory location	File	
	Capacity	Limited by storage medium ¹⁾	
Message acquisition	Time of occurrence	Date and time	
	Message events	Arrived, departed, acknowledged	
Screens	Number	300	
	Fields per screen	400	
	Tags per screen	400	
	Complex elements per screen (trends, bar graphs, etc.)	20	
	View	x	
	Print (hardcopy)	x	
Screens	Number	300	
	Screen objects	<ul style="list-style-type: none"> • Text • Graphics • Output field • Input field • Symbolic output field • Selection field • Date and time • Graphic display • Graphics list • Graphic box • Button • Status button • State view 	

1) Storage media refers to PC cards, CF cards and network drives

Function		Keyboard unit	Touch panel unit
Screens	Screen objects	<ul style="list-style-type: none"> • Switches • Hidden button • Trend view • Bar • Message view • Single message display • Status/Force • Password list • Recipe display • Slider controls • Analog display • Digital/Analog clock • SIMATIC HMI Symbol Library 	
	Operator prompting		
	• Help text	x	x
	• Dynamic attributes	x	x
	• Call/Hide objects	x	x
• Icons for softkeys	x	–	
• TAB sequence	x	–	
• LEDs in function keys	x	–	
	Fixed window	x	
Tags	Number	2,048	
Limit value monitoring	Inputs/outputs	x	
Conversion functions	Inputs/outputs	x	
Help text	Lines/characters	7/35	
	For messages	x	
	For screens	x	
	For screen objects		
	• Input field	x	x
• Selection field	x	x	
• Button	x	–	
• Status button	x	–	
• Switches	x	–	
• Hidden button	x	–	

Function		Keyboard unit	Touch panel unit
Archiving	Messages	x	
	Tags	x	
	Archive type	Cyclic/Sequence archive	
	No. of archives	20	
	Max. no. of tags which can be archived	20	
	No. of sequence archives	40	
	Entries per archive	10,000	
	Memory location	File (CSV)	
Lists	Number	500	
	Graphic lists	500	
	Text lists	500	
Print functions	Hardcopy of the screen content, also in color	x	
	Direct message logging	x	
	Shift report	x	
Password protection	Number of passwords	50	
	Password level	10 (0..9)	
Recipes	Number	1000	
	Data records per recipe ¹⁾	1000	
	Entries per recipe	500	
Online language change	Number of languages	5	
PU functions (Status/Force)	SIMATIC S5	x	
	SIMATIC S7	x	
Screen settings	Blanking circuit	x	
	Brightness	x	
	Screen saver	x	
	Touch calibration	–	x
Scheduler	Trigger functions cyclically or once	x	
VB Script	User-specific expansions of functionality	x	
	Number of scripts	50	
	Number of lines per script	100	
Connections ²⁾	Number	6	

1) Storage media refers to PC cards, CF cards and network drives

2) With SIMATIC S7

Function		Keyboard unit	Touch panel unit	
Communication	SIMATIC S5			
	• AS511		×	
	• PROFIBUS-DP		×	
	SIMATIC S7-200		×	
	SIMATIC S7-300/400		×	
	SIMATIC 505			
	• NITP		×	
	• PROFIBUS-DP		×	
	SIMATIC WinAC		×	
	SIMOTION		×	
	Connection to PLCs from other manufacturers			
	Allen Bradley (PLC-5, SLC 500)			
	• DF1			×
	• DH+			×
	• DH485			×
	LG Lucky Goldstar			
• GLOFA GM			×	
Modicon				
• Modbus			×	
Mitsubishi FX / Mitsubishi Protocol 4			×	
GE Fanuc			×	
Omron Hostlink/Multilink			×	
Telemecanique TSX				
• Uni-Telway			×	

Commissioning

3

In this chapter

This chapter provides information on:

- Initial start-up of the MP 370 (Page 3-3)
- Recommissioning the MP 370 (Page 3-4)
- Options for download mode (Page 3-7)
- Testing the configuration on the MP 370 (Page 3-10)
- Uploading the configuration (Page 3-12)
- Backup/Restore (Page 3-14)
- License transfer ProSave (Page 3-19)
- Load application (Page 3-21)
- Service tool ProSave (Page 3-24)

Notice

In the case of the initial start-up, please observe the safety notes concerning reverse poling protection on Page 9-8.

Notice

High frequency radiation, e.g. from mobile telephones, can cause exceptional operating situations.

Caution

Always terminate the runtime software before switching off the voltage supply in order to prevent loss of data.

To terminate the runtime software, press the operating element assigned the *Exit_runtime* function in the configuration. Wait until the MP 370 start menu, namely the Loader menu (Figure 3-1, Page 3-6), appears and then switch off the power supply.

Note

During the start-up phase, it is possible to connect an external keyboard or mouse to the USB interface.

Further information

Further information on operating the MP 370 is provided in the following chapters:

General operation of the touch unit: Chapter 4.1

General operation of the keyboard unit: Chapter 4.2

Operating screens and screen objects: Chapter 5

3.1 Initial Startup

Action

When the MP 370 is started up for the first time, no configuration has been loaded on it. In order to download the necessary project data and the runtime software from the configuration computer to the operating units, proceed as follows, observing the sequence.

Step	Action
1	Use a suitable standard cable to connect the MP 370 via the IF2 (serial), IF1B (MPI/PROFIBUS-DP), USB or Ethernet interfaces to the configuration computer according to the required download type. Downloading is also possible via modem. Default setting: Serial connection
2	Switch on the MP 370's power supply.
3	When the unit is started up, it automatically switches from the Start menu to download mode. Press the Cancel button to access the Start menu and, from there, the Windows CE Control Panel.
4	Check the settings defined for the interface in the download settings (serial, MPI, USB or Ethernet) and adapt them as necessary (refer to Chapter 3.4). Default setting: Serial connection
5	Close the Control Panel and activate download mode.
6	Start downloading the configuration on the configuration computer. Further settings necessary on the configuration computer for the download operation are provided in the <i>ProTool Configuring Windows-based Systems User's Guide</i> . The configuration computer checks the connection to the MP 370. If the connection is not available or defective, the corresponding error message appears. If downloading from the configuration computer is terminated as a result of a compatibility conflict, the MP 370's operating system must be replaced (refer to Chapter 13). If the connection is correct, the project data is downloaded to the MP 370. Following successful downloading, the configuration is started and the unit displays the start screen of the configuration that has just been loaded.

Set date/time

When the MP 370 is started up for the first time or has been disconnected from the power supply for a longer period without the backup battery being used, the date and time must be updated. Information on this is provided on Page 5-13.

3.2 Recommissioning

Purpose

During recommissioning, a configuration already loaded on the MP 370 is replaced by another. In this case, the project data is downloaded from the configuration computer to the MP 370.

The following options are available to switch the MP 370 to Download mode:

- Start downloading during the start-up phase of the MP 370 manually (Page 3-4)

- Start downloading during normal operation of the MP 370 automatically (Page 3-5)

- Start downloading during normal operation of the MP 370 via a correspondingly configured operating element (Page 8-3)

3.2.1 Start downloading manually

Start downloading during the start-up phase of the MP 370 manually:

Step	Action
1	Use a suitable standard cable to connect the MP 370 via the IF2 (serial), IF1B (MPI/PROFIBUS-DP), USB or Ethernet interfaces to the configuration computer according to the required. Downloading is also possible via modem.
2	Switch on the MP 370's power supply.
3	Check the settings defined for the interface in the download settings (serial, MPI, USB or Ethernet) and adapt them as necessary (refer to Chapter 3.4).
4	Close the Control Panel and activate download mode.
5	<p>Start downloading the configuration on the configuration computer.</p> <p>The configuration computer checks the connection to the MP 370. If the connection is not available or defective, the configuration computer issues the corresponding error message.</p> <p>If downloading from the configuration computer is terminated as a result of a compatibility conflict, the MP 370's operating system must be replaced (refer to Chapter 13).</p> <p>If the connection is correct, the new configuration is downloaded to the MP 370. Following successful downloading, the configuration is started and the unit displays the start screen of the configuration that has just been loaded.</p>

3.2.2 Start downloading automatically during normal operation

Download settings

The MP 370 can be switched to download mode automatically when in normal operation as soon as downloading is started on the configuration computer connected to it. This option is particularly recommended for the test phase involving a new configuration project because the data is transferred without having to intervene on the MP 370.

A condition for this is that the required connection is set in the *Download* option in the Windows CE Control Panel and the corresponding *Remote Control* function is activated.

A detailed description of the possible download settings is provided on Page 3-7.

Close modal dialogs

If the *Remote Control* option is active, the runtime is automatically shut down and the MP 370 switched to download mode. If dialogs are still open, the runtime cannot be shut down when downloading has been started on the MP 370.

In such cases, close the dialog or interrupt downloading on the configuration computer.

Recommendation

Following the start-up phase, switch the automatic download option off to prevent inadvertently switching the MP 370 to download mode in a system which is running. To do this, deactivate the *Remote Control* option in the download settings defined for the MP 370 (Figure 3-2, Page 3-7).

3.3 MP 370 Start Menu (Loader)

During the start-up phase, the Start menu (Loader) depicted below appears. When the runtime has ended, the following appears:

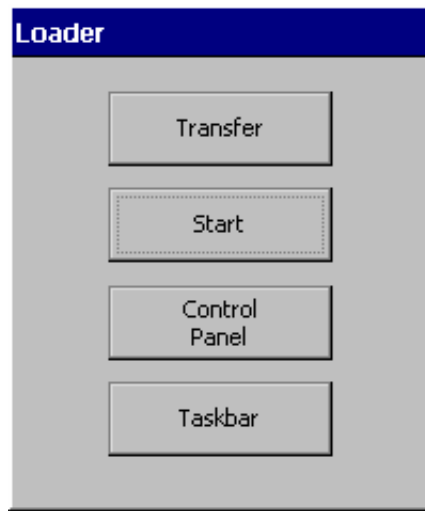

Figure 3-1 MP 370 Start menu (Loader)

Press the *Transfer* button to switch the MP 370 to download mode.

Press the *Start* button to start the runtime automatically.

Press the *Control Panel* button to access the Windows CE Control Panel (see Figure 8-1 on Page 8-5) in which various settings can be defined. The settings for the download mode options can be defined here, for example.

Press the *Taskbar* button to activate the toolbar when the Start menu is open.

It is possible to protect the Start menu from unauthorized access by assigning a password. If the password is subsequently not entered, only the *Transfer* and *Start* buttons are available. This prevents incorrect operation and increases system or machine security since settings cannot be modified.

3.4 Options for Download Mode

Overview

The following options can be set for download mode:

Automatic switching to download mode from normal operation when data transfer is initiated from the connected configuration computer.

Download mode can be restricted to a specific connection type so that downloading can only occur either via a serial connection, MPI/PROFIBUS-DP, USB or Ethernet connection.

Download mode settings

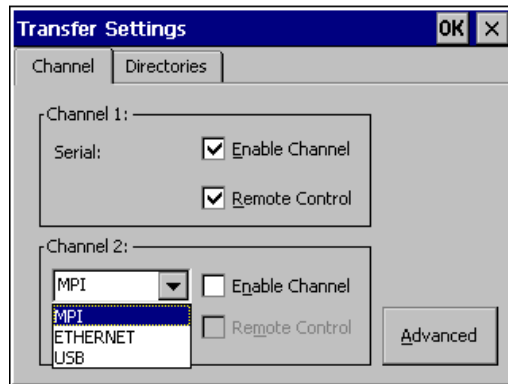

Figure 3-2 Transfer Settings menu with *Channel* tab control

The *Channel* tab control in the Transfer Settings menu can be used to activate the required communication channel and the respective *Remote Control* option. In addition to the serial communication channel, a second channel can also be selected to download data from the configuration computer to the MP 370.

Press the *Advanced* button to define the *Address* bus parameter setting and *Transmission Rate* and *Highest Station* network parameter settings for downloading via MPI or PROFIBUS-DP. The relevant driver must be set for downloading via Ethernet.



Warning

When the *Remote Control* option is active, ensure that the MP 370 is not inadvertently switched to download mode from the configuration computer when in normal operation.

Notice

Deactivate the *Remote Control* option when selecting the communication channel if a serial printer is connected to the MP 370.

Notice

If no communication channel has been enabled using the *Enable Channel* option, it is not possible to download a configuration from the configuration computer to the MP 370.

Note

The bus parameters for the **MPI transfer** (e.g. MPI address, baud rate, etc.) are read out of the configuration currently loaded on the MP 370.

The settings for MPI transfer can be modified. To do this, stop the runtime, modify the settings and switch to download mode. When the runtime is subsequently started, the bus parameters are overwritten by values from the configuration.



Warning

In the case of Profibus-DP, modifications here may only be made for start up purposes.

Each modification of the settings for Profibus-DP, the operating units only set one corresponding standard bus parameter set. In unfavorable conditions, this can lead to faults on the DP bus.

In order to calculate the bus parameters exactly, the entire bus topology must be known.

Correct definition of the bus parameters for runtime is automatically ensured by the integrated operation of ProTool in STEP 7.

Note

Modifications must not be carried out when the runtime is in operation or the unit is in download mode.

Note

Downloading is not possible using an interface which is busy with another program.

In addition to the setting options for download mode, the *Directories* tab control can be used to specify the following paths (refer to Figure 3-3):

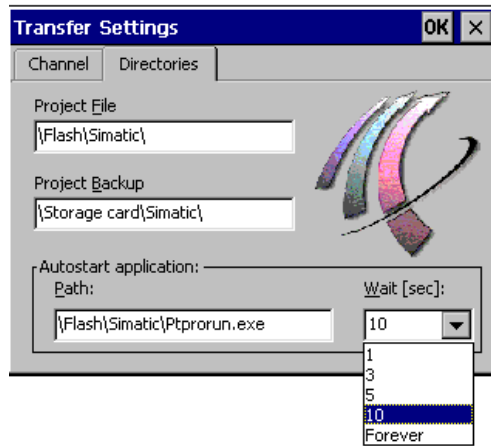

Figure 3-3 Transfer Settings menu with *Directories* tab control

Project File

The predefined storage location for the project file can be changed here. The internal Flash memory or external Flash cards can be set for the MP 370. During the next downloading process, the configuration is stored in the storage location specified.

Project Backup

The predefined storage location for the source file of your configuration can be changed here. This file can be used for restoring (uploading) the configuration. External Flash cards or network connections can be set for the MP 370. Information on uploading is provided on Page 3-12.

Autostart application

Path

This defines the storage location for the ProTool runtime software. This is the application with which the configuration runs under Windows CE.

Wait

It is possible to define the number of seconds the Start menu should remain on screen before the runtime is started (1 s, 3 s, 5 s, 10 s or constantly). If no runtime software is available, the unit automatically switches to download mode.

Notice

Do not change the default settings in the *Project File* and *Path* fields when working with ProTool. Otherwise, the MP 370 can no longer start the configuration.

Press the *OK* button or Enter key to confirm the settings currently defined for the download options. Ensure that no buttons have been selected. The Transfer Settings menu is closed and the Windows CE Control Panel is displayed.

Press the *X* button or *ESC* key to close the Transfer Settings menu and call in the Windows CE Control Panel. Any modifications made to the settings are rejected.

Note

If the unit is in download mode while changes are made to the download settings, the settings only take effect after the download function is restarted. This can occur when the Control Panel is selected via the Windows Start menu in order to modify the downloading properties.

3.5 Test the Configuration on the MP 370

Conditions

In order to switch the MP 370 between the operating modes *OFFLINE* and *ONLINE*, the function *Change_mode* must be linked to an operating element in the configuration.

Note

During the test phase, it is recommended to enable switching to download mode from normal operation. Further information on this is provided on Page 3-5.



Warning

After the test phase, do not forget to deactivate the *Remote Control* option to prevent inadvertently switching to download mode from the configuration computer when in normal operation.

Testing without a PLC connected (OFFLINE mode)

After setting the MP 370 to operating mode *OFFLINE*, the individual project functions can be tested without them being affected by the PLC. PLC tags are not updated in *OFFLINE* mode.

Step	Action
1	Switch the MP 370 to operating mode <i>OFFLINE</i> (refer to Page 8-3).
2	Check all the configured screens in respect of correct representation.
3	Check the screen hierarchy.
4	Check the input fields.
5	Test the function keys on the keyboard unit.

Testing with a PLC connected (ONLINE mode)

When a PLC is connected, it is possible to test the communication between the MP 370 and PLC in ONLINE mode. This includes checking that the correct data areas have been configured.

Step	Action
1	Connect the MP 370 to the PLC.
2	Test all the items in the configuration for which communication with the PLC is necessary e.g.: <ul style="list-style-type: none"> messages, print functions automatic message logging selecting screens etc.

Testing on the configuration computer

The material supplied with ProTool contains a simulation program which can be used to test the configuration on the configuration computer without the necessity of connecting a PLC or MP 370. Detailed information on this is provided in the *ProTool Configuring Windows-based Systems User's Guide* and in the online help to ProTool CS.

The simulation program can be started using the corresponding button in the toolbar in ProTool



or via *File* → *Test* → *Start Simulator*.

3.6 Uploading

Purpose

During transfer, generally only the run-capable configuration (*.fwd) which has been generated is downloaded on the MP 370. If the original project file is to be used for further development of the configuration or for fault analysis, it must remain on the configuration computer.

Not only the generated configuration can be stored on the MP 370, but also the source file (*), so that it can be retrieved (uploaded) from the MP 370 later, if necessary.

Advantage

After uploading a configuration, it can be analyzed and modified even if the original configuration computer cannot be accessed or the source file on it for the configuration is no longer available.

Conditions

The following conditions must be fulfilled in order to retrieve the source file from the run-capable project file:

Sufficient memory space must be available on the MP 370 for the additional source file

The storage location for the source file must be set on the MP 370 (refer to Page 3-9). The storage location can be defined separately: Network path or memory card

Note

The uploaded file is considerably larger than the run-capable configuration. The internal Flash memory is not large enough to store this file.

Transfer of the current project file from the configuration computer to the MP 370 must be performed using the *Upload* option. This option can be activated in ProTool CS via *File* → *Download* → *Preferences*.

What happens during download/uploading?

In the case of downloading including transfer of the source file, the configuration is compressed from the source format (*.pdb) and downloaded to the MP 370 as a *.pdz file. After uploading, the file is decompressed in the ProTool CS configuration software.

Following uploading, the configuration must be given a new name on the configuration computer.

Notice

The uploaded, decompressed project file can only be opened with a ProTool CS whose version number is greater than or equal to that of the configuration software with which the project was created.

ProTool CS cannot check whether the source file on the MP 370 matches the configuration actually run on it. If downloading is performed at any time without the option *Upload* being activated, it is possible that old project data is on the MP 370 which no longer matches the current project.

Instructions

Downloading a configuration back from the MP 370:

Step	Action
1	Select the menu option <i>File</i> → <i>Upload</i> → <i>Preferences</i> in ProTool CS on the configuration computer.
2	Use the <i>Upload</i> dialog to select the required connection type between the operating unit and configuration computer and set the relevant connection parameters.
3	Click on <i>OK</i> .
4	Switch the operating unit to download mode according to the setting in the <i>Transfer</i> settings configuration menu.
5	Start the upload function using the menu item <i>Upload</i> → <i>Start</i> in ProTool.
6	Enter a new name or select an existing configuration to be overwritten and click <i>Save</i> . The uploaded configuration is saved and automatically opened in ProTool CS.

3.7 Backup/Restore the Internal Flash Memory

Purpose

The functions *Backup* and *Restore* provide the following options:

- creating a copy of the entire configuration on a memory card.
- creating a copy of the entire configuration on PC (ProSave).
- copying selected objects, such as recipes and passwords, on PC (ProSave).
- restoring the stored elements in the case of a fault.
- updating the MP 370 regardless of where it is in use without the need of a configuration computer.

Notice

If the restore process is interrupted due to a power failure, the operating system is deleted. In this case, the operating system must be reloaded (refer to Chapter 13).

Note

If a message appears during the restore process indicating a compatibility conflict has occurred, the operating system must be reloaded.

Note

Close all applications before starting the backup or restore process.

Note

Licenses on the operating unit are not stored with a backup.
Each restore on the operating unit deletes all the licenses on it permanently.
Therefore, save this data beforehand.

3.7.1 Backup/Restore on memory cards

During a backup process, the operating system, application and data are copied from the internal Flash memory to an external storage medium. The minimum size of the storage medium must be 24 Mbyte.

In the case of a restore process, the content of a Flash memory stored on an external storage medium is reloaded into the internal Flash memory. Prior to this, the MP 370's internal Flash memory is completely cleared following confirmation.

Backup on CF card or PC card

Proceed as follows to create a backup copy of the internal Flash memory:

Step	Action
1	Deactivate the write protection on the memory card, if set.
2	Depending on the target medium used, insert the memory card in the required slot (Figure 11-1, Page 11-3).
3	Call in the Windows CE Control Panel (refer to Page 3-6) and, from there, select the <i>Backup/Restore</i> option depicted on the right. 
4	Start the Backup process by using the Backup button.
5	Confirm that any backup files which exist on the storage medium should be completely deleted beforehand.
6	When the data has been downloaded successfully, the MP 370 issues a message.
7	Remove the memory card.
8	Activate the write protection on the memory card, if available.
9	Label the memory card, e.g. with the date and version of the configuration saved, and keep it in a safe place.

Note

Insert the memory card in the relevant expansion slot before starting the Backup/Restore process:

PC card: Slot A (storage location \Storage Card\...)

CF card: Slot B (storage location \Storage Card2\...)

Information on the memory cards which can be used is provided on Page 11-3.

Notice

A plug-in memory card is used for Backup/Restore.

If both slots are occupied when Backup/Restore is initiated on the MP 370, the PC card (Slot A) is used first. In case of doubt, remove the memory card not to be used from the MP 370.

Restore from CF card or PC card

Proceed as follows to restore the content of the internal Flash memory:

Step	Action
1	For security reasons, activate the write protection on the memory card, if available.
2	Depending on the target medium used, insert the memory card in the required slot (Figure 11-1, Page 11-3).
3	Call in the Windows Control Panel and select the <i>Backup/Restore</i> option.
4	Start the restore process by clicking on the Restore button.
5	Confirm that the internal Flash memory and licenses should be completely deleted.
6	After confirmation, the operating system is reloaded and the MP 370 is automatically restarted. Finally, the remaining data is downloaded.
7	When the data has been downloaded successfully, the MP 370 issues a message.
8	Remove the memory card.
9	Restart the MP 370.

3.7.2 Backup/Restore using ProSave

In order to save the entire configuration, or even specific parts such as recipes and passwords, on a PC use the *ProSave* service tool. The advantage of *ProSave* is that the Backup/Restore can be performed via the following transfer channels without ProTool:

- Serial
- MPI / PROFIBUS-DP
- Ethernet
- USB

During a backup process, the operating system, application and data are copied from the internal Flash memory to a PC.

In the case of a restore process, the content of a Flash memory stored on the PC is reloaded into the internal Flash memory on the operating unit. Prior to this, the MP 370's internal Flash memory is completely cleared.

Backup using stand-alone ProSave

Creating a backup using ProSave as a stand-alone application:

Step	Action
1	Start <i>ProSave</i> on the PC using the Windows Start menu.
2	Use the <i>General</i> tab register to select the required device type and connection type with corresponding connection parameters.
3	Use the <i>Backup</i> tab control to select the data to be saved (<i>Recipes, Passwords</i> or <i>Complete Backup</i>).
4	Select the path in which the backup file (*.psb) should be saved.
5	Configure the MP 370 according to the required transfer channel and switch to download mode (Ch. 3.1 and Ch. 3.2).
6	Start the Backup process in ProSave by using the Start backup button.
7	A progress indicator appears during the data transfer. When the transfer is successfully completed, a message appears briefly.

Backup using ProSave integrated in ProTool

Creating a backup using ProSave integrated in ProTool:

Step	Action
1	In <i>ProTool</i> , select <i>File</i> → <i>Download</i> → <i>Preferences</i> and use the <i>Set download</i> window to define the connection type with the corresponding connection parameters.
2	Open the <i>Backup</i> window in <i>ProTool</i> by selecting the menu items <i>File</i> → <i>Download</i> → <i>Backup</i> .
3	Select the data to be saved (<i>Recipes, Passwords</i> or <i>Complete Backup</i>).
4	Select the path in which the backup file (*.psb) should be saved.
5	Configure the MP 370 according to the required transfer channel and switch to download mode (Ch. 3.1 and Ch. 3.2).
6	Start the Backup process in ProTool by using the Start backup button.
7	A progress indicator appears during the data transfer. When the transfer is successfully completed, a message appears briefly.

Restore using stand-alone ProSave

Proceed as follows to restore the content of the internal Flash memory:

Step	Action
1	Start <i>ProSave</i> on the PC using the Windows Start menu.
2	Use the <i>General</i> tab register to select the required device type and connection type with corresponding connection parameters.
3	Use the <i>Restore</i> tab register to select the path in which the file to be restored is located.
4	The <i>Archive Description</i> displays the unit concerned and the type of backup data contained in the file.
5	Configure the MP 370 according to the required transfer channel and switch to download mode (Ch. 3.1 and Ch. 3.2).
6	Start the Restore process in <i>ProSave</i> by using the Start restore button.
7	A progress indicator appears during the data transfer. When the transfer is successfully completed, a message appears briefly.

Restore using ProSave integrated in ProTool

Proceed as follows to restore the content of the internal Flash memory:

Step	Action
1	In <i>ProTool</i> , select <i>File</i> → <i>Download</i> → <i>Preferences</i> and use the <i>Set download</i> window to define the connection type with the corresponding connection parameters.
2	Open the <i>Restore</i> window in <i>ProTool</i> by selecting the menu items <i>File</i> → <i>Download</i> → <i>Restore</i> .
3	The <i>Archive Description</i> displays the unit concerned and the type of backup data contained in the file.
4	Configure the MP 370 according to the required transfer channel and switch to download mode (Ch. 3.1 and Ch. 3.2).
5	Start the Restore process in <i>ProTool</i> by using the Start restore button.
6	A progress indicator appears during the data transfer. When the transfer is successfully completed, a message appears briefly.

Note

Licenses on the MP 370 are not stored with a backup.

All licenses are permanently deleted following each restore on the MP 370. Therefore, save this data beforehand.

3.8 License Transfer (Authorization) Using ProSave

To protect the software, licenses supplied on a Siemens disk can be transferred to the MP 370 via a PC and enabled (e.g. ProAgent authorization).

License transfer using stand-alone ProSave

Transferring a license to the MP 370:

Step	Action
1	Start <i>ProSave</i> on the PC using the Windows Start menu.
2	Use the <i>General</i> tab register to select the required device type and connection type with corresponding connection parameters.
3	Select the <i>Authorize</i> tab control.
4	Select the disk drive containing the license disk.
5	The licenses available on the disk are displayed under <i>Selection</i> .
6	Select the required license.
7	Configure the MP 370 according to the required transfer channel and switch to download mode (Ch. 3.1 and Ch. 3.2).
8	Press the button depicted to transfer the license to the MP 370. The selection appears in the <i>Installed authorizations</i> : field. 

Deinstalling licenses from the MP 370:

Step	Action
1	Start <i>ProSave</i> on the PC using the Windows Start menu.
2	Use the <i>General</i> tab register to select the required device type and connection type with corresponding connection parameters.
3	Select the <i>Authorize</i> tab control.
4	Configure the MP 370 according to the required transfer channel and switch to download mode (Ch. 3.1 and Ch. 3.2).
5	Press the Device Status button to display all the licenses installed on the MP 370. These appear in the <i>Installed authorizations</i> : field.
6	Select the license to be deinstalled.
7	Press the button depicted to deinstall the license from the MP 370. The selected licenses appear under <i>Selection</i> . 

License transfer using ProSave integrated in ProTool

Transferring a license to the MP 370:

Step	Action
1	In <i>ProTool</i> , select <i>File</i> → <i>Download</i> → <i>Preferences</i> and use the <i>Set download</i> window to define the connection type with the corresponding connection parameters.
2	Open the <i>Authorization</i> window in <i>ProTool</i> by selecting the menu items <i>File</i> → <i>Download</i> → <i>Authorize</i> .
3	Select the disk drive containing the license disk.
4	The licenses available on the disk are displayed under <i>Selection</i> .
5	Select the required license.
6	Configure the MP 370 according to the required transfer channel and switch to download mode (Ch. 3.1 and Ch. 3.2).
7	Press the button depicted to transfer the license to the MP 370. The selection appears in the <i>Installed authorizations</i> : field. 

Deinstalling licenses from the MP 370:

Step	Action
1	In <i>ProTool</i> , select <i>File</i> → <i>Download</i> → <i>Preferences</i> and use the <i>Set download</i> window to define the connection type with the corresponding connection parameters.
2	Open the <i>Authorization</i> window in <i>ProTool</i> by selecting the menu items <i>File</i> → <i>Download</i> → <i>Authorize</i> .
3	Configure the MP 370 according to the required transfer channel and switch to download mode (Ch. 3.1 and Ch. 3.2).
4	Press the <i>Device Status</i> button to display all the licenses installed on the MP 370. These appear in the <i>Installed authorizations</i> : field.
5	Select the license to be deinstalled.
6	Press the button depicted to deinstall the license from the MP 370. The selected license appears under <i>Selection</i> . 

Note

Downloading back licenses can only be done to a disk which contained or still contains the same license.

3.9 Load Application

3.9.1 Load application using ProSave

Applications (e.g. drivers) specially developed for the MP 370 can be installed on the MP 370 using *ProSave*.

Normally, the driver is supplied with *ProSave* enabling implementation of an uninterruptible power supply and Internet Explorer.

Load applications using stand-alone ProSave

Loading applications on the MP 370:

Step	Action
1	Start <i>ProSave</i> on the PC using the Windows Start menu.
2	Use the <i>General</i> tab register to select the required device type and connection type with corresponding connection parameters.
3	Select the <i>Options</i> tab control.
4	Use <i>Selection</i> to select the path containing the required application.
5	The corresponding application appears under <i>Available Options</i> :. Select the required application.
6	Configure the MP 370 according to the required transfer channel and switch to download mode (Ch. 3.1 and Ch. 3.2).
7	Press the button depicted in ProSave to transfer the application to the MP 370. The selection appears in the <i>Installed options</i> : field. 

Deinstalling an application from the MP 370:

Step	Action
1	Start <i>ProSave</i> on the PC using the Windows Start menu.
2	Use the <i>General</i> tab register to select the required device type and connection type with corresponding connection parameters.
3	Select the <i>Options</i> tab control.
4	Configure the MP 370 according to the required transfer channel and switch to download mode (Ch. 3.1 and Ch. 3.2).
5	Press the Device Status button to display all the applications installed on the MP 370. These appear in the <i>Installed options</i> : field.
6	Select the application to be deinstalled.
7	Press the button depicted in ProSave to deinstall the application from the MP 370. The selected application appears under <i>Available options</i> :. 

Load applications using ProSave integrated in ProTool

Loading applications on the MP 370:

Step	Action
1	In <i>ProTool</i> , select <i>File</i> → <i>Download</i> → <i>Preferences</i> and use the <i>Set download</i> window to define the connection type with the corresponding connection parameters.
2	Open the <i>Options</i> window in <i>ProTool</i> by selecting the menu items <i>File</i> → <i>Download</i> → <i>Options</i> .
3	Use <i>Selection</i> to select the path containing the required application.
4	The corresponding information appears under <i>Available Options</i> :. Select the required application.
5	Configure the MP 370 according to the required transfer channel and switch to download mode (Ch. 3.1 and Ch. 3.2).
6	Press the button depicted in ProSave to transfer the application to the MP 370. The selection appears in the <i>Installed options</i> : field. 

Deinstalling an application from the MP 370:

Step	Action
1	In <i>ProTool</i> , select <i>File</i> → <i>Download</i> → <i>Preferences</i> and use the <i>Set download</i> window to define the connection type with the corresponding connection parameters.
2	Open the <i>Options</i> window in <i>ProTool</i> by selecting the menu items <i>File</i> → <i>Download</i> → <i>Options</i> .
3	Configure the MP 370 according to the required transfer channel and switch to download mode (Ch. 3.1 and Ch. 3.2).
4	Press the <i>Device Status</i> button to display all the licenses installed on the MP 370. These appear in the <i>Installed options</i> : field.
5	Select the application to be deinstalled.
6	Press the button depicted in ProSave to deinstall the application from the MP 370. The selected application appears under <i>Available options</i> :. 

3.9.2 Load applications using Active Sync

Other applications can be loaded which can run under Windows CE with MIPS CPUs and comply with the properties of the MP 370. The installation and deinstallation of external applications and drivers can be performed using the *Active Sync* tool from Microsoft. The tool is not part of the material supplied by Siemens and must be obtained from Microsoft, if necessary. At the time of print, the tool could be obtained from the Microsoft homepage free of charge.

By selecting *Start* → *Communication* → *PC Link* in the Windows CE Start menu, the connection to the host PC, containing *Active Sync*, is established. In addition, data can be transferred between the PC and MP 370 in both directions by using the Internet Explorer view. Only a serial interface can be used for the connection between PC and MP 370.

Note

It cannot be guaranteed that external applications run on the MP 370 without any problems if the operating unit properties are not complied with e.g. screen resolution.

When applications are loaded, they are initially stored in the DRAM file system.

The following memory locations are available for applications:

Internal Flash: 5 MB

DRAM file system: 2 MB

Working memory: 7 MB

Files created by applications are also normally stored in the DRAM file system. The DRAM file system is deleted when the unit is switched off. Using the system settings (*OP Properties* → *Persistent Storage* → *Save Files*, refer to Ch. 8.3.1), however, it is possible to save the data currently available in the DRAM file system in the Flash memory. When the unit is started up, the data saved is automatically restored.

When an application is deinstalled, ensure that the files created by the application are also deleted. In this case, delete the files in the DRAM file system first in the normal Explorer and then backup the DRAM file system (*OP Properties* → *Persistent Storage* → *Save Files*, refer to Ch. 8.3.1).

Note

By exchanging the operating system (Chapter 13), the initial MP 370 configuration can be restored simply.

Note

Active Sync constantly uses the serial interface. If the interface is also required for the ProTool download, the interface must first be enabled again via *Active Sync*.

3.10 ProSave Service Tool

The *ProSave* tool is supplied together with ProTool. All the functions are provided which are necessary for the transfer of data between the configuration computer and MP 370:

Installation and deinstallation of drivers, options and add-ons, i.e. applications and drivers independent of ProTool, such as the UPS (Page 3-21, Page 8-13)

Data backup using Backup/Restore (Page 3-14)

License transfer (Page 3-19)

Operating system update (Page 13-1)

Integrated operation

ProSave is part of the material supplied with ProTool and can be automatically loaded on the configuration computer with the ProTool installation. The entire function range of *ProSave* is available within ProTool. In integrated operation, the *ProSave* dialogs are called from the project. In this way, all the necessary specifications (e.g. target device and download settings) are assumed from the project.

Stand-alone operation

ProSave can also be installed as a stand-alone application. In this case, the settings concerning the device and downloading must be defined in the *ProSave* user interface and match the MP 370 settings.

Operating the MP 370

4

In this chapter

The MP 370 is available as a touch panel version and a version with an integrated membrane keyboard. Both models can be operated by an external keyboard or mouse connected to the USB interface.

This chapter provides information on the general operating procedures of the MP 370

- as a touch panel (Page 4-2)
- as a keyboard unit (Page 4-8)
- with an external keyboard/mouse (Page 4-19)

4.1 Touch Panel Operation

Overview

This chapter describes the general operation procedures for the MP 370 touch panel model. Information on the general operation procedures for the keyboard model is provided in Chapter 4.2.

The MP 370 screen is used to observe the operating status of the machine or system being monitored and, at the same time, to intervene directly in the process running simply by touching the buttons and input fields displayed on it.

Information regarding operation of screens and screen objects is provided in Chapter 5.

4.1.1 Operating touch elements

Definition

Touch elements are contact-sensitive operating elements provided on the MP 370 screen, such as buttons, input fields and message windows. Their operation is basically no different from pressing conventional keys. Touch elements are operated by touching them lightly with a finger.



Caution

Be sure to touch only **one** screen element of the MP 370. Never touch more than one touch element at a time. Otherwise, an action may be unintentionally initiated.

Caution

Never use pointed or sharp instruments to operate the MP 370 to prevent damage to the plastic surface of the touch screen.

Direct key

In the case of a DP connection, buttons can be configured as direct keys in order to achieve fast keyboard operation. Fast key operation is a condition for Jogging mode (Inching mode), for example.

PROFIBUS direct keys set bits in the I/O area of a SIMATIC S7 directly from the MP 370.

Operation acknowledgement

As soon as the MP 370 detects contact has been made on a touch element, it responds with an optical and acoustic acknowledgement. An acknowledgment is independent of communication with the PLC. It is not an indication of the required action actually having been executed.

Acoustic acknowledgement

As soon as the MP 370 detects contact has been made on a touch element, it responds with an acoustic signal. This acoustic signal can be deactivated if required (Page 8-11).

Optical acknowledgement

The type of visual acknowledgement is dependent on the operating element touched:

- **Buttons**

In the case of 3D-effect configurations, visual representation is distinguished according to the statuses *touched* and *untouched*. The figures below illustrated examples of representation by means of the Status button:

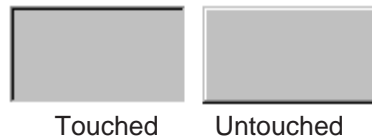

The way in which the selected field appears on the screen can be configured (line widths 1 - 10 for the focus and the color of the frame).

- **Hidden buttons**

The focus for hidden buttons does not appear following selection (value for the focus line width is 0, default setting). If the value for the focus width is changed, the dotted outline of the button changes to a line when touched. The outlines remain visible until the focus is moved to another operating element.

- **Input fields**

After touching an input field, the screen keyboard appears as the operation acknowledgement.

Screen keyboard

In order to enter values, the MP 370 automatically displays a screen keyboard within the ProTool configuration after touching an input field, for example. The screen keyboard is also displayed automatically if a password needs to be entered in order to activate a password protected function (also refer to Page 5-40). After completing the input, the screen keyboard is automatically hidden.

The screen keyboard can be activated in the following ways:

- The screen keyboard is always displayed during runtime as soon as the operator selects an input field (default setting).
- A button is configured with which the user can automatically activate or deactivate the appearance of the screen keyboard as necessary. This is useful, for example, when an external keyboard is connected to the operating unit rendering the screen keyboard unnecessary.

Configure a button, call in the context menu and select the *Properties* dialog.

In the *Functions* tab control, select "click" as the event and assign this event to the *Use_Screen_Keyboard_On/Off* function in the "Keyboard" category. During runtime, the operator can use the button to activate or deactivate the mechanism controlling the appearance of the screen keyboard.

- The screen keyboard is activated via the corresponding icon in the toolbar (refer to Chapter 4). The position of the screen keyboard can be defined in the *Input Panel* option in the Windows CE Control Panel.

Note

Use the *Start Screen Keyboard* function to display the screen keyboard permanently. The screen keyboard remains visible until it is explicitly closed by the user. It can, thus, be used for input in other applications.

Depending on the input field configured, the screen keyboard button provides buttons for purely numeric input or alphanumeric values.

External USB keyboard

An external USB keyboard can be connected to the USB interface (refer to Chapter 4.3 on Page 4-19).

Operating screen objects using buttons

Screen objects which are assigned pre-defined buttons can also be operated by buttons outside the screen object. A condition for this is that each function has been linked to the respective button in the configuration.

These functions are compiled in ProTool CS within the *Keyboard action for screen objects*.

4.1.2 Enter numeric values

Numeric screen keyboard

In order to enter numeric values, the MP 370 automatically displays a numeric screen keyboard as depicted in Figure 4-1 directly after touching an input field on the touch screen. After completing the input, the screen keyboard is automatically hidden.

The **Help** key is only active when a help text has been configured for that particular input field.

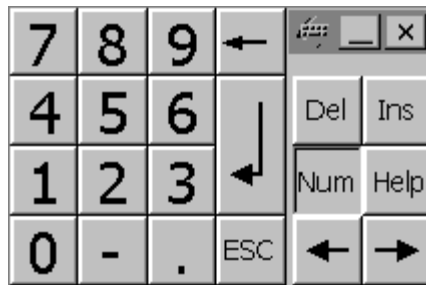

Figure 4-1 Screen keyboard for numeric input

Procedure

Numeric values are entered character by character using the buttons provided on the screen keyboard. Confirm the value entered by pressing the Enter key or cancel the input by pressing ESC. The screen keyboard is closed in both cases.

Note

Limit values can be configured for numeric input fields. In this case, values entered are only accepted when they lie within the limits configured. If an attempt is made to enter a value which is outside the configured limits, it is rejected and the original value automatically reinserted. In this case, the operating unit issues a system message.

Note

On entering the first character, a tooltip appears with the lower and upper limit values related to the input window.

4.1.3 Enter alphanumeric values

Alphanumeric screen keyboard

In order to enter character strings and numeric values in hexadecimal format, the MP 370 automatically displays an alphanumeric screen keyboard directly after touching an input field on the touch screen. After completing the input, the screen keyboard is automatically hidden.

Keyboard levels

The alphanumeric screen keyboard has several levels:

- Normal level (Figure 4-2)
- Shift level
- Alt Gr level
- Shift + Alt Gr level

The Alt Gr and Shift + Alt Gr levels serve to enter special characters.

The Help key is only active when a help text has been configured for that particular input field.



Figure 4-2 Alphanumeric screen keyboard: Normal level (example)

Procedure

Alphanumeric values are entered character by character using the buttons provided on the screen keyboard. Confirm the value entered by pressing the Enter key or cancel the input by pressing ESC. The screen keyboard is closed in both cases.

Note

Press the button depicted twice (locking button) to activate the toolbar.



4.1.4 Navigation using buttons

It is possible to assign system key function to buttons:

- *Page_Up*
A button is assigned the *Page_Up* function.
- *Page_Down*
A button is assigned the *Page_Down* function.
- *Go_to_Home*
A button is assigned the *Go_to_Home* function.
- *Go_to_End*
A button is assigned the *Go_to_End* function.



These functions are compiled in ProTool CS within the *Keyboard* group.

4.1.5 Call help text

Purpose

Help texts consist of additional information and operating instructions provided by the configuration planner concerning messages, screens and input fields. Help text, concerning an input field for example, may provide information on permissible value ranges (refer to Figure 4-3) or, in the case of an alarm message, information related to the cause and its elimination.

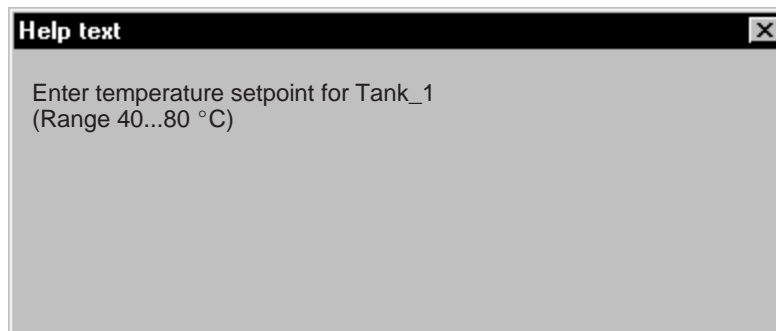



Figure 4-3 Help text for an input field (example)

Procedure

- **Help on messages**
Touch the following button in the message window, on the message page, in the message buffer or the message display 
- **Help on input fields**
Touch the Help key on the screen keyboard. This key only appears if a configured help text exists.
- **Help on current screen**
If the function *Display Help Text* has been assigned to a button, for example, touch that button to call in the help text configured for the current screen.
- **Help on focussed screen object**
Press the key combination **ALT + H** either on the screen keyboard or the USB keyboard connected to call in the configured help text to the trend view which has been focussed, for example.

4.2 Operating Keyboard Units

Overview

This chapter describes the general operation procedures for the MP 370 keyboard unit. Information on the general operation procedures for the touch panel model is provided in Chapter 4.1.

The operating status of the machine or system to be monitored can be observed on the MP 370 screen and the running process directly influenced by using the integrated membrane keyboard.

Information regarding operation of screens and screen objects is provided in Chapter 5.

Keypads

The MP 370 keyboard consists of two functional blocks (Figure 4-4):

- Function keys/Softkeys:
 - Keys S1 to S16
 - Keys F1 to F20
- System keys:
 - Alphanumeric keys
 - Cursor keys
 - Control keys

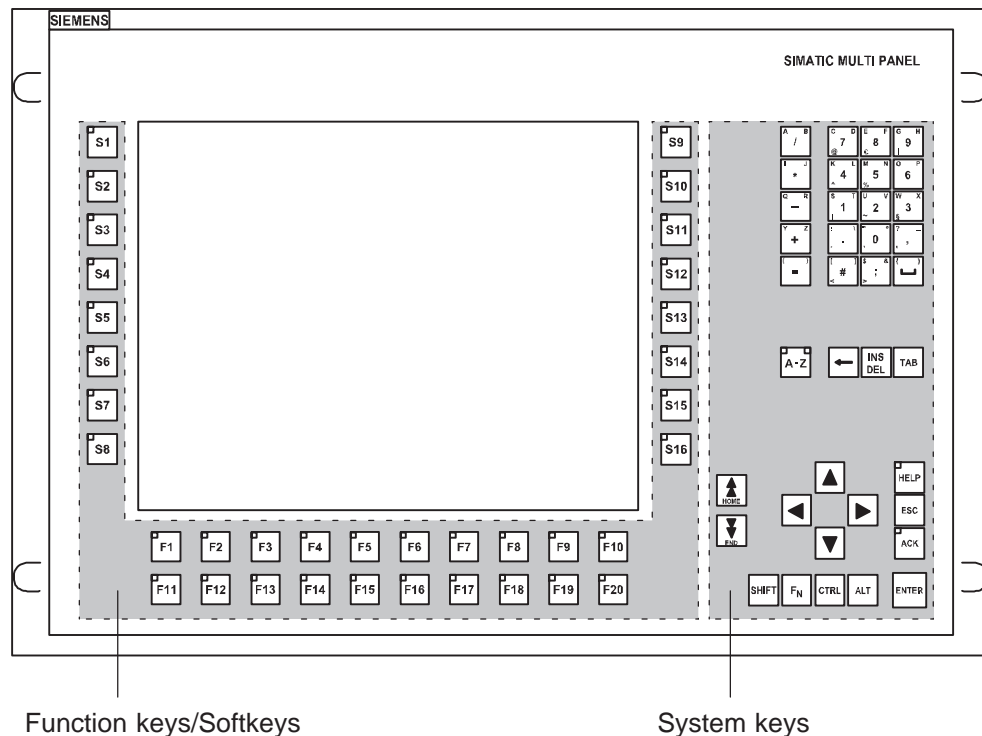

Figure 4-4 Assignment of the keypads

4.2.1 Function keys/Softkeys

Function keys with global function assignment

A function key with **global** function assignment always triggers the same action on the MP 370 or in the PLC regardless of the screen currently open. These actions could include:

- Open screen
- Display current alarm messages
- Start screen printing (hardcopy)

All S and F keys can be configured with global assignments.

Function keys with local function assignment (softkeys)

A function key with **local** function assignment (softkey) can trigger different actions on the MP 370 or in the PLC according to the screen currently open (local significance of current screen). An icon can be configured for each softkey which can then be positioned at the edge of the screen.

All function keys can be assigned locally significant functions during configuration. Icons cannot be configured for the keys F11 to F20.



Caution

If a function key is pressed directly following changing screens, the corresponding function associated with the new screen can be triggered before the screen is generated.

Note

A two-key operation is possible for the MP 370, i.e. two keys can be pressed thus triggering two functions (refer to *Communication for Windows-based Systems User's Guide*).

LED assignment

The Light Emitting Diodes (LEDs) in the function keys can be controlled from the PLC. A luminous or flashing LED can indicate to the operator which key to press according to specific situations, for example.

In order to trigger LEDs, the corresponding data areas must be set up in the PLC and specified as area pointers in the configuration. The assignment of the individual LEDs to the bits in the database must be defined by the project engineer when configuring the function keys. In this case, the bit number within the mapping area is specified for each LED.

Detailed information on LED control is provided in the *Communication for Windows-based Systems User's Guide*.

4.2.2 System keys

Control keys

The following control keys serve superordinated editing and control functions:

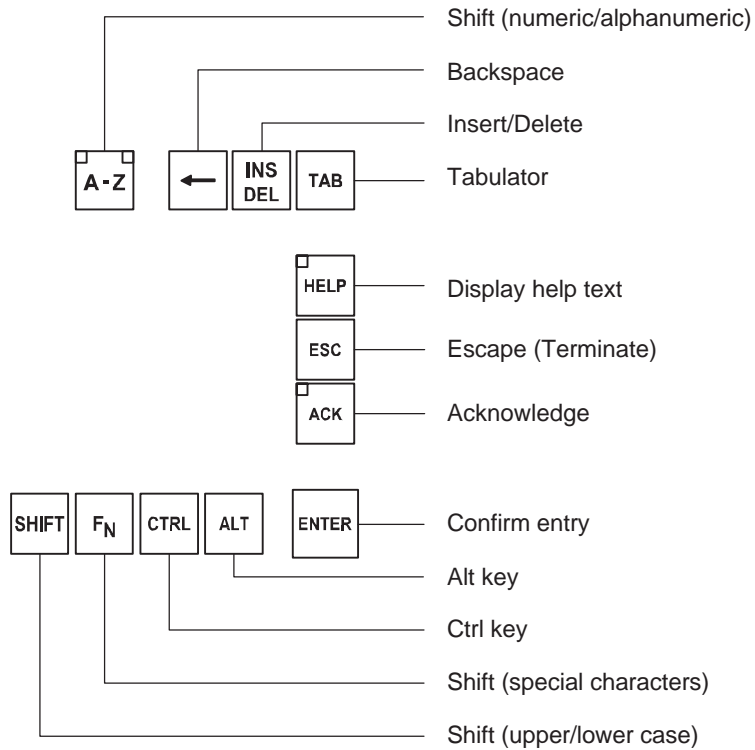

Figure 4-5 Control keys

The system keys ACK, ESC, HELP and ENTER can also be assigned functions.

Alphanumeric keys

Use the following alphanumeric keys to enter digits, letters and special characters.

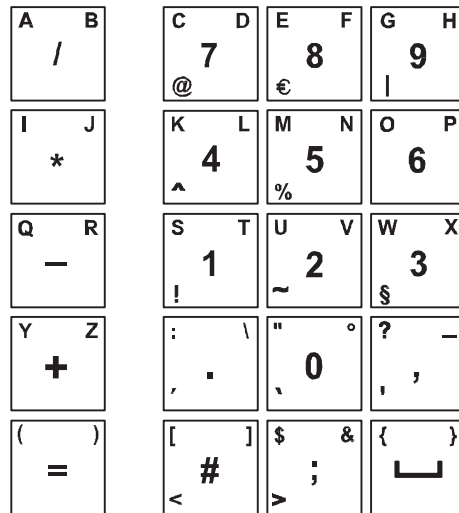

Figure 4-6 Alphanumeric keys

Cursor keys

The cursor keys (Figure 4-7) are used to move the text cursor and to navigate in screens and screen objects. The functions of the keys corresponds to the cursor keys on a standard PC keyboard.

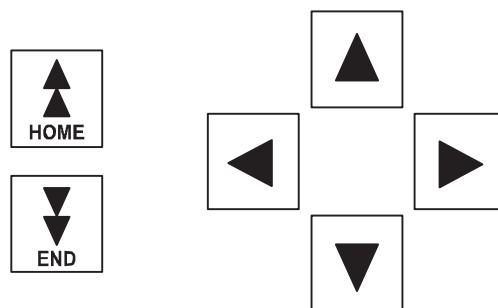

Figure 4-7 Cursor keys

The Home and End keys can also be assigned functions.

System key function overview

Table 4-1 Functions of the system keys

















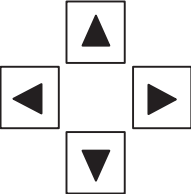

Key	Function	Purpose
	Shift (numeric/alphanumeric)	<p>Switches the assignment of the input keys from digits to letters.</p> <ul style="list-style-type: none"> No LED lights up: The numeric keyboard assignment is active. Press the key once to switch to alphanumeric assignment. An LED lights up: The left or right-hand letter assignment is activated. <p>Each time the key is pressed, the level switches between the left-hand letter assignment, right-hand letter assignment and numeric keyboard assignment.</p>
	Delete character	<ul style="list-style-type: none"> Deletes an individual character <p>Delete character in the numeric keyboard assignment. To insert characters, press the Shift (digits/letters) key to access alphanumeric assignment.</p>
	Cancel	<ul style="list-style-type: none"> Deletes the character of a value entered and resets the original value. Closes the active window.
	Acknowledge	<p>Acknowledges the currently displayed alarm message or all messages in an acknowledgment group (group acknowledgement).</p> <p>The LED lights up as long as unacknowledged alarm messages are queued.</p>
	Display help text	<p>Opens a window with help text in respect of the selected object (message, input field). The LED indicates if help text exists for the selected object.</p>
	Confirm input	<ul style="list-style-type: none"> Accepts and ends the input Opens a selection field for symbolic input Triggers the function on the selected button
	Tabulator	<p>Moves to the next screen object available for selection in the configured tabulation sequence.</p>
	Delete character	<p>Deletes the character to the left of the cursor.</p>







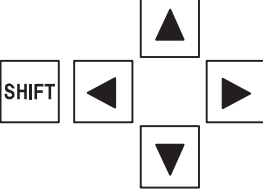

















Table 4-1 Functions of the system keys, continued

Key	Function	Purpose
	Move cursor	<ul style="list-style-type: none"> Move to the next screen object available for selection to the right, left, above or below the current screen object. Navigation in the screen object.
	Scroll back	Scroll one page back.
	Scroll forward	Scroll one page forward.
	Shift (upper/lower case)	Use in combination with other keys, e.g. shift to capital letters.
	Enter special characters	Use in combination with other keys: Enter special characters. Some keys have special characters, imprinted in blue at the bottom left, e.g. the percent character %. To enter the character, press the key simultaneously with the Shift key depicted to the left.
	General control function	Use in combination with other keys, e.g. navigation in trend views
	General control function	Use in combination with other keys, e.g. Status/Force







4.2.3 Key combinations







General operation

Key combination	Function
Navigation	
	Moves to the previous screen object available for selection in the configured tabulation sequence.
	Positions the cursor within a screen object, e.g. in an input field.
	Skip to the start, e.g. of a selection list.

Key combination	Function
 	Skip to the end, e.g. of a selection list.
  	Marks all the entries, e.g. in a selection list, from the current cursor position to the start.
  	Marks all the entries, e.g. in a selection list, from the current cursor position to the end.
 	Opens a selection field.
Screen settings	
 	Increases the screen brightness.
 	Reduces the screen brightness.
During the start-up phase	
  	Switches the MP 370 to download mode. As long as no data transfer is taking place, it is possible to exit from download mode.
Other functions (e.g. in Explorer)	
 	Accepts the selected value in the selection field without closing it.
 	<ul style="list-style-type: none"> Changes the active window. Switches between basic area and window.
 	Mark all (left-hand letter assignment is active).
 	Display the properties of the marked element.

Navigation in the operating system

Key combination	Function
 	Opens the Start menu (Loader).
 	Opens the Task Manager.
Explorer:	
	Switches to superordinate level.
	Switches the display area.

Key combination	Function
	Activates the menu bar.
Dialogs:	
	Moves to next field.
 	Moves to previous field.
	Opens the next tab control. ¹⁾
	Opens the previous tab control. ¹⁾
	Closes the dialog without saving.

1) When the name of the tab control has the focus.

Operating screen objects using function keys

Screen objects assigned to buttons, e.g. message display, trend view representation, recipe view or status/force, can also be operated by means of function keys or softkeys. A condition for this is that each relevant function has been linked to a function key or softkey in the configuration.

These functions are compiled in ProTool CS within the *Keyboard action for screen objects*.

4.2.4 Entering values

Marking

On selecting an input field, the entire field content is marked by changing color. After pressing a key (except a cursor key), the field content is deleted and the new input displayed.

After selecting a field, press the SHIFT key and a cursor key simultaneously to clear the marking on the field contents and enable the cursor to be moved freely within the field.

Note

To enter the hexadecimal characters A...F, switch the input keys to alphanumeric assignment.

Note

Limit values can be configured for numeric input fields. In this case, values entered are only accepted when they lie within the limits configured. If an attempt is made to enter a value which is outside the configured limits, it is rejected and the original value automatically reinserted. In this case, the keyboard unit issues a system message.

Note

On entering the first character, a tooltip appears with the lower and upper limit values related to the input window.

External USB keyboard and screen keyboard

An external USB keyboard can be connected to the USB interface (refer to Chapter 4.3 on Page 4-19).

The dialog to activate the screen keyboard, defined by the user in ProTool CS itself, continues to be offered for the keyboard unit and the screen keyboard can then be operated by an external mouse connected to the USB interface.

4.2.5 Call help text

Purpose

Help texts consist of additional information and operating instructions provided by the configuration planner concerning messages, screens and operable screen objects. Help text, concerning an input field for example, may provide information on permissible value ranges (refer to Figure 4-8) or, in the case of an alarm message, information related to the cause and its elimination.

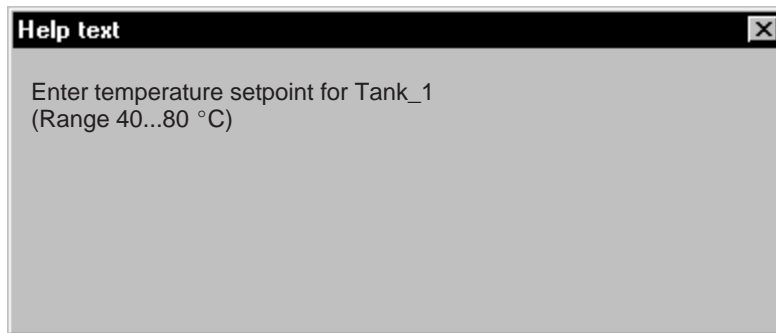





Figure 4-8 Help text for an input field (example)

Procedure

Proceed as follows in order to call in the configured help text e.g. for an input field:

Step		Procedure	
1	Select input field	 (e.g.)	The input field is marked.
2	Call in the help text		The LED in the key lights up, indicating that help text is available. Press the key to call in the help text. The configured help text is displayed in the language currently set on the MP 370. If help text is also configured for the current picture, it is displayed after pressing the key again.
3	Close help window		The help window is closed.

4.3 Operating Using an External Keyboard/Mouse

Overview

An external keyboard or mouse can be connected to the USB interface on the MP 370. Connection and disconnection is possible during normal operation of the MP 370 ("hot plug in/out").

Operation of the MP 370 via an external keyboard/mouse is particularly recommended during the commissioning and test phases for both keyboard units and touch panels.

Operation

Operation of the MP 370 via a mouse is only a little different from operation using the touch screen. After connecting a mouse, the mouse pointer appears on the screen .

When the mouse pointer is positioned on an operable button, for example, the mouse pointer symbol changes .



Caution

When using a keyboard unit, do not operate the integrated membrane keyboard and external USB keyboard simultaneously. Otherwise, an action may be unintentionally initiated.

Notice

USB mouse:

- Use a standard mouse.

USB keyboard:

- Use a standard keyboard with a USA/International keyboard layout.
- Operation of the configured function keys is not possible via the external keyboard.

Commercially available USB devices do not normally fulfill the higher industrial demands with regard to interference resistance and can have negative effects on the device.

Operating Screens and Screen Objects

5

In this chapter

Operation of the visualization processes on the MP 370 is dependent on the configuration created with the ProTool CS configuration software. This chapter provides general information on screens and on operating predefined screen objects for touch panels and keyboard units.

Information on the general operation procedures for the touch panel model is provided in Chapter 4.1. Information on the general operation procedures for the keyboard units is provided in Chapter 4.2.

5.1 Operating Screens

What is a screen?

Screens visualize the progress of processes and display specified process values. A screen contains logically related process data which the MP 370 can both display and modify by operating the individual values.

Screens display the current process status in the form of numeric values, bar graphs or trend curves for example. Dynamic screen objects enable, for instance, the current position of a production process to be tracked on the MP 370.

Screen partitions

A screen is basically composed of static and dynamic sections. The terms “static” and “dynamic” do not refer to the possibility of dynamically positioning screen partitions but to the connection to the PLC.

Static partitions, e.g. text and graphics, are not updated by the PLC. Dynamic partitions, e.g. input and output fields, trend curves and bars, are linked to the PLC and display current values constantly read in from the PLC memory. Their connection to the PLC is established by means of tags.

A summary of all the screen objects which a ProTool configuration may contain for an MP 370 is provided from Page 5-6.

The display area of a screen can be divided into various areas. These areas are either moveable (message area and message indicator) or fixed (fixed window, icons for function keys).

Fixed window

The fixed window is an area at the top of the screen. The height of the fixed window can be configured. Since the content of the fixed window is independent of the screen currently displayed, it is especially suited for displaying important process magnitudes or date and time.

An operating element configured in the fixed window is available in every screen. In the case of a touch panel, a button located in the fixed window can represent a globally effective function key.

Icons for keyboard units

Icons are graphics of a fixed size located at the bottom and sides of the keyboard unit screen. They are defined during configuration and clearly indicate the screen-specific functions of the softkeys in graphic form.

After pressing the respective softkey, S1 to S16 and F1 to F10 the function symbolized by the icon is activated either on the MP 370 or the PLC.

Message indicator

The message indicator is a configurable graphical symbol which is displayed on the screen when at least one alarm message is present or needs to be acknowledged on the MP 370.

The indicator continues to blink as long as unacknowledged messages are present.

The number (in this case 3) represents the number of alarm messages present.

The message indicator can be operated on touch panels.



Operate message indicator on touch panels:

The response of the message indicator is dependent on whether or not alarm messages are present on the MP 370 which still have to be acknowledged at the moment the indicator is touched.

- **Alarm messages to be acknowledged** (message indicator flashing):
The alarm message window opens on touching the message indicator (Page 5-25).
- **No alarm messages to be acknowledged:**
The alarm message window opens on touching the message indicator (Page 5-27).



Use the button illustrated to close the alarm window on touch panels in order to operate screens. The alarm message window can be opened again by touching the message indicator.

In the case of keyboard units, the messages must be acknowledged by pressing the ACK button.

Message window

System messages

The MP 370 displays internal operating statuses in the system message window. System messages indicate, for example, incorrect operations or communication faults. A summary of some of the most important system messages and explanations on how to eliminate the causes are provided in Appendix C of this manual.

Proceed as follows to close the system message window:

- **Keyboard unit:**
Press the ESC key.
- **Touch panel:**
Press the button illustrated.



Event messages

The MP 370 uses the event message window to display operating statuses concerning the machine or system connected to the PLC. The position of the window can be configured.

Alarm messages

The MP 370 uses the alarm message window to display faults concerning the machine or system connected to the PLC. The position of the window can be configured.

Since alarm messages indicate abnormal operating statuses, they must be acknowledged. Proceed as follows to acknowledge alarm messages:

- **Keyboard unit:**
Press the ACK key.
- **Touch panel:**
Press the button illustrated.



More options for displaying messages are described from Page 5-21. Detailed information regarding the message window is provided on Page 5-25.

Changing active window

Several windows can be opened simultaneously when the MP 370 is running in normal operation. Proceed as follows to change the active window:

- **Keyboard unit:**
In order to operate a window, use the key combination depicted on the right to move between the basic screen area and the windows. Each time the combination is pressed, the cursor moves to the next window.
- **Touch panel:**
A window becomes active after touching it.



The window in which the cursor is located is the active window. Input/Operations are possible in the active window. It is not possible to change to a window which contains no operable objects.

Select screen

The MP 370 can be used to view, edit and print screens. The relevant screen must have been selected beforehand. There are several ways in which to select a screen:

- **Function key/Button**
Pressing a function key or button opens the corresponding screen defined in the configuration.
- **Input field**
Enter the corresponding number of the screen to be viewed in the input field.
- **Edit messages**
When configured, pressing the Edit button calls in the message assigned to the screen in the message window or message display, for example.

Note on configuration

Press the key with which the screen should be selected. Select the *Select_screen_permanent* function and enter a name for the screen under the *Screen Name* parameter. In the *Field Number* box, enter the Tab key sequence number of the field in which cursor should be located following a change of screens. As soon as the key is subsequently pressed, the function is triggered and the content of the *Screen Name* and *Field Number* parameters evaluated. The corresponding screen is displayed on the operating unit.

5.2 Logging On and Off from the MP 370

Purpose

Operable screen objects, such as input fields and buttons, can be assigned passwords during configuration to prevent them being modified by unauthorized personnel. Important parameters and settings can then only be modified by authorized personnel.

Information on the *Password List* screen object is provided on Page 5-40.

Login

In order to access password protected operating elements, it is necessary to log in on the MP 370. If an element is operated which is protected by a password, the login window automatically appears. In addition, the *Logon_User* function can be linked to an input field, for example, in the configuration. The user then has access to all the protected operating elements on the MP 370 for which the password is valid until logging off.

When correspondingly configured, it is also possible to log on via an input field for confidential password entry (Page 5-10). The character string entered is represented by placeholders (*).

Logoff

In order to rule out operation by unauthorized personnel, the login should not remain active on the operating unit for too long a period of time. The following options are available with which to log off from the MP 370:

- **Configured logout time expires**
If the MP 370 is not operated by the user within a configured period (logout time), the user is automatically logged off
- **Log out of the operating unit**
If the configuration links the function *Logoff_User* with an operating element, the element can be used log off from the MP 370.

Note

It is possible to log off by entering an incorrect password.

5.3 Overview of Screen Objects

A summary of the screen objects which an MP 370 configuration may contain is provided in the following table.

Screen object	Use/Description
Text	<p>Texts are used in the configuration to label display and operating elements, for example. Texts cannot be modified.</p> <p>The importance of different texts within a screen can be distinguished by assigning different fonts and formats.</p> <p>Texts can be configured to cover several lines and in different languages.</p>
Graphics	<p>Graphics can be used in the configuration, for example, to display the system or as explanatory symbols for display and operating elements which have been configured.</p>
Output field	<p>An output field displays current values from the PLC in numeric or alphanumeric form.</p>
Input field (Page 5-9)	<p>The input field is used to enter values which are then transferred to the PLC. The values can be in numeric or alphanumeric form. Entries which lie outside the specified value range are rejected according to the limit values which have been configured.</p> <p>The input can be protected by means of a password.</p>
Symbolic output field	<p>A symbolic output field displays current values from the PLC as plain text.</p> <p>Example: Instead of the values 0 and 1 the symbolic output field displays the texts <code>Motor OFF</code> and <code>Motor ON</code>.</p>
Selection field (Page 5-11)	<p>Values are not entered in the selection field character by character but are selected from a text list. This enables, for example, a motor to be switched on and off by means of the entries <code>ON</code> and <code>OFF</code>.</p>
Date/Time (Page 5-13)	<p>This screen object is used to display and enter the calendar date and time. The way in which the date and time are displayed depends on the language set on the MP 370.</p>
Graphic display	<p>The graphic display enables the dynamic positioning of graphics from external graphic programs in the project.</p> <p>Example: Instead of using a numeric value indicator, the fill level of a tank can be visualized by a dynamic graphic.</p>

Screen object	Use/Description
Graphics list	<p>A graphic list displays current values from the PLC in the form of a graphic. It assigns a graphic to each tag value. The value of the tag during runtime determines which graphic is selected from the list and displayed on the operating unit.</p> <p>Example: Instead of the values 0 and 1, the graphics list displays graphical representations for open and closed valves.</p>
Graphic box	<p>A graphic box enables the selection of a graphic by selecting an entry from a graphics list.</p> <p>Example: Using a graphic selection list it is possible to design the user interface as language independent, for example.</p>
Vector graphics	<p>The following vector graphic objects can be configured:</p> <ul style="list-style-type: none"> • Line • Rectangle/Square • Rounded rectangle/square • Circle/Ellipse • Polyline/Polygon <p>These objects are combined to form vector graphics with simple, basic geometrical shapes in your configuration. The type, color and width of the lines and their transparency, color filling, rounding radius, etc. can be configured as desired.</p>
Button (Page 5-16)	<p>A button is a virtual key on the MP 370 screen that can be assigned one or more functions, depending on the configuration.</p> <p>After pressing the button, the functions configured for the event <i>press</i> are triggered. On releasing the button, the functions configured for the event <i>release</i> are triggered.</p>
Status button (Page 5-18)	<p>A Status button is a display and operating element which has one of two states: <i>Touched</i> and <i>Untouched</i>. The states can be indicated by means of text or graphics.</p> <p>The Status button can be configured to be locking (switch function) or non-locking (keying function).</p>
State view	<p>The state view can be used to configure a warning display or to indicate the status of a unit which cannot be viewed from the MP 370 (e.g. a motor).</p> <p>The response of the state view can be configured.</p>
Switch (Page 5-20)	<p>A switch serves to enter and display a binary status. It can only be switched on or off.</p>

Screen object	Use/Description
Hidden button (Page 5-16)	<p>A hidden button is a transparent button that is not displayed on the MP 370. If hidden buttons are located over graphics, for example, it is possible to operate part of the graphic, e.g. a motor or valve.</p> <p>After pressing the button, the functions configured for the event <i>press</i> are triggered. On releasing the button, the functions configured for the event <i>release</i> are triggered.</p>
Bar (Page 5-32)	<p>Bars represent values from the PLC as rectangular areas. The MP 370 thus provides a clear indication of how far the current value is from the limit values, or if a setpoint value has been reached, at a glance. Bars are often used to represent fill levels or workpiece numbers.</p> <p>Direction, scaling, bar and background color and labeling the Y-axis can be configured as required. In order to identify limit values, limit value lines can be called in.</p>
Trend view (Page 5-33)	<p>A trend view provides a particularly clear representation of process data when displayed as a continual progression.</p> <p>Several different trends can be displayed simultaneously in the trend view, e.g. current and archived trend curves.</p>
Slider control (Page 5-36)	<p>Use a slider control to enter and display numeric values in analog form. To enter values, move the slider to the required position.</p> <p>When used as a display element, the value is represented by the position of the slider.</p>
Message view (Page 5-30)	<p>Special filter criteria are configured in the message view for displaying the volatile message buffer and/or message archive.</p>
Single message view (Page 5-31)	<p>A single message display can provide a subset of the functionality of a message display. It can be used, for example, to simply realize a message line in a screen.</p>
Status/Force (Page 5-44)	<p>By implementing Status/Force, the MP 370 can be used to access the connected PLC (SIMATIC S5 and SIMATIC S7) in order to read and write values directly. PLC operands can be monitored and modified without having to connect an additional programming unit or PC to the PLC.</p> <p>This facility is of special use during the testing and commissioning phases of the configuration.</p>
Password list (Page 5-40)	<p>The password list can be used to display, enter and modify passwords on the MP 370.</p>
Recipe view (Page 6-11)	<p>A recipe view can be used to create, save and transfer data records on the MP 370.</p>
Analog display (Page 5-38)	<p>An analog display indicates numeric values by means of a pointer instrument.</p>

Screen object	Use/Description
Digital/Analog clock (Page 5-39)	A digital/analog clock enables the system time to be displayed either as digits or as a traditional clock with hands.
SIMATIC HMI Symbol Library (Page 5-39)	The SIMATIC HMI Symbol Library, containing numerous graphics from production and techniques, enables graphics to be created in the project in both abundance and realistically. They include: valves, motors, tank containers, conveyor belts, cooling systems and heating equipment as well as ISA symbols.

5.4 Input Field

Purpose

Numeric or alphanumeric values are entered character by character in an input field. A numeric value is a number, e.g. 80 as a setpoint value for a temperature. An alphanumeric value can contain text and digits e.g. Valve_12.

Limit value check

If limit values are configured for the input field tags, the values entered are only accepted when they are within the configured limits. If an attempt is made to enter a value which is outside the configured limits, it is rejected and the original value automatically reinserted. In this case, the MP 370 issues a system message.

Display

Input fields can be configured differently according to their purpose, e.g.:

- **Numeric input field**
to enter numeric values in decimal, hexadecimal or binary format.
- **Alphanumeric input field**
to enter character strings. It is only possible to enter ASCII characters. They are dependent on the language selected.

- **Input field for date and time**

to enter the calendar date and time. The format is dependent on the language currently set on the MP 370. The figure below illustrates examples of input fields for date and time in US English language format.



- **Input field for confidential password entry**

to enter passwords confidentially. The character string entered is represented by placeholders (*). The figure below illustrates an example.

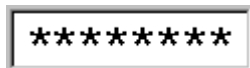

Operation

Proceed as follows to operate an input field:

- **Keyboard unit:**

- Select the input field required. The field content changes color when the field is accessed.
- Use the cursor keys to position the cursor and then enter the required value.
- Confirm the entry



or

- Discard the entry.



Also refer to Page 4-16.

- **Touch panel:**

- Touch the input field on the MP 370 touch screen. The screen keyboard automatically appears.
- Enter the required value.
- Confirm the entry



or

- Discard the entry.



Also refer to Page 4-5.

5.5 Selection Field

Purpose

Values are entered in a selection field not character-by-character but are selected from a list provided (Figure 5-1).

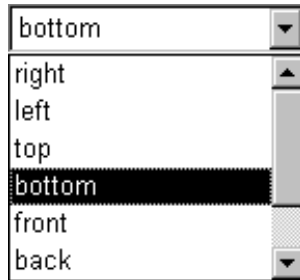







Figure 5-1 Selection field in opened state (example)

Operation using the keyboard unit

Proceed as follows to operate a selection field on the keyboard unit:

Step		Procedure	
1	Select the selection field	 (e.g.)	The selection field is marked.
2	Open selection list		The selection list opens up.
3	Select entry	 , 	Moves cursor line by line.
4	Apply selection or Cancel selection	 	The selected entry becomes valid. The selection field is closed. The original value is reapplied. The selection field is closed.

Note

After pressing an alphanumeric key, the first list entry which begins with that letter appears.

Operation on the touch panel

Touch the selection field on the MP 370 touch screen. In this case, the selection list opens up immediately. After selecting an element from the list, the selection list is closed and the selected text appears in the list box.

If the touch screen is touched outside the pulled down selection list, the list is closed and the entry with the focus appears in the selection field.



Caution

When released, the focussed list entry is immediately accepted. Therefore, continue to press the screen with your finger while sliding it to the required entry.

5.6 Date/Time

Purpose

The screen object *Date/Time* displays the current values for the time and/or date. The time can be modified online if the corresponding feature is configured.

The calendar data and time values are synchronized with the operating system values or are read from the PLC. The MP 370 accesses these values, for example, to assign time stamps to message events.

Notice

Without the optionally available backup battery (Chapter 11) the MP 370 stores the system time for approx. 3 days ¹⁾. If the unit is disconnected from the power supply for a longer period, the date and time must be updated following recommissioning.

Format

The format of the date and time depends on the language currently set. It corresponds to the standard international conventions:

Table 5-1 Examples of language-dependent formats for Date/Time

Language	Example		
	long	short	Time
German	Samstag, 25. November 2000	25.11.00	12:59:32
English (USA)	Saturday, November 25, 2000	11/25/00	12:59:32 PM
French	samedi 25 novembre 2000	25/11/00	12:59:32
Italian	sabato 25 novembre 2000	25/11/00	12.59.32
Spanish (traditional)	sábado 25 de noviembre de 2000	25/11/00	12:59:32

The format set for Date and Time can be modified using the *Regional Settings* option in the Windows CE Control Panel. To do so, select the icon depicted on the right. Information on opening the Windows CE Control Panels is provided on Page 8-4.



1) The unit must have been in operation for approx. 6–8 hours, without any interruptions, beforehand.

Notice

When entering the date and time, ensure that the two values are separated by a space.

Notice

If the operating unit does not support the language specified in the configuration, the display of Date and Time will assume the format of the language currently set in the *Regional Settings* option under *Format*.

Synchronizing date/time with the PLC

The date and time in the MP 370 and PLC can be synchronized if this feature is defined in the configuration and PLC program. To do this, the PLC jobs **14** (*Set Time*) and **15** (*Set Date*) are provided. Use PLC jobs **40** and **41** to transfer the date and time from the MP 370 to the PLC.

Further information on this is available in the *Communication for Windows-based Systems* user's guide.









5.7 Graphic Box

Purpose

The graphic box is an input field for symbolic values. A graphic can be selected by selecting an entry in the graphic list.

Operation using the keyboard unit

Proceed as follows to operate a graphic box on the keyboard unit.

Step		Procedure	
1	Select graphic box	 (e.g.)	The graphic box is marked.
2	Open the graphic selection list		The graphic selection list opens up.
3	Select entry	 ,   , 	Moves cursor line by line.
4	Apply selection or Cancel selection	 	The selected entry becomes valid. The original value is reapplied.

Operation on the touch panel

Touch the graphic box on the MP 370 touch screen. Selection mode is activated. Scroll through the graphic selection list using the scroll bar (vertical or horizontal). Click on the required graphic to select it. The graphic is transferred.

By clicking outside the graphic frame, the graphic selection is rejected.

5.8 Buttons

Purpose

A button is a virtual key located on the MP 370 screen. Functions which have been assigned to buttons can be triggered, for example, by the following, configurable events:

- Clicking
- Pressing
- Releasing

Display

- **Labeling**
Buttons can be labeled statically or dynamically. In the case of dynamic labeling, the text or graphic on the button changes during runtime according to the value of a configured tag.
- **Operation acknowledgement**
As soon as the operating element detects a valid operation, it responds with a visual acknowledgement. The acknowledgement, however, does not infer that the required action is actually being executed.

Figure 5-2 illustrates examples of buttons which are pressed (right) and not pressed (left).

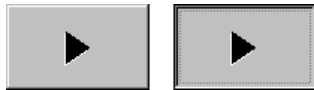

Figure 5-2 Example of a button

Hidden buttons

Hidden buttons are transparent buttons which may lie over graphics, for example. This enables plant parts which are graphically displayed on the MP 370 to be operated easily (e.g. a motor or valve). If a hidden button is selected on the MP 370, its contour becomes visible and remains so as long as the button is selected. The contour enables the user to detect the operable area of the button.

Operation

Proceed as follows to operate a button:

- **Keyboard unit:**

- Select the required button, e.g. using a cursor key.
- Press either the Enter key or the Spacebar.



(e.g.)



or



- **Touch panel:**

- Touch the button on the MP 370 touch screen.

Note

Click

In the case of a button, a function is triggered when the pressed button is released within the contours of the button.

If the button is pressed using the mouse button or finger (when using touch panels) but moved outside the contour before releasing, the operating unit does not interpret the action as a *click* event. The action is not executed.

Release

In the case of a button, a function is triggered when the pressed button is released.

If the button is pressed using the mouse button or finger (when using touch panels) but moved outside, the function is triggered when the function is released.

Press

In the case of a button, a function is triggered as soon as the button is pressed.

5.9 Status Button

Purpose

The Status button is an operating and display element with the two states *Pressed* and *Released*. Status buttons indicate the status of a device which cannot be determined from the MP 370 (e.g. a motor). At the same time, it is also possible to change the status of the device concerned on the MP 370.

Behavior

The behavior of the Status button can be configured:

- **Switch:**
The switch has two stable states. It toggles from one state to the other each time it is operated, and remains in the respective state until it is operated again.
- **Key:**
The button has a fixed, stable home position. When operated, it switches to the status *pressed* and remains in this state as long as it is kept pressed. When released, it automatically switches back to its *released* position.

Functions which have been assigned to the Status button can be triggered, for example, by the following configurable events:

- Status change
- Pressing
- Releasing

If the status of a *switch* type Status button changes as a result of a modification of configured tags, not through operation, the corresponding function is not executed.

Display

The two indicator statuses of the types *Switch* and *Button with acknowledgement* can be assigned different texts or graphics in ProTool CS which are then displayed on the Status button during runtime.

Figure 5-3 illustrates an example of a Status button of the type *Switch* when pressed (left) and not pressed (right).



Figure 5-3 The two statuses relate to the Status button when the Switch option is set

Operation

Proceed as follows to operate a Status button:

- **Keyboard unit:**

- Select the Status button e.g. using a cursor key.
- Press either the Enter key or the Spacebar.



(e.g.)



or



- **Touch panel:**

Touch the Status button on the MP 370 touch screen.

Note

Release

In the case of a button, a function is triggered when the pressed button is released.

If the button is pressed using the mouse button or finger (when using touch panels) but moved outside, the function is triggered when the function is released.

Press

In the case of a button, a function is triggered as soon as the button is pressed.

5.10 Switch

Purpose

A switch serves for the input and output of a binary status. It can only be switched on or off. It is linked to a tag to do this. The status *OFF* corresponds to the value 0 (a logical FALSE) of the tag linked to the switch. All tag values other than zero (a logical TRUE) are interpreted as the status *ON*.

Behavior

Functions which have been assigned to the switch, can be triggered, for example, by the following, configurable events:

- Status change
- Switched on
- Switched off

If the switch status changes as a result of a modification of configured tags, not through operation, the corresponding function is not executed.

Display

Figure 5-4 illustrates an example of two switches with different orientation.

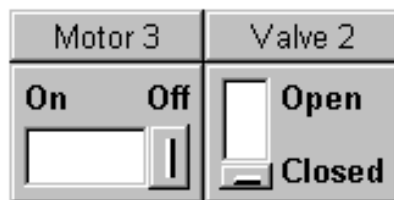

Figure 5-4 Switches with different orientation

Operation

Proceed as follows to operate a switch:

- **Keyboard unit:**

- Select the required button e.g. using a cursor key.
- Press either the Enter key or the Spacebar.

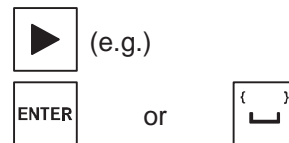

- **Touch panel:**

- Slide the sliding lever to the required position or double-click on the object. The switch moves to the new position.

5.11 Messages

Message categories

Messages on the MP 370 indicate events and statuses related to control processes. The MP 370 differentiates between the following message categories:

- **Event messages**
indicate a status in the process, for example, `Motor ON`. Event messages are configured.
- **Alarm messages**
indicate an equipment failure, for example, `Motor temperature too high`. Alarm messages are configured. Alarm messages must be acknowledged due to their critical nature.
- **HMI system messages**
are triggered by the MP 370. They are not configured. System messages indicate, for example, incorrect operations or communication faults. A selection of important system messages is provided in Appendix C.
- **SIMATIC diagnostic events**
provide information on the status of the SIMATIC S7 and SIMOTION. They are not configured in the ProTool CS configuration software. Refer to the S7 manual for the error number indicated on the MP 370 to determine the cause of the error.

Acknowledging alarm messages

Alarm messages must be acknowledged due to their importance. This can be done manually on the MP 370 or automatically by the PLC. The message indicator depicted continues to flash as long as queued messages still need to be acknowledged, when this feature has been configured.



The message indicator on the **touch panel** can be operated (refer to Page 5-2).

In order to acknowledge alarm messages on the **keyboard unit** manually, press the key depicted on the right. The message must not have been selected. The LED integrated in the key lights up when unacknowledged messages are present.



If several messages are displayed at the same time and the user acknowledges alarm messages, the acknowledgement acts in hierarchical sequence on the various message displays:

1. Message display with focus
2. Alarm window
3. Message line
4. Message display in basic screen

When configuring messages, it is possible to define whether the operator must acknowledge each message individually or whether the acknowledgement is valid for a group of messages (group acknowledgement). The use of group acknowledgement in respect of messages is particularly useful when they relate to the same cause, e.g. the messages for the first-up fault and the follow-up faults.

Buffering messages

All message events (arrived, departed, acknowledged) are stored in an internal volatile buffer. If a message archive has been configured, the message events are also stored in this message archive.

Display messages

The events stored in the message buffer can be displayed according to different criteria. The following predefined objects are available for display purposes:

- Message line (Page 5-25)
- Message window (Page 5-25)
- Message page (Page 5-27)
- Message buffer (Page 5-28)
- Message view
 - Message display with full functionality (Page 5-30)
 - Single message display with restricted functionality (Page 5-31)

Deleting messages

All message events concerning event and alarm messages are automatically stored in the message buffer. There are two methods of deleting message events from the message buffer:

- **Automatic deletion on buffer overflow**
When the message buffer is no longer capable of accepting new message events, the MP 370 automatically deletes a number of message events until the configured remaining buffer capacity is reached. In this case, the oldest message events are deleted first.
- **Deletion by operating the MP 370**
In order that message events can be deleted manually from the message buffer, the function *Delete_message_buffer* must be defined in the configuration, e.g. linked to a button or function key. In this way, the following message categories can be selected for deletion according to the configuration:
 - All messages
 - Alarm messages
 - Event messages
 - HMI system messages
 - SIMATIC diagnostic events

Print messages

When correspondingly configured, event messages can be printed out directly when the message events *Arrived* and *Departed* occur, and also alarm messages when the event *Acknowledged* occurs. System messages are not logged.

Information on setting printer parameters is provided in Chapter 8.

5.11.1 ALARM_S

Definition

ALARM_S is a message number procedure. The message identification numbers are assigned automatically by the configuration in STEP 7 or SIMOTION SCOUT. The unique assignment of the message text is made according to these numbers. The advantage here is that the message texts can be used on various operating units but only need to be entered once.

If a fault occurs, the operating unit receives the message by means of the message number. The associated message is determined and issued according to the number.

In addition to the message status (*arrived, cleared, acknowledged*), the PLC also stores time. This information is retained even after the message has been sent, so that individual network components (e.g. operating units) can log on later and be updated.

Configuring ALARM_S messages

ALARM_S messages are not configured in ProTool CS but in STEP 7, e.g. for S7-300/400-CPU's or in SIMOTION SCOUT. The display of ALARM_S messages can only be configured when a SIMATIC S7 PLC is used and the ProTool CS configuration software has been integrated in STEP 7.

During the configuration, it is useful to define the time of occurrence of a message in milliseconds. In contrast to this, bit messages can only be accurately defined to the second.

Detailed information on the configuration of ALARM_S messages is available in the *ProAgent/MP and ProAgent/PC* user guides.

Restarting S7 CPUs

Depending on the hardware configuration of the CPUs, it is possible that under certain circumstances all queued ALARM_S messages will be deleted when S7 CPUs are restarted. Older stocks of S7 300 CPUs cannot inform the operating units involved of the restart. The result of this is that messages are indicated on the operating unit as being queued although the CPU has already deleted them.

Remedy:

Disconnect the connection between the operating unit and CPU and then reconnect them again. Use the function *Connect_Disconnect_PLC* if configured.

5.11.2 Message line

Purpose

When a message line has been configured it is always displayed, regardless of the screen selected. The message line displays the last alarm or event message received. The message line is a permanent feature on the MP 370 and always displays the current message. If a separate window has been configured for alarm messages, the message line only receives the current event message.

Display priorities

Alarm messages always have priority over event messages. If no alarm messages are present or they have all been acknowledged, event messages are displayed.

In order to differentiate between event and alarm messages, alarm messages can be configured to flash in the display.

5.11.3 Message window

Purpose

The message window displays all messages in the respective message categories which are queued or need to be acknowledged.

It is possible to configure how the alarm messages are sorted. It is also possible to select whether the latest or oldest message is displayed first.

Alarm messages

If one of the display modes *Window/Window*, *Window/Line* or *Window/Off* is configured, the message window for alarm messages opens automatically as soon as an alarm message arrives. Figure 5-5 illustrates an example.

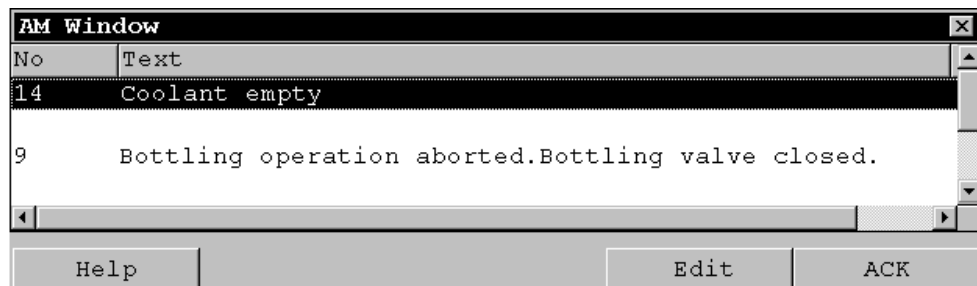

Figure 5-5 Alarm window (example)

Significance of the buttons



Call help text

Use this button to call in the help text configured for the selected message.



Edit message

Use this button to trigger the function assigned to the `Edit Message` event for the selected message.



Acknowledge messages

Use this button to acknowledge messages.

Event messages

In order to be able to open the event message window by means of unit operation, the function `Display_event_message_window` must be linked to a function key or button in the configuration.

System messages

The message window for system messages opens automatically as soon as a system message arrives. The window is closed automatically after the configured

duration of display has expired or by pressing ESC or .

Close alarm window manually

Proceed as follows to close the message window manually:

- **Touch panel:**

Press the button illustrated.



In the case of the keyboard units, the alarm window can only be closed after acknowledging all the alarm messages displayed.

5.11.4 Message page

Purpose

The message page displays all messages allocated a time stamp. It is also possible to select whether the latest or oldest message is displayed first. Open message pages are constantly updated.

Structure

In order to have access to the message page for event messages and/or alarm messages, the following functions must have been configured:

- for event messages: *Display_event_message_page*
- for alarm messages: *Display_alarm_message_page*

Figure 5-6 illustrates an example of the message page for alarm messages.

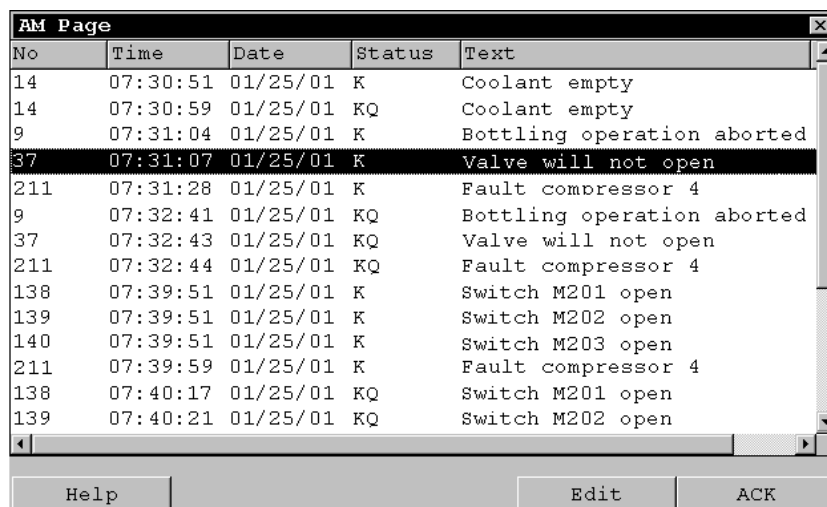

No	Time	Date	Status	Text
14	07:30:51	01/25/01	K	Coolant empty
14	07:30:59	01/25/01	KQ	Coolant empty
9	07:31:04	01/25/01	K	Bottling operation aborted
37	07:31:07	01/25/01	K	Valve will not open
211	07:31:28	01/25/01	K	Fault compressor 4
9	07:32:41	01/25/01	KQ	Bottling operation aborted
37	07:32:43	01/25/01	KQ	Valve will not open
211	07:32:44	01/25/01	KQ	Fault compressor 4
138	07:39:51	01/25/01	K	Switch M201 open
139	07:39:51	01/25/01	K	Switch M202 open
140	07:39:51	01/25/01	K	Switch M203 open
211	07:39:59	01/25/01	K	Fault compressor 4
138	07:40:17	01/25/01	KQ	Switch M201 open
139	07:40:21	01/25/01	KQ	Switch M202 open

Buttons: Help, Edit, ACK

Figure 5-6 Alarm message page (example)

Information on the significance of the buttons is provided on Page 5-26.

In the case of the touch panel, the queued alarm message page can also be selected via the message indicator (Page 5-2).

It is possible to configure how the alarm messages are sorted.

5.11.5 Message buffer

Purpose

The message buffer displays all message events allocated a time stamp. It is also possible to select whether the latest or oldest message is displayed first.

Structure

In order to have access to the message buffer for event messages and/or alarm messages, the following functions must have been configured:

- for event messages: *Display_event_message_buffer*
- for alarm messages: *Display_alarm_message_buffer*

Figure 5-7 illustrates an example alarm message buffer.

No	Time	Date	Status	Text
14	07:30:51	01/25/01	K	Coolant empty
14	07:30:59	01/25/01	(K)Q	Coolant empty
9	07:31:04	01/25/01	K	Bottling operation aborted
37	07:31:07	01/25/01	K	Valve will not open
14	07:31:09	01/25/01	(Q)G	Coolant empty
211	07:31:28	01/25/01	K	Fault compressor 4
9	07:31:31	01/25/01	(K)G	Bottling operation aborted
37	07:32:43	01/25/01	(K)Q	Valve will not open
211	07:32:47	01/25/01	(K)Q	Fault compressor 4
9	07:33:00	01/25/01	(G)Q	Bottling operation aborted
138	07:39:51	01/25/01	K	Switch M201 open
139	07:39:51	01/25/01	K	Switch M202 open
140	07:39:51	01/25/01	K	Switch M203 open
37	07:39:59	01/25/01	(Q)G	Valve will not open

Figure 5-7 Alarm buffer (example)

Information on the significance of the buttons is provided on Page 5-25.

The message buffer is organized so that in the case of a buffer overflow the oldest message events are overwritten ("FIFO buffer"). It is also possible to delete the entire buffer or specific message categories from time to time (*Delete_message_buffer*) function. This relieves the system load and provides a clearer overview of the message buffer.

Note

The data in the message buffer is volatile and is deleted when voltage is applied.

It is possible to configure how the alarm messages are sorted.

5.11.6 Message display

Purpose

Certain views are defined for messages which are queued or still to be acknowledged or for message events in the message buffer (volatile or archive) in the message indicator. Various filter criteria are available in ProTool CS for this purpose.

Filter criteria include:

- Message number
- Time
- Message states
- Message text
- Date
- Category name
- Acknowledgment group
- Diagnostics capability
- PLC

The attribute *PLC* is only useful when more than one PLC is configured as source of the message. In this way, the precise fault location can be displayed with date/time of the message event.

Note

Please note that the millisecond display for the time concerning the occurrence of message events is only accurate for *ALARM_S* messages. In the case of event and alarm messages, the milliseconds always appear with the value *ooo*.

Structure

The message display (Figure 5-8) can display the following messages:

- queued messages,
- archived messages,
- messages to be acknowledged,
- message events, located in the buffer,
- diagnostic events.

No	Time	Date	Status	Text
\$ 140004	07:30:51	01/25/01	K	Connection has been estab
\$ 140001	07:30:51	01/25/01	K	Connection has been clear
\$ 110001	07:30:51	01/25/01	K	Change to offline mode.
\$ 240000	07:30:51	01/25/01	K	Demo version!

Help
Edit
ACK

Figure 5-8 Example of a message display

Significance of the buttons

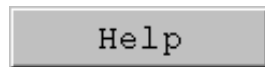

Call Help text

Use this button to call in the help text configured for the selected message.

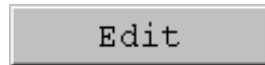

Edit Message

Use this button to trigger the function assigned to the Edit Message event for the selected message.



Acknowledge messages

Use this button to acknowledge messages.

Message categories

In order to be able to distinguish between the different message categories, they are marked in the first column of the message display:

- ! Alarm messages
- Empty Event messages
- \$ HMI system messages
- S7 SIMATIC diagnostic events

Alarm-S messages are displayed either as alarm messages or event messages. SFM messages (System Fault Messages) are displayed as alarm messages.

5.11.7 Single message display

Purpose

A single message display provides a subset of the functionality of a message display (Page 5-30). This provides a simple method with which, for example, to create a message line to display event and system messages in a screen.

Structure

The figure below provides an example of a single message display with the following columns configured:

- Date
- Time
- Message number
- Message states
- Message text

```
25.01.01 14:27:06 110001 K  
Change to operating status 'online'  
25.01.01 14:27:07 140001 K  
Connection discontinued: Station 2, Rack 0, Slot 0
```

5.12 Bar Graphs

Purpose

Bar graphs present a value in the form of a rectangular area. The MP 370 thus provides a clear indication of how far the current value is from the limit values, or if a setpoint value has been reached, at a glance. Bar graphs can be used to display fill levels or quantities, for example.

Display

It is possible to configure minimum and maximum values and the direction bar graph moves by increasing the tag value:

Figure 5-9 depicts the various states of a horizontal bar graph:

1. Value drops below the minimum value configured
2. Value lies within the configured display range
3. Value exceeds the maximum value configured
4. Value lies within the configured limit range

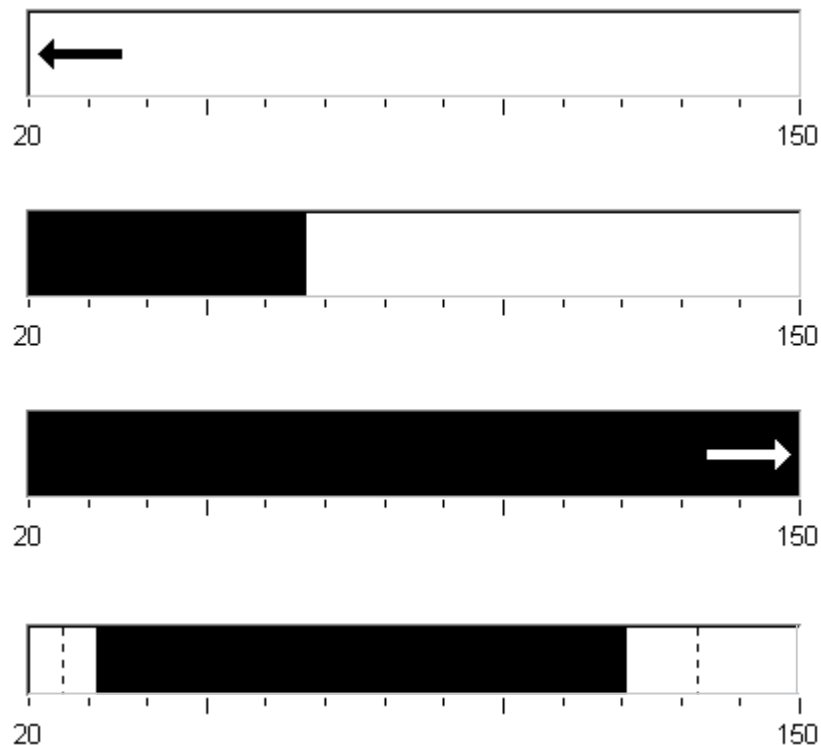

Figure 5-9 Different bar states

5.13 Trend View

Purpose

The trend view is a particularly clear form of displaying process data in a continuous manner. In the case of processes that only change slowly, the trend view can visualize events that have already occurred and provides access to, and estimate of trends in the process sequence. On the other hand, data issued concerning processes which run quickly can be easily evaluated using this form of trend view.

Configurable properties

A number of different trends can be displayed simultaneously in the trend view. The following properties are among those which can be configured for a trend graphic:

- **Trend Type:** *Realtime trend* or *History trend*
- **Triggering:** *Cycle triggering* or *Bit triggering*
- **Limit values:** *Upper and lower limits*
The MP 370 displays the points at which configured limit values are reached or exceeded by changing the color of the trend display.
- **Color:** *Uncertain status*

The *uncertain status* function highlights areas of the trend view in which communication to the unit was interrupted and, as a result, no values could be recorded.

Read line

The *read line* function is used in a trend graphic to display or hide a read line which displays Y-values associated to an X-value.

The read line can be activated by means of the *Trend_view_read_mark_on_off* function or the *X-axis* tab control of the trend view Properties dialog (default: Off). When the function is activated, a button is provided in the trend view with which to activate and deactivate the read line. The color of the read line can be configured in the *Color* tab control.

If the *Display Values Table* function is activated in the *Value Table* tab control, a table appears in the trend view containing the values of the trend curve displayed.

The read line can be operated in the trend view by means of touch, mouse (cursor), keyboard (Ctrl + Alt + cursor right/left) or button. It is also possible to configure buttons for the functions *Trend_view_read_mark_forward* and *Trend_view_read_mark_backward*. When the read line is moved, the values in the value table (when activated) are automatically updated accordingly.

Structure

Figure 5-10 illustrates an example of a trend view with a trend and buttons configured for navigating within the trend.

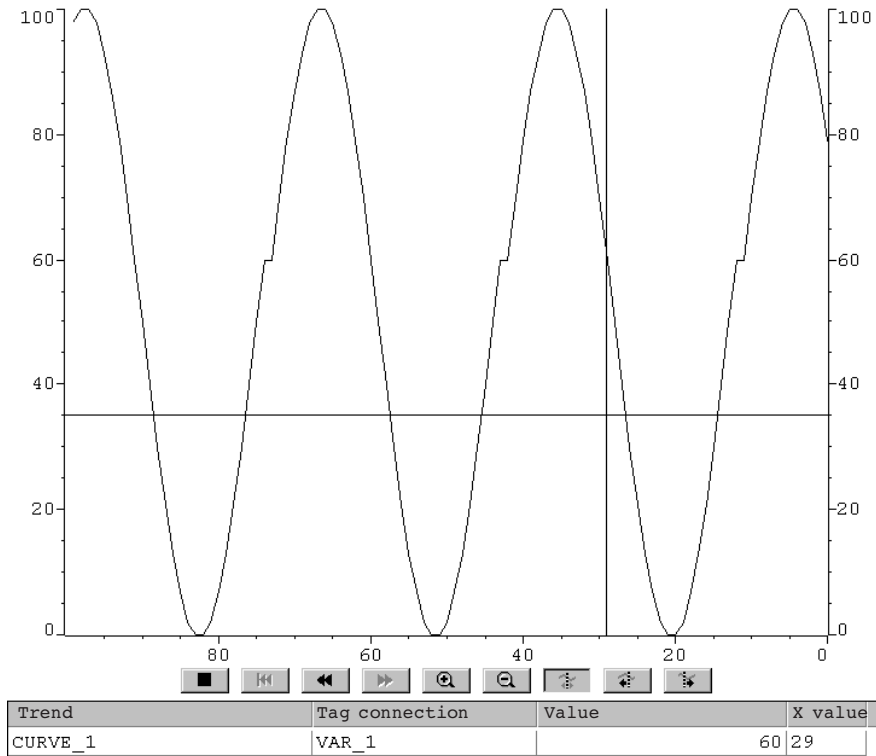





Figure 5-10 Operable trend view with read line (example)

Navigation using buttons

















It is possible to navigate through the trend view using the configured buttons. The individual buttons have the following significance:

Button	Function
Start/Stop update	Interrupts the current updating process for the trend view until the button is pressed again.
Back to start	Scrolls back to the start of the trend recording.
Scroll	Shifts the trend section half a window width to the left/right.
Zoom in/out section	Expands/compresses the trend view horizontally.

Button		Function
	Read line on/off	Switches the reading line on or off.
	Read line forwards	Moves the read line to the right.
	Read line backwards	Moves the read line to the left.

Navigation using the keyboard unit keyboard

If no buttons have been configured in the trend view, use the operating unit keyboard to navigate in the trend view. A condition for this is that the configuration supports navigation using the keyboard.

Keys		Function	
		Back to start Scrolls back to the start of the trend recording.	
		Scroll back Scroll one screen width back.	
		Scroll forward Scroll one screen width forward.	
		Zoom section Expands the trend view horizontally.	
		Reduce section Compresses the size of the trend view horizontally.	
			Read line forwards Moves the read line to the right in the trend curve.
			Read line backwards Moves the read line to the left in the trend curve.

Notice

It is not possible to interrupt the updating of the trend view using the keyboard.

Display archive data as a trend

If data stored in an archive is displayed in the trend view, it is represented as history trends, i.e. the trend data is read out of the archive and displayed according to events. Application for trends of this kind are power-on processes or temperature patterns on heating up an oven.

The trend view is not updated when the archive data changes.

5.14 Slider Control

Purpose

Use a slider control to enter and display numeric values in analog form. To enter values, move the slider to the required position. When used as a display element, the value is represented by the position of the slider.

Function

The slider control is linked to a tag. On moving the user-controlled slider, the corresponding value is written to the tag. Conversely, when the tag value is changed, the position of the moving slider is changed correspondingly, unless it being moved by the operator at that moment.

Display

The figure on the right illustrates an example of a slider for setting and displaying temperature values. The current value (in this case: 50) appears as plain text and as a bar graph.

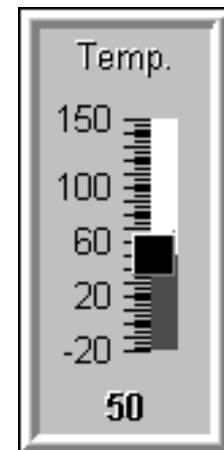

Operation

Proceed as follows to operate a slider control:

- **Touch panel:**
Point to the moveable slider and move it to the desired value.
- **Keyboard unit:**

In order to operate the slider, select it using a cursor key, for example. Use the following keys to actually move the slider:

Function	Keys
Increase value	SHIFT ▲ / SHIFT ►
Reduce value	SHIFT ▼ / SHIFT ◀
Increase/Decrease value in steps of 5%	▲ HOME / ▼ END
Move to maximum value/minimum value	FN ▲ HOME / FN ▼ END



Caution

In the following cases, it is possible that the value indicated by the slider control differs from the real value of the related tag:

- The value range configured for the slider control (minimum and maximum values) does not correspond with the limit values configured for the slider control tag.
 - An invalid password is entered for a slider control protected by a password.
-

5.15 Analog Display

Purpose

An analog display indicates numeric values as a pointer instrument.

Function

The analog display is linked to a tag. When the tag value changes, the pointer position changes correspondingly. The display can be configured to include a non-return pointer. At runtime, the non-return pointer indicates the maximum value reached so far by the value being displayed. It is reset when the current window is opened.

The analog display is purely a display element. Therefore, it is not possible to enter values.

Display

Figure 5-11 illustrates an example of an analog display indicating temperatures.

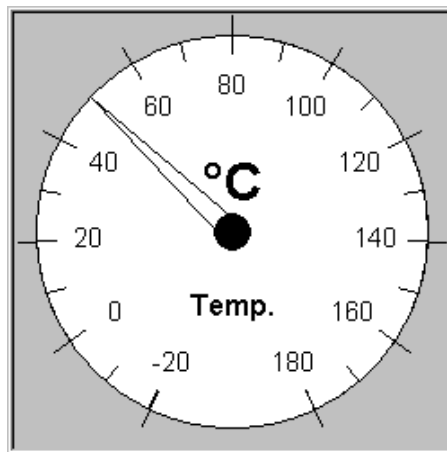

Figure 5-11 Example of a typical analog display

Note on instrument scale

Any color-code differentiations configured for various scale ranges are not displayed on the MP 370.

5.16 Digital/Analog Clock

Purpose

The digital/analog clock provides the option of displaying the system time in numbers (digital) or as a clock with hands (analog). The digital display also includes the current date. The display format is language dependent. It is based on the format defined by the MP 370 operating system.

Display

The digital/analog clock is purely a display element. This means that the date and time cannot be set using the MP 370. In order to set the date and time, use the *Date/Time* screen object (Page 5-13).

Figure 5-12 illustrates an example of a configured analog clock.

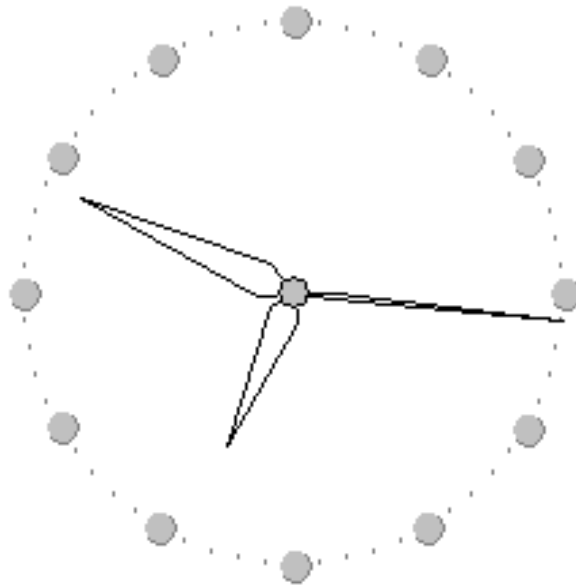

Figure 5-12 Example of a typical analog clock

5.17 Password List

Purpose

While the system is being configured using ProTool CS, additional operating elements can be protected against unauthorized use by means of passwords. Important parameters and settings can then only be modified by authorized personnel. The password level and user name are stored with the password.

The *Report_password_change* function causes a system message to be issued when a different password is entered on the operating unit, i.e. a new user logs on. If the system messages are archived, all login and logout procedures can be established.

The *Write_user_name_to_tag* function is used to write the name of the user currently logged on into a tag of type "STRING". If the tag is one with a PLC link, the user name also exists in the PLC and can be used for the user-dependent enabling of certain functions. User names must always be unique for the assignment. They are stored in a password file.

Password hierarchy

Hierarchically defined password levels from 0 to 9 exist for password protection purposes. When a password is assigned to an individual user or to a whole user group, the permission to execute functions at a specific level is assigned simultaneously. If, for example, a user is assigned to password level 4, he or she is authorized to execute functions of password levels 0 to 4.

Password level

Password level 0:

This minimum password level is assigned to functions that have no, or only a minimal effect on the course of the process. In order to trigger functions assigned to Password Level 0, no password needs to be entered.

Password levels 1 to 8:

Functions are assigned to levels 1 to 8 according to their increasing importance. Before triggering a function with a password level greater than 0, the MP 370 requests the corresponding password to be entered.

Password level 9:

Only the supervisor (system support specialist or service technician) is granted authorization to execute functions assigned to password level 9. The supervisor is authorized to access all the functions on the MP 370.

Logging in on the MP 370 (Login)

After calling a function protected by a password, the MP 370 automatically requests the entry of a password. Once entered, the password need not be entered again in order to call in other functions of this password level or lower.

When correspondingly configured, it is also possible to log in on the MP 370 via an input field for confidential password entry (Page 5-10). The character string entered is represented by placeholders (*).

Logging off from the MP 370 (Logout)

In order to rule out operation by unauthorized personnel, a password level greater than 0 should not remain active on the MP 370 over too long a period of time. The following options are available to explicitly reset passwords levels:

- **Configured logout time expires**
If the MP 370 is not operated within the period of time configured (logout time), the current password level is automatically reset to 0.
- **Manual logout**
If the function *Logoff_user* is linked to an operating element in the configuration, it can be used to reset the current password level to 0.

Note

It is also possible to reset the current password level to 0 by entering an incorrect password.

5.17.1 Password management

Purpose

Individual users can be entered in a password list on the MP 370 and assigned password levels according to specific responsibilities. When processing the list, conclude each field entry by pressing the Enter key. The password list contains all the passwords configured on the MP 370. The list is coded and stored on the MP 370, protected against a power failure.

Figure 5-13 illustrates an example of a password list with six entries.

User	Password	Level
Superuser	100	9
Bayer	pw1	1
Lerp	pw2	2
Müller	pw3	3
Schmidt	pw4	4
Service	pw5	5

Figure 5-13 Example of a password list

View password list

Only those passwords with user names are displayed which have a password level equal to or lower than that with which the user is currently logged in. The MP 370 displays the password list entries in alphabetic order.

Creating a password

The user can only edit the password list up to the level with which he is currently logged in. All passwords used in the system must be unique. It is not possible to assign the same password to different password levels. However, there are no restrictions in assigning different passwords to the same password levels.

Deleting a password

To delete a password from the password list, overwrite the password level assigned to it with 0.

5.17.2 Export/Import password list

Purpose

If a system includes several operating units which are accessed by the same users, the same passwords must be installed on each operating unit. In order that the password list need not be re-entered on each operating unit, it can be created on one unit and then exported and imported on other units.

Note

During an import, all currently valid passwords are overwritten. The imported passwords become valid immediately.

If an existing user name or password is entered, the corresponding system message is issued.

Condition

In order to be able to export/import password lists on the MP 370, the *Export_Import_Passwords* function must be linked to a button or function key, for example. The file name of the password list to be exported/imported must be specified as the function parameter during configuration.

Notice

- The password list is coded. It cannot be edited with external tools.
 - Do not export a password list directly after it has been modified. Exit the screen object *Password List* after changing it and wait with the export function until modifications have been written in the internal Flash memory.
-

5.18 Status/Force

Purpose

The MP 370 can be used to access the connected PLC and periphery directly to read and write values. PLC program operands can be monitored and modified easily without having to connect an additional programming unit or PC to the PLC.

This option is particularly useful during the testing and commissioning phase of the configuration.

Condition

The following conditions must be fulfilled in order to be able to access operands in the PLC program directly from the MP 370:

- The connected PLC is a SIMATIC S5 or SIMATIC S7
- The configuration must contain the screen object *Status/Force* (Figure 5-14)

Structure

Figure 5-14 illustrates the basic structure of the screen object *Status/Force*. Each line represents an operand.



Connection	Type	DB Number	Offset	Bit	Data Type	Format	Status Value	Force Value
PLC_1	E		0		CHAR	BIN	0000 0...	
PLC_1	DB	10	10		WORD	DEC	42994	
PLC_1	M		25	0	BOOL	HEX	0	
PLC_1	A		34		WOR	DEC		

Figure 5-14 Status/Force: Example for SIMATIC S7

The column sequence may be different when using a touch panel or if a USB mouse is connected. In order, for instance, to swap the *Format* and *Control Value* columns, move the column heading *Control Value* onto the column heading *Format*.

The table indicates the significance of the individual columns and buttons.

Column/Button	Function
Connection	Select the PLC whose address area is to be displayed and/or modified.
Type, DB number, Offset, Bit	Specify the address in this column.
Data type, Format	This column is used to change the format of the output.
Status value	The MP 370 uses this column to display the values of the operands read from the PLC.

Column/Button	Function
Force value	Use this column to enter the values to be written to the operands.
	This button is used to update the display in the column <i>Status value</i> . The button is locked after being pressed. None of the input fields can then be used until the button is pressed again, thus stopping the update.
	This button is used to apply the new value specified in the column <i>Force value</i> . The value is then written to the PLC.

Operation























Proceed as follows to operate the *Status/Force* screen object:

Touch panel:

Touch the operating element required. Either the screen keyboard is displayed or a selection list is opened, depending on the input field.

Keyboard unit:

The table depicts the key combinations for operation using the keyboard.

Keys	Function
 	Operate button Write.
 	Operate button Read.
  /  	Select first/last field in current line.
  /  	Select first/last field in current column.
  	Increase width of current column.
  	Reduce width of current column.
 	Delete current line. Alternatively: Do not select a PLC from the <i>Connection</i> column.
 	Optimize column width.
	Open selection field.

5.19 SIMATIC HMI Symbol Library

Purpose

The *SIMATIC HMI Symbol Library* is a comprehensive library containing graphics from the areas of techniques and production. The library extends the possibilities of producing screens for the project in large numbers and representing aspects realistically. The following screen objects (graphics) are included, for example, in a wide range of categories:

- valves, motors, tank containers,
- conveyor belts,
- factory buildings,
- 3D ISA symbols,
- cooling and heating systems.

Settings

Using the screen editor, any object in the SIMATIC HMI Symbol Library can be inserted in the current screen and edited as required. In addition to the standard tab controls for all the screen objects (*Functions, Position, Color, Attributes, Name* and *Enable*), the SIMATIC HMI Symbol Library provides two further tab controls:

- **Symbol:**
Selection of the required symbol.
- **Style:**
Settings for color filling, transparency and orientation of the screen object and configuration of a tag:
 - It is possible to modify the appearance and representation of symbols and background.
 - Symbols can be mirrored and/or turned in steps of 90°.
 - The cursor can be assigned an additional lightning symbol when moving over the screen in order to emphasize to a user the configuration of a function, for example (only possible with touch panels).
 - It is possible to configure a tag for the symbol and, thus, control its color representation in accordance with falling below or exceeding limit value ranges.

Recipes

6.1 Overview

Purpose

The purpose of recipes is to transfer of quantities of related data **together** and **synchronously** from the operating unit to the PLC and back again.

Principles of operation

Using the example of the filing cabinet (Figure 6-1), the two terms *Recipe* and *Data Record* should be defined because they are important for subsequent understanding of the process.

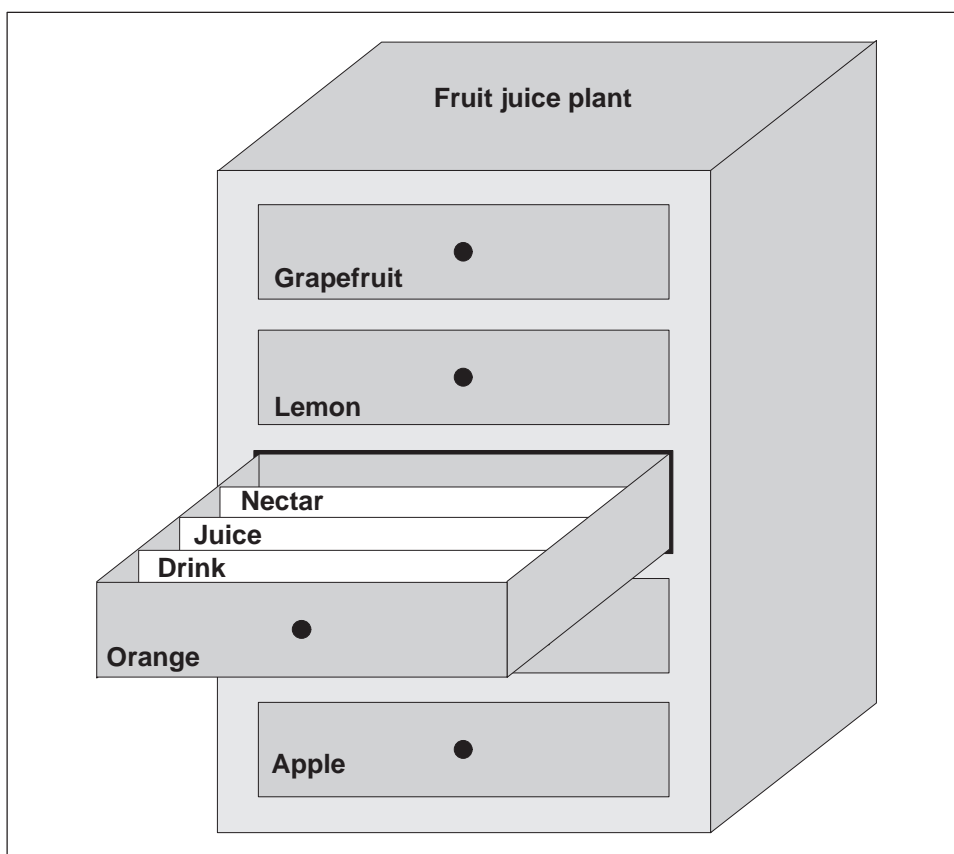

Figure 6-1 Recipe and Data Record, using a filing cabinet as an analogy

- **Recipe**

Recipes correspond to the individual drawers of the filing cabinet illustrated (e.g. grapefruit or lemon). The reference value fields (tags) belonging to the particular recipe are defined in each drawer. The recipes define the data structure in ProTool CS. This structure cannot be modified later on the MP 370.

- **Data record**

Data records correspond to the filing cards in the individual drawers of the cabinet (e.g. Drink, Juice and Nectar). A data record contains the values for a recipe. Data records are created, modified and deleted on the MP 370. The data records are also stored on the MP 370. This saves storage space on the PLC.

The Import/Export function provides the additional option of using external tools to edit exported data records, e.g. using Excel and then reimporting them on the MP 370.

Example of a recipe

An example for use of a recipe is its application on a filling station of a fruit juice system. The same filling station is used to produce orange drink, orange juice and orange nectar. The mixing ratios are different for each product. The ingredients are always the same.

Assume that a recipe called *Mixture* is created, which has the following data structure:

Tag	Name
Var_2	l orange
Var_3	l water
Var_4	kg sugar
Var_5	g flavor

The designations l Orange, g Aroma etc. of the tags are the so called *entry names*. The entry names are also displayed on the MP 370. In this way, for example, the tag var_2 can be identified as the tag designating the mixture component Orange.

The data records contain the values for the different drink types. The data records may appear as follows, for instance:

Orange drink		Orange juice		Orange nectar	
l orange	90	l orange	95	l orange	70
l water	10	l water	5	l water	30
kg sugar	1.5	kg sugar	0.5	kg sugar	1.5
g flavor	200	g flavor	100	g flavor	400

6.2 Use of Recipes

The following section contains a description of the data flow for recipes and three application scenarios illustrating the use of recipes in the form of short, practical examples. They should provide a top level overview of the possibilities for using recipes:

- The first scenario illustrates a recipe configuration in which the data entered is not immediately transferred to the PLC. This configuration is used, for example, when it is necessary to enter data on the operating unit without interfering with an active process.
- In the second scenario, data is immediately transferred to the PLC. This configuration can be used, for example, to start up a machine and correct the positioning data online.
- The third scenario implements data record functions in order to control production automatically via a job list.

6.2.1 Data flow for recipes

The diagram illustrates various possibilities concerning data flow when using recipes. The data flow between the active components operating unit (A), PLC (B) and external data medium (C) is dependent on the configuration of the recipe and the functions used.

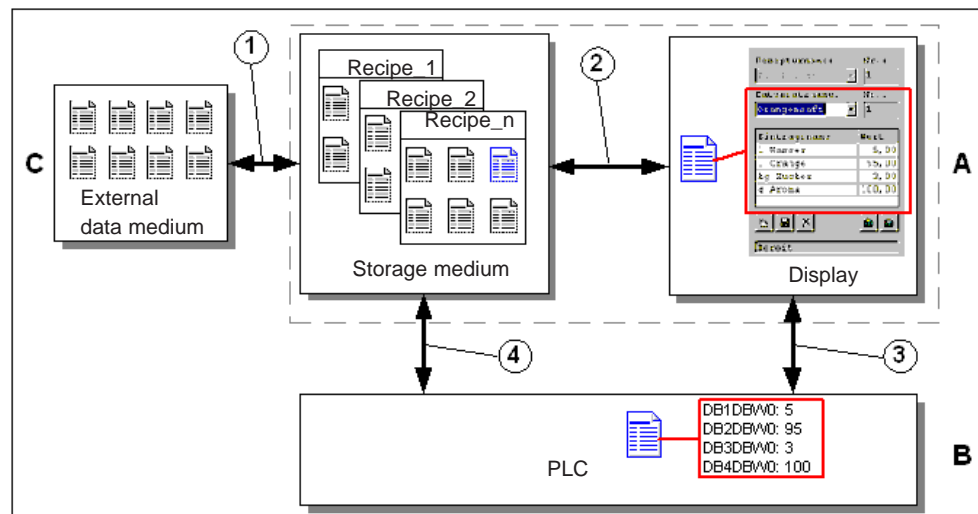

Figure 6-2 Data flow for recipes

The operating unit (A) stores the recipe data records on a storage medium, e.g. Flash or hard disk. The recipe data record can be edited in a recipe view or recipe screen on the operating unit display:

- A new data record can be entered and can then, for example, be stored (2) on the storage medium and transferred (3) to the PLC (B).
- The data record can be exported to an external data medium (C), e.g. a PC. The data record is saved in CSV format, regardless of the recipe. This file can then be loaded and edited in MS Excel, for example.
- A data record can be loaded (2) from the operating unit storage medium or import (1) it as a *.CSV file from an external data medium.

A recipe data record can also be transferred (4) directly from the storage medium to the PLC or loaded from the PLC to the storage medium. In the same way, a recipe in the display can be transferred (3) to the PLC or loaded from it.

6.2.2 Application examples

Scenario 1: Enter data record

Production data must be entered on operating unit (A) without interfering in the active process. The production data should not be transferred to the PLC (B).

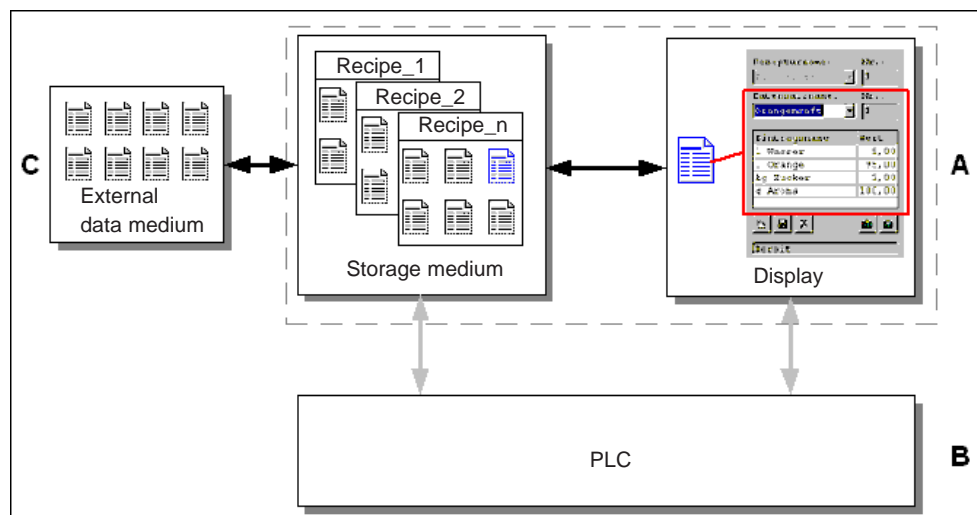

Figure 6-3 Process

Enter the production data in the recipe view or recipe screen, assign a data record name and save the new data record on the operating unit storage medium.

Scenario 2: Manual production process

The production data should be read from the PLC (B) according to the workpiece to be processed and displayed on the operating unit screen (A) to be checked. It should be possible to correct the production data transferred online, if necessary.

Notice

This is a special application scenario because it cannot be realized on all HMI devices.

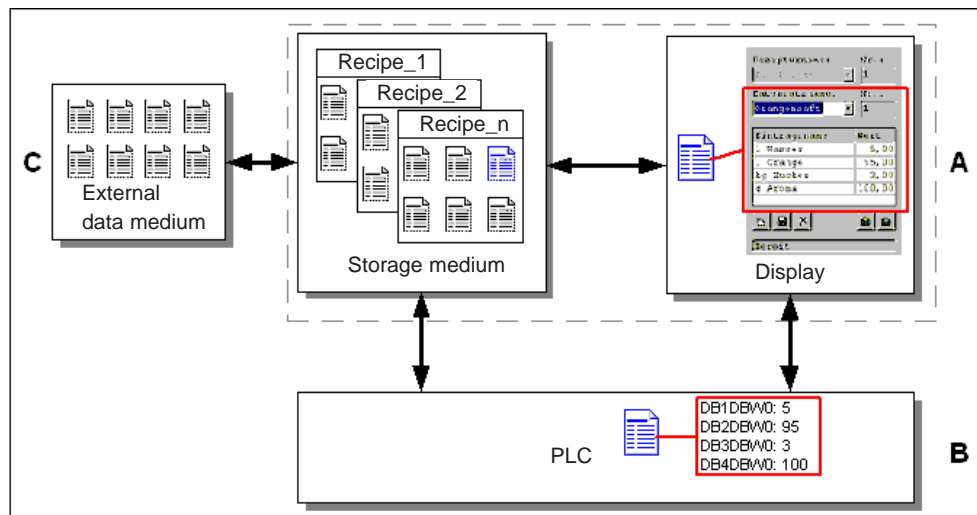

Figure 6-4 Process

A reading device, e.g. connected to the PLC, reads out a bar-code from the workpiece to be edited. The data record name corresponds to the respective bar-code designation. As a result, the PLC can load the required data record from the operating unit's storage medium. The data record appears in the display for control purposes. Modifications are immediately transferred to the PLC.

Scenario 3: Automatic production process

Production should be automated by means of a job list. The production data should be transferred directly to the PLC (B) either from the data medium in the operating unit (A) or from an external data medium (C). It is not necessary to show it in the display.

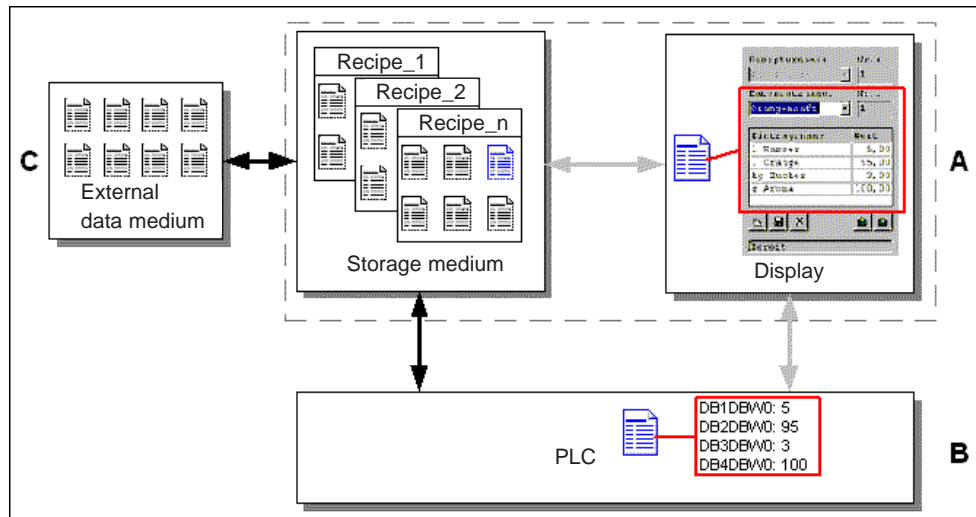

Figure 6-5 Process

Production can be controlled via one or more VB scripts which automatically transfer the production data records to the PLC. The process can be controlled by means of return values of the functions used.

The automatic production process can be realized using the data record functions provided: The *Import_Data_Records* function loads data records from a *.CSV file to the data medium. The *Data_Record_DAT_to_PLC* function transfers a data record from the data medium to the PLC.

6.3 Recipe Configuration

Basic procedure

The basic steps to configuring a recipe are listed below:

1. Define the structure of the recipe:

Assign tags to the recipe structure. These tags are provided with entries from the data records.

Define a name for the recipe. This name is used to select the recipe in the configuration and on the MP 370.

2. Set recipe tag properties

The following options can be configured in ProTool CS:

– *Synchronize tags*

This option defines that the data from a data record has been read from the PLC or data medium and written in the tag or read from the tags configured for the recipe. This establishes a connection between the tags configured in the recipe and the tags in the screens. When a data record is loaded, the values are written to the tags used in the screens.

– *Tags offline*

If this option is also activated, the values entered are only stored in the tags, and not transferred to the PLC. Otherwise, values entered are transferred directly to the PLC.

3. Define storage location for data records on the MP 370

The data storage location for data records can be configured. The following settings are possible:

Storage location	Setting in ProTool CS
Internal Flash memory	\Flash\...
Memory card <ul style="list-style-type: none"> • PC card • CF card 	<ul style="list-style-type: none"> • \Storage Card\... • \Storage Card2\...
Network	Any path in the network, e.g. \\PC_Name\... (target computer)

Caution

Cyclical writing access is not permitted for the internal Flash memory because it reduces the service life of the Flash memory and thus the service life of the unit. Use an external memory card instead.

4. Set download synchronization

It is possible to configure whether the data records are downloaded to the PLC with or without synchronization.

5. Creating a recipe screen

Configure one or more screens in order to create, store, and download data records on the MP 370. Depending on the application, use either the recipe view or create a copy of the system, e.g. using input/output fields in recipe screens.

- Recipe view:
The recipe view enables an uncomplicated, quick method of handling recipes and data records with a minimum of configuration work. Normally, they are used to process data records with smaller recipes in table form.
- Recipe screen:
The operator can use recipe screens to customize the user interface for editing data records and, for example, simulating the system visually, providing graphics and individual masks for entering data records. Recipe screens are particularly recommended for data records with a relatively large number of entries.

Further information

Detailed information on how to create a recipe is provided in the online help to the ProTool CS configuration software and in the *ProTool Configuring Windows-based Systems* user's guide.

System limits

The table provides an overview of the system limits for recipes.

Elements	Number
Number of recipes	500
Data records per recipe	1000 (limited by storage medium)
Entries per recipe	1000

Memory requirements for data records

The memory requirements per recipe (in kByte) is calculated from the three summands D1 + D2 + D3.

$$D1 = [(no. of entries \times 9 + tag name total length) + 4] : 1024$$

$$D2 = [(no. of data records \times 12) + 4] : 1024$$

$$D3 = [no. of data records \times (data record length + N) + 4] : 1024$$

D1, D2 and D3 are rounded up to the next whole number.

A data record length is the sum of all the tag lengths configured for the data record in bytes. For example, a tag of the type *FLOAT* has a length of 4 byte.

The tag name total length is the sum of the length of all the tag names which are used in the entries.

The following applies for N:

Data record name < 13 characters: N = 12

Data record name > 12 characters: N = 40

Notice

The internal Flash memory has a maximum storage capacity of 128 kByte.

Note:

In the interest of optimizing the service life of the unit and achieving a better performance, use either the network or an external memory card to store data records.

6.4 Editing Data Records

In this chapter

This chapter provides information on how to edit data records on the MP 370. The following information is also included:

- Layout of the recipe view (Page 6-11)
- Displaying data records (Page 6-14)
- Creating new data records (Page 6-14)
- Copying data records (Page 6-15)
- Modifying data records (Page 6-16)
- Copying data records by selecting a data record name (Page 6-16)
- Renaming data records (Page 6-17)
- Deleting data records (Page 6-17)
- Reading data records from the PLC (Page 6-18)
- Downloading data records to the PLC (Page 6-18)
- Synchronizing a data record (Page 6-18)
- Editing data records in recipe screens (Page 6-19)
- Functions and PLC jobs (Page 6-23)
- Exporting/Importing data records (Page 6-25)
- Exporting, editing and importing data records (Page 6-27)
- Reaction to changing the recipe structure (Page 6-28)

Methods

Data records can be edited on the MP 370 in tables or screens:

- **Tabular editing**

The recipe view is available for the tabular editing of data records (Page 6-11). The recipe view enables recipes and data records to be handled in an uncomplicated, quick way.

Normally, they are used to process data records with smaller recipes offline. Values entered on the MP 370 are not directly transferred to the PLC when entered.

- **Editing in recipe screens**

The project engineer can use recipe screens (Page 6-19) to customize the user interface for editing data records and, for example, simulating the system visually, providing graphics and individual masks for entering data records.

This method is typically used for processing medium and large data records offline in the recipe view. The values entered on the MP 370 are only saved in the tags, but not transferred directly to the PLC on input.

6.4.1 Recipe view

Purpose

The recipe view is typically used to edit recipe data records in tabular form. This provides an uncomplicated method of displaying, creating, copying, modifying, deleting and downloading data records on the MP 370.

All descriptions on editing data records provided in this Chapter 6.4.1 relates purely to the use of the recipe view. Information on editing data records in recipe screens is provided from Page 6-19.



















Display





Figure 6-6 illustrates an example of the layout of the recipe view. Some of the operating and display elements can be configured so that they are faded out on the MP 370.

Entry Name	Value
l orange	95
l water	5
kg sugar	0.5000000
g aroma	100

Figure 6-6 Layout of the recipe view (example)







Significance of the operating and display elements

No.	Function
	<p>Select recipe If the corresponding function is enabled in ProTool CS, it is possible to select a configured recipe in this selection field. The number of the selected recipe is displayed to the right of the selection field. This number is only relevant during the configuration. It cannot be modified on the MP 370.</p>
	<p>Select data record As soon as a recipe has been selected, the data records available are displayed in this field. In addition, the data record number is displayed to the right. The number field only becomes active when the input of a data record number is permitted, e.g. after changing the data record number or creating a new data record.</p>
	<p>View/Edit entries This table contains all the entries which are configured in the selected data record. Sorting complies to the configured sequence. The right-hand column displays the associated values. The entry names cannot be edited on the MP 370.</p>
	<p> Create new data record This button initiates the creation of a new data record. The setpoint values are predefined with default values configured as start values for the respective tags. Key combinations:  </p>
	<p> Save data record This button is used to save the current values of the data record displayed on the MP 370 data medium. The memory location is defined in ProTool CS. The data record is stored under the currently defined name and number. Key combinations:  </p>
	<p> Delete data record This button is used to delete the data record currently displayed for the defined recipe from the MP 370 data medium. Key combinations:  </p>
	<p> Read data record from the PLC This button is used to read the data record related to the currently set recipe from the PLC and display the values on the MP 370. Key combinations:  </p>

No.	Function
	 <p>Write data record in the PLC</p> <p>This button is used to write the current data record values in the PLC.</p> <p>Key combinations:  </p>
	<p>Status bar</p> <p>The MP 370 displays the status of the current operation in this line, e.g. Downloading.</p>

Other buttons

The following buttons are only visible when they have been correspondingly configured by means of an attribute in the recipe view:

	<p>Synchronize</p> <p>This button is used to synchronize the data in a recipe view with the associated tag. Modified values are written in the corresponding tags in the table of a recipe view. Finally, all the values are read from the tags to table, which is updated accordingly. This ensures consistency between the recipe view and tags.</p> <p>The button is only enabled for use in the case or recipes with synchronized tags.</p> <p>Key combinations:  </p>
	<p>Save data record as</p> <p>This button can be used to store a data record from a recipe screen on a storage medium under a different name, regardless of the recipe view. After pressing the button, a dialog appears in which to enter the name.</p> <p>Key combinations:  </p>



Caution

- If the two options *Synchronize Tags* and *Tags Offline* are activated in the configuration, the values from the table are applied when values in the tables and screens are changed simultaneously.
- If the data record currently being edited in the recipe view is changed in the background (e.g. by means of a PLC job), the recipe view is not automatically updated.

Notes on operation using the keyboard unit

- **Quick selection of recipes and data records**

When the selection field is opened up, enter the first letter of the recipe or data record to be selected to access the relevant area of long lists, thus speeding up the selection procedure.

- **Edit entries**

If the value marked in the recipe view is to be modified, it is initially deleted by pressing one of the alphanumeric keys. This occurs with regard to all list elements in Windows. In order to prevent this, proceed as follows:

- After selecting the value to be changed, press the Enter key.
- Move the text cursor to the relevant position by pressing the cursor key or *SHIFT* and cursor key.
- Insert the modifications.
- Confirm the changes, e.g. by pressing the Enter key.

Displaying data records

Proceed as follows to display data records from the MP 370 data medium:

Step		Procedure
1	Select recipe	<p>Step 1 is only possible when recipe selection has been configured.</p> <ul style="list-style-type: none"> • Select the selection field for the configured recipes (Position 1 in the figure on Page 6-11). • Open the selection field and mark the required recipe in the opened selection list. • Confirm the selection.
2	Select data record	<ul style="list-style-type: none"> • Select the selection field for the existing data records (Position 2 in the figure on Page 6-11). • Open the selection field and mark the required data record in the opened selection list. • Confirm the selection. <p>The selected data record is loaded. The configured entries are displayed in table form with name and setpoint value.</p>

Creating new data records

Proceed as follows to create new data records on the MP 370:

Step		Procedure
1	Select recipe	<ul style="list-style-type: none"> • Select the required recipe, as described in Step 1 on Page 6-14.
2	Create data record 	<ul style="list-style-type: none"> • Press the key depicted on the left. <p>The name and number of the data record displayed are deleted. The entries in the table are assigned the configured start values.</p>

Step		Procedure
3	Enter data record name	<ul style="list-style-type: none"> Enter a new data record name in the selection field for data records (Position 2 in the figure on Page 6-11). After entering the data record name, the next free data record number is automatically entered on the right. This number can be changed, if necessary.
4	Change values	<ul style="list-style-type: none"> Enter a setpoint value for each entry configured in the table (Position 3 in the figure on Page 6-11).
5	Save data record 	<ul style="list-style-type: none"> Press the key depicted on the left. The new data record is written on the data medium. The operating unit responds with a system message if the name or number entered already exist.

Storage location for new data records

The data storage location for the new data record can be configured. The following settings are possible:

- Internal Flash memory
- Memory card
 - PC card
 - CF card
- Any path in the network

Copying data records

In order to copy data records, save them under new names. Proceed as follows:

Step		Procedure
1	Select recipe and data record	<ul style="list-style-type: none"> Select the required recipe and the data record to be copied as described in Steps 1 and 2 on Page 6-14.
2	Enter data record name	<ul style="list-style-type: none"> Enter a new data record name in the selection field for data records (Position 2 in the figure on Page 6-11). After entering the data record name, the next free data record number is automatically entered on the right. This number can be changed, if necessary.
3	Save data record 	<ul style="list-style-type: none"> Press the key depicted on the left. The new data record is written on the data medium. The MP 370 responds with a system message if the name or number entered already exists. The system message contains the recipe and data record name concerned so that, if several recipe views are open, the correct data record is stored.

Copying data records after selecting a data record name

Proceed as follows to copy an existing data record after selecting the data record name:

Step		Procedure
1	Select recipe and data record	<ul style="list-style-type: none"> Select the required recipe and data record, as described in Steps 1 and 2 on Page 6-14.
2	Change values	<ul style="list-style-type: none"> Modify the values necessary.
3	Save data record as 	<ul style="list-style-type: none"> Press the key depicted on the left. A dialog opens containing a data record name selection field which can be edited. The selection field contains the name of the data record selected. Select the required data record name and edit it. After confirming with <i>OK</i>, a new data record is created under the name specified with the current values based on the previously selected data record. The newly created data record is displayed in the recipe view.

Changing data records

Proceed as follows to change existing data records:

Step		Procedure
1	Select recipe and data record	<ul style="list-style-type: none"> Select the required recipe and the data record to be changed as described in Steps 1 and 2 on Page 6-14.
2	Change values	<ul style="list-style-type: none"> Change the setpoint value in the table (Position 3 in the figure on Page 6-11). The entry names cannot be edited on the MP 370.
3	Save data record 	<ul style="list-style-type: none"> Press the key depicted on the left. The modified data record overwrites the original data record on the data medium.

Notice

If large-scale modifications have been carried out in recipes in ProTool CS and, after downloading the modified project, the data records on the operating unit data medium deviate a great deal from the original recipe structure, it is recommended to reorganize the data medium:

- export the data records of all the recipes (refer to Page 6-25).
- delete the data records using the function *Delete_Data_Record_Memory*.
- import the data records using the function *Import_Data_Records*.

In this way, all the tags no longer used are deleted.

Renaming data records

Proceed as follows to rename existing data records:

Step		Procedure
1	Select recipe and data record	<ul style="list-style-type: none"> Select the required recipe and the data record to be copied as described in Steps 1 and 2 on Page 6-14.
2	Enter data record name	<ul style="list-style-type: none"> Enter a new data record name in the selection field for data records (Position 2 in the figure on Page 6-11). After entering the data record name, the next free data record number is automatically entered on the right. Reset this number to its original value.
3	Save data record 	<ul style="list-style-type: none"> Press the key depicted on the left. The modified data record is written on the data medium. The operating unit responds with a system message if the name or number entered already exist.

Deleting data records

Proceed as follows to delete data records on the MP 370 data medium:

Step		Procedure
1	Select recipe and data record	<ul style="list-style-type: none"> Select the required recipe and the data record to be changed as described in Steps 1 and 2 on Page 6-14.
2	Delete data record 	<ul style="list-style-type: none"> Press the key depicted on the left. The data record is deleted from the data medium after confirming a confirmation request.

Note

It is possible to configure the *Delete_Data_Records* function to directly delete individual recipes, all data records in a recipe or all recipes. To delete data records using this function, it is not necessary to configure a recipe view.

It is still possible to configure the *Delete_Data_Record_From_Display* function with which the currently displayed data record will be deleted.

Reading data records from the PLC

Proceed as follows to update data records in the MP 370 working memory with values from the PLC:

Step		Procedure
1	Select recipe	<ul style="list-style-type: none"> Select the required recipe, as described in Step 1 on Page 6-14.
2	Read values 	<ul style="list-style-type: none"> Press the key depicted on the left. The current values are read from the PLC and displayed.
3	Edit data records	<ul style="list-style-type: none"> The data can then be edited, e.g. values modified, saved, downloaded to PLC, etc. <p>The MP 370 responds with a system message if downloading from the PLC is not possible because, in cases where synchronization with the PLC is configured, for example, the data mailbox is currently locked.</p>

Downloading data records to the PLC

In order that a modified or new data record can take effect in the PLC, it must be downloaded to the PLC.

Proceed as follows to download data records to the PLC:

Step		Procedure
1	Select recipe and data record	<ul style="list-style-type: none"> Select the required recipe and the data record to be downloaded as described in Steps 1 and 2 on Page 6-14.
2	Write values 	<ul style="list-style-type: none"> Press the key depicted on the left. <p>The values are written in the PLC.</p> <p>The MP 370 responds with a system message if downloading to the PLC is not possible because, in cases where synchronization with the PLC is configured, for example, the data mailbox is currently locked.</p>

Synchronizing a data record

Proceed as follows to synchronize the data in a recipe view with the associated tag:

Step		Procedure
1	Select recipe and data record	<ul style="list-style-type: none"> Select the required recipe and the data record to be changed as described in Steps 1 and 2 on Page 6-14.
2	Synchronize data record 	<ul style="list-style-type: none"> Press the key depicted on the left. <p>The data record is synchronized with the tags.</p>

6.4.2 Recipe screens

Purpose

Recipe screens are typically representations of the system. The screens provide display and operating elements with which to create, save, modify, delete and download data records. Large recipes can be split into several topic-specific screens and clearly displayed, e.g. with graphic elements.

Components for editing data records

In order to be able to edit data records in recipe screens on the MP 370 the corresponding components, e.g. input/output fields and functions, must be configured:

- **Recipe view:**
Recipe screens can contain a recipe view (Page 6-11) not only to enable the easy selection of recipes and data records but also for editing data records. The configured functional range of the recipe view can vary, according to the intended purpose.

Information on editing data records in recipe screens is provided from Page 6-11. The instructions stipulated there generally also apply for editing data records in recipe screens. However, in this case, input is performed in the screens.

- **Functions:**

Depending on whether a recipe view is configured in the project or not, and on the properties assigned to it, there are various functions available to transfer data records between MP 370 and PLC, e.g.:

for recipe views

- *Load_Data_Record*
- *Save_As_Data_Record_From_Display*
- *Save_Data_Record_from_Display*
- *Delete_Data_Record_from_Display*
- *Synchronize_Data_Record_in_Display*
- *Data_Record_Display_to_PLC*
- *Data_Record_PLC_to_Display*

for recipe screens

- *Load_Data_Record*
- *Save_Data_Record*
- *Delete_Data_Record*
- *Data_Record_PLC_to_Tags*
- *Data_Record_Tags_to_PLC*
- *Recipe_Tags_Online_Offline*

for downloading data records between data medium and PLC

- *Data_Record_DAT_to_PLC*
- *Data_Record_PLC_to_DAT*

for exporting and importing data records

- *Export_Data_Records*
- *Import_Data_Records*

Further functions for recipes:

- *Delete_Data_Record_Memory*
- *Convert_Data_Record_Number_to_Name*

More functions and PLC jobs, which are linked to the downloading of data records, are described on Page 6-23.

Note

It is possible to read in data or data records from the PLC. To do this, functions such as *Data_Records_PLC_to_Tags* or *Data_Records_Tags_to_PLC* and parameters such as *Recipe number/name* and *Data record number/name* are available in which to assign specific names.

Editing data records offline

The way in which data records are edited on the MP 370 is defined during configuration. It is typically used for the offline editing of data records in recipe screens. Values entered on the MP 370 are not directly transferred to the PLC when entered.

Proceed as follows to edit data screens in recipe screens offline:

Step	Procedure
1	Select a data record as described on Page 6-14.
2	Trigger reading of the selected data record from the storage medium: <ul style="list-style-type: none"> • With recipe view It is automatically loaded on selecting the data record. • Without recipe view Activate the operating element linked with the <i>Load_Data_Record</i> function. The function parameters must have been set accordingly beforehand.
3	The data of the data record is written to the tags.
4	Edit the tags using the configured input/output fields.
5	Save the modified tags. <ul style="list-style-type: none"> • With recipe view Click the Save button. If necessary, you must first specify a new name. • Without recipe view Activate the operating element linked with the <i>Save_Data_Record</i>. The function parameters must have been set accordingly beforehand.

Editing data records online

In order to edit data records online, the option must either be defined during configuration or the *Recipe_Tags_Online_Offline* function defined in the configuration. In the case of online editing, the values entered are transferred directly to the PLC. This method is normally used when commissioning the machine/system in order to test, run-up and position.

Proceed as follows to edit data records on the MP 370 online:

Step	Procedure
1	Select a data record as described on Page 6-14.
2	Trigger reading of the selected data record from the storage medium: <ul style="list-style-type: none"> • With recipe view It is automatically loaded on selecting the data record. • Without recipe view Activate the operating element linked with the <i>Load_Data_Record</i> function. The function parameters must have been set accordingly beforehand.
3	The data of the data record is written to the tags and thus also to the PLC.

Step	Procedure
4	Edit the tags using the configured input/output fields. This will simultaneously change the values in the PLC as well.
5	Save the modified tags. <ul style="list-style-type: none"><li data-bbox="505 400 1351 455">• With recipe view Click the Save button. If necessary, you must first specify a new name.<li data-bbox="505 463 1351 551">• Without recipe view Activate the operating element linked with the <i>Save_Date_Record</i>. The function parameters must have been set accordingly beforehand.

**Warning**

When editing data records online, the entered values are transferred to the PLC without synchronization. Therefore, when changing individual values, ensure that no impermissible operating statuses occur in the machine/system.

6.4.3 Functions and PLC jobs

Functions

The following functions can be used to import and export recipe data records for editing with external tools:

- *Export_Data_Records*
- *Import_Data_Records*

They can be used to either import and export either individual data records or all data records in a recipe, according to the configured parameters.

The following functions can be used to transfer data records between the PLC and MP 370.

- *Data_Record_DAT_to_PLC*
- *Data_Record_PLC_to_DAT*

The data medium is the internal Flash memory, the memory card or any network path. Both the recipe and data record must be specified as parameters in which the values should be written.

The following functions enable data records to be transferred to the PLC which are currently being displayed in the recipe view on the operating unit.

- *Data_Record_PLC_to_Display*
- *Data_Record_Display_to_PLC*

The values from the data record tags are written directly to the addresses in the PLC.

Parameters which can be changed for recipe functions

- **Return values**

It is possible to configure the optional *Return values* parameter for various recipe functions. This parameter enables a message to be issued concerning the status of a function. Functions can be processed in succession using *Change value*.

Values

2: Function in progress
4: Function completed without errors
12: Function completed with errors

- **Status message**

It is possible to configure the *Status message* parameter for various recipe functions. This parameter defines whether a corresponding system message should appear when a function has been completed.

Values

1: After executing the function, a status message is issued
0: No status message

PLC jobs

The following two PLC jobs can be used to transfer data records between the PLC and MP 370 automatically:

- *No. 69*: "PLC → DAT" (read data record from PLC)
- *No. 70*: "DAT → PLC" (write data record in PLC)

Information on PLC jobs is provided in the *Communication for Windows-based Systems* User's Guide.

6.4.4 Import/Export data records

Purpose

When the appropriate features have been configured, data records on the MP 370 can be exported as CSV files to the data medium. This feature can be used to edit data records with external tools, e.g. with a spreadsheet program or text editor and import them on the MP 370 again.

Condition

In order to export and import data records during runtime, the configuration must contain the following functions:

- *Export_Data_Records*
- *Import_Data_Records*

These functions must be linked in the ProTool CS configuration software, e.g. to a function key or button.

File format CSV

With file format CSV, the table columns (entry name and value) are separated by a separator (e.g. semicolon). Each table row (entry) is terminated by a line feed.

The example in Figure 6-6 (Page 6-11) appears as follows in CSV format for the individually exported data record *Juice*:

```
Orange;Juice
3;2
Var_2;95
Var_3;5
Var_4;0.5
Var_5;100
```

Additional information is stored in the first two lines:

- Line 1:
Name of the recipe and data record
- Line 2:
Number of the recipe and data record

The MP 370 interprets the information on importing the file.

Notice

When the CSV files are edited with an external text editor, the modifications are saved in text format (without control codes).

Export/Import all data records of a recipe or all recipes

When appropriately configured, all the data records in a recipe or all recipes can be imported/exported together. The CSV file for the example on Page 6-2 then appears as follows:

```
Orange;Drink;Juice;Nectar
3;1;2;3
Var_2;90;95;70
Var_3;10;5;30
Var_4;1.5;0.5;1.5
Var_5;200;100;400
```

Additional information is stored in the first two lines:

- Line 1:
Name of the recipe and all the configured data records
- Line 2:
Number of the recipe and all the configured data records

The MP 370 interprets the information on importing the file.

In this way, the CSV file can be used, for example, to create new data records by means of a spreadsheet program (Figure 6-7). After importing the modified file, the new data records can be used on the MP 370.

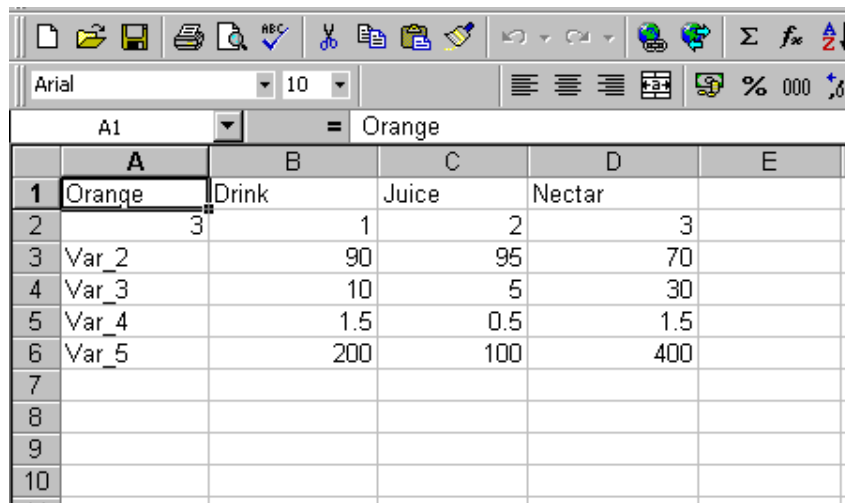

Figure 6-7 Create data records externally (example: Microsoft Excel)

If all the recipes are exported, a CSV file is created for each recipe.

Exporting, editing and importing data records

Proceed as follows in order to export data records on the MP 370 in a CSV file, edit it using with an external tool (e.g. spreadsheet program or text editor) and import it back on the MP 370:

Step		Procedure
1	Export data record	<ul style="list-style-type: none"> Press the operating element linked with the <i>Export_Data_Records</i> function (e.g. function key or button). Depending on the parameterization, either all the data records are exported to the data medium or only the data record defined in the configuration. The data records are exported in the file which was configured in the parameter <i>File Name</i> in the function <i>Export_Data_Records</i>. Copy the CSV file onto a transferable data medium or in a directory which can be accessed by the external tool.
2	Edit CSV file	<ul style="list-style-type: none"> Carry out the modifications in the CSV file with an external tool, e.g. Microsoft Excel or a text editor. Save the modifications on the data medium. Copy the CSV file back to the original directory.
3	Import data records	<ul style="list-style-type: none"> Activate the operating element linked with the <i>Import_Data_Records</i> function. The data records are copied in the data storage area configured for the recipe.

Notice

If data records should be exported and the CSV files edited on a different Windows system using a spreadsheet program (e.g. Microsoft Excel), ensure that the decimal separator and list separator are identical on the two different systems.

These settings can be modified from the Windows Start menu using: *Settings* → *Control Panel* → *Language* on the *Numbers* tab control (refer to Page 8-11).

The MP 370 is supplied with the German language options set.

6.4.5 Reaction on changing the recipe structure

Standard behavior

The following section describes the standard behavior of the MP 370 when it detects differences between the data record structure stored on the data medium and the recipe structure currently loaded on the MP 370.

Load and export data records, and write in the PLC

- The data record on the data medium contains additional tags:
The values are rejected.
- The data record on the data medium contains values which cannot be converted to the assigned tag type:
The configured start value for the tag is used.
- Tags are missing in the data record on the data medium:
The configured start value for the tag is used.



Warning

The assignment is lost on changing the tag name.

Import data records

- The imported data record contains additional tags:
The values are rejected.
- The imported data record contains values which cannot be converted to the assigned tag type:
The configured start value for the tag is used. This occurs, for example, when the tag type has been changed in the configuration.
- Tags are missing in the imported data record:
The configured start value for the tag is used.

Note

Export the data record after changing the recipe structure and check the exported values. Please observe the related safety notes provided on Page 6-17.

Archives

Overview

Process data can be archived on the MP 370, i.e. stored permanently and evaluated.

Different archives are possible depending on the process data stored:

- **Message archive**

Message archives are used to store message events from one or more message categories (e.g. event messages/alarm messages/system messages).

However, each message category can only be assigned to one specific archive.

The message archive can be used, for example, to store login and logout procedures on the operating unit as system messages. In this way, it is possible to determine which user is currently logging in on an operating unit at any time.

- **Tag archive**

A tag archive contains the values from one or more tags at specific points of time.

However, each tag can only be assigned to one specific archive.

The properties of an archive, e.g. memory location and archive size, is defined by the configuration planner in ProTool CS.

Archive file format

Each archive is stored as an individual file. Data is stored in the archive file in CSV format. This enables archived data to be processed and evaluated using external tools, e.g. with a spreadsheet program or text editor.

In file format CSV, table columns are separated by a separator (e.g. semicolon). Each table row is terminated by a line feed.

Notice

When the CSV files are edited with an external text editor, the modifications are saved in text format (without control codes).

Storage location

The memory location for archive files is defined during configuration. Possible targets are:

- Memory card (PC and/or CF card)
- Any path in the network

Caution

The internal Flash memory is not permissible as the memory location for archive files because cyclic archiving reduces the service life of the Flash memory and thus, that of the MP 370.

Archive functions

The following functions are available in the ProTool CS configuration software in order to be able to work with archives on the MP 370:

- *Open_archive*
The connection between the MP 370 and all archive files is established.
- *Close_archive*
All archive files are closed and the connection between the MP 370 and all archive files is disconnected. A memory card can then be removed or exchanges without any risks involved. Archive files queued during this time are buffered, up to a limit of 512 entries.
- *Copy_archive*
The content of an archive is copied to another archive. This enables backup copies of archives to be produced.
- *Start_archive, Stop_archive*
Starts or stops the archiving process in the selected archive. Normally, messages and tags are archived throughout the entire process. The function can be used to start the archiving to the specified archive by pressing an operating element on the operating unit and stopped with the *Stop_archive* function.
- *Delete_archive*
Deletes all the entries in the selected archive.
- *Start_sequence_archive*
Switches from the current archive to the following one. If no sequence archive has been configured, the function is not executed.
- *Archive_tag*
Archives the status of a tag in the archive configured for the tag. This function can be used to trigger the archiving of a tag to the specified archive by pressing an operating element on the MP 370. The archive must have been started beforehand.

Evaluating message archives

The ProTool settings dialog for message archives provides the option of activating an extended data storage process. When activated, the message text, including tags and storage location, are archived. This enables a useful analysis to be made using external tools.

Note on performance using memory cards

If a network is not used when archiving on the MP 370 but an ATA-Flash or SRAM PC card is used as the archive data medium instead, the archive memory space available is limited. The archiving performance of a FLASH PC card is also very limited. FLASH modules cannot be read from or written to in fine tracks, as opposed to a hard disk. Each access to a FLASH card requires copying large sectors of the FLASH card which greatly reduces the performance.

For this reason, the MP 370 should not be used primarily for the cyclical archiving of data but rather for archiving non-cyclically occurring fault states (alarm and event messages).

The MP 370 has not been conceived for archiving tasks with more heavy demands in respect of high quantity structure or performance.

Examples of performance

The table provide examples for the maximum performance possible:

Task	ATA-FLASH/SRAM
Recording rate [entries per second]	25
View of a message archive (10 messages from 2,000 entries)	5 s
Trend view of a tag archive (300 trend values from 2,000 entries)	5 s

Note:

In the case of large archives, reading in and displaying require considerably less time when several sequence archives are configured rather than one large cyclic archive. A new sequence archive is recommended following approx. 10,000 entries.

Switch off the MP 370 with memory card inserted

Caution

Always terminate the runtime software before switching off the voltage supply in order to prevent loss of data.

Operate the operating element linked to the *Exit_runtime* function in the configuration. Wait until the MP 370 displays the Start menu, namely the Loader menu (Figure 3-1, Page 3-6), appears and then switch off the power supply.

If the power supply is interrupted inadvertently during normal operation, the MP 370 checks the memory card after power is returned, repairing defect areas if necessary.

Remove memory card

Caution

Before removing the memory card, either use the operating element linked with the *Close_archive* function in the configuration or stop the runtime software. Operate the operating element linked to the *Exit_runtime* function in the configuration.

Closing the archive or terminating the runtime software may take several minutes, depending on the size and number of the archives stored.

System Settings

Overview

The general settings listed below can be modified on the MP 370:

- Language (Page 8-2)
- Operating mode (Page 8-3)
- Settings on Windows CE Control Panel (from Page 8-5)
 - Screen settings
 - Communication
 - Date/Time
 - Network
 - Unit properties
 - Language settings
 - Screen keyboard
 - Volume (touch feedback)
 - Printer
 - S7 download settings
 - Password
- Network operation (Page 8-15)

8.1 Language

Language-dependent objects

When downloading the configuration from the configuration computer, up to five languages can be loaded on the MP 370 simultaneously. The ASIA language variants are also supported. It is possible to switch between the languages, online, at any time and display language-dependent objects (texts and formats) in other languages.

The following are language-dependent, for example

- Messages
- Screens
- Text lists
- Help texts
- Date/Time
- Decimal separating character
- Static texts

Condition

In order to change languages on the MP 370 while it is in operation, the following conditions must be fulfilled:

- The editing language must be available on the MP 370. The languages available during runtime are defined during configuration in ProTool CS under *System* → *Language Assignment: OP Languages*.
- The *Language* function must be linked to an operating element, e.g. to a button or a selection field.

Change language

Immediately after activating the function, all the language-dependent objects are displayed in the new language.

Two different types of language change can be configured:

1. Each time the function is activated, the MP 370 switches one language further, cyclically.
2. After activating the function, the language can be explicitly selected.

8.2 Setting an Operating Mode

Conditions for changing operating modes

In order to switch the MP 370 between the operating modes described below, the *Change_mode* function must be linked to an operating element in the configuration.

Operating modes

It is possible to switch between various operating modes on the MP 370 according to the configuration:

Offline mode

In this mode there is no logical connection between the MP 370 and PLC. The MP 370 can be operated but data cannot be downloaded.

Online mode

When using this mode, processes can be operated and visualized without restriction. There is a logical connection between the MP 370 and PLC or the MP 370 attempts to establish one.

Online mode is the predefined operating mode each time the MP 370 is started up.

Download mode

This operating mode is used to transfer a configuration from the configuration computer to the MP 370. Further information on download mode is provided in Chapter 3.4.

8.3 Windows CE Control Panel Settings

The Windows CE Control Panel

The following settings can be defined for the system using the Windows CE Control Panel:

- Date/Time
- Network
- Device properties (e.g. brightness and calibration of touch screens)
- Language settings
- Screen saver
- Screen keyboard
- Volume (touch feedback)
- Printer
- Backup/Restore
- Transfer (download)
- UPS (option only)

Open Control Panel

Various settings can be defined after pressing the *Control Panel* button in the start menu. It may be necessary to enter a password.

The following possibilities are available with which to open the Control Panel (Figure 8-1, Page 8-5):

- **During the start-up phase:**
Use the *Control Panel* button in the Start menu to open the Windows CE Control Panel containing the various options.
- **In normal operation:**
 - If configured, use the operating element assigned to the *Start_Control_Panel* function.
 - It is also possible to open the *Windows CE Control Panel* via the *Settings* item in the Windows CE Start menu.

Keyboard unit:

Open the Windows CE Start menu with the key combination depicted



Touch panel:

Press the button depicted twice (locking button) to activate the toolbar.



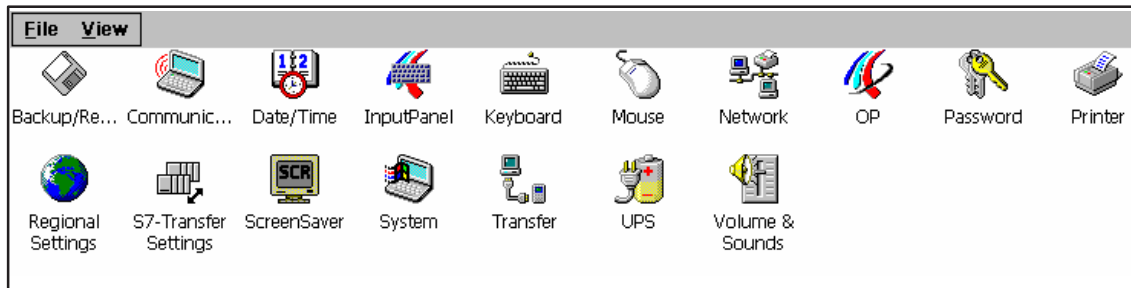

Figure 8-1 Windows CE Control Panel with options

Change language settings



Caution

Stop the runtime software before modifying the system settings otherwise the changes, e.g. for downloading, do not take effect.

Proceed as follows to change settings in the Windows CE Control Panel:

Step	Procedure
1	Exit_runtime Stop the runtime software before starting to change any system settings.
2	Open Control Panel Open the Control Panel as described on Page 8-4.
3	Change language settings Change the settings for the system in the Control Panel.
4	Close Control Panel Close the Control Panel. Touch panel: Press the button illustrated.  Keyboard unit: Press the Alt key and use the cursor keys to select the menu item <i>Close</i> . Confirm the selection by pressing the Enter key.
5	Restart runtime Start the runtime software via the Start menu.

8.3.1 Device properties

Purpose

The *OP Properties* option provides the following setting options.

- Set brightness,
- Calibrate touch screen (for touch panels),
- Display device data,
- Backup non-resistant data.

Set brightness

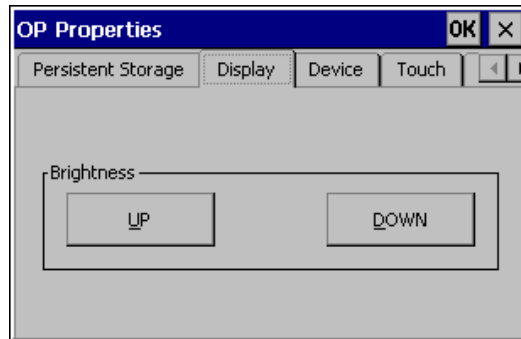





Figure 8-2 *OP Properties* option, *Display* tab control

Step	Procedure
1	Open the <i>Display</i> tab control (Figure 8-2) in the <i>OP Properties</i> option.
2	Use the <i>Brightness up</i> and <i>Brightness down</i> buttons to adjust the screen brightness.
3	In the case of the touch panel, close the settings menu using the <i>OK</i> button, in the case of the keyboard unit, move the focus to the tab control heading and press <i>Enter</i> .

In the case of the keyboard unit, the screen brightness can be changed outside the Windows CE Control Panel by using the following key combination:

  Increases the brightness.

  Reduces the brightness.

Note

Wait at least 10 seconds after changing the setting before switching the unit off. Otherwise, the changes will not be saved.

Calibrate touch screen

Figure 8-3 *OP Properties* option, *Touch* tab control

Purpose

Depending on the installation position and viewing angle, it is possible that a more or less strong parallax may occur when operating the touch panel screen. In order to prevent operating errors occurring as a result, the screen can be calibrated during the start-up phase and normal operation.

Step	Procedure
1	Open the <i>Touch</i> tab control (Figure 8-3, Page 8-7) in the <i>OP Properties</i> option.
2	Press the <i>Recalibrate</i> button to start the calibration process. Five calibration crosses appear in succession on the screen. Follow the instructions provided on the screen and touch the respective calibration cross.
3	Apply calibration: Touch any point of the screen after the calibration process for the new calibration data to take effect. Reject calibration: Wait 30 seconds, until the seconds counter displayed has reached zero, before rejecting the new calibration data. If calibration is not performed correctly, the new values are not accepted.
4	Touch the <i>OK</i> button to close the <i>OP Properties</i> menu.

Configured function

When the *Touch Calibration* function has been linked to an operating element in the configuration, the touch screen can be calibrated while in normal operation. The triggering operating element can be configured so that a password must be entered to enable the touch calibration process.

The calibration process is identical with steps described for the start-up phase 2 and 3.

Persistent storage of registrations

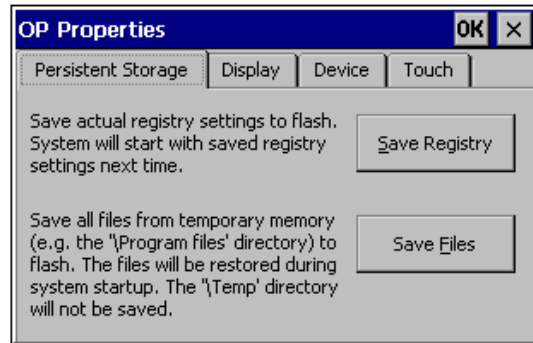

Figure 8-4 *OP Properties* option, *Persistent Storage* tab control

Step	Procedure
1	Open the <i>Persistent Storage</i> tab control (Figure 8-2, Page 8-6) in the <i>OP Properties</i> option.
2	Press the <i>Save Registry</i> button to start the storage process. The current registration settings are stored in the Flash memory.
3	Press the <i>Save Files</i> button to start the copy the files in the RAM file system to the Flash memory. When the system is restarted, the files saved are restored in the file system.
4	In the case of the touch panel, close the settings menu using the <i>OK</i> button, in the case of the keyboard unit, move the focus to the tab control heading and press <i>Enter</i> .

Display device data

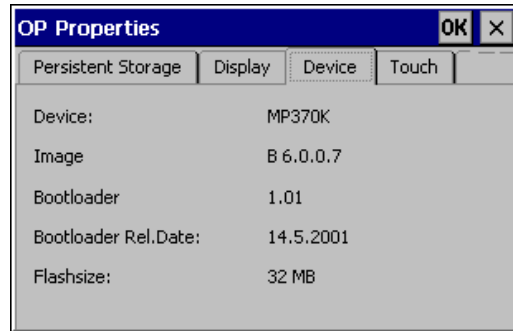

Figure 8-5 *OP Properties* option, *Device* tab control

Step	Procedure
1	Open the <i>Device</i> tab control (Figure 8-5) in the <i>OP Properties</i> option.
2	Various device data is displayed.
3	Close the menu using the <i>OK</i> button in the case of touch panels or press the <i>Enter</i> button in the case of keyboard units.

8.3.2

Screen saver

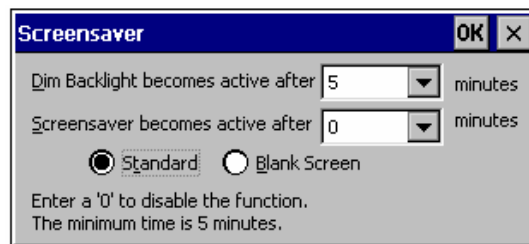

Figure 8-6 *Screensaver* option

It is possible to define a period of time (in minutes) for automatic activation of the screen saver on the operating unit. The screen saver settings are defined in the *Screensaver* option of the Windows CE Control Panels (refer to Page 8-4).

The screen saver is automatically activated if the operating unit is not operated within the defined period of time.

Note

When the screen saver is activated, the back-lighting is automatically dimmed.

The screen saver is deactivated on pressing any key or touching the touch screen. The function assigned to that key is not triggered.

On entering the value 0, the screen saver is deactivated permanently.

Dim back-lighting

The brightness of the back-lighting for the screen is reduced with increasing operational use for technological reasons. In order to increase the service life of the back-lighting it is also possible to use the *Screensaver* option in the Windows CE Control Panel to set the period of time after which the back-lighting should be dimmed.

The back-lighting is automatically activated if the operating unit is not operated within the defined period of time.

The back-lighting is deactivated on pressing any key or touching the touch screen. The function assigned to that key/button is triggered.

If the value 0 is set, the back-lighting is deactivated permanently.

8.3.3 Communication



The name of the MP 370 can be modified here in order, for example, to identify it within a network. Further information regarding configuration of the network operation is provided from Page 8-16.

8.3.4 Set date/time



Enter the values to set the current date and time. The way in which these settings are modified directly in the active configuration is explained on Page 5-13.

8.3.5 Network



This is used to configure the network properties.

Information concerning configuration of the network operation is provided from Page 8-16.

8.3.6 Regional setting

Language-specific settings can be defined here, e.g.:

- Date and time format (refer to Page 5-13)
- Decimal separator and list separator (refer to Page 6-27)

The MP 370 is supplied with the German options set.

8.3.7 Screen keyboard

This is used to define the position and size of the screen keyboard when it appears on the MP 370. Proceed as follows:

Step	Procedure
1	Select the <i>Input Panel</i> option.
2	Move the screen keyboard to the required position.
3	To change the size, press the <i>Start Resize</i> button.
4	Store the new settings by pressing the <i>Save</i> button.
5	Close the option using the button depicted on the right or with the ESC key. 

8.3.8 Volume

This is used to change the setting for the volume of acoustic signals and operating acknowledgement. The *Volume* tab control includes the following options:

- acoustic operating acknowledgement for touch operation,
- volume control

The *Sounds* tab control is irrelevant for runtime settings.

8.3.9 Set printer

A printer can be selected and set up at this point. Some settings are only relevant for printing a hardcopy of the screen contents and have no influence on the message logging, e.g. color or quality of graphics printing.

Information on connecting printers is provided on Page 9-15.

Adjustable options

The setting possibilities available are dependent on the printer selected:

- **Printer**
Select the printer from the list to which the MP 370 is connected.
- **Port**
Select the port and baud rate used by the MP 370 to transfer data to the printer, e.g. IF2: 9600.
- **Net path**
If a network has been configured (refer to Page 8-15), enter a path for a network printer here. Select "Network" as the port.
- **Paper size**
Select the paper size used in the printer, e.g. A4 or Letter.
- **Draft mode**
Define the quality of the printout of graphics. If the option is activated, printout is performed in draft quality, if deactivated printout is in high quality.
- **Color**
When a color printer is connected, this is used to define whether printing should be in color or black and white.
- **Print range**
Define whether only the selected area should be printed or the entire contents.
- **Orientation**
Define whether the page should be printed in Portrait or Landscape format.
- **Margins**
The values entered here for the margins are ignored by the MP 370.

Note

If a serial printer is connected, the following settings are necessary on the printer:

- RS 232, whereby only the RxD, TxD and GND signals are required (refer to Appendix B),
 - 8 data bits,
 - 1 stop bit,
 - No parity,
 - Baud rate between 9600 and 57600, printer-dependent,
 - XON / XOFF protocol.
-

Default settings

When the MP 370 is supplied, the following default settings are defined:

- Printer: EPSON 9 matrix printer
- Port: IF2
- Baud rate: 9600 bit/s

8.3.10 Uninterruptible Power Supply UPS

(only loadable as an option) 

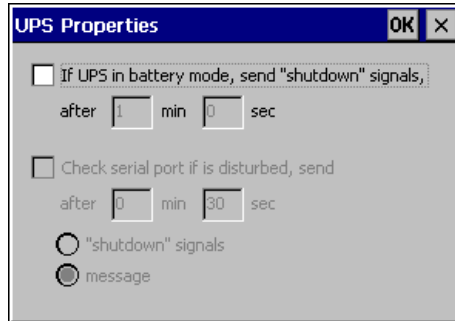

Figure 8-7 UPS option

To prevent the loss of data in the event of a power failure, e.g. while archiving process values/messages, a *UPS* can ensure a controlled shutdown of the MP 370. An external Uninterruptible Power Supply *UPS* detects when the power supply has failed and reports this to the operating panel via the serial interface.

The UPS driver is installed as an add-on using the *ProSave* tool. The associated *UPS* icon only appears in the Windows CE Control Panel after it has been installed via *ProSave*.

It is possible to define how long the power failure may continue without the runtime being shut down. The driver is suitable for the *SITOP DC-UPS Module A*.

8.3.11 System properties

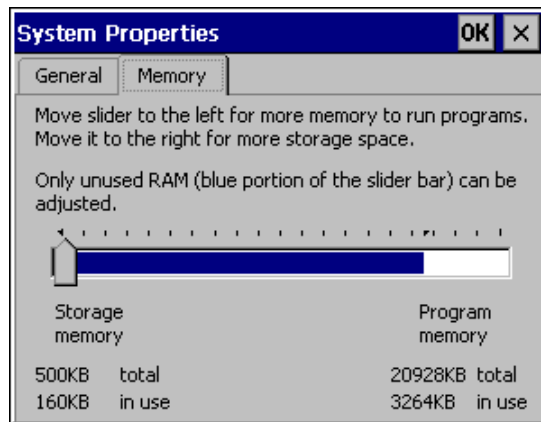

Figure 8-8 *System Properties* option

The *System Properties* can be used to define the size of the memory for the DRAM file system (storage memory). It defines how much memory can be used by the applications. Values can be modified using a slider control. The standard size of a memory in the DRAM file system for applications is 6 MB.



Caution

If too much DRAM file memory is provided, ProTool runtime has too little working memory available. Therefore, in the case of incorrect settings, there is no guarantee that the runtime process can run properly.

8.4 Network Operation

Purpose

The standard MP 370 is equipped with an on-board Ethernet interface. implementing the network function enables the MP 370 to be used for:

- archiving data via the network
- printing via a network printer
- storing recipe data records in the network
- exporting recipe data records in the network
- importing recipe data records from the network
- downloading projects
- backing up data

Notice

- The MP 370 can only be implemented in TCP/IP networks.
 - The MP 370 can only access files from other units which have a TCP/IP server functionality (the MP 370 only has client functionality). It is not possible to access MP 370 files on a PC connected via Ethernet.
-

Condition

Within a TCP/IP network, computers are addressed by means of network names. These network names are translated from a DNS or WINS server to TCP/IP addresses. Direct addressing via TCP/IP addresses is not currently supported by the operating system. Therefore, to ensure the functionality of the MP 370 in a TCP/IP network, it is useful to employ a DNS or WINS server. Appropriate servers are available in common TCP/IP networks. Please contact your network administrator.

printing via a network printer

The MP 370 operating system does not support the direct message logging via a network printer. All other printer functions, such as hardcopy or shift log, are possible via the network without restriction.

8.4.1 Configuring the MP 370 for network operation

Overview

The MP 370 must be appropriately configured before setting into network operation. The configuration is basically divided into the following steps:

- Set computer name of the MP 370
- Configure network address
- Set login information
- Save settings



Preparation

Before beginning with the configuration, request the specific network parameters from the network administrator. The following information is of particular interest:

- Does the network use DHCP for dynamic assignment of network addresses? If not: Instigate the assignment of a new TCP/IP network address for the MP 370.
- What is the TCP/IP address of the default gateway?
- What are the DNS addresses of the name server?
(if DNS is used in the network)
- Which WINS addresses has the name server?
(if WINS is used in the network)

Procedure

The following instructions describe how to define the general settings step by step. Additional steps or procedures may be necessary depending on the network infrastructure.



Step	Procedure
Open Control Panel	
1	Open the Control Panel as described on Page 8-4.
Set computer name of the operating unit	
2	In order to identify the MP 370 within the network, it must be assigned a unique name (device name) within the network using the Control Panel option <i>Communication</i> . Apply the settings and close the dialog by pressing ENTER. 
Configure network address	
3	Use the <i>Network</i> option to call in the network configuration. Select an appropriate network driver in the <i>Adapters</i> tab control.  When using operating units with an integrated Ethernet card, use <i>Onboard LAN</i> , with network cards, normally use the NE2000-compatible driver.

Step	Procedure
4	Press the <i>Properties</i> button in order to configure the network characteristics of the network card used. Complete the dialog according to the network driver selected in Step 3. If the network implements DHCP, skip Step 5.
5	Select the tab control <i>IP Address</i> then option <i>Specify an IP Address</i> . Enter the TCP/IP address of the operating unit (e.g. 233.239.2.100), subnet mask (e.g. 255.255.255.0) and default gateway (e.g. 223.239.2.200).
6	Enter the name server address of the network in the tab control <i>Name Servers</i> . Close the dialog with ENTER or OK in order to apply the settings.
Set login information	
7	In order to login correctly into the network, enter your user permissions in the <i>Identification</i> tab control. Enter the user name valid for the network or the network server and the associated password (max. 8 characters). If the network administrates users via domain controllers, enter the relevant domain controller name. Close the dialog with ENTER or OK in order to apply the settings.
Save settings	
8	Switch off the MP 370.
9	Before switching the operating unit on, insert the network cable in the corresponding interface so that a unique IP address can be assigned during the start-up phase.
10	Switch the MP 370 on again.

8.4.2 Test network

Procedure

It is then possible to access the network. To test it, assess the network server via the Explorer. Proceed as follows:

Step	Procedure
1	Start Explorer via the Windows Start menu. Keyboard unit: Use the key combination depicted.  Touch panel: Double click on the icon depicted in the screen keyboard.  From the <i>Programs</i> program group, select the <i>Windows Explorer</i> application.

Step	Procedure
2	Use the <i>Address</i> input field to enter the UNC name of the directory/drive provided on the server. Example: The server is called: mrnbg2 The name provided is: daten The resulting UNC name is: \\mrnbg2\daten
3	After entering the UNC name, press the ENTER key. When all the network settings are correct, Explorer displays the files located under the directory provided on the TCP/IP server.

Note

In addition, the network program *ipconfig* are available in the operating system.

8.4.3 Configure network functions

Condition

Before accessing the network, it must have been set up on the MP 370.

Procedure

In order to be able to use the network functions in the ProTool CS configuration software, it is only necessary to specify the relevant UNC assigned names at those points where paths have been entered for files or directories.

- **Example 1: Archives**

If, for example, it is necessary to carry out archiving on the server in the example above (Step 2 in the table on Page 8-18), replace the predefined archive memory location *\Storage Card\ProCSVarc* by the UNC assigned name for the server, i.e. *\\mrnbg2\daten\ProCSVarc*.

- **Example 2: Recipe data records**

In order to store recipe data records in the network, replace the predefined path name *\Flash\ProCSVdata* by the UNC assigned name for the server, i.e. *\\mrnbg2\daten\ProCSVarc*. The same applies for exporting and importing recipe data records using the functions *Export_Data_Records* and *Import_Data_Records*. In this case, too, replace the parameter *File name* with the UNC assigned name for the server.

Installation

In this chapter

This chapter provides information on:

- installation of the MP 370
 - keyboard unit (Page 9-2)
 - touch panel (Page 9-4)
- electrical connections to
 - the power supply (Page 9-9)
 - the configuration computer (Page 9-12)
 - the PLC (Page 9-13)
 - the printer (Page 9-15)
 - USB keyboard/mouse (Page 9-16)

9.1 Mechanical Installation

Installation location and conditions

The MP 370 is designed for installation in the front panels of cabinets and consoles. Keyboard units are also prepared for installation in 19" cabinets and racks.

Cut a mounting cut-out in the front panel prior to installation. The thickness of the front panel must not exceed 6 mm. Additional fixation holes are not necessary due to the tensioning mechanism used.

Details regarding the installation depth and mounting cut-out are provided on:

- Touch panel: Page 10-2.
- Keyboard unit: Page 10-6.

Degree of protection

The operating unit must be installed in such a way that at least Protection Class IP54 is guaranteed. The IP65 degree of protection for the front panel can only be ensured when the seal on the front plate of the MP 370 is fitted correctly.

Notice

The NEMA 4, NEMA 12 and IP65 degrees of protection are only guaranteed when the thickness of the installation support is at least 2.5 mm.

**Caution**

- The operating unit must be brought to room temperature before it is started up. If condensation forms, do not switch the unit on until it is absolutely dry.
 - To prevent the MP 370 from overheating during operation,
 - the angle of inclination from vertical installation may not exceed a maximum of $\pm 35^\circ$.
 - do not expose the operating unit to direct sunlight
 - ensure that the ventilation slits in the housing remain free after installation.
-

Notice

The operating unit was function-tested before shipping. If a fault occurs nevertheless, please enclose a full account of the fault when returning the unit.

9.1.1 Install keyboard unit

Before installation

If the labeling of the function keys needs to be modified, replace the labeling strips before installing the MP 370. Information on this is provided on Page 10-7.

Installation in 19" cabinets/racks

Use the profiles provided by the respective cabinet or rack manufacturer to install the unit in a 19" cabinet/rack.

Installation dimensions of standard 19" cabinets:

- Width: 19" (482.6 mm)
 - Height: 7 HE (310 mm)
- MP 370 fixation: To the profiles using four screws

Installation in front panels

The keyboard unit can be fixed in the mounting cutout using either screw-type clamps or screw fittings. When fixing with screw-type clamps, no extra fixation holes are necessary in the front panel.

Screw-type clamps used in conjunction with an outer seal can achieve degree of protection IP65. Screwed supports achieve the degree of protection IP54.

Proceed as follows to install keyboard units in the front panel:

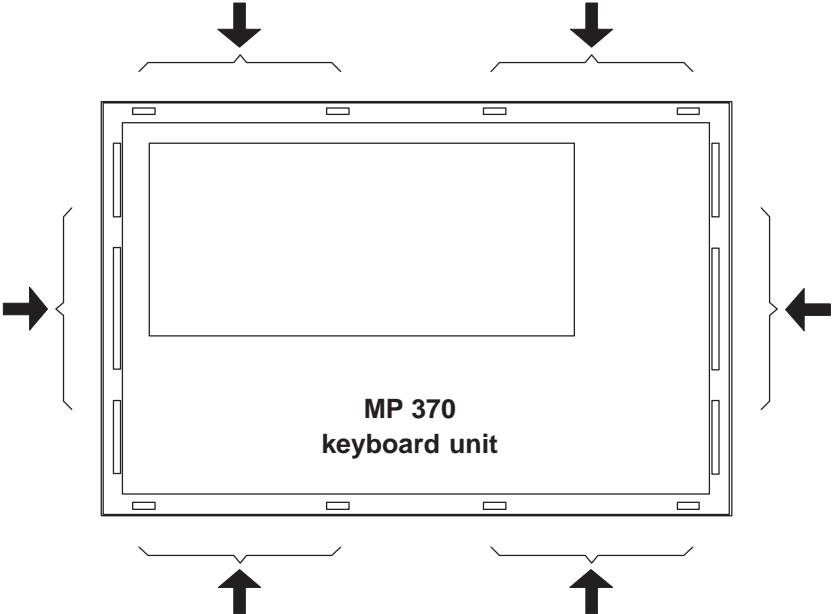
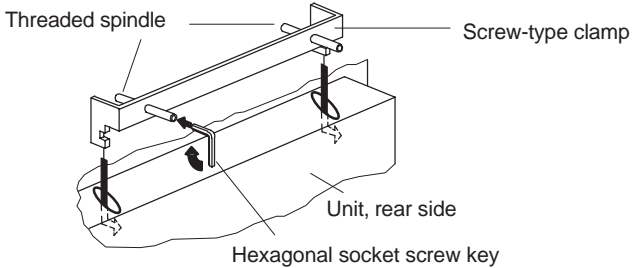
Step	Procedure
1	Working from the front, insert the MP 370 in the mounting cut-out prepared. Make sure the unit cannot drop out of the front panel before it has been secured.
2	<p>Insert the hooks of the six screw-type clamps enclosed in the corresponding recesses in the housing of the MP 370.</p> <p>The individual positions are indicated in the figure by means of arrows.</p>  <p style="text-align: center;">MP 370 keyboard unit</p>
3	<p>Secure the MP 370 to the front panel, from the rear, using a hexagonal socket-head screw key.</p>  <p style="text-align: center;">Caution</p> <ul style="list-style-type: none"> • Make sure the seal is seated correctly against the front panel. • Do not overtighten the screws to avoid damage.

9.1.2 Install touch panel

Installation in front panels

Proceed as follows to install touch panels in the front panel:

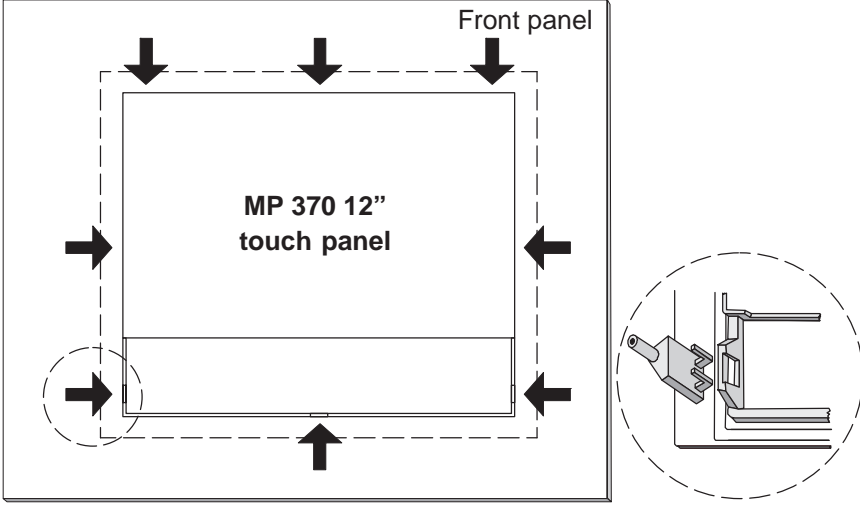
Step	Procedure
1	Working from the front, insert the MP 370 in the mounting cut-out prepared. Make sure the unit cannot drop out of the front panel before it has been secured.
2	<p>MP 370 12”: Insert the hooks of the eight screw-type clamps enclosed in the corresponding recesses in the housing of the MP 370 ein. The individual positions are indicated in the figure by means of arrows.</p> 

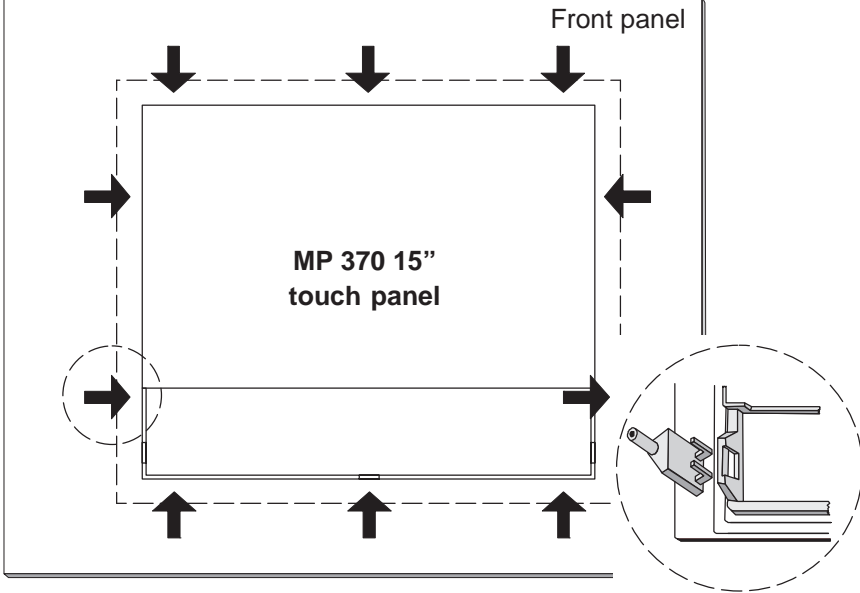
Step	Procedure
	<p>MP 370 15”: Insert the hooks of the ten screw-type clamps enclosed in the corresponding recesses in the housing of the MP 370. The individual positions are indicated in the figure by means of arrows.</p> 
3	<p>Secure the MP 370 to the front panel, from the rear, using a hexagonal socket-head screw key.</p> <p>Caution</p> <ul style="list-style-type: none"> • Make sure the seal is seated correctly against the front panel. • Do not overtighten the screws to avoid damage.

9.2 Electrical Installation

Electrical connections

The MP 370 requires electrical connections:

- to the power supply,
- to the configuration computer (PU or PC),
- to the PLC,
- to the printer.

An electrical connection to the PU/PC is only required for downloading the project data. Following the configuration and test phases, a serial printer can be connected to the MP 370 instead of the configuration computer.

EMC compatible installation

A precondition for error-free operation is an EMC hardware design of the PLC and the use of interference-proof cables. The guidelines on interference-free design of the PLCs apply equally to installation of the MP 370.



Caution

- Only shielded cables are permitted for all signal connections.
 - Screw or lock all plug connections.
 - Do not install signal lines in the same cable ducts as power cables.
 - Siemens AG refuses to accept liability for malfunctions and damage arising from use of self-made cables or cables from other manufacturers.
-

Grounding connection



Connect the grounding connection of the MP 370 to the rack ground. Use the grounding screw provided and a conducting cable with a diameter of $\geq 2.5 \text{ mm}^2$.

Connection elements

Figure 9-1 illustrates the arrangement of the connection elements on the underside of the unit.

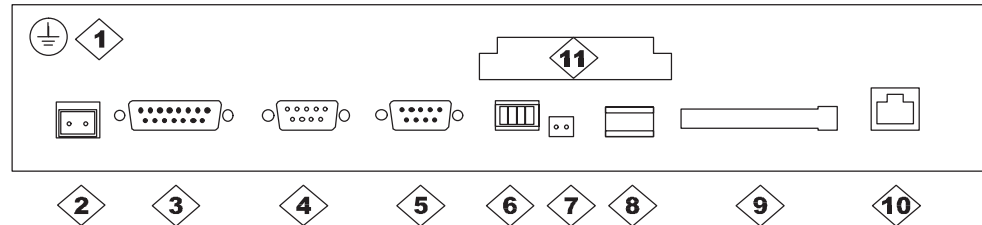

Figure 9-1 Arrangement of connection elements

No.	Name	Usage	
1	Grounding connection	For connection to cabinet ground	
2	Power supply ¹⁾	Connection for power supply (+24 V DC)	
3	Interface IF1A ²⁾	Level:	Usage:
		RS232/TTY (active/passive)	PLC
4	Interface IF2 ²⁾	RS232	PC, PU, printer
5	Interface IF1B ²⁾	RS422/RS485 (floating)	PLC
6	Switch ⁴⁾	To configure interface IF1B	
7	Battery connection ³⁾	Connection for optional backup battery	
8	USB interface ²⁾	Connection for external keyboard, mouse, etc.	
9	Slot B	For compact Flash	
10	Ethernet interface	Connection of a RJ45 Ethernet line	
11	Slot A	For PC card	
<p>1) Connection pin assignment, refer to Page 9-9</p> <p>2) Connection pin assignment, refer to Appendix B</p> <p>3) Refer to Page 11-2</p> <p>4) Switch settings, refer to Page 9-14</p>			

Communication options

Table 9-1 indicates the peripheral units with which the MP 370 can communicate.

Table 9-1 Communication options

Device	Connection	Interface
SIMATIC S5	<ul style="list-style-type: none"> • AS511 (TTY) • PROFIBUS-DP 	IF1 A IF1 B
SIMATIC S7	<ul style="list-style-type: none"> • MPI • PROFIBUS-DP 	IF1 B IF1 B
SIMATIC 505	<ul style="list-style-type: none"> • RS 232 • RS 422/RS485 	IF1 A IF1 B
Other PLCs	<ul style="list-style-type: none"> • RS 232/TTY • RS 422/RS485 	IF1 A IF1 B
Configuration computer	<ul style="list-style-type: none"> • RS 232 	IF2
Printer	<ul style="list-style-type: none"> • Local printer • Network printer • UBS printer 	IF2 Ethernet USB
External keyboard/mouse	USB	

Reverse battery protection

Caution

The MP 370 is equipped with reverse poling protection.

Proceed as follows when commissioning:

1. Disconnect all connections to external units and remove any cards from Slot A or Slot B.
2. Connect the MP 370 to the power supply.
3. Switch on the power supply.
If the MP 370 does not start up, the connections are probably reversed. Swap the connections over in this case.
4. When the MP 370 has been powered up, connect the configuration computer or other peripheral equipment to it.

Power supply

The power supply for the MP 370 is connected at the 2-pin plug connector on the underside of the unit. Use the 2-pin terminal block supplied for this purpose. The terminal block is designed for cables with a cross-section not larger than 2.5 mm².

The figure illustrates the pin assignment of the terminal block.

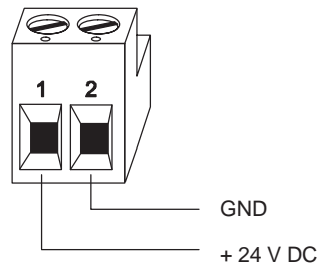

Caution

- When using a 24 V supply, make sure that the extra-low voltage is isolated safely. Use only power supply units complying with IEC 364-4-41 or HD 384.04.41 (VDE 0100, Part 410).
- Only use power supply units which meet SELV-PELV standards.
- The supply voltage must be within the specified voltage range. Voltages outside this range can cause malfunctions.

Please refer to the technical data in Appendix A for information on the power supply requirements.

9.2.1 Equipotential

Potential differences

Differences of potential can occur in separate system sections which lead to high equipotential flows, e.g. when cable screening is applied on both sides and grounded at two different system parts.

The cause of potential differences may be due to different mains power feed sources.



Warning

Cable screening is not designed for potential equalization. Only use lines provided for the purpose (e.g. with a 16 mm² cross-section). When setting up MPI/DP networks, ensure cables with a sufficient cross-section are used otherwise the interface hardware may be damaged or even destroyed.

Potential equalization lines

The potential differences must be reduced by the provision of potential equalization lines so that proper functioning of the electrical components installed is guaranteed.

When installing potential equalization lines, observe the following points:

- The efficiency of the potential equalization is greater the smaller the impedance of the potential equalization line is.
- If two system parts are connected by screened signal lines, whose screening is connected on both sides to the grounding/earthed conductor, the impedance of the additionally laid potential equalization lines may be maximally 10% of the screening impedance.
- The cross-section of a potential equalization line must be dimensioned for the maximum equalizing current which can flow. Experience has shown that potential equalization lines with a cross-section of 16 mm² suffice.
- Use potential equalization lines made of copper or galvanized steel. Connect the lines with the ground connection/ground conductor and protect from corrosion.
- Lay the potential equalization lines so that the area between the potential equalization line and signal lines is small (refer to the following diagram).

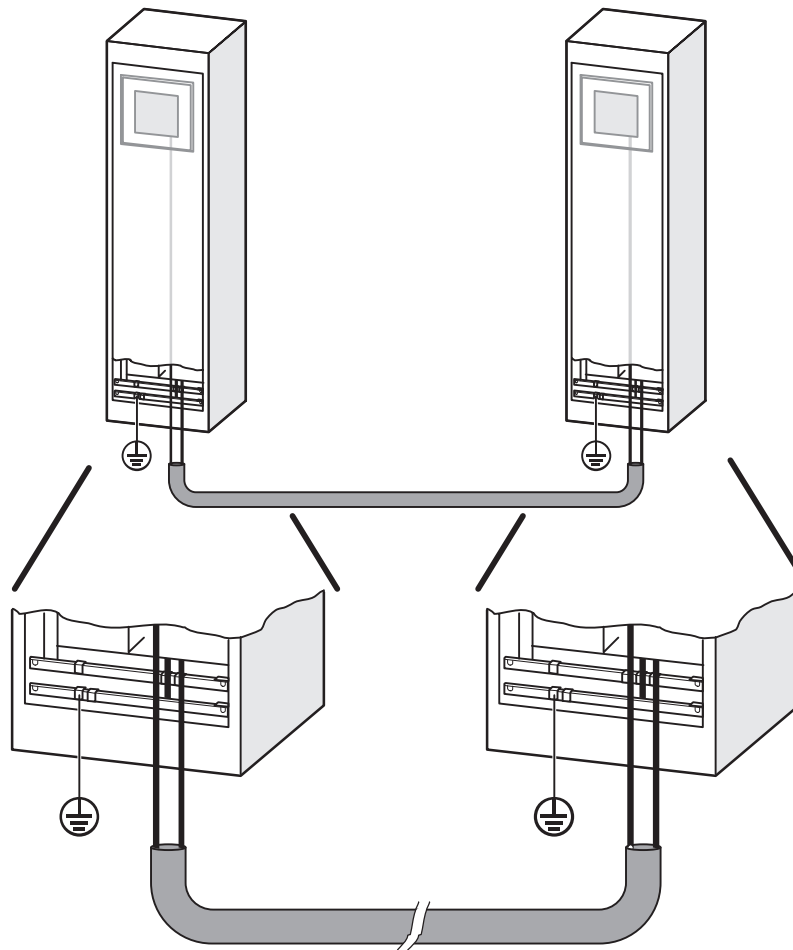
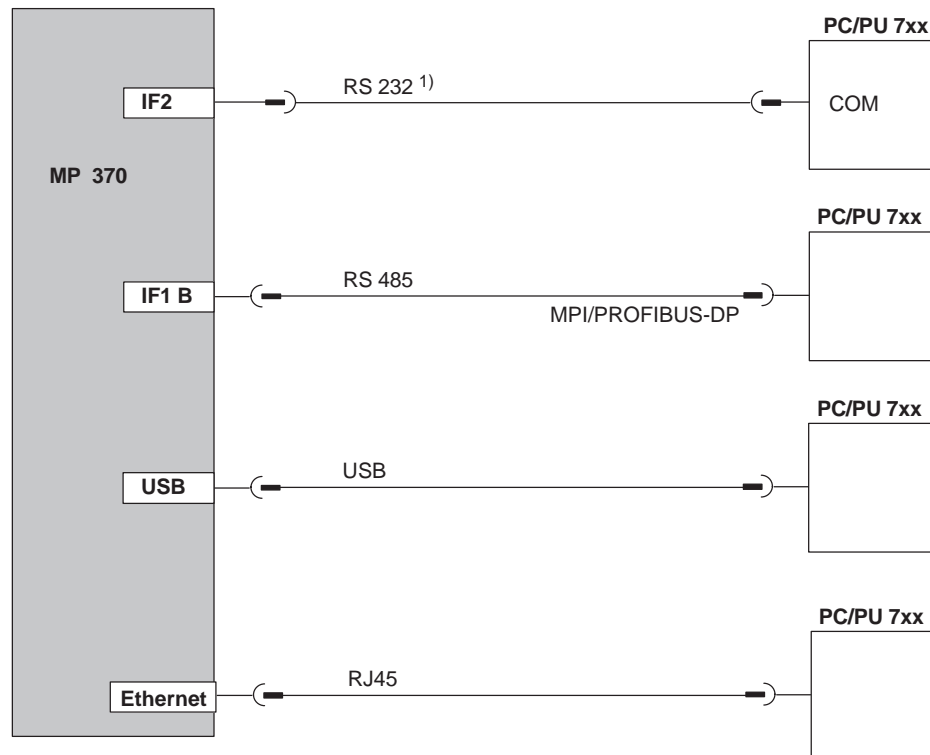

Figure 9-2 Equipotential

9.2.2 Connect configuration computer

Connection configuration

Figure 9-3 illustrates how to connect a configuration computer (PU or PC) to the MP 370 for downloading project data. Standard cables are available for the connections shown (refer to the ST80 catalog).



¹⁾ Operating system update only via RS 232 (refer to Chapter 13)

Figure 9-3 Connection configuration diagram for configuration computer

Notice

Use a host-host USB cable for the connection between MP 370 and configuration computer. Please note that only the USB driver on the ProTool CD must be installed on the configuration computer. The driver enclosed with the cable cannot be used for downloading.

9.2.3 Connect PLC

Connection configuration

Figure 9-4 illustrates the basic connection possibilities between the MP 370 and PLC. Standard cables are available for the connections shown (refer to the ST80 catalog).

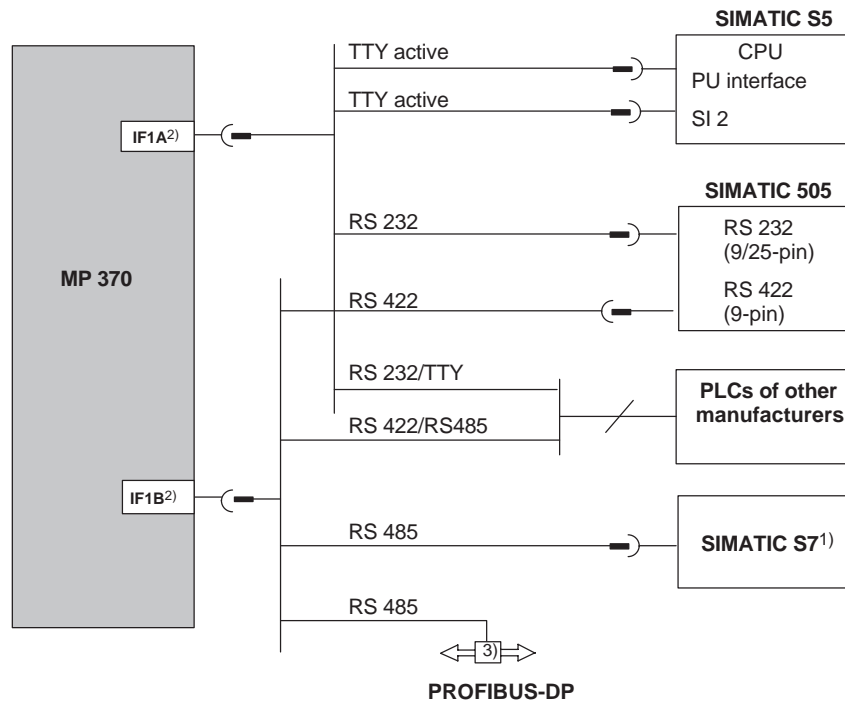







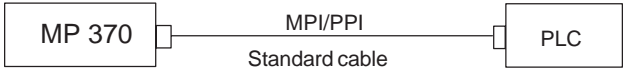

- 1) Use only the approved cables for connection to the SIMATIC S7.
- 2) To enable operation using the serial interface, connect either the IF1A (RS 232/TTY) or IF1B (RS 422/485), but not both. The IF1B interface can be configured by means of the switch (Page 9-14).
- 3) Any PROFIBUS-DP bus terminal

Figure 9-4 Connection configuration for PLCs

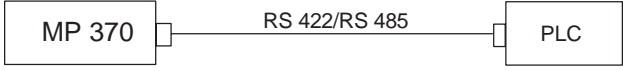
Configure interface IF1B

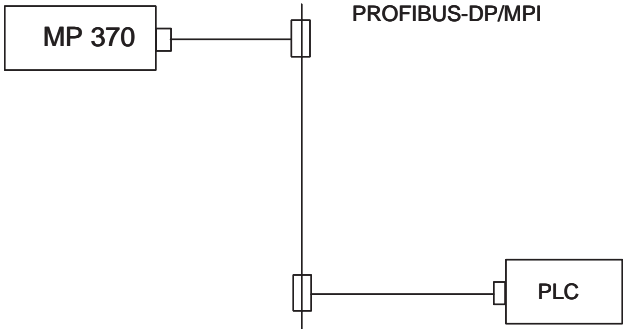
The IF1B interface can be configured via the switches on the rear side of the operating unit. In this case, the RTS signal is interchanged for RS485 and the RS422 receive data. By default, the RTS signal is not required by the communication peer.

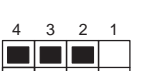
The table shows the permissible switch settings.

Communication	Switch Setting
	 ON No RTS on connector ¹⁾
	 ON
	 ON RTS on pin 4 (default)  ON RTS on pin 9 (as PU)
	 ON No RTS on connector ¹⁾

1) State on delivery

Compressing the internal program memory with SIMATIC S5



Warning

With the SIMATIC S5, compression of the internal program memory on the PLC (PU "Compress" function, integrated FB COMPR) is not permitted when an operating unit is connected. Compression modifies the absolute addresses of the blocks in the program memory. Since the operating unit only reads the address list during startup, it does not detect any address modifications and subsequently accesses the wrong memory areas.

If compression is inevitable during running operations, the operating unit must be switched off before compressing.

9.2.4 Connect printer

Connection configuration

Figure 9-5 illustrates how to connect a serial printer to the MP 370. The MP 370 supports the following printer standards:

- compatible with ESC/P, 9-pin ESC/P or ESC/P2 (EPSON)
e.g. EPSON FX850
- compatible with PCL3 (Hewlett Packard)
HP LaserJet 5M

USB printers can still be used for PCL and Epson9 mode.

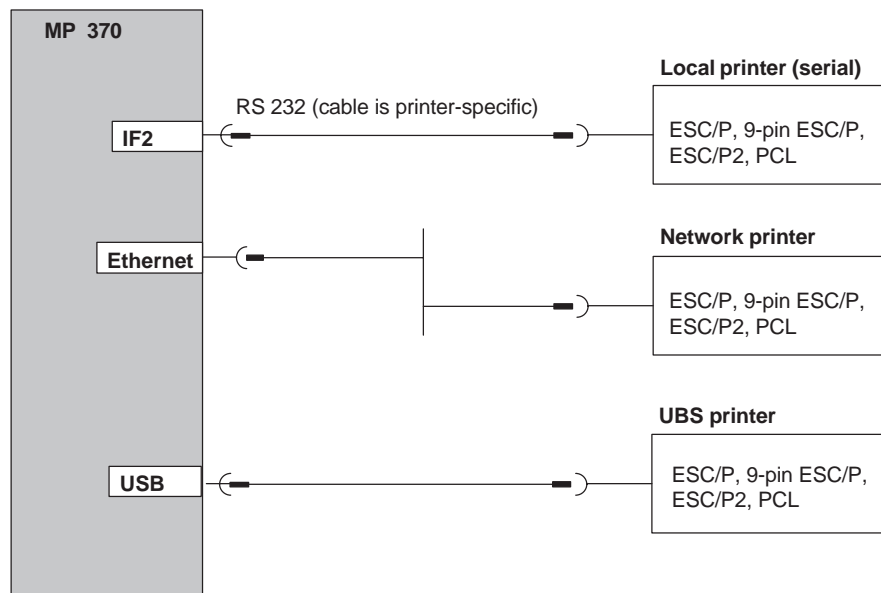

Figure 9-5 Printer connection configuration

Information on printer settings is provided on Page 8-11.

Notice

- Only use a cable with braided metal screening grounded at each end for connecting the MP 370 and printer.
 - Deactivate the (Page 3-7) *Serial Transfer Remote Control* option in the Configuration menu if a serial printer is connected to the operating unit via the IF2 interface.
 - Some printers may require that the ASCII character set used in the configuration is defined on the printer as well.
-

Note

If a serial printer is connected, the following settings are necessary on the printer:

- RS 232, whereby only the RxD, TxD and GND signals are required (refer to Appendix B),
 - 8 data bits,
 - 1 stop bit,
 - No parity,
 - Baud rate between 9600 and 57600, printer-dependent,
 - XON / XOFF protocol.
-

9.2.5 Connect external keyboard and mouse

Connection configuration

Figure 9-6 illustrates alternative methods of connecting a keyboard, mouse or external printer to the MP 370's USB interface. A keyboard, mouse or printer can be connected and disconnected during normal operation.

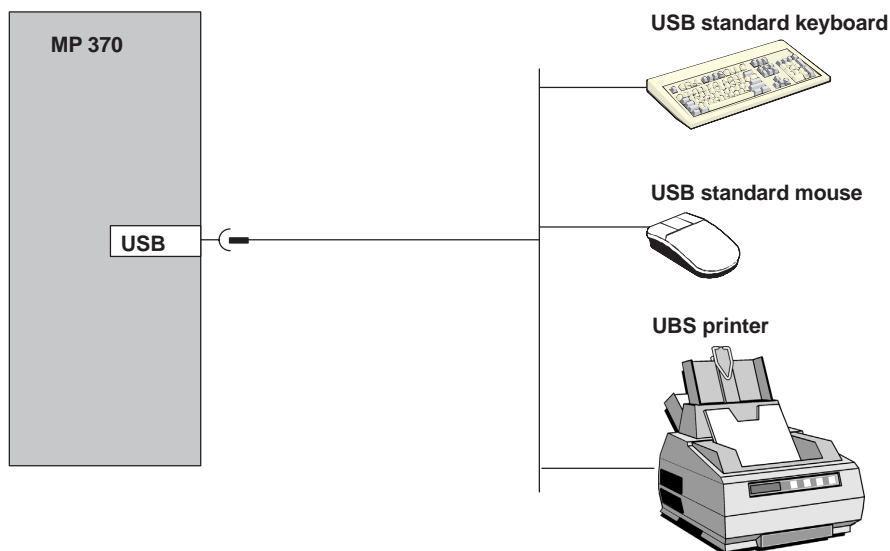

Figure 9-6 Connection configuration for external keyboard, mouse and printer

Notice

Use a standard mouse and keyboard with a USA/International keyboard layout. Commercially available USB devices do not normally fulfill the higher industrial demands with regard to interference resistance and can have negative effects on the device.

The power consumption must not exceed 500 mA with the USB units connected.

9.2.6 Connecting an Uninterruptible Power Supply (UPS)

Connection configuration

Figure 9-7 illustrates the way to connect an uninterruptible power supply (UPS) to the MP 370.

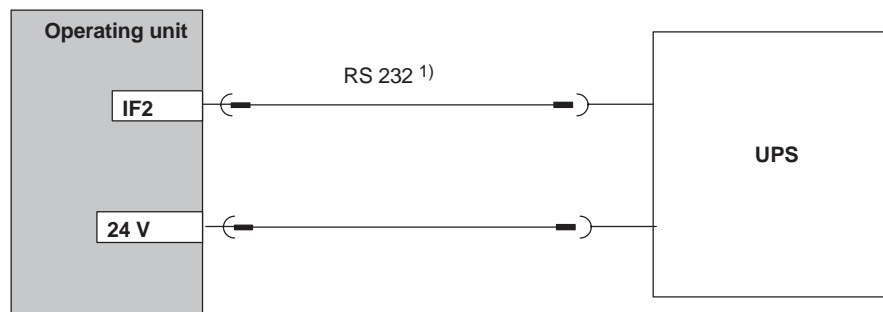

1) Only for UPS with serial connection

Figure 9-7 Connection configuration for UPS

A serial connection is only necessary when using *SITOP DC-UPS Module A*. The driver for detecting and configuring the UPS (Ch. 8.3.10) is contained on the ProTool CD and must be installed on the operating unit with ProSave.

UPS without a serial connection can supply a digital signal in the case of a power failure in the connected PLC. In turn, the PLC program can then inform the MP 370 that the runtime will be shut down. To do this, the PLC modifies a tag on which the *Exit_runtime* function is configured in ProTool.

Dimensions

10

In this chapter

This chapter provides information on:

- Dimensions of the MP 370 12" touch panel (Page 10-2),
- Dimensions of the MP 370 15" touch panel (Page 10-4),
- Keyboard unit dimensions (Page 10-6),
- Labeling strips for keyboard unit (Page 10-7).

10.1 MP 370 12" Touch Panel

Installation cut-out

For installation in the front panel, the touch panel requires an installation cut-out (WxH) of 310 ⁺¹ mm x 248 ⁺¹ mm. The thickness of the front panel must not exceed 6 mm.

Unit dimensions MP 370 12" touch panel

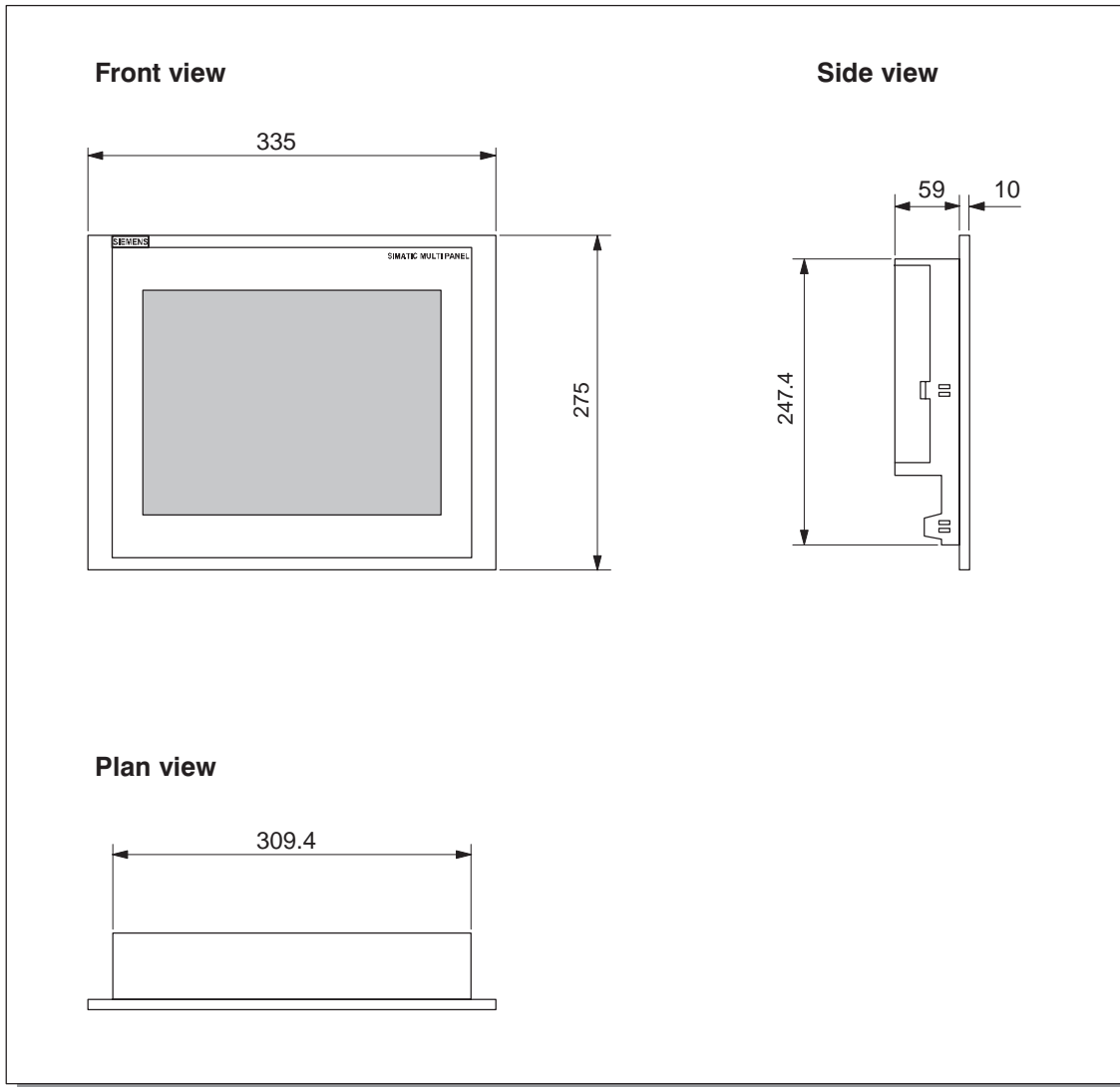

Figure 10-1 Dimensions of the MP 370 12" touch panel

Notice

The following free space must be maintained following installation:

- 100 mm above the unit,
- 50 mm below the unit,
- 15 mm at the sides of the unit.

When using plug-in boards, ensure sufficient space is provided to insert or remove them.

10.2 MP 370 15" Touch Panel

Installation cut-out

For installation in the front panel, the touch panel requires an installation cut-out (WxH) of 368 ⁺¹ mm x 290 ⁺¹ mm. The thickness of the front panel must not exceed 6 mm.

Unit dimensions MP 370 15" touch panel

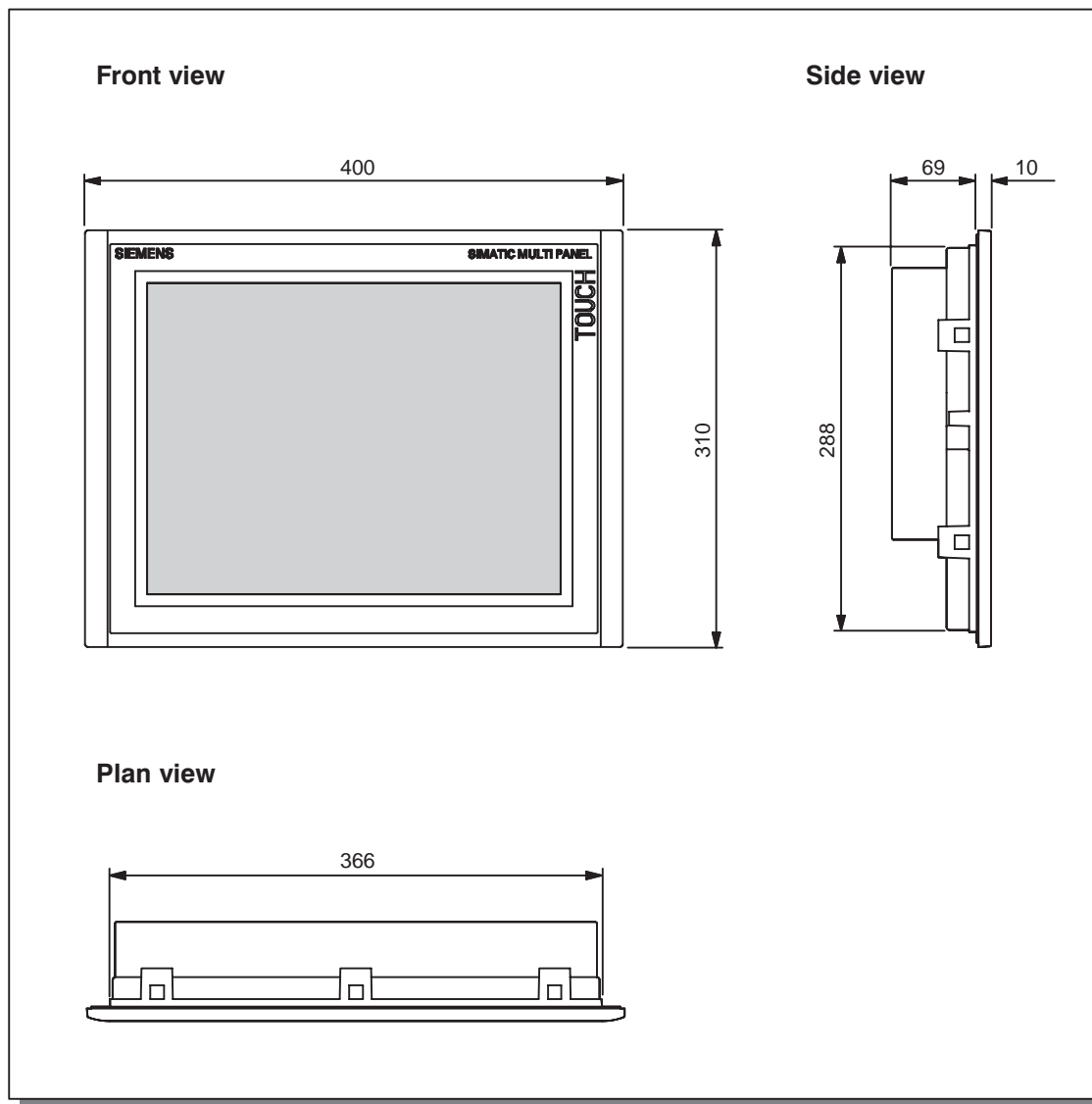

Figure 10-2 Dimensions of the MP 370 15" touch panel

Notice

The following free space must be maintained following installation:

- 100 mm above the unit,
- 50 mm below the unit,
- 15 mm at the sides of the unit.

When using plug-in boards, ensure sufficient space is provided to insert or remove them.

10.3 Keyboard Unit

Installation cut-out

For installation in the front panel, the keyboard unit requires a mounting cut-out (WxH) of 450 ⁺¹ mm x 290 ⁺¹ mm. The thickness of the front panel must not exceed 6 mm.

10.3.1 Unit dimensions

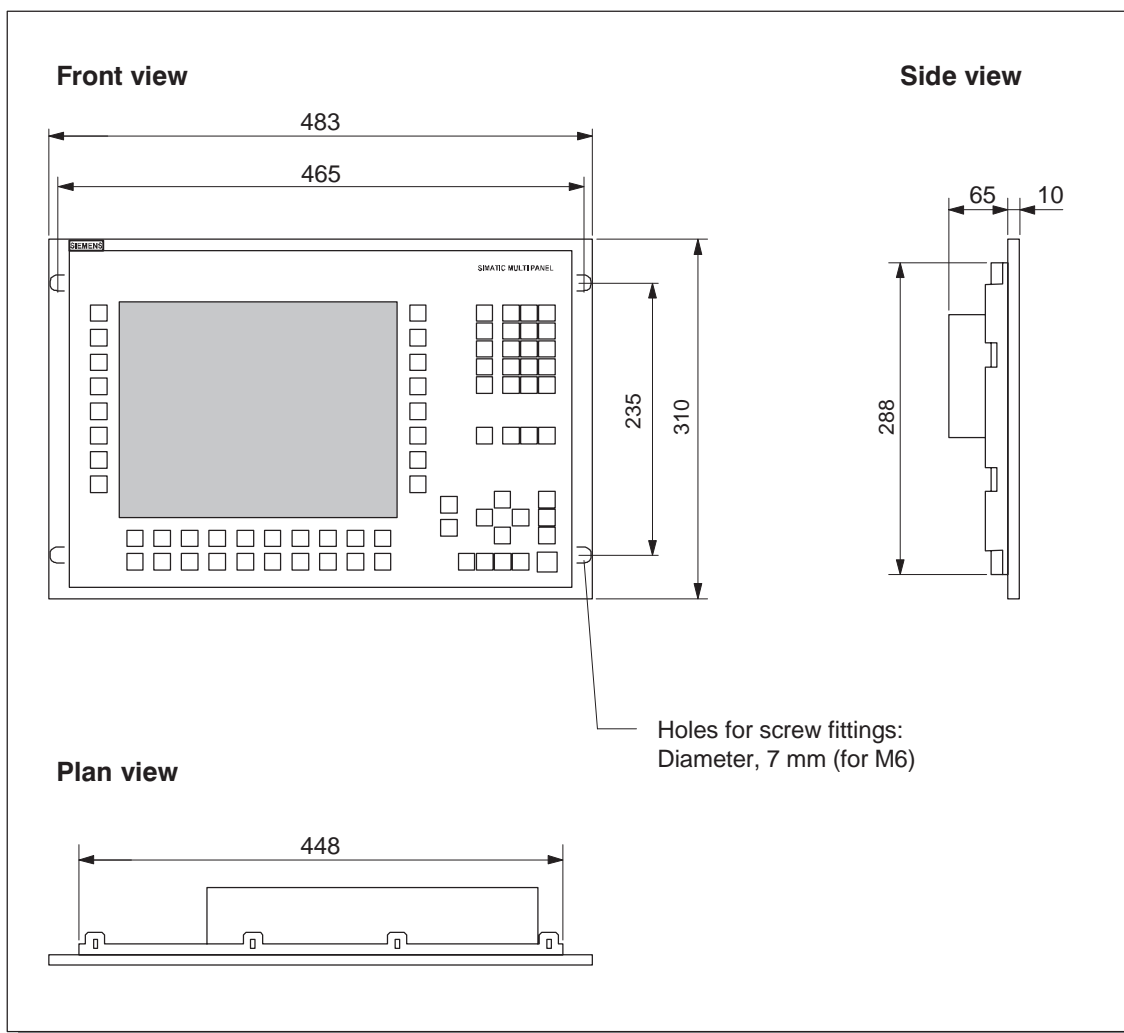

Figure 10-3 Keyboard unit dimensions

Notice

The following free space must be maintained following installation:

- 100 mm above the unit,
- 50 mm below the unit,
- 15 mm at the sides of the unit.

When using plug-in boards, ensure sufficient space is provided to insert or remove them.

10.3.2 Labeling function keys

Labeling

The keyboard unit function keys are labeled as follows on supply:

- **F1** to **F20** and
- **S1** to **S16**.

The function keys are labeled by means of 4 labeling strips which are inserted in the unit from the rear. These strips can be exchanged in order to label the MP 370 specifically for the system.

Exchange labeling strips



Warning

When the cabinet is opened, certain parts of the system that may conduct hazardous voltage are exposed.

Proceed as follows:

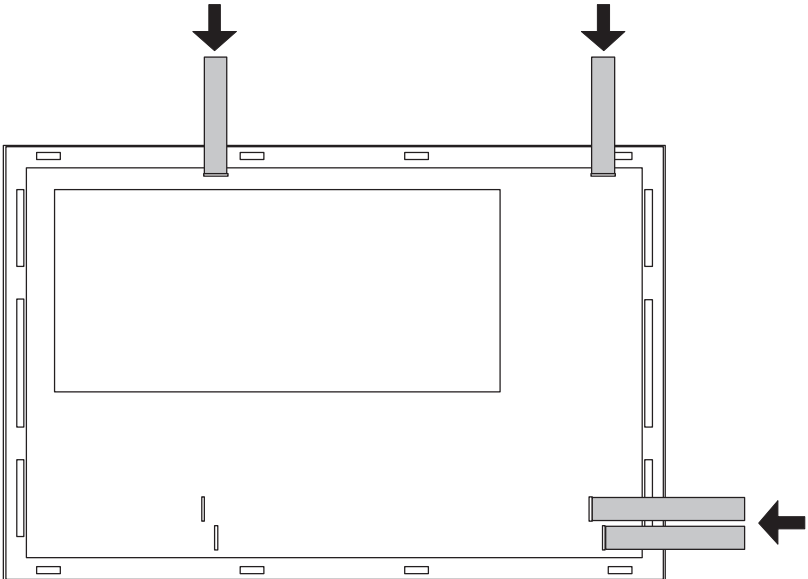
Step	Procedure
1	Place the unit down with the front plate at the bottom.
2	Remove the labeling strips already inserted.
3	<p>Insert the newly labeled strips in the slots in the front plate with the inscription facing down. The individual positions are indicated in the figure by means of arrows.</p> <p>Caution Before inserting the strips, wait until the inscription is dry. A keyboard foil which is dirty on the inside cannot be cleaned and can only be replaced at the manufacturer's factory.</p> 

Create labeling strips

Only use transparent foil to create your own labeling strips so that the LEDs in the function keys remain visible. Label the foil either with a printer or a waterproof felt-tip pen. Cut the strips according to the specifications depicted in Figure 10-4.

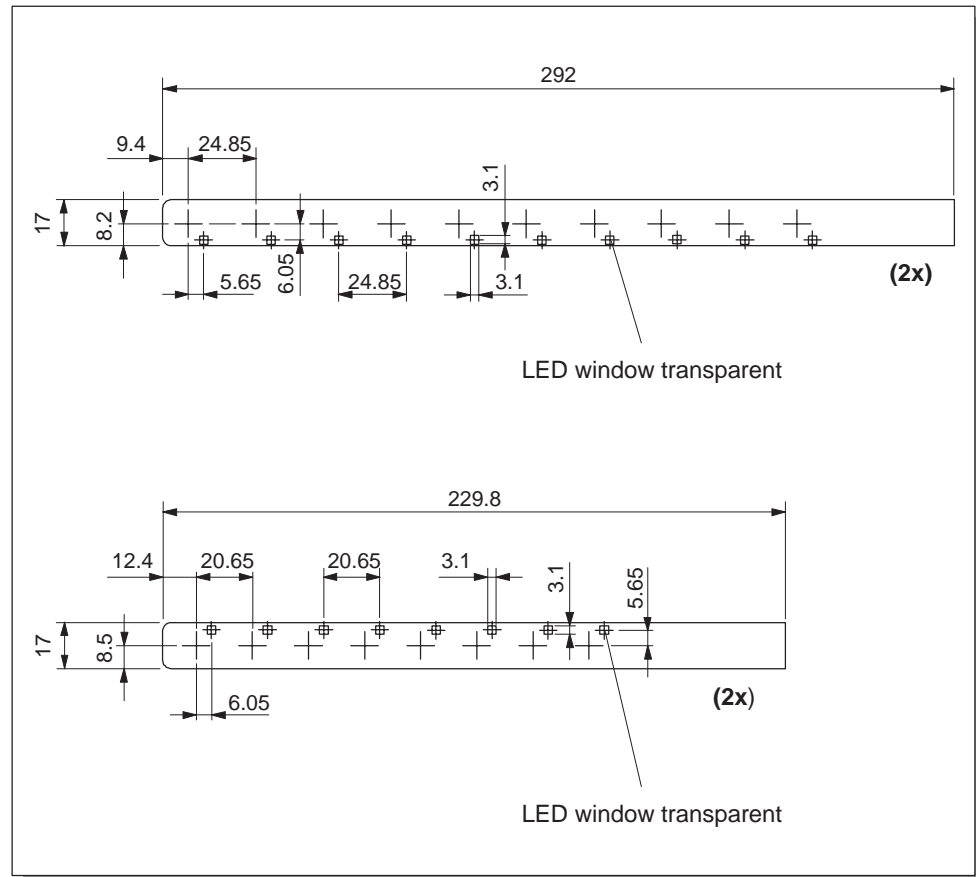

Figure 10-4 Labeling strip dimensions

File

The ProTool CS configuration software contains formatted patterns for labeling function keys individually for various SIMATIC operating units.

The patterns for the MP 370 are stored on the ProTool installation CD under `\UTILITY\SLIDE370.DOC` in Word format. This enables labeling strips to be created for the keyboard unit without extensive design and printing operations.

Options

11

In this chapter

This chapter provides information on the options available with which to retrofit the MP 370.

The following hardware options are available:

- Backup battery (Page 11-2)
- PC card / CF card (Page 11-3)

The following software option is available:

- Internet Explorer (Page 11-5)

11.1 Hardware Options

11.1.1 Backup battery

Backup battery function

The battery ensures that the internal hardware clock of the MP 370 continues to run even when the power supply is interrupted. The clock is buffered for approx. 3 days if no battery is provided ¹⁾.

The battery is not part of the material supplied with the MP 370.

Installation

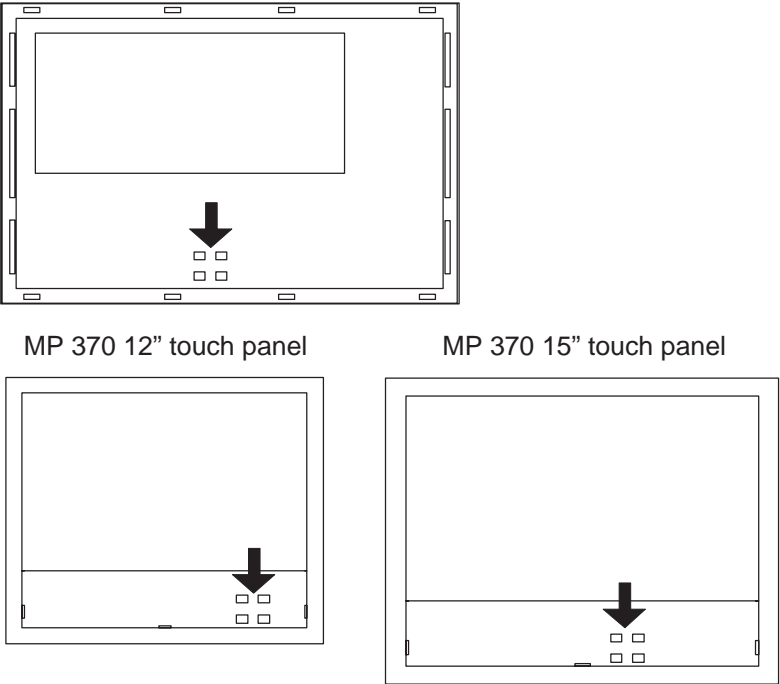
Step	Procedure
1	<p>Secure the battery by means of two cable ties on the rear side of the MP 370. The respective location in touch panels and keyboard units is indicated in the following diagram by means of arrows.</p> <p style="text-align: center;">Keyboard unit</p>  <p style="text-align: center;">MP 370 12" touch panel MP 370 15" touch panel</p>

1) The unit must have been in operation for approx. 6–8 hours, without any interruptions, beforehand.

Step	Procedure
2	Insert the battery power feed connector in the two-pin connector strip (Position 7 in Figure 9-1 on Page 9-7). The connector is coded and thus protected against polarity reversal.

Further information

Information concerning replacing the battery, supply source and related safety notes on handling and disposing of the batteries is provided from Page 12-3.

11.1.2 PC card / CF card

Purpose

Two slots are provided, namely *Slot A* and *Slot B* (Figure 11-1) located on the rear side of the unit in which to insert changeable PC cards and Compact Flash cards. These are not part of the material supplied with the MP 370.

The interchangeable memory cards can be used, for example, to archive important process data or execute a backup/restore of the internal Flash memory (refer to Page 3-14).

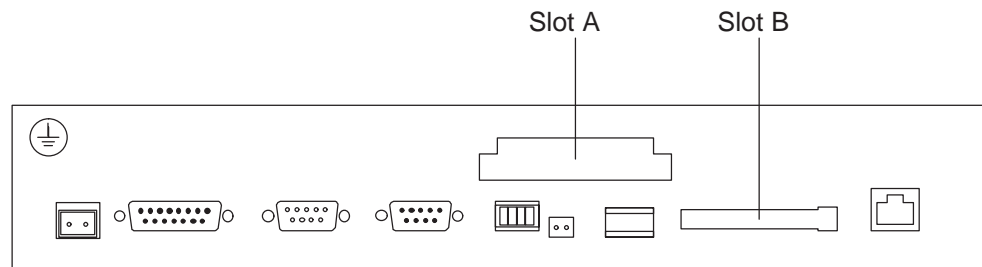

Figure 11-1 Position of the slots

Cards supported

The MP 370 supports the use of all standard cards which operate with a programming voltage of 5 V (types I and II), e.g.:

- **Slot A** (PC card):
 - ATA Flash card
 - SRAM card
 - NE2000-compatible Ethernet card
- **Slot B** (Compact Flash card):
 - ATA Flash card
 - NE2000-compatible Ethernet card

Remove memory card

Caution

Before removing a memory card, ensure that the MP 370 does not access the card during the removal process.

Before removing the memory card, either use the operating element linked with the *Close_archive* function in the configuration or stop the runtime software. Operate the operating element linked to the *Exit_runtime* function in the configuration. Wait until the MP 370 start menu (Figure 3-1, Page 3-6) is displayed. This may take several minutes, depending on the size and number of archives stored.

Switch the MP 370 off with the memory card inserted

Caution

Always terminate the runtime software before switching off the voltage supply in order to prevent loss of data.

To terminate the runtime software, press the operating element assigned the *Exit_runtime* function in the configuration. Wait until the MP 370 displays the start menu, namely the Loader menu (Figure 3-1, Page 3-6), appears and then switch off the power supply. Changeover to the start menu may take several minutes depending on the size and number of archives stored.

If the power supply is interrupted inadvertently during normal operation, the MP 370 checks the memory card after power is returned, repairing defect areas if necessary.

11.2 Software Option

11.2.1 Internet Explorer

The Internet Explorer supplied concerns an Explorer which has been especially adapted to the Windows CE operating system with a restricted functional scope (Pocket Internet Explorer). Only small HTML pages, not larger than 100 kb, are basically suitable to be displayed.

Installation of the Internet Explorer is performed using the ProSave service tool (refer to Chapter 3.9).

Files created in Internet Explorer (e.g. Favorites) are stored in the DRAM file system. The DRAM file system is deleted when the unit is switched off. Using the system settings (*OP Properties* → *Persistent Storage* → *Save Files*, refer to Ch. 8.3.1), however, it is possible to save the data currently available in the DRAM file system in the Flash memory. When the unit is started up, the data saved is automatically restored.

In the case of deinstallation of the Internet Explorers, the files created from Internet Explorer must also be deleted. To do this, delete the files in the DRAM file system using the standard Explorer. Then backup the DRAM file system (*OP Properties* → *Persistent Storage* → *Save Files*, refer to Chapter) 8.3.1).

Note

By updating the operating system (Chapter 13) the initial configuration can be restored simply.

Maintenance/Upkeep

Scope

The MP 370 has been designed for low maintenance operation. Maintenance of the unit is limited to

- regular cleaning of the screen,
- regular cleaning of the keyboard foil (keyboard unit),
- changing the optional backup battery.

12.1 Clean Screen/Keyboard

12.1.1 General notes

Preparation

Clean the MP 370 screen at regular intervals and also the keyboard foil in the case of keyboard units. Use a damp cloth.



Caution

Do not clean the unit while it is turned on. This ensures that functions are not inadvertently triggered on touching the keys or the touch screen.

Cleaning agents

Only use water with washing-up liquid or a screen cleaning foam to dampen the cloth. Never spray the cleaning agent directly onto the screen but onto the cloth. Never use aggressive solvents or scouring powder.

12.1.2 Notes on the touch panel

Clean screen

If the *Clean Screen* function has been assigned to an operating element in the configuration, the screen can be cleaned while it is turned on. After the Clean Screen function has been started, all input via the touch screen is deactivated for a defined period of time. The remaining time is indicated by a bar graph.

Protective foil

A protective foil is available for the touch panel (refer to Catalog ST80). The protective foil is not part of the material supplied with the MP 370.

The self-adhesive foil prevents the screen being scratched and soiled. In addition, the matt surface of the foil reduces reflections.

The protective foil can be removed as necessary without leaving any adhesive residue on the screen.

Caution

Never use sharp or pointed tools to remove the protective foil, such as a knife for instance. This may cause damage to the touch screen.

12.2 Replacing the Optional Backup Battery

Backup battery function

An optional backup battery is available for the MP 370 (refer to Chapter 11). The battery ensures that the internal hardware clock continues to run even when the power supply is interrupted.

Under normal operating conditions, the battery has a service life of approx. 4 years. It is not part of the material supplied with the MP 370.

Supply source

The battery can be ordered from the Siemens spare parts service. It is shipped ready for installation with a lead and connector. Please refer to our catalog *ST80* for the order number.

Before replacing

Observe the following safety notes before changing the battery:



Caution

- Change the battery while power is still being supplied to ensure the internal hardware clock continues to run.
 - The battery must be changed by a properly qualified person.
 - Before replacing the battery, refer to the ESD Guidelines in Appendix D.
-

Procedure

Step	Procedure
1	Unplug the battery cable connector from the two pin socket (Position 7 in Figure 9-1 on Page 9-7).
2	The battery is normally secured by means of two cable ties on the rear side of the MP 370. Cut the cable ties, using pliers for instance, and remove the empty battery.
3	Secure the new battery by means of two cable ties on the rear side of the MP 370.
4	Insert the battery lead connector back into the socket. The connector is coded and thus protected against polarity reversal.

General notes

Please observe the following safety notes to ensure correct handling and disposal of lithium batteries:



Warning

- If the lithium battery is not handled properly, there is a risk of explosion.
- Batteries
 - should never be charged
 - should not be opened
 - should not be short-circuited
 - should be safeguarded against polarity reversal
 - should not be exposed to temperatures in excess of 100 °C
 - should be protected against direct sunlight.
- Do not allow condensation to form on batteries.
- Should shipping become necessary, ensure compliance with the Dangerous Chemicals Ordinance for the carrier concerned (coding obligation).
- Treat used lithium batteries as special waste. Pack them in separate leakproof plastic bags to dispose of them.

Operating System Update

Purpose

If there is a conflict between the configuration software version and current operating system on the MP 370, downloading of a configuration from the configuration computer to the MP 370 is terminated and a compatibility conflict is indicated.

In this case, synchronize the MP 370 operating system with the version of the SIMATIC ProTool CS configuration software. The procedure is described below.

Notice

When the operating system is updated, all the existing data on the operating system is deleted, including licenses (authorizations) (see Chap. 3.8), applications (see Chap. 3.9), passwords (see Chap. 5.17) and recipes (see Chap. 6)!

13.1 Operating system update with ProSave

The ProSave service tool can be used to update the operating system. An advantage of this is that the operating system can be called in without ProTool and transferred via the following channels:

- Serial
- MPI/PROFIBUS-DP
- USB
- Ethernet

Principles of operation

After ProTool has been installed, ProSave can be activated in one of two ways:

- stand-alone,
- from ProTool.

If an operating system transfer should be performed using ProTool, activate ProSave within the scope of a project. The general settings (device and connection selection) need not then be entered since they are assumed from the project.

The same dialog boxes are opened in both cases.

A distinction must be made between two cases of operating system transfer:

to a target system on which an operating system already exists,

In this case, the operating system transfer can be executed without activating the *Booting* checkbox.

to a target system on which no operating system exists, or a non-compatible operating system exists,

In this case, the operating system transfer can be executed by activating the *Booting* checkbox.

The procedure for both is described below.

Operating system transfer without Booting

In the case of an operating system transfer without Booting, the configuration computer communicates with the target device by means of the target device's operating system.

Connect the target device to the configuration computer according to the connection type selected.

Proceed as follows in order to adapt the operating system on the operating unit to the configuration software version used:

Step	Procedure
1	Start ProTool via the Windows Start menu and open a project or start ProSave via the Windows Start menu.
2	Select the menu options <i>File</i> → <i>Upload</i> → <i>Preferences</i> in ProTool. Select the <i>General</i> tab control in ProSave and activated the <i>MP 370</i> operating unit. Select a connection and enter the connection parameters.
3	In ProTool, select the menu options <i>File</i> → <i>Upload</i> → <i>OS Update</i> . In ProSave, select the <i>OS Update</i> tab control. Deactivate the <i>Booting</i> checkbox if it is already activated.
4	In <i>Imagepath</i> , select the directory which contains the image file belonging to the operating unit (file extension <i>.img</i>). The file name contains the character string <i>MP 370</i> .

Step	Procedure
5	Select the <i>Open</i> button. When the image file has been opened successfully, various information related to the version status appears in a screen window.
6	Configure the operating unit according to the required transfer channel and switch to download mode (refer to Chapters 3.1 and 3.2).
7	Start the operating system transfer by pressing the <i>Update OS</i> button. This process takes a different length of time, depending on the connection selected. A progress indicator appears during the data transfer. When the transfer is successfully completed, a message appears briefly.

When downloading is performed successfully, there is no project data on the operating unit. The behavior of the operating unit when no project has been loaded is described in Chapter 3.1.

Operating system transfer with Booting

In the case of an operating system transfer with Booting, ProSave communicates with the booting loader on the target device.

Connect the target device to the configuration computer.

Notice

The operating system transfer with Booting is only possible via the serial connection.

After starting the operating system transfer, the target device must be switched off and on again (rebooted) so that the target device establishes contact via the serial interface.

Proceed as follows in order to adapt the operating system on the operating unit to the configuration software version used:

Step	Procedure
1	Switch off the power supply to the target device.
2	Start ProTool via the Windows Start menu and open a project or start ProSave via the Windows Start menu.
3	Select the menu options <i>File</i> → <i>Upload</i> → <i>Preferences</i> in ProTool. Select the <i>General</i> tab control in ProSave and activated the <i>MP 370</i> operating unit. Select a connection and enter the connection parameters.

Step	Procedure
4	<p>In ProTool, select the menu options <i>File</i> → <i>Upload</i> → <i>OS Update</i>.</p> <p>In ProSave, select the <i>OS Update</i> tab control.</p> <p>Deactivate the <i>Booting</i> checkbox if it is already activated.</p>
5	<p>In <i>Imagepath</i>, select the directory which contains the image file belonging to the operating unit (file extension <i>.img</i>). The file name contains the character string <i>MP 370</i>.</p>
6	<p>Select the <i>Open</i> button.</p> <p>When the image file has been opened successfully, various information related to the version status appears in a screen window.</p>
7	<p>Start the operating system transfer by pressing the <i>Update OS</i> button.</p>
8	<p>Switch the power supply to the target device on again to start the download process.</p> <p>A progress indicator appears during the data transfer. When the transfer is successfully completed, a message appears briefly.</p> <p>This process takes a different length of time, depending on the connection selected.</p> <p>A progress indicator appears during the data transfer. When the transfer is successfully completed, a message appears briefly.</p>

When downloading is performed successfully, there is no project data on the operating unit. The behavior of the operating unit when no project has been loaded is described in Chapter 3.1.

13.2 Operating system update using PtUpdate

Note

PtUpdate must be used for an operating system update in the case of ProTool versions earlier than 6.0.

Proceed as follows in order to adapt the operating system on the MP 370 to the configuration software version used implementing PtUpdate:

Step	Procedure
1	Switch off the MP 370's power supply.
2	Connect the IF2 (serial) interface on the MP 370 to a serial interface on the configuration computer via a serial zero modem cable.
3	Start the <i>PTUpdate</i> utility program on the configuration computer. It is contained on the configuration software installation CD. It is located in the directory \Images in the device-specific subdirectory.
4	Select menu item <i>File</i> → <i>Open</i> and open the image file (file extension .img) appropriate for the MP 370. The image files are located in the same directory as the <i>PTUpdate</i> utility program. The file name contains the character string MP 370. When the image file has been opened successfully, various information related to the version status appears on the screen.
5	Select the menu item <i>File</i> → <i>Settings</i> . Set the interface and applicable baud rate (max. 115200) on the designated interface for the download.
6	Start downloading with the menu option <i>File</i> → <i>Download</i> . When the appropriate message appears on the screen, switch on the power supply for the MP 370.

When downloading is performed successfully, there is no project data on the MP 370. The behavior of the MP 370 when no configuration has been loaded is described in Chapter 3.1.

Note

When the MP 370 is switched on following an operating system update, it needs several minutes before the startup routine is completed for the first time.

APPENDIX

- A Technical Data**
- B Interface Assignments**
- C HMI System Messages**
- D ESD Guidelines**

Technical Data

A

In this Appendix

This Appendix contains the following technical data for the MP 370:

- Housing
- Processor
- Memory
- Software
- Display
- Keyboard (keyboard unit)
- Acoustic acknowledgement
- Power supply
- Backup battery (option)
- Network connection
- Ambient conditions
- Noise immunity / Noise transmission
- Approvals

Housing	Keyboard unit	Touch panel MP 370 12"	Touch panel MP 370 15"
External dimensions (W x H)	483 mm x 310 mm	335 mm x 275 mm	400 mm x 310 mm
Mounting cut-out (W x H)	450 ⁺¹ mm x 290 ⁺¹ mm	310 ⁺¹ mm x 248 ⁺¹ mm	368 ⁺¹ mm x 290 ⁺¹ mm
Mounting depth	65 mm	59 mm	69 mm
Degree of protection <ul style="list-style-type: none"> • Front panel • Rear panel 	IP65/NEMA 4x INDOOR USE ONLY IP20		
Weight	Approx. 6 kg	Approx. 4.5 kg	Approx. 5.7 kg

Processor	
Type	64 bit RISC CPU

Memory	
Memory	Free for user data: Flash memory: 12 MByte (of which, max. 7 MByte for ProTool configurations)
Storage media <ul style="list-style-type: none"> • Expansion slot for PC card • Slot for Compact Flash card 	e.g. <ul style="list-style-type: none"> • ATA Flash card • SRAM cards • NE2000-compatible Ethernet card e.g. <ul style="list-style-type: none"> • ATA Flash card

Software	
Operating system environment	MS Windows CE

Color display	Keyboard unit	Touch panel MP 370 12"	Touch panel MP 370 15"
LCD type	TFT LCD	TFT LCD with touch panel (analog resistive)	
Active screen diagonal	12.1 "		15.1 "
Resolution (pixels)	800 x 600 (Super VGA)		1024 x 768 (XGA)
No. of colors	256		
Back-lighting Half Brightness Life ¹⁾	CCFL tube Approx. 50,000 h		

1) Time period after which the brightness of the lighting tube only achieves 50 % of its original value. The specified value is dependent on the operating temperature.

Keyboard	Keyboard unit
Type	Membrane keyboard
System keys with dedicated functions	38 (3 with LEDs)
Configurable function keys <ul style="list-style-type: none"> • Number • Those usable as softkeys • Labeling 	36 (with LED) 36 System-specific with labeling strips

Acoustic acknowledgement	Touch panel unit
In the case of touch operation	× (can be disabled)

Power supply	Keyboard unit	Touch panel MP 370 12"	Touch panel MP 370 15"
Rated voltage	+ 24 V DC		
Permissible voltage range	+18.0...+30.0 V DC		
Max. permissible transients	35 V (500 msec)		
Time between two transients	50 sec minimum		
Power consumption <ul style="list-style-type: none"> • Typical • Max. constant current • Switch-on current I²t 	Approx. 0.6 A Approx. 0.9 A Approx. 0.5 A ² s	Approx. 1.4 A Approx. 1.8 A Approx. 0.5 A ² s	
Fuse, internal	Electronic		

Backup battery (option)	
Type	Lithium battery
Voltage/Capacity ²⁾	3.6 V/approx. 1.5 Ah
Service life	Approx. 4 years

2) Technical details subject to change without notice.

Network connection	
Type	1 × Ethernet (10/100 Mbit)



Ambient conditions	Keyboard unit	Touch panel unit
Location Max. permissible angle of inclination without external ventilation	vertical ± 35°	
Max. permissible ambient temperature • Operation – Vertical installation – Installation angled from the perpendicular to max. 35° • Shipping, storage	0...+50 °C 0...+35 °C –20...+60 °C	
Relative humidity Operation, transport, storage	Max. 85%, no condensation	
Shock loading • Operation • Shipping, storage	15 g / 11 msec 25 g / 6 msec	
Vibration • Operation • Shipping, storage	0.075 mm (10 – 58 Hz) 1 g (58 – 500 Hz) 3.5 mm (5 – 8.5 Hz) 1 g (8.5 – 500 Hz)	
Barometric pressure • Operation • Shipping, storage	706 to 1030 hPa 581 to 1030 hPa	

Compliance of the named products with the regulations of Directive 89/336 EEC is verified by conformance with the following standards:

Noise immunity	
Static discharge (contact discharge/air discharge)	EN 61000-4-2 6 kV/8 kV
RF irradiation	EN 61000-4-3 10 V/m, 80% AM, 1 kHz
Pulse modulation	ENV 50204 900 MHz \pm 5 MHz 10 V/m _{eff.} , 50% ED, 200 Hz
RF conduction	EN 61000-4-6 150 kHz – 80 MHz 10 V, 80% AM, 1 kHz
Burst interference <ul style="list-style-type: none"> • Supply lines • Process data lines • Signal lines 	EN 61000-4-4 2 kV 2 kV 1 kV
Surge coupling <ul style="list-style-type: none"> • Supply line 	EN 61000-4-5 1 kV with choke, Type DEHNrail (Order No. 901 104) 2 kV with choke Type DEHNrail (Order No. 901 104)
Magnetic fields	EN 61000-4-8 30A/m 50/60 Hz

Radio interference	
Radio interference level complying to EN 55011	Class A

The following approvals have been applied for or already granted on supply. Please refer to the rating plate on the rear of the unit for identification.

Approvals	
CE conformity approval	EMC guidelines
C-Tick	EMC radio interference, Australia
UL approval	UL Recognition Mark ³⁾ Underwriters Laboratories (UL) complying with Standard UL 508, File E 116536
UL approval	In accordance with the UL/CSA Approval Agreement
Ex Zone 2/22	Ex zone, Europe EN 50021, EN 50281-1-1
FM Approval	FM Approval Complying with Factory Mutual Approval Standard Class Number 3611 Hazardous (classified) Locations Class I, Division 2, Group A, B, C, D
	 <p>Warning: Personal injury and equipment damage can occur. Personal injury and equipment damage can occur in hazardous areas if a plug connection is disconnected from the operating unit while the system is running. In hazardous areas, always switch off the power supply to the operating unit before disconnecting plugs.</p>
	 <p>Warning: DO NOT DISCONNECT WHILE CIRCUIT IS LIVE UNLESS LOCATION IS KNOWN TO BE NON-HAZARDOUS.</p>

3) The UL and CSA file numbers are dependent on the production site. The numbers specified here changes according to the change of production site.

B

Interface Assignments

IF1A

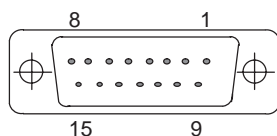

Table B-1 15-pin Sub-D socket

Pin	RS232	TTY	General
1	Screening		
2	–	RxD–	RxD–
3	RxD	–	–
4	TxD	–	–
5	CTS	–	–
6	–	TxD+	–
7	–	TxD–	RTS
8	Screening		
9	–	RxD+	–
10	RTS	–	–
11	–	+20 mA	–
12	GND		
13	–	+20 mA	–
14	+5 V/100 mA		
15	GND		

IF1B

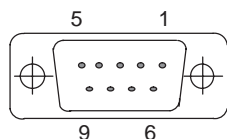

Table B-2 9-pin Sub-D socket (configuration via switch, see Page 9-14)

Pin	RS422	RS485 / PROFIBUS-DP / MPI
1	N. c.	
2	N. c.	
3	TxD+	Data B
4	RxD+	RTS-AS
5	GND (floating)	
6	+5 V (floating)	
7	N. c.	
8	TxD–	Data A
9	RxD–	–

IF2

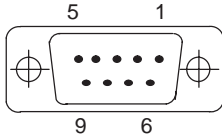

Table B-3 9-pin Sub-D plug (pin)

Pin	RS232
1	DCD
2	RxD
3	TxD
4	DTR
5	GND
6	DSR
7	RTS
8	CTS
9	RI

Ethernet interface

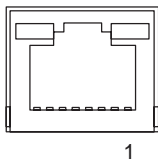

Table B-4 RJ45 plug connection

Pin	RJ45
1	10BaseT: TX+
2	10BaseT: TX-
3	10BaseT: RX+
4	-
5	-
6	10BaseT: RX-
7	-
8	-

USB interface

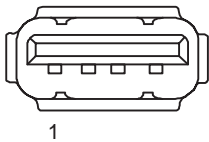

Table B-5 USB standard plug

Pin	USB
1	+5V
2	+5V
3	USB-DM
4	USB-DP
5	0V
6	0V

HMI System Messages

In this chapter

This chapter contains a selection of important HMI system messages for Windows-based systems. The table indicates when the messages occur and how they, or their cause, can be cleared. Not every message is relevant for each operating unit.

HMI system message parameters

The HMI system messages may contain parameters which are not decoded for the user but which are relevant in respect of the cause of an error since they provide a reference to the source code of the runtime software. These parameters are issued according to the text "Error code:".

Notice

HMI system messages are issued in the language currently set on the operating unit.

Number	Effect/Cause	Remedy
10000	The print job could not be started or was terminated for an unknown reason. The printer is incorrectly configured. Or: There are no rights for a network printer available.	Check the printer settings and cable connections. If a fault occurs repeatedly, contact the hotline.
10001	No printer has been installed or no standard printer configured.	Install a printer and/or mark one as standard printer.
10002	The intermediate buffer for printing graphics is full. Up to two graphics can be buffered.	Do not issue print jobs so quickly in succession.
10003	Graphics can be buffered again.	–
10004	The intermediate buffer for printing lines in text mode (e.g. messages) is full. Up to 1000 lines can be buffered.	Do not issue print jobs so quickly in succession.
10005	Lines of text can be buffered again.	–
10006	The Windows print system reports an error. For information on the cause, refer to the text printed and, if available, the error number. Printing is not performed or it is incorrect.	Repeat the action, if necessary.

Number	Effect/Cause	Remedy
20010	A fault has occurred in the script line called in from the specified script. Execution of the script function was, therefore, terminated. In this case, it is advisable to check any previous system messages too.	Select the specified script line in the configuration. Check tags, whether the types used are permissible. Check Functions, whether the number and types of parameter are correct.
20011	An error has occurred in a script called in by the script specified. Execution of the script function- has, therefore, been terminated in the subscript. In this case, it is advisable to check any previous system messages too.	Select the scripts from the configuration which are called in directly or indirectly via the specified script. Check tags, whether the types used are permissible. Check Functions, whether the number and types of parameter are correct.
20012	Inconsistent configuration data is present. Therefore, the script could not be created.	Compile the configuration again.
20013	VBScript.dll is not correctly installed. Therefore, no scripts can be executed.	Re-install ProTool/Pro RT.
20014	A value is returned by the script function which is not written in any configured return tag.	Select the specified script in the configuration. Check whether the script name has been assigned a value.
20015	Too many scripts have been triggered in quick succession. If more than 20 scripts are queued to be processed, any subsequent scripts are rejected. In this case, the script indicated in the message is not executed.	Check where the scripts are being triggered from. Extend the times, e.g. the polling time of the tags, which trigger the scripts.
30010	The tag could not accept the function result, e.g. in the case of exceeding the value range.	Check the tag type of the function parameter.
30011	A function could not be executed because the function was assigned an invalid value or type in the parameter.	Check the parameter value and tag type of the invalid parameter. If a tag is used as a parameter, check its value.
40010	The function could not be executed since the parameters could not be converted to a common tag type.	Check the parameter types in the configuration.
40011	The function could not be executed since the parameters could not be converted to a common tag type.	Check the parameter types in the configuration.
50000	The operating unit receives data faster than it is capable of processing. Therefore, no further data is received until the data currently available has been processed. Data exchange then resumes.	–
50001	Data exchange has been resumed.	–

Number	Effect/Cause	Remedy
60000	This message is generated by the function "Display system messages". The text to be displayed is transferred to the function as a parameter.	–
60010	The file could not be copied in the direction defined because one of the two files is currently open or the source/target path is not available. It is possible that the Windows NT user has no access rights to one of the two files.	Restart the function or check the paths of the source/target files. Using Windows NT with NTFS: The user executing ProTool/Pro RT must be granted access rights for the files.
60011	An attempt was made to copy a file to itself. It is possible that the Windows NT user has no access rights to one of the two files.	Check the path of the source/target file. Using Windows NT with NTFS: The user executing ProTool/Pro RT must be granted access rights for the files.
70010	The application could not be started because it could not be found in the path specified or insufficient memory space was available.	Check whether the application exists in the specified path or close other applications.
70011	The system time could not be modified. The error message only appears in connection with area pointer Date/Time PLC. Possible causes: <ul style="list-style-type: none"> • an impermissible time was transferred in the PLC job, • the Windows NT user has no user rights to modify the system time. If the first parameter in the system message is displayed with the value 13, the second parameter indicates the byte containing the incorrect value.	Check the time which is to be set. Under Windows NT: The user executing ProTool/Pro RT must be assigned the rights to modify the system time from Windows NT (administration/user manager, guidelines).
70012	An error occurred when executing the function <i>Exit Runtime</i> with the option <i>Exit also Windows</i> . Windows and ProTool/Pro RT are not terminated. A possible cause is that other applications cannot be terminated.	Terminate all applications currently running. Then terminate Windows.
70013	The system time could not be modified because an invalid value was entered. Incorrect separators may have been used.	Check the time which is to be set.
70014	The system time could not be modified. Possible causes: <ul style="list-style-type: none"> • an impermissible time was transferred • the Windows NT user has no user rights to modify the system time, • Windows rejects the setting request. 	Check the time which is to be set. Under Windows NT: The user executing ProTool/Pro RT must be assigned the rights to modify the system time from Windows NT (administration/user manager, guidelines).
70015	The system time could not be read because Windows rejects the reading function.	–

Number	Effect/Cause	Remedy
70016	An attempt was made to select a screen by means of a function or job. This is not possible because the screen number specified does not exist. Or: a screen could not be generated due to insufficient system memory.	Check the screen number in the function or job with the screen numbers configured. Refer the number to a screen, if necessary.
70017	Date/Time is not read from the area pointer because the address set in the PLC is either not available or has not been set up.	Change the address or set up the address in the PLC.
70018	Acknowledgement that the password list has been successfully imported.	–
70019	Acknowledgement that the password list has been successfully exported.	–
70020	Acknowledgement for activation of message recording.	–
70021	Acknowledgement for deactivation of message recording.	–
70022	Acknowledgement to starting the <i>Import Password List</i> action.	–
70023	Acknowledgement to starting the <i>Export Password List</i> action.	–
70027	Backing up the RAM file system has been started.	–
70028	Backing up of the RAM file system has been completed successfully. The files from the RAM have been copied in the Flash memory. Following a restart, these saved files will be copied back in the RAM file system.	–
70029	Backup of the RAM file system has failed. No backup copy of the RAM file system has been made.	Check the settings in the <i>OP Properties</i> dialog and save the RAM file system using the <i>Save Files</i> button in the <i>Persistent Storage</i> tab control.
70030	The parameters configured for the function are faulty. The connection to the new PLC was not established.	Compare the parameters configured for the function with the parameters configured for the PLC and correct them as necessary.
70031	The PLC configured in the function is not an S7 PLC. The connection to the new PLC was not established.	Compare the <i>S7 PLC name</i> parameter configured for the function with the parameters configured for the PLC and correct them as necessary.
80001	The archive specified is filled to the size defined (in percent) and must be stored elsewhere.	Store the file or table by executing a 'move' or 'copy' function.
80002	A line is missing in the specified archive.	–

Number	Effect/Cause	Remedy
80003	The copying process for archiving was not successful. In this case, it is advisable to check any subsequent system messages, too.	–
80006	Since archiving is not possible, this causes a permanent loss of the functionality.	In the case of databases, check whether the corresponding data source exists and start up the system again.
80009	A copying action has been completed successfully.	–
80010	Since the path was incorrectly entered in ProTool, this causes a permanent loss of the functionality.	Configure the path for the respective archive again and restart the system when the full functionality is required.
80012	Archive values are stored in a buffer. If the values are read to the buffer faster than they can be physically written (e.g. using a hard disk), overloading may occur and recording is then stopped.	Archive less values. Or increase the recording interval.
80013	The overload status no longer applies. Archiving resumes the recording of all values.	–
80014	The same action was triggered twice in quick succession. Since the process is already in operation, the action is only carried out once.	–
80016	The archives are separated by the function <i>Close archive</i> and the incoming entries exceed the defined buffer size. All the jobs in the buffer are deleted.	Reconnect the archives.
80017	The incoming entries cause the defined buffer size to be exceeded. This can be caused, e.g. by several copying actions being activated at the same time. All the copy jobs in the buffer are deleted.	Terminate the copy process.
80018	All the archives are reconnected by means of the DB layer, e.g. after executing the function <i>Open_archive</i> . Values are then written back into the tables.	–
80019	All the archives are separated from the DB layer and all connections terminated, e.g. after executing the function <i>Close_archive</i> . Values are temporarily buffered and written in the tables when the connection is re-established. There is no connection to the storage medium and a change can take place.	–
80020	The max. number of simultaneously activated copy actions has been exceeded. Copying is not executed.	Wait until the current copying actions have been completed and restart the last copy action.

Number	Effect/Cause	Remedy
80021	An attempt was made to delete an archive which is still involved with a copy action. Deletion has not been executed.	Wait until the current copying action has been completed and restart the last action.
80022	An attempt was made to start a sequence archive, which is not a sequence archive, from an archive using the function <i>Start_sequence_archive</i> . No sequence archive is created.	Check the project for the following: <ul style="list-style-type: none"> the function <i>Start_sequence_archive</i> is correctly configured. the variable parameters are being correctly provided at the operating unit.
80023	An attempt was made to copy an archive to itself. The archive is not copied.	Check the project for the following: <ul style="list-style-type: none"> the function <i>Copy_archive</i> is correctly configured. the variable parameters are being correctly provided at the operating unit.
80024	The function <i>Copy_archive</i> is configured not to permit copying when the target archive already contains data (Parameter: <i>Write mode</i>). The archive is not copied.	Modify the function <i>Copy_archive</i> in the project, if necessary. Before initiating the function, delete the target archive.
80025	The copy action is interrupted. Data written up to this point is retained. Deletion of the target table (if configured) is not executed. The cancellation is documented by an error entry <i>\$RT_ERR\$</i> at the end of the target table.	–
80026	The message is issued after all the archives have been successfully initialized. Values are written in the archives from this moment on. Prior to this, no values are archived even though the runtime software is operating.	–
80027	The internal Flash memory has been specified as the memory location for an archive. This is not permissible. No values will be archived for this archive and the archive will not be created.	Configure "Storage Card" as the memory location or a network path.
80028	The message serves as a status acknowledgment that initialization of the archives is currently running. No values are archived until system message 80026 is issued.	–
80029	The number of archives specified in the message could not be initialized. Initialization of the archives has been completed. The faulty archives are not available for archiving jobs.	Evaluate the additional system message, related to this message, which is also issued. Check the configuration, the ODBC (Open Database Connectivity) and the specified drive.

Number	Effect/Cause	Remedy
80030	The structure of the table(s) available does not match the archiving structure expected. The archiving process is stopped for this archive.	Delete the existing tables manually, in advance.
80032	Archives can be configured with a function trigger. This is triggered as soon as the archive is full. If runtime is started and the archive is already full, the trigger function will not be initiated. The archive specified no longer archives data since it is full.	Stop the runtime, delete the archive and restart the runtime again. Or: Configure a button in the runtime which contains the same actions as the function trigger and press it.
110000	The operating mode status has been changed. The operating mode is now <i>offline</i> .	–
110001	The operating mode status has been changed. The operating mode is now <i>online</i> .	–
110002	The operating mode status has not been changed.	Check the connection to the PLCs. Check whether the address area for the area pointer "Coordination" in the PLC is available.
110003	The operating status of the PLC specified is changed by the function <i>Connect/Disconnect PLC</i> . The operating mode is now <i>offline</i> .	–
110004	The operating status of the PLC specified is changed by the function <i>Connect/Disconnect PLC</i> . The operating mode is now <i>online</i> .	–
110005	An attempt was made to use the function <i>Connect/Disconnect PLC</i> to switch the specified PLC to operating mode <i>online</i> although the entire system is in operating mode <i>Offline</i> . This switch-over is not permissible. The PLC remains in operating mode <i>offline</i> .	Switch the complete system to operating mode <i>online</i> and execute the function again.
110006	The Colorado system has been extended by the addition of the <i>User Version</i> area pointer. If the user version is not correct, the runtime is stopped.	Check the user versions. Either the wrong version was entered in the PLC or configuration or the wrong configuration was started for the PLC user version.
120000	The trend is not displayed because an incorrect axis to the trend, or incorrect trend, has been configured.	Change the configuration.
120001	The trend is not displayed because an incorrect axis to the trend, or incorrect trend, has been configured.	Change the configuration.

Number	Effect/Cause	Remedy
120002	The trend is not displayed because the tag assigned tries to access an invalid PLC address.	Check whether the data area for the tag exists in the PLC, the configured address is correct or the value range for the tag is correct.
130000	The action was not executed.	Close other applications. Delete files no longer required from the hard disk.
130001	The action was not executed.	Delete files no longer required from the hard disk.
130002	The action was not executed.	Close other applications. Delete files no longer required from the hard disk.
130003	No target data carrier is inserted. The process is stopped.	Check, for example, whether: <ul style="list-style-type: none"> access has been made to the correct data carrier the data carrier has been inserted
130004	The target data carrier is write-protected. The process is stopped.	Check whether access has been made to the correct data carrier. Remove the write protection.
130005	The file is write-protected. The process is stopped.	Check whether access has been made to the correct file. Modify the file attributes, if necessary.
130006	No access to file is possible. The process is stopped.	Check, for example, whether: <ul style="list-style-type: none"> access has been made to the correct file the file exists a different action prevents simultaneous access to the file
140000	Online connection to the PLC has been successfully established.	–
140001	Online connection to the PLC has been disconnected.	–
140003	No tag updating or writing is executed.	Check the connection and whether the PLC is switched on. Check the parameter definitions in the Control Panel using "Set PU/PC interface". Restart the system.
140004	No tag updating or writing is executed because the access point or the subrack configuration is incorrect.	Check the connection and whether the PLC is switched on. Check the access point or the subrack configuration (MPI, PPI, PROFIBUS) in the Control Panel with "Set PU/PC interface". Restart the system.

Number	Effect/Cause	Remedy
140005	No tag updating or writing is executed because the address of the operating unit is incorrect (possibly too high).	Use a different operating unit address. Check the connection and whether the PLC is switched on. Check the parameter definitions in the Control Panel using "Set PU/PC interface". Restart the system.
140006	No tag updating or writing is executed because the baud rate is incorrect.	Select a different baud rate in ProTool/Pro (according to subrack, profile, communication peer, etc.).
140007	No tag updating or writing is executed because the bus profile is incorrect (see %1). The following parameters could not be entered in the registry: 1: Tslot 2: Tqui 3: Tset 4: MinTsdr 5: MaxTsdr 6: Trdy 7: Tid1 8: Tid2 9: Gap Factor 10: Retry Limit	Check the user defined bus profile. Check the connection and whether the PLC is switched on. Check the parameter definitions in the Control Panel using "Set PU/PC interface". Restart the system.
140008	No tag updating or writing is executed because the configuration data is incorrect: The following parameters could not be entered in the registry: 0: General errors 1: Incorrect version 2: Profile cannot be entered in the registry. 3: Sub-network type cannot be entered in the registry. 4: Target rotation time cannot be entered in the registry. 5: Highest address (HSA) incorrect.	Check the connection and whether the PLC is switched on. Check the parameter definitions in the Control Panel using "Set PU/PC interface". Restart the system.
140009	No tag updating or writing is executed because the module for the S7 communication was not found.	Re-install the module in the Control Panel using "Set PU/PC interface".
140010	No S7 communication peer could be found because the PLC is switched off. DP/T: The option "Is not active as the only master" is set in the Control Panel under "Set PU/PC interface".	Switch the PLC on. DP/T: If only one master is connected to the network, deactivate the option "Is not active as the only master" in "Set PU/PC interface". If the network has more than one master, switch this master on. Do not modify any settings here, otherwise a bus fault may occur.
140011	No tag updating or writing is executed because communication is interrupted.	Check the connection and that the communication peer is switched on.

Number	Effect/Cause	Remedy
140012	There is an initialization problem (e.g. when ProTool/Pro RT has been terminated in the Task Manager). Or: another application (e.g. STEP7, WINCC) is active with different bus parameters and the driver cannot be started with the new bus parameters (e.g. baud rate).	Restart the operating unit. Or start ProTool/Pro RT first and then the other applications.
140013	The MPI cable is not plugged in and, thus, there is no power supply.	Check the connections.
140014	–	Modify the operating unit address in the configuration in <i>PLC</i> .
140015	Incorrect baud rate Or: incorrect bus parameter (e.g. HSA) Or: OP address HSA Or: incorrect interrupt vector (interrupt does not arrive at the driver)	Correct the incorrect parameters.
140016	–	Change the interrupt number.
140017	–	Change the interrupt number.
140018	The consistency check was deactivated by Simotion Scout. Only one appropriate note appears.	Activate the consistency check with Simotion Scout again and load the configuration in the project once more.
140019	Simotion Scout loads a new project in the PLC. Connection to the PLC is interrupted.	Wait until the end of the reconfiguration.
140020	The version in the PLC and that in the configuration (FWD file) do not match. Connection to the PLC is interrupted.	<ul style="list-style-type: none"> • Load the current version in the PLC using Simotion Scout. • Generate the anew project using ProTool CS, end ProTool RT and start with the new configuration.
150000	No more data is read or written. Possible causes: <ul style="list-style-type: none"> • The cable is defective. • The PLC does not respond, is defective, etc. • Connection is established via the wrong interface. • The system is overloaded. 	Check that the cable is plugged in, the PLC is operational, the correct interface is used. Reboot the system if the system message is displayed continuously.
150001	Connection is re-established because the cause of the interruption has been eliminated.	–

Number	Effect/Cause	Remedy
160000	No more data is read or written. Possible causes: <ul style="list-style-type: none"> The cable is defective. The PLC does not respond, is defective, etc. Connection is established via the wrong interface. The system is overloaded. 	Check that the cable is plugged in, the PLC is operational, the correct interface is used. Reboot the system if the system message is displayed continuously.
160001	Connection is re-established because the cause of the interruption has been eliminated.	–
160010	There is no connection to the server because the server identification (CLS-ID) cannot be established. Values cannot be read or written.	Check the access rights.
160011	There is no connection to the server because the server identification (CLS-ID) cannot be established. Values cannot be read or written.	Check, for example, whether: <ul style="list-style-type: none"> the server name is correct the computer name is correct the server is registered
160012	There is no connection to the server because the server identification (CLS-ID) cannot be established. Values cannot be read or written.	Check, for example, whether: <ul style="list-style-type: none"> the server name is correct the computer name is correct the server is registered Information for experienced users: Interpret the value from HRESULT.
160013	The specified server was started as InProc Server. This has not been released and may possibly lead to incorrect behavior because the server is running in the same process area as the ProTool/Pro RT runtime software.	Configure the server as OutProc Server or Local Server.
160014	Only one OPC server project can be started on a PC/MP. An error message appears when an attempt is made to start a second project. The second project has no OPC server functionality and cannot be located as an OPC server from external sources.	Do not start a second project with OPC server functionality on the computer.
160015	The deviceCOM software for the OPC communication cannot be started.	Execute an operating system transfer. Observe the online help for ProSave. If the problem continues, contact the Hotline.
160016	The deviceCOM transport software for the OPC communication cannot be started.	If the deviceCOM parameter on the operating unit have been manually entered, check the changes made. If the problem continues, contact the Hotline.

Number	Effect/Cause	Remedy
170000 ¹⁾	S7 diagnostics messages are not displayed because it is not possible to logon to the S7 diagnostics with this unit. The service program is not supported.	–
170001 ¹⁾	The S7 diagnostics buffer cannot be displayed because communication with the PLC has been switched off.	Switch the PLC <i>online</i>
170002 ¹⁾	The S7 diagnostics buffer cannot be displayed because reading in the diagnostics buffer (SZL) was terminated due to an error.	–
170003 ¹⁾	The display of an S7 diagnostics message is not possible. An internal error %2 has been reported.	–
170004 ¹⁾	The display of an S7 diagnostics message is not possible. An internal error with error class %2, error number %3 has been reported.	–
170007 ¹⁾	It is not possible to read in the S7 diagnostics buffer (SZL) because it was terminated with an internal error with error class %2 and error code %3.	–
180000	A component/OCX receives configuration data with a version identification which is not supported.	Install a newer component.
180001	The system is overloaded because too many actions have been activated simultaneously. Not all the actions can be executed, some are rejected.	<ul style="list-style-type: none"> • Increase the configured cycle times or basic clock. • Generate the messages slower (polling). • Trigger the scripts and functions at greater intervals. • If the message appears more frequently: Restart the operating unit.
180002	The screen keyboard could not be activated. Possible causes: <ul style="list-style-type: none"> • The screen keyboard is not generally supported under Windows 95. • The file "TouchInputPC.exe" was not registered due to an incorrectly executed Setup. 	If Windows 95 is not available: Install the runtime software again.
190000	It is possible that the tag will not be updated.	–
190001	The tag is updated following an error status after the cause of the last error state has been eliminated (return to normal operation).	–
190002	The tag is not updated because communication to the PLC has been switched off.	Switch on communication via the function "Set Online".

Number	Effect/Cause	Remedy
190004	The tag is not updated because the configured address is not available for this tag.	Check the configuration.
190005	The tag is not updated because the configured PLC type does not exist for this tag.	Check the configuration.
190006	The tag is not updated because it is not possible to map the PLC type in the tag type.	Check the configuration.
190007	The tag values are not modified because the connection to the PLC has been terminated or the tag is offline.	Switch <i>Online</i> or re-establish connection to the PLC.
190008	The threshold values configured for the tag have been violated, e.g. by <ul style="list-style-type: none"> • an entered value, • a function, • a script. 	Observe the configured or current threshold value of the tag.
190009	An attempt has been made to assign a value to a tag which is outside the value range permitted for this type. E.g. a value of 260 entered for a byte tag or a value of -3 for a signless word tag.	Observe the value range for the tag type.
190010	The tag is described with values too often (e.g. in a loop triggered by a script). Values are lost because the maximum of 100 event have been stored in the buffer.	Increase the time interval between the multi-writing tasks.
190011	Possible causes: <ul style="list-style-type: none"> • The value entered could not be written to the configured PLC tag because it was either above or below the value range. The input is rejected and the original value is reset. • Connection to the PLC has been interrupted. 	Ensure that the value entered is within the value range of the PLC tags. Check the connection to the PLC.
190012	It is not possible to convert a value from a source format to a target format, e.g.: <ul style="list-style-type: none"> • A value should be assigned to a counter which is outside the valid, PLC-dependent value range. • A tag of the type <i>Integer</i> should be assigned a value of the type <i>String</i>. 	Check the value range or type of the variable.

Number	Effect/Cause	Remedy
190100	The area pointer is not updated because the configured address for this area pointer is not available. Type: 1 Event messages 2 Alarm messages 3 PLC acknowledgment 4 Operating unit acknowledgment 5 LED assignment 6 Trend request 7 Trend transfer 1 8 Trend transfer 2 No.: is the consecutive number displayed in ProTool/Pro.	Check the configuration.
190101	The area pointer is not updated because it is not possible to map the PLC type in the area pointer type. Parameter type and no.: See message 190100	–
190102	The area pointer is updated following an error status after the cause of the last error state has been eliminated (return to normal operation). Parameter type and no.: See message 190100	–
200000	Coordination is not executed because the address configured in the PLC does not exist/has not been set up.	Change the address or set up the address in the PLC.
200001	Coordination is not executed because the address configured in the PLC cannot be written.	Change the address or set up the address in the PLC in an area which can be written.
200002	Coordination is not carried out at the moment because the address format of the area pointer does not match the internal storage format.	Internal error
200003	Coordination can be executed again because the last error status has been eliminated (return to normal operation).	–
200004	It is possible that coordination is not executed.	–
200005	No more data is read or written. Possible causes: <ul style="list-style-type: none"> • The cable is defective. • The PLC does not respond, is defective, etc. • The system is overloaded. 	Check that the cable is connected and the PLC is in order. Reboot the system if the system message is displayed continuously.

Number	Effect/Cause	Remedy
210000	Jobs are not processed because the address configured in the PLC does not exist/has not been set up.	Change the address or set up the address in the PLC.
210001	Jobs are not processed because the address configured in the PLC cannot be written to/read from.	Change the address or set up the address in the PLC in an area which can be written to/read from.
210002	Commands are not executed because the address format of the area pointer does not match the internal storage format.	Internal error
210003	The job mailbox is processed again because the last error status has been eliminated (return to normal operation).	–
210004	It is possible that the job mailbox is not processed.	–
210005	A PLC job was triggered by an impermissible number.	Check the PLC program.
210006	A fault occurred while attempting to execute the PLC job. The PLC job is, therefore, not executed. Observe the subsequent/previous system message, if appropriate.	Check the parameter types in the PLC job. Compile the configuration again.
220000 ²⁾	See footnote	See footnote
220001	The tag is not downloaded because the associated channel/the unit does not support downloading the data type bool/bit.	Change the configuration.
220002	The tag is not downloaded because the associated channel/the unit does not support downloading the data type byte.	Change the configuration.
220003	The associated driver could not be uploaded. It is possible that the driver is not installed.	Install the driver by re-installing ProTool/Pro RT.
220004	Communication is terminated and no update is executed because the cable is not connected or is defect etc.	Check the connection.
220005	Communication is running.	–
220006	The connection is established to the specified PLC at the specified interface.	–
220007	The connection to the specified PLC at the specified interface is disconnected.	Check that: <ul style="list-style-type: none"> • the cable is plugged in • the PLC is OK • the correct interface is used • the configuration is OK (interface parameters, protocol settings, PLC address). Reboot the system if the system message is displayed continuously.

Number	Effect/Cause	Remedy
220008	The PLC driver cannot access the specified interface or open it. It is possible that another application is using this interface or an interface is used which is not available on the target device. There is no communication with the PLC.	Terminate all the programs which access the interface and reboot the computer. Use another interface which is available in the system.
230000	The value entered could not be accepted. The entered value is rejected and the previous value is specified again. Either the value range has been exceeded or impermissible characters were entered.	Enter a permissible value.
230002	Since the current password level is inadequate or the password dialog box was closed with ESC, the entry is rejected and the previous value is specified again.	Activate an adequate password level using Login.
230003	Changeover to the specified screen is not executed because the screen is not available/configured. The current screen remains selected.	Configure the screen. Check the selection function.
240000 ³⁾	Runtime is operating in Demo mode. There is either no Stopcopy license or it is defect.	Load the license.
240001 ³⁾	Runtime is operating in Demo mode. Too many tags are configured for the installed version.	Load an adequate license / powerpack.
240002 ³⁾	Runtime is operating with a time-limited standby authorization.	Restore the full authorization.
240003	Authorization cannot be executed. ProTool/Pro RT is running in Demo mode.	Restart ProTool/Pro RT or reinstall it.
240004	Error during reading the standby authorization. ProTool/Pro RT is running in Demo mode.	Restart ProTool/Pro RT, install the authorization or repair the authorization (see Commissioning Instructions Software Protection).
250000	The tag in the specified line in Status/Control is not updated because the address configured for this tag is not available.	Check the set address and then check that the address has been set up in the PLC.
250001	The tag in the specified line in Status/Control is not updated because the PLC type configured for this tag is not available.	Check the set address.
250002	The tag in the specified line in Status/Control is not updated because it is not possible to map the PLC type in the tag type.	Check the set address.
250003	No connection could be established to the PLC. The tags will not be updated.	Check the connection to the PLC. Check that the PLC is switched on and <i>online</i> is activated.

Number	Effect/Cause	Remedy
260000	A password has been entered which is unknown to the system. Therefore, the lowest password level has been set. This corresponds to the status following <i>Logout</i> .	Enter a known password in the password input field (with corresponding level).
260001	A password has been entered whose assigned level does not permit execution of the function. The password level currently set is displayed for information purposes.	Modify the password level in the password input field enter a password with a sufficiently high level.
260003	The user has logged off from the system. If the password level is 0, no user is logged on.	–
270000	A tag is not displayed in the message because it attempts to access an invalid address in the PLC.	Check whether the data area for the tag exists in the PLC, the configured address is correct or the value range for the tag is correct.
270001	There is a unit-dependent limit as to how many messages may be queued simultaneously in order to be displayed (see GHB). This limit has been exceeded. The display no longer contains all the messages. However, all the messages are recorded in the message buffer.	–
270002	Messages are displayed from an archive are displayed for which there is no data in the current project. Placeholders are issued for the messages.	Delete older archive files, if necessary.
270003	The service cannot be set up because too many devices was to set up this service. A maximum of four devices can execute this action.	Connect fewer operating units which want to use the service.
280000	Connection is re-established because the cause of the interruption has been eliminated.	–
280001	No more data is read or written. Possible causes: <ul style="list-style-type: none"> • The cable is defective. • The PLC does not respond, is defective, etc. • Connection is established via the wrong interface. • The system is overloaded. 	Check that the cable is plugged in, the PLC is operational, the correct interface is used. Reboot the system if the system message is displayed continuously.
280002	A connection is used which requires a function module in the PLC. The function block has replied. Communication can now proceed.	–

Number	Effect/Cause	Remedy
280003	<p>A connection is used which requires a function module in the PLC.</p> <p>The function block does not reply.</p>	<p>Check that the cable is plugged in, the PLC is operational, the correct interface is used.</p> <p>Reboot the system if the system message is displayed continuously.</p> <p>The remedy is dependent on the error code:</p> <ol style="list-style-type: none"> 1: The function block must set the COM bit in the response container. 2: The function block may not set the ERROR bit in the response container 3: The function block must respond within the specified time (timeout) 4: Establish an online connection to the PLC
280004	<p>The online connection to the PLC has been interrupted. There is no data exchange at present.</p>	<p>Check the PLC parameters in ProTool Pro: baud rate, block length, station address.</p> <p>Check that the cable is plugged in, the PLC is operational, the correct interface is used.</p> <p>Reboot the system if the system message is displayed continuously.</p>
290000	<p>The tag could not be read or written. It is assigned the start value.</p> <p>The message can be entered in the message buffer for up to four more failed tags, if necessary. After that, the message number 290003 is issued.</p>	<p>Check in the configuration that the address has been set up in the PLC.</p>
290001	<p>An attempt has been made to assign a value to a tag which is outside the value range permitted for this type.</p> <p>The message can be entered in the message buffer for up to four more failed tags, if necessary. After that, the message number 290004 is issued.</p>	<p>Observe the value range for the tag type.</p>
290002	<p>It is not possible to convert a value from a source format to a target format.</p> <p>The message can be entered in the message buffer for up to four more failed tags, if necessary. After that, the message number 290005 is issued.</p>	<p>Check the value range or type of the variable.</p>
290003	<p>This message is issued when message number 290000 is triggered more than five times.</p> <p>In this case, no further individual messages are generated.</p>	<p>Check in the configuration that the tag addresses have been set up in the PLC.</p>
290004	<p>This message is issued when message number 290001 is triggered more than five times.</p> <p>In this case, no further individual messages are generated.</p>	<p>Observe the value range for the tag type.</p>

Number	Effect/Cause	Remedy
290005	This message is issued when message number 290002 is triggered more than five times. In this case, no further individual messages are generated.	Check the value range or type of the variable.
290006	The threshold values configured for the tag have been violated by values entered.	Observe the configured or current threshold value of the tag.
290007	There is a difference between the source and target structure of the recipe currently being processed. The target structure contains an additional data record tag which is not available in the source structure. The data record tag specified is assigned its start value.	Insert the specified data record tag in the source structure.
290008	There is a difference between the source and target structure of the recipe currently being processed. The source structure contains an additional data record tag which is not available in the target structure and therefore cannot be assigned. The value is rejected.	Remove the specified data record tag in the specified recipe from the project.
290010	The storage location configured for the recipe is not permitted. Possible causes: Impermissible characters, write protected, data medium full or does not exist.	Check the path specification configured.
290011	The data record specified by the number does not exist.	Check the source for the number (constant or variable value).
290012	The recipe specified by the number does not exist.	Check the source for the number (constant or variable value).
290013	An attempt was made to save a data record under a data record number which already exists. The process is not executed.	<ul style="list-style-type: none"> • Check the source for the number (constant or variable value). • Delete the data record beforehand. • Change the function parameter "Overwrite".
290014	The file specified to be imported could not be found.	<ul style="list-style-type: none"> • Check the file name. • Ensure that the file is in the specified directory.
290020	Acknowledgement that downloading of data records from operating unit to PLC has started.	–
290021	Acknowledgement that downloading of data records from operating unit to PLC has been completed without any errors.	–

Number	Effect/Cause	Remedy
290022	Acknowledgement that downloading of data records from operating unit to PLC has been terminated due to an error.	Check the configuration: <ul style="list-style-type: none"> • have the tag addresses been set up in the PLC? • does the recipe number exist? • does the data record number exist? • has the function parameters "Overwrite"?
290023	Acknowledgement that downloading of data records from the PLC to the operating unit has started.	–
290024	Acknowledgement that downloading data records from the PLC to the operating unit has been completed without any errors.	–
290025	Acknowledgement that downloading of data records from the PLC to the operating unit has been terminated due to an error.	Check the configuration: <ul style="list-style-type: none"> • have the tag addresses been set up in the PLC? • does the recipe number exist? • does the data record number exist? • has the function parameters "Overwrite"?
290026	An attempt has been made to read/write a data record although the data mailbox is not free at present. This error may occur in the case of recipes for which downloading with synchronization has been configured.	Set the data mailbox status to zero.
290027	No connection to the PLC can be established at present. Therefore, the data record can neither be read nor written. Possible causes: No physical connection to the PLC (no cable plugged in, cable is defect) or the PLC is switched off.	Check the connection to the PLC.
290030	This message is issued after reselecting a screen that contains a recipe display in which a data record has already been selected.	Reload the data record from the data medium or retain the current values.
290031	While saving, it was detected that a data record with the specified number already exists.	Overwrite the data record or cancel the process.
290032	While exporting data records, it was detected that a file with the specified name already exists.	Overwrite the file cancel the process.
290033	Confirmation request before deleting data records.	–

Number	Effect/Cause	Remedy
290040	A data record error with error code %1 has occurred which cannot be described in more detail. The action was canceled. It might be that the data mailbox has not been installed correctly on the PLC.	Check that the data carrier, the data record, the data mailbox and, if necessary, the connection to the PLC. Trigger the action again after waiting a short period. If the error occurs again, please contact the Customer Support. Specify the error code displayed.
290041	A data record or file cannot be saved because the data medium is full.	Delete files no longer required.
290042	An attempt was made to execute several recipe actions simultaneously. The last action was not executed.	Trigger the action again after waiting a short period.
290043	Confirmation request before storing data records.	–
290044	The data store for the recipe has been destroyed and will be deleted.	–
290050	Acknowledgement that the exportation of data records has started.	–
290051	Acknowledgement that the exportation of data records has been completed successfully.	–
290052	Acknowledgement that the exportation of data records has been terminated due to errors.	Ensure that the structure of the data records on the data medium and the current recipe structure on the operating unit are identical.
290053	Acknowledgement that the importation of data records has been started.	–
290054	Acknowledgement that the importation of data records has been completed successfully.	–
290055	Acknowledgement that the importation of data records has been terminated due to errors.	Ensure that the structure of the data records on the data medium and the current recipe structure on the operating unit are identical.
290056	The value in the specified line/column could not be read/written without errors. The action was canceled.	Check the specified line/column.
290057	The tags of the recipe specified have been switched from operating mode “offline” to “online”. Each modification of a tag in this recipe is now immediately transferred to the PLC.	–

Number	Effect/Cause	Remedy
290058	The tags of the recipe specified were switched from operating mode "online" to "offline". Modifications to tags in this recipe are no longer immediately transferred to the PLC but must be transferred there explicitly by means of downloading a data record, if necessary.	–
290059	Acknowledgement that the specified data record has been stored successfully.	–
290060	Check-back message that the data record memory has been successfully erased.	–
290061	Check-back message, that erasing the data record memory was aborted with errors.	–
290068	Request to confirm whether all data records in the recipe should be deleted.	–
290069	Request to confirm whether all data records of all recipes should be deleted.	–
290070	The data record specified is not contained in the import file.	Check the source of the data record number or data record name (constant or tag value).
300000	Process monitoring (e.g. using PDiag or S7-Graph) has been incorrectly programmed: More messages are queued than specified in the technical data of the CPU. No further ALARM_S messages can be managed by the CPU and reported to operating systems.	Change the CPU configuration.
310000	An attempt is being made to print too many protocols simultaneously. Since only one protocol can be printed at a time, the print job is rejected.	Wait until printout of the last active protocol has been concluded. Repeat the print job, if necessary.
310001	An error occurred on triggering the printer. The protocol is either not printed or printed with errors.	Evaluate the additional system message, related to this message, which is also issued. Repeat the print job, if necessary.
320000	The movements have already been indicated by another device. The movements can no longer be served.	Select the movements on the other display units and select the movement screen on the required display unit.
320001	The network is too complex. The defective operands cannot be displayed.	Display the network in AWL.
320002	No diagnostics-capable alarm messages have been selected. The units related to the alarm messages could not be selected.	Select a diagnostics-capable alarm message in the message screen ZP_ALARM.

Number	Effect/Cause	Remedy
320003	No alarm messages exist in respect of the selected unit. No network can be displayed in the detail display.	Select the defective unit in the general view screen.
320004	The required signal statuses could not be read by the PLC. The defective operands cannot be established.	Check the consistency between the configuration on the display unit and the PLC program loaded.
320005	The project contains ProAgent partitions which are not installed. No ProAgent diagnostics can be performed.	In order to run the project, install the ProAgent option packet.
320014	The selected PLC cannot be evaluated for ProAgent. The message display configured with the <i>Evaluate_message_display_fault</i> function could not be found.	Check the parameters of the <i>Evaluate_message_display_fault</i> function.

- 1) The optional parameter %1 at the start of the message may contain an identification for the S7 connection when several S7s are in parallel operation and are connected to diagnostics equipment.
- 2) A WinCC channel provides the message texts via an interface. This text is issued via this message. ProTool/Pro RT has no influence on this texts.
- 3) The specified text comes from the component resources.

Procedure in the case of “internal errors”

Please proceed as follows in the case of all system messages related to “internal errors”:

1. Start up the operating unit again.
2. Download the configuration again.
3. Switch the operating unit off, stop the PLC and then restart both.
4. If the error occurs again, please contact the SIMATIC Customer Support. Make reference to the specified error number and message tags.

ESD Guidelines

What does ESD mean?

Virtually all present-day modules incorporate highly integrated MOS devices or components. For technological reasons, these electronic components are very sensitive to overvoltages and consequently therefore to electrostatic discharge:

These devices are referred to in German as Elektrostatisch Gefährdeten Baulemente/ Baugruppen: “**EGB**”

The more frequent international name is:

“**ESD**” (Electrostatic Sensitive Device)

The following symbol on plates on cabinets, mounting racks or packages draws attention to the use of electrostatic sensitive devices and thus to the contact sensitivity of the assemblies concerned:



ESDs may be destroyed by voltages and energies well below the perception threshold of persons. Voltages of this kind occur as soon as a device or an assembly is touched by a person who is not electrostatically discharged . Devices exposed to such overvoltages cannot immediately be detected as defective in the majority of cases since faulty behavior may occur only after a long period of operation.

Precautions against electrostatic discharge

Most plastics are capable of carrying high charges and it is therefore imperative that they be kept away from sensitive components.

When handling electrostatic sensitive devices, make sure that persons, workplaces and packages are properly grounded.

Handling ESD assemblies

A general rule is that assemblies should be touched only when this cannot be avoided owing to the work that has to be performed on them. Under no circumstances should you handle printed-circuit boards by touching device pins or circuitry.

You should touch devices only if

- you are grounded by permanently wearing an ESD wrist strap or
- you are wearing ESD shoes or ESD shoe-grounding protection straps in conjunction with an ESD floor.

Before you touch an electronic assembly, your body must be discharged. The simplest way of doing this is to touch a conductive, grounded object immediately beforehand – for example, bare metal parts of a cabinet, water pipe etc.

Assemblies should not be brought into contact with charge-susceptible and highly insulating materials such as plastic films, insulating table tops and items of clothing etc. containing synthetic fibers.

Assemblies should be deposited only on conductive surfaces (tables with an ESD coating, conductive ESD cellular material, ESD bags, ESD shipping containers).

Do not place assemblies near visual display units, monitors or television sets (minimum distance to screen > 10 cm).

Measuring and modifying ESD assemblies

Perform measurements on ESD assemblies only when

- the measuring instrument is grounded – for example, by means of a protective conductor – or
- the measuring head has been briefly discharged before measurements are made with a potential-free measuring instrument – for example, by touching a bare metal control cabinet.

When soldering, use only grounded soldering irons.

Shipping ESD assemblies

Always store and ship assemblies and devices in conductive packing – for example, metallized plastic boxes and tin cans.

If packing is not conductive, assemblies must be conductively wrapped before they are packed. You can use, for example, conductive foam rubber, ESD bags, domestic aluminum foil or paper (never use plastic bags or foils).

With assemblies containing fitted batteries, make sure that the conductive packing does not come into contact with or short-circuit battery connectors. If necessary, cover the connectors beforehand with insulating tape or insulating material.

Glossary

A

Acknowledgement

Acknowledgement of an **alarm message** on the operating unit confirms that it has been noted. After acknowledgement, the message disappears from the operating unit. Alarm messages can be acknowledged either on the operating unit or PLC. Alarm messages can be compiled into groups so that several messages can be acknowledged simultaneously.

Acknowledgement groups

During configuration, several alarm messages can be compiled to form an acknowledgement group. After acknowledging the first message, all the other messages belonging to the same group are simultaneously acknowledged. This enables, for example, acknowledgement of alarm messages for the cause of a fault and all resulting faults (**group acknowledgement**).

Alarm message

Provides information on the operating unit concerning operating errors on the machine or system connected to the **PLC**. The message text may also contain current measured values.

Since alarm messages indicate abnormal operating status, they must be acknowledged.

ALARM_S

Active message procedure by which the CPU issued messages to all the registered network participants. ALARM_S messages are configured in STEP 7.

Analog display

A screen object which displays numeric values by means of a pointer instrument.

Archive

A memory area on a data storage medium in which messages or tags can be stored. The size of the archive is defined in ProTool/Pro CS.

Area pointer

Defines a memory area in the **PLC** for data exchange between the PLC and operating unit.

B**Bar graphs**

Represent values from the **PLC** as rectangular areas. This is a way of displaying filling levels or workpiece numbers, for example, on the operating unit.

Baud rate

Rate of speed at which data is downloaded. Baud rate is specified in Bit/s.

Blanking circuit

Switch off or dim the screen back-lighting.

Boot

A loading process which downloads the operating system in the working memory of the operating unit

Buttons

A virtual button on the operating unit screen. Buttons on operating units with touch screens are contact sensitive.

C

Clicking

Configurable **event** which can trigger a function assigned to a button, for example, when the button is pressed and released (clicked) within the contour of the button.

If the button is pressed using the mouse button or finger (when using touch panels) but moved outside the contour before releasing, the operating unit does not interpret the action as a *click* event.

Clock

Screen object which displays the system time either as digits (digitally) or in the form of a clock (analog).

Combo box

Contains a list of entries from which one can be selected on the operating unit.

Configuration

Definition of basic, system-specific settings, messages and screens using the **ProTool CS** configuration software.

D

Data record

A **recipe** containing data. A recipe can be comprised of several data records. When a data record is downloaded, all the assigned data is transferred to the PLC together and synchronously.

Direct key

Buttons can be configured as direct keys in order to achieve fast keyboard operation without any resulting communication-related delays.

Display period

Defines whether and how long a system message is displayed on the operating unit.

Download

The transfer of run-capable project data to the operating unit. Connect the operating unit to the configuration computer with a standard cable beforehand.

Download mode

Operating unit operating mode in which data can be downloaded from the configuration computer to the operating unit (also refer to **Download**).

E**Event**

Functions are triggered by the arrival of defined events. Events can be configured according to the object. Events which can be configured for a button include:

- **Click**
- **Press**
- **Release**

Event message

Provides information on the operating unit concerning the operating statuses of the machine or system connected to the **PLC**. The message text may also contain current measured values.

F**Fixed window**

Window which always appears at the top of the operating unit screen. The content of the fixed window is independent of the screen currently open.

Flash memory

Programmable memory which can be electrically deleted and written to again segment-by-segment.

Function key

Key on the operating unit to which a configurable function can be assigned. A function key with a global function assignment always initiates the same function regardless of the screen currently open. A function key with a local function assignment (**softkey**) can have a different function for each screen.

G

Global tag

This is a process tag linked to the PLC. Global tags have a fixed address in the PLC. The operating unit accesses this address for reading and writing purposes.

Graphic display

This enables the dynamic positioning of graphics created in external graphics programs in a project.

Graphic box

A graphic can be selected by selecting an entry in the graphic list.

Graphics list

A list in which each value relates to a tag assigned to a graphic. This enables, for example, the assigned graphic to be displayed on the operating unit output field instead of the value.

Group acknowledgement

During the configuration, each **alarm message** can be assigned to an **acknowledgement group**. When the alarm message is acknowledged, all the other alarm messages in the same group are simultaneously acknowledged.

H

Half Brightness Life

Time period after which the brightness of the lighting tube only achieves 50% of its original value.

Hardcopy

Represents a printout of the current screen content. Windows called in on top are not printed.

Help text

Configurable, additional information on messages, screens and fields. The help text concerning an alarm message can, for example, contain information on the cause of the fault and methods of elimination.

History trend

After setting a trigger bit that reads all the trend values simultaneously from the PLC, they are displayed as a history trend on the operating unit. History trends are well suited for displaying distinct changes in a trend when the progress of a trend curve is of more interest with regard to its full course (history) than to the individual values.

I

Icon

Pixel graphic of a fixed size, e.g. assigned to a **softkey**, to identify its function.

Input field

Enables the user to enter values which are subsequently downloaded to the **PLC**.

Invisible buttons

Buttons which are only visible during configuration, not on the operating unit. If invisible buttons are superimposed on components in the process screen, the respective components can be operated by clicking the button with the mouse or pressing them on the touch screen.

L

Limit value

Configurable values of a tag defining a value range. Attempts to define values outside these limits, may cause the following effects on the operating unit:

- Input field
input is rejected
- Output field
values are displayed in the configured color
- Trend/Bar
values are displayed in the configured color

Local tag

A tag without a link to the PLC. Local tags are only available on the operating unit.

Logout time

Configurable interval of time after which the password level is reset to zero when the operating unit is not used.

M**Message arrival**

Time at which a message was triggered by the **PLC** or operating unit.

Message buffer

Memory area in the operating unit in which **message events** can be stored in chronological order as they arrive. Event messages and alarm messages are stored in separate message buffers.

Message departure

Time at which a message was withdrawn by the **PLC**.

Message events

These are stored in chronological order in the operating unit message archive. Message events consist of:

- Message arrival
- Message acknowledgement
- Message departure

Message indicator

A configurable graphical symbol displayed on the operating unit when at least one alarm message is present.

Message logging

Printout of messages parallel to their display on the operating unit display.

Message view

A screen object with configurable filter criteria which is used to display the volatile **message buffer** or message archive.

Multi Panel

Multi-purpose, configurable operating unit with graphic display and Windows CE operating system for operating and monitoring machines and systems.

N**Normal operation**

Operating unit operating mode in which messages are displayed and screens can be operated.

O**Object**

Is a component part of a screen or message. Depending on the object type, objects serve to display or enter texts and values on the operating unit.

Operator Panel

Configurable operating unit for operating and monitoring machines and systems. Operation is via buttons.

Output field

Displays current values from the **PLC** on the operating unit.

P**Password**

A character string which must be entered on the operating unit before a protected function can be activated. Each password is assigned to a defined **password level**.

Password level

The rights to use operating units can be specifically restricted to certain users and user groups. To do this, the individual functions and operating elements are assigned to hierarchically defined password levels. The password level linked to the **password** allocates the rights to execute functions on the operating unit belonging to that level or lower.

Password list

A screen object for entering passwords related to different authorization levels.

PCL

Hewlett Packard printer language (**P**rinter **C**ontrol **L**anguage).

PLC

General term for units and systems with which the operating unit communicates (e.g. SIMATIC S7 or PC).

PLC job

PLC jobs can be used by the **PLC** to trigger functions on the operating unit, e.g. display a screen.

Power-up test

Checks the status of the CPU and memory each time the power is switched on.

Press

Configurable **event** which may trigger a function assigned to a button, for example, as the button is pressed.

Print screen

Printout of a copy of the screen contents.

Process screen

The display of process values and process progress on the operating unit in the form of screens, which may contain graphics, texts and values.

Programmable controller

PLC from the SIMATIC S5 series (e.g. AG S5-115U/135U).

Programmable system

PLC from the SIMATIC S7 series (SIMATIC S7-200/300/400).

ProSave

A service tool which provides all the functions which are necessary for the transfer of data between the configuration computer and operating unit.

ProTool

Full-graphic configuration software for configuring text displays, text-based and graphics operator panels as well as units from the Windows CE range, such as TP170/OP170/MP270/MP370.

ProTool CS

General name for the three configuration software variants **ProTool/Pro CS**, **ProTool** and **ProTool/Lite**.

ProTool/Lite

Full-graphic configuration software for configuring text displays and text-based operator panels as well as Windows-based 6" units such as TP170 A.

ProTool/Pro CS

Full-graphic configuration software for configuring the entire SIMATIC HMI product range and Windows-based systems.

Q**Queued messages**

Messages which have been detected as having been received by the operating unit (message event **Arrived**) but for which the message event **Departed** has still not occurred.

R**Recipe**

A combination of tags to a fixed data structure. The data structure configured can be assigned data on the operating unit and is then referred to as a data record. The use of recipes ensures that when a data record is downloaded, all the assigned data is transferred to the PLC together and synchronously.

Recipe view

Screen object to create, edit, store and download **data records**.

Release

Configurable **event**, e.g. for a button, which triggers a function as soon as the pressed button is released.

If the button is pressed using the mouse button or finger (when using touch panels) but moved outside, the function is triggered when the function is released.

Remaining buffer

Configurable size of the message buffer. In the case of a buffer overflow, the operating unit deletes message events until the configured remaining buffer capacity is reached.

RS232

Standard interface for serial data transmission with defined voltage levels. Sender and receiver are electrically connected.

RS485

Standard interface for serial data transmission with very high transmission rates.

Runtime software

The program visualization software SIMATIC ProTool/Pro RT with which the project created using ProTool CS can be run on your Windows-based system.

S**Screen**

A screen displays all the logically related process data on the operating unit, whereby the individual values can be modified. Screens are composed of static and dynamic parts. Static parts refer to text and graphics, dynamic parts to input and output fields.

Screen keyboard

A virtual keyboard which appears on the operating unit screen. This enables values to be entered without a keyboard actually being connected, in the case of a touch panel for example.

Selection field

Contains a list of entries from which one can be selected on the operating unit.

SIMATIC HMI Symbol Library

Comprehensive library containing graphics from the areas of technology and production. Extends the ProTool library.

Slider controls

Screen object for entering and displaying numeric values in analog form.

Softkey

Function key on the operating unit with a local function assignment. The function triggered by a softkey varies according to the screen currently open.

Start screen

The first screen which automatically appears after the operating unit has started up.

State view

The State view is a configurable display element. Depending on the configuration, it can signal a warning or the status of a unit which cannot be viewed from the operating unit.

Status button

A status button is a display and operating element with two possible states: **ON** and **OFF**, i.e. **touched** and **untouched**. Both states can be configured for display with text or graphics, which then label the status button.

Status/Force tag

Screen object which enables direct read and write access from the operating unit to individual address areas in the connected SIMATIC S5 or SIMATIC S7.

STEP 7

Programming software for SIMATIC S7, SIMATIC C7 and SIMATIC WinAC.

Superuser

A user with permissions to trigger functions of the highest **password level**. The superuser has access to all the operating unit functions.

Switch

A screen object for entering and displaying a binary status. A switch can only be in the status on or off .

System message

Provides information on the operating unit concerning internal statuses of the operating unit and **PLC**.

T**Trend curve**

Curve type by which just one curve value is read from the PLC per cycle or trigger resulting in a curve display. If the configured number of measured values is not achieved, each new value overwrites the oldest value. Trend curves are especially suited to displaying continual progress.

Trend curve graphic

A screen object for displaying the continual progress of process data. Several different **trend curves** can be shown in the trend curve display simultaneously.

Trend view

Screen object providing a clear, continuous display of process data. Several different curves can be displayed simultaneously in the trend curve display, e.g. in the form of **trend curves** or **history trends**.

Index

A

- Acknowledge
 - alarm messages, 5-26 , 5-30
 - Key, 4-13
- Acknowledgement
 - acoustic, 1-4 , 4-3 , 8-11 , A-3
 - optical, 4-3
 - to touch operation, 4-3
- Acknowledging, Alarm message, 5-21
- Acknowledgment groups, 2-1
- Acoustic acknowledgement, 1-4 , 4-3 , 8-11 , A-3
- Acoustic signal, 8-11
- Active Sync, 3-23
 - load applications, 3-23
- Air discharge, A-5
- Alarm message buffer, example, 5-28
- Alarm message page, 5-27
- Alarm messages, 5-3 , 5-21 , 5-25
 - acknowledge, 5-26 , 5-30
 - Acknowledging, 5-21
- ALARM_S, 2-1 , 5-24
- Alignment, printer, 8-12
- Alphanumeric input field, 5-9
- Alphanumeric key assignment, 4-13
- Alphanumeric keys, 4-12
- Alphanumeric screen keyboard, 4-6
- ALT, key, 4-14
- Alt Gr level, screen keyboard, 4-6
- Ambient conditions, A-4
- Analog clock, 5-39
- Analog display, 5-8 , 5-38
- Analog/Digital clock, 5-9
- Angle of inclination, 9-2 , A-4
- Application examples, Recipes, 6-4
- Application scenarios, recipes, 6-3
- Apply, Status/Force, 5-45
- Approvals, A-6
- Archive, display data as trend, 5-35
- Archive functions, 7-2
- Archive_tag, function, 7-2
- Archives, 7-1
- Archiving, 2-4
- Area of use, 1-2

- AS511, 2-5
- ASCII character set, Printer, 9-15
- Assignment of interfaces, B-1
- Authorization, 3-19
 - password protection, 5-40
- Automatic downloading, 3-5

B

- Back-lighting
 - off, 8-10
 - Screen, 1-4 , A-2
- Backspace, key, 4-13
- Backup, 3-14
 - CF card, 3-15
 - integrated ProSave, 3-17
 - PC card, 3-15
 - Stand-alone ProSave, 3-17
- Backup battery, 5-13 , 9-7 , 11-2 , A-3
 - Changing, 12-3
- Backup/Restore, memory cards, 3-15
- Bar graph, 5-8
- Bar graphs, 5-32
- Barometric pressure, A-4
- Battery, 5-13 , 11-2 , A-3
 - Changing, 12-3
- Battery connection, 9-7
- Baud rate
 - download mode, 3-7
 - printer, 8-12
- Bit triggering, 5-33
- Blanking, screen, 2-4
- Brightness
 - Screen, 2-4
 - Set, 4-15 , 8-6
- Buffer overflow, Messages, 5-23
- Buffering, Messages, 5-22
- Burst interference, A-5
- Button, 5-7
 - Apply (Status/Force), 5-45
 - Message display, 5-30
 - Messages, 5-26
 - Status/Force, 5-44
 - Update (Status/Force), 5-45

- Buttons
 - hidden, 5-16
 - trend views, 5-34
- Buttons , 5-16
- C**
- C-Tick, A-6
- Cable cross-section, 9-9
- Cables, 9-6
- Calculate, memory requirements, 6-9
- Calendar dates, 5-13
- Calibrate, touch screen, 8-7
- Call
 - help text
 - keyboard unit, 4-18
 - touch panel, 4-5 , 4-6 , 4-7
 - screen, 5-4
- Cancel, Key, 4-13
- Capacity
 - backup battery, A-3
 - memory, 1-4
 - Message buffer, 2-2
- CE conformity approval, A-6
- CF card, 6-7 , 6-15 , 11-3
- Change
 - data record, 6-16
 - Language, 8-2
 - recipe structure, 6-28
- Change structure, recipe, 6-28
- Change window, 5-3
- Change_mode, Function, 8-3
- Changing, Battery, 12-3
- Changing active window, 5-3
- Character set, Printer, 9-15
- Check, Limit value, 5-9
- Circle, 5-7
- Clean, unit, 12-1
- Cleaning agents, 12-1
- Click, event, 5-16
- Clock, 5-9 , 5-39
 - Internal, 11-2
- Close, dialog, 4-16
- Close_archive, function, 7-2
- Color change
 - Input field, 4-16
 - input field, 5-10
 - trend view, 5-33
- Color display, 1-4 , A-2
- Colors, 1-4 , A-2
- Commissioning, 3-1
- Communication, 2-5
- Communication options, 9-8
- Compact Flash Card, 11-4 , A-2
- Compatibility conflict, 3-3 , 3-4 , 13-1
- Compress
 - project file, 3-12
 - PU function, 9-14
 - trend view, 5-34 , 5-35
- Condensation, 9-2
- Conduction, RF, A-5
- Configuration
 - source file, 3-9 , 3-12
 - storage location, 3-9
 - test, 3-10
 - uploading, 3-12
- Configuration computer, Connect, 9-12
- Configuration phase, 1-3
- Configuration software, 1-3 , 1-5
- Configure, Interface IF1B, 9-14
- Confirm input, key, 4-13
- Conflict, compatibility, 3-3 , 3-4 , 13-1
- Connect
 - Configuration computer, 9-12
 - PLC, 9-13
 - Printer, 9-15
- Connecting
 - electrical connections, 9-6
 - Power supply, 9-9
- Connection
 - external keyboard, 9-16
 - mouse, 9-16
 - Status/Force, 5-44
 - to configuration computer, 9-12
 - to external keyboard, 9-16
 - to mouse, 9-16
 - To PLC, 9-13
 - to PLC, 8-3
 - To printer, 9-15
 - UPS, 9-17
- Connections, Electrical, 9-6
- Connector pin-out, B-1
- Contact discharge, A-5
- Contour, 5-16
- Control keys, 4-11
- Conventions, Date/Time, 5-13
- Conversion functions, 2-3
- Convert_Data_Record_Number_to_Name,
 - Function, 6-20
- Copy, data records, 6-15
- Copy data record, selecting a data record
 - name, 6-16
- Copy_archive, function, 7-2

- Copying data records after selecting a data record name, 6-16
- Create
 - data record, 6-14
 - Labeling strips, 10-9
- Cross-section, Power supply, 9-9
- CSV file, 6-25 , 6-26 , 7-1
- CTRL, key, 4-14
- Cursor
 - Key, 4-14
 - keys, 4-12
- Cut-out, installation, A-2
- Cycle triggering, 5-33
- Cyclic archive, 7-3
- Cyclic archiving, 7-2 , 7-3

- D**
- Data, Technical, A-1
- Data record
 - change, 6-16
 - copy, 6-15
 - create, 6-14
 - definition, 6-1 , 6-2
 - downloading, 6-18 , 6-20
 - editing, 6-10
 - import, 6-28
 - memory requirements, 6-9
 - number, 6-8
 - renaming, 6-17
 - save, 6-14
 - save as, 6-17
 - synchronization, 6-18
- Data records
 - deleting, 6-17
 - display, 6-14
 - editing, 6-27
 - export/import, 6-25
 - exporting, 6-27
 - importing, 6-27
 - read from PLC, 6-18
- Data structure, 6-2
- Data type, Status/Force, 5-44
- Data_Record_DAT_to_PLC
 - Function, 6-20
 - function, 6-23
- Data_Record_Display_to_PLC, Function, 6-23
- Data_Record_PLC_to_DAT
 - Function, 6-20
 - function, 6-23
- Data_Record_PLC_to_Display, 6-23
 - Function, 6-20
- Data_Record_PLC_to_Tags, function, 6-20
- Data_Record_Tags_to_PLC, Function, 6-20
- Data_Record_to_Display_PLC, Function, 6-20
- Date, 3-3 , 5-10 , 5-13
 - synchronization, 5-14
- Date/Time, 5-6 , 8-10
- DB number, Status/Force, 5-44
- Decompress, project file, 3-12
- Default settings, printer, 8-12
- Degree of protection, 1-2 , 9-1 , A-2
- Delete
 - data records, 6-17
 - key, 4-13
 - Messages, 5-23
 - messages, 5-23
 - On buffer overflow, 5-23
 - password, 5-42
- Delete_archive, function, 7-2
- Delete_Data_Record, Function, 6-20
- Delete_Data_Record_from_Display, Function, 6-20
- Delete_Data_Record_Memory, Function, 6-20
- Delete_message_buffer, Function, 5-23
- Depth, Installation, A-2
- Device data, display, 8-9
- Dialog, close, 4-16
- Digital/Analog clock, 5-9 , 5-39
- Dim, screen, 8-9
- Dimensions, A-2
 - keyboard unit, 10-6
 - MP 370 12", 10-2
 - MP 370 15", 10-4
- Direct key, 4-2
- Discharge, Static, A-5
- Display, 1-4 , A-2
 - analog, 5-36
 - data records, 6-14
 - date/time, 5-13
 - messages, 5-22
 - numeric values, 5-36 , 5-38
 - set brightness, 8-6
 - time, 5-39
- Display element
 - analog display, 5-38
 - date/time, 5-13
 - digital/analog clock, 5-39
 - message display, 5-29
 - output field, 5-6
 - status button, 5-18

- Display elements
 - bar graphs, 5-32
 - Recipe display, 6-12
 - trend view, 5-33
 - Display fill level, 5-32
 - Display Information Text, function, 4-8
 - Display priorities, Messages, 5-25
 - Display_alarm_message_buffer, Function, 5-28
 - Display_alarm_message_page, Function, 5-27
 - Display_event_message_buffer, Function, 5-28
 - Display_event_message_page, Function, 5-27
 - Display_event_message_window, Function, 5-26
 - DNS server, 8-15
 - Documentation, vii
 - Download
 - Operating mode, 8-3
 - options, 3-7
 - start automatically, 3-5
 - start manually, 3-4
 - TeleService, 1-1
 - Download mode, 3-4 , 4-15
 - Downloading, data records to PLC, 6-18
 - Duration of display, 5-26
 - Dynamic labeling, 5-16
 - Dynamic screen partitions, 5-1
- E**
- Edit
 - data records, 6-10 , 6-27
 - messages, 5-26 , 5-30
 - Electrical connections, 9-6
 - Electrical installation, 9-6
 - Ellipse, 5-7
 - EMC-compatible installation, 9-6
 - Enter
 - alphanumeric values, touch panel, 4-6
 - key, 4-13
 - numeric values, 5-36
 - password, 5-42
 - Enter alphanumeric values, touch panel, 4-6
 - Enter numeric values, touch panel, 4-5
 - Enter symbolic value, 5-11
 - Entering
 - password, 5-40
 - Values, 4-16
 - Entering values, 4-16
 - Entry name, 6-2
 - Equipotential, 9-9
 - ESC/P compatible, 9-15
 - ESD guidelines, D-1
 - Ethernet, 8-15
 - Ethernet interface, 9-7
 - pin assignment, B-2
 - Event
 - click, 5-16
 - message processing, 5-26 , 5-30
 - pressing, 5-16 , 5-18
 - releasing, 5-16 , 5-18
 - status change, 5-18 , 5-20
 - switched off, 5-20
 - switched on, 5-20
 - Event message screen, 5-27
 - Event messages, 5-3 , 5-21 , 5-26
 - Events, 5-16 , 5-18 , 5-20
 - Ex Zone 2/22, A-6
 - Example
 - CSV file, 6-25 , 6-26
 - Date/Time, 5-13
 - Network functions, 8-18
 - password list, 5-42
 - performance (archives), 7-3
 - recipe, 6-2
 - Exchange, Labeling strips, 10-7
 - Exit_runtime, function, 7-4
 - Expand
 - trend view, 5-34
 - trend views, 5-35
 - Expansion, memory, 11-3
 - Export
 - data record, 6-25
 - data records, 6-27
 - password list, 5-43
 - Export_Data_Records
 - Function, 6-20
 - function, 6-23
 - Export_Import_Passwords, function, 5-43
 - External dimensions, A-2
 - External keyboard
 - connection, 9-16
 - operation, 4-19
- F**
- File, Labeling strips, 10-9
 - File format, CSV, 6-25
 - Filter criteria, Message display, 5-29
 - Fixation, 9-2
 - keyboard unit, 9-3
 - touch panel, 9-4 , 9-5

- Fixed window, 5-2
 - Flash memory, 6-7 , 6-15
 - Backup/Restore, 3-14
 - Flashing
 - LED, 4-10
 - messages, 5-25
 - FM Approval, A-6
 - Foil, Labeling strips, 10-9
 - Force, Status/Force, 5-8
 - Force value, 5-45
 - Format
 - archive file, 7-1
 - Date/Time, 5-13
 - Paper, 8-12
 - Status/Force, 5-44
 - Front panel, Thickness, 9-1 , 10-2 , 10-4 , 10-6
 - Front view
 - keyboard unit, 10-6
 - MP 370 12", 10-2
 - MP 370 15", 10-4
 - Function
 - Convert_Data_Record_Number_to_Name, 6-20
 - Copy_archive, 7-2
 - Data_Record_DAT_to_PLC, 6-20
 - Data_Record_Display_to_PLC, 6-20 , 6-23
 - Data_Record_PLC_to_DAT, 6-20
 - Data_Record_PLC_to_Display, 6-20 , 6-23
 - Data_Record_PLC_to_Tags, 6-20
 - Data_Record_Tags_to_PLC, 6-20
 - Delete_Data_Record, 6-20
 - Delete_Data_Record_from_Display, 6-20
 - Delete_Data_Record_Memory, 6-20
 - Export_Data_Records, 6-20
 - Load_Data_Record, 6-20
 - Recipe_Tags_Online_Offline, 6-20
 - Save_As_Data_Record_From_Display, 6-20
 - Save_Data_Record, 6-20
 - Save_Data_Record_from_Display, 6-20
 - Synchronize_Data_Record_in_Display, 6-20
 - Function keys, 1-4 , 4-9
 - Label, 10-7
 - LED, 4-10
 - Functionality, 2-1
 - Functions
 - Archive_tag, 7-2
 - Change_mode, 8-3
 - Close_archive, 7-2
 - Connect_Disconnect_PLC, 5-24
 - Data_Record_DAT_to_PLC, 6-23
 - Data_Record_PLC_to_DAT, 6-23
 - Delete_archive, 7-2
 - Delete_message_buffer, 5-23
 - Display Information Text, 4-8
 - Display_alarm_message_buffer, 5-28
 - Display_alarm_message_page, 5-27
 - Display_event_message_buffer, 5-28
 - Display_event_message_page, 5-27
 - Display_event_message_window, 5-26
 - Exit_runtime, 7-4
 - Export_Data_Records, 6-23 , 6-25 , 6-27
 - Export_Import_Passwords, 5-43
 - Go_to_End, 4-7
 - Go_to_Home, 4-7
 - Import_Data_Records, 6-20 , 6-23 , 6-25 , 6-27
 - Language, 8-2
 - Login_user, 5-5
 - Logoff_user, 5-5 , 5-41
 - Open_archive, 7-2
 - Page_Down, 4-7
 - Page_Up, 4-7
 - read line, 5-33
 - Start Screen Keyboard, 4-4
 - Start_archive, 7-2
 - Start_sequence_archive, 7-2
 - Stop_archive, 7-2
 - Trend_view_read_mark_backward, 5-33
 - Trend_view_read_mark_forward, 5-33
 - Trend_view_read_mark_on_off, 5-33
 - Use_Screen_Keyboard_On/Off, 4-4
 - Fuse, A-3
 - FWD files, 3-12
- G**
- General information, keyboard units , 4-8
 - General operation, touch panel, 4-2
 - global function keys, 4-9

Go_to_End, function, 4-7
 Go_to_Home, function, 4-7
 Graphic, 5-6
 Graphic box, 5-7 , 5-15
 Graphic display, 5-6
 Graphics list, 5-7
 Grounding, 9-6
 Grounding connection, 9-6 , 9-7
 Grounding screw, 9-6
 Group acknowledgement, 2-1 , 4-13
 Guidelines, EEC, A-5

H

Hardcopy, 2-2
 Hardware Options, 11-2
 Hazardous area, A-6
 Help text, 2-3
 call, keyboard unit, 4-18
 call in, touch panel, 4-5 , 4-6 , 4-7
 Display (key), 4-13
 messages, 5-26 , 5-30
 Hidden buttons, 5-8 , 5-16
 Hide, screen keyboard, 4-5 , 4-6
 Hierarchy, Password, 5-40
 HMI system messages, C-1
 Language, C-1
 Home position, Status button, 5-18
 Housing, A-2
 Humidity, A-4

I

Icon, 4-9
 Icons, 5-2
 IF1A interface, assignment, B-1
 IF1B interface, assignment, B-1
 IF2 interface, assignment, B-2
 Import
 data record, 6-25
 data records, 6-27
 password list, 5-43
 Import_Data_Records, function, 6-20 , 6-23
 Increase, Brightness, 8-6
 Initial startup, 3-3
 Initial value, tags, 6-28
 Input, numeric values, touch panel, 4-5
 Input field, 5-6 , 5-9
 Insert, key, 4-13

Installation, 9-1
 Configuration computer, 9-12
 electrical, 9-6
 external keyboard, 9-16
 in 19, 9-2
 keyboard unit, 9-2
 keyboard units, 9-3
 mechanical, 9-1
 mouse, 9-16
 PLC, 9-13
 Printer, 9-15
 touch panel, 9-4
 Installation conditions, 9-1
 Installation cut-out
 keyboard unit, 10-6
 MP 370 12", 10-2
 MP 370 15", 10-4
 Installation dimensions, 19" cabinets, 9-2
 Installation location, 1-2 , 9-1
 Interface assignment, B-1
 Interfaces, 1-4
 Configure IF1B, 9-14
 IF1A, 9-13
 IF1B, 9-13
 IF2, 9-12
 Interference-free, 9-6
 Internet Explorer, 11-5
 Interrupt
 trend views, 5-35
 trends, 5-34
 Introduction, 1-1
 Irradiation, RF, A-5
 Isolation, Electrical, 9-9

K

Key, Status button, 5-18
 Key combinations, 4-14
 Keyboard, 1-4 , A-3
 connection, 9-16
 Keyboard layout, 4-19 , 9-17
 Keyboard levels, 4-6
 Keyboard unit operation, 4-8
 Keypads, 4-8

L

Labeling
 buttons, 5-16
 Function keys, 10-7
Labeling strips, 9-2
 Exchange, 10-7
Landscape, printer, 8-12
Language
 Function, 8-2
 Set, 8-2
 System messages, C-1
Language change, 2-4 , 8-2
Language setting, 8-11
Language-dependent objects, 8-2
LCD type, A-2
LED, 4-18
 Acknowledge, 4-13 , 5-21
 Help text, 4-13
 Shift, 4-13
LED assignment, 4-10
LEDs, function keys, 4-10
Length, message text, 2-1
Level, Password, 5-40
License transfer (authorization)
 integrated ProSave, 3-20
 ProSave, 3-19
 Stand-alone ProSave, 3-19
Limit value check, 5-9
Limit value monitoring, 2-3
Limit values, trend view, 5-33
Line, 5-7
List, passwords, 5-40
Literature, vii , 1-5
Lithium battery, A-3
 Warning note, 12-4
Load, project data, 3-3
Load application, 3-21
 ProSave, 3-21
 Stand-alone ProSave, 3-21
Load applications
 Active Sync, 3-23
 integrated ProSave, 3-22
Load_Data_Record, function, 6-20
Local function keys, 4-9
Location, A-4
Log on, 5-41
Logging off, 5-41
Login, 5-5 , 5-41
Logoff, 5-5
Logoff_user, Function, 5-5 , 5-41
Logout, 5-41

Logout time, 5-5 , 5-41
Low-voltage, 9-9

M

Maintenance, 12-1
Management, passwords, 5-42
Manual download, 3-4
Margin, printer, 8-12
Mark, all, 4-15
Marking, Input field, 4-16
Maximum value, bar graph, 5-32
Mechanical installation, 9-1
Membrane keyboard, 1-4 , A-3
Memory, 1-4 , A-2
Memory card, 6-7 , 6-15 , 11-3
 backup/restore, 3-15
Memory extension, 1-5
Memory location, archive files, 7-2
Memory requirements, data records, 6-9
Menu bar, activate, 4-16
Message acquisition, 2-2
Message archive, 5-22
Message buffer, 2-2 , 5-22 , 5-28
 archive, 2-2
Message categories, 5-21 , 5-30
Message display, 5-29
 single, 5-31
Message editing, event, 5-26 , 5-30
Message events, 2-2 , 5-22
Message indicator, 5-2
Message line, 5-22 , 5-25
Message logging, 2-1 , 5-23
Message number, C-1
Message page, 5-22 , 5-27
Message view, 5-8 , 5-22
 simple, 5-8
Message window, 5-3 , 5-22 , 5-25
Messages, 5-21
 acknowledge, 5-26 , 5-30
 buffering, 5-22
 Delete, 5-23
 display, 5-22
 edit, 5-26 , 5-30
 functional range, 2-1
 HMI system messages, C-1
 Print, 5-23
Minimum value, bar graph, 5-32
Modal dialogs, 3-5
Mode, printer, 8-12
Mounting cut-out, A-2

Mounting depth, A-2
 Mouse
 connection, 9-16
 operation, 4-19
 Mouse pointer, 4-19
 MPI address, download mode, 3-7
 MPI transfer, 3-8
 Multi Panel, 1-1
 Multifunctional platform, 1-1

N

Navigation
 buttons, 4-7
 operating system, 4-15
 trend views, 5-34
 Network connection, A-3
 NITP, 2-5
 Noise immunity, A-5
 non-return pointer, 5-38
 Normal level, screen keyboard, 4-6
 Number
 colors (display), A-2
 data records, 2-4
 data records per recipe, 6-8
 fields per screen, 2-2
 graphic lists, 2-4
 HMI system message, C-1
 languages, 2-4
 messages, 2-1
 passwords, 2-4
 Recipes, 2-4
 recipes, 6-8
 screens, 2-2
 scripts, 2-4
 tags per screen, 2-2
 text lists, 2-4
 Numeric input field, 5-9
 Numeric key assignment, 4-13
 Numeric screen keyboard, 4-5

O

Offline
 editing data records, 6-21
 Operating mode, 8-3
 operating mode, 3-10
 tags, 6-7
 Offset, Status/Force, 5-44

Online
 editing data records, 6-21
 Operating mode, 8-3
 operating mode, 3-11

Open
 screen, 5-4
 selection fields, 4-15
 Start menu, 4-15
 tab control, 4-16
 Task Manager, 4-15

Open_archive, function, 7-2
 Operand, Status/Force, 5-44
 Operating
 screens, 5-1
 screens and screen objects, 5-1

Operating element
 graphic box, 5-15
 selection fields, 5-11
 slider control, 5-36
 status button, 5-18
 switch, 5-20

Operating elements
 buttons , 5-16
 date/time, 5-13
 recipe view, 6-12

Operating mode
 Download, 8-3
 Offline, 8-3
 Online, 8-3
 Setting, 8-3

Operating system, 1-4 , A-2
 navigation, 4-15
 update, 13-1

operating system, 1-1

Operation
 keyboard unit, 4-8
 touch elements, 4-2
 touch panel, 4-2
 unauthorized, 5-5 , 5-40

Operation acknowledgement, 4-3 , 5-16
 Operator prompting, 2-3
 Optical acknowledgement, 4-3
 Optimize, brightness, 8-6
 Option OP, 8-6
 Options, 11-1
 Backup battery, 11-2
 CF card, 11-3
 memory card, 11-3
 PC card, 11-3
 Output field, 5-6

Overheating, 9-2
 Overview, 1-4

P

Page_Down, function, 4-7
 Page_Up, function, 4-7
 Paper size, 8-12
 Parameters, system messages, C-1
 Password
 delete, 5-42
 management, 5-42
 set up, 5-42
 Password hierarchy, 5-40
 Password level, 5-40
 Password list, 5-8 , 5-40
 view, 5-42
 password list, export/import, 5-43
 Password protection, 2-4 , 5-5 , 5-40
 Passwords
 entry, 5-10
 import/export, 5-43
 number of, 2-4
 Path specification, project file, 3-9
 PC, Connecting, 9-12
 PC card, 6-7 , 6-15 , 11-3 , 11-4 , A-2
 PCL compatible, 9-15
 PDB file, 3-12
 PDZ file, 3-12
 PELV-Standard, 9-9
 Performance, archives, 7-3
 Performance features
 MP 370, 1-4
 Multi Panels, 1-1
 Pin array, 9-9
 Pin assignment, B-1
 Plan view
 MP 370 12", 10-2
 MP 370 15", 10-4
 Plan view|, keyboard unit, 10-6
 PLC, Connect, 9-13
 PLC jobs, 5-14 , 6-24
 Plug connections, 9-6
 Pointer instrument, 5-38
 Polygon, 5-7
 Polyline, 5-7
 Port, printer, 8-12
 Portrait, printer, 8-12
 Positioning, 6-21
 Power cables, 9-6
 Power consumption, A-3
 Power supply, 9-7 , 9-9 , A-3

Power supply unit, 9-9
 Press, event, 5-16 , 5-18
 Print, Messages, 5-23
 Print functions, 2-4
 Print quality, set, 8-12
 Printer
 Connect, 9-15
 Set, 8-11
 Process running phase, 1-3
 Processor type, 1-4 , A-2
 Product category, 1-1
 PROFIBUS-DP, 2-5 , 9-13
 Profiles, 9-2
 Programming voltage, 11-4
 Project data, load, 3-3
 ProSave, 3-24
 Backup/Restore, 3-16
 License transfer (authorization), 3-19
 load application, 3-21
 Protection
 password, 5-40
 passwords, 5-5
 ProTool CS, 1-3
 PTUpdate, utility program, 13-5
 PU, Connecting, 9-12
 PU functions, 2-4
 PU interface, 9-13
 Pulse modulation, A-5
 Purpose of recipes, 6-1

Q

Quality, graphics printout, 8-12
 Quick selection of data records, 6-14

R

Radio interference, A-5
 Radio interference level, A-5
 Range, printer, 8-12
 Rated voltage, A-3
 Read, data record from PLC, 6-18
 Read line
 backwards, 5-35
 forwards, 5-35
 functions, 5-33
 on/off, 5-35
 Realtime trend, 5-33
 Recipe functions
 return values, 6-23
 Status message, 6-23

- Recipe screens, 6-19
 - Recipe view, 5-8 , 6-11 , 6-19
 - display, 6-11
 - operating elements, 6-12
 - Recipe_Tags_Online_Offline, Function, 6-20
 - Recipes, 2-4 , 6-1
 - Application examples, 6-4
 - Application scenarios, 6-3
 - change structure, 6-28
 - configuring, 6-7
 - data flow, 6-3
 - definition, 6-1 , 6-2
 - example, 6-2
 - name, 6-7
 - number, 6-8
 - overview, 6-1
 - Use, 6-3
 - Recommissioning, 3-4
 - Rectangle, 5-7
 - Reduce, Brightness, 8-6
 - Relative humidity, A-4
 - Releasing, event, 5-16 , 5-18
 - Remaining capacity, Message buffer, 5-23
 - Remove, memory card, 7-4
 - Renaming, data records, 6-17
 - Reset, Password level, 5-41
 - Resolution, Display, 1-4 , A-2
 - Restore, 3-14
 - CF card, 3-16
 - integrated ProSave, 3-18
 - PC card, 3-16
 - Stand-alone ProSave, 3-18
 - Return values, Recipe functions, 6-23
 - Reverse battery protection, 9-8
 - RF conduction, A-5
 - RF irradiation, A-5
 - RJ45 connector, B-2
 - RTS signal, 9-14
 - Runtime software, 3-9
 - load, 3-3
- S**
- Save, data record, 6-14
 - Save_As_Data_Record_From_Display, Function, 6-20
 - Save_Data_Record, function, 6-20
 - Save_Data_Record_from_Display, Functions, 6-20
 - Scheduler, 2-4
 - Screen, A-2
 - brightness, 4-15
 - operation, 5-1
 - selection, 5-4
 - set brightness, 8-6
 - settings, 2-4
 - Screen change, 4-10
 - Screen diagonal, 1-4
 - Screen keyboard, 4-3
 - alphanumeric, 4-6
 - MP 370, 4-17
 - numeric, 4-5
 - set, 8-11
 - Screen objects, 2-2 , 2-3
 - operation, 5-1
 - Overview, 5-6
 - Screen partitions, 5-1
 - Screen saver, 8-9
 - Screens, operation, 5-1
 - Screensaver, 8-9
 - Screw-type clamp, 9-4 , 9-5
 - Screw-type clamps, 9-3
 - Scripts, 2-4
 - Scroll, key, 4-14
 - Scroll back, key, 4-14
 - Scroll forward, key, 4-14
 - Scrolling, trend views, 5-34 , 5-35
 - Seal, 9-1 , 9-3 , 9-5
 - Section
 - enlarge (trend views), 5-35
 - zoom In (trend curve display), 5-34
 - zoom out (trend view), 5-34 , 5-35
 - Select, screen, 5-4
 - Selection field, 5-6 , 5-11
 - Selection fields, open, 4-15
 - Selection list, 5-11
 - SELV-Standard, 9-9
 - Separator , 6-25
 - Sequence archive, 7-3
 - Serial printer, 9-15
 - Serial zero modem cable, 13-5
 - Service life, Backup battery, 12-3

- Set up
 - network, 8-15
 - Password, 5-42
 - Printer, 8-11
- Setting, Brightness, 4-15 , 8-6
- Settings
 - Brightness, 8-6
 - brightness, 8-6
 - communication, 8-10
 - contrast, 8-6
 - Date/Time, 8-10
 - date/time, 5-13
 - Language, 8-2
 - language-specific, 8-11
 - network, 8-10
 - Operating mode, 8-3
 - Printer, 8-11
 - save, 8-8
 - screen keyboard, 8-11
 - system, 8-1
 - touch calibration, 8-6 , 8-7
 - volume, 8-11
 - Windows CE Control Panel, 8-4
- Shift
 - Active window, 5-3
 - key, 4-13 , 4-14
- Shift + Alt Gr level, screen keyboard, 4-6
- Shift level, screen keyboard, 4-6
- Shock loading, A-4
- Side view
 - keyboard unit, 10-6
 - MP 370 12", 10-2
 - MP 370 15", 10-4
- Signal lines, 9-6
- SIMATIC 505, 2-5
- SIMATIC diagnostic events, 5-23
- SIMATIC HMI Documentation, vii
- SIMATIC HMI Symbol Library, 5-9 , 5-46
- SIMATIC S5, 2-5
- SIMATIC S7-200, 2-5
- SIMATIC S7-300/400, 2-5
- Simple Message view, 5-8
- Single message display, 5-31
- Size, paper, 8-12
- Slider control, 5-8 , 5-36
- Slot A, 11-3
- Slot B, 11-3
- Softkeys, 1-4 , 4-9
- Software, A-2
- Software Option, 11-5
- Sorting
 - Message buffer, 5-28
 - Message page, 5-27
 - password list, 5-42
- Source file
 - storage location, 3-9
 - uploading, 3-12
- Special character, key, 4-14
- Spreadsheet program, 6-25
- Square, 5-7
- Standard cable, 9-12
- Standards, A-5
- Start, update trend view, 5-34
- Start menu, 3-6
- Start screen, 3-3
- Start Screen Keyboard, function, 4-4
- Start_archive, Function, 7-2
- Start_sequence_archive, function, 7-2
- State view, 5-7
- Static discharge, A-5
- Static screen partitions, 5-1
- Status button, 5-7 , 5-18
- Status change, event, 5-18 , 5-20
- Status message, Recipe functions, 6-23
- Status value, 5-44
- Status/Force, 5-8 , 5-44
- Stop, update trend view, 5-34
- Stop_archive, Function, 7-2
- Storage location
 - archive files, 7-2
 - data records, 6-7 , 6-15
 - project file, 3-9
 - runtime software, 3-9
- Storage media, 11-3 , A-2
- Storage medium, source file, 3-9
- Structure of the documentation, vii
- Sub-D plug, B-2
- Sub-D socket, B-1
- Sunlight, 9-2
- Superuser, 5-40
- Supply source, Backup battery, 12-3
- Surge coupling, A-5
- Switch, 5-7 , 5-20
 - for interface IF1B, 9-14
 - Status button, 5-18
- Switch off
 - back-lighting, 8-9
 - voltage supply, 11-4
- Switch setting, interface IF1B, 9-14
- Switched off, event, 5-20

Switched on, event, 5-20
 Symbol Library, 5-46
 Symbolic output field, 5-6
 Symbolic value, entry, 5-11
 Synchronization
 data records, 6-8
 date/time, 5-14
 Synchronize, data record, 6-18
 Synchronize_Data_Record_in_Display,
 Function, 6-20
 System keys, 1-4 , 4-8 , 4-11
 System limits, 6-8
 System messages, 5-3 , 5-21 , 5-26
 System Settings, 8-1

T

Tabulator, Key, 4-13
 Tags
 initial value, 6-28
 offline, 6-7
 synchronizing, 6-7
 Target groups, vii
 Task Manager, 4-15
 Technical Data, A-1
 TeleService, 1-1
 Terminal block, 9-9
 Test
 configuration, 3-10
 network, 8-17
 Text, 5-6
 Text editor, 6-25
 Thickness, Front panel, 9-1 , 10-2 , 10-4 , 10-6
 Time, 3-3 , 5-10 , 5-13
 synchronization, 5-14
 Time specification
 Date/Time, 5-39
 date/time, 5-13
 Time stamp, 5-27 , 5-28
 Time/Date, 5-6 , 8-10
 Tips on recipe views, 6-14
 Torque, 9-3 , 9-5
 Touch elements, operation, 4-2
 Touch panel operation, 4-2
 Touch screen, calibrate, 8-7
 Transients, A-3
 Trend type, 5-33
 Trend view, 5-8 , 5-33
 uncertain status, 5-33
 Trend_view_read_mark_forward, functions,
 5-33

Trend_view_read_mark_on_off, functions, 5-33
 Triggering, Trends, 5-33

U

UL Approval, A-6
 UL approval, A-6
 Unauthorized use, 5-5 , 5-40
 Uncertain status, trend view, 5-33
 Unit dimensions
 keyboard unit, 10-6
 MP 370 12", 10-2
 MP 370 15", 10-4
 Update
 date/time, 3-3 , 5-13
 operating system, 13-1
 Status/Force, 5-45
 trend view, 5-34
 Upkeep, 12-1
 Uploading, 3-12
 uploading, 3-12
 UPS, 8-13
 USB interface, 9-16
 assignment, B-2
 USB keyboard, 4-4 , 4-19
 USB mouse, 4-19
 Use, Recipes, 6-3
 Use_Screen_Keyboard_On/Off, functions, 4-4
 Utility program, PTUpdate, 13-5

V

VB Script, 2-4
 Vector graphics, 5-7
 Ventilation slits, 9-2
 Vibration, A-4
 View, password list, 5-42
 Virtual key, 5-16

W

Weight, A-2
 Windows CE, 1-1 , 8-4 , A-2
 Windows CE Control Panel, 8-4
 WINS server, 8-15
 Writing, data records to PLC, 6-18

Z

Zero modem cable, 13-5

Zoom

- trend view, 5-34

- trend views, 5-35

Zoom in, trend view, 5-34

Zoom out

- trend display, 5-33

- trend view, 5-34 , 5-35

