

SIEMENS

Ingenuity for life

Industry Online Support

Home

Programming Guideline for S7-1200/1500

TIA Portal

<https://support.industry.siemens.com/cs/ww/en/view/81318674>

Siemens
Industry
Online
Support



Legal information

Use of application examples

Application examples illustrate the solution of automation tasks through an interaction of several components in the form of text, graphics and/or software modules. The application examples are a free service by Siemens AG and/or a subsidiary of Siemens AG ("Siemens"). They are non-binding and make no claim to completeness or functionality regarding configuration and equipment. The application examples merely offer help with typical tasks; they do not constitute customer-specific solutions. You yourself are responsible for the proper and safe operation of the products in accordance with applicable regulations and must also check the function of the respective application example and customize it for your system.

Siemens grants you the non-exclusive, non-sublicensable and non-transferable right to have the application examples used by technically trained personnel. Any change to the application examples is your responsibility. Sharing the application examples with third parties or copying the application examples or excerpts thereof is permitted only in combination with your own products. The application examples are not required to undergo the customary tests and quality inspections of a chargeable product; they may have functional and performance defects as well as errors. It is your responsibility to use them in such a manner that any malfunctions that may occur do not result in property damage or injury to persons.

Disclaimer of liability

Siemens shall not assume any liability, for any legal reason whatsoever, including, without limitation, liability for the usability, availability, completeness and freedom from defects of the application examples as well as for related information, configuration and performance data and any damage caused thereby. This shall not apply in cases of mandatory liability, for example under the German Product Liability Act, or in cases of intent, gross negligence, or culpable loss of life, bodily injury or damage to health, non-compliance with a guarantee, fraudulent non-disclosure of a defect, or culpable breach of material contractual obligations. Claims for damages arising from a breach of material contractual obligations shall however be limited to the foreseeable damage typical of the type of agreement, unless liability arises from intent or gross negligence or is based on loss of life, bodily injury or damage to health. The foregoing provisions do not imply any change in the burden of proof to your detriment. You shall indemnify Siemens against existing or future claims of third parties in this connection except where Siemens is mandatorily liable.

By using the application examples you acknowledge that Siemens cannot be held liable for any damage beyond the liability provisions described.

Other information

Siemens reserves the right to make changes to the application examples at any time without notice. In case of discrepancies between the suggestions in the application examples and other Siemens publications such as catalogs, the content of the other documentation shall have precedence.

The Siemens terms of use (<https://support.industry.siemens.com>) shall also apply.

Security information

Siemens provides products and solutions with industrial security functions that support the secure operation of plants, systems, machines and networks.

In order to protect plants, systems, machines and networks against cyber threats, it is necessary to implement – and continuously maintain – a holistic, state-of-the-art industrial security concept. Siemens' products and solutions constitute one element of such a concept.

Customers are responsible for preventing unauthorized access to their plants, systems, machines and networks. Such systems, machines and components should only be connected to an enterprise network or the Internet if and to the extent such a connection is necessary and only when appropriate security measures (e.g. firewalls and/or network segmentation) are in place. For additional information on industrial security measures that may be implemented, please visit <https://www.siemens.com/industrialsecurity>.

Siemens' products and solutions undergo continuous development to make them more secure. Siemens strongly recommends that product updates are applied as soon as they are available and that the latest product versions are used. Use of product versions that are no longer supported, and failure to apply the latest updates may increase customer's exposure to cyber threats.

To stay informed about product updates, subscribe to the Siemens Industrial Security RSS Feed at: <https://www.siemens.com/industrialsecurity>.

Table of Contents

	Legal information	2
1	Preface	6
2	S7-1200/S7-1500 innovations	8
2.1	Introduction	8
2.2	Terms	8
2.3	Programming languages	11
2.4	Optimized machine code	11
2.5	Block creation	12
2.6	Optimized blocks	13
2.6.1	S7-1200: Structure of optimized blocks	13
2.6.2	S7-1500: Structure of optimized blocks	14
2.6.3	Processor-optimized data storage for S7-1500	15
2.6.4	Conversion between optimized and non-optimized tags	18
2.6.5	Parameter transfer between blocks with optimized and non-optimized access	19
2.6.6	Communication with optimized data	20
2.7	Block properties	21
2.7.1	Block sizes	21
2.7.2	Number of organization blocks (OB)	21
2.7.3	Block interface – hide block parameters (V14 or higher)	22
2.8	New data types for S7-1200/1500	23
2.8.1	Elementary data types	23
2.8.2	Data type Date_Time_Long	24
2.8.3	Other time data types	24
2.8.4	Unicode data types	25
2.8.5	Data type VARIANT (S7-1500 and S7-1200 from FW4.1)	26
2.9	Instructions	29
2.9.1	MOVE instructions	29
2.9.2	VARIANT instructions (S7-1500 and S7-1200 FW4.1 and higher)	31
2.9.3	RUNTIME	32
2.9.4	Comparison of tags from PLC data types (V14 or higher)	33
2.9.5	Multiple assignment (V14 or higher)	34
2.10	Symbolic and comments	35
2.10.1	Programming editor	35
2.10.2	Comment lines in watch tables	36
2.11	System constants	37
2.12	User constants	38
2.13	Internal reference ID for controller and HMI tags	39
2.14	STOP mode in the event of errors	41
3	General programming	42
3.1	Operating system and user program	42
3.2	Program blocks	42
3.2.1	Organization blocks (OB)	43
3.2.2	Functions (FC)	45
3.2.3	Function blocks (FB)	47
3.2.4	Instances	48
3.2.5	Multi-instances	49
3.2.6	Transferring instance as parameters (V14)	51
3.2.7	Global data blocks (DB)	52
3.2.8	Downloading without reinitialisation	53
3.2.9	Reusability of blocks	57
3.2.10	Auto numbering of blocks	58

3.3	Block interface types	59
3.3.1	Call-by-value	59
3.3.2	Call-by-reference	59
3.3.3	Overview for transfer of parameters.....	60
3.4	Memory concept.....	60
3.4.1	Block interfaces as data exchange	60
3.4.2	Global memory	61
3.4.3	Local memory.....	62
3.4.4	Access speed of memory areas	63
3.5	Retentivity.....	64
3.6	Symbolic addressing	67
3.6.1	Symbolic instead of absolute addressing.....	67
3.6.2	ARRAY data type and indirect field accesses.....	69
3.6.3	Formal parameter Array [*] (V14 or higher).....	71
3.6.4	STRUCT data type and PLC data types	72
3.6.5	Access to I/O areas with PLC data types.....	75
3.6.6	Slice access	76
3.6.7	SCL networks in LAD and FBD (V14 and higher)	77
3.7	Libraries.....	78
3.7.1	Types of libraries and library elements	79
3.7.2	Type concept.....	80
3.7.3	Differences between the typifiable objects for CPU and HMI	81
3.7.4	Versioning of a block.....	81
3.8	Increased performance for hardware interrupts	86
3.9	Additional performance recommendations.....	88
3.10	SCL programming language: Tips and Tricks.....	89
3.10.1	Using call templates	89
3.10.2	What instruction parameters are mandatory?	90
3.10.3	Drag-and-drop with entire tag names.....	90
3.10.4	Structuring with the keyword REGION (V14 or higher).....	91
3.10.5	Correct use of FOR, REPEAT and WHILE loops	92
3.10.6	Using CASE instruction efficiently	93
3.10.7	No manipulation of loop counters for FOR loop	93
3.10.8	FOR loop backwards.....	94
3.10.9	Easy creation of instances for calls	94
3.10.10	Handling of time tags.....	94
3.10.11	Unnecessary IF instruction.....	96
4	Hardware-independent programming	97
4.1	Data types of S7-300/400 and S7-1200/1500.....	97
4.2	No bit memory but global data blocks	99
4.3	Programming of "Cycle bits"	99
5	STEP 7 Safety in the TIA Portal	100
5.1	Introduction.....	100
5.2	Terms	101
5.3	Components of the safety program	102
5.4	F-runtime group.....	103
5.5	F signature	103
5.6	Assigning the PROFIsafe address at the F-I/O.....	105
5.7	Evaluation of F-I/O	105
5.8	Value status (S7-1200F/1500F)	106
5.9	Data types	107
5.9.1	Overview.....	107
5.9.2	Implicit conversion	107
5.10	F-conform PLC data type	109
5.11	TRUE / FALSE	111
5.12	Optimizing the compilation and program runtime	112

Table of Contents

5.12.1	Avoiding of time-processing blocks: TP, TON, TOF	113
5.12.2	Avoiding deep call hierarchies	113
5.12.3	Avoiding JMP/Label structures.....	113
5.13	Data exchange between standard program and F program	114
5.14	Testing the safety program.....	115
5.15	STOP mode in the event of F errors	116
5.16	Migration of safety programs.....	116
5.17	General recommendations for safety.....	116
6	Automatically generate visualization using the user program	117
6.1	Introduction.....	117
6.2	How automatic generation works	118
6.3	Controlling the HMI generator	119
6.3.1	Using network comments for control.....	119
6.3.2	Using SiVArc variables for control.....	120
6.4	Additional recommendations.....	121
7	The most important recommendations	122
8	Appendix	123
8.1	Service and support	123
8.2	Links and literature	124
8.3	Change documentation	125

1 Preface

Objective for the development of the new SIMATIC controller generation

- An engineering framework for all automation components (controller, HMI, drives, etc.)
- Uniform programming
- Increased performance
- Complete set of command for every language
- Fully symbolic program generation
- Data handling also without pointer
- Reusability of created blocks

Objective of the guideline

The new controller generation SIMATIC S7-1200 and S7-1500 has an up-to-date system architecture, and together with the TIA Portal offers new and efficient options of programming and configuration. It is no longer the resources of the controller (e.g. data storage in the memory) that are paramount but the actual automation solution itself.

This document gives you many recommendations and notes on optimal programming of S7-1200/1500 controllers. Some differences in the system architecture of the S7-300/400, as well as the thus connected new programming options are explained in an easy to understand way. This helps you to create standardized and optimal programming of your automation solutions.

The examples described can be universally used for the controllers S7-1200 and S7-1500.

Core contents of this programming guideline

The following key issues on the TIA Portal are dealt with in this document:

- S7-1200/1500 innovations
 - Programming languages
 - Optimized blocks
 - Data types and instructions
- Recommendations on general programming
 - Operating system and user program
 - Memory concept
 - Symbolic addressing
 - Libraries
- Recommendations on hardware-independent programming
- Recommendations on STEP 7 Safety in TIA Portal
- Overview of the most important recommendations

Advantages and benefits

Numerous advantages result from applying these recommendations and tips:

- Powerful user program
- Clear program structures
- Intuitive and effective programming solutions

Further information

When programming SIMATIC controllers, the task of the programmer is to create as clear and readable a user program as possible. Each user uses their own strategy, for example, how to name tags or blocks or the way of commenting. The different philosophies of the programmers create very different user programs that can only be interpreted by the respective programmer.

The programming style guide offers you coordinated set of rules for consistent programming. These specifications for example describe a uniform assignment of tags and block names right up to clear programming in SCL.

You can use these rules and recommendations freely; they serve as a suggestion (not a standard in programming) for consistent programming.

Note

The programming style guide for S7-1200 and S7-1500 can be found at the following link:

<https://support.industry.siemens.com/cs/ww/en/view/81318674>

2 S7-1200/S7-1500 innovations

2.1 Introduction

In general, the programming of the SIMATIC controllers from S7-300/400 to S7-1500 has stayed the same. There are the known programming languages such as LAD, FBD, STL, SCL or graph and blocks such as organization blocks (OBs), function blocks (FBs), functions (FCs) or data blocks (DBs). S7-300/400 programs created can be easily implemented on S7-1500 and existing LAD, FBD and SCL programs can be easily implemented on S7-1200 controllers.

In addition, there are many innovations that facilitate programming for you and enables powerful and memory-saving code.

For programs that are implemented for S7-1200/1500 controllers, we recommend not to implement them one-to-one, but also to check new options and if possible, to use them. The extra effort is often limited and you will receive a program code that is, for example,

- optimal for memory and runtime for the new CPUs,
- easier to understand,
- and easier to maintain.

Note

Information for the migration of S7-300/S7-400 to S7-1500 can be found in the following entry:

<https://support.industry.siemens.com/cs/ww/en/view/109478811>

2.2 Terms

General terms in the TIA Portal

Some terms have change to enable easier handling with the TIA Portal.

Figure 2-1: New terms in the TIA Portal

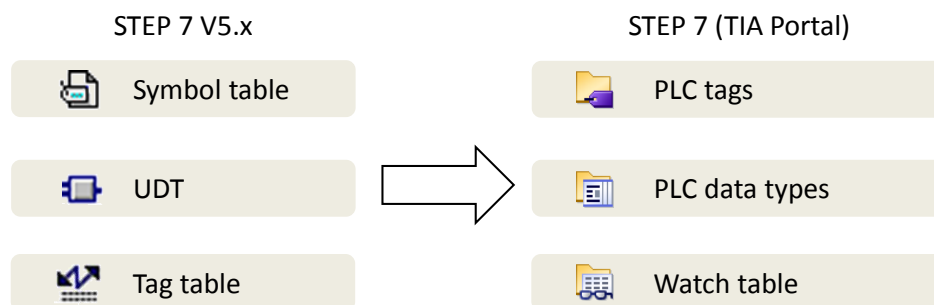

Terms for tags and parameters

When dealing with tags, functions, and function blocks, many terms are repeatedly used differently or even incorrectly. The following figure clarifies these terms.

Figure 2-2: Terms for tags and parameters

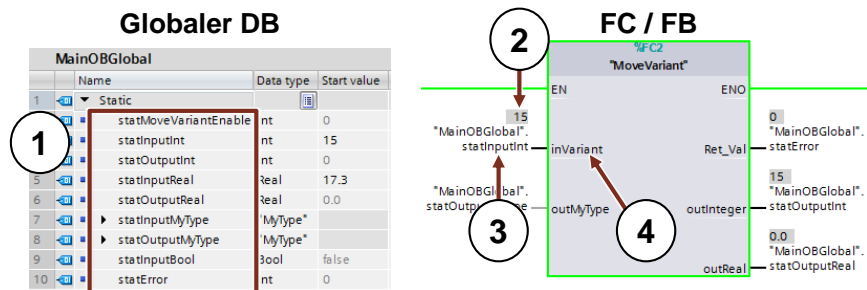

Table 2-1: Terms for Tags and parameters

	Term	Description
1.	Tags	Tags are labeled by a name/identifier and use an address in the memory of the controller. Tags are always defined with a certain data type (Bool, Integer, etc.): <ul style="list-style-type: none"> • PLC tags • Individual tags in data blocks • Complete data blocks
2.	Tag value	Tag values are values stored in a tag (for example, 15 as value of an integer tag).
3.	Actual parameter	Actual parameters are tags interconnected at the interfaces of instructions, functions, and function blocks.
4.	Formal parameters (transfer parameter, block parameter)	Formal parameters are the interface parameters of instructions, functions, and function blocks (Input, Output, InOut, and Ret_Val).

Note

More information can be found in the following entries:

What entries are available on the internet for the migration to STEP 7 (TIA Portal) and WinCC (TIA Portal)?

<https://support.industry.siemens.com/cs/ww/en/view/56314851>

What system requirements have to be fulfilled to migrate a STEP 7 V5.x project in STEP 7 Professional (TIA Portal)?

<https://support.industry.siemens.com/cs/ww/en/view/62100731>

PLC migration to S7-1500 with STEP 7 (TIA Portal)

<https://support.industry.siemens.com/cs/ww/en/view/67858106>

How can you program efficiently and performant in STEP 7 (TIA Portal) for S7-1200/S7-1500?

<https://support.industry.siemens.com/cs/ww/en/view/67582299>

Why is it not possible to mix register passing and explicit parameter transfer with the S7-1500 in STEP 7 (TIA Portal)?

Among other topics, the migration of STL programs to S7-1500 is described in this entry.

<https://support.industry.siemens.com/cs/ww/en/view/67655405>

2.3 Programming languages

Different programming languages are available for the programming of a user program. Each language has its own advantages that can be used flexibly depending on application. Thus, each block in the user program can be created in any programming language.

Table 2-2: Programming languages

Programming language	S7-1200	S7-1500
Ladder diagram (LAD)	yes	yes
Function block diagram (FBD)	yes	yes
Structured Control Language (SCL)	yes	yes
Graph	no	yes
Statement list (STL)	no	yes

Note

More information can be found in the following entries:

SIMATIC S7-1200 / S7-1500 Comparison List for Programming Languages
Based on the International Mnemonics

<https://support.industry.siemens.com/cs/ww/en/view/86630375>

What should you watch out for when migrating an S7-SCL program in STEP 7 (TIA Portal)?

<https://support.industry.siemens.com/cs/ww/en/view/59784005>

Which instructions can you not use in an SCL program in STEP 7 (TIA Portal)?

<https://support.industry.siemens.com/cs/ww/en/view/58002709>

How do you define the constants in an S7-SCL program in STEP 7 (TIA Portal)?

<https://support.industry.siemens.com/cs/ww/en/view/52258437>

2.4 Optimized machine code

TIA Portal and S7-1200/1500 enable an optimized runtime performance in every programming language. All languages are compiled directly in machine code in the same way.

Advantages

- All programming languages have the same level of performance (for the same access types)
- No reduction of performance through additional compilation with interim step via STL

Properties

In the following figure, the difference in the compilation of S7-programs in machine code is displayed.

2.5 Block creation

Figure 2-3: Machine code creation with S7-300/400/WinAC and S7-1200/1500

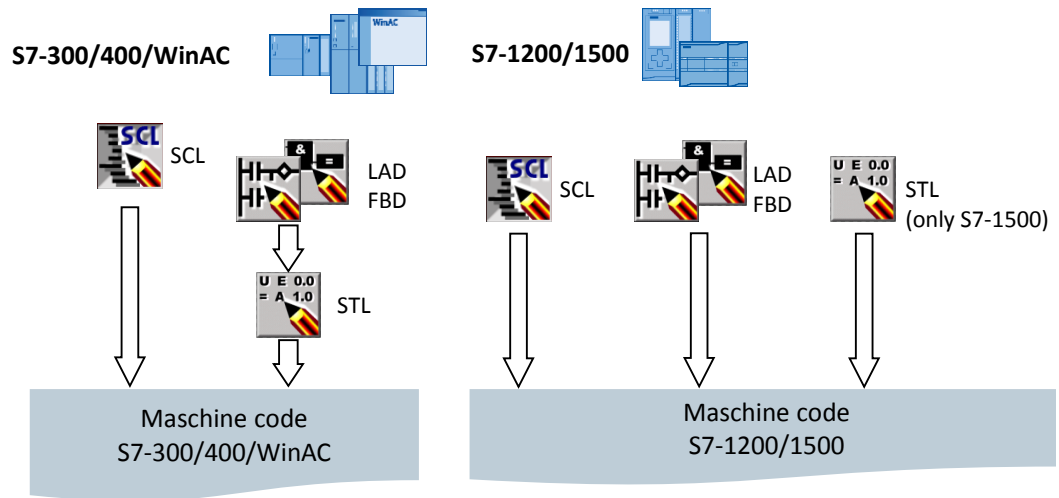

- For S7-300/400/WinAC controllers LAD and FBD programs are first compiled in STL before machine code is created.
- For S7-1200/1500 controllers all programming languages are directly compiled in machine code.

2.5 Block creation

All blocks such as OBs, FBs and FCs can be directly programmed in the desired programming language. Therefore no source has to be created for SCL programming. Only select the block and SCL as programming language. You can then program the block directly.

Figure 2-4: Dialog "Add new Block"

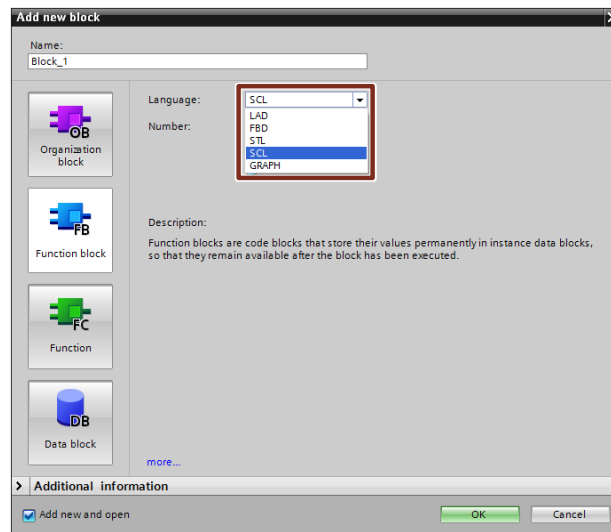

2.6 Optimized blocks

S7-1200/1500 controllers have an optimized data storage. In optimized blocks all tags are automatically sorted according to their data type. The sorting ensures that data gaps between the tags are reduced to a minimum and that the tags are stored access-optimized for the processor.

Non-optimized blocks are only available for compatibility reasons in S7-1200/1500 controllers.

Advantages

- Access always takes place as quickly as possible since the data storage is optimized by the system and independent of the declaration.
- No danger of inconsistencies due to faulty, absolute access, since access is generally symbolic
- Declaration changes do not lead to access errors since, for example, HMI access is symbolic.
- Individual tags can be specifically defined as retentive.
- No settings required in the instance data block. Everything is set in the assigned FB (for example, retentivity).
- Storage reserves in the data block enables changes without loss of current values (see chapter [3.2.8 Downloading without reinitialisation](#)).

2.6.1 S7-1200: Structure of optimized blocks

Figure 2-5: Optimized blocks for S7-1200

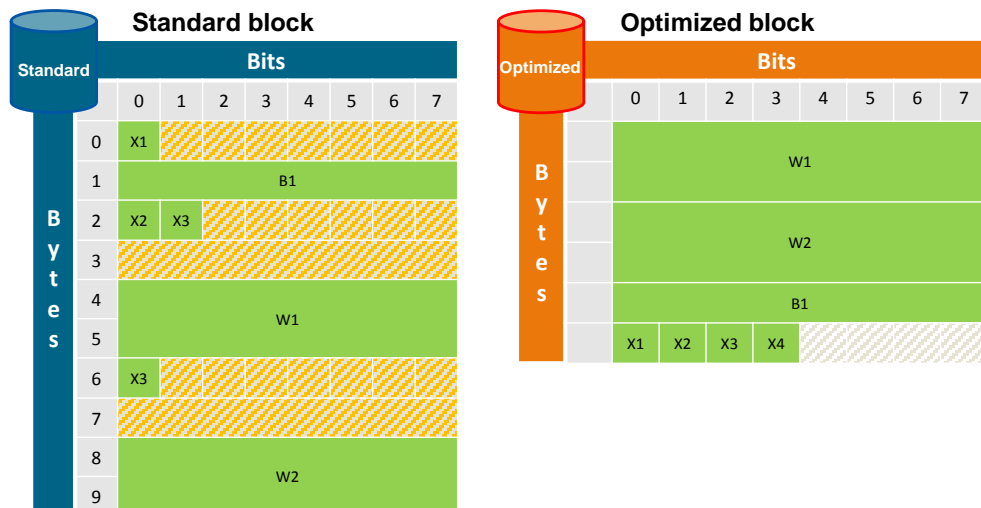

Properties

- No data gaps are formed since larger tags are located at the start of a block and smaller ones at the end.
- There is only symbolic access for optimized blocks.

2.6.2 S7-1500: Structure of optimized blocks

Figure 2-6: Optimized blocks for S7-1500

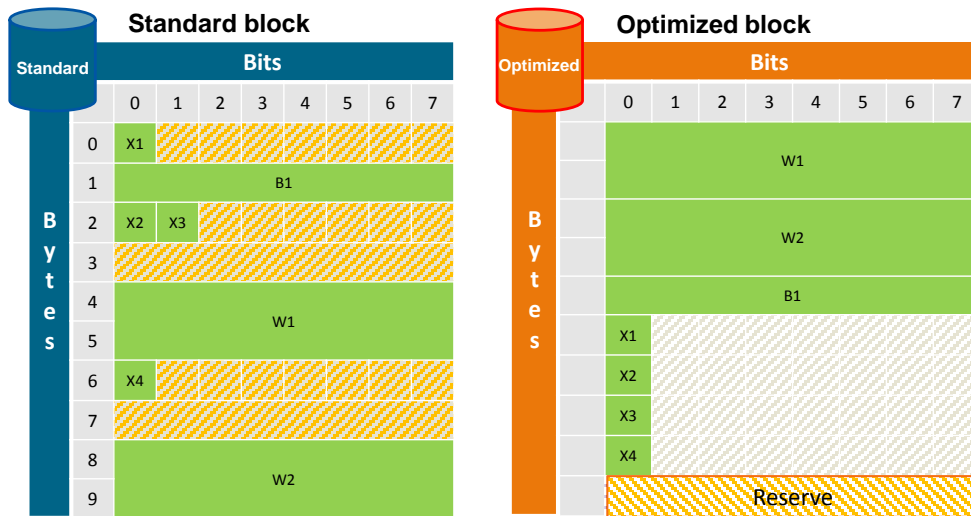
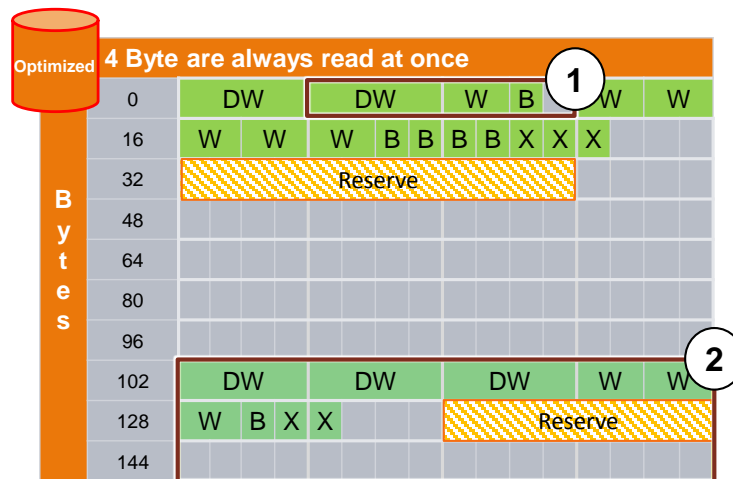

Figure 2-7: Memory mapping for optimized blocks



1. Structures are located separately and can therefore be copied as block.
2. Retentive data is located in a separate area and can be copied as block. In the event of a loss of voltage this data is saved internally in the CPU. "MRES" resets this data to the start values located in the load memory.

Properties

- No data gaps are formed since larger tags are located at the start of a block and smaller ones at the end.
- Faster access due to processor-optimized storage (all tags are stored in a way so that the processor of the S7-1500 can directly read or write them with only one machine command).
- Boolean tags are stored as byte for faster access. Thus, the controller does not have to mask the access.

2.6 Optimized blocks

- Optimized blocks have a storage reserve for loading in running operation (see chapter [3.2.8 Downloading without reinitialisation](#)).
- There is only symbolic access for optimized blocks.

2.6.3 Processor-optimized data storage for S7-1500

For reasons of compatibility to the first SIMATIC controllers, the principle of the "Big Endian" data storage was accepted in the S7-300/400 controllers.

Based on the changed processor architecture, the new S7-1500 controller generation always accesses 4 byte (32 bit) in "Little-Endian" sequence. Thus the following properties result on the system side.

Figure 2-8: Data access of a S7-1500 controller

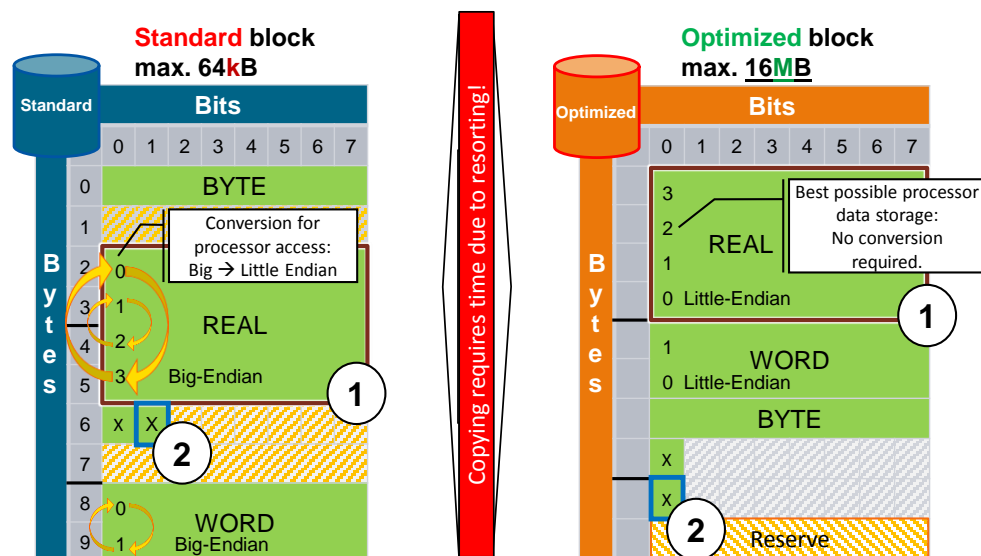

Table 2-3: Data access of a S7-1500 controller

	Standard block	Optimized block
1.	In the event of an unfavorable offset, the controller requires 2x16 bit access to read a 4 byte value (for example, REAL value). In addition the bytes have to be turned.	The controller stores the tags access-optimized. Access is with 32 bit (REAL). Turning the bytes is not required.
2.	The entire byte is read and masked per bit access. The complete byte is blocked for any other access.	Each bit is assigned a byte. The controller does not have to mask the byte when accessing.
3.	Maximum block size is 64kB.	Maximum block size can be up to 16MB.

Recommendation

- In general, only use optimized blocks.
 - You do not require absolute addressing and you can always address with symbolic data (object-related). Indirect addressing is also possible with symbolic data (see chapter [3.6.2 ARRAY data type and indirect field accesses](#)).
 - Processing optimized blocks in the controller is considerably faster than for standard blocks.
- Avoid the copying/assigning of data between optimized and non-optimized blocks. The data conversion required between source and target format requires high processing time.

Example: Setting optimized block access

By default, the optimized block access is enabled for all newly created blocks for S7-1200/1500. Block access can be set for OBs, FBs and global DBs. For instance DBs, the setting derives from the respective FB.

Block access is not automatically reset if a block is migrated from a S7-300/400 controller to a S7-1200/1500. You can later change the block access to "Optimized block access". After changing the block access, you have to recompile the program. If you change FBs to "Optimized block access", the assigned instance data blocks are automatically updated.

Follow the instructions to set the optimized block access.

Table 2-4: Setting optimized block access

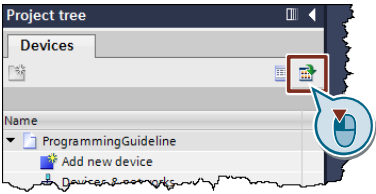
Step	Instruction
1.	Click the "Maximizes/minimizes the Overview" button in the project tree. 
2.	Navigate to "Program blocks".

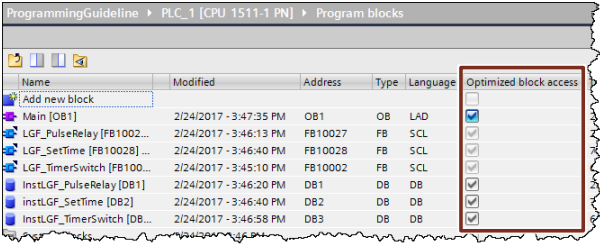
Step	Instruction
3.	<p>Here, you see all blocks in the program and whether they are optimized or not. In this overview the status "Optimized block access" can be conveniently changed.</p>  <p>Note: Instance data blocks (here "Function_block_1_DB") inherit the status "optimized" from the associated FB. This is why the "optimized" setting can only be changed on the FB. After the compilation of the project, the DB takes on the status depending on the associated FB.</p>

Display of optimized and non-optimized blocks in the TIA Portal

In the two following figures the differences between an optimized and a non-optimized instance DB can be seen.

For a global DB there are the same differences.

Figure 2-9: optimized data block (without offset)

InstLGF_PulseRelay			
	Name	Data type	Start value
1	Input		
2	trigger	Bool	false
3	set	Bool	false
4	reset	Bool	false
5	Output		
6	out	Bool	false

Figure 2-10: non-optimized data block (with offset)

InstLGF_PulseRelay				
	Name	Data type	Offset	Start value
1	Input			
2	trigger	Bool	0.0	false
3	set	Bool	0.1	false
4	reset	Bool	0.2	false
5	Output			
6	out	Bool	2.0	false

Table 2-5: Difference: Optimized and non-optimized data block

Optimized data block	Non-optimized data block
Optimized data blocks are addressed symbolically. Therefore no "offset" is shown.	For non-optimized blocks the "offset" is shown and can be used for addressing.
In the optimized block you can declare each tag individually with "Retain".	In non-optimized blocks only all or no tag can be declared with "Retain".

2.6 Optimized blocks

The retentivity of tags of a global DB is directly defined in the global DB. By default, non-retain is preset.

Define the retentivity of tags in an instance in the function block (not the instance DB). These settings are therefore valid for all instances of this FB.

Access types for optimized and non-optimized data blocks

In the following table all access types for blocks are displayed.

Table 2-6: Access types

Access type	Optimized block	Non-optimized block
Symbolic	yes	yes
Indexed (fields)	yes	yes
Slice access	yes	yes
AT instruction	no (Alternative: slice access)	yes
Direct absolute	no (Alternative: ARRAY with INDEX)	yes
Indirect absolute (pointer)	no (Alternative: VARIANT / ARRAY with index)	yes
Load without reinitialization	yes	no

Note

More information can be found in the following entries:

What types of access are available in STEP 7 (TIA Portal) to access data values in blocks and what should you watch out for with the differences between the types?

<https://support.industry.siemens.com/cs/ww/en/view/67655611>

Which properties should you watch out for in STEP 7 (TIA Portal) for the instructions "READ_DBL" and "WRIT_DBL" when using DBs with optimized access?

<https://support.industry.siemens.com/cs/ww/en/view/51434747>

2.6.4 Conversion between optimized and non-optimized tags

It is generally recommended to work with optimized tags. However, if in individual cases, you want to keep your programming so far, there will be a mix of optimized and non-optimized data storage in the program.

The system knows the internal storage of each tag, irrelevant whether structured (derived from an individually defined data type) or elementary (INT, LREAL, ...).

For assignments with the same type between two tags with different memory storage, the system converts automatically. This conversion requires performance for structured tags and should therefore be avoided, if possible.

2.6.5 Parameter transfer between blocks with optimized and non-optimized access

When you transfer structures to the called block as in/out parameters (InOut), they are transferred by default as reference (see [chapter 3.3.2 Call-by-reference](#)).

However, this is not the case if one of the blocks has the property "Optimized access" and the other block the property "Default access". In this case, all parameters are generally transferred as copy (see [chapter 3.3.1 Call-by-value](#)).

In this case the called block always works with the copied values. During block processing, these values may be changed and they are copied back to the original operand, after processing of the block call.

This may cause problems if the original operands are changed by asynchronous processes, for example, by HMI access or interrupt OBs. If the copies are copied back to the original operands after the block processing, the asynchronously performed changes on the original operands are overwritten.

Note

More information can be found in the following entries:

Why is data of the HMI system or the web server sometimes overwritten in the S7-1500?

<https://support.industry.siemens.com/cs/ww/en/view/109478253>

Recommendation

- Always set the same access type for the two blocks that communicate with each other.

2.6.6 Communication with optimized data

The interface (CPU, CM) transfers the data in the way it is arranged (irrespective of whether it is optimized or non-optimized).

Figure 2-11: CPU-CPU communication

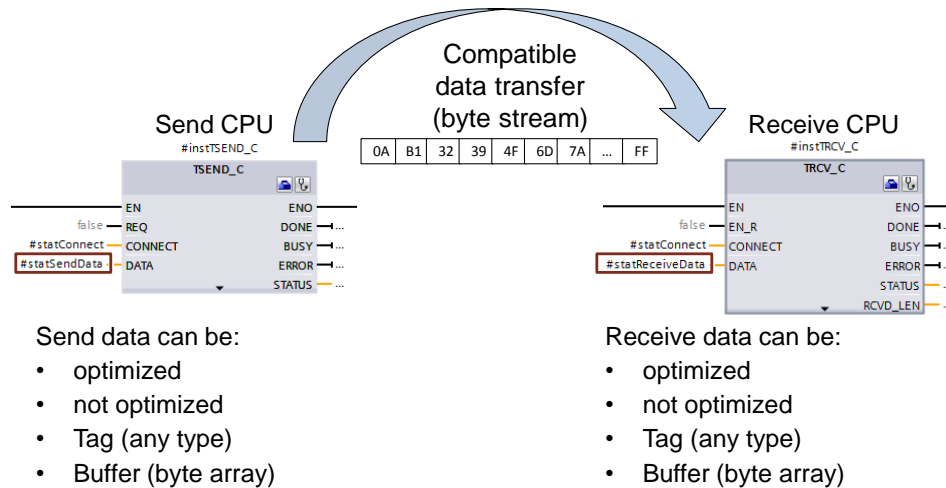

Example

- A tag with PLC data type (data record) shall be passed on to a CPU.
- In the send CPU the tag is interconnected as actual parameter with the communication block (TSEND_C).
- In the receive CPU the receive data is assigned to a tag of the same type.
- In this case symbolic work on the received data can be directly continued.

Note Any tags or data blocks can be used as data records (derived from PLC data types).

Note It is also possible to define the send and receive data differently:

Send data		Receive data
optimized	-->	non-optimized
non-optimized	-->	optimized

The controller automatically makes sure that the data transfer and storage is correct.

2.7 Block properties

2.7.1 Block sizes

For S7-1200/1500 controllers the maximum size of blocks in the main memory was noticeably enlarged.

Table 2-7: Block sizes

Max. size and number (without consideration of memory size)		S7-300/400	S7-1200	S7-1500
DB	Max. size	64 kB	64 kB	64 kB 16 MB (optimized CPU1518)
	Max. number	16.000	65.535	65.535
FC / FB	Max. size	64 kB	64 kB	512 kB
	Max. number	7.999	65.535	65.535
FC / FB / DB	Max. number	4.096 (CPU319) 6.000 (CPU412)	1.024	10.000 (CPU1518)

Recommendation

- Use DBs for S7-1500 controllers as data container of very large data volumes.
- You can store data volumes of > 64 kB with S7-1500 controllers in an optimized DB (max. size 16 MB).

2.7.2 Number of organization blocks (OB)

With OBs a hierarchical structure of the user program can be created. There are different OBs available for this.

Table 2-8: Number of organization blocks

Organization block type	S7-1200	S7-1500	Benefits
Cyclic and startup OBs	100	100	Modularization of the user program
Hardware interrupts	50	50	Separate OB for each event possible
Delay interrupts	4 *	20	Modularization of the user program
Cyclic interrupts		20	Modularization of the user program
Clocked interrupts	no	20	Modularization of the user program

* As of firmware V4, 4 delay interrupts and 4 cyclic interrupts are possible.

Recommendation

- Use OBs in order to structure the user program hierarchically.
- Further recommendations for the use of OBs can be found in chapter [3.2.1 Organization blocks \(OB\)](#).

2.7.3 Block interface – hide block parameters (V14 or higher)

When calling the block, block parameters can be specifically displayed or hidden. Here, you have three options that you can configure individually for each formal parameter.

- "Show"
- "Hide"
- "Hide if no parameter is assigned"

Advantages

- Better overview for blocks with many optional parameters

Properties

- Can be used for:
 - FCs, FBs
 - In, Out, InOut

Example

Figure 2-12: Hide block parameters

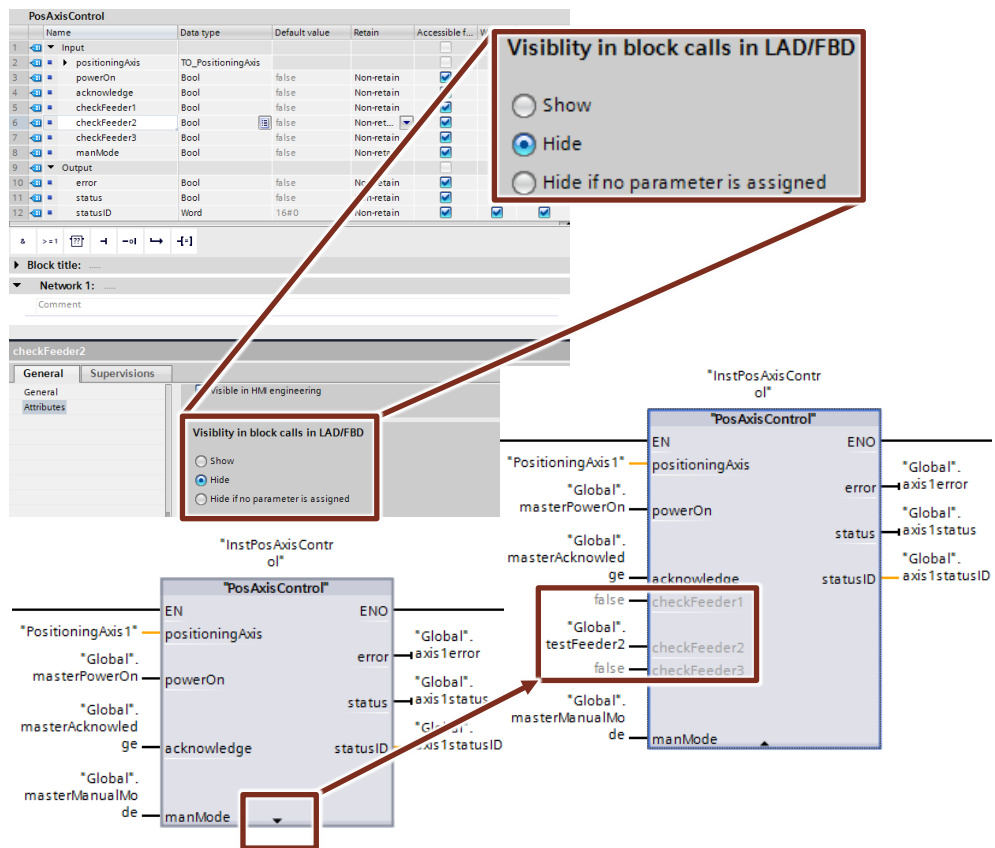

2.8 New data types for S7-1200/1500

S7-1200/1500 controllers support new data types to make programming more convenient. With the new 64 bit data types, considerably larger and more precise values can be used.

Note

More information can be found in the following entry:

In STEP 7 (TIA Portal), how do you convert the data types for the S7-1200/1500?

<https://support.industry.siemens.com/cs/ww/en/view/48711306>

2.8.1 Elementary data types

Table 2-9: Integer data types

Type	Size	Value range
USint	8 bit	0 .. 255
SInt	8 bit	-128 .. 127
UInt	16 bit	0 .. 65535
UDInt	32 bit	0 .. 4.3 Mio
ULInt*	64 bit	0 .. 18.4 Trio (10 ¹⁸)
LInt*	64 bit	-9.2 Trio .. 9.2 Trio
LWord	64 bit	16#0000 0000 0000 0000 to 16# FFFF FFFF FFFF FFFF

* only for S7-1500

Table 2-10: Floating-point data types

Type	Size	Value range
Real	32 bit (1 bit prefix, 8 bit exponent, 23 bit mantissa), precision 7 places after the comma	-3.40e+38 .. 3.40e+38
LReal	64 bit (1 bit prefix, 11 bit exponent, 52 bit mantissa), precision 15 places after the comma	-1.79e+308 .. 1.79e+308

Note

More information can be found in the following entries:

Why, in STEP 7 (TIA Portal), is the result of the DInt Addition in SCL not displayed correctly?

<https://support.industry.siemens.com/cs/ww/en/view/98278626>

2.8.2 Data type Date_Time_Long

Table 2-11: Structure of DTL (Date_Time_Long)

Year	Month	Day	Weekday	Hour	Minute	Second	Nanosecond
------	-------	-----	---------	------	--------	--------	------------

DTL always reads the current system time. Access to the individual values is by the symbolic names (for example, `My_Timestamp.Hour`)

Advantages

- All subareas (for example, Year, Month, ...) can be addressed symbolically.

Recommendation

Use the new data type DTL instead of LDT and address it symbolically (for example `My_Timestamp.Hour`).

Note

More information can be found in the following entries:

In STEP 7 (TIA Portal), how can you input, read out and edit the date and time for the CPU modules of S7-300/S7-400/S7-1200/S7-1500?

<https://support.industry.siemens.com/cs/ww/en/view/43566349>

Which functions are available in STEP 7 V5.5 and in TIA Portal for processing the data types DT and DTL?

<https://support.industry.siemens.com/cs/ww/en/view/63900229>

2.8.3 Other time data types

Table 2-12: Time data types (only S7-1500)

Type	Size	Value range
LTime	64 Bit	LT#-106751d23h47m16s854ms775us808ns to LT#+106751d23h47m16s854ms775us807ns
LTIME_OF_DAY	64 Bit	LTOD#00:00:00.000000000 to LTOD#23:59:59.999999999

2.8.4 Unicode data types

With the help of the data types WCHAR and WSTRING Unicode characters can be processed.

Table 2-13: Time data types (only S7-1500)

Type	Size	Value range
WCHAR	2 Byte	-
WSTRING	$(4 + 2 \cdot n)$ Byte	Preset value: 0 ..254 characters Max. Value: 0 ..16382

n = length of string

Properties

- Processing of characters in, for example, Latin, Chinese or other languages.
- Line breaks, form feed, tab, spaces
- Special characters: Dollar signs, quotes

Example

- `WCHAR# 'a '`
- `WSTRING# 'Hello World! '`

2.8.5 Data type VARIANT (S7-1500 and S7-1200 from FW4.1)

A parameter from the type VARIANT is a pointer that can point to tag of different data types. In contrast to the ANY pointer, VARIANT is a pointer with type test. This means that the target structure and source structure are checked at runtime and have to be identical.

VARIANT, for example, is used for communication blocks (TSEND_C) as input.

Figure 2-13: Data type VARIANT as input parameters for instruction TSEND_C

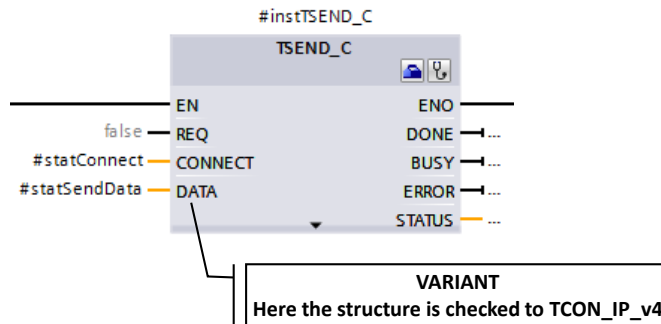

Advantages

- Integrated type test prevents faulty access.
- The code can be more easily read through the symbolic addressing of the variant tags.
- Code is more efficiently and within a shorter time.
- Variant pointers are clearly more intuitive than ANY pointers.
- The right type of variant tags can be used directly with the help of system functions.
- Flexible and performant transfer of different structured tags is possible.

Properties

In a comparison between ANY and variant, the properties can be seen.

Table 2-14: Comparison ANY and variant

ANY	Variant
Requires 10 byte memory with defined structure	Does not require a main memory for the user
Initialization either via assignment of the data area or by filling the ANY structure	Initialization by assigning the data area or system instruction
Non-typed – type of an interconnected structure cannot be recognized	Typed – interconnected type and for arrays the length can also be determined
Partly typed – for arrays the length can also be determined	VARIANT can be evaluated and also created via system instructions

Recommendation

- Check where before you had to use the ANY pointer. In many cases a pointer is no longer necessary (see following table).
- Use the data type VARIANT only for indirect addressing when the data types are only determined at program runtime.
 - Use the data type VARIANT as InOut formal parameter to create generic blocks that are independent from the data type of the actual parameters (see example in this chapter).
 - Use the VARIANT data type instead of the ANY pointer. Errors are detected early on due to the integrated type test. Due to the symbolic addressing, the program code can be easily interpreted.
 - Use the variant instruction, for example, for type identification (see following example and chapter [2.9.2 VARIANT instructions](#))
- Use the index for arrays instead of addressing the array elements via ANY (see chapter [3.6.2 ARRAY data type and indirect field accesses](#)).

Table 2-15: Comparison ANY pointer and simplifications

What are ANY pointers used for?		Simplification with S7-1200/1500
Programming functions that can process different data types	→	Functions with variant pointer as InOut parameter for blocks (see following example)
Processing of arrays <ul style="list-style-type: none"> • for example, reading, initializing, copying of elements of the same type 	→	Default array functions <ul style="list-style-type: none"> • Reading and writing with #myArray[#index] (see chapter 3.6.2 ARRAY data type and indirect field accesses) • Copying with MOVE_BLK (see chapter 2.9.1 MOVE instructions)
<ul style="list-style-type: none"> • Transferring structures and performant processing via absolute addressing for example, transferring user-defined structures via ANY pointer to functions 	→	Transferring structures as InOut parameters <ul style="list-style-type: none"> • see chapter 3.3.2 Call-by-reference

Note

If values of non-structured VARIANT tags are to be copied, you can also use VariantGet instead of MOVE_BLK_VARIANT (chapter [2.9.2 VARIANT instructions](#)).

Example

With the data type VARIANT it is possible to identify data types in the user program and to respond to them accordingly. The following code of the FCs "MoveVariant" shows a possible programming.

- The InOut formal parameter "InVar" (data type VARIANT) is used to show a tag independent from the data type.
- The data type of the actual parameter is detected with the "Type_Of" instruction
- Depending on the data type, the tag value is copied with the "MOVE_BLK_VARIANT" instruction to the different output formal parameters.
- If the data type of the actual parameter is not detected, the block will output an error code.

Figure 2-14: Formal parameter of the FC "MoveVariant"

MoveVariant			
	Name	Data type	Default value
1	Input		
2	Output		
3	outInteger	Int	
4	outReal	Real	
5	outTypeCustom	*typeCustom*	
6	InOut		
7	inOutVariant	VARIANT	
8	Temp		
9	Constant		
10	Return		

```

CASE TypeOf(#inOutVariant) OF // Check datatypes
  Int: // Move Integer
    #MoveVariant := MOVE_BLK_VARIANT(SRC := #inOutVariant,
                                     COUNT := 1,
                                     SRC_INDEX := 0,
                                     DEST_INDEX := 0,
                                     DEST => #outInteger);

  Real: // Move Real
    #MoveVariant := MOVE_BLK_VARIANT(SRC := #inOutVariant,
                                     COUNT := 1,
                                     SRC_INDEX := 0,
                                     DEST_INDEX := 0,
                                     DEST => #outReal);

  typeCustom: // Move outTypeCustom
    #MoveVariant := MOVE_BLK_VARIANT(SRC := #inOutVariant,
                                     COUNT := 1,
                                     SRC_INDEX := 0,
                                     DEST_INDEX := 0,
                                     DEST => #outTypeCustom);

ELSE // Error, no sufficient datatype
  #MoveVariant := WORD_TO_INT(#NO_CORRECT_DATA_TYPE);
  // 80B4: Error-Code of MOVE_BLK_VARIANT: Data types do
  not correspond
END_CASE;

```

2.9 Instructions

The TIA Portal supports the programmer with ready instructions (bit logic, times, counter, comparator...).

Note

Further functions can be downloaded in the following entry:

Library with general functions for (LGFP) for STEP 7 (TIA Portal) and S7-1200 / S7-1500

<https://support.industry.siemens.com/cs/ww/en/view/109479728>

2.9.1 MOVE instructions

In STEP 7 (TIA Portal) the following MOVE instructions are available. The MOVE_BLK_VARIANT instruction is new for S7-1200/1500.

Table 2-16: Move instructions

Instruction	Usage	Properties
MOVE	Copy value	<ul style="list-style-type: none"> Copies the content of the parameter on the input IN to the parameter of the output OUT. The parameters on the input and output must be of the same data type. Parameters can also be structured tags (PLC data types). Copies complete arrays and structures.
MOVE_BLK	Copy array	<ul style="list-style-type: none"> Copies the content of an array to another array. Source and target array must be of the same data type. Copies complete arrays and structures. Copies several array elements with structures as well. In addition, start and number of elements can be specified.
UMOVE_BLK	Copies array without interruption	<ul style="list-style-type: none"> Copies the content of an array consistently without the risk of the OB interrupting the copying process. Source and target array must be of the same data type.
MOVE_BLK_VARIANT (S7-1500 and S7-1200 FW4.1 or higher)	Copy array	<ul style="list-style-type: none"> Copies one or several structured tag(s) (PLC data types) Recognizes data types at runtime Supplies detailed error information Apart from the elementary and structured data types, PLC data types, arrays, and array DBs are also supported.

Instruction	Usage	Properties
Serialize (S7-1500 and S7-1200 FW4.1 or higher)	converts structured data into a byte array	<ul style="list-style-type: none"> Several data records can be combined into a single byte array and, for example, be sent to other devices as a message frame. Input and output parameters can be transferred as data type Variant.
Deserialize (S7-1500 and S7-1200 FW4.1 or higher)	converts one byte array into one or several structure/s	<ul style="list-style-type: none"> Application case I-Device: The I device receives several data records in the input area which are copied to different structures. Several data records can be combined into a single byte array. Deserialize enables copying these to different structures.

Figure 2-15: Serialize and deserialize (S7-1500 and S7-1200 FW4.1 or higher)

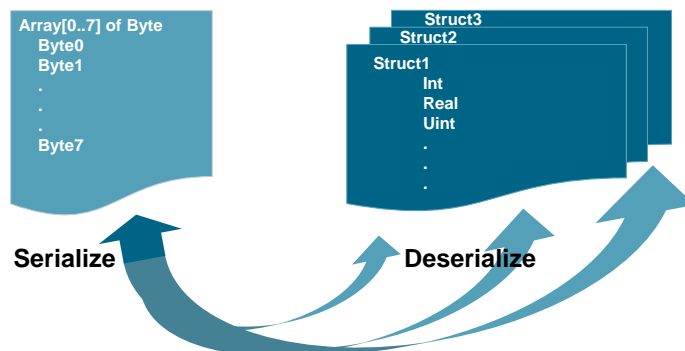

Properties

Instructions such as "Serialize", "Deserialize", "CMP" (comparator) and "MOVE: copy value" can process very large and complex structured tags. In the process, the CPU analyses the tag structure at runtime. Processing time depends on the following properties of the tag structure to be processed:

- Complexity of the structure
- Number of structures without the use of PLC data types
- Array of byte can be saved in optimized blocks (V14 or higher).

Recommendation

- Declare the structures with the help of PLC data types instead of with "STRUCT"
- Reduce the number of structures used:
 - Avoid, for example, multiple declaration of very similarly made up structures. Summarize them in one single structure.
 - When many elements of the structure have the same data type, use the data type ARRAY, if possible.

2.9 Instructions

- Generally, you need to distinguish between MOVE, MOVE_BLK and MOVE_BLK_VARIANT
 - Use the MOVE instruction to copy complete structures.
 - Use the MOVE_BLK instruction to copy parts of an ARRAY of a known data type.
 - Only use the MOVE_BLK_VARIANT instruction if you wish to copy parts of ARRAYS with data types which are only known during program run-time.

Note UMOVE_BLK: The copy process cannot be interrupted by another activity of the operating system. Therefore, the alarm reaction times of the CPU might increase during processing of the instruction "Copy array without interruption".

For the complete description of the MOVE instructions, please refer to the TIA Portal Online Help.

Note More information can be found in the following entries:

How do you copy memory areas and structured data in STEP 7 (TIA Portal)?
<https://support.industry.siemens.com/cs/ww/en/view/42603881>

2.9.2 VARIANT instructions (S7-1500 and S7-1200 FW4.1 and higher)

Table 2-17: Move instructions

Instruction	Usage	Properties
MOVE instructions		
VariantGet	Read value	This instruction enables you to read the value of a tag pointing to a VARIANT.
VariantPut	Write value	This instruction enables you to write the value of a tag pointing to a VARIANT.
Enumeration		
CountOfElements	Counting elements	With this instruction you poll the number of ARRAY elements of a tag pointing to a VARIANT.
Comparator instructions		
TypeOf() (only SCL)	Determining the data type	Use this instruction to poll the data type of a tag pointing to a VARIANT.
TypeOfElements() (only SCL)	Determining the array data type	Use this instruction to poll the data type of the ARRAY elements of a tag pointing to a VARIANT.

2.9 Instructions

Instruction	Usage	Properties
Comparator instructions		
VARIANT_TO_DB_ANY (only SCL)	Determining the data block number	This instruction queries the data block number of an instance data block of a PLC data type, system data type or array DB.
DB_ANY_TO_VARIANT (only SCL)	Created from a data block of a variant tag.	This instruction creates the variant tag of an instance data block of a PLC data type, system data type or array DB.

Note For more VARIANT instructions, please refer to the online help of the TIA Portal.

Properties

Due to their complex algorithm, variant instructions require a longer processing time than direct instructions.

Recommendation

- If possible, do not use variant instructions in loops (FOR, WHILE...) in order to prevent an unnecessary increase of cycle time.
- Do not use a loop via the elements to copy an array, but the direct assignment of the complete array.

2.9.3 RUNTIME

The "RUNTIME" instruction measures the runtime of the entire program, individual blocks or command sequences. You can call this instruction in LAD, FBD, SCL and in STL (only S7-1500).

Note More information can be found in the following entry:
 With S7-1200/S7-1500, how do you measure the total cycle time of an organization block?
<https://support.industry.siemens.com/cs/ww/en/view/87668055>

2.9.4 Comparison of tags from PLC data types (V14 or higher)

Two tags of the same PLC data type can be checked for similarities or dissimilarities.

Figure 2-16: Comparison of tags from PLC data types in LAD

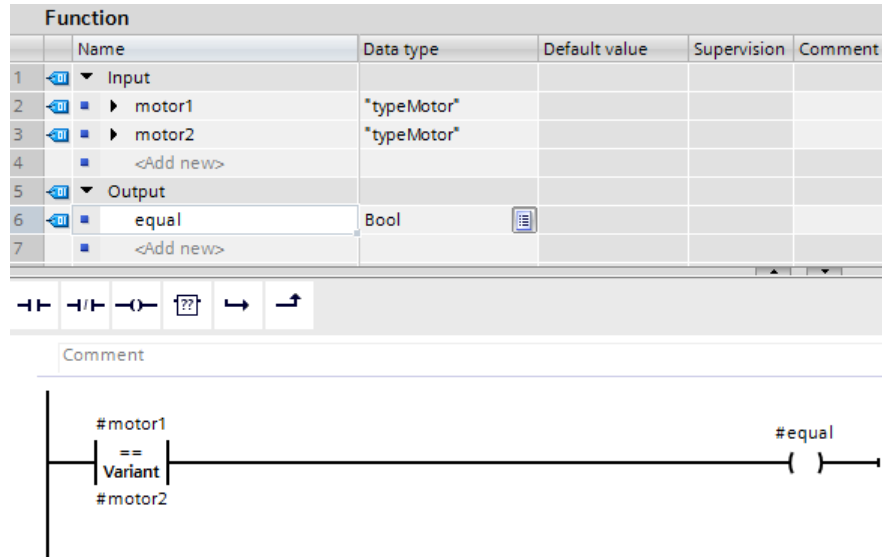

Advantages

- Symbolic programming with structured tags
- Comparison with optimum performance
- Comparison is possible in LAB, FBD, STL.
- Comparison directly possible in STL instruction.

Example

Figure 2-17: Comparison of tags from PLC data types in STL instructions

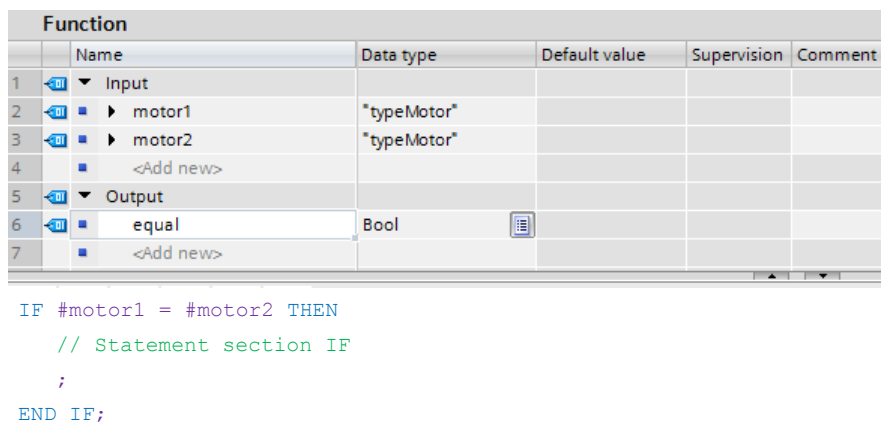

2.9.5 Multiple assignment (V14 or higher)

Advantages

Multiple assignment enables optimum programming for several tags (e.g., for initializations).

Example

```
#statFillLevel := #statTemperature := #tempTemperature := 0.0;
```

2.10 Symbolic and comments

2.10.1 Programming editor

Advantages

You can make the code easy to understand and readable for your colleagues by using symbolic names and comments in your program. The complete symbolic is saved together with the program code during the download to the controller and therefore allows fast maintenance of the plant even when no offline project is available.

Recommendation

- Use the comments in the programs in order to improve readability. Network title comments are visible even if networks are collapsed.
- Design the program code in a way so that colleagues can also understand the program straight away.

In the following example you can see the extensive options for commenting the program in the editors.

Example

In the following figure you can see the options for commenting in the LAD editor (same functionality in FDB).

Figure 2-18: Commenting in the user program (LAD)

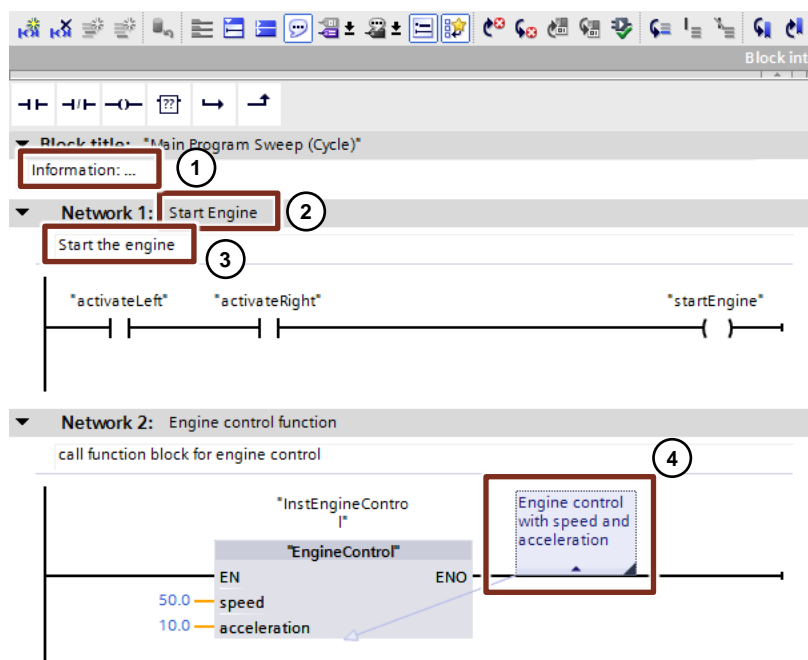

The following comments are possible:

1. Block comment
2. Network title comment
3. Network comment
4. Comment on instructions, blocks and functions (open, close, etc.)

2.10 Symbolic and comments

In the programming languages SCL and STL, it can be commented with // in every row.

Example

```
statFillingLevel := statRadius * statRadius * PI * statHeight;
// Calculating the filling level for medium tank
```

Note

For further information, refer to the following entry:

In STEP 7 (TIA Portal), why are the display texts, titles and comments no longer displayed after opening the project in the block editor?

<https://support.industry.siemens.com/cs/ww/en/view/41995518>

2.10.2 Comment lines in watch tables**Advantages**

- For better structuring it is possible to create comment lines in the watch table.

Recommendation

- Always use comment lines and sub-divide your watch table.
- Please also comment on the individual tags.

Example

Figure 2-19: Watch table with comment lines

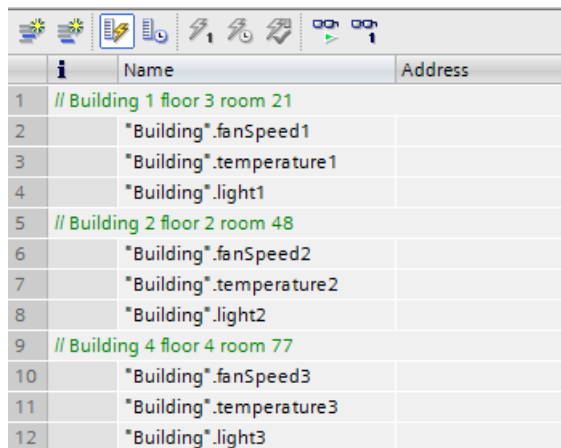

	Name	Address
1	// Building 1 floor 3 room 21	
2	"Building".fanSpeed1	
3	"Building".temperature1	
4	"Building".light1	
5	// Building 2 floor 2 room 48	
6	"Building".fanSpeed2	
7	"Building".temperature2	
8	"Building".light2	
9	// Building 4 floor 4 room 77	
10	"Building".fanSpeed3	
11	"Building".temperature3	
12	"Building".light3	

2.11 System constants

For S7-300/400 controllers the identification of hardware and software components is performed by logic address or diagnostic addresses.

For S7-1200/1500 the identification is by system constants. All hardware and software components (e.g., interfaces, modules, OBs, ...) of the S7-1200/1500 controllers have their own system constants. The system constants are automatically created during the setup of the device configuration for the central and distributed I/O.

Advantages

- You can address via module names instead of hardware identification.

Recommendation

- Assign function-related module names in order to identify the module easily during programming.

Example

In the following example you can see how system constants are used in the user program.

Figure 2-20: "System constants" in the user program

The screenshot shows the TIA Portal interface. On the left, the 'Project tree' shows the 'Default tag table' folder (1) containing 'System constants' (2). The 'Default tag table' table lists various system constants, with 'Local-RobotArmLeft' (3) highlighted. On the right, a ladder logic diagram shows a 'GET_DIAG' block with inputs 'Local-RobotArmLeft' and 'Global.diagMode', and outputs 'Global.diagRetVal' and 'Global.diagCNTDiag'.

Name	Name	Data type	Value
37	Local-Display	Hw_SubModule	54
38	Local-Exec	Hw_SubModule	52
39	Local-DP_interface_1	Hw_Interface	60
40	Local-PROFINET_interface_1	Hw_Interface	64
41	Local-PROFINET_interface_1-Port_1	Hw_Interface	65
42	Local-PROFINET_interface_1-Port_2	Hw_Interface	66
43	Local-PROFINET_interface_2	Hw_Interface	72
44	Local-PROFINET_interface_2-Port_1	Hw_Interface	73
45	OB_Main	OB_PCYCLE	1
46	OB_pull or plug of modules	OB_Any	83
47	OB_programming error	OB_Any	121
48	Local-PROFINET_IOsystem	Hw_IOSystem	260
49	OB_Hardware interrupt Test Station	OB_HWINT	40
50			
51			
52	Local-RobotArmLeft	Hw_SubModule	16#C
53			
54			
55			
56			
57			
58			
59			
60			
61			
62			
63			
64			
65			
66			
67			
68			
69			
70			
71			
72			
73			
74			
75			
76			
77			
78			
79			
80			
81			
82			
83			
84			
85			
86			
87			
88			
89			
90			
91			
92			
93			
94			
95			
96			
97			
98			
99			
100			

- System constants of a controller can be found in the "PLC tags – Default tag table" folder.
- The system constants are in a separate list in the "Default tag table".
- In this example the symbolic name "RobotArmLeft" was assigned for a DI module. You can also find the module under this name in the system constant table. In the user program "RobotArmLeft" is interconnected with the "GET_DIAG" diagnostic block.

Note

Open the "Device configuration" to quickly find the system constant for each device.

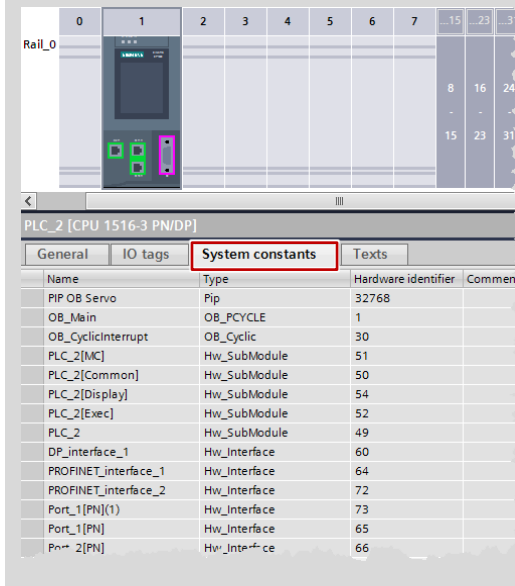
**Note**

More information can be found in the following entries:

What meaning do the system constants have for the S7-1200/1500 in STEP 7 (TIA Portal)?

<https://support.industry.siemens.com/cs/ww/en/view/78782835>

2.12 User constants

Constant values can be saved with the help of user constants. Generally, there are local constants for OBs, FCs and FBs and global constants for the entire user program in a controller.

Advantages

- User constants can be used for changing constant values globally or locally for all usage locations.
- With user constants, the program can be made more readable.

Properties

- Local user constants are defined in the block interface.
- Global user constants are defined in "PLC tags".
- The user program only enables read access to the user constants.
- For know-how protected blocks the user constants are not visible.

Recommendation

- Use the user constants for improved readability of the program and central changeability of ...
 - error codes,
 - CASE instructions,
 - conversion factors,
 - natural constants ...

Example

Figure 2-21: Local user constant of a block for CASE instructions

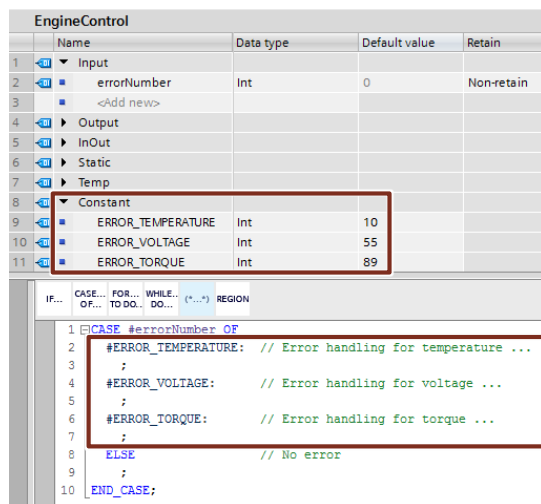
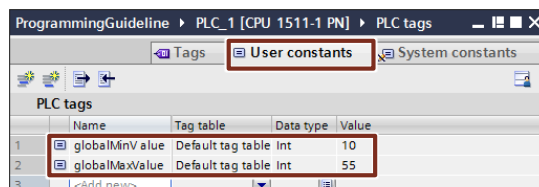

Figure 2-22: Global user constant of a controller



Note

Another application case of constants is available in the following FAQ:

How can you convert the unit of a tag in STEP 7 (TIA Portal)?

<https://support.industry.siemens.com/cs/ww/en/view/61928891>

2.13 Internal reference ID for controller and HMI tags

STEP 7, WinCC, Startdrive, Safety and others integrate into the joint data base of the TIA Portal engineering framework. Changes of data are automatically accepted in all the locations in the user program, independent from whether this happens in a controller, a panel or a drive. Therefore no data inconsistencies can occur.

If you create a tag, the TIA Portal automatically creates a unique reference ID. The reference ID cannot be viewed or programmed by you. This procedure is internal referencing. When changing tags (address), the reference ID remains unchanged.

2.13 Internal reference ID for controller and HMI tags

In the figure below the internal reference to the data is displayed schematically.

Figure 2-23: Internal reference ID for PLC and HMI

PLC1				HMI1		
PLC Symbol name	Absolute address	Internal PLC reference ID	Internal HMI Reference ID	HMI Symbol name	Access mode	Connection with PLC
motor1	I0.0	000123	009876	motor1	<symbolic access>	PLC1_HMI1
valve2	Q0.3	000138	000578	valve2	<symbolic access>	PLC1_HMI1

Note

The ID is changed by ...

- renaming tag.
- changing type.
- deleting the tag.

Advantages

- You can rewire tags without changing internal relations. The communication between controller, HMI and drive also remains unchanged.
- The length of the symbolic name does not have an influence on the communication load between controller and HMI.

Properties

If you change the addresses of PLC tags, you only have to reload the controller since the system also addresses the system internally with the reference IDs. It is not necessary to reload the HMI devices (see [Figure 2-24: Changing address or adding row](#)).

Figure 2-24: Changing address or adding row

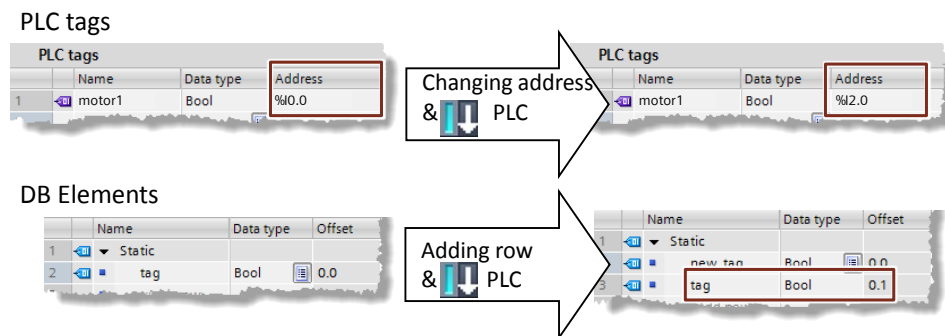

2.14 STOP mode in the event of errors

In comparison to S7-300/400 there are fewer criteria with the S7-1200/1500 that lead to the "STOP" mode.

Due to the changed consistency check in the TIA Portal, the "STOP" mode for S7-1200/1500 controllers can already be excluded in advance in most cases. The consistency of program blocks is already checked when compiling in the TIA Portal. This approach makes the S7-1200/1500 controllers more "fault tolerant" to errors than their predecessors.

Advantages

There are only three fault situations that put the S7-1200/1500 controllers into the STOP mode. This makes the programming of the error management clearer and easier.

Properties

Table 2-18: Response to errors of S7-1200/1500

	Error	S7-1200	S7-1500
1.	Cycle monitoring time exceeded once	RUN	STOP (when OB80 is not configured)
2.	Cycle monitoring time exceeded twice	STOP	STOP
3.	Programming error	RUN	STOP (when OB121 is not configured)

Error OBs:

- OB80 "Time error interrupt" is called by the operating system when the maximum cycle time of the controller is exceeded.
- OB121 "Programming error" is called by the operating system when an error occurs during program execution.

For every error, in addition, an entry is automatically created in the diagnostic buffer.

Note

For S7-1200/1500 controllers there are other programmable error OBs (diagnostic error, module rack failure, etc.).

More information on error responses of S7-1200/1500 can be found in the online help of the TIA Portal under "Events and OBs".

3 General programming

3.1 Operating system and user program

SIMATIC controllers consist of operating system and user program.

- The operating system organizes all functions and sequences of the controller that are not connected with a specific control task (e.g. handling of restart, updating of process image, calling the user program, error handling, memory management, etc.). The operating system is an integral part of the controller.
- The user program includes all blocks that are required for the processing of your specific automation task. The user program is programmed with program blocks and loaded onto the controller.

Figure 3-1: Operating system and user program

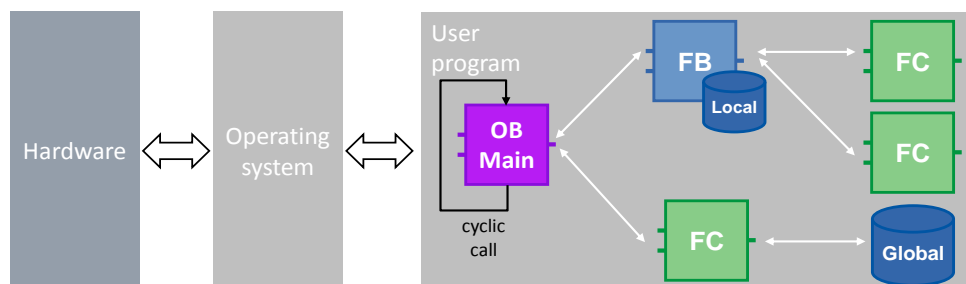

For SIMATIC controllers the user program is always executed cyclically. The "Main" cycle OP already exists in the "Program blocks" folder after a controller was created in STEP 7. The block is processed by the controller and recalled in an infinite loop.

3.2 Program blocks

In STEP 7 (TIA Portal) there are all familiar block types from the previous STEP 7 versions:

- Organization blocks
- Function blocks
- Functions
- Data blocks

Experienced STEP 7 users will know their way around straight away and new users can very easily get familiar with the programming.

Advantages

- You can give your program a good and clear structure with the different block types.
- Due to a good and structured program you get many function units that can be multiply reused within a project and also in other projects. These function units then usually only differ by a different configuration (see chapter [3.2.9 Reusability of blocks](#)).

3 General programming

3.2 Program blocks

- You project or your plant becomes more transparent. This is to say, error states in a plant can be more easily detected, analyzed and removed. In other words, the maintainability of your plant becomes easier. This is also the case for errors in programming.

Recommendation

- Structure your automation task.
- Divide the entire function of your plant into individual areas and form sub-function units. Divide these function units again into smaller units and functions. Divide until you get functions that you can use several times with different parameters.
- Specify the interfaces between the function units. Define the unique interfaces for functionalities that are to be delivered by "external companies".

All organization blocks, function blocks and functions can be programmed with the following languages:

Table 3-1: Programming languages

Programming language	S7-1200	S7-1500
Ladder diagram (LAD)	yes	yes
Function block diagram (FBD)	yes	yes
Structured Control Language (SCL)	yes	yes
Graph	no	yes
Statement list (STL)	no	yes

3.2.1 Organization blocks (OB)

Figure 3-2: "Add new block" dialog (OB)

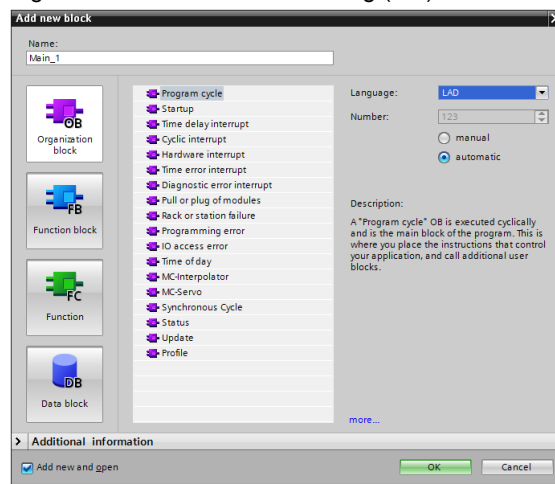

OBs are the interface between the operating system and the user program. They are called by the operating system and control, for example, the following processes:

- Startup behavior of the controller
- Cyclic program processing
- Interrupt-controlled program processing
- Error handling

Depending on the controller a number of different OB types are available.

Properties

- OBs are called by the operating system of the controller.
- Several Main OBs can be created in a program. The OBs are processed sequentially by OB number.

Figure 3-3: Using several Main OBs

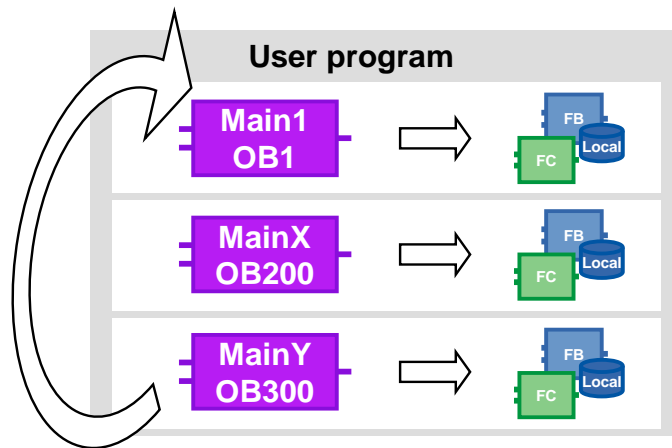

Recommendation

- Encapsulate the different program parts which should maybe be replaceable from controller to controller, into several Main OBs.
- Avoid the communication between the different Main OBs. They can then be used independent of each other. If you nevertheless exchange data between the individual main OBs, use the global DBs (see chapter [4.2 No bit memory but global data blocks](#)).
- Divide all program parts that belong to each other into folders and store them for reusability in the project or global library.

Figure 3-4: Storing program parts in order in the project library

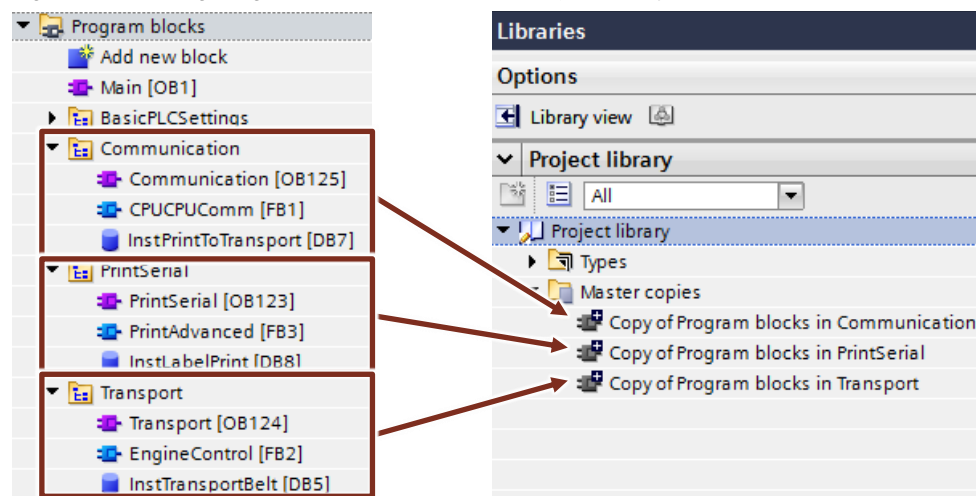

Further information is available in chapter [3.7 Libraries](#).

3 General programming

3.2 Program blocks

Note

More information can be found in the following entry:

Which organization blocks can be used in STEP 7 (TIA Portal)?

<https://support.industry.siemens.com/cs/ww/en/view/40654862>

3.2.2 Functions (FC)

Figure 3-5: "Add new block" dialog (FC)

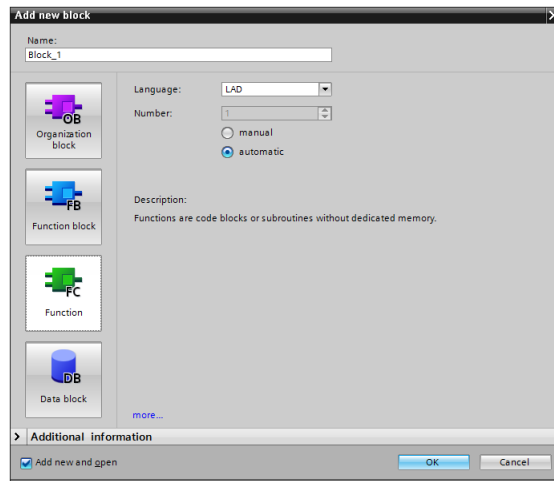

FCs are blocks without cyclic data storages. This is why the values of block parameters cannot be saved until the next call and have to be provided with actual parameters when called.

Properties

- FCs are blocks without cyclic data storages.
- Temporary tags are undefined when called in non-optimized blocks. In optimized blocks, the values are always preset with the default value (S7-1500 and S7-1200 firmware V4 and higher). Thus, the resulting behavior is not accidental but reproducible behavior.
- In order to permanently save the data of an FC, the functions of the global data blocks are available.
- FCs can have several outputs.
- The function value can be directly reused in SCL in a formula.

Recommendation

- Use the functions for frequently recurring applications that are called several times in different locations of the user program.
- Use the option to directly reuse the function value in SCL.
`<Operand> := <FC name> (Parameter list);`

Example

In the following example a mathematical formula is programmed in a FC. The result of the calculation is directly declared as return value and the function value can be directly reused.

Table 3-2: Reusing function value

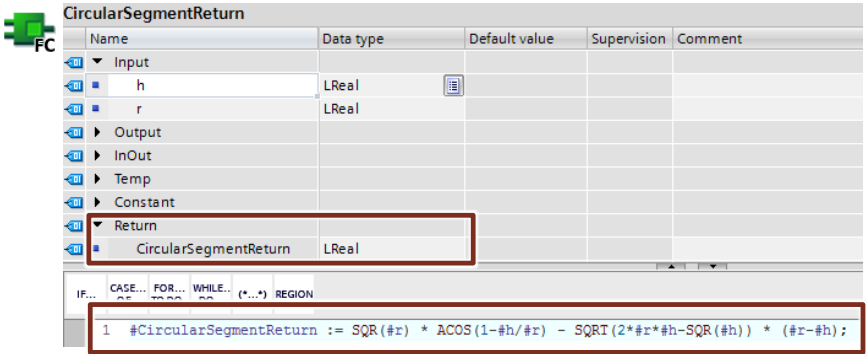
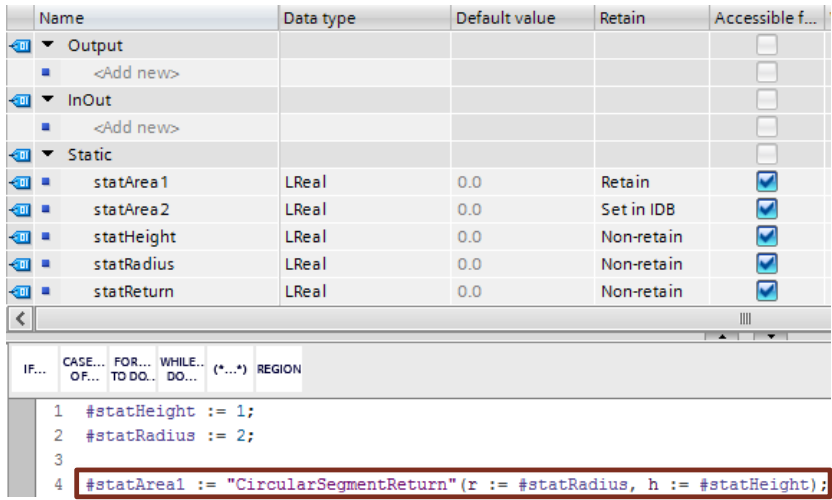
Step	Instruction
1.	<p>Create an FC with the mathematical formula (circular segment) and define the "return" value as the result for the formula.</p> 
2.	<p>Call the FC with the circular segment calculation in any block (SCL).</p> <p><Operand> := <FC name> (parameter list);</p> 

Note

More information can be found in the following entries:

What is the maximum number of parameters you are allowed to define in STEP 7 (TIA Portal) for a function in the S7-1200/S7-1500 CPU?

<https://support.industry.siemens.com/cs/ww/en/view/99412890>

3.2.3 Function blocks (FB)

Figure 3-6: "Add new block" dialog (FB)

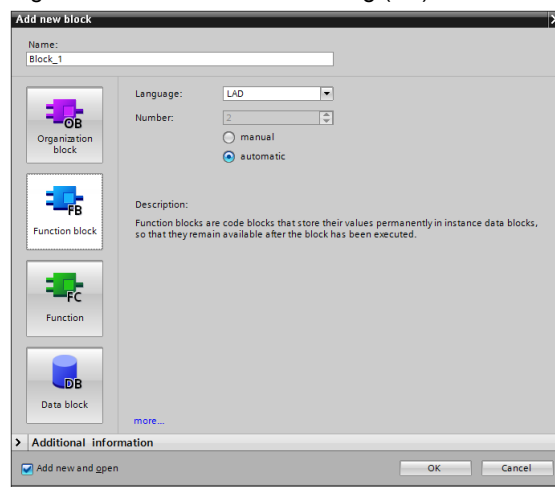

FBs are blocks with cyclic data storage, in which values are permanently stored. The cyclic data storage is realized in an instance DB.

Figure 3-7: Calling a function block

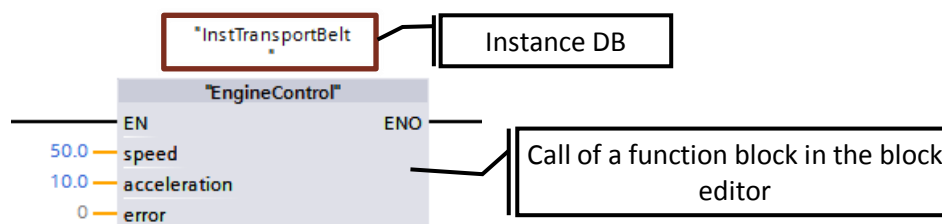

Properties

- FBs are blocks with cyclic data storage.
- Temporary tags are undefined when called in non-optimized blocks. In optimized blocks, the values are always preset with the default value (S7-1500 and S7-1200 firmware V4). Thus, the resulting behavior is not accidental but reproducible.
- Static tags keep the value from cycle to cycle

Recommendation

- Use the function blocks in order to create subprograms and structure the user program. A function block can also be called several times in different locations of the user program. This makes programming of frequently recurring program parts easier.
- If function blocks are applied multiply in the user program, use separate instances, preferably multi-instances.

3.2.4 Instances

The call of a function block is called instance. The data with which the instance is working is saved in an instance DB.

Instance DBs are always created according to the specifications in the FB interface and can therefore not be changed in the instance DB.

Figure 3-8: Structure of the interfaces of an FB

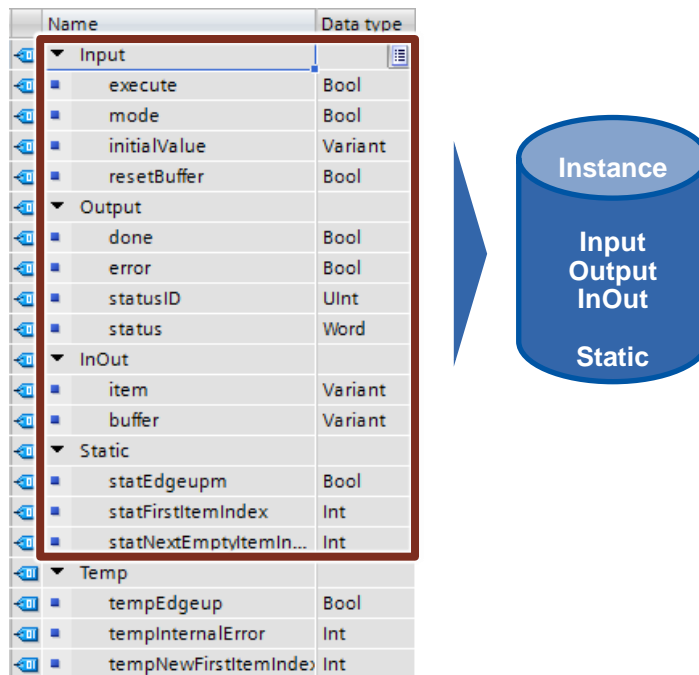

The instance DB consists of a permanent memory with the interfaces input, output, InOut and static. Temporary tags are stored in a volatile memory (L stack). The L stack is always only valid for the current processing. I.e. temporary tags have to be initialized in each cycle.

Properties

- Instance DBs are always assigned to a FB.
- Instance DBs do not have to be created manually in the TIA Portal and are created automatically when calling an FB.
- The structure of the instance DB is specified in the appropriate FB and can only be changed there.

Recommendation

- Program it in a way so that the data of the instance DB can only be changed by the appropriate FB. This is how you can guarantee that the block can be used universally in all kinds of projects.

For more information, please refer to chapter [3.4.1 Block interfaces as data exchange](#).

3.2.5 Multi-instances

With multi-instances called function blocks can store their data in the instance data block of the called function block. This means, if another function block is called in a function block, it saves its data in the instance DB of the higher-level FBs. The functionality of the called block is thus maintained even when the calling block is transferred.

The following figure shows an FB that uses another FB ("IEC Timer"). All data is saved in a multi instance DB. It is thus possible to create a block with an independent time behavior, for example, a clock generator.

Figure 3-9: Multi-instances

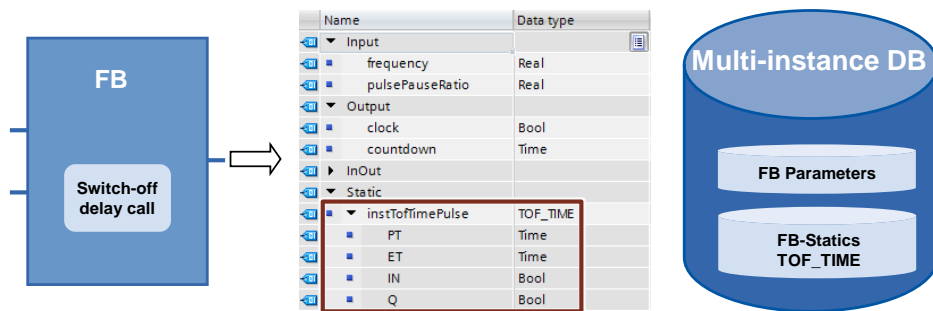

Advantages

- Reusability
- Multiple calls are possible
- Clearer program with fewer instance DBs
- Simple copying of programs
- Good options for structuring during programming

Properties

- Multi-instances are memory areas within instance DBs.

Recommendation

Use multi-instances in order to ...

- reduce the number of instance DBs.
- create reusable and clear user programs.
- program local functions, for example, timer, counter, edge evaluation.

Example

If you require the time and counter function, use the "IEC Timer" blocks and the "IEC Counter" blocks instead of the absolutely addressed SIMATIC Timer. If possible, also always use multi-instances here. Thus, the number of blocks in the user program is kept low.

3 General programming

3.2 Program blocks

Figure 3-10: Library of the IEC Timer

Timer operations	
TP	Generate pulse
TON	Generate on-delay
TOF	Generate off-delay
TONR	Time accumulator
-(TP)-	Start pulse timer
-(TON)-	Start on-delay timer
-(TOF)-	Start off-delay timer
-(TONR)-	Time accumulator
-(RT)-	Reset timer
-(PT)-	Load time duration
Legacy	
S_PULSE	Assign pulse timer parameters and start
S_PEXT	Assign extended pulse timer parameters and start
S_ODT	Assign on-delay timer parameters and start
S_ODTS	Assign retentive on-delay timer parameters and start
S_OFFDT	Assign off-delay timer parameters and start
-(SP)	Start pulse timer
-(SE)	Start extended pulse timer
-(SD)	Start on-delay timer
-(SS)	Start retentive on-delay timer
-(SF)	Start off-delay timer

Note

More information can be found in the following entries:

How do you declare the timers and counters for the S7-1500 in STEP 7 (TIA Portal)?

<https://support.industry.siemens.com/cs/ww/en/view/67585220>

3.2.6 Transferring instance as parameters (V14)

Instances of called blocks can be defined as InOut parameters.

Advantages

- It is possible to create standardized functions whose dynamic instances are transferred.
- Only when calling the block it is specified what instance is used.

Example

Figure 3-11: Transferring instance as parameter

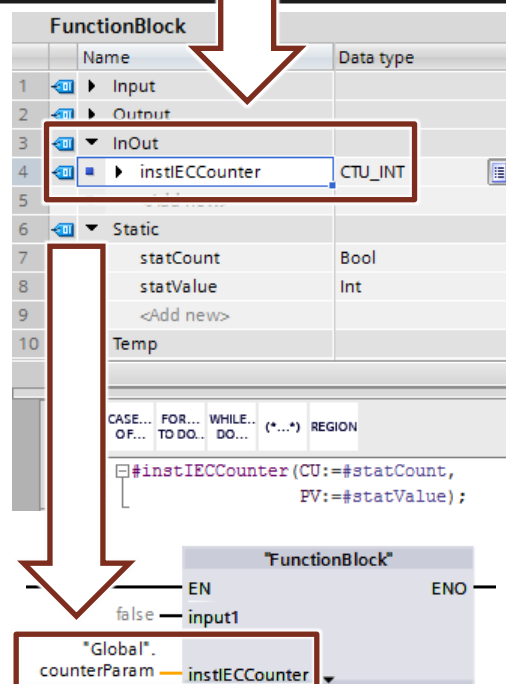
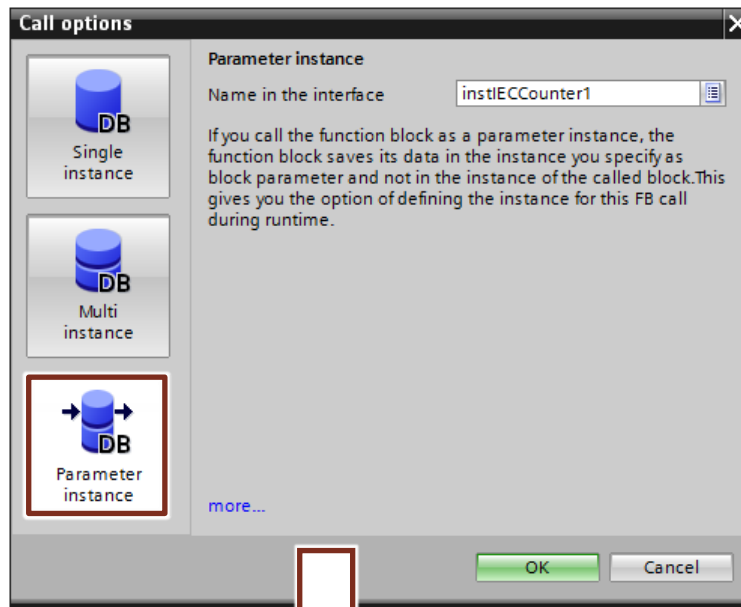

3.2.7 Global data blocks (DB)

Figure 3-12: "Add new block" dialog (DB)

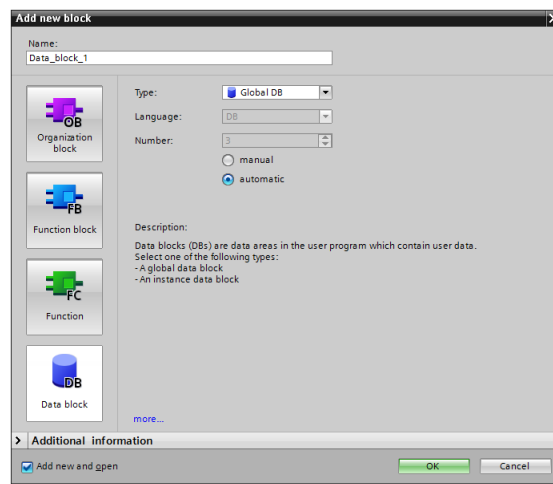

Variable data is located in data blocks that are available to the entire user program.

Figure 3-13: Global DB as central data memory

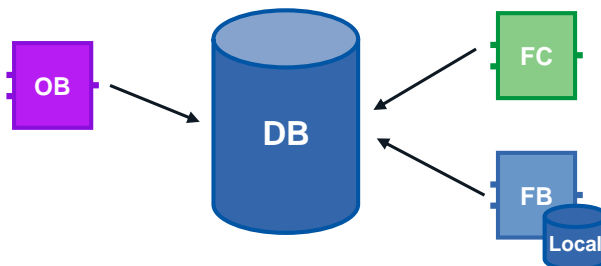

Advantages

- Well-structured memory area
- High access speed

Properties

- All blocks in the user program can access global DBs.
- The structure of the global DBs can be arbitrarily made up of all data types.
- Global DBs are either created via the program editor or according to a previously created "user-defined PLC data type" (see chapter [3.6.4 STRUCT data type and PLC data types](#)).
- A maximum of 256 structured tags (ARRAY, STRUCT) can be defined. This does not apply to tags that are derived from a PLC-data type.

Recommendation

- Use the global DBs when data is used in different program parts or blocks.

Note

More information can be found in the following entry:

How is the declaration table for global data blocks structured in STEP 7 (TIA Portal)?

<https://support.industry.siemens.com/cs/ww/en/view/68015630>

3.2.8 Downloading without reinitialisation

In order to change user programs that already run in a controller, S7-1200 (firmware V4.0) and S7-1500 controllers offer the option to expand the interfaces of optimized function or data blocks during operation. You can load the changed blocks without setting the controller to STOP and without influencing the actual values of already loaded tags.

Figure 3-14: Load without reinitialization

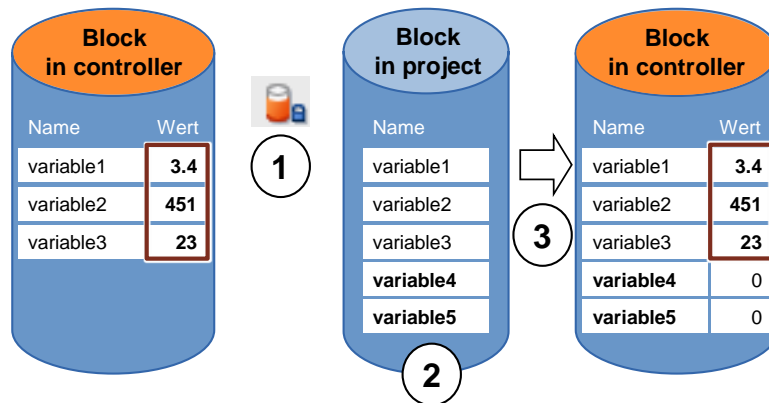

Execute the following steps whilst the controller is in RUN mode.

1. Enable "Downloading without reinitialisation"
2. Insert newly defined tags in existing block
3. Load block into controller

Advantages

- Reloading of newly defined tags without interrupting the running process. The controller stays in "RUN" mode.

Properties

- Downloading without reinitialization is only possible for optimized blocks.
- The newly defined tags are initialized. The existing tags keep their current value.
- A block with reserve requires more memory space in the controller.
- The memory reserve depends on the work memory of the controller; however, it is max. 2 MB.
- It is assumed that a memory reserve has been defined for block.
- By default, the memory reserve is set to 100 byte.
- The memory reserve is defined individually for every block.
- The blocks can be variably expanded.

3 General programming

3.2 Program blocks

Recommendation

- Define a memory reserve for blocks that are to be expanded during commissioning (e.g. test blocks). The commissioning process is not disturbed by a download since the actual values of the existing tags remain.

Example: Setting memory reserve on the block

The following table describes how you can set the memory reserve for the downloading without reinitializing.

Table 3-3: Setting memory reserve

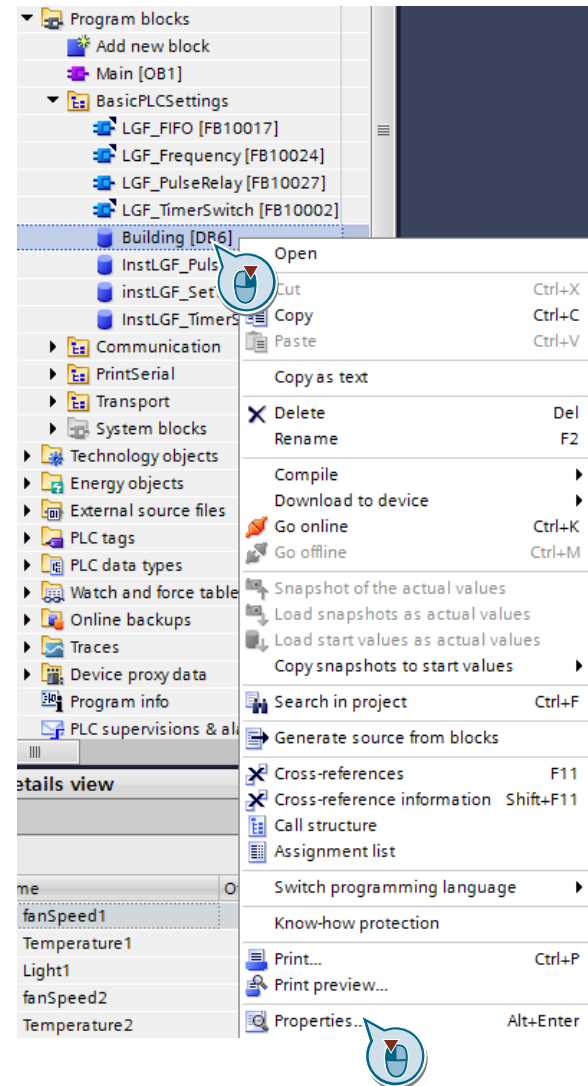
Step	Instruction
1.	<p>Right-click any optimized block in the project tree and select "Properties".</p> 

3 General programming

3.2 Program blocks

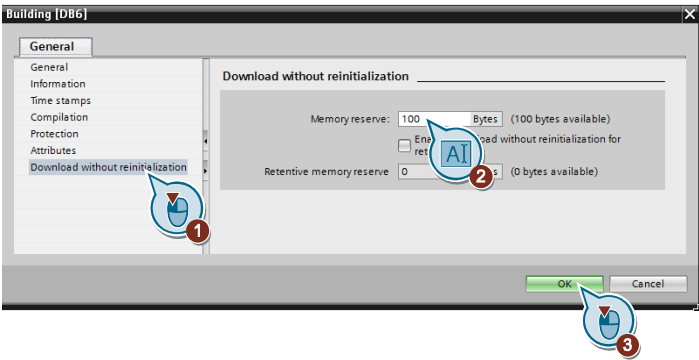
Step	Instruction
2.	 <p>Click "Download without reinitialization".</p> <p>3. Enter the desired memory reserve for "Memory reserve".</p> <p>4. Confirm with "OK".</p>

Note

You can also set a default value for the size of the memory reserve for new blocks in the TIA portal.

In the menu bar, navigate to "Options – Settings" and then to "PLC programming – General – Download without reinitialization".

Example: Downloading without reinitialisation

The following example displays how to download without reinitialization.

Table 3-4 Load without reinitialization

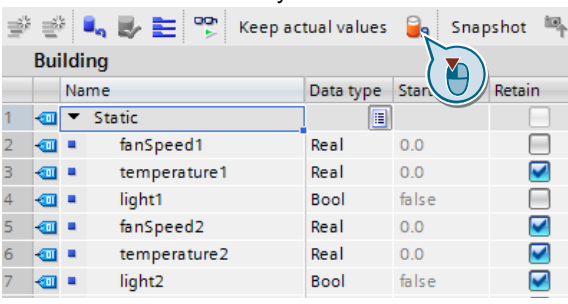
Step	Instruction																																								
1.	Prerequisite: a memory reserve has to be set (see above)																																								
2.	Open, e.g. an optimized global DB.																																								
3.	<p>Click the "Activate memory reserve" button and confirm the dialog with "OK".</p>  <table border="1"> <thead> <tr> <th></th> <th>Name</th> <th>Data type</th> <th>Start</th> <th>Retain</th> </tr> </thead> <tbody> <tr> <td>1</td> <td>Static</td> <td></td> <td></td> <td></td> </tr> <tr> <td>2</td> <td>fanSpeed1</td> <td>Real</td> <td>0.0</td> <td><input type="checkbox"/></td> </tr> <tr> <td>3</td> <td>temperature1</td> <td>Real</td> <td>0.0</td> <td><input checked="" type="checkbox"/></td> </tr> <tr> <td>4</td> <td>light1</td> <td>Bool</td> <td>false</td> <td><input type="checkbox"/></td> </tr> <tr> <td>5</td> <td>fanSpeed2</td> <td>Real</td> <td>0.0</td> <td><input checked="" type="checkbox"/></td> </tr> <tr> <td>6</td> <td>temperature2</td> <td>Real</td> <td>0.0</td> <td><input checked="" type="checkbox"/></td> </tr> <tr> <td>7</td> <td>light2</td> <td>Bool</td> <td>false</td> <td><input checked="" type="checkbox"/></td> </tr> </tbody> </table>		Name	Data type	Start	Retain	1	Static				2	fanSpeed1	Real	0.0	<input type="checkbox"/>	3	temperature1	Real	0.0	<input checked="" type="checkbox"/>	4	light1	Bool	false	<input type="checkbox"/>	5	fanSpeed2	Real	0.0	<input checked="" type="checkbox"/>	6	temperature2	Real	0.0	<input checked="" type="checkbox"/>	7	light2	Bool	false	<input checked="" type="checkbox"/>
	Name	Data type	Start	Retain																																					
1	Static																																								
2	fanSpeed1	Real	0.0	<input type="checkbox"/>																																					
3	temperature1	Real	0.0	<input checked="" type="checkbox"/>																																					
4	light1	Bool	false	<input type="checkbox"/>																																					
5	fanSpeed2	Real	0.0	<input checked="" type="checkbox"/>																																					
6	temperature2	Real	0.0	<input checked="" type="checkbox"/>																																					
7	light2	Bool	false	<input checked="" type="checkbox"/>																																					

3 General programming

3.2 Program blocks

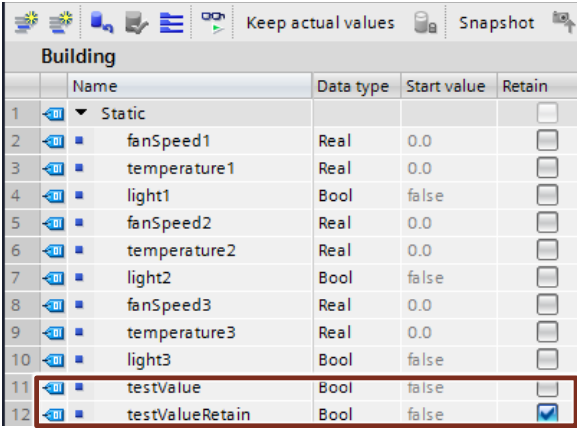
Step	Instruction																																																																	
4.	<p>Add a new tag (retentive tags are also possible).</p>  <table border="1"> <thead> <tr> <th></th> <th>Name</th> <th>Data type</th> <th>Start value</th> <th>Retain</th> </tr> </thead> <tbody> <tr> <td>1</td> <td>Static</td> <td></td> <td></td> <td><input type="checkbox"/></td> </tr> <tr> <td>2</td> <td>fanSpeed1</td> <td>Real</td> <td>0.0</td> <td><input type="checkbox"/></td> </tr> <tr> <td>3</td> <td>temperature1</td> <td>Real</td> <td>0.0</td> <td><input type="checkbox"/></td> </tr> <tr> <td>4</td> <td>light1</td> <td>Bool</td> <td>false</td> <td><input type="checkbox"/></td> </tr> <tr> <td>5</td> <td>fanSpeed2</td> <td>Real</td> <td>0.0</td> <td><input type="checkbox"/></td> </tr> <tr> <td>6</td> <td>temperature2</td> <td>Real</td> <td>0.0</td> <td><input type="checkbox"/></td> </tr> <tr> <td>7</td> <td>light2</td> <td>Bool</td> <td>false</td> <td><input type="checkbox"/></td> </tr> <tr> <td>8</td> <td>fanSpeed3</td> <td>Real</td> <td>0.0</td> <td><input type="checkbox"/></td> </tr> <tr> <td>9</td> <td>temperature3</td> <td>Real</td> <td>0.0</td> <td><input type="checkbox"/></td> </tr> <tr> <td>10</td> <td>light3</td> <td>Bool</td> <td>false</td> <td><input type="checkbox"/></td> </tr> <tr> <td>11</td> <td>testValue</td> <td>Bool</td> <td>false</td> <td><input type="checkbox"/></td> </tr> <tr> <td>12</td> <td>testValueRetain</td> <td>Bool</td> <td>false</td> <td><input checked="" type="checkbox"/></td> </tr> </tbody> </table>		Name	Data type	Start value	Retain	1	Static			<input type="checkbox"/>	2	fanSpeed1	Real	0.0	<input type="checkbox"/>	3	temperature1	Real	0.0	<input type="checkbox"/>	4	light1	Bool	false	<input type="checkbox"/>	5	fanSpeed2	Real	0.0	<input type="checkbox"/>	6	temperature2	Real	0.0	<input type="checkbox"/>	7	light2	Bool	false	<input type="checkbox"/>	8	fanSpeed3	Real	0.0	<input type="checkbox"/>	9	temperature3	Real	0.0	<input type="checkbox"/>	10	light3	Bool	false	<input type="checkbox"/>	11	testValue	Bool	false	<input type="checkbox"/>	12	testValueRetain	Bool	false	<input checked="" type="checkbox"/>
	Name	Data type	Start value	Retain																																																														
1	Static			<input type="checkbox"/>																																																														
2	fanSpeed1	Real	0.0	<input type="checkbox"/>																																																														
3	temperature1	Real	0.0	<input type="checkbox"/>																																																														
4	light1	Bool	false	<input type="checkbox"/>																																																														
5	fanSpeed2	Real	0.0	<input type="checkbox"/>																																																														
6	temperature2	Real	0.0	<input type="checkbox"/>																																																														
7	light2	Bool	false	<input type="checkbox"/>																																																														
8	fanSpeed3	Real	0.0	<input type="checkbox"/>																																																														
9	temperature3	Real	0.0	<input type="checkbox"/>																																																														
10	light3	Bool	false	<input type="checkbox"/>																																																														
11	testValue	Bool	false	<input type="checkbox"/>																																																														
12	testValueRetain	Bool	false	<input checked="" type="checkbox"/>																																																														
5.	Download the block to the controller.																																																																	
6.	<p>Result:</p> <ul style="list-style-type: none"> Actual values of the block remain 																																																																	

Note

Further information can be found in the online help of the TIA Portal under "Loading block extensions without reinitialization".

For further information, refer to the following entry:

How is the declaration table for global data blocks structured in STEP 7-1500 (TIA Portal)?

<https://support.industry.siemens.com/cs/ww/en/view/68015630>

3.2.9 Reusability of blocks

The block concept offers you a number of options to program in a structured and effective way.

Advantages

- Blocks can be used universally in any location of the user program.
- Blocks can be used universally in different projects.
- When every block receives an independent task, a clear and well-structured user program is automatically created.
- There are clearly fewer sources of errors.
- Simple error diagnostic possible.

Recommendation

If you want to reuse the block, please note the following recommendations:

- Always look at blocks as encapsulated functions. I.e. each block represents a completed partial task within the entire user program.
- Use several cyclic Main OBs to group the plant parts.
- Always execute a data exchange between the blocks via its interfaces and not via its instances (chapter [3.4.1 Block interfaces as data exchange](#)).
- Do not use project-specific data and avoid the following block contents:
 - Access to global DBs and use of single-instance DBs
 - Access to tags
 - Access to global constants
- Reusable blocks have the same requirements as know-how-protected blocks in libraries. This is why you have to check the blocks for reusability based on the "Multiple instance capability" block property. Compile the block before the check.

Figure 3-15: Block attributes

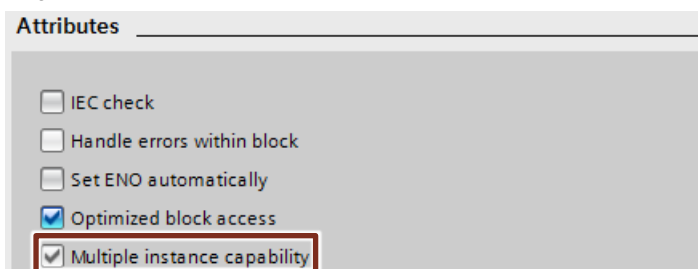

3.2.10 Auto numbering of blocks

For internal processing, required block numbers are automatically assigned by the system (setting in the block properties).

Figure 3-16: Auto numbering of blocks

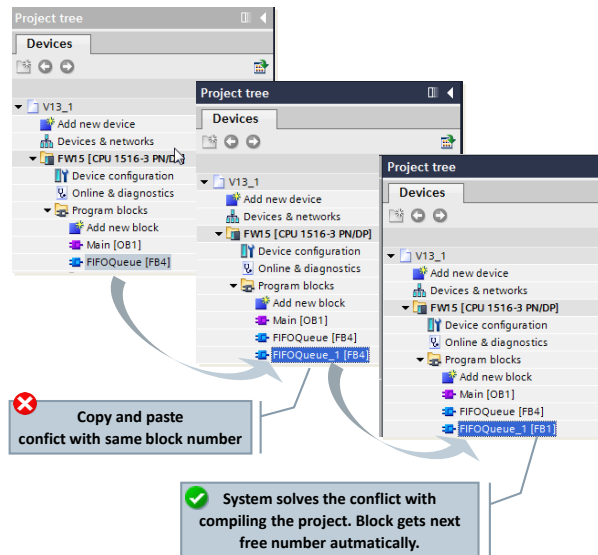

Copyright © Siemens AG 2018 All rights reserved

Advantages

- Conflicting block numbers, e.g. as a result of copying, automatically deletes the TIA Portal during compilation.

Recommendation

- Leave the existing setting "Automatic" unchanged.

Figure 3-17: Setting in the block

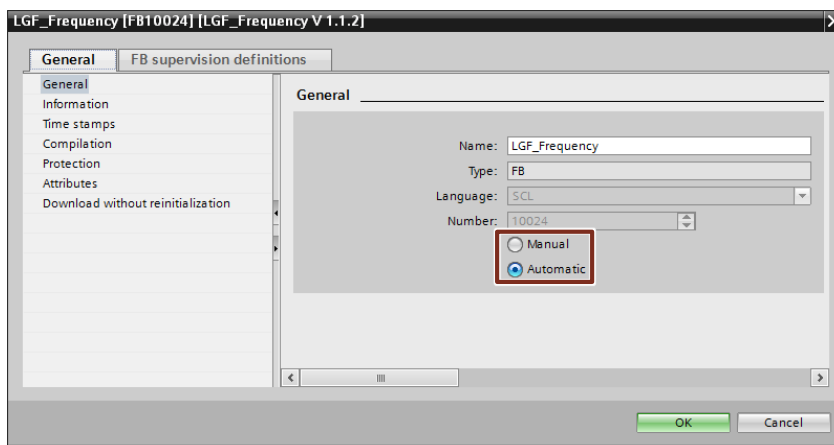

3.3 Block interface types

FBs and FCs have three different interface types: In, InOut and Out. Via these interface types the blocks are provided with parameters. The parameters are processed and output again in the block. InOut parameters serve for the transfer of data to the called block as well as the return of results. There are two different options for the parameter transfer of data.

3.3.1 Call-by-value

When calling the block, the value of the actual parameter is copied onto the formal parameter of the block. For this, an additional memory in the called block is provided.

Figure 3-18: Transfer of the value



Properties

- Each block displays the same behavior as the transferred parameters
- Values are copied when calling the block

3.3.2 Call-by-reference

When calling the block, a reference is transferred to the address of the actual parameter. For this, no additional memory is required.

Figure 3-19: Referencing the actual parameter (pointer to data storage of the parameter)

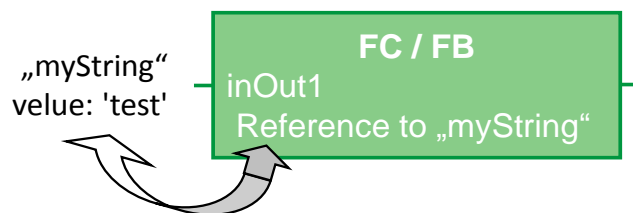

Properties

- Each block displays the same behavior as the referenced parameters.
- Actual parameters are referenced when the block is called, i.e. with the access, the values of the actual parameter are directly read or written.

Recommendation

- Generally use the InOut interface type for structured tags (e.g. of the ARRAY, STRUCT, STRING, type...) in order to avoid enlarging the required data memory unnecessarily.

3.3.3 Overview for transfer of parameters

The following table gives a summarized overview of how S7-1200/1500 block parameters with elementary or structured data types are transferred.

Table 3-5: Overview for transfer of parameters

Block type / formal parameter		Elementary data type	Structured data type
FC	Input	Copy	Reference
	Output	Copy	Reference
	InOut	Copy	Reference
FB	Input	Copy	Copy
	Output	Copy	Copy
	InOut	Copy	Reference

Note

When optimized data with the property "**non-optimized access**" is transferred when calling the block, it is generally transferred as copy. When the block contains many structured parameters this can quickly lead to the temporary storage area (local data stack) of the block to overflow.

This can be avoided by setting the same access type for both blocks (chapter [2.6.5 Parameter transfer between blocks with optimized and non-optimized access](#)).

3.4 Memory concept

For STEP 7 there is generally the difference between the global and local memory area. The global memory area is available for each block in the user program. The local memory area is only available within the respective block.

3.4.1 Block interfaces as data exchange

If you are encapsulating the functions and program the data exchange between the blocks only via the interfaces, you will clearly have advantages.

Advantages

- Program can be made up modularly from ready blocks with partial tasks.
- Program is easy to expand and maintain.
- Program code is easier to read and test since there are no hidden cross accesses.

Recommendation

- If possible, only use local tags. Thus, you can use the blocks universally and in a modular fashion.

- Use the data exchange via the block interfaces (In, Out, InOut), this guarantees the reusability of the blocks.
- Only use the instance data blocks as local memory for the respective function block. Other blocks should not be written into instance data blocks.

Figure 3-20: Avoiding access to instance data blocks

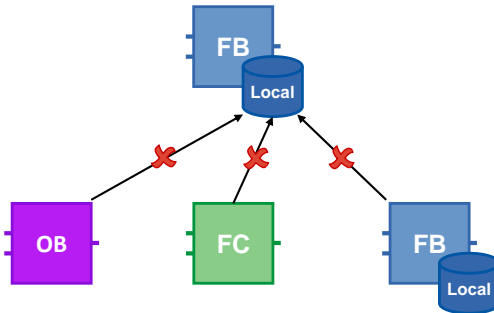

If only the block interfaces are used for the data exchange it can be ensured that all blocks can be used independent from each other.

Figure 3-21: Block interfaces for data exchange

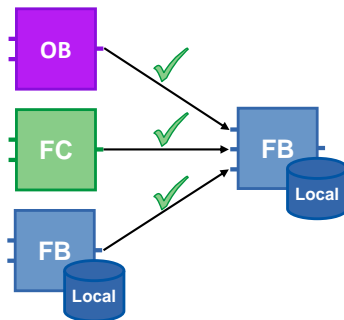

3.4.2 Global memory

Memories are called global when they can be accessed from any location of the user program. There are hardware-dependent memories (for example, bit memory, times, counters, etc.) and global DBs. For hardware-dependent memory areas there is the danger that the program may not be portable to any controller because the areas there may already be used. This is why you should use global DBs instead of hardware-dependent memory areas.

Advantages

- User programs can be used universally and independent from the hardware.
- The user program can be modularly configured without having to divide bit memory areas for different users.
- Optimized global DBs are clearly more powerful than the bit memory address area that is not optimized for reasons of compatibility.

Recommendation

- Do not use any bit memory and use global DBs instead.
- Avoid hardware-dependent memory, such as, for example, clock memory or counter. Use the IEC counter and timer in connection with multi-instances instead (chapter [3.2.5 Multi-instances](#)). The IEC timers can be found in "Instructions – Basic Instructions – Timer operations".

Figure 3-22: IEC timers

Timer operations	
TP	Generate pulse
TON	Generate on-delay
TOF	Generate off-delay
TONR	Time accumulator
-[TP]-	Start pulse timer
-[TON]-	Start on-delay timer
-[TOF]-	Start off-delay timer
-[TONR]-	Time accumulator
-[RT]-	Reset timer
-[PT]-	Load time duration

3.4.3 Local memory

- Static tags
- Temporary tags

Recommendation

- Use the static tags if the values are required in the next cycle.
- Use the temporary tags as intermediate memory in the current cycle. The access time for temporary tags is shorter than for static ones.
- If an Input/Output tags is accessed very frequently, use a temporary tag as intermediate memory to save runtime.

Note

Optimized blocks: Temporary tags are initialized in each block call with the default value (S7-1500 / S7-1200 firmware V4 or higher).
Non-optimized blocks: Temporary tags are undefined for each call of the block.

3.4.4 Access speed of memory areas

STEP 7 offers different options of memory access. For system-related reasons there are faster and slower accesses to different memory areas.

Figure 3-23: Different memory access

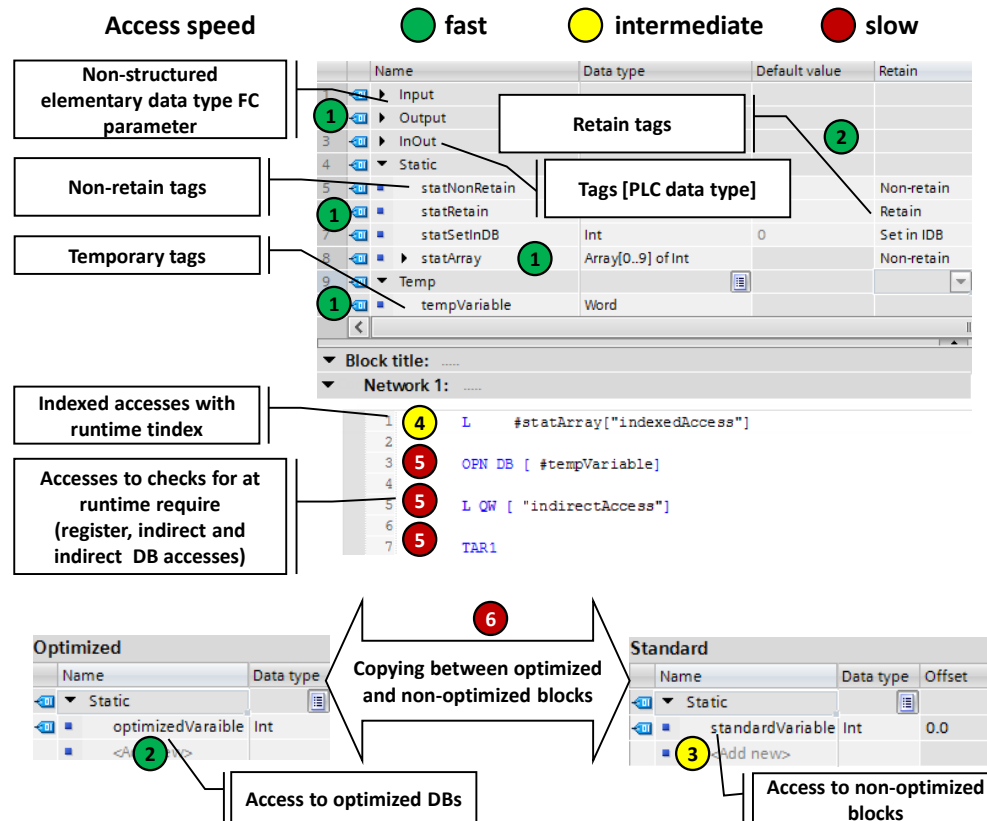

3.5 Retentivity

In the event of a failure of the power supply, the controller copies the retentive data with its buffer energy from the controller's work memory to a non-volatile memory. After restarting the controller, the program processing is resumed with the retentive data. Depending on the controller, the data volume for retentivity has different sizes.

Table 3-6: Retentive memory for S7-1200/1500

Controller	Usable retentive memory for bit memory, times, counters, DBs and technology objects
CPU 1211C, 1212C, 1214C, 1215C, 1217C	10 kByte
CPU 1511-1 PN	88 kByte
CPU 1513-1 PN	88 kByte
CPU 1515-2 PN, CPU 1516-3 PN/DP	472 kByte
CPU 1518-4 PN/DP	768 kByte

Table 3-7: Differences of S7-1200 and S7-1500

S7-1200	S7-1500
Retentivity can only be set for bit memory	Retentivity can be set for bit memory, times and counters

Advantages

- Retentive data maintains its value when the controller goes to STOP and back to RUN or in the event of power failure and a restart of the controller.

Properties

For elementary tags of an optimized DB the retentivity can be set separately. Non-optimized data blocks can only be defined completely retentive or non-retentive.

Retentive data can be deleted with the actions "memory reset" or "Reset to factory settings" via:

- Operating switch on the controller (MRES)
- Display of the controller
- Online via STEP 7 (TIA Portal)

Recommendation

- Do not use the setting "Set in IDB". Always set the retentive data in the function block and not in the instance data block.
The "Set in IDB" setting increases the processing time of the program sequence. Always either select "Non-retain" or "Retain" for the interfaces in the FB.

3 General programming

3.5 Retentivity

Figure 3-24: Program editor (Functions block interfaces)

Static				
instToTimePulse	TOF_...			Non-retain
instToTimePause	TOF_TIME			Non-retain
statFrequency	Real	0.0		Non-retain
statTimePeriod	Time	T#0ms		Non-retain
statTimePulse	Time	T#0ms		Non-retain

Figure 3-25: Program editor (data block)

Building					
Name	Data type	Start value	Retain	Accessible f...	
Static					
fanSpeed1	Real	0.0	<input type="checkbox"/>	<input checked="" type="checkbox"/>	
temperature1	Real	0.0	<input checked="" type="checkbox"/>	<input checked="" type="checkbox"/>	
light1	Bool	false	<input type="checkbox"/>	<input checked="" type="checkbox"/>	
fanSpeed2	Real	0.0	<input checked="" type="checkbox"/>	<input checked="" type="checkbox"/>	
temperature2	Real	0.0	<input checked="" type="checkbox"/>	<input checked="" type="checkbox"/>	
light2	Bool	false	<input checked="" type="checkbox"/>	<input checked="" type="checkbox"/>	
fanSpeed3	Real	0.0	<input type="checkbox"/>	<input checked="" type="checkbox"/>	
temperature3	Real	0.0	<input checked="" type="checkbox"/>	<input checked="" type="checkbox"/>	
light3	Bool	false	<input checked="" type="checkbox"/>	<input checked="" type="checkbox"/>	

Example: Retentive PLC tags

The setting of the retentive data is performed in the tables of the PLC tags, function blocks and data blocks.

Figure 3-26: Setting of the retentive tags in the table of PLC tags

Name	Tag table	Data type	Address
activateLeft	Default tag table	Bool	%I0.0
activateRight	Default tag table	Bool	%I0.1

Retain memory

Number of memory bytes starting at MB0: 0

Number of SIMATIC timers starting at TO: 0

Number of SIMATIC counters starting at CO: 0

Currently available retain memory (bytes): 90784

OK Cancel

Retentivity can be set from address 0 onward!
e.g. from MB0, TO or CO

Example: Retentive counter

You can also declare instances of functions (timer, counter, etc.) retentive. As already described in chapter [3.2.5 Multi-instances](#), you should always program such functions as multi-instance.

Figure 3-27: Retentive counter as multi-instance

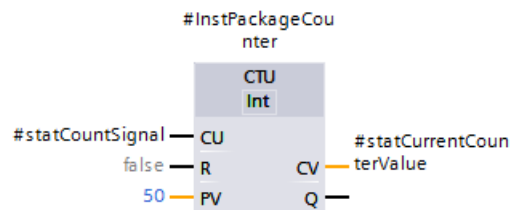
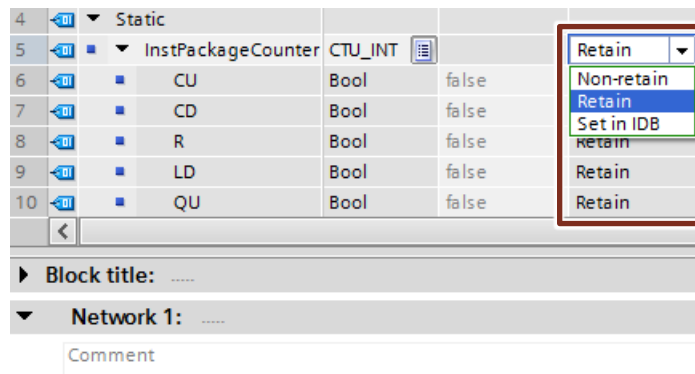

Note

If the retentive memory on the PLC is not sufficient, it is possible to store data in the form of data blocks that are only located in the load memory of the PLC. The following entry is described by taking the example of an S7-1200. This programming also works for S7-1500.

More information can be found in the following entries:

How do you configure data blocks in STEP 7 (TIA Portal) with the "Only store in load memory" attribute for a S7-1200?

<https://support.industry.siemens.com/cs/ww/en/view/53034113>

Using Recipe Functions for persistent Data with SIMATIC S7-1200 and S7-1500

<https://support.industry.siemens.com/cs/ww/en/view/109479727>

3.6 Symbolic addressing

3.6.1 Symbolic instead of absolute addressing

The TIA Portal is optimized for symbolic programming. This results in many advantages. Due to symbolic addressing, you can program without having to pay attention to the internal data storage. The controller handles where the best possible storage is for the data. You can therefore completely concentrate on the solution for your application task.

Advantages

- Easier to read programs through symbolic tag names
- Automatic update of tag names at all usage locations in the user program
- Memory storage of the program data does not have to be manually managed (absolute addressing)
- Powerful data access
- No manual optimization for performance or program size reasons required
- Auto-complete for fast symbol input
- Fewer program errors due to type safety (validity of data types is checked for all accesses)

Recommendation

- "Don't worry about the storage of the data"
- "Think" symbolically. Enter the "descriptive" name for each function, tag or data, such as, for example, Pump_boiler_1, heater_room_4, etc. Thus a created program can be simply read, without requiring many comments.
- Give all the tags used a direct symbolic name and define them afterwards with a right-click.

Example

Table 3-8: Example for creating symbolic tags

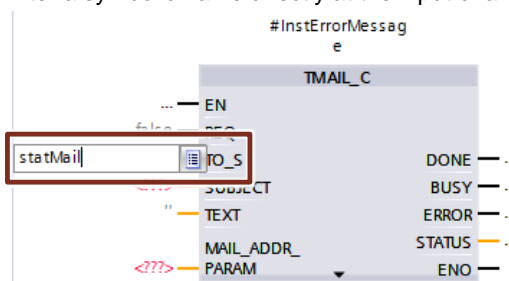
Step	Instruction
1.	Open the program editor and open any block.
2.	Enter a symbolic name directly at the input of an instruction. 

3 General programming

3.6 Symbolic addressing

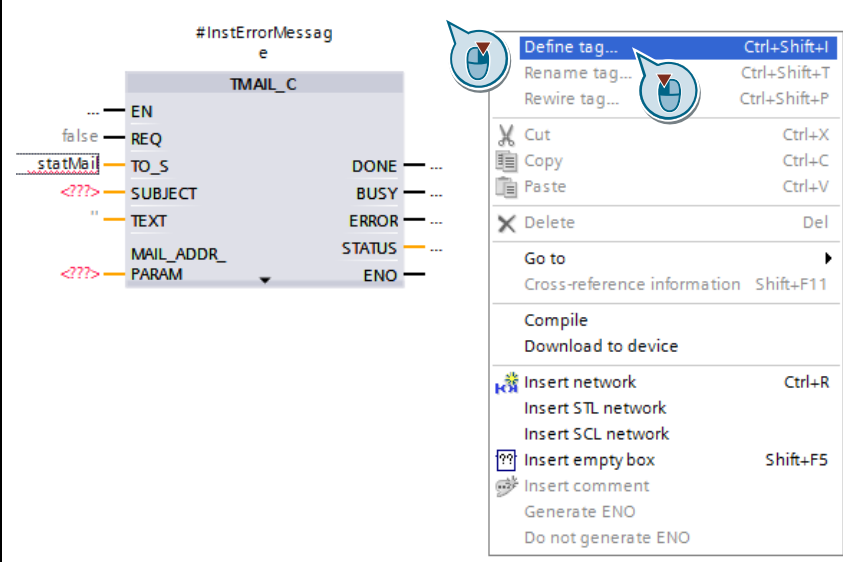
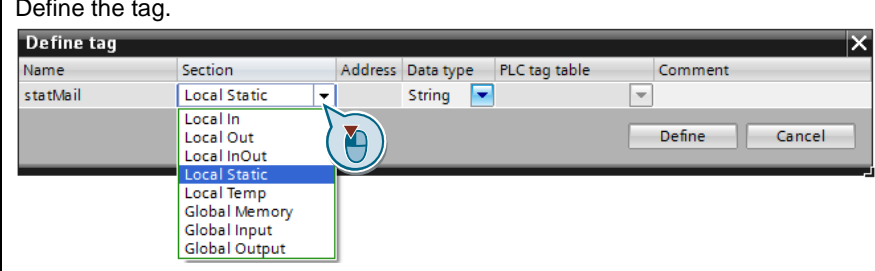
Step	Instruction
3.	<p>Right-click next to the block and select "Define tag..." in the context menu.</p> 
4.	<p>Define the tag.</p> 

There is an elegant method to save time, if you want to define several tags in a network. First of all, assign all tag names. Then define all tags at the same time with the dialog of step 4.

Note

More information can be found in the following entry:

What are the advantages of using symbolic addressing for S7-1500 in STEP 7 (TIA Portal)?

<https://support.industry.siemens.com/cs/ww/en/view/67598995>

3.6.2 ARRAY data type and indirect field accesses

The ARRAY data type represents a data structure which is made up of several elements of a data type. The ARRAY data type is suitable, for example, for the storage of recipes, material tracking in a queue, cyclic process acquisition, protocols, etc.

Figure 3-28: ARRAY with 10 elements of the Integer (INT) data type

Name	Data type
statArray	Array[0..9] of Int
statArray[0]	Int
statArray[1]	Int
statArray[2]	Int
statArray[3]	Int
statArray[4]	Int
statArray[5]	Int
statArray[6]	Int
statArray[7]	Int
statArray[8]	Int
statArray[9]	Int

You can indirectly access individual elements in the ARRAY with an index (array ["index"]).

Figure 3-29: Indirect field access

KOP / FUP:

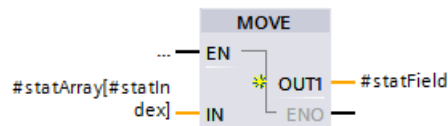

SCL:

```
1 #statField := #statArray[#statIndex];
```

Advantages

- Easy access through ARRAY index
- No complicated pointer creation required
- Fast creation and expansion possible
- Useable in all programming languages

Properties

- Structured data type
- Data structure made of fixed number of elements of the same data type
- ARRAYS can also be created multi-dimensional
- Possible indirect access with runtime tag with dynamic index calculation at runtime

Recommendation

- Use ARRAY for indexed accesses instead of pointer (e.g. ANY pointer). This makes it easier to read the program since an ARRAY is more meaningful with a symbolic name than a pointer in a memory area.
- As run tag use the DINT data type as temporary tag for highest performance.
- Use the "MOVE_BLK" instruction to copy parts of an ARRAY into another one.
- Use the "GET_ERR_ID" instruction to catch access errors within the Array.

Note

More information can be found in the following entries:

How do you implement an array access with an S7-1500 with variable index?
<https://support.industry.siemens.com/cs/ww/en/view/67598676>

How do you address securely and indirectly in STEP 7 (TIA Portal)?
<https://support.industry.siemens.com/cs/ww/en/view/97552147>

In STEP 7 (TIA Portal), how do you transfer S7-1500 data between two tags of the data types "Array of Bool" and "Word"?
<https://support.industry.siemens.com/cs/ww/en/view/108999241>

3.6.3 Formal parameter Array [*] (V14 or higher)

With the formal parameter Array [*], arrays with variable length can be transferred to functions and function blocks.

With the instructions "LOWER_BOUND" and "UPPER_BOUND" the array limits can be determined.

Advantages

- Blocks that can process the flexible arrays with different lengths
- Optimum readability due to fully-symbolic programming
- No pointer programming for arrays of different lengths necessary anymore

Example

Figure 3-30: Initializing different arrays

The figure illustrates the initialization of two arrays, `tempArray1` and `tempArray2`, in a ladder logic network. The network consists of two `InitArray` function blocks. The first block is connected to `#tempArray1` and the second to `#tempArray2`. Both blocks have their `quantityArray` input connected to the respective array symbol. The `InitArray` function block is detailed below:

Name	Data type	Default value
1 Input		
2 Output		
3 InOut		
4 <code>quantityArray</code>	Array[*] of Real	
5 Temp		
6 <code>tempLower</code>	Dint	
7 <code>tempUpper</code>	Dint	
8 <code>count</code>	Dint	

```

1 #tempLower := LOWER_BOUND (ARR := #quantityArray, DIM := 1);
2 #tempUpper := UPPER_BOUND (ARR := #quantityArray, DIM := 1);
3
4 FOR #count := #tempLower TO #tempUpper DO
5   #quantityArray[#count] := 0.0;
6 END_FOR;

```

3.6.4 STRUCT data type and PLC data types

The STRUCT data type represents a data structure which is made up of elements of different data types. The declaration of a structure is performed in the respective block.

Figure 3-31: Structure with elements with different data types

Name	Data type	Default value
statEngineData	Struct	
power	Struct	
maxpower	Int	1000
cosPhi	Real	0.89
<Add new>		
outputValues	Struct	
voltage	Real	0.0
current	Real	0.0
frequency	Real	0.0
<Add new>		

In comparison to structures, PLC data types are defined across the controller in the TIA Portal and can be centrally changed. All usage locations are automatically updated.

PLC data types are declared in the "PLC data types" folder in the project navigation before being used.

Figure 3-32: PLC data types

The screenshot shows the TIA Portal interface. On the left, the project navigation tree is visible, with 'PLC data types' highlighted in a red box. The main window displays a table for 'typeEngineData' with the following data:

Name	Data type	Default value
power	Struct	
maxpower	Int	1000
cosPhi	Real	0.89
outputValues	Struct	
voltage	Real	0.0
current	Real	0.0
frequency	Real	0.0
<Add new>		

Advantages

- A change in a PLC data type is automatically updated in all usage locations in the user program.
- Simple data exchange via block interfaces between several blocks
- In PLC data types STRING tags with defined length can be declared (e.g., String[20]). As of TIA V14 a global constant can also be used for the length (e.g., String[LENGTH]).
If a STRING tag is declared without defined length, the tag has the maximum length of 255 characters.

Properties

- PLC data types always end at WORD limits (see the figures below).
- Please consider this system property when ...
 - using structures in I/O areas (see chapter [3.6.5 Access to I/O areas with PLC data types](#)).
 - using frames with PLC data types for communication.
 - using parameter records with PLC data types for I/O.
 - using non-optimized blocks and absolute addressing.

Figure 3-33: PLC data types always end at WORD limits

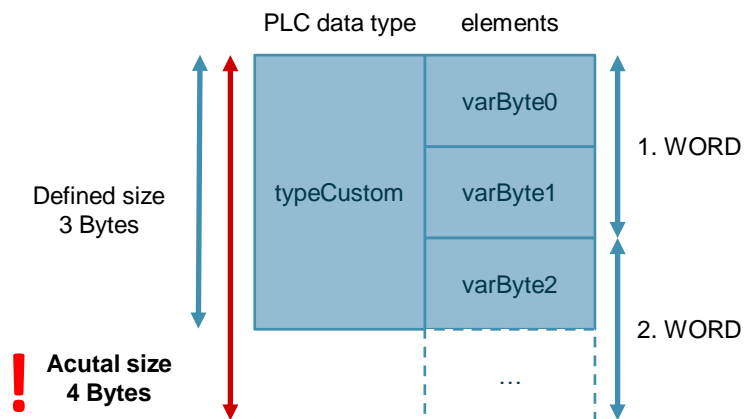
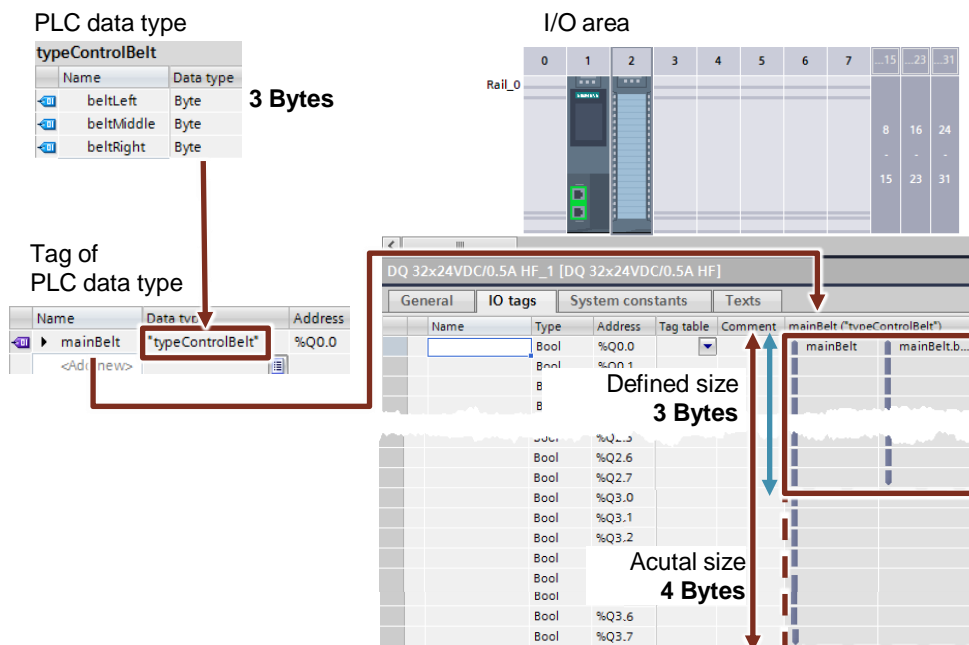

Figure 3-34: PLC data types on I/O areas



Recommendation

- Use the PLC data types to summarize several associated data, such as, e.g. frames or motor data (setpoint, speed, rotational direction, temperature, etc.)

- Always use PLC data types instead of structures for the multiple uses in the user program.
- Use the PLC data types for structuring into data blocks.
- Use the PLC data types in order to specify a structure for a data block. The PLC data type can be used for any number of DBs. You can easily and conveniently create any number of DBs of the same structure and adjust them centrally on the PLC data type.

Note

More information can be found in the following entries:

Libraries with PLC data types (LPD) for STEP 7 (TIA Portal) and S7-1200 / S7-1500

<https://support.industry.siemens.com/cs/ww/en/view/109482396>

How do you initialize structures into optimized memory areas for the S7-1500 STEP 7 (TIA Portal)?

<https://support.industry.siemens.com/cs/ww/en/view/78678760>

How do you create a PLC data type for an S7-1500 controller?

<https://support.industry.siemens.com/cs/ww/en/view/67599090>

In STEP 7 (TIA Portal), how do you apply your own data types (UDT)?

<https://support.industry.siemens.com/cs/ww/en/view/67582844>

Why should whole structures instead of many single components be transferred for the S7-1500 when a block is called?

<https://support.industry.siemens.com/cs/ww/en/view/67585079>

3.6.5 Access to I/O areas with PLC data types

With S7-1500 controllers, you can create PLC data types and use them for structured and symbolic access to inputs and outputs.

Figure 3-35: Access to I/O areas with PLC data types

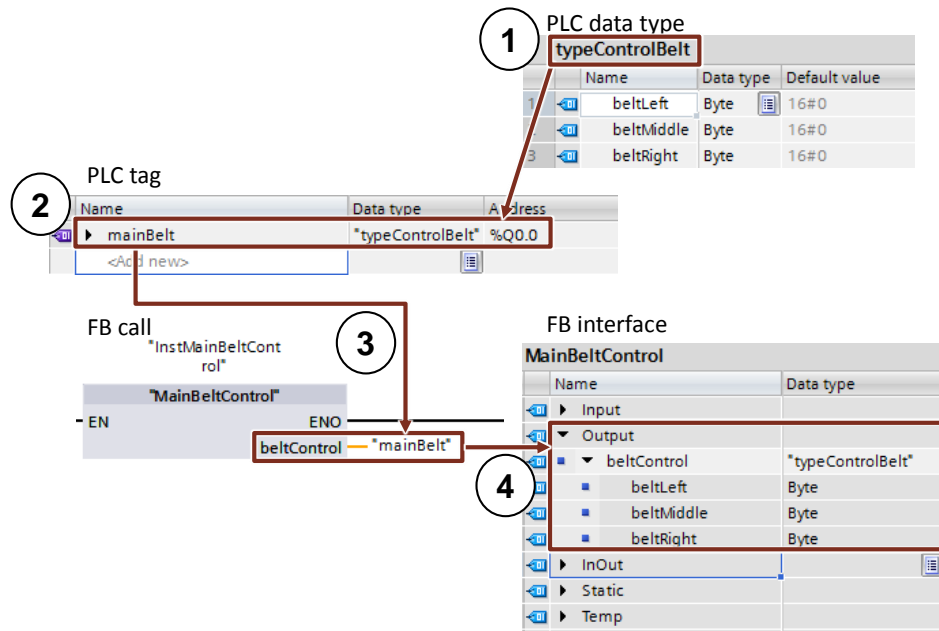

7. PLC data type with all required data
8. PLC tag of the type of the created PLC data type and start address of the I/O data area (%Ix.0 or %Qx.0, e.g., %I0.0, %Q12.0, ...)
9. Transfer of the PLC tag as actual parameter to the function block
10. Output of the function block is of the type of the created PLC data type

Advantages

- High programming efficiency
- Easy multiple usability thanks to PLC data types

Recommendation

- Use PLC data types for access to I/O areas, for example, to symbolically receive and send drive telegrams.

Note

Individual elements of a PLC data type of a tag can also be directly accessed in the user program:

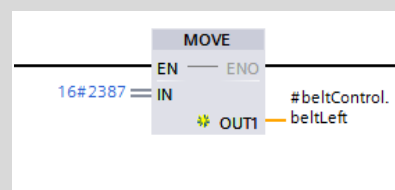

3.6.6 Slice access

For S7-1200/1500 controllers, you can access the memory area of tags of the Byte, Word, DWord or LWord data type. The division of a memory area (e.g. byte or word) into a smaller memory area (e.g. Bool) is also called slice. The figure below displays the symbolic bit, byte and word accesses to the operands.

Figure 3-36: Symbolic bit, byte, word, DWord slice access

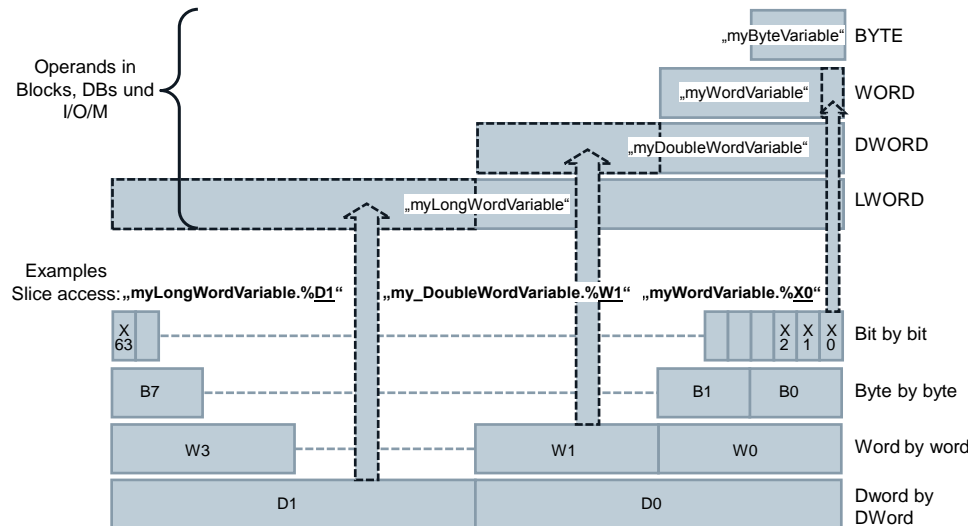

Advantages

- High programming efficiency
- No additional definition in the tag declaration required
- Easy access (e.g. control bits)

Recommendation

- Use the slice access via AT construct rather than accessing certain data areas in operands.

Note

More information can be found in the following entry:

How in STEP 7 (TIA Portal) can you access the unstructured data types bit-by-bit, byte-by-byte or word-by-word and symbolically?

<https://support.industry.siemens.com/cs/ww/en/view/57374718>

3.6.7 SCL networks in LAD and FBD (V14 and higher)

With SCL networks you can make calculations in LAD and FBD that can only be programmed with considerable effort in LAD and FBD instructions.

Figure 3-37: Inserting SCL network

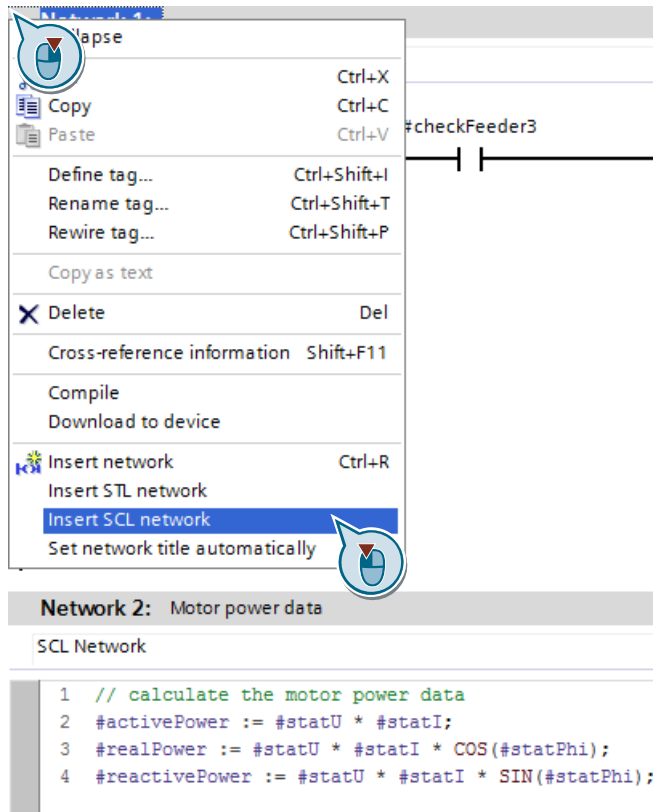

Advantages

- Time saving through efficient programming
- Clear code, thanks to symbolic programming

Properties

- Supports all SCL instructions
- Supports comments

Recommendation

- Use the SCL networks in LAD and FBD for mathematical calculations instead of instructions, such as ADD, SUBB etc.

3.7 Libraries

With the TIA Portal you can establish independent libraries from different project elements that can be easily reused.

Advantages

- Simple storage for the data configured in the TIA Portal:
 - Complete devices (controller, HMI, drive, etc.)
 - Blocks, tag tables, PLC data types, watch tables, etc.
 - HMI screens, HMI tags, scripts, etc.
- Cross-project exchange via libraries
- Central update function of library elements
- Versioning of library elements
- Fewer error sources when using control blocks through system-supported consideration of dependencies

Recommendations

- Create the master copies for easy reusability of blocks, hardware configurations, HMI screens, etc.
- Create the types for the system-supported reusability of library elements:
 - Versioning of blocks
 - Central update function of all usage locations
- Use the global library for the exchange with other users or as central storage for the simultaneous use of several users.
- Configure the storage location of your global library so it can automatically be opened when starting the TIA Portal.
Further information is available at:
<https://support.industry.siemens.com/cs/ww/en/view/100451450>

Note

More information can be found in the following entries:

Which elements of STEP 7 (TIA Portal) and WinCC (TIA Portal) can you store in a library as Type or as Master Copy?

<https://support.industry.siemens.com/cs/ww/en/view/109476862>

How can you open a global library with write access rights in STEP 7 (TIA Portal)?

<https://support.industry.siemens.com/cs/ww/en/view/37364723>

3.7.1 Types of libraries and library elements

Generally there are two different types of libraries:

- "Project library"
- "Global library"

The content consists of two storage types each:

- "Types"
- "Master Copies"

Figure 3-38: Libraries in the TIA Portal

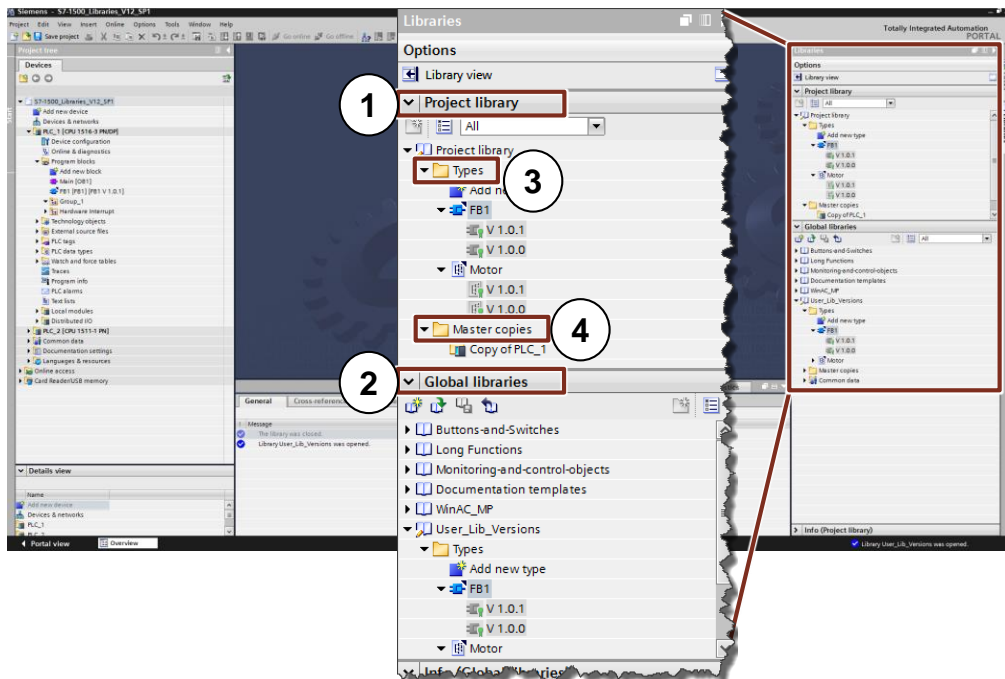

(1) "Project library"

- Integrated in the project and managed with the project
- Allows the reusability within the project

(2) "Global library"

- Independent library
- Use within several projects possible

A library includes two different types of storage of library elements:

(3) "Master copies"

- Copies of configuration elements in the library (e.g. blocks, hardware, PLC tag tables, etc.)
- Copies are not connected with the elements in the project.
- Master copies can also be made up several configuration elements.

(4) "Types"

- Types are connected with your usage locations in the project. When types are changed, the usage locations in the project can be updated automatically.

- Supported types are control blocks (FCs, FBs), PLC data types, HMI screens, HMI faceplates, HMI UDT, scripts).
- Subordinate elements are automatically typified.
- Types are versioned: Changes can be made by creating a newer version.
- There can only be one version of a used type within a controller.

3.7.2 Type concept

The type concept allows the creation of standardized automation functions that you can use in several plants or machines. The type concept supports you with versioning and updating functions.

You can use types from the library in the user program. This offers the following advantages:

Advantages

- Central update of all usage locations in the project
- Unwanted modifications of usage locations of types are not possible.
- The system guarantees that types always remain consistent by hindering unwanted delete operations.
- If a type is deleted, all usage locations in the user program are deleted.

Properties

By using types you can make the changes centrally and update them in the complete project.

Figure 3-39: Typifying with user libraries

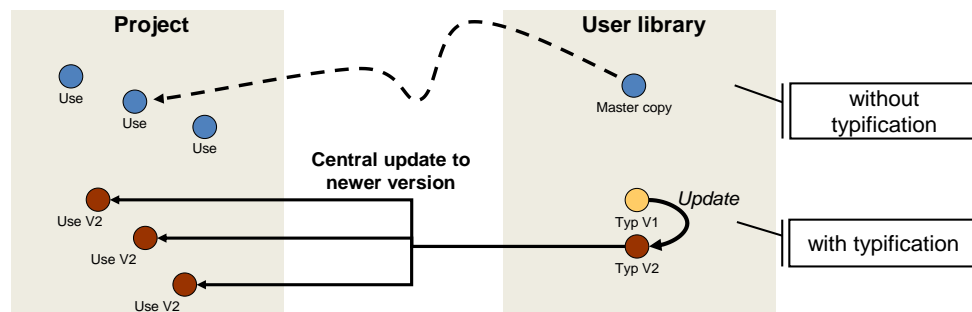

- Types are always marked for better identification

3.7.3 Differences between the typifiable objects for CPU and HMI

There are system-related differences between the typifiable objects for controllers and HMI:

Table 3-9: Differences of types for controller and HMI

Controller	HMI
Subordinate control elements are typified.	Subordinate HMI elements are not typified.
Subordinate control elements are instanced.	Subordinate HMI elements are not instanced.
Control elements are edited in a test environment .	HMI images and HMI scripts are edited in a test environment. Faceplates and HMI - UDTs are directly edited in the library without test environment .

Further information on the handling of libraries can be found in the following example.

3.7.4 Versioning of a block

Example: Creating a type

The following example shows you how the basic functions of the libraries are used with types.

Table 3-10: Creating a type

Step	Instruction																								
1.	<p>Create a new PLC data type with "Add new data type" and create some tags. Later on this is the subordinate type.</p> <table border="1" style="margin-left: 20px;"> <thead> <tr> <th>Name</th> <th>Data type</th> <th>Default value</th> </tr> </thead> <tbody> <tr> <td>power</td> <td>Struct</td> <td></td> </tr> <tr> <td> maxpower</td> <td>Int</td> <td>1000</td> </tr> <tr> <td> cosPhi</td> <td>Real</td> <td>0.89</td> </tr> <tr> <td> outputValues</td> <td>Struct</td> <td></td> </tr> <tr> <td> voltage</td> <td>Real</td> <td>0.0</td> </tr> <tr> <td> current</td> <td>Real</td> <td>0.0</td> </tr> <tr> <td> frequency</td> <td>Real</td> <td>0.0</td> </tr> </tbody> </table>	Name	Data type	Default value	power	Struct		maxpower	Int	1000	cosPhi	Real	0.89	outputValues	Struct		voltage	Real	0.0	current	Real	0.0	frequency	Real	0.0
Name	Data type	Default value																							
power	Struct																								
maxpower	Int	1000																							
cosPhi	Real	0.89																							
outputValues	Struct																								
voltage	Real	0.0																							
current	Real	0.0																							
frequency	Real	0.0																							

3 General programming

3.7 Libraries

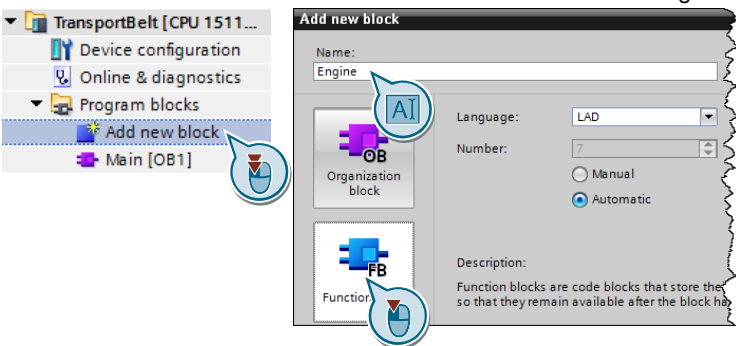
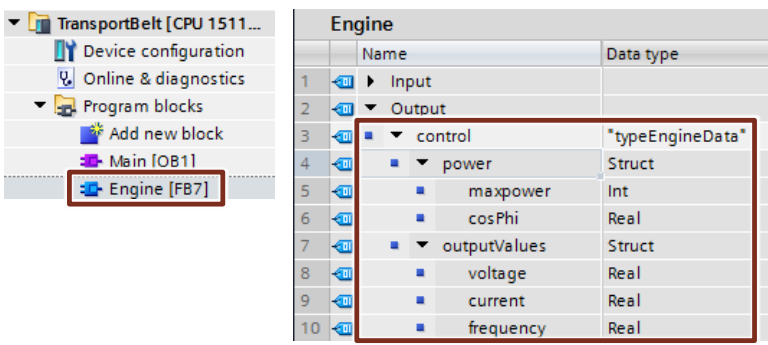
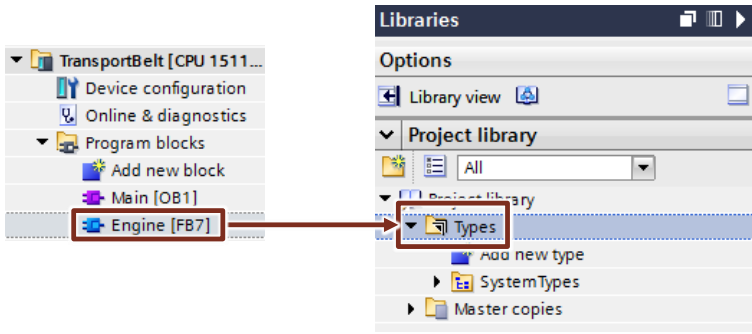
Step	Instruction																																	
2.	<p>Create a new function block with "Add new Block". This is the higher-level type.</p> 																																	
3.	<p>Define an output tag of the data type you have created. The PLC data type is therefore subordinate to the function block.</p>  <table border="1" data-bbox="799 786 1278 1122"> <thead> <tr> <th></th> <th>Name</th> <th>Data type</th> </tr> </thead> <tbody> <tr> <td>1</td> <td>Input</td> <td></td> </tr> <tr> <td>2</td> <td>Output</td> <td></td> </tr> <tr> <td>3</td> <td>control</td> <td>*typeEngineData*</td> </tr> <tr> <td>4</td> <td>power</td> <td>Struct</td> </tr> <tr> <td>5</td> <td>maxpower</td> <td>Int</td> </tr> <tr> <td>6</td> <td>cosPhi</td> <td>Real</td> </tr> <tr> <td>7</td> <td>outputValues</td> <td>Struct</td> </tr> <tr> <td>8</td> <td>voltage</td> <td>Real</td> </tr> <tr> <td>9</td> <td>current</td> <td>Real</td> </tr> <tr> <td>10</td> <td>frequency</td> <td>Real</td> </tr> </tbody> </table>		Name	Data type	1	Input		2	Output		3	control	*typeEngineData*	4	power	Struct	5	maxpower	Int	6	cosPhi	Real	7	outputValues	Struct	8	voltage	Real	9	current	Real	10	frequency	Real
	Name	Data type																																
1	Input																																	
2	Output																																	
3	control	*typeEngineData*																																
4	power	Struct																																
5	maxpower	Int																																
6	cosPhi	Real																																
7	outputValues	Struct																																
8	voltage	Real																																
9	current	Real																																
10	frequency	Real																																
4.	<p>Drag the function block via drag-and-drop into the "Types" folder in the project library.</p> 																																	

3 General programming

3.7 Libraries

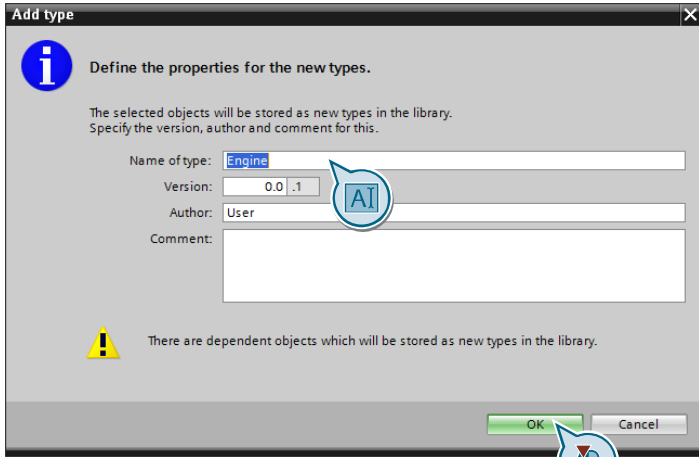
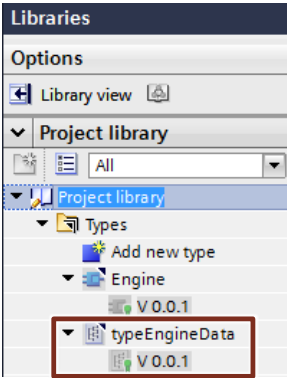
Step	Instruction
5.	<p>Optionally assign: Type name, version, author and comment and confirm the dialog with "OK".</p> 
6.	<p>The subordinate PLC data type is automatically also stored in the library.</p> 

Example: Changing a type

Table 3-11: Changing a type

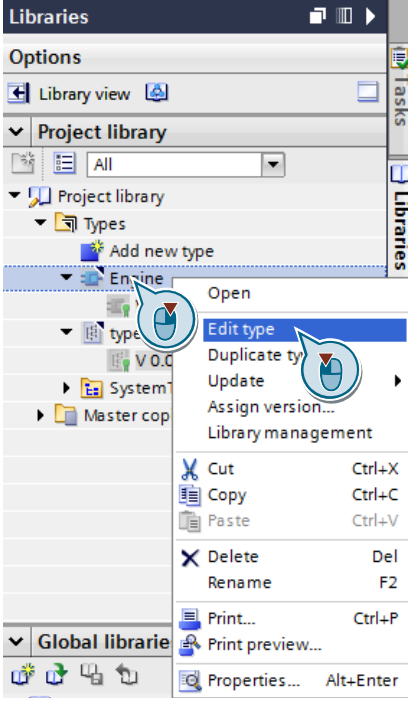
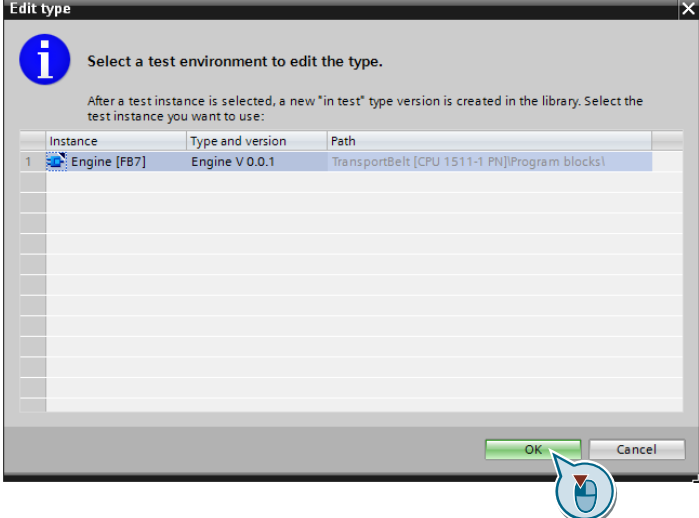
Step	Instruction
1.	<p>Right-click the block in the "Project library" and select "Edit type"</p> 
2.	<p>Select which controller is to be used as test environment and confirm the dialog with "OK".</p>  <p>If several controllers in the project use the selected block, a controller has to be selected as test environment.</p>

3 General programming

3.7 Libraries

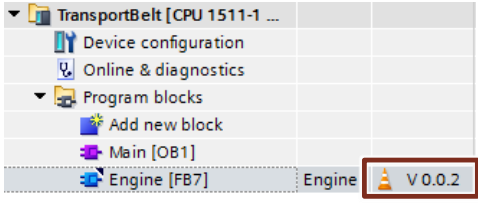
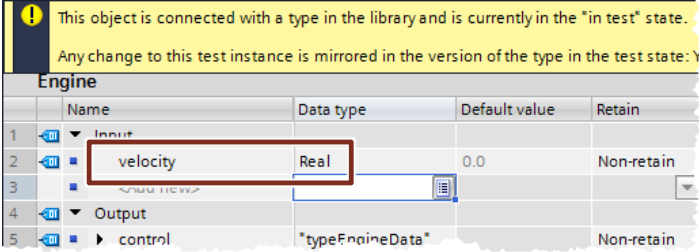
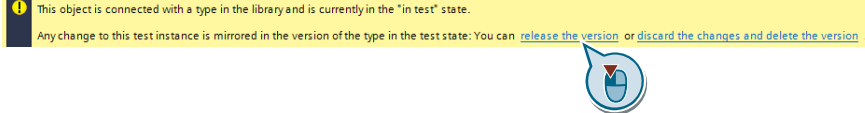
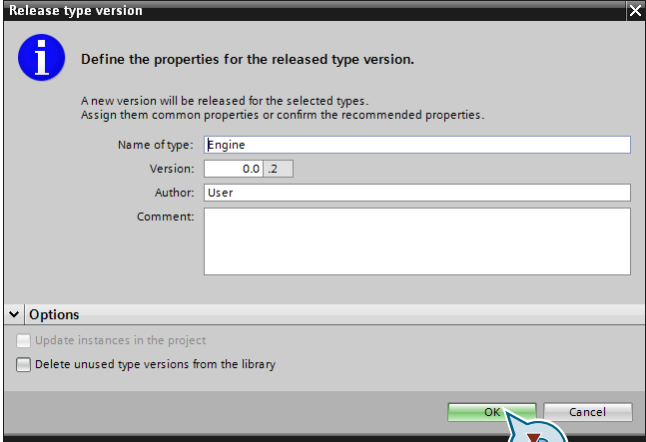
Step	Instruction
3.	<p>The block opens. A new version of the block is created.</p> 
4.	<p>Add an input tag.</p> <p>In this place you have the option to test the change on the block by loading the project onto a controller. When you have finished testing the block, continue with the following steps.</p> 
5.	<p>Click the "release the version" button.</p> 
6.	<p>A dialog box opens. Here you can store a version-related comment. Confirm the dialog with "OK".</p>  <p>If there are several usage locations of the block in different controllers of the project, you can update them all at the same time: "Update instances in the project".</p> <p>If older versions of the element are no longer required you can delete them by clicking "Delete unused type versions from library"</p>

3.8 Increased performance for hardware interrupts

The processing of the user program can be influenced by events such as hardware interrupts. When you need a fast response of the controller to hardware events (e.g. a rising edge of a channel of a digital input module), configure a hardware interrupt. For each hardware interrupt a separate OB can be programmed. This OB is called by the operating system of the controller in the event of a hardware interrupt. The cycle of the controller is therefore interrupted and continued after processing the hardware interrupt.

Figure 3-40: Hardware interrupt is calling OB

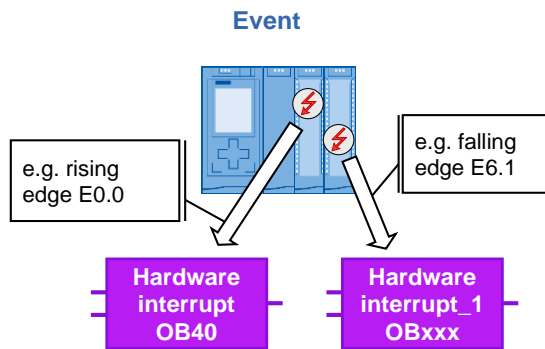

In the following figure you can see the configuration of a "hardware interrupt" in the hardware configuration of a digital input module.

Figure 3-41: Configuring hardware interrupt

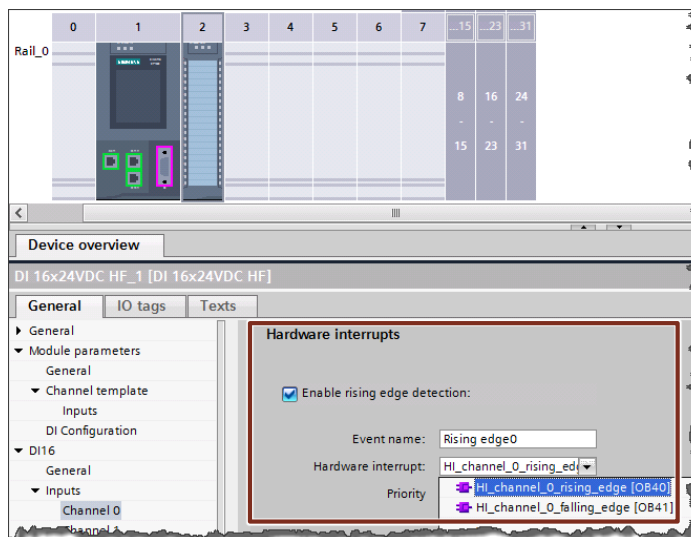

Advantages

- Fast system response to events (rising, falling edge, etc.)
- Each event can start a separate OB.

Recommendation

- Use the hardware interrupts in order to program fast responses to hardware events.
- If the system response is not fast enough despite programming a hardware interrupt, you can still accelerate the response. Set as small an "Input delay" as possible in the module. A response to an event can always only occur if the input delay has lapsed. The input delay is used for filtering the input signal in order to, for example, compensate faults such as contact bounce or chatter.

Figure 3-42: Setting input delay

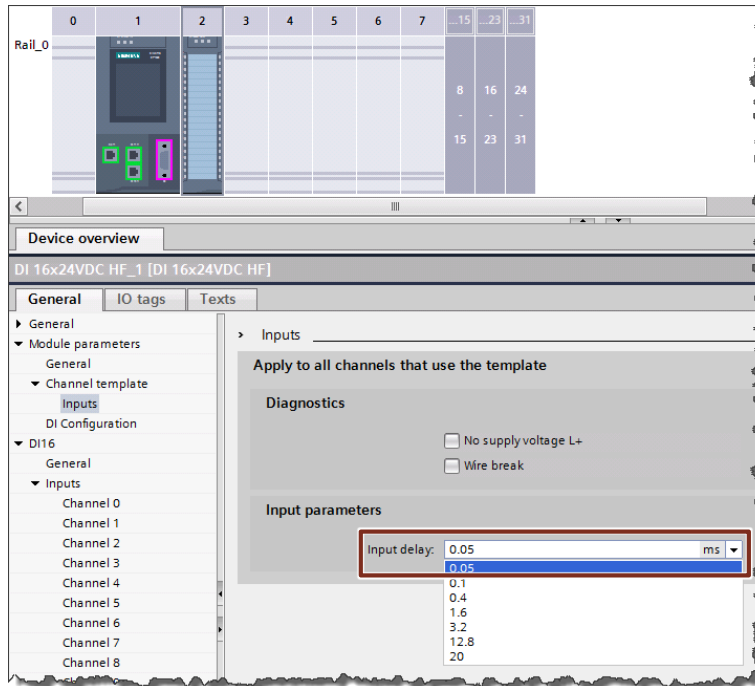

3.9 Additional performance recommendations

Here you can find some general recommendations that enable faster program processing of the controller.

Recommendation

Note the following recommendations for programming S7-1200/1500 controllers in order to achieve a high performance:

- LAD/FBD: Disable "evaluate ENO" for blocks. This avoids tests at runtime.
- STL: Do not use registers since address and data registers are only emulated for compatibility reasons by S7-1500.

Note

More information can be found in the following entries:

How do you disable the ENO enable output of an instruction?

<https://support.industry.siemens.com/cs/ww/en/view/67797146>

How can you improve the performance in STEP 7 (TIA Portal) and in the S7-1200/S7-1500 CPUs?

<https://support.industry.siemens.com/cs/ww/en/view/37571372>

3.10 SCL programming language: Tips and Tricks

3.10.1 Using call templates

Many instructions of the programming languages offer a call template with a list of existing formal parameters.

Example

Table 3-12: Easy expanding of the call template

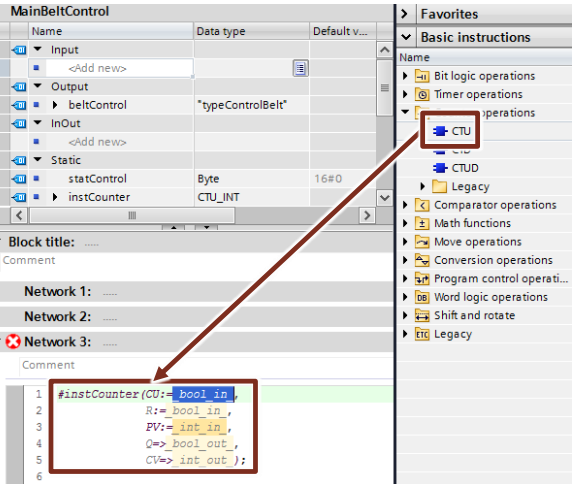
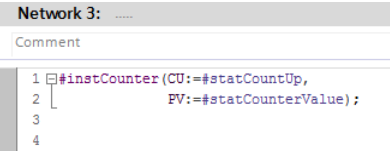
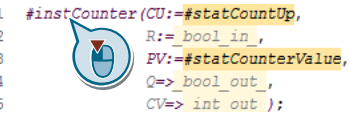
Step	Instruction
1.	<p>Drag an instruction from the library into the SCL program. The editor shows the complete call template.</p> 
2.	<p>Now fill in the required parameters "CU" and "PV" and finish the entry with the "Return" button.</p>
3.	<p>The editor automatically reduces the call template.</p> 
4.	<p>If you want to edit the complete call later on again, proceed as follows. Click into the call at any place and then click "CTRL+SHIFT+SPACE". You are now in the "Call Template" mode. The editor expands the call again. You can navigate with the "TAB" button through the parameters.</p> 
5.	<p>Note: In the "Call Template" mode the writing is in italics.</p>

3.10.2 What instruction parameters are mandatory?

If you are expanding the call template, the color coding will show you straight away what formal parameters of an instruction are optional and which ones are not. Mandatory parameters are marked dark.

3.10.3 Drag-and-drop with entire tag names

In the SCL editor you can also use drag-and-drop functions. For tag names you are additionally supported. If you want to replace one tag by another, proceed as follows.

Table 3-13: Drag-and-drop with tags in SCL

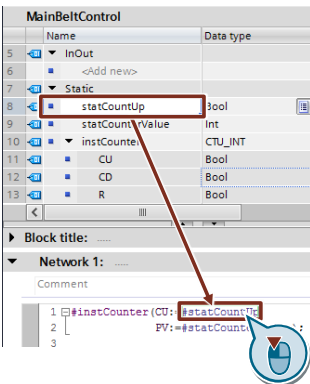
Step	Instruction
1.	<p>Drag the tag via drag-and-drop to the tag in the program that is to be replaced. Hold the tag for more than 1 second before releasing it.</p>  <p>The complete tag is replaced.</p>

3.10.4 Structuring with the keyword REGION (V14 or higher)

The SCL code can be divided in areas with the keyword REGION. These areas can be given a name and can be collapsed and expanded.

Advantages

- Better overview
- Easy navigation even in large blocks
- Ready code fragments can be collapsed.

Properties

REGIONS can be nested.

Recommendation

Use the keyword REGION for the structuring of your SCL blocks.

Example

Figure 3-43: SCL editor

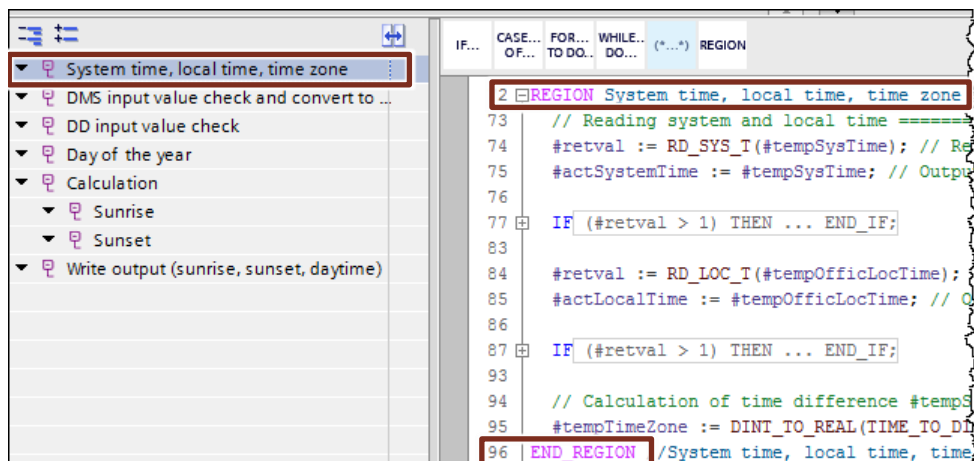

3.10.5 Correct use of FOR, REPEAT and WHILE loops

There are different versions and applications for the use of loops. The following examples show the differences.

Properties: FOR loop

The FOR loop runs through a **defined number of runs**. The loop variable is assigned a start value at the beginning. Afterwards it is incremented up to the end value in each loop run with the specified step size.

For reasons of performance, the start as well as the end value is calculated once at the beginning. Consequently, the loop variable can no longer influence the loop code.

Syntax

```
FOR statCounter := statStartCount TO statEndCount DO
    // Statement section ;
END_FOR;
```

With the EXIT command the loop can be interrupted at any time.

Properties: WHILE loop

The WHILE loop is ended by a termination condition. The **termination condition** is checked **before the start** of the loop code. I.e., the loop is not executed, if the condition is not instantly fulfilled. Each variable can be adjusted for the next run in the loop code.

Syntax

```
WHILE condition DO
    // Statement section ;
END_WHILE;
```

Properties: REPEAT loop

The REPEAT loop is ended by a termination condition. The **termination condition** is checked **at the end** of the loop code. This means the loop is **run through at least once**. Each variable can be adjusted for the next run in the loop code.

Syntax

```
REPEAT
    // Statement section ;
UNTIL condition
END_REPEAT;
```

Recommendation

- Use FOR loops if the loop variable is clearly defined.
- Use the WHILE or REPEAT loop if a loop variable has to be adjusted during the loop processing.

3.10.6 Using CASE instruction efficiently

With the CASE instruction in SCL, it will be exactly jumped to the selected CASE block condition. After executing the CASE block the instruction is finished. This allows you, for example, to check frequently required value ranges more specifically and easily.

Example

```
CASE #myVar OF
    5:
        #Engine(#myParam);
    10,12:
        #Transport(#myParam);
    15:
        #Lift(#myParam);
    0..20:
        #Global(#myParam);
// Global is never called for the values 5, 10, 12 or 15!
ELSE
END_CASE;
```

Note

CASE instructions also work with CHAR, STRING data types, as well as with elements (see example in chapter [2.8.5 Data type VARIANT](#)).

3.10.7 No manipulation of loop counters for FOR loop

FOR loops in SCL are pure counter loops, i.e. the number of iterations is fixed when the loop is entered. In a FOR loop, the loop counter cannot be changed. With the EXIT instruction a loop can be interrupted at any time.

Advantages

- The compiler can optimize the program better, since it does not know the number of iterations.

Example

```
FOR #statVar := #statLower TO #statUpper DO
    #statVar := #statVar + 1; // no effect, compiler warning
END_FOR;
```

3.10.8 FOR loop backwards

In SCL you can also increment the index of FOR loops backwards or in another step width. For this, use the optional "BY" key word in the loop head.

Example

```
FOR #statVar := #statUpper TO #statLower BY -2 DO

END_FOR;
```

If you are defining "BY" as "-2", as in the example, the counter is lowered by 2 in every iteration. If you omit "BY", the default setting for "BY" is 1

3.10.9 Easy creation of instances for calls

If you prefer to work with the keyboard, there is a simple possibility to create instances for blocks in SCL.

Example

Table 3-14: Easy creation of instances

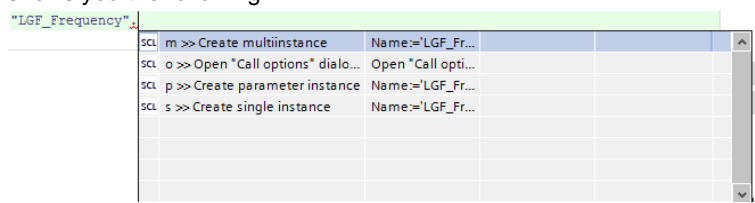
Step	Instruction															
1.	<p>Give the block a name, followed by a "." (dot). The automatic compilation now shows you the following.</p>  <p>The screenshot shows a table with the following content:</p> <table border="1"> <thead> <tr> <th>Shortcut</th> <th>Action</th> <th>Name</th> </tr> </thead> <tbody> <tr> <td>scl m >></td> <td>Create multiinstance</td> <td>Name:=LGF_Fr...</td> </tr> <tr> <td>scl o >></td> <td>Open "Call options" dialo...</td> <td>Open "Call opti...</td> </tr> <tr> <td>scl p >></td> <td>Create parameter instance</td> <td>Name:=LGF_Fr...</td> </tr> <tr> <td>scl s >></td> <td>Create single instance</td> <td>Name:=LGF_Fr...</td> </tr> </tbody> </table>	Shortcut	Action	Name	scl m >>	Create multiinstance	Name:=LGF_Fr...	scl o >>	Open "Call options" dialo...	Open "Call opti...	scl p >>	Create parameter instance	Name:=LGF_Fr...	scl s >>	Create single instance	Name:=LGF_Fr...
Shortcut	Action	Name														
scl m >>	Create multiinstance	Name:=LGF_Fr...														
scl o >>	Open "Call options" dialo...	Open "Call opti...														
scl p >>	Create parameter instance	Name:=LGF_Fr...														
scl s >>	Create single instance	Name:=LGF_Fr...														
2.	<p>On the top you can see the already existing instances. In addition, you can directly create a new single instance or multi-instance. Use the shortcuts "s" or "m" to go directly to the respective entries in the automatic compilation window.</p>															

3.10.10 Handling of time tags

You can calculate the time tags in SCL just as with normal numbers i.e. you do not need to look for additional functions, such as, e.g. T_COMBINE but you can use simple arithmetic. This approach is called "overload of operands". The SCL compiler automatically uses the suitable functions. You can use a reasonable arithmetic for the time types and can therefore program more efficiently.

Example

```
time difference := time stamp_1 - time stamp_2;
```

The following table summarizes the overloaded operators and the operations behind it:

3 General programming

3.10 SCL programming language: Tips and Tricks

Table 3-15: Overloaded operands for SCL

overloaded operand	Operation
ltime + time	T_ADD LTime
ltime – time	T_SUB LTime
ltime + lint	T_ADD LTime
ltime – lint	T_SUB LTime
time + time	T_ADD Time
time - time	T_SUB Time
time + dint	T_ADD Time
time - dint	T_SUB Time
ldt + ltime	T_ADD LDT / LTime
ldt – ltime	T_SUB LDT / LTime
ldt + time	T_ADD LDT / Time
ldt – time	T_SUB LDT / Time
dtl + ltime	T_ADD DTL / LTime
dtl – ltime	T_SUB DTL / LTime
dtl + time	T_ADD DTL / Time
dtl – time	T_SUB DTL / Time
ltod + ltime	T_ADD LTOD / LTime
ltod – ltime	T_SUB LTOD / LTime
ltod + lint	T_ADD LTOD / LTime
ltod – lint	T_SUB LTOD / LTime
ltod + time	T_ADD LTOD / Time
ltod – time	T_SUB LTOD / Time
tod + time	T_ADD TOD / Time
tod – time	T_SUB TOD / Time
tod + dint	T_ADD TOD / Time
tod – dint	T_SUB TOD / Time
dt + time	T_ADD DT / Time
dt – time	T_SUB DT / Time
ldt – ldt	T_DIFF LDT
dtl – dtl	T_DIFF DTL
dt – dt	T_DIFF DT
date – date	T_DIFF DATE
ltod – ltod	T_DIFF LTOD
date + ltod	T_COMBINE DATE / LTOD
date + tod	T_COMBINE DATE / TOD

3.10.11 Unnecessary IF instruction

Programmers often think in IF-THEN-ELSE instructions. This frequently leads to unnecessary constructs in programs.

Example

```
IF (statOn1 = TRUE AND statOn2 = TRUE) THEN
    statMotor := TRUE;
ELSE
    statMotor := FALSE;
END_IF
```

Recommendation

Remember that for Boolean requests a direct assignment is often more effective. The entire construct can be programmed with one line.

Example

```
statMotor := statOn1 AND statOn2;
```

4 Hardware-independent programming

To make sure that a block can be used on all controllers without any further adjustments, it is important not use hardware-dependent functions and properties.

4.1 Data types of S7-300/400 and S7-1200/1500

Below is a list of all elementary data types and data groups.

Recommendation

- Only use the data types that are supported by the controllers on which the program is to run.

Table 4-1: Elementary data types correspond to standard EN 61131-3

	Description	S7-300/400	S7-1200	S7-1500
Bit data types	<ul style="list-style-type: none"> • BOOL • BYTE • WORD • DWORD 	yes	yes	yes
	<ul style="list-style-type: none"> • LWORD 	no	no	yes
Character type	<ul style="list-style-type: none"> • CHAR (8 bit) 	yes	yes	yes
Numerical data types	<ul style="list-style-type: none"> • INT (16 bit) • DINT (32 bit) • REAL (32 bit) 	yes	yes	yes
	<ul style="list-style-type: none"> • SINT (8 bit) • USINT (8 bit) • UINT (16 bit) • UDINT (32 bit) • LREAL (64 bit) 	no	yes	yes
	<ul style="list-style-type: none"> • LINT (64 bit) • ULINT (64 bit) 	no	no	yes
Time types	<ul style="list-style-type: none"> • TIME • DATE • TIME_OF_DAY 	yes	yes	yes
	<ul style="list-style-type: none"> • S5TIME 	yes	no	yes
	<ul style="list-style-type: none"> • LTIME • L_TIME_OF_DAY 	no	no	yes

4 Hardware-independent programming

4.1 Data types of S7-300/400 and S7-1200/1500

Table 4-2 Data groups that are made up of other data types

	Description	S7-300/400	S7-1200	S7-1500
Time types	• DT (DATE_AND_TIME)	yes	no	yes
	• DTL	no	yes	yes
	• LDT (L_DATE_AND_TIME)	no	no	yes
Character type	• STRING	yes	yes	yes
Feld	• ARRAY	yes	yes	yes
Structure	• STRUCT	yes	yes	yes

Table 4-3: Parameter types for formal parameters that are transferred between blocks

	Description	S7-300/400	S7-1200	S7-1500
Pointer	• POINTER • ANY	yes	no	yes ¹⁾
	• VARIANT	no	yes	yes
Blocks	• TIMER • COUNTER	yes	yes ²⁾	yes
	• BLOCK_FB • BLOCK_FC	yes	no	yes
	• BLOCK_DB • BLOCK_SDB	yes	no	no
	• VOID	yes	yes	yes
PLC data types	• PLC DATA TYPE	yes	yes	yes

¹⁾ For optimized access, only symbolic addressing is possible

²⁾ For S7-1200/1500 the TIMER and COUNTER data type is represented by IEC_TIMER and IEC_Counter.

4.2 No bit memory but global data blocks

Advantages

- Optimized global DBs are clearly more powerful than the bit memory address area that is not optimized only for reasons of compatibility.

Recommendation

- Dealing with bit memory (system and clock flags also) is problematic since the size of the flag area of each controller has is different. Do not use bit memory for the programming but always global data blocks. This is how the program can always be used universally.

4.3 Programming of "Cycle bits"

Recommendation

For the programming of clock memory, the hardware configuration always has to be correct.

Use a programmed block as clock generator. Below, you can find a programming example for a clock generator in the SCL programming language.

Example

The programmed block has the following functions. A desired frequency is preset. The "Q" output is a Boolean value that toggles in the desired frequency. The "countdown" output outputs the remaining time of the current state of "q".

If the desired frequency is smaller or equal 0.0, then the output q = FALSE and Countdown = 0.0.

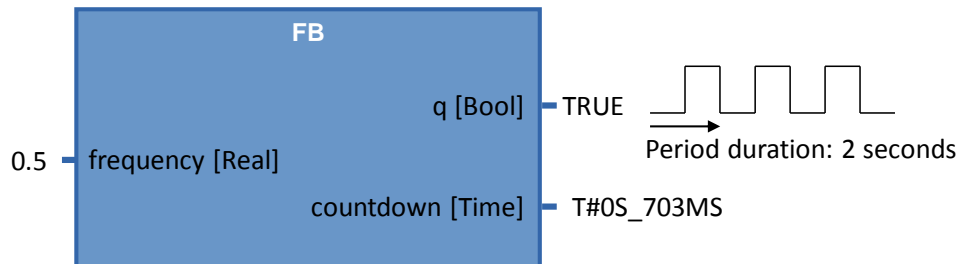

Note

The complete programming example can be found in the following entry:

<https://support.industry.siemens.com/cs/ww/en/view/109479728>

5 STEP 7 Safety in the TIA Portal

5.1 Introduction

TIA Portal V13 SP1 or higher are supported by fail-safe S7-1200F and S7-1500F CPUs. In these controllers, standard as well as fail-safe programming is possible in one device. For programming the fail-safe user programs, the SIMATIC STEP 7 Safety (TIA Portal) option package is used.

Figure 5-1: Standard and safety program

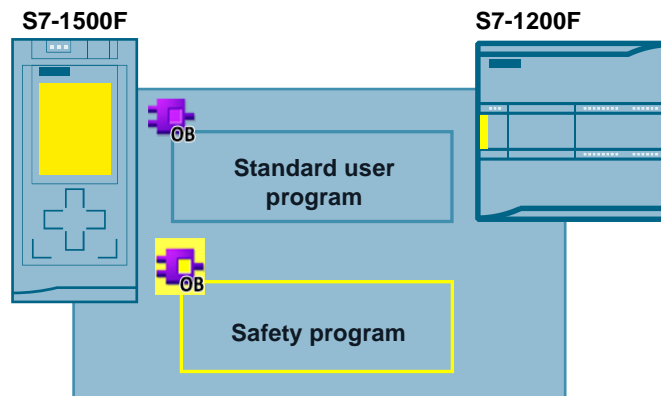

Advantages

- Uniform programming in standard and fail-safe program with an engineering tool: TIA Portal
- Familiar programming in LAD and FBD
- Uniform diagnostic and online functions

Note

Fail-safe does not mean that the program contains no errors. The programmer is responsible for the correct programming logic.

Fail-safe means that the correct processing of the fail-safe user program in the controller is ensured.

Note

Further information on the topic of safety, such as safety requirements or the principles of safety programs can be found in:

TIA Portal - An Overview of the Most Important Documents and Links - Safety
<https://support.industry.siemens.com/cs/ww/en/view/90939626>

Applications & Tools – Safety Integrated
<https://support.industry.siemens.com/cs/ww/en/ps/14675/ae>

STEP 7 Safety (TIA Portal) - Manuals
<https://support.industry.siemens.com/cs/ww/en/ps/14675/man>

5.2 Terms

This document consistently uses the terms with the following meaning.

Table 5-1: Safety terms

Term	Description
Standard user program	The standard user program is the program part, which is not connected with F programming.
Safety program (F program, failsafe user program)	The fail-safe user program is the program part which is processed fail-safe independently of the controller. All fail-safe blocks and instructions are shaded yellow at the software user interface (e. g. in the project navigation) in order to distinguish blocks and instructions of the standard user program. The fail-safe parameters of F-CPU's and F-I/O are shaded yellow in the hardware configuration.

5.3 Components of the safety program

Das safety program always consists of user-generated, system-generated F blocks and the "Safety administration" editor.

Table 5-2 Components of the safety program

Description	Screen
<p>1. "Safety administration" editor</p> <ul style="list-style-type: none"> - Status of the safety program - F collective signature - Status of the safety operation - Creating/organizing F runtime groups - Information on the F blocks - Information on F-conform PLC data types - Defining/changing the access protection 	
<p>2. User-created F blocks</p>	
<p>3. System-generated F runtime blocks</p> <ul style="list-style-type: none"> - Blocks contain status information on the F runtime group. 	
<p>4. System-generated F-I/O data blocks</p> <ul style="list-style-type: none"> - Blocks contain tags for evaluating the F modules. 	
<p>5. "Compiler blocks" System-generated verification blocks</p> <ul style="list-style-type: none"> - These run in the background of the controller and provide for fail-safe processing of the safety program. - These blocks cannot be processed by the user. 	

5.4 F-runtime group

A safety program is always processed in an F runtime group with defined cycle. An F runtime group consists of a "Fail-safe organization block" which calls a "Main safety block". All user-generated safety functions are called from the "Main safety block".

Figure 5-2 F runtime group in the "Safety administration" editor

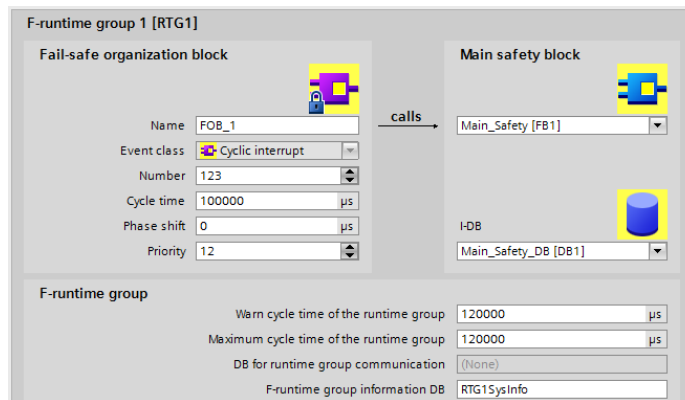

Advantages

- Runtime groups can simply be created and configured in the "Safety Administrator".
- F-blocks in the runtime group are automatically created.

Properties

- A maximum of two F runtime groups can be created.

5.5 F signature

Each F component (station, I/O, blocks) has a unique F signature. Using the F signature it can be quickly detected whether an F device configuration, F blocks or a complete station still corresponds to the original configuration or programming.

Advantages

- Simple and quick comparison of F blocks and F device configurations

Properties

- F parameter signature (without address of F-I/O)...
 - only changed by adjusting the parameters.
 - remains unchanged when changing the PROFIsafe address. However, the F collective signature of the station changes.
- F block signature is only changed when the logic in the F block changes.
- F block signature remains unchanged by changing the
 - block number,
 - block interface,

5.5 F signature

- block version.

Example

Figure 5-3 Examples of F signatures

1

Description	Offline signature	Time stamp
Collective F-signature	675CB803	7/29/2014 4:20:41 PM (UTC +2:00)

2

Description	Used and compiled	Function in safety program	Offline signature	Time stamp
Program blocks				
FOB_1 [OB123]	Yes	F-OB	0xB4427972	7/29/2014 4:20:41 PM (UTC +2:00)
FOB_2 [OB124]	Yes	F-OB	0xF6658D19	7/29/2014 4:20:41 PM (UTC +2:00)
Main_Safety_1 [FB1]	Yes	F-FB	0x61F8DE42	7/29/2014 4:20:41 PM (UTC +2:00)
Main_Safety_2 [FB0]	Yes	F-FB	0x65ED5CB2	7/29/2014 4:20:41 PM (UTC +2:00)
Main_Safety_DB_1 [DB1]	Yes	I-DB for F-FB	0x27E959F6	7/29/2014 4:20:41 PM (UTC +2:00)

3

Manual assignment of F-monitoring time:

F-monitoring time: 150 ms

F-source address: 1

F-destination address: 65532

F-parameter signature (without addresses): 18133

Behavior after channel fault: Passivate channel

F-I/O DB manual number assignment:

1. F collective signature of the station in the "Safety administration" editor
2. F block signatures in the "Safety Administration" editor (can also be read out from the properties of the block)
3. F parameter signature in the "Device view" at "Devices & Networks"

Note

For S7-1500F controllers it is possible to read the F overall signature directly on the installed display or in the integrated web server.

5.6 Assigning the PROFIsafe address at the F-I/O

Each F-I/O device has a PROFIsafe address for identification and communication with F controllers. When assigning the PROFIsafe address, two different configurations are possible.

Table 5-3: Setting the F address

ET 200M / ET 200S (PROFIsafe address type 1)	ET 200MP / ET 200SP (PROFIsafe address type 2)
Assigning the PROFIsafe address directly at the modules via DIL switch In the device configuration of the TIA Portal and in the DIL switch position at the periphery, the PROFIsafe address must be the same.	Assigning the PROFIsafe address exclusively via TIA Portal The configured PROFIsafe address is loaded onto the intelligent coding module of the module.

Advantages

- Replacing an F module is possible without reassigning the PROFIsafe address at ET 200MP and ET 200SP. The intelligent coding module remains in the BaseUnit during module exchange.
- Simple configuration since TIA Portal indicates a faulty assignment of the PROFIsafe address warnings.
- The PROFIsafe addresses of all F modules can be assigned at the same time within an ET 200SP.

Note

Further information on assigning the PROFIsafe address for the F-I/O is available at:

SIMATIC Industrial Software SIMATIC Safety – Configuring and Programming
<https://support.industry.siemens.com/cs/ww/en/view/54110126>

5.7 Evaluation of F-I/O

All of the current states of the respective F-I/O are saved in the F-I/O blocks. In the safety program the states can be evaluated and processed. The following differences exist between S7-1200F/1500F and S7-300F/400F.

Table 5-4: Tags in the F-I/O DB with S7-300F/400F and S7-1500F

Tag in F-I/O DB or value status in PAE	F-I/O with S7-300/400F	F-I/O with S7-1200F/1500F
ACK_NEC	yes	yes
QBAD	yes	yes
PASS_OUT	yes	yes
QBAD_I_xx *	yes	no
QBAD_O_xx *	yes	no
Value status	no	yes

5.8 Value status (S7-1200F/1500F)

* QBAD_I_xx and QBAD_O_xx show you the validity of the channel value and correspond to the **inverted** value status at S7-1200F/1500F (further information is available in the following chapter).

5.8 Value status (S7-1200F/1500F)

In addition to the diagnostic messages and the status and error display, the F module provides information on the validity of each input and output signal - the value status. The value status is stored in the same way as the input signal in the process image:

The value status informs about the validity of the respective channel value.

- 1: A valid process value is output for the channel.
- 0: a substitute value is output for the channel.

Table 5-5: Differences Q_BAD (S7-300F/400F) and value status (S7-1200F/1500F)

Scenario	QBAD (S7-300F/400F)	Value status (S7-1200F/1500F)
Valid values at the F-I/O (no error)	FALSE	TRUE
Channel error occurs	TRUE	FALSE
Channel error going (ACK_REQ)	TRUE	FALSE
Acknowledgement of the failure (ACK_REI)	FALSE	TRUE

Properties

- The value status is entered into the process image of the inputs and outputs.
- Channel value and value status of an F-I/O must only be accessed from the same F run-time group.

Recommendation

- For improved readability assign the ending "VS", e.g. "TagIn1VS" as the symbolic name for the value status.

Example

Position of the value status bits in the process image using the example of an F-DI 8x24VDC HF module.

Table 5-6: Value status bits in the process image using the example of an F-DI 8x24VDC HF

Byte in the F-CPU	Assigned bits in the F-CPU							
	7	6	5	4	3	2	1	0
x + 0	DI ₇	DI ₆	DI ₅	DI ₄	DI ₃	DI ₂	DI ₁	DI ₀
x + 1	Value status for DI ₇	Value status for DI ₆	Value status for DI ₅	Value status for DI ₄	Value status for DI ₃	Value status for DI ₂	Value status for DI ₁	Value status for DI ₀

x = module start address

5.9 Data types

Note

More information about the value status of all ET 200SP modules is available at:

Failsafe CPUs - Manuals

<https://support.industry.siemens.com/cs/ww/en/ps/13719/man>

Failsafe I/O modules - Manuals

<https://support.industry.siemens.com/cs/ww/en/ps/14059/man>

5.9 Data types

5.9.1 Overview

There is an unrestricted scope of data types for the safety programs of the S7-1200/1500F.

Table 5-7 Integer data types

Type	Size	Value range
BOOL	1 bit	0 .. 1
INT	16 bit	-32.768 .. 32.767
WORD	16 bit	-32.768 .. 65.535
DINT	32 bit	-2.14 .. 2.14 Mio
TIME	32 bit	T#-24d20h31m23s648ms to T#+24d20h31m23s647ms

5.9.2 Implicit conversion

In safety-relevant applications it may be necessary to carry out mathematical functions with tags of different data types. The function blocks necessary for this, require a defined data format of the formal parameters. If the operand does not comply with the expected data type, a conversion has to be carried out first.

Under the following circumstances can the S7-1200/1500 also perform the data conversion implicitly:

- IEC check is disabled.
- The data types have the same length.

For this reason, the following data types can be converted implicitly in the safety program:

- WORD ↔ INT
- DINT ↔ TIME

A practical application is the addition of two time values, although the function "Add" is required as "DInt" input. The result is then also output as "Time" tag.

5 STEP 7 Safety in the TIA Portal

5.9 Data types

Figure 5-4: Addition of two time values

	Name	Data type	Default value
6	<Add new>		
7	Static		
8	statTimeValue1	Time	T#0ms
9	statTimeValue2	Time	T#0ms
10	statTimeSum	Time	T#0ms
11	<Add new>		

The screenshot shows the 'ADD Dint' function block in the TIA Portal. The block has three inputs: EN, IN1, and IN2. IN1 is connected to #statTimeValue1 and IN2 is connected to #statTimeValue2. The output is OUT, which is connected to #statTimeSum. The ENO output is also visible.

Enable or disable the IEC check in the properties of the respective function block or function.

Figure 5-5: Disabling IEC check

The screenshot shows the 'Block_1 [FB2]' properties dialog box in the TIA Portal. The 'Attributes' tab is selected, and the 'IEC check' checkbox is unchecked. Other attributes like 'errors within block', 'can be used as know-how protected library element', 'Optimized block access', and 'Multiple instance capability' are also visible. The 'User-defined attributes' section shows 'Enable tag readback' unchecked and a 'Block properties' field.

5.10 F-conform PLC data type

For safety programs it is also possible to structure data optimal with PLC data types.

Advantages

- A change in a PLC data type is automatically updated in all usage locations in the user program.

Properties

- F-PLC data types are declared and used in the same way as PLC data types.
- As F-PLC data types, all data types which are allowed in the safety program can be used.
- Nesting of F-PLC data types within other F-PLC data types is not supported.
- F-PLC data types can be used in the safety program as well as in the standard user program.

Recommendation

- You use F-PLC data types for accessing I/O areas (as in chapter [3.6.5 Access to I/O areas with PLC data types](#))
- The following rules must be observed here:
 - The structure of the tags of the F-conform PLC data type must match the channel structure of the F-I/O.
 - An F-conform PLC data type for an F-I/O with 8 channels is, for example:
 - 8 BOOL tags (channel value) or
 - 16 BOOL tags (channel value + value status)
 - Access to F-I/O is only permitted for activated channels. When configuring a 1oo2 (2v2) evaluation, the higher channel is always deactivated.

Example

Figure 5-6: Access to I/O areas with F-PLC data types

The figure illustrates the configuration of an F-PLC data type for an 8-channel F-I/O module. It is divided into three main sections:

- F-PLC data type:** A table showing the structure of the 'typeFDIx24VDC HF' data type. It lists 16 channels, each with a 'Bool' data type.

name	Data type
fInputCh0	Bool
fInputCh1	Bool
fInputCh2	Bool
fInputCh3	Bool
fInputCh4	Bool
fInputCh5	Bool
fInputCh6	Bool
fInputCh7	Bool
fInputCh0VS	Bool
fInputCh1VS	Bool
fInputCh2VS	Bool
fInputCh3VS	Bool
fInputCh4VS	Bool
fInputCh5VS	Bool
fInputCh6VS	Bool
fInputCh7VS	Bool
- F-I/O:** A rack diagram showing an 8x24VDC HF module in Rack 0, with channels 0-7 highlighted in yellow. The rack also shows other modules and their channel addresses (e.g., 8-15, 16-23, 24-31, 32-39).
- PLC tag:** A configuration window for the 'fDI1' tag. The 'Data type' is set to 'typeFDIx24VDC HF'. The 'IO tags' tab shows a table of 8 Boolean tags, each mapped to a specific address.

Name	Type	Address	Tag table	Comment
fDI1	Bool	%4.0		
	Bool	%4.1		
	Bool	%4.2		
	Bool	%4.3		
	Bool	%4.4		
	Bool	%4.5		
	Bool	%4.6		
	Bool	%4.7		

Red arrows indicate the flow of information: from the 'typeFDIx24VDC HF' data type definition to the 'fDI1' tag configuration, and from the 'fDI1' tag configuration to the 'IO tags' table in the configuration window.

5.11 TRUE / FALSE

The use of "TRUE" and "FALSE" signals in the safety programs can be differentiated in two application cases:

- as actual parameter at blocks
- as assignment to operations

Actual parameter at blocks

For S7-1200F/1500F controllers you can use the Boolean constants "FALSE" for 0 and "TRUE" for 1 as actual parameter for supplying formal parameters during block calls in the safety program. Only the keyword "FALSE" or "TRUE" is written to the formal parameter.

Figure 5-7: "TRUE" and "FALSE" signals as actual parameter

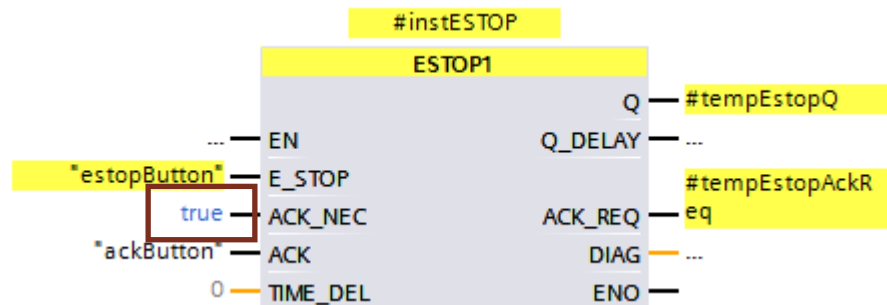

Assignments to operations

In order to create "TRUE" or "FALSE" signals for operations, proceed as follows:

1. Create two static tags "statTrue" and "statFalse" of the type BOOL.
2. Assign the default value "false" to the statFalse tag.
3. Assign the default value "true" to the statTrue tag.

You can use the tags as "True" and "False" read signals in the complete function block.

Figure 5-8: "TRUE" and "FALSE" signals

Name	Data type	Default value	Retain
Static			
statTrue	Bool	true	Non-retain
statFalse	Bool	false	Non-retain

5.12 Optimizing the compilation and program runtime

An important part of the safety program is the protection of the user programming by coded processing. The aim is to discover any kind of data corruption in the safety program and therefore to prevent unsafe conditions.

This protection program is created during the compilation and therefore prolongs the compilation time. The runtime of the F-CPU is also prolonged through the protection program, since the F-CPU processes it additionally and compares the results with the user program.

The protection program that is generated automatically by the system can be found in the system block folder of your F-CPU.

Example

Figure 5-9: User and system created F blocks

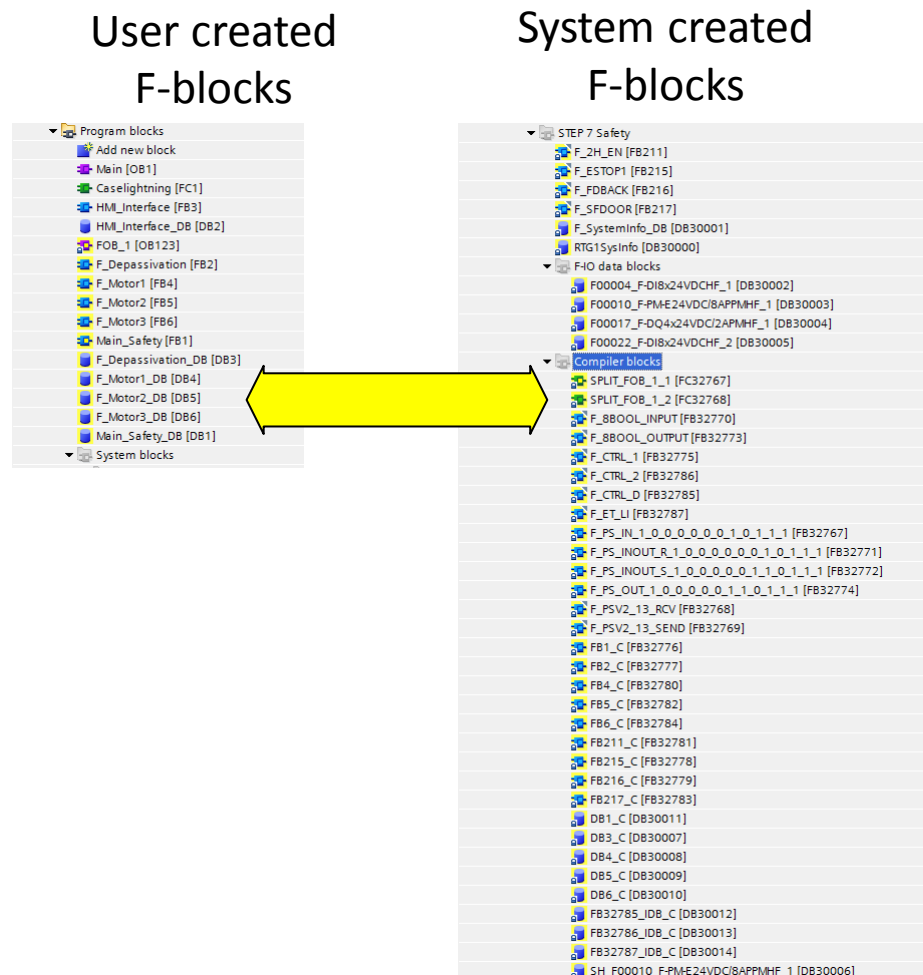

This chapter shows you the different options for shortening the compilation and program runtime.

Depending on the use it will not always be possible to use all suggestions. They nevertheless provide information why certain programming methods cause shorter compilation and program runtimes than a non-optimized program.

5.12 Optimizing the compilation and program runtime

5.12.1 Avoiding of time-processing blocks: TP, TON, TOF

Every time-processing block (TP, TON, TOF) requires additional blocks and global data corrections in the protection code.

Recommendation

Use these blocks as little as possible.

5.12.2 Avoiding deep call hierarchies

Deep call hierarchies enlarge the code of the system-created F blocks, since a larger scope of protective functions and test is required. When the nesting depth of 8 is exceeded, the TIA Portal will emit a warning during the compilation.

Recommendation

Structure your program in a way as to avoid unnecessary deep call hierarchies.

5.12.3 Avoiding JMP/Label structures

If a block call is jumped via JMP/LABEL this leads to an additional protection in the F blocks on the system side. Here, a correction code has to be carried out for the skipped block call. This costs performance and time in the compilation

Recommendation

Avoid JMP/Label structures as far as possible to reduce F-blocks on the system side.

5.13 Data exchange between standard program and F program

In some cases it is necessary to exchange data between the safety program and the standard user program. The following recommendations should urgently be noted in order to guarantee data consistency between standard and the safety program.

Recommendations

- No data exchange via bit memory (see chapter [4.2 No bit memory but global data blocks](#))
- Concentrate the access between safety program and the standard user program on two standard DBs.

Changes in the standard program will therefore have no influence on the safety program. The controller also does not need to be in STOP mode to load the standard program.

Figure 5-10: Data exchange between standard and safety program

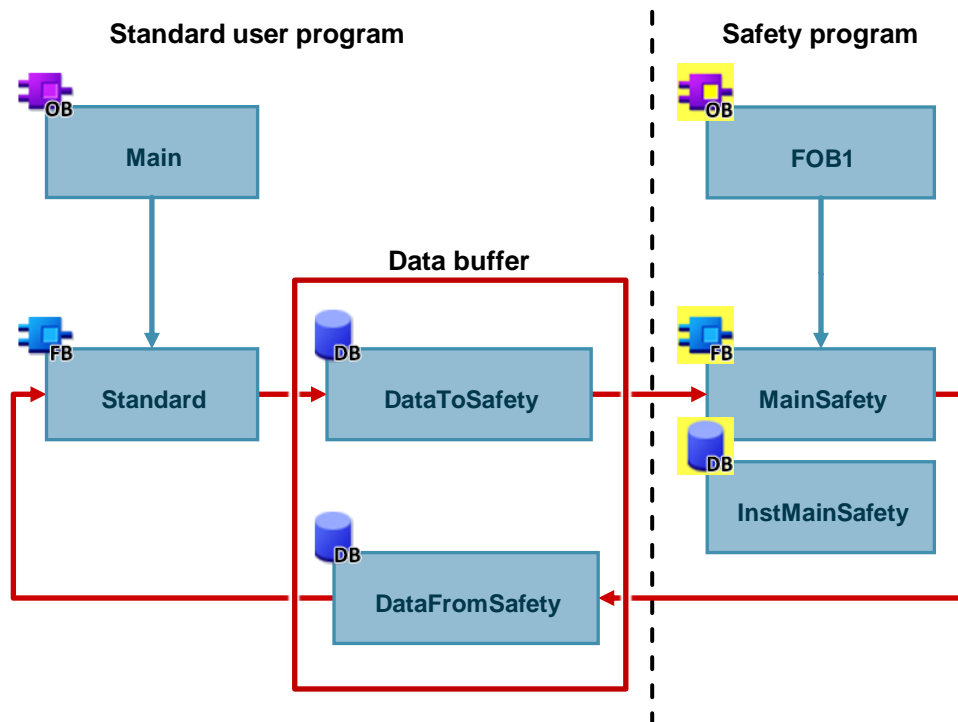

5.14 Testing the safety program

In addition to the always controllable data of a standard-user program you can change the following data of a safety program in the deactivated safety mode.

- Process image of F-I/O
- F-DBs (except DB for F-runtime group communication), instance-DBs of F-FBs
- F-I/O DBs

Properties

- Controlling F-I/O is only possible in F-CPU RUN mode.
- From a watch table you can control a maximum of 5 inputs/outputs in a safety program.
- You can use several watch tables.
- As trigger point you need to set "permanent" or "once" for "cycle start" or "cycle end".
- Forcing is not possible for the F-I/O.
- If you still wish to use stop points for testing, you need to deactivate the safety mode beforehand. This leads to the following errors:
 - Error during communication with the F-I/O
 - Error at fail-safe CPU-CPU communication

5.15 STOP mode in the event of F errors

In the following cases, the STOP mode is triggered for F-CPU:

- In the "System blocks" folder you must not add, change or delete any blocks.
- -There must not be any access to instance DBs of F-FBs which are not called in the safety program.
- The "Maximum cycle time of the F-runtime group" must not be exceeded. Select the maximal permitted time for "Maximum cycle time der F run-time group" which can elapse between two calls of this F runtime group (maximum 20000 ms).
- If tags are read from a DB for F runtime group communication whose runtime group is not processed (main safety block of the F runtime group is not called).
- Editing the start values in instance DBs of F-FBs is not permitted online and offline and can lead to STOP of the F-CPU.
- The main safety block must not contain any parameters since they cannot be supplied.
- Outputs of F-FCs must always be initialized.

5.16 Migration of safety programs

Information on migrating safety programs is available at:

<https://support.industry.siemens.com/cs/ww/en/view/109475826>

5.17 General recommendations for safety

Generally, the following recommendations apply for handling STEP 7 Safety and F modules.

- Whenever possible, always use F controllers. Thus, a later expansion of safety functions can be realized very easily.
- Always use one password for the safety program to prevent unauthorized changes. The password is set in the "Safety administration" editor.

6 Automatically generate visualization using the user program

6.1 Introduction

As of TIA Portal V14, you can use the SiVArc (SIMATIC Visualization Architect) option package to automatically generate the visualization of your plant from a visualization library and the user program in the controller.

In this chapter you optimize your user program for use with SiVArc.

Advantages of generation with SiVArc

- Automatic generation of the visualization with process connection
- Standardization of user interfaces
- Simple and consistent adaptations to operating screens

Requirements

The basic requirement for the use of SiVArc is a high **degree of standardization** of your plant. Modularizing the system into individual function groups has the advantage that SiVArc can use these function groups to generate and interconnect the operating screen from existing library screens. Standardization of the interfaces contributes to efficient work and automatic generation of the visualization.

Compliance with the general recommendations of this programming guide will help you.

Note

SiVArc is an interface topic between HMI and controller. This section looks at SiVArc from the control side.

The following links will give you an insight into the functionality of SiVArc:

Application example "SiVArc Getting Started"

<https://support.industry.siemens.com/cs/ww/en/view/109740350>

Manual SiVArc

<https://support.industry.siemens.com/cs/ww/en/view/109755214>

SITRAIN course: SIMATIC Visualization Architect, automatic HMI generating

<https://support.industry.siemens.com/cs/ww/en/view/109758628>

6.2 How automatic generation works

Standardized blocks, e.g. for engine control, are called up in your user program. Using so-called SiVArc rules, you link the called blocks with visualization elements (text fields, IO fields, image blocks, etc.).

Figure 6-1: Example call hierarchy in the control system

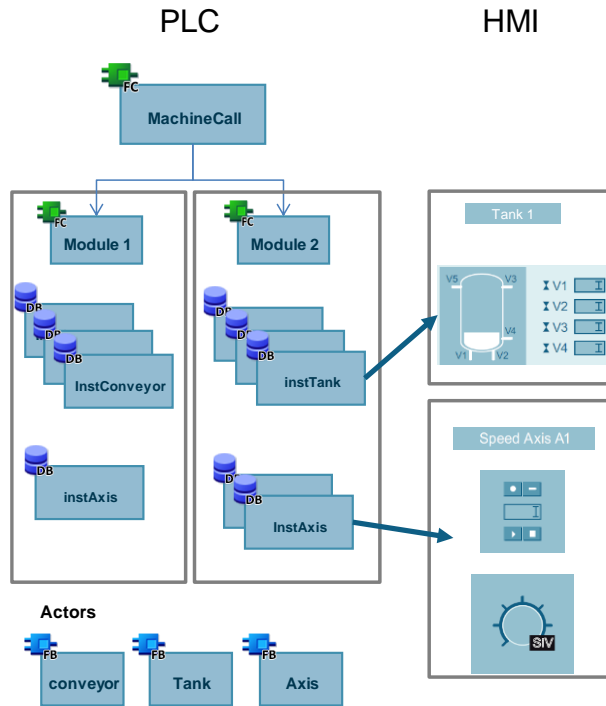

SiVArc uses the rules to generate the specified visualization element on a copy of an image template for each call of the specified block.

Figure 6-2: SiVArc rule

	Name	Program block	Screen object	Master copy of a screen	Layout field
1	rule	EnS_EnergyDataBasic	EnS_EnergyObjectVisualization	EnS_EnergyO...	EnS_Visu_Field

Note

You also have the option of restricting or blocking the execution of the rule in the controller.

6.3 Controlling the HMI generator

You have the following options for controlling the HMI generator:

- Disable SiVArc generation for specific calls
- Sort SiVArc generation by function or plant location
- Add further properties to SiVArc generation

In SiVArc rules, you can use the following information from the controller, among other things:

- Network comments
- SiVArc variable

This gives you the option of providing additional information for SiVArc in the controller, which you can use as a condition in the SiVArc rules.

6.3.1 Using network comments for control

In the network comments, you can add information on controlling the generator that the SiVArc rules search for during generation:

Figure 6-3: Network commentary with SiVArc extension

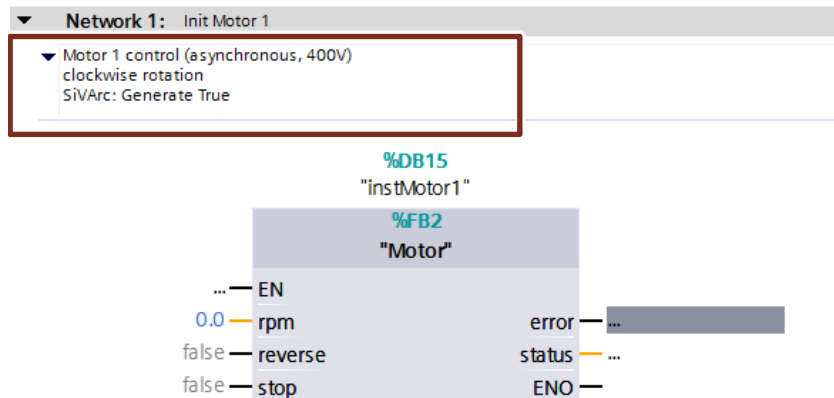

In the rule editor, use the "Contains" function in the "Condition" column and search for the information, e.g. "Contains(Block.NetworkComment, "String")".

Figure 6-4: Use Network Comment in Rule

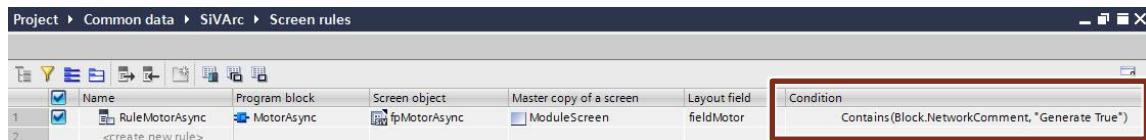

With this function you have a free design framework to restrict the execution of rules or to execute a rule only for some networks.

Recommendation

Clearly mark the information for SiVArc generation in the network comments, e.g. "SiVArc: Generate True".

6.3.2 Using SiVArc variables for control

You can define special SiVArc variables for each network in the device and use these variables in the SiVArc rules.

To create SiVArc tags, proceed as follows:

4. Open the block.
5. Switch to the "Plug-Ins" tab in the Inspector window.
6. For each network, enter the name of the variable in the Name column and a value as a string in the "Value" column.

Figure 6-5: Creating SiVArc Variables

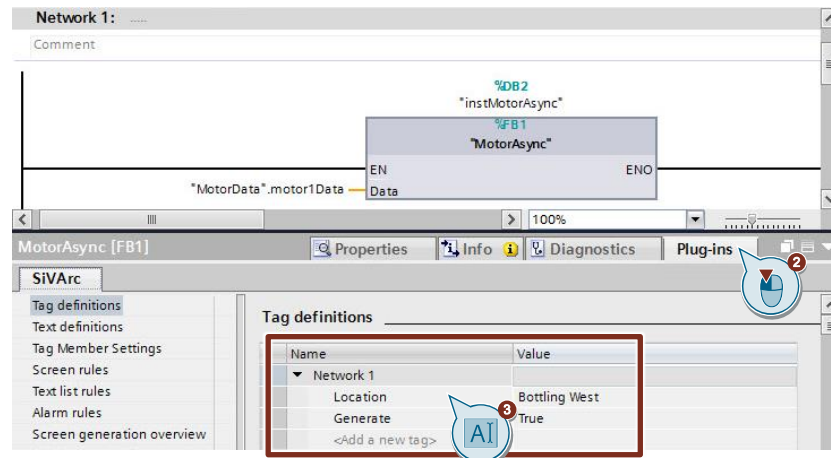

In the rule editor, you can query the SiVArc variables with the expression "variable name = "value"" and thereby influence the exercise of the rule.

In the rule editor, enter the SiVArc variable in the "Condition" column, e.g. "Location = "Bottling West"".

In this example, the rule is only executed if the SiVArc variable "Location" has been set to the value "Bottling West" in the network to be generated.

Figure 6-6: Use SiVArc variable in rule

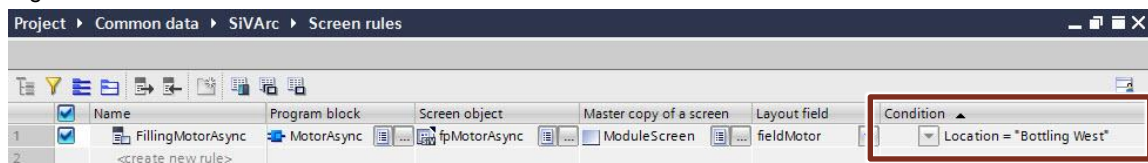

Recommendation

Use common variable names to control the generator to simplify rule creation. The following table shows an example of SiVArc variables:

Table 8: Example for SiVArc variables

Name	Value	Meaning
Generate	true, false	SiVArc generates elements for this network.
Location	Bottling West, Mixing etc.	You can automatically assign elements to an HMI image using this function.

Note

You must define the effects listed in the "Meaning" column yourself using the conditions in the rule editor. The SiVArc variables themselves have no influence on the generator.

6.4 Additional recommendations

Use only characters supported by WinCC

Only use characters that are supported by WinCC for the designation of variables.

When generating the images, SiVArc accesses the identifiers of data blocks, variables or network comments. SiVArc removes all characters that are not supported by WinCC.

This leads to inconsistencies in the project.

Characters not supported:

- %, @, ?, ", /, \, <, >, ., :

Calling the blocks with programming language FBD

So that you can control the generator via network comments or SiVArc variables, call the blocks from which visualization elements are to be generated in the programming language FBD.

Note

This recommendation applies up to and including TIA Portal V15.

As of TIA Portal V15.1, SCL modules can also be used.

7 The most important recommendations

- Use optimized blocks
 - Chapter [2.6 Optimized blocks](#)
- Use data type VARIANT instead of ANY
 - Chapter [2.8.5 Data type VARIANT](#)
- Structuring the program clearly and well
 - Chapter [3.2 Program blocks](#)
- Inserting instructions as multi-instance (TON, TOF ..)
 - Chapter [3.2.5 Multi-instances](#)
- Reusable programming of blocks
 - Chapter [3.2.9 Reusability of blocks](#)
- Symbolic programming
 - Chapter [3.6 Symbolic addressing](#)
- When handling data, work with ARRAY
 - Chapter [3.6.2 ARRAY data type and indirect field accesses](#)
- Creating PLC data types
 - Chapter [3.6.5 Access to I/O areas with PLC data types](#)
- Using libraries for storing program elements
 - Chapter [3.7 Libraries](#)
- No bit memory but global data blocks
 - Chapter [4.2 No bit memory but global data blocks](#)

8 Appendix

8.1 Service and support

Industry Online Support

Do you have any questions or need assistance?

Siemens Industry Online Support offers round the clock access to our entire service and support know-how and portfolio.

The Industry Online Support is the central address for information about our products, solutions and services.

Product information, manuals, downloads, FAQs, application examples and videos – all information is accessible with just a few mouse clicks:

<https://support.industry.siemens.com>

Technical Support

The Technical Support of Siemens Industry provides you fast and competent support regarding all technical queries with numerous tailor-made offers – ranging from basic support to individual support contracts. Please send queries to Technical Support via Web form:

www.siemens.com/industry/supportrequest

SITRAIN – Training for Industry

We support you with our globally available training courses for industry with practical experience, innovative learning methods and a concept that's tailored to the customer's specific needs.

For more information on our offered trainings and courses, as well as their locations and dates, refer to our web page:

www.siemens.com/sitrain

Service offer

Our range of services includes the following:

- Plant data services
- Spare parts services
- Repair services
- On-site and maintenance services
- Retrofitting and modernization services
- Service programs and contracts

You can find detailed information on our range of services in the service catalog web page:

<https://support.industry.siemens.com/cs/sc>

Industry Online Support app

You will receive optimum support wherever you are with the "Siemens Industry Online Support" app. The app is available for Apple iOS, Android and Windows Phone:

<https://support.industry.siemens.com/cs/ww/en/sc/2067>

8.2 Links and literature

Table 8-1: Links and literature

	Topic
\1\	Siemens Industry Online Support https://support.industry.siemens.com
\2\	Download page of the entry https://support.industry.siemens.com/cs/ww/en/view/81318674
\3\	Programming Styleguide for S7-1200 and S7-1500 https://support.industry.siemens.com/cs/ww/en/view/81318674
\4\	Library with general functions for (LGF) for STEP 7 (TIA Portal) and S7-1200 / S7-1500 https://support.industry.siemens.com/cs/ww/en/view/109479728
\5\	Libraries with PLC data types (LPD) for STEP 7 (TIA Portal) and S7-1200 / S7-1500 https://support.industry.siemens.com/cs/ww/en/view/109482396
\6\	TIA Portal - An Overview of the Most Important Documents and Links https://support.industry.siemens.com/cs/ww/en/view/65601780
\7\	STEP 7 (TIA Portal) manuals https://support.industry.siemens.com/cs/ww/en/ps/14673/man
\8\	S7-1200 (F) Manuals https://support.industry.siemens.com/cs/ww/en/ps/13683/man
\9\	S7-1500 (F) Manuals https://support.industry.siemens.com/cs/ww/en/ps/13716/man
\10\	ET 200SP CPU manuals https://support.industry.siemens.com/cs/ww/en/ps/13888/man
\11\	S7-1200 Getting Started https://support.industry.siemens.com/cs/ww/en/view/39644875
\12\	S7-1500 Getting Started https://support.industry.siemens.com/cs/ww/en/view/78027451
\13\	SIMATIC S7-1200 / S7-1500 Comparison List for Programming Languages Based on the International Mnemonics https://support.industry.siemens.com/cs/ww/en/view/86630375

8.3 Change documentation

Table 8-2: Change documentation

Version	Date	Modifications
V1.0	09/2013	First version
V1.1	10/2013	Corrections in the following chapters: 2.6.3 Processor-optimized data storage for S7-1500 2.12 User constants 3.2.2 Functions (FC) 3.2.3 Function blocks (FB) 3.4.3 Local memory
V1.2	03/2014	New chapters: 2.6.4 Conversion between optimized and non-optimized tags 2.6.6 Communication with optimized data 2.9.1 MOVE instructions 2.9.2 VARIANT instructions 3.6.5 Access to I/O areas with PLC data types Corrections in the following chapters: 2.2 Terms 2.3 Programming languages 2.6 Optimized blocks 2.10 Symbolic and comments 3.2 Program blocks 3.5 Retentivity 4.3 Programming of "Cycle bits" Various corrections in different chapters
V1.3	09/2014	New chapters: 2.8.4 Unicode data types 2.10.2 Comment lines in watch tables 2.12 User constants 3.2.10 Auto numbering of blocks 5 STEP 7 Safety in the TIA Portal Corrections in the following chapters: 2.7 Block properties 2.8 New data types for S7-1200/1500 2.9 Instructions 2.10 Symbolic and comments 3.6.4 STRUCT data type and PLC data types 3.7 Libraries Various corrections in different chapters

Version	Date	Modifications
V1.4	11/2015	New chapters: 2.6.5 Parameter transfer between blocks with optimized and non-optimized access 3.3.3 Overview for transfer of parameters 3.10.5 Correct use of FOR, REPEAT and WHILE loops 5.12 Optimizing the compilation and program runtime
V1.5	03/2017	New chapter: 2.7.3 Block interface – hide block parameters (V14 or higher) 2.9.4 Comparison of tags from PLC data types (V14 or higher) 2.9.5 Multiple assignment (V14 or higher) 3.2.6 Transferring instance as parameters (V14) 3.6.3 Formal parameter Array [*] (V14 or higher) 3.6.7 SCL networks in LAD and FBD (V14 and higher) 3.10.4 Structuring with the keyword REGION (V14 or higher) 3.10.11 Unnecessary IF instruction Several corrections in different chapter
V1.6	12/2018	New chapter: 6 Automatically generate visualization using the user program Update of title page and legal information