

SIEMENS

Industrial Controls

SIRIUS Safety Integrated Application Manual

Application Manual

<u>Introduction</u>	1
<u>Safety systems - General information</u>	2
<u>Application examples</u>	3
<u>Regulations and Standards</u>	4
<u>Specification and design of safety-related controls for machines</u>	5
<u>Service & Support</u>	6

Legal information

Warning notice system

This manual contains notices you have to observe in order to ensure your personal safety, as well as to prevent damage to property. The notices referring to your personal safety are highlighted in the manual by a safety alert symbol, notices referring only to property damage have no safety alert symbol. These notices shown below are graded according to the degree of danger.

 DANGER
indicates that death or severe personal injury will result if proper precautions are not taken.

 WARNING
indicates that death or severe personal injury may result if proper precautions are not taken.

 CAUTION
indicates that minor personal injury can result if proper precautions are not taken.

NOTICE
indicates that property damage can result if proper precautions are not taken.

If more than one degree of danger is present, the warning notice representing the highest degree of danger will be used. A notice warning of injury to persons with a safety alert symbol may also include a warning relating to property damage.

Qualified Personnel

The product/system described in this documentation may be operated only by **personnel qualified** for the specific task in accordance with the relevant documentation, in particular its warning notices and safety instructions. Qualified personnel are those who, based on their training and experience, are capable of identifying risks and avoiding potential hazards when working with these products/systems.

Proper use of Siemens products

Note the following:

 WARNING
Siemens products may only be used for the applications described in the catalog and in the relevant technical documentation. If products and components from other manufacturers are used, these must be recommended or approved by Siemens. Proper transport, storage, installation, assembly, commissioning, operation and maintenance are required to ensure that the products operate safely and without any problems. The permissible ambient conditions must be complied with. The information in the relevant documentation must be observed.

Trademarks

All names identified by ® are registered trademarks of Siemens AG. The remaining trademarks in this publication may be trademarks whose use by third parties for their own purposes could violate the rights of the owner.

Disclaimer of Liability

We have reviewed the contents of this publication to ensure consistency with the hardware and software described. Since variance cannot be precluded entirely, we cannot guarantee full consistency. However, the information in this publication is reviewed regularly and any necessary corrections are included in subsequent editions.

Table of contents

1	Introduction	7
1.1	Siemens Industry Online Support	9
1.2	Siemens Industry Online Support app.....	11
2	Safety systems - General information	13
2.1	Basic terminology	13
2.2	General Information.....	16
2.2.1	The objective of safety systems	16
2.2.2	Local legislation	16
2.2.3	Functional safety	16
2.2.4	Objective of the standards	17
2.2.5	Safety-related functions	17
2.2.6	Stopping.....	18
2.2.7	Procedure in an emergency situation.....	18
2.2.8	Emergency off.....	18
2.2.9	Emergency stop	19
2.2.10	Safety function	20
2.2.11	Resetting and starting devices.....	20
2.2.12	Mode selector switches.....	21
2.2.13	Connection of actuators.....	22
2.2.14	Power contactor as actuator	24
2.2.15	Series connection of sensors	26
3	Application examples	27
3.1	Introduction.....	27
3.2	Stopping in an emergency.....	35
3.2.1	Introduction.....	35
3.2.2	Emergency stop shutdown to SIL 1 or PL c with a 3SK1 safety relay	36
3.2.3	Emergency stop shutdown to SIL 1 or PL c with a 3SK2 safety relay	38
3.2.4	Emergency stop shutdown up to SIL 1 or PL c with a 3RW55 Failsafe soft starter	39
3.2.5	Emergency stop shutdown to SIL 2 or PL c with a contactor with F-PLC-IN and 3SK2 safety relay	41
3.2.6	Emergency stop shutdown to SIL 2 or PL c with a contactor with F-PLC-IN and fail-safe controller	43
3.2.7	Emergency stop shutdown to SIL 3 or PL e with a 3SK1 safety relay.....	45
3.2.8	Emergency stop shutdown to SIL 3 or PL e with a 3SK2 safety relay.....	47
3.2.9	Emergency stop shutdown to SIL 3 or PL e with fail-safe motor starters and a 3SK1 safety relay	48
3.2.10	Emergency stop shutdown to SIL 3 or PL e with fail-safe motor starters and a 3SK2 safety relay	50
3.2.11	Emergency stop shutdown via AS-i to SIL 3 or PL e with a Modular Safety System	52
3.2.12	Emergency stop shutdown to SIL 3 or PL e with contactors with F-PLC-IN and 3SK2 safety relay	54

3.2.13	Emergency stop shutdown to SIL 3 or PL e with contactors with F-PLC-IN and fail-safe controller.....	56
3.2.14	Emergency stop shutdown to SIL 3 or PL e with a fail-safe motor starter in the ET 200SP system and a 3SK1 safety relay.....	58
3.2.15	Emergency stop shutdown to SIL 3 or PL e with a fail-safe motor starter in the ET 200SP system and a 3SK2 safety relay.....	60
3.2.16	Emergency stop shutdown to SIL 3 or PL e with fail-safe digital output module and fail-safe motor starters in the ET 200SP system.....	62
3.2.17	Emergency stop shutdown to SIL 3 or PL e with fail-safe power module and fail-safe motor starters in the ET 200SP system.....	64
3.2.18	Emergency stop shutdown up to SIL 3 or PL e via 3SK2 safety relay with PROFINET connection and fail-safe motor starters.....	66
3.2.19	Emergency stop group shutdown up to SIL 3 or PL e via 3SK2 safety relay with PROFINET connection and fail-safe motor starters.....	69
3.2.20	Emergency stop shutdown up to SIL3 or PL e with a 3RW55 Failsafe soft starter and 3SK1 safety relay.....	73
3.2.21	Emergency stop shutdown to SIL 3 or PL e with a 3RQ1 coupling relay and fail-safe controller.....	75
3.3	Protective door monitoring.....	78
3.3.1	Introduction.....	78
3.3.2	Terminology from the standard.....	78
3.3.3	Protective door monitoring to SIL 1 or PL c with a 3SK1 safety relay.....	85
3.3.4	Protective door monitoring to SIL 1 or PL c with a 3SK2 safety relay.....	87
3.3.5	Protective door monitoring to SIL 3 or PL e with a 3SK1 safety relay.....	89
3.3.6	Protective door monitoring to SIL 3 or PL e with a 3SK2 safety relay.....	91
3.3.7	Protective door monitoring to SIL 3 or PL e with a fail-safe motor starter and a 3SK1 safety relay.....	93
3.3.8	Protective door monitoring to SIL 3 or PL e with fail-safe motor starters and a 3SK2 safety relay.....	95
3.3.9	Protective door monitoring via AS-i to SIL 3 or PL e with a Modular Safety System.....	97
3.3.10	Protective door monitoring by means of RFID switch to SIL 3 or PL e with a 3SK1 safety relay...	100
3.3.11	Protective door monitoring by means of RFID switch to SIL 3 or PL e with a 3SK2 safety relay...	101
3.3.12	Protective door monitoring with tumbler to SIL 2 or PL d with a 3SK2 safety relay.....	103
3.3.13	Protective door monitoring with tumbler up to SIL 2 or PL d via ET 200eco PN and F-CPU...	106
3.3.14	Protective door monitoring with tumbler using 3SE64 RFID safety switch up to SIL 3 or PL e using a 3SK2 safety relay.....	108
3.3.15	Protective door monitoring with tumbler using 3SE64 RFID safety switch up to SIL 3 or PL e using a fail-safe controller.....	111
3.4	Monitoring of open danger zones.....	113
3.4.1	Introduction.....	113
3.4.2	Access monitoring using a light curtain to SIL 3 or PL e with a 3SK1 safety relay.....	113
3.4.3	Access monitoring using a light curtain to SIL 3 or PL e with a 3SK2 safety relay.....	115
3.4.4	Access monitoring using a safety mat to SIL 3 or PL e with a 3SK1 safety relay.....	117
3.4.5	Access monitoring using a safety mat to SIL 3 or PL e with a 3SK2 safety relay.....	119
3.4.6	Area monitoring using a laser scanner to SIL 2 or PL d with a 3SK1 safety relay.....	121
3.4.7	Area monitoring using a laser scanner to SIL 2 or PL d with a 3SK2 safety relay.....	123
3.5	Safe speed and standstill monitoring.....	126
3.5.1	Introduction.....	126
3.5.2	Safe speed monitoring to SIL 3 or PL e with a speed monitor.....	126
3.5.3	Safe standstill monitoring including protective door tumbler to SIL 3 or PL e with a 3SK2 safety relay.....	129

3.5.4	Safe speed monitoring, protective door monitoring and tumbler monitoring to SIL 3 or PL e with a speed monitor	131
3.6	Safe operator input	133
3.6.1	Introduction.....	133
3.6.2	Two-hand operation to SIL 3 or PL e with a 3SK1 safety relay.....	133
3.6.3	Two-hand operation to SIL 3 or PL e with a 3SK2 safety relay.....	135
3.7	Typical combinations of multiple safety functions	138
3.7.1	Introduction.....	138
3.7.2	Safe temperature monitoring up to SIL 1 or PL c with a 3RS2 temperature monitoring relay... ..	139
3.7.3	Safe temperature monitoring and protective door monitoring with tumbler up to SIL 1 or PL c with a 3RS2 temperature monitoring relay and 3SK2 safety relay	141
3.7.4	Safe current monitoring including emergency stop shutdown up to PL d with a 3SK2 safety relay and two current monitoring relays	143
3.7.5	Emergency stop monitoring and protective door monitoring to SIL 3 or PL e with a 3SK1 safety relay	146
3.7.6	Emergency stop monitoring and protective door monitoring to SIL 3 or PL e with a 3SK2 safety relay	148
3.7.7	Access monitoring using a light curtain with two-hand operation and emergency stop to SIL 3 or PL e with a 3SK2 safety relay	150
3.7.8	Cascading of 3SK1 safety relays to SIL 3 or PL e.....	153
3.7.9	Safe slave-to-slave communication between several plant sections to SIL 3 or PL e via AS-i... ..	155
3.7.10	Protective door monitoring by means of magnetically-operated switches and emergency shutdown using cable-operated switches up to SIL3 or PL e by means of AS-i ET 200SP Master and AS-i SlimLine compact modules	157
3.7.11	Emergency stop shutdown up to SIL 3 or PL e and protective door monitoring up to SIL 2 or PL d with tumbler via AS-i ET 200SP Master	159
3.7.12	Emergency stop shutdown and protective door monitoring up to SIL 3 or PL e via ET 200ecoPN and F-CPU	162
3.7.13	Emergency stop shutdown of more than one motor up to SIL 3 or PL e with one 3SK1 safety relay, output expansion and 3RQ1 coupling relay.....	165
3.7.14	Protective door monitoring with tumbler by means of a 3SE64 RFID safety switch including emergency stop shutdown up to SIL 3 or PL e and via ET 200AL and F-CPU	167
3.7.15	Cascading of 3SK2 safety relays up to SIL 3 or PL e.....	170
3.8	Further application examples and FAQs	173
3.8.1	General	173
3.8.2	Subsystem detection.....	173
3.8.3	Subsystem evaluation	173
3.8.4	Subsystem reaction.....	174
4	Regulations and Standards	175
4.1	Regulations and standards in the European Union (EU).....	175
4.1.1	Safety of machinery in Europe.....	175
4.1.1.1	Legal basis.....	175
4.1.1.2	CE conformity process.....	177
4.2	Regulations and standards outside the European Union (EU)	183
4.2.1	Regulations and standards outside the European Union - Overview.....	183
4.2.2	Legal requirements in the U.S.A.	183
4.2.3	Legal requirements in Brazil	183
4.2.4	Legal requirements in Australia	185

- 5 Specification and design of safety-related controls for machines 187**
 - 5.1 Safety-related parts for the machine control 187
 - 5.1.1 Four risk elements 187
 - 5.2 Specification of the safety requirements 191
 - 5.3 Design and implementation of the (safety-related) controller in accordance with IEC 62061 192
 - 5.3.1 Philosophy/theory 192
 - 5.3.2 Design process of a safety-related control system (SRECS)..... 193
 - 5.3.3 System design for a safety function 196
 - 5.3.4 Implementation of the safety-related control system 197
 - 5.3.4.1 Achieved safety performance 198
 - 5.3.5 System integration for all safety functions 199
 - 5.3.6 Design and implementation of subsystems..... 200
 - 5.4 Design and implementation of safety-related parts of a controller in accordance with ISO 13849-1 204
 - 5.4.1 Design and implementation of categories..... 207
- 6 Service & Support 213**
 - 6.1 Service & Support 213
- Index 215**

Introduction

Purpose of the documentation

This documentation provides an insight into the fundamental safety requirements in the manufacturing industry. Using the SIRIUS Safety Integrated products, the documentation shows you simple example circuits for safety functions from the application areas:

- Stopping in an emergency
- Protective door monitoring
- Speed/standstill monitoring
- Monitoring of open danger zones
- Safe operator input
- Typical combinations of safety functions

Following the simple example circuits, you will find detailed background information on regulations and standards, as well as the specification and design of safety-related controller parts.

Target group

This documentation contains information for the following target groups:

- Decision makers
- Technologists
- Configuration engineers

Required knowledge

A general knowledge of the following areas is needed in order to understand this documentation:

- Low-voltage controls and distribution
- Digital circuit logic
- Automation technology

Warranty and liability

Note

The application examples are non-binding and do not claim to be complete in terms of configuration and equipment or to take account of any other contingencies. The application examples do not represent specific customer solutions; they are intended only as support for typical tasks. The user has sole responsibility for ensuring correct operation of the products described. These application examples do not exempt the user from their due diligence obligation with regard to application, installation, operation and maintenance. We reserve the right to make changes to these application examples at any time and without prior notice. In the case of deviations between the recommendations in this information and other Siemens publications, such as catalogs, the contents of the other documentation have priority.

We give no guarantee that the information contained in this document is complete, accurate, or up-to-date.

We assume no liability, irrespective of the legal basis, for any damage arising from the use of the examples, instructions, programs, configuring and performance data, etc., in this application example.

This exclusion does not apply in cases of intentional or negligent loss of life, physical injury or damage to health, or any other damage if these are the result of intentional or grossly negligent misconduct.

Any form of duplication of these application examples or excerpts hereof is not permitted without the express consent of Siemens Industry Sector.

History

The following versions of this documentation have been released to date. The changes apply to the previous version:

Edition	Remark/change
09/2013	Initial release
10/2013	Small editorial improvements, defective Web links repaired
03/2014	Integration of additional application examples, content expansions, and corrections
09/2014	Supplements and corrections to the contents
10/2015	Integration of additional application examples, content expansions, and corrections
09/2016	Integration of additional application examples, content expansions, and corrections
08/2017	Integration of additional application examples, content expansions, and corrections
09/2019	Integration of additional application examples, content expansions, and corrections
09/2020	Integration of additional application examples, content expansions, and corrections
07/2021	Integration of additional application examples, content expansions, and corrections
09/2022	Integration of additional application examples, content expansions, and corrections

1.1 Siemens Industry Online Support

Information and service

At Siemens Industry Online Support you can obtain up-to-date information from our global support database:

- Product support
- Application examples
- Forum
- mySupport

Link: Siemens Industry Online Support (<https://support.industry.siemens.com/cs/de/en>)

Product support

You can find information and comprehensive know-how covering all aspects of your product here:

- **FAQs**
Answers to frequently asked questions
- **Manuals/operating instructions**
Read online or download, available as PDF or individually configurable.
- **Certificates**
Clearly sorted according to approving authority, type and country.
- **Characteristics**
For support in planning and configuring your system.
- **Product announcements**
The latest information and news concerning our products.
- **Downloads**
Here you will find updates, service packs, HSPs and much more for your product.
- **Application examples**
Function blocks, background and system descriptions, performance statements, demonstration systems, and application examples, clearly explained and represented.
- **Technical data**
Technical product data for support in planning and implementing your project

Link: Product support (<https://support.industry.siemens.com/cs/ww/en/ps>)

mySupport

The following functions are available in your personal work area "mySupport":

- **Support Request**
Search for request number, product or subject
- **My filters**
With filters, you limit the content of the online support to different focal points.

- **My favorites**
With favorites you bookmark articles and products that you need frequently.
- **My notifications**
Your personal mailbox for exchanging information and managing your contacts. You can compile your own individual newsletter in the "Notifications" section.
- **My products**
With product lists you can virtually map your control cabinet, your system or your entire automation project.
- **My documentation**
Configure your individual documentation from different manuals.
- **CAX data**
Easy access to CAX data, e.g. 3D models, 2D dimension drawings, EPLAN macros, device circuit diagrams
- **My IBase registrations**
Register your Siemens products, systems and software.

1.2 Siemens Industry Online Support app

Siemens Industry Online Support app

The Siemens Industry Online Support app provides you access to all the device-specific information available on the Siemens Industry Online Support portal for a particular article number, such as operating instructions, manuals, data sheets, FAQs etc.

The Siemens Industry Online Support app is available for Android and iOS:



Android



iOS

Safety systems - General information

2.1 Basic terminology

Redundancy

With redundancy, more than one component is implemented for the same function, so the function of a faulty component is performed instead by the other component(s). A redundant configuration reduces the probability of a function failing due to a single defective component. This requirement is necessary for achieving Safety Integrity Level SILCL 3 per IEC 62061, SIL 3 per IEC 61508 and PL e per ISO 13849-1 (also necessary for SIL 2 / PL d under certain circumstances).

The simplest form of redundancy is two-channel redundancy. If a circuit fails, two-channel redundancy ensures that the safety function is maintained. In a redundant system configuration, the subsystems for detecting and reacting must also be implemented with two-channel redundancy.

Note

All SIRIUS Safety devices that comply with SILCL 3 per IEC 62061, SIL 3 per IEC 61508 and PL e per ISO 13849-1 are redundantly configured with regard to the internal logic as well as with regard to the output circuits.

Cross-circuit detection

Cross-circuit detection is a diagnostic function of an evaluation unit that detects short-circuits and cross-circuits between the input channels (sensor circuits) during two-channel detecting or reading. A cross-circuit can be caused, for example, by a cable casing being squashed. In devices without cross-circuit detection, this can mean that a two-channel emergency stop circuit does not trip even though only one NC contact is faulty (secondary error).

Enabling circuit

An enabling circuit provides a safety-related output signal. From an external viewpoint, enabling circuits usually act as NO contacts (however, in terms of functionality, safety-oriented opening is always the most important aspect). An individual enabling circuit that is redundantly configured internally in the safety relay can be used for SIL 3 / PL e. Note: Enabling current paths can also be used for signaling purposes.

Feedback circuit

A feedback circuit is used to monitor controlled actuators (e.g. relays or load contactors) with positively-driven contacts or mirror contacts. The enabling circuits can only be activated when the feedback circuit is closed.

2.1 Basic terminology

When using a redundant shutdown path, the feedback circuit of both actuators must be evaluated. These may also be connected in series.

Automatic start

For an automatic start, the device is started without manual confirmation, but only after the input image has been checked and a positive test of the evaluation unit has been conducted. This function is also known as dynamic operation and is not permissible for emergency stop devices. Safety devices for prohibited danger zones (e.g. position switches, light arrays, safety mats) can use the automatic start function if this does not pose any risk.

Monitored start

For a monitored start, machine operation is initiated by actuating the Start button, but only after the input image has been checked and a positive test of the evaluation unit has been conducted. The monitored start evaluates the signal change of the Start button. This means that the Start button cannot be manipulated/tampered with (misuse). For PL e (ISO 13849-1) as well as SIL 3 (IEC 62061), the monitored start must be used in the case of emergency stop. For other safety sensors/functions, the necessity for a monitored start command depends on the risk assessment.

Manual start

For a manual start, device operation is initiated by operating the Start button, but only after the input image has been checked and a positive test of the safety relay has been conducted. On a manual start, the Start button is not monitored for correct functioning. A positive edge of the Start button is sufficient for starting.

Note

Manual start is not permitted for emergency stop devices.

Two-hand operation / synchronism

Synchronous sensor operation is a special form of simultaneity of sensors. In this case, it is not sufficient for sensor contacts 1 and 2 to be switched to the closed state at different times. Instead, they must be closed within 0.5 seconds. Synchronism of sensors is required, in particular, in the case of two-hand operation of presses. This ensures that the presses only become active when the sensors are operated simultaneously with both hands. This minimizes the risk of the operator getting a hand in the press.

Positive opening operation

Positive-opening switches are designed in such a way that actuation of the switch always results in opening of the contacts. Welded contacts are opened by actuation (EN 60947-5-1).

Positively-driven contacts

A component with positively-driven contacts guarantees that the NC and NO contacts are never closed simultaneously (EN 60947-5-1).

Mirror contacts

A mirror contact is an NC contact that is guaranteed not to be closed at the same time as a main contact (EN 60947-4-1).

2.2 General Information

This chapter contains general and overall information on the topic of safety systems.

Details of regulations and standards, as well as the specification and design of safety-related parts of controllers, can be found at the end of the manual.

2.2.1 The objective of safety systems

The objective of safety systems is to keep potential hazards for both people and the environment as low as possible by means of design measures and suitable technical equipment, without restricting, more than absolutely necessary, industrial production, the use of machines and the production of chemical products. The protection of man and environment has to be put on an equal footing in all countries by applying rules and regulations that have been internationally harmonized. At the same time, the distortion of competition due to differing safety requirements in international trade are to be avoided.

2.2.2 Local legislation

The most important thing for machine manufacturers and plant builders is that the legislation and regulations in the country where the machine or plant is being operated always apply. For instance, the control system of a machine that is to be used in the US must fulfill the local US requirements even if the machine manufacturer (OEM) is based in Europe. Although the technical concepts with which safety is achieved are subject to the rules of technology, it is nevertheless important to note whether any legal specifications or restrictions apply.

2.2.3 Functional safety

From the perspective of the object to be protected, safety is indivisible. The causes of danger and also the technical measures to avoid them can vary widely. This is the reason that a differentiation is made between various types of safety, e.g. by specifying the particular cause of a potential hazard. Thus we speak of "electrical safety" when protection against hazards is to be implemented by electrical means, or "functional safety" when safety depends on correct functioning.

To ensure the functional safety of a machine or plant, the safety-related parts of the protection and control devices must function correctly. In addition, the systems must behave in such a way that either the plant remains in a safe state, or it is put into a safe state if a fault occurs.

In this case, it is necessary to use specially qualified technology that fulfills the requirements described in the relevant standards. The requirements for achieving functional safety are based on the following basic goals:

- Avoiding systematic faults
- Controlling systematic faults
- Controlling random faults or failures

The measure for the achieved functional safety is the probability of dangerous failures, the fault tolerance and the quality that is to be guaranteed as a result of freedom from systematic faults. It is expressed in the standards using different terms:

- In IEC 62061: "Safety Integrity Level" (SIL)
- In ISO 13849-1: "Performance Level" (PL)

2.2.4 Objective of the standards

Manufacturers and operators of technical equipment and products are responsible for safety. This means that plants, machines, and other technical equipment must be made as safe as possible in accordance with the current state of the art. To ensure this, companies describe in the various standards the current state of the art regarding all aspects relevant to safety. Observance of the relevant standards ensures that state-of-the-art technology has been utilized and thus the plant builder or machine/device manufacturer has fulfilled his duty of care.

You can find details of regulations and standards in the chapter Regulations and Standards (Page 175).

Note

No claim to completeness

The standards, directives and legislation listed in this manual represent a selection to communicate the essential goals and principles. This list does not claim to be complete.

2.2.5 Safety-related functions

Safety-related functions encompass classic and more complex functions.

Classic functions:

- Stopping
- Procedures in an emergency situation
- Preventing unintentional start-up

More complex functions:

- Status-dependent interlocks
- Velocity limiting
- Position limiting
- Controlled stop
- Controlled holding (stopping the machine but maintaining power), and others

2.2.6 Stopping

Stopping (stop categories of EN 60204-1)

EN 60204-1 (VDE 0113 Part 1) defines three stop categories for stopping a machine. These describe the control sequence for stopping independently of any emergency situation:

Stop category	Description
0	Uncontrolled stopping by immediately switching off the power to the machine's drive elements
1	Controlled stopping; the power feed is only interrupted when the motor has come to a standstill.
2	Controlled stopping where the energy feed is still maintained even at standstill.

Note

Switching off only interrupts the energy feed that can cause the movement. Disconnection from the energy source does not take place.

2.2.7 Procedure in an emergency situation

EN 60204-1 / 11.98 has established and defined possible procedures for emergencies (EN 60204-1 Annex D). The terms in brackets correspond to implementation in the final draft of Edition 5.0 of IEC 60204-1.

A procedure in an emergency includes the following individually or in combination:

- Emergency stop
- Emergency start
- Emergency switching off
- Emergency switching on

In accordance with EN 60204-1 and ISO 13850, these functions are initiated exclusively by deliberate human action. We will concentrate below on "emergency switching off" and "emergency stop" only. The latter is defined in the EU Machinery Directive. For simplicity, we will use the terms "emergency off" and "emergency stop" below.

2.2.8 Emergency off

This is an operation in an emergency that is intended to disconnect the electrical energy to a complete installation or part of an installation if there is a risk of electric shock or another risk having an electrical cause (from EN 60204-1 Annex D).

Functional aspects for switching off in an emergency are defined in IEC 60364-4-46 (identical to HD 384-4-46 and VDE 0100 Part 460). Switching off in an emergency must be provided where

- protection against direct contact (e.g. with sliding contacts, slipping elements, switchgear in electrical operating areas) is only achieved by clearance or obstacles;
- There is a possibility of other hazards or damage caused by electrical energy.

The following still applies in 9.2.5.4.3 of EN 60204-1: Switching off in an emergency is achieved by shutting down the machine resulting in a Category 0 stop.

If Stop Category 0 is not permissible for a machine, it can be necessary to provide another form of protection, e.g. against direct contact, so that switching off in an emergency is not necessary.

This means the emergency off is only to be used where the risk analysis identifies a hazard from electrical voltage / energy requiring immediate and full disconnection of the electrical voltage.

2.2.9 Emergency stop

An emergency operation intended to stop a process or movement that has become hazardous (from EN 60204-1 Annex D). The following still applies in 9.2.5.4.2 of EN 60204-1:

In addition to the requirements for stopping (see 9.2.5.3 of EN 60204-1), the following requirements apply for stopping in an emergency:

- It must take priority over all other functions and operations in all operating modes
- The power to the machine drive elements, which could result in a potentially hazardous condition or potentially hazardous conditions, must be disconnected as quickly as possible without creating other hazards (e.g. using mechanical stopping devices which do not require an external supply, using counter-current braking for stop Category 1).
- Resetting must not initiate restart.

Stopping in an emergency must have the effect of either a Category 0 stop or a Category 1 stop (see 9.2.2 of EN 60204-1). The category for stopping in an emergency must be defined using the risk assessment for the machine.

Devices for stopping in an emergency must be available at all operating workstations and other locations where stopping in an emergency can be necessary.

To comply with the safety objectives of EN 60204-1, the following requirements apply:

- When the contacts switch, even if only briefly actuated, the command device must latch positively.
- It must not be possible for the machine to be restarted from a remote main console without first eliminating the hazard. The emergency stop device must be released locally in the form of a conscious operator action.

2.2.10 Safety function

A safety function describes the reaction of a machine/plant to the occurrence of a specific event (e.g. opening of a protective door). Execution of the safety function(s) is carried out by a safety-related control system. This usually comprises three subsystems: detecting, evaluating, reacting.

Detecting (sensors):

- Detecting a safety requirement, e.g.: Emergency stop or a sensor for monitoring a danger zone (light array, laser scanner, etc.) is actuated.

Evaluating (evaluation unit):

- Detection of a safety requirement and the safe initiation of the reaction (e.g. switching off the enabling circuits).
- Monitoring the correct operation of sensors and actuators.
- Initiating a reaction upon detection of faults.

Reacting (actuators):

- Shutdown of the hazard in accordance with the switching command of the evaluation unit.

2.2.11 Resetting and starting devices

The necessity of implementing a reset device and a (machine) start device in safety functions or machine controllers is dependent on several factors, in particular on the type of safety function. The structuring of the command setup also offers various possibilities.

Dependence on the type of safety function

The necessity of a start device arises from the requirements of EN 60204-1 "Safety of machinery – Electrical equipment of machines – Part 1: General requirements".

Paragraph 9.2.5.2, "Start", states that starting may only be possible if all applicable safety functions and/or protective measures are in the right position and are ready for operation.

In the case of machines that require more than one control station to initiate a start, each control station shall have a separate, manually operated start control device. The conditions for initiating a start must be:

- all required conditions for operating the machine shall be met
- all start control devices shall be in the released position (OFF)
- all start control devices shall be actuated simultaneously.

This part of IEC 60204 also specifies the requirements for EMERGENCY STOP functions. If an active actuation of an EMERGENCY STOP device has triggered a subsequent control command, the effect of this command must be maintained until it is reset.

"This reset shall only be possible by a manual action at the device where the command has been initiated. The reset of the command shall not restart the machinery but only permit restarting."

In this case, it demands not only the resetting mechanism at the location of the EMERGENCY STOP device, but also the start device of the machine in order to reenergize this after a

successful reset. (see also EN ISO 13849-1 Paragraph 5.2.2 "Manual reset function")
In many cases, the reset function in the case of an emergency stop can already be guaranteed by the mechanical unlocking of the EMERGENCY STOP device on site (see EN ISO 13850 Paragraph 4.1.4. "Disengagement (e.g. unlatching) of the emergency stop device")

A similar requirement for reset functions exists for isolating protection equipment:

"The (re-)closing or resetting of a locked protective device must not initiate any hazardous machine operation.

NOTE: Requirements for isolating protective devices with a start function (control guards) are defined in ISO 12100-2, 5.3.2.5."

Here too, not only the reset device for the protective door is described, but also the necessity of a start device for getting the machine running again.

One exception here is provided by the control guards that permit an automatic restart (e.g. guard fences preventing access, see EN ISO 13849-1) and other command devices with automatic reset (e.g. two-hand operation devices, jogging etc., see EN 60204-1). In this case, no reset or start device is necessary in order to get the machine running again after this safety function has been triggered.

Color-coding of the command devices according to standard

The color-coding of the reset or start device is also defined in EN 60204-1 (Section 10.2)

- "The colors for START/ON actuators should be WHITE, GRAY, BLACK or GREEN, with a preference for WHITE. RED shall not be used."
- "The color RED shall be used for EMERGENCY STOP and EMERGENCY SWITCHING OFF actuators."
- "Reset actuators shall be BLUE, WHITE, GRAY or BLACK."

See also

Detailed FAQ on the subject of reset and start devices (<http://support.automation.siemens.com/WW/view/en/109748231>)

2.2.12 Mode selector switches

Machines often have several operating modes that can be changed using a mode selector switch. Every machine must be designed in such a way that it is safe in every operating mode. Since the mode selector switch can only change between these safe operating modes protected by safety functions, the mode selector switch itself does not have to be safe by design or included in the calculation of these safety functions.

The mode selector switch must not itself trigger any machine operation. This must be done by means of a separate operator action.

If an operating mode requires a safety function to be revoked (e.g. for setup or maintenance purposes), the safety function must be replaced by another safety function in accordance with EN 60204-1 Chapter 9.2.4.

2.2 General Information

In this case, the recommendation is that the electrical design of the mode selector switch should be similar to the highest safety level of all operating modes. But here too, it is not included in the calculation of the safety functions.

In addition, there are special requirements regarding mode switching for specific machine types. These requirements are mentioned in the C standards for these machine types and must be applied.

See also

More detailed FAQs on the subject of mode selection (<http://support.automation.siemens.com/WW/view/en/89260861>)

2.2.13 Connection of actuators

Note

To achieve the Performance Level / Safety Integrity Level given in the following examples, the actuators shown must be monitored in the feedback circuit of the corresponding safety relay.

Note

For capacitive and inductive loads, we recommend an adequate protective circuit. In this way, electromagnetic interference can be suppressed and contact service life increased.

Actuator wiring up to PL c acc. to ISO 13849-1, or SIL CL 1 acc. to IEC 62061

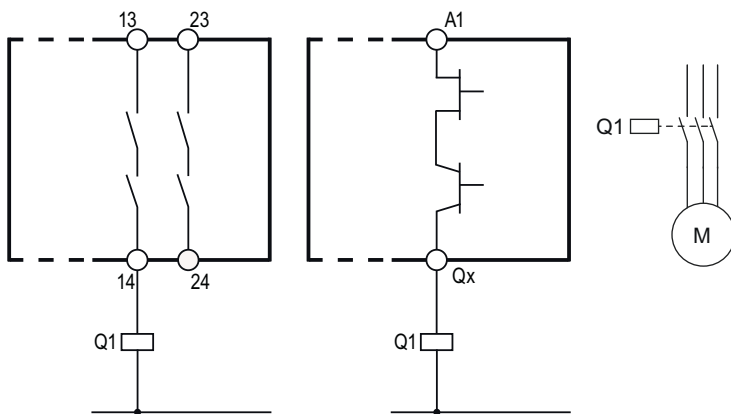

Figure 2-1 PL e acc. to ISO 13849-1, or SIL CL 1 acc. to IEC 62061

Actuator wiring for protected laying up to PL e / Cat. 4 acc. to ISO 13849-1, or SIL CL 3 acc. to IEC 62061

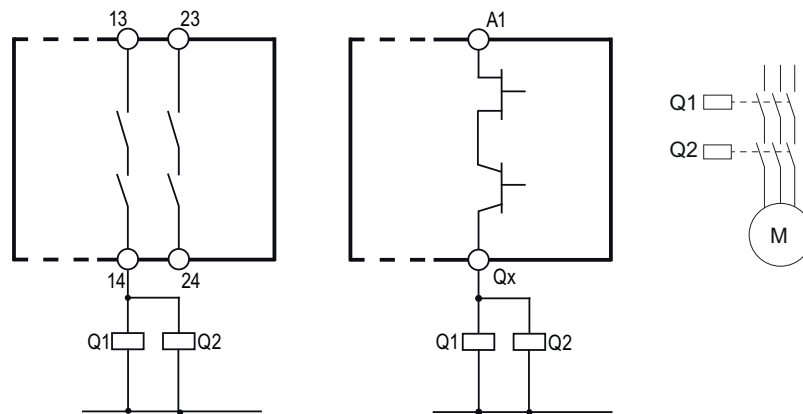

Figure 2-2 PL e acc. to ISO 13849-1, or SIL CL 3 acc. to IEC 62061

⚠ WARNING

Laying of the control lines

PL e acc. to ISO 13849-1 or SIL CL 3 acc. to IEC 62061 can only be achieved with cross-circuit-proof/short-circuit to P-proof laying of the control cables from the relay output (e.g. 14) to the control relays/contactors (Q1 and Q2) (e.g. as a separately sheathed cable or in its own cable duct).

Restrictions with regard to the safety levels attainable in the individual controllers must be taken into account. Please refer to the specifications in the relevant device manual.

Actuator wiring up to PL e acc. to ISO 13849-1, or SIL CL 3 acc. to IEC 62061

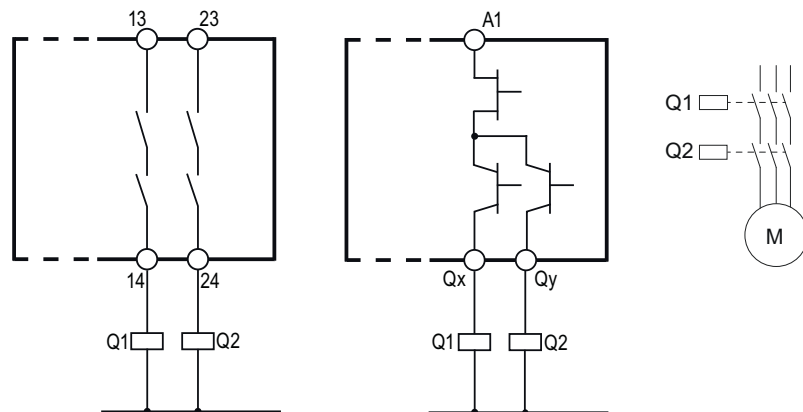

Figure 2-3 PL e acc. to ISO 13849-1, or SIL CL 3 acc. to IEC 62061

Monitoring the feedback circuit

Monitoring of the actuator technology is a diagnostic function and thus contributes significantly to the achieved SIL or PL of the respective subsystem. In the case of electromechanical components (e.g. relays or contactors), a forced auxiliary contact (mirror contact) of the component is often fed back to the controller and evaluated there. This is referred to as monitoring the feedback circuit or reading back the contactors.

This is particularly necessary in a redundant setup since if one of the two contactors became welded without being detected, the two-channel system would become a single-channel system. Instead, contact welding is detected and a new switch on is prevented until the fault is rectified.

When using an F-PLC as an evaluation unit, the NC-contact does not necessarily have to be read back to a fail-safe input (F-DI) – a standard input (DI) is sufficient in most applications.

When using a 3SK2 safety relay with PROFINET connection this means that, as an alternative to direct connection to an F-INx of the 3SK2, the feedback circuit signal can also be read in via a standard input (DI) of the higher-level controller and transmitted to the 3SK2 via PROFINET.

In the following cases, connecting the feedback circuit to an F-DI may be useful or necessary:

- Single-channel design of the actuator technology, but still requiring a high level of diagnostic coverage.
- Certain diagnostic functions (e.g. STEP 7 block "FDBACK") are not possible.
- Use of a fail-safe module in the distributed I/O in order to utilize the safety mechanisms of PROFIsafe.

For more information on feedback circuit monitoring with an F-PLC, refer to the following application example (<https://support.industry.siemens.com/cs/ww/en/view/21331098>).

2.2.14 Power contactor as actuator

Contactors are an essential component in safety-related applications. In many safety-related applications, a power contactor is used as the actuator in order to set the machine to the safe state when a requested safety function is performed (e.g. opening of an locked protective door).

This chapter briefly explains the safety-related calculation of a power contactor.

A separate application guide explains in detail the options and requirements when using contactors in safety-related applications:

Contactors in safety applications – Application guide (<https://support.industry.siemens.com/cs/de/en/view/109807687>)

The focus is primarily on applications in the manufacturing industry, but a separate chapter also explains their use in the process industry.

To this end, the fundamentals of the use of contactors in functional safety engineering are initially taught on the basis of the relevant standards. The user is then provided with a concrete guideline for selecting the right contactor for a wide range of applications.

Calculation of the safety integrity

B10 values are required for calculating the Safety Integrity Level for these electromechanical devices. The B10 value for devices subject to wear is expressed as the number of operating cycles and reflects the number of operations after which 10% of devices failed in a service life test. With the help of the B10 value and a simplified formula (see Section 6.7.8.2.1 of EN 62061), the user can then calculate the total failure rate of an electromechanical component:

$$\lambda = 0.1 \times C / B10$$

where C = operating cycles per hour. C is specified by the user and must be determined separately for each application.

The failure rate is made up of safe (λ_S) and dangerous (λ_D) failures:

$$\lambda = \lambda_S + \lambda_D$$

or

$$\lambda_D = [\text{proportion of dangerous failures in \%}] \times \lambda$$

$$\lambda_S = [\text{proportion of safe failures in \%}] \times \lambda$$

The failure rate of the dangerous failures λ_D of the components used is needed for further calculations.

The B10d value used in EN ISO 13849-1:2008 is determined as follows:

$$B10d = B10 / \text{Proportion of dangerous failures}$$

The standard B10 values and percentage proportions of dangerous failures for industrial control components that are subject to wear/electromechanical can be found in the data sheets of the product. The values are also stored in the Safety Evaluation in the TIA Selection Tool and are therefore available for every calculation.

In particular, the conditions under which these characteristic values apply must be observed. The B10 value of a power contactor is usually determined at 66 % of the rated operational current. This results from the necessity of over-dimensioning as one of the field-proven safety principles, and must therefore also be complied with in the application.

Functional switching

If the power contactors are also to be functionally switched, it must be noted that this also affects the calculation of the Safety Integrity Level. Thus, the value that includes both functional switching and safety-related switching must be taken as the operating cycle when calculating the failure rate. The requirements with respect to fault detection times must be taken into account so that any risk of fault accumulations during functional switching can be reliably eliminated. If these requirements cannot be fulfilled, functional switching must be implemented by a different method.

2.2.15 Series connection of sensors

Series connection of emergency stop command devices

It is possible to connect emergency stop command devices in series up to the highest safety level (SILCL 3 per IEC 62061, SIL 3 per IEC 61508 and PL e per ISO 13849-1), because it is assumed that only one emergency stop is operated at a time. This ensures that errors and defects can be detected. See the "Stopping in an emergency" section - Introduction (Page 35).

Series connection of position switches

In general, position switches may be connected in series if measures ensure that multiple protective doors are not regularly opened simultaneously (otherwise a fault cannot be detected)

However, for safety level SILCL 3 per IEC 62061, SIL 3 per IEC 61508, and PL e per ISO 13849-1, they must never be connected in series, because every dangerous fault must be detected (independently of the operating personnel).

See the "Protective door monitoring" section - Terminology from the standard (Page 78).

Series connection of an emergency stop command device and a protective door monitor

In general, an emergency stop command device and a position switch may be connected in series if measures ensure that the two are not regularly opened/operated simultaneously (otherwise a fault cannot be detected).

However, for safety level SILCL 3 per IEC 62061, SIL 3 per IEC 61508, and PL e per ISO 13849-1, they must never be connected in series, because every dangerous fault must be detected (independently of the operating personnel).

See the chapter "Typical combinations of safety functions" - Introduction (Page 138).

Application examples

3.1 Introduction

People working near machinery (e.g. in the manufacturing industry) must be appropriately protected by means of technical equipment. This results in a host of safety functions designed to meet precisely this purpose. The implementation of some of the most essential safety functions is shown in the subsequent sections using easily understandable application examples. The examples are divided according to the type of safety function to be implemented:

- Stopping in an emergency
- Protective door monitoring
- Monitoring of open danger zones
- Speed/standstill monitoring
- Safe operator input
- Typical combinations of safety functions

Application examples per evaluation unit

In the tables below, the application examples are also grouped according to the respective evaluation unit. This means that, in addition to the section-based structure, it is also possible to make a direct selection of examples for specific evaluation units (e.g. 3SK2).

Table 3-1 3SK1

Safety level		Detecting						Reacting			Link
SIL	PL	Emergency stop	Position switches				Other	Con-tactor	Motor-starter	Other	
			Mecha-nical	RFID	Mag-netic	Tum-bler mecha-nism					
1	c	x	-	-	-	-	-	x	-	-	Section 3.2.2 (Page 165)
3	e	x	-	-	-	-	-	x	-	-	Section 3.2.7 (Page 45)
3	e	x	-	-	-	-	-	-	x	3RM1	Section 3.2.9 (Page 48)
3	e	x	-	-	-	-	-	-	x	ET 200SP	Section 3.2.14 (Page 58)
3	e	x	-	-	-	-	-	-	-	3RW55	Section 3.2.20 (Page 73)

3.1 Introduction

Safety level		Emergency stop	Detecting					Reacting			Link
SIL	PL		Position switches				Other	Con-tactor	Motor starter	Other	
			Me-chani-cal	RFID	Mag-netic	Tum-bler mech-anism					
1	c	-	x	-	-	-	-	x	-	-	Section 3.3.3 (Page 85)
3	e	-	x	-	-	-	-	x	-	-	Section 3.3.5 (Page 89)
3	e	-	x	-	-	-	-	-	x	3RM1	Section 3.3.7 (Page 93)
3	e	-	-	x	-	-	-	x	-	-	Section 3.3.10 (Page 100)
3	e	-	-	-	-	-	Light curtain	x	-	-	Section 3.4.2 (Page 113)
3	e	-	-	-	-	-	Safety shutdown mat	x	-	-	Section 3.4.4 (Page 117)
2	d	-	-	-	-	-	Laser scanner	x	-	-	Section 3.4.6 (Page 121)
3	e	-	-	-	-	-	Two-hand operation	x	-	-	Section 3.6.2 (Page 133)
3	e	x	x	-	-	-	-	x	-	-	Section 3.7.5 (Page 146)
3	e	x	x	-	-	-	Cascading	x	-	-	Section 3.7.8 (Page 153)
3	e	x	-	-	-	-	-	x	-	3RQ1	Section 3.7.13 (Page 165)

Table 3-2 3SK2

Safety level		Detecting						Reacting			Link
SIL	PL	Emergency stop	Position switches				Other	Con-tac-tor	Motor starter	Other	
			Me-chani-cal	RFID	Mag-netic	Tum-bler mech-anism					
1	c	x	-	-	-	-	-	x	-	-	Section 3.2.3 (Page 38)
2	c	x	-	-	-	-	-	x	-	F-PLC IN contactor	Section 3.2.5 (Page 41)
3	e	x	-	-	-	-	-	x	-	-	Section 3.2.8 (Page 47)
3	e	x	-	-	-	-	-	-	x	3RM1	Section 3.2.10 (Page 50)
3	e	x	-	-	-	-	-	x	-	F-PLC IN contactor	Section 3.2.12 (Page 54)
3	e	x	-	-	-	-	-	-	x	ET 200SP	Section 3.2.15 (Page 60)
3	e	x	-	-	-	-	-	-	x	3RM1	Section 3.2.18 (Page 66)
3	e	x	-	-	-	-	-	-	x	3RM1	Section 3.2.19 (Page 69)
1	c	-	x	-	-	-	-	x	-	-	Section 3.3.4 (Page 87)
3	e	-	x	-	-	-	-	x	-	-	Section 3.3.6 (Page 91)
3	e	-	x	-	-	-	-	-	x	3RM1	Section 3.3.8 (Page 95)
3	e	-	-	x	-	-	-	x	-	-	Section 3.3.11 (Page 101)
2	d	-	x	-	-	x	-	x	-	-	Section 3.3.12 (Page 103)
3	e	-	-	-	-	-	Light curtain	x	-	-	Section 3.4.3 (Page 115)

3.1 Introduction

Safety level		Detecting					Reacting			Link	
SIL	PL	Emergency stop	Position switches				Other	Con-tac-tor	Motor starter		Other
			Me-chani-cal	RFID	Mag-netic	Tum-ble-mech-anism					
3	e	-	-	-	-	-	Safety shutdown mat	x	-	-	Section 3.4.5 (Page 119)
2	d	-	-	-	-	-	Laser scanner	x	-	-	Section 3.4.7 (Page 123)
3	e	-	x	-	-	x	Zero speed monitor	x	-	-	Section 3.5.3 (Page 129)
3	e	-	-	-	-	-	Two-hand operation	x	-	-	Section 3.6.3 (Page 135)
2	d	x	-	-	-	-	Current monitoring	x	-	-	Section 3.7.4 (Page 143)
3	e	x	x	-	-	-	-	x	-	-	Section 3.7.6 (Page 148)
3	e	x	-	-	-	-	Light curtain + Two-hand operation	x	-	-	Section 3.7.7 (Page 150)
3	e	-	-	x	-	x	-	x	-	-	Section 3.3.14 (Page 108)
3	e	x	x	-	-	x	Light curtain	x	-	-	Section 3.7.15 (Page 170)

Table 3-3 3RK3 MSS

Safety level		Detecting					Reacting			Link	
SIL	PL	Emergency stop	Position switches				Other	Con-tac-tor	Motor starter		Other
			Mechanical	RFID	Magnetic	Tumbler mechanism					
3	e	x	-	-	-	-	AS-i	x	-	-	Section 3.2.11 (Page 52)
3	e	-	x	-	-	-	AS-i	x	-	-	Section 3.3.9 (Page 97)
3	e	x	x	-	-	-	AS-i direct communication	x	-	-	Section 3.7.9 (Page 155)

Table 3-4 F-CPU

Safety level		Detecting					Reacting			Link	
SIL	PL	Emergency stop	Position switches				Other	Con-tac-tor	Mo-tor starter		Other
			Mechanical	RFID	Magnetic	Including tumbler					
2	c	x	-	-	-	-	-	x	-	F-PLC IN contactor	Section 3.2.6 (Page 43)
3	e	x	-	-	-	-	-	x	-	F-PLC IN contactor	Section 3.2.13 (Page 56)
3	e	x	-	-	-	-	-	-	x	ET 200SP	Section 3.2.16 (Page 62)
3	e	x	-	-	-	-	-	-	x	ET 200SP	Section 3.2.17 (Page 64)
3	e	x	-	-	-	-	-	x	-	3RQ1	Section 3.2.21 (Page 75)
3	e	x	-	-	x	-	Cable-operated switch, AS-i	x	-	-	Section 3.7.10 (Page 157)
3	e	x	-	-	-	x	AS-i	x	-	-	Section 3.7.11 (Page 159)
3	e	x	x	-	-	-	ET 200eco PN	x	-	-	Section 3.7.12 (Page 162)
3	e	-	x	-	-	x	ET 200eco PN	x	-	-	Section 3.3.13 (Page 106)

3.1 Introduction

Safety level		Detecting						Reacting			Link
SIL	PL	Emergency stop	Position switches				Other	Con-tactor	Mo-tor starter	Other	
			Me-chani-cal	RFID	Mag-netic	Inclu-ing tumber					
3	e	-	-	x	-	x	-	x	-	-	Section 3.3.15 (Page 111)
3	e	x	-	x	-	x	ET 200AL	x	-	-	Section 3.7.14 (Page 167)

Handling application examples

The application examples are easy to handle thanks to a uniform structure. The application is described briefly at the start of each example. This is followed with the design of the safety function using simple overview pictures.

Sensor signals and activation of the actuator technology are indicated by blue lines, while the feedback circuit for monitoring the actuators is represented by a dashed line.

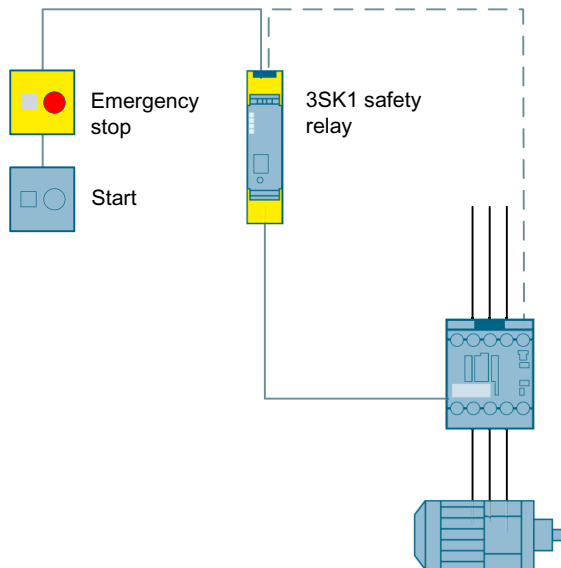
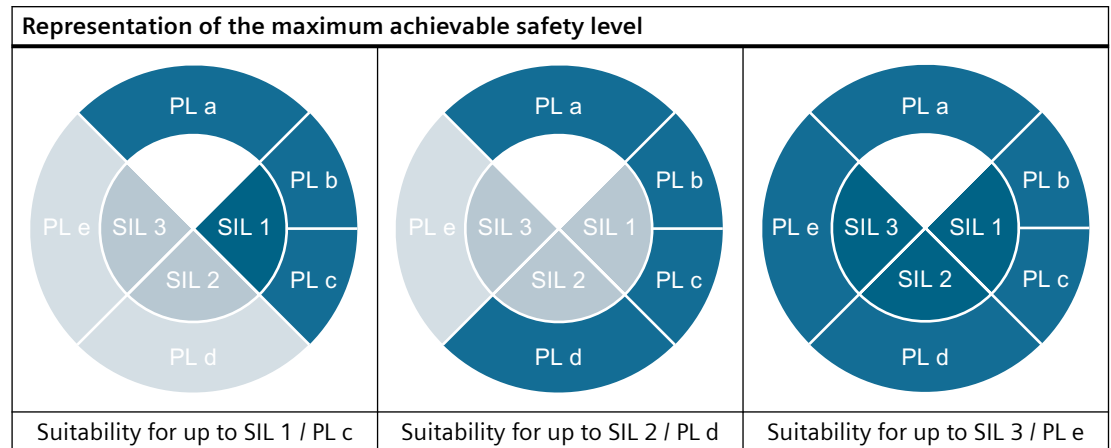

Figure 3-1 Example representation: Structure of a safety function

The precise functional principle is explained, as well as the maximum achievable safety level in SIL per IEC 62061 and PL per ISO 13849-1.



Some application examples contain several safety functions. The representation then describes the achieved safety level of the safety function given in the title. The achieved safety level of the additional safety functions is then explained in the text.

As a rule, the application examples are designed as SIL 1 / PL c and SIL 3 / PL e examples. Of course, an SIL 2 / PL d can also be achieved. As the differences in the physical structure between SIL 3 / PL e and SIL 2 / PL d are minimal or non-existent, this example is generally ignored. The difference between the two classifications can be attributed to a difference in quality of diagnostics. The necessary diagnostic mechanisms are already integrated in signal evaluators (cross circuit diagnoses, discrepancy, etc.). In most cases, this does not result in a different structure and therefore no difference in the number of components used for a SIL 2 / PL d or SIL 3 / PL e example.

Note

The achieved safety level depends on the implementation of the application examples in each case. In particular, the assumptions made with regard to switching frequency or fault exclusions, for example, must be checked or observed.

The safety-related components used are listed for easy replication of the application.

As a rule, the safety application examples represent only one safety function on a machine. Frequently, however, there are a great many safety functions that are combined in one machine. In addition, operational switching of the outputs, motors etc., is also performed on a machine. Start devices and logic operations are also present in the machine for this purpose. These are not given any further consideration in the safety application examples. For this reason, there is generally no need to represent the start device of the machine, but only to represent one reset device (Reset or Start) of the safety function.

The functions have been tested with the indicated hardware components. You can also use other similar products not on this list. In this case, please note that changes in the wiring of the hardware components (e.g. different terminal assignment) may be necessary.

3.1 Introduction

At the end of each example, there is an Internet link under which further information on the respective application example is stored. This encompasses, for example:

- Wiring diagrams
- The project files (when using the modular safety system or the 3SK2 safety relay)
- CAx data of the hardware components used

You can find a detailed safety calculation with all key values in the stored safety evaluation project file. To use the file, you need the TIA Selection Tool with integrated safety evaluation (<http://www.siemens.com/safety-evaluation-tool>).

You can download (<http://www.siemens.com/cax>) all the documentation on the hardware components used with just a few clicks at the CAx download link. This requires a Siemens Service & Support Portal or Siemens Industry Mall account.

The safety relays are parameterized using DIP switches. You can find the relevant setting in the circuit diagrams.

Note

Details of regulations and standards, as well as the specification and design of safety-related parts of controllers, can be found at the end of this manual.

3.2 Stopping in an emergency

3.2.1 Introduction

The emergency stop command device is a component that is widely used to protect people, equipment and the environment against possible hazards, and to initiate stopping in an emergency. This chapter describes applications with safety functions from precisely this application area.

Typical application

The emergency stop command device with its positive opening contact is monitored here using an evaluation unit. If emergency stop is actuated, the evaluation unit switches the downstream actuators off via safe outputs in accordance with Stop Category 0 per EN 60204-1. Before restarting or acknowledging the emergency stop switch-off by means of the Start button, a check is made as to whether the contacts of the emergency stop command device have been closed and the actuators switched off.

Note

- Lay the sensor lines with protection; use only safety sensors with positive-opening contacts as sensors.
 - Equipment, functional aspects and design guidelines for emergency stop are found in EN ISO 13850. Take the standard EN 60204-1 into account as well.
 - "Emergency stop" is not a way of reducing the risk.
 - "Emergency stop" is a "supplementary safety function". (When "emergency stop" is operated, you must switch the motor off).
-

Unintentional actuation

There is frequently a requirement to protect an emergency stop command device against unintentional actuation, and thus to enhance plant availability. The first step is to correctly position the emergency stop command device on the machine. The emergency stop command device must be easily accessible, free from obstruction and its actuation must not present a hazard. There is also the option of using a protective collar to prevent unintentional actuation. Make sure here that unhindered accessibility is ensured.

Note

SIEMENS SIRIUS emergency stop command devices with protective collar correspond to the requirements of EN ISO 13850 "Safety of machinery. Emergency stop. Principles for design" and may be used in safety applications.

Conditions in series connection

Up to PL e (per ISO 13849-1) or SIL 3 (per IEC 62061) emergency-stop command devices may only be connected in series if measures ensure that failure and simultaneous pressing of the emergency-stop command devices is not possible.

If multiple emergency stop command devices are electrically connected in series, each safety-related shutdown via an emergency stop command device is a single supplementary safety function. If identical emergency stop command devices are used, it is sufficient to regard one supplementary safety function as representing all supplementary safety functions.

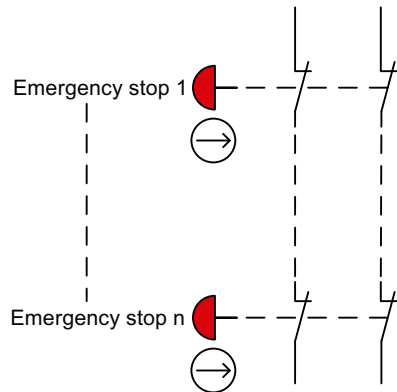

3.2.2 Emergency stop shutdown to SIL 1 or PL c with a 3SK1 safety relay

Application

Single-channel emergency stop shutdown of a motor by a 3SK1 safety relay and a power contactor.

Design

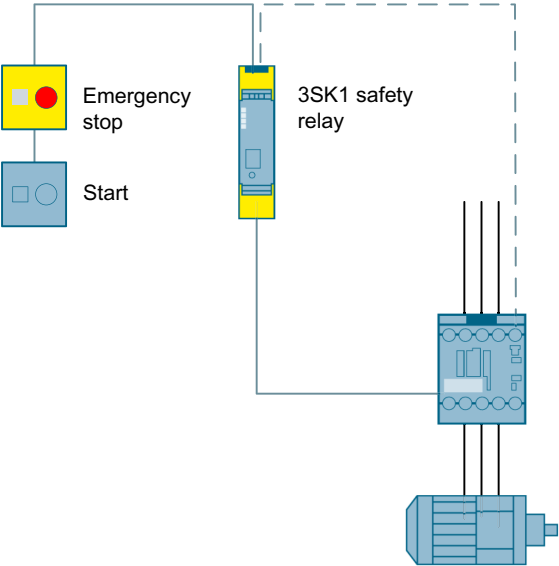
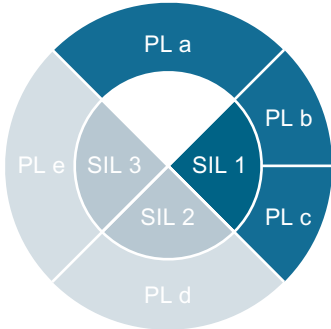

Figure 3-2 Emergency stop shutdown to SIL 1 or PL c with a 3SK1 safety relay

Operating principle

The 3SK1 safety relay monitors the emergency stop command device. When the emergency stop command device is actuated, the safety relay opens the enabling circuits and switches the power contactor off in a safety-related way. If the emergency stop command device is unlatched and the feedback circuit is closed, the Start button can be used to switch on again.



Safety-related components

Emergency stop command device	Safety relay	Contactor
		
3SU1 (http://www.siemens.com/sirius-act)	3SK1 (http://www.siemens.com/safety-relays)	3RT20 (http://www.siemens.com/sirius-control)

See also

Circuit diagram and safety evaluation (<http://support.automation.siemens.com/WW/view/en/73134129>)

3.2.3 Emergency stop shutdown to SIL 1 or PL c with a 3SK2 safety relay

Application

Single-channel emergency stop shutdown of a motor by a 3SK2 safety relay and power contactor.

Design

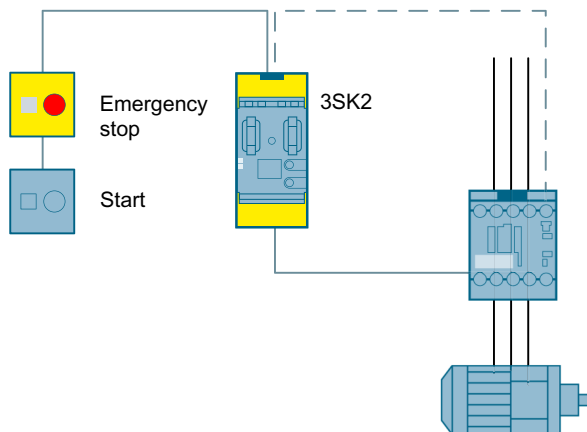
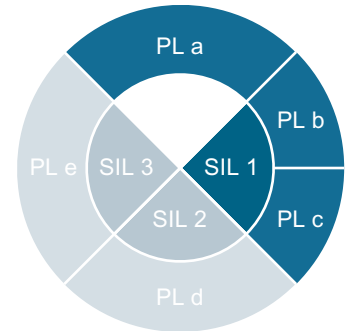



Figure 3-3 Emergency stop shutdown to SIL 1 or PL c with a 3SK2 safety relay

Operating principle

The 3SK2 safety relay monitors the emergency stop command device. When the emergency stop command device is actuated, the safety relay opens the enabling circuits and switches the power contactor off in a safety-related way. If the emergency stop command device is unlatched and the feedback circuit is closed, the Start button can be used to switch on again.

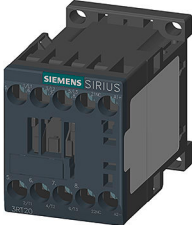

Safety-oriented components

Emergency stop command device	Modular safety system	Contactor
		
3SU1 (http://www.siemens.com/sirius-act)	3SK2 (http://www.siemens.com/safety-relays)	3RT20 (http://www.siemens.com/sirius-control)

See also

Circuit diagram, 3SK2 project and safety evaluation (<http://support.automation.siemens.com/WW/view/en/109485642>)

3.2.4 Emergency stop shutdown up to SIL 1 or PL c with a 3RW55 Failsafe soft starter

Application

To be able to safely shut down a machine even in an emergency, an emergency stop command device is attached and monitored by a 3RW55 Failsafe soft starter. The 3RW55 Failsafe soft starter is used for both functional switching with soft start and soft stop as well as safe shutdown.

Design

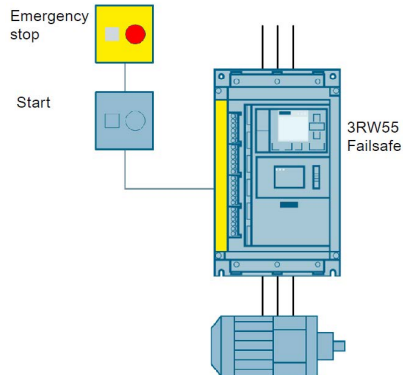

Figure 3-4 Emergency stop shutdown up to SIL 1 or PL c with a 3RW55 Failsafe soft starter

Operating principle

The 3RW55 Failsafe soft starter monitors the emergency stop command device. When the emergency stop command device is actuated, the soft starter safely disconnects the load. If the emergency stop command device is unlocked, a restart can be initiated by means of the toggle switch S2. In order to restart the 3RW55 Failsafe soft starter after an STO shutdown and subsequent release of the emergency stop command device, a positive edge must be present at the start input (default: DI1). In this application, this is done by switching the toggle switch S2 off and on.

The 3RW55 Failsafe soft starters can be used to implement applications with the Safe Torque Off (STO) safety function according to EN 61800-5-2 and stop category 0 according to EN 60204-1.

The 3RW55 Failsafe soft starter is designed in such a way that STO applications up to SIL 1 or PL c can be implemented without the user having to use additional devices in the shutdown path (single-channel shutdown using the 3RW55 Failsafe soft starter).

The switch-off command at the fail-safe input F-DI of the 3RW55 Failsafe can come from a directly connected emergency stop command device or from a safe output of a higher-level safety relay or a higher-level fail-safe control system.

An evaluation of the fail-safe signaling output F-RQ (terminal 41 / 42) is not required for applications up to SIL 1 or PL c. However, it can also be used in these cases, e.g. to signal an error on the 3RW55 Failsafe to the operator via an indicator light.

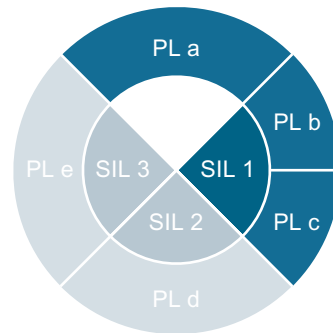

The motor can only be restarted after resetting the F-DI signal and switching the control source from OFF to ON. Possible control sources as well as detailed information on the 3RW55 Failsafe soft starter can be found in the Manual (<https://support.industry.siemens.com/cs/de/en/view/109753752>).



Note

For diagnostics, it is absolutely essential that the 3RW55 Failsafe is always connected directly to the principal voltage. Additional contacts such as a redundant contactor may only be connected in series downstream of the 3RW55 Failsafe.

Safety-oriented components

Emergency stop command device	Failsafe soft starter
	
3SU1 (http://www.siemens.com/sirius-act)	3RW55 (https://new.siemens.com/global/en/products/automation/industrial-controls/sirius/sirius-hybrid/3rw-soft-starter.html)

See also

Circuit diagram and safety evaluation (<https://support.industry.siemens.com/cs/ww/en/view/109780385>)

Detailed FAQ on the topic: 3RW soft starter: Safe shutdown according to IEC 62061 (SIL) or ISO 13849-1 (PL) (<https://support.industry.siemens.com/cs/ww/en/view/67474130>)

3.2.5 Emergency stop shutdown to SIL 2 or PL c with a contactor with F-PLC-IN and 3SK2 safety relay

Application

Single-channel emergency stop shutdown of a motor by a 3SK2 safety relay and 3RT1 power contactor with fail-safe control.

Design

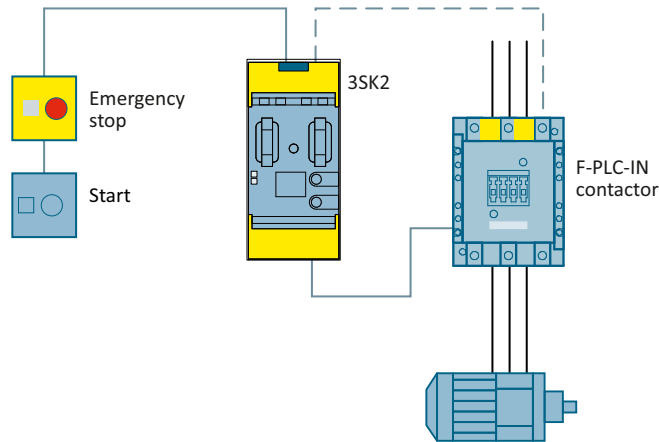
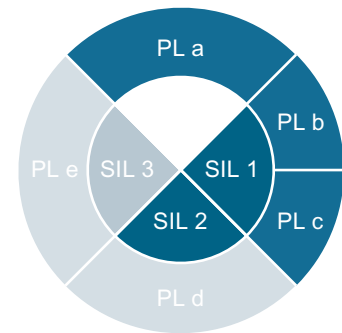

Figure 3-5 Emergency stop shutdown to SIL 2 or PL c with a contactor with F-PLC-IN and 3SK2 safety relay

Operating principle

The 3SK2 safety relay monitors the emergency stop command device. When the emergency stop device is actuated, the safety relay opens the enabling circuits and switches the power contactor off by means of its fail-safe input (F-PLC-IN) in a safety-related way. If the emergency stop command device is unlatched and the feedback circuit is closed, the Start button can be used to switch on again.



In the example shown here, a contactor with fail-safe control input in size S6 is used.

Contactors with a fail-safe control input are available in sizes S2 to S12 up to 250 kW:

- 3RT20...S contactors in sizes S2 and S3
- 3RT10...S contactors in sizes S6 to S12

Note

To achieve PL c, a single-channel design of the emergency stop device is sufficient. For consistency of representation, a two-channel design has been selected here. This is necessary for an SIL 2 application.

Note

Please note that the hardware fault tolerance (HFT) must also be observed in addition to the PFHd values for the SIL when using the contactor with an F-PLC-IN acc. to IEC 62061. In this example, SIL 2 is achieved, but due to the HFT of 0, welding of the contactor contacts can lead to a loss of the safety function.



The mirror contact of the contactor is used for fault diagnostics and must be monitored in the higher-level application (evaluation unit) in order to be able to initiate appropriate response in the event of a fault.

For example, a circuit-breaker can be used here as the second shutdown path. More information is available in the following FAQ:

Which Safety Integrity Level can be achieved using a contactor and a circuit breaker? (<http://support.automation.siemens.com/WW/view/en/40349715>)

When transferring this example as a subsystem to a complete application acc. to ISO 13849, the architecture of the subsystem and common cause failures (CCF) must also be taken into account in order to obtain the corresponding PL. This means that it is not possible to directly transfer a SIL to a PL.

Safety-oriented components

Emergency stop command device	Modular safety system	Contactor
		
3SU1 (http://www.siemens.com/sirius-act)	3SK2 (http://www.siemens.com/safety-relays)	3RT1 (http://www.siemens.com/sirius-control)

See also

Circuit diagram, 3SK2 project and safety evaluation (<http://support.automation.siemens.com/WW/view/en/109747648>)

3.2.6 Emergency stop shutdown to SIL 2 or PL c with a contactor with F-PLC-IN and fail-safe controller**Application**

Single-channel emergency stop shutdown of a motor by a fail-safe controller and 3RT1 power contactor with fail-safe control.

Design

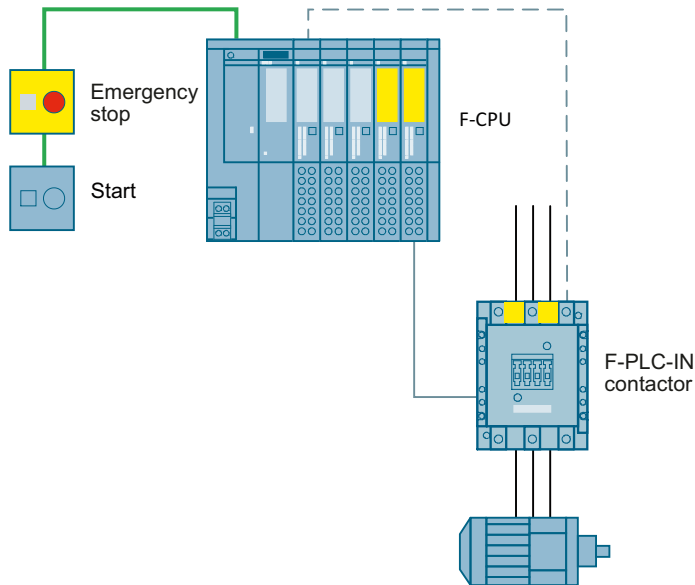
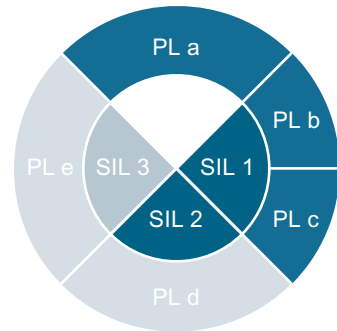

Figure 3-6 Emergency stop shutdown to SIL 2 or PL c with a contactor with F-PLC-IN and fail-safe controller

Operating principle

The fail-safe controller monitors the emergency stop device. When the emergency stop device is actuated, the fail-safe controller switches the power contactor off by means of its fail-safe input (F-PLC-IN) in a safety-related way. If the emergency stop command device is unlatched and the feedback circuit is closed, the Start button can be used to switch on again.



In the example shown here, a contactor with a fail-safe control input in size S6 is used.

Contactors with a fail-safe control input are available in sizes S2 to S12 up to 250 kW:

- 3RT20...S contactors in sizes S2 and S3
- 3RT10...S contactors in sizes S6 to S12

Note

Please note that the hardware fault tolerance (HFT) must also be observed in addition to the PFHd values for the SIL when using the contactor with an F-PLC-IN acc. to IEC 62061. In this example, SIL 2 is achieved, but due to the HFT of 0, welding of the contactor contacts can lead to a loss of the safety function.

The mirror contact of the contactor is used for fault diagnostics and must be monitored in the higher-level application (evaluation unit) in order to be able to initiate appropriate response in the event of a fault.

For example, a circuit-breaker can be used here as the second shutdown path. More information is available in the following FAQ:

Which Safety Integrity Level can be achieved using a contactor and a circuit breaker? (<http://support.automation.siemens.com/WW/view/en/40349715>)

When transferring this example as a subsystem to a complete application acc. to ISO 13849, the architecture of the subsystem and common cause failures (CCF) must also be taken into account in order to obtain the corresponding PL. This means that it is not possible to directly transfer a SIL to a PL.

Safety-oriented components

SIRIUS ACT PROFINET interface module	Fail-safe controller	Contactor
		
3SU1 (http://www.siemens.com/sirius-act)	S7 F-PLC (http://www.siemens.com/simatic-safety)	3RT1 (http://www.siemens.com/sirius-control)

See also

Circuit diagram, TIA Portal project and safety evaluation (<http://support.automation.siemens.com/WW/view/en/109747647>)

3.2.7 Emergency stop shutdown to SIL 3 or PL e with a 3SK1 safety relay**Application**

Two-channel emergency stop shutdown of a motor by a 3SK1 safety relay and power contactors.

Design

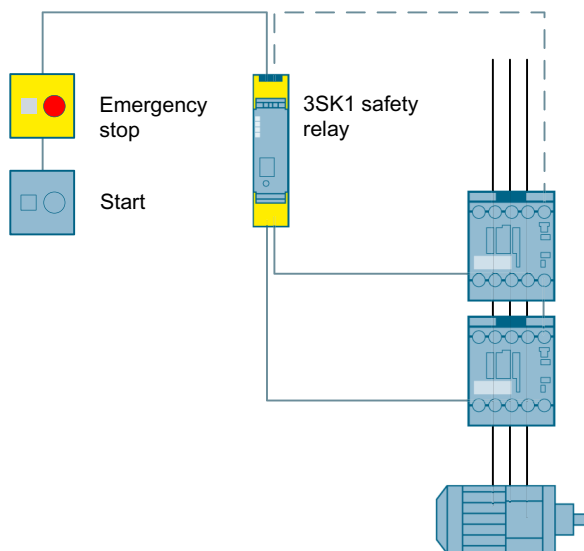
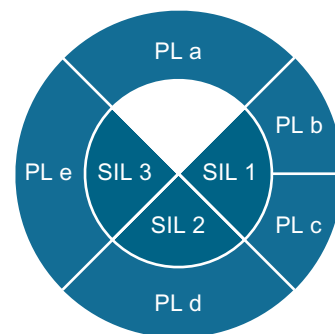

Figure 3-7 Emergency stop shutdown to SIL 3 or PL e with a 3SK1 safety relay

Operating principle

The safety relay monitors the emergency stop command device on two channels. When the emergency stop command device is actuated, the safety relay opens the enabling circuits and switches the power contactors off in a safety-related way. If the emergency stop command device is unlatched and the feedback circuit is closed, the Start button can be used to switch on again.



Safety-oriented components

Emergency stop command device	Safety relay	Contactors
		
3SU1 (http://www.siemens.com/sirius-act)	3SK1 (http://www.siemens.com/safety-relays)	2x 3RT20 (http://www.siemens.com/sirius-control)

See also:

Circuit diagram and safety evaluation (<http://support.automation.siemens.com/WW/view/en/73136378>)

Application with cable-operated switch instead of emergency stop (<https://support.industry.siemens.com/cs/document/109738710/using-a-sirius-3se7-cableoperated-switch-with-a-safety-relay?dti=0&lc=en-WW>)

3.2.8 Emergency stop shutdown to SIL 3 or PL e with a 3SK2 safety relay

Application

Two-channel emergency stop shutdown of a motor by a 3SK2 safety relay and power contactors.

Design

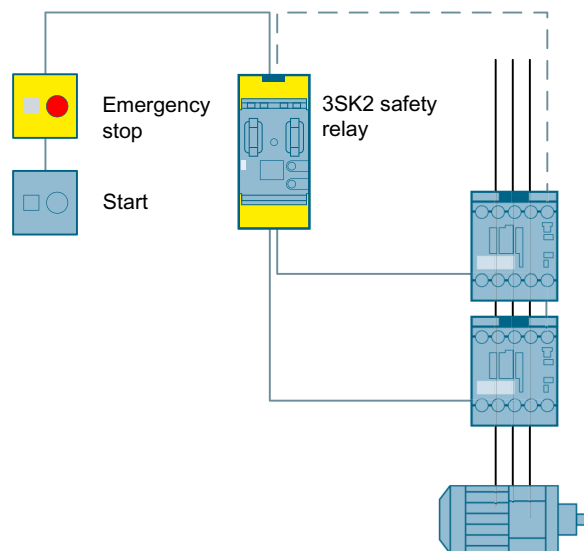
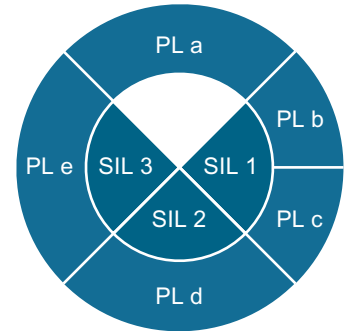

Figure 3-8 Emergency stop shutdown to SIL 3 or PL e with a 3SK2 safety relay

Operating principle

The safety relay monitors the emergency stop command device on two channels. When the emergency stop command device is actuated, the safety relay opens the enabling circuits and switches the power contactors off in a safety-related way. If the emergency stop command device is unlatched and the feedback circuit is closed, the Start button can be used to switch on again.



Safety-oriented components

Emergency stop command device	Safety relay	Contactors
		
3SU1 (http://www.siemens.com/sirius-act)	3SK2 (http://www.siemens.com/safety-relays)	2x 3RT20 (http://www.siemens.com/sirius-control)

See also:

Circuit diagram, 3SK2 project and safety evaluation (<http://support.automation.siemens.com/WW/view/en/109479271>)

Application with cable-operated switch instead of emergency stop (<https://support.industry.siemens.com/cs/document/109738710/using-a-sirius-3se7-cableoperated-switch-with-a-safety-relay?dti=0&lc=en-WW>)

3.2.9 Emergency stop shutdown to SIL 3 or PL e with fail-safe motor starters and a 3SK1 safety relay

Application

To be able to safely shut down a machine in an emergency, an emergency stop command device is attached and monitored by a 3SK1 safety relay. Safe shutdown takes place via fail-safe motor starters.

Design

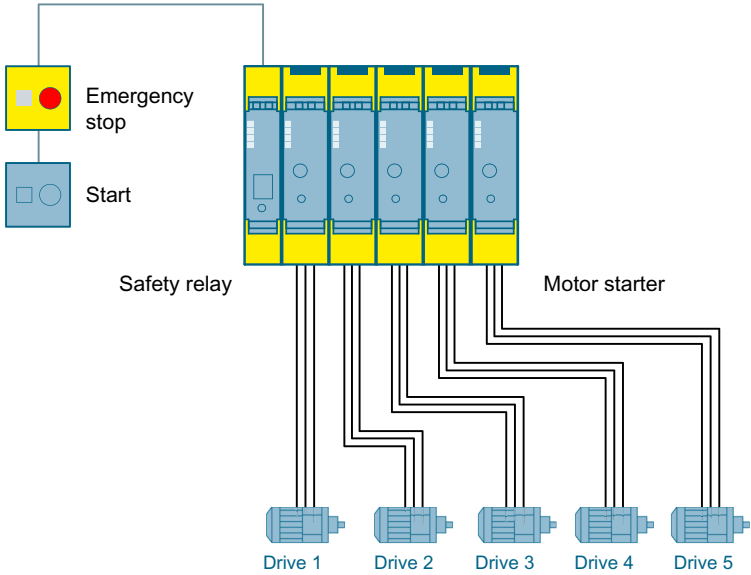
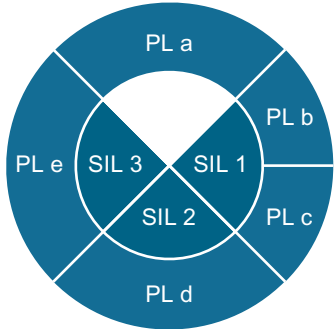

Figure 3-9 Emergency stop shutdown to SIL 3 or PL e with fail-safe motor starters and a 3SK1 safety relay

Operating principle

The safety relay monitors the emergency stop command device. When the emergency stop command device is actuated, the safety relay switches the fail-safe motor starters off via the device connectors. The motor starters then safely shut down the load. If the emergency stop command device is unlocked, the Start button can be used to switch on again.



Note

In this example, it is assumed that the hazard emanates from only one of the drives in each case, but that an emergency stop switches off a group of drives. For this reason, only a single motor starter is considered in the safety evaluation, and this is used as an example.

If the hazard emanates from the movement of several drives, all motor starters involved with this hazard must be taken into account in the safety evaluation.

Safety-related components

Emergency stop command device	Safety relay	Fail-safe motor starters
		
3SU1 (http://www.siemens.com/sirius-act)	3SK1 (http://www.siemens.com/safety-relays)	3RM1 (http://www.siemens.com/motorstarter/3rm1)

See also

Circuit diagram and safety evaluation (<http://support.automation.siemens.com/WW/view/en/88411471>)

More detailed FAQs on: Safe shutdown with the 3RM1 motor starters (<http://support.automation.siemens.com/WW/view/en/67478946>)

3.2.10 Emergency stop shutdown to SIL 3 or PL e with fail-safe motor starters and a 3SK2 safety relay

Application

To be able to safely shut down a machine in an emergency, an emergency stop command device is attached and monitored by a safety relay. Safe shutdown takes place via fail-safe motor starters.

Design

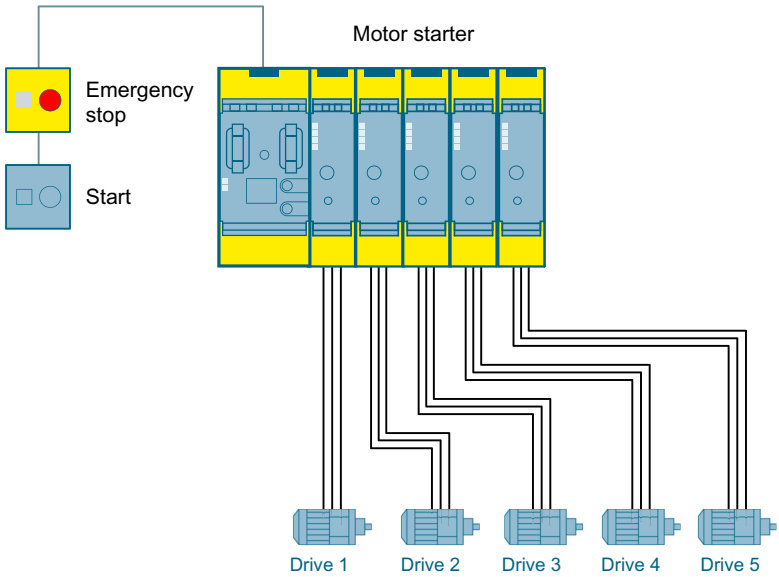
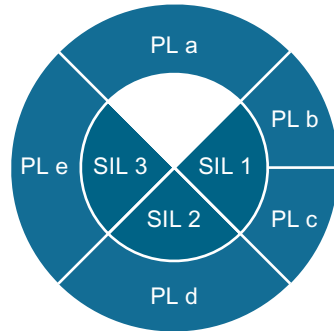

Figure 3-10 Emergency stop shutdown to SIL 3 or PL e with fail-safe motor starters and a 3SK2 safety relay

Operating principle

The safety relay monitors the emergency stop command device. When the emergency stop command device is actuated, the safety relay switches the fail-safe motor starters off via the device connectors. The motor starters then safely shut down the load. If the emergency stop command device is unlocked, the Start button can be used to switch on again.



Note

In this example, it is assumed that the hazard emanates from only one of the drives in each case, but that an emergency stop switches off a group of drives. For this reason, only a single motor starter is considered in the safety evaluation, and this is used as an example. If the hazard emanates from the movement of several drives, all motor starters involved with this hazard must be taken into account in the safety evaluation.

Safety-related components

Emergency stop command device	Safety relay	Fail-safe motor starters
		
<p>3SU1 (2-channel) (http://www.siemens.com/sirius-act)</p>	<p>3SK2 (http://www.siemens.com/safety-relays)</p>	<p>3RM1 (http://www.siemens.com/motorstarter/3rm1)</p>

See also

Circuit diagram, 3SK2 project and safety evaluation (<http://support.automation.siemens.com/WW/view/en/109485643>)

More detailed FAQs on: Safe shutdown with 3RM1 motor starters (<http://support.automation.siemens.com/WW/view/en/67478946>)

3.2.11 Emergency stop shutdown via AS-i to SIL 3 or PL e with a Modular Safety System

Application

Monitoring of multiple emergency stop command devices via AS-i with a 3RK3 Modular Safety System.

Design

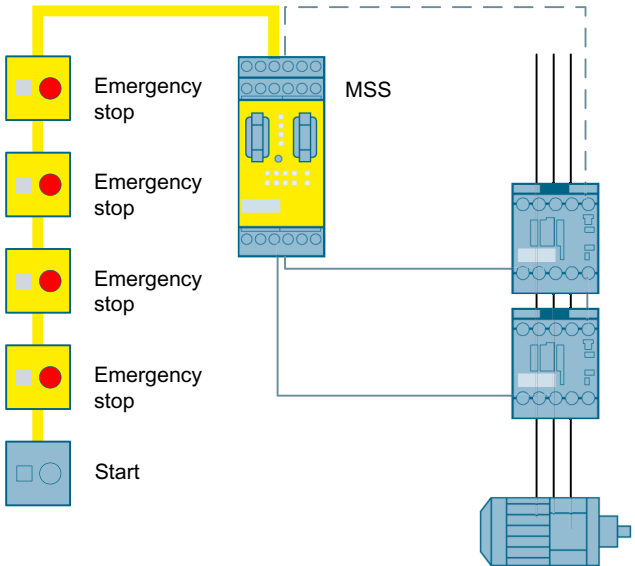
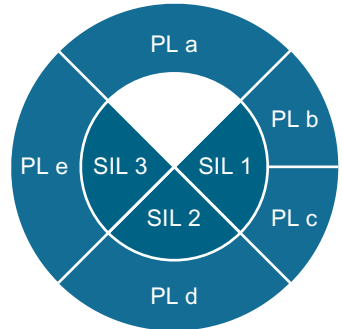





Figure 3-11 Emergency stop shutdown via AS-i to SIL 3 or PL e with a Modular Safety System

Operating principle

The Modular Safety System monitors each of the two-channel emergency stop command devices connected to AS-i. When one of the emergency stop command devices is actuated, the Modular Safety System opens the enabling circuits and switches the power contactors off in a safety-related way. If the emergency stop command device is unlatched and the feedback circuit is closed, the Start button can be used to switch on again.



Safety-related components

Emergency stop command device	Modular Safety System	Contactor
		
<p>3SU1 (http://www.siemens.com/sirius-act)</p>	<p>3RK3 (http://www.siemens.com/sirius-monitor)</p>	<p>2x 3RT20 (http://www.siemens.com/sirius-control)</p>

Note

In addition to the safety-related components, operation of an AS-i network requires an AS-i master and an AS-i power supply.

See also

MSS project and safety evaluation (<http://support.automation.siemens.com/WW/view/en/73133559>)

3.2.12 Emergency stop shutdown to SIL 3 or PL e with contactors with F-PLC-IN and 3SK2 safety relay

Application

Two-channel emergency stop shutdown of a motor by a 3SK2 safety relay and 3RT1 power contactors with fail-safe control.

Design

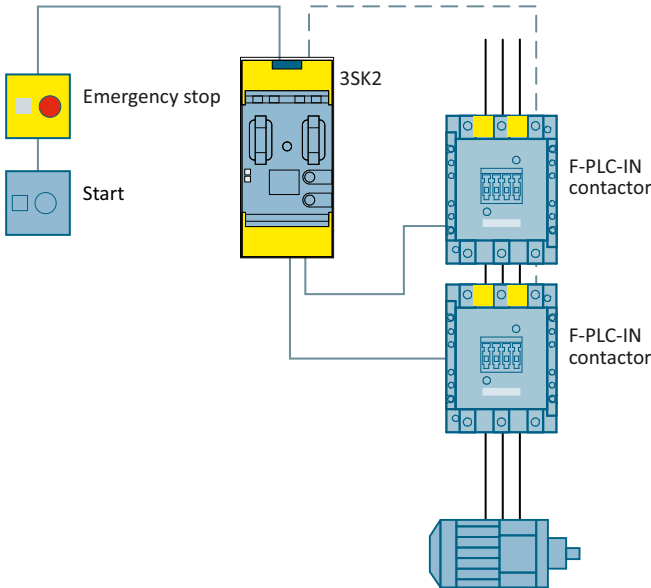
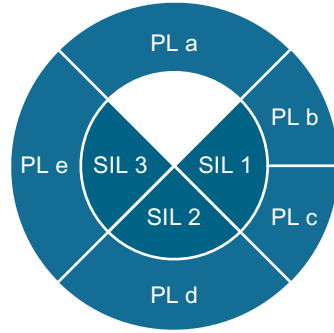

Figure 3-12 Emergency stop shutdown to SIL 3 or PL e with contactors with F-PLC-IN and 3SK2 safety relay

Operating principle

The 3SK2 safety relay monitors the emergency stop device. When the EMERGENCY STOP device is actuated, the safety relay opens the enabling circuits and switches the power contactors off in a safety-related way by means of their fail-safe inputs (F-PLC-IN). If the emergency stop command device is unlatched and the feedback circuit is closed, the Start button can be used to switch on again.



In the example shown here, contactors with a fail-safe control input in size S6 are used. Contactors with a fail-safe control input are available in sizes S2 to S12 up to 250 kW:

- 3RT20...S contactors in sizes S2 and S3
- 3RT10...S contactors in sizes S6 to S12

Safety-related components

Emergency stop device	Safety relay	Contactor
		
3SU1 (http://www.siemens.com/sirius-act)	3SK2 (http://www.siemens.com/safety-relays)	2 x 3RT1 (http://www.siemens.com/sirius-control)

See also

Circuit diagram, 3SK2 project and safety evaluation (<http://support.automation.siemens.com/WW/view/en/109747650>)

3.2.13 Emergency stop shutdown to SIL 3 or PL e with contactors with F-PLC-IN and fail-safe controller

Application

Two-channel emergency stop shutdown of a motor by a fail-safe controller and 3RT1 power contactors with fail-safe controller.

Design

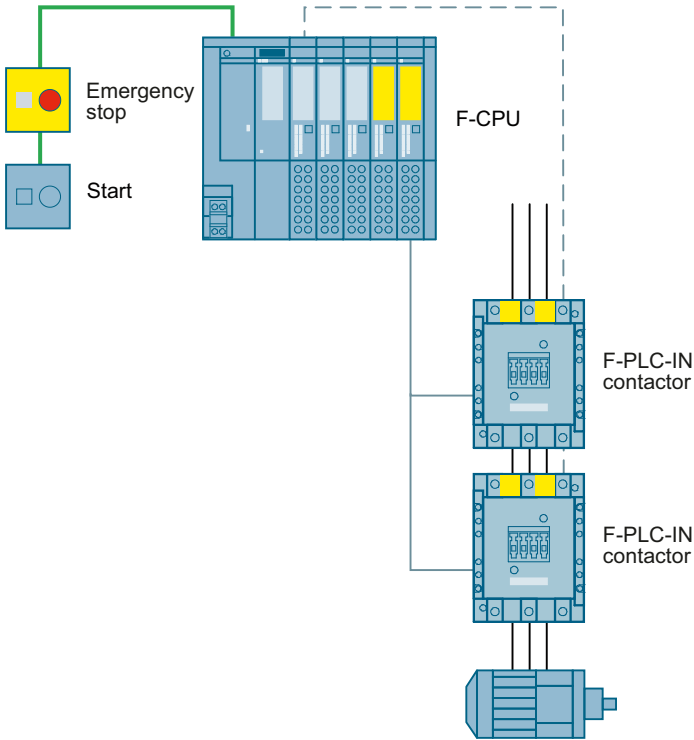
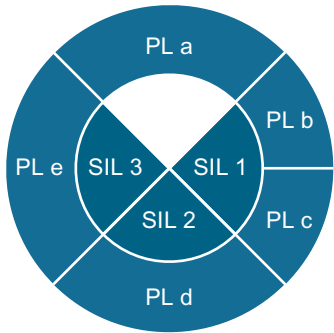

Figure 3-13 Emergency stop shutdown to SIL 3 or PL e with contactors with F-PLC-IN and fail-safe controller

Operating principle

The fail-safe controller monitors the emergency stop device. When the emergency stop device is actuated, the fail-safe controller switches the power contactors off by means of its fail-safe inputs (F-PLC-IN) in a safety-related way. If the emergency stop command device is unlatched and the feedback circuit is closed, the Start button can be used to switch on again.



In the example shown here, contactors with a fail-safe control input in size S6 are used. Contactors with a fail-safe control input are available in sizes S2 to S12 up to 250 kW:

- 3RT20...-S contactors in sizes S2 and S3
- 3RT10...-S contactors in sizes S6 to S12

Safety-oriented components

SIRIUS ACT PROFINET interface module	Fail-safe controller	Contactors
		
3SU1 (http://www.siemens.com/sirius-act)	S7 F-PLC (http://www.siemens.com/simatic-safety)	2 x 3RT1 (http://www.siemens.com/sirius-control)

See also

Circuit diagram, TIA Portal project and safety evaluation (<http://support.automation.siemens.com/WW/view/en/109747649>)

3.2.14 Emergency stop shutdown to SIL 3 or PL e with a fail-safe motor starter in the ET 200SP system and a 3SK1 safety relay

Application

To be able to safely shut down a machine in an emergency, an emergency stop device is attached and monitored by a 3SK1 safety relay. Safe shutdown takes place via a 3RK1 fail-safe motor starter.

Design

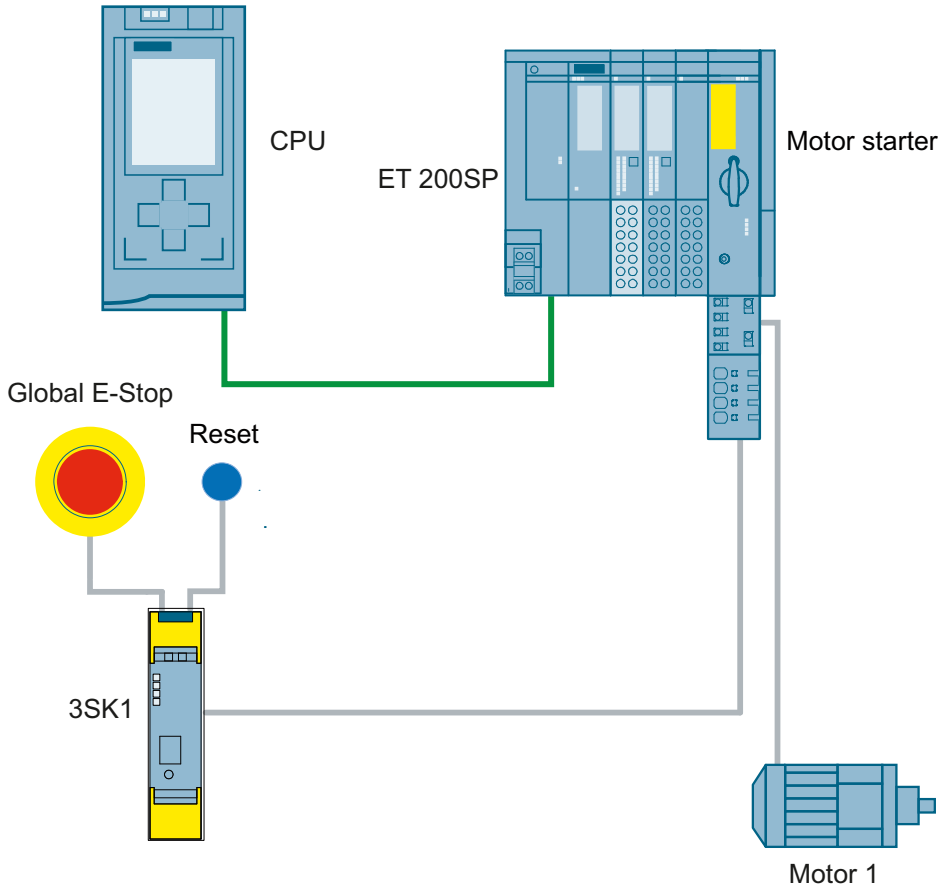
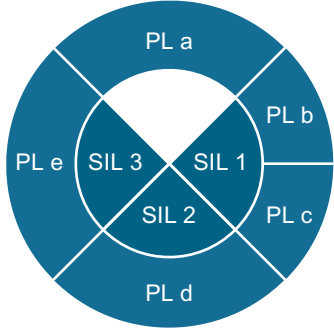

Figure 3-14 Emergency stop shutdown to SIL 3 or PL e with a fail-safe motor starter in the ET 200SP system and a 3SK1 safety relay

Operating principle

The 3SK1 safety relay monitors the emergency stop device. When the emergency stop device is actuated, the safety relay switches the fail-safe motor starter off by means of its fail-safe input (F-DI). The motor starter then safely shuts down the load. If the emergency stop device is unlocked, the Start button can be used to switch on again.



Safety-related components

Emergency stop device	Safety relay	Fail-safe motor starters
		
3SU1 (http://www.siemens.com/sirius-act)	3SK1 (http://www.siemens.de/safety-relays)	3RK1 (http://www.siemens.com/et200sp-motorstarter)

See also

Circuit diagram, TIA Portal project and safety evaluation (<http://support.automation.siemens.com/WW/view/en/109748128>)

3.2.15 Emergency stop shutdown to SIL 3 or PL e with a fail-safe motor starter in the ET 200SP system and a 3SK2 safety relay

Application

To be able to safely shut down a machine in an emergency, an emergency stop command device is attached and monitored by a 3SK2 safety relay. Safe shutdown takes place via a 3RK1 fail-safe motor starter.

Design

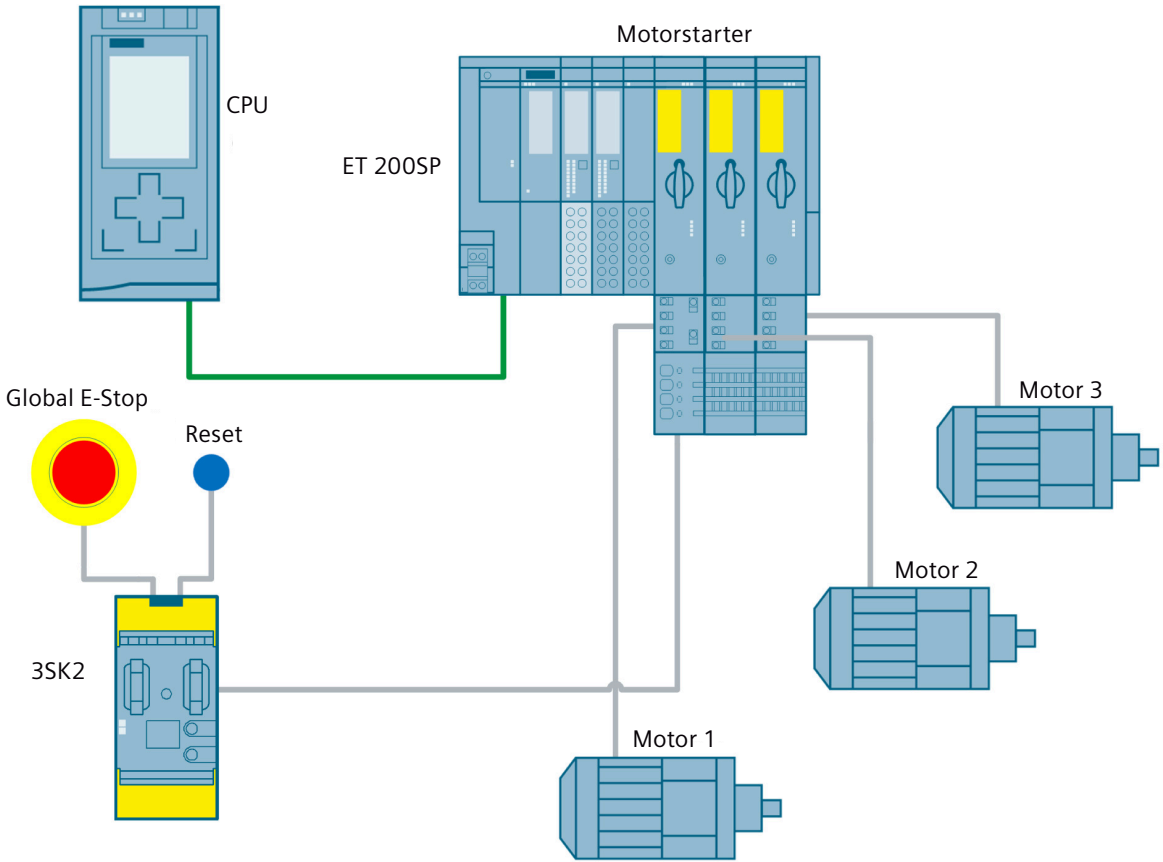
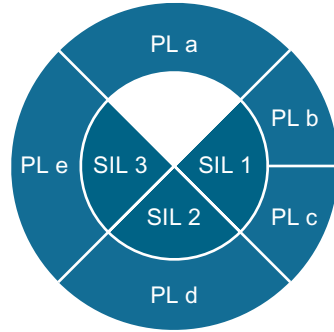





Figure 3-15 Emergency stop shutdown to SIL 3 or PL e with fail-safe motor starters in the ET 200SP system and a 3SK2 safety relay

Operating principle

The 3SK2 safety relay monitors the emergency stop command device. When the emergency stop command device is actuated, the safety relay switches the first motor starter off by means of its fail-safe input (F-DI). The second motor starter, or all other motor starters, are connected to this F-DI via their bridged BaseUnit and are also switched off by this. The motor starters then safely shut down the load. If the emergency stop command device is unlocked, the Start button can be used to switch on again.



Safety-related components

Emergency stop control device	Safety relay	Fail-safe motor starters
		
3SU1 (http://www.siemens.com/sirius-act)	3SK2 (http://www.siemens.de/safety-relays)	3RK1 (http://www.siemens.com/et200sp-motorstarter)

See also

Circuit diagram, safety evaluation, TIA Portal and 3SK2 project (<http://support.automation.siemens.com/WW/view/en/109748128>)

3.2.16 Emergency stop shutdown to SIL 3 or PL e with fail-safe digital output module and fail-safe motor starters in the ET 200SP system

Application

To be able to safely shut down a machine in an emergency, an emergency stop command device is attached and monitored by a fail-safe controller. Safe shutdown takes place via a fail-safe digital output module F-DQ and a 3RK1 fail-safe motor starter.

Design

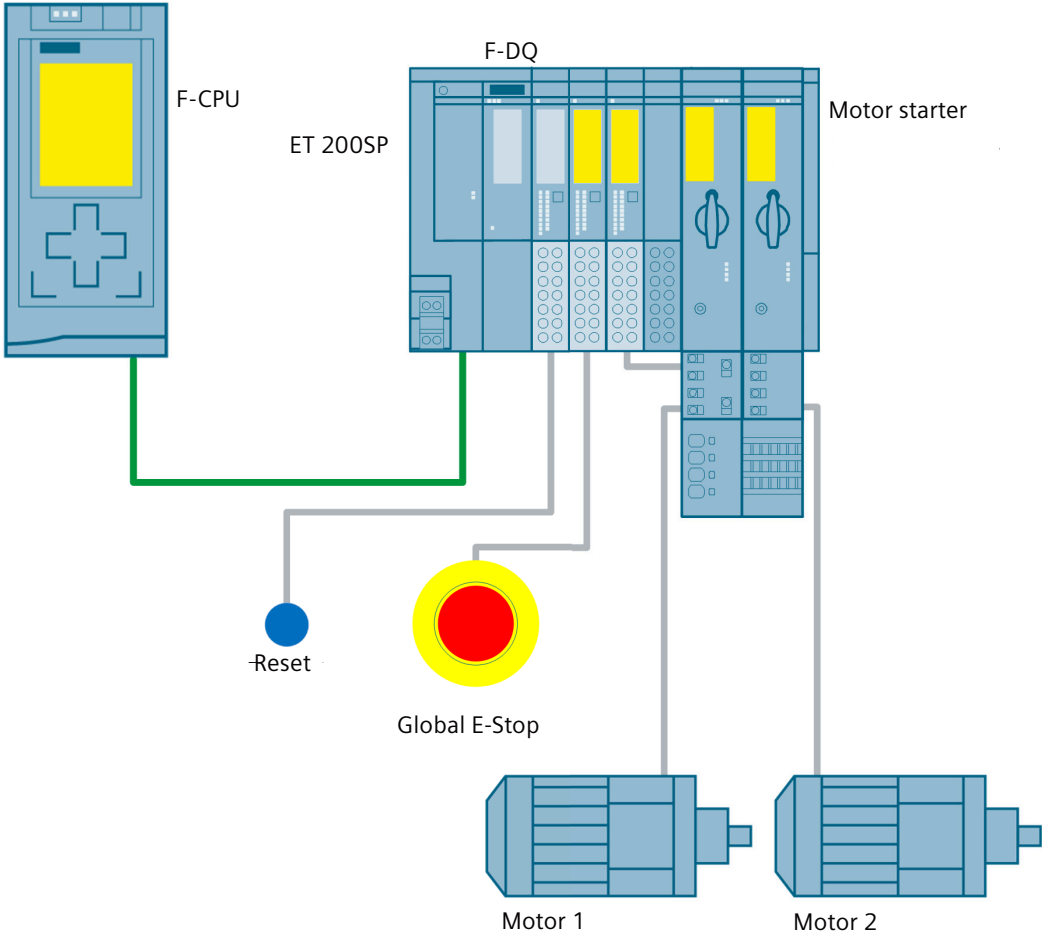
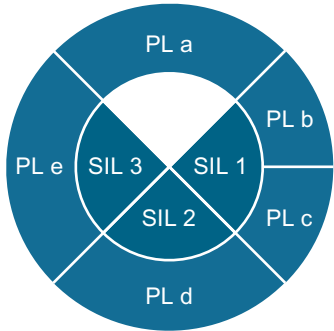





Figure 3-16 Emergency stop shutdown to SIL 3 or PL e with fail-safe digital output module and fail-safe motor starters in the ET 200SP system

Operating principle

The fail-safe controller monitors the emergency stop command device. When the emergency stop command device is actuated, the fail-safe controller (via the F-DQ module) switches the first motor starter off by means of its fail-safe input (F-DI). The second motor starter, or all other motor starters, are connected to this F-DI via their bridged Base-Unit and are also switched off by this. The motor starters then safely shut down the load. If the emergency stop command device is unlocked, the Start button can be used to switch on again.



Safety-related components

Emergency stop control device	Fail-safe controller	Fail-safe motor starters
		
3SU1 (http://www.siemens.com/sirius-act)	S7-1500 (http://www.siemens.com/simatic-safety)	3RK1 (http://www.siemens.com/et200sp-motorstarter)

See also

Circuit diagram, TIA Portal project, and safety evaluation (<http://support.automation.siemens.com/WW/view/en/109748128>)

3.2.17 Emergency stop shutdown to SIL 3 or PL e with fail-safe power module and fail-safe motor starters in the ET 200SP system

Application

To be able to safely shut down a machine in an emergency, an emergency stop device is attached and monitored by a fail-safe controller. Safe shutdown takes place via an F-PM-E fail-safe power module and a 3RK1 fail-safe motor starter.

Design

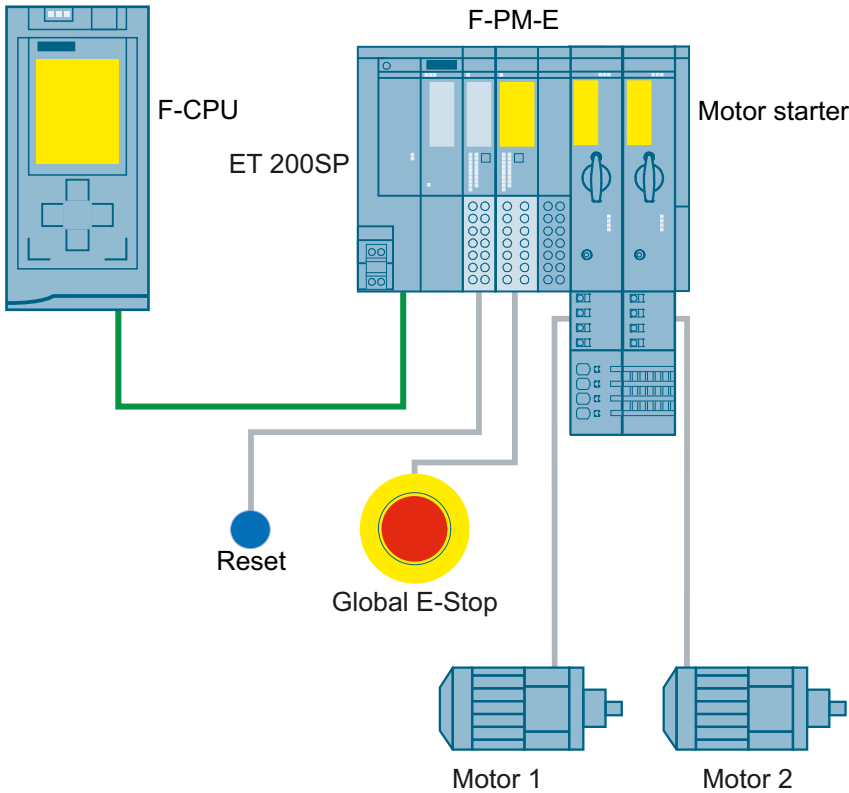
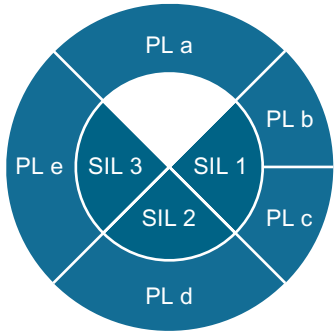

Figure 3-17 Emergency stop shutdown to SIL 3 or PL e with fail-safe power module and fail-safe motor starters in the ET 200SP system

Operating principle

The fail-safe controller monitors the emergency stop device. When the emergency stop device is actuated, the fail-safe controller switches off the F-PM-E fail-safe power module and thus also the fail-safe motor starter. The motor starter then safely shuts down the load. If the emergency stop device is unlocked, the Start button can be used to switch on again.



Safety-related components

Emergency stop device	Fail-safe controller	Fail-safe motor starters
		
<p>3SU1 (http://www.siemens.com/sirius-act)</p>	<p>S7-1500 (http://www.siemens.com/simatic-safety)</p>	<p>3RK1 (http://www.siemens.com/et200sp-motorstarter)</p>

See also

Circuit diagram, TIA Portal project and safety evaluation (<http://support.automation.siemens.com/WW/view/en/109748128>)

3.2.18 Emergency stop shutdown up to SIL 3 or PL e via 3SK2 safety relay with PROFINET connection and fail-safe motor starters

Application

To be able to safely shut down a machine in an emergency, an emergency stop command device is attached and monitored by a 3SK2 safety relay. The safe individual shutdown and the functional switching of the 3RM1 Failsafe motor starters are performed locally via individual wiring between the 3RM1 motor starter and 3SK2 safety relay. The signal for operational switching is transferred by the higher-level controller to the safety relay via PROFINET.

Design

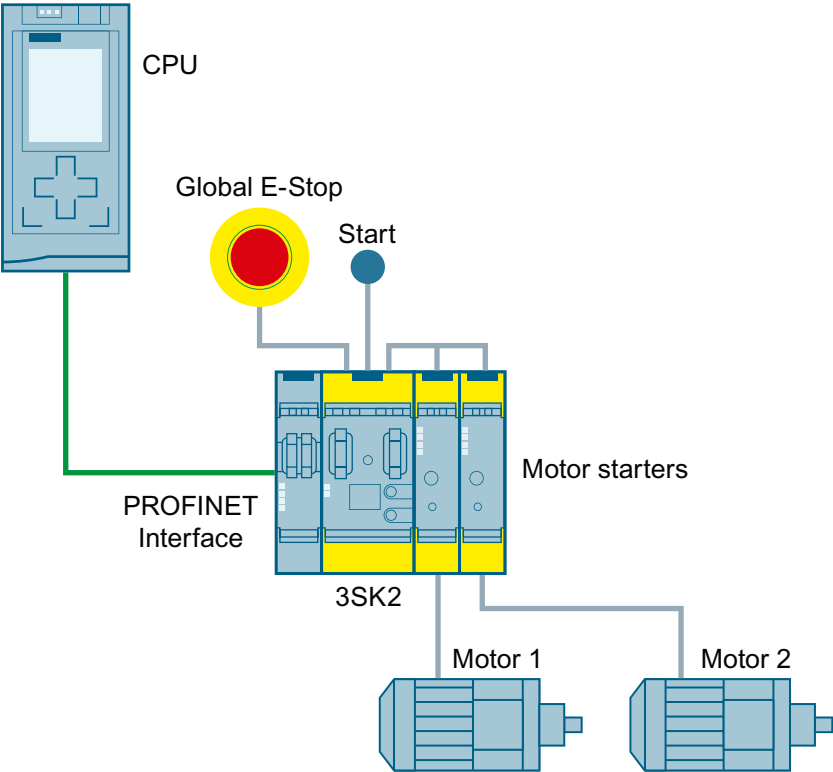

Figure 3-18 Emergency stop shutdown up to SIL 3 or PL e via 3SK2 safety relay with PROFINET connection and fail-safe motor starters

Operating principle

The 3SK2 safety relay monitors the emergency stop command device. If the emergency stop command device is actuated, the safety relay switches the fail-safe motor starters off. The motor starters then safely shut down the load. If the emergency stop command device is unlocked, the Start button can be used to switch on again.

The controller is connected with the safety relay via the PROFINET interface module. The functional switching of the motor starters is implemented in the user program of the control system and transferred to the 3SK2 via PROFINET. The 3SK2 forwards these control signals – linked to the emergency stop signal – via its fail-safe outputs to the control inputs of the motor starters (IN1 for direct on-line starters or IN1 and IN2 for reversing starters). Thus, the operational switching and the safe shutdown are achieved via the same signal when the safety function is activated.

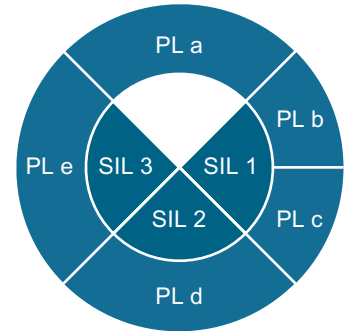

The feedback message of the 3SK2 regarding the current status of the safety function is sent to the controller via PROFINET. It is also possible to read in the start button for re-activation via input modules of the controller instead of directly on the 3SK2 and to also transfer the signal to the safety relay via PROFINET.



Note

In this example, it is assumed that the hazard is caused by only one of the drives at a time, but that a group of drives is shut down in the event of an emergency stop. For this reason, only a single motor starter is considered in the safety evaluation, and this is used as an example. If the hazard emanates from the movement of several drives, all motor starters involved with this hazard must be taken into account in the safety evaluation.

Safety-oriented components

Emergency stop command device	Safety relay with PROFINET interface module	Fail-safe motor starters
		
3SU1 (http://www.siemens.com/sirius-act)	3SK2 (http://www.siemens.com/safety-relays)	3RM1 (https://w3.siemens.com/mcms/industrial-controls/en/motor-starter-soft/control-cabinet/3rm1/Pages/default.aspx)

See also

Circuit diagram, safety evaluation, TIA Portal and 3SK2 project (<http://support.automation.siemens.com/WW/view/en/109769504>)

3.2.19 Emergency stop group shutdown up to SIL 3 or PL e via 3SK2 safety relay with PROFINET connection and fail-safe motor starters

Application

To be able to safely shut down a machine in an emergency, an emergency stop command device is attached and monitored by a 3SK2 safety relay. The safe

group shutdown of the 3RM1 fail-safe motor starter is performed locally via device connectors via the safety relay. The higher-level controller functionally switches the motor starters via PROFINET.

Design

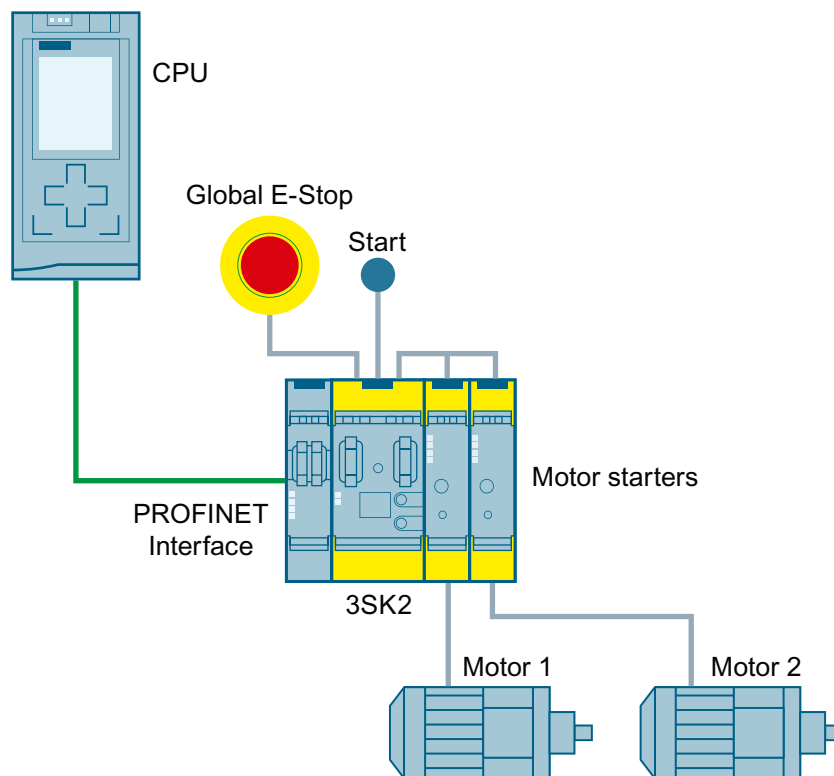

Figure 3-19 Emergency stop group shutdown up to SIL 3 or PL e via 3SK2 safety relay with PROFINET connection and fail-safe motor starters

Operating principle

The 3SK2 safety relay monitors the emergency stop command device. When the emergency stop command device is actuated, the safety relay switches the fail-safe motor starters off via the device connectors. The motor starters then safely shut down the load. If the emergency stop command device is unlocked, the Start button can be used to switch on again.

The controller is connected with the safety relay via the PROFINET interface module. The operational switching of the motor starter is implemented in the user program of the controller and transferred to the 3SK2 via PROFINET. The 3SK2 forwards these control signals via its outputs (F-DQ or QM) to the control inputs of the motor starters (IN1 for direct on-line starters or IN1 and IN2 for reversing starters).

The feedback message regarding the current status of the safety function is sent from 3SK2 to the controller via PROFINET. It is also possible to read in the start button for re-activation via input modules of the controller instead of directly on the 3SK2 and to also transfer the signal to the safety relay via PROFINET.

In addition, a remote reset of the motor starters can be initiated by the controller via the PROFINET interface module in order to clear an error from one or more motor starters. The motor starters are shut down via the device connectors and then switched on again. In this way, group errors of the 3RM1 can be easily acknowledged without having to push the reset button on the device. The shutdown signal must be active for longer than 1 second. Please note that only group errors can be acknowledged. Device faults or a tripping of the motor or relay require acknowledgement via the reset button on the device. For more information, refer to the 3RM1 Equipment Manual (<https://support.industry.siemens.com/cs/document/66295730/manual-sirius-3rm1-motor-starter?dti=0&lc=en-WW>).

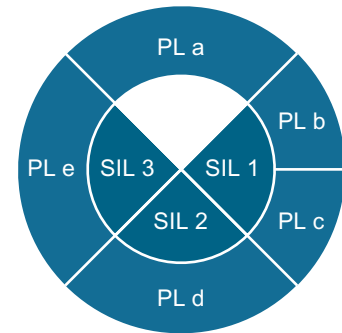



Note

In this example, it is assumed that the hazard emanates from only one of the drives in each case, but that an emergency stop switches off a group of drives.

For this reason, only a single motor starter is considered in the safety evaluation, and this is used as an example. If the hazard emanates from the movement of multiple drives,

all motor starters involved with this hazard must be taken into account in the safety evaluation.

Safety-oriented components

Emergency stop command device	Safety relay with PROFINET interface module	Fail-safe motor starters
		
<p>3SU1 (http://www.siemens.com/sirius-act)</p>	<p>3SK2 (http://www.siemens.com/safety-relays)</p>	<p>3RM1 (https://w3.siemens.com/mcms/industrial-controls/en/motor-starter-soft/control-cabinet/3rm1/Pages/default.aspx)</p>

See also

Circuit diagram, safety evaluation, TIA Portal and 3SK2 project (<http://support.automation.siemens.com/WW/view/en/109769503>)

3.2.20 Emergency stop shutdown up to SIL3 or PL e with a 3RW55 Failsafe soft starter and 3SK1 safety relay

Application

To be able to safely shut down a machine in an emergency, an emergency stop device is attached and monitored by a 3SK1 safety relay. The 3RW55 Failsafe soft starter is used for both functional switching with soft start and soft stop as well as safe shutdown.

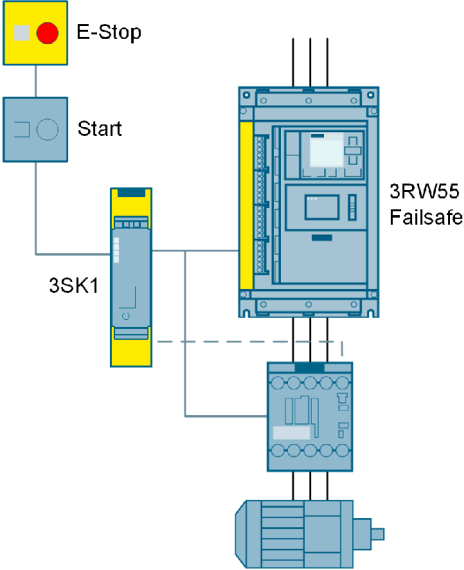

Figure 3-20 Emergency stop shutdown up to SIL 3 or PL e with a 3RW55 Failsafe soft starter and 3SK1 safety relay

Operating principle

The 3SK1 safety relay monitors the emergency stop device. When the emergency stop command device is actuated, the safety relay opens the enabling circuits and shuts down the 3RW55 Failsafe soft starter via its STO input (F-DI), as well as the downstream power contactor in a safety-oriented manner. If the emergency stop command device is unlocked, the feedback circuit of the power contactor is closed and the soft starter reports its fault-free state via its output F-RQ output, it can be switched on again using the start button.

In conjunction with an additional, redundant motor contactor, which is connected between the 3RW55 Failsafe soft starter and the motor, the 3RW55 Failsafe can be used to implement two-channel Safe Torque Off (STO) applications up to SIL 3 or PL e (two-channel shutdown using the 3RW55 Failsafe soft starter in one of the two channels).

The safe signaling output F-RQ (terminal 41/42) of the 3RW55 Failsafe and the auxiliary contacts of the contactor are monitored by a higher-level 3SK1 safety relay. Alternatively, monitoring can also be performed by a fail-safe control system. In this example, the control commands at the fail-safe input F-DI of the 3RW55 Failsafe and at the contactor come from two failsafe outputs of the higher-level safety relay.

Since the safe signaling output F-RQ must be monitored for applications up to SIL 3 or PL e, only the "3SK1 Advanced" variant – with integrated cascading input INK – can be used from the portfolio of 3SK1 safety relays.

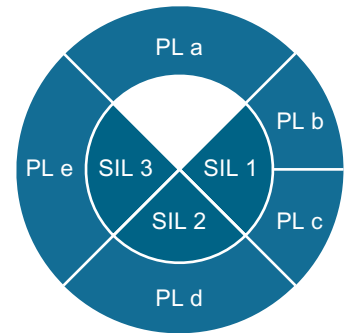

If the control source of the 3RW55 Failsafe is ON, after an STO request on the 3SK1 and with release of the F-DI signal via the start button on the 3SK1, the motor is automatically started again via the 3RW55 Failsafe without the need for a further release action via a control source on the 3RW55 Failsafe. Possible control sources, an example without coupling of digital input DI with the fail-safe digital input F-DI, as well as detailed information on the 3RW55 Failsafe soft starter can be found in the Manual (<https://support.industry.siemens.com/cs/de/en/view/109753752>).



Note

For diagnostics, it is absolutely essential that the 3RW55 Failsafe is always connected directly to the principal voltage. Additional contacts such as a redundant contactor may only be connected in series downstream of the 3RW55 Failsafe.

Safety-oriented components

Emergency stop command device	Failsafe soft starter	Contactors
		
3SU1 (http://www.siemens.com/sirius-act)	3RW55 (https://new.siemens.com/global/en/products/automation/industrial-controls/sirius/sirius-hybrid/3rw-soft-starter.html)	3RT20 (http://www.siemens.com/sirius-control)

See also:

Circuit diagram and safety evaluation (<https://support.industry.siemens.com/cs/ww/en/view/109780386>)

Detailed FAQ on the topic: 3RW soft starter: Safe shutdown according to IEC 62061 (SIL) or ISO 13849-1 (PL) (<https://support.industry.siemens.com/cs/ww/en/view/67474130>)

3.2.21 Emergency stop shutdown to SIL 3 or PL e with a 3RQ1 coupling relay and fail-safe controller

Application

Two-channel emergency stop shutdown of a motor by a fail-safe controller, a 3RQ1 force-guided coupling relay, and a 3RT2 power contactor.

Design

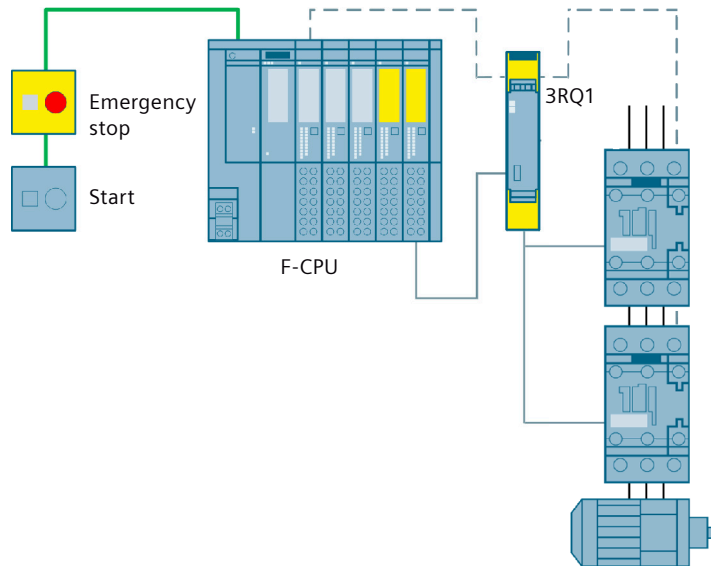

Figure 3-21 Emergency stop shutdown to SIL 3 or PL e with a 3RQ1 coupling relay and fail-safe controller

Operating principle

The fail-safe controller monitors the emergency stop command device on two channels. When the emergency stop command device is actuated, the fail-safe controller switches the coupling relay off in a safety-related way. This in turn switches the power contactors off in a safety-oriented way by means of its force-guided contacts. If the emergency stop command device is unlatched and the feedback circuit is closed, the Start button can be used to switch on again.



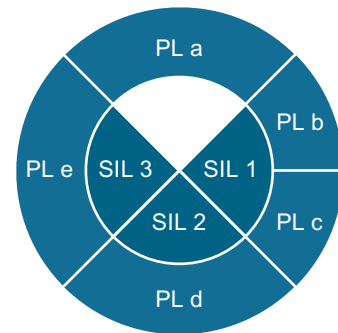

Due to the high holding power, a direct connection of a size S2 contactor (power > 18.5 kW) with the semiconductor outputs of the F-DQ module (e.g. ET 200SP F-DQ 8x 24VDC/0.5A PP) is not possible. This example shows how it is possible to circumvent this problem by using a 3RQ1 coupling relay. The combination of the 3RQ12 coupling relay variant and contactor used here is designed up to SIL 3 or PL e.

The 3RQ10 force-guided coupling relays are also suitable for applications with lower functional safety requirements. These can be used in fail-safe applications up to SIL 2 or PL c. In order to achieve this safety level, however, attention must be paid to an appropriate design of the contactor (e.g. redundant installation).

The 3RQ1 coupling relay is also suitable for extending the contacts of a fail-safe controller. This enables the number of outputs of the fail-safe controller to be multiplied, or their switching capacity to be expanded.



Safety-oriented components

SIRIUS ACT PROFINET inter- face module	Fail-safe controller	Coupling relay	Contactor
			
3SU1 (http://www.siemens.com/sirius-act)	S7 F-PLC (http://www.siemens.com/simatic-safety)	3RQ1 (http://www.siemens.com/relays)	3RT20 (http://www.siemens.com/sirius-control)

See also

Circuit diagram, TIA Portal project and safety evaluation (<https://support.industry.siemens.com/cs/ww/en/view/109769502>)

Detailed FAQ on the topic: Contact extension of a fail-safe controller with 3SK1 and 3RQ1 (<https://support.industry.siemens.com/cs/de/en/view/76676971>)

3.3 Protective door monitoring

3.3.1 Introduction

This section describes applications with separating protective devices in the form of a protective door. The most frequently used solution in the area of plants and machinery is to protect danger zones by means of protective devices or access flaps which ensure mechanical separation. The aim here is to monitor unauthorized access to parts of a plant or equipment and to prevent dangerous machine functions when the protective device is not in the closed position. Protective equipment can be monitored both with mechanical position switches or safety switches, as well as with non-contact safety switches based on solenoid or RFID technology.

A tumbler is frequently also implemented in conjunction with protective door monitoring. Interlocking devices with a tumbler are used to protect danger zones against undesired entry. There are usually two reasons for this:

1. To protect personnel against overtravel of dangerous machine movements, high temperatures, etc. ISO 14119 describes principles for the design and selection of interlocking devices. These standards state that the danger zone must not be accessible until after the dangerous machine movement has been stopped.
2. A tumbler may be useful for reasons of process safety. This situation occurs when the hazard is stopped after opening the guard, but damage can occur to the machine or workpiece as a result. In this case, the machine is first moved to a controlled stop position before access is enabled.

3.3.2 Terminology from the standard

ISO 14119 "Interlocking devices associated with guards – Principles for design and selection" defines different types of interlocking devices. These differ from each other essentially in terms of their actuation type and thus also in their coding for preventing simple defeat.

See the table below for the properties of types 1 to 4:

Design	Actuation principle		Examples of actuators	
Type 1	Mechanical	Contact, force	Not coded	Cam
				Linear output cams
				Hinge
Type 2			Coded	Tab (shaped actuator)
				Key transfer system
Type 3	Non-contact	Inductive	Not coded	Suitable ferrous metal
		Magnetic		Magnet, electromagnet
		Capacitive		Any suitable object
		Ultrasound		
		Optical		
Type 4		Magnetic	Coded	Coded magnet
		RFID		Coded RFID transponder
		Optical		Optically coded transponder

Protection against tampering:

Another essential aspect from the standard is tamper protection. Each machine must be designed in such a way that any motivation to defeat the interlocking device is reduced to a minimum. In Chapter 7, the standard describes how this aim can be achieved.

1. Application of fundamental measures for arranging and fixing
2. Check whether there is a motivation to defeat (assessment guide in Annex H of the standard)
3. Minimizing the motivation through design measures/operating modes
4. If motivation persists → additional measures required

The additional measures for minimizing motivation are also listed in the standard:

Prevent accessibility to the elements of the interlocking device:

1. Mounting out of reach
2. Obstacles or shielding
3. Mounting in concealed position

Prevent substitute actuation of the interlocking device by means of easily available objects:

1. Coded actuator with low coding level (1-9 coding levels)
2. Coded actuator with medium coding level (10-1000 coding levels)
3. Coded actuator with high coding level (>1000 coding levels)

Prevent disassembly or position changing of elements of the interlocking device by means of non-removable fasteners (e.g. by welding, bonding, disposable screws, rivets, etc.).

Prevent circumvention:

1. Integration of defeat monitoring into the controller by means of:
 - Condition monitoring
 - Periodic tests
2. Plausibility check with the help of an additional interlocking device whereby defeat is only possible by means of an additional action

3.3 Protective door monitoring

Measures:

See the following table for the measures you can or must adopt depending on the design of the interlocking device:

Principles and measures	Type 1 (without hinge) and type 3	Type 1 (hinge)	Type 2 and type 4 (low or medium coding level)	Type 2 and type 4 (high coding level)
Mounting out of reach	①		①	
Obstacles/shielding				
Mounting in concealed position				
Condition monitoring or periodic inspection				
Non-removable fixing of the position switch and the actuator				
Non-removable fixing of the position switch		②		
Non-removable fixing of the actuator			②	②
Additional interlocking device and gradient check	③		③	

- ① At least one of these measures must be applied
- ② Measure to be applied
- ③ Recommended measure (additional)

Position switches

The position switches are normally used as positively operated switches on protective doors. If the protective door is opened, the position switch is actuated and the switch is reliably opened (see "Basic terminology: Positive opening operation (Page 13)"). Position switches correspond to type 1 as specified in ISO 14119 and are not coded.

Mechanical safety switches (with separate actuator)

Unlike position switches, safety switches cannot simply be bypassed. The safety switch can only be operated with the associated coded actuator. Safety switches correspond to type 2 of ISO 14119 and are coded.

Mechanical safety switches (hinge switches)

Hinge switches are used in those areas where the position of swiveling protective devices such as doors or flaps must be monitored. Hinged switches correspond to type 1 as specified in ISO 14119 and are not coded.

Mechanical safety switches (with tumbler)

Safety switches with tumblers are special safety engineering devices which prevent accidental or intentional opening of protective doors, guards or other covers while a dangerous state prevails (e.g. overtravel of the machine). Independently of the tumbler, position detection is also implemented by means of this type of switch with the help of a separate actuator. Safety switches correspond to type 2 of ISO 14119 and are coded.

Non-contact safety switches (solenoid-operated switches)

Solenoid-operated switches comprise a coded solenoid and a switching element. They are intended for attachment to movable protective equipment. Their closed design makes them especially suitable for areas subject to heavy contamination, cleaning agents or disinfectants. Safety solenoid-operated switches correspond to type 4 as specified in ISO 14119 and are coded.

Non-contact safety switches (RFID)

RFID safety switches comprise a coded non-contact safety switch and an RFID actuator of the same design. They are extremely versatile, especially for use in areas subject to extreme environmental conditions. Their electronic operating principle also makes these switches ideal for metalworking machinery. The switches have a larger switching interval than mechanical switches, improve the mounting tolerance, and offer a wide range of diagnostics capabilities. They also offer maximum protection against tampering thanks to individual coding of switch and actuator. RFID safety switches correspond to type 4 as specified in ISO 14119 and are highly coded.

Typical application

The protective door is monitored by an evaluation unit using SIRIUS position switches with positive opening contacts. If the protective door is opened, the evaluation unit switches the downstream actuators off via safe outputs in accordance with Stop Category 0 per EN 60204-1. If the protective door is closed, automatic starting takes place after the position switches and downstream contactors have been checked. In the case of manual start, this does not happen until the Start button is actuated.

Note

- Place the position switches in a location such that they are not damaged during approach and overtravel. For this reason, it is not permissible to use position switches as a mechanical end stop.
- Lay the sensor lines with protection; use only safety sensors with positive-opening contacts as sensors.
- The tumbler represents a single, separate safety function alongside the safety function of the protective door monitor by means of position switches. The control can have a required safety integrity that is one stage lower than that resulting from the risk evaluation for the protective door monitor. (Reason: The probability that both safety functions will fail at the same time can practically be ruled out.
Example: Protective door monitoring is required in PL d or SIL 2, tumbler control can be implemented in PL c or SIL 1.

Conditions in series connection



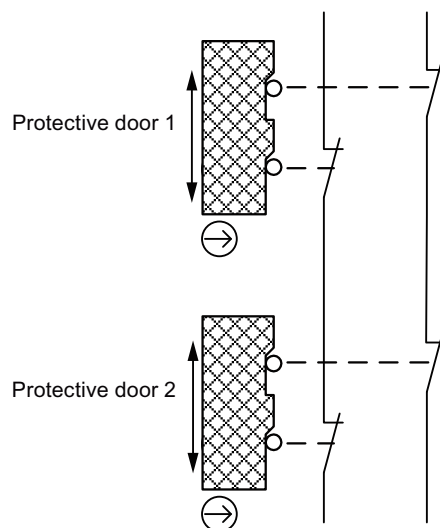





A series connection of position switches can be used up to PL d (according to ISO 13849-1) or up to SIL 2 (according to IEC 62061). The attainable safety level depends on the possible fault diagnosis, the number of doors used, and the frequency of door actuation. An estimation of the achievable diagnostics and thus the safety level can be taken from the technical report ISO/TR 24119. Series connection in PL e (per ISO 13849-1) or SIL 3 (per IEC 62061) is not possible.



Possible combinations for position detection and achievable safety level

The application examples in this chapter can only cover a fraction of the possible combinations of detection units. However, the tables below show in a simple form the maximum safety level that can be achieved by a given method of position detection.

Table 3-5 Safe position monitoring with mechanical switches

Evaluation units		Position switches	Safety switches, hinge switches	Safety switches with separate actuator	Safety switches with optional tumbler function
					
Achievable safety level with ONE position switch	Monitoring an NC contact	SIL 1 / PL c	SIL 1 / PL c	SIL 1 / PL c	SIL 1 / PL c
	Monitoring of 2 NC contacts or 1 NC contact + 1 NO contact	SIL 1 / PL c	SIL 2 / PL d	SIL 2 / PL d	SIL 2 / PL d
Achievable safety level with TWO position switches	Position switches 	SIL 3 / PL e	SIL 3 / PL e	SIL 3 / PL e	SIL 3 / PL e
	Safety switches, hinge switches 	SIL 3 / PL e	SIL 3 / PL e	SIL 3 / PL e	SIL 3 / PL e
	Safety switches with separate actuator 	SIL 3 / PL e	SIL 3 / PL e	SIL 3 / PL e	SIL 3 / PL e
	Safety switches with optional tumbler function 	SIL 3 / PL e	SIL 3 / PL e	SIL 3 / PL e	SIL 3 / PL e

Example 1:



A safety level of up to PL e or SIL 3 can be achieved by combining two mechanical safety switches (with separate actuator).

3.3 Protective door monitoring

Example 2:

A safety level of up to PL d or SIL 2 can be achieved by using a mechanical safety switch (hinge switch).

Table 3-6 Safe protective door tumbler

Safe evaluation units	Safety switch	
	Safety switches with tumbler	Safety switches with tumbler
		
 3SK2 safety relay	SIL 2 / PL d	SIL 3 / PL e

Note

Generally, positive actuation by means of the design of the protective equipment must be ensured to use this position switch. The values listed in the table are only permissible under this condition.

Note



Taking account of certain fault exclusions (e.g. actuator breakage), use of just one hinge switch or a switch with separate actuator up to SIL 2 or PL d is possible as described in the table. Since the machine manufacturer must provide proof of fault exclusion, the component manufacturer is unable to carry out a definitive assessment of the measures taken.

For further information, refer to the letter available at the following link: (<https://support.industry.siemens.com/cs/ww/en/view/35443942>)

Note

With a two-channel design with electro-mechanical sensors, SIL 3 or PL e can only be achieved when the sensors are supplied by the evaluation unit. Only this guarantees adequate diagnostics.

Table 3-7 Safe position monitoring with non-contact safety switches

Safe evaluation units	Detection units Non-contact safety switches	
		3SE66/3SE67 solenoid-operated switches  1 NO + 1 NC; 2 NC
 3SK safety relay	SIL 3 / PL e*	SIL 3 / PL e

* With the safety relays 3SK1111 and 3SK1112 (3SK1 standard), evaluation of 1 NO + 1 NC is not possible. 3SK112 (3SK1 Advanced) must be used for this purpose.

Note

The achievable safety level also depend on the type of the safety evaluation unit used (especially its diagnostics capability).

Note

If solenoid-operated switches are used, the magnetic contacts may weld on account of capacitive effects. The reason for this is that a high peak current may occur when switching these loads (e.g. also cable capacitances). A corresponding fuse protection with the rated current of the solenoid-operated switch must be provided if the device/sensor combinations have not been explicitly enabled. For more details, please refer to the documentation of the solenoid-operated switch.

See also:

Achievable safety level using only one SIRIUS position switch with or without tumbler (<http://support.automation.siemens.com/WW/view/en/35443942>)

3.3.3 Protective door monitoring to SIL 1 or PL c with a 3SK1 safety relay

Application

Protective doors are frequently used to fence off danger zones. These are monitored for position and, if necessary, the area from which the hazard emanates is switched off.

Design

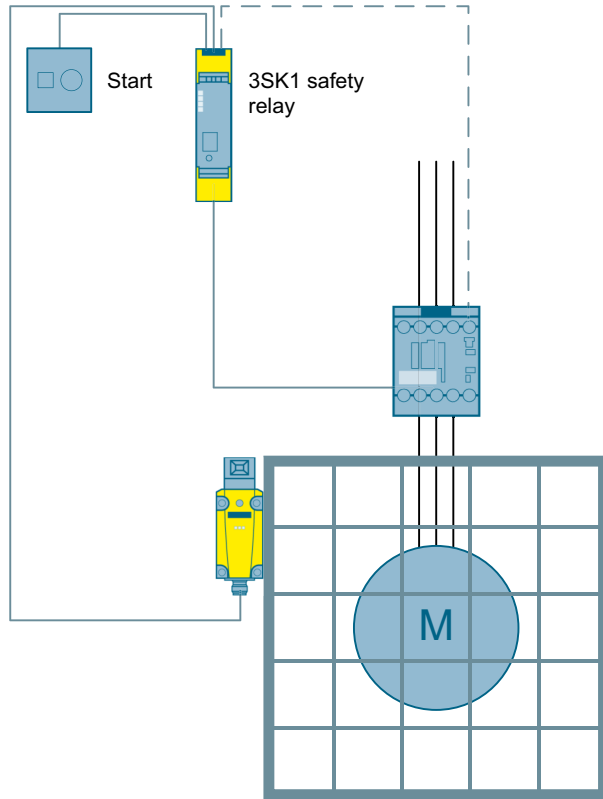
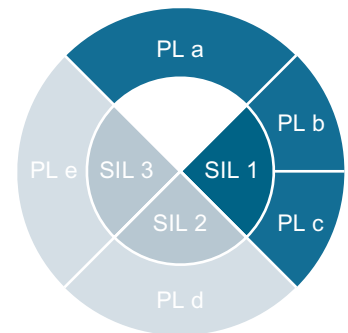

Figure 3-22 Protective door monitoring to SIL 1 or PL c with a 3SK1 safety relay

Operating principle

The position of a protective door is monitored via the contact of the safety switch. When the monitored door is opened, the safety relay triggers and opens the enabling circuits, switching off the power contactor in a safety-related manner. If the door is closed and the feedback circuit is closed, the Start button can be used to switch on again.



Safety-related components

Safety switch	Safety relay	Contactors
		
3SE5 (http://www.siemens.com/sirius-detecting)	3SK1 (http://www.siemens.com/safety-relays)	3RT20 (http://www.siemens.com/sirius-control)

See also

Circuit diagram and safety evaluation (<http://support.automation.siemens.com/WW/view/en/73135973>)

3.3.4 Protective door monitoring to SIL 1 or PL c with a 3SK2 safety relay

Application

Protective doors are frequently used to fence off danger zones. These are monitored for position and, if necessary, the area from which the hazard emanates is switched off.

Design

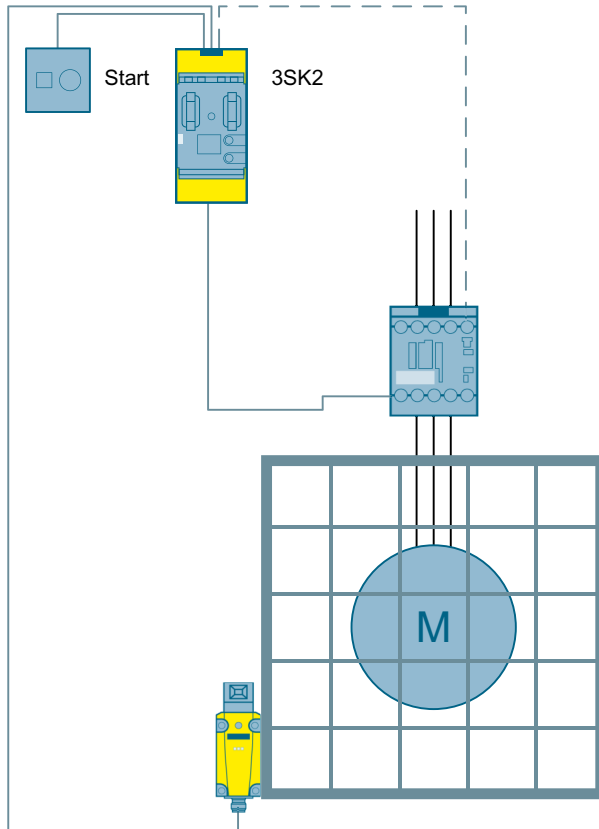
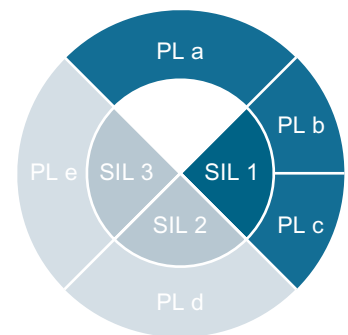

Figure 3-23 Protective door monitoring to SIL 1 or PL c with a 3SK2 safety relay

Operating principle

The position of a protective door is monitored via the contact of the safety switch. When the monitored door is opened, the safety relay triggers and opens the enabling circuits, switching off the power contactor in a safety-related manner. If the door is closed and the feedback circuit is closed, the Start button can be used to switch on again.



Safety-related components

Safety switch	Modular Safety System	Contactors
		
3SE5 (http://www.siemens.com/sirius-detecting)	3SK2 (http://www.siemens.com/safety-relays)	3RT20 (http://www.siemens.com/sirius-control)

See also

Circuit diagram, 3SK2 project and safety evaluation (<http://support.automation.siemens.com/WW/view/en/109485644>)

3.3.5 Protective door monitoring to SIL 3 or PL e with a 3SK1 safety relay

Application

Protective doors are frequently used to fence off danger zones. These are monitored for position and, if necessary, the area from which the hazard emanates is switched off.

Design

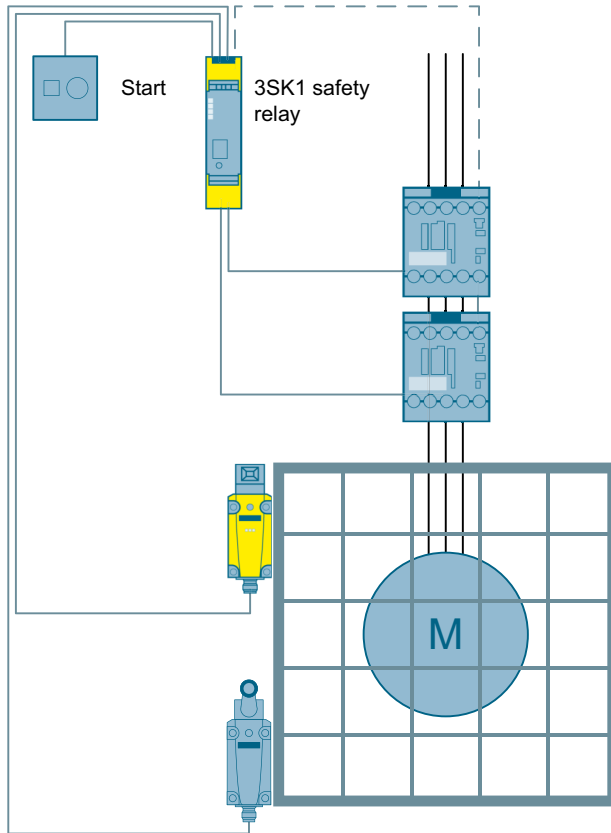
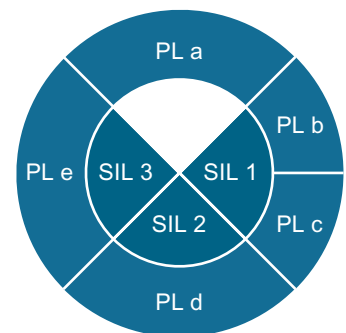

Figure 3-24 Protective door monitoring to SIL 3 or PL e with a 3SK1 safety relay

Operating principle

The position of a protective door is monitored via two safety switches. When the monitored door is opened, the safety relay triggers and opens the enabling circuits, switching off the power contactors in a safety-related manner. If the door is closed and the feedback circuit is closed, the Start button can be used to switch on again.



Safety-related components

Position switches		Safety relay	Contactors
			
2x 3SE5 (http://www.siemens.com/sirius-detecting)		3SK1 (http://www.siemens.com/safety-relays)	2x 3RT20 (http://www.siemens.com/sirius-control)

See also

Circuit diagram and safety evaluation (<http://support.automation.siemens.com/WW/view/en/73135309>)

3.3.6 Protective door monitoring to SIL 3 or PL e with a 3SK2 safety relay

Application

Protective doors are frequently used to fence off danger zones. These are monitored for position and, if necessary, the area from which the hazard emanates is switched off.

Design

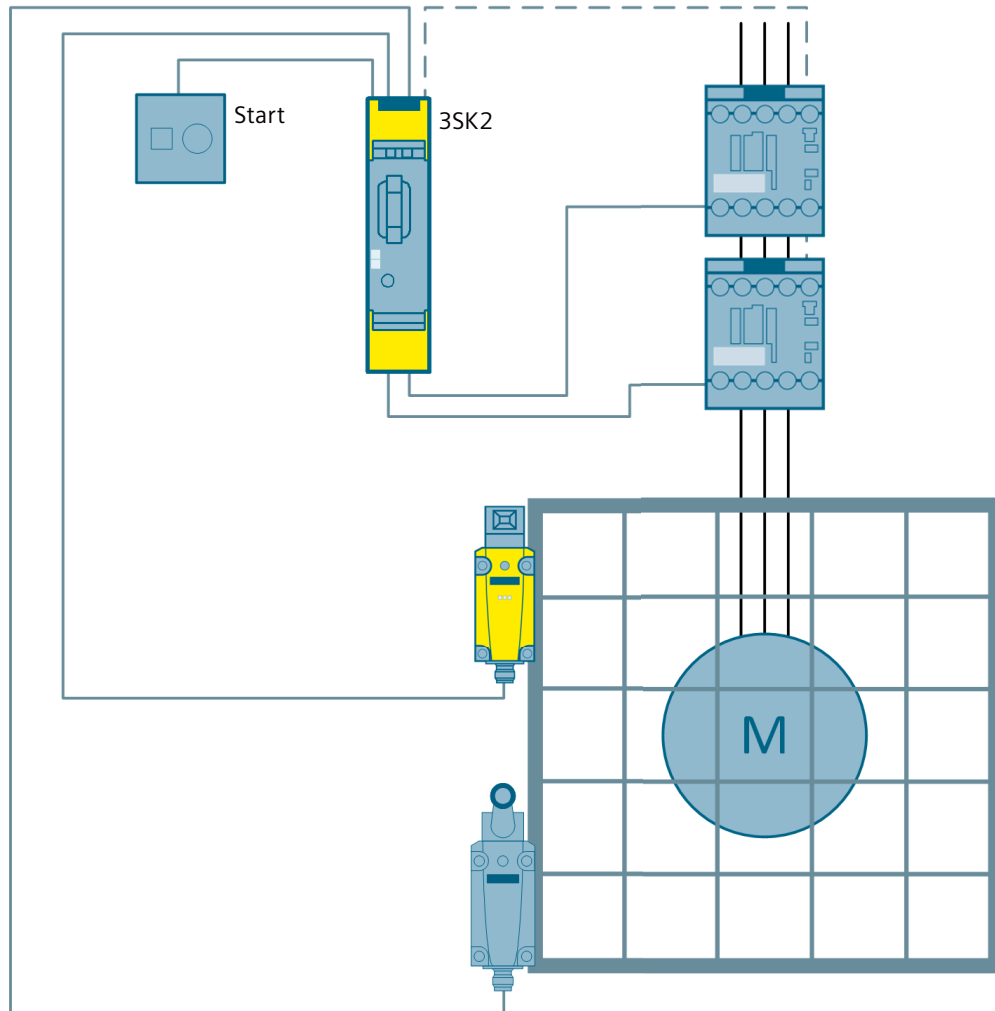
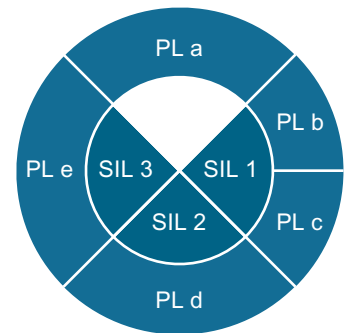

Figure 3-25 Protective door monitoring to SIL 3 or PL e with fail-safe motor starters and a 3SK2 safety relay

Operating principle

The position of a protective door is monitored via two safety switches. When the monitored door is opened, the safety relay triggers and opens the enabling circuits, switching off the power contactors in a safety-related way. If the door is closed and the feedback circuit is closed, the Start button can be used to switch on again.



Safety-related components

Position switches		Safety relay	Contactors
			
2x 3SE5 (http://www.siemens.com/sirius-detecting)		3SK2 (http://www.siemens.com/safety-relays)	2x 3RT20 (http://www.siemens.com/sirius-control)

See also

Circuit diagram, 3SK2 project and safety evaluation (<http://support.automation.siemens.com/WW/view/en/109479275>)

3.3.7 Protective door monitoring to SIL 3 or PL e with a fail-safe motor starter and a 3SK1 safety relay

Application

Protective doors are frequently used to fence off danger zones. These are monitored for position and, if necessary, the area from which the hazard emanates is switched off.

Design

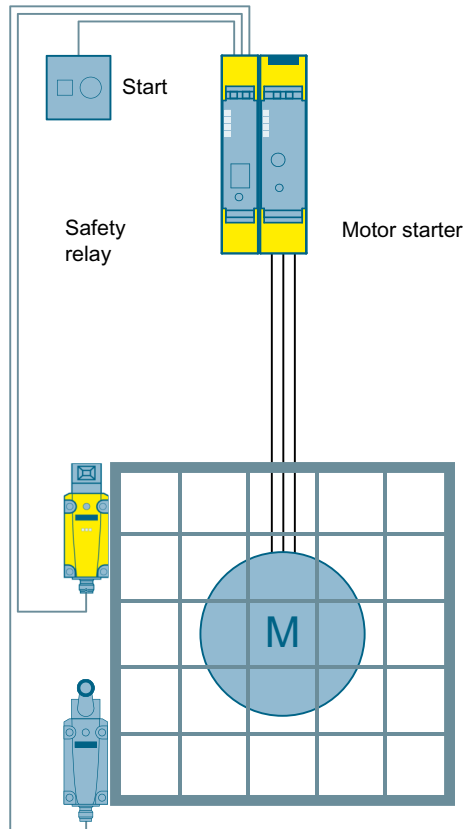
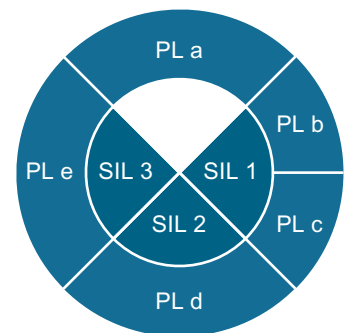

Figure 3-26 Protective door monitoring to SIL 3 or PL e with a fail-safe motor starter and a 3SK1 safety relay

Operating principle

The position of a protective door is monitored via the contact of the safety switch. When the monitored door is opened, the safety relay trips and switches the fail-safe motor starter off via the device connector. The motor starter then safely shuts down the load. If the door is closed, the start button can be used to switch on again.



Safety-related components

Safety switch		Safety relay	Fail-safe motor starters
			
2x 3SE5 (http://www.siemens.com/sirius-detecting)		3SK1 (http://www.siemens.com/safety-relays)	3RM1 (http://www.siemens.com/motorstarter/3rm1)

See also

Circuit diagram and safety evaluation (<http://support.automation.siemens.com/WW/view/en/88822953>)

More detailed FAQs on: Safe shutdown with the 3RM1 motor starters (<http://support.automation.siemens.com/WW/view/en/67478946>)

3.3.8 Protective door monitoring to SIL 3 or PL e with fail-safe motor starters and a 3SK2 safety relay

Application

Protective doors are frequently used to fence off danger zones. These are monitored for position and, if necessary, the area from which the hazard emanates is switched off.

Design

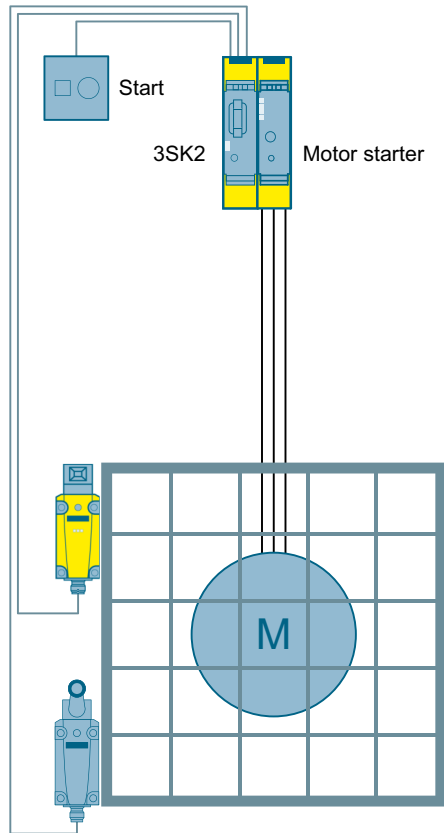
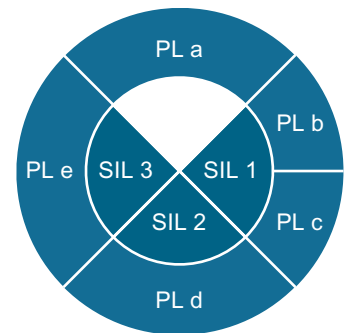

Figure 3-27 Protective door monitoring to SIL 3 or PL e with fail-safe motor starters and a 3SK2 safety relay

Operating principle

The position of a protective door is monitored via the contact of the safety switch. When the monitored door is opened, the safety switch relays trip and switch the fail-safe motor starter off via the device connector. The motor starter then safely shuts down the load. If the door is closed, the start button can be used to switch on again.



Safety-related components

Safety switch		Safety relay	Fail-safe motor starters
			
2x 3SE5 (http://www.siemens.com/sirius-detecting)		3SK2 (http://www.siemens.com/safety-relays)	3RM1 (http://www.siemens.com/motorstarter/3rm1)

See also

Circuit diagram, 3SK2 project and safety evaluation (<http://support.automation.siemens.com/WW/view/en/109485645>)

More detailed FAQs on: Safe shutdown with 3RM1 motor starters (<http://support.automation.siemens.com/WW/view/en/67478946>)

3.3.9 Protective door monitoring via AS-i to SIL 3 or PL e with a Modular Safety System

Application

Monitoring of multiple protective doors and control of the actuators via AS-i with a Modular Safety System.

Design

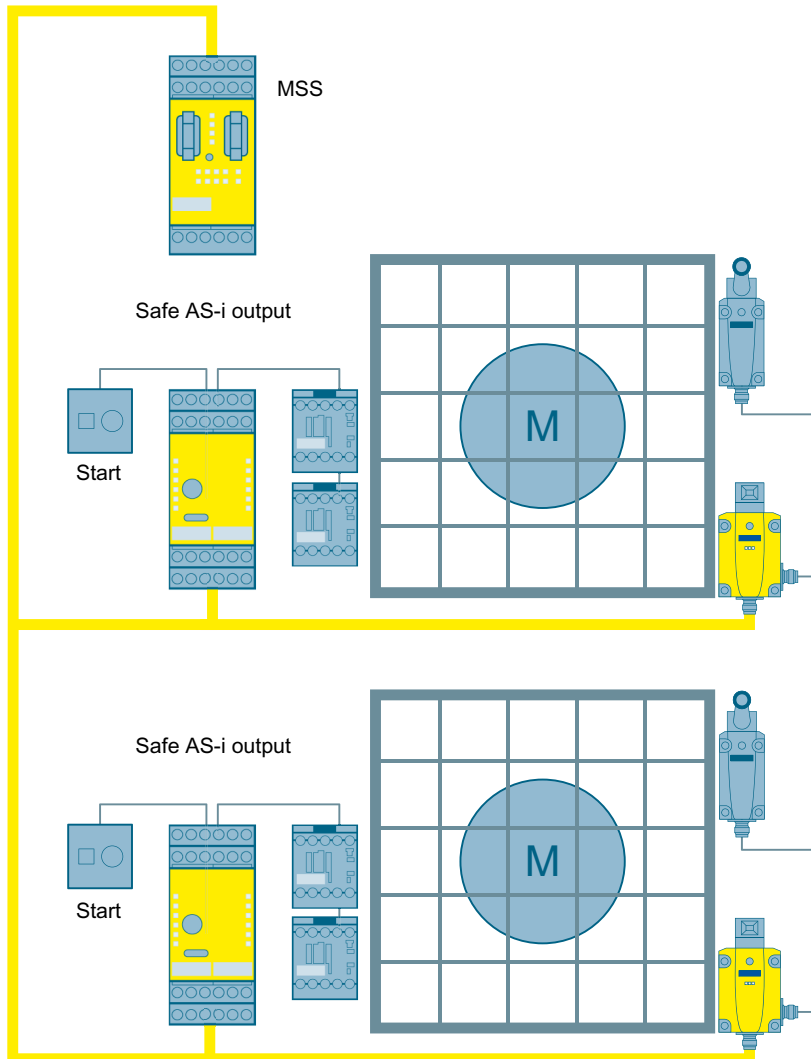
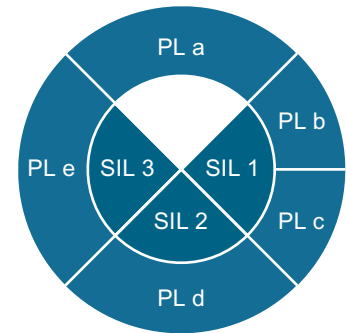

Figure 3-28 Protective door monitoring via AS-i to SIL 3 or PL e with a Modular Safety System

Operating principle

The Modular Safety System monitors the safety switches connected to AS-i, and transmits status signals via the AS-i bus in the form of simulated AS-i slaves. These simulated slaves are monitored by safe AS-i outputs. When one of the protective doors is opened, the Modular Safety System interrupts the respective status signal. The safe AS-i output then opens the enabling circuits and the power contactors switch off in a safety-related manner.

The signals from the start button and the auxiliary contacts of the contactors are sent from the safe AS-i output via the AS-i bus to the Modular Safety System, and evaluated there. If the respective door is closed and the feedback circuit is closed, the Start button can be used to switch on again.



Safety-related components

Position switches		Modular Safety System	Safe AS-i output	Contactor
				
2x 3SE5 (http://www.siemens.com/sirius-detecting)		3RK3 (http://www.siemens.com/sirius-monitor)	3RK1405 (www.siemens.com/as-interface)	2x 3RT20 (http://www.siemens.com/sirius-control)

Note

In addition to the safety-related components, operation of an AS-i network requires an AS-i master and an AS-i power supply.

See also

Circuit diagram, MSS project and safety evaluation (<http://support.automation.siemens.com/WW/view/en/73135311>)

3.3.10 Protective door monitoring by means of RFID switch to SIL 3 or PL e with a 3SK1 safety relay

Application

Protective doors are frequently used to fence off danger zones. These are monitored for position and, if necessary, the area from which the hazard emanates is switched off.

Design

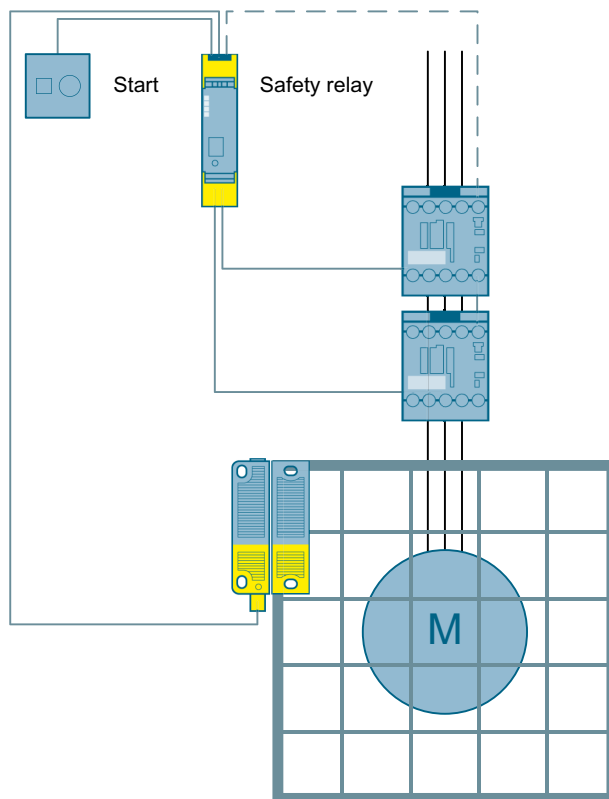
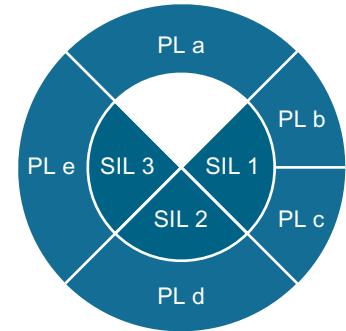

Figure 3-29 Protective door monitoring by means of RFID switch to SIL 3 or PL e with a 3SK1 safety relay

Operating principle

The position of a protective door is monitored via the non-contact safety switch. When the monitored door is opened, the safety relay triggers and opens the enabling circuits, switching off the power contactors in a safety-related manner. If the door is closed and the feedback circuit is closed, the Start button can be used to switch on again. The 3SE6315 non-contact safety switch has two channels internally and possesses its own diagnostics capability. Because of this, and because it is tamper-proof by virtue of its RFID technology, a redundant safety switch is not required to achieve up to PL e acc. to ISO 13849-1 or SIL 3 acc. to IEC 62061.

As an alternative to the RFID switches shown here, it is also possible to use the contact-free 3SE66 and 3SE67 magnetically-operated switches, which can be used up to PL e or SIL 3.



Safety-related components

Non-contact safety switch	Safety relay	Contactor
		
3SE6315 (http://www.siemens.com/sirius-detecting)	3SK1 (http://www.siemens.com/safety-relays)	2x 3RT20 (http://www.siemens.com/sirius-control)

See also

Circuit diagram and safety evaluation (<http://support.automation.siemens.com/WW/view/en/73134150>)

3.3.11 Protective door monitoring by means of RFID switch to SIL 3 or PL e with a 3SK2 safety relay

Application

Protective doors are frequently used to fence off danger zones. These are monitored for position and, if necessary, the area from which the hazard emanates is switched off.

Design

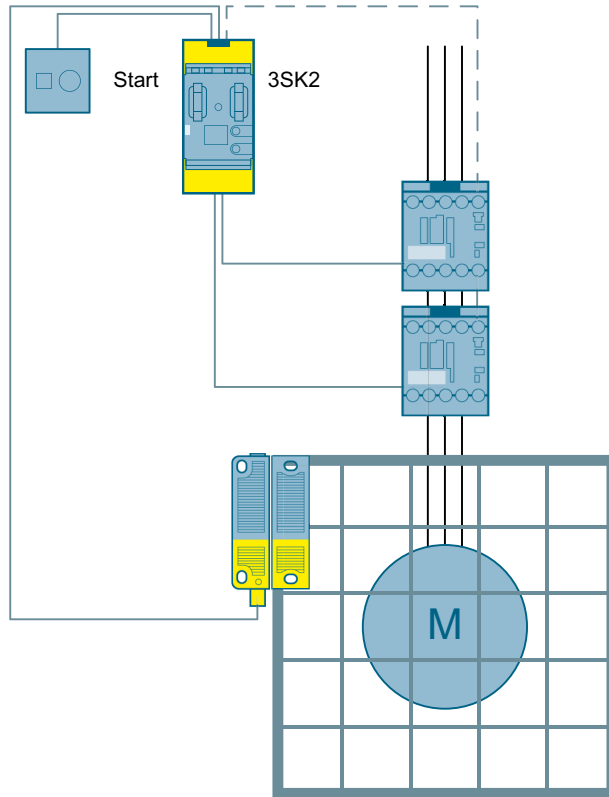
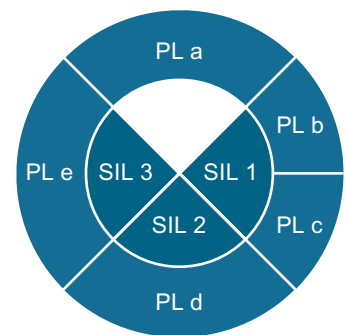

Figure 3-30 Protective door monitoring by means of RFID switch to SIL 3 or PL e with a 3SK2 safety relay

Operating principle

The position of a protective door is monitored via the non-contact safety switch. When the monitored door is opened, the safety relay triggers and opens the enabling circuits, switching off the power contactors in a safety-related manner. If the door is closed and the feedback circuit is closed, the Start button can be used to switch on again. The 3SE6315 non-contact safety switch has two channels internally and possesses its own diagnostics capability. Because of this, and because it is tamper-proof by virtue of its RFID technology, a redundant safety switch is not required to achieve up to PL e acc. to ISO 13849-1 or SIL 3 acc. to IEC 62061.

As an alternative to the RFID switches shown here, it is also possible to use the contact-free 3SE66 and 3SE67 magnetically-operated switches, which can be used up to PL e or SIL 3.



Safety-related components

Non-contact safety switch	Safety relay	Contactor
		
3SE6315 (http://www.siemens.com/sirius-detecting)	3SK2 (http://www.siemens.com/safety-relays)	2x 3RT20 (http://www.siemens.com/sirius-control)

See also

Circuit diagram, 3SK2 project and safety evaluation (<http://support.automation.siemens.com/WW/view/en/109485646>)

3.3.12 Protective door monitoring with tumbler to SIL 2 or PL d with a 3SK2 safety relay

Application

Protective doors are frequently used to fence off danger zones. These are monitored for position and, if necessary, the area from which the hazard emanates is switched off. If the machine continues to present a hazard even after switching off, access can be prevented for this period by a tumbler.

Design

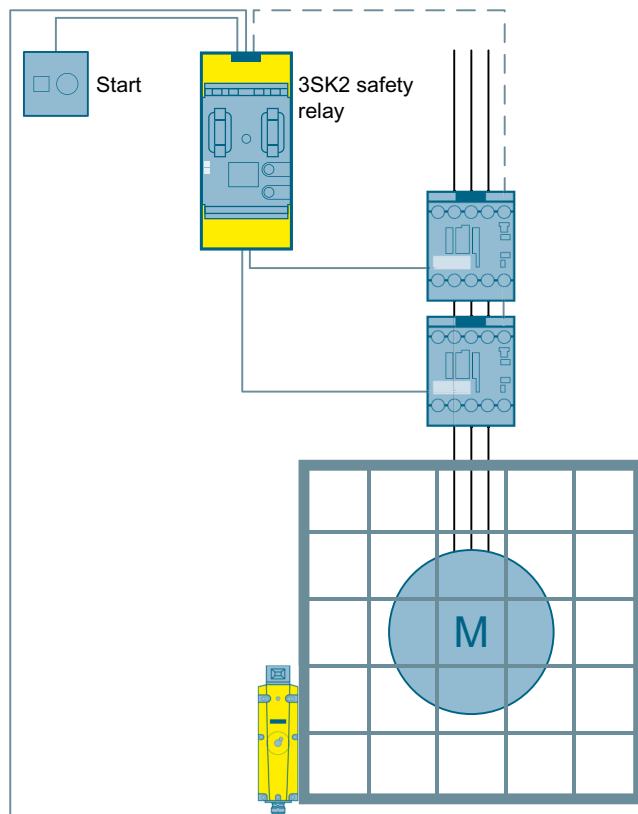

Figure 3-31 Protective door monitoring with tumbler to SIL 2 or PL d with a 3SK2 safety relay

Operating principle

The position of a protective door is monitored via one safety switch. In addition, the door is locked via the safety switch. If the command to unlock the door is issued, the safety relay triggers and opens the enabling circuits, switching off the power contactors in a safety-related manner. The tumbler is unlocked after expiry of a set time. If the door is closed and locked, and the feedback circuit is closed, the Start button can be used to switch on again.

The safety function "Protective door monitoring" and the safety function "Protective door tumbler" are designed for up to SIL 2 or PL d.

In this example, a safety switch with spring-actuated lock is used. This means that voltage must be actively applied to lift the tumbler.

In contrast, safety switches with magnetic force locking are also available, but these cannot be used to implement SIL or PL for the "protective door tumbler" safety function.

Taking account of fault exclusions, use of only one safety switch with or without tumbler is permissible to SIL 2 or PL d. For more information, refer to the letter given below.

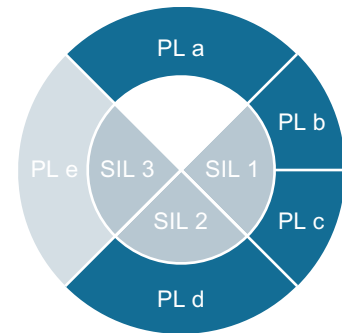

Safety-related components

Safety switches with tumbler	Safety relay	Contactors
		
3SE5 (http://www.siemens.com/sirius-detecting)	3SK2 (http://www.siemens.com/safety-relays)	2x 3RT20 (http://www.siemens.com/sirius-control)

See also

Circuit diagram, 3SK2 project and safety evaluation (<http://support.automation.siemens.com/WW/view/en/109479276>)

Letter concerning the use of safety relays to SIL 2 or PL d (<https://support.industry.siemens.com/cs/ww/en/view/35443942>)

3.3.13 Protective door monitoring with tumbler up to SIL 2 or PL d via ET 200eco PN and F-CPU

Application

To prevent access to the hazardous area of a machine during operation, a protective door is installed. If the machine continues to present a hazard even after shutdown, access can be prevented for this period by a tumbler.

Design

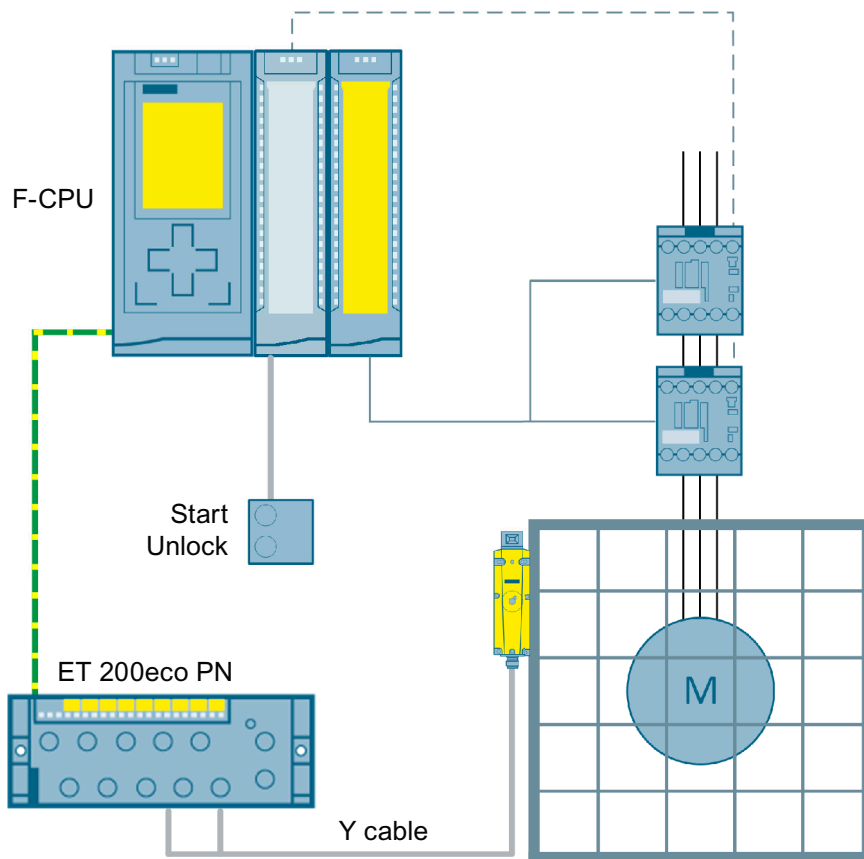

Figure 3-32 Protective door monitoring with tumbler up to SIL 2 or PL d e via ET 200eco PN and F-CPU

Operating principle

The position of a protective door is monitored via one safety switch. In addition, the door is locked via the safety switch. When the command to unlock the door is issued, the fail-safe control system switches off the power contactors in a safety-oriented manner. The tumbler is unlocked after expiry of a set time. If the door is closed and locked, and the feedback circuit is closed, the Start button can be used to switch on again.

The signals of the position switch are transferred to the failsafe ET 200eco PN-F I/O module via an M12 plug. Since both output and input signals are transferred, a Y cable is required.

Since the position switch has more contacts than can be read in at an F-DI port, there are 2 variants of the position switch, which differ in their pin assignment. Detailed documentation can be found via the Industry Online Support entry below.

The safety function "Protective door monitoring" and the safety function "Protective door tumbler" are designed for up to SIL 2 or PL d.



In this example, a safety switch with spring-actuated lock is used. This means that voltage must be actively applied to lift the tumbler.

In contrast, safety switches with magnetic force locking are also available, but these cannot be used to implement SIL or PL for the "protective door tumbler" safety function.

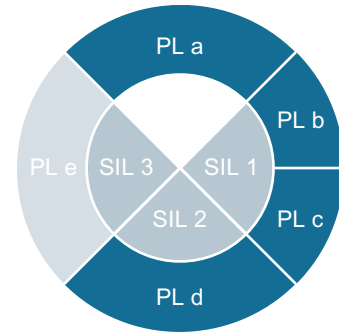
Taking account of fault exclusions, use of only one safety switch with or without tumbler is permissible up to SIL 2 or PL d. For more information, refer to the letter given below.



Safety-oriented components

Safety switch with tumbler	Distributed I/O IP67	Connecting cable
		
3SE5 (https://w3.siemens.com/mcms/industrial-controls/en/detecting-devices/Pages/default.aspx)	ET 200eco PN (https://new.siemens.com/global/en/products/automation/topic-areas/safety-integrated/factory-automation/offering/simatic-safety.html)	Y cable for ET 200eco PN (https://new.siemens.com/global/en/products/automation/topic-areas/safety-integrated/factory-automation/offering/simatic-safety.html)

Fail-safe controller	Contactor
	
<p>S7 F-PLC (https://new.siemens.com/global/en/products/automation/topic-areas/safety-integrated/factory-automation/offering/simatic-safety.html)</p>	<p>2x 3RT20 (http://www.siemens.com/sirius-control)</p>

See also

Detailed documentation, TIA Portal project, and safety evaluation (<https://support.industry.siemens.com/cs/ww/en/view/109778289>)

Letter concerning the use of safety switches up to SIL 2 or PL d (<https://support.industry.siemens.com/cs/ww/en/view/35443942>)

3.3.14 Protective door monitoring with tumbler using 3SE64 RFID safety switch up to SIL 3 or PL e using a 3SK2 safety relay

Application

Protective doors are frequently used to delimit danger zones. These are monitored for position and, if necessary, the area from which the hazard emanates is switched off. If the machine continues to present a hazard even after shutdown, access can be prevented for this period by a tumbler.

Design

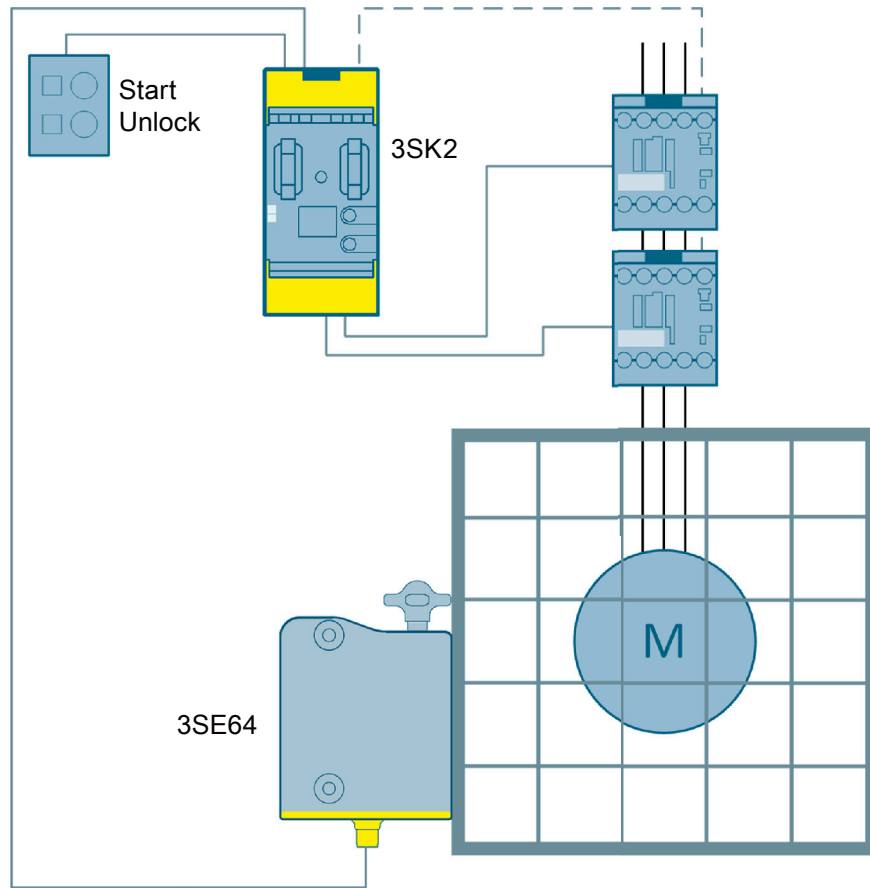

Figure 3-33 Protective door monitoring with tumbler by means of a 3SE64 RFID safety switch up to SIL 3 or PL e and a 3SK2 safety relay

Functional information

The position of a protective door is monitored via a safety switch. In addition, the door is locked via the safety switch. If the command to unlock the door is issued, the safety relay triggers and opens the enabling circuits, switching off the power contactors in a safety-related manner. The tumbler is unlocked after expiry of a set time. If the door is closed and locked, and the feedback circuit is closed, the Start button can be used for switching on again.

The 3SE64 RFID safety switch with tumbler is available in two variants, which differ in the control principle of the tumbler function (open-/closed-circuit principle).

In both variants, SIL 3 or PL e is possible for the "protective door monitoring" safety function. While SIL 2 or PL d can be achieved for the "protective door tumbler" safety function in variant 1 (closed-circuit principle), no SIL / PL is possible for the tumbler in variant 2 (open-circuit principle) since in this variant, the tumbler is used exclusively for protecting the process.

Variant 1 is used in this application example, since SIL 2 or PL d is required for the "protective door tumbler" safety function.

In variant 1, the RFID feedback (OSSD outputs of the 3SE64) only becomes active once the tumbler has been properly operated. Here, the tumbler is also monitored and the user program is able to evaluate whether the door is actually locked or not, taking into account the diagnostic requirements for SIL 2 or PL d.

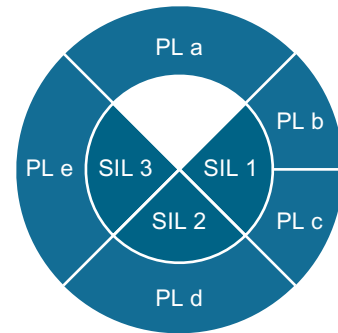

Safety-related components

RFID safety switch with tumbler	Safety relay	Contactor
		
3SE64 (https://w3.siemens.com/mcml/industrial-controls/en/detecting-devices/Pages/default.aspx)	3SK2 (http://www.siemens.com/safety-relays)	2x 3RT20 (http://www.siemens.com/sirius-control)

See also

Circuit diagram, 3SK2 project and safety evaluation (<https://support.industry.siemens.com/cs/ww/en/view/109811081>)

3.3.15 Protective door monitoring with tumbler using 3SE64 RFID safety switch up to SIL 3 or PL e using a fail-safe controller

Application

Protective doors are frequently used to delimit danger zones. These are monitored for position and, if necessary, the area from which the hazard emanates is switched off. If the machine continues to present a hazard even after shutdown, access can be prevented for this period by a tumbler.

Design

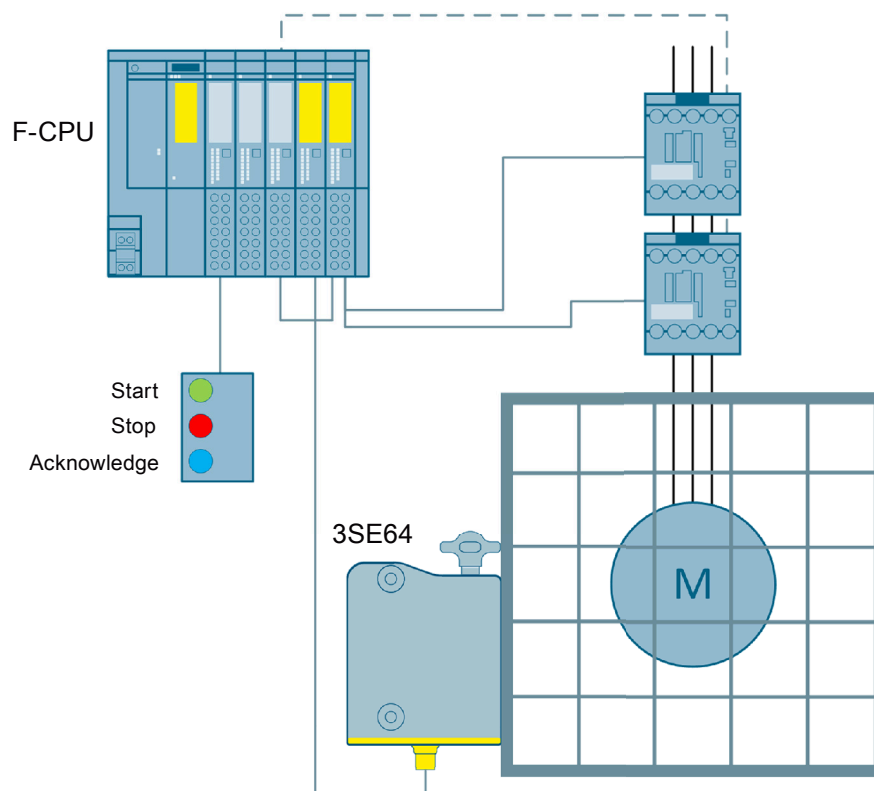

Figure 3-34 Protective door monitoring with tumbler by means of a 3SE64 RFID safety switch up to SIL 3 or PL e and a fail-safe controller

Operating principle

The position of a protective door is monitored via a safety switch. In addition, the door is locked via the safety switch. When the command to unlock the door is issued, the fail-safe controller switches off the power contactors in a safety-related manner. The tumbler is unlocked after expiry of a set time. If the door is closed and locked, and the feedback circuit is closed, the Start button can be used for switching on again.

The 3SE64 RFID safety switch with tumbler is available in two variants, which differ in the control principle of the tumbler function (open-/closed-circuit principle).



In both variants, SIL 3 or PL e is possible for the "protective door monitoring" safety function. While SIL 2 or PL d can be achieved for the "protective door tumbler" safety function in variant 1 (closed-circuit principle), no SIL / PL is possible for the tumbler in variant 2 (open-circuit principle) since in this variant, the tumbler is used exclusively for protecting the process.

Variant 1 is used in this application example, since SIL 2 or PL d is required for the "protective door tumbler" safety function.

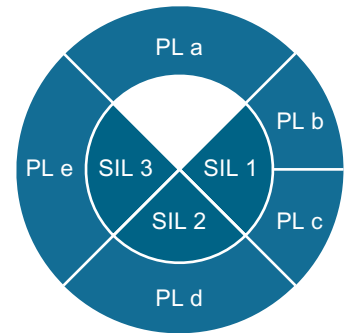
In variant 1, the RFID feedback (OSSD outputs of the 3SE64) only becomes active once the tumbler has been properly operated. Here, the tumbler is also monitored and the user program is able to evaluate whether the door is actually locked or not, taking into account the diagnostic requirements for SIL 2 or PL d.



Safety-related components

RFID safety switch with tumbler	Fail-safe controller	Contactor
		
3SE64 (https://w3.siemens.com/mcms/industrial-controls/en/detecting-devices/Pages/default.aspx)	S7 F-PLC (http://www.siemens.com/simatic-safety)	2x 3RT20 (http://www.siemens.com/sirius-control)

See also

Circuit diagram, TIA Portal project and safety evaluation (<https://support.industry.siemens.com/cs/ww/en/view/109811981>)

3.4 Monitoring of open danger zones

3.4.1 Introduction

Within an industrial plant there are often areas that must be made inaccessible to personnel for certain periods due to the high level of hazard. There must, for example, be no parts of the body in the interior of a press during the downward movement of the press. Monitoring for such hazards is often implemented using light curtains.

At certain times, it might be necessary to suppress the protective function. Muting is the intentional, temporary suppression of the protective function. This "muting mode" is triggered by muting sensors (e.g. while transporting material into the danger zone).

Note

Light curtains can only perform their function if they are installed with sufficient safety clearance. The calculation formulas for the safety clearance depend on the type of protection. Positioning situations and calculation formulas can be found in the standard EN 13855 ("Positioning of safeguards with respect to the approach speeds of parts of the human body").

3.4.2 Access monitoring using a light curtain to SIL 3 or PL e with a 3SK1 safety relay

Application

To monitor access to an open danger zone, so-called non-contact protective equipment such as a light curtain can be used. If the light beam is interrupted, a shutdown signal is triggered.

Design

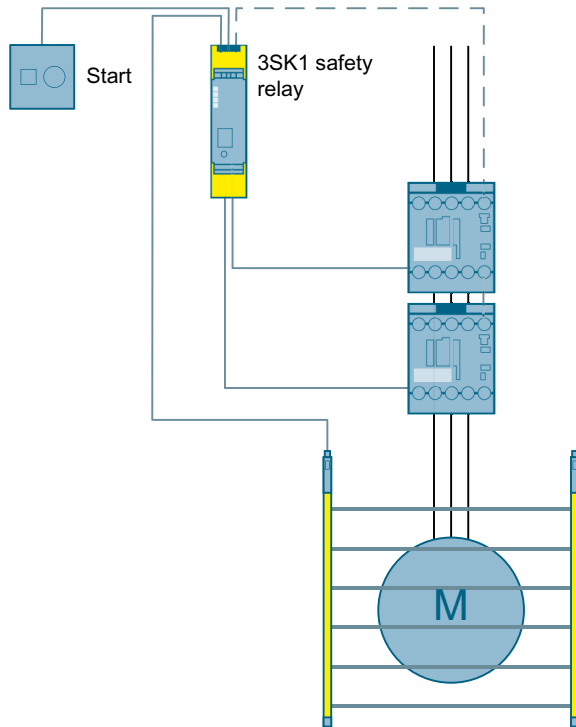
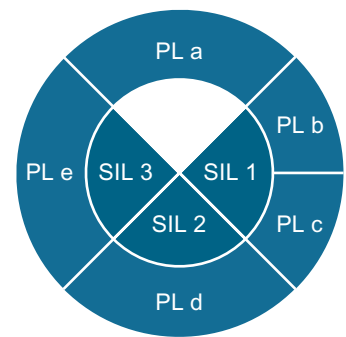

Figure 3-35 Access monitoring using a light curtain to SIL 3 or PL e with a 3SK1 safety relay

Operating principle

The light curtain consists of a send unit and a receive unit. Between the two is the protective zone. If the light beam is interrupted, outputs OSSD1 and OSSD2 carry voltage and are evaluated by the safety relay. When the light beam is interrupted, the two outputs switch off and the safety relay opens the enabling circuits, switching off the power contactors in a safety-related manner. If the light beam is uninterrupted and the feedback circuit is closed, you can switch on again. This can happen automatically or using a Start button, depending on the application.



Safety-related components

Light curtain	Safety relay	Contactors
		
SICK C4000	3SK1 (http://www.siemens.com/safety-relays)	2x 3RT20 (http://www.siemens.com/sirius-control)

See also

Circuit diagram and safety evaluation (<http://support.automation.siemens.com/WW/view/en/73136329>)

3.4.3 Access monitoring using a light curtain to SIL 3 or PL e with a 3SK2 safety relay

Application

To monitor access to an open danger zone, so-called non-contact protective equipment such as a light curtain can be used. If the light beam is interrupted, a shutdown signal is triggered.

Design

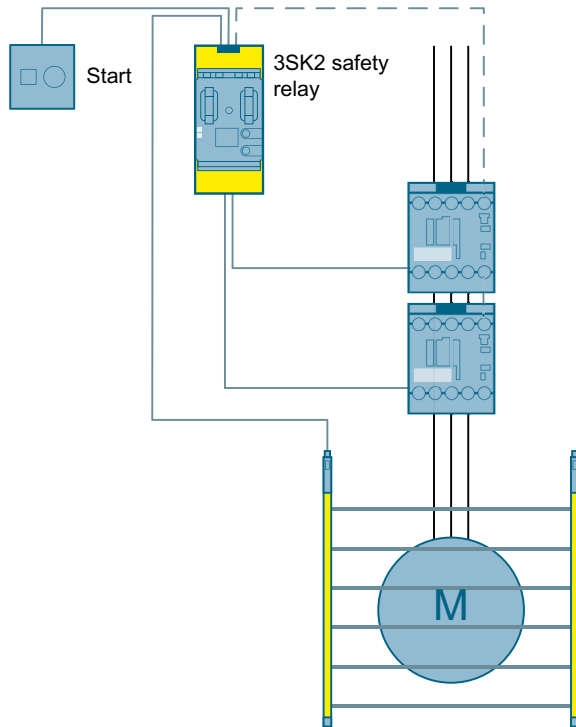
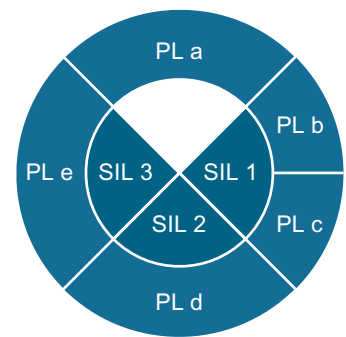

Figure 3-36 Access monitoring using a light curtain to SIL 3 or PL e with a 3SK2 safety relay

Operating principle

The light curtain consists of a send unit and a receive unit. Between the two is the protective zone. If the light beam is interrupted, outputs OSSD1 and OSSD2 carry voltage and are evaluated by the safety relay. When the light beam is interrupted, the two outputs switch off and the safety relay opens the enabling circuits, switching off the power contactors in a safety-related manner. If the light beam is uninterrupted and the feedback circuit is closed, you can switch on again. This can happen automatically or using a Start button, depending on the application.



Safety-related components

Light curtain	Safety relay	Contactors
		
SICK C4000	3SK2 (http://www.siemens.com/safety-relays)	2x 3RT20 (http://www.siemens.com/sirius-control)

See also

Circuit diagram, 3SK2 project and safety evaluation (<http://support.automation.siemens.com/WW/view/en/109479277>)

3.4.4 Access monitoring using a safety mat to SIL 3 or PL e with a 3SK1 safety relay

Application

Safety mats that trigger a shutdown signal when stepped on can be used to monitor access to an open danger zone.

Design

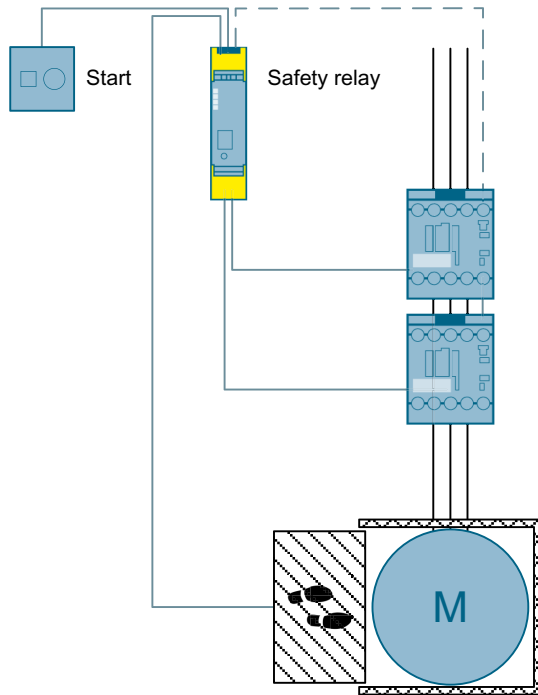
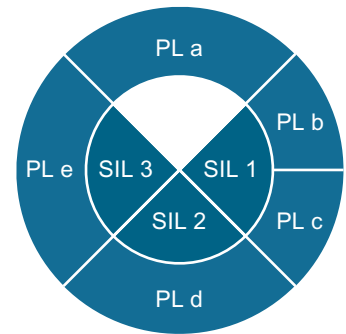

Figure 3-37 Access monitoring using a safety mat to SIL 3 or PL e with a 3SK1 safety relay

Operating principle

Safety mats based on the normally-closed (NC) principle (or NC-NO) can be evaluated with the 3SK1 safety relay. With this principle, the two-channel sensor circuit is interrupted if someone enters. The safety relay then opens the enabling circuits, switching the power contactors off in a safety-related manner. If the safety mat is free and the feedback circuit is closed, you can switch on again. This can happen automatically or using a Start button, depending on the application.



Safety-related components

Safety mat	Safety relay	Contactors
		
	3SK1 (http://www.siemens.com/safety-relays)	2x 3RT20 (http://www.siemens.com/sirius-control)

See also

Circuit diagram and safety evaluation (<http://support.automation.siemens.com/WW/view/en/77262359>)

3.4.5 Access monitoring using a safety mat to SIL 3 or PL e with a 3SK2 safety relay

Application

Safety mats that trigger a shutdown signal when stepped on can be used to monitor access to an open danger zone.

Design

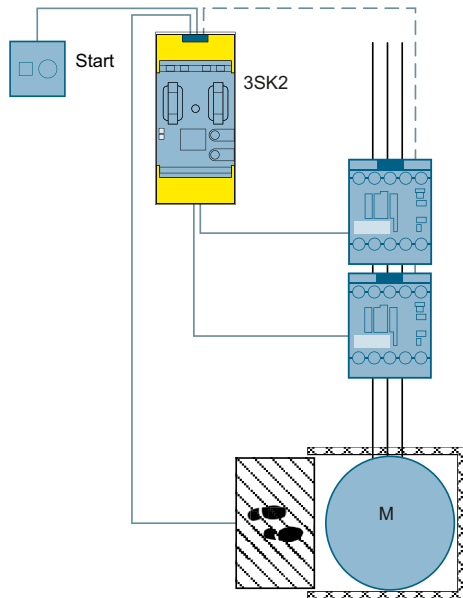
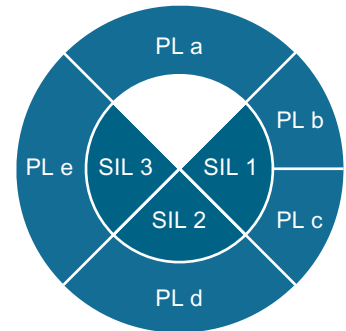

Figure 3-38 Access monitoring using a safety mat to SIL 3 or PL e with a 3SK2 safety relay

Operating principle

Safety mats can be based either on the normally-closed principle or on the cross-circuit principle. With the normally-closed principle, the two-channel sensor circuit is interrupted if someone enters. With the cross-circuit principle, on the other hand, a cross-circuit between the two sensor circuits is triggered if someone enters. In both cases, the signal is evaluated by the 3SK2 safety relay. The safety relay then opens the enabling circuits, switching the power contactors off in a safety-related manner. If the safety mat is free and the feedback circuit is closed, you can switch on again. This can happen automatically or using a Start button, depending on the application.



Safety-related components

Safety mat	Safety relay	Contactors
		
	3SK2 (http://www.siemens.com/safety-relays)	2x 3RT20 (http://www.siemens.com/sirius-control)

See also

Circuit diagram, 3SK2 project and safety evaluation (<http://support.automation.siemens.com/WW/view/en/109747651>)

3.4.6 Area monitoring using a laser scanner to SIL 2 or PL d with a 3SK1 safety relay

Application

Laser scanners are frequently used to monitor entire areas for unauthorized access. These provide wide-area monitoring of a danger zone, and they trigger a shutdown signal when objects are detected.

Design

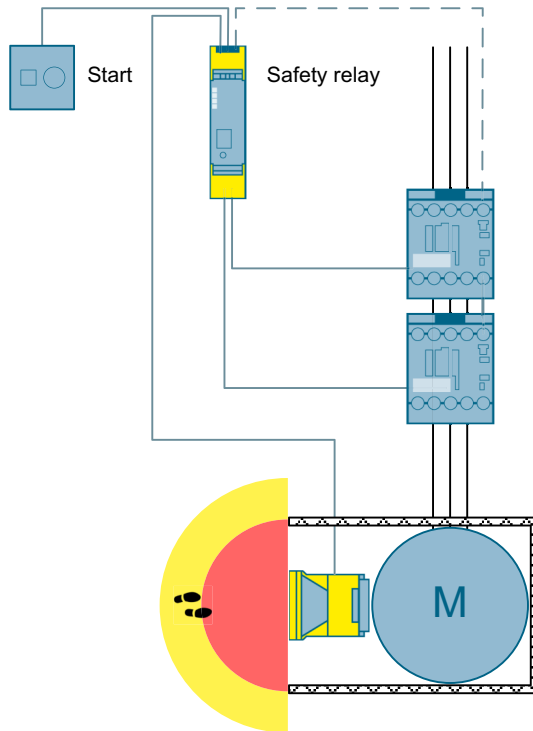
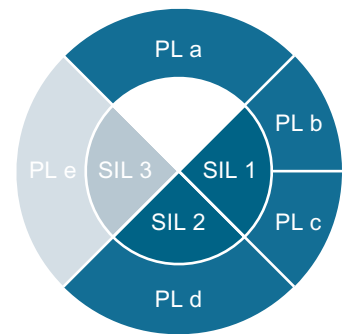

Figure 3-39 Area monitoring using a laser scanner to SIL 2 or PL d with a 3SK1 safety relay

Operating principle

The laser scanner provides wide-area monitoring of a safety area. This can usually be divided into a warning zone and a danger zone. When anyone enters the warning zone, a warning is output by means of an indicator light, for example. If anyone enters the safety zone on the other hand, the machine is switched off.

During operation, the outputs OSSD1 and OSSD2 carry voltage and are evaluated by the safety relay. When the light beam is interrupted, the two outputs switch off and the safety relay opens the enabling circuits, switching off the power contactors in a safety-related manner. If the light beam is uninterrupted and the feedback circuit is closed, you can switch on again. This can happen automatically or using a Start button, depending on the application.



Safety-related components

Laser scanner	Safety relay	Contactors
		
SICK S3000	3SK1 (http://www.siemens.com/safety-relays)	2x 3RT20 (http://www.siemens.com/sirius-control)

See also

Circuit diagram and safety evaluation (<http://support.automation.siemens.com/WW/view/en/77262367>)

3.4.7 Area monitoring using a laser scanner to SIL 2 or PL d with a 3SK2 safety relay

Application

Laser scanners are frequently used to monitor entire areas for unauthorized access. These provide wide-area monitoring of a danger zone, and they trigger a shutdown signal when objects are detected.

Design

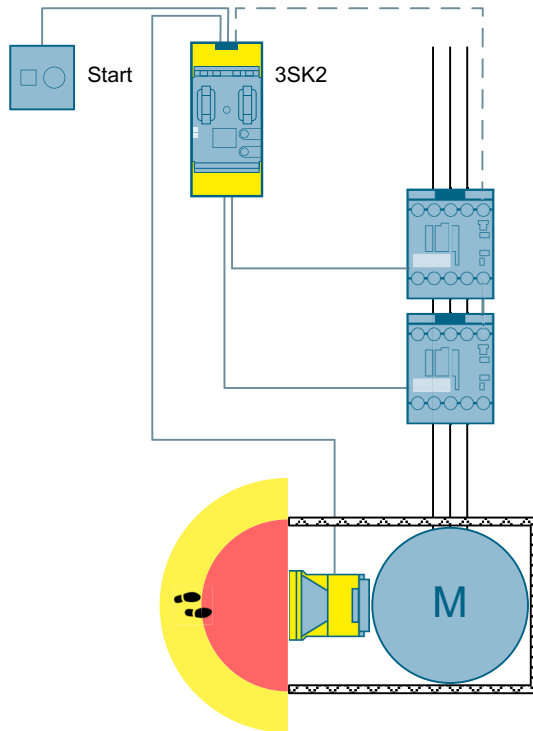
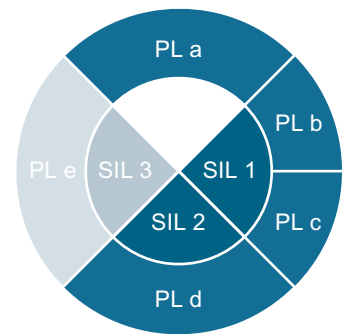

Figure 3-40 Area monitoring using a laser scanner to SIL 2 or PL d with a 3SK2 safety relay

Operating principle

The laser scanner provides wide-area monitoring of a safety area. This can usually be divided into a warning zone and a danger zone. When anyone enters the warning zone, a warning is output by means of an indicator light, for example. If anyone enters the safety zone on the other hand, the machine is switched off.

During operation, the outputs OSSD1 and OSSD2 carry voltage and are evaluated by the safety relay. When the light beam is interrupted, the two outputs switch off and the safety relay opens the enabling circuits, switching off the power contactors in a safety-related manner. If the light beam is uninterrupted and the feedback circuit is closed, you can switch on again. This can happen automatically or using a Start button, depending on the application.



Safety-related components

Laser scanner	Safety relay	Contactor
		
SICK S3000	3SK2 (http://www.siemens.com/safety-relays)	2x 3RT20 (http://www.siemens.com/sirius-control)

See also

Circuit diagram, 3SK2 project and safety evaluation (<http://support.automation.siemens.com/WW/view/en/109485647>)

3.5 Safe speed and standstill monitoring

3.5.1 Introduction

In machines in which the machine movement or moving parts can pose a hazard to people and machinery, speed monitoring or standstill monitoring is frequently used.

These applications are frequently implemented in conjunction with guards (protective door) and a protective door tumbler.

Interlocking devices with a tumbler are used to protect danger zones against undesired entry. There are usually two reasons for this:

1. To protect personnel against overtravel of dangerous machine movements, high temperatures, etc. ISO 14119 or EN 1088 provide guidelines for designing and selecting interlocking devices. These standards state that the danger zone must not be accessible until after the dangerous machine movement has been stopped.
2. A tumbler may be useful for reasons of process safety. This situation occurs when the hazard is stopped after opening the guard, but damage can occur to the machine or workpiece as a result. In this case, the machine is first moved to a controlled stop position before access is enabled.

With speed monitoring, a protective door tumbler is only unlocked, for example, when the moving part has come to a stop or is running at a safe speed.

With standstill monitoring, in contrast to speed monitoring, the protective door tumbler, for example, is only unlocked when standstill is achieved.

3.5.2 Safe speed monitoring to SIL 3 or PL e with a speed monitor

Application

To ensure that the speed of a motor is limited even in the event of a fault, and personnel are thus protected against possible falling tool parts, the speed is monitored with the help of a speed monitor.

Design

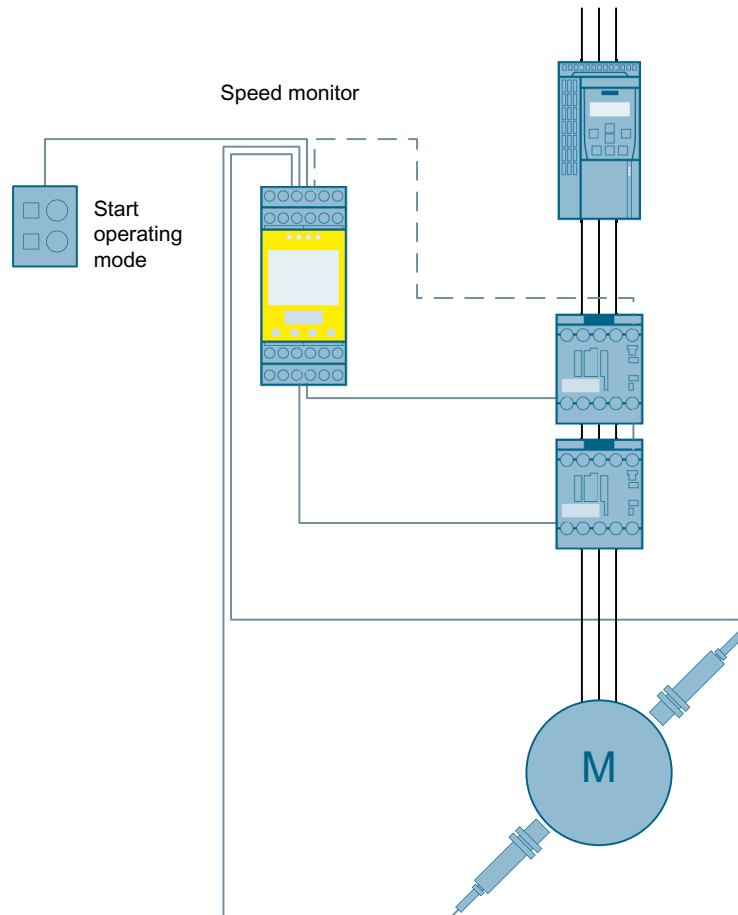

Figure 3-41 Safe speed monitoring to SIL 3 or PL e with a speed monitor

Operating principle

A specific speed limit or speed range (upper and lower limit) is set on the speed monitor.



You can change between setup mode and automatic mode with individual speed ranges using a mode switch.

If the respective speed window is overshoot or undershot, the power contactors are switched off in a safety-related manner.

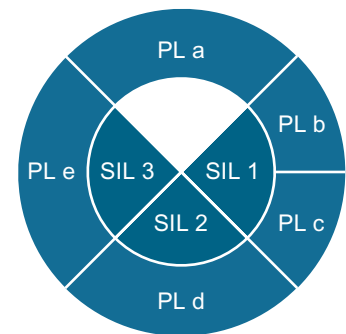
As soon as the actuators have switched off and the feedback circuit is closed, the Start button can be used to switch on again.



Safety-related components

Speed monitor	Contactor
 A Siemens 3TK2810-1 speed monitor, a yellow and black industrial device with a small LCD screen and multiple terminal blocks on top and bottom.	 A Siemens 2x 3RT20 contactor, a black industrial device with a handle on top and several terminals on the front and bottom.
3TK2810-1 (http://www.siemens.com/sirius-monitor)	2x 3RT20 (http://www.siemens.com/sirius-control)

See also

Circuit diagram and safety evaluation (<http://support.automation.siemens.com/WW/view/en/69065043>)

3.5.3 Safe standstill monitoring including protective door tumbler to SIL 3 or PL e with a 3SK2 safety relay

Application

The safety system monitors a protective door. The standstill monitor ensures access to the moving, dangerous machine parts is not permitted while the motor is operating.

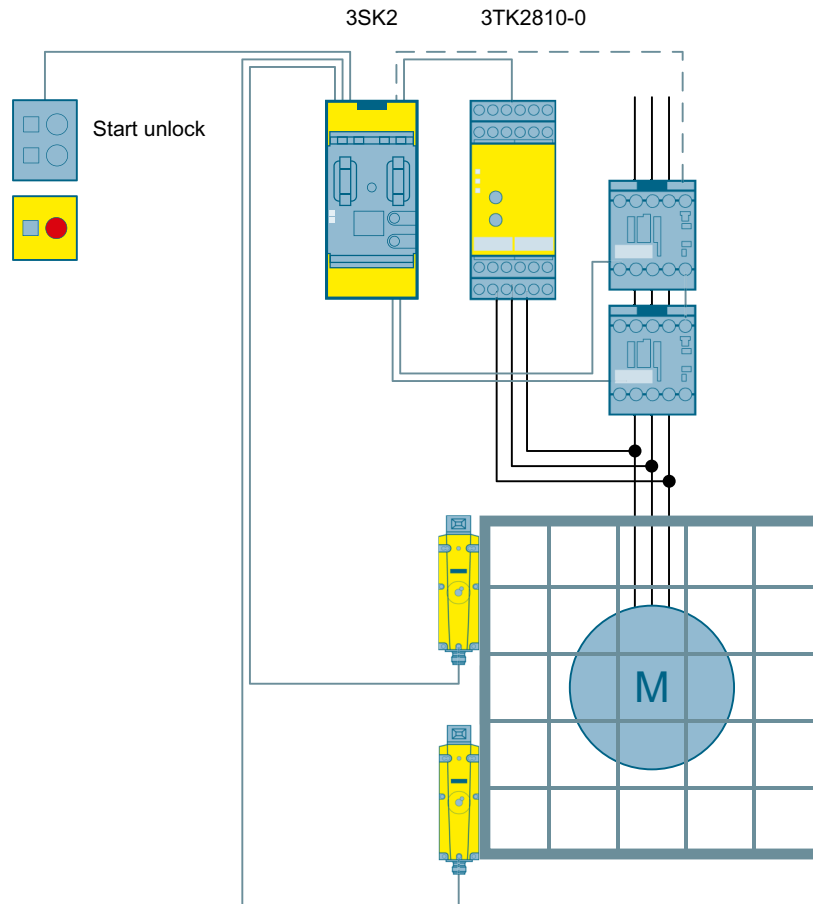

Figure 3-42 Safe standstill monitoring including protective door tumbler to SIL 3 or PL e with a 3SK2 safety relay

Operating principle

The 3TK2810-0 safe standstill monitor measures a voltage of the coasting motor induced by residual magnetization at three terminals of the stator winding. If the induction voltage approaches 0, this means motor standstill for the device and the output relays are activated.

The Modular Safety System monitors this signal from the standstill monitor as well as the two safety switches.

If motor standstill is detected and the button for unlocking is pressed, the tumbler is unlocked and the protective door can be opened. At the same time, the contactors are shut down in a safety-related manner, thus preventing unexpected restart of the motor.

If the door is locked and the feedback circuit is closed, the Start button can be used to switch on again.



The emergency stop is an additional safety function that is not considered further here.

In this example, safety switches with spring-actuated locks are used. This means that voltage must be actively applied to lift the tumbler.

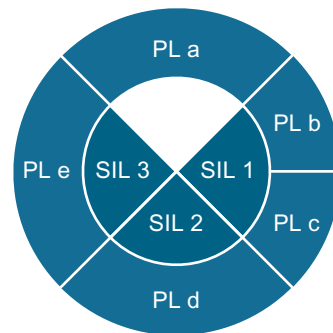
In contrast, safety switches with magnetic force locking are also available, but these cannot be used to implement SIL or PL for the "protective door tumbler" safety function.

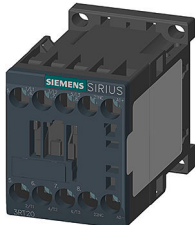

Safety-related components

Safety switches with tumbler	Standstill monitor	Safety relay	Contactors
			
2x 3SE5 (http://www.siemens.com/sirius-detecting)	3TK2810-0 (http://www.siemens.com/sirius-monitor)	3SK2 (http://www.siemens.com/safety-relays)	2x 3RT20 (http://www.siemens.com/sirius-control)

See also

Circuit diagram, 3SK2 project and safety evaluation (<http://support.automation.siemens.com/WW/view/en/109479278>)

3.5.4 Safe speed monitoring, protective door monitoring and tumbler monitoring to SIL 3 or PL e with a speed monitor

Application

The speed monitor ensures that no access is permitted to the moving, dangerous machine parts above an adjustable speed.

Design

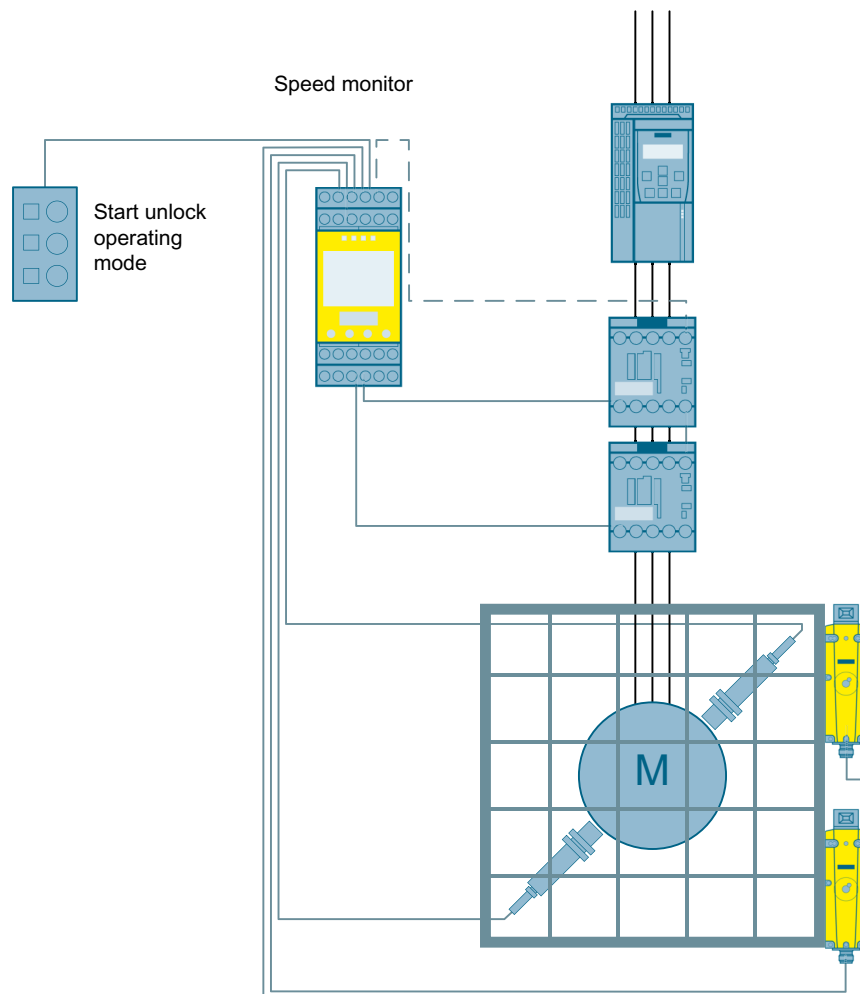
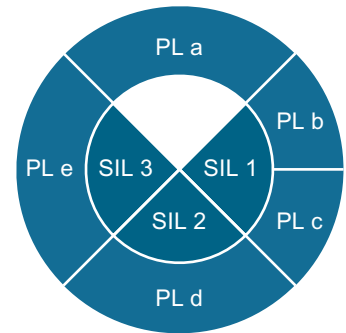

Figure 3-43 Safe speed monitoring, protective door monitoring and tumbler monitoring to SIL 3 or PL e with a speed monitor

Operating principle

A safe speed window is set on the speed monitor. As long as the speed is outside this safe speed window, access to the moving, dangerous machine parts is prevented by a protective door with a tumbler. At the same time, the speed monitor monitors the position of the protective door.

You can change between setup mode and automatic with individual speed windows using a mode switch. A detected standstill and observance of the set speed window are output via two relay outputs.





In automatic mode, the protective door remains locked as long as no standstill is detected. If the automatic speed window is overshoot or undershot, the power contactors are switched off in a safety-related way.

In setup mode, the protective door is permanently enabled. If the setup speed window is overshoot or undershot, the power contactors are switched off.

If the protective door is open, the speed monitor ensures that the motor cannot be switched on. If the door is closed and the feedback circuit is closed, the Start button can be used to switch on again.

Safety-related components

Safety switches with tumbler	Speed monitors	Contactors
		
2x 3SE5 (http://www.siemens.com/sirius-detecting)	3TK2810-1 (http://www.siemens.com/sirius-monitor)	2x 3RT20 (http://www.siemens.com/sirius-control)

See also

Circuit diagram and safety evaluation (<http://support.automation.siemens.com/WW/view/en/77284316>)

3.6 Safe operator input

3.6.1 Introduction

If an operator has to work within a danger zone, e.g. when positioning or removing workpieces for presses, stamping presses or similar machinery, safety functions must be implemented for the safe operation of the machine. Starting of the dangerous movement must only be allowed if, for example, no parts of the operator's body are within the danger zone. One method of implementing this is by using two-hand operation. This involves the operator pressing two pushbuttons almost simultaneously with both hands to start the machine or the dangerous movement. Releasing either of the pushbuttons causes the machine or the movement to stop.

The following chapter contains application examples with two-hand operation for safe operation of a machine.

Note

Selection of a two-hand control device as suitable safety equipment depends on the risk assessment.

For certain applications, two-hand operation may not be suitable because manual operation is not possible. The single-pedal safety foot switches 3SE2924-3AA20 are the ideal solution here. The switches have an interlock function according to EN ISO 13850 and are protected against unintentional operation by a protective cover. The switches are provided with two contact blocks with one NO contact and one NC contact each.

The normal workflow is initiated by pressing down the pedal as far as the pressure point so that the two NO contacts close and, for example, the motor starts to run. If the pedal is pressed beyond the resistance of the pressure point in case of danger, the positively driven NC contacts are opened and the motor is stopped. At the same time, the automatic latching takes effect and holds the NC contacts in the open position. This prevents an uncontrolled continued operation or a restart of moving machine parts. Once the hazard has been eliminated, the machine can only be restarted after manual unlocking via a pushbutton on the top of the enclosure. The contacts are then released again and return to their initial state.

3.6.2 Two-hand operation to SIL 3 or PL e with a 3SK1 safety relay

Application

Two-hand operation consoles comprise two pushbuttons that must be pressed simultaneously to operate a machine. This prevents the operator from reaching into the danger zone during operation.

Design

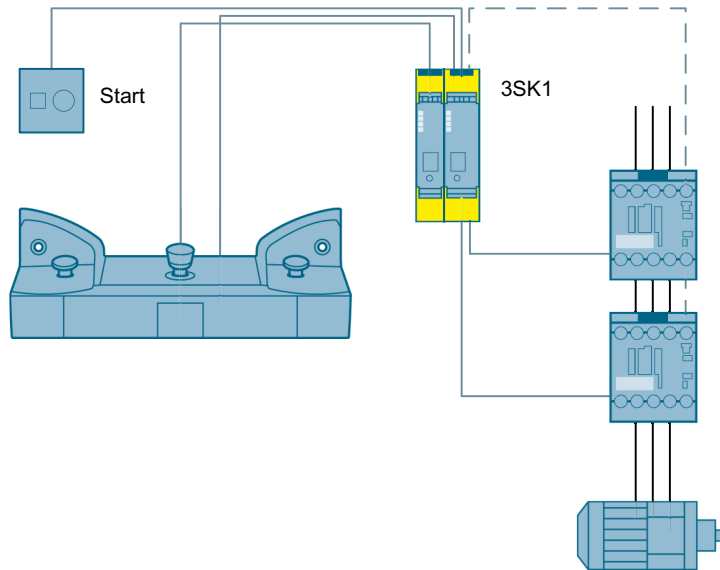

Figure 3-44 Two-hand operation to SIL 3 or PL e with a 3SK1 safety relay

Operating principle

By imposing the condition of simultaneous pressing of both pushbuttons, the operator is restricted to the two-hand operation console and is thus unable to reach into the danger zone. The 3SK1 safety relay only switches the enabling circuits when both signals are active within 500 ms and the feedback circuit is closed.

If one of the two pushbuttons is released, the 3SK1 safety relay immediately switches the machine off in a safety-related way.

After the emergency stop is actuated, the Start button must be used to restart.

The circuit shown here (with only one NO contact per switch sensor) meets the requirements of Type IIIB according to EN574 or EN ISO 13851. By using appropriately approved switches and cross-circuit proof wiring, applications up to type IIIC in acc. with EN 574 or EN ISO 13851 can be set up with the 3SK1 safety relays. For details, refer to the 3SK1 Equipment Manual (<https://support.industry.siemens.com/cs/document/67585885/equipment-manual-sirius-3sk1-safety-relays?dti=0&lc=en-AT>).

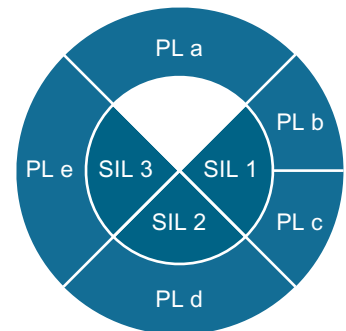

Safety-related components

Two-hand operation console	Safety relay	Input expansion	Contactors
			
3SU18 (http://www.siemens.com/sirius-command)	3SK1 (http://www.siemens.com/safety-relays)	3SK1 (http://www.siemens.com/safety-relays)	2x 3RT20 (http://www.siemens.com/sirius-control)

See also

Circuit diagram and safety evaluation (<http://support.automation.siemens.com/WW/view/en/74562494>)

Use of the sensor switch in the two-hand operation console (<http://support.automation.siemens.com/WW/view/en/109479531>)

3.6.3 Two-hand operation to SIL 3 or PL e with a 3SK2 safety relay

Application

Two-hand operation consoles comprise two pushbuttons that must be pressed simultaneously to operate a machine. This prevents the operator from reaching into the danger zone during operation.

Design

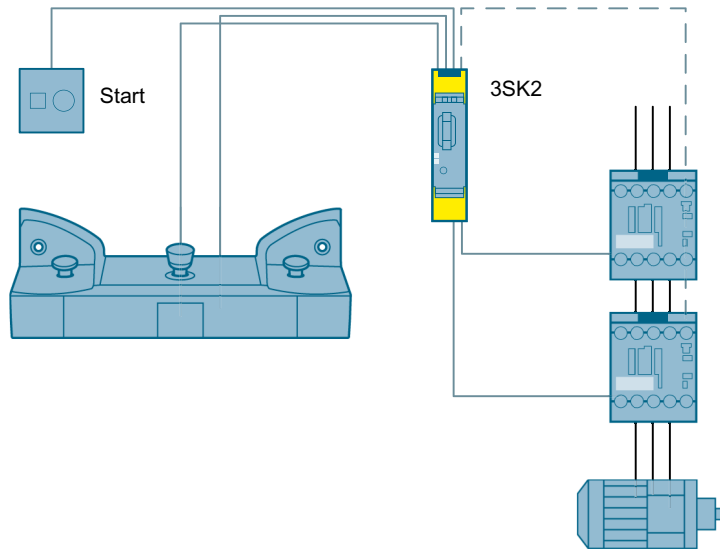

Figure 3-45 Two-hand operation to SIL 3 or PL e with a 3SK2 safety relay

Operating principle

By imposing the condition of simultaneous pressing of both pushbuttons, the operator is restricted to the two-hand operation console and is thus unable to reach into the danger zone. The 3SK2 safety relay only switches the enabling circuits when both signals are active within 500 ms and the feedback circuit is closed.

If one of the two pushbuttons is released, the 3SK2 safety relay immediately switches the machine off in a safety-related way.

The four-channel design in the two-hand operation console ensures that possible welding of one of the contacts is detected immediately.

After the emergency stop is actuated, the Start button must be used to restart.

The circuit shown here meets the requirements of Type III C according to EN574 or EN ISO 13851.

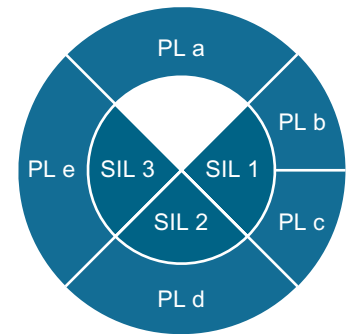

Safety-oriented components

Two-hand operation console	Safety relay	Contactor
		
3SU18 (http://www.siemens.com/sirius-command)	3SK2 (http://www.siemens.com/safety-relays)	2x 3RT20 (http://www.siemens.com/sirius-control)

See also

Circuit diagram, 3SK2 project and safety evaluation (<http://support.automation.siemens.com/WW/view/en/109479279>)

Use of the sensor switch in the two-hand operation console (<http://support.automation.siemens.com/WW/view/en/109479531>)

3.7 Typical combinations of multiple safety functions

3.7.1 Introduction

Only in the rarest of cases is it sufficient to implement only one safety function on a machine. Different safety functions from the previous chapters are frequently implemented on one machine to achieve the required level of safety.

Application examples containing typical combinations of safety functions are shown in the following chapter.

Conditions for series connection of emergency stop command devices and protective door monitoring with position switches

Emergency stop command devices and position switches may only be connected in series up to PL d (per ISO 13849) or SIL 2 (per IEC 62061) if it can be ensured that the emergency stop command device and the protective door will not be actuated simultaneously (otherwise a fault cannot be detected).

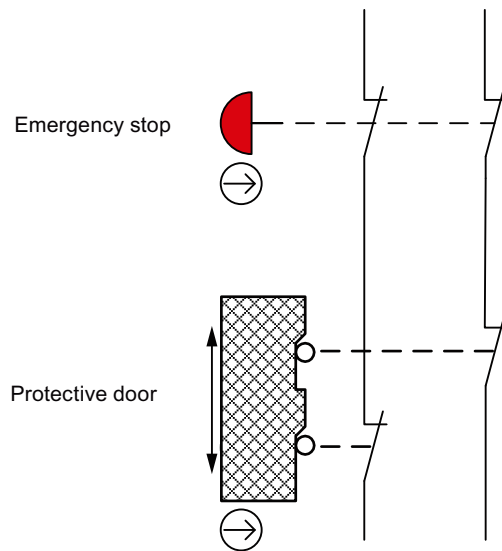

Linking or cascading safety functions

If two or more plant sections are linked together, in other words, the requirement for a safety function in one plant section triggers the requirement for a safety function in the other plant section, transfer of the signal must meet the same safety function requirements in the affected plant section.

Example:

An emergency stop command device is monitored in both plant sections. The emergency stop function in plant section 1 is designed according to SIL 3 or PL e, and in plant section 2 according to SIL 2 or PL d.

Although an emergency stop command issued in plant section 2 only affects this plant section, an emergency stop command issued in plant section 1 must bring both plant sections to a safe standstill.

Since the risk assessment for plant section 2 requires SIL 2 or PL d, transfer of the signal for the emergency stop command from plant section 1 must correspond at least to this safety level. The signal lines must, therefore, be cross-circuit proof, or the signal must be transferred via a safe communication line (such as ASIsafe).

The hazard zone must always be clearly visible from the position from which the start/restart command is issued. Whether or not each plant section requires its own Start button depends on the plant and the risk assessment.

Note

Linking may be implemented within a control cabinet in a single-channel configuration. This is even permissible up to SIL 3 or PL e, because cable routing within a control cabinet is regarded as short-circuit-proof and short-circuit- to-P-potential-proof (fault exclusion in accordance with ISO 13849-2).

3.7.2 Safe temperature monitoring up to SIL 1 or PL c with a 3RS2 temperature monitoring relay

Application

The temperature of bodies that can develop a corresponding heat and are freely accessible must be monitored. If a defined temperature limit is exceeded, the 3RS2 switches the overheated motor off via a contactor in a safety-oriented manner.

Design

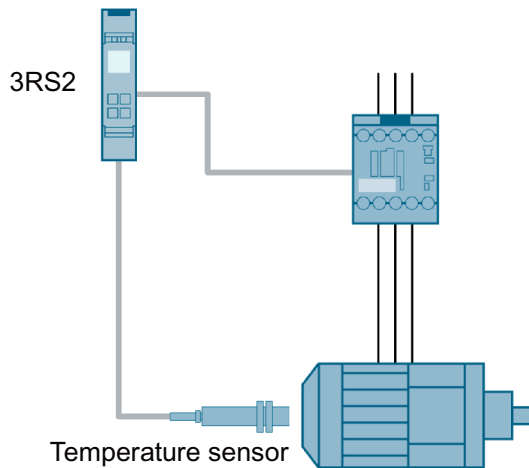

Figure 3-46 Safe temperature monitoring up to SIL 1 or PL c with a 3RS2 temperature monitoring relay

Operating principle



According to EN ISO 12100, Annex B, there is a potential hazard "burns due to contact with high-temperature material", which must be evaluated and reduced if necessary during the risk assessment. The temperature of bodies that can develop a corresponding heat and are freely accessible must be monitored. The 3RS2 switches off the overheated motor directly via a contactor in a safety-oriented manner up to SIL 1 / PL c if a defined temperature limit value is exceeded, without the need for an intermediate safety relay.

A 3RS26 or 3RS28 temperature monitoring relay from the 3RS2 series is used here. These two device types can be used in safety applications up to SIL 1 / PL c.

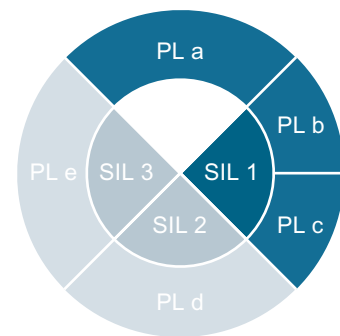
Further information on the parameterization of the 3RS2 temperature monitoring relays can be found in the manual (<https://support.industry.siemens.com/cs/de/en/view/109772132>).



Safety-oriented components

Temperature monitoring relays	Contactor
	
3RS2 (http://www.siemens.com/sirius-monitor)	3RT20 (http://www.siemens.com/sirius-control)

See also

Circuit diagram and safety evaluation (<https://support.industry.siemens.com/cs/ww/en/view/109780387>)

3.7.3 Safe temperature monitoring and protective door monitoring with tumbler up to SIL 1 or PL c with a 3RS2 temperature monitoring relay and 3SK2 safety relay

Application

Access to an area with bodies that can develop a corresponding heat is prevented by an enclosure with a protective door. The 3SK2 monitors the position of the protective door and switches off the motor in a safety-oriented manner if access is requested. Locking of the protective door is maintained by the 3SK2 until the 3RS2 signals to the 3SK2 that the temperature has fallen below a defined limit value.

Design

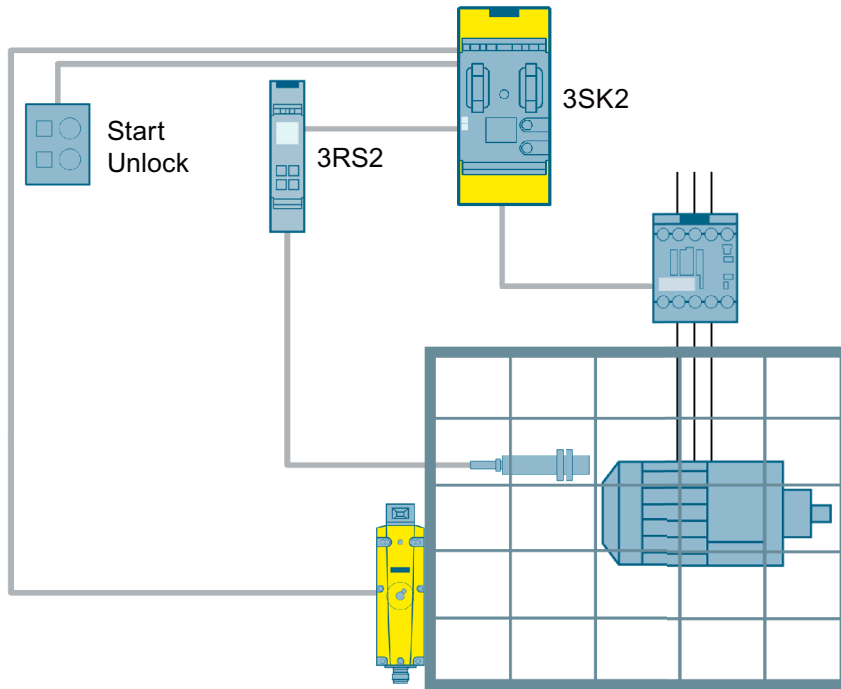
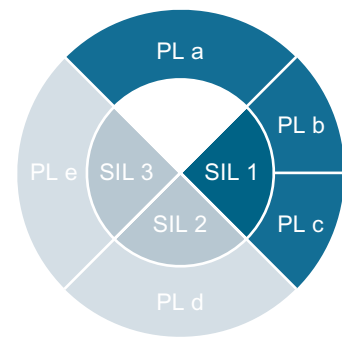

Figure 3-47 Safe temperature monitoring and protective door monitoring with tumbler up to SIL 1 or PL c with a 3RS2 temperature monitoring relay and 3SK2 safety relay



Operating principle

According to EN ISO 12100, Annex B, there is a potential hazard "burns due to contact with high-temperature material", which must be evaluated and reduced if necessary during the risk assessment. Bodies that can develop a corresponding heat are enclosed. However, for service work, for example, the area must be accessible via a protective door. In the event of an access request, the 3SK2 safety relay switches off the motor via a contactor in a safety-oriented manner. The 3RS2 signals the undershooting of a defined temperature limit to the 3SK2 in a safety-oriented manner up to SIL 1 / PL c. The 3SK2 then releases the protective door and the service personnel can enter the area. A 3RS26 or 3RS28 temperature monitoring relay from the 3RS2 series is used here. These two device types can be used in safety applications up to SIL 1 / PL c.

Further information on the parameterization of the 3RS2 temperature monitoring relays can be found in the manual (<https://support.industry.siemens.com/cs/defen/view/109772132>).

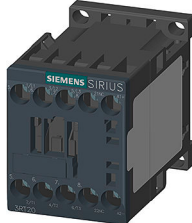

Safety-oriented components

Safety switch with tumbler	Temperature monitoring relays	Safety relay	Contactors
			
2x 3SE5 (https://w3.siemens.com/mcms/industrial-controls/en/detecting-devices/Pages/default.aspx)	3RS2 (https://new.siemens.com/global/en/products/automation/industrial-controls/sirius/sirius-monitor.html)	3SK2 (http://www.siemens.com/safety-relays)	3RT20 (http://www.siemens.com/sirius-control)

See also

Circuit diagram, 3SK2 project and safety evaluation (<https://support.industry.siemens.com/cs/ww/en/view/109780388>)

3.7.4 Safe current monitoring including emergency stop shutdown up to PL d with a 3SK2 safety relay and two current monitoring relays

Application

The current consumption of a fan motor, for example, rises as the filter becomes clogged. This is why drives have to be shut down when a set limit value is exceeded. The current consumption is monitored with the aid of two current monitoring relays with diverse technologies (3UG4 and 3RR2) and one 3SK2 safety relay. An emergency stop command device is additionally monitored for shutting down the motor in an emergency.

Design

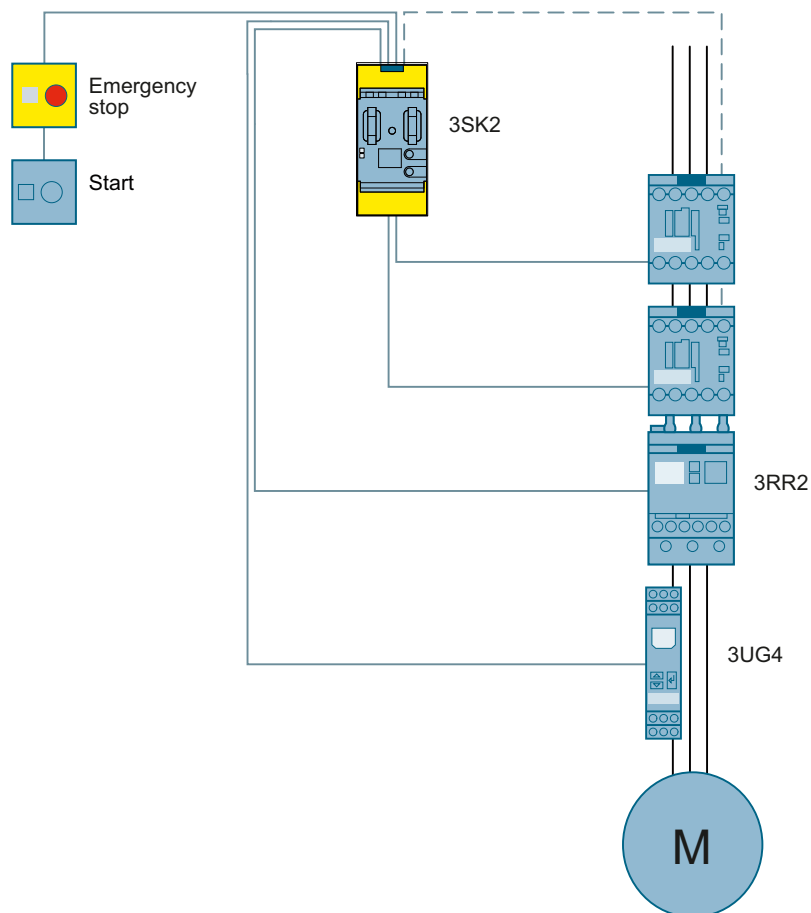

Figure 3-48 Safe current monitoring including emergency stop shutdown up to PL d with a 3SK2 safety relay and two current monitoring relays

Operating principle

It is possible to achieve up to PL d with the redundant use of two current monitoring relays with diverse technologies. A specific current limit or current range (upper and lower limit) is set here on both 3UG4 and 3RR2 current monitoring relays. These monitor the current consumption of the motor continuously and indicate via relay contacts whether the range or the limit is maintained or exceeded.

The safety relay in turn monitors the signals of the current monitoring relays, as well as the two emergency stop contacts, for discrepancy and cross circuit. If the current consumption of the motor exceeds the current limit or range, or if the emergency stop command device is actuated, the motor is immediately shut down in a safety-related way.

If the current consumption of the motor has fallen below the current limit again or is within the current range, if the emergency stop command device is unlatched and the feedback circuit is closed, the Start button can be used to switch on again.

This example was evaluated as PL d according to ISO 13849-1. This evaluation is not directly transferable to a SIL according to IEC 62061.

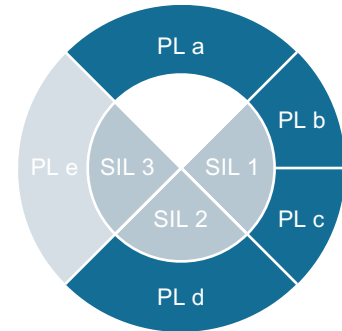



Note

If two redundant monitoring relays are used in the sensor circuit to detect process variables, this can result in one monitoring relay detecting a limit overshoot before the other. This can be caused by setting or measuring deviations of the devices.

In the example given above, one monitoring relay could detect the limit overshoot shortly before the other in the case of a continuous increase in current. In this case, the power supply to the drive is switched off. Due to the necessary cross-comparison of the inputs in safety-related evaluation, the discrepancy error remains active. The application can only be switched on again after zero crossing of both channels. In this case, the monitoring relays must be checked and manually reset.

This behavior can occur when monitoring slowly increasing process variables. One possibility for avoiding a discrepancy error, for example, is an empirical calculation of the setting parameters for synchronizing the monitoring relays

Safety-related components

Emergency stop command device	Current monitoring relay		Safety relay	Contactor
				
<p>3SU1 (http://www.siemens.com/sirius-act)</p>	<p>3UG4 and 3RR2 (http://www.siemens.com/sirius-monitor)</p>		<p>3SK2 (http://www.siemens.com/safety-relays)</p>	<p>2x 3RT20 (http://www.siemens.com/sirius-control)</p>

See also

Circuit diagram, 3SK2 project and safety evaluation (<http://support.automation.siemens.com/WW/view/en/109747652>)

Document on the use of monitoring relays in safety applications (<http://support.automation.siemens.com/WW/view/en/39863898>)

3.7.5 Emergency stop monitoring and protective door monitoring to SIL 3 or PL e with a 3SK1 safety relay

Application

Protective doors are frequently used to fence off danger zones. These are monitored for position and, if necessary, the area from which the hazard emanates is switched off. An emergency stop command device is additionally monitored for shutting down the machine in an emergency.

Design

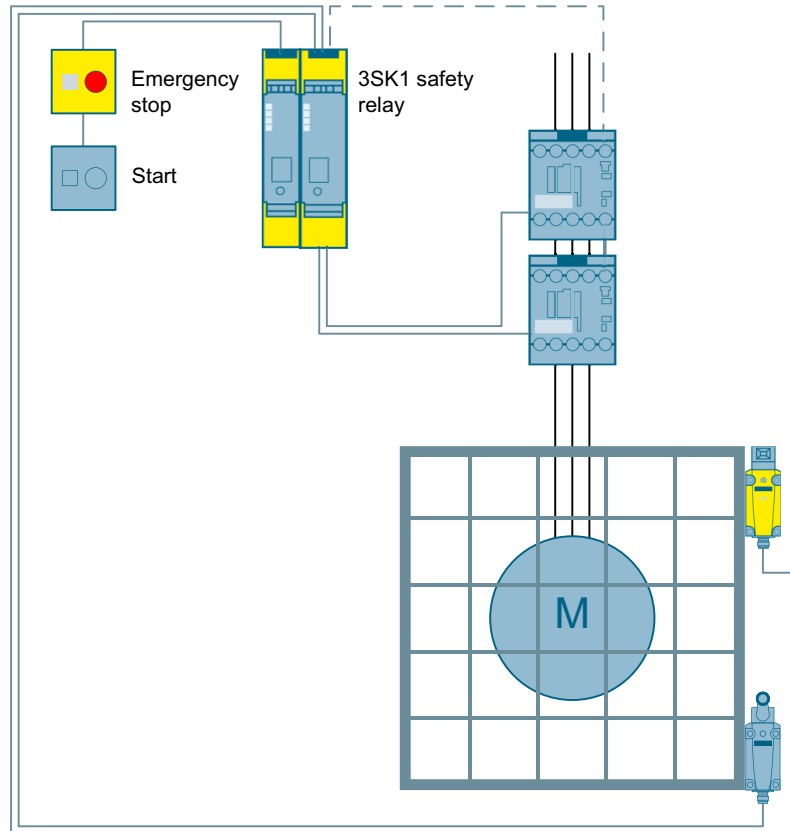
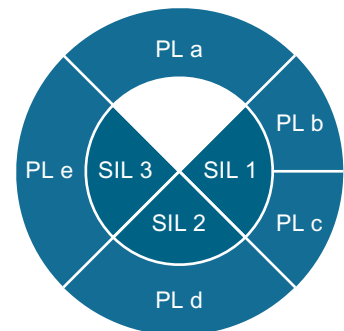

Figure 3-49 Emergency stop monitoring and protective door monitoring to SIL 3 or PL e with a 3SK1 safety relay

Operating principle

The safety relay monitors the two safety switches as well as the two emergency stop contacts via an additional input expansion. When the emergency stop command device is actuated or the protective door is opened, the safety relay opens the enabling circuits and switches the power contactors off in a safety-related way.

If the door is closed, the emergency stop command device is unlatched and the feedback circuit is closed, the Start button can be used to switch on again.



Safety-related components

Emergency stop command device	Position switches		Safety relay	Input expansion	Contactor
					
3SU1 (http://www.siemens.com/sirius-act)	2x 3SE5 (http://www.siemens.com/sirius-detecting)		3SK1 (http://www.siemens.com/safety-relays)	3SK1 (http://www.siemens.com/safety-relays)	2x 3RT20 (http://www.siemens.com/sirius-control)

See also

Circuit diagram and safety evaluation (<http://support.automation.siemens.com/WW/view/en/74562495>)

3.7.6 Emergency stop monitoring and protective door monitoring to SIL 3 or PL e with a 3SK2 safety relay

Application

Protective doors are frequently used to fence off danger zones. These are monitored for position and, if necessary, the area from which the hazard emanates is switched off. An emergency stop command device is additionally monitored for shutting down the machine in an emergency.

Design

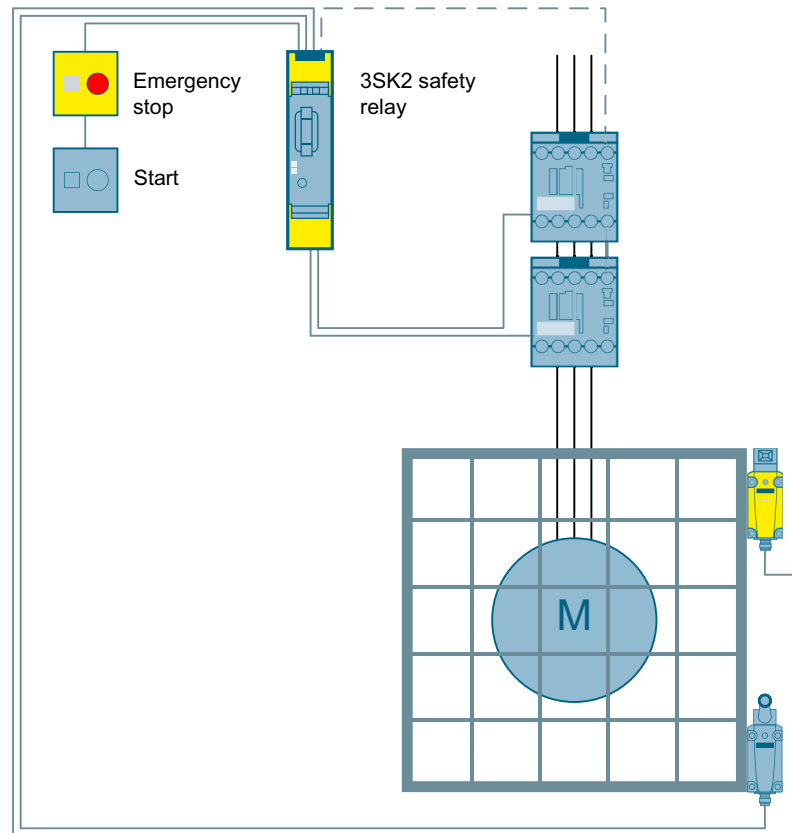
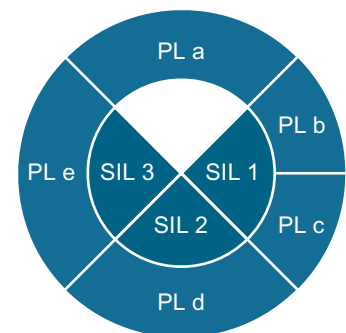

Figure 3-50 Emergency stop monitoring and protective door monitoring to SIL 3 or PL e with a 3SK2 safety relay



Operating principle

The safety relay monitors the two safety switches as well as the emergency stop command device on two channels. When the emergency stop command device is actuated or the protective door is opened, the safety relay opens the enabling circuits and switches the power contactors off in a safety-related way.

If the door is closed, the emergency stop command device is unlatched and the feedback circuit is closed, the Start button can be used to switch on again.



Safety-related components

Emergency stop command device	Position switches		Safety relay	Contactor
				
<p>3SU1 (http://www.siemens.com/sirius-act)</p>	<p>2x 3SE5 (http://www.siemens.com/sirius-detecting)</p>		<p>3SK2 (http://www.siemens.com/safety-relays)</p>	<p>2x 3RT20 (http://www.siemens.com/sirius-control)</p>

See also

Circuit diagram, 3SK2 project and safety evaluation (<http://support.automation.siemens.com/WW/view/en/109479280>)

3.7.7 Access monitoring using a light curtain with two-hand operation and emergency stop to SIL 3 or PL e with a 3SK2 safety relay

Application

To monitor access to an open danger zone, so-called non-contact protective equipment such as a light curtain can be used. If the light beam is interrupted, a shutdown signal is triggered.

To enable safe operation of the actuator, two-hand operation is used. This prevents the operator from reaching into the danger zone during operation.

Design

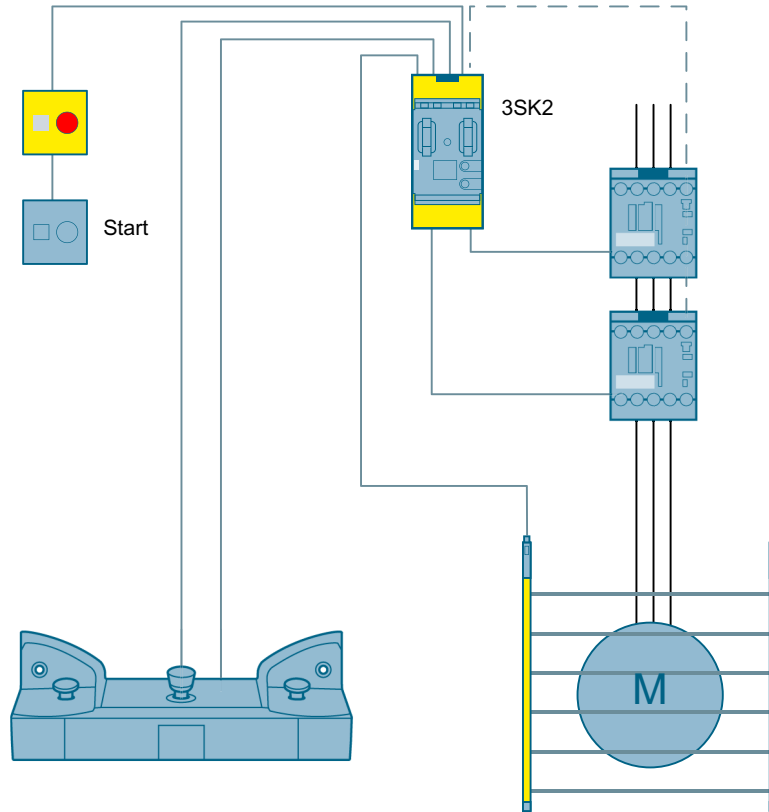

Figure 3-51 Access monitoring using a light curtain with two-hand operation and emergency stop to SIL 3 or PL e with a 3SK2 safety relay

Operating principle

The light curtain consists of a send unit and a receive unit. Between the two is the protective zone. If the light beam is not interrupted, outputs OSSD1 and OSSD2 carry voltage and are evaluated by the safety relay. When the light beam is interrupted, the two outputs switch off and the safety relay opens the enabling circuits, switching off the power contactors in a safety-related way.

In addition, simultaneous actuation of the two-hand operation console prevents the operator from reaching into the danger zone. The 3SK2 safety relay only switches the enabling circuits when both signals are active within 500 ms, the light beam of the light curtain is uninterrupted, and the feedback circuit is closed.

If one of the two pushbuttons is released, the 3SK2 safety relay immediately switches the machine off in a safety-related way.

The four-channel design in the two-hand operation console ensures that possible welding of one of the contacts is detected immediately.

The plant is also switched off in a safety-related way after operation of both emergency stop command units.

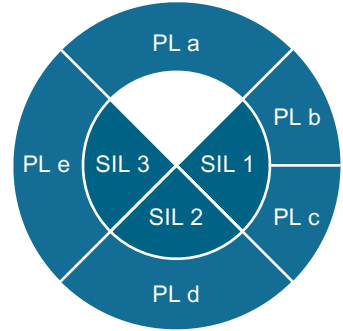

Safety-oriented components

Emergency stop command device	Light curtain	Two-hand operation console	Safety relay	Contactors
				
3SU1 (2-channel) (http://www.siemens.com/sirius-act)	SICK C4000	3SU18 (http://www.siemens.com/sirius-command)	3SK2 (http://www.siemens.com/safety-relays)	2x 3RT20 (http://www.siemens.com/sirius-control)

See also

Circuit diagram, 3SK2 project and safety evaluation (<http://support.automation.siemens.com/WW/view/en/109485648>)

3.7.8 Cascading of 3SK1 safety relays to SIL 3 or PL e

Application

Cascading of safety relays is used for tripping several safety relays in series. Multiple safety functions can then be logically connected to a shared shutdown path. At the same time, several enabling circuits can be created for selective shutdown of drive elements.

Design

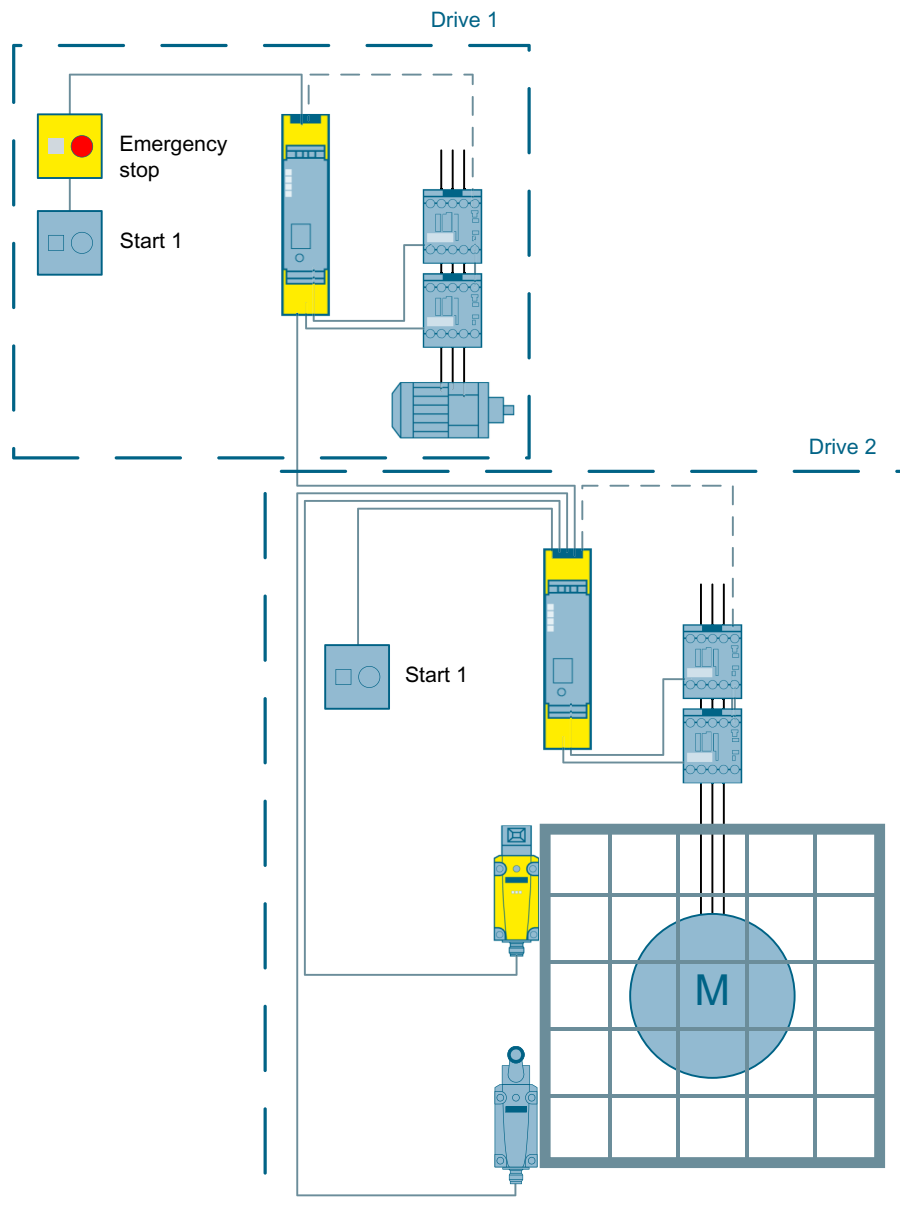
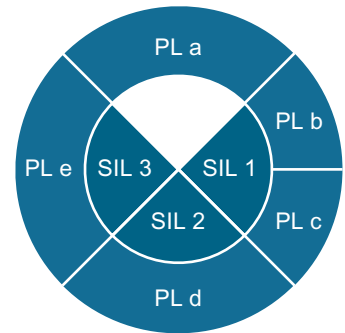

Figure 3-52 Cascading of 3SK1 safety relays to SIL 3 or PL e

Operating principle

The two safety relays represented are logically connected via the cascading input. If the emergency stop is triggered at the first safety relay, both safety relays then switch their actuators off. By contrast, if the protective hood shown is opened, only the associated actuators are switched off, for example.



If an emergency stop has been triggered by the higher-level safety relay, the lower-level safety relay must be switched on again manually using the Start button. A global Start button is only possible if all danger zones are visible from this Start button.



Note

This example applies to configurations within a control cabinet. If the two safety relays are not located in the same control cabinet, other precautions must be taken, such as cross-circuit-proof laying of the cascading signal.

Safety-related components

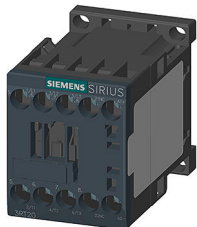
Emergency stop command device	Safety switch	Safety relay	Contactors
			
3SU1 (http://www.siemens.com/sirius-act)	2x 3SE5 (http://www.siemens.com/sirius-detecting)	2x 3SK1 (http://www.siemens.com/safety-relays)	4x 3RT20 (http://www.siemens.com/sirius-control)

See also

Circuit diagram and safety evaluation (<http://support.automation.siemens.com/WW/view/en/77282496>)

3.7.9 Safe slave-to-slave communication between several plant sections to SIL 3 or PL e via AS-i

Application

To link several plant sections logically to each other, slave-to-slave communication is required. This must be fail-safe in design to also enable transfer of safe shutdown signals. The modular safety system offers such an option with AS-i.

Design

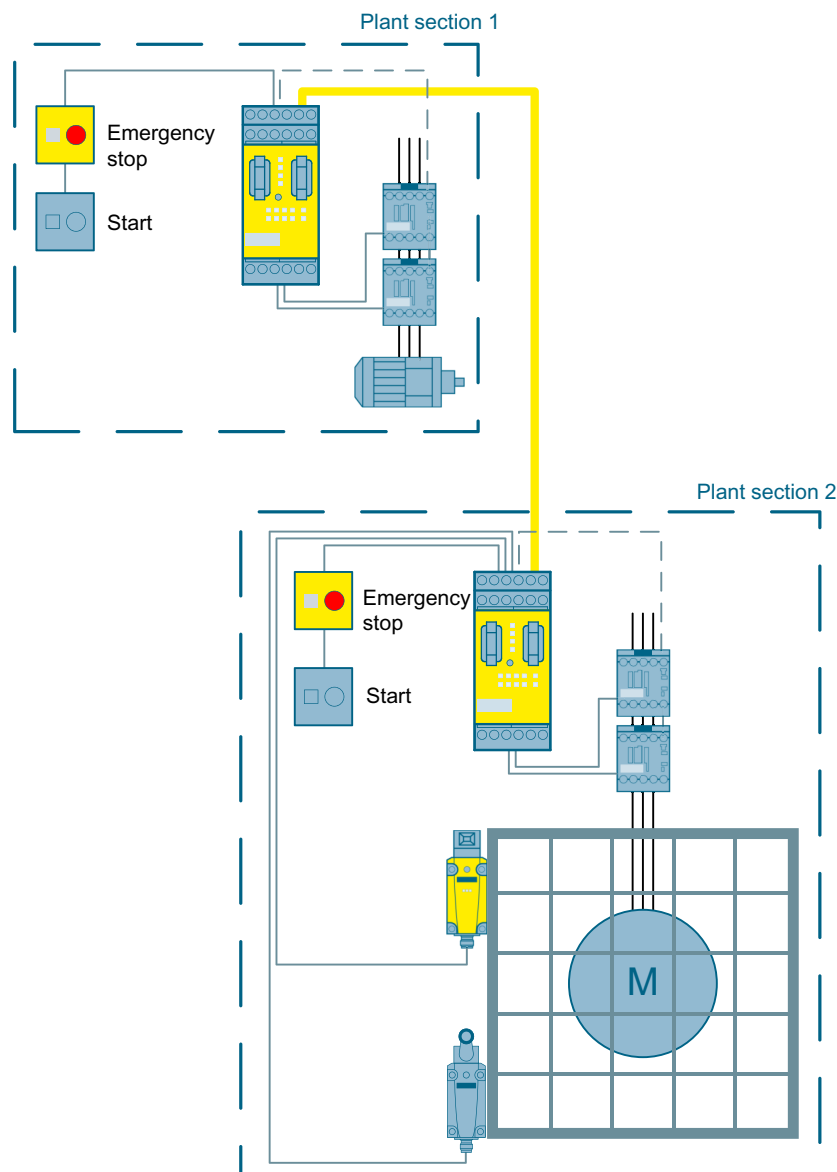
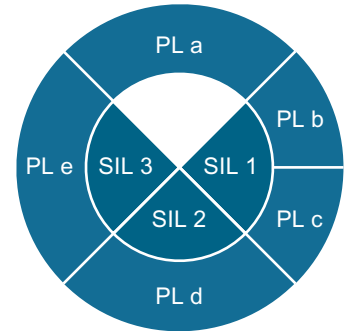

Figure 3-53 Safe slave-to-slave communication between several plant sections to SIL 3 or PL e via AS-i

Operating principle

Both plant sections are independent of each other due to the process. If the machine is shut down in one of the two plant sections, this shutdown command is forwarded to the modular safety system in the other plant section by means of safe slave-to-slave communication via AS-i.





In addition, diagnostics information and alarm signals can also be exchanged between the two plant sections.



Note

Whether both plant sections can be switched on again using the Start button, or whether each plant section requires its own Start button, depends on the plant and the risk assessment.

Safety-related components

Emergency stop command device	Safety switch	Modular safety system	Contactors
			
2x 3SU1 (http://www.siemens.com/sirius-act)	2x 3SE5 (http://www.siemens.com/sirius-detecting)	2x 3RK3 (http://www.siemens.com/sirius-monitor)	4x 3RT20 (http://www.siemens.com/sirius-control)

Note

In addition to the safety-related components, operation of an AS-i network requires an AS-i master and an AS-i power supply.

See also

MSS project and safety evaluation (<http://support.automation.siemens.com/WW/view/en/88823146>)

More detailed FAQs on: Safe slave-to-slave communication (<http://support.automation.siemens.com/WW/view/en/58512565>)

3.7.10 Protective door monitoring by means of magnetically-operated switches and emergency shutdown using cable-operated switches up to SIL3 or PL e by means of AS-i ET 200SP Master and AS-i SlimLine compact modules

Application

Protective doors are frequently used to fence off danger zones. These are monitored for position and, if necessary, the area from which the hazard emanates is switched off, by means of a 3SE6 solenoid-operated switch. A 3SE7 cable-operated switch is additionally monitored for shutting down the machine in an emergency. For connection to the fail-safe controller, AS-Interface SlimLine compact modules and CM AS-i Master and F-CM AS-i Safety are used.

Design

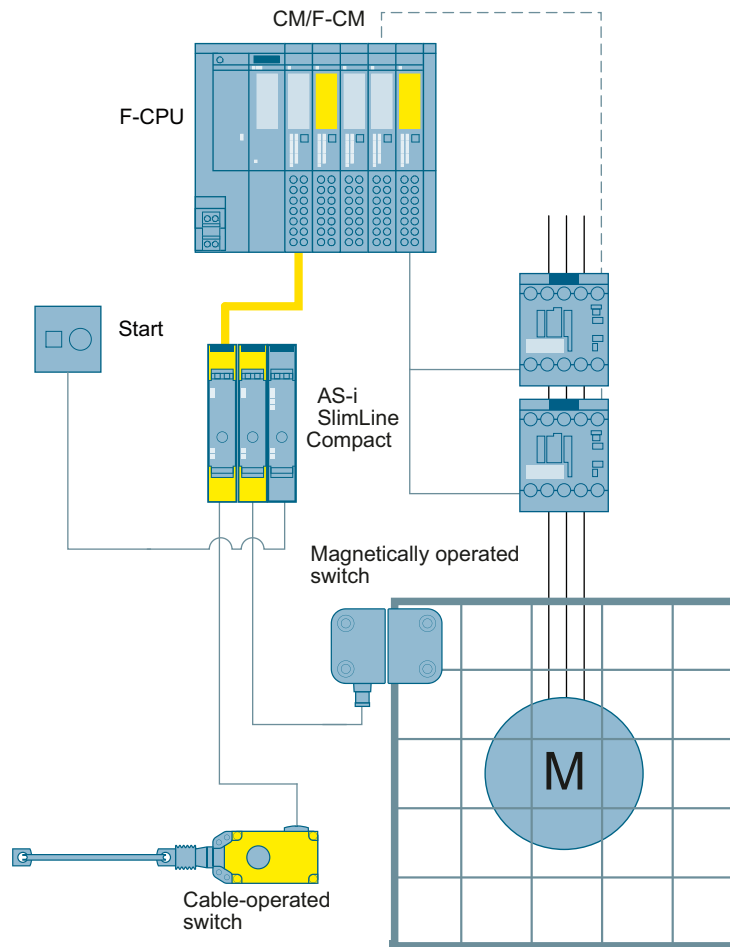
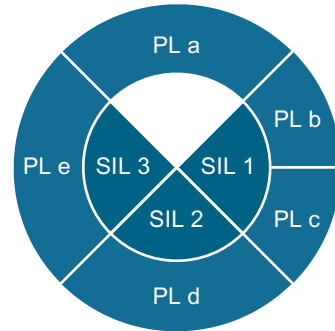





Figure 3-54 Protective door monitoring by means of solenoid-operated switches and emergency shutdown using cable-operated switch up to SIL 3 or PL e by means of AS-i ET 200SP Master and AS-i SlimLine compact modules





Operating principle

The fail-safe controller monitors the two-channel solenoid-operated switch as well as the two-channel cable-operated switch. Both signals are read via the ASIsafe SlimLine compact module. They are then forwarded to the fail-safe controller with the aid of the CM AS-i Master and the F-CM AS-i Safety module (modules of the ET 200SP station). When the cable-operated switch is actuated or the protective door is opened, the fail-safe controller switches the power contactors off in a safety-related way. If the door is closed, the cable-operated switch is reset and the feedback circuit is closed, the Start button can be used to switch on again. The Start button is also read by means of an AS-i SlimLine compact module. The three AS-i SlimLine compact modules are interconnected by means of device connectors, so that the AS-i flat ribbon cable only has to be connected once.



Safety-oriented components

Safety switch	Solenoid-operated switch	AS-i SlimLine Compact	
			
3SE7 (http://www.siemens.com/sirius-command)	3SE6 (http://www.siemens.com/sirius-detecting)	3x AS-i module (http://www.siemens.com/as-interface)	

Fail-safe controller	ET 200SP AS-i Master		Contactors
			
S7 F-PLC (http://www.siemens.com/simatic-safety)	CM AS-i Master and F-CM (http://www.siemens.com/as-interface)		2x 3RT20 (http://www.siemens.com/sirius-control)

See also

Circuit diagram, TIA Portal project and safety evaluation (<http://support.automation.siemens.com/WW/view/en/109747653>)

Document on the use of cable-operated switches in safety functions (<https://support.industry.siemens.com/cs/ww/en/view/69778886>)

3.7.11 Emergency stop shutdown up to SIL 3 or PL e and protective door monitoring up to SIL 2 or PL d with tumbler via AS-i ET 200SP Master**Application**

Protective doors are frequently used to fence off danger zones. These are monitored for position and, if necessary, the area from which the hazard emanates is switched off. To safeguard the production process, access can be prevented by a tumbler for as long as necessary. An emergency stop command device is additionally monitored for shutting down the machine in an emergency. For connection to the fail-safe controller, CM AS-i Master and F-CM AS-i Safety are used.

Design

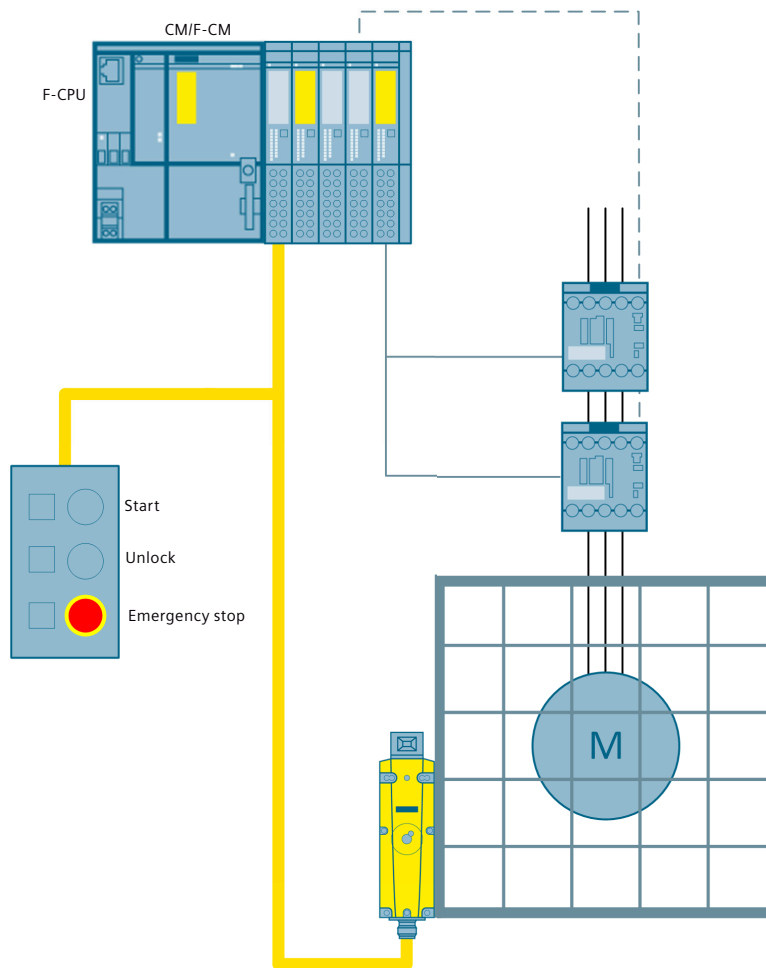

Figure 3-55 Emergency stop shutdown up to SIL 3 or PL e and protective door monitoring up to SIL 2 or PL d with tumbler via AS-i ET 200SP Master

Operating principle



The fail-safe controller monitors the emergency stop command device and the safety switch on two channels. Both devices have an integrated AS-i slave and are thereby connected to the AS-Interface. The two signals are transmitted to the fail-safe controller using the combination of CM AS-i Master and F-CM AS-i Safety (modules of the ET 200SP station). The position of a protective door is monitored via a safety switch. In addition, the door is locked by means of a tumbler integrated in the safety switch. When the command to release the door is issued by means of a selector switch, the fail-safe controller switches the power contactors off in a safety-related way. On expiry of a set time, the tumbler is unlocked and access to the machine is enabled. After the door has been closed and locked again, and the feedback circuit is closed, the Start button can be used to switch on again. When the emergency stop device is actuated, the fail-safe controller also switches off the power contactors in a safety-related way. If the emergency stop command device is reset and the feedback circuit is closed, the Start button can be used to switch on again. Start buttons and selector switches are also read in via AS-Interface.

The safety function "stopping in an emergency" is designed up to SIL 3 or PL e. The safety function "protective door monitoring" is designed up to SIL 2 or PL d. The protective door tumbler is not a safety function (non-safety-related control of the solenoid). It can be used to safeguard the production process.

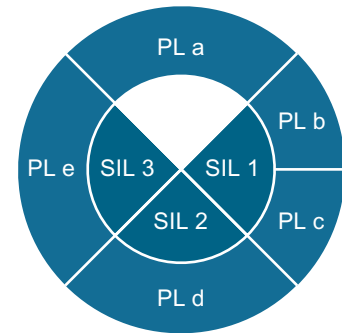
Taking account of fault exclusions, use of only one safety switch with or without tumbler is permissible up to SIL 2 or PL d. For further information, refer to the letter specified below.



Safety-related components

Emergency stop control device	Position switches	Fail-safe controller
		
3SU1 (http://www.siemens.com/sirius-act)	3SF1 (https://w3.siemens.com/mcms/industrial-controls/en/detecting-devices/Pages/default.aspx)	S7 F-PLC (http://www.siemens.com/simatic-safety)

3.7 Typical combinations of multiple safety functions

ET 200SP AS-i Master		Contactor
		
CM AS-i Master and F-CM (http://www.siemens.com/as-interface)		2x 3RT20 (http://www.siemens.com/sirius-control)

See also

Circuit diagram, TIA Portal project, and safety evaluation (<http://support.automation.siemens.com/WW/view/en/109769506>)

Letter concerning the use of safety switches up to SIL 2 or PL d ([https://support.industry.siemens.com/cs/document/35443942/performance-level-pl-d-with-category-3-\(iso-13849-1\)-or-sil-2-\(iec-62061\)-using-only-1-sirius-position-switch-with-or-without-solenoid-interlocking-or-only-1-sirius-hinge-switch-is-achievable?dti=0&lc=en-WW](https://support.industry.siemens.com/cs/document/35443942/performance-level-pl-d-with-category-3-(iso-13849-1)-or-sil-2-(iec-62061)-using-only-1-sirius-position-switch-with-or-without-solenoid-interlocking-or-only-1-sirius-hinge-switch-is-achievable?dti=0&lc=en-WW))

3.7.12 Emergency stop shutdown and protective door monitoring up to SIL 3 or PL e via ET 200ecoPN and F-CPU

Application

Protective doors are frequently used to fence off danger zones. These are monitored for position and, if necessary, the area from which the hazard emanates is switched off. An emergency stop command device is additionally monitored for shutting down the machine in an emergency. To record these two safety functions in the IP67 environment a fail-safe version of an ET 200eco PN is used.

Design

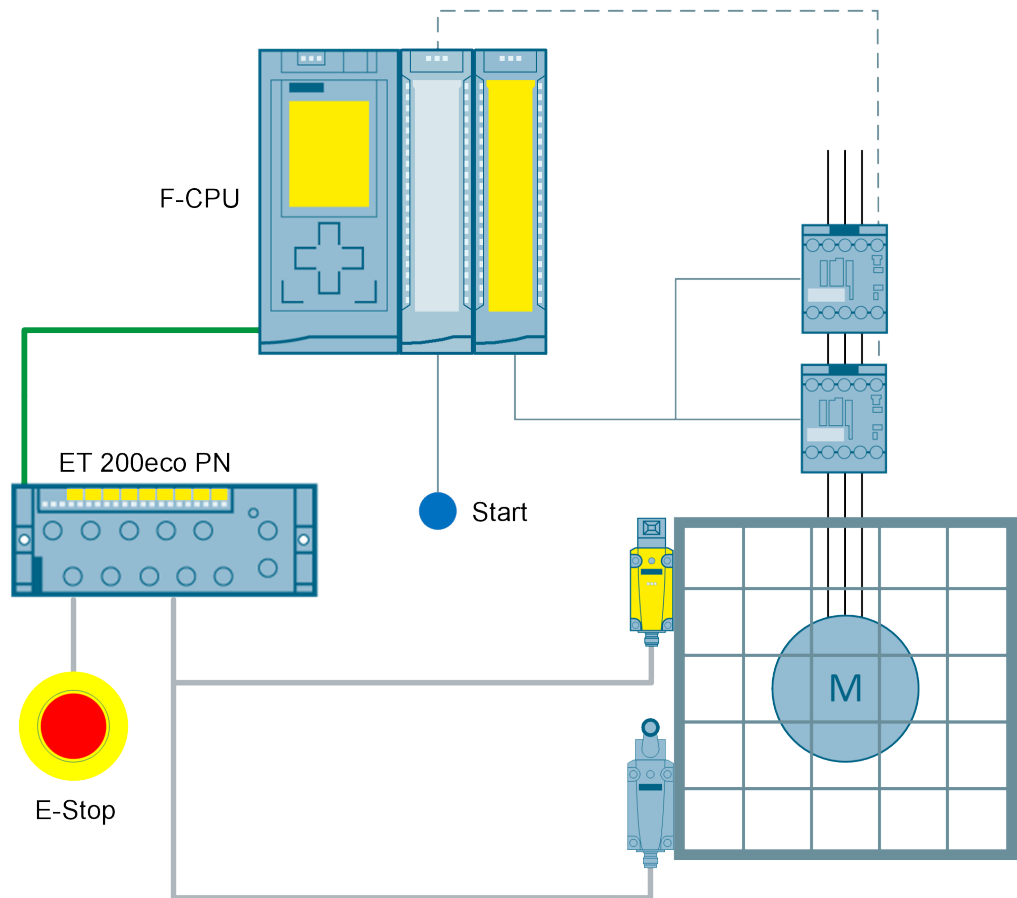
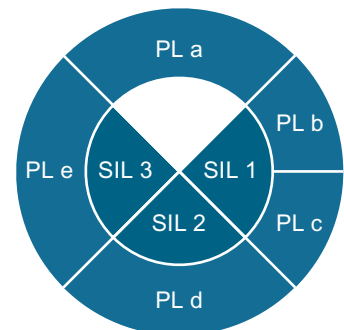





Figure 3-56 Emergency stop shutdown and protective door monitoring up to SIL 3 or PL e via ET 200ecoPN and F-CPU

Operating principle

The emergency stop command device is directly connected to a fail-safe input socket (F-DI) of the ET 200eco PN by means of an M12 cable. The two position switches are joined by means of a special M12 Y-cable and likewise connected directly to an individual F-DI of the ET 200eco PN. The fail-safe controller (F-CPU) monitors the two safety switches as well as the emergency stop command device on two channels. When the emergency stop command device is actuated or the protective door is opened, the fail-safe controller switches the power contactors off in a safety-related way. If the door is closed, the emergency stop command device is unlatched and the feedback circuit is closed, the Start button can be used to switch on again.



Safety-related components

Emergency stop control device	Position switches		Fail-safe controller
			
<p>3SU1 (http://www.siemens.com/sirius-act)</p>	<p>2x3SE5 (https://w3.siemens.com/mcms/industrial-controls/en/detecting-devices/Pages/default.aspx)</p>		<p>ET 200eco PN (https://new.siemens.com/global/en/products/automation/topic-areas/safety-integrated/factory-automation/offering/simatic-safety.html)</p>

Connecting cable	Fail-safe controller	Contactor
		
<p>Y-cable for ET 200eco PN (https://new.siemens.com/global/en/products/automation/topic-areas/safety-integrated/factory-automation/offering/simatic-safety.html)</p>	<p>S7 F-PLC (http://www.siemens.com/simatic-safety)</p>	<p>2x 3RT20 (http://www.siemens.com/sirius-control)</p>

See also

Circuit diagram, TIA Portal project and safety evaluation (<http://support.automation.siemens.com/WW/view/en/109769505>)

3.7.13 Emergency stop shutdown of more than one motor up to SIL 3 or PL e with one 3SK1 safety relay, output expansion and 3RQ1 coupling relay

Application

If there is a safety requirement to switch off more than one drive simultaneously (e.g. with tool slides, machine tools, suction equipment, etc.), this can be done with the help of output expansions or a coupling relay with additional enabling circuits.

Design

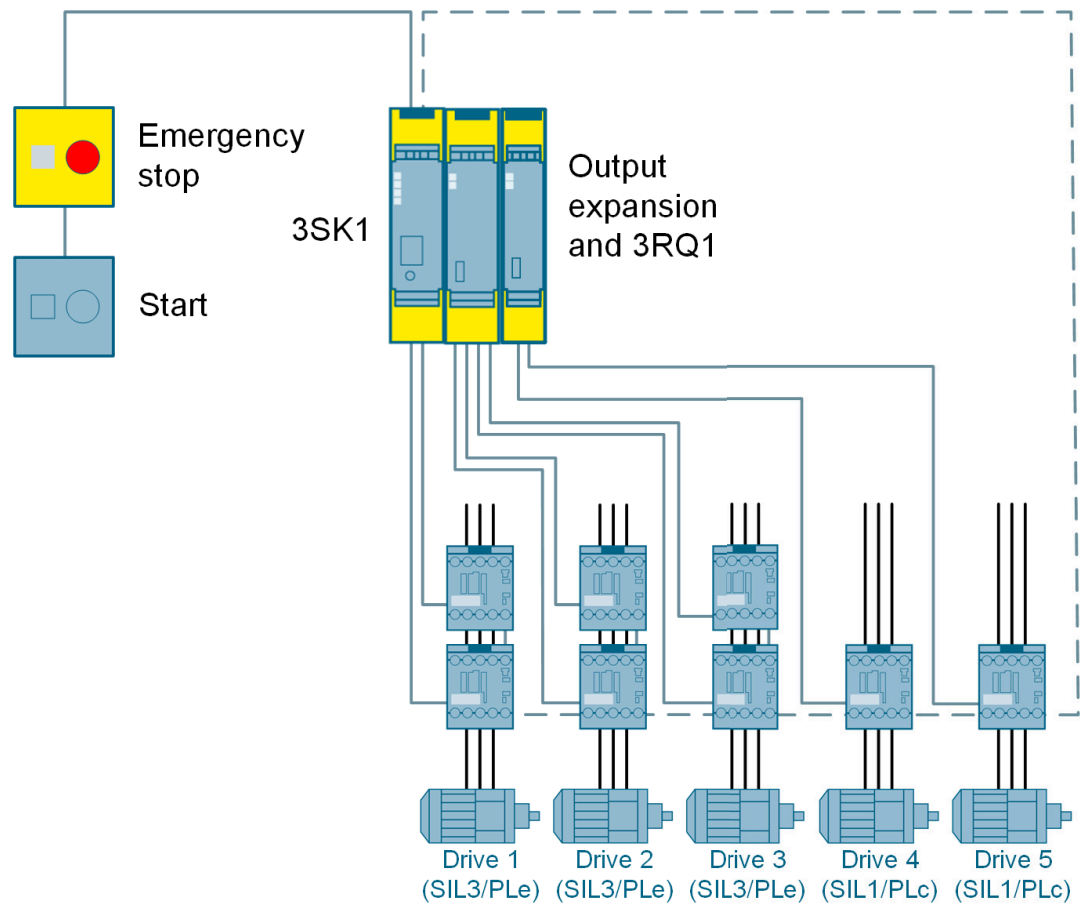

Figure 3-57 Emergency stop shutdown of multiple motors to SIL 3 or PL e with a 3SK1 safety relay

Operating principle

The safety relay monitors the emergency stop command device on two channels. When the emergency stop command device is actuated, the safety relay, the 3SK1 output expansion, and the coupling relay open the enabling circuits and switch the power contactors off in a safety-oriented way. If the emergency stop command device is unlatched and the feedback circuit of all actuators is closed, the Start button can be used to switch on again.

Shutdown of the individual drives represents a separate safety function in each case, even if the shutdown command originates in the same emergency stop command device and safety relay.



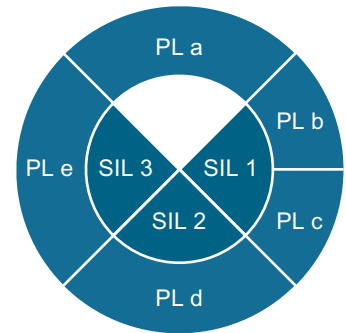

The safety-related tripping of drives 1, 2 and 3 directly via the 3SK1 safety relay or via its output extension and two redundant contactors in each case is designed up to SIL 3 or PL e. Feedback circuit monitoring of the contactors is mandatory for achieving this safety integrity.

The safety-related tripping of drives 4 and 5 via the 3RQ1 coupling relay and one contactor in each case is designed up to SIL 1 or PL c. The 3RQ10 coupling relay alone is approved up to SIL 2 or PL c. In order to achieve this safety level, however, attention must also be paid to an appropriate design of the contactor (e.g. redundant setup).

The 3RQ1 coupling relay is also available as a 3RQ12 variant, which is certified up to SIL 3 or PL e.



Safety-oriented components

Emergency stop command device	Safety relay	Output expansion	Coupling relay	Contactor
				
3SU1 (2-channel) (http://www.siemens.com/sirius-act)	3SK1 (http://www.siemens.com/safety-relays)	3SK1 (http://www.siemens.com/safety-relays)	3RQ1 (http://www.siemens.com/relays)	3RT20 (http://www.siemens.com/sirius-control)

See also

Circuit diagram and safety evaluation (<https://support.industry.siemens.com/cs/ww/en/view/74563681>)

Contact extension of a fail-safe controller with 3SK1 and 3RQ1 (<https://support.industry.siemens.com/cs/de/en/view/76676971>)

3.7.14 Protective door monitoring with tumbler by means of a 3SE64 RFID safety switch including emergency stop shutdown up to SIL 3 or PL e and via ET 200AL and F-CPU

Application

Danger zones are often fenced off by protective doors. The door positions are monitored and, if necessary, the area from which any hazard emanates is switched off. If the machine process is to be completed without interruption, access can be prevented for this length of time by the tumbler of the RFID safety switch 3SE64. The ET 200AL is the right choice for use directly on machines with a limited distributed design.

Design

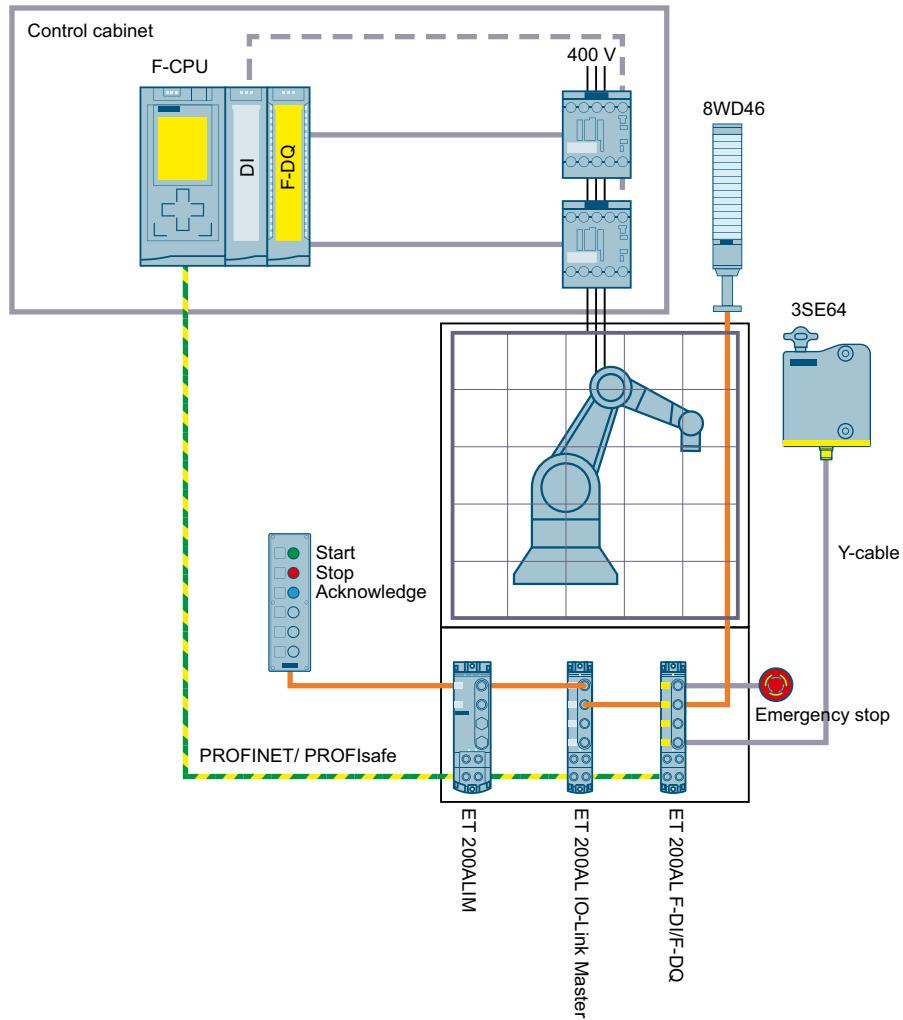

Figure 3-58 Protective door monitoring with tumbler by means of a 3SE64 RFID safety switch including emergency stop shutdown up to SIL 3 or PL e and via ET 200AL and F-CPU

Operating principle

The position of a protective door is monitored via a safety switch. In addition, the door is locked via the safety switch. When the command to unlock the door is issued, the fail-safe controller switches off the power contactors in a safety-related manner. The tumbler is unlocked after expiry of a set time and completion of the machine process. If the door is closed and locked, and the feedback circuit is closed, the Start button can be used for switching on again. The 3SE64 RFID safety switch with tumbler is available in two variants, which differ in the control principle of the tumbler function (open-/closed-circuit principle). In both variants, SIL 3 or PL e is possible for the "protective door monitoring" safety function. While SIL 2 or PL d can be achieved for the "protective door tumbler" safety function in variant 1 (closed-circuit principle), no SIL/PL is possible for this safety function in variant 2 (open-circuit principle). With this variant, the tumbler is used exclusively for process protection. Variant 2 is used in this application example, since no SIL or PL is required for the "protective door tumbler" safety function.

With variant 2, both OSSD outputs of the 3SE64 safety switch are already active when the protective door is closed. This means that the user program cannot be used to evaluate whether the door is actually locked or not. With the open-circuit principle (variant 2), however, no diagnosis of the tumbler is necessary either, since the type of interlocking prevents any SIL/PL. With this variant, the tumbler is used exclusively for process protection. For detailed information, please refer to the link below.

The connection of an emergency stop to a vacant port on the F-module of the AL is also shown since this constellation can cover most of the machines in terms of safety.

The control panel is connected via IO-Link to reduce wiring work. In this case it would also be possible to establish a connection via a standard input card of the ET 200AL. The signaling concept is implemented by means of the IO-Link variant of the 8WD46.

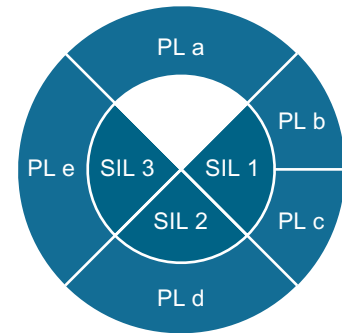

Safety-related components

RFID safety switch with tumbler	Emergency stop control device	Distributed I/O IP67
		
3SE64 (https://w3.siemens.com/mcml/industrial-controls/en/detecting-devices/Pages/default.aspx)	3SU1 (http://www.siemens.com/sirius-act)	ET 200AL (http://www.siemens.com/simatic-safety)

3.7 Typical combinations of multiple safety functions

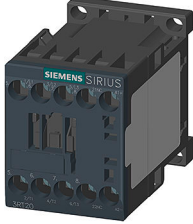
Fail-safe controller	Contactor
	
S7 F-PLC (http://www.siemens.com/simatic-safety)	2x 3RT20 (http://www.siemens.com/sirius-control)

See also

Detailed documentation, circuit diagram, TIA Portal project, and safety evaluation (<https://support.industry.siemens.com/cs/us/en/view/109818115>)

3.7.15 Cascading of 3SK2 safety relays up to SIL 3 or PL e

Application

Cascading of safety relays is used for linking different parts of the system and their safety functions.

In addition, cascading provides an implementation option if the quantity structure of a single 3SK2 safety relay is not sufficient for the application and additional inputs or outputs are required.

Design

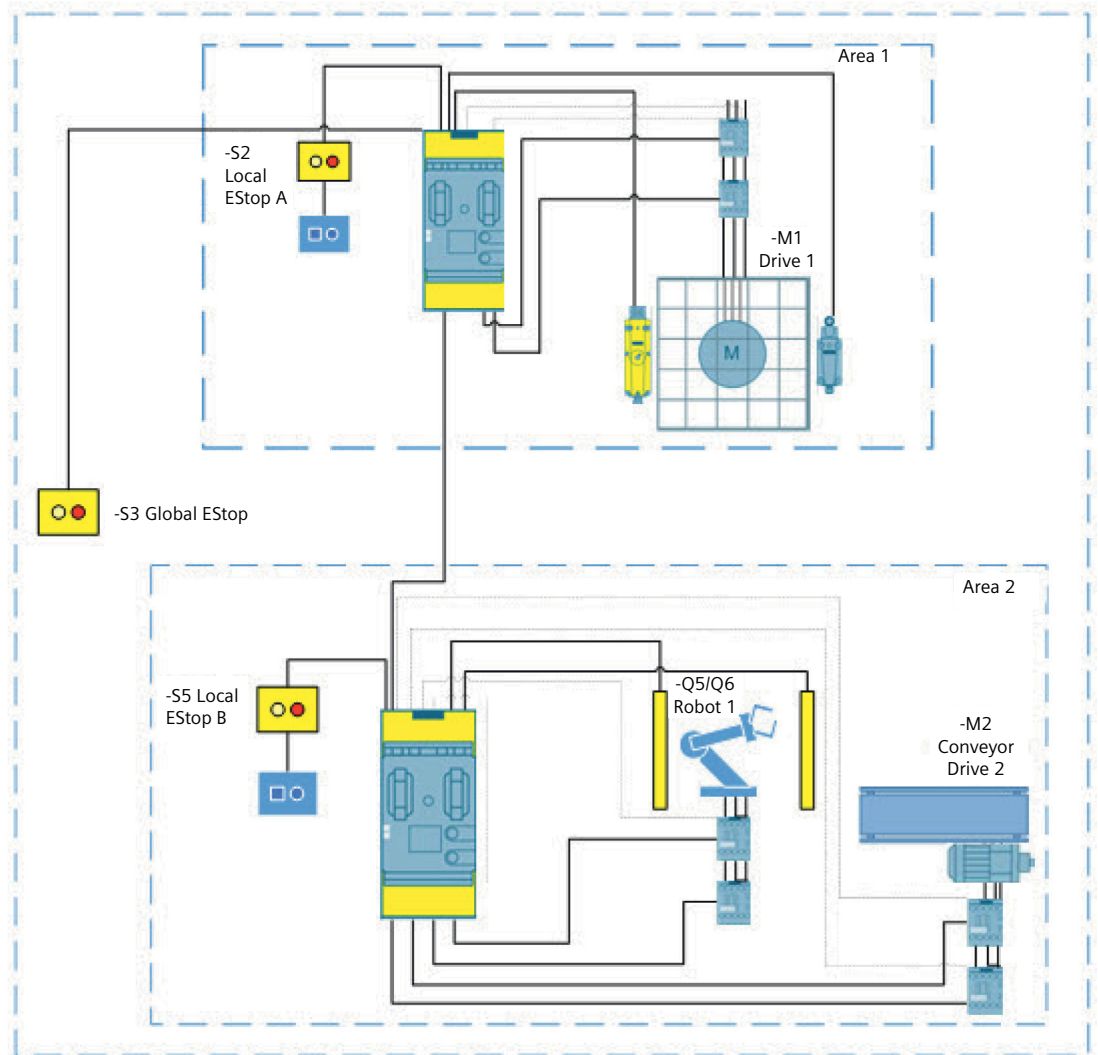

Figure 3-59 Cascading of 3SK2 safety relays up to SIL 3 or PL e

Operating principle

The two safety relays are interconnected by means of cascading. For clarity, an area was defined for each safety relay, each containing the respective sensors and actuators. When emergency stop A is triggered, only drive 1 is switched off. When emergency stop B is triggered, both the robot and drive 2 are switched off. When the global emergency stop is triggered, all actuators are switched off in a safety-related manner. The global emergency stop is wired here to the 3SK2 in Area 1. The emergency stop signal is transmitted to the 3SK2 in Area 2 via a fail-safe output.

After an emergency stop, a manual starting command must be executed in the respective safety relay by means of the start button. When the protective door is opened, only the actuator technology behind it is switched off. When the light curtain is detected, the robot is stopped in a safety-related manner.

The design of the safety functions and programming in the two 3SK2 safety relays is based on a cause-effect matrix. By linking causes and effects, it is easier to determine which safety functions are implemented in which 3SK2 device and to design the safety program accordingly.

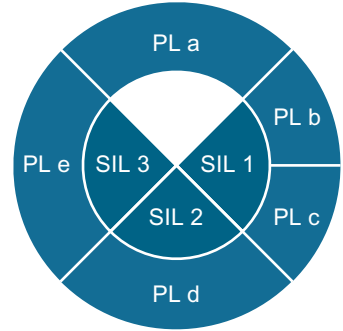

Safety-related components

Emergency stop control device	Position switches	Safety relay	Contactors
			
3SU1 (http://www.siemens.com/sirius-act)	3SE5 (https://w3.siemens.com/mcms/industrial-controls/en/detecting-devices/Pages/default.aspx)	3SK2 (http://www.siemens.com/safety-relays)	3RT20 (http://www.siemens.com/sirius-control)

See also

Circuit diagram, 3SK2 project, and safety evaluation (<https://support.industry.siemens.com/cs/us/en/view/109818869>)

3.8 Further application examples and FAQs

On the Industry Online Support pages you will find many application examples on the subject of safety in automation engineering. The Safety Selector helps you to find the appropriate safety application examples quickly in Industry Online Support (<https://support.industry.siemens.com/cs/de/en/view/109773295>) by suggesting categories.

3.8.1 General

- Safety-related parameters - standard B10 values/failure rates of SIRIUS and SENTRON electromechanical products (<https://support.industry.siemens.com/cs/ww/en/view/109739348>)
- Contactors in safety applications – application guide (<https://support.industry.siemens.com/cs/de/en/view/109807687>)
- Emergency stop shutdown up to SIL 2 or PL d with a SIRIUS 3SK1 safety relay and circuit breaker (<https://support.industry.siemens.com/cs/ww/en/view/38472027>)
- Protective door with spring-loaded tumbler on an S7-1500 (<https://support.industry.siemens.com/cs/ww/en/view/21063946>)

3.8.2 Subsystem detection

- What has to be taken into consideration for the operating mode selection in conjunction with functional safety? (<https://support.industry.siemens.com/cs/de/en/view/89260861>)
- Safe operating mode selection with IO-Link ID keyswitch (<https://support.industry.siemens.com/cs/de/en/view/109778665>)
- Application example: Operating mode selection in conjunction with functional safety (<https://support.industry.siemens.com/cs/ww/en/view/109757316>)

3.8.3 Subsystem evaluation

- Automatic restart after power failure with 3SK1 and time relay (<https://support.industry.siemens.com/cs/ww/en/view/109758052>)
- Contact extension of a fail-safe controller with 3SK1 and 3RQ1 (<https://support.industry.siemens.com/cs/ww/en/view/76676971>)
- How can a 3SK2 safety relay be commissioned with PROFINET? (<https://support.industry.siemens.com/cs/ww/en/view/109778581>)
- Safe over-travel testing of linear axes with 3SK2 (<https://support.industry.siemens.com/cs/ww/en/view/109782767>)
- Reading out the diagnostics data from the SIRIUS 3SK2 or 3RK3 (MSS) safety relay by means of a SIMATIC S7 CPU (<https://support.industry.siemens.com/cs/ww/en/view/109747831>)

3.8.4 Subsystem reaction

- What safety level can be achieved when using a contactor and a circuit breaker? (<https://support.industry.siemens.com/cs/ww/en/view/40349715>)
- IEC 62061 / ISO 13849-1 – explanation of application. What safety integrity can be achieved when using two circuit breakers? (<https://support.industry.siemens.com/cs/de/en/view/109483115>)
- What is the difference between force-guided contact elements of contactor relays and mirror contacts of power contactors? (<https://support.industry.siemens.com/cs/ww/en/view/109758261>)
- 3RW soft starter: Safe shutdown according to IEC 62061 (SIL) or ISO 13849-1 (PL) (<https://support.industry.siemens.com/cs/ww/en/view/67474130>)
- SINAMICS S120/S110, SIMOTION D: Connection of F-DIs to F-DQs (incl. 3SK) (<https://support.industry.siemens.com/cs/ww/en/view/39700013>)

Regulations and Standards

4.1 Regulations and standards in the European Union (EU)

4.1.1 Safety of machinery in Europe

4.1.1.1 Legal basis

Machinery Directive (2006 / 42 / EC)

When the European common market was launched, a decision was made to harmonize the domestic standards and regulations of all the EU Member States relating to the technical implementation of machines. This meant that, as an internal market directive, the content of the Machinery Directive had to be implemented by the individual member states as national legislation. In Germany, the content of the Machinery Directive was implemented as the 9th statutory instrument of the Product Safety Law (9. ProdSV). For the Machinery Directive, this was realized with the aim of achieving standard safety objectives and, in turn, removing technical trade barriers. In accordance with the definition of a machine ("an assembly of linked parts or components, at least one of which moves"), this directive has a very broad scope. The application area also extends to cover replaceable equipment, safety components, load carrying equipment, chains, belts, ropes, removable propshafts, and incomplete machines.

"Machine" also refers to an assembly of machines which, in order to achieve the same end, are arranged and controlled so that they function as an integral whole.

This means that the Machinery Directive is applicable from a basic machine up to a plant.

The basic safety and health requirements specified in Annex I of the Directive must be fulfilled for the safety of machines. The manufacturer must carefully observe the principles listed in Annex I, Paragraph 1.1.2 when it comes to integrating safety.

The safety objectives must be implemented responsibly to ensure compliance with the Directive. Manufacturers of a machine must verify that their machine complies with the basic requirements. This verification is facilitated by means of harmonized standards. In the case of machines that present an increased potential hazard as listed in Annex IV of the Machinery Directive, a certification procedure is demanded. (Recommendation: machines that are not listed in Annex IV can also present a significant potential hazard and must be dealt with accordingly.)

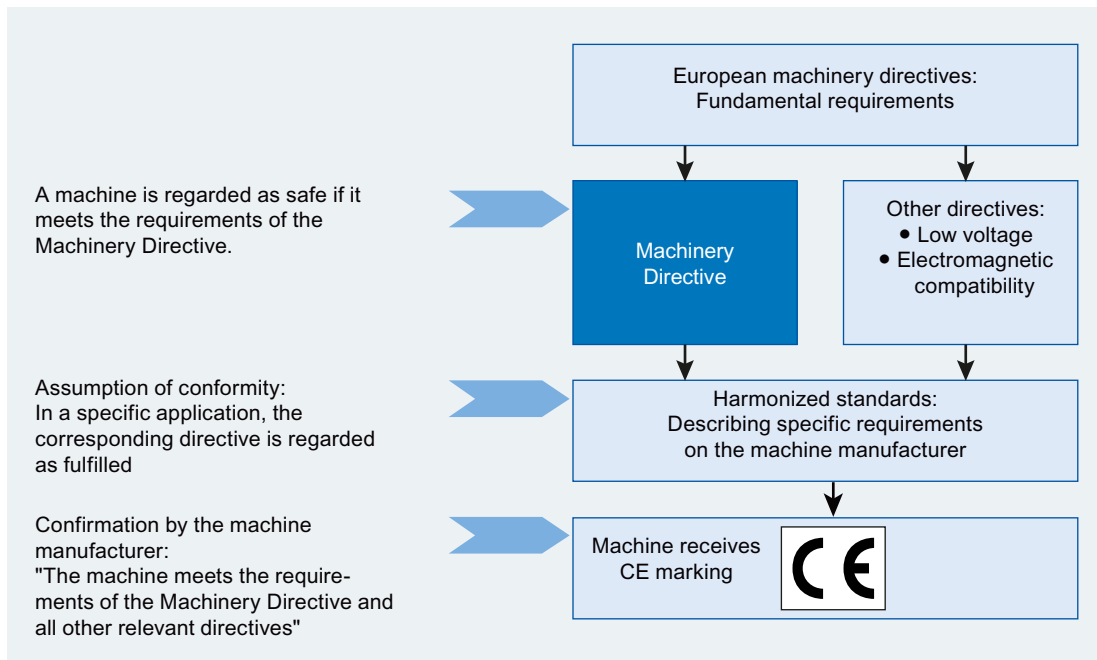

Figure 4-1 European Machinery Directives

Standards

Before any machines or plant can be put on the market or operated, they must meet the fundamental safety requirements of the EU Directives. Standards can be extremely helpful to achieving compliance with these safety requirements. In the EU, a distinction must be made here between standards that have been harmonized under an EU directive, and standards that have been ratified but not harmonized under a specific directive, as well as other technical rules also referred to as "national standards" in the directives.

Ratified standards describe the recognized state-of-the-art. In other words, by applying ratified standards, manufacturers can prove that the recognized state-of-the-art has been complied with.

All standards ratified as European standards must, in principle, be adopted unchanged as national standards of the member states, regardless of whether the standards have been harmonized under a directive or not. Existing national standards on the same subject must then be revoked. The intention is thus to create a uniform (consistent) body of standards in Europe over time.

Harmonized European standards

Harmonized European standards (EN standards) are published in the Official Journal of the European Communities and must be included in domestic standards without any revisions.

They are designed to fulfill basic health and safety requirements as well as the safety objectives specified in Annex I of the Machinery Directive.

When the harmonized standards are observed, it is "automatically assumed" that the directive is fulfilled, in other words, manufacturers can be confident that they have fulfilled the safety aspects of the directive in so far as they have been dealt with in the respective standard. However, not every European Standard is harmonized in this sense. The lists in the Official

European Journal is decisive. These lists can be viewed, always up to date, on the Internet (<http://www.newapproach.org/>).

4.1.1.2 CE conformity process

CE conformity process

Phases in the CE conformity process

The CE conformity process is divided into different phases that must be carried out throughout the entire life cycle (planning, design, installation, operation, and maintenance).

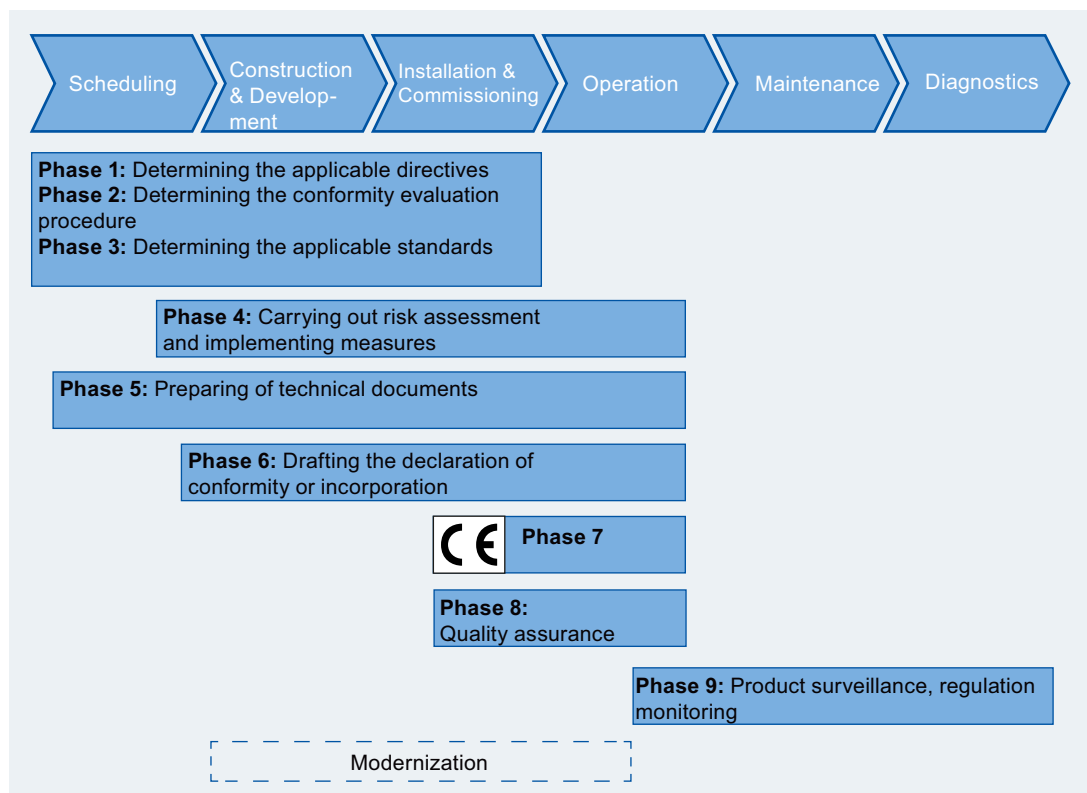

Figure 4-2 CE conformity process for machinery and plants

The applicable directives must be established in Phase 1 right back at the planning stage. This could involve one or more directives or none. (e.g. Machinery Directive, see Chapter 2.2.1)

In Phase 2, the conformity assessment procedure is established in accordance with the applicable directives from Phase 1.

Definition of the applicable standards follows in Phase 3.

Phase 4 then consists of risk assessment of the machine, risk reduction, and validation. This phase also includes assessment of the safety-related parts of the machine control. The individual steps of Phase 4 are explained in the sections below.

4.1 Regulations and standards in the European Union (EU)

The technical documentation is created in parallel with planning, development and commissioning. This is also called Phase 5. The technical documentation must be available in full at the time of supplying the machine. This includes technical documentation (see Annex VII of the Machinery Directive), conformity certification, acceptance protocols (if applicable), transport documentation, etc.

If the validation procedure has been successfully completed, the declaration of conformity or declaration of incorporation can be drafted in Phase 6, and in Phase 7, the CE mark can be affixed to the machine.

All manufacturers have an obligation to monitor their products for possible hidden shortcomings after placing them on the market. This is covered by Phase 8 quality assurance and Phase 9 product monitoring. For example, information must be gathered about whether the product is actually used as originally intended, and how it behaves during its life cycle.

In particular, dangerous shortcomings, and misuse or incorrect handling of the product must be prevented by appropriate measures. If hidden shortcomings are discovered, the user must be informed.

Risk assessment

Risks are intrinsic in machines due to their design and functionality. For this reason, the Machinery Directive requires that a risk assessment be performed for each machine and, if necessary, the level of risk reduced until the residual risk is less than the tolerable risk. The standard EN ISO 12100 "Safety of machinery - General principles for design - Risk assessment and risk reduction" (03 / 2011) is to be used for the process of assessing these risks.

EN ISO 12100 mainly describes the risks and design principles to be considered, and the iterative process when assessing and reducing risks to achieve the appropriate degree of safety.

Risk assessment is a procedure that allows hazards resulting from machines to be systematically investigated. Where necessary, the risk assessment is followed by a risk reduction procedure. When the procedure is repeated, this is known as an iterative process. This can help eliminate hazards (as far as this is possible) and can act as a basis for implementing suitable protective measures.

Risk assessment involves the following steps:

- Risk analysis
 - Determining the machine limits
 - Identifying the hazards
 - Risk estimation
- Risk evaluation

As part of the iterative process to achieve the required level of safety, a risk evaluation is carried out after risk estimation. A decision must be made here as to whether the residual risk needs to be reduced. If the risk is to be further reduced, suitable protective measures must be selected and applied. The risk assessment must then be repeated.

Risks must be reduced by designing and implementing the machine accordingly (e.g. by means of controllers or protective measures suitable for the safety-related functions).

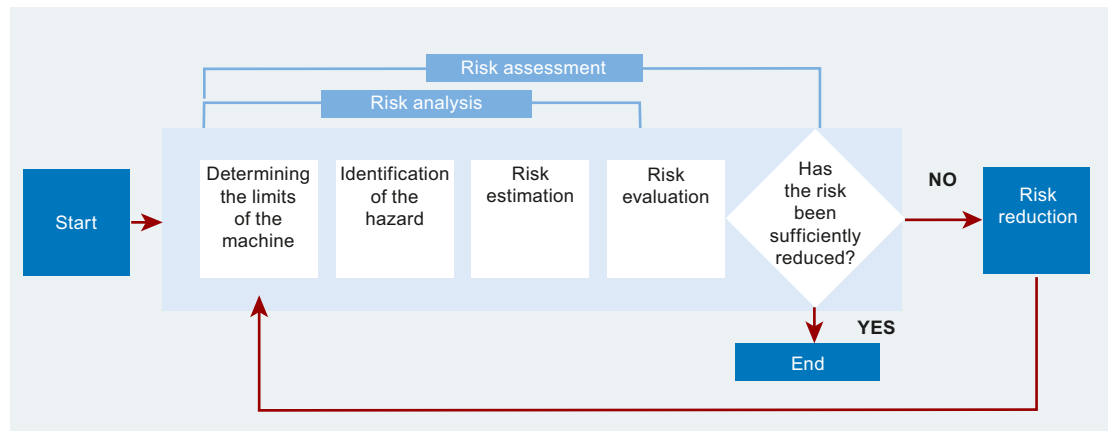

Figure 4-3 Iterative procedure for risk assessment in accordance with EN ISO 12100

Risk reduction

If the estimated risk appears to be too high, it must be reduced until the residual risk is less than the tolerable risk. For this purpose, an attempt must first be made to make the machine safe by modifying the design. If that is not possible, the risk must be reduced by applying suitable protective measures.

- The severity of possible injury can be reduced, for example, by reducing the speed of movement or power levels of the machine parts when personnel are present.
- The frequency with which personnel are present in the danger zone can be reduced by means of barriers.
- There is always a certain probability that a machine will not behave as intended, or that protective equipment will fail. This can be caused by faults in any parts of the machine. A reduction in the risk factor can be achieved by appropriate design of the safety-related parts. The safety-related parts also include the machine control if its failure can result in a hazard. The risk caused by failure of the control can be reduced by implementing the control in accordance with IEC 62061 or ISO 13849-1.
- The possibility of avoiding injury can be increased if hazard states can be detected in good time, by means of signal lamps, for example.

A common parameter in all these elements is the probability of the occurrence of an undesired event. Reducing this probability can reduce the risk.

Carry out the following steps for risk reduction:

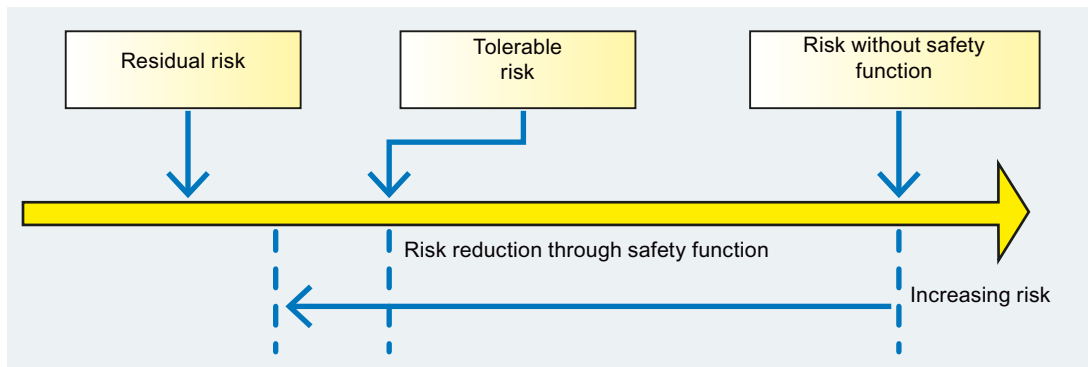

Figure 4-4 Risk reduction

Step 1: Inherently safe design

Inherently safe design removes hazards or reduces the associated risks by selecting appropriate design features of the machine itself and/or the interplay between personnel and the machine.

Safe design can be achieved, for example, by integrating safety into the machine (covers, barriers, etc.). These measures have top priority within the scope of risk reduction. They must:

- Avoid crush points
- Prevent electric shock
- Include concepts for stopping in an emergency
- Include concepts for operation and maintenance

Step 2: Technical protective measures and/or supplementary protective measures

Taking account of the intended use and reasonably foreseeable misuse, selected technical and supplementary protective measures can be suitably applied to reduce the risk if elimination of a hazard proves to be impossible, or if the associated risk cannot be sufficiently reduced by inherently safe design.

Step 2 also includes all the safety-related control functions of a machine. Special requirements apply to these. Compliance with these requirements must be tested.

Typical design of a safety-related control function:

- Sensing (position switch, emergency stop, light curtain, etc.)
- Evaluating (fail-safe controller, safety relay, etc.)
- Reacting (contactor, frequency converter, etc.)

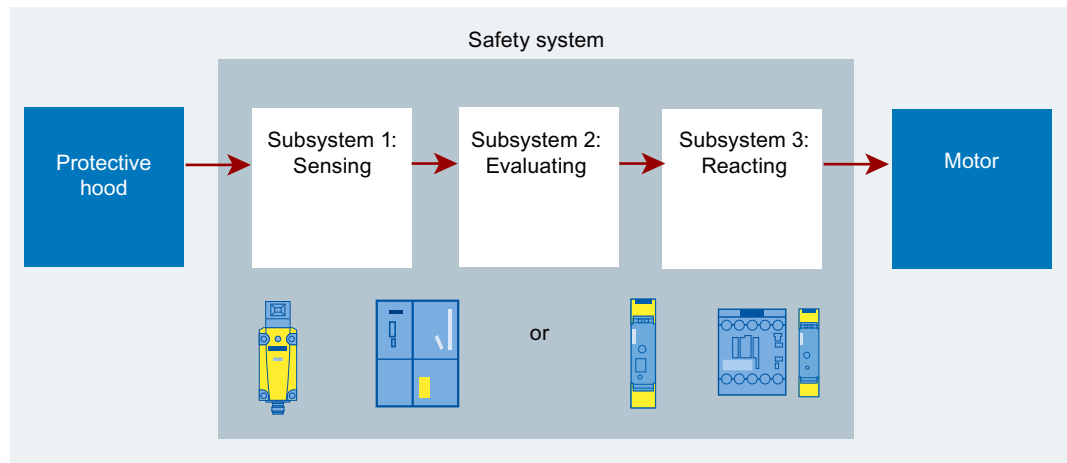

Figure 4-5 Safety system for the safety function

Step 3: User information

If risks remain despite inherently safe design and the use of technical and supplementary protective measures, the user information must draw attention to all residual risks.

This type of user information includes:

- Warning information in the operating instructions
- Special work instructions
- Pictograms
- Information on the use of personal protective equipment

Requirements regarding safety-related controller components are graded according to the magnitude of the risk and the level to which the risk needs to be reduced. EN ISO 13849-1 uses the hierarchically graded performance level (PL) for evaluation. IEC 62061 uses "safety integrity level" (SIL) to make this type of classification. Both are a measure of the safety-related performance of a control function.

It is always important - independent of which standard is applied - that all machine control parts involved in implementing these safety-related functions clearly fulfill these requirements.

Note

The control of a machine also includes the load circuits of the drives and motors.

When planning and implementing the controller, it is necessary to check whether the requirements of the selected PL or SIL are met. Since the requirements for achieving the necessary safety performance in EN ISO 13849 and IEC 62061 are structured differently, the requirements for checking are also structured differently. For design in accordance with EN ISO 13849, Part 2 (EN ISO 13849-2) gives the details of validation and describes what must be taken into account. The requirements for validation of a design in accordance with IEC 62061 are described in the standard itself.

Validation

Validation means an evaluating test of the safety functionality aimed at. The purpose is to confirm the definitions and the level of conformity of the safety-related parts of the controller within the overall definition for safety requirements on the machine. The validation must also indicate that every safety-related part meets the requirements of the relevant standard. The following aspects are described here:

- Error lists
- Validation of the safety functions
- Validation of the demanded and achieved safety performance (category, safety integrity level or performance level)
- Validation of the environmental requirements
- Validation of the maintenance requirements

A validation plan must describe the requirements for carrying out validation for the defined safety functions.

Aim of the validation:

Establishment of conformity with the requirements

- of the European directives.
- that result from the customer order, the use of the machine, and, if applicable, further national requirements that apply for the machine.

All the machine-related information must be provided when the machine is made available. This includes: the customer order, the technical documentation (see Annex VII of the Machinery Directive), conformity certification, acceptance certificate (if applicable), shipping documents, etc.

4.2 Regulations and standards outside the European Union (EU)

4.2.1 Regulations and standards outside the European Union - Overview

The following description is intended to provide an overview of the regulations of some countries outside the European Union. It must not be regarded as a complete description. The precise requirements, as well as national and local rules for a special application, must be checked in detail in each individual case. For further information regarding the specifications for safety engineering in other countries, contact the respective local approval authorities.

4.2.2 Legal requirements in the U.S.A.

With regard to the legal requirements for safety at work, a key difference between the U.S.A. and Europe is that in the U.S.A., no unified machinery safety legislation exists at the federal level that defines the responsibility of the manufacturer/supplier. Rather, there is a general requirement that employers must ensure safety at work. This is regulated by the Occupational Safety and Health Act (OSHA). The regulations of OSHA, relevant for safety at work, are described in OSHA 29 CFR 1910.xxx ("OSHA Regulations (29 CFR) PART 1910 Occupational Safety and Health"). (CFR: Code of Federal Regulations).

In addition to the OSHA Regulations, it is important to carefully observe the up-to-date standards of organizations such as NFPA and ANSI, as well as the extensive product liability legislation in the US. Two especially important standards for safety in industry are NFPA 70 (known as the National Electrical Code (NEC)) and NFPA 79 (Electrical Standard for Industrial Machinery). Both describe the fundamental requirements regarding the properties and implementation of electrical equipment. The National Electric Code (NFPA70) takes priority for buildings but also for the electrical connections of machines and machine parts. NFPA 79 applies to machines. This creates a gray area between the two standards when it comes to large machines that are made of machine parts. Large conveyor systems, for example, can be regarded as part of the building, making NFPA 70 and/or NFPA 79 applicable.

4.2.3 Legal requirements in Brazil

The Brazilian Ministry of Labor and Employment, which is responsible for regulating activities in the areas of health and safety at work, published the new version of Ordinance No. 12 in December 2010. Based on Article 137 of the EU Directives, this regulation is applicable to existing and new installations and ensures safety in the handling of machines according to the current state of the art. Similar to international technical standards, this Brazilian regulation also covers the complete life cycle of the machine, including design, trade, transportation, operation, maintenance and disposal.

Although the new version of NR 12 is based on the European model, in which Directives are supported by international standards, it differs from them in terms of legal instruments for the assessment of conformity and in its use of harmonized standards. Instead of checks performed by third-party regulatory bodies, the Brazilian government inspects machines and installations through nominated authorities at the place of operation. Only the specific

requirements described in the regulation are taken into account for this purpose. For this reason, NR 12 contains additional technical descriptions for specific machines.

In terms of structure, NR 12 is similar to a safety standard. It has general requirements that can be fulfilled by performing a risk assessment in accordance with Type-A standards such as ISO 12100, technical requirements as given in some Type-B standards as well as specific requirements for specific machines similar to Type-C standards.

The Annexes of NR 12 are not harmonized with Type-C standards; however, most of them were either heavily influenced by Type-C standards or based on them in order to in turn comply with established international standards. Although a presumption of conformity with NR 12 is not possible, most requirements can be fulfilled by meeting the stipulations of Type-C standards.

A summary of NR 12 can be found below:

12.1 to 12.5: General principles and scope of the standard.

12.6 to 12.13: Environmental conditions for safe operation around the machinery.

12.14 to 12.23: Electrical installations – application of regular technical requirements for switchgear, control gears and electrical installations (concepts from EN 60204). This part of the NR 12 makes reference to another regulatory standard for electrical installations (NR 10).

12.24 to 12.37: Control systems – application of concepts well defined in ISO 12100 referring to controls: arrangement and type of controls (two-hand control devices according to EN 574), mode selection, prevention of unexpected start-ups, manipulation, use of components that are 'proven-in-use' etc.

12.38 to 12.55: Safety Control Systems – general requirements, fault response and design based on categories (NRB 14153 or EN 954) in conformity with the risk assessment (ISO 12100). This part also includes requirements for fixed or movable guards (EN 953, EN 1088).

12.56 to 12.63: Emergency Stop Safety Systems – specific requirements (similar to ISO 13850).

12.64 to 12.76: Permanent means of access to parts of the machine

12.77 to 12.84: Pressurized systems

12.85 to 12.93: Conveyors and lifting systems

12.94 to 12.105: Ergonomic aspects

12.106 to 12.110: Additional risks

12.111 to 12.115: Maintenance, inspection and setup of machines

12.116 to 12.124: Signaling

12.125 to 12.129: Information for use, manuals, procedures

12.130 to 12.134: Safety procedures

12.135 to 12.147: Training and qualification

12.148 to 12.156: Supplementary requirements

ANNEX I: Safety clearances for the prevention of access to hazardous zones (ISO 13852, ISO 13853, ISO 13854 and ISO 13855)

ANNEX II: Training

ANNEX III: Means of permanent access (EN 14122)

ANNEX IV: Terms and definitions

ANNEX V: Portable saw machines

ANNEX VI: Machinery for production of bread, pastry and similar goods

ANNEX VII: Butcher shop and grocery machines

ANNEX VIII: Mechanical (EN 692), hydraulic presses (EN 693) and similar machines

ANNEX IX: Plastic injection molding machines (EN 201)

ANNEX X: Machinery for shoes production and similar goods

ANNEX XI: Machinery and devices for agricultural and forestry use

NOTE: NR 12 is currently under review and new Annexes may still be added.

4.2.4 Legal requirements in Australia

Health and safety at work also plays an essential role in Australia.

The January 2013 revision of the directives has also resulted in new requirements for machinery. The Directives "Work Health and Safety Act 2012" and "Work Health and Safety Regulations 2012" play a decisive role in conjunction with the corresponding Codes of Practice. The Directives define measures for specific hazards (such as protective fences) for the purpose of guaranteeing a safe workplace. The Codes of Practice also include practical implementations and aids for using Directives, but they are not themselves binding.

Specification and design of safety-related controls for machines

5

5.1 Safety-related parts for the machine control

5.1.1 Four risk elements

Four risk elements

Risk assessment allows determination of the risk by means of four risk elements:

- Severity of the possible harm
- Frequency with which personnel are present in the danger zone
- Probability of a hazardous event occurring
- Possibility of avoiding or minimizing the harm

These risk elements then form the input parameters for implementing a safety-related control function: They enable assignment of the risk to the requirements of the safety-related control. For this reason, the IEC 62061 offers procedures for evaluating the risk elements and grading the safety performance.

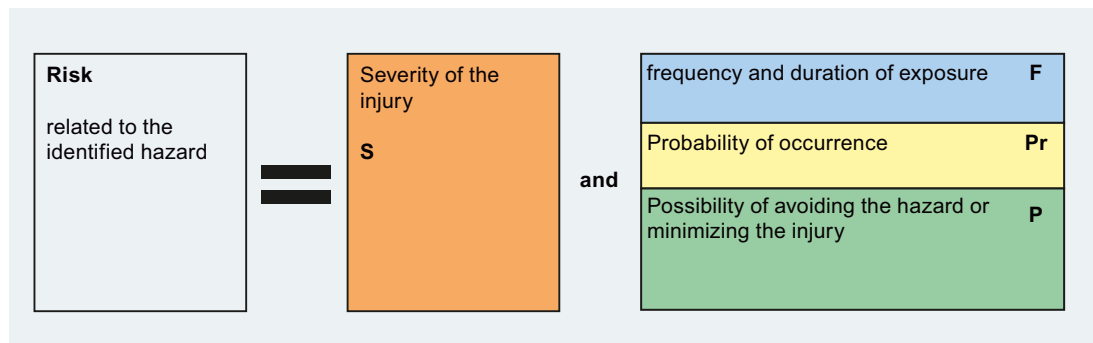

Figure 5-1 Risk related to the identified hazard

Determining the necessary safety performance (safety integrity)

If the risk assessment establishes that malfunctions of the controller or failure of the protective equipment can result in an excessively high risk, their probability must be reduced to the point where the residual risk is tolerable. In other words, the controller must achieve a sufficient "safety performance."

IEC 62061 provides a procedure that uses a system of safety performance grading that is probability-oriented, quantified and thus hierarchical. The result of the risk analysis is then the safety integrity level (SIL) for the related safety functions.

5.1 Safety-related parts for the machine control

ISO 13849-1 contains a similar quantified and thus hierarchical grading of safety performance. The measure called performance level (PL) there correlates with the SILs of IEC 62061 via the assigned probabilities of failure.

By applying the EN ISO 13849-1 and IEC 62061 standards, machine manufacturers comply with the new Machinery Directive and thus also achieve export capability and liability security. These standards have introduced quantitative aspects as well as qualitative considerations. Protective measures for reducing the risk by applying the appropriate safety functions are derived from the process of risk assessment. The solution of the safety function is then checked and evaluated with hardware components and, if applicable, software components, until the safety integrity required by the risk assessment is achieved.

Note

If a C standard exists for the machine type under consideration, the protective measures described there take precedence. However, a check must be made to ensure that the specifications are up to date with regard to later technical developments.

Risk graph acc. to ISO 13849-1

The aim is to use the risk elements to calculate the required performance level PL, in other words, the probability of dangerous system failures.

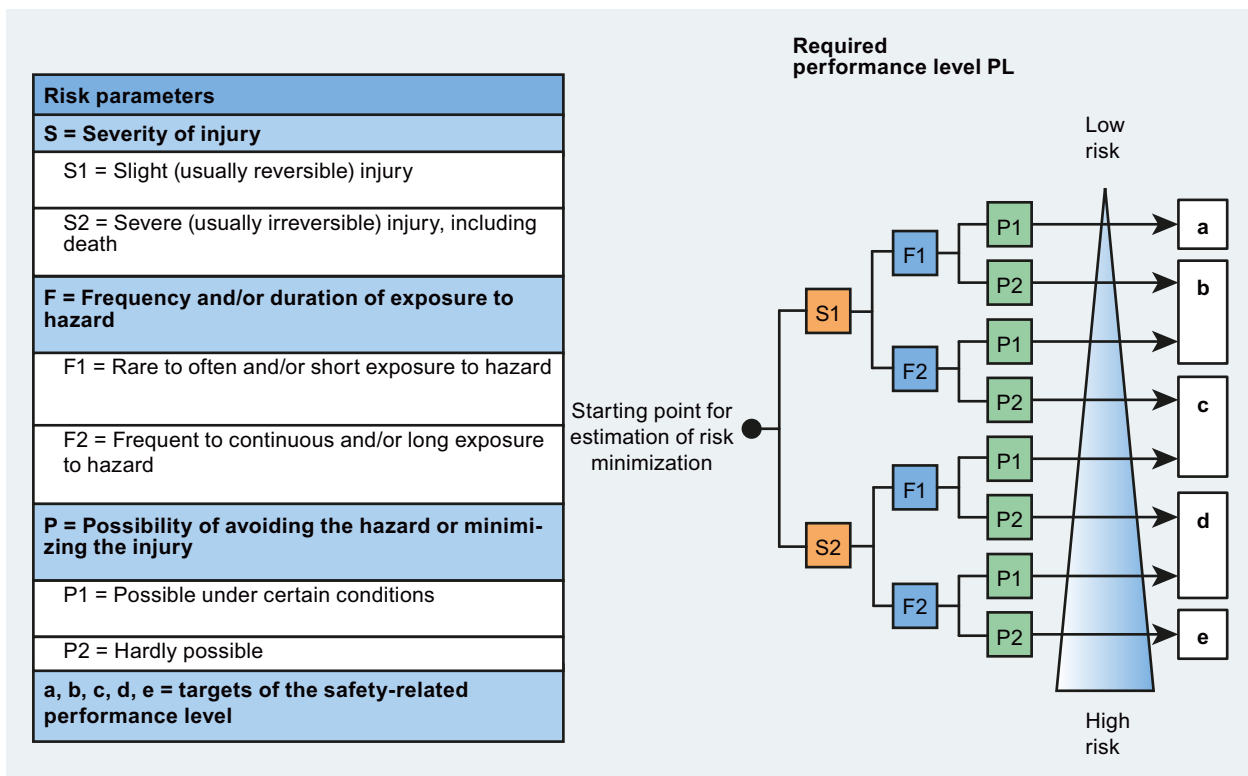

Figure 5-2 Risk graph in accordance with ISO 13849-1 for determining the required performance level

To determine the necessary performance level, the parameters **S** (severity of the injury), **F** (frequency/duration of exposure to the hazard), and **P** (possibility of avoidance) are used.

The severity of injury (S) is divided into reversible (e.g. crushing or flesh wounds) and irreversible (amputation, death).

There are no generally valid time periods for the frequency and duration of exposure to the hazard (F). If a person is exposed to the hazard more frequently than once per hour (e.g. to install workpieces), F2 (frequently to continuously) must be selected. It is also irrelevant whether the same person or different persons are exposed to the hazard. If access is only necessary from time to time, F1 (rarely to less frequently) can be selected.

If the frequency is higher than once every 15 minutes, and there is no other justification, F2 should be selected. F1 may be selected if the total exposure time does not exceed 1/20 of the total operating time, and the frequency is not higher than once every 15 minutes.

The possibility of avoidance (P) is influenced by different aspects. The training and level of knowledge of the operator must be considered here, as well as the possibilities of avoidance by means of, for example, escape or operation with or without supervision. The parameter **P1** (possible under certain conditions) must only be selected if there really is the possibility of avoiding an accident or of significantly reducing the level of injury caused.

If the probability of occurrence of the dangerous event can be assessed as low, the necessary performance level (PL) can be reduced by one.

The Performance Levels (PLs) are a quantitative measure of the safety performance, just like the Safety Integrity Levels (SILs) in IEC 61508 and IEC 62061.

Safety performance for implementing the controller in accordance with IEC 62061

The procedure described in IEC 62061, Annex A uses tables that can be used direct to document the executed risk assessment and SIL assignment.

For the individual risk parameters, the associated weighting is selected using the values given in the header of the table. The total of the weightings of all parameters provides the probability class of the injury.

$$C = F + Pr + P$$

The frequency and duration of exposure is expressed by the parameter "F." The necessity of access to the danger zone can vary in the individual operating modes (automatic, maintenance mode, etc.). The type of access (setting tools, delivering materials, etc.) also plays a role and must be considered under this aspect. The applicable frequency and duration is selected from the associated table. If the duration of exposure is less than 10 minutes, the value can be reduced to the next stage down. However, the frequency value ≤ 1 h must never be reduced.

The probability of occurrence of the hazardous event is expressed by the parameter "Pr". This must be estimated independently of the other parameters. Human behavior (conditioned, for example, by pressure of time, lack of awareness of the hazard, etc.) must also be taken into account here. Under normal production conditions, and taking account of the worst case, the probability is "extremely high." When using a low value, a detailed reason must be provided (e.g., operator abilities very high).

The possibility of avoidance or limitation of the injury is expressed by the parameter "P." Aspects must be taken into account here that affect both the machine (e.g., possibility of removing oneself from the hazard) and the possibility of detecting the hazard (e.g. detection impossible due to high surrounding noise levels). Grading is carried out in accordance with the table (probable, possible, impossible).

5.1 Safety-related parts for the machine control

With the help of this probability class and the potential severity of injury of the considered hazard, the necessary SIL for the associated safety function can be read from the table.

The aim is to determine a required safety integrity level SIL of the system from the risk elements.

Frequency and/or duration of exposure F		Probability of occurrence of the dangerous event Pr		Possibility of avoidance P	
≤ 1 hour	5	Frequent	5		
> 1 hour to ≤ 1 day	5	Probable	4		
> 1 day to ≤ 2 weeks	4	Possible	3	Impossible	5
> 2 weeks to ≤ 1 year	3	Rare	2	Possible	3
> 1 year	2	Negligible	1	Probable	1

Effects	Extent of injury S	Class $C = F + Pr + P$					
		3-4	5-7	8-10	11-13	14-15	
Death, loss of an eye or arm	4	SIL 2	SIL 2	SIL 2	SIL 3	SIL 3	
Permanent, loss of fingers	3	Other measures			SIL 1	SIL 2	SIL 3
Reversible, medical treatment	2				SIL 1	SIL 2	
Reversible, first aid	1						SIL 1

Figure 5-3 Determination of the required SIL

5.2 Specification of the safety requirements

Specification of the safety requirements

If control functions have been identified as safety-related, or if protective measures are to be implemented with controller resources, the precise requirements for these "safety functions" ("safety-related control functions") must be defined in the safety requirements specification. This specification includes descriptions of the following for each safety-related function:

- its functionality, that is, all the required input information, its logical combination, and the associated output states or actions, as well as the frequency of use
- the necessary response times
- the required safety performance

The specification of the safety requirements contains all the information required for designing and implementing the controller. It is the interface between the machine designer and the manufacturer/integrator of the controller, and can thus also be used to demarcate responsibilities.

5.3 Design and implementation of the (safety-related) controller in accordance with IEC 62061

5.3.1 Philosophy/theory

Structuring principle for a safety-related control system

Correct design is an essential prerequisite for the correct and intended functioning of a controller. To achieve this aim, IEC 62061 has defined a systematic top-down design process:

A safety-related electrical control system (SRECS) encompasses all components from information acquisition, through information combination, up to and including the execution of actions. To enable a simple systematic procedure for the design, safety-related assessment, and implementation of an SRECS that is to meet the requirements of IEC 61508, IEC 62061 uses a structuring principle based on the following architectural elements (see the figure below).

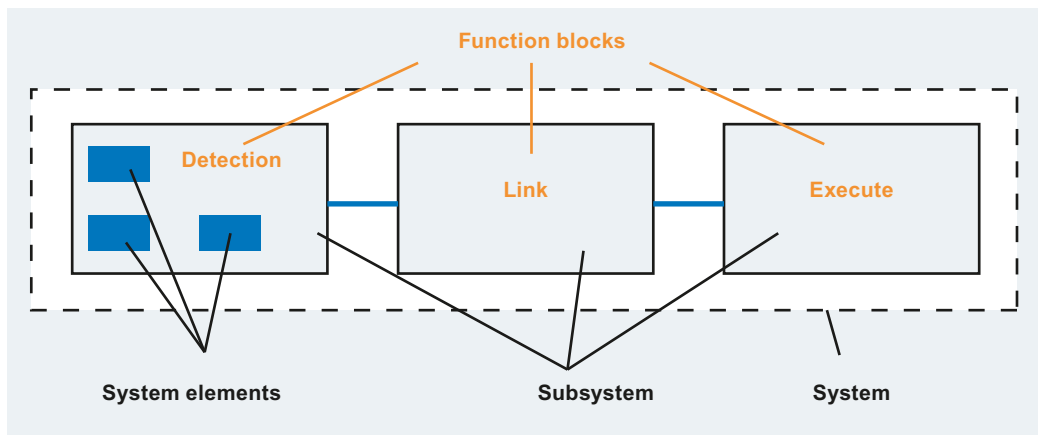

Figure 5-4 Structuring elements of the system architecture

Initially, a distinction is made between a "virtual" (that is, functional) view, and the "real" (that is, system) view. The functional view considers only the functional aspects, regardless of the hardware and software implementation. The virtual view only considers, for example, the information to be acquired, how that information is to be combined, and which action is to result. However, no statement is yet made about whether, for example, redundant sensors are required for gathering the information, or how the actuators are implemented. Only with the "real view" is implementation by the SRECS considered. A decision must then be made here as to whether, for example, one or two sensors are required to capture specific information to achieve the required safety performance. The following terms are defined.

Terms for structuring the functions (functional view)

- **Function block**
Smallest unit of a safety-related control function (SRCF) whose failure results in the failure of the safety-related control function.
Remark: In IEC 62061, an SRCF (F) is regarded as a logic "and" combination of the functions blocks (FBs), e.g. $F = FB1 \& FB2 \& \dots \& FBn$. The definition of a function block differs from the definition used in IEC 61131 and other standards.
- **Function block element**
Part of a function block.

Terms for structuring the real system (system view)

- **Safety-related electrical control system**
Electrical control system of a machine whose failure leads to a direct increase in the risk.
Remark: An SRECS encompasses all the parts of an electrical control system whose failure can lead to a reduction in, or the loss of, functional safety. This can encompass both energy and control circuits.
- **Subsystem**
Part of the SRECS architecture design on the topmost level. The failure of any one subsystem leads to a failure of the safety-related control function.
Remark: In contrast to general usage whereby "subsystem" can mean any subordinate unit, the term "subsystem" in IEC 62061 is used within a strictly defined hierarchy of terminology. "Subsystem" means subdivision at the topmost level. The parts resulting from further subdivision of a subsystem are called "subsystem elements"
- **Subsystem element**
Part of a subsystem that encompasses an individual component or group of components. With these structuring elements, control functions can be structured in accordance with a clear procedure in such a way that defined parts of the function (function blocks) can be assigned to specific hardware components, the subsystems. This results in clearly defined requirements for the individual subsystems so that they can be designed and implemented independently of each other. The architecture for implementing the full control system results from arranging the subsystems in the same way as the function blocks are arranged (logically) within the function.

5.3.2 Design process of a safety-related control system (SRECS)

Design process

If the safety requirements specification is available, the designated control system can be designed and implemented. A control system that meets the specific requirements of a specific application cannot generally be purchased off the shelf, but instead must be designed and built from available devices, individually for the machine in question.

The design process takes a step-by-step approach and starts by finding a suitable control system architecture for each safety function. The architectures of all the safety functions of the machine in question can then be integrated to form a control system.

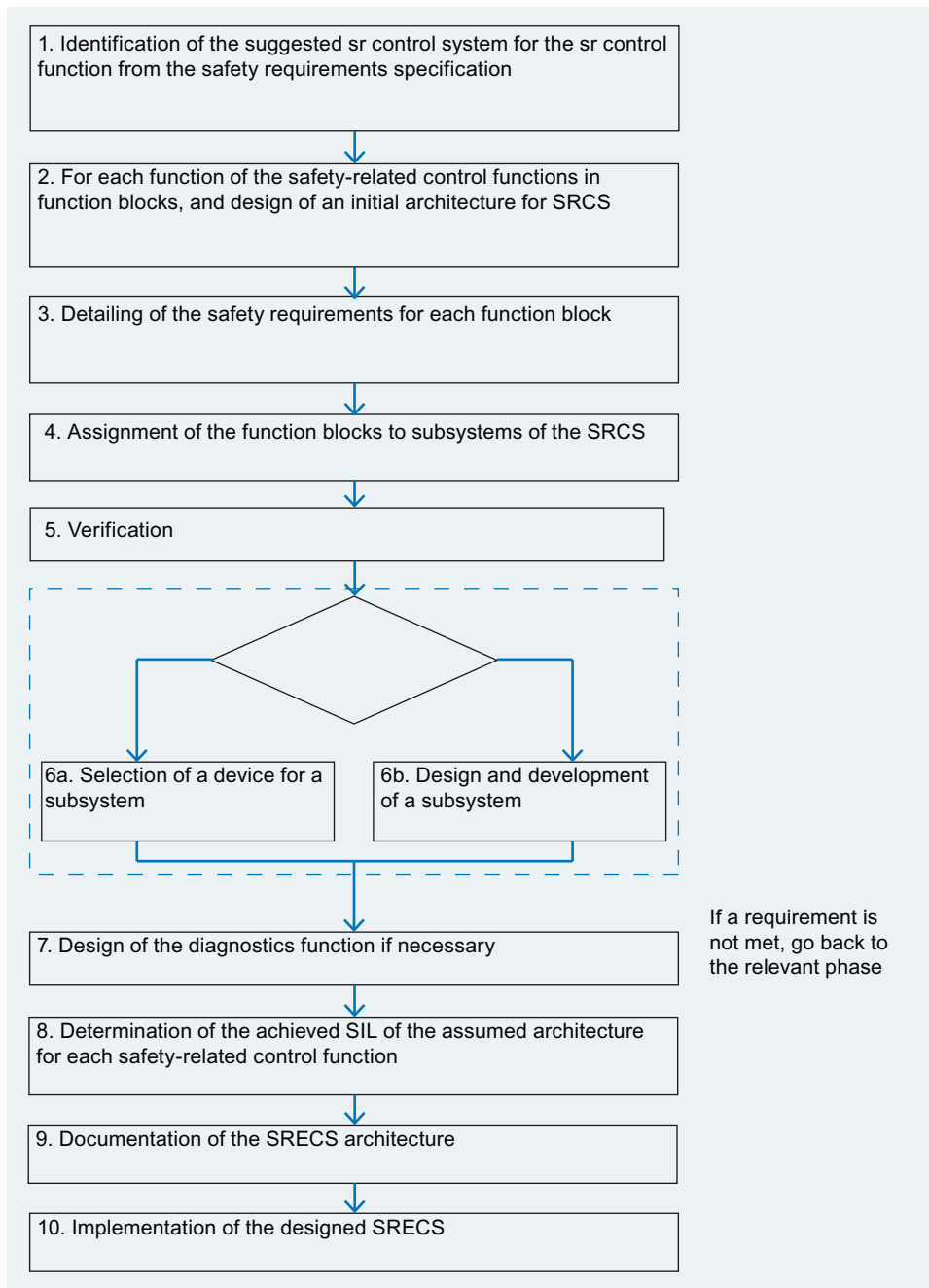

Figure 5-5 Design process of a safety-related control system

Structuring the safety function

The basic principle of structured design involves subdividing each control function into (conceptual) function blocks in such a way that these can be assigned to specific subsystems. The demarcation of the individual function blocks is selected in such a way that they can be fully executed by specific subsystems. It is important here that each function block represents a logical unit that must be executed correctly for the correct execution of the overall safety function.

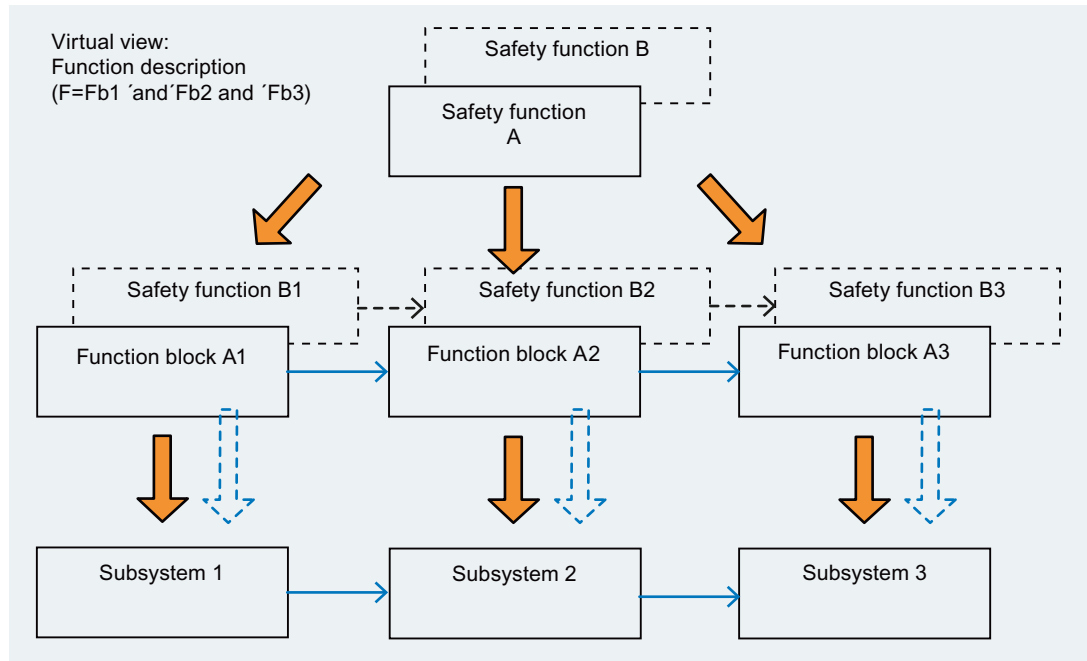

Figure 5-6 Subdivision of a safety function into function blocks and assignment to subsystems

Safety performance of a subsystem in accordance with IEC 62061

"Safety integrity" in accordance with IEC 62061 requires the fulfillment of the three basic requirements that are graded according to the SIL:

1. Systematic integrity
2. Structural constraints, in other words, fault tolerance, and
3. Limited probability of hazardous, random (hardware) failures (PFH_D).

The systematic integrity (1) of the system required for the whole function, and the structural constraints (2) apply for the individual subsystems just as for the system. In other words, if each individual subsystem meets the required systematic integrity and the structural constraints of a specific SIL, the system also meets them. However, if a subsystem meets only the lower requirements of a lower SIL, this limits the SIL that the system can achieve. We therefore refer to the "SIL claim limit" (SIL CL) of a subsystem.

- Systematic integrity: $SIL_{SYS} \leq SIL_{CL_{lowest}}$
- Structural constraints: $SIL_{SYS} \leq SIL_{CL_{lowest}}$

Limiting the probability of hazardous, random faults (3) applies for the overall function; in other words, it must not be exceeded by all subsystems together. The following therefore applies:

$$PFH_D = PFH_{D1} + \dots + PFH_{Dn}$$

5.3.3 System design for a safety function

Architectural design

The architecture of a control system for a specific safety function corresponds in its logical structure to the previously determined structure of the safety function. To define the real system structure, the function blocks of the safety function are assigned to specific subsystems. The subsystems are then interconnected in such a way that the connections specified by the function structure are established. The physical interconnection takes place in accordance with the properties of the selected technology, e.g. by means of single wiring (point-to-point) or bus connection.

The same procedure is used for further safety functions of the machine or plant. However, in doing so, function blocks that correspond to those of other safety functions can be assigned to the same subsystems. So if, for example, the same information has to be acquired for two different functions (the position of the same protective door, for example), the same sensors can be used for the purpose.

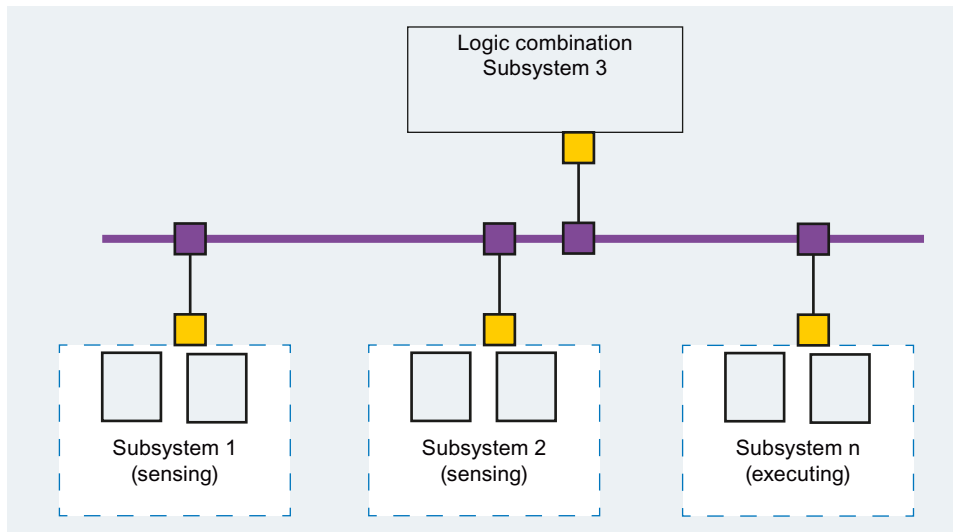

Figure 5-7 Example of a system architecture for a safety function

Selection of suitable devices (subsystems)

A subsystem that is to be used for implementing a safety function must have the required functionality and must meet the relevant requirements of IEC 62061. Microprocessor-based subsystems must comply with IEC 61508 for the relevant SIL.

The individual subsystems must meet the safety parameters (SIL CL and PFH₀) required in the specification.

In many cases, devices require additional fault detection measures (diagnostics) to actually achieve the safety performance specified for their use as a subsystem. This fault detection can, for example, can be carried out by means of additional devices (such as SIRIUS 3SK1 safety relays) or corresponding software diagnostics blocks in the logic processing. For such cases, the device description must include the corresponding information.

If a suitable device that meets the requirements of a subsystem specified in this way is not available, it must be assembled by combining available devices. This requires a subsequent design step. For details, see section "Design and implementation of subsystems (Page 200)."

5.3.4 Implementation of the safety-related control system

A safety-related control system must be implemented in such a way that it meets all the requirements in accordance with the demanded SIL. The aim is to sufficiently reduce the probability both of systematic and random faults that can result in dangerous failure of the safety function. The following aspects should be noted:

- Hardware integrity, in other words, architectural constraints, (fault tolerance) and limited probability of failure
- Systematic integrity, in other words, requirements for avoiding and controlling faults
- Behavior when a fault is detected, and software design / software development

Hardware integrity

Each subsystem must possess adequate fault tolerance for the SIL of the system. This depends on the proportion of faults tending toward a safe state related to the probability of all possible faults of the subsystem. Potentially dangerous faults of a subsystem detected in good time by the diagnostics are among the faults tending toward a safe state.

The permitted probability of failure of a safety function is limited by the SIL defined in the specification.

Systematic integrity

Measures must be applied both for avoiding systematic faults and for controlling faults remaining in the system.

Avoiding systematic faults:

- The system must be installed in accordance with the safety plan
- The manufacturer's specifications for the devices used must be followed

- The electrical installation must be carried out in accordance with IEC 60204-1 (7.2, 9.1.1 and 9.4.3)
- Check the design for suitability and correctness
- Use of a computer-aided tool that uses pre-configured and tested elements.

Controlling systematic faults:

- Use of the principle of energy shutdown
- Measures for controlling temporary subsystem failures or faults, due to voltage interruptions, for example
- When connecting the subsystems by means of a bus, the data communication requirements of IEC 61508-2 must be fulfilled (e.g. PROFIsafe and ASIsafe)
- Faults in the connection (wiring) and the interfaces of the subsystems must be detected, and appropriate responses must be initiated. For systematic handling, the interfaces and the wiring are regarded as a component part of the relevant subsystem.

For details, see IEC 62061 6.4

Behavior when a fault is detected

If subsystem faults can result in a dangerous failure of a safety function, the faults must be detected in good time, and an appropriate response must be initiated to avoid the hazard. The extent to which automatic fault detection (diagnostics) are necessary depends on the failure rate of the devices used, and the SIL to be achieved (or the required PFH of the subsystem).

How the system or subsystem must behave when a fault is detected depends on the fault tolerance of the relevant subsystem. If the detected fault does not result directly in the failure of the safety function, in other words, fault tolerance > 0, a fault response is not necessary immediately, but only when the probability of the occurrence of a second fault becomes high (usually after hours or days). If the detected fault results directly in the failure of the safety function, in other words, fault tolerance = 0, a fault response is necessary immediately, that is, before a hazard occurs.

5.3.4.1 Achieved safety performance

Achieved safety performance

The specification of every safety function defines the safety performance the function requires. This must be fulfilled by the safety-related control system.

Which safety performance a system achieves must be determined for each safety function. This is done using the architecture of the system and the safety parameters of the subsystems involved in executing the safety function under consideration.

5.3 Design and implementation of the (safety-related) controller in accordance with IEC 62061

Design according to IEC 62061

The achieved SIL is limited by the "SIL suitability" of its subsystems. The lowest value of the subsystems used limits the SIL of the system to this value. (The chain is only as strong as its weakest link.)

- Systematic integrity: $SIL_{SYS} \leq SIL_{CL_{lowest}}$
- Structural constraints: $SIL_{SYS} \leq SIL_{CL_{lowest}}$

For connecting the subsystems together, the same requirements must be met. For this, individual wiring is regarded as a component part of each of the two connected subsystems. In the case of bus connection, send and receive hardware and software are component parts of the subsystems.

Apart from this basic suitability, the probability of a dangerous failure of every safety function must be considered. This value is derived from the simple addition of the failure probabilities of the subsystems involved in the function:

$$PFH_D = PFH_{D1} + \dots + PFH_{Dn}$$

In the case of bus connections, the probability of possible data transmission errors (PTE) must also be added.

The value determined in this way for a specific safety function must be less than (or equal to) the value determined by the associated SIL.

Table 5-1 Limits to the probabilities of dangerous faults of a safety function

Probability of a dangerous failure per hour (PFH _D)			
	SIL 1	SIL 2	SIL 3
PFH _D	< 10 ⁻⁵	< 10 ⁻⁶	< 10 ⁻⁷

5.3.5 System integration for all safety functions

After the architectures for all safety functions have been designed, the next step is the integration of these function-specific architectures to form the complete safety-related control system.

Wherever multiple safety functions have identical function blocks, shared subsystems can be used for their implementation:

- For example, you need only one safety PLC to implement the logic of all safety functions.
- If the status of the same protective door has to be sensed to eliminate a number of different hazards (in other words, for different safety functions), only one sensor only has to be installed on this door for them all.

This does not affect the safety integrity that has already been determined for the individual functions. This only has to be taken into account when determining the switching frequency of the electromechanical (wear-prone) devices.

5.3.6 Design and implementation of subsystems

As an alternative to the selection of an existing subsystem, a subsystem can also be assembled by combining devices that do not on their own meet the safety requirements, but that achieve the necessary safety performance when combined. This is the SIL claim limit (SIL CL) dictated by the SIL of the safety function with regard to systematic integrity and structural restrictions. For the probability of dangerous, random faults (PFH_D), the maximum PFH values for the individual subsystems has been defined when designing the system architecture.

Redundancy is generally required, at least for SIL 2 and SIL 3, whether to achieve the necessary fault tolerance, or to enable fault detection (diagnostics). However, the combination of two devices to form one subsystem can also be required to reduce the probability of a dangerous failure.

The precise requirements for designing and implementing subsystems are described in IEC 62061, Section 6.7 and 6.8. The following description provides an overview.

Subsystem architectural design

A special subsystem architecture must always be designed when the necessary safety integrity (safety performance) cannot be achieved direct with the devices provided for a specific task (subfunction, "function block"). In general, the safety-related features

- Low probability of failure
- Fault tolerance, fault control
- Fault detection

can only be achieved by means of special architectural measures. The extent to which specific measures are necessary depends on the required safety performance (safety integrity).

A specific (sub)function, the function block (e.g. locking of a door), is assigned to the subsystem. This function block is initially (conceptually) subdivided into individual elements (function block elements) that can then be assigned to specific devices, the subsystem elements. In general, the same function can be assigned to two function block elements (the function has been effectively doubled). If these function block elements are then implemented using separate devices, the subsystem has single fault tolerance (single redundancy).

Detecting faults in a subsystem (diagnostics)

For a subsystem without fault tolerance, every fault results in a loss of function. The failure of the function can result in a dangerous or safe machine state, depending on the type of fault. Faults that result in a dangerous machine state are critical. They are called "dangerous faults." To avoid a dangerous fault actually resulting in a hazard, you can detect certain faults by means of diagnostics, and put the machine into a safe state before the hazard occurs. A dangerous fault detected by diagnostics can thus be converted to a "safe fault."

In a redundant subsystem, the first fault does not yet result in failure of the function. Only a further fault can cause the loss of the function. To avoid failure of the subsystem, the first fault must therefore be detected before a second fault occurs. Fault detection must, of course, be linked to an appropriate system response. In the simplest case, the machine is stopped, for example, to bring it to a safe state that does not require the (faulty) safety function.

5.3 Design and implementation of the (safety-related) controller in accordance with IEC 62061

As a result of fault detection (diagnostics) linked to an appropriate fault response, the probability of a dangerous failure of the relevant safety function is reduced in both cases. The degree to which the probability is reduced depends, among other things, on how many of the possible hazardous faults are detected. The measure for this is the diagnostic coverage (DC).

Fault detection in a subsystem can be carried out in the relevant subsystem itself or by another device, e.g. the safety PLC.

Systematic integrity of a subsystem

When designing and implementing a subsystem, measures must be taken both to avoid and to control systematic faults, for example:

- The devices used must comply with the relevant international standards.
- The manufacturer's conditions of use must be observed.
- The design and the materials used must be such that they withstand all expected environmental conditions.
- Behavior in response to environmental influences must be pre-defined so that a safe state of the machine can be maintained.
- Online fault detection
- Positive actuation to initiate a protective measure

The requirements described in IEC 62061 refer only to the design of electrical subsystems of a low level of complexity, in other words, not to subsystems with microprocessors. The required measures apply equally for all SILs.

Probability of failure (PFH_D) of a subsystem

Possible failures are differentiated according to whether they are "safe" or "dangerous." Dangerous failures of a subsystem are defined as follows.

Dangerous failure

Failure of an SRECS, a subsystem, or subsystem element with the potential to cause a hazard or non-functional state.

Note: Whether such a state occurs or not can depend on the system architecture; in systems with multiple channels for improving safety, the probability of a dangerous hardware failure resulting in a dangerous overall state or a functional failure is low.

This means, for example: In a redundant subsystem (that is, fault tolerance 1), a fault in a channel is said to be dangerous if it is potentially dangerous, in other words, if it can result in a dangerous state of the machine in the absence of a second channel.

For the safety requirements, only the probability of dangerous failures is significant. Although "Safe faults" impair the availability of the system, they do not cause a hazard.

The probability of failure of a subsystem depends on the failure rates of the devices that make up the subsystem, the architecture and the diagnostics measures. For the two most commonly used architectures, the formulas are specified in IEC 62061.

Structure without fault tolerance with diagnostics

With this structure (see the figure below), the subsystem fails if any one of its elements fails, in other words, a single fault results in the failure of the actual safety function. But this does not yet necessarily mean a dangerous loss of the safety function. Depending on the type of the fault, the machine can go to a safe or a dangerous state, in other words, the subsystem has a "safe" or a "dangerous" fault. If the probability of dangerous failure per hour (PFHd) is greater than given in the specification, these faults must be detected by means of diagnostics, and a fault response must be initiated before a hazard arises. This turns dangerous faults into safe faults, and consequently the probability of a dangerous failure of the subsystem is reduced, so that the probability of failure permitted in the specification can possibly be achieved.

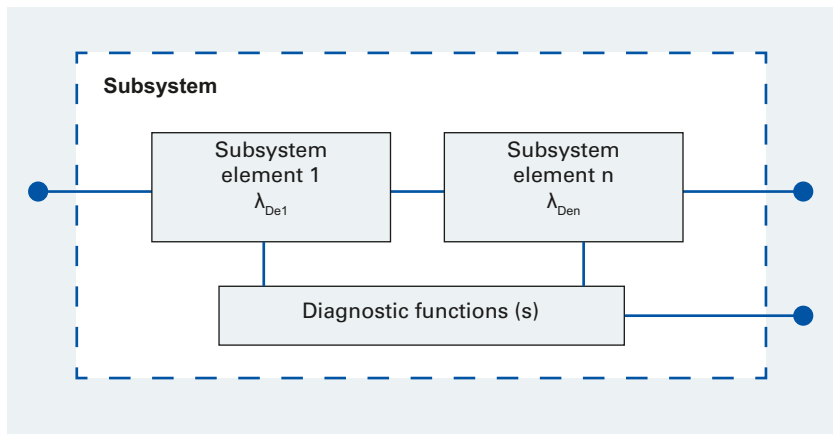

Figure 5-8 Logic structure of a subsystem without fault tolerance with diagnostics

Structure with simple fault tolerance and diagnostics

With this structure (see the figure below), the first fault does not yet result in failure of the function. However, the fault must be detected before the probability of occurrence of a second fault, that is, the failure of the subsystem, exceeds the limit given in the specification.

As well as independent, random faults, the possibility of common cause failures must be noted in redundant subsystems. Homogenous redundancy does not help against such faults. At the design stage, systematic measures must therefore be taken to make their probability sufficiently low. Since common cause faults can never be completely ruled out, they must be taken into account in calculating the probability of failure of a subsystem. This is done with the help of the common cause factor (β) with which the effectiveness of the adopted measures is evaluated. Annex F of IEC 62061 contains a table for determining the achieved common cause factor.

With this structure, a single failure of any subsystem element does not result in the failure of the safety-related control function.

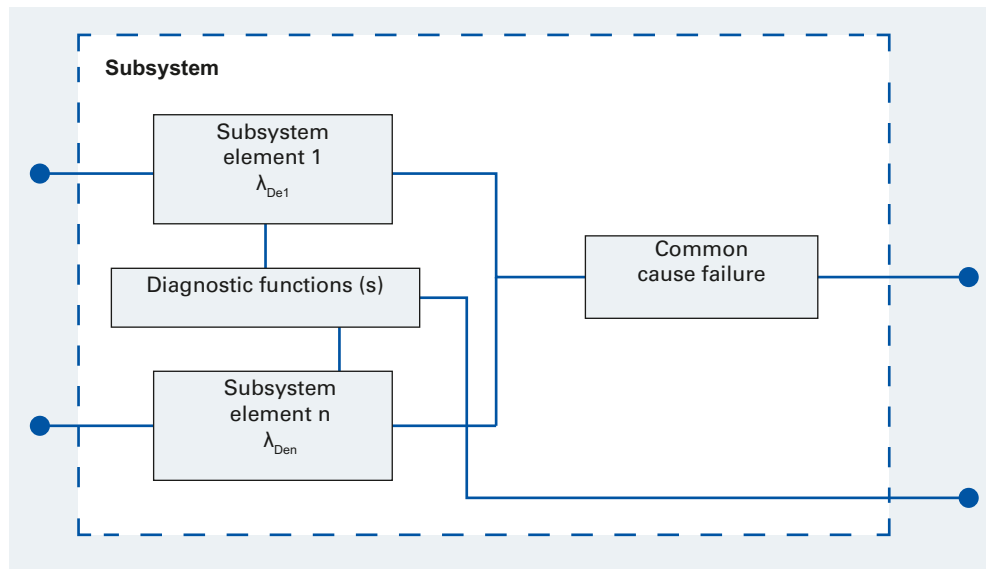

Figure 5-9 Logic structure of a subsystem with simple fault tolerance with diagnostics

Structural constraints of a subsystem

The structural constraints demand a minimum of fault tolerance depending on the type of the possible faults of the subsystem. The greater the proportion of "safe" faults, the lower is the required fault tolerance for a specific SIL.

The table below shows the relevant limits. "Safe faults" in this context are also potentially dangerous faults that are detected by diagnostics.

Table 5-2 Structural constraints of a subsystem

Proportion of safe faults	Hardware fault tolerance	
	0	1
< 60 %	Not permissible (see the standard for exceptions)	SIL 1
60% to < 90%	SIL 1	SIL 2
90% to < 99%	SIL 2	SIL 3
≥ 99 %	SIL 3	SIL 3

Note: A hardware fault tolerance of N means N+1 faults can result in the loss of the function.

So for a subsystem, for example, that is to be used for SIL 2, no fault tolerance is required (FT = 0) if the proportion of its faults that tend toward a safe state is more than 90%. Most devices do not achieve this value on their own. However, you can reduce the proportion of dangerous faults by detecting the faults by means of diagnostics and initiating an appropriate response in good time.

The safe failure fraction of a subsystem is the proportion of faults that result in a safe state of the machine as a percentage of all faults of the subsystem weighted according to the probability of their occurrence.

5.4 Design and implementation of safety-related parts of a controller in accordance with ISO 13849-1

Purpose

A safety-related (control) system must execute a safety function correctly. Even in the event of a fault, it must behave in such a way that the machine or plant remains in, or is brought to, a safe state.

Determining the necessary safety performance (safety integrity)

The requirements of the safety function have been determined by means of the process of risk assessment (see chapter "Safety-related parts for the machine control (Page 187)").

ISO 13849-1 prescribes a required performance level PL_r . See chapter "Safety-related parts for the machine control (Page 187)."

Design process of the safety-related parts of a controller

The categories in accordance with ISO 13849-1 refer equally to the system (safety function) and its subsystems. When implementing in accordance with ISO 13849-1, the same principle of structuring the safety-related system can be used as that described in IEC 62061. Each subsystem separated in this way must then achieve the performance level demanded for the protective function. The requirements of the relevant category also apply for wiring of the subsystems together.

In ISO 13849-1, the performance level PL_r is additionally introduced at the design stage as the quantitative variable for the probability of failure alongside the categories.

The figure below shows the iterative process for structuring the safety-related parts of the controllers (SRP / CS):

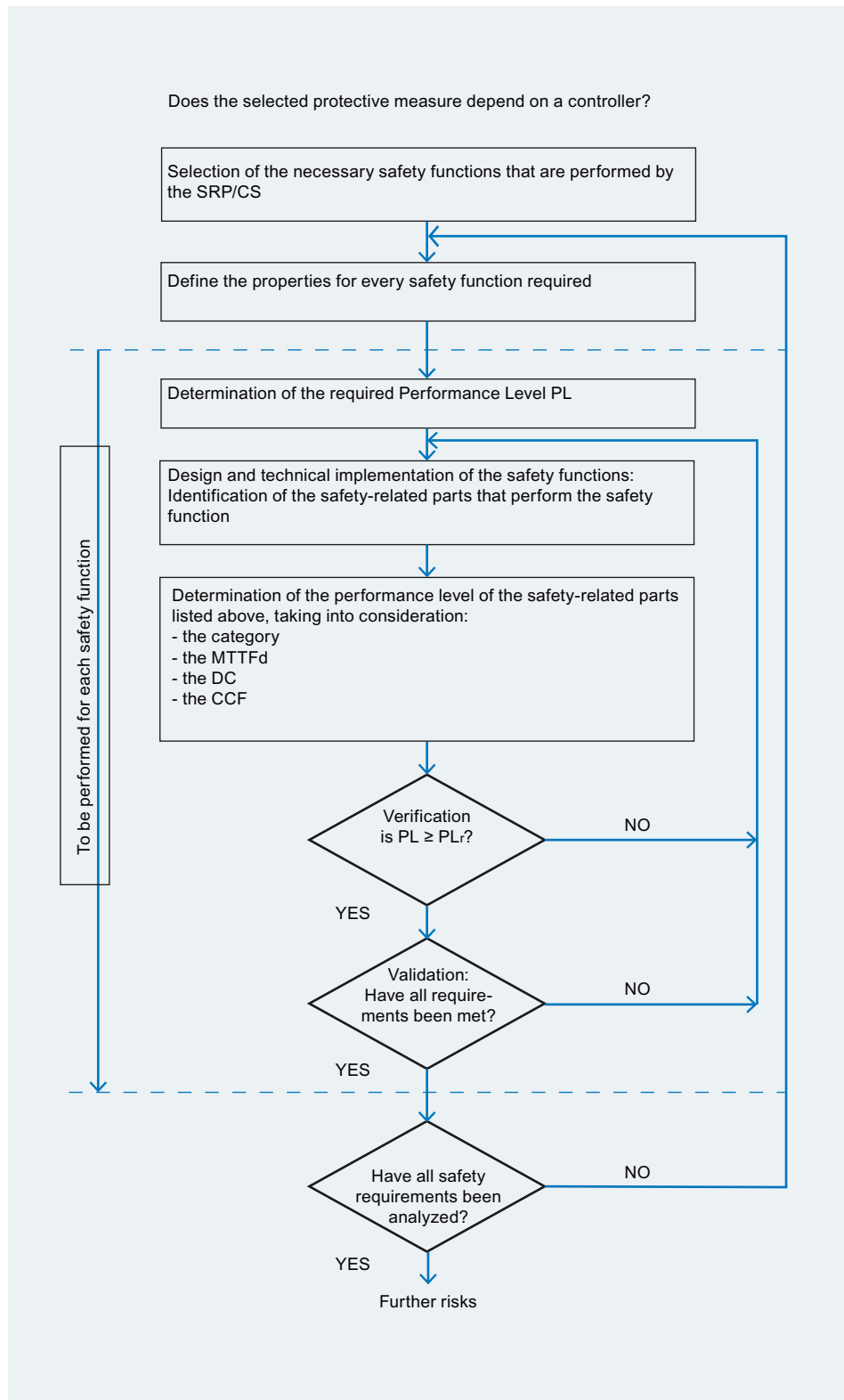

Figure 5-10 Iterative process for structuring the safety-related parts of controllers

Design in accordance with ISO 13849-1

The architecture design is oriented toward the required performance level PL_r .

The design concept of ISO 13849-1 is based on specially pre-defined architectures of the safety-related parts of the controller.

A safety function can comprise one or more safety-related parts of a controller (SRP / CS).

A safety function can also be an operating function such as a two-hand control device for initiating a process.

A typical safety function comprises the following safety-related parts of a controller:

- Input (SRP/CS_a)
- Logic / processing (SRP/CS_b)
- Output / energy transmission element (SRP/CS_b)
- Connections (i_{ab} , i_{ac}) (e.g. electrical, optical)

Note: Safety-related parts comprise one or more components; components can comprise one or more elements.

All connecting elements are included in the safety-related parts.

If the safety functions of the controller have been determined, the safety-related parts of the controller must be identified. Their contribution to the process of risk reduction (ISO 12100) must also be assessed.

Performance level PL

When using ISO 13849, the ability of safety-related parts to execute a safety function is expressed by determining a performance level.

The PL must be estimated for each selected SRP/CS and/or combination of SRP/CS that executes a safety function.

The PL of the SRP/CS must be determined by estimating the following aspects:

- $MTTF_d$ (mean time to dangerous failure)
- DC (diagnostic coverage)
- CCF (common cause failure)
- Structure
- Behavior of the safety function under fault condition(s)
- Safety-related software
- Systematic failures

Mean time to dangerous failure of each channel (MTTF_d)

The value of the MTTF_d of each channel is specified in three stages, and must be taken into account for each channel individually (e.g. single channel or each channel of a redundant system). A maximum value of 100 years can be fixed with regard to the MTTF_d. One exception is represented by the channels with PL e, where the MTTF_d is limited to 2500 years.

MTTF _d	
Low	3 years ≤ MTTF _d < 10 years
Average	10 years ≤ MTTF _d < 30 years
High	30 years ≤ MTTF _d ≤ 100 years

Diagnostic coverage (DC)

The value for DC is specified in four stages. To estimate the DC, failure mode and effects analysis (FMEA), or similar procedures, can be used in most cases. In this case, all relevant faults and/or failure modes must be taken into account, and the PL of the SRP/CS combination that is to execute the safety function must be tested against the required performance level (PL_r). For a simplified approach to estimating the DC, see ISO 13849-1 Annex E.

Diagnostic coverage (DC)	
None	DC < 60%
Low	60% ≤ DC < 90%
Average	90% ≤ DC < 99%
High	99% ≤ DC

5.4.1 Design and implementation of categories

Category B

To achieve Category B, the safety-related parts of the controller must meet the following requirements and they must be structured, selected and combined in accordance with these requirements.

- Application of the fundamental safety principles
- Ability to withstand the expected operating demands, including switching capacity or the frequency of operations of the components
- Robustness in respect of the influences of the material to be processed and the environmental conditions, including, for example, substances such as oils, cleaning agents, salt spray
- Robustness in respect of other relevant external influences, including mechanical vibration, electromagnetic interference, and interruptions or faults in the energy supply.

In a Category B system, the MTTF_d of each channel can be low to average. There is no diagnostics coverage (DC avg = none). Since the structure is usually single-channel, CCFs are not considered in this category since they are not relevant. The maximum achievable

performance level of a Category B system is $PL = b$.
The single-channel design means a fault can result in the loss of the safety function.

Example of a designated Category B architecture:

- I1: Sensor 1 (e.g. a position switch)
- L1: Logic unit 1 (e.g. a safety relay)
- O1: Actuator 1 (e.g. a contactor)

The structural features are:

- Single-channel design

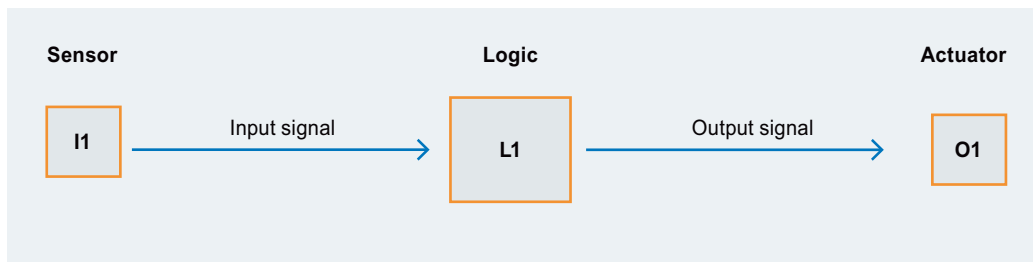

Figure 5-11 Designated architecture for Category B

Category 1

To achieve Category 1, the requirements for Category B must be met.
In addition, the following requirements must be met:

Field-proven components must be used for the safety-related parts of the controller, and field-proven safety principles must be adhered to (see ISO 13849-2).

In a Category 1 system, the MTTFd of each channel must be high.

The maximum achievable performance level is $PL = c$.

Example of a designated Category 1 architecture:

- I1: Sensor 1 (e.g. a position switch)
- L1: Logic unit 1 (e.g. a safety relay)
- O1: Actuator 1 (e.g. a contactor)

The structural features are:

- Single-channel design
- Use of field-proven components

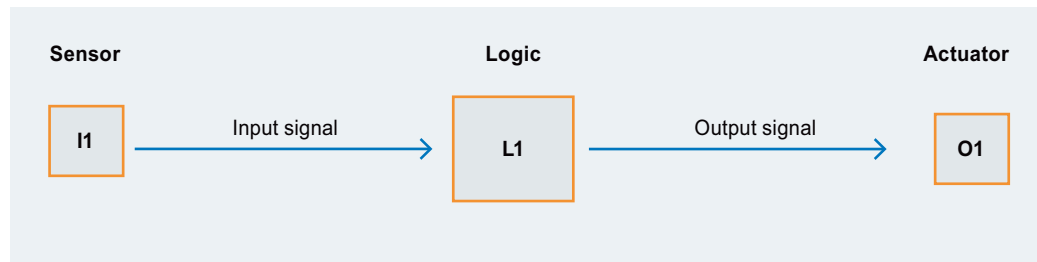

Figure 5-12 Designated architecture for Category 1

Category 2

To achieve Category 2, the requirements for Category B must be met. Field-proven safety principles must also be adhered to. The following requirements also apply:

The safety-related parts of the controller of a Category 2 system must be tested by the machine controller at appropriate intervals. This test of the safety function by the machine controller must be carried out:

- During machine start-up, and
- Before initiation of each dangerous situation, e.g. at the start of a new machine cycle, or the initiation of other movements, etc.

As the result of the test by testing equipment

- An appropriate fault response must take place if a fault is detected
- Operation must not be permitted if a fault is detected

The fault response must initiate a safe state whenever possible. Only when the fault has been remedied may normal operation be resumed. If the safe state cannot be entered (e.g. if the contacts have welded), a warning against the hazard must be provided.

In a Category 2 system, the MTTFd of each channel must be low to high depending on the required PLr. The safety-related parts of the control system must have low to average diagnostic coverage. At the same time, CCF measures must be used (see ISO 13849-1 Annex F).

In addition, the test itself must not result in any further hazards. The test equipment may be one of the safety-related parts of the control system, or it can be implemented separately.

The maximum achievable performance level of a Category 2 system is PL = d.

Note

Category 2 is a single-channel tested system as defined in the simplified procedure of ISO 13849-1: if a dangerous fault occurs, fault detection is only (meaningfully) effective if the fault-detecting test takes place before the next demand for the safety function. Against this background, a test rate is demanded that is 100 times faster than the demand rate of the safety function.

Example of a designated Category 2 architecture

- I1: Sensor 1 (e.g. a position switch)
- L1: Logic unit 1 (e.g. a safety relay)

- O1: Actuator 1 (e.g. a contactor)
- TE: Test equipment

The structural features are:

- Single-channel design
- Monitoring by the test equipment

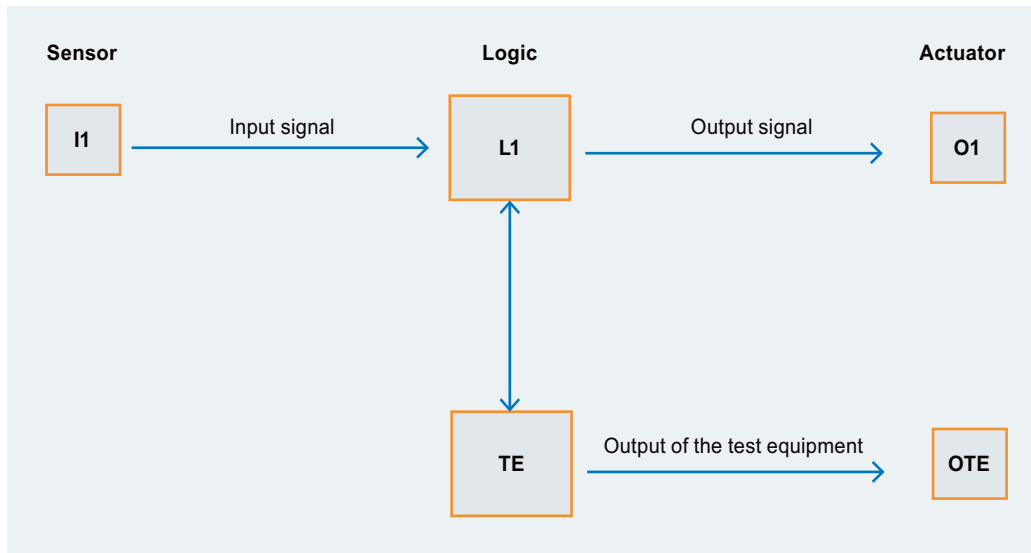

Figure 5-13 Designated architecture for Category 2

Category 3

To achieve Category 3, the requirements for Category B must be met. Field-proven safety principles must also be adhered to. The following requirements also apply:

The safety-related parts of the control system of Category 3 must be designed in such a way that the safety function is not lost if a single fault occurs. The single fault must be detected at or before the next demand for the safety function whenever possible.

In a Category 3 system, the MTTFd of each redundant channel must be low to high depending on the required PLr. The safety-related parts of the control system must have low to average diagnostic coverage. At the same time, CCF measures must be used (see ISO 13849-1 Annex F).

Example of a designated Category 3 architecture:

- I1 and I2: Sensor 1 and 2 (e.g. two position switches with positive opening contacts)
- L1 and L2: Logic unit 1 and 2 (a safety relay, for example, already includes these two units)
- O1 and O2: Actuator 1 and 2 (e.g. two contactors)

The structural features are:

- Redundant design
- Monitoring of the sensors (discrepancy monitoring)
- Monitoring of the enabling circuits (monitoring, comparable with the feedback circuits today)

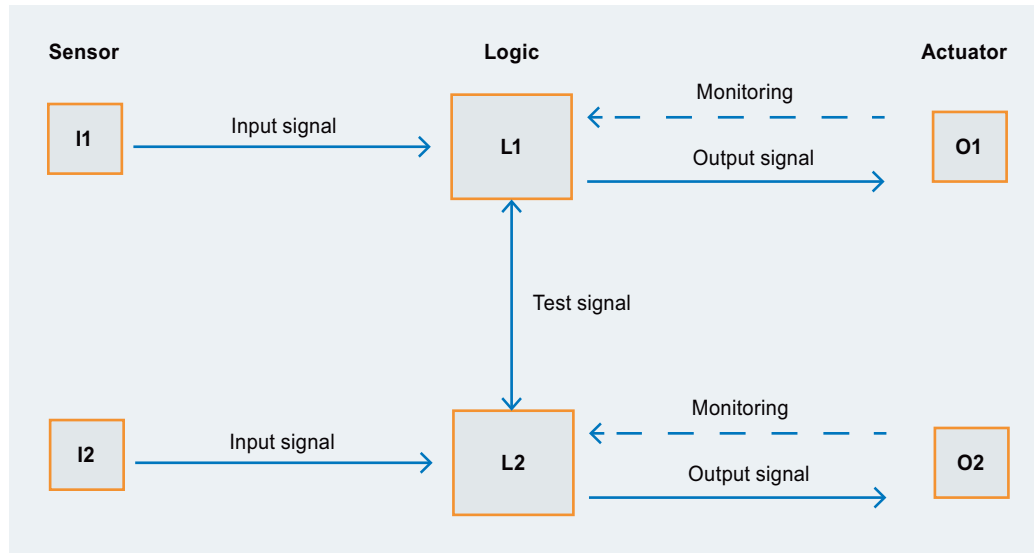

Figure 5-14 Designated architecture for Category 3

Category 4

To achieve Category 4, the requirements for Category B must be met. Field-proven safety principles must also be adhered to. The following requirements also apply:

The safety-related parts of the control system of Category 4 must be designed in such a way that the safety function is not lost if a single fault occurs. The single fault must be detected at or before the next demand for the safety function. If a fault cannot be detected, an accumulation of these faults must not result in the loss of the safety function.

In a Category 4 system, the MTTFd of each redundant channel must be high. The safety-related parts of the control system must have high diagnostic coverage. At the same time, CCF measures must be used (see ISO 13849-1 Annex F).

Example of a designated Category 4 architecture:

- I1 and I2: Sensor 1 and 2 (e.g. two position switches with positive opening contacts)
- L1 and L2: Logic unit 1 and 2 (a safety relay, for example, already includes these two units)
- O1 and O2: Actuator 1 and 2 (e.g. two contactors)

The structural features are:

- Redundant design
- Monitoring of the sensors (discrepancy monitoring)

- Monitoring of the enabling circuits (monitoring, comparable with the feedback circuits)
- High diagnostic coverage in all subsystems

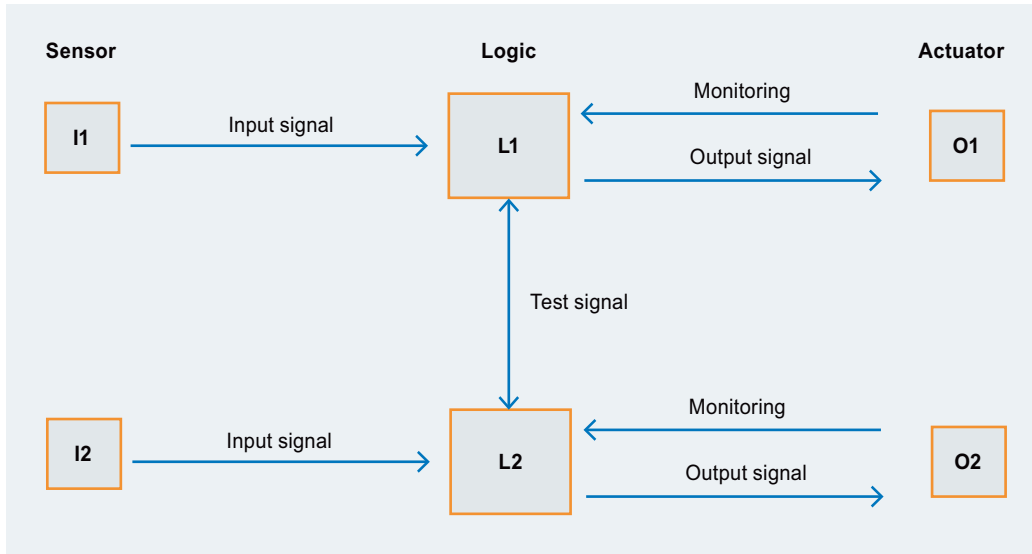

Figure 5-15 Designated architecture for Category 4

Evaluation of the safety functions

Each provided safety function and its implementation and evaluation must be documented in accordance with the specifications of the standard.

The quick and easy handling of the Safety Evaluation in the TIA Selection Tool offers you valuable support when evaluating safety functions on machines and in plants.

The offline tool guides the operator step by step from defining the structure of the safety system, through the selection of components, to the calculation of the achieved safety integrity in accordance with ISO 13849-1 and IEC 62061.

The integrated and extensive libraries also support you here. Users receive a standard-compliant report that can be integrated into the documentation as a safety verification.

You can keep the safety-related data from Siemens up to date by performing regular updates of the TIA Selection Tool. This ensures that the calculations are always carried out according to the current standards, and the latest technical data for all safety-related components from SIEMENS are accessed.

The Safety Evaluation in the TIA Selection Tool can be found on the Internet (<http://www.siemens.com/safety-evaluation-tool>).

Service & Support

6.1 Service & Support

Safety Integrated on the Internet

Our online presence offers you up-to-date information on all aspects of safety engineering. Here you will find helpful documents, links, films and tools about Safety Integrated products and solutions, and about applying the standards.

Safety Integrated on the Internet (<http://www.siemens.com/safety-integrated>)

Safety Consulting

Machine safety is a complex, sensitive, and cost-intensive topic. Our Safety Consulting service provides tailored answers to your questions and leads you smoothly through a process at the end of which one thing is certain: the safety of your machine.

Safety Consulting on the Internet (<http://www.siemens.com/safety-consulting>)

SITRAIN Training for Safety Integrated

Risk assessment, standards, CE marking, product training: You can find everything worth knowing about our extensive training program SITRAIN on the Internet.

SITRAIN Training for Safety Integrated on the Internet (<http://www.siemens.com/sitrain>)

Catalogs and information material

In the Information and Download Center, you will find all the up-to-date catalogs, customer magazines, brochures, demo software, and special-offer packages for downloading. Including our "Safety Integrated" Catalog.

Information and Download Center (<http://www.siemens.com/safety-infomaterial>)

Functional examples

You can find on the Internet further practice-oriented functional examples covering typical requirements within industrial safety engineering. They contain typical applications with product examples including wiring diagram, programming code, and evaluation in accordance with EN 62061 and EN ISO 13849.

Functional examples on the Internet (<http://www.siemens.com/safety-functional-examples>)

Safety Integrated Newsletter

Our regular Newsletter offers you up-to-date information on all aspects of safety engineering.

Safety Integrated Newsletter (<http://www.siemens.com/safety-integrated>)

On-site service

Siemens supports its customers worldwide with product-, system-, and application-related services throughout the entire life cycle of a plant. From planning and development, through operation, right up to modernization, customers profit from the service, and also from the extensive technology/product know-how and industry competence of the Siemens experts.

Industry Services (<http://www.siemens.com/services>)

Configurators

Assemble products and systems simply with the help of our configurators.

Industry Mall

Then order online in the Industry Mall – it's as simple as that.

Industry Mall (<http://www.siemens.com/industrymall/>)

Consulting

To be able to handle the growing demands in the area of safety engineering, Siemens uses selected Siemens Solution Partners Automation as well as its own safety experts. These highly qualified partner companies offer professional consulting and active support with all the relevant safety aspects of your automation projects.

Solution Partner Internet (<http://www.siemens.com/solutionpartner>)

Index

A

- Access monitoring, 114, 116, 118, 120
 - Light curtain, 150
- Actuators, 20
- ANSI, 183
- Application examples
 - Handling, 32
- Architectural design, 206
 - Subsystem, 200
- Architecture
 - Control system, 193
- Architecture category 2, 209
- Architecture category 3, 210
- Architecture category 4, 211
- Architecture category B, 208
- Area monitoring, 122, 124
- Australia, 185
- Automatic start, 14

C

- Cascading
 - Safety relays, 153
- Catalogs, 213
- Category 1, 208
- Category 2, 209
- Category 3, 210
- Category 4, 211
- Category B, 207
- CAX data, 34
- CE conformity process, 177
- Combination for position detection, 83
- Combinations of safety functions, 138
- Configurators, 214
- Control function, 193
- Control system, 193
 - Architectural design, 196
- Cross-circuit detection, 13

D

- Dangerous failure, 201
- Design concept, 206
- Design process, 193, 204
- Detecting, 20
- Diagnostic coverage, 201, 207

- Diagnostic coverage DC, 201
- Diagnostics, 202, 203
- Documentation
 - History, 8
 - Required knowledge, 7
 - Target group, 7
- Duty of care, 17

E

- Emergency off, 18
- Emergency on, 18
- Emergency start, 18
- Emergency stop, 18, 144, 147, 149
- Emergency stop shutdown, 36, 38, 41, 43, 45, 47, 53, 165
- EN 60204-1, 18
- EN ISO 12100, 178
- EN 60204-1, 18
- EN ISO 13849-1, 181
- Enabling circuit, 13
- EU directives, 176
- European standards
 - Harmonized, 176
- Evaluating, 20
- Evaluation unit, 20
- Evaluation units
 - Safe, 84

F

- Fault, 200
 - Hazardous, 200
 - Systematic, 197
- Fault detection, 197, 198, 200
- Fault tolerance, 197, 198, 200, 202, 203
- Feedback circuit, 13
- Function block, 193
- Function block element, 193
- Functional examples, 213

H

- Hardware integrity, 197
- Harmonized European standards, 176
- Hazardous event, 189
- Hazardous fault, 200
- Hinge switches, 81

History, 8

I

IEC 62061, 187
IEC 61508, 192
IEC 62061, 17, 33, 181, 187, 189, 195
Industry Mall, 214
Info material, 213
Interlocking devices, 78, 126
ISO 13849-1, 33
ISO 13849-1, 17, 188, 206
 Categories, 204

L

Laser scanner, 122, 124
Liability, 8
Lifecycle, 177
Light curtain, 114, 116
Light curtains, 113

M

Machine safety directive
 Brazil, 185
Machinery Directive, 175
Manual start, 14
Mechanical safety switches, 80
Misuse, 180
Monitored start, 14
Muting, 113
Muting mode, 113

N

National Electrical Code (NEC), 183
NFPA, 183
NFPA 70, 183
NFPA 79, 183
Non-contact safety switch, 81

O

Open danger zone, 113, 115, 117, 119
OSHA Regulations, 183

P

Performance Level, 17, 181, 188, 206
PL, 181
PL c, 33
PL d, 33
PL e, 33
Position detection, 83
Position monitoring, 83
Position switches, 80
Probability of failure, 188, 201
Probability of failure (PFHD), 201
Product liability, 183
Product Safety Act (Germany), 175
Protective door, 132, 146, 148
Protective door monitoring, 78, 86, 88, 90, 98, 100, 102, 104, 147, 149, 158
Protective door tumbler, 129
Protective door tumbler mechanism, 158
Protective doors, 85, 87, 89, 91, 93, 95, 97, 100, 101, 103
Protective function
 Suppression, 113
Protective measure, 188
Protective measures, 178, 180

R

Reacting, 20
Redundancy, 13
Regulations, 17
Required knowledge, 7
Residual risk, 178, 179
Response to faults, 198
Risk analysis, 178
Risk assessment, 178, 187, 204, 213
Risk elements, 187, 188, 190
Risk evaluation, 178, 188
Risk graph, 188
Risk parameters, 189
Risk reduction, 178, 179, 188
Risks, 179

S

Safe fault, 203
Safe operator input, 133
Safe speed monitoring, 127
Safe standstill monitoring, 129
Safety calculation, 34

- Safety evaluation, 34, 212
 - Safety function, 196, 198, 206
 - Evaluation, 212
 - Structuring, 195
 - Safety functions
 - Combinations, 138
 - Validation, 182
 - Safety Integrated, 213
 - Safety integrity, 212
 - Safety Integrity, 204
 - Safety integrity level, 190
 - Safety Integrity Level, 17, 181
 - Safety Integrity Level (SIL), 187
 - Safety level, 33, 83
 - Safety mat, 117, 119
 - Safety objectives, 175
 - Safety Performance, 187, 189, 195, 204
 - Safety related electrical control system, SRECS, 192
 - Safety requirements
 - Specification, 191
 - Safety switch
 - Non-contact, 81
 - Sensors, 20
 - Series connection, 36, 82, 138
 - Severity of injury, 190
 - SIL, 181, 189
 - SIL 1, 33
 - SIL 2, 33
 - SIL 3, 33
 - SIL claim limit, 195, 200
 - SITRAIN, 213
 - Solenoid-operated switch, 81
 - Specification
 - Safety requirements, 191
 - Speed monitor, 127
 - Speed monitoring, 126, 127
 - Speed monitors, 131
 - SRCF, 193
 - SRECS, 192, 201
 - Standards, 176
 - Standstill monitor, 129
 - Standstill monitoring, 126, 129
 - Stop categories, 18
 - Stopping, 18
 - controlled, 18
 - uncontrolled, 18
 - Stopping in an emergency, 19, 35
 - Structural constraints, 203
 - Structuring elements, 192
 - Structuring principle, 192
 - Subsystem, 193, 197, 200, 201
 - Design, 201
 - Selection, 197
 - Subsystem element, 193
 - Synchronism, 14
 - System architecture, 192, 196
 - Systematic faults, 16, 197
 - Systematic integrity, 195, 197, 201
- T**
- Target group, 7
 - Tumbler mechanism, 81, 126
 - Tumbler monitoring, 131
 - Two-hand circuit, 133
 - Two-hand operation, 14
 - Two-hand operation console, 133, 135
- U**
- USA, 183
 - User information, 181
- V**
- Validation, 182
- W**
- Warranty, 8

