

The background features a dark blue space with glowing blue wireframe models of industrial switch disconnectors. In the foreground, a physical Siemens SENTRON switch disconnecter is shown in detail, with its handle and internal components visible. The overall aesthetic is high-tech and industrial.

**SIEMENS**

*Ingenuity for life*

# SENTRON

## Switch disconnectors Technology primer

Protecting, switching and  
disconnecting with switch  
disconnectors and fuses

[www.siemens.com/switching-devices](http://www.siemens.com/switching-devices)

# Contents

Preface	4
Table of abbreviations	5
List of figures	6
List of tables	7
<b>1. Introduction to electrical protection</b>	<b>8</b>
<b>2. Technical basics</b>	<b>9</b>
2.1. Certification and approval	10
2.2. Utilization categories	12
2.3. Selectivity	14
2.4. Basic principles of a fuse	18
2.4.1. Designs	18
2.4.2. Function, technical specifications, and characteristic curves	19
2.5. Basic device types and application examples	26
2.5.1. Switch disconnectors	26
2.5.2. Switch disconnectors with fuses	28
2.5.3. Fuse switch disconnectors	30
2.5.4. Transfer switching equipment or load transfer switches	32
2.6. Basic principles of switchover	34
2.6.1. Types of transfer switches	34
2.6.2. Selection criteria for switchover	37
<b>3. General technology comparison: Fuse versus circuit breaker</b>	<b>40</b>
<b>4. The Siemens product portfolio for switch disconnectors, fuses and transfer switches</b>	<b>42</b>
4.1. Switch disconnectors	43
4.1.1. 3LD switch disconnectors	43
4.1.2. 3KD switch disconnectors	44

4.2. Fuse systems	45
4.2.1. LV HRC fuses	45
4.2.2. SITOR fuses	46
4.2.3. Cylindrical fuses	47
4.2.4. DIAZED/NEOZED fuses	48
4.3. Fuse switch disconnectors	49
4.3.1. 3NP fuse switch disconnectors	49
4.3.2. 3NJ4 fuse switch disconnectors	50
4.4. Switch disconnectors with fuses	51
4.4.1. 3KF switch disconnectors with fuses	51
4.4.2. 3NJ6 switch disconnectors with fuses	52
4.5. Load transfer switches and transfer switching equipment	53
4.5.1. 3LD load transfer switches	53
4.5.2. 3KC transfer switching equipment	54
4.5.2.1. 3KCO manual transfer switching equipment (MTSE)	55
4.5.2.2. Transfer switching equipment with motor operator	55
4.5.2.2.1. 3KC3 and 3KC4 remote transfer switching equipment (RTSE)	55
4.5.2.2.2. 3KC6 and 3KC8 automatic transfer switching equipment (ATSE)	56
4.5.2.3. Transfer control devices	56
4.5.2.3.1. ATC3100	57
4.5.2.3.2. ATC6300 and ATC6500	57
<hr/>	
<b>5. Application example in the Siemens portfolio</b>	<b>58</b>
<hr/>	
<b>Closing words</b>	<b>60</b>
<hr/>	
<b>6. Appendix: Definition of the key features</b>	<b>61</b>
6.1. Rated voltages	61
6.2. Currents	62
6.3. Key features of load and overload	63
6.4. Key features under short-circuit conditions	63

# Preface

According to the requirements outlined in international standards and installation regulations (e.g. fire protection or escape stairs), electrical equipment must be effectively protected against overload and short circuits.

Protection, switching, measuring, monitoring or power monitoring – Siemens low-voltage circuit protection technology offers a broad portfolio of devices and software solutions for all areas of electrical installation technology. This puts you in full control of all electric circuits – in industry as well as in non-residential and residential buildings. Particular attention must be paid to the selection and installation of the relevant protective devices and disconnecting elements – in this case: fuses and switch disconnectors.

This technology primer is intended to serve as an introduction to the topic and as a decision-making aid for the selection of the required fuse and switch disconnector families, in order to help you achieve an optimally adapted and safe electrical system.

Detailed technical information, e.g. notes on installation and use, can be found in the technology primer “Fuse Systems”. You are therefore sure of always selecting the right device.

Your Team for  
Low-Voltage Circuit Protection  
from Siemens

## Table of abbreviations

<b>A</b>	ampere	<b>M effect</b>	mesomeric effect
<b>AC</b>	alternating current	<b>MTSE</b>	manually operated transfer switching equipment
<b>ACB</b>	air circuit breaker	<b>N</b>	neutral conductor
<b>ATC</b>	automatic transfer control device	<b>NEC</b>	National Electrical Code
<b>ATSE</b>	automatic transfer switching equipment	<b>NEMA</b>	National Electrical Manufacturers Association
<b>CCC</b>	China Compulsory Certification	<b>NFPA</b>	National Fire Protection Association
<b>cos</b>	cosine	<b>LV HRCfuse</b>	Low-voltage high rupture capacity fuse
<b>CSA</b>	Canadian Standards Association	<b>PE</b>	protective conductor
<b>DC</b>	direct current	<b>RTSE</b>	remotely operated transfer switching equipment
<b>DIN</b>	Deutsches Institut für Normung e.V.	<b>sec</b>	second(s)
<b>EN</b>	European standard	<b>SIOS</b>	Siemens Industry Online Support
<b>G</b>	generator	<b>t</b>	time
<b>I</b>	electrical current intensity	<b>t<sub>A</sub></b>	break time
<b>I<sup>2</sup>t</b>	I <sup>2</sup> t value	<b>t<sub>LB</sub></b>	arcing time
<b>I<sub>c</sub></b>	let-through current	<b>t<sub>s</sub></b>	melting time
<b>IEC</b>	International Electrotechnical Commission	<b>U</b>	electrical voltage
<b>IEV</b>	International Electrotechnical Vocabulary	<b>UL</b>	Underwriters Laboratories
<b>kA</b>	kiloampere	<b>UPS</b>	uninterruptable power supply
<b>kVA</b>	kilovolt-ampere	<b>V</b>	volt
<b>L/R</b>	inductance/resistance	<b>VDE</b>	Verband der Elektrotechnik, Elektronik und Informationstechnik e.V. (German registered association for electrical, electronic and information technology)
<b>LRS</b>	Lloyd's Register of Shipping		
<b>MCC</b>	motor control center		
<b>MCCB</b>	molded case circuit breaker		

## List of figures

Figure 1: IEC and UL markets at a glance	11
Figure 2: Selective system vs. non-selective system	14
Figure 3: Combination of characteristic curves for full selectivity	16
Figure 4: Combination of characteristic curves for partial selectivity	17
Figure 5: Structure of a fuse (example: LV HRC fuse)	19
Figure 6: Short-circuit current limiting	20
Figure 7: Characteristic curve for gG, gR and gS	23
Figure 8: Time/current characteristic	25
Figure 9: Switch disconnectors as EMERGENCY-STOP, repair or main control switch of machinery and plants	27
Figure 10: Switch disconnectors with fuses as functional switch of machinery and plants	29
Figure 11: Fuse switch disconnectors for occasional switching of machinery and plants	31

Figure 12: Transfer switches for switching over between networks or loads	33
Figure 13: Types of transfer switches	34
Figure 14: Transfer switching with switch disconnectors and circuit breakers	35
Figure 15: Exemplary structure of transfer switching considering the criticality of the loads	38
Figure 16: Schematic application structure	58

## List of tables

Table 1: Utilization categories for switch disconnectors and fuse technology	13
Table 2: Designs	18
Table 3: Operational classes and applications	22
Table 4: Comparison of fused solution and circuit breaker solution	40

# 1. Introduction to electrical protection

When dealing with electricity, safety has top priority. According to the requirements outlined in international standards and installation regulations, every qualified electrician must effectively protect electrical equipment, in particular cables and conductors, against overload and short circuits by implementing suitable (protective) measures. Preferably, such protection is achieved with the use of suitable switching/protective devices, which will automatically disconnect defective circuits or system sections from mains power in case of a fault.

A key consideration here is the prevention or limitation of negative concomitant phenomena associated with electric overloads. When performing simultaneous switching operations or using defective loads, personal protection against electric shock must be ensured during direct or indirect contact with live system components. The service life of equipment may be durably compromised, or entire production facilities may shut down after a short circuit, where system faults are not detected in time or deactivation occurs too late. Short circuits in electric systems can occur suddenly, e.g. as the result of an operational fault during switching, an installation/commissioning fault or force majeure (e.g. lightning strike, earthquake, flooding, etc). These short circuits conduct high amounts of energy, which are released explosively. Where they occur, their destructive potential is enormous.

Far more frequent, but no less dangerous is the gradual build-up of cable overloads or short circuits, e. g. due to cable breaks, or aging of the cable insulation and plug-in connections. Fuses and/or contact-based protective devices such as miniature circuit breakers or circuit breakers reliably protect against the possible consequences of such faults.



## 2. Technical basics

Various factors play a decisive role in the selection of the right switching and protection device. First and foremost is the choice of a basic device from the various switch disconnectors, fuse switch disconnectors, switch disconnectors with fuses and changeover switches.

In the next step, the technical data and specifications are most relevant. For better understanding, these key features are explained in more detail in the appendix.

Finally, it must be ensured that the approval requirements of the respective country or area of application are met.

## 2.1. Certification and approval

The use of electrical equipment for switchgear and controlgear assemblies is regulated by the legislation of the corresponding country. The most important technical features of low-voltage fuses and switchgear are codified in the standards of the International Electrotechnical Commission (IEC) based in Geneva. Even beyond Europe, devices in accordance with the IEC standard are used in Asia, South and Central America and Australia. The European standards (EN) are generally identical to those of the IEC. In some cases, they may contain deviations which then apply throughout Europe.

With just a few exceptions, the German standards (DIN, VDE) and other national standards in Europe are translations of the international standards. In the North American region, the standards UL (USA) and CSA (Canada) as well as the guidelines of the National Electrical Manufacturers Association (NEMA), National Fire Protection Association (NFPA) and the National Electrical Code (NEC) apply. All standards and regulations are intended to ensure the safety of electrical installations.

Relevant standards for the products described in this technical guide are:

- IEC 60269 Low-voltage fuses
- IEC 60947 Low voltage switchgear and controlgear

The standards describe the technical characteristics and test conditions that all devices available for the IEC market must meet. Both standards are further divided into subcategories, which specify the requirements for the individual device types.

These are in particular:

- IEC 60947-1 (VDE 0660-100)  
Valid for all types of low-voltage switchgear and controlgear
- IEC 60947-3 (VDE 0660-107)  
Switches, disconnectors, switch disconnectors and fuse-combination units
- IEC 60947-6-1 (VDE 0660-114)  
Multiple function equipment – Transfer switching equipment

Approval bodies certify the switchgear on the basis of standardized procedures. Equipment sold on the Chinese market must be certified by the Chinese approval authority and marked with the CCC mark of conformity. For the US market, the standards UL 489 (circuit breakers, disconnectors), UL 98 (switch disconnectors, fuse switch disconnectors) and UL 508 (motor-protective circuit breakers) are particularly relevant. In addition, certification may be required for special applications such as shipbuilding (LRS, DNV GL).

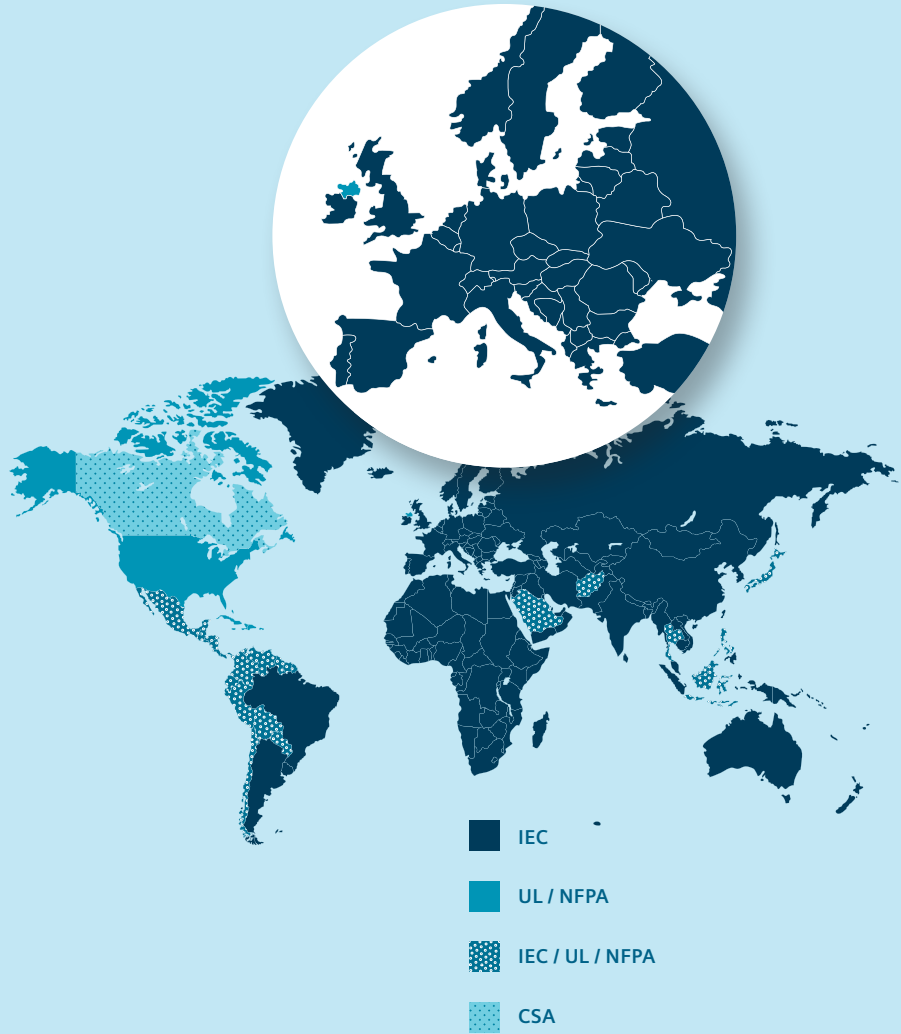

Figure 1:  
IEC and UL markets at a glance

## 2.2. Utilization categories



Utilization categories are a “combination of specified requirements related to the condition in which the switching device or the fuse fulfills its purpose, selected to represent a characteristic group of practical applications” (International Electrotechnical Vocabulary – IEC 441-17-19). Utilization categories subdivide the various switching tasks (applications), whereby there are different test conditions for each category.

Utilization categories provide the user with orientation in the selection of low-voltage controlgear by defining the intended use and the associated loading of the various devices. This significantly reduces the complexity of equipment selection. In most cases, the user only has to ensure that the performance data of the device in relation to the load reach or exceed the required rated data.

The specified requirements include, for example, making and breaking capacity as well as other parameters such as short-circuit capacity, the data of the associated circuits, and the corresponding conditions for operation characteristic and function. In the technical data of the devices, the rated operational currents or the rated operational powers are listed for the individual utilization categories – usually for different rated operational voltages.

Different test conditions are provided for each category. The test parameters are specified in the IEC standards for the individual utilization categories. Manufacturers of low-voltage switchgear and controlgear are obliged to test according to these regulations.

The respective designations of the utilization categories are supplemented by the letters A or B. The suffix A identifies switches for applications requiring frequent switching, while the suffix B identifies devices that are only switched occasionally.

The relevant utilization categories for switch disconnectors and fuse technology are summarized in the following table.

Utilization category		Typical applications
Frequent actuation	Occasional actuation	
AC-20A DC-20 A	AC-20B DC-20B	Closing and opening without load
AC-21A DC-21 A	AC-21B DC-21B	Switching of resistive loads including low overload
AC-22A	AC-22B	Switching of light inductive loads ( $\cos > 0.65$ ) including low overload
AC-23A	AC-23B	Switching of highly inductive loads, e.g. motors
DC-22A	DC-22B	Switching of light inductive loads ( $L/R < 2.5$ ms) including low overload
DC-23A	DC-23B	Switching of highly inductive loads, e.g. series-wound motors ( $L/R < 15$ ms)

AC = alternating current  
DC = direct current

Table 1: Utilization categories for switch disconnectors and fuse technology

### 2.3. Selectivity

In addition to the basic technical data, selectivity is one of the most important criteria in planning. A system with several protective devices connected in series is described as selective if, in the event of a fault, only the protective device located directly in front of the fault location trips and switches off the fault alone (Figure 2). Upstream protective device should only trip if the responsible protective device fails. This ensures that branch circuits that are not affected by the fault continue to be supplied with energy and that as much functionality as possible is maintained. Selectivity thus limits the effects of a fault in space and time to the smallest possible extent.

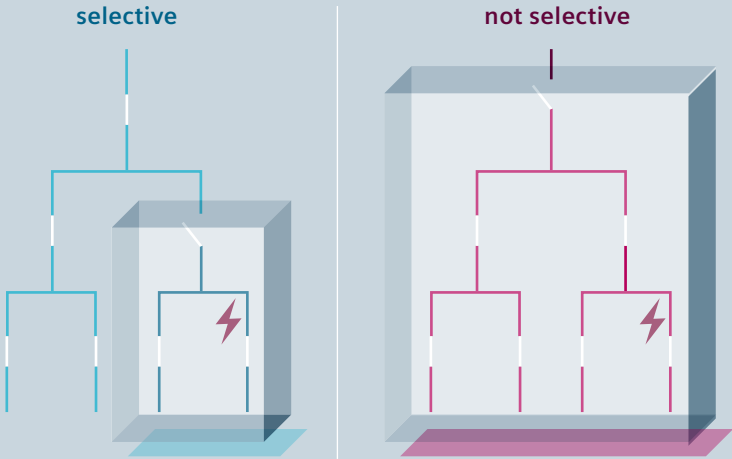

Figure 2:  
Selective system vs. non-selective system



Short-circuit point

Selectivity is achieved when the switching devices are matched to each other by means of selection, configuring and trip settings in such a way that, in the event of a fault, only the switching device closest to the location of the fault trips. In this case, one also speaks of **full selectivity**. If this is not the case with the combination of certain switching devices, there is **partial selectivity**. This occurs when selective tripping in response to a system fault is not ensured up to the maximum ultimate short-circuit breaking capacity of the combination of switching devices. As long as the limit current is not reached, the respective combination is selective. If the limit current is exceeded, selectivity is no longer guaranteed. This so-called selectivity limit must be taken into account in the planning.

To realize **selectivity with fuses** is relatively uncomplicated, because their melting time-current characteristics are nearly parallel over the whole current range and there is no make-before-break. According to the standard, fuses in which the rated current levels differ in the ratio 1:1.6 are basically mutually selective over the entire fault current range. With Siemens fuses, this value can even be reduced to 1:1.25. For other fuses, the selectivity can be determined via the manufacturer's documentation using the time/current characteristics.

The **selective behavior of circuit breakers** is more complex. This is influenced by the parameters selected on the electronic trip unit, the device-dependent tripping and break times, the let-through current values and the underlying switching principles of the circuit breakers.

If fuses are combined with circuit breakers, the combination of the characteristics of both protective devices plays an important role. In Figure 3, the characteristic curves were selected in such a way that the fuse always trips before the circuit breaker – if the fuse is then located downstream of the circuit breaker in the distribution, this is called full selectivity.

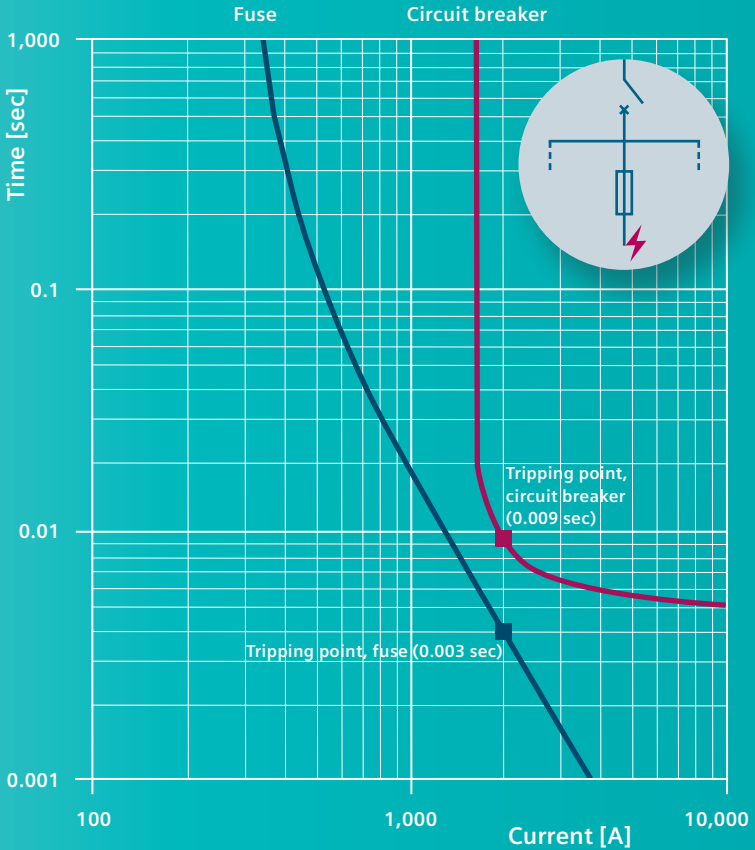

Figure 3: Combination of characteristic curves for full selectivity





In Figure 4, the characteristic curves have been chosen so that at lower currents the circuit breaker trips first and then the fuse, and vice versa at higher currents. This is called partial selectivity, which can be desirable depending on the application.

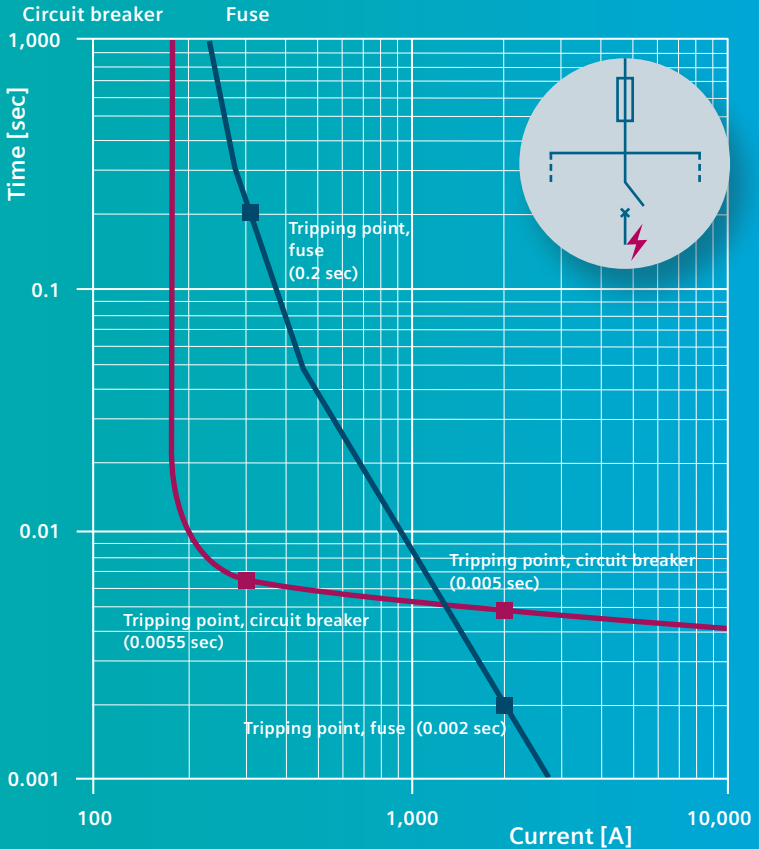

Figure 4: Combination of characteristic curves for partial selectivity

## 2.4. Basic principles of a fuse

Fuses protect devices and systems against overcurrent and short circuits by having a melting fuse element interrupt the current flow when a certain current intensity is exceeded.

### 2.4.1. Designs

For the low-voltage range according to IEC, there are three main types of design, which are briefly compared in the table.

#### LV HRC fuses for large currents

- Fuse links with blade contacts
- Comparatively large construction volume
- Robust design



#### Cylindrical fuses for small to medium currents

- Cylinder-shaped fuse links
- Easy to change



#### NEOZED/DIAZED fuses for small to medium currents

- Screw-in fuse links with base contacts
- Compact design



Table 2: Designs

## 2.4.2. Function, technical specifications, and characteristic curves

Fuses consist of two contacts on an insulation body that are connected to a fusible conductor, the fuse element. The fuse element is surrounded by air or silica sand and has constrictions which act like premachined breaking points. These areas heat up faster when current flows and are dimensioned in such a way that they melt in case of overcurrent and thus interrupt the circuit.

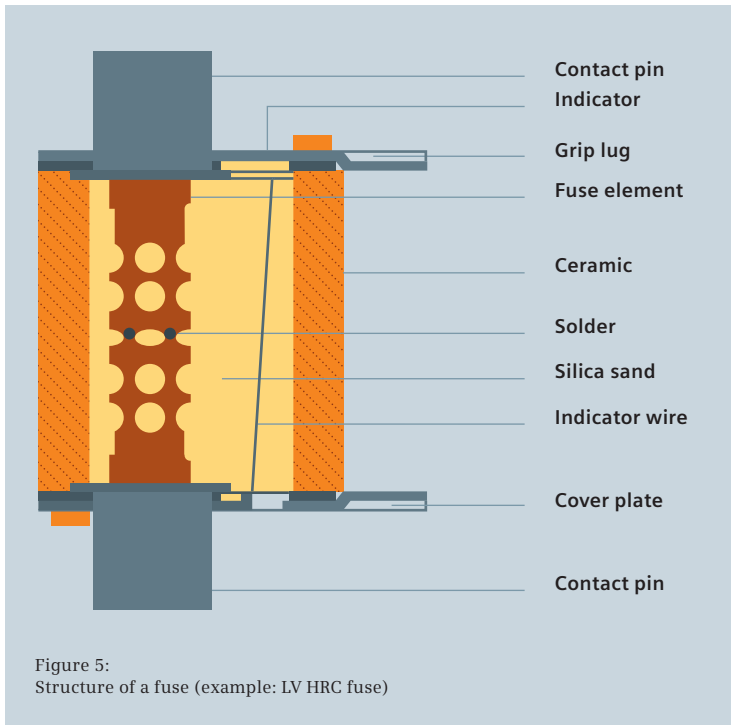
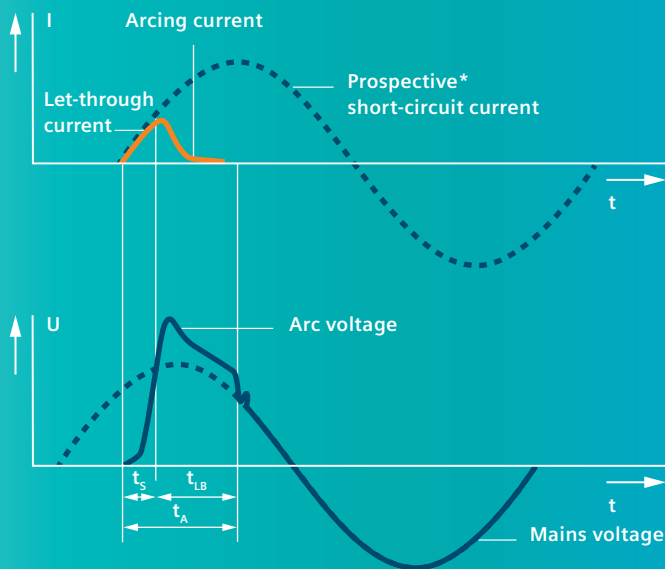

Figure 5:  
Structure of a fuse (example: LV HRC fuse)

At **short-circuit currents** (very high overcurrents), the constrictions evaporate explosively. The silica sand inside the fuse cools the arc that occurs, so that the peak value of the prospective short-circuit current is not reached if the fuse is correctly designed.

Melting fuses thus have a current-limiting effect that surpasses all other overcurrent protection devices. This reduces direct and indirect damage caused by heat effects as well as the danger to persons when working under voltage.



$t_s$  Melting time

$t_{LB}$  Arcing time

$t_A$  Break time

\* Prospective = short-circuit current characteristic without protective device



Figure 6: Short-circuit current limiting

If **overloads** (relatively small overcurrents) are to be disconnected, a material with a low melting point, such as tin or tin alloys, is applied as solder-forming flux at the constrictions.

The solder that melts on overload reacts with the fuse element material and dissolves the constrictions (M effect). This shifts the time/current characteristic, which makes it possible to switch off the overload current without undue heating. Once the constriction is melted through, an arc is formed which is cooled by the melting silica sand inside the fuse. This creates a characteristic “fusing bead”, a non-conductive sintered body of fuse element metal, solder and silica. Based on the shape of this bead, it is possible to reconstruct the current intensity that caused the fuse to trip.

Special fuses with an appropriate characteristic have been developed to protect equipment that is used on a regular basis. Characteristics for cables, electrical motor circuits, and semiconductor components have been standardized globally. In Germany, additional standards for transformer protection and protecting equipment in the mining industry apply. The fuse links are labeled with the codes for the relevant applications and/or characteristics (Table 3).

The first, lower-case letter indicates the breaking range of the fuse:

- **“g”** indicates a full-range fuse and means that the fuse can interrupt any overcurrent, from the smallest melting current up to its rated breaking capacity. Full-range fuses can be used as sole protective elements.
- **“a”** indicates a partial-range fuse and means that the fuse can only interrupt high currents from a multiple of its rated current. Partial-range fuses are only suitable for short-circuit protection, which is why they are combined with other equipment for overload protection. They are often used as back-up protection for other switching devices with a lower breaking capacity, e.g. contactors or circuit breakers.

The second, upper-case letter indicates the characteristic and, in turn, the area of application (Table 3). Since fuses are highly durable products, operators can still come across products with labels that are not explained in current standards. For this reason, Table 3 also contains some descriptions that are no longer in use today.

Operational class	Application (characteristic)
-------------------	------------------------------

### IEC / VDE operational classes

gG	Full-range fuse for general use, primarily cable and line protection
aM	Partial-range switching device protection for electrical motor circuits
gR	Full-range fuses for protecting semiconductor components (faster acting than gS)
gS	Full-range fuses for protecting semiconductor components, for increased line capacity
aR	Partial-range fuse for protecting semiconductor components

### VDE operational classes

gB	Full-range fuse for equipment in the mining industry
gTr	Full-range fuse for transformer protection, rated according to apparent transformer power (kVA), not rated current (A)
Slow	Full-range fuse for cable and line protection
Quick	Full-range fuse for cable and line protection

### Other operational classes

gM	Full-range fuse for protecting electrical motor circuits with two rated currents (widespread in Great Britain)
gN	North American fuse for general use, primarily cable and line protection
gD	North American fuse with slow-acting characteristic for general use and motor protection
gI	Formerly IEC operational class (slow acting), replaced by gG
gII	Formerly IEC operational class (fast acting), replaced by gG
gL	Formerly VDE operational class, replaced by gG
gT	Formerly VDE operational class (slow acting), replaced by gG
gF	Formerly VDE operational class (fast acting), replaced by gG
gTF	Formerly VDE operational class (slow/fast acting), replaced by gB

Table 3: Operational classes and applications

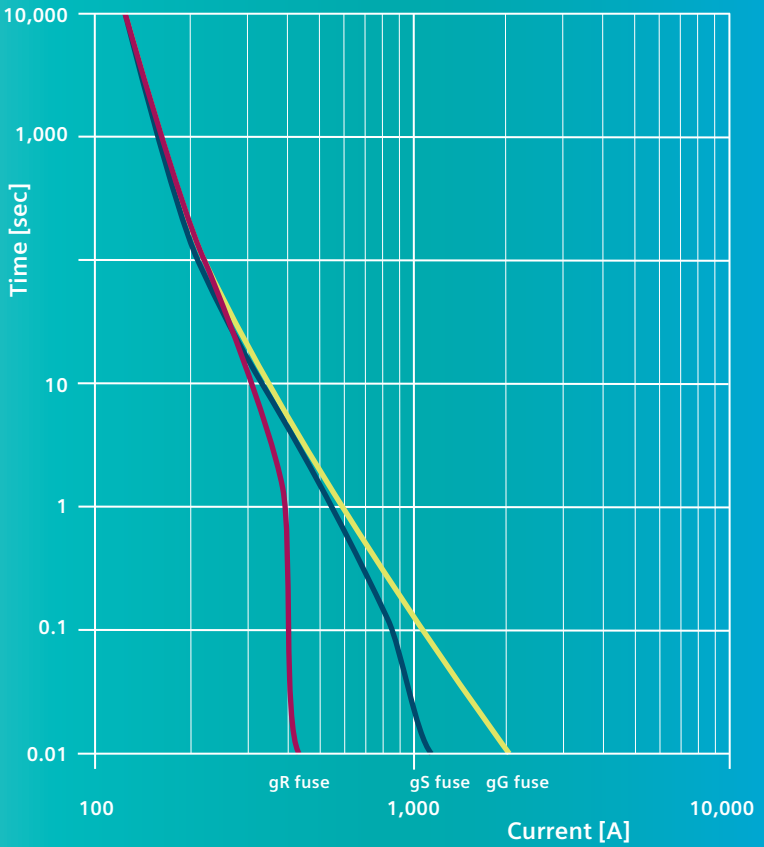

Figure 7: Characteristic curve for gG, gR and gS



**Time/current characteristics** determine the application area of a fuse by showing the time period after which a fuse will blow.

In contrast to other overcurrent protection devices, melting fuses do not have a fixed tripping current at which the protective effect begins. The decisive factor is the melting time of the fuse element, which in turn depends on the level of the overcurrent.

When the protective effect occurs and the fuse trips can be determined as a function of the respective overcurrent on the basis of the time/current characteristic.

In the example on the left, the fuse would blow after 0.5 sec. at a current flow of 400 A.

The energy passed is called the let-through current; see Figure 8. Downstream fuses or switching devices must be able to withstand this let-through current. The let-through current is specified in all technical data sheets both as maximum value  $I_c$  and as transmitted energy  $I^2t$  value. For more detailed information, please refer to the technology primer "Fuse Systems".

Supporting tools for this are:



- SIMARIS Curves (SIOS-ID: 35526338)
- SIMARIS Design (SIOS-ID: 35527800)
- SIMARIS Therm (SIOS-ID: 109482729)
- Technology primer "Fuse systems" (SIOS-ID: 109482303)



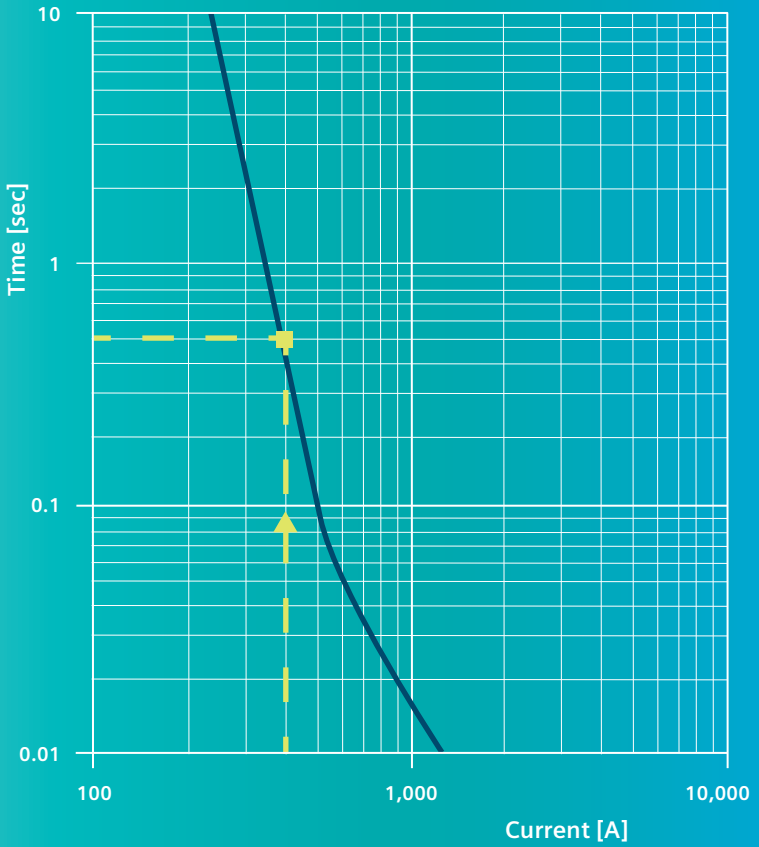

Figure 8: Time/current characteristic

## 2.5. Basic device types and application examples

In the following sections, the different basic device types and their application are briefly described, in order to enable the user to differentiate between the devices in the switch disconnector and changeover range.

### 2.5.1. Switch disconnectors

Simple main and EMERGENCY-STOP switches are used in many smaller machines and systems as well as portable devices, but also in larger rated current ranges. They are only suitable for all-pole switching on and off and have no protection function. However, it is a condition that a separate protective device should be connected upstream of the systems.



#### Application examples

- Switching of portable machines (e.g. woodworking machines, construction machines such as screeding/plastering machines)
- Mains disconnect switches for maintenance purposes
- Main and EMERGENCY-STOP switches on machines and systems of all kinds, e.g. automatic assembly machines in production lines, maintenance switches for isolating motors
- Main control switch for complete branch circuits in larger rated current ranges

These switches are also often found as “repair switches” between frequency converters and motors. There they ensure that the system is de-energized during repair and maintenance work on the respective drive.

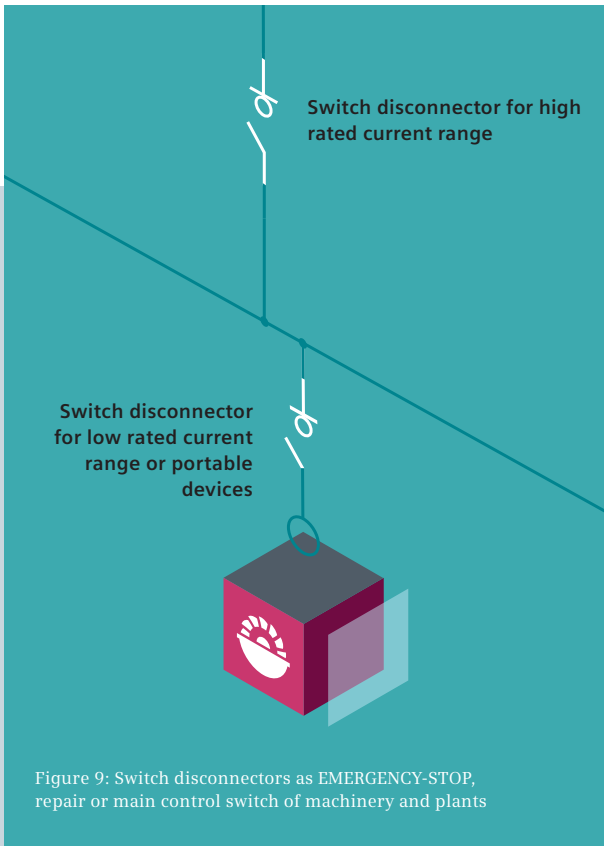

Figure 9: Switch disconnectors as EMERGENCY-STOP, repair or main control switch of machinery and plants

## 2.5.2. Switch disconnectors with fuses

Switch disconnectors with fuses meet all the requirements of a switch disconnector and also offer a protective function by means of fittable fuses. Compared to fuse switch disconnectors, they have a higher switching capacity. They are suitable for the normal switching duty of loads. Arcing occurs whenever electrical currents are switched. Switching devices with stored energy mechanisms, such as those used in switch disconnectors and circuit breakers, always switch smoothly and abruptly, minimizing the energy released during switching. This means that a change of the melting fuses in a de-energized state is possible without risk, since the fuses are de-energized due to the double-break of the devices.



### Application examples

- Protection and switching of series machines, e.g. power tap-off units in motor control centers, airports and railway stations
- Power distribution
- Main and EMERGENCY-STOP switch on machines and systems of all kinds
- Feed-in with cost-effective fuse
- Power feeder with de-energized fuse change

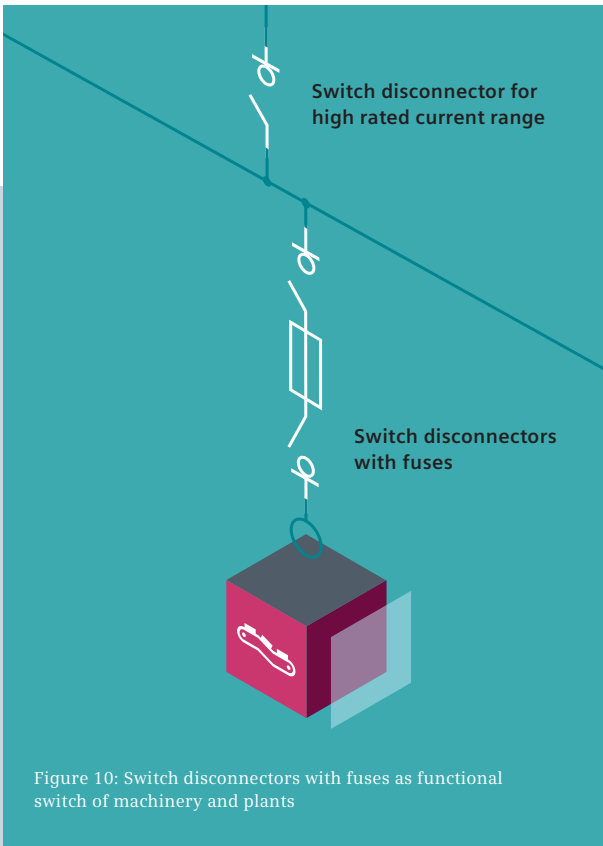

### 2.5.3. Fuse switch disconnectors

The easiest and cheapest way to combine fuse holders and disconnectors is the fuse switch disconnector. With these devices, the melting fuse simultaneously takes over the function of the switching element. When removing the fuse carrier, which also contains the fuses, a visibly open isolating distance is created, which allows safe maintenance work. The melting fuses can be easily removed and replaced.

Unlike a switch disconnector with fuses, the speed of the switching operation of a fuse switch disconnector is dependent on the operator, so that if the device is operated slowly, very high energies may be released.



#### Application examples

- Protection of auxiliary units and continuous operation equipment which is not switched during operation (e.g. oil pumps, fans)
- Feed-in of a control cabinet
- Main fuse in machinery terminal boxes
- Cost-effective power feeders, e.g. in street distributors
- Base for fuses for semiconductor protection in frequency converters

For these reasons, a fuse switch disconnector is in practice only operated by trained, qualified staff and, depending on local regulations, protective clothing is worn.

Fuse switch disconnectors have only a limited switching capacity. They are therefore particularly suitable for applications where the switching function is only occasionally required.

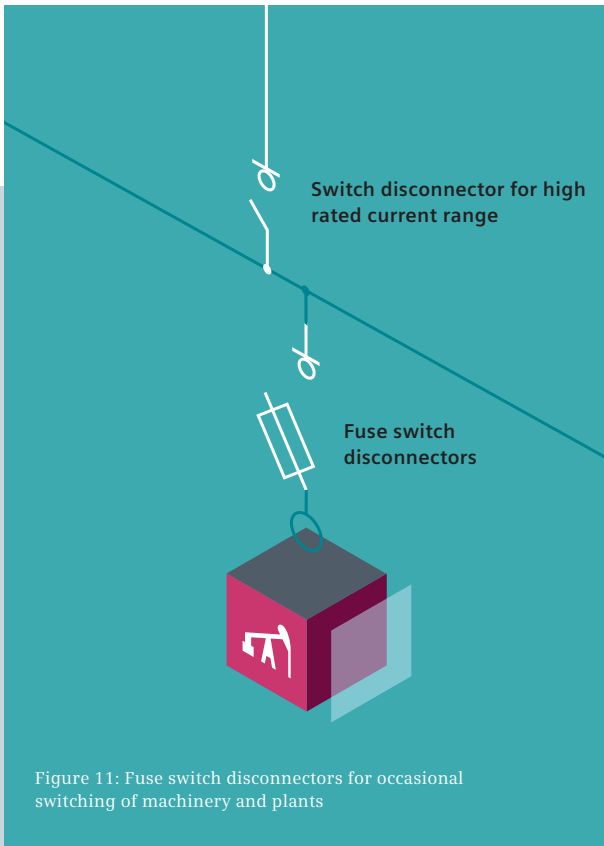

## 2.5.4. Transfer switching equipment or load transfer switches

Transfer switches can be used, depending on the device, both for switching between different power sources and for switching between different loads. A further field of application is the use as a reversing switch (also known as direction of rotation switch). Applications where it is not critical if the power supply fails for a few minutes can be covered economically with a manual transfer switch (manually operated transfer switching equipment, MTSE). Motor-driven switches are required for faster switchover.

A distinction is made between RTSE (remotely operated transfer switching equipment) and ATSE (automatic transfer switching equipment). RTSE have a motorized operating mechanism, which allows transfer switching by remote control. In addition to the motor drive, ATSE have their own control unit, which enables automatic transfer switchover between two networks.



### Application examples

- Switchover between two networks for particularly critical loads (e.g. emergency power)
- Manual switchover to alternative power sources, e.g. for network maintenance
- Switchover of one feed-in to two different loads
- Reversing switch (reversing the direction of rotation of a motor)



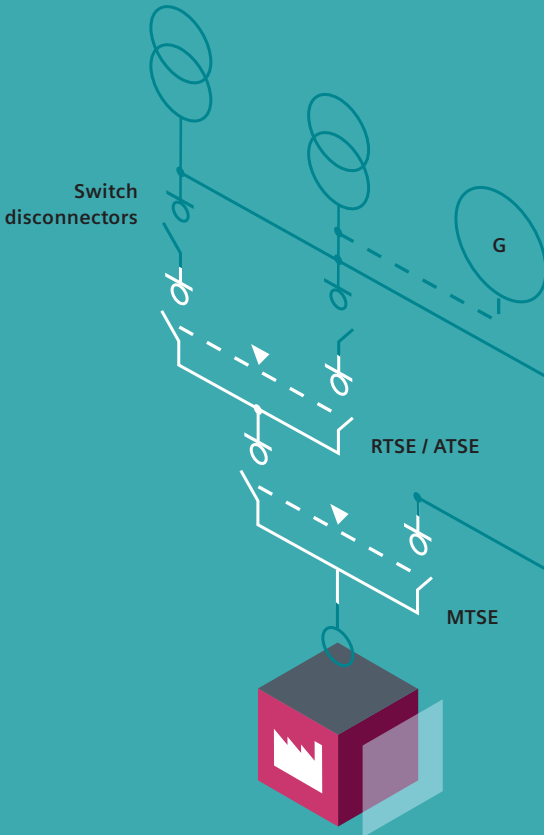

Figure 12: Transfer switches for switching over between networks or loads

## 2.6. Basic principles of switchover

### 2.6.1. Types of transfer switches

In switchover technology, a distinction is made between load switching and transfer switching. **Load switching** means that the system switches between two loads, but only one supply source is available. In contrast, **transfer switching** means switching between two different supply sources, which usually supply only one load line.

#### Load switching

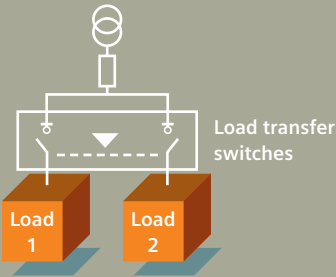

#### Transfer switching

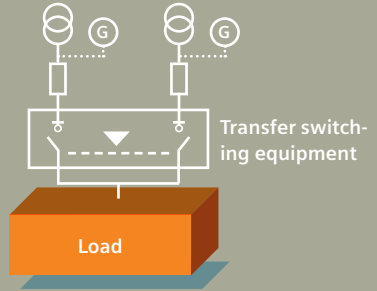

Figure 13: Types of transfer switches

Transfer switching can be achieved by means of switch disconnectors or circuit breakers. Circuit breakers already have an integrated protection function, while switch disconnectors must be additionally protected by fuses.

Load / transfer switches are again subdivided into: manually operated, remotely

### Transfer switching with switch disconnectors

without protection function

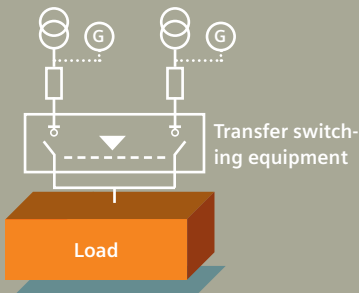

### Transfer switching with circuit breakers

with protection function

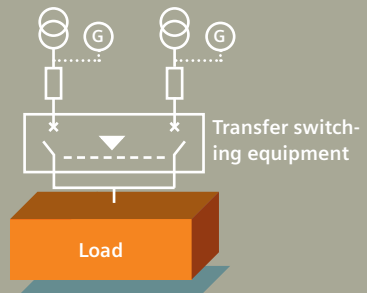

Figure 14: Transfer switching with switch disconnectors and circuit breakers

operated, automatic load / transfer switches as well as transfer control devices:

**Manually operated transfer switching equipment (MTSE)**

enable manual switching between two loads or supply sources. Usually, these switches are operated by a rotary drive and have the switch positions I-0-II or, less often, I-II.

**Remotely operated transfer switching equipment (RTSE)**

have a motorized operating mechanism, which allows transfer switching by remote control. For this purpose, numerous possibilities are available, such as external control systems, toggle switches or the like.

**Automatic transfer switching equipment (ATSE)**

have their own control unit in addition to the motor drive, which enables automatic switchover between two networks. The control unit has a monitoring function that detects voltage or frequency drops and switches over from the main to the standby supply if necessary.

**Transfer control devices (ATC)**

enable transfer switching between a main and alternative source in conjunction with motor-driven circuit breakers (ACB, MCCB), remotely operated transfer switches (RTSE) or contactors. The stability of the power supply is analyzed by means of voltage taps upstream of the switching devices. User-defined limit values (voltage, frequency, phase sequence) function as framework conditions for analyzing the quality of the power supply. If the actual value exceeds or falls below the limit value for a defined period of time, the transfer control devices initiate a switchover to the alternative source.

## 2.6.2. Selection criteria for switchover

In the context of efficient plant planning, it is common practice to dimension the standby supply to be smaller than the main supply. In the event of a power failure, the criticality of the individual loads must therefore be clearly defined. A distinction is made between:

- 1 Critical loads:**  
Safety-related components or severe economic damage in case of failure  
→ Standby supply required!
- 2 Important loads:**  
Impairment of production processes or medium economic damage in case of failure  
→ Standby supply recommended.
- 3 Unimportant loads:**  
Minimal impairment of production processes, hardly any economic damage in case of failure  
→ Load shedding possible.

Critical loads should be protected by automatic transfer switching, so that faults are reliably detected and the switchover can be carried out quickly without human intervention. Depending on the application, manual or remote switchover can also be used for important loads.

When choosing the type of switchover, the sensitivity of the loads plays an additional important role. This determines how long loads are allowed or required to be switched off during switchover. Highly critical loads, such as devices of the IT infrastructure, usually require an uninterruptable power supply and should therefore be protected by an automatic transfer switch, whereby the switching time of the transfer switch is bridged by an energy store.

### Selection criteria

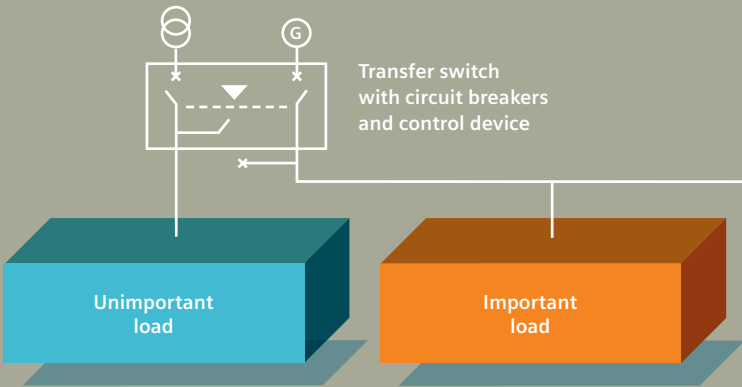

In contrast, certain components, such as motors, even require a certain switchover time to be maintained so that they can run down or come to a standstill. In such cases, remote or manual transfer switches can also be used.

Figure 15:  
Exemplary structure of transfer  
switching considering  
the criticality of the loads

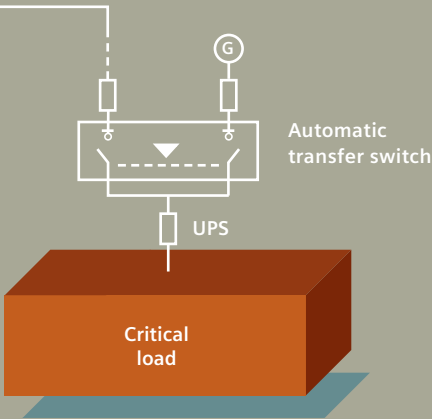

### 3. General technology comparison: Fuse versus circuit breaker

When deciding between the use of fuses or circuit breakers, neither technology is fundamentally superior to the other. The planner has to make the decision for the suitable components depending upon the individual requirements. In Table 4, fundamental characteristics and differences of the different versions are summarized as decision-making aids.



Fused solution	
	<ul style="list-style-type: none"><li>• Very good current-limiting capability</li><li>• High breaking capacity &gt; 100 kA, 690 V</li><li>• Low costs</li><li>• Easy selection and installation</li><li>• Simple scaling between the fuses, thus easier configuration with regard to selectivity</li></ul>
	<ul style="list-style-type: none"><li>• Longer outage after malfunction</li><li>• Only available up to 1250 A</li><li>• Aging of the fuses influences the tripping characteristic</li><li>• Replacement only by qualified staff</li><li>• Interlocking not available</li></ul>

Table 4: Comparison of fused solution and circuit breaker solution



### Circuit breaker solution

- Protection function specially adjustable to the application (tripping time / overload / short circuit)
  - Switching off all poles in case of a malfunction
  - Simple and fast commissioning after malfunction
  - Communication-capable / power monitoring
- 
- High costs
  - Lower breaking capacity
  - Higher power loss
  - Contact erosion through breaking of short circuits
  - Selectivity is not as easy to achieve as with fuses

## 4. The Siemens product portfolio for switch disconnectors, fuses and transfer switches



### Overview

#### 4.1. Switch disconnectors

- 3LD switch disconnectors
- 3KD switch disconnectors

#### 4.2. Fuse systems

- LV HRC fuses
- SITOR fuses
- Cylindrical fuses
- DIAZED/NEOZED fuses

#### 4.3. Fuse switch disconnectors

- 3NP fuse switch disconnectors
- 3NJ4 fuse switch disconnectors

#### 4.4. Switch disconnectors with fuses

- 3KF switch disconnectors with fuses
- 3NJ6 switch disconnectors with fuses

#### 4.5. Load transfer switches and transfer switching equipment

- 3LD load transfer switches
- 3KC transfer switching equipment
  - 3KC0 manual transfer switching equipment (MTSE)
  - Transfer switching equipment with motor operator
  - 3KC3 and 3KC4 remote transfer switching equipment (RTSE)
  - 3KC6 and 3KC8 automatic transfer switching equipment (ATSE)
  - Transfer control devices
  - ATC3100
  - ATC6300 and ATC6500

---

→ Configurators for these products can be found in the Industry Mall under “**Configurator Overview**”

## 4.1. Switch disconnectors



Detailed information about the switch disconnectors can be found in the **Configuration Manual "Switch Disconnectors"** (SIOS-ID: 109769744)

Switch disconnectors are used for the all-pole switching on and off of machinery and plants. They have no protection function and should therefore be used in connection with a separate upstream protective device.

### 4.1.1. 3LD switch disconnectors

3LD switch disconnectors are used for safe switching on and off of electrical equipment in machinery and plant engineering, infrastructure and buildings. Particularly in machine tools and processing machines, in the chemical or food and beverage industry, they are indispensable as main, EMERGENCY-STOP and repair switches.

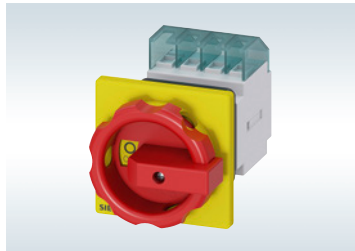

The portfolio comprises compact and narrow switches of various sizes with rated currents of 16 to 250 A in 3-, 4- and 6-pole versions. They are suitable for AC applications up to 690 V.

Versions for front and floor mounting, for distribution board installation or in an insulated enclosure enable application-compliant and versatile mounting. Door couplings for operating outside the control cabinet are also available as an option. The clearly recognizable switch position guarantees simple and intuitive operation. As a safety measure, the switches can be secured with a padlock, for example during maintenance work. The functionality can be further enhanced with accessories such as N/PE terminals or auxiliary switches.

### 4.1.2. 3KD switch disconnectors

As main, EMERGENCY-STOP and repair switches in industrial plants, infrastructure and buildings, 3KD switch disconnectors prevent electrical accidents. They allow electrical equipment to be safely switched on and off, even under load, and offer a safety disconnection function and isolating section in all low-voltage circuits.

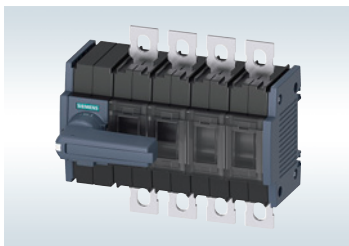

The product range comprises compact switches of various sizes with a rated current of 16 to 2000 A in 3-, 4- and 6-pole versions. They are designed for AC applications up to 690 V and DC applications up to 1200 V. The switches are suitable for very high short-circuit currents, so they can be used close to the feed-in.

The switch disconnectors can be installed in various mounting positions and offer several connection options. They are provided as a complete unit including front direct operating mechanism or as a basic unit without handle. The basic units have a front or side operating mechanism and can be equipped with direct operating mechanisms or door mounted rotary operators for actuation outside the control cabinet door. If required, further functionalities can be retrofitted, such as additional poles or auxiliary switches.

## 4.2. Fuse systems

The product portfolio of Siemens covers fuse systems of different designs, which are briefly presented in the following. More information can be found in the "Fuse systems" technology primer. All fuses comply with the sections of IEC 60296.

### 4.2.1. LV HRC fuses

Low-voltage high rupture capacity fuses (LV HRC fuses) are used for installation systems in non-residential, commercial and industrial buildings as well as in the switchgear of power supply companies. Compared to screw-in fuses, they can carry and disconnect significantly higher currents.

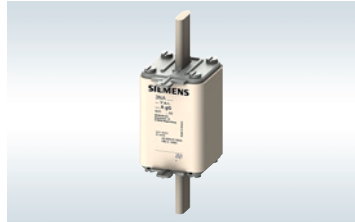

LV HRC fuses are available in the sizes 000, 00, 0, 1, 2, 3, 4 and 4a with rated currents up to 1250 A.

LV HRC fuse links fit into switching devices / bases of the next size. For example, fuse links of size 000 can be used in size 00 devices or fuse links of size 1 can be used in size 2 devices, and so on. This applies to all fuse links and all devices in which fuses can be installed.

For LV HRC fuses, there are no constructional requirements for non-interchangeability of rated current and touch protection. They may therefore only be operated or maintained by qualified staff. If necessary, appropriate accessories can be retrofitted to prevent accidental contact.

LV HRC fuse links are available in the following operational classes:

- gG: Cable and line protection
- aM: Short-circuit protection of switching devices in motor circuits
- gR or aR: Protection of power semiconductors
- gS: Cable, line and semiconductor protection

### 4.2.2. SITOR fuses

SITOR semiconductor fuses protect power semiconductors against the effects of a short circuit and their supply cables against overload. They have a super-quick disconnect characteristic and protect high-quality devices and system components, such as converters with fuses in the input and the DC link, UPS systems and soft starters for motors. The SITOR thyristor sets were developed for special applications, such as railroad rectifiers or electrolysis systems.



SITOR fuses do not have standardized designs and connections and therefore do not form a separate fuse system. The Siemens product portfolio includes SITOR fuses for LV HRC, NEOZED, DIAZED and cylindrical fuse systems. When selecting products, please note that fuses for semiconductor protection can become significantly hotter than conventional fuses due to their design. Therefore, they may not be able to operate at full rated current when installed in a safety switching device or fuse holder. To ensure correct application, Siemens provides extensive information and combination lists in the configuration manuals. Here, SIMARIS Therm can also be used as an aid.

### 4.2.3. Cylindrical fuses

In Europe, cylindrical fuses are used as standard in industry, and in Southwest Europe also in residential buildings. They have cylindrical contact caps and are inserted into a fuse holder.



The fuses are available in various sizes with a rated current up to 100 A. They require only one modular width per pole and are therefore especially characterized by their small space requirement in the control cabinet.

Cylindrical fuses can optionally be supplied with or without signaling detectors. On devices with signaling detector, a flashing LED indicates whether the fuse link has tripped. In addition, the switching state can be reported via mountable auxiliary switches and used for automation purposes.

#### 4.2.4. DIAZED/NEOZED fuses

The **DIAZED** fuse system is a development of Siemens and is one of the oldest fuse systems in the world. Even today, this robust system is still used in many countries as a standard in industrial plants.



DIAZED fuse links are available in various sizes with a rated current of 2 to 100 A.

The **NEOZED** fuse system is the further development of the DIAZED system and is mainly used in distribution technology and industrial plants. The use of adapter sleeves ensures non-interchangeability, i.e. it is not possible to insert an incompatible fuse link into the respective base. For this reason, the system can also be operated by laymen and is suitable for domestic installations. It has a compact design and its functionality can be extended in many ways by accessories.



NEOZED fuse links are available in various sizes with a rated current of 2 to 100 A.



## 4.3. Fuse switch disconnectors

Fuse switch disconnectors are used for the all-pole switching of machinery and plants. In contrast to plain switch disconnectors, they have a protection function due to the fuse integrated as a switching element.

### 4.3.1. 3NP fuse switch disconnectors

**3NP1** fuse switch disconnectors are used for protection and switching of diverse electrical loads in infrastructure and industry. They are suitable, for example, for low-voltage switchgear for power distribution and motor control centers (MCC), and for the construction of distribution systems and machinery. The all-round touch protection ensures a high level of system protection and personal safety.



The compact devices are available for fuse sizes from LV HRC 000 to LV HRC 3. The integrated fuse monitoring detects, displays and reports fault conditions.

The LV HRC fuse system is designed in such a way that, in a switching device of a certain size, fuses of the next smaller fuse size can generally also be installed. For example, fuses of the sizes LV HRC 3 and LV HRC 2 can be installed in a size 3 switching device.

### 4.3.2 3NJ4 fuse switch disconnectors

3NJ4 fuse switch disconnectors combine the functions of load switching and disconnection in one device. They are designed in a compact in-line design and enable a high packing density. The integrated LV HRC fuse protects systems against overload and short circuit. The switches are suitable for occasional manual switching and isolation of load feeders and low-voltage distributions in industry and non-residential buildings.



The portfolio includes 1- and 3-pole switchable versions with a rated operational current from 160 to 1250 A. The switches are suitable for AC applications up to 690 V. Versions with integrated current transformer, with electronic fuse monitoring or for the secondary protection of transformers are available.

When using SITOR fuses, the derating values must be calculated in combination with the 3NJ4 based on the power loss of the fuses and switching devices. The reason is the higher power losses of the SITOR fuses.

Fuse switch disconnectors can be mounted vertically and offer a wide range of connection possibilities.

## 4.4. Switch disconnectors with fuses

Switch disconnectors with fuses are used for the protection and switching of loads. Compared to fuse switch disconnectors, they have a higher switching capacity.

### 4.4.1. 3KF switch disconnectors with fuses

As main, EMERGENCY-STOP or repair switches of switchgear assemblies, power distribution boards, power supply and motor outgoing feeders in low-voltage circuits, 3KF switch disconnectors with fuses protect against overload and short circuits. The switches can also be deployed close to the feed-in.



Depending upon their size, 3KF switch disconnectors with fuses allow a rated current between 32 and 850 A to be switched on and off. In addition, they offer a safety disconnection function and isolating section in all low-voltage electrical circuits and are suitable for LV HRC and SITOR fuses in LV HRC design.

The LV HRC fuse system is designed in such a way that, in a switching device of a certain size, fuses of the next smaller fuse size can generally also be installed. For example, fuses of the sizes LV HRC 3 and LV HRC 2 can be installed in a size 3 switching device.

The switch disconnectors can be installed in various mounting positions and offer several connection options. The basic units have a front or side operating mechanism and can be equipped with direct operating mechanisms or door mounted rotary operators for actuation outside the control cabinet door. Common switch versions consisting of basic unit and handle are available as complete units. If required, further functionalities can be retrofitted, such as additional poles or auxiliary switches.

#### 4.4.2. 3NJ6 switch disconnectors with fuses

The 3NJ6 switch disconnectors with fuses are installed in low-voltage distribution boards where a minimum amount of space is available for a maximum number of cable ducts to the power distribution. The compact in-line design with plug-in contact enables easy installation and high packing density in the field. They protect against short circuit and overload and are suitable for LV HRC fuse links.

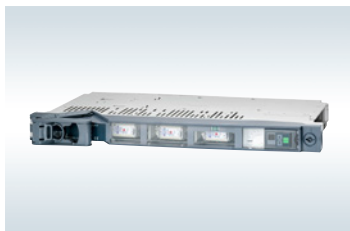

The portfolio includes 2-, 3- and 4-pole versions with a rated operational current from 160 to 630 A. The switches are suitable for AC applications up to 690 V and DC applications up to 440 V.

When using SITOR fuses, the derating values must be calculated in combination with the 3NJ6 based on the power loss of the fuses and switching devices. The reason is the higher power losses of the SITOR fuses.

The LV HRC fuse system is designed in such a way that, in a switching device of a certain size, fuses of the next smaller fuse size can generally also be installed. For example, fuses of the sizes LV HRC 3 and LV HRC 2 can be installed in a size 3 switching device.

3NJ6 are installed in control cabinets by means of draw-out technology. Contacting to the busbars located in the control cabinet takes place automatically during installation. The switch disconnectors can be extended with add-on modules, such as auxiliary switches, ammeters or current transformers, without requiring additional space. Conversion or replacement of components can be performed during operation. The electronic fuse monitoring indicates and records fault conditions.

## 4.5. Load transfer switches and transfer switching equipment

Load transfer switches are used for switching between different loads. Transfer switches additionally enable switching between different power networks.

### 4.5.1. 3LD load transfer switches

The 3LD load transfer switches are used for switching between two loads during an input feed-in. Through the switch position (I – 0 – II), one of the two loads can be switched on in alternation. This allows switching between two induction motors and other loads.

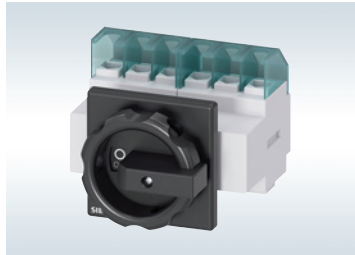

The switches are based on the 3LD2 switch disconnecter and are available with a rated operational current of 25 to 250 A.

According to the standard, the 3LD2 load transfer switch is approved exclusively for switching between two loads.

## 4.5.2. 3KC transfer switching equipment

The 3KC transfer switching equipment provides for simple and secure switching between the main system and an alternative system. With three possible switch positions (I – 0 – II), they are suitable both for isolation of electrical systems and for switching between two networks. All versions of the 3KC transfer switching equipment are suitable for conventional network configurations. Depending on the design type, the transfer switching equipment can be used in any application area, e.g. in computer centers, infrastructures and in the chemical and metalworking industry.



Depending on the application area and range of requirements, there is a choice between manual (MTSE), remote (RTSE) and automatic (ATSE) transfer switching equipment. The switches are designed for a rated current of 16 to 3200 A, depending on the design type and are available in 3- and 4-pole versions.

3KC transfer switching equipment is characterized by high short-circuit values, a compact design with sizes up to 160 A and, in the case of the RTSE and ATSE transfer switching equipment, by an extremely short operating time. They are mounted by installation on a mounting plate or standard mounting rail. The switches can be interlocked mechanically or electrically in switch position I or II. A padlock for the 0 position enables secure maintenance work.

3KC transfer switching equipment is approved according to the product standards IEC 90947-6 and IEC 90947-3.



Detailed information can be found in the **Configuration Manual** Transfer switching equipment and load transfer switches (SIOS-ID: 109769745)

#### 4.5.2.1. 3KC0 manual transfer switching equipment (MTSE)

The 3KC0 manual transfer switching equipment (MTSE) is suitable for applications in which short-term power failure is acceptable, pending manual intervention. The transfer switch is available in five sizes from 16 to 1600 A, each with a 3- and 4-pole version. The MTSE offers an economical solution, for example for switching between two loads, and switches inductive loads.

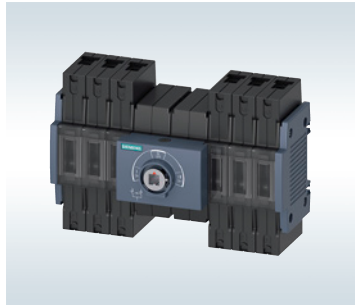

#### 4.5.2.2. Transfer switching equipment with motor operator

##### 4.5.2.2.1. 3KC3 and 3KC4 remote transfer switching equipment (RTSE)

The 3KC remote transfer switching equipment (RTSE) is available in a 4-pole version 3KC3 for the rated current range from 40 to 160 A and in a 3- or 4-pole version 3KC4 for currents between 250 and 3200 A. They ensure a high level of power supply reliability for systems that already have a separate control device, e.g. from the SIMATIC range. In combination with a suitable control device, RTSE can be used for automatic remote switching and network to generator applications, along with generator to generator applications.



#### 4.5.2.2.2. 3KC6 and 3KC8 automatic transfer switching equipment (ATSE)

The 3KC automatic transfer switching equipment (ATSE) is available as a 4-pole version 3KC6 for the rated current range from 40 to 160 A. For the range between 250 and 3200 A, 3 and 4 pole versions 3KC8 are available. The ATSE automatic transfer switching equipment has a motor operator and an integrated controller. It can therefore be integrated into existing systems where automatic remote switching is necessary and no separate control device is available.

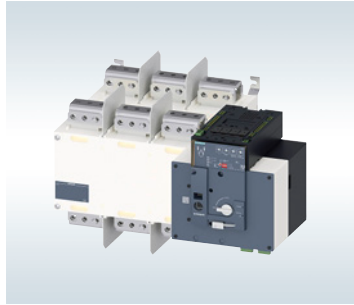

The switching conditions can be set by the user directly on the device in a few steps. All design types of the ATSE automatic transfer switching equipment offer an integrated dual power supply and thus require no external power source. The 3KC6 versions can optionally be remote controlled via inputs. Through the possibility of directly controlling a generator by means of the integrated controller, these sizes are also suitable for network to generator applications.

#### 4.5.2.3. Transfer control devices

The 3KC ATC transfer control devices enable automatic or manual switching between two supply networks in low-voltage power distribution. 3KC ATC are pure controllers for automatic switchover between two networks and have no integrated switching devices. In the event of a power failure, they control switching devices, such as ACB or MCCB, and allow a flexible design. They are therefore used in particular where a power failure is critical, for example in power networks with UPS supply and in industrial processes. The devices quickly and fully automatically detect fluctuations in the main supply network and switch to a backup network if necessary. As soon as the main supply network is available again in the quality specified by the user, the control device switches back to it.



#### 4.5.2.3.1. ATC3100

The ATC3100 transfer control device is a cost-effective way of implementing automatic switching applications. It can be configured without software and can be mounted flexibly without accessories. The system status is indicated by ten LEDs.



#### 4.5.2.3.2. ATC6300 and ATC6500

The ATC6300 and ATC6500 transfer control devices provide enhanced functionality for controlling the transfer switching. The devices were developed for industrial and infrastructure-related applications, such as supplying production lines, all machines, pumps, cooling and lighting systems.



The device can be operated and parameterized via the front display. In addition, parameterization and monitoring is possible with the free powerconfig software. The control device offers numerous measuring functions and, depending on the series, can be extended with two or three expansion modules as well as communication interfaces.

## 5. Application example in the Siemens portfolio



### Schematic structure

Feed-in  
(3WL, 3WA)

Sub-distribution  
(3NP, 3NJ, 3VA, 3KD)

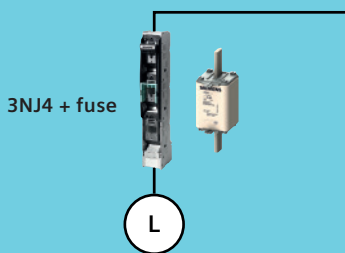
Small distribution / control cabinet  
(3KF, 3NP, 3LD)



-  Other loads (max. AC23)
-  Motor loads (AC3)

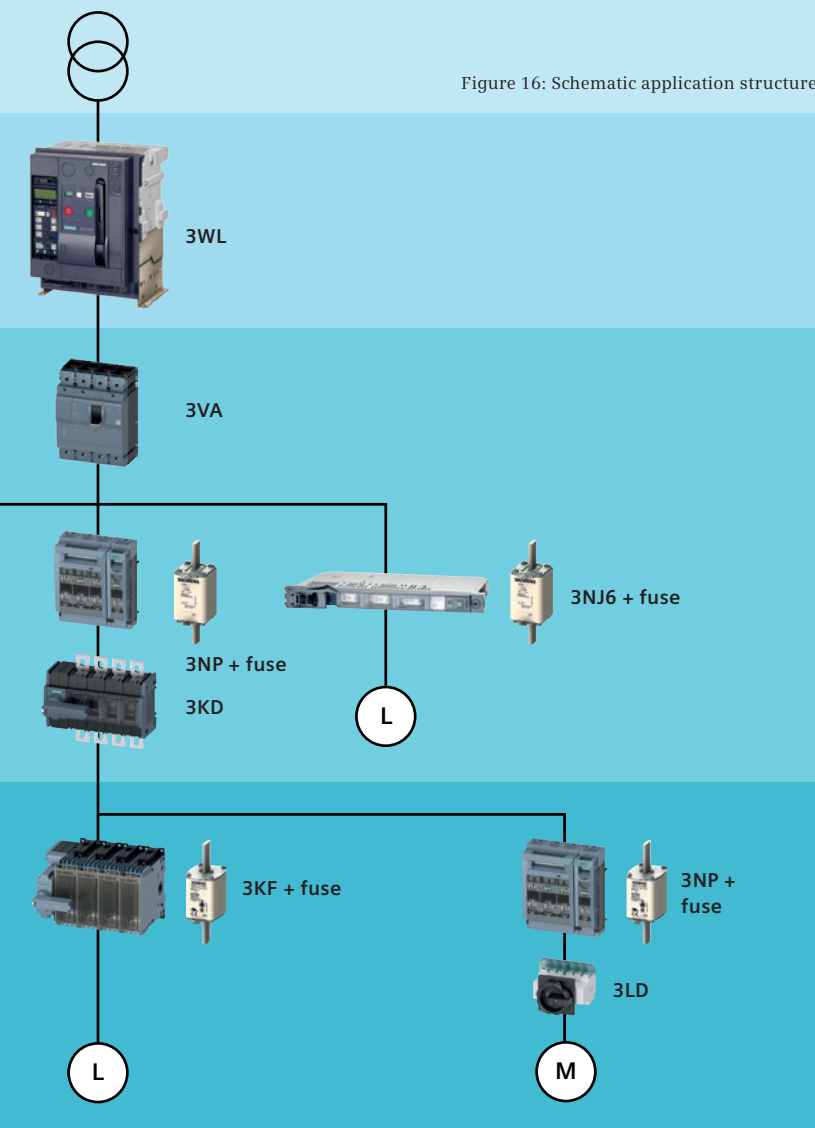

Figure 16: Schematic application structure

# Closing words

Now more than ever, the safe disconnection and switching of electrical systems is essential for the effective protection of human and machine. The selection of devices is becoming increasingly challenging for the plant constructor, due to increasing requirements for safety and cost-effectiveness as well as growing demands for functionality and flexibility. Our experts for low-voltage technology at Siemens are always available to answer your questions and help solve your problems.

Explanations of the key features of switch disconnectors, fuse switch disconnectors and transfer switches can be found in the appendix.

## 6. Appendix: Definition of the key features

To record the performance characteristics of switch disconnectors, fuse switch disconnectors and transfer switches, a number of key technical features are defined by the IEC 60947-3 standard. These values are determined under standard conditions, so that the user can compare the technical data of various manufacturers. Depending on the user's application, different characteristics are relevant for selection. A brief description of the individual technical features is given here and illustrated with examples.

### 6.1. Rated voltages

The devices are described by the following rated voltages.

#### 6.1.1. Rated operational voltage ( $U_o$ )

The rated operational voltage of a device is the voltage that occurs at the rated operational current. The rated operational voltage is used to perform the various tests of the utilization categories. If a single-pole device is determined by it, the voltage over one pole is generally specified. For multipole devices, the rated operational voltage is specified as the phase-to-phase voltage.

#### 6.1.2. Rated insulation voltage ( $U_i$ )

The rated insulation voltage  $U_i$  is the voltage of electrical equipment according to which insulation tests and creepage distances are referred. Creepage distance is the shortest distance between two conductive components along the surface of an insulator. The insulation test ensures that the existing creepage distance is sufficiently large. The highest operational voltage of a circuit must not exceed the rated insulation voltage.

#### 6.1.3. Rated impulse withstand voltage ( $U_{imp}$ )

The rated impulse withstand voltage is the peak value of an impulse voltage in a defined form and polarity that an equipment or a circuit must withstand without failure under specified test conditions. It is therefore a measure of the dielectric strength. Dielectric strength is the maximum electric field strength that may be present in a material before a voltage breakdown in the form of a spark is imminent.

## 6.2. Currents

### 6.2.1. Conventional free-air thermal current ( $I_{th}$ )

The conventional free-air thermal current  $I_{th}$  denotes the maximum current loading that a switching device can carry over a period of eight hours without thermal overload. Free air is defined as air under normal room conditions, i.e. largely free of external radiation and drafts.

### 6.2.2. Conventional thermal current of enclosed devices ( $I_{the}$ )

The conventional thermal current of enclosed devices  $I_{the}$  denotes the maximum current loading that a switching device in a given enclosure can carry over a period of eight hours without thermal overload.

### 6.2.3 Rated operational current ( $I_o$ ) or rated operational power

The rated operational current is the current that a switching device is able to switch. The value is specified by the manufacturer and takes into account the rated operational voltage, rated frequency, rated load, utilization category and ambient temperature.

### 6.2.4 Rated uninterrupted current ( $I_u$ )

The rated uninterrupted current is the maximum permissible current for which an electrical device is designed under defined operating conditions (e.g. ambient temperature, installation altitude...) for continuous operation at constant load (symbol S1).

### 6.3. Key features of load and overload

#### 6.3.1. Ability to withstand motor switching overload currents

Devices or systems are overload-proof if they are protected against destruction through an overload of indefinite duration.

#### 6.3.2. Rated making capacity

The rated making capacity is the maximum current that a switching device can switch on. The value is specified in relation to the utilization category and the respective rated operational voltage.

#### 6.3.3. Rated breaking capacity

The rated breaking capacity is the maximum current that a switching device can switch off. The value is specified in relation to the utilization category as well as the rated operational voltage and rated operational current.

### 6.4. Key features under short-circuit conditions

#### 6.4.1. Rated short-time withstand current ( $I_{cw}$ )

The rated short-time withstand current is a measure of the thermal strength of a switching device under a short-term load. Usually, the value is given for a duration of one second.

#### 6.4.2. Rated short-circuit making capacity ( $I_{cm}$ )

The rated short-circuit making capacity describes the maximum short-circuit current that a switching device can switch on without damage. The value refers to the rated operational voltage and frequency.

#### 6.4.3. Rated short-circuit breaking capacity ( $I_{cn}$ )

The rated short-circuit breaking capacity describes the maximum short-circuit current that a switching device can switch off at the rated operational voltage and rated frequency.

#### 6.4.4. Conditional rated short-circuit current ( $I_g$ )

The conditional rated short-circuit current is the prospective current that a switching device in conjunction with a short-circuit back-up fuse can disconnect without subsequent impairment of function.

**Published by  
Siemens AG 2020**

Siemens AG  
Smart Infrastructure  
Electrical Products  
Siemensstrasse 10  
93055 Regensburg  
Germany

SIEP-T10024-00  
Dispo 25601-0220-3.0  
Printed in Germany  
© Siemens 2020

Help is always at hand:  
Our comprehensive support  
**[www.siemens.com/online-support](http://www.siemens.com/online-support)**

Subject to change without notice

The information in this document contains general descriptions of the technical options, which may not always be available in each case. The required features should therefore be defined on a case by case basis when concluding the contract.

**[www.siemens.com/switching-devices](http://www.siemens.com/switching-devices)**