

# SIMOTICS servomotors

## Technical definitions for AC motors

### Overview

#### Regulations, standards and specifications

The motors comply with the appropriate standards and regulations, see table below.

As a result of the fact that in many countries the national regulations have been completely harmonized with the international IEC 60034-1 recommendation, there are no longer any differences with respect to coolant temperatures, temperature classes and temperature rise limits.

General specifications for rotating electrical machines	IEC 60034-1
Terminal designations and direction of rotation for electrical machines	IEC 60034-8
Types of construction of rotating electrical machines	IEC 60034-7
Cooling methods of rotating electrical machines	IEC 60034-6
Degrees of protection of rotating electrical machines	IEC 60034-5
Vibration severity of rotating electrical machines	IEC 60034-14
Noise limit values for rotating electrical machines	IEC 60034-9
Cylindrical shaft extensions for electrical machines	DIN 748-3/IEC 60072-1

The motors listed below are UL-approved by Underwriters Laboratories Inc. and also comply with Canadian cUR standards:

SIMOTICS S-1FK7/1FT7/SIMOTICS T-1FW3/1FW6/  
SIMOTICS M-1PH8 (without brake)/SIMOTICS L-1FN3/1FN6.

#### Degrees of protection for AC motors

A suitable degree of protection must be selected to protect the machine against the following hazards depending on the relevant operating and environmental conditions:

- Ingress of water, dust and solid foreign objects,
- Contact with or approach to rotating parts inside a motor and
- Contact with or approach to live parts.

Degrees of protection of electric motors are specified by a code. This comprises 2 letters, 2 digits and, if required, an additional letter.

#### IP (International Protection)

Code letter designating the degree of protection against contact and the ingress of solid foreign objects and water

#### 0 to 6

1st digit designating the degree of touch protection and protection against ingress of solid foreign objects

#### 0 to 8

2nd digit designating the degree of protection against ingress of water (no oil protection)

#### W, S and M

Additional code letters for special degrees of protection

Most motors are supplied with the following degrees of protection:

Motor	Degree of protection	1st digit: Touch protection	Protection against foreign objects	2nd digit: Protection against water
Internally cooled	<b>IP23</b>	Protection against finger contact	Protection against medium-sized, solid foreign objects above 12 mm Ø	Protection against spray water up to 60° from the vertical
Surface-cooled	<b>IP54</b>	Complete protection against accidental contact	Protection against harmful dust deposits	Splash water from any direction
	<b>IP55</b>			Jet-water from any direction
	<b>IP64</b>	Complete protection against accidental contact	Protection against dust ingress	Splash water from any direction
	<b>IP65<sup>1)</sup></b>			Jet-water from any direction
	<b>IP67<sup>1)</sup></b>			Motor under defined pressure and time conditions under water

#### Recommended degrees of protection for AC motors

When cooling lubricants are used, protection against water alone is inadequate. The IP rating should only be considered here as a guideline. The motors may have to be protected by suitable covers. Attention must be paid to providing suitable sealing of the motor shaft for the selected degree of protection for the motor (for 1FT7: degree of protection IP67 and flange 0).

The table can serve as a decision aid for selecting the proper degree of protection for motors. A permanent covering of liquid on the flange must be avoided when the motor is mounted with the shaft extension facing upwards (IM V3, IM V19).

Effect	Liquids General workshop environment	Water; gen. cooling lubricant (95 % water, 5 % oil)
Dry	IP64	–
Water-enriched environment/ increased humidity	–	IP64
Mist	–	IP65
Spray	–	IP65
Jet	–	IP67
Splash/ brief immersion/ constant inundation	–	IP67

<sup>1)</sup> DIN VDE 0530 Part 5 or EN 60034 Part 5 specifies that there are only 5 degrees of protection for the first digit code and 8 degrees of protection for the second digit code in relation to rotating electrical machinery. However, IP6 is included in DIN 40050 which generally applies to electrical equipment.

**Overview (continued)**

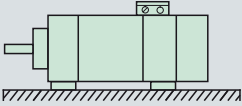
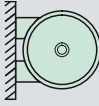
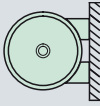
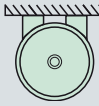
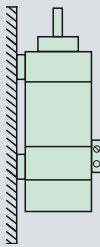
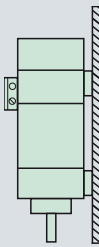
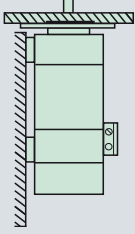
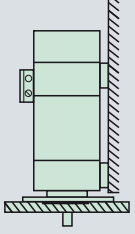
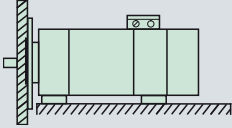
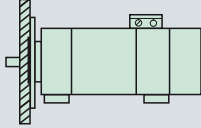
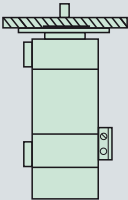
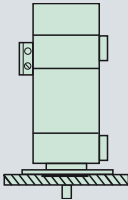
Types of construction/mounting positions	Types of construction/mounting positions
<b>IM B3</b> 	<b>IM B6</b> 
<b>IM B7</b> 	<b>IM B8</b> 
<b>IM V6</b> 	<b>IM V5</b> 
<b>IM V35<sup>1)</sup></b> 	<b>IM V15<sup>1)</sup></b> 
<b>IM B35<sup>1)</sup></b> 	<b>IM B5</b> 
<b>IM V3</b> 	<b>IM V1</b> 

<sup>1)</sup> Fixing on the flange and feet is necessary.

# SIMOTICS servomotors

## Technical definitions for AC motors

### Overview (continued)

#### Radial eccentricity tolerance of shaft in relation to housing axis

refers to cylindrical shaft extensions

Shaft height	Tolerance N	Tolerance R	Tolerance SPECIAL
SH	mm (in)	mm (in)	mm (in)
28/36	0.035 (0.0014)	0.018 (0.0007)	-
48/63	0.04 (0.0016)	0.021 (0.0008)	-
80/100/132	0.05 (0.0020)	0.025 (0.0010)	0.01 (0.0004)
160/180/225	0.06 (0.0024)	0.03 (0.0012)	0.01/- / - (0.0004/- / -)
280	0.07 (0.0028)	0.035 (0.0014)	-
355	0.08 (0.0031)	0.04 (0.0016)	-

#### Test: radial eccentricity

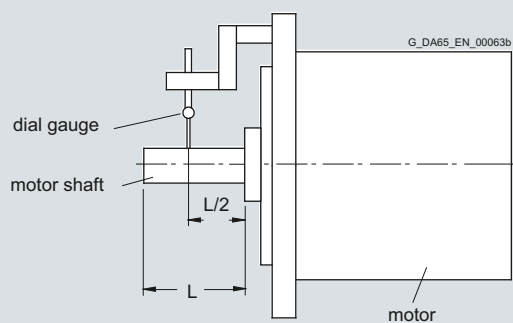

#### Concentricity and axial eccentricity tolerance of the flange surface to the shaft axis

referred to the centering diameter of the mounting flange

Shaft height	Tolerance N	Tolerance R	Tolerance SPECIAL
SH	mm (in)	mm (in)	mm (in)
28/36/48	0.08 (0.0031)	0.04 (0.0016)	-
63/80/100	0.1 (0.0039)	0.05 (0.0020)	- / 0.03/0.04 (- / 0.0012/0.0016)
132/160/180/225	0.125 (0.0049)	0.063 (0.0025)	0.04/0.04/ - / - (0.0016/0.0016/ - / -)
280/355	0.16 (0.0063)	0.08 (0.0031)	-

#### Test: concentricity

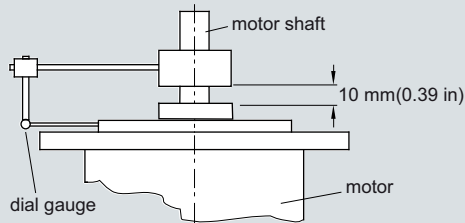

#### Test: axial eccentricity

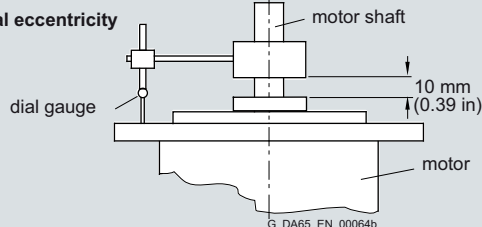

#### Vibration severity and vibration severity grade A according to IEC 60034-14

The vibration severity is the RMS value of the vibration velocity (frequency range from 10 to 1000 Hz). The vibration severity is measured using electrical measuring instruments in compliance with DIN 45666.

The values indicated refer only to the motor. These values can increase as a result of the overall system vibrational behavior due to installation.

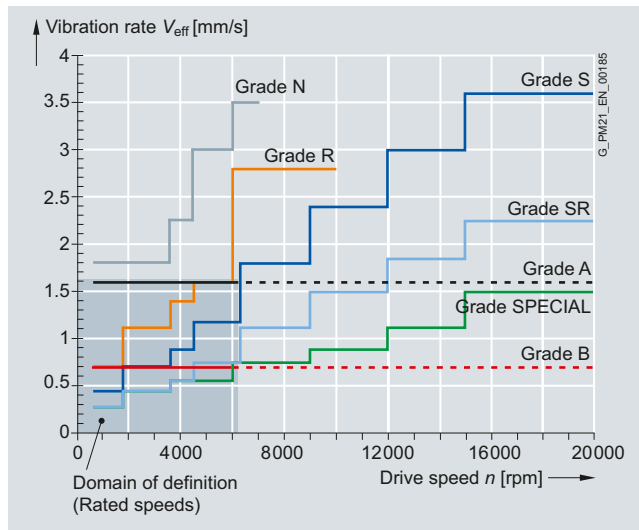

Vibration severity limit values for shaft heights 20 to 132

The speeds of 1800 rpm and 3600 rpm and the associated limit values are defined according to IEC 60034-14. Speeds of 4500 rpm and 6000 rpm and the specified values are defined by the motor manufacturer.

The motors maintain vibration severity grade A up to rated speed.

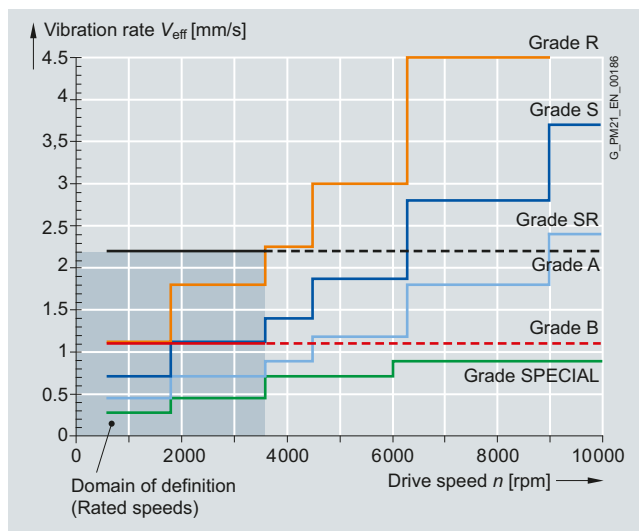

Vibration severity limit values for shaft heights 160 to 355

### Overview (continued)

#### Balancing according to DIN ISO 8821

In addition to the balance quality of the motor, the vibration quality of motors with mounted belt pulleys and coupling is essentially determined by the balance quality of the mounted component.

If the motor and mounted component are separately balanced before they are assembled, then the process used to balance the belt pulley or coupling must be adapted to the motor balancing type. The following different balancing methods are used on motors of types SIMOTICS M-1PH8:

- Half-key balancing
- Full-key balancing
- Plain shaft extension

The letter H (half key) or F (full key) is printed on the shaft extension face to identify a half-key balanced or a full-key balanced SIMOTICS M-1PH8 motor.

SIMOTICS S-1FT7/1FK7 motors with feather key are always half-key balanced.

In general, motors with a plain shaft are recommended for systems with the most stringent vibrational quality requirements. For full-key balanced motors, we recommend belt pulleys with two opposite keyways, but only one feather key in the shaft extension.

#### Vibration stress, immitted vibration values

The following maximum permissible vibration stress limits at full functionality apply only to the SIMOTICS S-1FT7/1FK7 permanent-magnet servomotors and SIMOTICS T-1FW3 torque motors.

Vibration stress according to DIN ISO 10816:

- 1 g at 20 Hz to 2 kHz

For all main motors of type SIMOTICS M-1PH8, the following limits are valid for (immitted) vibration values introduced into the motor from outside:

Vibration frequency	Vibration values for 1PH808/1PH810/1PH813/1PH816	
< 6.3 Hz	Vibration displacement $s$	$\leq 0.16 \text{ mm (0.01 in)}$
6.3 ... 250 Hz	Vibration velocity $V_{\text{rms}}$	$\leq 4.5 \text{ mm/s (0.18 in/s)}$
> 250 Hz	Vibration acceleration $a$	$\leq 10 \text{ m/s}^2 (32.8 \text{ ft/s}^2)$

Vibration frequency	Vibration values for 1PH818/1PH822/1PH828/1PH835	
< 6.3 Hz	Vibration displacement $s$	$\leq 0.25 \text{ mm (0.01 in)}$
6.3 ... 63 Hz	Vibration velocity $V_{\text{rms}}$	$\leq 7.1 \text{ mm/s (0.28 in/s)}$
> 63 Hz	Vibration acceleration $a$	$\leq 4.0 \text{ m/s}^2 (13.1 \text{ ft/s}^2)$

For all torque motors of type SIMOTICS T-1FW3, the following limits are valid for (immitted) vibration values introduced into the motor from outside:

Vibration frequency	Vibration values for 1FW3	
< 6.3 Hz	Vibration displacement $s$	$\leq 0.26 \text{ mm (0.01 in)}$
6.3 ... 63 Hz	Vibration velocity $V_{\text{am}}$	$\leq 7.1 \text{ mm/s (0.28 in/s)}$
> 63 Hz	Vibration acceleration $a$	$\leq 4.0 \text{ m/s}^2 (13.1 \text{ ft/s}^2)$

#### Coolant temperature (ambient temperature) and installation altitude

Operation (unrestricted): -15 °C to +40 °C (5 °F to 104 °F)

The rated power (rated torque) is applicable to continuous duty (S1) according to EN 60034-1 at rated frequency, a coolant temperature of 40 °C (104 °F) and an installation altitude of 1000 m (3281 ft) above sea level.

Apart from the SIMOTICS M-1PH8 motors, all motors are designed for temperature class 155 (F) and utilized according to temperature class 155 (F). The SIMOTICS M-1PH8 motors are designed for temperature class 180 (H). For all other conditions, the factors given in the table below must be applied to determine the permissible output (torque).

The coolant temperature and installation altitude are rounded to 5 °C and 500 m (1640 ft) respectively.

Installation altitude above sea level m (ft)	Coolant temperature (ambient temperature)			
	< 30 °C (86 °F)	30 ... 40 °C (86 ... 104 °F)	45 °C (113 °F)	50 °C (122 °F)
1000 (3281)	1.07	1.00	0.96	0.92
1500 (4922)	1.04	0.97	0.93	0.89
2000 (6562)	1.00	0.94	0.90	0.86
2500 (8203)	0.96	0.90	0.86	0.83
3000 (9843)	0.92	0.86	0.82	0.79
3500 (11484)	0.88	0.82	0.79	0.75
4000 (13124)	0.82	0.77	0.74	0.71

# SIMOTICS servomotors

## Technical definitions for AC motors

### Overview (continued)

#### Duty types S1 and S6 according to EN 60034-1

##### S1: Continuous duty

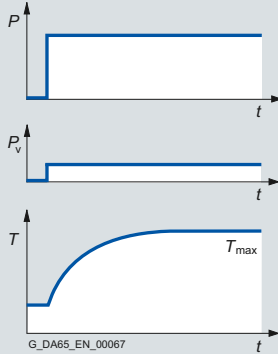

Duty cycle under constant load condition of sufficient duration to establish thermal equilibrium.

*Designation: S1*  
Output specification (torque).

##### S6: Continuous duty with intermittent loading

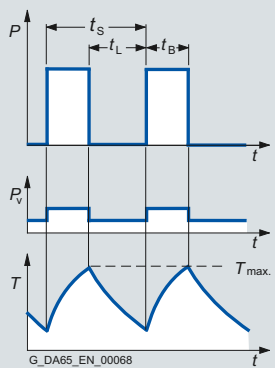

Duty cycle comprising a sequence of identical duty cycles, each of which consists of a period of constant load followed by an interval at no load. There are no de-energized intervals.

*Designation:*  
e.g.: S6 - 40 %, 85 kW (114 HP)

$$t_r = \frac{t_B}{t_B + t_L}$$

$$t_s = 10 \text{ min}$$

#### Characteristic curves

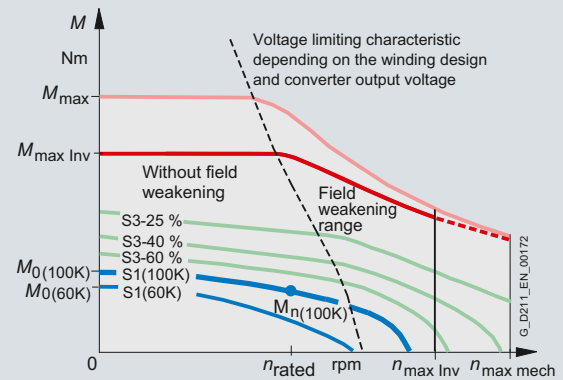

Torque characteristic of a synchronous motor operating on a converter with field weakening (example)

$n_{\text{rated}}$	Rated speed
$n_{\text{max Inv}}$	Maximum permissible electric speed limit
$n_{\text{max mech}}$	Maximum permissible mechanical speed limit
$M_0$	Static torque
$M_{\text{rated}}$	Rated torque at rated speed
$M_{\text{max Inv}}$	Achievable maximum torque with recommended motor module
$M_{\text{max}}$	Maximum permissible torque

#### Rated torque

The torque supplied on the shaft is indicated in Nm in the selection and ordering data.

$$M_{\text{rated}} = 9.55 \times P_{\text{rated}} \times \frac{1000}{n_{\text{rated}}}$$

$P_{\text{rated}}$  Rated power in kW  
 $n_{\text{rated}}$  Rated speed in rpm  
 $M_{\text{rated}}$  Rated torque in Nm

$$M_{\text{rated}} = P_{\text{rated}} \times \frac{5250}{n_{\text{rated}}}$$

$P_{\text{rated}}$  Rated power in HP  
 $n_{\text{rated}}$  Rated speed in rpm  
 $M_{\text{rated}}$  Rated torque in lb<sub>F</sub>-ft

#### DURIGNIT IR 2000 insulation system

The DURIGNIT IR 2000 insulation system consists of high-quality enamel wires and insulating sheeting in conjunction with a solvent-free resin impregnation.

The insulating material system ensures that these motors will have a high mechanical and electrical stability, high service value and a long service life.

The insulation system protects the winding to a large degree against aggressive gases, vapors, dust, oil and increased air humidity. It can withstand the usual vibration stressing.

### Overview (continued)

#### Motor protection

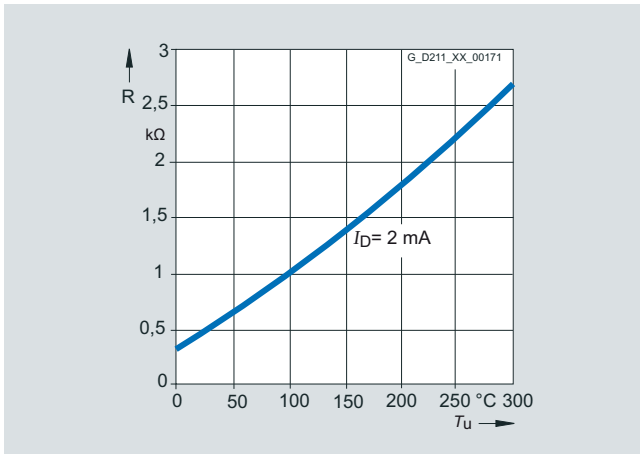

The KTY84-130 temperature sensor is used to measure the motor temperature for converter-fed motor operation.

This sensor is a semi-conductor that changes its resistance depending on temperature in accordance with a defined curve.

Siemens converters determine the motor temperature using the resistance of the temperature sensor.

Their parameters can be set for specific alarm and shutdown temperatures.

The SIMOTICS L-1FN3/-1FN6 and SIMOTICS T-1FW6 motors are additionally equipped with PTC sensors (PTC elements). In these motor series, evaluation is performed using the SME120/SME125 Sensor Module External or TM120 Terminal Module (see SINAMICS S120 drive system).

The KTY84-130 temperature sensor is embedded in the winding overhang of the motor like a PTC thermistor.

The sensor is evaluated in the SINAMICS S120 drive system as a standard function.

If the motors are operated on converters that do not feature a KTY84 evaluation circuit, the temperature can be measured with the external 3RS1040 temperature monitoring relay. For a detailed description, please see Catalog IC 10 or Siemens Industry Mall:

[www.siemens.com/industrymall](http://www.siemens.com/industrymall)

#### Paint finish

Motors without a paint finish have an impregnated resin coating. Motors with primer have corrosion protection.

All motors can be painted over with commercially available paints. Up to 2 additional paint coats are permissible.

Version	Suitability of paint finish for climate group according to IEC 60721, Part 2-1	
Paint finish	<b>Moderate</b> (expanded) for indoor and outdoor installation with roof protection	
	Briefly	Up to 150 °C (302 °F)
	Continuously	Up to 120 °C (248 °F)
Special paint finish	<b>Worldwide</b> (expanded) for outdoor installation	
	Briefly	Up to 150 °C (302 °F)
	Continuously	Up to 120 °C (248 °F)
	Also	For corrosive atmospheres up to 1 % acid and alkali concentration or permanent dampness in sheltered rooms

# SIMOTICS servomotors

## Technical definitions for AC motors

### Overview (continued)

#### Built-in encoder systems without DRIVE-CLiQ interface

For motors without an integrated DRIVE-CLiQ interface, the analog encoder signal in the drive system is converted into a digital signal. For these motors as well as external encoders, the encoder signals must be connected to SINAMICS S120 via Sensor Modules.

#### Built-in encoder systems with DRIVE-CLiQ interface

For motors with an integrated DRIVE-CLiQ interface, the analog encoder signal is internally converted to a digital signal. There is no further conversion of the encoder signal in the drive system. The motor-internal encoders are the same encoders that are used for motors without a DRIVE-CLiQ interface. Motors with a DRIVE-CLiQ interface simplify the commissioning and diagnostics, for example, due to automatic identification of the encoder system.

The different encoder types, incremental, absolute or resolver, are uniformly connected with one type of MOTION-CONNECT DRIVE-CLiQ cable.

#### Short designations for the encoder systems

The first letters of the short designation define the encoder type. This is followed by the resolution in signals per revolution if S/R is specified (for encoders without DRIVE-CLiQ interface) or in bits if DQ is specified (for encoders with DRIVE-CLiQ interface).

Type	Resolution/interface	
AM AS IC IN HTL	xxxxSR	Encoder <u>without</u> DRIVE-CLiQ interface Resolution = xxxx signals per revolution
AM AS IC IN R	xxDQ or xxDQI	Encoder <u>with</u> DRIVE-CLiQ interface Resolution = xx bits ( $2^{xx}$ )
AM		Multi-turn absolute encoder
AS		Single-turn absolute encoder
IC		Incremental encoder sin/cos with commutation position C and D tracks
IN		Incremental encoder sin/cos without commutation position
HTL		Incremental encoder with HTL signal
R		Resolver

#### Overview of motor encoder systems

Encoder <u>without</u> DRIVE-CLiQ interface					Encoder <u>with</u> DRIVE-CLiQ interface					Absolute position within a revolution (single-turn)	Absolute position over 4096 revolutions (multi-turn)	For use in Safety applications <sup>1)</sup>
Encoder	Identification letter in the motor order number				Encoder	Identification letter in the motor order number						
	1FT7	1FK7	1FW3	1PH8		1FT7	1FK7	1FW3	1PH8			
-	-	-	-	-	AM24DQI	C	C	-	-	Yes	Yes	Yes
-	-	-	-	-	AM20DQI	-	R	-	-	Yes	Yes	Yes
-	-	-	-	-	AS24DQI	B	B	-	-	Yes	No	Yes
-	-	-	-	-	AS20DQI	-	Q	-	-	Yes	No	Yes
AM2048S/R	M	E	E	E	AM22DQ	F	F	F	F	Yes	Yes	Yes
AM512S/R	-	H	-	-	AM20DQ	-	L	-	-	Yes	Yes	Yes
AM32S/R	-	G	-	-	AM16DQ	-	K	-	-	Yes	Yes	No
AM16S/R	-	J	-	-	AM15DQ	-	V	-	-	Yes	Yes	No
AS2048S/R	-	-	N	-	AS22DQ	-	-	P	-	Yes	No	No
IC2048S/R	N	A	A	M	IC22DQ	D	D	D	D	No	No	Yes
IN2048S/R	-	-	-	-	IN22DQ	-	-	-	-	No	No	Yes
HTL1024S/R	-	-	-	H	-	-	-	-	-	No	No	No
HTL2048S/R	-	-	-	J	-	-	-	-	-	No	No	No
Resolver p=1	-	T	-	-	R14DQ	-	P	-	-	Yes	No	No
Resolver p=3	-	S	S	-	R15DQ	-	U	U	-	No	No	No
Resolver p=4	-	S	S	-	R15DQ	-	U	U	-	No	No	No

All encoders are not available for every motor shaft height.

- Not possible

<sup>1)</sup> Not for 1FW3 motors.

### Overview (continued)

#### Multi-turn absolute encoder

This encoder outputs an absolute angular position between 0° and 360° in the specified resolution. An internal measuring gearbox enables it to differentiate 4096 revolutions.

So with a ball screw, for example, the absolute position of the slide can be determined over a long distance.

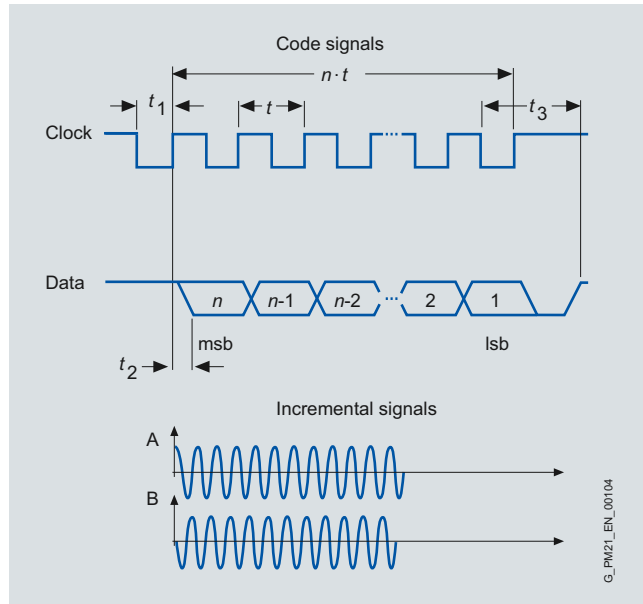

Multi-turn absolute encoder

#### Single-turn absolute encoder

This encoder outputs an absolute angular position between 0° and 360° in the specified resolution. In contrast to the multi-turn absolute encoder, it has no measuring gearbox and can therefore only supply the position value within one revolution. It does not have a traversing range.

#### Absolute encoders without DRIVE-CLiQ interface

AM2048S/R encoder	Absolute encoder 2048 S/R, 4096 revolutions, multi-turn, with EnDat interface
AM512S/R encoder	Absolute encoder 512 S/R, 4096 revolutions, multi-turn, with EnDat interface
AM32S/R encoder	Absolute encoder 32 S/R, 4096 revolutions, multi-turn, with EnDat interface
AM16S/R encoder	Absolute encoder 16 S/R, 4096 revolutions, multi-turn, with EnDat interface
AS2048S/R encoder	Absolute encoder single-turn 2048 S/R

#### Absolute encoders with DRIVE-CLiQ interface

AM24DQI encoder	Absolute encoder 24 bit (resolution 16777216, internal 2048 S/R) + 12 bit multi-turn (traversing range 4096 revolutions)
AM20DQI encoder	Absolute encoder 20 bit (resolution 1048576, internal 512 S/R) + 12 bit multi-turn (traversing range 4096 revolutions)
AM22DQ encoder	Absolute encoder 22 bit (resolution 4194304, internal 2048 S/R) + 12 bit multi-turn (traversing range 4096 revolutions)
AM20DQ encoder	Absolute encoder 20 bit (resolution 1048576, internal 512 S/R) + 12 bit multi-turn (traversing range 4096 revolutions)
AM16DQ encoder	Absolute encoder 16 bit (resolution 65536, internal 32 S/R) + 12 bit multi-turn (traversing range 4096 revolutions)
AM15DQ encoder	Absolute encoder 15 bit (resolution 32768, internal 16 S/R) + 12 bit multi-turn (traversing range 4096 revolutions)
AS24DQI encoder <sup>2)</sup>	Single-turn absolute encoder 24 bit
AS20DQI encoder <sup>2)</sup>	Single-turn absolute encoder 20 bit
AS22DQ encoder	Single-turn absolute encoder 22 bit

#### Technical specifications

##### Absolute encoders without DRIVE-CLiQ interface

Supply voltage	5 V
Absolute position interface via EnDat 2.1	
• Traversing range (multi-turn) <sup>1)</sup>	4096 revolutions
Incremental signals (sinusoidal, 1 V <sub>pp</sub> )	
• Signals per revolution	2048/512/32/16

##### Absolute encoders with DRIVE-CLiQ interface

Supply voltage	24 V
Absolute position via DRIVE-CLiQ	
• Resolution within one revolution	$2^{24}/2^{22}/2^{20}/2^{16}/2^{15}$ bit
• Traversing range (multi-turn) <sup>1)</sup>	4096 revolutions

<sup>1)</sup> Not for absolute encoder, single-turn AS.

<sup>2)</sup> The single-turn absolute encoder is used for the previous incremental encoders.



# SIMOTICS servomotors

## Technical definitions for AC motors

### Overview (continued)

#### Incremental encoder

This encoder senses relative movements and does not supply absolute position information. In combination with evaluation logic, a zero point can be determined using the integrated reference mark, which can be used to calculate the absolute position.

#### Incremental encoder IC/IN (sin/cos)

The encoder outputs sine and cosine signals. These can be interpolated using evaluation logic (usually 2048 points) and the direction of rotation can be determined.

In the version with DRIVE-CLiQ interface, this evaluation logic is already integrated in the encoder.

#### Commutation position

The position of the rotor is required for commutation of a synchronous motor. Encoders with commutation position (also termed C and D track) detect the angular position of the rotor.

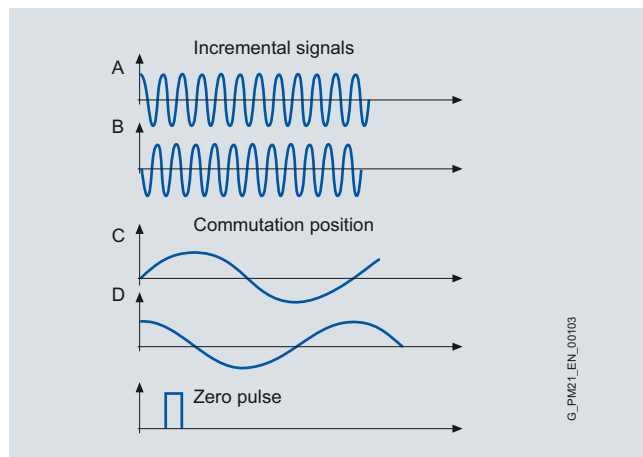

Incremental encoder IC/IN (sin/cos), commutation position only for IC

#### HTL incremental encoder

The encoder outputs square wave signals. The direction of rotation can be evaluated by means of edge evaluation.

The resolution is four times the number of encoder pulses. This encoder type is preferred for long signal cables.

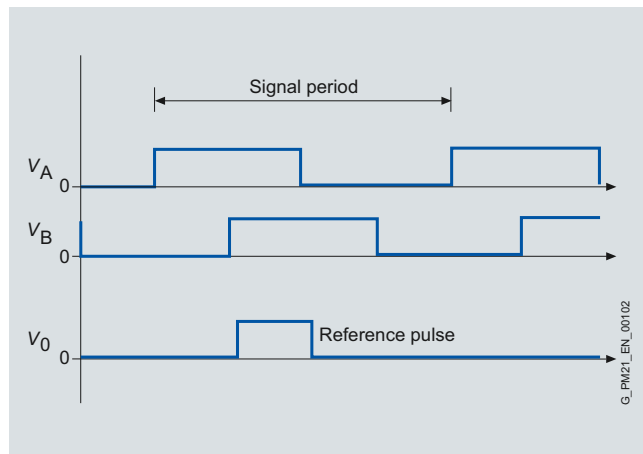

HTL incremental encoder

#### Incremental encoder without DRIVE-CLiQ interface

IC2048S/R encoder	Incremental encoder sin/cos 1 V <sub>pp</sub> 2048 S/R with C and D tracks
IN2048S/R encoder	Incremental encoder sin/cos 1 V <sub>pp</sub> 2048 S/R without C and D tracks
HTL2048S/R encoder	Incremental encoder HTL 2048 S/R
HTL1024S/R encoder	Incremental encoder HTL 1024 S/R

#### Incremental encoders with DRIVE-CLiQ interface<sup>1)</sup>

IC22DQ encoder	Incremental encoder 22 bit (resolution 4194304, internal 2048 S/R) + commutation position 11 bit
IN22DQ encoder	Incremental encoder 22 bit (resolution 4194304, internal encoder 2048 S/R) without commutation position

#### Technical specifications

##### Incremental encoders IC/IN (sin/cos) without DRIVE-CLiQ interface

Supply voltage	5 V
Incremental signals per revolution	
• Resolution (sin/cos)	2048
• Commutation position (for IC only)	1 sin/cos
• Reference signal	1

##### Incremental encoders IC/IN (sin/cos) with DRIVE-CLiQ interface

Supply voltage	24 V
Incremental signals per revolution	
• Resolution	2 <sup>22</sup> bit
• Commutation position in bit (for IC only)	11
• Reference signal	1

##### Incremental encoders HTL without DRIVE-CLiQ interface

Supply voltage	10 ... 30 V
Incremental signals per revolution	
• Resolution (HTL)	2048/1024
• Reference signal	1

<sup>1)</sup> Instead of the IC22DQ incremental encoder, the AS24DQ1 single-turn absolute encoder is used for SIMOTICS S-1FK7/1FT7.

### Overview (continued)

#### Resolver

The number of sine and cosine periods per revolution corresponds to the number of pole pairs of the resolver. In the case of a 2-pole resolver, the evaluation electronics may output an additional zero pulse per encoder revolution. This zero pulse ensures a unique assignment of the position information in relation to an encoder revolution. A 2-pole resolver can therefore be used as a single-turn encoder.

2-pole resolvers can be used for motors with any number of pairs of poles. In the case of multi-pole resolvers, the number of pairs of poles of the motor and resolver are always the same. The resolution is correspondingly higher than with 2-pole resolvers.

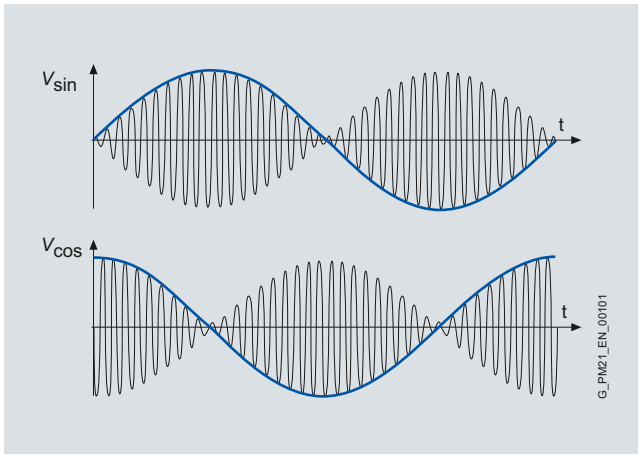

#### Resolvers without DRIVE-CLiQ interface<sup>1)</sup>

Resolver p = 1	2-pole resolver
Resolver p = 3	6-pole resolver
Resolver p = 4	8-pole resolver

#### Resolvers with DRIVE-CLiQ interface

R15DQ encoder	Resolver 15 bit (resolution 32768, internal, multi-pole)
R14DQ encoder	Resolver 14 bit (resolution 16384, internal, 2-pole)

#### Technical specifications

##### Resolvers without DRIVE-CLiQ interface

Excitation voltage, rms	2 ... 8 V
Excitation frequency	5 ... 10 kHz
Output signals	$U_{\text{sine track}} = r \times U_{\text{excitation}} \times \sin \alpha$ $U_{\text{cosine track}} = r \times U_{\text{excitation}} \times \cos \alpha$ $\alpha = \arctan (U_{\text{sine track}} / U_{\text{cosine track}})$
Transmission ratio	$r = 0.5 \pm 5 \%$

##### Resolvers with DRIVE-CLiQ interface

Supply voltage	24 V
Resolution	$2^{15}/2^{14}$ bit

<sup>1)</sup> Output signals:  
2-pole resolver: 1 sin/cos signal per revolution  
6-pole resolver: 3 sin/cos signals per revolution  
8-pole resolver: 4 sin/cos signals per revolution