

SINAMICS S120

SIMOTICS L-1FN6 linear motors

Configuration Manual · 06/2012

SINAMICS

SIEMENS

SIEMENS

SINAMICS

Drive Technologies SIMOTICS L-1FN6 linear motors



Configuration Manual

Preface	
General safety guidelines	1
Motor description	2
Motor components and options	3
System integration	4
Coupled motors	5
Order numbers	6
Configuring the motor	7
Mounting the motor	8
Connecting the motor	9
Commissioning	10
Operation	11
Maintenance and repairs	12
Storage and transport	13
Environmental compatibility	14
Technical data and characteristics	15
Installation diagrams and dimension tables	16
Appendix	A

Legal information

Warning notice system

This manual contains notices you have to observe in order to ensure your personal safety, as well as to prevent damage to property. The notices referring to your personal safety are highlighted in the manual by a safety alert symbol, notices referring only to property damage have no safety alert symbol. These notices shown below are graded according to the degree of danger.

 DANGER
indicates that death or severe personal injury will result if proper precautions are not taken.
 WARNING
indicates that death or severe personal injury may result if proper precautions are not taken.
 CAUTION
indicates that minor personal injury can result if proper precautions are not taken.
NOTICE
indicates that property damage can result if proper precautions are not taken.

If more than one degree of danger is present, the warning notice representing the highest degree of danger will be used. A notice warning of injury to persons with a safety alert symbol may also include a warning relating to property damage.

Qualified Personnel

The product/system described in this documentation may be operated only by **personnel qualified** for the specific task in accordance with the relevant documentation, in particular its warning notices and safety instructions. Qualified personnel are those who, based on their training and experience, are capable of identifying risks and avoiding potential hazards when working with these products/systems.

Proper use of Siemens products

Note the following:

 WARNING
Siemens products may only be used for the applications described in the catalog and in the relevant technical documentation. If products and components from other manufacturers are used, these must be recommended or approved by Siemens. Proper transport, storage, installation, assembly, commissioning, operation and maintenance are required to ensure that the products operate safely and without any problems. The permissible ambient conditions must be complied with. The information in the relevant documentation must be observed.

Trademarks

All names identified by ® are registered trademarks of Siemens AG. The remaining trademarks in this publication may be trademarks whose use by third parties for their own purposes could violate the rights of the owner.

Disclaimer of Liability

We have reviewed the contents of this publication to ensure consistency with the hardware and software described. Since variance cannot be precluded entirely, we cannot guarantee full consistency. However, the information in this publication is reviewed regularly and any necessary corrections are included in subsequent editions.

Preface

More information

Information on the following topics is available under the link:

- Ordering documentation/overview of documentation
- Additional links to download documents
- Using documentation online (find and search in manuals/information)

<http://www.siemens.com/motioncontrol/docu>

Please send any questions about the technical documentation (e.g. suggestions for improvement, corrections) to the following e-mail address:

docu.motioncontrol@siemens.com

Path to the manual and operating instructions

Current manuals and operating instructions for motors / direct drives are available on the Internet under the following link:

<http://www.siemens.com/motioncontrol/docu>

Any manuals or operating instructions that you may have in printed or electronic file form could be of an older product version.

Target group

This manual is intended for planning, configuring and mechanical engineers designing drives with linear motors, and also electricians, technicians and service personnel.

Benefits

This manual provides information on the rules and guidelines that must be observed when configuring a system with 1FN6 motors. It also helps with selection within the 1FN6 product family.

Keeping the documentation safe

This documentation should be kept in a location where it can be easily accessed and made available to the personnel responsible.

Standard scope

This documentation describes the functionality of the standard version. Extensions or changes made by the machine manufacturer are documented by the machine manufacturer.

Other functions not described in this documentation might be able to be executed in the drive system. This does not, however, represent an obligation to supply such functions with a new delivery or when servicing.

For reasons of clarity, this documentation does not contain all the detailed information about all types of the product and cannot cover every conceivable case of installation, operation or maintenance.

Technical Support

For technical support telephone numbers for different countries, go to:

<http://www.siemens.com/automation/service&support>

Websites of third parties

This publication contains hyperlinks to websites of third parties. Siemens does not take any responsibility for the contents of these websites or adopt any of these websites or their contents as their own, because Siemens does not control the information on these websites and is also not responsible for the contents and information provided there. Use of these websites is at the risk of the person doing so.

Internet address for products

<http://www.siemens.com/motioncontrol>

Standards and regulations

The product complies with the standards relating to the Low-Voltage Directive stated in the EC Declaration of Conformity.

Complying with the RoHS EC directive

The motor components and also the packaging comply with EC directive 2002/95/EC (RoHS).

Further notes

Besides the Danger and Warning Concept explained on the back of the cover sheet, this documentation also contains additional notes:

Note

in this document indicates important information about the product or the respective part of the documentation that is to be considered.

Table of contents

	Preface	5
1	General safety guidelines	13
	1.1 Introduction	13
	1.2 Personnel	15
	1.3 Intended use	16
	1.4 Danger from strong magnetic fields	16
	1.5 Attaching warning signs	20
2	Motor description	23
	2.1 Characteristics	23
	2.2 Approvals	26
	2.3 Protection against external phenomena	26
3	Motor components and options	29
	3.1 Overview of the motor construction	29
	3.2 Rating plate	30
	3.3 Temperature monitoring and thermal motor protection	30
4	System integration	33
	4.1 System requirements	33
	4.2 Standard integration of the motor	34
	4.3 Drive system	35
	4.4 Position measuring system	36
	4.5 Cooling system.....	39
	4.6 Braking concepts	45
5	Coupled motors	47
	5.1 Parallel connected motors	47
	5.2 Interdigital motors	54
6	Order numbers	55
	6.1 Structure of the order numbers	55
	6.2 Primary section	56
	6.3 Secondary section	57

7	Configuring the motor	59
7.1	Note on Mechatronic Support	59
7.2	Operation in an area of reduced secondary section coverage	59
7.3	S1, S2 and S3 duty types.....	60
7.4	Procedure for the configuration.....	62
7.5	Example: Positioning in a predefined time.....	76
8	Mounting the motor	83
8.1	Safety instructions for mounting.....	83
8.2	General procedure	84
8.3	Checking the mounting dimensions	84
8.4	Motor installation procedures	86
8.5	Assembling individual motor components.....	91
8.6	Checking the installation	93
9	Connecting the motor	95
9.1	Interfaces.....	95
9.2	Electrical connection	96
10	Commissioning	111
10.1	Safety instructions	111
10.2	Checking prior to the commissioning	112
10.3	Notes on commissioning system elements.....	112
10.4	Example for checking the commutation position	115
10.5	Commissioning multiple, parallel primary sections	117
10.6	Checking the linear motor by taking measurements.....	118
11	Operation	121
12	Maintenance and repairs	123
12.1	Safety instructions	123
12.2	Maintenance.....	126
13	Storage and transport	127
13.1	Specification of the UN number for permanent magnets as hazardous item	127
13.2	Safety instructions	127
13.3	Packaging specifications for air transportation	128
13.4	Storage.....	129
14	Environmental compatibility	131
14.1	Environmental compatibility during production	131
14.2	Disposal.....	131

15	Technical data and characteristics	133
15.1	Introduction	133
15.2	Definition of the motor data.....	133
15.3	Explanations of the characteristic curves	136
15.4	Motor data - Version with natural cooling	138
15.5	Motor data - Version with water cooling.....	222
16	Installation diagrams and dimension tables	271
16.1	Explanation of installation drawings.....	271
16.2	Position tolerance for fastening holes.....	272
16.3	1FN6 version with natural cooling.....	273
16.4	1FN6 version with water cooling	281
16.5	Secondary sections.....	283
A	Appendix	291
A.1	Overview of important motor data.....	291
A.2	1FNx declaration of conformity	295
A.3	Recommended manufacturers.....	301
	Abbreviations + glossary	303
	Index	307

General safety guidelines

1.1 Introduction

These safety guidelines apply for handling linear motors and their components. Please read these safety guidelines carefully to avoid accidents and/or property damage.

 DANGER
<p>There is a danger of death, severe physical injury, and/or damage to property if the safety instructions are not observed and complied with.</p> <p>It is essential that you observe the safety instructions in this documentation. This includes the special safety instructions in the individual sections.</p> <p>Observe all warning and information plates.</p> <p>Make sure that your end product satisfies all relevant standards and legal specifications. The applicable national, local, and machine-specific safety regulations and requirements must also be taken into account.</p> <p>Also observe the relevant operating instructions when working on the drive system.</p>

Residual risks of power drive systems

When carrying out a risk assessment of the machine in accordance with the EU Machinery Directive, the machine manufacturer must consider the following residual risks associated with the control and drive components of a power drive system (PDS).

1. Unintentional movements of driven machine components during commissioning, operation, maintenance, and repairs caused by, for example:
 - Hardware defects and/or software errors in the sensors, controllers, actuators, and connection technology
 - Response times of the controller and drive
 - Operating and/or ambient conditions not within the scope of the specification
 - Parameterization, programming, cabling, and installation errors
 - Use of radio devices / cellular phones in the immediate vicinity of the controller
 - External influences / damage
2. Exceptional temperatures as well as emissions of light, noise, particles, or gas caused by, for example:
 - Component malfunctions
 - Software errors
 - Operating and/or ambient conditions not within the scope of the specification
 - External influences / damage

1.1 Introduction

3. Hazardous shock voltages caused by, for example:
 - Component malfunctions
 - Influence of electrostatic charging
 - Induction of voltages in moving motors
 - Operating and/or ambient conditions not within the scope of the specification
 - Condensation / conductive contamination
 - External influences / damage
4. Electrical, magnetic and electromagnetic fields generated in operation that can pose a risk to people with a pacemaker, implants or metal replacement joints, etc. if they are too close.
5. Release of environmental pollutants or emissions as a result of improper operation of the system and/or failure to dispose of components safely and correctly.

More extensive information concerning the residual risks associated with the PDS is provided in the relevant chapters of the technical user documentation.

 **DANGER**

It may be dangerous for people to remain in the immediate proximity of the product – especially for those with pacemakers, implants or similar – due to electric, magnetic and electromagnetic fields (EMF) occurring as a consequence of operation.

The machine/system operator and the people present near the product must observe the relevant guidelines and standards! These are, for example, in the European Economic Area (EEA) the Electromagnetic Fields Directive 2004/40/EC and the standards EN 12198-1 to 12198-3 and in the Federal Republic of Germany the Employer's Liability Insurance Association Regulations for the Prevention of Industrial Accidents BGV 11, with the relevant rule BGR 11 "Electromagnetic Fields".

Then a risk assessment must be carried out for every workplace, activities for reducing dangers and exposure for people decided upon and implemented, as well as determining and observing exposure and danger areas.

Note

The following safety guidelines partly apply generally for direct drives, which also includes linear motors.

1.2 Personnel

DANGER

There is danger of death, serious bodily injury and/or property damage when untrained personnel is allowed to handle direct drives and/or their components.

Only personnel who are familiar with and who observe the safety guidelines are allowed to handle direct drives and their components.

Installation, commissioning, operation and maintenance may only be performed by qualified, trained and instructed personnel. The personnel must be thoroughly familiar with the content of this guide.

All work must be performed by at least two persons.

Note

Make sure that the information about the sources of danger and the safety measures is available at all times! Keep all the descriptions and safety guidelines concerning direct drives and their components if possible!

All descriptions and safety guidelines can also be requested from your local Siemens office.

1.3 Intended use

DANGER

There is a risk of death, serious personal injury and/or serious material damage when direct drives or their components are used for a purpose for which they were not intended.

The motors are designed for industrial or commercial machines. It is prohibited to use them in areas where there is a risk of explosion (Ex-zone) unless they are designed expressly for this purpose (observe the separately enclosed additional instructions where applicable). If increased demands (e.g. touch protection) are applicable in special cases – for use in non-commercial systems – these conditions must be ensured on the machine side during installation.

Direct drives and their components may only be used for the applications specified by the manufacturer. Please contact your Siemens branch responsible if you have any questions on this matter.

The motors must be protected from dirt and contact with aggressive substances.

Special versions and design variants whose specifications vary from the motors described herein are subject to consultation with your Siemens branch.

The on-site conditions must comply with the rating plate specifications and the condition specifications contained in this documentation. Any differences regarding approvals or country-specific guidelines must be taken into account separately.

DANGER

The products included in the scope of delivery are exclusively designed for installation in a machine. Commissioning is prohibited until it has been established that the end product conforms with Directive 2006/42/EC. All safety instructions must be observed and given to the end user for his/her information.

1.4 Danger from strong magnetic fields

Occurrence of magnetic fields

Strong magnetic fields occur in the components of the motor that contain permanent magnets. The magnetic field strength of the motors results exclusively from the magnetic fields of the components with permanent magnets in the de-energized state. Electromagnetic fields also occur during operation.

Components with permanent magnets

 CAUTION
For the motors described here, the permanent magnets are in the primary section. There are no magnets in the secondary section.

The figure below shows a diagram of the magnetic field strength characteristics depending on the distance from the primary section (motor housing).

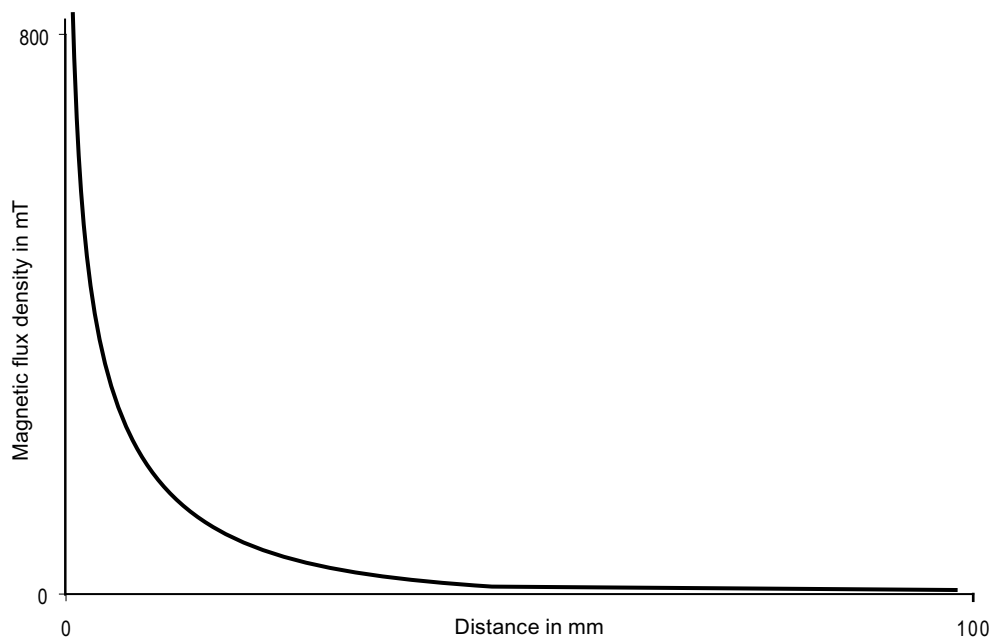

Figure 1-1 Schematic representation of the static magnetic field depending on distance

The European Directive 2004/40/EC specifies a limit value of 200 mT for static magnetic fields. This value is complied with for a minimum safety clearance of 20 mm from the primary section.

1.4 Danger from strong magnetic fields

The requirements of BGV B 11 must also be taken into account with regard to strong magnetic fields (BGV B 11 §14).

 **DANGER**

For people exposed to magnetic fields in the course of their work, a limit value of 21.2 mT has been specified, corresponding to a safety clearance of at least 50 mm to the primary section.

For people with pacemakers the limit value is 0.7 mT. In this case the safety clearance to the primary section must be at least 500 mm.

In other countries, the relevant applicable national and local regulations and requirements must be taken into account.

Danger from strong magnetic fields

 **DANGER**

Strong magnetic fields can pose a risk to personnel and cause damage.

With regard to the effect of strong magnetic fields on people, the work guideline BGV B 11 "Electromagnetic Fields" applies in Germany. This specifies all the requirements that must be observed in the workplace. In other countries, the relevant applicable national and local regulations and requirements must be taken into account.

People with active electrical component implants (e.g. pacemakers, insulin pumps), metal implants and magnetic or electrically conducting foreign bodies are urgently advised to avoid direct contact with components containing permanent magnets. This applies to, e.g., any work connected with assembly, maintenance or storage.

Humans have no sensory organs for picking up strong magnetic fields and have no experience with them as a rule. Therefore, the magnetic forces of attraction emanating from strong magnetic fields are often underestimated.

The magnetic forces of attraction may be several kN in the vicinity of the motor components containing permanent magnets (within a distance of less than 100 mm). – Example: Magnetic attractive forces are equivalent to a mass of several hundred kilos, which can trap a part of the body (hands, fingers, feet etc.)!

! DANGER

Strong attractive forces on magnetizable materials lead to a great danger of crushing in the vicinity of components with permanent magnets (distance less than 100 mm).

Do not underestimate the strength of the attractive forces!

Do not carry any objects made of magnetizable materials (e. g. watches, steel or iron tools) and/or permanent magnets close to the motor or close to a component with permanent magnets.

For the event of accidents when working with permanent magnets, the following objects must be on hand to free clamped body parts (hands, fingers, feet etc.):

- a hammer (about 3 kg) made of solid, non-magnetizable material
- two pointed wedges (wedge angle approx. 10° to 15°) made of solid, non-magnetizable material (e.g. hard wood)

First aid in the case of accidents involving permanent magnets

- Stay calm.
- Press the emergency stop switch and, where necessary, switch off the main switch if the machine is live.
- Administer FIRST AID. Call for further help if required.
- To free jammed body parts (e.g., hands, fingers, feet), pull apart components that are clamped together.
 - To do this, use a hammer to drive a wedge into the separating rift
 - Release the jammed body parts.
- If necessary, call for an EMERGENCY DOCTOR.

! WARNING

Any movement of electrically conductive materials in relation to permanent magnets leads to induced voltages. Risk of electric shock!

Movement of components with permanent magnets in relation to electrically conductive materials must be avoided.

! CAUTION

Magnetic fields can lead to loss of data on magnetic or electronic data media.

Do not carry any magnetic or electronic data media with you!

1.5 Attaching warning signs

Any danger areas encountered during normal operation, maintenance, and servicing must be identified by well visible warning and prohibiting signs (pictograms) in the immediate vicinity of the danger (close to the motor). The associated texts must be available in the language of the country in which the product is used.

Pictograms supplied

Primary sections





For all primary sections, warning and prohibiting signs are enclosed in the packaging in the form of permanent adhesive stickers. These should be applied where they are easily seen and as close as possible to the motor.

The following table shows the signs included with the primary sections and their meaning:

Table 1- 1 Warning signs according to BGV A8 and DIN 4844-2 included with primary sections and their meaning

Sign	Description	Sign	Description
A yellow triangular warning sign with a black border and three wavy lines representing heat.	Warning: hot surfaces (D-W026)	A yellow triangular warning sign with a black border and a lightning bolt symbol.	Warning: hazardous electric voltage (D-W008)
A yellow triangular warning sign with a black border and a horseshoe magnet symbol.	Warning: strong magnetic field (D-W013)	A yellow triangular warning sign with a black border and a hand symbol with a downward arrow pointing to the palm.	Warning: hand injuries (D-W027)

Table 1- 2 Prohibiting signs according to BGV A8 and DIN 4844-2 included with primary sections and their meaning

Sign	Description	Sign	Description
	No people with a pacemaker (D-P011)		No people with metal implants (D-P016)
	No metal objects or watches (D-P020)		No magnetic or electronic data media (D-P021)

Secondary sections

No warning or prohibiting signs are provided for the secondary sections.

Note

The quality of the label can diminish as result of extreme environmental conditions.

Motor description

2.1 Characteristics

Basic characteristics of the motor

The 1FN6 product family motors are 3-phase synchronous motors for operation on a frequency converter. The secondary section segments are not magnetic. They have a laminated core design and a toothed structure in the direction of travel. Alongside the motor winding in the primary section there are additional permanent magnets which create the excitation field.

The motor is delivered in components (at least primary section and secondary sections) and installed directly in the machine. Due to the series connection of primary and secondary sections, user-defined motor forces and straight traversing paths of various lengths can be achieved.

Please take note of national and international license terms when operating direct motors so that no patent rights are violated.

 WARNING
--

The motors cannot be operated directly on the supply system, but may only be operated with a suitable drive system.

Standards and regulations

The product complies with the standards relating to the Low-Voltage Directive stated in the EC Declaration of Conformity.

Advantages for the customer

The technology involved in the 1FN6 motor series offers significant advantages for customers due to the magnet-free secondary sections. These include:

- No significant temperature rise of the secondary sections due to power loss (as for linear induction motors, for example)
- It is not necessary to cool the secondary sections
- Typical advantages of a synchronous linear motor (e.g. freedom from wear, precision, high speed and dynamic response)
- Low force ripple, the motor is suitable for precision applications
- Simple installation of the magnet-free secondary sections

2.1 Characteristics

- No magnetic fields on the secondary section and so no protection from strong magnetic fields on the open secondary section track needed
- Easier to protect the secondary section track from contamination
- Comprehensively tested drive system of control, converter and motors in one package

Area of application

- Applications for which magnetic secondary sections cannot be used, due to the attraction effect on metal and magnetic deposits
- Applications where the secondary section is openly accessible
- Applications with long traversing paths
- Transfer lines (electrical industry, automotive)
- Handling and robotic axes
- Woodworking (machining centers and handling)
- General automation (handling axes, complete axes)
- Cutting machines involving laser beams or water jets

Overview of the technical features

Table 2- 1 The motors of the 1FN6 product family have the following technical features as standard:

Technical feature	Version
Motor type	Permanently excited synchronous linear motor
Magnet material	Rare-earth permanent magnets
Cooling	Natural cooling 1FN6003 to 1FN6024 Water cooling 1FN6003 to 1FN6007
Temperature monitoring in primary section According to DIN 44081/DIN 44082 According to DIN EN 60034-11	PTC thermistor temperature sensor in triple circuit KTY84 thermistor temperature sensor
Insulation According to DIN EN 60034-1	Temperature class 155 (F)
Construction type	Individual components
Degree of protection According to DIN EN 60034-5	Primary section: IP65 The degree of protection of the motor is determined by the installation design in the machine; minimum requirement: IP23 (see Section titled "Degrees of protection")

Technical feature	Version
Encoder system	Not included in the scope of supply Selection based on application- and drive-specific supplementary conditions.
Connection	1FN6003 Securely connected signal line and power cable with a length of 0.5 m plus connectors 1FN6007 to 1FN6024 Power and signal connection established on the front via two flush-mounted boxes

Ambient conditions

Based on DIN EN 60721-3-1 (for long-term storage), DIN EN 60721-3-2 (for transport), and DIN EN 60721-3-3 (for use in fixed, weather-protected locations)

Table 2- 2 Climatic ambient conditions

During operation	Lower limit ambient temperature:	- 5 °C (deviates from 3K3)
	Upper limit ambient temperature:	+ 40 °C
	Lower relative humidity limit:	5%
	Upper relative humidity limit:	85%
	Rate of temperature fluctuations:	Max 0.5 K/min
	Installation altitude (according to DIN EN 60034-1)	≤ 1,000 m above sea level Otherwise: rated data to be reduced
	Condensation:	Not permissible
	Formation of ice:	Not permissible
	Fixed location	Class 3K3
Long-term storage (in transport packaging)		Class 1K3 and class 1Z1 have a different upper relative humidity
Transport (in transport packaging)		Class 2K2

Transport and storage without suitable additional protective packaging is not permissible. Similarly, operation in areas without complete protection from the weather (DIN EN 60721-3-3) is not permissible.

Table 2- 3 Biological ambient conditions

Long-term storage:	Class 1B1
Transportation:	Class 2B1
Fixed location:	Class 3B1

Table 2- 4 Chemical ambient conditions

Long-term storage:	Class 1C1
Transportation:	Class 2C1
Fixed location:	Class 3C2 Different to class 3C2: Operating site in the immediate vicinity of industrial plants with chemical emissions

Table 2- 5 Mechanically active ambient conditions

Long-term storage:	Class 1S2
Transportation:	Class 2S2
Fixed location:	Class 3S1

Table 2- 6 Mechanical ambient conditions

Long-term storage:	Class 1M2
Transportation:	Class 2M2
Fixed location:	Class 3M3

2.2 Approvals

Validity

Generally the approvals for the motor are listed on the rating plate. As a rule, these approvals are valid for the operating mode specified in the data sheets.

2.3 Protection against external phenomena

Primary section

The primary sections meet the requirements for IP65 degree of protection in accordance with DIN EN 60529 and DIN EN 60034-5.

Secondary section

The secondary section is protected from corrosion by the housing and casing.

Installed motor

The installation area, particularly the air gap, must be kept free of chips, other foreign bodies, and aggressive substances.

When the motor is in the installed state, the machine design must ensure a minimum degree of protection of IP23 in accordance with DIN EN 60529.

 **WARNING**

Contamination in the motor compartment can cause the motor to stop functioning or cause wear and tear!

The motor compartment must be protected as well as possible from pollution!

Motor components and options

3.1 Overview of the motor construction

Motor components

Motors of the 1FN6 product family consist of the following components:

- Primary section:
 - with 3-phase winding and integrated permanent magnets
 - encapsulated, protected from corrosion and other external phenomena
- Secondary section:
 - laminated core design
 - encapsulated, protected from corrosion and other external phenomena

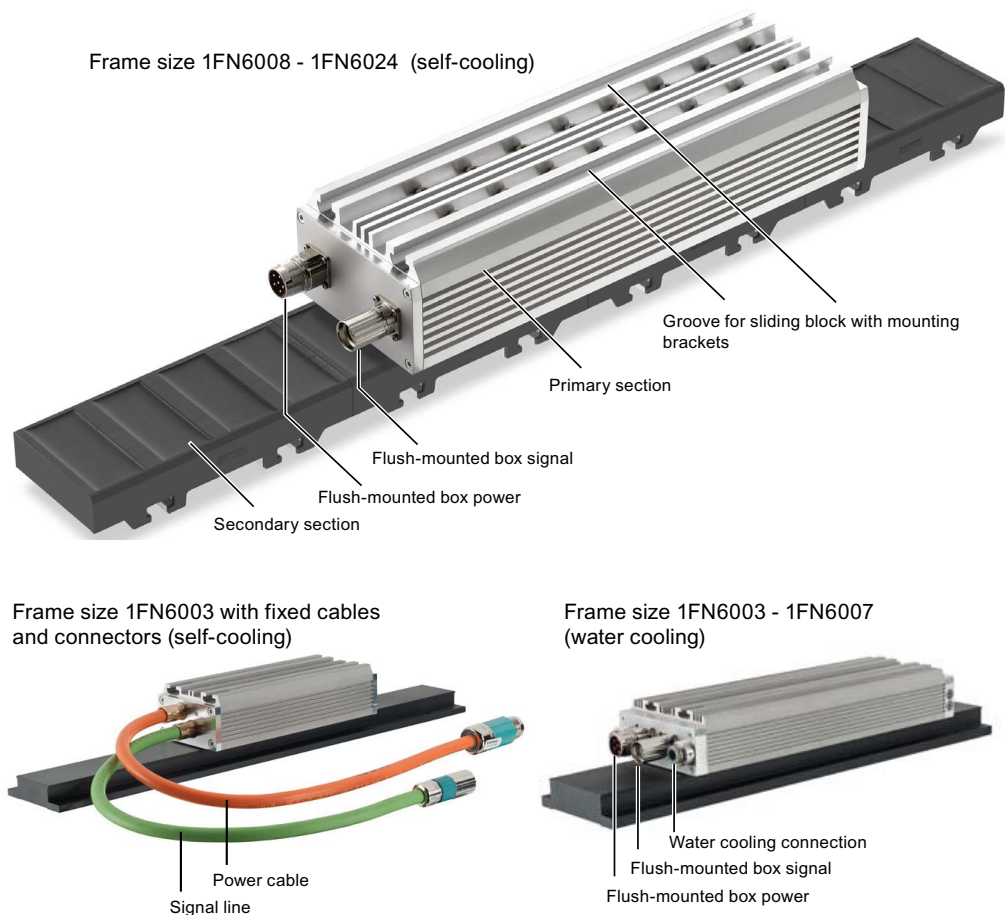

Figure 3-1 Overview of the motor components of the 1FN6 product family

3.2 Rating plate

Supplied rating plates

A rating plate is attached to each primary section of a 1FN6 motor. Additionally, a second rating plate is included in the delivery for the customer to attach to the machine in which the motor is installed, if necessary.

Note

The rating plates should not be misused! If a rating plate is removed from the motor or machine, it must be made unusable.

Data on the rating plate

The following data is on the rating plate:

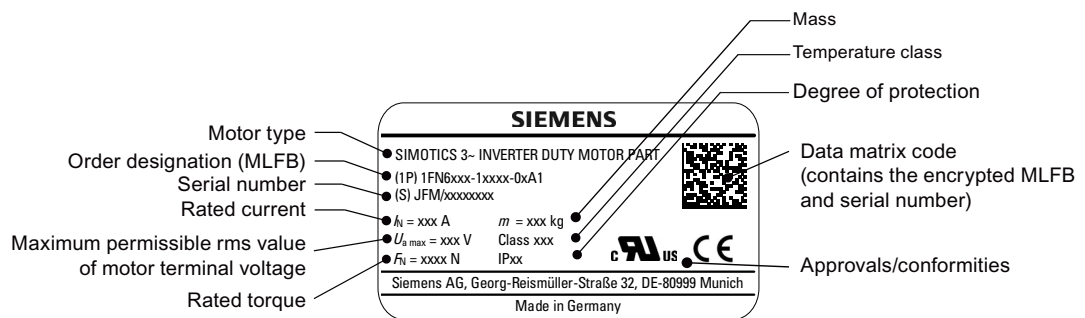

Figure 3-2 Data on the rating plate (schematic)

3.3 Temperature monitoring and thermal motor protection

3.3.1 Temperature monitoring circuits

Temperature monitoring circuits Temp-F and Temp-S

The motors are supplied with two temperature monitoring circuits: Temp-F and Temp-S. Temp-F is used to monitor and evaluate the temperature characteristic in the motor. Temp-S is used to activate the motor protection when the motor windings become too warm.

Both circuits are independent of each other. They are generally evaluated via the drive system.

Temp-F (KTY 84 Sensor)

The *temperature monitoring circuit* Temp-F consists of a KTY 84 temperature sensor located at the coils. Under certain circumstances – especially with varying current feed of the individual phases – this can result in the maximum temperature of the three phase windings not being measured. An evaluation of Temp-F for motor protection is thus not permissible. Temp-F is used rather to observe the temperature and if necessary to warn that the drive is being switched off due to a response from Temp-S.

Temp-S (PTC element)

The *overtemperature shutdown circuit* consists of thermistor temperature sensors (PTC elements). There is a thermistor temperature sensor for monitoring the motor winding in each of the three phase-windings (U, V and W). This ensures overload protection, even if the current feed is uneven in a primary section's individual phases or if several primary sections are being loaded differently. The PTC elements are connected in series.

Note

The drive control reaction time may not exceed one second, from the response of the PTC element (Temp-S) to the disconnection of the power supply (pulse inhibit in the drive control).

The total reaction time from the event occurrence to the shutdown must not exceed two seconds and must be guaranteed irrespective of the evaluation.

3.3.2 Description of temperature sensors used

Technical properties of the KTY 84

The KTY 84 produces a resistance/temperature characteristic curve that is progressive and approximately linear (see the figure below). In addition, the KTY 84 has a low thermal capacity and provides good thermal contact with the motor winding.

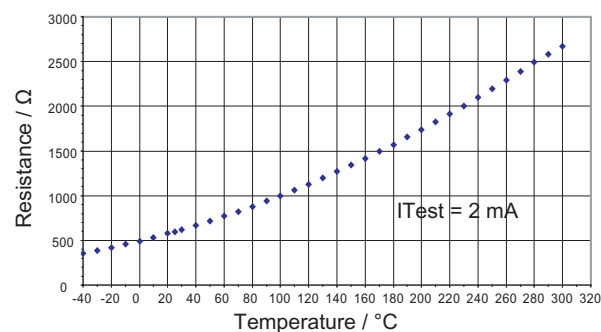

Figure 3-3 Characteristic curve of a KTY 84

Technical properties of PTC elements

Each PTC element displays a sudden increase in resistance in the region of the rated response temperature ϑ_{NAT} , see following figure. This gives it a quasi-switching characteristic. Due to low thermal capacity and good thermal contact between the PTC element and the motor winding, the sensors - and therefore the system - are able to react quickly to inadmissibly high temperatures in the winding.

The PTC elements of the triplet are connected in series. The characteristics correspond with DIN EN 60947-8, DIN 44081, and DIN 44082.

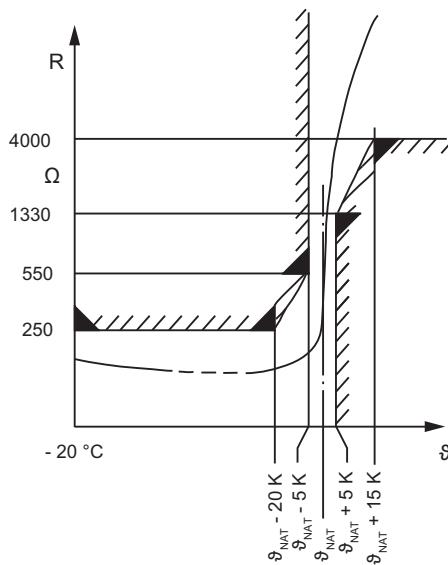

Figure 3-4 Typical characteristic curve of a PTC element; source: DIN 44081 / DIN 44082

Note

The PTC elements are pure sensors and can only disconnect the motor via an external evaluation

Note

When connecting temperature sensors with open cable ends, please pay attention to how the core colors are assigned (described in the section dealing with connections).

System integration

4.1 System requirements

Possible installation situation of a linear motor

Linear motors are built-in motors. The following figure shows a typical installation situation.

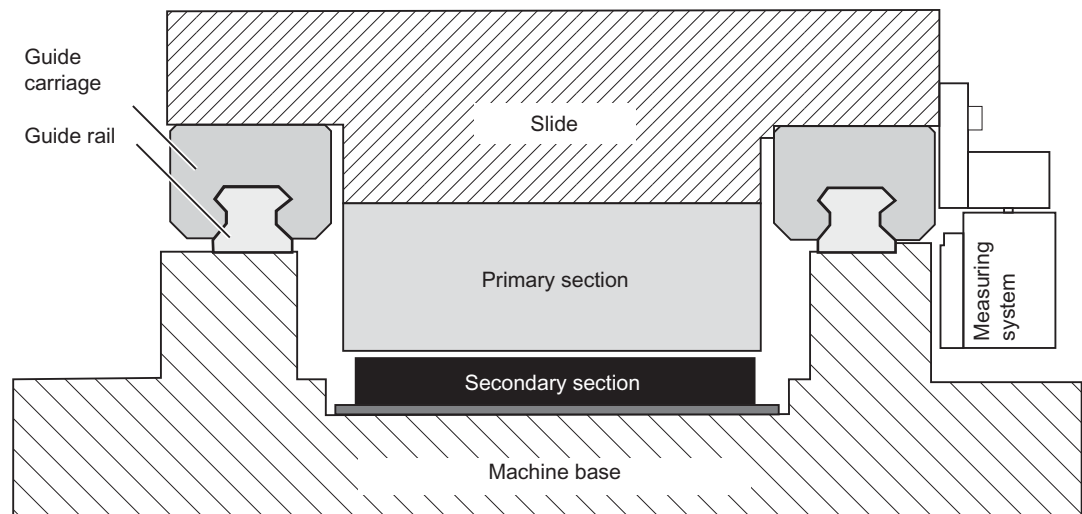

Figure 4-1 Typical installation situation of the 1FN6

WARNING

Contamination in the motor compartment can cause the motor to stop functioning or cause wear and tear!

The motor compartment must be protected as well as possible from pollution!

Attraction force

The attraction force between the primary section and the secondary section track can be several 10 kN. You can find more details on this attraction force F_A in the motor data sheet.

Note

The mechanical construction must be suitably stiff so that the functionality of the installed motor is not impaired and to avoid direct contact between the primary section and the secondary section.

As the air gap decreases, the forces of attraction between the primary section and the secondary section track increase strongly!

4.2 Standard integration of the motor

⚠ WARNING
The motors cannot be operated directly on the supply system, but may only be operated with a suitable drive system.

The motors are operated within a system. Generally, a drive system and a position measuring system are part of this system.

A sensor module (SME) that combines the signals of the position measuring system and the temperature signals is required for the evaluation of all of the temperature sensors.

All of the 1FN6003 to 1FN6024 motors feature natural cooling and so do not require a cooling system. Water-cooled versions of the 1FN6003 to 1FN6007 motors are also available for you to order as a special option.

The following figure is a schematic diagram of the integration of a motor in such a system.

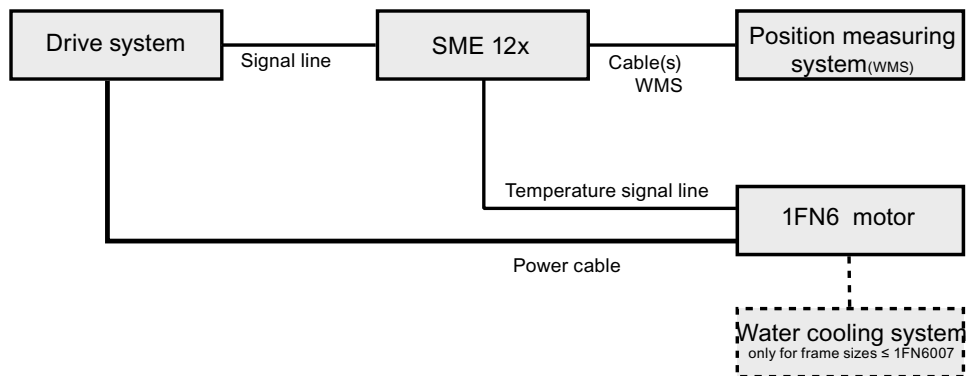

Figure 4-2 Integration of a 1FN6 motor in a system

For special drive requirements, the system configuration may differ from that shown above.

4.3 Drive system

Components

The drive system that feeds a motor comprises an infeed module, a power module and a control module. For the SINAMICS S120 drive system, these modules are called "Line Modules", "Motor Modules" and "Control Units". Line Modules can be regulated with feedback (ALM, Active Line Module), unregulated with feedback (SLM, Smart Line Module), or unregulated without feedback (BLM, Basic Line Module).

To operate several motors simultaneously on a single drive system, either one Motor Module per motor or one Motor Module for several motors can be provided, depending on the application. The appropriate choice of Line Module is primarily determined by the power consumption of the motors used. Other important related factors are the line voltage, regenerative feedback, and the DC-link voltage.

Operation of the linear motors with SINAMICS

The linear motors can be operated on the SINAMICS S120 (booksize and blocksize formats) drive system. The corresponding control systems are listed in the following table. The following conditions apply:

- The selection of the power module depends on the rated current or the maximum motor current
- The linear motors are to be configured as feed drives
- The position measuring system depends on the application

Table 4- 1 Examples of suitable control systems for the SINAMICS S120 drive system

Control system	Control Unit
No control	CU-320
SINUMERIK 840D sl	NCU-7x0 / NX1x
SINUMERIK 840Di sl	with CU-320
SIMATIC	CU-320
SIMOTION	D4x0 /CX32

Permissible voltages

The following table shows the permissible line voltages of TN line supply systems for the motors.

Table 4- 2 Permissible line voltages of TN line supply systems, resulting DC link voltages and converter output voltages

Permissible line supply voltage	Resulting DC link voltage U_{zk}	Drive output voltage (rms value) U_{amax}
400 V	600 V (controlled)	425 V (controlled)
	528 V (uncontrolled)	380 V (uncontrolled)
480 V	634 V (uncontrolled)	460 V (uncontrolled)

In combination with the drive system SINAMICS S120, the motors are generally approved for operation on TN and TT networks with grounded neutral and for IT networks. Protective equipment which will shut down the drive system in the event of a ground fault must be provided for motors operated on IT systems.

In operation with a grounded external conductor, an isolating transformer with grounded neutral (secondary side) must be connected between the supply and the drive system to protect the motor insulation from excessive stress.

4.4 Position measuring system

Methods to determine the pole position of the motor

When 1FN6 motors are to be operated in conjunction with SINAMICS, the following procedures for determining the pole position are permitted:

- Saturation-based procedure with evaluation of the 1st harmonic (fundamental)
- movement-based procedure

The methods for determining the pole position are described in more detail in the section titled "Commissioning".

Note

It is not possible to use a Hall sensor box to determine the pole position.

Suitable measuring systems

The selection of the measuring system to determine the position of the motor in the machine depends on the application-specific and drive-specific supplementary conditions. Generally, the following measuring systems can be used:

- Incremental measuring system

After each power-off state, the machine must travel to a reference point, as the motor position is not stored in the controller. Also, movements are not recorded while the power is off. Higher speeds can be reached if open incremental encoders are used.

The output signal for incremental measuring systems is 1 V_{SS} (peak-to-peak value).

- Absolute measuring system

The scanning principle of absolute value encoders is constructed the same way as for incremental encoders. Unlike an incremental encoder, the current position value can be detected without a traversing distance and be transmitted to an EnDat or SSI interface. The length of the measurement path is limited due to the more complex measurement track.

In addition to the absolute track, there needs to be an incremental track with an output signal of V_{SS} = 1 V (peak-to-peak) value.

The required resolution of the position measuring system depends on the requirements in terms of accuracy and noise immunity.

Mounting the measuring system

The measuring system should be as rigid as possible and mounted as close as possible to the motor components.

Note

Respect the temperature range of the position measuring system

The surface temperature of the naturally cooled 1FN6 motors can exceed 100 °C. Consequently, temperature-sensitive parts and electric cables must not be placed on hot surfaces.

The position measuring system must be capable of withstanding the prevailing temperatures. Therefore, please respect the temperature range specified by the manufacturer.

Note

Assistance for optimizing the mounting of the measuring system, e.g. through calculation of the resonant frequencies of the position control loop, can be obtained from your local Siemens office.

Functions of the SME12x

The SME12x (**S**ensor **M**odule **E**xternal) is a device with connectors that enables the connection of various sensors of a direct drive (position measuring system and temperature sensors). The output of the SME12x is connected to SINAMICS drive systems via DRIVE-CLiQ.

The SME12x therefore fulfills the following functions:

- All signal lines can be connected close to the motor
- Temperature sensors can be fully evaluated
 - Thermal motor protection through evaluation of Temp-S
 - Display of the temperature curve through evaluation of Temp-F
- Protective separation in accordance with DIN EN 61800-5-1 for temperature sensors

Versions

Two versions of the SME12x are provided that differ regarding their inputs for the position measuring system:

- SME120 for incremental position measuring systems
- SME125 for absolute position measuring systems

The following figure shows the SME120 version.

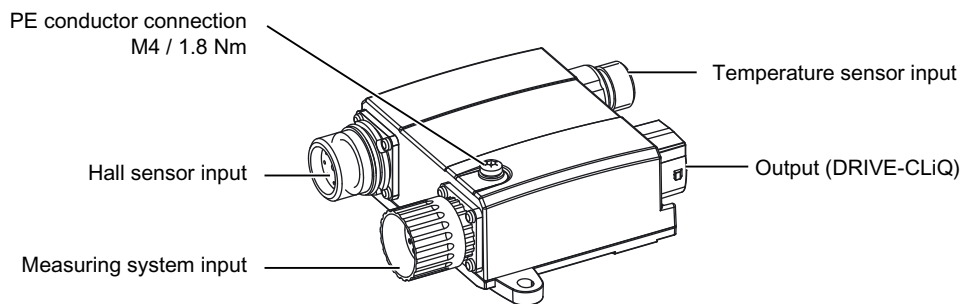

Figure 4-3 SME120

Further information

Additional information, e.g. regarding interfaces and dimensions are provided in the documentation on SINAMICS S120 "Control Units and supplementary system components".

No direct connection of the temperature monitoring circuits!

 **DANGER**

The temperature monitoring circuits pose a risk of electric shock!

If temperature monitoring circuits Temp-F And Temp-S are connected directly using the encoder connector of the SMC20 (X520), the requirements of DIN EN 61800-5-1 will not be met in respect of protective separation. Therefore, temperature monitoring circuits Temp-F and Temp-S must not be connected via the encoder connector of the SMC20 (X520) unless a suitable protection module (e.g. SME12x) is used.

4.5 Cooling system

4.5.1 "Cooling"

Note

Throughout this document, "cooling" refers to water cooling of the motor.

4.5.2 Motor cooling

Cooling connection possibility (\leq 1FN6007)

During operation, the motor heats up. To maintain the highest power density possible, cooling is required. 1FN6003 and 1FN6007 motors offer this possibility and are also available with a primary section main cooler.

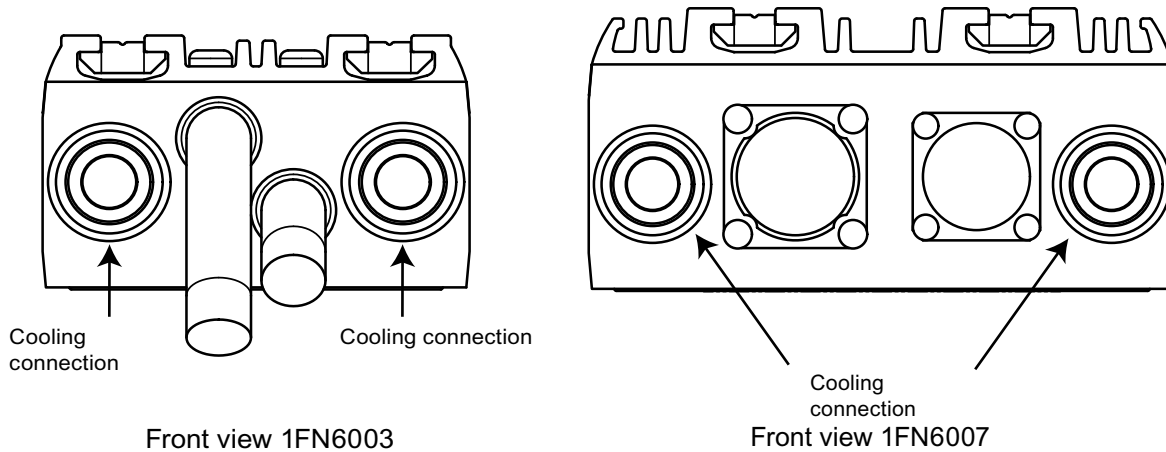

Figure 4-4 Front view of 1FN6 motors with water cooling

The assignments of the cooling circuit input and output are not fixed and can be freely defined by the user. The plug-in connections on the front have been designed to accommodate cooling hoses with a diameter of 10 mm.

Materials used

The following materials are used for the primary section main cooler inside the motors:

- **Cooling connection** : Aluminum 3.3535 (AlMg3); ENAW-5754
- **Front and rear plates**: Aluminum 3.3547 (AlMg4,5Mn); ENAW-5083
- **Housing**: Aluminum 3.3206 (AlMgSi0,5); ENAW-6063 T66
- **Seal**: Viton

4.5.3 Cooling circuits

Cooling circuit requirements

We recommend that the cooling circuits be designed as closed systems, to prevent the growth of algae. The maximum permissible pressure is 10 bar.

Note

We do not recommend that the cooling circuits of machines are also used to cool the motors: Due to accumulated dirt and long-term deposits, blockage may result! This especially applies to cooling-lubricating medium circuits.

If the cooling circuits of the machines are also used to cool the motors, then they must fulfill all of the requirements listed here. Also note the demands on the cooling medium as well as the maximum standstill times of cooling circuits according to the specifications of the cooling medium manufacturer!

Interconnecting cooling circuits

If several motors are connected to the cooling circuit, the cooling equipment for the primary sections must be connected in parallel. In this case, temperature and pressure differences between the intake and return must be carefully taken into consideration.

 CAUTION
Rigid connections between the cooling circuits can lead to problems with leaks!
It is strongly recommended that only flexible connections (hoses) be used for the interconnection of cooling circuits!

Use of cold water units

One system that is relatively cost-effective consists of using an unregulated cold water unit that can be connected to all the coolers involved. The disadvantage of this is that the intake temperature can fluctuate. The maximum power density of the motor and its heat insulation in relation to the machine cannot be considered to be constant, and this must be taken into consideration in the design.

However, it is of course also possible to assign each cooler its own regulated cold water unit. With regard to the cooling system, this enables complete control over the motor's power density, since the intake temperature is always kept constant.

Recommended manufacturers
Recommended manufacturers of cold water units are listed in the appendix

4.5.4 Coolants

Provision of the cooling medium

The customer must provide the cooling medium. Only water with anti-corrosion agent should be used as the cooling medium.

Reason for the use of water with an anti-corrosion agent

The use of untreated water may lead to considerable damage and malfunctions due to water hardness deposits, the formation of algae and slime, as well as corrosion, for example:

- Worsening of the heat transfer
- Higher pressure losses due to reductions in cross-sectional area
- Blockage of nozzles, valves, heat exchangers and cooling ducts

General requirements placed on the cooling medium

The cooling medium must be pre-cleaned or filtered in order to prevent the cooling circuit from becoming blocked. The formation of ice is not permitted!

Note

The maximum permissible size for particles in the cooling medium is 100 µm.

Requirements placed on the water

The water used as the basis of the cooling medium must fulfill the following minimum requirements:

- Concentration of chloride: $c < 100 \text{ mg/l}$
- Concentration of sulfate: $c < 100 \text{ mg/l}$
- $6.5 \leq \text{pH value} \leq 9.5$

Please check further requirements with the manufacturer of the anti-corrosion agent!

Requirements placed on the anti-corrosion agent

The anti-corrosion agent must fulfill the following requirements:

- The basis is ethylene glycol (also called ethanediol)
- The water and anti-corrosion agent do not segregate
- The freezing point of the water used is reduced to at least -5°C
- The anti-corrosion agent used must be compatible with the fittings and cooling system hoses used as well as the materials of the motor cooler

Check these requirements, especially in regard to material compatibility, with the cooling unit manufacturer and the manufacturer of the anti-corrosion agent!

Suitable mixture

- 25 % - 30 % ethylene glycol (= ethanediol)
- The water used contains a maximum of 2 g/l dissolved mineral salt and is largely free from nitrates and phosphates

Recommended manufacturers
Recommended manufacturers of anti-corrosion agents are listed in the appendix

4.5.5 Specifying the intake temperature

Fundamentals

Two variables play a role when specifying the intake temperature of the coolers: The power density of the motor and damage due to condensation.

Power density

The lower the intake temperature of the cooling, the greater the heat losses of the motor that can be dissipated. This increases the power density of the motor.

Condensation

Condensation typically occurs when parts of the cooling circuit or outer parts are colder than the surrounding air: The air in the vicinity of the colder surfaces is cooled down. The relative humidity then rises and in certain circumstances can reach the limit value of 100%.

To minimize the formation of condensation, the intake temperature of the cooling circuits must be no more than 3 K below the temperature of the surrounding air. When the machines are used in regions with very high humidity, the intake temperature should even be higher than the temperature of the surrounding air.

Specifying the intake temperature

The following rules apply when specifying the flow temperature:

- Lowest intake temperature possible for the highest possible power density
- An intake temperature that is not too low to avoid condensation

Note

Condensation can lead to damage of the encased machine (e.g. rust).

Condensation must be avoided!

Select intake temperatures that rule out the possibility of any condensation occurring.

The following figure shows a solution for controlling the intake temperature of the cooling circuits. The ambient temperature of the machine should be selected as a setpoint of the intake temperature for servo control: $T_{VORL} = T_{Umgebung} - 3\text{ K}$ protects the areas close to the motor from condensation. If the intake temperature is controlled via a fixed setpoint controller, the temperature value depends on the maximum ambient temperature. $T_{VORL} = T_{Umgebung,MAX} - 3\text{ K}$.

If the constant feed force of the motor must be completely exhausted, the intake temperature must be limited to a maximum of 35° C. In this case, moisture condensation may occur under unfavorable ambient conditions.

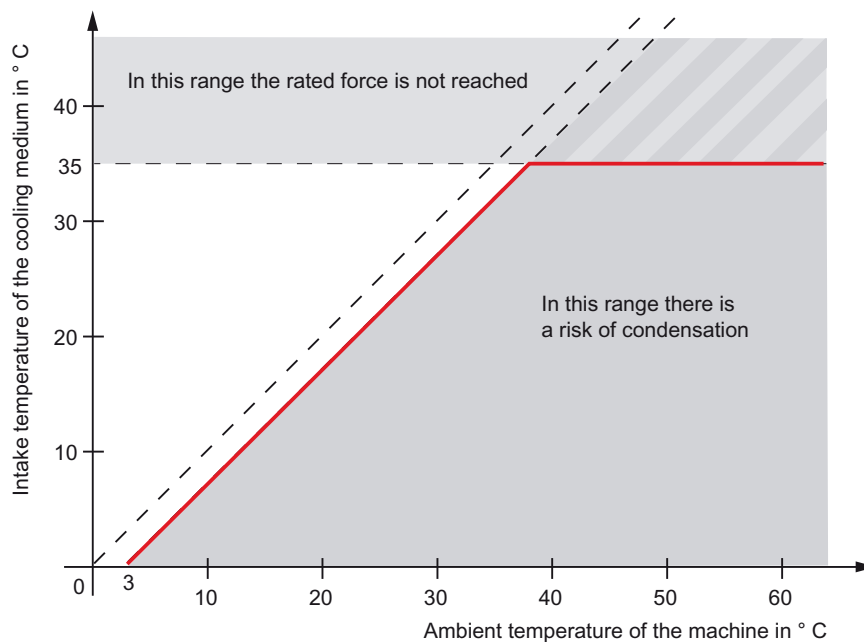



Figure 4-5 Characteristic curve of the intake temperature of the cooling circuits

Intake temperature servo control

With the servo control, the intake temperature is adapted to the current ambient temperature at the location of use of the motor. In this way, the motor can generally be kept cooler than with the fixed setpoint control. The service life and power density of the motor thus increase. The servo control is therefore better than the control of the intake temperature via a fixed setpoint controller.

4.6 Braking concepts

Safety guideline

 WARNING
Malfunctions can lead to uncontrolled motion of the drive. Measures must be taken to brake the maximum possible kinetic energy of the machine slide in the event of a fault.

Possible malfunctions

Malfunctions can occur e.g. for:

- Power failure
- Encoder failure, encoder monitoring responds
- Higher-level control failure (e.g., NCU); bus failure
- Control Unit failure
- Drive fault
- NC fault

Braking concepts

The design and calculation of brake systems depends on the maximum kinetic energy, i.e., on the maximum mass of the machine slide and its maximum speed. The calculation can therefore only be performed for a specific machine.

To ensure safe braking of the machine slide in the event of faults, adequately dimensioned damping elements and devices must be used at the ends of the traversing paths. If there are several slides on one axis, damping elements and devices must also be mounted between the slides.

In order to reduce the kinetic energy of the slide before it hits the damping elements, the following additional measures can also be applied (including in combinations):

1. Electrical braking using the energy in the DC link:

Consult the documentation of the drive system being used.

2. Electrical braking by short-circuiting the primary section (corresponds to an armature short-circuit):

Also see the documentation of the drive system used.

Disadvantage: The brake force depends on the speed (see the short-circuit braking characteristic in the chapter: "Technical data and characteristics") The short-circuit braking is not suitable for braking the slide fully.

Note

If electrical braking by short-circuiting the primary section is used, special contactors are required because the currents can be very high. - The release timing for the drive system must be taken into account.

3. Mechanical braking via braking elements:

The braking capacity must be dimensioned as highly as possible so that the slide can be safely braked at maximum kinetic energy.

Disadvantage: The relatively long response time of the brake control system leads to long, unbraked traversing distances.

We recommend that all three measures be implemented together. Measures (2) and (3) are used as an additional protection here in case Measure (1) fails: The short-circuiting of the primary section works at high velocities first and then the mechanical brake takes effect at lower velocities.

Recommended manufacturers

Recommended manufacturers of braking elements are listed in the appendix
--

Use of a holding brake

Due to latching forces, the motors can be pulled into a preferred magnetic position if the motor is no longer supplied with power from the drive. If the drive is already at a standstill, this can cause unexpected movements in up to a half magnetic pole pitch in both directions. To prevent possible damage to the workpiece and/or tool, the use of a holding brake may be appropriate.

Due to the missing mechanical self-locking, a holding brake should be provided in case of inclined or vertical drives without weight compensation so that the drive can be shut down and de-energized in any position.

A holding brake may also be required if:

- The bearing friction does not compensate or exceed the latching forces and unexpected movements result
- Unexpected movements of the drive can lead to damage (e.g. a motor with a large mass also achieves a large kinetic energy)
- Weight-loaded drives must be shut down and de-energized in any position

Coupled motors

5.1 Parallel connected motors

Prerequisite for the parallel connection

The position of the primary sections connected in parallel to each other must fulfill certain conditions for operation. The basic prerequisite for parallel connection is a sufficiently rigid, mechanical coupling. The following limitations must also be ensured:

- Identical primary section models
- Identical winding type
- Identical air gap

When more than one motor is operated in parallel on a single power unit, the relevant national regulations must be observed. In particular, special precautions must be taken in North America (special motor protection).

Note

Order designations for motors connected in parallel

The order designations (MLFB) of the motors may only differ in the "electrical connection" character. When ordering motors, the connection type is of no relevance as far as the MLFB is concerned. However, if you are connecting primary sections in parallel it is important to ensure that the power cables are of equal length in order to achieve even current distribution.

To offer better understanding, a Rumpf-MLFB is shown in the following. Only with the placeholder shown as "□" may the MLFB deviate. Otherwise it must match up:

1FN3xxx-xxx0-0□A1

Mechanical arrangements

Two primary sections, which are to be electrically operated in parallel, can be assigned to either a single secondary section track or to two individual secondary section tracks. The cable outlets can run in the same or opposite direction. For motors connected electrically in parallel (Master M and Stoker S), this results in four basic mechanical arrangements that are shown in the following table.

Table 5- 1 Basic mechanical arrangements of motors connected in parallel

	Same cable outlet direction	Opposite cable outlet direction
One secondary section track	<p>TANDEM arrangement</p>	<p>JANUS arrangement</p>
Two secondary section tracks	<p>PARALLEL arrangement</p>	<p>ANTIPARALLEL arrangement</p>

Reference points for aligning the primary sections

Note

If linear motors on a joint secondary section track are connected in parallel, the position of the primary sections with respect to one another must exhibit a specific grid to achieve a matching pole position.

With separate secondary section tracks, the position of the tracks in relation to one another must also be taken into account.

The reference points for aligning the linear motors that are connected in parallel always relate to the master:

- For the primary section: Edge of housing profile on the front
- For the secondary section: Center of a drilled hole provided for fixation to the machine base

The following figure shows these reference points.

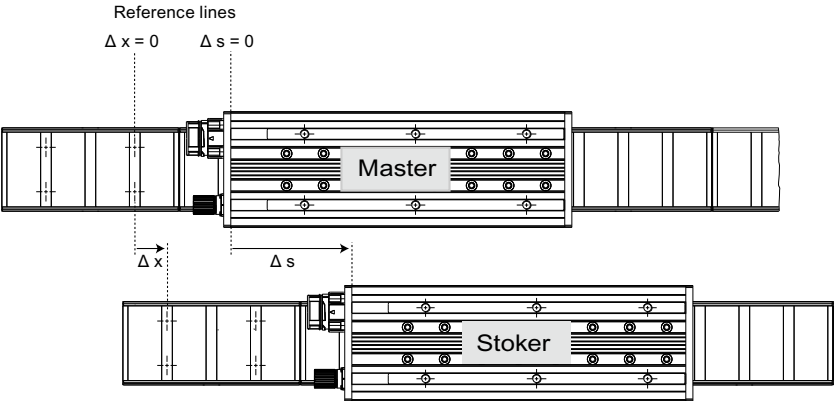

Figure 5-1 Parallel alignment with two secondary section tracks

The distance Δs is the distance from the profile edge of the master to the profile edge of the stoker. It is the sign of Δs that determines the direction of motion for the shift.

Note

When specifying the position of master and stoker, the decisive factor is always the position of the housing profile edge of the master ($\Delta s = 0$).

Same cable outlet direction

The phase sequence of master and stoker is identical when the cable outlet is the same. Correspondingly, the position of master and stoker to the position of the secondary section track(s) must be identical, ($x_M = x_S$) see following figure.

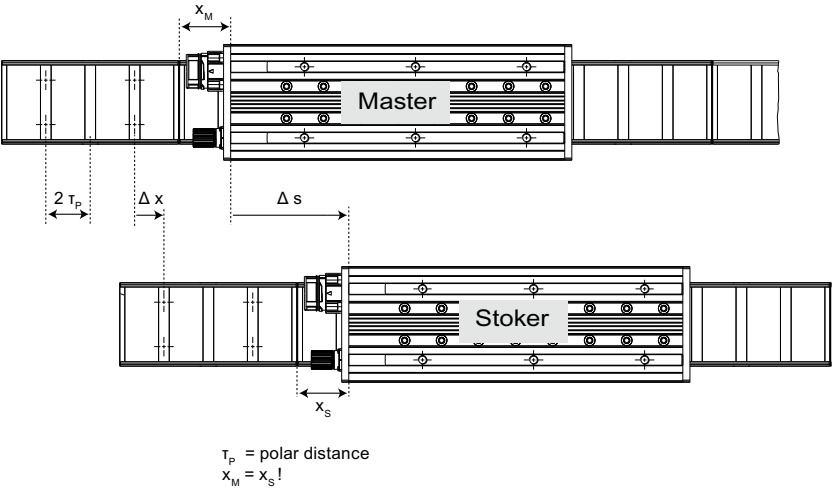

Figure 5-2 Position of master and stoker with the same cable outlet

PARALLEL arrangement

With the PARALLEL arrangement, you have the option of shifting the second secondary section track by Δx , see above figure. The reference distance Δs between the holes is calculated as follows:

$$\Delta s = \Delta x \pm n \cdot 2T_P$$

Where $n = 0, 1, 2$, etc.

If the secondary section track has not been shifted ($\Delta x = 0$) the reference distance Δs is calculated as follows:

$$\Delta s = \pm n \cdot 2T_P$$

Where $n = 0, 1, 2$, etc.

TANDEM arrangement

With the TANDEM arrangement, the distance to the reference edges must correspond to an integer multiple of the polar distance; see following figure:

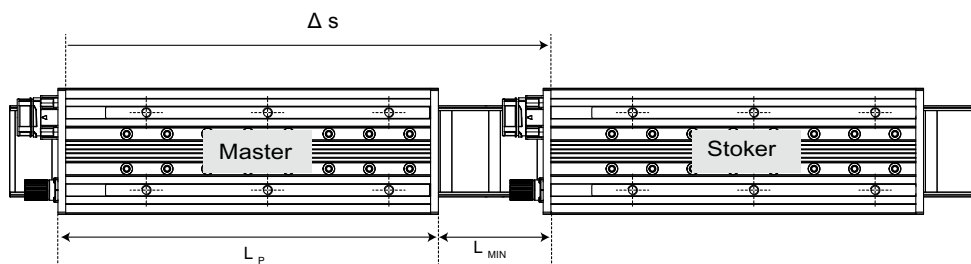

Figure 5-3 Position of master and stoker with TANDEM arrangement

$$\Delta s = \Delta s_{MIN} + n \cdot 2T_P$$

Where $n = 0, 1, 2$, etc.

Δs_{MIN} comprises the total length of the primary section (L_P) plus a minimum distance between master and stoker (L_{MIN}) as required for the stoker cable outlet depending on the application. Δs_{MIN} must always be an integer multiple of $2T_P$.

Frame size	Overall length	Δs ($n = 0, 1, 2, \dots$) [mm]	$2T_P$ [mm]
1FN6003 Natural and water cooling (2 securely connected lines)	1LCxx / 1WCxx	375 + n · 2TP	25
	1LExx / 1WExx	500 + n · 2TP	
	1LGxx / 1WGxx	625 + n · 2TP	
	1LJxx / 1WJxx	750 + n · 2TP	
	1LLxx / 1WLxx	875 + n · 2TP	
	1LNxx / 1WNxx	1000 + n · 2TP	

Frame size	Overall length	Δs ($n = 0, 1, 2, \dots$) [mm]	$2T_P$ [mm]
1FN6007 Natural and water cooling (2 flush-mounted boxes)	1LCxx / 1WCxx	375 + $n \cdot 2T_P$	25
	1LExx / 1WExx	500 + $n \cdot 2T_P$	
	1LGxx / 1WGxx	625 + $n \cdot 2T_P$	
	1LJxx / 1WJxx	750 + $n \cdot 2T_P$	
	1LLxx / 1WLxx	875 + $n \cdot 2T_P$	
	1LNxx / 1WNxx	1000 + $n \cdot 2T_P$	
1FN6008 1FN6016 1FN6024 Natural cooling (2 flush-mounted boxes)	1LCxx	500 + $n \cdot 2T_P$	50
	1LExx	700 + $n \cdot 2T_P$	
	1LGxx	1000 + $n \cdot 2T_P$	

Note**Minimum distance with Tandem arrangement**

Provided that power cable installation provides the necessary scope, distance Δs can be reduced in increments of $2T_P$. The decisive factor for the minimum distance between the stoker and the master is the smallest possible bending radius of the power cable plus any plug-in connection length that may be applicable.

Opposite cable outlet direction

One phase of the stoker is assigned as for master, the other two are switched. Therefore, the position of the primary sections with respect to the secondary section track is no longer identical: The stoker must be shifted by a distance of $\Delta s \neq 2T_P$ so that the force generation in both motors is the same.

ANTIPARALLEL arrangement

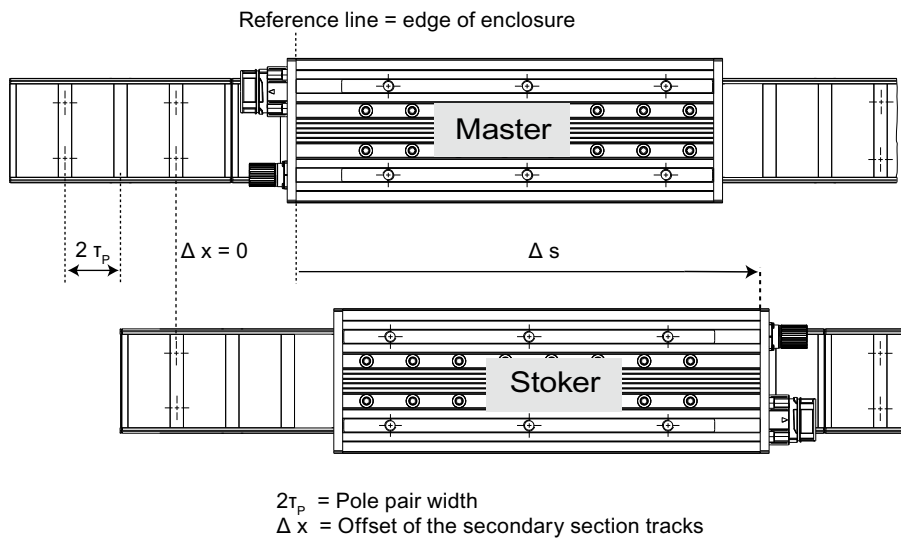

Figure 5-4 Position of master and stoker with antiparallel arrangement

The aim of the antiparallel arrangement is to position the two primary sections next to one another while taking up as little space as possible. Within this context, the cable outlet of the primary sections has a key role to play, for example.

The calculation is based on a notional Janus arrangement, where the master and stoker have the defined distance Δs (see section entitled "Janus arrangement"). The stoker is actually located on a parallel secondary section track that is not shifted in relation to the master track (ΔX = 0). The distance Δs corresponds exactly to distance Δs of the ideal Janus arrangement.

By shifting the stoker to the left by an integer multiple of 2τ_p, it is possible to minimize the space requirements of the primary section arrangement.

$\Delta s = \pm n \cdot 2\tau_p$	$n = 0, 1, 2, 3, \text{etc.}$
----------------------------------	-------------------------------

JANUS arrangement

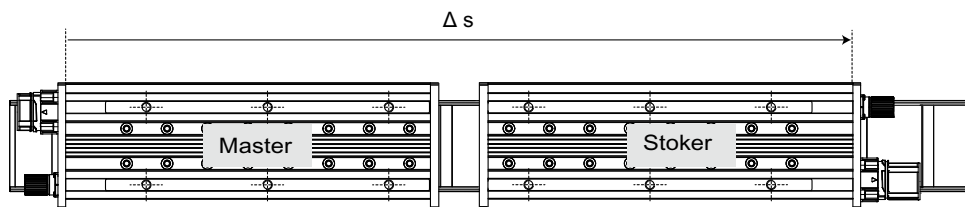

Figure 5-5 Position of master and stoker with JANUS arrangement

With the Janus arrangement, the smallest possible distance Δs_{\min} is used between the master and stoker to achieve uniform force generation.

$\Delta s = \Delta s_{\min} + n \cdot 2T_p$	$n = 0, 1, 2, 3, \text{etc.}$
---	-------------------------------

Frame size	Overall length	Δs ($n = 0, 1, 2, \dots$) [mm]	$2T_p$ [mm]
1FN6003 1FN6007 Natural cooling	1LCxx	$398.1 + n \cdot 2T_p$	25
	1LExx	$648.1 + n \cdot 2T_p$	
	1LGxx	$898.1 + n \cdot 2T_p$	
	1LJxx	$1148.1 + n \cdot 2T_p$	
	1LLxx	$1398.1 + n \cdot 2T_p$	
	1LNxx	$1648.1 + n \cdot 2T_p$	
1FN6003 1FN6007 Water cooling	1WCxx	$423.1 + n \cdot 2T_p$	25
	1WExx	$673.1 + n \cdot 2T_p$	
	1WGxx	$923.1 + n \cdot 2T_p$	
	1WJxx	$1173.1 + n \cdot 2T_p$	
	1WLxx	$1423.1 + n \cdot 2T_p$	
	1WNxx	$1673.1 + n \cdot 2T_p$	
1FN6008, 1FN6016, 1FN6024 Natural cooling	1LCxxx	$783.9 + n \cdot 2T_p$	50
	1LExxx	$1283.9 + n \cdot 2T_p$	
	1LGxxx	$1783.9 + n \cdot 2T_p$	

5.2 Interdigital motors

Structure of an interdigital motor

The figure below shows the structure of an interdigital motor involving the 1FN6. This type of structure minimizes the attraction forces on the moving slide.

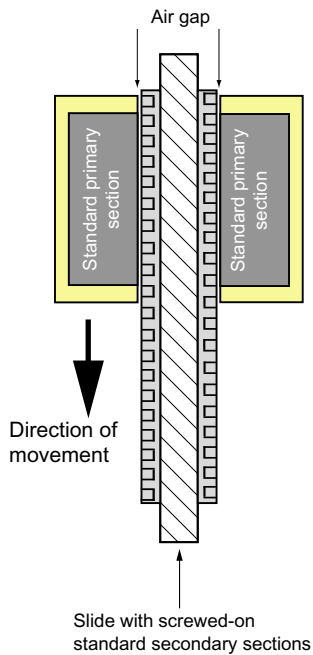

Figure 5-6 Schematic diagram showing the structure of an interdigital motor involving the 1FN6

When the 1FN6 is used to create the interdigital motor structure, no electromagnetic restrictions need to be imposed in terms of the material used for the slide and its thickness. Two standard primary sections can be used and, in principle, the structure can be created using any motors.

Configuration

Interdigital motors are mainly configured in the normal way. Only difference: In this case the dynamic mass is determined by the slide and the secondary sections that are attached to it. Consequently, these masses must be taken into account:

- The mass of the secondary sections
- The mass of the slide
- The mass of the guide elements
- The mass of the length measuring system

Order numbers

6.1 Structure of the order numbers

The order designation consists of a combination of alphanumeric characters, the machine-readable product designation MLFB. When placing an order, it is sufficient just to specify the unique MLFB.

The MLFB consists of three blocks that are separated by hyphens. The first block incorporates seven characters and designates the product family and size of the primary or secondary section. In the second block, further design features are encoded, such as length and speed. The third block is provided for additional data.

Note that not every theoretical combination is possible in practice.

6.2 Primary section

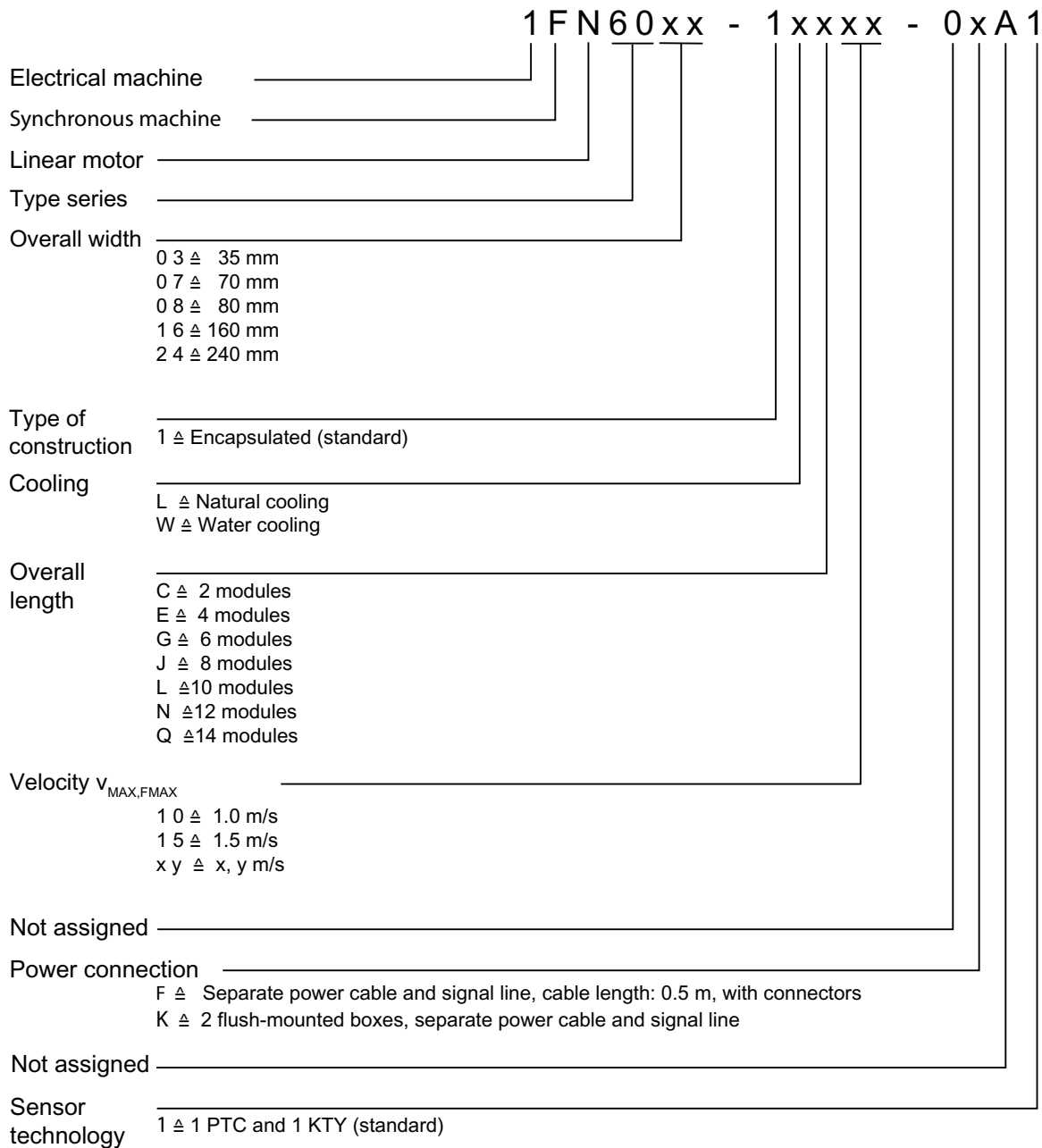

6.3 Secondary section

1FN60xx - 1Sx00 - 0AA0

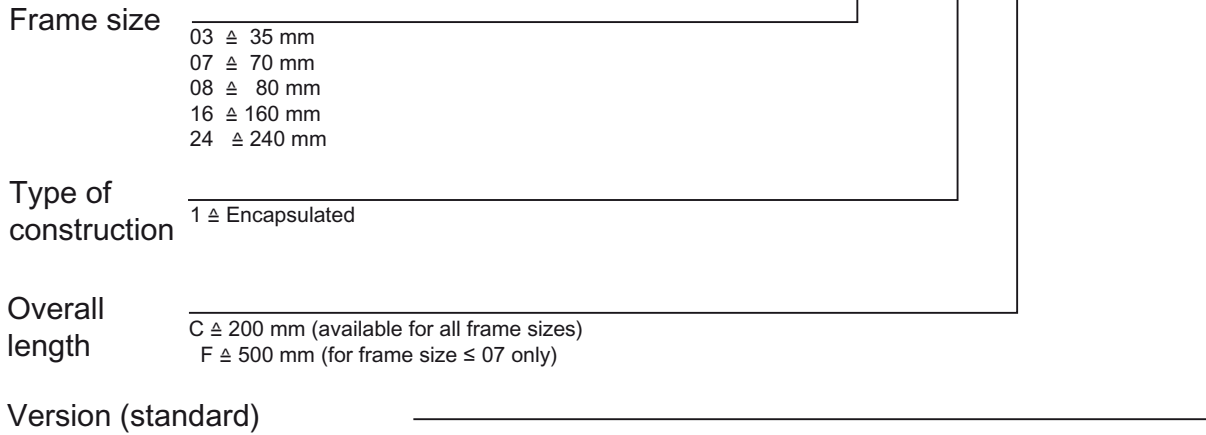

Configuring the motor

7.1 Note on Mechatronic Support

Note

Please contact your local Siemens office if you require Mechatronic Support with regard to the mechanical design of the machine, the control technology used, or the resolution and measuring accuracy of the encoder. For instance, we can assist you with analyses or with optimizations to the machine based on FEM (finite element method) through every stage of your engineering process.

7.2 Operation in an area of reduced secondary section coverage

Option

If the primary section moves beyond the ends of the secondary section track, the motor force is reduced.

Fundamentals and information

The available motor force is almost proportional to the percentage of the surface under the secondary section to the total magnetically active surface of the primary section. Depending on the extent of the frictional forces in the guides, the motor force of the drive may be too low to independently return to the secondary section track if the degree of coverage is too low. External force is then required to return to the track.

Note

The degree of coverage should not be below 50% in order to ensure that the drive can independently return to the secondary section track.

In the area of reduced secondary section coverage, the phases are asymmetrically loaded - especially at high velocities. This leads to additional heating.

Note

The velocity in areas of reduced secondary section coverage should not exceed 10% of the rated velocity $v_{MAX, FN}$.

The area of reduced secondary section coverage should be used only to approach parking or service positions, but not for machining.

The drive is normally operated position-controlled. As the loss of motor force changes the behavior of the control circuit, stable operation can only be achieved when the value of the position controller gain k_v is reduced.

The appropriate k_v value for each case depends on the mechanical design of the respective machine. It can only be determined by tests during commissioning. The search for the suitable value of k_v should start with 5% of its value at full secondary section coverage.

7.3 S1, S2 and S3 duty types

Uninterrupted duty S1

With uninterrupted duty S1, the motor runs permanently with a constant load. The load period is sufficient to achieve thermal equilibrium.

The rated data is of relevance when dimensioning the motor for uninterrupted duty.

 **CAUTION**

An excessive load can lead to the destruction of the motor.

The load must not exceed the value I_N specified in the data sheets!

Short-time duty S2

In the case of short-time duty S2, the load time is so short that the final thermal state is not reached. The subsequent zero-current break is so long that the motor practically cools down completely.

 **CAUTION**

An excessive load can lead to the destruction of the motor.

The load may not exceed the value I_{MAX} specified in the data sheets!

The motor may only be operated for a limited time $t < t_{MAX}$ with a current $I_N < I_M \leq I_{MAX}$. The time t_{MAX} can be calculated using the following logarithmic formula:

$$t_{MAX} = t_{TH} \cdot \ln \left(\frac{v}{v-1} \right)$$

with $v = (I_M / I_N)^2$ and the thermal time constant t_{TH} .

The thermal time constants, the maximum currents and the rated currents of the motors can be taken from the data sheets.

Intermittent duty S3

With intermittent duty S3, periods of load time Δt_B with constant current alternate with periods of downtime Δt_S with no current feed. The motor heats up during the load time and then cools down again while at standstill. After a sufficient number of duty cycles with cycle duration $\Delta t_{\text{Spiel}} = \Delta t_B + \Delta t_S$, the temperature characteristic oscillates between a constant maximum value T_o and a constant minimum value T_u ; see figure below.

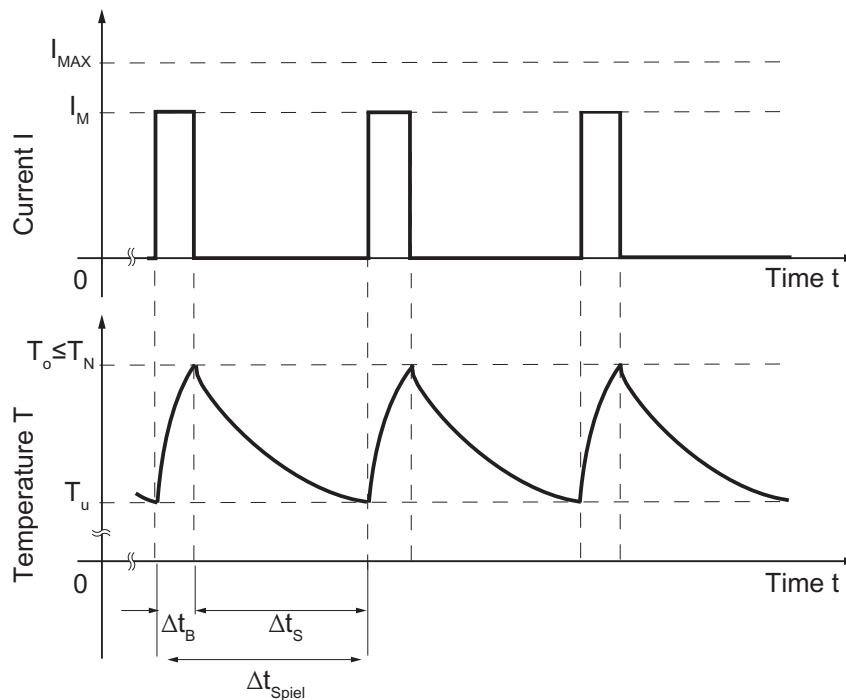

Figure 7-1 Current and temperature characteristic for intermittent duty S3

For currents $I_N < I_M \leq I_{MAX}$, the rms continuous current may not exceed the rated current:

$$I_{\text{eff}} = \sqrt{\frac{1}{\Delta t_{\text{Spiel}}} (I_M^2 \cdot \Delta t_B)} = I_M \sqrt{\frac{\Delta t_B}{\Delta t_{\text{Spiel}}}} < I_N$$

In this respect, the cycle duration should not exceed 10% of the thermal time constant t_{TH} . If a longer cycle duration is necessary, please contact your local Siemens office.

7.4 Procedure for the configuration

7.4.1 Overview of the configuration sequence

Basics

The selection of a suitable linear motor depends on:

- The peak thrust, continuous thrust and stall thrust needed for the application
- The desired velocity and acceleration
- The installation space available
- The desired or possible drive arrangement (e.g. single-sided, parallel, or double-sided arrangement)
- The type of motor cooling (cooling only via the motor housing or cooling via the motor housing and fixing plate)

Procedure

As a rule, the motor selection is an iterative process as, especially with high dynamic direct drives, the intrinsic mass of the motor type also determines the required thrusts. The following figure is a flowchart of this process.

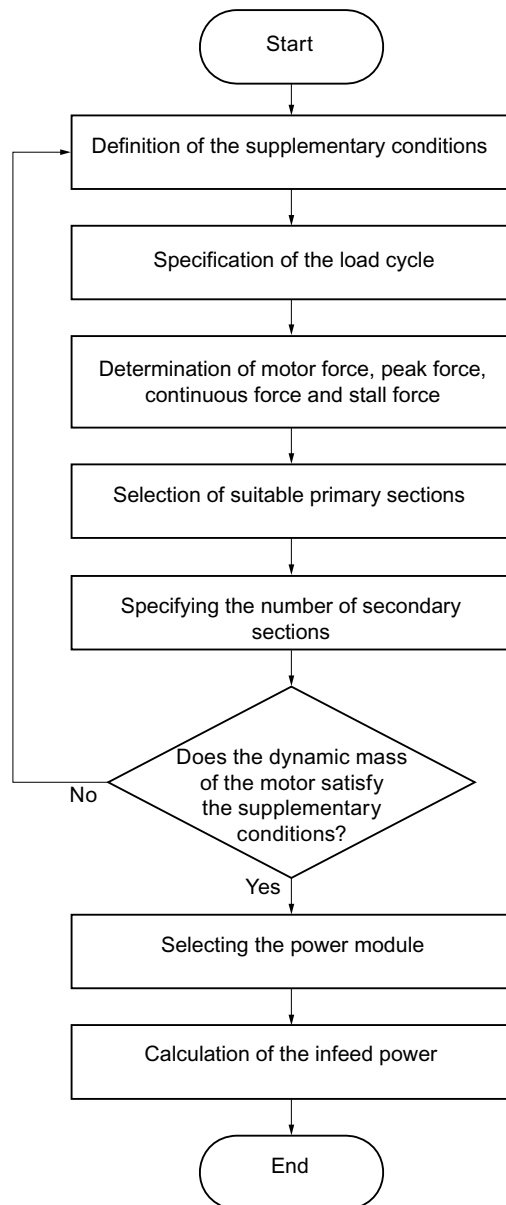

Figure 7-2 Flowchart for the drive configuration

7.4.2 Definition of the mechanical supplementary conditions

Introduction

The supplementary conditions that influence the selection of the motor include:

- Dynamic masses (incl. motor mass)
- Effects of gravitation
- Friction
- Machining forces
- Travel lengths
- The drive configuration

Dynamic masses

All machine parts, equipment in the tow chain, covers, mounting parts, etc. that the motor has to move, must be included in the calculation of the dynamic mass. This includes the mass of the motor component to be moved itself. As this is not known – the motor still has to be selected – the mass of a motor type that is approximately suitable must be used. If, during the further calculation, it is found that the assumed mass is badly incorrect, an additional iteration step is required for the motor selection.

In contrast to rotary drives with a mechanical gear reduction, all load masses are fully included in the acceleration capacity of the drive for a direct drive.

Gravitation

Every mass is subject to gravity. The motor must thus compensate part of the gravitational force F_G that has an effect on the dynamic mass. This component F_g depends on the dynamic mass m , the mounting position of the axis in relation to the earth's normal (angle α) and any weight compensation used. The following figure shows the forces on the motor due to gravitation for an inclined mounting position. The variable F_{\perp} is the component of the gravitational force perpendicular to the inclined axis.

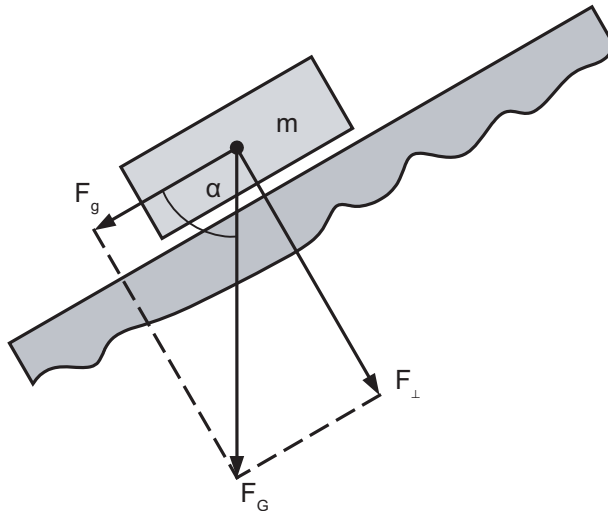

Figure 7-3 Forces on the motor for an inclined mounting position

According to the force components in the above figure, the component of the gravitational force that has to be compensated by the motor is calculated using

$$F_g = m \cdot g \cdot \cos \alpha$$

with the gravitational acceleration g .

When using a weight compensation, you must consider that the compensation does not automatically amount to 100% and is linked to additional friction forces and inert masses.

Friction

Friction that impedes the movement of a linear motor occurs between the guide carriage and the guide rail. The corresponding force F_r opposes the direction of motion of the slide.

Essentially, the frictional force F_r consists of a constant component F_{rc} and a component F_{rv} that is proportional to the speed v :

$$F_r = F_{rc} + F_{rv}$$

Both components depend on the type of linear guide used and its loading. Depending on the mechanical structure, the loading includes all gravitational forces (F_{\perp} from the above figure) and magnetic forces of attraction F_{magn} between the motor components as well as the clamping forces F_{spann} between the various guide elements. All these forces result in a force F_n which is perpendicular ("normal") to the axis:

$$F_n = F_{\perp} + F_{\text{magn}} + F_{\text{spann}}$$

If $F_{rc} = \mu_{rc} \cdot F_n$ and $F_{rv} = \mu_{rv} \cdot v \cdot F_n$ is set, the resulting frictional force is

$$F_r = \mu_{rc} \cdot F_n + \mu_{rv} \cdot v \cdot F_n$$

Note

High linear motor speeds can also result in extremely high frictional force values. Note the specifications of the linear guide manufacturer for the calculation of the frictional forces!

The following figure shows a simplified example for the speed curve and the correspondingly occurring frictional forces in a motor.

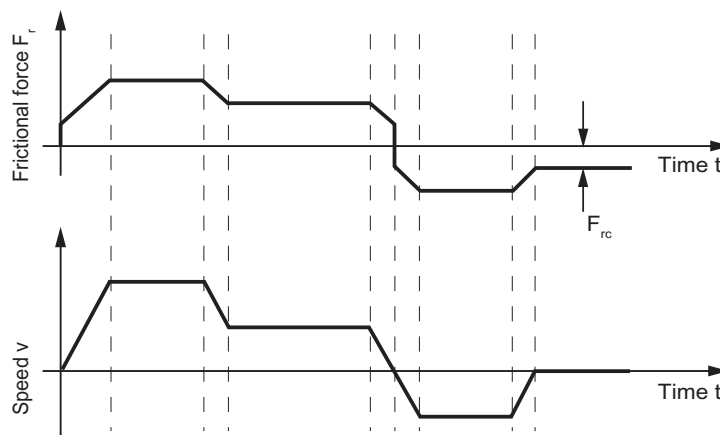

Figure 7-4 Example of frictional forces

7.4.3 Specification of the load cycle

In addition to the frictional and gravitational forces, the load cycle is decisive for the selection of the motor. The load cycle contains information regarding the sequence of motion of the drive axis and the machining forces that occur in the process.

The *motion sequence* can be specified as a distance-time diagram, velocity-time diagram or acceleration-time diagram, see following figure.

In accordance with the following relationships:

$$a(t) = \frac{dv}{dt} = \frac{d^2s}{dt^2}$$

the diagrams for the sequence of motion can be converted to one other.

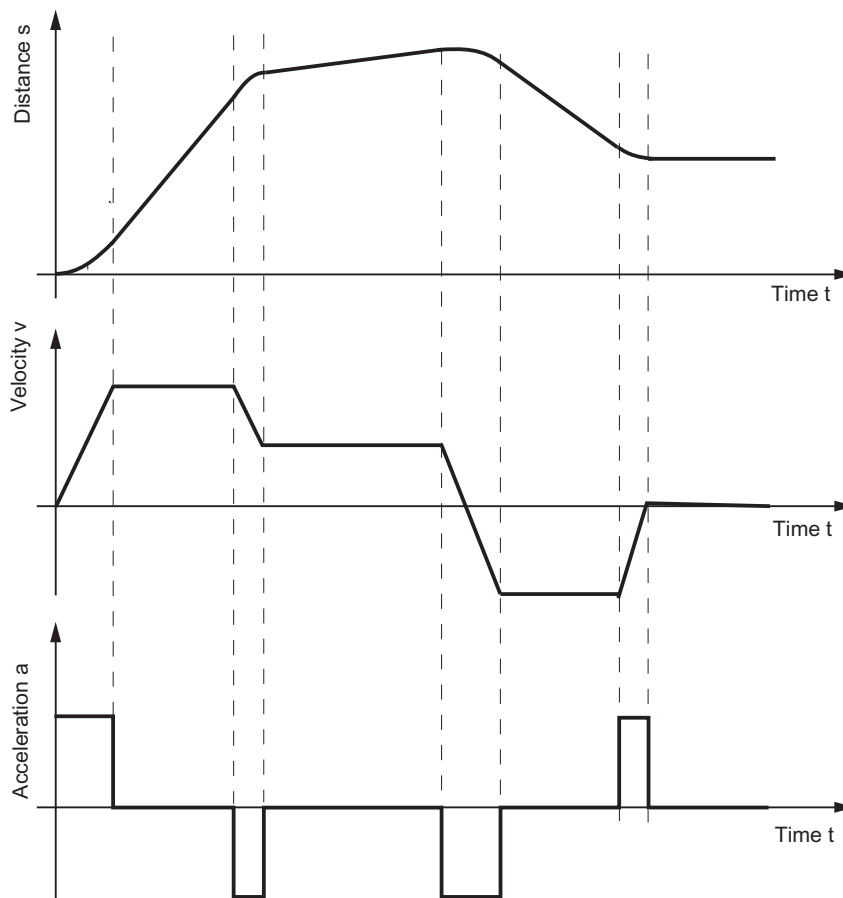

Figure 7-5 Example for the sequence of motion of a linear motor in diagrams

The inertia forces resulting from the sequence of motion that the motor must compensate, are proportional to the acceleration a and the dynamic mass m :

$$F_a = m \cdot a$$

They oppose the direction of acceleration.

A *machining force* - time diagram for a motor could look like the following figure. The speed - time diagram serves as a comparison.

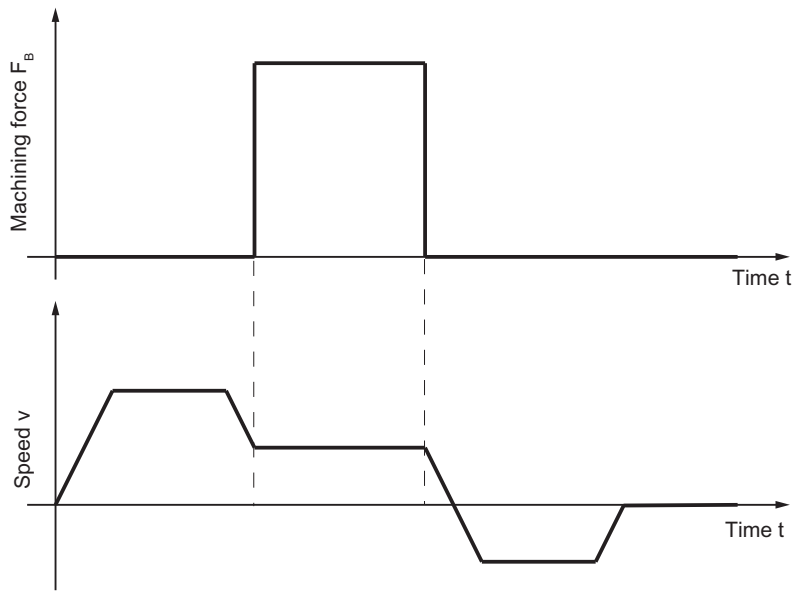

Figure 7-6 Example of a machining force - time diagram

7.4.4 Determination of the motor thrust, peak thrust and continuous thrust

Determination of the motor thrust

The thrust that the motor has to provide consists of the sum of the individual forces at any time. The signs of the forces must be taken into account!

The following figure shows an example of the individual forces for a linear motor and the resulting motor thrust F_M .

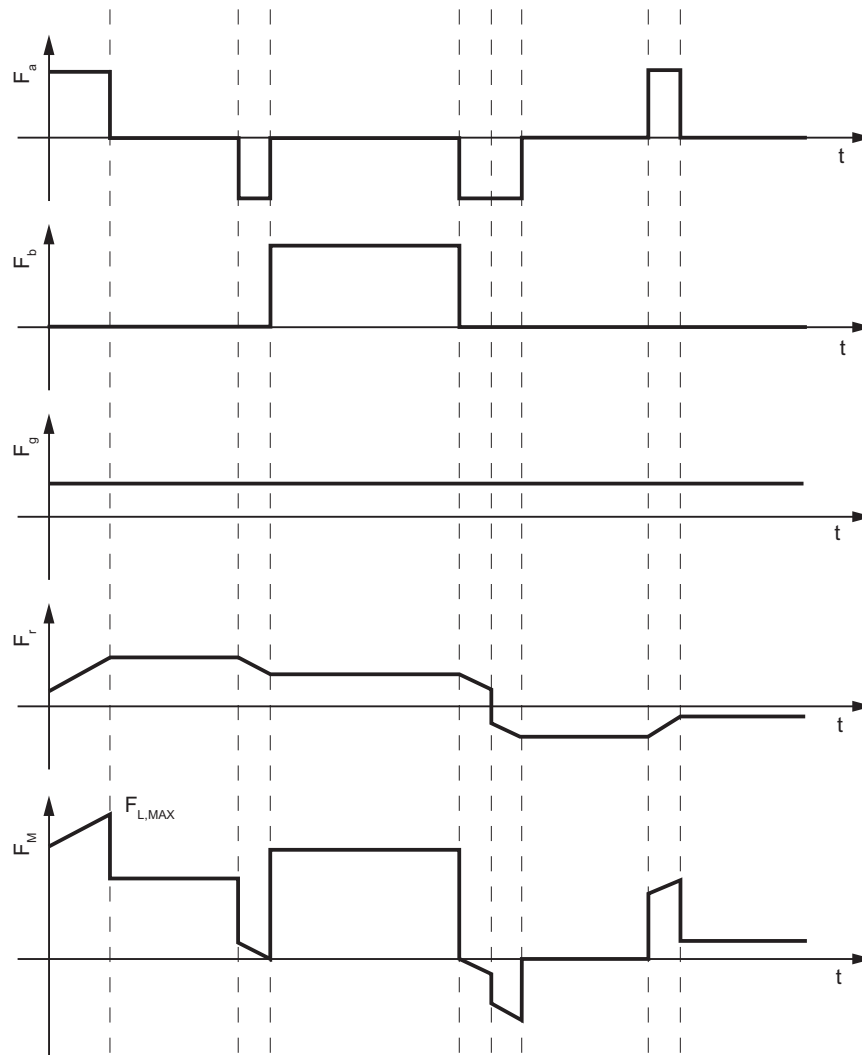

Figure 7-7 Example of the individual forces for a linear motor and the resulting motor thrust

Determination of the peak thrust

The peak thrust $F_{L,MAX}$ (= at maximum the force of the load cycle) that the motor must provide can be easily determined from the above figure.

Determination of the continuous thrust

In addition to the peak thrust, the required continuous thrust (effective thrust) of the motor is decisive for its dimensioning. The *maximum* continuous thrust of the motor F_{eff} is calculated from the square mean of the motor thrust over the entire time of a sequence of motion and may not exceed the rated thrust F_N :

$$F_{eff} = \sqrt{\frac{1}{\Delta t_{ges}} \int_0^{\Delta t_{ges}} F^2(t) dt} \leq F_N$$

When the motor thrust is constant over sections as in the following figure, this simplifies the integral for the sum:

$$F_{\text{eff}} = \sqrt{\frac{1}{\Delta t_{\text{ges}}} \sum F_i^2 \cdot \Delta t_i} = \sqrt{\frac{1}{\Delta t_{\text{ges}}} (F_1^2 \cdot \Delta t_1 + F_2^2 \cdot \Delta t_2 + F_3^2 \cdot \Delta t_3 + \dots)}$$

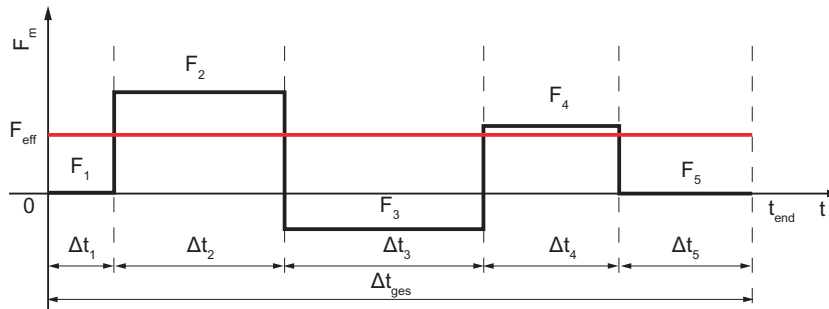

Figure 7-8 Continuous thrust with motor thrust constant over sections

The above equations apply for the calculation of the effective forces. For more exact calculations, the forces must be replaced by the corresponding currents and the effective current determined. Here the effects of the motor saturation must be taken into account.

7.4.5 Selection of the 1FN6 primary sections

Requirement

Whether a primary section can fulfill the requirements from the load cycle, depends on the following requirements:

- The continuous thrust of the primary section (rated thrust F_N) must be greater than or equal to the determined continuous thrust value F_{eff} of the load cycle.
- For natural cooling, the rated thrust F_N depends on which thermal conductivity the motor has to the surroundings. This is influenced by, for example, the thermal contact to the machine, the temperature difference to the surroundings, the flow velocity of the cooling air and the increase in surface area due to cooling fins or similar. In the worst case, natural cooling only takes place via the motor housing.
- The primary section should have approx. 10% control reserve with respect to the peak thrust F_{MAX} , in order to avoid undesired limitation effects for overshoot of control loops.
- At every operating point the required thrust can be achieved at the required velocities.
- Overload phases of the load cycle must not lead to shutdown by the temperature monitoring.

In addition to the requirements resulting from the load cycle, mechanical installation conditions may influence your choice of motor. The same motor thrusts may often be generated by different types of primary sections.

If several primary sections are involved in the thrust generation of the axis, the values for the peak and continuous thrusts of the individual motors must be added. If the distribution of thrust among the individual motors is not even, such as in the case of the gantry axis with an uneven distribution of weight, the thrust requirements on the individual motors must be taken into consideration separately.

Procedure

The first two items are used for a preselection of the possible primary sections. If some supplementary conditions such as the machining forces and frictional forces are not exactly known, it is best to plan with larger reserves.

To determine whether a primary section actually fulfills the requirements from the load cycle, the motor force - speed characteristic curve, which results from the required sequence of motion and the motor force - time diagram, is required. Whereby only the absolute values for motor thrust and speed are decisive, not the directions. All points of the motor force - speed characteristic curve must be below the force - speed characteristic curve of the primary section that is specified in the data sheets.

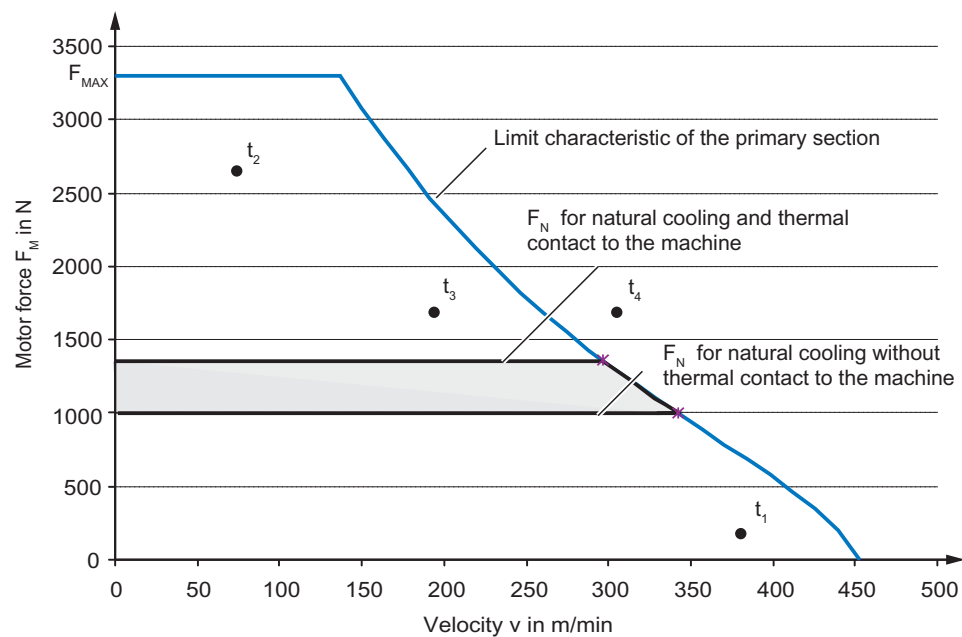

Figure 7-9 Example for points of a motor force - speed characteristic curve in comparison with the force - speed characteristic curve of the primary section

The above figure shows an example of some operating points from a specified load cycle at times $t_1 \dots t_4$ in comparison with the force - speed characteristic curve of a primary section:

7.4 Procedure for the configuration

- t_1 : This operating point is not critical, since it lies below the limit characteristic of the motor.
- t_2, t_3 : These operating points are critical, because although they lie below the limit characteristic of the motor, they may only be approached briefly. It should be checked, whether the motor can be run as long as intended at overload.
- t_4 : If such an operating point occurs, the required motor thrust cannot be achieved at this speed. In this case, you must select another primary section at which the operating point t_4 lies below the new limit characteristic curve.

Note

Not in all motor operating states are all three phases evenly loaded with current, for example:

- Standstill with current feed of the motor, e.g. for:
 - Compensation of a weight force
 - Start-up against a brake system (damping and impact absorption elements)
- Low speeds (< 0.5 m/min)
- Cyclic traversing distances less than the pole width

With long-term uneven loading, the motor may be operated only at about 70% of the rated thrust, see F_0^* in the data sheets.

For exact configurations, contact your local Siemens office.

7.4.6 Specifying the number of secondary sections

Basics

Irrespective of the length, the secondary sections must have at least the same track width as the selected primary section. This can be guaranteed through a selection using the order number: The digits of the order number that indicate the frame size of the motor must be the same.

The number of required secondary sections depends on:

- The desired traversing distance
- The drive arrangement

Specifying the total length of the secondary section track

The total length of a secondary section track determines the number of required secondary sections. It depends on the length of the desired traversing path and the number of primary sections on this secondary section track.

Note

The calculation of the total length of the secondary section track specified here guarantees the maximum motor force over the entire traversing path.

A single primary section on the secondary section track

If it is intended that only one primary section should be on the secondary section track, the length of the secondary section track is calculated using the length of the required traversing distance and the magnetically active length of the primary section ($l_{P,AKT}$), see following figure.

The variable $l_{P,AKT}$ is specified in the dimension sheets

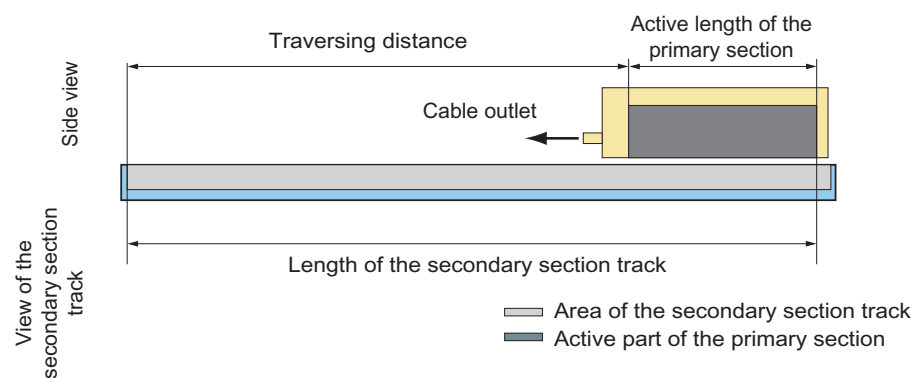

Figure 7-10 Determination of the length of the secondary section track with one primary section

Several primary sections on a secondary section track

If several primary sections are to be mounted on a secondary section track, the required length of the secondary section increases by the active length of the additional primary sections and the distances between them (see following figure).

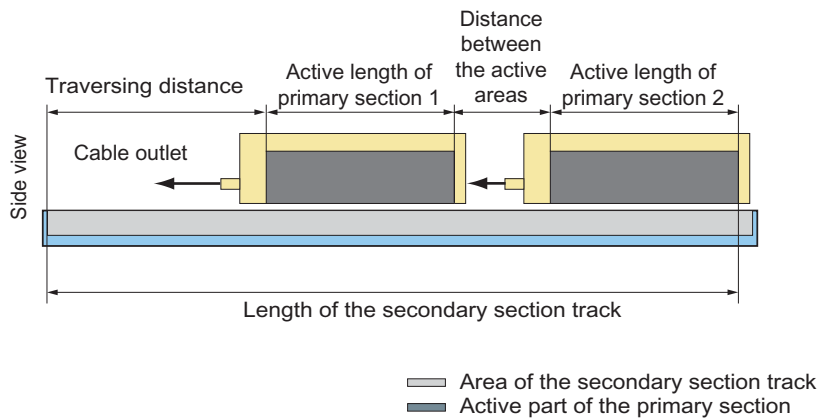

Figure 7-11 Determination of the length of the secondary section with several primary sections

If the various primary sections are operated from separate drive systems with separate measuring systems, for example, for gantry or master/slave operation, the distance between the primary sections is limited only by mechanical supplementary conditions such as the length of the connecting plugs and the bending radii of the cables. As long as the primary sections are being electrically operated in parallel on a drive system, the pole position of the two primary sections must be the same. The distance can only accommodate certain values.

Specifying the number of secondary sections

The total required length of the secondary section track is calculated from the individual secondary sections. The available lengths are listed in the motor data.

7.4.7 Checking the dynamic mass

Procedure

The dynamic mass of the motor or the axis is determined at the latest after the secondary sections have been selected. With this data, the assumptions specified as mechanical supplementary conditions can be checked. When the mass of the motor assumed there differs considerably from the actual mass of the motor, a new calculation of the load cycle is required.

7.4.8 Selecting the power module

The required power modules are selected according to the peak and continuous currents that occur in the load cycle. If several primary sections are operated in parallel on one power module, then the sum values of the continuous and peak currents must be taken into account.

A selection of available power modules can be found, for example, in the relevant catalogs.

Note

In systems where direct drives are used on controlled infeeds, electrical oscillations can occur with respect to ground potential. These oscillations are, among other things, influenced by:

- The lengths of the cables
- The rating of the infeed/regenerative feedback module
- The type of infeed/regenerative feedback module (particularly when an HFD commutating reactor is already present)
- The number of axes
- The size of the motor
- The winding design of the motor
- The type of line supply
- The place of installation

The oscillations lead to increased voltage loads and may damage the main insulation! We thus recommend using an HFD commutating reactor with damping resistance for damping the oscillations. For specific details, refer to the documentation of the drive system being used or contact your local Siemens office.

7.4.9 Note regarding Active Line Modules

Note

The corresponding Active Interface Module or the appropriate HFD line reactor must be used to operate the Active Line Module controlled infeed unit.

7.4.10 Calculation of the required infeed

Dimensioning the Active Infeed

Use the drive's power balance to dimension the Active Infeed.

The first important quantity to know is the mechanical power P_{mech} to be produced on the motor shaft. Based on this shaft output, the electrical active power P_{Line} to be drawn from the supply system can be determined by adding the power loss of the motor $P_{V \text{ Mot}}$, the power loss of the Motor Module $P_{V \text{ MoMo}}$ and the power loss of the Active Infeed $P_{V \text{ AI}}$ to the mechanical power P_{mech} :

$$P_{\text{Line}} = P_{\text{mech}} + P_{V \text{ Mot}} + P_{V \text{ MoMo}} + P_{V \text{ AI}}$$

The active power to be drawn from the power system depends on the line voltage U_{Line} , the line current I_{Line} and the line-side power factor $\cos\phi_{\text{Line}}$ as defined by the relation

$$P_{\text{Line}} = \sqrt{3} \cdot U_{\text{Line}} \cdot I_{\text{Line}} \cdot \cos\phi_{\text{Line}}$$

7.5 Example: Positioning in a predefined time

This is used to calculate the required line current I_{Line} of the Active Infeed as follows:

$$I_{Line} = P_{Line} / (\sqrt{3} \cdot U_{Line} \cdot \cos\phi_{Line}).$$

If the Active Infeed is operated according to the factory setting, i.e. with a line-side power factor of $\cos\phi_{Line} = 1$, so that it draws only pure active power from the supply, then the formula can be simplified to

$$I_{Line} = P_{Line} / (\sqrt{3} \cdot U_{Line}).$$

The Active Infeed must now be selected such that the permissible line current of the Active Infeed is higher or equal to the required value I_{Line} .

7.4.11 Selecting an infeed unit

Selecting an infeed unit

The electrical power can be calculated for every point in time in the load cycle. For the selection of an infeed unit for the DC link, it generally suffices to determine the required maximum infeed power for the load cycle for high dynamic direct drives: the constant input is generally considerably lower. The maximum infeed power is usually required when accelerating to the maximum speed. Since accelerating is only for a very short period in the case of high dynamic drives, the 200 ms value can generally be used as design criterion for the maximum infeed power of the infeed units.

The overload capability of the converter should be checked for longer acceleration phases.

In the case of several axes, the infeed powers of the individual axes are to be added together with the corresponding simultaneity conditions for the selection of the infeed unit.

7.5 Example: Positioning in a predefined time

Note

Possible differences to data provided in the data sheets have no effect on the calculation method shown here.

Objective

To find an appropriate primary segment from the 1FN6 product line and appropriate secondary sections, and determine the number of secondary sections in accordance with the following specifications:

The motor should move on a horizontal axis during time period Δt_1 to a certain point S_{MAX} . It should then wait there for time period Δt_2 and then return to the starting position. The following figure shows these variables in a distance - time diagram.

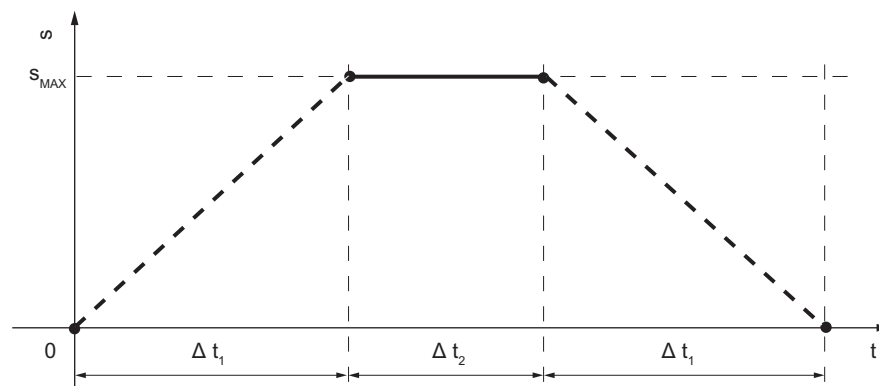

Figure 7-12 Example: Representation of the predefined variables in the distance/time graph

Supplementary conditions/specification of the load cycle

Traversing profile

The form of the velocity profile during time Δt_1 is not explicitly specified. Therefore, a suitable velocity profile must be specified first. The following figure shows three examples of possible traversing distances.

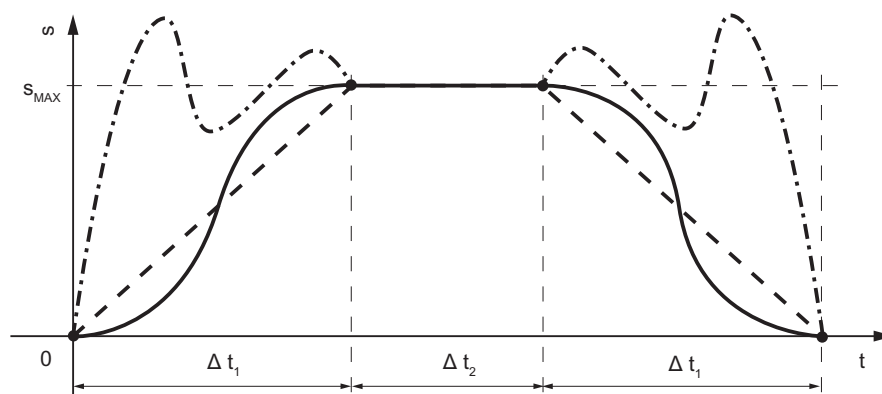

Figure 7-13 Example: Examples of velocity profiles

The solid line indicates the velocity profile that is easiest to implement: With this profile, only one acceleration phase and one deceleration phase with constant force are required to reach position s_{MAX} , see also following figure. This type of velocity profile has the shortest positioning times.

Predefinitions

In the case of positioning in predefined time, only the end points of the path and the duration of the individual motion sections are predefined.

1. 0 - t_a : Motor acceleration
2. t_a - t_0 : Constant, maximum velocity
3. t_0 - t_1 : delay

7.5 Example: Positioning in a predefined time

The individual predefined variables are:

- $s_{MAX} = 7 \text{ m}$ (traversing distance)
- $\Delta t_1 = 5 \text{ s}$ (traversing time)
- $\Delta t_2 = 4 \text{ s}$ (dwell time)
- $m = 500 \text{ kg}$ (mass to be moved, without motor mass)
- $F_r = 100 \text{ N}$ (constant friction)
- $F_g = 0 \text{ N}$ (horizontal axis)

In addition, a power module is to be selected and the maximum infeed power calculated.

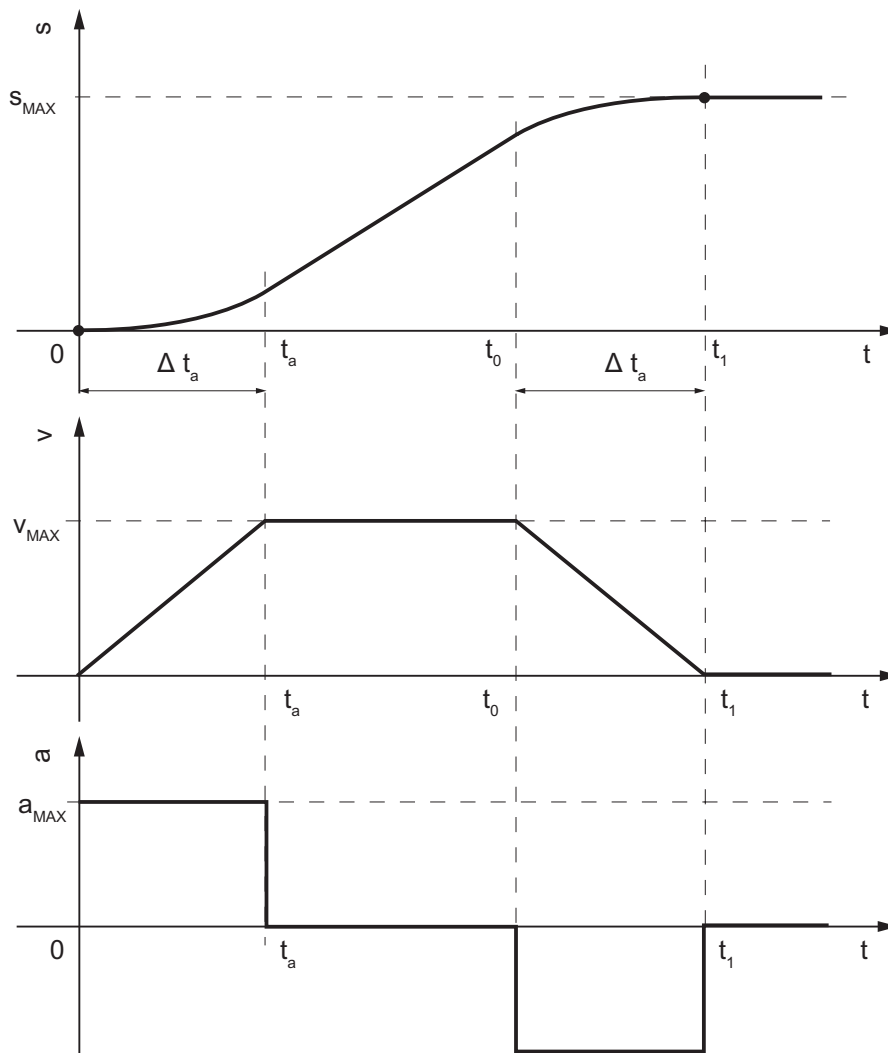

Figure 7-14 Example representation of a specified traversing profile

For the maximum velocity that the motor should achieve, the following should apply:

$$s_{MAX} < v_{MAX} \cdot t_1 \Rightarrow v_{max} > s_{max} / t_1$$

Otherwise, the duration of time t_1 will not be long enough to position the motor at s_{MAX} . In the current example, the following must apply for the maximum velocity of the motor:

$$v_{MAX} > (7 \text{ m}/5 \text{ s}) = 1.4 \text{ m/s} = 84 \text{ m/min}$$

At the defined maximum velocity, this acceleration can be calculated:

$$s_{MAX} = 2 \cdot \left(\frac{a_{MAX}}{2} t_a^2 \right) + (t_1 - 2t_a)v_{MAX} \quad \text{mit } t_a = \frac{v_{MAX}}{a_{MAX}}$$

$$a_{MAX} = \frac{v_{MAX}^2}{v_{MAX}t_1 - s_{MAX}}$$

A primary section can be selected using this data.

Selecting the primary section

In order that the configuration is not too restricted, a maximum velocity of

$$v_{MAX} = 1.5 \text{ m/s} = 90 \text{ m/min}$$

is assumed.

In the example, the maximum acceleration is

$$a_{MAX} = (1.5 \text{ m/s})^2 / (1.5 \text{ m/s} \cdot 5 \text{ s} - 7 \text{ m}) = 4.5 \text{ m/s}^2$$

The maximum force $F_{L,MAX}$ that the motor must supply during this load cycle is calculated as follows:

$$F_{L,MAX} = m \cdot a + F_r = 500 \text{ kg} \cdot 4.5 \text{ m/s}^2 + 100 \text{ N}$$

$$F_{L,MAX} = 2,350 \text{ N}$$

An example of a motor that achieved this force is 1FN6008-1LG16-0KA1 ($F_{MAX} = 2,690 \text{ N}$). Even the required velocity of 1.5 m/s (= 90 m/min) does not exceed the given maximum velocity at peak force ($v_{MAX,FMAX} = 96.7 \text{ m/min}$)

Checking the mechanical supplementary conditions

You must now check two points:

- Is the reserve force of the selected primary section also sufficient for the mass of the primary section (which has not yet been taken into account)?
- Does the continuous force lie below the permissible continuous force?

Reserve force

The mass m_{P1} of the primary section 1FN6008-1LG16-0KA1 is 39.6 kg (see section titled "Technical data and characteristics")

So the total mass to be moved m_1 is $(500 + 39.6) \text{ kg} = 539.6 \text{ kg}$. The maximum force that the motor must supply is:

$$F_{L,MAX,P1} = F_a + F_r = m \cdot a + F_r = 539.6 \text{ kg} \cdot 4.5 \text{ m/s}^2 + 100 \text{ N}$$

$$F_{L,MAX,P1} = 2,528 \text{ N}$$

7.5 Example: Positioning in a predefined time

This force lies just below the limit of the selected motor and cannot meet the requirement of a 10% reserve force. Therefore, a new primary section has to be selected.

Another primary section that fulfills all requirements is the 1FN6016-1LE17-0KA1. The mass of this primary section m_{P2} is 48.2 kg; the motor must therefore supply a maximum force $F_{L,MAX,P2}$ of approximately 2,567 N. The maximum force listed in the data sheet is 3,590 N. The recommended control reserve of 10% is also available with this maximum force.

$$F_a = (m_{P2} + m) \cdot a = (48.2 + 500) \text{kg} \cdot 4.5 \text{ m/s} \approx 2467 \text{ N}$$

$$F_{Max} = 3,590 \text{ N (acc. to data sheet)}$$

Continuous thrust

The following figure shows the force/time graph for the entire sequence of motion for this example.

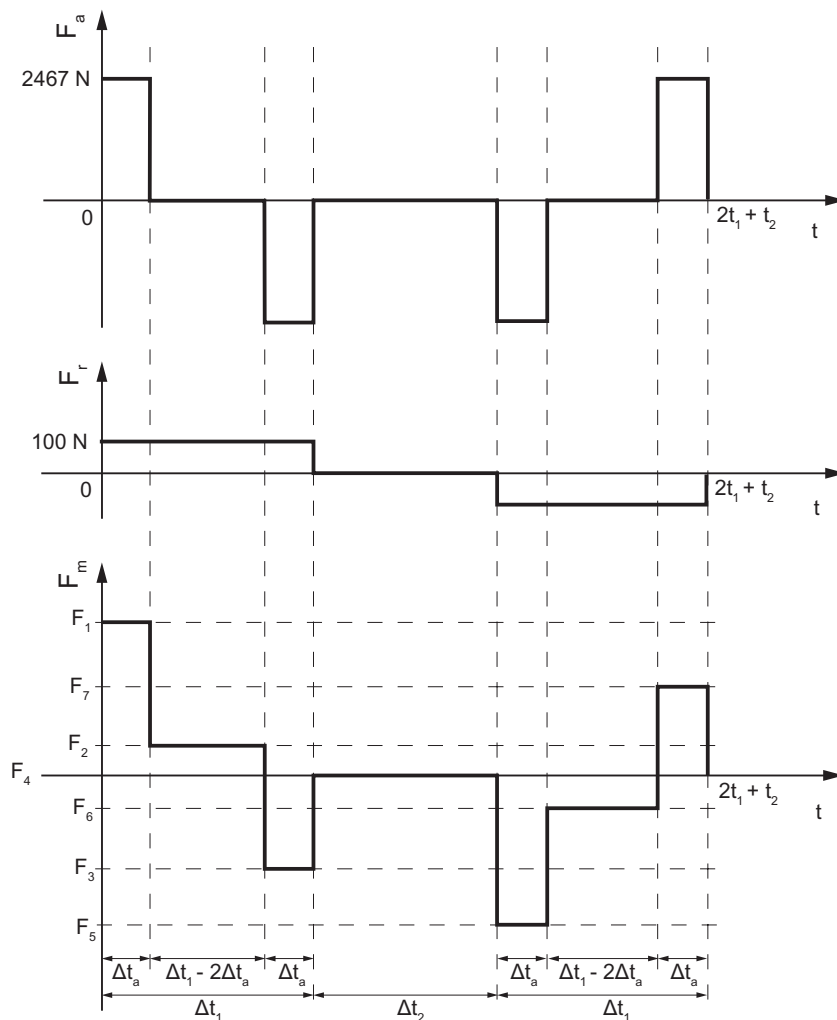

Figure 7-15 Example: Force/time graph and continuous force of the load cycle in this example

To calculate the continuous force, the summation formula can be used here since the motor force F_m is constant in sections:

$$F_{\text{eff}} = \sqrt{\frac{1}{2 \Delta t_1 + \Delta t_2} [F_1^2 \Delta t_a + F_2^2 (\Delta t_1 - 2\Delta t_a) + F_3^2 \Delta t_a + F_4^2 \Delta t_2 + F_5^2 \Delta t_a + F_6^2 (\Delta t_1 - 2\Delta t_a) + F_7^2 \Delta t_a]}$$

With:

$F_1 = F_a + F_r = 2,567 \text{ N}$	$\Delta t_1 = 5 \text{ s}$
$F_2 = F_r = 100 \text{ N}$	$\Delta t_2 = 4 \text{ s}$
$F_3 = -F_a + F_r = -2,367 \text{ N}$	$\Delta t_a = v_{\text{max}} / a_{\text{max}} = 0.3 \text{ s}$
$F_4 = 0 \text{ N}$	
$F_5 = -F_a - F_r = -2,567 \text{ N}$	
$F_6 = -F_r = -100 \text{ N}$	
$F_7 = F_a - F_r = 2,367$	

$$F_{\text{eff}} = 727.2 \text{ N}$$

Thus, the continuous force also remains below the permissible value of $F_N = 1,380 \text{ N}$ (see data sheet).

Interim result

For the example shown here, the primary section 1FN6016-1LE17-0KA1 is suitable.

Specifying the number of secondary sections

Type of secondary section

The order number is used to select the secondary section that is suitable for primary section 1FN6016-1LE17-0KA1. The suitable secondary section has the order number 1FN6016-1SC00-0AA0.

Length of the secondary section track

The magnetically active length of the primary section $L_{P,AKT}$ is 583.3 mm (see data sheet). Together with the traversing distance s_{max} , the length of the secondary section track L_{Spur} is calculated as follows:

$$L_{\text{Spur}} = L_{P,AKT} + s_{\text{max}} = (583.3 + 7000) \text{ mm}$$

$$L_{\text{Spur}} \approx 7,583 \text{ mm}$$

Number of secondary sections

The 1FN6016-1SC00-0AA0 secondary sections have a length of $L_S = 200 \text{ mm}$. Therefore, 38 secondary sections are required; the total length of the secondary section track is $38 \cdot 200 \text{ mm} = 7600 \text{ mm}$.

Selecting the power module

The selected motor has the following data:

- Maximum force $F_{MAX} = 3,590 \text{ N}$
- Rated force $F_N = 1,380 \text{ N}$
- Maximum current $I_{MAX} = 36.0 \text{ A}$
- Rated current $I_N = 10.4 \text{ A}$

A suitable power module for this data is selected from the relevant catalog.

Calculating the maximum infeed power

The electrical infeed power is calculated using the mechanical power P_{MECH} and the power loss P_V . Both values in this example reach the maximum if the motor runs at the maximum velocity and force indicated by the required load cycle. In the example shown here, these values are as follows:

- $v_{MAX} = 1.5 \text{ m/s}$
- $F_{L,MAX} = F_{L,MAX,P2} = 2,567 \text{ N}$

This results in the following upper estimation for the maximum infeed power:

$$P_{EL,MAX} = F_{L,MAX} \cdot v_{MAX} + 3 \cdot R_{STR}(T_N) \cdot \left(\frac{F_{L,MAX}}{k_F} \right)^2$$

with $R_{STR,20} = 0.925 \Omega$ (acc. to motor data sheet), $\alpha_{Cu} = 0.00394 \text{ 1/K}$ and $T_N = 120 \text{ °C}$, the line resistance for the rated temperature is calculated as follows:

$$\begin{aligned} R_{STR}(T_N) &= R_{STR,20} [1 + \alpha(T_N - 20 \text{ °C})] \\ &= 0,925 \Omega \cdot [1 + 0,00393 \text{ 1/K} \cdot 100 \text{ K}] \\ &= 1,3 \Omega \end{aligned}$$

According to the formula above, the maximum infeed power is therefore:

$$P_{EL,MAX} = 2,567 \text{ N} \cdot 1.5 \text{ m/s} + 3 \cdot 1.3 \Omega \left(\frac{2567 \text{ N}}{135 \text{ N/A}} \right)^2 = 5,260.6 \text{ W}$$

$$\begin{aligned} \text{Units: } [P_{EL}] &= \frac{\text{N} \cdot \text{m}}{\text{s}} + \frac{\Omega \cdot \text{N}^2 \cdot \text{A}^2}{\text{N}^2} \\ &= \frac{\text{N} \cdot \text{m}}{\text{s}} + \frac{\text{V} \cdot \text{A}^2}{\text{A}} \quad (1 \text{ W} = 1 \text{ Nm/s} = 1 \text{ VA}) \\ &= \text{W} \end{aligned}$$

$k_F = 135 \text{ N/A}$ (value from motor data sheet)

The value of 5391.8 W must be added to the infeed powers of other loads that are also operated on the DC link. A corresponding infeed/regenerative feedback module can thus be selected.

Mounting the motor

8.1 Safety instructions for mounting

 DANGER
<p>The primary section has permanent magnets. These can develop extreme magnetic attraction forces with ferromagnetic objects (machine parts or tools containing steel or iron) in the surrounding area.</p> <p>The following must be observed during mounting:</p> <ul style="list-style-type: none">• Only remove the packaging from the motor components immediately prior to installation• Do not bring any loose ferromagnetic parts (tool, fixing accessories etc.) near the primary section• Never use magnetizable tools! If such tools are required, they must be held firmly with both hands and moved slowly towards the direct drive• Never place metals on magnetic surfaces and vice versa• All work must be performed by two persons• Prevent unintentional movement of pre-assembled direct drives• Only carry out work on the motor if it is de-energized and isolated from the power supply! Risk of electric shock

 WARNING
<p>Sharp edges can cause cuts.</p> <p>Wear protective gloves!</p>

 WARNING
<p>Falling objects can injure feet.</p> <p>Wear safety shoes!</p>

 **DANGER**

Defective connecting cables can cause an electric shock and/or material damage (e.g. by fire).

When installing the motor, make sure that the connection cables

- are not be damaged,
- are not under tension,
- cannot be caught up in moving parts,
- and that the minimum bending radius is adhered to.

It is not permissible to hold or pull the motor using the cables!

8.2 General procedure

The installation of a linear motor is divided into the following steps:

1. Checking the mounting dimensions before the installation of the motors
2. Cleaning of the attachment surfaces of motor parts and the machine
3. Installation of primary sections, secondary sections and components
4. Checking the motor installation

8.3 Checking the mounting dimensions

Basics

For the observance of the electrical and system-technical properties of the motor, only the mounting dimensions and not the measurable air gap are decisive. The mounting dimensions must lie within the specified tolerances over the complete traversing distance.

Checking

The mounting dimensions can be checked before installing the motor, e.g. using final dimensions and feeler gauges.

Installation dimensions

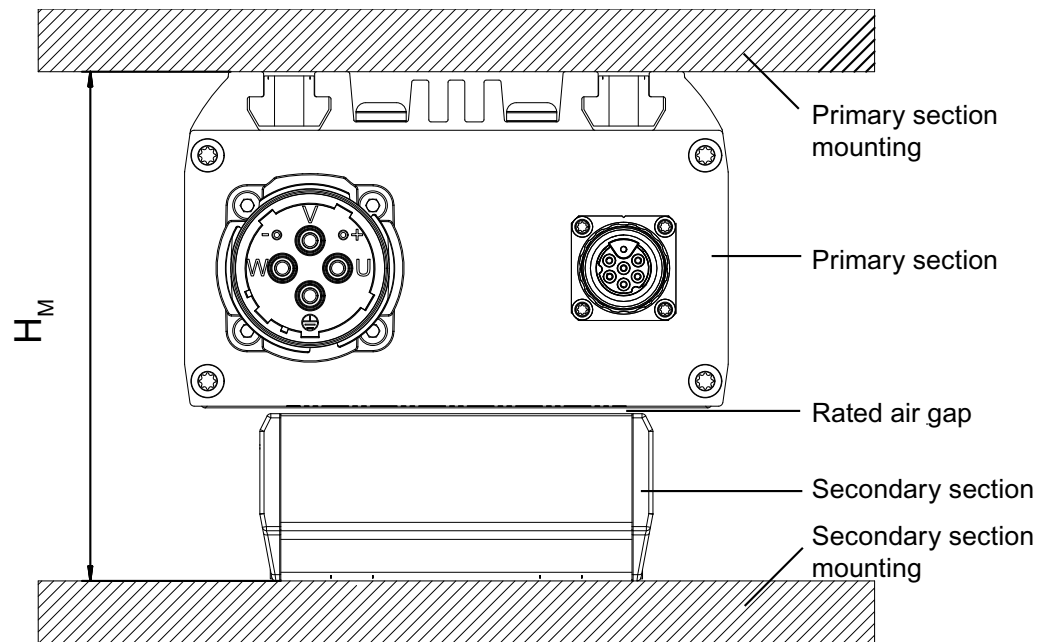

Figure 8-1 Installation dimensions for mounting

Type series	Frame size	Installation dimension	Mounting tolerance	Rated air gap
		H_M [mm]	[mm]	(mechanical) [mm]
1FN6003	1Lxxx	70.0	± 0.1	0.6
	1Wxxx			
1FN6007	1Lxxx	82.0	± 0.1	0.6
	1Wxxx			
1FN6008	1Lxxx	121.8	± 0.1	1.4
1FN6016				
1FN6024				

Note

An air gap that is smaller than the rated air gap increases the risk of a motor failure.

A reduction of the mounting dimension is not recommended. The motor becomes more robust by increasing the mounting dimensions.

8.4 Motor installation procedures

 **WARNING**

Use of lifting devices

At least three load suspension devices (e.g. lifting eyebolts) must be screwed into the sliding blocks in order to lift the primary section. The load suspension devices must be arranged symmetrically in relation to one another to provide a stable lifting position. The devices must be used in accordance with their specified load-carrying capacity. The fixing screws of the sliding blocks must be tightened to prevent the primary section from slipping and sliding. The following secondary conditions also apply:

- Lift in the horizontal position
- Do not apply loads to the flush-mounted boxes or connection cables
- Only remove the protective cover on the lower side of the motor if this is absolutely necessary for assembly

Lifting the primary section without fixed sliding blocks can cause bodily injury and property damage.

Overview of the assembly procedures

There are three different procedures for installing a linear motor in a machine:

1. Assembly with divided secondary section track (recommended procedure)
2. Assembly by introducing the slide (for frequent maintenance and operation purposes)
3. Assembly by mounting the motor components (if other procedures are not possible)

Motor assembly with divided secondary section track

The easiest way is to assemble the motor with a divided secondary section track. The prerequisite is that the entire secondary section track can be divided into two sections, of which each has at least the length of the slide.

Procedure

1. Assembly of the slide including the linear guide and the primary section

 **WARNING**

There are permanent magnets in the primary section!

The primary section's protective cover must not be removed yet. No loose ferromagnetic parts may be in the surrounding area of the primary section.

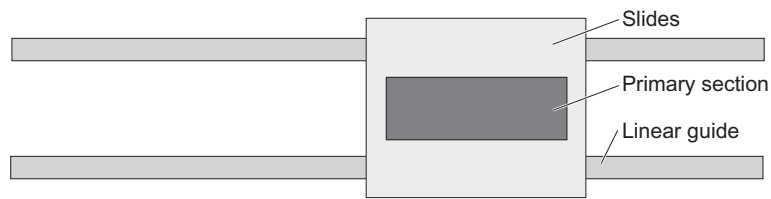

2. Move the slide to one side and mount the secondary section track on the other side.

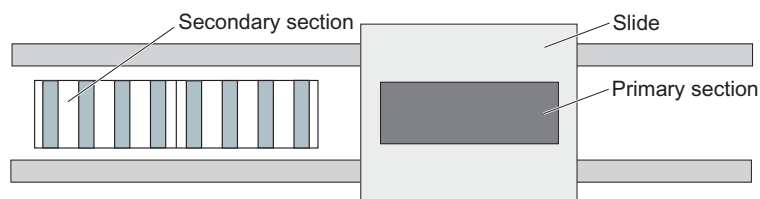

3. Push the slide over the mounted secondary section track. Here, make sure you are standing so that no injuries may occur in the direction of attraction. The attraction forces are taken up by the linear guides.

⚠ WARNING

When sliding the primary section onto the secondary section, there are significant attraction forces in the direction of the secondary section track. Danger of crushing!

Make sure that your fingers do not reach into the danger zone! This is especially true when the primary section is slid in the direction of the secondary section track.

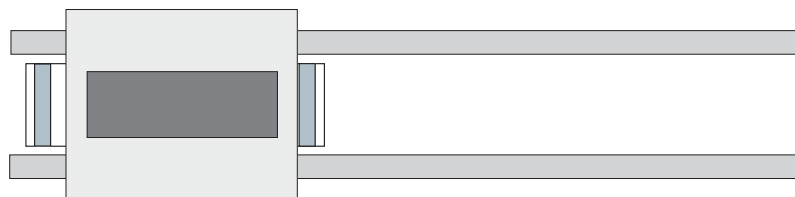

4. Assembly of the second secondary section track.

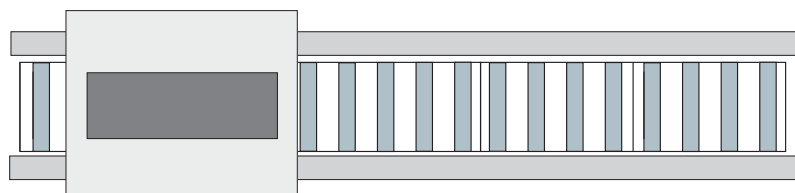

Motor assembly by insertion of the slide

This assembly procedure can be used if the motor is frequently assembled and disassembled for operational or maintenance purposes. Other application areas are if the secondary section track cannot be divided into several sections – for example, because the total length of the secondary section track is too small, or for a double-chamber motor.

Here, using a guide, the movable part of the motor (slide) is inserted into the stationary housing with already assembled motor parts. Normally, a special engaging device is used for this.

Note

Care should be taken that the guide fixture is accurately designed and can withstand the high attraction forces.

WARNING

In this procedure, pulling forces towards the stationary motor component occur. Danger of crushing!

The guide must take hold before the slide plate is inserted in the magnetically active section.

Before inserting the linear motor into the active zone, remember that guiding or supporting elements (motor bearing) must already be effective!

Motor assembly by mounting the motor components

In the third procedure for motor assembly, the primary section is mounted on the secondary section track before assembly in the slide, using a spacer and an extractor. The primary section is then mounted on the slide pushed over it. This procedure is the most difficult of the described procedures. It should be used only if the other procedures are not possible. The spacer and the extractor must be provided by the customer.

Procedure

WARNING

When the primary section is being mounted, high attraction forces (up to 30 kN) act in the direction of the secondary section track. Danger of crushing!

The forcing-off screws may not press on the secondary section and must be long enough to be able to lift the primary section after mounting.

1. Assembly of the secondary section track

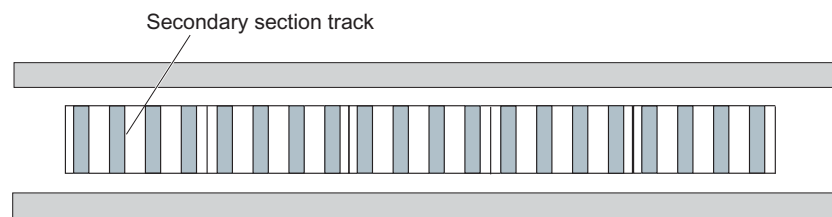

2. Mounting of the primary section

With the aid of an extractor, the primary section is positioned centrally above the secondary section track and lowered onto a spacer. Due to the attraction forces, the extractor must permit a clearance of 20 - 30 mm from the primary section to the surface of the secondary section track

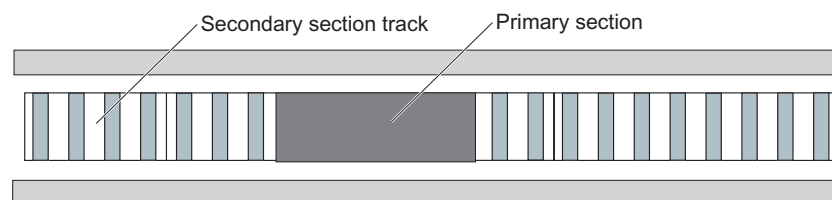

WARNING

Danger of crushing when mounting the primary section on the secondary section!

Never place the primary section directly onto the secondary section, but rather use a spacer made of non-magnetizable material (e.g. 1 mm plastic sheeting). The primary section must be carefully and slowly lowered using a suitable fixture.

3. Removing the extractor

The extractor and the thrust bearing blocks are removed, the spacers remain between the primary section and the secondary section track.

4. Assembly of the slide.

The primary section lifts into its specified position when the slide is evenly screwed into place. After that, the spacers are removed.

WARNING

Tightening the fixing screws on the primary section

All the fixing screws must be tightened uniformly, otherwise damage to the motor can result.

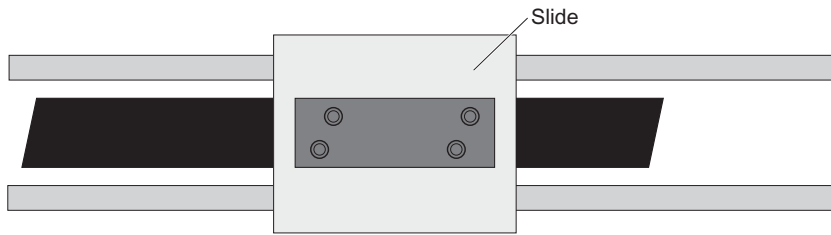

The extractor

The extractor to be made by the customer consists of a sufficiently thick plate to provide the stiffness. It is made from non-magnetic material and has through holes for fixing the primary section and threaded holes for mounting the forcing-off screws.

The following figures show the principle structure. Two thrust bearing blocks, also of non-magnetic material, are used to guide the forcing-off screws. The spacer prevents direct contact between the primary section and the secondary section.

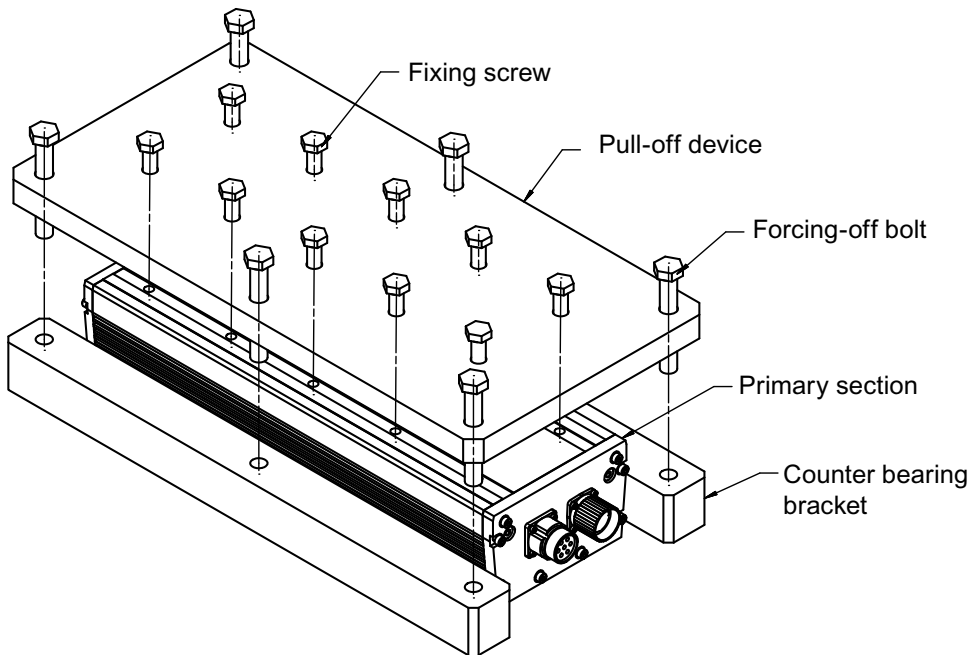

Figure 8-2 Principle structure of an extractor

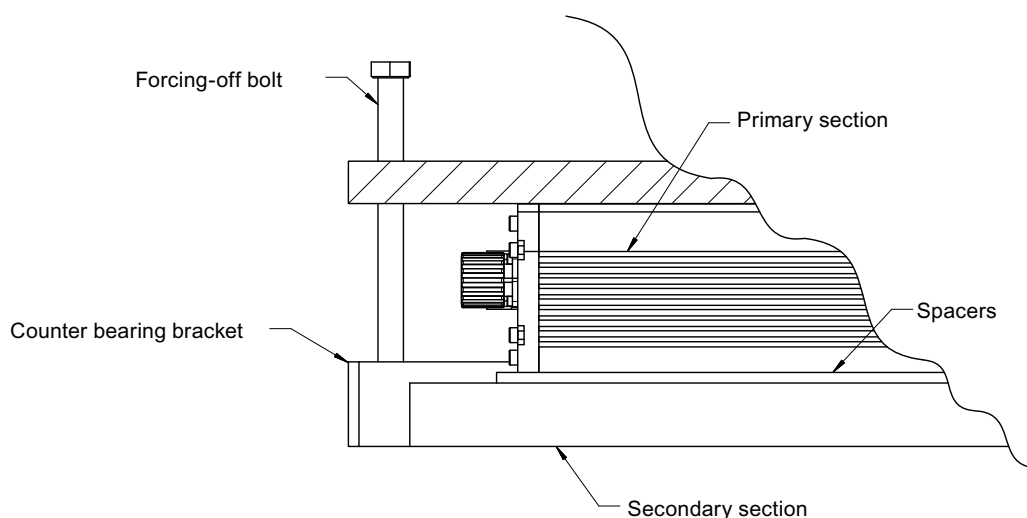

Figure 8-3 Principle structure of an extractor (longitudinal section)

8.5 Assembling individual motor components

Assembly of the secondary sections

The secondary sections are mounted to the machine base using a direct screw connection. The fixing screws are fastened to the secondary section sliding block from underneath via the hole in the machine base. The dimension of the holes can be found in the installation drawings of the relevant secondary section.

It is recommended to first screw in the secondary section lightly, adjusting if necessary (rubber hammer) and then finally to fix it permanently using the torque wrench.

The secondary section track must be level and clean.

Assembling the primary section

The primary section is mounted on the slide via threaded holes in the T-sliding blocks using a direct screw connection. The T-sliding blocks are inserted in the profile housing of the primary section back and prevented from slipping and sliding using threaded pins (T-slide locking mechanisms). When using a crane for handling purposes, locking is particularly important. The threaded pins should not be removed during assembly and must only be loosened if necessary.

CAUTION

If the reach of the fixing screws is incorrect, this can damage the motor components or cause other unfavorable conditions due to an insufficiently solid attachment of the motor components to the machine.

Please respect the maximum and minimum reach for the fixing screws!

General rules

- Use screws of property class 8.8 or 10.9
- Use only new, unused screws
- The mounting surfaces must be free from oil and grease and must not be painted
- Optimum surface roughness depth of the connection surface (R_z value = 10 to 40 μm)
- The number of joints should be minimized to keep down the amount of settling of material and screws (settling effect)
- Do not exceed the maximum bore hole depth on the primary section
- The screws are best tightened so that the angle of rotation is controlled. They should, however, at least be tightened with a calibrated torque wrench with as short a bit as possible
- Tighten the screws gradually
- Select a large clamp length l_k for securing the screws, if possible $l_k/d > 5$;
- Alternate: Secure the screws to prevent them from coming loose (e.g. with Loctite 242)

Fixing screws

Table 8-1 Secondary section fixing screws

Secondary section	Length of the secondary section	Number of fixing screws	Thread size
1FN6003	200	4	M 6
	500	10	M 6
1FN6007	200	4	M 6
	500	10	M 6
1FN6008	200	4	M 10
1FN6016	200	4	M 10
1FN6024	200	6	M 10

Tightening torques

Table 8-2 Tightening torques for fixing screws

Property class $\mu_{ges} = 0.1$	Thread size	Tightening torque
8.8	M 6	9.0 Nm
	M 8	21.6 Nm
	M 10	43.0 Nm
10.9	M 6	13.2 Nm
	M 8	31.8 Nm
	M 10	63 Nm

Note

The shaft of the bolts which are used to attach the secondary section to the machine base may not reach the thread.

Reach of screws

1FN6003 to 1FN6007:

Material	EN GJL-250	EN GJL-300	EN GJS-600-3	G-ALZN10Si8Mg	St 37	St 50
Reach of screw	1.4 • d	1.3 • d	0.7 • d	2.8 • d	1.8 • d	1.3 • d

1FN6008 to 1FN6024:

The maximum reach of screw of the secondary section supporting surface in the sliding block is 12 mm.

8.6 Checking the installation

Checking the smooth running of the slide

The motor assembly must be especially checked for the smooth running of the slide.

 **DANGER**

Any movement of primary sections in relation to secondary sections leads to induced voltages at the motor connections. Risk of electric shock!

Motor power connections must be properly connected and insulated.

Remove all tools and objects from the traversing range before moving the slide.

The slide of the linear motor must be able to be moved over the entire traversing range with uniform, minimum friction. The slide may not jam! If you suspect a jam, check the air gap at the appropriate position!

Note

When the motor is moved evenly, increased resistances ("power waves") may be noticeable at regular intervals, especially in case of short-circuits of the phases. These are related to the motor type and do not indicate faulty mounting.

Checking the air gap

After installing the motor components, the air gap can be subjected to an optional, approximate spot check. The mechanical air gap between the primary section and the surface of the secondary section track depends on the motor frame size:

Frame size	Mechanical air gap
1FN6003 to 1FN6007	0.6 mm
1FN6008 to 1FN6024	1.4 mm

For checking, several non-magnetic test strips with a graduation of 1/10 mm thickness are pushed into the air gap.

Generally, this test is not necessary. If the mounting dimensions are correct, the correct air gap is set automatically. If the tolerances for the air gap are exceeded, this is usually due to incorrect installation.

Note

The air gap must be checked when the motor is cold ($T < 30^{\circ} \text{C}$).

Connecting the motor

9.1 Interfaces

Position of the connections

The separate connections for power and temperature sensors are on the front face of the primary section. This makes them easily accessible for installation and servicing. All dimensions for the position of the connection elements can be taken from the installation diagrams.

Note

The connection system requires installation space!

Depending on the connection system, cables and hoses used, sufficient installation space should be provided in the longitudinal direction of the primary section.

9.2 Electrical connection

9.2.1 Safety instructions

! DANGER

Parts of electrical devices may be under voltage. There is a risk of electric shock.

A hazardous voltage is present at the motor terminals when the primary section is moving. All work involving the electrics must always be carried out by skilled personnel when the device is disconnected from the power supply and the motor is at a standstill.

The regulations for working on electrical installations must be strictly observed. In particular, the following safety rules for working on electrical installations in accordance with DIN EN 50110-1/BGV A3 must be observed:

- Disconnecting the system
- Secure against switching back on
- Make sure that the equipment is de-energized
- Ground and short-circuit
- Cover or cordon off adjacent live parts

It is only possible to work on electrical devices when they are de-energized. The protective conductor should be the first thing to be connected and the last to be disconnected.

All cables in safety extra-low voltage circuits (PELV), for example temperature sensor cables, must meet the requirements of protective separation in accordance with DIN EN 61800-5-1.

! DANGER

There is a danger of death, serious bodily injury (electrical shock) and/or property damage if direct drives are connected incorrectly.

The motors may only be connected according to the instructions. Direct connection of the motors to the three-phase supply is not permissible.

Consult the documentation of the drive system being used.

! DANGER

Any movement of primary sections in relation to secondary sections leads to induced voltages at the motor connections. Risk of electric shock!

Motor power connections must be properly connected and insulated.

Protective measures against residual voltages

! DANGER

There is a shock hazard danger due to the residual voltages at the motor terminals!

When the power supply voltage is switched-out, active parts of the motor can have a charge of more than 60 μC . In addition, at open-circuit cable ends - e.g. when a connector is withdrawn - even after the power has been disconnected, a voltage of more than 60 V can be present for 1 s. This is the reason that you must apply the appropriate measures to provide protection against residual voltages!

9.2.2 Prerequisites

Standard connection to SINAMICS

The following figure is a schematic representation of the standard electrical connection of linear motors of the 1FN6 product family to SINAMICS drive systems with MOTION-CONNECT® prefabricated cables.

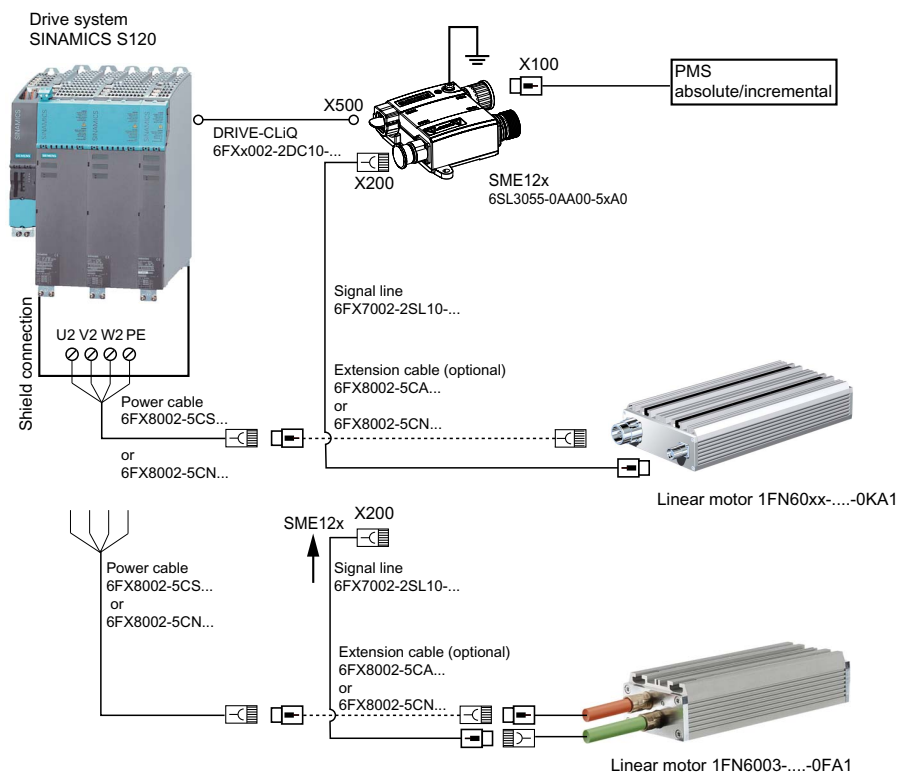

Figure 9-1 Standard connection of the 1FN6 product family

Signal connection

In the case of a signal connection, only connection cables with fully threaded connectors can be used on the motor side. SPEED CONNECT connections cannot be used. This applies both to the motor with flush-mounted box and the motor with fixed cable and connection socket.

Power connection

For the power connection, prefabricated cables with fully-threaded connectors or SPEED CONNECT connectors can be used as follows:

Table 9- 1 Compatible combinations for the power connection with fixed cables



Connection type on motor	Extension (option)	Connection cable on drive system
		
Fixed power cable with SPEED CONNECT connector, size 1	SPEED CONNECT 6FX8002-5CN05-1xx0	SPEED CONNECT 6FX8002-5CN01-1xx0 or fully-threaded connector 6FX8002-5CS01-1xx0
Fixed power cable with SPEED CONNECT connector, size 1	Fully-threaded connector 6FX8002-5CA05-1xx0	Fully-threaded connector 6FX8002-5CS01-1xx0

Table 9- 2 Compatible combinations for the power connection with flush-mounted boxes

Connection type on motor	Extension (option)	Connection cable on drive system
		
Flush-mounted box with SPEED CONNECT connector, size 1	SPEED CONNECT 6FX8002-5CN05-1xx0	SPEED CONNECT 6FX8002-5CN01-1xx0 or fully-threaded connector 6FX8002-5CS01-1xx0
Flush-mounted box with SPEED CONNECT connector, size 1	Fully-threaded connector 6FX8002-5CA05-1xx0	Fully-threaded connector 6FX8002-5CS01-1xx0
Flush-mounted box with SPEED CONNECT connector, size 1.5	SPEED CONNECT 6FX8002-5DQ48-1xx0	SPEED CONNECT 6FX8002-5CN41-1xx0 or fully-threaded connector 6FX8002-5CS41-1xx0
Flush-mounted box with SPEED CONNECT connector, size 1.5	Fully-threaded connector 6FX8002-5CA48-1xx0	Fully-threaded connector 6FX8002-5CS41-1xx0

Note

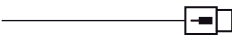
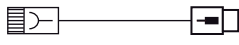
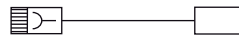
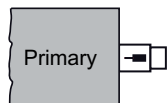
Remove the O-ring from the SPEED CONNECT connector before connecting it to a SPEED CONNECT mating connector.

In the case of a plug-in connection with a combination of SPEED CONNECT and fully-threaded connectors, the O-ring is necessary to ensure that the connection is tight and resistant to vibrations. Do not remove the O-ring if this combination is used.

Once a SPEED CONNECT connector has been correctly connected to a fully-threaded connector, a gap will remain between the connector and mating connector. This gap is due to the production process used. Do not try to eliminate this gap by tightening the connectors further. This could damage the connectors.

Releasing the plug-in connection for motors with flush-mounted boxes

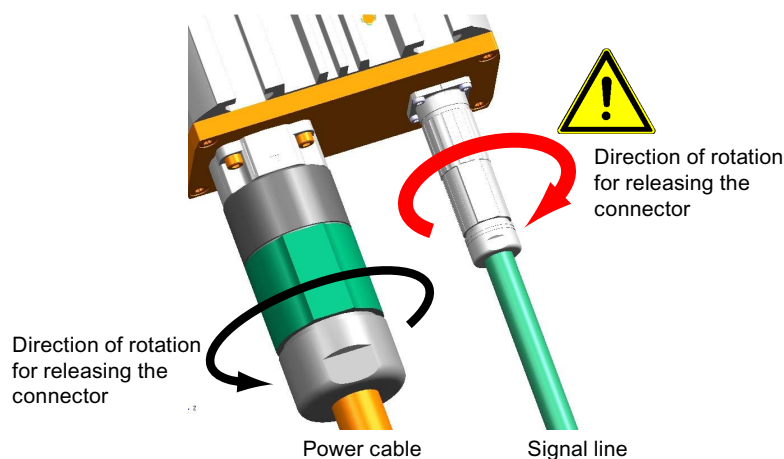

Figure 9-2 Releasing plug-in connections for motors with flush-mounted boxes

Note

Releasing the signal line from the motor by turning clockwise

When releasing the signal line from the motor, please be aware that (in contrast to the power cable) the screw cap is located on the flush-mounted box. To disconnect the signal line from the motor, you will need to turn the screw cap clockwise.

The power cable can be released in the usual way by turning the screw cap counterclockwise.

Maximum permissible cable lengths

The maximum permissible cable lengths depend, among other things, on the rated current and the size of the drive system. You can find details on the maximum lengths in the SIEMENS NC 61 (SINUMERIK & SINAMICS Equipment for Machine Tools) and PM 21 (SIMOTION, SINAMICS S120, and Motors for Production Machines) catalogs.

The figure below shows the maximum lengths for a circuit design with a shielded power cable and for the SINAMICS S120 drive system in booksize format.

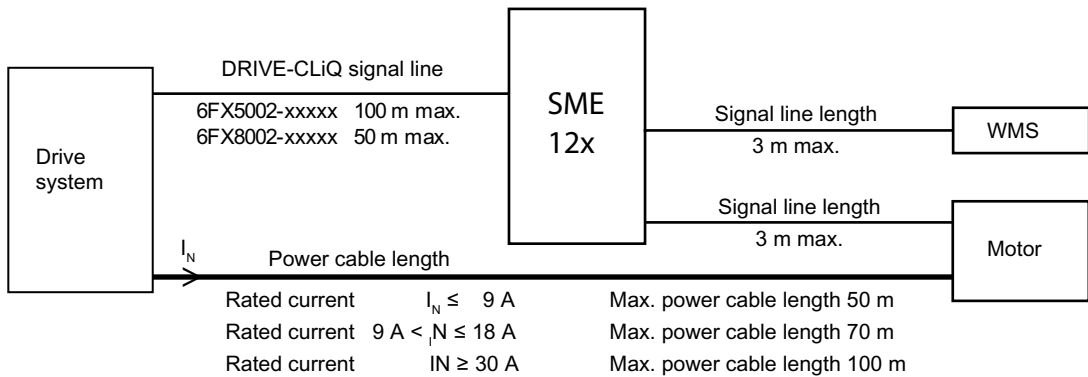

Figure 9-3 Maximum permissible cable lengths (shielded and drive system in booksize format)

Advantages of pre-assembled cables

Pre-assembled cables provide safety, perfect function and often cost advantages compared with self-assembled cables. Technical data for MOTION-CONNECT® signal lines (such as core cross-section, external diameter, maximum current load) is listed in the catalog.

Internal wiring of the primary section

The following figure shows the internal wiring of the primary section.

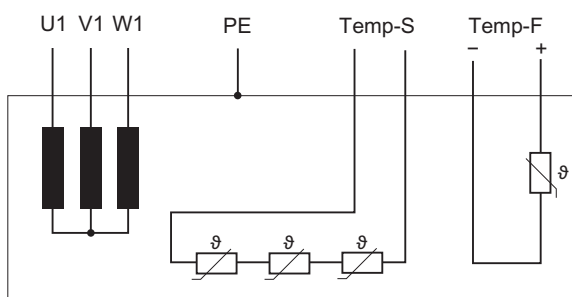
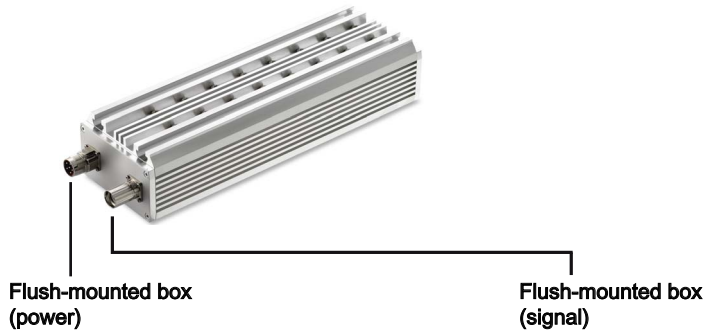

Figure 9-4 Internal wiring of the primary section

9.2.3 Electrical connections on the motor

Frame sizes 1FN6007 to 1FN6024



Frame size 1FN6003

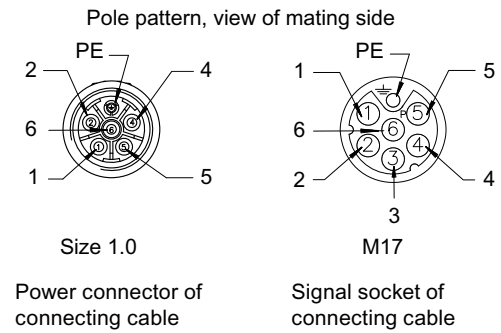
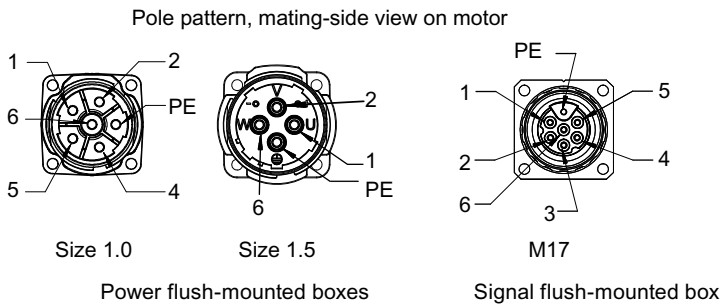
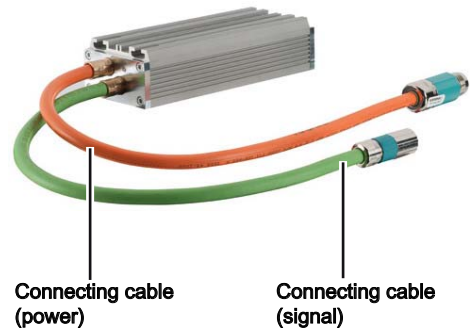

Electrical pin assignment for power

PIN	Power cable
1	U
2	V
PE	PE
4	-
5	-
6	W

Electrical pin assignment for signals

PIN	Signal line
1	+1R2:KTY -
2	+1R1:KTY +
3	1TP1: PTC
4	1TP2: PTC
5	
6	
⏏	PE

Figure 9-5 Pin assignment of flush-mounted boxes/connecting cables

Number of conductors and cable cross-sections

Cables that are connected to the motor must have four conductors for the power cable / five conductors (4 signal cables + PE) for the signal cable. The cross-section for each of the signal cable conductors is 0.5 mm². The cross-section of the power cable conductors is based on the rated current of the motor. The rated current of the motor must be smaller than the current carrying capacity of the cable according to IEC 60204-1 (laying system C). The table below specifies the maximum permissible rated current of the motor for different cross-sections of the power cable conductors.

Table 9- 3 Maximum permissible rated current with different cross-sections of the power cable conductors at an ambient temperature of 40 °C

Power cable conductor cross-section	2.5 mm ²	4 mm ²	6 mm ²	10 mm ²	16 mm ²	25 mm ²
Maximum permissible rated current	21 A	28 A	36 A	50 A	66 A	84 A

9.2.4 Connection of the power and signal cables

The power cables are connected directly or via an intermediate terminal to the designated positions on the power module. Take the shielding and grounding into account!

In the same way, the signal cables are connected directly or via an intermediate terminal to a sensor module.

9.2.5 Connecting the temperature monitoring circuits

Protective separation in accordance with DIN EN 61800-5-1

The temperature monitoring circuits do not meet the requirements for protective separation in accordance with DIN EN 61800-5-1. Consequently, evaluation units may only be connected via circuits that feature integrated protective separation, e.g. SINAMICS SME 12x.

No direct connection of the temperature monitoring circuits!

! DANGER

The temperature monitoring circuits pose a risk of electric shock!

If temperature monitoring circuits Temp-F And Temp-S are connected directly using the encoder connector of the SMC20 (X520 pin 13 and pin 15), the requirements of DIN EN 61800-5-1 will not be met in respect of safety isolation. This type of connection is therefore not permitted. Use, for example, the SME12x or TM120 to connect the Temp-F and Temp-S temperature monitoring circuits.

Possible connections

The connection of the temperature sensors via an SME is the standard version of the temperature evaluation.

Connection of the temperature sensors via SME12x

Plug-in connections are used to connect the temperature sensors via the SME12x. The temperature sensor signals are transmitted to the drive system, along with the position measuring system signals, via a DRIVE-CLiQ connection.

Pin assignment of the temperature sensor - SME interface

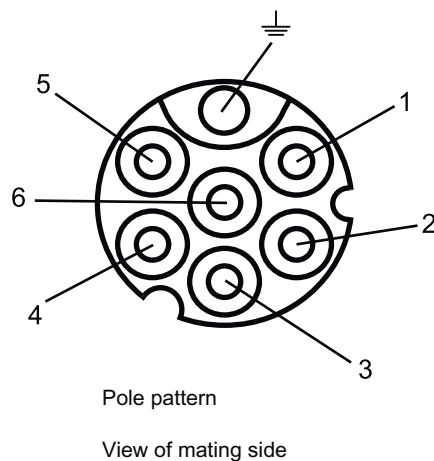

Figure 9-6 Pole layout of the temperature sensor - SME interface

Table 9- 4 Pole layout of the temperature sensor - SME interface

Conductor assignment for cable 6FX7002-2SL00-...	Pin	Sensor contact
white	1	-1R2: KTY-
brown	2	+1R1: KTY+
green	3	1TP1: PTC
yellow	4	1TP2: PTC
gray	5	
pink	6	
green/yellow	\perp	PE

Note

To connect the motor to the SME, you need a signal connector with the MLFB 6FX2003-0SU07.

9.2.6 Connection of the position measuring system

Connection method

The required connection method for the length scales depends mainly on the type of scale used. Connection via an SME is the standard method. There the signals of the temperature monitoring circuits are combined with the signals of the position measuring system and forwarded to the drive system interface.

Cable laying regulations

Encoder cables must be laid separately from the power cables.

Advantages of pre-assembled cables

Pre-assembled cables provide safety, perfect function and often cost advantages compared with self-assembled cables. Technical data for MOTION-CONNECT® signal lines (such as core cross-section, external diameter, maximum current load) is listed in the catalog.

9.2.7 Connecting the motors in parallel

Connection diagram

The following figure shows the connection diagram for two primary sections connected in parallel. The power cables for each motor are connected to the designated terminals on the power module. An intermediate terminal is possible in order to combine the power cables of the individual motors before they are connected to the power module.

! DANGER

Risk of electric shock!

Only 2x2 conductors of the signal cables are required. Free signal conductors must be insulated. The insulation must be able to withstand the rated voltage of the motor.

Note

When connecting primary sections in parallel, the power cables should be of equal length in order to ensure even current distribution.

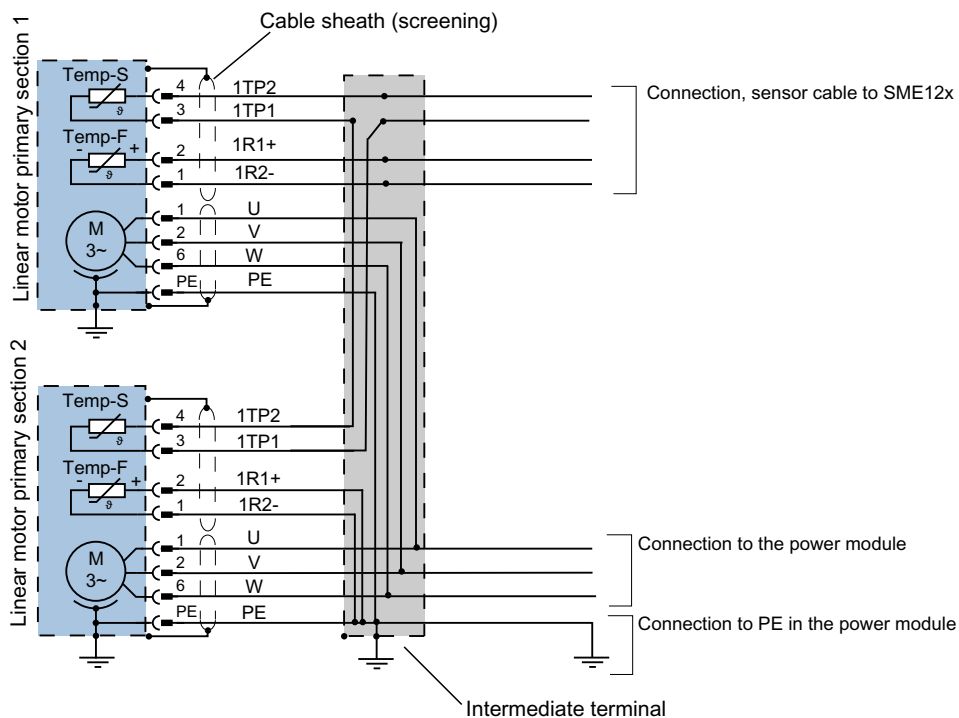

Note:

The terminal box for the intermediate terminal is not required when cables are directly connected at the power module.

Figure 9-7 Connection diagram for two primary sections connected in parallel

Note

Temperature sensors on the SME12x

The SME 12x enables you to evaluate a total of three temperature channels. This means that if you have 2 parallel motors, the Temp-S signals can be connected separately to the SME12x as well as the Temp-F signal. In contrast to series connection, the motor responsible for triggering a fault can be pinpointed.

Note

When connecting the motors, please follow the instructions for shielding and grounding.

⚠ WARNING

A failure of the phase current circuit of one primary section can cause excessively high currents in the primary sections connected in parallel. This may result in a demagnetization of the permanent magnets.

Be careful with all connections and wiring and replace worn power cables immediately!

Phase sequence with the same cable outlet direction

The phase sequence from master and stoker is identical if the cable outlet direction is the same, see the following table.

Table 9- 5 Phase sequence for PARALLEL and TANDEM arrangement

	Phase		
Master	U	V	W
Stoker	U	V	W

Phase sequence with opposite cable outlet direction

One phase of the stoker is assigned as for the master, the other two are switched. The following table shows the phase sequence of the master and stoker with opposite cable outlet direction.

Table 9- 6 Phase sequence for ANTI-PARALLEL and JANUS arrangement for 1FN6 motors

	Phase		
Master	U	V	W
Stoker	U	W	V

Connection of the primary sections for double-sided motors

The primary sections of double-sided motors are connected in parallel in accordance with the following table.

Table 9- 7 Connection of double-sided motors

	Phase		
Master	U	V	W
Stoker	U	V	W

9.2.8 Cable routing regulations

General notes for the laying of electric cables

Note

Drives with linear motors are exposed to a high dynamic load. The operator must ensure that mechanical vibrations are not transmitted to the plugs by using suitable wiring and tension relief of the cables.

When laying electrical cables, observe the following:

- The cables must fulfill the following requirements:
 - Sufficiently high dynamic-mechanical strength (due to high accelerations and velocities)
 - Thermal stability up to 80° C (static) or 60° C (dynamic)The recommended MOTION-CONNECT® cables fulfill these requirements.
- The cables may not chafe anywhere.
- The cables must be fixed into place after a maximum of 200 mm.
- The signal cables must be separated from the power cables in order to avoid cross interference
- Always observe the manufacturer's specifications regarding installation.
- The permissible bending radii must be adhered to.

Note

Please also observe the details in catalog NC 61 here.

Using the cables in the cable carrier

Note

When laying cables, carefully observe the instructions given by the cable carrier manufacturer!

To maximize the service life of the cable carrier and cables, cables in the carrier made from different materials must be installed in the cable carrier with spacers.

The chambers must be filled evenly to ensure that the position of the cables does not change during operation. The cables should be distributed as symmetrically as possible according to their mass and dimensions.

If possible, use only cables with equal diameters in one chamber. Cables with very different outer diameters should be separated by spacers.

The cables must not be fixed in the carrier and must have room to move. It must be possible to move the cables without applying force, in particular in the bending radii of the carrier.

The specified bending radii must be adhered to. The cable fixings must be attached at both ends at an appropriate distance away from the end points of the moving parts in a dead zone.

A tension relief must be installed at least at the ends of the cable carrier. Be sure to mount the cables along the casing without crushing them.

The cables are to be taken off the drum free of twists, i.e. roll the cables off the drum instead of taking them off in loops from the drum flange.

9.2.9 Shielding, grounding, and equipotential bonding

Rules

Correct installation, correctly connecting cable shields and protective conductors is very important, not only for the safety of personnel but also for the effect on interference emission and interference immunity. Therefore, the following must be carefully observed:

- All cable shields must be connected to the respective housing using clamps or suitable terminal or screwed connectors
- Connecting only a few shield conductors or combining shield conductors in one cable is not permitted
- Connect the power cable shield at the shield connection of the power module.
- Apply the EMC installation guideline of the converter manufacturer. For Siemens converters, this is available under Order No. 6FC5297-□AD30-0AP□.

! DANGER

Risk of electric shock!

Hazardous touch voltages can be present at unused cores and shields if they have not been grounded or insulated.

Unused cores of unshielded or shielded cables and their shields must either be connected at one end to the grounded housing potential or they must be insulated. The insulation must be able to withstand the rated voltage.

Electrical charges that are the result of capacitive cross coupling are discharged by connecting the cores and shields.

Note

Unshielded or incorrectly shielded cables can lead to faults in the drive – particularly the encoder – or in external devices.

Note the topics mentioned above!

Note

High leakage currents may damage other devices if the motor PE is not directly connected to the power unit.

Connect the motor protective conductor (PE) directly at the power unit.

Advantages of pre-assembled cables

Pre-assembled cables provide safety, perfect function and often cost advantages compared with self-assembled cables. Technical data for MOTION-CONNECT® signal lines (such as core cross-section, external diameter, maximum current load) is listed in the catalog.

10.1 Safety instructions

 **DANGER**
There is a danger of death, serious bodily injury and/or property damage if a machine is commissioned which does not meet the recognized safety requirements.

 **DANGER**
Unexpected movements of the motor may present a danger of death, serious bodily injury (crushing) and/or property damage.
Never reach into the moving parts of the machine when it is switched on.
Keep persons away from moving parts and areas where there is a danger of crushing.
Make sure the machine can move unobstructed.
Check the commutation before switching on. Also observe the instructions of the drive system being used.
Limit the motor currents.
Set the velocity limit to low values.
Monitor the end positions of the motor.

 **DANGER**
Danger due to high leakage currents
If high leakage currents are present, more stringent requirements may apply to the PE conductor. Warning signs may also be required on the PDS. You can find more detailed information in the standard DIN EN EN 61800-5-1.

 **WARNING**

The surface temperature of the motors may be more than 100 °C (212 °F). Risk of burns

Make sure that the cooling system (if available) is working properly.

Do not touch the motor during/directly after use.

Display the "Hot Surface Do Not Touch" (D-W026) warning sign clearly in the vicinity of the motor.

Temperature-sensitive parts (electric cables, electronic components) may not be placed on hot surfaces.

10.2 Checking prior to the commissioning

Prior to commissioning the motor, the following items should be checked once more:

- The smooth running of the slide
- The effectiveness of the temperature protection

NOTICE

The motor may overheat without temperature protection and be destroyed.

Check whether the temperature protection is effective before (!) switching on the DC link voltage for the first time!

10.3 Notes on commissioning system elements

Commissioning a holding brake

When a holding brake is used, the response of the holding brake must be synchronized with the drive. This prevents movement when switching the drive on and off. For commissioning, please observe the documentation of the drive system being used.

Pole position identification (SINAMICS adjustable parameter: p1980)

Unless an absolute position measuring system is used, pole position identification must be carried out (p1982= 1) whenever the drive is reinitialized.

Both the techniques available for identifying the pole position for 1FN6 motors have the following adjustable parameters:

p1980 = 1: Saturation-based procedure with evaluation of the 1st harmonic

p1980 = 10: Movement-based procedure

The technique used depends on the supplementary conditions of the axis. A detailed description of the pole position identification process can be found in the SINAMICS S120 (6SL3097-2AB00-0AP5) Function Manual.

Encoder adjustment (SINAMICS adjustable parameter: p1990)

The function for determining the commutation angle offset is activated via p1990=1.

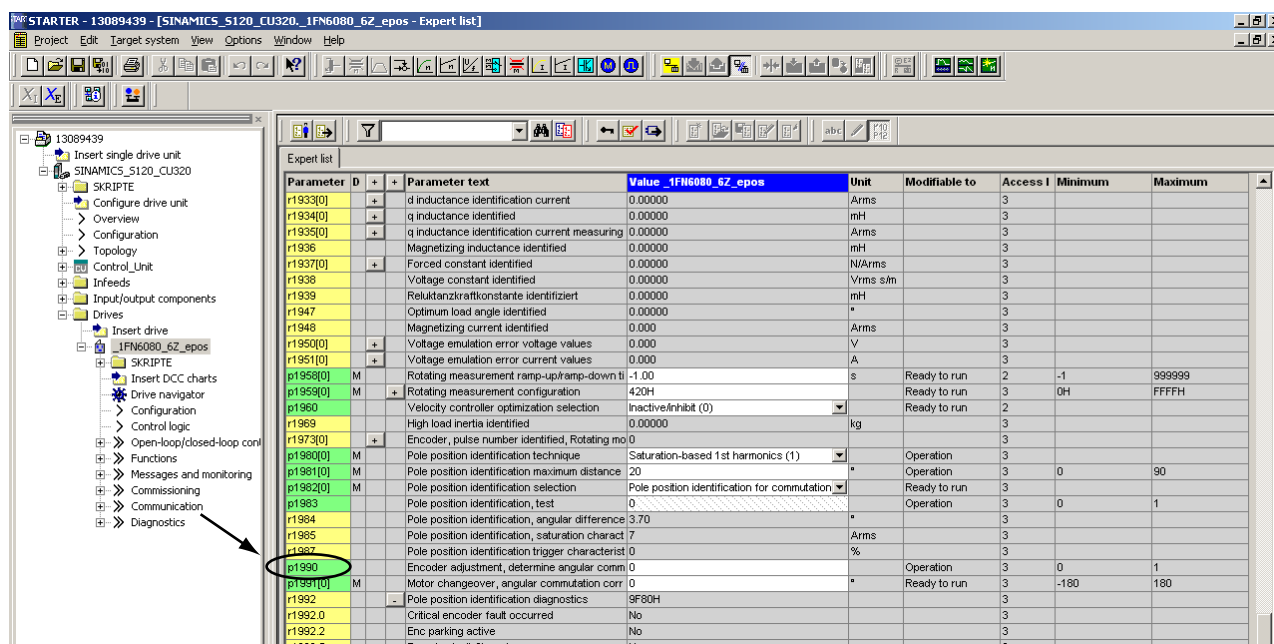

Figure 10-1 Menu for activating the commutation angle offset

The commutation angle offset is entered in parameter p431. It is used for one-off calibration of the pole position for encoders with absolute information, or for calibrating the zero mark position for fine synchronization for incremental measuring systems. A detailed description of p1990 can be found in the SINAMICS S120 (6SL3097-2AB00-0AP5) Function Manual.

The pole position identification process (p1980) can determine a commutation angle offset (p431) for 1FN6 motors which deviates more than $\pm 7^\circ$ from the optimum pole position. It is dependent on the position of the motor at the start of the measuring routine. Therefore it is necessary to check the value determined for p431 to see if it is plausible. To find out how this is done, see the parameter description of p1990 in the SINAMICS S120 Function Manual.

Mechanical checking of the commutation position

The section below explores a way of checking the commutation position based on a mechanical method.

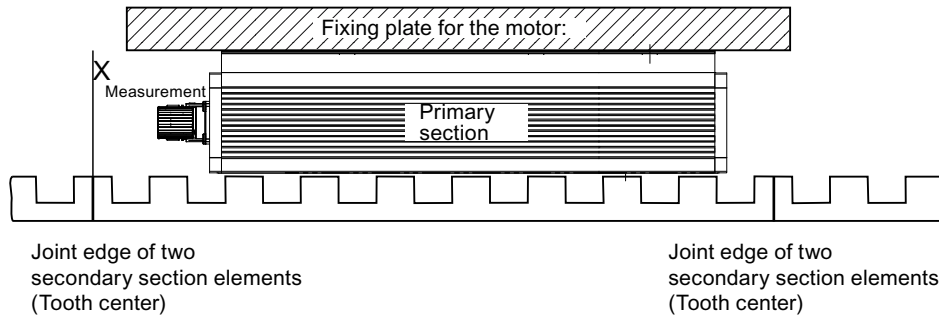

Figure 10-2 Schematic representation for checking the commutation position

After successful commissioning and fine synchronization of the axis, the drive must first be moved to a distance X, as described above. Since the position may not be measured during regular operation, it is enough if the axis stands at approximately the desired position. The precise relative position of the drive can be read via parameter r93.

r76	CO: Current actual value, field-generating	-0.00	Arms	3
r77	Stromsollwert kraftbildend	0.00	Arms	3
r78[0]	Current actual value, torque-generating, Uns	0.00	Arms	3
r79[0]	Torque setpoint total, Unsmoothed	0.00	N	3
r80	Force actual value	-0.10	N	3
r81	Force utilization	0.0	%	3
r82[0]	Active power actual value, Unsmoothed	0.00	kW	3
r83	CO: Flux setpoint	100.0	%	3
r84	CO: Flux actual value	100.0	%	3
r89[0]	Actual phase voltage, Phase U	0.0	V	3
r93	CO: Pole position angle electrically normalized	0.29	°	3
r94	CO: Transformation angle	67.68	°	3
p100	IEC/NEMA mot stds	IEC-Motor (50 Hz, SI units) (0)		Commissioning (P1)
r103	Application-specific view	0		2
p105	Activate/de-activate drive object	Activate drive object (1)		Ready to run

Figure 10-3 Menu for setting the pole position angle r93

Calculation formulae for theoretical pole position = 0° with distance X

(opposite side of the cable outlet)

n = multiple of the pole pitch (1,2,3,...), select n large enough, so that $\Delta X > 0$

$X_{\text{Pollage} = 0^\circ}$ = distance X at pole position = 0°

X_{Messung} = measured distance from the abutting edge of two secondary section elements to the housing profile edge of the primary section

Frame size	Pole pitch $2T_P$ [mm]	Calculation of $X_{Pollage = 0^\circ}$ [mm]	Thickness of front/rear plate
1FN6003...1FN6007	25	$1 + n \cdot 2T_P$	Natural cooling = 6 mm Water cooling = 14 mm
1FN6008...1FN6024	50	$8 + n \cdot 2T_P$	Natural cooling = 8 mm

1FN6003 to 1FN6007

$$\Delta X = X_{Pollage = 0^\circ} - X_{Messung}$$

$$\Delta \phi = \Delta X \cdot 360^\circ / 25 \text{ mm}$$

1FN6008 to 1FN6024

$$\Delta X = X_{Pollage = 0^\circ} - X_{Messung}$$

$$\Delta \phi = \Delta X \cdot 360^\circ / 50 \text{ mm}$$

Commutation angle offset

The commutation angle offset p431 is set correctly if $\Delta \phi$ and r93 have the same value.

p421[0]	E	+	Absolute encoder rotary multi-turn resolution	4096		Commissioning (P1	3	0
p422[0]	E	+	Absolute encoder linear measuring step resol	100	mm	Commissioning (P1	3	0
p423[0]	E	+	Absolute encoder rotary single-turn resolutio	8192		Commissioning (P1	3	0
p424[0]	E	+	Encoder, linear zero mark distance	80	mm	Commissioning (P1	3	0
p425[0]	E	+	Encoder, rotary zero mark distance	2048		Commissioning (P1	3	0
p427[0]	E	+	Encoder SSI baud rate	100	kHz	Commissioning (P1	3	0
p428[0]	E	+	Encoder SSI monoflop time	30	µs	Commissioning (P1	3	0
p429[0]	E	+	Encoder SSI configuration	0H		Commissioning (P1	3	0H
p429[0]	E	+	Sensor Module configuration	0H		Commissioning (P1	3	0H
p431[0]	E	-	Angular commutation offset	143.46	*	Commissioning (P1	3	-180
p431[1]	E	-	Angular commutation offset	172.64	*	Commissioning (P1	3	-180
p431[2]	E	-	Angular commutation offset	0.00	*	Commissioning (P1	3	-180
p432[0]	E	+	Gearbox factor, encoder revolutions	1		Commissioning (P1	3	1
p433[0]	E	+	Gearbox factor, motor load revolutions	1		Commissioning (P1	3	1
p434[0]	E	+	Encoder SSI error bit	0		Commissioning (P1	3	0
p435[0]	E	+	Encoder SSI alarm bit	0		Commissioning (P1	3	0
p436[0]	F	+	Encoder SSI parity bit	n		Commissioning (P1	3	n

Figure 10-4 Menu for setting the commutation angle offset p431

If there is a difference greater than $\pm 5^\circ$ between $\Delta \phi$ and r93, the commutation angle offset p431 must be adjusted by the difference:

10.4 Example for checking the commutation position

Prerequisites

- Drive is fine synchronized ($r1992.8 = 1$)
- Jog operation
- The distance from the housing profile to the secondary section abutting edge can be measured

Measuring the distance

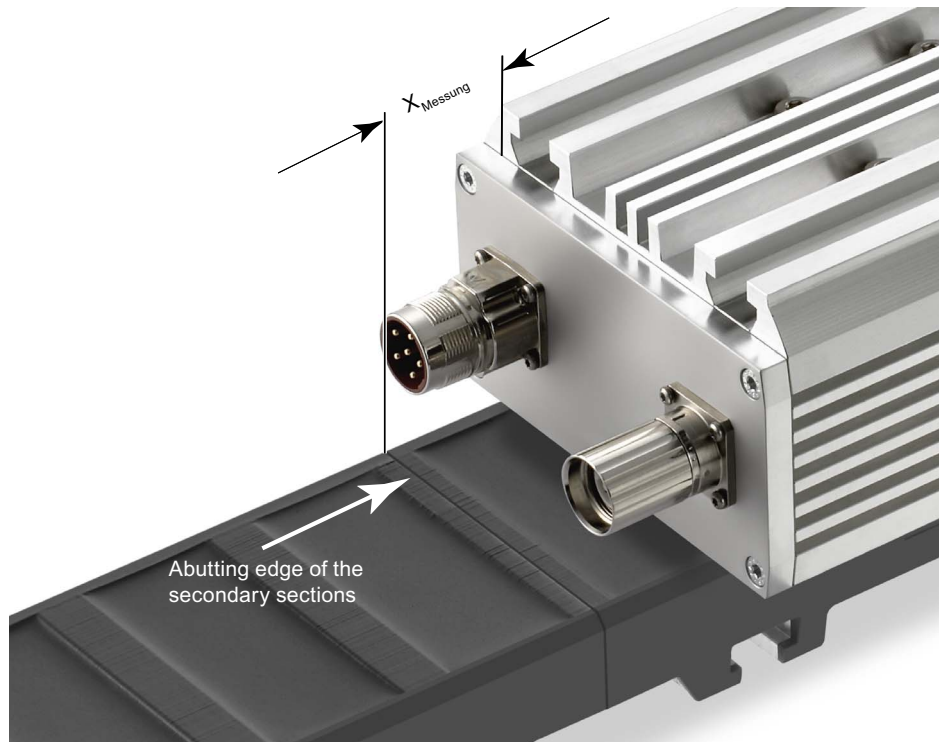

Figure 10-5 Measuring point for the slide gauge

Measured distance: $X_{\text{Messung}} = 45 \text{ mm}$

Example calculation of pole position deviation for 1FN6008

$$X_{\text{Pollage}=0^\circ} = 8 \text{ mm} + n \cdot 50 \text{ mm}$$

$$X_{\text{Pollage}=0} = 58 \text{ mm}$$

$$X_{\text{Pollage}=0} > X_{\text{Messung}}$$

$$\Delta X = X_{\text{Pollage}=0} - X_{\text{Messung}}$$

$$\Delta X = 58 \text{ mm} - 45 \text{ mm} = 13 \text{ mm}$$

$$\Delta \phi = \Delta X \cdot 360^\circ / 50 \text{ mm}$$

$$\Delta \phi = 13 \text{ mm} \cdot 360^\circ / 50 \text{ mm} = 93.6^\circ$$

Pole position angle $r_{93} = 46.87^\circ$ (value determined during commissioning)

This gives a deviation of $(93.6^\circ - 46.87^\circ) = 46.73^\circ$.

Since the deviation lies outside the $\pm 5^\circ$ tolerance, the commutation angle offset determined during commissioning ($p_{431} = 143.46^\circ$) must be increased by 46.73° .

$$\text{New value for } p_{431} = 143.46^\circ + 46.73^\circ = 190.19^\circ$$

Check the commutation angle offset

- Save value p431
- Carry out fine synchronization again
- Check the distance
- Recalculate pole position deviation

10.5 Commissioning multiple, parallel primary sections

General Information

If you are sure that the EMFs of more than one motor have the same phase relation to one another, the connecting cables can be connected in parallel and operated on one converter.

Parallel linear motors are commissioned based on the commissioning of a single linear motor. The number of primary sections is entered in the STARTER tool using the menu item "Motor" (p0306) during drive configuration

Note**Prerequisites for parallel connection of linear motors**

Which primary sections can be connected in parallel and what needs to be observed when doing so is described in the chapter "Motors connected in parallel".

Procedure

- First, only one linear motor (motor 1) is connected to the converter and is commissioned as an individual motor. The commutation angle offset is automatically determined and noted.
- One of the other motors is then connected in place of motor 1 and commissioned as an individual motor. The commutation angle offset is also automatically determined and noted here.
- If the difference between the commutation angle offset of motor 1 and the other motors is less than 10 degrees electrically, all linear motors can be connected to the converter in parallel and commissioned with parallel connection.

Temperature sensor connection

The evaluation of the temperature switches takes place via the connection to an SME..12x

10.6 Checking the linear motor by taking measurements

Why make measurements?

If the linear motor was commissioned according to the relevant instructions, and unexplained fault messages still occur, then all of the EMF signals must be checked using an oscilloscope.

Checking the phase sequence U-V-W

For primary sections connected in parallel, the EMF_U from motor 1 must be in phase with the EMF_U from motor 2. The same is true for EMF_V and EMF_W. It is absolutely necessary that this is checked by making the appropriate measurements.

Taking the necessary measurements

- Disconnect the drive line-up from the power supply.
- Notice: Wait until the DC link has been discharged!
- Disconnect the power cables from the drive.
Disconnect any primary components connected in parallel.
- Form an artificial neutral point using 1 kOhm resistors.

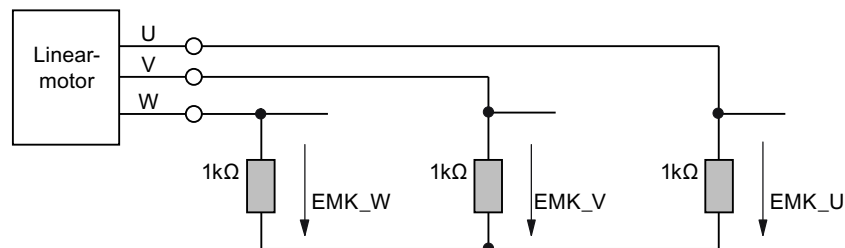

Figure 10-6 Configuration for taking the measurements

For a positive traversing direction, the phase sequence must be U-V-W. The direction of the drive is positive if the primary section moves relative to the secondary section in the opposite direction to the cable outlet direction.

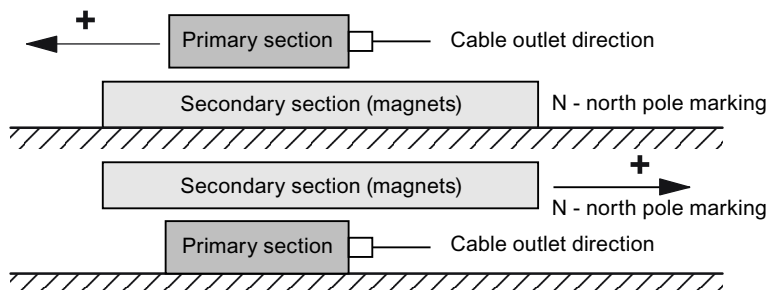

Figure 10-7 The positive direction of the drive (clockwise rotating field)

Determining the commutation angle using an oscilloscope

Once the oscilloscope has been connected, the drive must first pass the zero mark so that fine synchronization can be carried out.

The angular, commutation offset can be determined by measuring the EMF and normalized electrical pole position via an analog output.

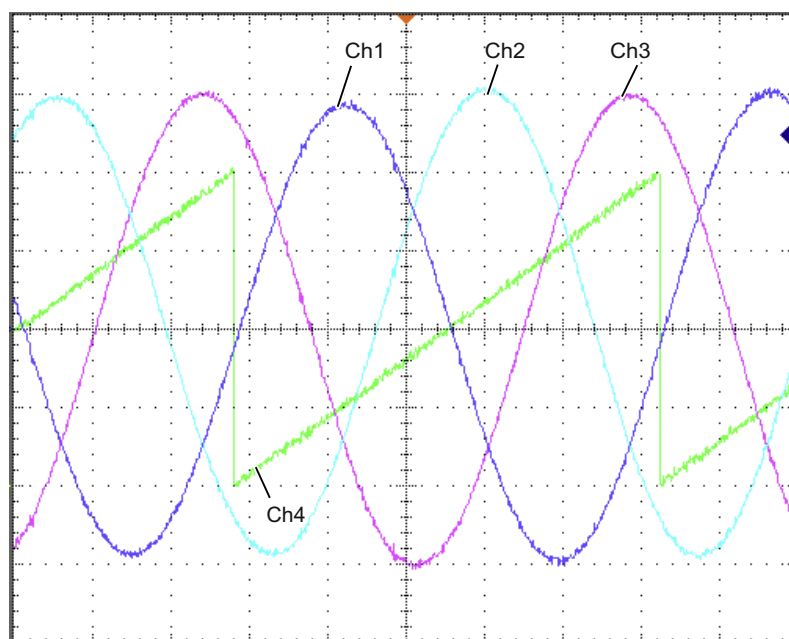

Figure 10-8 Oscillogram

Definition of channels (Ch1 ... Ch4):

- Ch1 EMF phase U to neutral point
- Ch2: EMF phase V to neutral point
- Ch3: EMF phase W to neutral point
- Ch4: Normalized electrical angular pole position via analog output

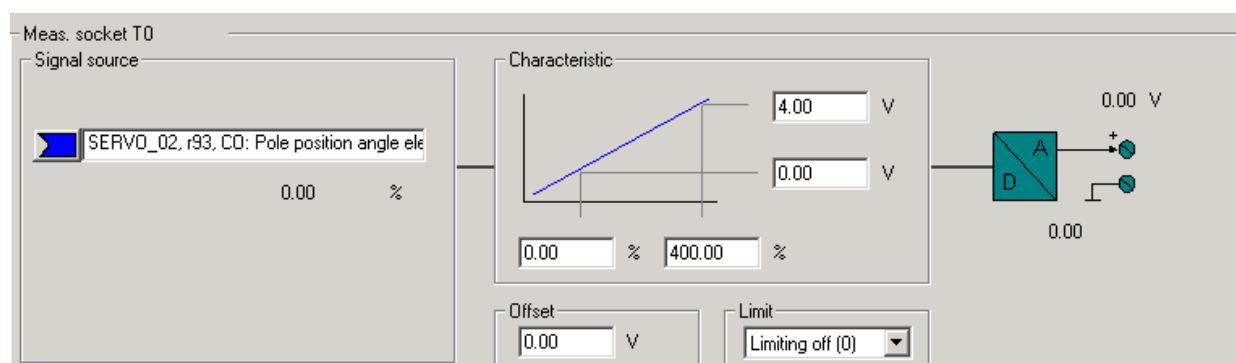

Figure 10-9 Setting of the measuring socket T0 on CU320

10.6 Checking the linear motor by taking measurements

When the drive is synchronized, the difference between the EMF/phase U and the electrical rotor position is a maximum of 10°.

If the difference is greater, the commutation angle offset must be adjusted.

 **DANGER**

Machine parts driven by direct motors pose a considerable danger of injury – e. g. crushing – due to the very high speed and acceleration and the low friction and self-locking characteristics.

Keep people away from moving parts and areas where there is a danger of crushing.

 **WARNING**

Improper operation can lead to serious property damage.

Check continuously whether the temperature protection is effective!

Keep the motor compartment free from foreign bodies (chips, particles, liquids, oils, screws, tools, etc.).

Listen for noise!

If there are problems during operation (e.g. problems with positioning accuracy), check the freedom of movement and the current consumption of the motor. Problems with accuracy may also have other causes (e.g. machine design).

Maintenance and repairs

12.1 Safety instructions

Safety guidelines for maintenance

 **DANGER**

There is a danger of death, serious bodily injury and/or property damage when maintenance work is performed with the machine switched on.

Always isolate the machine reliably from the power supply before working in areas with moving parts! The machine must also be secured against unwanted movements.

 **DANGER**

If work is carried out on the motor immediately after it has been in operation, there is a risk of burns if you come into contact with hot surfaces. The cooling water temperature can also increase after the motor has already been switched off.

To cool the motor down to the level of the inlet temperature T_{VORL} , the cooler must remain in operation for at least 30 minutes after the motor has been switched off. If the cooler is switched off, however, it takes significantly longer for the motor to cool down. This depends to a large extent on the installation situation.

 **DANGER**

Risk of burns

Risk of pressure surges: Do not switch the cooler on if the motor was operated without a cooler beforehand. The major build-up of steam can cause burns or destroy the motor.

When you open the cooling circuit, there is a risk of burning when the hot cooling water and steam escapes. If the motor is operated with the cooler, the cooling water in the cooling system heats up.

Do not open the motor cooling circuit until the motor has cooled down.

The motors have been designed for a long service life. Carefully ensure that maintenance work is correctly performed, e.g. removing chips and particles from the air gap.

For safety reasons it is not permissible to repair the motors:

 **DANGER**

Risk of death, serious bodily injury and/or material damage if the safety-relevant motor properties are changed.

Examples of changed safety-relevant motor properties:

- Damaged insulation does not protect against arcing. There is a risk of electric shock!
- Damaged sealing no longer guarantees protection against shock, ingress of foreign bodies and water, which is specified as IP degree of protection on the rating plate.
- Diminished heat dissipation can result in the motor being prematurely shut down and in machine downtime.

Do not open the motor.

Note

If incorrect changes or corrective maintenance are carried out by you or a third party on the contractual objects, then for these and the consequential damages, no claims can be made against Siemens regarding personal injury or material damage.

Siemens service centers are available to answer any questions you may have. Siemens Service Center addresses can be found at <http://www.automation.siemens.com/partner/>

 **WARNING**

Sharp edges can cause cuts and falling objects can injure feet.

Always wear work gloves and safety shoes.

Notes for checking the insulation resistance

 WARNING

An insulation resistance inspection under high-voltage conditions can damage the motor insulation!

If insulation resistance inspections need to be carried out on a machine/plant with direct drives or directly on the motors (e.g. installation inspection, preventive maintenance, troubleshooting), only inspection devices that comply with DIN EN 61557-1, DIN EN 61557-2, and DIN EN 61010-1 (or the relevant IEC standards) can be used.

The inspection may only be carried out with a maximum direct voltage of 1000 V for a maximum time of 60 s! The test voltage should be measured with respect to ground or the motor enclosure. If a higher DC or AC voltage is necessary for the purposes of inspecting the machine/plant, you must arrange the inspection with your local Siemens office.

Please follow the operating instructions for the inspection device!

Inspections of the insulation resistance on individual motors must always be carried out as follows:

1. Connect all winding and temperature sensor connectors with each other; inspection voltage not to exceed 1000 VDC, 60 s against PE connection.
2. Connect all temperature sensor connectors to the PE connector and all winding connectors with each other; the inspection voltage must not exceed 1000 VDC, 60 s, winding against PE connector.

Each insulation resistance must be at least 10 MΩ, otherwise the motor insulation is defective.

12.2 Maintenance



WARNING

The permanent magnets are in the primary section.

During maintenance, care must be taken that magnetizable materials and tools are kept far away from the primary section housing.

Measures to lengthen the service life

Because of their principle of operation, direct drives are in principle free of wear. To ensure the function and the freedom from wear of the motor, the following maintenance work is necessary:

- Check for freedom of movement regularly
- Clear foreign objects (e.g. chips) regularly from the motor area
- Check the general condition of the motor components regularly
- Check the current consumption in a fixed test cycle (compare with values of the reference run)

Intervals between maintenance

Since operating conditions differ greatly, it is not possible to specify intervals between maintenance work.

Indications that maintenance work is required

- Dirt in the motor cabinet
- Distinctive changes in the behavior of the machine
- Unusual sounds emitted by the machine
- Problems with positioning accuracy
- Higher current consumption

Storage and transport

13.1 Specification of the UN number for permanent magnets as hazardous item

UN number 2807 is allocated to permit magnets as hazardous item.

13.2 Safety instructions

! DANGER

Improper storage and/or transport can cause death, serious bodily injury and/or property damage.

Never store or transport unpacked motor components, even within your own premises!
Only use undamaged original packaging!

Take into account the maximum loads that people can lift and carry. The motors and their components can weigh more than 13 kg.

When transporting machines or machine parts with pre-assembled motors, protect the components from moving unintentionally!

IATA regulations must be observed when components are transported by air.

The storage locations of components with permanent magnets must be marked with the appropriate warning signs (pictograms).

Keep storage areas dry and ensure that they are not subject to heat or cold.

Note the warnings on the packaging.

Wear safety shoes and work gloves.

When installing the motor, wait until the last possible moment before removing the protective cover on the lower side of the primary section.

The packaging of the direct drives and their components provides reliable protection during transport and storage especially against the strong magnetic forces of components with permanent magnets.

Note

Keep the packaging of components with permanent magnets where possible!

Original packaging can also be requested from your local Siemens office.

13.3 Packaging specifications for air transportation

When transporting products containing permanent magnets by air, the maximum permissible magnetic field strengths specified by the appropriate IATA Packing Instruction must not be exceeded. Special measures may be required so that these products can be shipped. Above a certain magnetic field strength, shipping requires that you notify the relevant authorities and appropriately label the products.

Note

The magnetic field strengths listed in the following always refer to values for the DC magnetic field specified in the IATA packaging instruction 953, which has been in force since January 1, 2011. If the values change, then we will take this into account in the next edition.

13.3.1 IATA limit values for magnetic field strengths

Products whose highest field strength exceeds 0.418 A/m, as determined at a distance of 4.6 m from the product, require shipping authorization. This product will only be shipped with previous authorization from the responsible national body of the country from where the product is being shipped and the country where the airfreight company is based. Special measures need to be taken to enable the product to be shipped.

When shipping products whose highest field strength is equal to or greater than 0.418 A/m, as determined at a distance of 2.1 m from the product, you have a duty to notify the relevant authorities and appropriately label the product.

When shipping products whose highest field strength is less than 0.418 A/m, as determined at a distance of 2.1 m from the product, you do not have to notify the relevant authorities and you do not have to label the product.

Primary sections

Shipping primary sections with the order designation 1FN6xxx-xLxxx-xxxx and 1FN6xxx-xWxxx-xxxx, which are in an individual package, does not require that the relevant authorities are notified and labels attached. An additional sheet metal case is not required for individual packages.

Shipping individually packed and stacked primary sections in the same bulk packaging also does not require that the relevant authorities are notified and labels attached.

13.4 Storage

The motors can be stored for up to two years under the following conditions:

Storing indoors

- Apply a preservation agent (e.g. Tectyl) to bare external components if this has not already been carried out in the factory.
- Store the motors as described in Section "Ambient conditions". The storeroom must be:
 - Dry, free of dust and not subject to vibration
 - Well ventilated
 - Provide protection against extreme weather conditions
 - Free of aggressive gases
- Protect the motor against shocks and humidity.
- Make sure that the motor is covered properly.

Protection against humidity

If a dry storage area is not available, then take the following precautions:

- Wrap the motor in humidity-absorbent material and then wrap it in film so that it is air tight.
- Include several bags of desiccant in the seal-tight packaging. Check the desiccant and replace as required.
- Place a humidity meter in the seal-tight packaging to indicate the level of air humidity inside it in four steps.
- Inspect the motor on a regular basis.

Protecting the cooling system for motors with integrated cooling

Before you store the motor after use:

- Empty the cooling channels
- Blow air through to completely empty them and
- Seal them

Environmental compatibility

14.1 Environmental compatibility during production

- The packaging material is made primarily from cardboard.
- Energy consumption during production was optimized.
- Production has low emission levels.

14.2 Disposal

The product must be disposed of in the normal recycling process in compliance with national and local regulations.

 DANGER
Death, serious bodily injury and/or property damage may result from improper disposal of direct drives or their components (especially components with permanent magnets).
Direct drives or their components must be disposed of properly.

Main constituents of a proper disposal procedure

- Complete demagnetization of the components that contain permanent magnets
- Components that are to be recycled should be separated into:
 - Electronics scrap (e.g. encoder electronics, sensor modules)
 - Electrical scrap (e.g. laminated cores, motor windings, cables)
 - Iron to be recycled
 - Aluminum
 - Insulating materials
- No mixing with solvents, cold cleaning agents, or remains of paint, for example

Demagnetizing the primary section

Disposal companies who specialize in demagnetization use special disposal furnaces. The interior of the disposal furnace is made of non-magnetic material.

The primary sections are placed inside a solid, heat-resistant container (such as a skeleton container), which is made of non-magnetic material and left in the furnace during the entire demagnetization procedure. The temperature in the furnace must be at least 300 °C over a holding time of at least 30 minutes.

Escaping gases must be collected and decontaminated without damaging the environment.

Disposal of packaging

The packaging and packing aids we use contain no problematic materials. With the exception of wooden materials, they can all be recycled and should always be disposed of for reuse. Wooden materials should be burned.

Only recyclable plastics are used as packing aids:

- Code 02 PE-HD (polyethylene)
- Code 04 PE-LD (polyethylene)
- Code 05 PP (polypropylene)
- Code 04 PS (polystyrene)

Technical data and characteristics

15.1 Introduction

This collection of data provides the motor data required for configuration and contains some additional data for more detailed calculations within the scope of detailed investigation and problem analyses.

Note

Insofar as nothing else is specified, the following supplementary conditions apply for the data:

- The DC link voltage U_{ZK} is 600 V, the converter output voltage U_a is 425 V
 - Voltages and currents are specified in rms values.
 - Installation altitude of the motors up to 1000 m above sea level.
-

Parameters that are used in the drive system for the control of a drive can differ from the data specified here.

Technical data is subject to change.

15.2 Definition of the motor data

Content of the data sheet

The data specified on the data sheets is explained in the following section. It is categorized as follows:

- Supplementary conditions
- Rated data
- Limit data
- Physical constants

Supplementary conditions

U_{ZK}	DC-link voltage of the converter
T_N	Rated temperature of the motor winding

Note: The rated temperature of the motor winding corresponds to the shutdown temperature of the Temp-S temperature monitoring circuit.

Rated data (S1 operation)

F_N	The rated force F_N of the motor depends on the type of motor cooling. The lowest rated force is reached if the motor is operated only with natural cooling. Here cooling takes place only via the motor housing, without thermal contact to the machine. The better the motor heat can be conducted away to the machine mounting, the higher the rated force achieved will be. The rated force for a magnet temperature of 70 °C is specified. The rated force specified in the data sheets has been determined with a defined form of machine mounting (see section titled "Explanation of characteristic curves").
I_N	Rated motor current at rated force F_N
$v_{MAX, FN}$	Maximum velocity up to which the motor can deliver the rated force F_N
$P_{V,N}$	Power loss of the motor at the rated point ($F_N, v_{MAX, FN}$) at the rated temperature T_N . Losses due to friction and eddy currents are ignored. Note: The power loss is calculated using $P_V = 3 \cdot R_{STR}(T) \cdot I^2$. $P_{V,N}$ is calculated accordingly via $P_{V,N} = 3 \cdot R_{STR}(T_N) \cdot I_N^2$.

Limit data

F_{MAX}	Maximum motor force for a magnet temperature of 70 °C in the primary section
$F_{L,MAX}$	Peak force for the load cycle that the motor must supply on account of the load cycle
I_{MAX}	Maximum motor current at maximum force F_{MAX}
$v_{MAX, FMAX}$	Maximum velocity up to which the motor can deliver the maximum force F_{MAX}
$P_{EL,MAX}$	Electric power input of the motor at point ($F_{MAX}, v_{MAX, FMAX}$) at rated temperature T_N . Losses due to friction and eddy currents are ignored. Note: The sum of the mechanical output P_{MECH} and the power loss P_V equals the electric power input of the motor P_{EL} : $P_{EL} = P_{MECH} + P_V = F \cdot v + 3 \cdot R_{STR}(T) \cdot I^2$ Accordingly, $P_{EL,MAX}$ can be calculated: $P_{EL,MAX} = P_{MECH,MAX} + P_{V,MAX} = F_{MAX} \cdot v_{MAX, FMAX} + 3 \cdot R_{STR}(T) \cdot I_{MAX}^2$
F_0^*	Stall force: Motor force that can be achieved continuously when only two phases are under load The stall force for a magnet temperature of 70 °C in the primary section is specified. Note: F_0^* can be approximately calculated from the rated force F_N while ignoring the influence of the saturation of the motor: $F_0^* \approx \frac{1}{\sqrt{2}} F_N$
I_0^*	Stall current of the motor at stall force F_0^* Note: I_0^* can be calculated from the rated current I_N : $I_0^* \approx \frac{1}{\sqrt{2}} I_N$

Physical constants

k_F	Force constant of the motor with a rated air gap and a magnet temperature of 70 °C in the primary section. Note: The force constant refers to the linear (lower) part of the motor force/current characteristic curve.
k_E	Voltage constant for calculating the back electromotive force between the phase and the star point with a rated air gap
$k_{M,20}$	Motor constant at a winding temperature of 20 °C. Note: The motor constant k_M can be calculated for other temperatures: $k_M(T) = k_{M,20}[1 + \alpha(T - 20 \text{ °C})]$ with temperature coefficient $\alpha = 0.001 \text{ 1/K}$ for the magnets being used.
$R_{STR,20}$	Line resistance (= ½ terminal resistance) of the winding at a winding temperature of 20 °C. Note: The line resistance R_{STR} can be calculated for other temperatures: $R_{STR}(T) = R_{STR,20}[1 + \alpha(T - 20 \text{ °C})]$ with temperature coefficient $\alpha = 0.00393 \text{ 1/K}$ for copper.
L_{STR}	Phase inductance (= ½ terminal inductance) of the winding with a rated air gap.
F_A	Attraction force between the primary section and the secondary section with a rated air gap and a primary section temperature of 70 °C.
τ_Z	Pole pitch is the distance between the centers of two neighboring secondary section teeth
τ_P	Pole pitch of the primary section , $\tau_P = \frac{1}{2} \tau_Z$
m_P	Mass of the primary section with flush-mounted boxes, without fixing screws
m_S	Mass of a secondary section without fixing screws
F_{COGG}	Cogging force (peak value) that occurs due to the magnetic interaction between the de-energized primary section and secondary section

Primary section main cooler data (only for water cooling)

$Q_{P,H,MAX}$	Maximum heat dissipated via the main cooler using rated force F_N and rated temperature T_N .
$V_{P,H,MIN}$	Recommended minimum volume flow in the main cooler to achieve the rated force F_N .
$\Delta T_{P,H}$	Temperature increase of the cooling medium between the intake and return lines of the main cooler at the operating point ($Q_{P,H,MAX}, V_{P,H,MIN}$)
$\Delta p_{P,H}$	Pressure drop of the cooling medium between the intake and return lines of the main cooler at volume flow $V_{P,H,MIN}$

15.3 Explanations of the characteristic curves

Motor force vs. velocity

In each diagram that shows the motor thrust F_M depending on the speed v of the respective motor, there are characteristic curves for the various DC-link voltages U_{ZK} or converter output voltages U_{amax} .

One of these characteristic curves is shown with explanations of the most important points in the following figure.

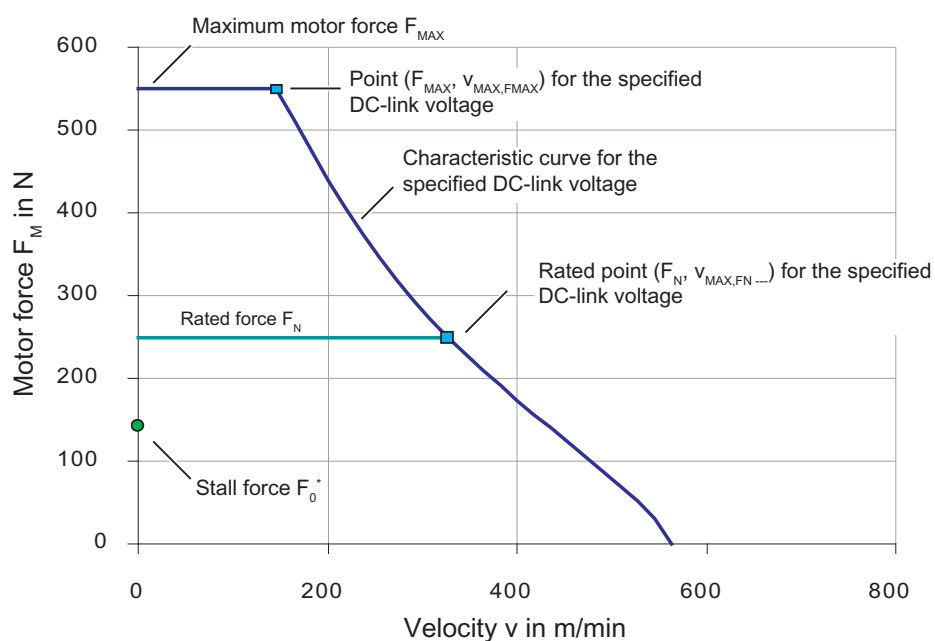

Figure 15-1 Characteristic curve_motor thrust over velocity, schematic

The rated force F_N depends on the type of motor cooling. In a worst-case scenario, the motor will be operated with natural cooling only, i.e. heat is only dissipated via the motor housing and the motor is thermally insulated in relation to the machine.

Fixing the motor to thermally conducting materials (e.g. steel) improves heat dissipation and increases the rated force. The better the motor heat can be dissipated, the higher the rated force will be.

Definition of screw-on plate for the specified rated force

So that a realistic value could be specified for the rated force F_N , a defined screw-on plate was devised for the size of motor concerned. This consists of a rectangular aluminum plate with a thickness of 30 mm and a length corresponding to the overall length of the primary section. The width selected for the screw-on plate has to ensure that the radiating surface is three times larger than the primary section's screw-on surface.

The plate's radiating surface is the sum of the top and bottom surfaces plus the lateral edge surfaces. As the primary section is mounted on the bottom of the screw-on plate and no heat can be transferred to the motor, the primary section's screw-on surface must be subtracted from the plate surface in order to obtain the correct radiating surface.

Braking force vs. velocity

The characteristic curve shows the brake force of a short-circuited motor as a function of the velocity and various brake resistor resistance values R_{BR} . For braking, the brake resistors are connected in series with the phase resistors and the higher their resistance, the greater the braking effect at high velocities. Any friction that occurs is ignored. The following figure shows what this kind of characteristic curve looks like with different resistance values.

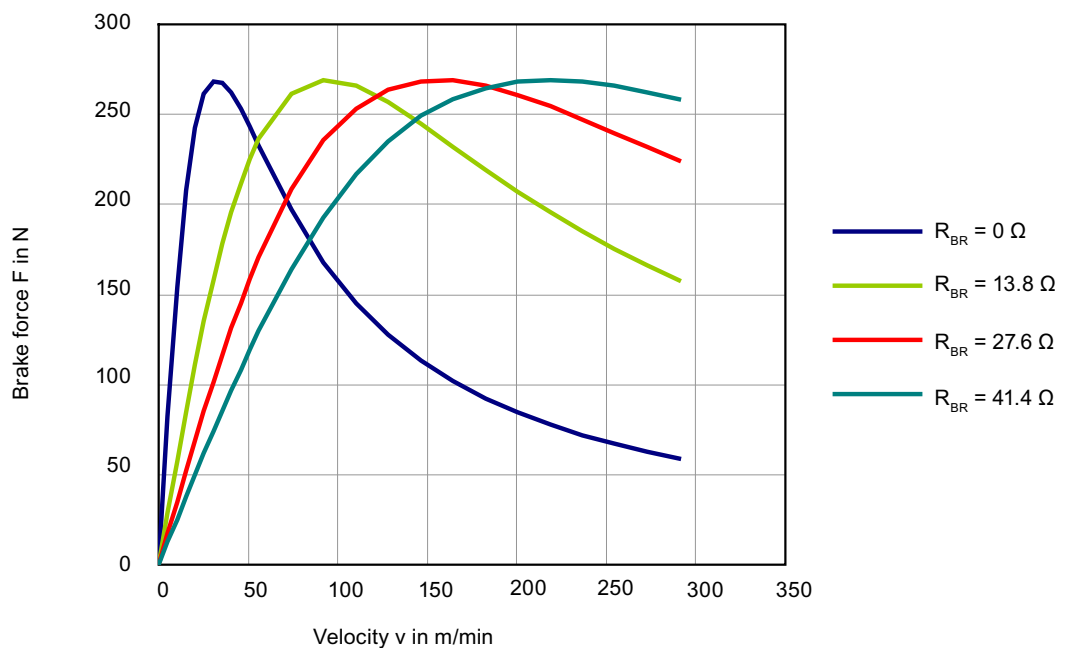

Figure 15-2 Characteristic curve for braking force plotted against velocity with various short-circuit resistance values.

15.4 Motor data - Version with natural cooling

15.4.1 1FN6003-1LCxx

Motor data 1FN6003-1LC57-0FA1

1FN6003-1LC57-0FA1			
Technical data	Short name	Unit	Value
Supplementary conditions			
DC-link voltage	U _{ZK}	V	600
Rated temperature	T _N	°C	120
Rated data			
Rated force	F _N	N	66.3
Rated current	I _N	A	1.61
Maximum velocity at rated force	v _{MAX, FN}	m/min	748
Rated power dissipation	P _{V, N}	kW	0.037
Limit data			
Maximum force	F _{MAX}	N	157
Maximum current	I _{MAX}	A	5.18
Maximum velocity at maximum force	v _{MAX, FMAX}	m/min	345
Maximum electric power input	P _{EL, MAX}	kW	1.29
Stall force	F _{0*}	N	47.5
Stall current	I _{0*}	A	1.14
Physical constants			
Force constant at 70 °C	K _{F, 20}	N/A	42.1
Voltage constant (phase-to-phase)	k _E	Vs/m	25.4
Motor constant at 20 °C	k _{M, 20}	N/W ^{0.5}	13.1
Motor winding resistance at 20 °C	R _{STR, 20}	Ω	3.43
Phase inductance	L _{STR}	mH	28.2
Attraction force	F _A	N	585
Thermal time constant	t _{TH}	s	3210
Polar distance	t _P	mm	12.5
Cogging force	F _{COGG}	N	6.92
Mass of the primary section	m _P	kg	3.19
Secondary section data			
Mass of the secondary section (l = 500 mm)	m _S	kg	1.89
Mass of the secondary section (l = 200 mm)	m _S	kg	0.76

Characteristic curves 1FN6003-1LC57-0FA1

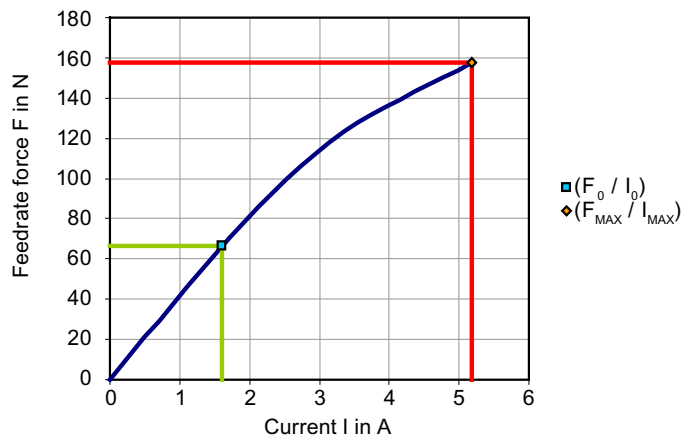
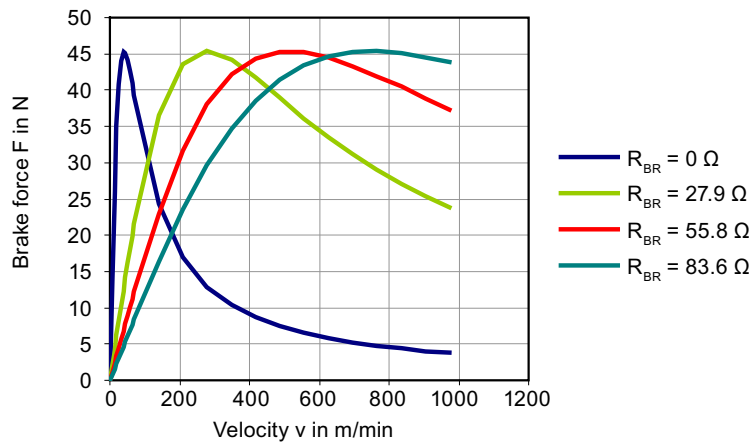
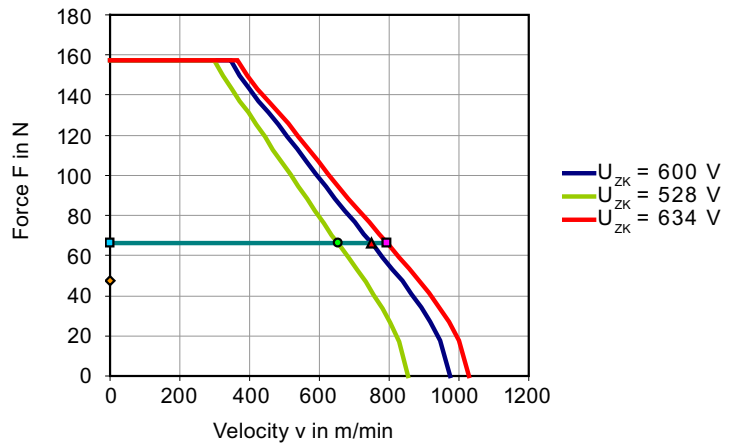

Motor data 1FN6003-1LC84-0FA1

1FN6003-1LC84-0FA1			
Technical data	Short name	Unit	Value
Supplementary conditions			
DC-link voltage	U_{ZK}	V	600
Rated temperature	T_N	°C	120
Rated data			
Rated force	F_N	N	66.3
Rated current	I_N	A	2.31
Maximum velocity at rated force	$v_{MAX, FN}$	m/min	1080
Rated power dissipation	$P_{V, N}$	kW	0.0379
Limit data			
Maximum force	F_{MAX}	N	157
Maximum current	I_{MAX}	A	7.45
Maximum velocity at maximum force	$v_{MAX, FMAX}$	m/min	503
Maximum electric power input	$P_{EL, MAX}$	kW	1.71
Stall force	F_0^*	N	47.5
Stall current	I_0^*	A	1.63
Physical constants			
Force constant at 70 °C	$k_{F, 20}$	N/A	29.2
Voltage constant (phase-to-phase)	k_E	Vs/m	17.6
Motor constant at 20 °C	$k_{M, 20}$	N/W ^{0.5}	13
Motor winding resistance at 20 °C	$R_{STR, 20}$	Ω	1.7
Phase inductance	L_{STR}	mH	13.6
Attraction force	F_A	N	585
Thermal time constant	t_{TH}	s	3210
Polar distance	T_P	mm	12.5
Cogging force	F_{COGG}	N	6.92
Mass of the primary section	m_P	kg	3.19
Secondary section data			
Mass of the secondary section (l = 500 mm)	m_S	kg	1.89
Mass of the secondary section (l = 200 mm)	m_S	kg	0.76

Characteristic curves 1FN6003-1LC84-0FA1

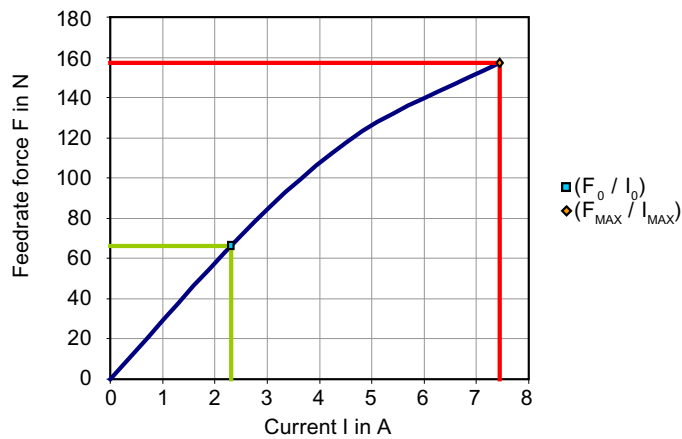
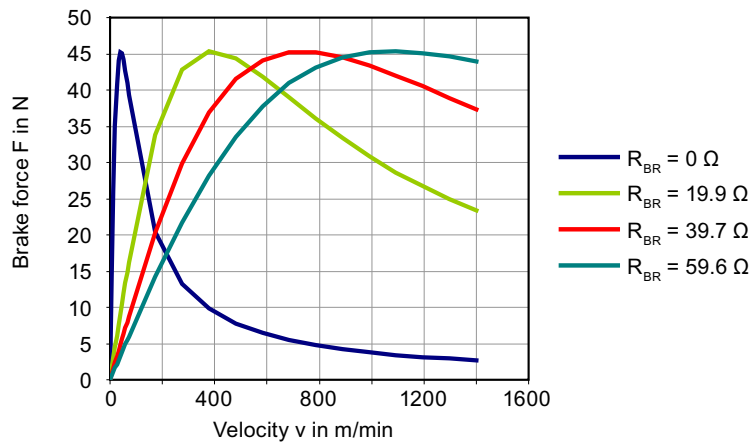
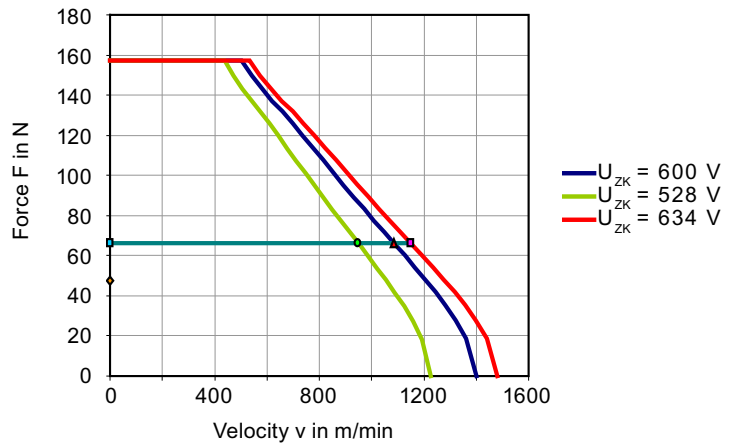

15.4.2 1FN6003-1LExx

Motor data 1FN6003-1LE38-0FA1

1FN6003-1LE38-0FA1			
Technical data	Short name	Unit	Value
Supplementary conditions			
DC-link voltage	U_{ZK}	V	600
Rated temperature	T_N	°C	120
Rated data			
Rated force	F_N	N	133
Rated current	I_N	A	2.31
Maximum velocity at rated force	$v_{MAX, FN}$	m/min	515
Rated power dissipation	$P_{V, N}$	kW	0.0754
Limit data			
Maximum force	F_{MAX}	N	315
Maximum current	I_{MAX}	A	7.45
Maximum velocity at maximum force	$v_{MAX, FMAX}$	m/min	226
Maximum electric power input	$P_{EL, MAX}$	kW	1.97
Stall force	F_0^*	N	95
Stall current	I_0^*	A	1.63
Physical constants			
Force constant at 70 °C	$k_{F, 20}$	N/A	58.5
Voltage constant (phase-to-phase)	k_E	Vs/m	35.3
Motor constant at 20 °C	$k_{M, 20}$	N/W ^{0.5}	18.4
Motor winding resistance at 20 °C	$R_{STR, 20}$	Ω	3.38
Phase inductance	L_{STR}	mH	29.7
Attraction force	F_A	N	1250
Thermal time constant	t_{TH}	s	3210
Polar distance	T_P	mm	12.5
Cogging force	F_{COGG}	N	8.45
Mass of the primary section	m_P	kg	4.99
Secondary section data			
Mass of the secondary section (l = 500 mm)	m_S	kg	1.89
Mass of the secondary section (l = 200 mm)	m_S	kg	0.76

Characteristic curves 1FN6003-1LE38-0FA1

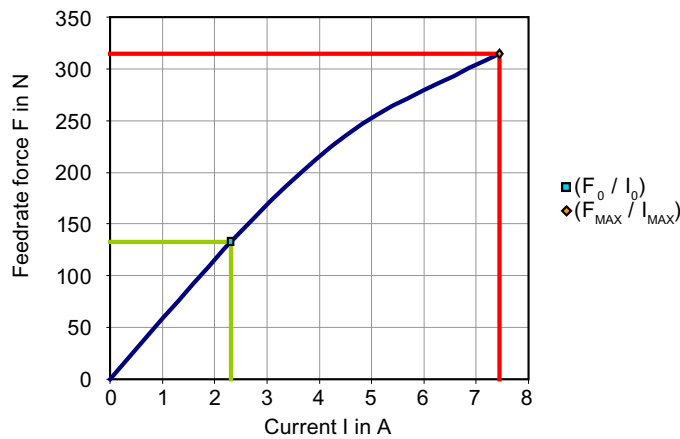
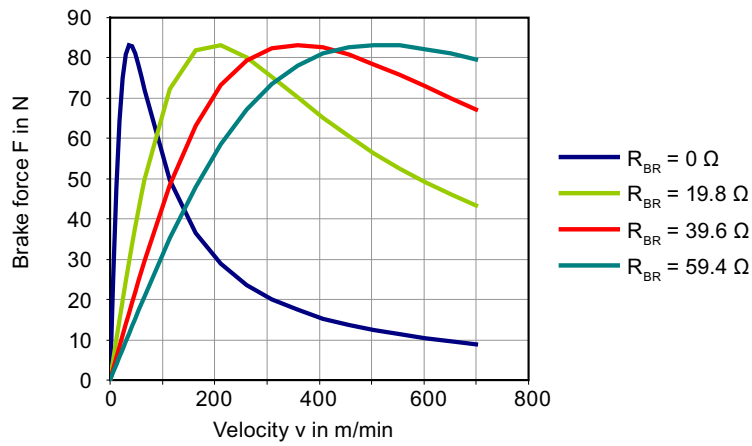
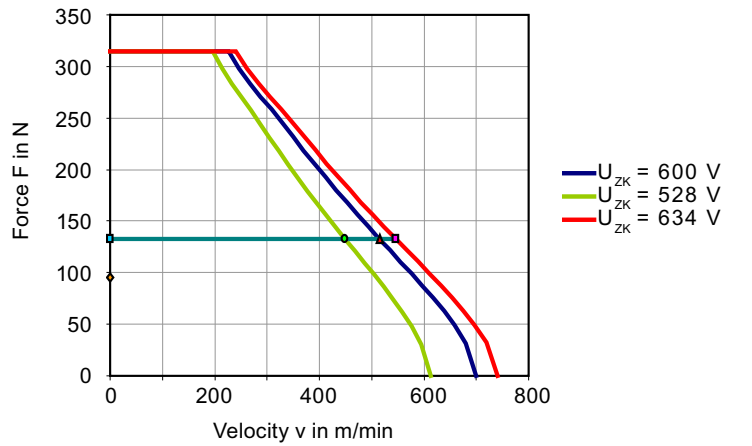

Motor data 1FN6003-1LE88-0FA1

1FN6003-1LE88-0FA1			
Technical data	Short name	Unit	Value
Supplementary conditions			
DC-link voltage	U _{ZK}	V	600
Rated temperature	T _N	°C	120
Rated data			
Rated force	F _N	N	133
Rated current	I _N	A	5.63
Maximum velocity at rated force	v _{MAX, FN}	m/min	1280
Rated power dissipation	P _{V, N}	kW	0.0826
Limit data			
Maximum force	F _{MAX}	N	315
Maximum current	I _{MAX}	A	18.2
Maximum velocity at maximum force	v _{MAX, FMAX}	m/min	572
Maximum electric power input	P _{EL, MAX}	kW	3.86
Stall force	F ₀ *	N	95
Stall current	I ₀ *	A	3.98
Physical constants			
Force constant at 70 °C	k _{F, 20}	N/A	24
Voltage constant (phase-to-phase)	k _E	Vs/m	14.5
Motor constant at 20 °C	k _{M, 20}	N/W ^{0.5}	17.6
Motor winding resistance at 20 °C	R _{STR, 20}	Ω	0.623
Phase inductance	L _{STR}	mH	5
Attraction force	F _A	N	1250
Thermal time constant	t _{TH}	s	3210
Polar distance	T _P	mm	12.5
Cogging force	F _{COGG}	N	8.45
Mass of the primary section	m _P	kg	4.99
Secondary section data			
Mass of the secondary section (l = 500 mm)	m _S	kg	1.89
Mass of the secondary section (l = 200 mm)	m _S	kg	0.76

Characteristic curves 1FN6003-1LE88-0FA1

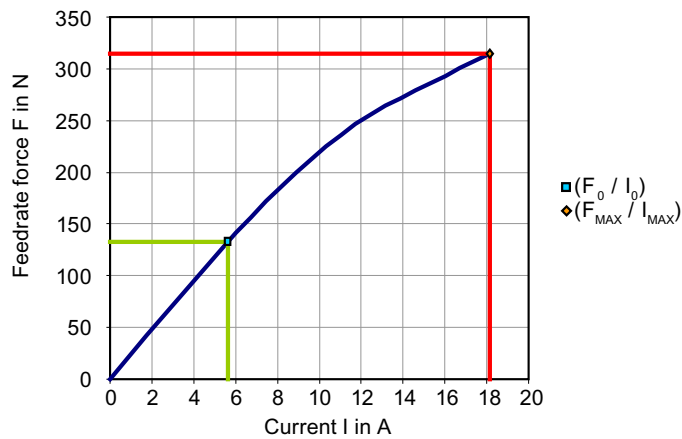
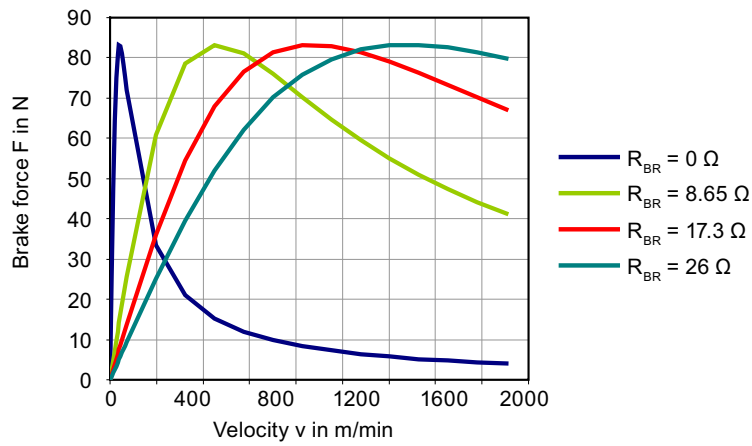
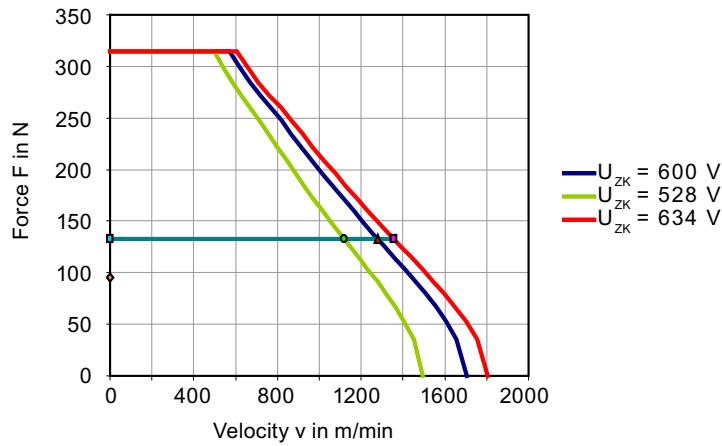

15.4.3 1FN6003-1LGxx

Motor data 1FN6003-1LG24-0FA1

1FN6003-1LG24-0FA1			
Technical data	Short name	Unit	Value
Supplementary conditions			
DC-link voltage	U _{ZK}	V	600
Rated temperature	T _N	°C	120
Rated data			
Rated force	F _N	N	199
Rated current	I _N	A	2.31
Maximum velocity at rated force	v _{MAX,FN}	m/min	333
Rated power dissipation	P _{V,N}	kW	0.113
Limit data			
Maximum force	F _{MAX}	N	472
Maximum current	I _{MAX}	A	7.45
Maximum velocity at maximum force	v _{MAX,FMAX}	m/min	141
Maximum electric power input	P _{EL,MAX}	kW	2.28
Stall force	F _{0*}	N	143
Stall current	I _{0*}	A	1.63
Physical constants			
Force constant at 70 °C	k _{F,20}	N/A	87.7
Voltage constant (phase-to-phase)	k _E	Vs/m	52.9
Motor constant at 20 °C	k _{M,20}	N/W ^{0.5}	22.5
Motor winding resistance at 20 °C	R _{STR,20}	Ω	5.05
Phase inductance	L _{STR}	mH	46
Attraction force	F _A	N	1930
Thermal time constant	t _{TH}	s	3210
Polar distance	T _P	mm	12.5
Cogging force	F _{COGG}	N	10.0
Mass of the primary section	m _P	kg	6.79
Secondary section data			
Mass of the secondary section (l = 500 mm)	m _S	kg	1.89
Mass of the secondary section (l = 200 mm)	m _S	kg	0.76

Characteristic curves 1FN6003-1LG24-0FA1

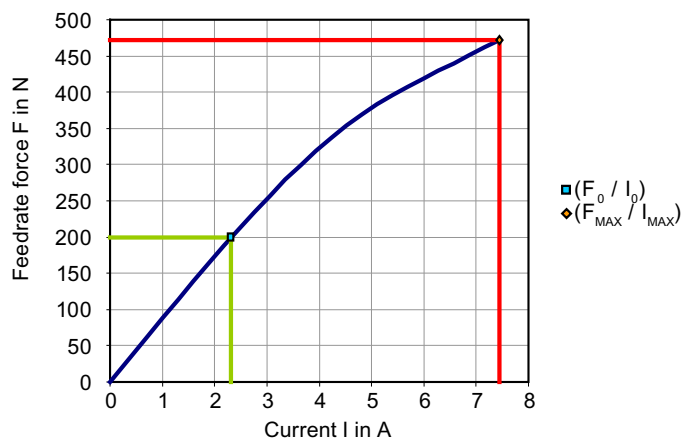
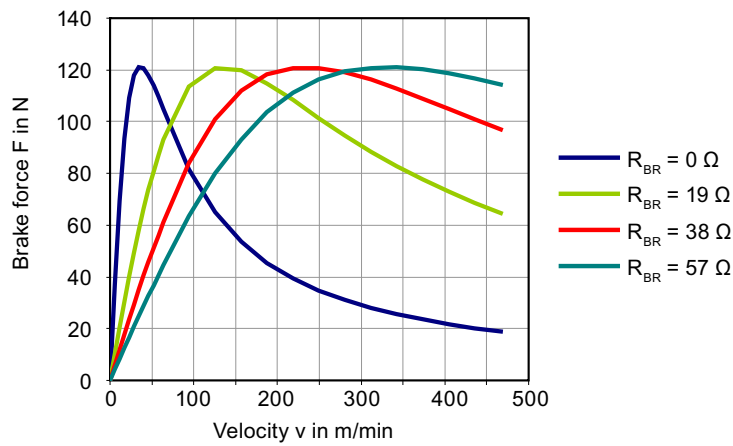
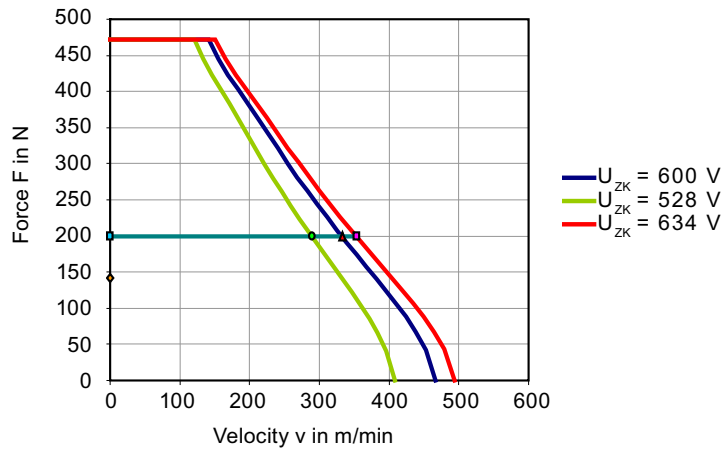

Motor data 1FN6003-1LG61-0FA1

1FN6003-1LG61-0FA1			
Technical data	Short name	Unit	Value
Supplementary conditions			
DC-link voltage	U_{ZK}	V	600
Rated temperature	T_N	°C	120
Rated data			
Rated force	F_N	N	199
Rated current	I_N	A	5.63
Maximum velocity at rated force	$v_{MAX, FN}$	m/min	836
Rated power dissipation	$P_{V, N}$	kW	0.123
Limit data			
Maximum force	F_{MAX}	N	472
Maximum current	I_{MAX}	A	18.2
Maximum velocity at maximum force	$v_{MAX, FMAX}$	m/min	366
Maximum electric power input	$P_{EL, MAX}$	kW	4.16
Stall force	F_0^*	N	143
Stall current	I_0^*	A	3.98
Physical constants			
Force constant at 70 °C	$k_{F, 20}$	N/A	36
Voltage constant (phase-to-phase)	k_E	Vs/m	21.7
Motor constant at 20 °C	$k_{M, 20}$	N/W ^{0.5}	21.6
Motor winding resistance at 20 °C	$R_{STR, 20}$	Ω	0.926
Phase inductance	L_{STR}	mH	7.74
Attraction force	F_A	N	1930
Thermal time constant	t_{TH}	s	3210
Polar distance	T_P	mm	12.5
Cogging force	F_{COGG}	N	10.0
Mass of the primary section	m_P	kg	6.79
Secondary section data			
Mass of the secondary section (l = 500 mm)	m_S	kg	1.89
Mass of the secondary section (l = 200 mm)	m_S	kg	0.76

Characteristic curves 1FN6003-1LG61-0FA1

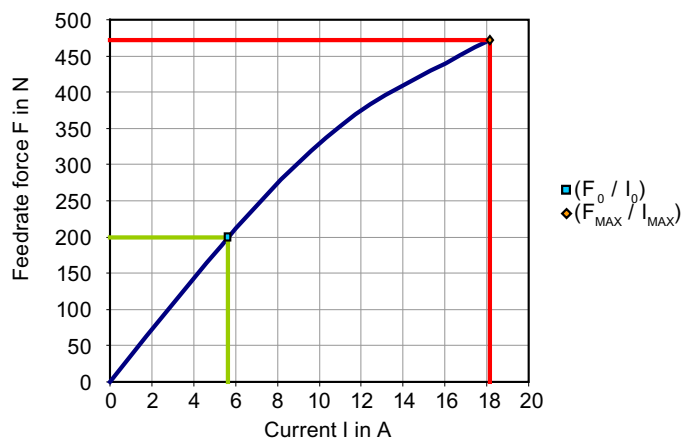
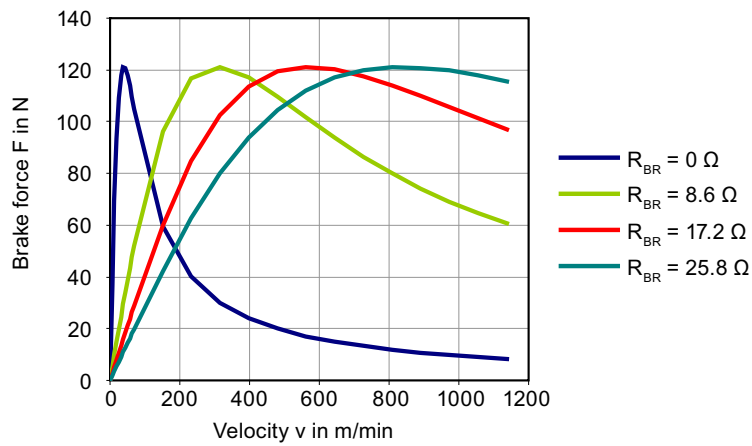
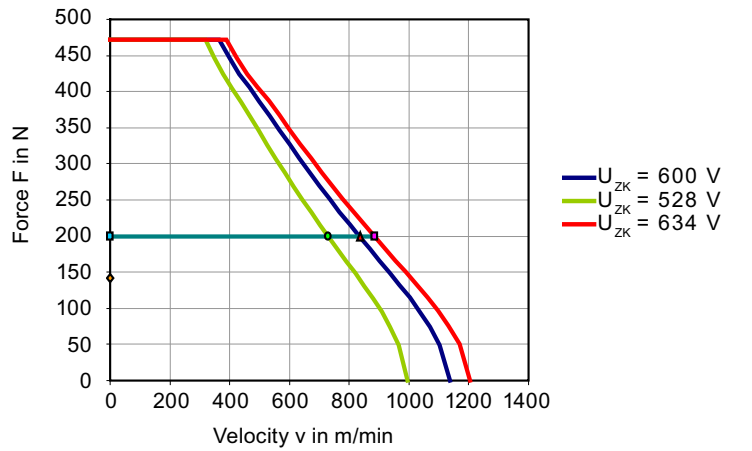

15.4.4 1FN6003-1LJxx

Motor data 1FN6003-1LJ17-0FA1

1FN6003-1LJ17-0FA1			
Technical data	Short name	Unit	Value
Supplementary conditions			
DC-link voltage	U _{ZK}	V	600
Rated temperature	T _N	°C	120
Rated data			
Rated force	F _N	N	265
Rated current	I _N	A	2.31
Maximum velocity at rated force	v _{MAX,FN}	m/min	243
Rated power dissipation	P _{V,N}	kW	0.15
Limit data			
Maximum force	F _{MAX}	N	630
Maximum current	I _{MAX}	A	7.45
Maximum velocity at maximum force	v _{MAX,FMAX}	m/min	99.6
Maximum electric power input	P _{EL,MAX}	kW	2.61
Stall force	F _{0*}	N	190
Stall current	I _{0*}	A	1.63
Physical constants			
Force constant at 70 °C	k _{F,20}	N/A	117
Voltage constant (phase-to-phase)	k _E	Vs/m	70.5
Motor constant at 20 °C	k _{M,20}	N/W ^{0.5}	26
Motor winding resistance at 20 °C	R _{STR,20}	Ω	6.73
Phase inductance	L _{STR}	mH	62.3
Attraction force	F _A	N	2610
Thermal time constant	t _{TH}	s	3210
Polar distance	T _P	mm	12.5
Cogging force	F _{COGG}	N	11.5
Mass of the primary section	m _P	kg	8.59
Secondary section data			
Mass of the secondary section (l = 500 mm)	m _S	kg	1.89
Mass of the secondary section (l = 200 mm)	m _S	kg	0.76

Characteristic curves 1FN6003-1LJ17-0FA1

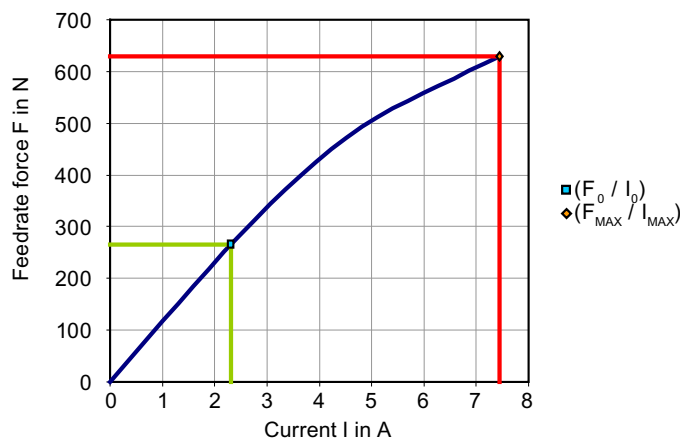
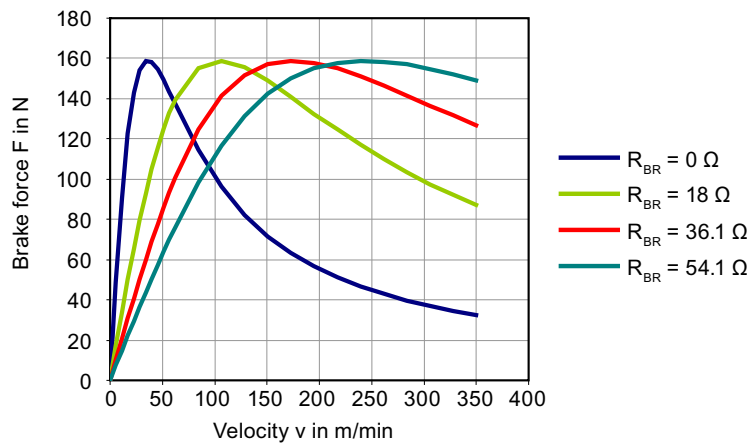
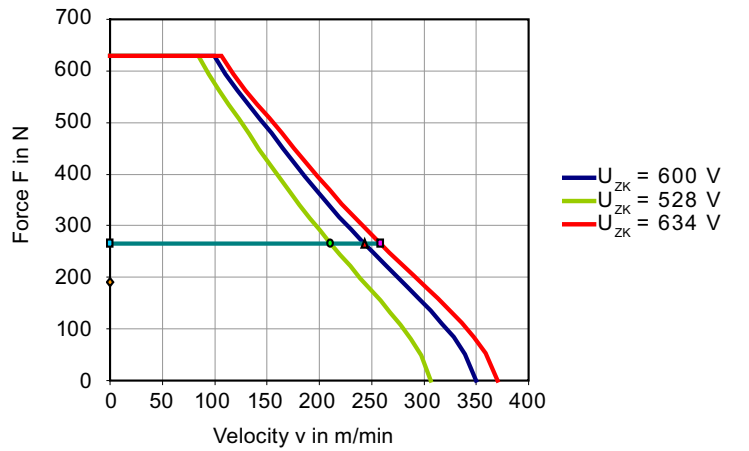

Motor data 1FN6003-1LJ44-0FA1

1FN6003-1LJ44-0FA1			
Technical data	Short name	Unit	Value
Supplementary conditions			
DC-link voltage	U_{ZK}	V	600
Rated temperature	T_N	°C	120
Rated data			
Rated force	F_N	N	265
Rated current	I_N	A	5.63
Maximum velocity at rated force	$v_{MAX,FN}$	m/min	618
Rated power dissipation	$P_{V,N}$	kW	0.163
Limit data			
Maximum force	F_{MAX}	N	630
Maximum current	I_{MAX}	A	18.2
Maximum velocity at maximum force	$v_{MAX,FMAX}$	m/min	267
Maximum electric power input	$P_{EL,MAX}$	kW	4.49
Stall force	F_0^*	N	190
Stall current	I_0^*	A	3.98
Physical constants			
Force constant	k_F	N/A	48
Voltage constant	k_E	Vs/m	28.9
Motor constant at 20 °C	$k_{M,20}$	N/W ^{0.5}	25
Motor winding resistance at 20 °C	$R_{STR,20}$	Ω	1.23
Phase inductance	L_{STR}	mH	10.5
Attraction force	F_A	N	2610
Thermal time constant	t_{TH}	s	3210
Polar distance	T_P	mm	12.5
Cogging force	F_{COGG}	N	11.5
Mass of the primary section	m_P	kg	8.59
Secondary section data			
Mass of the secondary section (l = 500 mm)	m_S	kg	1.89
Mass of the secondary section (l = 200 mm)	m_S	kg	0.76

Characteristic curves 1FN6003-1LJ44-0FA1

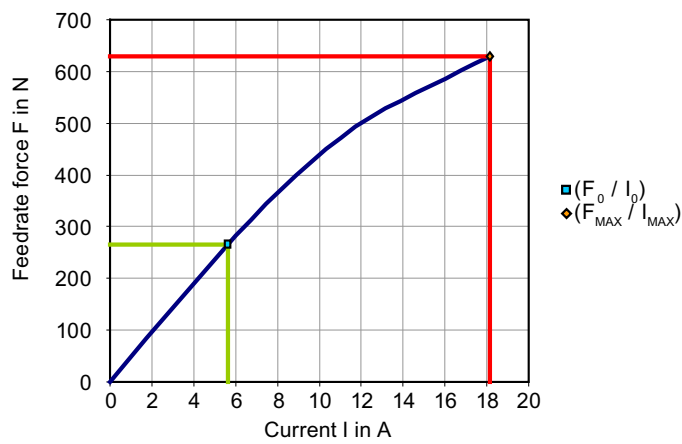
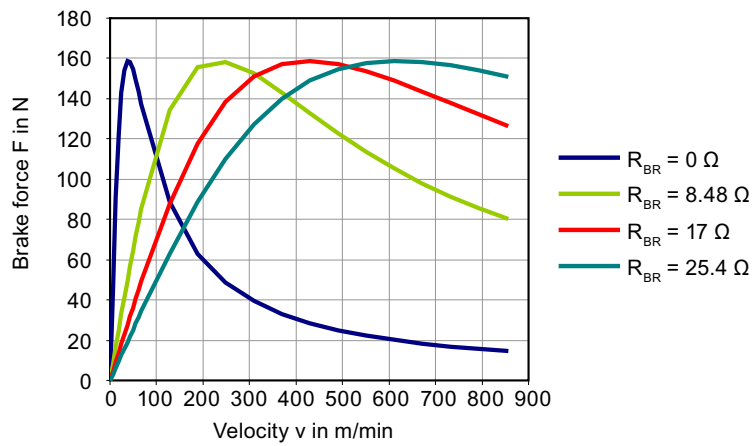
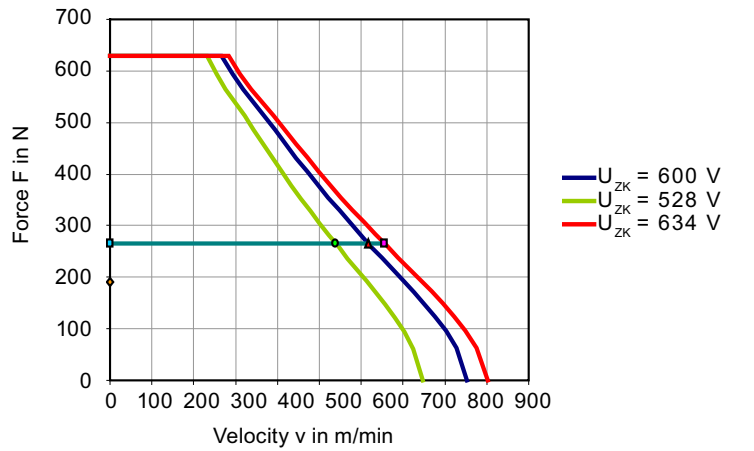

15.4.5 1FN6003-1LLxx

Motor data 1FN6003-1LL12-0FA1

1FN6003-1LL12-0FA1			
Technical data	Short name	Unit	Value
Supplementary conditions			
DC-link voltage	U _{ZK}	V	600
Rated temperature	T _N	°C	120
Rated data			
Rated force	F _N	N	332
Rated current	I _N	A	2.31
Maximum velocity at rated force	v _{MAX, FN}	m/min	190
Rated power dissipation	P _{V, N}	kW	0.188
Limit data			
Maximum force	F _{MAX}	N	787
Maximum current	I _{MAX}	A	7.45
Maximum velocity at maximum force	v _{MAX, FMAX}	m/min	74.7
Maximum electric power input	P _{EL, MAX}	kW	2.93
Stall force	F _{0*}	N	238
Stall current	I _{0*}	A	1.63
Physical constants			
Force constant	k _F	N/A	146
Voltage constant	k _E	Vs/m	88.2
Motor constant at 20 °C	k _{M, 20}	N/W ^{0.5}	29.1
Motor winding resistance at 20 °C	R _{STR, 20}	Ω	8.41
Phase inductance	L _{STR}	mH	78.7
Attraction force	F _A	N	3290
Thermal time constant	t _{TH}	s	3210
Polar distance	T _P	mm	12.5
Cogging force	F _{COGG}	N	13.1
Mass of the primary section	m _P	kg	10.4
Secondary section data			
Mass of the secondary section (l = 500 mm)	m _S	kg	1.89
Mass of the secondary section (l = 200 mm)	m _S	kg	0.76

Characteristic curves 1FN6003-1LL12-0FA1

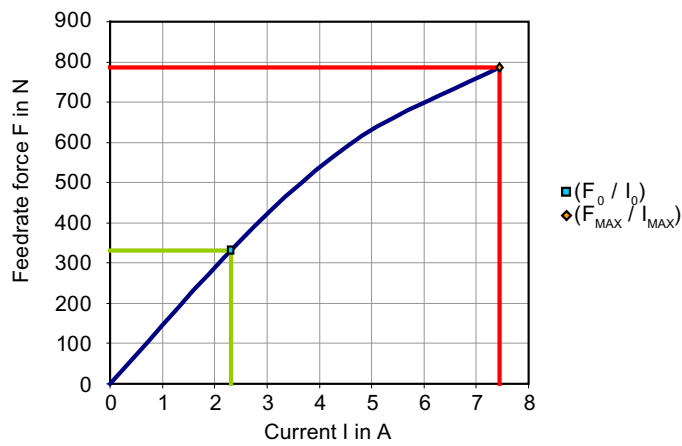
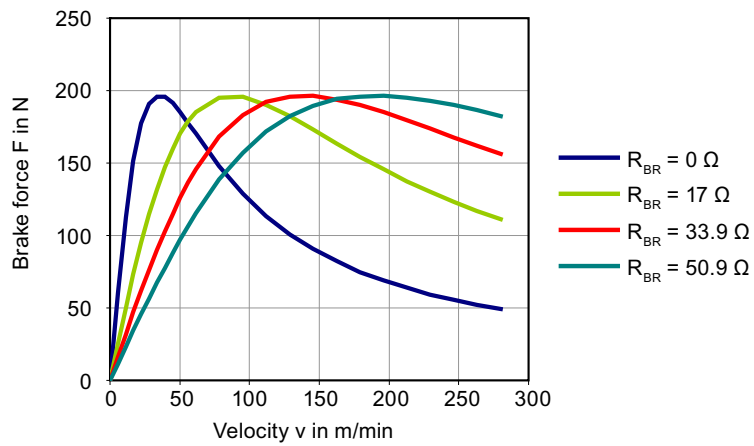
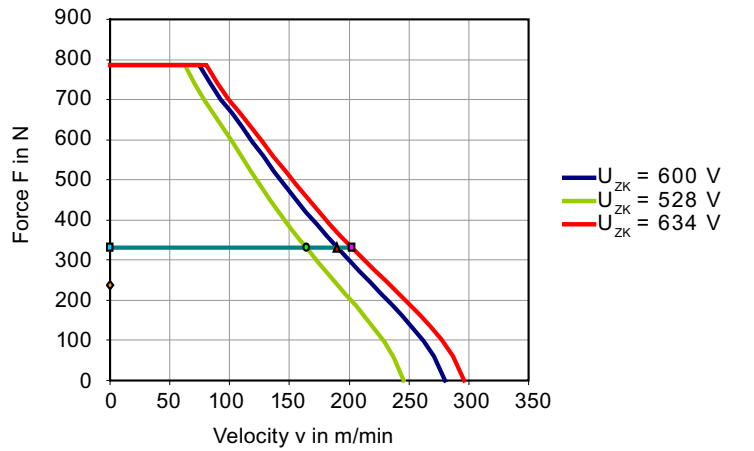

Motor data 1FN6003-1LL35-0FA1

1FN6003-1LL35-0FA1			
Technical data	Short name	Unit	Value
Supplementary conditions			
DC-link voltage	U _{ZK}	V	600
Rated temperature	T _N	°C	120
Rated data			
Rated force	F _N	N	332
Rated current	I _N	A	5.63
Maximum velocity at rated force	v _{MAX, FN}	m/min	488
Rated power dissipation	P _{V, N}	kW	0.203
Limit data			
Maximum force	F _{MAX}	N	787
Maximum current	I _{MAX}	A	18.2
Maximum velocity at maximum force	v _{MAX, FMAX}	m/min	208
Maximum electric power input	P _{EL, MAX}	kW	4.84
Stall force	F _{0*}	N	238
Stall current	I _{0*}	A	3.98
Physical constants			
Force constant	k _F	N/A	60
Voltage constant	k _E	Vs/m	36.2
Motor constant at 20 °C	k _{M, 20}	N/W ^{0.5}	28
Motor winding resistance at 20 °C	R _{STR, 20}	Ω	1.53
Phase inductance	L _{STR}	mH	13.3
Attraction force	F _A	N	3290
Thermal time constant	t _{TH}	s	3210
Polar distance	τ _P	mm	12.5
Cogging force	F _{COGG}	N	13.1
Mass of the primary section	m _P	kg	10.4
Secondary section data			
Mass of the secondary section (l = 500 mm)	m _S	kg	1.89
Mass of the secondary section (l = 200 mm)	m _S	kg	0.76

Characteristic curves 1FN6003-1LL35-0FA1

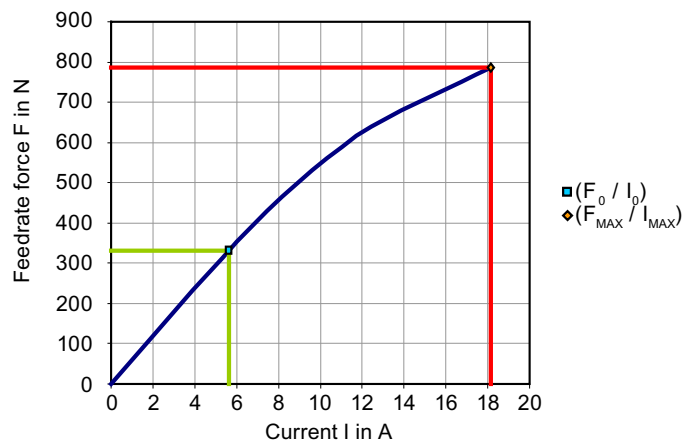
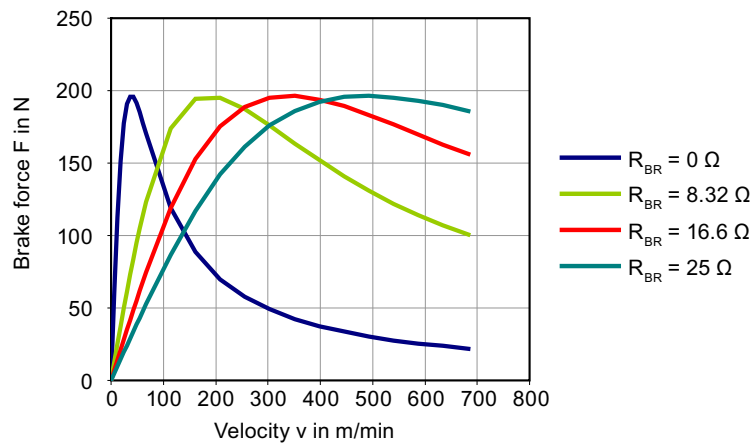
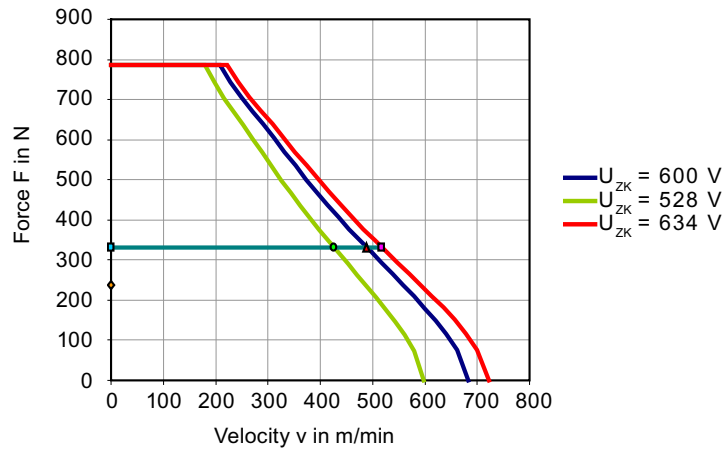

15.4.6 1FN6003-1LNxx

Motor data 1FN6003-1LN10-0FA1

1FN6003-1LN10-0FA1			
Technical data	Short name	Unit	Value
Supplementary conditions			
DC-link voltage	U _{ZK}	V	600
Rated temperature	T _N	°C	120
Rated data			
Rated force	F _N	N	398
Rated current	I _N	A	2.31
Maximum velocity at rated force	V _{MAX, FN}	m/min	155
Rated power dissipation	P _{V, N}	kW	0.225
Limit data			
Maximum force	F _{MAX}	N	945
Maximum current	I _{MAX}	A	7.45
Maximum velocity at maximum force	V _{MAX, FMAX}	m/min	57.9
Maximum electric power input	P _{EL, MAX}	kW	3.25
Stall force	F _{0*}	N	285
Stall current	I _{0*}	A	1.63
Physical constants			
Force constant	k _F	N/A	175
Voltage constant	k _E	Vs/m	106
Motor constant at 20 °C	k _{M, 20}	N/W ^{0.5}	31.9
Motor winding resistance at 20 °C	R _{STR, 20}	Ω	10.1
Phase inductance	L _{STR}	mH	95.2
Attraction force	F _A	N	3980
Thermal time constant	t _{TH}	s	3210
Polar distance	T _P	mm	12.5
Cogging force	F _{COGG}	N	14.6
Mass of the primary section	m _P	kg	12.2
Secondary section data			
Mass of the secondary section (l = 500 mm)	m _S	kg	1.89
Mass of the secondary section (l = 200 mm)	m _S	kg	0.76

Characteristic curves 1FN6003-1LN10-0FA1

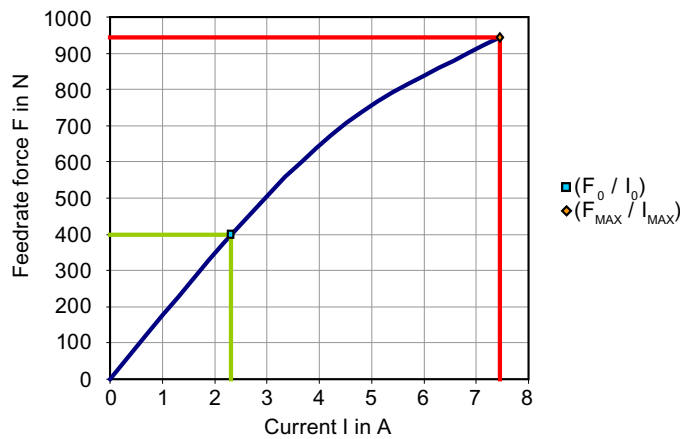
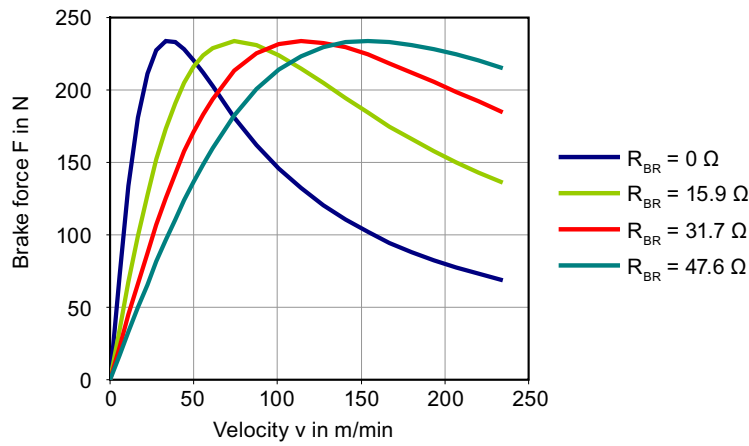
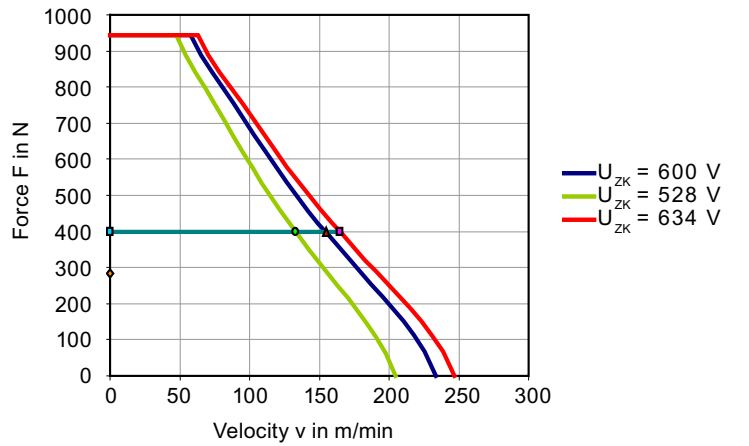

Motor data 1FN6003-1LN28-0FA1

1FN6003-1LN28-0FA1			
Technical data	Short name	Unit	Value
Supplementary conditions			
DC-link voltage	U _{ZK}	V	600
Rated temperature	T _N	°C	120
Rated data			
Rated force	F _N	N	398
Rated current	I _N	A	5.63
Maximum velocity at rated force	v _{MAX, FN}	m/min	402
Rated power dissipation	P _{V, N}	kW	0.243
Limit data			
Maximum force	F _{MAX}	N	945
Maximum current	I _{MAX}	A	18.2
Maximum velocity at maximum force	v _{MAX, FMAX}	m/min	169
Maximum electric power input	P _{EL, MAX}	kW	5.2
Stall force	F _{0*}	N	285
Stall current	I _{0*}	A	3.98
Physical constants			
Force constant	k _F	N/A	72
Voltage constant	k _E	Vs/m	43.4
Motor constant at 20 °C	k _{M, 20}	N/W ^{0.5}	30.7
Motor winding resistance at 20 °C	R _{STR, 20}	Ω	1.83
Phase inductance	L _{STR}	mH	16
Attraction force	F _A	N	3980
Thermal time constant	t _{TH}	s	3210
Polar distance	τ _P	mm	12.5
Cogging force	F _{COGG}	N	14.6
Mass of the primary section	m _P	kg	12.2
Secondary section data			
Mass of the secondary section (l = 500 mm)	m _S	kg	1.89
Mass of the secondary section (l = 200 mm)	m _S	kg	0.76

Characteristic curves 1FN6003-1LN28-0FA1

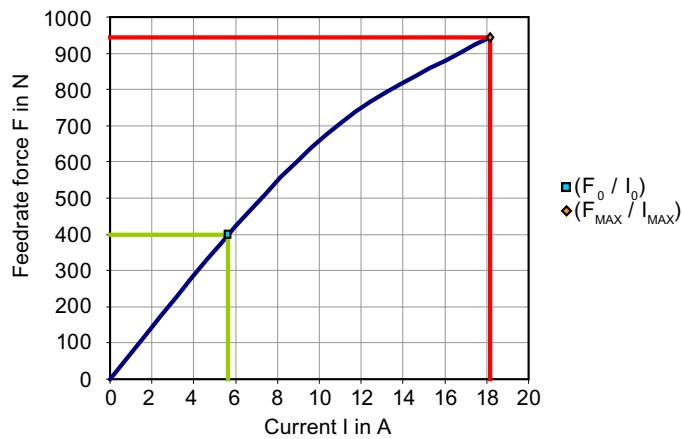
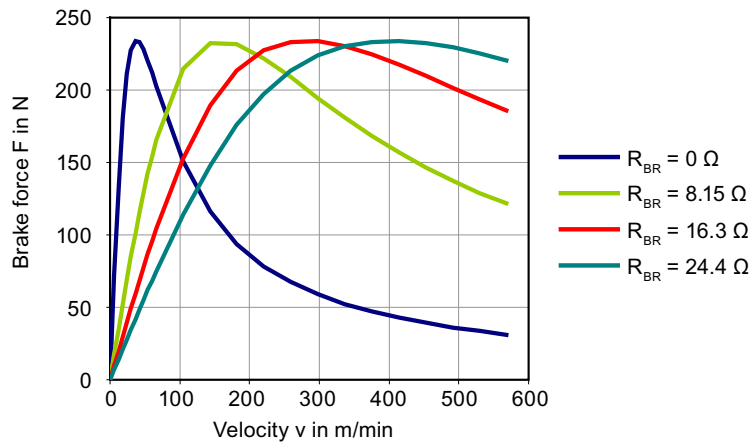
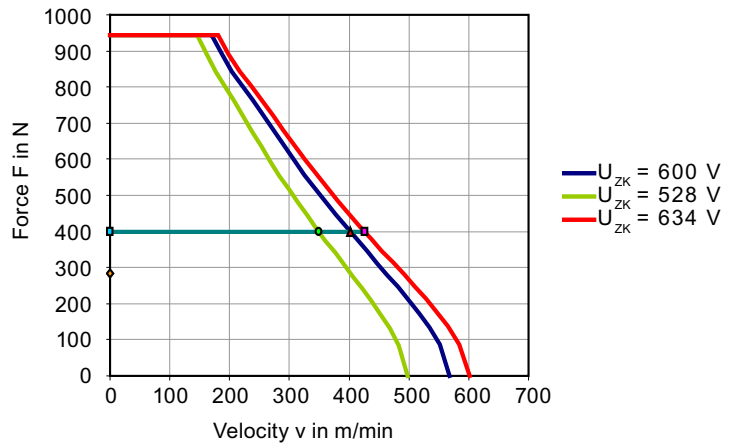

15.4.7 1FN6007-1LCxx

Motor data 1FN6007-1LC31-0KA1

1FN6007-1LC31-0KA1			
Technical data	Short name	Unit	Value
Supplementary conditions			
DC-link voltage	U _{ZK}	V	600
Rated temperature	T _N	°C	120
Rated data			
Rated force	F _N	N	133
Rated current	I _N	A	1.61
Maximum velocity at rated force	V _{MAX, FN}	m/min	386
Rated power dissipation	P _{V, N}	kW	0.0584
Limit data			
Maximum force	F _{MAX}	N	315
Maximum current	I _{MAX}	A	5.18
Maximum velocity at maximum force	V _{MAX, FMAX}	m/min	187
Maximum electric power input	P _{EL, MAX}	kW	1.59
Stall force	F _{0*}	N	95
Stall current	I _{0*}	A	1.14
Physical constants			
Force constant	k _F	N/A	84.1
Voltage constant	k _E	Vs/m	50.7
Motor constant at 20 °C	k _{M, 20}	N/W ^{0.5}	20.9
Motor winding resistance at 20 °C	R _{STR, 20}	Ω	5.4
Phase inductance	L _{STR}	mH	49.1
Attraction force	F _A	N	1170
Thermal time constant	t _{TH}	s	6480
Polar distance	T _P	mm	12.5
Cogging force	F _{COGG}	N	13.8
Mass of the primary section	m _P	kg	5.08
Secondary section data			
Mass of the secondary section (l = 500 mm)	m _S	kg	4.03
Mass of the secondary section (l = 200 mm)	m _S	kg	1.61

Characteristic curves 1FN6007-1LC31-0KA1

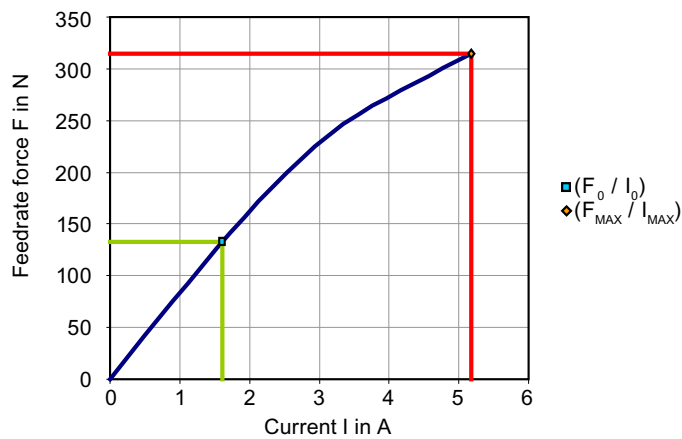
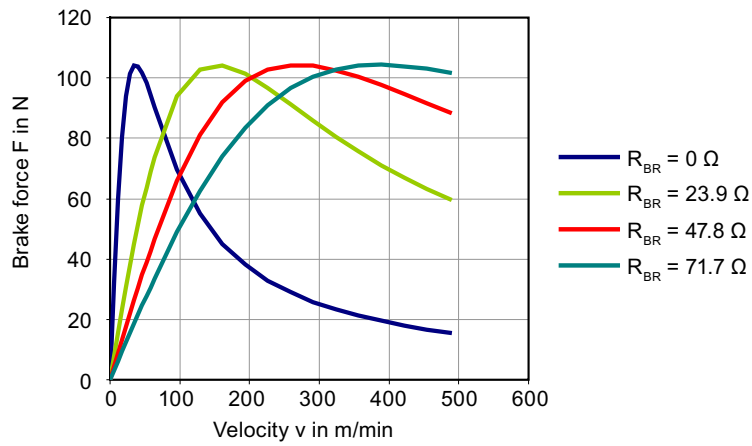
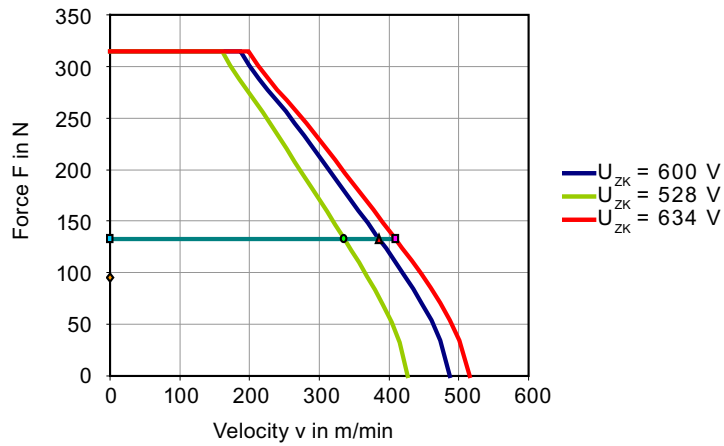

Motor data 1FN6007-1LC46-0KA1

1FN6007-1LC46-0KA1			
Technical data	Short name	Unit	Value
Supplementary conditions			
DC-link voltage	U _{ZK}	V	600
Rated temperature	T _N	°C	120
Rated data			
Rated force	F _N	N	133
Rated current	I _N	A	2.31
Maximum velocity at rated force	v _{MAX, FN}	m/min	562
Rated power dissipation	P _{V, N}	kW	0.0596
Limit data			
Maximum force	F _{MAX}	N	315
Maximum current	I _{MAX}	A	7.45
Maximum velocity at maximum force	v _{MAX, FMAX}	m/min	276
Maximum electric power input	P _{EL, MAX}	kW	2.07
Stall force	F _{0*}	N	95
Stall current	I _{0*}	A	1.63
Physical constants			
Force constant	k _F	N/A	58.5
Voltage constant	k _E	Vs/m	35.3
Motor constant at 20 °C	k _{M, 20}	N/W ^{0.5}	20.7
Motor winding resistance at 20 °C	R _{STR, 20}	Ω	2.67
Phase inductance	L _{STR}	mH	23.7
Attraction force	F _A	N	1170
Thermal time constant	t _{TH}	s	6480
Polar distance	τ _P	mm	12.5
Cogging force	F _{COGG}	N	13.8
Mass of the primary section	m _P	kg	5.08
Secondary section data			
Mass of the secondary section (l = 500 mm)	m _S	kg	4.03
Mass of the secondary section (l = 200 mm)	m _S	kg	1.61

Characteristic curves 1FN6007-1LC46-0KA1

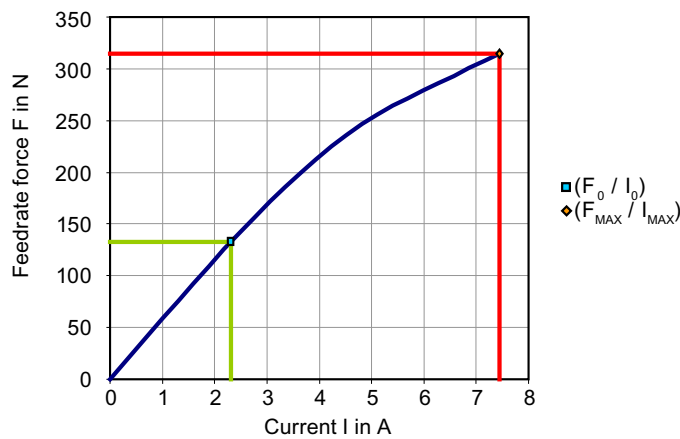
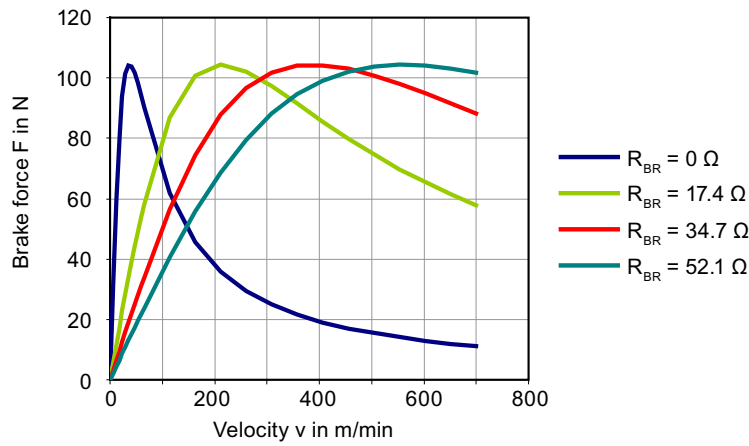
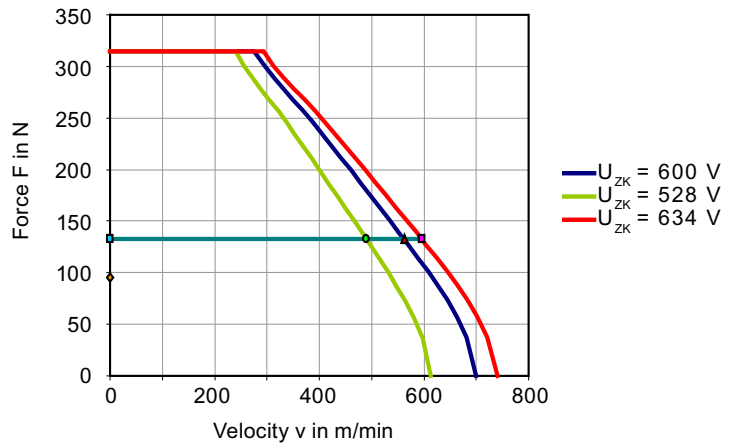

15.4.8 1FN6007-1LExx

Motor data 1FN6007-1LE20-0KA1

1FN6007-1LE20-0KA1			
Technical data	Short name	Unit	Value
Supplementary conditions			
DC-link voltage	U _{ZK}	V	600
Rated temperature	T _N	°C	120
Rated data			
Rated force	F _N	N	265
Rated current	I _N	A	2.31
Maximum velocity at rated force	v _{MAX, FN}	m/min	265
Rated power dissipation	P _{V, N}	kW	0.119
Limit data			
Maximum force	F _{MAX}	N	630
Maximum current	I _{MAX}	A	7.45
Maximum velocity at maximum force	v _{MAX, FMAX}	m/min	120
Maximum electric power input	P _{EL, MAX}	kW	2.5
Stall force	F _{0*}	N	190
Stall current	I _{0*}	A	1.63
Physical constants			
Force constant	k _F	N/A	117
Voltage constant	k _E	Vs/m	70.5
Motor constant at 20 °C	k _{M, 20}	N/W ^{0.5}	29.3
Motor winding resistance at 20 °C	R _{STR, 20}	Ω	5.32
Phase inductance	L _{STR}	mH	51.8
Attraction force	F _A	N	2510
Thermal time constant	t _{TH}	s	6480
Polar distance	T _P	mm	12.5
Cogging force	F _{COGG}	N	16.9
Mass of the primary section	m _P	kg	8.39
Secondary section data			
Mass of the secondary section (l = 500 mm)	m _S	kg	4.03
Mass of the secondary section (l = 200 mm)	m _S	kg	1.61

Characteristic curves 1FN6007-1LE20-0KA1

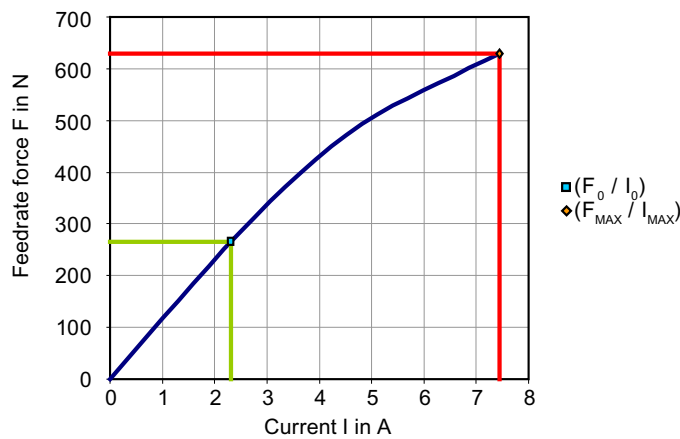
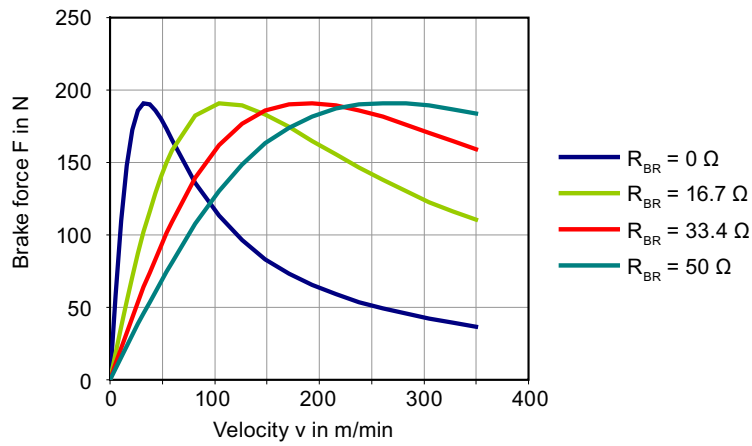
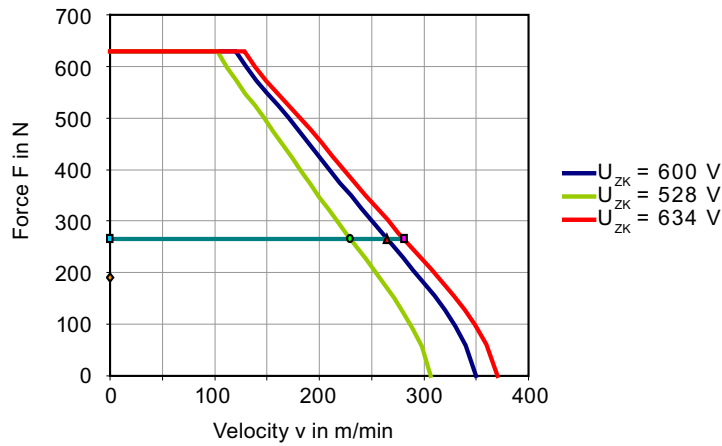

Motor data 1FN6007-1LE53-0KA1

1FN6007-1LE53-0KA1			
Technical data	Short name	Unit	Value
Supplementary conditions			
DC-link voltage	U _{ZK}	V	600
Rated temperature	T _N	°C	120
Rated data			
Rated force	F _N	N	265
Rated current	I _N	A	5.63
Maximum velocity at rated force	v _{MAX, FN}	m/min	668
Rated power dissipation	P _{V, N}	kW	0.129
Limit data			
Maximum force	F _{MAX}	N	630
Maximum current	I _{MAX}	A	18.2
Maximum velocity at maximum force	v _{MAX, FMAX}	m/min	315
Maximum electric power input	P _{EL, MAX}	kW	4.65
Stall force	F _{0*}	N	190
Stall current	I _{0*}	A	3.98
Physical constants			
Force constant	k _F	N/A	48
Voltage constant	k _E	Vs/m	28.9
Motor constant at 20 °C	k _{M, 20}	N/W ^{0.5}	28.1
Motor winding resistance at 20 °C	R _{STR, 20}	Ω	0.974
Phase inductance	L _{STR}	mH	8.72
Attraction force	F _A	N	2510
Thermal time constant	t _{TH}	s	6480
Polar distance	τ _P	mm	12.5
Cogging force	F _{COGG}	N	16.9
Mass of the primary section	m _P	kg	8.39
Secondary section data			
Mass of the secondary section (l = 500 mm)	m _S	kg	4.03
Mass of the secondary section (l = 200 mm)	m _S	kg	1.61

Characteristic curves 1FN6007-1LE53-0KA1

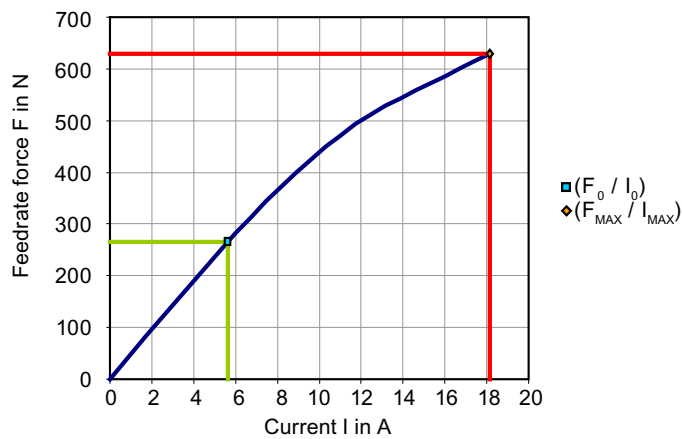
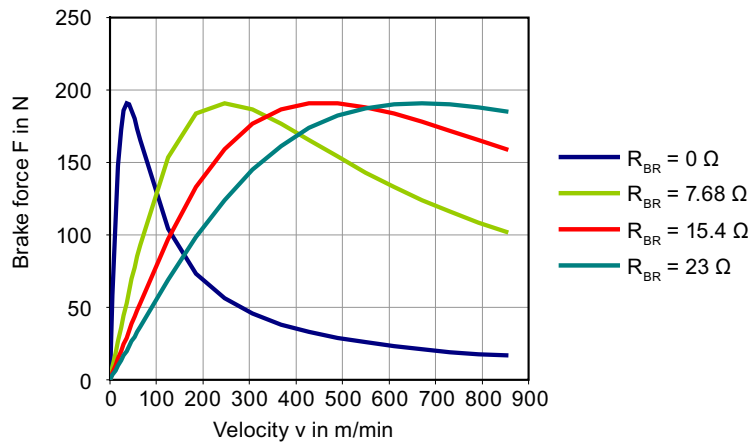
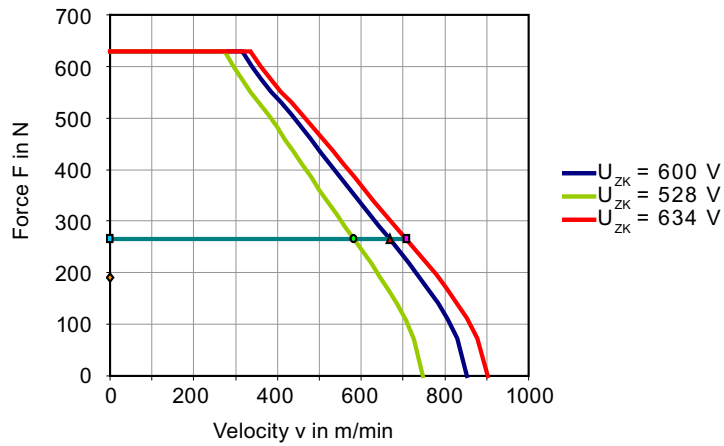

15.4.9 1FN6007-1LGxx

Motor data 1FN6007-1LG12-0KA1

1FN6007-1LG12-0KA1			
Technical data	Short name	Unit	Value
Supplementary conditions			
DC-link voltage	U _{ZK}	V	600
Rated temperature	T _N	°C	120
Rated data			
Rated force	F _N	N	398
Rated current	I _N	A	2.31
Maximum velocity at rated force	V _{MAX, FN}	m/min	169
Rated power dissipation	P _{V, N}	kW	0.178
Limit data			
Maximum force	F _{MAX}	N	945
Maximum current	I _{MAX}	A	7.45
Maximum velocity at maximum force	V _{MAX, FMAX}	m/min	71.7
Maximum electric power input	P _{EL, MAX}	kW	2.98
Stall force	F _{0*}	N	285
Stall current	I _{0*}	A	1.63
Physical constants			
Force constant	k _F	N/A	175
Voltage constant	k _E	Vs/m	106
Motor constant at 20 °C	k _{M, 20}	N/W ^{0.5}	35.9
Motor winding resistance at 20 °C	R _{STR, 20}	Ω	7.97
Phase inductance	L _{STR}	mH	80.2
Attraction force	F _A	N	3860
Thermal time constant	t _{TH}	s	6480
Polar distance	T _P	mm	12.5
Cogging force	F _{COGG}	N	20.0
Mass of the primary section	m _P	kg	11.7
Secondary section data			
Mass of the secondary section (l = 500 mm)	m _S	kg	4.03
Mass of the secondary section (l = 200 mm)	m _S	kg	1.61

Characteristic curves 1FN6007-1LG12-0KA1

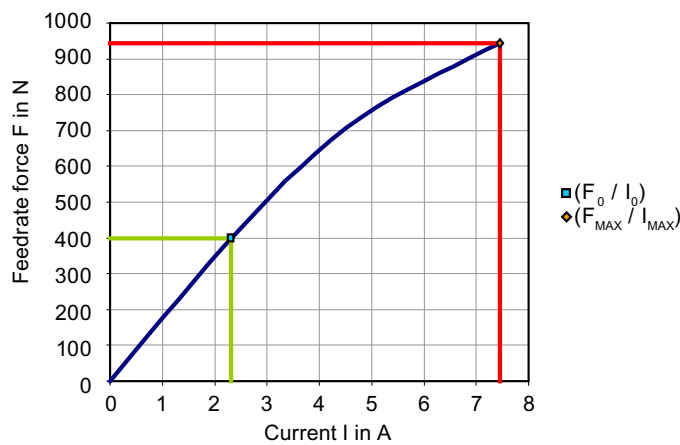
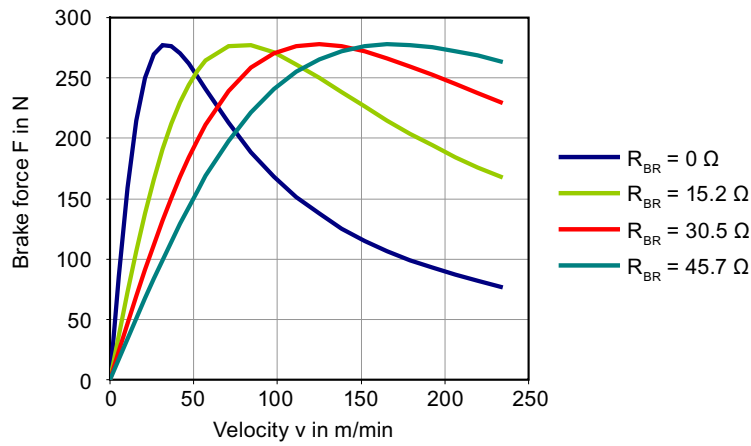
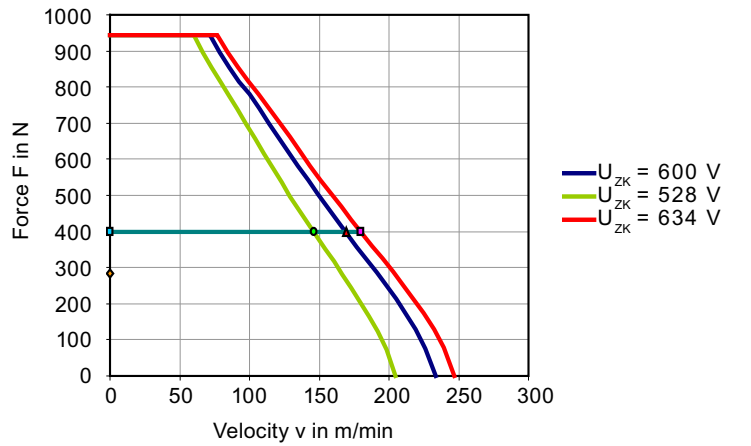

Motor data 1FN6007-1LG33-0KA1

1FN6007-1LG33-0KA1			
Technical data	Short name	Unit	Value
Supplementary conditions			
DC-link voltage	U _{ZK}	V	600
Rated temperature	T _N	°C	120
Rated data			
Rated force	F _N	N	398
Rated current	I _N	A	5.63
Maximum velocity at rated force	v _{MAX, FN}	m/min	435
Rated power dissipation	P _{V, N}	kW	0.193
Limit data			
Maximum force	F _{MAX}	N	945
Maximum current	I _{MAX}	A	18.2
Maximum velocity at maximum force	v _{MAX, FMAX}	m/min	200
Maximum electric power input	P _{EL, MAX}	kW	5.14
Stall force	F _{0*}	N	285
Stall current	I _{0*}	A	3.98
Physical constants			
Force constant	k _F	N/A	72
Voltage constant	k _E	Vs/m	43.4
Motor constant at 20 °C	k _{M, 20}	N/W ^{0.5}	34.5
Motor winding resistance at 20 °C	R _{STR, 20}	Ω	1.45
Phase inductance	L _{STR}	mH	13.5
Attraction force	F _A	N	3860
Thermal time constant	t _{TH}	s	6480
Polar distance	τ _P	mm	12.5
Cogging force	F _{COGG}	N	20.0
Mass of the primary section	m _P	kg	11.7
Secondary section data			
Mass of the secondary section (l = 500 mm)	m _S	kg	4.03
Mass of the secondary section (l = 200 mm)	m _S	kg	1.61

Characteristic curves 1FN6007-1LG33-0KA1

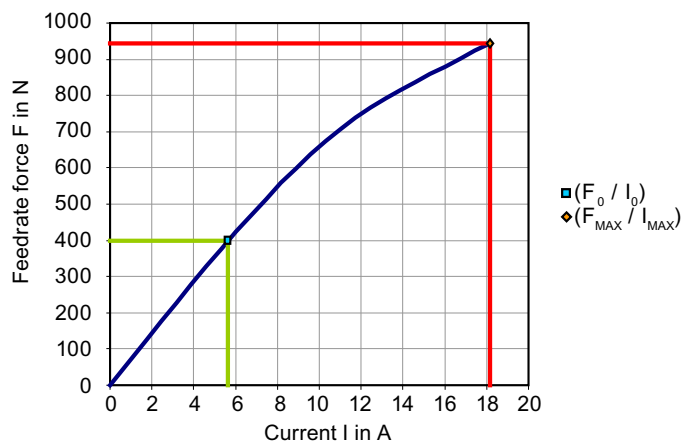
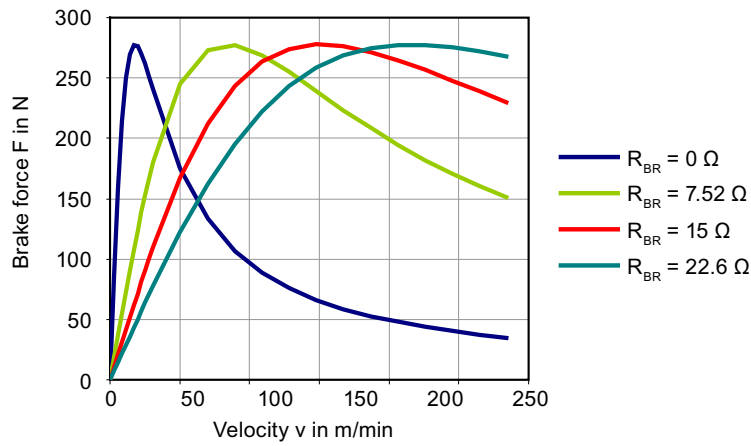
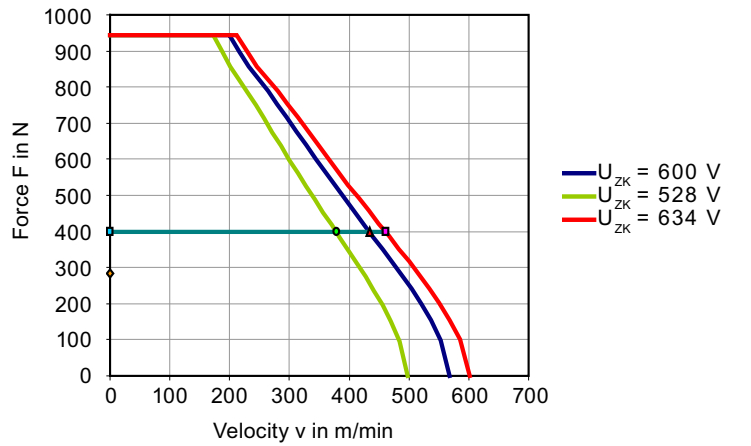

15.4.10 1FN6007-1LJxx

Motor data 1FN6007-1LJ08-0KA1

1FN6007-1LJ08-0KA1			
Technical data	Short name	Unit	Value
Supplementary conditions			
DC-link voltage	U _{ZK}	V	600
Rated temperature	T _N	°C	120
Rated data			
Rated force	F _N	N	531
Rated current	I _N	A	2.31
Maximum velocity at rated force	V _{MAX, FN}	m/min	122
Rated power dissipation	P _{V, N}	kW	0.237
Limit data			
Maximum force	F _{MAX}	N	1260
Maximum current	I _{MAX}	A	7.45
Maximum velocity at maximum force	V _{MAX, FMAX}	m/min	47.4
Maximum electric power input	P _{EL, MAX}	kW	3.46
Stall force	F _{0*}	N	380
Stall current	I _{0*}	A	1.63
Physical constants			
Force constant	k _F	N/A	234
Voltage constant	k _E	Vs/m	141
Motor constant at 20 °C	k _{M, 20}	N/W ^{0.5}	41.4
Motor winding resistance at 20 °C	R _{STR, 20}	Ω	10.6
Phase inductance	L _{STR}	mH	109
Attraction force	F _A	N	5220
Thermal time constant	t _{TH}	s	6480
Polar distance	T _P	mm	12.5
Cogging force	F _{COGG}	N	23.0
Mass of the primary section	m _P	kg	15
Secondary section data			
Mass of the secondary section (l = 500 mm)	m _S	kg	4.03
Mass of the secondary section (l = 200 mm)	m _S	kg	1.61

Characteristic curves 1FN6007-1LJ08-0KA1

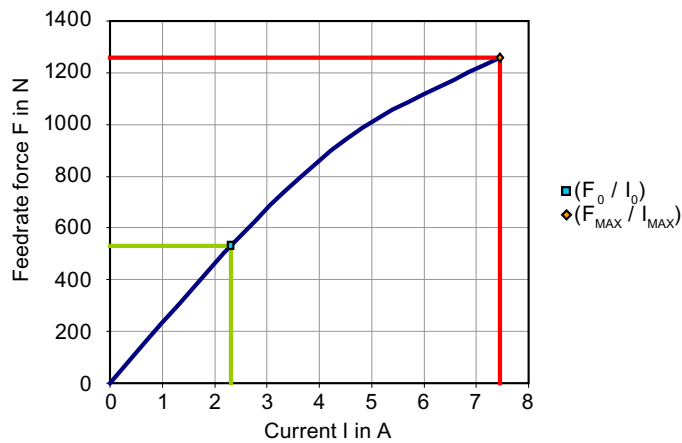
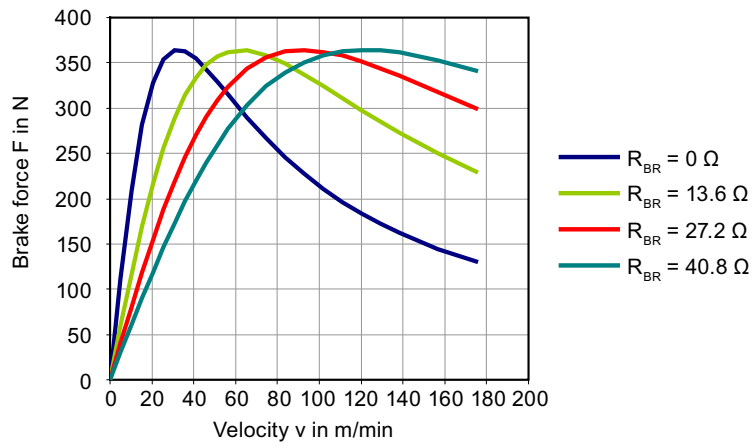
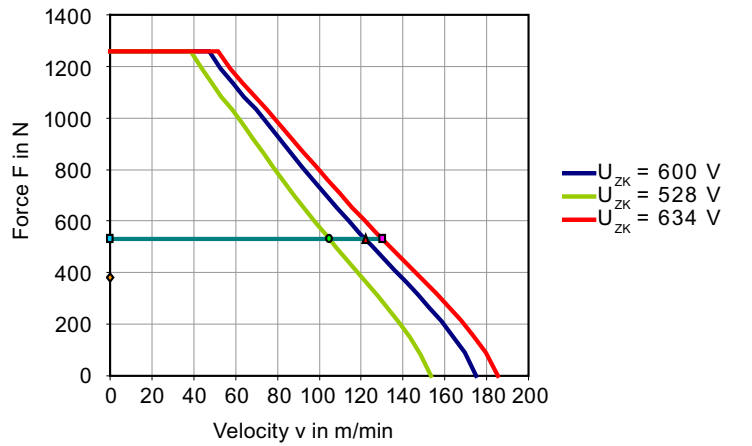

Motor data 1FN6007-1LJ24-0KA1

1FN6007-1LJ24-0KA1			
Technical data	Short name	Unit	Value
Supplementary conditions			
DC-link voltage	U _{ZK}	V	600
Rated temperature	T _N	°C	120
Rated data			
Rated force	F _N	N	531
Rated current	I _N	A	5.63
Maximum velocity at rated force	v _{MAX, FN}	m/min	320
Rated power dissipation	P _{V, N}	kW	0.256
Limit data			
Maximum force	F _{MAX}	N	1260
Maximum current	I _{MAX}	A	18.2
Maximum velocity at maximum force	v _{MAX, FMAX}	m/min	143
Maximum electric power input	P _{EL, MAX}	kW	5.67
Stall force	F _{0*}	N	380
Stall current	I _{0*}	A	3.98
Physical constants			
Force constant	k _F	N/A	96
Voltage constant	k _E	Vs/m	57.9
Motor constant at 20 °C	k _{M, 20}	N/W ^{0.5}	39.9
Motor winding resistance at 20 °C	R _{STR, 20}	Ω	1.93
Phase inductance	L _{STR}	mH	18.3
Attraction force	F _A	N	5220
Thermal time constant	t _{TH}	s	6480
Polar distance	T _P	mm	12.5
Cogging force	F _{COGG}	N	23.0
Mass of the primary section	m _P	kg	15
Secondary section data			
Mass of the secondary section (l = 500 mm)	m _S	kg	4.03
Mass of the secondary section (l = 200 mm)	m _S	kg	1.61

Characteristic curves 1FN6007-1LJ24-0KA1

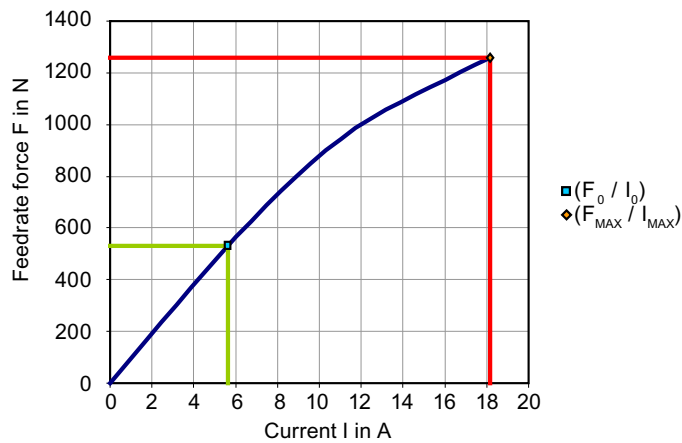
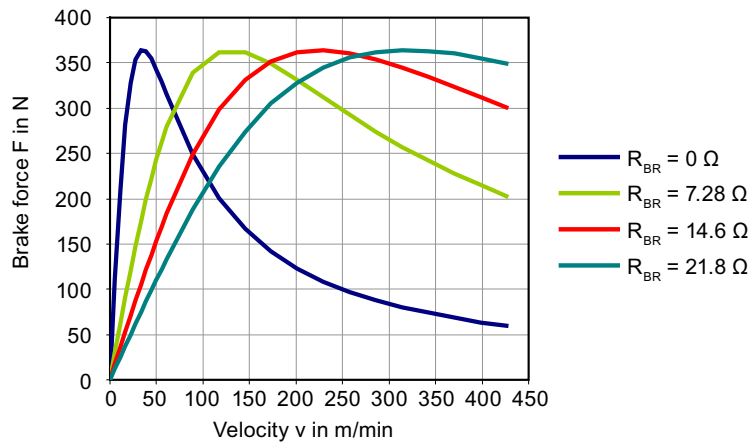
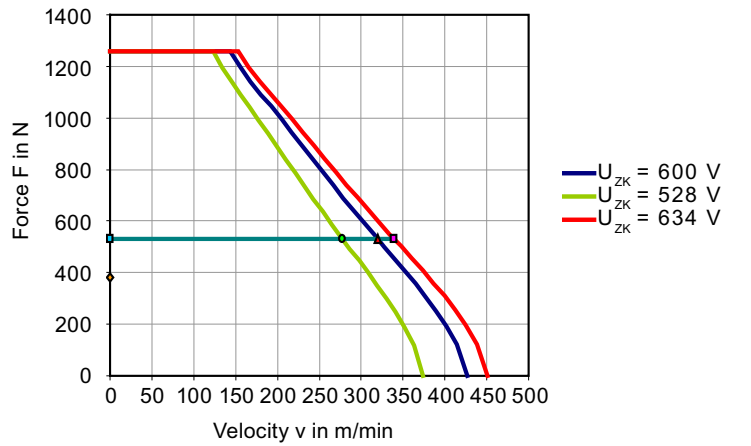

15.4.11 1FN6007-1LLxx

Motor data 1FN6007-1LL05-0KA1

1FN6007-1LL05-0KA1			
Technical data	Short name	Unit	Value
Supplementary conditions			
DC-link voltage	U _{ZK}	V	600
Rated temperature	T _N	°C	120
Rated data			
Rated force	F _N	N	663
Rated current	I _N	A	2.31
Maximum velocity at rated force	V _{MAX, FN}	m/min	93.9
Rated power dissipation	P _{V, N}	kW	0.296
Limit data			
Maximum force	F _{MAX}	N	1570
Maximum current	I _{MAX}	A	7.45
Maximum velocity at maximum force	V _{MAX, FMAX}	m/min	32.4
Maximum electric power input	P _{EL, MAX}	kW	3.93
Stall force	F _{0*}	N	475
Stall current	I _{0*}	A	1.63
Physical constants			
Force constant	k _F	N/A	292
Voltage constant	k _E	Vs/m	176
Motor constant at 20 °C	k _{M, 20}	N/W ^{0.5}	46.3
Motor winding resistance at 20 °C	R _{STR, 20}	Ω	13.3
Phase inductance	L _{STR}	mH	137
Attraction force	F _A	N	6590
Thermal time constant	t _{TH}	s	6480
Polar distance	T _P	mm	12.5
Cogging force	F _{COGG}	N	26.1
Mass of the primary section	m _P	kg	18.3
Secondary section data			
Mass of the secondary section (l = 500 mm)	m _S	kg	4.03
Mass of the secondary section (l = 200 mm)	m _S	kg	1.61

Characteristic curves 1FN6007-1LL05-0KA1

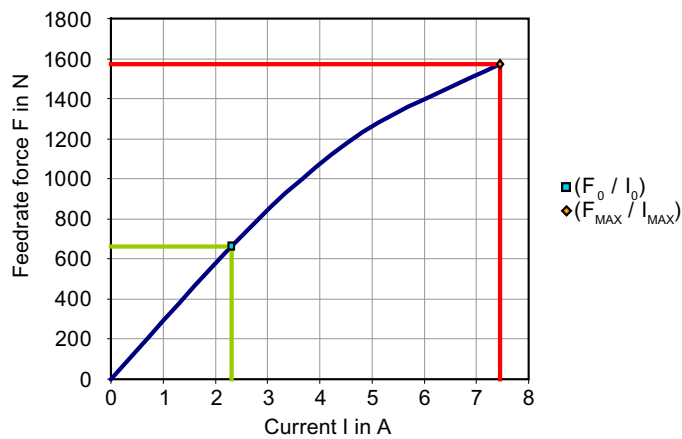
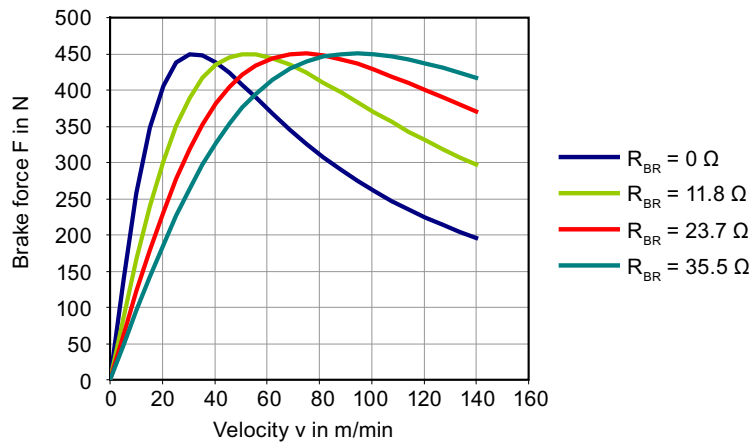
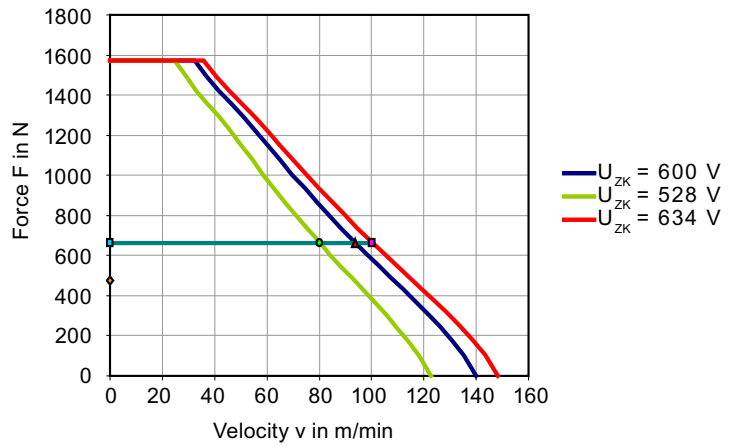

Motor data 1FN6007-1LL18-0KA1

1FN6007-1LL18-0KA1			
Technical data	Short name	Unit	Value
Supplementary conditions			
DC-link voltage	U _{ZK}	V	600
Rated temperature	T _N	°C	120
Rated data			
Rated force	F _N	N	663
Rated current	I _N	A	5.63
Maximum velocity at rated force	v _{MAX, FN}	m/min	251
Rated power dissipation	P _{V, N}	kW	0.319
Limit data			
Maximum force	F _{MAX}	N	1570
Maximum current	I _{MAX}	A	18.2
Maximum velocity at maximum force	v _{MAX, FMAX}	m/min	110
Maximum electric power input	P _{EL, MAX}	kW	6.21
Stall force	F _{0*}	N	475
Stall current	I _{0*}	A	3.98
Physical constants			
Force constant	k _F	N/A	120
Voltage constant	k _E	Vs/m	72.4
Motor constant at 20 °C	k _{M, 20}	N/W ^{0.5}	44.6
Motor winding resistance at 20 °C	R _{STR, 20}	Ω	2.41
Phase inductance	L _{STR}	mH	23.1
Attraction force	F _A	N	6590
Thermal time constant	t _{TH}	s	6480
Polar distance	τ _P	mm	12.5
Cogging force	F _{COGG}	N	26.1
Mass of the primary section	m _P	kg	18.3
Secondary section data			
Mass of the secondary section (l = 500 mm)	m _S	kg	4.03
Mass of the secondary section (l = 200 mm)	m _S	kg	1.61

Characteristic curves 1FN6007-1LL18-0KA1

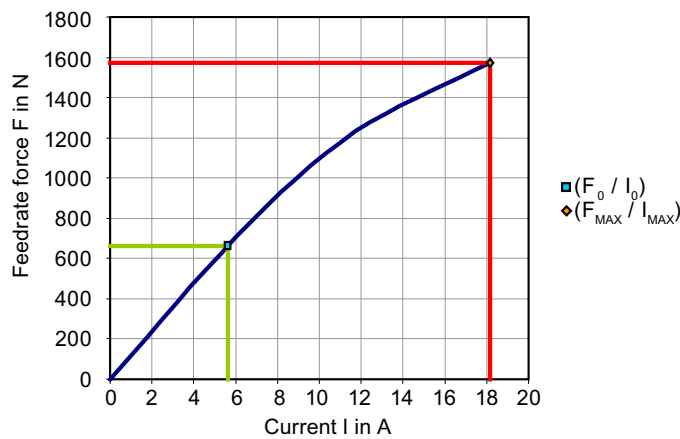
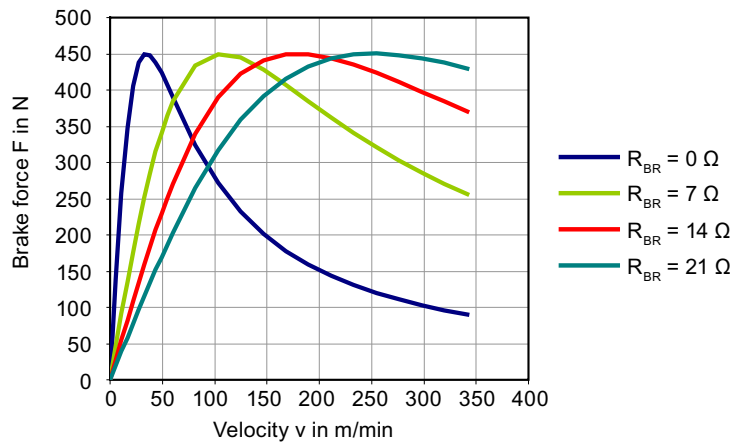
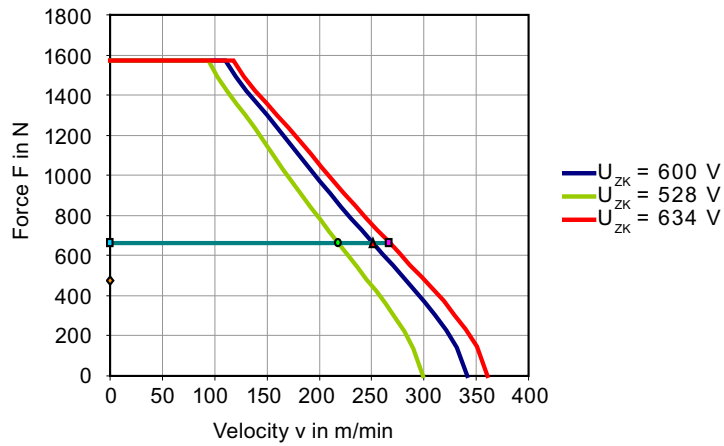

15.4.12 1FN6007-1LNxx

Motor data 1FN6007-1LN15-0KA1

1FN6007-1LN15-0KA1			
Technical data	Short name	Unit	Value
Supplementary conditions			
DC-link voltage	U _{ZK}	V	600
Rated temperature	T _N	°C	120
Rated data			
Rated force	F _N	N	796
Rated current	I _N	A	5.63
Maximum velocity at rated force	V _{MAX, FN}	m/min	206
Rated power dissipation	P _{V, N}	kW	0.383
Limit data			
Maximum force	F _{MAX}	N	1890
Maximum current	I _{MAX}	A	18.2
Maximum velocity at maximum force	V _{MAX, FMAX}	m/min	87.9
Maximum electric power input	P _{EL, MAX}	kW	6.74
Stall force	F _{0*}	N	570
Stall current	I _{0*}	A	3.98
Physical constants			
Force constant	k _F	N/A	144
Voltage constant	k _E	Vs/m	86.8
Motor constant at 20 °C	k _{M, 20}	N/W ^{0.5}	48.9
Motor winding resistance at 20 °C	R _{STR, 20}	Ω	2.89
Phase inductance	L _{STR}	mH	28
Attraction force	F _A	N	7960
Thermal time constant	t _{TH}	s	6480
Polar distance	T _P	mm	12.5
Cogging force	F _{COGG}	N	29.2
Mass of the primary section	m _P	kg	21.6
Secondary section data			
Mass of the secondary section (l = 500 mm)	m _S	kg	4.03
Mass of the secondary section (l = 200 mm)	m _S	kg	1.61

Characteristic curves 1FN6007-1LN15-0KA1

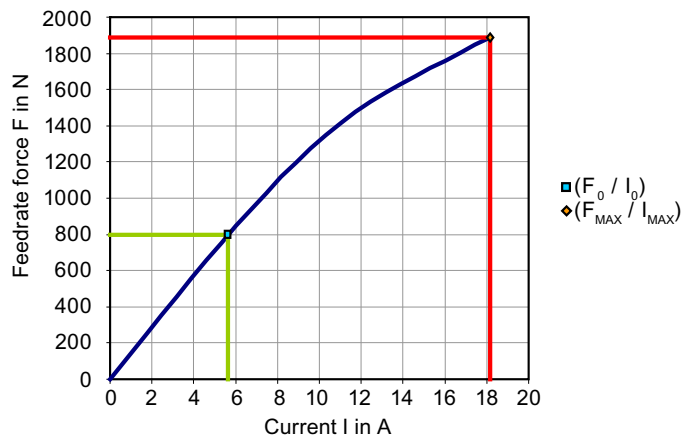
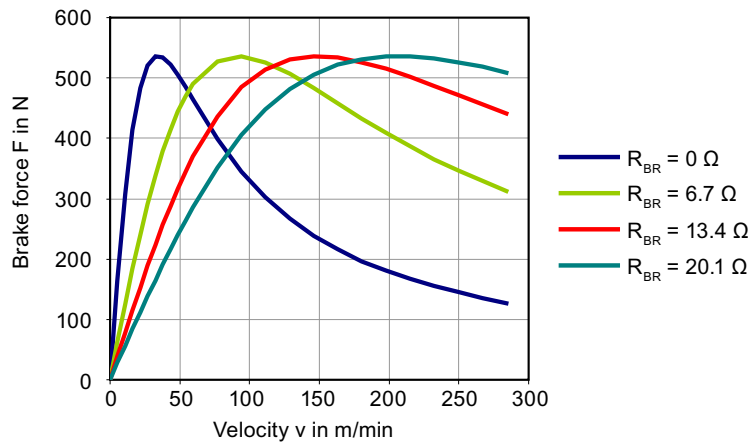
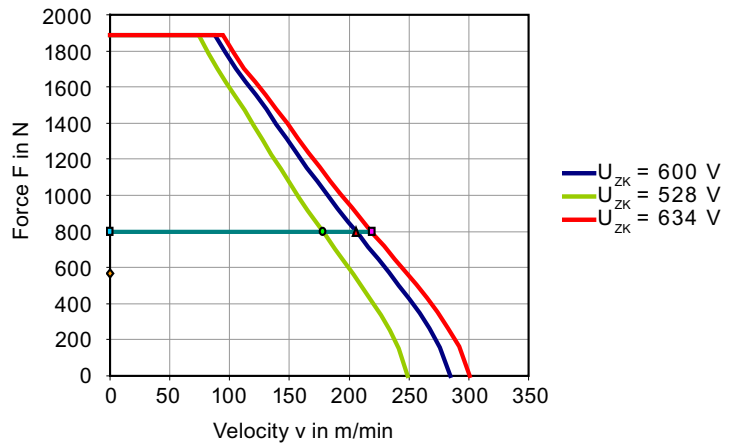

Motor data 1FN6007-1LN32-0KA1

1FN6007-1LN32-0KA1			
Technical data	Short name	Unit	Value
Supplementary conditions			
DC-link voltage	U _{ZK}	V	600
Rated temperature	T _N	°C	120
Rated data			
Rated force	F _N	N	796
Rated current	I _N	A	11.3
Maximum velocity at rated force	v _{MAX, FN}	m/min	429
Rated power dissipation	P _{V, N}	kW	0.39
Limit data			
Maximum force	F _{MAX}	N	1890
Maximum current	I _{MAX}	A	36.3
Maximum velocity at maximum force	v _{MAX, FMAX}	m/min	194
Maximum electric power input	P _{EL, MAX}	kW	10.1
Stall force	F _{0*}	N	570
Stall current	I _{0*}	A	7.97
Physical constants			
Force constant	k _F	N/A	72
Voltage constant	k _E	Vs/m	43.4
Motor constant at 20 °C	k _{M, 20}	N/W ^{0.5}	48.5
Motor winding resistance at 20 °C	R _{STR, 20}	Ω	0.734
Phase inductance	L _{STR}	mH	6.99
Attraction force	F _A	N	7960
Thermal time constant	t _{TH}	s	6480
Polar distance	τ _P	mm	12.5
Cogging force	F _{COGG}	N	29.2
Mass of the primary section	m _P	kg	21.6
Secondary section data			
Mass of the secondary section (l = 500 mm)	m _S	kg	4.03
Mass of the secondary section (l = 200 mm)	m _S	kg	1.61

Characteristic curves 1FN6007-1LN32-0KA1

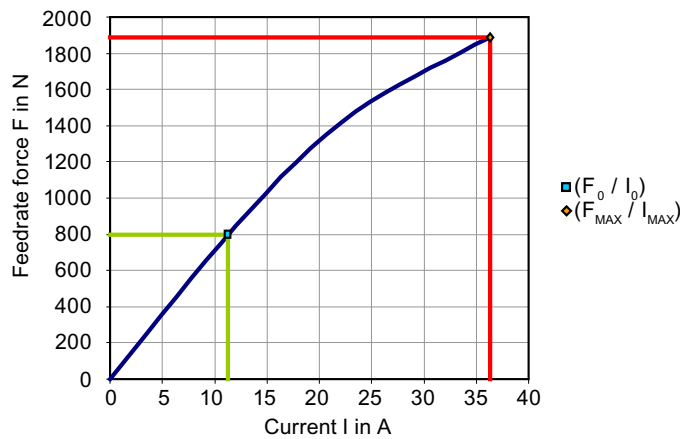
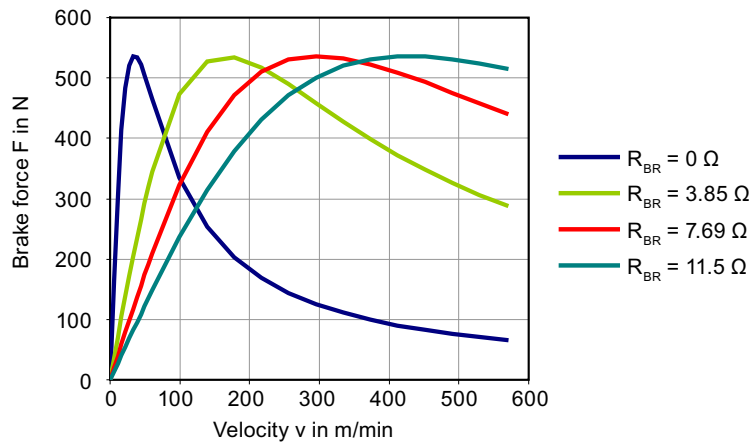
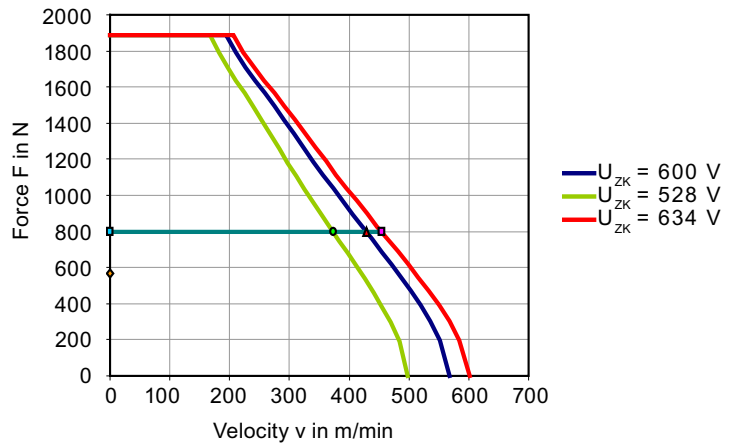

15.4.13 1FN6008-1LCxx

Motor data 1FN6008-1LC17-0KA1

1FN6008-1LC17-0KA1			
Technical data	Short name	Unit	Value
Supplementary conditions			
DC-link voltage	U _{ZK}	V	600
Rated temperature	T _N	°C	120
Rated data			
Rated force	F _N	N	374
Rated current	I _N	A	2.71
Maximum velocity at rated force	V _{MAX, FN}	m/min	218
Rated power dissipation	P _{V, N}	kW	0.159
Limit data			
Maximum force	F _{MAX}	N	898
Maximum current	I _{MAX}	A	8.64
Maximum velocity at maximum force	V _{MAX, FMAX}	m/min	98.5
Maximum electric power input	P _{EL, MAX}	kW	3.09
Stall force	F _{0*}	N	268
Stall current	I _{0*}	A	1.92
Physical constants			
Force constant	k _F	N/A	141
Voltage constant	k _E	Vs/m	84.9
Motor constant at 20 °C	k _{M, 20}	N/W ^{0.5}	35.7
Motor winding resistance at 20 °C	R _{STR, 20}	Ω	5.17
Phase inductance	L _{STR}	mH	107
Attraction force	F _A	N	3590
Thermal time constant	t _{TH}	s	5540
Polar distance	T _P	mm	25
Cogging force	F _{COGG}	N	20.2
Mass of the primary section	m _P	kg	16.3
Secondary section data			
Mass of a secondary section (l = 200 mm)	m _S	kg	2.81

Characteristic curves 1FN6008-1LC17-0KA1

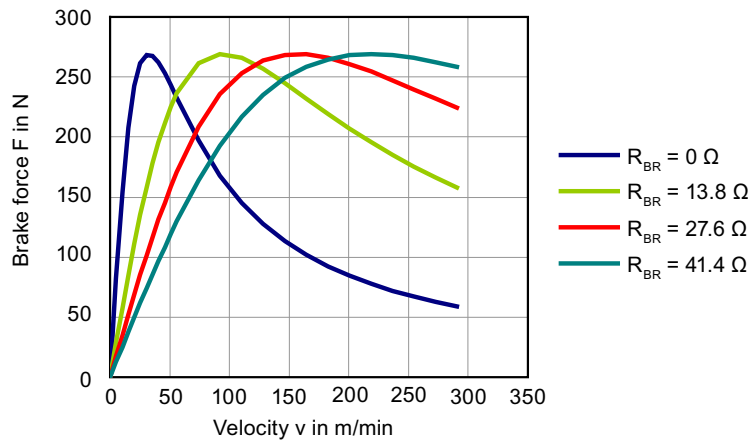
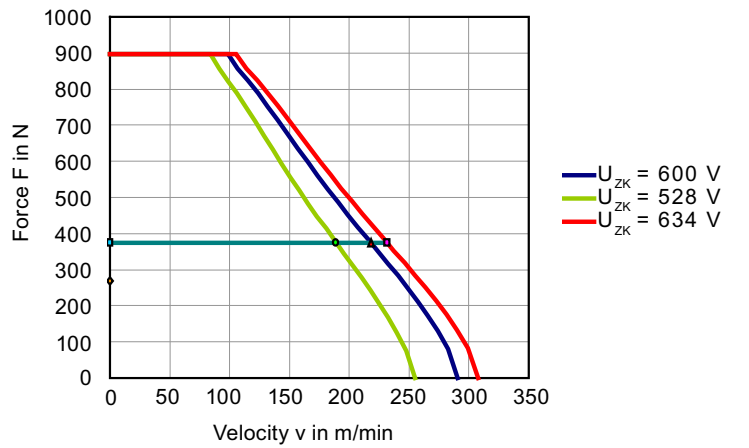

Motor data 1FN6008-1LC37-0KA1

1FN6008-1LC37-0KA1			
Technical data	Short name	Unit	Value
Supplementary conditions			
DC-link voltage	U _{ZK}	V	600
Rated temperature	T _N	°C	120
Rated data			
Rated force	F _N	N	374
Rated current	I _N	A	5.65
Maximum velocity at rated force	V _{MAX, FN}	m/min	473
Rated power dissipation	P _{V, N}	kW	0.15
Limit data			
Maximum force	F _{MAX}	N	898
Maximum current	I _{MAX}	A	18
Maximum velocity at maximum force	V _{MAX, FMAX}	m/min	224
Maximum electric power input	P _{EL, MAX}	kW	4.88
Stall force	F _{0*}	N	268
Stall current	I _{0*}	A	4
Physical constants			
Force constant	k _F	N/A	67.5
Voltage constant	k _E	Vs/m	40.7
Motor constant at 20 °C	k _{M, 20}	N/W ^{0.5}	36.7
Motor winding resistance at 20 °C	R _{STR, 20}	Ω	1.13
Phase inductance	L _{STR}	mH	24.5
Attraction force	F _A	N	3590
Thermal time constant	t _{TH}	s	5540
Polar distance	T _P	mm	25
Cogging force	F _{COGG}	N	20.2
Mass of the primary section	m _P	kg	16.3
Secondary section data			
Mass of a secondary section (l = 200 mm)	m _S	kg	2.81

Characteristic curves 1FN6008-1LC37-0KA1

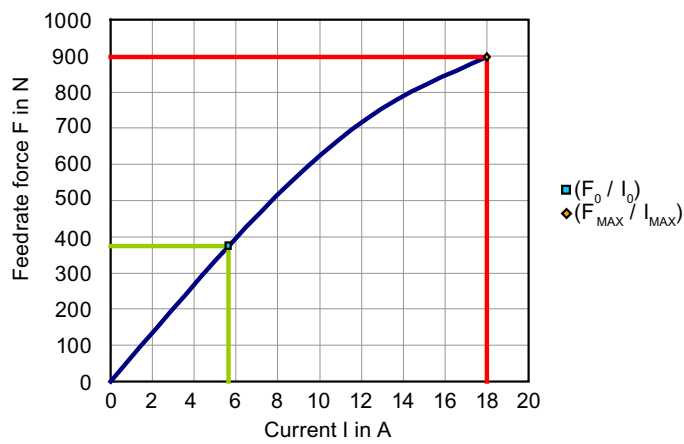
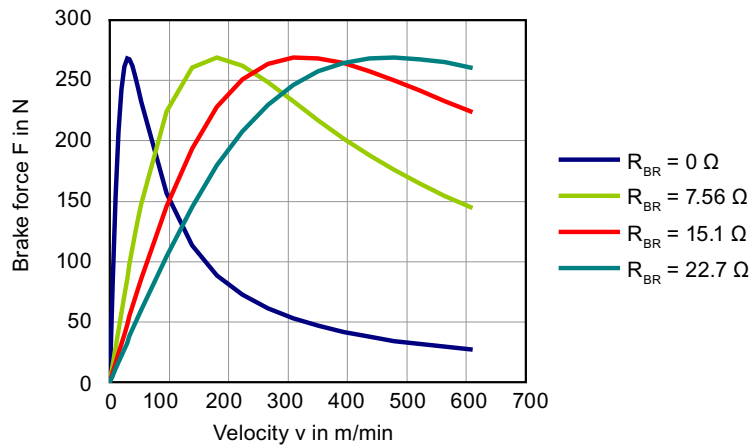
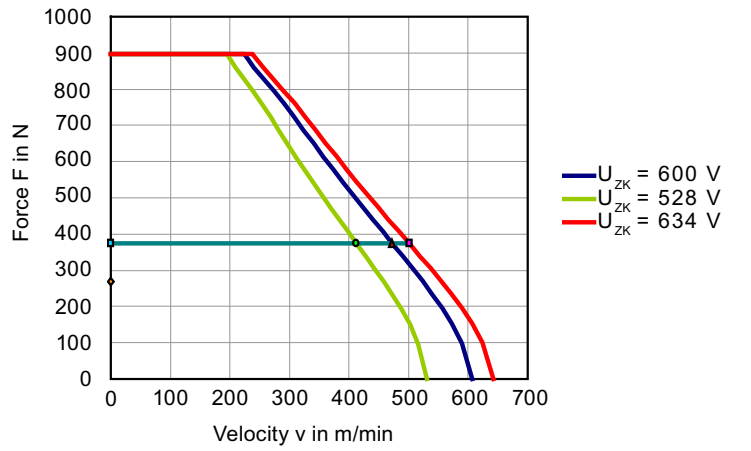

15.4.14 1FN6008-1LExx

Motor data 1FN6008-1LE16-0KA1

1FN6008-1LE16-0KA1			
Technical data	Short name	Unit	Value
Supplementary conditions			
DC-link voltage	U _{ZK}	V	600
Rated temperature	T _N	°C	120
Rated data			
Rated force	F _N	N	749
Rated current	I _N	A	5.65
Maximum velocity at rated force	V _{MAX, FN}	m/min	221
Rated power dissipation	P _{V, N}	kW	0.298
Limit data			
Maximum force	F _{MAX}	N	1800
Maximum current	I _{MAX}	A	18
Maximum velocity at maximum force	V _{MAX, FMAX}	m/min	96.8
Maximum electric power input	P _{EL, MAX}	kW	5.93
Stall force	F _{0*}	N	536
Stall current	I _{0*}	A	4
Physical constants			
Force constant	k _F	N/A	135
Voltage constant	k _E	Vs/m	81.4
Motor constant at 20 °C	k _{M, 20}	N/W ^{0.5}	52.1
Motor winding resistance at 20 °C	R _{STR, 20}	Ω	2.24
Phase inductance	L _{STR}	mH	54.1
Attraction force	F _A	N	7600
Thermal time constant	t _{TH}	s	5540
Polar distance	T _P	mm	25
Cogging force	F _{COGG}	N	25.0
Mass of the primary section	m _P	kg	27.9
Secondary section data			
Mass of a secondary section (l = 200 mm)	m _S	kg	2.81

Characteristic curves 1FN6008-1LE16-0KA1

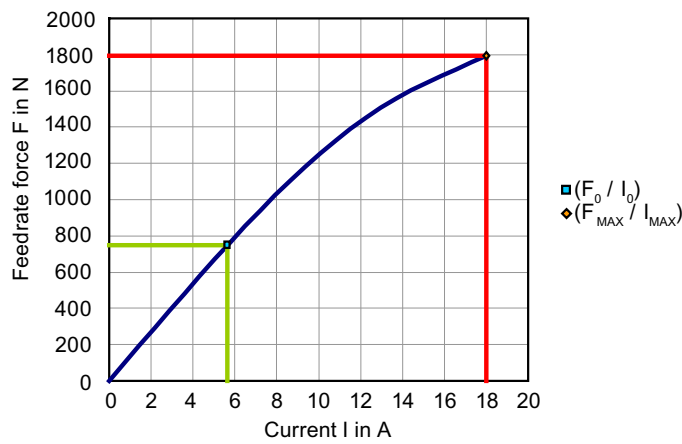
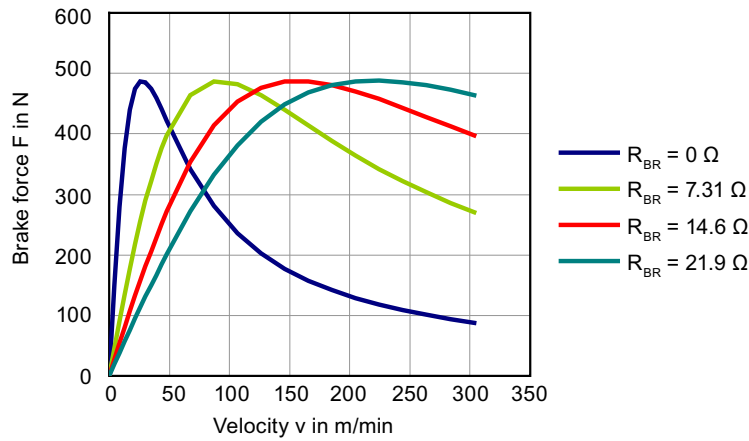
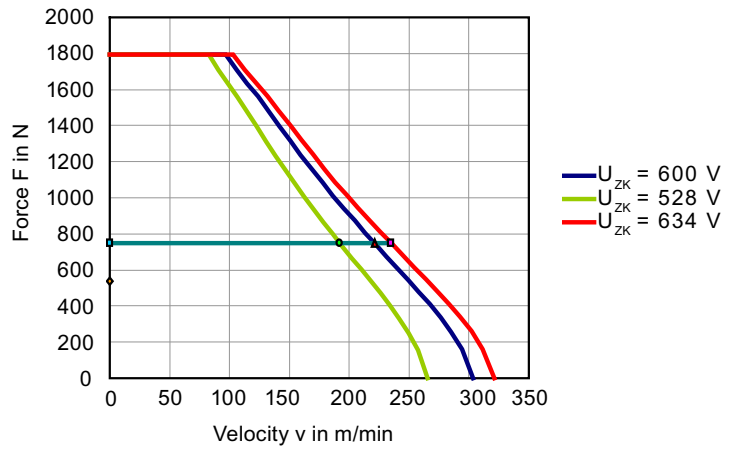

Motor data 1FN6008-1LE34-0KA1

1FN6008-1LE34-0KA1			
Technical data	Short name	Unit	Value
Supplementary conditions			
DC-link voltage	U _{ZK}	V	600
Rated temperature	T _N	°C	120
Rated data			
Rated force	F _N	N	749
Rated current	I _N	A	11.3
Maximum velocity at rated force	V _{MAX, FN}	m/min	456
Rated power dissipation	P _{V, N}	kW	0.305
Limit data			
Maximum force	F _{MAX}	N	1800
Maximum current	I _{MAX}	A	36
Maximum velocity at maximum force	V _{MAX, FMAX}	m/min	207
Maximum electric power input	P _{EL, MAX}	kW	9.28
Stall force	F _{0*}	N	536
Stall current	I _{0*}	A	7.99
Physical constants			
Force constant	k _F	N/A	67.5
Voltage constant	k _E	Vs/m	40.7
Motor constant at 20 °C	k _{M, 20}	N/W ^{0.5}	51.5
Motor winding resistance at 20 °C	R _{STR, 20}	Ω	0.572
Phase inductance	L _{STR}	mH	13.5
Attraction force	F _A	N	7600
Thermal time constant	t _{TH}	s	5540
Polar distance	T _P	mm	25
Cogging force	F _{COGG}	N	25.0
Mass of the primary section	m _P	kg	27.9
Secondary section data			
Mass of a secondary section (l = 200 mm)	m _S	kg	2.81

Characteristic curves 1FN6008-1LE34-0KA1

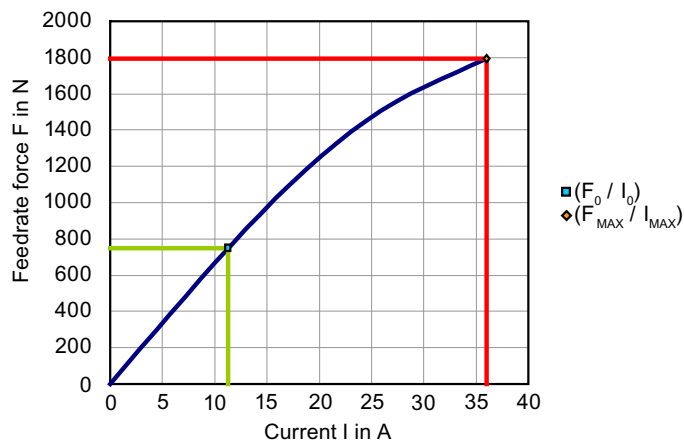
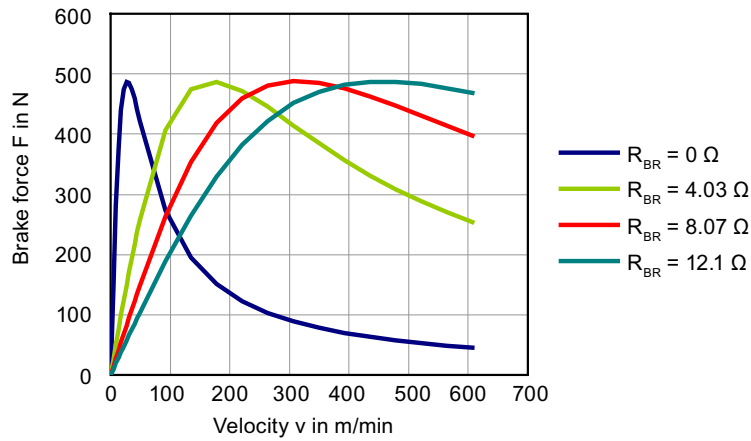
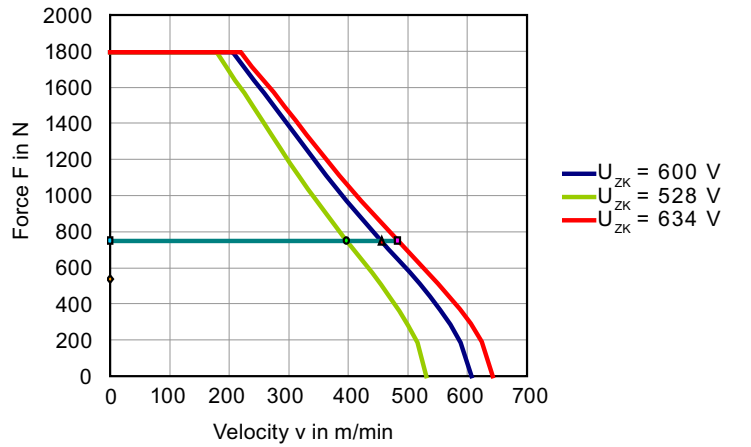

15.4.15 1FN6008-1LGxx

Motor data 1FN6008-1LG16-0KA1

1FN6008-1LG16-0KA1			
Technical data	Short name	Unit	Value
Supplementary conditions			
DC-link voltage	U _{ZK}	V	600
Rated temperature	T _N	°C	120
Rated data			
Rated force	F _N	N	1120
Rated current	I _N	A	8.69
Maximum velocity at rated force	V _{MAX, FN}	m/min	224
Rated power dissipation	P _{V, N}	kW	0.446
Limit data			
Maximum force	F _{MAX}	N	2690
Maximum current	I _{MAX}	A	27.7
Maximum velocity at maximum force	V _{MAX, FMAX}	m/min	96.7
Maximum electric power input	P _{EL, MAX}	kW	8.87
Stall force	F _{0*}	N	804
Stall current	I _{0*}	A	6.15
Physical constants			
Force constant	k _F	N/A	132
Voltage constant	k _E	Vs/m	79.4
Motor constant at 20 °C	k _{M, 20}	N/W ^{0.5}	64
Motor winding resistance at 20 °C	R _{STR, 20}	Ω	1.41
Phase inductance	L _{STR}	mH	35.6
Attraction force	F _A	N	11700
Thermal time constant	t _{TH}	s	5540
Polar distance	T _P	mm	25
Cogging force	F _{COGG}	N	29.8
Mass of the primary section	m _P	kg	39.6
Secondary section data			
Mass of a secondary section (l = 200 mm)	m _S	kg	2.81

Characteristic curves 1FN6008-1LG16-0KA1

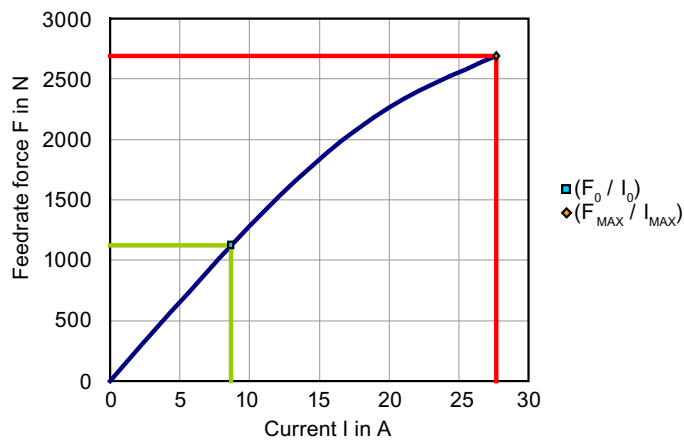
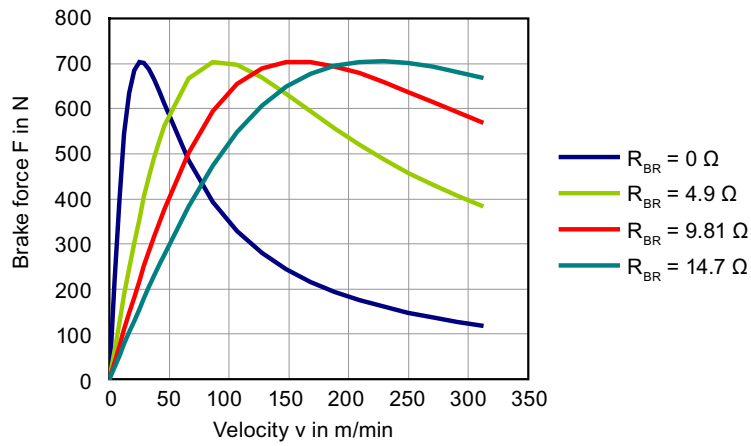
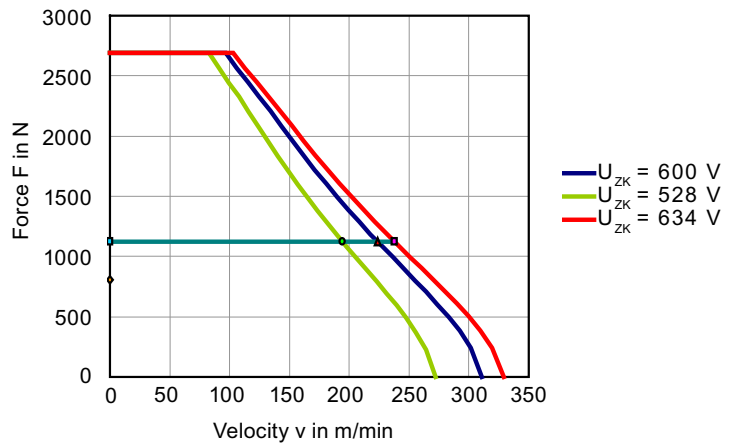

Motor data 1FN6008-1LG33-0KA1

1FN6008-1LG33-0KA1			
Technical data	Short name	Unit	Value
Supplementary conditions			
DC-link voltage	U _{ZK}	V	600
Rated temperature	T _N	°C	120
Rated data			
Rated force	F _N	N	1120
Rated current	I _N	A	17
Maximum velocity at rated force	V _{MAX, FN}	m/min	449
Rated power dissipation	P _{V, N}	kW	0.465
Limit data			
Maximum force	F _{MAX}	N	2690
Maximum current	I _{MAX}	A	54
Maximum velocity at maximum force	V _{MAX, FMAX}	m/min	200
Maximum electric power input	P _{EL, MAX}	kW	13.7
Stall force	F _{0*}	N	804
Stall current	I _{0*}	A	12
Physical constants			
Force constant	k _F	N/A	67.5
Voltage constant	k _E	Vs/m	40.7
Motor constant at 20 °C	k _{M, 20}	N/W ^{0.5}	62.7
Motor winding resistance at 20 °C	R _{STR, 20}	Ω	0.387
Phase inductance	L _{STR}	mH	9.35
Attraction force	F _A	N	11700
Thermal time constant	t _{TH}	s	5540
Polar distance	T _P	mm	25
Cogging force	F _{COGG}	N	29.8
Mass of the primary section	m _P	kg	39.6
Secondary section data			
Mass of a secondary section (l = 200 mm)	m _S	kg	2.81

Characteristic curves 1FN6008-1LG33-0KA1

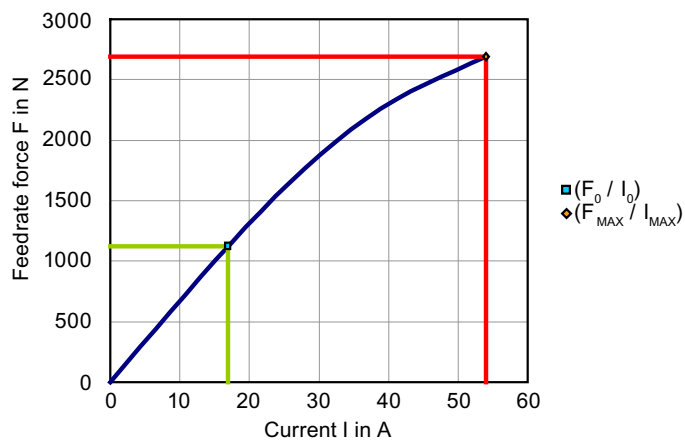
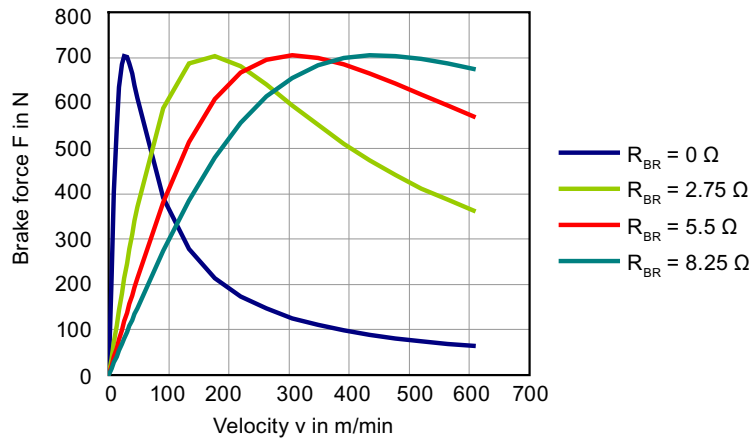
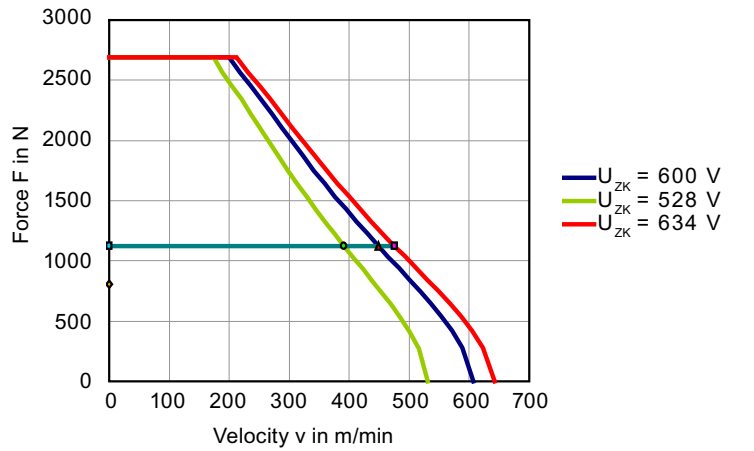

15.4.16 1FN6016-1LCxx

Motor data 1FN6016-1LC18-0KA1

1FN6016-1LC18-0KA1			
Technical data	Short name	Unit	Value
Supplementary conditions			
DC-link voltage	U _{ZK}	V	600
Rated temperature	T _N	°C	120
Rated data			
Rated force	F _N	N	692
Rated current	I _N	A	5.2
Maximum velocity at rated force	V _{MAX, FN}	m/min	241
Rated power dissipation	P _{V, N}	kW	0.207
Limit data			
Maximum force	F _{MAX}	N	1800
Maximum current	I _{MAX}	A	18
Maximum velocity at maximum force	V _{MAX, FMAX}	m/min	110
Maximum electric power input	P _{EL, MAX}	kW	5.77
Stall force	F _{0*}	N	494
Stall current	I _{0*}	A	3.68
Physical constants			
Force constant	k _F	N/A	135
Voltage constant	k _E	Vs/m	81.4
Motor constant at 20 °C	k _{M, 20}	N/W ^{0.5}	57.6
Motor winding resistance at 20 °C	R _{STR, 20}	Ω	1.83
Phase inductance	L _{STR}	mH	47.6
Attraction force	F _A	N	7180
Thermal time constant	t _{TH}	s	7010
Polar distance	T _P	mm	25
Cogging force	F _{COGG}	N	40.4
Mass of the primary section	m _P	kg	27.6
Secondary section data			
Mass of a secondary section (l = 200 mm)	m _S	kg	5.42

Characteristic curves 1FN6016-1LC18-0KA1

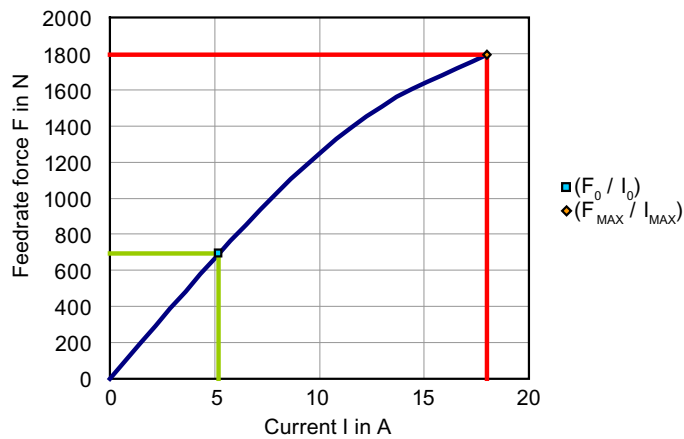
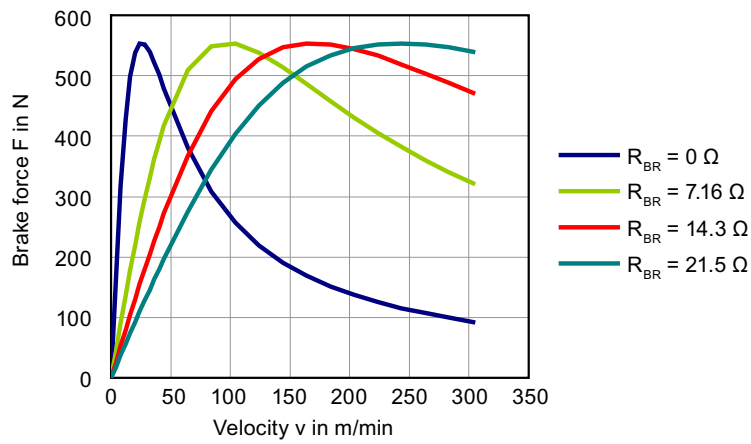
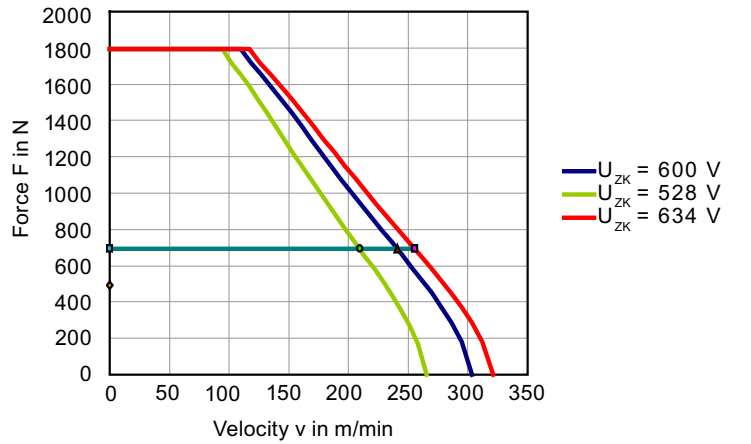

Motor data 1FN6016-1LC30-0KA1

1FN6016-1LC30-0KA1			
Technical data	Short name	Unit	Value
Supplementary conditions			
DC-link voltage	U _{ZK}	V	600
Rated temperature	T _N	°C	120
Rated data			
Rated force	F _N	N	692
Rated current	I _N	A	8
Maximum velocity at rated force	V _{MAX, FN}	m/min	377
Rated power dissipation	P _{V, N}	kW	0.208
Limit data			
Maximum force	F _{MAX}	N	1800
Maximum current	I _{MAX}	A	27.7
Maximum velocity at maximum force	V _{MAX, FMAX}	m/min	176
Maximum electric power input	P _{EL, MAX}	kW	7.75
Stall force	F _{0*}	N	494
Stall current	I _{0*}	A	5.65
Physical constants			
Force constant	k _F	N/A	87.8
Voltage constant	k _E	Vs/m	52.9
Motor constant at 20 °C	k _{M, 20}	N/W ^{0.5}	57.4
Motor winding resistance at 20 °C	R _{STR, 20}	Ω	0.779
Phase inductance	L _{STR}	mH	20.1
Attraction force	F _A	N	7180
Thermal time constant	t _{TH}	s	7010
Polar distance	T _P	mm	25
Cogging force	F _{COGG}	N	40.4
Mass of the primary section	m _P	kg	27.6
Secondary section data			
Mass of a secondary section (l = 200 mm)	m _S	kg	5.42

Characteristic curves 1FN6016-1LC30-0KA1

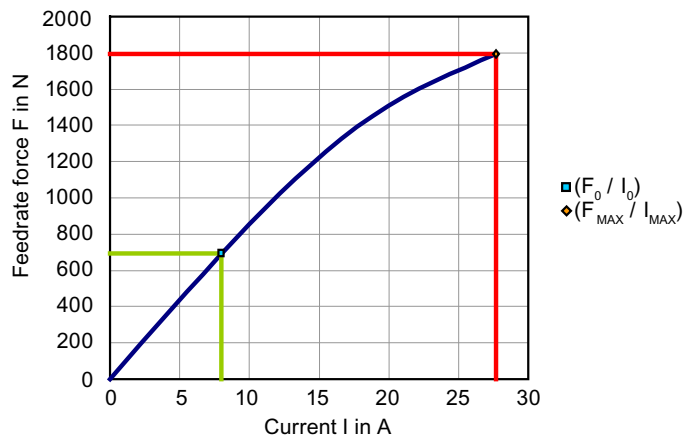
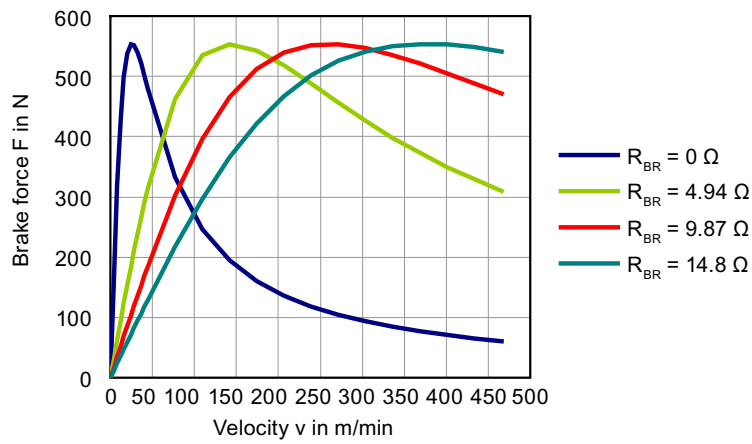
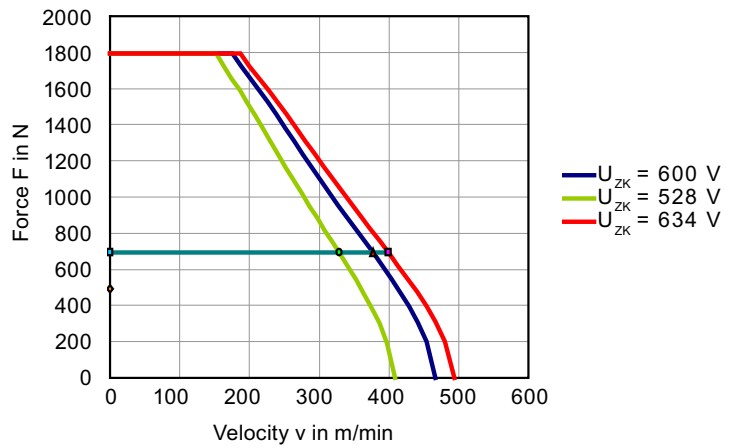

15.4.17 1FN6016-1LExx

Motor data 1FN6016-1LE17-0KA1

1FN6016-1LE17-0KA1			
Technical data	Short name	Unit	Value
Supplementary conditions			
DC-link voltage	U _{ZK}	V	600
Rated temperature	T _N	°C	120
Rated data			
Rated force	F _N	N	1380
Rated current	I _N	A	10.4
Maximum velocity at rated force	v _{MAX, FN}	m/min	233
Rated power dissipation	P _{V, N}	kW	0.418
Limit data			
Maximum force	F _{MAX}	N	3590
Maximum current	I _{MAX}	A	36
Maximum velocity at maximum force	v _{MAX, FMAX}	m/min	101
Maximum electric power input	P _{EL, MAX}	kW	11.1
Stall force	F _{0*}	N	987
Stall current	I _{0*}	A	7.35
Physical constants			
Force constant	k _F	N/A	135
Voltage constant	k _E	Vs/m	81.4
Motor constant at 20 °C	k _{M, 20}	N/W ^{0.5}	81
Motor winding resistance at 20 °C	R _{STR, 20}	Ω	0.925
Phase inductance	L _{STR}	mH	26.4
Attraction force	F _A	N	15200
Thermal time constant	t _{TH}	s	7010
Polar distance	T _P	mm	25
Cogging force	F _{COGG}	N	50.0
Mass of the primary section	m _P	kg	48.2
Secondary section data			
Mass of a secondary section (l = 200 mm)	m _S	kg	5.42

Characteristic curves 1FN6016-1LE17-0KA1

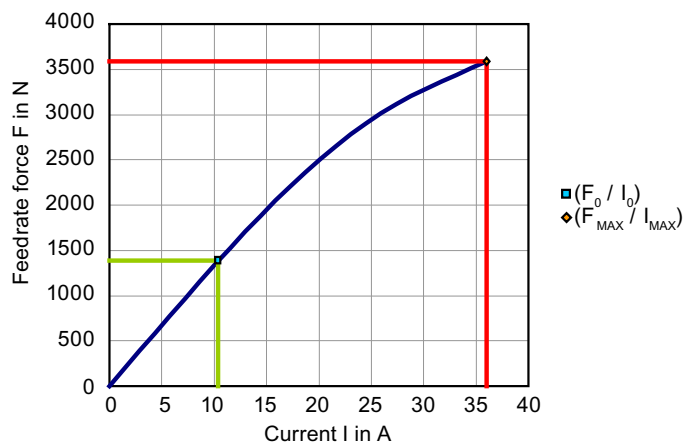
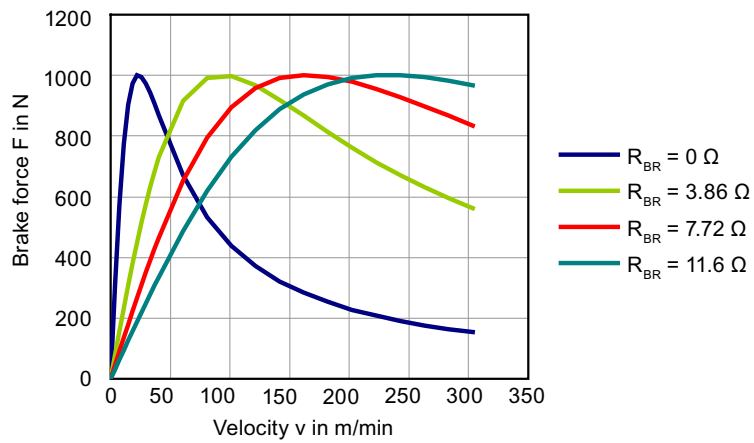
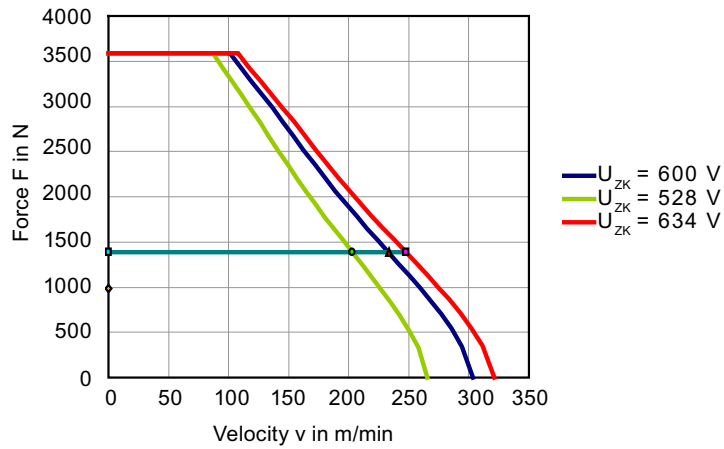

Motor data 1FN6016-1LE27-0KA1

1FN6016-1LE27-0KA1			
Technical data	Short name	Unit	Value
Supplementary conditions			
DC-link voltage	U _{ZK}	V	600
Rated temperature	T _N	°C	120
Rated data			
Rated force	F _N	N	1380
Rated current	I _N	A	16
Maximum velocity at rated force	v _{MAX, FN}	m/min	365
Rated power dissipation	P _{V, N}	kW	0.425
Limit data			
Maximum force	F _{MAX}	N	3590
Maximum current	I _{MAX}	A	55.4
Maximum velocity at maximum force	v _{MAX, FMAX}	m/min	162
Maximum electric power input	P _{EL, MAX}	kW	14.8
Stall force	F _{0*}	N	987
Stall current	I _{0*}	A	11.3
Physical constants			
Force constant	k _F	N/A	87.8
Voltage constant	k _E	Vs/m	52.9
Motor constant at 20 °C	k _{M, 20}	N/W ^{0.5}	80.4
Motor winding resistance at 20 °C	R _{STR, 20}	Ω	0.398
Phase inductance	L _{STR}	mH	11.1
Attraction force	F _A	N	15200
Thermal time constant	t _{TH}	s	7010
Polar distance	τ _P	mm	25
Cogging force	F _{COGG}	N	50.0
Mass of the primary section	m _P	kg	48.2
Secondary section data			
Mass of a secondary section (l = 200 mm)	m _S	kg	5.42

Characteristic curves 1FN6016-1LE27-0KA1

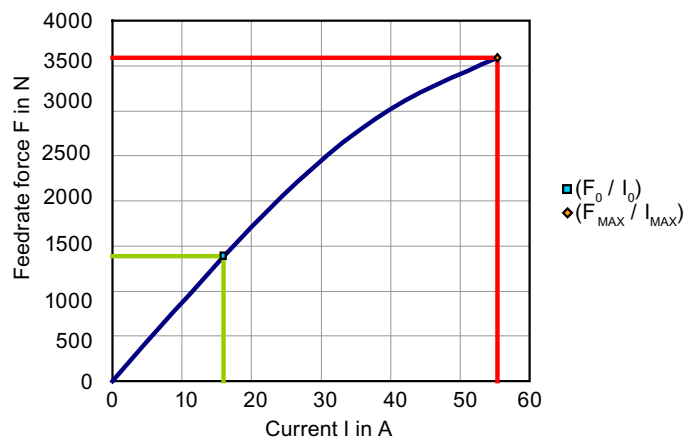
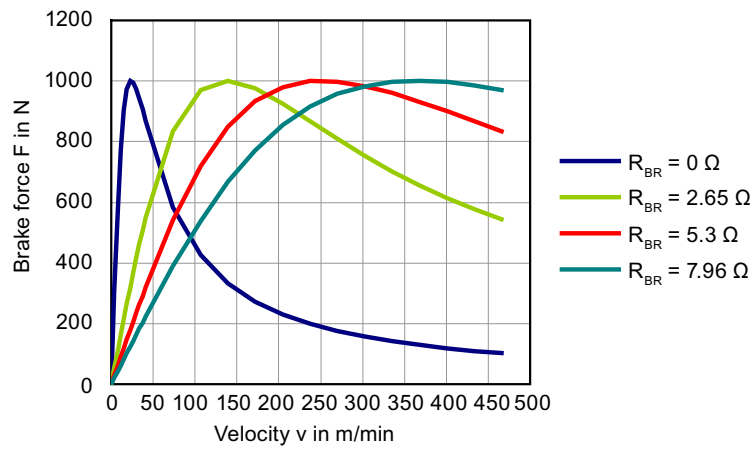
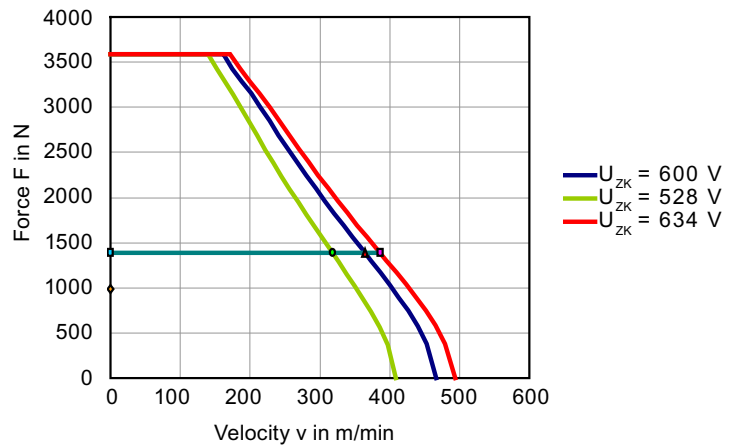

15.4.18 1FN6016-1LGxx

Motor data 1FN6016-1LG16-0KA1

1FN6016-1LG16-0KA1			
Technical data	Short name	Unit	Value
Supplementary conditions			
DC-link voltage	U _{ZK}	V	600
Rated temperature	T _N	°C	120
Rated data			
Rated force	F _N	N	2070
Rated current	I _N	A	15.6
Maximum velocity at rated force	V _{MAX, FN}	m/min	230
Rated power dissipation	P _{V, N}	kW	0.633
Limit data			
Maximum force	F _{MAX}	N	5390
Maximum current	I _{MAX}	A	54.1
Maximum velocity at maximum force	V _{MAX, FMAX}	m/min	98.2
Maximum electric power input	P _{EL, MAX}	kW	16.4
Stall force	F _{0*}	N	1480
Stall current	I _{0*}	A	11
Physical constants			
Force constant	k _F	N/A	135
Voltage constant	k _E	Vs/m	81.4
Motor constant at 20 °C	k _{M, 20}	N/W ^{0.5}	98.8
Motor winding resistance at 20 °C	R _{STR, 20}	Ω	0.622
Phase inductance	L _{STR}	mH	18.2
Attraction force	F _A	N	23300
Thermal time constant	t _{TH}	s	7010
Polar distance	T _P	mm	25
Cogging force	F _{COGG}	N	59.5
Mass of the primary section	m _P	kg	68.5
Secondary section data			
Mass of a secondary section (l = 200 mm)	m _S	kg	5.42

Characteristic curves 1FN6016-1LG16-0KA1

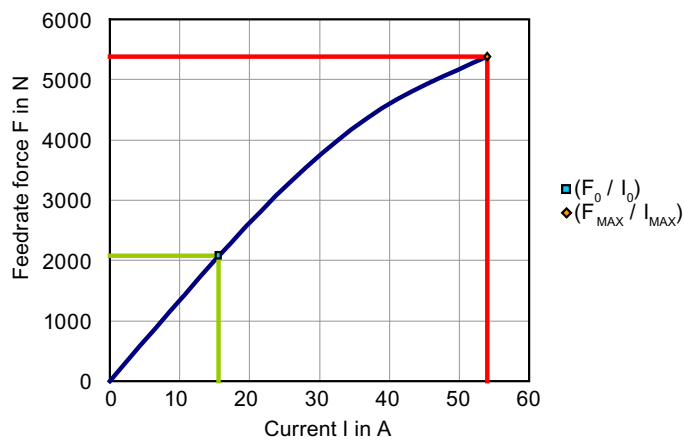
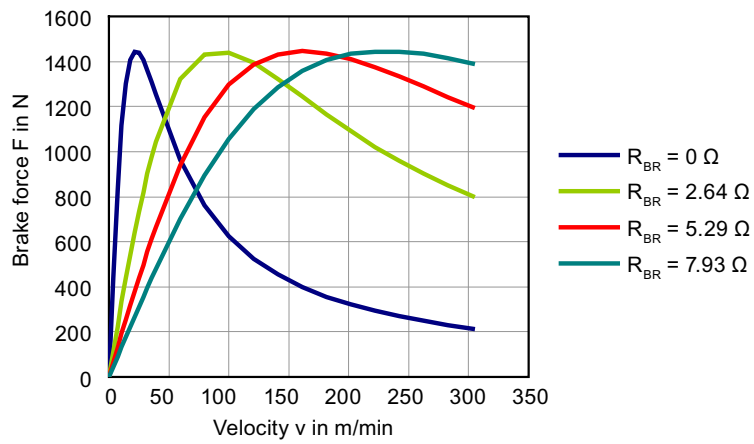
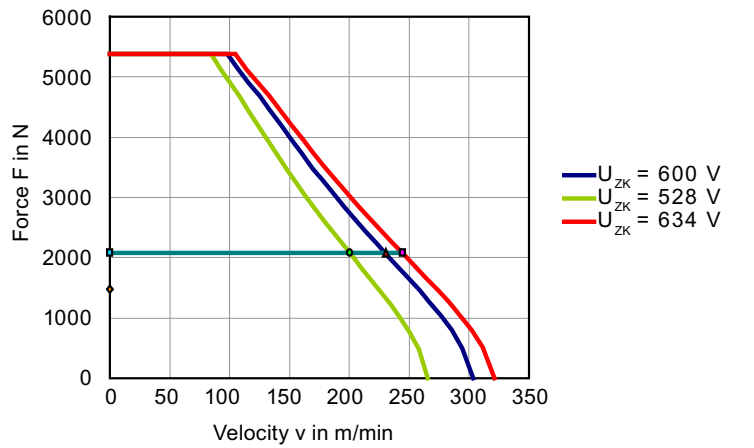

Motor data 1FN6016-1LG26-0KA1

1FN6016-1LG26-0KA1			
Technical data	Short name	Unit	Value
Supplementary conditions			
DC-link voltage	U _{ZK}	V	600
Rated temperature	T _N	°C	120
Rated data			
Rated force	F _N	N	2070
Rated current	I _N	A	24
Maximum velocity at rated force	V _{MAX, FN}	m/min	360
Rated power dissipation	P _{V, N}	kW	0.651
Limit data			
Maximum force	F _{MAX}	N	5390
Maximum current	I _{MAX}	A	83.1
Maximum velocity at maximum force	V _{MAX, FMAX}	m/min	156
Maximum electric power input	P _{EL, MAX}	kW	21.9
Stall force	F _{0*}	N	1480
Stall current	I _{0*}	A	17
Physical constants			
Force constant	k _F	N/A	87.8
Voltage constant	k _E	Vs/m	52.9
Motor constant at 20 °C	k _{M, 20}	N/W ^{0.5}	97.4
Motor winding resistance at 20 °C	R _{STR, 20}	Ω	0.271
Phase inductance	L _{STR}	mH	7.71
Attraction force	F _A	N	23300
Thermal time constant	t _{TH}	s	7010
Polar distance	T _P	mm	25
Cogging force	F _{COGG}	N	59.5
Mass of the primary section	m _P	kg	68.5
Secondary section data			
Mass of a secondary section (l = 200 mm)	m _S	kg	5.42

Characteristic curves 1FN6016-1LG26-0KA1

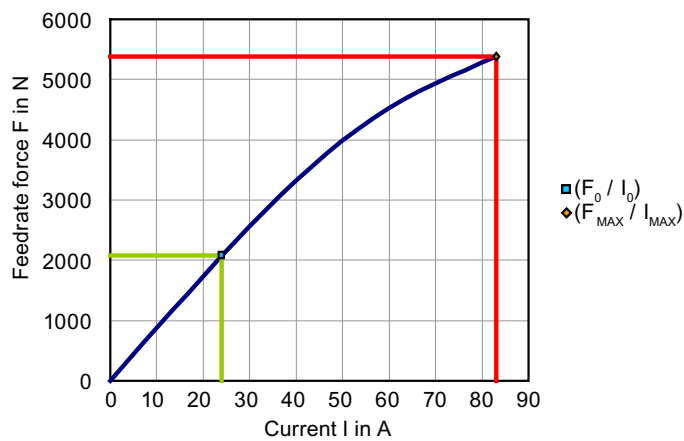
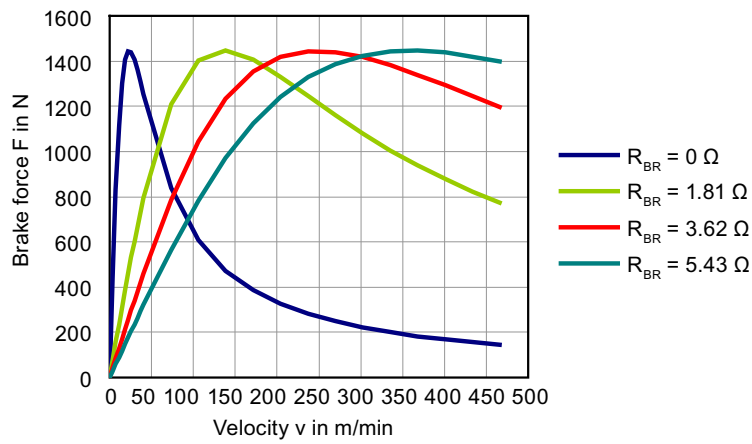
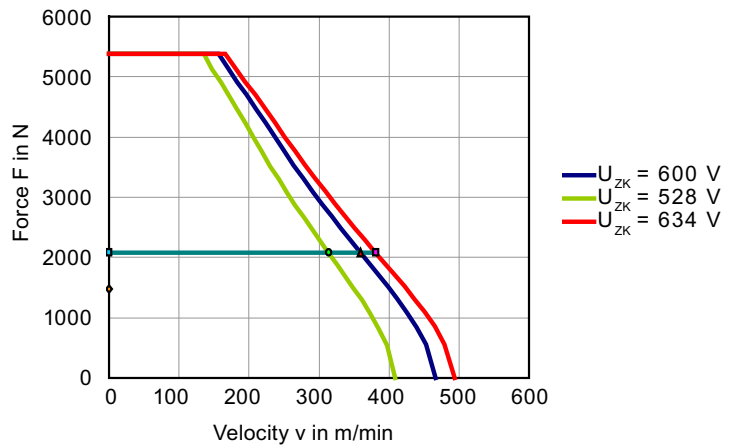

15.4.19 1FN6024-1LCxx

Motor data 1FN6024-1LC12-0KA1

1FN6024-1LC12-0KA1			
Technical data	Short name	Unit	Value
Supplementary conditions			
DC-link voltage	U _{ZK}	V	600
Rated temperature	T _N	°C	120
Rated data			
Rated force	F _N	N	1000
Rated current	I _N	A	5
Maximum velocity at rated force	V _{MAX, FN}	m/min	160
Rated power dissipation	P _{V, N}	kW	0.266
Limit data			
Maximum force	F _{MAX}	N	2690
Maximum current	I _{MAX}	A	18
Maximum velocity at maximum force	V _{MAX, FMAX}	m/min	70.1
Maximum electric power input	P _{EL, MAX}	kW	6.59
Stall force	F _{0*}	N	713
Stall current	I _{0*}	A	3.54
Physical constants			
Force constant	k _F	N/A	203
Voltage constant	k _E	Vs/m	122
Motor constant at 20 °C	k _{M, 20}	N/W ^{0.5}	73.4
Motor winding resistance at 20 °C	R _{STR, 20}	Ω	2.54
Phase inductance	L _{STR}	mH	70.7
Attraction force	F _A	N	10800
Thermal time constant	t _{TH}	s	7010
Polar distance	T _P	mm	25
Cogging force	F _{COGG}	N	60.7
Mass of the primary section	m _P	kg	39.9
Secondary section data			
Mass of a secondary section (l = 200 mm)	m _S	kg	7.96

Characteristic curves 1FN6024-1LC12-0KA1

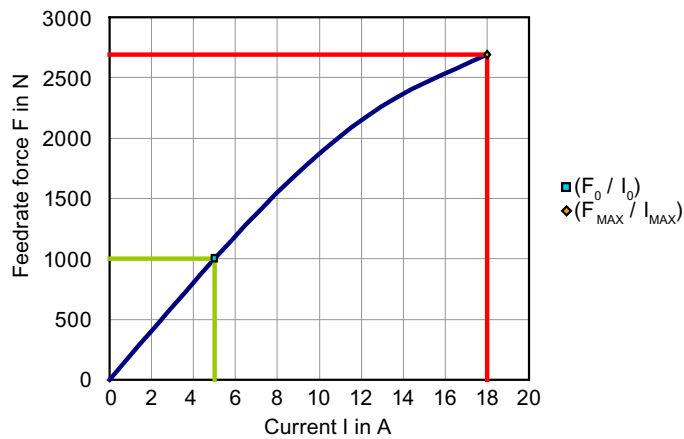
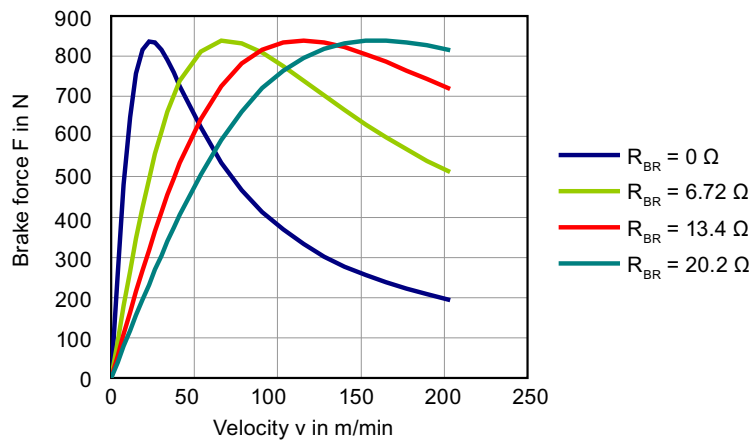
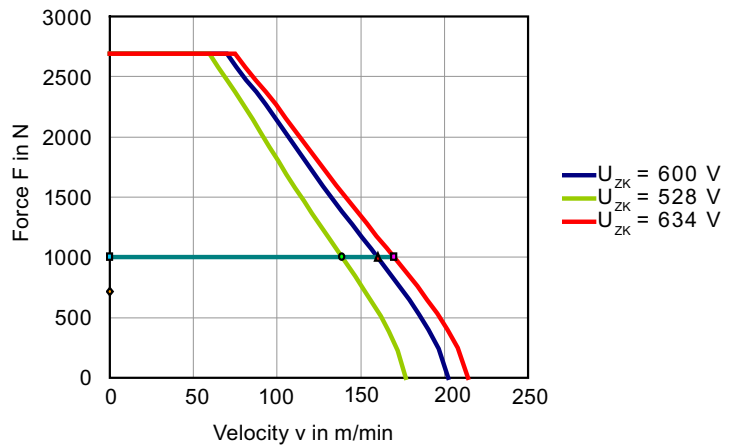

Motor data 1FN6024-1LC20-0KA1

1FN6024-1LC20-0KA1			
Technical data	Short name	Unit	Value
Supplementary conditions			
DC-link voltage	U _{ZK}	V	600
Rated temperature	T _N	°C	120
Rated data			
Rated force	F _N	N	1000
Rated current	I _N	A	7.69
Maximum velocity at rated force	V _{MAX, FN}	m/min	252
Rated power dissipation	P _{V, N}	kW	0.266
Limit data			
Maximum force	F _{MAX}	N	2690
Maximum current	I _{MAX}	A	27.7
Maximum velocity at maximum force	V _{MAX, FMAX}	m/min	115
Maximum electric power input	P _{EL, MAX}	kW	8.6
Stall force	F _{0*}	N	713
Stall current	I _{0*}	A	5.44
Physical constants			
Force constant	k _F	N/A	132
Voltage constant	k _E	Vs/m	79.4
Motor constant at 20 °C	k _{M, 20}	N/W ^{0.5}	73.3
Motor winding resistance at 20 °C	R _{STR, 20}	Ω	1.07
Phase inductance	L _{STR}	mH	29.9
Attraction force	F _A	N	10800
Thermal time constant	t _{TH}	s	7010
Polar distance	T _P	mm	25
Cogging force	F _{COGG}	N	60.7
Mass of the primary section	m _P	kg	39.9
Secondary section data			
Mass of a secondary section (l = 200 mm)	m _S	kg	7.96

Characteristic curves 1FN6024-1LC12-0KA1

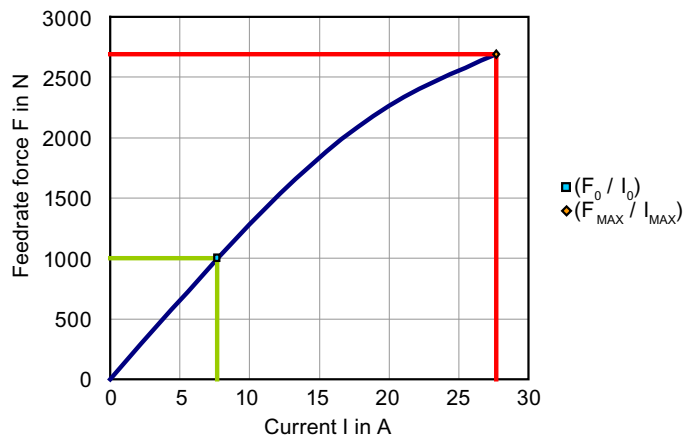
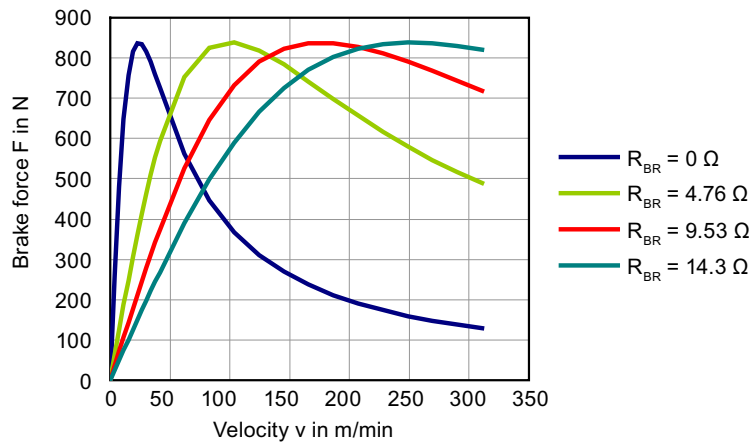
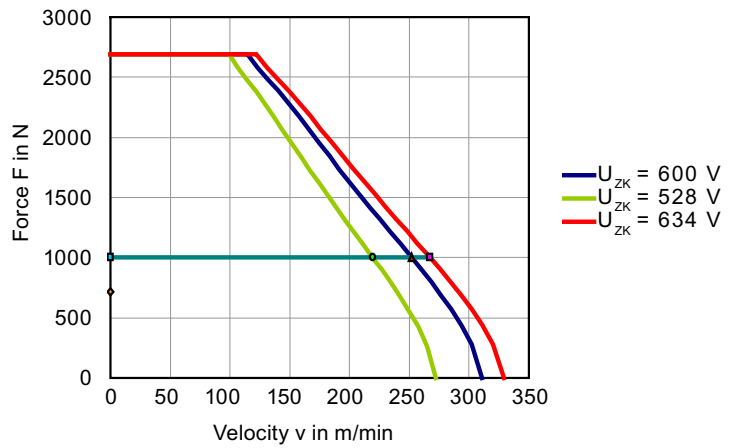

15.4.20 1FN6024-1LExx

Motor data 1FN6024-1LE11-0KA1

1FN6024-1LE11-0KA1			
Technical data	Short name	Unit	Value
Supplementary conditions			
DC-link voltage	U _{ZK}	V	600
Rated temperature	T _N	°C	120
Rated data			
Rated force	F _N	N	2000
Rated current	I _N	A	10
Maximum velocity at rated force	V _{MAX, FN}	m/min	155
Rated power dissipation	P _{V, N}	kW	0.535
Limit data			
Maximum force	F _{MAX}	N	5390
Maximum current	I _{MAX}	A	36
Maximum velocity at maximum force	V _{MAX, FMAX}	m/min	64.8
Maximum electric power input	P _{EL, MAX}	kW	12.8
Stall force	F _{0*}	N	1430
Stall current	I _{0*}	A	7.07
Physical constants			
Force constant	k _F	N/A	203
Voltage constant	k _E	Vs/m	122
Motor constant at 20 °C	k _{M, 20}	N/W ^{0.5}	103
Motor winding resistance at 20 °C	R _{STR, 20}	Ω	1.28
Phase inductance	L _{STR}	mH	39.2
Attraction force	F _A	N	22800
Thermal time constant	t _{TH}	s	7010
Polar distance	T _P	mm	25
Cogging force	F _{COGG}	N	75.0
Mass of the primary section	m _P	kg	69.5
Secondary section data			
Mass of a secondary section (l = 200 mm)	m _S	kg	7.96

Characteristic curves 1FN6024-1LE11-0KA1

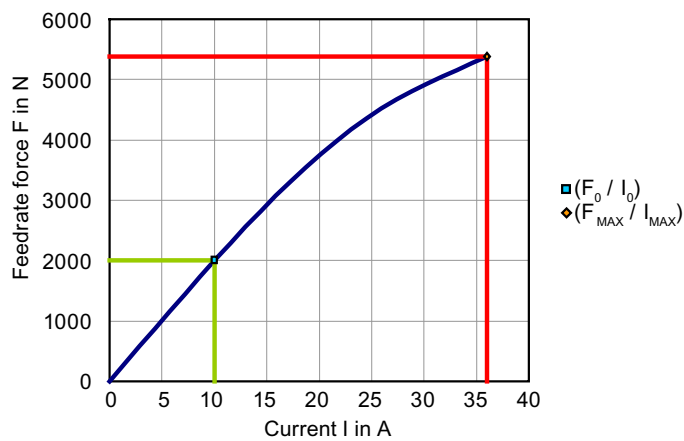
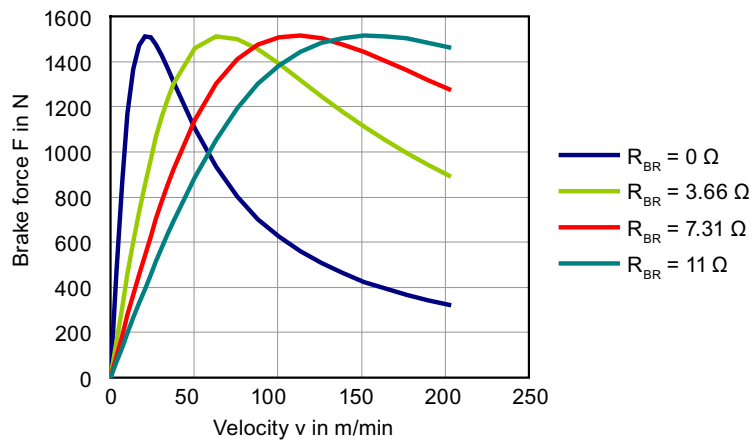
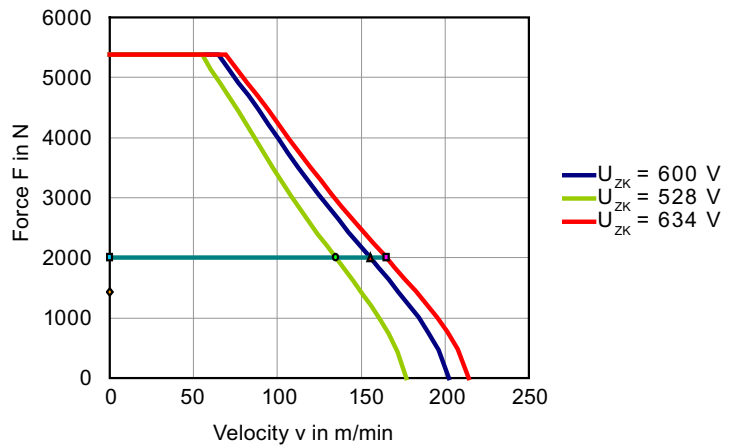

Motor data 1FN6024-1LE18-0KA1

1FN6024-1LE18-0KA1			
Technical data	Short name	Unit	Value
Supplementary conditions			
DC-link voltage	U _{ZK}	V	600
Rated temperature	T _N	°C	120
Rated data			
Rated force	F _N	N	2000
Rated current	I _N	A	15.4
Maximum velocity at rated force	v _{MAX, FN}	m/min	244
Rated power dissipation	P _{V, N}	kW	0.54
Limit data			
Maximum force	F _{MAX}	N	5390
Maximum current	I _{MAX}	A	55.4
Maximum velocity at maximum force	v _{MAX, FMAX}	m/min	106
Maximum electric power input	P _{EL, MAX}	kW	16.5
Stall force	F _{0*}	N	1430
Stall current	I _{0*}	A	10.9
Physical constants			
Force constant	k _F	N/A	132
Voltage constant	k _E	Vs/m	79.4
Motor constant at 20 °C	k _{M, 20}	N/W ^{0.5}	103
Motor winding resistance at 20 °C	R _{STR, 20}	Ω	0.546
Phase inductance	L _{STR}	mH	16.6
Attraction force	F _A	N	22800
Thermal time constant	t _{TH}	s	7010
Polar distance	τ _P	mm	25
Cogging force	F _{COGG}	N	75.0
Mass of the primary section	m _P	kg	69.5
Secondary section data			
Mass of a secondary section (l = 200 mm)	m _S	kg	7.96

Characteristic curves 1FN6024-1LE18-0KA1

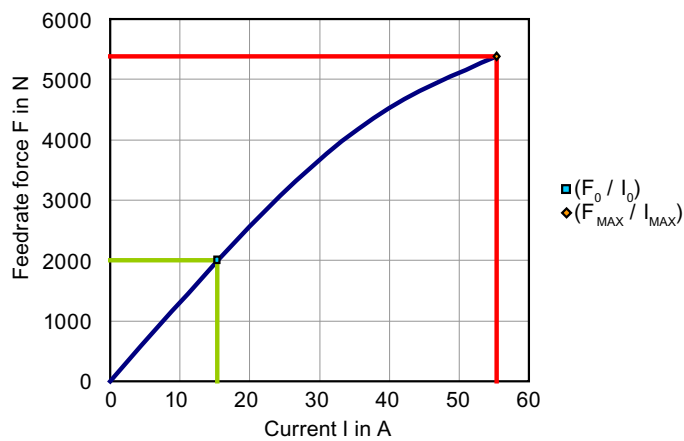
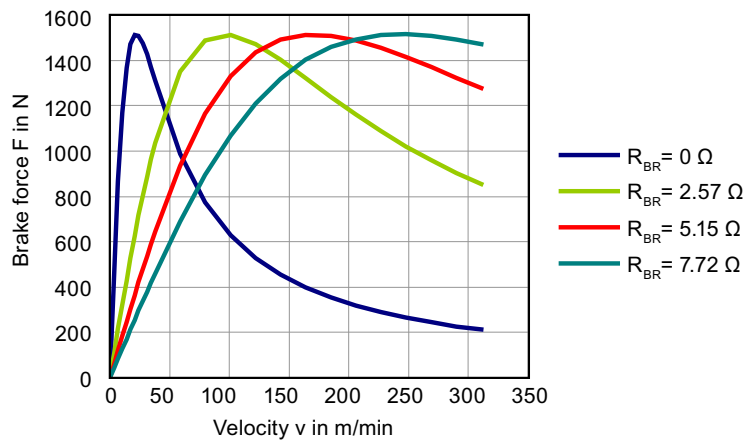
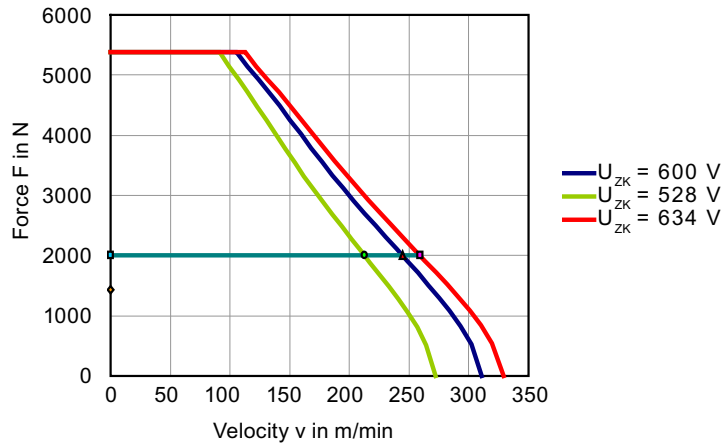

15.4.21 1FN6024-1LGxx

Motor data 1FN6024-1LG10-0KA1

1FN6024-1LG10-0KA1			
Technical data	Short name	Unit	Value
Supplementary conditions			
DC-link voltage	U _{ZK}	V	600
Rated temperature	T _N	°C	120
Rated data			
Rated force	F _N	N	3000
Rated current	I _N	A	15
Maximum velocity at rated force	v _{MAX, FN}	m/min	153
Rated power dissipation	P _{V, N}	kW	0.807
Limit data			
Maximum force	F _{MAX}	N	8080
Maximum current	I _{MAX}	A	54.1
Maximum velocity at maximum force	v _{MAX, FMAX}	m/min	62.8
Maximum electric power input	P _{EL, MAX}	kW	18.9
Stall force	F _{0*}	N	2140
Stall current	I _{0*}	A	10.6
Physical constants			
Force constant	k _F	N/A	203
Voltage constant	k _E	Vs/m	122
Motor constant at 20 °C	k _{M, 20}	N/W ^{0.5}	126
Motor winding resistance at 20 °C	R _{STR, 20}	Ω	0.858
Phase inductance	L _{STR}	mH	27.1
Attraction force	F _A	N	35000
Thermal time constant	t _{TH}	s	7010
Polar distance	T _P	mm	25
Cogging force	F _{COGG}	N	89.3
Mass of the primary section	m _P	kg	99.2
Secondary section data			
Mass of a secondary section (l = 200 mm)	m _S	kg	7.96

Characteristic curves 1FN6024-1LG10-0KA1

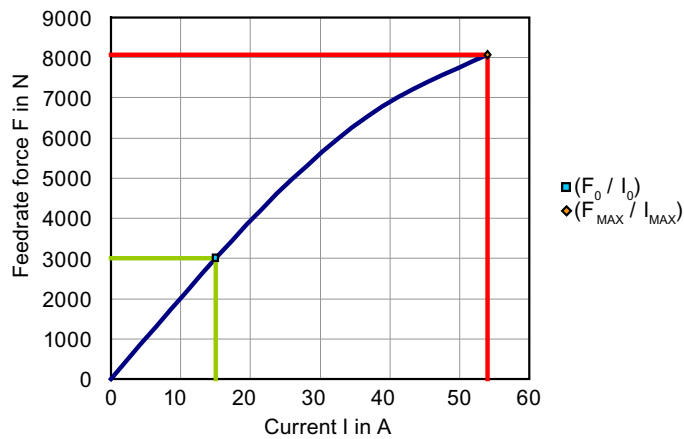
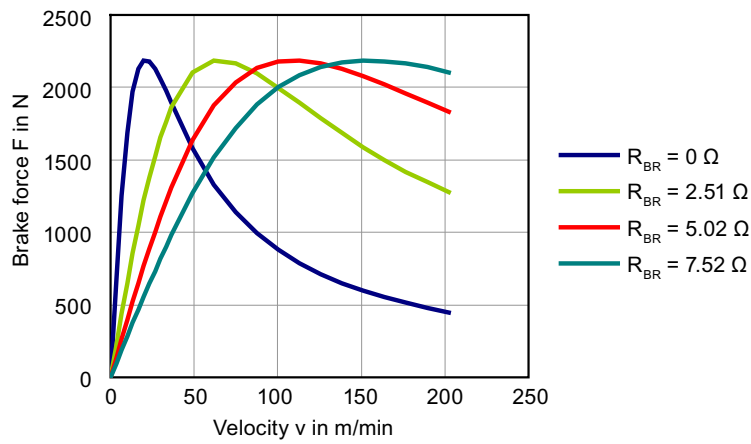
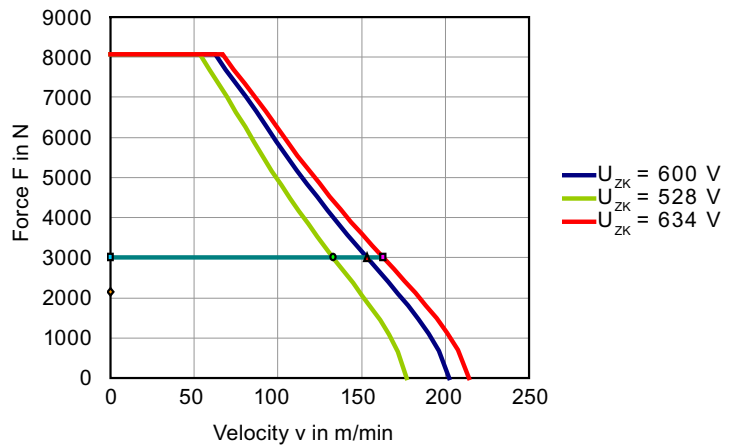

Motor data 1FN6024-1LG17-0KA1

1FN6024-1LG17-0KA1			
Technical data	Short name	Unit	Value
Supplementary conditions			
DC-link voltage	U _{ZK}	V	600
Rated temperature	T _N	°C	120
Rated data			
Rated force	F _N	N	3000
Rated current	I _N	A	23.1
Maximum velocity at rated force	v _{MAX, FN}	m/min	241
Rated power dissipation	P _{V, N}	kW	0.823
Limit data			
Maximum force	F _{MAX}	N	8080
Maximum current	I _{MAX}	A	83.1
Maximum velocity at maximum force	v _{MAX, FMAX}	m/min	102
Maximum electric power input	P _{EL, MAX}	kW	24.5
Stall force	F _{0*}	N	2140
Stall current	I _{0*}	A	16.3
Physical constants			
Force constant	k _F	N/A	132
Voltage constant	k _E	Vs/m	79.4
Motor constant at 20 °C	k _{M, 20}	N/W ^{0.5}	125
Motor winding resistance at 20 °C	R _{STR, 20}	Ω	0.37
Phase inductance	L _{STR}	mH	11.5
Attraction force	F _A	N	35000
Thermal time constant	t _{TH}	s	7010
Polar distance	T _P	mm	25
Cogging force	F _{COGG}	N	89.3
Mass of the primary section	m _P	kg	99.2
Secondary section data			
Mass of a secondary section	m _S	kg	7.96

Characteristic curves 1FN6024-1LG17-0KA1

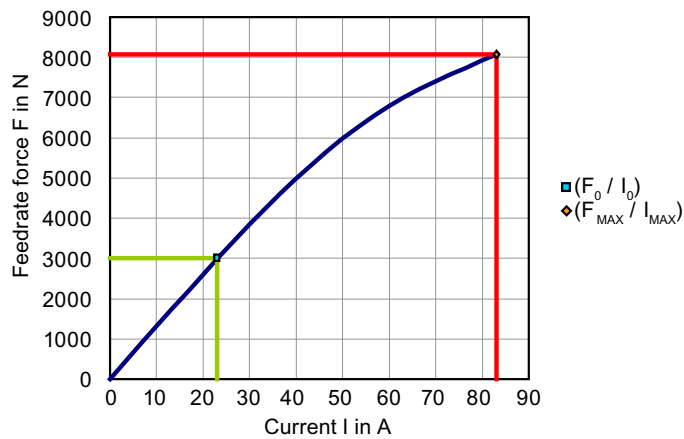
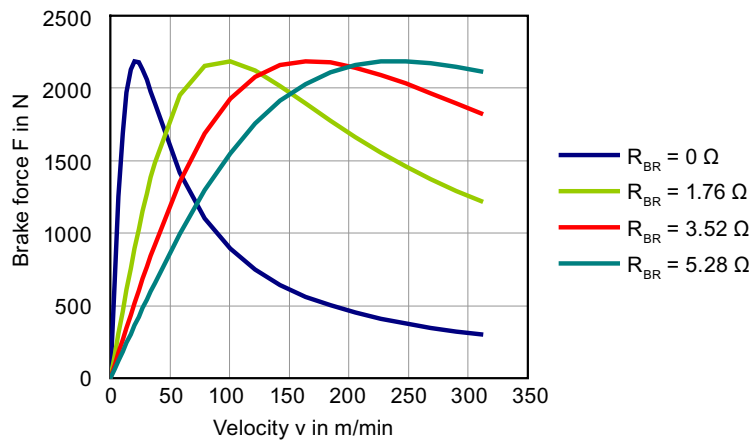
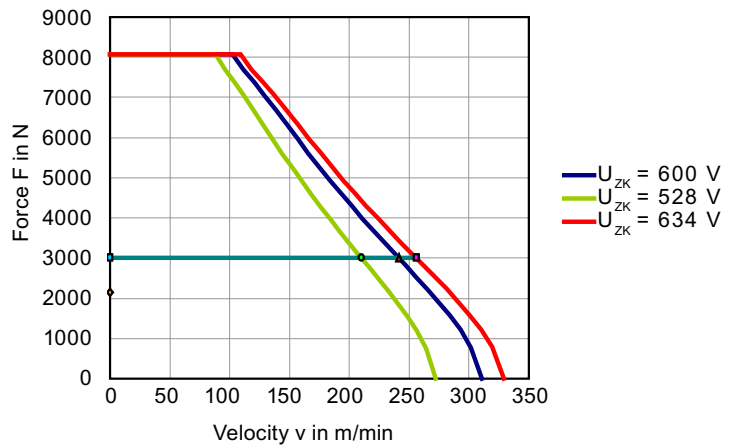

15.5 Motor data - Version with water cooling

15.5.1 1FN6003-1WCxx

Motor data 1FN6003-1WC57-0FA1

1FN6003-1WC57-0FA1			
Technical data	Short name	Unit	Value
Supplementary conditions			
DC-link voltage	U _{ZK}	V	600
Rated temperature	T _N	°C	120
Rated data			
Rated force	F _N	N	119
Rated current	I _N	A	3.2
Maximum velocity at rated force	v _{MAX, FN}	m/min	509
Rated power dissipation	P _{V, N}	kW	0.146
Limit data			
Maximum force	F _{MAX}	N	157
Maximum current	I _{MAX}	A	5.18
Maximum velocity at maximum force	v _{MAX, FMAX}	m/min	345
Maximum electric power input	P _{EL, MAX}	kW	1.29
Stall force	F _{0*}	N	90.5
Stall current	I _{0*}	A	2.26
Physical constants			
Force constant at 70 °C	k _{F, 20}	N/A	42.1
Voltage constant (phase-to-phase)	k _E	Vs/m	25.4
Motor constant at 20 °C	k _{M, 20}	N/W ^{0.5}	13.1
Motor winding resistance at 20 °C	R _{STR, 20}	Ω	3.43
Phase inductance	L _{STR}	mH	28.2
Attraction force	F _A	N	585
Thermal time constant	t _{TH}	s	250
Polar distance	T _P	mm	12.5
Cogging force	F _{COGG}	N	6.92
Mass of the primary section	m _P	kg	3.19
Primary section main cooler data			
Maximum dissipated heat output	Q _{P, H, MAX}	kW	0.146
Recommended minimum volume flow	V _{P, H, MIN}	l/min	0.6
Cooling medium temperature increase	ΔT _{P, H}	K	3.5
Pressure drop	Δp _{P, H}	bar	0.1
Secondary section data			
Mass of the secondary section (l = 500 mm)	m _S	kg	1.89
Mass of the secondary section (l = 200 mm)	m _S	kg	0.76

Characteristic curves 1FN6003-1WC57-0FA1

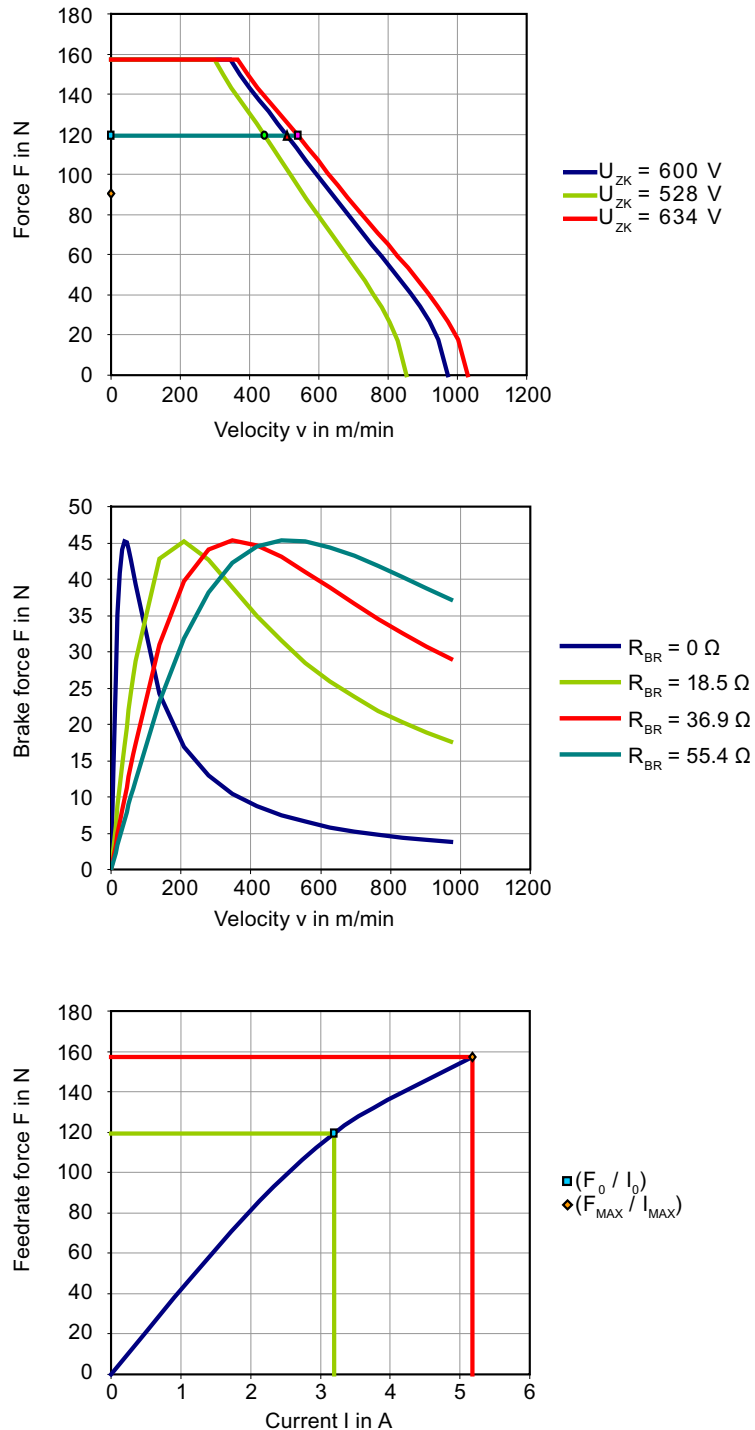

Motor data 1FN6003-1WC84-0FA1

1FN6003-1WC84-0FA1			
Technical data	Short name	Unit	Value
Supplementary conditions			
DC-link voltage	U_{ZK}	V	600
Rated temperature	T_N	°C	120
Rated data			
Rated force	F_N	N	119
Rated current	I_N	A	4.6
Maximum velocity at rated force	$v_{MAX, FN}$	m/min	740
Rated power dissipation	$P_{V, N}$	kW	0.15
Limit data			
Maximum force	F_{MAX}	N	157
Maximum current	I_{MAX}	A	7.45
Maximum velocity at maximum force	$v_{MAX, FMAX}$	m/min	503
Maximum electric power input	$P_{EL, MAX}$	kW	1.71
Stall force	F_0^*	N	90.5
Stall current	I_0^*	A	3.25
Physical constants			
Force constant at 70 °C	$k_{F, 20}$	N/A	29.2
Voltage constant (phase-to-phase)	k_E	Vs/m	17.6
Motor constant at 20 °C	$k_{M, 20}$	N/W ^{0.5}	13
Motor winding resistance at 20 °C	$R_{STR, 20}$	Ω	1.7
Phase inductance	L_{STR}	mH	13.6
Attraction force	F_A	N	585
Thermal time constant	t_{TH}	s	250
Polar distance	T_P	mm	12.5
Cogging force	F_{COGG}	N	6.92
Mass of the primary section	m_P	kg	3.19
Primary section main cooler data			
Maximum dissipated heat output	$Q_{P, H, MAX}$	kW	0.15
Recommended minimum volume flow	$V_{P, H, MIN}$	l/min	0.614
Cooling medium temperature increase	$\Delta T_{P, H}$	K	3.5
Pressure drop	$\Delta p_{P, H}$	bar	0.1
Secondary section data			
Mass of the secondary section (l = 500 mm)	m_S	kg	1.89
Mass of the secondary section (l = 200 mm)	m_S	kg	0.76

Characteristic curves 1FN6003-1WC84-0FA1

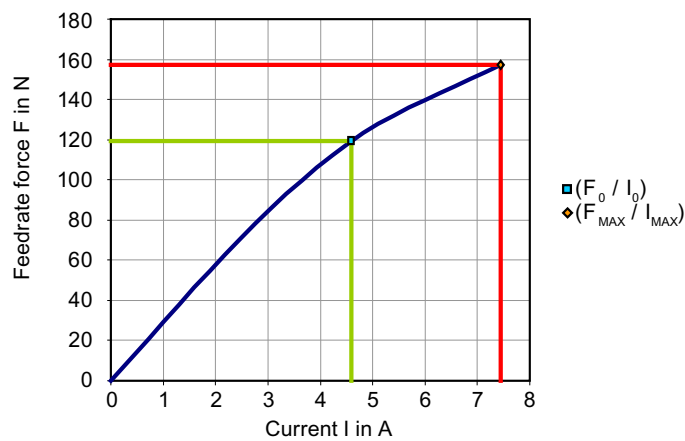
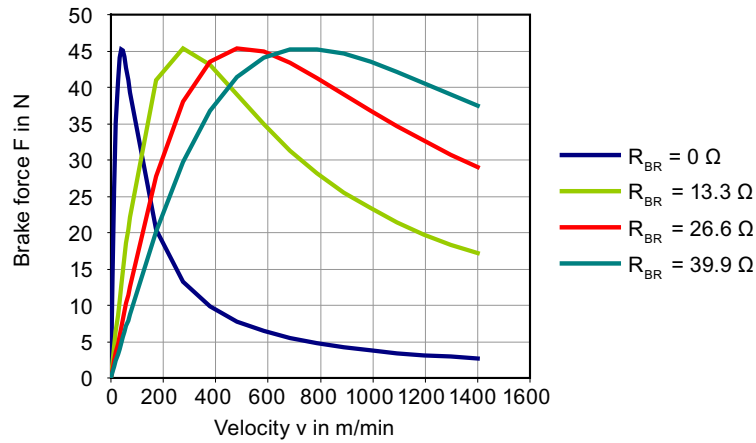
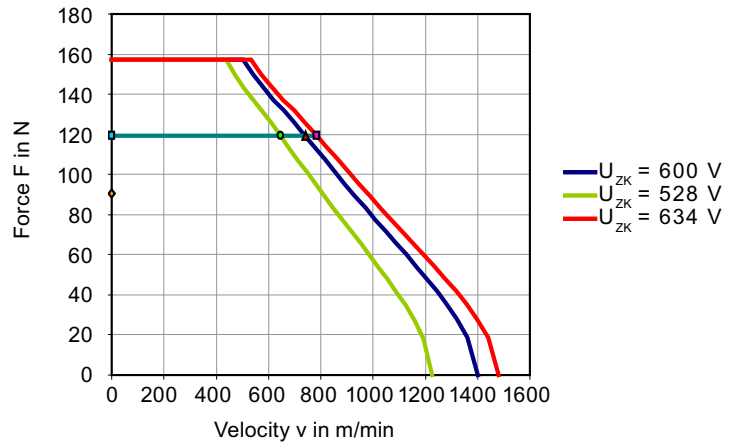

15.5.2 1FN6003-1WExx

Motor data 1FN6003-1WE38-0FA1

1FN6003-1WE38-0FA1			
Technical data	Short name	Unit	Value
Supplementary conditions			
DC-link voltage	U _{ZK}	V	600
Rated temperature	T _N	°C	120
Rated data			
Rated force	F _N	N	239
Rated current	I _N	A	4.6
Maximum velocity at rated force	v _{MAX, FN}	m/min	339
Rated power dissipation	P _{V, N}	kW	0.298
Limit data			
Maximum force	F _{MAX}	N	315
Maximum current	I _{MAX}	A	7.45
Maximum velocity at maximum force	v _{MAX, FMAX}	m/min	226
Maximum electric power input	P _{EL, MAX}	kW	1.97
Stall force	F _{0*}	N	181
Stall current	I _{0*}	A	3.25
Physical constants			
Force constant at 70 °C	k _{F, 20}	N/A	58.5
Voltage constant (phase-to-phase)	k _E	Vs/m	35.3
Motor constant at 20 °C	k _{M, 20}	N/W ^{0.5}	18.4
Motor winding resistance at 20 °C	R _{STR, 20}	Ω	3.38
Phase inductance	L _{STR}	mH	29.7
Attraction force	F _A	N	1250
Thermal time constant	t _{TH}	s	250
Polar distance	t _P	mm	12.5
Cogging force	F _{COGG}	N	8.45
Mass of the primary section	m _P	kg	4.99
Primary section main cooler data			
Maximum dissipated heat output	Q _{P, H, MAX}	kW	0.298
Recommended minimum volume flow	V _{P, H, MIN}	l/min	1.22
Cooling medium temperature increase	ΔT _{P, H}	K	3.5
Pressure drop	Δp _{P, H}	bar	0.1
Secondary section data			
Mass of the secondary section (l = 500 mm)	m _S	kg	1.89
Mass of the secondary section (l = 200 mm)	m _S	kg	0.76

Characteristic curves 1FN6003-1WE38-0FA1

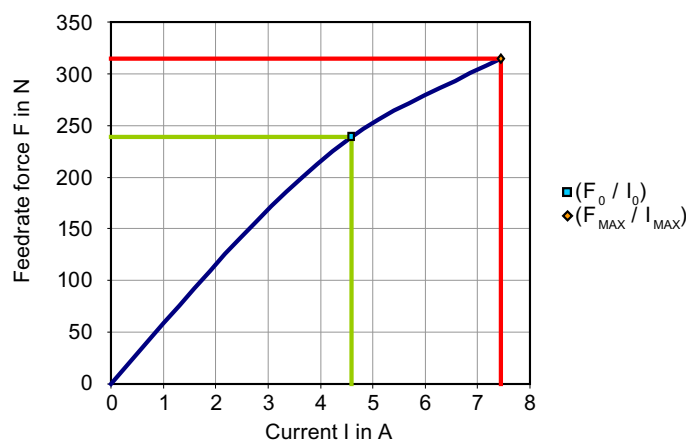
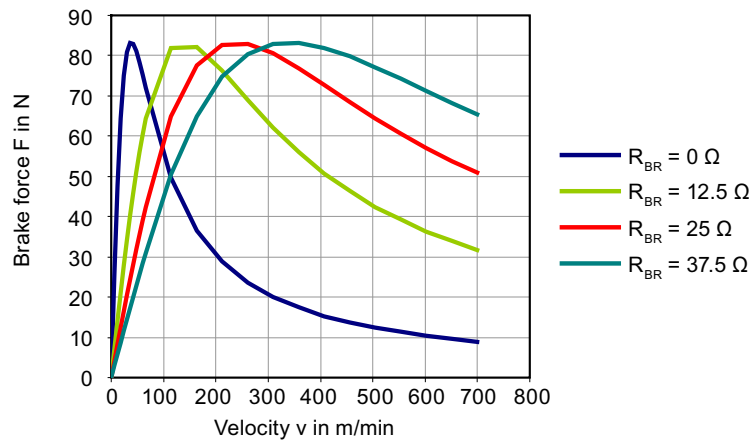
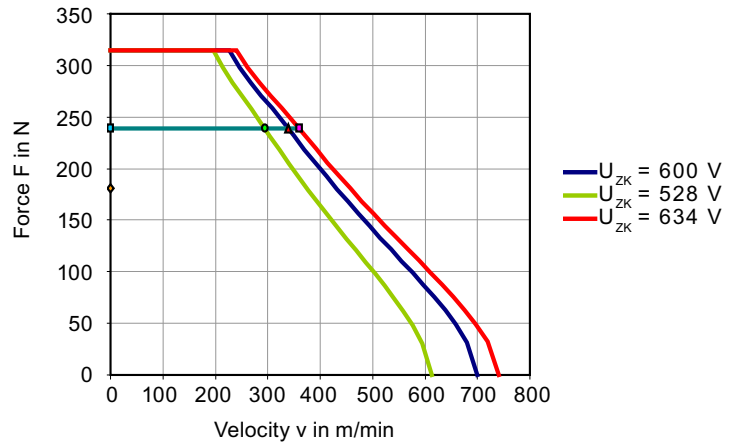

Motor data 1FN6003-1WE88-0FA1

1FN6003-1WE88-0FA1			
Technical data	Short name	Unit	Value
Supplementary conditions			
DC-link voltage	U_{ZK}	V	600
Rated temperature	T_N	°C	120
Rated data			
Rated force	F_N	N	239
Rated current	I_N	A	11.2
Maximum velocity at rated force	$v_{MAX, FN}$	m/min	852
Rated power dissipation	$P_{V, N}$	kW	0.326
Limit data			
Maximum force	F_{MAX}	N	315
Maximum current	I_{MAX}	A	18.2
Maximum velocity at maximum force	$v_{MAX, FMAX}$	m/min	572
Maximum electric power input	$P_{EL, MAX}$	kW	3.86
Stall force	F_0^*	N	181
Stall current	I_0^*	A	7.92
Physical constants			
Force constant at 70 °C	$k_{F, 20}$	N/A	24
Voltage constant (phase-to-phase)	k_E	Vs/m	14.5
Motor constant at 20 °C	$k_{M, 20}$	N/W ^{0.5}	17.6
Motor winding resistance at 20 °C	$R_{STR, 20}$	Ω	0.623
Phase inductance	L_{STR}	mH	5
Attraction force	F_A	N	1250
Thermal time constant	t_{TH}	s	250
Polar distance	T_P	mm	12.5
Cogging force	F_{COGG}	N	8.45
Mass of the primary section	m_P	kg	4.99
Primary section main cooler data			
Maximum dissipated heat output	$Q_{P, H, MAX}$	kW	0.326
Recommended minimum volume flow	$V_{P, H, MIN}$	l/min	1.34
Cooling medium temperature increase	$\Delta T_{P, H}$	K	3.5
Pressure drop	$\Delta p_{P, H}$	bar	0.1
Secondary section data			
Mass of the secondary section (l = 500 mm)	m_S	kg	1.89
Mass of the secondary section (l = 200 mm)	m_S	kg	0.76

Characteristic curves 1FN6003-1WE88-0FA1

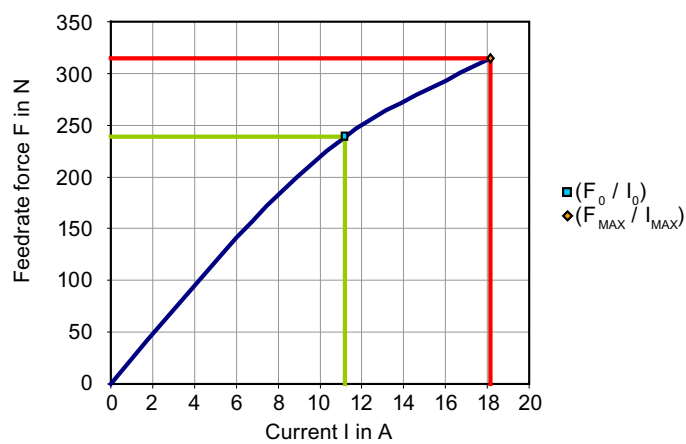
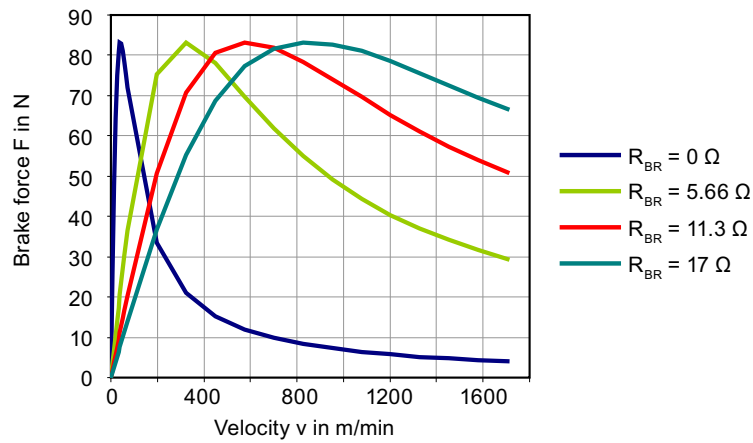
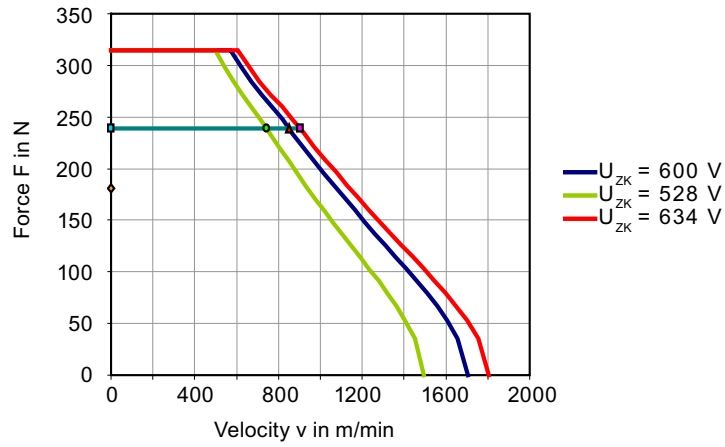

15.5.3 1FN6003-1WGxx

Motor data 1FN6003-1WG24-0FA1

1FN6003-1WG24-0FA1			
Technical data	Short name	Unit	Value
Supplementary conditions			
DC-link voltage	U _{ZK}	V	600
Rated temperature	T _N	°C	120
Rated data			
Rated force	F _N	N	358
Rated current	I _N	A	4.6
Maximum velocity at rated force	v _{MAX,FN}	m/min	215
Rated power dissipation	P _{V,N}	kW	0.446
Limit data			
Maximum force	F _{MAX}	N	472
Maximum current	I _{MAX}	A	7.45
Maximum velocity at maximum force	v _{MAX,FMAX}	m/min	141
Maximum electric power input	P _{EL,MAX}	kW	2.28
Stall force	F ₀ *	N	271
Stall current	I ₀ *	A	3.25
Physical constants			
Force constant at 70 °C	k _{F,20}	N/A	87.7
Voltage constant (phase-to-phase)	k _E	Vs/m	52.9
Motor constant at 20 °C	k _{M,20}	N/W ^{0.5}	22.5
Motor winding resistance at 20 °C	R _{STR,20}	Ω	5.05
Phase inductance	L _{STR}	mH	46
Attraction force	F _A	N	1930
Thermal time constant	t _{TH}	s	250
Polar distance	t _P	mm	12.5
Cogging force	F _{COGG}	N	10.0
Mass of the primary section	m _P	kg	6.79
Primary section main cooler data			
Maximum dissipated heat output	Q _{P,H,MAX}	kW	0.446
Recommended minimum volume flow	V _{P,H,MIN}	l/min	1.83
Cooling medium temperature increase	ΔT _{P,H}	K	3.5
Pressure drop	Δp _{P,H}	bar	0.1
Secondary section data			
Mass of the secondary section (l = 500 mm)	m _S	kg	1.89
Mass of the secondary section (l = 200 mm)	m _S	kg	0.76

Characteristic curves 1FN6003-1WG24-0FA1

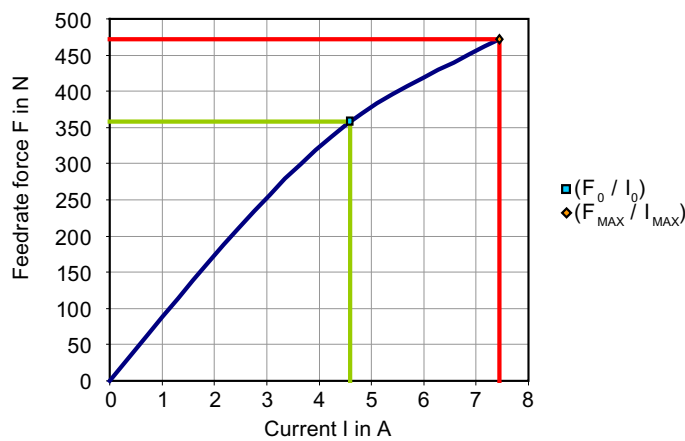
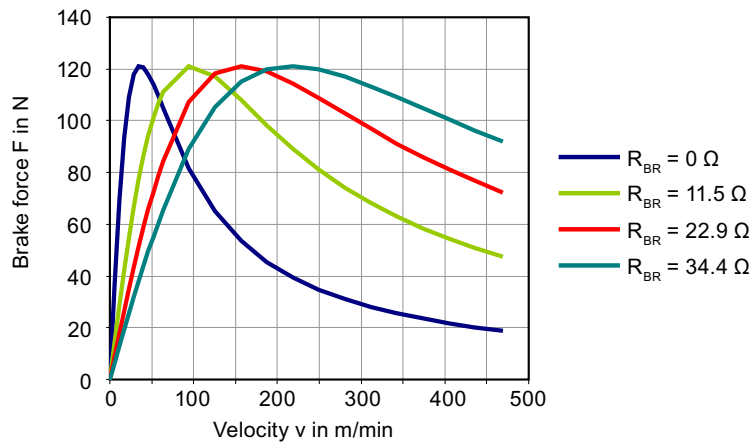
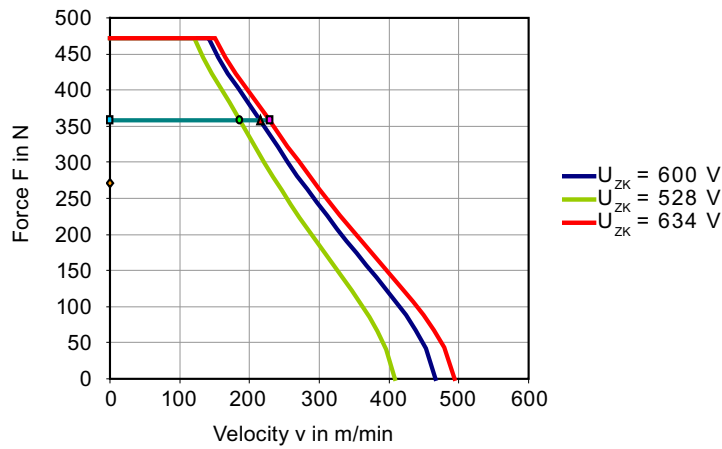

Motor data 1FN6003-1WG61-0FA1

1FN6003-1WG61-0FA1			
Technical data	Short name	Unit	Value
Supplementary conditions			
DC-link voltage	U_{ZK}	V	600
Rated temperature	T_N	°C	120
Rated data			
Rated force	F_N	N	358
Rated current	I_N	A	11.2
Maximum velocity at rated force	$v_{MAX,FN}$	m/min	549
Rated power dissipation	$P_{V,N}$	kW	0.485
Limit data			
Maximum force	F_{MAX}	N	472
Maximum current	I_{MAX}	A	18.2
Maximum velocity at maximum force	$v_{MAX,FMAX}$	m/min	366
Maximum electric power input	$P_{EL,MAX}$	kW	4.16
Stall force	F_0^*	N	271
Stall current	I_0^*	A	7.92
Physical constants			
Force constant at 70 °C	$k_{F,20}$	N/A	36
Voltage constant (phase-to-phase)	k_E	Vs/m	21.7
Motor constant at 20 °C	$k_{M,20}$	N/W ^{0.5}	21.6
Motor winding resistance at 20 °C	$R_{STR,20}$	Ω	0.926
Phase inductance	L_{STR}	mH	7.74
Attraction force	F_A	N	1930
Thermal time constant	t_{TH}	s	250
Polar distance	T_P	mm	12.5
Cogging force	F_{COGG}	N	10.0
Mass of the primary section	m_P	kg	6.79
Primary section main cooler data			
Maximum dissipated heat output	$Q_{P,H,MAX}$	kW	0.485
Recommended minimum volume flow	$V_{P,H,MIN}$	l/min	1.99
Cooling medium temperature increase	$\Delta T_{P,H}$	K	3.5
Pressure drop	$\Delta p_{P,H}$	bar	0.1
Secondary section data			
Mass of the secondary section (l = 500 mm)	m_S	kg	1.89
Mass of the secondary section (l = 200 mm)	m_S	kg	0.76

Characteristic curves 1FN6003-1WG61-0FA1

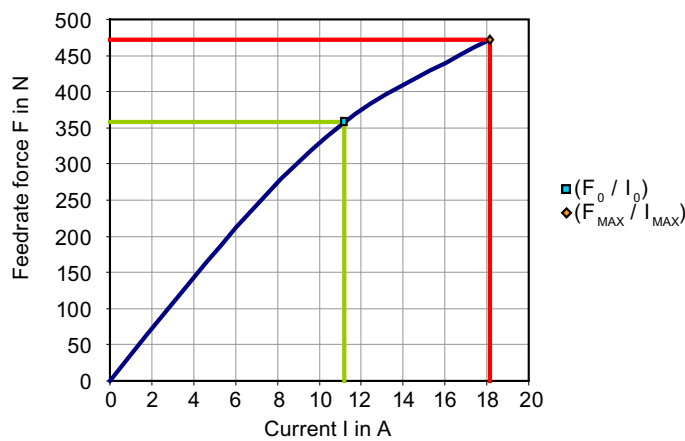
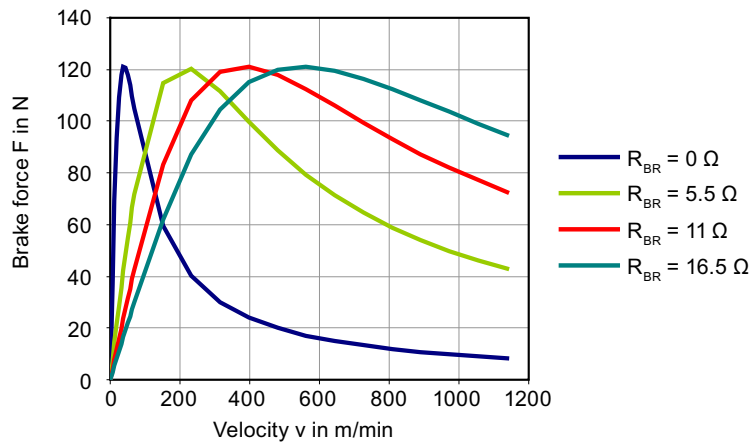
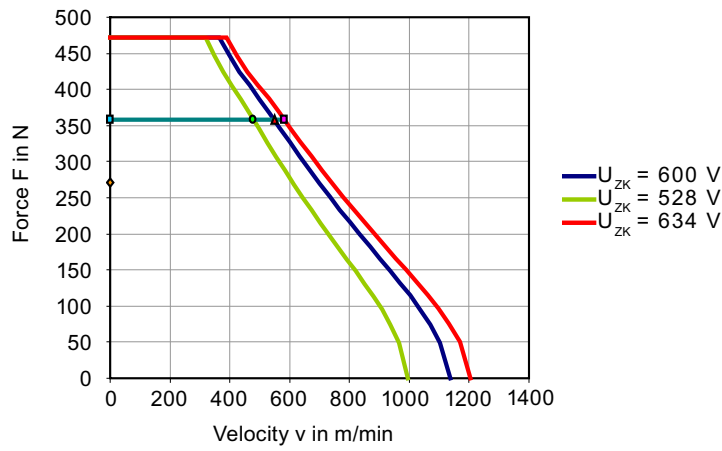

15.5.4 1FN6003-1WJxx

Motor data 1FN6003-1WJ17-0FA1

1FN6003-1WJ17-0FA1			
Technical data	Short name	Unit	Value
Supplementary conditions			
DC-link voltage	U _{ZK}	V	600
Rated temperature	T _N	°C	120
Rated data			
Rated force	F _N	N	477
Rated current	I _N	A	4.6
Maximum velocity at rated force	v _{MAX, FN}	m/min	155
Rated power dissipation	P _{V, N}	kW	0.594
Limit data			
Maximum force	F _{MAX}	N	630
Maximum current	I _{MAX}	A	7.45
Maximum velocity at maximum force	v _{MAX, FMAX}	m/min	99.6
Maximum electric power input	P _{EL, MAX}	kW	2.61
Stall force	F _{0*}	N	362
Stall current	I _{0*}	A	3.25
Physical constants			
Force constant at 70 °C	k _{F, 20}	N/A	117
Voltage constant (phase-to-phase)	k _E	Vs/m	70.5
Motor constant at 20 °C	k _{M, 20}	N/W ^{0.5}	26
Motor winding resistance at 20 °C	R _{STR, 20}	Ω	6.73
Phase inductance	L _{STR}	mH	62.3
Attraction force	F _A	N	2610
Thermal time constant	t _{TH}	s	250
Polar distance	t _P	mm	12.5
Cogging force	F _{COGG}	N	11.5
Mass of the primary section	m _P	kg	8.59
Primary section main cooler data			
Maximum dissipated heat output	Q _{P, H, MAX}	kW	0.594
Recommended minimum volume flow	V _{P, H, MIN}	l/min	2.44
Cooling medium temperature increase	ΔT _{P, H}	K	3.5
Pressure drop	Δp _{P, H}	bar	0.1
Secondary section data			
Mass of the secondary section (l = 500 mm)	m _S	kg	1.89
Mass of the secondary section (l = 200 mm)	m _S	kg	0.76

Characteristic curves 1FN6003-1WJ17-0FA1

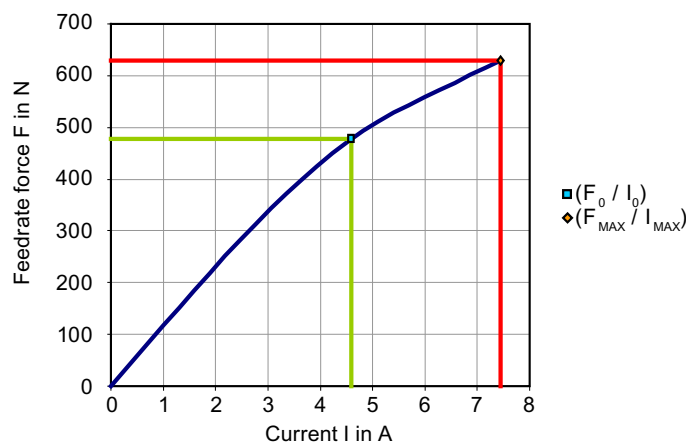
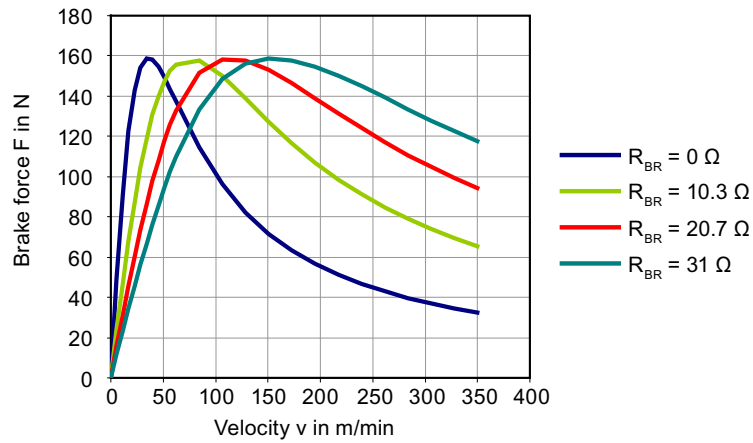
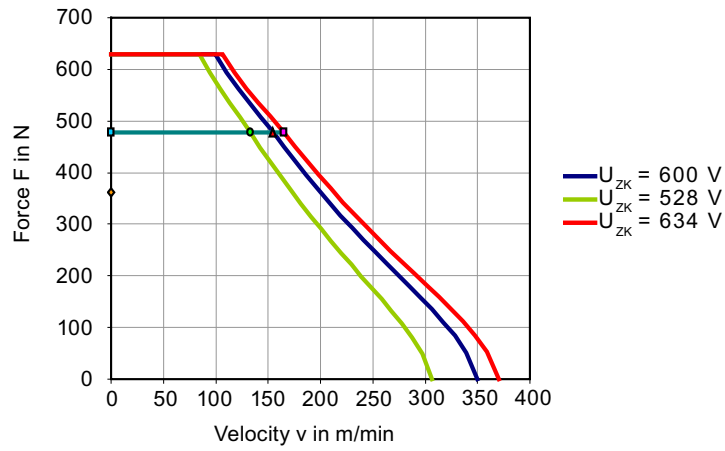

Motor data 1FN6003-1WJ44-0FA1

1FN6003-1WJ44-0FA1			
Technical data	Short name	Unit	Value
Supplementary conditions			
DC-link voltage	U_{ZK}	V	600
Rated temperature	T_N	°C	120
Rated data			
Rated force	F_N	N	477
Rated current	I_N	A	11.2
Maximum velocity at rated force	$v_{MAX, FN}$	m/min	402
Rated power dissipation	$P_{V, N}$	kW	0.644
Limit data			
Maximum force	F_{MAX}	N	630
Maximum current	I_{MAX}	A	18.2
Maximum velocity at maximum force	$v_{MAX, FMAX}$	m/min	267
Maximum electric power input	$P_{EL, MAX}$	kW	4.49
Stall force	F_0^*	N	362
Stall current	I_0^*	A	7.92
Physical constants			
Force constant at 70 °C	$k_{F, 20}$	N/A	48
Voltage constant (phase-to-phase)	k_E	Vs/m	28.9
Motor constant at 20 °C	$k_{M, 20}$	N/W ^{0.5}	25
Motor winding resistance at 20 °C	$R_{STR, 20}$	Ω	1.23
Phase inductance	L_{STR}	mH	10.5
Attraction force	F_A	N	2610
Thermal time constant	t_{TH}	s	250
Polar distance	T_P	mm	12.5
Cogging force	F_{COGG}	N	11.5
Mass of the primary section	m_P	kg	8.59
Primary section main cooler data			
Maximum dissipated heat output	$Q_{P, H, MAX}$	kW	0.644
Recommended minimum volume flow	$V_{P, H, MIN}$	l/min	2.64
Cooling medium temperature increase	$\Delta T_{P, H}$	K	3.5
Pressure drop	$\Delta p_{P, H}$	bar	0.1
Secondary section data			
Mass of the secondary section (l = 500 mm)	m_S	kg	1.89
Mass of the secondary section (l = 200 mm)	m_S	kg	0.76

Characteristic curves 1FN6003-1WJ44-0FA1

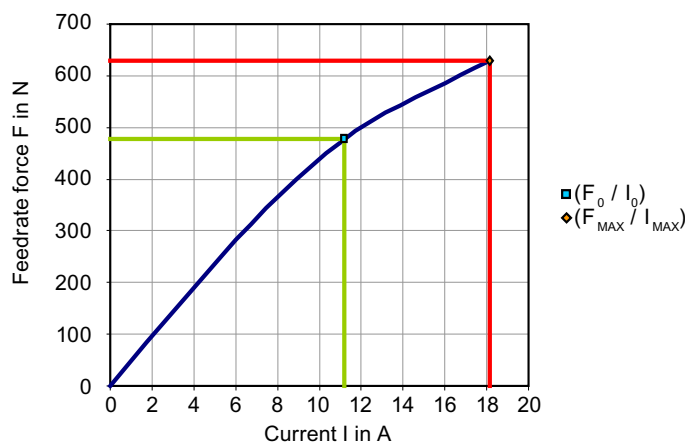
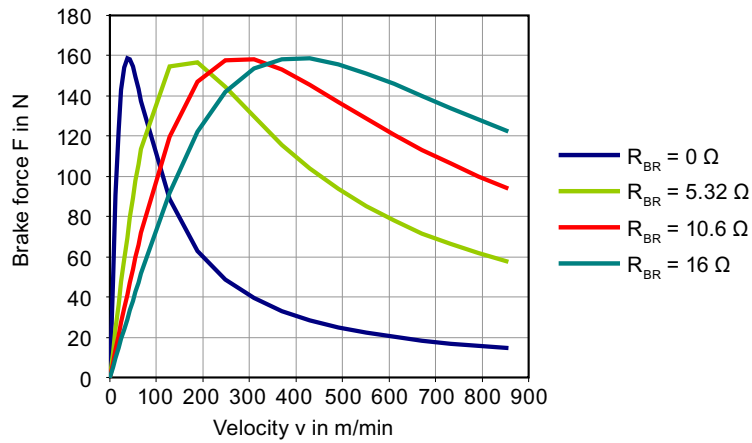
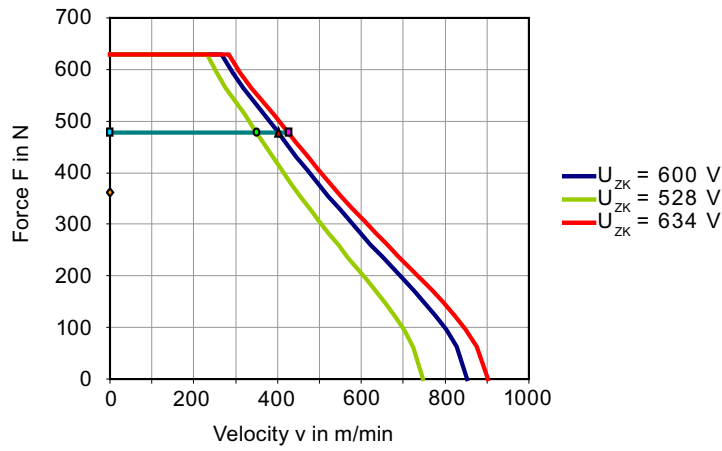

15.5.5 1FN6003-1WLxx

Motor data 1FN6003-1WL12-0FA1

1FN6003-1WL12-0FA1			
Technical data	Short name	Unit	Value
Supplementary conditions			
DC-link voltage	U _{ZK}	V	600
Rated temperature	T _N	°C	120
Rated data			
Rated force	F _N	N	597
Rated current	I _N	A	4.6
Maximum velocity at rated force	v _{MAX, FN}	m/min	119
Rated power dissipation	P _{V, N}	kW	0.743
Limit data			
Maximum force	F _{MAX}	N	787
Maximum current	I _{MAX}	A	7.45
Maximum velocity at maximum force	v _{MAX, FMAX}	m/min	74.7
Maximum electric power input	P _{EL, MAX}	kW	2.93
Stall force	F _{0*}	N	452
Stall current	I _{0*}	A	3.25
Physical constants			
Force constant at 70 °C	k _{F, 20}	N/A	146
Voltage constant (phase-to-phase)	k _E	Vs/m	88.2
Motor constant at 20 °C	k _{M, 20}	N/W ^{0.5}	29.1
Motor winding resistance at 20 °C	R _{STR, 20}	Ω	8.41
Phase inductance	L _{STR}	mH	78.7
Attraction force	F _A	N	3290
Thermal time constant	t _{TH}	s	250
Polar distance	t _P	mm	12.5
Cogging force	F _{COGG}	N	13.1
Mass of the primary section	m _P	kg	10.4
Primary section main cooler data			
Maximum dissipated heat output	Q _{P, H, MAX}	kW	0.743
Recommended minimum volume flow	V _{P, H, MIN}	l/min	3.05
Cooling medium temperature increase	ΔT _{P, H}	K	3.5
Pressure drop	Δp _{P, H}	bar	0.1
Secondary section data			
Mass of the secondary section (l = 500 mm)	m _S	kg	1.89
Mass of the secondary section (l = 200 mm)	m _S	kg	0.76

Characteristic curves 1FN6003-1WL12-0FA1

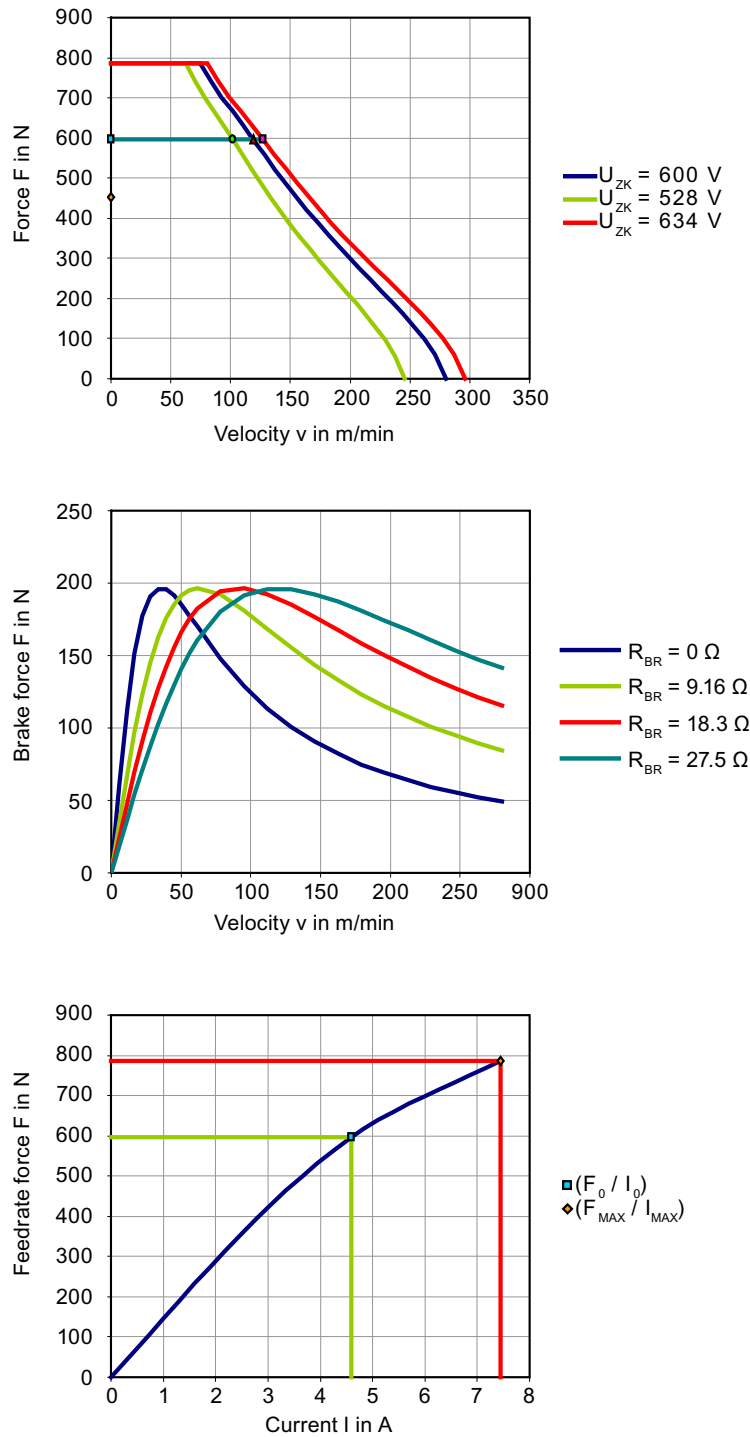

Motor data 1FN6003-1WL35-0FA1

1FN6003-1WL35-0FA1			
Technical data	Short name	Unit	Value
Supplementary conditions			
DC-link voltage	U_{ZK}	V	600
Rated temperature	T_N	°C	120
Rated data			
Rated force	F_N	N	597
Rated current	I_N	A	11.2
Maximum velocity at rated force	$v_{MAX, FN}$	m/min	316
Rated power dissipation	$P_{V, N}$	kW	0.803
Limit data			
Maximum force	F_{MAX}	N	787
Maximum current	I_{MAX}	A	18.2
Maximum velocity at maximum force	$v_{MAX, FMAX}$	m/min	208
Maximum electric power input	$P_{EL, MAX}$	kW	4.84
Stall force	F_0^*	N	452
Stall current	I_0^*	A	7.92
Physical constants			
Force constant at 70 °C	$k_{F, 20}$	N/A	60
Voltage constant (phase-to-phase)	k_E	Vs/m	36.2
Motor constant at 20 °C	$k_{M, 20}$	N/W ^{0.5}	28
Motor winding resistance at 20 °C	$R_{STR, 20}$	Ω	1.53
Phase inductance	L_{STR}	mH	13.3
Attraction force	F_A	N	3290
Thermal time constant	t_{TH}	s	250
Polar distance	T_P	mm	12.5
Cogging force	F_{COGG}	N	13.1
Mass of the primary section	m_P	kg	10.4
Primary section main cooler data			
Maximum dissipated heat output	$Q_{P, H, MAX}$	kW	0.803
Recommended minimum volume flow	$V_{P, H, MIN}$	l/min	3.29
Cooling medium temperature increase	$\Delta T_{P, H}$	K	3.5
Pressure drop	$\Delta p_{P, H}$	bar	0.1
Secondary section data			
Mass of the secondary section (l = 500 mm)	m_S	kg	1.89
Mass of the secondary section (l = 200 mm)	m_S	kg	0.76

Characteristic curves 1FN6003-1WL35-0FA1

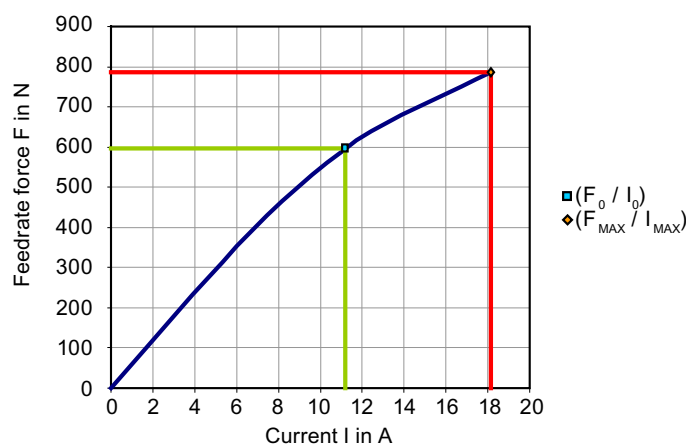
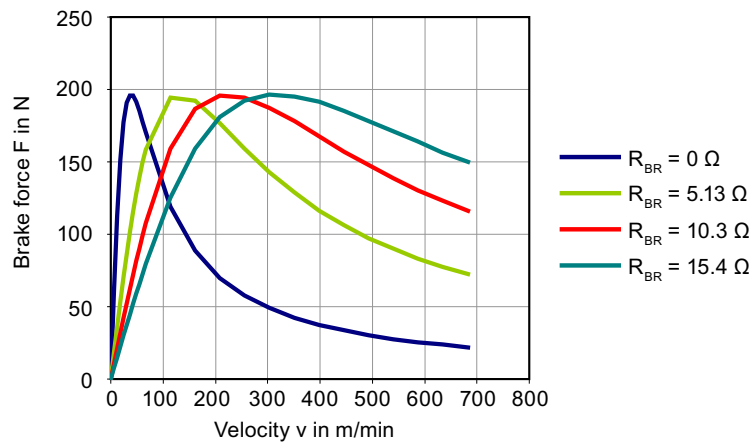
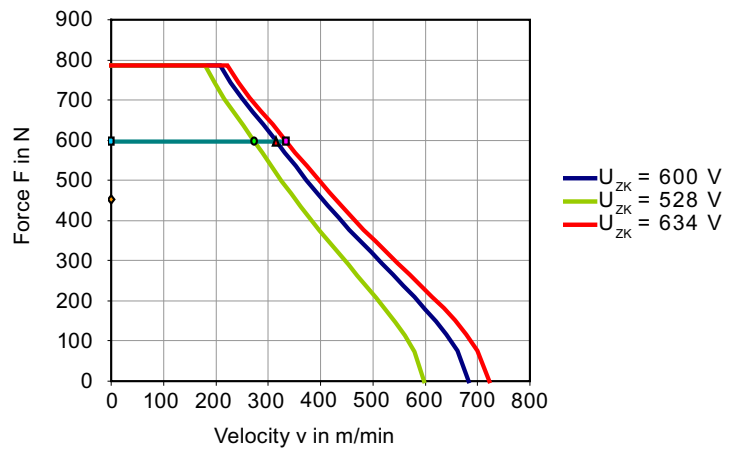

15.5.6 1FN6003-1WNxx

Motor data 1FN6003-1WN10-0FA1

1FN6003-1WN10-0FA1			
Technical data	Short name	Unit	Value
Supplementary conditions			
DC-link voltage	U _{ZK}	V	600
Rated temperature	T _N	°C	120
Rated data			
Rated force	F _N	N	716
Rated current	I _N	A	4.6
Maximum velocity at rated force	v _{MAX, FN}	m/min	95.1
Rated power dissipation	P _{V, N}	kW	0.891
Limit data			
Maximum force	F _{MAX}	N	945
Maximum current	I _{MAX}	A	7.45
Maximum velocity at maximum force	v _{MAX, FMAX}	m/min	57.9
Maximum electric power input	P _{EL, MAX}	kW	3.25
Stall force	F _{0*}	N	543
Stall current	I _{0*}	A	3.25
Physical constants			
Force constant at 70 °C	k _{F, 20}	N/A	175
Voltage constant (phase-to-phase)	k _E	Vs/m	106
Motor constant at 20 °C	k _{M, 20}	N/W ^{0.5}	31.9
Motor winding resistance at 20 °C	R _{STR, 20}	Ω	10.1
Phase inductance	L _{STR}	mH	95.2
Attraction force	F _A	N	3980
Thermal time constant	t _{TH}	s	250
Polar distance	t _P	mm	12.5
Cogging force	F _{COGG}	N	14.6
Mass of the primary section	m _P	kg	12.2
Primary section main cooler data			
Maximum dissipated heat output	Q _{P, H, MAX}	kW	0.891
Recommended minimum volume flow	V _{P, H, MIN}	l/min	3.65
Cooling medium temperature increase	ΔT _{P, H}	K	3.5
Pressure drop	Δp _{P, H}	bar	0.1
Secondary section data			
Mass of the secondary section (l = 500 mm)	m _S	kg	1.89
Mass of the secondary section (l = 200 mm)	m _S	kg	0.76

Characteristic curves 1FN6003-1WN10-0FA1

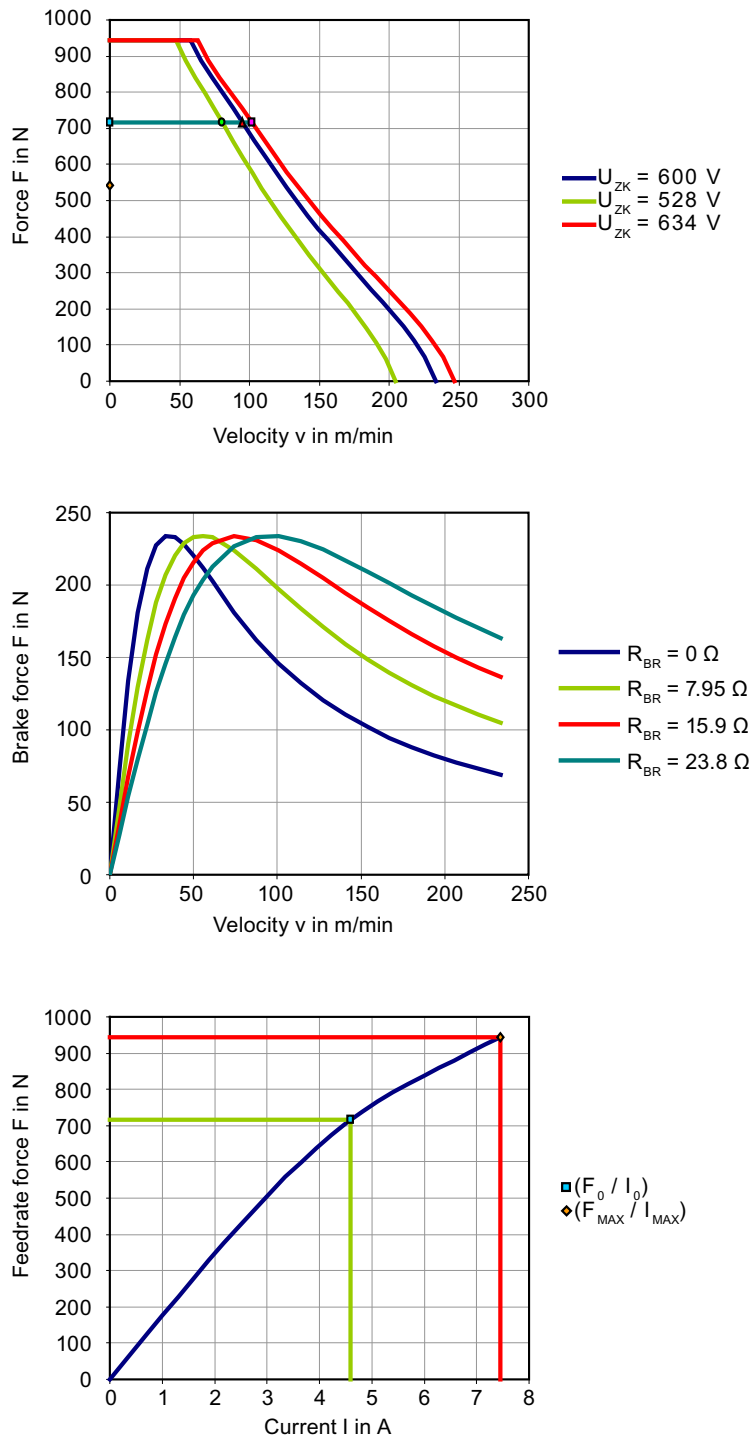

Motor data 1FN6003-1WN28-0FA1

1FN6003-1WN28-0FA1			
Technical data	Short name	Unit	Value
Supplementary conditions			
DC-link voltage	U_{ZK}	V	600
Rated temperature	T_N	°C	120
Rated data			
Rated force	F_N	N	716
Rated current	I_N	A	11.2
Maximum velocity at rated force	$v_{MAX,FN}$	m/min	258
Rated power dissipation	$P_{V,N}$	kW	0.962
Limit data			
Maximum force	F_{MAX}	N	945
Maximum current	I_{MAX}	A	18.2
Maximum velocity at maximum force	$v_{MAX,FMAX}$	m/min	169
Maximum electric power input	$P_{EL,MAX}$	kW	5.2
Stall force	F_0^*	N	543
Stall current	I_0^*	A	7.92
Physical constants			
Force constant at 70 °C	$k_{F,20}$	N/A	72
Voltage constant (phase-to-phase)	k_E	Vs/m	43.4
Motor constant at 20 °C	$k_{M,20}$	N/W ^{0.5}	30.7
Motor winding resistance at 20 °C	$R_{STR,20}$	Ω	1.83
Phase inductance	L_{STR}	mH	16
Attraction force	F_A	N	3980
Thermal time constant	t_{TH}	s	250
Polar distance	T_P	mm	12.5
Cogging force	F_{COGG}	N	14.6
Mass of the primary section	m_P	kg	12.2
Primary section main cooler data			
Maximum dissipated heat output	$Q_{P,H,MAX}$	kW	0.962
Recommended minimum volume flow	$V_{P,H,MIN}$	l/min	3.95
Cooling medium temperature increase	$\Delta T_{P,H}$	K	3.5
Pressure drop	$\Delta p_{P,H}$	bar	0.1
Secondary section data			
Mass of the secondary section (l = 500 mm)	m_S	kg	1.89
Mass of the secondary section (l = 200 mm)	m_S	kg	0.76

Characteristic curves 1FN6003-1WN28-0FA1

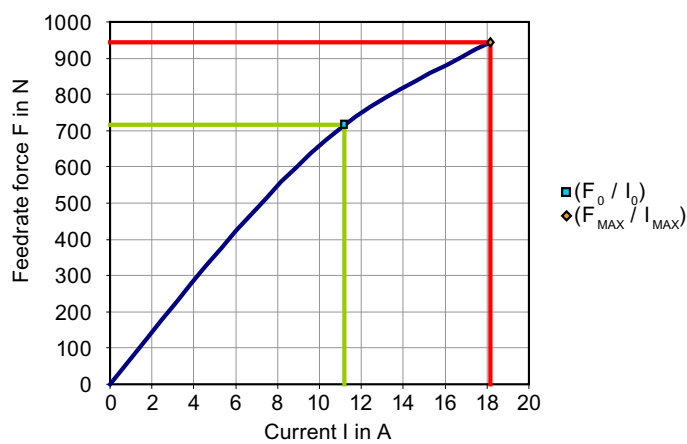
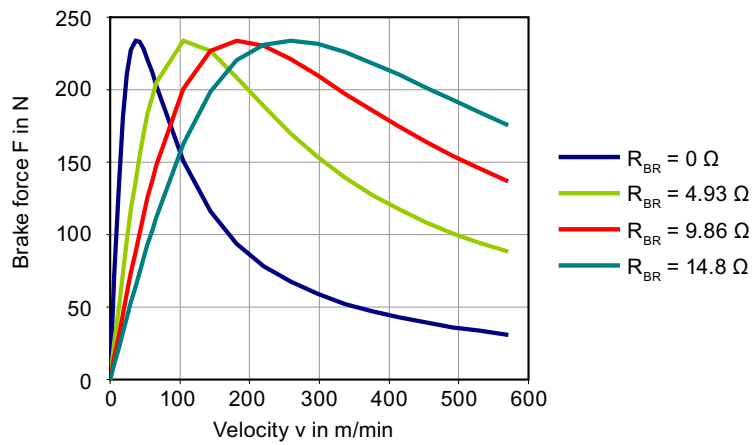
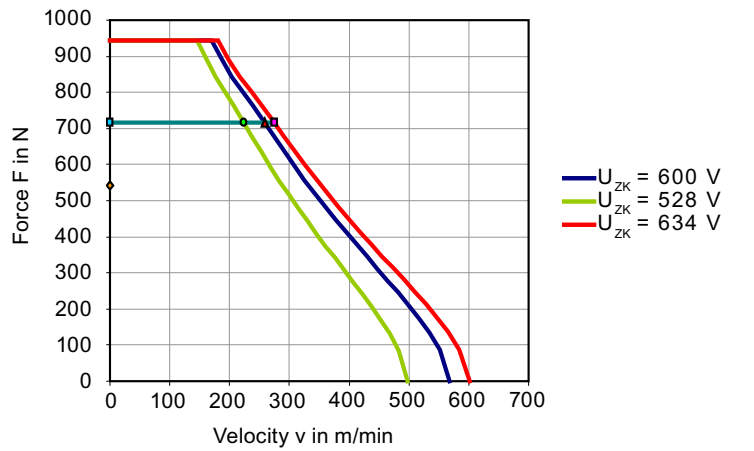

15.5.7 1FN6007-1WCxx

Motor data 1FN6007-1WC31-0KA1

1FN6007-1WC31-0KA1			
Technical data	Short name	Unit	Value
Supplementary conditions			
DC-link voltage	U _{ZK}	V	600
Rated temperature	T _N	°C	120
Rated data			
Rated force	F _N	N	239
Rated current	I _N	A	3.2
Maximum velocity at rated force	v _{MAX, FN}	m/min	272
Rated power dissipation	P _{V, N}	kW	0.231
Limit data			
Maximum force	F _{MAX}	N	315
Maximum current	I _{MAX}	A	5.18
Maximum velocity at maximum force	v _{MAX, FMAX}	m/min	187
Maximum electric power input	P _{EL, MAX}	kW	1.59
Stall force	F ₀ *	N	181
Stall current	I ₀ *	A	2.26
Physical constants			
Force constant at 70 °C	k _{F, 20}	N/A	84.1
Voltage constant (phase-to-phase)	k _E	Vs/m	50.7
Motor constant at 20 °C	k _{M, 20}	N/W ^{0.5}	20.9
Motor winding resistance at 20 °C	R _{STR, 20}	Ω	5.4
Phase inductance	L _{STR}	mH	49.1
Attraction force	F _A	N	1170
Thermal time constant	t _{TH}	s	313
Polar distance	t _P	mm	12.5
Cogging force	F _{COGG}	N	13.8
Mass of the primary section	m _P	kg	5.08
Primary section main cooler data			
Maximum dissipated heat output	Q _{P, H, MAX}	kW	0.231
Recommended minimum volume flow	V _{P, H, MIN}	l/min	0.946
Cooling medium temperature increase	ΔT _{P, H}	K	3.5
Pressure drop	Δp _{P, H}	bar	0.1
Secondary section data			
Mass of the secondary section (l = 500 mm)	m _S	kg	4.03
Mass of the secondary section (l = 200 mm)	m _S	kg	1.61

Characteristic curves 1FN6007-1WC31-0KA1

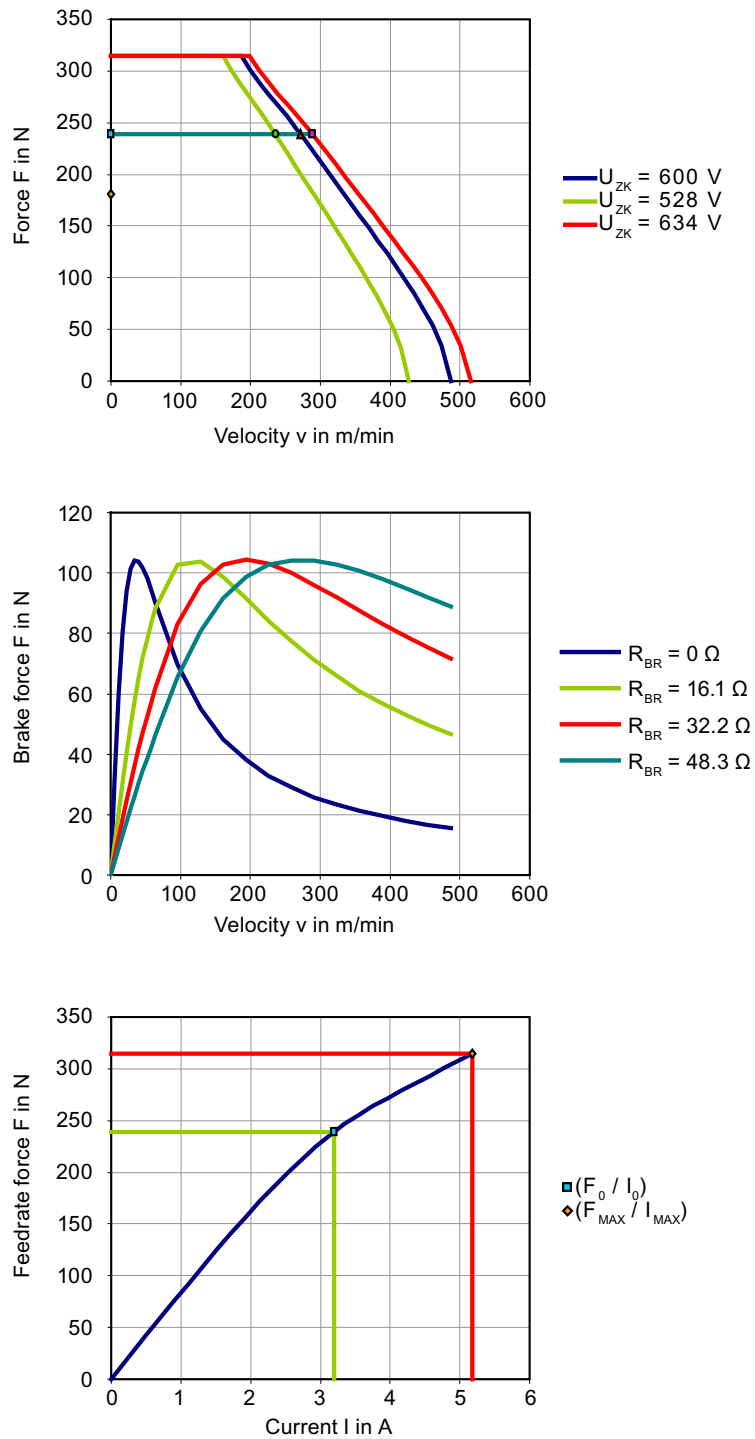

Motor data 1FN6007-1WC46-0KA1

1FN6007-1WC46-0KA1			
Technical data	Short name	Unit	Value
Supplementary conditions			
DC-link voltage	U_{ZK}	V	600
Rated temperature	T_N	°C	120
Rated data			
Rated force	F_N	N	239
Rated current	I_N	A	4.6
Maximum velocity at rated force	$v_{MAX,FN}$	m/min	399
Rated power dissipation	$P_{V,N}$	kW	0.235
Limit data			
Maximum force	F_{MAX}	N	315
Maximum current	I_{MAX}	A	7.45
Maximum velocity at maximum force	$v_{MAX,FMAX}$	m/min	276
Maximum electric power input	$P_{EL,MAX}$	kW	2.07
Stall force	F_0^*	N	181
Stall current	I_0^*	A	3.25
Physical constants			
Force constant at 70 °C	$k_{F,20}$	N/A	58.5
Voltage constant (phase-to-phase)	k_E	Vs/m	35.3
Motor constant at 20 °C	$k_{M,20}$	N/W ^{0.5}	20.7
Motor winding resistance at 20 °C	$R_{STR,20}$	Ω	2.67
Phase inductance	L_{STR}	mH	23.7
Attraction force	F_A	N	1170
Thermal time constant	t_{TH}	s	313
Polar distance	T_P	mm	12.5
Cogging force	F_{COGG}	N	13.8
Mass of the primary section	m_P	kg	5.08
Primary section main cooler data			
Maximum dissipated heat output	$Q_{P,H,MAX}$	kW	0.235
Recommended minimum volume flow	$V_{P,H,MIN}$	l/min	0.966
Cooling medium temperature increase	$\Delta T_{P,H}$	K	3.5
Pressure drop	$\Delta p_{P,H}$	bar	0.1
Secondary section data			
Mass of the secondary section (l = 500 mm)	m_S	kg	4.03
Mass of the secondary section (l = 200 mm)	m_S	kg	1.61

Characteristic curves 1FN6007-1WC46-0KA1

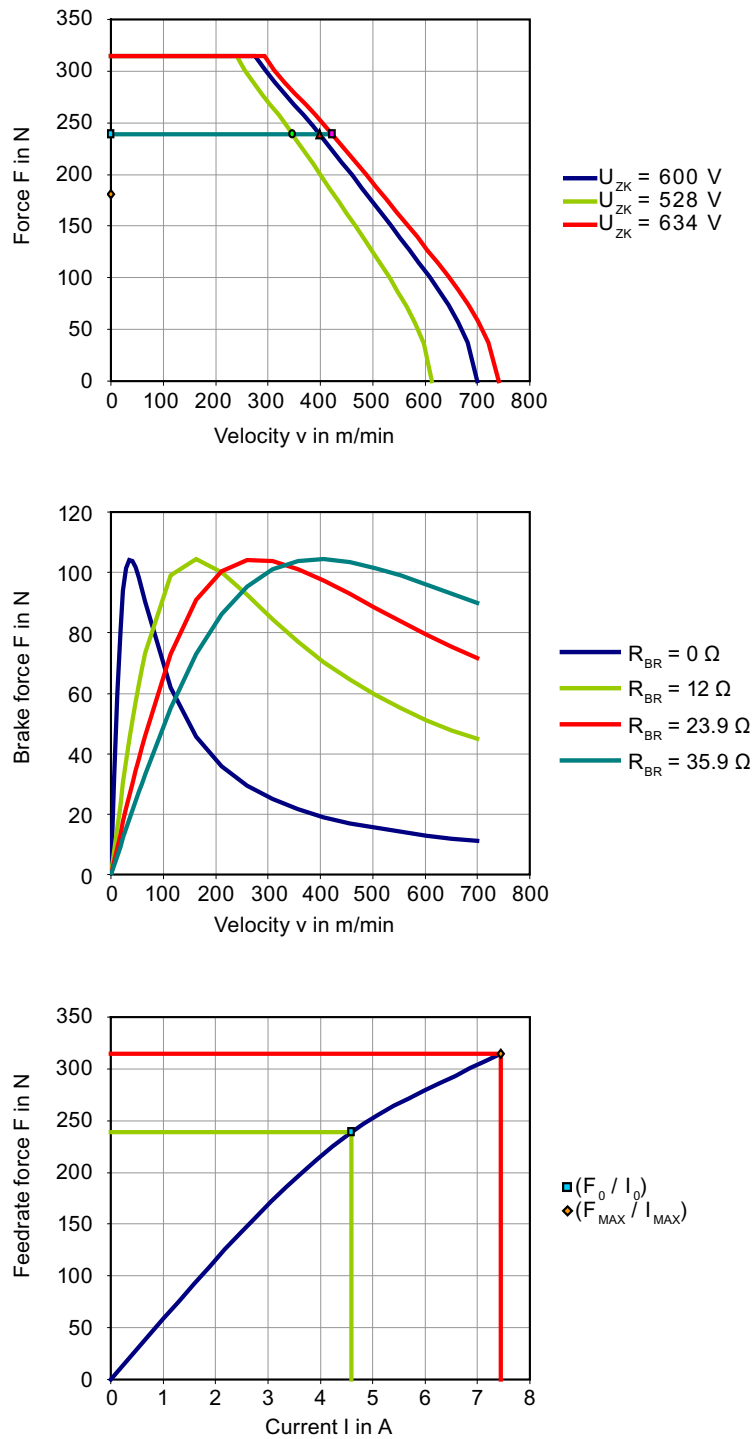

15.5.8 1FN6007-1WExx

Motor data 1FN6007-1WE20-0KA1

1FN6007-1WE20-0KA1			
Technical data	Short name	Unit	Value
Supplementary conditions			
DC-link voltage	U _{ZK}	V	600
Rated temperature	T _N	°C	120
Rated data			
Rated force	F _N	N	477
Rated current	I _N	A	4.6
Maximum velocity at rated force	v _{MAX, FN}	m/min	180
Rated power dissipation	P _{V, N}	kW	0.469
Limit data			
Maximum force	F _{MAX}	N	630
Maximum current	I _{MAX}	A	7.45
Maximum velocity at maximum force	v _{MAX, FMAX}	m/min	120
Maximum electric power input	P _{EL, MAX}	kW	2.5
Stall force	F _{0*}	N	362
Stall current	I _{0*}	A	3.25
Physical constants			
Force constant at 70 °C	k _{F, 20}	N/A	117
Voltage constant (phase-to-phase)	k _E	Vs/m	70.5
Motor constant at 20 °C	k _{M, 20}	N/W ^{0.5}	29.3
Motor winding resistance at 20 °C	R _{STR, 20}	Ω	5.32
Phase inductance	L _{STR}	mH	51.8
Attraction force	F _A	N	2510
Thermal time constant	t _{TH}	s	313
Polar distance	t _P	mm	12.5
Cogging force	F _{COGG}	N	16.9
Mass of the primary section	m _P	kg	8.39
Primary section main cooler data			
Maximum dissipated heat output	Q _{P, H, MAX}	kW	0.469
Recommended minimum volume flow	V _{P, H, MIN}	l/min	1.93
Cooling medium temperature increase	ΔT _{P, H}	K	3.5
Pressure drop	Δp _{P, H}	bar	0.1
Secondary section data			
Mass of the secondary section (l = 500 mm)	m _S	kg	4.03
Mass of the secondary section (l = 200 mm)	m _S	kg	1.61

Characteristic curves 1FN6007-1WE20-0KA1

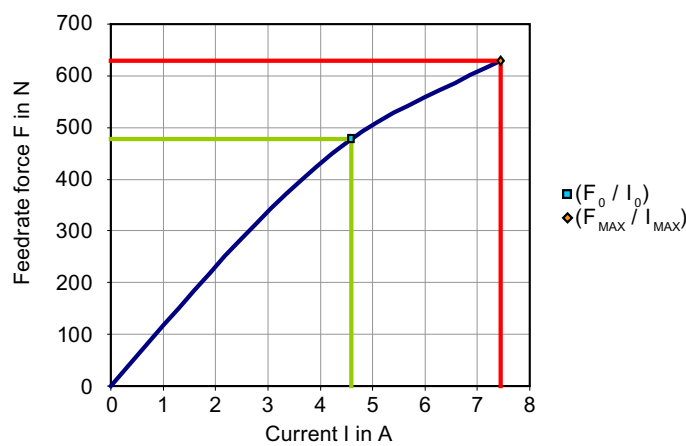
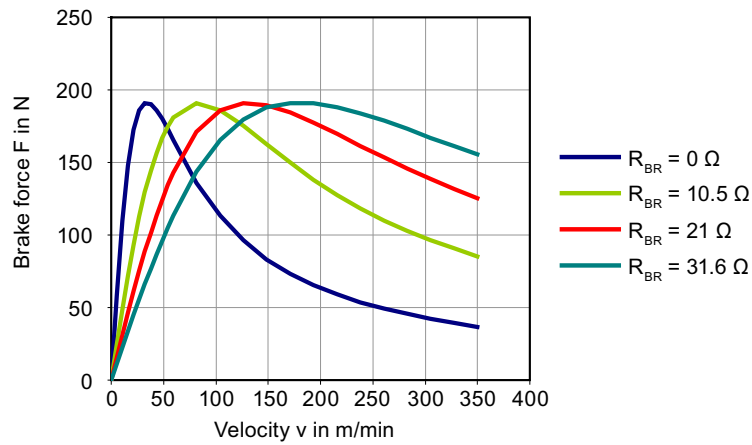
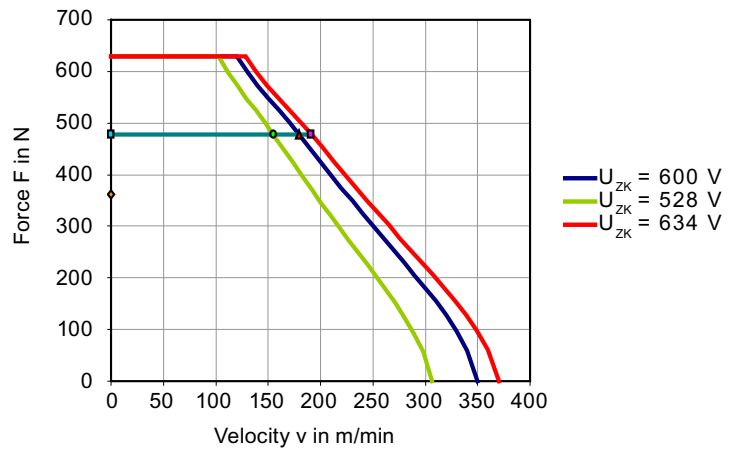

Motor data 1FN6007-1WE53-0KA1

1FN6007-1WE53-0KA1			
Technical data	Short name	Unit	Value
Supplementary conditions			
DC-link voltage	U_{ZK}	V	600
Rated temperature	T_N	°C	120
Rated data			
Rated force	F_N	N	477
Rated current	I_N	A	11.2
Maximum velocity at rated force	$v_{MAX, FN}$	m/min	462
Rated power dissipation	$P_{V, N}$	kW	0.51
Limit data			
Maximum force	F_{MAX}	N	630
Maximum current	I_{MAX}	A	18.2
Maximum velocity at maximum force	$v_{MAX, FMAX}$	m/min	315
Maximum electric power input	$P_{EL, MAX}$	kW	4.65
Stall force	F_0^*	N	362
Stall current	I_0^*	A	7.92
Physical constants			
Force constant at 70 °C	$k_{F, 20}$	N/A	48
Voltage constant (phase-to-phase)	k_E	Vs/m	28.9
Motor constant at 20 °C	$k_{M, 20}$	N/W ^{0.5}	28.1
Motor winding resistance at 20 °C	$R_{STR, 20}$	Ω	0.974
Phase inductance	L_{STR}	mH	8.72
Attraction force	F_A	N	2510
Thermal time constant	t_{TH}	s	313
Polar distance	T_P	mm	12.5
Cogging force	F_{COGG}	N	16.9
Mass of the primary section	m_P	kg	8.39
Primary section main cooler data			
Maximum dissipated heat output	$Q_{P, H, MAX}$	kW	0.51
Recommended minimum volume flow	$V_{P, H, MIN}$	l/min	2.09
Cooling medium temperature increase	$\Delta T_{P, H}$	K	3.5
Pressure drop	$\Delta p_{P, H}$	bar	0.1
Secondary section data			
Mass of the secondary section (l = 500 mm)	m_S	kg	4.03
Mass of the secondary section (l = 200 mm)	m_S	kg	1.61

Characteristic curves 1FN6007-1WE53-0KA1

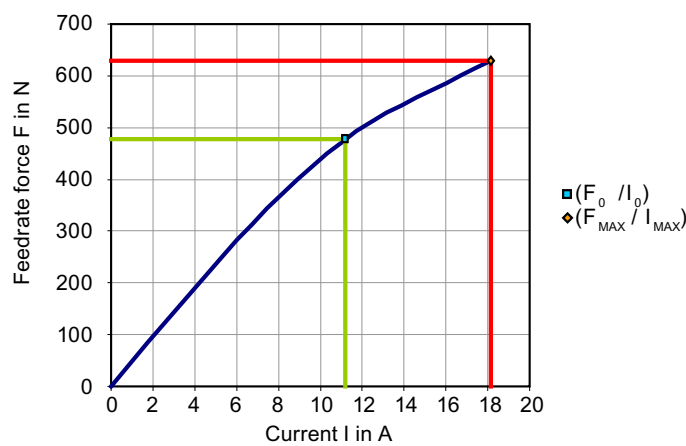
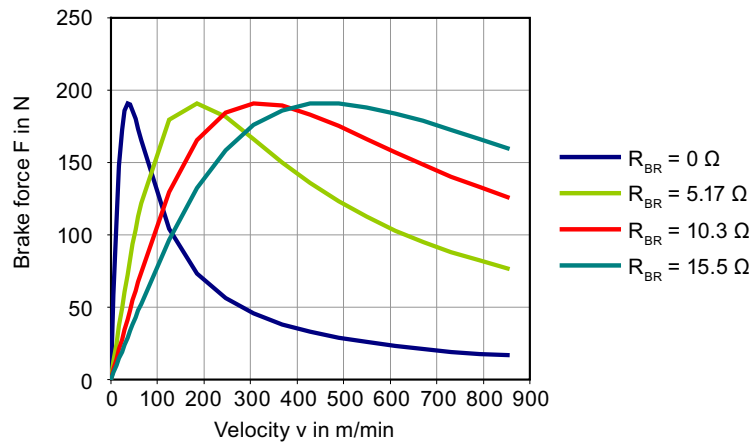
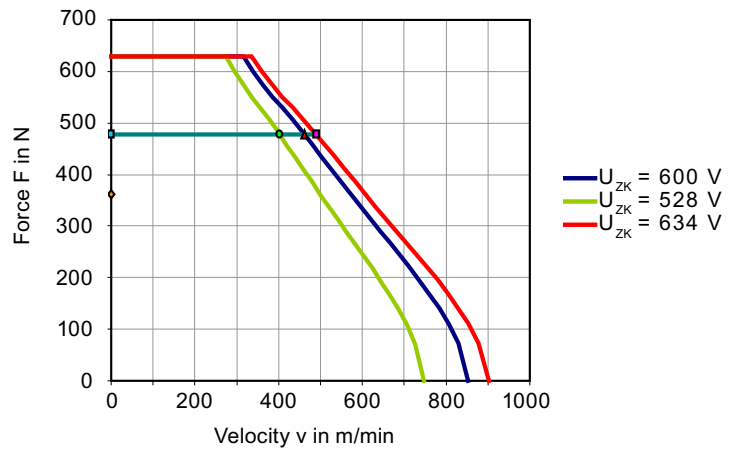

15.5.9 1FN6007-1WGxx

Motor data 1FN6007-1WG12-0KA1

1FN6007-1WG12-0KA1			
Technical data	Short name	Unit	Value
Supplementary conditions			
DC-link voltage	U _{ZK}	V	600
Rated temperature	T _N	°C	120
Rated data			
Rated force	F _N	N	716
Rated current	I _N	A	4.6
Maximum velocity at rated force	v _{MAX, FN}	m/min	111
Rated power dissipation	P _{V, N}	kW	0.704
Limit data			
Maximum force	F _{MAX}	N	945
Maximum current	I _{MAX}	A	7.45
Maximum velocity at maximum force	v _{MAX, FMAX}	m/min	71.7
Maximum electric power input	P _{EL, MAX}	kW	2.98
Stall force	F ₀ *	N	543
Stall current	I ₀ *	A	3.25
Physical constants			
Force constant at 70 °C	k _{F, 20}	N/A	175
Voltage constant (phase-to-phase)	k _E	Vs/m	106
Motor constant at 20 °C	k _{M, 20}	N/W ^{0.5}	35.9
Motor winding resistance at 20 °C	R _{STR, 20}	Ω	7.97
Phase inductance	L _{STR}	mH	80.2
Attraction force	F _A	N	3860
Thermal time constant	t _{TH}	s	313
Polar distance	t _P	mm	12.5
Cogging force	F _{COGG}	N	20.0
Mass of the primary section	m _P	kg	11.7
Primary section main cooler data			
Maximum dissipated heat output	Q _{P, H, MAX}	kW	0.704
Recommended minimum volume flow	V _{P, H, MIN}	l/min	2.89
Cooling medium temperature increase	ΔT _{P, H}	K	3.5
Pressure drop	Δp _{P, H}	bar	0.1
Secondary section data			
Mass of the secondary section (l = 500 mm)	m _S	kg	4.03
Mass of the secondary section (l = 200 mm)	m _S	kg	1.61

Characteristic curves 1FN6007-1WG12-0KA1

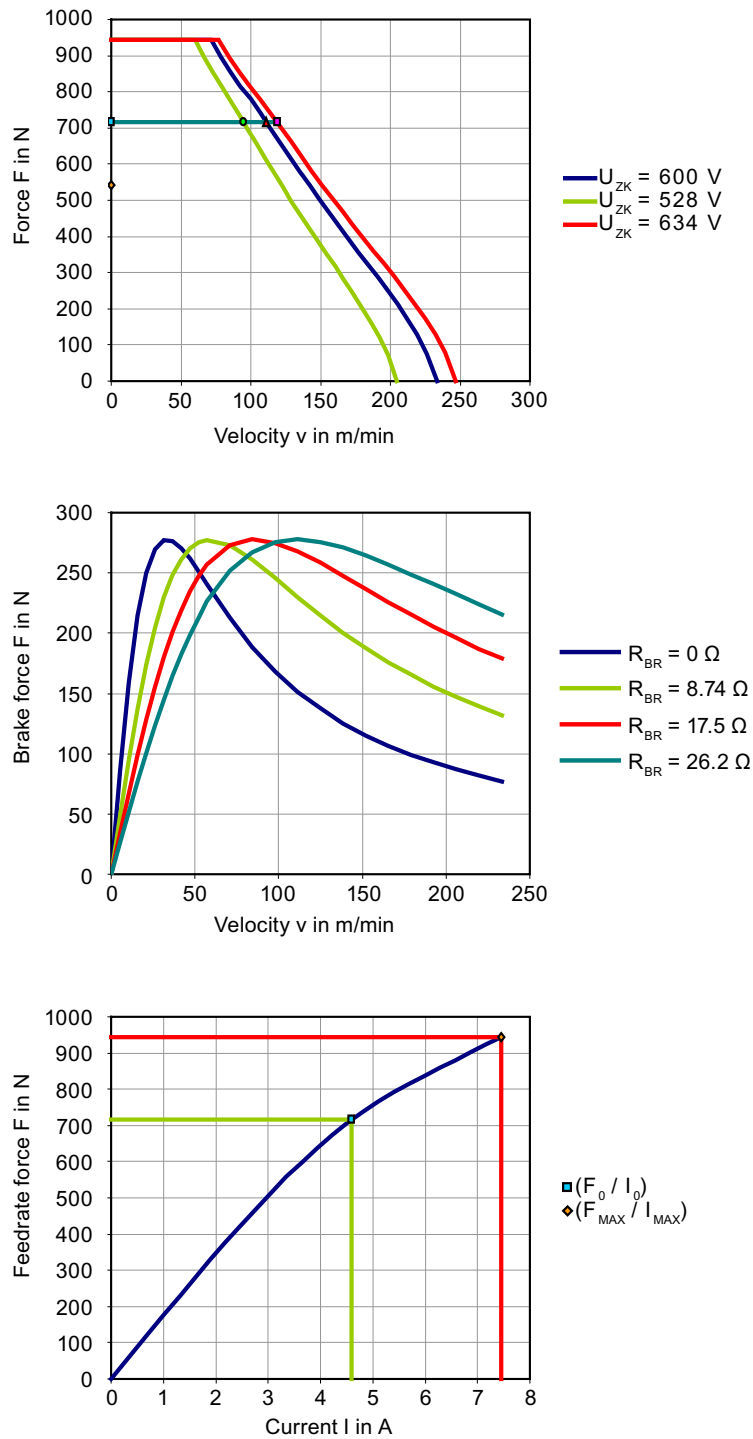

Motor data 1FN6007-1WG33-0KA1

1FN6007-1WG33-0KA1			
Technical data	Short name	Unit	Value
Supplementary conditions			
DC-link voltage	U_{ZK}	V	600
Rated temperature	T_N	°C	120
Rated data			
Rated force	F_N	N	716
Rated current	I_N	A	11.2
Maximum velocity at rated force	$v_{MAX, FN}$	m/min	296
Rated power dissipation	$P_{V, N}$	kW	0.761
Limit data			
Maximum force	F_{MAX}	N	945
Maximum current	I_{MAX}	A	18.2
Maximum velocity at maximum force	$v_{MAX, FMAX}$	m/min	200
Maximum electric power input	$P_{EL, MAX}$	kW	5.14
Stall force	F_0^*	N	543
Stall current	I_0^*	A	7.92
Physical constants			
Force constant at 70 °C	$k_{F, 20}$	N/A	72
Voltage constant (phase-to-phase)	k_E	Vs/m	43.4
Motor constant at 20 °C	$k_{M, 20}$	N/W ^{0.5}	34.5
Motor winding resistance at 20 °C	$R_{STR, 20}$	Ω	1.45
Phase inductance	L_{STR}	mH	13.5
Attraction force	F_A	N	3860
Thermal time constant	t_{TH}	s	313
Polar distance	T_P	mm	12.5
Cogging force	F_{COGG}	N	20.0
Mass of the primary section	m_P	kg	11.7
Primary section main cooler data			
Maximum dissipated heat output	$Q_{P, H, MAX}$	kW	0.761
Recommended minimum volume flow	$V_{P, H, MIN}$	l/min	3.12
Cooling medium temperature increase	$\Delta T_{P, H}$	K	3.5
Pressure drop	$\Delta p_{P, H}$	bar	0.1
Secondary section data			
Mass of the secondary section (l = 500 mm)	m_S	kg	4.03
Mass of the secondary section (l = 200 mm)	m_S	kg	1.61

Characteristic curves 1FN6007-1WG33-0KA1

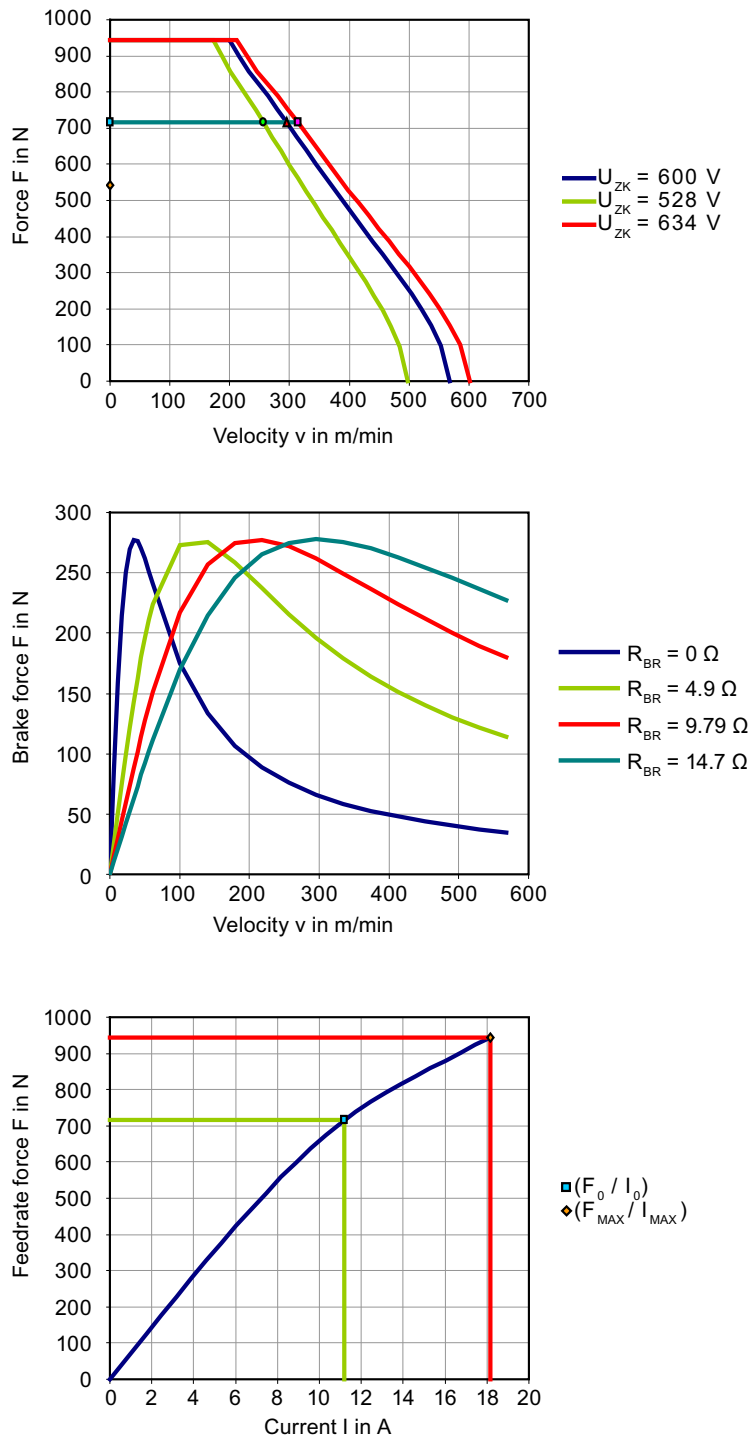

15.5.10 1FN6007-1WJxx

Motor data 1FN6007-1WJ08-0KA1

1FN6007-1WJ08-0KA1			
Technical data	Short name	Unit	Value
Supplementary conditions			
DC-link voltage	U _{ZK}	V	600
Rated temperature	T _N	°C	120
Rated data			
Rated force	F _N	N	955
Rated current	I _N	A	4.6
Maximum velocity at rated force	v _{MAX, FN}	m/min	77.6
Rated power dissipation	P _{V, N}	kW	0.938
Limit data			
Maximum force	F _{MAX}	N	1260
Maximum current	I _{MAX}	A	7.45
Maximum velocity at maximum force	v _{MAX, FMAX}	m/min	47.4
Maximum electric power input	P _{EL, MAX}	kW	3.46
Stall force	F _{0*}	N	724
Stall current	I _{0*}	A	3.25
Physical constants			
Force constant at 70 °C	k _{F, 20}	N/A	234
Voltage constant (phase-to-phase)	k _E	Vs/m	141
Motor constant at 20 °C	k _{M, 20}	N/W ^{0.5}	41.4
Motor winding resistance at 20 °C	R _{STR, 20}	Ω	10.6
Phase inductance	L _{STR}	mH	109
Attraction force	F _A	N	5220
Thermal time constant	t _{TH}	s	313
Polar distance	t _P	mm	12.5
Cogging force	F _{COGG}	N	23.0
Mass of the primary section	m _P	kg	15
Primary section main cooler data			
Maximum dissipated heat output	Q _{P, H, MAX}	kW	0.938
Recommended minimum volume flow	V _{P, H, MIN}	l/min	3.85
Cooling medium temperature increase	ΔT _{P, H}	K	3.5
Pressure drop	Δp _{P, H}	bar	0.1
Secondary section data			
Mass of the secondary section (l = 500 mm)	m _S	kg	4.03
Mass of the secondary section (l = 200 mm)	m _S	kg	1.61

Characteristic curves 1FN6007-1WJ08-0KA1

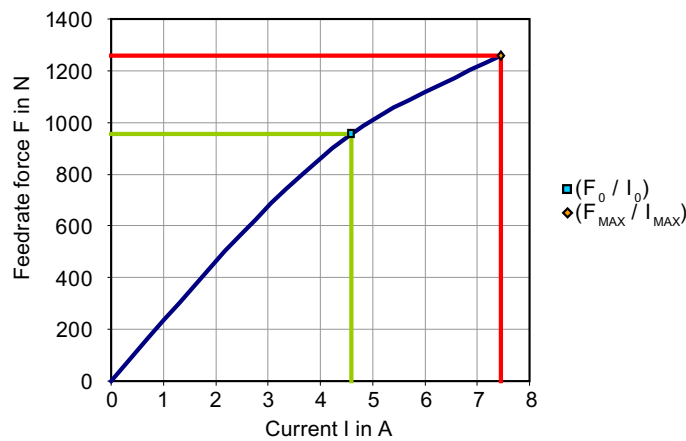
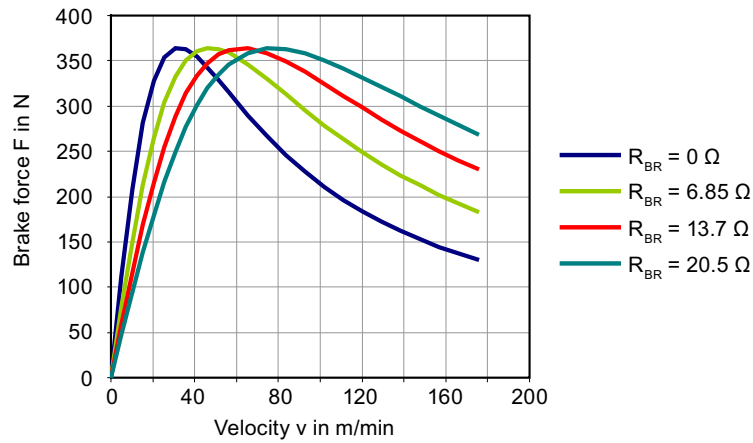
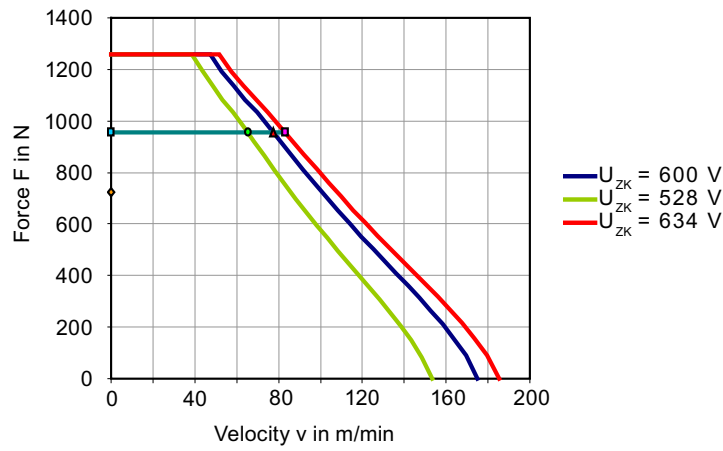

Motor data 1FN6007-1WJ24-0KA1

1FN6007-1WJ24-0KA1			
Technical data	Short name	Unit	Value
Supplementary conditions			
DC-link voltage	U_{ZK}	V	600
Rated temperature	T_N	°C	120
Rated data			
Rated force	F_N	N	955
Rated current	I_N	A	11.2
Maximum velocity at rated force	$v_{MAX, FN}$	m/min	215
Rated power dissipation	$P_{V, N}$	kW	1.01
Limit data			
Maximum force	F_{MAX}	N	1260
Maximum current	I_{MAX}	A	18.2
Maximum velocity at maximum force	$v_{MAX, FMAX}$	m/min	143
Maximum electric power input	$P_{EL, MAX}$	kW	5.67
Stall force	F_0^*	N	724
Stall current	I_0^*	A	7.92
Physical constants			
Force constant at 70 °C	$k_{F, 20}$	N/A	96
Voltage constant (phase-to-phase)	k_E	Vs/m	57.9
Motor constant at 20 °C	$k_{M, 20}$	N/W ^{0.5}	39.9
Motor winding resistance at 20 °C	$R_{STR, 20}$	Ω	1.93
Phase inductance	L_{STR}	mH	18.3
Attraction force	F_A	N	5220
Thermal time constant	t_{TH}	s	313
Polar distance	T_P	mm	12.5
Cogging force	F_{COGG}	N	23.0
Mass of the primary section	m_P	kg	15
Primary section main cooler data			
Maximum dissipated heat output	$Q_{P, H, MAX}$	kW	1.01
Recommended minimum volume flow	$V_{P, H, MIN}$	l/min	4.15
Cooling medium temperature increase	$\Delta T_{P, H}$	K	3.5
Pressure drop	$\Delta p_{P, H}$	bar	0.1
Secondary section data			
Mass of the secondary section (l = 500 mm)	m_S	kg	4.03
Mass of the secondary section (l = 200 mm)	m_S	kg	1.61

Characteristic curves 1FN6007-1WJ24-0KA1

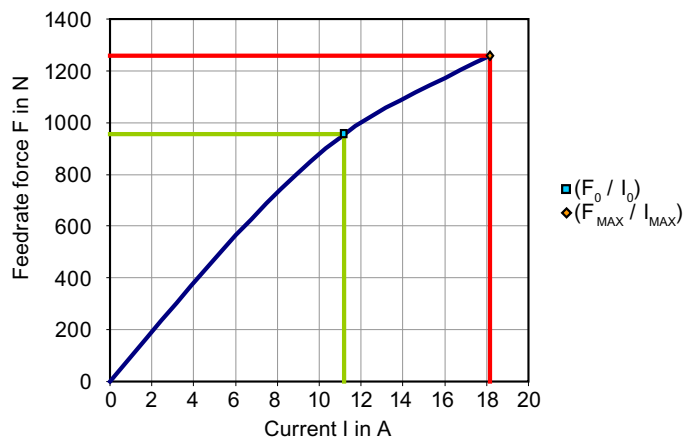
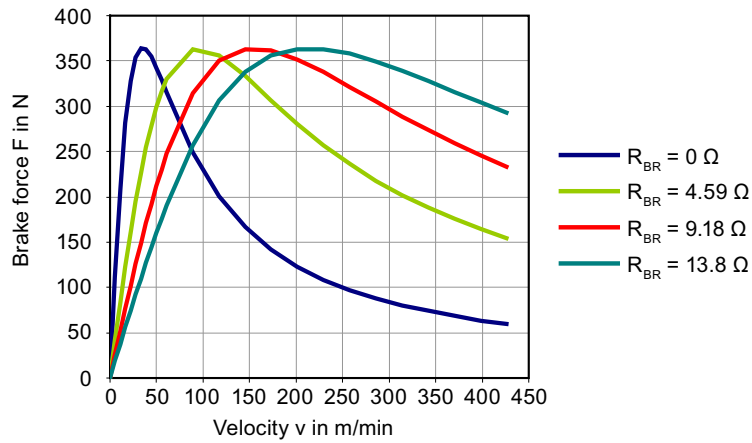
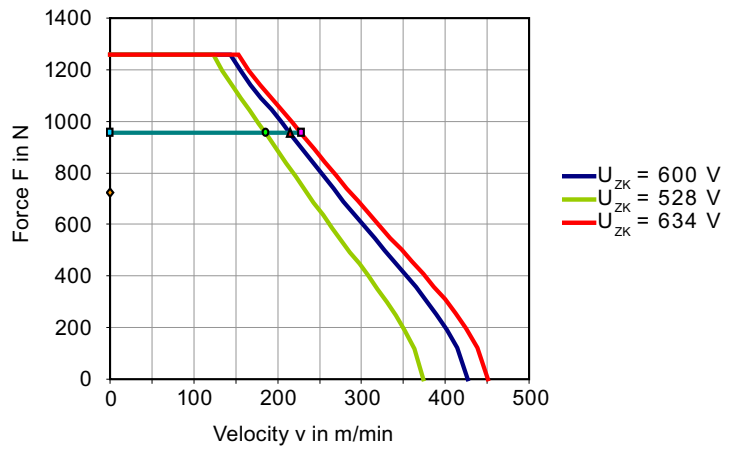

15.5.11 1FN6007-1WLxx

Motor data 1FN6007-1WL05-0KA1

1FN6007-1WL05-0KA1			
Technical data	Short name	Unit	Value
Supplementary conditions			
DC-link voltage	U _{ZK}	V	600
Rated temperature	T _N	°C	120
Rated data			
Rated force	F _N	N	1190
Rated current	I _N	A	4.6
Maximum velocity at rated force	v _{MAX, FN}	m/min	57.5
Rated power dissipation	P _{V, N}	kW	1.17
Limit data			
Maximum force	F _{MAX}	N	1570
Maximum current	I _{MAX}	A	7.45
Maximum velocity at maximum force	v _{MAX, FMAX}	m/min	32.4
Maximum electric power input	P _{EL, MAX}	kW	3.93
Stall force	F ₀ *	N	905
Stall current	I ₀ *	A	3.25
Physical constants			
Force constant at 70 °C	k _{F, 20}	N/A	292
Voltage constant (phase-to-phase)	k _E	Vs/m	176
Motor constant at 20 °C	k _{M, 20}	N/W ^{0.5}	46.3
Motor winding resistance at 20 °C	R _{STR, 20}	Ω	13.3
Phase inductance	L _{STR}	mH	137
Attraction force	F _A	N	6590
Thermal time constant	t _{TH}	s	313
Polar distance	t _P	mm	12.5
Cogging force	F _{COGG}	N	26.1
Mass of the primary section	m _P	kg	18.3
Primary section main cooler data			
Maximum dissipated heat output	Q _{P, H, MAX}	kW	1.17
Recommended minimum volume flow	V _{P, H, MIN}	l/min	4.81
Cooling medium temperature increase	ΔT _{P, H}	K	3.5
Pressure drop	Δp _{P, H}	bar	0.1
Secondary section data			
Mass of the secondary section (l = 500 mm)	m _S	kg	4.03
Mass of the secondary section (l = 200 mm)	m _S	kg	1.61

Characteristic curves 1FN6007-1WL05-0KA1

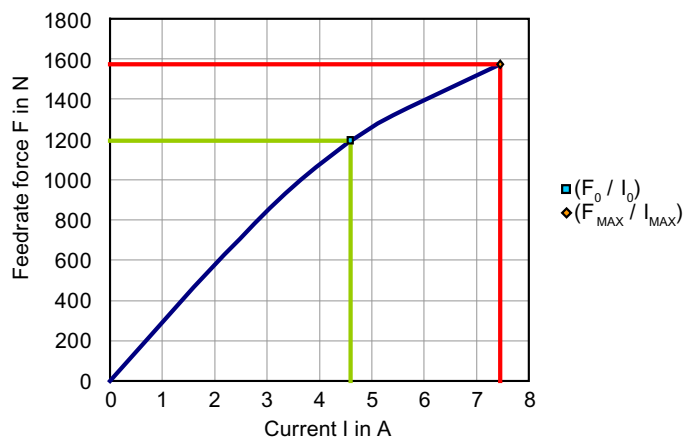
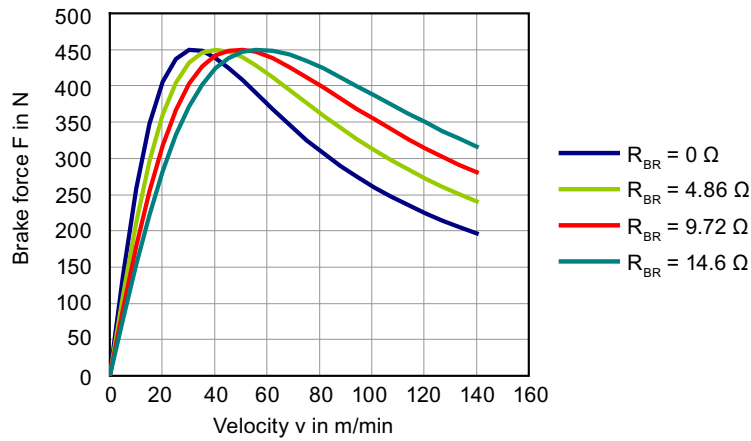
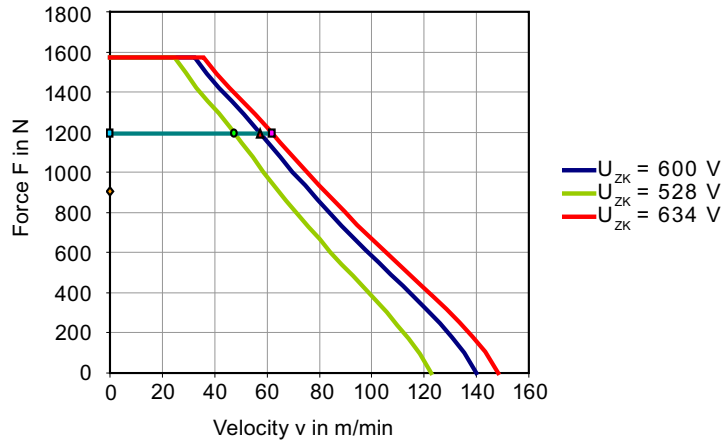

Motor data 1FN6007-1WL18-0KA1

1FN6007-1WL18-0KA1			
Technical data	Short name	Unit	Value
Supplementary conditions			
DC-link voltage	U_{ZK}	V	600
Rated temperature	T_N	°C	120
Rated data			
Rated force	F_N	N	1190
Rated current	I_N	A	11.2
Maximum velocity at rated force	$v_{MAX, FN}$	m/min	167
Rated power dissipation	$P_{V, N}$	kW	1.26
Limit data			
Maximum force	F_{MAX}	N	1570
Maximum current	I_{MAX}	A	18.2
Maximum velocity at maximum force	$v_{MAX, FMAX}$	m/min	110
Maximum electric power input	$P_{EL, MAX}$	kW	6.21
Stall force	F_0^*	N	905
Stall current	I_0^*	A	7.92
Physical constants			
Force constant at 70 °C	$k_{F, 20}$	N/A	120
Voltage constant (phase-to-phase)	k_E	Vs/m	72.4
Motor constant at 20 °C	$k_{M, 20}$	N/W ^{0.5}	44.6
Motor winding resistance at 20 °C	$R_{STR, 20}$	Ω	2.41
Phase inductance	L_{STR}	mH	23.1
Attraction force	F_A	N	6590
Thermal time constant	t_{TH}	s	313
Polar distance	T_P	mm	12.5
Cogging force	F_{COGG}	N	26.1
Mass of the primary section	m_P	kg	18.3
Primary section main cooler data			
Maximum dissipated heat output	$Q_{P, H, MAX}$	kW	1.26
Recommended minimum volume flow	$V_{P, H, MIN}$	l/min	5.18
Cooling medium temperature increase	$\Delta T_{P, H}$	K	3.5
Pressure drop	$\Delta p_{P, H}$	bar	0.1
Secondary section data			
Mass of the secondary section (l = 500 mm)	m_S	kg	4.03
Mass of the secondary section (l = 200 mm)	m_S	kg	1.61

Characteristic curves 1FN6007-1WL18-0KA1

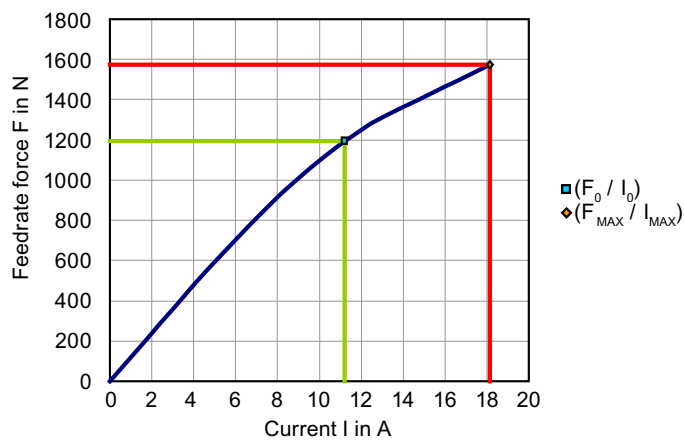
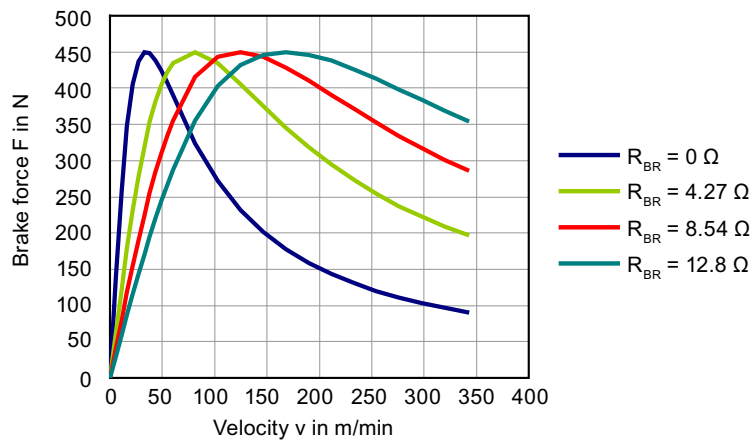
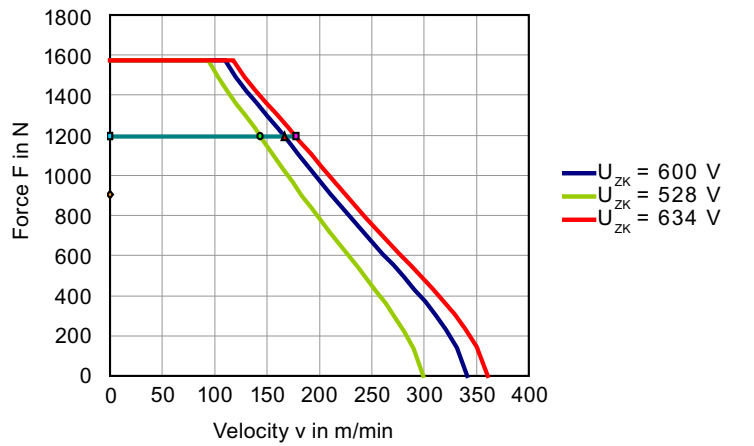

15.5.12 1FN6007-1WNxx

Motor data 1FN6007-1WN15-0KA1

1FN6007-1WN15-0KA1			
Technical data	Short name	Unit	Value
Supplementary conditions			
DC-link voltage	U _{ZK}	V	600
Rated temperature	T _N	°C	120
Rated data			
Rated force	F _N	N	1430
Rated current	I _N	A	11.2
Maximum velocity at rated force	v _{MAX, FN}	m/min	135
Rated power dissipation	P _{V, N}	kW	1.51
Limit data			
Maximum force	F _{MAX}	N	1890
Maximum current	I _{MAX}	A	18.2
Maximum velocity at maximum force	v _{MAX, FMAX}	m/min	87.9
Maximum electric power input	P _{EL, MAX}	kW	6.74
Stall force	F ₀ *	N	1090
Stall current	I ₀ *	A	7.92
Physical constants			
Force constant at 70 °C	k _{F, 20}	N/A	144
Voltage constant (phase-to-phase)	k _E	Vs/m	86.8
Motor constant at 20 °C	k _{M, 20}	N/W ^{0.5}	48.9
Motor winding resistance at 20 °C	R _{STR, 20}	Ω	2.89
Phase inductance	L _{STR}	mH	28
Attraction force	F _A	N	7960
Thermal time constant	t _{TH}	s	313
Polar distance	t _P	mm	12.5
Cogging force	F _{COGG}	N	29.2
Mass of the primary section	m _P	kg	21.6
Primary section main cooler data			
Maximum dissipated heat output	Q _{P, H, MAX}	kW	1.51
Recommended minimum volume flow	v _{P, H, MIN}	l/min	6.21
Cooling medium temperature increase	ΔT _{P, H}	K	3.5
Pressure drop	Δp _{P, H}	bar	0.1
Secondary section data			
Mass of the secondary section (l = 500 mm)	m _S	kg	4.03
Mass of the secondary section (l = 200 mm)	m _S	kg	1.61

Characteristic curves 1FN6007-1WN15-0KA1

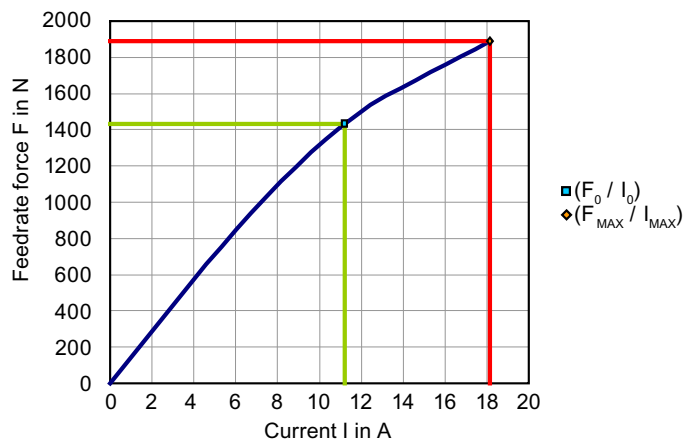
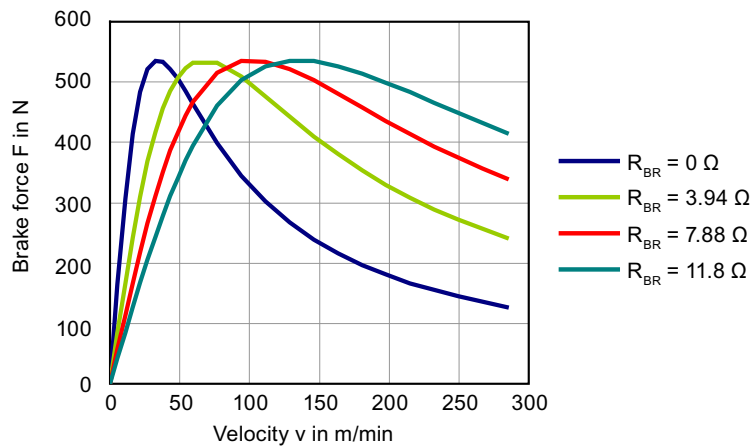
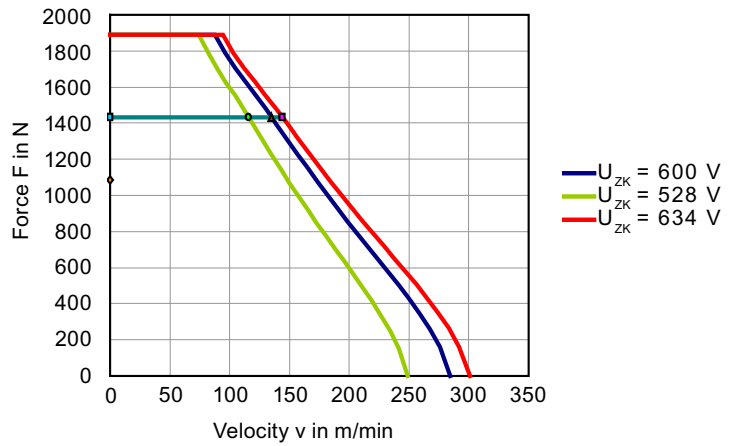

Motor data 1FN6007-1WN32-0KA1

1FN6007-1WN32-0KA1			
Technical data	Short name	Unit	Value
Supplementary conditions			
DC-link voltage	U_{ZK}	V	600
Rated temperature	T_N	°C	120
Rated data			
Rated force	F_N	N	1430
Rated current	I_N	A	21
Maximum velocity at rated force	$v_{MAX,FN}$	m/min	288
Rated power dissipation	$P_{V,N}$	kW	1.54
Limit data			
Maximum force	F_{MAX}	N	1890
Maximum current	I_{MAX}	A	36.3
Maximum velocity at maximum force	$v_{MAX,FMAX}$	m/min	194
Maximum electric power input	$P_{EL,MAX}$	kW	10.1
Stall force	F_0^*	N	1090
Stall current	I_0^*	A	15.8
Physical constants			
Force constant at 70 °C	$k_{F,20}$	N/A	72
Voltage constant (phase-to-phase)	k_E	Vs/m	43.4
Motor constant at 20 °C	$k_{M,20}$	N/W ^{0.5}	48.5
Motor winding resistance at 20 °C	$R_{STR,20}$	Ω	0.734
Phase inductance	L_{STR}	mH	6.99
Attraction force	F_A	N	7960
Thermal time constant	t_{TH}	s	313
Polar distance	T_P	mm	12.5
Cogging force	F_{COGG}	N	29.2
Mass of the primary section	m_P	kg	21.6
Primary section main cooler data			
Maximum dissipated heat output	$Q_{P,H,MAX}$	kW	1.54
Recommended minimum volume flow	$V_{P,H,MIN}$	l/min	6.32
Cooling medium temperature increase	$\Delta T_{P,H}$	K	3.5
Pressure drop	$\Delta p_{P,H}$	bar	0.1
Secondary section data			
Mass of the secondary section (l = 500 mm)	m_S	kg	4.03
Mass of the secondary section (l = 200 mm)	m_S	kg	1.61

Characteristic curves 1FN6007-1WN32-0KA1

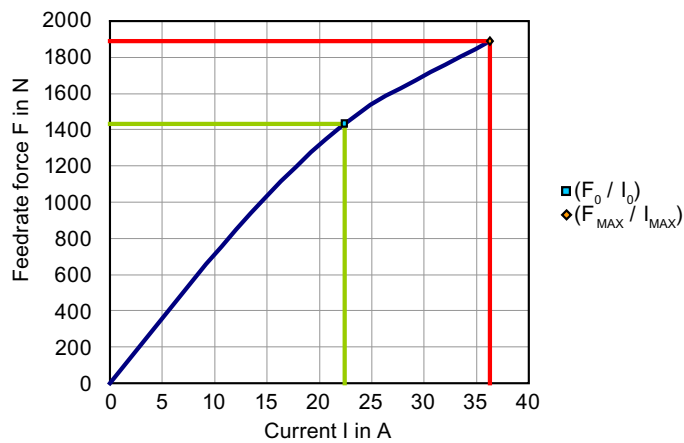
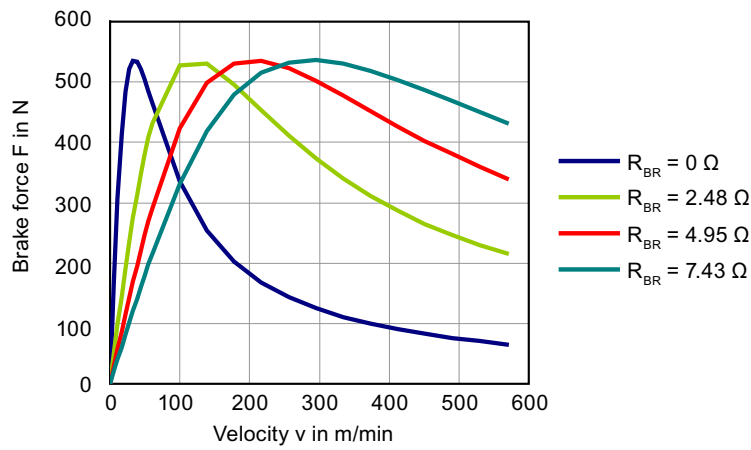
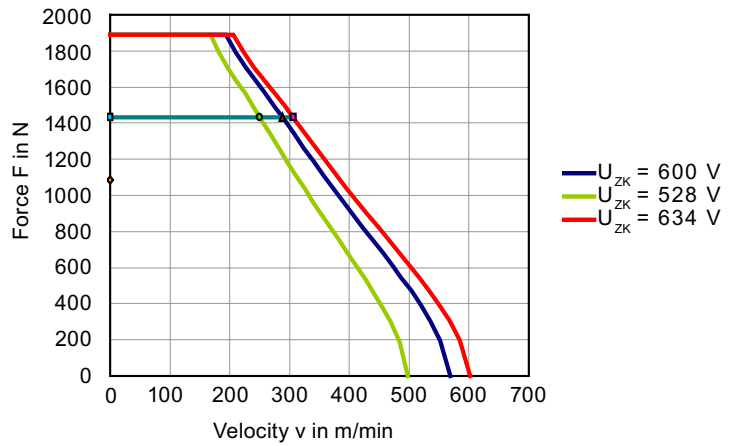

Installation diagrams and dimension tables

16.1 Explanation of installation drawings

In the installation drawings for primary sections that appear below, the following designations are used for geometry data:

N3:	Number of hole rows (lengthways)
LP_AKT:	Magnetically active length in mm
LP4:	Position of the magnetically active surface in mm
LP:	Length excluding connection socket in mm

Note

Siemens AG reserves the right to change the motor dimensions as part of design improvements without prior notification. The dimension drawings provided in this documentation, therefore, may not necessarily be up to date.

Up-to-date dimension drawings can be requested at no charge.

16.2 Position tolerance for fastening holes

Fastening holes

The schematic representation below shows the position tolerance for fastening holes according to DIN EN ISO 1101:2008-08. The diameter "d" of the circular tolerance zone indicates the tolerance.

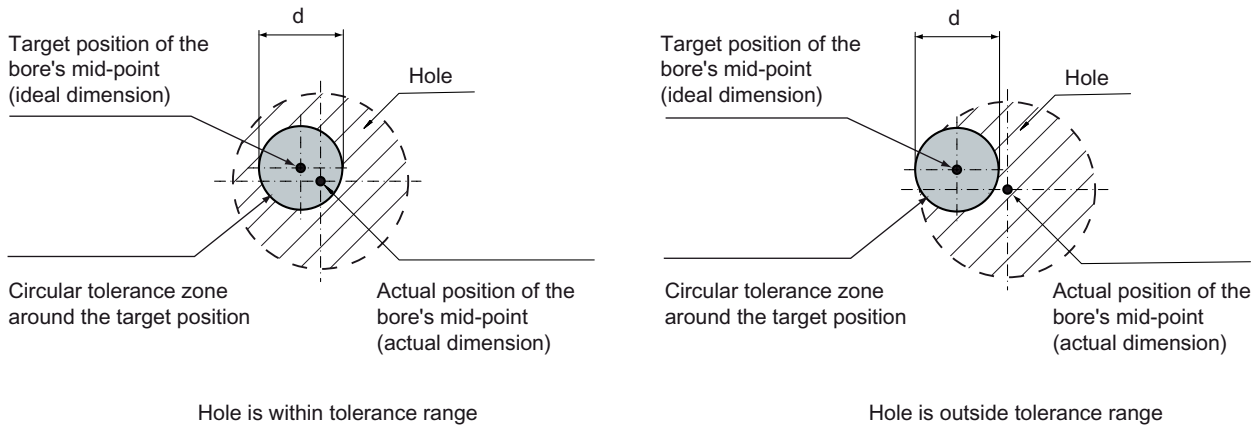

Figure 16-1 Position tolerance for fastening holes

The actual position of the hole's mid-point (actual dimension) must lie within the circular tolerance zone to enable the motor components to be attached without any problems. If no specific value has been stated, the standard tolerance of $d = 0.2 \text{ mm}$ (as used by the machine tool industry) applies.

16.3 1FN6 version with natural cooling

16.3.1 1FN6003-1Lxxx-0FA1

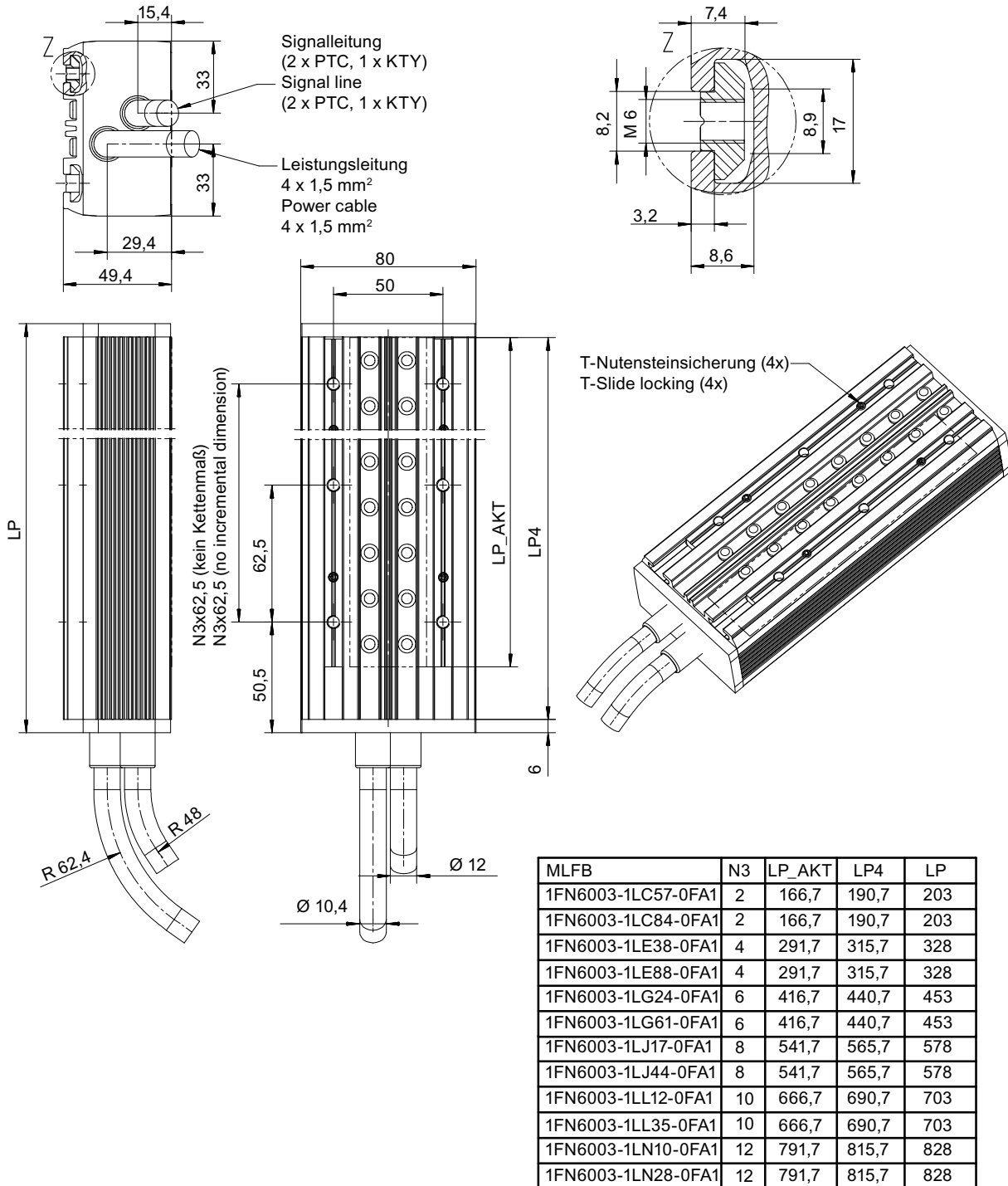

Figure 16-2 Installation dimensions of the primary section in the case of the 1FN6003-1Lxxx-0FA1 (connection via cables)

16.3.2 1FN6007-1Lxxx-0KA1

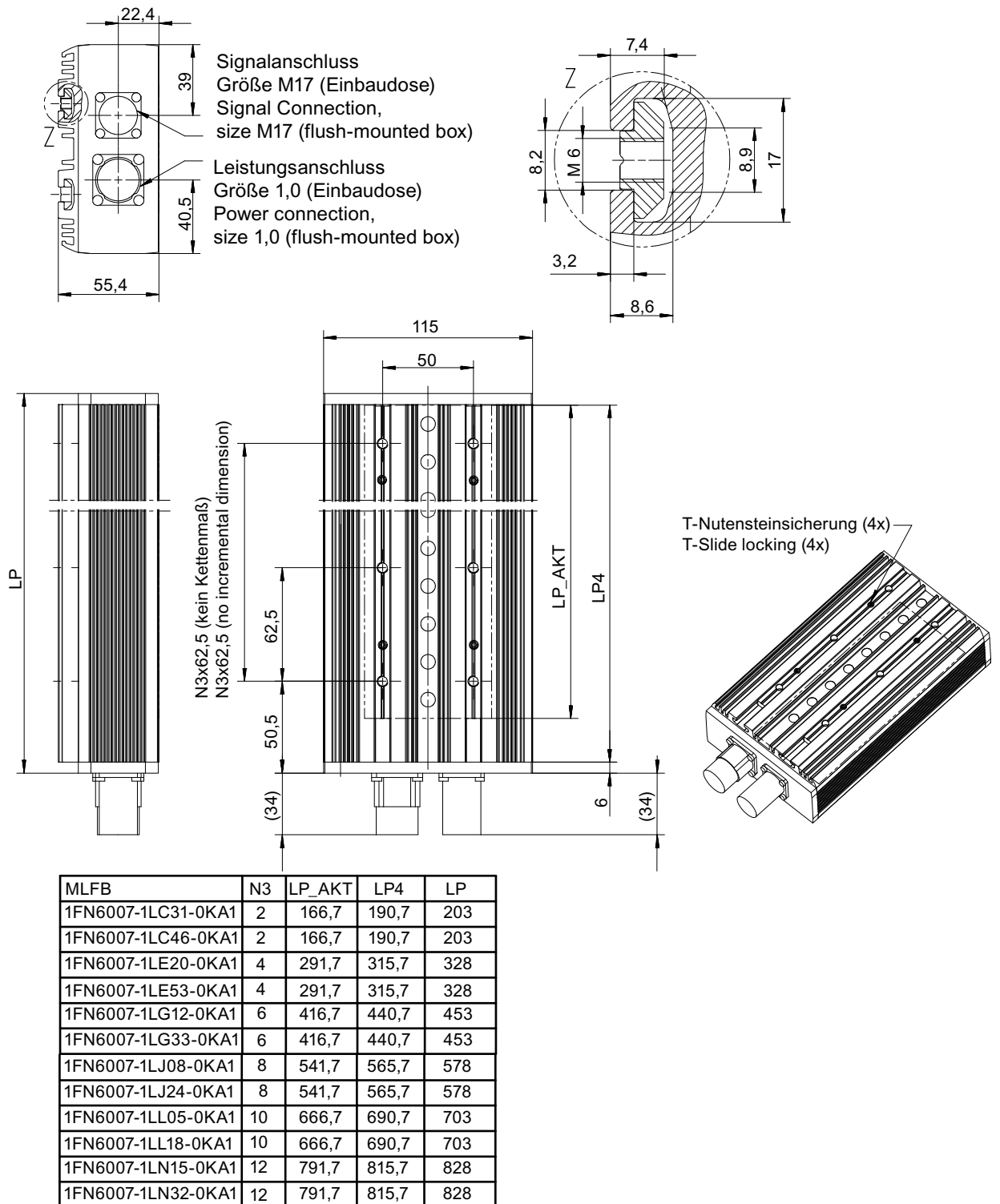
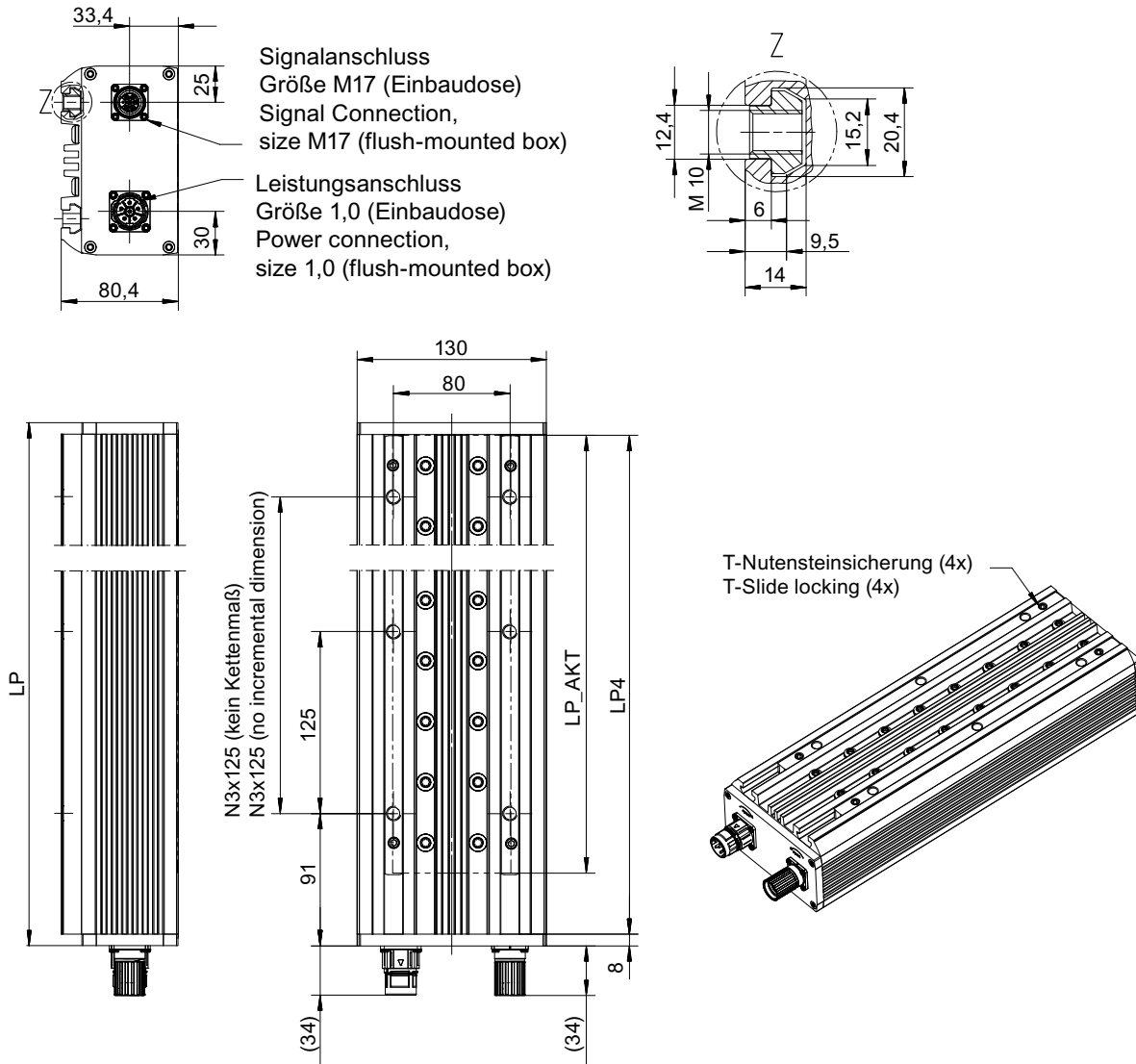

Figure 16-3 Installation dimensions of the primary section in the case of the 1FN6007-1Lxxx-0KA1 (power connection socket, size 1.0)

16.3.3 1FN6008-1Lxxx-0KA1



MLFB	N3	LP_AKT	LP4	LP
1FN6008-1LC17-0KA1	2	333,3	375,3	392
1FN6008-1LC37-0KA1	2	333,3	375,3	392
1FN6008-1LE16-0KA1	4	583,3	625,3	642
1FN6008-1LE34-0KA1	4	583,3	625,3	642
1FN6008-1LG16-0KA1	6	833,3	875,3	892

Figure 16-4 Installation dimensions of the primary section in the case of the 1FN6008-1Lxxx-0KA1 (power connection socket, size 1.0)

16.3 1FN6 version with natural cooling

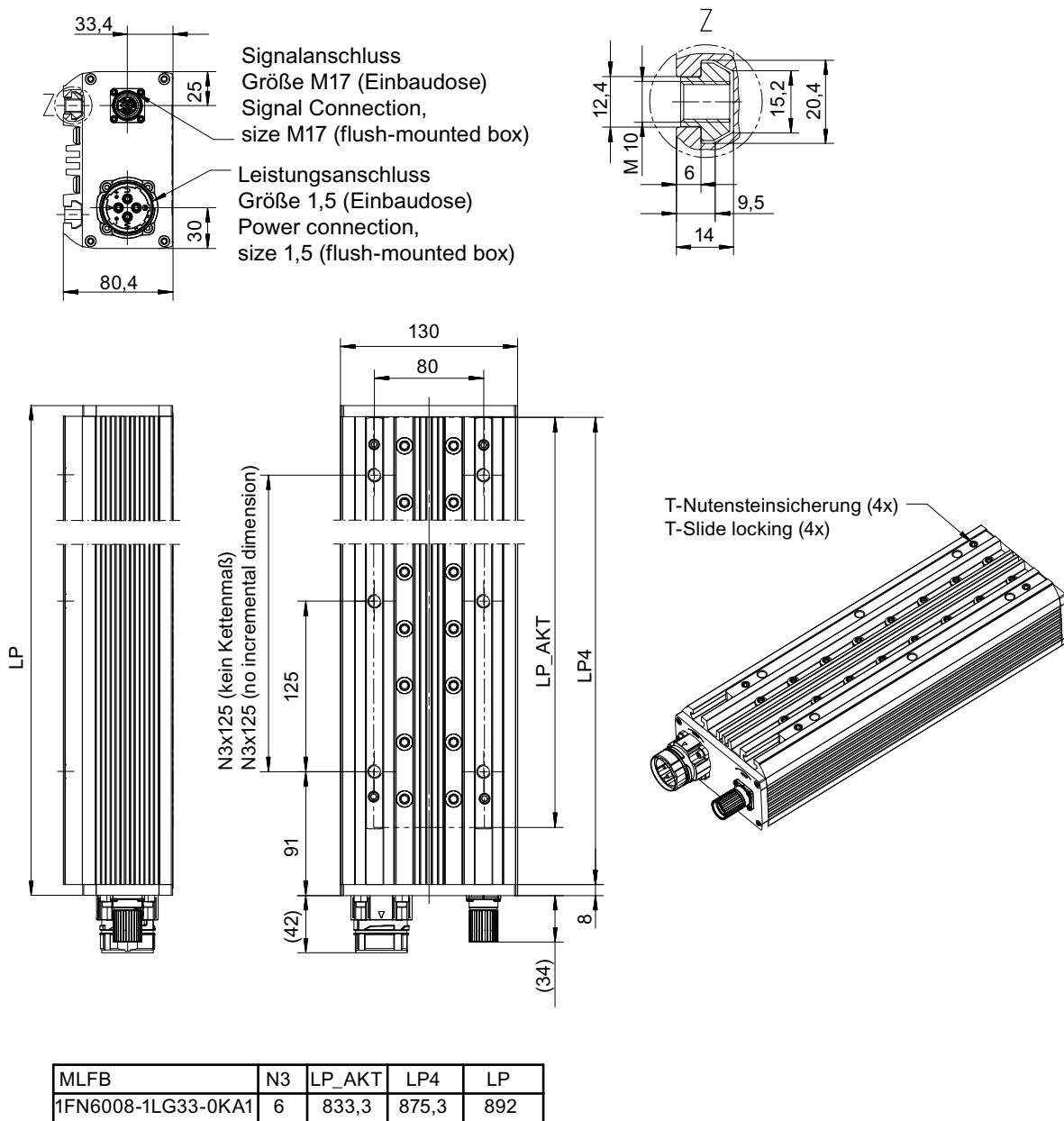

Figure 16-5 Installation dimensions of the primary section in the case of the 1FN6008-1LG33-0KA1 (power connection socket, size 1.5)

16.3.4 1FN6016-1Lxxx-0KA1

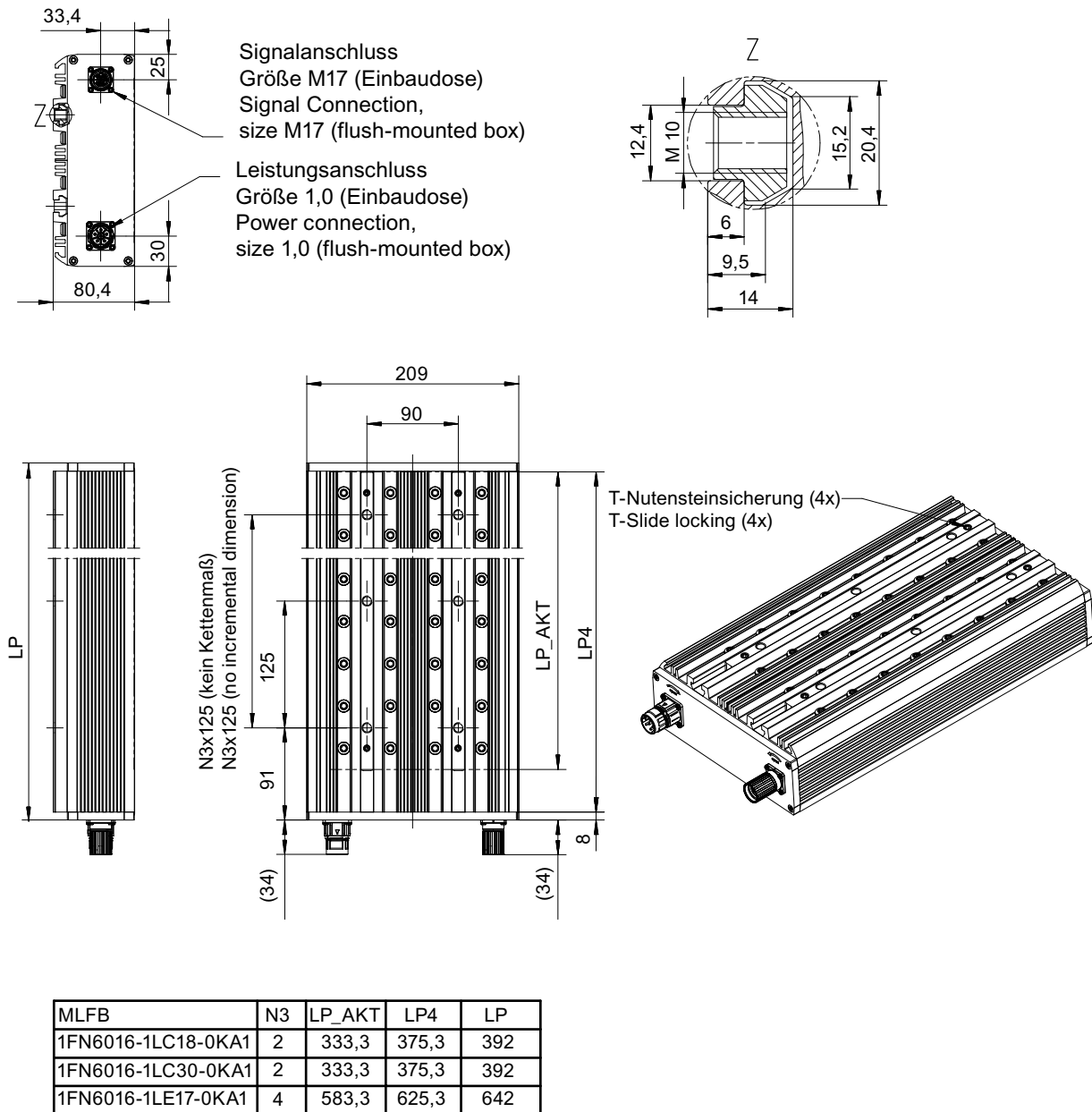

Figure 16-6 Installation dimensions of the primary section in the case of the 1FN6016-1Lxxx-0KA1 (power connection socket, size 1.0)

16.3 1FN6 version with natural cooling

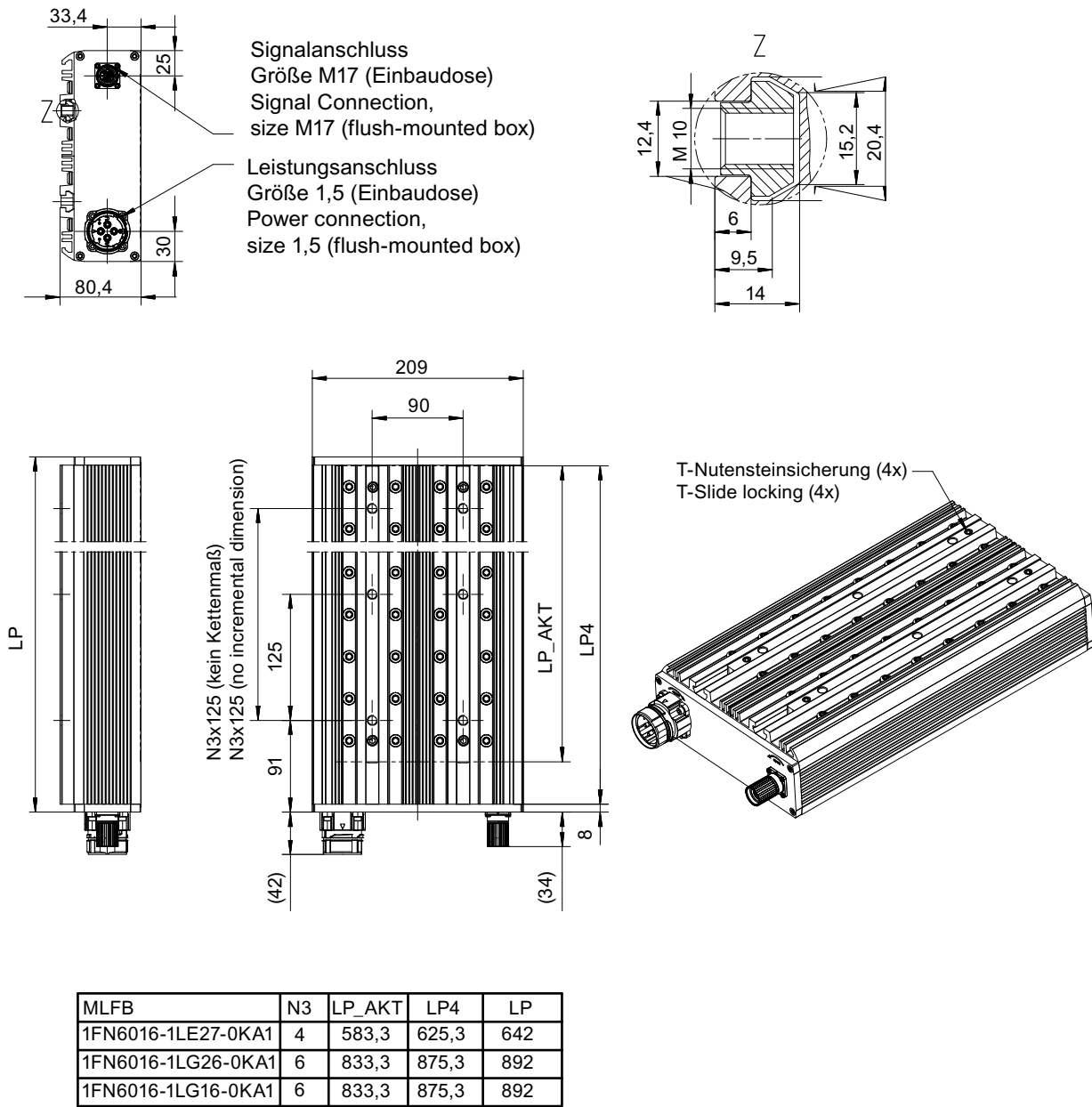

Figure 16-7 Installation dimensions of the primary section in the case of the 1FN6016-1Lxxx-0KA1 (power connection socket, size 1.5)

16.3.5 1FN6024-1Lxxx-0KA1

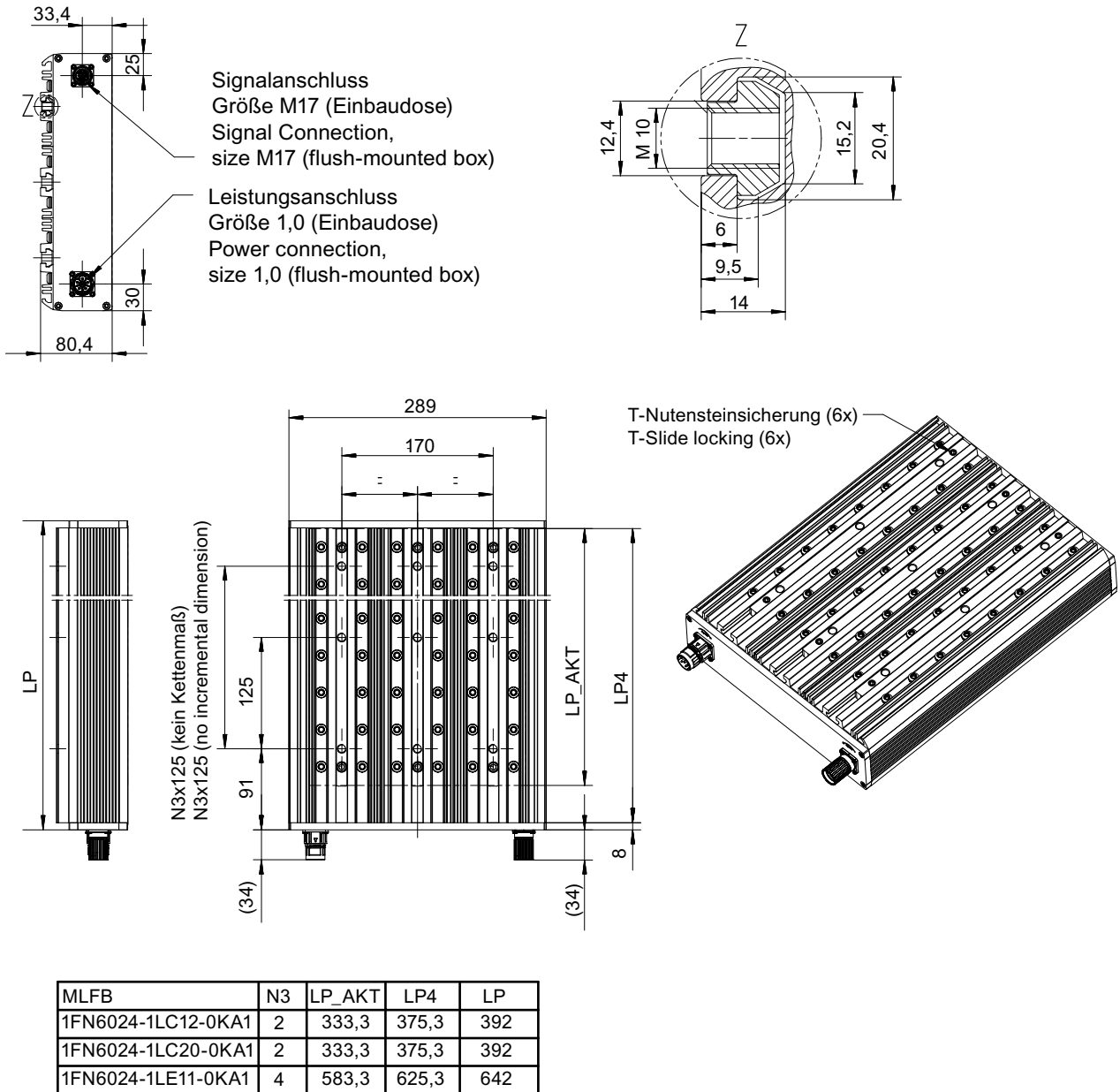

Figure 16-8 Installation dimensions of the primary section in the case of the 1FN6024-1Lxxx-0KA1 (power connection socket, size 1.0)

16.3 1FN6 version with natural cooling

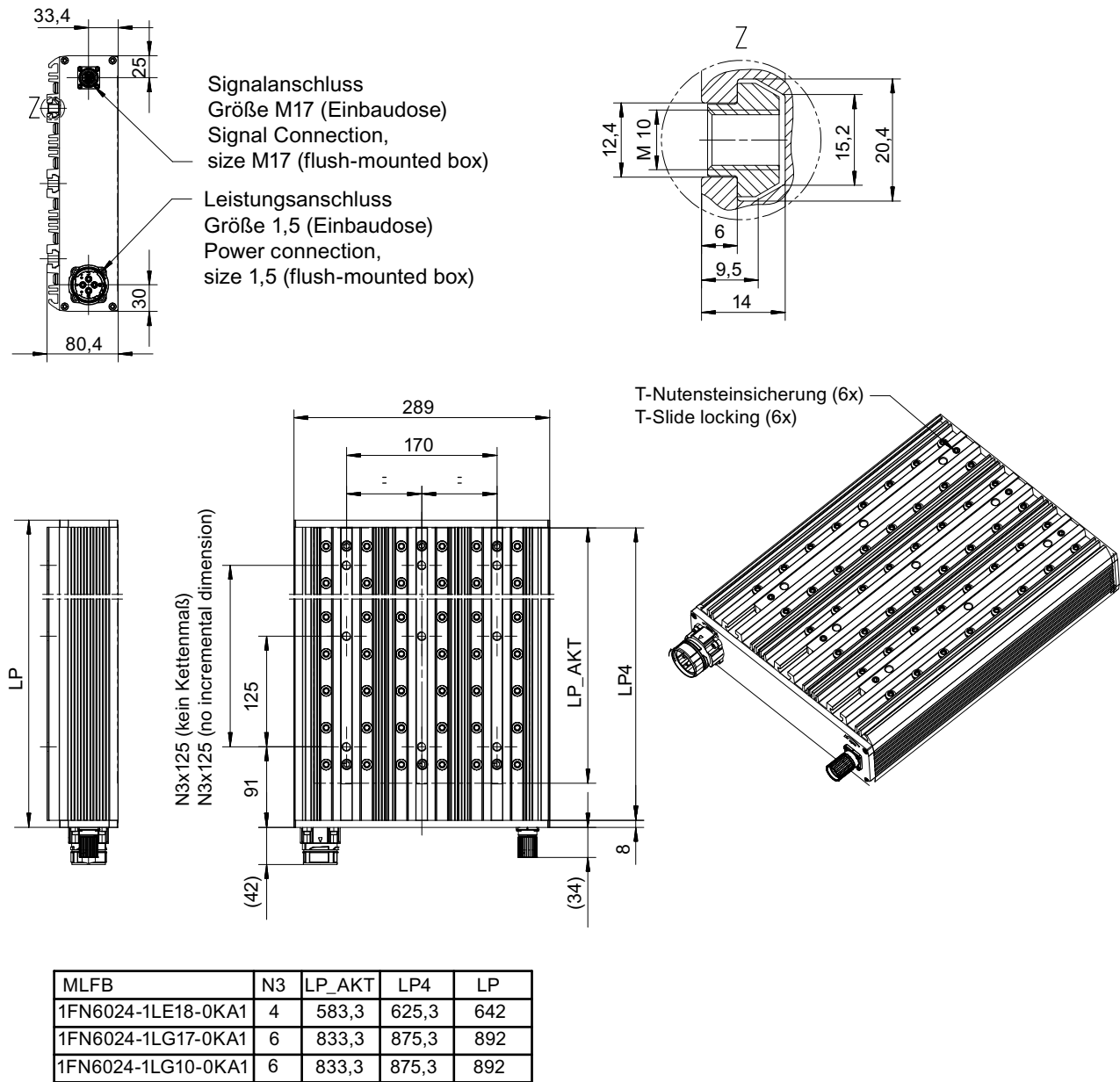

Figure 16-9 Installation dimensions of the primary section in the case of the 1FN6024-1Lxxx-0KA1 (power connection socket, size 1.5)

16.4 1FN6 version with water cooling

16.4.1 1FN6003-1Wxxx-0FA1

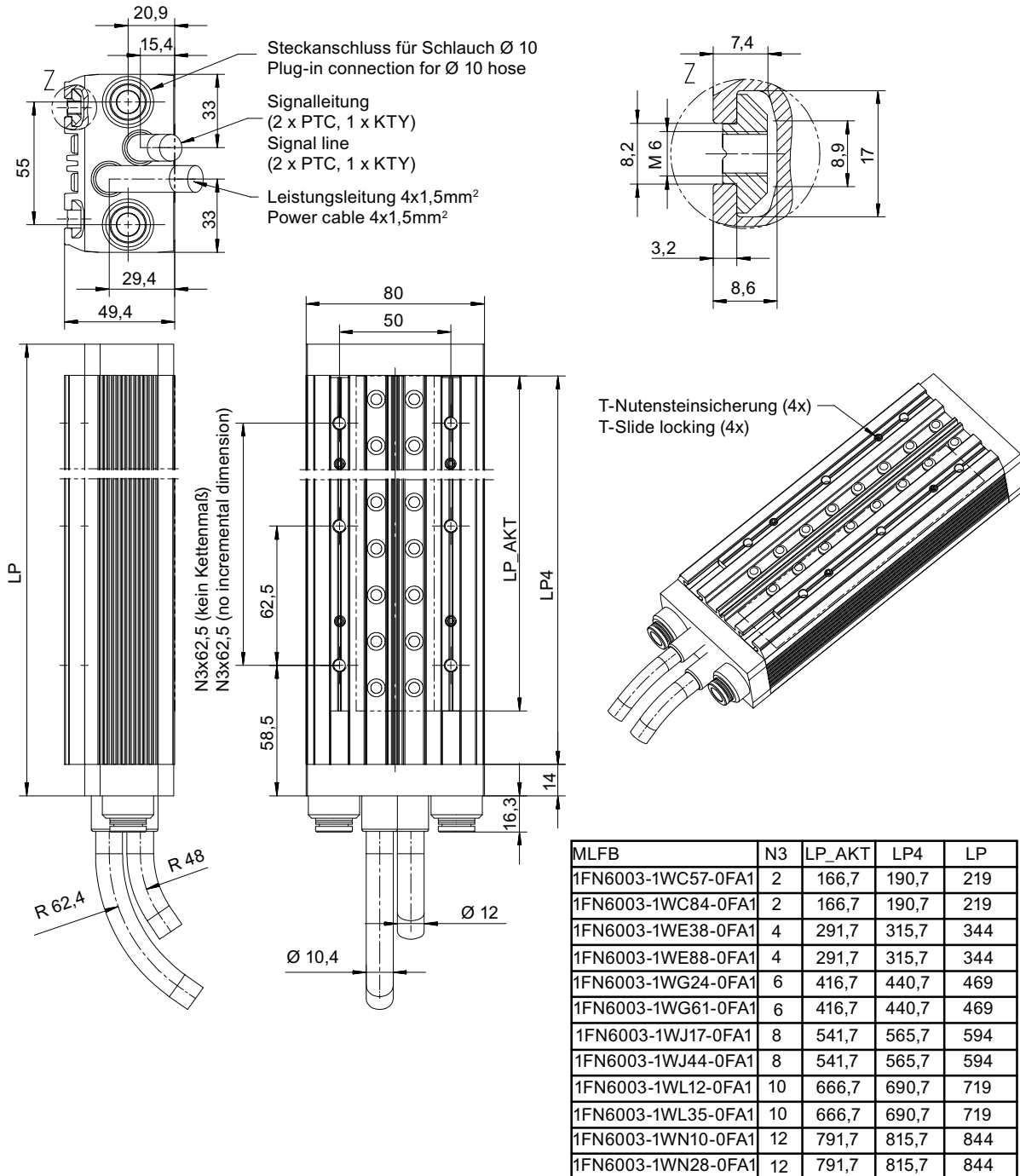
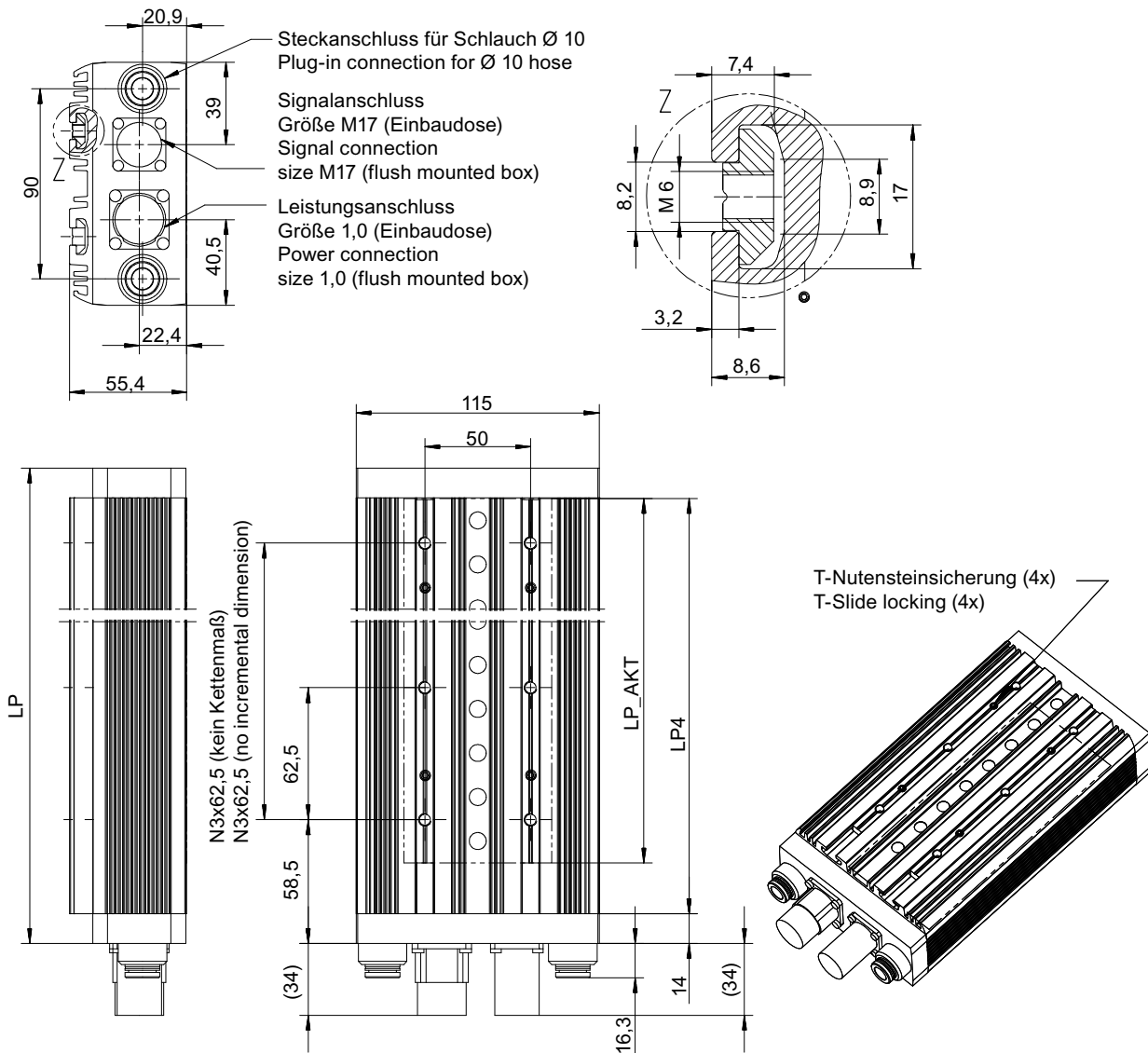

Figure 16-10 Installation dimensions of the primary section in the case of the 1FN6003-1Wxxx-0FA1 (connection via cables)

16.4.2 1FN6007-1Wxxx-0KA1



MLFB	N3	LP_AKT	LP4	LP
1FN6007-1WC31-0KA1	2	166,7	190,7	219
1FN6007-1WC46-0KA1	2	166,7	190,7	219
1FN6007-1WE20-0KA1	4	291,7	315,7	344
1FN6007-1WE53-0KA1	4	291,7	315,7	344
1FN6007-1WG12-0KA1	6	416,7	440,7	469
1FN6007-1WG33-0KA1	6	416,7	440,7	469

MLFB	N3	LP_AKT	LP4	LP
1FN6007-1WJ08-0KA1	8	541,7	565,7	594
1FN6007-1WJ24-0KA1	8	541,7	565,7	594
1FN6007-1WL05-0KA1	10	666,7	690,7	719
1FN6007-1WL18-0KA1	10	666,7	690,7	719
1FN6007-1WN15-0KA1	12	791,7	815,7	844
1FN6007-1WN32-0KA1	12	791,7	815,7	844

Figure 16-11 Installation dimensions of the primary section in the case of the 1FN6007-1Wxxx-0KA1 (power connection flush-mounted box, size 1.0)

16.5 Secondary sections

16.5.1 1FN6003-1Sx00-0AA0

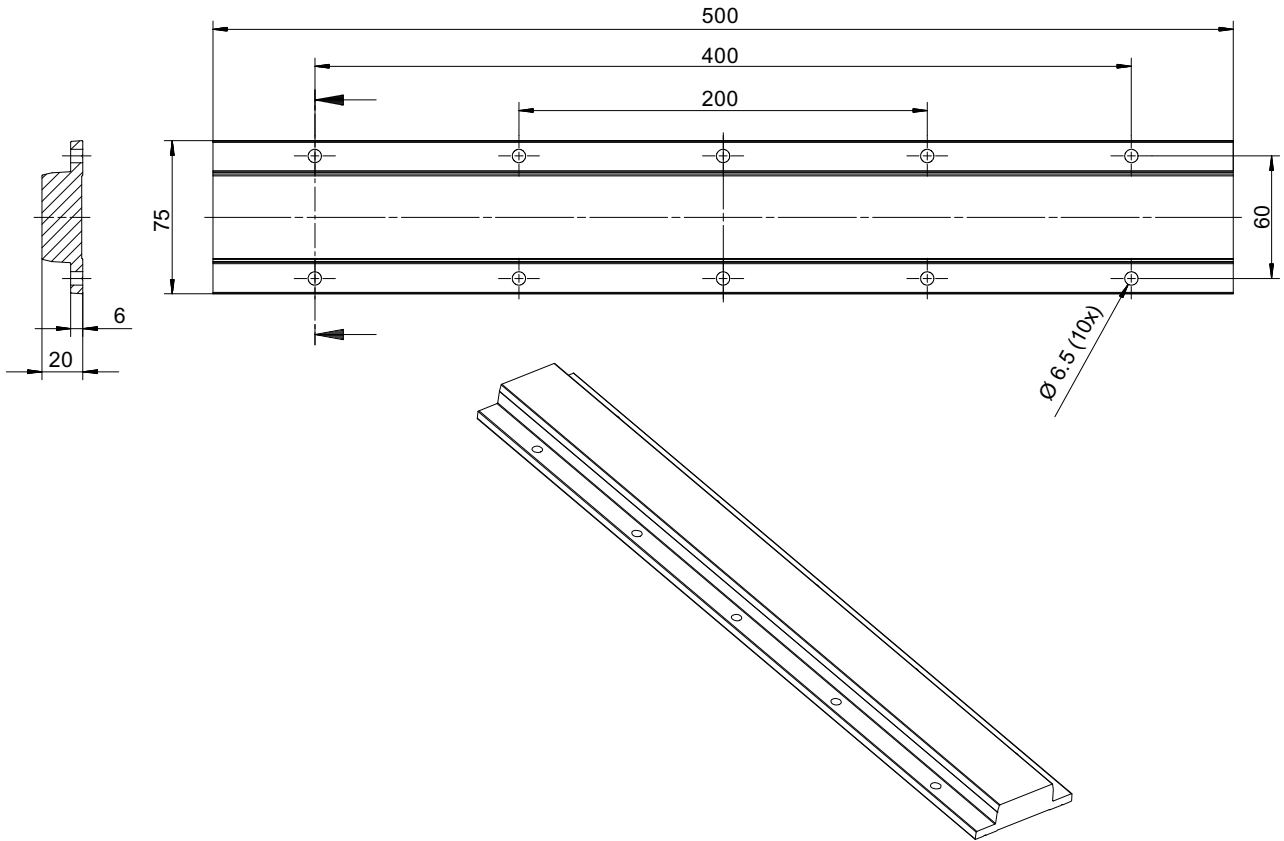

Figure 16-12 Installation dimensions of the secondary section in the case of the 1FN6003-1SF00-0AA0

16.5 Secondary sections

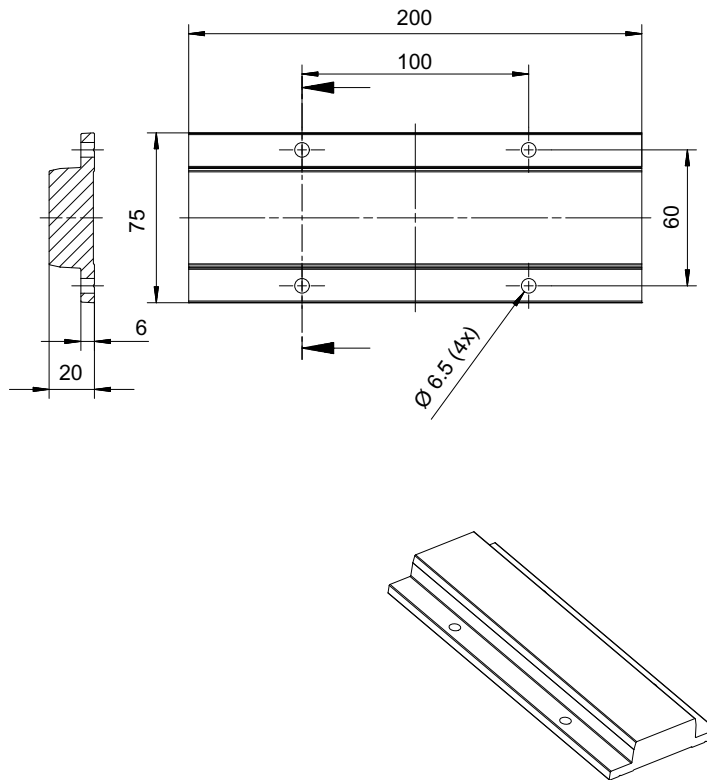

Figure 16-13 Installation dimensions of the secondary section in the case of the 1FN6003-1SC00-0AA0

16.5.2 1FN6007-1Sx00-0AA0

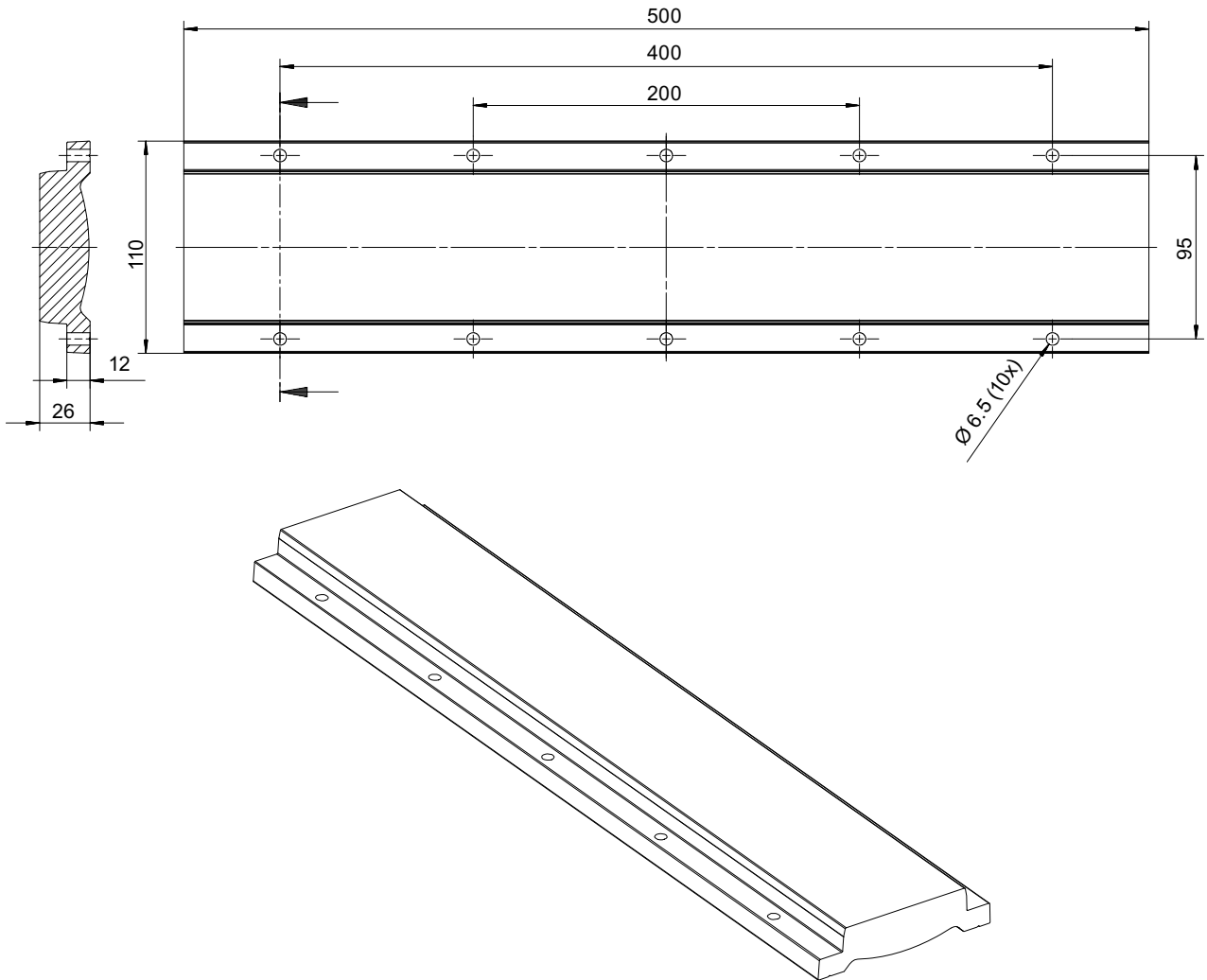

Figure 16-14 Installation dimensions of the secondary section in the case of the 1FN6007-1SF00-0AA0

16.5 Secondary sections

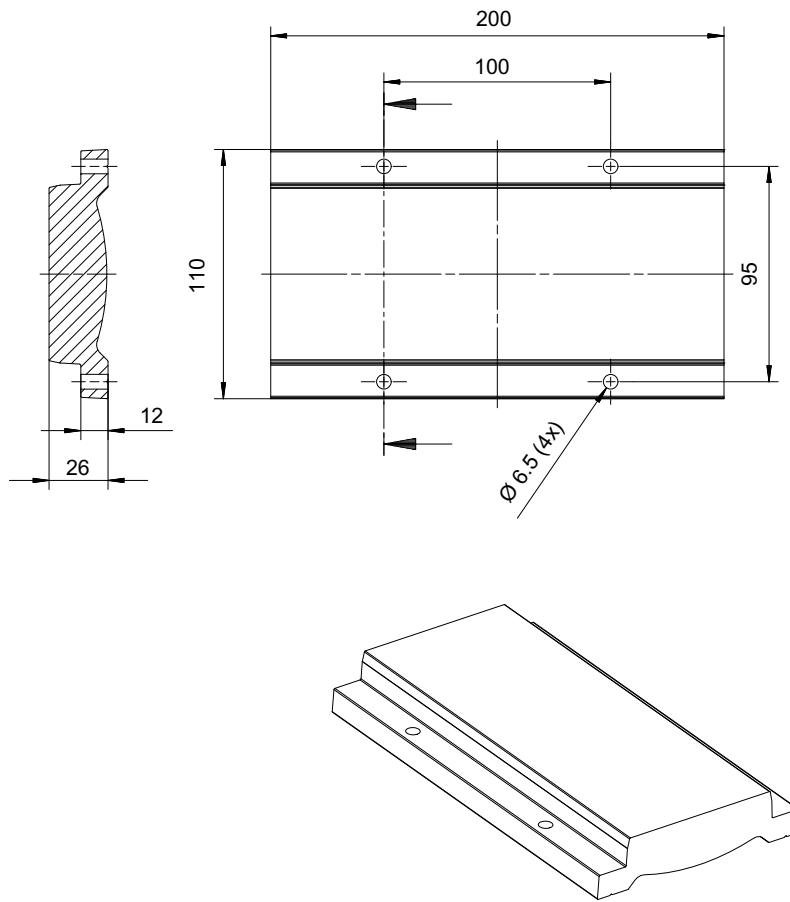

Figure 16-15 Installation dimensions of the secondary section in the case of the 1FN6007-1SC00-0AA0

16.5.3 1FN6008-1SC00-0AA0

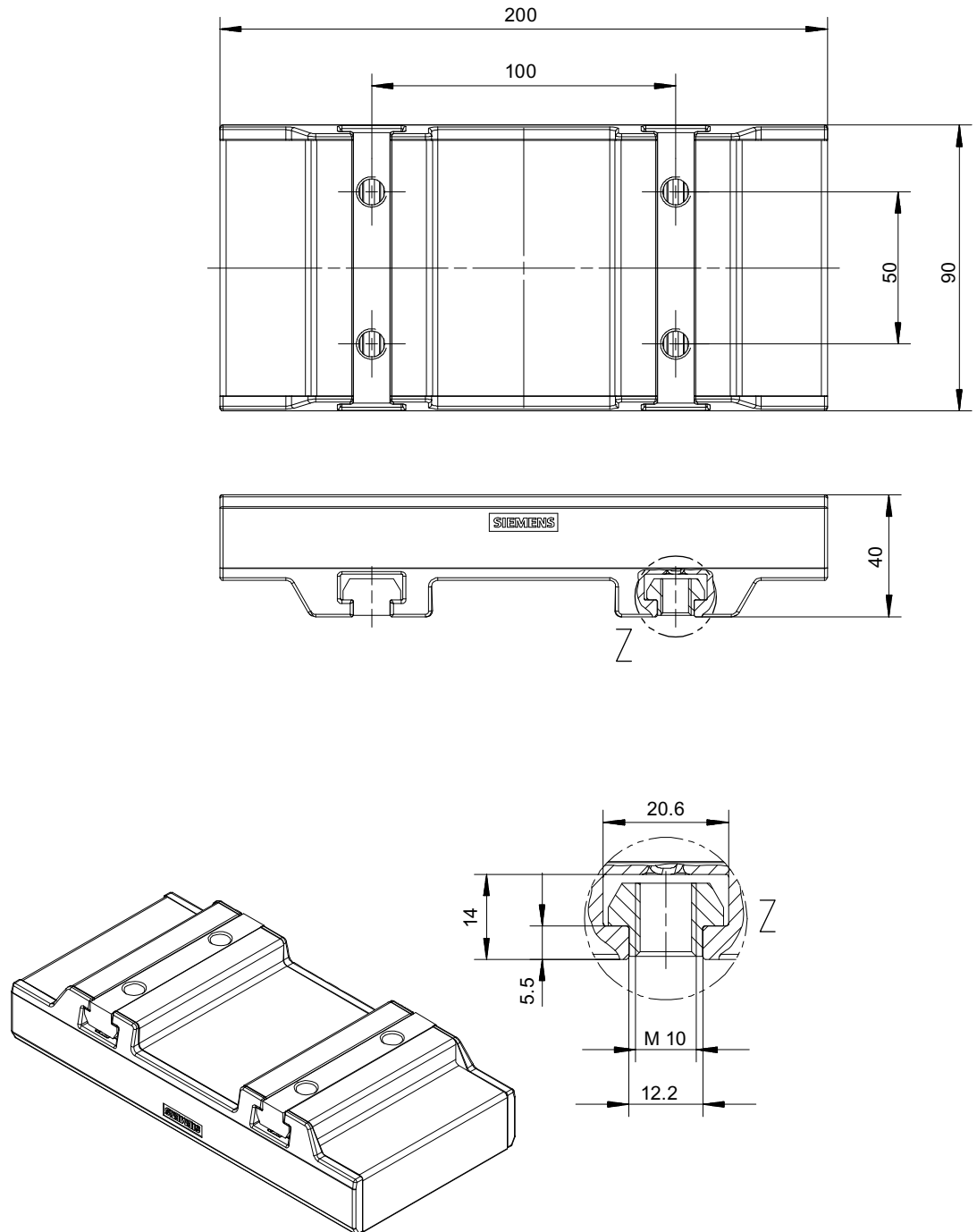

Figure 16-16 Installation dimensions of the secondary section in the case of the 1FN6008-1SC00-0AA0

16.5.4 1FN6016-1SC00-0AA0

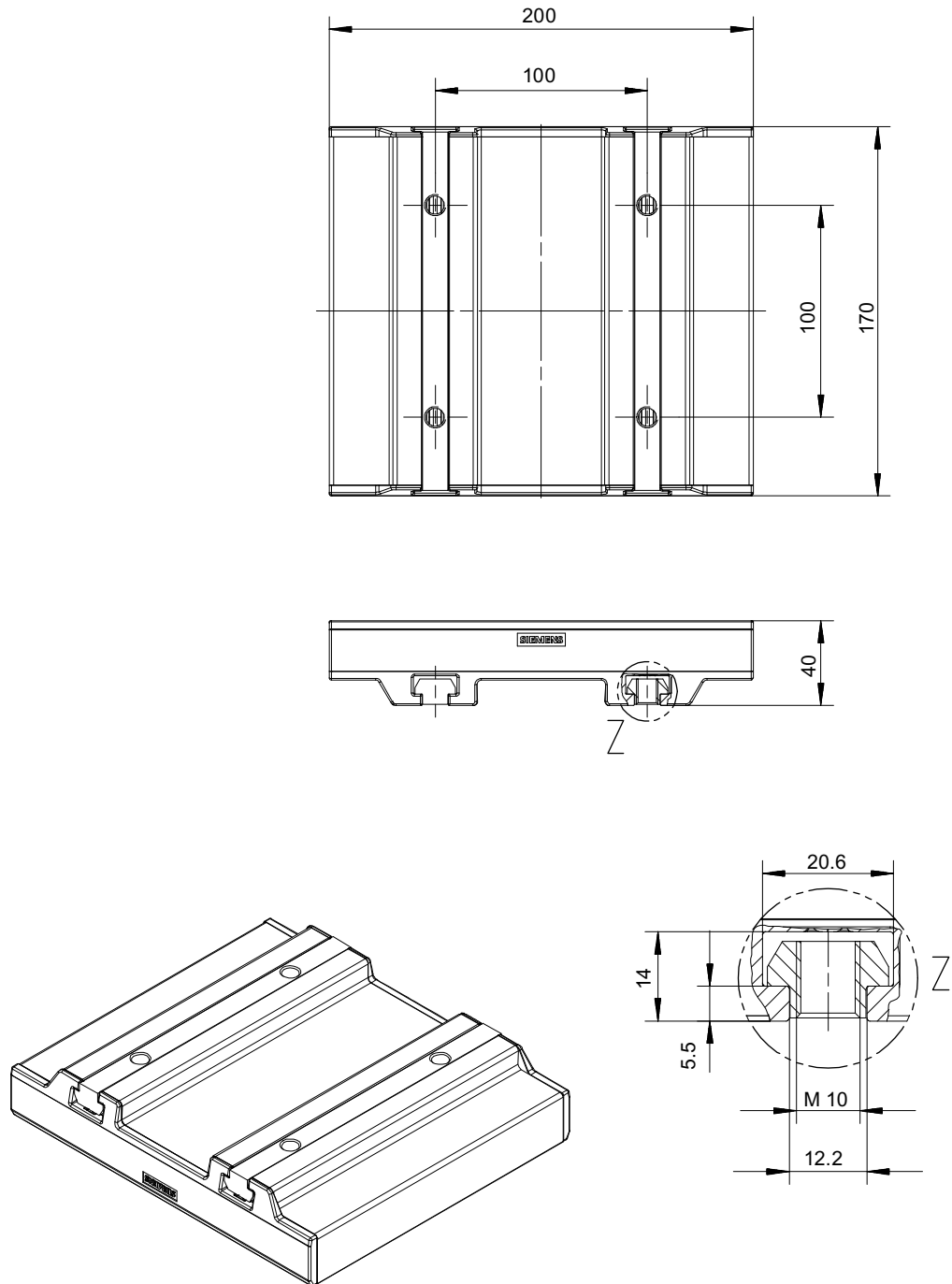

Figure 16-17 Installation dimensions of the secondary section in the case of the 1FN6016-1SC00-0AA0

16.5.5 1FN6024-1SC00-0AA0

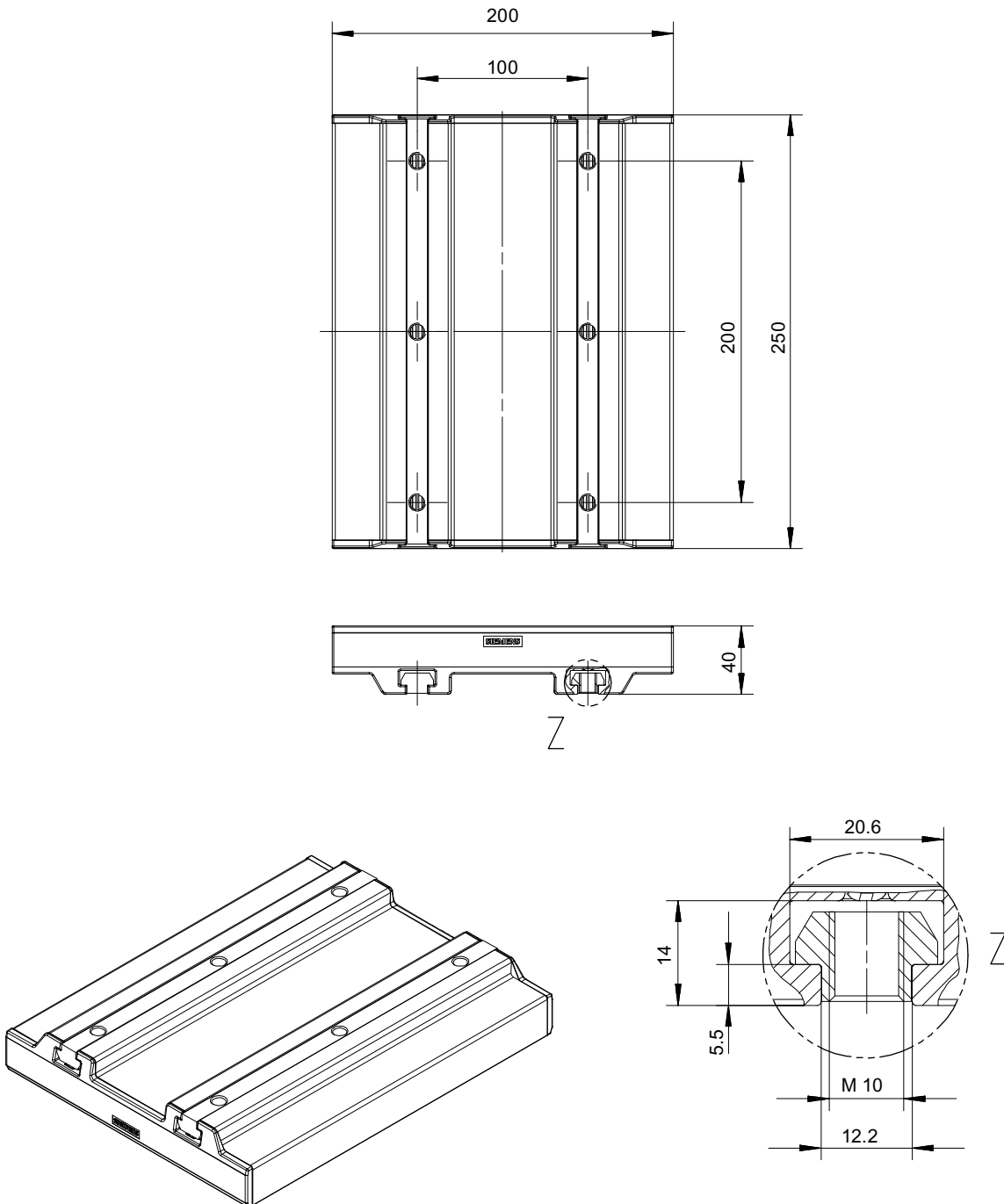

Figure 16-18 Installation dimensions of the secondary section in the case of the 1FN6024-1SC00-0AA0

Appendix

A.1 Overview of important motor data

Overview of important data for the 1FN6 motors

The tables below provide an overview of the most important data for the 1FN6 motors.

Table A- 1 Overview of important rated and limit data (natural cooling)

Order number primary section	F _N [N]	F _{MAX} [N]	I _N [A]	I _{MAX} [A]	V _{MAX,FN} [m/min]	V _{MAX,FMAX} [m/min]
1FN6003-1LC57-0FA1	66,3	157	1,61	5,18	748	345
1FN6003-1LC84-0FA1	66,3	157	2,31	7,45	1080	503
1FN6003-1LE38-0FA1	133	315	2,31	7,45	515	226
1FN6003-1LE88-0FA1	133	315	5,63	18,2	1280	572
1FN6003-1LG24-0FA1	199	472	2,31	7,45	333	141
1FN6003-1LG61-0FA1	199	472	5,63	18,2	836	366
1FN6003-1LJ17-0FA1	265	630	2,31	7,45	243	99,6
1FN6003-1LJ44-0FA1	265	630	5,63	18,2	618	267
1FN6003-1LL12-0FA1	332	787	2,31	7,45	190	74,7
1FN6003-1LL35-0FA1	332	787	5,63	18,2	488	208
1FN6003-1LN10-0FA1	398	945	2,31	7,45	155	57,9
1FN6003-1LN28-0FA1	398	945	5,63	18,2	402	169
1FN6007-1LC31-0KA1	133	315	1,61	5,18	386	187
1FN6007-1LC46-0KA1	133	315	2,31	7,45	562	276
1FN6007-1LE20-0KA1	265	630	2,31	7,45	265	120
1FN6007-1LE53-0KA1	265	630	5,63	18,2	668	315
1FN6007-1LG12-0KA1	398	945	2,31	7,45	169	71,7
1FN6007-1LG33-0KA1	398	945	5,63	18,2	435	200
1FN6007-1LJ08-0KA1	531	1260	2,31	7,45	122	47,4
1FN6007-1LJ24-0KA1	531	1260	5,63	18,2	320	143
1FN6007-1LL05-0KA1	663	1570	2,31	7,45	93,9	32,4
1FN6007-1LL18-0KA1	663	1570	5,63	18,2	251	110
1FN6007-1LN15-0KA1	796	1890	5,63	18,2	206	87,9
1FN6007-1LN32-0KA1	796	1890	11,3	36,3	429	194
1FN6008-1LC17-0KA1	374	898	2,71	8,64	218	98,5
1FN6008-1LC37-0KA1	374	898	5,65	18	473	224
1FN6008-1LE16-0KA1	749	1800	5,65	18	221	96,8
1FN6008-1LE34-0KA1	749	1800	11,3	36	456	207

A.1 Overview of important motor data

Order number primary section	F _N [N]	F _{MAX} [N]	I _N [A]	I _{MAX} [A]	V _{MAX,FN} [m/min]	V _{MAX,FMAX} [m/min]
1FN6008-1LG16-0KA1	1120	2690	8,69	27,7	224	96,7
1FN6008-1LG33-0KA1	1120	2690	17	54	449	200
1FN6016-1LC18-0KA1	692	1800	5,2	18	241	110
1FN6016-1LC30-0KA1	692	1800	8	27,7	377	176
1FN6016-1LE17-0KA1	1380	3590	10,4	36	233	101
1FN6016-1LE27-0KA1	1380	3590	16	55,4	365	162
1FN6016-1LG16-0KA1	2070	5390	15,6	54,1	230	98,2
1FN6016-1LG26-0KA1	2070	5390	24	83,1	360	156
1FN6024-1LC12-0KA1	1000	2690	5	18	160	70,1
1FN6024-1LC20-0KA1	1000	2690	7,69	27,7	252	115
1FN6024-1LE11-0KA1	2000	5390	10	36	155	64,8
1FN6024-1LE18-0KA1	2000	5390	15,4	55,4	244	106
1FN6024-1LG10-0KA1	3000	8080	15	54,1	153	62,8
1FN6024-1LG17-0KA1	3000	8080	23,1	83,1	241	102

Table A-2 Overview of important rated and limit data (water cooling)

Order number primary section	F _N [N]	F _{MAX} [N]	I _N [A]	I _{MAX} [A]	V _{MAX,FN} [m/min]	V _{MAX,FMAX} [m/min]
1FN6003-1WC57-0FA1	119	157	3,2	5,18	509	345
1FN6003-1WC84-0FA1	119	157	4,6	7,45	740	503
1FN6003-1WE38-0FA1	239	315	4,6	7,45	339	226
1FN6003-1WE88-0FA1	239	315	11,2	18,2	852	572
1FN6003-1WG24-0FA1	358	472	4,6	7,45	215	141
1FN6003-1WG61-0FA1	358	472	11,2	18,2	549	366
1FN6003-1WJ17-0FA1	477	630	4,6	7,45	155	99,6
1FN6003-1WJ44-0FA1	477	630	11,2	18,2	402	267
1FN6003-1WL12-0FA1	597	787	4,6	7,45	119	74,7
1FN6003-1WL35-0FA1	597	787	11,2	18,2	316	208
1FN6003-1WN10-0FA1	716	945	4,6	7,45	95,1	57,9
1FN6003-1WN28-0FA1	716	945	11,2	18,2	258	169
1FN6007-1WC31-0KA1	239	315	3,2	5,18	272	187
1FN6007-1WC46-0KA1	239	315	4,6	7,45	399	276
1FN6007-1WE20-0KA1	477	630	4,6	7,45	180	120
1FN6007-1WE53-0KA1	477	630	11,2	18,2	462	315
1FN6007-1WG12-0KA1	716	945	4,6	7,45	111	71,7
1FN6007-1WG33-0KA1	716	945	11,2	18,2	296	200
1FN6007-1WJ08-0KA1	955	1260	4,6	7,45	77,6	47,4
1FN6007-1WJ24-0KA1	955	1260	11,2	18,2	215	143

1FN6007-1WL05-0KA1	1190	1570	4,6	7,45	57,5	32,4
1FN6007-1WL18-0KA1	1190	1570	11,2	18,2	167	110
1FN6007-1WN15-0KA1	1430	1890	11,2	18,2	135	87,9
1FN6007-1WN32-0KA1	1430	1890	21	36,3	288	194

Table A- 3 Overview of important mechanical motor data (natural cooling)

Order number primary section	L _P [mm]	L _{P,AKT} [mm]	H _P [mm]	B _P [mm]	m _P [kg]
1FN6003-1LC57-0FA1	203	166,7	49,4	80	3,19
1FN6003-1LC84-0FA1	203	166,7	49,4	80	3,19
1FN6003-1LE38-0FA1	328	291,7	49,4	80	4,99
1FN6003-1LE88-0FA1	328	291,7	49,4	80	4,99
1FN6003-1LG24-0FA1	453	416,7	49,4	80	6,79
1FN6003-1LG61-0FA1	453	416,7	49,4	80	6,79
1FN6003-1LJ17-0FA1	578	541,7	49,4	80	8,59
1FN6003-1LJ44-0FA1	578	541,7	49,4	80	8,59
1FN6003-1LL12-0FA1	703	666,7	49,4	80	10,4
1FN6003-1LL35-0FA1	703	666,7	49,4	80	10,4
1FN6003-1LN10-0FA1	828	791,7	49,4	80	12,2
1FN6003-1LN28-0FA1	828	791,7	49,4	80	12,2
1FN6007-1LC31-0KA1	203	166,7	55,4	115	5,08
1FN6007-1LC46-0KA1	203	166,7	55,4	115	5,08
1FN6007-1LE20-0KA1	328	291,7	55,4	115	8,39
1FN6007-1LE53-0KA1	328	291,7	55,4	115	8,39
1FN6007-1LG12-0KA1	453	416,7	55,4	115	11,7
1FN6007-1LG33-0KA1	453	416,7	55,4	115	11,7
1FN6007-1LJ08-0KA1	578	541,7	55,4	115	15
1FN6007-1LJ24-0KA1	578	541,7	55,4	115	15
1FN6007-1LL05-0KA1	703	666,7	55,4	115	18,3
1FN6007-1LL18-0KA1	703	666,7	55,4	115	18,3
1FN6007-1LN15-0KA1	828	791,7	55,4	115	21,6
1FN6007-1LN32-0KA1	828	791,7	55,4	115	21,6
1FN6008-1LC17-0KA1	392	333,3	80,4	130	16,3
1FN6008-1LC37-0KA1	392	333,3	80,4	130	16,3
1FN6008-1LE16-0KA1	642	583,3	80,4	130	27,9
1FN6008-1LE34-0KA1	642	583,3	80,4	130	27,9
1FN6008-1LG16-0KA1	892	833,3	80,4	130	39,6
1FN6008-1LG33-0KA1	892	833,3	80,4	130	39,9
1FN6016-1LC18-0KA1	392	333,3	80,4	209	27,6
1FN6016-1LC30-0KA1	392	333,3	80,4	209	27,6

A.1 Overview of important motor data

Order number primary section	L _P [mm]	L _{P,AKT} [mm]	H _P [mm]	B _P [mm]	m _P [kg]
1FN6016-1LE17-0KA1	642	583,3	80,4	209	48,2
1FN6016-1LE27-0KA1	642	583,3	80,4	209	48,2
1FN6016-1LG16-0KA1	892	833,3	80,4	209	68,5
1FN6016-1LG26-0KA1	892	833,3	80,4	209	68,5
1FN6024-1LC12-0KA1	392	333,3	80,4	289	39,9
1FN6024-1LC20-0KA1	392	333,3	80,4	289	39,9
1FN6024-1LE11-0KA1	642	583,3	80,4	289	69,5
1FN6024-1LE18-0KA1	642	583,3	80,4	289	69,5
1FN6024-1LG10-0KA1	892	833,3	80,4	289	99,2
1FN6024-1LG17-0KA1	892	833,3	80,4	289	99,2

Table A-4 Overview of important mechanical motor data (water cooling)

Order number primary section	L _P [mm]	L _{P,AKT} [mm]	H _P [mm]	B _P [mm]	m _P [kg]
1FN6003-1WC57-0FA1	219	166,7	49,4	80	3,19
1FN6003-1WC84-0FA1	219	166,7	49,4	80	3,19
1FN6003-1WE38-0FA1	344	291,7	49,4	80	4,99
1FN6003-1WE88-0FA1	344	291,7	49,4	80	4,99
1FN6003-1WG24-0FA1	469	416,7	49,4	80	6,79
1FN6003-1WG61-0FA1	469	416,7	49,4	80	6,79
1FN6003-1WJ17-0FA1	594	541,7	49,4	80	8,59
1FN6003-1WJ44-0FA1	594	541,7	49,4	80	8,59
1FN6003-1WL12-0FA1	719	666,7	49,4	80	10,4
1FN6003-1WL35-0FA1	719	666,7	49,4	80	10,4
1FN6003-1WN10-0FA1	844	791,7	49,4	80	12,2
1FN6003-1WN28-0FA1	844	791,7	49,4	80	12,2
1FN6007-1WC31-0KA1	219	166,7	55,4	115	5,08
1FN6007-1WC46-0KA1	219	166,7	55,4	115	5,08
1FN6007-1WE20-0KA1	344	291,7	55,4	115	8,39
1FN6007-1WE53-0KA1	344	291,7	55,4	115	8,39
1FN6007-1WG12-0KA1	469	416,7	55,4	115	11,7
1FN6007-1WG33-0KA1	469	416,7	55,4	115	11,7
1FN6007-1WJ08-0KA1	594	541,7	55,4	115	15
1FN6007-1WJ24-0KA1	594	541,7	55,4	115	15
1FN6007-1WL05-0KA1	719	666,7	55,4	115	18,3
1FN6007-1WL18-0KA1	719	666,7	55,4	115	18,3
1FN6007-1WN15-0KA1	844	791,7	55,4	115	21,6
1FN6007-1WN32-0KA1	844	791,7	55,4	115	21,6

A.2 1FNx declaration of conformity

EC declaration of conformity of the 1FNx linear motor

SIEMENS

EG-Konformitätserklärung EC Declaration of Conformity

No. 400006446-04

Hersteller: SIEMENS AG
 Manufacturer: I DT MC MF-M EWM
 Anschrift: Georg-Reismüller-Str. 32
 Address: 80999 München
 Produkt: **Drehstrom-Linearmotoren, Typ 1FNx...**
 Product: Built-in three-phase synchronous motors, type 1FNx...

Die bezeichneten Produkte stimmen in der von uns in Verkehr gebrachten Ausführung mit den Vorschriften folgender Europäischer Richtlinien überein:

The products described above in the form as delivered are in conformity with the provisions of the following European Directives:

2006/95/EG Richtlinie des Rates zur Angleichung der Rechtsvorschriften der Mitgliedstaaten betreffend elektrische Betriebsmittel zur Verwendung innerhalb bestimmter Spannungsgrenzen.

Council Directive on the approximation of the laws of the Member States related to electrical equipment designed for use within certain voltage limits.

CE-Kennzeichnung: siehe Anhang A (5 Seiten) / CE marking: see Annex A (5 pages)

Die Konformität mit den Richtlinien wird nachgewiesen durch die Einhaltung der zutreffenden Kapitel folgender Normen:

Conformity to the Directives is assured through the application of the applicable sections of the following standards:

Referenznummer Reference number	Referenznummer Reference number
DIN EN 60034-1	EN 60204-1

München, 23.02.2011
 Siemens AG I DT MC MF-M EWM

Dipl.-Ing. (FH)
 Georg Ketzer
 Werksleitung
 Name, Funktion
 Name, function

 Unterschrift
 signature

Dipl.-Ing.
 Christian Volmert
 Leitung Entwicklung
 Name, Funktion
 Name, function

 Unterschrift
 signature

Dipl.-Ing. (FH)
 Konrad Freundorfer
 Approbationsbeauftragter
 Name, Funktion
 Name, function

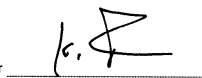
 Unterschrift
 signature

Diese Erklärung bescheinigt die Übereinstimmung mit den genannten Richtlinien, ist jedoch keine Zusicherung von Eigenschaften. Die Sicherheitshinweise der mitgelieferten Produktdokumentation sind zu beachten.
This declaration certifies the conformity to the specified directives but contains no assurance of properties. The safety documentation accompanying the product shall be considered in detail.

Seite 1 von 1

SIEMENS

Anhang A zur EG-Konformitätserklärung Nr. 400006446-04
Attachment A to EC Declaration of Conformity No. 400006446-04

Lfd. Nr.	Komponente	Bestellbezeichnung	Erstmalige CE-Anbringung
1	Primärteil	1FN107x-xxxxx-xxxx	1997
2	Primärteil	1FN112x-xxxxx-xxxx	1997
3	Primärteil	1FN118x-xxxxx-xxxx	1997
4	Primärteil	1FN124x-xxxxx-xxxx	1997
5			
6			
7			
8			
9			
10			
11			
12			
13			
14			
15			
16			
17			
18			
19			
20			

SIEMENS

Anhang A zur EG-Konformitätserklärung Nr. 400006446-04
 Attachment A to EC Declaration of Conformity No. 400006446-04

Lfd. Nr.	Komponente	Bestellbezeichnung	Erstmalige CE-Anbringung
1	Primärteil	1FN2045-xLxxx-xxxx	2000
2	Primärteil	1FN2090-xJxxx-xxxx	2000
3	Primärteil	1FN2090-xLxxx-xxxx	2000
4	Primärteil	1FN2090-xWxxx-xxxx	2000
5	Primärteil	1FN2135-xWxxx-xxxx	2000
6			
7			
8			
9			
10			
11			
12			
13			
14			
15			
16			
17			
18			
19			
20			

SIEMENS

Anhang A zur EG-Konformitätserklärung Nr. 400006446-04
Attachment A to EC Declaration of Conformity No. 400006446-04

Lfd. Nr.	Komponente	Bestellbezeichnung	Erstmalige CE-Anbringung
1	Primärteil	1FN3050-xWxxx-xxxx	1999
2	Primärteil	1FN3100-xVxxx-xxxx	1999
3	Primärteil	1FN3150-xWxxx-xxxx	1999
4	Primärteil	1FN3300-xWxxx-xxxx	1999
5	Primärteil	1FN3450-xWxxx-xxxx	1999
6	Primärteil	1FN3600-xWxxx-xxxx	1999
7	Primärteil	1FN3900-xVxxx-xxxx	1999
8	Primärteil	1FN3300-xVxxx-xxxx	2002
9	Primärteil	1FN3450-xVxxx-xxxx	2002
10	Primärteil	1FN3600-xVxxx-xxxx	2002
11	Primärteil	1FN3900-xVxxx-xxxx	2002
12	Primärteil	1FN3050-xNxxx-xxxx	03/2006
13	Primärteil	1FN3100-xNxxx-xxxx	03/2006
14	Primärteil	1FN3150-xNxxx-xxxx	03/2006
15	Primärteil	1FN3300-xNxxx-xxxx	03/2006
16	Primärteil	1FN3450-xNxxx-xxxx	03/2006
17	Primärteil	1FN3600-xNxxx-xxxx	03/2006
18	Primärteil	1FN3900-xNxxx-xxxx	03/2006
19	Primärteil	1FN3050-xKxxx-xxxx	01/2008
20	Primärteil	1FN3100-xKxxx-xxxx	01/2008
21	Primärteil	1FN3150-xKxxx-xxxx	01/2008
22			
23			
24			
25			

SIEMENS

Anhang A zur EG-Konformitätserklärung Nr. 400006446-04
Attachment A to EC Declaration of Conformity No. 400006446-04

Lfd. Nr.	Komponente	Bestellbezeichnung	Erstmalige CE-Anbringung
1	Primärteil	1FN4030-xKxxx-xxxx	2001
2	Primärteil	1FN4050-xKxxx-xxxx	2001
3	Primärteil	1FN4070-xKxxx-xxxx	2001
4	Primärteil	1FN4100-xKxxx-xxxx	2001
5	Primärteil	1FN4120-xKxxx-xxxx	2001
6	Primärteil	1FN4150-xKxxx-xxxx	2001
7	Primärteil	1FN4030-xPxxx-xxxx	2001
8	Primärteil	1FN4050-xPxxx-xxxx	2001
9	Primärteil	1FN4070-xPxxx-xxxx	2001
10	Primärteil	1FN4100-xPxxx-xxxx	2001
11	Primärteil	1FN4120-xPxxx-xxxx	2001
12	Primärteil	1FN4150-xPxxx-xxxx	2001
13	Primärteil	1FN4030-xWxxx-xxxx	2001
14	Primärteil	1FN4050-xWxxx-xxxx	2001
15	Primärteil	1FN4070-xWxxx-xxxx	2001
16	Primärteil	1FN4100-xWxxx-xxxx	2001
17	Primärteil	1FN4120-xWxxx-xxxx	2001
18	Primärteil	1FN4150-xWxxx-xxxx	2001
19			
20			

SIEMENS

Anhang A zur EG-Konformitätserklärung Nr. 400006446-04
Attachment A to EC Declaration of Conformity No. 400006446-04

Lfd. Nr.	Komponente	Bestellbezeichnung	Erstmalige CE-Anbringung
1	Primärteil	1FN6003-xxxx-xxxx	2008
2	Primärteil	1FN6007-xxxx-xxxx	2008
3	Primärteil	1FN6008-xxxx-xxxx	2008
4	Primärteil	1FN6016-xxxx-xxxx	2008
5	Primärteil	1FN6024-xxxx-xxxx	2008
6			
7			
8			
9			
10			
11			
12			
13			
14			
15			
16			
17			
18			
19			
20			

A.3 Recommended manufacturers

A.3.1 Manufacturers of braking elements

Zimmer GmbH Technische Werkstätten	
	www.zimmer-gmbh.com

Schaeffler KG	
	www.schaeffler.com

A.3.2 Manufacturers of cold water units

Helmut Schimpke Industriekühlanlagen GmbH + Co. KG	
	www.schimpke.de

BKW Kälte-Wärme-Versorgungstechnik GmbH	
	www.bkw-kuema.de

Rittal GmbH & Co. KG	
	www.rittal.de

Pfannenberg GmbH	
	www.pfannenberg.com

Hydac International GmbH	
	www.hydac.com

A.3.3 Manufacturers of anti-corrosion agents

TYFOROP CHEMIE GmbH	
Anti-corrosion protection: Tyfocor	www.tyfo.de

Clariant Produkte (Deutschland) GmbH	
Anti-corrosion protection: Antifrogen N	www.clariant.de

Fuchs Europe Schmierstoffe GmbH	
Anti-corrosion protection: Maintain Fricofin	FUCHS EUROPE SCHMIERSTOFFE GMBH Friesenheimer Straße 15 68169 Mannheim, Germany Phone: 0621-3701-0 Fax: 0621-3701-570 E-mail: zentrale@fuchs-europe.de www.fuchs-europe.de

NALCO Europe BV	
Anti-corrosion protection: Nalco Varidos FSK	Nalco European Operations 2342 BV Oegstgeest P.O. Box 627, 2300 AP Leiden, The Netherlands Phone: 31.71.524.1100 Fax: 31.71.524.1197 www.nalco.com

Abbreviations + glossary

AAA - abbreviations

BGR	Employer's Liability Insurance Association Regulations; Health and safety at work regulations (in Germany)
BGV	Employer's Liability Insurance Association Regulations; Binding regulations for health and safety in the workplace in Germany; Accident prevention regulations
CE	Communaute Europeene
DIN	Deutsches Institut für Normung (German standards organization)
EC	European Community
EMC	Electromagnetic Compatibility
EMK	Electromotive force
EN	European standard
FAQ	Frequently Asked Questions
HFD	High-frequency Damping
HSB	Hall Sensor Box
HW	Hardware
IATA	International Air Transport Association
IEC	International Electrotechnical Commission
IP	International Protection or Ingress Protection; type of protection für electric devices according to DIN EN 60529
ISO	International Standardization Organization
KTY	Temperature sensor with progressive, almost linear characteristic
LU	Length Unit
MLFB	Machine-readable product designation; Order number
NC	Numerical Control
PDS	Power Drive System
PE	Protection Earth (protective conductor)
PELV	Protective Extra Low Voltage
PLC	Programmable logic controller
PTC	Temperature sensor with positive temperature coefficient
RoHS	Restriction of (the use of certain) Hazardous Substances
S1	"Continuous operation" mode
S2	"Short-time duty" mode
S3	"Intermittent operation" mode
SME	Sensor Module External
SSI	Synchronous Serial Interface
SW	Software

Temp-F	Circuit for monitoring the temperature of the motor winding
Temp-S	Temperature monitoring circuit for switching off the drive at overtemperature
VDE	Association of Electrical Engineering, Electronics and Information Technology (in Germany)
WMS	Position measuring system; including WMS: incremental position measuring system; abs. WMS: absolute position measuring system

Condensation

When the relative humidity in the immediate vicinity of the motor reaches 100%, the excess moisture in the air condenses on the surface of the motor. The resulting water film is called *condensation*.

Gantry operation

In gantry operation, the synchronous motion of two motors is implemented via two independent axis drives including position measuring system.

Janus arrangement

In a Janus arrangement, the phases V and W must be swapped for the → stoker, so that → master und → stoker run in the same direction. The cable outlets of the motors are located on opposite sides.

Master

The term "Master" describes the first of two motors in an axis fed by a shared power module, which are therefore connected in parallel. → Parallel connection

Parallel connection of motors

The parallel connection of two identical motors to one power module doubles the power available for the drive in comparison with just one such motor. Both motors must have a defined position to one another for synchronous power generation. The motors must be rigidly coupled to one another to guarantee the defined position of the motors relative to one another throughout operation.

Only one position measuring system is required to control the motors.

Primary section

The primary section is the electrically active component of a linear motor. Usually this is also the moving component.

Secondary section

In contrast to the → Primary section, the secondary section is not electrically active. The → Secondary section track is made up to secondary sections.

Secondary section track

As a rule, the secondary section track is made up of several → Secondary sections. Usually this is a non-moving component of a linear motor.

Stoker

The term "Stoker" describes the second of two motors in an axis fed by a shared power module, which are therefore connected in parallel. → Parallel connection

Tandem arrangement

In a tandem arrangement, → Master and → Stoker have the same phase sequence UVW. The cable outlets of the motors are located on the same side.

Index

A

- Accidents
 - First aid, 19
- Air gap
 - Check, 94
- Anti-corrosion protection, 42
- Approvals, 26
- Assembly
 - Secondary section, 92

B

- Braking, 45
- Braking concepts, 45

C

- Cable
 - Cable laying regulations, 108
 - Characteristics, 107
- Cable carrier, 108
- Characteristics of the motor
 - Area of application, 24
- Check
 - Air gap, 94
 - Motor assembly, 93
- Condensation, 43
- Configuration
 - Duty cycle, 66
 - Example, 77
 - General conditions, 64
- Connection
 - Electrical, 96, 100
 - Encoder, 104
 - Temperature monitoring, 102
- Connection system
 - Installation space, 95
- Continuous thrust, 69
- Cooling, 40
 - Intake temperature, 43
- Cooling circuits, 41
 - Series connection, 41

Cooling medium

- Anti-corrosion agent properties, 42
- General properties, 42
- Provision, 42
- Water properties, 42

D

- Degree of protection
 - Installed motor, 27
 - Primary section, 26
- Disposal, 131
- Documentation
 - Storage, 15

E

- Environmental compatibility, 131
- Example
 - Configuration, 77

F

- Fastening hole, 272
- Forces of attraction, 33
- Form of operation
 - Intermittent duty, 61
 - Short-time duty, 60
 - Uninterrupted duty, 60

G

- Grounding, 108

H

- Holding brake
 - Commissioning, 112
- Hole distance, 50
- Hotline, 6

- I**
 - IATA, 128
 - Installation situation
 - General, 33
 - Insulation resistance, 125
 - Intake temperature, 43
 - Interdigital motor, 54
 - Intermittent duty, 61

- K**
 - KTY 84, 31

- M**
 - Magnetic fields
 - First aid in the case of accidents, 19
 - Forces of attraction, 33
 - Occurrence, 16
 - Strength, 18
 - Maintenance, 126
 - Malfunctions
 - Braking, 45
 - Motor
 - Components, 29
 - Disposal, 131
 - Storage, 127
 - Transport, 127
 - Motor assembly, 84
 - Check, 93
 - Procedures, 86

- P**
 - Packaging, 127, 132
 - Parallel connection of motors
 - Arrangement, 48
 - Hole distance, 50
 - Interdigital motor, 54
 - Peak thrust, 69
 - Pole pair width, 50
 - Pole position identification, 112
 - Power module
 - Selection, 74
 - Primary section
 - Order designations, 55
 - Selection, 71

- R**
 - Rating plate, 30
 - RoHS, 6

- S**
 - Safety guidelines
 - Commissioning, 111
 - Maintenance, 123
 - Safety instruction
 - Disposal, 131
 - Safety instructions
 - Electrical connection, 96
 - Operation, 121
 - Storage, 15
 - Safety notes for electrical connections, 96
 - Secondary section
 - Assembly, 92
 - Order designations, 55
 - Quantity, 72
 - Secondary section track
 - Reduced secondary section coverage, 59
 - Total length, 73
 - Shielding, 108
 - Short-time duty, 60

- T**
 - Technical Support, 6
 - Temperature monitoring
 - Connection, 102
 - Temperature sensor
 - KTY 84, 31
 - PTC element, 32
 - Temp-F, 31

- U**
 - Uninterrupted duty, 60

Siemens AG
Industry Sector
Drive Technologies
Motion Control Systems
P.O. Box 3180
91050 ERLANGEN
GERMANY

Subject to change without prior notice
© Siemens AG 2010

www.siemens.com/motioncontrol