

Power Relays ( Over 2 A )  
**ST RELAYS**

Product Catalog

**IN Your  
Future**

# ST RELAYS

## 1 Form A 1 Form B/2 Form A, 8 A, Polarized power relays

Protective construction : Sealed type

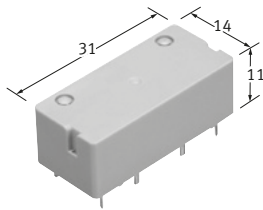

(Unit : mm)

### FEATURES

- 8 A, Multi-channel, 1 Form A 1 Form B/ 2 Form A contact relay
- Dielectric strength: 3,750 V rms  
Surge withstand voltage: 6,000 V
- Sockets for PC board and soldering are available
- Latching types available

### TYPICAL APPLICATIONS

- Electric power equipment
- Industrial machines

### ORDERING INFORMATION ( PART NO. : Ordering part number for Japanese market )

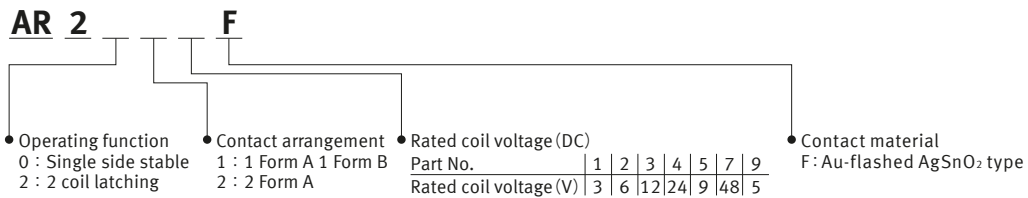

### ORDERING INFORMATION ( TYPE NO. : Ordering part number for non Japanese market )

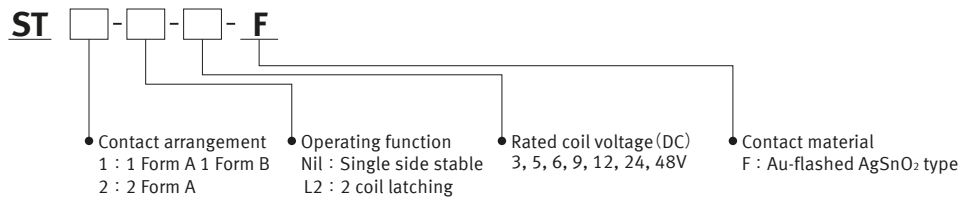

# Power Relays ( Over 2 A ) ST RELAYS

## TYPES

" Type No. " is ordering part number for non Japanese market. " Part No. " is ordering part number for Japanese market.

Contact arrangement	Rated coil voltage	Single side stable		2 coil latching		Standard packing	
		Type No.	Part No.	Type No.	Part No.	Inner carton	Outer carton
1 Form A 1 Form B	3 V DC	ST1-DC3V-F	AR2011F	ST1-L2-DC3V-F	AR2211F	50 pcs.	500 pcs.
	5 V DC	ST1-DC5V-F	AR2019F	ST1-L2-DC5V-F	AR2219F		
	6 V DC	ST1-DC6V-F	AR2012F	ST1-L2-DC6V-F	AR2212F		
	9 V DC	ST1-DC9V-F	AR2015F	ST1-L2-DC9V-F	AR2215F		
	12 V DC	ST1-DC12V-F	AR2013F	ST1-L2-DC12V-F	AR2213F		
	24 V DC	ST1-DC24V-F	AR2014F	ST1-L2-DC24V-F	AR2214F		
	48 V DC	ST1-DC48V-F	AR2017F	ST1-L2-DC48V-F	AR2217F		
2 Form A	3 V DC	ST2-DC3V-F	AR2021F	ST2-L2-DC3V-F	AR2221F		
	5 V DC	ST2-DC5V-F	AR2029F	ST2-L2-DC5V-F	AR2229F		
	6 V DC	ST2-DC6V-F	AR2022F	ST2-L2-DC6V-F	AR2222F		
	9 V DC	ST2-DC9V-F	AR2025F	ST2-L2-DC9V-F	AR2225F		
	12 V DC	ST2-DC12V-F	AR2023F	ST2-L2-DC12V-F	AR2223F		
	24 V DC	ST2-DC24V-F	AR2024F	ST2-L2-DC24V-F	AR2224F		
	48 V DC	ST2-DC48V-F	AR2027F	ST2-L2-DC48V-F	AR2227F		

For the sockets, please refer to the " PC board socket/Soldering socket ".

## RATING

### Coil data

- Operating characteristics such as " Operate voltage " and " Release voltage " are influenced by mounting conditions or ambient temperature, etc.  
Therefore, please use the relay within  $\pm 5\%$  of rated coil voltage.
- " Initial " means the condition of products at the time of delivery.

### Single side stable

Rated coil voltage	Operate voltage* ( at 20 °C )	Release voltage* ( at 20 °C )	Rated operating current ( $\pm 10\%$ , at 20 °C )	Coil resistance ( $\pm 10\%$ , at 20 °C )	Rated operating power	Max. allowable voltage ( at 20 °C )
3 V DC	Max. 80 % V of rated coil voltage ( Initial )	Min. 10 % V of rated coil voltage ( Initial )	78.9 mA	38 $\Omega$	Approx. 240 mW	150 % V of rated coil voltage
5 V DC			47.6 mA	105 $\Omega$		
6 V DC			40 mA	150 $\Omega$		
9 V DC			25 mA	360 $\Omega$		
12 V DC			20 mA	600 $\Omega$		
24 V DC			10 mA	2,400 $\Omega$		
48 V DC			5.3 mA	9,000 $\Omega$		

\* Square, pulse drive

### 2 coil latching

Rated coil voltage	Set voltage* ( at 20 °C )	Reset voltage* ( at 20 °C )	Rated operating current ( $\pm 10\%$ , at 20 °C )		Coil resistance ( $\pm 10\%$ , at 20 °C )		Rated operating power		Max. allowable voltage ( at 20 °C )
			Set coil	Reset coil	Set coil	Reset coil	Set coil	Reset coil	
3 V DC	Max. 80 % V of rated coil voltage ( Initial )	Max. 80 % V of rated coil voltage ( Initial )	75 mA	75 mA	40 $\Omega$	40 $\Omega$	Approx. 240 mW	Approx. 240 mW	150 % V of rated coil voltage
5 V DC			45 mA	45 mA	110 $\Omega$	110 $\Omega$			
6 V DC			37.5 mA	37.5 mA	155 $\Omega$	155 $\Omega$			
9 V DC			25 mA	25 mA	360 $\Omega$	360 $\Omega$			
12 V DC			18.8 mA	18.8 mA	640 $\Omega$	640 $\Omega$			
24 V DC			10 mA	10 mA	2,400 $\Omega$	2,400 $\Omega$			
48 V DC			4.7 mA	4.7 mA	10,200 $\Omega$	10,200 $\Omega$			

\* Square, pulse drive

# Power Relays ( Over 2 A ) ST RELAYS

## Specifications

Item	Specifications	
Contact data	Contact arrangement	1 Form A 1 Form B, 2 Form A
	Contact resistance ( initial )	Max. 30 mΩ ( by voltage drop 6 V DC 1 A )
	Contact material	Au-flashed AgSnO <sub>2</sub> type
	Contact rating ( resistive )	8 A 250 V AC, 5 A 30 V DC
	Max. switching power ( resistive )	2,000 VA, 150 W
	Max. switching voltage	250 V AC, 30 V DC
	Max. switching current	8 A ( AC ) , 5 A ( DC )
	Min. switching load ( reference value ) *1	100 mA 5 V DC
Insulation resistance ( initial )		Min. 1,000 MΩ ( at 500 V DC, Measured portion is the same as the case of dielectric strength. )
Dielectric strength ( initial )	Between open contacts	1,200 V rms for 1 min ( detection current: 10 mA )
	Between contact sets	2,000 V rms for 1 min ( detection current: 10 mA )
	Between contact and coil	3,750 V rms for 1 min ( detection current: 10 mA )
Surge withstand voltage ( initial ) *2	Between contact and coil	6,000 V
Time characteristics ( initial )	Operate ( Set ) time	Max. 15 ms ( Max. 15 ms ) at rated coil voltage ( at 20 °C, without bounce )
	Release ( Reset ) time	Max. 10 ms ( Max. 15 ms ) at rated coil voltage ( at 20 °C, without bounce, without diode )
Shock resistance	Functional	196 m/s <sup>2</sup> ( half-sine shock pulse: 11 ms, detection time: 10 μs )
	Destructive	980 m/s <sup>2</sup> ( half-sine shock pulse: 6 ms )
Vibration resistance	Functional	10 to 55 Hz ( at double amplitude of 2 mm, detection time: 10 μs )
	Destructive	10 to 55 Hz ( at double amplitude of 3 mm )
Expected life	Mechanical life	Min. 10 × 10 <sup>6</sup> ope. ( switching frequency: at 180 times/min )
Conditions	Conditions for usage, transport and storage*2	Ambient temperature: -40 to +60 °C, Humidity: 5 to 85 % RH ( Avoid icing and condensation )
Unit weight		Approx. 10 g

\*1: This value can change due to the switching frequency, environmental conditions, and desired reliability level, therefore it is recommended to check this with the actual load.

\*2: Wave is standard shock voltage of  $\pm 1.2 \times 50 \mu s$  according to JEC-212-1981

\*3: For ambient temperature, please read " GUIDELINES FOR RELAY USAGE ".

## Expected electrical life

Conditions: Resistive load, switching frequency ON : OFF = 1 s : 5 s

Type	Switching capacity	Number of operations
1 Form A 1 Form B, 2 Form A	8 A 250 V AC	Min. 100 × 10 <sup>3</sup> ope.

## REFERENCE DATA

### 1. Max. switching capacity

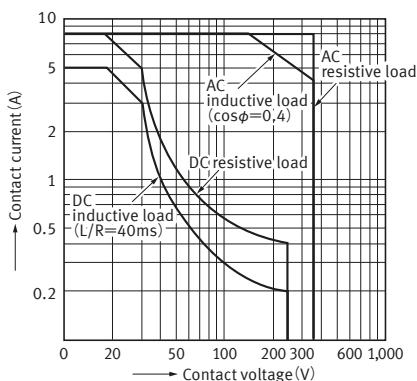

### 2. Coil temperature characteristics

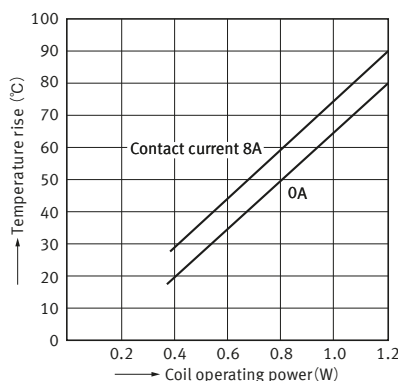

# Power Relays ( Over 2 A ) ST RELAYS

3-1. Ambient temperature characteristics ( 1 Form A 1 Form B: Average )      3-2. Ambient temperature characteristics ( 2 Form A: Average )      4. Influence of proximity mounting

Tested sample : AR2013F, 4 pcs.

Tested sample : AR2024F, 4 pcs.

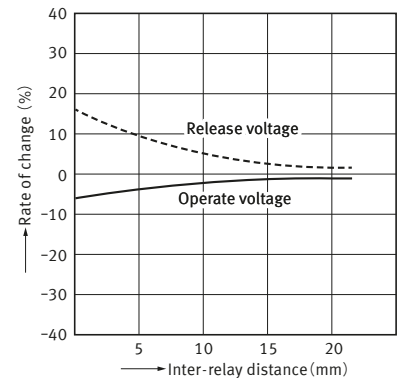
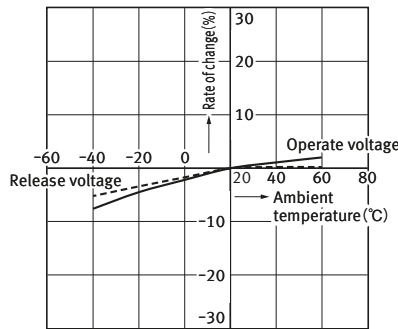
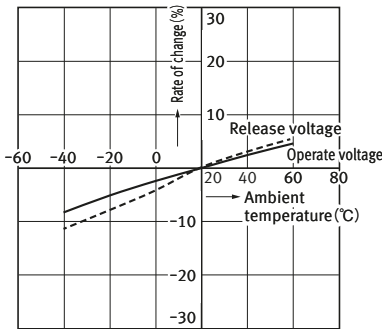

## DIMENSIONS ( Unit: mm )

**CAD** The CAD data of the products with a " CAD " mark can be downloaded from our Website.

### Single side stable

**CAD**

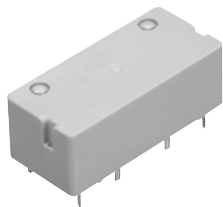

External dimensions

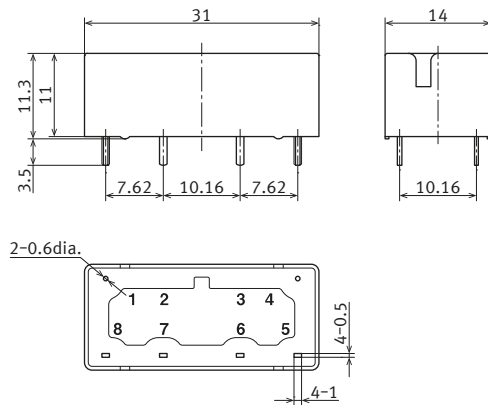

Recommended PC board pattern ( BOTTOM VIEW )  
1 Form A

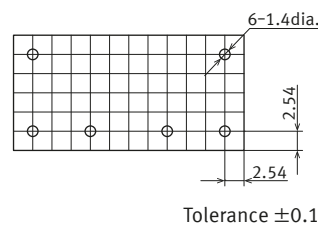

Schematic ( BOTTOM VIEW )  
( De-energize )  
1 Form A 1 Form B

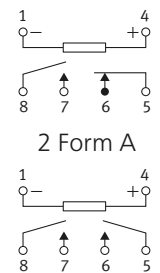

General tolerance  $\pm 0.5$

### 2 coil latching

**CAD**

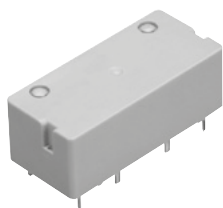

External dimensions

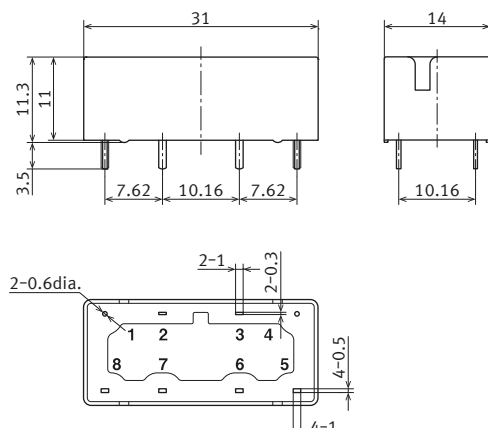

Recommended PC board pattern ( BOTTOM VIEW )  
1 Form A

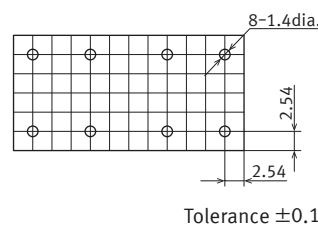

Schematic ( BOTTOM VIEW )  
( Reset )  
1 Form A 1 Form B

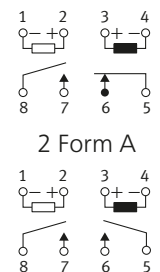

General tolerance  $\pm 0.5$

# Power Relays ( Over 2 A ) ST RELAYS

## SAFETY STANDARDS

Each standard may be updated at any time, so please check our Website for the latest information.

### UL ( Approved )

File No.	Contact rating
E43028	8 A 250 V AC
	5 A 30 V DC
	¼ HP 125, 250 V AC

### CSA ( Approved )

File No.	Contact rating
2369519	8 A 250 V AC
	5 A 30 V DC
	¼ HP 125, 250 V AC

### VDE ( Approved )

File No.	Contact rating
40017740	8 A 250 V AC ( $\cos\phi = 1.0$ )
	5 A 30 V DC ( 0 ms )
	4 A 250 V AC ( $\cos\phi = 0.4$ )

### TV rating

File No.	Contact rating
UL: E43028	TV-3
CSA: 2369519	TV-3

## INSULATION CHARACTERISTICS ( IEC61810-1 )

Item	Characteristics
Clearance/Creepage distance ( IEC61810-1 )	Min. 1.5/2.5 mm
Category of protection ( IEC61810-1 )	RT III
Tracking resistance ( IEC60112 )	PTI 100
Insulation material group	III a
Over voltage category	II
Rated voltage	250 V
Pollution degree	2
Type of insulation ( Between contact and coil )	Basic insulation
Type of insulation ( Between open contacts )	Micro disconnection

Note) EN/IEC VDE Certified.

## GUIDELINES FOR USAGE

■ For cautions for use, please read " GUIDELINES FOR RELAY USAGE ".  
[https://industrial.panasonic.com/ac/e/control/relay/cautions\\_use/index.jsp](https://industrial.panasonic.com/ac/e/control/relay/cautions_use/index.jsp)

### ■ Cautions for usage of ST relays

- The standard values of operate ( set ) and release ( reset ) voltage are for when the relay is installed with the terminals oriented downward.
- When using, please be aware that the N.C. and N.O. sides of 1 Form A 1 Form B type may go on simultaneously at operate time and release time.

### ● Set and reset pulse time

Regarding the set and reset pulse time of the latching type, for the purpose of reliable operation under ambient temperature fluctuations and different operating conditions, we recommend setting the coil applied set and reset pulse time to 50 ms or more at the rated coil voltage.

## PC board socket/Soldering socket



Terminal socket  
for PC board

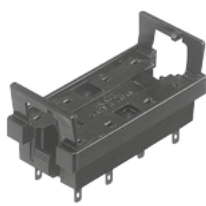

Terminal socket  
for soldering

### TYPES

Product name	Type No.	Part No.	Standard packing	
			Inner carton	Outer carton
PC board socket	ST-PS	AR2800	50 pcs.	500 pcs.
Soldering socket	ST-SS	AR2806		

### RATING

Item	Specifications
Dielectric strength ( initial )	Between contact and coil: 4,000 V rms for 1 min ( detection current: 10 mA ) Between contact and terminal: 2,000 V rms for 1 min ( detection current: 10 mA )
Insulation resistance ( initial )	Between terminals: Min. 1,000 MΩ ( at 500 V DC, Measured portion is the same as the case of dielectric strength. )
Maximum carrying current	10 A
Conditions for usage, transport and storage	Ambient temperature: -40 to +60 °C Humidity: 5 to 85 % RH ( Avoid icing and condensation )

# Power Relays ( Over 2 A ) ST RELAYS

## DIMENSIONS ( Unit: mm )

**CAD** The CAD data of the products with a " CAD " mark can be downloaded from our Website.

### ■ PC board Socket

**CAD** External dimensions

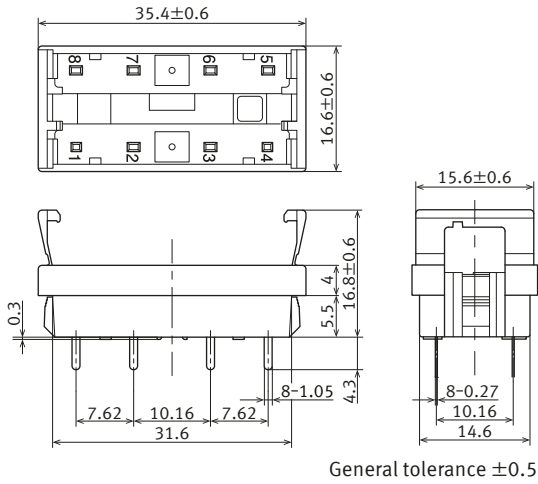

Recommended PC board pattern  
( BOTTOM VIEW )

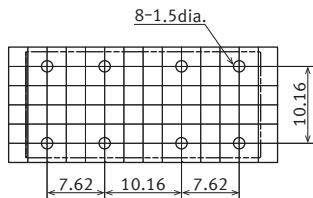

Tolerance  $\pm 0.1$

### ■ Soldering socket

**CAD** External dimensions

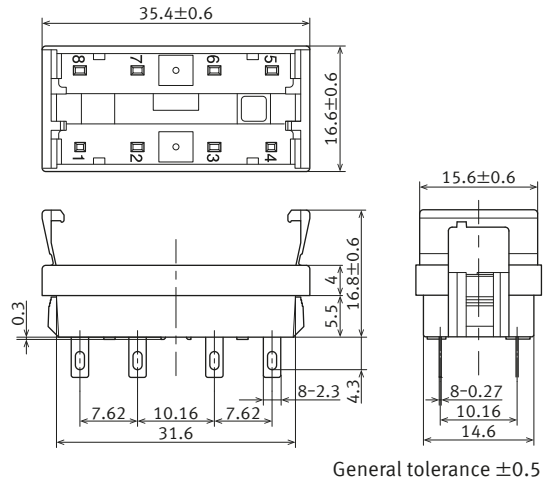

Panel cut-off

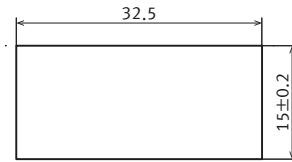

Tolerance  $\pm 0.1$

- The range for chassis thickness is 0.6 to 2.2 mm.
- If the chassis hole is punched with a press, set so the release R on the front side (A side).

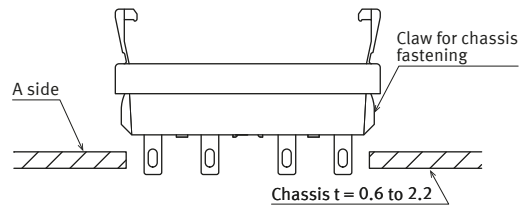



## HANDLING

### ■ Mounting method of relay

1) Align the direction of relay and socket.

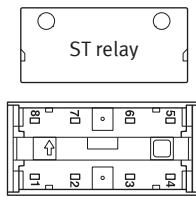

- 2) Insert the relay all the way in, so it is securely in place.
- 3) Press the hook section in the direction of the arrow and firmly secure the relay with the hook.

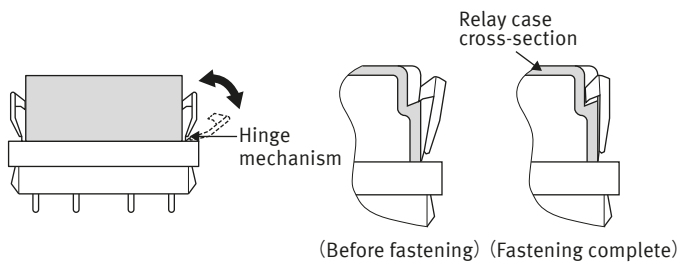

### ■ Removing method of relay

1) When removing the relay, completely release the hooks on both sides and pull the relay out.

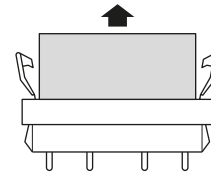

- 2) In case there is not enough space to grasp relay with fingers, after completely removing both hooks, use screwdrivers in the way shown.

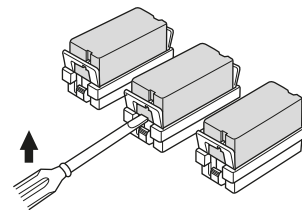

- 3) Exercise care when removing relays. If greater than necessary force is applied at the socket hooks, deformation may alter the dimensions so that the hook will no longer catch, and other damage may also occur.

- For cautions for use, please read " GUIDELINES FOR RELAY USAGE ".  
[https://industrial.panasonic.com/ac/e/control/relay/cautions\\_use/index.jsp](https://industrial.panasonic.com/ac/e/control/relay/cautions_use/index.jsp)

## Precautions for Coil Input

### ■ Long term current carrying

A circuit that will be carrying a current continuously for long periods without relay switching operation. ( circuits for emergency lamps, alarm devices and error inspection that, for example, revert only during malfunction and output warnings with form B contacts ) Continuous, long-term current to the coil will facilitate deterioration of coil insulation and characteristics due to heating of the coil itself. For circuits such as these, please use a magnetic-hold type latching relay. If you need to use a single stable relay, use a sealed type relay that is not easily affected by ambient conditions and make a failsafe circuit design that considers the possibility of contact failure or disconnection.

### ■ DC Coil operating power

Steady state DC current should be applied to the coil. The wave form should be rectangular. If it includes ripple, the ripple factor should be less than 5 %. However, please check with the actual circuit since the electrical characteristics may vary. The rated coil voltage should be applied to the coil and the set/reset pulse time of latching type relay differs for each relays, please refer to the relay's individual specifications.

### ■ Coil connection

When connecting coils of polarized relays, please check coil polarity ( + , - ) at the internal connection diagram ( Schematic ). If any wrong connection is made, it may cause unexpected malfunction, like abnormal heat, fire and so on, and circuit do not work. Avoid impressing voltages to the set coil and reset coil at the same time.

### ■ Maximum allowable voltage and temperature rise

Proper usage requires that the rated coil voltage be impressed on the coil. Note, however, that if a voltage greater than or equal to the maximum continuous voltage is impressed on the coil, the coil may burn or its layers short due to the temperature rise. Furthermore, do not exceed the usable ambient temperature range listed in the catalog.

### ● Operate voltage change due to coil temperature rise

In DC relays, after continuous passage of current in the coil, if the current is turned OFF, then immediately turned ON again, due to the temperature rise in the coil, the operate voltage will become somewhat higher. Also, it will be the same as using it in a higher temperature atmosphere. The resistance/temperature relationship for copper wire is about 0.4 % for 1 °C, and with this ratio the coil resistance increases. That is, in order to operate of the relay, it is necessary that the voltage be higher than the operate voltage and the operate voltage rises in accordance with the increase in the resistance value. However, for some polarized relays, this rate of change is considerably smaller.

## Ambient Environment

### Usage, Transport, and Storage Conditions

During usage, storage, or transportation, avoid locations subjected to direct sunlight and maintain normal temperature, humidity and pressure conditions.

#### Temperature/Humidity/Pressure

When transporting or storing relays while they are tube packaged, there are cases the temperature may differ from the allowable range. In this case be sure to check the individual specifications.

Also allowable humidity level is influenced by temperature, please check charts shown below and use relays within mentioned conditions. ( Allowable temperature values differ for each relays, please refer to the relay's individual specifications. )

##### 1) Temperature:

The tolerance temperature range differs for each relays, please refer to the relay's individual specifications

##### 2) Humidity: 5 to 85 % RH

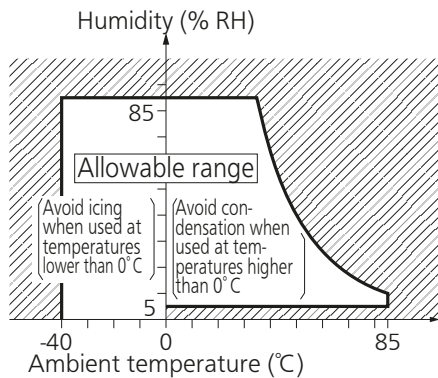

##### 3) Pressure: 86 to 106 kPa

#### Dew condensation

Condensation occurs when the ambient temperature drops suddenly from a high temperature and humidity, or the relay is suddenly transferred from a low ambient temperature to a high temperature and humidity.

Condensation causes the failures like insulation deterioration, wire disconnection and rust etc.

Panasonic Industry Co., Ltd. does not guarantee the failures caused by condensation.

The heat conduction by the equipment may accelerate the cooling of device itself, and the condensation may occur.

Please conduct product evaluations in the worst condition of the actual usage. ( Special attention should be paid when high temperature heating parts are close to the device. Also please consider the condensation may occur inside of the device. )

#### Icing

Condensation or other moisture may freeze on relays when the temperature become lower than 0 °C. This icing causes the sticking of movable portion, the operation delay and the contact conduction failure etc. Panasonic Industry Co., Ltd. does not guarantee the failures caused by the icing.

The heat conduction by the equipment may accelerate the cooling of relay itself and the icing may occur. Please conduct product evaluations in the worst condition of the actual usage.

#### Low temperature and low humidity

The plastic becomes brittle if the relay is exposed to a low temperature, low humidity environment for long periods of time.

#### High temperature and high humidity

Storage for extended periods of time ( including transportation periods ) at high temperature or high humidity levels or in atmospheres with organic gases or sulfide gases may cause a sulfide film or oxide film to form on the surfaces of the contacts and/or it may interfere with the functions. Check out the atmosphere in which the units are to be stored and transported.

#### Package

In terms of the packing format used, make every effort to keep the effects of moisture, organic gases and sulfide gases to the absolute minimum.

#### Silicon

When a source of silicone substances ( silicone rubber, silicone oil, silicone coating materials and silicone filling materials etc. ) is used around the relay, the silicone gas ( low molecular siloxane etc. ) may be produced.

This silicone gas may penetrate into the inside of the relay. When the relay is kept and used in this condition, silicone compound may adhere to the relay contacts which may cause the contact failure. Do not use any sources of silicone gas around the relay ( Including plastic sealed types ).

#### NOx Generation

When relay is used in an atmosphere high in humidity to switch a load which easily produces an arc, the NOx created by the arc and the water absorbed from outside the relay combine to produce nitric acid.

This corrodes the internal metal parts and adversely affects operation.

Avoid use at an ambient humidity of 85 % RH or higher ( at 20 °C ). If use at high humidity is unavoidable, please contact our sales representative.

## Others

### ■ Cleaning

- Although the environmentally sealed type relay ( plastic sealed type, etc. ) can be cleaned, avoid immersing the relay into cold liquid ( such as cleaning solvent ) immediately after soldering. Doing so may deteriorate the sealing performance.
- Cleaning with the boiling method is recommended ( The temperature of cleaning liquid should be 40 °C or lower ). Avoid ultrasonic cleaning on relays. Use of ultrasonic cleaning may cause breaks in the coil or slight sticking of the contacts due to ultrasonic energy.

Please refer to "**the latest product specifications**" when designing your product.

- Requests to customers:

<https://industrial.panasonic.com/ac/e/salespolicies/>

■ Global Sales Network Information: [industrial.panasonic.com/ac/e/salesnetwork](https://industrial.panasonic.com/ac/e/salesnetwork)

---

**Panasonic**  
INDUSTRY

**Panasonic Industry Co., Ltd.**

Electromechanical Control Business Division

■ 1006, Oaza Kadoma, Kadoma-shi, Osaka 571-8506, Japan  
[industrial.panasonic.com/ac/e/](https://industrial.panasonic.com/ac/e/)