

GX-U SERIES GX-FU SERIES GX-N SERIES

Related Information

- General terms and conditions..... F-3
- Selection guide P.781~
- Glossary of terms..... P.1576~
- General precautions P.1579~

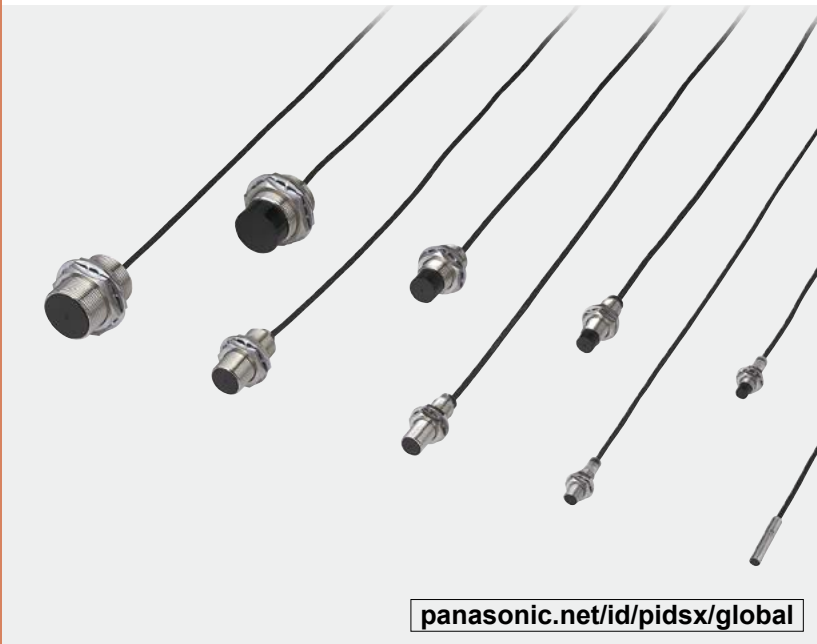

panasonic.net/id/pidsx/global



Improved performance, environmental resistance, and operability

BASIC PERFORMANCE

About four times more robust in tightening

As the sensor can be securely tightened, it does not get loose due to vibration or shock.



Long sensing range

GX-12MLU(B)/N12ML(B) feature 1.6 times longer sensing range than previous model [**GX-12ML(B)**]. It can be mounted at a sufficient distance from the object.

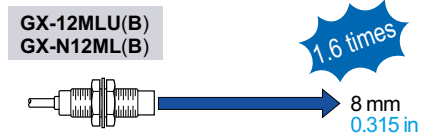

ENVIRONMENTAL RESISTANCE

Spatter-resistant type available **DC 2-wire type**

As the enclosure is entirely coated by fluorine resin, the sensor can be safely used at a place where welding spatters fly around. Both the pigtail cable and the mating cable are also spatter-resistant.



FUNCTIONS

Visible 2-color indicator

The normally open type [**GX-(F)□U(-J)**] is equipped with a 2-color indicator. (The normally closed type and **GX-N□** have the operation indicator instead.)

The operation is easily observable from any direction because the entire sensor tail (transparent, **GX-5SU(B)**: enclosure) lights up.



VARIETIES

Compact size: $\phi 5.4$ mm $\phi 0.213$ in

GX-5SU(B) is just 5.4 mm 0.213 in in diameter, the smallest in existing DC two-wire sensors. It saves space.



Simple wiring

DC 2-wire type

The wiring cost of the DC 2-wire type is 2/3 that of a conventional model. Further, each of **GX-12M(L)U(B)**, **GX-18M(L)U(B)**, **GX-30M(L)U(B)** is available as a pigtailed model that makes replacement easy and quick.

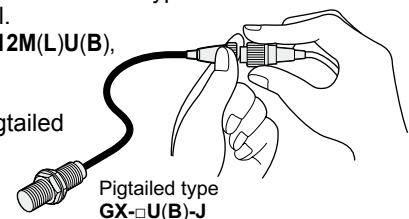

- FIBER SENSORS
- LASER SENSORS
- PHOTOELECTRIC SENSORS
- MICRO PHOTOELECTRIC SENSORS
- AREA SENSORS
- SAFETY LIGHT CURTAINS / SAFETY COMPONENTS
- PRESSURE / FLOW SENSORS
- INDUCTIVE PROXIMITY SENSORS
- PARTICULAR USE SENSORS
- SENSOR OPTIONS
- SIMPLE WIRE-SAVING UNITS
- WIRE-SAVING SYSTEMS
- MEASUREMENT SENSORS
- STATIC CONTROL DEVICES
- LASER MARKERS
- PLC
- HUMAN MACHINE INTERFACES
- ENERGY MANAGEMENT SOLUTIONS
- FA COMPONENTS
- MACHINE VISION SYSTEMS
- UV CURING SYSTEMS
- Selection Guide
- Amplifier Built-in
- Amplifier-separated Other Products
- GX-F/H
- GXL
- GL
- GX-M
- GX-U/GX-FU/GX-N
- GX

APPLICATIONS

Detecting traveling aluminum pallets

It can reliably detect even aluminum pallets because of its long sensing range.

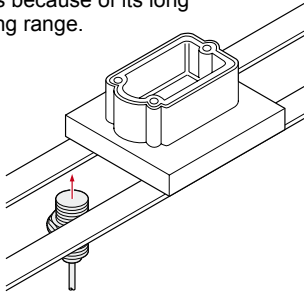

Positioning object at welding station (GX-F□U-J only)

It can be safely used even where welding sparks (spatter) fly around.

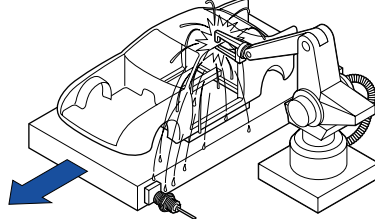

ORDER GUIDE

DC 2-wire type

Type	Appearance (mm in)	Sensing range (Note)	Model No.	Output	Output operation	
DC 2-wire	Non-threaded type	<p>1.5 mm 0.059 in ← Maximum operation distance (0 to 1.2 mm 0 to 0.047 in) ← Stable sensing range</p>	GX-5SU	Non-contact DC 2-wire type	Normally open	
			GX-5SUB		Normally closed	
	Shielded type	Threaded type	<p>2 mm 0.079 in (0 to 1.6 mm 0 to 0.063 in)</p>		GX-8MU	Normally open
					GX-8MUB	Normally closed
		Threaded type	<p>3 mm 0.118 in (0 to 2.4 mm 0 to 0.094 in)</p>		GX-12MU	Normally open
					GX-12MUB	Normally closed
		Threaded type	<p>7 mm 0.276 in (0 to 5.6 mm 0 to 0.220 in)</p>		GX-18MU	Normally open
					GX-18MUB	Normally closed
		Threaded type	<p>10 mm 0.394 in (0 to 8 mm 0 to 0.315 in)</p>		GX-30MU	Normally open
					GX-30MUB	Normally closed
	Non-shielded type	Threaded type	<p>4 mm 0.157 in (0 to 3.2 mm 0 to 0.126 in)</p>		GX-8MLU	Normally open
					GX-8MLUB	Normally closed
		Threaded type	<p>8 mm 0.315 in (0 to 6.4 mm 0 to 0.252 in)</p>		GX-12MLU	Normally open
					GX-12MLUB	Normally closed
		Threaded type	<p>15 mm 0.591 in (0 to 12 mm 0 to 0.472 in)</p>		GX-18MLU	Normally open
					GX-18MLUB	Normally closed
Threaded type		<p>22 mm 0.866 in (0 to 17.6 mm 0 to 0.693 in)</p>	GX-30MLU	Normally open		
			GX-30MLUB	Normally closed		

Note: The maximum operation distance stands for the maximum distance for which the sensor can detect the standard sensing object. The stable sensing range stands for the sensing range for which the sensor can stably detect the standard sensing object even if there is an ambient temperature drift and/or supply voltage fluctuation.

- FIBER SENSORS
- LASER SENSORS
- PHOTO-ELECTRIC SENSORS
- MICRO PHOTO-ELECTRIC SENSORS
- AREA SENSORS
- SAFETY LIGHT CURTAINS / SAFETY COMPONENTS
- PRESSURE / FLOW SENSORS
- INDUCTIVE PROXIMITY SENSORS
- PARTICULAR USE SENSORS
- SENSOR OPTIONS
- SIMPLE WIRE-SAVING UNITS
- WIRE-SAVING SYSTEMS
- MEASUREMENT SENSORS
- STATIC CONTROL DEVICES
- LASER MARKERS
- PLC
- HUMAN MACHINE INTERFACES
- ENERGY MANAGEMENT SOLUTIONS
- FA COMPONENTS
- MACHINE VISION SYSTEMS
- UV CURING SYSTEMS
- Selection Guide
- Amplifier Built-in
- Amplifier-separated
- Other Products
- GX-F/H**
- GXL**
- GL**
- GX-M**
- GX-U/GX-FU/GX-N
- GX**

- FIBER SENSORS
- LASER SENSORS
- PHOTO-ELECTRIC SENSORS
- MICRO PHOTO-ELECTRIC SENSORS
- AREA SENSORS
- SAFETY LIGHT CURTAINS / SAFETY COMPONENTS
- PRESSURE / FLOW SENSORS
- INDUCTIVE PROXIMITY SENSORS
- PARTICULAR USE SENSORS
- SENSOR OPTIONS
- WIRE-SAVING UNITS
- WIRE-SAVING SYSTEMS
- MEASUREMENT SENSORS
- STATIC CONTROL DEVICES
- LASER MARKERS
- PLC
- HUMAN MACHINE INTERFACES
- ENERGY MANAGEMENT SOLUTIONS
- FA COMPONENTS
- MACHINE VISION SYSTEMS
- UV CURING SYSTEMS
- Selection Guide
- Amplifier Built-in
- Amplifier-separated
- Other Products
- GX-F/H
- GXL
- GL
- GX-M
- GX-U/GX-FU/GX-N
- GX

ORDER GUIDE

Spatter-resistant of DC 2-wire type (Pigtailed type)

Type	Appearance (mm in)	Sensing range (Note)	Model No.	Output	Output operation
DC 2-wire Shielded type Threaded type		3 mm 0.118 in ← Maximum operation distance (0 to 2.4 mm 0 to 0.094 in) ← Stable sensing range	GX-F12MU-J	Non-contact DC 2-wire type	Normally open
		7 mm 0.276 in (0 to 5.6 mm 0 to 0.220 in)			
		10 mm 0.394 in (0 to 8 mm 0 to 0.315 in)	GX-F30MU-J		

Note: The maximum operation distance stands for the maximum distance for which the sensor can detect the standard sensing object.
The stable sensing range stands for the sensing range for which the sensor can stably detect the standard sensing object even if there is an ambient temperature drift and/or supply voltage fluctuation.

• Mating cable

Model No.	Description
CN-22G-C2	Length: 2 m 6.562 ft 0.3 mm ² 2-core flame-resistant, spatter-resistant cable with connector at one end
CN-22G-C5	Length: 5 m 16.404 ft Cable outer diameter: ø3.6 mm ø0.142 in

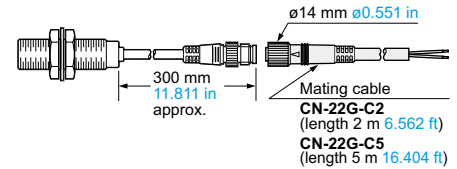

DC 3-wire type

Type	Appearance (mm in)	Sensing range (Note)	Model No.	Output	Output operation
DC 3-wire Shielded type Threaded type		3 mm 0.118 in ← Maximum operation distance (0 to 2.4 mm 0 to 0.094 in) ← Stable sensing range	GX-N12M	NPN open-collector transistor	Normally open
			GX-N12MB		Normally closed
		7 mm 0.276 in (0 to 5.6 mm 0 to 0.220 in)	GX-N18M		Normally open
			GX-N18MB		Normally closed
		10 mm 0.394 in (0 to 8 mm 0 to 0.315 in)	GX-N30M		Normally open
			GX-N30MB		Normally closed
DC 3-wire Non-shielded type Threaded type		8 mm 0.315 in (0 to 6.4 mm 0 to 0.252 in)	GX-N12ML	NPN open-collector transistor	Normally open
			GX-N12MLB		Normally closed
		15 mm 0.591 in (0 to 12 mm 0 to 0.472 in)	GX-N18ML		Normally open
			GX-N18MLB		Normally closed
		22 mm 0.866 in (0 to 17.6 mm 0 to 0.693 in)	GX-N30ML		Normally open
			GX-N30MLB		Normally closed

Note: The maximum operation distance stands for the maximum distance for which the sensor can detect the standard sensing object.
The stable sensing range stands for the sensing range for which the sensor can stably detect the standard sensing object even if there is an ambient temperature drift and/or supply voltage fluctuation.

ORDER GUIDE

5 m 16.404 ft cable length type

5 m 16.404 ft cable length type (standard: 2 m 6.562 ft) is also available for cable type. When ordering this type, suffix “-C5” to the model No. (e.g.) 5 m 16.404 ft cable length type of GX-5SU is “GX-5SU-C5”.

Pigtailed type

Pigtailed type (standard: cable type) is also available for DC 2-wire type.

• Table of Model Nos.

Type		Standard	Pigtailed type (Note)	
DC 2-wire	Shielded type	Non-threaded type	GX-5SU	_____
			GX-5SUB	_____
		Threaded type	GX-8MU	_____
			GX-8MUB	_____
			GX-12MU	GX-12MU-J
			GX-12MUB	GX-12MUB-J
			GX-18MU	GX-18MU-J
			GX-18MUB	GX-18MUB-J
			GX-30MU	GX-30MU-J
	GX-30MUB	GX-30MUB-J		
	Non-shielded type	Threaded type	GX-8MLU	_____
			GX-8MLUB	_____
			GX-12MLU	GX-12MLU-J
			GX-12MLUB	GX-12MLUB-J
			GX-18MLU	GX-18MLU-J
			GX-18MLUB	GX-18MLUB-J
			GX-30MLU	GX-30MLU-J
			GX-30MLUB	GX-30MLUB-J

Note: Please order the suitable mating cable separately for pigtailed type.

• Mating cable

Model No.	Description	
CN-22G-C2	Length: 2 m 6.562 ft	0.3 mm ² 2-core flame-resistant, spatter-resistant cable with connector at one end Cable outer diameter: ø3.6 mm ø0.142 in
CN-22G-C5	Length: 5 m 16.404 ft	
CN-24-C2	Length: 2 m 6.562 ft	0.34 mm ² 4-core cabtyre cable with connector at one end Cable outer diameter: ø5.0 mm ø0.197 in
CN-24-C5	Length: 5 m 16.404 ft	

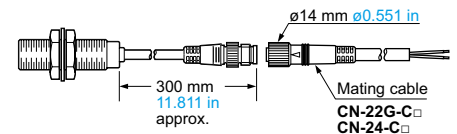

FIBER SENSORS

LASER SENSORS

PHOTO-ELECTRIC SENSORS

MICRO PHOTO-ELECTRIC SENSORS

AREA SENSORS

SAFETY LIGHT CURTAINS / SAFETY COMPONENTS

PRESSURE / FLOW SENSORS

INDUCTIVE PROXIMITY SENSORS

PARTICULAR USE SENSORS

SENSOR OPTIONS

SIMPLE WIRE-SAVING UNITS

WIRE-SAVING SYSTEMS

MEASUREMENT SENSORS

STATIC CONTROL DEVICES

LASER MARKERS

PLC

HUMAN MACHINE INTERFACES

ENERGY MANAGEMENT SOLUTIONS

FA COMPONENTS

MACHINE VISION SYSTEMS

UV CURING SYSTEMS

Selection Guide

Amplifier Built-in

Amplifier-separated

Other Products

GX-F/H

GXL

GL

GX-M

GX-U/GX-FU/GX-N

GX

OPTIONS

Designation	Model No.	Description	
Sensor mounting bracket	MS-SS5	For GX-5SU(B)	The sensor is easily mounted with this bracket.
Protection cover	MS-H12	For GX-12MU(B) For GX-N12M(B)	It protects the sensing surface from welding sparks (spatter), etc.
	MS-H18	For GX-18MU(B) For GX-N18M(B)	
	MS-H30	For GX-30MU(B) For GX-N30M(B)	

Sensor mounting bracket

- **MS-SS5**

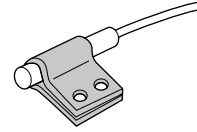

Protection cover

- **MS-H12**
- **MS-H18**
- **MS-H30**

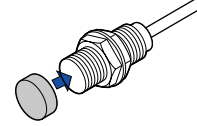

SPECIFICATIONS

DC 2-wire type

Item	Type	Shielded type					Non-shielded type				
		Model No.	Non-threaded type	Threaded type				Threaded type			
			Normally open	GX-5SU	GX-8MU	GX-12MU	GX-18MU	GX-30MU	GX-8MLU	GX-12MLU	GX-18MLU
	Normally closed	GX-5SUB	GX-8MUB	GX-12MUB	GX-18MUB	GX-30MUB	GX-8MLUB	GX-12MLUB	GX-18MLUB	GX-30MLUB	
Max. operation distance (Note 2)		1.5 mm 0.059 in ±10 %	2 mm 0.079 in ±10 %	3 mm 0.118 in ±10 %	7 mm 0.276 in ±10 %	10 mm 0.394 in ±10 %	4 mm 0.157 in ±10 %	8 mm 0.315 in ±10 %	15 mm 0.591 in ±10 %	22 mm 0.866 in ±10 %	
Stable sensing range (Note 2)		0 to 1.2 mm 0 to 0.047 in	0 to 1.6 mm 0 to 0.063 in	0 to 2.4 mm 0 to 0.094 in	0 to 5.6 mm 0 to 0.220 in	0 to 8 mm 0 to 0.315 in	0 to 3.2 mm 0 to 0.126 in	0 to 6.4 mm 0 to 0.252 in	0 to 12 mm 0 to 0.472 in	0 to 17.6 mm 0 to 0.693 in	
Standard sensing object		Iron sheet 6 × 6 × t 1 mm 0.236 × 0.236 × t 0.039 in	Iron sheet 8 × 8 × t 1 mm 0.315 × 0.315 × t 0.039 in	Iron sheet 12 × 12 × t 1 mm 0.472 × 0.472 × t 0.039 in	Iron sheet 18 × 18 × t 1 mm 0.709 × 0.709 × t 0.039 in	Iron sheet 30 × 30 × t 1 mm 1.181 × 1.181 × t 0.039 in	Iron sheet 20 × 20 × t 1 mm 0.787 × 0.787 × t 0.039 in	Iron sheet 30 × 30 × t 1 mm 1.181 × 1.181 × t 0.039 in	Iron sheet 50 × 50 × t 1 mm 1.969 × 1.969 × t 0.039 in	Iron sheet 70 × 70 × t 1 mm 2.756 × 2.756 × t 0.039 in	
Hysteresis		20 % or less of operation distance (with standard sensing object)									
Supply voltage		12 to 24 V DC ⁺¹⁰ / ₋₁₅ % Ripple P-P 10 % or less									
Current consumption (Note 3)		0.8 mA or less									
Output		Non-contact DC 2-wire type • Load current: 3 to 70 mA (Note 4) • Residual voltage: 3 V or less (Note 5)									
Short-circuit protection		Incorporated									
Max. response frequency		1.7 kHz	1.2 kHz	1.2 kHz	500 Hz	350 Hz	1 kHz	650 Hz	350 Hz	220 Hz	
Operation indicator		Normally closed type: Orange LED (lights up when the output is ON)									
2-color indicator		Normally open type: Lights up in green under stable sensing condition, lights up in orange under unstable sensing condition									
Environmental resistance	Protection	IP67 (IEC), IP67G (Note 6)									
	Ambient temperature	-25 to +70 °C -13 to +158 °F , Storage: -30 to +80 °C -22 to +176 °F									
	Ambient humidity	45 to 85 % RH, Storage: 35 to 95 % RH									
	Voltage withstandability	1,000 V AC for one min. between all supply terminals connected together and enclosure									
	Insulation resistance	50 MΩ, or more, with 250 V DC megger between all supply terminals connected together and enclosure									
	Vibration resistance	10 to 55 Hz frequency, 1.5 mm 0.059 in double amplitude in X, Y and Z directions for two hours each									
Shock resistance	1,000 m/s ² acceleration (100 G approx.) in X, Y and Z directions three times each										
Sensing range variation	Temperature characteristics	Over ambient temperature range -25 to +70 °C -13 to +158 °F : within ±10 % of sensing range at +20 °C +68 °F									
	Voltage characteristics	Within ±2 % for ±10 % fluctuation of the supply voltage									
Material		Enclosure: Brass (Nickel plated) [Stainless steel (SUS303) for GX-5SU(B) , GX-8MU(B) and GX-8MLU(B)] Sensing part: Nylon [Polyarylate for GX-5SU(B)], Indicator part: Nylon [excluding GX-5SU(B)]									
Cable		0.3 mm ² [0.15 mm ² for GX-5SU(B) , GX-8MU(B) and GX-8MLU(B)] 2-core oil, heat and cold resistant cabtyre cable, 2 m 6.562 ft long									
Cable extension		Extension up to total 50 m 164.042 ft is possible with 0.3 mm ² , or more, cable.									
Weight (Note 7)		Net weight: 20 g approx.	Net weight: 30 g approx.	Net weight: 55 g approx.	Net weight: 95 g approx.	Net weight: 220 g approx.	Net weight: 30 g approx.	Net weight: 55 g approx.	Net weight: 95 g approx.	Net weight: 220 g approx.	
Accessories		Nut: 2 pcs., Toothed lock washer: 1 pc.									

- Notes: 1) Where measurement conditions have not been specified precisely, the conditions used were an ambient temperature of +23 °C **+73.4 °F**.
 2) The maximum operation distance stands for the maximum distance for which the sensor can detect the standard sensing object.
 The stable sensing range stands for the sensing range for which the sensor can stably detect the standard sensing object even if there is an ambient temperature drift and/or supply voltage fluctuation.
 3) It is the leakage current when the output is in the OFF state.
 4) The maximum load current varies depending on the ambient temperature. Refer to "I/O CIRCUIT AND WIRING DIAGRAMS (p.832)" for more details.
 5) When the cable is extended, the residual voltage becomes larger.
 6) If using the sensor in an environment where cutting oil droplets splatter, the sensor may be deteriorated due to added substances in the oil.
 Please check the resistivity of the sensor against the cutting oil you are using beforehand.
 7) The weight of the threaded type includes the weight of two nuts and one toothed lock washer.

SPECIFICATIONS

Spatter-resistant of DC 2-wire type (Pigtailed type)

Item	Model No.	Type		
		Shielded type		
		Threaded type		
		GX-F12MU-J	GX-F18MU-J	GX-F30MU-J
Max. operation distance (Note 2)		3 mm 0.118 in ±10 %	7 mm 0.276 in ±10 %	10 mm 0.394 in ±10 %
Stable sensing range (Note 2)		0 to 2.4 mm 0 to 0.094 in	0 to 5.6 mm 0 to 0.220 in	0 to 8 mm 0 to 0.315 in
Standard sensing object		Iron sheet 12 × 12 × t 1 mm 0.472 × 0.472 × t 0.039 in	Iron sheet 18 × 18 × t 1 mm 0.709 × 0.709 × t 0.039 in	Iron sheet 30 × 30 × t 1 mm 1.181 × 1.181 × t 0.039 in
Hysteresis		20 % or less of operation distance (with standard sensing object)		
Supply voltage		12 to 24 V DC $\begin{matrix} +10 \\ -15 \end{matrix}$ % Ripple P-P 10 % or less		
Current consumption (Note 3)		0.8 mA or less		
Output		Non-contact DC 2-wire type • Load current: 3 to 70 mA (Note 4) • Residual voltage: 3 V or less (Note 5)		
	Output operation	Normally open		
	Short-circuit protection	Incorporated		
Max. response frequency		1.2 kHz	500 Hz	350 Hz
2-color indicator		Lights up in green under stable sensing condition, lights up in orange under unstable sensing condition		
Environmental resistance	Protection	IP67 (IEC), IP67G (Note 6)		
	Ambient temperature	-25 to +70 °C -13 to +158 °F , Storage: -30 to +80 °C -22 to +176 °F		
	Ambient humidity	45 to 85 % RH, Storage: 35 to 95 % RH		
	Voltage withstandability	1,000 V AC for one min. between all supply terminals connected together and enclosure		
	Insulation resistance	50 MΩ, or more, with 250 V DC megger between all supply terminals connected together and enclosure		
	Vibration resistance	10 to 55 Hz frequency, 1.5 mm 0.059 in double amplitude in X, Y and Z directions for two hours each		
	Shock resistance	1,000 m/s ² acceleration (100 G approx.) in X, Y and Z directions three times each		
Sensing range variation	Temperature characteristics	Over ambient temperature range -25 to +70 °C -13 to +158 °F : within ±10 % of sensing range at +20 °C +68 °F		
	Voltage characteristics	Within ±2 % for ±10 % fluctuation of the supply voltage		
Material		Enclosure: Brass (Fluorine resin coated), Sensing part: Polyarylate (Fluorine resin coated), Indicator part: Polyarylate		
Cable		0.3 mm ² 2-core spatter-resistant cable, 0.3 m 0.984 ft long with round type connector		
Cable extension		Extension up to total 50 m 164.042 ft is possible with 0.3 mm ² , or more, cable.		
Weight (Note 7)		Net weight: 35 g approx.	Net weight: 75 g approx.	Net weight: 200 g approx.
Accessories		Nut: 2 pcs. (Fluorine resin coated), Toothed lock washer: 1 pc. (Fluorine resin coated)		

Notes: 1) Where measurement conditions have not been specified precisely, the conditions used were an ambient temperature of +23 °C **+73.4 °F**.

2) The maximum operation distance stands for the maximum distance for which the sensor can detect the standard sensing object.

The stable sensing range stands for the sensing range for which the sensor can stably detect the standard sensing object even if there is an ambient temperature drift and/or supply voltage fluctuation.

3) It is the leakage current when the output is in the OFF state.

4) The maximum load current varies depending on the ambient temperature. Refer to "**I/O CIRCUIT AND WIRING DIAGRAMS** (p.832)" for more details.

5) When the cable is extended, the residual voltage becomes larger.

6) If using the sensor in an environment where cutting oil droplets splatter, the sensor may be deteriorated due to added substances in the oil.

Please check the resistivity of the sensor against the cutting oil you are using beforehand.

7) The given weight includes the weight of two nuts and one toothed lock washer.

FIBER

SENSORS

LASER

SENSORS

PHOTO-

ELECTRIC

SENSORS

MICRO

PHOTO-

ELECTRIC

SENSORS

AREA

SENSORS

SAFETY LIGHT

CURTAINS /

SAFETY

COMPONENTS

PRESSURE /

FLOW

SENSORS

INDUCTIVE

PROXIMITY

SENSORS

PARTICULAR

USE

SENSORS

SENSOR

OPTIONS

SIMPLE

WIRE-SAVING

UNITS

WIRE-SAVING

SYSTEMS

MEASURE-

MENT

SENSORS

STATIC

CONTROL

DEVICES

LASER

MARKERS

PLC

HUMAN

MACHINE

INTERFACES

ENERGY

MANAGEMENT

SOLUTIONS

FA

COMPONENTS

MACHINE

VISION

SYSTEMS

UV

CURING

SYSTEMS

Selection

Guide

Amplifier

Built-in

Amplifier-

separated

Other

Products

GX-F/H**GXL****GL****GX-M****GX-U/GX-FU/****GX-N****GX**

FIBER SENSORS
LASER SENSORS
PHOTO-ELECTRIC SENSORS
MICRO PHOTO-ELECTRIC SENSORS
AREA SENSORS
SAFETY LIGHT CURTAINS / SAFETY COMPONENTS
PRESSURE / FLOW SENSORS
INDUCTIVE PROXIMITY SENSORS
PARTICULAR USE SENSORS
SENSOR OPTIONS
SIMPLE WIRE-SAVING UNITS
WIRE-SAVING SYSTEMS
MEASUREMENT SENSORS
STATIC CONTROL DEVICES
LASER MARKERS
PLC
HUMAN MACHINE INTERFACES
ENERGY MANAGEMENT SOLUTIONS
FA COMPONENTS
MACHINE VISION SYSTEMS
UV CURING SYSTEMS
Selection Guide
Amplifier Built-in
Amplifier-separated
Other Products
GX-F/H
GXL
GL
GX-M
GX-U/GX-FU/GX-N
GX

SPECIFICATIONS

DC 3-wire type

Item	Model No.	Shielded type						Non-shielded type					
		Threaded type						Threaded type					
		GX-N12M	GX-N12MB	GX-N18M	GX-N18MB	GX-N30M	GX-N30MB	GX-N12ML	GX-N12MLB	GX-N18ML	GX-N18MLB	GX-N30ML	GX-N30MLB
Max. operation distance (Note 2)		3 mm 0.118 in ±10 %		7 mm 0.276 in ±10 %		10 mm 0.394 in ±10 %		8 mm 0.315 in ±10 %		15 mm 0.591 in ±10 %		22 mm 0.866 in ±10 %	
Stable sensing range (Note 2)		0 to 2.4 mm 0 to 0.094 in		0 to 5.6 mm 0 to 0.220 in		0 to 8 mm 0 to 0.315 in		0 to 6.4 mm 0 to 0.252 in		0 to 12 mm 0 to 0.472 in		0 to 17.6 mm 0 to 0.693 in	
Standard sensing object		Iron sheet 12 × 12 × t 1 mm 0.472 × 0.472 × t 0.039 in		Iron sheet 18 × 18 × t 1 mm 0.709 × 0.709 × t 0.039 in		Iron sheet 30 × 30 × t 1 mm 1.181 × 1.181 × t 0.039 in		Iron sheet 30 × 30 × t 1 mm 1.181 × 1.181 × t 0.039 in		Iron sheet 50 × 50 × t 1 mm 1.969 × 1.969 × t 0.039 in		Iron sheet 70 × 70 × t 1 mm 2.756 × 2.756 × t 0.039 in	
Hysteresis		20 % or less of operation distance (with standard sensing object)											
Supply voltage		12 to 24 V DC ⁺¹⁰ / ₋₁₅ % Ripple P-P 10 % or less											
Current consumption		10 mA or less											
Output		NPN open-collector transistor • Maximum sink current: 100 mA • Applied voltage: 30 V DC or less (between output and 0 V) • Residual voltage: 1.5 V or less (at 100 mA sink current) 0.4 V or less (at 16 mA sink current)											
Output operation		Normally open	Normally closed	Normally open	Normally closed	Normally open	Normally closed	Normally open	Normally closed	Normally open	Normally closed	Normally open	Normally closed
Short-circuit protection		Incorporated											
Max. response frequency		450 Hz		300 Hz		300 Hz		350 Hz		100 Hz		100 Hz	
Operation indicator		Orange LED (lights up when the output is ON)											
Environmental resistance	Protection	IP67 (IEC), IP67G (Note 3)											
	Ambient temperature	-25 to +70 °C -13 to +158 °F, Storage: -30 to +80 °C -22 to +176 °F											
	Ambient humidity	45 to 85 % RH, Storage: 35 to 95 % RH											
	Voltage withstandability	1,000 V AC for one min. between all supply terminals connected together and enclosure											
	Insulation resistance	50 MΩ, or more, with 250 V DC megger between all supply terminals connected together and enclosure											
	Vibration resistance	10 to 55 Hz frequency, 1.5 mm 0.059 in double amplitude in X, Y and Z directions for two hours each											
Shock resistance	1,000 m/s ² acceleration (100 G approx.) in X, Y and Z directions three times each												
Sensing range variation	Temperature characteristics	Over ambient temperature range -25 to +70 °C -13 to +158 °F: within ±10 % of sensing range at +20 °C +68 °F											
	Voltage characteristics	Within ±2 % for ±10 % fluctuation of the supply voltage											
Material		Enclosure: Brass (Nickel plated), Sensing part: Nylon, Indicator part: Nylon											
Cable		0.3 mm ² 3-core oil, heat and cold resistant cabtyre cable, 2 m 6.562 ft long											
Cable extension		Extension up to total 100 m 328.084 ft is possible with 0.3 mm ² , or more, cable.											
Weight (Note 4)		Net weight: 65 g approx.		Net weight: 110 g approx.		Net weight: 240 g approx.		Net weight: 65 g approx.		Net weight: 110 g approx.		Net weight: 240 g approx.	
Accessories		Nut: 2 pcs., Toothed lock washer: 1 pc.											

- Notes: 1) Where measurement conditions have not been specified precisely, the conditions used were an ambient temperature of +23 °C +73.4 °F.
 2) The maximum operation distance stands for the maximum distance for which the sensor can detect the standard sensing object. The stable sensing range stands for the sensing range for which the sensor can stably detect the standard sensing object even if there is an ambient temperature drift and/or supply voltage fluctuation.
 3) If using the sensor in an environment where cutting oil droplets splatter, the sensor may be deteriorated due to added substances in the oil. Please check the resistivity of the sensor against the cutting oil you are using beforehand.
 4) The given weight includes the weight of two nuts and one toothed lock washer.

I/O CIRCUIT AND WIRING DIAGRAMS

GX-U(B)

DC 2-wire type

I/O circuit diagram

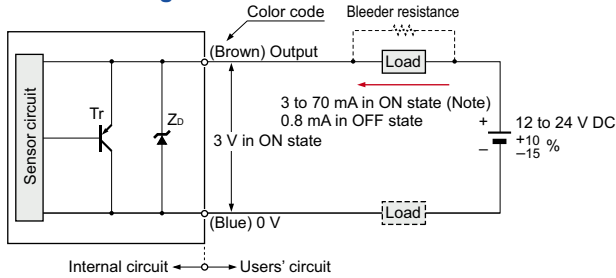

Note: The maximum load current varies depending on the ambient temperature.

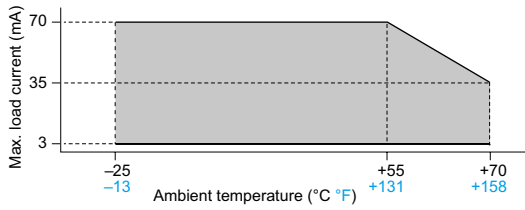

Symbols ... ZD: Surge absorption zener diode
Tr: PNP output transistor

Wiring diagram

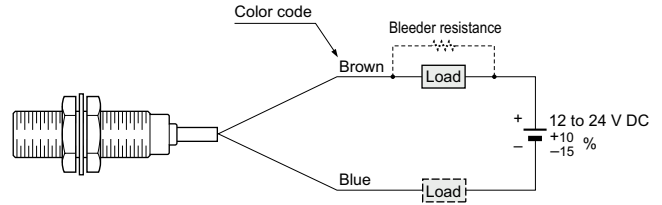

Conditions for the load

- 1) The load should not be actuated by the leakage current (0.8 mA) in the OFF state.
- 2) The load should be actuated by (supply voltage - 3 V) in the ON state.
- 3) The current in the ON state should be between 3 to 70 mA DC.

[In case the current is less than 3 mA, connect a bleeder resistance in parallel to the load so that a current of 3 mA, or more, flows.]

GX-U(B)-J GX-F(U)-J

DC 2-wire type (Pigtailed)

I/O circuit diagram

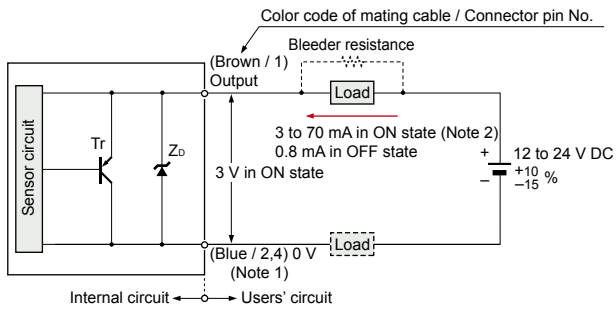

- Notes: 1) This is when the mating cable **CN-22G-C** is connected. The connector pins No.2 and No.4 are short-circuited inside the mating cable connector. However, when the mating cable **CN-24-C** is connected; **GX-U-J** (normally open): (Black / 4) 0 V
GX-UB-J (normally closed): (White / 2) 0 V
- 2) The maximum load current varies depending on the ambient temperature.

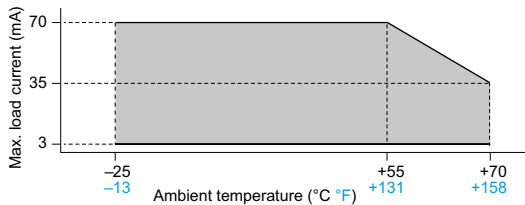

Conditions for the load

- 1) The load should not be actuated by the leakage current (0.8 mA) in the OFF state.
- 2) The load should be actuated by (supply voltage - 3 V) in the ON state.
- 3) The current in the ON state should be between 3 to 70 mA DC.

[In case the current is less than 3 mA, connect a bleeder resistance in parallel to the load so that a current of 3 mA, or more, flows.]

Symbols ... ZD: Surge absorption zener diode
Tr: PNP output transistor

Wiring diagram

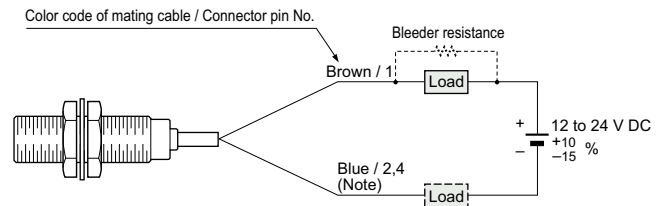

Note: This is when the mating cable **CN-22G-C** is connected. The connector pins No.2 and No.4 are short-circuited inside the mating cable connector. However, when the mating cable **CN-24-C** is connected; **GX-U-J** (normally open): Black / 4
GX-UB-J (normally closed): White / 2

Connector pin position

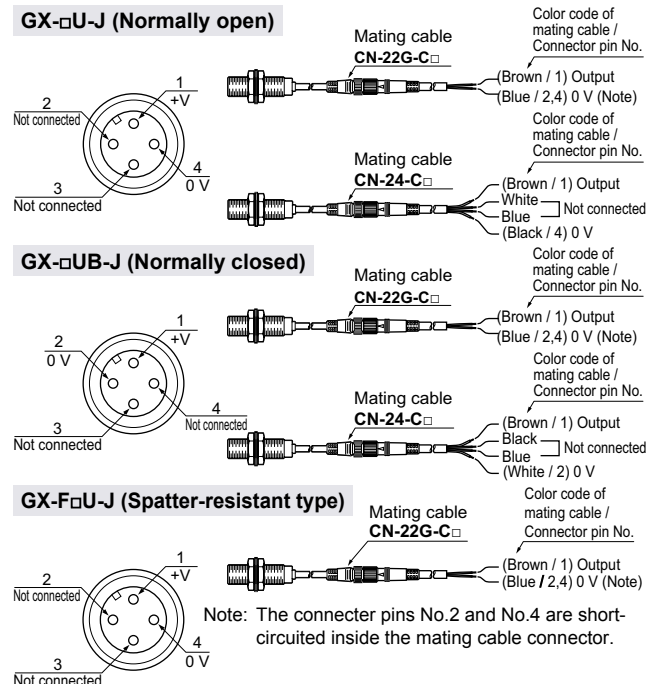

FIBER SENSORS

LASER SENSORS

PHOTO-ELECTRIC SENSORS

MICRO PHOTO-ELECTRIC SENSORS

AREA SENSORS

SAFETY LIGHT CURTAINS / SAFETY COMPONENTS

PRESSURE / FLOW SENSORS

INDUCTIVE PROXIMITY SENSORS

PARTICULAR USE SENSORS

SENSOR OPTIONS

SIMPLE WIRE-SAVING UNITS

WIRE-SAVING SYSTEMS

MEASUREMENT SENSORS

STATIC CONTROL DEVICES

LASER MARKERS

PLC

HUMAN MACHINE INTERFACES

ENERGY MANAGEMENT SOLUTIONS

FA COMPONENTS

MACHINE VISION SYSTEMS

UV CURING SYSTEMS

Selection Guide

Amplifier Built-in

Amplifier-separated

Other Products

GX-F/H

GXL

GL

GX-M

GX-U/GX-FU/GX-N

GX

- FIBER SENSORS
- LASER SENSORS
- PHOTO-ELECTRIC SENSORS
- MICRO PHOTO-ELECTRIC SENSORS
- AREA SENSORS
- SAFETY LIGHT CURTAINS / SAFETY COMPONENTS
- PRESSURE / FLOW SENSORS
- INDUCTIVE PROXIMITY SENSORS
- PARTICULAR USE SENSORS
- SENSOR OPTIONS
- SIMPLE WIRE-SAVING UNITS
- WIRE-SAVING SYSTEMS
- MEASUREMENT SENSORS
- STATIC CONTROL DEVICES
- LASER MARKERS
- PLC
- HUMAN MACHINE INTERFACES
- ENERGY MANAGEMENT SOLUTIONS
- FA COMPONENTS
- MACHINE VISION SYSTEMS
- UV CURING SYSTEMS
- Selection Guide
- Amplifier Built-in
- Amplifier-separated
- Other Products
- GX-F/H**
- GXL**
- GL**
- GX-M**
- GX-U/GX-FU/GX-N
- GX**

I/O CIRCUIT AND WIRING DIAGRAMS

GX-N□

DC 3-wire type (NPN output)

I/O circuit diagram

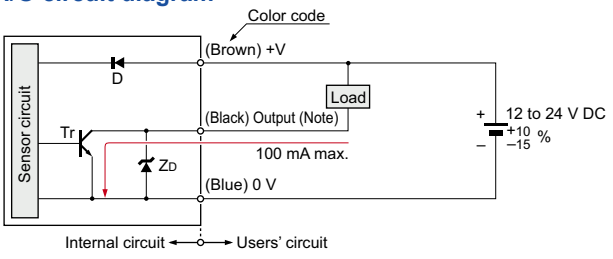

Wiring diagram

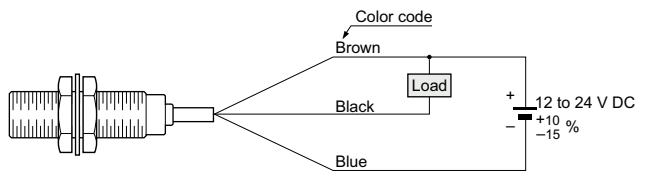

Note: If a capacitive load is directly connected to the output, malfunction may occur.

Symbols ... D : Reverse supply polarity protection diode
 ZD: Surge absorption zener diode
 Tr : NPN output transistor

SENSING CHARACTERISTICS (TYPICAL)

GX-5SU GX-5SUB

Sensing field

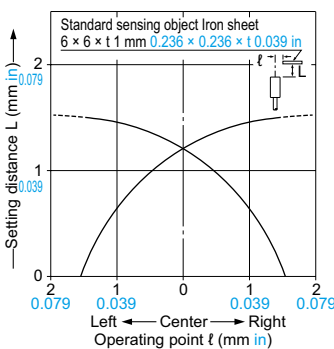

Correlation between sensing object size and sensing range

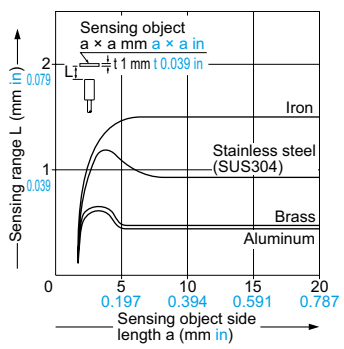

As the sensing object size becomes smaller than the standard size (iron sheet 6 × 6 × t 1 mm 0.236 × 0.236 × t 0.039 in), the sensing range shortens as shown in the left figure.

GX-8MU GX-8MUB

Sensing field

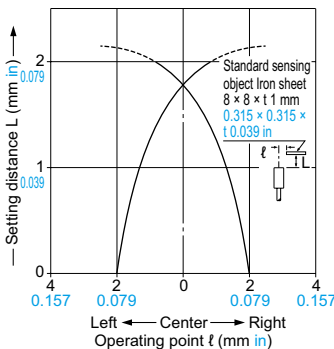

Correlation between sensing object size and sensing range

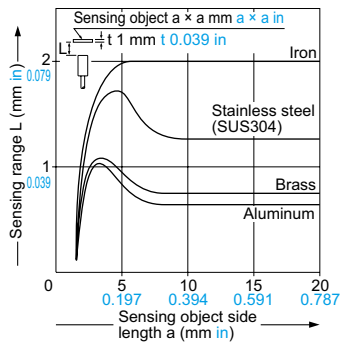

As the sensing object size becomes smaller than the standard size (iron sheet 8 × 8 × t 1 mm 0.315 × 0.315 × t 0.039 in), the sensing range shortens as shown in the left figure.

GX-12MU(B) GX-F12MU-J

Sensing field

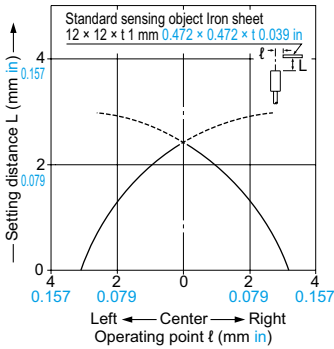

Correlation between sensing object size and sensing range

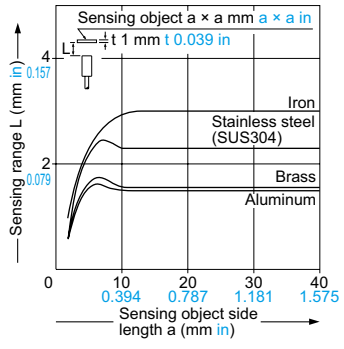

As the sensing object size becomes smaller than the standard size (iron sheet 12 × 12 × t 1 mm 0.472 × 0.472 × t 0.039 in), the sensing range shortens as shown in the left figure.

SENSING CHARACTERISTICS (TYPICAL)

GX-18MU(B) GX-F18MU-J

Sensing field

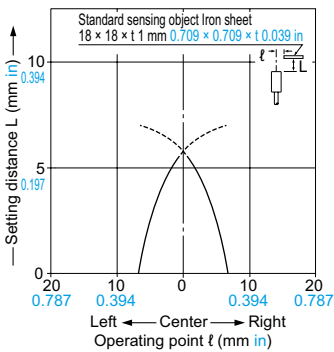

Correlation between sensing object size and sensing range

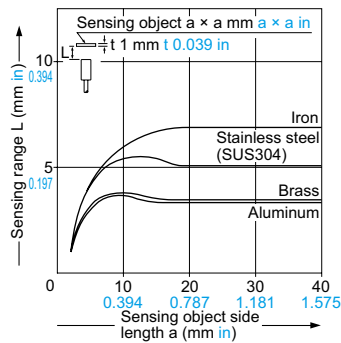

As the sensing object size becomes smaller than the standard size (iron sheet 18 × 18 × t 1 mm 0.709 × 0.709 × t 0.039 in), the sensing range shortens as shown in the left figure.

GX-30MU(B) GX-F30MU-J

Sensing field

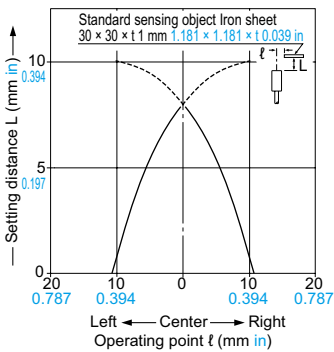

Correlation between sensing object size and sensing range

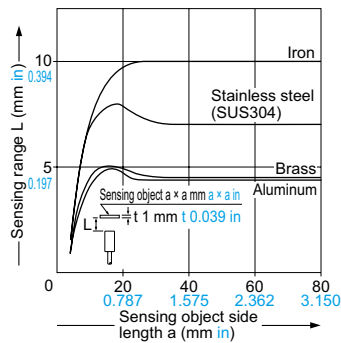

As the sensing object size becomes smaller than the standard size (iron sheet 30 × 30 × t 1 mm 1.181 × 1.181 × t 0.039 in), the sensing range shortens as shown in the left figure.

GX-8MLU GX-8MLUB

Sensing field

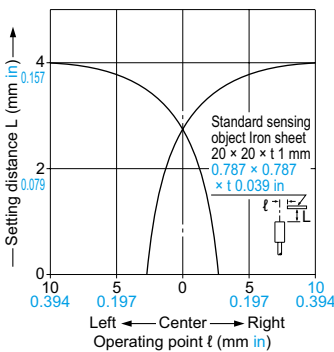

Correlation between sensing object size and sensing range

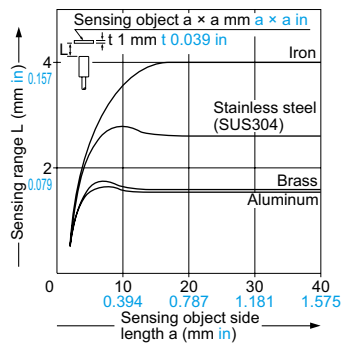

As the sensing object size becomes smaller than the standard size (iron sheet 20 × 20 × t 1 mm 0.787 × 0.787 × t 0.039 in), the sensing range shortens as shown in the left figure.

GX-12MLU GX-12MLUB

Sensing field

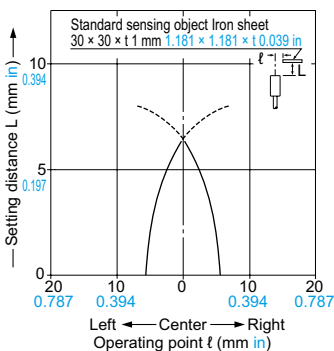

Correlation between sensing object size and sensing range

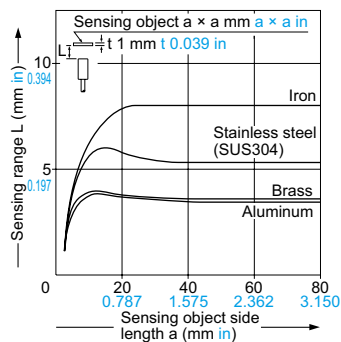

As the sensing object size becomes smaller than the standard size (iron sheet 30 × 30 × t 1 mm 1.181 × 1.181 × t 0.039 in), the sensing range shortens as shown in the left figure.

- FIBER SENSORS
- LASER SENSORS
- PHOTO-ELECTRIC SENSORS
- MICRO PHOTO-ELECTRIC SENSORS
- AREA SENSORS
- SAFETY LIGHT CURTAINS / SAFETY COMPONENTS
- PRESSURE / FLOW SENSORS
- INDUCTIVE PROXIMITY SENSORS
- PARTICULAR USE SENSORS
- SENSOR OPTIONS
- WIRE-SAVING UNITS
- WIRE-SAVING SYSTEMS
- MEASUREMENT SENSORS
- STATIC CONTROL DEVICES
- LASER MARKERS
- PLC
- HUMAN MACHINE INTERFACES
- ENERGY MANAGEMENT SOLUTIONS
- FA COMPONENTS
- MACHINE VISION SYSTEMS
- UV CURING SYSTEMS
- Selection Guide
- Amplifier Built-in
- Amplifier-separated
- Other Products
- GX-F/H**
- GXL**
- GL**
- GX-M**
- GX-U/GX-FU/GX-N**
- GX**

SENSING CHARACTERISTICS (TYPICAL)

GX-18MLU GX-18MLUB

Sensing field

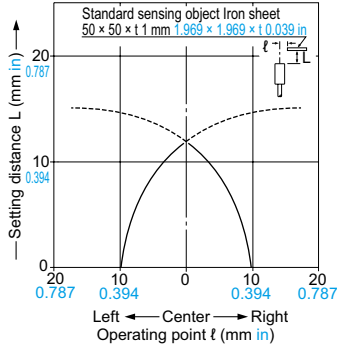

Correlation between sensing object size and sensing range

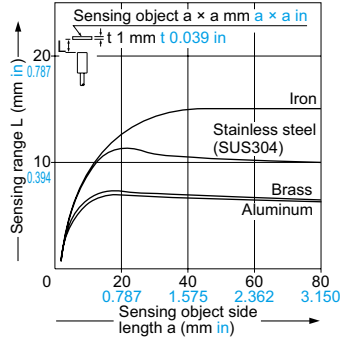

As the sensing object size becomes smaller than the standard size (iron sheet 50 × 50 × t 1 mm 1.969 × 1.969 × t 0.039 in), the sensing range shortens as shown in the left figure.

GX-30MLU GX-30MLUB

Sensing field

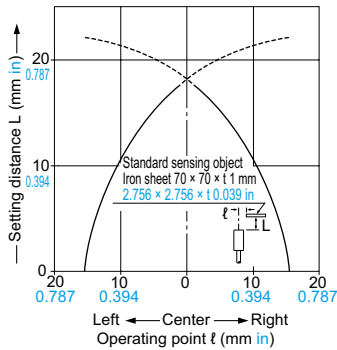

Correlation between sensing object size and sensing range

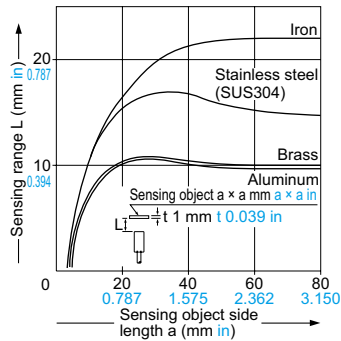

As the sensing object size becomes smaller than the standard size (iron sheet 70 × 70 × t 1 mm 2.756 × 2.756 × t 0.039 in), the sensing range shortens as shown in the left figure.

GX-N12M GX-N12MB

Sensing field

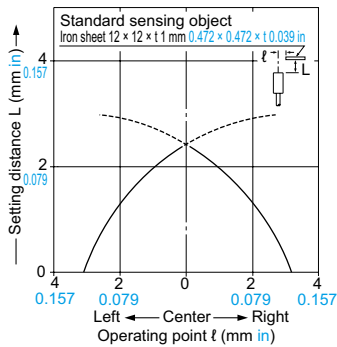

Correlation between sensing object size and sensing range

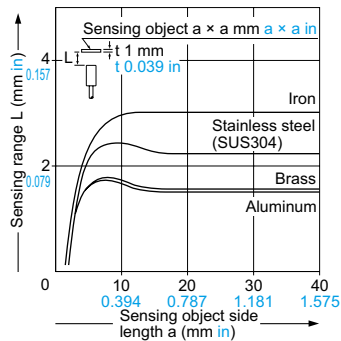

As the sensing object size becomes smaller than the standard size (iron sheet 12 × 12 × t 1 mm 0.472 × 0.472 × t 0.039 in), the sensing range shortens as shown in the left figure.

GX-N18M GX-N18MB

Sensing field

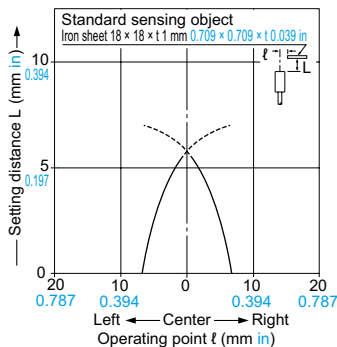

Correlation between sensing object size and sensing range

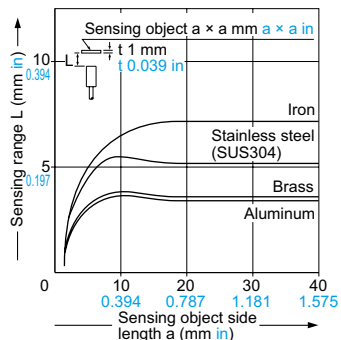

As the sensing object size becomes smaller than the standard size (iron sheet 18 × 18 × t 1 mm 0.709 × 0.709 × t 0.039 in), the sensing range shortens as shown in the left figure.

- FIBER SENSORS
- LASER SENSORS
- PHOTO-ELECTRIC SENSORS
- MICRO PHOTO-ELECTRIC SENSORS
- AREA SENSORS
- SAFETY LIGHT CURTAINS / SAFETY COMPONENTS
- PRESSURE / FLOW SENSORS
- INDUCTIVE PROXIMITY SENSORS
- PARTICULAR USE SENSORS
- SENSOR OPTIONS
- SIMPLE WIRE-SAVING UNITS
- WIRE-SAVING SYSTEMS
- MEASUREMENT SENSORS
- STATIC CONTROL DEVICES
- LASER MARKERS
- PLC
- HUMAN MACHINE INTERFACES
- ENERGY MANAGEMENT SOLUTIONS
- FA COMPONENTS
- MACHINE VISION SYSTEMS
- UV CURING SYSTEMS
- Selection Guide
- Amplifier Built-in
- Amplifier-separated
- Other Products
- GX-F/H
- GXL
- GL
- GX-M
- GX-U/GX-FU/GX-N
- GX

SENSING CHARACTERISTICS (TYPICAL)

GX-N30M GX-N30MB

Sensing field

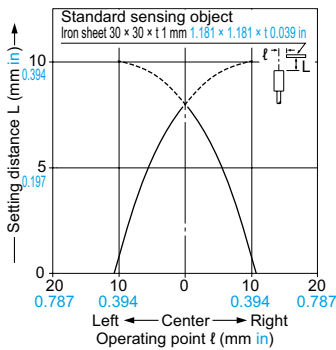

Correlation between sensing object size and sensing range

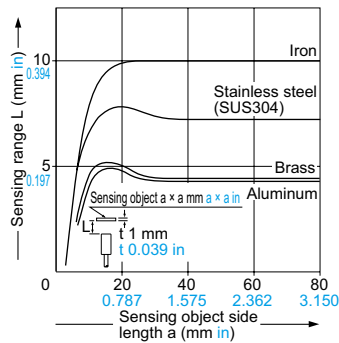

As the sensing object size becomes smaller than the standard size (iron sheet 30 × 30 × t 1 mm 1.181 × 1.181 × t 0.039 in), the sensing range shortens as shown in the left figure.

GX-N12ML GX-N12MLB

Sensing field

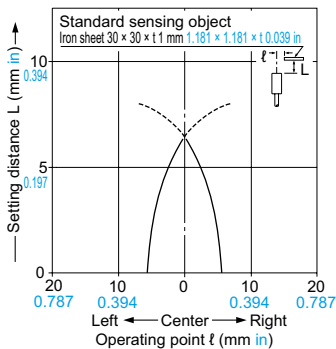

Correlation between sensing object size and sensing range

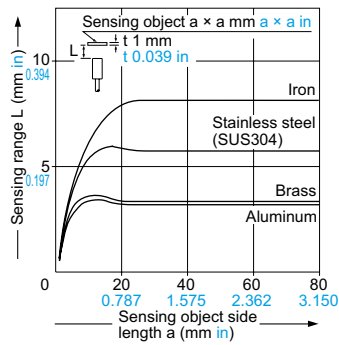

As the sensing object size becomes smaller than the standard size (iron sheet 30 × 30 × t 1 mm 1.181 × 1.181 × t 0.039 in), the sensing range shortens as shown in the left figure.

GX-N18ML GX-N18MLB

Sensing field

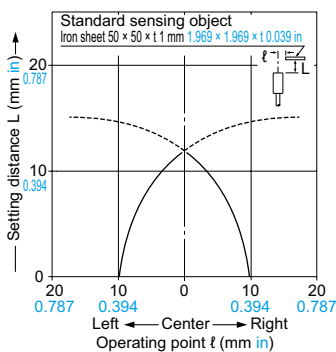

Correlation between sensing object size and sensing range

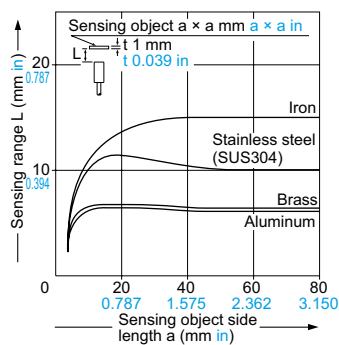

As the sensing object size becomes smaller than the standard size (iron sheet 50 × 50 × t 1 mm 1.969 × 1.969 × t 0.039 in), the sensing range shortens as shown in the left figure.

GX-N30ML GX-N30MLB

Sensing field

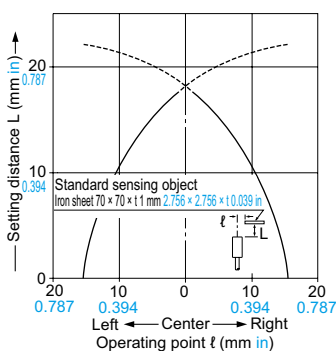

Correlation between sensing object size and sensing range

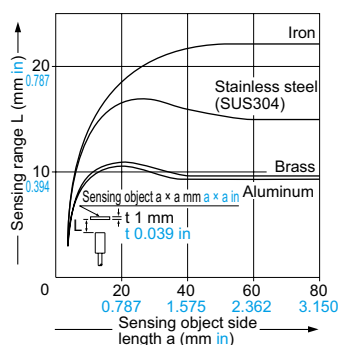

As the sensing object size becomes smaller than the standard size (iron sheet 70 × 70 × t 1 mm 2.756 × 2.756 × t 0.039 in), the sensing range shortens as shown in the left figure.

- FIBER SENSORS
- LASER SENSORS
- PHOTO-ELECTRIC SENSORS
- MICRO PHOTO-ELECTRIC SENSORS
- AREA SENSORS
- SAFETY LIGHT CURTAINS / SAFETY COMPONENTS
- PRESSURE / FLOW SENSORS
- INDUCTIVE PROXIMITY SENSORS
- PARTICULAR USE SENSORS
- SENSOR OPTIONS
- SIMPLE WIRE-SAVING UNITS
- WIRE-SAVING SYSTEMS
- MEASUREMENT SENSORS
- STATIC CONTROL DEVICES
- LASER MARKERS
- PLC
- HUMAN MACHINE INTERFACES
- ENERGY MANAGEMENT SOLUTIONS
- FA COMPONENTS
- MACHINE VISION SYSTEMS
- UV CURING SYSTEMS
- Selection Guide
- Amplifier Built-in
- Amplifier-separated
- Other Products
- GX-F/H**
- GXL**
- GL**
- GX-M**
- GX-U/GX-FU/GX-N**
- GX**

PRECAUTIONS FOR PROPER USE

Refer to p.1579~ for general precautions.

All models



- Never use this product as a sensing device for personnel protection.
- In case of using sensing devices for personnel protection, use products which meet laws and standards, such as OSHA, ANSI or IEC etc., for personnel protection applicable in each region or country.

Mounting

- The tightening torque should be under the value given below.

Mounting with a set screw

- Tighten with the cup-point of a set screw (M4).

<Non-threaded type>

Mounting hole process dimension

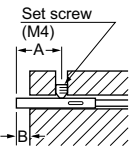

Model No.	A (mm in)	B (mm in)	C (mm in)	Tightening torque
GX-5SU(B)	5 to 30 0.197 to 1.181	3 0.118	$\phi 5.5^{+0.2}_0$ $\phi 0.217^{+0.008}_0$	0.29 N·m (Note)

Note: From the shipment on October, 2019.

- Do not fix on the operation indicator and opposite to it.

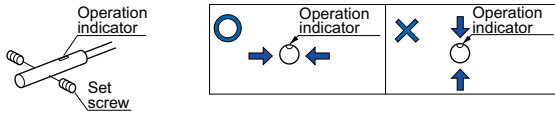

Mounting with nut

<Shielded of threaded type>

<Non-shielded of threaded type>

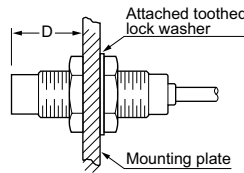
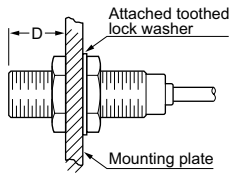

Model No.	Dimension D (mm in)	Tightening torque
GX-8MU(B)	3 to 10.3 0.118 to 0.406	5.9 N·m
	10.3 0.406 or more	11.8 N·m
GX-12MU(B) GX-F12MU-J GX-N12M(B)	3.5 to 13.5 0.138 to 0.531	10 N·m
	13.5 0.531 or more	20 N·m
GX-18MU(B) GX-F18MU-J GX-N18M(B)	4 to 18 0.157 to 0.709	45 N·m
	18 0.709 or more	80 N·m
GX-30MU(B) GX-F30MU-J GX-N30M(B)	5 to 21 0.197 to 0.827	80 N·m
	21 0.827 or more	180 N·m
GX-8MLU(B)	12 0.472 or more	11.8 N·m
GX-12MLU(B) GX-N12ML(B)	15 0.591 or more	20 N·m
GX-18MLU(B) GX-N18ML(B)	25 0.984 or more	80 N·m
GX-30MLU(B) GX-N30ML(B)	30 1.181 or more	180 N·m

Note: Mount such that the nuts do not protrude from the threaded portion.

- The root truncation of the threads is shallow owing to strengthening of the sensors against tightening. When tapping holes on equipment to fix the sensors, the prepared holes must be value in the table below.

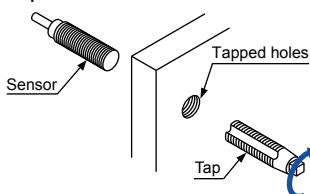

Model No.	Prepared hole
GX-8MU(B) GX-8MLU(B)	$\phi 7.2$ mm $\phi 0.283$ in
GX-12MU(B) GX-12MLU(B) GX-F12MU-J GX-N12M(B) GX-N12ML(B)	$\phi 11.2$ mm $\phi 0.441$ in

Distance from surrounding metal

- As metal around the sensor may affect the sensing performance, pay attention to the following points.

Influence of surrounding metal

- The surrounding metal will affect the sensing performance. Keep the minimum distance specified in the table below.

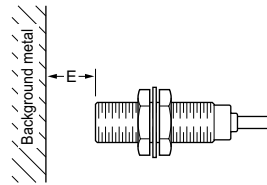

Model No.	E (mm in)
GX-5SU(B)	4.5 0.177
GX-8MU(B)	4.5 0.177
GX-12MU(B) GX-F12MU-J GX-N12M(B)	8 0.315
GX-18MU(B) GX-F18MU-J GX-N18M(B)	20 0.787
GX-30MU(B) GX-F30MU-J GX-N30M(B)	40 1.575
GX-8MLU(B)	8 0.315
GX-12MLU(B) GX-N12ML(B)	22 0.866
GX-18MLU(B) GX-N18ML(B)	45 1.772
GX-30MLU(B) GX-N30ML(B)	75 2.953

Embedding of the sensor in metal

- Sensing range may decrease if the sensor is completely embedded in metal. Especially for the non-threaded type and the non-shielded type, keep the minimum distance specified in the table below.

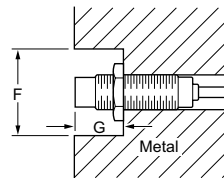

Note: With the non-shielded type, the sensing range may vary depending on the position of the nuts.

Model No.	F (mm in)	G (mm in)
GX-5SU(B)	$\phi 12$ $\phi 0.472$	3 0.118
GX-8MLU(B)	$\phi 24$ $\phi 0.945$	12 0.472
GX-12MLU(B) GX-N12ML(B)	$\phi 50$ $\phi 1.969$	15 0.591
GX-18MLU(B) GX-N18ML(B)	$\phi 75$ $\phi 2.953$	25 0.984
GX-30MLU(B) GX-N30ML(B)	$\phi 105$ $\phi 4.134$	30 1.181

Mutual interference

- When two or more sensors are installed in parallel or face to face, keep the minimum separation distance specified below to avoid mutual interference.

Face to face mounting

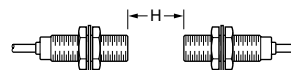

Parallel mounting

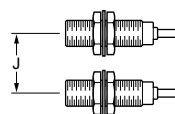

Model No.	H (mm in)	J (mm in)
GX-5SU(B)	19 0.748	14 0.551
GX-8MU(B)	20 0.787	15 0.591
GX-12MU(B) GX-F12MU-J	35 1.378	20 0.787
GX-18MU(B) GX-F18MU-J	70 2.756	45 1.772
GX-30MU(B) GX-F30MU-J	115 4.528	70 2.756
GX-8MLU(B)	60 2.362	45 1.772
GX-12MLU(B)	145 5.709	95 3.740
GX-18MLU(B)	250 9.843	165 6.496
GX-30MLU(B)	350 13.780	250 9.843
GX-N12M(B)	25 0.984	15 0.591
GX-N18M(B)	50 1.969	35 1.378
GX-N30M(B)	90 3.543	55 2.165
GX-N12ML(B)	120 4.724	70 2.756
GX-N18ML(B)	180 7.087	125 4.921
GX-N30ML(B)	290 1.417	190 7.480

PRECAUTIONS FOR PROPER USE

Refer to p.1579~ for general precautions.

All models

Sensing range

- The sensing range is specified for the standard sensing object. With a non-ferrous metal, the sensing range is obtained by multiplying with the correction coefficient specified below. Further, the sensing range also changes if the sensing object is smaller than the standard sensing object or if the sensing object is plated.

Correction coefficient

Model No. \ Metal	Iron	Stainless steel (SUS304)	Brass	Aluminum
GX-5SU(B)	1	0.63 approx.	0.32 approx.	0.30 approx.
GX-8MU(B)	1	0.59 approx.	0.32 approx.	0.29 approx.
GX-12MU(B) GX-F12MU-J	1	0.75 approx.	0.51 approx.	0.49 approx.
GX-18MU(B) GX-F18MU-J	1	0.75 approx.	0.50 approx.	0.48 approx.
GX-30MU(B) GX-F30MU-J	1	0.69 approx.	0.44 approx.	0.42 approx.
GX-8MLU(B)	1	0.64 approx.	0.38 approx.	0.38 approx.
GX-12MLU(B)	1	0.67 approx.	0.44 approx.	0.43 approx.
GX-18MLU(B)	1	0.68 approx.	0.45 approx.	0.43 approx.
GX-30MLU(B)	1	0.67 approx.	0.44 approx.	0.43 approx.
GX-N12M(B)	1	0.77 approx.	0.52 approx.	0.51 approx.
GX-N18M(B)	1	0.73 approx.	0.50 approx.	0.48 approx.
GX-N30M(B)	1	0.70 approx.	0.45 approx.	0.44 approx.
GX-N12ML(B)	1	0.66 approx.	0.44 approx.	0.43 approx.
GX-N18ML(B)	1	0.68 approx.	0.46 approx.	0.44 approx.
GX-N30ML(B)	1	0.65 approx.	0.44 approx.	0.43 approx.

Protection cover (Optional)

- It protects the sensing surface from welding sparks (spatter), etc.

Mounting method

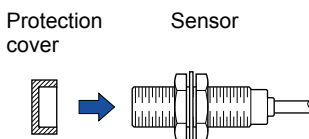

Material: Fluorine resin

Model No.	Applicable model No.
MS-H12	GX-12MU(B) GX-N12M(B)
MS-H18	GX-18MU(B) GX-N18M(B)
MS-H30	GX-30MU(B) GX-N30M(B)

Note: Mount the protection cover so that there is no gap between it and the sensing surface.

Others

- Do not use during the initial transient time (50 ms) after the power supply is switched on.
- Make sure that stress by forcible bend or pulling is not applied directly to the sensor cable joint.

DC 2-wire type

Wiring

- The sensor must be connected to a power supply via a load. If the sensor is connected to a power supply without a load, the short-circuit protection makes the sensor inoperable. (The output stays in the OFF state and the indicator does not light up.) In this case, rectify by connecting the power supply via a load. Now, the sensor becomes operable. Further, take care that if the power supply is connected with reverse polarity without a load, the sensor will get damaged.

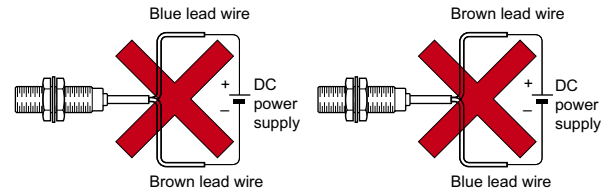

- For series connection (AND circuit) or parallel connection (OR circuit) of sensors, take care of the following.

Series connection (AND circuit)

When all sensors are in the ON state, the load voltage V_{RL} is given by:

$$V_{RL} = V_{CC} - n \times 3 \text{ (V)}$$

(V_{CC} : supply voltage (24 V DC max.)
 n : number of sensors)

Make sure that the load can work properly at this voltage.

Note: The output is generated normally even if the indicator does not light up properly.

Parallel connection (OR circuit)

When all sensors are in the OFF state, the load leakage current I_{CC} is given by:

$$I_{CC} = n \times 0.8 \text{ (mA)} \text{ (n: number of sensors)}$$

Make sure that the load can work properly.

Note: The load current in the ON state is given by:

$$I_L = \frac{V_{CC} - 3V}{\text{Load resistance}} \text{ (mA)}$$

The load current must be $3 \text{ mA} \times n \leq I_L \leq 70 \text{ mA}$ (n: number of sensors turned ON)

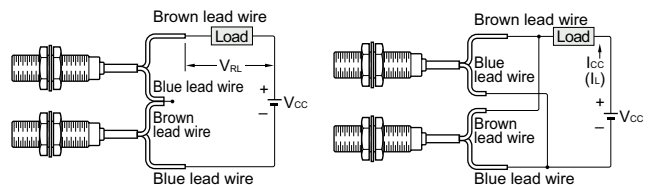

- The residual voltage of the sensor is 3 V. Before connecting a relay as the load, take care of its actuation voltage. (Some 12 V relays may not be usable.)

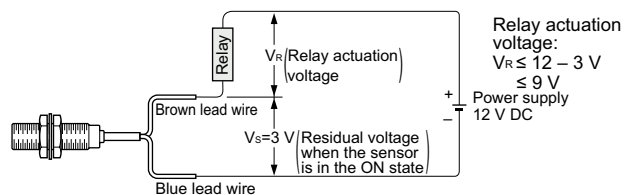

2-color indicator [GX-(F)□U-(J) only]

- When the sensing object is in the stable sensing range, the LED lights up in green, and when the sensing object is in the unstable sensing range, the LED lights up in orange. While the LED lights up in green, the sensing is performed stably without being affected by temperature drifts or voltage fluctuations.

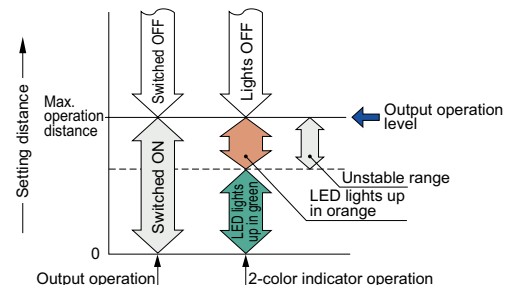

FIBER SENSORS
LASER SENSORS
PHOTO-ELECTRIC SENSORS
MICRO PHOTO-ELECTRIC SENSORS
AREA SENSORS
SAFETY LIGHT CURTAINS / SAFETY COMPONENTS
PRESSURE / FLOW SENSORS
INDUCTIVE PROXIMITY SENSORS
PARTICULAR USE SENSORS
SENSOR OPTIONS
SIMPLE WIRE-SAVING UNITS
WIRE-SAVING SYSTEMS
MEASUREMENT SENSORS
STATIC CONTROL DEVICES
LASER MARKERS
PLC
HUMAN MACHINE INTERFACES
ENERGY MANAGEMENT SOLUTIONS
FA COMPONENTS
MACHINE VISION SYSTEMS
UV CURING SYSTEMS

Selection Guide
Amplifier Built-in
Amplifier-separated
Other Products

GX-F/H
GXL
GL
GX-M
GX-U/GX-FU
GX-N
GX

DIMENSIONS (Unit: mm in)

The CAD data can be downloaded from our website.

- FIBER SENSORS
- LASER SENSORS
- PHOTO-ELECTRIC SENSORS
- MICRO PHOTO-ELECTRIC SENSORS
- AREA SENSORS
- SAFETY LIGHT CURTAINS / SAFETY COMPONENTS
- PRESSURE / FLOW SENSORS
- INDUCTIVE PROXIMITY SENSORS
- PARTICULAR USE SENSORS
- SENSOR OPTIONS
- SMILE WIRE-SAVING UNITS
- WIRE-SAVING SYSTEMS
- MEASURE-MENT SENSORS
- STATIC CONTROL DEVICES
- LASER MARKERS
- PLC
- HUMAN MACHINE INTERFACES
- ENERGY MANAGEMENT SOLUTIONS
- FA COMPONENTS
- MACHINE VISION SYSTEMS
- UV CURING SYSTEMS
- Selection Guide
- Amplifier Built-in
- Amplifier-separated
- Other Products
- GX-F/H**
- GXL**
- GL**
- GX-M**
- GX-U/GX-FU/GX-N**
- GX**

GX-5SU GX-5SUB Sensor

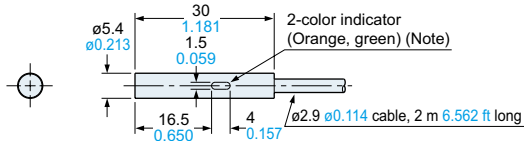

Note: **GX-5SUB** has an operation indicator (orange) instead of the 2-color indicator.

GX-8MU GX-8MUB Sensor

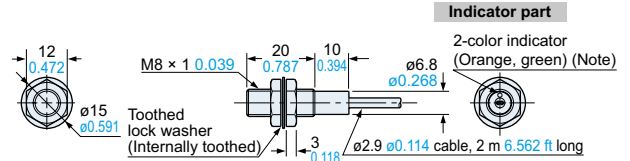

Note: **GX-8MUB** has an operation indicator (orange) instead of the 2-color indicator.

GX-12MU(B) GX-N12M(B) Sensor

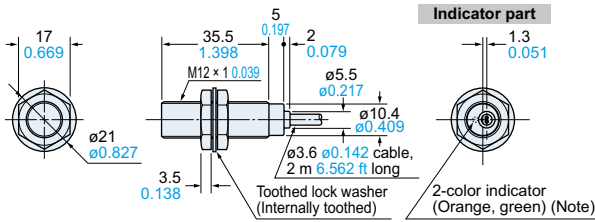

Note: **GX-12MUB** and **GX-N12M(B)** have an operation indicator (orange) instead of the 2-color indicator.

GX-18MU(B) GX-N18M(B) Sensor

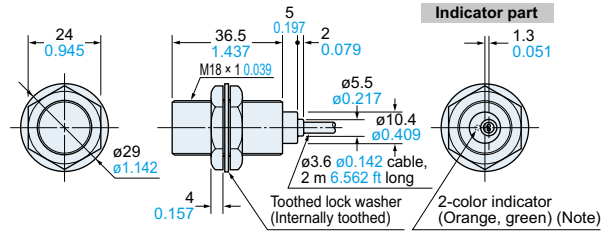

Note: **GX-18MUB** and **GX-N18M(B)** have an operation indicator (orange) instead of the 2-color indicator.

GX-30MU(B) GX-N30M(B) Sensor

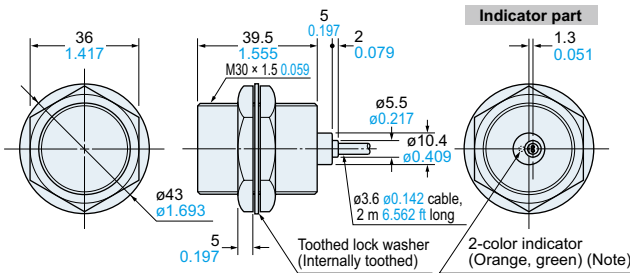

Note: **GX-30MUB** and **GX-N30M(B)** have an operation indicator (orange) instead of the 2-color indicator.

GX-8MLU GX-8MLUB Sensor

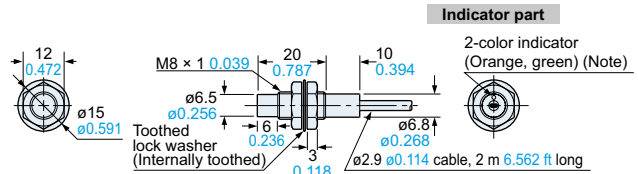

Note: **GX-8MLUB** has an operation indicator (orange) instead of the 2-color indicator.

GX-12MLU(B) GX-N12ML(B) Sensor

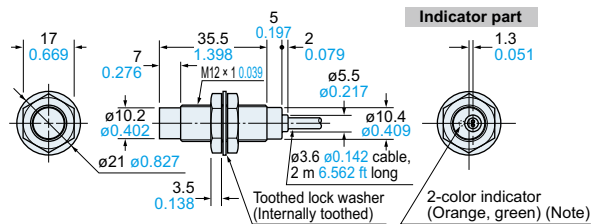

Note: **GX-12MLUB** and **GX-N12ML(B)** have an operation indicator (orange) instead of the 2-color indicator.

GX-18MLU(B) GX-N18ML(B) Sensor

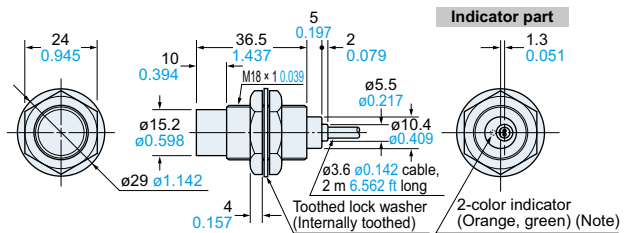

Note: **GX-18MLUB** and **GX-N18ML(B)** have an operation indicator (orange) instead of the 2-color indicator.

GX-30MLU(B) GX-N30ML(B) Sensor

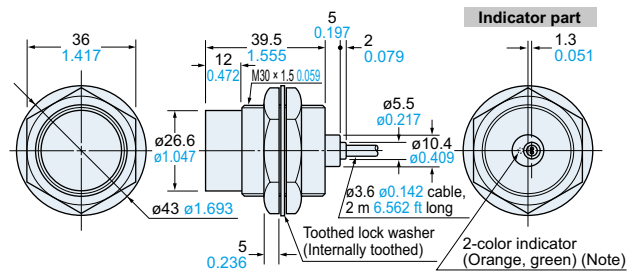

Note: **GX-30MLUB** and **GX-N30ML(B)** have an operation indicator (orange) instead of the 2-color indicator.

GX-12MU(B)-J GX-F12MU-J Sensor

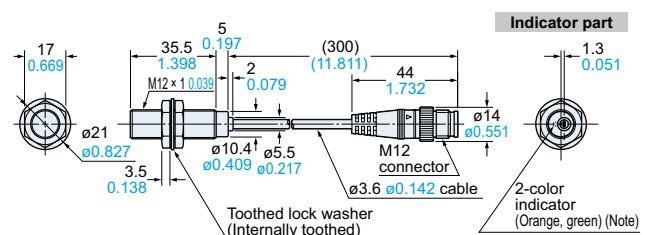

Note: **GX-12MUB-J** has an operation indicator (orange) instead of the 2-color indicator.

DIMENSIONS (Unit: mm in)

The CAD data can be downloaded from our website.

FIBER SENSORS
LASER SENSORS
PHOTO-ELECTRIC SENSORS
MICRO PHOTO-ELECTRIC SENSORS
AREA SENSORS
SAFETY LIGHT CURTAINS / SAFETY COMPONENTS
PRESSURE / FLOW SENSORS
INDUCTIVE PROXIMITY SENSORS
PARTICULAR USE SENSORS
SENSOR OPTIONS
SIMPLE WIRE-SAVING UNITS
WIRE-SAVING SYSTEMS
MEASUREMENT SENSORS
STATIC CONTROL DEVICES
LASER MARKERS
PLC
HUMAN MACHINE INTERFACES
ENERGY MANAGEMENT SOLUTIONS
FA COMPONENTS
MACHINE VISION SYSTEMS
UV CURING SYSTEMS
Selection Guide
Amplifier Built-in
Amplifier-separated
Other Products
GX-F/H
GXL
GL
GX-M
GX-U/GX-FU/GX-N
GX

GX-18MU(B)-J GX-F18MU-J Sensor

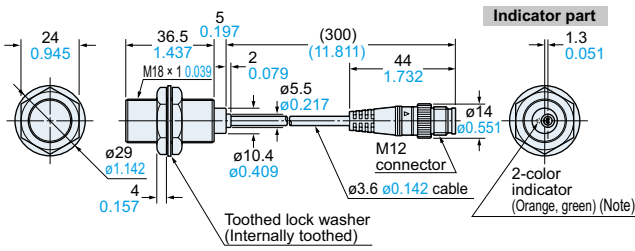

Note: **GX-18MUB-J** has an operation indicator (orange) instead of the 2-color indicator.

GX-30MU(B)-J GX-F30MU-J Sensor

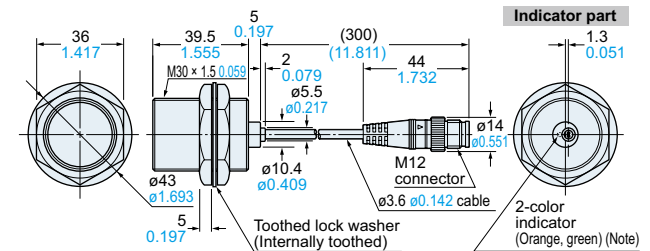

Note: **GX-30MUB-J** has an operation indicator (orange) instead of the 2-color indicator.

GX-12MLU-J GX-12MLUB-J Sensor

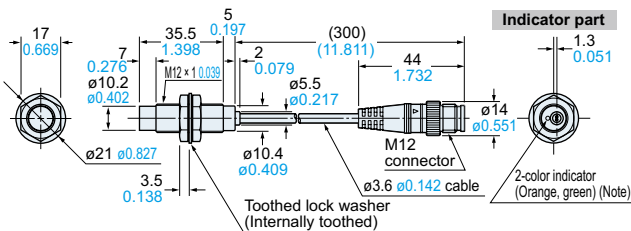

Note: **GX-12MLUB-J** has an operation indicator (orange) instead of the 2-color indicator.

GX-18MLU-J GX-18MLUB-J Sensor

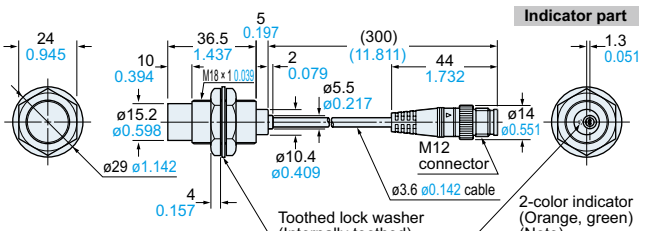

Note: **GX-18MLUB-J** has an operation indicator (orange) instead of the 2-color indicator.

GX-30MLU-J GX-30MLUB-J Sensor

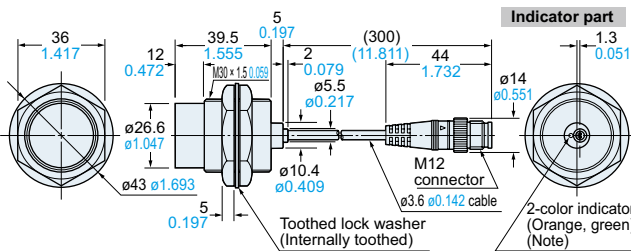

Note: **GX-30MLUB-J** has an operation indicator (orange) instead of the 2-color indicator.

MS-SS5 Sensor mounting bracket for **GX-5SU(B)** (Optional)

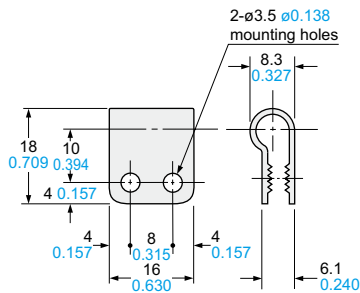

Material: Nylon 66

MS-H12 MS-H18 MS-H30 Protection cover (Optional)

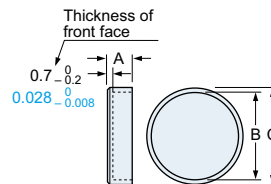

Material: Fluorine resin

Symbol / Model No.	A	B	C	Applicable model No.
MS-H12	5	Ø11.5 Ø0.453	Ø14 Ø0.551	GX-12MU(B) GX-N12M(B)
MS-H18	6	Ø17.5 Ø0.689	Ø20 Ø0.787	GX-18MU(B) GX-N18M(B)
MS-H30	8	Ø29.4 Ø1.157	Ø33 Ø1.299	GX-30MU(B) GX-N30M(B)