

Varistors (ZNR Surge Absorber)

SMD type

VF series

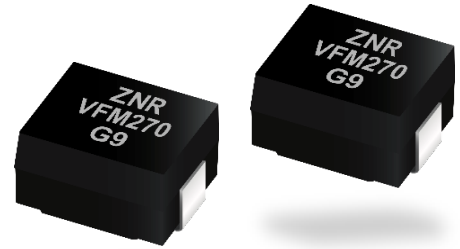

Features

- Large withstanding surge current capability in compact sizes
- Designed for flow/reflow solderings
- Low clamping voltage
- RoHS compliant

Recommended applications

- Protection of communication modules (Modem, xDSL, Terminal Adopler)
- Protection of consumer, industrial equipment
- Absorption of switching surge from relays

■ As for handling precautions and minimum quantity / Packing unit please see related information.

Applicable Standards

- CQC (GB/T10193, GB/T10194)
Registered in "Panasonic Part No."

Explanation of part numbers

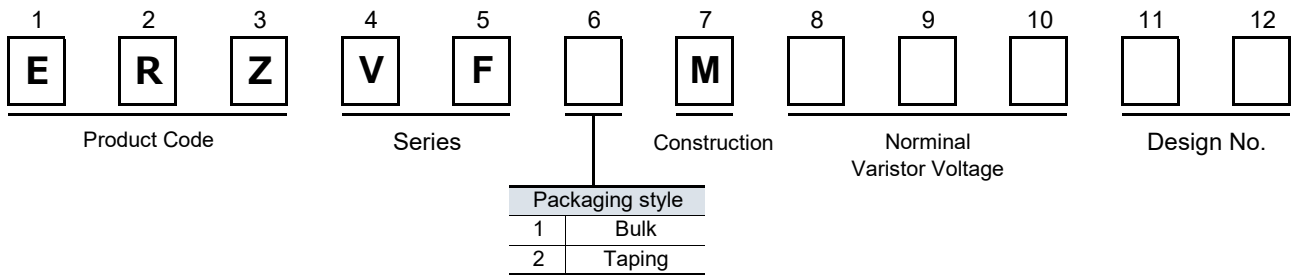

Construction

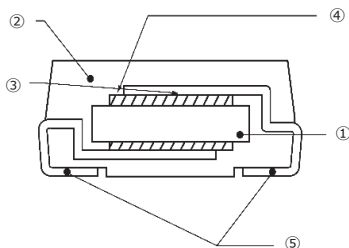

① ZNR element	ZnO etc.
② Resin mold	Epoxy Resin(UL94V-0 approved)
③ Conductive adhesive	Silver
④ Electrode	Silver
⑤ Lead terminals	Sn plated Ni-Fe Alloy

Dimensions in mm (not to scale)

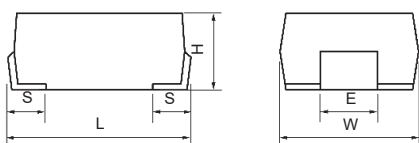

Unit : mm

Part No.	W	L	H	S	E
ERZVF□M□□□	6.0±0.4	8.0±0.5	3.2±0.3	1.3±0.3	2.5±0.2

Ratings and characteristics

● Operating temperature range : -40 to 85 °C

● Storage temperature range : -40 to 125°C

Part No.	Varistor voltage at 1 mA	Maximum allowable voltage		Clamping voltage at I _p (max.)		Rated power (W)	Maximum energy (2 ms) (J)	Maximum peak current (8/20μs, 2 times) (A)
	(V)	ACrms (V)	DC (V)	(V)	Measuring current (A)			
ERZVF□M220	22(20 to 24)	14	18	43	2.5	0.02	0.9	125
ERZVF□M270	27(24 to 30)	17	22	53	2.5	0.02	1.0	125
ERZVF□M330	33(30 to 36)	20	26	65	2.5	0.02	1.2	125
ERZVF□M390	39(35 to 43)	25	31	77	2.5	0.02	1.5	125
ERZVF□M470	47(42 to 52)	30	38	93	2.5	0.02	1.8	125
ERZVF□M560	56(50 to 62)	35	45	110	2.5	0.02	2.2	125
ERZVF□M680	68(61 to 75)	40	56	135	2.5	0.02	2.5	125
ERZVF□M820	82(74 to 90)	50	65	135	10	0.25	3.5	600
ERZVF□M101	100(90 to 110)	60	85	165	10	0.25	4.0	600
ERZVF□M121	120(108 to 132)	75	100	200	10	0.25	5.0	600
ERZVF□M151	150(135 to 165)	95	125	250	10	0.25	6.0	600
ERZVF□M201	200(185 to 225)	130	170	340	10	0.25	8.0	600
ERZVF□M221	220(198 to 242)	140	180	360	10	0.25	9.0	600
ERZVF□M241	240(216 to 264)	150	200	395	10	0.25	10.0	600
ERZVF□M271	270(247 to 303)	175	225	455	10	0.25	12.0	600
ERZVF□M331	330(297 to 363)	210	270	545	10	0.1	8.0	300
ERZVF□M361	360(324 to 396)	230	300	595	10	0.1	9.0	300
ERZVF□M391	390(351 to 429)	250	320	650	10	0.1	9.0	300
ERZVF□M431	430(387 to 473)	275	350	710	10	0.1	10.0	300
ERZVF□M471	470(423 to 517)	300	385	775	10	0.1	10.0	300



Packaging Style Code: "1" for bulk, "2" for embossed taping

Typical characteristics

Voltage vs. Current

ERZVF1(2)M220 to ERZVF1(2)M680

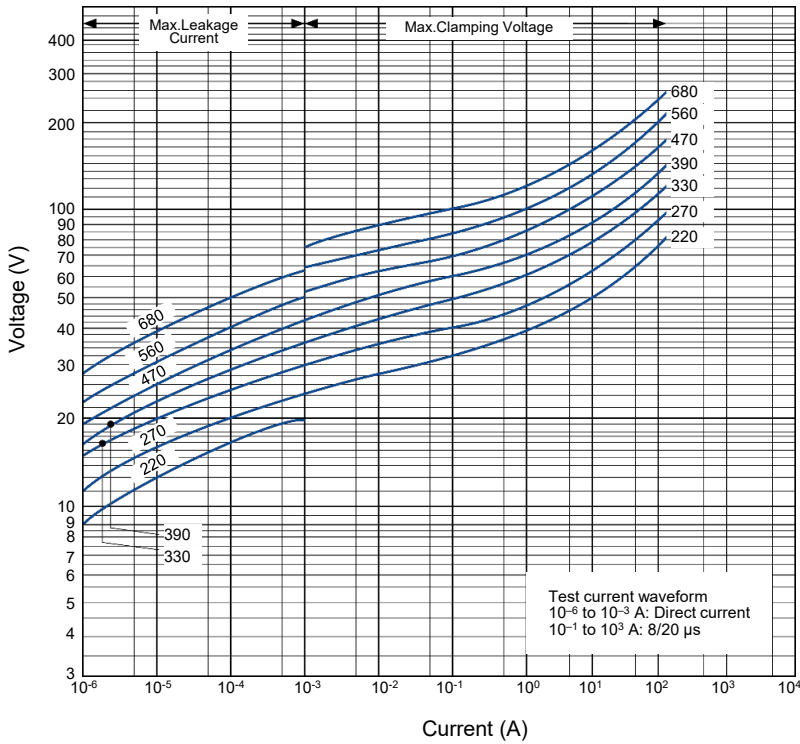

Impulse Derating (Relation between impulse width and impulse current multiple)

ERZVF1(2)M220 to ERZVF1(2)M680

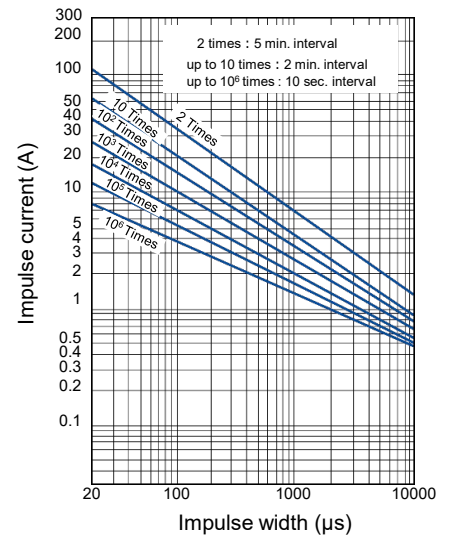

ERZVF1(2)M820 to ERZVF1(2)M271

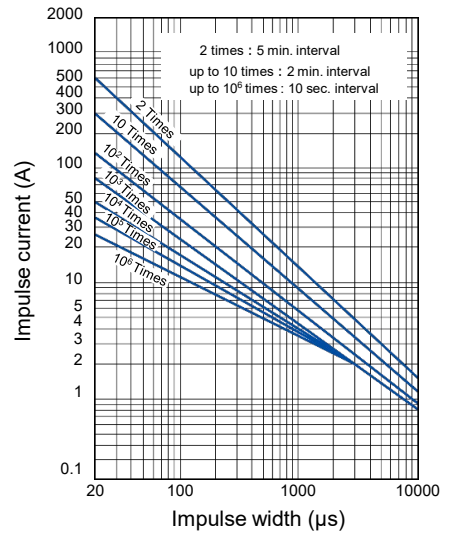

ERZVF1(2)M820 to ERZVF1(2)M471

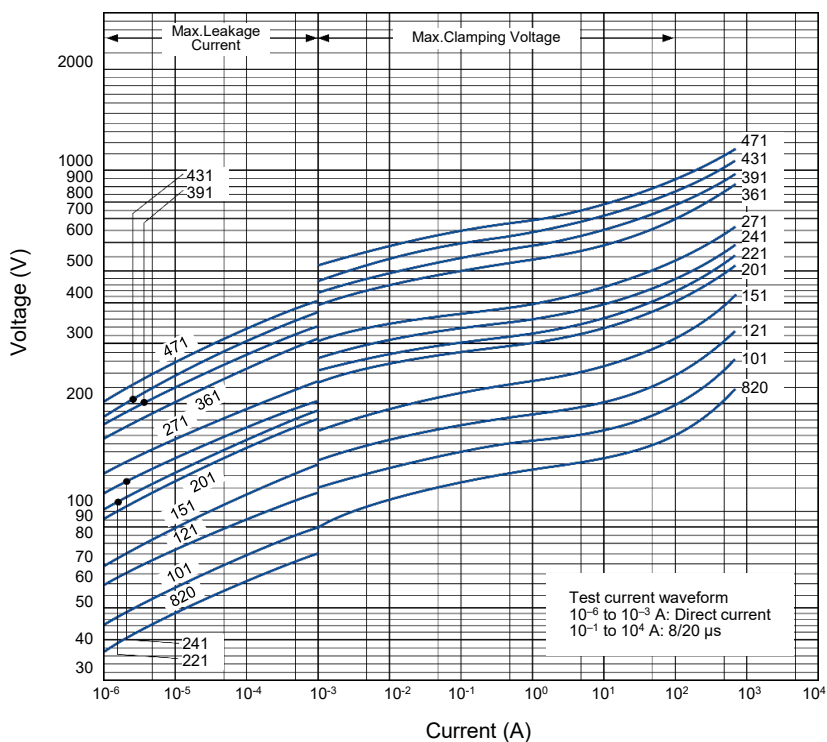

ERZVF1(2)M331 to ERZVF1(2)M471

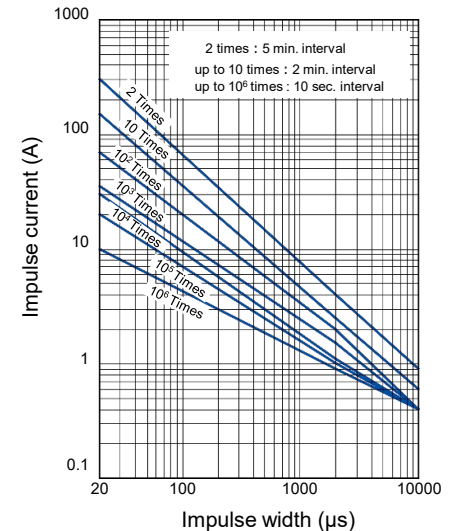

Marking contents

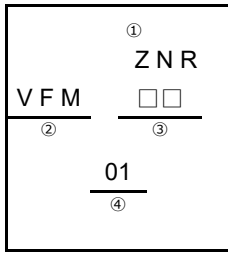

① Product Name	ZNR Surge Absorbers
② Series	VF□M VF Series
③ Abbreviation of Part No.	The first two digits are significant figures and the third one denotes the number of zeros following.
④ Date Code	Left* (Year) 2019:9, 2020:K, 2021:A, 2022:B, 2023:C, 2024:D Right(Month) Jan. to Sep.:1 to 9, Oct.:O, Nov.:N, Dec.:D

* If the 10's digit of a Christian year is an even year, as an end abbreviation, an alphabetic character is used.

1 : A, 2 : B, 3 : C, 4 : D, 5 : E, 6 : F, 7 : G, 8 : H, 9 : J, 0 : K

If the 10's digit of a Christian year is an odd year, as an end abbreviation, a number is used.

Minimum quantity

● Packing Quantity

Product	Series / Type	Part number	Minimum quantity / Packing unit	Packing quantity in carton	Carton (about) L×W×H (mm)	
"ZNR" Transient/surge absorbers	SMD type	Bulk (VF)	ERZVF1	200	2000	210×340×80
	Embossed (VF)	ERZVF2	2000	6000	340×345×75	

※ Part No., quantity and country of origin are designated on outer packages in English.

※ Please contact local sales office about packing specifications.

● Reel

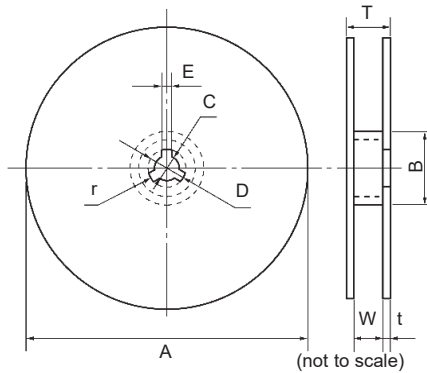

Unit : mm

Part No.	A	B	C
ERZVF□M□□□□	382 max.	50 min.	13.0±0.5
Part No.	D	E	W
ERZVF□M□□□□	21.0±0.8	2.0±0.5	16.4 ^{+2.0} _{..0}
Part No.	T	t	r
ERZVF□M□□□□	22.4 max.	2.5±0.5	1.0

● Embossed Taping

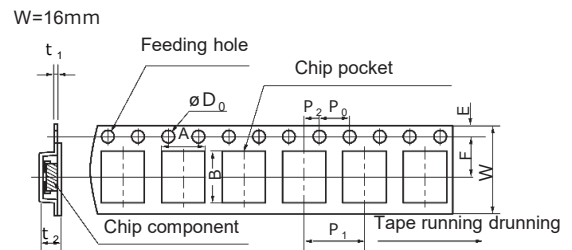

Unit : mm

Part No.	A	B	W
ERZVF□M□□□□	6.8±0.2	11.9 max.	16.0±0.3
Part No.	F	E	P ₁
ERZVF□M□□□□	7.5±0.10	1.75±0.10	8.0±0.1
Part No.	P ₂	P ₀	∅D ₀
ERZVF□M□□□□	2.0±0.1	4.0±0.1	1.5 ^{+0.1} _{..0}
Part No.	t ₁	t ₂	
ERZVF□M□□□□	0.6 max.	6.5 max.	

Performance characteristics														
Characteristics	Test methods	Specifications												
Standard test condition	Electrical measurements (initial/after tests) shall be conducted at temperature of 5 to 35 °C, relative humidity of maximum 85 %.	—												
Varistor voltage	The voltage between two terminals with the specified measuring current 1 mA DC applied is called V_1 or $V_{1\text{ mA}}$. The measurement shall be made as fast as possible to avoid heat affection.	To meet the specified value.												
Maximum allowable voltage	The maximum sinusoidal RMS voltage or maximum DC voltage that can be applied continuously.													
Clamping voltage	The maximum voltage between two terminals with the specified standard impulse current (8/20 μs) illustrated below applied.													
Rated power	The power that can be applied in the specified ambient temperature.													
Maximum energy	Maximum energy of less than $\pm 10\%$ of the varistor voltage change when the standard impulse (2 ms) is applied one time.													
Maximum peak current (Withstanding surge current)	Maximum current of less than $\pm 10\%$ of the varistor voltage change when impulse current (8/20 μs) is applied twice continuously with an interval of 5 minutes.													
Temperature coefficient of varistor voltage	$\frac{V_{1\text{ mA}} \text{ at } 85\text{ }^\circ\text{C} - V_{1\text{ mA}} \text{ at } 25\text{ }^\circ\text{C}}{V_{1\text{ mA}} \text{ at } 25\text{ }^\circ\text{C}} \times \frac{1}{60} \times 100(\%/^\circ\text{C})$	0 to -0.05 %/°C												
Impulse life (I)	<p>The change of V_c shall be measured after the specified impulse is applied 10000 times continuously with an interval of 10 seconds at room temperature.</p> <table border="1"> <thead> <tr> <th>Part No.</th> <th>Waveform</th> <th>Current</th> </tr> </thead> <tbody> <tr> <td>ERZVF□M220 to ERZVF□M680</td> <td>8/20 μs</td> <td>18 A</td> </tr> <tr> <td>ERZVF□M820 to ERZVF□M271</td> <td>8/20 μs</td> <td>50 A</td> </tr> <tr> <td>ERZVF□M331 to ERZVF□M471</td> <td>8/20 μs</td> <td>30 A</td> </tr> </tbody> </table>	Part No.	Waveform	Current	ERZVF□M220 to ERZVF□M680	8/20 μs	18 A	ERZVF□M820 to ERZVF□M271	8/20 μs	50 A	ERZVF□M331 to ERZVF□M471	8/20 μs	30 A	$\Delta V_{1\text{ mA}}/V_{1\text{ mA}} \leq \pm 10\%$
Part No.	Waveform	Current												
ERZVF□M220 to ERZVF□M680	8/20 μs	18 A												
ERZVF□M820 to ERZVF□M271	8/20 μs	50 A												
ERZVF□M331 to ERZVF□M471	8/20 μs	30 A												
Impulse life (II)	<p>The change of V_c shall be measured after the specified impulse is applied 10000 times continuously with an interval of 10 seconds at room temperature.</p> <table border="1"> <thead> <tr> <th>Part No.</th> <th>Waveform</th> <th>Current</th> </tr> </thead> <tbody> <tr> <td>ERZVF□M220 to ERZVF□M680</td> <td>8/20 μs</td> <td>12 A</td> </tr> <tr> <td>ERZVF□M820 to ERZVF□M271</td> <td>8/20 μs</td> <td>35 A</td> </tr> <tr> <td>ERZVF□M331 to ERZVF□M471</td> <td>8/20 μs</td> <td>20 A</td> </tr> </tbody> </table>	Part No.	Waveform	Current	ERZVF□M220 to ERZVF□M680	8/20 μs	12 A	ERZVF□M820 to ERZVF□M271	8/20 μs	35 A	ERZVF□M331 to ERZVF□M471	8/20 μs	20 A	$\Delta V_{1\text{ mA}}/V_{1\text{ mA}} \leq \pm 10\%$
Part No.	Waveform	Current												
ERZVF□M220 to ERZVF□M680	8/20 μs	12 A												
ERZVF□M820 to ERZVF□M271	8/20 μs	35 A												
ERZVF□M331 to ERZVF□M471	8/20 μs	20 A												

Recommendation land size

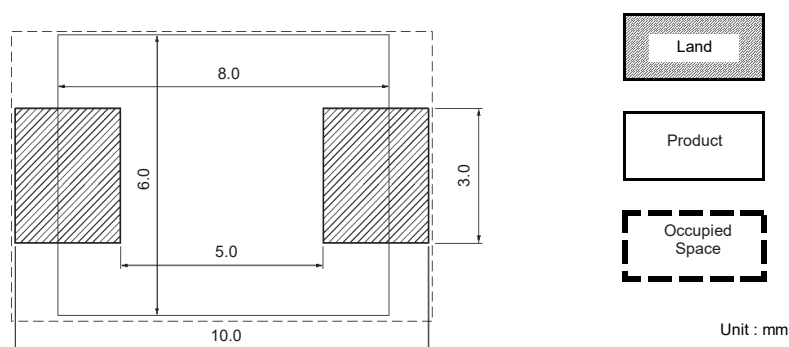

Safety and Legal Matters to Be Observed

Product specifications and applications

- Please be advised that this product and product specifications are subject to change without notice for improvement purposes. Therefore, please request and confirm the latest delivery specifications that explain the specifications in detail before the final design, or purchase or use of the product, regardless of the application. In addition, do not use this product in any way that deviates from the contents of the company's delivery specifications.
- Unless otherwise specified in this catalog or the product specifications, this product is intended for use in general electronic equipment (AV products, home appliances, commercial equipment, office equipment, information and communication equipment, etc.).
When this product is used for the following special cases, the specification document suited to each application shall be signed/sealed (with Panasonic Industry and the user) in advance..These include applications requiring special quality and reliability, wherein their failures or malfunctions may directly threaten human life or cause harm to the human body (e.g.: space/aircraft equipment, transportation/traffic equipment, combustion equipment, medical equipment, disaster prevention/crime prevention equipment, safety equipment, etc.).

Safety design and product evaluation

- Please ensure safety through protection circuits, redundant circuits, etc., in the customer's system design so that a defect in our company's product will not endanger human life or cause other serious damage.
- This catalog shows the quality and performance of individual parts. The durability of parts varies depending on the usage environment and conditions. Therefore, please ensure to evaluate and confirm the state of each part after it has been mounted in your product in the actual operating environment before use.
If you have any doubts about the safety of this product, then please notify us immediately, and be sure to conduct a technical review including the above protection circuits and redundant circuits at your company.

Laws / Regulations / Intellectual property

- The transportation of dangerous goods as designated by UN numbers, UN classifications, etc., does not apply to this product. In addition, when exporting products, product specifications, and technical information described in this catalog, please comply with the laws and regulations of the countries to which the products are exported, especially those concerning security export control.
- Each model of this product complies with the RoHS Directive (Restriction of the use of hazardous substances in electrical and electronic equipment) (2011/65/EU and (EU) 2015/863). The date of compliance with the RoHS Directive and REACH Regulation varies depending on the product model.
Further, if you are using product models in stock and are not sure whether or not they comply with the RoHS Directive or REACH Regulation, please contact us by selecting "Sales Inquiry" from the inquiry form.
- During the manufacturing process of this product and any of its components and materials to be used, Panasonic Industry does not intentionally use ozone-depleting substances stipulated in the Montreal Protocol and specific bromine-based flame retardants such as PBBs (Poly-Brominated Biphenyls) / PBDEs (Poly-Brominated Diphenyl Ethers). In addition, the materials used in this product are all listed as existing chemical substances based on the Act on the Regulation of Manufacture and Evaluation of Chemical Substances.
- With regard to the disposal of this product, please confirm the disposal method in each country and region where it is incorporated into your company's product and used.
- The technical information contained in this catalog is intended to show only typical operation and application circuit examples of this product. This catalog does not guarantee that such information does not infringe upon the intellectual property rights of Panasonic Industry or any third party, nor imply that the license of such rights has been granted.
- Design, materials, or process related to technical owned by Panasonic Industry are subject to change without notice.

Panasonic Industry will assume no liability whatsoever if the use of our company's products deviates from the contents of this catalog or does not comply with the precautions. Please be advised of these restrictions.

Matters to Be Observed When Using This Product

(D-type : V series / SMD-type : HF·VF series)

Safety measures

An abnormal state for varistors (ZNR surge absorbers) of the D type/V series and SMD-Type/HF, VF Series (hereinafter the product or "the surge absorber") that results from a problem with service conditions (materials used, the surrounding environment, power conditions, circuit conditions, etc.) may cause a fire accident, electric shock accident, burn accident, or product failure. Matters to note when handling this product will hereinafter be described. What is described below should be checked sufficiently before the product is used.

■ Confirming rated capabilities

Use the surge absorber within the range of its rated capabilities. Each type of surge absorber has specified rated capabilities including a maximum allowable circuit voltage, a surge current tolerance, an energy tolerance, an impulse lifespan (surge lifespan), average pulse power, and a service temperature. Using the surge absorber under severe service conditions that are beyond the rated capabilities causes degraded performance of the surge absorber or destruction of a circuit element, which may lead to smoke generation, ignition, etc.

■ Take the following measures in order to avoid an accident caused by expected phenomenon.

- (1) Destruction of the surge absorber may scatter its fractured pieces around. To protect other elements from these pieces, set product in a case or shield it with a cover.
- (2) Do not place the surge absorber near combustible materials (vinyl cable, resin mold, etc.). If avoiding the vicinity of combustible materials is difficult, protect the combustible material with an incombustible cover.

(3) Surge absorber placed between lines

When the surge absorber is placed between lines, connect a normal type current fuse in series with the surge absorber.

* See "Current fuse" in the "Circuit design and circuit board design" section.

(4) Surge absorber placed between a line and the ground

- ① When the surge absorber is placed between a line and the ground, even if the surge absorber short-circuits, ground resistance will remain in the section between the line and the ground, leaving a possibility that the current fuse won't blow, in which case the outer sheath resin of the surge absorber may generate smoke or ignite due to current flow. To prevent such a case, place an earth leakage breaker in a location closer to the power supply than the surge absorber. When not using an earth leakage breaker, use a current fuse and temperature fuse in series with each other.

* See Table 1 in the "Circuit design and circuit board design" section.

- ② When the surge absorber is placed between a live part and a metal case, it may cause electric shock if the surge absorber short-circuits. To avoid this, ground the metal case or shield it to prevent direct contact with the metal case.

■ In case the surge absorber should short-circuit and generate smoke or ignite, immediately cut off current flow to the surge absorber.

■ Rated voltage for UL certification, etc.

To allow the surge absorber to meet leak current requirements, etc., a maximum allowable circuit voltage and rated voltage are specified for the surge absorber.

When applying for UL certification, etc. of a device equipped with a surge absorber, ensure the working voltage of the device does not exceed the rated voltage of the surge absorber.

■ An unexpected sharp rise in the working voltage, an incoming excessive surge, etc., may cause the surge absorber to generate smoke or ignite.

In such a case, fire spreading through the device should be prevented to avoid expanded damage. To achieve this, take a multi-protection measure, such as adopting fire-resistant materials that make up the outer shell components and structural materials.

Use environments and cleaning conditions

- Do not use the surge absorber in an outdoor environment where the surge absorber is exposed to sunlight.
- Do not use the surge absorber in which direct sunlight hits the surge absorber or near a heating element where the temperature of the surge absorber would rise above its working temperature.
- Do not use the surge absorber in a place where the surge absorber is exposed to wind or rain or a highly humid place where steam is emitted or dew concentrates.
- Do not use the surge absorber in a place filled with dust or salt, in an atmosphere contaminated with a corrosive gas, etc., or in liquids such as water, oil, chemical, or organic solvents.
- Do not wash the surge absorber with a solvent (thinner, acetone, etc.) that damages the outer sheath resin.

Response to anomalies and handling conditions

Be careful not to drop the surge absorber on the floor, etc. The product is likely to suffer mechanical or electrical damage when dropped on the floor. Avoid using such a product.

Reliability

A capacitor conforming to "AEC-Q200" refers to a capacitor having passed some or all of evaluation test items defined in AEC-Q200.

To know the detailed specifications of each capacitor or specific evaluation test scores, please contact us.

We issue a delivery specification sheet for each product ordered. Please confirm the delivery specification sheet when you place an order with us.

Circuit design and circuit board design

Meet the following requirements. Not following the requirements can result in a shorter lifespan of the surge absorber or its failure.

- Choose a surge absorber whose maximum allowable circuit voltage has a margin relative to the maximum voltage range including source voltage fluctuations.
 - * See Table 1 in the "Circuit design and circuit board design" section.
- When surges are applied intermittently to the surge absorber at short intervals (when pulses of voltages are applied in a noise simulator test, etc.), make sure that the surge power does not exceed the maximum average pulse power of the surge absorber.
- The product numbers of recommended surge absorbers to choose are shown in Table 1.

(1) The case of placing the surge absorber between lines

When the source voltage is expected to rise temporarily due to unbalanced single-wire loads in a three-phase three-wire connection configuration, a short circuit between a voltage line and a neutral line, loss of the neutral line, or resonance of a capacitive load caused by switching on/off, use a surge absorber (varistor) indicated by "*" in Table 1.

(2) The case of placing the surge absorber between a line and the ground

Line-to-ground voltage may rise with a single-wire ground fault, etc. Use a recommended surge absorber in Table 1 that is different from the surge absorber placed between lines. When the device is subjected to an insulation resistance test (500 V DC), use a D-type surge absorber indicated by "*" in Table 1.

According to "Electrical Appliance Technical Standards" based on the Electrical Appliance and Material Safety Act, when using a varistor voltage which would fail the insulation performance test, the surge absorber may be removed from the device when being subjected to the test, depending on circuit test conditions.

* See attached table 4, appendix 4, "Electrical Appliance Technical Standards" based on the Electrical Appliance and Material Safety Act.

When conducting a withstand voltage test (1000 V AC or 1200 V AC) of the device, use the recommended D type / V series surge absorber indicated by "*" in Table 1.

■ Current fuse

- (1) Select a surge absorber and the rated current for a current fuse to be used in a manner shown in the following table. Confirm that no secondary accident arises when the surge absorber in an actual circuit breaks. Selected rated currents of current fuses shown in the following table are exemplary one and may vary depending on circuit conditions used. Confirm the rated current by a test, etc., before using the current fuse.

<Rated currents of current fuses for the D-type / V series surge absorber>

Standard product number	ERZV05D□□□	ERZV07D□□□	ERZV09D□□□	ERZV10D□□□	ERZV14D□□□	ERZV20D□□□
Rating current	3 A max.	5 A max.	7 A max.	7 A max.	10 A max.	10 A max.

* Use the rated voltage of the current fuse that corresponds to the circuit voltage of a circuit including the current fuse.

<Rated current of a current fuse for the SMD-type / VF series surge absorber>

Standard product number	ERZVF□M□□□
Rating current	5 A max.

* Use the rated voltage of the current fuse that corresponds to the circuit voltage of a circuit including the current fuse.

* For the HF series surge absorber, select the rated current of the fuse after confirming the way the fuse handles a load dump surge and the protective coordination action it makes when the surge absorber is destroyed.

- (2) Recommended parts where fuses are connected are shown in Table 1. When a load current to a protected device is so large as to exceed the rated current of the fuse, however, connect the fuse in a location shown in the following diagram.

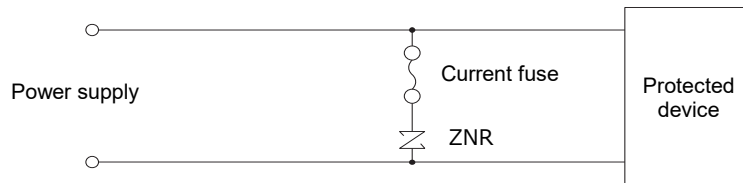

■ Temperature fuse

When connecting the surge absorber to a temperature fuse, choose a connection method and a temperature fuse that allow fine thermal coupling between the surge absorber and the temperature fuse.

Table 1 Application example of the product (ordinary application example)

Connection	Surge absorber placed between lines	Surge absorber placed between a line and the ground																																																							
		<p>DC Single-phase AC</p>	<p>DC Single-phase AC</p>																																																						
	<p>Three-phase AC</p>	<p>Three-phase AC</p>																																																							
Varistor voltage selection	<table border="1"> <thead> <tr> <th rowspan="2">ZNR</th> <th rowspan="2">Power supply voltage [AC]</th> <th colspan="2">Nominal varistor voltage</th> </tr> <tr> <th>D-type</th> <th>SMD-type</th> </tr> </thead> <tbody> <tr> <td rowspan="6">ZNR 1 ZNR 3</td> <td>100 V</td> <td>201 to 361*</td> <td>201 to 361*</td> </tr> <tr> <td>120 V</td> <td>241 to 431*</td> <td>241 to 431*</td> </tr> <tr> <td>200 V</td> <td>471 to 621*</td> <td>471</td> </tr> <tr> <td>220 V</td> <td>471 to 621*</td> <td>471</td> </tr> <tr> <td>240 V</td> <td>511, 621*</td> <td>-</td> </tr> <tr> <td>380 V</td> <td>751, 821*</td> <td>-</td> </tr> </tbody> </table>	ZNR	Power supply voltage [AC]	Nominal varistor voltage		D-type	SMD-type	ZNR 1 ZNR 3	100 V	201 to 361*	201 to 361*	120 V	241 to 431*	241 to 431*	200 V	471 to 621*	471	220 V	471 to 621*	471	240 V	511, 621*	-	380 V	751, 821*	-	<table border="1"> <thead> <tr> <th rowspan="2">ZNR</th> <th rowspan="2">Power supply voltage [AC]</th> <th colspan="2">Nominal varistor voltage</th> </tr> <tr> <th>D-type</th> <th>SMD-type</th> </tr> </thead> <tbody> <tr> <td rowspan="10">ZNR 2 ZNR 4</td> <td rowspan="5">100 V 220 V</td> <td>471</td> <td>471</td> </tr> <tr> <td>511</td> <td>-</td> </tr> <tr> <td>621*</td> <td>-</td> </tr> <tr> <td>821 or higher**</td> <td>-</td> </tr> <tr> <td>182***</td> <td>-</td> </tr> <tr> <td rowspan="3">230 V</td> <td>511</td> <td>-</td> </tr> <tr> <td>621*</td> <td>-</td> </tr> <tr> <td>821 or higher**</td> <td>-</td> </tr> <tr> <td rowspan="2">380 V</td> <td>112**</td> <td>-</td> </tr> <tr> <td>182***</td> <td>-</td> </tr> </tbody> </table>	ZNR	Power supply voltage [AC]	Nominal varistor voltage		D-type	SMD-type	ZNR 2 ZNR 4	100 V 220 V	471	471	511	-	621*	-	821 or higher**	-	182***	-	230 V	511	-	621*	-	821 or higher**	-	380 V	112**	-	182***	-
	ZNR			Power supply voltage [AC]	Nominal varistor voltage																																																				
D-type		SMD-type																																																							
ZNR 1 ZNR 3	100 V	201 to 361*	201 to 361*																																																						
	120 V	241 to 431*	241 to 431*																																																						
	200 V	471 to 621*	471																																																						
	220 V	471 to 621*	471																																																						
	240 V	511, 621*	-																																																						
	380 V	751, 821*	-																																																						
ZNR	Power supply voltage [AC]	Nominal varistor voltage																																																							
		D-type	SMD-type																																																						
ZNR 2 ZNR 4	100 V 220 V	471	471																																																						
		511	-																																																						
		621*	-																																																						
		821 or higher**	-																																																						
		182***	-																																																						
	230 V	511	-																																																						
		621*	-																																																						
		821 or higher**	-																																																						
	380 V	112**	-																																																						
		182***	-																																																						
	<p>* Choose the element size while taking surge conditions into consideration.</p>																																																								

Processing conditions

- Do not apply vibration, impact (drop impact, etc.), or pressure strong enough to crack the outer sheath resin or absorber body of the surge absorber.
- When coating the surge absorber with a resin or embedding it in a resin mold, avoid using a resin that degrades the surge absorber.
- Do not bend or apply a force to the lead of a D-type surge absorber close to the outer sheath resin.

Mounting and storage conditions

- When soldering the surge absorber, follow recommended soldering conditions shown in the following table so that solder or the insulation material making up the surge absorber is not melted.
- When making holes for mounting the surge absorber on the board, check the dimensions of the holes on the board, referencing the central point of the interval between the leads.
Because the overall dimensional tolerance is large, forming the holes with high precision requires careful processing.

	Soldering method	Recommended conditions	Mater to note
D-type	Flow soldering (solder bath immersion method)	260 °C, 10 seconds or less	The D-type surge absorber should not be soldered by reflow soldering.
SMD-type	Flow soldering (solder bath immersion method)	260 °C, 10 seconds or less	A high component mounting density may lead to poor solderability. In such a case, consider vent hole formation.
	Reflow soldering (controlled atmosphere heating method)	Refer to the recommended soldering temperature profile.	When a land is excessively larger than the terminal surface of a component, the component may shift position when solder is melted.

- Note 1: Soldering the surge absorber under soldering conditions different from the recommended soldering conditions requires extra checking to ensure it won't cause any problems.
Additional soldering is allowed only once. It must be done within 5 seconds, with the soldering iron temperature kept at 400 °C or lower.
- Note 2: A temperature profile may include a large error, depending on the measurement method used.
Be careful in such cases.
- Note 3: Board temperatures vary depending on the sizes of boards and mounting densities. Confirm the temperature for each type of board.

<Recommended soldering temperature profile>

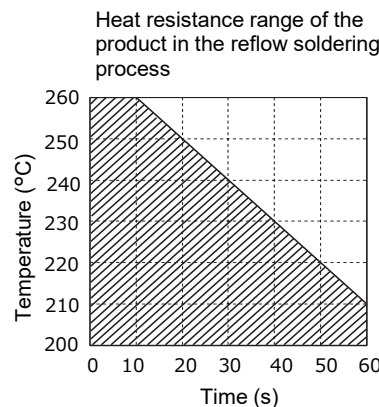
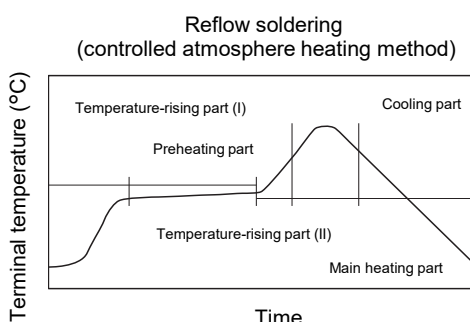
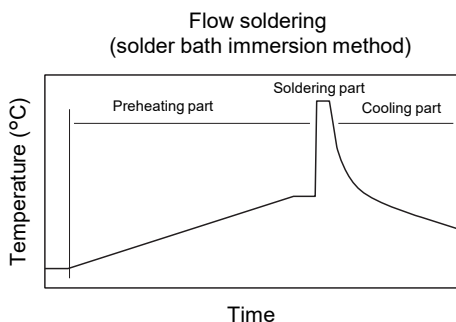

Preheating part	Normal temperature to 130 °C	120 seconds or less
Soldering part	260 °C or less	10 seconds or less
Cooling part	Gradual cooling (cooling under the normal temperature)	

Temperature-rising part I	Normal temperature to preheating temperature	30 to 60 seconds
Preheating part	150 °C to 180 °C	60 to 120 seconds
Temperature-rising part II	Preheating temperature to 200 °C	2 to 6 °C per second
Main heating part	Refer to the heat resistance range of the product in the reflow soldering process.	
Cooling part	200 °C to 100 °C	1 to 4 °C per second

* Do not perform reflow soldering more than two times.

- Mounting the surge absorber (SMD-type)
When mounting the surge absorber on the board, make sure that no excessive impact or load, such as pressure from a suction nozzle for mounting the absorber, positional shift, or mechanical impact/stress caused by a positioning of the absorber, is applied to the surge absorber. There are cases where the surge absorber shifts from its intended position when mounted on the board. In such cases, consider a method of bonding the board and the outer sheath resin together.
- Do not keep the product in a high-temperature or high-humidity condition. Keep the surge absorber in a room with a temperature of 40 °C or lower and a relative humidity of 75% or lower and use the surge absorber within two years of storage. Check the solderability of a surge absorber stored for a long period (two years or more) before using the surge absorber.
- Keep the surge absorber in a place where no corrosive gas atmosphere (hydrogen sulfide, sulfurous acid, chlorine, ammonia, etc.) is present.
- Keep the surge absorber in a place where the surge absorber is protected from direct sunlight, dew concentration, etc.