



Discontinued: Built-in diode type
Last time buy: February 29, 2012

Panasonic

ideas for life

AUTOMOTIVE RELAY WITH ISO TERMINAL ARRANGEMENT

CB RELAYS



RoHS compliant

FEATURES

• **This relay has an ISO (International Organization for Standardization) terminal arrangement.**

Terminals are all solder plated.

*35 A type: Terminal is the plug-in type (no plating).

• **Relay is compact and high capacity (40 A).**

Compact form factor realized with space saving 22 × 26 mm .866 × 1.024 inch small base area thanks to integrated bobbin and base construction. Features high switching capacity of 40 A

• **Features high thermal resistance of 125°C 257°F (heat resistant type).**

Heat resistant type is available that can withstand use near engines. (40 A switching capacity)

• **Sealed type available for resisting adverse environments.**

• **Surge absorbing built-in diode type that works when the relay coil is off and an internal resistor type are available. (Please inquire.)**

• **Protective element type is also available.**

• **For only plug-in types, types with nominal switching capacities of 35 A (12 V) and 15 A (24 V) are available.**

TYPICAL APPLICATIONS

• **Automobiles**

Headlights, Cell motors, Air conditioners, ABS, EPS, etc.

• **Construction equipment**

• **Agricultural equipment, Conveyor, etc.**

ORDERING INFORMATION

CB - -

Contact arrangement

1a: 1 Form A

1: 1 Form C

Contact rating

Nil: Standard type

H: High contact capacity type

V: 35 A type

Protective construction

Nil: Sealed type

F: Flux-resistant type

Heat resistant of types

Nil: Standard type

T: Heat resistant type

Protective element

Nil: None

D: with diode inside

R: with resistor inside

Mounting classification

Nil: Plug-in type

P: PC board type

M: Bracket type

Coil voltage (DC)

12V, 24 V



TYPES

1. Standard type

Contact arrangement	Mounting classification	Nominal coil voltage	Sealed type	Flux-resistant type
			Part No.	Part No.
1 Form A	PC board type	12V DC	CB1a-P-12V	CB1aF-P-12V
		24V DC	CB1a-P-24V	CB1aF-P-24V
	Plug-in type	12V DC	CB1a-12V	CB1aF-12V
		24V DC	CB1a-24V	CB1aF-24V
	Bracket type	12V DC	CB1a-M-12V	CB1aF-M-12V
		24V DC	CB1a-M-24V	CB1aF-M-24V
1 Form C	PC board type	12V DC	CB1-P-12V	CB1F-P-12V
		24V DC	CB1-P-24V	CB1F-P-24V
	Plug-in type	12V DC	CB1-12V	CB1F-12V
		24V DC	CB1-24V	CB1F-24V
	Bracket type	12V DC	CB1-M-12V	CB1F-M-12V
		24V DC	CB1-M-24V	CB1F-M-24V
High contact capacity (1 Form A)	PC board type*	12V DC	CB1aH-P-12V	CB1aHF-P-12V
		24V DC	CB1aH-P-24V	CB1aHF-P-24V
	Plug-in type	12V DC	CB1aH-12V	CB1aHF-12V
		24V DC	CB1aH-24V	CB1aHF-24V
	Bracket type	12V DC	CB1aH-M-12V	CB1aHF-M-12V
		24V DC	CB1aH-M-24V	CB1aHF-M-24V

Standard packing; Carton: 50 pcs. Case: 200 pcs.

Notes: 1. Please use "CB***R**" to order built-in resistor type and "CB***D**" to order built-in diode type. (Asterisks "*" should be filled in from ORDERING INFORMATION.)
 2. *Regarding solder, this product is not MIL (Military Standard) compliant. Please evaluate solder mounting by the actual equipment before using.

2. Heat resistant type

Contact arrangement	Mounting classification	Nominal coil voltage	Sealed type	Flux-resistant type
			Part No.	Part No.
1 Form A	PC board type	12V DC	CB1a-T-P-12V	CB1aF-T-P-12V
		24V DC	CB1a-T-P-24V	CB1aF-T-P-24V
	Plug-in type	12V DC	CB1a-T-12V	CB1aF-T-12V
		24V DC	CB1a-T-24V	CB1aF-T-24V
	Bracket type	12V DC	CB1a-T-M-12V	CB1aF-T-M-12V
		24V DC	CB1a-T-M-24V	CB1aF-T-M-24V
1 Form C	PC board type	12V DC	CB1-T-P-12V	CB1F-T-P-12V
		24V DC	CB1-T-P-24V	CB1F-T-P-24V
	Plug-in type	12V DC	CB1-T-12V	CB1F-T-12V
		24V DC	CB1-T-24V	CB1F-T-24V
	Bracket type	12V DC	CB1-T-M-12V	CB1F-T-M-12V
		24V DC	CB1-T-M-24V	CB1F-T-M-24V
High contact capacity (1 Form A)	PC board type*	12V DC	CB1aH-T-P-12V	CB1aHF-T-P-12V
		24V DC	CB1aH-T-P-24V	CB1aHF-T-P-24V
	Plug-in type	12V DC	CB1aH-T-12V	CB1aHF-T-12V
		24V DC	CB1aH-T-24V	CB1aHF-T-24V
	Bracket type	12V DC	CB1aH-T-M-12V	CB1aHF-T-M-12V
		24V DC	CB1aH-T-M-24V	CB1aHF-T-M-24V

Standard packing; Carton: 50 pcs. Case: 200 pcs.

Notes: 1. Please use "CB***R**" to order built-in resistor type and "CB***D**" to order built-in diode type. (Asterisks "*" should be filled in from ORDERING INFORMATION.)
 2. *Regarding solder, this product is not MIL (Military Standard) compliant. Please evaluate solder mounting by the actual equipment before using.

New

3. 35 A type (*Terminals are all of the plug-in type.)

Contact arrangement	Nominal coil voltage	Sealed type	Flux-resistant type
		Part No.	Part No.
1 Form A	12V DC	CB1aV-12V	CB1aVF-12V
	24V DC	CB1aV-24V	CB1aVF-24V
1 Form C	12V DC	CB1V-12V	CB1VF-12V
	24V DC	CB1V-24V	CB1VF-24V
1 Form A with resistor inside	12V DC	CB1aV-R-12V	CB1aVF-R-12V
	24V DC	CB1aV-R-24V	CB1aVF-R-24V
1 Form C with resistor inside	12V DC	CB1V-R-12V	CB1VF-R-12V
	24V DC	CB1V-R-24V	CB1VF-R-24V
1 Form A with diode inside	12V DC	CB1aV-D-12V	CB1aVF-D-12V
	24V DC	CB1aV-D-24V	CB1aVF-D-24V
1 Form C with diode inside	12V DC	CB1V-D-12V	CB1VF-D-12V
	24V DC	CB1V-D-24V	CB1VF-D-24V

Standard packing; Carton: 50 pcs. Case: 200 pcs.



Discontinued: Built-in diode type
Last time buy: February 29, 2012

CB

RATING

1. Coil data

1) No protective element and with diode inside

Contact arrangement	Nominal coil voltage	Pick-up voltage	Drop-out voltage	Nominal operating current	Coil resistance	Nominal operating power	Usable voltage range
1 Form A, 1 Form C	12V DC	3 to 7V DC	1.2 to 4.2V DC	117mA	103Ω	1.4W	10 to 16V DC
	24V DC	6 to 14V DC	2.4 to 8.4V DC	75mA	320Ω	1.8W	20 to 32V DC
High contact capacity (1 Form A)	12V DC	3 to 7V DC	1.2 to 4.2V DC	117mA	103Ω	1.4W (PC board type)	10 to 16V DC
				150mA	80Ω	1.8W	
	24V DC	6 to 14V DC	2.4 to 8.4V DC	58mA	411Ω	1.4W (PC board type)	20 to 32V DC
				75mA	320Ω	1.8W	

Note: Other pick-up voltage types are also available. Please contact us for details.

2) With resistor inside

Contact arrangement	Nominal coil voltage	Pick-up voltage (Initial, at 20°C 68°F)	Drop-out voltage (Initial, at 20°C 68°F)	Nominal operating current (at 20°C 68°F)	Combined resistance (±10%) (at 20°C 68°F)	Nominal operating power (at 20°C 68°F)	Usable voltage range
1 Form A, 1 Form C	12V DC	3 to 7V DC	1.2 to 4.2V DC	134mA	89.5Ω	1.6W	10 to 16V DC
	24V DC	6 to 14V DC	2.4 to 8.4V DC	84mA	287.2Ω	2.0W	20 to 32V DC

2. Specifications

1) Standard type (12 V coil voltage)

Characteristics	Item	Specification	
Contact	Arrangement	1 Form A 1 Form C High contact capacity (1 Form A)	
	Contact resistance (Initial)	Typ2mΩ (By voltage drop 6 V DC 1 A)	
	Contact material	Ag alloy (Cadmium free)	
Rating	Nominal switching capacity (Initial)	40A 14V DC N.O.: 40A 14V DC N.C.: 30A 14V DC 70A 14V DC (at 20°C 68°F) 50A 14V DC (at 85°C 185°F)	
	Max. carrying current (Initial) (14V DC, at 85°C 185°F, continuous)	N.O.: 40A N.O.: 40A, N.C.: 30A N.O.: 40A	
	Nominal operating power	1.4W 1.4W 1.8W (1.4W: PC board type)	
	Min. switching capacity (resistive load)*1	1A 12V DC (12V DC), 1A 24V DC (24V DC)	
Electrical characteristics	Insulation resistance (Initial)	Min. 20 MΩ (at 500 V DC)	
	Breakdown voltage (Initial)	Between open contacts	500 Vrms for 1 min. (Detection current: 10mA)
		Between contacts and coil	500 Vrms for 1 min. (Detection current: 10mA)
	Operate time (at nominal coil voltage) (at 20°C 68°F)	Max. 15ms (excluding contact bounce time) (Initial)	
Release time (at nominal coil voltage) (at 20°C 68°F)	Max. 15ms (excluding contact bounce time, without diode) (Initial)		
Mechanical characteristics	Shock resistance	Functional	Min. 200 m/s ² {20G}
		Destructive	Min. 1,000 m/s ² {100G}
	Vibration resistance	Functional	10 Hz to 500 Hz, Min. 44.1m/s ² {4.5G}
Expected life	Electrical (at nominal switching capacity)	Flux-resistant type: Min. 10 ⁵ , Sealed type: Min. 5×10 ⁴ (Operating frequency: 2s ON, 2s OFF)	
	Mechanical	Min. 10 ⁶ (at 120 cpm)	
Conditions	Conditions for operation, transport and storage*2	Standard type; Ambient temperature: -40 to +85°C -40 to +185°F, Humidity: 5 to 85% R.H. (Not freezing and condensing at low temperature)	
		Heat resistant type; Ambient temperature: -40 to +125°C -40 to +257°F, Humidity: 5 to 85% R.H. (Not freezing and condensing at low temperature)	
	Max. operating speed	15 cpm (at nominal switching capacity)	
Mass		Approx. 33 g 1.16 oz	

Notes: *1. This value can change due to the switching frequency, environmental conditions, and desired reliability level, therefore it is recommended to check this with the actual load.

*2. The upper operation ambient temperature limit is the maximum temperature that can satisfy the coil temperature rise value. Please refer to "Usage ambient condition" in CAUTIONS FOR USE OF AUTOMOTIVE RELAYS.

2) Standard type (24 V coil voltage)

Characteristics	Item	Specifications
Contact	Arrangement	1 Form A 1 Form C High contact capacity (1 Form A)
	Contact resistance (Initial)	Max. 15mΩ (By voltage drop 6 V DC 1 A)
	Contact material	Ag alloy (Cadmium free)
Rating	Nominal switching capacity (Initial)	20A 28V DC N.O.: 20A 28V DC N.C.: 10A 28V DC 20A 28V DC
	Max. carrying current (Initial) (28V DC, at 85°C 185°F, continuous)	20A N.O.: 20A, N.C.: 10A 20A
	Nominal operating power	1.8W 1.8W 1.8W, 1.4W (PC board type)

Note: All other specifications are the same as those of standard type (12 V coil voltage)



3) Heat resistant type (12 V and 24 V coil voltage)

Characteristics	Item	Specifications						
		12V			24V			
Contact	Arrangement	1 Form A	1 Form C	High contact capacity (1 Form A)		1 Form A	1 Form C	High contact capacity (1 Form A)
	Contact resistance (Initial)	Max. 15mΩ (By voltage drop 6 V DC 1 A)						
	Contact material	Ag alloy (Cadmium free)						
Rating	Nominal switching capacity (Initial)	40A 14V DC	N.O.: 40A 14V DC N.C.: 30A 14V DC	40A 14V DC		20A 28V DC	N.O.: 20A 28V DC N.C.: 10A 28V DC	20A 28V DC
	Max. carrying current (Initial) (at 85°C 185°F, continuous)*	50A 14V DC	N.O.: 50A 14V DC N.C.: 30A 14V DC	45A 14V DC	50A 14V DC	25A 28V DC	N.O.: 25A 28V DC N.C.: 10A 28V DC	25A 28V DC
	Nominal operating power	1.4W	1.4W	1.8W	1.4W (PC board type)	1.8W	1.8W	1.8W, 1.4W (PC board type)

Notes: 1. All other specifications are the same as those of standard type (12 V coil voltage)
2. *Current value in which carry current is possible when the coil temperature is 180°C 356°F

4) 35 A type (12 V coil voltage)

Characteristics	Item	Specifications	
		1 Form A	1 Form C
Contact	Arrangement		
	Contact resistance (Initial)	Typ2mΩ (By voltage drop 6 V DC 1 A)	
	Contact material	Ag alloy (Cadmium free)	
Rating	Nominal switching capacity (Resistive load)	35A 14V DC	
	Max. carrying current (Initial) (14V DC, at 85°C 185°F, continuous)	N.O.: 35A	
	Nominal operating power	1.4W, 1.6W (with resistor inside)	
	Min. switching capacity (Reference value)*	1A 12V DC (12V DC), 1A 24V DC (24V DC)	
Electrical characteristics	Insulation resistance (Initial)	Min. 20 MΩ (at 500 V DC)	
	Breakdown voltage (Initial)	Between open contacts	500 Vrms for 1 min. (Detection current: 10mA)
		Between contacts and coil	500 Vrms for 1 min. (Detection current: 10mA)
	Operate time (at nominal coil voltage)	Max. 15ms (excluding contact bounce time) (Initial)	
	Release time (at nominal coil voltage)	Max. 15ms (excluding contact bounce time, without diode) (Initial)	
Mechanical characteristics	Shock resistance	Functional	Min. 100 m/s ² {approx. 10G} (Half-wave pulse of sine wave: 11ms; detection time: 10μs)
		Destructive	Min. 1,000 m/s ² {approx. 100G} (Half-wave pulse of sine wave: 6ms)
	Vibration resistance	Functional	10 Hz to 100 Hz, Min. 44.1m/s ² {approx. 4.5G} (Detection time: 10μs)
		Destructive	10 Hz to 2,000 Hz, Min. 44.1m/s ² {approx. 4.5G} Time of vibration for each direction; X, Y, Z direction: 4 hours
Expected life	Electrical (at nominal switching capacity)	Flux-resistant type: Min. 10 ⁵ , Sealed type: Min. 5×10 ⁴ (Operating frequency: 2s ON, 2s OFF) With diode inside: Min. 5×10 ⁴ (Operating frequency: 2s ON, 2s OFF)	
	Mechanical	Min. 10 ⁶ (at 120 cpm)	
Conditions	Conditions for operation, transport and storage	Ambient temperature: -40°C to +85°C -40°F to +185°F Humidity: 5% R.H. to 85% R.H. (Not freezing and condensing at low temperature)	
	Max. operating speed	15 cpm (at nominal switching capacity)	
Mass		Approx. 26 g .92 oz, Approx. 28 g .99 oz (with diode inside)	

Note: * This value can change due to the switching frequency, environmental conditions, and desired reliability level, therefore it is recommended to check this with the actual load.

5) 35 A type (24 V coil voltage)

Characteristics	Item	Specifications	
		1 Form A	1 Form C
Contact	Arrangement		
	Nominal switching capacity (Resistive load)	15A 28V DC	N.O.: 15A 28V DC, N.C.: 8A 28V DC
Rating	Max. carrying current (14V DC, at 85°C 185°F, continuous)	N.O.: 15A	
	Nominal operating power	1.8W, 2.0W (with resistor inside)	

Note: All other specifications are the same as those of 35 A type (12 V coil voltage).



Discontinued: Built-in diode type
Last time buy: February 29, 2012

CB

REFERENCE DATA

CB RELAYS (Standard type)

1. Allowable ambient temperature
 (Heat resistant standard type)

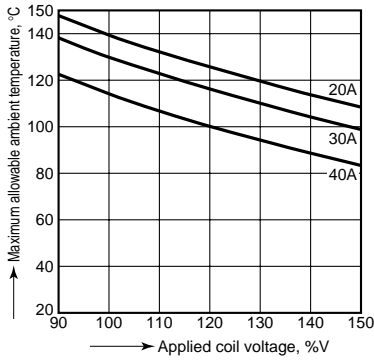

Assumption:

- Maximum mean coil temperature: 180°C
- Curves are based on 1.4W (Nominal power consumption of the unsuppressed coil at nominal voltage)

2. Max. switching capability (Resistive load)
 (Standard type)

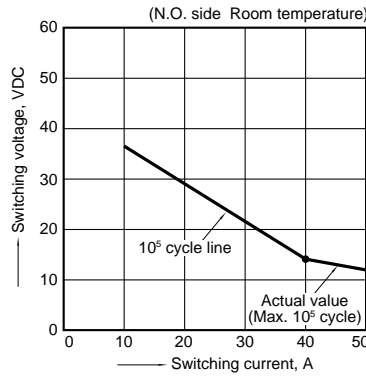

3. Ambient temperature and operating voltage range
 (Standard type)

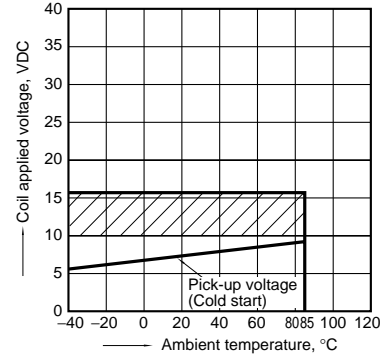

4. Distribution of pick-up and drop-out voltage
 Sample: CB1-P-12V, 42pcs.

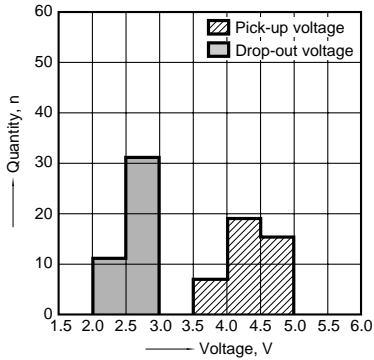

5. Distribution of operate and release time
 Sample: CB1-P-12V, 42pcs.
 * Without diode

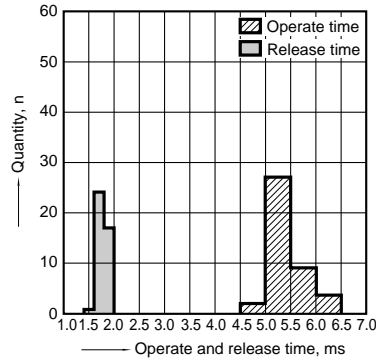

6-(1). Electrical life test (Motor free)

Sample: CB1F-12V, 5pcs.
 Load: 25A 14V DC, motor free actual load
 Operating frequency: ON 1s, OFF 9s
 Ambient temperature: Room temperature
 Circuit

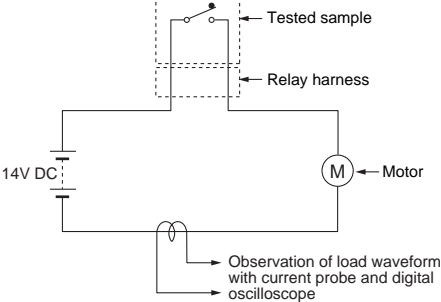

Load current waveform

Inrush current: 80A, Steady current: 25A

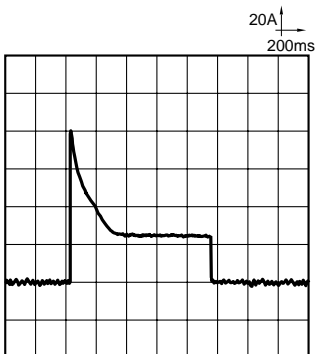

Change of pick-up and drop-out voltage

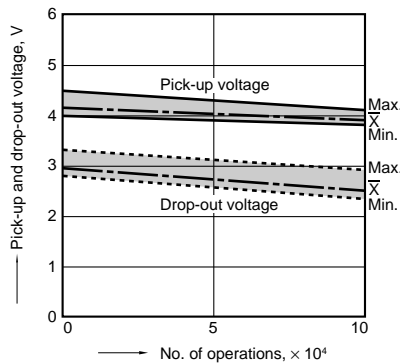

Change of contact resistance

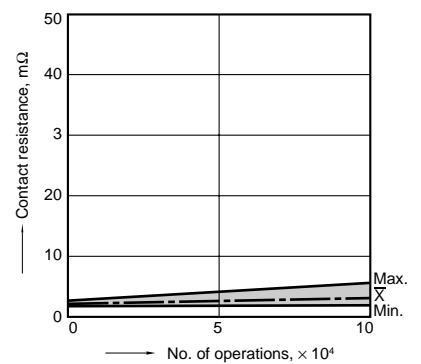



6-(2). Electrical life test (Lamp load)

Sample: CB1F-12V, 5pcs.
 Load: 45/65Wx5 parallel, 14V DC, halogen lamp actual load
 Operating frequency: ON 1s, OFF 8s
 Ambient temperature: Room temperature
 Circuit

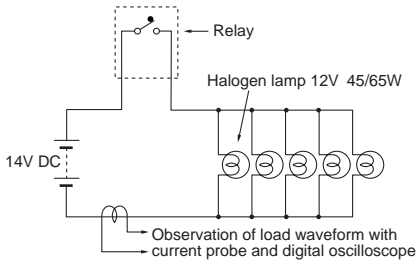

Load current waveform

Inrush current: 100A, Steady current: 20A

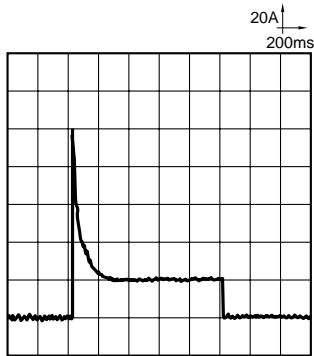

Change of pick-up and drop-out voltage

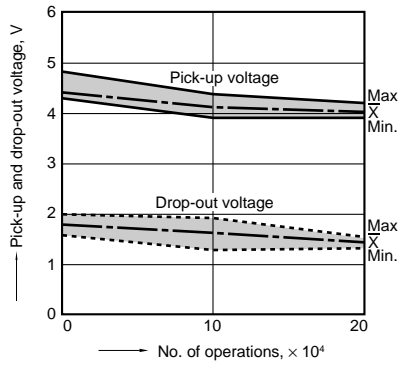

Change of contact resistance

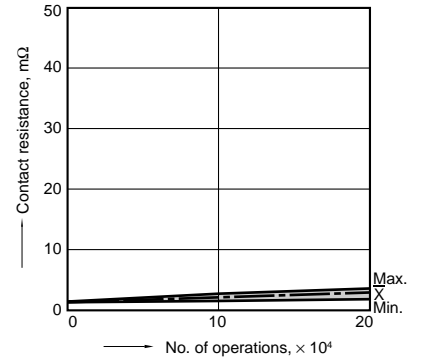

CB RELAYS (High contact capacity type)

1. Allowable ambient temperature
 (High resistant/high contact capacity type)

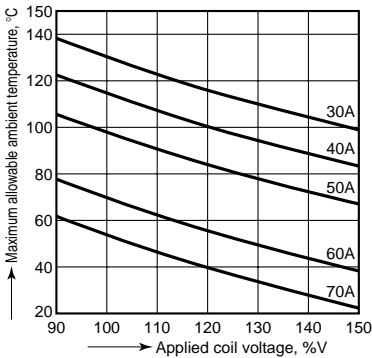

Assumption:

- Maximum mean coil temperature: 180°C
- Curves are based on 1.4W (Nominal power consumption of the unsuppressed coil at nominal voltage)

2. Max. switching capability (Resistive load)
 (High contact capacity/standard type)

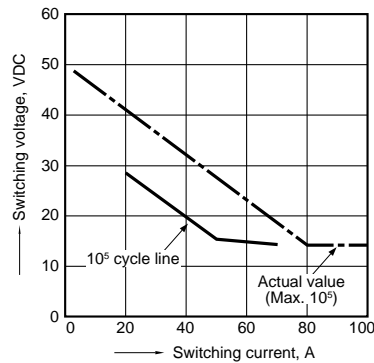

3. Ambient temperature and operating voltage range
 (High contact capacity/standard type)

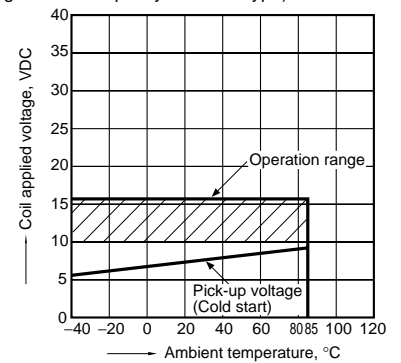

4. Distribution of pick-up and drop-out voltage
 Sample: CB1aHF-12V, 53pcs.

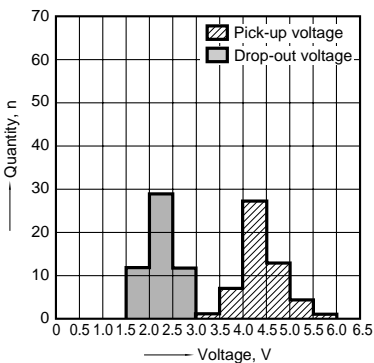

5. Distribution of operate and release time
 Sample: CB1aHF-12V, 53pcs.

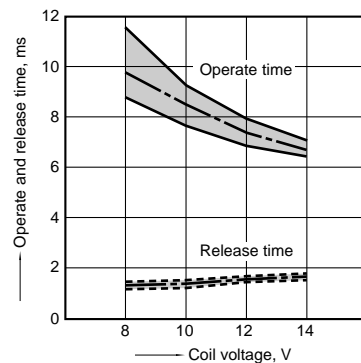

6. Contact resistance
 Sample: CB1aHF-12V, 53pcs.
 (By voltage drop 6V DC 1A)

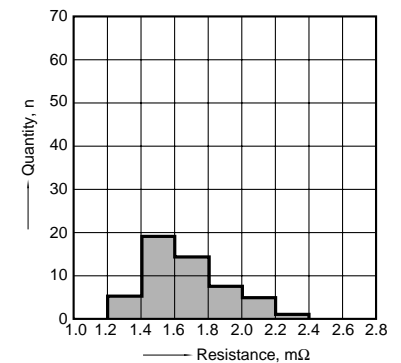



Discontinued: Built-in diode type
Last time buy: February 29, 2012

CB

7-(1). Electrical life test (Motor free)

Sample: CB1aH-12V, 3pcs.
 Load: Inrush current: 64A/Steady current: 35A
 Fan motor actual load (motor free) 12V DC
 Operating frequency: ON 3s, OFF 7s
 Ambient temperature: Room temperature
 Circuit

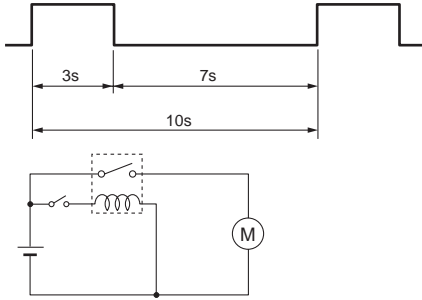

Load current waveform

Inrush current: 64A, Steady current: 35A

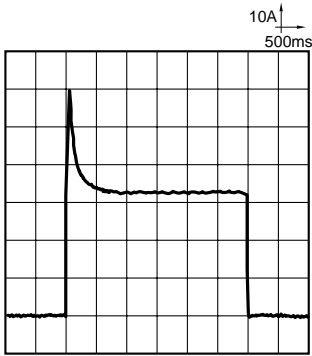

Change of pick-up and drop-out voltage

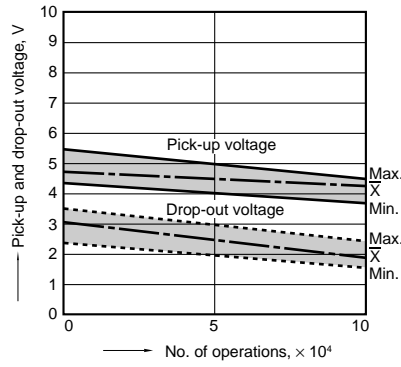

Change of contact resistance

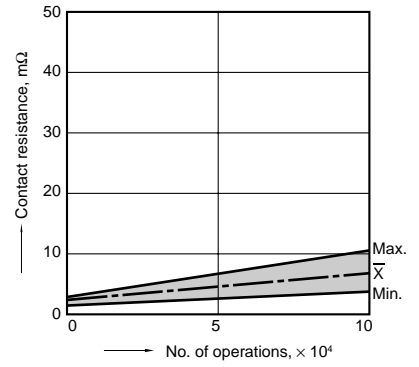

7-(2). Electrical life test (Motor lock)

Sample: CB1aH-12V, 5pcs.
 Load: 100A 14V DC
 Magnet clutch actual load (lock condition)
 Operating frequency: ON 1s, OFF 9s
 Ambient temperature: Room temperature
 Circuit

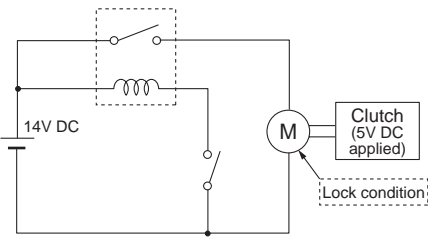

Load current waveform

100A 14V DC

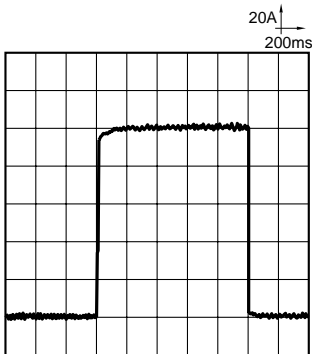

Change of pick-up and drop-out voltage

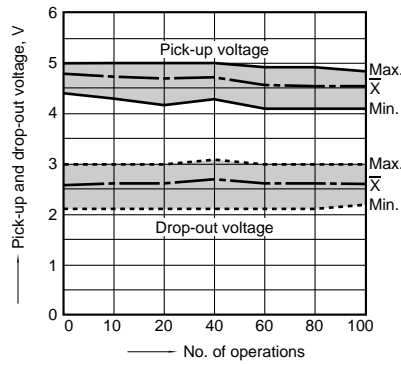

Change of contact resistance

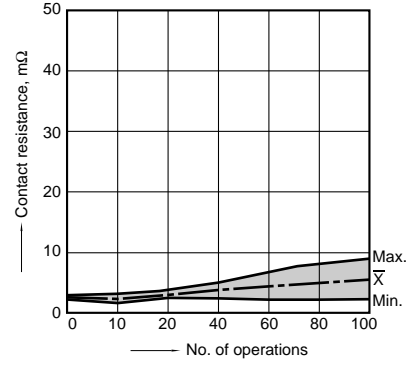



CB RELAY (35 A type)

1-(1). Distribution of pick-up and drop-out voltage

Sample: CB1aV-12V, 30pcs.

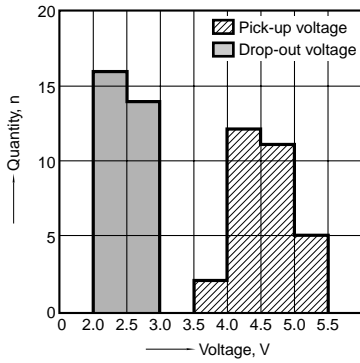

1-(2). Distribution of pick-up and drop-out voltage

Sample: CB1aV-24V, 30pcs.

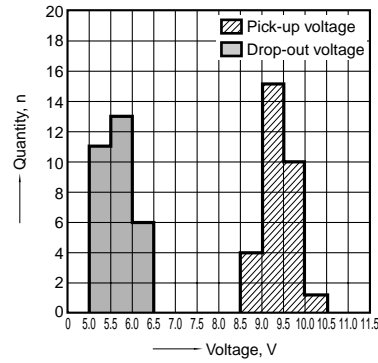

1-(3). Distribution of pick-up and drop-out voltage

Sample: CB1V-24V, 30pcs.

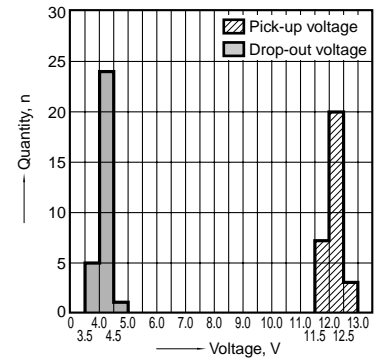

2-(1) Contact resistance

Sample: CB1aV-12V, 30pcs.
 (By voltage drop 12 V DC 1A)

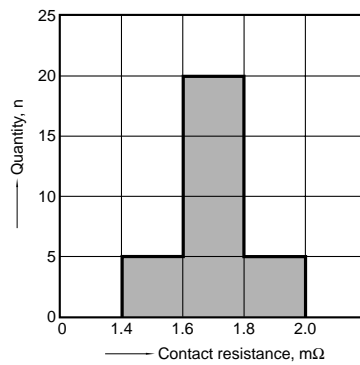

2-(2) Contact resistance

Sample: CB1aV-24V, 30pcs.
 (By voltage drop 24 V DC 1A)

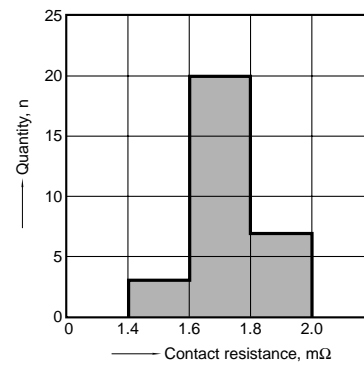

2-(3) Contact resistance

Sample: CB1V-24V, 30pcs.
 (By voltage drop 24 V DC 1A)

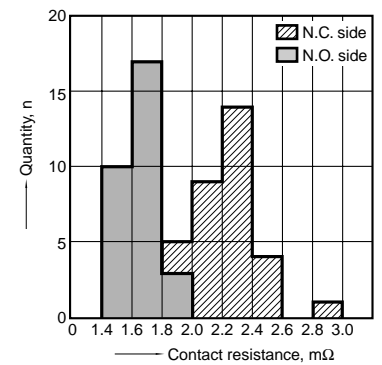

3. Electrical life test (Blower fan)

Sample: CB1aV-D-24V, 3pcs.
 Load: Blower fan load 28 V DC
 Inrush current: 30 A/Steady current: 10 A
 Operating frequency: ON 3s, OFF 3s
 Switching cycle: 10⁵
 Ambient temperature: 85°C
 Coil protective element: Diode
 Circuit

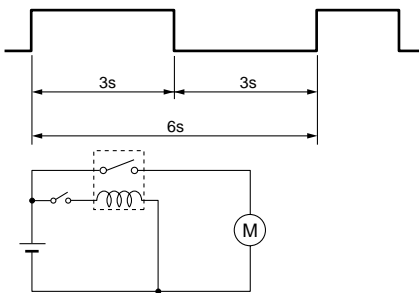

Load current waveform

Inrush current: 30 A, Steady current: 10 A

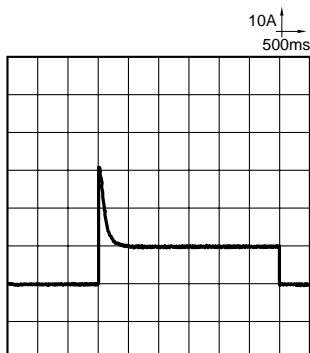

Change of pick-up and drop-out voltage

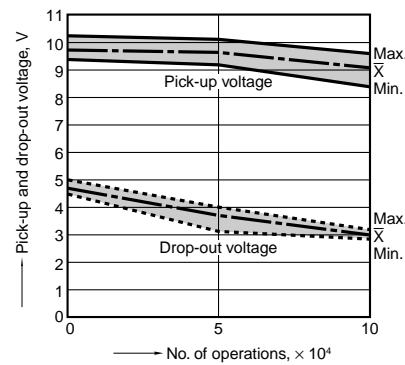

Change of contact resistance

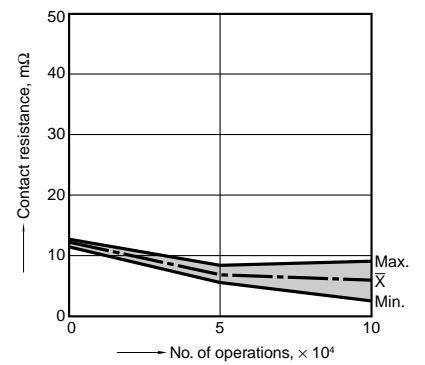

CB

DIMENSIONS (mm inch)

The CAD data of the products with a **CAD Data** mark can be downloaded from: <http://industrial.panasonic.com/ac/e>

1. PC board type

CAD Data



External dimensions

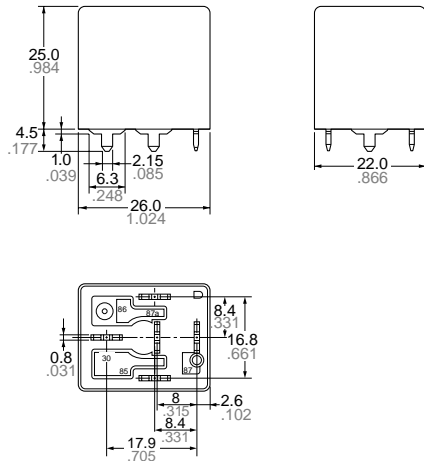

Dimension:
 Max. 1mm .039 inch: $\pm 0.1 \pm .004$
 1 to 3mm .039 to .118 inch: $\pm 0.2 \pm .008$
 Min. 3mm .118 inch: $\pm 0.3 \pm .012$

General tolerance
 $\pm 0.1 \pm .004$
 $\pm 0.2 \pm .008$
 $\pm 0.3 \pm .012$

Schematic (Bottom view)

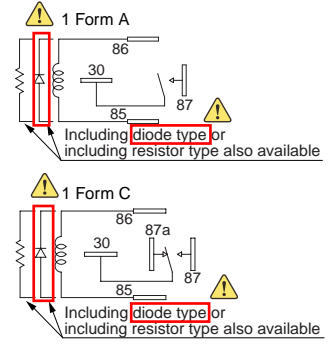

PC board pattern (Bottom view)

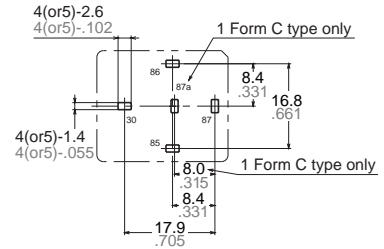

2. Plug-in type * The dimensions are the same as those of 35A type.

CAD Data



External dimensions

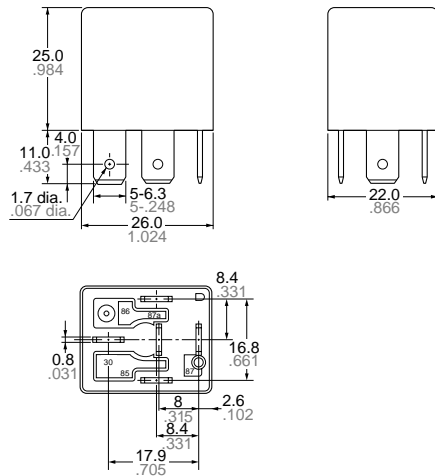

Dimension:
 Max. 1mm .039 inch: $\pm 0.1 \pm .004$
 1 to 3mm .039 to .118 inch: $\pm 0.2 \pm .008$
 Min. 3mm .118 inch: $\pm 0.3 \pm .012$

General tolerance
 $\pm 0.1 \pm .004$
 $\pm 0.2 \pm .008$
 $\pm 0.3 \pm .012$

Schematic (Bottom view)

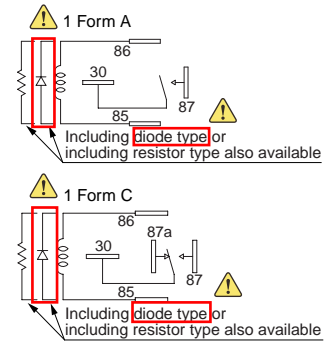



3. Bracket type

CAD Data



External dimensions

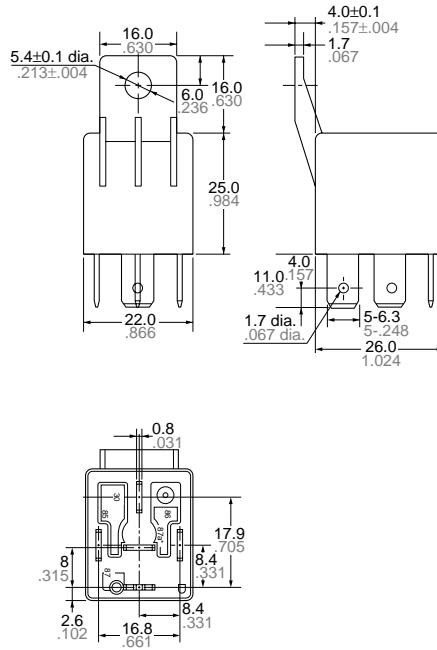

Schematic (Bottom view)

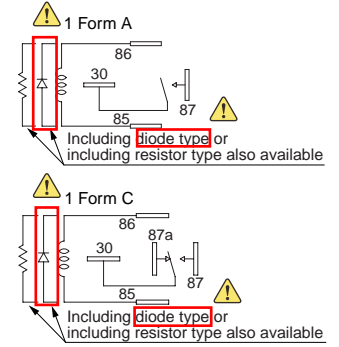

Dimension:	General tolerance
Max. 1mm .039 inch:	±0.1 ±.004
1 to 3mm .039 to .118 inch:	±0.2 ±.008
Min. 3mm .118 inch:	±0.3 ±.012

4. High contact capacity type (1 Form A) (Plug-in type)

CAD Data



External dimensions

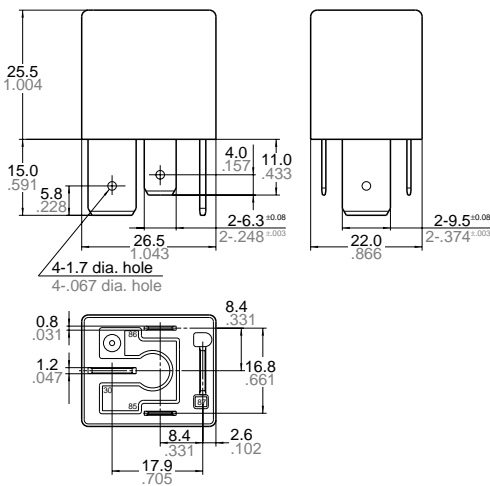

Schematic (Bottom view)

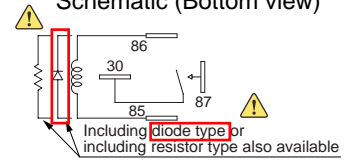

Dimension:	General tolerance
Max. 1mm .039 inch:	±0.1 ±.004
1 to 3mm .039 to .118 inch:	±0.2 ±.008
Min. 3mm .118 inch:	±0.3 ±.012



Discontinued: Built-in diode type
Last time buy: February 29, 2012

CB

5. High contact capacity type (1 Form A) (PC board type)

CAD Data



External dimensions

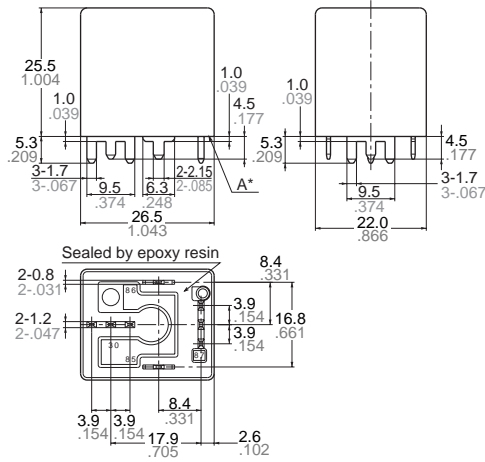

Schematic (Bottom view)

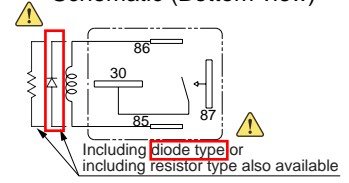

PC board pattern (Bottom view)

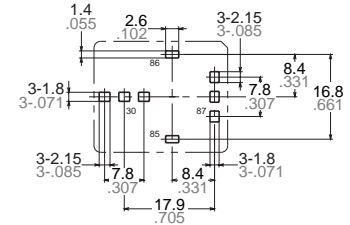

<u>Dimension:</u>	<u>General tolerance</u>
Max. 1mm .039 inch:	±0.1 ±.004
1 to 3mm .039 to .118 inch:	±0.2 ±.008
Min. 3mm .118 inch:	±0.3 ±.012

For Cautions for Use, see Relay Technical Information.