

**!** Partly to Be Discontinued  
Last time buy: March 31,2025

Automotive Relays  
**EV RELAYS**  
(DC Contactors)

Product Catalog

**IN Your  
Future**

# High voltage DC, High capacity Cut-off Relays using Capsule Contact Mechanism

◀Protective construction▶ Capsule contact

■ Normal types

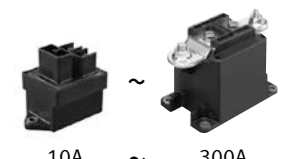

10A ~ 300A

■ High short circuit capacity type



■ Compact high short-circuit capacity type



■ Quiet types



Vertical type



Horizontal type

**FEATURES**

- **Compact, lightweight and safety**  
To realize quick gap cutoff with high voltage DC, hydrogen gas, which has superior arc cooling capability, is sealed in the capsule contact chamber. At the same time, superior safety is achieved owing to an airtight construction that prevents arc leakage.
- **High contact reliability**  
Since the contact portion is sealed in hydrogen gas, there is no contact oxidation. It is also dustproof and waterproof.
- **Richly varied lineup**  
Types that are quiet in operation types and high short-circuit capacity types are also available. Moreover, the lineup includes plenty of all plug-in types, as well as high carrying current types.

**APPLICATIONS**

- **Electric vehicles (HEV, PHEV, BEV, and FCV)**
- **Battery charge and discharge systems**
- **High voltage DC applications such as hybrid construction equipment**

■ EV Relay [Normal type]

**ORDERING INFORMATION (PART NO.)**

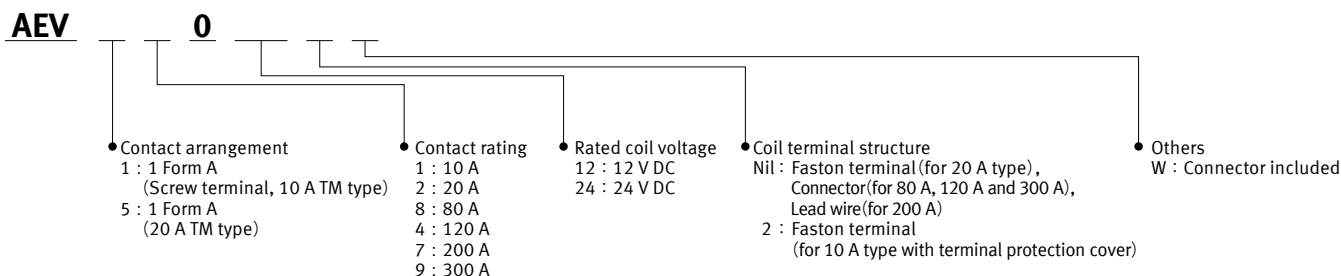

Note : EV80A, EV120A, and EV200A have vertical type, EV120A has high short-circuit capacity type, and high carrying current type (135A, 200A) : please inquire our sales representative for more information.

**TYPES**

Contact rating	Rated coil voltage	Contact arrangement	Part No.	Standard packing	
				Carton	Outer carton
10 A	12 V DC	1 Form A	AEV110122	25 pieces	100 pieces
20 A			AEV52012	25 pieces	50 pieces
80 A			AEV18012*	1 piece	20 pieces
120 A			AEV14012*	1 piece	20 pieces
200 A			AEV17012	1 piece	10 pieces
300 A			AEV19012*	1 piece	5 pieces
10 A	24 V DC	1 Form A	AEV110242	25 pieces	100 pieces
80 A			AEV18024*	1 piece	20 pieces
120 A			AEV14024*	1 piece	20 pieces
200 A			AEV17024	1 piece	10 pieces
300 A			AEV19024*	1 piece	5 pieces

\* When ordering connector included, please add suffix "W"

<Specifications>

· Housing: Yazaki 7283-1020(light gray)

· Lead wire: 0.5 mm<sup>2</sup> dia./ 300±10 mm length

· Lead wire coating color: Pin No.1; white/ Pin No.2; green

Note: The letter of "W" is not marked on the device (relay). It is only marked on the inner and outer carton.

**RATING**

**Coil data**

Contact rating	Rated coil voltage	Operate (Set) voltage (at 20°C) (Initial)	Release (Reset) voltage (at 20°C) (Initial)	Rated operating current (±10%, at 20°C)	Coil resistance (±10%, at 20°C)	Rated operating power (at 20°C)	Usable voltage range*2
10 A	12 V DC	Max. 9 V DC	Min. 1 V DC	0.103 A	116 Ω	1.24 W	10 V DC to 16 V DC
20 A*1			Min. 0.5 V DC	0.327 A	36.7 Ω	3.9 W	
80 A			Min. 1 V DC	0.353 A	34 Ω	4.2 W	
120 A			Min. 1 V DC	0.353 A	34 Ω	4.2 W	
200 A			Min. 1 V DC	0.5 A	24 Ω	6 W	
300 A			Min. 2 V DC	3.2 A (Inrush)	–	Inrush : 37.9 W *3 Stable : 3.6 W	
10 A	24 V DC	Max. 18 V DC	Min. 2 V DC	0.052 A	464 Ω	1.24 W	20 V DC to 32 V DC
80 A			Min. 2 V DC	0.176 A	136 Ω	4.2 W	
120 A			Min. 2 V DC	0.176 A	136 Ω	4.2 W	
200 A			Min. 2 V DC	0.25 A	96 Ω	6 W	
300 A			Min. 4 V DC	1.85 A (Inrush)	–	Inrush : 44.4 W *3 Stable : 3.8 W	

\*1. Please inquire our sales representative for more information about EV20 A with rated coil voltage of 24 V DC.

\*2. Max. continuous applied voltage to the coil is the maximum value in the allowable voltage range.

\*3. Approx. 0.1 sec.

**Specifications**

**10 A Type / 20 A Type**

Item	Specifications			
	10 A Type	20 A Type		
Contact data	Contact arrangement	1 Form A		
	Contact material	Molybdenum	Copper alloy	
	Rated switching capacity (resistive)	10 A 450 V DC (2mm <sup>2</sup> wire)	20 A 400 V DC (Carry, 3mm <sup>2</sup> wire)	
	Max. carrying current	10 A Continuity 15 A 2 min. 30 A 30 sec. (2 mm <sup>2</sup> wire)	20 A Continuity 40 A 10 min. 60 A 1 min. (3 mm <sup>2</sup> wire)	
	Min. switching load (resistive)*1	1 A 12 V DC (at 20°C)		
	Contact voltage drop (initial)	Max. 0.5 V (by voltage drop 6 V DC 10 A)	Max. 0.2 V (by voltage drop 6 V DC 20 A)	
Insulation resistance (initial)	Min. 100 MΩ (At 500 V DC, Measured portion is the same as the case of dielectric strength.)			
Dielectric strength (initial)	Between open contacts	2,500 Vrms for 1 min. (detection current: 10 mA)		
	Between contact and coil	2,500 Vrms for 1 min. (detection current: 10 mA)		
Time characteristics (initial)	Operate (Set) time	Max. 50 ms (at rated coil voltage at 20°C, without bounce)		
	Release (Reset) time	Max. 30 ms (at rated coil voltage at 20°C, with no coil protective elements)		
Shock resistance	Functional	For ON: Min. 196 m/s <sup>2</sup> (half-sine shock pulse: 11 ms, detection time: 10 μs)		
		For OFF: Min. 196 m/s <sup>2</sup> (half-sine shock pulse: 11 ms, detection time: 10 μs)	For OFF: Min. 98 m/s <sup>2</sup> (half-sine shock pulse: 11 ms, detection time: 10 μs)	
Destructive	Min. 490 m/s <sup>2</sup> (half-sine shock pulse: 6 ms)			
Vibration resistance	Functional	10 to 200 Hz, 43 m/s <sup>2</sup> (detection time: 10 μs)		
	Destructive	10 to 200 Hz, 43 m/s <sup>2</sup> (Time of vibration for each direction; X, Y, Z direction: 4 hours)		
Expected life	Mechanical life	Min. 10 <sup>5</sup>	Min. 2 × 10 <sup>5</sup>	
	Electrical life (resistive)*2	10 A 400 V DC, Min. 75,000 operations 10 A 450 V DC, Min. 30,000 operations		
		20 A 400 V DC, Min. 3,000 operations		
	Switch off life*2,*3	Forward direction	30 A 450 V DC, Min. 50 operations	
		Reverse direction	–	
Inrush resistance current (capacitor)	30 A 400 V DC, Min. 50,000 operations 15 A 450 V DC, Min. 70,000 operations		40 A 400 V DC, Min. 75,000 operations	
Conditions	Conditions for usage, transport and storage*4	Ambient temperature: –40 to +80°C (Storage: Max. +85°C) Humidity: 5 to 85% R.H. (Avoid icing when using at temperatures lower than 0°C.)		
Unit weight	Approx. 90 g		Approx. 180 g	

Note: The coil voltage 12 V DC type and 24 V DC type have the same specifications.

\*1. This value can change due to the switching frequency, environmental conditions, and desired reliability level, therefore it is recommended to check this with the actual load.

\*2. Coil applied voltage is 12 V DC and a varistor is connected in parallel. If a protective element is connected, please refer to "Other cautions for use" 3.

\*3. at L/R ≤ 1 ms

\*4. The upper operation ambient temperature limit is the maximum temperature that can satisfy the coil temperature rise value. For details, please refer to the "Automotive Relay Users Guide".

# Automotive Relays EV RELAYS (DC Contactors)

## ● 80 A Type / 120 A Type / 200 A Type / 300 A Type

Item		Specifications				
		80 A Type	120 A Type	200 A Type	300 A Type	
Contact data	Contact arrangement	1 Form A				
	Contact material	Tungsten and copper alloys		Copper alloy		
	Rated switching capacity (resistive)	80 A 450 V DC (Carry, 15mm <sup>2</sup> wire)	120 A 450 V DC (Carry, 38mm <sup>2</sup> wire)	200 A 450 V DC (Carry, 60mm <sup>2</sup> wire)	300 A 450 V DC (Carry, 100mm <sup>2</sup> wire)	
	Max. carrying current	80 A Continuity 120 A 15 min. 180 A 2 min. (15 mm <sup>2</sup> wire)	120 A Continuity 225 A 3 min. 400 A 30 sec. (38 mm <sup>2</sup> wire)	200 A Continuity 300 A 15 min. (60 mm <sup>2</sup> wire)	300 A Continuity 400 A 10 min. 600 A 1 min. (100 mm <sup>2</sup> wire)	
	Min. switching load (resistive) <sup>1</sup>	1 A 12 V DC (at 20°C)			1 A 24 V DC (at 20°C)	
	Contact voltage drop (initial)	Max. 0.067 V (by voltage drop 6 V DC 20 A)	Max. 0.03 V (by voltage drop 6 V DC 20 A)	Max. 0.1 V (200 A carry current)	Max. 0.06 V (300 A carry current)	
Insulation resistance (initial)		Min. 100 MΩ (At 500 V DC, Measured portion is the same as the case of dielectric strength.)				
Dielectric strength (initial)	Between open contacts	2,500 Vrms for 1 min. (detection current: 10 mA)				
	Between contact and coil	2,500 Vrms for 1 min. (detection current: 10 mA)				
Time characteristics (initial)	Operate (Set) time	Max. 50 ms (at rated coil voltage at 20°C, without bounce)			Max. 30 ms (at rated coil voltage at 20°C, without bounce)	
	Release (Reset) time	Max. 30 ms (at rated coil voltage at 20°C, with no coil protective elements)			Max. 10 ms (at rated coil voltage at 20°C)	
Shock resistance	Functional	For ON: Min. 196 m/s <sup>2</sup> (half-sine shock pulse: 11 ms, detection time: 10 μs) For OFF: Min. 98 m/s <sup>2</sup> (half-sine shock pulse: 11 ms, detection time: 10 μs)				
	Destructive	Min. 490 m/s <sup>2</sup> (half-sine shock pulse: 6 ms)				
Vibration resistance	Functional	80 A, 120 A, 200 A Type: 10 to 200 Hz, 43 m/s <sup>2</sup> (detection time: 10 μs) 300 A Type: 10 to 200 Hz, 44.1 m/s <sup>2</sup> (detection time: 10 μs)				
	Destructive	80 A, 120 A, 200 A Type: 10 to 200 Hz, 43 m/s <sup>2</sup> (Time of vibration for each direction; X, Y, Z direction: 4 hours) 300 A Type: 10 to 200 Hz, 44.1 m/s <sup>2</sup> (Time of vibration for each direction; X, Y, Z direction: 4 hours)				
Expected life	Mechanical life	Min. 2 × 10 <sup>5</sup>				
	Switch off life <sup>2,3</sup>	Forward direction	80 A 300 V DC, Min. 1 operation	1,200 A 300 V DC, Min. 1 operation	2,000 A 350 V DC, Min. 1 operation	2,500 A 300 V DC, Min. 3 operations <sup>4</sup>
			120 A 450 V DC, Min. 50 operations	120 A 450 V DC, Min. 50 operations	400 A 450 V DC, Min. 50 operations	600 A 450 V DC, Min. 50 operations
		Reverse direction	-120 A 200 V DC, Min. 50 operations	-120 A 200 V DC, Min. 50 operations	-200 A 200 V DC, Min. 1,000 operations	-300 A 200 V DC, Min. 100 operations
	Inrush resistance current (capacitor)	150 A 20 V DC, Min. 70,000 operations	120 A 20 V DC, Min. 70,000 operations	140 A 20 V DC, Min. 70,000 operations	240 A 20 V DC, Min. 70,000 operations	
Conditions	Conditions for usage, transport and storage <sup>5</sup>	Ambient temperature: -40 to +80°C Humidity: 5 to 85% R.H. (Avoid icing when using at temperatures lower than 0°C.)		Ambient temperature: -40 to +85°C Humidity: 5 to 85% R.H. (Avoid icing when using at temperatures lower than 0°C.)		
Unit weight		Approx. 400 g		Approx. 600 g	Approx. 750 g	

Note: The coil voltage 12 V DC type and 24 V DC type have the same specifications.

\*1. This value can change due to the switching frequency, environmental conditions, and desired reliability level, therefore it is recommended to check this with the actual load.

\*2. Coil applied voltage is 12 V DC and a varistor is connected in parallel. If a protective element is connected, please refer to "Other cautions for use" 3.

\*3. at L/R ≤ 1 ms

\*4. Condition: Nominal switching 10 cycles, each switch-off 2,500 A.

\*5. The upper operation ambient temperature limit is the maximum temperature that can satisfy the coil temperature rise value. For details, please refer to the "Automotive Relay Users Guide".

## EV Relay [High short-circuit capacity type]

### ORDERING INFORMATION (PART NO.)

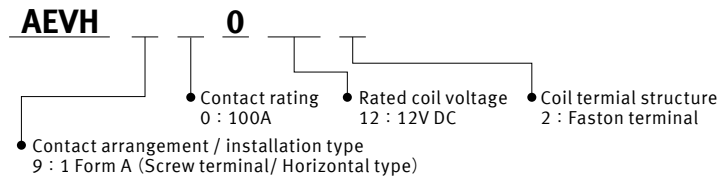

### TYPES

Contact rating	Rated coil voltage	Contact arrangement	Part No.	Standard packing
100 A	12 V DC	1 Form A	AEVH900122	20 pieces (Carton 20 pieces / 1 tray)

### RATING

#### Coil data

Contact rating	Rated coil voltage	Operate (Set) voltage (at 20°C) (Initial)	Release (Reset) voltage (at 20°C) (Initial)	Rated operating current (±10%, at 20°C)	Coil resistance (±10%, at 20°C)	Rated operating power (at 20°C)	Usable voltage range*1
100 A	12 V DC	Max. 9 V DC	Min. 0.5 V DC	0.453 A	26.5 Ω	5.4 W	10 V DC to 16 V DC

\*1. When continually powered, the applied voltage is 14 V DC.

#### Specifications

Item	Specifications	
Contact data	Contact arrangement	1 Form A
	Contact material	Cu alloy
	Rated switching capacity (resistive)	100 A 450 V DC (Carry, 30mm <sup>2</sup> wire)
	Max. carrying current	100 A continuous (30 mm <sup>2</sup> wire)
	Min. switching load (resistive)*1	1 A 12 V DC (at 20°C)
	Contact voltage drop (initial)	Max. 0.1 V (by voltage drop 12 V DC 100 A)
Insulation resistance (initial)	Min. 100 MΩ (At 500 V DC, Measured portion is the same as the case of dielectric strength.)	
Dielectric strength (initial)	Between open contacts	2,500 Vrms for 1 min. (detection current: 10 mA)
	Between contact and coil	2,500 Vrms for 1 min. (detection current: 10 mA)
Time characteristics (initial)	Operate (Set) time	Max. 50 ms (at rated coil voltage at 20°C, without bounce)
	Release (Reset) time	Max. 30 ms (at rated coil voltage at 20°C, with no coil protective elements)
Shock resistance	Functional	For ON: Min. 196 m/s <sup>2</sup> (half-sine shock pulse: 11 ms, detection time: 10 μs) For OFF: Min. 98 m/s <sup>2</sup> (half-sine shock pulse: 11 ms, detection time: 10 μs)
	Destructive	Min. 490 m/s <sup>2</sup> (half-sine shock pulse: 6 ms)
Vibration resistance	Functional	10 to 200 Hz, 44.1 m/s <sup>2</sup> (detection time: 10 μs)
	Destructive	10 to 200 Hz, 44.1 m/s <sup>2</sup> (Time of vibration for each direction; X, Y, Z direction: 4 hours)
Expected life	Mechanical life	Min. 2 × 10 <sup>5</sup>
	Switch off life*2 *3	1,000 A 400 V DC, Min. 1 operation (No polarity)
	Inrush resistance current (capacitor)	100 A 20 V DC, Min. 70,000 operations
Conditions	Conditions for usage, transport and storage*4	Ambient temperature: -40 to +80°C Humidity: 5 to 85% R.H. (Avoid icing when using at temperatures lower than 0°C.)
Unit weight		Approx. 275 g

\*1. This value can change due to the switching frequency, environmental conditions, and desired reliability level, therefore it is recommended to check this with the actual load.

\*2. Coil applied voltage is 12 V DC and a varistor is connected in parallel. If a protective element is connected, please refer to "Other cautions for use" 3.

\*3. at L/R ≤ 1 ms

\*4. The upper operation ambient temperature limit is the maximum temperature that can satisfy the coil temperature rise value. For details, please refer to the "Automotive Relay Users Guide".

## EV Relay [Compact high short-circuit capacity type]

### ORDERING INFORMATION (PART NO.)

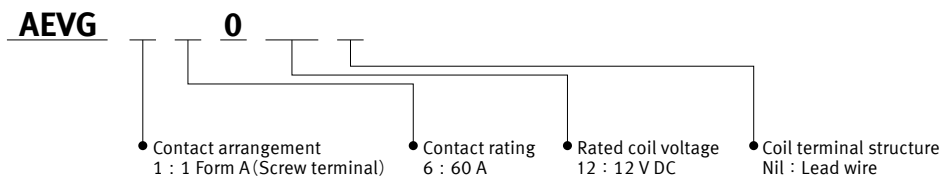

Note : There are also all plug-in types : please inquire our sales representative for more information.

### TYPES

Contact rating	Rated coil voltage	Contact arrangement	Part No.	Standard packing
60 A	12 V DC	1 Form A	AEVG16012	40 pieces (Carton 40 pieces / 1 tray)

### RATING

#### Coil data

Contact rating	Rated coil voltage	Operate (Set) voltage (at 20°C) (Initial)	Release (Reset) voltage (at 20°C) (Initial)	Rated operating current (±10%, at 20°C)	Coil resistance (±10%, at 20°C)	Rated operating power (at 20°C)	Usable voltage range*1
60 A	12 V DC	Max. 9 V DC	Min. 0.5 V DC	0.429 A	28 Ω	5.2 W	10 V DC to 16 V DC

\*1. When continually powered, the applied voltage is 14 V DC.

#### Specifications

Item	Specifications	
Contact data	Contact arrangement	1 Form A
	Contact material	Copper alloy
	Rated switching capacity (resistive)	60 A 450 V DC (Carry, 15mm <sup>2</sup> wire)
	Max. carrying current	60 A Continuity, 120 A 5 min., 180 A 30 sec. (15 mm <sup>2</sup> wire)
	Min. switching load (resistive)*1	1 A 12 V DC (at 20°C)
	Contact voltage drop (initial)	Max. 0.15 V (by voltage drop 6 V DC 60 A)
	Short circuit capacity	4,500 A (at Max. 10 ms), No smoke and no ignition
Insulation resistance (initial)	Min. 100 MΩ (At 1,000 V DC, Measured portion is the same as the case of dielectric strength.)	
Dielectric strength (initial)	Between open contacts	2,500 Vrms for 1 min. (detection current: 10 mA)
	Between contact and coil	2,500 Vrms for 1 min. (detection current: 10 mA)
Time characteristics (initial)	Operate (Set) time	Max. 50 ms (at rated coil voltage at 20°C, without bounce)
	Release (Reset) time	Max. 30 ms (at rated coil voltage at 20°C, with no coil protective elements)
Shock resistance	Functional	For ON: Min. 196 m/s <sup>2</sup> (half-sine shock pulse: 11 ms, detection time: 10 μs) For OFF: Min. 98 m/s <sup>2</sup> (half-sine shock pulse: 11 ms, detection time: 10 μs)
	Destructive	Min. 490 m/s <sup>2</sup> (half-sine shock pulse: 6 ms)
Vibration resistance	Functional	10 to 200 Hz, 44.1 m/s <sup>2</sup> (detection time: 10 μs)
	Destructive	10 to 200 Hz, 44.1 m/s <sup>2</sup> (Time of vibration for each direction; X, Y, Z direction: 4 hours)
Expected life	Mechanical life	Min. 2 × 10 <sup>5</sup>
	Switch off life*2 *3	400 A 300 V DC, Min. 1 operation (No polarity)
	Inrush resistance current (capacitor)	30 A 450 V DC, Min. 70,000 operations 120 A 20 V DC, Min. 70,000 operations
Conditions	Conditions for usage, transport and storage*4	Ambient temperature: -40 to +80°C Humidity: 5 to 85% R.H. (Avoid icing when using at temperatures lower than 0°C.)
Unit weight	Approx. 165 g	

\*1. This value can change due to the switching frequency, environmental conditions, and desired reliability level, therefore it is recommended to check this with the actual load.

\*2. Coil applied voltage is 12 V DC and a varistor is connected in parallel. If a protective element is connected, please refer to "Other cautions for use" 3.

\*3. at L/R ≤ 1 ms

\*4. The upper operation ambient temperature limit is the maximum temperature that can satisfy the coil temperature rise value. For details, please refer to the "Automotive Relay Users Guide".

## EV Relay [Quiet type]

### ORDERING INFORMATION (PART NO.)

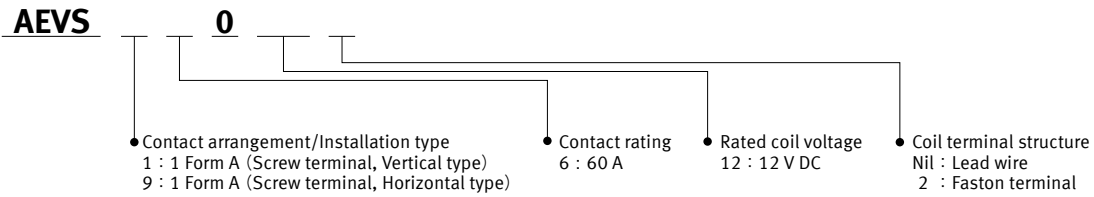

Note : There are also all plug-in types and 150A carry current type : please inquire our sales representative for more information.

### TYPES

Contact rating	Rated coil voltage	Contact arrangement	Installation type	Part No.	Standard packing	
					Carton	Outer carton
60 A	12 V DC	1 Form A	Vertical type	AEVS16012	1 piece	20 pieces
			Horizontal type	AEVS960122		

### RATING

#### Coil data

Contact rating	Rated coil voltage	Operate (Set) voltage (at 20°C) (Initial)	Release (Reset) voltage (at 20°C) (Initial)	Rated operating current (±10%, at 20°C)	Coil resistance (±10%, at 20°C)	Rated operating power (at 20°C)	Usable voltage range*1
60 A	12 V DC	Max. 9 V DC	Min. 1 V DC	0.375 A	32 Ω	4.5 W	10 V DC to 16 V DC

\*1. When continually powered, the applied voltage is 14 V DC (at 65°C).

#### Specifications

Item	Specifications		
	Vertical Type	Horizontal Type	
Contact data	Contact arrangement	1 Form A	
	Contact material	Tungsten and copper alloys	
	Rated switching capacity (resistive)	60 A 450 V DC (Carry, 15mm <sup>2</sup> wire)	
	Max. carrying current	60 A Continuity, 100 A 10 min., 180 A 1 min. (15 mm <sup>2</sup> wire)	
	Min. switching load (resistive)*1	1 A 12 V DC (at 20°C)	
	Contact voltage drop (initial)	Max. 0.067 V (by voltage drop 6 V DC 20 A)	
Insulation resistance (initial)		Min. 100 MΩ (At 500 V DC, Measured portion is the same as the case of dielectric strength.)	
Dielectric strength (initial)	Between open contacts	2,500 Vrms for 1 min. (detection current: 10 mA) / 2,000 Vrms for 1 min. (detection current: 10 mA)	
	Between contact and coil	2,500 Vrms for 1 min. (detection current: 10 mA) / 2,000 Vrms for 1 min. (detection current: 10 mA)	
Time characteristics (initial)	Operate (Set) time	Max. 50 ms (at rated coil voltage at 20°C, without bounce)	
	Release (Reset) time	Max. 50 ms (at rated coil voltage at 20°C, with no coil protective elements)	
Shock resistance	Functional	For ON: Min. 196 m/s <sup>2</sup> (half-sine shock pulse: 11 ms, detection time: 10 μs) For OFF: Min. 98m/s <sup>2</sup> (half-sine shock pulse: 11 ms, detection time: 10 μs)	
	Destructive	Min. 490 m/s <sup>2</sup> (half-sine shock pulse: 6 ms)	
Vibration resistance	Functional	10 to 100 Hz, 43 m/s <sup>2</sup> 100 to 200 Hz, 19.6 m/s <sup>2</sup> (detection time: 10 μs)	
	Destructive	10 to 100 Hz, 43 m/s <sup>2</sup> 100 to 200 Hz, 19.6 m/s <sup>2</sup> (Time of vibration for each direction; X, Y, Z direction: 4 hours)	
Expected life	Mechanical life	Min. 2 × 10 <sup>5</sup>	
	Electrical life (resistive)*2	60 A 450 V DC, Min. 800 operations	
	Switch off life*2,3	Forward direction	600 A 300 V DC, Min. 5 operations 120 A 450 V DC, Min. 50 operations
		Reverse direction	-120 A 200 V DC, Min. 50 operations
Inrush resistance current (capacitor)	60 A 20 V DC, Min. 70,000 operations		
Conditions	Conditions for usage*4	Ambient temperature: -40 to +80°C (When continuous steady current at 14 V DC: -40 to +65°C) Humidity: 5 to 85% R.H. (Avoid icing when using at temperatures lower than 0°C.)	
	Conditions for transport and storage	Ambient temperature: -40 to +80°C Humidity: 5 to 85% R.H. (Avoid icing when using at temperatures lower than 0°C.)	
Unit weight	Approx. 250 g	Approx. 240 g	

\*1. This value can change due to the switching frequency, environmental conditions, and desired reliability level, therefore it is recommended to check this with the actual load.

\*2. Coil applied voltage is 12 V DC and a varistor is connected in parallel. If a protective element is connected, please refer to "Other cautions for use" 3.

\*3. at L/R ≤ 1 ms

\*4. The upper operation ambient temperature limit is the maximum temperature that can satisfy the coil temperature rise value. For details, please refer to the "Automotive Relay Users Guide".

EV Relay [Normal type]

REFERENCE DATA

1-1. Ambient temperature characteristics (10 A Type)

Sample : AEV110122, 3pcs.

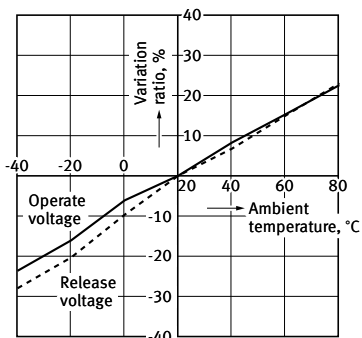

1-2. Ambient temperature characteristics (20 A Type)

Sample : AEV52012, 3pcs.

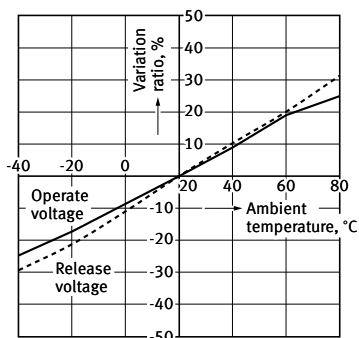

1-3. Ambient temperature characteristics (80 A Type)

Sample : AEV18012, 3pcs.

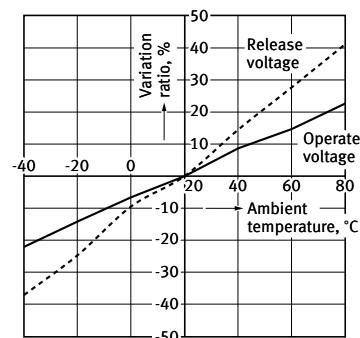

1-4. Ambient temperature characteristics (120 A Type)

Sample : AEV14012, 3 pcs.

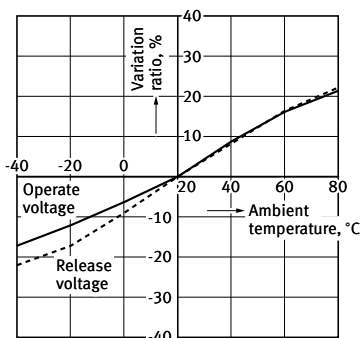

1-5. Ambient temperature characteristics (200 A Type)

Sample : AEV17012, 3 pcs.

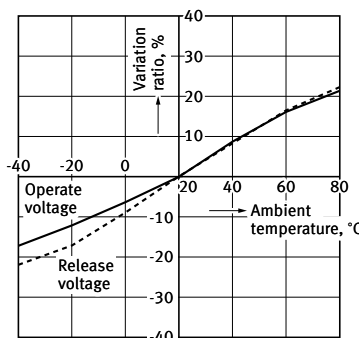

1-6. Ambient temperature characteristics (300 A Type)

Sample : AEV19012, 3 pcs.

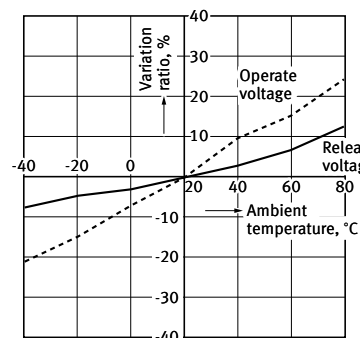

2. Max. switching capacity

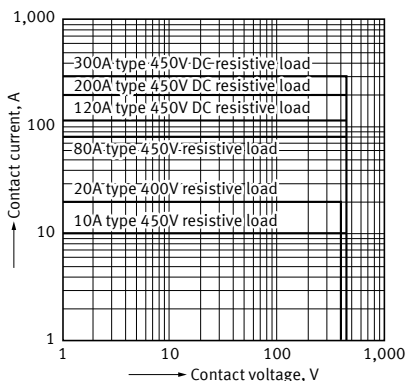

3. Switching life curve (Forward direction)

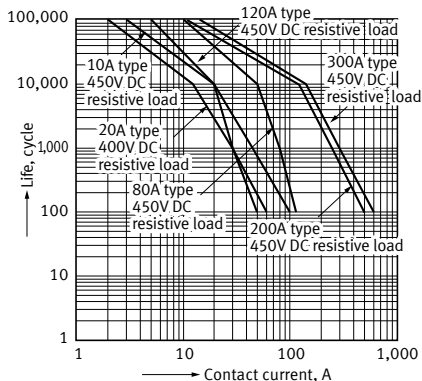

4. Switching and cut-off life curve (Forward direction)

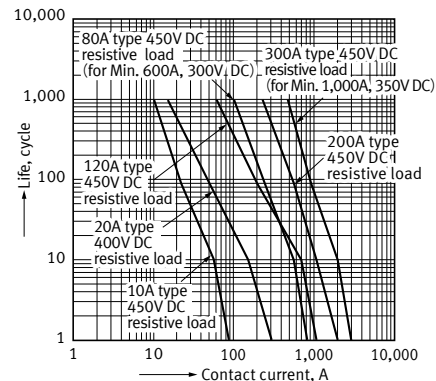

5. Carrying performance life curve (80°C)

Note : For 200 A and 300 A, at 85°C

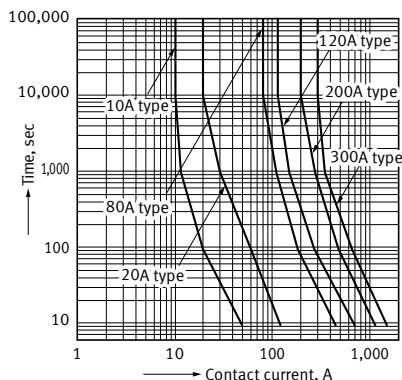



# Automotive Relays EV RELAYS (DC Contactors)

## EV Relay [High short-circuit capacity type]

### REFERENCE DATA

1. Ambient temperature characteristics

Sample : AEVH900122, 3pcs.

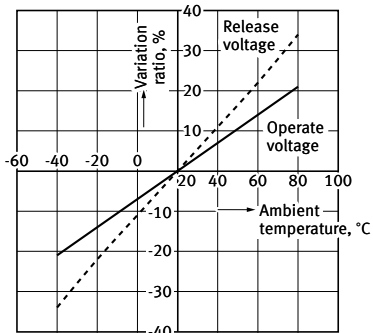

2. Max. switching capacity

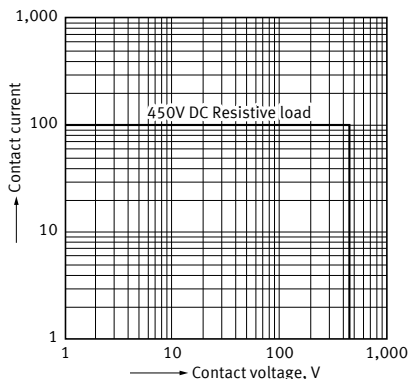

3. Switching life curve

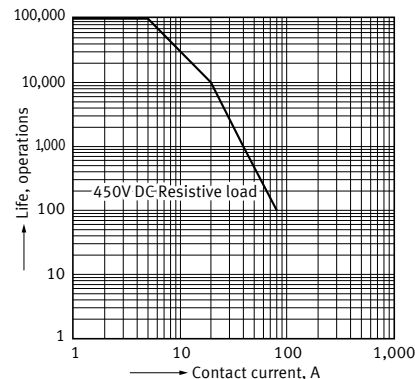

4. Switching and cut-off life curve

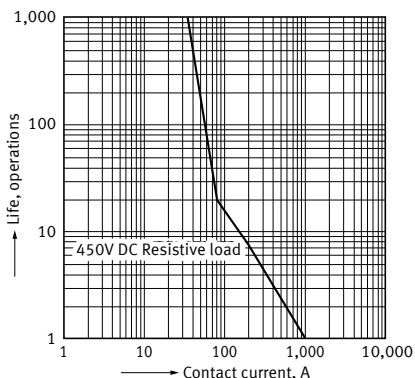

5. Carrying performance life curve (80°C)

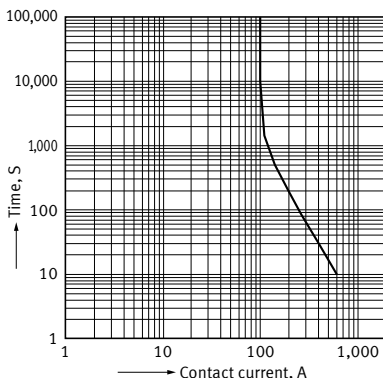

## EV Relay [Compact high short-circuit capacity type]

### REFERENCE DATA

1. Ambient temperature characteristics

Sample : AEVG16012, 3 pcs.

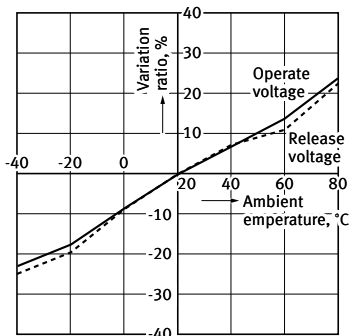

2. Max. switching capacity

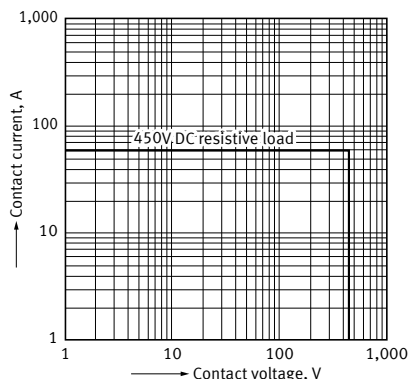

3. Switching life curve  
(Forward direction)

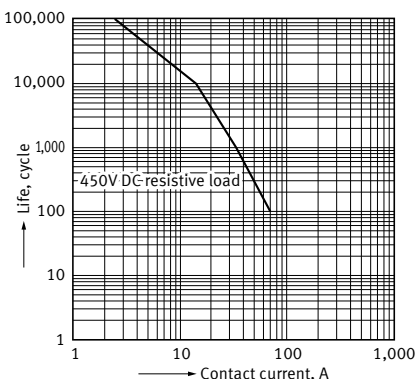

# Automotive Relays EV RELAYS (DC Contactors)

4. Switching and cut-off life curve (Forward direction)

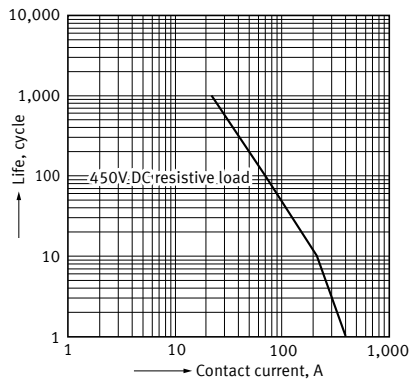

5. Carrying performance life curve (80°C)

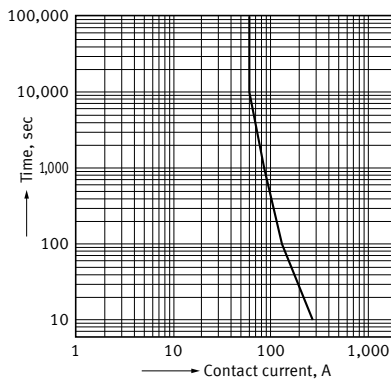

## EV Relay [Quiet type]

### REFERENCE DATA

1. Ambient temperature characteristics

Sample : AEVS16012, 3 pcs.

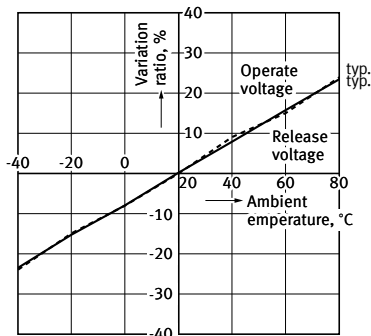

2. Max. switching capacity

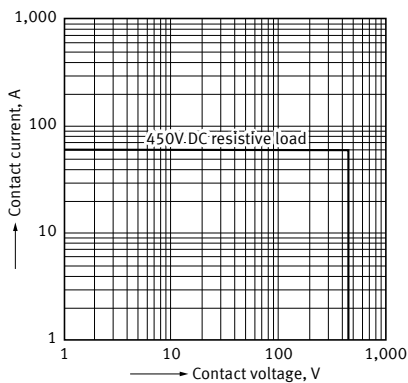

3. Switching life curve (Forward direction)

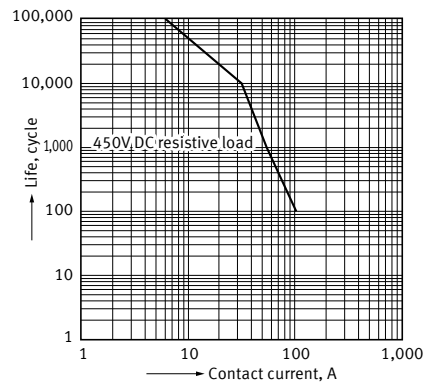

4. Switching and cut-off life curve (Forward direction)

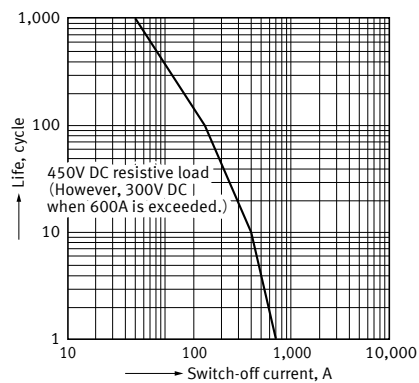

5. Carrying performance life curve (80°C)

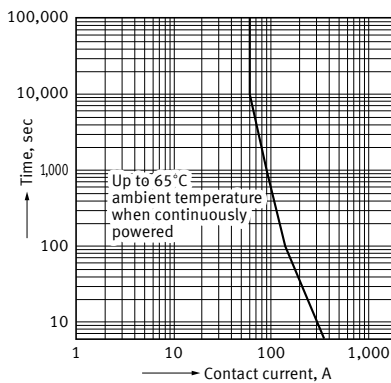

# Automotive Relays EV RELAYS (DC Contactors)

## 6-1. Distribution of operation noise (vertical type)

Measuring conditions  
 Sample : AEVS16012, 50pcs  
 Equipment setting : "A" weighted, Fast, Max. hold  
 Coil voltage : 12V DC  
 Coil connection device : 18V zener diode  
 Background noise : approx. 20dB

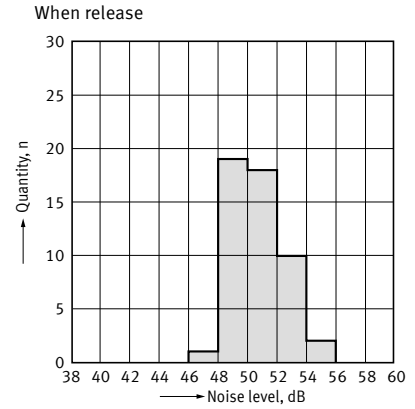
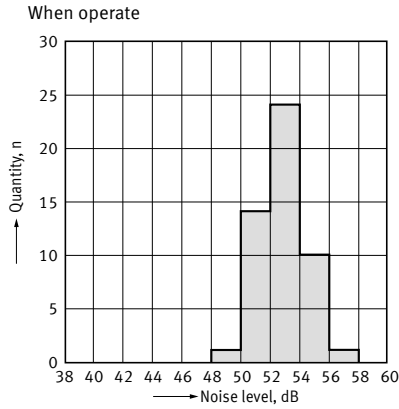
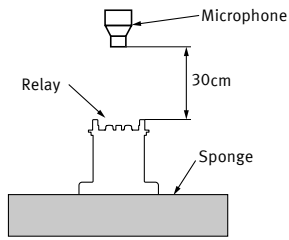

## 6-2. Distribution of operation noise (horizontal type)

Measuring conditions  
 Sample : AEVS960122, 50pcs  
 Equipment setting : "A" weighted, Fast, Max. hold  
 Coil voltage : 12V DC  
 Coil connection device : 18V zener diode  
 Background noise : approx. 20dB

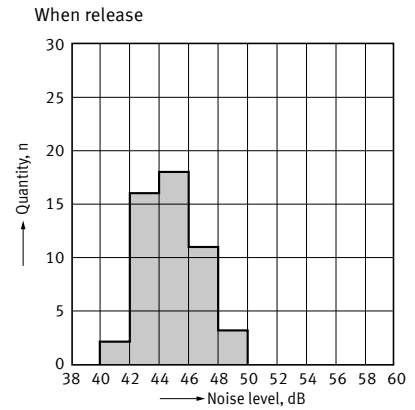
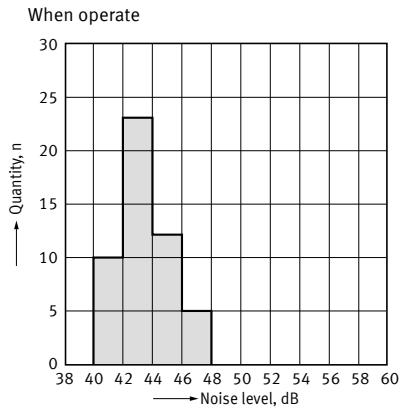
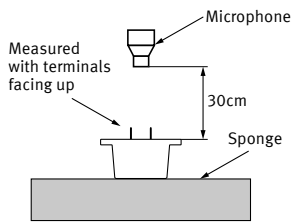

# Automotive Relays EV RELAYS (DC Contactors)

## EV Relay [Normal type]

### DIMENSIONS

**CAD** The CAD data of the products with a "CAD" mark can be downloaded from our Website.

Unit: mm

### 10 A

#### CAD

#### External dimensions

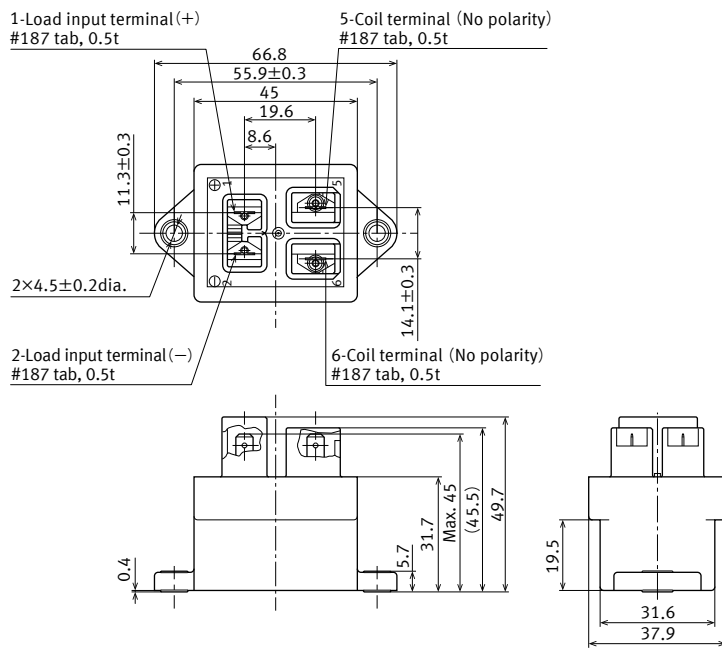

#### Schematic (TOP VIEW)

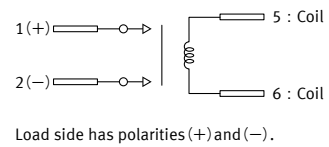

#### Mounting dimensions

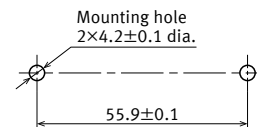

Tolerance  
Less than 10mm : ±0.3  
10 to 50mm : ±0.6  
More than 50mm : ±1.0

### 20 A

#### CAD

#### External dimensions

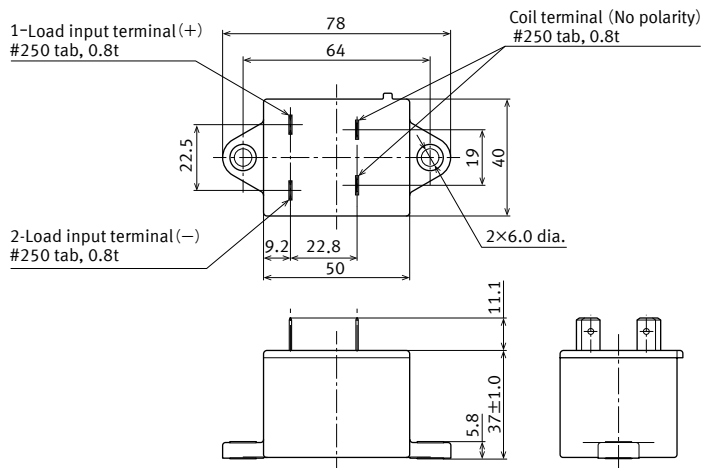

#### Schematic (TOP VIEW)

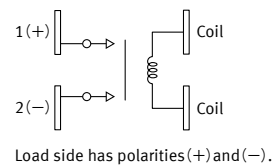

#### Mounting dimensions

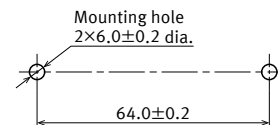

Tolerance  
Less than 10mm : ±0.3  
10 to 50mm : ±0.6  
More than 50mm : ±1.0

# Automotive Relays EV RELAYS (DC Contactors)

80 A

CAD

## External dimensions

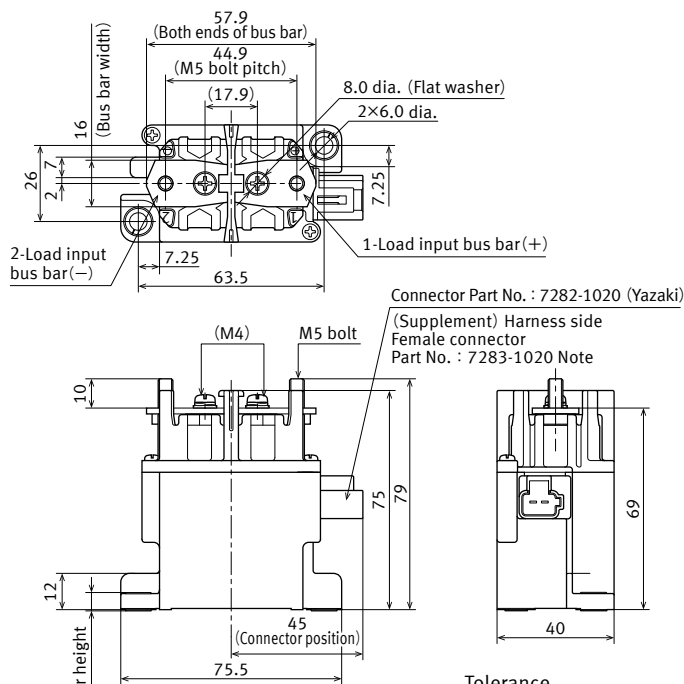

Note : Separate connection of the terminal and lead wire is required.

Tolerance  
Less than 10mm :  $\pm 0.3$   
10 to 50mm :  $\pm 0.6$   
More than 50mm :  $\pm 1.0$

## Schematic (TOP VIEW)

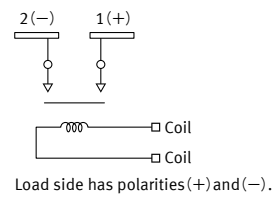

## Mounting dimensions

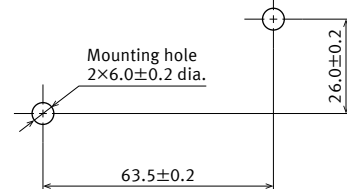

## Accessories (included)

AEV18012W / AEV18024W

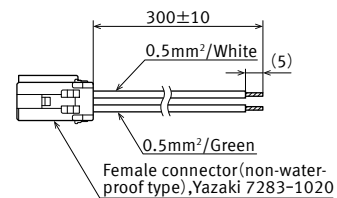

120 A

CAD

## External dimensions

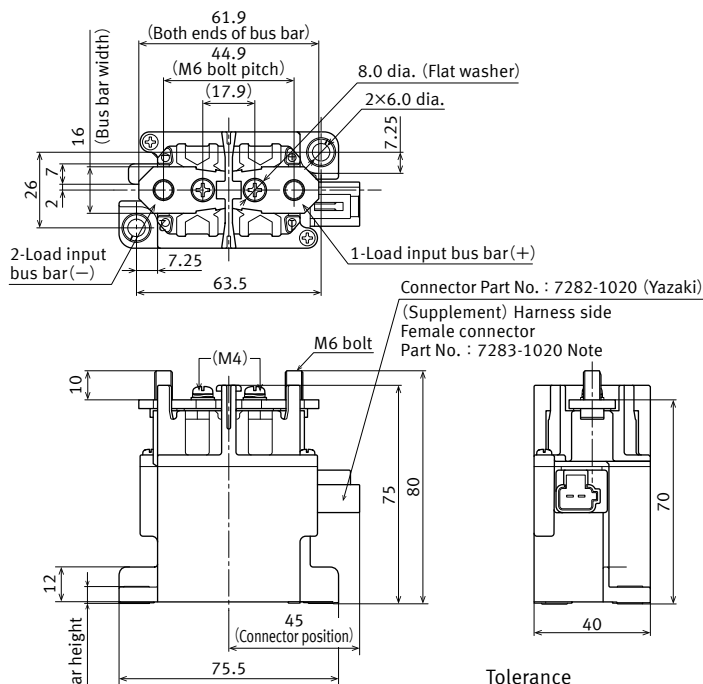

Note : Separate connection of the terminal and lead wire is required.

Tolerance  
Less than 10mm :  $\pm 0.3$   
10 to 50mm :  $\pm 0.6$   
More than 50mm :  $\pm 1.0$

## Schematic (TOP VIEW)

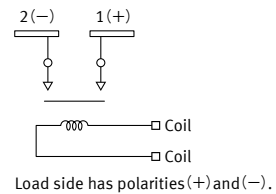

## Mounting dimensions

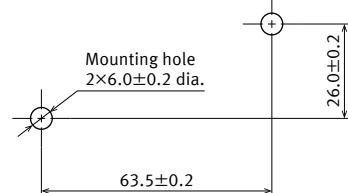

## Accessories (included)

AEV14012W / AEV14024W

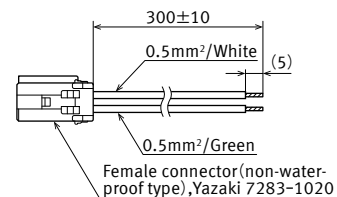

200 A

CAD

External dimensions

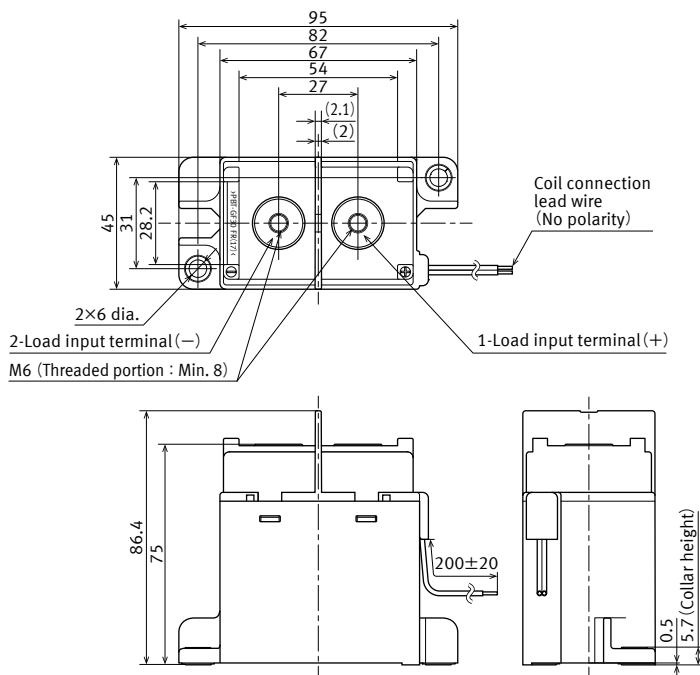

Schematic (TOP VIEW)

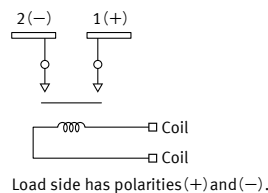

Mounting dimensions

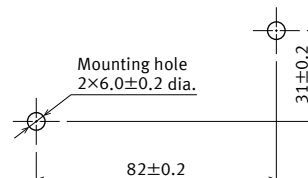

Tolerance  
Less than 10mm : ±0.3  
10 to 50mm : ±0.6  
More than 50mm : ±1.0

300 A

CAD

External dimensions

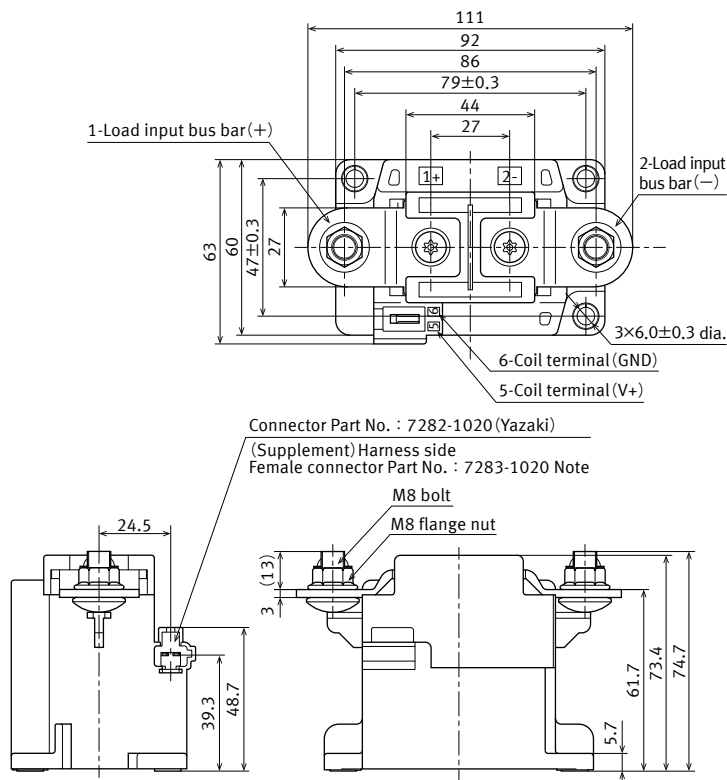

Schematic (TOP VIEW)

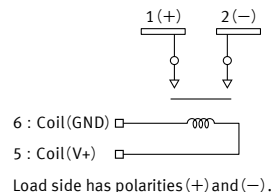

Mounting dimensions

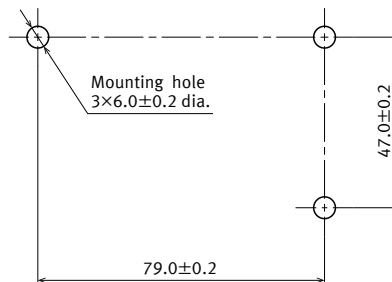

Accessories (included)  
AEV19012W / AEV19024W

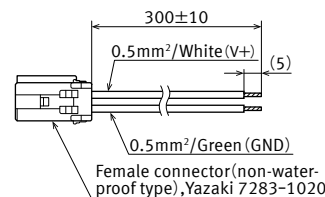

Tolerance  
Less than 10mm : ±0.3  
10 to 50mm : ±0.6  
50 to 100mm : ±1.0  
More than 100mm : ±1.6

Note : Separate connection of the terminal and lead wire is required.

# Automotive Relays EV RELAYS (DC Contactors)

## EV Relay [High short-circuit capacity type]

### DIMENSIONS

**CAD** The CAD data of the products with a "CAD" mark can be downloaded from our Website.

Unit: mm

#### CAD

#### External dimensions

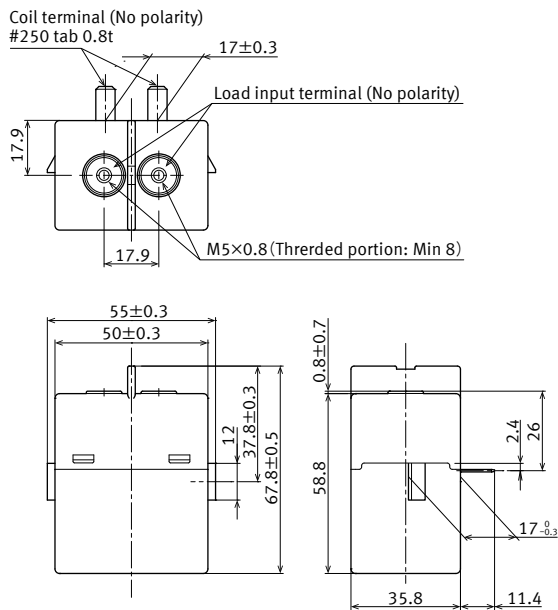

Tolerance:  
Less than 10mm: ±0.3  
10 to 50mm: ±0.6  
More than 50mm: ±1.0

#### Schematic (TOP VIEW)

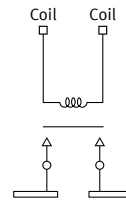

There is no polarity on the load side.

## EV Relay [Compact high short-circuit capacity type]

### DIMENSIONS

**CAD** The CAD data of the products with a "CAD" mark can be downloaded from our Website.

Unit: mm

#### CAD

#### External dimensions

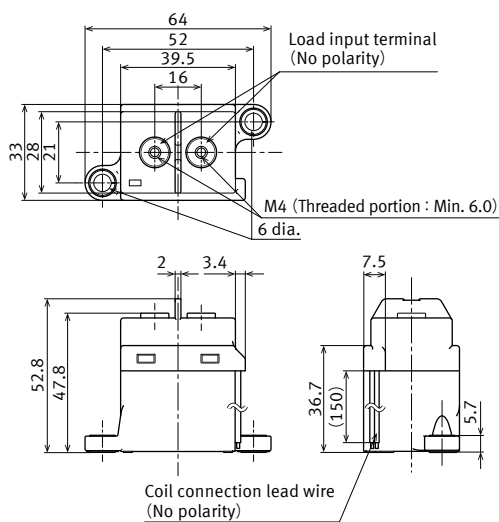

Tolerance  
Less than 10mm : ±0.3  
10 to 50mm : ±0.6  
More than 50mm : ±1.0

#### Schematic (TOP VIEW)

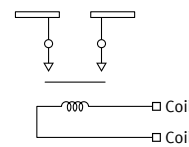

There is no polarity on the load side.

#### Mounting dimensions

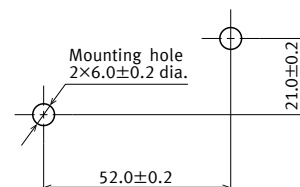

# Automotive Relays EV RELAYS (DC Contactors)

## EV Relay [Quiet type]

### DIMENSIONS

**CAD** The CAD data of the products with a "CAD" mark can be downloaded from our Website.

Unit: mm

### 60 A Vertical type

#### CAD

#### External dimensions

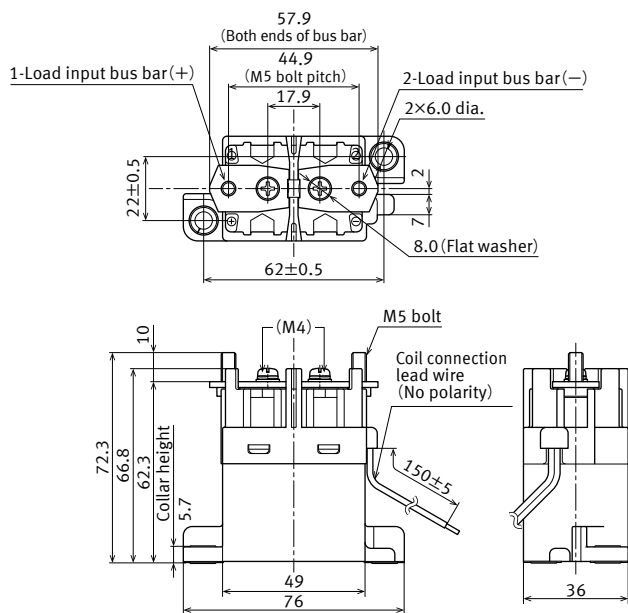

#### Schematic (TOP VIEW)

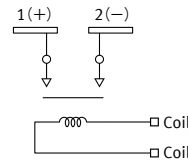

#### Mounting dimensions

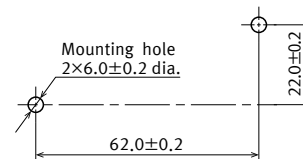

Tolerance  
Less than 10mm : ±0.3  
10 to 50mm : ±0.6  
More than 50mm : ±1.0

### 60 A Horizontal type

#### CAD

#### External dimensions

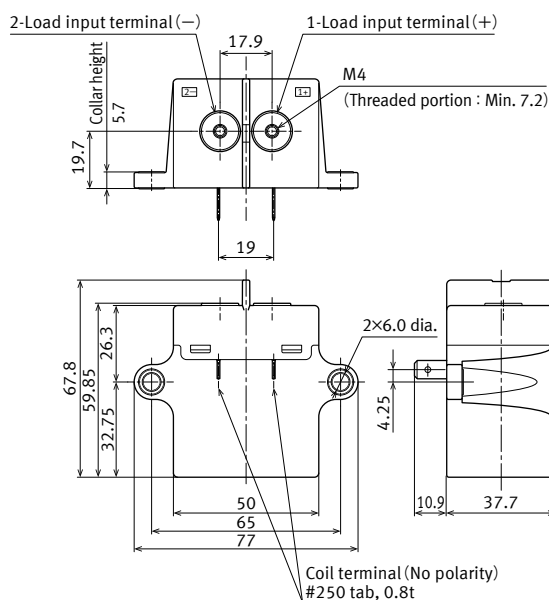

#### Schematic (TOP VIEW)

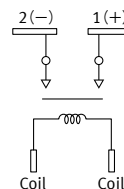

#### Mounting dimensions

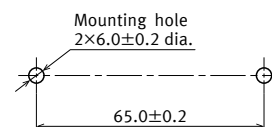

Tolerance  
Less than 10mm : ±0.3  
10 to 50mm : ±0.6  
More than 50mm : ±1.0



## NOTES

### ■ Safety precautions

We are doing our best to constantly improve the quality and reliability of our products. However, some electric items/components do in fact fail despite our efforts.

The durability of products also varies depending on service environments and conditions. Please check your product under actual service conditions before use.

If you continue to use a product in a poor condition, items with deteriorated insulation performance may generate abnormal heat or smoke or even ignite. The product's failure or end of service life may cause accidents involving risks to human health, fire, or danger to the public at large. We advise you to apply safety measures and regular maintenance work, such as the use of redundant design, fireproofing, and malfunction-preventing design, to rule out such accidents.

■ For general cautions for use, please refer to the "Automotive Relay Users Guide".

### ■ Precautions when using EV relays

#### ● Usage, transport and storage conditions

1. Ambient temperature, humidity and air pressure during usage, transport and storage of the relay.

(1) Temperature:  $-40$  to  $+80^{\circ}\text{C}$

(200 A and 300 A types:  $-40$  to  $+85^{\circ}\text{C}$ )

(2) Humidity: 5 to 85% RH

(Avoid icing and condensation.)

Notes: The humidity range varies with the temperature.  
Use within the range indicated in the graph below.

(3) Air pressure: 86 to 106 kPa

[Temperature and humidity range for usage, transport, and storage]

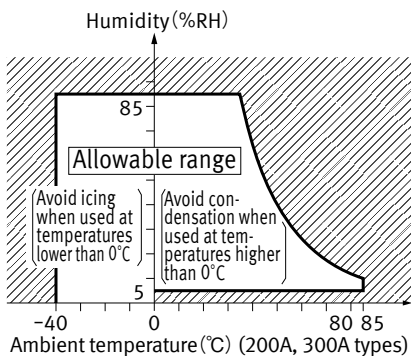

2. Water condensation

Water condensation occurs when the ambient temperature drops suddenly from a high temperature and humidity, or, the relay is suddenly transferred from a low ambient temperature to a high temperature and humidity.

Condensation causes the failures like insulation deterioration, wire disconnection and rust etc. Panasonic Industry Co., Ltd. does not guarantee the failures caused by condensation.

The heat conduction by the equipment may accelerate the cooling of relay itself, and the condensation may occur. Please confirm no condensation in the worst condition of the actual usage.

(Special attention should be paid when high temperature heating parts are close to the relay. Also, please consider the condensation may occur inside of the relay.)

3. Icing

Please check the icing when an ambient temperature is lower than  $0^{\circ}\text{C}$ . Icing means, the moisture contained in the surrounding environment and inside the relay freezes when the ambient temperature falls below the freezing point. The icing causes the sticking of movable portion, the operation delay and the contact conduction failure etc.

Panasonic Industry Co., Ltd. does not guarantee the failures caused by the icing.

The heat conduction by the equipment may accelerate the cooling of relay itself and the icing may occur. Icing condition is changed by ambient environment, please make sure to confirm no icing in the worst condition of the actual usage.

4. Low-temperature, low-humidity atmosphere;

If the relay is exposed to a low-temperature, low-humidity atmosphere for a long time, its plastic parts may become brittle and fragile.

5. Storage

Do not keep under high-temperature and high-humidity.

## Automotive Relays EV RELAYS (DC Contactors)

- When installing the relay, always use washers to prevent the screws from loosening.
- Condition of tightening screw  
Tighten each screw within the rated range given below.  
Exceeding the maximum torque may result in breakage.  
Mounting is possible in either direction.

### Relay attaching portion

M4 screw	10 A type	1.8 to 2.7 Nm
M5 screw	Except 10 A type	3 to 4 Nm

### Main terminal attaching portion

M4 bolt	Compact high short-circuit capacity, Quiet horizontal types	2.2 to 2.8 Nm
M5 nut	80 A, High short-circuit capacity, Quiet types	3 to 4 Nm
M6 nut	120 A, 200 A types	6 to 8 Nm
M8 nut	300 A type	10 to 12 Nm

- **Electrical life**  
This relay is a high-voltage direct-current switch. In its final breakdown mode, it may lose the ability to provide the proper switch-off. Therefore, do not exceed the indicated switching capacity and life.  
(Please treat the relay as a product with limited life and replace it when necessary.)  
In the event that the relay loses switch-off ability, there is a possibility that burning may spread to surrounding parts, so configure the layout so that the power is turned off within one second.
- When the relay is used for quick or normal charging, the coil will not operate and the contacts will be turned off while the vehicle is running.  
Please be sure to verify the vibration and shock tests under the actual use conditions and judge whether or not it can be used.
- **Permeation life of internal gas**  
This relay uses a hermetically encased contact (capsule contact) with gas inside. The gas has a permeation life that is affected by the temperature inside the capsule contact (ambient temperature and temperature rise due to flow of electrical current). For this reason, make sure the ambient operating temperature is between  $-40$  and  $+80^{\circ}\text{C}$  (200 A and 300 A types: Max.  $+85^{\circ}\text{C}$ ), and the ambient storage temperature is between  $-40$  and  $+85^{\circ}\text{C}$ .
- The coils (300 A type) and contacts (except compact high short-circuit capacity type) of the relay are polarized, so follow the connection schematic when connecting the coils and contacts.  
The 300 A type contains a reverse surge voltage absorption circuit; therefore a surge protector is not needed.
- For the 300 A type, drive the coil with a quick startup (apply 100 to 130% of rated coil voltage in less than 10 ms). (Built-in one-shot pulse generator circuit)
- After the ON signal enters the 300 A type, automatic coil current switching occurs after approximately 0.1 seconds.  
Do not repeatedly turn it OFF within that 0.1 seconds interval, as doing so may damage the relay.
- Be careful that foreign matter and oils and fats kind don't stick to the main terminal portion because it is likely to cause terminal portion to give off unusual heat.  
Also, please use the following materials for connected harnesses and bus bars.

### Nominal cross-sectional area

10 A type	Min. 2 mm <sup>2</sup> nominal cross-sectional area
20 A type	Min. 3 mm <sup>2</sup> nominal cross-sectional area
60 A, 80 A types	Min. 15 mm <sup>2</sup> nominal cross-sectional area
120 A type	Min. 38 mm <sup>2</sup> nominal cross-sectional area
200 A type	Min. 60 mm <sup>2</sup> nominal cross-sectional area
300 A type	Min. 100 mm <sup>2</sup> nominal cross-sectional area

- As a guide, the insertion strength of the plug-in terminal into the relay tab terminal should be 40 to 70 N (10 A type), 40 to 80 N (20 A and Quiet horizontal types). Please select a plug in terminal (flat connection terminal) which comply with JIS C2809-2014.

10 A type	Plate thickness 0.5 mm and #187 tab terminal
20 A, Quiet horizontal types	Plate thickness 0.8 mm and #250 tab terminal

- Avoid excessive load applied to the terminal in case of installing such as a bus bar etc., Because it might adversely affect the switching performance.
- Use the specified connector for the connector terminal connection (80 A, 120 A and 300 A types).
  - Yazaki Corporation: 7283 – 1020 or equivalent

# Automotive Relays EV RELAYS (DC Contactors)

● Other cautions for use

1. Please make sure to contact our sales representative when the product is used not in accordance with its specifications. Your nearest sales office staff will review the required specification from your company and perform confirmation tests in actual condition as needed.
2. When the voltage is applied to the relay coil beyond the max. allowable voltage range, the relay operation cannot be assured. Additionally the ambient temperature and condition of your application should be considered under the worst condition of the actual usage because they may change the relay operate and release voltage.  
Note: It is not allowed to apply the continuous maximum voltage to the coil. In order to obtain the specified performance, please apply the rated voltage.
3. If it includes ripple, the ripple factor should be max. 5%. In addition, do not have a parallel connection with diode for the purpose of coil surge absorber. If only diode is connected in parallel to the relay coil, break performance of relay cannot be assured because contact release speed becomes slower. So do not use such a circuit. Instead of diode, a Varistor or Zener diode (ZD) when clamp voltage is 1.5 times larger than the rated voltage (Min. 18 V for the rated 12 V-relay), shall be used for the absorber.

Ex. 1 When Varistor is used

Recommended Varistor	Energy capability: Min. 1 J (However, please set up the value with consideration of the worst value in use condition.)
Varistor Voltage	Min. 18 V at 12 V DC Min. 36 V at 24 V DC

Ex.2 When Zener diode (circuit) is used

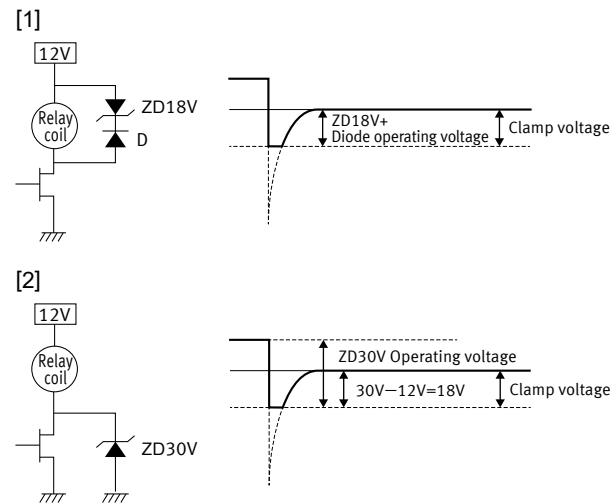

4. Lifetime is specified under the standard test conditions in JIS C 5442. (temperature 15°C to 35°C, humidity 25% R.H. to 75% R.H.)  
 Lifetime is dependent on the coil driving circuit, load type, operation frequency and ambient conditions.  
 Check lifetime under the actual condition. Especially, contact terminals have polarity. So if the contact terminals were connected with opposite pole, the electrical life would be shortened.  
 We can not guarantee the relay's quality in case the relay is operated without load current (Dry-switching).
5. If the relay is dropped, it should not be used again.
6. This relay cannot be used for switching with AC load.

7. Please check the internal connection diagram in the catalog or specification, and connect the terminals correctly. If any wrong connection is made, it may cause circuit damage by unexpected malfunction, abnormal heat, fire, and so on.
8. Please check the insulation distance between each terminal and ground.
9. Please perform evaluation under the worst case condition in actual use when new component is adopted and when there is a change of actual use condition in order to enhance the reliability in actual use.
10. Please absolutely avoid the ultrasonic and high frequency vibration to the relay that adversely affects its performance.
11. Minimum switching load is the lower limit switching current under the micro-load.  
 When the relay is used below minimum switching load, reliability becomes lower. Please use the relay beyond minimum switching load. Additionally, minimum switching load is changed by coil drive circuit, type of load, switching frequency and environment condition. So please confirm the reliability with actual load under the assumed actual environment.
12. As for the screws of fixing relay-body and screws of fixing contact terminal, the tightening torque must be within the specified range.
  - The purpose of the tightening torque for the contact terminal is to secure adhesion force (axial force) at the fixing part and provide stable electrical connection. Therefore, do not use the screws (bolts and nuts) which require rotation torque of locking type (prevailing torque type) because sufficient adhesion force (axial force) may not be secured.  
 In addition, if the locking type nut is used, an excessive torque may be applied to the case before generating of axial force and may cause breakage of the case.
  - Regarding the screw for fixing relay body, please use suitable screws after adequate verification at user's side.
13. The relay should not be installed near strong magnetic fields (transformers, magnets, etc.) and should not be installed near heat source.
14. If the several relays are mounted closely or a heatgeneration object is close to the relay, it may cause troubles the abnormal temperature-rise and the short insulation distance terminals outside of the relay so please assure the evaluation of the relay under the actual worst condition.
15. The relay contacts are encapsulated in an inert gas atmosphere. So, please avoid using or storing beyond the allowable ambient temperature range.
16. After that the relay has been applied with the rated voltage and current to the coil continuously and then the relay is once switched off and switched on immediately, the relay coil resistance may be increased due to the coil temperature increase. This will result in higher operate voltage and the value will surpass the rated operate voltage value. In order to avoid this failure, the following countermeasures are recommended.
  - decrease of the load current
  - restriction of time to apply voltage
  - restriction of operating ambient temperature, etc.
17. If an inductive load ( $L/R > 1$  ms) is applied, add surge protection in parallel with the inductive load. If this is not done, the electrical life will be shortened and cut-off failure may occur.

## Automotive Relays EV RELAYS (DC Contactors)

18. In case using a capacitive load (C-load), please take a countermeasure as pre-charging to the capacitive load so that the inrush current will not surpass performance condition. The relay may have a contact welding without such countermeasure.
19. Use the suitable wire or bus bar according to the current. If the wire diameter is thin, maximum allowable contact current cannot be assured.  
Ex.) Carrying current; 120 A: diameter of 38 mm<sup>2</sup> (minimum) (for wire at the load side)
20. Take care to disconnect from the power supply when wiring.
21. The tension load applied to the coil lead wire when wiring should be max. 10 N.  
In addition, take care not to bend at the lead wire pullout portion when wiring or apply a stationary load to the lead wire after wiring to avoid failure of the relay such as breaking of wire.  
(only applicable to the relay with the coil lead wire type and connector included type. )
22. This relay is not a waterproof type. Therefore, please take any countermeasures when it is used in a place where waterproof is necessary.
23. Do not use this product in such atmosphere where any kind of organic solvent (as benzene, thinner and alcohol) and the strong alkali (as ammonia and caustic soda) may be adhered to this product.
24. Be careful that oils and foreign matter do not stick to the main terminal part because it is likely to cause a terminal part to give off unusual heat.
25. Do not make additional manufacturing upon the relay housing.
26. Maximum overcurrent value in this specification is limited as single operation only. In the case of multiple operation, this relay may cause malfunction by heating.  
So, please confirm the temperature / operation using your application. In the case of multiple operation, please stop applying the over current to secure the relay's temperature under the maximum ambient temperature.
27. When applying current which includes precipitous changes or ripple, the relay may generate buzzing sound.  
Therefore, please confirm with the actual load.

---

**Panasonic**  
INDUSTRY

**Panasonic Industry Co., Ltd.**

Electromechanical Control Business Division  
■1006, Oaza Kadoma, Kadoma-shi, Osaka 571-8506, Japan  
[industrial.panasonic.com/ac/e/](http://industrial.panasonic.com/ac/e/)