 This series is not a recommended product.  
Not recommended for new design.

## Pressure Sensor

### PS-A (ADP5) series

(Built-in amplification and temperature compensating circuit)



### Built-in amplifier and compensating circuit

#### Feature

- Built-in amplifier and temperature compensation circuit, no need for circuit design and characteristic adjustment.
- High accuracy and reliability : overall accuracy  $\pm 1.25\%$  FS (Standard),  $\pm 2.5\%$  FS (Low-pressure type)
- Compact size, space-saving : compatible size for PS type (Standard/Economy, S and M packages)
- RoHS compliant

#### Typical applications

- Industrial use : Pressure switches and pneumatic components, compressed air pressure measuring devices
  - Medical use : Airbeds
  - Others : Pressure sensing devices for air pressure mediums
- [Low-pressure type]
- Water level detection for domestic appliances : Washing machines and dishwashers
  - Air pressure control : Cleanrooms and smoking rooms



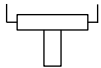
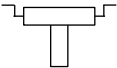

#### Ordering information

<b>ADP5</b>	<b>1</b>	<b>5</b>	<b>1</b>
Terminal profile	Code	Rated pressure	Code
1 : DIP terminal	0	$\pm 100$ kPa	0
	1	-100 kPa	S package length : 3 mm 0.118 inch, dia : 3 mm 0.118 inch
2 : SMD terminal	2	25 kPa	
	4	100 kPa	1
	5	200 kPa	M package length : 5 mm 0.197 inch, dia : 3 mm 0.118 inch
	6	500 kPa	3
	7	1000 kPa	
	B6	6 kPa (Low pressure type)	P package (Only low pressure type) length : 15.6 mm 0.615 inch, dia : 5.45 mm 0.215 inch

Note : Some part numbers may not be available depending on the combination.  
Please refer to the Table of PRODUCT TYPES on the next page.

#### Product types

Standard packing : Carton : 100 pcs.; Case : 1,000 pcs.

Pressure	Terminal	Package (Pressure inlet hole length)		Part No.				
		Standard type		Standard / Economy type		Low pressure type		
		S package (3 mm 0.118 inch)		M package (5 mm 0.118 inch)		P package (15.6 mm 0.614 inch)		
		DIP terminal 	SMD terminal 	DIP terminal 	SMD terminal 	DIP terminal 		
<b>Standard type (with glass base)</b>								
$\pm 100$ kPa		ADP5100	ADP5200	ADP5101	ADP5201	-		
-100 kPa		ADP5110	ADP5210	ADP5111	ADP5211	-		
25 kPa		ADP5120	-	ADP5121	-	-		
100 kPa		ADP5140	ADP5240	ADP5141	ADP5241	-		
200 kPa		ADP5150	ADP5250	ADP5151	ADP5251	-		
500 kPa		ADP5160	ADP5260	ADP5161	ADP5261	-		
1000 kPa		ADP5170	ADP5270	ADP5171	ADP5271	-		
<b>Low pressure type</b>								
6 kPa		-	-	-	-	ADP51B63		

## Rating

### ● Standard type

Item	Standard type (with glass base)						
Type of pressure	Gauge pressure						
Pressure medium	Air <sup>*1</sup>						
Rated pressure (kPa)	±100	-100	25	100	200	500	1000
Max. applied pressure	Twice of the rated pressure						1.5 times the rated pressure
Ambient temperature	-10 °C to +60 °C 14 °F to +140 °F (no freezing or condensation)						
Storage temperature	-20 °C to +85 °C -4 °F to +185 °F (no freezing or condensation)						
Drive voltage	5±0.25 V						
Temperature compensation range	0 °C to 50 °C 32 °F to 122 °F						
Offset voltage <sup>*2,3,5</sup>	2.5±0.05						0.5±0.05 V
Rated output voltage <sup>*2,3,5</sup>	4.5±0.05 (+when +100kPa)						4.5±0.05 V
Overall accuracy	±1.25 %FS <sup>*3,4,5</sup>						
Current consumption	Max. 10 mA <sup>*2,3</sup>						

\*1: Please consult us for pressure media other than dry air, nitrogen, oxygen, carbon dioxide.

\*2: Indicates output when temperature is 25 °C 77 °F.

\*3: Indicates output when drive voltage is 5 V. Although output fluctuates due to fluctuations in the drive voltage, this is not included.

\*4: Overall accuracy indicates the accuracy of the offset voltage and rated output voltage at a temperature compensation range of 0 to 50 °C 32 to 122 °F.

\*5: Accuracy is the value at the time of our shipping. Please set Zero-point calibration function on your products in order to safely use if the offset voltage is shifted.

### ● Low pressure type

Item	Economy type (without glass base)						
Type of pressure	Gauge pressure						
Pressure medium	Air <sup>*1</sup>						
Rated pressure (kPa)	6						
Max. applied pressure	Twice of the rated pressure						
Ambient temperature	0 °C to +70 °C 32 °F to +158 °F (no freezing or condensation)						
Storage temperature	-30 °C to +100 °C -22 °F to +212 °F (no freezing or condensation)						
Drive voltage	5±0.25 V						
Temperature compensation range	0 °C to 70 °C 32 °F to 158 °F						
Offset voltage	0.5 V (Typical) <sup>*2</sup>						
Span voltage	4.0 V (Typical) <sup>*2</sup>						
Overall accuracy	±2.5 %FS <sup>*2,3,4</sup>						
Current consumption	Max. 10 mA						

\*1: Please consult us for pressure media other than dry air, nitrogen, oxygen, carbon dioxide.

\*2: Indicates output when drive voltage is 5 V. Although output fluctuates due to fluctuations in the drive voltage, this is not included.

\*3: Overall accuracy indicates the accuracy of the offset voltage and span voltage at temperatures between 0 to 70 °C 32 to 158 °F (FS=4V)

\*4: The initial offset voltage error is not included in the overall accuracy.

Reference data

[Standard type]

1. - ① Output voltage

(Representative example : ADP5170)  
 Drive voltage : 5 V  
 Temperature : 25 °C 77 °F  
 Applied pressure : 0 to +1,000 kPa

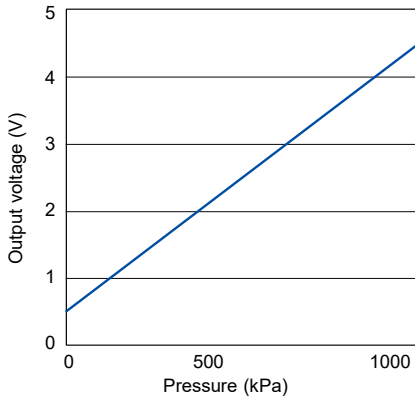

1. - ② Overall accuracy (Offset voltage)

(Representative example : ADP5170)  
 Drive voltage : 5 V  
 Temperature : 0 to 50 °C 32 to 122 °F  
 Applied pressure : 0 kPa

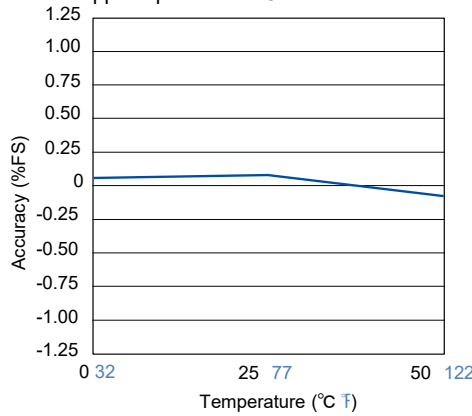

1. - ③ Overall accuracy (Rated output voltage)

(Representative example : ADP5170)  
 Drive voltage : 5 V  
 Temperature : 0 to 50 °C 32 to 122 °F  
 Applied pressure : +1,000 kPa

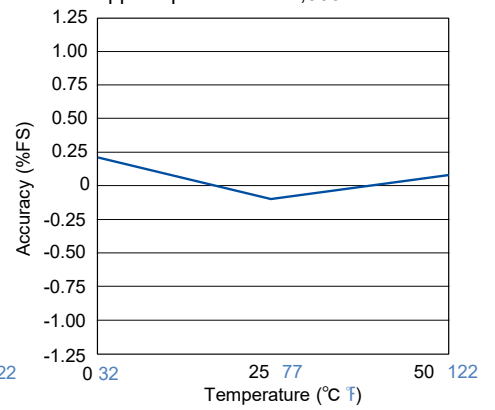

2. - ① Output voltage

(Representative example : ADP5100)  
 Drive voltage : 5 V  
 Temperature : 25 °C 77 °F  
 Applied pressure : -100 to +100 kPa

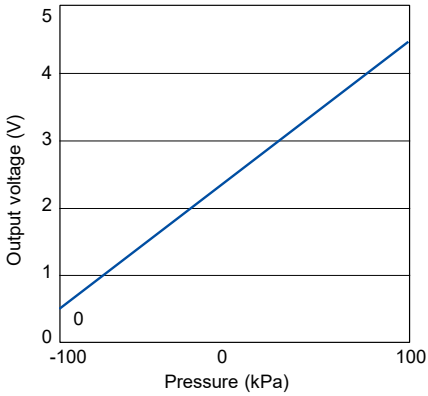

2. - ② Overall accuracy (Offset voltage)

(Representative example : ADP5100)  
 Drive voltage : 5 V  
 Temperature : 0 to 50 °C 32 to 122 °F  
 Applied pressure : 0 kPa

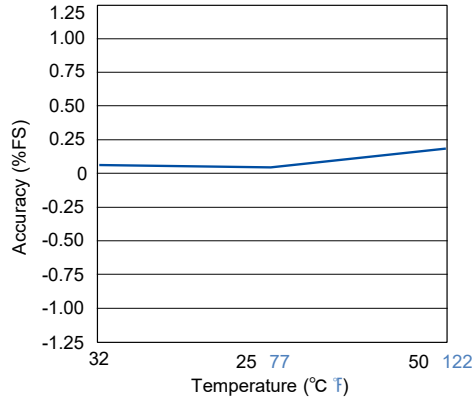

2. - ③ Overall accuracy (Rated output voltage)

(Representative example : ADP5100)  
 Drive voltage : 5 V  
 Temperature : 0 to 50 °C 32 to 122 °F  
 Applied pressure : +100 kPa

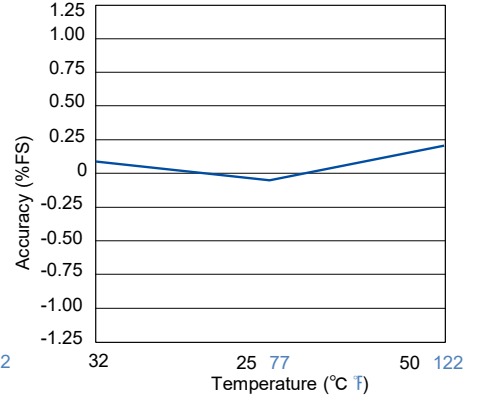

Reference data

[Low pressure type]

1. Output voltage

(ADP51B63)

Drive voltage : 5 V

Temperature : 25 °C 77 °F

Applied pressure : 0 to 6 kPa

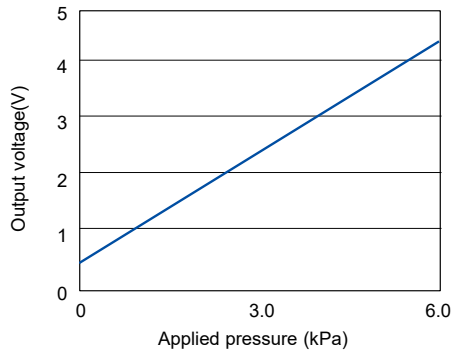

2. THB (high temperature high humidity bias test)

(ADP51B63)

Within 85 °C 185 °F and 85% RH

5 V applied between No.2 (Vdd) and No.3 (GND)

Applied pressure : 0 kPa

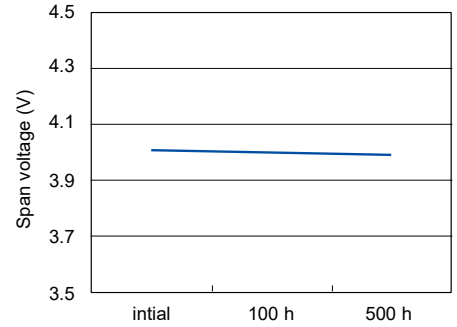
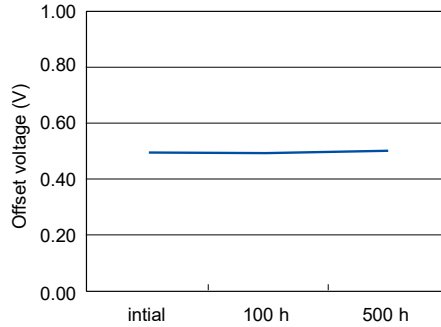

3. Ambient temperature characteristics (ADP51B63)

Ambient temperature : 25 °C 77 °F → 0 °C 32 °F → 10 °C 50 °F → 60 °C 140 °F → 70 °C 158 °F

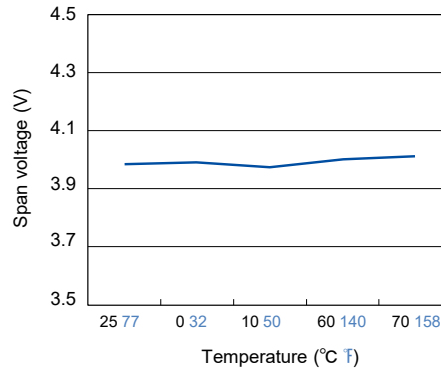
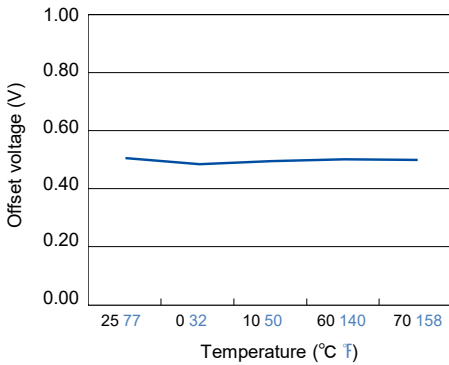

4. Shock test

(ADP51B63)

Shock applied (981 m/s<sup>2</sup>, 3 times in x, y and z directions)

Applied pressure : 0 kPa

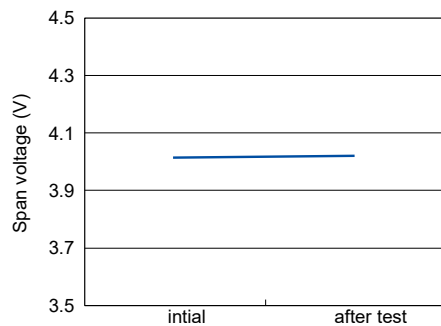
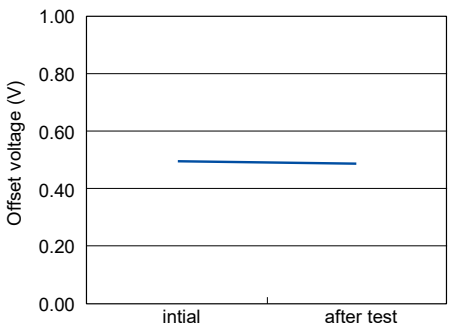

5. Vibration test

(ADP51B63)

Vibration applied (10 to 55 Hz, amplitude : 1.5mm, x, y and z directions, 2 hrs each)

Applied pressure : 0 kPa

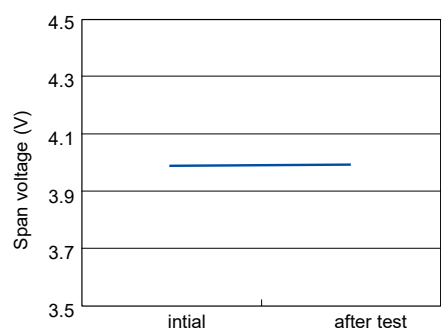
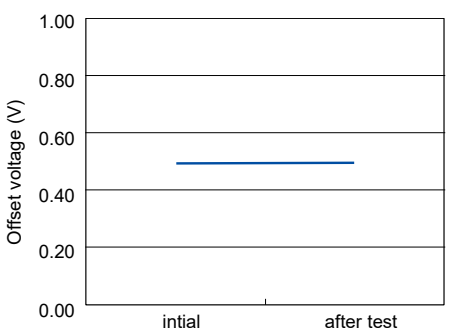

**Reference data**

6. Temperature/humidity cycle test  
(ADP51B63)

Exposed to 10 cycles in the temperature and humidity conditions given below.

Applied pressure : 0 kPa

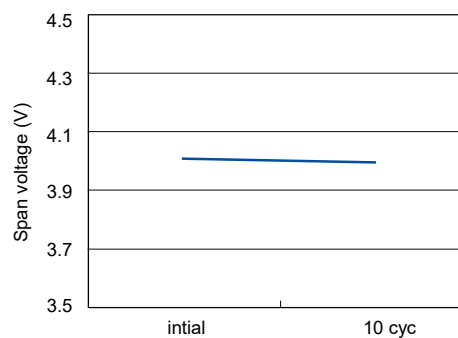
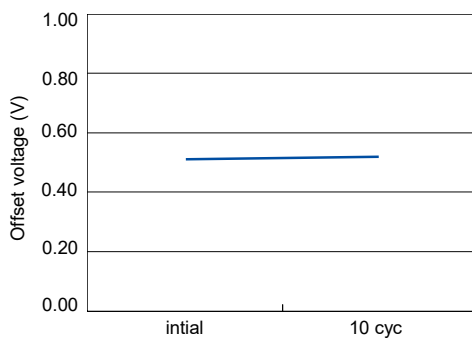
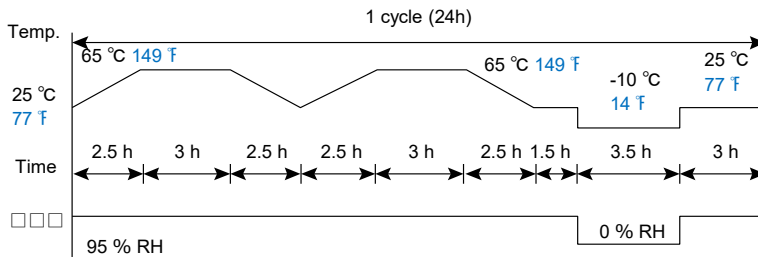

**Evaluation test**

Classification	Tested item	Tested condition	Result
Environmental characteristics	Storage at high temperature	Temperature : Left in a 85 °C 185 °F constant temperature bath Time : 100 hrs	Passed
	Storage at low temperature	Temperature : Left in a -20 °C -4 °F constant temperature bath Time : 100 hrs	Passed
	Humidity	Temperature/humidity : Left at 40 °C 104 °F, 90 % RH Time : 100 時間	Passed
	Temperature cycle	Temperature : -20 °C to 85 °C -4 °F to 185 °F 1 cycle : 30 min Times of cycle : 100 cycle	Passed
Endurance characteristics	High temperature/high humidity operation	Temperature/humidity : 40 °C 104 °F, 90% RH Operation times : 10 <sup>6</sup> , rated voltage applied	Passed
Mechanical characteristics	Vibration resistance	Double amplitude : 1.5 mm 0.059 inch Vibration : 10 to 55 Hz Applied vibration direction : X, Y, Z 3 directions Time : 2 hrs each	Passed
	Dropping resistance	Dropping height : 75 cm 29.528 inch Times : 2 times	Passed
	Terminal strength	Pulling strength : 9.8 N {1 kgf}, 10 sec Bending strength : 4.9 N {0.5 kgf}, left and right 90 ° 1 time	Passed
Soldering characteristics	Solderability	Temperature : 230 °C 446 °F Time : 5 sec	Passed
	Heat resistance (DIP)	Temperature : 260 °C 500 °F Time : 10 sec	Passed

Note: For details other than listed above, please consult us.

Items	Criteria
Offset voltage	Variation amount
Output span voltage	within ±2.5 %FS of value

**Dimensions**

The CAD data of the products with a **CAD data** mark can be downloaded from: <http://industrial.panasonic.com/>

- Standard type S package (Terminal direction : DIP terminal Pressure inlet hole length : 3 mm 0.118 inch) ADP51□0

**CAD data**

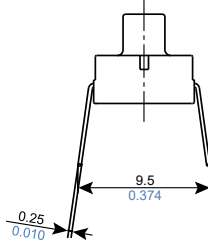
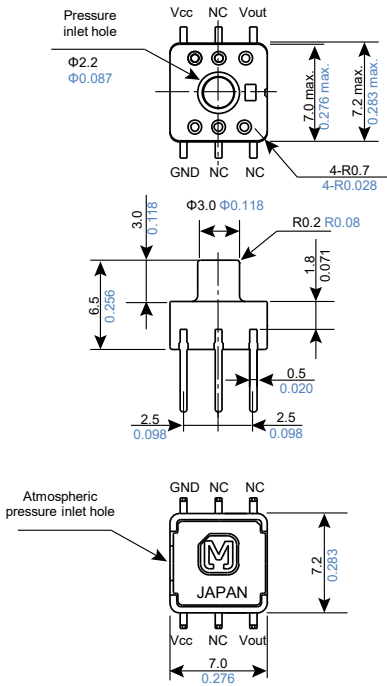

Recommended PC board pattern (TOP VIEW)

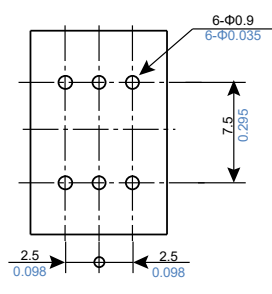

Terminal connection diagram

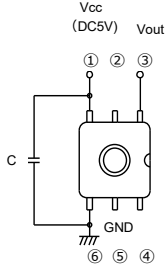

Terminal No.	Name
1	Vcc (Power supply ⊕)
2	NC (No connection)
3	Vout (Output)
4	NC (No connection)
5	NC (No connection)
6	GND (Ground)

Note: leave terminal "No connection" unconnected.

Unit : mm inch, General tolerance ±0.3 ±0.012

- Standard type S package (Terminal direction : SMD terminal Pressure inlet hole length : 3 mm 0.118 inch) ADP52□0

**CAD data**

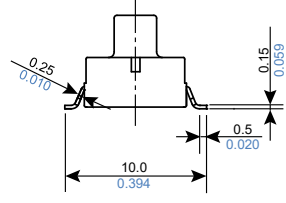
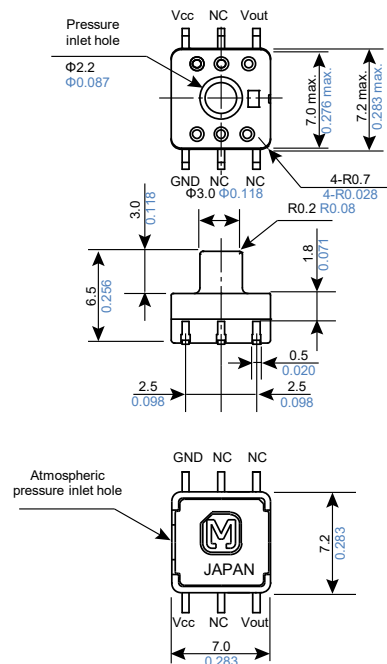

Recommended PC board pattern (TOP VIEW)

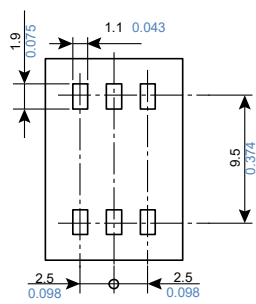

Terminal connection diagram

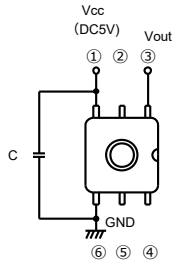

Terminal No.	Name
1	Vcc (Power supply ⊕)
2	NC (No connection)
3	Vout (Output)
4	NC (No connection)
5	NC (No connection)
6	GND (Ground)

Note: leave terminal "No connection" unconnected.

Unit : mm inch, General tolerance ±0.3 ±0.012

**Dimensions**

The CAD data of the products with a **CAD data** mark can be downloaded from: <http://industrial.panasonic.com/>

- Standard/Economy type M package (Terminal direction : DIP terminal Pressure inlet hole length : 5 mm 0.197 inch) ADP51□1

ADP51□1/ADP51A11

**CAD data**

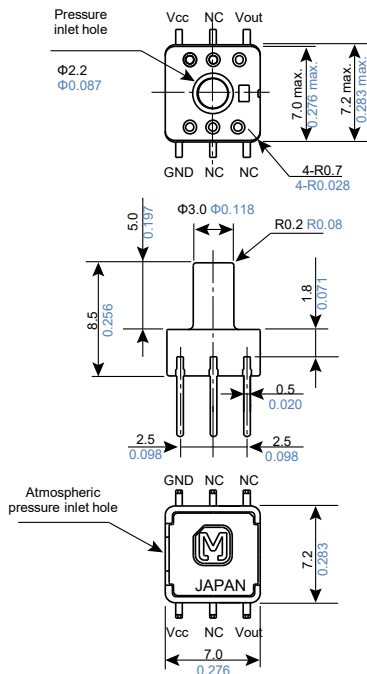

Recommended PC board pattern (TOP VIEW)

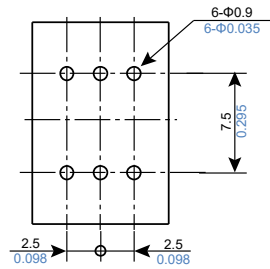

Terminal connection diagram

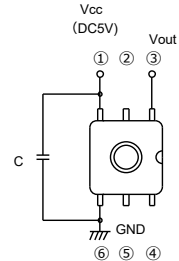

Terminal No.	Name
1	Vcc (Power supply ⊕)
2	NC (No connection)
3	Vout (Output)
4	NC (No connection)
5	NC (No connection)
6	GND (Ground)

Note: leave terminal "No connection" unconnected.

Unit : mm inch, General tolerance  $\pm 0.3 \pm 0.012$

- Standard/Economy type M package (Terminal direction : SMD terminal Pressure inlet hole length : 5 mm 0.197 inch) ADP52□1

**CAD data**

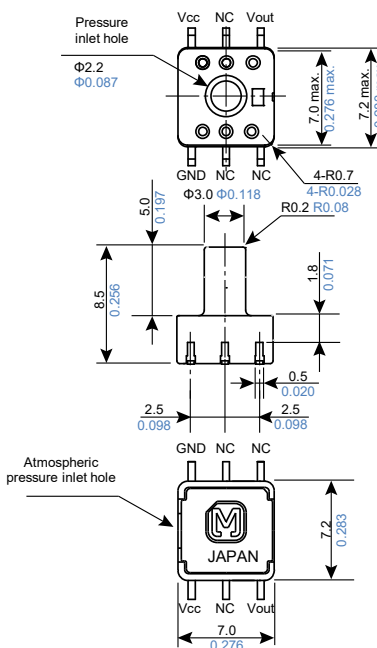

Recommended PC board pattern (TOP VIEW)

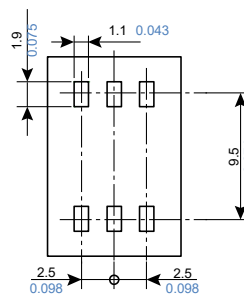

Terminal connection diagram

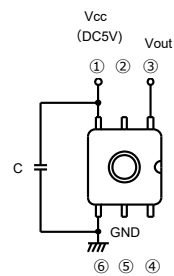

Terminal No.	Name
1	Vcc (Power supply ⊕)
2	NC (No connection)
3	Vout (Output)
4	NC (No connection)
5	NC (No connection)
6	GND (Ground)

Note: leave terminal "No connection" unconnected.

Unit : mm inch, General tolerance  $\pm 0.3 \pm 0.012$

**Dimensions**

The CAD data of the products with a **CAD data** mark can be downloaded from: <http://industrial.panasonic.com/>

- Low pressure type P package (Terminal direction : DIP terminal, Pressure inlet hole length : 15.6 mm 0.614 inch) ADP51B63

**CAD data**

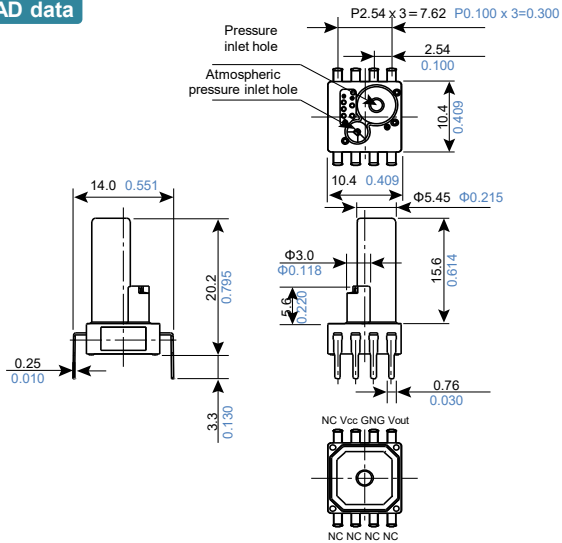

Recommended PC board pattern (BOTTOM VIEW)

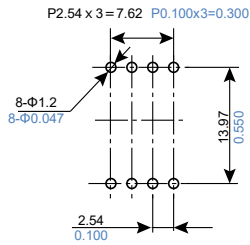

Terminal connection diagram

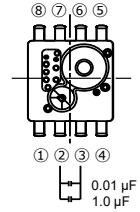

Unit : mm inch, General tolerance  $\pm 0.3 \pm 0.012$

Terminal No.	Name
1	NC (No connection)
2	Vcc (Power supply <sup>⊕</sup> )
3	GND (Ground)
4	Vout (Output)

Terminal No.	Name
5	NC (No connection)
6	NC (No connection)
7	NC (No connection)
8	NC (No connection)

Note: leave terminal "No connection" unconnected.



## Explanation of terms

### ■ Pressure object

This is what can be used to activate the pressure sensor.  
(The Panasonic Corporation pressure sensor can be used with gas.)

### ■ Rated pressure

The pressure value up to which the specifications of the pressure sensor are guaranteed.

### ■ Maximum applied pressure

The maximum pressure that can be applied to the pressure sensor, after which, when the pressure is returned to below the rated pressure range, the specifications of the pressure sensor are guaranteed.

### ■ Temperature compensation range

The temperature range across which the specification values of the pressure sensor are guaranteed.

### ■ Drive current (voltage)

The supply current (voltage) required to drive a pressure sensor.

### ■ Output span voltage

The difference between the rated output voltage and the offset voltage. The output span voltage is also called the full-scale voltage (FS).

### ■ Offset voltage

The output voltage of a pressure sensor when no pressure is applied.

### ■ Rated pressure output voltage

Output voltage when rated pressure is applied.

### ■ Linearity

When the pressure is varied from no load to the rated pressure, the linearity is the amount of shift between the straight line that joins the no-load voltage value and the rated pressure voltage value (expressed as the ratio of the amount of shift (D1) at half of the rated pressure value with respect to the full scale voltage (FS)).

### ■ Output hysteresis

The ratio of the difference (D2) in the no-load output voltages when the pressure is varied from no load to the rated pressure then reduced back to no load, with respect to the full scale voltage (FS).

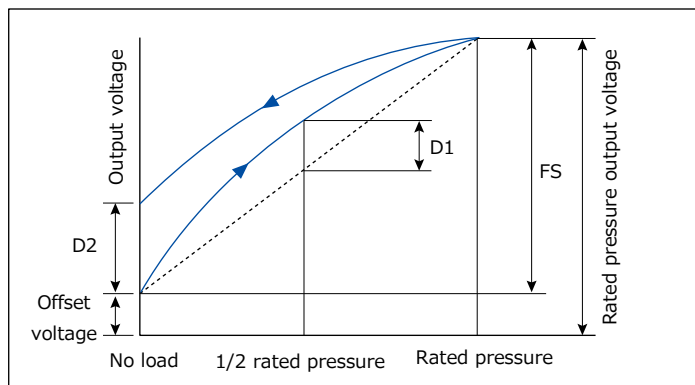

### ■ Offset voltage temperature characteristic

The variation of the offset voltage with changes in ambient temperature. The difference between the offset voltage at the standard temperature and the offset values at the compensation lower limit temperature (low temperature) (D1) and compensation upper limit temperature (high temperature) (D2) are obtained, and the offset voltage temperature characteristic is expressed as the ratio of the larger of these two differences (absolute) with respect to the full scale voltage (FS).

**Explanation of terms**

■ **Temperature sensitivity characteristic**

The variation of the sensitivity with changes in ambient temperature (variation in full scale (FS)). The difference between the full scale voltage at the standard temperature (FS) and the full scale values at the compensation lower limit temperature (low temperature) (FS1) and compensation upper limit temperature (high temperature) (FS2) are obtained, and the offset voltage temperature characteristic is expressed as the ratio of the larger of these two differences (FS1 - FS and FS2 - FS (absolute)) with respect to the full scale voltage (FS).

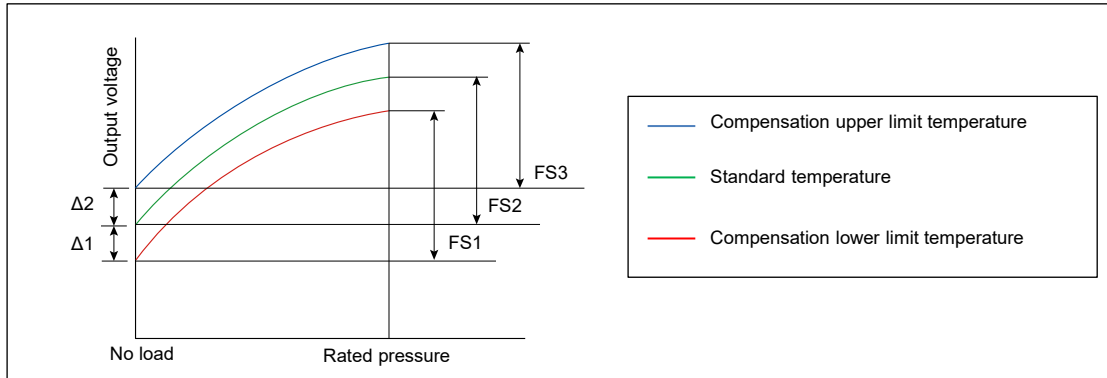

■ **Bridge resistance**

Refers to the resistance value of a piezo resistance formed on a monolithic silicon substrate. For example, the values of the resistances R1 to R4 in the bridge are typically 5 kΩ each.

\* When the resistances of the resistive elements R1 to R4 that comprise the bridge are 5 kΩ each, the equivalent composite resistance of the bridge is 5kΩ (3 kΩ bridges are also available).

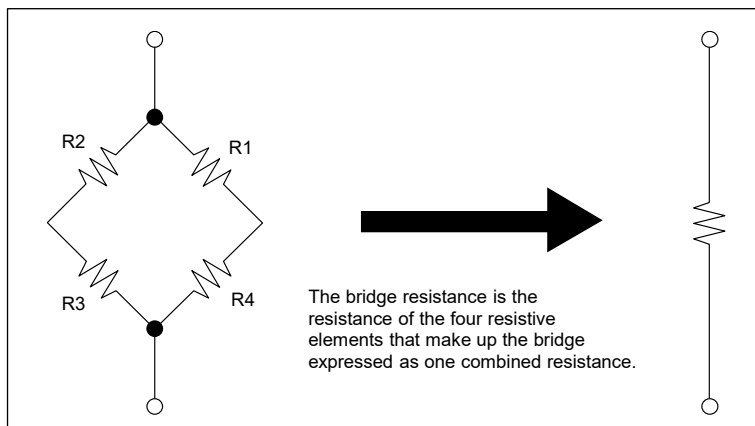

■ **Overall accuracy**

Accuracy of offset voltage and rated pressure output voltage within the temperature compensation range.

## Safety and Legal Matters to Be Observed

### Product specifications and applications

- Please be advised that this product and product specifications are subject to change without notice for improvement purposes. Therefore, please request and confirm the latest delivery specifications that explain the specifications in detail before the final design, or purchase or use of the product, regardless of the application. In addition, do not use this product in any way that deviates from the contents of the company's delivery specifications.
- Unless otherwise specified in this catalog or the product specifications, this product is intended for use in general electronic equipment (AV products, home appliances, commercial equipment, office equipment, information and communication equipment, etc.).  
When this product is used for the following special cases, the specification document suited to each application shall be signed/sealed (with Panasonic and the user) in advance..These include applications requiring special quality and reliability, wherein their failures or malfunctions may directly threaten human life or cause harm to the human body (e.g.: space/aircraft equipment, transportation/traffic equipment, combustion equipment, medical equipment, disaster prevention/crime prevention equipment, safety equipment, etc.).

### Safety design and product evaluation

- Please ensure safety through protection circuits, redundant circuits, etc., in the customer's system design so that a defect in our company's product will not endanger human life or cause other serious damage.
- This catalog shows the quality and performance of individual parts. The durability of parts varies depending on the usage environment and conditions. Therefore, please ensure to evaluate and confirm the state of each part after it has been mounted in your product in the actual operating environment before use.  
If you have any doubts about the safety of this product, then please notify us immediately, and be sure to conduct a technical review including the above protection circuits and redundant circuits at your company.

### Laws / Regulations / Intellectual property

- The transportation of dangerous goods as designated by UN numbers, UN classifications, etc., does not apply to this product. In addition, when exporting products, product specifications, and technical information described in this catalog, please comply with the laws and regulations of the countries to which the products are exported, especially those concerning security export control.
- Each model of this product complies with the RoHS Directive (Restriction of the use of hazardous substances in electrical and electronic equipment) (2011/65/EU and (EU) 2015/863). The date of compliance with the RoHS Directive and REACH Regulation varies depending on the product model.  
Further, if you are using product models in stock and are not sure whether or not they comply with the RoHS Directive or REACH Regulation, please contact us by selecting "Sales Inquiry" from the inquiry form.
- During the manufacturing process of this product and any of its components and materials to be used, Panasonic does not intentionally use ozone-depleting substances stipulated in the Montreal Protocol and specific bromine-based flame retardants such as PBBs (Poly-Brominated Biphenyls) / PBDEs (Poly-Brominated Diphenyl Ethers). In addition, the materials used in this product are all listed as existing chemical substances based on the Act on the Regulation of Manufacture and Evaluation of Chemical Substances.
- With regard to the disposal of this product, please confirm the disposal method in each country and region where it is incorporated into your company's product and used.
- The technical information contained in this catalog is intended to show only typical operation and application circuit examples of this product. This catalog does not guarantee that such information does not infringe upon the intellectual property rights of Panasonic or any third party, nor imply that the license of such rights has been granted.

**Panasonic Industry will assume no liability whatsoever if the use of our company's products deviates from the contents of this catalog or does not comply with the precautions. Please be advised of these restrictions.**

## Matters to Be Observed When Using This Product

### (Pressure sensor / PS-A)

#### Use environments and cleaning conditions

- Do not use or store the sensor with a non-air medium, especially in a medium containing a corrosive gas (organic solvent, sulfur dioxide, hydrogen sulfide, etc.), moisture, foreign matter, or the like. Do not use the sensor with a harmful medium, such as a corrosive gas, a combustible gas, or a toxic gas. There is a possibility that a tiny amount of the harmful medium will leak out and exert a harmful effect on the surrounding environment and the human body.
- The sensor does not have a waterproof structure. Avoid using the sensor in a place where water, etc., may splash on the sensor or an environment where dew concentrates on the sensor. When water on the sensor freezes, it may lead to a change in the output from the sensor or even the destruction of the sensor.
- Because of the structural features of the sensor, the sensor output fluctuates when the sensor is exposed to light. Avoid the sensor being exposed to light, etc., especially, when pressure is applied to the sensor through a transparent tube.
- Do not use the sensor in a situation where high-frequency vibrations, such as ultrasonic waves, are applied to the sensor.
- The sensor may malfunction when exposed to static electricity, lightning, or electric noise from a cellular phone, radio transmitter, broadcasting station, etc.
- Since the sensor is open to the ambient air, be careful not to let cleaning solution flow into the sensor. Do not clean the sensor by using ultrasonic waves. It may cause the sensor to fail.

#### Handling conditions

- Use the sensor in the rated voltage range. Applying voltage outside the rated voltage range to the sensor can cause an accident or breakage of the sensor. Select the way the sensor, lead-in tube, etc., are fixed in accordance with the pressure being applied to the sensor. If you have any question, please feel free to contact us.
- The sensor has a built-in sensor chip located close to the pressure lead-in port. Inserting a foreign object, such as a needle, in the pressure lead-in port damages the chip or blocks up the lead-in port. Never do this. Do not block up the pressure lead-in port.
- When coating the board carrying the sensor with a potting agent, etc., make sure that the potting agent does not go into the pressure lead-in port and the ambient pressure lead-in port. Thermal expansion/shrinkage of a resin coating the sensor applies stress to the sensor. Use a resin with elasticity as a sealing agent (potting agent) after sufficiently evaluating its properties.
- The sensor may be destroyed by static electricity. Keep the sensor in a storage condition in which its terminals are short-circuited via a conductive material or the whole sensor is wrapped with aluminum foil, etc. Because a plastic container becomes charged with static electricity easily, avoid using a plastic container for storage or transportation of the sensor. When using the sensor, let surrounding objects release static electricity safely by grounding the operator, charged objects on the table, etc.

#### Circuit design and circuit board design

- Connect the sensor in accordance with the terminal connection diagram. Do not connect the sensor in reverse polarity to the power supply or connect a free terminal. Such wiring will lead to breakage or deterioration of the sensor.
- To ensure the sensor's resistance to noise superposed on source voltage, make sure to provide the power input terminals of the sensor with capacitors to stabilize the source voltage. We recommend to dispose a 0.1  $\mu\text{F}$  capacitor and a 1,000 pF capacitor in parallel with each other. Make sure to select or add an optimum capacitor after confirming the sensor's resistance to noise in the actual circuit configuration where the sensor is provided with the capacitor.
- An external surge voltage applied to the sensor damages its internal circuit. Use a surge absorber to protect the sensor from incoming surges.
- Adopt a printed board with a land wide enough to affix the sensor thereon.

## Mounting conditions

- A sensor has a small structure with a small heat capacity. When soldering the sensor, keep the effects of external heat on the sensor as small as possible. A sensor exposed to intensive heat thermally deforms, which may lead to breakage or change in characteristics.
- Use non-corrosive, rosin-based solder flux. The sensor is structured to be open to the ambient air. Make sure that solder flux does not flow into the sensor.
- Perform manual soldering in the following manner: clean the soldering iron tip sufficiently and then finish soldering, with the soldering iron tip heated to 260 °C to 300 °C (30 W), within 5 seconds. Do not apply a load to the sensor terminals. It may change the output from the sensor.
- Perform flow soldering (DIP terminal type) with a flow soldering tank temperature kept at 260 °C or lower and within 5 seconds. When the sensor is mounted on a board with a small heat capacity, the sensor may thermally deform when exposed to soldering heat. In this case, avoid flow soldering.
- In the case of reflow soldering (SMD terminal type), we recommend solder-paste screen printing as a solder paste printing method.
- For a footprint pattern on the printed board, refer to the printed board recommended specification diagram. Because self-alignment of solder is insufficient in some cases, carefully align the terminals of the sensor and the pattern.
- The recommended reflow temperature profile is shown below. The temperature measurement shown in the temperature profile is the value measured at a part of board that is close to the terminals.

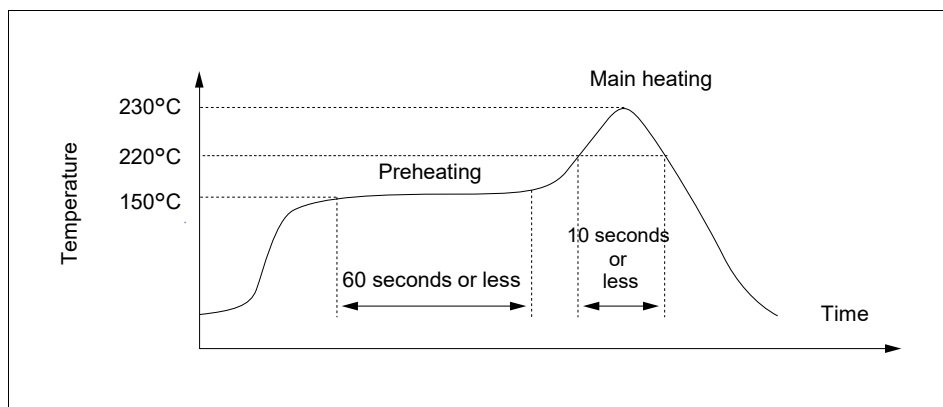

- The front end of the pressure lead-in port may melt or deform under high temperature, depending on the equipment or conditions. Make sure to conduct a confirmation test under the actual mounting conditions.
- Complete rework on a soldered part in a single process. When reworking a solder bridge, use a solder iron with a flat tip and do not apply any additional solder flux. Use a solder iron with a tip temperature equal to or lower than the tip temperature specified in the specification sheet.
- A warped printed board applies stress to the sensor, which may change the characteristics of the sensor. Conduct a characteristics confirmation test after the soldering process. When cutting or folding the board after mounting the sensor on the board, be careful that no stress is applied to the soldered area.
- The sensor has external terminals exposed from its body. A metal piece, etc., coming in contact with the exposed terminals, causes problems with output from the terminals. Prevent metal pieces, bare hands, etc., from coming in contact with the terminals. Excessive force applied to the terminals deforms the terminals, thus impairing the solderability of the sensor. Do not drop the sensor, and do not handle it roughly, either.
- When coating the board to prevent the deterioration of insulation properties after the soldering process, make sure that no chemical sticks to the sensor.