

PAN1326C2

Bluetooth® Basic Data Rate and Low Energy Module

Quick Start Guide

Rev. 1.0



Overview

Panasonic's new PAN1326C2 is a Host Controller Interface (HCI) Bluetooth® Radio Frequency (RF) module that brings Texas Instruments™ seventh generation Bluetooth core integrated circuit, the CC2564C, to an easy-to-use module format. The PAN1326C2 is Bluetooth 5 compliant and it offers best-in-class RF performance with about twice the range of other Bluetooth Low Energy (LE) solutions. Panasonic's tiny footprint technology has produced a module of only 85.5 mm². The module is designed to accommodate PCBs pad pitch of 1.3 mm and as few as two layers for easy implementation and manufacturing. The module has been designed to be 100 percent pin compatible with previous generations of Texas Instruments based Bluetooth HCI modules.

Features

- Bluetooth 5 compliant up to the HCI layer
- Best-in-class Bluetooth RF performance (Tx, Rx sensitivity, blocking)
- Dimensions: 9 mm × 9.5 mm × 1.8 mm
- Based upon Texas Instruments CC2564C
- Interfaces: UART, GPIO, PCM

Characteristics

- Bluetooth 5
- Receiver sensitivity: -90 dBm
- Output power: 8 dBm
- Power supply: 1.7 V to 4.8 V
- Power consumption: Tx 40 mA
- Operating temperature range: -40 °C to 85 °C

Block Diagram

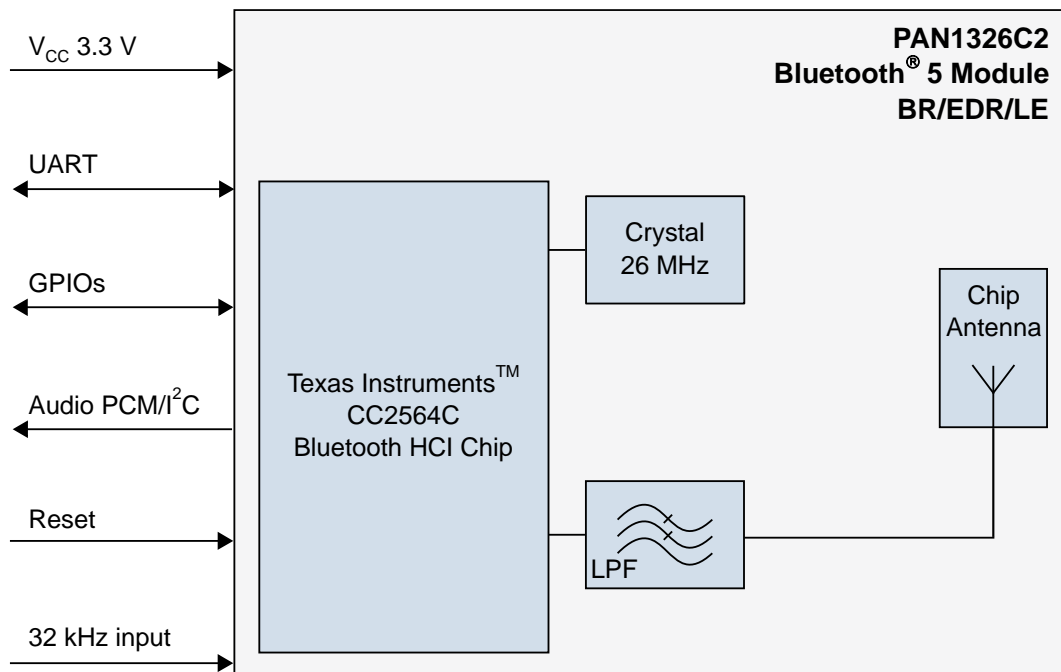

By purchase of any of the products described in this document the customer accepts the document's validity and declares their agreement and understanding of its contents and recommendations. Panasonic Industrial Devices Europe GmbH (Panasonic) reserves the right to make changes as required at any time without notification.

© Panasonic Industrial Devices Europe GmbH 2021.

This document is copyrighted. Reproduction of this document is permissible only if reproduction is without alteration and is accompanied by all associated warranties, conditions, limitations, and notices. Do not disclose it to a third party.

All rights reserved.

This Quick Start Guide does not lodge the claim to be complete and free of mistakes.

The information contained herein is presented only as guidance for Product use. No responsibility is assumed by Panasonic for any infringement of patents or any other intellectual property rights of third parties that may result from the use of Product. No license to any intellectual property right is granted by this document, whether express or implied, by estoppel or otherwise.

Description of hardware, software, and other information in this document is only intended to illustrate the functionality of the referred Panasonic product. It should not be construed as guaranteeing specific functionality of the product as described or suitable for a particular application.

Any provided (source) code shall not be used or incorporated into any products or systems whose manufacture, use or sale is prohibited under any applicable laws or regulations.

Any outlined or referenced (source) code within this document is provided on an "as is" basis without any right to technical support or updates and without warranty of any kind on a free of charge basis according to § 516 German Civil Law (BGB) including without limitation, any warranties or conditions of title, non infringement, merchantability, or fitness for a particular purpose. Customer acknowledges that (source) code may bear defects and errors.

The third party tools mentioned in this document are offered by independent third party providers who are solely responsible for these products. Panasonic has no responsibility whatsoever for the performance, product descriptions, specifications, referenced content, or any and all claims or representations of these third party providers. Panasonic makes no warranty whatsoever, neither express nor implied, with respect to the goods, the referenced contents, or any and all claims or representations of the third party providers.

To the maximum extent allowable by Law Panasonic assumes no liability whatsoever including without limitation, indirect, consequential, special, or incidental damages or loss, including without limitation loss of profits, loss of opportunities, business interruption, and loss of data.

Table of Contents

- 1 About This Document.....5**
 - 1.1 Purpose and Audience5
 - 1.2 Revision History.....5
 - 1.3 Use of Symbols5
 - 1.4 Related Documents6
- 2 Overview.....7**
- 3 Setting up the Toolchain8**
 - 3.1 Installing “CC2564CMSP432BTBLESW1”8
 - 3.2 Installing “Code Composer Studio”8
 - 3.3 Starting “Code Composer Studio”9
- 4 Setting up the Demo11**
 - 4.1 Loading the Demo11
 - 4.2 Connecting the Evaluation Board13
 - 4.3 Flashing the Code13
 - 4.4 Setting up “iBeacon (Bluetooth Low Energy)”14
 - 4.5 Setting up “SPP (Bluetooth Classic)”15
- 5 Restricted Use.....19**
 - 5.1 Life Support Policy.....19
 - 5.2 Restricted End Use.....19
- 6 Contact Details.....20**
 - 6.1 Contact Us.....20
 - 6.2 Product Information20

1 About This Document

1.1 Purpose and Audience

This Quick Start Guide provides details on how to start developing applications on the Panasonic PAN1326C2 module:

- Installing toolchain,
- Setting up the demo “**iBeacon** (Bluetooth Low Energy)” demo by using Panasonic development kit and receive beacon data in app, and
- Setting up the demo “**SPP** (Bluetooth Classic)” by using Panasonic development kit and transmit strings from terminal to application via PAN1326C2.



It is intended for research and development engineers.

The product is referred to as “the PAN1326C2” or “the module” within this document.

1.2 Revision History

Revision	Date	Modifications/Remarks
1.0	2021-05-31	First version

1.3 Use of Symbols

Symbol	Description
	Note Indicates important information for the proper use of the product. Non-observance can lead to errors.
	Attention Indicates important notes that, if not observed, can put the product’s functionality at risk.
	Tip Indicates useful information designed to facilitate working with the software.
⇒ [chapter number] [chapter title]	Cross reference Indicates cross references within the document. Example: Description of the symbols used in this document ⇒ 1.3 Use of Symbols.
✓	Requirement Indicates a requirement that must be met before the corresponding tasks can be completed.
➔	Result Indicates the result of a task or the result of a series of tasks.

Symbol	Description
This font	<p>GUI text</p> <p>Indicates fixed terms and text of the graphical user interface.</p> <p>Example:</p> <p>Click Save.</p>
Menu > Menu item	<p>Path</p> <p>Indicates a path, e.g. to access a dialog.</p> <p>Example:</p> <p>In the menu, select File > Setup page.</p>
This font	<p>File names, userinput</p> <p>Indicates file names or messages and information displayed on the screen or to be selected or entered by the user.</p> <p>Examples:</p> <p>pan1760.c contains the actual module initialization.</p> <p>Enter the value Product 123.</p>
This font	<p>Systemoutput</p> <p>Indicates messages and information displayed on the screen.</p> <p>Example:</p> <p>The message Failed to save your data is displayed.</p>
Key	<p>Key</p> <p>Indicates a key on the keyboard.</p> <p>Example:</p> <p>Press F10.</p>

1.4 Related Documents

For related documents please refer to the Panasonic website ⇒ [6.2 Product Information](#).

2 Overview

Panasonic's new PAN1326C2 is a Host Controller Interface (HCI) Bluetooth RF module that brings Texas Instrument's seventh generation Bluetooth core integrated circuit, the CC2564, to an easy-to-use module format. The PAN1326C2 is Bluetooth 5 compliant and it offers best-in-class RF performance with about twice the range of other Bluetooth LE solutions. Panasonic's tiny footprint technology has produced a module of only 85.5 mm². The module is designed to accommodate PCBs pad pitch of 1.3 mm and as few as two layers for easy implementation and manufacturing. The module has been designed to be 100 percent pin compatible with previous generations of Texas Instruments based Bluetooth HCI modules.

For related documents please refer to [⇒ 6.2 Product Information](#).

3 Setting up the Toolchain

The following guide is based on a Windows 64-Bit desktop version and CCSTUDIO single file installation.

3.1 Installing “CC2564CMSP432BTBLESW1”

The following requirement must be met:

- ✓ Account at Texas Instruments (<https://www.ti.com>)

1. Go to <https://www.ti.com/tool/CC2564CMSP432BTBLESW> and download **CC2564CMSP432BTBLESW1**.



2. Start and install the downloaded file `setup.exe`.
The executable file has installed all the necessary drivers, libraries, and code examples to develop Bluetooth applications on MSP432 MCUs.

Now the “CC2564CMSP432BTBLESW1” is installed.

3.2 Installing “Code Composer Studio”

The following requirement must be met:

- ✓ Account at Texas Instruments (<https://www.ti.com>)

1. Go to <https://www.ti.com/tool/CCSTUDIO> and download the “Code Composer Studio”. There are two options available, the desktop version (**CCSTUDIO**) and cloud version (**CCSTUDIO-CLOUD**).

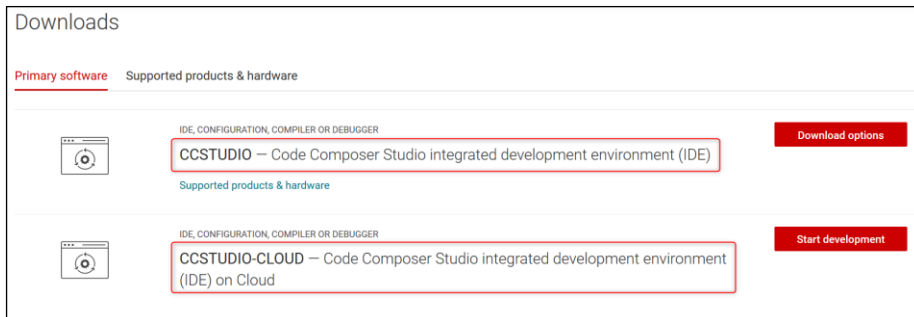



CCSTUDIO can be downloaded as “single file” or “on-demand”. If you do not want interference with your installed anti-virus program, then it is recommended to use the single file installer.

2. Extract the downloaded file `CCS10.x.x.xxxxx_win64` and locate the file `ccs_setup_10.x.x.xxxxx.exe` in the extracted folder.
3. Start and install the setup.
If you want to install specific devices to save disk space, choose **Recommended Installation**, otherwise choose **Full Installation**.
4. Select the component **SimpleLink MSP432 low power + performance MCUs** (1) for applications with PAN1326C2 and TI EVK (Texas Instruments evaluation kit).

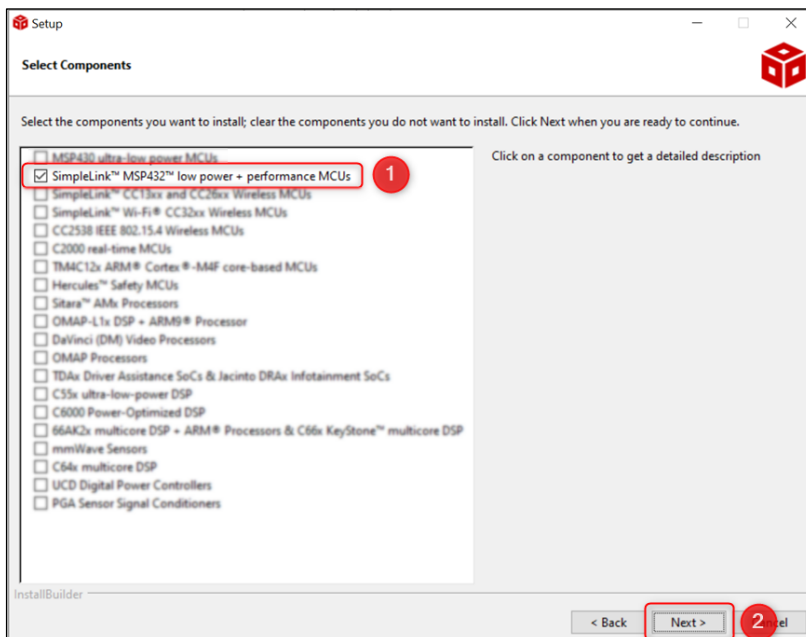

5. Click **Next >** (2) and complete the setup by following the instructions. Leave the debug probes selection as it is.

Now the “Code Composer Studio” is installed.

3.3 Starting “Code Composer Studio”



Before starting programming, always update “Code Composer Studio” and the compilers to the newest version.

The following requirements must be met:

- ✓ The “CC2564CMSP432BTBLESW1” is installed ⇒ [3.1 Installing “CC2564CMSP432BTBLESW1”](#).
- ✓ The “Code Composer Studio” is installed ⇒ [3.2 Installing “Code Composer Studio”](#).

1. Start **Code Composer Studio**.
2. Choose the location for your workspace.



The path to your workspace must include only alphanumeric characters to avoid compiler errors in some examples.

The default workspace by “Code Composer Studio” includes always an underline “_”. Change the name of the workspace or create a new one without special characters.

3. Click the tab **Help** (1) > **Check for Updates** (2) to update “Code Composer Studio” and the compilers to the newest version.

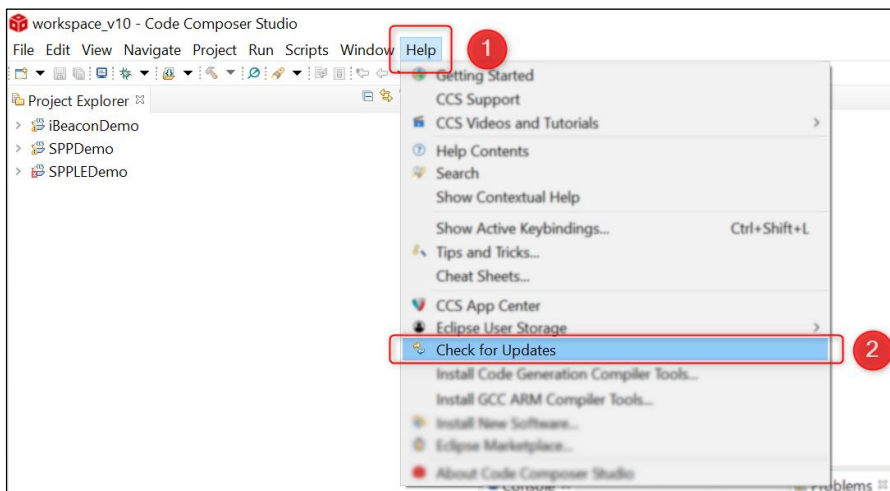

➔ The updating process will start.

4. After the updating process is completed: Go to the page **Getting Started** and click **Import Project**.

Alternatively click the tab **File** > **Open Project from File System**.

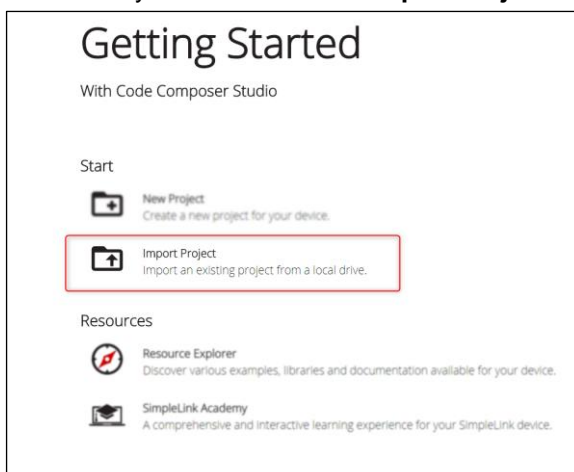

Choose only projects from the folder “Code Composer Studio” because “Code Composer Studio” ist used.

4 Setting up the Demo



Two different demos can be set up:

- “**iBeacon**” which is based on Bluetooth Low Energy.
- “**SPP**” which is based on Bluetooth Classic.

This chapter explains how to set up the demos:

- “**iBeacon** (Bluetooth Low Energy)” by using Panasonic development kit and receive beacon data in app.
- “**SPP** (Bluetooth Classic)” by using Panasonic development kit and transmit strings from terminal to application via PAN1326C2.

To set up the demo, the following steps must be done:

1. ⇒ [4.1 Loading the Demo](#)
2. ⇒ [4.2 Connecting the Evaluation Board](#)
3. ⇒ [4.3 Flashing the Code](#)
4. For the demo “**iBeacon** (Bluetooth Low Energy)” please refer to ⇒ [4.4 Setting up “iBeacon \(Bluetooth Low Energy\)”](#),
for the demo “**SPP** (Bluetooth Classic)” please refer to ⇒ [4.5 Setting up “SPP \(Bluetooth Classic\)”](#).

4.1 Loading the Demo

1. Go to C:\ti\Connectivity\CC256X BT\CC256x MSP432 Bluetopia SDK\v4.2.1.1\Samples\XXXX and load the demo (iBeaconDemo or SPPDemo).
2. Click the tab **Project > Properties**.

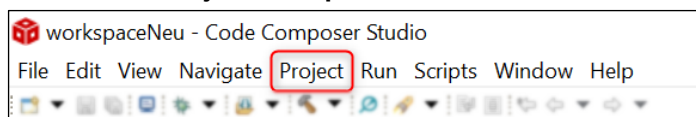

3. Make sure that the box **Manage the project's target-configuration automatically** (2) is checked.

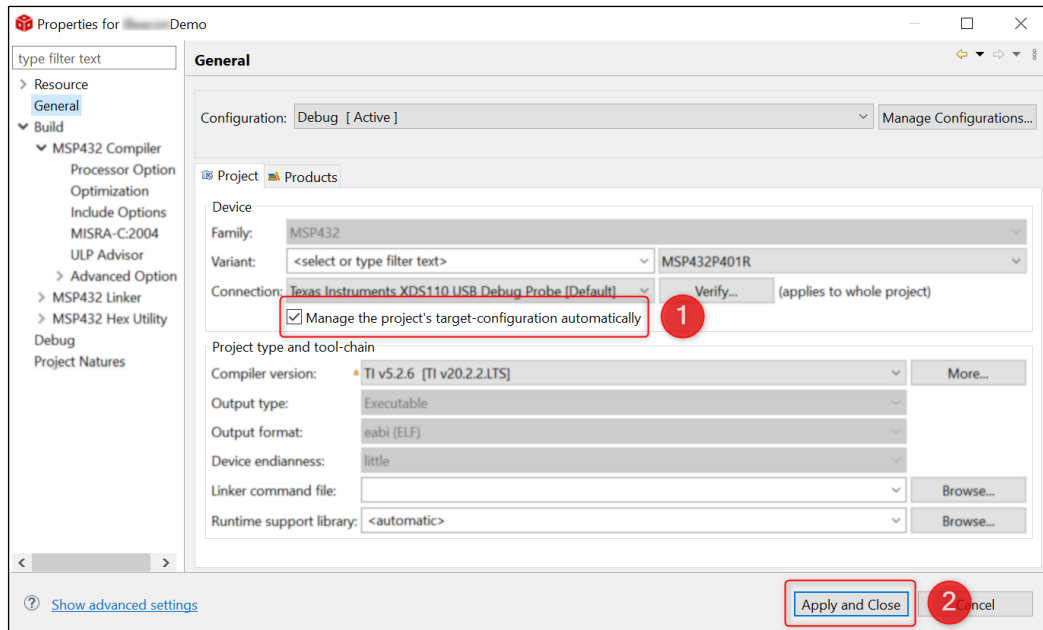

4. Click **Apply and Close** (2).
5. Open the source code file (`iBeaconDemo.c` or `SPPDemo.c`) in the application file of the project.
6. Go to line 166. Change `0x4c` to `0x3a` and change `0x00` to `0x00` (Panasonic Company ID: `0x003A`) to change the manufacturer name of the Bluetooth Beacon. Keep the little-endian byte format in mind (LSB first).

```

165
166 static Byte_t _Prefix[] = {0x02,0x01,0x1a,0x1a,0xff,0x3a,0x00,0x02,0x15};|
167 #define _PREFIX_LEN (sizeof(_Prefix)/sizeof(char))
168

```

7. Press **CTRL** + **S** to save the changes.

Now the demo is loaded.

4.2 Connecting the Evaluation Board

The following requirement must be met:

- ✓ The demo is loaded ⇒ [4.1 Loading the Demo](#).

1. Connect the evaluation board as shown in the picture.

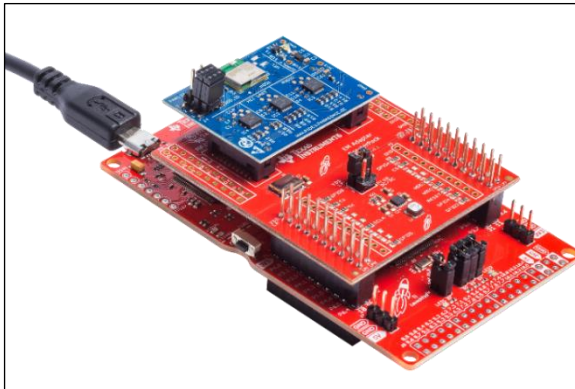

2. Connect the evaluation kit to the PC.

Now the evaluation board is connected.

4.3 Flashing the Code

The following requirements must be met:

- ✓ The demo is loaded ⇒ [4.1 Loading the Demo](#).
- ✓ The evaluation board is connected ⇒ [4.2 Connecting the Evaluation Board](#).

1. Click the icon  "Debug" to compile the code and flash it onto the microcontroller.

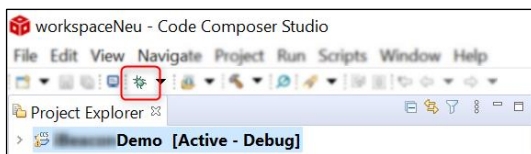

2. If you are asked for a firmware update: confirm the update.



Always keep the firmware updated, otherwise some applications will not work.

➔ The compilation is finished and loaded into the microcontroller.

3. Click the icon  "Run" to execute the application.

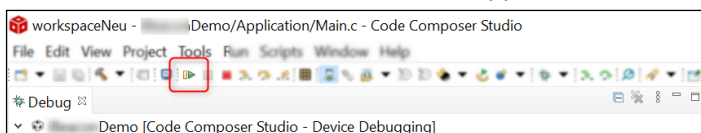

Now the code is flashed.

For the demo “iBeacon (Bluetooth Low Energy)” please refer to ⇒ [4.4 Setting up “iBeacon \(Bluetooth Low Energy\)”](#).

For the demo “SPP (Bluetooth Classic)” please refer to ⇒ [4.5 Setting up “SPP \(Bluetooth Classic\)”](#).

4.4 Setting up “iBeacon (Bluetooth Low Energy)”

This chapter explains how to set up the demo “iBeacon” which is based on Bluetooth Low Energy.

The following requirements must be met:

- ✓ The demo is loaded ⇒ [4.1 Loading the Demo](#).
- ✓ The evaluation board is connected ⇒ [4.2 Connecting the Evaluation Board](#).
- ✓ The code is flashed ⇒ [4.3 Flashing the Code](#).

Starting “TI SimpleLink Starter”

1. Download the application **TI SimpleLink Starter** from the Apple® App Store or Google Play Store.
2. Open the application **TI SimpleLink Starter**.
 - The device `Matsushita Electric Industrial Co. Ltd iBeacon` with the UUID `E2C56DB5-DFFB-4848-D2B0-60D0F5A71096` is displayed.

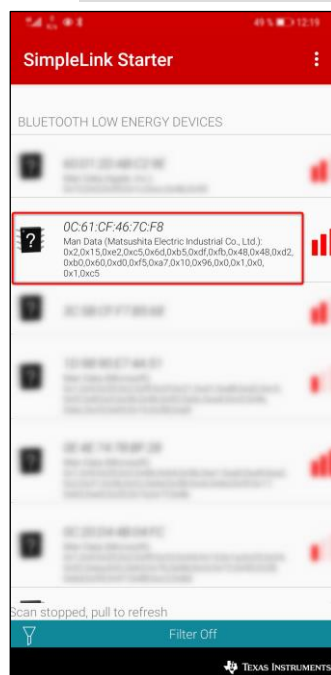

Now the demo “iBeacon (Bluetooth Low Energy)” is set up.

4.5 Setting up “SPP (Bluetooth Classic)”

This chapter explains how to set up the demo “SPP” which is based on Bluetooth Classic.

The following requirements must be met:

- ✓ The demo is loaded ⇒ [4.1 Loading the Demo](#).
- ✓ The evaluation board is connected ⇒ [4.2 Connecting the Evaluation Board](#).
- ✓ The code is flashed ⇒ [4.3 Flashing the Code](#).

Setting the Evaluation Board as Server

1. Download a Serial terminal program. In this guide “PuTTY” is used.
2. Open the terminal program and select the connection type **Serial**.
3. Set the assigned COM port to the evaluation board (in this case “COM4”) and set the speed to **115 200 kBit/s**.
4. Enter **server** in the prompt `Choose Mode>` (1) to set the evaluation board as server.

```

COM4 - PuTTY
OpenStack().
Bluetooth Stack ID: 1
Device Chipset: Unknown (greater 4.1)
BTFS Version : 4.2.1.0
PLAT Version : 1.0
App Name : SPPDemo
App Version : 0.3
Project Type : 6
FW Version : 12.16
Local BD_ADDR: 0x0C61CF467CF8

*****
* Command Options: Server, Client, Help
*****

Choose Mode>Server ①

*****
* Command Options: Inquiry, DisplayInquiryList, Pair,
* EndPairing, PINCodeResponse, PassKeyResponse,
* UserConfirmationResponse,
* SetDiscoverabilityMode, SetConnectabilityMode,
* SetFairabilityMode,
* ChangeSimplePairingParameters,
* GetLocalAddress, GetLocalName, SetLocalName,
* GetClassOfDevice, SetClassOfDevice,
* GetRemoteName, SetName, ExitNameMode,
* Open, Close, Read, Write,
* GetConfigParam, SetConfigParam,
* GetQueueParam, SetQueueParam,
* Loopback, DisplayRawModeData,
* AutomaticReadMode, SetRawData, Send
* Help, Quit
*****

Server>Open 1 ②
Server Opened: 1.
Server>
  
```

5. Entering **Open 1** in the prompt `Server>` (2) to open a server port.



You can replace “1” with any number between 1 and 30, if there is no server open on that port.

➔ The evaluation board is set as server.

Pairing the Device with the Evaluation Board

- Go to the Bluetooth settings on your smartphone and press **SPPDemo** to pair with the device.

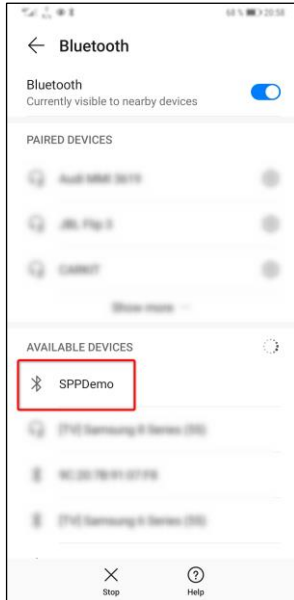

- Type in a random PIN (for example 0000) and confirm it.
 - The smartphone will send a `PINCodeRequest` (1) to the terminal.

```

COM4 - PuTTY
Server>Open 1
Server Opened: 1.
Server>
atPINCodeRequest: 0xD016B47CC167
Respond with: PINCodeResponse
Server>PINCodeResponse 0000
GAP_Authentication_Response(), Pin Code Response Success.
Server>
atLinkKeyCreation: 0xD016B47CC167
Link Key Stored.
    
```

- Enter `PINCodeResponse 0000` in the prompt `Server>` (2) to confirm the `PINCodeRequest`.
 - The smartphone is paired with the evaluation board.

Connecting to the SPPDemo Device

- Download a Bluetooth terminal on your smartphone. In this guide “Serial Bluetooth Terminal” by Kai Morich is used.
- Open the serial Bluetooth terminal.
- Press the icon “menu” and go to **Devices**.

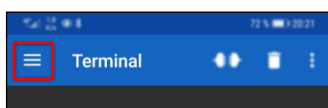

12. Press **SPPDemo** to connect to the SPPDemo device.

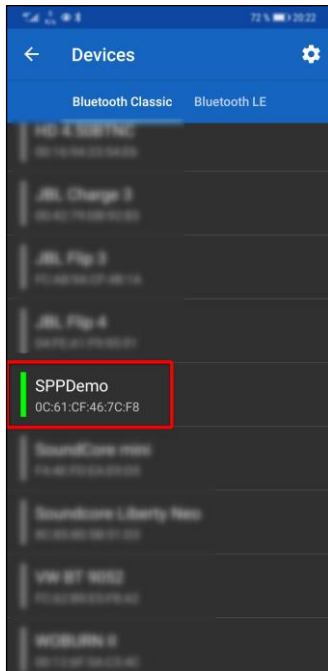

Now the demo “SPP (Bluetooth Classic) is set up and strings from terminal to smartphone and vice versa can be sent (⇒ [Sending Strings from Terminal to Smartphone and vice versa](#)).

Sending Strings from Terminal to Smartphone and vice versa

1. Type in **read** in the prompt `Server>` (1) to read out the buffer.

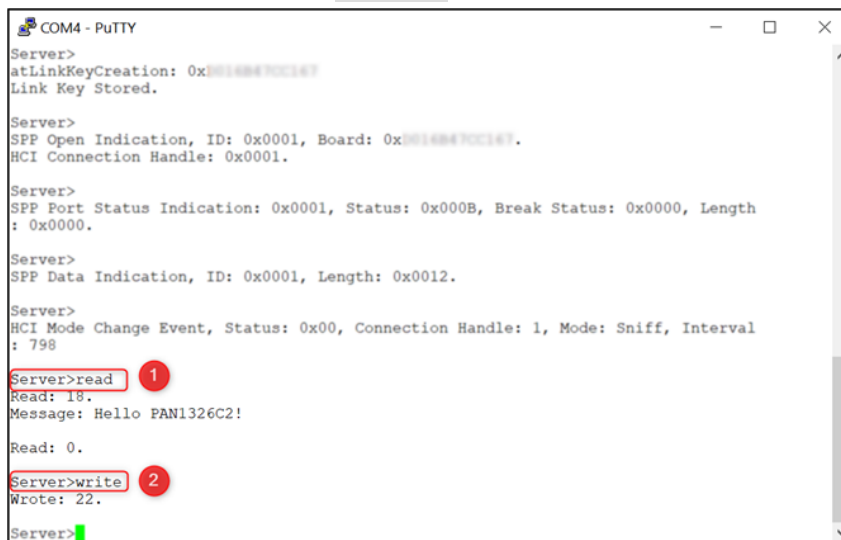

2. Type in **write** in the prompt `Server>` (2).

→ The hardcoded string `This is a test string.` will be sent to the smartphone.

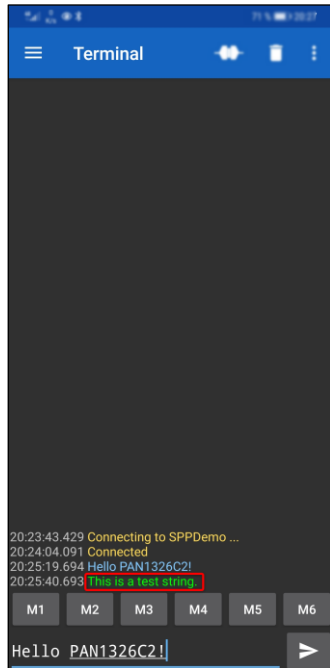

5 Restricted Use

5.1 Life Support Policy

This Panasonic Industrial Devices Europe GmbH product is not designed for use in life support appliances, devices, or systems where malfunction can reasonably be expected to result in a significant personal injury to the user, or as a critical component in any life support device or system whose failure to perform can be reasonably expected to cause the failure of the life support device or system, or to affect its safety or effectiveness.

Panasonic customers using or selling these products for use in such applications do so at their own risk and agree to fully indemnify Panasonic Industrial Devices Europe GmbH for any damages resulting.

5.2 Restricted End Use

This Panasonic Industrial Devices Europe GmbH product is not designed for any restricted activity that supports the development, production, handling usage, maintenance, storage, inventory or proliferation of any weapons or military use.

Transfer, export, re-export, usage or reselling of this product to any destination, end-user or any end-use prohibited by the European Union, United States or any other applicable law is strictly prohibited.

6 Contact Details

6.1 Contact Us

Please contact your local Panasonic Sales office for details on additional product options and services:

For Panasonic Sales assistance in the **EU**, visit

<https://eu.industrial.panasonic.com/about-us/contact-us>

Email: wireless@eu.panasonic.com

For Panasonic Sales assistance in **North America**, visit the Panasonic website “Sales & Support” to find assistance near you at

<https://na.industrial.panasonic.com/distributors>

Please visit the **Panasonic Wireless Technical Forum** to submit a question at

<https://forum.na.industrial.panasonic.com>

6.2 Product Information

Please refer to the Panasonic Wireless Connectivity website for further information on our products and related documents:

For complete Panasonic product details in the **EU**, visit

<http://pideu.panasonic.de/products/wireless-modules.html>

For complete Panasonic product details in **North America**, visit

<http://www.panasonic.com/rfmodules>