

VER: 1.3 | 02.20.2017

# ABB Welcome®

M22001-.

M22002-.

M22003-.

Audio handset

indoor station

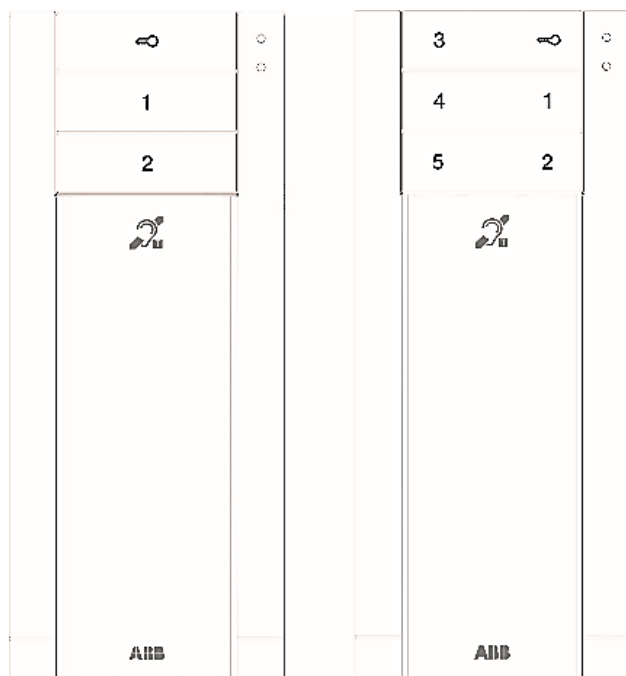

# ABB Welcome®

- 1 Safety..... 3
- 2 Intended use..... 3
- 3 Environment ..... 3
  - 3.1 ABB devices..... 3
- 4 Operations..... 4
  - 4.1 Standard operations ..... 4
    - 4.1.1 Control elements ..... 4
  - 4.2 Settings..... 6
    - 4.2.1 Ringtone type settings ..... 6
    - 4.2.2 Default outdoor station settings ..... 6
    - 4.2.3 Programming the auxiliary buttons ..... 6
  - 4.3 Adjusting the device..... 7
- 5 Technical data ..... 8
- 6 Mounting and installation..... 9
  - 6.1 Requirements for the electrician ..... 9
  - 6.2 General installation instructions..... 9
  - 6.3 Mounting ..... 10

## 1 Safety



### Warning

#### **Electric voltage!**

Direct or indirect contact with live components can cause dangerous currents to flow through the body, which may result in electric shock, burns or even death.

- Always disconnect the main power supply prior to installation and/or disassembly.
- Work on the 110 V - 240 V supply system must be performed only by qualified personnel.

## 2 Intended use

The M2200x-x indoor station is an integral part of the ABB Welcome door entry system and operates exclusively with components from this system. The device must only be installed in dry indoor rooms.

## 3 Environment



### **Consider the protection of the environment!**

Used electric and electronic devices must not be disposed of with household waste.



- The device contains valuable raw materials that can be recycled and should be disposed of at an appropriate recycling facility.

### 3.1 ABB devices

All packaging materials and devices from ABB bear the markings and test seals for proper disposal. Always dispose of the packaging material, electronic devices and their components via authorized recycling facilities or disposal companies.

4 Operations

4.1 Standard operations

4.1.1 Control elements

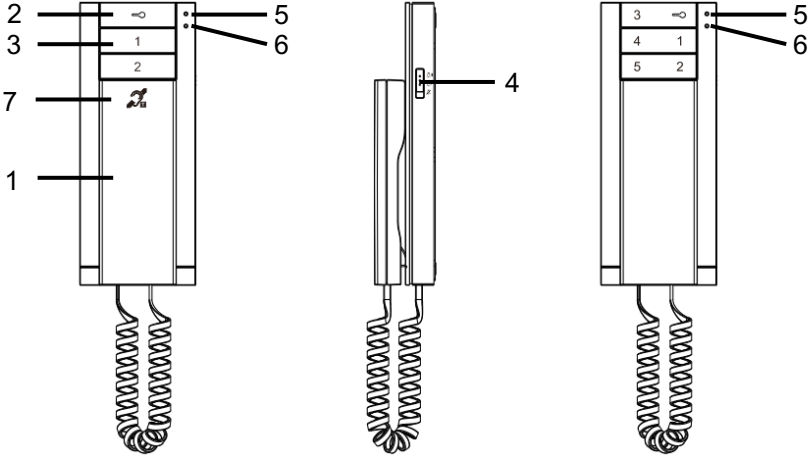







Fig. 1 Control elements

No.	Function
1	<p><b>Handset</b></p> <p>For an incoming call, pick up the handset within 30 seconds to activate communication. Hang up the handset to end the call.</p>
2	<p><b>Unlock button</b></p> <p>2A Press this button to open the door at any time.</p> <p>2B Auto-unlock: the door is automatically opened for an incoming call. (Hold this button for approximately 10 seconds until the blue LED turns on; the same operation will switch off the function, and the blue LED will turn off.)</p>
3	<p><b>Programmable button</b></p> <p>3A *Programmable for additional functions, e.g., call guard unit, intercom, etc.</p> <p>3B Default function of button 1 is the release of the lock connected with an outdoor station (COM-NC-NO).</p>
4	<p><b>Three-level selector for call volume adjustment (maximum/medium/mute).</b></p>
5	<p><b>LED (Red)</b></p> <div style="display: flex; justify-content: space-around; align-items: flex-start;"> <div style="text-align: center;">  <p>- indicates that the door is open over the set time (sensor must be connected).</p> </div> <div style="text-align: center;">  <p>- when any button is pressed.</p> </div> <div style="text-align: center;">  <p>- indicates mute.</p> </div> </div>
6	<p><b>LED (Blue)</b></p> <div style="display: flex; justify-content: space-around; align-items: flex-start;"> <div style="text-align: center;">  <p>- indicates that the system is busy</p> </div> <div style="text-align: center;">  <p>- indicates an incoming call</p> </div> <div style="text-align: center;">  <p>- indicates auto-unlock</p> </div> </div>
7	<p><b>**Induction loop function</b></p>

\*For use, please contact your electrical installer.

\*\*This function is only available in M22003-.

## 4.2 Settings

### 4.2.1 Ringtone type settings

1. Hold "  +  " for about 3 seconds to enter the system setting mode (with blue LED and red LED flashing simultaneously).
2. Press  to set the next ringtone type for the doorbell. Long press this button for about 3 seconds to repeat the ringtone, if desired.
3. Press  to set the next ringtone type for a call from an outdoor station.
4. Press  to set the next ringtone type for an intercom call from other apartments or the guard unit.
5. Hold "  +  " for about 3 seconds to save the selected ringtone type and exit the system settings mode.







### 4.2.2 Default outdoor station settings

1. Pick up the handset, hold  for about 3 seconds to enter the default outdoor station setting mode.
2. Press  button to set the address of the default outdoor station. (The value is indicated by the flash times of the red LED. It can be set from 1 to 9. The default setting is 1.)
3. Hold  for about 3 seconds or put down the handset to save the setting and exit the settings mode.

### 4.2.3 Programming the auxiliary buttons

Each programmable button is available only after setting has been selected. These buttons can be set for different functions, e.g., call guard unit, intercom call or controls switch actuator.

1. Enter the programming mode.  
Hold the programmable button for 3 seconds in the standby mode to enter the programming mode.
2. Set the function for each programmable button.  
Check the needed function and press  to program the corresponding function code that is indicated by the flash times of the blue LED.  
- The function code can be changed: 0->1->2->3->4->5->0.

Function list	Function code	Blue LED flashing
No function	0	 Always on
Control switch actuator	1	 Flash once
Intercom call in the same apartment	2	 Flash twice
Intercom call among different apartments	3	 Flash 3 times
Call guard unit	4	 Flash 4 times
Release second lock of a default outdoor station (the lock connected with an outdoor station, COM-NC-NO)	5	 Flash 5 times

Function code is indicated by flash times of blue LED. If the blue LED is always on, this represents code 0.

3. Set the address for each programmable button.  
Only the following two functions are assigned to the programmable buttons. The address of each programmable button needs to be set. Other functions are inapplicable to this step.  
Function 1: Controls switch actuator. Set the address of the switch actuator under control. The address can be set from 01 to 99.  
Function 2: Intercom call among different apartments. Set the address of an indoor station. The address can be set from 01 to 99.  
Hold this programmable button again for 3 seconds until the LED begins to flash (tens digit or units digit address is other than 0) or lights on (tens digit or units digit address is 0) to enter the address settings mode.  
Press  repeatedly to set the tens digit. Each press means one increment to the previous address. The value is indicated by the flash times of the red LED.  
Press  repeatedly to set the units digit in the same manner. The value is indicated by the flash times of the blue LED.  
Both tens digit and units digit can be changed in a sequence of: 0->1->2->3->4->5->6->7->8->9->0 by pressing  or .  
During settings, if the value set is beyond the desired number, press , and both tens digit and units digit will go back to the default value 0.
4. Exit the programming mode.  
Hold programmable button for 3 seconds until the blue LED and red LED flash once simultaneously.

## 4.3 Adjusting the device

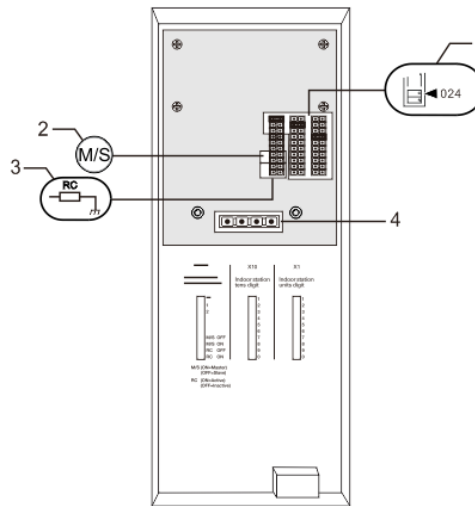

Fig. 2:

**1. X100 X10 X1**

Jumper to set the address of the indoor station.

EXAMPLE: setting address 024

**2. Master or slave function**

One indoor station in each apartment must be set as "Master." (Jumper should be set as "M/S on.") All additional indoor stations in the same apartment must be set as "Slave." (Jumper should be set as "M/S off.")

**3. Terminal resistor**

In video installations or mixed audio and video installations, the Jumper must be set as "RC on" on the last device of the line.

**4. a b = Bus connection**

 = Doorbell connection

## 5 Technical data

<b>Designation</b>	<b>Value</b>
Operating temperature	+14 °F to +131 °F
Storage temperature	-40 °F to +158 °F
Protection	IP 30
Single-wire clamps	2 x 22 AWG - 2 x 18 AWG
Fine-wire clamps	2 x 22 AWG - 2 x 18 AWG
Bus voltage	20 V - 30 V



## 6 Mounting and installation



### Warning

#### **Electric voltage!**

Direct or indirect contact with live components can cause dangerous currents to flow through the body, which may result in electric shock, burns or even death.

- Always disconnect the main power supply prior to installation and/or disassembly.
- Work on the 110 V - 240 V supply system must be performed only by qualified personnel.

### 6.1 Requirements for the electrician



### Warning

#### **Electric voltage!**

Install the device only if you have the necessary qualifications.

- Incorrect installation endangers your life and that of the user of the electrical system.
- Incorrect installation can cause serious damage to property, such as a fire.

The minimum necessary expert knowledge and requirements for the installation are as follows:

- Apply the "five safety rules" (DIN VDE 0105, EN 50110):
  1. Disconnect from power.
  2. Secure against being re-connected.
  3. Ensure there is no voltage.
  4. Connect to earth.
  5. Cover or barricade adjacent live parts.
- Wear suitable personal protective clothing.
- Use only suitable tools and measuring devices.
- Check the type of supply network (TN system, IT system, TT system) to secure the following power supply conditions (classic connection to ground, protective earthing, necessary additional measures, etc.).

### 6.2 General installation instructions

- Terminate all branches of the wiring system via a connected bus device (e.g., indoor station, outdoor station, system device).
- Do not install the system controller directly next to the bell transformer or other power supplies (to avoid interference).
- Do not install the wires of the system bus together with 100 V - 240 V wires.
- Do not use common cables for the connecting wires of the door openers and wires of the system bus.
- Avoid bridges between different cable types.
- Use only two wires for the system bus in a four-core or multi-core cable.
- When looping, never install the incoming and outgoing bus inside the same cable.
- Never install the internal and external bus inside the same cable.

# ABB Welcome<sup>®</sup>

## 6.3 Mounting

### Recommended installation height

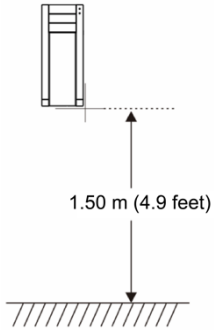

### Dismantling

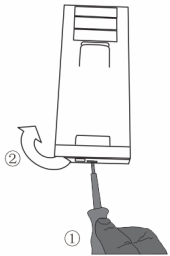

Pull the clamp on the bottom of the device and then open the housing of the panel.

### Installation dimensions for slotted screw holes

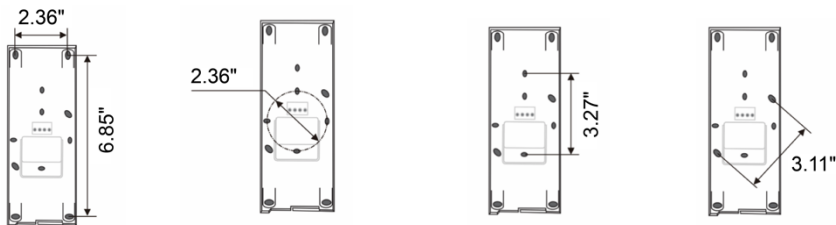

1. The bottom of the device has screw holes for fastening on the wall according to the above dimensions.
2. In addition, the bottom of the device can be affixed to an existing flush-mounted box. The dimensions of a compatible flush-mounted box are shown above.

### Wiring

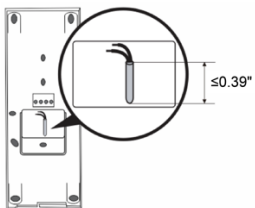

Affix the bottom of the device and connect it according to the illustration. The insulated section of the cable end must not be longer than 0.39".

# ABB Welcome<sup>®</sup>

## Settings

Set addresses for the preferred outdoor stations and the address for the indoor station on the jumper. (See Chapter 4.3, Adjusting the device.)

### Mounted on the wall

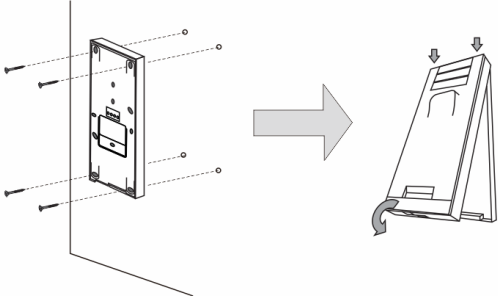

1. Affix the bottom of the device to the wall.
2. Latch the upper part of the device onto its bottom part. Place the upper side of the device on the lock-in lugs, and then press the bottom side onto the bottom part of the device until the clamp catches.

### Mounted with flush-mounted box

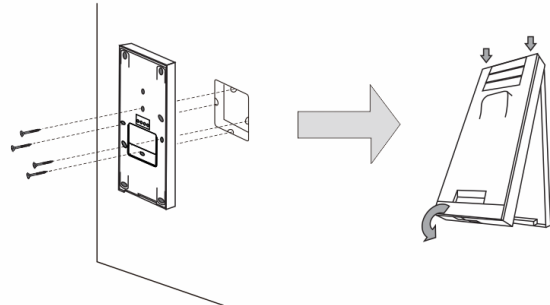

1. Fix the bottom of the device to the existing flush-mounted box.
2. Latch the upper part of the device onto its bottom part. Place the upper side of the device on the lock-in lugs, and then press the bottom side onto the bottom part of the device until the clamp catches.

The installation of the indoor station is now complete.



—

**ABB Inc.**

Electrification Products  
860 Ridge Lake Blvd.  
Memphis, TN 38120  
[www.abb.com/door-entry-system-us](http://www.abb.com/door-entry-system-us)  
[abbwelcomeinfo@us.abb.com](mailto:abbwelcomeinfo@us.abb.com)

Customer Service: 800-816-7809  
7:00 a.m. - 5:30 p.m., CST, Monday-Friday  
[elec\\_custserv@tnb.com](mailto:elec_custserv@tnb.com)

Technical Support: 888-385-1221, Option 1  
7:00 a.m. - 5:00 p.m., CST, Monday-Friday  
[lvps.support@us.abb.com](mailto:lvps.support@us.abb.com)

—

We reserve the right to make technical changes or modify the contents of this document without prior notice. With regard to purchase orders and/or contracts, the agreed particulars shall prevail. ABB Inc. does not accept any responsibility whatsoever for potential errors or possible lack of information in this document.

We reserve all rights in this document and in the subject matter and illustrations contained therein. Any reproduction, disclosure to third parties or utilization of its contents - in whole or in parts - is forbidden without prior written consent of ABB Inc.

© Copyright 2018 ABB. All rights reserved.