

2CSG445001D5601

**AMTD-1 P**

2CSG213615R4011

**AMTD-1-R P**

2CSG213645R4011

**AMTD-2 P**

2CSG213625R4011

**AMTD-2-R P**

2CSG213655R4011

**VLMD P**

2CSG213605R4011

**VLMD-R P**

2CSG213635R4011

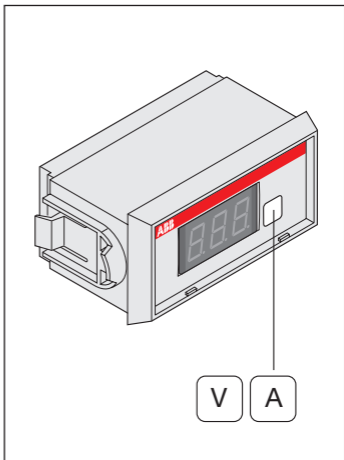

**ABB**

[mm]

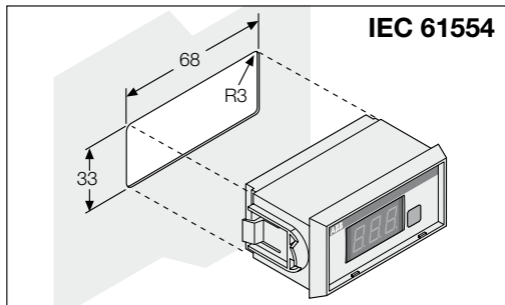
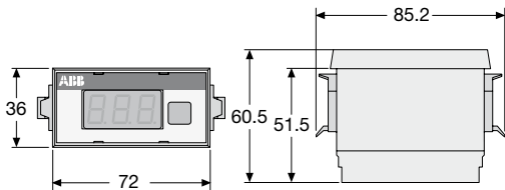

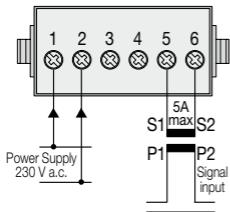
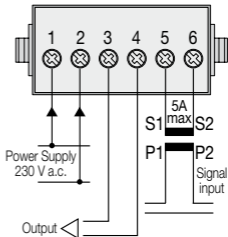
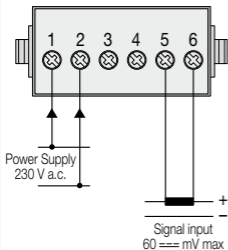
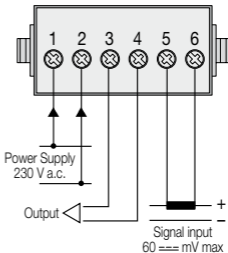
**AMTD-1 P****AMTD-1-R P****AMTD-2 P****AMTD-2-R P**

### VLMD P

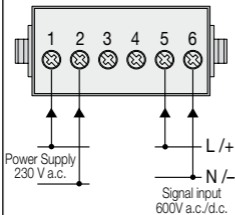

### VLMD-R P

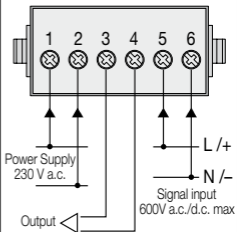

---

**Digital measurement instruments**

Assembly and operating instructions

EN

---

**Strumenti digitali con relé**

Istruzioni per il montaggio e l'uso

IT

---

**Messgeräte mit digitaler Anzeige**

Montageanleitung

D

---

**Instruments de mesure numériques**

Instructions pour le montage et l'utilisation

F

---

**Instrumentos digitales**

Instrucciones de montaje

ES

---

**Instrumentos de medição digital**

Instruções de montagem

P

---

**Ψηφιακά όργανα**

Οδηγίες χρήσης

GR

## Contents

### 1. Settings

AMTD-1 P / AMTD-2 P .....	3
AMTD-1-R P / AMTD-2-R P .....	4
VLMD P .....	7
VLMD-R P .....	8

### 2. AMTD-1-R P / AMTD-2-R P / VLMD-R P functions

Viewing peak values .....	13
Min and max relay operation.....	14
Alarm enabling logic .....	14

### 3. Technical characteristics..... 15

## 1. Settings

### AMTD-1 P / AMTD-2 P

1

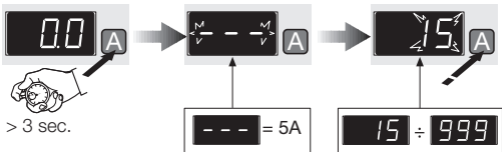

3

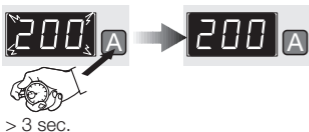

### Setting the full scale

- 1 Press and hold the button for at least 3 seconds to access the programming menu.
- 2 Press the button briefly to move on to the next item (--- = 5A).
- 3 Press and hold the button for at least 3 seconds to select and confirm the item/parameter.

## 1. Adjustments and settings

### AMTD-1-R P / AMTD-2-R P

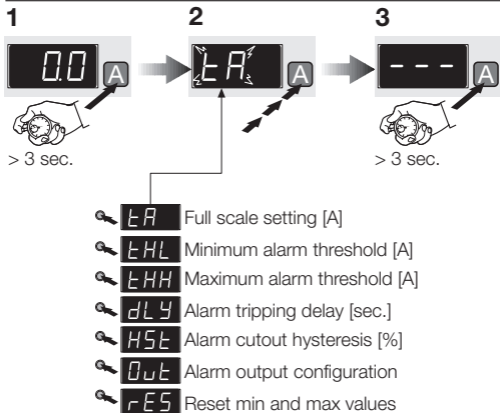

- 1 Press and hold the button for at least 3 seconds until the display flashes.
- 2 Press the button repeatedly until the indication of the parameter to set appears.
- 3 Press and hold the button for at least 3 seconds to select the required full scale.
- 4



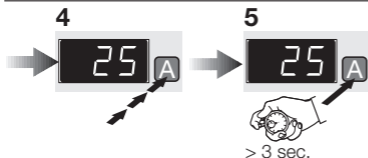

4 Press the button repeatedly to view the required value.

5 Press and hold the button for at least 3 seconds to confirm the value selected.

### Functions available

EA

#### Full scale setting [A]

- --- = direct insertion without CT
- 15, 20, 25, 40, 60, 100, 150, 200, 250, 400, 600, 999 A full scale values available

dLY

#### Alarm tripping delay in seconds

- 1-5-10-20-30
- / = tripping without delay

HSt

#### Alarm cutout hysteresis in % of the threshold

- 5-10-20-40

Out

#### Alarm output configuration

- nO/nC

### 1. Settings

EN

#### AMTD-1-R P / AMTD-2-R P



#### Reset min and max values

- Select the number 5 to reset the values, which is subsequently confirmed by the displaying three points



#### Maximum alarm threshold [A]

- **---** = alarm function disabled
- CT up to 100 A, resolution 1A
- CT up to 600 A, resolution 10A



#### Minimum alarm threshold [A]

- **---** = alarm function disabled
- CT up to 100 A, resolution 1A
- CT up to 600 A, resolution 10A

When you select tHH or tHL:

1. the first digit on the right starts flashing
2. press repeatedly to select the required value
3. press and hold the button at least >3sec to confirm

The max selectable value of tHH is always lower than the full scale-value formerly selected.

Changing the full scale setting automatically enables the resetting of the minimum and maximum values, and when you exit from programming mode **...** will be displayed during the time it takes to recalculate the values.

VLMD P

1



> 3 sec.

2



3



> 3 sec.

- 1 Press and hold the button for at least 3 seconds until the display flashes.
- 2 Press the button briefly to move on to the next item:
  - AC = alternating current;
  - CC = direct current.
- 3 Press and hold the button for at least 3 seconds to select the item required.

## 1. Settings

### VLMD-R P

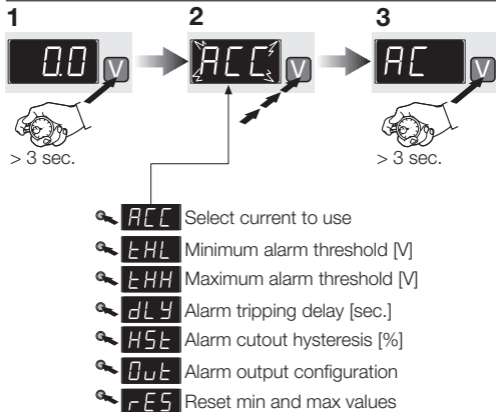

- 1 Press and hold the button for at least 3 seconds until the display flashes.
- 2 Press the button repeatedly until the indication of the parameter to set appears.
- 3 Press and hold the button for at least 3 seconds to select the required full scale.

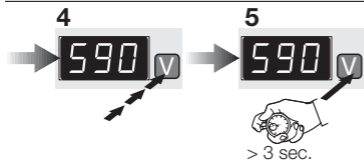

4 Press the button repeatedly to view the required value.

5 Press and hold the button for at least 3 seconds to confirm the value selected.

### Functions available

ACC

#### Select current to use

- CC = direct current
- AC = alternating current

dLY

#### Alarm tripping delay in seconds

- 1-5-10-20-30
- = tripping without delay

HSt

#### Alarm cutout hysteresis in % of the threshold

- 5-10-20-40

Out

#### Alarm output configuration

- nO/nC

### 1. Settings

#### VLMD-R P



#### Reset min and max values

- Select the number 5 to reset the values, which is subsequently confirmed by the displaying three points



#### Minimum alarm threshold [V]

- **---** = alarm function disabled
- 10 ÷ 590 V full scale values available, resolution 10 V



#### Maximum alarm threshold [V]

- **---** = alarm function disabled
- 10 ÷ 590 V full scale values available, resolution 10 V

When you select tHH or tHL:

1. the first digit on the right starts flashing
2. press repeatedly to select the required value
3. press and hold the button at least >3sec to confirm

The max selectable value of tHH is always lower than the full scale value formerly selected.

Changing the full scale setting automatically enables the resetting of the minimum and maximum values, and when you exit from programming mode **---** will be displayed during the time it takes to recalculate the values.

## 2. AMTD-1-R P / AMTD-2-R P / VLMD-R P functions

### Displaying and saving minimum and maximum peak values

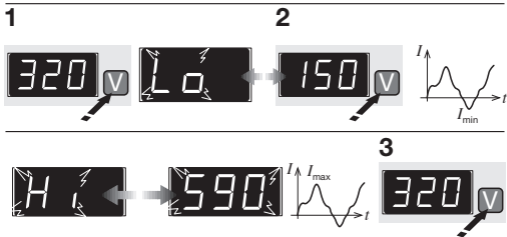

- 1 When you briefly press the front button, the word Lo and the minimum value measured appear alternately.
- 2 If you press the button again, the word Hi appears with the maximum value measured.
- 3 Press the button again to return to normal view.

The peak values recorded (minimum and maximum) are saved in the instrument's nonvolatile memory, and are available after any power failure. You can reset the peak values by means of the corresponding RES command in the programming menu.

When you change the value of the CT the maximum and minimum alarm threshold are automatically disabled.

### 2. AMTD-1-R P / AMTD-2-R P / VLMD-R P functions

#### Maximum and minimum relay operation

When the measurement exceeds the threshold value, the relay changes state and the alarm is tripped after a programmable delay dLY, which appears on the display alternately with the normal instantaneous measurement.

ALL [ALarm Low] indicates that the minimum threshold has been exceeded

ALH [ALarm High] indicate that the maximum threshold has been exceeded

Even in alarm conditions, pressing the button briefly enables you to view the minimum and maximum values.







The alarm stops when the measurement returns within the threshold including the value of the hysteresis.

#### Alarm enabling logic

The output from the relay is an open contact type. You can program the configuration of the relay:

nO [normally Open] the contact is open when the relay is not energized.

nC [normally Closed] the contact is closed when the relay is not energized.

State of device	nO (default)	Positive safety nC
Not powered		
Powered, alarm not on		
Powered, alarm on		



### 3. Technical characteristics

<b>Power supply voltage</b>	[V]	230 AC $\pm$ 10%
<b>Frequency</b>	[Hz]	50/60
<b>Max input signal value</b>		
AMTD-1 P, AMTD-1-R P	[A]	5 AC
VLMD P, VLMD-R P	[V]	600 AC/DC
AMTD-2 P, AMTD-2-R P	[mV]	60 DC
<b>Full scale values available on AMTD-1 P and AMTD-1-R P</b>	[A]	Indirect insertion by means of CT .../5A 15 20 25 40 60 100 150 200 250 400 600 999
<b>Full scale values available on AMTD-2 P and AMTD-2-R P</b>	[A]	Indirect insertion by means of shunt 60mV 15 20 25 40 60 100 150 200 250 400 600 999
<b>Measurement range</b>		
AMTD-1 P, AMTD-1-R P	[A]	0...999 AC
VLMD- P, VLMD-R P	[V]	0...600 AC/DC
AMTD-2 P, AMTD-2-R P	[A]	0...999 DC
<b>Accuracy class</b>		
AMTD-1 P, AMTD-1-R P	[%]	0,5 $\pm$ 1 digit
AMTD-2 P, AMTD-2-R P	[%]	0,5 $\pm$ 1 digit
VLMD P, VLMD-R P	[%]	0,5 $\pm$ 1 digit
<b>Memory</b>		EEprom
<b>Power consumption</b>	[VA]	4

## 3. Technical characteristics

### Relay output characteristics

Configuration of contact		N.O.
Rated voltage	[V]	230 AC
Rated load	[A]	16 AC1 - 3 AC15
Contact configuration		nO the relay closes in the event of an alarm nC the relay opens in the event of an alarm, positive safety
Display		LED 3 digits
Storage temperature	[°C]	-40...70
Working temperature	[°C]	-10...55
Degree of protection		IP20
Modules		3
Standards		CEI EN 61010-1

### Default values

	VLMD-R P	AMTD-1-R P AMTD-2-R P
Insertion	AC	---
Alarm	Disabled	Disabled
Alarm tripping delay	1 sec	1 sec
Hysteresis	10%	10%
Contact configuration	nO	nO



## Indice

### 1. Regolazioni e settaggi

AMTD-1 P / AMTD-2 P .....	3
AMTD-1-R P / AMTD-2-R P .....	4
VLMD P .....	7
VLMD-R P .....	8

### 2. Funzioni AMTD-1-R P / AMTD-2-R P / VLMD-R P

Visualizzazione dei valori di picco.....	13
Funzionamento relè di minima e massima.....	14
Logica attivazione allarme.....	14

### 3. Caratteristiche tecniche ..... 15

## 1. Regolazioni e settaggi

### AMTD-1 P / AMTD-2 P

# 1



> 3 sec.



# 2

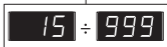

# 3



> 3 sec.



### Impostazione del fondo scala

- 1 Tener premuto il pulsante per più di 3 secondi per entrare nel menu di programmazione.
- 2 Pressione breve tasto per passare alla voce successiva (--- = 5A).
- 3 Pressione lunga > 3 secondi per selezionare la voce/parametro e confermare il valore del parametro.

IT

## 1. Regolazioni e settaggi

### AMTD-1-R P / AMTD-2-R P

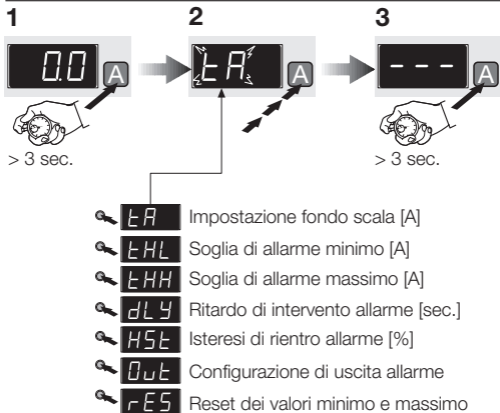

- 1 Tener premuto il pulsante per 3 secondi fino a far lampeggiare il display.
- 2 Premere ripetutamente il pulsante fino a che non appare l'indicazione del parametro da impostare.
- 3 Pressione lunga > 3 secondi per selezionare il fondo scala desiderato.

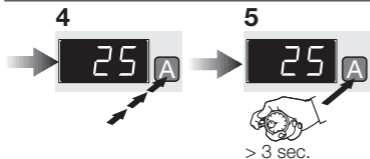

- 4 Premere ripetutamente il pulsante per visualizzare il valore desiderato.  
 5 Pressione lunga > 3 sec per confermare il valore scelto.

### Funzioni disponibili

EA

#### Impostazione del fondo scala [A]

- --- = inserzione diretta senza TA
- 15, 20, 25, 40, 60, 100, 150, 200, 250, 400, 600, 999 A valori di fondo scala impostabili

dLY

#### Ritardo di intervento allarme in secondi

- 1-5-10-20-30
- / = attivazione senza ritardo

HSt

#### Isteresi di rientro allarme in % della soglia

- 5-10-20-40

Out

#### Configurazione dell'uscita di allarme

- nO/nC

### 1. Regolazioni e settaggi

#### AMTD-1-R P / AMTD-2-R P

IT

#### Reset dei valori minimo e massimo

- Selezionare il numero 5 per ottenere il reset dei valori, confermato successivamente dalla visualizzazione di tre punti

#### Soglia di allarme massimo [A]

- **---** = funzione di allarme non attiva
- TA fino 100 A, risoluzione 1A
- TA fino 600 A, risoluzione 10A

#### Soglia di allarme minimo [A]

- **---** = funzione di allarme non attiva
- TA fino 100 A, risoluzione 1A
- TA fino 600 A, risoluzione 10A

Una volta che si seleziona l'impostazione tHH o tHL

1. inizia a lampeggiare la prima cifra a destra
2. pressione breve per selezionare il valore desiderato
3. pressione >3sec per passare a cifra successiva

Il valore max di tHH che si può impostare è sempre minore rispetto al valore di fondo scala impostato precedentemente.

Cambiando la programmazione del fondo scala si attiva automaticamente il reset del minimo e massimo, e all'uscita della programmazione sarà visualizzato **---** durante il tempo di ricalcolo.



## VLMD P

1



&gt; 3 sec.

2



3



&gt; 3 sec.

- 1 Tener premuto il pulsante per più di 3 secondi fino a far lampeggiare il display.
- 2 Pressione breve tasto per passare alla voce successiva:
  - AC = corrente alternata;
  - CC = corrente continua.
- 3 Pressione lunga > 3 secondi per selezionare la voce desiderata.

## 1. Regolazioni e settaggi

### VLMD-R P

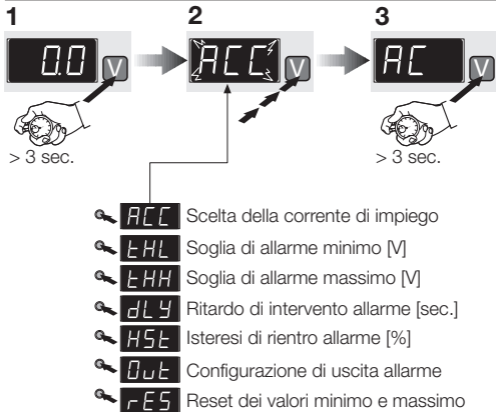

- 1 Tener premuto il pulsante per 3 secondi fino a far lampeggiare il display.
- 2 Premere ripetutamente il pulsante fino a che non appare l'indicazione del parametro da impostare.
- 3 Pressione lunga > 3 sec per selezionare il fondo scala desiderato.

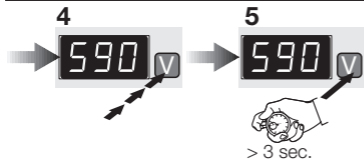

- 4 Premere ripetutamente il pulsante per visualizzare il valore desiderato.  
 3 Pressione lunga > 3 sec per confermare il valore scelto.

### Funzioni disponibili

ACC

#### Scelta della corrente di impiego

- CC = corrente continua
- AC = corrente alternata

dLY

#### Ritardo di intervento allarme in secondi

- 1-5-10-20-30
- [ ] = attivazione senza ritardo

HSt

#### Isteresi di rientro allarme in % della soglia

- 5-10-20-40

Out

#### Configurazione dell'uscita di allarme

- nO/nC

### 1. Regolazioni e settaggi

#### VLMD-R P

IT

#### Reset dei valori minimo e massimo

- Selezionare il numero 5 per ottenere il reset dei valori, confermato successivamente dalla visualizzazione di tre punti

#### Soglia di allarme minimo [V]

- = funzione di allarme non attiva
- 10 ÷ 590 V valori di fondo scala impostabili, risoluzione 10 V

#### Soglia di allarme massimo [V]

- = funzione di allarme non attiva.
- 10 ÷ 590 V valori di fondo scala impostabili, risoluzione 10 V

Una volta che si seleziona l'impostazione tHH o tHL

1. inizia a lampeggiare la prima cifra a destra
2. pressione breve per selezionare il valore desiderato
3. pressione >3sec per passare a cifra successiva

Il valore max di tHH che si può impostare è sempre minore rispetto al valore di fondo scala impostato precedentemente.

Cambiando la programmazione del fondo scala si attiva automaticamente il reset del minimo e massimo, e all'uscita della programmazione sarà visualizzato durante il tempo di ricalcolo.

## 2. Funzioni AMTD-1-R P / AMTD-2-R P / VLMD-R P

### Visualizzazione e memorizzazione valori di picco minimo e massimo

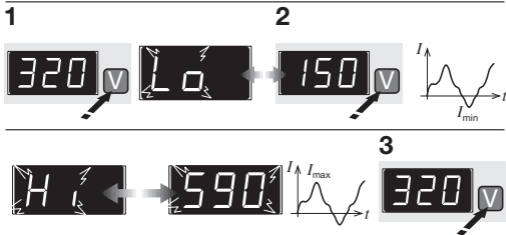

- 1 Premendo brevemente il pulsante frontale comparirà alternativamente la scritta Lo e il valore minimo misurato.
- 2 Premendo nuovamente il pulsante apparirà la scritta Hi e il valore massimo misurato .
- 3 Premere nuovamente per tornare alla visualizzazione normale.

I valori di picco registrati (minimo e massimo) sono salvati nella memoria non volatile dello strumento, disponibili dopo un'eventuale mancanza di alimentazione. È possibile resettare i valori di picco tramite il relativo comando RES nel menù di programmazione.

Modificando il valore del TA sono automaticamente disabilitate le soglie di allarme massimo e minimo.

### 2. Funzioni AMTD-1-R P / AMTD-2-R P / VLMD-R P

#### Funzionamento relè di massima e minima

Quando la misura supera il valore di soglia il relè cambia stato e l'allarme si attiva dopo un ritardo programmabile dLY, sul display compare alternato con la normale misura istantanea.

ALL [ALarm Low] indica che è stata superata la soglia minima

ALH [ALarm High] indica che è stata superata la soglia massima

Anche in stato di allarme l'eventuale pressione breve del tasto permette la visualizzazione dei valori minimo e massimo.







Il rientro dell'allarme avviene, quando la misura si riporta sotto la soglia comprensiva del valore di isteresi.

#### Logica di attivazione allarme

L'uscita del relè è a contatto aperto. È possibile tramite programmazione impostare la polarità del relè

n0 [normally Open] in condizioni di riposo il contatto rimane aperto

nC [normally Close] in condizioni di riposo il contatto rimane chiuso.

Stato del dispositivo	Tradizionale nO	Sicurezza positiva nC
Non alimentato		
Alimentato - non in allarme		
Alimentato - in allarme		

### 3. Caratteristiche tecniche

<b>Tensione di alimentazione</b>	[V]	230 c.a. $\pm 10\%$
<b>Frequenza</b>	[Hz]	50/60
<b>Max valore ingresso segnale</b>		
AMTD-1 P, AMTD-1-R P	[A]	5 c.a.
VLMD P, VLMD-R P	[V]	600 c.a./c.c.
AMTD-2 P, AMTD-2-R P	[mV]	60 c.c.
<b>Valori fondo scala impostabili su AMTD-1 P e AMTD-1-R P</b>	[A]	Inserzione indiretta tramite TA .../5A 15 20 25 40 60 100 150 200 250 400 600 999
<b>Valori fondo scala impostabili su AMTD-2 P e AMTD-2-R P</b>	[A]	Inserzione indiretta tramite shunt 60mv 15 20 25 40 60 100 150 200 250 400 600 999
<b>Range di misura</b>		
AMTD-1 P, AMTD-1-R P	[A]	0...999 c.a.
VLMD P, VLMD-R P	[V]	0...600 c.a./c.c.
AMTD-2 P, AMTD-2-R P	[A]	0...999 c.c.
<b>Classe di precisione</b>		
AMTD-1 P, AMTD-1-R P	[%]	0,5 $\pm 1$ digit
VLMD P, VLMD-R P	[%]	0,5 $\pm 1$ digit
AMTD-2 P, AMTD-2-R P	[%]	0,5 $\pm 1$ digit
<b>Memoria dati</b>		EEprom
<b>Potenza dissipata</b>	[VA]	4

## 3. Caratteristiche tecniche

### Caratteristiche uscita a relè

Configurazione del contatto		N.A.
Tensione nominale	[V]	230 c.a.
Carico nominale	[A]	AC1 16 - AC15 3
Configurazione del contatto		nO il relè si chiude in stato di allarme nC il relè si apre in stato di allarme, sicurezza positiva
<b>Display</b>		A LED 3 cifre
<b>Temperatura di stoccaggio</b>	[°C]	-40...70
<b>Temperatura di funzionamento</b>	[°C]	-10...55
<b>Grado di protezione</b>		IP20
<b>Normativa</b>		CEI EN 61010-1

### Valori impostati di default

	<b>VLMD-R P</b>	<b>AMTD-1-R P</b> <b>AMTD-2-R P</b>
<b>Inserzione</b>	AC	---
<b>Allarme</b>	Disattivato	Disattivato
<b>Ritardo attivazione allarme</b>	1 sec	1 sec
<b>Isteresi</b>	10%	10%
<b>Polarità</b>	nO	nO





## Inhaltsverzeichnis

### 1. Einstellungen

AMTD-1 P / AMTD-2 P .....	3
AMTD-1-R P / AMTD-2-R P .....	4
VLMD P .....	7
VLMD-R P .....	8

### 2. Funktionen AMTD-1-R P / AMTD-2-R P / VLMD-RP

Spitzenwertanzeige .....	13
Funktionsweise des Minimum-Maximum-Relais..	14
Logik der Alarmauslösung .....	14

### 3. Technische Eigenschaften..... 15

## 1. Einstellungen

## AMTD-1 P / AMTD-2 P

1

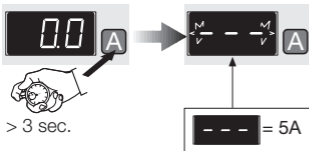

2

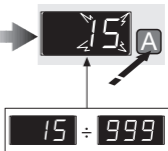

3

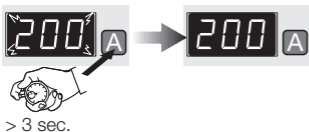

## Einstellung des Skalenendwerts

- 1 Die Taste länger als 3 Sekunden gedrückt halten, um das Programmiermenü aufzurufen.
- 2 Durch kurzes Drücken der Taste gelangt man zum nächsten Eintrag (**---** = 5A).
- 3 Länger als 3 Sekunden gedrückt halten, um den Eintrag/Parameter zu wählen und den Parameterwert zu bestätigen.

D

## 1. Einstellungen

### AMTD-1-R P / AMTD-2-R P

1



> 3 sec.







2



3



> 3 sec.

-  **tA** Einstellung Skalendwert [A]
-  **tHL** Untere Alarmschwelle [A]
-  **tHH** Obere Alarmschwelle [A]
-  **dLY** Alarmauslöseverzögerung [s]
-  **HSt** Alarmhysterese [%]
-  **Out** Polarität des Alarmausgangs
-  **rES** Zurücksetzen der Mindest- und Höchstwerte

- 1 Die Taste 3 Sekunden gedrückt halten, bis das Display zu blinken beginnt.
- 2 Die Taste wiederholt drücken, bis der einzustellende Parameter angezeigt wird.
- 3 Länger als 3 Sekunden gedrückt halten, um den gewünschten endwert zu wählen.

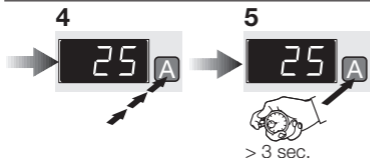

- 4 Die Taste wiederholt drücken, um den gewünschten Wert anzuzeigen.  
 5 Länger als 3 Sekunden drücken, um den gewählten Wert zu bestätigen.

### Verfügbare Funktionen

LA

#### Einstellung des Skalenendwerts [A]

- --- = Direktanschluss ohne Stromwandler
- 15, 20, 25, 40, 60, 100, 150, 200, 250, 400, 600, 999 A einstellbare Skalenendwerte

dLY

#### Alarmauslöseverzögerung in Sekunden

- 1-5-10-20-30
- / = Aktivierung ohne Verzögerung

HSt

#### Alarmpysterese in % des Schwellwerts

- 5-10-20-40

Out

#### Polarität des Alarmausgangs

- nO/nC

### 1. Einstellungen

#### AMTD-1-R P / AMTD-2-R P



#### Rücksetzen der Mindest- und Höchstwerte

- Die Zahl 5 wählen, um die Werte zurückzusetzen; dieser Vorgang wird durch die Anzeige von drei Punkten bestätigt.

D



#### Obere Alarmschwelle [A]

- **---** = Alarmfunktion nicht aktiviert
- Stromwandler bis 100 A, Auflösung 1A
- Stromwandler bis 600 A, Auflösung 10A



#### Untere Alarmschwelle [A]

- **---** = Alarmfunktion nicht aktiviert
- Stromwandler bis 100 A, Auflösung 1A
- Stromwandler bis 600 A, Auflösung 10A

Wenn Sie tHH oder tHL wählen:

1. Die 1.Stelle von rechts beginnt zu blinken.
2. Die Taste wiederholt drücken, um den gewünschten Wert zu wählen.
3. Länger als 3 Sekunden gedrückt halten, um den gewählten Wert zu bestätigen.

Der max. wählbare Wert von tHH ist immer niedriger als der vorher gewählte Skalenendwert.

Wenn die Programmierung des Skalenendwerts geändert wird, wird automatisch die Rücksetzung des Mindest- und des Höchstwerts veranlasst. Beim Verlassen der Programmierfunktion wird **...** während der Dauer der Neuberechnung angezeigt.

## VLMD P

1



&gt; 3 sec.

2



3



&gt; 3 sec.

- 1 Die Taste länger als 3 Sekunden gedrückt halten, bis das Display zu blinken beginnt.
- 2 Durch kurzes Drücken der Taste gelangt man zum nächsten Eintrag:
  - AC = Wechselstrom;
  - CC = Gleichstrom.
- 3 Länger als 3 Sekunden gedrückt halten, um den gewünschten Eintrag zu wählen.

## 1. Einstellungen

### VLMD-R P

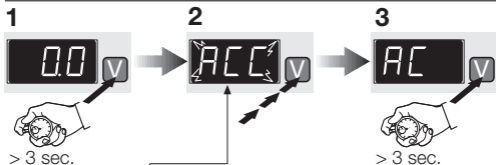

D

- ACC** Wahl des Betriebsstroms
- EHl** Untere Alarmschwelle [V]
- EHH** Obere Alarmschwelle [V]
- dLY** Alarmauslöseverzögerung [s]
- HSE** Alarmhysterese [%]
- Out** Polarität des Alarmausgangs
- rES** Zurücksetzen der Mindest- und Höchstwerte

- 1** Die Taste 3 Sekunden gedrückt halten, bis das Display zu blinken beginnt.
- 2** Die Taste wiederholt drücken, bis der einzustellende Parameter angezeigt wird.
- 3** Länger als 3 Sekunden gedrückt halten, um den gewünschten endwert zu wählen.



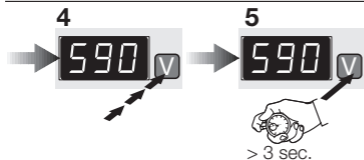



- 4 Die Taste wiederholt drücken, um den gewünschten Wert anzuzeigen.  
 5 Länger als 3 Sekunden drücken, um den gewählten Wert zu bestätigen.

### Verfügbare Funktionen

ACC

#### Wahl des Betriebsstroms

-  = Gleichstrom
-  = Wechselstrom

dLY

#### Alarmauslöseverzögerung in Sekunden

- 1-5-10-20-30
-  = Aktivierung ohne Verzögerung

HSt

#### Alarmhysterese in % des Schwellwerts

- 5-10-20-40

Out

#### Polarität des Alarmausgangs

- nO/nC

### 1. Einstellungen

#### VLMD-R P



#### Rücksetzen der Mindest- und Höchstwerte

- Die Zahl 5 wählen, um die Werte zurückzusetzen; dieser Vorgang wird durch die Anzeige von drei Punkten bestätigt.

D



#### Untere Alarmschwelle [V]

- **---** = Alarmfunktion nicht aktiviert
- 10 ÷ 590 V einstellbare Skalenendwerte, Auflösung 10V



#### Obere Alarmschwelle [V]

- **---** = Alarmfunktion nicht aktiviert
- 10 ÷ 590 V einstellbare Skalenendwerte, Auflösung 10V

Wenn Sie tHH oder tHL wählen:

1. Die 1.Stelle von rechts beginnt zu blinken.
2. Die Taste wiederholt drücken, um den gewünschten Wert zu wählen.
3. Länger als 3 Sekunden gedrückt halten, um den gewählten Wert zu bestätigen.

Der max. wählbare Wert von tHH ist immer niedriger als der vorher gewählte Skalenendwert.

Wenn die Programmierung des Skalenendwerts geändert wird, wird automatisch die Rücksetzung des Mindest- und des Höchstwerts veranlasst. Beim Verlassen der Programmierfunktion wird **---** während der Dauer der Neuberechnung angezeigt.

## 2. Funktionen AMTD-1-R P / AMTD-2-R P / VLMD-R P

### Anzeigen und Speicher des minimalen und des maximalen Spitzenwerts

1



2



3



- 1 Wenn man die Taste auf der Bedienfront kurz drückt, werden abwechselnd das Kürzel Lo und der gemessene Mindestwert angezeigt.
- 2 Drückt man die Taste erneut, werden das Kürzel Hi und der gemessene Höchstwert angezeigt.
- 3 Die Taste erneut drücken, um zur normalen Anzeige zurückzukehren.

Die aufgezeichneten Spitzenwerte (Mindest- und Höchstwert) werden im nichtflüchtigen Speicher des Geräts gespeichert und können daher auch nach einer Unterbrechung der Spannungsversorgung abgerufen werden. Die Spitzenwerte können mit dem Befehl RES im Programmiermenü zurückgesetzt werden.

Wird der Wert des Stromwandlers geändert, werden die obere und die untere Alarmschwelle automatisch deaktiviert.

## 2. Funktionen AMTD-1-R P / AMTD-2-R P / VLMD-R P

### Funktionsweise des Minimum-Maximum-Relais

Wenn der Messwert den Schwellwert über- bzw. unterschreitet, ändert das Relais seinen Zustand und der Alarm wird nach einer programmierbaren Verzögerung dLY ausgegeben. Auf dem Display erscheint abwechselnd mit der Anzeige des normalen Momentanmesswerts:

ALL [Alarm Low] gibt an, dass der untere Schwellwert unterschritten wurde.

ALH [Alarm High] gibt an, dass der obere Schwellwert überschritten wurde.

Auch im Alarmzustand gestattet das kurze Drücken der Taste das Anzeigen des Mindest- und des Höchstwerts.







Der Alarm wird aufgehoben, wenn der Messwert wieder um den Hysteresewert in den gültigen Wertekorridor eingetreten ist.

### Logik der Alarmauslösung

Der Ausgang des Relais hat einen Schließerkontakt. Man kann durch die Programmierung die Polung des Relais einstellen.

n0 [normally Open] im Ruhezustand bleibt der Kontakt offen.

nC [normally Close] im Ruhezustand bleibt der Kontakt geschlossen.

Zustand des Geräts	Polung nO (Standard- einstellung)	Positive Sicherheit nC
Nicht gespeist		
Gespeist - nicht im Alarmzustand		
Gespeist - im Alarmzustand		

### 3. Technische Eigenschaften

<b>Versorgungsspannung</b>	[V]	230 AC $\pm$ 10%
<b>Frequenz</b>	[Hz]	50/60
<b>Höchstwert Signaleingang</b>		
AMTD-1P, AMTD-1-R P	[A]	5 AC
VLMD P, VLMD-R P	[V]	600 AC/DC
AMTD-2 P, AMTD-2-R P	[mV]	60 DC
<b>Einstellbare Skalenendwerte bei AMTD-1 P und AMTD-1-R P</b>	[A]	Indirekter Anschluss über Stromwandler .../5A 15 20 25 40 60 100 150 200 250 400 600 999
<b>Einstellbare Skalenendwerte bei AMTD-2 P und AMTD-2-R P</b>	[A]	Indirekter Anschluss über Nebenwiderstand 60 mV 15 20 25 40 60 100 150 200 250 400 600 999
<b>Messbereich</b>		
AMTD-1P, AMTD-1-R P	[A]	0...999 AC
VLMD P, VLMD-R P	[V]	0...600 AC/DC
AMTD-2 P, AMTD-2-R P	[A]	0...999 DC
<b>Überlastbarkeit</b>		
AMTD-1P, AMTD-1-R P	[%]	0,5 $\pm$ 1 Skaleneinheiten
VLMD P, VLMD-R P	[%]	0,5 $\pm$ 1 Skaleneinheiten
AMTD-2 P, AMTD-2-R P	[%]	0,5 $\pm$ 1 Skaleneinheiten

## Messgeräte mit digitaler Anzeige

### 3. Technische Eigenschaften

<b>Datenspeicher</b>		EEProm
<b>Verlustleistung</b>	[VA]	4
<b>EigenschaftenRelaisausgang</b>		
Konfiguration des Kontakts		N.A.
Schließer	[V]	230 AC
Bemessungsspannung	[A]	AC1 16A - AC15 3A
Einstellung des Kontakts		nO Das Relais schließt im Alarmzustand nC Das Relais öffnet im Alarmzustand; positive Sicherheit
<b>Display</b>		3-stellige LED-Anzeige
<b>Lagertemperatur</b>	[°C]	-40...70
<b>Betriebsumgebungstemperatur</b>	[°C]	-10...55
<b>Schutzart</b>		IP20
<b>Norm</b>		CEI EN 61010-1

### Standardeinstellungen

	<b>VLMD-R P</b>	<b>AMTD-1-R P</b> <b>AMTD-2-R P</b>
<b>Standardeinstellungen</b>	AC	---
<b>Anschluss</b>	Deaktiviert	Deaktiviert
<b>Alarmauslöseverzögerung</b>	1 s	1 s
<b>Hysterese</b>	10%	10%
<b>Einstellung des Kontakts</b>	nO	nO



## Sommaire

### 1. Réglages et configurations

AMTD-1 P / AMTD-2 P .....	3
AMTD-1-R P / AMTD-2-R P .....	4
VLMD P .....	7
VLMD-R P .....	8

### 2. Fonctions AMTD-1-RP/AMTD-2-RP/VLMD-RP

Affichage des valeurs de crête.....	13
Fonctionnement du relais mini/maxi.....	14
Logique d'activation de l'alarme .....	14

### 3. Caractéristiques techniques .....

15



## 1. Réglages et configurations

### AMTD-1 P / AMTD-2 P

1

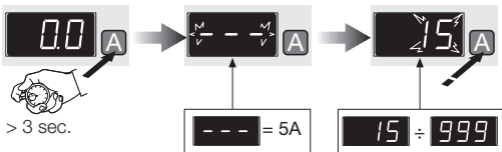

3

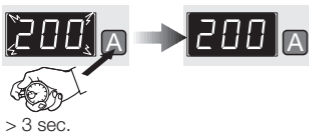

### Réglage de la pleine échelle





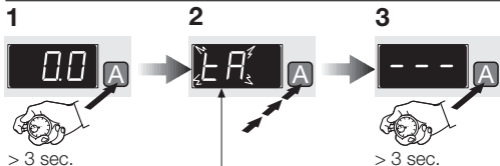

- 1 Garder la touche appuyée pendant plus de 3 secondes pour entrer dans le menu de programmation.
- 2 Pression brève sur la touche pour passer à l'option suivante (--- = 5A).
- 3 Pression longue > 3 secondes pour sélectionner l'option ou le paramètre et valider la valeur du paramètre.

## 1. Réglages et configurations

### AMTD-1-R P / AMTD-2-R P



F

-  EA Réglage pleine échelle [A]
-  EHL Seuil d'alarme minimale [A]
-  EHH Seuil d'alarme maximale [A]
-  dLY Délai de déclenchement alarme [s]
-  HSE Hystérésis de fin alarme [%]
-  Out Polarité de sortie alarme
-  RES RAZ des valeurs mini et maxi

- 1 Garder la touche appuyée pendant 3 secondes jusqu'à ce que l'afficheur clignote.
- 2 Appuyer plusieurs fois sur la touche jusqu'à ce que l'indication du paramètre à configurer s'affiche.
- 3 Pression longue > 3 secondes pour sélectionner la pleine échelle désirée.

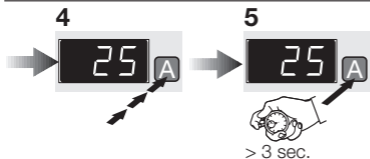

4 Appuyer plusieurs fois sur la touche pour afficher la valeur désirée.

5 Pression longue > 3 s pour valider la valeur choisie.

### Fonctions disponibles

EA

#### Réglage de la pleine échelle [A]

- --- = raccordement direct sans TC
- 5, 15, 20, 25, 40, 60, 100, 150, 200, 250, 400, 600, 999 A valeurs de pleine échelle réglables

dLy

#### Délai de déclenchement alarme en secondes

- 1-5-10-20-30
- / = activation sans délai

HSt

#### Hystérésis de fin alarme en % du seuil

- 5-10-20-40

Out

#### Polarité de la sortie d'alarme

- nO/nC

### 1. Réglages et configurations

#### AMTD-1-R P / AMTD-2-R P

##### RAZ des valeurs mini et maxi

- Sélectionner le chiffre 5 pour obtenir la RAZ des valeurs, qui est ensuite confirmée par l'affichage de trois points

##### Seuil d'alarme maximale [A]

- = fonction d'alarme non active
- TC jusqu'à 100 A, résolution 1 A
- TC jusqu'à 600 A, résolution 10A

F

##### Seuil d'alarme minimale [A]

- = fonction d'alarme non active
- TC jusqu'à 100 A, résolution 1 A
- TC jusqu'à 600 A, résolution 10A

Après la choix de la fonction tHH ou tHL:

1. le premier chiffre à droite clignote
2. pression brève pour sélectionner la valeur désirée
3. pression longue > 3s pour passer au chiffre suivant

La valeur maxi de tHH est toujours plus petite que la pleine échelle réglée avant.

En changeant le réglage de la pleine échelle, on active automatiquement la RAZ du minimum et du maximum; en quittant le réglage sera affiché pendant le temps de recalcul.

VLMD P

1



> 3 sec.

2



3



> 3 sec.

- 1 Garder la touche appuyée pendant plus de 3 secondes jusqu'à ce que l'afficheur clignote.
- 2 Pression brève sur la touche pour passer à l'option suivante:
  - AC = courant alternatif;
  - CC = courant continu.
- 3 Pression longue > 3 secondes pour sélectionner l'option désirée.

F

## 1. Réglages et configurations

### VLMD-R P

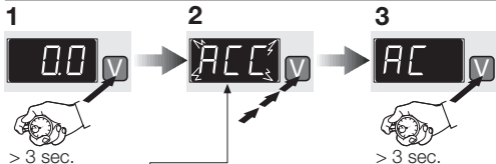

F

- ACC** Choix du courant d'emploi
- EHl** Seuil d'alarme minimale [V]
- EHH** Seuil d'alarme maximale [V]
- dLY** Délai de déclenchement alarme [s]
- HSE** Hystérésis de fin alarme [%]
- Out** Polarité de sortie alarme
- rES** RAZ des valeurs mini et maxi

- 1 Garder la touche appuyée pendant 3 secondes jusqu'à ce que l'affichage clignote.
- 2 Appuyer plusieurs fois sur la touche jusqu'à ce que l'indication du paramètre à configurer s'affiche.
- 3 Pression longue > 3 s pour sélectionner la pleine échelle désirée.

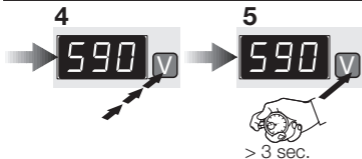

- 4 Appuyer plusieurs fois sur la touche pour afficher la valeur désirée.
- 5 Pression longue > 3 s pour valider la valeur choisie.

F

### Fonctions disponibles

ACC

#### Choix du courant d'emploi

- CC = courant continu
- AC = courant alternatif

dLY

#### Délai de déclenchement alarme en secondes

- 1-5-10-20-30
- [ ] = activation sans délai

HSt

#### Hystérésis de fin alarme en % du seuil

- 5-10-20-40

Out

#### Polarité de la sortie d'alarme

- nO/nC

### 1. Réglages et configurations

#### VLMD-R P



#### RAZ des valeurs mini et maxi

- Sélectionner le chiffre 5 pour obtenir la RAZ des valeurs, qui est ensuite confirmée par l'affichage de trois points



#### Seuil d'alarme minimale [V]

- **---** = fonction d'alarme non active
- 10 ÷ 590 V valeurs de pleine échelle réglables, résolution 10 V



#### Seuil d'alarme maximale [V]

- **---** = fonction d'alarme non active
- 10 ÷ 590 V valeurs de pleine échelle réglables, résolution 10 V

Après la choix de la fonction tHH ou tHL:

1. le premier chiffre à droite clignote
2. pression brève pour sélectionner la valeur désirée
3. pression longue > 3s pour passer au chiffre suivant

La valeur maxi de tHH est toujours plus petite que la pleine échelle réglée avant.

En changeant le réglage de la pleine échelle, on active automatiquement la RAZ du minimum et du maximum; en quittant le réglage **---** sera affiché pendant le temps de recalcul.



## 2. Fonctions AMTD-1-R P / AMTD-2-R P / VLMD-R P

## Affichage et enregistrement des valeurs de crête mini et maxi

1



2



3



F

- 1 En appuyant brièvement sur la touche frontale, on voit s'afficher alternativement Lo et la valeur minimale mesurée.
- 2 En appuyant de nouveau sur la touche, on voit s'afficher Hi et la valeur maximale mesurée.
- 3 Appuyer de nouveau pour revenir à l'affichage normal.

Les valeurs de crête (mini et maxi) sont enregistrées dans la mémoire non volatile de l'instrument, disponibles après une éventuelle coupure de courant. On peut faire une RAZ des valeurs de crête par l'intermédiaire de la commande RES correspondante du menu de programmation.

En modifiant la valeur du TC, les seuils d'alarme maxi et mini sont automatiquement désactivés.

### 2. Fonctions AMTD-1-R P / AMTD-2-R / VLMD-R P

#### Fonctionnement des relais à mini/maxi de courant/tension

Quand la mesure franchit la valeur de seuil, le relais change d'état et l'alarme s'active après un délai programmable dLY; elle s'affiche en alternance avec la mesure instantanée normale.

ALL [ALarm Low] indique que le seuil minimal a été franchi

ALH [ALarm High] indique que le seuil maximal a été franchi

Même pendant un état d'alarme, une éventuelle brève pression sur la touche permet d'afficher les valeurs mini et maxi.

**F**







On a la fin de l'alarme quand la mesure arrive au-dessous ou au-dessus d'une valeur de sécurité, déterminée comme % du seuil d'alarme, qu'on indique comme valeur d'hystérésis.

#### Logique d'activation alarme

La sortie du relais est à contact ouvert. Par programmation, on peut configurer la polarité du relais

n0 [normally Open] en conditions de repos, le contact reste ouvert

nC [normally Close] en conditions de repos, le contact reste fermé.

État du dispositif	Polarité nO (par défaut)	Sécurité positive nC
Non alimenté		
Alimenté - pas en alarme		
Alimenté - en alarme		

### 3. Caractéristiques techniques

<b>Tension d'alimentation</b>	[V]	230 CA $\pm$ 10%
<b>Fréquence</b>	[Hz]	50/60
<b>Valeur maxi entrée signal</b>		
AMTD-1 P, AMTD-1-R P	[A]	5 CA
VLMD P, VLMD-R P	[V]	600 CA/CC
AMTD-2 P, AMTD-2-R P	[mV]	60 CC.
<b>Valeurs de pleine échelle réglables sur AMTD-1 P et AMTD-1-R P</b>	[A]	Raccordement indirect par TC .../5A 15 20 25 40 60 100 150 200 250 400 600 999
<b>Valeurs de pleine échelle réglables sur AMTD-2 P et AMTD-2-R P</b>	[A]	Raccordement indirect par shunt 60 mV 15 20 25 40 60 100 150 200 250 400 600 999
<b>Plage de mesure</b>		
AMTD-1 P, AMTD-1-R P	[A]	0...999 CA
VLMD P, VLMD-R P	[V]	0...600 CA/CC
AMTD-2 P, AMTD-2-R P	[A]	0...999 CC
<b>Capacité de surcharge</b>		
AMTD-1 P, AMTD-1-R P	[%]	0,5 $\pm$ 1 digit
VLMD P, VLMD-R P	[%]	0,5 $\pm$ 1 digit
AMTD-2 P, AMTD-2-R P	[%]	0,5 $\pm$ 1 digit

## 3. Caractéristiques techniques

<b>Mémoire données</b>		EEprom
<b>Puissance dissipée</b>	[VA]	4
<b>Caractéristiques sortie à relais</b>		
Configuration du contact		N.A.
Tension assignée	[V]	230 c.a.
Charge assignée	[A]	AC1 16A - AC15 3A
Réglage du contact		nO le relais se ferme en condition d'alarme nC le relais s'ouvre en condition d'alarme, sécurité positive
<b>Afficheur</b>		À LEDs 3 chiffres
<b>Température de stockage</b>	[°C]	-40...70
<b>Température de fonctionnement</b>	[°C]	-10...55
<b>Degré de protection</b>		IP20
<b>Normes</b>		CEI EN 61010-1

### Valeurs configurées par défaut

	<b>VLMD-1-2-R P</b>	<b>AMTD-1-R P AMTD-2-R P</b>
<b>Raccordement</b>	CA	---
<b>Alarme</b>	Désactivée	Désactivée
<b>Délai activation alarme</b>	1 s	1 s
<b>Hystérésis</b>	10%	10%
<b>Réglage du contact</b>	nO	nO



## Índice

### 1. Ajustes

AMTD-1 P / AMTD-2 P .....	3
AMTD-1-R P / AMTD-2-R P .....	4
VLMD P .....	7
VLMD-R P .....	8

### 2. Funciones AMTD-1-RP/AMTD-2-RP/VLMD-RP

Visualización de los valores de cresta .....	13
Funcionamiento relés de mínima y máxima .....	14
Lógica de activación de las alarmas .....	14

### 3. Características técnicas .....

15

## 1. Ajustes

### AMTD-1 P / AMTD-2 P

1



> 3 sec.



2

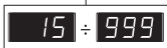

3



> 3 sec.



ES





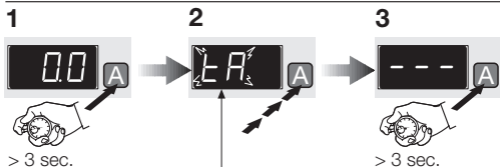

### Ajuste del fondo de escala

- 1 Mantener presionado el botón durante más de 3 s para entrar en el menú de programación.
- 2 Presionar brevemente el botón para pasar a la opción siguiente (--- = 5A).
- 3 Presionar durante más 3 s para seleccionar la opción o el parámetro y confirmar el parametro.

## 1. Ajustes

### AMTD-1-R P / AMTD-2-R P



-  **EA** Ajuste del fondo de escala [A]
-  **EHL** Umbral mínimo de alarma [A]
-  **EHH** Umbral máximo de alarma [A]
-  **dLY** Retardo de actuación de la alarma [s]
-  **HSt** Histéresis de cese de la alarma [%]
-  **Out** Configuración de la salida de alarma
-  **rES** Puesta a cero de los valores mínimos y máximos

- 1 Mantener presionado el botón durante 3 s hasta que el display comience a parpadear.
- 2 Pulsar repetidamente el botón hasta que aparezca la indicación del parámetro que se desee configurar.
- 3 Presionar durante más de 3 s para seleccionar el fondo de escala.



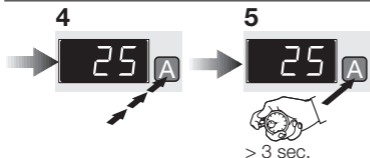

4 Pulsar repetidamente el botón para visualizar el valor deseado.

5 Pulsar durante más de 3 s para confirmar el valor seleccionado.

### Funciones disponibles

EA

#### Ajuste del fondo de escala [A]

- --- = conexión directa sin TA
- 15, 20, 25, 40, 60, 100, 150, 200, 250, 400, 600, 999 A valores posibles de fondo de escala

dLy

#### Retardo de actuación de la alarma en segundos

1-5-10-20-30

- / = activación sin retardo

HSt

#### Histéresis de cese de la alarma en % del umbral

5-10-20-40

Out

#### Configuración de la salida de alarma

- nA/nC

ES

### 1. Ajustes

#### AMTD-1-R P / AMTD-2-R P



#### Puesta a cero de los valores mínimos y máximos

- Seleccionar el número 5 para poner a cero los valores, aparecen tres puntos para confirmar la operación.



#### Umbral máximo de alarma [A]

- = función de alarma desactivada
- TA hasta 100 A, resolución 1 A
- TA hasta 600 A, resolución 10 A



#### Umbral mínimo de alarma [A]

- = función de alarma desactivada
- TA hasta 100 A, resolución 1 A
- TA hasta 600 A, resolución 10 A

Cuando selecciones tHH o tHL:

1. El primer dígito de la derecha comienza a parpadear
2. Presionar repetidamente para seleccionar el valor deseado
3. Pulsar durante más de 3 segundos para confirmar el valor

El Máx. valor seleccionado de tHH es siempre más bajo que el valor de fondo de escala seleccionado.

Cuando se cambia el fondo de escala se activa automáticamente la puesta a cero del mínimo y el máximo, y al salir de la programación se visualiza durante el tiempo de recálculo.

## VLMD P

1



&gt; 3 sec.

2



3



&gt; 3 sec.





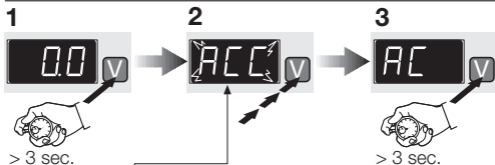

- 1 Mantener presionado el botón durante más de 3 s hasta que el display comience a parpadear.
- 2 Presionar el botón brevemente para pasar a la opción siguiente:
  - AC = corriente alterna;
  - CC = corriente continua.
- 3 Presionar durante más de 3 s para seleccionar la opción deseada.

ES

## 1. Ajustes

### VLMD-R P



-  **ACC** Selección de la corriente de servicio
-  **EHl** Umbral mínimo de alarma [V]
-  **EHH** Umbral máximo de alarma [V]
-  **dLY** Retardo de actuación de la alarma [s]
-  **HSE** Histéresis de cese de la alarma [%]
-  **Out** Configuración de la salida de alarma
-  **rES** Puesta a cero de los valores mínimo y máximo

- 1 Mantener presionado el botón durante 3 s hasta que el display comience a parpadear.
- 2 Pulsar repetidamente el botón hasta que aparezca la indicación del parámetro que se desee configurar.
- 3 Presionar durante más de 3 s para seleccionar el fondo de escala deseado.

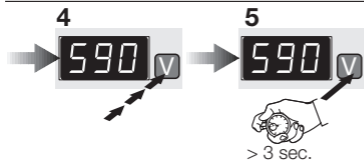

4 Pulsar repetidamente el botón para visualizar el valor deseado.

5 Pulsar durante más de 3 s para confirmar el valor seleccionado.

## Funciones disponibles

ACC

### Selección de la corriente de servicio

- CC = corriente continua
- AC = corriente alterna

dLY

### Retardo de actuación de la alarma en segundos

- 1-5-10-20-30
- [ ] = activación sin retardo

HSt

### Histéresis de cese de la alarma en % del umbral

- 5-10-20-40

Out

### Configuración de la salida de alarma

- NO/NC

### 1. Ajustes

#### VLMD-R P



#### Puesta a cero de los valores mínimo y máximo

- Seleccionar el número 5 para poner a cero los valores, aparecen tres puntos para confirmar la operación.



#### Umbral mínimo de alarma [V]

- **---** = función de alarma desactivada
- 10 ÷ 590 V valores posibles de fondo de escala, resolución 10 V



#### Umbral máximo de alarma [V]

- **---** = función de alarma desactivada
- 10 ÷ 590 V valores posibles de fondo de escala, resolución 10 V

Cuando selecciones tHH o tHL:

1. El primer dígito de la derecha comienza a parpadear
2. Presionar repetidamente para seleccionar el valor deseado
3. Pulsar durante más de 3 segundos para confirmar el valor

El Máx. valor seleccionado de tHH es siempre más bajo que el valor de fondo de escala seleccionado.

Cuando se cambia el fondo de escala se activa automáticamente la puesta a cero del mínimo y el máximo, y al salir de la programación se visualiza **...** durante el tiempo de recálculo.

## 2. Funciones AMTD-1-R P / AMTD-2-R P / VLMD-R P

### Visualización y guardado de los valores de cresta mínimo y máximo

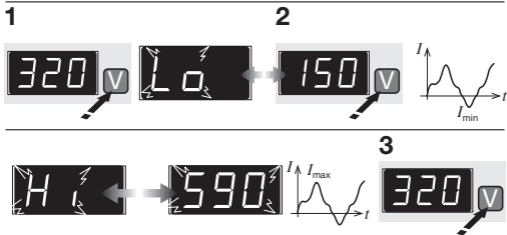

- 1 Al presionar brevemente el botón frontal aparecen alternativamente la expresión Lo y el valor mínimo medido.
- 2 Si se presiona otra vez el botón aparecen la expresión Hi y el valor máximo medido.
- 3 Presionar nuevamente para volver a la visualización normal.

Los valores de cresta registrados (mínimo y máximo) se guardan en la memoria no volátil del instrumento y quedan disponibles aunque se corte la corriente. Se pueden poner a cero mediante la opción RES del menú de programación.

Al modificar el valor del TA, se inhabilitan automáticamente los umbrales de alarma mínimo y máximo.

### 2. Funciones AMTD-1-R P / AMTD-2-R P / VLMD-R P

#### Funcionamiento del relé de máxima y mínima

Cuando la medida supera el valor límite, el relé cambia de estado y la alarma se activa tras un retardo programable dLY. En pantalla aparece alternado con la medida normal instantánea.

ALL [ALarm Low] indica que el valor se ha hecho inferior al umbral mínimo.

ALH [ALarm High] indica que el valor ha superado el umbral máximo.

Aun en estado de alarma, presionando brevemente el botón, se pueden ver los valores mínimo y máximo.







La alarma se resuelve cuando la medida vuelve al campo de funcionamiento correcto, determinado como porcentaje del umbral de alarma, que se indica como valor de histéresis.

#### Lógica de activación de la alarma

La salida del relé es de contacto abierto. Mediante la programación se puede configurar la polaridad del relé,

nA (normalmente abierto): en condición de reposo el contacto permanece abierto.

nC (normalmente cerrado): en condición de reposo el contacto permanece cerrado.

Estado del dispositivo	nA (predeterminada)	Seguridad positiva nC
No alimentado		
Alimentado - no en alarma		
Alimentado - en alarma		



### 3. Características técnicas

<b>Tensión de alimentación</b>	[V]	230 c.a. $\pm 10\%$
<b>Frecuencia</b>	[Hz]	50/60
<b>Valor máx. entrada señal</b>		
AMTD-1 P, AMTD-1-R P	[A]	5 c.a.
VLMD P, VLMD-R P	[V]	600 c.a./c.c.
AMTD-2 P, AMTD-2-R P	[mV]	60 c.c.
<b>Valores posibles de fondo de escala en AMTD-1 P y AMTD-1-R P</b>	[A]	Conexión indirecta mediante TA .../5 A 15 20 25 40 60 100 150 200 250 400 600 999
<b>Valores posibles de fondo de escala en AMTD-2 P y AMTD-2-R P</b>	[A]	Conexión indirecta mediante shunt 60 mV 15 20 25 40 60 100 150 200 250 400 600 999
<b>Rango de medida</b>		
AMTD-1 P, AMTD-1-R P	[A]	0...999 c.a.
VLMD P, VLMD-R P	[V]	0...600 c.a./c.c.
AMTD-2 P, AMTD-2-R P	[A]	0...999 c.c.
<b>Capacidad de sobrecarga</b>		
AMTD-1 P, AMTD-1-R P	[%]	0,5 $\pm 1$ dígito
VLMD P, VLMD-R P	[%]	0,5 $\pm 1$ dígito
AMTD-2 P, AMTD-2-R P	[%]	0,5 $\pm 1$ dígito

ES

## 3. Características técnicas

<b>Memoria de datos</b>		EEprom
<b>Potencia disipada</b>	[VA]	4
<b>Características salida de relé</b>		
Configuración del contacto		N.A.
Tensión asignada	[V]	230 c.a.
Carga asignada	[A]	AC1 16A - AC15 3A
Configuración del contacto		nA el relé se cierra en estado de alarma nC el relé se abre en estado de alarma, seguridad positiva
<b>Display</b>		de LEDs 3 dígitos
<b>Temper. de almacenamiento</b>	[°C]	-40...70
<b>Temper. de funcionamiento</b>	[°C]	-10...55
<b>Grado de protección</b>		IP20
<b>Normativa</b>		CEI EN 61010-1

ES

### Valores predeterminados

	<b>VLMD-R P</b>	<b>AMTD-1-R P</b> <b>AMTD-2-R P</b>
<b>Conexión</b>	AC	---
<b>Alarma</b>	Desactivada	Desactivada
<b>Retardo activación alarma</b>	1 s	1 s
<b>Histéresis</b>	10%	10%
<b>Configuración del contacto</b>	nA	nA



## Índice

### 1. Definições

AMTD-1 P / AMTD-2 P .....	3
AMTD-1-R P / AMTD-2-R P .....	4
VLMD P .....	7
VLMD-R P .....	8

### 2. Funções de AMTD-1-R P / AMTD-2-R P / VLMD-R P

Visualização dos valores máximos.....	13
Funcionamento mínimo e máximo do relé .....	14
Lógica de alarme.....	14

### 3. Características técnicas .....

15

## 1. Definições

## AMTD-1 P / AMTD-2 P

1

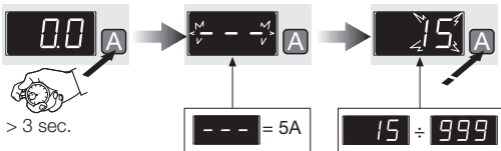

3

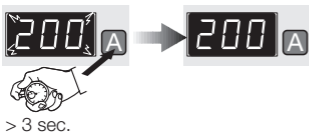



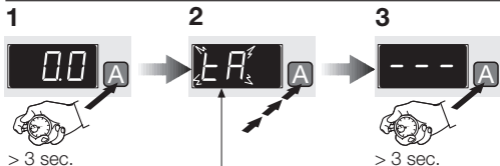

**Ajustar a extremidade da escala**

- 1 Pressione o botão durante pelo menos 3 segundos para aceder ao menu de programação.
- 2 Prima brevemente o botão para passar ao item seguinte ( $--- = 5A$ ).
- 3 Pressione o botão durante pelo menos 3 segundos para seleccionar e confirmar o item/parâmetro.

## 1. Definições

### AMTD-1-R P / AMTD-2-R P



-  **EA** Definição de extremidade da escala [A]
-  **EHL** Alarme limiar mínimo [A]
-  **EHH** Alarme limiar máximo [A]
-  **dLY** Atraso no disparo do alarme [seg.]
-  **HSt** Corte de histerese do alarme [%]
-  **Out** Polaridade de saída do alarme
-  **rES** Restaurar o valor mínimo e máximo

- 1 Pressione o botão durante pelo menos 3 segundos até que o mostrador fique intermitente.
- 2 Prima o botão repetidamente até que apareça a indicação do parâmetro pretendido.
- 3 Pressione o botão durante pelo menos 3 segundos para seleccionar a extremidade da escala pretendida.

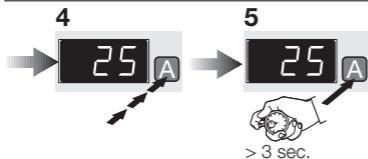

- 4 Prima o botão repetidamente para visualizar o valor pretendido.
- 5 Pressione o botão durante pelo menos 3 segundos para confirmar o valor seleccionado.

### Funções disponíveis

LA

#### Definição de extremidade da escala [A]

- --- = inserção directa sem CT
- 15, 20, 25, 40, 60, 100, 150, 200, 250, 400, 600, 999 A alores de extremidade da escala disponíveis

dLY

#### Alarme limiar mínimo [A]

- 1-5-10-20-30
- / = disparo sem atraso

HSt

#### Atraso no disparo do alarme em segundos

- 5-10-20-40

Out

#### Polaridade de saída do alarme

- nO/nC

### 1. Definições

#### AMTD-1-R P / AMTD-2-R P



#### Restaurar os valores mínimo e máximo

- Seleccionar o número 5 para reajustar os valores, os quais são subsequentemente confirmados pelos três pontos apresentados



#### Alarme limiar máximo [A]

- **---** = função de alarme desactivada
- CT até 100 A, resolução 1A
- CT até 600 A, resolução 10A



#### Alarme limiar mínimo [A]

- **---** = função de alarme desactivada
- CT até 100 A, resolução 1A
- CT até 600 A, resolução 10A

Quando você seleciona tHH ou tHL:

1. O primeiro dígito na direita começa a piscar;
2. Pressione repetidas vezes para seleccionar o valor desejado;
3. Pressione e segure o botão pelo menos 3 seg para confirmar

O máximo valor seleccionável de tHH é sempre menor que o valor máximo previamente seleccionado.

A alteração automática da definição da extremidade da escala permite reajustar o valor mínimo e máximo, e quando sair do modo de programação, irá surgir **...** durante o tempo que demorar a recalculer os valores.



## VLMD P

**1**



> 3 sec.

**2**



**3**









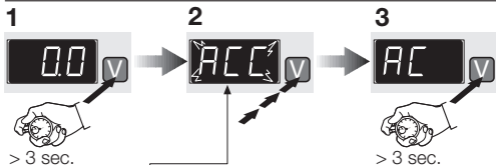

> 3 sec.

- 1** Pressione o botão durante pelo menos 3 segundos até que o mostrador fique intermitente.
- 2** Prima brevemente o botão para passar ao item seguinte:
  - AC = corrente alternada;
  - CC = corrente contínua.
- 3** Pressione o botão durante pelo menos 3 segundos para seleccionar o item pretendido.

## 1. Definições

### VLMD-R P



-  **ACC** Seleccione a corrente a utilizar
-  **EHl** Alarme limiar mínimo [V]
-  **EHH** Alarme limiar máximo [V]
-  **dLY** Atraso no disparo do alarme [seg.]
-  **HSE** Corte de histerese do alarme [%]
-  **Out** Polaridade de saída do alarme
-  **RES** Restaurar o valor mínimo e máximo

- 1 Pressione o botão durante pelo menos 3 segundos até que o mostrador fique intermitente.
- 2 Prima o botão repetidamente até que apareça a indicação do parâmetro pretendido.
- 3 Pressione o botão durante pelo menos 3 segundos para seleccionar a extremidade da escala pretendida.

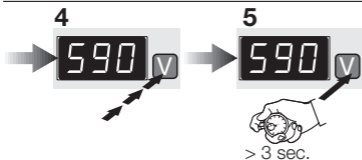

- 4 Prima o botão repetidamente para visualizar o valor pretendido.
- 5 Pressione o botão durante pelo menos 3 segundos para confirmar o valor seleccionado.

### Funções disponíveis

ACC

#### Selecione a corrente a utilizar

- CC = corrente contínua
- AC = corrente alternada

dLY

#### Atraso no disparo do alarme em segundos

- 1-5-10-20-30
- [ ] = disparo sem atraso

HSt

#### Corte de histerese do alarme em % do limiar

5-10-20-40

Out

#### Polaridade de saída do alarme

- nO/nC

### 1. Definições

#### VLMD-R P



#### Restaurar os valores mínimo e máximo

- Seleccionar o número 5 para reajustar os valores, os quais são subsequentemente confirmados pelos três pontos apresentados



#### Alarme limiar mínimo [V]

- **---** = função de alarme desactivada
- 10 ÷ 590 V valores de extremidade de escala disponíveis, resolução 10 V



#### Alarme limiar máximo [V]

- **---** = função de alarme desactivada.
- 10 ÷ 590 V valores de extremidade de escala disponíveis, resolução 10 V

Quando você seleciona tHH ou tHL:

1. O primeiro dígito na direita começa a piscar;
2. Pressione repetidas vezes para selecionar o valor desejado
3. Pressione e segure o botão pelo menos 3seg para confirmar

O máximo valor selecionável de tHH é sempre menor que o valor máximo previamente selecionado

A alteração automática da definição da extremidade da escala permite reajustar o valor mínimo e máximo, e quando sair do modo de programação, irá surgir **...** durante o tempo que demorar a recalculer os valores.

## 2. Funções AMTD-1-R P / AMTD-2-R P / VLMD-R P

### Visualização e memorização dos valores mínimo e máximo

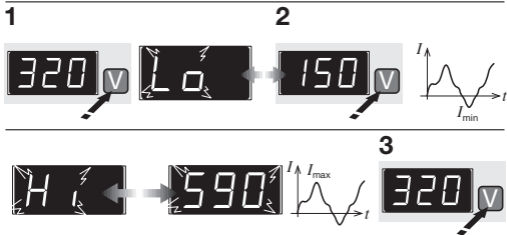

- 1 Quando premir brevemente o botão frontal, irão surgir alternadamente a palavra Lo e o valor mínimo medido.
- 2 Se premir novamente o botão, irá surgir a palavra Hi com o valor máximo medido.
- 3 Prima novamente o botão para voltar à visualização normal.

Os valores máximos registados (mínimo e máximo) são guardados na memória não volátil do instrumento, e encontram-se disponíveis após qualquer falha de energia. Pode reajustar os valores máximos através do comando RES correspondente no menu de programação.

Quando alterar o valor da CT, o alarme limiar máximo e mínimo são automaticamente desactivados.

### 2. Funções AMTD-1-R P / AMTD-2-R P / VLMD-R P

#### Funcionamento mínimo e máximo do relé

Quando a medição exceder o valor limiar, o estado do relé altera-se e o alarme é disparado após um atraso programável dLY, o qual surge alternadamente no mostrador, com a medição instantânea normal.

ALL [ALarm Low] indica que o limiar mínimo foi excedido

ALH [ALarm High] indica que o limiar máximo foi excedido

Ao premir brevemente o botão, mesmo com o alarme activado, pode visualizar o valor mínimo e máximo.







O alarme pára quando a medição retorna ao limiar, incluindo o valor da histerese.

#### Lógica de alarme

A saída do relé é do tipo contacto aberto. A polaridade do relé pode ser programada

nO [normalmente Aberto] em condições de repouso, o contacto permanece aberto

nC [normalmente Fechado] em condições de repouso, o contacto permanece fechado.

Estado do aparelho	Polaridade nO (padrão)	Polaridade nC
Não alimentado		
Alimentado – Não em alarme		
Alimentado – Em alarme		

### 3. Características Técnicas

<b>Tensão da fonte de alimentação</b>	[V]	230 AC $\pm$ 10%
<b>Frequência</b>	[Hz]	50/60
<b>Valor máx. do sinal de entrada</b>		
AMTD-1 P, AMTD-1-R P	[A]	5 AC
VLMD P, VLMD-R P	[V]	600 AC/DC
AMTD-2 P, AMTD-2-R P	[mV]	60 DC
<b>Valores de extremidade da escala disponíveis em AMTD-1 P e AMTD-1-R P</b>	[A]	Inserção directa por CT .../5A 15 20 25 40 60 100 150 200 250 400 600 999
<b>Valores extremidade da escala disponíveis em AMTD-2 P e AMTD-2-R P</b>	[A]	Inserção indirecta por derivação 60mV 15 20 25 40 60 100 150 200 250 400 600 999
<b>Gama de modulação</b>		
AMTD-1 P, AMTD-1-R P	[A]	0...999 AC
VLMD P, VLMD-R P	[V]	0...600 AC/DC
AMTD-2 P, AMTD-2-R P	[A]	0...999 DC
<b>Classe de precisão</b>		
AMTD-1 P, AMTD-1-R P	[%]	0,5 $\pm$ 1 dígito
VLMD P, VLMD-R P	[%]	0,5 $\pm$ 1 dígito
AMTD-2 P, AMTD-2-R P	[%]	0,5 $\pm$ 1 dígito

### 3. Características Técnicas

Dados em memória		EEprom
Potência dissipada	[VA]	4
<b>Características da saída do relé</b>		
Configuração de contacto		N.A.
Tensão nominal	[V]	230 AC
Carga Nominal	[A]	AC1 16A - AC15 3A
Modo de contacto		nO o relé fecha em estado de alarme nC o relé abre em estado de alarme, segurança positiva
Mostrador		LED 3 dígitos
Temperatura de armazenamento	[°C]	-40...70
Temperatura de funcionamento	[°C]	-10...55
Grau de protecção		IP20
Normas		CEI EN 61010-1

P

#### Valores padrão

	<b>VLMD-R P</b>	<b>AMTD-1-R P</b> <b>AMTD-2-R P</b>
Inserção	AC	---
Alarme	Desactivado	Desactivado
Atraso no disparo do alarme	1 sec	1 sec
Histerese	10%	10%
Modo de contacto	nO	nO





## Περιεχόμενα

### 1. Ρυθμίσεις

AMTD-1 P / AMTD-2 P .....	3
AMTD-1-R P / AMTD-2-R P.....	4
VLMD P .....	7
VLMD-R P .....	8

### 2. AMTD-1-R P / AMTD-2-R P / VLMD-R P λειτουργίες

Απεικόνιση τιμών αιχμής .....	13
Ελάχιστη και μέγιστη λειτουργία ηλεκτρονόμου .....	14
Προγραμματιζόμενη επαφή συναγερμού.....	14

### 3. Τεχνικά χαρακτηριστικά..... 15

## 1. Ρυθμίσεις

## AMTD-1 P / AMTD-2 P

1



&gt; 3 sec.



2

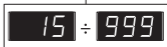

3



&gt; 3 sec.



## Ρύθμιση πλήρους κλίμακας

- 1 Πιέστε και κρατήστε το μπουτόν πατημένο για τουλάχιστον 3 δευτερόλεπτα, για να μπείτε στο μενού προγραμματισμού.
- 2 Πιέστε το μπουτόν στιγμιαία για να μετακινηθείτε στην επόμενη προβολή της οθόνης ( **---** = 5A). Οι τρεις παύλες δηλώνουν απευθείας σύνδεση, χωρίς μετασχηματιστή έντασης για ρεύμα μέχρι 5A.
- 3 Πιέστε και κρατήστε το μπουτόν πατημένο για τουλάχιστον 3 δευτερόλεπτα για να αποθηκευτεί η επιλεγμένη τιμή στη μνήμη του οργάνου.

# Ψηφιακά όργανα

## 1. Ρυθμίσεις

AMTD-1-R P / AMTD-2-R P

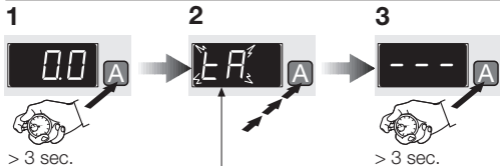

- EA Ρύθμιση πλήρους κλίμακας [A]
- EHL Ελάχιστο κατώφλι συναγερμού [A]
- EHH Μέγιστο κατώφλι συναγερμού [A]
- dLY Χρονοκαυστήρηση σήμανσης συναγερμού [sec.]
- HSE Υστέρηση επαναφοράς από συναγερμό [%]
- Out Διάταξη εξόδου συναγερμού
- rES Reset (επανακαθορισμός) ελάχιστων και μέγιστων τιμών

- 1 Πατήστε και κρατήστε το μπουτόν πατημένο για τουλάχιστον 3 δευτερόλεπτα, έως ότου αρχίσει να αναβοσβήνει η οθόνη.
- 2 Πιέστε το μπουτόν επαναλαμβανόμενα έως ότου εμφανιστεί η ένδειξη καθορισμού των παραμέτρων.
- 3 Πιέστε και κρατήστε το μπουτόν πατημένο για τουλάχιστον 3 δευτερόλεπτα, για να επιλέξετε την επιθυμητή πλήρη κλίμακα.

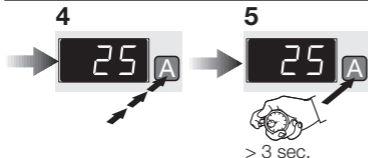

4 Πατήστε το μπουτόν επαναλαμβανόμενα, για να δείτε την επιθυμητή τιμή.

5 Πιέστε και κρατήστε το μπουτόν πατημένο για τουλάχιστον 3 δευτερόλεπτα, για να αποθηκευτεί η επιλεγμένη τιμή στη μνήμη του οργάνου.

#### Διαθέσιμες λειτουργίες

EA

#### Ρύθμιση πλήρους κλίμακας [A]

- --- = απευθείας σύνδεση, χωρίς μετασχηματιστή έντασης
- 15, 20, 25, 40, 60, 100, 150, 200, 250, 400, 600, 999 A

Επιλέξτε μία από τις διαθέσιμες τιμές πλήρους κλίμακας, δηλ. πρωτεύοντος του μετασχηματιστή έντασης .../5, πιέζοντας διαδοχικά το μπουτόν.

dLY

#### Χρονοκαυστήρηση σήμανσης συναγερμού σε δευτερόλεπτα

- 1-5-10-20-30
- / = απόζευξη χωρίς καθυστέρηση

HSt

#### Υστέρηση επαναφοράς από συναγερμό σε ποσοστό % του κατωφλίου

- 5-10-20-40

Out

#### Διάταξη εξόδου συναγερμού

- Ανοιχτή/Κλειστή επαφή, τιμές πλήρους κλίμακας διαθέσιμες

# Ψηφιακά όργανα

## 1. Ρυθμίσεις

### AMTD-1-R P / AMTD-2-R P



#### Reset (επανακαθορισμός) ελάχιστων και μέγιστων τιμών

- Επιλέξτε το νούμερο 5 για να κάνετε reset (επανακαθορισμό) στις τιμές, το οποίο στη συνέχεια επιβεβαιώνεται από τα απεικονιζόμενα τρία σημεία



#### Μέγιστο κατώφλι συναγερμού [A]

- = αδρανοποίηση συναγερμού
- μετασχηματιστής έντασης έως 100 A, βήματος 1A
- μετασχηματιστής έντασης έως 600 A, βήματος 10A



#### Ελάχιστο κατώφλι συναγερμού [A]

- = αδρανοποίηση συναγερμού
- μετασχηματιστής έντασης έως 100 A, βήματος 1A
- μετασχηματιστής έντασης έως 600 A, βήματος 10A

Όταν επιλέγετε tHH ή tHL:

- 1.το πρώτο ψηφίο στα δεξιά αρχίζει να αναβοσβήνει
- 2.πατήστε επαναλαμβανόμενα για να επιλέξετε την επιθυμητή τιμή
- 3.πατήστε και κρατήστε το μπουτόν πατημένο για τουλάχιστον 3 δευτερόλεπτα για να αποθηκευτεί η επιλεγμένη τιμή στη μνήμη του οργάνου.

Η μέγιστη επιλεγόμενη τιμή του HH είναι πάντοτε χαμηλότερη της τυπικής πλήρους κλίμακας που επιλέγεται.

Η αυτόματη αλλαγή της πλήρους κλίμακας επιτρέπει τον επανακαθορισμό των ελάχιστων και μέγιστων τιμών και όταν βγαίνετε από την κατάσταση προγραμματισμού, θα απεικονίζεται, όσο χρόνο χρειάζεται, για να επαναυπολογιστούν οι τιμές.

## VLMD P

1



&gt; 3 sec.

2



3



- 1 Πατήστε και κρατήστε το μπουτόν πατημένο για τουλάχιστον 3 δευτερόλεπτα έως ότου αρχίζει να αναβοσβήνει η οθόνη.
- 2 Πιέστε το μπουτόν στιγμιαία για να μετακινηθείτε στην επόμενη προβολή της οθόνης:
  - ac = εναλλασσόμενο ρεύμα
  - dc = συνεχές ρεύμα.
- 3 Πατήστε και κρατήστε πατημένο το μπουτόν τουλάχιστον για 3 δευτερόλεπτα, για να αποθηκευτεί η επιλεγμένη τιμή στη μνήμη του οργάνου.

**ΠΡΟΣΟΧΗ:** Απαγορεύεται η παράλληλη σύνδεση άκρων τάσης εισόδου και άκρων τάσης μέτρησης εάν η τάση ενδέχεται να ξεπεράσει τα 253V. Επιπλέον για τάσεις κάτω από 140V ac το όργανο δεν μετράει σωστά.

# Ψηφιακά όργανα

## 1. Ρυθμίσεις

VLMD-R P

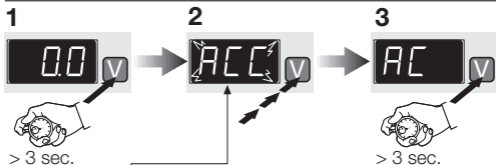

- ACC** Επιλογή ρεύματος για χρήση
- εHL** Ελάχιστο κατώφλι συναγερμού [V]
- εHH** Μέγιστο κατώφλι συναγερμού [V]
- dLY** Χρονοκαθυστέρηση σήμανσης συναγερμού [sec.]
- HSE** Υατέρηση επαναφοράς από συναγερμό [%]
- OUT** Διάταξη εξόδου συναγερμού
- RES** Reset (επανακαθορισμός) ελάχιστων και μέγιστων τιμών

- 1 Πατήστε και κρατήστε το μπουτόν πατημένο για τουλάχιστον 3 δευτερόλεπτα, έως ότου αρχίζει να αναβοσβήνει η οθόνη.
- 2 Πιέστε το μπουτόν επαναλαμβανόμενα, έως ότου εμφανιστεί η ένδειξη καθορισμού των παραμέτρων.
- 3 Πιέστε και κρατήστε το μπουτόν πατημένο για τουλάχιστον 3 δευτερόλεπτα, για να επιλέξετε την επιθυμητή πλήρη κλίμακα.



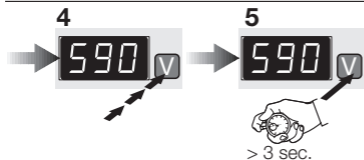

- 4 Πατήστε το μπουτόν επαναλαμβανόμενα, για να δείτε την επιθυμητή τιμή.
- 3 Πιέστε και κρατήστε το μπουτόν πατημένο για τουλάχιστον 3 δευτερόλεπτα, για να αποθηκευτεί η επιλεγμένη τιμή στη μνήμη του οργάνου.

### Διαθέσιμες λειτουργίες

ACC

#### Επιλογή ρεύματος για χρήση

- CC = συνεχές ρεύμα
- AC = εναλλασσόμενο ρεύμα

dLY

#### Χρονοκαθυστέρηση σήμανσης συναγερμού σε δευτερόλεπτα

- 1-5-10-20-30
- ! = απόζευξη χωρίς καθυστέρηση

HSt

#### Υστέρηση επαναφοράς από συναγερμό σε ποσοστό % του κατωφλιού

- 5-10-20-40

Out

#### Διάταξη εξόδου συναγερμού

- Ανοιχτή/Κλειστή επαφή τιμές πλήρους κλίμακας διαθέσιμες

## Ψηφιακά όργανα

### 1. Ρυθμίσεις

VLMD-R P



**Reset (επανακαθορισμός) ελάχιστων και μέγιστων τιμών**

- Επιλέξτε το νούμερο 5 για να κάνετε reset (επανακαθορισμό) στις τιμές, το οποίο στη συνέχεια επιβεβαιώνεται από τα απαικονιζόμενα τρία σημεία



**Ελάχιστο κατώφλι συναγερμού [V]**

- **---** = κατάργηση λειτουργίας συναγερμού
- 10 ÷ 590 V διαθέσιμες τιμές, βήματος 10 V



**Μέγιστο κατώφλι συναγερμού [V]**

- **---** = κατάργηση λειτουργίας συναγερμού
- 10 ÷ 590 V διαθέσιμες τιμές, βήματος 10 V

Όταν επιλέγετε tHH ή tHL:

1. το πρώτο ψηφίο στα δεξιά αρχίζει να αναβοσβήνει
2. πατήστε επαναλαμβανόμενα για να επιλέξετε την επιθυμητή τιμή
3. πατήστε και κρατήστε το μπουτόν πατημένο για τουλάχιστον 3 δευτερόλεπτα, για να αποθηκευτεί η επιλεγμένη τιμή στη μνήμη του οργάνου.

Η μέγιστη επιλεγόμενη τιμή του HH είναι πάντοτε χαμηλότερη της τυπικής πλήρους κλίμακας που επιλέγεται.

Η αυτόματη αλλαγή της πλήρους κλίμακας επιτρέπει τον επανακαθορισμό των ελάχιστων και μέγιστων τιμών και όταν βγαίνετε από την κατάσταση προγραμματισμού, **...** θα εμφανίζονται, όσο χρόνο χρειάζεται για να επαναυπολογιστούν οι τιμές.

## 2. AMTD-1-R P / AMTD-2-R P / VLMD-R P λειτουργίες

## Προβολή και αποθήκευση ελάχιστων και μέγιστων τιμών αιχμής

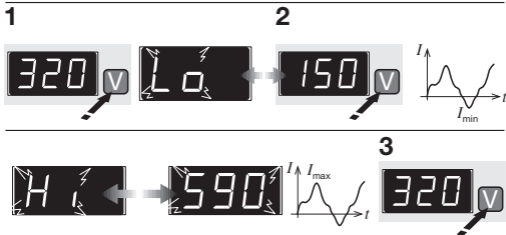

- 1 Εάν πιάσετε στιγμιαία το μπουτόν, η λέξη Lo και η ελάχιστη τιμή μέτρησης εμφανίζονται εναλλάξ.
- 2 Εάν πιάσετε το μπουτόν ξανά, η λέξη Hi εμφανίζεται με τη μέγιστη μετρούμενη τιμή.
- 3 Πιάστε το μπουτόν ξανά, για να επιστρέψετε στην καθορισμένη προβολή της οθόνης.

Οι καταγραφόμενες τιμές αιχμής (ελάχιστες και μέγιστες) αποθηκεύονται στη μη διαγραφόμενη μνήμη και είναι διαθέσιμες μετά από οποιαδήποτε διακοπή ρεύματος. Μπορείτε να κάνετε reset (επανακαθορισμό) μέσω της αντίστοιχης εντολής RES του μενού προγραμματισμού. Όταν αλλάζετε την τιμή του μετασχηματιστή ρεύματος, το μέγιστο και ελάχιστο κατώφλι συναγερμού απενεργοποιείται αυτόματα.

### 2. AMTD-1-R P / AMTD-2-R P / VLMD-R P λειτουργίες

#### Μέγιστη και ελάχιστη λειτουργία ηλεκτρονόμου

Όταν η μέτρηση υπερβεί την τιμή του κατωφλίου, ο ηλεκτρονόμος αλλάζει κατάσταση και ο συναγερμός διακόπτεται μετά από μία προγραμματιζόμενη καθυστέρηση dLY, η οποία εμφανίζεται στην οθόνη εναλλάξ με τη στιγμιαία μέτρηση.

ALL [ALarm Low] δηλώνει ότι το ελάχιστο κατώφλι έχει ξεπεραστεί

ALH [ALarm High] δηλώνει ότι το μέγιστο κατώφλι έχει ξεπεραστεί





Ακόμη και σε καταστάσεις συναγερμού, το διαδοχικό πάτημα του μπουτόν σας επιτρέπει να δείτε τις ελάχιστες και μέγιστες τιμές.

Ο συναγερμός σταματάει όταν η μέτρηση επιστρέφει εντός των κατωφλίων συμπεριλαμβάνοντας την τιμή της υστέρησης.

#### Προγραμματιζόμενη επαφή συναγερμού

Ο ηλεκτρονόμος είναι τύπου ανοιχτής επαφής. Μπορείτε να προγραμματίσετε τις ρυθμίσεις του ηλεκτρονόμου

- NO [ανοιχτή επαφή] η επαφή είναι ανοιχτή, όταν ο ηλεκτρονόμος δεν είναι ενεργοποιημένος.
- NC [κλειστή επαφή] η επαφή είναι κλειστή, όταν ο ηλεκτρονόμος δεν είναι ενεργοποιημένος.

Κατάσταση οργάνου	NO Εργοστασιακή ρύθμιση	NC Αυτοεπιτηρούμενη
Μη ενεργή		
Ενεργή, συναγερμός ανενεργός		
Ενεργή, συναγερμός ενεργός		

## 3. Τεχνικά χαρακτηριστικά

Τάση τροφοδοσίας	[V]	230 ac $\pm$ 10%
Συχνότητα	[Hz]	50/60
<b>Μέγιστη τιμή σήματος εισόδου</b>		
AMTD-1 P, AMTD-1-R P	[A]	5 ac
VLMD P, VLMD-R P	[V]	600 ac/dc
AMTD-2 P, AMTD-2-R P	[mV]	60 dc
Διαθέσιμες τιμές για τον AMTD-1 P και τον AMTD-1-R P	[A]	Απευθείας σύνδεση μέσω του μετασχηματιστή έντασης .../5A 15 20 25 40 60 100 150 200 250 400 600 999
Διαθέσιμες τιμές για τον AMTD-2 P και τον AMTD-2-R P	[A]	Σύνδεση μέσω μετρητικής αντίστασης (shunt) 60mV 15 20 25 40 60 100 150 200 250 400 600 999
<b>Εύρος μέτρησης</b>		
AMTD-1 P, AMTD-1-R P	[A]	0...999 ac
VLMD P, VLMD-R P	[V]	0...600 ac/dc
AMTD-2 P, AMTD-2-R P	[A]	0...999 dc
<b>Κλάση ακριβείας</b>		
AMTD-1 P, AMTD-1-R P	[%]	0,5 $\pm$ 1 ψηφίο
VLMD P, VLMD-R P	[%]	0,5 $\pm$ 1 ψηφίο
AMTD-2 P, AMTD-2-R P	[%]	0,5 $\pm$ 1 ψηφίο
Μνήμη		EEprom
Κατανάλωση Ισχύος	[VA]	4
<b>Χαρακτηριστικά εξόδων ηλεκτρονόμου</b>		

## Ψηφιακά όργανα

### 3. Τεχνικά χαρακτηριστικά

Διάταξη επαφής		NO
Ονομαστική τάση	[V]	230 ac
Ονομαστικό ρεύμα	[A]	AC1 16A - AC15 3A
Διάταξη επαφής		NO ο ηλεκτρονόμος κλείνει σε περίπτωση συναγερμού NC ο ηλεκτρονόμος ανοίγει σε περίπτωση συναγερμού
Οθόνη		LED 3 ψηφία
Θερμοκρασία αποθήκευσης	[°C]	-40...70
Θερμοκρασία λειτουργίας	[°C]	-10...55
Βαθμός προστασίας		IP20
Κανονισμοί		CEI EN 61010-1

### Εργοστασιακές ρυθμίσεις

	VLMD-R P	AMTD-1-R P AMTD-2-R P
Σύνδεση	ac	---
Συναγερμός	Ανενεργός	Ανενεργός
Χρονοκαθυστέρησησήμανσης συναγερμού	1 sec	1 sec
Υστέρηση	10%	10%
Διάταξη επαφής	NO	NO



**ABB SACE**

**Una divisione di ABB S.p.A.**

**Apparecchi modulari**

Viale dell'Industria, 18

20010 Vittuone (MI)

Tel.: 02 9034 1

Fax: 02 9034 7609

**bol.it.abb.com**

**www.abb.com**

2CSM450001R5601

Power and productivity  
for a better world™

